

Exclusive PM Owners Report: All 4 GM Compacts

JUNE 1975 75 CENTS

# Popular Mechanics

## MONEYSAVING HOW-TO:

- Make your yard prettier, safer with light
- Choose and use portable sanders
- Pick a cordless soldering iron

## INSTANT HOUSES: YOUR WAY TO A LOW-COST HOME

Graceful colonial china cabinet you can build for \$70

Scanners—radios that seek out shortwave action

Now it's easy to make your own color prints at home

Can balloonists beat the deadly Atlantic jinx?



R. Ginnell



Warning: The Surgeon General Has Determined That Cigarette Smoking Is Dangerous to Your Health.



Full flavor to match  
the best of times.

# RALEIGH



This Swiss made Stop watch by Zodiac times the action to 1/10 of a second. Yours for free B&W coupons, the valuable extra on every pack of Raleigh.

To see over 1000 gifts, write for your free Gift Catalog: Box 12, Louisville, Ky. 40201.

Filter Kings, 15 mg. "tar," 1.0 mg. nicotine; Longs, 17 mg. "tar," 1.1 mg. nicotine, av. per cigarette, FTC Report Oct. '74



# Tune-up times demand the finest lubrication you can buy



## Try our Castrol GTX Motor Oil

*Castrol  
Expertise  
in  
Lubrication*

Available in SAE 10W/40,  
10W/50 and 20W/50

Burmah-Castrol Inc. Member Burmah Group  
Hackensack, New Jersey 07601



This One



Q1GE-N5W-U436



# Your personal handgun has to be a gun you can rely on.

Let's face it. If you wanted to take chances, you wouldn't own a personal revolver in the first place. That's why only a Colt makes sense.

**UNIQUE LOCK-UP.** On any revolver the cylinder advancing hand moves each chamber into alignment with the barrel. On this Colt the advancing hand also functions as part of the lock-up mechanism. At the critical moment of discharge, the Colt advancing hand holds the cylinder rigidly in line with the barrel. That means less chance of shaving lead as the bullet enters the barrel. And that means a safer, more accurate gun.

Some revolvers use the barrel end of the ejector rod as part of their locking mechanism. Trouble is, if

As a safety feature, every Colt Detective Special is proof fired with special high pressure ammunition before it leaves the plant. That's why Colt can recommend any major brand of ammo. For additional facts on the safety and use of handguns, send for Colt's free booklet, "Handling the Handgun." Write Colt Firearms, Dept. 31M, Hartford, Conn. 06102. There is no obligation, of course.

Colt Cobra .38 Special • Lightweight (15 oz.) version of Detective Special.

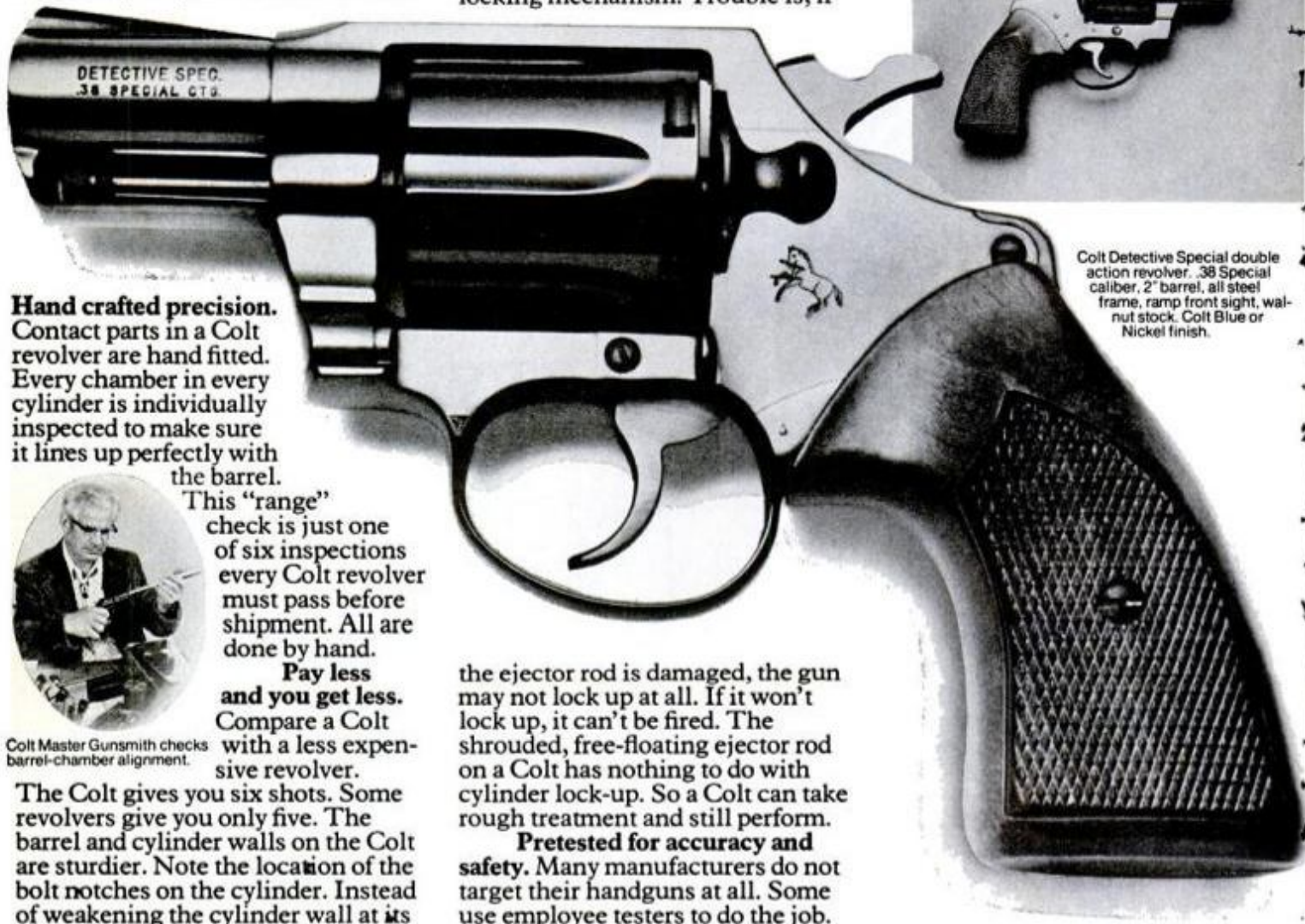

**Hand crafted precision.** Contact parts in a Colt revolver are hand fitted. Every chamber in every cylinder is individually inspected to make sure it lines up perfectly with the barrel.



Colt Master Gunsmith checks barrel-chamber alignment.

This "range" check is just one of six inspections every Colt revolver must pass before shipment. All are done by hand.

**Pay less and you get less.** Compare a Colt with a less expensive revolver.

The Colt gives you six shots. Some revolvers give you only five. The barrel and cylinder walls on the Colt are sturdier. Note the location of the bolt notches on the cylinder. Instead of weakening the cylinder wall at its thinnest point, Colt cuts these notches off to the side where the metal is thicker. The cylinder release latch on a Colt pulls to the rear. With the forward moving latch found on many revolvers, the shooter can inadvertently open the cylinder and dump the cartridges.

the ejector rod is damaged, the gun may not lock up at all. If it won't lock up, it can't be fired. The shrouded, free-floating ejector rod on a Colt has nothing to do with cylinder lock-up. So a Colt can take rough treatment and still perform.

**Pretested for accuracy and safety.** Many manufacturers do not target their handguns at all. Some use employee testers to do the job. Only Colt uses a laser boresighting system that completely removes the human factor. This remarkable instrument consistently holds center-of-impact variability to within one tenth of an inch. Every Colt revolver is laser targeted before shipment.

Colt Detective Special double action revolver, .38 Special caliber, 2" barrel, all steel frame, ramp front sight, walnut stock. Colt Blue or Nickel finish.

**You can count on a Colt.** If you buy a revolver that isn't a Colt, you'll probably pay less money. You'll definitely get less gun. Only a Colt gives you the reliability your personal handgun has to have. Even if you never use it.

Off-center bolt notches strengthen Colt cylinder.

Shrouded Colt ejector rod won't catch on clothes or holster.



**COLT** - an American heritage



# WHY WOULD ANYBODY WANT A CORDLESS ELECTRIC SCREWDRIVER?



**Because cordless power takes the work out of driving screws, and does the job in far less time.**

And there you have it. The reason why the people who invented cordless garden tools decided to bring you the Disston Cordless Screwdriver—a brand new twist to save you time and a tired wrist. Using the Disston, you'll whiz through jobs that used to be really tedious—putting up drapery hardware, building furniture, repairing appliances. Flip the control switch, put the bit in the slot, and in a few seconds the screw's in tight.



#### **Pre-drills and removes screws, too.**

Now one tool does the whole job for you, beginning to end. The Disston Cordless Screwdriver comes not only with a slotted and Phillips bit, but a bit for pre-drilling. Reverse the control

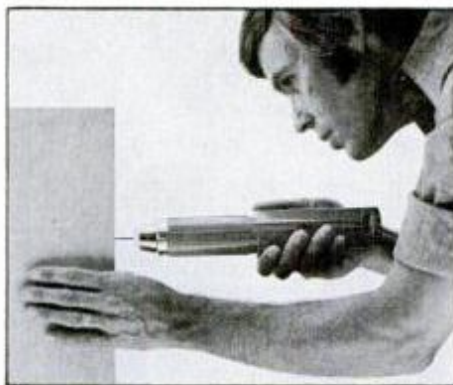

switch and it takes screws out as fast as it puts them in. Great when you're taking apart and repairing appliances, bikes, furniture.

#### **Goes a long way on one charge.**

Enough power to drive 80 one-inch screws into pine without pre-drilling or 140 screws with pre-drilling.



**Goes where you go**—into tight corners at home or wide open spaces away from home. You don't need an electric outlet because Disston does the job without a cord. Of course, it's rechargeable.



**See the Disston Cordless Electric Screwdriver where you buy hardware.** Makes a welcome gift, too. \$29.99 complete with bits and charger.

Cordless is **DISSTON**

For your nearest Disston dealer, phone 800-243-6100 FREE, day or night. In Connecticut, phone 1-800-882-6500.



## AUTOMOBILES AND BIKES

- 11 Imports and Motorsports
- 36 Detroit Listening Post
- 62 The miles-per-gallon game
- 66 PM Owners Reports: 1975 General Motors compacts
- 74 A new engine can save old Betsy
- 98 Saturday Mechanic: Check your cooling system . . . now!

## HOME AND YARD

- 34 Carry your tools in this sawhorse
- 58 Transform your yard into a night-blooming beauty
- 80 How to create the illusion of a sunken tub
- 88 Mobile, modular: Two ways to low-cost housing
- 107 Three great ways with walls
- 108 Shoo garden pests with a new weapon: Aluminum
- 118 How to keep your chain saw cutting

## SCIENCE AND ENGINEERING

- 53 Apollo-Soyuz: Manned space mission with a new accent
- 70 Transatlantic balloon jinx: Who'll be first to beat it?
- 77 Aquapolis: City in the sea

## ELECTRONICS, RADIO, TV

- 20 New tape equipment
- 41 8-track goes hi-fi—at last
- 49 GFCIs: Is circuit breaker or receptacle better for you?
- 50 Latest in loudspeakers
- 64 How to solder when there's no place to plug in
- 95 Scanners: Radios that stop and listen when there's something to hear

## BOATING, OUTDOORS

- 56 257 close-to-home vacationlands—ready and waiting
- 100 Boats you once dreamed about
- 124 Trailer hitches vs. the new bumpers

## SHOP AND CRAFTS

- 92 Pad sander know-how
- 102 Make this colonial cupboard to display your best china

## PHOTOGRAPHY

- 10 Built-in telephoto, FlipFlash for new pocket cameras
- 14 Photo hints
- 78 Color printing: Now it's easy to make color prints at home

## AVIATION, SPACE

- 53 Apollo-Soyuz: Manned space mission with a new accent

## ON THE COVER

Can balloonists beat the deadly transatlantic jinx? Bob Sparks, who tried in 1973 and does not believe in jinxes, is getting set to take off again. *Illustration, Roy Grinnell*

**AS A SERVICE TO READERS,** *Popular Mechanics* publishes newsworthy products, techniques and scientific and technological developments. Due to possible variance in the quality and condition of materials and workmanship, *Popular Mechanics* cannot assume responsibility for proper application of techniques or proper and safe functioning of manufactured products or reader-built projects resulting from plans published in this magazine.

# Popular Mechanics®

JUNE 1975 • Vol. 143 No. 6

INTERNATIONAL EDITIONS: Australia, Caribbean, Mexico, Southern Hemisphere

## SPECIAL FEATURES:

**Mobile, modular: Two ways to low-cost housing.** At today's prices, homes prebuilt on factory production lines may be your best buy. Page 88.

**Transform your yard into a night-blooming beauty.** Inexpensive ways you can create lighting effects for greater safety and enjoyment. Page 58.

**Graceful colonial china cabinet you can build for \$70.** This Early American design offers the perfect setting for displaying your best china. Page 102.

**Scanners:** Radios that automatically zip across "Public Safety" shortwave bands, then stop and listen to channels you want that are busy. Page 95.

**Apollo-Soyuz: Manned space mission with a new accent.** How American and Soviet spacecraft will dock in an orbit 140 miles above the Earth. Page 53.

**Now it's easy to make your own color prints at home.** You can take as little as 6 to 10 minutes to process your prints in full room light. Page 78.



Page 74



Page 58



Page 100



Page 95

## EVERY MONTH

- |                       |                     |
|-----------------------|---------------------|
| 8 Letters             | 30 All Outdoors     |
| 12 The Bicycle Shop   | 38 Car Clinic       |
| 16 Science Worldwide  | 46 Appliance Clinic |
| 28 Homeowners' Clinic | 82 It's New Now!    |

**POPULAR MECHANICS IS PUBLISHED MONTHLY** by the Hearst Corporation, 224 West 57th Street, New York, N.Y. 10019, U.S.A. Single copy for the United States and Canada, 75 cents. Subscription prices: United States and Possessions, \$7.00 for one year, \$13.00 for two years; \$18.00 for three years. Canada, add \$2.00 for each year. All other countries, add \$5.00 for each year. When changing address, give old address as well as the new, with zip code, and allow six weeks for change to become effective. Second-class postage paid at New York, N.Y., and at additional mailing offices. Authorized as second-class mail by the Post Office Department, Ottawa, and for payment of postage in cash. Registered as second-class matter at the Post Office at Mexico, D.F., Mexico, June 20, 1950. © 1975 by The Hearst Corporation. All rights reserved. Printed in U.S.A. Mail all Postmaster notices of undeliverable copies to Popular Mechanics, P.O. Box 646, New York, N.Y. 10019.





## The Delco Jac Pac levels your load with the turn of a knob.



Regardless of your location, from the boat ramp to the off-road boondocks, the Delco Jac Pac helps level the load with a turn of the knob. With the Delco Jac Pac shock absorber system, you can raise and lower the rear of your car just by turning a dial from the driver's seat. The big feature of the Jac Pac is the on-board air compressor for adjustment anywhere, plus two Delco air-adjustable shocks and the dial unit that mounts under the dash.

Delco Jac Pac can help you keep things on the level. You can install the Jac Pac yourself or have it done by your favorite AC-Delco serviceman.



**AC-Delco**  
Division of General Motors Corporation

AC-DELCO DIVISION OF GENERAL MOTORS CORPORATION





# The Load Tamer

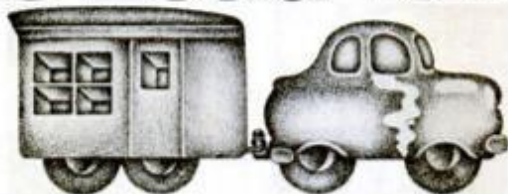

Air shocks are a must for any car with a heavy load or tow behind. And the Schrader Load-Tamer is a must for any pair of air shocks.

The Load-Tamer® eliminates service station filling of air shocks. It lets you level your car automatically, by controlling air shock pressure right from the dash—even while driving. The Load-Tamer gives you fingertip control for a safe, level, comfortable ride.

See your shock-absorber installer today and ask about the Schrader Load-Tamer. The only control that fits every brand of air shock on the market.

For more information write:

Schrader Automotive Products Division  
Load-Tamer Department LT 7502  
2000 Richard Jones Road  
Nashville, Tenn. 37215

## Schrader Load-Tamer®



# WINNEBAGO KAPS

## Free folder shows you why we're number 1 in pickup covers.

Get the full story and pictures of Winnebago's full line of Thermo-Panel®, fiberglass, rotocast and aluminum KAPS, plus names of your nearest distributor.

NAME \_\_\_\_\_

ADDRESS \_\_\_\_\_ PHONE \_\_\_\_\_

CITY \_\_\_\_\_ STATE \_\_\_\_\_ ZIP \_\_\_\_\_

I do  do not  presently own a pickup truck. Make \_\_\_\_\_

Mail to Winnebago Industries, P.O. Box 152,  
Forest City, Iowa 50436.

De 50

## WINNEBAGO®

# Popular Mechanics®

**JOHN A. LINKLETTER**

Editor

**SHELDON M. GALLAGER**

Executive Editor

**DANIEL C. FALES**

Managing Editor

**WAYNE C. LECKEY**

Home and Shop Editor

**ALVIN KIETZ**

Art Director

**BILL HARTFORD**

Automotive

**JOHN F. PEARSON**

Science and Engineering

**WM. T. MCKEOWN**

Boating and Outdoors

**IVAN BERGER**

Electronics and Photography

**HARRY WICKS**

Home Workshop

**STEPHEN WALTON**

Assistant, Home and Shop

**MICHAEL LAMM**

West Coast

**ROBERT LUND**

Detroit Automotive

**GARRY WINTER**

Copy Chief

**RICHARD H. FUNK**

Production

**ALFREDO VEGA**

Assistant, Production

**DAVID KOMITAU**

Assistant Art Director

**IRA HERRICK**

Assistant Art Director

**DON L. MANNES**

Assistant Art Director

**ED MENTKEN**

Assistant Art Director

**CLIFFORD B. HICKS**

Special Publications

**LUDWIG ARONS**

Special Projects

**SOPHIE GRONOWICZ**

Director, Bureau of Information

**EVERETT JOHNSON**

Cabinetmaker

**DANIEL J. COLEMAN**

Director of Advertising

**ADVERTISING OFFICES:** New York: 224 W. 57th St., 262-4282; Chicago: 520 N. Michigan Ave., 527-2400; Detroit: General Motors Bldg., TRinity 5-8711; Cleveland: 20310 Chagrin Blvd., Shaker Heights, Ohio, 283-7788; Los Angeles: 601 N. Vermont Ave., 666-6263.

**JOHN A. REGINA**

Advertising Production Manager

Published by The Hearst Corporation

**JOHN R. MILLER**

President

**RANDOLPH A. HEARST**

Chairman

**RICHARD E. DEEMS**

President, Magazines Division

**JOSEPH F. KERN**

Publisher

**POPULAR MECHANICS IS PUBLISHED MONTHLY** by the Hearst Corporation, 224 West 57th Street, New York, N.Y. 10019, U.S.A., John R. Miller, President; Randolph A. Hearst, Chairman; Harrison A. Mitnick, Treasurer; Harvey L. Lipton, Vice President and Secretary, Hearst Magazines Division; Richard E. Deems, President; Gilbert C. Maurer, Executive Vice President, Operations; Raymond J. Peterson, Executive Vice President, Advertising; William S. Campbell, Vice President and General Manager; John F. D'Avolio, Vice President and Resident Controller; Albert A. Racho, Vice President and Director of Circulation; Joseph F. Kern, Vice President for Popular Mechanics.

**ADDRESS ALL EDITORIAL COMMUNICATIONS** to 224 West 57th St., New York, N.Y. 10019. For additional sources of information on the articles and products in this issue, write to the Bureau of Information, Popular Mechanics, for free "Where-to-Find-It" List.



# IT'S LIKE GETTING EVERY FIFTH TANKFUL OF GAS FREE!

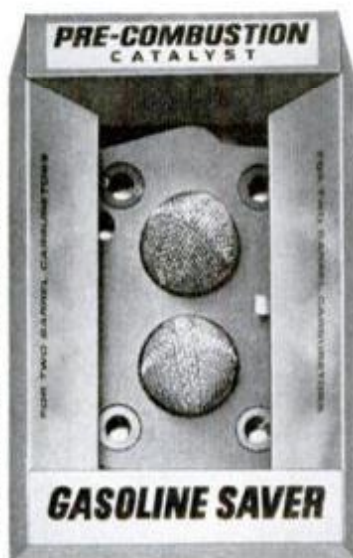

Install an MBI Catalyst and a unique engineering principle goes to work for you . . . it actually **ELECTRO-CHARGES** your gas so you can get up to 22% more mileage from every gallon when installed as instructed.

You should know two facts from the start. One, the MBI Pre-combustion Catalyst is **not** a mechanical gimmick or gadget. It is a scientific device based on an exclusive design protected by a U.S. Patent.

Secondly, you should know its remarkable mileage economy has been proved by exhaustive, independent tests. Leaded gasoline is required. And normally, full economy is realized only after a break-in period of 1000 to 1500 miles following installation. Effectiveness reports from Scott Laboratory, national magazines, fleet and municipal users are available.

## HOW THE CATALYST WORKS

What makes the MBI Catalyst so effective is its unique electro-chemical charging action.

You install the device between the carburetor and the intake manifold. It is a specially molded gasket incorporating two separate cone-shaped screens — one of cadmium fitting within another of nickel, with air space between.

As gasoline is injected, the dual screens give each drop a positive electrical charge, drawing it instantly to the negatively charged walls of the manifold.

On contact, manifold heat completely vaporizes the fuel so it enters all cylinders much more evenly than before.

## HOW YOU BENEFIT

You get a totally clean burn. There are no rich or lean cylinders. Carbon build-up is prevented. Your gasoline burns with maximum efficiency. Hesitation, pre-ignition and dieseling are usually eliminated.

Your engine operates with smooth, even power all the time. So efficiently in fact that if your car now requires high octane gas, you can probably switch to regular leaded gasoline without knocking or pinging.\*

Regular or premium, you can get up to 22% better mileage when the MBI Catalyst is properly installed, according to simple instructions in the package. That's like getting every fifth tankful **FREE**. Mail the coupon and start saving.

**YES, I'D LIKE TO GET EVERY FIFTH TANKFUL FREE.**

Send me prepaid the proper model MBI Catalyst for my car.

Name \_\_\_\_\_

Address \_\_\_\_\_

City \_\_\_\_\_

State \_\_\_\_\_

Zip \_\_\_\_\_

Car make \_\_\_\_\_

Model \_\_\_\_\_

Year \_\_\_\_\_

Engine size (cu. inches) \_\_\_\_\_

Carburetor make & number of barrels \_\_\_\_\_

**1-Barrel Models \$23.15**

**2-Barrel Models \$23.95 4-Barrel Models \$24.75**

Mail with check or money order to:

# MBI

**MO-BILE INDUSTRIES, INC.**

244 NORTH RANDOLPHVILLE RD. • PISCATAWAY, N.J. 08854

\*Note: The MBI Catalyst is not yet available for 1975 cars, which require unleaded gas.

PM



# Two more ways to be a hero in your own home!



## Renew rusted surfaces

Make rusted lawn furniture, bicycles, mowers look like new again with Derusto Minute Finish Spray. Special rust inhibitive primer is built into every color for one-step rust prevention. For old and new surfaces. In 18 gloss colors.



## Stop paint peeling on downspouts

Derusto Galv-A-Grip™ is specially formulated to stick tight to gutters, downspouts, all galvanized metal. Won't check, peel or crack like ordinary paint. Dries in 3 to 4 hours. Choice of 4 long-lasting colors.

# DAP

# Derusto

The name people know best in home fix-up

DAP Inc., General Offices: Dayton, Ohio 45401  
Subsidiary of Plough, Inc.

# LETTERS

## FROM READERS

### Propelled into action

Each year, as the time for our participation in what we fondly call "Justice Douglas' Canal Hike" approaches, our mostly deskbound group here in Washington ponders how winter's stiff bones will hold up, under even this minimal-stress initiation to our hiking season.

A friend just provided us with your April issue, with Jack Galub's *Are You in Shape for Spring?* (page 101). Articles on fitness are somewhat the going thing right now, so I thought you'd like to know that it was yours that had that something special that has propelled us from our chairs and into action.

PATTY ROYSTON  
SPRINGFIELD, VA.

The article is one of the finest I have read on the subject of exercising to get into shape.

AL BURROWS  
MOUNT RAINIER, MD.

### New twist on teeth

List me among the hundreds (or thousands) of nitpickers who will point out an error in the April issue. There is another explanation for the difference in appearance between the two sets of teeth shown in *Science Worldwide* (page 8). The left-hand set is upside down.

D. S. DUGUID  
WARREN, N.J.

*It's a rare case of dental inversion, somewhat akin to putting one's foot in one's mouth. Anyway, the patient survived.*

### Anybody want to talk?

Is there a tape recording club in existence any more?

I should like to meet some who have cassette recorders to talk with—anywhere.

JOSEPH E. THOMAS  
PHOENIX, ARIZ.

### More do-it-yourself camp gear

I was interested in *Sew—You Save With Camp-Gear Kits* (page 118, March '75).

As someone who enjoys camping and saving money on camping equipment, knowing the article is well put together is very important.

Having sewn several items over the last couple of years, I want you

to know of another company dealing in kit items: Sun Down, Inc., Box 1023, Burnsville, Minn. 55337.

From experience, I find this company's articles of the highest quality and easy to assemble.

SHARYN HARVEY  
SELINGSGROVE, PA.

*Sorry we missed Sun Down; we just didn't know about the company. The firm's catalog has a dandy lineup of outdoor gear.*

### His own version of tune-up bench

The auto tune-up bench for your garage shown in the April '75 issue (page 105) makes sense. Do-it-yourself, if at all possible, in maintaining your own vehicle sure beats the high cost of mechanics' labor these days.

I've had my version for several years now and it is a real stepsaver. As you can see, it is simply constructed and features a converted

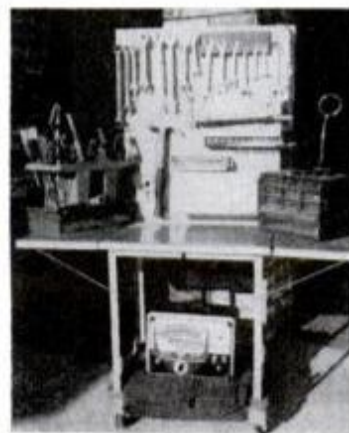

typewriter stand as a base for the mobile tool bench. Pushing it out in the driveway makes my tools easily accessible for most any outdoor project.

Thought you would be interested in the foregoing from an avid fan of your Class A magazine for just about the past half century.

KEN WORDEN  
SUN CITY, ARIZ.

### Really a cafe racer

*Easy Riders* (page 82, March '75) by Jake Grubb is good but misleading in that he does not differentiate between touring bikes and cafe racers. I'm referring to the Ducati 750 Sport which is mentioned as a touring bike, but it is in fact a cafe



racer. They are used, as Mr. Grubb mentions them to be, "riding for short fast jaunts."

Ducati makes a touring model from the same bike but it's called the 750 GT and in 1975 comes with an 860-cc engine. It is specifically a touring bike, and compared to the 750 Sport, it can be ridden for hours on end.

GREGORY MCKENNA  
LENNOXVILLE, QUE.

### Seeing spots

The Top 20 Lures (page 63, April '75) was very good. I noticed a black spot on Mann's Lil' George, the Bomber, the Cordell Big O and the Heddon Sonar. What is the purpose of this spot?

RODNEY DOE  
WADDINGTON, N.Y.

The black spot on the lures makes them look like that panfish favorite, the bluegill. As for why showing spots makes them look tasty, you'd better ask a fish.

I, like many, many other fishermen and/or women, have been using the Bomber lure for years, and it bears no resemblance to the one identified as a Bomber on page 64.

You'll undoubtedly receive a ton of mail on this possible error.

Your new format is a vast improvement: size, readability, reproductions and depth of information.

JOHN R. SMITH, M.D.  
LOUISVILLE, KY.

Bomber lures are available in 13 popular designs, offered in 29 sizes and over 163 assorted colors. The selection shown is the Bomber Pin-fish.

### Will slide rules become extinct?

Are conventional slide rules in danger of extinction now that faster and much more accurate electronic calculators with slide rule functions are so prevalent?

Is there still any situation where a conventional slide rule might be preferred?

KEN GREENBERG  
SKOKIE, ILL.

Yes: Where you'll be out of reach of power or batteries for a long, long time.

# Give an Old Timer for Father's Day.

(June 15)

Surprise Dad with something different this year. An original Schrade Old Timer® pocket knife or Sharp Finger® Made of the finest high-carbon edge holding steel. Old Timers have the rugged good looks and sharpness you expect in a great knife. Made by America's oldest cutler. It has the quality that lasts and lasts. At better hardware and sporting goods departments!

**Schrade Cutlery**  
Ellenville, N.Y. 12428



1520T Sharp Finger 7 1/4" overall, blade 3 1/2"  
Under \$16 Includes leather case and gift box

340T 3 5/16" closed  
Under \$10 Gift Boxed





**GARAGE DOOR OPERATOR**

**RADIO CONTROLLED**

**\$99<sup>95</sup>!**

- RADIO CONTROLLED from car transmitter or wall switch
- SAFETY night and day, year 'round
- SECURITY door locks tight when closed
- CONVENIENCE in-car control any weather
- LIGHTING garage lights automatically
- VERSATILE fits all lifting type wood, metal or fiberglass doors, sectional and 1-piece
- EASY HOME INSTALLATION in just 2-3 hours
- SAVE up to 50% direct factory purchase and PP or UPS home delivery
- GUARANTEED one year
- FREE brochure

HELPMATE EQUIPMENT CO., Box 217PM, Baroda, MI 49101 (616-422-2311)



# To help stop Athlete's Foot more families buy Desenex® than any other remedy.

That's because anti-fungal Desenex contains a medically-proven formula that has successfully helped millions of sufferers. And the number gets bigger every year.

To help heal Athlete's Foot, use Desenex Ointment at night and Desenex Powder, or Aerosol, during the day.

When used routinely, Desenex provides continuing protection against fungus infection.



Also available in solution form.

© 1974 Pharmacrast Consumer Products

A PRODUCT OF PENNALT CORPORATION



## Built-in telephoto, FlipFlash for new pocket cameras

Kodak's latest Pocket Instamatics (they're called Trimlite Instamatics, now) feature a soft-touch shutter release, an all-new flash system and, on one model, a built-in telephoto auxiliary lens.

The new GE FlipFlash panels hold eight tiny bulbs that fire in sequence, with green dots behind the panel turning black to show how many you've fired. After four shots, you flip the panel upside down, to keep the live bulbs well above the lens, preventing "red-eye" reflections. An accessory extender lets you hold the flash off-camera, too, and an electronic flash is also available. FlipFlash requires no batteries—a piezoelectric element in the shutter generates electricity.

The telephoto, on the new Trimlite 608 (\$36) flips in when desired to increase the lens's focal length to 43 mm—like 85 mm on a 35-mm camera.—Ivan Berger

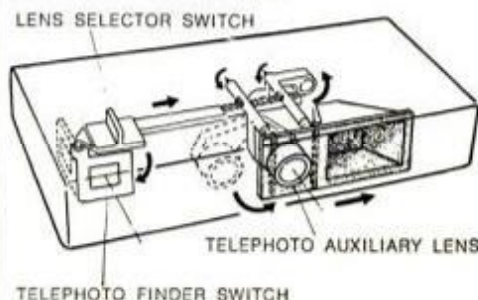

TELEPHOTO FINDER SWITCH

## How to pay for home improvements without getting nailed.

Borrow the money you need at your credit union. You'll find their low annual percentage rate helps you put things together without breaking up your family budget. There's a minimum of red tape. Many times your signature is all that's required. At your credit union, you're more than a customer. You belong.

Join your credit union. It's where you belong.

For more information write to your state's Credit Union League or Credit Union Nat. Assoc., Inc., Dept. B, P. O. Box 431, Madison, WI 53701.



## THE SCOTT ENGRAVER Your spare time money-maker

Scott's SM300K turns 10¢ worth of plastic laminate into a product you can sell for 75¢ to \$1.00. Every business is a prospect. Make name plates, signs, plaques and more... in just minutes, using just one hand. A complete, ready-to-operate engraving shop to help you make big money in your spare time!

To find out more, send for free catalog, today.

Dept. 06501,

SCOTT MACHINE DEVELOPMENT CORP.

P. O. Box 217  
Walton, New York 13856

Scott fills every engraving need—  
from stock to fonts.







# IMPORTS AND MOTORSPORTS

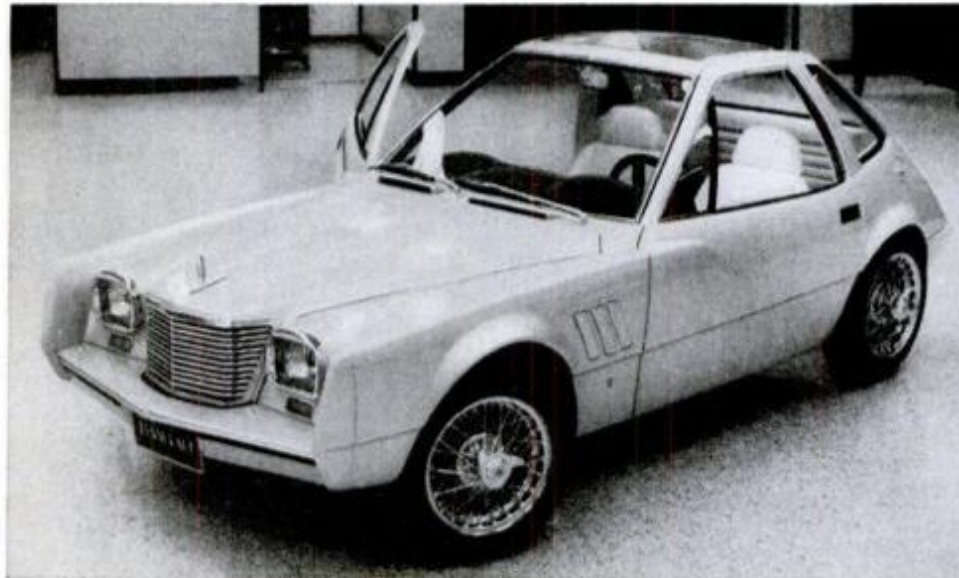

## Ford and fun

You don't hear much about boredom on the drafting board at auto companies, but just imagine if you had to spend all your working hours designing shift-lever knobs or dashboard switches. To keep sane, you'd look forward to the excitement of doing project cars like the one shown here. Designers from Ford in Dearborn and from Ford's Ghia Operations in Turin, Italy, conceived this two-seater Ghia Flashback. It was styled to evoke the classics of the past, but be a lightweight, fuel-efficient car for the future. It may never see production, but if it did it would weigh in under 2000 pounds. Wheelbase is 84 inches; overall length, 134 in.; width, 55 in., and height, 48.6 in. The Flashback was shown earlier this year in Detroit and will be at other automotive exhibitions around the country. You can't miss it!

## Fox box

New to the 1975 Audi Fox model lineup is this station-wagon version. It looks very utilitarian here—and it is. But the first one I saw actually lured me away from a couple of Porsche sports cars: It was gold metallic, had a sun roof and cast alloy wheels as options. Back on the practical side is the Fox's 24 to 34-mpg economy from its ohc 1600-cc fuel-injected engine and it needs no catalytic converter. It's not cheap but it's a good value.

## Golden oldie

MG No. 1 is still in topnotch running order as you can see here. It was on the road to celebrate 50 years of MG production. The year was 1925



when Cecil Kimber rolled the first car out of the Morris Garages.

Other news from British Leyland: The E-Type Jaguar will be replaced with a new sports model, the XJ-S, which will arrive in the U.S. this month. Stay tuned.

## Car buff's bible

*World Cars 1975* just arrived here and all work stopped. The 440 glossy pages show over 900 models from 31 countries. The four-pound, \$22.50 volume is in book stores now. Herald Books, Box 17, Pelham, N.Y. 10803.

## Chic Jeep

Underneath the slick fiberglass body it's an AMC Jeep CJ5. The bolt-on body is the design work of Tom Parmley who needed new skin for his Jeep after he crumpled it up in a roll over. His replacement body improves on the original in aerody-



namics, roominess and other conveniences. His design also leaves room to install 10-inch-wide wheels and a bigger engine. The kit is \$1000. Parmley Engineering is at 419 East Euclid Ave., Compton, Calif. 90222. ★★★





# THE BICYCLE SHOP

BY EUGENE A. SLOANE



## On flat prevention

*I would like to know how well "skim-mers" keep glass and other flat-producing stuff out of tires.—A. Bater, Rochester, N.Y.*

People who use them swear by them. These are little wire gadgets that fit on the brake bolt and rub on the tire so any imbedded particle that would cause a flat would get pulled off before it could do so. These tire savers work only on smooth-tread tubular tires and not on any other tire, including any wired-on tire. Personally, the noise of rubbing is more annoying to me than any benefit these items offer, and I don't use them.

## Drill or don't?

*I'm wondering if it is a good idea to drill holes in certain parts of my bicycle to remove weight. If so, where? If not, why not?—Rob Muller, Sioux Falls, Iowa.*

I don't recommend drilling out any part of a bicycle for weight saving, unless you're a dedicated amateur or a money-making professional racing cyclist. Photos of bikes ridden by such world champions as Eddy Merckx of Belgium show brake levers, chainwheels, crank arms and even derailleur bodies drilled out in a frantic effort to save an ounce or two that *might* make the difference between losing and winning a crucial race. But for the average bike owner to go to all this work and expense to save a few ounces is simply time and money wasted, in my opinion. When you drill out these parts you weaken them. If interested in the cosmetics of bike appearance, you might send your cranks, seat post, stem and chainwheels to VSP, 5000 West Fitch Ave., Skokie, Ill. 60076 or write for its price list for this drilling and fluting service.

## No 15-speeds?

*How come I never see any 15-speed bicycles on the road? Also, we have five bikes, and I notice that their tires need air far more frequently than auto tires. Why is this?—Ken Greenberg, Skokie, Ill.*

Yes, 15-speed bikes are relatively rare, especially these days when they do cost a bit more. Reason for the 15-speeds is that very wide ratio



(Granny-gear) bikes with only 10 speeds give you too much of a jump between gears. If you have a free-wheel (pictured) with 14, 17, 22, 28 and 34 teeth, combined with a chainwheel of 49 and 54 teeth, you would have trouble finding the exact gear for comfortable cycling under the varying conditions of wind velocity, road grade and how you feel at the moment. If you convert that dual chainwheel to a triple one with a small chainwheel of 36 teeth you would have another five gear ratios to choose from, and would find cycling much more enjoyable since you would now be able to select just the gear ratio you need to cope with wind and road conditions. Also, yes, bike tires do lose air faster than car tires, because bike tires have thinner tubes more permeable to air than heavy car tire tubes or tubeless tires. You can reduce bike tire leakage by using butyl tubes.

## Improving hindsight

*Where can I buy a small mirror with ball joints that would fit on the downtube, so I can eliminate having to put it on the handlebars?—Stanley Goldsmith, Webster, N.Y.*

On the bars or on the tube, a mirror either place means you have to remove your eyes from the road in



front for a second or two. That's all it takes to create an accident. Far better is a little mirror (photo) you can clip on your glasses, available for around \$3.50 from Ultra-Light Touring Shop, Box 308, Brinkhaven, Ohio 43006. Specify kind of glasses

you wear (thick horn rim, wire type, flexible wire type, etc.). This mirror is much safer as you can see the entire road behind you, it does not vibrate and you don't have to look away from traffic ahead.

## Best and the brightest

*What is the best and lightest generator light?—Roger DeAmicis, Monte Vista, Calif.*

I like the Soubitez (French) generator light set. Schwinn sells its version of this set which has a good head and taillight. If you can't find either one, ask for a generator which has eight poles and puts out six volts at three watts. Cheaper generators have six poles, put out less wattage and accordingly, less light.

The Soubitez three-piece set (generator, front light and rear light) sells for around \$10.50.

## Getting back copies

*I would like to buy tearsheets of Bicycle Shop articles which have appeared in previous issues of PM. How can I get these?—Mrs. G. Daisley, Trenton, N.J.*

Best way to get back copies is to go to your local library and dig out the ones you need and have them photocopied. Many libraries have coin-operated copying machines for this purpose. You can also order them from the Bureau of Information, Popular Mechanics, 224 West 57th St., New York, N.Y. 10019, for 25 cents per page, plus 25 cents for postage and handling for each order.

I also receive many letters from readers with stamped, self-addressed envelopes or coins for stamps requesting a personal reply from me. I do regret to state I cannot make personal replies. There just aren't enough hours in the day even to return the stamps or coins, let alone write individual letters. I do try to select questions from readers that have broad application to answer in this column. ★★★

*If you have any questions about bicycling send them to The Bicycle Shop, Popular Mechanics, 224 West 57th St., New York, N.Y. 10019. Sorry, but letters cannot be answered individually. Problems of wide interest will be discussed in this column.*



## NEXT MONTH IN PM . . .

- **Pilot's report: New warning heads off air disasters**
- **Rust: Your car's worst enemy**
- **World's biggest car crash: How it happened**
- **15 ingenious workshop ideas**
- **Attic fans: Low-cost way to cool your home**
- **Amazing synthetic motor oil: No more oil changes?**

**SUBSCRIPTION SERVICE:** Mail all subscription orders, changes of address (with your latest label), and Postmaster notices of undeliverable copies to Popular Mechanics, P.O. Box 646, New York, N.Y. 10019. All other correspondence relating to your subscription: James Gable, Customer Service Department, Popular Mechanics, P.O. Box 1567, New York, N.Y. 10019. Please enclose your latest mailing label for quickest service when writing about your subscription.

# New NRI AUTOMOTIVE MECHANICS HOME TRAINING acclaimed by experts



**TOM McCAHILL**

"I'm beginning to have some hope about finding good mechanics again."

"It's a great relief to see a highly qualified school like NRI come up with home training in the automotive mechanics field that should do much to improve the sad state of the car repair industry. The Master Automotive Technician course gives ambitious guys a great start on a top-dollar career. And that Tune-Up and Electrical System program can save do-it-yourselfers a bundle, or lead to some lucrative part-time bucks. To find top mechanics again—I'll just look for an NRI diploma on the repair shop wall."

*Tom McCahill*

America's foremost automotive editor/critic



**RICHARD PETTY**

"It's a lot of training for a very few dollars."

"I especially like the way NRI has programmed essential training equipment they give you into step-by-step instruction. The fact that the Master Automotive Technician course includes (among other things) an ignition-analyzer scope, dwell tachometer, timing light and tune up tools is an indication that it's a lot of training for a very few dollars. Even the shorter Tune-Up course includes basic tools and equipment at no extra cost. I'm sure Petty Enterprises would give top consideration to a man with an NRI diploma."

*Richard Petty*

America's winningest stock car racing driver



**BILL FRANCE**

"I've seen a lot of training programs and this one is up there with the best."

"I'm very pleased to find that NRI has developed home training programs in car repair that are right up there with the times. Both the Master Technician and the Tune-Up and Electrical Systems courses are amazingly complete and up-to-date. They employ an easy to learn method that has successfully trained thousands for technical jobs. Subjects are broken down into 'bite-size' texts and programmed with essential equipment. I've seen a lot of training programs, and this one is up there with the best."

*William H. France*

President, International Speedway Corp.

William H. Crouse, author of the NRI mechanics training, is an internationally known automotive training expert. He has served as Director of Field Education for the Delco-Remy Division of General Motors. He has written over two dozen outstanding books on automotive subjects, and has been Editor of Technical Education Books for the McGraw-Hill Book Company. He knows what you need to know whether you choose NRI's Master course, or the shorter Automotive Tune-Up and Electrical Systems course. Mail coupon for full details. NRI SCHOOLS, 3939 Wisconsin, Wash., D.C. 20016.

## Popular Mechanics

250 West 55th St., New York, N.Y. 10019

WPM5F1

# YES!

Please enter my subscription to POPULAR MECHANICS for:

- 1 year \$7.00       New  
 2 years \$13.00     Renewal

Payment of \$\_\_\_\_\_ is enclosed.

Bill Me \_\_\_\_\_  
initial here

Name \_\_\_\_\_ (please print)

Address \_\_\_\_\_

City \_\_\_\_\_ State \_\_\_\_\_ Zip \_\_\_\_\_

On new subscriptions, first copy will arrive in about 8 weeks.

(Above prices apply in U.S. & Possessions only. Canada add \$2 per year. All other countries add \$5 per year.)

## CHANGING ADDRESS?

If you're planning to move, please let us know at least six weeks before changing your address. Attach current address label and fill in your name and your new address. This will serve to insure prompt service on your subscription.

Send old label with your name and new address to:  
 POPULAR MECHANICS, Subscription Dept.  
 Box No. 646, New York, N.Y. 10019

NAME \_\_\_\_\_ (Please print)

NEW ADDRESS \_\_\_\_\_

CITY \_\_\_\_\_ STATE \_\_\_\_\_ ZIP CODE \_\_\_\_\_

## RUSH COUPON FOR FREE CATALOG

NO SALESMAN WILL CALL



**NRI SCHOOLS**  
 McGraw-Hill Continuing Education Center  
 3939 Wisconsin Avenue,  
 Washington, D.C. 20016



946-065

Check below for your free Automotive Catalog. Or select one of the other courses instead.

- AUTOMOTIVE MECHANICS COURSES**     TV/Audio, Communications, and Computer Electronics Courses     Air Conditioning, Refrigeration, and Heating Courses

Name \_\_\_\_\_ Age \_\_\_\_\_

(Please Print)

Address \_\_\_\_\_

City \_\_\_\_\_ State \_\_\_\_\_ Zip \_\_\_\_\_

**APPROVED FOR CAREER STUDY UNDER G.I. BILL.**  
 Check for details.      Accredited Member National Home Study Council





## Omega Pro-Lab B66

The last word in medium-format enlargers.

For sheer ease of operation, no photo enlarger surpasses

Omega's Pro-Lab B66 for 35mm and 2 1/4" negatives.

The spring-loaded negative carrier opens wide when you lift the lamphouse, letting you advance negatives without disturbing their alignment. The lamphouse assembly is counterbalanced for smooth, easy movement. And a sliding panel allows instant access to the lamp, condensers and filter drawer. The



rigid, inclined girder keeps negative and baseboard perfectly aligned, and leaves maximum room to center your easel.

Yet the whole unit will come apart quickly and easily for storage.

The B66 comes with three condensers, for optimum light distribution with negs to 35mm; or switch to two condensers to match the 2 1/4" format optical requirement. Or get the optional dichroic color head and dial in the exact filtration needed for color or variable-contrast printing.



Priced as sensibly as it's designed, and for even greater savings, there's our "Two-Lens Outfit" for 2 1/4" square and 35mm formats.

Write for literature to Omega Division, Berkey Marketing Co., Inc., Woodside, N. Y. 11377. In Canada, Berkey Photo (Canada) Ltd., Ontario.



Ω OMEGA

The Greatest Name in Your Darkroom.

## You'd be surprised what you can buy for under \$100. Or \$200. Or over \$1,000. In fact, you'd be startled.

Konica is the world's most experienced maker of automatic cameras.

And we make them so every photographer can enjoy their advantages. Which is why our prices range from about \$100 for a compact C35, to over \$1,000 for the Autoreflex-T with varifocal lens.

Whether you're just beginning with 35mm photography, or you're an old

pro, you'll find that Konica automatics offer you more features for the money than any other cameras at their price.

For that happily startling experience, see the Konica system at your Konica dealer. Or write for literature to:

Konica Camera, Woodside, N. Y. 11377. 



### The Konica Automatics.

From under \$100 to over \$1,000.



## PHOTO HINTS

### FROM READERS

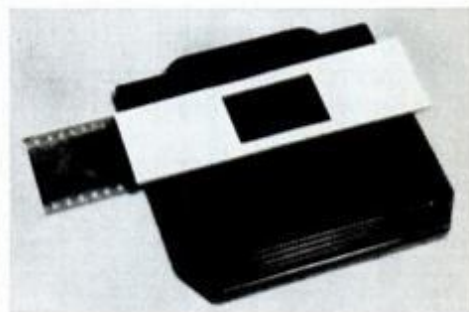

#### Cardboard stops 'shadows'

In many inexpensive enlargers, the negative is held flat by direct contact with a condenser element, which can cause Newton rings (irregular, concentric shadows). To cure this, place a thin piece of cardboard, cut out to match the negative frame, between the negative and the condenser.—Lane Sander, Yakima, Wash.



#### Easy racks for floodlamps

Two strips of curved-channel molding facing each other on a wall can store floodlight reflectors conveniently. I use "stucco mold" (shown in profile). Mount one molding first, then use a reflector to position the second. The reflector should fit snugly, but slide freely. The three-foot unit shown holds three of my floods. The moldings can be vertical or horizontal; if vertical, mount a piece of 1x1 at the bottom of keep the reflectors from falling out. Position brads so lower rims of top and middle reflectors can rest against the brads or be slipped past them to slide to the bottom position.

—E.V. Reyner, Salinas, Calif.





## The time to have your car's air conditioning serviced is before you need it.

If you're one of those people who believe in regular car maintenance, then you probably wouldn't think of putting off an engine tune-up. But do you give your car's air con-



ditioning system the same attention? You should.

A trained AC-Delco air conditioning serviceman is someone to see. When you ask him to check out your car's air conditioning system, you are getting someone who knows air conditioning.

And if you need a new part, he has Delco air conditioning parts available

for just about any car.

So put your car's air conditioning on a regular tune-up schedule. See your AC-Delco serviceman.



**AC-Delco**  
Division of General Motors Corporation

AC-DELCO DIVISION OF GENERAL MOTORS CORPORATION





# SCIENCE WORLDWIDE

## New medical use for laser

Laser-generated X-rays show promise as a new medical tool, especially in the early detection of breast cancer, according to scientists at the Battelle Laboratories, Columbus, Ohio. In the X-ray probe under development at Battelle, a powerful laser beam is used to produce X-rays that are emitted from the tip of a conelike device.

Shown preparing to take an X-ray photograph, Dr. Philip J. Mallozzi positions a sheet of film behind a "phantom" breast—a plastic model that is designed to simulate the X-ray absorption properties of the human breast.

The new device offers a combina-



tion of an X-ray source of small diameter, fast exposure time, and soft (not deeply penetrating) X-rays. These features permit the making of high-resolution X-ray photos. Since blurring due to bodily motion is eliminated in such photos, it is hoped they will provide distinct images of small incipient tumors.

## Now: new sugar substitute

Aspartame—a substance said to be 200 times sweeter than sugar—will be used by General Foods to sweeten a number of foods, including cereals and powdered beverage mixes. Unlike saccharin, an artificial sweetener, Aspartame has some nutritive value. But so little is needed to sweeten a food that it adds virtually no calories.

Discovered by research chemists at G.D. Searle & Co., Aspartame is a combination of two amino acids among the 22 that are called the "building blocks of life." These acids are constituents of protein.



## Computer simulates air pollution

A new mathematical model that describes how air pollution spreads over large cities has been developed by scientists of the International Business Machines Corp. The work of researchers Liao Jing Hsieh (seen at left in photo) and Ching Cheng Shir, the model enables a computer to simulate the complex interactions among geographical features, pollution sources and meteorological conditions that together produce the patterns of pollution occurring in a city's air.

Commands altering a city's environment are fed into a computer, and the results can be seen seconds later on the screen of a display device. Contour lines represent different levels of pollution concentration; the patterns of these lines change with varying weather conditions. The simulation is said to achieve a realism previously unattainable. It will be used in a St. Louis study by the U.S. Environmental Protection Agency.

## Waste gas going to waste

Some \$50-million worth of gas generated by treatment of human waste is being lost each year, says David Long, professor of engineering at Pennsylvania State University. "Most of the country's 10,000 sewage treatment plants make no use whatever of much of the gas that is a byproduct of bacterial digestion of sewage," according to Prof. Long. "They burn it unproductively in the air."

Though the gas is not as high in heating value as pure methane,

it could be used to run engines to generate electricity or heat homes and factories. "We have the technology and it is relatively inexpensive," says Prof. Long.

## Toy may be therapeutic device

Spacepod (below) is an English amusement park toy that tilts and rotates as the strapped-in pilot "flies" it by shifting his weight. The tubular steel frame is fitted with nylon bearings that cause movement to be almost completely free of friction.

Spacepod is now being studied by RAF scientists for possible use in reconditioning pilots who have developed a fear of flying.



## Map from satellite for sale

A space "map" of the conterminous United States is now available. A mosaic of images made by NASA's LANDSAT-1 satellite, the map shows what the nation looks like from 570 miles in space.

Two versions are available. One was made in visible band of the spectrum (called Band 5), and it accentuates urban areas. The second, composed of infrared images (Band 7), highlights topographical features. In ordering, you should specify Band desired. The 29-by-41-inch maps—at \$1.25 each—may be ordered from the Branch of Distribution, U.S. Geological Survey, 1200 South Eads St., Arlington, Va. 22202.

★★★



**When you say Budweiser, you've said it all!**

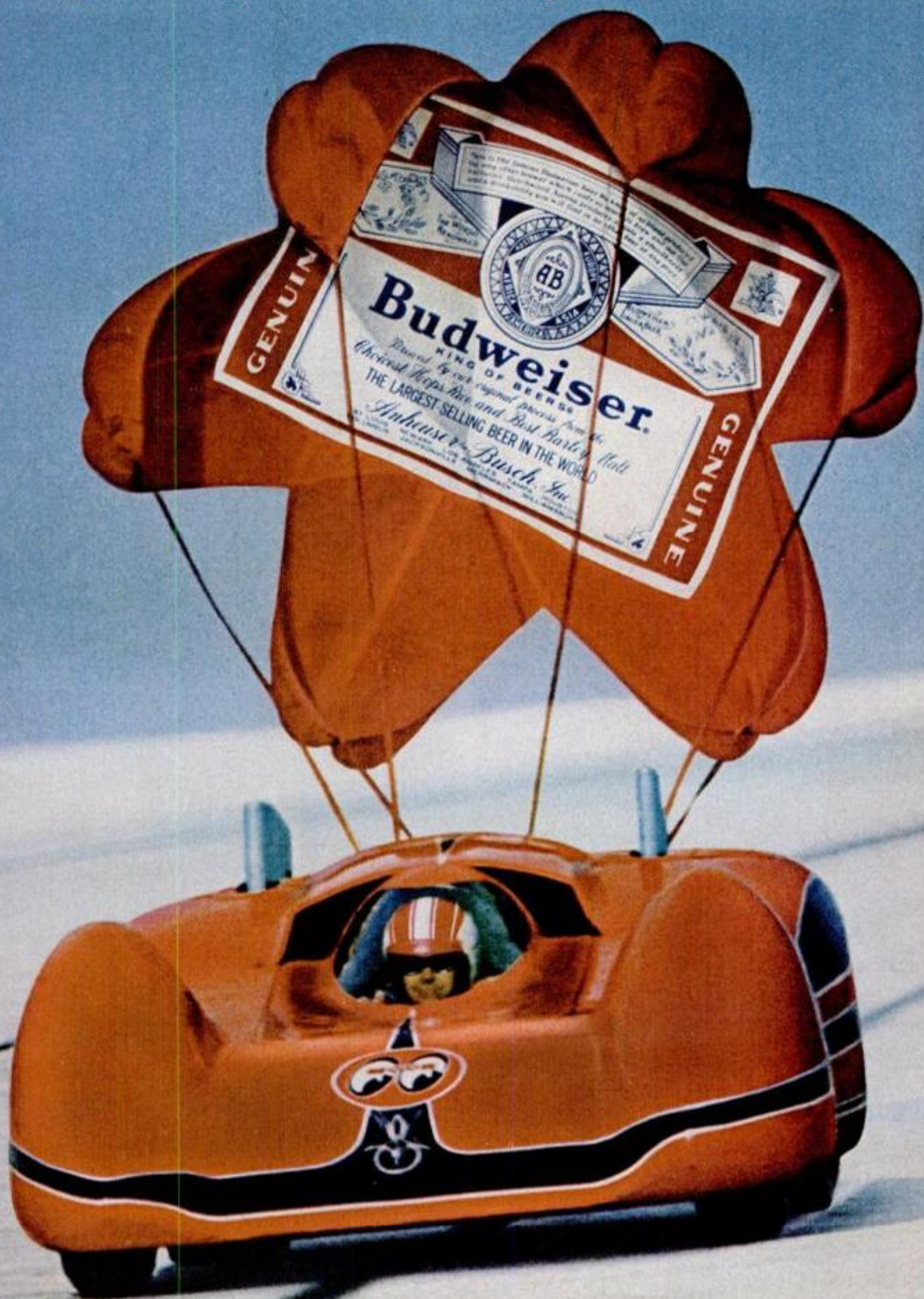



# You only ride like a Pacer if you're wide like a Pacer.

The Pacer is wider than any other small car.

It's this extraordinary width that gives you such incredible stability. It also gives you much more.

For example, the width combined with rack-and-pinion steering gives you the sort of handling and agility found in sports cars.

And the Pacer's width combined with a unique isolated suspension system gives you a smooth and steady ride around tricky curves as well as over bumps.

And speaking of a smooth ride, the Pacer's width also means you get an unusual amount of room so you can ride around in comfort.

(The Pacer comes with AMC's proven 6-cylinder engine and a 22-gallon gas tank. Which means, in addition to everything already mentioned, you also get outstanding performance, excellent economy and long-distance driving range.)

When you ride in the Pacer you'll know what it's like to have width going for you.



**AMC**  **PACER**  
The first wide small car.



# And with the Pacer you get the wide coverage.

## THE AMC BUYER PROTECTION PLAN.™

THE FOLLOWING PARTS AND SERVICES ARE COVERED  
AGAINST FACTORY DEFECTS OR FAILURE DUE TO WEAR  
FOR 12 MONTHS OR 12,000 MILES.\*\*

### PARTS FIXED OR REPLACED FREE

	AMC	GM	FORD	CHRYSLER
Engine/Drive train	YES	YES	YES	YES
Spark plugs	YES	NO	NO	NO
Shock absorbers	YES	NO	NO	YES
Brake linings	YES	NO	NO	YES
Clutch linings	YES	NO	NO	YES
Wiper blades	YES	NO	NO	NO
All light bulbs	YES	NO	NO	NO
Hoses & Belts	YES	YES	NO	NO

### SERVICES PROVIDED FREE

Wheel alignment	YES	NO	NO	NO
Wheel balancing	YES	NO	NO	NO
Align headlights	YES	NO	NO	NO
Adjust carburetor	YES	NO	NO	NO
Adjust distributor	YES	NO	NO	NO
Adjust brakes	YES	NO	NO	NO
Adjust clutch	YES	NO	NO	NO
Adjust transmission bands	YES	NO	NO	NO
Adjust & tighten belts	YES	NO	NO	NO
Tighten nuts & bolts	YES	NO	NO	NO
Free loaner car	YES	NO	NO	YES
Trip Interruption Protection	YES	NO	NO	NO

™ Buyer Protection Plan is a Trade Mark of American Motors Corporation.

\*\*Chrysler coverage is 12 months, unlimited mileage.

AMC will fix or replace free every part (except tires) for 12 months or 12,000 miles, whether the part is defective or just plain wears out under normal use and service.

And when we say every part, we mean every single part. Even all those annoying little things that occasionally wear out. Like spark plugs, wiper blades, yes, even light bulbs.

AMC also has a plan to provide a free loaner car should guaranteed repairs take overnight. And a special Trip Interruption Plan that pays up to \$150 for food and lodging if guaranteed repairs have to take place more than 100 miles from home.

To cover a car with a plan as wide as ours, you have to have a car as good as the Pacer.

# \$3,299\*

\*Manufacturers suggested retail price not including state and local taxes, destination charges. Wheel covers, white side wall tires, other options, extra.



**We back them better because we build them better.**



# AVIS

## INDUSTRIAL CORPORATION

Here's **POWER** when and where you need it most. Dependability and confidence will be your mood with an Avis trouble free **Powr-Pak** engine generator unit. Whether it be for your home, your home on wheels, your camp, or your shop, we want to tell you about **Powr-Pak**. For further information please write or call.

**DEALER OPENINGS STILL AVAILABLE**

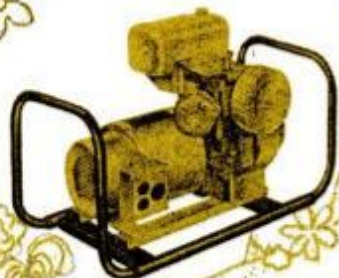

### powr-pak

#### Engine Generator Units

AVIS INDUSTRIAL CORPORATION  
Dept. PM, Decatur, Indiana 46733  
Telephone (219) 565-3191

## New tape equipment



ADVENT CR/70 CASSETTES



CRAIG 2625



PHONE-CHEK



PANASONIC CQ-898/CJ-20H

## FREE COLOR CATALOG



Build Your Own  
Grandfather Clock  
starting under

### \$200

(Including West  
German Movement)

- Do-It-Yourself Case Kits, parts pre-cut
- Solid 3/4" Black Walnut, Cherry, Mahogany, Oak
- Movements and dials
- Finished Clocks
- Direct Factory prices



Write for free color catalog

## EMPEROR CLOCK COMPANY

Dept. 905, Fairhope, Ala 36532

WORLD'S LARGEST MANUFACTURER  
OF GRANDFATHER CLOCKS

Visit our Factory

New treats keep cropping up for tape enthusiasts. Among them: Advent's Dolby-encoded cassette recordings combine great music (and some great performances) with crystal-clear sound. A mix of classical works from Nonesuch, Connoisseur Society and Advent's own recordings, the tapes are made on chromium dioxide tape and packed in premium cassette shells to prevent jamming.

Craig's \$150 Electronic Notebook model 2624 claims to be the world's smallest portable recorder using standard cassette tapes.

It also features a digital tape counter, and lets you backspace while

recording to correct wrong words.

Compactness of a different sort is featured by the Answerline Phone-Chek LP5 recorder, that crams 12 hours of talk onto a standard C180 three-hour cassette. At ultraslow tape speed of 15/32 inches per second, fidelity won't be high enough for music. But this is useful for taping phone calls, sales orders and so forth. \$209 to \$249.

Panasonic's CQ898 FM/Stereo radio with 8-track cartridge player is built to be at home in a dashboard—so they built their CJ-20H power supply home and digital clock to look like one.—Ivan Berger



# Welcome to **The Insurance Store**



## **We service what we sell.**

When you shop at The Insurance Store, you'll find every kind of insurance.

And you'll find a choice of insurance companies, policies, and prices.

Whatever you buy—the first thing we'll tell you is:

If you ever need help, just call the Store.

After all, we know you.

And, quite frankly, we'd like to sell you more insurance someday.

So the day you need service is our day to shine.

In many cases, we can handle your problem right on the phone.

And in all cases, your claim will be settled promptly and fairly.

Because at The Insurance Store, we represent only those insurance companies that work that way.

Take Continental Insurance.

Continental has 1600 claims adjusters located throughout the United States and Canada.

So anytime, anywhere you need help—

help is always nearby. Even on a holiday, if you have an emergency.

At The Insurance Store, we service what we sell. Because that's the best way to keep you sold.

For The Insurance Store nearest you, just check the Agent listing under Continental Insurance in the Yellow Pages.



**Continental Insurance**  
featured at  
**The Insurance Store**



# Gasoline or

Either way, your best choice



## Most campers go with gasoline. Here's why:

Four out of five outdoorsmen prefer gasoline appliances for their light, heat and cooking power. (You just won't find many campsites without a Coleman gasoline lantern and stove.) And there's more than one good reason:

1. **LOWER COSTS:** Lanterns, stoves and heaters powered by Coleman fuel cost much less to operate than propane appliances. (In fact, cooking on a propane stove using the standard 16.4 ounce bottle costs over five times more than cooking on a gasoline stove with Coleman fuel.) The use of a big propane bulk tank and hoses bring operating costs down to compare favorably with gasoline . . . but the cost of the equipment goes up and portability goes down. So any way you look at it, using gasoline appliances cost you less.

2. **DEPENDABILITY:** Coleman gasoline stoves and lanterns bought twenty years ago are still going. Trip after trip. Because Coleman builds in dependability into every appliance. Just take the exclusive Band-A-Blu® burners on all Coleman stoves, for instance. They're stainless steel. Self-cleaning and spill-resistant. And you always get even-burning cooking power. No hot spots. The deep ports make the burners wind resistant and assure you of no backfires.

3. **PUMP POWER:** The Coleman gasoline stove delivers plenty of cooking power. And there are times you really need it. Like when the wind kicks up. Or the temperature drops. Or at high altitudes, where the air gets thin. That little pump on the gas tank does it. It lets you get an approximate input of 25,000 BTU's of cooking power on a single burner. That's more than twice the maximum cooking power you will get on a single burner of a propane stove.

4. **FUEL AVAILABILITY:** Coleman Fuel is readily available in better sporting goods and hardware departments and stores throughout the United States.

5. **MORE ABOUT COLEMAN FUEL:** There is no better fuel made for gasoline appliances. Period. Coleman Fuel is triple-filtered to burn clean and prevent clogging or gumming up. And a rust inhibitor is added to fight corrosion. Coleman Fuel makes any gasoline appliance perform better . . . and protects it for longer life, surer service. You're always assured of better results . . . especially if the equipment bears the Coleman name.



# Propane?

is Coleman.



## Or, if you prefer the convenience of propane:

If you decide upon propane, pick the appliances that are designed to use it best. You'll find the same Coleman quality, safety and know-how that goes into the construction of gasoline appliances . . . in a full line of convenient Coleman propane equipment.

1. **CONVENIENCE:** A twist of a knob starts the propane flowing. You operate the appliances like you would a gas range. Coleman's exclusive 15 PSI regulator assures constant fuel pressure. There's no pressure build-up in the hoses. No wasted fuel.
2. **COLEMAN SAFETY:** Coleman builds in safety on all appliances, gasoline and propane. On the propane equipment, all hoses have safety shut offs . . . so if the appliance is disconnected while operating . . . the fuel flow stops. Automatically.
3. **RUGGED CONSTRUCTION:** Gasoline or propane, Coleman doesn't believe in cutting corners. The propane line is built

with high quality metal formed in stylish, modern design. The Band-A-Blu® stove burners are stainless steel. And the pyrex globes on the lanterns can take the heat, hard knocks and scratching brush.

4. **PROPANE FUEL SUPPLY:** Coleman propane comes in handy disposable bottles . . . or a refillable bulk tank. (Hose extensions and accessories let you run up to three appliances off one bulk propane tank.)
5. **PROPANE EXPERIENCE:** Coleman has been making propane equipment for 15 years. And it shows. Coleman propane appliances are dependable, durable and safe. The best way to shop for a propane appliance . . . is to look for the Coleman name.

Gasoline or propane...Coleman makes the products you can depend on. Ask someone who has one.



WICHITA, KANSAS

The Greatest Name in the Great Outdoors





# *“I’ll never forget how when they laid off*

*By Nick Martin*

“April 20, 1971. Fran still calls it ‘Black Tuesday.’ And even though we can laugh about it now, it’s a day we’ll never forget.

“It couldn’t have happened at a worse time—so soon after the baby was born. By the time I got home from work Fran had already heard the news on the radio—the company lost their major contract and 3,000 men were laid off. Just like that.

“Before I could say a word her eyes filled with tears. ‘Nick,’ she cried, ‘How are we going to pay the bills? Oh, Nick, why did this have to happen to us?’

“I didn’t have any answers. I knew what she was thinking about—that little house we hoped to buy soon, with a yard for the baby. The honeymoon we never had, that we were planning for. Now these things were out of the

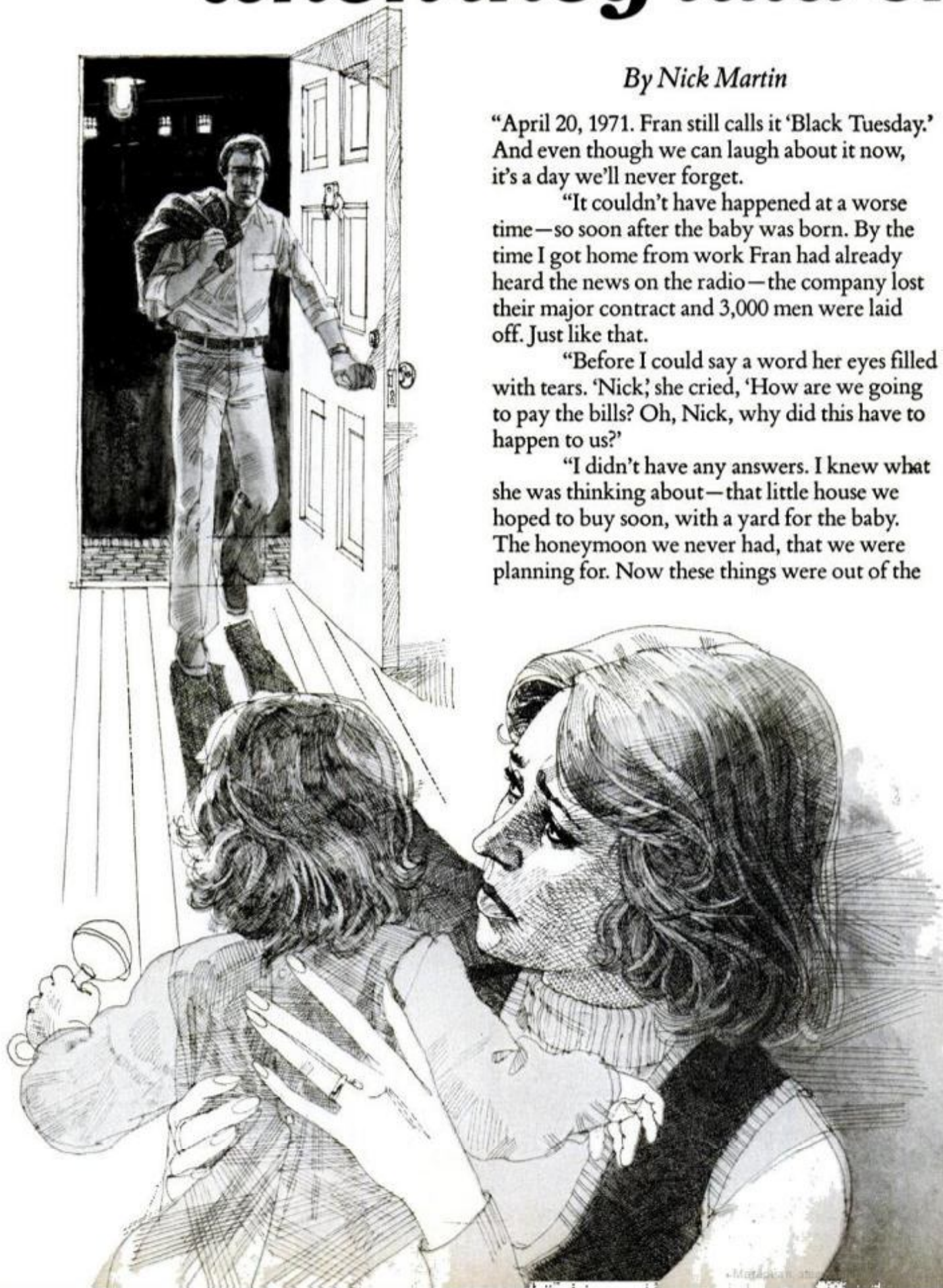



# scared Fran was half the plant.”

(A DRAMATIZATION)

question—with no job, we'd be lucky just keeping our heads above water.

“It was a tough six months. With all the bills we had to pay there was no room for luxury. My wife went back to her waitress job part-time, I went on unemployment and stayed home with the baby, and we ate an awful lot of macaroni and cheese.

“Being broke changed us both. Our tempers were short, and we argued with each other all the time. It's true when they say that money problems can destroy a marriage quicker than anything. They almost destroyed mine.

“Somehow we survived until the plant opened again, but there were no houses or honeymoons. Right after I went back to work I vowed that I would never be so bad off again. And I decided to enroll in a program that would train me to be an electrician.

“That all happened over four years ago. But now, a lot of places are laying off again. Only this time, I'm not scared. My studies really paid off.

“I'm my own boss now, repairing electrical machinery. And even though some companies aren't buying new equipment these days, there's plenty of work for me. The people I service figure whatever I charge is cheaper than buying new machinery.

“I'm making good money, I've got something put away in the bank, and I'm proud of myself and my work. No matter what happens with the economy, my wife's never going to have to wait on tables again. And my daughter is going to grow up with a nice yard to play in, decent clothes to wear and a room of her own.

“I got burned once, but it taught me a lesson. And I found I could put what I learned to work for me. I've come a long way since that Tuesday. Thanks to ICS.”

“Nick Martin” is fictional. But for over 83 years, ICS, International Correspondence Schools, has helped a lot of guys like Nick find a better, more secure way to earn a living. And we can help you, too. Especially if you're inter-

ested in one of the careers where ICS concentrates its training. Like Electrician. Engineering. Auto Mechanics. Electronics. Drafting. Air-Conditioning. Or TV Repair and Servicing.

As an ICS student, you study at home, on your own schedule. You waste no time traveling to classes. And you never miss a paycheck. Since 1890, millions of men and women around the world have turned to ICS for career training. Government agencies, unions and some of America's top corporations (including Ford, U.S. Steel, Mobil, Alcoa, GE, Motorola, and RCA) use ICS. In fact, 71 of the 100 largest American companies have purchased ICS training for their employees. We're approved for veterans' training, too, under the new GI bill.

America is the greatest country on earth. It's come through worse recessions than this, and it will again. But there are always going to be slow times and layoffs. And there are always going to be some people who are hurt by them and some who were smart enough to plan ahead.

## Free Demonstration Lesson

If you want more—more money, more security, more day-to-day satisfaction and more future out of your work, our free Career Guidance Booklet and free Demonstration Lesson can help you get started in the right direction. Just check the box next to the field that interests you most and mail the postpaid card today. There's no obligation.

Remember, it's your life. You might as well make the most of it.

# ICS

International Correspondence Schools  
Scranton, Pa. 18515



who says  
the shortest  
distance between  
two points  
has to be  
a straight line?



### INSTALL YOUR OWN SPIRAL STAIRS!

It's fun to put  
together in less  
than 2 hours!

- COMPLETE INSTRUCTIONS INCLUDED
- NO SPECIAL TOOLS OR SKILLS NEEDED

STOCK KITS  
AVAILABLE  
FROM \$295.00

SEND FOR BROCHURE

SHOWROOM OPEN 9-5  
—EXCEPT SUNDAY—

DESIGN SERVICES AVAILABLE

*Mylen*

INDUSTRIES

650 W WASHINGTON STREET  
PEEKSKILL, N.Y. 10566

212-LU 5-6767 914-739-8486

QUESTIONS ANSWERED BY W. CLYDE LAMMEY



## HOMEOWNERS' CLINIC

### Shower floor peels

*I have a shower stall in my basement, built over the floor drain. Paint on the shower floor peels and flakes away repeatedly. What can I use as a "stay-on" coating?—Roger Brent, Chicago.*

If the concrete is smooth, not checked, hairline-cracked or otherwise rough and difficult to keep clean, then why paint it? I'd take off all the paint with a remover, rinse and leave the floor as is.

Of course, it's true that paint gives a more acceptable appearance, a cleaner look. If you want to keep the shower floor painted, take off the old coating with a remover and etch the floor with a prepared muriatic-acid etching solution you can get from your paint dealer. Follow instructions carefully and rinse thoroughly. When the floor is dry, apply an epoxy enamel, taking special care to put down a coating of uniform thickness. While this should not be considered permanent, it will outlast most other coatings.

### Flues stain walls

*My old brick house has chimney flues built into solid-brick walls. A discoloration shows outside, following the line of the flues in each end wall. Is there any way to eliminate and prevent this?—Harold Sparks, Erie, Pa.*

No easy way I know of. But you can remove most of the stain by scrubbing with a strong solution of a cleaner such as trisodium phosphate, two or three heaping tablespoonfuls to a gallon of water. Wear rubber gloves and protect eyes from spatters. This scrubbing will remove only the surface stain. Eventually the discoloration will bleed through and show up again. The only way to eliminate it more or less permanently is to have the flues rebuilt. This may be necessary both inside and out, although the stain shows more on the outside, as a rule.

### Checking for termites

*A neighbor and myself have reason to suspect the presence of termites in our houses. How can we check for sure?—George Desmond, Indianapolis.*

Termites usually indicate their

presence by tiny mud tunnels on masonry foundations, these tunnels extending from ground level or below up the walls to the wood framing. Tunnels can appear on masonry walls, inside or outside, in a crawlspace or on a basement wall. To discover them, one must make a foot-by-foot search, inside and out. There are other wood-boring insects—often mistaken for termites—that attack buildings. Powderpost beetles and carpenter ants are those most often found. They make small entry holes in exposed ends of rafters and especially in floor joists and the wood posts that support center beams in basements. Look for holes in the beams and wood dust below them, as an indication of their presence.

### Corroded lamp base

*I have a floor lamp with a large brass base and column. There's a small discolored area on the base that defies removal with any solvent or polish that I know of. It's dark-colored, located near the point where the base joins the column. Is there any possible way to remove this blemish?—Mrs. L. Murray, Northfield, Minn.*

There's a metal polish sold under the trade name of "Simichrome" that usually is quite effective. Sometimes such a blemish will be difficult to remove entirely if the metal is pitted, but you can at least dull the contrast sufficiently to make it less visible. This polish is generally available from paint or antique dealers, or you can contact Competition Chemicals, Box 141, Iowa Falls, Iowa 50126.

You can also use a water-diluted solution of muriatic acid (wear rubber gloves and eye protection) or what is known as "jeweler's rouge," a hard wax containing a very fine abrasive; this can be applied and worked as a polish. Your local jeweler might supply you with a small cake of this wax. ★★★

*Do you have a home maintenance or repair problem? Send it to Homeowners Clinic, Popular Mechanics, 224 West 57th St., New York, N.Y. 10019. Letters cannot be answered individually, but problems of wide interest will be discussed in this column. For more home repair and maintenance help, get PM's Home Care Guide, \$4.45 postpaid. Send orders to PM, Dept. HF5, Box 1014, New York, N.Y. 10019.*



Forget hot taste.  
Only KOOL, with pure menthol  
has the taste of extra coolness.  
Come up to KOOL.



KINGS

SUPER LONGS

Warning: The Surgeon General Has Determined  
That Cigarette Smoking Is Dangerous to Your Health.



14 mg. tar,  
0.9 mg. nicotine

Now, lowered tar KOOL Milds



# ALL OUTDOORS

WITH BILL McKEOWN



## Computer mating—out in the open

For families who want to vacation in a motor home or travel trailer, chopped van or pickup camper—but don't own one or don't feel like driving it cross country—a new answer has been announced by Kampgrounds of America. People who own a recreational vehicle and want to rent it part time, plus campers who are looking for one to rent, can get in touch with KOA at Box 1138, Billings, Mont. 59103. Initial expense is modest.

First, an owner sends a description of his rig, and what he wants to charge per week and per mile, plus \$10 to KOA. In return he gets a rental packet with information about RV leasing, rental agreement forms, suggestions about necessary insurance and \$10 worth of coupons that can be used for KOA campground registrations.

Someone who wants to rent a rig but lives in Biloxi, Miss., perhaps, and doesn't know of any RV rental outfits near Seattle, can also write KOA and send \$5. By return mail, he'll receive a leaflet of tips for renters, a computer print-out of rigs available, \$5 worth of coupons good at KOA campgrounds, and \$100 worth of discount coupons for tourist attractions around the country. He then can contact an RV owner in an area and with rates that are appealing to him.

For a fly-in vacation, he might be able to arrange to have a rental trailer preparked at a campground, ready to be lived in without any tow car necessary, and during a peak-season period when commercial RV rentals are hard to find.

The program may turn up discount rates for people who don't want to invest in their own RV rigs, and provide some welcome extra cash for RV owners as well.

## How to get reshafted

Graphite, the new "miracle" material for golf clubs, fishing rods, archery bows, bicycle frames and other high-strength lightweight uses, is now available as a replacement for steel golf club shafts. 3M Co. has announced there are now over 60 "reshafting centers" around the country where pro and dedicated amateur

golfers can take their steel-shafted clubs. There Carbonite pure graphite shafts can be fitted to the old club heads, with a choice from six assorted flexes.

Increased driving accuracy is claimed for the graphite because of less radial torque clubhead twist. Longer drives are reported because of the clubs' lighter weights and less energy loss from flexing. And at a cost of about \$70 to \$90 per club, you hope so.

Locations of Carbonite 3M reshafting centers are available from the 3M Co., Box 33601, St. Paul, Minn. 55133.

## Glove-compartment guide

A small new 48-page paperback booklet that is \$2.50, and worth it for the traveler, is called *Full-Service Auto-Truck Stops*. It lists over 500 truck stops, but big ones. These service centers are open 24 hours a day for fueling up and usually have round-the-clock food as well, plus a lot of other convenient services. Each center is listed by name, address, telephone number, brand of gas sold and a key to facilities such as sleeping accommodations, repairs, laundry, barber shop, truck wash and Insta/Com for the transmission of funds.

Until you've rolled down a lonely Interstate at 3:00 a.m. on a hunting, fishing or RV trip, passing darkened filling stations as your gas gauge drops, you don't really know how welcome can be the lights of an all-night truck stop ahead. Prices are usually reasonable, services today rival a shopping center, and with this \$2.50 postpaid directory from Reymont Associates, 29-M Reymont Avenue, Rye, N. Y. 10580, you can mark potential late stops on your road map ahead of time and leave one worry behind.

## Safety solution

National Park Service Director Gary Everhardt credits a campaign to alert national park visitors to outdoor hazards with reducing accidental deaths by 14 percent last year. Visitor fatalities of 155 were down 24 from the previous year, but still indicate that beautiful scenery can

be hazardous as well for the careless or unsuspecting.

Motor vehicle deaths were 20 fewer and fatalities from falls were down by six, but drownings remained at the same level—73. A flash flood in a canyon of the Lake Mead National Recreation Area on the Arizona-Nevada border accounted for nine of these.

"We don't want to scare the public away from parks," Everhardt notes, "but it is important to realize that there are hazards in nature that may catch the average person, or at least the average urban dweller, off guard if he is not careful."

## Boating briefs

For northern boatmen just starting their season afloat, the Coast Guard is offering a number of timely reminders:

Too many boats, according to Coast Guard inspection records, have handrails and lifeline stanchions that are deck-mounted with wood screws or self-tapping screws. A boat makes a quick turn; a passenger reaches for a grab rail, and it pulls loose in his hand as he falls overboard. Too often, it turns out, the handrails have only been installed for decoration. Even leaning on some lifelines will tear them loose. Best installation, of course, is with through-bolts and, if necessary, backing blocks under the deck.

Personal flotation devices, (as the Coast Guard calls life jackets, life vests and other kinds of life preservers), must be bought in the proper size—and not necessarily "the bigger the better." If the vest slides off when you jump in the water or if it twists and fails to keep your head above water, it's not going to do you much good. This is also true if you rearrange the straps or don't learn to secure them properly. While some preservers have lacings and adjustments to improve the fit, it is most inconvenient to work on them while you're floundering in the water. Starting out with the proper size of flotation device and fit, according to the Coast Guard, is a better procedure.

And until recently, the Coast Guard has allowed kayak and white-

*(Please turn to page 32)*



# Something special for the man who'd rather drive a truck than a car. The Dodge Custom Special.

The man who'd rather drive a truck than a car  
doesn't give his truck the weekend off.

So we're giving him a truck that looks great  
no matter where he goes.

We've dressed up our Dodge Custom pickup with  
a whole lot of extras. And  
we've given the package  
a special low price.

The result is a  
truck that looks as good  
as it works.

There are bright  
drip mouldings that curve  
around the door.

There's a sporty  
chrome strip that runs the whole length of the body.

And, so that you'll look as good going as coming,  
there's more bright trim in back.

It runs clear across the tailgate and wraps around  
the tail lamps.

And we didn't leave the inside out. It's completely  
color-keyed and completely  
comfortable.

Rest your feet on soft  
rubber mats. And rest the  
rest of you on one of the best-  
looking seats you've ever  
seen. It's covered in hand-  
some Boca Raton cloth and  
Oxford-grained vinyl in blue,  
green, gold, or parchment.

Ask your Dodge Dealer about the Dodge Custom  
Special with the special low price.

It's one more reason why the man who'd rather  
drive a truck than a car would rather drive a Dodge.



CHRYSLER  
MOTORS CORPORATION





... here Today!

# "IGNITION OF THE FUTURE" ALLISON "OPTO-ELECTRIC"

★ The BEST...the ULTIMATE...  
of ALL the Ignition Systems!

● (We challenge ANYONE  
to dispute this Fact.)



● Never wears out or needs any Maintenance!



● Does more than Pay for itself in  
GAS SAVINGS

...it gives you Maximum Power  
with continuous PEAK PERFORMANCE

...while reducing Maintenance  
and Operating Costs!



● The Allison OPTO-ELECTRIC System eliminates the Points and Condenser, replacing them with an OPTO-ELECTRONIC TRIGGER, using a Light-Emitting Diode and Photo transistor. As there are NO moving parts in rubbing contact...Timing adjustments are PERMANENT. The only "TRUE" Electronic Ignition...that you can buy for under \$100.

● Gives 40-Times more Timing Accuracy than ANY system using "Mechanical" Breaker-Points! UNLIMITED RPM! "Electronically-Controlled" DWELL automatically supplies HIGHEST Performance at both Low and High speeds. Spark strength does not fall off at high RPM. POSITIVE SPARK helps eliminate "Misfire" for faster acceleration and improved Engine Performance! Smoother Running (No timing fluctuation as with Magnetic Units). Easier Starting under any condition! Sparkplugs LAST 3 to 10-Times LONGER.

All SOLID-STATE Components. UNAFFECTED By Temperature, Moisture, or Vibration! Highest grade materials Guarantee you solid, Dependable Performance.

★ Perfect Timing and Dwell never change.

Pays for itself! Eliminates Ignition Tune-Ups forever!  
"INFINITE LIFE"...Once installed...Never needs replacing.

● PERFECT TIMING INCREASES Engine Efficiency and Gas Mileage. SAVES Precious Fuel! Allison gives you MAXIMUM Engine Efficiency 100% of the time...and that's the name of the game for BETTER Gas Mileage and Economy.



★ PROVEN RELIABILITY!

Dyno Tested up to 15,000 RPM.  
Road and Race Proven.  
(Opto-Electric Systems won at  
INDY Two years in a row!)

● QUICK AND EASY INSTALLATION

★ If you want the BEST, and SAVE! This is IT!

● ORDER with CONFIDENCE...

SATISFACTION GUARANTEED!

1-YEAR FACTORY WARRANTY.

Only \$49.95  
COMPLETE.

● As you can see, you're not taking any  
chances at all...Send your Order Today.

State Make, Year, Engine Size. (Calif. Res. add Tax).  
● (So New...it's Sold ONLY FROM FACTORY DIRECT).

You may use your MASTER CHARGE or BANKAMERICARD.  
Send us (1) Your Number, (2) Interbank No., (3) Exp. Date.

● Before buying any other Type Ignition system...

Send Postcard for our FREE BROCHURE.

★ If you have already installed a C-D ignition system,  
Modernize and Increase its Efficiency...

CONVERT YOUR "C-D" UNIT TO BREAKERLESS!  
Opto-Electric "TRIGGER UNIT"...Only \$34.95

● Our BEST Salesmen are the owners  
and users of our ALLISON System!



**ALLISON**  
AUTOMOTIVE COMPANY

1269-X, East EDNA PL., COVINA, CAL. 91722

## ALL OUTDOORS

(Continued from page 30)

water canoeists to wear nonapproved life preservers. As of Oct. 1 of this year, however, they expect to change the regulation since recently a number of lightweight vests which don't restrict paddling action have received Coast Guard approval. A number of canoeing outfitters already carry the approved white-water PFDs.

Powercraft boatmen are reminded that, as of last July, all boats of 26 feet and over must mount in the engine compartment or near the bilge pump a plaque or sticker that says "DISCHARGE OF OIL PROHIBITED." The Federal Water Pollution Control Act prohibits the discharge of oil or oily waste into or upon the navigable waters and contiguous zone of the United States if such discharge causes a film or sheen upon, or discoloration of, the surface of the water, or causes a sludge or emulsion beneath the surface of the water. Violators are subject to a penalty of \$5000." You can type or print your own sign, of course, or get one with adhesive backing, ready for mounting, from Goldbergs' Marine, 202 Market St., Philadelphia, Pa., or many other mail-order sources.

Boats fitted with terneplate fuel tanks (constructed of steel coated with a lead-tin alloy) are subject to fire and explosion hazards, the Coast Guard has found, as the tank corrodes and develops possible leaks. Inspection and testing of terneplate tanks are recommended, plus replacement with a different material when advisable. Fuel hoses, lines, fittings and tank supports should also be checked.

Outboards that use stick steering systems have been found, according to accident statistics, to be notably dangerous when used with a high-horsepower motor. Installation is sometimes careless and makeshift which can lead to steering failures. But the main danger is the possibility of oversteering. A small movement of the stick is sufficient to throw the boat into a turn sharp enough to toss driver or passengers overboard. Stick steering should be limited to low-horsepower motors; 33 hp is the limit allowed in Bass Anglers Sportsman Society (B.A.S.S.) tournaments when stick steering is used. Even then, stick movements should be gentle and small. A low-power outboard can capsize a fishing boat if it is steered abruptly.

## Mapping the action

Every year, the U.S. Geological Sur-

vey of the Department of Interior distributes 10 million of its 40,000 different topographic quadrangle maps. Outdoorsmen particularly can find them of great use for travel by foot, trail bike and four-wheel-drive vehicle. Maps with the largest scale have the most detail and are usually the most helpful. One inch of the 1-to-24,000 scale quadrangle map equals 2000 feet on the ground and may cover about 60 square miles. Indexes to topo maps for each of the 50 states, American Samoa, Guam, Puerto Rico and the U.S. Virgin Islands are available from USGS Distribution Offices and the National Cartographic Information Center, U.S. Geological Survey National Center, Reston, Va. 22092.

Smart fishermen have found that once an area is scheduled to be dammed and flooded to make a reservoir, getting hold of old topographic maps or aerial photos can give them a head start for "structure" fishing. The old maps will show where roads, forests and buildings are located underwater, and as a result, just where fish are likely to find the shelter they prefer. A number of fishing-gear dealers and sporting goods stores in Virginia now stock just such maps, and a visiting fisherman who comes equipped with an electronic fish finder can find these charts particularly useful.

## Camping clues

Cutting costs by camping this time of year can now be arranged through organizations and travel agents as well as on your own. Nonprofit Wilderness Society trips may still have a few openings. Its 25-cent booklet lists 115 and is available from Trip Dept., The Wilderness Society, 4260 East Evans Ave., Denver, Colo. 80222.

Mountain Travel, 1398 Solano Ave., Albany, Calif. 94706, schedules adventure expeditions everywhere from Colorado to the Sahara and Nepal.

Manitours, a division of the Manitoba Dept. of Tourism, 200 Vaughan St, Winnipeg, Man., has just announced special tours designed for naturalists and traveling interested in wilderness observation of waterfowl.

And for seeing Europe on a bargain budget, British Airways is offering a series of camping tours. Basic price of the programs ranges from \$323 to \$692 from New York, and the cost includes transportation, tolls, taxes, side excursions, plus



# Rally® can make your \$89.95 vinyl top look like \$89.95 again.

camping and cooking equipment. Designed primarily for campers under 30, their six tours last as long as nine weeks, travel by Continental Coach Tours buses, and provide a chance to camp all the way to Istanbul, Athens, Moscow or Marrakech and back with payments for the food kitty the only other major expense. While your continual comfort cannot be guaranteed at all times, the variety of camping offered can hardly be equalled.

Campers who are joiners can belong to the Association of Camping & Hiking Clubs of America at what probably rates as minimal cost. You need to send a 3x5 index card with your name and address printed on it, plus a stamped, self-addressed envelope and 25 cents. It goes to ACHCA, Box 330, Cedar Knolls, N. J. 07927, and that is your last expense. All officers and members contribute their time to band together for the benefit of the sport.

## Your own fishing hole

If you have the land and the inclination but no little lake there to go fishing, you can make one of your own. An illustrated booklet called *Building a Pond—FB2256*, prepared by the Soil Conservation Service of the U.S. Department of Agriculture, gives advice on selecting a site, building an embankment or excavating, requirements for satisfactory spillways, sealing leaks and maintenance. The study is 25 cents from the Government Printing Office, Washington, D.C. 20402.

Then suppose your fish grow so well that commercial fish farming seems interesting. Sources of information about starting fish hatcheries, suitability of ponds and streams, construction and development costs, and profit margins for catfish and some other species are maintained by Catfish Farmers of America, Tower Building, Little Rock, Ark. 72201.

## Outdoor education

Skills in camping, mountaineering, field biology and ecology, technical climbing and wilderness survival can now be learned from courses offered by a number of established schools. Based in Lander, Wyo. Paul Petzoldt's nonprofit National Outdoor Leadership School schedules sessions of NOLS classes from Alaska to Mexico throughout the year. Home-study lessons have been announced by School of Outdoor Survival, Box 44, Glenwood, Wash. ★★

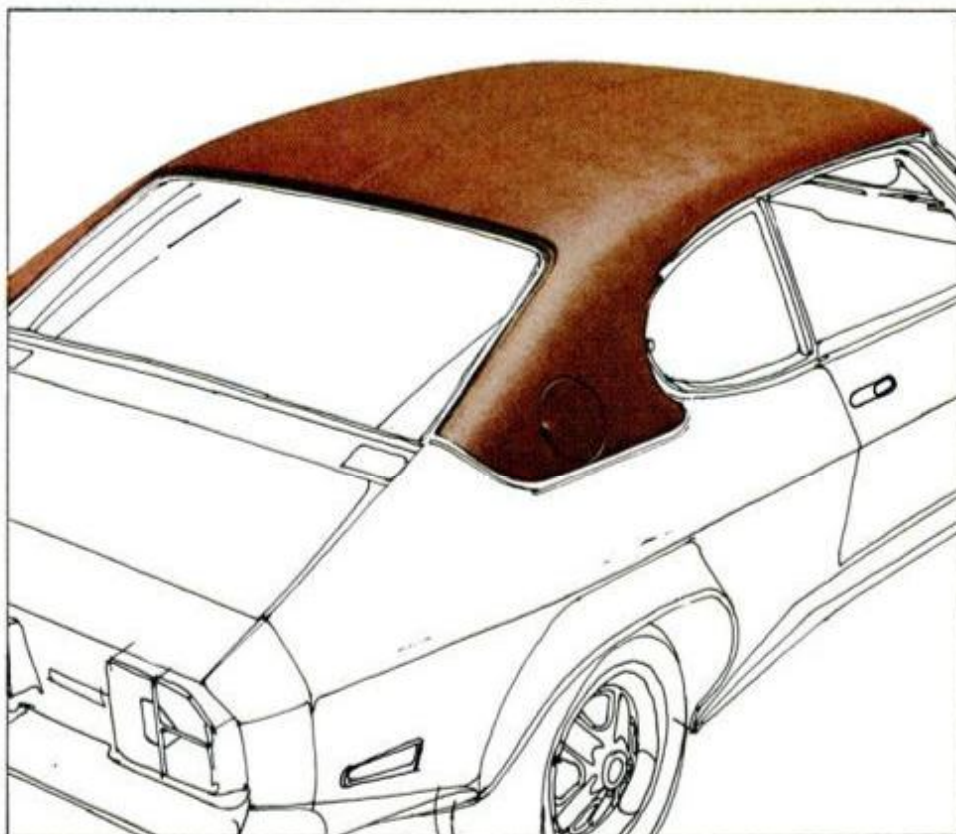

**"Rally" Vinyl Top Cleaner** is a spray-on foam cleaner made especially to use on vinyl tops of any color before you apply a top dressing or wax. The foaming action quickly removes surface stains and dull road film that you can't get off by just washing.

**"Rally" Vinyl Top Dressing** is a clear wax that liquefies as it's spread. It brightens any color top as it leaves a rich luster. It helps seal vinyl against weather, detergents and surface stains. With an easy-to-use applicator.

**"Rally" Black Vinyl Top Wax** gives you the same liquefying action, the same beautiful luster and protection as our Top Dressing. But it contains a black dye to give a deeper, richer look to black vinyl. With applicator.



**Du Pont helps you take better care of your car.**



Consumer Products Division





## TYME<sup>®</sup> Savers for weekend mechanics.

Make short work of clean-up and lubricating jobs with TYME car care products. Try fast-acting TYME Carburetor and Cold Parts Cleaner in a handy 1/2 gallon pail with its own dip basket, to remove grime and grease in minutes.

Other professional TYME saver products in easy-to-use aerosols include:

- Demoisturizer, Lube & Penetrant
- Carb & Choke Cleaner • Silicone Lubricant • Vinyl Top Cleaner Wax
- Vinyl Interior Cleaner • Waterless Hand Cleaner • Engine Cleaner

TYME savers work fast... work hard to give you "professional" results every time.

Use them to save time and money on servicing outboards, guns, lawnmowers, tools and household appliances, too. Your local auto supply store has TYME Savers now. See them all before you tackle your next job!

The toughest jobs take just a little TYME.



**PENWALT**  
**TYME**  
AUTOMOTIVE PRODUCTS

# Carry your tools in this sawhorse



Photos: Rosario Capatosto



With sawhorse strapped to bottom of toolbox, you are never without a suitable bench to work on when home repair jobs take you outside. Father and son aprons, by the way, can be purchased for \$5.95 per set postpaid from Popular Mechanics, Box 1014, Dept. JD, Radio City, New York, N. Y. 10019.

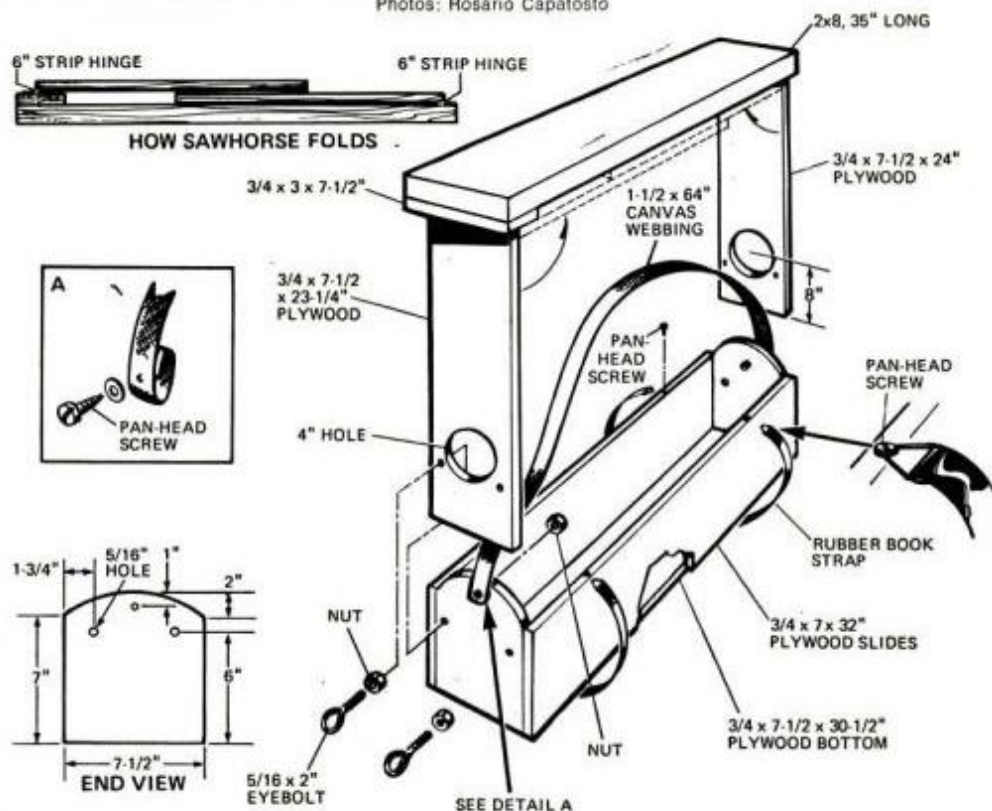

With this unique toolbox you'll not have to wish you brought along a sawhorse—it totes one. Strapped to the bottom is a horse that's there when you need it. To set it up, you unhook the straps that hold it, unfold its three hinged pieces and attach it with thumbscrews to the ends of the toolbox. Its wide 2x8 top provides a dandy flat surface for saw-

ing and hammering, and the toolbox provides a sturdy, stable base. When the job's done, you pack up and sling the box over your shoulder.

Rubber book straps are used to lash the sawhorse to the box, and a length of canvas webbing is used for the sling. Holes in the sawhorse uprights clear the ends of the sling.

—Arthur Cassidy.





# Datsun Li'l Hustler. First, it's built to last.

Nowadays, good long-term investments are hard to find. Datsun's Li'l Hustler is one exception. Sure, it's a gas saver. In fact, according to the EPA's 1975 test results, Li'l Hustler gets better mileage (31 mpg\*) than any other pickup in America, import or domestic. But the real test of an investment is how it holds up in the long run.

**Example 1:** Our '75 Li'l Hustler has a new, more powerful 2000cc overhead cam engine.

**Benefits:** Less internal friction than in a pushrod engine, and about 43% fewer moving parts. More efficient power.

**Example 2:** Our cam is driven

by a twin chain, completely covered and bathed in engine oil.

**Benefits:** Less subject to wear and stretching than semi-exposed belt-drives. Tension adjustment is automatic, too.

**Example 3:** For '75 our axle ratio is an economical 4.37.

**Benefits:** Fewer engine revs per mile, longer engine life and great gas mileage.

**Example 4:** Improved ferrite stainless steel exhaust components and improved muffler construction.

**Benefits:** Extra corrosion protection and reduced back pressure for more efficiency, longer life.

**Example 5:** A nearly indestructible welded lattice frame.

**Benefits:** The strength and support to endure a lifetime of rocks and ruts and grinding bumps.

Add 1400 lbs. of payload and passenger capacity, plus options like factory-approved air and 3-speed automatic transmission, and you've got one investment that just won't quit ... Datsun's Li'l Hustler. Available in two models: Standard 6-ft. load bed or the new 7-ft. Li'l Hustler Stretch.

**America's #1 Selling Small Pickup**

(\*1975 EPA highway test results, all states except California.)



## Datsun Saves



# DETROIT LISTENING POST



BY ROBERT LUND

## GM mini delivering 40 mpg!

GM is shooting for an August production start for its smallest-yet car, a mini Chevrolet. This would put it in showrooms around September or October. The car will have a rear seat—good for lining up grocery bags, but not very comfortable for humans because there will be only a few inches of legroom. There will be a plug-in receptacle in the car for computer diagnosis of service problems. The vehicle will have an overall length of about 175 inches on a 95-inch wheelbase.

On test cars, GM is getting 39 to 40 miles on a gallon of gas. We knew they could do it!

## Ford considering son of Pinto

Ford has got wind of the GM mini and is in a tizzy to come up with something to match it. The only thing on the fire that might serve the purpose is a thinned-down Pinto—basically the current Pinto made with lighter materials to reduce weight. When GM springs with a new product, Ford usually waits about a year before putting a counterpunch car in production. But Ford doesn't want to let GM get too much of a lead with the shavetail Chevy. So Ford's strategy will probably be to put a lighter, less expensive Pinto derivative in production as soon as possible.

Incidentally, Ford says engineers and designers will no longer be equals in deciding the shape of new cars. Engineers will work out the package in terms of size, weight, materials and such key components as engine and drive train. Only then, after the engineers have assembled the contents of the package, will the stylists be allowed to decide how the package will be wrapped. This is a complete about-face from customary practice. In the past, the stylists dominated, and the engineers had to shoehorn the pieces in after the designers created the box.

## Plug-in service on the way

Getting back to the GM mini, one of its most interesting features will be the on-car plug for hooking up to service equipment to track down mechanical problems. What items or systems on the car will be connected

to the plug? GM isn't saying. But as of a few months ago the company had test cars equipped with microprocessors—the much discussed “little black box”—combining controls for six items in a single unit. These included cruise control, electronic fuel injection, turn signals, antiskid brakes, electric clock and the seat-belt interlock. The latter has since been dropped.

I recently asked a GM engineer when we can expect to see microprocessors on production cars. He refused to be pinned down on a date, but pegged his answer to a price: “When we can put a microprocessor on a car for \$25 or \$30.”

## Piston engine still champ

The auto companies now feel they have a good handle on what the government is going to ask of them through the rest of this decade and into the early 1980s. As a result, they are narrowing down the types of cars they will build over the next six or seven years. There isn't a single car under consideration that calls for other than a piston engine. That includes American Motors. AMC is still working on the Wankel, but its enthusiasm for the rotary isn't as high as it was a few months ago.

## New breed of cars taking shape

Carmakers are beginning to be a little more open about discussing future products, and aren't adverse to dropping a few hints about what the new breed of economy/ecology cars will look like. Here's a skeleton view:

Cars will not have tucks and bulges on the sides. They will be plain and straight to reduce wind resistance and cut repair bills if you get smacked in the side. Cars will sit a little higher off the ground. Not much, but an inch or two for more headroom. Front ends will get tighter. There will be very little overhanging metal in front. Trunks may get smaller as the rear seat is pushed back for more interior room.

## Parts that 'talk' to mechanics

If you have trouble with your car and take it in to be serviced, most mechanics follow an A B C approach to locate the problem and correct it. If A doesn't work, the mechanic

moves on to B and if that doesn't do it, he goes on to C. That's not a knock against mechanics. There's a logic to the method.

But the try and try again method is expensive, wasteful and time-consuming. Expensive because the customer must pay for each step, fix or no fix. Wasteful because parts that still have life are pulled out and replaced. Time-consuming for both mechanic and car owner.

GM is working on a fascinating concept that could do away with a lot of guesswork in auto repairs. In effect, parts that may be causing a problem “talk” to the mechanic. The part says, “I'm good. Leave me alone. Go on to step B or C.” Or the opposite: “I'm defective or worn out. Fix me or replace me.”

That sounds like Alice in Wonderland, but I've seen some of the parts. Here are two examples:

One of the first things a mechanic will do to correct a problem with an air conditioner is replace the thermal fuse. The part doesn't cost much and thousands of perfectly good fuses are pinched off and pitched out. GM has a thermal fuse with a small nipple built in. As long as the nipple doesn't show, the fuse is good. If the fuse blows, heat generated in the case causes the nipple to pop out. The absence of the nipple tells the mechanic, “Leave me alone.” If it shows, it tells him, “Replace me.”

Another example. If you get moisture in an air conditioner, the unit has to be disassembled and dried out. But the mechanic has no way of knowing if there's moisture in the system without tearing it down. So he takes the piece apart and you pay for it. GM has developed a unit that has a small window in it. A disc about the size of a dime is visible through the window. The disc is blue and pink. This means the system is all right. “Don't touch me. Go on to step C.” But if the disc turns all pink, that tells the mechanic there's moisture in the system. “Take me apart and dry me out.”

GM is working on this idea in other areas, not just the air conditioner. “Talking parts” will save car owners money, save time for mechanics and avoid wasteful replacement of parts that still have good life left in them. ★★



# After going 212 m.p.h., he's not about to smoke a boring cigarette.



Warning: The Surgeon General Has Determined That Cigarette Smoking Is Dangerous to Your Health.



Viceroy has full-bodied flavor that doesn't flatten out. Always rich...always smooth...always exciting. Get a taste of Viceroy. Get a taste of excitement.

## Viceroy. Where excitement is now a taste.

Kings, 16 mg. "tar," 1.1 mg. nicotine; Longs, 17 mg. "tar," 1.1 mg. nicotine, av. per cigarette, FTC Report Oct. '74





BY MORT SCHULTZ

# CAR CLINIC

## Sunk trunk

The taillight assembly of my 1972 Plymouth Duster does not seal properly, and the trunk floods with every heavy rain. The dealer has tried to fix the condition, and I have tried everything that I can think of. Now the trunk is starting to rust, especially in the spare-tire well where water accumulates. Please—please—help.—P. F. Louie, Hollis, N.Y.

I'm pretty sure I can. (Although it's little consolation, you aren't alone.) In any event, see if an auto-parts (or even a hardware) dealer can get you a container of Bedding and Glazing Compound (stock No. 10255) made by Kent Industries, Euclid Ave., Cleveland, Ohio. You might write the company directly.

Remove the entire taillight assembly and clean off its mounting surface thoroughly. Use a solvent, such as gum turpentine, to wash down the surface, just to make sure it's clean. Apply a 1/2-inch bead of the compound all around the mounting area and sock the taillight assembly back into its hole. Run the screws up real tight.

## Oil slick

We owners of 1971 and 1972 Ford Pintos have to bear the cross of motor oil loss. It doesn't matter whether I drive in the city or on the highway—I have to add a quart every 400 miles. You would be doing a lot of people a favor if you could tell us if this defect can be repaired.—Steve Conley, Kent, Ohio.

Ask your dealer to consult article No. 130 of service bulletin 12 (3/3/72). If excessive oil consumption is confirmed, the dealer is to remove the valve-stem seals of the exhaust valves only and discard them. He is then to install a differently designed exhaust-valve-stem seal (part No. D1FZ-6571-C). Valve-stem seals originally installed in the exhaust valves of this engine didn't fit tight enough.

The above applies also to owners who are having the same trouble with their 1971 and 1972 Capris equipped with the 2000-cc engine.

## Lost lube fitting

In the Feb. '75 Car Clinic you were asked a question by F. Geraets re-

garding a lubrication fitting on the front propeller shaft on his 1972 Chevrolet Blazer. In your answer you stated that this grease fitting was located inside the yoke of the prop shaft and was difficult to find. Since I own a 1972 Blazer and am very particular about its maintenance, and since I had never heard of a grease fitting in this particular place, I started looking for it—and looking—and looking. I spent a considerable amount of time at the service station and the dealer's where I bought the vehicle trying to find this fitting. I think you owe me and a lot of other Blazer owners, who are probably looking high and low for that fitting, an explanation.—Comer A. Robertson, Visalia, Calif.

There is a fitting in the 1972 Blazer front shaft, but you need a real sharp eye to pick it up, as you can see in the photo below. Also shown is the needle-nose fitting you need to lubricate the joint. This should be done every 6000 miles.



## Mystery leak

My problem is with the cooling system of my 1974 Pontiac LeMans station wagon, equipped with a 350-cu.-in. engine. The coolant level refuses to maintain itself at the FULL mark of the overflow reservoir (plastic bottle). Where it goes, nobody including my Pontiac dealer knows. There are no visible signs of leaking. The bottle just empties itself down to the ADD mark. Give a guess, huh?—F. C. Rohman, Cumberland, Md.

Here are a few:

1. Tell your dealer to get a copy of AC bulletin No. 322 (11/73), which applies to 1973 and early model 1974 vehicles. The bulletin points out that if a hood on some models is slammed down it will compress the upper engine-to-radiator hose, causing the hose to flatten. This creates a suction effect, which can cause coolant to be

lost from around a radiator pressure cap, which may not be sealing completely, or through the overflow leading off the reservoir. The bulletin explains how to reshape the hose to prevent the problem.

2. Maybe the transmission oil cooler has sprung a slight leak and coolant is being lost in dribs and drabs into the oil cooler. Pull the transmission dipstick. If the fluid is any color but red—that's to say, if it's pink or whitish, you have found the trouble.

3. Maybe one of the engine freeze plugs has developed a slight leak. This may not be visible; it occurs only when the engine is under load.

4. Finally, it is always possible there is a slight intake-manifold or head-gasket rupture, causing loss of coolant into the engine.

## Exhaust reroute

I am the owner of a 1974 Chevrolet Nova with six-cylinder engine, and have had an unbelievable problem with the exhaust pipe contacting the transmission linkage. Is there any repair?—Herb Rose, New York,

Yes, indeed. You have to route the exhaust pipe around the transmission linkage, which means that the pipe has to be bent 1 1/2 to 2 inches. To do this, you need either a pipe bender or lots of heat (or both). The pipe has to be removed and the bow put into it.

One caution, though. You could destroy the seal between the exhaust pipe and exhaust manifold flange, so to be safe I would have a new gasket installed at this point and make awfully sure that the connection is good and tight.

## Shifting simplified

My 1973 Buick Century, with column stick shift, is giving me fits. Shifting is too hard, even for a strong guy like me. The dealer can't fix it, he says. Would I be better off modifying the car and shifting the shift to the floor? Stephen Pinchot Jr., Youngstown, Ohio.

There's no guarantee that would solve the problem and it would mean much reworking of the floor pan. Why not check the following?

1. Remove side cover on the trans-

(Please turn to page 40)



Photographed at Smiths Cove, Nova Scotia



# Canada at its best.

Try the light, smooth whisky that's becoming America's favorite Canadian.  
Imported Canadian Mist®

IMPORTED BY BROWN-FORMAN DISTILLERS IMPORT COMPANY, N.Y., N.Y., CANADIAN WHISKY—A BLEND, 80 OR 86.8 PROOF, © 1974.

Материал, защищенный авторским правом



## CAR CLINIC

(Continued from page 38)

mission and replace shifter springs.

2. See if the shift column lever is binding in the shift tube and if shift levers have excessive play or are not adjusted properly.

3. See that clutch releases properly. If it doesn't when pedal is pressed to floor, the shift lever won't move freely in and out of first gear. This could mean improper linkage adjustment or pedal travel, loose linkage or faulty pilot bearing.

### Radials and chains

*I have equipped my 1968 Oldsmobile 98 with steel-belted radials. Here in the snowy Blue Ridge-Allegheny region, I have found tire chains more effective than snow tires. Is there any hazard in placing tire chains on*

*steel-belted radials?—Gilmore L. Agnor, Lynchburg, Va.*

Heck, no! But make sure, as with any other kind of tire, that the chains fit properly.

### SERVICE TIPS

■ **The Delcotron indicator light** on the dash of a 1975 Buick Regal may glow when the car is started and continue to glow with the engine idling. This is a normal condition! But the light should go out as you accelerate from idle.

■ **Some car owners have voiced concern** over how the 55-mph speed limit is affecting sparkplug efficiency. Specifically, they're worried that plugs will have a greater tendency to carbon-foul. Such is not the case. The ideal operating temperature range of sparkplugs is 1000° to 1200°F., give or take 100°. Tests conducted by the Champion Spark Plug Co. reveal that at 50 mph, sparkplug temperature is 900°F. and at 55 mph it is

1000°F. "Such a range is well above the normal cold-fouling range and is high enough to burn off low-speed deposits," Champion engineers state.

■ **High Energy Ignition systems** in 1975 Chevrolets don't have parts that are interchangeable with HEI parts of other GM cars. Certain model Buicks, Oldsmobiles and Pontiacs employ distributor pickups and high-tension coils having opposite polarity. If you use one of these, your Chevy will be hard to start and it will backfire during engine cranking. The wisest course of action when it comes to any GM car, then, is to use only the parts made for your particular model. ★★★

### GOT A PROBLEM WITH YOUR CAR?

Just ask Mort about it. Send your question to the Car Clinic, Popular Mechanics, 224 West 57th St., New York, N.Y. 10019. While letters cannot be answered individually, problems that are of general interest will be published in the column.

## Some more good things you should know about Honda

**Meet the Honda Power Products.** They all give you famous Honda four-stroke dependability and ruggedness. And they eliminate the mess of mixing oil and gas.

**Honda F-28 Tiller.** Churns up a whole garden plot in minutes. Tines cut a swath from 13 to 37 inches. Fully adjustable handles also fold for easy carrying or storage. During winter, use the optional snowblower to clear your way.

**Honda Portable Generators.** Take electric power wherever you go. Honda generators shown here provide 400 to 2,500 watts AC output; 12 to 24 volts DC output. Dependable power for lighting, operating tools, or charging batteries. Use one on your boat, camper or job site.

**Honda B-75 K1 Outboard Motor.** Easy-starting. Quiet. Water-cooled. Twin-cylinder with 7.5 hp. Terrific troller. Comes in two shaft lengths to fit your needs.

**Honda General Purpose Engines.** Versatile 4.5 hp engines provide power for running pumps, compressors, lawn mowers, belt conveyors, generators... you name it. Precision-built. Available with either 1,800 or 3,600 rpm shaft speed.

**See Honda Power Products** at most Honda dealers. Look in your Yellow Pages...or call us collect at (213) 389-1291 for the name **HONDA** of your nearby dealer. **Power Products**



For optimum performance and safety, it is recommended that the owner's manual be reviewed prior to operation of unit. "K" numbers indicate model changes





3M-Wollensak 8075 8-track tape cartridge deck has facilities for hi-fi, low-noise recording on special tape and costs \$340.

## 8-track goes hi-fi—at last

Eight-track cartridge tape—the most popular tape format in the country—has long been a technical stepchild. All the latest advances in tape recording, such as improved tape formulations and Dolby noise reduction, have been applied to cassette and open-reel tape for years, but not to 8-track until now.

But the 3M Wollensak 8075 we tested has Dolby noise reduction (including facilities for listening to Dolby-processed FM programs picked up by your tuner or receiver), and a special switch setting for 3M's "Classic" tape formulation. The result, according to 3M, is frequency response that's flat within  $\pm 3$  db from 30 to 15,000 Hz, and a signal-to-noise ratio as high as 60 db at the highest frequencies (where Dolby action—and the need for it—are greatest) and still as high as 53 db at the lower frequencies.

With standard tape and without Dolby, performance slopes off to a still-quite-respectable 30-12,000-Hz response and better than 50-db signal-to-noise ratio. Listening tests



Tape counter shows actual recording time in minutes and seconds, not just numbers.

confirmed that frequency response and noise were far better with Classic tape and Dolby than without. Wow and flutter, even on slow piano music, were unobjectionable—surprisingly good for an 8-track unit.

Fidelity isn't the unit's only strong point. It has VU meters, sliding record-level controls and a pause control for more convenient recording. There's also a tape counter that reads in minutes and seconds rather than in arbitrary numbers.

As with all 8-track decks, there is no rewind facility (a major convenience in cassette decks), and the fast-forward is comparatively slow by cassette or open-reel standards—only  $3\frac{1}{2}$  times normal playing speed. But the inconvenience of getting back to the beginning of a track is eased by a pair of controls that can be set to automatically stop and eject the tape as soon as its gets to the end of its track—you needn't stand around and wait the  $6\frac{1}{2}$  minutes that a 90-minute cartridge takes to go around once (on fast-forward). The same controls can be adjusted to play the whole tape before ejecting or to endlessly repeat either the whole tape or a single track.—*Ivan Berger.*

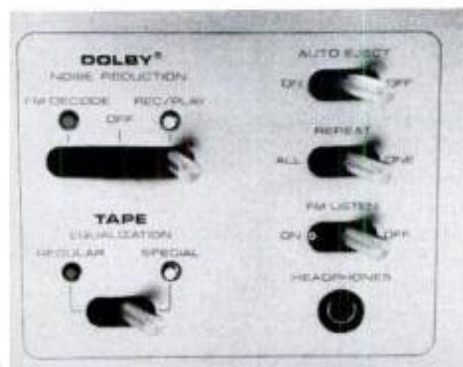

Unusually complete controls include Dolby noise reduction switch, equalization selector for different tape types, versatile eject and repeat controls (see text).

# SIMONIZ HEAVY DUTY AUTOMOTIVE ENGINE TRIM WHEEL TIRE VINYL UPHOLSTERY FLOOR MAT

or just  
about any  
thing  
else on  
your car



# CLEANER DEGREASER

Available in 28 oz. spray gun container and 64 oz. refill wherever you buy auto parts and accessories.

© MNP TEXIZ CHEMICALS COMPANY, DIVISION OF MORTON-NORWICH PRODUCTS, INC., GREENVILLE, S.C. 29602



# You can tear out all the cards in this magazine...

# But this is the one you should mail!

---

**If you're thinking of investing your money  
in a learn-at-home program in electronics, there are  
a few things you should know first.**

---

Selecting a home electronics program isn't easy. It could be one of the most important decisions you'll ever make for your future. So you want to decide carefully and get the best education you can.

After all, you're investing your time and money, and you want a full return on that investment.

**What should you look  
for before you select a school?**

You probably want a school with a proven track record of quality and performance. You want personal attention plus, the convenience of learning at home. You want the most up-to-date technical texts... teaching aids and learning methods.

But most of all you want to actually learn what electronics is all about. Not just theory, but actual hands-on experience with the latest and best technical equipment available today!

**At Bell & Howell Schools, you get  
all that... and so much more!**

Bell & Howell Schools has been in the home-study electronics business a long time. Almost half a century. In that time, we have developed teaching techniques that provide our students with the most vital and comprehensive learning system available for at-home study.

**Techniques like our "step-by-step"  
concept of learning.**

At Bell & Howell Schools, we start you off with the basics. Then take you step by step through the learning process. You work at a comfortable pace—not too fast... not too slow. If you already have some learning or experience, we'll arrange advanced standing in the program so you can skip the beginning lessons. And don't worry if you don't have any electronics background. 25% of our graduates never



even had any electronics training before enrolling with Bell & Howell Schools. (Based on a recent survey of our graduates conducted by an independent research firm. Survey results available on request.)

### Or our system of personal contact.

No course is without its problems. And when you get hung up on a problem, you want answers and you want them fast. Here at Bell & Howell Schools, we combine the convenience and pleasure of learning at home with a system of personal contact with faculty and other students that rivals—if not beats—any other program available.

For problems that "just can't wait" we have a toll-free "hot-line" that you can call and discuss your questions with an experienced instructor. You get real attention—someone whose only job is to see to it that your individual questions are answered. And answered quickly and clearly!

To help you develop your thoughts and understand electronics principles more thoroughly, Bell & Howell Schools has developed a unique feature that no other learn-at-home program has—In-Person Help Sessions in 50 major cities throughout the United States. These let you get together with instructors and other fellow students. There you can talk shop with other people who share your interests... explore your problems further... and get additional assistance.

But that's not all that Bell & Howell Schools will do for you! In addition to our vast experience and expertise, is a philosophy that the best learning comes from working with the best equipment available! And that's exactly what our students do!

### What better way to learn electronics than to actually work with electronics equipment?

And what better way to find out how things fit together... how they work and why they work than to actually build the equipment? And we don't mean gadgets that will be worthless to you later.

We mean equipment like the Bell & Howell Schools exclusive "Electro-Lab<sup>SM</sup>" electronic training system including design console, digital multimeter and oscilloscope, that you can use professionally after you've graduated.

The design console will allow you to set up and examine circuits without having to solder them in place.

The digital multimeter measures voltage, current and resistance and displays its findings in big clear numbers for easier reading.

And the solid-state "triggered sweep" oscilloscope is similar in principle to the kind used in hospital operating rooms to monitor heartbeats. But you'll use it to monitor and analyze tiny integrated circuits. And you'll find the "triggered sweep" feature locks in signals for easier observation.

### That's not all you build when you choose a course from Bell & Howell Schools!

To learn the most advanced electronics technology, you have to work with the most advanced training tools.

So in addition to the exclusive "Electro Lab<sup>SM</sup>" system that you will build as part of Bell & Howell's Home Entertainment Electronics program, you'll also build a 25" diagonal color TV with digital features.

Sounds exciting, doesn't it? Well, digital electronics is exciting! Its growth and application are giving us new and better products and a whole new realm of split-second accuracy that was just a dream a few years ago. And this new technology is being applied more and more to TV's, clocks, radios and other home entertainment equipment.

By studying with Bell & Howell Schools—one of the first schools to introduce digital electronics as part of its training program—you can actually get in on the ground floor of this new technology while learning all the basic electronics principles and skills you'll need to detect and troubleshoot problems professionally on digital and other electronic equipment.

Make no mistake about it! As you build your digital color TV, you'll get a thorough grounding in electronics principles. You'll develop a working knowledge of "state of the art" integrated circuitry and the 100% solid-state chassis. Plus you'll actually know how to program a special automatic channel selector to skip over "dead" channels and how to build a remarkable on-the-screen digital clock that flashes the time in hours, minutes and seconds.

### But most importantly, you'll have the skills that could lead you to a brighter future...

And isn't that what education is supposed to be all about? At Bell & Howell Schools we've always thought so. Get full details about us, our courses, our philosophy of education by mailing the postage-paid card today. If you take one of our courses for vocational purposes, this program is approved by the state approval agency for Veterans' Benefits.

### Mail card today for full details!

"Electro-Lab<sup>SM</sup>" is a registered trademark of the Bell & Howell Company.  
Simulated TV test pattern.



If card has been removed, write:  
An Electronics Home Study School  
DEVRY INSTITUTE OF TECHNOLOGY

763/4



ONE OF THE  
**BELL & HOWELL SCHOOLS**  
4141 Belmont, Chicago, Illinois 60641



# APPLIANCE CLINIC

BY PAUL MANN



## Getting grounded

*I own an old circular saw not fitted with a ground wire. Is the tool dangerous to use? If it is, is there a way of attaching a ground wire?—Peter Lougias, Ridgefield Park, N.J.*

Yes, the tool is dangerous to use. Yes, you can attach a ground wire.

Go to a power-tool dealer and purchase a three-wire line cord. The green wire is the ground wire. Solder a terminal clip to it. Now open the tool where the switch is (usually in the handle). Disconnect the old line cord and discard it. Attach the live wires of the new cord to the switch in their proper positions. Attach the ground wire to the saw's metal housing (or a metal part if the housing is plastic). An ideal place would be beneath a screw that holds the switch in place. Loosen screw, slip terminal clip under it and fasten it firmly. You now have a grounded line cord.

If you have only a two-slotted wall outlet to use the saw with, you can use a three-prong-to-two plug adapter—but you'll be defeating the purpose of installing a grounded line cord if you're not careful to ground the adapter by fastening its pigtail down under the outlet's cover plate screw. Make sure this screw is metal and that the threaded hole it goes into under the cover is also metal and grounded to the outlet box. If not, you still have a dangerous tool.

## Trouble cooking

*A noncompany serviceman told us we probably need a new thermostat for our Roper gas range, only 15 months old. The flame doesn't stay on enough to get the oven hot. It lights, but cooking takes a year and a day. Is the serviceman right?—S. L. Headlee, Van Meter, Iowa.*

He might be, but I wouldn't re-

place that thermostat just yet. There are two more likely possible causes: 1. A defective FM control. This has a capillary tube filled with mercury to maintain oven temperature at the setting chosen. When the temperature exceeds this setting, the FM-capillary cuts off the heat; When it falls, the system lets it rise again. 2. A partially clogged pilot. The pilot effects the operation of the FM control. If it is partially blocked, heat needed for the control to operate the gas valve is never provided. The oven then operates at half speed, so to speak.

If there is no Roper service facility nearby, ask your local gas company to send or recommend a serviceman.

## Better way

*About one foot of the rubber gasket around my Frigidaire refrigerator*

*(Please turn to page 48)*

## "Grit-Edge" blades trim tile with style.

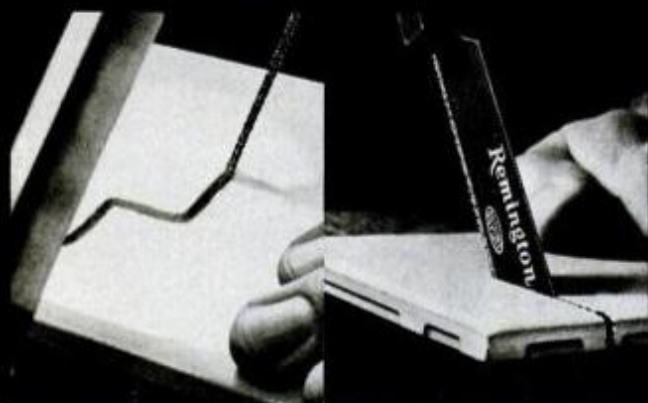

Remington "Grit-Edge" rod saw and hacksaw blades make contour cuts in ceramic tile, snag-free cuts in high-pressure hose, cuts at any angle in hardened steel, space-age alloys and plenty of the other "unsawables".

Hundreds of tungsten carbide particles permanently bonded to "Grit-Edge" blades make them a match for materials conventional blades can't tackle.

Economical, durable "Grit-Edge" blades take the tough out of tough jobs.

For more information, see your hardware dealer or write: Abrasive Products, Dept. 945, Remington Arms Company, Inc., Bridgeport, Conn. 06602.



When ordinary blades can't cut it.



"Grit-Edge" is a trademark registered in the U.S. Patent Office. "Remington" is a trademark of the Remington Arms Company, Inc.

## "Grit-Edge" blades can cut it.

Material	Rod Saw	Hack Saw	Saber Saw	Circ. Saw	Band Saw
Asbestos-Cement	X	X	X	X	X
Beryllium	X	X			X
Carbon	X	X		X	X
Cast Iron	X	X			X
Composites	X	X	X		X
Composition Board			X	X	X
Fiberglass	X	X	X	X	X
Foamed Glass	X	X			X
Friction Materials	X	X	X	X	X
Glass	X	X			X
Hardened Steel	X	X			X
Honeycomb Materials					X
Marble, Natural	X	X	X		X
Marble, Synthetic	X	X	X	X	X
Plaster			X	X	
Plastic Laminates	X	X	X	X	X
Plywood			X	X	X
Stainless Steel	X	X	X*		X
Stranded Cable	X	X			X
Superalloys, Iron-base	X	X			X
Superalloys, Nickel-base	X	X			X
Tempered Hardboard			X	X	X
Tires, Steel-reinforced					X
Titanium	X	X			X
Tile, Ceramic	X	X	X		X

\*Requires coolant and variable-speed machine



When ordinary blades can't cut it.



"Grit-Edge" is a trademark registered in the U.S. Patent Office. "Remington" is a trademark of the Remington Arms Company, Inc.



# 15 and 9.9 hp compacts. More of everything but size.

Nobody gives fishermen more in an outboard they can carry. Yet, our 9.9 hp and 15 hp are more compact than any comparable competitive motor. And electric starts, which include a 5 amp alternator to charge the battery, are sized the same as our manuals.

All have FireFlash ignition for quick, easy starts, long spark plug life. A programmed tilt-lock for shallow water running. Co-pilot steering for hands-off trolling. A sound-sealed powerhood,

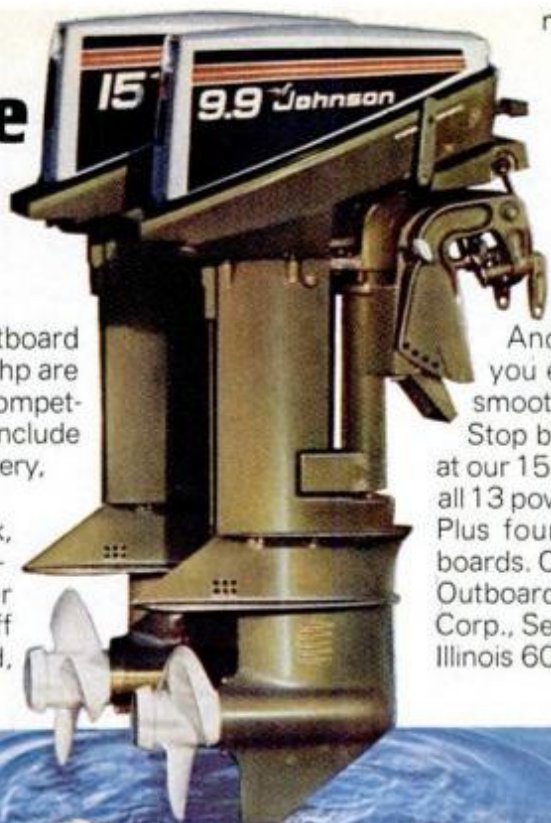

mid-section Watershield silencing and thru-propeller-hub exhaust to keep you running quiet.

And our 1975 compacts give you still more of what you need for fishing. A new longer tiller handle puts twist-grip throttle and steering closer to you. Manual models can be started in gear at low trolling speeds.

And a new, heavier flywheel gives you easier starting, smoother idling, smoother trolling.

Stop by your Johnson dealer for a look at our 15 and 9.9 hp compacts. Look over all 13 power choices... 2 through 135 hp. Plus four new high-thrust electric outboards. Or write for free catalog, Johnson Outboards, Div. Outboard Marine Corp., Sea-Horse Dr., Waukegan, Illinois 60085, Dept. PM-65.



Performance-engineered by the world leader

First in Dependability  
**Johnson**  
OUTBOARDS

Материал, защищенный авторским правом



## APPLIANCE CLINIC

(Continued from page 46)

has come loose at the bottom. The rubber is tight around the rest of the door. I'm using electrical tape to hold the loose material in place. Could you suggest a better solution?—Elmer W. Kufalk, Antioch, Ill.

Yes—a new gasket. This one may be split or starting to wear in the weak area. Your tape idea is okay but temporary. Eventually, hot air will begin to leak into the refrigerator. The gasket is probably held to the door with screws, so I would first see whether a loosened screw in the

affected area is causing the problem. But if screws are tight, I'd buy a new gasket. If the damage spreads, you'll need one eventually anyway, and then it might not be available. A new one will cost \$20 to \$30.

### Dropping the pilot

I recently heard about a kitchen range that employs an electric igniter to light the gas burners rather than a conventional gas pilot. I would like to know more about it. Where can I write?—Donald Anderson, Burdick, Kans.

This innovation is now used only on self-cleaning models made by

Caloric Corp., Tipton, Pa. 19562. Write to the director of advertising; I'm sure he will be pleased to provide full details. Suggested retail prices are in the mid-\$300 and upper-\$400 levels. With burner pilots eliminated, the ranges should use less gas. Although the igniters won't work during power failures, you'll still be able to light burners with matches.

### Wireless

I have a Shetland heavy-duty floor scrubber. The control wire that operates the valve to release water from the canister has rusted off. I can't find anyone who can help me. Can you tell me how to fix this wire?—James Trumbull, Ridgway, Pa.

No, because it can't be fixed. It's an integral part of the dispenser. The whole dispenser has to be replaced, which will cost \$5 to \$10. Replacement is simple enough; you merely snap out the old dispenser and snap in the new one, running the wire in correct position. Write the company, furnishing the model number of your unit. If it can't send a new dispenser, it will tell you how to get one. The address is Shetland Floor Care Div., Shetland-Lewyt Corp., 700 West Tabor Rd., Philadelphia, Pa. 19120.

### All wet

Dishes dried in our Waste King Universal dishwasher don't dry thoroughly. Many are pretty wet after washing. What is wrong?—Elmer Wobach, Harbor City, Calif.

If all the dishes were wet, I might conclude there is a mechanical malfunction. But in your case I would examine two other possibilities. First, if the temperature of the water is not high enough, dishes will not dry thoroughly; the ideal temperature is about 160° F. Second, the door of the dishwasher should be opened as soon as possible after drying is done; keeping it closed allows condensation to form on dishes.

### Address seeker

Several months ago we received a Magic Maid waffle iron as a gift. I have a complaint and want to contact the manufacturer, but no one can give me his address. Please help.—Lois E. Blumberg, Douglassville, Pa.

Magic Maid is a trade name used by Son-Chief Electrics, Inc., Winsted, Conn. 06098. ★★★

If you have a question about any appliance, send it to Appliance Clinic, Popular Mechanics, 224 West 57th St., New York, N. Y. 10019. Sorry, but letters cannot be answered individually. Problems of wide interest will be discussed in this column.



CARPET DETERGER



UPHOLSTERY DETERGER



WALL DETERGER

# Use your SPARE TIME beat inflation with added income

You offer a service everybody needs . . . work part time or full time . . . own your equipment . . . keep all you earn . . . start with just a small investment . . . and we help you every step of the way!

Have your own money-making business and make the kind of income you probably thought impossible. You can when you clean carpeting or upholstery or walls with Von Schrader professional cleaning equipment. Every home, every building are potential customers. And every customer can become repeat business. The demand for on-location cleaning is growing so fast that how much you earn depends solely on just your time and effort.

Moreover, we help you every step of the way . . . just as we have helped thousands of others build money-making businesses for 40 years. Typical comments: "Cleaning is a very good business—have been most grateful for your advice and help. You have fine machines—can recommend them to anyone."—R. Herbst. "Never have we made this good a living and been so

content and happy."—N. Hanna. "Have all 3 machines and very pleased with each one."—C. Reiner. "You people sure helped me and I'll never forget it."—H. Kendall.

There are three easy-to-use Von Schrader machines. You need no special skills or education to operate them. (1) CARPET DETERGER®. Its performance cannot be duplicated by any other cleaning machine. (2) UPHOLSTERY DETERGER®. Using dry foam, cleans fabrics beautifully and safely. (3) WALL DETERGER®. Washes walls and ceilings 5 times faster than by hand—no dripping or streaking.

You can start with just one machine. Then, as your business keeps growing, you may want to add the other two and thus offer a complete cleaning service.

You pay no fees, royalties, sign no contracts. You own your equipment, the finest of its kind. Keep all you earn. And your investment is so small you may find it hard to believe. For complete information—without any obligation—send for booklet.



**"Let me send you our free booklet that gives all the facts"**  
—Francis von Schrader, President

Read about the big demand for on-location cleaning, see why Von Schrader Detergers are the finest of their kind, how easy they are to operate. Learn how other men have become financially independent, how Von Schrader helps you every step of the way. Fill in the coupon and send for booklet. **Extra! Special Recorded Message included with booklet.** Listen as Francis von Schrader talks to you personally about your growing future using Von Schrader Detergers.



**Take the 1st step Mail coupon**  
**VON SCHRADER company**  
40 years of helping people earn good money  
1065 Place, Racine, Wisconsin 53403  
Please send complete information on Von Schrader Detergers. No salesman will call.

Name \_\_\_\_\_  
Street \_\_\_\_\_  
City \_\_\_\_\_  
State \_\_\_\_\_ Zip \_\_\_\_\_



# GFCIs: Is circuit breaker or receptacle better for you?

Since 1971, the National Electrical Code has recognized the need for ground-fault circuit interrupters (GFCIs, sometimes referred to as GFIs) in the home by establishing GFI requirements to better protect people against dangerous electric shocks. Two types of GFI devices permitted under the code are the GFI breaker that monitors the entire house circuit, and GFI wall receptacle. Both offer ground-fault protection, and both are being studied by contractors to determine which is most economical and dependable.

A GFI prevents electric shock due

The GFI receptacle at left monitors only what is plugged into it and not what is beyond on circuit. The breaker (right) continuously monitors accumulated ground fault currents.



to equipment failure. Unlike fuses and regular circuit breakers designed to protect house wiring and appliances, the GFI is intended to protect lives by instantaneously sensing ground faults at very low ampere levels and turning off power.

Both GFI breakers and receptacles have their advantages; which to use depends on your needs. A GFI breaker protects the entire circuit, but that can be a disadvantage because of nuisance tripping. A receptacle, such as Leviton's Sure-Gard shown here, monitors only what is plugged into it. Since GFIs should be tested monthly, it's a lot easier done with a GFI receptacle that is installed near the appliance.

—Ronald J. Landisi

# Us Tareyton smokers would rather fight than switch!

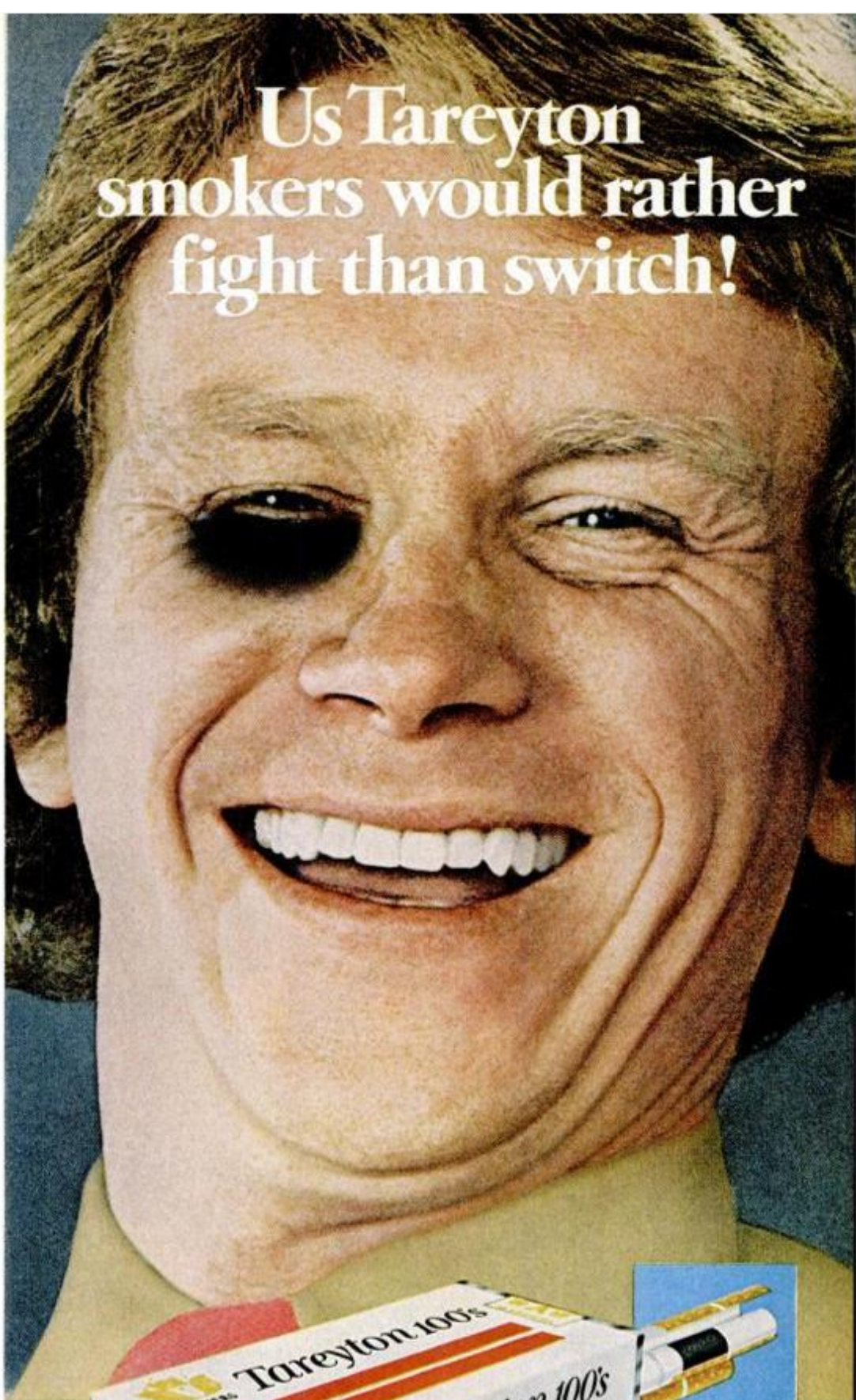

**Tareyton is better.  
Charcoal is why.**

Tareyton's activated charcoal delivers a better taste. A taste no plain white filter can match.

Warning: The Surgeon General Has Determined  
That Cigarette Smoking Is Dangerous to Your Health.

King Size: 20 mg. "tar", 1.3 mg. nicotine; 100 mm: 19 mg. "tar", 1.4 mg. nicotine, av. per cigarette, FTC Report Oct. '74.



SAVE UP TO **\$150**  
ON AUTOMATIC  
TRANSMISSION REPAIR



## TRANS-MEDIC

Before you have your transmission overhauled... try Trans-Medic! Trans-Medic eliminates slippage and downshifting, smooths rough shifting... cures sluggish action!

For really dirty hands... use

## LAN-LIN



Gets down deep into skin crevices to get hands really clean! Removes oil, grease, stain, dirt.



## BRAKE CLEANER

Degreases instantly and can be used without disassembling brake units. Quickly dissolves and flushes away brake fluid, oil and grease.

## LIQUID WRENCH

Regular (No. 1) the super-penetrant that loosens rusted nuts, bolts and parts... in seconds!



## LIQUID WRENCH

New (No. 2) stops squeaks, cleans and lubricates... protects metal tools, parts. Dries wet engines. Protects against rust and corrosion.



WRITE FOR CATALOG  
RADIATOR SPECIALTY CO.  
CHARLOTTE, N. C. 28237

# Latest in loudspeakers



Acoustic  
Research AR-10 $\pi$



Electrostatic  
Research  
ER-139



Yamaha NS-1000M



ESS "Tempest" bookshelf  
line with Heil tweeters

After last year's flood of wild-looking speaker systems (page 122, Sept. '74) this year's new models incorporate more conventional-looking improvements.

Acoustic Research's new AR-10 $\pi$ , for instance, has a woofer level control to maintain flat bass response wherever the speaker is placed within the room. The woofer, midrange and tweeter controls are easily accessible through a door in the front of the cabinet. The AR-10 $\pi$  lists for \$395.

Yamaha's latest development is an ultralight yet rigid beryllium diaphragm dome used on the tweeter and midrange of its NS-1000M. It's made by depositing beryllium vapor on a ballon, which is then deflated. Per pair (note right and left-hand versions at top, right), they're priced at \$960.

The ER-139, from Electrostatic Research has eight small, electrostatic tweeters made from a new design by Arthur Janszen. The tweeter as-

sembly also spreads the downward-facing 10-inch woofer's rear radiation, while an upward-facing cone handles the midrange. Without cover grille, it's \$179.90; \$199.90 with cover.

ESS now has a series of four bookshelf speakers using the Heil "air-motion transformer" tweeter that squeezes out high frequencies instead of pushing them. The four "Tempest" models, from \$99 to \$199, are efficient enough to produce high volume from amplifiers of only 10 watts RMS per channel.—Ivan Berger



# Off the road, on your own.



**Chevy Pickup.** Carries three with standard seating (bucket seats also available). GVW ratings up to 8400 lbs. with 4-wheel drive.



### Handsome new interiors

This is Chevy's brand-new Silverado package with added insulation and other improvements for your comfort and convenience. Also available, depending on model: Cheyenne, new Scottsdale and Custom Deluxe interiors.

When you're in the back country where the road you're on is far from perfect, and far from town, it's good to have Chevy 4-wheeler durability and dependability going for you.

### Choice of 4-wheel drives

Specify a V8 with Turbo Hydra-matic and you get Chevy's full-time system, drivepower at all four corners on and off the road. Or go conventional 4-wheel drive with a Six or a manual gearbox. Either way, Chevy 4-wheelers are low and easy to get in and out of, yet offer a full 7 inches of ground clearance.



**Chevy Suburban.** Carries nine with available seating. Or with only the front seat in position can move up to 144 cu. ft. of cargo.

### High Energy Ignition

It delivers a spark that's up to 85% hotter compared to conventional systems; provides all-weather protection from moisture and dirt. Saves maintenance—no points or condenser to replace periodically. Standard on Chevy 4-wheelers.



### Tough, double-wall construction

Chevy uses two walls of steel instead of one for strength, durability. In the hood. Front fenders. And other critical body areas.

**Chevy Blazer.** Carries five with available seating, plus 44 cu. ft. of cargo. Hardtop model has roll bar.



## LASTING CHEVY VALUE

**Chevrolet**

## '75 CHEVY

# 4-WHEELERS





The traditional plumed helmet  
of an officer in the Royal Horse Guards.



**Classically smooth. Unclassically priced.**

You can buy a more expensive Canadian, but not a smoother one.

**Windsor. A rare breed of Canadian.**





# Apollo Soyuz

**manned space mission with a new accent**

**H**alf a world apart, on pillars of roiling flame, two Russian cosmonauts and three U.S. astronauts will lift off from Earth in their respective spacecraft on the 15th of next month if the plan goes according to schedule. Soyuz will rise from the Soviet launch complex at Baikonur, Kazakhstan, at 3:20 p.m. Moscow time. Seven and a half hours later Apollo will be inserted in a smaller initial orbit, along the same track around the Earth, on a Saturn 1B rocket from Kennedy Space Center.

Apollo, from its elliptical inside track, will juggle its orbit until—two days later—both craft are aligned. Apollo then will close in and the two craft will perform a tricky rendezvous and docking sequence at an altitude of about 140 statute miles. Crews will visit back and forth via a unique airlock tunnel, during which time each will be talking the other's language.

The American-Soviet link-up—a blend of hard work and sophisticated engineering—points toward even more spectacular cooperative space efforts in years ahead.

by Richard Dempewolf



**Crewmen train** in simulator at Star City center near Moscow. From left: astronaut Thomas P. Stafford, cosmonaut Aleksey A. Leonov and astronaut Donald K. Slayton. Illustration (top of page) shows how tapered petals will permit Soviet and U.S. craft to effect docking in orbit.

After two days, the vehicles will separate and redock, this time with the Soviet docking mechanism being the active one. Some 27 space experiments will be conducted; five of them jointly. The rest will be spread over Apollo's nine-day flight span. At the end of its fifth day from launch, Apollo will make a final separation from Soyuz and continue in orbit for another four days before landing in the Pacific. After the final undocking, Soyuz will circle the Earth for two days before parachuting home to Kazakhstan.

The Apollo-Soyuz Test Project (ASTP) is a \$250-million milestone in international cooperation. It was born on May 4, 1972, when the United States and the Soviet Union—until then space rivals—agreed to conduct the joint venture. Purposes of the mission will be:

- To provide an international plat-

(Please turn page for full-color illustration; text continues on page 110)







## Apollo-Soyuz Mission Sequence

1. SOYUZ LIFT-OFF
2. SOYUZ ORBIT ADJUSTMENT MANEUVER
3. APOLLO LIFT-OFF
4. TRANSPOSITION
5. DOCKING
6. DOCKING MODULE EXTRACTION
7. APOLLO RENDEZVOUS MANEUVERS
8. SOYUZ CIRCULARIZATION MANEUVER
9. DOCKING
10. CREW ACTIVITIES
11. SOYUZ DEORBIT MANEUVER
12. SOYUZ LANDING
13. APOLLO DEORBIT MANEUVER
14. APOLLO LANDING

**American and Soviet spacecraft** will dock in an orbit some 140 miles above the Earth, as shown in this artist's concept. The two crews will work together in carrying out five scientific experiments.

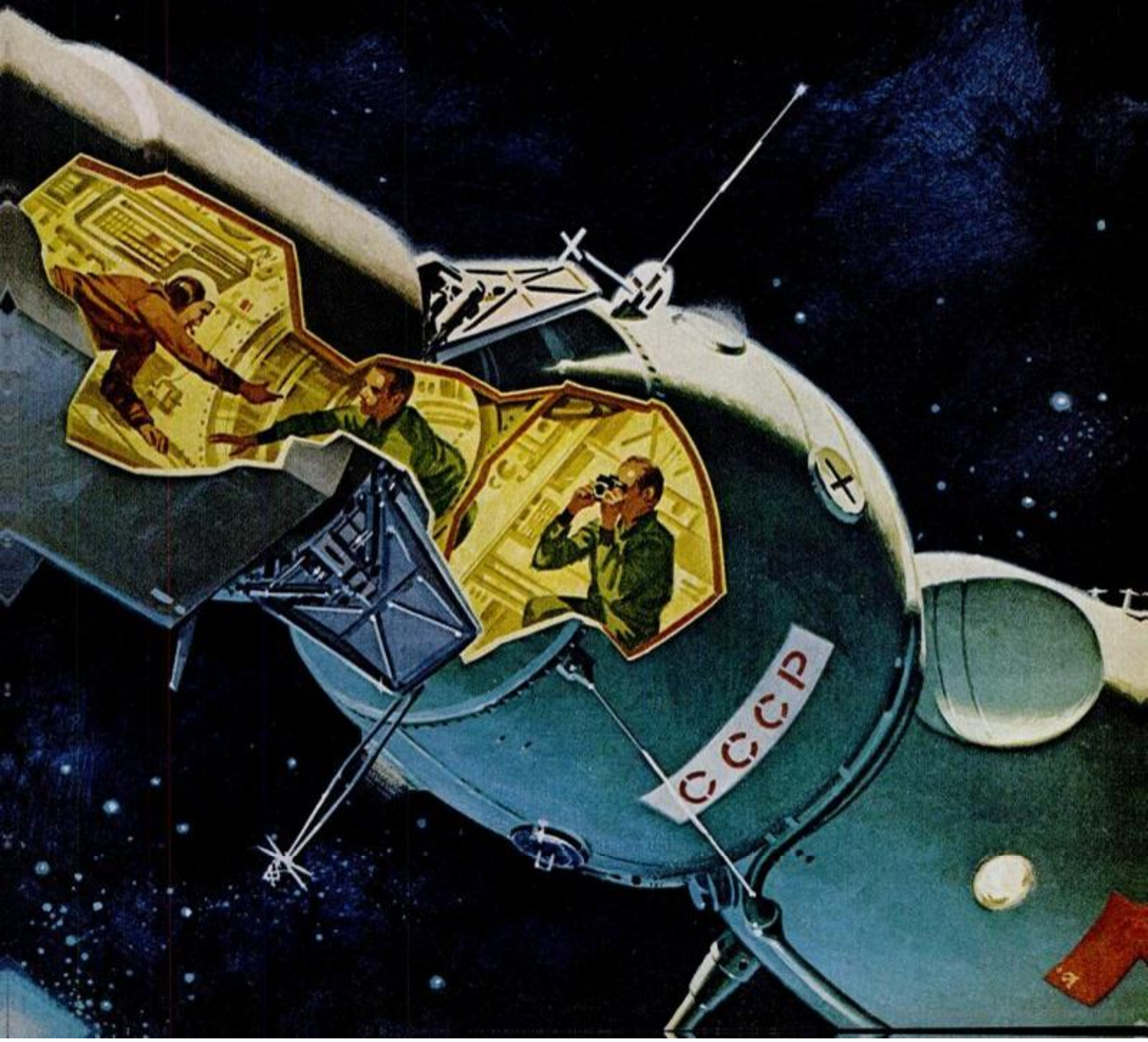
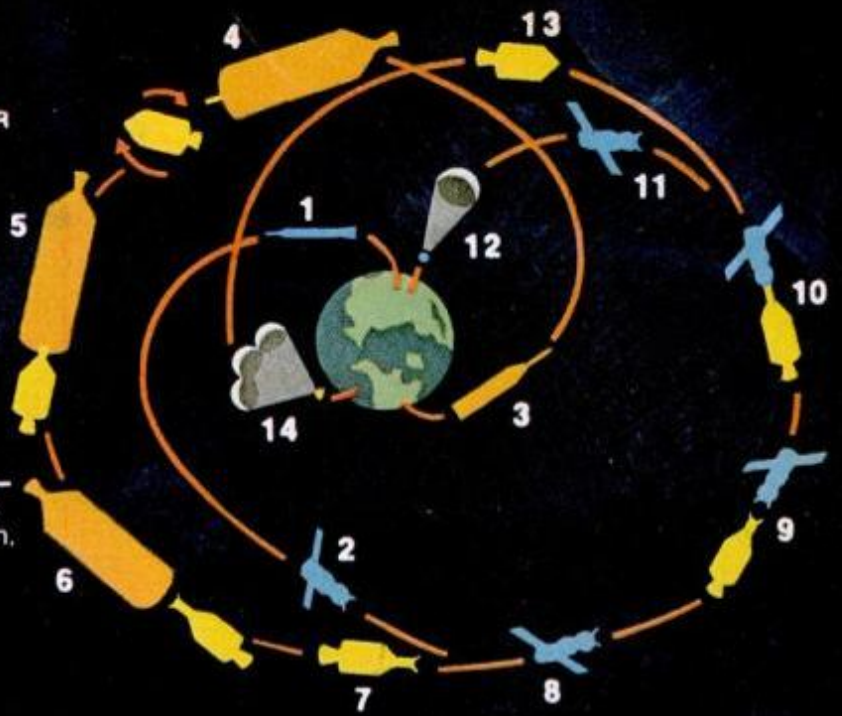



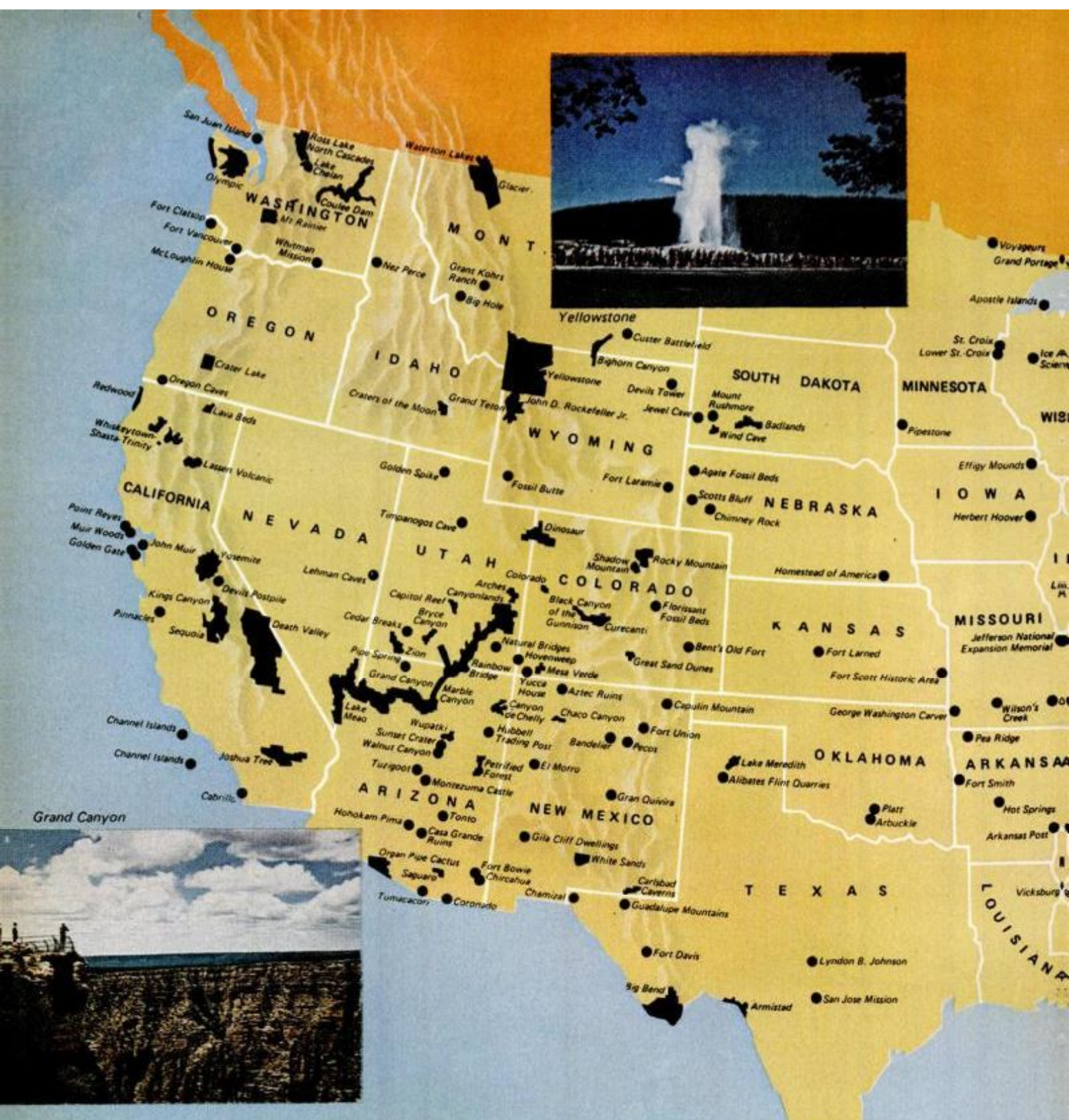

Seashores, mountains, deserts and lakes—all offer unequalled outdoor recreation.

# 257 close-to-home vacationlands-

# READY AND WAITING

by Jack Galub

Art: Adolph Brotman and Marian Manfredi



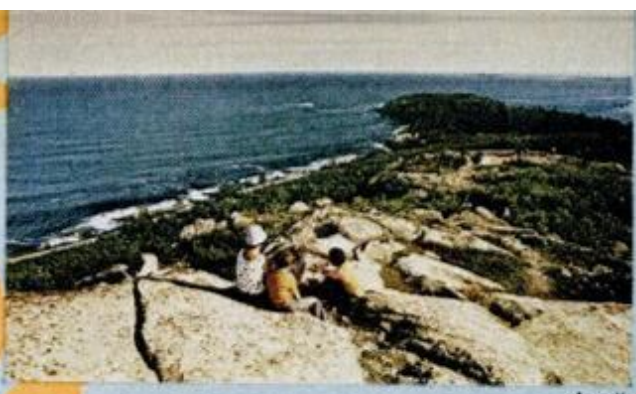
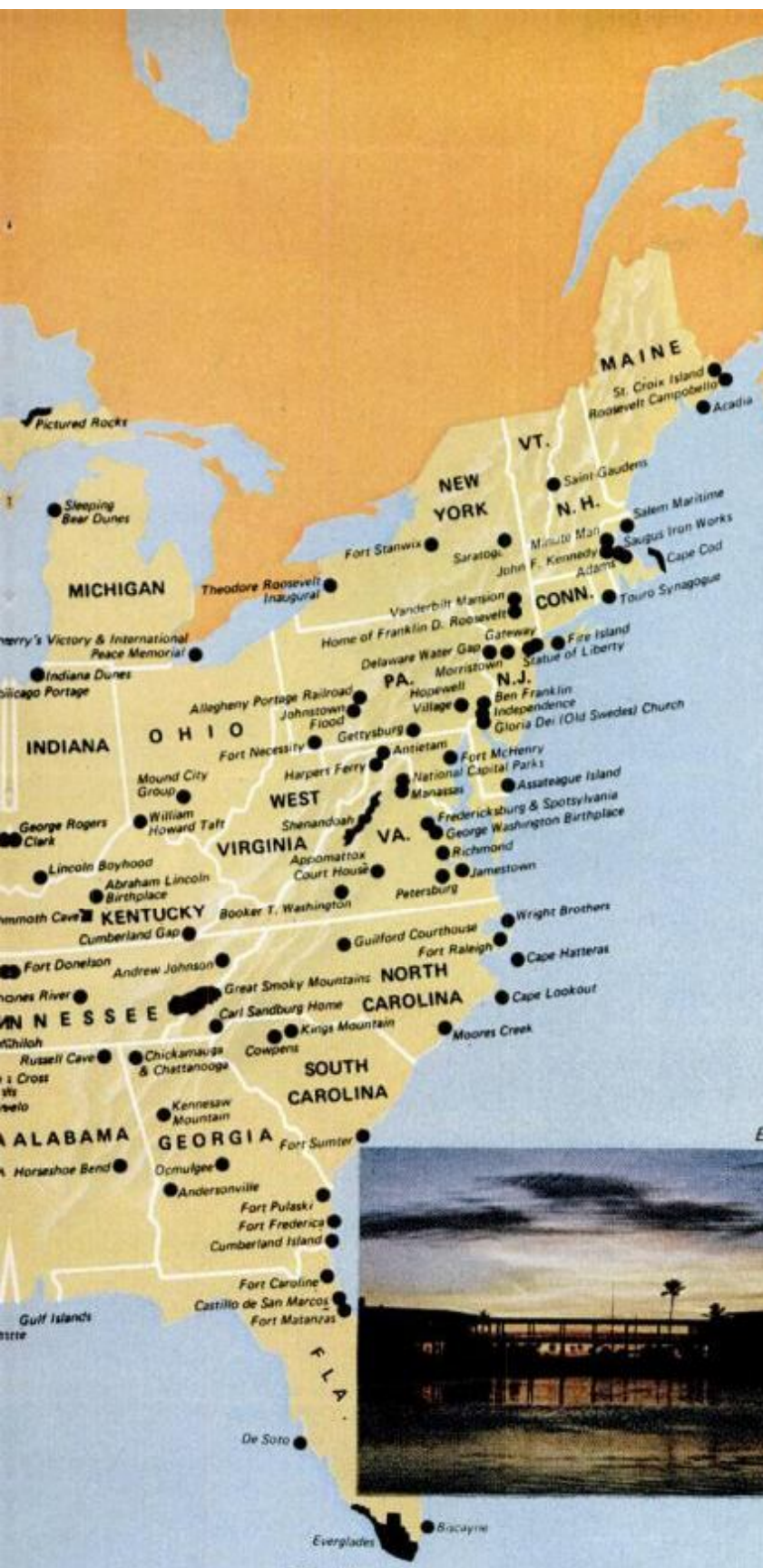

Acadia

No matter where you live, there are likely to be vacation spots within a day's drive from your home. Over 30.5 million acres and 29,000 developed campsites are within our national park system, and they offer unequalled opportunities for outdoor fun. Best of all, particularly nowadays, all these areas are yours to use at a price that's almost impossible to beat. Admission to any fee-charging facility runs from \$2 to \$4 for the family or carload. Overnight tenting fees are about \$2. And if you become addicted to visiting national parks frequently, as so many do, a \$10 Golden Eagle Passport admits you and your group free to any admission-charging area for a full year. If you've celebrated your 62nd birthday, a free Golden Age Passport may be picked up at any facility. Just present proof of age at the gate. You'll get all the privileges of the Golden Eagle plus a 50-percent discount on camping and other use fees.

Grandfather of the system was Abraham Lincoln, who took time out during the Civil War to turn over Yosemite Valley and the Mariposa Sequoia Grove to California for use as parks. That was in 1864. Eight years later, President Grant approved the naming of Yellowstone as our first national park. Today, the system is recognized as one of the world's wonders, copied by more than 90 other countries.

The national park system, administered by the U.S. Department of the Interior, has 38 national parks (where no hunting is permitted), 16 recreation areas (many of which allow hunting), 10 national seashores and 81 national monuments. And the numbers keep changing and growing. Urban-area parks, such as Gateway in New York City and

[\(Please turn to page 128\)](#)

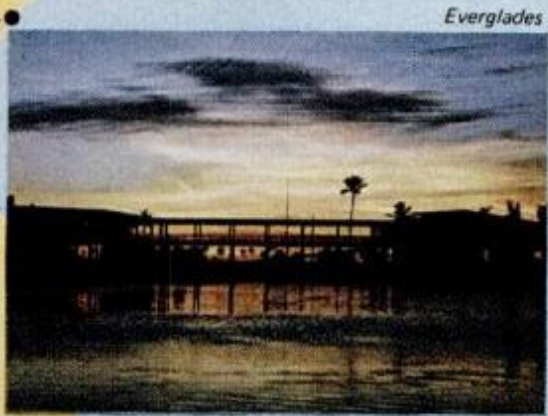

Everglades

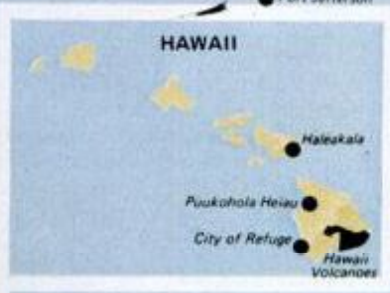

HAWAII

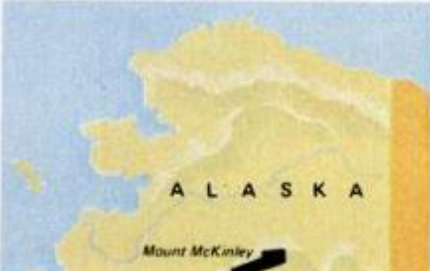

ALASKA

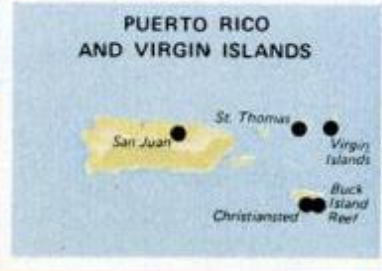

PUERTO RICO AND VIRGIN ISLANDS





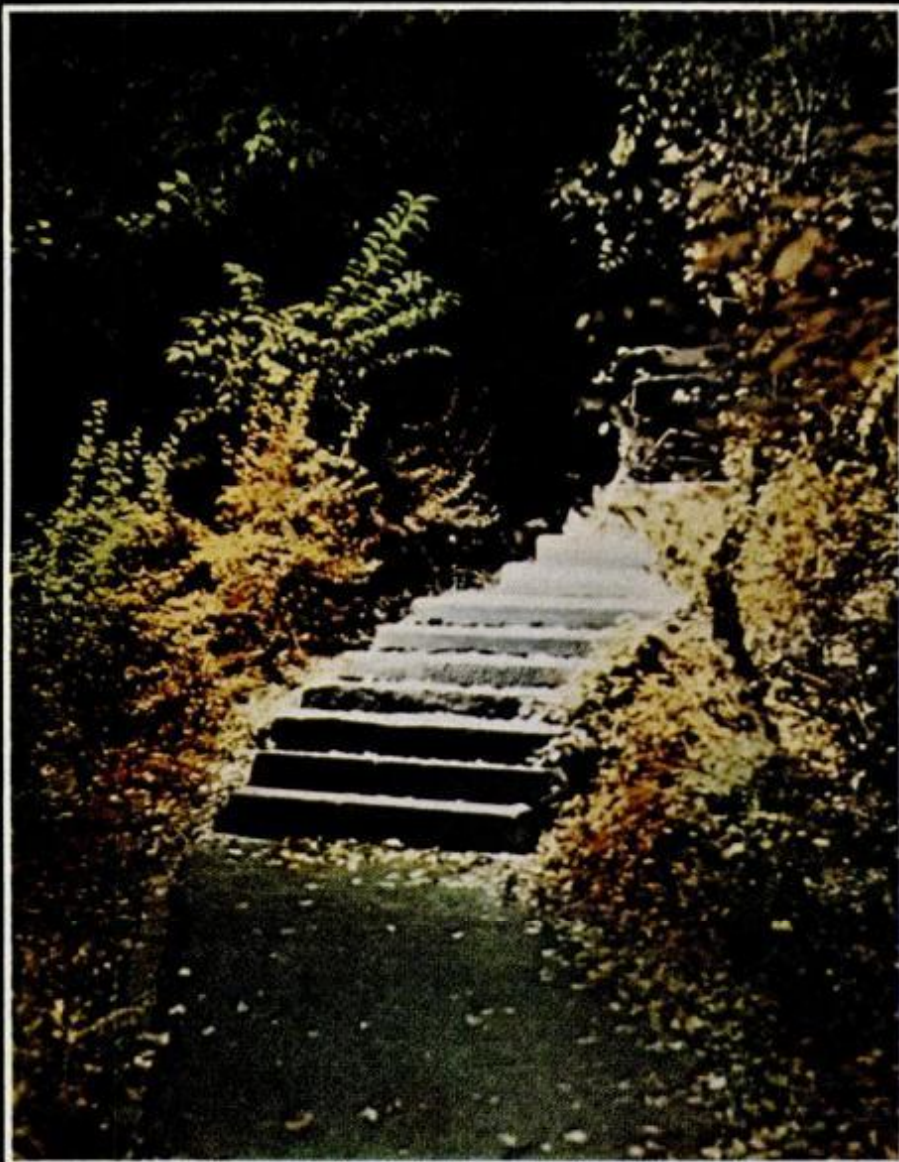

1

## LOW-COST LIGHT-UP Transform your yard into a night-blooming beauty

by Harry Wicks WORKSHOP EDITOR

Not too long ago, outdoor residential lighting consisted of little more than placing a few floodlights around the grounds in rather bare-looking fixtures. Usually, these functional lights were affixed to buildings or parked on poles to provide broad, general illumination for safety and security for family and visitors.

Though safety and security are both still good and valid reasons for lighting

your property at night, a third consideration — beautification — now plays an equally important role in outdoor lighting. Actually, "lightscaping" is simply an outside extension of indoor lighting. But if it's carefully done, you can add new dimensions to your home environment to create, in effect, a totally new living area.

Don't think that lighting your property automatically means that you will



3

Used creatively, night lighting will beautify your yard as well as make it safer. The lighting shown includes:

1. Illuminated steps with light-distribution pattern that permits clear view along entranceway; 2. Underwater lighting with lily-pad fixtures; 3. Area lighting which emphasizes shadows; 4. Spotlight on a focal point; 5. Silhouetting dark objects against light, achieved by beaming light through translucent materials; 6. Pond illuminated by low-voltage incandescent at pond bottom; 7 and 8. Wall and ground-mounted fixtures for small-area lighting. Photos 1 through 6 are from General Electric Co., Nela Park, Cleveland, Ohio; 7 and 8 are courtesy of Intermatic, Inc., Spring Grove, Ill.



be using energy capriciously. For one thing, when exterior lights are turned on for outdoor family use, it means that indoor lights can be turned off or used minimally.

Additionally, you can save even more by installing a low-voltage outdoor system. How such systems work is explained on the following page.

This article shows you how to create attractive outdoor lighting effects—for greater safety and enjoyment—through the variety of fixtures and lamps now available. With these, plus a generous helping of your own imagination, you will be able to turn your backyard into a nighttime wonderland.

### Basics of outdoor lighting

There is no great mystery to successful outdoor lighting, but there are basic principles you should know about. For example, be aware that it is important to avoid flat lighting—a look that is inevitable if you try to duplicate daylight. Instead, plan light placement so you create a scene with highlights and shadows that has a painting or sketch-like quality.

Generally, a touch of light here and there, cast by the appropriate fixture, is the kind of lighting that will give your nighttime setting a charm of its own. And that's what you should aim for—a look that is distinctly different from your yard's daytime appearance.

Shielding fixtures are frequently used today even though they're slightly less efficient and, thus, more expensive to operate. On the plus side, however, these do eliminate irritating glare yet provide illumination where



4



5



6

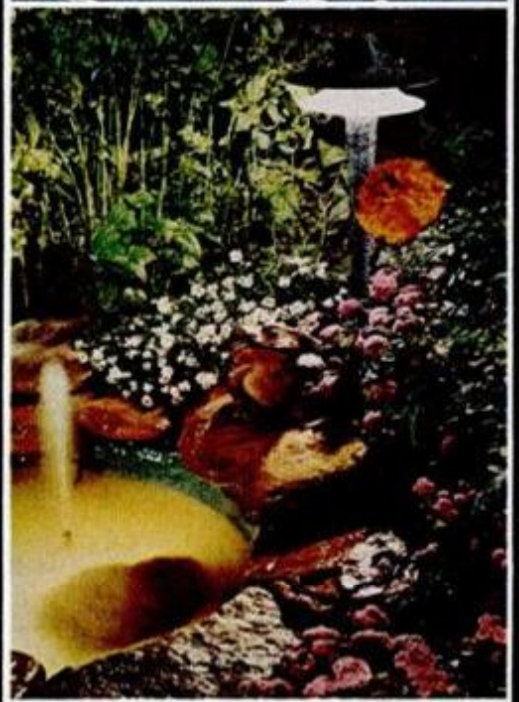

8



## Use lighting to create interesting forms



Rooftop view shows position of three 300-watt PAR units aimed at lawn and trees for dramatic effect.



Bamboo trellis is cross-lighted by two floodlamps; 75-watt lamp adds interesting shadow shapes.

Art: Adolph Brotman

### ABOUT LOW-VOLTAGE LIGHTING SYSTEMS

A low-voltage lighting system has two advantages—economy and safety. Such systems generally use low-wattage bulbs that are intended for accent lighting; these, of course, will use less electricity. The equipment is also lower in cost than comparable high-voltage counterparts. And you also save because ease of installation makes this a do-it-yourself task all the way. Safety is good because the transformer reduces voltage from the standard 117 volts to 6 or 12 volts. Dangerous shocks are much less likely.

The transformer is the heart of the low-voltage system. A simple device, it sometimes comes with a timer that automatically

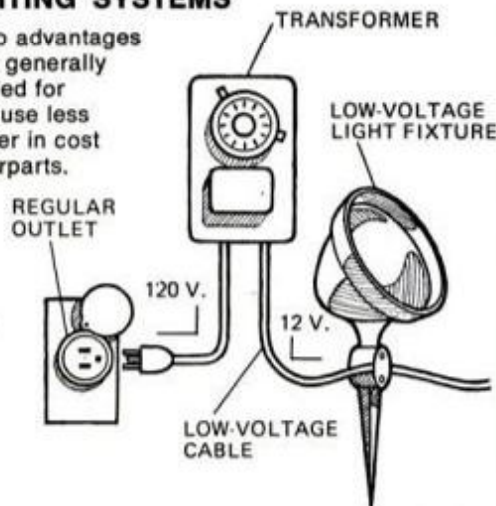

turns lights on and off. The components shown are part of a system called Malibu. The cable can be attached to the floodlight with the floodlight turned on, as shown at left. Or you can attach the power cable to the short fixture cable using Malibu

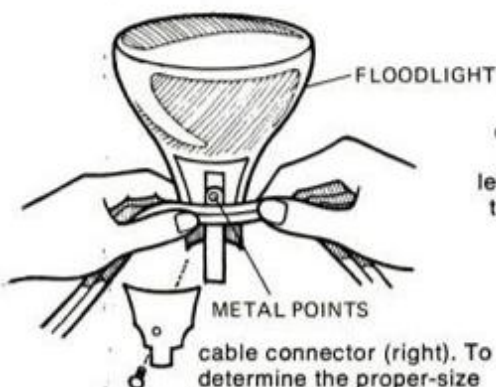

cable connector (right). To determine the proper-size transformer, add up the wattage of all fixtures and select one that closely matches the total load. The load wattage should not be less than half the transformer rating or more than transformer capacity. For the best lighting results, combine regular voltage equipment with low-voltage equipment. Low voltage is best used for lighting small areas and for accent. For more information on the Malibu system, write Intermatic, Inc., Dept. PM, Spring Grove, Ill. 60081.

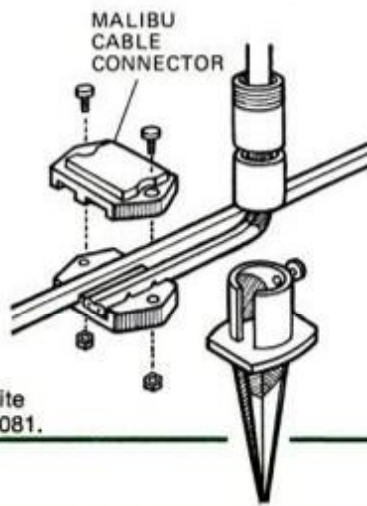

it is wanted. Local or border lighting and spotlighting are usually based more upon esthetics than the ability to see.

One way to determine how and where to place various light fixtures is by working with long extension cords and incandescent lamps. By using this trick you can fiddle with a number of lighting arrangements until you find a setup you'd like to make permanent.

*Play it safe.* All electric fixtures and wiring used for outside lighting must be weatherproof and installed in accordance with the National Electric Code (as well as your local building department).

### About outdoor lamps

Currently, many installations use a floodlight holder for incandescent lamps with built-in reflectors (PAR). Some holders shield the entire lamp so that indoor lamps can be used. Others shield only the lamp base; with these you must use outdoor (weatherproof) lamps.

Outdoor incandescents are available in colors if you want to emphasize color, control insect attraction or create special-effect foliage lighting.

Tungsten halogen lamps are generally tubular in shape. These longer-life incandescents are generally used in higher-wattage floodlights.

You can use fluorescents outdoors provided you meet three criteria:

- Use only weatherproof fixtures.
- Make certain ballasts and fixtures are designed for use at below-freezing temperatures.



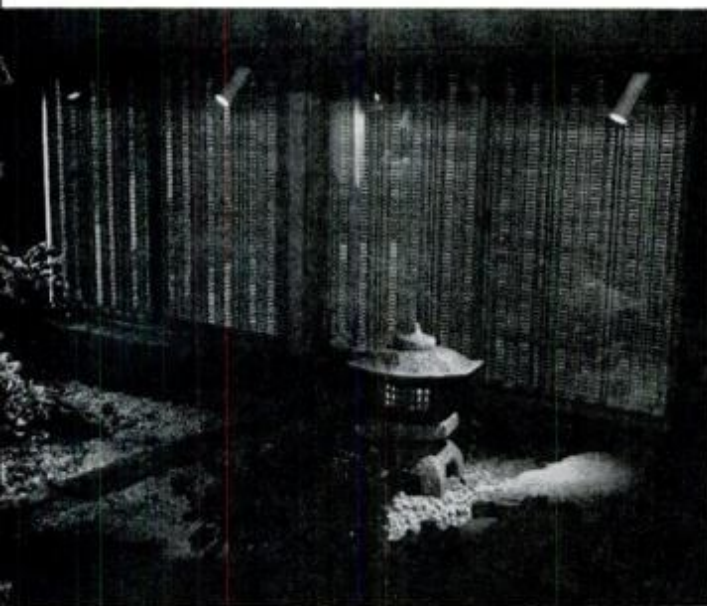

Low-voltage units under an overhang light planters and rock garden; transformer is mounted in soffits.

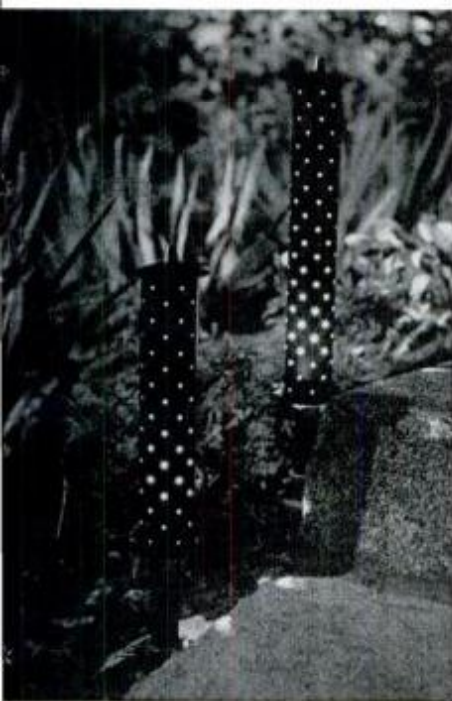

**Bug Chaser** bulb above by Duro-Lite has a special yellow coating. GE border lights (left) seem to sparkle because of perforated housings. These are available in varied heights.

■ Lamps exposed to temperatures ranging from 32° to 50° F. must be enclosed.

High-intensity discharge lamps (HID) are used for floodlighting larger areas and are not commonly used in residential outdoor lighting.

There is a wide variety of lamps and fixtures available to suit all outdoor lighting needs; typical shapes are shown in the drawings at right and on page 117.

### Ideas for lightscaping

■ **Automation.** Consider installing equipment which will turn lights on and off automatically. It is relatively inexpensive and can save many dollars over the course of a season by completely eliminating wasted electricity.

■ **Accent lighting.** Trees, shrubbery and the like can

*(Please turn to page 117)*

## OUTDOOR LIGHTING FIXTURES AND KNOW-HOW

### LIGHT BULBS

Many lamps and fixtures are available. Typical units shown here are usually made of brass, steel, copper or aluminum. Bulbs shown at right are the most commonly used 115-120-volt types. The reflector bulbs must be used in fixtures, while the PAR type (not shown) need no shielding because they are made of hard glass that will not crack or break due to weather or moisture conditions.

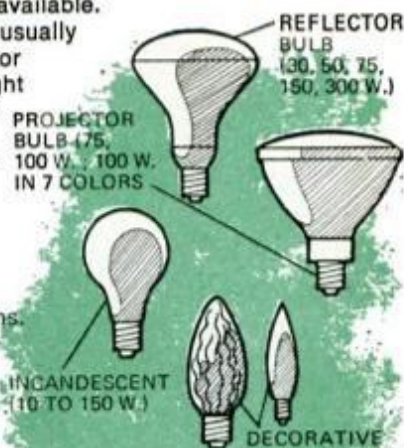

### FLOODLIGHT HOLDERS

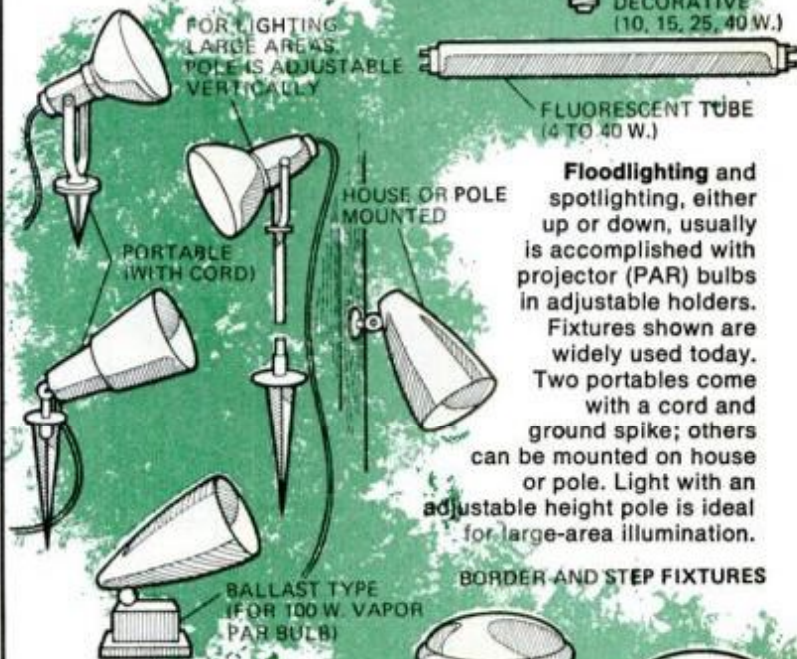

**Floodlighting** and spotlighting, either up or down, usually is accomplished with projector (PAR) bulbs in adjustable holders. Fixtures shown are widely used today. Two portables come with a cord and ground spike; others can be mounted on house or pole. Light with an adjustable height pole is ideal for large-area illumination.

### BORDER AND STEP FIXTURES

To light steps, paths and borders, select fixtures having neither glass nor plastic parts because the resulting glare will be annoying. Fixtures for this use range from 6 to 18 in. in diameter and 8 to 30 in. tall. From a wide selection you can pick fixtures that give down-lighting for steps, borders, low plantings. Designs vary considerably; simply choose fixtures compatible with your garden. Depending on size of fixture size and function, bulb sizes vary from 10 to 100 watts.

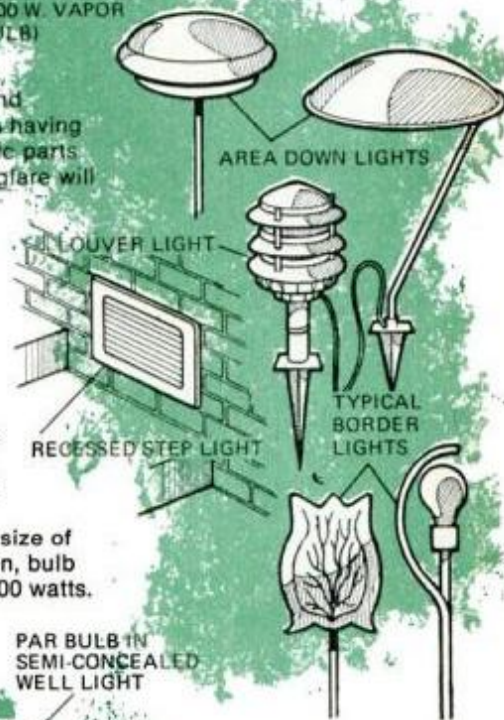

### UP-LIGHT FIXTURES



Trees, shrubbery and fences are lighted by locating fixtures on ground, aimed upward. To produce a dimensional rather than flat appearance, direct two or more up-lights at an angle to the feature being specially lighted.



# The miles per gallon

In the Shell  
Marathon competition,  
the current record  
is 376.59 mpg!

by Michael Lamm WEST COAST EDITOR

What do you consider good gas mileage? The government wants Detroit to increase the average miles per gallon 40 percent by 1980. That means about 20 mpg from a full-sized Ford.

Twenty sounds pretty good for an LTD, but what if I tell you that in 1949 a Shell Oil engineer modified his two-year-old Studebaker Champion and got 150 mpg? That's right: 150 mpg. Not bad, you say.

Well, hang onto your hat, because that's not the record by a long shot. Shell started playing this little game back in 1939, letting its engineers tune and modify cars for maximum gas mileage. They called it "Marathoning," and they still do it every season. It's done in-house, not for publicity. Over the years, the mpg figures kept going up. The remarkable results are listed in the table below.

How do the competitors get that sort of mileage from their special cars? Two things are paramount: 1. Driving technique; 2. The way the car is set up.

Economy drivers have found that the best technique for racking up record gas mileage is to drive in bursts. Burst driving isn't practical on the highway, nor can you do it with power steering or an automatic transmission. But here's the way it works.

First, they accelerate with maximum throttle in high gear from 3 to 15 mph—in other words, holding the



Yes, this odd vehicle ran 376.59 miles on a gallon. Among tricks used: cutting off tire tread to leave only a one-inch strip in contact with the ground and then inflating to 200 p.s.i.

gas pedal to the floor all the way. There's no accelerator pump in the carburetors of these record cars, so full-throttle acceleration doesn't waste gasoline.

When they reach 15 mph, they shove in the clutch, take the transmission out of gear, switch off the ignition, and coast back down to three mph. They repeat this cycle over and over for the duration of the test. Shell

Marathon participants average about six such cycles per mile and try to cover as much distance as possible on one measured gallon of gas. They drive a 14.067-mile circular route near Woods River, Ill. The course follows normal, typical roads and has uphill and downhill sections, but no stops.

Now preparing the car is another matter and perhaps more important. Let's look at two examples—the 1924 Chevrolet roadster that got 168.47 mpg back in 1952 (it set a record that lasted 16 years), and the current record-holder, a three-wheeled 1959 Opel that reached a phenomenal 376.59 mpg in 1973. Here's what their owners did to these cars.

The 1924 Chevy used its original 154-c.i.d., ohv, four-cylinder engine. This engine was completely taken apart, new sleeves installed and new two-ring aluminum pistons fitted for

(Please turn to page 122)

SHELL MARATHON MILEAGE RECORDS

Year	Car	Ton mpg	Actual mpg
1939	1933 Plymouth 6	71.6	49.7
1949	1947 Studebaker 6	240.0	150.0
1952	1924 Chevrolet 4	206.4	168.5
1968	1959 Fiat 600	186.9	244.4
1972	1959 Opel 4	306.7	297.7
1973	1959 Opel 4	451.9	376.59



# game

This owner boosted the mileage of his family Pinto to 44.5 mpg. Here's how he did it.

by Nils Nelson

Can a basic little economy car like Pinto be coaxed into giving you better gas mileage? After gas prices started climbing and we weren't even sure there would be enough gas to buy, I decided this was a question worth looking into.

I worked on the project carefully for eight months, and found that, yes, you can increase mpg substantially—without going broke, and with a minimum investment of time and not a whole lot of mechanical know-how. A 1973 Pinto Runabout with a two-liter engine, four-speed transmission and dealer-installed airconditioning was the subject of this experiment, but I'm sure any Pinto can obtain similar results. The filling method was to top up the tank until I could see it and just keep it filled to that point for each check on mileage.

Friction was my first concern. How much can we reduce it? Changing oil frequently not only reduces internal friction, but it also allows you to run cooler and prolongs the life of your engine. Check your transmission, rear end, and wheel bearings to make sure they are at proper levels and turning freely. Brakes are another source of friction. The self-adjusting drums in the rear and front discs all create some drag, but I will not sacrifice safety for no friction. What I did find was that one of my front discs had a rusty piston and was constantly dragging—enough to give me an increase of 2.5 mpg after it was repaired. This

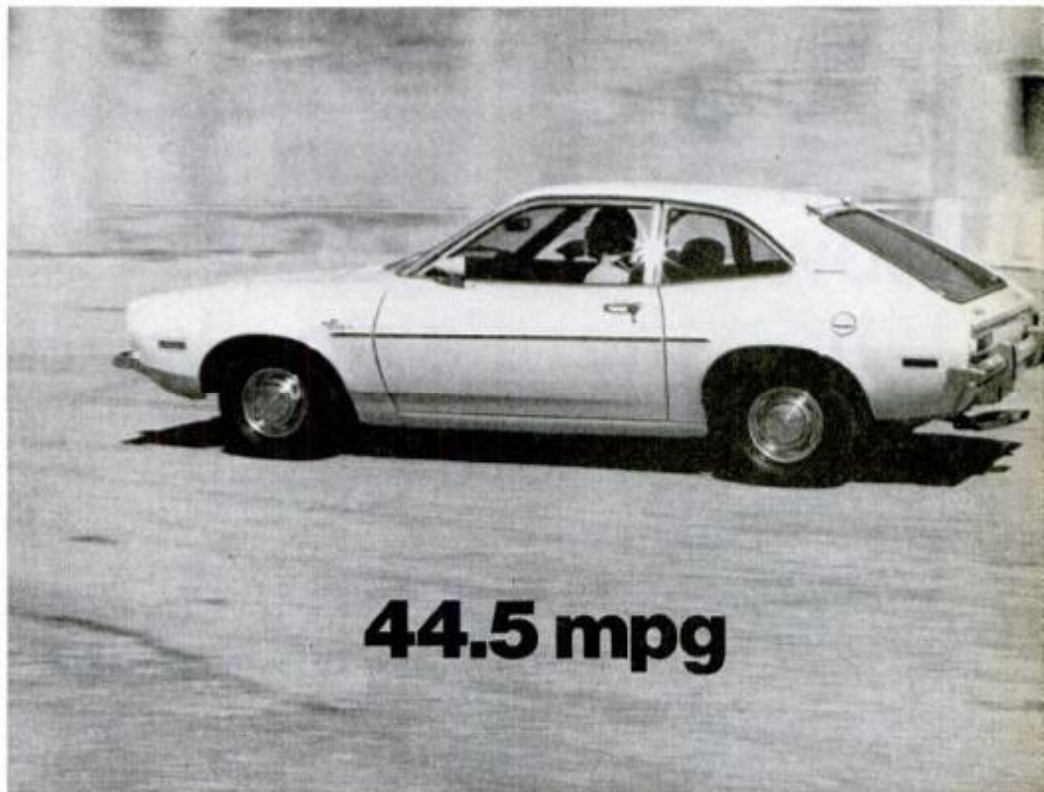

## 44.5 mpg

is the kind of friction to keep a constant lookout for.

The first thing I did under the hood was change the air cleaner. It took some hunting to find one for the Pinto's little two-barrel, but there are several available. I bought a Cal-Custom. The car ran better, performed better and immediately gave me better mileage. Shortly after the air cleaner came a flexible-blade fan.

This fan weighs about half that of the stock item, drawing less power from that little four-banger. It flattens out at high speeds, drawing still less power from the engine and it cools better when idling in traffic because of the steeper pitch of the blades.

Again, there was better mpg. It was at this point that I decided to go for further mileage boosts: After all, if an air cleaner does that much, think about some sophisticated changes.

Ignition seemed to be the next likely place to improve economy. It figured that if you can burn gas more completely, you'll get more power and economy—you won't just be blowing it out the exhaust. The Nolan Technical Center in Dallas is the local distributor for the Geraghty Dyno-tune kits.

The kit has new wiring, weaker

*(Please turn to page 123)*

### MILEAGE BOOSTS ON AUTHOR'S 1973 PINTO (Starting Point: 24.5 mpg)

Parts Changed or Added	New Mileage (mpg at 50 mph)	Price of Parts (\$)
Air cleaner	29.0	10
Flexible fan	30.5	10
Electronic magneto	33.3	39
Ignition kit	36.5	50
Vapor injector	40.2	47
Headers, exhaust system	44.5	103

Total investment: \$259



Free-breathing air cleaner installed by author netted him a gain of 4.5 mpg.



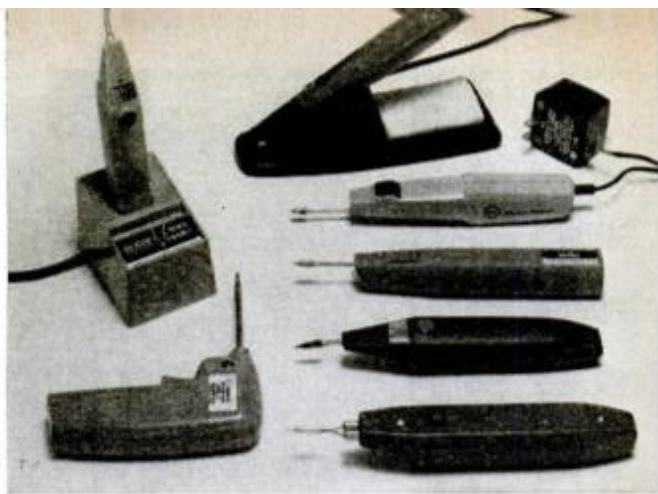

**Cordless irons, clockwise from upper right, are:** Ungar (in charger stand), \$26; Black & Decker (with plug-in charger), \$15; Weller, \$15; Wahl 7500, \$20; Wall-Lenk, \$21; Wen gun, \$20; and Wahl Quick-Charge in charger stand.

**S**oldering irons are just about the last power tools to go cordless—but they may be the most useful ones.

If you've ever used a soldering iron for any job besides electronic soldering at your bench—repairing ceiling fixtures, auto wiring, or connections inside a console TV—you'll appreciate the cordless irons' obvious advantages. But there are less obvious advantages, too. Even in bench work, an iron without a cord to trail across a crowded work surface, or to pull and twist when you're working in tight places, can be a boon. And since the cordless irons generate no electromagnetic fields, they're just perfect for soldering field-effect transistors, which could otherwise be damaged.

Not all cordless irons are alike—though there are significant similarities. Most of them weigh about 6 ounces—slightly more than a conventional iron and cord, but not enough so to be bothersome. They heat up in five or six seconds to a



# How to solder when there's no place to plug in

Cordless, rechargeable soldering irons are popping up all over.

by Ivan Berger ELECTRONICS EDITOR

Even for benchtop jobs like this, where power is available, cordless irons are handy.

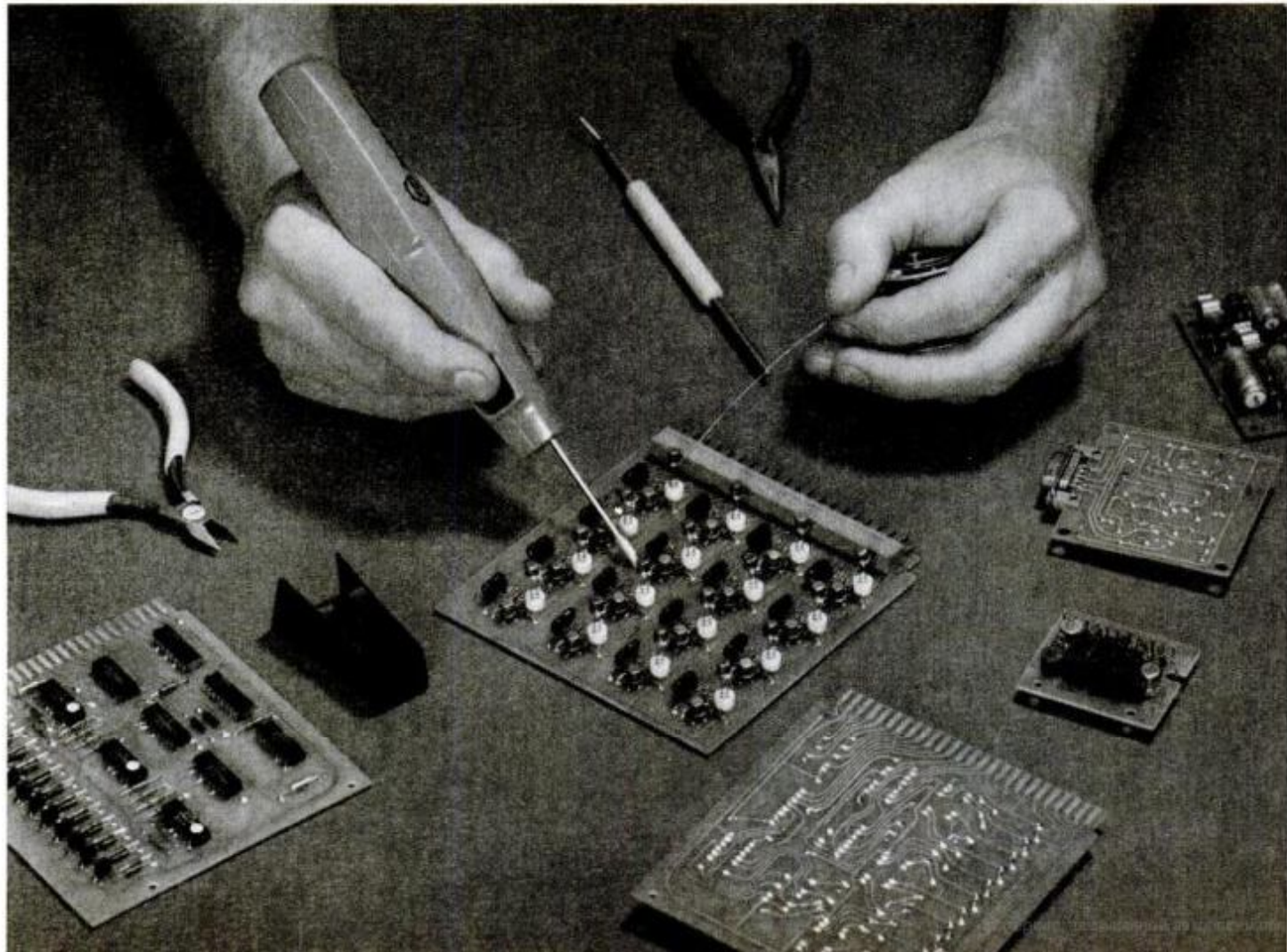



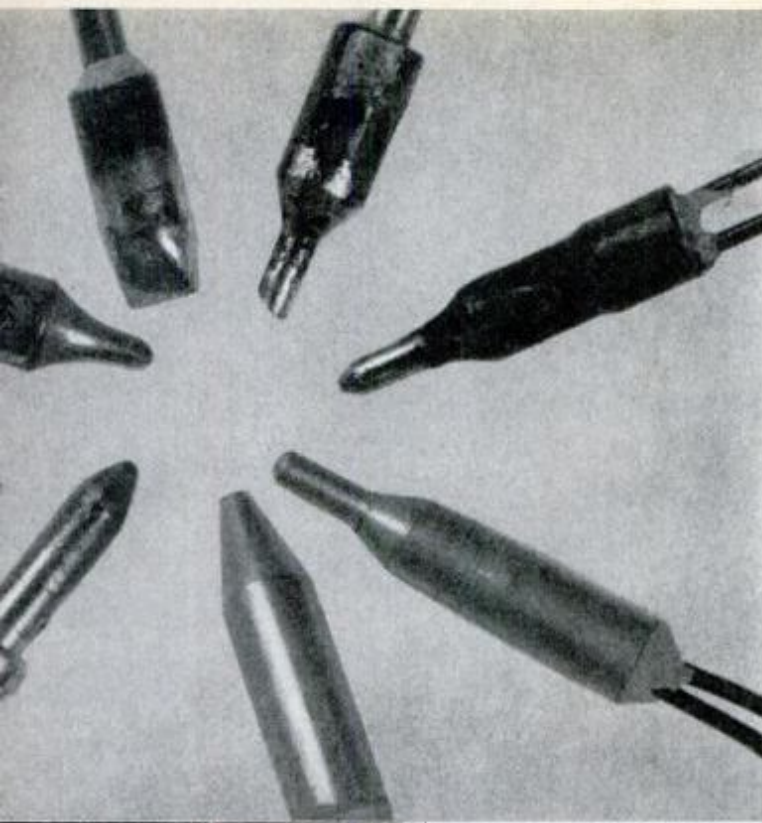

Tips for cordless irons come in many shapes and sizes. Wahl has largest choice, followed by Weller and Ungar.

For bench work, we preferred the drop-in charger stands of Ungar (below, with handy tip-cleaning sponge) and Wahl, (below left) to chargers that had to be plugged into irons (like that shown with Black & Decker's on the facing page).



Photos: Benn Mitchell



Switch locks on Wahl (right), and Lenk, Ungar and Weller irons prevent accidental heating or battery discharge. Black & Decker uses a switch guard instead; pistol grip protects Wen's trigger switch.

tip temperature of about 700° F., make about 100 joints per charge (depending on the size of the wires and your speed in making joints), and are good for about 500 to 1000 battery charge/discharge cycles before their built-in batteries need replacement.

All have built-in bulbs to illuminate the work as you solder. And all fall within a fairly narrow range of prices, from \$15 to \$26.

But the differences are also worth knowing before you buy. While most irons take overnight to charge, one—the Wahl Iso-Tip 7700 Quick-Charge—recharges in one to 4½ hours. And the power available differs from iron to iron, too. The Lenk and Black & Decker irons are about equal, at 10 and 12 watts; the Wen runs 15 to 25 watts; the Ungar, 35 watts; and the similarly named, similar-looking Wahl and Wall-Lenk irons, 50 watts each.

With the exception of the gun-style Wen, all the irons are pencil-shaped; but their balance and trigger locations differ, so heft the various models in your local stores to determine the ones that feel most comfortable.

For bench work, we preferred the Ungar and Wahl irons, whose handy stands recharge the batteries as you rest the irons in them between joints. Of the two, Ungar's stand was handiest, but the Wahl iron felt a bit better in my hand.

For getting into tight corners, the easiest irons were the Ungar, Black & Decker and the Wen, in about that order, followed by the Wahl with its optional tuner extension tip. Optional tips in different shapes and sizes were available for most models: Wahl, the original cordless iron, now offers five tips (which also fit the Wall-Lenk), while Weller and Ungar, the biggest names in soldering generally, offer four and three tips respectively.

Wahl is also offering a 12-volt, \$5 charger that plugs into a car's cigaret-lighter socket, as well as a portable carrying case that will protect the tip but is a tight squeeze for the iron.

Ungar gave us some useful tips on how to get the most from cordless irons: To make the most joints per charge, start soldering as soon as the iron is hot enough to melt the solder, and try to solder several joints each time you turn the iron on. Use your iron as much as possible, and discharge most of the way before recharging—the more you use nickel-cadmium batteries like the ones that are built into these irons, the greater amount of charge these batteries will hold. ★★★



# Chevy, Olds, Pontiac



NOVA

OMEGA

No, they're not at all the same—at least not in a few important respects.

True, the 1975 Chevy Nova, Olds Omega, Pontiac Ventura and Buick Apollo do share identical body shells—the General Motors X-body. Also true, the engines are nearly the same in all cases—only Apollo offers the V6, while all four cars come with GM's 250-c.i.d. in-line Six and two sizes of V8s.

But several important differences become clear in our survey of Nova/Ventura/Omega/Apollo owners.

First, there's apparently a big difference in the way the four GM divisions put these cars together. Under workmanship, 54.5 percent of Ventura owners rated their cars "good to excellent." Among Nova owners, this figure drop-

Forecasters claim that today's compacts will be the full-sized cars of 1980. Maybe so. The swing to standardized body shells and engines is already under way.

Lots of owner complaints about having to take cars back for the same problem two, three, sometimes even four times.

ped to 39.8 percent (*see summary table, page 78*); the other cars also outperformed the Nova in workmanship.

About mechanical problems, Nova owners reported the most—61.9 percent stating they had to take their cars back for service (much of it minor). Most trouble-free was the Apollo, with only 41.1 percent of owners reporting trips back to the dealer. Apollo owners also gave Buick mechanics highest marks for successful first-time repairs. They boasted not having to come back **twice or a third time** to get the same problem re-repaired.

Keep in mind these four compacts are relatively close in price. Least expensive is the Nova at \$3526 f.o.b. The Ventura lists for \$3623, the Apollo at \$3756, and the Omega is



# and Buick: All the same?

A nationwide survey based on 1,283,000 owner-driven miles

by Michael Lamm WEST COAST EDITOR



VENTURA

APOLLO

the most expensive at \$3769. Only \$243 separates the top-priced Omega from the least expensive Nova. These figures are for base four-door sedans with the 250-cu.-in. Six.

Those, then, are the major factual differences plus those brought out in our survey. We'd hoped to find a clear-cut, consistent "winner" among these four cars, but no single victor emerged. The Nova managed to trail in enough categories so that its owners seem less satisfied than the rest—only 62.4 percent said they'd buy another.

We found it noteworthy, too, that most owners tended to be up in years—50 and above. Only among Nova owners did the 30-49-year age group predominate, and even that isn't young. The more mature ownership brings

◀ With options and taxes, these tabs rise to \$5000 range; we hear persistent grumbles that "cars simply aren't worth their price anymore."

Compromises, yes, but with genuine room for six passengers plus normal luggage—no need to carry around a lot of wasted overhang. ▶

with it some interesting trends.

For one, styling did not rank as a prime reason for buying any of the cars. Styling traditionally ranks No. 1 for U.S. cars (see *previous Owners Reports*). Instead, economy came in first as the principal reason for purchase of a GM compact. Styling became a secondary influence.

Owners chose automatic transmissions over manual three-speeds by an overwhelming majority. Ordinarily, in cars chosen for economy, we've found manual transmissions balance automatics to a much greater extent. Thus our overall conclusion: These cars were selected because they were *more economical* than cars owned previously. These compacts were usually purchased as **compromises** between



the large automobiles traded for them and the maximally economical subcompacts that were simply too small to suit drivers used to full-sized American cars. That's one reason "size" ranks so high under "Why did you choose this car?"

Here are typical comments from typical owners of all four nameplates. First, Nova:

From a New York college student: "There are eight members in my family, and although I can't get them all into my Nova at once, five passengers and I find the car comfortable front and rear. The only drawback is the way the shoulder belts are arranged. Anyone getting into or out of the rear practically hangs himself."

A printer from Franklin Springs, N.Y., notes, "I went to high-volume dealers in the city, got prices, then went to my small-town dealer here. I was treated better in Franklin Springs, plus getting the Nova \$400 cheaper with trade. This car is a real Chevy, so it's too bad they don't put decals on the air cleaner anymore and stamp 'Chevrolet' into the rocker covers. Also, I wish they'd offer a Nova wagon, preferably with vent wings and a four-speed V8."

RFD mail carriers usually know how to choose cars. Here's a rural mailman from Bennettsville, S.C., who comments, "I owned Chevilles previously; would have bought another if gasoline consumption were equal. The Nova's short wheelbase causes some pitching on rough roads. Gas mileage is good on the route for a 3500-pound car with the 262 V8, although smog controls seem to stifle the engine. It has a slight ping on leadfree gas, is hard to start and takes too long to warm up and run free. But it's a good-looking car and handles very well. The interior is fitted very well, materials are of good quality, and the rest of the car shows a good grade of workmanship."

From a retired gentleman living in Troy, N.Y.: "At 100 miles, I noticed oil leaking from my new Nova's engine. This is the 250-inch Six. Took the car back to the dealer and got

Rest assured that his oil leak wasn't something simple. This Chevy dealer was doing his level best despite delay.

Mercedes, BMW, VW, Volvo and others have managed to develop comfortable, simple shoulder harnesses. Why can't Detroit?

it back 1½ days later. Next day same leak. Returned car to dealer for another half day, and he said it was repaired. Next day oil leaked again. This time the dealer ordered me a new engine! At least he was trying! Four weeks went by and I got a note saying the engine had come in. Took car back, and they said it would be a two-day job. Fifteen days later, after lots of phone calls, I finally got the car back. The front end of my Nova is now covered with red paint spots, thanks to the dealer. My car is a light gray."

And a California construction supervisor observes, "My Nova's gas mileage is a far cry from the 15 mpg advertised. I'm getting about 11 in town. I used to get 16 mpg around town from my old Dart slant Six."

Turning to Ventura owners, this from a

Photos: Steve Pereira



Apollo's V6 beat the other GM engines in gas mileage; averaged 20.6 mpg in normal open-road driving.

These two cars were just a few inches longer than today's Ventura, and they delivered about the same fuel mileage.

Actually workmanship came in for drubbing from most owners, with Nova and Apollo rating lower than Ventura and Omega.

Jamaica, N.Y., secretary: "I wanted a reasonably small but not minute six-passenger sedan. Although I realize other carmakers offer such cars, too, I have had good success with Pontiacs. My car before this was a 1965 Tempest, and a 1950 Pontiac before that. Both wore very well. This car seems to fit my needs. But I did go to the Dodge dealer and looked at their Dart. I've since heard several Dart owners say they liked them, but when I was there it seemed that I'd have to buy a package of options to get a good deal. This would have meant paying more for the Dart than I paid for the Ventura."

Croons an Illinois retiree: "We particularly

## Summary of Owners Reports on 1975 General Motors Compacts\*

	Chevrolet Nova	Oldsmobile Omega	Pontiac Ventura	Buick Apollo	Chevrolet Nova	Oldsmobile Omega	Pontiac Ventura	Buick Apollo
Total miles driven	318,454	362,752	339,278	262,729				
Average miles per gallon:								
250-cu. in. L6								
Local driving	15.0	14.8	14.8	—				
Long trips	18.9	17.8	18.8	—				
231-cu. in. V6								
Local driving	N.O.	N.O.	N.O.	16.6				
Long trips	N.O.	N.O.	N.O.	20.6				
260-cu. in. V8								
Local driving	N.O.	14.6	13.9	14.1				
Long trips	N.O.	17.6	17.9	16.7				
262-cu. in. V8								
Local driving	13.7	N.O.	N.O.	N.O.				
Long trips	17.6	N.O.	N.O.	N.O.				
350-cu. in. V8								
Local driving	13.4	13.9	13.3	13.3				
Long trips	16.8	17.9	16.1	17.1				
Engines:								
250-cu.-in. L6	40.7%	35.8%	29.8%	6.7%				
231-cu.-in. V6	N.O.	N.O.	N.O.	25.8				
260/262-cu.-in. V8	21.2	35.8	36.8	29.2				
350-cu.-in. V8	35.4	26.1	30.7	38.2				
Transmissions:								
Automatic	92.3%	95.7%	92.4%	97.8%				
Manual	7.7	4.3	7.6	2.2				
Body styles:								
Two-door coupe	43.2%	41.1%	58.0%	38.2%				
Four-door sedan	36.4	37.6	21.8	43.8				
Three-door hatchback	20.3	21.3	20.2	18.0				
Why did you choose this car?								
Economy	32.4%	24.0%	34.8%	42.6%				
Styling	19.6	25.6	30.4	—				
Size	18.6	28.1	23.9	33.8				
Past experience	16.7	13.2	12.0	13.2				
Price	—	15.7	16.3	—				
Specific likes:								
Handling	53.6%	53.9%	48.2%	48.8%				
Styling	30.0	35.2	42.7	33.3				
Ride	25.5	29.7	23.6	23.8				
Economy	18.2	18.0	20.0	20.2				
Comfort	16.4	28.9	18.2	34.5				
Size	10.9	—	—	—				
Specific dislikes:								
Poor gas mileage	22.0%	20.6%	21.3%	24.7%				
Sloppy workmanship	12.8	13.2	13.0	14.1				
Poorly planned seat belts	10.1	8.1	9.3	—				
Rattles	10.1	—	—	—				
Poor service	8.3	—	—	—				
Poor finish	—	—	8.3	—				
Tight legroom	—	8.1	—	—				
Poor-grade materials	—	8.1	—	—				
Cold starts	—	7.4	—	—				
What changes would you like?								
Better gas mileage	22.7%	9.1%	23.4%	16.7%				

\*Percentages might not equal 100% due to rounding or insufficient data. N.O.: Not offered. —Data not available or too small to tabulate.



love the appearance of our Ventura—red body with red-and-black upholstery.”

A Texas electronic tech isn't so taken. "I traded a 1967 Ford pickup with a worn-out engine. It got 13 mpg in town and 15 mpg on the road, which is exactly what my new Ventura gets. And to top it off, I now have to use unleaded gas at 2 cents more a gallon."

A retired foreman in Saginaw, Mich.: "I've bought four Pontiacs from this dealer, and he's always been fair. I find this Ventura better than my 1970 Le Mans and equal to my 1967 Tempest. What irks me is my older passengers have to climb over and under the shoulder harnesses—it's a nightmare. The front buckets are very comfortable, but people get cramps in the rear. **Handling** is terrific, and I consider the corduroy velour seats very comfortable, especially in winter. My biggest complaint so far is sluggish acceleration with the 260 V8. And gas mileage, at 13 mpg around town, is not good."

Now to Omega owners. From Nashua, N.H.: "As in all other Oldsmobiles I've owned, mechanical components seem to be above average and relatively trouble-free. For the do-it-yourselfer, most components are easily accessible for routine servicing. **Sulfur dioxide** from the exhaust does smell up the interior when idling in traffic—a price I imagine we all have to pay for catalytic converters."

A Georgia Air Force officer added, "When I first obtained my new Omega, I noticed that the steering felt like it over-responded. On narrow, two-lane highways, I tended to drift off the edge. I understand that radial tires might be the cause. This is the first car I've owned with radials."

A New Hampshire mechanical engineer said "I find the Omega overpriced at \$4578. I had to pay for an ignition interlock, which the factory installed at considerable cost and the dealer disconnected at an additional charge. I wish Nader and the Feds would get together so Detroit could stop adding this stuff and raising the price. The catalytic converter alone costs a fortune, and chances are

He shouldn't be so surprised. An in-line Six is inherently better balanced than a V8, so with today's lean fuel/air ratios, Sixes idle more smoothly.

Handling came in as top-rated "specific like." Ease of parking and maneuverability in traffic received praise aplenty.

He certainly makes an important point. Compare prices with BMW, Mercedes, Jaguar XJ and the Volvo 264.

One owner predicted there'd soon be a market for gas masks for drivers doing a lot of heavy-traffic commuting.

they'll rescind that one, too."

Turning to Apollo owners, a retiree from Hollywood, Fla.: "What I like best about my Apollo is the smoothness and silence of the motor. It's extremely quiet, indeed, considering it's a Six, not an Eight. Most V8s don't run so quietly as my Six. The one thing I dislike is that the engine is slow-starting, and it takes too long to warm up."

A Buffalo cereal company employee: "Workmanship is average—numerous small dents, water in left front blinker, radio can't define stations, rear courtesy light cracked, paint dull in spots, unpainted other places."

A hemodialysis specialist in Texas reports, "My Apollo is a common-sense car in that the Six offers gas economy, and my four-door is a lot roomier and less expensive than most imports of similar size. After shopping salesrooms of Audi, VW Dasher, Volvo, Datsun, Toyota and Ford, my Apollo spelled savings of \$400 to \$2600 for a car with equipment I wanted. The 1975 Apollo in Nov. 1974 was cheaper than any '74 imports I looked at. I'm very pleased and happy with this automobile and plan to keep it a very long time."

A draftsman from Queens: "Since GM has instituted a cash rebate policy, I feel I should receive at least \$100 back. I realize the rebates applied only to 1975 cars bought in February and March, but I bought my 1975 Apollo last October when sales were lousy. I didn't expect a rebate, but since they were handing them out in February and March, I think it only fair not to discriminate against buyers who stuck with Detroit through its hour of need."

Finally, from a Texas personnel officer: "Put me down as a very happy Apollo owner. The service I've gotten from Buick since 1968, when I bought my first Opel, was the major factor in returning for this larger car. And no matter where I go in the U.S., Buick dealers have always been very helpful, courteous and reasonable in costs. I'll buy another Buick when I need to replace either the Opel or this Apollo, but I hope that won't be for many, many years." ★ ★ ★

	Chevrolet Nova	Oldsmobile Omega	Pontiac Ventura	Buick Apollo
Revised seat belts	12.4	12.7	11.7	15.3
More legroom	8.2	10.0	—	16.7
Better workmanship	8.2	8.2	11.7	9.7
Better materials	7.2	—	—	—
More trunk/headroom	—	7.3	7.4	8.3
<b>Number of vehicles owned:</b>				
This car only	55.5%	52.5%	56.2%	45.1%
Two cars	35.3	34.8	36.4	38.5
Three cars	7.6	8.5	5.8	14.3
Four or more cars	1.7	4.2	1.6	2.2
<b>Other cars owned:</b>				
Chevrolet	42.3%	34.3%	17.3%	20.0%
Ford	9.6	7.5	11.5	—
Pontiac	—	—	25.0	—
Plymouth	—	11.9	—	—
Oldsmobile	—	32.8	—	8.0
Buick	—	—	—	24.0
Cadillac	—	—	9.6	—
Volkswagen	—	7.5	—	—
<b>Comfort opinion:</b>				
Good to excellent	54.5%	66.6%	59.3%	66.0%
Average to poor	39.3	33.0	33.1	34.0
<b>Workmanship opinion:</b>				
Good to excellent	39.8%	50.0%	54.2%	42.7%
Average to poor	60.2	50.0	45.9	54.4
<b>Dealer service opinion:</b>				
Good to excellent	30.4%	30.0%	—	—
Average to poor	69.5	70.0	—	—

	Chevrolet Nova	Oldsmobile Omega	Pontiac Ventura	Buick Apollo
<b>Had any mechanical trouble?</b>				
Yes	61.9%	46.0%	51.7%	41.1%
No	38.1	54.0	48.3	58.9
<b>Type of trouble:</b>				
Carburetor	24.7%	11.1%	6.6%	10.8%
Transmission	16.4	7.9	8.2	10.8
Cold starting	9.6	15.9	6.6	10.8
Electrical	—	—	18.0	—
Brakes	—	9.5	—	10.8
Dieseling	8.2	—	—	—
Speedometer and cable	—	—	8.2	13.5
Power steering leaks	—	7.9	—	—
<b>Did you repair it yourself?</b>				
No	98.6%	98.4%	98.3%	97.2%
Yes	1.4	1.6	1.7	2.8
<b>Dealer repairs satisfactory?</b>				
Yes	58.2%	59.6%	61.8%	65.5%
<b>Dealer repairs satisfactory?</b>				
No	41.8	40.4	38.2	34.5
<b>Age distribution of owners:</b>				
15-29 years	27.4%	26.9%	30.2%	12.9%
30-49 years	41.5	27.5	27.7	34.9
50-plus years	31.1	45.6	41.0	52.2
<b>Would you buy another?</b>				
Yes	62.4%	71.8%	73.0%	73.9%
No	37.6	28.2	27.0	26.1



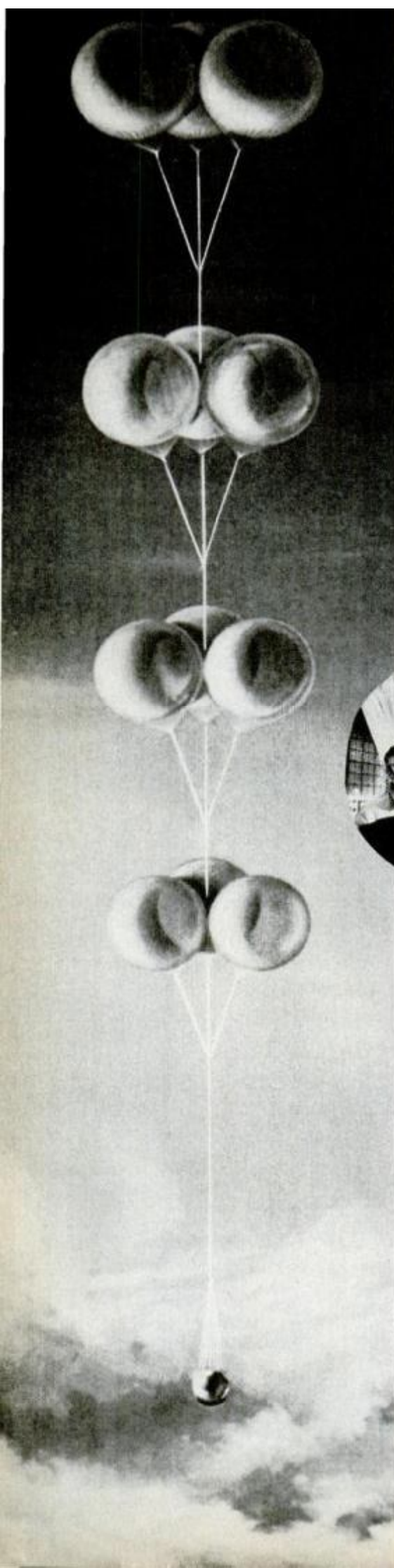

**Launch that failed:** Forbes (left, below) and Heinsheimer chat before their aborted attempt early this year. Artist concept of the *Windborne* depicts 60-story-tall cluster of balloons designed to carry them across the Atlantic.

**1975**



**1973**

**Aloft for 23 hours,** Bob Sparks in the *Yankee Zephyr* was forced down off Newfoundland by severe storm, later picked up by Canadian Coast Guard.

## Transatlantic balloon jinx Who'll be first to beat it?

In 100 years, there have been seven unsuccessful attempts and five deaths. Bob Sparks will make his second try this summer.

by Paul Wahl

**N**obody has ever crossed the Atlantic Ocean in a balloon, even though such a flight has been possible since the mid-19th century. Misfortune has befallen all who have tried. Thirteen balloons, at least,

have been prepared for the voyage, yet only seven have gotten off the ground on the actual flight.

Five aeronauts lost their lives in three of four such tries since 1970. Malcolm Brighton, Rod and Pam Anderson aboard *The Free Life*, Tom Gatch in *Light Heart*, disappeared without a trace. Bob Berger's *Spirit of Man* crashed shortly after lift-off when the balloon burst. Of this group Bob Sparks is the sole survivor.

Soon, on an early summer day, when the weather is fair and the breezes are right, Sparks will climb into the gondola of a huge red, white





No trace was ever found of *The Free Life* flown by Rod and Pam Anderson, Malcolm Brighton. After 30 hours, they radioed ditching in heavy rain off Newfoundland, were never heard from again.

## 1970

and blue balloon, with the name *Odyssey* on its rain skirt, and take off alone on the flight of his life—challenging the transatlantic balloon jinx again.

A native Virginian, Bob Sparks, at 39, is one of the world's top balloonists, having logged some 700 flights on hot air or gas. He barnstorms the country with the Lark balloon and is the man you see flying it in all those cigaret ads.

Pictured on this month's cover, the new *Odyssey*, aside from increased gas capacity, is essentially the same

as the 73,000-cubic-foot *Yankee Zephyr*, flown in Sparks's unsuccessful 1973 transatlantic attempt. Both were designed

by veteran balloon expert Mark Semich and built by Semco Balloon Inc., Griffin, Ga.

Ninety-two feet tall, almost as high as a 10-story building, the *Odyssey* is a constant-temperature helium balloon. Its 100,000-cubic-foot gas bag is a 58-foot-diameter, nylon globe retained inside a natural-shape envelope like that of a hot-air balloon.



**1873** First transatlantic attempt was made by Washington Donaldson, Alfred Ford and George Lunt in the balloon *Daily Graphic*. Taking off from Brooklyn, N.Y., they got only 60 miles away before being forced down in raging storm at New Canaan, Conn.

At the mouth of the outer envelope, a small propane gas burner heats the air inside as needed to maintain the helium at constant temperature and lift—that's important to long-distance flight.

Backing up the constant-temperature system is recoverable ballast, a 500-foot cable strung near the end with thirty 24 by 5½-inch sections of PVC pipe fitted with end caps. Should the balloon start to descend, the pilot can put this drag line on the water and, if necessary, keep going that way for many days. When ballast is required again, the drag



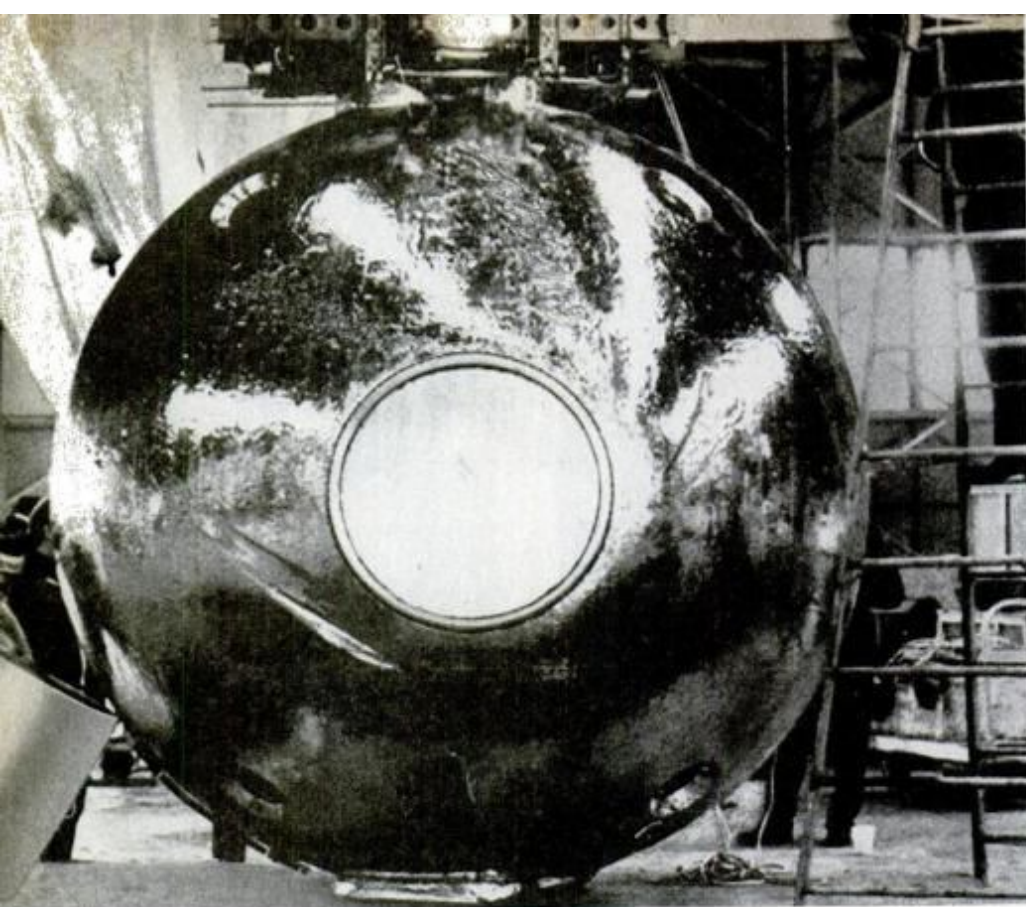

**1975** Slightly damaged gondola of Forbes' *Windborne*, salvaged after near-tragic launch failure, may fly again—but with new, less-complex balloon system.



**1958** Seaworthy gondola saved lives of *Small World* crew. After ditching in Atlantic, they sailed 1500 miles to safety at Barbados.

line in winched up to the gondola.

Attached to the rigging is the load ring from which the gondola is suspended by nylon webbing straps fitted with parachute-type Capewell disconnects for quick release in emergency. Previously used in the *Yankee Zephyr*, the gondola actually is a seaworthy boat, 14½ feet long, with a beam of 7 feet and a height of 3 feet. With a sea sled's inverted "V" hull, made of lightweight aluminum with foam flotation inside, the boat is self-righting and self-bailing. Aboard are mast and sail, in case the voyage should go from air to sea.

**1844**

Courtesy, American Antiquarian Society



### The Great Balloon Hoax

On Apr. 13, 1844, a jubilant *New York Sun* thought it had scooped its competitors with an "exclusive" story of a dramatic transatlantic balloon crossing plus an illustration. Irate *Sun* editors, checking, found the story an elaborate hoax contrived by that strange genius of American letters—Edgar Allen Poe.

For communications and navigation, the *Odyssey* will have advanced avionics equipment including radios, transponder, loran and emergency locator transmitter. It also will carry oxygen equipment for high-altitude flight, ample supplies for a long journey, and elaborate survival gear.

Sparks's departure will be timed to follow a westerly (eastward-moving) pressure cell to provide prevailing wind and to avoid rainstorms. Normal wind line due east from the Massachusetts launch site should deliver the *Odyssey* somewhere in



**1974** Second fatal attempt last year occurred Aug. 6 when Bob Berger's *Spirit of Man* plunged into Barnegat Bay, N.J., shortly after lifting off from Lakehurst, N.J. Apparently, the homebuilt balloon had burst.





**1973** "Hands off!" commands aeronaut Bob Sparks, and the ground crew releases his ill-fated balloon *Yankee Zephyr*. Undaunted by this 1973 experience, Sparks will try to cross the Atlantic in the *Odyssey* early this summer.

France—with the flight roughly following Lindbergh's transatlantic course. During the flight, altitudes as high as 15,000 to 20,000 feet will be reached. Speeds should average about 30 mph. The voyage of perhaps 3500 miles could be completed in less than a week.

Talk of flying across the Atlantic began soon after man's first free balloon flights in 1783 in France—although the longest of these covered only three miles. Writing to a friend in France, on Apr. 4, 1784, George Washington having read newspaper accounts of the new balloons, predicted: ". . . our friends at Paris, in a little time, will come flying thro' the air, instead of ploughing the ocean, to get to America."

As gas balloons were improved and pilots gained experience, longer flights became practicable.

Having observed strong westerly air currents at higher altitudes, balloonists became convinced that they could ride these winds across the ocean to Europe in a matter of a few days—and some wanted to try.

In 1836, Charles Green, England's leading aeronaut, was the first to announce the intention to make a transatlantic flight on the westerlies. Later, he displayed a model of the

"Atlantic Balloon" designed for his New York-to-London journey. Although Green's project never went beyond the planning stage, it may have inspired Edgar Allan Poe's famous "Balloon Hoax" of 1844.

John LaMountain's *Atlantic*, completed early in 1859, was the first balloon built for transatlantic flight. With a small lifeboat slung under the basket, it was 130 feet high, 60 feet in diameter, and held 60,000 cubic feet of gas. While it never attempted the voyage for which it was designed, the *Atlantic* did make two spectacular and historic flights.

On July 2, 1859, John Wise joined LaMountain, his backer O. A. Gager, and reporter William Hyde, aboard the *Atlantic* for a shakedown flight, St. Louis to New York, before the upcoming ocean crossing. The balloon took off, headed northeast, climbing as high as 10,000 feet, crossed Lakes Erie and Ontario, flew through a heavy storm, and crash-landed in woods near Henderson, N.Y., on the eastern shore of Lake Ontario. The *Atlantic* was badly damaged, but those aboard were unhurt.

*Scientific American*, on July 16, 1859, reported this flight lasted 19 hours and covered 1150 miles. The

*(Please turn to page 129)*

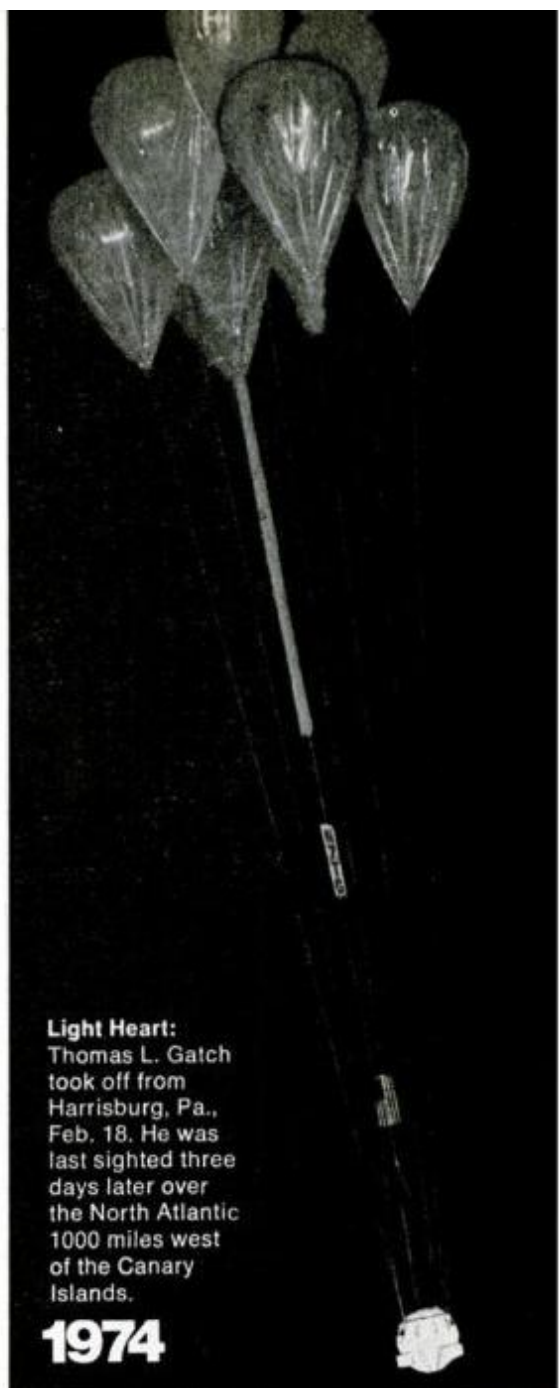

**Light Heart:** Thomas L. Gatch took off from Harrisburg, Pa., Feb. 18. He was last sighted three days later over the North Atlantic 1000 miles west of the Canary Islands.

**1974**







**Instead of trading,  
try replacing...**

# A new engine can save old Betsy

by Robert Lund

Would you put \$500 to \$700 in your old car to get another 125,000 to 150,000 miles out of it?

That's what it would cost to replace the engine.

You can put new life in an old car for a lot less than \$500. For something around \$200—less than that if you do the work yourself—you can buy new tires, a tune-up, have the brakes relined and take care of any minor mechanical repairs. But \$200 will buy only an additional 20,000 to 30,000 miles. A new engine will buy as many miles as you got out of the car when it was new.

A new engine is a pretty good buy when you look at prices of new cars. Any new car will set you back a minimum of \$3000. A replacement engine will give you as many miles of transportation as a new car for a fraction of the price of a new car.

But there's another side to the coin. If your car has reached an age where the engine is shot, the car is probably showing its age elsewhere. Body rust, for example. Even if you replace the engine, you will still need tires, maybe a brake job and a general fixing up. But these items are considered routine maintenance and you would have to pay for them, new engine or not.

New engine or new car?

If you add the price of a new engine to what you would receive for

your old car on a trade-in, you will probably have enough to make the down payment on a new car. You will still have to make payments for X number of months. As you build equity and the new car becomes an old car, you can trade in three or four years for another new car.

If you go for a new engine instead of a new car, the initial outlay will be much smaller, you won't be making payments for the next three years or longer and you should save on insurance premiums. On the minus side, an old car with a new engine won't bring much more than an old car with an old engine if you decide to trade in a few years. Used cars sell largely on appearance, not on mechanical condition.

But if you really like your present car and plan to keep it another four or five years, a new engine is a good investment.

There are several sources of supply for replacement engines. You can buy an original equipment engine—same everything as in a new car—from the auto companies. These engines are sold through automobile dealers. Detroit doesn't sell direct to individuals. You can also buy from the big mail-order houses, Sears and Wards, from jobbers who sell automotive parts, engine rebuilders and service outlets all of which specialize in replacement engines.

There are three types of replacement engines: factory originals, re-

## Engine swap at a pro shop . . . almost a day's job



It takes a professional almost a whole day to do the job. At the Michigan Motor Exchange, Vaughn Hayes shows how the engine is replaced in a '69 Skylark with 350 V8. Before chain is hooked to lifting rig on this engine (left), the following is done; Hood is removed, fan and radiator hoses removed, radiator removed (not necessary, but it gives you more room to work), alternator and air-conditioner removed, power steering disconnected. Throttle linkage and other connections are removed. The car is then raised for access to the underside: Transmission housing bolts are removed, starter and exhaust removed, torque converter and engine mount-





**Engine replacement** used to be a standard Rx for owners of tired cars. All the old-timers needed was a block and tackle and a big shade tree.

remanufactured and custom rebuilds.

Don't let the word remanufactured scare you and don't be misled by Detroit propaganda you may have heard about the dangers of using other than "genuine factory parts" in your car.

A remanufactured engine consists of a core that is put on a production line and rebuilt to original equipment specifications. The reputable remanufacturers are actually licensed by the car factories. That is, the car-makers tell the remanufacturers what they must do to bring the engines up to original equipment specs. All engines sold by mail-order houses are production-line rebuilds.

The third type of replacement engine is a custom rebuild. Replace-

ment is a misnomer because the engine isn't replaced. It's rebuilt. A mechanic pulls the original engine out of the car, rebuilds it, then puts the same engine back in. Most custom rebuilds are turned out by parts wholesalers and jobbers who operate rebuilding shops. There are some 6000 to 7000 custom rebuilders around the country.

If you want to do your own custom rebuilding, you can buy a kit with necessary parts from an auto-supply store or mail-order house.

The replacement engine business has a lingo of its own and it's important to know the language before you buy an engine or tackle the job yourself. If you don't know the language, you can be swindled or make trouble for yourself. Such as dismantling the engine—if you do the work yourself—and then discovering you don't have all the parts to complete the job.

There are different types of replacement engine packages within the three categories—original factory engine, remanufactured and custom rebuilt. The four basic packages are:

Package A, also known as a complete engine assembly. This is the best, most expensive, most complete replacement engine you can buy. You get about 250 new parts.

Package B, also known as a block assembly. You don't get as many parts as in an A package and some of the replacement parts are remanufactured, instead of new parts as in an A package. The block assembly does not include cylinder heads, rocker arms, oil pan or front cover, which are salvaged from the old engine.

Package C, also known as a short block, next step down from the B package. Fewer parts than in a B. The C deal does not include cylinder heads, oil pump, pick-up pipe, lifters, front cover, pulley or installation gaskets. Again, these parts are salvaged from the old engine and used on the replacement.

Package D, the rebuild-it-yourself

kit. Different kits contain different items. The Sears kit contains pistons, pins, rings, pin bushings, a reconditioned camshaft with bearings, oil pump, hydraulic or mechanical lifters, timing chain or camshaft gear and crankshaft gear, connecting-rod bearings and all seals and gaskets.

How do you decide among A, B, C and D?

One way is by price. A is the most expensive. B costs less than A. C costs less than B. D is rock bottom.

If you're considering a replacement engine, chances are you have taken care of your car. If that's the case you can rule out the A package. You don't need 250 new parts. Many of the original equipment parts are still usable. This narrows the choice to a B or C package if you are going to hire the work done.

Scott Connor, a consultant to the Automotive Parts and Accessories Assn., says replacement shops prefer to sell the bigger packages, the A or B, rather than the short block C. This isn't necessarily a case of oversell, of pushing more parts than the customer really needs, Scott explains. "The more precision work you take out of the hands of the mechanic, the less likelihood there is of making a mistake, of something going wrong."

Prices of replacement engines vary all over the lot, depending on the type of engine, what's included or left out of the package, the honesty/dishonesty and the competence/incompetence of the shop doing the work, make of car, whether the original engine was a Six or V8, the labor rate in your part of the country and a dozen other shakes of the dice.

Rule No. 1 in buying a replacement engine is to avoid the guy with the lowest price in town. Beware of the deal if you are quoted a price under \$300 including labor. The exception to this rule would be a custom rebuild done by an experienced mechanic with whom you have a personal relationship. He may be



ing bolts removed. The old engine is then lifted out. The new engine, shown at left, is prepared for installation. First, parts that can still be used are transferred from the old engine to the new one. Some of these include front cover, water pump, oil pump, oil pan, distributor, intake manifold, fuel pump, carb linkage, valve covers, flywheel. The new engine is lowered into place as shown at right. A jack under the transmission supports it during this step. When engine and transmission are lined up, the upper transmission bolt is connected. This is a key step. After the engine is positioned on its mounts, everything is reconnected.





able to do the job for less than \$300. The less you pay for a replacement engine, the more likely it is to blow up. Blowups are not uncommon on cheap jobs. It is almost impossible to get your money back on a blow-up, even if you hire a lawyer, because there are a hundred ways the shop can weasel out of responsibility.

The highest priced replacement engines are those sold by the auto companies through car dealers. Here are some typical prices for short block factory engines:

#### V8

American Motors	304 c.i.d.:	\$655.99
Chrysler	318 c.i.d.:	\$751.40
Ford	351 c.i.d.:	\$620.40
GM	350 c.i.d.:	\$586.30

#### Six

American Motors	232 c.i.d.:	\$547
Chrysler	225 c.i.d.:	\$329.37
Ford	250 c.i.d.:	\$503.90
GM	250 c.i.d.:	\$564.55

(Don't get sore at the dealer if he quotes prices higher than these. The auto companies are increasing prices of replacement parts, just as they have increased prices of cars, and the dealer may have had a price increase by the time you read this.)

Prices of replacement engines sold by car dealers are suggested list. Same as an automobile. This means the price is negotiable between dealer and customer. If a dealer is trying to increase his replacement parts business, he might be willing to shave something off list price.

Replacement engines sold by mail-order houses are cheaper than those sold by automakers. It isn't possible to draw a comparison between Detroit prices and mail-order prices for several reasons. The mail-order houses do not sell engines for cars made after 1973. Prices quoted in mail-order catalogs run about two years behind the current model year.

Mail-order houses list two different prices for every engine they sell: a complete price and then a second something-off the complete price, depending on what they can salvage from the old engine. Salvaged parts have to be returned to the mail-order house—at your expense. The parts are then put through a remanufacturing process and used on other engines.

To find out what a mail-order engine would cost, for your car, get the catalogs. They list complete engines, block assemblies, short blocks and rebuilding kits going back to 1942. Sears alone lists more than 250 engines in its current catalog.

Your next choice, if you don't want to buy an original factory engine or mail-order engine, is a parts

jobber, local rebuilding shop or an engine replacement shop. Prices of engines sold by these sources are generally on a par with each other.

One of the leading rebuilding/replacement shops in the Detroit area, Michigan Motor Exchange, charges \$335, plus labor for a 307-c.i.d. Chevrolet V8, and \$295, plus labor for a 250 c.i.d. Chevy Six. The labor rate for installing the Eight is about \$125 and around \$115 for the Six.

The labor rate is an important factor. Regardless of where you buy the engine, you will have to pay to have it installed if you don't do the work yourself. Labor rates vary around the country, from a low of \$8 an hour in some rural areas up to \$20 an hour in some cities.

An experienced engine man can pull an old engine out in an hour and a half to two hours and install the replacement in three to four hours. That's assuming the mechanic doesn't run into complications when he gets into the job—which can double these time allowances. The car manufacturers figure about seven hours of labor to pull

---

**If you like your present car and plan to keep it another four or five years, a new engine is a good investment.**

---

and replace a Six and around nine hours of labor on a V8.

Some shops offer one-day service. But that's pushing it. Most shops like to keep the car two to three days to cover themselves in the event they encounter problems or if they have to send out for parts.

As in any trade, there are bumbler and outright crooks selling replacement engines. Here are some of the shady tricks to watch for:

■ *The low-ball quote.* The shop quotes a bargain price on the engine to get your name on the dotted line. Then they drop the other shoe—the labor charge. "We can't give you an exact price on labor," the salesman fudges "because we won't know what we will get into until we tear out the old engine." This is a sucker deal. Don't sign.

■ *Low-ball quote No. 2.* The shop quotes a price for both engine and labor, but there's a footnote saying the price is based on the pull-out engine having a rebuildable core. If the core isn't salvageable, the replacement engine will cost more. Again, don't go for the deal. Demand a yes or no decision on the core before you sign up.

■ *Cheating on parts.* There are ump-

teen ways of cheating on parts, and the flim-flam is difficult to detect. Once the engine is in the car, the customer has no way of knowing what he got for his money short of tearing the job down and examining the individual pieces. Did the mechanic use new parts, used parts, remanufactured parts, parts pulled off a junked car, carry-over parts from the old engine and, if so, were the carry-overs trued up?

"Know what you're getting and get it in writing." That's the advice of all the experts—the Automotive Engine Builders Assn., Automotive Parts and Accessories Assn. and Assn. of Auto and Truck Recyclers.

"We spell everything out when we quote on a job," says Richard Kay, of Michigan Motor Exchange. Kay gives the customer a printed sheet listing the parts to be used and whether they are new or rebuilt.

Even the reputable shops that give written guarantees with their work usually break the guarantee down into two parts. The engine itself and materials used in it are guaranteed for 12 months or 12,000 miles. But the guarantee on labor is usually good for only 90 days or 4000 miles. The thinking on this is that if an engine is put together right, any problem that is the responsibility of the mechanic will show up within three months. After 90 days or 4000 miles, an engine can develop problems through normal wear and use; the mechanic should not be blamed for difficulties resulting from wear.

Suppose you have a car you really like and it's in good shape except for the engine. The engine is one of those gas-guzzling V8s Detroit turned out by the millions before the fuel shortage. Can you replace the gas hog with a small Six?

The answer is yes. But a qualified yes.

To pull a V8 and replace it with a Six, you're talking big money. Not less than \$1000 and possibly \$1200 to \$1300. Many engine-related parts on an Eight can't be adapted to a Six. Although the original equipment fittings and parts may have thousands of miles left on them, they can't be connected up to a Six. They have to be scrapped for new hardware that can be mated with a Six, and that runs up the price.

If what you want out of a car is transportation, miles of use, and if you don't mind being a few years out of step on styling, a replacement engine is a good way to go. New car or replacement engine, you are buying about 150,000 miles of there-and-back. You get a lot more miles for the buck with a new engine than with a new car. ★★





# Aquapolis: City in the sea

by Bob Berger

**Massive Aquapolis**, shown under construction in Hiroshima, provides ample room for 2400 visitors and a crew of 195. Its cost will top \$35 million.

That iron monster of the sea, the semisubmersible drilling rig, has come into its own as the search for offshore oil intensifies in many corners of the world. A number of nations build the huge platforms, but Japan is the first to use the basic design to create something that is completely different—a floating tourist attraction.

Called "Aquapolis," the semisubmersible will be the Japanese government's star attraction at International Ocean Expo '75, an exhibition devoted to increasing our awareness of the ocean's importance to life. Japanese officials regard Aquapolis as a prototype of the self-contained marine community of the future.

Site of the exposition will be the island of Okinawa, a subtropical spit of land familiar to some veterans of World War II. Expo will run from July, 1975, to January, 1976.

Like its drilling-rig cousins, Aquap-

opolis is big. It displaces 28,000 tons and its upper deck contains over 100,000 square feet of space—room enough for a heliport, and trees and park benches for the weary of foot. The main deck contains the central hall, reputedly the largest single room ever to put to sea.

Visitors ride escalators through some exhibits. One feature of the "sea forest" display is a tank holding billions of one-celled organisms called chlorella, which give off a green glow. They also have the peculiar ability to manufacture fresh water, a talent used as part of the project's life-support system.

At this writing, finishing touches are being put on Aquapolis at a Hiroshima shipyard. From there, it will be towed some 600 miles south to Okinawa and moored off the Motobu Peninsula. A bridge will link the floating island with the onshore segments of Expo '75. ★★★



**Huge ballasted hulls**, which may ride some 60 feet under water, provide great stability for the structure. Artist's concept shows how Aquapolis will be moored off one of Okinawa's beaches.



# Now it's easy to make color prints at home

by Bob Nadler

Color printing today is not only quicker and easier than it used to be, but often even easier than black-and-white. Today, it can take as little as six to 10 minutes to process a batch of color prints—in full room light, and without getting your hands wet.

But just a few years ago, to make a Kodak color print you'd have had to spend half an hour agitating the print in trays (nine of those minutes in nearly total darkness—color-printing safelights are very, very dim), while trying to keep the temperature within half a degree of 85°

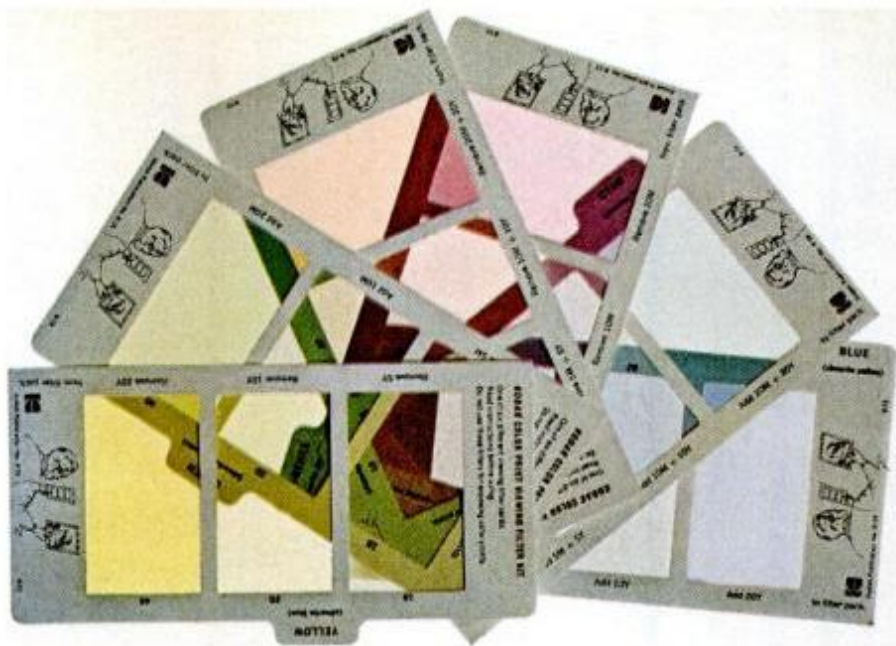

Viewing filters help you analyze printing goofs, find correct filtration. This Kodak set is \$7.

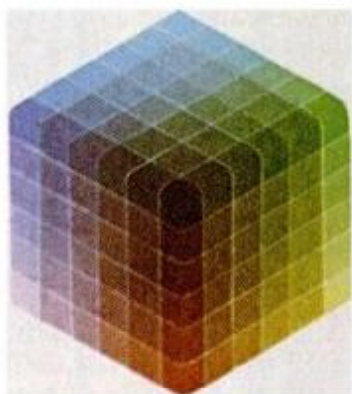
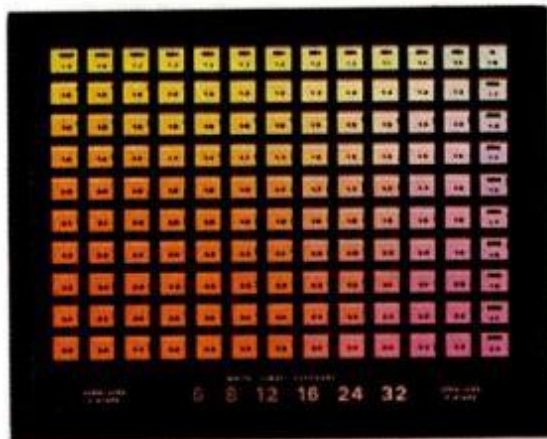
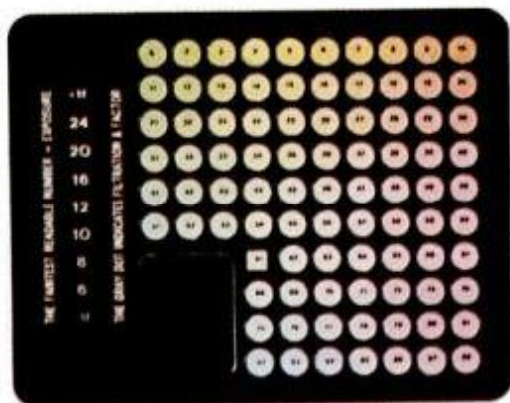

Calculators can show filtration, exposure, with one test print—for "average" negatives: Just find the gray square on the print at right and note that colors of calculator above it are reversed. Omega calculator (top) costs \$20; Beseler (shown above) is \$25, while Unicolor Unicube (above, right) is \$18.

Contact sheets indicate relative exposure and the filtration needs of all negatives on a roll.





F. (29½° C.). You could cut that time to only seven minutes (and only 2½ minutes in the dim or dark) by investing \$200 in Kodak's drum processor—but then you'd have had to hold an even higher temperature of 100° F. (38° C.) to the same half-degree accuracy.

Even after you'd finished processing your print, you still couldn't judge its color till it was dry—a problem now eased by quick-drying "RC" resin-coated papers. True, there was a paper, Agfa's, whose color could be judged when wet; but in my experience it was almost impossible to find. Today, there are several such "Type B" papers.

Since then, several new names have entered the home color darkroom field, with the result that you can now make prints in less time, at lower and less scrupulously maintained temperatures, using less chemicals and spending less on equipment than ever before—and still get better results with fewer test prints.

Perhaps the most significant of these new advances was one of the simplest: the plastic drum. It's little more than an opaque plastic tube a few inches in diameter and a bit longer than the largest sheet of paper it's designed to hold, with light-tight caps at both ends. At least one of those end caps is usually removable so a sheet of paper can be loaded into the drum, emulsion-side in. In one or both caps is a light-trapped spout so chemicals can be poured in and out.

So now all you have to do in darkness (or in the gloom of a safelight) is to remove your color paper from the box, put it in your easel, expose it under your enlarger and put it into the drum. After recapping the drum, the lights go on and you begin to process.

These drums may resemble film tanks, but they're used quite differently. Instead of filling them with chemicals and standing them on end, you pour in just a few ounces of solution, lay the drum on its side and roll it, either by hand or with a motorized agitator (one, the new Paterson, uses a crank) so that the tiny puddle of chemicals within the drum passes over and over every square inch of the paper. After each step, you simply pour out the solution, and you're ready for the next step.

The introduction of the daylight color print processing drum has almost eliminated time spent in the

dark; has helped prevent some dark-room accidents and has much reduced darkroom boredom. Because the drum uses only small quantities of chemicals, these can be discarded after use, allowing the use of fresh chemicals each time, with a resulting increase in print-to-print consistency. The drum, along with other advances in chemicals and papers, makes it possible to get a wet, but evaluable, print in just a few minutes without a real darkroom or even running water. All you need now is a dark closet for your enlarger.

But intimidating as the wet side of color printing was reputed to be, the dry side was thought even more mysterious and demanding. For years, would-be color printers have quaked in their boots at the thought of juggling colored plastic filters to get a filter pack that would produce something called a "balanced" print without the help of an electronic device called a "color analyzer," costing between \$100 and \$500. Actually, it doesn't take expensive equipment, just patience and a bit of intelligence.

To begin with, only three colors of filters are in common use, and you never use more than two at a time. Using all three adds no color to the filter pack, just a neutral density (gray) which lengthens the exposure time. These days, there are plenty of sources of clear and simple information on how to regulate the filter pack, and some positive-to-positive processes now used seldom require much pack manipulation at all, after a base pack has been determined.

Still, determining a base pack can take a lot of time using trial-and-error methods. But there are several devices to help you determine which filter pack will print which negative. The most useful, to my mind, are the inexpensive subtractive color calculators marketed by Unicolor, Beseler, Simmard and Omega—Unicolor's Unicube being perhaps the best known. To use them, you put the negative in the enlarger, slip a diffuser under your enlarger lens to homogenize all the colors together, "contact print" the calculator in the resulting scrambled light and develop. Then (following instructions which range from simple to incredibly complicated, depending on the manufacturer), you decipher the dried resulting print which is a pattern of many-colored dots to get close to the right filter pack (or close to the almost-right one, if you're really critical about your results).

Cheap to buy, calculators can be expensive to use, since they require that you make a test print for each negative you wish to find a pack for

(a series of shots on the same roll made under the same lighting conditions may require no change of pack, though).

Calculators are designed to work with "average" negatives. Unfortunately, I seldom see an "average" negative, though manufacturers claim 85 percent of all negatives fall into that category; maybe their definition of "average" is a lot broader than mine. Negatives that are a little off the average will give results a little off (perhaps acceptably so, depending on subject matter and your standards); negatives that are a lot off (warm-toned sunset shots, seascapes with a lot of blue, or any other shots with one predominant color) will give way-out results—for which returning to a normal negative filter pack will usually get you closer to the right color rendition.

Electronic analyzers, though expensive, may save money in the long run if you do a lot of printing, since they read the enlarger's light directly, without test prints. But they must be laboriously calibrated for each new package of printing paper, as well as for several additional factors. The most limited of them work

*(Please turn to page 120)*

**Drum processors** save time and chemicals, and let you process in full room light.





# How to create the illusion of a sunken tub

Tubs set in islands of shag carpet or slat-covered platforms add a bold new look to the modern bath.

by Wayne C. Leckey  
HOME AND SHOP EDITOR

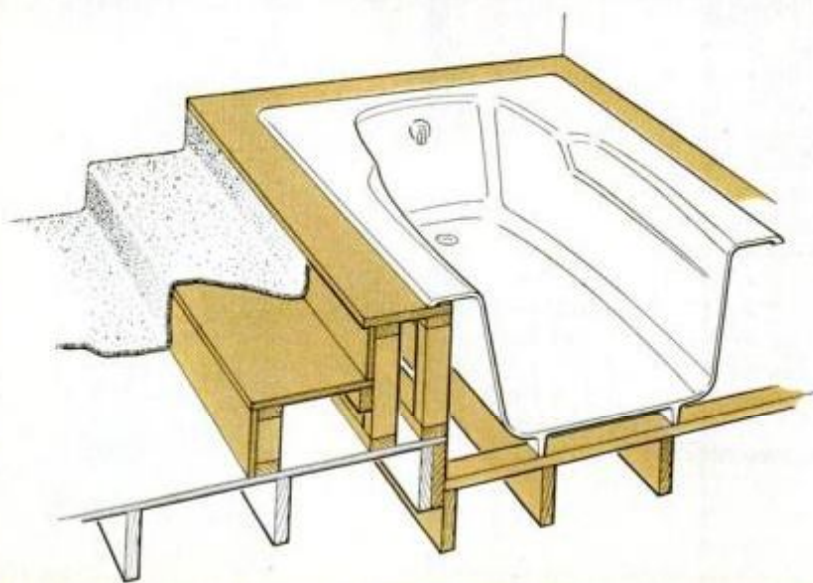

When modernizing a bathroom, you probably think you're limited to replacing old fixtures with new ones and possibly adding tile or carpeting. You're stuck with the original layout, and your new fixtures have to stay in the same old spots.

But when an adjoining room makes it possible to move a wall back a few feet, no longer are you limited to a 5 x 7-ft. floor plan. With an enlarged area, you can start thinking "sunken tub"—the latest innovation in modern bathroom planning.





A true sunken tub, of course, requires extensive structural modifications. A raised platform, however, can actually create the illusion of a sunken tub that's just as dramatic and attractive as a real one. The examples here by Kohler Co. show how a rim tub can be set in a wood-framed platform surrounded by steps and covered with shag carpet. In one (left), a 20-in.-high tub is in a well a little below floor level; in the other (above), a 14-in.-high apron tub sits on the floor and wood-slatted, split-level platforms are built around it. ★★

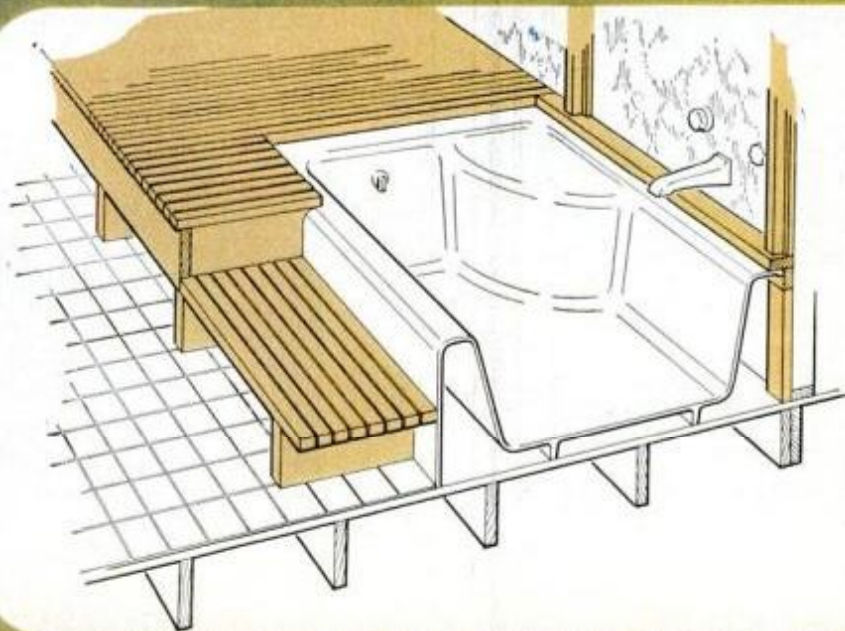



# IT'S NEW NOW

## Father-son toolbox you can build from plans

An ideal father-son project is this classic-styled, junior-size toolbox you can make from plans for a budding young carpenter. Plans and matching father-son carpenter aprons in blue denim are \$5.95 postpaid. Plans alone, \$1.15 postpaid. Popular Mechanics, Just Like Dad's Offer, 224 West 57th St., New York, N.Y. 10019.



## Kit-built trike: Added power, easier ride

New beefed-up Heald three-wheeler ATV has 10-hp, four-cycle engine, full suspension and large 12 by 21-inch tires. Super Tryke comes in semikit form, can be made street-legal with lights and other accessories. Base price with electric start is \$539.95. Heald, Inc., Box 1148, Benton Harbor, Mich. 49022.



## 'Convertible' biplane—open or closed

Builders of this sporty Wichawk biplane will be glad to know there's now a bubble canopy available to fit its open two-place cockpit (see *Tough Little Biplane Built for Two*, page 74, June '74). Adding or removing the canopy takes only minutes so you can enjoy your flying enclosed or exposed. For more about plans and other prefab parts, write Javelin Aircraft Co., 9175 East Douglas, Wichita, Kans. 67207.

## Damageproof plastic doors

The young lady below isn't really trying to kick the door down—just demonstrating the chip and dentproof qualities of new louvered bifold doors of tough plastic. Unlike wood, they won't warp, shrink, crack or rot. Designed to circulate air in clothes, linen, utility closets, hinged panels 12, 15 and 18 inches wide come from Como Plastics, Inc., subsidiary of PPG Industries, One Gateway Center, Pittsburgh, Pa. 15222.



## One-touch-control camp lantern

Latest Coleman camp lantern features double mantle for increased brightness, a single control knob for "light," "on" and "off" functions and a decorative ring of frosted bars around the globe to diffuse and soften illumination. The new Model 275-710 holds two pints, operates on white gasoline or special lantern fuels. Coleman Co., 250 North St. Francis St., Wichita, Kans. 67201.



# THE LATEST PRODUCTS AND DEVELOPMENTS



## TV camera goes tubeless

This TV camera has no camera tube—or any others. Instead, it uses the tiny light-sensitive, charge-coupled device shown in the model's hand. With 163,840 sensing elements, it's as sharp as some conventional TV cameras, and more than 100 times as sharp as RCA's 1972 prototype (page 102, Aug. '72). It's small, light, reliable and uses little power. Eventually, it will be economical, too—but for now, it's \$3000 to \$3800.



## Boxless 'miterbox'

Stanley's new saw angle guide for straight or miter cuts positions any-size saw at angles of 45°, 60°, 75° and 90°. The tool assembles with a bolt and wingnut for left or right-handed cuts, weighs one pound, fits compactly in a toolbox. Suggested price, \$6.10. The Stanley Works, 195 Lake St., New Britain, Conn. 06050.

## School keeps its cool—with heat from the sun

A lot is being done with solar heating these days, but this solar-cooled school in Timonium, Md., is said to be the first to use sun energy for airconditioning as well. Solar roof collectors feed heated water to an absorption-type airconditioner, which then by means of an energy-exchange process circulates chilled water through the building for cooling on hot days. AAI Corp. developed the system in conjunction with the York Div. of Borg-Warner.

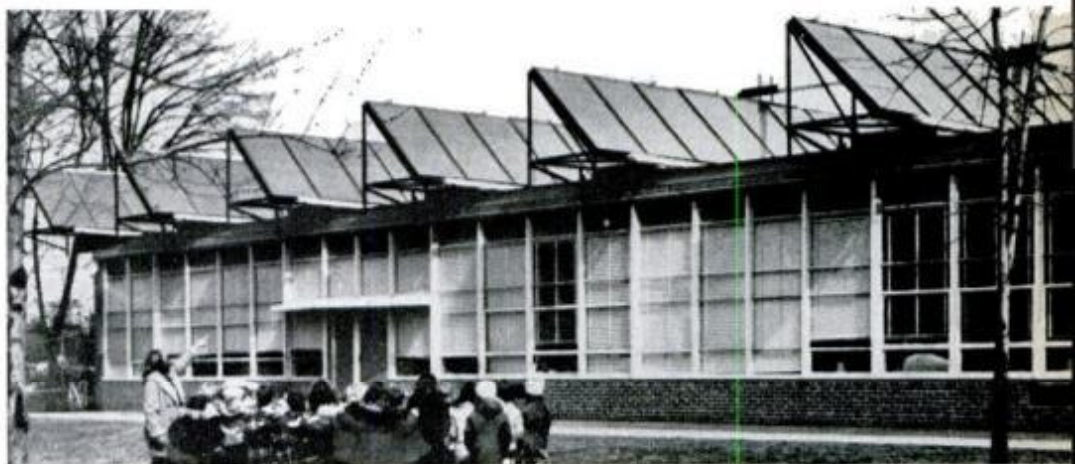

## Bird feeder comes in a kit

This plastic kit makes an attractive, put-it-together-yourself bird feeder that can be suspended from overhead or mounted on a pole. Its molded parts snap quickly together, and four screws complete the assembly. The feeder measures about 7 inches square and just over 4 inches high. A transparent front panel retains the seed, while a slot at the bottom releases it gradually as it's used. Lindberg Line kit, No. 323, is \$4.55 postpaid from Stock Sales Co., Box 606, Mineola, N.Y. 11501.

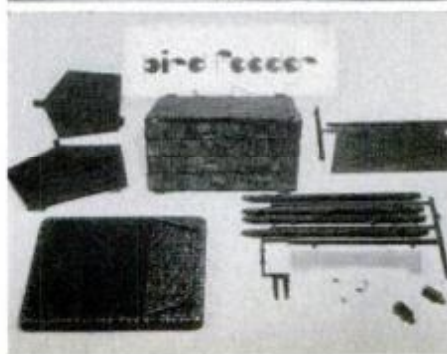
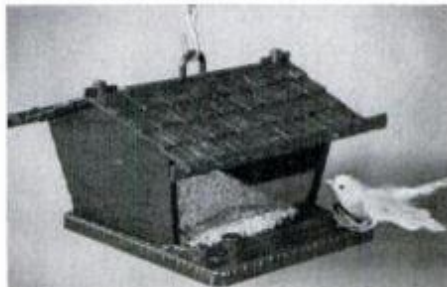

## Portable plug-in sauna bath

You can take this portable one-man (or one-woman) sauna anywhere, plug it into a wall outlet and enjoy a refreshing sauna bath, complete with real steam and a cold shower to end up with. All you do is fill it with 1½ gallons of water; a built-in heater produces steam. After a preselected period, on comes the shower automatically. Developed in England, it's not yet on the market.



**NOW**



**Mobile yard sprayer rolls to work**

This mobile garden sprayer shoots a stream 30 feet high, can be towed by a lawn tractor for easy reaching of all yard areas. Powered by a 3-hp engine, its pump has an adjustable setting for varying pressure up to 300 p.s.i. to give a gentle spray for delicate plants or a powerful one for tall trees. Mighty Mac comes in 22 and 50-gallon tank sizes. Amerind-MacKissic, Inc., Box 111, Parker Ford, Pa. 19457.



**Mini greenhouse gives garden a head start**

This "garden starter" lets you begin growing flowers and vegetables up to two months ahead of normal planting time. Plastic-covered 36 by 52-inch Growing Dome assembles in minutes, is \$34.99. Arrow Group Industries, 100 Alexander Ave., Pompton Plains, N.J. 07444.

**Modern architecture? No, modern hi-fi**

The flat box below is Lecson's \$535 stereo preamplifier, with swank color-coded controls. Ribbed column is a \$565 100-watt-per-channel stereo amplifier. Audiophile Imports, 8 East Erie St., Chicago, Ill. 60611.



**Collector's series chess set**

The figures of this handsome chess set have been fashioned after the classic sculpture representative of the Roman Empire. Cast figures of set No. 135 (king 4 7/8 in. high) are heavily weighted, felted, finished in antique gold and silver, come in imitation leather chest. \$45 post-paid, Armor Co., Box 290, Deer Park, N.Y. 11729.

**Tables combine country look and chrome**

Accent tables in "country modern" style feature natural look with tops that simulate random planking, but are highly resistant to alcohol and stains. In either pine or white color, they have chrome-finished legs. Tables are \$24.95 and \$39.99, matching battery clock is \$39.95; at furniture, department and gift stores. Burwood Products Co., Traverse City, Mich. 49684.







### 'Talking book' tells stories

Young children no longer must look at picture books and just guess at what's going on. With this "talking book" invented in Germany, they actually hear a story being told as they follow the pictures. Attached to each page is a record over which is placed a player (far left). Instead of the record turning, a pickup stylus in the player revolves to follow the grooves and reproduce spoken words. Text-Ton GmbH, Box 240, 8052 Moosburg, Germany, is the maker.



### New features improve FM listening, taping

For taping off the air, Pioneer's new TX-9500 AM/FM tuner (upper unit above) has a front-panel output level control and a built-in oscillator that provides a test signal for setting recording levels before a program starts. It's priced at \$400. The major feature of Kenonic's Accuphase T-101 FM tuner (lower unit) is an IF section whose bandwidth can be changed from wide (for lowest-distortion reception) to narrow (to eliminate noise and interference). The \$450 tuner also has a separate meter for multipath interference, plus signal-strength and center-of-channel tuning meters. Like the Pioneer, it has a front-panel level control, and both tuners have phase-locked-loop multiplex sections, extra-long tuning dials, buffered tuning oscillators for greater stability, as well as multiplex filter switches.

### Advent's expensive radio is cheap hi-fi

Advent's new Model 400 FM radio costs \$125. But it picks up stations as well as component tuners do, has true high-fidelity (if monophonic) sound, with bass and treble controls and a speaker you can place wherever it sounds best.

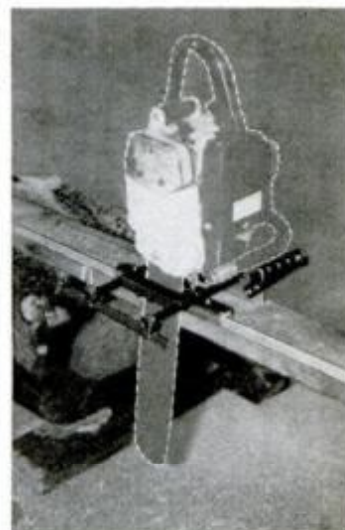

### Attachment turns chain saw into lumber mill

Mini-Mill is a simple clamp-on chain-saw accessory that makes it easy to mill accurately sized lumber from logs, its maker claims. Cuts boards to any thickness from 1/2 in. to 3 1/2 in. \$49.50, at hardware, garden-supply stores or postpaid from manufacturer, Granberg Industries, 200 South Garrard Blvd., Richmond, Calif. 94804.

### Slip-on wheels roll your boat to water

Launching a small sailboat is an easy one-man job with these hook-on wheels. The wheels fit Sailfish-type craft and are quickly attached and removed using existing rudder fittings. Models are available for Sunfish, Minifish, Sailfish, Flite 12, Windflite 14, Butterfly, Laser and Force 5. \$24.95 postpaid, Midwest Aquatics, 6800 Telegraph, Birmingham, Mich. 48010.





# NOW



## It may look funny, but it's no laughing matter

Slow-moving highway-maintenance crews in Michigan take no chances of being hit by unwary speeding motorists. The last truck in each convoy trails a "crash cushion" of 34 steel barrels to absorb the impact of any rear-end collision, thus protecting both workmen and drivers alike.

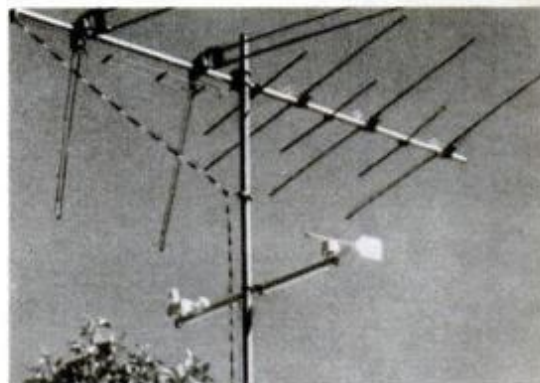
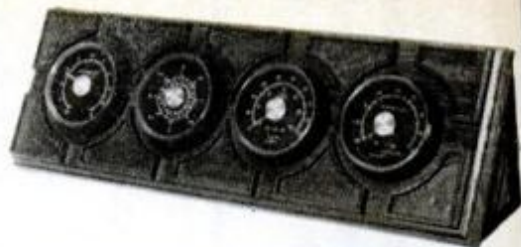

## Rooftop reports from weather kit

Want to know wind speed and direction, humidity and indoor and outdoor temperatures—not at some far-away weather bureau but right at your own house? Build this Heathkit home weather station. mount its weather sensors on your TV antenna mast, and you can read it all on four dials. Removable ends let dials sit upright (top) or mount flat on a wall for vertical or horizontal hanging. Kit is \$90, plus cables. Heath Co., Benton Harbor, Mich. 49022.



## Easy oil changer for your car

Your own engine helps you change oil in this quick, no-mess system for draining out old oil. You simply attach a drain hose to the oil-filter port, then run the engine to pump used, dirty oil into a disposable plastic bag. Kit of parts for \$9.95 fits all American-made car and boat engines with spin-on-type oil filters. (Late-model Chevy V8s from '68 on require extra adapter for \$2.95.) Goodrich Co., 9641 Garfield Ave. South, Bloomington, Minn. 55420.

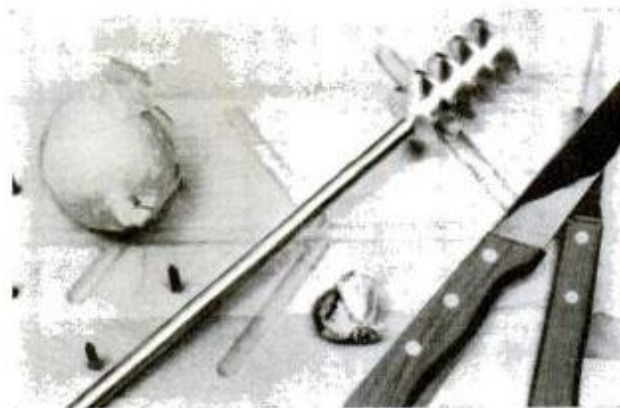

## Super cooking

Super Skewer (the finned spike at left) is said to reduce cooking time of roasts up to 50 percent and meat shrinkage up to 40 percent by conducting heat directly to the center of the meat. The hollow, wick-filled tube contains a self-circulating heat-transfer liquid that works on a evaporation-condensation cycle. \$9.95 post-paid from Isothermics, Inc., Box 86, Augusta, N. J. 07822.



## Add-on steps for your boat

These bolt-on aluminum transom platforms give you a handy place to stand when working on an outboard motor or stern drive, also serve as steps for swimmers, skiers and divers. Adjustable, they mount level regardless of transom angle. \$59 each, Bay Pattern Works, Box 1250, Milan, Ohio 44846.

## Cable lock also triggers alarm

This antitheft device for motorcycles, snowmobiles and trailers combines locking cable, audible alarm and license-plate holder into one handy accessory. The alarm sounds if the cable is cut or the vehicle is subjected to any sudden impact. Dualock is made by Ryco, 2010 Hartog Drive, San Jose, Calif. 95131.



## Fast meals for trees

Made of compacted 16-8-8 analysis fertilizer, these tree food spikes are simply driven into the ground around a tree trunk and are said to be highly effective in delivering fertilizer to roots. Box of five spikes fertilizes a 20-foot tree for a full season, sells for \$2.95. Jobe's Tree Food Spikes, 462 East High St., Lexington, Ky. 40508.





### Can a good little \$125 calculator beat a \$395 one?

Remember the first pocket scientific calculator? When Hewlett-Packard introduced it three years ago at \$395, it was a sensation. Here's a \$125 Hewlett-Packard model that does everything the old one did, plus converting rectangular to polar coordinates and doing trigonometric functions in radians as well as degrees. The new model is smaller and lighter, too. Operating time on rechargeable batteries is three to five hours (recharging takes six hours); you can carry a spare battery.

### Infinitely adjustable socket

Adjustable socket (below) replaces several socket sets, since it lets you dial any size—including metric—from  $\frac{1}{8}$  to  $1\frac{1}{2}$  inches. Fits any socket wrench. \$25.95 postpaid from Schlesinger's for Tools, Ltd., 1261 Utica Ave., Brooklyn, N.Y. 11203.

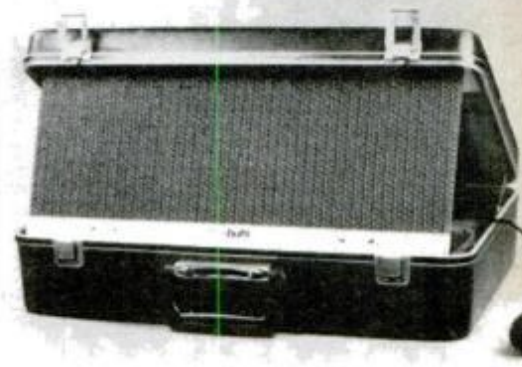
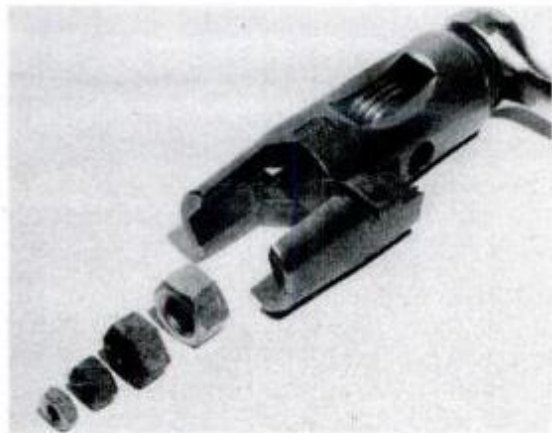

### Portable slide-sound and PA systems fold to briefcase size

The names are on the cute side, but the features are even cuter in these two portable fold-up show systems from Buhl. Viewa-buhl (left, above) holds a Carousel slide projector, cassette tape recorder and Programma-buhl slide-tape synchronizer for putting on slide-sound shows on a built-in rear-projection screen. About \$280. Audi-buhl (right) is a public-address system with built-in speaker and amplifier that folds into an attache case, leaving room for speech notes. About \$150. Buhl, 60 Spruce St., Paterson, N.J. 07501.



### Tapeless tape measure

Just sight through this optical "tape measure" and you can tell how far away anything is to 100 feet. Working on the same principle as a camera rangefinder, it has a dial you turn until two images merge, then distance shows up on a scale. \$24 postpaid. The Gallery, Amsterdam, N.Y. 12010.

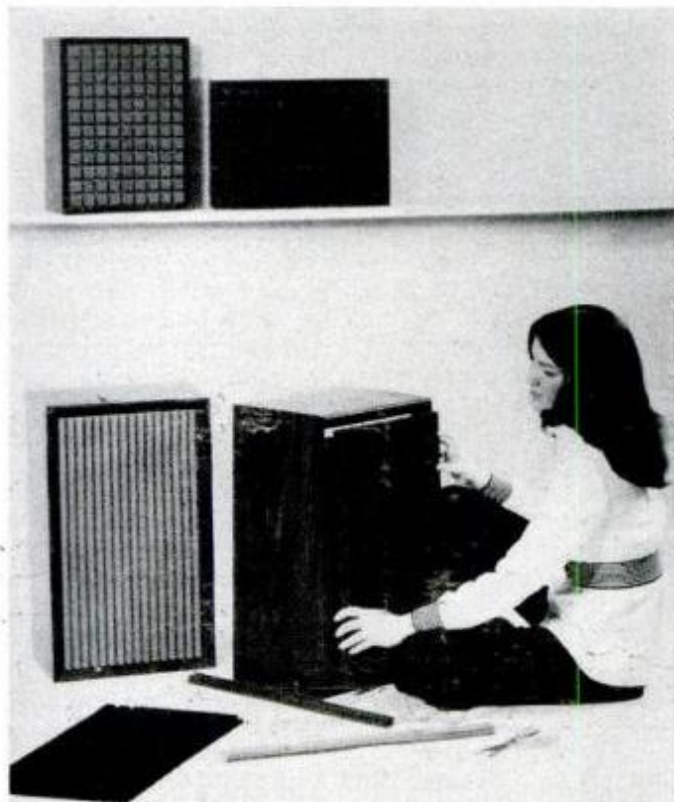

### Sculptured speaker grilles improve looks, sound

Now your old speakers can sport those fancy, sculptured-foam grilles found on many of today's new models. Though thick, the foam restricts high frequencies even less than cloth grilles. Available in 8 by 15 and 14 by 24 inches, the grilles are easily trimmed to size and attached. Republic Systems Corp., 9160 South Green St., Chicago, Ill. 60620.

Copyright © 1978 by авторским правом



# Mobiles, modulars: Two ways to low-cost housing

## 1. The case for the modular home

Factory-built, it may be better made than an on-site construction job—and save you money as well. But there are pitfalls. Here's what you should know to shop wisely.

by David Lampe

In this time of soaring and uncertain housing costs, a house built on a factory production line may be just about your best dollar-for-dollar new home buy. This prebuilt house may arrive at your site on a truck, or it may have its own wheels and be a trailer. In the former case, it's called a modular home; in the latter, a mobile home.

While it's not possible to compare the two directly because they represent basically different concepts, it is possible to make a case for each. Both offer a way to help beat the high cost of housing, have certain advantages and disadvantages, and are sold through more or less the same kinds of dealers—some reputable, some not so reputable—so it's important to know exactly what you're getting into before considering the purchase of either type.

For this reason, PM presents here a detailed look at the modular and mobile home in two companion articles. On these pages, we'll discuss the modular home and its special peculiarities. On the following pages, we'll take up the mobile.

Of the two, the mobile is the considerably cheaper way to go, but, being a trailer, is subject to legal restrictions—you can't just park it anywhere you want. Most building codes and zoning laws prohibit its use on private residential property and restrict it to legally established "trailer parks." This is not necessarily a serious drawback—just a fact of life to be faced.

The big advantage of modular homes, also called sectionals, is that, once completed, they are virtually indistinguishable from a conventionally built home and are accepted in most communities provided their

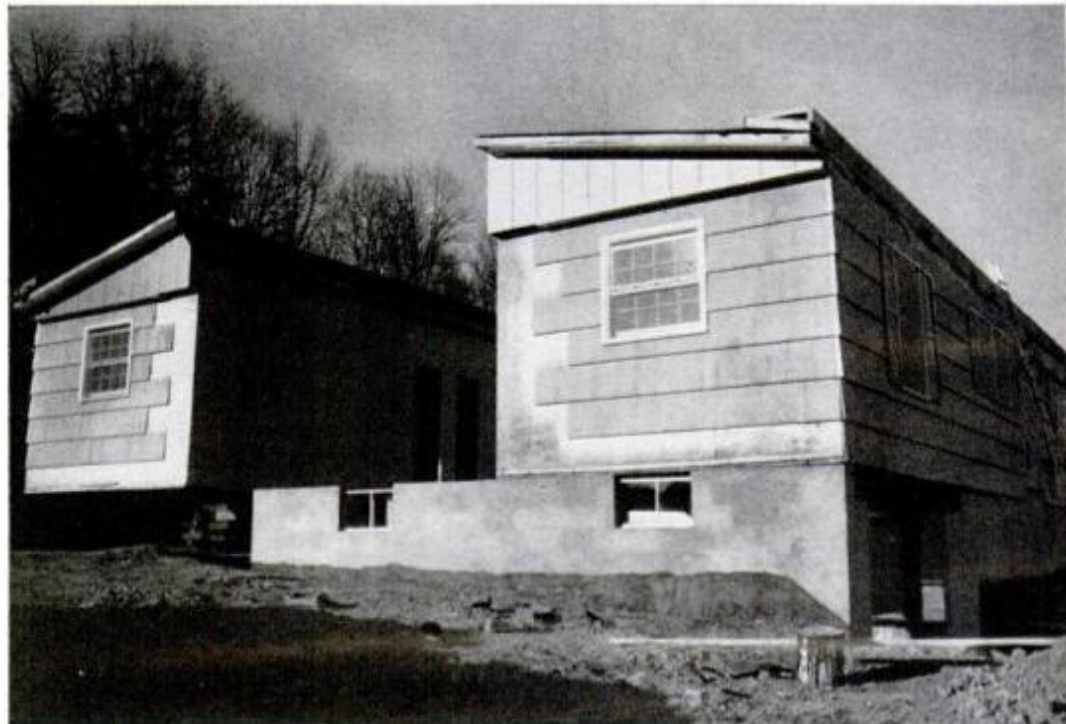

specifications meet local building standards. They may even be better constructed than a site-built house because they're made under controlled conditions. What's more, cost savings based on a comparable site-built house—a three-bedroom ranch, say—can run as high as \$10,000.

Your modular home will probably be delivered in two halves after, of course, a suitable foundation is prepared first. The halves, carried on long flatbed trailer trucks, will then be spliced together on the foundation, built-in wiring and plumbing will be hooked up, and your new "instant home" will be ready for occupancy. If you're lucky, you may even be able to move in the same day.

But like all "almost-too-good-to-be-true" pitches, there are a lot of curves involved.

### ■ On the plus side:

You save money and get a house that was built truer because it was made on uniform factory jigs by production-line workers skilled in the tasks they perform. It was made indoors out of dry lumber and usually is shipped wrapped in plastic, so it will probably warp, crack and shrink less than a site-built house.

Most modulars are built to comply

"Instant house" arrives in two halves, each on a truck, can be pieced together and made livable in as little as a day.

with one or more industrywide building codes, meaning you are assured of certain basic construction standards. Thus, you may find mortgage money a bit easier to track down; bankers don't like surprises, and with a modular they at least have some idea of what they are being asked to back.

You can—in many instances—"customize" your modular. When placing your order, you can specify the relocation or elimination of room-dividing walls, say, or the addition or elimination of windows, or provision for a future fireplace. Usually, if you provide them, you can have such things as your choice of carpeting and wall covering installed at the factory.

Once your modular is lived in and your site landscaped and "aged," Sherlock Holmes would have a tough time distinguishing between it and an individually built house, a comforting thought should you ever want to sell.

### ■ On the minus side:

Like an assortment of chocolates,

(Please turn to page 132)

Материал, защищенный авторским правом



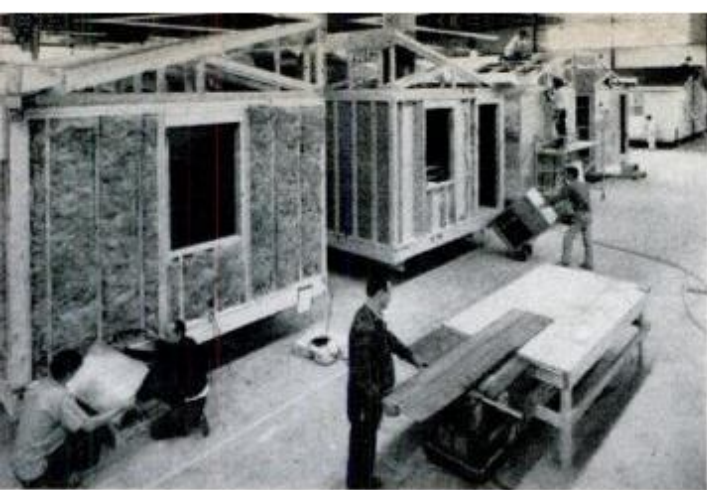

Made on precise jigs in dry, controlled facilities, factory-built home may be better constructed than many site-built houses.



Appearances can be deceiving as here. If you hadn't seen them being built, you'd be hard-pressed to tell if these two homes were trucked in or erected on the spot. Actually, both are modulars, proving such homes can look just as normal and attractive as any conventional house.

TYPICAL SIDE-BY-SIDE ARRANGEMENT OF 2 12-FT.-WIDE UNITS

STAGGERED ARRANGEMENT OF 3 12-FT.-WIDE UNITS

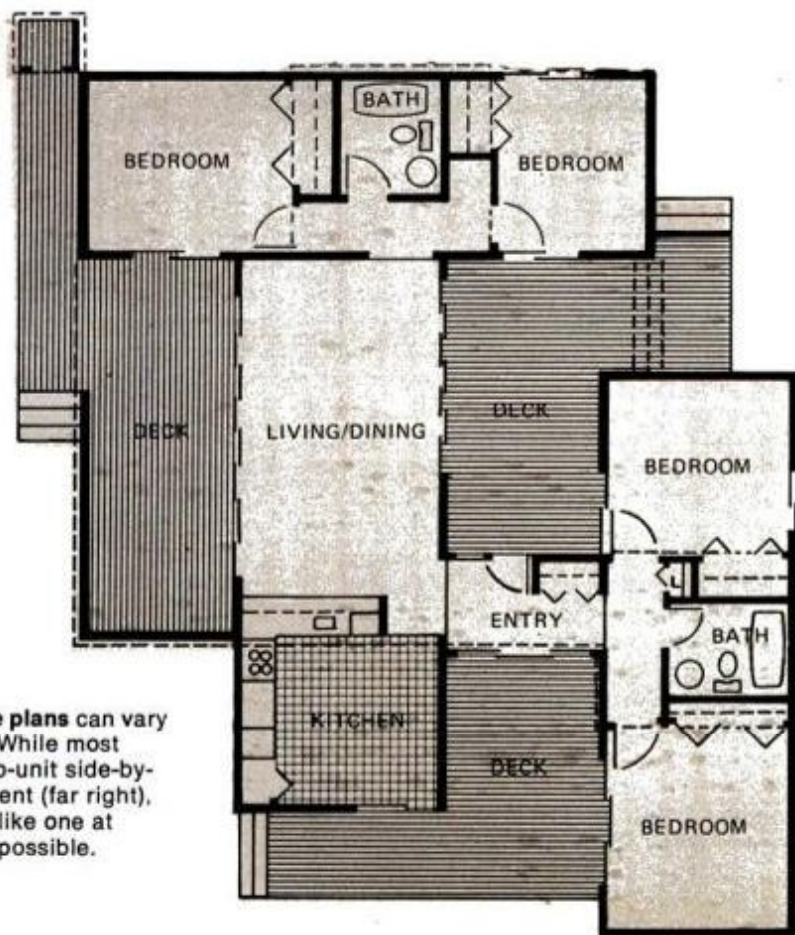

Modular house plans can vary considerably. While most common is two-unit side-by-side arrangement (far right), lavish layouts like one at near right are possible.





## 2. The case for the mobile home

Trailer parks are improving in appearance and facilities, offer low-cost living if you can put up with some limitations.

by Robert C. Reschke

About the least expensive form of new, single-family dwelling available in the United States today is the so-called mobile home—"so-called" because more than 90 percent of such homes, once set up and lived in, are never again moved. They may be bought and sold, their owners may change, but seldom are they transported to a new location. For one thing, hauling a 14-foot-wide by 70-foot-long wheeled monster over the road just isn't very practical. "Mobile" homes simply aren't really mobile—and aren't designed to be.

While somewhat looked down on in the past, mobile homes are following several new trends that make them worthy of serious consideration for inexpensive, permanent living quarters. First, the old run-down, slum-like trailer parks with their units packed tightly together row upon row are beginning to disappear. In their place are coming carefully planned, attractively landscaped mobile home "communities," with forest lands, winding rural roads, trickling brooks, flower-lined garden paths, clean surroundings and plenty of elbow room between units. Not all are like this yet, but more are appearing every day and are worth searching out.

Secondly, the homes themselves are improving greatly in appearance. Gone are the old round-cornered, aluminum-sheathed boxes with port-holes for windows. Modern mobile homes have real houselike peaked roofs, residential-type windows, shingled or wood-paneled exterior walls and lower side skirting to gracefully conceal their ancestral underpinnings. Optional add-ons such as porches, sun decks, awnings, carports and toolsheds also do much to enhance the looks and livability of such units. You aren't restricted to a single unit, either. As with modular homes (see preceding pages), you can combine two mobile units to double your living space. Imagine a structure 28 feet wide by 65 to 70 feet long. That's nearly 2000 square feet of floor space—a lot of house!

Starting as low as \$6000 for a single unit, mobile homes are attracting more and more budget-conscious buyers, particularly those retired and/or living on fixed, relatively modest incomes. Nation-

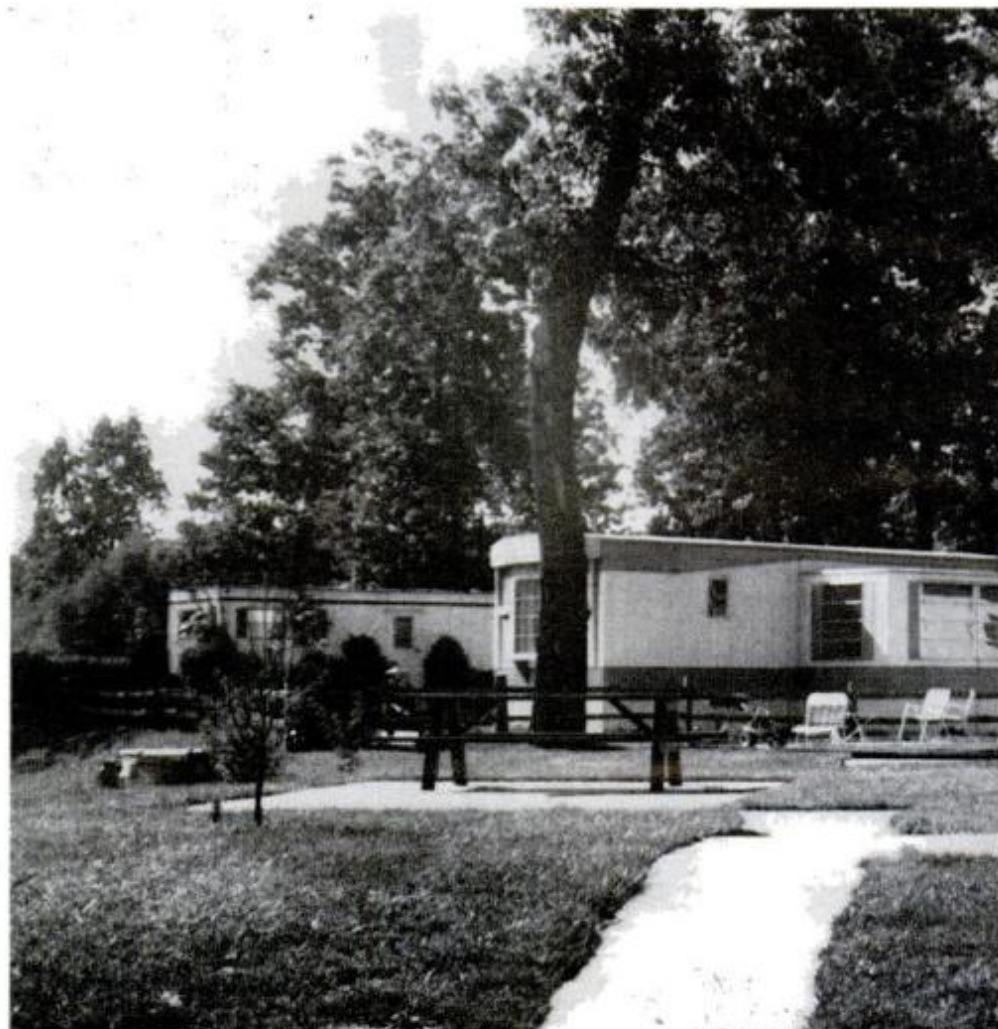

wide, the average selling price for a new mobile home is about \$8000—including appliances and furnishings. If you want to go up to \$20,000, loaded-with-extras luxury models rival in interior appearance and appointments those of lavish conventionally built custom homes. While their rooms are somewhat small, most mobile homes—even single-unit models—offer two bathrooms and up to three bedrooms, plus living, dining and kitchen facilities. That's remarkable when you consider the limited space and narrow shape of a typical unit.

Although estimates are just that—estimates—up to 10 million Americans may be living in mobile homes, with major concentrations in the Northeast, Florida and California.

Essentially, the homes are of three types—a *single living* unit, pretty much fixed in size, but generally 12 feet wide (although some are being built two feet wider in states that allow over-the-highway movement of 14-foot units); a *single-wide basic*

unit featuring some form of rectangularly expandable arrangement or add-on provision for a larger living room, extra bedroom, family room and so on; a *double-wide* unit that usually consists of two halves, shipped separately and joined together at the site to form a larger, more conventional-looking house. (The latter units are often similar to modular homes in construction and appearance and thus are sometimes called "modulars"—a possibly confusing use of the term to watch out for.)

A fourth type of mobile home, gaining in popularity, is the "tag along," a special double-wide that consists of one basic, 12-foot-wide unit 60 or 65 feet long to which can be coupled a "companion" unit perhaps 20 or 30 feet long. An attractive feature can be a complete unit of other than rectangular configuration.

Traditionally, mobile homes are sold on a fully furnished basis. For a buyer who goes along with a manufacturer's tastes, this can be a bar-



House-type roof and windows, base skirting around sides and added entry steps do much to conceal the fact that this mobile home is a trailer. Other possible touches are awnings, sun decks, carports.

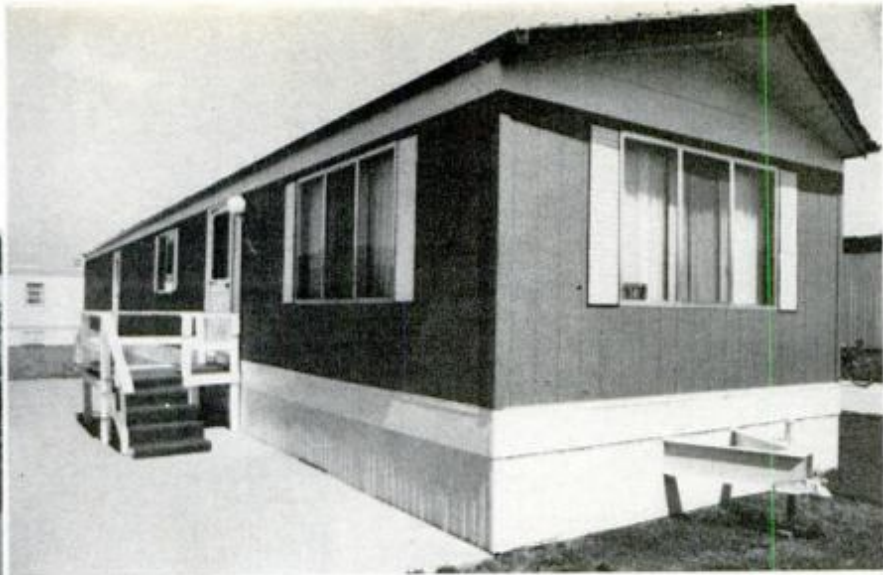

Surprisingly roomy interior shown below results from joining two mobile home units side by side. Removing trailers' side walls opens up double-width area into large, comfortable living space.



Clean, peaceful, pleasantly landscaped trailer sites like this tree-lined Timberbrook Park near Elkhart, Ind., are doing much to upgrade the image of mobile homes and make them more enjoyable to live in.

TYPICAL SINGLE-WIDTH UNIT

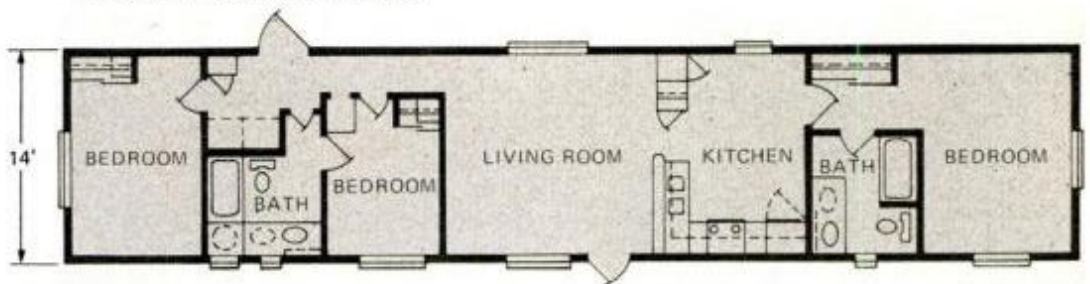

TYPICAL DOUBLE-WIDTH UNIT

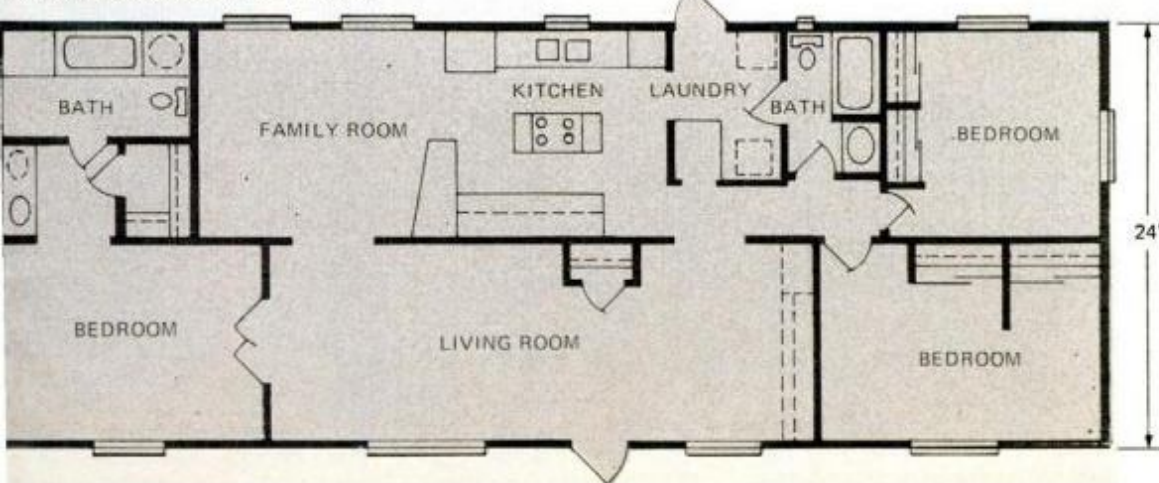

Mobile homes give you a choice of single or double-width units. By combining two units, you can increase living quarters to as much as 28 feet wide by 70 feet long. (Width depends on width of trailer permitted by state—either 12 or 14 feet.) Note that even single unit offers two baths, three bedrooms, kitchen and living/dining area.



# Pad sander know-how

by Harry Wicks  
WORKSHOP EDITOR

Often called a finishing sander, this efficient power tool can save you hours of arm-wearying hand sanding.

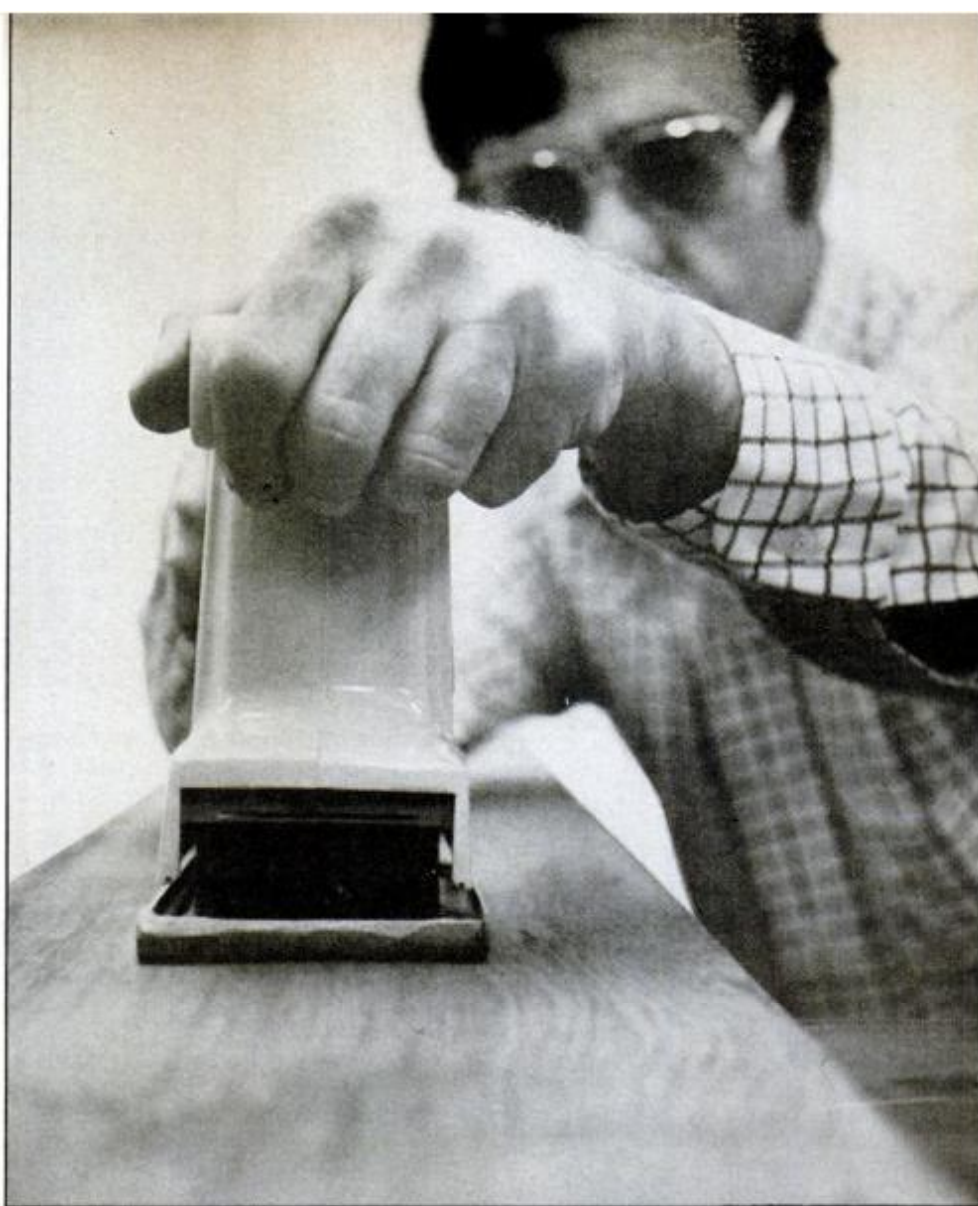

Photos: Abe Dulberg and author

No matter what other uses you have for your pad sander—some people have been known to use the felt pad for massages—this power tool is designed basically to make finishing easier. That's why it's popularly called a finishing sander.

Make no mistake about it, a pad

sander is a great saver of time and effort. A project that might take hours if sanded by hand can be done in a fraction of that time with power.

Besides saving time, a power pad sander lets you do a better job. There is no way you can smooth a flat surface by hand as efficiently as

you can with abrasive paper clamped about the felt pad of a sander.

Though a finishing sander is one of the first three power tools most do-it-yourselfers buy, it is often a misused tool. It is not uncommon for a beginner (and even experienced woodworkers) to use the pad sander for jobs that would be best per-

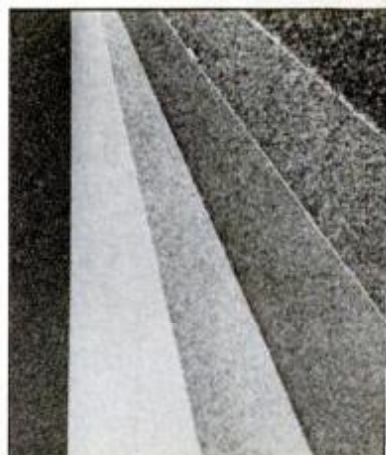
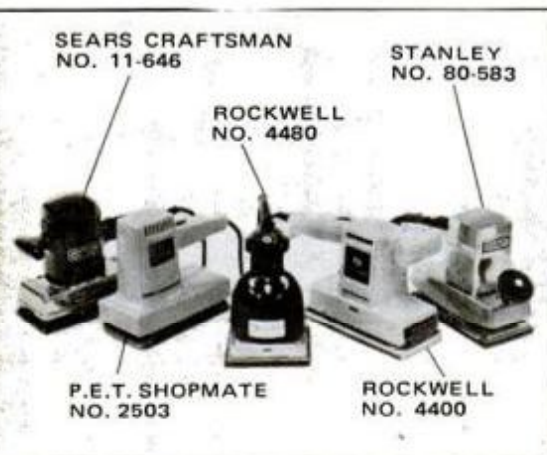

**Sanders vary** in quality and cost; tools here range in price from \$20 to \$60.

**Papers sized to suit** various makers' sander shoes come packaged all-one-grit or with mixed grits.

**Grit variety**, from left—wet or dry fine, 280, 120, 100, 80 and 60



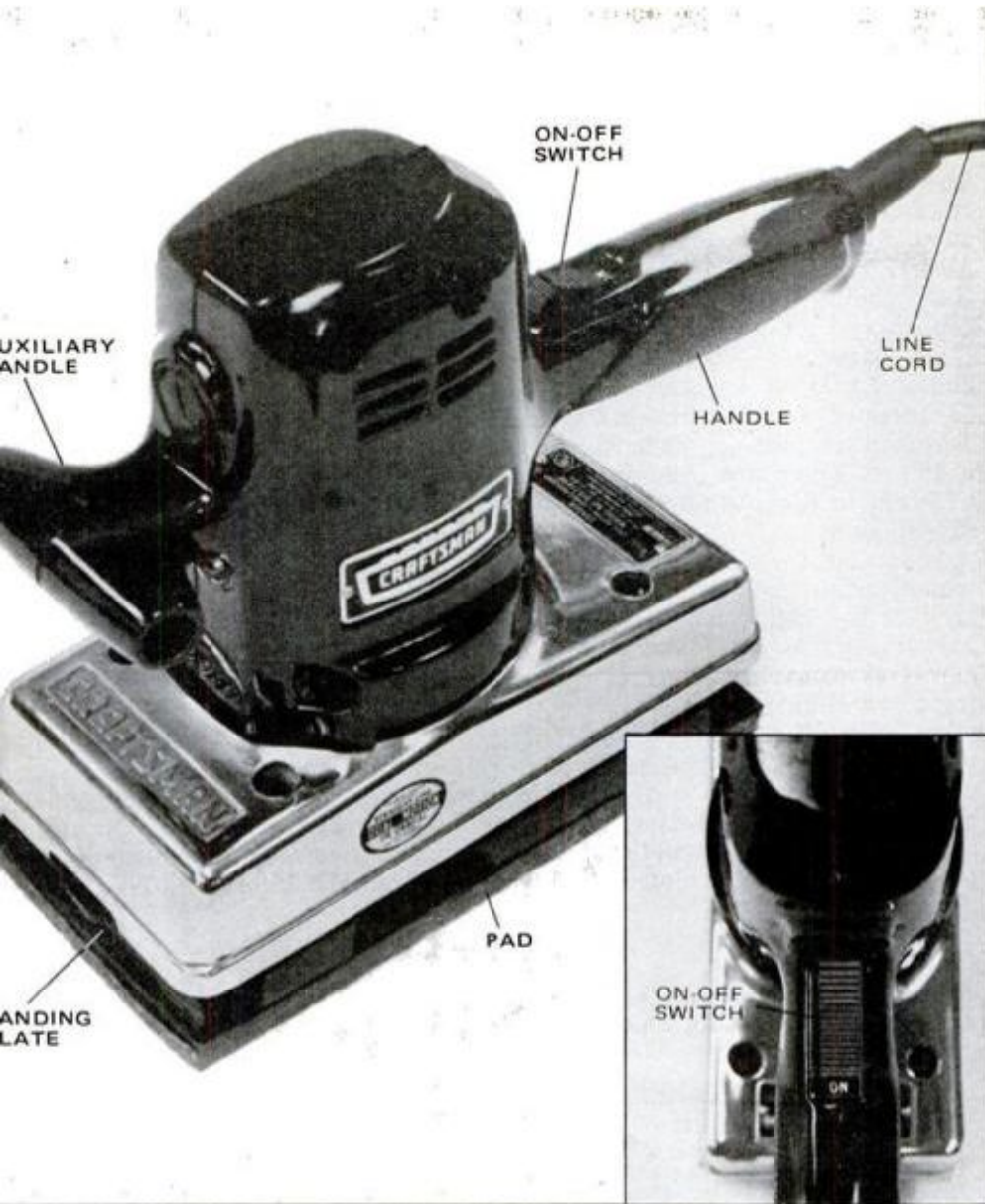

### Dual-action sanders

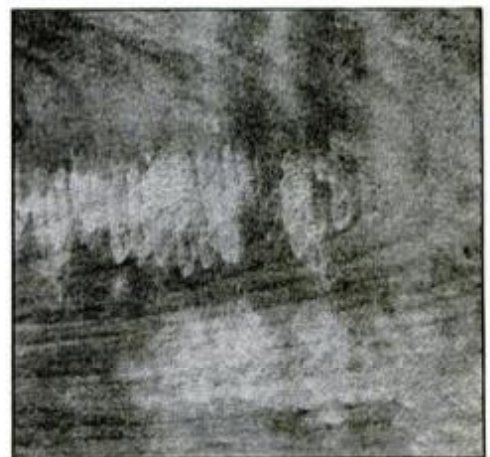
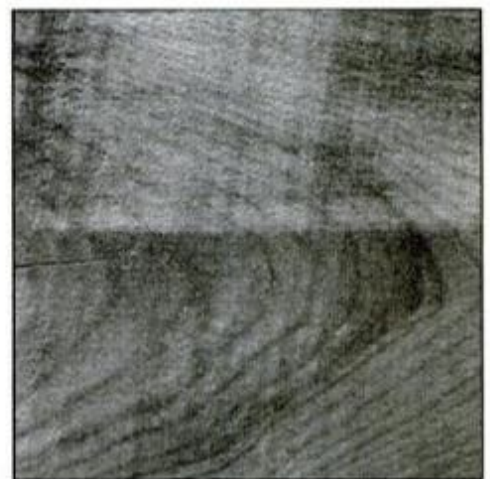
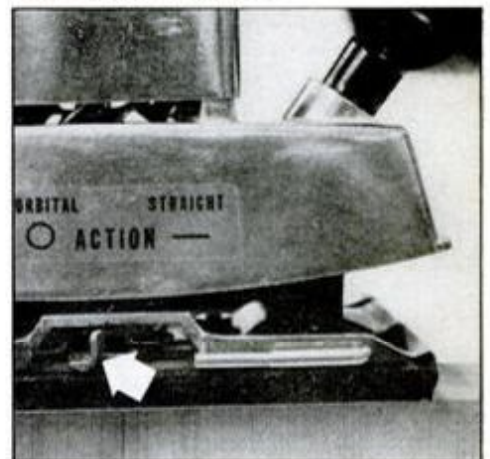

**Two-way sander** gives you a choice between straight-line (center photo) and orbital sanding (bottom). Coarse grits and birch wood were used here to illustrate patterns sander creates in both positions.

**Different manufacturers** use various kinds of on-off switches. Sears model shown here has a thumb-operated slide type (inset) instead of a toggle switch.

formed by other tools such as the block plane or belt sander. In any event, remember that the tool is not designed for heavy stock removal.

Basically, the pad sander is used to finish-sand wood just prior to applying the stain and finish to a project. By changing paper (grits), the tool also can be used to smooth

paints, varnishes, lacquers and the like between coats. Finally, when fitted with a lamb's-wool pad, a pad sander can be used with polishes and paste waxes to bring furniture to a high luster.

### Types of pad sanders

There are two types, straight-line and orbital. The former has a back-and-forth motion which makes it ideal for with-the-grain sanding as you get close to the final stages of the sanding operation. The straight-line action removes stock more slowly than the orbital type, but does a smoother job. On some soft woods, stock removal can be speeded up by sanding across the grain in the early coarse-grit stages.

Orbital sanders, on the other hand, combine a slight side-to-side motion with back-and-forth motion to form small orbits. If speed is slow, swirls will be obvious on the finished product and mar its beauty.

Both types are readily available, and now most manufacturers offer sander models which combine both



**Method of holding sandpaper** varies with makers; author liked Stanley's version.



actions in one tool. With these you simply select the action you want with a switch.

### Choosing a pad sander

The pad sander is a simple tool—one which you can learn to use correctly in a short time. Before buying one, the smartest thing you can do is to pick up and heft the various models you are considering. The better hardware and building supply outlets usually have sample boards available for customer tool tests. You should take advantage of this service if it's available.

By doing so, you will quickly find out that some tools feel extra comfortable in your hand, while others will be just plain cumbersome. Now is the time—before spending—to find out whether or not a tool gives you satisfactory working comfort.

You will also have to decide whether you want straight-line or orbital action or both. Many craftsmen are content with an orbital sander with

a high speed and very small orbits. With one of these, it is just about impossible to see any swirl marks in the finished project unless you have super vision (or use a magnifying glass). These models also cost more than their slower, larger-orbiting cousins.

Of course, with coarse-grit paper, almost any orbital sander is certain to produce some swirl marks as shown in the photo on page 93. Here, a 40-grit paper was used on a piece of birch to demonstrate the look of sander swirls.

If you opt for a dual-action model, make certain that the switch controlling the sander action is easy to use, yet located and operated in such a way as to avoid accidental changing of sanding strokes.

As with all power tools, you get what you pay for in pad sanders. In general, it's safe to say that the higher the price, the better the quality will be: The construction of the tool plus the number and type of

bearings definitely affect the sander's price tag.

As a rule of thumb, you can figure that sanders priced under \$20 will serve just fine for the once-in-a-while user. Those equipping a wood-working shop, with the idea of doing most home handyman chores themselves and taking on occasional furniture projects, will usually be content with a tool in the \$30 to \$40 price range.

In general, pad sanders priced over \$40 are geared for the professional market. However, many serious do-it-yourselfers want the best tools; for these, sanders rated commercial or industrial are the only choices.

New on the power-tool scene and something you should think about seriously before buying, as far as I'm concerned, are the short, pigtail-like line cords which now come on many new tools—including sanders.

On these, the line cord measures a mere foot or so instead of the traditional 6 to 8 ft. The reason

*(Please turn to page 137)*

## Typical pad-sander chores

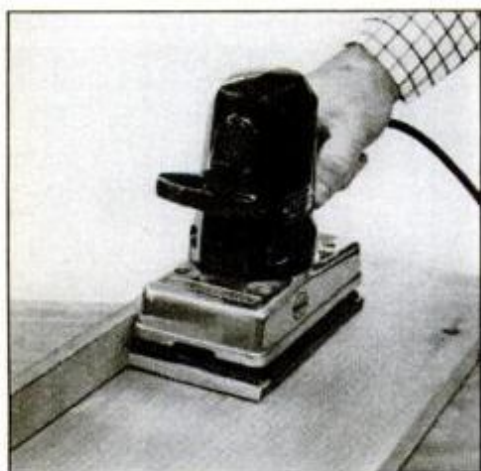

**To sand corner** with minimum chatter, let side of shoe (not end) contact vertical.

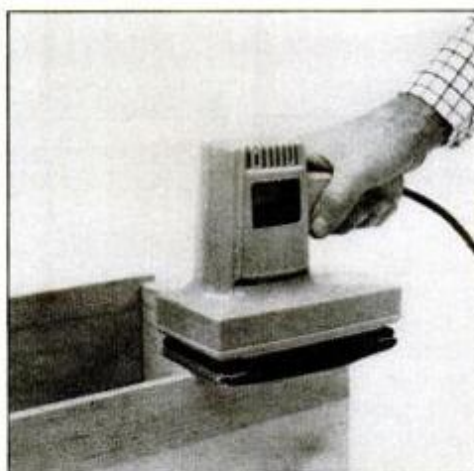

**Narrow surface** can be accurately sanded if you work carefully and hold shoe flat.

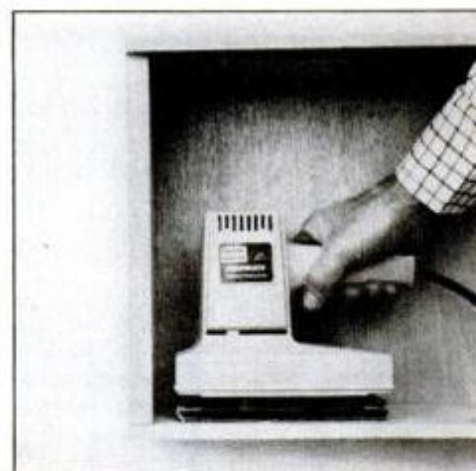

**Pad sander** gets into tight corners; the orbital type usually leaves marks here.

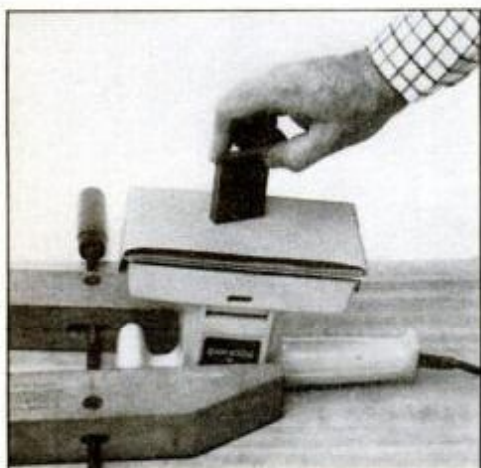

**Sand small objects** by clamping sander upside down. Don't overtighten the clamp.



**Fitted with a polishing pad**, sander brings paste wax to smooth, high luster.



**With care and fine emery paper**, in a pinch, sander can be used to hone a chisel.



# Scanners:

radios that stop and listen when there's something to hear

Fire and police channels aren't always busy—scanners automatically zip across the bands to the channels that are.

by Len Buckwalter

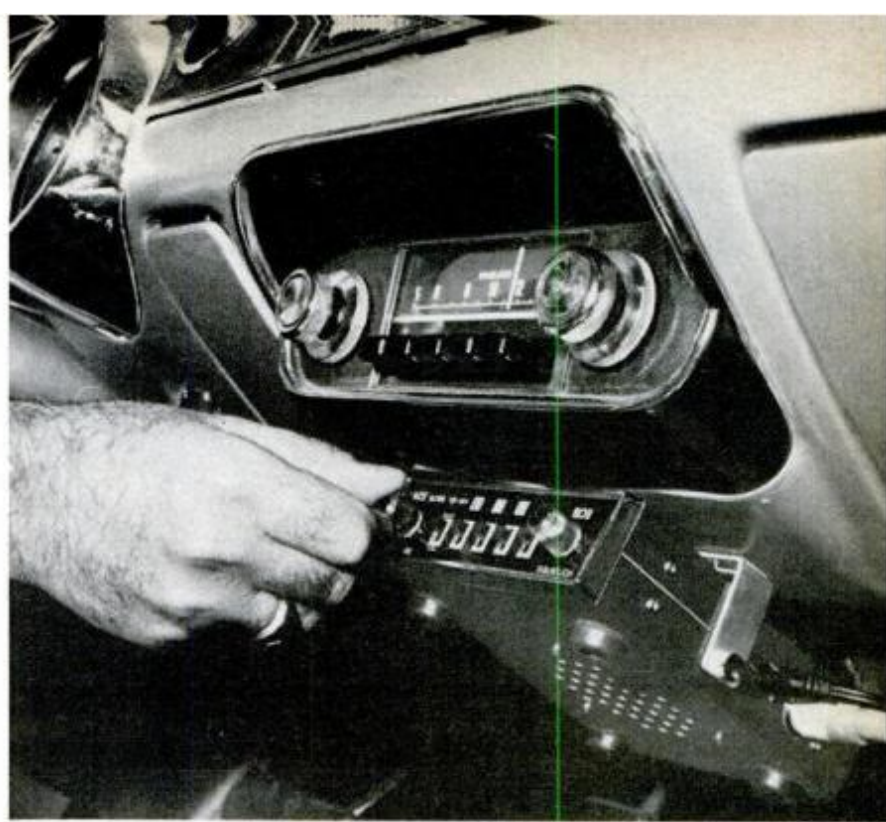

Mobile installations like this are easy with most scanners, but may be illegal some places.



Lafayette Monitorscan DB-8 covers any eight channels on high VHF or low VHF bands, has automatic scan delay (see page 97), costs \$150.



Realistic 16-channel unit covers UHF, low and high VHF, has adjustable scan rate, dual conversion, ceramic filters, is \$230.



Heathkit 8-channel covers 9-MHz slice of high VHF band, has one priority channel, takes four evenings to build, is \$100.

Eavesdropping on murder, mayhem and disaster is the latest in shortwave these days. Radios to pick up police, fire and other broadcasts on the "Public Safety" bands aren't just aimed at the electronic hobbyist any more—today they're offered even by such giant retailers as J.C. Penney, Sears and Wards. You may even have seen TV commercials for public-safety radios—sure signs that they've arrived.

One-way radios to listen in on two-way communications aren't new. Multiband receivers with one or two public safety bands in addition to the standard AM and FM have been around for a decade. Boat owners especially buy them to hear the National Weather Service's continuous VHF marine forecasts. If the listener explores the band, he'll also pick up occasional police calls, marine signals, fire alarms or other bits of real-life dramas.

Multibanders with standard, continuous-



### VHF LOW BAND (MHz)

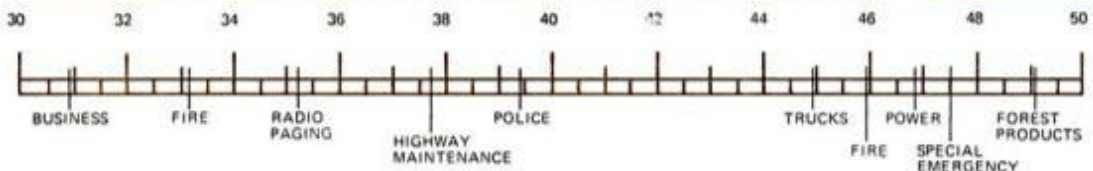

### VHF HIGH BAND (MHz)

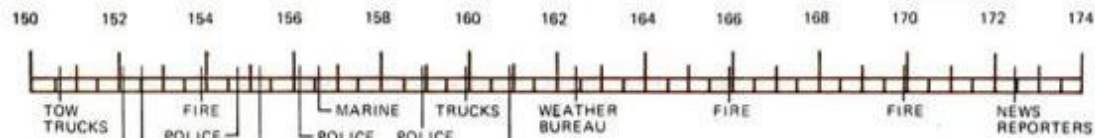

### UHF BAND (MHz)

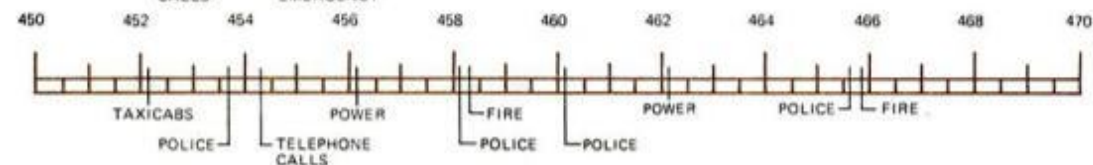

Emergency communication bands include low and high VHF, and UHF (above).

## National 10 Codes:

Police and other emergency services often use these number codes to keep transmissions short. But there are variations from city to city—in New York, for example, "10-13" means "officer needs assistance."

10-0	Caution	10-49	Traffic light out
10-1	Unable to copy—change location	10-50	Accident—PI, PD, F
10-2	Signal good	10-51	Wrecker needed
10-3	Stop transmitting	10-52	Ambulance needed
10-4	Acknowledgement	10-53	Road blocked
10-5	Relay	10-54	Livestock on highway
10-6	Busy—stand by unless urgent	10-55	Intoxicated driver
10-7	Out of service (give location and telephone number)	10-56	Intoxicated pedestrian
10-8	In service	10-57	Hit and run—(PD, PI, F)
10-9	Repeat	10-58	Direct traffic
10-10	Fight in progress	10-59	Convoy or escort
10-11	Dog case (specify)	10-60	Squad in vicinity
10-12	Standby (stop)	10-61	Personnel in area
10-13	Weather and road report	10-62	Reply to message
10-14	Report of prowler	10-63	Prepare to make written copy
10-15	Civil disturbance	10-64	Message for local delivery
10-16	Domestic trouble	10-65	Net message assignment
10-17	Meet complainant	10-66	Message cancellation
10-18	Complete assignment quickly	10-67	Clear to read net message
10-19	Return to _____	10-68	Dispatch information
10-20	Location	10-69	Message received
10-21	Call _____ by telephone	10-70	Fire alarm
10-22	Disregard	10-71	Advise nature of fire (Size, type, etc.)
10-23	Arrived at scene	10-72	Report progress of fire
10-24	Assignment completed	10-73	Smoke report
10-25	Report in person to _____	10-74	Negative
10-26	Detaining subject—expedite	10-75	In contact with _____
10-27	Drivers license information (MCF)	10-76	En route
10-28	Vehicle registration information	10-77	ETA (Estimated time of arrival)
10-29	Check records for wanted	10-78	*Lead assistance
10-30	Illegal use of radio	10-79	Notify coroner
10-31	Crime in progress	10-80	Chase in progress
10-32	Man with a gun	10-81	Breathalyzer report
10-33	Emergency	10-82	Reserve lodging
10-34	Riot	10-83	Work school Xing at _____
10-35	Major crime alert	10-84	If meeting _____ advise ETA
10-36	Correct time	10-85	Delayed due to _____
10-37	Investigate suspicious vehicle	10-86	Officer/operator on duty
10-38	Stopping suspicious vehicle (Give complete description before stop)	10-87	Pick up checks for distribution
10-39	Urgent—use red light and siren	10-88	Advise present telephone Number of _____
10-40	Silent run—no light or siren	10-89	Bomb threat
10-41	Beginning tour of duty	10-90	Bank alarm at _____
10-42	Ending tour of duty	10-91	Pick up personnel, prisoners, or property
10-43	Information	10-92	Improperly parked vehicle
10-44	Request permission to leave patrol for _____	10-93	Blockade
10-45	Animal carcass in _____ lane at _____	10-94	Drag racing
10-46	Assist motorist	10-95	Prisoners, subjects, or property in custody
10-47	Emergency road repairs needed	10-96	Mental subject
10-48	Traffic standard needs repairs	10-97	Check (test signal)
		10-98	Prison or jail break
		10-99	Records indicate wanted or stolen

tuning dials, though, are only useful for the most casual monitoring. That's because emergency channels—even in major cities like Los Angeles or New York—aren't always "on" the way the entertainment radio channels are. So, with continuous-dial radios, you run the risk of staying tuned to a police channel that's temporarily silent, while the fire department is yelling for more engines just a dial-twirl away. But try tuning from one active channel to another, and all you'll get are a very tired wrist and fingers.

That's where scanners come in: They search out, latch onto and deliver the action as it happens—far faster and more accurately than you can do by hand. A set equipped to scan eight local channels can check out each one about twice each second. It's all silent, but the action's visible as a spot of light that flashes across the front panel, briefly illuminating each channel's control button as it's scanned.

**Johnson Duo-Scan** covers eight channels on either low and high VHF or high VHF and UHF, costs \$130-\$180, according to bands.





But let one channel crackle to life with a voice, and the scanning light freezes on that channel as you hear the voice through your speaker. When the message ends and the channel falls silent again, the spot of light hurtles across the panel hunting more activity.

Channels you hear needn't be limited to police and fire calls. Sprinkled in are ambulances, marine, highway maintenance, motion picture crews, aircraft and the news media. By choosing appropriate crystals—plug-in devices that tune the receiver to an exact frequency—you can scan a mixture of services. Crystals, incidentally, are not included with a scanner because there are some 18,000 possibilities! Your dealer will know the exact frequencies you need in your area, or he can look them up in a directory.

But before shopping for a radio, it's a good idea to know something about the public service bands themselves. Equipment now available may cover from one to four bands: low VHF, high VHF, UHF, or Aviation.

**Low VHF**, running from 30 to 50 MHz, is the oldest band, now mostly used in smaller towns and rural areas. As two-way radio grew rapidly after World War II, congestion on this low band led to . . .

**High VHF**, running from 150-174 MHz. This is the major monitoring band, supplying police, fire and other public-safety channels for larger metropolitan areas, as well as the new marine VHF band for both pleasure and commercial boats. But pressure for still more channels led to the opening of . . .

**UHF**, running from 450-470 MHz on much present equipment, but recently extended out to 512 MHz (gobbling up some vacant UHF TV channels in the process).

Aviation frequencies from 108 to 136 MHz are only occasionally covered by scanners, though they're

common in continuously tuned multi-band radios.

In choosing a scanner, the most important points to check are its channel and band capacities. But don't confuse the two: A two-band set rated for eight channels has eight individual frequencies on either of two bands. More expensive equipment may have 16 channels that you can split among two or three bands.

Some listeners find public-service chatter fascinating—to others it's a massive bore. Spend some time listening at a dealer's or friend's to tell if you want a scanner.

If you do, and your pocketbook can stand it, choose a scanner with more channels than you think you need today. New service channels and stations keep increasing. You'll still buy only the crystals you need now (at about \$5 each), but you'll be able to add more as you need them. If there are already many active channels in your area, you might consider a scanner with, say, 32-channel *capability*: Such a set will only scan 16 channels, but lets you load 32 crystals; when you're tired of listening to one channel, you can then just switch in a reserve crystal, instead of having to open the cabinet and replace the old crystal.

Even if you've operated conventional shortwave sets, scanner controls, features and specifications may be unfamiliar. Here are some of the most important:

**Programming.** All scanners can be set up to sweep every channel automatically up to their full capacity. Sometimes, though, you might want to eliminate certain channels during the scan. For this reason, each channel has a lock-out switch to cause the scanner to "flash past" these frequencies. Or, you can use the switches to stop the scanning action and manually select any channel.

**Squelch.** This keeps noise and

annoying static from reaching the loudspeaker when no signals are being received.

**Display.** Most scanners show which channel is being scanned by flashing a light, but some have digital readouts that show in a window.

**Carrier delay.** With this common circuit, the receiver won't start scanning again until about two seconds after a message ends. This lets you hear a possible reply from another station on the channel. Otherwise, the scanner might fly on to an unrelated signal.

**Priority.** Your occupation or special interest may make one channel more important than the others. A boat owner, for example, might be most interested in the marine distress channel, while a volunteer fireman would want to hear his local fire company in preference to other signals. A priority circuit automatically locks the receiver to that channel whenever it is on the air. Every other station is excluded until the priority transmission is over. Some sets exercise priority for any crystal plugged into the No. 1 position; others do it for crystals both in the 1 and 8 positions.

**Variable scanning.** A typical scanning rate is about 15 channels per second, but some receivers let the listener vary the rate between 2 and 50 channels per second.

**Channel separation.** This figure, stated by the manufacturer, tells the span of frequencies a scanner can cover without losing sensitivity;

*(Please turn to page 138)*

**Gladding Cherokee 8+8** has dual conversion, one priority channel, covers eight low and high VHF channels.

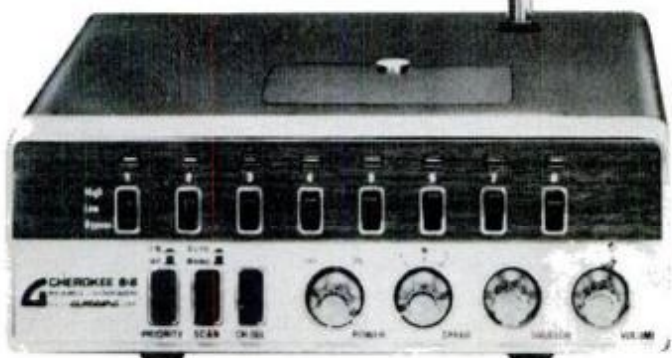

**Hand-held models** usually cover just four channels, 1 band. This Regency is \$120.





by Mort Schultz

Every two years you should give your car a major cooling system check. Before you start this presummer servicing, get a can of radiator flush, a can of antirust and water-pump lubricant and ethylene glycol antifreeze—the amount determined by the lowest anticipated temperature of the area and the capacity of your car's cooling system.

Regardless of climate or whether protection is thought to be needed, you should have a minimum solution of water and ethylene glycol in the



# Check your cooling system...NOW!

cooling system for protection to 0° F. This guards the system against corrosion and coolant boiling.

## Hoses first

With your engine cold, inspect all hoses for cracking, rotting and extreme weather checking (tiny cracks). Include the upper radiator hose, lower radiator hose, water pump bypass hose if one is there, and heater hoses.

Squeeze each hose, feeling for extreme softness. By its nature, a radiator hose that has been in use will be soft, but this doesn't mean it is rotting internally. A defective hose is one that feels really "mushy."

## How to replace hoses

1. The engine should be cool. Remove the radiator cap. Drain the radiator by opening the petcock on the bottom or side of the radiator. Catch the coolant in suitable containers.

2. If you are replacing an upper radiator hose only, you need drain only the radiator. If replacing other hoses (or draining the system for flushing), you must remove cylinder-block drain plugs.

Some drain plugs incorporate the cooling-system temperature sending unit or sensor devices that are part of exhaust emissions systems. Do *not* remove one of these. Instead, you can complete draining by disconnect-

ing the lower radiator hose at the radiator, bending the hose down to acts as a nozzle, and letting coolant drain from the cylinder block.

3. When all coolant has drained, replace drain plug(s) and close the petcock. Loosen clamps at each end of the bad hose (usually done with a socket wrench) and slide them back. But if they freeze, cut clamps off with wirecutters or tinsnips.

4. Twist hose back and forth to break it loose; then slide it off its connections. If it's stubborn, cut it off with a sharp knife.

5. Clean all foreign matter from hose connections with a wire brush or scraper. Place clamps a minimum of 1/8-inch from each end of the new hose. Coat hose connections with a water-resistant radiator hose and gasket sealer you can buy from an auto-supply house. Slide hose firmly onto its connections.

6. See that clamps go beyond connections' beads and are positioned in the center of the clamping surface. Clamps must not be placed at the very end of the hose. Don't overtighten the clamps.

## Flushing the system

Now that the hoses are reconnected, go to the next operation—flushing. To flush a cooling system chemically, after draining, fill the radiator with water and pour in

radiator flush. Follow instructions on the can. Most chemical flushes call for running the engine for 15 minutes to one-half hour. This time can often be reduced by driving the car rather than letting it idle.

Flush the system again. If the draining fluid is sludgy after all fluid has drained, reinstall the drain plug(s), but leave the radiator petcock open. Remove the thermostat, place a garden hose in the radiator filler neck and turn it on to get a good flow of water into the radiator. Start the engine and let it run for a few minutes as the water flushes out particles.

## Removing the thermostat

The thermostat in most cars is in the upper end of the top radiator hose. To remove it, take off the radiator cap (engine cold) and remove the bolts attaching the thermostat housing to the engine. Pull the housing off the engine, and remove the thermostat and gasket.

When you reinstall the thermostat, clean housing and engine gasket surface with a clean rag. If old gasket material sticks to either surface, scrap it off with a putty knife.

You will probably have to use a new gasket. Coat it with the same sealer you used for hose connections. In placing the thermostat back into the engine, make sure it goes in the





**Cooling system flushing** is a job that should be done every two years. You can use a chemical fast flush or garden-hose attachments that let you backflush the system to give it a most efficient cleaning.

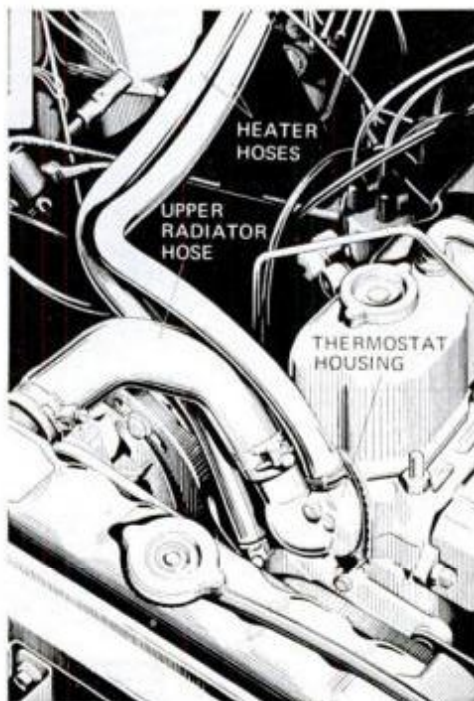

**Cooling system hoses** are easy to locate in the engine compartment. Heater hoses run back to the firewall and through to the car heater in the passenger compartment. Check condition of all hoses periodically.

right way. Examine it for a stamping that tells you which end goes toward the radiator.

With hoses okay and cooling system flushed, close all drain points and pour in your antifreeze mixture until the level comes to within 1½ to 2 inches of the bottom of the filler neck or to the cold-fill line that may be cast into the side of the radiator or to whatever spec is provided. Now pour in a can of rust inhibitor and water-pump lubricant.

As a last step, clean debris from the radiator fins. Use a soft-bristled brush.

Every day for a few days, check the coolant level with the engine cold to make sure there's no leak.

### Don't forget drive belts

Finally, check drive belts. Press in on a belt midway between its pulleys. It should "give" no more than ½ inch.

Generally, a drive belt is adjusted by loosening the alternator mounting and adjusting bracket-arm bolts and applying pressure on the alternator housing. If you use a pry bar, place it on the front half of the alternator housing—never on the rear where electrical components are located.

When tension is correct, tighten bolts firmly. ★★★

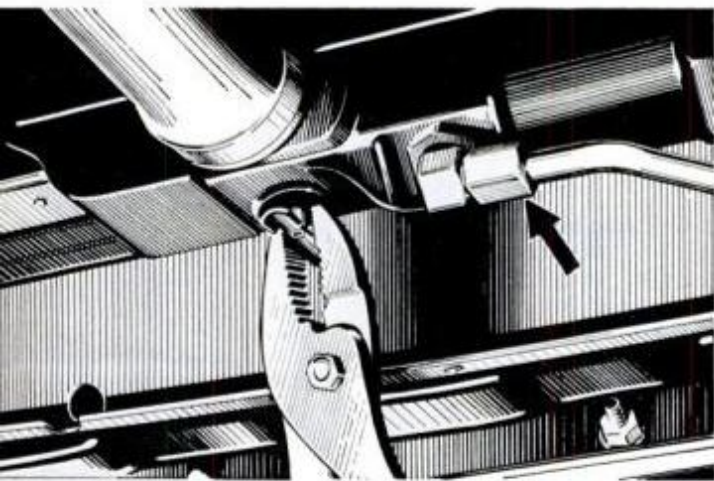

**Open and close petcock** on bottom of radiator with pliers; don't force. Drain system through bottom radiator hose rather than cause damage by forcing a frozen petcock. Arrow points to connection that's found on some cars; line goes to automatic transmission for cooling fluid.

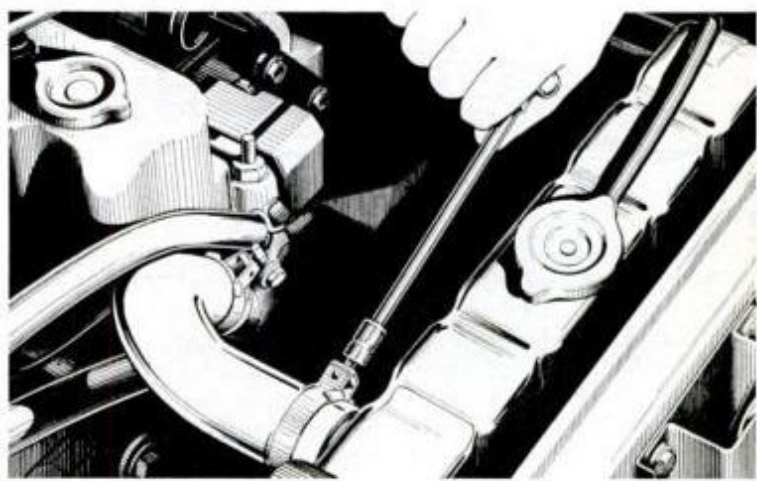

**Hose-clamp bolts** are slotted for screwdrivers, but a socket wrench is the best tool to use for loosening and tightening. Install hose clamps as shown—not at end of hose.

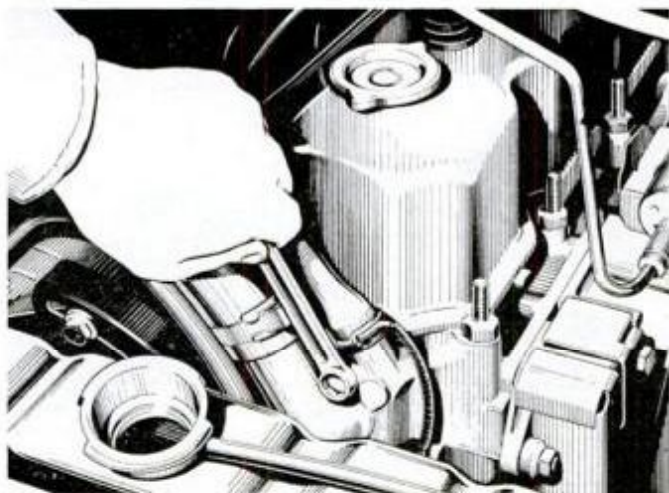

**Removal of thermostat** should not be done without having a spare thermostat-housing gasket on hand. Almost always a gasket will have deteriorated and need replacing.



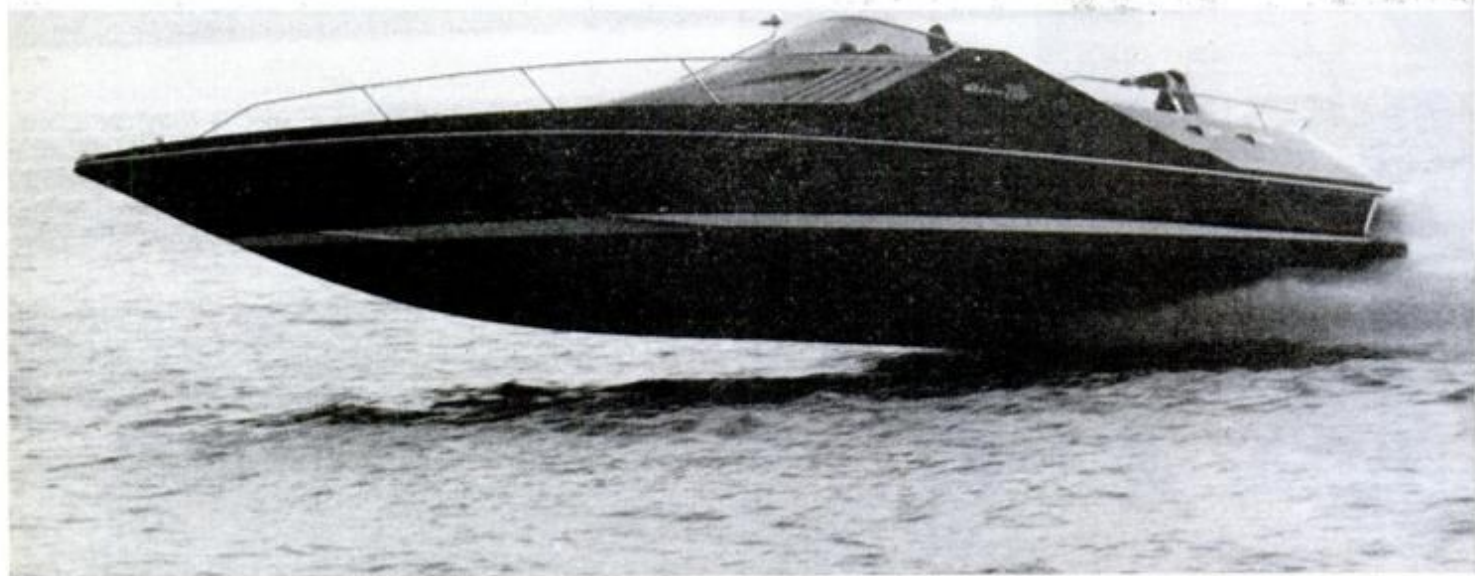

## Boats you once dreamed about

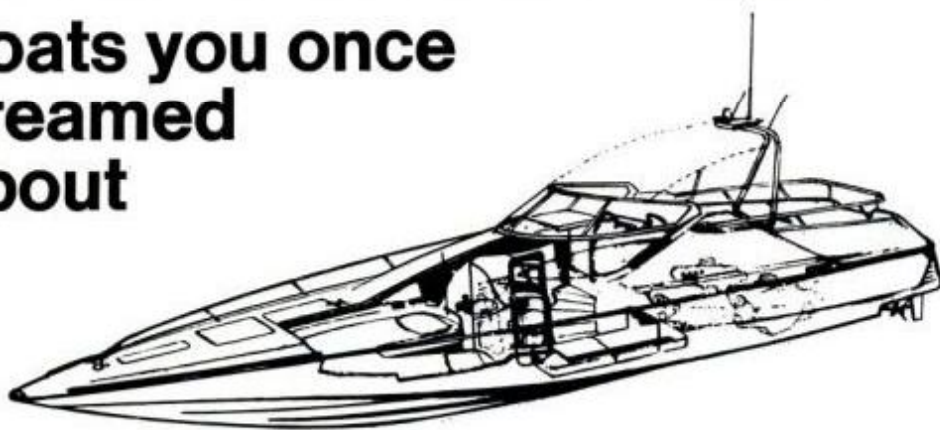

Remember the boats you designed as a boy in the back of a homework notebook—those streamlined speedsters that looked part plane, torpedo, rocketship? You were going to build one once you got to be a millionaire.

Now they are being built in Italy and imported to America by the Riva Div. of the Whittaker Marine Group in Miami, and to buy one it does help to be a millionaire. Sizes now range up from their famous runabouts to a 70-mph 37-foot overnighter and the Superamerica 42-foot cruiser that does 35 mph, and looks it.—*Bill McKeown*

**Rakish runabout** with 1000 hp from three engines, Riva 2000 (above and at right) was designed by famous offshore racer Renato (Sonny) Levi. With bar and shower both in cockpit and below in the cabin down circular staircase, it is \$93,000.

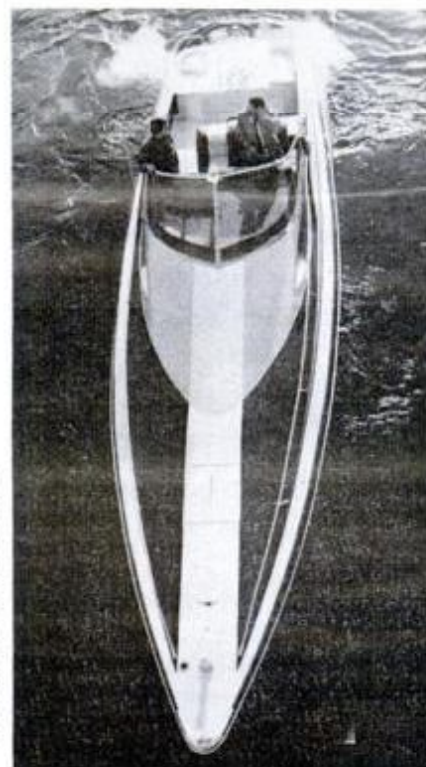

**Superamerica**, new 42-foot Cantieri Riva cruiser, can sleep seven in her deep-V fiberglass hull, is twin-diesel-powered and only about \$200,000.



**Famous for fun** along the French and Italian rivieras, the Riva runabouts, with sunken sun deck and reverse transom, are finished in varnished mahogany.



Today's L&M... Proud tradition. Proud heritage. Proud taste.

# The proud smoke.



RICH MELLOW DISTINCTIVELY SMOOTH

**L&M**  
FILTER KINGS

©LIGGETT & MYERS INCORPORATED, 1975

Filter King: 18 mg. "tar", 1.2 mg. nicotine av. per cigarette, by FTC Method.

Warning: The Surgeon General Has Determined That Cigarette Smoking Is Dangerous to Your Health.

Материал, защищенный авторским правом











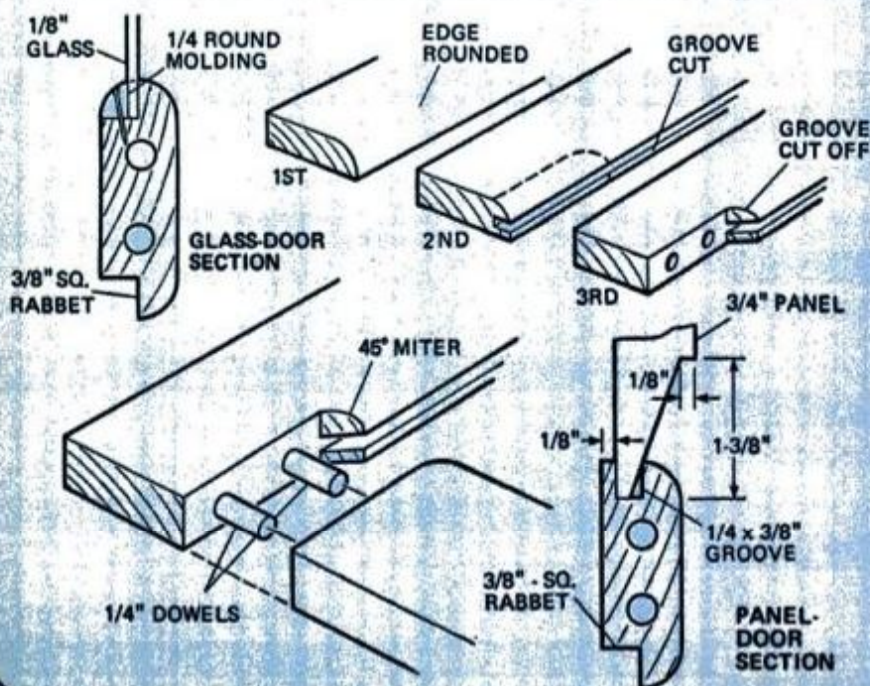
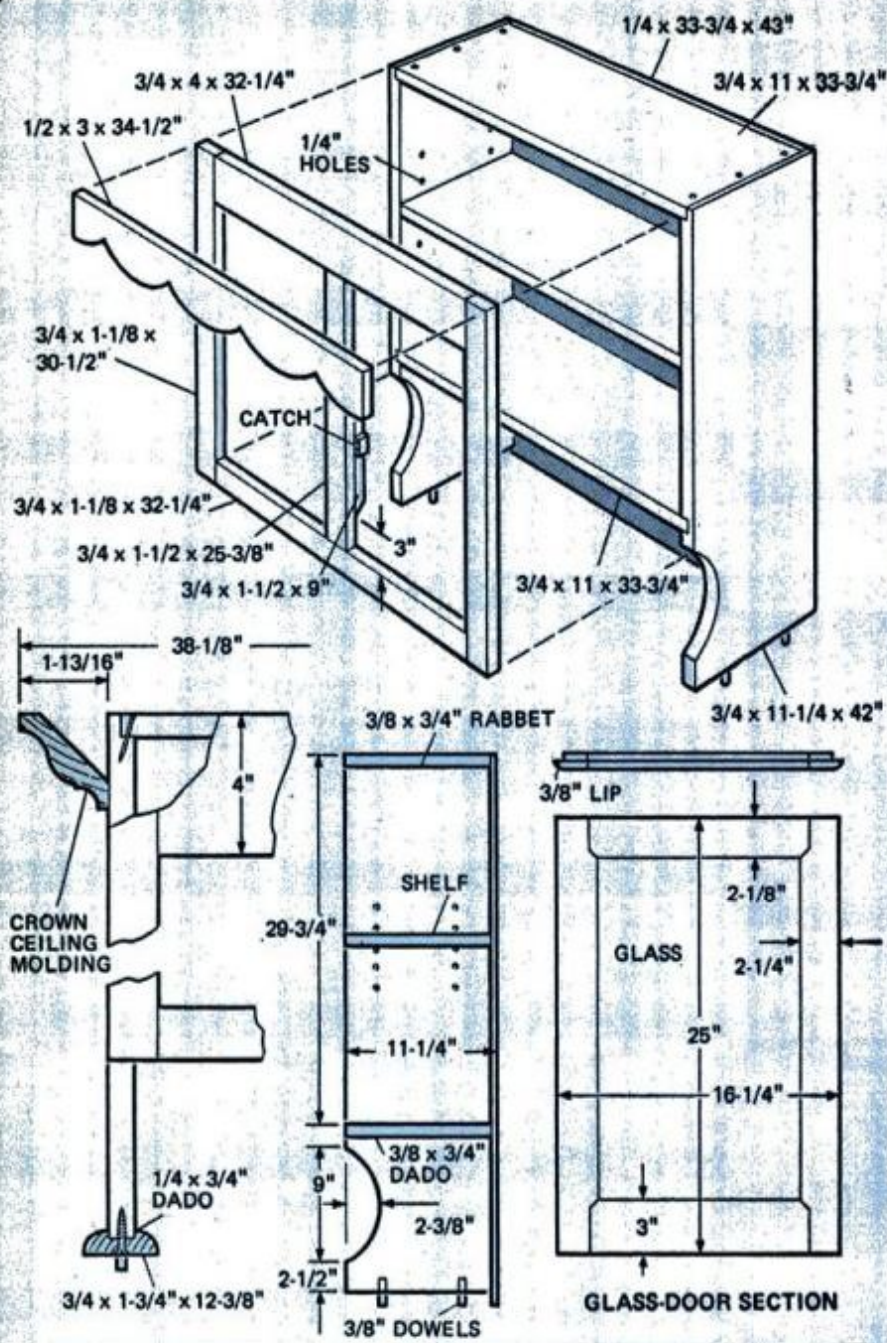

separate unit, using dowels and glue to join its seven members. Apply the facing so it is even with the cabinet ends and top cross rail. Use glue, clamps and finishing nails to attach it, then set and putty the heads.

Next install the drawer guides and shelf cleats following the end and front plan views. Notice that the drawer guides are supported at the back by a 2-in. cross member and placed so they will be in line and even with the drawer openings in the front frame.

The drawers have lip fronts that lap the openings. Use 3/4-in. pine for fronts, 1/2-in. for sides and backs, 1/8-in. hardboard for bottoms. Fronts are rabbeted 3/8 in. top and bottom, 7/8 in. at ends.

The three-piece mitered base laps the front and ends 1 1/8 in. Rip it 3 3/4 in. wide, scroll-cut it and glue and draw the mitered corners together with clamp nails. When dry, attach it from the back with No. 8 x 1 1/4-in. flathead screws. Finally, miter, glue and brad a molding to finish off the top edges.

The upper unit is simpler to make since the ends, top and bottom are cut from 1x12 boards. Run dados and rabbets in the end pieces as before, saw the half-moon cutouts and bore a series of 1/4-in. holes 1/4 in. deep and 1 in. apart for shelf supports. Rip the top and the bottom 11 in. wide to allow for the 1/4-in. back which sits in a rabbet. Before gluing and nailing the two members in place, run plate grooves in the bottom shelf, one 2 in. from the back edge, another 5 in. Make similar grooves in the adjustable middle shelf. Make grooves wide and deep enough to suit your china.

A separate frame, glued and doweled together as before, covers the front edges. Glue it on and use a finishing nail here and there to help hold it. Glue a decorative facing, scroll-cut

(Please turn to page 141)





# We could all use less friction.

Friction? Who needs it? Friction leads to wear and tear.

STP Oil Treatment does something about friction by helping to protect your engine from it. Just add a can to the crankcase when the oil is changed, and the first time it's down.

That'll help the oil lubri-



cate better than it would without STP. And a well lubricated motor is the best way to help reduce oil consumption, bearing wear and prolong engine life.

Try a can of STP Oil Treatment. See what driving's like when everything's running smoothly.

**It helps your oil do a better job.**



# SEVEN & SEVEN



SEAGRAM DISTILLERS CO., N.Y.C. AMERICAN WHISKEY—A BLEND. 80 PROOF. "SEVEN-UP" AND "7 UP" ARE REGISTERED TRADEMARKS IDENTIFYING THE PRODUCT OF THE SEVEN-UP COMPANY.

The trick to washing a dog is to somehow keep the dog from washing you.

The trick to a Seven & Seven? That's no trick at all. Just plunk a few ice cubes in a tall glass, add a jigger of Seagram's 7, and then fill'er up with 7 Up. You can even toss in a lemon peel, just to give this old favorite a new twist.

But whatever, the easiest part is liking it.

The Seven & Seven.

You make it with Seagram's 7, the whiskey America likes best.

**Seagram's 7 Crown.**  
**It's America's whiskey.**





## 3 great ways with walls

Most interior walls end up being painted, papered or paneled and looking like most other walls. But there are some that refuse to be look-alikes and end up being dramatic walls to be talked about, admired and remembered. Three such walls are pictured here, accent walls that come alive with a new and unusual beauty.

Among the common building materials employed to create glamorous walls are red-cedar shingles. Used primarily for roofs and exterior walls, shingles are now being applied to interior walls to add a rich textural appeal to a room that will harmonize beautifully with most furnishings.

The rough-sawn texture of red-wood lath, applied vertically, makes another handsome and unusual wall.

Lath varies from light beige to mahogany red in bundle and produces an interesting effect when colors are intermixed as strips are applied. Unusual designs are achieved by combining vertical patterns with herringbone.

Still another dramatic and exciting wall is one that's covered with a white simulated stone called Wallsculpture. Molded in a blend of deep dimensions, chiseled shapes and textured planes, the material creates interesting shadow patterns, subtle and simple under soft lights, beautifully bold when flooded with bright lights. It's simple to apply; you just cement it in place. ★★★



**Shingle Interior-Tex** 4-ft. panels by Shakertown feature self-aligning backing. You rest back of a panel on panel below, nail or staple it in place and continue application up the wall. Molding is used at the ceiling to complete the job.



**Lath in lengths of 6, 8 or 12 feet** is applied to wall with panel cement or colored nails. Sand lightly, then leave it natural or coat it with satin varnish.



**Wallsculpture** is a molded vinyl sheet by Decro-Wall; comes in 2-ft.-sq. panels you can apply to any dry, flat wall surface—even concrete and cinder block—with tubes of contact cement. The cement wipes clean with damp cloth. Four-panel pack covers 8 sq. ft.



# Shoo garden pests with a new weapon: aluminum

by David Lampe



Foil is secured with soil (above). Crop (right) and larger of two oriental cabbage plants (lower photo at right) benefitted from mulching. Stunted plant, from unmulched plot, has virus disease.



At a conference of entomologists some years ago, Dr. Floyd F. Smith paid close attention when one of the speakers told the audience that aphids are attracted by the yellow paint on tractors and the center lines of highways.

The speaker was Dr. James B. Kring, a Connecticut Experiment Station entomologist. He explained how he and his colleagues had painted shallow aluminum pans yellow and set them out to attract aphids for various studies. When he collected the crop of bugs, he observed that some of the yellow pans were empty. He further observed that all the empties were located near unpainted aluminum pans that had been left on the test site unintentionally.

Kring's report fascinated Dr. Smith, a Dept. of Agriculture Research Service entomologist who was working with plant pathologists at the USDAR research center at Beltsville, Md., on the control of aphid-transmitted viruses.

"People tend to think that aphids mostly harm plants they like to eat," explains Dr. Smith. "As a matter of fact, one aphid can do more damage to plants it finds distasteful than 500 aphids can do to plants they like. The one aphid lands on a plant, bites its stem or leaf, finds the juice distasteful, then hurries to the next plant, leaving damaging viruses on each. In no time at all, entire crops are knocked out this way.

"So I decided to turn Jim Kring's experiment around, using unpainted

aluminum as an aphid repellent."

The result: a farming technique that this summer can help you grow bigger, healthier vegetables than ever before. The system has proven a success with commercial growers.

"What had repelled those aphids from Jim Kring's unpainted pans," Dr. Smith explains, "was the strong ultraviolet reflection. In the spring of 1963 I repeated Kring's experiment. In two days, more than 2000 aphids landed in my yellow pan and only 19 in the unpainted aluminum one next to it."

To test the ability of ultraviolet reflection to divert aphids from growing plants, Dr. Smith bought rolls of aluminum-faced felt (tarpaper) and spread them shiny side up along both sides of rows of young plants in an experimental garden at Beltsville.

Results were phenomenal. Although a few fairly uncommon species of aphids were attracted by the aluminum's ultraviolet radiation, an overwhelming number of others were repelled by it. And so, Dr. Smith discovered, were certain other major garden pests, among them leaf hoppers, thrips and Mexican bean beetles. Leaf miners, a menace only to commercial growers, were attracted to the ultraviolet rays, and so were honey bees, whose activity would later help pollinate the plants.

Dr. Smith's experiments indicated that, in good weather and bad, ultraviolet radiation from aluminum reflectors can keep aphids at least 30



inches away from plants. He found that effective reflectors must be at least two feet wide and be placed within six inches of the stems of plants they protect. Aphids, he noticed, will traverse narrower bands and alight on plants long enough to inject viruses before finding the ultraviolet unpleasant.

He and his associates also discovered that aluminum is a superb mulching agent, not only keeping the soil underneath it moist but also almost weed-free. Aluminum also acts as a thermal insulator, so the soil beneath it remains seven or eight degrees cooler than exposed soil.

"This makes the mulched plants come up slower," says Smith, "which is generally good. Plants that attain their first growth less quickly tend to come on stronger later on, especially when they're as virus-free as ours."

Dr. Smith also observes that

*(Please turn to page 114)*



# Chrysler: "The Great Getaway"

Pick yourself a spot where you can forget the everyday world and leave boredom behind.

And when you go take plenty of power to get you there and back. Like this Chrysler Funster powered by the famous Chrysler 60, with exclusive Magnapower II ignition. It's dependable. It's powerful. And it's designed simply — for ease of service. Let Chrysler take you out of the ordinary and power your Getaway with engines ranging from 3.6 to the 135. Take your choice and hang it on a Chrysler Hydro-Vee, Runabout, Cruiser, Bass Boat or Sailboat. See them at your Chrysler Crew dealers.



Two more ways to Getaway: Check your TV listing for Chrysler-sponsored "Fishin' Hole" and "Water World."



## APOLLO-SOYUZ: MANNED SPACE MISSION WITH A NEW ACCENT

(Continued from page 55)

form for conducting scientific experiments.

■ To pave the way for development of optimal rendezvous and docking systems for future manned spacecraft and space stations.

■ To prove out techniques for crew transfers, systems of bilingual communication and intercontrol-center activities for future international space flights.

■ To provide experience in developing techniques for carrying out experiments for the Space Shuttle and other future programs.

The space rescue capability of such a system would be implicit, though not an objective of this flight. The mission also could point the way to such exotic future potentials as a U.S.-Soviet space station far larger and more elaborate than Skylab, which would be resupplied by space shuttles from the Earth and from which deep space probes could be launched.

More than three years of intensive effort were required to bring the ASTP scientific détente to launch. The project's U.S. program director, Capt. Chester Lee, puts the problems into clear focus: "Tracking networks are different, spacecraft hardware is different, language differences can play an important role, communications air-to-air, air-to-ground and between control centers must be planned in great detail . . . it's much more than just blasting off and meeting another craft in space."

How have our astronauts and Russia's cosmonauts coped with these difficulties, and how do they view the upcoming mission? I've just returned from a visit to Johnson Space Center in Houston, where I discussed these matters with each member of our first crew.

The commander of Apollo is Brig. Gen. Thomas P. Stafford (USAF), a crew member on two Gemini flights that executed some of the first dockings in space, and command pilot of Apollo 10, which flew a low lunar orbit in preparation for Apollo 11's historic moon landing.

He will be accompanied by Vance D. Brand, several times an Apollo and Skylab back-up crewman who is now making his first trip into space, and Donald K. (Deke) Slayton, an old hand in the space business. Slayton will be making his first space trip, thanks to his own dogged determination. He'd been tagged to pilot Mercury 7 in 1962 but was grounded when flight medics discovered an erratic pulse following one of his runs in the human centrifuge. He

resigned his Air Force commission and spent the next decade as NASA's civilian director of Flight Crew Operations. Meantime, he fought for restoration to full flight status.

"It was a common arterial fibrillation," he says. "I'd get a pulse feeling in the throat, that's all. They say 80 percent of such cases are caused by heart disease; the other 20 percent—like mine, probably—are not."

After many visits on his own to heart experts, Slayton was provided corrective medication. Then a clean bill of health from the Mayo Clinic finally convinced the space doctors. In March '72 he went back on flight status, just in time for ASTP.

The Russians know about Deke's 10-year fight. "Whenever he makes a talk over there," says a NASA official, "he gets a standing ovation. They admire that kind of guts."

Commander of the Soviet Soyuz

---

**Tracking networks are different, spacecraft hardware is different . . . it's much more than just blasting off and meeting another craft in space.**

---

is Col. Aleksey A. Leonov, who copiled Voskhod 2 in 1965, and was the first man to "walk in space." His teammate is Valeriy N. Kubasov, who served as flight engineer on Soyuz 6 in 1969.

One of the first problems facing spacecraft engineers was the vast difference in physical systems used in Apollo and Soyuz.

The atmosphere in Apollo, Stafford explains, is "standard old oxygen" at five pounds per square inch pressure, whereas Soyuz uses a nitrogen-oxygen mixture at sea-level pressure—about 15 p.s.i. Each craft has entirely different support, communications and operating equipment. To alter either craft to accommodate the other would have meant complete redesign.

The solution was ingenious. "Designers from both countries devised a docking module interface that would accommodate both vehicles without requiring major modification of either," says Stafford. "Soyuz's big modification is the docking mechanism on the front of their orbital module."

This circular array of three flaring petals is, as Slayton puts it, "a very nice design" contrived by Soviet



Cosmonaut Valeriy N. Kubasov (left) marks food-rating chart while Vance Brand drinks orange juice. Their aim is to choose acceptable food items for the space venture.

engineers. As both craft approach, the tapered petals on the Soyuz end of the docking module will slide between similar petals on the docking end of the Soyuz spacecraft—like three ferryboats entering three slips simultaneously—guiding both ends to perfect capture. Already this "ring and petal" principle is under consideration as standard docking equipment for our Space Shuttle program.

The Apollo end of the docking module will accommodate Apollo's present "probe-and-drogue"—an entirely different system used in the lunar program for docking with the lunar module (LM).

On this mission, the docking module (instead of an LM) will be stowed in the Apollo launch vehicle's adapter section—the tapered cone of the Saturn—right behind the command service module (CSM). Once in orbit, the CSM will detach from the Saturn, turn, dock with its own probe-and-drogue end of the docking module, extract it, turn again and set off to chase the Soyuz spacecraft coasting in orbit above it.

There's a reason for this order of events. "One of the toughest things in putting the mission together," Tom Stafford observes, "was to negotiate and work out procedures. Soyuz flies by a whole series of ground control sequences; the crew is not nearly as involved as we are. We fly our spacecraft; we track manually."

Standing at a blackboard in his office at the Space Center, Vance Brand draws an ellipse within a circle. "We start here, at a much lower altitude than Soyuz, in a tighter orbit, and we're thousands of miles behind them. They're not going to do anything, basically, but stay there in orbit and wait for us. Since our orbit has a smaller radius than theirs, we're going faster over the

(Please turn to page 112)



# Surform® tool shaves, planes easier. Free plans prove it.

Now and then a woodworking project can turn you off. Especially if it calls for a lot of planing, filing and smoothing



grater" blade can't clog either; shavings pass right through.

All of this you can prove for yourself. Our free plan set to make these animal rocking toys calls for a good amount of planing, forming and smoothing

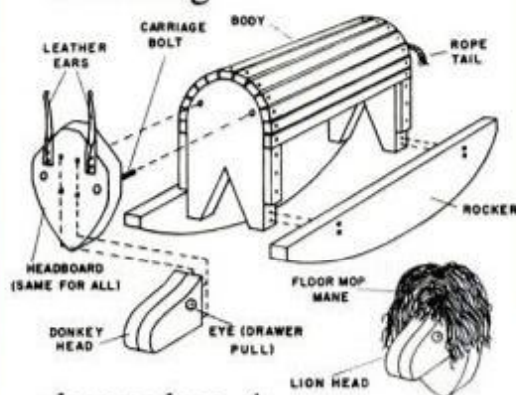

down edges. A Stanley Surform plane or file or even pocket-size model makes it a pleasure. And — by the way — Surform tools aren't just for woodworking; they also take on soft metals, plastics, material like autobody filler. Another thing — if a Surform blade wears out, you just snap on a new one.

So go take a look at

Stanley Surform tools. Any store with a good tool department sells Stanley Surform tools and replacement blades.

For the free rocking donkey and lion plans, send your name and address, plus 25¢ to cover postage, to Stanley Tools, Dept. AM, New Britain, Conn. 06050.

— which sometimes can be tricky work.

It's no problem with Stanley Surform tools. They let you trim away material fast, easy, without goofing. Really make you look like a pro. Surform's "cheese-

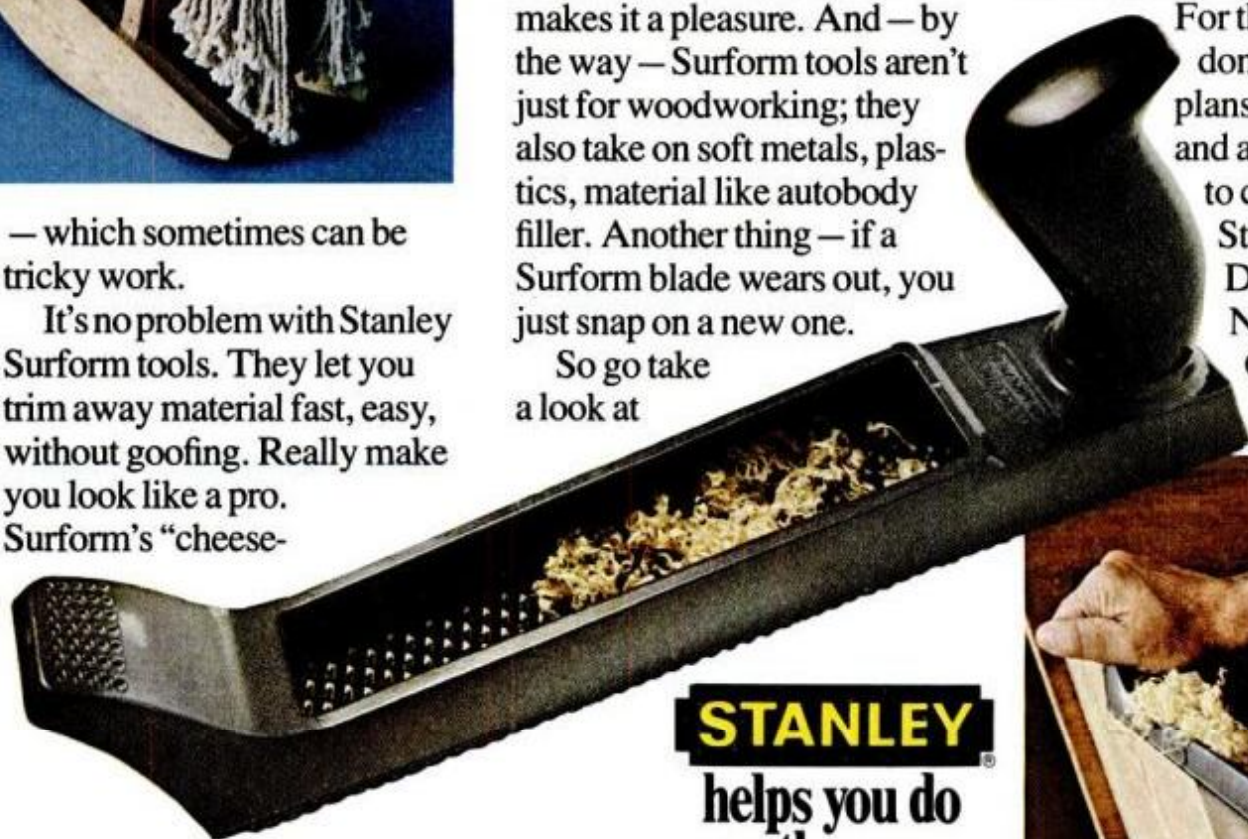

**STANLEY**  
helps you do  
things  
right





(Continued from page 110)

Earth's surface. With each orbit, we're catching up . . ."

Brand scribed a series of chalk ellipses in clockwise sequence within the circle, each larger and more circular than the one before. ". . . and each time around we're raising and circularizing our orbit a little more. Finally, when we get fairly close to them, we start doing burns that raise our orbit so we're approaching theirs. That slows the relative velocity between us. Once in plane—maybe several hundred miles behind them—we'll coast in to about 100 feet. Then it only takes a few minutes."

In that "few minutes" a lot happens. Tom Stafford will be doing the docking. "I'll do it manually," he says. "They'll use an automatic hold system. They'll roll to a specific attitude so we can get the high-gain antenna locked on and see our approach on TV. I have to know to the second what the time sequence is so I can coordinate manually."

During all joint maneuvers, the Americans will be speaking Russian and vice versa. "You think slower and more carefully, speak slower and more distinctly in a foreign language," Stafford explains.

Beauty of the docking module is that it will allow crews to transfer with a minimum of waiting time for adjusting to changes in pressure and atmosphere.

"While we're docked," Tom Stafford reveals, "the Russians have agreed to reduce Soyuz's pressure to 10 p.s.i. This saved us millions of dollars. Without that we'd have had men sitting in that airlock pre-breathing for two hours to avoid the bends. Now we just need to build airlock pressure to 10 pounds by adding nitrogen. Coming back, we bleed the docking module from 10 to 5 p.s.i. and add oxygen."

Plans call for 44 hours of joint activity after rendezvous and docking. The docking module, five feet in diameter and nine-and-a-half-feet long, will accommodate two men simultaneously. The schedule is arranged to give each man some time in the other craft.

Aside from the concept of joint operations in space, and testing the practicality of new space hardware to carry them out, one of the most interesting aspects of the mission will be the scientific experiments. Each country proposed some.

Deke Slayton, who has been involved in scientific logistics and problems for a decade of NASA missions in space, takes a deep interest in the experimental work.

"One category is automatic," he explains. "It's essentially a matter of putting the craft in a predetermined attitude and letting the experiment run. But in others, everyone will get involved. There's a joint microbiology experiment where we take microbe swab samples from the Russians and they take them from us—in both vehicles. Space medics will be looking for interchange of microbes in zero gravity, and maybe changes or mutations in the bugs in a space environment."

Several experiments will require careful maneuvering of both spacecraft, and precise team cooperation. In one, Apollo will undock and move out of plane until its shape blots out the disc of the sun, producing an artificial eclipse with respect to Soyuz. Characteristics of the corona will be photographed.

A series of space manufacturing experiments will be run in an electric

---

***Theoretically, in space you can make superstrong structural materials, supermagnets and superconductor crystals. And it doesn't take much room or energy.***

---

furnace. "Due to lack of gravity, hence lack of convection," explains Deke, "you can get homogeneous mixtures. On Earth, heavier particles settle out. Theoretically, in space you can make superstrong structural materials, supermagnets and superconductor crystals. And it doesn't take much room or energy."

"One of these years," he adds, "you'll see factories running out there."

Of all the work scheduled, Earth observations will require what Deke calls "the most man interface."

"We'll all be doing it depending on who's available over a given area. This all started back in Mercury," he adds. "Gordon Cooper came back and said he could see railroads and highways. The medics said he was out of his mind. Well, it turns out we're seeing a lot more with the old eyeball than anyone ever thought we could. We've discovered a huge dam across a big lake in South America that no one ever knew was there. Then there's that big nickel deposit in Sudbury, Canada. From the ground it's nothing, but look at it from space and it's obviously a huge meteoroid crater; a distinctive geological formation.

"I don't propose that we'll solve the world energy crisis by spotting formations, but we could make significant discoveries if we spot formations like that Sudbury crater in South America or Africa."

While none of the ASTP spacemen admit that any of the mission problems were particularly "tough," all agree that learning the opposite language and procedural systems was the "hardest training task."

Early in the joint training sessions there were some memorable language boffos. "Many Russian words look similar to ours, but watch out for syllable emphasis," Vance Brand warns. "A word that looks like *kabahl* should mean *cable*. Easy. But if you emphasize the last syllable instead of the first it means a male dog. That one got us some laughs. Then the Russians kept pronouncing maneuver 'manure' and that got them some laughs."

The joint training that brought the cosmonauts and their back-ups to Houston for lectures, and work on the Apollo simulator, also saw our ASTP astronauts—and back-ups Alan Bean, Ronald Evans and Jack Lousma—practicing on the Soyuz simulator in Star City outside Moscow. There have been seven such exchanges, plus a constant two-way stream of engineering, logistical and other space personnel.

"One thing should be made clear," says Stafford. "In all this training and observation, none of our technical secrets or know-how have been given away."

Throughout the training, spacemen of both nations established an attitude of mutual respect and friendliness. "We've gotten to know each other real well," says Brand. "One of the most interesting things was practicing transfers, with them speaking English and us Russian."

Our astronauts have practiced to proficiency the attitude control maneuvers required for braking and docking in the Soyuz simulator and are familiar with its systems. "If we ended up with mixed crews for some reason," says Brand, "there's no doubt we could re-enter safely in this mode."

The cosmonauts' view of joint training has been similarly positive. Last fall, Kubasov observed that ". . . relations between astronauts and cosmonauts are very friendly and warm. We not only work together but relax together perfectly well. We hope to have the same friendly relations not only before the flight but also after it." ★★





GLIDE AWAY TAILGATE.

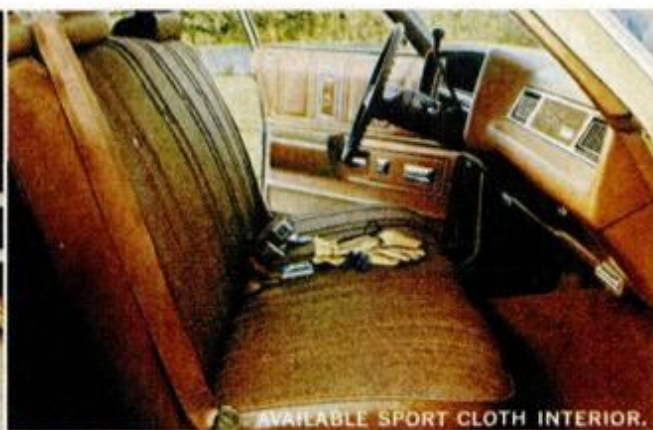

AVAILABLE SPORT CLOTH INTERIOR.



CHEVROLET CAPRICE ESTATE.



## CAPRICE ESTATE: PRACTICALITY PLUS LOWER MAINTENANCE COSTS.

Caprice Estate is clearly Chevrolet's finest wagon, offering room, comfort and style to help make family chores or recreational excursions more pleasurable. Power steering and brakes, an automatic transmission, and steel-belted radials are standard.

But in the '75 Caprice Estate with standard 400-4 V8 engine, there is also an important savings story to consider: lower recommended maintenance costs.

**\$348 lower maintenance costs.**

Let's compare our '74 and '75 models over a 50,000-mile period.

While parts and labor costs will vary throughout the country, we've used current list prices for parts and a figure of \$11 an hour for labor and found this: If you follow the Owner's Manual for recommended service, a 1975 Caprice Estate with 400-4 V8 using unleaded fuel could save you nearly \$350 in parts, lubricants and labor over a '74 model using leaded fuel.

### Family-size comfort.

There's a satisfaction that comes with giving your family the finest. And Caprice Estate is Chevrolet's finest blend of wagon practicality and tasteful styling.

Outside there's opaque "Mozambique" vinyl wood-grain paneling.

And inside, automatic dome and courtesy lamp switches at all doors.

There's a special sound insulation package that includes roof padding over the cargo area and a thick underhood insulation blanket.

The available sport cloth interior in classic herringbone tweed (shown above) is a no-cost option.

### Practicality wagon families like.

There are many Chevrolet wagon features you and your family will like.

The Glide-Away tailgate helps make loading easy, even in tight quarters. You don't even have to unhitch when unloading if you're trailering.

There's storage space behind the forward-facing third seat on 3-seat models. And the rear seats flip down easily from the right rear door.

Caprice Estate, part of the full line from Chevrolet, America's Family Station Wagon Builder.

**CHEVROLET  
MAKES SENSE  
FOR AMERICA**

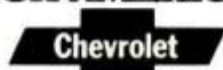



## SHOO GARDEN PESTS WITH A NEW WEAPON: ALUMINUM

(Continued from page 108)

"plants are helped most by aluminum mulching during their first six to eight weeks above ground. After that those with broad foliage often completely screen the reflecting surfaces from the sunlight."

The researcher experimented with several other reflecting surfaces but found none better than aluminum foil. Aluminum paint sprayed on hardboard worked fairly well but had no special advantages.

By 1968 Dr. Smith felt he had something to tell commercial growers. As a result, two truck farmers in Cumberland County, N.J., tried aluminum mulching the next spring. The special Reynolds foil, 3/1000-inch thick and backed by thin kraft paper, cost them between \$120 and \$140 an acre and disintegrated within six to eight weeks, leaving only shreds of the inert metal to be plowed harmlessly into the soil. Planting of squash, a 42-day crop, was done through holes in the aluminum.

Their first crop was of high quality, and instead of the usual 1500 pounds per acre they reportedly harvested 8000 pounds. This big harvest would not have happened with-

out the mulching because of the intensity of aphid infestation.

The following year, 1970, about 20 Cumberland County farmers turned to aluminum mulching. One farmer who specializes in vegetables for oriental restaurants planted Chinese cabbage, a crop that in New Jersey must go into the ground in late summer, when the weather is cool enough to prevent plants from bolting (growing into stalks). But late summer is also the aphid season.

The aluminum mulch did the job. The Chinese cabbages grew splendidly and brought an exceptionally good price on the market. The results convinced other farmers of the value of the mulch.

Current work at Beltsville includes using aluminum foil to propagate young trees. As well as repelling aphids and leafhoppers, the ultraviolet reflection speeds leaf growth. Given an added boost with plant-forcing lights, their year-old trees are all as big as conventionally grown three-year-old ones.

"Normal year-old saplings sell for 15 or 20 cents," Dr. Smith says. "Our big ones are worth \$1.50 each."

Several aluminum companies are preparing special mulching foil. Whether or not your local garden center gets supplies this year, you can start using this system with materials already available—aluminum roofing, aluminum vapor barrier or aluminum paint sprayed or brushed on hardboard. For best results, put down the aluminum as soon as you've planted.

Special watering won't be necessary because tests show that aluminum-mulched fields hold 40 percent of the water beneath the mulch, and rain that falls alongside the panels will be drawn laterally beneath them. If you don't want cool soil under the aluminum at the base of your plants, try painting a strip of black paint down the edges of your panels.

It's important to remember that mulching strips must extend two feet from both sides of your rows of plants.

There are, says Dr. Smith, no negative effects of aluminum mulching. But he cautions you to wear sunglasses if you're working with the system on a bright day. The ultraviolet reflection is dazzling. ★★★

## Dutch Boy® Latex Stain beats oil stains two ways.

### Protects longer.

At the Dutch Boy testing fields oil stain and Dutch Boy Latex Stain had a duel in the sun, wind, and freezing cold for 3 years. Look at the pictures of the actual boards and judge the results for yourself.

As you can see, the oil stain has faded and left the wood exposed in several spots.

Meanwhile Dutch Boy is still giving good protection. And the colors are rich and strong.

### Cleans up easier.

If you've ever used oil stain we don't have to tell you how hard it is to clean up.

With Dutch Boy, on the other hand, all you need is water. Dutch Boy Latex Stain. Protects longer. Cleans up easier.

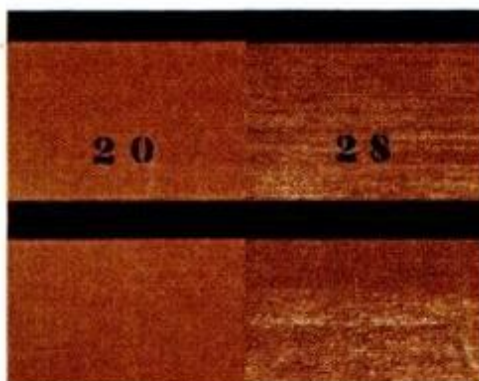

Dutch Boy Latex Stain

Oil Stain



**Dutch Boy Paints**

Division of **NL**  
NL Industries Inc.



# TWO INFLATION FIGHTERS FROM

Dick  
**CEPEK®**

A COMPLETE  
SET OF 4

## INFLATION GAUGES

Over or under inflated tires can cause poor gas mileage and excessive tire wear . . . just what you don't need with today's economy. You'll want a set of these "on the wheel tire air gauges" for every vehicle you own. They install in minutes on all valve stems and they stay there. Push in and twist and you read tire pressure from 16 to 32 lbs. No need to remove . . . place air hose directly on gauges to fill. Extend tire life, increase driving safety. Thousands sold at \$3.98. Now for a limited time \$1.00. We pay the postage.

\$1.00  
SET OF 4



SAVE ON  
ELECTRICITY  
WITH THE

## WIND-UP MONACO SHAVER

This is the same one that the Apollo astronauts used . . . and the same one that has sold for \$24.95 by the thousands. You've seen it advertised in Time Magazine and now Cepek offers it at a one time low price . . . \$14.95. 4500 RPM's shave you clean without soap and water. Battery or electric power. Precision made . . . permanently lubricated . . . self sharpening. It will last for years. Complete with vinyl carrying case. We pay the postage. Hurry . . . Quantity limited!

\$14.95



"The shaver the astronauts used."

### LOOKING FOR MORE UNIQUE ITEMS

at super prices? Then you'll want the new 1975 Dick Cepek Catalog. 116 pages chuck full of goodies and gift ideas. Thousands of items you've been looking for and many you've never seen... Racks, Roll Bars, C.B. Radios, Stoves, Cots, Portable Showers, Lightweight Gear. Plus one of the most complete and informative tire sections featuring Armstrong, Goodyear, Gates, National and Desert Dog tires.



And it's  
**FREE!**

Yes, I want to fight inflation. Send me

- \_\_\_ sets of inflation gauges at ~~\$3.98~~ a set **\$1.00** "postpaid"
- \_\_\_ windup Monaco shavers ~~\$24.95~~ ea. **\$14.95** "postpaid"
- the Dick Cepek 116 page Catalog **FREE**

No Canadian or foreign orders at these prices please.  
(Calif. res. add 6% sales tax)

Enclosed is my  "cash"  money order for \$\_\_\_\_\_ (total)  
NO C.O.D.

Name \_\_\_\_\_  
Address \_\_\_\_\_  
City \_\_\_\_\_ State \_\_\_\_\_ Zip \_\_\_\_\_

Dick  
**CEPEK®**

9201 California Avenue, PM, South Gate, CA 90280



# Evinrude fishing 15

## The motor is compact, the features are full size.



Short as a yardstick. A nicely balanced handful that hides away in the trunk of a compact car. Powerful enough to hustle a fast fishing skiff at mile-eating speeds.

That's Evinrude's remarkable super-compact 15. It looks, totes, trolls, stows, and sips fuel like a 10. But the resemblance stops when the performance starts.

When it comes to features, Evinrude's fishing 15 is top-of-the-line all the way.

It has sound-sealed, sea-tight powerhood. High intensity Quick-rise ignition. Gearshift. Water silenced mid section.

Prop-hub exhaust. Power gearing. Quick-set shallow water drive. And shock-mounted propeller.

It comes in electric and manual start models, with an alternator on the electric model. Both starter and alternator are out of sight under the powerhood. They're built in, not added on.

The Evinrude 15 has a companion 9.9 hp twin — identical in size and appearance — with much of the same performance and all of the same features.

In case you prefer to go first class on a little smaller scale.

**EVINRUDE**   
DIVISION OF OUTBOARD MARINE CORP.  
*first in outboards*



## NIGHT-BLOOMING BEAUTY

(Continued from page 61)

be mood-lighted by directing accent lights from above or below. Use such lights in addition to soft tinted, directed or reflected lighting. Keep in mind that overall floodlighting tends to "whitewash" a garden; accent lights are your best tools for avoiding that much-dreaded look.

■ **Eliminate hazards.** Walks, steps and paths should be lighted to avoid any chance of missteps, falls and injuries. Do not use any bright or glaring fixtures on steps because they are too likely to blind step users. Ideally, fixtures for step lighting conceal all bulbs yet provide desired safety lighting. Often the locating of fixtures behind foliage will hide lamps, too.

■ **Dining out.** For patios and the like, you want lighting that will draw everyone together into a group. Try for good visibility without harsh, irritating light.

Keep in mind that you should also have some transitional lighting on the fringe area so that the change from lighted to dark areas will not be too sudden.

■ **Lawn games.** Most games can be adequately illuminated using two poles 18 to 20 ft. high with two or more 150-watt flood bulbs per pole. For net games, light poles should be about 3 ft. from each end of the net. Regardless of the game, place fixtures so light will not shine in players' eyes.

**A final word.** When you plan your outdoor lighting arrangement, don't overlook your neighbors' right to privacy. Aim all of the lights toward your own property—not theirs—or you will almost certainly trigger squabbles every time you turn on your lights. ★★★

**CAUTION:** For maximum safety, all outdoor circuits should be protected by a Ground Fault Circuit Interrupter (GFCI).

### THINK SAFETY

- Work on electrical system only when the ground is dry.
- All outdoor circuits should be controlled by a switch; turn off all current while working on your outdoor system.
- Use only outdoor-type equipment with waterproof cords, plugs, sockets and connections. Buy only equipment that is UL-Listed.
- Tape temporary connections and elevate them to keep them out of puddles (because circuit must be tested before it is buried).
- If equipment comes with seals, gaskets or rubber rings, use them. These are intended to keep moisture out of sockets.
- Use only molded rubber socket for any bulb to be placed in water.

## FIXTURES AND KNOW-HOW continued

To illuminate large areas such as patio, terrace, driveway, lawn or garden, consider using fixtures suspended from tree branches. Those designed for hanging in trees are available in many shapes and sizes; bulbs ranging from 60 to 150 watts are often used to add sparkle, color and charm to above noted areas.

### TREE DOWN-LIGHT FIXTURES

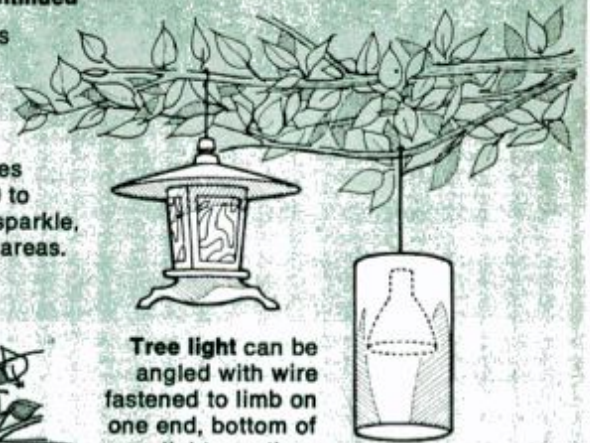

Tree light can be angled with wire fastened to limb on one end, bottom of light on other.

Turn your imagination loose to create do-it-yourself fixtures from objects you may have lying about your yard. Start by looking for places to hide a light; here, lamps are placed in a flowerpot, watering can and coffee can. Fixtures like these should be stored away when you've not using them.

### DO-IT-YOURSELF FIXTURES

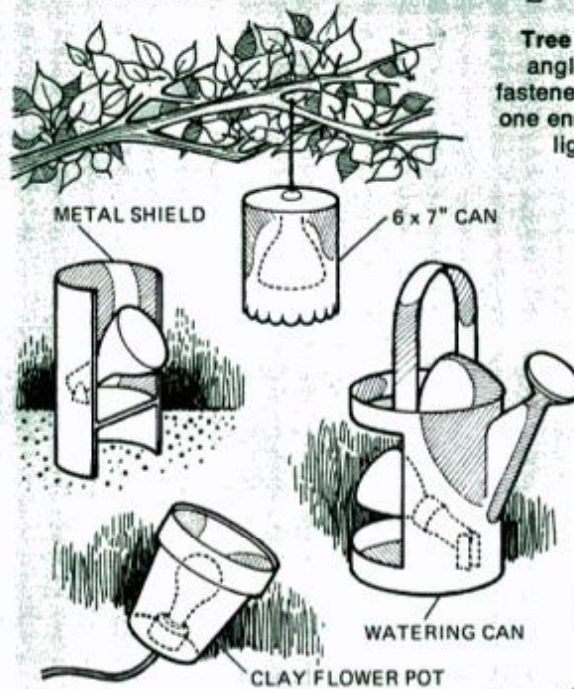

Accent lighting is fun, usually provides the final touch. Fixtures are often shaped to resemble common garden elements such as lily pads and toadstools. Lily-pad fixtures are designed for use in water; follow maker's installation instructions.

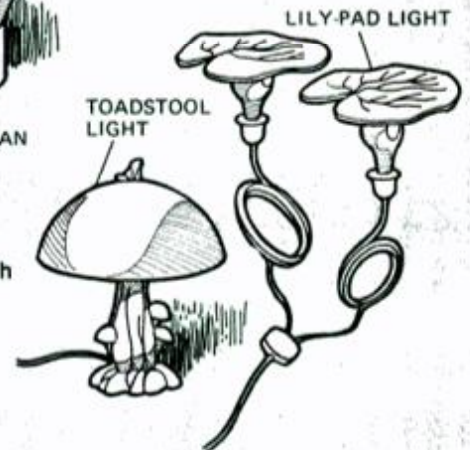

## OUTDOOR WIRING

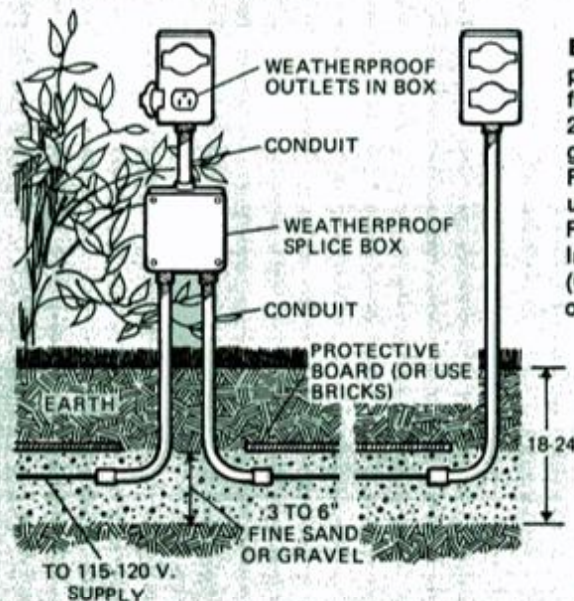

Extension cords and portable outlet fixtures come in 2 and 3-conductor grounded types. For top safety, use Ground Fault Circuit Interrupter (GFCI) outlets.

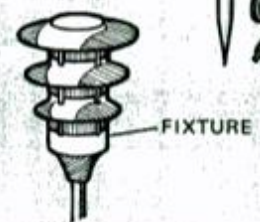
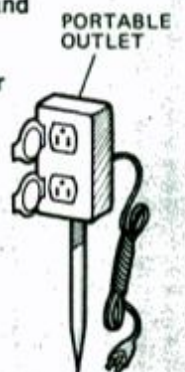

Unless you're experienced at electrical work and familiar with the codes, leave permanent outdoor wiring chores to the professionals. Use ground burial cable (type UF) in trenches to areas to be lighted. The cable is then connected to weatherproof outlet boxes or to underground junction boxes for fixtures.



# HOW TO KEEP YOUR

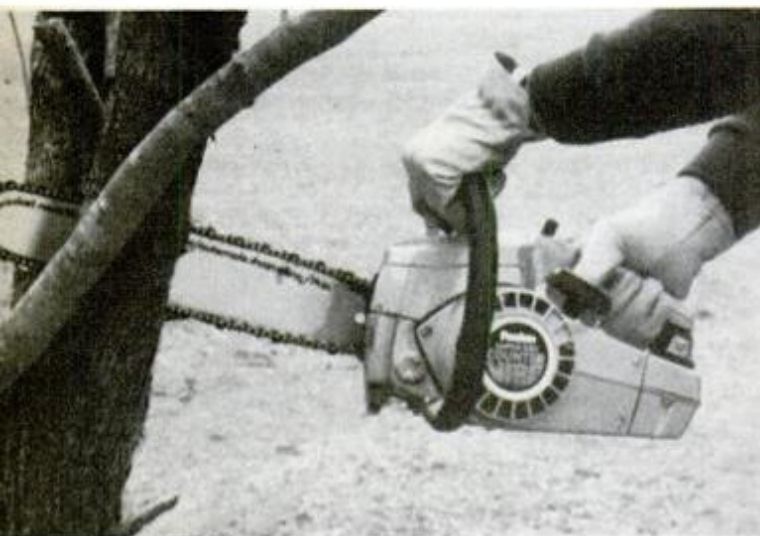









Photo: Beard-Poulan Co.

Having the right saw chain on your chain saw and making sure it is kept sharp is the surest way of getting the most out of the tool. You can tell when your chain is getting dull by the size of the chips that fall at your feet. When the chain is sharp, the chips are large. A dull chain, on the other hand, spews out small, almost powdery sawdust.

A sharp chain will slice through a log with little pressure, whereas a dull chain requires excessive pressure, causing rapid wear of chain, bar and sprocket, as well as overloading of the engine. It takes only a few file strokes to keep a chain cutting efficiently. The correct way to file a chain, plus other information on maintaining your saw, is covered in a booklet, *All About Using Chain Saws*, excerpted here. For a copy send \$1 to Omark Industries, 9701 S.E. McLoughlin Blvd., Portland, Ore. 97722.

## HOW TO SELECT THE RIGHT SAW CHAIN

Series	No.	Pitch	Gauge	No.	Pitch	Gauge	Series
<b>MICRO CHISEL</b> 	20	.325"	.050"	102C	.250"	.050"	<b>CHIPPER</b> 
	21	.325"	.058"	45C	.354"	.058"	
	22	3/8"	.050"	12C	3/8"	.050"	
	23	3/8"	.058"	51AC	.404"	.058"	
	24	3/8"	.063"	52AC	.404"	.063"	
	25	.250"	.050"	50C	7/16"	.050"	
	26	.404"	.058"	61AC	7/16"	.058"	
	27	.404"	.063"	62AC	1/2"	.063"	
	28	.404"	.050"	9AC	1/2"	.058"	
	10AC	3/4"	.063"	11AC	3/4"	.122"	
11BC	3/4"	.122"				World favorite for over 20 years. Sizes for all saws, all timber. Fast cutting, easy sharpening. A real workhorse.	
<b>CHISEL</b> 	9AL	1/2"	.058"	72D	3/8"	.050"	<b>OREGON S-70</b> 
	10AL	1/2"	.063"	73D	3/8"	.058"	
				75D	3/8"	.063"	
Square cutting edge never cuts same cross grain twice, removes more wood in a single pass. Requires skillful filing.						A good chain for lightweight compact saws. Cuts fast and smooth. Easily sharpened with round file.	
<b>SUPER CHISEL</b> 	50L	.404"	.050"	58AC	.404"	.058"	<b>MICRO BIT</b> 
	51L	.404"	.058"	59AC	.404"	.063"	
	52L	.404"	.063"	68C	7/16"	.058"	
	50AL	.404"	.050"	69C	7/16"	.063"	
	51AL	.404"	.058"	31C	1/2"	.058"	
	52AL	.404"	.063"	32C	1/2"	.063"	
	High-cutting efficiency and smoothness in both small or big timber. Easily sharpened with round file or chisel file.						
<b>OREGON 80</b> 	84	.404"	.063"				<b>GUARD LINK</b> 
	85	.404"	.050"				
	86	.404"	.058"				
	87	.325"	.050"				
	88	.325"	.058"				
Fastest, smoothest chain made. Sharpens in seconds with Power Sharp system. Can also be hand-sharpened.						Guard links are available on .325" and 3/8"-pitch micro chisel and 3/8" pitch S-70 (Speed guard).	
						Guard links provide increased protection from kickback when limbing and cutting in brushy areas. Good for use around home.	



# CHAIN SAW CUTTING

## CHAIN-SAW TROUBLESHOOTING

Most chain-saw problems are caused by incorrect filing and improper chain tensions. Here are some common problems, their causes and remedies:

### Cutters won't stay sharp

CAUSES	REMEDIES
1. Incorrect filing angle (blunt or sloped).	Hold file correctly. Use a file holder.
2. Depth gauges too high.	Lower the depth gauges uniformly. Use depth-gauge jointer of the correct size.
3. Cutter lengths not uniform.	File all cutters to the same length.
4. Chain not tensioned properly.	Adjust tension.
5. Abrasive wear on cutters due to dirt and sand.	File away all abrasive damage. File undamaged cutters so that they match in length.

### Chain cuts roughly, chatters or grabs

CAUSES	REMEDIES
1. Incorrect filing angles: feathered edge, hook, back-sloped, top angle not 35°.	File to specifications. Use a file holder and watch carefully to see that you are holding the file in correct position.
2. Depth gauges set unevenly.	Use jointed and file uniformly.
3. Improper chain tension.	Adjust tension correctly. <i>Caution:</i> When adjusting chain tension, be sure saw is turned off. If electric, see also that it is unplugged.
4. Worn sprocket.	Replace sprocket.
5. Rivet bearings worn out due to lack of oil.	Replace chain. Always use plenty of oil when cutting.

### Chain doesn't cut straight (slanted cut)

CAUSES	REMEDIES
1. Saw not supported properly.	Hold saw with both hands and guide it through the cut.
2. Cutters not filed uniformly; one side of chain uneven.	File all cutters to same length and angles.
3. Depth gauges not uniform; some being higher than others.	Lower all gauges to the same setting; use jointer of the correct size.
4. Abrasive damage to cutters on one side of chain.	File away damaged portions, then file undamaged cutters to match.
5. Bar rails worn and spread.	Have bar rebuilt or replaced.

## How to break in your saw

Before starting your saw, do the following:

1. Be sure the chain is mounted correctly, facing the right direction and properly tensioned. If possible, soak the chain in oil overnight before using it.

2. Fill the chain-oil tank with chain oil and check the chain oiler button to be sure it's working.

3. If it's a gas-operated chain saw, mix fuel and oil for engine in a clean container in the proper proportion. Use chain-saw oil recommended by the manufacturer. With an electric model, you can start cutting as soon as the tool is plugged in.

To adjust tension, loosen the bar stud nuts slightly. On hard-nose bars, tighten the tension screw until you can just pull the chain around the bar by hand. Hold tip of bar up while adjusting the tension screw and tightening the stud nuts. Otherwise, the chain will loosen on the first cut. Pump the oiler a few times, while pulling the chain around the bar by hand. Then start the saw and run the chain at fast idle for two minutes—without cutting! Stop the saw and recheck the tension. To check tension, let the chain cool and pump the oiler while pulling the chain around the bar by hand. Snap the chain in the bar groove to loosen and straighten all parts. If chain is loose, readjust tension.

Start cutting—only small limbs or logs for the first half hour. Use plenty of chain oil during break-in period and watch chain tension. A new chain will "stretch" during break-in and become loose. A chain can be ruined in five minutes of cutting if it is too loose. If it is too tight or slow cutting, excess heat and friction cause rapid wear.

## Type and size of saw

Most saws are of the direct-drive type today. There are gear-drive saws available, used mostly by professionals. The direct-drive saw is lighter, has fewer parts, requires less maintenance. It's easier to use, less tiring as the chain speed pulls the saw through the log without pressure. It cuts easily on any part of the bar.

For the occasional user, a lightweight saw is the best choice. Power is difficult to determine as there are no published horsepower ratings. The cubic-inch displacement of the engine is a rough guide to power—the larger the displacement, the higher the power. But there are other factors which affect the power output, such as compression, type of valving, and timing. The type of cutting chain, sprocket and guide bar are very important in the efficient use of available power. A small-pitch, fast-cutting chain running in a low-friction roller nose bar can effectively increase power. ★★



on the same averaging system as the calculators and, like them, require an "average" negative. The best analyzers read a small, specific spot of the enlarger-projected image, such as a middle tone on a person's face.

Unfortunately, no two people have the same kind of complexion, so results may not be all that exact, even with these electronic aids. Professionals frequently shoot test shots of gray cards at the beginning of each roll and with each change of subject illumination, to give their analyzers a standard spot to read.

Personally, I use neither calculators nor analyzers. I simply make a contact sheet of the negatives I want to print. With very little experience and, perhaps, a set of viewing filters (see page 78) to help out, you can quickly determine the proper pack to print almost any frame on such a color contact sheet, with an accuracy at least as good as that obtained with these devices, and at less cost—especially if you'd normally make a contact sheet for your records, anyway.

So take my word, you can quickly master the skills required on the dry side of the color darkroom, too.

The easiest—but not the only—way to set up a filter pack, is with a color enlarger (or a color head for your existing enlarger, if one's available). All the filters are built in—all you do is set two of three dials for the filtration you want, and you have it. Some heads have an additional control that lets you focus by bright light without affecting your filter setting—handy, but a luxury. Color enlargers for 35-mm or 120 film run from \$250 to \$500; color heads, \$125 to \$250. Less conveniently, but at a lot lower cost, you can use individual CP (Color Printing) filters (about \$30 per set) that fit into the filter drawer above the negative stage of your enlarger.

If your enlarger has no drawer, you'll need color compensating (CC) filters and a holder that swings in below the lens. CC filters must be more optically perfect than CP's since they go between the negative and the paper, and must be handled more carefully. You'll also need a heat-absorbing glass and a CP2B ultraviolet filter with either CC or CP filters, for about \$5 more.

What else do you need? If you don't already own one, you should acquire a good thermometer accurate to about  $\frac{1}{2}^{\circ}$  F., with a quick response time (\$5). About the only other thing you will need is a daylight processing drum (around \$20 for 8x10 prints) so you can avoid

### Where the filters go



Under-lens filters fit any enlarger—but must be the expensive, fragile CC type.



Filter drawers found in many enlargers take inexpensive CP acetate filters.



Color heads let you dial in exact filtration wanted; diffuse light to minimize negative spots, scratches and finger marks.

working in trays in the dark (and do avoid it—it's no fun at all). If you're in a position to spend another \$50, invest in a motor base to agitate the drum at a uniform rate; but if money's tight now, you can always add one later.

Now that I've allayed your fears, I hope, it's time to explore the rewards in doing your own color prints, rather than letting the corner drugstore do it.

The big advantage of doing your own color printing is control: control not only over quality but over cropping, burning, dodging, paper surface, finish, mood, balance and so on. These are the same reasons that anyone who is serious about his black-and-white photography will never dream of sending his negatives out to the drugstore for printing.

The black-and-white photographer can send his shots to a custom lab, with detailed instructions on development and printing; but when you go that route with color, you'd better be very, very rich. Costs for first-rate lab work are fierce, and there are very few first-rate workers, even if you can afford them.

But there is one function the corner drugstore can serve—if the drugstore sends your color shots to the film's manufacturer for processing, you can leave your exposed color-negative film for *development only*. For, while the black-and-white worker can exercise a great deal of control over his final printed results by the way he processes his negatives, this isn't as true in color. Instead of juggling the processing to get the results you want, you're largely restricted to following the manufacturer's recommendations very closely.

Temperature, for instance, is specified to be held within  $\pm \frac{1}{2}^{\circ}$  F. during part of Kodak's home processing routine for Kodacolor, though for practical purposes it's not really all that critical. So the best you can hope to do is to spend between a quarter of an hour to an hour (depending on which chemistry you decide to use) working under restrictive conditions to process your negatives almost as well as the film's manufacturer will do it for you—and at just about the same or even greater cost, unless you shoot and process very large quantities of film. If your druggist says he won't send out your film for developing only (no prints), either he's ignorant of the fact that this is a standard Kodak service (at about \$2.20 per 36-exposure roll of 35-mm film) or he doesn't deal with Kodak (the Agfa, Fuji and GAF labs work by mail), but only with an

(Please turn to page 122)



# Checkout these informative and useful Popular Mechanics publications and services

PM's famous Master Guides, the only index of its kind, unique tool markers, and a complete reprint service administered by PM's Bureau of Information.

## B1252 PM's Famous "Master Shop Guide"

No workshop should be without one! Everything you need to know about nails, screws, bolts, drills, adhesives, lumber, masonry, plumbing, electrical work and much more! 24 stand-up, hang-up, wipe-clean pages. 56 charts plus a built-in ruler, protractor and compass. Solid value at \$4.49.

## B1280 PM's Bestselling "Complete Garden Guide"

For the man who needs all the basics . . . fast! Superbly organized in famous "Master Guide" format. Dozens of tables, charts and illustrations. Literally crammed with timely bonus specialties like vegetables, fruits, nuts and herbs. Garden pools, storage structures and planting dates. \$4.49.

## B1701 PM's Great, New "Master Home Care Guide"

The latest and greatest in the Popular Mechanics Master Guide Series. All you need to know about home repairs, from basement waterproofing to roof repair. 24 laminated, wipe-clean surfaces on 12 stand-up, hang-up boards. 150 charts and illustrations. Properly used, it can save you hundreds of dollars. \$4.49.

## B1278 PM's "Index-Shelf Wrapper" Combination

Here's an Index-Wrapper for every years issues since 1971. Each index has over 5,000 references and cross ref-

erences to every article and item published that year. Yes, you can actually convert your back issues into a complete reference library. Tens of thousands of readers now keep the Index-Shelf Wrapper as an integral part of their library. The built-in wrapper which holds a full years issues is made of handsome, sturdy red lacquer board. Order by number: B1278-1971; B1278A-1972; B1278B-1973; B1278C-1974 (1975 will be ready in early 1976) Only \$2.69 each year.

## B1282 The handiest shop organizers ever designed!

Seventy-four of the most widely used shop tools including power tools have been professionally drawn and printed on die-cut, pressure sensitive, reusable appliques. Put them on the tool wall or peg board of your workshop and you'll never misplace another tool. In bright yellow and black so a missing tool will stand out like a sore thumb. Can be lifted and rearranged. Extra blank sheet supplied for your own special tools. \$4.49.

## B1700 PM's Plans, Publications & Projects Catalog

Hundreds of timely do-it-yourself articles available for reprint at modest cost highlight this excellent review of the many special plans, projects and publications available to our readers. Inexpensive plans for proven designs of everything from a houseboat or a catamaran to a ranch house or a mini-barn. 25¢.

## Photocopies of Past Popular Mechanics Articles—A Valuable Service.

Popular Mechanics receives thousands of requests for reprints of articles from past issues. You can order custom photocopies of articles that interest you, exciting and useful projects, plans and stories that have appeared over the years, and at modest cost. Because they are photocopies, they are not quite as

sharply printed as the originals however the text is clear and legible and all photos and drawings are included. The following list is just a small sampling of available articles that you may order. Hundreds more are listed in the Plans, Publications and Projects Catalog described above.

X000 Abrasive cut-off machine, 85¢	X297 Furnace smelting, \$1.05	X402 Log cabin, 85¢
X21A Arc welder, carbon, 65¢	X308 Gemstone tumbler, 85¢	X419 Metal Detector, 65¢
X107 Brick, 8 types of mortar joints, 65¢	X317 Go-kart, \$1.25	X448 Mulch-making machine, \$1.05
X181A Connecticut Shelf Clock, \$1.05	X334 Hacksaw, motorized, 45¢	X523 Radio, all wave, 85¢
X184 Cobblers bench, 45¢	X335 Hacksaw, power, 65¢	X528 Radius turning, 85¢
X210 Dado cutting, 65¢	X346 Hydraulic ram from pipe fittings, \$2.25	X603 Shaper for \$60, \$1.20
X225 Disc sander for lathe, 45¢	X362 Folding kayak, 85¢	X796 Wind generators, \$1.45
X246 Drill press from auto parts, 65¢	X364 Kilns, \$1.45	X806 Workshop in a wall, \$1.25
X268 Fences, 14 types, 85¢	X380 Wood lathe, 65¢	X806B Workshop for apartment, \$1.00
X282 Fireplace, garden, 45¢	X381 Lathe bench, 45¢	X807 Workbench, heavy duty, \$1.00
	X205B Crossbow, two types, \$1.20	X414A Marionettes, secret of making, \$3.60

ORDER BY NUMBER ON COUPON BELOW

### HOW TO ORDER

All items are mailed postpaid. There is no minimum order. List the items you wish to order in the spaces below, by order number only. All orders will be processed promptly. Allow two to four weeks for delivery. Make check or money order payable to "Popular Mechanics". Clip coupon and mail to: PM SPECIAL PUBLICATIONS, Box 1014, New York, N.Y. 10019

POPULAR MECHANICS SPECIAL PUBLICATIONS DEPARTMENT  
Box 1014, New York, N.Y. 10019

Please send me the items I have listed. \_\_\_\_\_

Total items requested: \_\_\_\_\_ Total money enclosed \_\_\_\_\_

Name \_\_\_\_\_

Address \_\_\_\_\_ Town \_\_\_\_\_ State \_\_\_\_\_ Zip \_\_\_\_\_



**OVER 100 MILES PER GALLON**



**Lambretta**

FOR COMMUTING BUSINESS, WORK OR JUST FOR FUN

EUROPE'S MOST POPULAR MOTOR SCOOTER

No energy crunch with Lambretta... popular for its good looks, ease of riding and gas economy. Over 500 purchased by N.Y.C. Police Dept. For dealer info & prices, call or write International Sportcycles, Importer-Distributor, 4000 Kennedy Blvd., Union City, N.J. 07087 (201)863-2500.

**BUILD YOUR OWN GRANDFATHER CLOCK**



Save over 50% by building your own grandfather clock. Stately, straight-sided "AMERICAN CLASSIC" with beveled plate glass sides. Narrow waist designs: "SPIRIT OF '76" with finely sculptured crown and brass-tipped pillars; or easy to build, always popular "SPIRIT OF THE CENTURY." Our kits are Red-I-Kut, semi-assembled, hand-crafted of solid 3/4" kiln-dried mahogany, cherry or walnut. Tubular bell or Westminster rod chimes. Moving moon dials painted by our own artists, and our own original Goddess Diana or Lady Florentine pendulums. Gorgeous solid bronze dials with raised numerals and corners. Send \$2.50 for all three plans, plus description of kits and movements, as folks have for more than fifty years.

**KUEMPEL CHIME CLOCK WORKS & STUDIO**  
1119 Minnesota Blvd. PM-56 Excelsior, Mo. 65131

**Print Your Own**



Cards, Stationery, Advertising, labels, tickets, announcements, QSL cards, greeting, sympathy, prayer cards, etc. Save money. **Print for others, good profit.** Have home print shop. Pays for itself in a short time. Sold direct from factory. Easy rules sent. We supply everything. Send Zie for catalog. **KELSEY PRESSES** 75-85 Meriden, Conn. 06450

**PUMP DRAINS pools, cellars, laundry tubs IRRIGATES - CIRCULATES - SPRAYS**



Heavy duty ball bearing pump. All metal, rust-proof Type XB. Stainless shaft. Use 1/4 HP or larger. 1 HP 1,200 GPH 60" high or 3,000 GPH 25" well. 5,200 GPH max. 1 1/4" in; 1" out. Belt or direct drive. \$17.95 Type P won't rust or clog. Bronze bearing. To 2,400 GPH. 1" in; 3/4" out. \$11.95 p/d cash with order. Money back Guarantee.

**LABAWCO. Box 40. Belle Mead, N.J. 08502**

**MAKE UP TO \$12 AN HOUR AT HOME**

Let Me Prove It To You FREE! I'll show you how Plastic Sealing and Laminating at home, spare time, can give you as much as \$12 each hour you operate. Table-top machine sets up anywhere. Easy. Fun. No experience needed. We furnish everything. We'll even help finance you. No house-to-house selling. Orders come by mail. Write for facts FREE. No salesman will call.



**WARNER ELECTRIC, 1512 Jarvis, Dept. L-2-EF, Chicago, IL 60626**

**MAKE MONEY! REPAIR HYDRAULIC JACKS**



Earn while you learn at home. Millions of jacks in gas and auto service stations, trucking firms, body shops, riggers, factories and farms need servicing... most of which you can learn to repair. We show you HOW. Start spare time in your basement or garage. Big opportunity for mechanics. ACT NOW! Write for folder. No. PMG, and free bonus offer.

**Hydraulic Jack Repair Manual Co., Inc.**  
G. P. O. BOX 3 - STATEN ISLAND, N.Y. 10314

**LEARN MEAT CUTTING**



Train quickly in 8 short weeks at Toledo for a bright future with security in the vital meat business. Big pay, full-time jobs—HAVE A PROFITABLE MARKET OF YOUR OWN! Time payment plan available. Diploma given. Job help. Thousands of successful graduates. OUR 52nd YEAR! Send NOW for big new illustrated FREE catalog. No obligation. G.I. approved. **NATIONAL SCHOOL OF MEAT CUTTING NO. 01971** Dept. 50-V, Toledo, Ohio 43604

**IT'S EASY TO MAKE COLOR PRINTS AT HOME** (Continued from page 120)

independent processor. I avoid independent processors. The same holds true of color slides, by the way, with one exception: It is possible to "push" slide films to higher speeds in home (or custom) processing. Again, unless you expect to do this often, you won't save much money over what even a custom lab would charge, and probably won't develop the expertise to be sure of doing it right every time, either.

Now that you are, I hope, unafraid, motivated, and have some properly developed negatives on hand, it's time to mention that there have been a lot of improvements in color darkroom equipment beyond those I've mentioned. A principal one is the color head, which I referred to earlier as the easiest way to color filtration. What I didn't mention is that these heads also turn your enlarger from a condenser to a diffuser type, which suppresses print spots caused by dust, scratches, fingermarks and so forth on the negative. If you don't like spotting black-and-white prints, wait till you try it with color! And the filters in today's color heads are "dichroic" types that don't fade like acetate CP and gelatin CC filters.

While the 8x10 drums are standard for beginners, 16x20 drums are another nice luxury item. They can make four 8x10s or two 11x14s at the same time, thus cutting your processing time. Print-and-repeat easels, which let you make a number of smaller prints on one 8x10 sheet, also help you save time on the wet side of your darkroom. Drums are available from Beseler, Omega, Simmard (in Canada), Unicolor and several others. Kodak's is sold only in England. Motor bases are available from Simmard, Beseler, Omega and Unicolor. Print-and-repeat easels are available from Omega, Premier, Unicolor and others.

There are two basic papers to choose from: type A and type B. Type A (which must be dried before you evaluate its color balance) is sold by Kodak, Beseler, Omega and Unicolor, among others, with GAF manufacturing the papers for the latter three. All of these papers are plastic-coated (RC) types, though, so you don't have to wait long for them to dry.

Type B papers, which can be evaluated when still wet, are sold by Unicolor and Agfa (but I still can't find any of the Agfa products on the shelves in New York where I shop).

All of the firms mentioned above also sell processing chemicals. Processing takes between 8 and 10 min-

utes per print, except with Beseler's system, which is claimed to turn out good prints in about two minutes and only three steps.

If you shoot color slides, you have two choices for print-making: You can make internegatives, or have them made, and print from those; or you can make color prints directly from transparencies, using color paper and chemicals from Kodak, Cibachrome or Unicolor.

Kodak's current slide-printing paper is called Type 1993, and is quite simple to use: Once a filter pack is determined (including infrared and ultraviolet filtration), that filter pack will print almost any slide properly. Results are contrasty but otherwise quite good, but the paper requires long exposures. Kodak in France has a paper called RD-14 which is said to be about 14 to 15 times faster, and makes Type 1993 look like greasy kid stuff—I can't wait for Rochester to catch up. The Cibachrome P-12 process, in my very limited experience with it, seems to have four main disadvantages compared to the Kodak process (less maximum density, higher cost, higher contrast and a decided lack of consistency) but two big advantages, too. While all color prints fade, Cibachromes fade much more slowly than any others, and their colors are tremendously saturated to begin with.

Keeping track of color printing developments these days is a sort of Alice-in-Wonderland problem: Blink your eyes, and there's something new and strange in front of you. But all of the new wonder developments are likely to follow the same basic rules as the existing ones do. So the basic color-printing skills you learn now probably won't become obsolete. If you've been putting off your first try at color printing while waiting to see what tomorrow may bring, you need wait no longer. Tomorrow will be better than today. But today is pretty good. ★★

**THE MILES-PER-GALLON GAME**

(Continued from page 62)

by Michael Lamm

0.003-0.004-inch running clearance. Compression went from 5:1 to 6:1 and the rocker arms got needle bearings. The engineers built a special intake manifold, mounted a tiny carburetor, converted the ignition to 12 volt, put in special wide-gap plugs covered the radiator and insulated the block for optimum heat retention, and poured SAE 5-weight oil into the crankcase.

This roadster ran no fan, used to



ly bald tires pumped up to 150 p.s.i., and even the generator was cut to the minimum voltage. At steady cruising speeds instead of burst driving, this 24 Chevrolet averaged about 50 mpg. In bursts, it tripled that.

Turning now to the 1959 Opel, we did most of the above tricks incorporated, but with the addition of a few new ones. First, it's a three-speeder, with the engine mounted transversely in the rear. It has no multi-gear transmission—just a single speed—and it uses chain drive to the single rear wheel. This arrangement reduces friction and includes a freewheeling device to aid in coasting. There's no need to throw in the clutch or take the transmission out of gear with freewheeling.

Tires are not only bald, but the tread is trimmed so that only a one-inch strip in the center touches the ground. To further reduce rolling resistance, all tires are inflated to 200 p.s.i. Wheel bearings are so delicately adjusted that spinning one tire by hand keeps it rotating for more than half an hour. The usual 90-weight motor lubricant is replaced with 5-weight engine oil.

Since these cars never go above 15 mph, wind drag isn't much of a factor, so I use full belly-pans and home-made streamlining, usually built of plywood. Weight, of course, is kept to a minimum.

What are *your* chances of cracking the 100-mpg barrier, you ask? Not likely in the old family bus, I'm afraid. I tried out the burst-driving technique long ago in a 1975 Honda CVCC hatchback, using 5 and 30 mph as my test limits. Over a 10-mile level course, I managed to get 54.4 mpg. This was in fourth gear. At a steady 50 mph, this same car got only (*only!*) 15 mpg. So burst driving does work. And if you should ever find yourself 50 miles away from a filling station with only a gallon of gas left in your tank, you might try it as a last resort. ★ ★ ★

(Continued from page 63)

### Nils Nelson

ings for the distributor, and new parts for the carburetor. You'll have to add points, plugs, condenser, but it turns out to be one big tune-up. They convinced me it was better to install the kit because the distributor needs to be recurved on a machine. This was the only job I did myself, and it was worth doing them do it. Not only did the engine get done properly, but they got hooked on by the project and have provided me with constant technical assistance and testing on emissions equipment and the Dyno machine.

Along with the kit, I installed a Judson Electronic Magneto, which increases the spark from a stock 20,000 volts to a minimum of 30,000 volts. In a well-tuned condition, my spark has been measuring 50,000 volts. This has got to be burning more gas, more efficiently.

At this point, I became aware of a device called a vapor injector. The principle, as explained to me, is that it further breaks down gas in the carburetor and makes a finer vapor. It sounded like a good idea, so I got in touch with APO of America here in Dallas and got one. I had expected a 20-percent increase in mpg, so when I got 10 percent, I talked to them. After learning what I had already done, they patiently explained there was a limit to what could be done with an already efficient engine. In fairness, I really believe that if it had been one of the initial improvements I probably would have gotten closer to 20 percent.

My final modification was one I had been deliberately putting off. First, because the average car-owner wouldn't do it; second, because I'm really not the hot-rod type vroom-vrooming around town. Headers and tuned exhaust had been recommended since I first started talking about this project. I finally ordered a set from Sparco, an outfit that specializes in performance parts for Pintos. Fear One vanished because it really is a simple job—old parts out, new ones in thanks to clear instructions, and all necessary parts installed in about four hours with not a knuckle skinned.

It's quite important to note here that the larger jets supplied with the Dyno tuning kit keep the improved exhaust system from scavenging all the gas which would otherwise cause lean running and would eventually burn valves. As far as noise goes, it's not much louder, but it sounds better—kind of mellow.

I sat down, checked test results and mpg figures I've been keeping for a year and a half. No, I didn't get the 100-percent mpg improvement I had hoped for. But for around-town driving, the improvement was a 32-percent increase in mpg. Turnpike driving at a steady, sensible 50 mph yielded a really good 82-percent mpg increase. What really surprised me was the final test on the Dyno and emission-test equipment. A 91-percent increase in hp—which every Pinto can use! Emissions tested: hydrocarbons 185 parts per million and carbon monoxide 2 percent at idle—both well below 1975 standards—even in California.

All this for a cost of \$259. I think it was worth it. ★ ★ ★

## TURBO BLAST

Get Up To 50,000 Miles On Your Spark Plugs

- Cleans all types of plugs in seconds
- Requires no compressed air



- Supply of glass bead abrasive for cleaning 250 plugs. Additional beads available
- Rugged, long life without maintenance
- Powered by rugged 12,000 RPM 120V motor

NEW



JAYCRAFT CORP. DEPT. PM-6  
760 North Marshall Ave., El Cajon, Calif. 92020

Name \_\_\_\_\_

Address \_\_\_\_\_

City \_\_\_\_\_ State \_\_\_\_\_ Zip \_\_\_\_\_

**\$19.95** Plus \$1.55 for shipping and handling  
SATISFACTION GUARANTEED or your money refunded in 30 days  
California Residents Add State Sales Tax

Let Belsaw prove YOU can

Earn Up To  
**\$800** an  
Hour



In  
YOUR  
OWN  
SPARE  
TIME or  
FULLTIME

## SHARPENING BUSINESS!

On our  
30-DAY  
FREE  
TRIAL  
OFFER

LIFETIME SECURITY  
with YOUR OWN BUSINESS

You risk nothing by accepting this offer to see how easily you can turn your spare time into big Cash Profits with your own Complete Sharpening Shop. No selling... no previous experience needed. Our famous Sharp-All and show-how instruction set you up to make \$200, \$500, \$700 a month CASH sharpening Saws, Knives, Scissors, Lawnmowers, Shop and Garden Tools... all cutting edges.



Send for all the facts! Our Free Book tells how to start a profitable, lifetime home sharpening business, how we help you grow, how we'll finance you.

Send for FREE details mail coupon below or postcard TODAY  
BELSAW SHARP-ALL CO., 716H Field Bldg. Kansas City, Mo. 64111

No Obligation... No Salesman Will Call

• YES,  BELSAW, 716H Field Bldg., Kansas City, Mo. 64111  
• please send me the FREE BOOK that gives full details.

Name \_\_\_\_\_ Place Print \_\_\_\_\_

Address \_\_\_\_\_

City/State \_\_\_\_\_ Zip \_\_\_\_\_



# Trailer hitches vs. the new bumpers

Can you clamp a hitch ball behind your new car? The answer seems to be: "Yes, if . . ."

by Ray Gill



Until recently, towing a trailer behind your car seemed to be getting easier and better every year. For lightweight loads like a lawnmower on a flatbed, a small boat rig or a tent trailer, you clamped a hitch on your rear bumper and off you went. With that most popular of all recreational vehicles, the travel trailer, you considered a larger tow car or small truck and learned about frame-mounted weight-equalizing hitches for the long haul. Or if you wanted to move furniture or bulky gear, you went to a cargo trailer rental outfit and they supplied you with a detachable multiclamp bumper hitch to tow it.

But now conditions have changed. The revised automotive industry standards to make bumpers able to withstand five-mph collisions have raised questions about attachment of hitches to these new shock-absorbing units. Experience since the introduction of 1973 model cars with impact-absorbing bumpers has shown that bumper hookup with the proper types of hitches can be very satisfactory.

Recently, however there has been a new suggestion that the National Highway Traffic Safety Administration relax the five-mph requirement and allow lighter "soft" plastic bumpers in order to "save gas" and possibly cut costs to help car sales. The proposed bumpers, it is believed,

would not take either bumper hitches or bumper jacks. Some car manufacturers are even recommending against the use of bumper hitches on present cars.

So where does that leave you if you want to tow a trailer? With current passenger cars, figure the small compact can handle light trailers up to 1000 pounds, tongue weight of 100 pounds. Bumper hitches should prove satisfactory on any car for occasional trips when towing these light loads. The installation, however, should not include a rigid connection between the impact-absorbing bumper and the car frame, preventing the bumper from functioning properly.

Manufacturers recommend frame-mounted hitches, along with the other components of special trailer-towing packages such as extra cooling and heavy-duty suspension, when regular long trips with heavy trailers are planned. Chrysler, for example, now offers a Heavy Trailer Tow Package that will handle trailers up to 6000 pounds when used on Chrysler-Plymouth intermediate cars, and up to 7000 pounds on full-size cars.

Included are a load-distributing hitch platform, trailer brake control-

ler, dual battery-charging circuitry, wiring harness with connector and 65-ampere alternator. Also recommended are heavy-duty suspension, wide-rim wheels with appropriate tires, constant-rate signal flasher, high-amp. battery, 3.23-to-1 rear axle ratio, maximum cooling system with recovery bottle, and auxiliary transmission oil cooler. Ford, General Motors and International are offering similar packages.

Individual trailer hitch manufacturers such as Reese, of Elkhart, Ind., and Valley Tow-Rite, in Lodi, Calif., provide under-chassis-attachment hitches which can be clamped, bolted or welded in place and which do not secure to the bumper. Some keep the square tow-bar sleeve shorter than the bumper to prevent impact to chassis through the tow bar itself. A Valley Tow-Rite hitch for the Volkswagen attaches to the rear bumper but uses a U-bolt which lets the no-damage feature function.

Carmakers recommend against the use of axle-mounted hitches because of the chance of damage to housing, bearings, wheels or tires, and warn that a chassis-mount hitch must clear the gas tank with enough space to prevent chafing.

Insurance company figures indicate that five-mph bumpers can mean savings of up to 85 percent in a low-speed crash and present standards should not be relaxed. ★★★

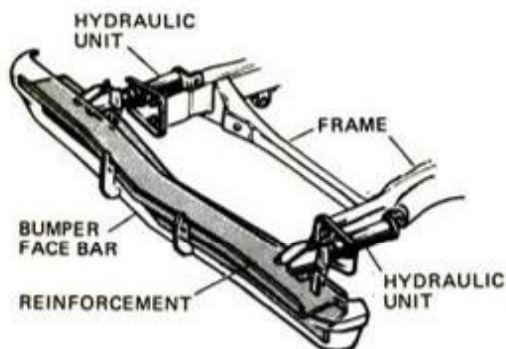

Attachment of hitches, particularly of the detachable multiclamp type, has proved out on bumpers like this Dodge hydraulic.

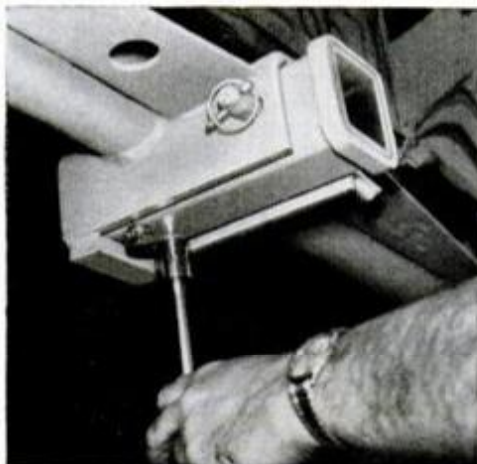

Installation of bolt-on hitches can bypass bumper and allow switching to new model if car is sold. Hitch must not chafe tank.



With hitch sleeve behind bumper and tow ball arm removed when not in use, rear impact will not pass from sleeve to chassis.



# Compare TV/Audio home training and you'll choose NRI.



## Compare costs

Only NRI offers five complete TV/Audio Servicing Courses from \$395 to \$1095 . . . with easy budget terms also available. In the Master Course in color TV servicing, with its 25" diagonal solid-state color TV kit designed specifically for training, you save as much as \$650 under a comparable course from the next leading home study school.

NRI saves you money because we pay no salesmen, and we design our own kits and equipment. We pass that savings on to you.

## Compare choices

NRI has five levels of TV/Audio training to match your specific needs. The basic course offers 65 lessons, including color TV training. Or you can step up to a more advanced course including a 12"

diagonal B&W TV training kit. Then there's the 19" diagonal solid-state color TV training kit; the advanced color TV course for technicians—with an 18" diagonal color TV for experiments and troubleshooting; and finally, the new 25" diagonal solid-state color TV course—engineered specifically for training. Training Kits for this course include an oscilloscope, TV Pattern generator, and digital multimeter.

## Compare training

NRI maintains its own full-time staff of technical writers, editors, illustrators, development engineers and publications experts. The people who design the kits also design the lessons, so theory and practice go hand in hand. Along with each course, NRI provides bite-size, fully illustrated lessons; personally-graded tests; and the kind of person-to-person teaching that makes learning easier and faster.

More than one million students have enrolled with NRI. NRI graduates will tell you: you can pay more, but you can't buy better training.

## Compare equipment

Don't just count kits. Count the experiments . . . compare the components. NRI has engineered the widest variety of electronic lab equipment ever designed for training at home. When you enroll in the Master Course in TV/Audio Servicing, you receive kits to build a solid-state, triggered sweep, service type 5" oscilloscope; color pattern generator; solid-state radio trainer; and 3½ digit digital multimeter.

Send for the free NRI full-color electronics catalog. You'll find courses offered in TV/Audio Servicing, FCC License, Complete Communications Electronics, Marine and Aircraft Electronics, Mobile Communications, etc.

**Mail For FREE  
NRI Catalog.**

No salesman will call.



AVAILABLE FOR CAREER STUDY UNDER GI BILL.  
Check line on card for details.



**NRI SCHOOLS**  
McGraw-Hill Continuing Education Center  
3939 Wisconsin Avenue,  
Washington, D.C. 20016



# Get the Irwin workshop special



Have Irwin quality Speedbor® "88" bits— $\frac{1}{4}$ " to 1"—at your fingertips

Get 13 precision-engineered Irwin Speedbor® "88" wood bits with  $\frac{1}{4}$ " electric drill shank, sizes  $\frac{1}{4}$ ",  $\frac{3}{8}$ ",  $\frac{1}{2}$ ",  $\frac{5}{8}$ ",  $\frac{3}{4}$ ",  $\frac{7}{8}$ ",  $1$ ". Plus an all metal storage rack. Popularly priced for home, farm, factory, school workshop. Bits forged from finest tool steel. Heat-tempered full length. Machine-sharpened for fast, clean, accurate cutting power. 6-bit set with rack also available,  $\frac{3}{8}$ " to 1". 4, 6 and 13-bit sets also available in plastic kits. Buy Speedbor bits in sets—or select 17 individual sizes,  $\frac{1}{4}$ " to  $1\frac{1}{2}$ ",—at your Irwin hand tools dealer.



### Irwin Screw Starter.

Marks hole, starts hole, threads hole for screw to easily enter wood and non-metal materials. Handiest tool in years for home and job. Get one soon.



# IRWIN

every bit as good as the name

at Wilmington, Ohio 45177, since 1885

## INTRODUCTION TO REFRIGERATION

a technical home study course covering fundamental principals and practical applications of domestic and commercial refrigeration. The course includes instruction with 16 personally graded correspondence lessons. The cost, including text book, is \$70.27. We have offered courses since 1891 and have many to choose from.

### UNIVERSITY OF WISCONSIN-EXTENSION

Departments of Engineering, Mathematics & Applied Sciences

432 North Lake St. Madison, Wis. 53706

Please send me complete details on your REFRIGERATION course

NAME \_\_\_\_\_  
STREET \_\_\_\_\_  
CITY \_\_\_\_\_ STATE \_\_\_\_\_ ZIP \_\_\_\_\_

## 257 VACATIONLANDS—READY AND WAITING (Continued from page 57)

Golden Gate in San Francisco, are being added to the roster, and Congress is considering the addition of parks in the Santa Monica Mountains of Los Angeles, the Potomac River near Washington and the Chattahoochee River outside Atlanta. National preserves and shrines, monuments and historical sites are scattered through the 50 states, Puerto Rico and the Virgin Islands, and are available to all.

Information about specific parks may be obtained by writing in advance to the U.S. Government Printing Office, Washington, D.C. 20402, or directly to the parks. Many are very popular and can be crowded on occasion. This year, campers should write for reservations to Acadia, Me.; Grand Canyon, Ariz.; Mount McKinley, Alaska; and Platt, Okla. Other parks expect to offer campsites on a first-come, first-served basis.

One way to avoid peak midsummer crowds is to pick the lesser-known locations. Listed here are particularly popular spots *plus* our choices of additional sites having a special appeal:

**Alaska**—Mount McKinley Nat'l Park, Box 9, McKinley Park, 99755. Plus, Glacier Bay Nat'l Monument, Gustavus, 99825, with tidewater glaciers, forests, rare wildlife.

**Arizona**—Grand Canyon Nat'l Park, Box 129, Grand Canyon, 86023. Plus, Organ Pipe Cactus Nat'l Monument, Box 38, Ajo, 85321, in Sonoran Desert near Mexican border.

**Arkansas**—Hot Springs Nat'l Park, Box 1219, Hot Springs, 71901.

**California**—Point Reyes Nat'l Seashore, Point Reyes, 94956. Yosemite Nat'l Park, Box 577, Yosemite Park, 95389. Plus, Pinnacles Nat'l Monument, Paicines, 95043, with volcanic pinnacles, caves, canyons.

**Colorado**—Rocky Mountain Nat'l Park, Estes Park, 80517. Plus, Dinosaur Nat'l Monument, Box 101, Dinosaur, 81610, panorama of canyons cut by Green, Yampa Rivers.

**Florida**—Everglades Nat'l Park, Box 279, Homestead, 33030. Plus, Biscayne Nat'l Monument, Box 1369, Homestead, with a living coral reef, boating, fishing, scuba.

**Hawaii**—Haleakala Nat'l Park, Box 456, Kahului, Maui, 96732.

**Idaho**—Craters of the Moon Nat'l Monument, Box 29, Arco, 83213, with moonlike volcanic formations.

**Iowa**—Effigy Mounds Nat'l Monument, Box K, McGregor, 52157, with 1000-year-old Indian mounds shaped like birds and animals.

**Kentucky**—Cumberland Gap Nat'l Historical Park, Box 840, Middlesboro, 40965. Famous Civil War region where Boone blazed his Wilderness Trail in 1775.

**Maine**—Acadia Nat'l Park, Box 1, Bar Harbor, 04609.

**Maryland**—Assateague Island Nat'l Seashore, Box 294, Berlin, 21811.

**Massachusetts**—Cape Cod Nat'l Seashore, South Wellfleet, 02663.

**Michigan**—Isle Royale Nat'l Park, 87 North Ripley St., Houghton, 49931.

**Minnesota**—Voyageurs Nat'l Park, Box 50, International Falls, 56649. Plus, Grand Portage

Nat'l Monument, Box 666, Grand Marais, 55604, where Great Lakes fur traders from Montreal crossed overland to the interior.

**Montana**—Glacier Nat'l Park, West Glacier, 59936. Plus, Bighorn Nat'l Recreation Area, Box 458 YRS, Hardin, 59022, with game, fishing, agate and fossil collecting.

**Nevada**—Lake Mead Nat'l Recreation Area, 601 Nevada Hwy., Boulder City, 89005. Plus, Lehman Caves Nat'l Monument, Baker, 89311, where underground tour follows limestone tunnels and galleries.

**New Jersey**—Delaware Water Gap Nat'l Recreation Area, Columbia, 07832.

**New Mexico**—Carlsbad Caverns Nat'l Park, 3225 El Paso Rd., Carlsbad, 88220. Plus, Chaco Canyon Nat'l Monument, Box 539, Farmington, 87401, with major Indian ruins, nature trails, campground.

**New York**—Fire Island Nat'l Seashore, NPS, 26 Wall St., New York City, 10005.

**North Carolina**—Cape Hatteras Nat'l Seashore, Manteo, 27954. Plus, Blue Ridge Parkway, Box 7606, Asheville, 28807, running 473 miles along scenic mountain crests.

**Oklahoma**—Platt Nat'l Park, Box 201, Sulphur, 73086.

**South Dakota**—Wind Cave Nat'l Park, Hot Springs, 57747. Mount Rushmore Nat'l Monument, Keystone, 57751.

**Tennessee**—Great Smoky Mountains Nat'l Park, Gatlinburg, 37738.

**Texas**—Padre Island Nat'l Seashore, Box 8560, Corpus Christi, 78412. Plus, Big Bend Nat'l Park, 79834, with mountains and deserts in great bend of the Rio Grande River.

**Utah**—Zion Nat'l Park, Springdale, 84767. Plus, Canyonlands Nat'l Park, Moab, 82532, where the Green and Colorado Rivers converge in spectacular red-rock canyons.

**Virgin Islands**—Buck Island Reef Nat'l Monument, Box 160, Christiansted, St. Croix, 00820.

**Washington**—Olympic Nat'l Park, Port Angeles, 98362. Plus, Coulee Dam Nat'l Recreation Area, Box 37, Coulee Dam, 99116, sailing, fishing, hunting, camping, swimming, scenery.

**Wyoming**—Yellowstone Nat'l Park, 82190. Plus, Devil's Tower Nat'l Monument, Devil's Tower, 82714, 865-foot natural rock column overlooking forests; hiking, camping.

In addition to these and hundreds of other points of interest in the National Park System, there are often state-run recreational areas near popular national parks that may be less well known and crowded. For information write to Dept. of Tourism of the state involved. It can usually furnish lists of adjacent motels, cabins and lodges as well.

For overall information, the Government Printing office sells a *National Park Map and Guide* for 35 cents listing all installations with addresses, with checklists for campgrounds, swimming, boating, horseback riding, winter sports and other activities. Additional 30-cent booklets cover camping, fishing and boating regulations in the National Park System. A booklet on *Winter Activities* is 35 cents, a map folders packet, \$1.50. Our parks remain one of our great bargain vacations. ★ ★ ★



## TRANSATLANTIC BALLOON JINX

(Continued from page 73)

editor said: "If a balloon were to move across the ocean with the same speed with which the *Atlantic* sailed from St. Louis, it would take only two days to fly from New York to England; such a feat really does not appear to be an impossible thing, and we hope to live to see it done."

Still planning a flight to Europe, LaMountain rebuilt the *Atlantic*. On Sept. 22, 1859, with newsman John Haddock as passenger, he took off from Watertown, N.Y., on the *Atlantic's* last flight. Intended as a practice ascent, this turned into a wild, four-hour ride, covering 300 miles, and ending with a rough landing in the Canadian bush. After wandering lost, for four days, LaMountain and Haddock were rescued 150 miles north of Ottawa.

Meanwhile, at New York, Thaddeus S. C. Lowe had constructed a mammoth balloon for his planned 1859 transatlantic attempt. The *City of New York* was described as 350 feet high, 130 feet in diameter, with a gas capacity of 725,000 cubic feet. Below its 10-passenger gondola hung a 30-foot steam-powered launch.

When the New York Gas Co. was unable to deliver gas in sufficient volume fast enough for proper inflation of the giant bag, in November, 1859, Lowe accepted an invitation to take his balloon to Philadelphia, where adequate gas supply was promised. The balloon was renamed *Great Western* and its transatlantic attempt rescheduled for the next summer. On Sept. 8, 1860, near completion of inflation before launching for Europe, the balloon was caught in a squall, burst and was destroyed.

John Wise and Washington H. Donaldson joined forces in 1873 to get the *New York Daily Graphic* to sponsor a transatlantic flight. Their balloon, the *Daily Graphic*, was 160 feet high, 110 feet in diameter and held 600,000 cubic feet of gas. It had a two-story gondola with the usual lifeboat suspended underneath and auxiliary balloons to carry an extra gas supply.

Under the strain of gusty winds, the balloon burst during its inflation and a disgruntled Wise then withdrew from the project. Donaldson rebuilt the *Daily Graphic* and, on Oct. 6, 1873, with reporters Alfred Ford and George Ashton Lunt, he took off on the first transatlantic balloon flight in history. A severe rainstorm forced them down in New Canaan, Conn., 60 miles from the Brooklyn, N.Y., lift-off site.

Samuel King's million-cubic-foot

(Please turn to page 130)

## LIVE IN THE WORLD OF TOMORROW... TODAY!

And our FREE 180 PAGE CATALOG is packed with exciting and unusual values in hobby, electronic and science items — plus 4,500 finds for fun, study or profit... for every member of the family.

### A BETTER LIFE STARTS HERE

#### OWN A WORKING DUTCH WINDMILL

Easily build a charming 1/5 scale replica of the real thing with our detailed plans, blueprints, list of materials needed and explicit instructions. 8' size can generate 1000w (12v current) of free electricity from the wind! 2', 4' & 8' sizes stand 3'6", 7' & 14' high, respectively. Get kudos from your neighbors for the beauty & practicality. If you're the least bit handy you can do it for \$250-\$350 (est. complete material cost). Go Dutch!

Stock No. 9130H ..... \$15.95 Ppd.



#### TOTAL KIRLIAN PHOTOGRAPHY SET

Explore "aura" photography w/ superb new self-contained Kirlian Electrophotography Research Unit. Terrific value—introduced at \$99.95 (\$140 in Sept.)! Has everything but vinyl photo changing bag. Ideal for color or b/w 35mm, sheet or Polaroid film for photos up to 5x7" all without camera or lens. Variable voltage 12v to 32kv. Ultimate safety design—fully encased in plastic; patented electronics, Instrs.

No. 72,104H ..... (3x5 1/2 x 7 1/2") ..... \$99.95 Ppd.

No. 42,240H (CHANGING BAG) ..... \$ 6.50 Ppd.



#### BIG 6 x 6" OPAQUE PROJECTOR!

Great buy! New light-weight compact enlarges any picture or print matter (up to 6x8") for big projection 30 to 144" away. True color reproduction! Feet: optically polished glass lenses, heat-resist. plate glass mirror, curl-free slide tray, heavy duty motor, large fan. Reas two 200w household bulbs (not incl). Steel body, 8' cord. 13x13 1/2 x 7 1/2".

Stock No. 80,217H ..... (9 LB.) ..... \$79.95 Ppd.

DELUXE 5x5" OPAQUE PROJECTOR No. 71,272H (SUPER SHARP) ..... \$139.95 Ppd.



#### ACTUAL WORKING SOLAR HOME PLANS

Learn all about the most fascinating possible home of the future. It can be your "now" answer to today's energy crisis in housing. Expert Dr. Harry E. Thomason tells advantages, problems, savings, and more in this important 20-pg fact-filled booklet. Also includes 8-page oversize insert of basic, actual solar home plans, a valuable guideline to you and your architect in fitting space requirements, design ideas, and local area building codes.

No. 9440H (Solar House Plans) ..... \$10.00 Ppd.



#### AM RADIO FITS IN/ON YOUR EAR!



Wear it inconspicuously or proudly. Listen as you work (class, yard, office), watch (game, beach) or wait. Instant music, news, sports. No gimmick, our 8-10 ohm, low-impedance wonder has integrated circuit, 11 transistors, patented ferrite antenna-tuner volume dial. Uses normal silver oxide hearing aid batt. (incl) for approx. 100 hrs. playing. New batt. to ship in avail. at drug stores (about \$0.61). No lengthy wires, bulky cases, or power packs!

Stock No. 42,275H ..... \$14.95 Ppd.

#### KNOW YOUR ALPHA FROM THETA!



For greater relaxation, concentration, listen to your Alpha-Theta brainwaves. Ultra-sensitive, electronic hand-held slips on/off in seconds—eliminates need for messy creams, etc. Also'd to amplifier, filters brainwaves, signals beep for ex-Alpha or Theta wave passed. Monitoring button stimulates Alpha sound; audio & visual (L.E.D.) feedback. Reliable, easy-to-use unit—comparable to costlier models. Completely safe. Comprehensive instruction booklet.

No. 1635H ..... (8x3x4", 24 oz.) ..... \$134.50 Ppd.

LOW COST "STARTER" UNIT No. 71809H ..... \$55.00 Ppd.

DELUXE "ON" TIME MONITOR—MEASURES & RECORDS % No. 1652H ..... \$349.50 Ppd.

#### "FISH WITH A MAGNET"



Go treasure hunting on the bottom! Fascinating fun & sometimes profitable! Tie a line to our 5 lb. Magnet—drop it overboard in bay, river, lake or ocean. Trawl it along bottom—your "treasured" haul can be outboard motors, anchors, other metal valuables. 5 lb. Magnet is war surplus—Alnico V Type—Govt. cost twice our price. Lifts over 150 lbs. on land—much greater weight under water.

Stock No. 72,103H ..... (5 lbs.) ..... \$17.50 Ppd.

GIANT ELECTROMAGNET LIFTS 500 lbs. Stock No. 71,936H ..... \$34.50 Ppd.

#### AUTHENTIC SCALED WINDMILLS



Real-thing replicas show wind direction, wheel silently revolves on ball bearings. Give your grounds unique rural charm! Great centerpiece for planter, flowers. Use to hold yard light, house number, sign or as mailbox. For school, a fine "energy crisis" science project—does everything but pump water. Heavy gauge steel, durable outdoor finish; aluminum color w/red trim.

(17" DESK MOD.) No. 71,923H ..... \$11.95 Ppd.

(4 1/2"-14 LB.) No. 71,924H ..... \$34.95 Ppd.

(8"-46 LB.) No. 85,229H ..... \$49.95 Ppd.

#### PRO ELECTRONIC SOUND-CATCHER



Parabolic mike w/ 18 1/2" reflecting shield & 2 I.C.'s in amplifier magnifies signals 100X that of omnidirectional mikes. Catch a songbird 1/2 mile off! QB's huddle strategy; sounds never before heard. Super directivity gives highest signal to noise ratio possible. Safe; auto. cuts off ear-damaging noise. Earphones, tapes recorder output, tripod socket. Reas. two 9v trans. batt. (not incl).

No. 1649H ..... (5 1/2" LB.) ..... \$299.00 Ppd.

BIG EAR "TOY" MODEL No. 80,176H \$32.25 Ppd.



### MAIL COUPON FOR GIANT FREE CATALOG!

180 PAGES • MORE THAN 4500 UNUSUAL BARGAINS

Completely new Catalog Packed with huge selection of telescopes, microscopes, binoculars, magnets, magnifiers, prisms, photo components, ecology and Unique Lighting items, parts, kits, accessories — many hard-to-get surplus bargains. 100's of charts, illustrations. For hobbyists, experimenters, schools, industry.

EDMUND SCIENTIFIC CO. 300 Edcorp Building, Barrington, N.J. 08007

Please rush Free Giant Catalog "H"

Name \_\_\_\_\_  
Address \_\_\_\_\_  
City \_\_\_\_\_ State \_\_\_\_\_ Zip \_\_\_\_\_



### COMPLETE AND MAIL WITH CHECK, M.O. OR CHARGE NO.

EDMUND SCIENTIFIC COMPANY 300 Edcorp Building, Barrington, N.J. 08007

How Many	Stock No.	Description	Price Each	Total

SEND FREE 180 PAGE CATALOG "H" Add Handling Chg. \$1.00. Orders Under \$5.00. 50¢. Orders Over \$5.00

Charge my BankAmericard \* I enclose  check  money order for TOTAL \$

Charge my Master Charge \* My Card No. is \_\_\_\_\_ Interbank No. \_\_\_\_\_

Signature \_\_\_\_\_

Card Expiration Date \_\_\_\_\_ NAME \_\_\_\_\_

30-DAY MONEY-BACK GUARANTEE. ADDRESS \_\_\_\_\_  
You must be satisfied or return by purchase in 30 days for full refund.

\*\$15.00 minimum. CITY \_\_\_\_\_ STATE \_\_\_\_\_ ZIP \_\_\_\_\_



# TOOL BARGAINS OF THE MONTH BY

## SCHLESINGER'S

**Stainless Steel DIAL CALIPERS**  
Measures inside, outside, & depth readings. Dial graduated in .001"

No.	Range	Price	List
704	4"	\$25.00	39.50
806	6"	37.00	49.00
908	8"	52.40	59.00
1212	12"	79.00	99.00

Add \$1.00 for UPS charges



### NEW SWISS MEASURING TOOL



unbreakable, rust proof, construction.

No.	Graduation	Range	only
80D	.01" AND 1/64"	5 1/2"	\$10.95
80M	.1 MM	140 MM	\$1.00 UPS

### MACHINE DIVIDED SATIN-CHROMED RULES

Type A: 10ths, 100ths, 32nds & 64ths Flexible  
Type B: 50ths, 100ths, 32nds & 64ths Flexible  
Type C: 8ths, 16ths, 32nds, 64ths... Flexible  
Type D: 8ths, 16ths, 32nds, 64ths... Rigid  
Type E: Millimetre & 1/2 Millimetres  
32nds & 64ths... Rigid

(Type E available in 6" only) Others

in 1/2', 1' 1 1/2' & 2'

Prices: 1/2'...\$3.50.

1'... \$6.00; 1 1/2'... \$11.00 2' \$15.00



50c UPS

### Hi-Power MAGNETIC BASE with scriber

Model MB...  
Buy 3-10% Off.  
Buy 6-20% Off.  
Buy 12-25% Off.

\$19.95

Dial Indicator for

above 1/4" range in .001" only \$13.00

Add \$1.50 per base for UPS charges



### H.S.S. DRILL SETS IN INDEXES

TOP QUALITY U.S. Made

1-60...Only \$25.00  
A-Z...Only \$3.00  
1/16 - 1/2 by  
64ths...Only \$3.00  
All 3 Sets \$85.00

Add \$2.00 for UPS charges



### DRILL PRESS VISES



2 1/2" Size \$14.95

3" Size...\$19.95

2 1/2" Size Angle

Vise same price as 3" vise.

UPS charge 2.00

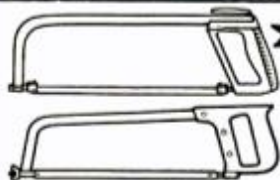

**WORLD'S FINEST HACKSAW FRAMES**

DELUXE \$6.00

STANDARD 5.25

**SPECIAL ON BLADES!**

World's only patented HSS

and all hard & flexible: 10 for \$5.00

Add \$1.00 for UPS charges

### FILES SET OF 3 TOP QUALITY FILES

U.S. Gov't Specs.  
Mill bastard: 8" 10" & 12"  
Free File Handles included

only \$ 4 95

Add 50c for UPS charges

SEND FOR OUR HUGE CATALOG \$1.00

SCHLESINGER'S FOR TOOLS LTD.

1261 UTICA AVE., BROOKLYN, N.Y. 11203

(212) 451-2556

## TRANSATLANTIC BALLOON JINX: WHO'LL BE FIRST TO BEAT IT?

(Continued from page 129)

*Great Northwest* was the biggest transatlantic balloon ever built. On Sept. 12, 1881, with King and six passengers aboard, it took off from Minneapolis on a flight to New York, planned as the first stage of a voyage to Europe. Narrowly missing a dunking in the Mississippi, the *Great Northwest* came down near Minneapolis's twin city, St. Paul. King never attempted the ocean crossing for which this lighter-than-air monster was built.

Eighty-five years after the last try at ballooning across the Atlantic, a British team—Arnold Eiloart, his son, Tim; Colin Mudie and his wife, Rosemary—attempted an east-west crossing from the Canary Islands to the West Indies. On Dec. 12, 1958, they set out from Tenerife in their 53,000-cubic-foot hydrogen balloon *Small World*. Forced down by a violent storm, after nearly four days and some 1200 miles of flying, the Eiloarts and Mudies sailed their gondola, a seaworthy boat, the rest of the way—1500 miles—to Barbados, arriving there Jan. 5, 1960, after three harrowing weeks at sea.

In spring, 1968, Francis Brenton, described by the press as "a British-born adventurer from Chicago," made several unsuccessful attempts to get underway on a balloon trip from the Canary Islands to the Bahamas. At Madeira in 1969, he scrubbed another transatlantic flight when his balloon could not lift the loaded gondola.

Two Canadian actors, Jerry Kostur and Mark Winters, tried on Aug. 10, 1968 to fly to Europe in the *Maple Leaf*, a 32,000-cubic-foot balloon with a 15-foot plastic boat for a gondola. Short of helium at launching, the *Maple Leaf* never rose higher than 200 feet and spent most of the flight bouncing off the waves. After 17 hours of this, Kostur and Winters released the balloon and waited in their boat to be picked up. Spotted 45 miles southeast of Halifax, they were rescued by a fishing trawler. Their adventure had lasted 24 hours.

The tragic flight of *The Free Life* cost the lives of Rod Anderson, his wife, Pamela, and their British pilot, Malcolm Brighton. It began at East Hampton, N.Y., on Sept. 20, 1970—too late in the year for favorable weather over the North Atlantic.

Thirty hours and some 1000 miles into the flight, they encountered storms southeast of Newfoundland. Brighton radioed Gander: "Now at 600 feet and descending. Signing off to go through safest possible landing procedure. Will try

to contact you after landing. Over and out." *The Free Life* was never heard from again. A 19-day air and sea search failed to find any trace of the lost balloon or its crew.

It is believed that *The Free Life* dropped into high seas and was dragged under, all hands drowning as they tried to hack away the 10 heavy straps joining the balloon to the gondola. Reportedly, owner Rod Anderson had refused to install a quick-release system, the safety device that might have saved their lives.

Originally, this balloon was a good one, similar to Bob Sparks's *Yankee Zephyr* and *Odyssey*, but it had been extensively modified against the builder's advice. *The Free Life* took off with a three-foot tear in the outer envelope and the propane burner was out of order, so the essential system for maintaining the helium at

**It is believed The Free Life dropped into high seas and was dragged under, all hands drowning as they tried to hack away 10 heavy straps joining the balloon to the gondola.**

constant temperature was inoperative. Experts say this flight was foredoomed.

Early in the morning of Aug. 8, 1973, Bob Sparks lifted off from Bar Harbor, Me., alone in the *Yankee Zephyr*, headed for Europe on a westerly wind. Through the day, all systems worked perfectly; weather advisories were favorable. Before signing off to bed down for the night at 8:25 p.m., Sparks radioed from over Prince Edward Island: "It's a going balloon!"

An hour later, he awakened to find himself in the middle of a freak thunderstorm that hurled the *Yankee Zephyr* as high as 13,000 feet and dragged it down to less than 1000 feet from the ocean. For seven terrible hours, while the storm raged around him, Sparks fought desperately to stay aloft. Finally, exhausted and convinced that his balloon could not keep flying, he released it, splashing down in the gondola at 4:35 a.m. on Aug. 9, 45 miles northeast of St. John's, Newfoundland. The *Yankee Zephyr* had traveled about 850 miles in almost 24 hours. The Canadian Coast Guard found Bob Sparks at noon that day, riding eight-foot waves in his 14-foot open boat.

Tom Gatch planned to travel the



70-mph jet stream to Europe, at 39,000 feet—above uncertain weather—sealed in a six-foot pressurized sphere suspended below a flotilla of ten 23-foot superpressure helium balloons. Taking off from Harrisburg, Pa., on the evening of Feb. 18, 1974, he expected to reach France or Spain in a few days.

Just 75 minutes into the flight, Gatch radioed that a balloon had burst, causing a sudden 3000-foot drop in altitude, and that, after he released ballast to compensate, the aerostat leveled off at 35,550 feet. He was on a southeasterly course, in communication with ships and planes en route. Final radio contact was with a BOAC airliner at midday on Feb. 19. Gatch was then 925 miles northeast of San Juan, Puerto Rico.

Two days later, the *Light Heart* was sighted by the Liberian freighter, *Ore Meridian*, 1000 miles west of the Canary Islands. There were no signs of life as the aerostat drifted slowly by, only 1000 feet up, its balloons slack, the orange signal banner dragging limply below the gondola, registration number panel and U.S. flag gone. The *Light Heart* vanished over the horizon and was never seen again. Unaware of Gatch's flight, the captain of the *Ore Meridian* assumed that the strange craft was unmanned, did not investigate, and only some time later made a routine report of the sighting. Subsequent land, sea and air searches found nothing. Tom Gatch and the *Light Heart* had disappeared.

The *Spirit of Man* was designed, built, and flown by Bob Berger. Confident that his homebuilt jetstream balloon would carry him to France, fame and fortune, he bet his life on it and lost. Cramped into the gondola of the 115-foot-tall helium balloon, he took off from Lakehurst, N.J., on Aug. 6, 1974. About an hour into the flight, during which time there had been no radio contact, fishermen in nearby Barnegat Bay spotted the balloon at an altitude of several miles. They watched it descend slowly, then the envelope seemed to collapse and the *Spirit of Man* crashed into the water. Berger was dead when rescuers reached him.

Forbes Magazine's Atlantic Project, was the most elaborate and technically sophisticated transatlantic balloon attempt in history. It is said to have cost about \$1 million—twice as much as all previous attempts combined. Involved were communications links with satellites, computerization of flight data, even an airborne mission control center aboard

Forbes' DC-9, the *Capitalist Tool*.

Christened *Windborne*, the vehicle itself was right out of a science fiction movie. A one-ton, pressurized gondola for two was suspended below a flotilla of thirteen 33-foot superpressure helium balloons arranged in clusters, making the height of the whole structure 624 feet—about 60 stories tall.

The flight plan, like those of the ill-fated Gatch and Berger, was to rise to 40,000 feet, pick up the jet stream and get blown to Europe. However, Forbes' plan called for a West Coast launch, permitting systems checks over continental United States, with an abort possibility before entering the wet cruise phase.

At 3:00 a.m. on Jan. 6, 1975, millionaire publisher Malcolm Forbes and his scientist copilot, Dr. Thomas Heinsheimer, were inside the *Windborne's* 7½-foot gondola, awaiting lift-off. Then one of the balloon clusters broke its mooring and dragged the gondola for 20 feet, bouncing it across the concrete runway. Water ballast tanks ruptured and the liquid oxygen store was in danger of exploding. Launch director Jean Pierre Pommerau pulled the outside emergency release, cutting loose the balloons and aborting the flight. As he climbed from the gondola, Forbes wryly remarked: "So far, the Atlantic Project is the most expensive 20-foot trip in history."

The strung-out, 13-balloon flotilla was too complicated, presented too many possibilities of handling problems on the ground and during flight, and for entanglement, rubbing and bursting of balloons.

Recently, Malcolm Forbes announced that studies made since January indicate that another attempt with the same balloon system is not feasible, and that the Atlantic Project would be suspended indefinitely, pending development of an entirely new, single superpressure balloon concept.

So now it's up to Bob Sparks and the *Odyssey*. Will he make it? I think his chances are incomparably better than those of any previous attempt. The *Odyssey* is considered the best type of balloon, at the present state of the art, for transatlantic flight. Sparks not only has the courage and stamina required, but also is easily the best prepared, most experienced and competent balloonist ever to try an Atlantic crossing—factors that helped to save his life in 1973. And what about the transatlantic balloon jinx? Well, Bob Sparks doesn't believe in jinxes! ★ ★ ★

# INVENTORS WANTED

## IF YOU HAVE AN IDEA...

for a new product—or a way to make an old product better, contact us, "the idea people". We'll develop your idea, introduce it to industry, publicize it, negotiate for a cash sale or royalty licensing.

## SUCCESS HAS MANY FACES



### "CAROUSEL" FIREPLACE

Over \$50,000.00 in royalties already paid to inventor for invention RLO licensed to industry.



### "TWIST-OFF" CAP

Trademark and cash payment negotiated by Raymond Lee with manufacturer.



### LAWN ROLLER

Invention helped publicize inventor's crane repair business.

## TAKE ACTION ON YOUR IDEA!

If you want recognition, financial reward or just credit for having "invented it first", write for our FREE "Inventor's Kit." It tells how your idea may become a reality. It includes a special "Invention Record Form", an important brochure—"Your Invention... Its Development, Protection & Marketing", and a Directory of 500 Corporations Seeking New Products.



**RAYMOND LEE  
ORGANIZATION, INC.**  
230 Park Avenue No.  
New York, N.Y. 10017

Yes, I'd like to find out how to take action on my idea. Rush your FREE "Inventor's Kit No. A-129"

Name  Please Print

Address

City

State

Zip



## You never know when carbon monoxide is sneaking up on you.



### Lifesign® does.

Carbon monoxide can come from a motor, engine, furnace, boiler or burner. It's odorless, invisible. It can cause severe illness, blindness, accidents long before it gets to the point where it can kill you. Only Lifesign® can see carbon monoxide even though you can't. And if you keep your eye on Lifesign®, you'll see it, too.

Lifesign® quickly indicates the danger of deadly carbon monoxide. If carbon monoxide is present, the replaceable indicator tablet changes from its normal tan color to progressively darker shades of grey.

Wear it as a badge, or put it in your basement, workshop or garage... your car, truck, boat, plane or camper. Be safe. Protect your loved ones.

Lifesign® is widely used in industrial safety programs. Now you may order direct from the manufacturer. Send \$2.00 ea., postpaid

**Tempit** Division, Big Three Industries, Inc.  
Hamilton Blvd., So. Plainfield, N.J. 07080

Please send \_\_\_\_\_ Lifesign® indicators @ \$2 ea. p.p.d.  
Send \_\_\_\_\_ refills @ \$1 ea. p.p.d. Enclosed is \$ \_\_\_\_\_

Cash,  Check (No C.O.D. or Charges)

Name \_\_\_\_\_

Address \_\_\_\_\_

City \_\_\_\_\_ State \_\_\_\_\_ Zip \_\_\_\_\_

## MOLDS

for making  
Ornamental Concrete  
Items...



Book about Aluminum  
Molds with prices and  
production trade secrets  
direct from world's largest  
mold manufacturer.

SEND  
\$3.00

CONCRETE MACHINERY COMPANY, INC.

P. O. BOX 499 - HICKORY, N. C. 28601



## Be a MOTOR cycle MECHANIC

Make big money. Train at home. No need to quit school or job. Special cycle tools and test instruments included.

Cycles are "BIG BUSINESS" ... and so is Fixing Them!

Write for FREE "Career Kit." State age.

NORTH AMERICAN SCHOOL OF MOTORCYCLE REPAIR  
4500 Campus Dr., Dept. P0551 Westport, Calif. 92663



## BUILD THESE BEAUTIFUL CLOCKS



NOW AT BIG SAVINGS!

Send Just \$1 for plans & instructions to build choice of: (A) Grandfather, (B) Steeple, (C) grandmother—plus information-packed catalog of movements, dials, parts & kits to build these & 16 other fine clocks. All 3 plans—\$2.50. Catalog alone—25¢.

MASON & SULLIVAN COMPANY  
Dept. PM Osterville, Mass. 02655

## CASE FOR THE MODULAR HOME (Continued from page 88)

builders of modular houses are a mixed lot, some good, some simply awful. If you've ever shopped carefully in your life, do it for a modular home. It's worth a visit or two to factories where such houses are made to familiarize yourself with what's involved. Certain patterns, good and bad, will be apparent, and you can plan accordingly.

Get everything in writing, particularly a salesman's rosy promises. It helps, too, to familiarize yourself with the industry's jargon; an "all costs package" may mean one thing to you, but something less to the guy trying to sell you a house. Hang around, ask questions, do your homework. Talk to owners of similar houses.

Costs can multiply like rabbits. That nifty lot you plunked down good money on can be virtually inaccessible to a dealer's work crew, meaning erecting your modular may require, say, a crane. And you have no concept of how fast money can be spent until you get into the crane-hiring business. Or you may have to have a special road bulldozed—not exactly nickels and dimes.

Building codes vary from area to area. Make sure you get in writing the dealer's promise that the house he sells you will, when erected, comply with all legal wrinkles applicable to the locale where you wish to build. If you don't, you might find yourself on the hook for on-site alterations, another way to spend money quickly.

Highway regulations and conditions limit the dimensions of modular houses somewhat. Although 14-foot-wide sections are becoming fairly common, some states won't allow sections more than 12 feet wide on their highways, so while a modular house can consist of two or more modules, the possibilities are limited.

Designs of modular homes tend to be limited, too. Floor plans and both interior and exterior appearances are often sort of blah, mainly because such houses are usually designed by engineers, rather than architects. Engineers have on-line production problems and sometimes tend to take the easiest, most workable way out. Room-dividing walls, for example, almost invariably run down the centerline between the joined house halves. This often makes for small rooms and a chopped-up floor plan even though there may be no structural reason why the walls have to be there. Since most roofs are of the self-supporting truss type requiring no internal load-bearing walls, it ought to be possible to place room partitions where you want them

—within reason, of course, and within a manufacturer's capability.

Dealers and their salesmen often insist the floor plans they show you are the only arrangements available. Maybe so. Check with the factory, and if it can't satisfy you, look around for other manufacturers that may be able to. Never accept a floor plan that doesn't please you without checking to see if an alternate, more efficient plan is structurally possible.

### Some tips, thoughts, warnings:

Contact your local building inspector's office for a list of manufacturers whose modular houses are approved for erection in your area. If none of those listed makes a house you like, try the National Assn. of Building Manufacturers (NABM), 1619 Massachusetts Ave., Washington, D.C. 20036. The NABM lists about 50 manufacturers, all members. Remember, however, that most modular home manufacturers are *not* NABM members, so you might find handy the annual "Directory of Mod-

### If you can, order your modular from nearest factory possible.

Not only does long-distance delivery add to the shipping cost, but extensive travel doesn't do a modular much good.

ular Housing Producers" published by the building trade magazine *House & Home*, 1221 Avenue of the Americas, New York, N.Y. 10020. It's \$2 and worth it because it lists about 250 such manufacturers.

Even if officialdom in your area says okay, avoid manufacturers whose modulars meet *only* the Federal Housing Administration Code minimums. Conscientious building inspectors consider the FHA Code rather weak.

If you can, order your modular from the nearest factory possible. Not only does long-distance delivery add to the shipping cost, but extensive travel doesn't do a modular much good. Nails can pop, grouting can crack, mirrors break. Also, if the distance is considerable, after-sale service can be almost impossible to get. Your sales contract should specify that the seller has checked your site and its access and can deliver your modular house accordingly. Special arrangements necessary to set the house in place should be spelled out, mutually understood and agreed upon.

Specify a heating/cooling system appropriate to your area. Electric baseboard heaters lend themselves



to assembly-line production, but may not be what you need or want. You can have just the start of a system built in. Later, when the house is up, you can have a complete and appropriate system installed.

Dealers may show you limited selections of wall and floor coverings and insist that's it. Again, maybe so. Many manufacturers will let you provide your own coverings if you get them to the factory in time for installation. In any event, check this point out carefully.

If you intend to replace any wall or floor coverings later, find out how easy or difficult it's going to be. These guys are great for glue; you may find tearing up carpet or vinyl will mean a new underfloor.

Unless his factory is near your site, don't buy a modular directly from its manufacturer unless he's willing to do everything necessary to give you a finished home. If he sells you only the house, you can get caught in a hassle between him and your site contractor regarding after-sale service. A good rule of thumb is to do business with a reputable dealer rather than the manufacturer.

Not everyone in the modular game is honest, so beware of fly-by-night outfits. Salesmen exist to make sales, and to do so they've been known to tell you what they think you want to hear, not necessarily the truth. Again, get it all in writing. If a salesperson suggests you be your own contractor, run—do not walk—to the nearest exit. Even if you're an experienced builder, don't even consider such a deal unless the salesperson agrees to act as a co-applicant for the necessary permits, thus agreeing to share responsibility for mishaps. One more time: Get it all in writing.

If you plan to make changes or additions later on (earlier we mentioned a fireplace), tell your builder/dealer beforehand so that provision for your anticipated changes can be made when your house is being built at the factory. You can thus save yourself a lot of grief—and money.

Nail down the *exact* date by which your house will be completed and you will be able to move in. Allow for strange bounces of the ball, of course, but be tough about it. Contractors can have a short attention span, too.

Before you sign a contract for a specific house, get a price from more than one builder/dealer.

The same house built on your site by different dealers in your area may vary as much as \$3000 in estimated price. Don't be surprised, but make darn sure you know why before you use your pen and checkbook. ★ ★ ★

# Itching, chafing, rash, excessive perspiration, irritation, in the groin area, could be **Jock Itch**

Whether you're suffering from the bothersome symptoms, or Jock Itch (*Tinea cruris*), you should be using Cruex® Medicated Spray-On Powder.

Cruex provides fast relief. It soothes itchy, inflamed skin. Absorbs perspiration. Helps cushion against further irritation. And, because it's medicated, Cruex is strong enough to help prevent the fungous infection that can develop when these annoying symptoms are improperly treated.

Since Cruex is a spray-on powder: it penetrates into hard-to-reach places... you avoid the messiness of creams, ointments, and powders... and you eliminate the pain of rubbing, dabbing, or smearing on to sore, inflamed skin.

Get relief—fast. Avoid embarrassing itch, too. With Cruex. Soothing, cooling Cruex.

## Cruex

Guaranteed to work, or your money back from the manufacturer.





## MUZZLE LOADER KITS



### By CVA

- Complete Instructions
- Rifled Barrel
- Fully Shaped & 90% Inletted

Well known, Connecticut Valley Arms Philadelphia Derringer Kit. Complete with all parts needed to make a handsome, fully shootable replica. Features .45 cal. octagonal barrel and authentic style percussion lock. Only \$21.95 postpaid.

Ruger Old Army Revolver .44cal, list \$125.00 SALE \$112.50. Lyman Enfield Muskatooon .58cal, list \$225.00 SALE \$179.95. T/C Hawken Perc. Rifle .45 or .50cal, list \$205.00 SALE \$174.50. Bank Americard & Master Charge accepted.

## FREE SPORTSMAN'S CATALOG Buy Direct & Save

Send for FREE Muzzleloading, Hunting, Fishing and camping catalog. All nationally advertised brands at lowest possible prices. Page after page of bargains. Write Today!

CHARTER OAK DISTRIBUTORS, INC.  
Dept. PMM65 50 Walnut St., Middletown, Ct. 06475

## You're Never Out of a Job With a Sparetime

### BUSINESS OF YOUR OWN



Turn your spare hours into extra dollars this proven, practical way—start your own money-making sharpening business! No selling or canvassing, no experience needed... you do it all automatically with the Foley Saw Filer or Mower Sharpener.

## Earn \$5<sup>00</sup> to \$8<sup>00</sup> an Hour in Sparetime



Hundreds of people like yourself are making cash like this—\$50 to \$90 a week—right now in spare time. "My spare time saw filing business has made me \$952 these first few months!"—says R. T. Chapman. Many have built a complete sharpening service with year-around profits. You can, too, simply by following the sure, easy Foley plan.

## No Experience or Training Needed

You can sharpen combination (rip and crosscut) circular saws, hand saws, band saws, crosscut circular saws—and do a perfect job every time without experience or special training. The precision Foley Filer does it for you automatically! A complete repair shop in one machine! Set up in basement or garage, work your own hours in your own way and earn big sparetime profits.



## Husband and Wife Have Going Business

Here's the story from Dick and Jo Ann Koester after being in business 10 months: "We have acquired another Foley Saw Filer and for the past two months we have been in full-time operation. As we live in a small town of 150 population in farm area we use our truck to pick up saws in five nearby towns. With a family to support and plans for building our house we had to pick up business fast and already sharpen an average of 15-20 saws a day. Business for the future looks even better as good machine filing is our best advertising."

## Minimum Cash Needed

No franchise fees! Foley will help finance you and will also help you establish your own profitable business in your garage or basement. Your profits easily handle the low monthly payments. Send coupon for complete information. No salesman will call on you.

WE FINANCE YOU

FOLEY MFG. CO. 616-5 Foley Bldg.  
Minneapolis, Minn. 55418

Send more information.

Name \_\_\_\_\_

Address \_\_\_\_\_

City \_\_\_\_\_ State \_\_\_\_\_ Zip Code \_\_\_\_\_

## CASE FOR THE MOBILE HOME

(Continued from page 90)

gain. His volume buying enables him to offer the "furniture package" at a big saving over what such furnishings would cost at conventional outlets. And, a buyer can finance the "furniture package" and accompanying appliances along with the cost of the unit. In recent years, however, more dealers and manufacturers have offered such items on an optional basis, especially with double-wides.

An often-heard criticism of mobile homes is that furnishings are smaller, or scaled down, to give a unit's interior the appearance of being larger. Manufacturers say nothing is smaller, but admit some features might be scaled down slightly. Chairs and tables, say, might indeed be a bit closer to the floor than standard items. But the makers maintain—probably correctly—that "adjusting" to such slight differences is hardly noticeable.

Interiors of mobile homes can be open and handsome, albeit somewhat lacking in distinction. Many are garish, even a bit pretentious. All are "done" by interior decorators, which may or may not be your cup of tea. Keep in mind that manufacturing costs rule the day, so you'll note a lot of plastics, synthetics and fake-whatevers of one sort or another. Some units feature such things as sunken bathtubs, cocktail bars and even cathedral ceilings—touches you might find a bit much for what a small voice within you will always refer to as a trailer.

In the past, purchases of mobile homes have been financed through commercial credit outfits—finance companies. Recently, other lenders have been active, notably banks, savings and loan associations and credit unions. Like car financing, nearly all such loans are of the chattel mortgage type—fail to keep up payments and you'll lose your home.

Typical down payments run about 10 percent with the balance financed over 7 to 10 years. Some loans will run to 12 years, depending on what you want to buy and ability to pay.

It's common practice for mobile home insurance to be handled more or less in tandem with the financing. Traditionally, such insurance has been of the casualty type to protect both buyer and lender against such contingencies as fire, storm damage, theft and so on. Recently, however, as mobile homes have grown in both size and acceptance, more lenders require life insurance on the buyer. A prospective buyer should check all insurance provisions carefully; what fulfills the needs of a lender may not fulfill the needs of a buyer.

One wrinkle of mobile-home ownership is finding a spot to place the home. Aside from individual homesites—few of which are zoned to permit mobile homes—a typical buyer must arrange for the use of a lot in a mobile home park or community. Most such parks or communities are rental operations—lots or spaces are leased on a monthly basis. In newer, better-equipped parks, rents can run as high as \$60 a month, even a bit more. Older parks, with spaces renting for as little as \$30 to \$45 a month, are usually filled, and vacancies occur infrequently.

Thus, a prospective buyer should start park shopping when he starts his mobile-home shopping, maybe sooner. Never buy a mobile home until you are first assured of a place to put it. Often mobile-home dealers own or operate a park and are prepared to solve your space problems—

**Careful shopping for space is advisable because a major source of occupant complaints is park management and policies. Know exactly what you can and cannot do before you sign a space-rental lease.**

on their terms, of course. Or, because he wants to make sales, he'll have access to, or be familiar with, an area's available spaces. Chances are he can start you on your search, anyway. (You might find helpful Woodall's *Mobile-home Park Directory*, available from Woodall Publishing Co., 500 Hyacinth Pl., Highland Park, Ill. 60035. It costs \$5.95 and lists about 13,000 better parks, rated as to facilities and amenities.)

Careful shopping for space is advisable because a major source of occupant complaints is park management and policies. Know exactly what you can and cannot do before you sign a space-rental lease. Make sure you know beforehand what fees or charges may be involved in setting up your mobile home. Charges may run as high as \$300 to \$500, depending upon your home's size. The park management may require certain extras such as base skirting, a special entry or outside storage shed.

There may be connection fees regarding utilities. With large homes such as double-wides, special site-preparation charges could run to \$1000 or more. You might do much of this work yourself, including—later on—building a carport, porch or whatever, but, again, determine







Tom McCahill says:

# "If you'd rather put money in your pocket than watch TV..."

## Grab this Free Book!"

I'm not against watching the tube, but I'd hate to pass up extra folding money just to catch old movie reruns. You can make cash in your spare time by being the man in demand: an Appliance repairman. Guys who can keep appliances going are wanted in more states than the FBI's top ten. And NRI can teach you everything you have to know . . . at home . . . in your spare time.

### So you've never wired a plug . . . NRI can show you how.

Even Edison had to do some studying. And there's no easier way to learn than the low-cost, home study course put together by the Appliance Division of NRI Home Training. All the lessons are fully-illustrated and easy to understand. Thousands of guys like yourself have learned basic electricity and how to use test instruments. The course covers the electrical and mechanical operation of every type of appliance from toasters and coffee makers to dishwashers; from vacuum cleaners and automatic laundry equipment to air conditioning and refrigerators. They even show you how to fix farm and commercial appliances and small, one-lung engines. Their staff of experts works with you every step of the way. NRI includes a professional Appliance tester in the low tuition. Over a million men have studied with this great school, so you know they've got this home study business down pat.



### Hang onto the job you've got; learn in your spare time.

With NRI, you study in your spare time, at your own rate. Many of their students have more than paid for the tuition fee within their first couple months servicing electric Appliances. The important thing is to make up your mind that you really want to get ahead. Do yourself a favor and send in the coupon below. You'll get back a colorful catalog that spells out everything about the course. There's no obligation and no salesman will call . . . NRI doesn't need any with this course. All you invest is a stamp, and you've got nothing to lose, except that empty feeling in your wallet.

*Tom McCahill*

For the career minded, this course is available under the GI Bill. Check GI line in coupon for information.

## CASE FOR THE MOBILE HOME

(Continued from page 135)

out "that mobile homes are not as prone to fire as are other forms of single-family housing."

In Alaska, second highest of all states in percentage of mobile-home ownership, Anchorage Fire Marshal John F. Franklin reported a few years ago that his department's experience indicated that those who contend "trailers are always burning up" are off base; of 89 serious fires in the city in 1972, only three were in mobile homes.

In addition to fire hazards, you'll hear other horror stories about mobile homes—that they can be toppled over and even flattened in high winds, that materials and workmanship are often shoddy with ill-fitting doors and drawers, sagging floors and leaking roofs, that kerosene stoves and heaters are unsafe and emit foul-smelling, choking fumes. Other grim tales tell of park owners who are virtual dictators, who establish excessive demands and restrictions, who arbitrarily evict tenants for breaking even a minor park rule.

Undoubtedly, there is some truth in these accusations; then too, some are exaggerated. Many apply to the old slum park, now happily vanishing. As for storm damage, mobile homes are subject to some danger here. Current practice calls for an anchoring system—cables or straps running to tie-down points in the ground. Properly anchored, such a home should be as stable as any other under normal conditions. Construction quality, park rules and rental practices are all elements that vary widely from area to area and maker to maker. That's why you should ask questions and investigate carefully before you consider buying a mobile home.

Unfortunately, few governmental regulations have existed regarding mobile-home quality, sales practices, service requirements and park operating procedures. That situation is gradually changing. Thanks to the rapid proliferation of mobile homes and parks, more state governments and local municipalities are becoming aware of the need for appropriate regulations. Not all studies have been completed or acted on, however.

To find out the situation in your particular area, your best bet is to start with your local housing authorities. Get their opinions, recommendations, warnings, suggestions. Ask—and keep asking—until you get meaningful answers. A mobile home can be a good buy, but be sure it's the kind you want before you take the plunge. ★★★

Grab this FREE book today and see what NRI can do for you.



McGraw-Hill Continuing Education Center  
3939 Wisconsin Avenue,  
Washington, D.C. 20016

600-065

Send me the free book on Professional Appliance Servicing.  
NO SALESMAN WILL CALL.

Name \_\_\_\_\_ Age \_\_\_\_\_  
(Please Print)

Address \_\_\_\_\_

City \_\_\_\_\_ State \_\_\_\_\_ Zip \_\_\_\_\_

Accredited Member National Home Study Council  Check for facts on GI Bill



## PAD-SANDER KNOW-HOW

(Continued from page 94)

for shorter cords is both obvious and understandable. The cords are made of copper. When less of it is used, retail prices can be kept down. For my money however, I find the resulting inconvenience an expensive price to pay.

Active do-it-yourselfers will find it necessary to have on hand an extension cord for each tool in use on the bench or suffer the time-consuming inconvenience of disconnecting from one tool to plug in another each time a change is desired. If you think the short pigtail will bother you, too, stick with a model that sports a conventional-length cord.

### Mounting paper

There are as many different ways of putting sandpaper in a pad sander as there are pad sanders. Some tools are easy to load and some are not. Check this feature before buying and pick a sander that makes it easy to mount and remove papers.

No matter how paper is mounted and held, it must remain flat as well as secure. The action of the sander itself is a pulling one, and if the paper is loose and flaps about, it will soon tear and become useless.

Check the maker's instructions for mounting papers and make certain that all papers you mount are stretched tightly across the pad.

The shoe (or pad) on most sanders is sized so you will be able to get three strips of paper from a standard-size sheet of abrasive paper. Some of the commercial-duty sanders have larger shoes; with these you get two sander-size pieces from each sheet. Sized sandpapers are also available as accessories: These are packaged both in assorted grits and in all-one-type papers, as shown on page 92.

### Maintaining the sander

No matter what price tool you buy, it will last longer if you use and maintain it properly. Pad sander maintenance, for the most part, consists of little more than keeping the air ports free of dust accumulation (so the tool won't overheat) and periodic lubrication. The best way to do the former is by blowing out the tool with compressed air. If you lack a compressor, periodically take your sander to the local gas station to blow out all dust. If you do own a compressor, use it on the sander after every work session. Lubricate the tool following the manufacturer's instructions with regard to points, frequency and type of lubricant to use. Today, many sanders are sealed and

require no further lubrication by the owner. But since that's not the case for all sanders, carefully read that section of the manual (which comes with the tool) covering lubrication.

### Using the tool

No matter which type of pad sander you buy, it will come equipped with a felt pad on its shoe. The rigidity—or degree of softness—of this pad is intended to suit most of the average jobs a do-it-yourselfer encounters. However, on occasion a softer or harder pad is required.

For example, on some plastics, woods with hard-and-soft grains and for honing of chisels, a more-rigid pad is desirable. In this event, you simply place a piece of 1/8-in. hardboard between the paper and felt pad. To hold it in place, drive three or four brads through the hardboard and into the felt.

If the occasion demands a softer pad, try substituting foam rubber for the felt pad. That's how the dowel in the photo below was sanded (without flattening it).

Some sanders come equipped with an auxiliary handle. On certain jobs, such as for vertical sanding, this can be very handy. A spare handle is often useful on the bench, too, because two-hand operation will assist you in keeping the shoe flat on the workpiece.

No matter which action your sander has—orbital or straight-line—it is usually best to work the tool back and forth parallel with the grain of the wood.

When edge sanding a narrow surface, use both hands to maintain maximum control. If the job is a critical one, clamp boards on both sides of the surface being sanded to prevent any chance of rounding over corners. ★★★

## Other jobs for pad sanders

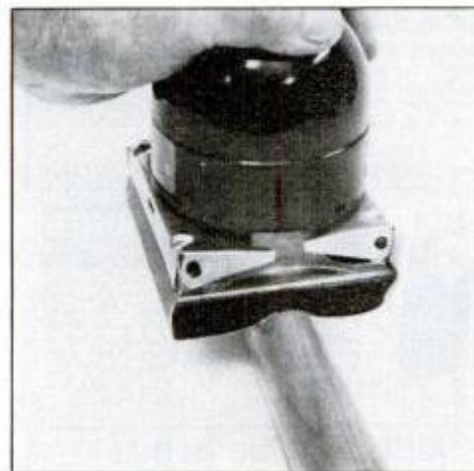

Rockwell's best has 12,000 tiny orbits a minute, conforms to irregular shapes.



To renew a disfigured felt pad, work it against coarse 60 or 80-grit paper.



Dustless sanding is possible with vacuum attachment as on Black & Decker model.

## Sander safety

- Do** secure the workpiece with clamps whenever possible.
- Do** follow maker's instructions for maintaining and lubricating tool.
- Do** use safety glasses for all pad sander operations.
- Do** wear proper apparel—no loose clothing or jewelry.
- Don't** abuse the line cord; never yank it to remove from receptacle.
- Don't** use the tool in the rain or in wet or damp locations.

Материал защищен авторским правом



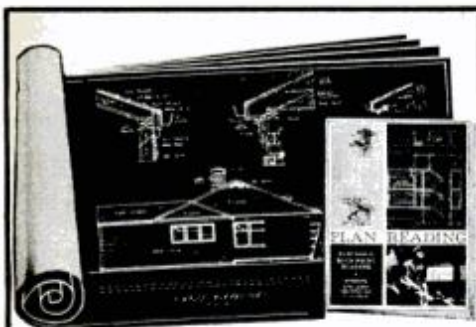

**FREE BLUEPRINTS and TRIAL LESSON**  
—for your greater success in Building

Beginners, craftsmen, even foremen and superintendents, have sent for these free blueprints and trial lesson in Plan Reading as a means of trying out Chicago Tech's home-study Builders training. Learn how you can master Plan Reading—Estimating—and the practical details of all types of construction in your spare time at home. Mail coupon below today—see how you, too can prepare for a better job—higher income, or start your own contracting business.

**CHICAGO TECHNICAL COLLEGE/School for Builders**  
2000 S. Michigan Avenue, Chicago, Ill. 60616

**CHICAGO TECHNICAL COLLEGE** Dept. PM-65, 2000 S. Michigan Ave., Chicago, Ill. 60616  
Veterans Check Here

Please mail me a Free Trial Lesson, Blueprints and Builders Catalog. I understand there is no obligation—no salesman will call.

NAME \_\_\_\_\_ AGE \_\_\_\_\_  
ADDRESS \_\_\_\_\_  
CITY \_\_\_\_\_ STATE \_\_\_\_\_ ZIP \_\_\_\_\_

**SEEDS FOR THOUGHT**

First the editors of Popular Mechanics assembled every bit of data a man needs to know to make his lawn, garden or house plant display the envy of his neighborhood... THIS YEAR!

Then they condensed and programmed these essentials and added twenty fact-packed charts and tables along with scores of show-how drawings.

Then they printed this vital material on heavy, plastic coated stock (so it would be washable) and spiral bound and hole punched it so it could lay flat on a table, set up as an easel on his potting bench or hang on a wall.



Order your copy today!

**Popular Mechanics Complete Gardening Guide**

Box 1014, Dept. F-5, Radio City, N.Y. 10019

Please rush \_\_\_\_\_ copy(ies) Popular Mechanics Complete Gardening Guide. I am enclosing my check or M.O. for \$4.49 postpaid.

Name \_\_\_\_\_  
Address \_\_\_\_\_  
City \_\_\_\_\_ State \_\_\_\_\_ Zip \_\_\_\_\_

Make checks payable to Popular Mechanics

HM Specialties

**LEARN UPHOLSTERY**  
PROFESSIONAL AT HOME! SPARE OR FULL TIME...  
**MEN & WOMEN ALL AGES!** Send for free book on learning to reupholster chairs, divans, footstools, all furniture for **BIG MONEY** in spare or full time. No experience needed, no age or educational limits. We show you how and provide **EVERYTHING** needed to start: (1) Home training covering all phases. (2) All tools and 6 big furniture kits for practice. (3) Free supplies, frames and materials to build \$300 worth of furniture, yours to keep or sell. Write for big free upholstery career book. No obligation, no salesman will call. Veteran Approved. **MODERN UPHOLSTERY INSTITUTE**, 1205 W. Barkley, Box 16, 2PM, Orange, CA 92669

**Repair any watch**  
... LEARN AT HOME  
Unique Sweeney System develops your watch repair skills step by step at home in spare time. No previous experience needed. Low tuition. Free sample lesson and full information.  
**CHICAGO SCHOOL OF WATCHMAKING**  
Dept. 165, Fox River Grove, Ill. 60021

**FIND BURIED TREASURE!**  
DETECTS COINS, RINGS, GOLD, SILVER Dealers Wanted  
Send for FREE Catalog  
**white's electronics, inc.**  
Dept. PA5F  
1011 Pleasant Valley Rd. Phone  
Sweet Home, Oregon 97386 (503) 367-2138

**WE'VE GOT A DEAL YOU CAN'T REFUSE!!**  
Make 200% profit selling the world's best storage system. Every home, factory, and business needs this peg-board mounted cap and unbreakable jar, hard \$3.00 (check or M.O.) to receive a ten unit demonstration kit of our Handy Storage System, our complete sales program, and our lowest direct factory prices.  
**WICKLIFFE INDUSTRIES**  
P.O. Box 286, #365  
Wickliffe, Ohio 44092

**FREE CATALOG!**  
Make \$25 to \$50 per hour selling our jewelry. Sell our exquisite lady's and men's jewelry that will make **BIG MONEY** for you. Write today for **FREE** full color catalog and **FREE** starting outfit.  
**HERITAGE HOUSE,**  
Dept PM, 103 Goodhue Building, Beaumont, TX 77701

**MINIATURE TRANSMITTER**  
WIRELESS MICROPHONE  
Among world's smallest, improved solid state design. Picks up and transmits most sounds without wires thru FM radio up to 300 ft. Use as mike, music amp., baby sitter, burglar alarm, hot line, etc. For fun, home and business. Batt. incl. Money back guar. B/A, M/C cds., COD ok. Only \$14.95 plus 50¢ Post and hdg. **AMC SALES, Dept. 17, Box 929, Downey, Ca. 90241.**

**AAMCO® And You Can Make It!**  
The world's largest transmission chain is still growing strong after eleven years. Over 500 of our franchises located from coast to coast. New openings in some markets mean you too might qualify. For further information write:  
**AAMCO Transmissions, Dept. 613**  
408 E. Fourth St., Bridgeport, Pa. 19405

**Knowing the LAW**  
means **MONEY** to YOU. Today, it pays to know the "rules"—the **LAW**. Basic principles explained, illustrated by authoritative texts, study aids, self-tests, etc. (Not a correspondence course.) Send for interesting **FREE** booklet, "The People vs. YOU" and full details. No obligation.  
**BLACKSTONE SCHOOL OF LAW** Dept. 50-A  
209 N. Michigan Ave., Chicago, Ill. 60601

**FLUSH-UP**  
BASEMENT TOILET  
Flushes up to existing sewer or septic tank by powerful self-contained pump. No digging up floors, etc. Clog resistant. Make basement into game room, bar, guest room, etc. with private bath.  
Write for **FREE LITERATURE**  
**DOSS MFG. CO., Dept. J-25**  
Box 10947, Houston, Tex. 77018

**SCANNERS**

(Continued from page 97)

the number may be 10 MHz, meaning that all crystals you choose within a given band must fall within 10 MHz of each other. (Actual bands are at least twice that wide.) Sometimes the dealer can retune your radio if you choose crystals out of the popular band segments.

**Duplex operation.** This is needed for services that send and receive on two different channels; if there are such services in your area, and you have a strong interest in hearing them, you'll need two crystals for each duplex service.

**Dual conversion.** This is an elaborate circuit that eliminates *images*—a type of interference from signals on other channels—in some expensive sets.

**Crystal or ceramic filters.** Found on higher-priced sets, these improve the set's rejection of adjacent-channel interference caused by signals lying very close to the channels you want to hear.

**Digital synthesizers.** These are now planned for the marketplace, and use no crystals at all. Instead, individual channel frequencies are tuned with computer-like circuits that let you program your scanner to any desired channels on the band, simply by presetting some switches, or, in a new SBE Linear Systems model, by inserting optically encoded cards into slots.

**Other features** to look for depend on your application. You may need a.c. and d.c. power cables, for example, so your set can operate from house current or the 12-volt d.c. of your car or boat. In that case, you'd also want a mobile mounting bracket for easy fastening under the dash. If you listen outdoors or at a distance from the receiver, you may need an external speaker jack.

**Installation.** Since a telescoping antenna is often supplied with a monitor or scanner receiver, there's not much installation for home listening. Much of the time the built-in antenna pulls in sufficiently strong signals for good reception. One trick to improve signals is to slide the antenna to different heights, depending on the band in use; try full length for the VHF low band, 18 inches for the VHF high band and 6 inches for UHF. (These are only approximate dimensions, so experiment on your own). Sometimes you'll improve reception by angling the antenna or moving the receiver to another part of the room. For UHF reception, receiving conditions are more critical and small changes in location, even a

(Please turn to page 140)



the key—

to your future!

SOLVE THESE PROBLEMS FOREVER:



WAGE FREEZE!  
AUTOMATION!  
INFLATION!  
RECESSION!  
LOW WAGES!  
EXTRA MONEY!  
TOO OLD!  
RETIREMENT INCOME!

# BEA LOCKSMITH



**JAMES D. SOULE**  
(West Chester, Pa.)  
"Excellent course—very thorough and no short cuts! Am semi-retired. My wife and I are moving to Florida to open a combination gift and locksmith shop."



**PETER H. ROOD**  
(Torrance, Calif.)  
"School and instructor were excellent. Really gave me incentive to get much deeper into the security end of it... earned \$1500 spare time while enrolled."



**GEORGE JAMES LUZZI**  
(Norwood, N. J.)  
"Earned \$1000 while training. Method of instruction, personalization... and overall thoroughness are wonderful. My instructor was encouraging and informative."

★ Newspaper headlines tell the story.



Pick up a paper any day. Burglary, house-breaking, vandalized homes — no wonder America is locked up tighter than ever before. And there are more homes, more stores and factories, more hotels, more cars, and more people. And that means more keys and locks.

★ The fast way to success... independence.



From the start you get practical experience doing real jobs on car locks, home locks, padlocks, and safes. Within six months you can be on the road to complete independence of bosses, low wages, layoffs, small retirement income.

Don't you owe it to yourself to get the facts today? The card below won't even cost you postage. No salesman will call. You and you alone can make your decision based on the straight-forward facts you will receive.

★ Earn as much as \$10 an hour—or more.



Today a trained locksmith can just about write his own ticket. Earn as much as he wants to work. Earn in his spare time, in a business of his own, or in a highly-paid position with someone else. Earn in almost any part of the country he wishes to live.

★ Learn at home—earn as you learn.



Let Locksmithing Institute show you absolutely free how you can qualify for this exciting, action field. The information card below will bring you full details about the fast, easy course that trains you by "doing" for this highly-paid profession. See how you can learn at home, in your spare time, even while you hold down your present job. See how the key-making machine and complete set of tools included with the course can put you in business earning money right while you are learning.

## LOCKSMITHING INSTITUTE

TECHNICAL HOME STUDY SCHOOLS, Little Falls, New Jersey 07424  
LICENSED BY STATE OF NEW JERSEY. ACCREDITED MEMBER NATIONAL HOME STUDY COUNCIL.  
STATE APPROVED DIPLOMA. APPROVED FOR VETERANS TRAINING.

### HURRY! MAIL THIS POSTAGE-FREE CARD!

↓ CUT OUT. Ready to Mail Coupon Below. ↓

THIS KEY MACHINE



PLUS 306

pieces of equipment  
LOCKS, PICKS & TOOLS  
supplied for use  
with course



State Approved Diploma

NEW Special Instruction in Electronic Burglar Alarm Security Systems at no extra cost if you act now!

Unlock Your Full Money-Earning Capacity  
SEND FOR THIS FREE BOOK TODAY  
No salesman will call

POSTAGE WILL BE PAID BY  
LOCKSMITHING INSTITUTE  
DIV. OF TECHNICAL HOME STUDY SCHOOLS  
Little Falls, New Jersey 07424

BUSINESS REPLY MAIL  
No Postage Stamp Necessary if Mailed in the United States



First Class  
Permit Number 137  
Little Falls, N.J.

## YES, send me free information on opportunities in Locksmithing

Mail me sample lesson pages, details of the critical need for locksmiths. I understand there is no obligation on my part and no salesman will call upon me. Dept. 1110-065



Name \_\_\_\_\_  
Address \_\_\_\_\_  
City \_\_\_\_\_  
State \_\_\_\_\_ Zip \_\_\_\_\_

Check here if eligible for Veteran's Benefits.

↑ DO NOT CUT BUT FOLD HERE—Seal.



# YOUR OWN "REFERENCE LIBRARY" ONLY \$2.69 A YEAR

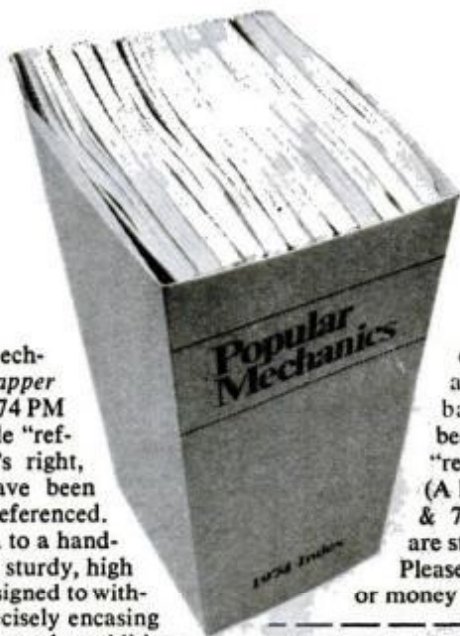

The 1974 Popular Mechanics *Index-Shelf Wrapper* actually converts your '74 PM issues into a formidable "reference library." That's right, over 5,000 entries have been indexed and cross referenced.

The index is built-in to a handsome shelf wrapper of sturdy, high gloss lacquer board designed to withstand years of use. Precisely encasing twelve issues, it's an attractive addition to the most tasteful book shelf arrangement.

As years pass, your PM issues will increase in value. You'll enjoy the satisfaction of retrieving articles, as you need them, from a growing *information bank*.

Needed information "jumps out" of back issues at your beck and call—A Cartop Penthouse For VW Beetles; 16 Ways To Hide Plywood Edges; How To Build Custom Camera Bags, and hundreds more, all at your finger tips! Or you can find *all* the articles

on broad categories such as auto repairs, aviation, basements, batteries and beds. Why wait? Start your "reference library" now! (A limited supply of 1971, 72 & 73 Index-Shelf Wrappers are still available.) Please clip and mail with check or money order.

**TO: PM INDEX-SHELF WRAPPER,**  
Dept. F5, Box 1014, New York, N.Y. 10019  
Please rush me the Index-Shelf Wrappers for the years checked below. I enclose a check or money order for \$2.69 Postpaid.

1974     1973     1972     1971

Name \_\_\_\_\_

Address \_\_\_\_\_

City \_\_\_\_\_ State \_\_\_\_\_ Zip \_\_\_\_\_

## HOW TO WIN GAMBLING GAMES

Win at dice, roulette, horses, dogs — even with limited capital. Frank B. Flint shows you how to enjoy the good life. Write for free details.

Professional, Box 551 PMD6  
Mineola, N.Y. 11501

## THROTTLE-SPEED CONTROL \$18.95 P. PD.

A quality manual speed control at the lowest prices. You can enjoy luxury driving and benefit from a terrific 15% saving on gas. Safe, system will not operate if electrical system or stoplights burnout. Just a touch of the illuminated switch turns it on. A touch of the brake pedal releases it. 45 min. installation time, out of the way on engineside firewall. Guaranteed. Fits all 12V. cars and trucks. Send in **PERFORMANCE**  
Box 129 Westport, Mass. 02790

## An Atlas Body—In 7 Days

my method of DYNAMIC-TENSION starts giving you results that you can feel and your friends will notice. Big, useful muscles. Gain pounds in weight where needed. Lose "pot belly." Send me your name and address for my 32-page book—FREE.  
CHARLES ATLAS, 49 West 23rd St., New York, N.Y. 10010 Dept. F8

## 110 VOLT A.C. GENERATORS

60 cycles, 3000 watts. Wt. 27 pounds, 5"x10" Fanbelt driven from car or pickup. Operates T.V. All power tools. Over 13,000 in service. This is our 25th year. Guaranteed 6 months. \$115.50 Postpaid while supply lasts. Our X1200-watt generator needs no battery. Special price—\$95.00 Postpaid.

Virden Perma-Bilt, P.O. Box 7160 PM,  
2821 Mays, Amarillo, Texas 79109

## NEW! FUN AUTOGIRO KIT

10-60 Ft. Line Control for .049 Gas Engines. 17 inch Rotor.

\$8.95 + 1.00 Shipping

**KOPTER KIT CO.**

Box 607  
Saddle Brook, N.J. 07562

HEADQUARTERS FOR EVERY TYPE & SIZE AT REAL DOWN-TO-EARTH MONEY SAVING PRICES!

**TIRES!** ALL FAMOUS BRANDS! TREMENDOUS SAVINGS! LET US PROVE IT TO YOU! WRITE US TODAY...

Send for your FREE catalog!

RELIABLE TIRE CO. 1111 Chestnut St. Camden, N.J. 08103

## SCANNERS

(Continued from page 138)

matter of inches, affect signals. Only if you have poor results with a built-in antenna should you try one of the monitor types made for the purpose. Signals travel line-of-sight, so an outdoor antenna placed as high as possible will almost certainly improve reception.

For mobile installation of a scanner hold the mounting bracket under the dash and use it as a template to mark mounting holes. Drill holes for self-tapping screws (after checking clearance above the lip of the dash) and fasten the bracket. Power comes from a nearby fuse block. Your antenna cable can run to a special monitor antenna on the car, or to a *splitter*—an accessory that allows a car's regular AM antenna to feed monitor and regular radios simultaneously.

**The legal question.** Along with master keys, crowbar, mask and hand tools, a burglar's best friend is often a receiver capable of picking up police calls. In fact, when New York City police arrived at a bank robbery a few years ago they found a monitor, dropped by the fleeing felons, blaring our police calls. Outlawing the sets, however, would hardly curb this activity because receivers could be easily built anyway. There are, however, a few restrictions that anyone buying these sets should know. Most important is a catch-all federal law about "secrecy of communications." It doesn't forbid you from listening, but says you may not *disclose* what you hear to anyone else (a "third party"). Also, the law doesn't want you to profit from anything you hear on the airwaves.

The most important restriction on the local level in some areas says you cannot install a monitor in your car. This is largely to keep nuisance-type thrill-seekers from becoming fire, police and ambulance-chasers and also to prevent criminals from listening in on police operations. It is up to the buyer to determine whether his state or town has such a law. In more than 15 years of following monitor developments, though, I've discovered no law which says you cannot listen to any communications while you're at home.

There are towns that apparently welcome the use of monitors by the public. According to Regency, a leading manufacturer, they include Detroit, Indianapolis and Dallas. Seems that police there enjoy some image-boosting when people listen to their exploits over the radio! ★★

USE ZIP CODES  
WHEN ANSWERING ADS



## COLONIAL CUPBOARD

(Continued from page 104)

from 1/2-in. pine, to the front across the top, then miter crown molding to go around three sides. Finally, glue and screw grooved pieces to lower ends of the uprights.

Put the four door frames together with dowels and rabbet the outer edges so that doors lap the openings. The lower doors are grooved for raised-panel inserts; upper doors are like picture frames, with a rabbet cut all around the inside for window glass. In each case, the grooves and rabbets must be cut before assembly. The raised panels have to be in place in the grooves as clamps are applied.

The pine-faced plywood back of the upper unit extends 1/2 in. at the bottom to fit into the rear rabbet in the base unit, and screws are used to hold the two together.

We finished the prototype with Minwax's Liberty blue Americolor, a one-coat, bluish-on, wipe-off wood finish that gives an ageless patina effect. You also have a choice of Independence red, Lexington green or Conestoga white. Brass hinges, knobs and drop-drawer pulls are from Christensen Hardware Co., Caldwell, N.J. ★ ★ ★

### MATERIALS LIST

BASE UNIT		Amt.	Size	Use
2	3/4 x 15 1/2 x 29 1/2"	2	3/4 x 15 1/2 x 29 1/2"	Ends
1	3/4 x 15 1/4 x 35 1/4"	1	3/4 x 15 1/4 x 35 1/4"	Bottom
1	3/4 x 15 1/4 x 34 3/8"	1	3/4 x 15 1/4 x 34 3/8"	Shelf
1	3/4 x 17 1/4 x 37 3/4"	1	3/4 x 17 1/4 x 37 3/4"	Top
2	3/4 x 2 1/2 x 35 1/4"	2	3/4 x 2 1/2 x 35 1/4"	Cross members
1	3/4 x 2 3/4 x 32 3/4"	1	3/4 x 2 3/4 x 32 3/4"	Front facing (bottom)
2	3/4 x 1 5/8 x 29 1/2"	2	3/4 x 1 5/8 x 29 1/2"	Front facing (sides)
2	3/4 x 1 3/8 x 15 7/8"	2	3/4 x 1 3/8 x 15 7/8"	Front facing (center)
1	3/4 x 1 5/8 x 25 1/2"	1	3/4 x 1 5/8 x 25 1/2"	Front facing (vertical)
1	3/4 x 1 1/4 x 32 3/4"	1	3/4 x 1 1/4 x 32 3/4"	Front facing (top)
2	3/4 x 1 1/4 x 14 1/2"	2	3/4 x 1 1/4 x 14 1/2"	Drawer guides
2	3/4 x 1 1/4 x 15 1/4"	2	3/4 x 1 1/4 x 15 1/4"	Drawer guides
1	3/4 x 1 3/4 x 15 1/4"	1	3/4 x 1 3/4 x 15 1/4"	Drawer guide
1	3/4 x 2 3/4 x 14 1/2"	1	3/4 x 2 3/4 x 14 1/2"	Drawer guide
2	3/4 x 1 x 15 1/4"	2	3/4 x 1 x 15 1/4"	Shelf cleats
1	3/4 x 2 x 34 1/2"	1	3/4 x 2 x 34 1/2"	Back cleat
2	3/4 x 3 3/4 x 17"	2	3/4 x 3 3/4 x 17"	Base apron (sides)
1	3/4 x 3 3/4 x 37 1/2"	1	3/4 x 3 3/4 x 37 1/2"	Base apron (front)
1	3/4 x 3/4 x 72"	1	3/4 x 3/4 x 72"	Base molding
1	3/4 x 29 1/2 x 35 1/4"	1	3/4 x 29 1/2 x 35 1/4"	Plywood back
UPPER UNIT				
2	3/4 x 11 1/4 x 42"	2	3/4 x 11 1/4 x 42"	Ends
2	3/4 x 11 x 33 3/4"	2	3/4 x 11 x 33 3/4"	Top and bottom
1	3/4 x 11 x 33"	1	3/4 x 11 x 33"	Shelf
1	3/4 x 33 3/4 x 43"	1	3/4 x 33 3/4 x 43"	Plywood back
1	3/4 x 1 1/8 x 32 1/4"	1	3/4 x 1 1/8 x 32 1/4"	Front facing (bottom)
1	3/4 x 1 1/2 x 25 3/4"	1	3/4 x 1 1/2 x 25 3/4"	Front facing (vertical)
2	3/4 x 1 1/8 x 30 1/2"	2	3/4 x 1 1/8 x 30 1/2"	Front facing (sides)
1	3/4 x 4 x 32 1/4"	1	3/4 x 4 x 32 1/4"	Front facing (top)
1	1/2 x 3 x 34 1/2"	1	1/2 x 3 x 34 1/2"	Scroll facing
1	3/4 x 3 x 68"	1	3/4 x 3 x 68"	Crown molding
2	3/4 x 1 3/4 x 12 3/4"	2	3/4 x 1 3/4 x 12 3/4"	End feet
1	3/4 x 1 1/2 x 9"	1	3/4 x 1 1/2 x 9"	Door-catch cleat
DRAWERS				
2	3/4 x 4 1/2 x 16 1/4"	2	3/4 x 4 1/2 x 16 1/4"	Fronts
4	1/2 x 3 3/8 x 15 3/4"	4	1/2 x 3 3/8 x 15 3/4"	Sides
2	1/2 x 3 1/2 x 15"	2	1/2 x 3 1/2 x 15"	Backs
2	1/2 x 15 x 15"	2	1/2 x 15 x 15"	Bottoms
DOORS (BASE)				
4	3/4 x 2 1/4 x 20 3/4"	4	3/4 x 2 1/4 x 20 3/4"	Side stiles
2	3/4 x 2 1/8 x 12 3/4"	2	3/4 x 2 1/8 x 12 3/4"	Top rails
2	3/4 x 2 3/4 x 12 3/4"	2	3/4 x 2 3/4 x 12 3/4"	Bottom rails
2	3/4 x 12 1/2 x 16 3/4"	2	3/4 x 12 1/2 x 16 3/4"	Raised panels
DOORS (UPPER)				
4	3/4 x 2 1/4 x 25"	4	3/4 x 2 1/4 x 25"	Side stiles
2	3/4 x 3 x 12 1/2"	2	3/4 x 3 x 12 1/2"	Bottom rails
2	3/4 x 2 1/8 x 12 1/2"	2	3/4 x 2 1/8 x 12 1/2"	Top rails
2	1/2 x 12 1/2 x 20 1/2"	2	1/2 x 12 1/2 x 20 1/2"	Glass panes
1	3/4 x 3/4 x 11 1/2"	1	3/4 x 3/4 x 11 1/2"	Quarter-round molding
HARDWARE (BRASS)				
4	1"-dia. door knobs	4	1"-dia. door knobs	
2	3"-wide drawer drop pulls	2	3"-wide drawer drop pulls	
8	2 1/2" lip-door hinges	8	2 1/2" lip-door hinges	
4	Spring-loaded, cupboard-door catches	4	Spring-loaded, cupboard-door catches	

# BARGAIN HUNTER

## DUNE-BUG

Complete plans & specs on how to build or buy - disc. prices on parts, kits, engines, & raw material.



Send \$2 for DUNE-BUG pkg. to:  
Box 987M6, Azusa, Ca. 91702,  
Ph (213) 334-0334

## 110 VOLT "PLUG-IN" YOUR TRUCK OR CAR!

Mounts Under Dash or Hood in 10 Minutes—Has Off-On Sw.—Voltage Ind. Light! Up To 4000 Watts—110 Volt DC Power from car Alternator. Runs Carpenter - Farm - Builders - Tools - Lights - Heaters - Drills - Saws, Starts Cars, Quik Charges - Welds - Brazes, Solders, (cash, Ck., M.O.) and pay postman \$12.99 plus COD postage, or send \$14.99 for Paid Del. in USA. Complete Ready To Use With Specs-Controls-Full Instructions. One Year Service Warranty—10 Day Money Back Trial—Ideal for pickups—All Cars-Campers—Hush order.

WESTERN ELECTRONICS, Dept. PM-6, Kearney, Nebr. 68847

**PROTECT YOUR CHILD PROTECT YOUR VALUABLES**  
Stainless Steel Dog Tags.  
26" Chain and Clip. Great for luggage—Cameras—Pets—Etc. Send Name, Address, Phone Number and \$2.00 for each Tag to:  
Futura Enterprises  
Dept. PMJ  
602 Syracuse Ave.  
N. Massapequa N.Y. 11758

**JUNGLE FIGHTER'S KNIFE**  
Your Name Engraved On Blade  
Same razor sharp knife used by WWII jungle fighters for night fighting. Excellent for hunting and camping. Also makes a fine display piece, 6" black double edged hard-steel blade with black handle and leather case. Send first name or initial only to be engraved with \$3.95 to:  
SAFECO UNLIMITED  
New York, N.Y. 10017  
10 DAY FULL MONEY BACK GUARANTEE

**PLANS AND INSTRUCTIONS FOR**  
Go Kart .....\$2.00  
Mini Bike .....\$2.00  
Mini Car .....\$3.00  
Pedal Boat .....\$4.00  
12" Sail Boat .....\$4.00  
Snowmobile Sleigh .....\$3.00  
Mini Jeep .....\$3.00  
Mini Vehicles Plans Dept.-C  
Chazy, N.Y. 12921

**ORIGINAL W.W.II HELMET** ONLY \$19.95 PLUS \$2.00 POSTAGE & HANDLING  
(NOT A REPLICA)  
OVER 10,000 HELMS IN STOCK COLLECTORS! OVER 10,000 HELMS IN STOCK  
Helmets, Uniforms, Bayonets etc. FREE CATALOG  
UNIQUE IMPORTS, INC. Dept. PM1  
610 Franklin St., Alexandria, VA 22314

**BURIED TREASURE**  
Locate from a LONG DISTANCE!  
with Ultra-Sensitive DIRECTIONAL Locator  
SEND FOR FREE INFORMATIVE BROCHURE  
RESEARCH PRODUCTS  
BOX 13441-AM TAMPA, FLORIDA 33611

**DON'T REMODEL ANYTHING**  
until you've seen the exciting new catalog of unusual tools, appliances, cabinet hardware, woodworking, home improvements. Would you believe a hinge that makes a square table round? Professional brass bar railing? Unusual clamps, adhesives, table extension slides, butcher block tops, more. 40¢ to:  
W & L Mfg.  
343 Cortland St. Belleville, NJ. 07104

**AMAZING NEW ELECTRIC ARC WELDER \$14.99!**  
Twice as big-better-more power! welds, brazes, solders, cuts all metals! Use any 110 volt house plug! Multitheat. Build-repair, most anything for car-factory-home. Complete ready to use with kit of steel, bronze, carbon welding rods—flux-eyesshield-automatic arc torch, welding instructions—no experience needed!  
SEND ONLY \$2.00 (cash, Ck. Mo.) and pay postman \$12.99 plus COD postage or send \$14.99 for Paid Del. in USA. Lifetime burnout guarantee—10 day money back free trial! Now, save and make money. Order yours today! Midway Welder Dept. KPM-6, Kearney, Nebr. 68847

## Do you know a kilometer from a mile? A Metric Memory Calculator Kit at less than half price

with 4 nicad batteries and charger-adapter and we guarantee to assemble it if you can't... for only \$10.00



You get a top quality memory calculator with all 5 functions. \$79 value plus a metric calculator for \$100 value in one case for only

**\$39.95** delivered

IMPERIAL Model at no extra charge. Kit requires soldering and simple one-hour assembly. The calculator sold by General's largest chain at \$149.95 retail. Assemble it at home. Any time within one year that you find that either assembly is incorrect or was never started, return the kit to us for a guaranteed assembly job.

### Natural Logic METRIC MASTER

U.S. MADE PRECISION CALCULATORS  
Save Dollars with Rechargeable Batteries Included.  
PROTECTIVE COVER

NO. 5M73C METRIC MASTER Adds, subtracts, multiplies, divides, takes percent. Addressable memory and recall, constant and chain calculations on all five functions. Calculates pounds to kilograms, gallons to liters, miles to kilometers, yards and feet to meters, inches to centimeters, quarts to liters, ounces to grams, ounces to cubic centimeters, Fahrenheit to Centigrade, cubic and square as well as powers, reciprocals, fractions and complex quotients.  
All UL Approved  
Instruction Book and 110V AC Battery Charger Included. One Year Guarantee

CPA DIGICOMP PM 6  
9743 Lurline Avenue Chatsworth, California 91311  
Please find my  check/  money order enclosed in the amount of \$ \_\_\_\_\_ for \_\_\_\_\_ No. 5M73C METRIC MASTER Calculator Kits and ship postage prepaid to:  
NAME \_\_\_\_\_  
ADDRESS \_\_\_\_\_  
CITY \_\_\_\_\_ STATE \_\_\_\_\_ ZIP \_\_\_\_\_

**DISCOUNT SALE \$9.95**  
**AIR PISTOL \$7.95** (WITH FREE CAN OF PELLETS)  
IMPROVED MODEL. Built to last a Lifetime.  
Shoots both pellets and darts. This fine, well made .177 cal. German air pistol is just the ticket for target or Varmints. Accurate. No CO2 cartridges to replace, either. Once in a lifetime bargain. Order several. Only \$7.95  
Secret Leather Holster, \$2.95 ppd. • 600 Deluxe Pellets, \$2.40 ppd. 20 Deluxe .177 cal. Steel Darts, \$2.00 ppd.  
AIR PISTOL, Dept. PM-6  
4535 Huntington Dr. So., Los Angeles, Calif. 90032

**SAVE MONEY WITH THE LANZI MATCHLESS GAS LIGHTER**  
Think of the convenience of a gas lighter that requires no matches. Safely easily lights natural gas, propane, kerosene, liquid gas. Because it lights even in wind or rain, it's perfect for campers, outdoors, or dentists, torch users, labs etc. At home close the pilot light and use it for your gas stove, water heater, barbecue, etc.  
Operates with two "C" Batteries (not included). Does not spark, cannot ignite flammable materials.  
SAVES YOU MONEY 365 DAYS A YEAR  
Only \$2.98  
Send Check or Money Order to  
LANZI ENTERPRISE OF AMERICA  
108 St. Stephens Place  
Staten Island, N.Y. 10306



# The Bargain Hunter

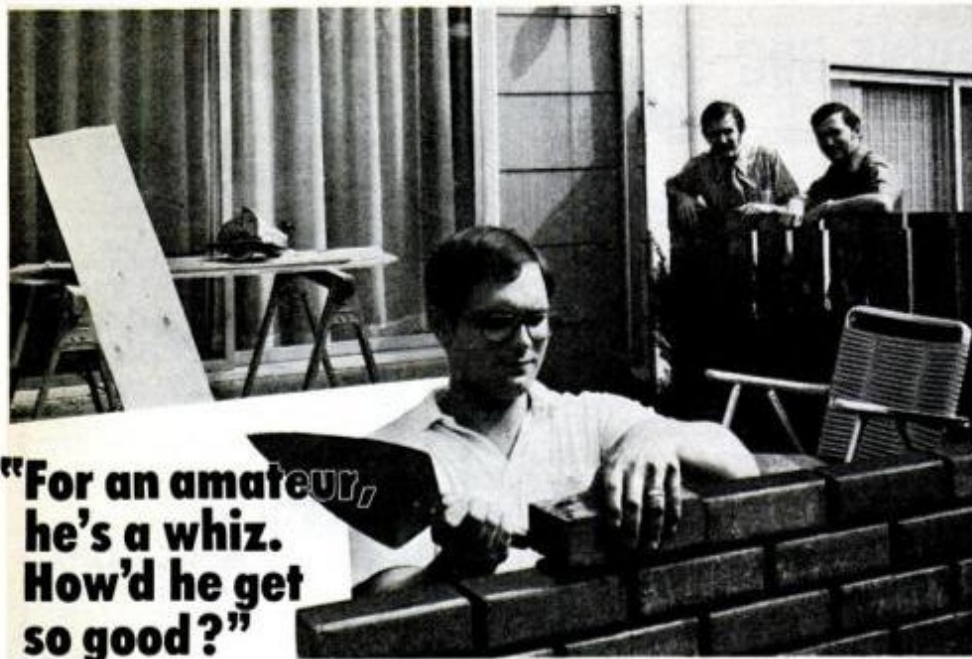

**"For an amateur,  
he's a whiz.  
How'd he get  
so good?"**

Whatever practical skills you've been wanting to develop, Audel has comprehensive, step-by-step Guides to help you. They show you all the professional tricks of the trades

in clearly diagrammed and illustrated "how-to" steps. They can save for you, over and over. Here are four of Audel's many fields . . .



#### CARPENTERS AND BUILDERS LIBRARY

1490 pages of the latest information on modern construction in four volumes. They cover every phase of carpentry from foundations to finishing with easy-to-grasp, step-by-step instructions . . . all illustrated with thousands of diagrams, charts and photos. No. 23169—4 Volumes—\$21.25



#### MASONS AND BUILDERS LIBRARY

Two illustrated volumes on the science of masonry and bricklaying. Packed with how-to information and directions, rules, processes, definitions, formulas, diagrams, tables, estimating. A complete and authentic trade reference library. 752 pages. No. 23185—2 Volumes—\$12.75



#### PLUMBERS AND PIPEFITTERS LIBRARY

A valuable 3-volume guide to the principles, methods and short cuts of modern plumbing. Tools, fittings, fixtures, installation, drainage, welding and much more are all covered in these fully illustrated, easy to understand volumes. No. 23155—3 Volumes—\$15.50



#### MACHINISTS LIBRARY

Three books covering the entire field—1216 profusely illustrated pages on practical fundamentals of basic machine shop operations, setup and operation of spot machines, down-to-earth data on toolmaking procedures, layouts, jigs and fixtures, etc. . . . equally valuable for beginners and experienced men alike. No. 23174—3 Volumes—\$19.50

#### SATISFACTION GUARANTEED OR YOUR MONEY BACK!

If you are not completely satisfied with the books, you may return them within 10 days for a full refund.

THEODORE AUDEL & CO.  
Division of  
Howard W. Sams & Co., Inc.  
Indianapolis, Indiana 46206

#### ORDER TODAY—JUST USE THIS COUPON

Theodore Audel & Co.  
4300 West 62nd Street, Indianapolis, Indiana 46206  
Please send me, postage prepaid, the books checked at right. I enclose full purchase price, plus applicable sales tax.

Name \_\_\_\_\_  
Address \_\_\_\_\_  
City \_\_\_\_\_ State \_\_\_\_\_ Zip \_\_\_\_\_

P065

- 23169  
 23185  
 23155  
 23174

#### MAKE \$25 to 100 PER HOUR

**BADGE-A-MINIT**, a complete badge making system lets you make permanent metal pin back badges for fun or profit. Badge parts cost pennies, you sell slogan buttons for up to 75c each, photo buttons for up to \$2.50 ea. Get FREE illustrated money making plans by return mail, or send \$34.95 plus \$1.75 for shipping to RPM Assoc. Ltd., Box 618, Dept PM65, LaSalle, Ill. 61301

#### THE ORIGINAL IMPORTED SWITCH-BLADE COMB

9" overall length  
5 1/4" closed  
• FUN  
• PRACTICAL  
• GUARANTEED

Spring action comb snaps into place at push of button. Locks shut to avoid opening in pocket. Perfect for conversation piece and practical use. Replaceable comb blades 50 cents each. Money back if not completely satisfied.

Send \$4.75 plus 25c postage and handling to:

EXECUTEK  
777 South Central Expressway  
Richardson, Texas 75080



#### BUILD FOR FUN OR PROFIT

Attract purple martins to your yard with this inviting bird barn. You will have more appreciation for them when you consider that the adult martin can eat up to 2000 mosquitoes a day. Step by step plans, no trouble with angles or degrees, just use our rafter pattern. Hinged and removable dividers for easy opening and cleaning. Sixteen apartments. Send \$1.75 for plans and material list plus 30 cents postage.

#### HAMMOND BARN

Dept. PM35 BOX 584  
NEW CASTLE, INDIANA 47362

#### Tiller Users!



If the tiller you've been using has its revolving blades in **FRONT** and **NO** power to the wheels (See 'TORTURE!' above left), you won't ever be happy with it again once you try the **TROY-BILT® Roto Tiller-Power Composter** which has its revolving blades in the **REAR** and **POWER DRIVEN WHEELS** — and is **SO EASY** to use you guide it with **JUST ONE HAND!** (See 'JOY' above right). You do **NOT** have to walk behind it, leaving footprints! It does **NOT** shake you half to death! It leaves **NO** wheelmarks! There's **NO** unbearable tangling! The **TROY-BILT®** is now in its 14th great year. **SO** if you want tilling to be a **JOY** instead of **TORTURE** from now on, please clip this ad now and send today for the whole story of this wonderfully different and better design in tillers! We'll send complete details, including prices and **OFF-SEASON SAVINGS** now in effect for a limited time! Just ask for **FREE BOOKLET**.

**TROY-BILT® Roto Tiller-Power Composters**  
Dept. 50196  
102nd St. & Ninth Ave., Troy, N.Y. 12180



#### FREE! POWERFUL MUSCLES FAST!

Fantastic New Discoveries in the science of bodybuilding. Add inches of powerful muscles to arms, chest, shoulders and legs. Secrets on trimming the waist with ultra-modern methods—fast! Results Guaranteed! Send for free brochure!

Universal Bodybuilding Box 485 Dept. M  
Dearborn, Michigan 48121

GATEWAY TO ADVENTURE  
QUALITY CANOES SINCE '32

**TRAILCRAFT**  
CANOE & KAYAK KITS

BUILD YOUR OWN FROM WOOD-CANVAS OR  
FACTORY MOLDED FIBERGLASS — BIG SAVINGS

MANY MODELS — BOX 60010 — FREE CATALOG

FROM \$29.50 & UP

Ph. 813/243-1312 — CONCORDIA, KANSAS 66001



# Silvo (BRAND NAME) Tool Catalog Specials



**No. 9216 (old 315K) Rockwell 7 1/4" Heavy Duty Builders' Saw Kit**—Contains: No. 215 (old 315) H.D. Builders Saw plus Rip Guide and Carrying Case. Specs: Speed 5800 RPM, 11.5 Amps, Cuts 2 1/4" at 90° and 1 7/8" at 45°. External gear lubrication, 100% ball bearing construction. Wrap around base. Auxiliary front blade shield. Depth and angle adjustment scales. Kickproof clutch. Lightweight aluminum alloy housing. Blade included. UL Listed. Add \$4.00 for shipping weight of 24 lbs. Reg. \$101.95  
**9216-R7 P-24 lbs. .... Special—\$76.50**

**No. 215 (old 315) Rockwell 7 1/4" H.D. Builders Saw**—See description above. Net weight of saw is 12 1/2 lbs., add \$3.00 for shipping weight of 16 lbs., Reg. \$89.95  
**215-R7 P-16 lbs. .... Special—\$68.50**



**No. 260 (4684) Rockwell 1 1/2 H.P. Router**—Commercial Duty—Exclusive D-handle design with trigger switch. 100% ball bearing construction. Pin and groove depth adjustment. 1/2" collet available. Includes 1/4" collet and wrenches. UL Listed. Speed—22,000 RPM, 8.0 AMPs, add \$2.00 for shipping weight of 9 lbs. Reg. \$99.95  
**260-R7 P-9 lbs. .... Special—\$69.95**



**Rockwell Sander-Grinder combination**—Most versatile finishing machine—sands, grinds, sharpens, deburrs, finishes, contours, polishes • Precision ground 7 x 8" tilting table • All ball bearing construction • Balanced heat resistant Cycloac® belt wheels with Texin® tires, crowned for easy belt tracking. Table tilts 10° in and 90° out—Uses 1" x 42" standard Abrasive Belts or 1/8" to 1" wide by 40" to 44" Belts—Speed: Using Standard Pulleys and 3450 RPM Motor ..... 4000 SFPM; 4600 SFPM (w/contact wheel)

**No. 31-350 Rockwell Sander-Grinder**—Includes Basic Machine, Flat Platen for 1" Abrasive Belts, Arbor Pulley and, 1 Abrasive Belt. Add \$3.50 for shipping weight of 20 lbs. Reg. \$66.95  
**31-350-R8 P-20 lbs. .... Special—\$49.98**

**No. 31-355 Rockwell Sander/Grinder**—with Standard Duty Motor and Base. Includes 31-350 plus 1/2 HP Motor with Switch, Cord and 3-Prong Plug, Base, V-Belt and Motor Pulley. Add \$6.50 for shipping weight of 48 lbs. Reg. \$125.00  
**31-355-R8 P-48 lbs. .... Special—\$89.98**

**No. 31-354 Rockwell Sander/Grinder**—with Heavy Duty Motor and Base. Includes 31-350 plus 1/2 HP Motor with Switch, Cord and 3-Prong Plug, Base, V-Belt and Motor Pulley. Add \$6.50 for shipping weight of 48 lbs. Reg. \$135.00  
**31-354-R8 P-48 lbs. .... Special—\$99.98**

**SILVO (BRAND NAME) TOOL CATALOG**  
 Thousands of Exciting Tool Values! Stanley, Skil, Millers Falls, Wellsway, Dremel, Disston, Helios, Speedy Sprayers, Plumb, Kennedy, Huot, Rockwell, Channellock, Crescent, Vise-Grip, Ridgid, Unimat, Audel Books, Nicholson, General, Indestro, Xacto, Wiss, Pony Clamps, Wen, and many other Nationally Advertised brands of Tools & Supplies. We ship Coast to Coast at prices hard to beat. Send \$1.00 for our big 196 page tool catalog today.  
**Special extra discounts of 5% to 20% on quantity purchases on above special priced items and other items listed in our 196 Page Silvo Tool Catalog.**  
**Note:** Reg.—Regular Manufacturers' suggested List price.  
**Note:** Minimum order is \$10.00—our minimum shipping charge is \$1.25. We will refund over payment or charge for underpayment of above estimated shipping cost. Catalogs are free with order.



**No. 74 Millers Falls Mitre Box**—World famous for quality, one piece cast iron bed and back for strength, Oilite bearing, saw guides, Graduated arc and index plate, travels freely from 45° to 90° right or left and locks at any angle (automatic locks at 0°, 9°, 22 1/2°, 30° and 90° right or left). Complete with 28" x 5" saw. Capacity 10 1/2" at 90°, 7 1/4" at 45° add \$6.00 for shipping weight of 37 lbs. Reg. \$157.45  
**74-M18 P-37 lbs. .... Special—\$99.98**



**No. 300 — Millers Falls Hacksaw** — Deep Throat Frame. Extra capacity 4 3/4" depth of cut for professionals. Blade tension lever for positive guide tensioning, adjustable for 10" and 12" blades. Four blade positions—ideal for left, right, vertical and flush cutting. Molded handle with hand guard. Blade included. Add \$1.00 for shipping. Reg. \$14.69  
**300-M18 P-2 lbs. .... Special—\$9.75**

**No. 48 — Millers Falls Hacksaw** — Semi-Industrial, rigid steel frame with high impact molded handle. Frame easily adjusts for 8", 10" and 12" blades. Ideal for, left, right, vertical and flush cutting. Plated. Blade included. 3 3/4" depth of cut. Add \$1.00 for shipping. Reg. \$8.19  
**48-M18 P-2 lbs. .... Special—\$5.75**



**No. 9870—Hammer Holster**—Fine grade of fine cowhide leather with belt loop and steel ring to hold any nail hammer. Add .50¢ for shipping. Reg. \$2.75  
**9870-M18 P-1lb. .... Special—\$1.69**



**Stanley Bench Planes** — Made of finest iron castings—machined true—adjustable cutter—hardwood handles and knobs.  
**3-519 P-4 lbs. add \$1.10 — 1 3/4" Cut x 8" long—Reg. \$21.15 ..... \$15.49**  
**4-519 P-4 lbs. add \$1.10 — 2" Cut x 9" long—Reg. \$21.15 ..... \$14.80**  
**5-519 P-5 lbs. add \$1.25 — 2" Cut x 14" long—Reg. \$24.25 ..... \$16.89**  
**6-519 P-8 lbs. add \$1.60 — 2 3/4" Cut x 18" long—Reg. \$44.45 ..... \$27.50**  
**7-519 P-9 lbs. add \$1.75 — 2 3/4" Cut x 22" long—Reg. \$56.45 ..... \$34.85**



**NEW!**  
**SKIL**  
**Cordless 3/8" Drill & Screwdriver**



**New! Skil No. 2002 Cordless 3/8" Drill — and Screwdriver**—Features: Forward and reversing action — No cord needed — self-contained powerhouse with rechargeable energy cells — high torque — 300 R.P.M. — Use indoors, outdoors, land, sea or air — lightweight only 2.7 lbs. — Recharger works on 115 Volts A.C. — Can be recharged hundreds of times and will perform with full power — Complete with recharger — Reg. \$39.99 — Refer to our Silvo Catalog for price that is hard to beat —



**No. 9 1/2 Stanley Block Plane**—Adj. cutter and Throat—21° angle of cutter—1 3/8" cut x 6" long. Add .85 for shipping — Reg. \$13.39  
**9 1/2-519 P-2 lbs. .... \$9.39**

**No. 60 1/2 P Stanley Block Plane** — Adj. cutter and throat — 12° low angle cutter for easy planing across hardwood—1 3/8" cut x 6" long—Add .85 for shipping—Reg. \$13.40 .... \$9.40

**Stanley Chisel sets**—Tang butt—Tough plastic handle—Steel cap—Blade and tang forged in one piece from heat treated alloy steel—**No. 66 set** contains 6 chisels 1/4 to 1 1/2 — **No. 69 set** contains 9 chisels 1/4 to 2"—each set packed in plastic roll—Add .85 for shipping—**No. 66 Reg.**—\$36.89 — **No. 69 Reg.**—\$61.45.  
**66-519 Set of 6 ..... \$25.85**  
**69-519 Set of 9 ..... \$40.35**

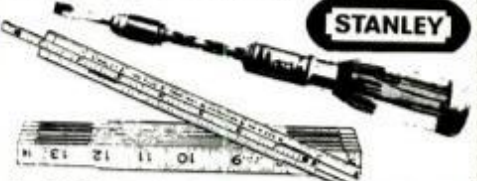

**No. X226 Stanley Extension Rule**—"100 Plus" The mechanics favorite—Superior surface protection lasts up to 26 times longer—Reg. \$6.15  
**X226-519 Ext. rule ..... \$4.45**

**No. 233H Stanley Screw Driver** — and Drill — 10" long with bit — The complete tool! Quick-Return style. Transparent plastic magazine handle holds extra 3/32" screw driver bit and set of three drill points. Add .50 for shipping.  
**233H-519 P-1 lb. Reg. \$8.55 ..... \$6.20**



**Stanley Tape Rules** — Power return tape; exclusive "Powerlock" feature gives positive blade lock with no creeping. Control knob on side. Sturdy belt clip. Life Guard yellow blade, Mylar® clad, easy to read and takes 3 to 10 times as much abrasive wear than other blades. Graduated in 16ths on both edges of one side. Stud marking every 16 in. PL316—Reg. \$8.65 — PL320—Reg. \$9.35 — PL425—Reg. \$10.25  
**PL316-519 3/4" x 16 ft. Blade ..... \$5.75**  
**PL320-519 3/4" x 20 ft. Blade ..... \$6.25**  
**PL425-519 1" x 25 ft. Blade ..... \$7.25**



**No. 534 — 6 1/2" Skilsaw** — Standard Duty — A lightweight saw for most home projects. 1 1/2 H.P. Burnout Protected Motor, 6,000 r.p.m. cutting speed. Cuts 2 3/4" at 90°; 1 3/4" at 45°. Safety switch helps prevent unintentional starts. Weight: 9 lbs. Supplied with hardtooth combination blade and blade wrench. UL listed. Spur gears, ball and sleeve bearings — add \$1.75 for shipping — Reg. \$39.99  
**534-537 P-11 lbs. .... Special—\$26.99**



**Skil Adjustable Dial Saw** — A unique drill accessory that fits any size and any make drill. Will cut perfectly round holes from 1 1/8" to 2 1/2" in wood, plastic or composition. Pilot drill bit in center of blades sets dial saw for easy, accurate cutting. Blades may be replaced when they become dull.  
**73400-537 P-1 lb. Reg. \$5.95. Special—\$3.75**

**Universal Router/Shaper Table**—Ideal for shaping and jointing small materials that are normally difficult to handle. Build picture frames, plaques, or easily add a decorative touch to moldings. Features miter gauge for safe cutting at any angle. Accepts most router Skil, B&D, Stanley or Rockwell — Add \$1.50 for shipping — Reg. \$16.95  
**73400-537 P-7 lbs. .... Special—\$10.98**



## Woodcrafting Is Easier, Quicker with These Top Quality Benches

Whether you're a hobbyist, craftsman, cabinetmaker, or wood sculptor, experienced or beginner. The Yankee Wood Craftsman's wide selection of superb European workbenches offers you the exact features you need to do your finest work precisely, quickly. Solid kiln-dried European hardwood construction; pre-mounted specialized vises for horizontal and vertical hold; some models feature world's finest Sheffield steel vises, up to 5 drawers, ability to work on 3 or even 4 sides of bench. Large tool tray.

Largest choice in U.S. of amateur and professional models, 5' to 8½'. One even folds to store — perfect for apartments. Also world's finest line of hand-forged European carving tools, clamps, and steel and exceptional wooden body planes available nowhere else in the U.S.



SEND TODAY FOR FREE COLOR CATALOG / WOODCRAFTING MANUAL

Garrett Wade Company, Inc.  
Dept. 6, 302 Fifth Ave., N.Y. 10001

Name \_\_\_\_\_  
Address \_\_\_\_\_  
City \_\_\_\_\_ St. \_\_\_\_\_ Zip \_\_\_\_\_

## NOW — EASIER THAN EVER TO BUILD AND FLY YOUR OWN BENSEN



Use our New Material Packages to build your own one-man Gyro with a small set of hand tools. Time-proven parts available. NASAD approved building Plans \$35. Colorful Info Packet \$5 (Copter) or \$3 (Glider).

SEND \$5 OR \$3  
NAME \_\_\_\_\_  
ADDRESS \_\_\_\_\_

**"OUR FOUNDRYETTE" BLAST FURNACE**  
SINCE 1935  
Hobbyists. Schools. Inventors, etc. Make your own castings of any metal from cast iron, down to lead and zinc. Available in sizes from 1½ to 285 lbs. RED BRASS. Complete units furnished with all sizes. Send 25¢ for circular.

**KANSAS CITY SPECIALTIES CO., INC.**  
Dept. P-6, P.O. Box 193, Middleton, Wisconsin 53562

**SAVE ELECTRICAL POWER!**  
Save up to 80% electrical power with this unique, inexpensive, portable, permanent and legal method applicable for shops, homes, factories, businesses, farms, sites. 100% Refund Guaranteed if not scientifically sound or if it employs gimmicks.  
Information \$1.00

**CONSUMERTRONICS CO.**  
P.O. Box 1399 Alamogordo, N.M. 88310

**MILITARY STUFF**  
5000 Products - All New! Mini-Medals, Patches, Flares, Insignia, Fatigues, Rings, Boots-50 Pages! Send 50¢ (It's refunded on 1st order). **KEN NOLAN**, Foxhole 105, Irvine, Calif. 92705.

## New Low-Cost Sources of ENERGY for the HOME

- WIND Power • WATER Power • WOOD Heating
- SOLAR Heating • METHANE Digestion

Yes! here is a home energy book which goes beyond discussions, and actually shows the basic "How-to" of installation! Covers: quick calculation of AMPLE ENERGY AVAILABILITY for your site; UP-TO-DATE SOURCE CATALOGS for everything from water pumps to Swiss windmill kits; HOW-TO INFORMATION galore so you can make alternate energy a money-saving reality NOW; COSTING ESTIMATES and ECONOMICS. Over 150 illustrations. Applicable to new or old, urban or rural homes. A huge leap forward in handling the energy crisis! 250 pp., large-size quality paperback, \$5.95 postpaid. Ask for ENERGY FOR THE HOME. Send to: GARDEN WAY PUBLISHING, Dept. 50196, Charlotte, Vermont 05445

**A YEAR'S INCOME IN 6 WEEKS BLACKJACK PLAYERS**  
Use my unbeatable, quickly-learned system to earn over \$50.00 an HOUR in any casino. Play relaxed. No cards or charts to memorize, and IT WORKS!  
• 30-DAY FREE HOME TRIAL •  
You must be satisfied 100%. No obligation. Get a deck of cards and try it. You'll be amazed.  
FREE DETAILS VIA AIRMAIL  
**MEL GRANT, Dept. 297**  
324 So. First Street Alhambra, CA 91802

**ROUTER BITS**  
HIGH SPEED STEEL, CARBIDE TIPPED, SOLID CARBIDE, FORMICA TRIMMERS, PILOTTED; ETC. Professional quality tools at lowest cost through mail order. What others call special, we have in stock. Send \$25 for catalog and price list to:  
**TECHNICUT TOOL SUPPLY**  
P.O. Box 233, Newbury, Ohio 44065

**FIX LAWN MOWERS**  
FOR FUN & PROFIT! Fascinating new Handbook by F. Peterson gives you the knowledge skilled mechanics learn. OVER 125 ILLUSTRATIONS show how to trouble shoot, repair carburetors, engines, balance and sharpen blades, etc. Exploded drawings are extensively used.  
INSTRUCTIONS COVER reel, rotary and rider mowers, preventive and routine maintenance, how to identify brand names, where to obtain replacement parts. How to buy and use a lawn mower. Friends gladly pay \$10 to \$50 to fix their lawn mowers. Try the HANDBOOK OF LAWN MOWER REPAIR.  
Rush only \$6.95 plus 50¢ handling on 10-day money-back guarantee.  
**EMERSON BOOKS, INC.**  
Dept. 288B Buchanan, New York 10511

**EXTRA MONEY '30 to '50 A DAY**  
Operate a community sharpening service with an investment of \$150. Work from your basement or garage. Our manual guides you in professional methods of grinding, of business promotion and in pricing your work.  
• Hand Saws • Circular Saws • Knives • Chain Saws  
• Scissors • Pinking Shears • Clipper Blades  
• Planer and Dado Blades • Mower Blades  
John Rodock says: "Thanks for shipping Model 331. It has paid for itself many times since I purchased it. Please send latest price list on grinding wheels."  
**TREYCO** P.O. Box 216-A North Tonawanda, N.Y. 14120  
**START NOW...WRITE TODAY**

**USE ZIP CODES WHEN ANSWERING ADS**

**DRILL YOUR OWN WATERWELL**  
With this low-priced outfit you can drill your own water well at a cost of about 12¢ per foot! Also, this unit can be operated horizontally to drill free-flowing springs in hillsides. A big, fact-filled package and 24-page book "How To Drill Your Own Water Well" is just \$1.00 PPD. (Refundable) "WRITE TODAY"  
**DEEPROCK MFG. CO.**  
1001 Lafayette Pkwy., Opelika, Ala. 36801

**KARATE**  
JUDO-SAVATE  
JIU-JITSU  
THE GREATEST SELF-DEFENSE SYSTEM KNOWN TO MAN!  
Learn-At-Home-Course reveals hundreds of deadly self-defense secrets, which will enable you to protect yourself from any attacker! Easy to learn! FREE COLORFUL BROCHURE REVEALS SELF-DEFENSE TECHNIQUES.  
Send to: **UNIVERSAL, Dept. M**  
BOX 39303 DETROIT, MICHIGAN 48239

**PORTABLE STEAM CLEANER**  
Steam in 60 seconds  
CLEAN:  
Engines, Air Filters, Lawn mowers. 3 year guarantee on fire box, coils. Uses liquid soap, propane fired. Weight 120 lbs. Auxiliary pump required on low water pressure.  
**WEDCO MFG. INC., Dept. M-6,**  
Box D, Jackson, Wyo. 83001

**CARBIDE CANNON**  
Get Now For July 4th, Bicentennial, Holidays, Celebrations  
Ready To Shoot!  
Modern 60mm Cannon, 9" long, 2 Tractor Wheels ... \$8.95  
World War I Cannon, 17" long, 2 Iron Wheels ... \$15.95  
Modern 155mm, (shown) 25" long, 8 Tractor Wheels \$24.95  
Carbide Ammo, About 500 shots ..... \$ 2.50  
Add \$1.75 Shipping. **JOHNSON SMITH CO.**  
Dept. 106, Mt. Clemens, Mich. 48043

**"LISTEN IN" TO POLICE-FIRE RADIO CALLS IN YOUR CAR!**  
WORKS WITH ANY CAR Portable or HOME RADIO! Just PLUGS IN—No wiring—3 minute hookup—swt. instantly from regular radio to ALL POLICE—FIRE—EMERGENCY—TAXI—STATE-GOV'T 2 way radio call! Works Everywhere—Anytime! Dual Band 36-49 & 150-175 MHz. Includes CK, M.G. and pay postman \$12.99 COD post. age or send \$14.95 for PPD Del in U.S.A. COMPLETE with Antenna and Plug in to use with ANY Home or Portable Radio! Full instructions—1 year Service Warranty—10 DAY MONEY BACK TRIAL—SOLD ONLY Direct from Factory—WESTERN RADIO DEPT. BPM-6 KEARNEY, NEBR. 68847

**IMPORTED LOCK BLADE KNIFE**  
ONLY \$275 each  
9" Overall Length  
5" When Closed  
• Opens instantly  
• Sharp and Tough  
• Stainless Steel Blade  
Flips open instantly and locks automatically to prevent accidental closing. Razor sharp tough stainless steel blade for reliable use and hard long service. Money back in 5 days if not satisfied. Send \$2.75 plus 25¢ to cover postage and handling.  
**WESTBURY SALES CO.**  
P.O. BOX 434, WESTBURY, N.Y. 11590  
DEPT. L-6-PM



# CLASSIFIED ADVERTISEMENTS

Rate: \$2.65 per word payable in advance each insertion. Bold face capitalized words—75¢ per word additional (First word set in Bold Face at no extra charge, Zip Code Free). Minimum insertion ten words. To be inserted under proper classification, copy must be in our office by the 10th of the second month preceding date of issue. The next available issue to place an advertisement in America's No. 1 Classified Section is August. The closing date is June 10th.

Send remittance and order to H. E. Kappel, Popular Mechanics, 224 West 57th Street, New York, New York 10019

Please make remittance payable to Popular Mechanics. . . . When answering advertisements please use the zip code number

## AUTOMOBILES

**GASOLINE SUBSTITUTES** - Inexpensive - Proven. Information 25¢. Ames, Box 52A, Detroit, Mich. 48223.

**SANDBLASTERS**, \$32.50—\$749.50. Free Catalog—Truman, 1330 Market, Youngstown, Ohio 44507.

**"50 MPG Carburetors—Do they Exist? Free Details."** Madison, Box 206-5, Berea, Kentucky 40403.

**V-8 Runs on 4. Proven Simplified Method.** Details \$3.00. Kinney, 2335 N. Milford, Highland, Mich. 48031.

**ELECTRIC CAR** Building Instructions. Free Information, Iott Engineering, 4660 73rd, La Mesa, Cal. 92041.

**PEDAL CAR.** Revolutionary New Design. Fast, Light, Fun To Drive. Easily Built From Kit or Plans. Complete Brochure \$2.00. (Refundable). Pedal Engineering, Box 1648, Largo, Florida 33540.

**DEPRECIATION!** Stop Buying Auto's Biggest Cost—\$2.00—Information Repays Many Dollars. Excel Cartacts, 26381 Farrington Ave., Euclid, Ohio 44132.

**DRIVERS'** intercommunication Flash Cards, Sixteen \$5.00 "Carversation's", Box 370670, Miami, Florida 33137.

**33% OFF** Delta CDI. Radar "Snooper", QI Lights, Gauges, Tools. Free catalog. Time Machines, 29M Falmouth St., Brooklyn, N.Y. 11235.

**SAVE GAS PLUS MORE POWER** With vapor injector. Free Information, Box 53A, Colbert, Wash. 99005.

**TOTAL RUSTPROOFING FOR YOUR CAR.** Rust can be stopped indefinitely no special materials, tools or know-how required. Instructions \$3.50. Lloyd Schumann, RD4, Geneva, Ohio 44041.

**REPAIR & RECHARGE AUTO AIR-CONDITIONERS** Illustrated instructions, ppd. \$5.50 - Ward, 101 Wilson, Hightstown, N.J. 08520.

**MOTALOY** Ring-Valve Replating Job—\$6.00 Money-Back Guarantee! Free Brochure! Arrow Products, Box 374M, Broken Arrow, Okla. 74012.

**ELECTRIC CAR** 55mph now 250 mile range hybrid, the original, most advanced compact car conversion manual, maintenance free solid state control—\$15.00, pictures, into only \$1.00. SEECOM, Box 1274, Tustin, Cal. 92680.

**AUTOMOBILE BATTERIES** last forever using simple instructions—\$1.00. M. Paquin, 32 Watson St., New Bedford, Mass. 02740.

**BUILD HYDRAULIC FLOOR JACK** From Hand Jack. Save up to 80%. Plans & Instructions, \$6.50, Jacco, Route 7, Box 359, Decatur, Ill. 62521.

**TRIPLE** Gas Mileage on Dodge Charger Size Car. Smooth Electric/Gasoline Drive. Charge Battery Driving or Overnight. Ten Pictures \$3.00. Plans \$20.00. Creative Automotive Research, 8136G Byron, Whittier, California, 90606.

**SAVE GASOLINE** 2-6 More Miles Per Gallon. \$5.00 post paid. Easily Installed. State Year. Make Of Car Or Pickup. Devise, Box 554, Albion, Mich. 49224.

**MANUALS** For Every American and Imported Car. Free Catalog. Carbooks, 181 Glen Ave., Sea Cliff, New York 11579.

**ADD PROPANE-BUTANE** To Your Engine. Keep Gasoline Stand-By! FREE DETAILS. LPGas Automotive, Box 2253, Eugene, Oregon 97402.

**SAVE** Gas Oil Plugs. Details free. Motaloy, 2532 Superior, Chicago, Ill. 60612.

**BUILD** Electric Car or welder! 400 Amp Generators \$90.00; CENACO, B777, Bethany, OK 73008.

**ARE YOU GETTING A GOOD "DEAL" ON A NEW CAR OR TRUCK? SHOULD YOU BUY, LEASE, RENT? GETTING MORE FOR YOUR TRADE-IN. PICKING YOUR DEALER. FINALLY, A CONSUMER REPORT THAT HELPS SOLVE THE "MYSTERY" OF THE GOOD DEAL. ONLY \$4.00. INDEPENDENT CONSUMER ADVISOR, P.O. BOX 33121, INDIANAPOLIS, IND. 46203.**

## AUTO SUPPLIES & EQUIPMENT

**LABOR** Is High. Do Your Own Repairs. Auto Repair Book Shows You How. \$3.95. Brown Industries, Route 4, Seminole, Texas 79360.

**DISK BRAKE PACKER** pack bearings without removal of wheels rotors calipers brakes lines. Trem Products, 7A Page Rd., Bedford, Mass. 01730.

**"ALTERNATOR/Generator Rebuilding Book."** Information: Hedelund Engineering, POB 5777, Las Vegas, NV. 89102.

**REVOLUTIONARY** Auto Air Conditioner You can build For About \$50. SAVE GAS. FREE Detailed Information. Space Age Research Co., Dept. PM6, Box 770, Columbus, Indiana 47201.

**ELECTRIFY YOUR VW BUG.** Beat the Gas Crunch. Dependable Non-Polluting Local Transportation. Complete Plans and all Parts Available. T. Frizzell's Electric Transportation, Charlestown, N.H. 03603.

**PARTS:** Army jeep and truck parts. Spare Parts & Equipment Co., P.O. Box 751, Lexington, Kentucky 40502.

**SAVE \$\$\$\$. Automotive valve tools—Guaranteed—Free Information.** Kwikseat, 2286, Box 1511, Redding, Calif. 96001.

**UNIQUE** Igit Continuously Monitors Ignition Performance. Q-Arc, Box 47876, Los Angeles, Calif. 90047.

**DO-IT-Yourself** Car Tune-up Product. \$2.00. Gao Enterprises, Box 1962, Brooklyn, New York 11202.

**"DON'T BUY** any auto gas saving device or plan before you read our time and money saving report. Send \$2.00, money back guaranteed. Consumer Research Association, P.O. Box 111, La Mirada, Ca. 90637."

**SUN-ROOFS,** Plexiglas, \$89.95 (Introductory Special non-electric normally \$129.95) Kit \$59.95, electric available, easily installed. Many models, literature. Write Sun-Air Sky-Roots, Box 8A, Breese, Ill. 62230.

**MOTALOY** Ring Valve Job While You Drive! \$6.50 Two \$12.00. Truck's-Tractors' \$8.00 Two \$15.00 postpaid. (Guaranteed.) Andris, Box 34237, Dept. 142, San Francisco, Cal. 94134.

**POWER FOR TOOLS ANYWHERE!!** 110 Volts, 3000 Watts. From Car, Truck Alternator. Build Converter Yourself for About \$5.50. Step by Step Plans, send \$2.00. DYN Enterprises, Box 1166, PM-2, Greensburg, Penna. 15601.

**BURN** Gasoline, Kerosene, Diesel, Alcohol. Increase Performance, Reduce Emissions. Kits \$5.00 up. Franchise's available. Power Genie, Box 872, Lancaster, Pa. 17604.

**KAR/Boodie/Kit** for glove box—eliminates fumbling for small items. Unstructured design—three zippered compartments—pliable black vinyl (12"x5" unfilled). Free gold initials. Superb Gift—\$4.95. Jacan Industries, Box 231, Boston 02146.

**RADAR** Snooper, Auto Accessory Literature. Fletcher . . . 906M Lindale, Richardson, Texas 75080.

**AUTO ENGINE HOIST** Plans \$4.00. Mark Peterson, PO Box 206, Steger, Ill. 60475.

**WATER ALCOHOL** Vapor Injector Rad-Ar Model 46 Increased POWER Increased GAS Mileage Complete Easy Installation \$9.95 Plus \$1.25 Shipping. 30 Day Money Back Guarantee. Rad-Ar Prod., Box 203, Farmingville, N.Y. 11738.

**HOMEMADE** Vapor Injector Increases Mileage. Instructions \$2.00. Vidmar Crafts, Freeburg, Ill. 62243.

**PREVENT** Car Thefts. Ignition De-Activator Kit installed in Minutes. \$3.95 Guaranteed. Lancer, Box 365-B, Prospect Heights, Ill. 60070.

**WANTED FORD '32-'48** New, Old Stock Body & Chassis Parts; Lionel Electric Trains-Garton's, 5th & Vine, Millville, N.J. 08332.

## MOTORCYCLES, BICYCLES, MOTORSCOOTERS, & SUPPLIES

**AMERICAN INDIAN MOTORCYCLE COMPANY, WORLDS LARGEST** Supply of Parts for AMERICAN INDIANS, 213-447-4078, 119 East Huntington Drive—Monrovia, California 91016.

**HONDA,** \$25.00. Other Bargains. Send \$1.00 (Refundable). Motorscooter, P443, Bend, Oregon 97701.

**MOTORIZE BICYCLES—PLANS!!!!** Electric, \$2.00 . . . Gasoline, \$2.00 . . . Both, \$3.00 . . . Guaranteed . . . Britt, 956 Springdale, Atlanta, Ga. 30306.

**REPAIR BICYCLES** For Fun and Profit. Send \$3.00 to Plaza Bike Shop, 1523 Woodside Rd., Redwood City, Ca. 94061.

**ILLUSTRATED** Catalog, 25¢. Parts and Accessories. Custom and Stock. For Most Makes and Models. Motorcycle Supply, Box 159M, Fairbury, Illinois 61739.

**MINI-BIKES.** Go-Karts. Engines. Clutches. Discount Catalog 25¢. Lorenzo, Danville, Illinois 61832.

**CHAIN-DOWN** Solid steel. Tamper-proof bolts. Stops theft of motorcycles, bicycles, boats, trailers. Anchors in concrete, cement. Thermo-Chem, P.O. Box 15457, Tulsa, Okla. 74116 \$14.95 Catalog \$1.00.

**GO-KARTS—\$29.95** send \$1.00 For Catalog and drawings. Schmieder, RD#1, Doylestown, Pa 18901.

## SPACE, ROCKETS, ASTRONAUTS

**UFO MESSAGE REVEALED!!** Will Jima's astounding 1973 encounter with aliens. Order now! Stereo album \$4.95, 8-track tape \$5.95. Add 75¢ handling. Encounters, 831 Jefferson, Bowling Green, Ohio 43402.

**ROCKET** Building Publications. Catalog .50¢. Refundable. Rockets, Box 7274, Long Beach, Ca. 90807.

**TELESCOPES** Observe outer space with a Superior Optics Astronomical Telescope, Superior Optics, 2984 Fair Avenue, Columbus, Ohio 43209.

## AVIATION

**HANG GLIDING** Handbook, 200 Pages, \$5.95 postpaid. Poynter, Box 4232-S, Santa Barbara, CA. 93103.

**AIRBOAT** Propellers, Engines, Hubs, Mounts, Supplies. Corvair. V-W Conversions. Removable Airdrives. Catalog \$1.00. Banks-Maxwell, Box 3301E, Ft. Worth, Texas 76105.

**ULTRA-LIGHT HANG GLIDERS** From world's largest manufacturer. Unsurpassed quality & safety. Rogallo plans—\$5.00. Kits, Complete gliders. Free Rogallo & Icarus information. Free-Flight, 12424 Gladstone, Sylmar, California 91342.

**BUILD—ONE-MAN JET HELICOPTER.** Easy inexpensive. Detailed plans, drawings—\$5.00. Helicopt, Box 7153, Baltimore, Maryland 21218.

**WATER KITE—Rogallo** Design. Unique Float and Release System for Exceptional Safety. Send \$15 for complete Plans & Detailed Flying Instructions. Price list Describing all Parts Available from Factory sent free Upon Request. Fred's Enterprises, P.O. Box 21212, Salt Lake City, Utah 84121.

**BUILD** Airplane Less 100 hours less \$1000.00 Dollars less 200wt. Send \$3.00 for picture, performance information. Baileyton Aircraft, Box 95, Baileyton, Ala. 35019.

**FLYBIKE,** World's Simplest Ultra-Light Airplane. Free Brochure. 1119 12th N.E., Ardmore, Oklahoma 73401.

**FAMOUS** Hang Glider Designs, Posters. Wright Brothers, Chanute, Pilcher. \$2.00 Each. Catalog 50¢. Conover Products, Rt. 1, Toddville, Iowa 52341.

**JET** Engine Plans, Catalog, Builders Newsletter \$1.00. Doyle, Box 310, Montclair, New Jersey 07042.

## HOVERCRAFT

**AERO-CAR** Amazing Hovercraft built easily with ordinary tools. Lawnmower engine power. Carries one man plus. Hovers, flies forward, backward. Sideways over land/snow/water. Complete construction plans and brochure. \$5.95. Aero-Projects, Box 5118PM, Clinton, New Jersey 08809.

## BOATS AND TRAILERS

**BOAT KITS, HULL KITS, FRAME KITS, PLANS & PATTERNS.** World's Largest catalog, over 300 modern designs for the amateur in fiberglass, plywood, strip planking, steel, aluminum, cement, from 7 to 70 feet. **SAIL**-Prams, Day Sailers, Motor Sailers, Ocean Racers Trimarans, Catamarans. **POWER**-Cruisers, Trawlers, Run-a-bouts, Fishing Boats, Kayaks, Inboard & Outboard Hydroplanes, Tunnel Boats. Also complete boat-building materials, sails, fiberglass, plywood, etc. Send \$1.00 for catalog or \$2.00 for catalog plus boat-building guide to Clark Craft, 16-P, Aqua Lane, Tonawanda, New York 14150.

**FIBERGLASS BUILDER'S MATERIALS.** Lowest factory prices in cloth, mat, roving, resin, epoxy, foam, bronze nails, plywood, mahogany. Send \$1.00 for literature or \$2.00 for literature plus booklet on mold making and "How to" fiberglass. **CLARK CRAFT**, 16-P1 Aqua Lane, Tonawanda, New York 14150.

**NEW 1974** Outboards Top Brands . . . 6 H.P. \$365 . . . 15 \$530 . . . 40 \$685 . . . 50 Electric 998 . . . 70 Electric \$1200. All Sizes. Evinrude-Scott-McCulloch-Parts. Handling \$1.00. Electra Marine, 610 Merrick Road, Lynbrook, N.Y. 11563.

**BOAT BAILER;** Automatic. "DRAIN CHECK". Fits popular transom drain tubes. \$6.95 At your dealers; or, add \$1.50 P.P., Handling. Write: De PERSIA, Grand Haven, Michigan 49417.

**BOAT** Kits. Molded Fiberglass. Save money-assemble yourself. Factory molded sections bond into one-piece craft. 20 models-14' to 32' Cruisers, Runabouts, Sailboats, Accessories, motors, trailers, Easy terms, Free catalog. Luger, Dept. BC-75, 3800 West Highway 13, Burnsville, Minnesota, 55337.

**BOAT PLANS, FRAME KITS, FULL SIZE PATTERNS** Especially for amateurs. Easy, proven methods, step-by-step pictorial instructions. All boat types 8' to 49'. Sail - Power - Inboards - Outboards - Jets - Houseboats - Cruisers - Hydroplanes - Trawlers - Catamarans - Ski Boats - Tunnel Hulls. Also fastenings, fiberglass, rigging, hardware, sails, spars, boat trailer plans. "How-to" Books. Send \$1.00 for HUGE NEW 120-page catalog plus FREE "Boatbuilding Supplies" brochure. Glen L. 9152MP Rosecrans, Bellflower, CA 90706.

**CANOE!!** Kayaks! Factory Direct quality kits, from \$30.00. Many different models. Canvas, hulls. Strongest construction materials. Free literature. Sportscraft, Box 636-P, Allentown, New Jersey 08501.

(Continued on next page)



## BOATS AND TRAILERS

(Continued from preceding page)

**FIBERGLASS** Cloth and resin. World's finest cloth and non-run resin, at direct mill prices. Complete line of plastics, silicon bronze and brass screws, save 60%. No sales tax. Boat Plans. Catalog 25¢. Stiles Boat Supply, Box 11P, Linden Ave., Mantua Heights, N.J. 08051.

**FIBERGLASS** Canoes, Kayaks, and Duckboats. Many exciting models. Easily assembled kits. \$49.95 up. Free Literature. Riverside Canoes, Box 5595P, Riverside, Calif. 92507.

**CANOE** Kits-Wood Canvas, Molded Fiberglass—Free Catalog. Trailcraft Inc., Box 60686, Concordia, Kansas 66901.

**BUILD A Powerful JET Drive System** for Small Boats. Plans \$4.00. Kits from \$32.00. **TURBY MARINE**, 617 Gladiola Street, Merritt Island, Florida 32952.

**FISHING/SURFING/SAILING/POWER DORIES. BROCHURE, PHOTOS: 40 PLANS \$1.00 AIR MAIL \$2.00. TEXAS DORY BOAT PLANS, BOX 720, GALVESTON, TEXAS 77550.**

**FIBERGLASSING?** Complete Instructions! "Craftsmans Fiberglass Manual" Only \$2.00 Postpaid! Edryn Corporation, Box 537-PB, Cocoa Beach, Florida 32931.

**"FIBERGLAS** Cloth, Matt, Polyester and Epoxy Resins. Wholesale catalog and Boat Molding Book \$1.00 (Refundable). Seifert's, Box 1206-M, Green Bay, Wis. 54305."

**PROPELLER** Maintenance And Repair Do It Yourself Manual \$4.00. Vast Products, P.O. Box 6034, Bakersfield, Calif. 93306.

## CAMPERS AND TRAILER KITS—PLANS

**COMPACT** Car and **MOTORCYCLE OWNERS** go on vacation in comfort Build your own luggage trailer from my plans will dropship Axle springs wheels tires wholesale \$62.56 (price subject to change) send \$5.00 for plans to Nieman, 14013 Iyopawa Island, Coldwater, Mi. 49036. Also Motorcycle trailer hitch plans \$2.00 Moneyback guarantee.

**BUILD YOUR OWN RV** with **GLEN L** Component Kits. Plans and Full Size Patterns. **FREE CATALOG**. Campers, pickup covers, fifth wheel trailers for domestic and import trucks. Travel Trailers, camping trailers, van conversions. **SAVE! PREPAID FREIGHT SPECIAL!** **GLEN-L**, 9152P, Rosecrans, Bellflower, California 90708.

## MARINE EQUIPMENT AND SERVICES

**MARINE** Engines, conversions, parts, equipment. Catalog Free! Stokes Marine Industries, Coldwater, Michigan 49036.

**CONVERT** Auto engines to marine. 68 Page Catalog, 50¢. Lehman Manufacturing Company, 800 Elizabeth Avenue, Linden 4, New Jersey 07036.

## ATHLETIC AND BODY BUILDING COURSES

**KUNG-FU!** Learn from disciple of Bruce Lee (Kato). Details 25¢. Galaxy Enterprises AAF, Box 2176, Northlake, Illinois 60164.

**WEIGHT** Exercising Equipment, send 25¢ to cover postage for illustrated catalog. Exercising Equipment, P.O. Box 662, Holyoke, Mass. 01040.

**DYNAMIC MUSCLES! FAST!** No Gimmicks. Free Illustrated Brochure. Inquire: Goliath Enterprises, Box 933F-PM, Wheeling, Illinois 60090.

**MUSCLE!!!** New Illustrated Bodybuilding Catalogue—25¢. 18483 Brady, Redford, Michigan 48240.

**INCREASE HEIGHT! 2-6"** 35¢ Guaranteed, Tall-Up, Box 16037C3, Cincinnati, Ohio 45217.

**ARMS, 18+ INCHES IN 90 DAYS** Or Refund! Revolutionary Arms Specialization. \$3.00—Complete! (Karate—Free Information) Phenoministics, Box 281D, Gresham, Oregon 97030.

## SPORTING GOODS AND EQUIPMENT

**ARCHERY** Lowest Discount Prices. All top brands. Orders shipped same day received. Money-back guarantee. World's Largest Supplier. Free catalog. Anderson Archery Corporation, Grand Ledge, Michigan 48837.

**FREE CATALOG.** Fishing Tackle, Archery, Hunting and Camping Equipment. Lowest Prices. Cabela's Inc., Dept. 5756, Sidney, Nebraska 69162.

**HUGE** Sportmans Catalog low direct factory prices, fishing, Hunting, Archery, reloading Camping. Send \$1.00 Refundable. Herters Inc., Dept. CPM, Waseca, Minn. 56093.

**BLOWGUN** Maximum performance design. Illustrated plans \$1.00. Dutton Sandlin, Box 142, Sterling Hts., Michigan 48078.

## FISHING, TACKLE, LURES

**SURF-ALERT!** Attaches to Tip of Rod. Rings Out Simultaneously With Nibble. Eliminates Constant Tending \$1.50 ppd. Gets Results. Acute, PO Box 139, Bank Plaza Station, Merrick Ave., Merrick, NY 11566.

**FREE** Lure Tape! Multicolor Prismflash . . . Hot Fluorescents . . . Luminescent GloTape . . . Eight Samples, Wholesale prices!! Send 25¢ (postage-handling): Lur-Tape, Box 1235P, Berkley, Mich., 48072.

**FANTASTIC** Price on Berkley Dew Flex monofilament. 1/4 pound spool just \$1.00 plus 25¢ postage & handling. #4, 6, 8, 10, 12, 15, 20, 25, 30, 40 lb. test. Send for **FREE** Hunting, Fishing, Campng Catalog. All nationally advertised brands at lowest prices. Charter Oak Distributors, Inc., Dept. PMC65, 50 Walnut St., Middletown, Ct. 06457.

## EARTHWORMS, LIVE BAIT

**EARN** Money raising fishworms for us! Exciting details free! Oakhaven—56, Cedar Hill, Texas 75104.

**FREE** Literature. Profitable Business Raising Fishworms, Crickets. We Teach you how to Raise and Sell. Write today. Carter Fishworms, Plains, Georgia 31780.

**SOILLESS** Method Raising Worms. Garage Basement, Three Oaks, Dresden, Tenn. 38225.

## HUNTING, GUNS, DECOYS

**PELLET GUNS** And Accessories. Sensible, Enjoyable Shooting Anywhere. Finest Adult Models; Satisfaction Guaranteed. Free Catalog. Write: Air Rifle Headquarters, Grantsville, WV 26147.

## POULTRY & GAME BIRDS

**QUAILS**, Incubators, cages, supplies catalog. Marsh, 14216 Brookhurst, Garden Grove, Calif. 92643.

**QUAILS** Incubator Eggs, Brodders—Price List. Box 4437, Charlotte, N.C. 28204.

**ANIMAL** Traps and Trapping \$8.95. Booking Now Upland Game Birds Dayold-Started Mature. Catalogue 50¢. Northwest Farms, Box 3003P, Portland, OR 97208.

## HAWKS, FALCONS

**INTRODUCTION** To Hawking, an Illustrated Guide to Falconry. \$5.00. "Hawking," P.O. Box 580, Davis, California, 95616.

## RABBITS, CHINCHILLAS, FUR BEARING ANIMALS

**\$300-\$700 MONTHLY.** Raise Rabbits, Laboratory Animals for us. We supply Equipment, Breeders, Instructions. Details 25¢ MP11 Rabbits of Michigan, Countyline Road, Pentwater, Michigan 49449.

**RAISE** Chinchillas. Guaranteed income. Illustrated catalog \$3.00. Refundable. DeShon Chinchilla, Route 2H, Roanoke, Indiana 46783.

**\$500-\$1000 MONTH** Plan raising rabbits for us. Free details. White's Rabbitry-PM, Hudson, Ohio 44236.

**AMAZING PROFITS!!** \$10,000 Yearly Raising Rabbits for Wool and Breeding. Send \$1.00 for Details. American Angora, Malta 12, Montana 59538.

**RAISE** Rabbits successfully by knowing facts. 25 cents for 64 page illustrated book describing 25 breeds, housing, breeding, feeding, markets and marketing. American Rabbit Association, 36 Arba Building, Bloomington, Illinois 61701.

**BIG Profit** Raising **QUALITY** Chinchillas. United Chinchilla, Box 334A, Grandview, Missouri 64030.

**WHY Not** Raise Mink? Information \$1.00 Refundable. Samuel Raines, Pointville Rd., Pemberton, N.J. 08068.

## PETS—BIRDS, CATS, HAMSTERS, ETC.

**PETS**, Reptiles, raccoons, skunks, squirrels. Catalogue 25¢. Trails End Zoo, St. Stephens, S.C. 29479.

## HORSES, LIVESTOCK

**"HOW TO TRAIN HORSES"**—FREE Book tells how to break, train, make money with horses, Beery School, 1106 Pleasant Hill, Ohio 45359.

## ELECTRICAL SUPPLIES

**ELECTRIC MOTOR SUPPLIES!** Equipment Plans! Modequip, Box 7266, Kansas City, Missouri 64113.

## ELECTRONICS

**FREE!** Bargain Catalog—I.C.'s, LED's, readouts, fiber optics, calculator parts & kits, semiconductors, parts. Poly Paks, Box 942PM, Lynnfield, Mass. 01940.

**TELEPHONES-EQUIPMENT-SUPPLIES**, All Types. Catalog 50¢. Box 1654T, Costa Mesa, California 92626.

## BATTERIES, GENERATORS

**BATTERY** Reconditioning Kit, includes molds, material, instructions. Apex Engineering, 3100 Ramona, Atascadero, California 93422.

## ENGINES, MOTORS, MAGNETS

**MOTORS**, shaded-pole gear, 110-V., 7 RPM, ideal for slow-moving displays, \$16.50 postpaid. Way-Mar, P.O. Box 164, Hartsdale, New York 10530.

**WINDING** Data, 275 motors, \$1.25. Data Company, 512 Kensington, Kansas City, Mo. 64124.

**REWIND** Car Generator for 110 VAC. Power Plant Plans \$2.00. Schmauss, 1228 East Cass, Tampa 33602.

**PLANS**—Heat, Power From 20,000 Watt Windmill or Solar Panels \$9.00 each. Convert Three Phase Motors to Single Phase, AC Motors to Generators \$2.00 Each, Complete Plan & Kit list 50¢. DanRan, Box D, Reno, Nevada 89506.

**RUN** Three Phase Motors on Single Phase! Three Methods! New Illustrated Manual. \$3.00 Guaranteed! Lindsay, Box 12-B, Bradley, IL 60915.

**STANLEY STEAMER** mini engine 2-4 H.P. with piston valves and stempson link. Designed for mini car or go-kart. Looks like real Stanley steamer engine. Detailed blueprints \$10.00 to W. J. Ryan, 1912 Sunset Ave., Waukegan, Illinois 60085.

**STIRLING** Hot Air Engine Plans \$5.00, self-addressed stamped envelope. Iger, 166 Palm, San Francisco 94118.

## TOOLS FOR SALE

**DREMEL**, Atlas, Maximat, Unimat, Toolkraft, X-acto, Foredom, etc. Priced For Your Pocket. Catalog \$1.00 Refundable. Visit our Showroom. Tools Unlimited Inc. PM, 2106 Union Boulevard, Bayshore, New York 11706.

## MACHINERY, TOOLS, & SUPPLIES

**UNIMAT** Lathes-Maximats-Metals-Micrometers. Catalogue \$1.00. Campbell, 1424 Barclay, Springfield, Ohio 45505.

**SMALL FOUNDRY** furnaces. Supplies. Free literature. Pyramid Products, 3736 South 7th Avenue, Phoenix, Arizona 85041.

**1400 CATALOGS** Listed and Described! Sources for **EVERYTHING** Imaginable! Rush \$2.00. **MASTERLOG**, Box 24413-YR, Oakland, California 94623.

**4" METAL** Cutting Lathe \$47.40. Taig Tools, 15048 Proctor, Industry, Calif. 91746.

**MILLING** Cutters, lathe milling attachments. Catalog \$1.00. Potter, Box 73, Cedar Rapids, Iowa. 52406.

**12 GROSS** Small Machine Screws Mixed-\$6.95 Nuts, Bolts, Screws, Washers, Assortments. Catalog 50¢. Nutty Co., 1576SMS, Fairfield, Conn. 06430.

**BANDSAW BLADES**, Any Size. Free catalog. Parker, R4, BX735, Sonora, Cal. 95370.

**WOOD** Lathes, large capacity, high quality bench models, factory direct sale. 10"x36"—\$75. 14"x48"—\$95. Literature \$1.00 (refundable) Premium. Box 1069, Ft. Collins, Colorado 80522.

**POWER TOOLS**—Coast to Coast at prices hard to BEAT. Rockwell, Skil, Milwaukee, Stanley, Miller Falls, & many other top quality lines. Send \$1.00 for catalog today. Also qualify for our special of the month sales for one year. Doro Sales, Inc., 926 Little East Neck Rd., West Babylon, L.I., 11704, Dept. 1.

**PLANS**, Tube bender, Press, Break. Info., P.O. Box 56, Campo, Calif., 92006.

**GIANT** 612 Page catalog. Big Discounts Thousands of items for industry and home. \$2.00 refundable with first order. Daytona Distributors, Inc. Box 829, Holly Hill, Florida 32017.

**RAZOR** Blades, Industrial Grade For Cutting And Scraping, Also Shaving Blades. Elwick, Dept. 210, 230 Woods Lane, Somerdale, N.J. 08083.

**BUILD** Upside Down Swing Saw—Also used As Bench Saw. Handiest Tool in shop. Works Beautiful, Plans \$5.00. Hugh Carnes, 2132 Carnes Dr., Bessemer, Ala. 35020.

**PORTABLE** Sandblaster—Free brochure. Billy D. Bass, 1179 Belvedere, Gallatin, Tenn. 37066.

## WELDING, SOLDERING, PLATING

**WELDERS**. Convert To Hellarc, High Frequency Unit 0-225AMP. Plans \$4.00. Convert To DC Plans \$3.00. Information Supply Co., Box 166, College Park, MD. 20740.

**ELECTROPLATING** Equipment, Portable Platers, Supplies, and "Know-How." Build your own tanks for nickel, chrome, etc. Easy-to-install PVC liners. Rectifier components—all sizes. Schematics, parts lists, formulas, operating instructions for all-plating. Guaranteed to save you 25%-75%. Some good used units for sale. Free Details. Platers Service Company, 1511-PM Esperanza, Los Angeles, California 90023.

## GOVERNMENT SURPLUS

**FREE!** Nationwide Surplus Data List. **WRITE TODAY!** **NATIONWIDE AUCTIONEERS**, Box 872PM, Anoka, Minnesota 55303.

**"U.S. GOVERNMENT SURPLUS DIRECTORY."** How, Where to buy 100,000 items (including Jeeps) . . . low as 2¢ on dollar! Most complete information available . . . \$2.00. **SURPLUS DISPOSAL**, Box 6586-AF, WASHINGTON, D.C. 20009.

**GOVERNMENT SURPLUS**, How and Where to buy in your area. Send \$2.00. **SURPLUS**, 30177PM **HEADQUARTERS BUILDING**, Washington, D.C. 20014.

**1975 SURPLUS** Army, Navy Store, 56 Page Illustrated catalog. Send \$1.00. Ruvel, 3037 North Clark, Dept. 6-J, Chicago, Illinois 60614.

**JEEPS** \$52.40. Airplanes \$75.01. Typewriters \$6.70. Boats \$7.50. Typical Bargains Available Nationwide. Sales Directory And Surplus Catalog \$1.00 (Refundable). Midwest Surplus, Box 401-PM, Dayton, Ohio 45401.

**JEEPS!!! PICKUPS!!!** 100,000 items direct from government. Your area. Latest information & surplus categories: \$2.00 **MONEYBACK GUARANTEE**. Order manual #149, from "Dependable Products", Box 113, Vista, California. 92083.

**JEEPS** From—\$52.50; Typewriters from—\$4.15; Cars from—\$31.50. Walkie-talkies, motorcycles, airplanes, boats. Typical "As Is" bid bargains from Uncle Sam. Tremendous variety. Exciting free list. Write Enterprises, Box 402-X113, Jamaica, New York 11430.

(Continued on next page)



## GOVERNMENT SURPLUS

(Continued from preceding page)

**BECOME** Government Surplus Information Dealer. Huge Market. Free Details. General Surplus Co., Box 915, 6PM1, Rochester, MN 55901.

**EVERYTHING** You Need to Bid On Government Surplus, \$2.00. Boyack, 603 1/2 Dogwood, Columbia, S.C. 29205.

## HOBBIES AND COLLECTIONS

**COLLECT** Military Medals. List 50¢. Vernon, Box 387PM, Baldwin, N.Y. 11510.

**AUTOGRAPHS**—Letters, Documents of Famous People, Bought and Sold. Monthly Catalogues Issued. Neale Lanigan, Box 133, Fairview Village, Pa. 19409.

**COLLECTORS!** Original WWII German Helmets, \$21.95. Other military collectibles, Free Catalog. Unique Imports, Dept. PM, 610 Franklin Street, Alexandria, VA 22314.

**COLLECT - MAKE MONEY PAINTING MILITARY MINIATURES.** Send 50¢ for details to practical new hobby. Executec, 777S Central Expressway, Richardson, Texas 75080.

**THREE VOLUMES** Buying - Selling Prices U.S. Stamps, Coins, and Bills. \$3.98. Shannon, 606 Shrewsbury St., Charleston, W.V. 25301.

**SEA** Shell Starter Collection. \$4.95. Allace, Box 628, Montreal, Canada, H3C 2T8.

## DECALS, EMBLEMS, PATCHES

**CUSTOM** Designed Embroidered Emblems, Decals. Inexpensive. Free Catalog, details. Southern Emblem, Box 8PMB, Toast, North Carolina 27049.

**DECALS**—Wildlife—Dogs—Horses. Send—10¢ for Free Folders. PM, Tyler, 1301 Methuen Street, Dracut, Mass. 01826.

**FRATERNAL** Specialties, Swiss Emblems. Free Brochure. Potter's, P.O. Box 1568, Tampa, Fla. 33601.

**FREE**, Three rare American Emblems. Send 50¢ Postage, Handling. German Badge Catalog; 50¢ Emblems, Box 365, Monroe, N.Y. 10950.

**EMBLEMS**, Patches, Beautifully Embroidered. Made To Order From Your Design. Low Cost, Fast Service. Free Catalog With Design Guide. Donalyn Creations, Box 247PM, Cliffside Park, N.J. 07010.

**BICENTENNIAL** - Be Proud, American Flag Decal, Send \$1.25., MPE, Box 84, Irvington, N.Y. 10533.

**BICENTENNIAL** Embroidered Patches. \$1.00 Sample, (4) Different-\$3.50 Collectors Items. Atkins, Berned Specialties, 100-4 Co-op City Blvd., Bronx, NYC 10475.

## STAMP COLLECTING

**FREE!** \$10.00 Giant Stamp Collection of 300 all different colorful valuable postage stamps from Africa—Europe—Asia—British Empire—Worth \$10.00—\$12.00 at catalogue prices. Also money-saving Booklet. All yours as a Get-Acquainted Gift. Adults only. Other fine stamps enclosed for your inspection. Frasek Co., Inc., PM-6, White Plains, New York 10601.

**COLORFUL** Miniature set of 8 only 10¢. Approvals. Gorliz, Box 76457 PM, Atlanta, Georgia 30328.

**50 COLORFUL** Worldwide Stamps. 25¢. Approvals. Christine & John, P.O. Box 213, Dept. G, Davis, Cal. 95616.

**SWITZERLAND** - 25 different 10¢. Hijop Approvals, Box 505, Norristown, Pa. 19404.

**ANIMAL KINGDOM!** Fifty Different- 25¢. Pictorial Approvals Included. Edmund Molzan, Drawer 2276, Alameda, Calif. 94501.

**FREE**, U.N. Mint Set. Approvals. Hildebrand, Box 5645, Redwood City, California 94063.

**SEND** Only 10¢ for nice collection of U.S. stamps including "\$5.00" issue and scarce mint Sipex Souvenir Sheet. You will also receive the most wonderful catalog of stamp offers in America. Littleton Stamps, Dept. 551, Littleton, New Hampshire 03561.

**STAMPS** Free! New Issues—New Countries—Triangles—Rockets—Olympics—Scouts—Birds—Flowers—Animals—Also Old Canadian and U. S. Stamps. Plus complete illustrated Canadian Stamp Catalog. Send 10¢ for mailing. Gray Stamp Co., Dept. A, Toronto, Canada.

**SEND** Only 5¢ for Worldwide Collection of over 50 different Singapore, Grenada, Chad, etc. Contains old and new issues, sports, animals etc. You will also receive interesting lists and a certificate worth 50¢ toward purchases. Goliath Co., Dept. TP-1, Bethlehem, New Hampshire 03574.

**NOW 50 IRAQ** 10¢ with Approvals. Box 307, Goshen, N.Y. 10924.

**65 DIFFERENT NUDES** \$2.00, 80 Diff. \$3.00. No Approvals. Kemp, 9952 Tamarack, Pacoima, California 91331.

**JAPANESE COMMEMORATIVES**—pictorials. Mint complete sets cataloging over \$10.00 only \$2.00 with accompanying mint approvals. Satisfaction guaranteed. Pagoda, Box 132P, Sidney, Ohio 45365.

**FOREIGN** Approvals! Gigantic values! 3¢ each, ABC, Dept. 3301-A, Box 6000, San Francisco 94101.

**FRANCE #1100**—\$4.95 each. Israel—1974 Jerusalem Exhibition—3-S/\$4.00 Set. Limited Quantity. Want Lists Solicited Europe 1964 to date. Mint only. Franklin, P.O. Box 467-PM6, Jamaica, New York 11434.

**20 HISTORICAL** U.S. Commemoratives 20¢, U.S. Approvals accompany. **PINTO STAMP CO.**, Box 111, Park Ridge, Ill. 60068.

**1500 FOREIGN** \$2.00; 5000 \$4.00; 9000 \$6.00. 1000 pre-1939 USA, contains dues, revenues, commemoratives, presidentials, older issues, etc. \$4.00. 4000 \$12.00. 300 USA high values \$2.00; 700 \$4.00. No approvals. Meyers, 5321 Fleming, Richmond, Calif. 94804.

**FROM FIVE CONTINENTS** 110 Different Stamps, All Yours for Only a Dime! Packages of Beautiful Approvals to Buy or Return. Send 10¢ to Stampac, Box 12005, San Francisco, California 94112.

**50 YEARS** Old, fifteen different United States, over fifty years old—25¢ with approvals. Jaxon, Box 145-P, Brooklyn, New York 11230.

**SINGLE STAMPS** 2¢ and up. Mounted in books. **TRUST STAMP COMPANY**, P.O. Box 100-P, Jamaica, New York 11435.

**U.N.** 9 Different Mint Sets \$1.00! U.S. 6 Different Commemorative Plate Blocks \$1.00! 30 Different Mint Commemoratives \$1.00! Approvals. Gordon Davison Hillsboro, New Hampshire 03244.

**FREE** Surprise collection sent with approvals. Gould, 1784 Union, San Francisco 94123.

**PENNY!** Approvals! Regardless catalogue! Kloster, 4164 52nd St., San Diego, Calif. 92105.

**50 DIFFERENT U.S. COMMEMORATIVES** 25¢ Fine Used U.S. Approvals Accompany. Craig Stamps, Box 425-N, Bellmore, New York 11710.

**BUILD** Large U.S. Collection Economically. Sherman, Box 15355G, Philadelphia, Pa. 19111.

**MYSTERY** Packet. \$9.00 Catalog Value. Only 35¢. Stamps, Box 27, Fremont, Michigan 49412.

**500 DIFFERENT** Stamps. \$1.50. Smith, 508-A Brooks. College Station, Texas 77840.

**100 OLD** United States between 1861 and 1939. \$1.00. Ed Roush, 423 Shepard, Mansfield, Ohio 44907.

**U.S. BARGAIN**, 50 Different 25¢, with beautiful worldwide, approvals. Stamp Center, Kennebunk, Maine 04043.

**RUSSIAN** Space Collection 50¢, including Russian Approvals. Snedco, Waldwick, New Jersey 07463.

**TEN** Different Nudes: 20¢. Approvals. Stamp Farm, 2M79, Oxford, Wis. 53952.

**100 DIFFERENT** United States Commemorative, 50¢ with Discount Price List. Shelron, Box 547C, North Miami, Fla. 33161.

**BETTER GRADE U.S.**, Canadian Stamps for advanced collectors. Borgen, Box 645, Seiad Valley, Calif. 96086.

**SCARCE** Guinea UN Airmails \$2.25, catalog 25¢. Approvals. Stamphaus, Box 533, Salisbury, Mass. 01950.

**U.S. MINT** Specials! Flag Set complete \$1.50. 1¢, 2¢, 3¢ Famous Americans (21 different) \$1.50. Free List. Brooks, 2601 Avenue "U", Brooklyn, N.Y. 11229.

**"INVERTED** Error" Dag Hammarskjold, 10¢ with approvals. Belmont Stamps, Washington, D.C. 20015.

**VIETNAM** 25 Different 10¢ approval. Sam Chazen, Box 95, Ozone Park, N.Y. 11417.

**110 DIFFERENT** U.S. Commemoratives. \$1.00. Stamps, 7607 Larchview Drive, Dallas, Texas 75240.

**50 DIFFERENT** U.S. Stamps. Includes 1943 flag stamp of occupied nations. Only 25¢. Approvals included. Willett Co., Box 338-C, Yorktown Heights, N.Y. 10598.

**TOPS!** 100 Popular Poland Stamps (all different) only 25¢. Mystic, Dept. PS 1, Camden, New York 13316.

**EISENHOWER, TRUMAN** or **LYNDON B. JOHNSON** Memorial Stamp on lovely, official, First Day Cover addressed any name of your choice. 60¢ each—all 3 for \$1.50. K. M. WALSH, Box 308AA TUCKAHOE, N.Y. 10707.

**50 DIFFERENT** Old U.S. Revenue Stamps \$1.00. Winchester Stamps, Box 3592, Mansfield, Ohio 44907.

**PICTORIALS** Collection! Fifty Different, 10¢. Approvals. Ross, Box 564-M, Yonkers, New York 10702.

**UNITED STATES** Commemorative Plate Blocks. 25 Different 3¢ - \$7.00, 4¢ - \$8.00, 5¢ - \$9.00. Village Stamps, 20929 Ventura Blvd. #20G, Woodland Hills, CA 91364.

**WORLDWIDE** 500 Different \$1.00. Nickel Approvals Accompany. Fies, Box A-6P, Thornville, Ohio 43076.

**EXOTIC** Sets, 100 Beautiful Stamps \$1.00! Approvals. Leonal, 2422 Ivy, McAllen, Texas 78501.

**OLDER U.S. ON APPROVAL. SURPRISINGLY GOOD SELECTIONS FOR ADULT COLLECTORS. RIVERTOWN, BOX 188P, LOWELL, MICHIGAN 49331.**

**FREE** Mint Philippines with Approvals. Chapmans, Box 487-P, Galesburg, Michigan 49053.

**50 DIFFERENT** Argentina- 10¢. Approvals. Gobe-stamps, Box 402-M, Biddeford, Maine 04005.

**WORLDWIDE** New Issues—Free Weekly Illustrated Lists. Brooks, 2601N Avenue "U", Brooklyn, N.Y. 11229.

**50 SPORTS PICTORIALS.** 25¢ with approvals. Arbour, 3727 Downey Dale, Randallstown, Maryland 21133.

**WORLDWIDE** Collection over 150 interesting stamps 10¢. Approvals Accompany. Casto, Box 927, Largo, Florida 33540.

**LOOK!** 300 Worldwide Stamps 25¢ with Approvals

**"COLLECTION BUILDERS"** Packet List Or Worldwide Approvals. CF Stamps, 655 Forbes, East Hartford, Conn. 06108.

**STEEL STAMPS.** Multicolored Paintings printed on USS steel foil. Mint set from Bhutan, 25¢. Topical Approvals. LeBlanc, Box 110P6, Glen Cove, New York 11542.

**WORLD** Stamps. 3¢ to 10¢ each. Write for approvals today. Thousands to choose from. Continental, 20929 Ventura Blvd. #20, Woodland Hills, CA 91364.

**UNBEATABLE!** Terrific! 200 Worldwide Stamps 25¢. Request Approvals. Sylvia Beatty, Dept. PM5, Eau Claire, Pa. 16030.

**INTRODUCTORY** Offer. World Wide Stamps. Over \$3.00 Value For 10¢ With Approvals. Continental, 20929 Ventura Blvd. #20F, Woodland Hills, CA 91364.

**225 DIFFERENT** Worldwide: 25¢. Approvals. Tibbets, 8675 Meadow. Downey, California 90242.

**FREE** New used Congo animal set. Approvals included. Alpaughco, Box 225, Highbridge, N.J. 08829.

**FREE** Watermark Detector, Perforation Gauge, 100 Different Stamps, Packet of Hinges, State Collecting interest for Approvals. Mail a quarter for Handling. H and L Stamp Company, Box 3090 Station B, Calgary, Alberta, Canada T2M 4L6.

**GUARANTEED:** Our selected stamp investments will increase in value or we will buy them back within five years. For Details Send \$1.00 (refundable). Fleming, Box 11225C, San Francisco, Calif. 94101.

**WOW! 110 ALL DIFFERENT GERMANY 10¢.** Commemoratives, Airmails, High Values, Big Catalog, bargain lists. Also, fine stamps from our approval service, which you may return without purchases and cancel service at any time. Jamestown Stamp, Dept. A65PM, Jamestown, N.Y. 14701.

**FREE LIST!** Discount prices. U.S. Plates-Singles. Scotco, Box 470855-PM5, Miami, Fla. 33147.

**FREE! BIG BARGAIN CATALOG - NEW EDITION** Listing thousands of bargains including U.S. & B.N.A. stamps, packets, albums, accessories and supplies. Also, fine stamps from our approval service which you may return without purchases and cancel service at any time. Jamestown Stamp, Dept. E65PM, Jamestown, N.Y. 14701.

**400 MIXED** U.S. 25¢. Approvals, Wright, Box 753-M. Hagerstown, Maryland 21740.

**FREE** Worldwide with approvals. Stamps Unlimited, Box 2295, Kalamazoo, Michigan 49003.

**3-DIMENSIONAL** Stamps 25¢. Approvals, Roy Scandura, 5512 Avenue H, Brooklyn, New York 11234.

**AINJILL'S FIRST MAIL SALE.** Packets from 25 Years of Worldwide Accumulation, \$1.00 each. FREE Gift with Order of Three or More Packets. AINJILL'S, Box 746, Dearborn, Mich., 48121.

**OLYMPIC GOLD COIN STAMPS,** 25¢. Beautiful mint set, embossed coin-shaped stamps from Sanda Island. Topical approvals. LeBlanc, Box 110-P10, Glen Cove, New York 11542.

**ELUSIVE** Mint 6.7 bulk rate Coil plus Bargain Lists only 10¢. Watson Stamps, P.O. Box 79, Tioga, Louisiana 71477.

**FREE!** Fantastic Nudes, With Beautiful Approvals. Summit, 1146C-49th, Brooklyn 11219.

**207 DIFFERENT** Triangles, Topicals, etc. Value \$7.00. Only 25¢. Approvals. Free catalog and coupon worth \$1.00. Jayto Stamps, Port Huron, Michigan 48060.

**US AND FOREIGN APPROVALS!** Pennies each! Adventure Stamps, Dept. C, PO Box 50262, Castleton, Indiana 46250.

**FREE!** 55 Triangles, Space, Others! Approvals. Baird, PM41, Box 8128, Portland, Oregon 97207.

**WORLDWIDE** Commemoratives. 25 Different 25¢. Approvals. Wilson, Box 116, Dollard des Ormeaux, Quebec, H9G-2H5 Canada.

## COINS, TOKENS, CURRENCY

**SEND** 10¢ for new edition valuable Guidebook "HOW TO COLLECT COINS." Also included 5 foreign coins from Turkey, Spain, etc., and best coins and supplies catalog in America. Littleton Coin Co., Dept. VB-1, Littleton, N.H. 03561.

**COINS** At Discount Prices! Free Brochure. Gene Carlton, Chandler, Okla. 74834.

**SILVER DOLLARS** Uncirculated. 1880-81—1883-84-85 \$10.00 Ea. Catalogue 50¢. Shultz, Salt Lake City, Utah 84110.

**UNCIRCULATED** Silver Dollar \$8.95. \$2 Bill \$3.95. Oz. Silver Bar \$6.95. Catalog 25¢. Coin Pocket, 342 S Central, Lawrence, N.Y. 11559.

**"S" MINT** Lincoln Cents. All Wheat Backs. Not Picked. 50-3¢.75, 100-3¢.90, 500-3¢.90. "S" Mint Nickels Before 1955 50-7¢.50, 100-13¢.00. Village Coin, 20929 Ventura, Woodland Hills, CA 91364.

**FREE:** Lists of Thousands of Stamps and Coins. No Approvals. Bryson, 612M White, Toledo, Ohio 43605.

**\$11 PER POUND!** My trunkful of Indian & Lincoln cents from 1880's up to World War II. Sample sack of 25-3¢. (Add \$1 per pound for postage & handling). Mrs. Penny Fisher, Box 1778-PM-2, Encino, Calif. 91316

**10 DIFFERENT** Mercury Dimes, \$8.50. Free Coin Catalog. Village Coin Shop, Dept. P, Plaistow, N.H. 03865.

(Continued on next page)



## COINS, TOKENS, CURRENCY

(Continued from preceding page)

**22 "S" Mint Wheat Pennies, \$1.99.** Coins, Ltd., Box 143-P, Canton, N.C. 28716.

**1939 UNCIRCULATED Liberty Dimes, \$2.00.** Michael Nelson, Rt. 1 Galaway, Cottage Grove, Wisconsin 53527.

**GOLD COINS** Of the World. Beautiful Low Prices. Plus thousands of United States Coins. Free price list. Please send long, airmail envelope. Self-addressed, stamped. Silver Center, Box 22171-M, San Francisco, California 94122.

**MERCURY Dimes - 2 different, \$1.00.** Free lists. Farley Coins, Metamora, IL 61548.

## ANTIQUES, RELICS, INDIAN GOODS AND CURIOS

**10 BEAUTIFUL Arrowheads \$3.00.** Guajardo's, 8713 Shaver, El Paso, Texas 79925.

**INDIAN Relic list.** Arrowheads \$4.00, doz. Folsom, \$5.00 each. C. Secrist, Deerfield, Missouri 64741.

**SELLING 10,000 Indian Relics.** Arrowheads, Knives, Spearheads, Scrapers, Etc. List Free. Lear's, Glenwood, Ark. 71943.

## MODELS—CARS, SHIPS, TRAINS, PLANES, ETC.

**NEWEST, GREATEST FLYING HOBBY—ROCKETS!** Zoom from Realistic Electric Launch Systems to 2,500 Feet on Safe, Thrifty, Solid-Propellant Power. Gentle Parachute Recovery For Over-and-Over-Again Flights. Tracking, Experiments, Real Miniaturized Still and Movie Cameras. Build your Own Exciting, Low-Cost Space-Age Adventure—Starting With a Big, New Full-Color Catalog of Over 80 Models (Including Ready-to-Fly). Send 25¢ to **ESTES INDUSTRIES**, Dept. 7K, Penrose, Colorado 81240.

**SHIP Model Kits, fittings, plans, books, tools, engines, motors.** Illustrated catalog 75¢. Mass. residents add 3% tax. James Bliss & Co., Dept. SM, Route 128, Dedham, Mass. 02026.

**MODEL Airplanes—Big 220 Page Catalog \$1.50.** Sig Company, Montezuma, Iowa 50171.

**LIVE Steam powered backyard railroads!** All sizes. Complete "bolt-together kits," and rough castings. Excellent drawings. 100 page catalog \$2.00. Little Engines, Lomita, California 90717.

**SHIP And Airplane model kits catalog 25¢.** Scientific, Inc., 340 Snyder, Berkeley Heights, N.J. 07922

**"SHIP And Yacht model fittings: Pine construction hull kits; blueprints.** Send \$1.00 for illustrated catalog. A.J. Fisher, Inc., 1002 Etowah Avenue, Royal Oak, Michigan 48067."

## GAMES, TOYS, PUZZLES, NOVELTIES

**LUCKY Charms. 2¢ Each. TREASURE CHEST, 9321-PM Capeview Ave., Norfolk, Va. 23503.**

**BINGO Games Complete—\$6.00 Up.** Sylvian's, 71 Circuit, Warwick, R.I. 02889.

**BE "last" and win.** How? Get the simple but challenging new game of Last and see. Send \$2.00 to: Ebel Enterprises, 309 West Chapel Hill St., Room 104, Durham, N.C. 27701. Allow 2 to 6 wks. for delivery.

## MAGIC TRICKS, JOKES, VENTRILOQUISM

**PROFESSIONAL MAGIC!** Direct From Factory To You. Giant 1975 Catalog - \$1.00. Refundable With First Order. Hank Lee's Magic Factory, 35 Hillside Avenue, Medford, Massachusetts, 02155.

**MAGIC!** Amaze, Mystify, Entertain! Large Catalog 25¢. Hundreds of Best Tricks for Stage, Pocket, Parlor. Jeffries Magicland, Dept. 11, Dallas, Texas 75201.

**FABULOUS MAGICS** New 1975 Catalog 50¢. Our Specialty Orders Shipped Same Day. No Substitutes. Fabulous Magic, 3319 East Charleston, Las Vegas, Nevada 89104.

**VENTRILOQUISM!** Information free. **EXCITING FULL COLOR DUMMY CATALOG—25¢.** Maher, Box 420PM, Littleton, Colorado 80120.

**TWO!** Different Magic Catalogs 25¢. Miami Magic, 9734 Bird Road, Miami 33165.

**COMPLETELY Illustrated catalog, 84 pages, 25¢.** Manhattan Magic, Box 334-M, N.Y.C. 10011.

**WORLD'S** Finest professional magic tricks. Joker's Novelties. Giant illustrated catalog 25¢. Top Hat, Evanston, Illinois 60204.

**WOW!** Magic, jokes. Largest selection. Amaze, mystify friends. Super Giant Catalog 25¢. Abracadabra-MP, Rahway, New Jersey 07065.

**GENI!** The International Conjurers' Magazine, P.O. Box 36068M, Los Angeles, Calif. 90019. Monthly Since 1936. Sample \$1.00. 1 year \$10.00. Not sold on newsstands. None free.

**FREE!** World's leading novelty catalog. 1600 Fun-makers, Jokes, Tricks, Science, Sports, Hobbies, Jewelry, Psychedelia. Johnson-Smith, C-4, Mt. Clemens, Mich. 48043.

**BE A Magician!** Two booklets explaining 156 tricks plus large professional catalog. \$1.00. Magic, Inc., 5082 Lincoln, Chicago, Illinois 60625.

**LEARNING VENTRILOQUISM BOOKLET 75¢** Courses, Books, Records, Dummies, Marionettes, Puppets. **CATALOG 25¢.** Ventriloquism, 6034 South Pulaski, Chicago, Illinois 60629.

**FREE 1975 Magic Catalog plus gift certificate!** Imperial, Box 623-P, Worcester, Massachusetts 01601.

**SAVE!** Warner's Magic Factory, catalog 50¢, Box 455C, Hinsdale, Ill. 60521.

**MAGIC TRICKS! CLOSEUP-STAGE AMATEUR-PROFESSIONAL. ORDER NOW! LIMITED SUPPLY OF NEW 1975 MAGIC CATALOGUES.** SEND \$1.25 TO: **THE MAGIC SHOP, STATEN ISLAND MALL, STATEN ISLAND, N.Y. 10314.**

**ONLY 50¢ Buys Big Exciting 78 Page Catalog, Free Magic Trick Included!** Chicago Magic Center, PM 65, 19 W. Randolph, Chicago, ILL. 60601.

**BE A MAGICIAN!** Mystify. Amaze. Giant Magicians Catalog, 75¢ plus FREE trick. Universal Magic, 256 South Robertson-MP, Beverly Hills, California 90211.

## BOOKS WANTED

**BOOKFINDER:** Vantreuren, 1950 Post PM, San Francisco, CA. 94115 Apt. 108. Send Wants.

## BOOKS, CATALOGS, NEWSPAPERS

**FREE list.** 290 books. Health, Love, Success, Happiness, Occult, Wealth, Hobbies and more. C. Ruderer, 98-25 Horace Harding Expy., Rego Park, New York 11368.

**NATIONAL Geographic Magazines, 1888-1971,** any issue. Buxbaum, Box 465-PM, Wilmington, Delaware 19899.

**PUBLISH Your book.** Join our successful authors: publicity, advertising, promotion, beautiful books. All subjects invited. Send for Free manuscript report and detailed Booklet. Carlton Press, Dept. PMR, 84 Fifth Ave., NY, NY 10011.

**FREE Book, Prophet Elijah Coming Before Christ.** Megiddo Mission, Dept. 63, 481 Thurston Road, Rochester, N.Y. 14619.

**BACK ISSUE MAGAZINES, 200 Titles 1890-1974.** Everybody's, 317 West Sixth Street, Los Angeles, California 90014.

**CLOCK And watch repairing books, tools, materials.** Free catalog, North American, Box 77AFA, Fox River Grove, Illinois 60021.

**FREE Illustrated Catalog, Unusual Products.** Some Not Available Until Recentiv. Send Post Card. Hal Easton, Dept. 756, 10281 Brookside Drive, Garden Grove, California 92640.

**SCIENCE FICTION, Mysteries, Westerns, Romance—3 For \$1.00!** Free Lists. Publications/24, 3121 Rendale, Richmond, Virginia 23221.

**HOMESTEADING, PROSPECTING, ROCKHOOUNDING** Information. Alan Books, Box 239-P, Evansburg, Alberta, Canada T0E 0T0.

**SPEEDREADING and Vision Training: Complete Course in one book; a must for busy people.** \$4.00. Promed Optical, Box 245, West Memphis, Arkansas 72301.

**BOOKS, how to, self improvement, 40/\$3.00 List 25¢.** Gunning, Box 457PM, Rd #8, York Pa. 17403.

**FREE Brochure Hundreds of Self-Improvement Books.** Shepard Associates, 80-A Shepard's Knoll Drive, Hamden, Ct. 06514.

**LEARN SUCCESS SECRETS!** Send \$2.00 Each Book. Confidence And Power. Success And Popularity. Attract Good Luck. National Company, Box 402, Flushing, New York 11352. Moneyback Guaranteed. Free Catalog.

**FREE List "How to" Books, patterns, etc.** Send postcard. Enterprise, 108 West 3rd, Port Angeles, Wa. 98362.

**CALCULATORS—LOWEST PRICES!!!** Major brands, guaranteed. Midwestco, Box 1382-PM, Evanston, Illinois 60204.

**FREE List Hundred Best Sellers.** All subjects. Dorrugh, 229 South Diamond, Ravenna, Ohio 44266.

**"AMAZING BOOK BUY!!!"** Huge Selection!! Free List. Goldie, Box 340, New City, New York 10956.

**FREE List! Hundreds of Books—all kinds.** Kirk Enterprises, 108B W. Monroe, Salisbury, N.C. 28144.

**"UNUSUAL" Books! Catalogue Free!** International Imports, Box 7798PM, Atlanta, Georgia 30309.

**509 BOOKS** for \$91.00. Free details—send stamped envelope to: Tamar-Kadesh Industries, P.O. Box 374, Bronx, NY 10462.

## PLAYS, SONGS, MANUSCRIPTS

**SONGWRITERS.** Want help placing songs? Write for Free details: Publications, Box 328-PM, Nashville, Tennessee 37202.

**SONGS-POEMS** Wanted for publishing-recording at our expense. Authors of accepted songs pay \$8.75 for one hand-cut record. Monthly awards. Fabulous \$1,000.00 Offer. Talent, 17 (PM) Longwood Road, Quincy, Mass. 02169.

**SONGWRITERS LOOKING for CO-WRITERS** on 50-50 basis. HAS songs recorded by **BRENDA LEE, EDDY ARNOLD,** and others. SEND lyrics to: **NASHVILLE CO-WRITER PLAN, BOX 1152, NASHVILLE, TENNESSEE**

**WANT Your book published?** Learn how—we publish, advertise, promote, distribute. Many successes. Free booklet **PM. Vantage, 516 W. 34th Street, New York City.**

## BUSINESS SERVICES

**PROFITS FROM CLASSIFIED ADVERTISING!** Booklet shows you how to start your own business with Classified Advertising. Only \$1.00 (Refundable with first order.) **H. E. KAPPEL, POPULAR MECHANICS, DEPT. P, 224 WEST 57TH STREET, NEW YORK, N.Y. 10019.**

## BUSINESS OPPORTUNITIES

**IMPORT-Export Opportunity, Profitable World-Wide.** Mail Order Business From Home, without Capital or Travel Abroad. We Ship Plan for No Risk Examination. Experience Unnecessary. Free Report. Mellinger, Dept. A2706, Woodland Hills, California 91364.

**AUTO/VAN CUSTOMIZING.** . . . Learn these high paying skills at home in spare time! Free Booklet. Auto Institute, 1205 W. Barkley, Dept. - 2PM, Box 16, Orange, Calif. 92666.

**CUSTOM PICTURE FRAMING - A Satisfying, Profitable Craft!** Learn at home - no experience needed, we supply everything. Booklet mailed Free. Creative Framers, 1205 W. Barkley, Box 16, Dept. 2PM, Orange, California 92666.

**100,000 JUNKMEN CAN'T BE WRONG!** How to make astounding profits in the second-hand business. Immediate spare-time income. Buy and sell clean, high-quality, name-brand tools, furniture, hardware, appliances! No investment. Easy to read report puts you in business overnight! Only \$2.00. Drexler-P2, Box 26419, Phoenix, Az. 85068.

**\$250/THOUSAND, STUFFING ENVELOPES, SUPPLIES FREE.** Send Stamped Addressed Envelope, Jen Enterprise, Box 703M, Brookings, S.D. 57006.

**VENDING Machines.** No selling. Routes earn amazing profits. Big catalogue Free. Parkway Machine Corporation, 1930PMB Greenspring Drive, Timonium, Maryland 21093.

**STUFF Envelopes Spare Time \$30.00 Per Hundred.** Immediate Earnings. Beginners instructions \$1.00. Refundable. JB, Box 225, Inver Grove Hts, Mn. 55075.

**PREPARE Tax Returns—Housewife Jo Ann Netzley** made \$5,500 last season. Train at home. VA Approved. National Tax School, Monsey 2FF, New York 10952.

**MAILORDER BEGINNERS:** Start instantly at home. Unlimited income possible! Complete step-by-step guide. \$5.00. **EDEN ENTERPRISES,** Box YY PM6, Cathedral City, Ca. 92234.

**"TRUTH About Mail Order."** \$2.00 plus .25¢ handling. You can save \$2,000.00. Business Consultants, Box 1228, Yuba City, CA 95991.

**SECRETS! Mail Order Success.** Internationally famous expert reveals how to make home business fortunes. Beginners: Get free report "Make Money By Mail." Discloses free advertising, profitable products. Mailco, Dept. AC706, Woodland Hills, California 91364.

**ABANDONED SILVER—YOURS FOR TAKING!** The only COMPLETE Salvage Method. Earns \$24,000 yearly. Details \$1.00 (refundable): Silverman C-13, Box 548, Woodville, Texas 75799.

**"SELL Books By Mail.** Complete Dealer Setup 25¢. Packerland Publishing, Box 3193J5, Green Bay, Wis. 54303.

**\$300-\$700 MONTHLY.** Raise Rabbits, Laboratory Animals for us. We supply Equipment, Breeders, Instructions. Details 25¢. MP11 Rabbits Of Michigan, Countyline Road, Pentwater, Michigan 49449.

**\$1,500+ MONTHLY** Stuffing envelopes. Details \$1.00 stamped addressed envelope. Gonzales, Box 3723, Beaumont, Texas 77704.

**INSTAMAIL** Means instant cash mailing program - Dealership: Instamail, 427B, New Castle, Pa. 16101.

**\$1200 MONTHLY.** Immediate income. Stuff envelopes at home. Information, send self-addressed stamped envelope. Cottage, Box 25053-CFF, Los Angeles, CA 90025.

**YOUR OWN Successful mailorder business!!** Learn how before investing. Free Details. Northeast Associates, Box 191-MF, Coventry, Connecticut 06238.

**MAILORDER Dealers** wanted. Earn outstanding profits using tested promotions! Executive Type Business. Rutward-PF, Georgetown, Conn. 06829.

**MAILORDER SUCCESS** Can Be Yours!! Sell Proven, Profitable "How-To" Books. Complete Instructions, Sample Catalog 25¢. BC Robinson, 3001 South Michigan, Chicago, Illinois 60616.

**EARN \$30.00 Per Hundred Stuffing Envelopes** Beginner's Kit \$1.00 (Refundable). Mary Mott, PMS, 5944 Long Meadow, Nashville, Tn. 37205.

**PIANO Tuning** Learned Quickly at Home! Musical knowledge unnecessary. Free Information. Empire School, Box 450327, Miami, 33145.

**MAIL ORDER SECTION AD SPACE! CONSUMER** tabloid. Low rates; proven results. Copy, rates \$1.00. Liebig, Cold Springs Road, Huntingdon, Pennsylvania 16652.

**YOUR OWN Mail Order Business.** How To Start. Particulars \$1.00. Del-Roi, Box 313, Rogers, Ark. 72756.

**COMPLETE MAIL ORDER BUSINESS \$5.00.** Enough starting supplies to net you \$100 profit. Liebig, Cold Springs Road, Huntingdon, Pennsylvania 16652.



## BUSINESS OPPORTUNITIES

(Continued from preceding page)

**OVER \$16.50 An Hour.** Spare time at home! Rubber Stamp industry needs small manufacturers. We furnish all equipment and know-how! Particulars free! Write: Roberts, Room RC-2-EF, 1512 Jarvis, Chicago, IL 60626.

**CALIFORNIA MANUFACTURER NEEDS MAN** to assemble our product and be local agent, experience unnecessary. May start while presently employed. Five-figure income for responsible applicant. S.K.R.M. Manufacturers, 911 N. Lagoon Ave., Wilmington, Ca. 90744.

**SELL Books by Mail.** Complete Dealer Set-Up 25¢. Ullis Distributors, Box 34029-PM, Los Angeles, California 90034.

**\$2000. MONTHLY** In Fabulous New Business. Rush for Free Details. Staro Co., 33 Kelley St., Taunton, Mass. 02780.

**\$70 TO \$200 WEEKLY**—Home, Spare Time Simplified Mail Bookkeeping. Immediate income. Easy. Auditax, Box 34741A, Los Angeles, Calif. 90034.

**FREE!! "Turn \$10 Into Fortune!"** Hotline, Box 3155-P, Springfield, Missouri 65804.

**EARN Money** raising fishworms for us! Write: Oakhaven-38, Cedar Hill, Texas 75104.

**BECOME** Our Mail Order Distributor with \$150 investment. Free Brochure. Audit Controls, 40 Brookside Ave., Fair Lawn, New Jersey 07410.

**VINYL'S** Where The Money Is! Invisibly repair, re-finish, recolor furniture, luggage, car tops. Quick, easy. Two small \$20 jobs a day earn you \$1,000 a month. Homes, cars, offices, restaurants, unlimited customers. Start earning after an hour's practice. Sensational details free. VIP, 2035 Montrose, Chicago, 60618.

**\$400.00 MONTHLY** Raising giant fishworms. Soilless method. Charlie Morgan, Bushnell, Florida 33513.

**\$12.50 HOUR** Spare Time—With Your Own Easy Vacuum Cleaner Repair—Rebuilding Business! Small Investment, "Results Guaranteed." Details Free! Baron, Box 863AB6, Portales, New Mexico 88130.

**MAKE \$92.00 FROM** Square Foot Plywood (Jigsaw or Bandsaw necessary). (Proof), details 25¢. (Refundable). Woodart, Bridgewater, Mass. 02324.

**FREE 100-Page Catalog** waiting to bring you Big spare-time cash commissions. Sell Advertising Book Matches. Every business a prospect . . . complete selling instructions furnished. Steady, repeat business. Dept. MX675, Superior Match Company, 7530 South Greenwood Avenue, Chicago, Illinois 60619.

**MAKE MAGNETIC SIGNS.** BIG PROFITS. FREE information. Universal, Lenora, Kansas 67645.

**MAKE \$7.50 to \$15.00 hourly** building portable custom cases in your home. Huge demand. Get orders by mail. We supply materials, instructions—everything. Free details. Customcase, 6075 De Soto, Dept. C-20-30, Woodland Hills, California 91365.

**PORTABLE Sandblaster** \$29.95. Distributor wanted. Free Brochure. Inka, Box 66573-A, Houston, Texas 77006.

**\$1.00 LISTS** You year sent to 1000 Importers, Jobbers, Mailers, our mailing year. Dixie, King, North Carolina 27021.

**\$200.00 SPARE TIME** earnings with your Tablesaw. Write: Workshop Five, 3800 Harney, Vancouver, Washington 98660.

**\$100.00 DAY.** Manufacturing Concrete Blocks, Posts, Semi-Automatic Block Machines. Mold Equipment Catalog, over sixty items, \$3.00 refundable. Carlayne, Route One, Box 95, Rapid City, South Dakota 57701.

**SELL Books by mail.** Complete dealer set-up—25¢. Midwest Mail Sales, Box 44R2-PM, Shawano, Wisconsin 54166.

**PIANO Tuning** Quickly learned with home study course. Diploma granted. American Tuning School, 17050 Teller Dr., Morgan Hill, Calif. 95037.

**\$200.00 DAILY** In Your Mailbox! Opportunity To Follow Mailorder Experts. Free Details. Associates, Box 136-A, Holland, Mich. 49423.

**BECOME "Mortgage Broker."** Lucrative! Capital Sources. Box 640099, Uleta, Florida 33164.

**FREE COLLECTION AGENCY** Details!! \$1000.00 Monthly Possible. Master-PM, Dawsonville, Georgia 30534.

**HOW TO RAISE \$100.00 to \$1,000,000.00!!** Write: Capital-PM, Dawsonville, Georgia 30534.

**MAILORDER Millionaire** helps beginners make \$50 weekly. Free report reveals secret plan! Executive (1A6), 333 North Michigan, Chicago 60601.

**I MADE \$40,000.00 Year** by Mailorder! Helped others make money! Free Proof! Torrey, Box 318YY, Ypsilanti, Michigan 48197.

**MAIL Baby Catalogs** to New Mothers for Big Profits! Details 25¢. Volz-PM, Ypsilanti, Michigan 48197.

**EARN \$60.00 Daily** manufacturing Concrete Fence Posts. Practically no investment. Send stamped-addressed envelope. American, Excelsior Springs, Mo. 64024.

**1000% PROFIT** Bronzing Baby Shoes At Home. FREE LITERATURE NBCPM, Gower, MO. 64454.

**NEW, Compact fire extinguisher.** Fantastic profits. Exclusive territories. Norwich Chemical, Norwich, Connecticut 06397.

**RECEIVE Mail Galore!** National Listing. \$1.00. Sullins, 1313-M, Brunswick, GA 31520.

**MAILORDER BEGINNERS LIBRARY.** Learn Professional Secrets Inexpensively! Write: HOW, Box 4457-PM6, Downey, California 90241.

**WATCH REPAIR.** Learn this cash business at home. \$5 monthly. Free details. Chicago School of Watchmaking, YSA, Fox River Grove, Illinois 60021.

**TAKE Catalog orders.** We drop-ship 1001 best selling specialty products. Lowest below wholesale prices. Immediate Delivery Spectacular home business opportunity. Free Book. Specialty Merchandise, Dept. 20-30, Woodland Hills, California 91365.

**\$200 WEEKLY!** Make, Sell Bricks! Free information! Xcito Bricks, 5715 N. Mozart, Chicago, Ill. 60659.

**MAKE MONEY** Clipping Newspaper Items. \$2.00-\$10.00 Each . . . Details Free, Clippings, Box 10344-PM14B, Palo Alto, California 94303.

**HOMEWORKERS**—Mailers Wanted! Free information, A. Allen, 2418 Lori, Santa Ana, California, 92706.

**HOW TO OPERATE** a Profitable Bookkeeping Service For Small Businesses. R.I. Systems., Co. 1645-A Warwick Avenue, Warwick, R.I. 02889.

**START Your Own Correspondence School** • Pioneer Schools, 209 S. Citrus, Suite 7, Covina, Ca. 91723.

**MAILORDER**—Establish own business. Everything supplied—catalogs, ads, mailing lists, Merchandise dropshipped. Gift-Guide, 1137 Crenshaw, Dept. 445, Los Angeles 90019.

**FREE WEALTH BOOK:** "2100 Unique Ways To Make Money!" Worlds Biggest Collection of Home Businesses!! Success-M, 26903 West Eight Mile, Detroit, Michigan 48240.

**EARN \$80.00 Daily** Manufacturing Concrete Bricks-Tiles-Wooden Molds. Send Stamp, Hilmar, Route One, Box 347-DH, Valrico, Florida 33594.

**"HAVE YOUR FORTUNE** Mailed to You." New booklet reveals mailorder techniques necessary to make it big. Only \$2.00 postpaid. Guaranteed. Treasures-A6, 670 East Market, Marietta, Pa. 17547.

**\$178.00 WEEKLY.** Spare Time. Completely Guaranteed. Brochure. FAS, Box 13703J, San Antonio, Texas 78213.

**LIQUID PLASTIC ROOFS**—Save Hundreds doing your own Roof—or Earn Unlimited Profits from Others. Revolutionary low Cost Method is Clean, Easy, Lightweight. Proven Superior in All Ways. No Experience Needed; Earn Immediately. Order Any Amount. Full Details: "PERMAPLASTIC", Box 1164, Meadow St., Ailenton, PA. 18102.

**OUTSTANDING Earnings** with Fantastic Money-Making Methods!! Free Details: Kin Gee Enterprises, Dept. 6PM1, 74 Mott Street, New York 10013.

**"YOU ARE THE PRIME SOURCE"** New Exclusive Folio, \$2.00, Capital PM6, Box 60538, Nashville, Tennessee 37200.

**\$15,000 + ANNUALLY.** IMPORT MAILORDER OPPORTUNITY. One year risk free trial basis. Details: Northeast Imports, Box 121M6, Fremont, NH 03044.

**\$100,000 YEARLY** Mailing Information! Free Proof! Albers, Box 17052, Minneapolis, Minnesota. 55417.

**\$50 DAILY** spare time with sensational new SPEED PAINTER. Paints an entire room in 30 minutes. Eliminates brushes, rollers, pans, cloths. No mess, drip, spills. Exciting details FREE or send \$5 refundable for pre-paid sample. VACUFEED, 34 East 12th Street, N.Y.C. 10003, Dept. CPM-2.

**NOW: A LUCRATIVE NEW FIELD!** Invest Dimes-Reach Dollars-Reach Millions. We Help. An Annual \$25,000 easy, Part Time. Write for Free Literature. Howell's NuDeal, 550 Redbud St., Waldron, Ark. 72958.

**SUCCESSFUL Mailorder Business!** We show you! Free! PW, Box 562, Royal Oak, Michigan 48073.

**WORLD'S Largest Supply.** 25% to 40% under wholesale. Closeouts. HONG KONG Clothes, Automobiles, Electronics. Free Details. International Buyers, Box 16386MM, Portland, Oregon. 97233.

**ASSEMBLE BALL POINT PENS** As Our Dealer. Excellent Part Time Income. \$1.00 Brings Details, Pens-Peggy Ann Pens, Attn. R. Cuppy, 2121 Madison, Charleston, Illinois 61920.

**CONVERT Used Beer Can Tabs** into Profitable business. Complete Method \$3.00—Tab, 15402 Corkhill, Maple Heights, Ohio 44137.

**REPAIR Hydraulic Jacks**—Details Free. Write: Hydraulic Parts Supply, Box 4157, Brownsville, Texas 78520.

**YOUR Own Mailorder Catalog Business.** No Merchandise Investment, Details Free. A.M. Sales 31-14 94 St., East Elmhurst, NY 11369.

**FLASH! Now "4,044" FREE SECRET BOOK** "2,042 Unique Proven Enterprises". Tiny Businesses but huge profits! How Little Fellows beat inflation. Work Home! Haylings, Carlsbad, California 92008.

**MAILORDER'S BEST SELLING BEGINNERS LIBRARY.** Reveals Professional Secrets—Helped Others Make Money! Barclay, Box 45PF, Halesite, N.Y. 11743.

**CLIP NEWSPAPER ITEMS.** \$500.00 monthly Possible: Send 50¢ and Stamped, Addressed Envelope. News Clip, P.O. Box 402, 310 Franklin Street, Boston, Mass. 02110.

**HOMEWORKERS** wanted! 50 firms listed. Details rush 25¢ and stamped addressed envelope, your name and address.—Strandco, Box 397, Dept. H, Bellingham, Wash. 98225.

**\$200 WEEKLY**—Guaranteed Easy, immediate spare-time earnings—Free Proof—Research, Box 90133PM—Atlanta, Georgia 30344.

**STUFF Envelopes.** Earn \$500 per thousand. Free Supplies. Send stamped addressed envelope. Gozdanovic, 160 Banner Way, Pittsburgh, Pa. 15201.

**\$40,000.00 YEAR** in your own carpet and rug business. Start spare time from your home. No stock or capital needed. Write for carpet sample—Moneymaking facts and prices. Carpets, Dept. B248, Resaca, Ga. 30735.

**80 WAYS** to Make Money! Free Details. Multiple Foundation Research, Box 4208P, Trenton, N.J. 08610.

**SELL Ordinary Sand** \$5 Pound. I Do it, So Can You! Details Free! Sandco, Ceres, Calif. 95307.

**\$2,500 MONTHLY!** Free information! Lowe, 6290A Avenida Ganso, Goleta, California 93017.

**\$500.00/THOUSAND** Stuffing envelopes—start immediately! Beginner's kit, \$1.00. Guaranteed! Contemporary, Box 1144F, Forest Park, GA 30050.

**STUFF Envelopes** \$500.00. Thousand. Free Details. Send Stamped Addressed Envelope. Mantor House, Dept. 8PM8, Minco, N.Y. 13116.

**STUFF Envelopes** \$250/Thousand. Guaranteed Advance Commissions! Information: Stamped, Addressed Envelope. NRG, Owego, New York 13827.

**"HOW TO START Your Own Mail Order Business"** \$1.00. Domkus Enterprises—C6, 623 N. Lamer St., Burbank, CA. 91506.

**START Profitable Mail Order Business** from home. COMPLETE SET UP. Free Details. Van Enterprises, Box 70, Artesia, CA. 90701.

**U.S. GOVERNMENT FINANCES SMALL BUSINESSES.** Quick action. Authentic instructions \$3.00. COUNSELOR. Box 1089, St. Petersburg, Florida 33731.

**BOOMING CATFISH FARMING. U.S. SPONSORED.** Proof of thrills-riches. FINANCING. Airmailed details 50¢. Catfish Industries, Box 1089, St. Petersburg, Florida 33731.

**NEW Mailorder publication.** Tells everything! Details free: Adams, Room 606, 12128 W. 70th., Arvada, Colorado 80004.

**JANITORS! BECOME INDEPENDENT** Building Services Contractors! Minimum Investment! Maximum Opportunity! Free Details—Shortcut To Success! Bigsky Report, Box 2102, Great Falls, Montana 59403.

**HOW Mail Order Fortunes** Are Made. Learn Secrets. Details Free. Stephen, Box 115B, West Chicago, Illinois 60185.

**BONANZA** - Hot, new mailorder item. Send \$2.00 sample, details. Satis, guaranteed. Allan Marketing, 305 Cumberland, Jellico, TN. 37762.

**BUILD BASKETWEAVE FENCE SECTIONS. BE YOUR OWN BOSS, WORK YOUR OWN HOURS, EARN \$100.00 A DAY. START YOUR OWN BUSINESS FOR UNDER \$100.00 TOTAL COST—GUARANTEED! INFORMATION \$1.00. BOMAR FENCING, BOX 312, FRASER, MICHIGAN 48026.**

**EARN \$700.00 Extra Monthly.** Free Details. Send Self-Addressed Stamped Envelope. Key Distributors, Box 5175, Willowick, Ohio 44094.

**\$50,000.00 YEARLY!! EASILY** By Mail! Instructions With Proof! Dollar Bill. Carter Company, 22 Laplaza Acres, Searcy, Ark. 72143.

**\$500 WEEKLY** Helping private owners sell used cars. Send stamped envelope. Koss-PM6, 6003 Kellow Drive, Jacksonville, Florida 32216.

**ESTABLISH Successful Home Mailorder Business!** Mears, C5363 Essex, Alexandria, Virginia 22311.

**"\$500/THOUSAND POSSIBLE STUFFING ENVELOPES, INFORMATION/SUPPLIES, STAMPED, ADDRESSED, ENVELOPE, Agent-56, Box 159, Clayton, Indiana 46118."**

**SUB Wholesalers** needed experience not necessary! Details \$1.00 refundable, B & B, R6B302, Chatsworth, Ca. 30705.

**NEW! Unique home business.** Unlimited profits immediately! \$2.00 brings complete instructions. J. Wood, 6330—5th N.E., Seattle, Wash. 98115.

**\$500 MONTHLY.** Spare time home business. Guaranteed. Details. Burns, 611 Gunderson, Carol Stream, Ill. 60187.

**\$27,000 RETURN** on \$250.00 Real Estate Investment. I'm doing it. You Can Too! Complete easy-to-follow, step-by-step instructions. Only \$5.00 postpaid. Harry Gillig, 2624PM Northeast 26th Avenue, Fort Lauderdale, Florida 33306.

**MAKE MONEY** in Mail Order! Free Booklet. Raymo, Box 3566, Chula Vista, Calif. 92011.

**STUFF Envelopes.** \$250.00 Thousand. Free Supplies. Rush Stamped Addressed Envelope. Cannon Enterprises, (PM-6) Morgantown, Kentucky 42261.

**\$500 WEEKLY** Possible Selling And Installing Security Devices. Ceco, Box 4205F, North Hollywood, Calif. 91607.

**EARN \$1000.00 A Month** in Mail Order. Establish Successful Business. Free Details. Watkins, Box 802PM Montebello, Ca. 90640.

**SELL World's Largest Selection Historical "antique"** reproduction on parchment! 100-300% profit! Wholesale—Retail! Volume advertising, freedom documents—Bicentennial! Hundreds of ideas! Catalogue, details, 10 samples \$1.00. Garen's, Box 28097-A, Columbus, Ohio 43228.

(Continued on next page)



## BUSINESS OPPORTUNITIES

(Continued from preceding page)

**AMAZING BUSINESSES** you can start at home. Free Details!!! UMC, PM-65A, 8228 Wynne, Reseda, Calif. 91335.

**KEEP \$40.00** From \$50.00 Mail Orders. We Deliver. "Know How." \$1.00. Richer, Box B1872, Albany, N.Y. 12201.

**CONTINUOUS Big Profits** Mailing Your Own Baby Gift Catalogues to New Mothers. Complete instructions, Sample catalog 25¢. Armstrong, Box 409PM, Kennett Square, Penna. 19348.

**CLIP Newspaper Items** For \$2.00 to \$10.00 each. No investment. Free details. Cardinal Publishing, Box 5200-C38, Jacksonville, Florida 32207.

**"EXHAUST-Powered Automobile** "Wheel-Cover" Turbine Motor Etc. Improves Performance, Doubles Gas Mileage. Patents Pending. Drawings, Details \$19.00 Refundable. Ark (PM), Box 8170, Kansas City, Missouri 64112.

**HOW** to start a publishing house in your spare room. Publish books, courses, newsletters inexpensively. Amazing profits. Information free. Specialty-6C8, Box 653, Newberry, South Carolina 29108.

**HOMEWORKERS**—Earn Up To \$250.00 Weekly Stuffing Envelopes for Our Firm. Details, \$1.00 (Refundable) and Stamped, self-addressed envelope. Giltrap, Box 246-A2, Cape Coral, Florida 33904.

**\$250-\$500/THOUSAND STUFFING ENVELOPES, COMPLETE ASSISTANCE**, Send Stamped Addressed Envelope, Henriksen, Box 6080-PM6, Mpls, Minn. 55406.

**MAILORDER BEGINNERS**, Complete Source of Information. Learn Professional Secrets Inexpensively! Write: Amex, 216 Jackson, 612-6PM, Chicago 60608.

**\$250-\$500/THOUSAND, STUFFING ENVELOPES**, Free Supplies, Send Stamped Addressed Envelope, "Mitch", Box 551-PM1, Havelock, N.C. 28532.

**"AMAZING Gyroscopic Levitation Craft**, Powerful Solar Air Tower Convection Current Generator, Practical Solar-Charger For Electric Car, Economical Solar-Electric Home Power Perfected, Super Powerful Endless Belt Wind Water Motors, Powerful Kite-Generator, Heat, Cool Home \$5.00 Month, Greatly Increase Gas Mileage. Patents Pending. Drawings, Details \$10.00 Each. All \$25.00 Refundable. Spaceman, Dept 666, Box 8170, Kansas City, Missouri 64112.

**\$250/THOUSAND, STUFFING ENVELOPES, FREE SUPPLIES**, Send Stamped Addressed Envelope, R&C, Box 22-F6, Carlisle, Ind. 47838.

**EASY WAY** to Extra Money. Start Profitable Home Business as Distributor of Gift Items, Novelties, Toys . . . Catalog \$1.00 Refundable. Piret, 2880 Valencia #16, CA 92262.

**MAILORDER**—Establish Your Own Business. Earn Outstanding Profits. THOMPSON-PM6, Route 2, Elmwood, Illinois 61529.

**\$200.00 WEEKLY**, Fantastic, (Instant profits) mail-order plan. Send 25¢ for confidential details. "UNICORN", PMA6, 7350 Nugget, Colorado Springs, Colo. 80911.

**FREE MAILORDER** Report! Plan Guarantees Beginners \$50.00 per order - to \$750 Weekly! Professionals, Box 21093-E, Seattle, WA. 98111.

**MAKE \$300 WEEKLY**. Everything Supplied. Send \$3.00 to: Ideal Sales, 16 Croyden Street, Malverne, New York 11565.

**MAILORDER FEVER? MONEYMAKING FACTS FREE!** Landmark Services, 4513 Robbins, Orlando, Florida 32808.

**"FLYING Saucer That Works**, Simplified Fusion Power, Levitation-Gravity Motor, Permanent Magnet Self Powered Motor Generator, Expansion-Contraction Motor, 1000 Horsepower Wind Motor, 1000 Horsepower Solar Freon Motor, 1000 Horsepower Water Motor, Make Car Get 100 Miles Per Gallon, Run Car On Alcohol-Water 12¢ Gallon. Patents Pending. Drawings, Details \$10.00 Each. All \$29.00 Refundable. Miracle Science (G), Box 16046, Kansas City, Missouri 64112.

**MAKE Durable Building Plastic Easily**, Waterproof, Fireproof, Economical. Bays Laboratory, Cedaredge, Colo. 81413.

**250/THOUSAND, STUFFING ENVELOPES, FREE SUPPLIES**. Rush Stamped, Addressed Envelope. Beach, Box 3505-A, Lancaster, Calif. 93534.

**BOOKKEEPERS** earn \$10.00-\$20.00 hour. Operate Bookkeeping Service by mail. Universal Bookkeeping, Box 664-M, Springfield, Missouri 65801.

**EARN Extra Money** mailing commission circulars. Free details! Send stamped addressed envelope. Luan Enterprises, Box 2771, South Bend, Ind. 46614.

**WORLD TRADE—IMPORT EXPORT—MAIL ORDER** five volume GUIDE, Reference library. Ideal, Fully Independent. Spare/full time Home Business Enterprise. Send today for your FREE. No obligation 16 page 4-color booklet outlining opportunities for men, women, families. Write: Henry Melvin, 130 West 42nd St., Suite 1305, New York, N.Y. 10036.

**ESTABLISH Highly Profitable Mailorder Business!** No Inventory. Free Details. Parrish, Box 3-PM, Albert Lea, Minnesota 56007.

**MAILORDER Professional Books** Learn Facts, Secrets Free Details. PERRY'S, Box 17194, West Hartford, Conn. 06117.

**EARN WHILE LEARNING**. Small Engine Repair Business. Details \$2.00. Refundable. Wagner Enterprises, Rt. 1-PM, Plymouth, Wis. 53073.

**\$60 DAILY**. Manufacturing New Building Block (Easy!) Complete Instructions \$2.00. Guaranteed. "Miracle Brick-D", 42308 284th SE, Enumclaw, Washington 98022.

**START YOUR OWN MAIL ORDER BUSINESS!** Booklet Shows You How. . . . RUSH \$1.00 Get BGNUS Profit Opportunity Catalog. WRITE: OPPORTUNITY, Box 22277PM, San Diego, Calif. 92122.

**\$300/THOUSAND** Stuffing Envelopes, Free Details Send Stamped-Address Envelope. MBM Distributors, 13297 Coyle, PM4, Detroit, Mich. 48227.

**\$500.00 WEEKLY** Selling GIFT ITEMS NOVELTIES CARDED MERCHANDISE 2 to 3 Times Your Cost Upon Resale. Send \$2.00 for Catalog Illustrating Hundreds of Fast Selling Impulse Appeal Items. EMPIRE HOUSE DISTRIBUTING, Dept. M.6, 1462 Empire, Lincoln Park, Michigan 48146.

**UNLIMITED Profits!** Best Mailorder Opportunities! Free Details! JM16, 555 Roscoe, Chicago 60657.

**COMPLETE HOME BUSINESS**—Magnetic Sign and Craft Mold Machine Plus Supplies \$695. Write Vac-U-Form, 10077 Edison Rd., Osceola, IN. 46561.

**HOLLYWOOD Cementcraft**: Offers Highly Profitable Home Business. Experience Unnecessary. Unlimited Unique Pottery Designs. Easily Made Without Moulds, Birdbaths, Fountains, Wishing Wells, Waterfalls, etc. Chemical Coloring Formulas, Marble-Glazing. Free Illustrated Brochure. Concrete Facts, 602 Athens Street, Altadena, Ca. 91001.

**GINSENG** Seeds, For planting. Roots bring over \$40. For information, seed price, Write: Blueridge Ginseng, Rt. 7, Ft. Payne, Ala. 35967.

**"SMART MONEY"** Newsletter, Free! Unique Opportunities! Box 134, Mossville, Illinois 61552.

**COLLECT** Names Earn \$300 Per Thousand Possible. Also, 50 Free Dealerships Available. Send 25¢ and Stamped Addressed Envelope. Peter Schetter, 40 West 85 Street, New York, New York 10024.

**\$500 MONTHLY** Possible. Information: Send Stamped, Addressed Envelope. D H Sales, Box 26563, Albuquerque, NM 87125.

**MAIL Order Business Books**. Brochure Free. Burton Distributors, Box 9-7, Paw Paw, Michigan 49079.

**\$35.00 HUNDRED STUFFING ENVELOPES. BEGINNERS KIT** \$1.50 (refundable) Suveges, Box 3732-M, Centerline, MI 48015.

**INTERESTING** Inventions Checklist. \$2.00 and addressed envelope. Rodlist, 2223 Eastview, Bremerton, Washington 98310.

**A FORTUNE IN JUNK! LEARN UPHOLSTERY AT HOME** . . . TURN CAST-OFFS INTO CHAIRS, SOFAS WORTH \$100'S. NO EXPERIENCE NEEDED. WE SHOW YOU HOW . . . EVEN SUPPLY ALL TOOLS AND PRACTICAL FURNITURE KITS! VETERAN APPROVED. BOOKLET MAILED FREE. MODERN UPHOLSTERY INSTITUTE, 1205 W. BARKLEY, DEPT. 2PM2, BOX 16, ORANGE, CALIF. 92666.

**CARPETLAYERS** Earn \$1,500 monthly. Easy home training. Big demand. Write Carpet Crafts, 2675½ Daily Drive, Camarillo, California 93010.

**SURVIVE!** Predict, Control your survival in business/personal life. Unique, easy methods! Details 25¢. Seawinds, 2M1, 1627 Pontius Ave., West Los Angeles, California 90025.

**WE NEED GINSENG GROWERS!** \$3,000-\$30,000 annually! We Buy Your Crop. Send \$2.00 for seed sample and information. Glass's Ginseng Exchange, Box 336 Rochdale Station, Jamaica, NY 11434.

**MAILORDER** Makes Extra Income. Operate Correctly. Complete Accurate Information For Starting. Free Details. Garbco, 11756A Lanett, Phila., Pa. 19154.

**MAIL Order Dealers** Wanted. Earn Outstanding Profits. Free Information. M. E. Nieman Co., Box 21132, Indpls., Ind. 46221.

**REPAIR AIR COMPRESSORS**. Full or spare time. Thousands need service and repair now. Very few trained in this field. New manual tells how. Theory, trouble-shooting, overhaul . . . Parts directory. \$3.00 Postpaid. Air-Power, Box 1411, Hickory, N.C. 28601.

**START YOUR OWN EMPLOYMENT AGENCY**. Enjoy personal satisfaction, prestige, profit. We provide necessary training. Personnel Resources, Inc., P.O. Box 15407, Seattle, Wa. 98115.

**LAZY?** Produce oil portraits in seconds! Details 25¢. JiffyPortrait, 2830PS Gaffey, San Pedro, Calif. 90731.

**PROFITS FROM CLASSIFIED ADVERTISING!** Booklet shows you how to start your own business with Classified Advertising. Only \$1.00 (Refundable with first order.) H. E. KAPPEL, POPULAR MECHANICS, DEPT. P, 224 WEST 57TH STREET, NEW YORK, N.Y. 10019.

## MONEYMAKING OPPORTUNITIES

**SPARE TIME CASH**. Sell famous Hanover Shoes. Samples, sales kit free. No experience needed. No age limit. Big commissions. Hanover Shoe, Dept. 1291, Hanover, Pa. 17331.

**IMMEDIATE** Unlimited earnings. Easy exciting ways. Detail Free!! TOH, Box 1741-TI, Honolulu, HI 96806.

**365 FAST**, Easy ways to make money! Free! Rush name, address, zip. Perry, 13263 PM Ventura Blvd. Studio City, Calif. 91604.

**HOMEWORKERS!** Learn how you can earn extra money in your spare time! Information, send stamped self-addressed envelope. Ark, Box 3373 B, Amarillo, Texas 79106.

**\$500 MONTHLY** Possible-Clipping newspaper items for publications. Details - Rush stamped envelope. Income, Box 721B, Lynbrook, N.Y. 11518.

**3 WAYS** to make big money being your own boss. Step-by-Step directions, for FREE Details Write: Get Ahead, Box 63, Albertson, L.I.N.Y. 11507.

**RACING FANS FREE INFORMATION**. Tote Board Secrets Revealed. Statistics-M, Box 1031, Bellingham, Wa. 98225.

**FREE OFFER!** Make Big Money Selling Beautiful Jewelry. Send for FREE catalog and FREE starting outfit. Heritage—23, 103 Goodhue Building, Beaumont, TX 77701.

**VENDING** Machines. No selling. Routes earn amazing profits. Big catalogue Free. Parkway Machine Corporation. 1930PMM Greenspring Drive, Timonium, Maryland 21093.

**FOOTBALL** Fans - Earn Possible \$10.00 Per Fan. Details \$1.00. VAB Enterprises, Box 6264, New Orleans, La. 70114.

**HORSEPLAYERS** - \$3.00 Brings You Copyrighted Selection Method With Workout Producing 74% Winners. Wagering Plan Included. Guaranteed. Crystal Publications, Box 11047, Newington, Conn. 06111.

**MAKE \$1,000** per month spare time. Free Details. Write A&I, Wright City, Okla. 74766.

**STUFF ENVELOPES 500/THOUSAND** Send Stamped Addressed Envelope. Kelly's Korner, Dept. 41, Mattydale, New York 13211.

**PROFITS!!** Many sources!! Free details. Gracmon, Box 2015, Monahan, Texas. 79756.

**\$31.80 DAILY**. Easy Homework. No Investment. Free Details: Self-addressed Stamped Envelope: Sbiapo, 6311-812 Yucca, Los Angeles, Calif. 90028.

**HOW** To Make Money writing short paragraphs. Information free. Barrett, Dept. C-27-A, 6216 N. Clark, Chicago, 60660.

**STUFF ENVELOPES. \$25.00 HUNDRED IMMEDIATE EARNINGS. SEND ADDRESSED, STAMPED ENVELOPE.** PALMER-K, P.O. Box 20028, El Cajon, Calif. 92021.

**FREE**—Easy Ways to make money selling exciting new products—Full—spare time. Send name, age for 5 months free subscription. Salesman's Opportunity Magazine, 1460 Hancock Center, Dept. 338, Chicago 60611.

**WORLD'S** Leading Contest Magazine, 50¢. Prize-winner, 1315 Central, St. Petersburg, Fla. 33705.

**SWEEPSTAKES** Contests. How to Win. Write for Free Information. General Contests, 1609-18 East 5th., Duluth, Minnesota 55812.

**CLIP Newspaper Items**. \$1.00-\$5.00 each. Details free. Walter, Box 1360-PA, Erie, Pa. 16512.

**MAKE** Big Money. We furnish everything. For details send self-addressed envelope. Enterprises, Box 4516-Z, Compton, Calif. 90224.

**LEARN, EARN** Mail Order from Home Spare Time. Been telling how since 1929. Facts, Stories, Sources, Thousand Offers, Complete Course in Mail Order. Sample Copy 50¢; Year \$12. Mail Trade Magazine, Box 1302, Springfield, IL 62705.

**\$40 DAILY** Possible tying fishing flies at home. Details 50¢. Flyco, Box 946-P, Albany, Oregon 97321.

**ADDRESSERS**—Mailers—Homeworkers—Needed! 50 Firms Listed. Rush 25¢. Stamped, Addressed Envelope. Cannon Enterprises, Box 34057, Bethesda, Md. 20034.

**MAKE** Statuettes, novelties, imitation marble. Sell to stores or start gift shop. Free details. Marbleizing, 41 Waverton, St. Louis, Mo. 63124.

**\$175.00 WEEKLY** Correcting Pupils' Lessons! Samples, \$1.00! Castle's, 507-LP Fifth, NYC 10017.

**LEARN** The secrets of repairing junk batteries. "Fabulous Profits" at home. Apex Engineering, 3100 Ramona, Atascadero, California 93422.

**FREE! LATEST DIRECTORY OF 500 CORPORATIONS SEEKING NEW PRODUCTS!** If you have an idea for a new product—or a way to make an old product better, send for our FREE INVENTORS KIT NO. A-85. It gives vital information on developing and marketing your invention/idea for Cash/Royalty Sales to corporations nationwide. Raymond Lee Organization, 230 Park Avenue, New York, N.Y. 10017.

**MONEY-MASTER'S MANUAL** Reveals Secrets of The Insiders. Chatham, 729 San Andreas Ct., Concord, Calif. 94518.

**THOUSANDS MONTHLY** in Your Mailbox. Free Details!!! Dollarwise, Dept. 16, Box 545, Bronx, N.Y. 10451.

**EARN** Immediately Stuffing Envelopes. \$250.00 Thousand Possible. Send Stamped Envelope. United, 3838½ Van Dyke, San Diego, CA. 92105.

**MAKE BIG MONEY!!!** Bargains-Worldwide Suppliers. Valuable List \$1.00. Bargains, Box 17992-A6, Honolulu, Hawaii 96817.

**GET** World's Biggest Wholesale Import Catalog. Write: World, Medina, Washington 98039.

**WILL** You actually (really & truly) address, stuff and mail 20 envelopes a day? Then don't let's mess around. Send \$5 and we'll show you how to make up to \$1,000 monthly and even much more. GUARANTEED! Contractual Arrangements. Habersham-Hall, Box 613-F, San Pedro, CA 90733.

**\$60 PER** Evening Addressing Envelopes. Homework Guaranteed. Free Details. Sterim, Box 23E, Sterling Heights, Mich. 48078.

(Continued on next page)



## MONEYMAKING OPPORTUNITIES

(Continued from preceding page)

**EARN AT HOME MAILING OUR CIRCULARS! EXPERIENCE UNNECESSARY!** Send stamped addressed envelope. Wright, 949 Broadway, 602-PM, New York City 10010.

**FREE WEALTH BOOK:** "2100 Unique Ways To Make Money!" Worlds Biggest Collection of Home Businesses!! Success-M, 26903 West Eight Mile, Detroit, Michigan 48220.

**FREE Details!** Win lifetime income from Dice, Roulette, Thoroughbred, Harness, Dog Racing. Guaranteed! Research, Box 551PM, Mineola, N.Y. 11501.

**\$1,000 MONTHLY!** Stuffing Envelopes and Clipping Newspapers: Send Stamped Addressed Envelope . . . JOY, Box 936-C, Hyattsville, Maryland 20783.

**GET RICH** With secret law that smashes debts and brings you \$500 to \$2 million cash. Free Report! Credit (6A6), 333 North Michigan, Chicago 60601.

**WOODWORKERS**—Earn \$10.00 per Hour Constructing Projects for Craft and Consignment Shops. Guaranteed Instructions describe Projects and Selling Methods. \$3.00. Woodcraft Ideas, Box 193, New Middletown, Ohio 44442.

**WIN CASH PRIZES** Solving Word Contests. Details: Send self-addressed stamped envelope. A&L Associates, Box 141-P, Newton, Mass. 02195.

**STUFF ENVELOPES, \$250/THOUSAND, IMMEDIATELY, FREE SUPPLIES, RUSH STAMPED, ADDRESSED ENVELOPE TO: DANNY INGE, BOX 115, SPIRO, OKLAHOMA 74959.**

**MONEY! MONEY!** All the homework you want. Guaranteed. Free details. Apply: Homeworkers, Drawer 428-B, Venice, Florida 33595.

**CASH Clipping Newspaper Articles!** Complete instruction Book \$1.00, Sunny, Box 579E, Plaistow, New Hampshire 03865.

**\$1,000 MONTHLY** in Astonishing Spare Time Business. Write: Williams, 4806WL-8, Lancaster, CA 93534.

**FREE SECRET BOOK** "2,042 Unique, Proven Enterprises." Largest successful collection! Fabulous "Little Knowns." Work home! Haylings, Carlsbad, Calif. 92008.

**FANTASTIC Business**—Huge Profits—Free Information. Revie, Box 40, Binbrook, Ontario, Canada.

**TRAVEL!** Anywhere Anytime. Earn \$65.00 Daily, Easily. Write: Travelers Club, Box 365A, New Port Richey, Fla. 33552.

**SMALL Investors**, How Can They Make Money in Silver? Free! Stagecoach, 1124 NW 40 Ave., Gainesville, Fla. 32601.

**\$1,000 MONTH** Mailing Letters. Guaranteed. Free Details. Sandco, Ceres, Calif. 95307.

**500/THOUSAND**, Stuffing Envelopes, Stamped Addressed Envelope: Wiley, 1833-31 Shoshone Drive, Lafayette, Indiana 47905.

**MAKE MONEY IN SPARE TIME.** Earn generous commissions as a subscription representative for leading magazines. For free details, send this ad with your name and address to: **POPULAR MECHANICS**, Room 1107S, 250 W. 55th St., New York, N.Y. 10019.

**TREMENDOUS PROFITS; CLIPPING NEWSPAPER ITEMS FOR US, DETAILS 50¢, DIAZ, BOX 642PMF, MARLBORO, MA. 01752.**

**STUFF ENVELOPES \$500/THOUSAND!** Free Supplies! Rush Stamped-Addressed Envelope. Jackson, 2150 PM Prospect, Cleveland, Ohio 44115.

**MAKE Money** in mail order **STREAMLINED HOME STUDY COURSE**. Send only \$2.00. Moore Enterprises, Dept. PM-1, P.O. Box 8272, Phoenix, AZ. 85066.

**HOMEWORKERS** - \$60 to \$100 plus Weekly. Details - 10¢ Stamp. H&K Inc., Box 8351-H, St. Louis, Missouri 63132.

**\$200.00 PROFIT.** Sheet 1/4" plywood. Details 50¢. Novelties, 610 So. 24th. Elwood, Indiana 46036.

**BIG Profits** in Sporting Goods. Rice's 107-A Thriftway Plaza, Ruskin, Fl. 33570.

**LAWN Mower repair**, make money at home or open shop. Source report, information on trainings, parts, tools, shop layout, \$2.00. Hopkins, 2916 Aurora, Melbourne, Florida 32935.

**SELL Sensational Low-Cost Burglar Alarm.** Lightning Seller. Exceptional Margin. Samples for Trial. Northwest Electric., Ave. 994, Mitchell, S. Dak. 57301.

**\$500/THOUSAND POSSIBLE STUFFING ENVELOPES, INFORMATION/SUPPLIES, STAMPED, ADDRESSED, ENVELOPE, Aaron-56, Box 466, Monrovia, Indiana 46157."**

**MAKE Money** Addressing Envelopes. Send stamped addressed envelope to: R. H. M. Productions, 11 Willard Avenue, Mt. Vernon, New York 10553.

**NOW!** New Informative French Associates Report 109A on "Monied Opportunities." Write, 148-25-89 Avenue, Jamaica, New York 11435.

**\$8,000 MONTHLY SPARE TIME!** No Selling! Start Now! —Free Proof!—Owco, Box 665, Inglewood, Ca. 90307.

**ADDRESSERS** Mailers, homeworkers, needed! 50 firms listed. Information: rush 25¢ stamped addressed envelope. Motley, Box 509, Oriskany, N.Y. 13424.

**COOL Pets** Inexpensively. Make Portable Unit. Plans \$2.00. Rabenbauer, 1495 Grandville, Pontiac, Mich. 48055.

**STOP WISHING**—This is it. Servicemen, vets, anyone. Make money at home, camp, anywhere. Nothing like it. Stamp, 25¢ brings loads particulars, info. Bill Smith, P.O. Box 1878, Cincinnati, Ohio 45201.

**MAIL Letters \$8.00 Profit Everything Furnished.** P.O. 8442, Toledo, Ohio 43623.

**\$250/THOUSAND, STUFFING ENVELOPES, FREE SUPPLIES,** Send Stamped Addressed Envelope, Juthor Enterprises, Box 420156, Miami, Fla. 33142.

**HOMEWORKERS!!** Earn Extra Cash Mailing Our Sales Circulars. Everything Supplied. Write: Enterprise, Box 129682, Newport News, Virginia 23601.

**\$800 MONTHLY**—Addressing Envelopes. Details 25¢. Nasco, Box 14342, Columbus, Ohio 43214.

**VERY PROFITABLE HOME BUSINESS**—Restoring Antique Furniture For Dealers Collectors Yourself. Earn \$100.00 Per Day And More—Fast Easy Method. Write Antiques, P.O. Box 184-PM, Elkhart, Indiana 46514.

**NEW \$42.00 net** each from selling beautiful teak jewelry chests. Details and Photos \$2.00. (Refundable.) Normer, Box 42262, Ft. Mugu, Calif. 93042.

**FREE Cash, benefits,** from government. Details. Moresearch, 16-PM6 McKinley, Albertson, NY 11507.

**DON'T GET RIPPED OFF** By Mail Order Schemes!! Free details!! Department 2F, North 1911 Ely, Spokane, Washington 99206.

**MY Mailorder manual** reveals everything!!! Free Details. MoneySaver, N. 1911 Ely, Spokane, Washington 99206

**STUFF ENVELOPES \$25.00 Hundred.** Clip News Items \$2.00 to \$10.00 each. Details Send \$1.00 and Self Addressed Stamped Envelope To: Bill Feeney, Jr., P.O. Box 318, Westville, N.J. 08093.

**MAKE Money** Writing Fillers and Short Paragraphs. Free information, Parker, Box 46548PM, Los Angeles, California 90046.

## PROFITABLE OCCASIONS

**FIREWOOD:** Get it Free - Sell For Unbelievable Profits. Complete Instruction Manual, \$3.95. Fortune, 165-244 Blossom Hill Road, San Jose, California 95123.

**\$400 FIRST WEEK** With Ad Clocks or money back. Your own Advertising Business. Action Ad Clock, Room AC-2-EF, 1512 Jarvis, Chicago, IL 60626.

**FREE Catalogs.** Repair air conditioning refrigeration. Tools, supplies, full instructions. Doolin, 2016 Canton, Dallas, Texas 75201.

**FT. SMITH Auction School,** Ft. Smith, Ark. 72901. Resident & Home study. Veteran approved.

**\$100.00/DAY POSSIBLE!!!** Buy Scrap Gold . . . Easy . . . Complete manual, \$4.00 Satisfaction Guaranteed . . . Brown, 956 Springdale, Atlanta, Ga. 30306.

**PLASTERCRAFT!!!** Profitable home business. Molds available. Details: Lynette, 6251C Mentor Park, Mentor, Ohio 44060.

**PICTURE Framing**—Profitable full or spare-time business. Easy to learn with handbook-course "Guide To Picture Framing Profits." \$2.00 Guaranteed. Free framing-supplies catalog included. Japs, 126-PM Seventh North, Hopkins, Minnesota 55343.

**YOUR OWN Security Guard Agency.** Complete Manual, \$5.00 Marsec, Box 621, Santa Fe, N.M. 87501.

**\$250/THOUSAND STUFFING ENVELOPES.** Rush stamped addressed envelope to: Ingram, Box 1331, Chickasha, Okla. 73018.

## SALESMEN—DISTRIBUTORS

**BIGGEST Earnings** ever! Famous Hertel fully referenced Bible! Proved plan. Starting 3-dimension cover. Easy credit plan. No investment. Demonstrator furnished. Write International Book, Dept. PM, Box 118, Wichita, Kansas 67201.

**NEED EXTRA INCOME?** Sell famous Knapp Cushion Comfort Shoes. Part-time, full-time. Over \$8 million in commissions last year. No investment. Free selling kit. Write I. Margolis, 612 Knapp Centre, Brockton, Mass. 02401.

**AUTOMATIC Fishhooks.** Profitable Samples, \$2.00 (refundable). Aron, 61-PM, Mastic Beach, New York 11951.

**HOUSEHOLD PRODUCTS ROUTE. EARN \$25** or more daily. Also Party Plan opportunities for men, women full, part time. McNess, Freeport (26065), Illinois 61032.

**EXCELLENT Commissions, Terrific Bonuses,** Showing Businessmen Pens, Calendars, Advertising Specialties, Etc., Dept. PM6, Imperial Ideas, Box 10093, Kansas City, Missouri 64111.

**BECOME A Successful Manufacturers' Representative.** Manufacturers' Agents' Newsletter Tells You Which Firms Are Looking For Representatives, the Firm's Product Line and Territories Available. For information write: Manufacturers' Agents' Newsletter, Dept. 152A, 23573 Prospect Ave., Farmington, Michigan 48024.

**FREE Sample.** Full size fabulous Victory Miracle Cloth. Hot \$1.00 seller; pays 80¢ profit. Startling demonstrator. Every surface sparkles like magic. Sample details: Barry, Dept. A4186, 1312 Washington, St. Louis, Missouri 63103.

**CANADIANS** Sell exclusive products, Details, OPTIMUS, Box 178, Brossard, Quebec, Canada.

## AGENTS WANTED

**HAND Embossed Leather Wallets** Fast Selling Imports. Details 25¢. Sample \$2.00. Hindia, Suite 915, 150 Broadway, New York, NY 10038.

**SELL Social Security Plates** Big Profits Free Kit! House of Plates, 1806 Dallas, Modesto, Calif. 95351.

**EVERY Man** a prospect. Refundable sales kit offer showing line belt buckles, tie clasps, money clips, cuff links, lapels, identification badges, individualized with customer's name and emblems. Cap badges for trucking, bus, taxi, police, firemen. Also postal, letter carriers and heavy construction emblems. Choice 5000 emblems. Hook-Fast, Box 1088-PM, Providence, R.I. 02901.

**YOUR Own business.** Used Suits \$1.50; Overcoats 65¢; Mackinaws 35¢; Shoes 12½¢; Ladies' Coats 30¢; Dresses 15¢. Enormous profits. Catalog Free. Nathan Portnoy Associates, 2109-AA Roosevelt Road, Chicago, Illinois 60608.

**FABULOUS New Beauty Mask.** Earn Fantastic Profits Part Time. Also Party Plan—Crew Manager Opportunities. Barnes, Box 759-H, Portsmouth, Va. 23705.

**DEALERS Wanted!** No Product Investment. Details 25¢. Giftworld, Box 567PM, Pontotac, MS. 38863.

## EMPLOYMENT INFORMATION

**AUSTRALIA—NEW ZEALAND WANT YOU !!!** 50,000 Jobs! Paid Transportation! Latest Information and Forms. \$1.00 Austco, Box 3623-E, Long Beach, California 90803.

**OVERSEAS JOBS**—Now Hiring, 103 Countries, All Occupations, High Pay, Free Transportation, Tax Benefits. Latest Computerized Reports—\$2.00. TRANSWORLD, International Airport, Box 90802-E, Los Angeles, California 90009.

**JOBS, Jobs**—Secret Information on How To Find a job during the recession—Send \$2.00—Refundable To: Wayne & Co., P.O. Box 37350, Jacksonville, Florida 32205.

**LATEST Australian Employment Directory** lists employer's names, addresses, government transportation, housing, taxes, application form. \$1.00 to: Countryside Specialties, Dept. 6PM, Box 5944, Texarkana, Texas 75501.

**AUSTRALIA WANTS YOU!!! THOUSANDS OF JOBS!!!** Paid Transportation. Complete Information And Forms. Plus Information On Housing! Taxes! Recreation! \$1.00. Liberty Enterprises, Box 1241AA, Rochester, New York, 14609.

**"CANADA - A SECURE LIVING"** Now You Can Work and Live In Clean Safe Surroundings. Canada Has Thousands of Job Vacancies In All Areas of The Labour Force. For No-Nonsense Information About Your New Future Send \$2.00 To-Day To: Opportunity Canada, 559 Lawrence Ave., Kelowna, B.C., Canada.

**IMPROVE** your job opportunity. Professionally written and printed resumes. Free Details. CBE, Box 5423, Kansas City, Mo. 64131.

**AUSTRALIA WANTS YOU!!!** 20,000 jobs! Paid transportation! Latest employment directory and forms. \$1.00. J & T Marketing, Box 1204-A Orange, Calif. 92666.

**AUSTRALIA**—New Zealand Need Population Millions!!! Jobs Plentiful!! Unemployment Rare! All Skills Needed. Paid Transportation. Settling-in Allowance. Details, Employers List, \$1.00 Moneyback Guarantee. Bilmor Sales, 8225A3, Northridge, CA. 91324.

**U.S. FIRMS OVERSEAS** Hundreds of World-Wide Companies Listed: American Addresses, Industry Classifications, Foreign Locations. Many Position Requirements Included. \$4 to OCONUS (Dept. D5), 704 Mira Vista, Huntsville, AL 35802.

**AUSTRALIA NEEDS YOU!!!** Thousands of jobs—FREE transportation. Forms, details, and **GIANT EMPLOYERS LIST.** \$1.00. Davco, Box 948-A1F, New London, Conn. 06320.

**AUSTRALIA WANTS YOU!!!** Free Transportation, Complete Details, Employers List, Forms, Guaranteed. \$1.00. Tri-State Sales, Box 4249-A, Evansville, IN. 47711.

**AUSTRALIA Wants You!!!** Jobs Galore! All Skills. Paid Transportation! Giant Employers List, Guaranteed \$1.00. Vanguard, Box 2243-B, St. Louis, Mo. 63109.

**JOBS** on oil rigs, yachts, cruise ships, tankers, trawlers. Experience unnecessary. Inside information. Giant international employers list. \$2.00 Refundable. NationWide, 13, 34234 Beachpart, Eastlake, Ohio 44034.

**TEXAS** Certain Areas Booming. Free **DETAILS, REPORTS,** Box 38618, DA3, Houston, Texas 77036.

## HELP WANTED

**OVERSEAS EMPLOYMENT** . . . Europe, Australia, South America, Asia! All Occupations! \$700 - \$4,000 monthly! Employment International, Box 29217-AF, Indianapolis, Indiana 46229.

**HELP Wanted:** Auto Mechanics. No experience needed. Free details on how to get jobs. Write: JCBS, Box 676, Dayton, Ohio 45402.

**AUSTRALIAN EMPLOYMENT.** Straight Facts. Send \$1.00 to Warner, Dept. C1, Box 147, Milldale, Conn. 06467.

**EARN At Home** Addressing Mail. Details 25¢ and Stamped Envelope. Deeco-151, Box 9308, North Hollywood, Cal. 91609.

(Continued on next page)



## STATE & FARMS

**Essary SUMMER Catalog!** Over 5000 described, pictured—Land, Farms, Hobbies—Recreation, Retirement. Selected from the U.S.! Over 700 Offices, 41 states. Mailed FREE from the World's Largest! REALTY, Inc. 7-MX S. Dearborn, Chicago, Ill.

**CANADIAN LAND FROM \$35.00 AN ACRE CHOICE.** Properties available across Canada. Low monthly payments. Ideal for farming, cottages, hunting, fishing. Free Catalogue. Canadian Estate Land, Dept. PMC-6, 286 Lawrence Ave. West, Toronto, Ont., Canada M5M 1B3.

**BIG . . . FREE . . . SUMMER CATALOG!** 256 Pages! Over 2,600 Top Values in 40 States Coast To Coast! UNITED FARM AGENCY, 612-PM West 47th St., Kansas City, Mo. 64112.

**GOVERNMENT LANDS FROM \$7.50 ACRE!** Vacationing, Farming, Investment! Exclusive "Government Land Buyer's Guide" . . . plus "Land Opportunity Review" listing lands throughout U.S. Send \$2.00. Surplus Lands, Box 6588-AF, Washington, D.C. 20009.

**\$5 ACRE, Canadian Border—hundreds campsites, islands, farmlands, directly from tax authorities. (Non-profit). Lists, photographs mailed. Register, Room 10, 110 Church Street, Toronto 1, Ont. Canada**

**\$3.50 ACRE! USA and Canada.** Lists, photographs mailed. Government Lands, 220-PM Delaware, Buffalo, New York 14202.

**"CANADIAN Country Acres and Lots."** Our 60th year. Free catalogue. Tax Sale Service, Room 301-PM, 85 Bloor Street, East, Toronto, Ontario M4W 1B5.

**CENTRAL Ontario—Choice 640 acre Sportsmen's paradises still available—\$20.00 plus \$6.50 taxes yearly. Maps, pictures, \$2.00 (Refundable). Information Bureau, Norval 4, Ontario, Canada.**

**SURPLUS Forest, Mountain, Desert, Waterfront Land. Neglected Estates, Farms, Groves, Cabins. In 50 States, Puerto Rico, Virgin Islands. Sales, Leases. Low Prices. Easy terms. Information 25c. Box 6498, Dept. 1, Santa Ana, California 92706.**

**GOVERNMENT LANDS FROM \$7.50 ACRE!** Vacationing, Farming, Investment! Exclusive "Government Land Buyer's Guide" . . . plus "Land Opportunity Review" listing lands throughout U.S. Send \$2.00. Surplus Lands, Box 6588-AF, Washington, D.C. 20009.

## GARDENING & LAWN CARE

**GOPHER Trap.** Steel Construction, \$1.98 each (\$20. dozen) postpaid. Literature Free. P-W Mfg., 16A South Waver, Sapulpa, Oklahoma 74066.

## FARM & GARDEN EQUIPMENT

**RIDINGS LAWNMOWERS** Shipped from factory bargain priced. Free Brochure. Tomco, Box 72, Oak Grove, Missouri 64075.

## FLOWERS, PLANTS, & NURSERY SUPPLIES

**LEARN** Landscaping and the growing of plants. Start a profitable business part or full time. Free information without obligation. Lifetime Career Schools, Dept. A-832, 2251 Barry Avenue, Los Angeles, California 90064.

## CONSTRUCTION PLANS, BLUEPRINTS

**BUILD A RECYCLED MARTIN HOUSE** That's right! Save your cans and send for plans, of a unique 12 apartment Purple Martin house. Anyone can build reasonably. Recycle cans for birds. Send \$1.25, plus self addressed envelope to Litch Const., Langford, So. Dak. 57434.

**INFLATED BUILDING COST—Build It Yourself.** Manufacture Your Own Building Material. Building Method and 5 Blueprints—Vacation—Hunting Cabin, Workshop, Storage Building, Garage, Leisure Room Addition—Package \$10.00. Dycos Building Systems, Box 2095, Kerrville, Texas 78028.

**BUILDING** And Alteration Plans Drawn. Michael-Douglas, 162 Gailmor, Yonkers, N.Y. 10710.

**HOW TO BUILD A HOUSE SIMPLY** for 1/2 to 1/3 cost. Novice or experienced builders can profit from this book. Illustrations, photos, costs. From plot plan to finished cabinetry. Meets most building codes. \$5.50. Calif. residents add 33¢ tax. Jay Publications, Box 833C2, Goleta, CA 93017.

## LOG CABINS AND "A" FRAMES

**BUILD** Log Cabins. Rustic furniture, Fireplaces!! Complete manual \$3.00 . . . "A" Frame plans, \$2.00 Guaranteed. . . . Beels, 956 Springdale, Atlanta, Georgia 30306.

## HOME CRAFTSMAN

**101 PATTERNS** of Smart Gifts, Novelties, Shelves, Action Windmills, plus "Make Money Jig Sawing." \$2.00. Mastercraft, 65M, 7041 Olcott, Chicago 60631.

**HOW** To Create Beautifully Veneered Furniture Quickly, Easily! Illustrated Veneering Manual/Catalog FREE. Exotic Veneers, Inlays, Supplies. Morgan, PO1K22, Box 18169, Louisville, Kentucky 40218.

**DUTCH** And Farm Windmills. Full size patterns. 4' to 6' high. Both only \$2.00. Mastercraft, 619M, 7041 Olcott, Chicago 60631.

**HOW TO Make Kitchen Cabinet's and Furniture.** New Illustrated Manual shows you the latest and easiest step by step Methods. Guaranteed Satisfaction. Write: Flint Woodworking, 1027 Mansfield City Road, Storrs, CT. 06268.

**WOOD—Domestic and Imported Hardwoods!** 3500 Items! Clock, Musical Instrument Kits. Tools . . . Discount Prices! Hard-To-Find Hardware. 144 Page Catalog, 50c. Craftsman, Dept. AX-65, 2729 Mary, Chicago, Illinois 60608.

**30 BIRD** House and Feeder patterns for Martins, Wrens etc. Only \$2.00. Mastercraft, 616M, 7041 Olcott, Chicago 60631.

**CLOCK** Movements, Dials, Kits. 40 Page Catalog 50c. Newport, Box 6848A, Burbank, Calif. 91510.

**CATALOG FULL SIZE FURNITURE PLANS—\$1.00** Refunded with first order. Traditional Early American, over 150! Furniture Designs, 1425 Sherman, Dept. CP-75, Evanston, Illinois 60201.

**CABINETMAKING MADE EASY** And "How to Make Formica Counter Tops." Two excellent guides let you build kitchen cabinets and counter tops like professionals. Extraordinary guides bring master craftsmen's shortcut methods. Satisfaction guaranteed. Write: Japs, 126-P Seventh North, Hopkins, Minn. 55343.

**PICTURE Framing—Profitable full or spare-time business.** Easy to learn with handbook-course "Guide To Picture Framing Profits." \$2.00 Guaranteed. Free framing-supplies catalog included. Japs, 126-PM Seventh North, Hopkins, Minnesota 55343.

**FREE PLAN** for Making Sir Isaac Newton's swinging-ball cradle which he used to demonstrate his theory of motion. Makes Unique Conversation piece for Coffee Table, great science-fair project for school shop. Way-Mar, 56 Underhill Road, Scarsdale, New York 10583.

**DOLL HOUSE FURNITURE KITS** 1/4th the cost of assembled furniture and fun to make. Catalog 25c. Scientific Models, Inc., J-0-ID Snyder Ave., Berkeley Heights, N.J. 07922.

**PLANTERS—(Hanging/Floor), Architect Designed, Easy To Make For Fun And Profit.** 10 Plans \$2.00. Planters, Box 367, Watertord, Michigan 48095.

**SAVE** and build it yourself. Fully illustrated booklet containing detailed instructions for building storage sheds and other small buildings. Plus 10 plans! Only \$4.95. Vaia, 1368 Weise, Green Bay, WI. 54302.

**BEGINNERS** Can learn woodworking in 25 lesson projects. Free details. Old Craftsman, 16115 Burton Court, Livonia, Michigan 48154.

**"PLANS** For Unique Wall Hung Wine Cabinet. \$2.00 S. Beisneim, 4127 Berryman Ave., Los Angeles, California 90066."

**20 PLANS—Full Size—Early American Novel Items** for Fun or Profit. Send \$2.50. Cerbone—Box 18099—Phila., Penna. 19147.

**FIXTURES** For Precision Sawing—Routing Operations. Time-Savers. Wood-Metal Components. Complete Drawings—\$3.00. J-R Tools, Box 666, Saugus, Calif. 91350.

**LITTLE Covered Wagon Carries Four Kids—Sleeps Two!** Build With Your Youngsters. Drawings—Details—75 Other Dad/Kid Projects Included. Fun Projects Book, \$2.95; Carter Co., 80 James, Poms River, N.J. 08753.

**WOODCRAFT** Patterns Handcrafts List—\$2.50. Martin Pond, The Forks, Maine 04985.

**FURNITURE PLANS,** Full size completely detailed and shop ready by pro designer. For Catalog send 50c to: PRO-AM PLANS Box-49, Dept. PMC-65, Mt. Prospect, Ill. 60056.

**PM'S GREAT, NEW MASTER HOME CARE GUIDE.** The Latest and Greatest in The Popular Mechanics Master Guide Series. Lays Out All You Need To Know About Home Repairs, From Basement Water-proofing to Roof Repair. 24 Laminated, Wipe-Clean Sheets on 12 Stand-Up, Hang-Up Boards. 150 Charts and Illustrations. Properly Used, It Can Save Thousands of Dollars. \$4.49 ppd. PM Master Home Care Guide, Dept. HE, Box 1014, Radio City, N.Y. 10019.

## HOME REMODELING

**FUEL SHORTAGE BURN** Hydrogen from WATER. Use existing Fuel System. Send \$3.00 to: Plans, Box 8279, North Royalton, Ohio 44133.

## DO-IT-YOURSELF

**CUT** Heating Costs by 75%. Convert your fireplace to heat entire home using your present heating system. Plans: hot air systems \$6.50; hot water systems \$7.50. Thermal Research, Box 761-PM, Station A, Eatontown, New Jersey 07724.

**BIG SAVINGS ON CENTRAL AIR CONDITIONING** . . . When you install it in your forced air furnace yourself. Easily done with simple hand tools and one of our complete kits. You save hundreds of dollars in installation costs. Write for free brochure showing step-by-step procedure. McGraw-Edison Company, Air Comfort Division, 7560 N. Clark St., Albion, Mich. 49224.

**SAVE!** Install central air conditioning yourself. Send \$1.00 For "How-To" Plans. Box 3329, Longwood, Florida 32750.

**SOLAR HEATING—Build your own SOLAR** heating system. Save hundreds of DOLLARS. Send \$5.00 to SOLAR ENERGY, BOX 263, MT. SIDNEY, VIRGINIA, 24467.

**SWIMMING POOL** Plans. Save Thousands Of Dollars. Build Your Own Inground Swimming Pool. Complete Instructions And Sources Of Materials For 3 Different Sizes, 16' x 32', 18' x 36', 20' x 40'. Send 3.00 Dollars To Combined Enterprises, P.O. Box 233, Jackson, Mich. 49204.

**SAVE** Money. Simplified "Do It Yourself" Auto Repair Book. Send \$1.95. Kittredge Sales, 13109 Kittredge Court, Woodbridge, Virginia 22193.

**KAHLUA** Recipe. \$1.00. No special equipment. Majors, Box 1580, Hawthorne, California 90250.

**FREE** Solar Energy Catalogue. Send Stamp. Centerline, 401R South 36th Street, Phoenix, Arizona 85034.

**AMAZING** Electronic Products Pocket Laser, See-In-The-Dark, Radio Scramblers, penlight Strobe, Bug Detectors, TV Disruptor, Many More, All New Catalog \$1. Information Unlimited, West St., Milford, New Hampshire 03055.

**BURGLAR-FIRE** Alarm Supplies and Information. Free Catalog. Protect Alarm Sales, Box 357A, Birch Run, Michigan 48415.

**ELECTROPLATING.** Complete amateur's textbook All metals Electroplate metallic/nonmetallic items \$7.00. Details free. Tropic, Box 95P3, Palm Bay, Fla. 32905.

**CONVERT** MOWER Engines into air compressors. Write: Showalter, Box 409, Abilene, Kansas 67410.

**1400 CATALOGS** Listed and Described Sources for EVERYTHING Imaginable! Rush \$2.00. MASTERLOG, Box 24413-YR, Oakland, California 94623.

**ELECTRIC MOTOR** Repair Guide & Catalog for Air Conditioning & Heating Fan Motors, New Motors, Parts & How To Repair Data. Send \$3.00. EMS, 1308 North 14th, Kingsville, Texas 78363.

**HYDROPONIC GREENHOUSE.** Free information, Iott Engineering, 4660 73rd, La Mesa, Cal. 92041.

**DAMP BASEMENT?** Book shows you how to fix it. GEPE, \$3.00 postpaid, Box 662, Elyria, Ohio 44035.

**STOP LEAKS,** Liquid plastic stops leaks on any surface. Excellent for roofs and basement walls. Protects and beautifies. Eight attractive colors. Easy to apply. For Free information call or write. (312) 568-3111 U.S. Polycoat. Corp.—850 West 119th. Street—Dept. 101 Chicago, Illinois 60643.

**REBATE-100%** if unsatisfied, Save \$150. Get your home electrician's Handbook, non-technical. \$1.50 Suburban Business, 192M, Northboro, MA. 01532.

**EYEGLASS** adjustment and repair kit, complete with instructions compiled by dispensing optician. \$3.00. Promed Optical, Box 245, West Memphis, Arkansas 72301.

**SOLAR** Pool Heater. Inexpensive. Easy plans. \$2.00. Sunsound, 256 S. Robertson, Beverly Hills, Calif. 90211.

**PLANS** For Childrens combination toy box, chalk board and book case. Send \$2.00 to Plans, Box 88452, Tukwila, Wash. 98188.

**FLYTRAPS** From your discarded jars. NO GIMMICK—they work. PLEASE send \$1.00 for complete details and material to convert one of yours. Flytrap, 625 E Rosewood, Layton, Utah 84041.

**KEEP COOL!** Simple, fast method finds air conditioner problems, inefficiency. No special tools required. Save \$\$\$ on operation, unnecessary repairs. Window, central units. Expert shows how in new 26 page booklet, \$2.50. Sta-Kool, Box 432 School Road, Lake Ozark, Missouri 65049.

**400% PROFIT.** Giant Blowup Pictures from your present darkroom. Easily built plans. \$3.00, Guaranteed! Sunsound, 256 S. Robertson, Beverly Hills, Calif. 90211.

**BUILD** Natural Stone houses, outbuildings, fireplaces, walls—without experience! Guaranteed "HOUSE OF STONE" manual, \$3.00. Stonehouse 74, Sweet, Idaho 83670.

**PLANS:** Water Wheels, Windmills, Solar Heat, Electric Cars, Etc. Send For Complete List. Goodman Associates, 4 Berryville Pike, Summit Point, W. Va. 25446.

**FREE** Information Windturbines, Solar Heating. Energycraft, 2350 W47PA, Denver, Co. 80211.

**GARDEN** Without Soil!! Small Space. High yield. Year around. Write: E & M Specialties A65, Box 11356, Albuquerque, New Mexico 87112.

**DISCREET ATMOSPHERE WITH A NEW IDEA.** . . . Surround Your Home With Music in Each and Every Room, yet Practically Nothing to Buy. Install in 30 Minutes on Your Hot-Air-System, Soft or Loud, Alone or With Company, it Will Set the Mood in Which You Want To Be In. Send \$1.50 to: House Of Torsten, Dept. 681, 4636 West 103 Street, Oaklawn, Illinois 60453.

**CARNIVAL** Building Plans: Rides, Shows, Games, Illusions, Calliope, Golf; 290 Page Catalog \$1.00. (Refundable); Brill, Box 875-P, Peoria, Ill. 61601.

**WINDMILL** Generators. Solar Heating. Plans, \$5.00 Each. Guaranteed. Free information. Energy, 1158, Lancaster, S.C. 29720.

**SYNTHETIC GASOLINE!** Make it yourself from common trash! Chemist's complete, simplified instructions \$2.00. Burchette, 1632 Tarterton, P.O. Box 1114, Spring Valley, CA 92077.

(Continued on next page)



## DO-IT-YOURSELF (Continued from preceding page)

**RELAX** With a Turbojet bath. Plans \$5.00 Kit \$20.00. BSI, Eva, Alabama 35621.

**INCREDIBLE CHEESE MACHINE!** Kit Complete with Instructions for Making Colby, Cheddar, mozzarella and Cottage Cheese. You're in for a Real Treat! Send Postcard for Free Details, or \$6.00 plus \$1.00 Postage. Budd Products (Since 1975), 9243 Clayton Road, St. Louis, Missouri 63124.

**NEW!** Revolutionary Paint Applicator. Automatic Speed Painter. Fast, Smooth, Clean, Easy. Homeowner and Professional Models. From \$5.98. Guaranteed! Inquire: Dudley Associates, 1291 Dean Street, Brooklyn, New York 11216.

**SAVE THOUSANDS,** Build Your Own Home, Free Details, "Home", Box 3056, Seattle, Washington 98114.

**SOLAR HEAT** Your swimming POOL: Install simple solar water heating system yourself, inexpensively. Detailed plans, illustrations and listing of materials. Send \$2.50 Solar Research, 687 Prospect St., Methuen, Massachusetts 01844.

**STRONGER** Tennis Serve. Simple invention. Recognized Pro. Plans \$1.00. R., Box 3691, Santa Barbara, CA 93105.

**IMPROVE YOUR SAW** TO CUT BETTER Than new and last beyond expectation. Complete illustrated instruction \$3.50. Pall, 2963 Mal Court, Anaheim, CA 92806.

**FREE ENERGY!** Sources of Supplies, Plans, Windmills, Solar, Methane, Etc. Send \$2.00. PER-O, 15 Riverside, Saginaw, Mich. 48602.

**NEVER PAINT STUCCO!** Old original formula Seals, waterproofs, beautifies in one coat. Won't peel, lasts 10 years or more. No primer or sandblasting. Booklet, "Science Overcomes Paint Failure", from Mica-Seal, Inc., 1734-P Fifth Street, Berkeley, California 94710.

**WINEMAKING** At It's Best! Easiest Recipe Yet! Free Details. Guaranteed. K. Parker, Box 46048PM, Los Angeles, California 90046.

**PM'S FAMOUS MASTER SHOP GUIDE.** One of The Most Important Tools You'll Ever Own! Lays Out Everything You Need To Know About Nails, Screws, Bolts, Drills, Adhesives, Lumber, masonry, Plumbing and Electrical Work. 24 Stand-Up, Hang-Up, Wipe-Clean Laminated Pages. 56 Charts plus a Built-In Ruler, Protractor and Compass. Solid Value at \$4.49 ppd. PM Master Shop Guide, Dept. HE, Box 1014, Radio City, N.Y. 10019.

## REPRODUCTION MOLDS

**FIBERGLASS/Latex** Molds for casting Ornamental Concrete and/or plaster. Catalog \$2.00. Freeman Industries, Joliet, Montana 59041.

**MOLDS** For Ornamental Concrete. Our Catalog Contains Over 700 rubber and fiberglass molds. Catalog \$2.00. Plycrete Mold Co., Elk Rapids, Mich. 49629.

## ARTS & CRAFTS

**RETAIL OUTLET** wants Homemade Handicrafts. Information \$1.00. Willoughby, 533 Main, Hartford, Michigan 49057.

**LIQUID LATEX** Paratol. 706-G compound for making rubber mold. Toughest, finest quality. Instructions. Money-back guarantee. Postpaid \$3.95 quart, \$12.00 gallon. Testworth Laboratories, Inc., 401 S. Main St., Columbia City, IN 46725.

**LEATHERCRAFT** Catalog. Tools, Leather, Dyes, Dressings, Saddle Stamps, Buckles, much more. Send 25¢ to MacPherson Bros., P.O. Box 395, San Francisco, Calif. 94109.

**GLASS BLOWING** Kits and Supplies—Literature Upon Request—Willis Glass, P.O. Box 3460, Anaheim, California 92803.

**MAKE** Figurines, plaques, lawn ornaments. Molds, plastercraft kits, liquid rubber. Sample and catalogue 25¢. Wooley Company, Box 29-B, Peoria, Illinois 61601.

**"GETTING Started** in Stained Glass" 25¢. Whittemore, Box 2065Y, Hanover, Mass. 02339.

**LARGEST HANDICRAFTS SUPPLY DIRECTORY** \$3.00. R.P.H. Manufacturing Co., 924 Winter Street, Stamford, Conn. 06905.

**TERRARIUMS** Colorful sand terrariums for under \$1.00. Send \$1.00 no stamps for photo and instructions. Terrariums, Box 12, Rockland, Delaware 19732.

**YOU** Can Make Spoon-Rings! Easy Profitable. Blueprint for Fixture. All Sizes. Send \$3.00. Box 260, Risingsun, Ohio 43457.

## BINOCULARS, TELESCOPES, MICROSCOPES, MAGNIFIERS

**FREE** Binocular, Rifle scope catalog. Discount sale. Save 50%. Free gift with order. Write: United Binoculars, BN-9408, 9043 So. Western, Chicago 60620.

## CAMERAS AND EQUIPMENT

**FREE! FREE! BARGAIN BOOK.** Central Camera Co., Dept. 361, 230 S. Wabash, Chicago, Ill. 60604.

**BUILD** Your Own Underwater Camera Case. Complete Plans, \$3.00. E.R.P., Box 98943, Des Moines, Washington 98188.

## PHOTO FINISHING

**CUSTOM PHOTO LAB,** Pro Quality, Write—Communications 411, 1012 N. 3rd, Milwaukee, Wisc.

**LOOK!**—Special Money Saving Offer! Kodacolor Roll developed with Jumbo Size Prints \$1.60. B&W 49¢. Big Discounts on supplies. Enclose advertisement. Wisconsin Film Service, LaCrosse, Wisconsin 54601.

## COLOR SLIDES

**GAF** Color Slides 12,500 all Countries Catalog 25¢. Worldwide, 7427-M Washburn, Minneapolis, Minn. 55423.

**FREE** 35MM Color Slide Encyclopedia. Same slides used in TV, national magazines. 126-pages individual listings. Write Wolfe Worldwide Films, Dept. 14-65, Los Angeles, Ca. 90025.

## MOTION PICTURES & SOUND EQUIPMENT

**175-FT. 8MM, CLASSIC SAMPLER . . . ONLY \$1.99.** Highlights from heyday of the silent! Chaplin, Laurel & Hardy, Fairbanks, Keystone Kops, Gish, Pickford, Chaney, the first Indianapolis 500 and more. Order today . . . specify standard or super-8. Free catalog: 8MM & 16MM movies & 35MM, 2" x 2" color slides. Blackhawk Films, 1678 Eastin-Pheasant Bldg., Davenport, Iowa 52808.

**UNUSUAL** Movie supplies. Free circular. Esor, 47th Holly, Kansas City, Missouri 64112.

**8MM—SUPER 8—16MM MOVIES!** Biggest Selection! Lowest Prices! Free Catalog! Cinema Eight, Box PM, Chester, Connecticut 06412.

**SUPER 8MM,** 16mm, 8mm silent and sound film classics. Free catalog. NILES, 1141PM Mishawaka, South Bend, Ind. 46615.

**SUPER 8, 8mm, 16mm, 35mm, B&W and Color Film,** Supplies, Processing Equipment. Send 25¢ for 84-page catalog refundable with order. Superior, 448 N. Wells, Chicago 60610.

**SUPER 8** Elvis Features; Shorts And More. 16MM Films; Lenses; Bargain. Gaines (PM) 15207 Stagg, Van Nuys, Ca. 91405.

## RADIO, TELEVISION & HAM EQUIPMENT

**HEAR POLICE/FIRE** Dispatchers! Catalog shows Directories of "Confidential" channels, Receivers. Send postage stamp! Communications, Box 56-PM, Commack, NY 11725.

**RADIO** Tubes, 1924 to 1974. Preller T.V., Augusta, Ark., 72006. (501) 347-2281.

**CANADIAN** Catalogs—Giant Savings, Surplus, Clear-outs, Bankruptcy Stocks, Factory Deals. Rush \$1.00. Etco-PM, Box 741, Montreal "A".

**GOVERNMENT** Surplus receivers, transmitters, snooperscopes, parts. Catalog 25¢. Meshna, Nahant, Mass. 01908.

**36¢** RADIO & TV Tubes. Free catalog. Cornell, 4213-17 University, San Diego, California 92105.

**FREE** Educational Electronics catalog. Edu-Kits Workshop, Dept. 745 B, Hewlett, N.Y. 11557.

**500 MILE** Daytime B.C. Reception. Plans—Kits—Tuners. SASE. Superceive, 2555 Sykes, Rogue River, OR. 97537.

**UNDERSTAND** POLICE RADIO CONVERSATIONS 10 Code and Meanings, \$3.00 per List. John W. Co. Kel, 3440 Burr St., Gary, Ind. 46406.

## HIFI, TAPES, & RECORDS

**FREE** Catalogues, 2000 hard to find unusual records. Rose's Records, Box 7216, Louisville, Ky. 40207.

**FREE** Catalog—Electronic Kits—Amplifiers—Pre-amplifiers—Psychedeic Strokes—SCA Adaptors—Color Organs—Digital Instruments—Guitar Amplifiers. FREE Subscriptions. SWTPC, Box PM32040, San Antonio, Texas 78284.

**8-TRACK** Fidelity Stereo Tapes. Any Top Rock, Oldies, Radio Shows, Humor, Party. \$3.50 you name it. List 50¢ (refundable). DiWan Company, Box 1302, Springfield, IL 62705.

**GOLDEN** Age Radio. Complete taped Shows. Box 25215-M, Portland, Oregon 97225.

**BIG** Discounts! Catalog 25¢. Tower, #33098, Washington 20028.

**OLDIES** 45 RPM Original Hits—Catalog 50¢. C&S Record Sales, Box 197, Wampsville, New York 13161.

**FREE** RECORD ALBUMS AVAILABLE For Postage and Handling. Details \$1.00: Lend-an-Album, Box 25, West Bend, Wisconsin 53095.

**"RECORD COLLECTORS JOURNAL"**, The Monthly Publication Reaching a World-Wide Audience of Collectors, Dealers, Beginners of 78's, 45's, LP's, Tapes. How to Evaluate, Sell, Buy, Locate Profitably. Submit Questions, Want/Sell List for Information. RCJ, Box 1200-P, Covina, California 91722.

## MUSIC INSTRUCTIONS & INSTRUMENTS

**"LEARN** To Read Music in one Evening!" Details—Diehle, Route 5-M, Staunton, Virginia 24401.

**ACCORDIONS**—Famous makes. 40 models. 5 Day Home Trial. Easy terms. Trades. Free Catalogs! Money saving Importer-to-You Price List. Write: Accordion Corporation, Dept. R, 5535 Belmont, Chicago 60641.

**LEARN** ROCK GUITAR. Complete course teaches Rock, Blues, Soul, Bass. 121 illustrations. Only \$4.00!

**ACCORDION** Top Brands. Cordovox, Buy direct. Tremendous discounts. Trades accepted. Free brochure PM. Accordion-O-Rama, 874 Broadway, N.Y.C. 10003.

**30% TO 50% DISCOUNT!** Any Model: Guitar, Amp, Drum, Banjo, Dobro! Free Catalog! Warehouse P58, Box 11449, Fort Worth, Texas 76109.

**WHOLESALE.** Musical Instruments—Accessories. Allied, 573 Route 17, Paramus, New Jersey 07652.

**KITS!** Build dulcimers, guitars, harps, banjos, mandolins. From \$2.95. Finished instruments from \$23.95. Free catalog. 8665 West 13th-PM, Denver, Colorado 80215.

**SWISS** Finest Music Boxes, Movements. Spielman, 55 West 42nd, New York, 10036.

**STRINGS!** Accessories, Parts, Discounts, FREE Catalog, Stringing, M6 Box 5444, Linden Hill, Flushing, N.Y. 11354.

**AMAZING!!! INSTANT FOLK GUITAR INSTRUCTION BOOK . . .** Teach Yourself To Play in 60 Minutes. . . COMPLETE FOR BEGINNERS. . . \$2.95 . . . Holiday, Box 591, Yonkers, N.Y. 10701.

**GUITAR,** Banjo, Violin, Mandolin Making Materials, Accessories, Books. Catalog 25¢. Guitar Center, Box 15444, Tulsa, Oklahoma 74115.

**EASY** To Play And Make, Quality Dulcimers, Banjos, Thumb Pianos; Instruments And Kits. Can Be Fromable Hobby. HERE, Inc. #P, 410 Cedar Avenue, Minneapolis, Minn. 55404.

**WHOLESALE!** Professional Guitars, PA Systems, Altec Speakers, 240W RMS Amplifiers. Free Catalog. Carvin, Escondido, Calif. 92027.

**POEMS** Wanted for songs. Nashville Music Productions, Box 40001-P, Nashville, Tennessee 37204.

**PLAYER PIANOS; PUMP ORGANS**—books; repair manuals. Catalog \$1.00, refundable first order. Vestal Press, Box 97, Vestal 11, NY 13850.

**LEARN** to Play Piano—Guitar—Accordion My Way. Write: Hall's, Box 181PM, Lynwood, California 90262.

**LEARN** Banjo. 5-String Bluegrass. No music. Makes learning easy. Free details. Blaylock, Box 25-M, Marietta, Georgia 30060.

**UP TO 60%** Discount Name Brand Instruments. Catalog. Freeport Music, 455F. Route 110, Melville, N.Y. 11746.

**ACCORDIONS** Manufacturing, 6846-P North, Chicago 60635. Concertinas - Chromatics - Heligons - Hohners - New - Used - Repairing - Wholesale Catalogs Free.

**VIOLIN** And Guitar makers—send for latest Free Catalogue of woods & accessories. international Violin, Pm1, 4026 W. Belvedere, Baltimore, Md. 21215.

**POEMS** Songs wanted. Recording. Publishing guaranteed. Royalties. Radio-TV release. Broadway Music, Box 11647-PM, Sarasota, Fla. 33578.

## EDUCATION & INSTRUCTIONS

**WELDING TRAINING** Basic and Advanced Training for Major Processes—Arc, Gas, Pipe, TIG, MIG, Plasma. Hobart, a non-profit school, is accredited member NATTS. Approved Ohio 70-12-0064 HT. Write for school bulletin and course schedule. HOBART SCHOOL OF WELDING TECHNOLOGY, Box 75, Troy, Ohio 45373.

**KNOW THE PEOPLE YOU DEAL WITH!** Learn how to analyze handwriting! 208 page book presents complete course. Send \$2.00. H. Clark, 505B6, 1776 Lambert, Provo, Utah 84601.

**LEARN** To fix typewriters and Office Machines. Many trained men needed. Make up to \$25.00 in one hour on overhaul. Learn at home in spare time. Facts Free. Send name. Typewriter Repair School (homestudy), Dept. 3310-065, Little Falls, N.J. 07424.

**LEARN ACCOUNTING!** U.S. Labor Department reports "33,000 NEW Accountants, 78,000 New Bookkeepers needed EACH YEAR for next ten years". . . Easy home-study plan prepares you. Approved for Veterans. Send for FREE "Accounting Career Kit". North American School of Accounting, Dept. PBC55, Newport Beach, California 92663.

**UPHOLSTERY** Decorating. Free Booklet. Learn at home. Upholstery Decorating School. Dept. 5310-065, Little Falls, N.J. 07424.

**SMALL ENGINE REPAIR**—Earn and learn at home. Modern Small Engine Repair School, Dept. P, 4225 N. Brown Ave., Scottsdale, Arizona 85251.

**LOVE THE OUTDOORS?** Interested in living, working in parks, recreation areas? See if you can qualify, training at home. Important, respected, rewarding field. Details Free by mail. National School (homestudy), Dept. 9310-065, Little Falls, N.J. 07424.

**SAVE MONEY,** Learn new monthly budgeting system. Proven Effective. Send \$1.00 for instructions and forms. Finance Educators, Box 1214, Minnetonka, Minnesota 55343.

**LEARN** Diesel Driving, How to Finance Your Truck. Free Details. Truck Driving, Box 44844-B, Los Angeles 90044.

**LEARN ELECTRONICS FAST!** You can begin secure high paying career within weeks. Includes test equipment, kits, tools. Diploma awarded. Amazing low price! Details 10¢. National Homestudy, 21733 Carriage Drive, South Bend, Indiana 46614.

(Continued on next page) авторские права



## EDUCATION & INSTRUCTIONS

(Continued from preceding page)

**EARN WHILE YOU LEARN** at home in your spare time. Modern Gun Repair School and Modern Outdoor Equipment Repair School. Send for brochure, full facts. Dept. PMC, 4225 N. Brown Ave., Scottsdale, Arizona 85251.

**LEARN** Asleep or awake! Records, tapes, equipment! Free catalog! Drawer PM-400, Ruidoso, New Mexico 88345.

**BARTENDING** Bar Management Course. Free information. Universal Academy. Box 8180-AB, Universal City, California 91608.

**COLLEGE** Degrees at home. Choice of subjects. Easy tuition. Free inf. Elyson College, B. C. Box 909, San Ysidro, Cal. 92173.

**UNLOCK** Your Future. Become Professional Locksmith By Spare Time Homestudy. \$13.00 in An Hour Possible. All Tools, Equipment Included. Facts Free. Send name. Locksmithing Institute (homestudy), Dept. 1310-065, Little Falls, N.J. 07424.

**COMPLETE YOUR HIGH SCHOOL** at home in spare time. Texts furnished. No classes. Our diploma awarded. Our 78th year. Free Brochure. American School, Dept. XA45, Drexel at 58th, Chicago 60637.

**ACCOUNTING CAREER.** Many make \$1,200 monthly. You start, only 20 lessons, \$5.00 each. Pay as you learn and earn. State approved. Certificate. Start by mailing \$5.00 for first lesson. Jenkins, Box 571, Taft, California, 93268.

**RADIESTHESIA, Radionics, Dowsing, E.S.P. Courses** and Equipment. Illustrated Catalog \$1.00 (refundable) Established 27 years. Dept PM/R Bruce Copen. Highfield, Danehill, Sussex, England RH17 7EX.

**NOW! YOUR OWN BURGLAR/FIRE ALARM BUSINESS** OR Alarm installation position through training at home. Great demand, rapidly expanding field. Full information by mail, no salesmen. Security Systems Management School (homestudy) Dept. 7310-065, Little Falls, N.J. 07424.

**AUCTIONEERING,** Resident or home Study Course. Free Catalog, Nashville Auction School, 1921 West End, Nashville, Tennessee 37203.

**AUTOSUGGESTION.** Sleep-learning headquarters! Tapes, records, books, Gigantic catalog free. Research Association, Box 24PM, Olympia, Washington 98501.

**DETECTIVE**—Training Course. American Detective Institute, Box 418-A, Fairfield, Alabama 35064.

**RELIGIOUS VOCATION?** Write: Church of Holy Light Inc., P.O. Box 4478, Pittsburgh, Pa. 15205.

**USED Courses! Books! List 10¢.** Smith's, 124 Marlborough, Salem, Massachusetts 01970.

**OWN** Collection agency. "Little Gold Mine!" Franklin Credit, Roanoke, Virginia 24004.

**PIANO** Tuning quickly learned with home study course. Diploma granted. American Tuning School, 17050 Terer Dr., Morgan Hill, California 95037.

**DETECTIVE** Profession. Easy home study; free tie-tack or lapel pin, certificate, future. GI approved. Professional Investigators, Box 41345, Dept. CP, Los Angeles, Calif. 90041.

**LEARN** Auctioneering. Term soon. Free Catalog. Reich World Wide College of Auctioneering, Inc., Box 949, Mason City, Iowa 50401.

**EARN ELECTRONICS DEGREE** by correspondence. Free brochure. Grantham, 2004 Stoner, Los Angeles, California 90025.

**LEARN** Sewing Machine Repairing. Men, Women. Lucrative profits. Profession with bright future. Gresslin Correspondence School, Box 927, Spencer, Iowa 51301.

**PROBLEMS? There's an Answer!** Free Home Study by Mail in the Torah or Confraternity New Testament. Please state your Religion. Lamplight Studios, Box 88-D, Brooklyn, New York 11229.

**EXTENSION** And Post-Graduate Awards in Philosophy, Art, Sciences, Botanic Medicine, Homeopathy, Radionics and others. 30 subjects. Curricular free (airmail \$1.00 refundable). Registrar, Sussex College of Technology, Highfield, Danehill Sussex, England.

**DETECTIVE** Course. Free Information. Universal Detectives, Box 8180-F, Universal City, California 91608.

**PIANO** Technology—Electronic organ servicing, learned easily at home. G.I. Approved. Free booklet. Niles Bryant School, Dept. P, 3631 Stockton, Sacramento, California 95820.

**FREE** Book tells how you can learn camera repair and service. Home study or classroom. Write today! National Camera, Dept. EAD, Englewood, Colorado 80110.

**ORDINATIONS, Lifetime!** Church chartered 1887! Write! 708 Bragg, Monroe, North Carolina 28110.

**WATCH REPAIRING.** 35 Lesson Home Study Course. Free sample. Diploma awarded. Chicago School of Watchmaking, Dept. YS, Fox River Grove, Illinois 60021.

**FREE** Lifetime Ordination. Become Chaplain Missionary. Bishop, Box 744, McKeesport, Pa. 15134.

**FINISH** High School Fast at home, spare time. Earn accredited diploma. Texts, guidance provided. Tuition and academic credit for subjects already taken. Write—Franklin Academy, Dept. 11, 2660 Quincy Adams Dr., Herndon, Va. 22070.

**PARAPSYCHOLOGY.** Complete Study Course, Certificate. Free information. American Parapsychological Research Foundation, Box 5395-BB, Sherman Oaks, Calif. 91413.

**PENMANSHIP** Corrector. Improve Poor Penmanship Quickly. Details Free. Thurmon, Box 824, Stinnett, Texas 79083.

**COLLEGE DEGREES AT HOME!** Complete Directory Accredited Universities offering Correspondence Courses \$3.00. Research, Box 4853JPM, Los Angeles, Calif. 90048.

**POCKET BILLIARDS**—'Inside Secrets' Revealed. Details—Mulhall, PM6, Sharon, New Hamp. 03458.

**ENTER** Ministry. Sincerity Essential. Way, Box 4842, San Francisco, California 94101.

**IMPROVE YOURSELF!** 290 practical booklets tell how to gain success, knowledge, self-help. **DETAILS FREE!** Ridge Associates, 25-M Cherry Lane, Ramsey, New Jersey 07446.

**USED** Courses! Books Catalog 10¢. (Courses Bought). Lee Mountain, Pisgan, Alabama 35765.

## FOR INVENTORS

**INVENTIONS** Needed immediately for manufacturers. For additional information write Kessler Corporation, C-56 Fl, Fremont, Ohio 43420.

**PATENT** Application Financing. Free patent search plan. Global Patent Division, 139-G Lake Merced Hill South, San Francisco, California 94132.

**MR. INVENTOR:** Manufacturers need inventions. For development assistance, patent searches, sales for cash or royalties, free "Proof of Invention" forms and other important information, write: Charles S. Prince, Inc., Invention Consultant, 509-A 5th Avenue, NYC, 10017.

**INVENTORS—UNITED STATES PATENT OFFICE** SEARCHES. **PATENT DEVELOPMENT** Engineering and **MARKETING** of your inventions, ideas with **MANUFACTURER CONTACTS.** Send for **FREE INVENTION CERTIFICATES** and invention information. Serving inventors since 1948. **GEORGE SPECTOR, LICENSED PROFESSIONAL ENGINEER—PATENT ENGINEER.** Former **UNITED STATES PATENT OFFICE EXAMINER**—3615 Woolworth Building, New York, New York 10007.

**U.S. PATENT** Office Searches, 234 Broadway, Room 3615, New York 10007. Free invention certificates.

**INVENTORS:** Your ideas and inventions (patented/unpatented) expertly searched, developed for commercial appeal and cash/royalty sales to manufacturers by professional invention developer with excellent record of experience. B. S. Industrial Engineering; United States Patent Office former Patent Examiner. United States Government former Patent Advisor. Second decade reliable service! Member: United States Council International Chamber Commerce. Free "Invention Record" and "Recommended Protection Procedure." Airmailed! Write: Raymond Lee, Invention Developer, 230P-Park Ave., New York, New York 10017.

**FREE PAMPHLET:** "Tips on Safeguarding Your Invention." Write: United States Inventors Service Company, 501-P Thirteenth Street N.W., Washington, D.C. 20004.

**AUCTION:** We Buy Ideas. For information send \$3.00 to: George W. Smith, Box 8436, McConnell, AFB, Kansas 67221.

**NEEDING** Assistance? **INVENTION DEVELOPMENT FOUNDATION,** 155 Kent Street, Ottawa, Canada K1P 9P3.

**HYDRAULIC** Systems Custom Designed for your project send specifics. H. Hydraulics, 115 River Ave., Eugene, Oregon 97402.

**INVENTORS:** With Common Sense and Adequate Information You Can Successfully Promote Your Own Inventions. We Stock Several Outstanding Manuals Completely Covering Patents—Promotion—Licensing—Royalties—Cash—etc. Free Information. Inventors Manuals, Box 69-3387, Norland, Miami, Florida 33169.

**SAVE** On patent search. Free information. Patentaid, Box 602, Campbell, CA 95008.

**ROYALTY** Money Paid For Inventions. American Square Factory, Jamestown, N.C. 27282.

**PATENT** Searches \$10.00, With Pat-appraisal Report \$18.00. Guide: Filing your own application \$12.50 Professional Engineer, Box 8001 JFK, P.O., Boston, Mass. 02114.

**PATENT SEARCHERS** Includes maximum speed, full Airmail report, copies of closest patents. Quality searches expertly administered with complete secrecy guaranteed. Ask for Free Invention Protection Form and "Patent Information". Write Dept. 706 **WASHINGTON PATENT OFFICE SEARCH BUREAU,** 734 15th St., N.W. Washington, D.C. 20005.

**INVENTORS:** Should you market your product? Only 5 of 100 succeed. Let our experts determine your success probability. Exclusive invention rating system. Rating \$15.00 each. Details Free. American Technology Exchange, Suite 1202—EDP, 1006 Grand, Kansas City, Missouri 64106.

## INVENTIONS WANTED

**INVENTORS**—If you have an invention for sale, patented or unpatented, write for free brochure outlining manufacturer requirements to sell your invention.

**CASH**—Royalties for patented, unpatented inventions. Global Marketing Service, 139-G Lake Merced Hill South, San Francisco, California 94132.

**INVENTORS!** Protect your ideas! Free "Recommended Procedures." Washington Inventors Service, 422F Washington Building, District of Columbia 20005.

**FREE! LATEST DIRECTORY OF 500 CORPORATIONS SEEKING NEW PRODUCTS!** If you have an idea for a new product—or a way to make an old product better, send for our **FREE INVENTORS KIT NO. A-84.** It gives vital information on developing and marketing your invention/idea for Cash/Royalty Sales to corporations nationwide. Raymond Lee Organization, 230 Park Avenue, New York, N.Y. 10017.

**INVENTIONS MARKETED** Cash, Royalties **FREE INVENTION PROTECTION CERTIFICATES.** George Spector Manufacturers Representative, Woolworth Building, New York, N.Y. 10007.

**INVENTIONS IDEAS WANTED** Developed, Marketed by leading professional organization for Cash/Royalty sales. **FREE EXAMINATION** and **CONFIDENTIAL REPORT** of the Commercial Features of Your Patented/Unpatented invention. **FREE COPY** "How to Safeguard and Market your Invention to Industry" Write or Call: **LAWRENCE PESKA ASSOCIATES,** Dept. C, 500 Fifth Ave., N.Y.C. 10036, (212)354-9696, 150 S. Wacker Dr., Chicago, Ill. 60606, (312)346-1172, 1 Biscayne Tower, 2 So. Biscayne Blvd., Miami, Florida 33131. (305)358-1366, 44 Montgomery St., San Francisco, Calif. 94164 (415)956-1212, 1888 Century Park East, Los Angeles, Calif. 90067 (213)552-2020.

**HONGKONG** factory needs 10-15 new products every month to satisfy their overseas buyers. Particularly interested household items, toys, games, gadgets. Please send sketches or detailed explanation for evaluation and cash/royalty purchase. If you have an article/accessory cannot produce domestically because of quantity, price, or labour; please try us. Hongkong Plastic & Metal Products Company, P.O. Box 9627, Kwunlong, Hongkong.

**NEW** Idea Show Coming! Spring-Fall Shows. All inventions Welcome. Free Details. Application, No Obligation. Write: Paul Paulsen, Jr., 401 So. Columbia St., Frankfort, Ind. 46041.

**INVENTORS! FREE BOOKLET LISTING 1,000 CORPORATIONS** Which may be interested in your invention. Many well-known manufacturers have engaged us to locate new products like yours. For Free **INVENTORS KIT** regarding the successful promotion of your invention or idea, contact: **GILBERT ADAMS ORGANIZATION,** Dept. 36F, 80 Wall Street, New York, N.Y. 10005.

## MANUFACTURING

**INVENTORS** Ideas Developed, Research, Models, Manufacturing, Sales. Free Brochure. Since 1942. William Parker, Box 6305, Orlando, Fla. 32803.

**NEW** Products Are Always Wanted By U.S. And Overseas Buyers. We Can Promote Your New Products Nationwide And Internationally. Send Today For Your Copy Of The Exciting New 8 Page Illustrated "International New Product News" Shows 60 New Products And List 15 Business Opportunities Available Now. Sample \$1.50 Postpaid 12 Issues\* \$16.00. Write: Farr International Product News, Dept. S-16, P.O. Box 392, Fruitport, Michigan 49456.

## BUY IT WHOLESALE

**BIBLES WHOLESALE**—Free Circulars, Brochures. Write Bible Publishers, Box P5065, San Antonio, Texas 78201.

**400,000 BARGAINS** Below Wholesale: Many Free! Liquidations . . . Closeouts . . . Job Lots . . . Single Samples. Free Details. Bargainhunters Opportunities, Box 730-A, Holland, Michigan 49423.

**WORLD'S** Largest wholesale supply. 7853 American, Foreign Wholesalers. Rockbottom prices. Hongkong Clothes. Automobiles. Japan electronics. Free details. International Buyers, Box 16386M, Portland, Oreg. 97233.

**DIRECTLY** From The Manufacturer. **SAVE 50%.** **TELEPHONE ANSWERING MACHINES** \$49.- (\$95.-) Remote Adapter \$99.- (\$200.-) **COMPLETE REMOTE SYSTEM** Holds A Two-Way Conversation, Takes 360 Messages \$165.- (\$350.-) Write For Details. Mitchell, 4880 49 Street North, St. Petersburg, Florida 33709.

**HEARING** Aids, batteries, Wholesale. Catalog 25¢. Fiston, Box 1444, New Preston, Conn. 06777.

**STOP** Paying Retail Prices! Get Wholesale Catalogs Stacked 6 Feet High! What's New, 25 East Washington, Chicago, Illinois 60602.

## EXPORT—IMPORT

**ORIGINAL** Oil Paintings \$96 Dozen, Color Brochure 25¢. M.Daniel, 3632 Topax, Claymont, Delaware 19703.

**HONG KONG** Shoppers Club. Free Details. Mercantile Associates, Box 8372, Fountain Valley, California, 92708.

## FOR THE HOME

**WALLPAPER!** Secret Methods From Top Professional Unavailable Elsewhere. Free Details. Roadrunner Publications, 7338 North 29th Ave., Phoenix, Arizona 85021.

## OF INTEREST TO ALL

**CRIMEFIGHTERS!** Detectives-Police Catalog \$1.00 Don-Q, Box 548-PMO, Seattle, Washington 98111.



## OF INTEREST TO ALL

(Continued from preceding page)

**HOMEWORKERS**, Mailers needed! 50 firms listed! Send 25¢, stamped, addressed envelope. Shirley's Services, Box 7947, Kansas City, Mo. 64129.

**FREE** Current illustrated list unique books. Reina's Treasures Etc., 1252 East Denwall Dr., Carson, Calif. 90746.

**"SURVIVAL"** Long Storage Foods. Descriptive List 50¢. "Survival/Military"—Books/Manuals Catalog 50¢. Hale Supply (K-50), McDonald, Ohio 44437.

**\$500 MONTHLY** Possible clipping items from your newspaper. Experience unnecessary. Details, send stamped addressed envelope, American, Excelsior Springs, Mo. 64024.

**ADDRESSERS**—Mailers—Homeworkers Needed! 50 Firms listed. Information: Rush 25¢, Stamped, Addressed Envelope. Vanlee's, Box 661, Provo, Utah 84601.

**TOP QUALITY CARPET - \$1.00 YARD!** Government Land Information! Government Surplus Information! **COMPLETE MONEY SAVING BOOKLET \$2.50.** R-J Enterprises, 768 W. Lane, Lima, Oh. 45801.

**SECRETS** of Personality Through Handwriting Analysis. Send - \$1.00 - Analysis, Box 6400, Baltimore, Maryland 21230.

**QUODDY MOCASSINS BEST OF MAINE. FREE COLORED CATALOG. SULLIVAN, AVALON, N.J. 08202.**

**BOOKLETS!**—How To Make Wine—Learn Sweepstakes—Australian Opportunities. \$1.00 each. W. Bennetsen, 207AA Davis, Yoakum, Texas, 77995.

**SOCIAL Security** Going Broke? Depositing \$20.00 Per Week In Your Savings Account For 15 Years Can Provide \$20,000.00 Annual Income For Your Retirement! Free Information, "Retirement," Box 13148, Orlando, Florida 32809.

**AUSTRALIAN** Hand Book And Employment Directory. How To Stop Smoking Instructions 1.00 Each Guaranteed. R. Jean, 63 Old Meadow Rd., Dracut, Mass. 01826.

**\$300/THOUSAND**, Stuffing envelopes, **RUSH** stamped, addressed envelope. J&J Systems, Box 608AG, Connersville, Indiana 47331.

**ADDRESSERS** - Mailers - Homeworkers Needed!! 50 Firms Listed, Rush 50¢ Stamped, Addressed Envelope, Paul Menden, R.R. 2 Box 827, Shakopee, Minnesota, 55379.

## OF INTEREST TO WOMEN

**\$500 MONTHLY** Possible clipping items from your newspaper. Experience unnecessary. Details, send stamped addressed envelope, American, Excelsior Springs, Mo. 64024.

**MONEY**, Harmony! New life in EMF Learn how. Free literature. P2W4, Box 3141, Carmel, California 93921.

## GIFT SHOPPING

**FREE GIFT CATALOG!** Special Discount Prices, plus Free Gifts. Varia, 1368 Weise, Green Bay, WI 54302.

**LUCKY** Charms. 2¢ Each. **TREASURE CHEST**, 9321-PGM Capeview Ave., Norfolk, Va. 23503.

**NEW** Specialty Catalog 25¢. Gifts, Novelties, Gadgets. Worldwide Stamps: 16 Nations, 48 Colonies. Pricelist 10¢. Salmon Gifts, Leontonia, Ohio 44431.

**FREE** Catalog! Bargains! Useful Items, Gifts. Parker, 4302 Garfield, Trevose, Pa. 19047.

**GIFTIME** Catalog. 50¢. Amazing Bonus. Generopel, Box 961, Lomita, Ca. 90717.

**LOW PRICED** Specialty Imports, High Quality Products. Write Free Color Catalog: Forest Road House, Dept. 456, 7319 Forest, Landover, MD 20785.

**FREE!** Gift Catalog Deflation Sale. Send 25¢ Postage! Handling, Neal's Gift World, Box C, Oil Creek Station, Oil City, Penna. 16301.

**GIFTIME** Catalog \$1.00 Refundable. Newest Items Made. Hanrahan Products, 7846-20th Ave., Kenosha, Wis. 53140.

## CLOCKS, WATCHES, OLD GOLD, JEWELRY

**HIGHEST CASH** Immediately for Old Gold, Jewelry, Gold Teeth, Watches, Diamonds, Spectacles, Silver, Platinum. Free Information. Rose Industries, 29-A East Madison, Chicago 60602.

**JEWELRY** Sample \$10.00. AED, #303, 3100 S. Michigan, Chicago, Ill. 60616.

**CLOCK** Repairing Parts, Tools, Supplies. Catalog. \$1.25. G/M, 22627 Berton, Woodland Hills, California 91364.

**WATCH** and Clock repairing books, tools, materials. Free catalogs. North American, Box 77-AF, Fox River Grove, Illinois 60021.

**WANTED**—Gold, silver, platinum (any form). Coins. Information Free. Wilmot's, 345 South Glassell, Orange, CA 92666.

**BEAUTIFUL** 31-day Pendulum Wall Clock. Rice's 107-B Thriftway Plaza, Ruskin, Fl. 33570.

**LUXURIOUS** Little Mink Accessories. Necklaces, Bracelets, Earrings. Free information. Dorraugh, 229 South Diamond, Ravenna, Ohio 44266.

**WE BUY** Old Gold, Diamonds, Platinum, Rings. Free Information. Jay's, 62 West 47th Street, New York, New York 10036.

**BUYING** Jewelry, Precious Metals! Write: Metallurgy, Box 33009PM, Charleston, S.C. 29407.

**PUKA SHELLS**. Hawaii's Fashion Jewelry. Write: Kawika, Box 8196, Honolulu, Hawaii 96815.

## HEARING AIDS

**HUGE SAVINGS**. Eliminate dealer mark-ups. Free Trial. Batteries Wholesale. Terms arranged. Lloyds-PMC, Rockford, Ill. 61104.

**HEARING Aids**, Batteries, Discount Prices. Free Trial. Write: Rhodes, Brookport, Illinois 62910.

**FREE HEARING AID CATALOG**—Save by mail. Write: "MONEYSAVERS", 9530-PM-6, Langdon, Sepulveda, California 91343.

**HEARING Aids**—Huge savings on tiny, all in the ear, eyeglass, behind the ear and body models. Free home trial. Low as \$10 monthly. Write for free catalog. Prestige, Dept. R-6, Box 10947, Houston, Texas 77018.

## TOBACCO

**HANDCARVED** Meerchaum Pipes Wholesale Catalog. Nichols, Box 3144, Enid, Oklahoma 73701.

**BRIAR, MEERSCHAUM**. Pipe making materials. Pimop, Box 59211, Chicago, Illinois 60659.

**MEERSCHAUM** Pipes—Free Catalog. Conner Imports, Box 9574-PM5, San Jose, Calif. 95157.

## SCIENCE & CHEMISTRY

**DISCOUNTED!** Laboratory Chemicals, Glassware, Apparatus. Catalog-50¢. Deluxe Scientific, 507 Huron, Manitowoc, Wisconsin 54220.

## FORMULAS, PLANS, ETC.

**1,000 FORMULAS**. My complete master collection only \$10.00. Distributor, R7868, Milton, Florida 32570.

**CALCULATOR** Conversion Tables U.S. and Metric. \$3.00. West, 3200 Pope St. S.E., Washington, D.C. 20020.

## PLASTICS

**CASTOLITE** Pours like water, hardens like glass without heat. Crystal clear, colors. Embed flowers, seashells, mementos, anything. Make fine gifts. Form flexible molds over patterns of any shape, size. Reproduce your own designs in plastics, candlewax, metal, plaster, cement. Send \$1.00 for illustrated Manual Catalog. Profitable. **CASTOLITE**, Dept. 75G/PM, Woodstock, Il. 60098.

## TREASURE FINDERS

**TIRED OF DIGGING UP TRASH?** The All New "Coin-Shooter" Rejects Bottle Caps, Tin Foils, Nails and Shallow Trash. Detects Gold, Silver Coins and Jewelry. Free Literature. **D-TEX ELECTRONICS**, Box 451-U, Garland, Texas 75040.

**POWERFUL** Metrotech locator detect gold, silver, coins, relics. Moneyback guarantee, terms. Free information. Underground Explorations, Dept. A, Box 793, Menlo Park, California 94025.

**BURIED TREASURE**—Locate up to Quarter Mile away with Ultra-Sensitive Directional Locator. Send for free, informative pamphlet. Research Products, Box 13441-AMC, Tampa, Florida 33611.

**FREE FACT-FILLED** Catalog! World's largest selection! Metal detectors starting at \$79.50. Two year guarantee! Three factories, U.S.-Canada. 1,200 dealers—Service Centers nationwide. Finest instruments at any price! Budget terms. Dealer inquiries invited. Write: White's Electronics, Inc., Dept. PA5T, 1011 Pleasant Valley Road, Sweet Home, Oregon 97386.

**FIND** Buried treasure with patented metal detectors that distinguish Metallic trash from treasure, have push button and automatic tuning, ground pickup eliminate feature, great range, etc. Free catalogue. Gardiner Electronics, Dept. 9, 4729 N. 7th Avenue, Phoenix, Arizona 85013.

**JOIN** Treasure Clubs and Treasure Hunts. Send stamped addressed envelope and \$1.00 for national list. Wolf, Box 187 MPO, Newport, RI 02840.

**DON'T DIG TRASH!** Owners report our "Selectmatic" Detector best. Differentiates treasure faster; deeper. Patented against imitations. Treasure Electronics, Rt. 1, Box 56MN, Benton, La. 71006 CALL 318-965-0277.

**TREASURE FINDER** Locates buried gold, silver, coins, treasures. 6 powerful models. Instant financing available. Write or call for free catalog. Phone (713) 682-2728 day or night. Dealer inquiries invited. Relco, Dept. AA21, Box 10839, Houston, Texas 77018.

**"DETECTOR** Buying Hints"; "Treasure Hunting Tips"; Both \$1.00. "Treasure Under Your Feet", adventurers' handbook of metal detecting \$3.95. Free catalog ghost town, treasure books. Slocum Books, Box 655A, Simi, Calif. 93065.

**GOLD!** Where to pan it throughout U.S. **FREE DETAILS:** Moran, 2-S Van Buren, Scotia, N.Y. 12302.

## GOLD

**NOW! FIND GOLD, OLD MINES, BURIED TREASURES, PAN NUGGETS, AMAZING GUIDE REVEALS HOW. DETAILS FREE.** Dave Hunt, Roosevelt, Utah 84066.

**SLUICE BOX** Complete Plans and Instructions \$1.00. McCormack Construction, 1955 So. 2nd, Pocatello, Idaho 83201.

## PRECIOUS STONES & MINERALS

**GET** Free catalog no serious rockhound, gem cutter, jewelry maker, hobbyist or craftsman can be without. Full of bargains, exclusive items, low prices from largest suppliers and authorities in the field. Free new catalog just off the press, yours for the asking. Write: Grieger's, Dept. C-12, 900 South Arroyo Pkwy., Pasadena, California 91105.

**500 POLISHED** Gemstones \$5.00. Tumblecraft, 5401 James North, Minneapolis, Minn. 55430.

**PLASTIC** Casting Supplies, Molds, Jewelry Mountings, Cut Stones. Wholesale Catalog 25¢. Eloxite, 806B 10th St., Wheatland, Wyo. 82201.

**SYNTHETIC YAG DIAMONDS**, Super Brilliant. Phillips, Box 126, Brady Lake, Ohio 44211.

**RECEIVE** Valuable Minerals Monthly!! Free Information. Mineral of Month Club, 13057M6 California, Yucaipa, California 92399.

## CARTOONING, COMMERCIAL ARTS,

**LEARN** Sign painting at home. Free Talent test. Ben Kerns, Box 812-PM, Greenville, S.C. 29601.

**SIGN** Painting—\$1000 per Month Part-Time. Free Catalogue. Kaufmann Supply, Centertown, Missouri 65023.

**MODERN** Cartooning taught by mail. Write for free brochure. Cartoonorama—Box 263-PMF, Branford, Conn. 06405.

**COMPACT** 23 lesson Cartoon Course and Cartoonist's Magazine. \$2.00. Hartman, Box 30367, Lincoln, Nebraska 68510.

**FASCINATING** Systems. Sign Painting-Cartooning. Straley, 1704 South Center, Springfield, Ohio 45506.

**MONEYMAKING** 32 Cartoon Lessons—Including Cartoonist's Folders! "Extras"!! \$2.50. Art, Box 89, Woodmere, New York 11598.

## ADVERTISING AGENCIES, ADV. SERVICES, MAILING LISTS

**ADVERTISING** Ratebook leading newspapers, magazines. \$1.00. Chicago Advertising Agency, 28-E Jackson, Chicago 60604.

**MAILING** List, Most all Kinds, \$10.00 per M, 500 Circulars mailed \$7.00. Dixmailers, King, NC 27021.

**MONEYMAKING** Mailbuyers lists! Details, Sample lists \$1.00. Garco, 507 Fifth Ave., NYC, NY 10017.

## TYPEWRITERS, DUPLICATORS, OFFICE EQUIPMENT

**MAILORDER RECORDS** Help get increased business! Complete 32 Page Record Book shows you inquires, orders, advertising, expense, etc. Only \$1.00. H. E. KAPPEL, POPULAR MECHANICS, DEPT. R, 224 WEST 57TH STREET, NEW YORK, N.Y. 10019.

## RUBBER STAMPS

**CUSTOM** Made Stamps. Free Catalog. ALLEGHENY, Box 14C, East McKeesport, PA 15035.

**PERSONAL** Printer—Self contained compact case. 3-4 lines. \$4.95. Accardo's, Box 29262, New Orleans, Louisiana 70189.

**FREE** catalog—Rubber Stamps—Signature Stamps—Business Cards. Youngers Stamp Shop, Princeton, Iowa 52768.

**3-LINE** Stamps, \$2.50. Signature Stamps, \$5.95. Tabco, Tomkins Cove, New York 10986.

**THREE** Line Stamps \$2.50. Signature Stamps \$5.50. Temple, Box 287, San Fernando, CA 91340.

**STAMPS** Reasonably Priced. Signature Stamps \$4.95. Free Circular. ERMAXI, Monrovia, Ind. 46157.

## OFFICE SUPPLIES

**PROFITS FROM CLASSIFIED ADVERTISING!** Booklet shows you how to start your own business with Classified Advertising. Only \$1.00 (Refundable with first order.) H. E. KAPPEL, POPULAR MECHANICS, DEPT. P, 224 WEST 57TH STREET, NEW YORK, N.Y. 10019.

## PRINTING PRESSES, RUBBER STAMP OUTFITS

**SIMPLE-X RUBBER STAMP PRESSES**, Hydraulic operated, electrically heated. Sizes 5" x 8", 8" x 12", 10" x 15". Starting outfits. Orders for presses, supplies shipped day received. Send \$2.00 for Catalog and brochure. Custom Manufacturers, 2251-P N. Golden, Springfield, Mo. 65806.

**PRINTING** Type. 8 to 48 point. \$4.00 per font. Free list. Superior Lino, Box 12324, North Kansas City, Mo. 64116.

**PRINTING** MACHINES. Offset, Mimeograph, Typewriters, Composing, Machines, Digraph, King, North Carolina 27021

**NEW** Catalog No. 13, 120 Pages, hand printing presses, type fonts, supplies. Send \$1.00 deductible first order. Acme Type, 732 Federal, Chicago, Illinois 60605.

**RUBBER** Stamp manufacturers supplies. Presses, starting outfits. Best prices, service. Catalog. Jackson Supply, Box 443A, Franklin Park, Ill. 60131.

(Continued on next page)



## PRINTING PRESSES, RUBBER STAMP OUTFITS

(Continued from preceding page)

**SAME** Day shipment on rubber stamp supplies. Revised wholesale price list No. 11 free. Star Stamp Supply, 732 Federal, Chicago, Ill. 60605.

**PRINT YOUR OWN**—Printing Presses, type, supplies direct from factory. Send 25¢ for catalog and samples to: Kelsey Co., DM, Meriden, Conn. 06450.

**PRINTING** Presses, type, Supplies Lists, 10¢. Turnbaugh Service, Mechanicsburg, Pennsylvania 17055.

**RUBBER** Stamp Presses, starting Kits, Type, Supplies. Barco Type Founders, 237 S. Evergreen, Bensenville, Ill. 60106.

**RUBBER** Stamp Supplies; Starting Outfits. Martin, 1432 Major, Jefferson City, Mo. 65101.

## PRINTING AND SUPPLIES

**1000** EMBOSSED Business Cards \$6.25 Postpaid. Agents Wanted. Elco, 181-A, Sylvania, Ohio 43560.

**NOVELTY** Business cards. Free sample. Empire-PM, 1916 Fifth, Sacramento, California 95814.

**FREE** Literature, Business Cards, Letterheads, Labels, Rubber Stamps. Geer's, 111 North Drive, Ottawa, Ohio 45875.

**SHIPPING LABELS**, gummed mailing, \$5.00 per 1,000 prepaid. Halderman's, Girard, Kansas 66743.

**\$7.90** YOUR COPY Reverse of 1000, 8 1/2 x 11 Circulars, your copy black ink. Mailtrade, Box 1302, Springfield, IL 62705. Samples 20¢ stamps.

**FREE** Literature: Rubber Stamps, Books, Business Cards, Printing, Labels. Jordan's, 552 West O'Connor, Lima, Ohio 45801.

**QUICK** Copy Offset Printing. Free Introductory Offer, Nationwide Printing, 614 North Main, Bloomington, Illinois 61701.

**EMBOSS** Business Cards \$6.10. Agents Wanted. Printers, Box 2426, Alderwood Manor, Wa. 98036.

**200** BUSINESS Letterheads, 200 envelopes! BOTH! \$9.00 Total! Halderman's, Girard, Kansas 66743.

**100** BUSINESS CARDS \$2.00 postpaid—3 Lines. Gateway, Box 927, Hialeah, Fla. 33011.

**STAMPS** - 3 Lines - \$2.50 - Business Cards - Catalog - Stamps, 1737 W. Coolidge, Phoenix, Az. 85015.

**PAPER MILL** SECONDS, Coated Card Stock. Generous Sample \$5.00. Willoughby, Box 121, Watervliet, Michigan 49098.

**IRON** ONS, BUMPER STICKERS Made to order Small orders preferred. Free Details. HUGH'S SCREEN SCENE, 7754 Emerson Road, Hyattsville, Md. 20784.

**FREE** Literature: Business Cards, Rubber Stamps, Printing. Monarch, Box 6716B, Reno, Nevada 89503.

## GUMMED LABELS

**1000** GUMMED Address Labels \$1.00. Walt's, Box 960A, South Bend, Indiana 46624.

**1,000** GUMMED ADDRESS LABELS \$1.00. FREE LITERATURE, Acme, 1238 Voskamp, Pittsburgh, Pennsylvania 15212.

**"STOP** LICKING POISON 500 pressure stick address labels @ \$2.25. Lundy, Box 941, La Habra, Calif. 90631."

## REMAILING SERVICE

**CONFIDENTIAL** Montreal Address. Receiving-Forwarding. Single remails 25¢. Business—Personal. Monthly rates. Postcards. Details, Quebec Dior Service, 6231 Louis-Hebert, Montreal, Canada H2G 2G6.

**YOUR** Mail Received, Forwarded. Details Free Westcoast, 1323 Euclid Avenue, M-65, Bellingham, Wash. 98225.

**MIAMI** 25¢. Letters remailed from 130 foreign cities. 300 U.S. cities. Marie, Box 1266, Miami, Florida 33134.

**SECRET.** Receiving—forwarding. Discreet and confidential. Remail 25¢ single. Mail Forwarding Service, 8050 S. Main, Houston, Texas 77025.

**HAWAII** Confidential Remailing 25¢. Bator, PO Box 8821-88, Honolulu, Hawaii 96815.

**DEPENDABLE.** Confidential, Free Information. Harding, 642 LaBrook Drive, Richmond, Virginia 23225.

**CONFIDENTIAL** New York Mail Address \$5.00 Month. Telephone service \$5.00 Remails 25¢. Call Director, 1540 Broadway, Suite 303, New York 10036 212-221-1246.

**CONFIDENTIAL!** Receiving-Forwarding. Free Brochure. Johl, Box 600-M, Stanton, Calif. 90680.

**K.C. CONFIDENTIAL** Remails 25¢. Forwarding. KCC, Box 412, Kansas City, Missouri 64141.

**PHILADELPHIA,** Bicentennial City, remails 25¢, 5/\$1.00. Mills, 36 Dewey, Cheltenham, Pa. 19012.

**CONCEAL** Your Location; Use Our Address. Wright, BOX-2112, Asheville, NC 28802.

**INDIANA** Remails. Monthly rates. LSFM, 2005 Water-view, Ct.-D, South Bend, IN. 46637.

**YOUR** Mail Received-Forwarded. Hedgpeth, 324-M South First, Alhambra, Calif. 91802.

**NEW YORK** Your Mail Received—Forwarded—25¢. Whalen, P.O. Box 1183, Woodhaven, New York 11421.

**FREE** NASA Viewcard. Space City Remails, Box 9296PM, Houston, Texas 77011.

**WILL** It Play in Peoria? Remails 25¢. Elocin Enterprises, Box 149, Peoria, Ill. 61601.

156 POPULAR MECHANICS

## SPECIAL SERVICES

**INFORMATION** On anything. Ferguson Research Specialists. 60-15 Woodside, Woodside, New York 11377.

**QUESTIONS** Answered, Library Research, Book Reports, Almost Any Subject. Write For Price For Question or report required. Tatum Research Service, 413 1/2 Montrose, Lufkin, Texas 75901.

**1974 POPULAR MECHANICS INDEX & SHELL WRAPPER** Actually Converts Your '74 PM Issues into a Complete "Reference Library." Over 5,000 Entries From the Past Year Are Cross Referenced and Built into a Handsome and Sturdy Lacquer Board Shelf Wrapper. From "A Penthouse for A VW Beetle" to "16 Ways to Hide Plywood Edges." It's All at Your Finger Tips. \$2.69 post paid. PM Index-Wrapper, Dept. HE, Box 1014, Radio City, N.Y. 10014.

## BETTER HEALTH

**WORLD'S** Most Outspoken Publication, Natural Health, Healing, Organic Gardening. Free Copy. Provoker Press, St. Catharines 102, Ontario. L2R 7C9

**NOW!** Security for your family in time of food crisis. Valuable free information. Clark, 503B6, 1776 Lambert, Provo, Utah 84601.

**STOP** Smoking—Easy 4-step formula. Guaranteed—\$2.00. Bob's Engraving, R.R.I., Albert Lea, Minn. 55007.

**BOOKLET**—"A Dozen And One Ways To Stop Smoking". Copyrighted. \$1.00. D. L. Fisher, P.O. Box 1517, Iowa City, Iowa 52240.

**STOP** Smoking! You Can! Act Now! \$1.00. Shu-Rich, Box 128, Tesuque, New Mexico 87574.

**PURE BEE PULLEN** The Scandinavian Secret from Lush Tropical Vegetation \$12.00 per 2 lbs. ppd. send 50¢ for the book POLLEN, STRENGTH, VITALITY, LONGEVITY. Postal, money orders only. Clarke Enterprises, 29 Shortwood Rd., Kingston Eight, Jamaica, W.I. Trade Enquiries invited.

**BREAST** Hygiene Self Examination - Other Information, Send \$1.00. Hygiene, Box 6400, Baltimore, Maryland 21230.

**SMOKERS**—Good News! No need to quit. Now there's a safe and practical alternative. Send \$2.00 to DELMET INC., 423 Orchard Place, Meadville, Pa. 16335.

**SAVE** Money - Stop Smoking. \$1.00. Seldnac, Box 163M, West End, N.J. 07740.

**ASTHMA RUPTURE**—I ENDED BOTH. Free Facts—Say Which. John Mortimer, Box 608, Victoria, B.C., Canada V8W 2P3.

## PERSONAL

**CONTEST WINNING SYSTEM.** Win Contests! Sweepstakes: Booklet containing the inside secrets of contest winning revealed! Send \$1.00 to RWA Systems, P.O. Box 1126, Glendale Hts., Ill. 60137.

**"HOW** To Make A Complaint And—Get Action!"—\$3.00. Details on other How-to-books, 35¢ and SASE. Books, 614-A South Summer St., Holyoke, Ma. 01040.

**CONTEST WINNER REVEALS METHOD!** Complete Details—Only \$1.00—Guaranteed. Anderson, Box 4491, Ft. Myers, Fla. 33903.

**TATTOO?** Remove: Slow, Sure Method! Mail \$3.00 To: Taurus Enterprises, Box 35237, Station 'E', Vancouver, British Columbia, Canada. V6M 4G4.

**PSORIASIS SUFFERERS: DISCOURAGED?** Write for Free important information that is helping thousands. Pixacol, Box 29277-PM, Parma, Ohio 44129.

**NEED** Money—Debts Too Big? Consolidate Bills. "Quick-Cash" Emergency Loans Available. Helped Thousands since 1936. Free Application. Interstate, 28 E. Jackson, Suite 1204-X3, Chicago 60604.

**INVESTIGATORS.** Latest electronic Aids. Free Literature. Clifton, 11500-P NW 7th Ave., Miami, Florida 33168.

**BIBLE** Questions answered. Stamped envelope. Bylon, 17167 Bentler, Detroit, Michigan 48219.

**ESCAPE** From debts and bill collectors! Have AAA-1 credit everywhere. Free report reveals secret plan! Credit 4A6, 333 North Michigan, Chicago 60601.

**RECORD** Telephone Conversation automatically. Leave Recorder Unattended. Robert's, Box 49-PM6, Parkridge, Illinois 60068.

**SECRET** LOANS By Mail. Borrow \$100 to \$3000 for any good reason in absolute privacy. No interviews, no endorsers, no co-signers. Fast service. Write: Dial Finance, Dept. 3079, 340 S.W. Eighth Street, Des Moines, Iowa 50309.

**LOOK** younger than your age, my secrets of health write for free information. "Secrets", P.O. Box 711, Metairie, Louisiana 70004.

**DON'T** DIE Without a will! Protect your family! Blank Will form only \$2 . . . guaranteed! Order today. Castleway, Box 29844, Dept. 1A6, Atlanta 30329.

**ARE YOU STILL PAYING TAXES?** Be President of your own tax-exempt Church or other non-profit Corporation. **FINANCE YOUR DREAMS.** Get Foundation grants. Free details. TOU-PM6, 6311 Yucca, Hollywood, California 90028.

**YOU** Can have Confidence and Power with other people. Create good first impressions, make them say yes. **CONFIDENCE,** the difference between a hero and a zero. 164 Page Book Reveals Ways. Send \$2.25 postpaid. George Grant, 1563 Tarberry Street, Houston, Texas 77088.

**INTERESTING** Electronic device for telephone "experiments." Info: Garrison Protective Service, 42-55 Golden, Flushing, New York, 11351

**BALD?** Details on all methods of hair replacement, \$3.00. Graham A6, 7305 Mayapple Road, Jacksonville, Florida 32211.

**CHEC.** AKA, J. ELLI BUKEAU SNOOPS Have filed on you. Demand your rights. Do it Yourself from Home. Protect your Name. Correct irregularities. Send \$5.00 to "Credit Watchers Kit." 2 Penn Plaza, New York, New York 10001.

**"NEW** Scientific Way To Predict Your Future. Free Details. J. Martin, 5459 Coolbrook, Montreal, Quebec."

**TELEPHONE** Recording, Debugging, Security Equipment. Factory Direct Prices. Top Quality. Viking International, P.O. Box 632, Newhall, California 91322.

**BALDNESS** & Hair transplant—Send for the only documented information—researched 19 yrs. Easy to read—Clinical procedure—Availability of Drs. \$3.75 M.O. Hair, 4050 So. Fox, Englewood, Colo. 80110.

**HOW TO STOP** SMOKING. Pamphlet giving psychological approach. \$2.00. Guaranteed. Limited supply. Bristol, Box 71, South Dartmouth, Massachusetts 02748.

## SOCIAL SECURITY PLATES

**GOLDEN** ENGRAVED SOCIAL SECURITY Plate with case \$2.00. Cloverleaf, Box 49, Selbyville, Del. 19975.

## WANTED MISCELLANEOUS

**MERCURY** Gold, Silver, Platinum; Ores assayed. Wholesale Terminal, Norwood, Mass. 02062.

## WINEMAKING & OTHER RECIPES

**WINEMAKERS** FREE ILLUSTRATED Supply catalog of yeast, equipment. Continental, Box 18223-rM, Indianapolis, Ind. 46218.

**WINEMAKERS** use at-home utensils to **CREATE DELICIOUS WINES** and Champagnes. Easy directions. No special equipment. Satisfaction Guaranteed. Send \$2.00. **MULTIPLE MARKETING SERVICE,** Box 2086D6, INGLEWOOD, CALIFORNIA 90305.

**HOT TAMALES**—Easy. How-to Photos. \$2.00 - Martinez, Box 621, Santa Fe, N.M. 87501.

**WINEMAKERS!!!** Make Delicious Wine and Champagne at Home. No Special Equipment Needed. Fantastic Taste!! Moneyback Guarantee. \$2.00. Combs, Box 12251, Cincinnati, Ohio 45212.

**WINEMAKING** Made Easy. Simple Instructions Using Kitchen Utensils. Guaranteed—\$1.00. Stardan, 10775 S.W. Hawthorne Lane, Portland, Oregon 97225.

**WINE—CHAMPAGNE—BEER!!!** Guaranteed recipes. No special equipment. \$1.98 Davco, Box 9488B1F, New London, Conn. 06320.

**CHILI,** Old family recipe \$1.50. Martco, Box 544, Westminster, Colo. 80030.

**DELICIOUS** Wine Recipes! . . . Only \$2.00! . . . Dale Co., Box N, Dept. 1-F, Osseo, Minn. 55369.

**MAKE . . .** Wine . . . Champagne . . . \$2.00. American Enterprises, Box 666D, San Juan Capistrano, California 92675.

**COUNTRY WINE** Made Easy. Surefire Methods for Making Wine at Home. No Special Equipment Needed. (Guaranteed). \$2.00. Arlens, 1302 Hawthorn Drive, West Bend, WI. 53095.

**FREE!** German Beer Recipe With Purchase of Delicious Home Wine And Champagne Recipe Booklet \$1.25. George, 436 Pluto Ct., Littleton, Colo. 80124.

**WINEMAKING** Instructions \$1.00. Ron Kelly, 25 Shadow Road, Melrose, Mass. 02176.

**WINEMAKING** Made Easy! Simple Instructions. Amazing Results. Guaranteed. \$2.00—D. Parker, Box 46548PM, Los Angeles, Calif. 90046.

**BETTER** Wines and Champagne. Kitchen Vessels used. Booklet \$3.98. J&L Place, Box 773, Tatum, Texas 75691.

**WINEMAKING,** Yogurt, Cheesemaking. Free catalog. Arbolyn, Box 663, West Columbia, S.C. 29169.

**WINEMAKER'S** Supply Catalog—Free. Bacchanalia, 273 Riverside Ave., Westport, Conn. 06880.

**WINEMAKERS.** Free illustrated catalog of yeasts, equipment. Semplex, Box 12276R, Minneapolis, Minn. 55412.

**WINEMAKERS** Free Informative Catalog, Yeast Equipment, Ingredients, DANENBERGER'S, Box 276-M, New Berlin, Ill. 62670.

**NEW! . . . FREE CATALOG . . . 30 VARIETIES FRUIT & GRAPE CONCENTRATES . . . 100 WINE & LIQUEUR FLAVORS.** Complete line of Winemaking Supplies. Kraus, Box 451-L, Nevada, Missouri 64772.

**FREE**—German Beer Recipe—With Purchase of Delicious Wine/Champagne Recipe booklet using Kitchen Utensils—Guaranteed \$2.00. Bob's Engraving, R.R.I., Albert Lea, Minn. 56007.

**BEER** Home Recipe—Real German Brew. Send \$1.75: Fredrick Enter., Box 272, Mt. Pleasant, Utah 84647.

## MISCELLANEOUS

**4 WHEEL** Drive, Build your ATV from readily available material (it works). Info Pak \$5.00—Plans \$20.00. Bulldog Engineering, 509 Industrial Ave., Boynton Beach, Fla. 33435.

**BOOKS** On antiques and their prices. Free circular!! P. Warman Publishers. Uniontown, Penna. 15401.

**DON'T** Die Without A Will! Protect Your Family. Quality Will Forms (2) Only \$2.00—Guaranteed. Order now! AJG, 12446 Otsego, Dept 1C6, No. Hollywood, Calif. 91607.

**DENIM** FADER . . . ! No more stiff, dark jeans!! Enjoy the look and feel of naturally aged jeans—create personalized designs!! Order now—Only 4.95—Guaranteed! Vitko, PM1, 6-355 Larouche Vania Ontario. K1L 7L7.

(Continued on next page) 



## MISCELLANEOUS

(Continued from preceding page)

**NOW!** Security for your family in time of food crisis. Valuable free information, Clark, 50486, 1776 Lambert, Provo, Utah 84601.

**SAUSAGE** Making 50 Recipes. Curing Smoking Hams Bacon Poultry Fish Venison. Premixed Spices Cures Casings Smokehouse Ideas. Free Catalog. RAK, Dept. 10, Box 4155, Las Vegas, Nevada 89106.

**ORNAMENTAL** Iron designs. Book of 1600 beautiful, practical designs for railings, columns, etc. Free literature. Cunningham, 3881 South 3200 West, Box 20005, Salt Lake City, Utah 84120.

**IDENTIFICATION CARDS.** Send stamped self-addressed envelope for samples. NIPCOM, 727 North Main, Las Vegas, Nevada 89101.

**WIN!** Casino Games! Free Details! Xcito Games, 5715 N. Mozart, Chicago, Illinois 60659.

**HEARING AID** batteries wholesale. Free list. Habs, Box 51, York, Penna. 17405.

**ROLL** Your own Cigarettes with American Blend or Menthol Tobacco. Cigarette Makers and papers available. For free Tobacco sample write Green River Tobacco, Box 1313M, Owensboro, Ky. 42301.

**PHOTO I.D. Cards.** Free Samples. Publications, Box 26062P, Los Angeles, Calif. 90026.

**WEALTH - HAPPINESS PRINCIPLES.** Free information. Arteric - PMB, Box 5025, Fresno, California 93755.

**PRESCRIPTION EYEGLASSES.** Free Catalog. A-Z Optical Company, Box 175, Dept. R26, Bay Station, Brooklyn, New York 11235.

**HORSEPLAYERS**—Free!!!! How Turfwin Won \$300 Weekly. Guaranteed! Turfwin, Box 581 PM6, Port Washington, N.Y. 11050.

**REVOLUTIONARY** Alternative Energy Source. Detailed booklet \$2.00. Technical Advances Co., 3465 Loma Vista, Flagstaff, Ariz. 86001.

**BLACKJACK PLAYERS!** Computer proven strategy. \$1.00. Guaranteed. Systems, Box 53485B, Houston 77052.

**I.Q. Test** in 45 minutes. Guaranteed!! \$4.00. Test, 971 Elden #45, Los Angeles 90006.

**SAVE HUNDREDS OF DOLLARS** By saving energy. "101 Ways You Can Save Money, Resources, and Energy." Only \$2.00 Project Energy, Box 30307B, Bethesda, Md. 20014.

**MIRACLE MIRROR!!** See yourself from head to toe—only 4" high—stands anywhere—case included—\$1.35—Guaranteed. Morgan's Specialties, Box 882, Homestead, Fla. 33030.

**MUGGING, Robbery.** Free Literature. Newest Items. Self and Family Protection. Safe and Legal. Scott, Box 1270P, Southampton, N.Y. 11968.

**STILL BUILDING BOOK,** 57 Drawings, 6 Models. All sizes from Stovetop to Mountaintop! 100 pages, \$3.75. DOCUMENTED, Box 1004, Fostoria, Ohio 44830.

**CHESSPLAYERS;** New Additional Game To Chess: "THE BIG WAR". Your Strategy Determines How Long it Lasts. Your Army Moves on Land, Air and Sea. Nothing to Learn if You Know Chess. Rules and Regulations \$3.00. House of Torsten, Dept. 6B1, 4636 West 103 Street, Oaklawn, Illinois 60453.

**"GET EVERYTHING YOUR GOVERNMENT HAS TO GIVE".** Details 25¢. Custom House, Patterson, New York 12563.

**DON'T DIE** without a will! Blank Will form protects your family. Only \$2—guaranteed! Order today!! World, Box 1891, Dept. 1A6, St. John's, Nfld., Canada.

**LOST DIPLOMA!!** Blank high school diploma, you fill in. Birth certificate included. Send \$2.00. Morgan House, A-1 6108 Spyglass, Garland, Texas 75041.

**TATTOOING:** Complete Inventory of Equipment and Supplies for Professional and Amateur. Transistor Driven Machines. Illustrated information. Paul's Art Supplies, Box 8073, LaCrescenta, California 91214.

**ADDRESS List** of 200 Professional Baseball Players \$2.00. Zwicke, 547 Hoboken Rd., Carlstadt, N.J. 07072.

**CLOCK** Movements, Dials—Cuckoo, Grandfather, Mantle, Chime, Wall, Battery, Electric. Details 50¢. Clock Repair Center, Dept. 26, P.O. Box 65, Carle Place, N.Y. 11514.

**11 RECIPES** 5 Beef-Venison Jerky, 3 Sausage, 2 Smoked Fish, Salami. Plus How To Build A Smokehouse. \$5.00 Write—Recipes, Box 152, Anaconda, Montana 59711.

**BARGAIN** Birth Certificate, Will, Diploma, plus free gift \$2.00. Zwicke, 547 Hoboken Rd., Carlstadt, NJ 07072.

**HOW INTELLIGENT** Are you? Self-scoring test reveals I.Q. in 45 minutes! Send \$2.00 today—guaranteed! Motivational Publications, Dept. 15C, Box 7147, London, Ont. Canada.

**VICTORY** Miracle Magic all purpose Polishing cloth. \$1.00. Ruth Brown, Route 3, Box 107, Alken, S.Car. 29801.

**YOUR DOG AND CAT MAY BE SUFFERING!!!** Learn how you can help your pet . . . Hundreds of questions and answers about: Emergency First-Aid, Fleas, Worms, Ticks, Feeding, Diseases, Neutering, Mating, and many more . . . Guaranteed!!! Send \$4.98. Prano, Dept. 1H6, 322 Sharrots Road, Staten Island, N.Y. 10309.

**BOOT-PULLER,** While Standing Up. Easy instructions 50¢ or ready made \$5.00. P.O. Box 335, Monticello, Indiana 47960.

## BURGLAR ALARMS & HOME PROTECTION

**FREE** Catalog On Burglar-Fire Alarm Equipment. Vancor Security Systems, Box 438N, Boston, Mass. 02144.

**LOCKSMITHING** Supplies—Buyers Guide \$1.00. Despubs, Box 22005H, Phoenix, Arizona 85028.

**FREE** Catalog on Burglar-Fire Alarm Equipment. Protecto Alarm Sales, Box 357-D, Birch Run, Michigan 48415.

**CHAIN** Burglar Alarm install on Windows or Doors. \$3.75. James E. Dow, Sr., P.O. Box 2342, S. Hackensack, N.J. 07606.

**DIALING** Unit automatically calls police. \$29.95. Free literature. S&S Supply, Box 12375D, North Kansas City, Mo. 64116.

**DOUBLE** Duty Alert—Combination burglar/fire alarm. 24 hour protection!! Installs in seconds. \$8.95 - batteries included. Guaranteed!! Order Now!! Sunshine, Box 2100, Dept. PM-6, Boca Raton, Florida 33432.

**PROTECT YOUR HOME!!** Alarm warns of excess heat or intruders with piercing siren. \$8.95 Batteries included. Guaranteed. Ray Enterprises, Box 274A, Norfolk, Virginia 23501.

**BURGLAR/FIRE** Alarm protection in seconds!! Easy Permanent/Portable installation home or away. Guaranteed! Send \$9.95. BNB Postals, Box 170, Birch Run, Mich. 48415.

**FIRE** And **BURGLAR** Alarm. Loud Warning! Needs 2 "D" Batteries. Only \$4.95-Guaranteed! Hawkins, 345 West Delz, Houston, 77018.

**FREE** Burglar/Fire Alarm Catalog! Simple installation instructions With Order. Steffenco, P.O. Box 624, Cranford, N.J. 07016.

**PROTECT YOURSELF** Against fire and intruders . . . "Dual Alarm System!" Alarm triggers automatically at 135°F and upon forceful entry. Easy Installation . . . battery powered. Protection guaranteed! Only \$8.95. Best Enterprise, 129 West 147 Street, New York 10039.

**PROTECT** Your home against fire and intruders for only \$6.00. Combined fire-burglar alarm. Mounts on doors, windows. \$10.50 for 2. Mac Security, 16643 Whitby, Livonia, Mi. 48154.



## THIS LABEL SAYS MORE

Popular Mechanics is far and away the acknowledged authority in the ever-expanding field of do-it-yourself activity. Our readers know the Popular Mechanics tradition of total involvement with leisure equipment, workshop accessories, tools, home and car care supplies—in virtually every area in which do-it-yourself products play a vital part. That's why, when you, the PM reader, see this Product Feature Mark on any product, anywhere, you know that product is a solid member of the growing family of products featured within the advertising pages of Popular Mechanics—a magazine devoted to serving the dedicated do-it-yourselfer for over 73 years.





### Handy sewing aid

They're versatile, can cut paper and all kinds of fabrics.

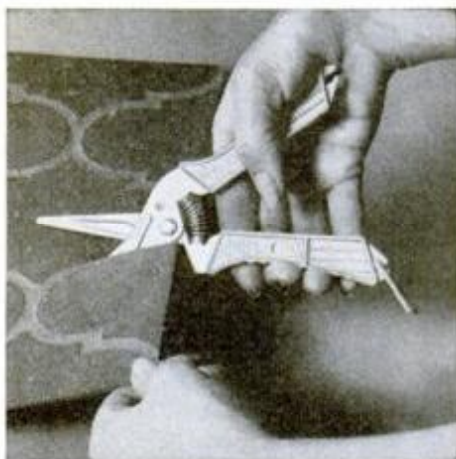

### Hard-working tool

Handles vinyl tiles, linoleum, carpet, wire, other tough material.



### Gardening shears

Snips flowers and shrubs, does work throughout the garden.

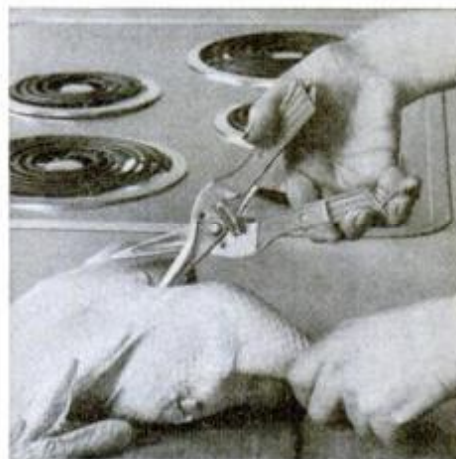

### Kitchen helper

Useful as poultry shears—they'll cut through bones and all.

# Yes! A scissors for almost any household job—only \$4.99

They're called Super Scissors because you can use them all through the house, and out in the garden too. The hard, blunt steel blades are tough enough to cut through almost anything, including baling wire, but designed for snipping paper and delicate fabrics as well. One pair can do it all, but for convenience sake you may want to keep one in the kitchen, where it can take on many cutting tasks, another in your tool kit, for tackling the hardest cutting jobs on do-it-yourself projects. They're handy to have with your sewing gear. Wherever you use them, the bright orange plastic handle makes the scissors easy to find, even in a crowded tool chest. And their blunt blades and safe rounded tips mean that children can use

them, too, for school and play projects. Size, 7¼" long. Price, just \$4.99 including postage, handling.

PM Specialties, Dept. PMAS 065  
P. O. Box 888, Teaneck, N. J. 07666

Enclosed is my check or money order (no cash, please) to POPULAR MECHANICS. Please send me \_\_\_\_\_ Super Scissors at \$4.99 each. Total amount enclosed, \$\_\_\_\_\_.

Name \_\_\_\_\_

Street \_\_\_\_\_

City \_\_\_\_\_

State \_\_\_\_\_ ZIP \_\_\_\_\_

Sorry, we cannot handle Canadian, foreign or C.O.D. orders. Please allow four weeks for delivery.





**Anything else is mock turtle.**



A man with a full, dark beard and long hair, wearing a tan, button-down shirt and blue jeans, is the central figure. He is looking directly at the camera with a serious expression. He holds a pack of Winston cigarettes in his left hand and a lit cigarette in his right. The background is a blurred indoor setting, possibly a workshop or a store, with various items visible on shelves.

If I'm going to smoke,  
I'm going to do it right.

Some people smoke a brand for its image.  
I don't. You can't taste image. I smoke for taste.  
I smoke Winston. All Winston will ever give you  
is real taste. And real pleasure. For some of us,  
that's enough. Winston is for real.

Warning: The Surgeon General Has Determined  
That Cigarette Smoking Is Dangerous to Your Health.

19 mg. "tar", 1.3 mg. nicotine av. per cigarette.  
FTC Report OCT. '74.