

MARCH 1975 75 CENTS

Popular Mechanics

8 pages: Better CAMPING in '75

- Backpacks, tents, equipment ...
20 make-it kits that cut your costs in half
- Lightweight gear for hikers, bikers, drivers
- 14 RVs for leisure living

**10 simple steps to a food bonanza
from a 6 x 15 garden!**

Plus: Composting made easy

**EASY RIDERS: A dozen
powerful new touring bikes —
and a first look
at the hot
Suzuki rotary**

**CASH-SAVING
HOW-TO:**

- Step-by-step
tune-up for your
power mower
- Choose the right
batteries for
home use
- Perk up your car's
ignition system

**10 smashing no-care
vacation homes — with 3
you build from stock plans**

**How to test your drinking water,
and 4 ways to purify it**



Introducing the first

You're looking at a unique-looking automobile.

It's called the Pacer.

And it looks different on the outside because it's different on the inside.

To begin with, the Pacer is wider than any other small car. So naturally, you get an unusual amount of room.

And since it's wider—and has a unique isolated suspension system—the Pacer also gives you an incredibly smooth and stable ride.

The hood of the Pacer looks the way

it does because it was designed for aerodynamic reasons. To reduce the wind resistance. So the engine doesn't have to work as hard at highway speeds. And so you wind up with better gas economy.

(The Pacer comes with AMC's proven 6-cylinder engine and a 22-gallon gas tank. Which means you get outstanding performance, excellent economy and long-distance driving range.)

With our doors we did something that borders on wizardry. We made the passenger



wide small car

door 4 inches bigger than the driver's. So you can get in and out of the back that much easier. (We also gave the Pacer a hatchback so you can get your luggage in and out that much easier, too.)

This same ingenuity was also applied to Pacer's visibility. We wanted you to see as far as your eye can see. From our point

of view, that meant designing the car for better all-round vision. From your point of view, you'll be able to notice all the people noticing you.

A final point. The AMC Pacer, the wide small car, is covered by the wide coverage: AMC's exclusive Buyer Protection Plan.

Everything about the Pacer—the look, the room, the ride, the doors, the visibility, our Plan—make it what it really is: Everything a small car never was.

AMC  PACER



This One



E5B8-Q4J-D7K5

Charlie couldn't hammer a nail straight but now he can panel a room.

"The Whammer made me do it"

Now there really is something that makes paneling a room easy, fast and goof proof. Swingline's Whammer drives and automatically countersinks wood colored nails with a single stroke.

The colored nails become almost invisible so there's no filling needed. No mars. No dents. No scratched panels or smashed fingers. Handles molding too. Pays for itself in no grief, no mistakes and "saved" paneling. Look for it wherever you'd buy a hammer or paneling. But beware—the Whammer will make you do it.

"PERFECT FOR PANELING." *Popular Mechanics*

"AMAZING—AUTOMATICALLY COUNTERSINKS IN ONE STROKE." *Jimmy Sumlin, Bronx, N.Y.*

"NO BANGED THUMBS, FLYING NAILS, MARS OR DENTS." *James Quinlan, Morton, Pa.*

"FAST. NEVER HURTS THE WOOD." *Bob Grisham, Spokane, Wash.*

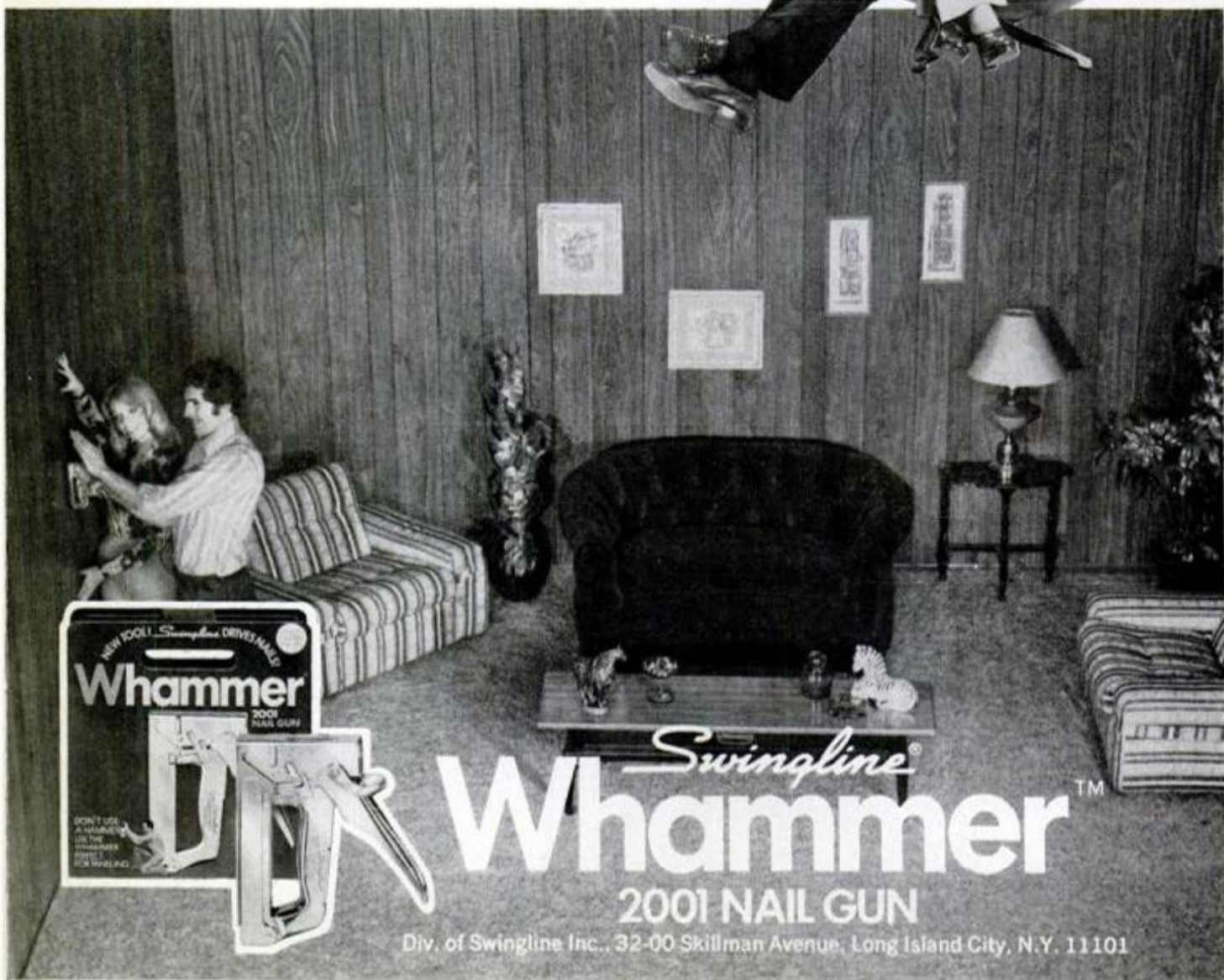

Swingline
Whammer™
2001 NAIL GUN

Div. of Swingline Inc., 32-00 Skillman Avenue, Long Island City, N.Y. 11101

The hole story.

The Rockwell 32-inch drill press starts demonstrating its flexibility when ordinary drill presses start showing their limitations.

For openers, it'll drill to the center of a 32-inch circle. Standard presses hold you to 15 inches. Or less.

For added versatility the head of the Rockwell radial swings a full 360°, giving you drilling accuracy for pieces that fit between the chuck and the floor (or low table).

By tilting the head 90°, you can handle even

larger items like the top of a door. With an ease and accuracy that simply aren't possible for lesser drill presses.

The table is an extra-big 23⁷/₈ inches by 15⁷/₈ inches. Adjustable depth stop, tilt degree scale, plus a host of other features.

Lets you perform horizontal and angular drilling, even multiple and series hole drilling. Get the full story from your local Rockwell retailer. Most have credit terms to fit most budgets. And that's the hole story.



Rockwell International

For more information, write: Power Tool Division, Rockwell International, Suite 303, 3171 Directors Row, Memphis, Tenn. 38131.

AUTOMOBILES AND BIKES

- [20](#) [Detroit Listening Post](#)
- [22](#) [Imports and Motorsports](#)
- [78](#) [PM Owners Report: Chevrolet Monza 2 + 2](#)
- [82](#) [Easy riders: The grand touring motorcycles for '75](#)
- [95](#) [Install a coolant recovery system](#)
- [104](#) [Saturday Mechanic: Service your own ignition system and save up to \\$40](#)
- [107](#) [Exotic materials make easy-going superlight bike frames](#)

HOME AND YARD

- [67](#) [Vacation homes: 10 great designs for leisure living](#)
- [72](#) [Grow a vegetable bonanza in a small plot](#)
- [76](#) [The tiller—backsaver for busting sod](#)
- [111](#) [How to get your power mower ready for the season](#)

ELECTRONICS, RADIO, TV

- [81](#) [The FTC makes amplifiers grow more 'honest'—and more fins](#)
- [92](#) [To buy the best battery, ask what it's going to drive](#)

CAMPING

- [116](#) [Camping goes compact . . . more convenience, less cost](#)
- [118](#) [Sew—You save with camp-gear kits](#)
- [120](#) [New road to Old Mexico](#)
- [120](#) [New RVs for the road](#)
- [122](#) [Rancho-poncho—A quick-change bivouac bag](#)

BOATING

- [102](#) [Seven tips for better boating](#)
- [103](#) [Roller tote for launching](#)
- [140](#) [Sun seats add style to your runabout](#)

SHOP AND CRAFTS

- [42](#) [Hold everything](#)
- [44](#) [Disston's cordless electric screwdriver](#)
- [54, 134, 140B-C-D](#) [Hints from readers](#)
- [86](#) [Shop that became a family fun center](#)
- [90](#) [Butler's table: Serve your guests with a dash of elegance](#)
- [114](#) [Go build a kite](#)

SCIENCE, INVENTIONS

- [46](#) [Holographic movies with white light](#)
- [108](#) [How to keep your drinking water safe](#)

EVERY MONTH

- [9](#) [Letters](#)
- [14](#) [The Bicycle Shop](#)
- [24](#) [Appliance Clinic](#)
- [30](#) [All Outdoors](#)
- [50](#) [Car Clinic](#)
- [60](#) [Homeowner's Clinic](#)
- [62](#) [Science Worldwide](#)
- [96](#) [It's New Now](#)

PHOTOGRAPHY

- [40, 140F](#) [Photo hints](#)

ON THE COVER

Camping is booming this year; these hikers are climbing in Arizona with Coleman backpacks and equipment. *Photo: Thayne Smith*

AS A SERVICE TO READERS, *Popular Mechanics* publishes newsworthy products, techniques and scientific and technological developments. Due to possible variance in the quality and condition of materials and workmanship, *Popular Mechanics* cannot assume responsibility for proper application of techniques or proper and safe functioning of manufactured products or reader-built projects resulting from plans published in this magazine.

Popular Mechanics

MARCH 1975 • Vol. 143 No. 3

INTERNATIONAL EDITIONS: Australia, Caribbean, Mexico, Southern Hemisphere

SPECIAL FEATURES:

More camping for the money in '75. Eight-page section covering backpacks, tents, equipment, cost-saving make-it kits, new RVs starts on page 116.

Vacation homes: 10 great designs for leisure living, including prefabs, a condominium, stock plans. A way to second-home ownership. Page 67.

Grow a vegetable bonanza in a small plot. How to produce plenty of good food for your table from a plot as modest as 6 by 15 feet. Page 72.

Easy riders—the grand touring motorcycles for '75. Your rundown of the great superbikes of cycledom that range from \$2000 to \$4000. Page 82.

The shop that became a family fun center. Basement multipurpose hobby center with sliding wall panels is most popular room in the house. Page 86.

How to keep your drinking water safe. Here's how to tell if you have a water contamination problem and what to do about it. Page 108.



Page 82



Page 120



Page 72



Page 86

POPULAR MECHANICS IS PUBLISHED MONTHLY by the Hearst Corporation, 224 West 57th Street, New York, N.Y. 10019, U.S.A. Single copy for the United States and Canada, 75 cents. Subscription prices: United States and Possessions, \$5.97 for one year; \$10.97 for two years; \$14.97 for three years. Canada, add \$2.00 for each year. All other countries, add \$4.00 for each year. When changing address, give old address as well as the new, with zip code, and allow six weeks for change to become effective. Second-class postage paid at New York, N.Y., and at additional mailing offices. Authorized as second-class mail by the Post Office Department, Ottawa, and for payment of postage in cash. Registered as second-class matter at the Post Office at Mexico, D.F., Mexico, June 20, 1950. © 1975 by The Hearst Corporation. All rights reserved. Printed in U.S.A. Mail all Postmaster notices of undeliverable copies to Popular Mechanics, P.O. Box 646, New York, N.Y. 10019.



If I'm going to smoke,
I'm going to do it right.

Some people smoke a brand for its image.
I don't. You can't taste image. I smoke for taste.
I smoke Winston. All Winston will ever give you
is real taste. And real pleasure. For some of us,
that's enough. Winston is for real.

Warning: The Surgeon General Has Determined
That Cigarette Smoking Is Dangerous to Your Health.

19 mg. "tar," 1.3 mg. nicotine av. per cigarette
FTC Report OCT. '74.

Old Timer knives from Schrade are built to last and last. And, like all good friends, they're dependable. They won't let you down. Every blade is of the finest, high-carbon edge-holding cutlery steel.

The Old Timers have the rugged good looks, comfortable, sturdy feel and sharpness that you expect in a great knife, but hardly ever find.

Schrade Cutlery

Ellenville, N.Y. 12428

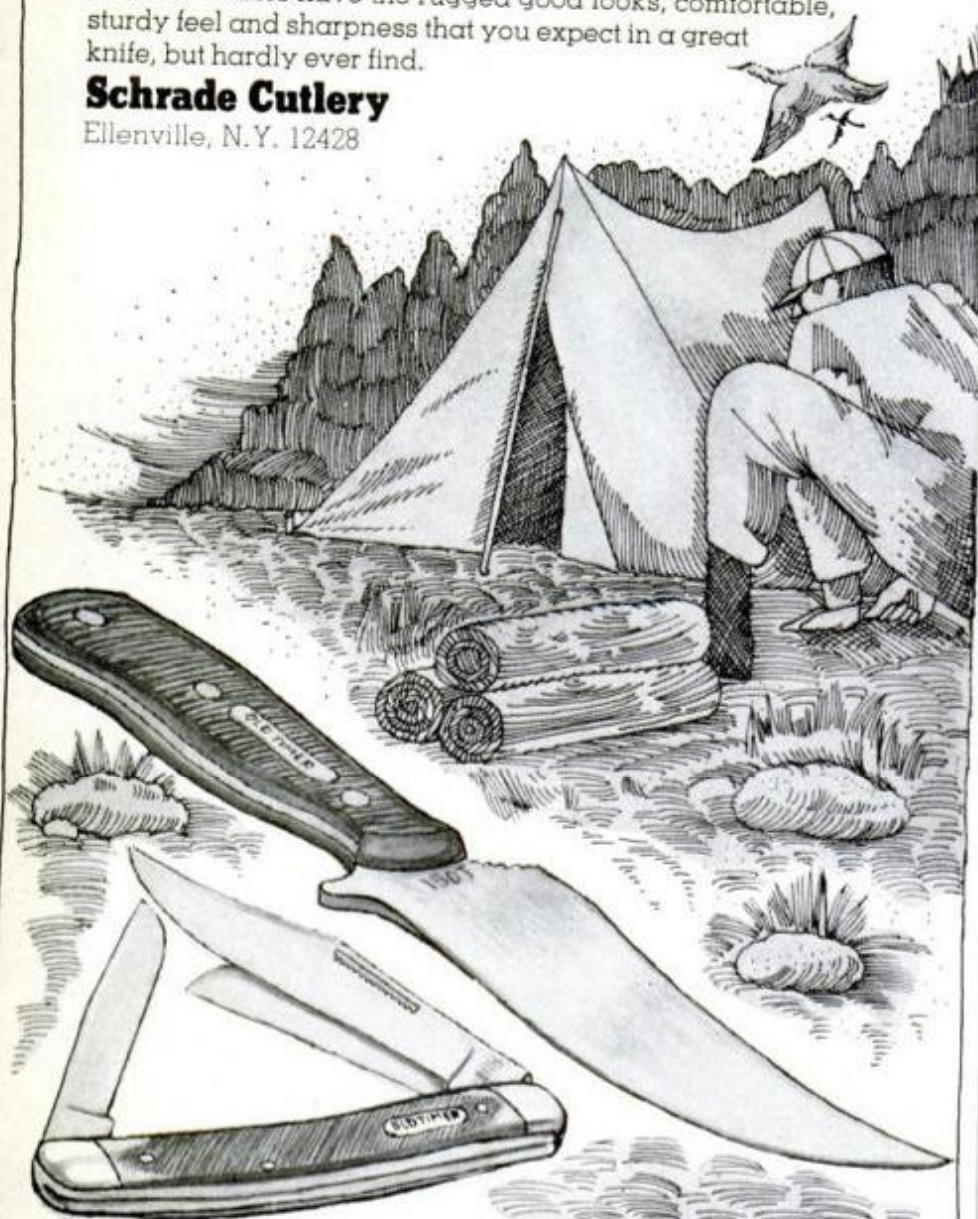

Old Timer[®]
A Man's Best Friend

Popular Mechanics[®]

JOHN A. LINKLETTER

Editor

SHELDON M. GALLAGER

Executive Editor

DANIEL C. FALES

Managing Editor

WAYNE C. LECKEY

Home and Shop Editor

ALVIN KIETZ

Art Director

BILL HARTFORD

Automotive

JOHN F. PEARSON

Science and Engineering

WM. T. McKEOWN

Boating and Outdoors

IVAN BERGER

Electronics and Photography

HARRY WICKS

Home Workshop

STEPHEN WALTON

Assistant, Home and Shop

MICHAEL LAMM

West Coast

ROBERT LUND

Detroit Automotive

GARRY WINTER

Copy Chief

RICHARD H. FUNK

Production

ALFREDO VEGA

Assistant, Production

DAVID KOMITAU

Assistant Art Director

IRA HERRICK

Assistant Art Director

DON L. MANNES

Assistant Art Director

CLIFFORD B. HICKS

Special Publications

LUDWIG ARONS

Special Projects

SOPHIE GRONOWICZ

Director, Bureau of Information

EVERETT JOHNSON

Cabinetmaker

DANIEL J. COLEMAN

Director of Advertising

ADVERTISING OFFICES: New York: 224 W. 57th St., 262-4282; Chicago: 520 N. Michigan Ave., 527-2400; Detroit: General Motors Bldg., TRinity 5-8711; Cleveland: 20310 Chagrin Blvd., Shaker Heights, Ohio, 283-7788; Los Angeles: 601 N. Vermont Ave., 666-6263.

JOHN A. REGINA

Advertising Production Manager

Published by The Hearst Corporation

FRANK MASSI

President

JOHN R. MILLER

Executive Vice President

RANDOLPH A. HEARST

Chairman

RICHARD E. DEEMS

President, Magazines Division

JOSEPH F. KERN

Publisher

POPULAR MECHANICS IS PUBLISHED MONTHLY by the Hearst Corporation, 224 West 57th Street, New York, N.Y. 10019, U.S.A., Frank Massi, President; John R. Miller, Executive Vice President; Randolph A. Hearst, Chairman; Harrison A. Mitnick, Treasurer; Harvey L. Lipton, Vice President and Secretary; Hearst Magazines Division; Richard E. Deems, President; Gilbert C. Maurer, Executive Vice President, Operations; Raymond J. Peterson, Executive Vice President, Advertising; William S. Campbell, Vice President and General Manager; John F. D'Avolio, Vice President and Resident Controller; Albert A. Rachoi, Vice President and Director of Circulation; Joseph F. Kern, Vice President for Popular Mechanics.

ADDRESS ALL EDITORIAL COMMUNICATIONS to 224 West 57th St., New York, N.Y. 10019. For additional sources of information on the articles and products in this issue, write to the Bureau of Information, Popular Mechanics, for free "Where-to-Find-It" List.



GARAGE DOOR OPERATOR RADIO CONTROLLED **\$99⁹⁵!**

- RADIO CONTROLLED from car transmitter or wall switch
- SAFETY night and day, year 'round
- SECURITY door locks tight when closed
- CONVENIENCE in-car control any weather
- LIGHTING garage lights automatically
- VERSATILE fits all lifting type wood, metal or fiberglass doors, sectional and 1-piece
- EASY HOME INSTALLATION in just 2-3 hours
- SAVE up to 50% direct factory purchase and PP or UPS home delivery
- GUARANTEED one year
- FREE brochure

HELMATE EQUIPMENT CO., Box 217PM, Baroda, MI 49101 (616-422-2311)



CHEVELLE.

Its standard V8 could save you \$348 in maintenance and 801 gallons of gas.

If you're looking for some clear information about what you can get in a 1975 mid-size car, this ad is written for you.

Very simply, it will tell you a few of the reasons why, in a time when new car shoppers are making extremely careful comparisons, Chevelle remains America's favorite mid-size car.

Chevelle maintenance savings.

While maintenance costs vary across the country, we used current list prices for parts, \$11 an hour for labor, and found this: If you follow the Owner's Manual for recommended service, a '75 Chevelle standard V8 using unleaded gas with the new Chevrolet Efficiency System could save you \$348 in 50,000 miles (about four years' average use) compared to its 1974 counterpart using leaded gas.

Not only less expense. Less hassle.

Anyone who doesn't enjoy taking his car in for recommended service will enjoy this:

In '74, we recommended that Chevelle owners get an oil change and chassis lubrication every 4 months or 6000 miles. Now it's every 6 months or 7500 miles.

Last year, we recommended new spark plugs every 6000 miles. Now it's 22,500 miles.

Now your Chevelle oil filter can be changed less often. And now you don't even need points or ignition condenser. Ever.

Less expense, yes. But also less hassle.

801 fewer gallons of gas to go 50,000 miles.

It's true.

The Environmental Protection Agency ran

Urban Driving Tests emphasizing stop-and-go city-type driving. We ran GM Proving Ground tests emphasizing suburban-type driving.

They show that a '75 Chevelle standard 350-2 V8 using unleaded fuel could use 801 fewer gallons of gas to go 50,000 miles than a comparable '74 Chevelle using leaded fuel.

801 gallons. Think about the difference that could make the next time you check out local gas prices.

Room you can handle nicely.

Chevelle efficiency goes beyond lower maintenance and fuel costs. So, importantly, Chevelle also offers efficiency of size.

On the one hand, it's large enough to give you room for six people.

On the other hand, it remains neatly manageable; a mid-size car both easy to drive and easy to park.

A wide, sensible choice.

Chevelle, happily, is not one of a kind. You'll find many to choose from, including coupes, sedans and wagons.

Malibu Classic (shown above) is our most distinctive Chevelle. Laguna Type S-3 is our sportiest Chevelle. And our Malibu Six is America's lowest priced mid-size car—based on Manufacturers' Suggested Retail Prices.

Chevelle. America's favorite mid-size. For all kinds of good reasons.

See them at your Chevrolet dealer's now.

CHEVROLET MAKES SENSE FOR AMERICA

Chevrolet

GRAVELY gets the best of the world's worst lawn

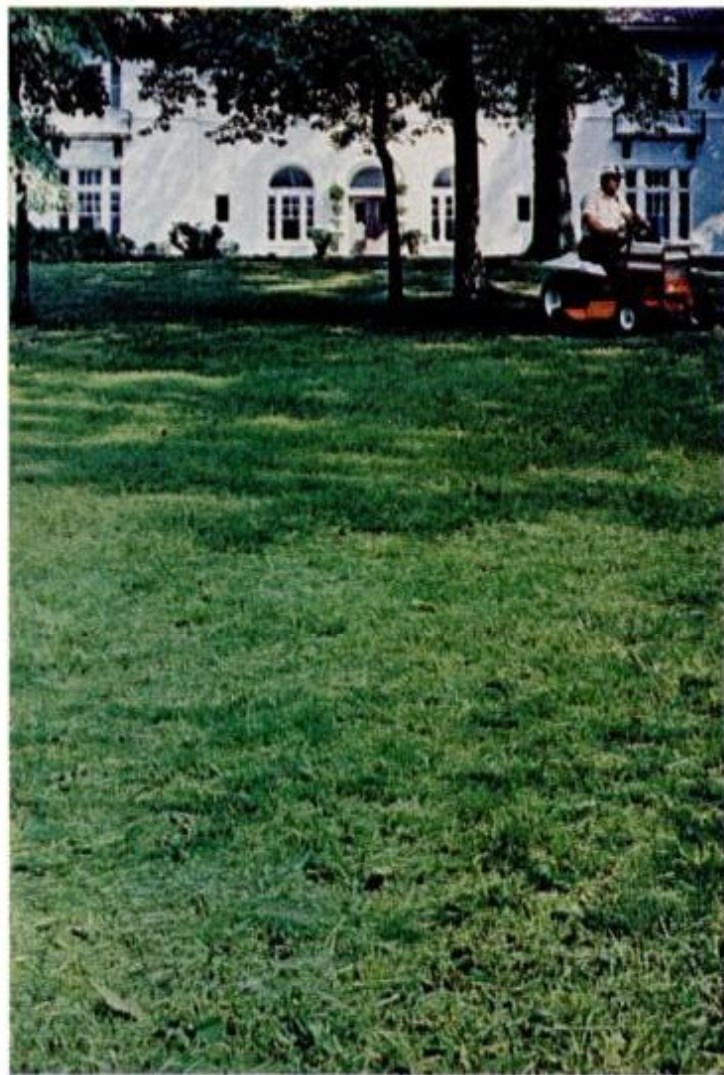

Instant forward-neutral-reverse. Detachable sulky attachment for convertible lets you walk or ride.

with power and ruggedness that mean years of reliable performance for you.

If you think you have a problem lawn, how about this neglected Georgia mansion? To us, it looked like the world's worst lawn, a challenge to any lawn and garden tractor.

But Gravelly was up to it. Knee-high grass, weeds, undergrowth, rough terrain, nothing stopped these rugged tractors and their mowing

attachments. With all-gear drive, plenty of power, and the tough construction to take a test like this in stride, imagine the years of reliable performance you can expect in everyday use.

Write for our free catalog or see your dealer and let him show you how Gravelly can get the best of your lawn, garden, and snow removal chores... even if they're the world's worst!

8-speed transmission gives 800-series riding tractors right speed for any job from 1/2 mph tilling or snow blowing crawl to 8 1/2 mph let's-get-home transport speed. Positive control without fluid drive "surging" or power losses, no belts to slip or break.



GRAVELLY
A DIVISION OF CLARKE-GRAVELLY CORPORATION

4303 Gravelly Lane, Clemmons, N.C. 27012

LETTERS

FROM READERS

Cindy Marie is under way

Thought your readers might like to know the latest on Bill Bodisch and the *Cindy Marie* (A Dreamboat Takes Shape in a Barnyard, page 96, Dec. '74). The boat was successfully launched on Dec. 2, 1974, and Bill headed her down the Mississippi to



New Orleans. Before leaving, he announced that he planned visits to Miami, Panama, Venezuela, the Galapagos Islands and points west.

JOHN MCCORMICK
DUBUQUE, IOWA

Two photos of the actual launching appear on page 96.

New size: The right direction

Good luck to the editors on your new look. We'll miss your old image, but nothing is more certain than change. We all know you can't stand still; you either go backward or forward. You're headed in the right direction—forward!

LEONARD OSOWSKI
BROOKFIELD, ILL.

Your new larger format for the January issue is excellent. It seems more readable. Maybe fewer articles are "continued" somewhere in the back pages. I like that.

E.C. KNUDSON
TIGARD, ORE.

A step in the right direction—the bigger, better size for *Popular Mechanics*. Wish you'd done it sooner. I'm sure I missed many good articles with the old harder-to-handle size. Sure enjoyed the January issue.

Looking forward to your future issues.

MRS. WILSON R. WOODS
ANCHORAGE, ALASKA

I would like to go on record as being one reader who does not especially like your new trim size. The smaller size was easier to handle, store and just carry around. The new size may be a little easier to read but not to use.

ROBERT RECKENBEIL
MERION STATION, PA.

Keeping out the burglars

Congratulations to Ivan Berger, Electronics Editor, for his article on *How To Burglar-Proof Your Home* (page 97, Jan '75).

As a reader of this great magazine for a long time, I would like to see more informative information on the subject of burglar/fire security systems that belong in every home in this country.

VERNON R. RYDER
SOUTH PORTLAND, ME.

Your article on home protection systems is the best we've read in a long time.

THOMAS A. HAEFNER
PROTECTO ALARM SALES
BIRCH RUN, MICH.

Clinic fan

I thoroughly enjoy reading *Appliance Clinic* in *Popular Mechanics* (which I have been reading for more than 50 years).

This column is one of the reasons that I have continued my reading of this magazine for such a long time—along with some other choice bits of information that I gather from other departments.

WILL A. SHAW
VENUS, TEX.

Fascinating Leonardo

A New Light on the Legendary Leonardo (page 66, Jan. '75) is fascinating. However, I would like to point out what I believe to be a discrepancy

(Please turn to page 10)

Two more ways to be a hero in your own home!



Fix a broken window

Reach for DAP '33' Glazing Compound to replace cracked or broken window glass. It's the nation's biggest seller. Sets new panes in wood or metal sash with an airtight, watertight seal. Takes paint. Outlasts ordinary putty by years.



Reduce your heating costs

DAP Butyl-Flex[®] Caulk seals around doors, windows; fills siding joints where heat escapes. Helps save energy, cuts heating bills. Butyl-Flex takes tough sealing problems in stride—lasts 5 times as long as ordinary caulks.

DAP

The name people know best in home fix-up

DAP Inc., General Offices: Dayton, Ohio 45401
Subsidiary of Plough, Inc.

The best way under the sun to brighten up your pictures. The Konica Auto-S3

Finally, the flash camera that eliminates harsh, unflattering shadows that were the nemesis of outdoor photos. It's called the Konica Auto-S3, with the world's first built-in daylight-Synchro/Flash System designed in a 35mm camera.

That means, fill-in outdoor flash *without* guesswork, calculations or overexposures. Simply slip-on the Konica X20 flash, focus, line up the synchro/sun indicator and shoot. Daylight and flash combined and balanced for perfect lighting... automatically.

This pocket-size marvel is a fully automatic rangefinder 35, as well, with a fast and sharp Konica 38mm f/1.8 lens. And loads of other pro features.

Auto-S3 is another breakthrough for Konica. And it can be your breakthrough to perfect pictures, as well.



Without
Daylight / Synchro Flash.



With
Daylight / Synchro Flash.



KONICA



At your Konica dealer. Or write for literature to
Konica Camera, Woodside, N.Y. 11377. In Canada: Garlick Films Ltd., Ontario.

LETTERS

(Continued from page 9)

ancy. On page 67, top photo, you compare Leonardo's sketch with an ordinary worm and worm wheel. What I see in Leonardo's sketch is an example of "double-enveloping worm gearing" as described in the 17th edition of *Machinery*.

It seems incredible that this could have been thought of nearly 500 years ago; but Leonardo DaVinci was a genius.

STEPHEN L. HEFFNER
KEEDYSVILLE, MD.

Everybody's talking



You couldn't have given the *Newton Cradle* (page 152, June '74) a better name than *Surefire Conversation Piece*, for it sure has been a conversation piece at our house. It was fun making it and fun to watch it work.

HANK WAKEFIELD
NORTH MIAMI, FLA.

The no-compromise vacation. The only place you cut corners is on the cost.

We'd like to help you spend less money for your vacation this year. Without getting less vacation for your money.

So we've put together what's probably the most helpful vacation planning guide in America. It's full of facts about things you can do here. And you'll be surprised how many of them are free.

Even the Trip Kit is free. Just send us the coupon.

And find out how far your vacation dollar can take you.



Name _____ Address _____
City _____ State _____ Zip _____

Free South Carolina Trip Kit

Mail to South Carolina Division of Tourism, Room 750, Box 78, Columbia, South Carolina 29202.

Marquetry made easy

I was pleased to read *Marquetry: A Difficult Art Made Easier* (page 88, Dec. '74). It was an excellent job of presenting the basic techniques in a concise, understandable manner.

For those interested in more information on marquetry, the Marquetry Society of America is a nonprofit organization which provides members monthly publications containing articles on all aspects of marquetry. Anyone interested in membership may contact me at R.R. 2, Salem Road, Pound Ridge, N.Y. 10576.

H. MALCOLM MORTON
PRESIDENT

Where to find cane laminate

In *Stuck With An Old House* (page 106, Jan. '75) you state: Cabinet doors are faced with Nevamar's natural cane plastic laminate. Can you tell me the name and address of the maker?

GEORGE KILDANY
ORMOND BEACH, FLA.

For the name of the nearest distributor write to: Public Relations, Nevamar Div., Exxon Chemical Co., Odenton, Md. 21113. ★★★

"Tell me the truth, Steve. What kind of tires do I need?"

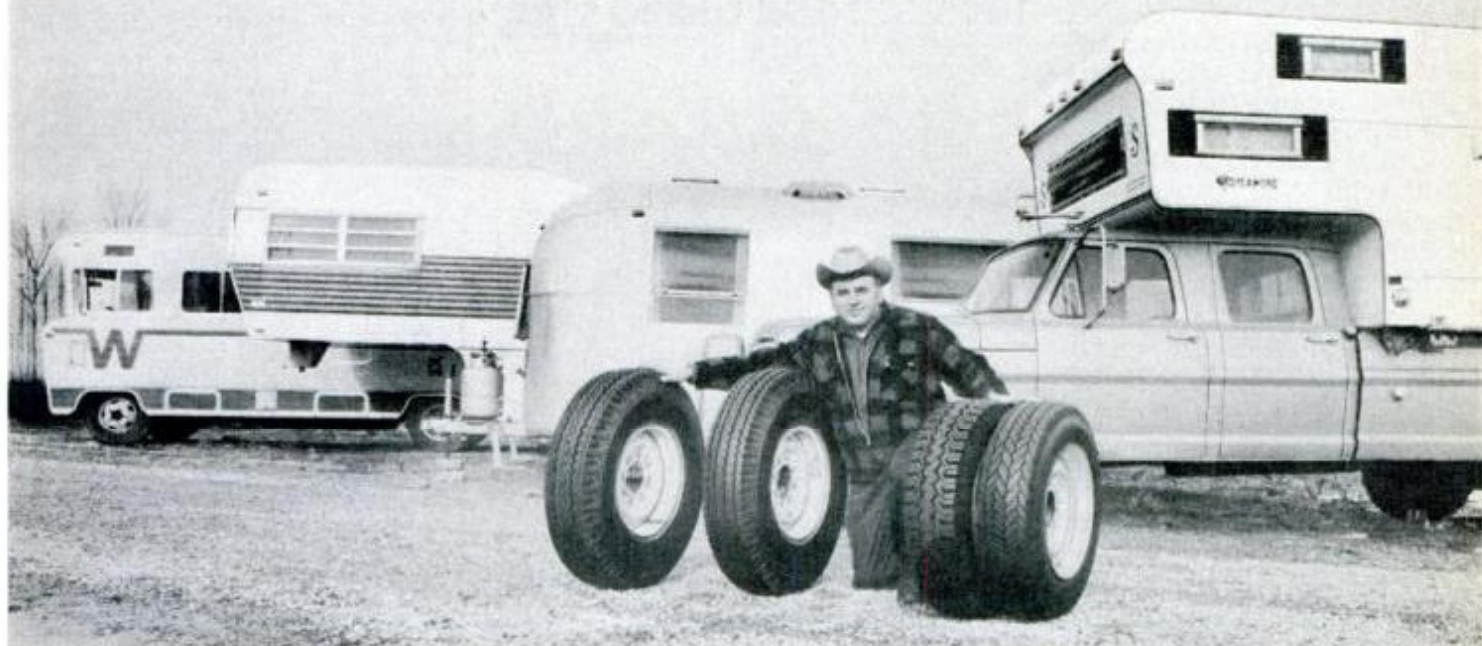

Here's Firestone Tire Engineer Steve Petrasek to answer your RV tire questions:

Q: I have a pickup camper. How do I know which tire to buy?

A: If you don't believe ads, read the articles in the RV magazines. In the Popular Science Motorcamping handbook for 1974, they talk about high flotation tires that give you an extra wide footprint and spread the camper's weight over more ground surface. Firestone strongly recommends them for pickup campers and fifth wheel campers — it's our Wide Oval System. On the front put the Firestone Transport 500 Wide Oval® for steering and stability. On the rear go the Traction All Season™ Wide Oval tires that are good on highways, great in soft stuff.

Q: What about tires for trailers?

A: Trailer tires need to carry load, and help in braking. So you can be sure you're getting what you need with Firestone's Transport® tire. You don't pay a lot for it, yet you have the capacity and load range of a truck tire.

Q: What do you recommend for motorhomes?

A: The same article tells it like it is — "Motorhomes are really trucks, and they require truck tires." So we say put on the Firestone Transport 110™ tire. Since you bought your unit for fun, not tire trouble, I think you'll like this tough, fleet-tested tire with a noise-treated tread that can handle a heavy chassis nicely.

Firestone

I love tobacco. I don't smoke.

**Walt Garrison,
football and rodeo star.**

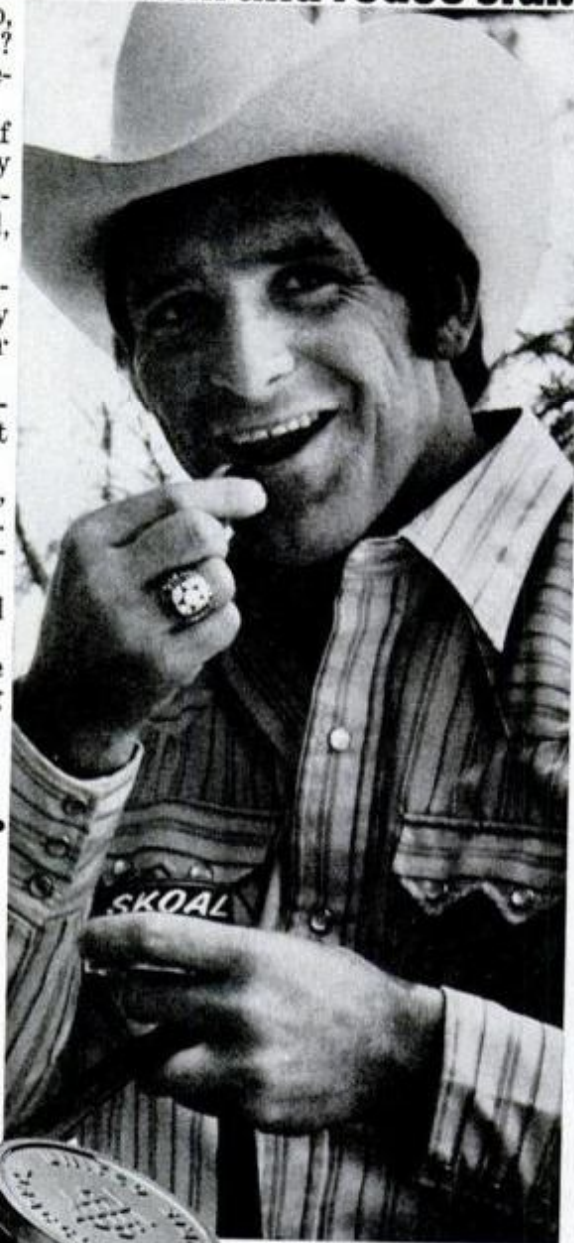

If I'm a guy who loves tobacco, how come I never take a puff?

Well, because I use "smokeless tobacco."

All it takes is a pinch of "smokeless" in between my cheek and gum. Feels real relaxin' in there. And I get full, rich tobacco pleasure.

Another thing is, "smokeless tobacco" can't tie up my hands. So I can use it no matter what I'm doing.

If you'd like to go "smokeless," here's what you do. Just look for three great brands.

There's Skoal, my favorite, which has a wintergreen taste.

Copenhagen, a straight tobacco.

And Happy Days Mint. All three dated for freshness.

They'll each give you the tobacco pleasure you're looking for.

**Smokeless tobacco.
A pinch is all it takes.**



NEXT MONTH IN PM . . .

- 30 fresh ways to spruce up your home
- 20 top fishing lures
- 56 riding mowers that make sport of yard care
- Specs and best-buy tips for all the '75 car imports
- 4-channel cartridges rated
- 10 best ways to trim down and shape up for summer

SUBSCRIPTION SERVICE: Mail all subscription orders, changes of address (with your latest label), and Postmaster notices of undeliverable copies to Popular Mechanics, P.O. Box 646, New York, N.Y. 10019. All other correspondence relating to your subscription: James Gable, Customer Service Department, Popular Mechanics, P.O. Box 1567, New York, N.Y. 10019. Please enclose your latest mailing label for quickest service when writing about your subscription.

Popular Mechanics

250 West 55th St., New York, N.Y. 10019
WPM5C1

YES! Please enter my subscription to POPULAR MECHANICS for:

- 1 year \$5.97 New
 2 years \$10.97 Renewal

Payment of \$ _____ is enclosed.

Bill Me _____
initial here

Name _____ (please print)

Address _____

City _____ State _____ Zip _____

On new subscriptions, first copy will arrive in about 8 weeks.

(Above prices apply in U.S. & Possessions only. Canada add \$2 per year. All other countries add \$4 per year.)

CHANGING ADDRESS?

If you're planning to move, please let us know at least six weeks before changing your address. Attach current address label and fill in your name and your new address. This will serve to insure prompt service on your subscription.

Send old label with your name and new address to:
POPULAR MECHANICS, Subscription Dept.
Box No. 646, New York, N.Y. 10019

NAME _____ (Please print)

NEW ADDRESS _____

CITY _____ STATE _____ ZIP CODE _____

For a free booklet that explains how to get the full enjoyment of "smokeless tobacco" —as well as a few free pinches that you can try for yourself—write to "Smokeless Tobacco," United States Tobacco Company, Dept. P99, Greenwich, Connecticut 06830.

Special Invitation to Inventors

If you have an invention or an idea for an invention, whether patented or unpatented, that you wish to sell outright or on a royalty basis, the booklet we offer free in the coupon below may be very valuable in saving you both time and money.

We are specialists in representing inventors and submitting their inventions and ideas to manufacturers. We work continuously with scores of manufacturers seeking new products, and we have connections from coast to coast and in foreign countries. We are well informed which manufacturers may be especially interested in your particular kind of invention. Hundreds of these manufacturers have written us descriptions of the types of inventions they want.

Our service is designed to do all the many things the average inventor does not have the time or facilities for doing, or who lacks knowledge of the proper markets. When you appoint us to represent you, we prepare sales material that points up your invention, its advantages, its construction, its market potential and profit possibilities.

For presenting your invention to selected manufacturers we charge a modest fee (which is refunded if we handle the sale of the invention for you) and the customary commission. We are a Nationally known concern, with an impeccable reputation for ethics and integrity. We believe ours is the finest service offered inventors.

We are not patent attorneys. However, if you have need for a patent attorney and do not know one, write us and we will tell you how to obtain the names of all U. S. Patent Attorneys in your area, and you can make your own choice.

To encourage inventors, whether their inventions are patented or unpatented we have prepared a booklet entitled "How to Go About Selling Your Invention." This booklet contains such information as current royalty rates being paid by manufacturers, discusses various types of inventions and the markets for them, and tells the most effective methods you can use in presenting your invention for sale, whether you employ us or do it yourself.

You can obtain a copy of this booklet merely by mailing the coupon below. It will be sent to you with our compliments, free, without any obligation whatever. If you wish to write us for comments about your invention, please do so. We make no charge for consultation. But please do NOT send blueprints or models. Just describe your invention briefly, its nature and purpose.

REFERENCES: Your own bank, or attorney, or Chamber of Commerce.

K. O. Kessler, President
KESSLER SALES CORPORATION
FREMONT, OHIO 43420

Accredited as a Corporation
Under the Laws of Ohio

MAIL THIS COUPON FOR FREE BOOKLET

Mr. K. O. Kessler, *President*

Kessler Sales Corporation, Dept. D-53 Fremont, Ohio 43420

Please mail me a copy of your FREE Booklet, "How to Go About Selling Your Invention," which reveals many points about selling inventions and explains your service. It is understood that there is no charge for this booklet now or at any other time and I am not obligated in any way.

MY NAME.....

STREET ADDRESS.....

CITY.....STATE.....ZIP.....



THE BICYCLE SHOP

BY EUGENE A. SLOANE

Just can't get up the wind

I have never had tubular tires or Presta valves before and I am a little confused. I have the type of pump you recommend, but can't pump the tire to the recommended 90 p.s.i. Air just leaks out around the pump and valve.—John Neidigh, Bremen, Ind.

You have to unscrew Presta valves before you can pump them up. Photo shows Presta valve unscrewed, ready



to be pumped. I recommend a Silca pump, but any good Presta valve pump should get you up to 90 p.s.i. If you can't pump that pressure, at least pump enough to get to a service station, where you can screw on a Schraeder (American) valve adapter and use their pump. You can buy such an adapter from any good bike store. When using a Presta valve hand pump, be sure to knock



it off with a blow (as shown) or you can break off the valve.

Winter wonderland—with rust?

You talk about riding through snow two or three inches deep, in winter cycling. Won't this snow get your bike pretty wet and rust it out?—Job Penzini, Scranton, Pa.

Not if you wipe off the accumulated snow, ice and assorted dirt when you are finished riding for the day. I bring my bike into the warm basement after riding in the snow. This gets the iced-up parts free of any frozen-on gunk, after which I rub the bike dry with rags, squirt a few dabs of oil on the chain and

front and rear derailleurs, and wipe the alloy cranks and chainwheel down with an oily rag. Sure, it's a bother and a hassle, but worth it just to get out and enjoy the sparkling white countryside.

Missing link

While cleaning the chain on my 10-speed bicycle I lost the chain master link. Could you advise me on how to replace it?—Bob Munson, Detroit, Mich.

You don't need a master link on derailleur bicycle chains. All you need is a rivet-removing tool (photo)



which costs about \$2.50 at any good bike store. Mount the tool as shown, force the rivet out by turning the handle clockwise. Don't push the rivet all the way out of the chain-plate; leave about 1/16 inch inside the plate. Break the chain by twisting, after removing the rivet tool. With a bit of the rivet still in one side, joining the chain is easier since the amount of rivet showing can hold the chain together while you push the rivet back in with the tool.

One-piece to three-piece crank?

I have a 10-speed with a one-piece steel crank. Can I change it to a three-piece crank?—Jeff Danz, St. Louis, Mo.

Probably. The problem is that so many of the less expensive 10-speeds with one-piece cranks aren't worth the trouble and expense of switching to three-piece cranks. One notable exception is Schwinn's Super Sport, which has a high-grade seamless steel, hand-brazed-up frame. Even for this bike the changeover would be largely cosmetic, since the weight saving is minimal. Schwinn has a conversion unit for changing any

one-piece crankset with 28 threads per inch axle threading, to a three-piece aluminum alloy cotterless crankset. This conversion unit fits only bikes with 28 threads-per-inch crank-axle threading, which includes most American-made bikes, but not CCM. This is not a metric threading, so forget European one-piece crank bikes for this conversion. Schwinn's conversion is simply a threaded crank spindle or axle which utilizes the existing old cups and locknut.

The conversion unit has a beveled shaft which should accept Shimano, Campagnolo or T.A. aluminum alloy cranks and chainwheels. Schwinn dealers charge around \$10 for the conversion spindle, but you would have to shell out about \$95 for the Campagnolo parts or about \$60 for the Shimano cranks and chainwheels.

How to warm cold feet?

Nothing seems to help keep my feet warm when I bicycle during winter months, particularly when it's below 40° outside. Any ideas?—Seymour Draper, Escanaba, Mich.

You need to use shoes that have thick soles to protect feet from pain as you press down on rat-trap pedals, shoes that are also lined with natural or man-made felt. Yet the shoes must be flexible so you can pedal comfortably. I recommend Detta Pietro "Corsa Inverno" fleece-wool-lined winter racing footwear. These are made in Italy, so if you have broad feet, with toes almost as wide as the widest part of your foot, you may have trouble with Italian shoes. Italians must have pointed feet, because they make shoes that way—at least for cyclists. You may be able to get by with lined "Hush Puppy" types, made in the United States. Get a size too large, so you can use heavy ski socks. If this makes toe clips too small, use a larger size clip or shim out the clip about 1/8 in. with a piece of aluminum stock. To protect feet from cold and keep them dry, I also like toe covers. A good pair is made by Robert L. Cartwright, P.O. Box 104, West Carrollton, Ohio. Forget electrically heated socks, they're more trouble than they're worth. ★★

LIVE IN THE WORLD OF TOMORROW... TODAY!

And our FREE 180 PAGE CATALOG is packed with exciting and unusual values in hobby, electronic and science items — plus 4,500 finds for fun, study or profit... for every member of the family.

A BETTER LIFE STARTS HERE

WAR SURPLUS ELECTRIC GENERATOR

Brand new Signal Corps Model. Up to 90 volts by turning crank. Use in high impedance relays. Charge ground & bring up night crawlers for bait or study. 2 Alnico Magnets alone now worth more than original \$15 gov't cost.



No. 50,225H (2 lbs.) \$8.50 Ppd.

A 1-YR. BIO-RHYTHM ANALYSIS!

Know for the next 12 mos. when to expect days of great energy & exactly when your physical & creative talents surface to do your best for happiness, success. Foresee your off days to avoid poss. errors or accidents! Personalized Bio-rhythm Chart-Report (by computer) gives you an accurate preview of your physical, emotional & intellectual high & low periods with variations, corresponding to your inner life. Send name, add., birth date (day, mo., yr).



Stock No. 19,200H \$15.95 Ppd.

BIG 6 x 6" OPAQUE PROJECTOR!

Great buy! New lightweight compact enlarges any picture or print matter (up to 6x6") for big projection 30 to 144" away. True color reproduction! Feat.: optically polished glass lenses, heat-resist. plate glass mirror, curi-free slide tray, heavy duty motor, large fan. Reqs two 200w household bulbs (not incl). Steel body, 8" cord. 13 x 13 1/2 x 7 3/4".

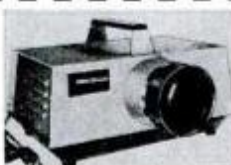

Stock No. 80,217H (9 LB.) \$79.95 Ppd.
DELUXE 5 x 5" OPAQUE PROJECTOR
No. 71,272H (SUPER SHARP) \$139.95 Ppd.

KNOW YOUR ALPHA FROM THETA!

For greater relaxation, concentration, listen to your Alpha-Theta brainwaves. Ultra-sensitive electrode headband slips on/off in seconds—eliminates need for messy creams, etc. Atch'd to amplifier, filters brainwaves, signals beep for ea. Alpha or Theta wave passed. Monitoring button simulates Alpha sound: audio & visual (L.E.D.) feedback. Reliable, easy-to-use unit—comparable to costlier models. Completely safe. Comprehensive instruction booklet.



No. 1635H (8x3x4"; 24 oz.) \$134.50 Ppd.
LOW COST "STARTER" UNIT
No. 71809H \$55.00 Ppd.
DELUXE "ON" TIME MONITOR—MEASURES & RECORDS %
No. 1652H \$349.50 Ppd.

"POP" YOUR OWN BUTTONS



Step-by-step instrs.

Stock No. 71,974H \$31.50 Ppd.

PRO ELECTRONIC SOUND CATCHER



Parabolic mike w/ 18 3/4" reflecting shield & 2 i.c.'s in amplifier magnifies signals 100X that of omni-directional mikes. Catch a songbird 1/2 mile off; QB's huddle strategy; sounds never before heard. Super directivity gives highest signal to noise ratio poss.

Safe: auto. cuts off ear damaging noises. Earphones, tape recorder output, tripod socket. Req. two 9v trans. batt. (not incl).

No. 1649H (5 1/2 LB.) \$299.00 Ppd.
BIG EAR "TOY" MODEL #80,176H \$32.25 Ppd.

AUTHENTIC SCALED WINDMILLS

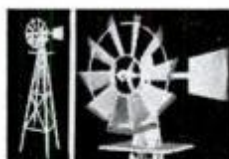

Real-thing replicas show wind direction, wheel silently revolves on ball bearings. Give your grounds unique rural charm! Great centerpiece for planter, flowers. Use to hold yard light, house number, sign or as mailbox. For school, a fine "energy crisis" science project—does everything but pump water. Heavy gauge steel, durable outdoor finish; aluminum color w/red trim.

No. 71,923 (17" DESK MOD.) \$11.95 Ppd.
No. 71,924H (4 1/2 FOOT—14 LB.) \$34.95 Ppd.
No. 85,229H (8 FOOT—46 LB.) \$49.95 FOB

"FISH" WITH A MAGNET



Go treasure hunting on the bottom! Fascinating fun & sometimes profitable! Tie a line to our powerful new specially designed 150 lb. pull PVC coated Magnet—drop it overboard in bay, river, lake or ocean. Troll it along bottom—your "treasured" haul can be

outboard motors, anchors, other metal valuables. Has 6 stacked ceramic magnets. Lifts more than 150 lbs. under water!

No. 71,135H (3 1/4 x 3 3/4") \$17.50 Ppd.
75-LB. PULL (1 LB.) W/ 3 CERAMIC MAGNETS
No. 71,150H (1 1/4 x 3 3/4") \$11.00 Ppd.

SUPER 6" SPACE CONQUEROR



Superb Astronomical Reflector—Up to 576X. Capable of revealing faint stars of nearly 13th magnitude, split double stars separated by less than 1 sec. of arc. Features 48" F.L. aluminized & overcoated 6" f/8 ground and polished parabolic mirror (Pyrex[®]) accurate to 1/4 wave. 6X achromatic finder scope, 3 eyepieces—wide field 48X Kellner, 1/4" 192X Ramsden, & a Barlow to double & triple power—rack & pinion focusing mount. 47 3/4" aluminum tube. Electric clock drive w/manual slow-motion control. Setting circles. Heavy-duty equatorial mount. Pedestal base. Compares to \$350—\$400 models.

No. 85,086H (Shp. Wt. 68 lbs.) \$285.00 F.O.B.
6" WITHOUT CLOCK DRIVE \$249.50 FOB
4 1/4" REFLECTOR (45X to 135X) No. 85,105H \$149.50 FOB
4 1/4" WITH CLOCK DRIVE No. 85,107H \$189.50 FOB
3" REFLECTOR (30X to 90X) .. No. 85,240H \$ 49.95 Ppd.



MAIL COUPON FOR GIANT FREE CATALOG!

180 PAGES • MORE THAN 4500 UNUSUAL BARGAINS

Completely new Catalog. Packed with huge selection of telescopes, microscopes, binoculars, magnets, magnifiers, prisms, photo components ecology and Unique Lighting items, parts, kits, accessories — many hard-to-get surplus bargains. 100's of charts, illustrations. For hobbyists, experimenters, schools, industry.

EDMUND SCIENTIFIC CO.
300 Edscorp Building, Barrington, N. J. 08007
Please rush Free Giant Catalog "H"

Name _____
Address _____
City _____ State _____ Zip _____



PLEASE SEND GIANT FREE CATALOG "H"

30 DAY MONEY-BACK GUARANTEE
YOU MUST BE SATISFIED OR RETURN ANY PURCHASE IN 30 DAYS FOR FULL REFUND

COMPLETE & MAIL WITH CHECK OR M.O.

EDMUND SCIENTIFIC CO. 300 Edscorp Building, Barrington, N.J. 08007

How Many	Stock No.	Description	Price Each	Total

Add Handling Chg.: \$1.00, Orders Under \$5.00, 50¢, Orders Over \$5.00

I enclose check money order for \$ _____ TOTAL \$ _____

NAME _____

ADDRESS _____

CITY _____ STATE _____ ZIP _____

If you've ever said...

"There must be a better

Send for a free Career Guidance Booklet that could start you on the road to success in a rewarding new career.

It happens to all of us, sooner or later. No matter what kind of job we have.

One day, it suddenly strikes home that we're going to have to work for a living, the rest of our lives. And most of us are horrified at the thought of forever being locked into the jobs we now hold.

"Surely," we tell ourselves, "there

must be a way to earn enough extra dollars each month to balance the family budget. Surely, there must be a way to get the kind of position where you don't have to worry about job security."

"Surely," in other words, "there must be a better way to earn a living!"

If you, too, have been thinking these same thoughts, you'll find one



way to earn a living..”

of our free Career Guidance Booklets very helpful at this time. We invite you to send for one.

Your free booklet will describe the opportunities for higher income and greater job security you might expect in one of the career fields listed on the coupon and card. It will also explain why ICS can prepare you for this new career field...right in your own home...in your spare time... *regardless of your education or past experience.*

In addition, you will receive a free "Demonstration Lesson" that lets you see for yourself why preparing for a more rewarding career—the ICS way—may be a lot easier than you think.

Please bear in mind, as you check off your career choice on the coupon or card, that ICS has a long and distinguished record of success. In fact, since 1890, more than 8,500,000 men and women have turned to ICS for career training.

Major corporations use ICS Career Training

ICS has provided training programs for various divisions and branches of companies like Ford; U.S. Steel; Chrysler; Mobil; DuPont; etc.

ICS Career Training is approved for Veterans and Servicemen under the new G.I. Bill, and is accredited by the Accrediting Commission of the National Home Study Council.

Now it's your turn to discover how ICS training can start *you* in a rewarding new profession. Just fill in the coupon or the attached postpaid card and mail it today for your free Career Guidance Booklet and free "Demonstration Lesson."

Mail attached postage-free card today. If card is missing, use coupon.

ICS International Correspondence Schools
Scranton, Pennsylvania 18515

XA802B

Please send me a free Career Guidance Booklet, and a free "Demonstration Lesson" for the field I have checked below. I understand that I am under no obligation.

Engineering

- Civil
- Mechanical
- Electrical
- Chemical
- Industrial
- Surveying & Mapping

Automotive

- Automotive Mechanic
- Air Conditioning Specialist
- Transmission Specialist
- Body Rebuilding
- Diesel/Truck Mechanic

Business Management

- Executive Mgt.
- Industrial/Production Mgt.
- Data Processing Mgt.
- Marketing/Advertising Mgt.

T.V. Servicing

- Color T.V. Technician
- Stereo-Hi-Fi Specialist
- CATV-MATV Specialist

Electronics

- Electronics Technician
- FCC Licensing
- Computer Servicing
- Communications/Broadcasting

Electrician

- Check here for special information, if age 16 or under

Accounting

- Business Accountant
- CPA Training
- Income Tax Specialist
- Bookkeeping

Air Conditioning/ Refrigeration/Heating

- Air Conditioning
- Refrigeration
- Heating Specialist

Interior Decorating and Design

- High School
- ICS H.S. Diploma Program
- H.S. Equivalency Program

Drafting

- General
- Mechanical
- Architectural

Motel/Hotel Management

- Motel Management
- Hotel Executive
- Restaurant/Club Mgt.
- Resort Management

Airline/Travel

- Reservations Specialist
- Travel Agent
- Passenger Service
- Cargo Agent

Name _____ Age _____

Address _____ Apt. _____

City _____ State _____ Zip _____

Telephone _____

Approved for Veterans' Training. Eligible Institution under the Guaranteed Student Loan Program. Accredited Member National Home Study Council. Canadian residents use Scranton, Pa. address for service from ICS Canadian, Ltd. In Hawaii: 931 University Ave., Honolulu, Hawaii 96814.

©1974 ICS

DETROIT LISTENING POST



BY ROBERT LUND



Chevrolet Monza "S", 1975½ model with formal roofline styling, will have optional five-speed transmission later in '75.

Car prices coming down?

It's been a long, dark winter for Detroit and the car companies have been looking to March, when car sales usually pick up. But what happens if business doesn't pick up in the next few weeks? Price cuts, that's what, and they will be deep down cuts.

The auto companies say there's no way they can reduce prices because everything that goes in a car costs more and because of add-on equipment required by government regulations. No argument there. But Detroit compounds the problem by making more optional items standard equipment—the old upgrading trick. If you make the automatic transmission standard, the buyer is forced to take it if he wants that particular car.

Force feeding of accessories—some more profitable to the maker than the car itself—has added hundreds of dollars to prices. So there is a way of reducing prices. Make the luxury and convenience devices optional instead of building them into the car and price. That's the bullet Detroit will have to bite if March sales figures are not up, up and away.

Two new engines—but when?

If the government lets up on emission standards, there will be two new engines in the next two years. Chrysler will pop with its electronically controlled, lean-burn engine this fall. (See *DLP*, page 40, Jan. *PM*.) Next up, on the '77 cars, will be a stratified-charge from Ford. Chrysler will do away with some emission-control hardware, including the catalytic converter, which should let it bring out the lean burn without raising prices. But Ford's stratified-charge

engine will be more expensive to produce and command a premium price.

GM rotary put in mothballs

Wankel enthusiasts are flogging a dead horse in trying to keep GM's rotary alive. The horse could enjoy a reincarnation later on, but you won't be able to buy a GM car with a Wankel this year, and your chances next year don't look much better. The company has a crew checking the tooling purchased to build the engine to see if it can be used elsewhere. Most of it can't because the machines are one-of-a-kind built for Wankel-only purposes. GM will continue its R & D program on the engine, but as a low-key, low-budget operation.

No tears for Tucker

Francis Ford Coppola, movie director of *The Godfather*, is talking about doing a picture on Preston Tucker and the Tucker automobile. If your memory doesn't go back that far, Tucker is the guy who was going to bring out a revolutionary car in the '40s. He ran into a lot of problems, many of his own making, and the car never got off the ground. Coppola apparently thinks Tucker was a victim of a conspiracy by government and Detroit. The martyr bit.

Well, I was working Detroit as a boy reporter then and I don't think there was any plot to give Tucker a bad time. He had an imaginative car ahead of its time, at least in looks. One problem was that he was always borrowing chips to cover his bets. One of his nuttier ideas was the great suitcase caper.

Everybody wanted to be an automobile dealer in those days and Tucker signed a lot of store-front operators to sell his car. Dealers had to pay for the franchise, but that money was soon gone and Tucker had to look for a new stake. That gave birth to the suitcase idea.

You had to get on a waiting list to buy a car back then and people were coming in Tucker showrooms to sign up. Through his would-be dealers, Tucker had a proposition for would-be buyers—a line of luggage designed to fit the trunk of his car. His-

and-her suitcases, overnight bags, satchels, vanity cases, everything except a steamer trunk. If you coughed up the \$600 price, your name was put on a special waiting list and you were supposed to get delivery ahead of other customers. Some government agency didn't like the smell of that one and Tucker had to withdraw it, but not before he unloaded a lot of luggage on a lot of people.

What tipped me that Tucker's car might not make it happened at his Detroit press preview. The car was made in Chicago. A few early jobs were shipped to Detroit and auto reporters were invited out to 8 Mile Road for a ride-and-drive. I was there and the thing that sticks in my memory is that the car had no reverse gear. You couldn't back it up. How the heck could you sell a car without a reverse? To be fair, the company eventually turned out a small number of cars with reverse.

I ran into Tucker at a University of Michigan football game years after he called it quits on the car. He didn't want to talk about it. He was an interesting guy, a great promoter. But he was not a victim of any Machiavellian plot to do him in.

Pontiac to get five-speed shift

Pontiac will be the next GM division to get a five-speed manual transmission—this summer or when the '76 cars go on the line. Made by Borg-Warner, it's the unit Chevrolet will offer as an option on Monza about the time you read this. The fifth gear is overdrive. ★★★



First five-speed mass-produced manual transmission in the United States for passenger cars is Borg-Warner's T50.

Warning: The Surgeon General Has Determined That Cigarette Smoking Is Dangerous to Your Health.

© B&W T Co.



Full flavor to match
the best of times.

RALEIGH



Cook outdoor meals easily with the Coleman Gasoline Camp Stove. Get it for free B&W coupons, the valuable extra on every pack of Raleigh.



To see over 1000 gifts, write for your free Gift Catalog: Box 12, Louisville, Ky. 40201.

Filter Kings, 15 mg. "tar," 1.0 mg. nicotine; Longs, 17 mg. "tar," 1.1 mg. nicotine, av. per cigarette, FTC Report Oct. '74

Материал, защищенный авторским правом



IMPORTS AND MOTORSPORTS



File your fright plan

When the pilot turned to his girl friend and said, "I'm Bob, fly me," she was confident enough to say yes. Bob Wills knows his business. Meanwhile, photographer Ulvis Alberts was nervously waiting and whistling a crossed-up version of *Come Along With Me*, *Lucille*, and *Bye, Bye, Miss American Pie*. As the dynamic duo took off from the ramp, Ulvis's anxiety came through as slight camera movement. But he continued panning them to a safe touchdown.

This latest form of motorcycle madness combines hang gliding and stunt jumping. The 12-foot kite is rigidly attached. Bob Wills, of Sport Kites in Santa Ana, Calif., built the special kite and has made many jumps on the kite bike. His longest so far is over 200 feet, but he looks forward to 400. It's easy to run up a 20-inch-high ramp at a casual 45 mph and glide over 100 feet. If the "sport" catches on, the kites will be marketed as a regular motorcycle accessory. Heads up!

A look at Lancia

The first Lancia to arrive in the United States was Vincenzo. His cars came later. He raced Fiats in the Vanderbilt Cup races on Long Island

back in '04, and was a wizard with motorcars when they were still a mystery to most people. He left Fiat, formed his own company in Torino, Italy, and by 1908 there was a Lancia Alfa model in America. His second model, the 1909 Beta, shown below in the new Lancia Museum in Torino, used an engine of his design—an inline Four with all cylinders cast in a single block.

Since 1909 many models have been available here. But the 1967 Fulvia was the last new Lancia sold in the United States. Meeting federal emissions and safety standards proved too costly for the small company. Since then, Fiat has taken over the firm and made the investment necessary to put Lancias back on U.S. roads. In fact,



the emissions-certified Fiat dohc, 1800-cc Four will power the 1975 Lancia Beta models that arrive here next month.

I had a chance to drive the new sedan and coupe that will carry the



old Beta name (but only caught a picture of a red coupe as it sped past a signpost!) Both models live up to Lancia's long reputation for finely crafted automobiles. The sedan will be up against tough competition from more established imports—Volvo, for example—but the coupe should have a



field day here. It's an absolutely extraordinary 2+2. There will be more on the cars, including specs, next month in PM's roundup of all 1975 imports.

The green mystery car? It's the Lancia Stratos. With it, Lancia won the 1974 World Rally Championship for Makes. No mean feat. ★★★

Because carburetors are
different on power mowers,
cars, boats and cycles,
there's a GUMOUT for each.



All carburetors are designed to do the same basic job—create a mixture of fuel and air. To function economically and efficiently, gum and varnish that build up in the carburetor must be removed.

However, because carburetors are used differently, you need a different Gumout for each. For example, infrequent use, oil

and gas mixtures, start and stop operation, exposure to dirt and moisture—all create their own special carburetor problems. That's why Gumout makes four different carburetor cleaners.

With Gumout, you'll get faster starts, fewer stalls and improved economy. GUMOUT, Cleveland, Ohio 44104.

GUMOUT

The Carburetor Cleaner

APPLIANCE CLINIC

BY PAUL MANN



Seal solution

I am having a problem with the ice-maker of my GE refrigerator (Model TCF). Water is leaking from the ice-cube molds down through the vertical shaft that ejects cubes. This is causing icicles to form on the end of the ejector shaft. What do you think?—Anthony Flasck, Warren, Ohio

I think the seal that is supposed to keep water from leaking has ruptured. This is not uncommon with original seals. GE has issued a seal kit to prevent a recurrence, but I suggest you get a qualified serviceman to handle the task as it requires special tools. If the repair is not handled properly, there is danger of scoring the sides of the mold which would cause permanent damage.

I can't tell you what the charge would be—it varies with the area and problems encountered. It would

be wise to get a few estimates—over the telephone, if possible. Compare them to the cost of installing a replacement icemaker incorporating the new seal.

Suggested price of the icemaker—you can get it from a GE dealer or service center—is \$34.95. It can be installed by a competent do-it-yourselfer who closely follows instructions accompanying the icemaker. No special tools are needed.

Basket-patching

The only complaint I have with my three-year-old KitchenAid dishwasher is that the utensil basket is rusting, and rust is being transferred to the dishes. A replacement basket is very expensive (about \$35). Can this one be repaired?—Alyce M. McMullan, Placentia, Calif.

Go to a hardware store and buy a silicone-rubber sealer—GE and Dow Corning make them. Sand all rust off affected areas of the basket, even if it means going down to bare metal, and apply the sealer to these spots. If the sealer fails to hold, buy an epoxy repair kit. GE makes one for its wire dishwasher baskets, but they're also sold in hardware stores. Make sure the areas to which epoxy is applied are clean. The color of the patched spots may not match the original color of the basket, but perhaps this won't matter if you save the \$35.

Beating around

A problem I have with my old (circa 1960) Sears electric food mixer is that the beaters slip from the gear case while the mixer runs. Should

Jeep® wrote the book on 4-wheel drive..



We pioneered 4-wheel drive over 30 years ago and we've been making improvements ever since. Jeep was first with automatic-transmission in a 4-wheel drive vehicle, the first 4-wheel drive maker to offer a really complete line of vehicles—one for every need.

And recently Jeep became the first American manufacturer to

offer automatic 4-wheel drive, Quadra-Trac™ the 4-wheel drive system that's caused such a stir in the 4-wheeler's world.

We are happy to compare our heritage, our know-how and our vehicles with any other manufacturer's. We do it in this book. Before you decide on a 4-wheel drive vehicle, read it. The facts are yours for the asking.

 **Jeep**
From a Subsidiary of
American Motors Corporation

I get rid of the unit?—Arnold B. Hawk, Hanover, N.H.

Why? Unless something quite unusual is wrong, what you need to get is a new set of beaters, since the shafts of the old ones are probably worn. See Sears.

Sentry's post

My belt sander dropped on a concrete floor, and the roller broke. The sander has Sentry Hardware Corp., U.S.A., printed on a plate, but no address. Can you locate this company for me, so I can get parts?—Paul Glicken, Pomona, N.Y.

Sure. It's Sentry Hardware Corp., 33 Public Square Building, Cleveland, Ohio 44113.

Airconditioner noises

From the first day, my relatively new Fedders 18,000-B.T.U. room airconditioner has given forth with a clunk when the compressor cuts out and has vibrated when running on HIGH COOL. The dealer tells me this is normal. Is it?—Harold B. Sherman, Montgomery, Ala.

No. It sounds as though the com-

pressor was knocked off its mount during shipment or installation. Another reason for noise can be that sections of tubing are touching and hitting against each other during operation. I suggest that the unit be slid from its sleeve, set on the floor and operated while you watch. If the compressor is off its mount, reposition it. If tubing is hitting, it can be bent apart or shimmed.

Cleaning coils

Here's a tip your readers who own Sears refrigerators may find useful. It concerns cleaning the coil behind the grill. No matter what vacuum attachment is used, you can't get to all parts of the coil behind the grill to clean it satisfactorily. I use a flexible plastic bottle with a small hole punched in the cap. Fill it with hot, soapy water. Disconnect the refrigerator and squirt the entire coil with water until clean. Water drains into the pan provided for the defrost cycle. The refrigerator will use less electricity with a clean coil.—Frank LePera, Weirton, W. Va.

Thanks for your suggestion, but this could prove messy if the coil is covered with lint that could get gum-

my when wet. For an alternate, slide the refrigerator away from the wall and go over the coil with a long-handled, soft-bristle brush, letting lint drop to the floor.

More efficiency tips

Here are several more ideas to help you reduce the bulge in your utility bill. They apply to your home's water heater—gas or electric.

1. Keep the thermostat set at 150° F. (or lower, if possible). This is hot enough for any household chore.

2. Check all hot-water faucets for leaks. Repair leaks, no matter how small.

3. Insulate hot-water pipes to reduce heat loss. Hardware and plumbing-supply stores sell effective insulating materials.

4. When it's time to buy a new water heater, match heater size to actual need—oversized units eat up gas and electricity dollars. ★★★

If you have a question about any appliance, send it to Appliance Clinic, Popular Mechanics, 224 West 57th St., New York, N. Y. 10019. Sorry, but letters cannot be answered individually. Problems of wide interest will be discussed in this column.

you can have it, free.

75 Jeep 4-wheel drive comparison book
A GUIDE TO JEEP VEHICLES AND THEIR COMPETITION

Jeep invites you to compare ours with theirs.

For your free copy, see your local Jeep dealer or write:
Jeep Corporation—Dept. PM, 14250 Plymouth Rd., Detroit, Michigan 48232.

NAME _____
ADDRESS _____
CITY _____ STATE _____ ZIP _____

The better the training the better you'll

Send for one of these **FREE** Illustrated

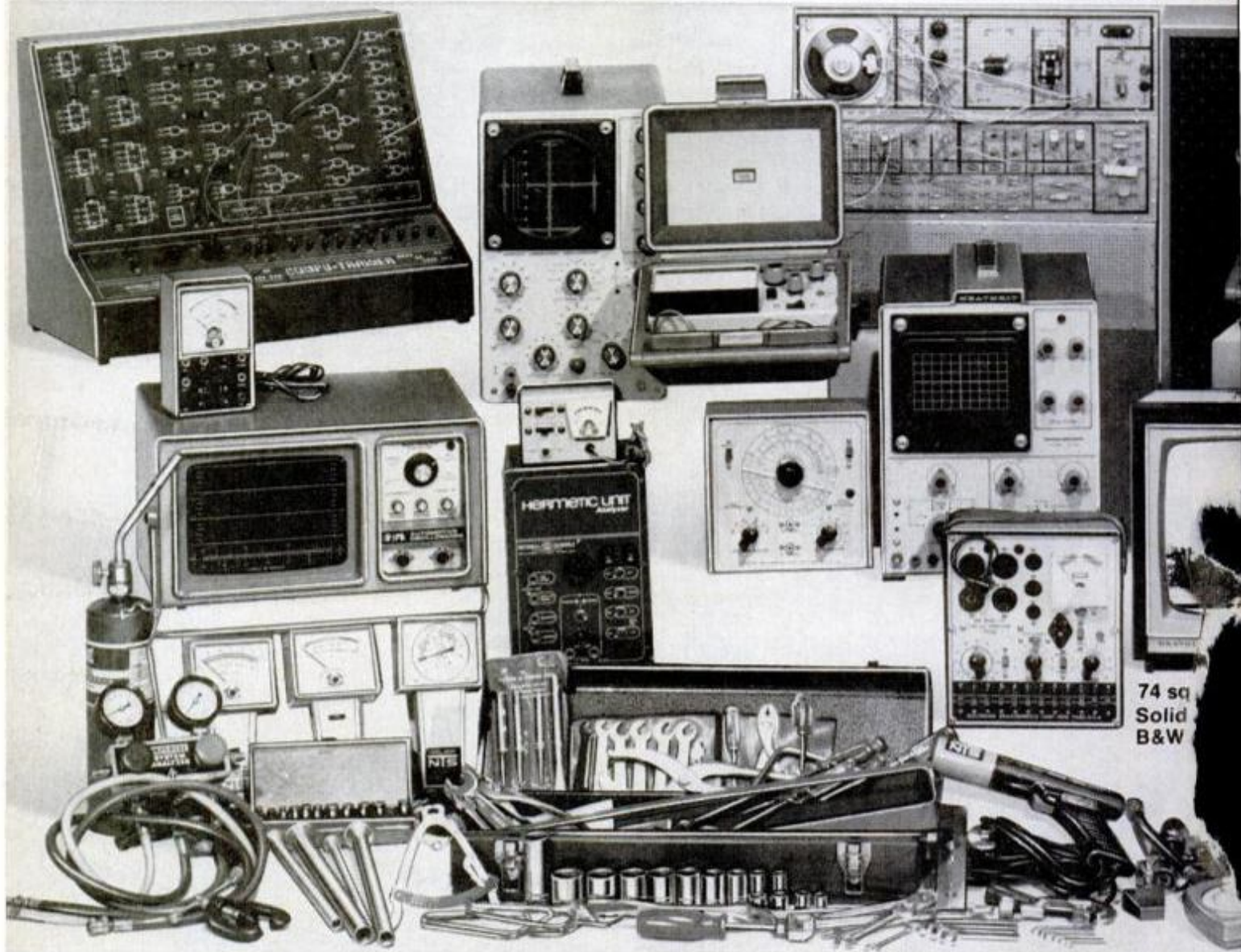

74 sq
Solid
B&W

Build and keep some of the finest technical equipment made when you train with an NTS Project-Method home study course. And it's usually the same type of equipment you'll meet in the field and use on the job. It will help you acquire first-hand experience and skill — help prepare you better for a variety of exciting technical careers:

ELECTRONICS DIVISION: Courses include professional equipment like 5" solid-state oscilloscope, transistor and tube-tester, vector monitor scope, 74 sq. in. B&W TV, and solid-state stereo AM-FM multiplex receiver, speakers. Color TV courses feature advanced NTS/HEATH DIGITAL GR-2000 Color TV with silent varactor diode tuning; digital read-out channel selection (with optional digital clock), big 315 sq. in. screen.

MECHANICS DIVISION: Learn engine diagnostics, motor overhaul, transmissions, automotive maintenance. Courses include 9 in. solid-state automotive oscilloscope, testers, tools, mechanic's steel tool box, & more.

AIR CONDITIONING, REFRIGERATION/HEATING DIVISION: Learn servicing of commercial, industrial and residential heating and cooling equipment. Courses include hermetic unit analyzer, leak detector, charging testing-purging manifold set, tools and more.

HOME APPLIANCES DIVISION: Courses cover repair and maintenance of washers, dryers, ranges, smaller appliances. Equipment includes NTS Circuit-Trainer and professional multimeter.

and the equipment be equipped.

Career Guides:

COMPARE OUR
KITS AND LESSONS.
COMPARE OUR
TUITION.

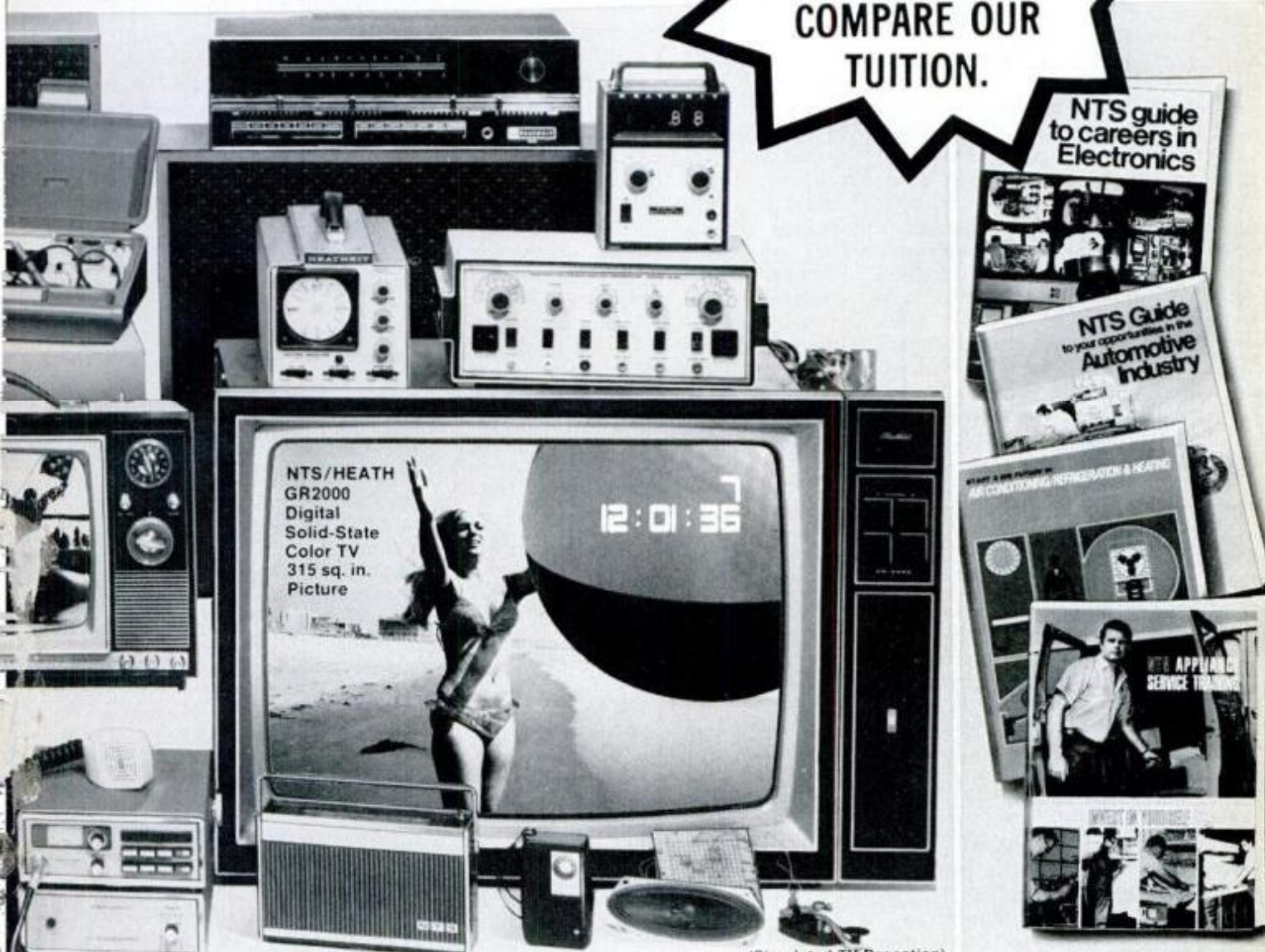

(Simulated TV Reception)

LOWER TUITION FOR YOU: We employ no salesmen, pay no commissions. You receive all home-study information by mail only. Make your own decision, your own comparisons. Send card today or write for illustrated catalog in field of your choice, all details.

NO OBLIGATION. NO SALESMAN WILL CALL.

APPROVED FOR VETERAN TRAINING
Get facts on new 2-year extension.

NATIONAL TECHNICAL SCHOOLS
TECHNICAL-TRADE TRAINING SINCE 1905
Resident and Home-Study Schools
4000 So. Figueroa St., Los Angeles, Calif. 90037

NATIONAL TECHNICAL SCHOOLS
4000 South Figueroa St., Los Angeles, Calif. 90037
Please send FREE Color Catalog and Sample Lesson.
NO OBLIGATION. NO SALESMAN WILL CALL.

Dept. 201-035

- Electronics Division
- Mechanics Division
- Air Conditioning/Refrigeration/Heating Division
- Home Appliances Division

NAME _____ AGE _____

ADDRESS _____

CITY _____ STATE _____

Please fill in Zip Code for fast service _____

- Check if interested in G.I. Bill information.
- Check if interested ONLY in classroom training in Los Angeles.



ALL OUTDOORS

Headwork

Accidents in national parks give a good indication of the hazards facing careless outdoorsmen. A recent survey shows drowning to be the most frequent cause of fatalities when a canoe or boat overturns, a youngster plays too near the water, or a good swimmer imagines a frigid lake is like a pool back home.

Then there are people who think wild animals are "cute," and those who want the parks to put guard rails on every crag and cliff after they fall. But there are also an amazing number of visitors who crack their heads on low-bridge doorways and turn ankles on uneven earthen floors of old relic buildings constructed when most pioneers were considerably shorter (though more agile) than we are today. A blow on the skull from a low beam or branch is seldom fatal but it's a painful reminder that safety habits are also important away from home.

Staying alive afloat

Swimming, treading water, floating face down with a periodic head lift for a breath using the "drown-proofing" method, wearing a life preserver—these popular methods of staying afloat are helpful in warm weather. But with water temperatures we still have across most of the country this time of year, any boatman rushing the season needs to be particularly careful.

In water 40° to 50° F., the Coast Guard points out, you can expect to pass out in less than an hour and be dead in less than three. The cause is not drowning; it's hypothermia, the abnormal lowering of the body core temperature. Vigorous swimming speeds up loss of heat and brings death more quickly. Wearing a life jacket will not save you.

Once you fall in from a deck, dock, beach or bank, you will be in serious trouble even if you can crawl back

Inflatables are gaining popularity with outdoorsmen as multipurpose craft for everything from still fishing to running up white-water rapids of the Snake in Idaho. This 14-foot Bonair III from Bonair Boats, Lenexa, Kans., can handle a 40-hp motor.

out but have nowhere to get warm and dry. Fall through thin ice and life expectancy goes down to 45 minutes at the most in the 32.5° water. Hypothermia is unpleasant to think about; essential to avoid.

For reel

For months now we've been hoping to run into the hot-shot fishing friend who predicted so strongly a couple years ago that all fishing reels would be of the spin-type by 1975. Instead, recent sales trends indicate that bait-casting and fly rodding are stronger than ever, and that many anglers now are carrying closed and open-faced spinning reels, bait-casting and trolling reels, and fresh and saltwater fly reels. They know how to use them all, and take special pleasure in choosing the one reel that will give them the most rewarding action.

For the beginner, a closed-face spinning rig is probably the best selection, but the new bait-casting jobs that are equipped with a centrifugal brake to prevent backlash deserve a test if you haven't tried them.

On target

The best influence on American marksmanship since the invention of the rifled barrel may be the current controversy over lead versus steel shot.

A number of ducks die from lead poisoning each year when they eat

spent shotgun pellets in marshes and ponds. Laws are now beginning to ban lead shot in some areas in favor of steel. But steel has less range and may cause more crippling.

No matter what the outcome, it is a good reminder that estimation of range is part of marksmanship, and "sky-busting" at distant targets is worse than futile. Now is the time to practice on ranges and afield the special skill of estimating how far it is from here to there.

RV growing pains

For a lot of us, recreational vehicles are ideal for roomy daily transportation plus the option anytime of getting away from it all. They provide more action for the energy and fuel dollars needed, but still are not fully appreciated by people who haven't tried one. Recently, however, several town ordinances that ban parking your RV in your front driveway have been challenged and cancelled in court. That's one encouraging sign of progress.

And then there was the time this summer when we stopped at the Atlantic City branch of the "world's inn keepers" chain and an attendant insisted he had to park our van conversion, for a tip, up in their garage. He hoped (successfully) we would be many miles away in the dark before we discovered they had smashed our roof on a low beam. We won't be back, and won't forget. RV owners, unfortunately, still have a real need to take extra precautions.

(Please turn to page 32)



Johnson V-4's. Where dependability runs deep.

You need big power for bigwater running. But you need dependable power and fuel efficiency, too. Both run deep through our V-4s—85, 115, 135 hp.

We've been refining the V-4 and the full 90°-V design ever since we introduced them to outboarding 17 years ago. Refining to give you more fun per gallon with exhaust tuning that clears burned gases

from combustion chambers. Then packs in more of a cleaner fuel/air charge.

With our patented Pressure-Back piston rings that use combustion chamber pressure for a better seal. For less friction. More fuel economy.

With MagFlash™ ignition for fast, sure starts. Smooth, gas saving running, troll to top end.

And now new Easy-Tilt shocks take half the effort out of raising our Vs to full tilt position. Or choose special T'N'T models with remote control power trim and tilt.

See our V-4s at your Johnson dealer. And our other models starting at 2 hp plus four high-thrust electric outboards. Or write for free catalog. Johnson Outboards, Division Outboard Marine Corporation, Sea-Horse Drive, Waukegan, Illinois 60085, Dept. PM-35.



See your Johnson dealer's All-Family Boat Show in March

First in Dependability
Johnson
OUTBOARDS

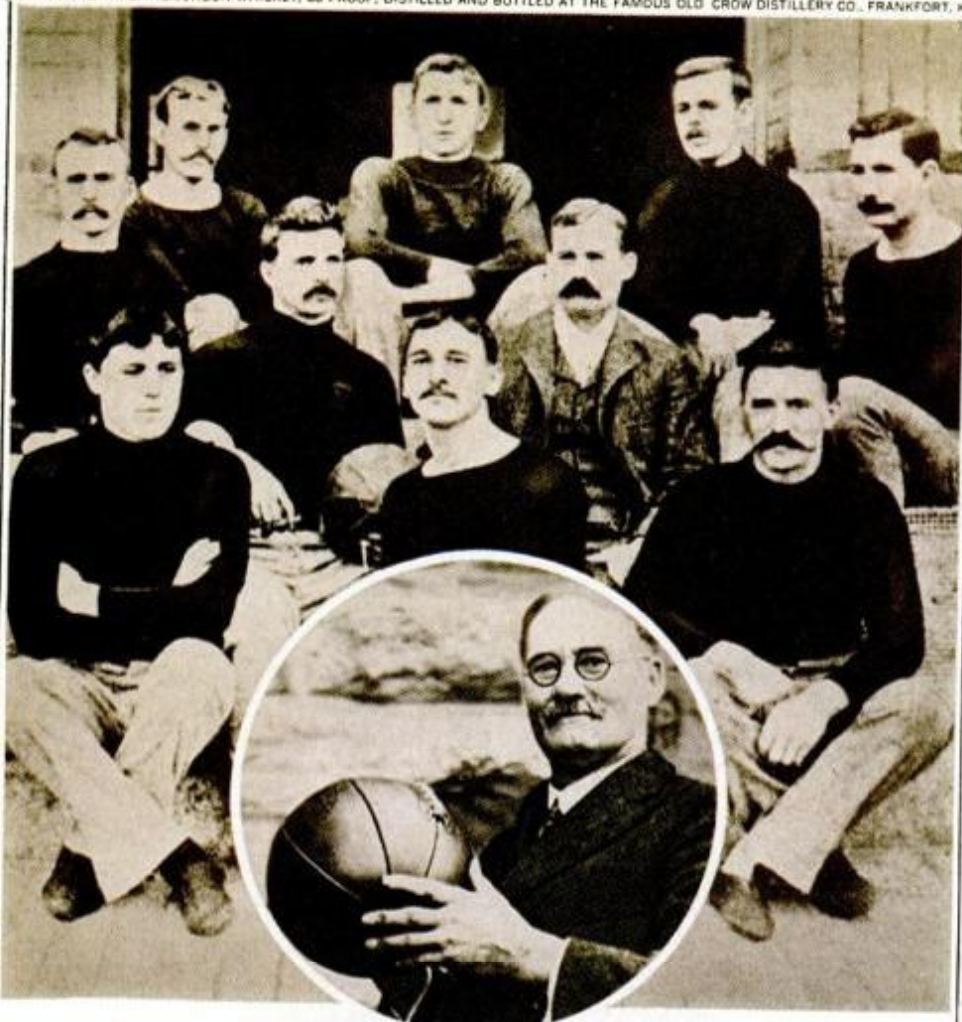

1891. The object of a fast-moving new game is to drop a leather ball into a peach basket. Dr. James Naismith, Springfield College professor, invents a training diversion for football players which becomes a world-wide craze. Above, the first basketball team.

1891. College professor invents basketball. And Old Crow is 56 years old.



Those were the days of real Bourbon. Old Crow Kentucky Straight Bourbon. Old Crow. In 1835, it was the original sour mash Bourbon. It still is. Accept no substitutes.

**The original
sour mash Bourbon.
Aged six years.**



ALL OUTDOORS

(Continued from page 30)



Stability of canoe means staying upright; the Safety-Foil ridge in the sides of new Michi-Craft models is reported to act as both stabilizer and splash rail. The aluminum 17-footer above weighs 79 pounds.



Badly tied knots can reduce strength of your fishing line by 30 percent. Knotmaster claims to tie strong knots properly in monofilament, Dacron, silk or wire. \$3 from Knotmaster Industries, San Diego.



Knots that equal nautical miles per hour are measured precisely while "efficiency meter" shows change in performance for racing sailboat skipper using new Midas System from Ray Jefferson. Set is \$295.

You can time speed on measured course with red sweep hand of new OMC Parts & Accessories boat clock that matches speedometer, tack from Johnson and Evinrude dealers.



Inflatable called Sears White Water Canoe is a new 10-footer said to have good directional stability when paddled. Splash guards act as fore-and-aft decking. Boat comes in 31x50-inch bag; \$180 from Sears.

(Please turn to page 34)

BEFORE YOU BUY A STERN DRIVE, TEST DRIVE THIS AD!

Ideally, you should test drive the boat you've chosen with an OMC Stern Drive, and MerCruiser or Volvo.

But, let's face it, such a test isn't easy to arrange. That's unfortunate (for you!) because OMC's superior combination of performance features really show up in an actual comparison.

So, compare OMC with the others right on this page. It's the next best thing to actually driving the boats.

Tru-Course Steering

This will spoil you. Engineers call

OMC's optional Tru-Course Steering "a non-reversing system that isolates steering loads from the wheel." In other words—when you turn the wheel, the wheel doesn't fight back. You don't have to wrestle it to hold course



or while trimming. In fact, you can take your hands off the wheel in a turn or straight ahead—at trolling speeds, or at any speed.

Better Maneuvering

You're in for a surprise the first time you put an OMC into a tight maneuver. Because the OMC outdrive swings 90°... 50% more than the others! In fact, an OMC powered boat can literally

turn inside the other two. Just look at the diagram at the right. Isn't that the extra margin you want for maneuvering into a tight slip?

The 75° Hi-Tilt

Only the OMC outdrive tilts up 75°—that's 25% higher than the MerCruiser or Volvo! A big advantage everytime you launch your boat from a trailer, beach it, or want to

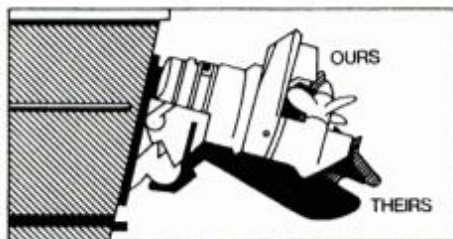

change a prop without getting into the water, or hauling the boat out of the water.

The Uni-Mount Difference

If you put your hand on the transom of the boat with an OMC Stern Drive and then do the same with MerCruiser or Volvo, you'll notice how much more the others vibrate. You can feel and hear the difference. That's because the others bolt the outdrive directly to the transom.

But OMC uses the Uni-Mount system. The outdrive and engine are an

integral unit, cushion mounted to the hull stringers. The outdrive doesn't touch any part of the transom. That's how we dampen gear train and propeller vibration and noise.

Exclusive Power Shift

When you shift the other stern drives, you do it with muscle. When you shift ours, you do it with power. Just move the control as smoothly and easily as the automatic shift lever in



your automobile. And it takes only a 22° movement of OMC's shift lever to go into forward or reverse. The others take 40° to 45°—which means slower response.

Check The OMC Test Charts

Want even more proof? Ask your dealer to show you the carefully documented OMC V-8 speed and fuel consumption tests.* Check OMC's winning V-8 fuel economy compared to competitors' engines of similar horsepower.

Now you're ready to buy your boat, with an OMC Stern Drive. There are fourteen models to choose from, including five top-performing V-8's.

*Verified by independent marine test laboratory.

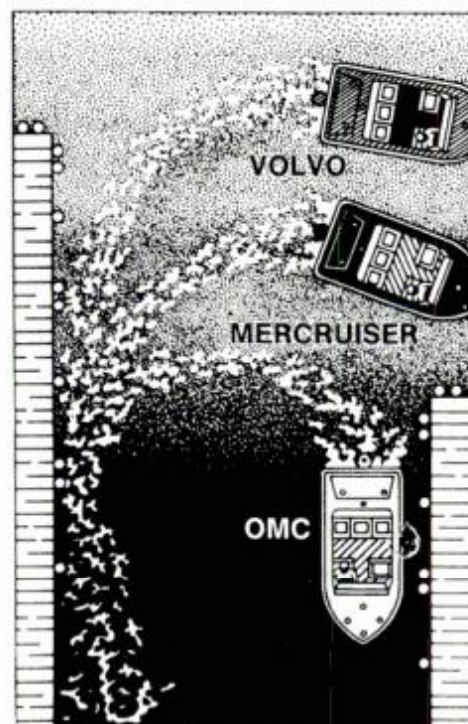

FROM THE MAKERS OF
JOHNSON & EVINRUDE

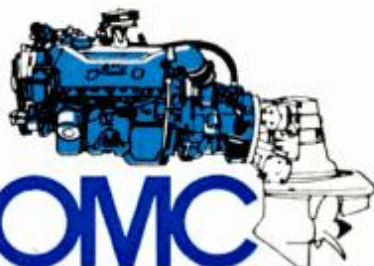

OMC
Stern Drive

A DIVISION OF OUTBOARD MARINE CORPORATION
21-45 CENTRAL AVENUE, WAUKEGAN, ILLINOIS 60095

In verified tests with 21' boats—
at identical speeds—OMC turned in 16'1",
MerCruiser in 34'10" and Volvo in 38'8".

WHAT TO DO UNTIL THE REPAIRMAN COMES

(learn to fix appliances yourself)

ALL OUTDOORS

(Continued from page 32)

Protection for the outdoorsman using trailered camping or travel rig, boat or snowmobile, can be provided with a \$6 Hitch-Lock that secures a trailer's hitch on or off car.



Van and panel-truck conversions and styled customizing by owner are easier with new roof scoop, paneling, bucket seats, dinette/bed/bench, shag rug, port-holes and other extras in Sears RV catalog.



Proper load determination for International light-duty trucks can be had by writing to International Harvester's Chicago headquarters. Dealer gives free gross-vehicle-weight check.



Propane-powered camping equipment, easy and convenient to use, is now available in numerous new models. Sears has two-burner stove, \$35; 11-pound refillable cylinder, \$22; double-mantle lantern, \$20.

(Please turn to page 36)



make extra money in your spare time repairing them for your friends and neighbors. Your instruction even includes advice on how to set up your own business, if you've a mind to.

Send today for our free catalog which describes the NRI electrical appliance repair course in detail, including a complete resume of lessons. There's absolutely no obligation and no salesman will call. Invest a postage stamp and see the money you can save . . . or make . . . with these easy-to-learn skills.

MAIL COUPON FOR FREE CATALOG NO SALESMAN WILL CALL

600-035
Please send me my free catalog on Appliance Servicing

(Please print)

Name Age

Street

City

State Zip

NRI Continuing Education Center
3939 Wisconsin Ave.
Washington, D.C. 20016
Accredited Member
National Home Study Council



With today's delays and today's prices, you can come out way ahead by fixing your own appliances. Not just a fuse or a switch, but almost anything that goes wrong with almost all your appliances. That includes your refrigerator, washing machine, and power mower, as well as your toaster, mixer, and vacuum cleaner.

It's really not as hard as it looks, once you know how things work, where to get parts, and a few tricks of the trade. And that's what NRI home training in servicing electrical appliances is all about.

It's far more than a reference book. It's a complete, 45-lesson program prepared by experts in home study to give you the know-how and skills you'll need. Easy-to-digest, bite-size lessons let you proceed at your own pace, and an experienced instructor is on tap to back you up with comments and advice. You also build a professional appliance tester, included at no extra charge as part of your training.

When you graduate, you're not only able to take care of your own appliances, but can

Just like Dad's...

The wholesome and unforgettable experience of working on a **FIRST** project with Dad.

The editors of Popular Mechanics have put together a delightful educational combination—a child's first workshop project and a father-son, look-alike workshop outfit.

The project is designed to demonstrate the relationship of plans, tools and labor with a useful finished product.

A surefire way to let him experience the solid fulfillment of creating with his hands while, at the same time, getting a little closer and identifying with his father.



Popular Mechanics Child's Tool Box

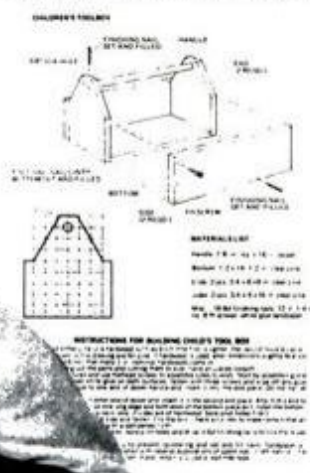

HERE'S THE PACKAGE —

1. **Popular Mechanics carpenter apron for Dad.**
Official PM apron of rugged blue denim. Bright yellow imprint. Three full depth nail pockets. Rule pocket **\$2.95 plus 35¢ shipping**
2. **Popular Mechanics pre-school carpenter's apron for Junior.**
Accurately scaled copy of full size model. Same imprint, material, details *plus* an adjustable neck strap **\$2.95 plus 35¢ shipping**
3. **Special Popular Mechanics Child's Tool Box Plan.**
Especially designed for this program. Simple enough for him to follow (with your help). Step-by-step instructions and specs for constructing a sturdy tool box that he'll use for years to come **\$1.00 plus 15¢ shipping**

Total \$6.90 plus 85¢ shipping

Complete Program Package Only \$5.95 postpaid—Save \$1.80

Popular Mechanics **JUST LIKE DAD'S** offer, Box 1014, Dept. C5, Radio City, N.Y. 10019

Please send me _____ **JUST LIKE DAD'S PROGRAM PACKAGE(S)** @ \$5.95 postpaid
 Please send me _____ **Pre-school carpenter apron(s)** @ \$2.95 plus 35¢ shipping
 Please send me _____ **Full size carpenter apron(s)** @ \$2.95 plus 35¢ shipping
 Please send me _____ **Child's tool box plan(s)** @ \$1.00 plus 15¢ shipping

I am enclosing my check or money order. (No stamps or cash please.)

Name _____
 Address _____
 City _____ State _____ Zip _____

FOR PROMPT SERVICE, PLEASE CLIP COUPON AND MAIL TODAY



When Jack Nicklaus makes a great golf shot, that shot is the result of careful study and the right choice of club for the job. Making the right choice for any job can make the difference . . . yards of difference. Year after year, hundreds of thousands of buyers have made the right choice by choosing walking mowers, riding mowers and tractor mowers made by Murray. The next time you have a choice, think of Murray.



MURRAY

makes yards of difference.



Look for the Jack Nicklaus tag on the full line of Murray Mowers at your dealer's, or write
THE MURRAY OHIO MFG. CO., BRENTWOOD, TENN. 37027

ALL OUTDOORS

(Continued from page 34)



Protection from scrapes on court when returning low shots is afforded by \$2.25 Racquet Guard from Future Products, Box 455, Lindenhurst, N.Y. Light weight and no vibration are reported for the guard.

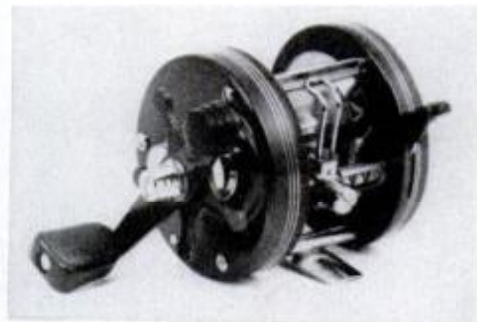

Free spool action for longer casts of lighter lures is claimed for Heddon's new Mark 3200. Gear train and even level-wind mechanisms are disengaged for casts; centrifugal brake system stops backlash.



Preset trolling depth is feature of the Gladding-South Bend Luxon Magill Planer in stainless steel. Planer assumes surfacing position when fish is hooked; is reported to have caught fish at 430 feet.

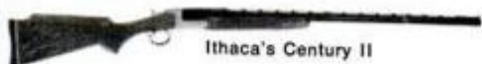

Ithaca's Century II



Florentine ornamental handgun

Single-barrel 12-gauge fully-choked trap gun from Ithaca Guns, the handsome new Century II, is available in 32 or 34-inch barrel, straight or Monte Carlo stock with silver scroll etching, gold trigger: \$599.

Flintlock holster pistol is a Florentine ornamental handgun in .52 cal., made in Belgium and fully functional. Decorated smooth-bore-barrel model, 21 inches long, is \$210. Dixie Guns, Union City, Tenn.

Compare TV/Audio home training and you'll choose NRI.



Compare costs

Only NRI offers five complete TV/Audio Servicing Courses from \$312 to \$1095 . . . with easy budget terms also available. In the Master Course in color TV servicing, with its 25" diagonal solid-state color TV kit designed specifically for training, you save as much as \$650 under a comparable course from the next leading home study school.

NRI saves you money because we pay no salesmen, and we design our own kits and equipment. We pass that savings on to you.

Compare choices

NRI has five levels of TV/Audio training to match your specific needs. The basic course offers 65 lessons, including color TV training. Or you can step up to a more advanced course including a 12"

diagonal B&W TV training kit. Then there's the 19" diagonal solid-state color TV training kit; the advanced color TV course for technicians—with an 18" diagonal color TV for experiments and troubleshooting; and finally, the new 25" diagonal solid-state color TV course—engineered specifically for training. Training Kits for this course include an oscilloscope, TV Pattern generator, and digital multimeter.

Compare training

NRI maintains its own full-time staff of technical writers, editors, illustrators, development engineers and publications experts. The people who design the kits also design the lessons, so theory and practice go hand in hand. Along with each course, NRI provides bite-size, fully illustrated lessons; personally-graded tests; and the kind of person-to-person teaching that makes learning easier and faster.

More than one million students have enrolled with NRI. NRI graduates will tell you: you can pay more, but you can't buy better training.

Compare equipment

Don't just count kits. Count the experiments . . . compare the components. NRI has engineered the widest variety of electronic lab equipment ever designed for training at home. When you enroll in the Master Course in TV/Audio Servicing, you receive kits to build a solid-state, triggered sweep, service type 5" oscilloscope; color pattern generator; solid-state radio trainer; and 3½ digit digital multimeter.

Send for the free NRI full-color electronics catalog. You'll find courses offered in TV/Audio Servicing, FCC License, Complete Communications Electronics, Marine and Aircraft Electronics, Mobile Communications, etc.

**Mail For FREE
NRI Catalog.**
No salesman will call.



AVAILABLE FOR CAREER STUDY UNDER GI BILL.
Check line on card for details.



NRI SCHOOLS
McGraw-Hill Continuing Education Center
3939 Wisconsin Avenue,
Washington, D.C. 20016

PHOTO HINTS

FROM READERS

Pinking shears cut dodgers

Shadow details that might get lost in the black areas of your prints can be saved by holding back part of the enlarging exposure with cardboard dodgers that have been cut to match the shadows' shapes, and glued to thin, stiff wire handles. The dodged areas will blend in better with their surroundings if the dodgers have indistinct edges, cut with pinking shears.

—Ken Patterson, Regina, Sask.

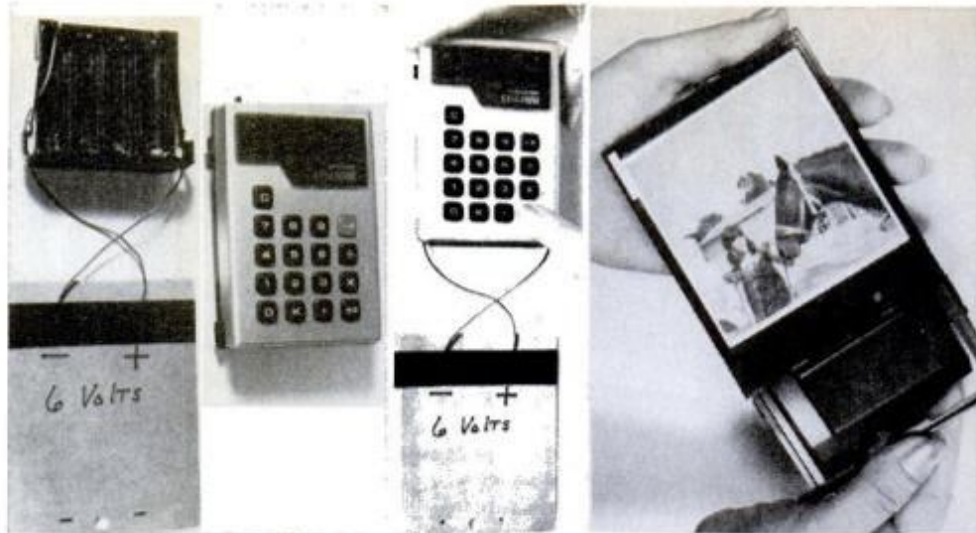
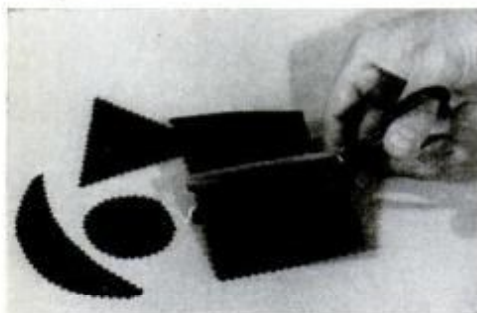

Recycle used SX-70 film packs

Polaroid's SX-70 film packs are still useful even after you've used up the film. The pack shell is the perfect size to frame one of your SX-70 pictures (above, right). Just snap out the larger end of the pack (saving the yellow tab), remove the pack's innards (saving the battery), and reinstall the flat spring to hold a print. Older Polaroid prints will also fit. Tape shut the end you opened. Now you can use the yellow tab to hold a paper-clip desk stand, or hook a paper clip through the two

battery contact holes, to hang the frame.

The batteries still have about 9/10 of their useful life left in them, too. You can wire one to the battery case of any 6-volt calculator or other 6-volt portable device. For 12 volts, you can wire two SX-70 batteries in series; for high current drains, wire several in parallel. Connections are soldered to the battery contacts, whose polarity is indicated in the photos.

—Rona Lee Okun, Harrisburg, Pa.

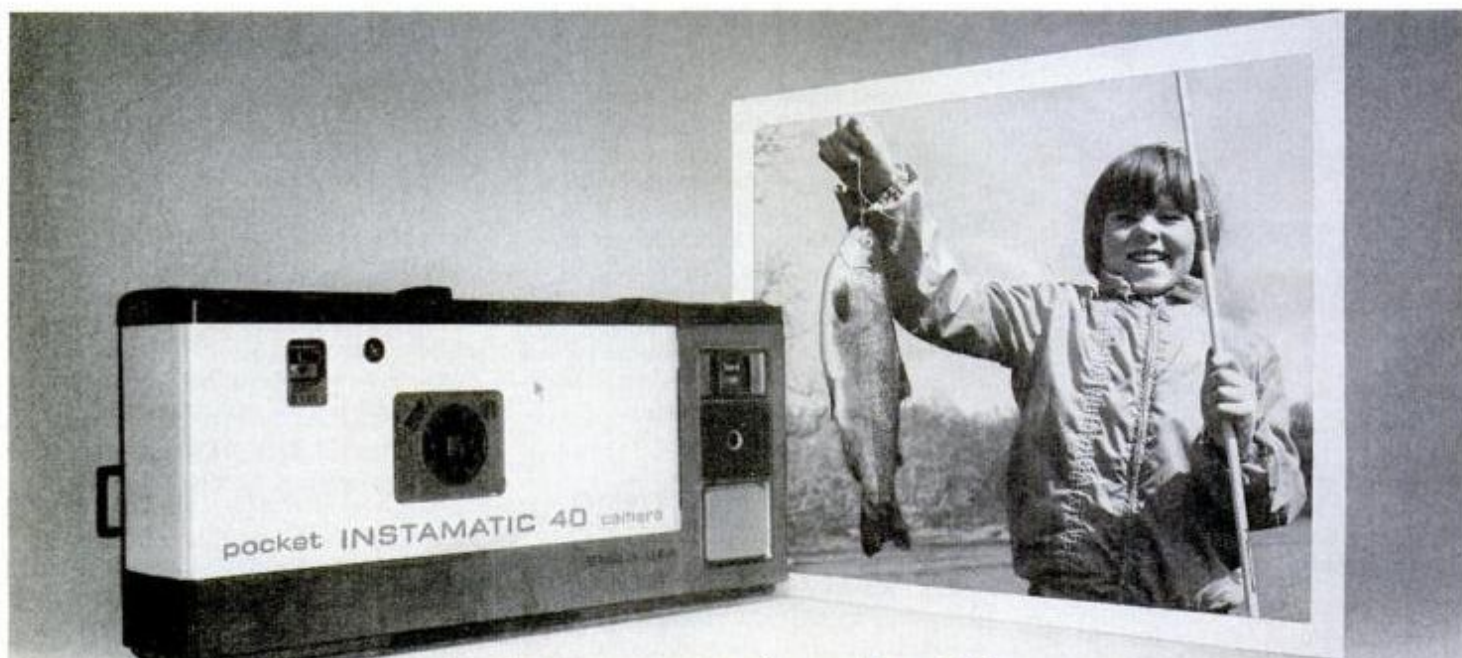

The little one catches the big one.

While it takes up very little space, the little Pocket 40 takes a lot of great big (3½" x 4½") pictures.

This little Pocket can take stop-action pictures in bright sunlight, because of its 1/225-second electronic shutter. That shut-

ter, together with the CdS electric eye, gives you highly accurate automatic exposure control. And a sharp 3-element lens focuses down to 3 feet for close-ups.

The Pocket 40 is yours for less than \$73. Other Pockets start at less than \$25.

Prices are subject to change without notice.

Kodak pocket Instamatic® cameras.



No 1975 pickup in America, big or little, gets gas mileage as good as Datsun's Li'l Hustler.

31 MPG.*

Li'l Hustler keeps on saving with the added response and dependability

of a new, more powerful 2000cc single overhead cam engine.

Then, too, there's a silky-smooth all-synchro 4-speed stick shift (3-speed automatic, optional). Durable steel disc wheels, 4.5-in.

rims, 6.00-14 heavy duty whitewall truck tires. A

rugged welded lattice frame, torsion bar front suspension, heavy duty leaves and double acting shocks in back. Interior comforts include a deep-padded contoured bench seat, Datsun's flow-through fresh air system or optional air conditioning, glove box, and a practical under-dash package tray, as well. So, no matter how you figure—economy, dependability, overall value—you'll be hard-pressed to outsave the 1975 Datsun Li'l Hustler.



(*1975 EPA Highway Results, Manual Transmission, all states except California)

Datsun Saves

America's #1 Selling Small Pickup.

Hold everything

Something different in holders—one for your shop, the other for your study

This novel drill holder is fancy enough to use most anywhere to corral many things other than just drills. If you are familiar with the egg-shaped plastic containers in which L'egg panty hose are packaged, you'll be quick to see that the ready-made dome shapes do the holding. As the two photos show at the right, you first drill a circle of holes in the top of each half shell, using each individual bit to drill its own hole, and drilling from the inside out. Then you cut a 2-in. Styrofoam ball in half, glue the pieces inside the half shells and finally cement the shells to a suitable wood base. Each drill bit is poked into the Styrofoam through the holes in the top of the shell.

Equally as eye-catching and handy as a desk accessory is the pen and pencil holder shown below. The twin cylinders are turned and grooved two at a time on a lathe from aluminum to represent revolver chambers, then bored from the top to accept pencils and ballpoint pens.

Start with a $\frac{3}{16}$ -in. drill bit to drill the seven holes from top to bottom, then redrill to final size with a larger bit for a depth of $1\frac{1}{2}$ in. Drill a couple of holes at a time, take a cof-

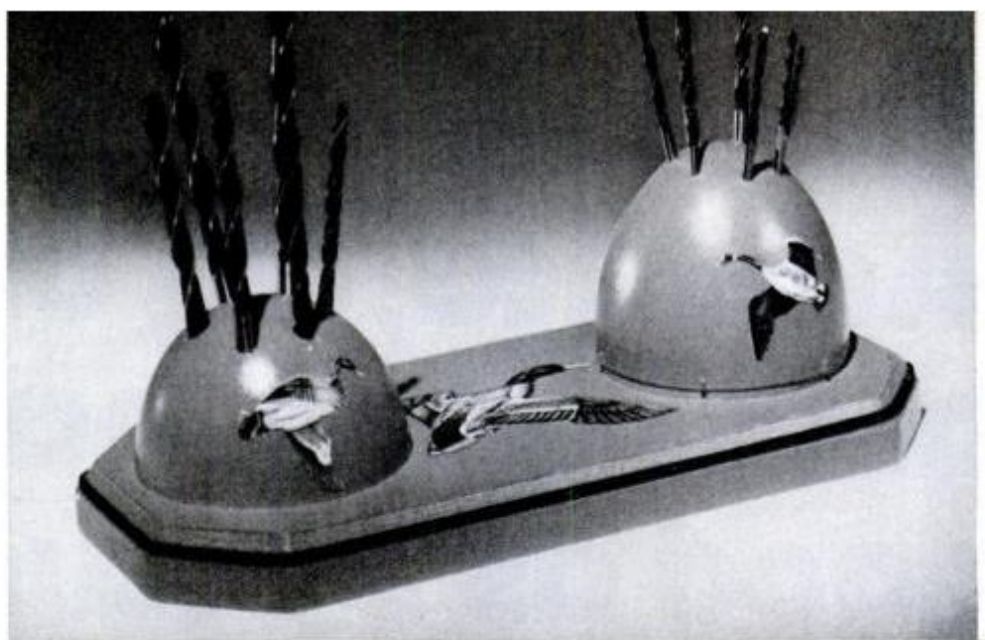

Line shell with masking tape to keep drill bit from wandering. Drill holes from inside.



Cut Styrofoam balls in half, glue inside shells. Drills are poked into foam from top.

fee break to allow the metal to cool to avoid overheating, then continue. One cylinder should be drilled to hold slender pens, the other to take fatter ones.

After polishing with fine abrasive cloth and chamfering the holes a wee bit to remove burrs, attach each cyl-

inder to a two-piece prefinished walnut base with a single wood screw down through the center hole.

By cutting the wood base longer, you can make the holder even more useful with a well between the cylinders to hold paper clips, stamps, or a rack to hold letters. ★★★

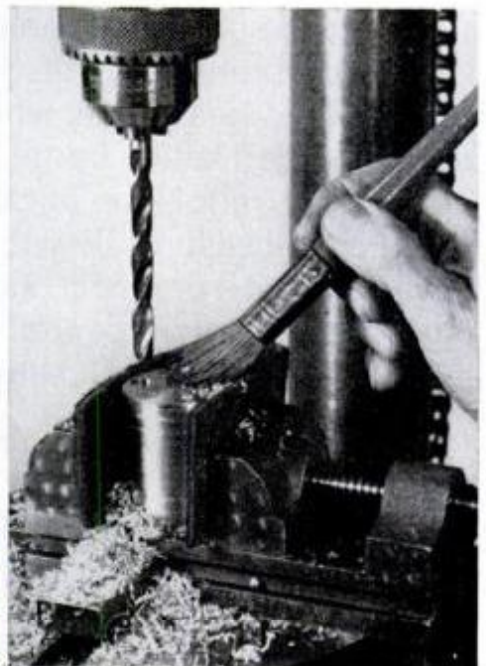
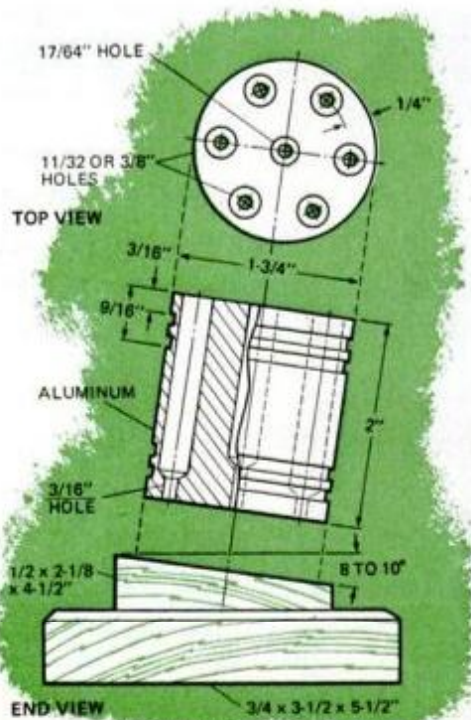

Pad vise jaws with leather when drilling holes. Start with small bit, switch to larger.

Warning: The Surgeon General Has Determined
That Cigarette Smoking Is Dangerous to Your Health.

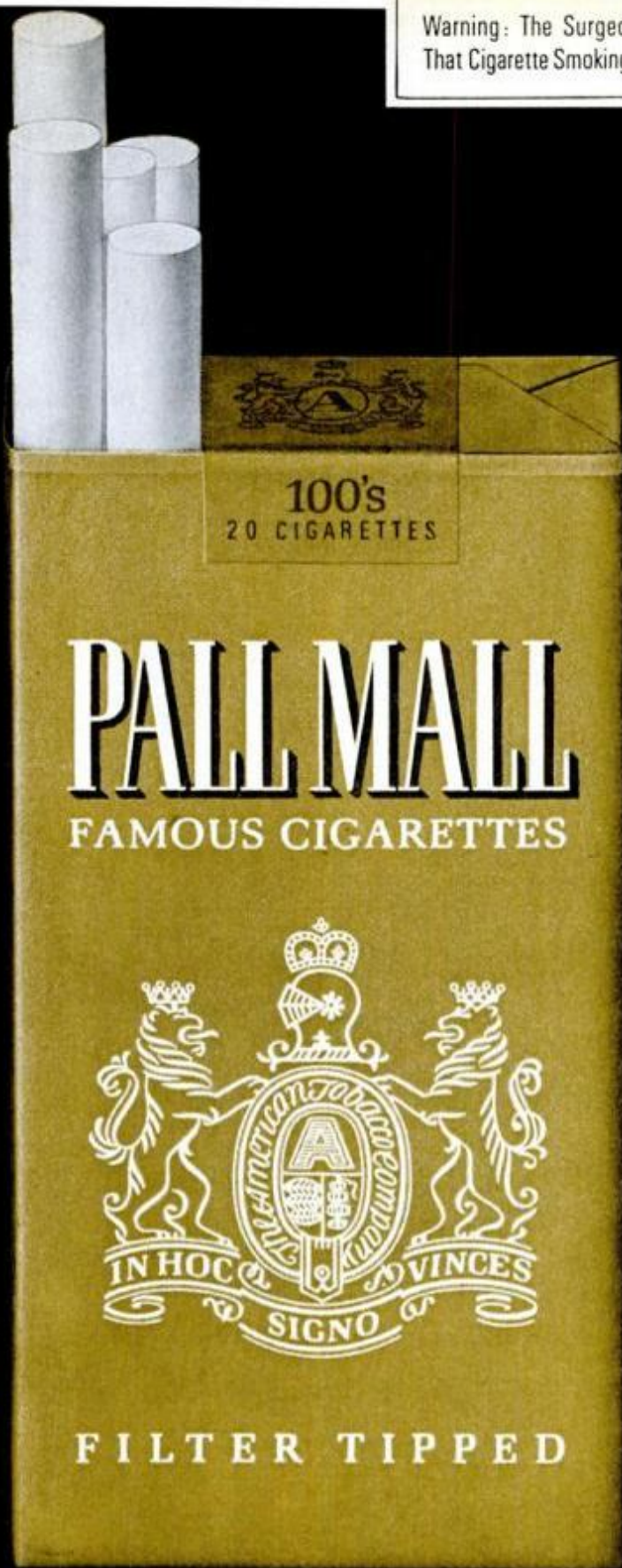

Longer...
yet
milder



Pall Mall Gold 100's

19 mg. "tar", 1.4 mg. nicotine av. per cigarette, FTC Report Oct. '74.

MARCH 1975

43

Материал, защищенный авторским правом

A cordless electric screwdriver

Though electric screwdrivers have been around awhile, Disston's cordless version, a year in the marketing, is a relatively new tool. An immediate—and obvious—advantage is that you are able to drive screws with power when there is none—on a job site or project where electricity has not yet been run in.

Having tried it personally, I can report firsthand that it is a tool many home handymen would like to have in their toolboxes. Under a full charge, the self-contained batteries store enough power to drive 80 1-in. screws. Obviously, that's ample for most home and shop projects.

I found that the bit turns rather slowly with a tendency to jump out of the screw's slot. Thus, when working with fine woods, it's a good idea to make the last few turns with a hand screwdriver to avoid marring the wood.

The driver operates with touch control; with the switch in either forward or reverse, the bit isn't actuated until you apply pressure to the working end of the tool. The housing is of tough plastic and the unit comes with charger, two drills and four driver bits.—Harry Wicks, *Workshop Editor*



Screwdriver is powered by self-contained batteries. Recharger comes with the tool; a full charge takes about 16 hours.

SPECIFICATIONS

Model S-100 Cordless Screwdriver

Weight (including battery): 28 oz.
Switch positions: forward, reverse, off
Batteries: nickel cadmium
Charger: use with 110-v., 60-cycle a.c.
Price: \$29.99
Manufacturer: Sales Dept., Disston Inc., 601 Grant St., Pittsburgh, Pa. 15219.

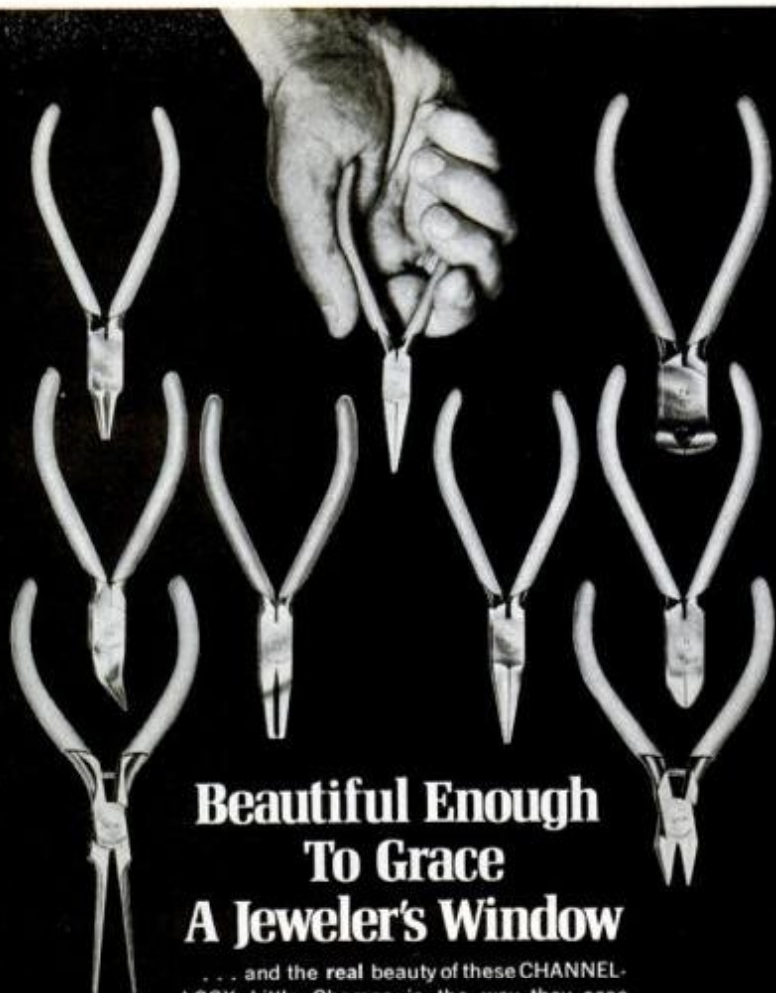

Beautiful Enough To Grace A Jeweler's Window

... and the real beauty of these CHANNELLOCK Little Champs is the way they ease hundreds of delicate, fine jobs that need firm treatment. Precision made of highest grade forged steel. High luster polished finish. Perfectly mated, hand honed cutters. Blue dipped plastic comfort grips. Specify CHANNELLOCK Little Champ precision pliers. You'll like 'em. Send for our free Catalog.

CHANNELLOCK, INC., Meadville, Pa. 16335

CHAN NEL LOCK

Little Champ Precision Pliers

CLOCK KITS

15th CENTURY CLOCK (at right) Plastic working replica of the earliest known mechanical clocks. Weight powered with nails inside plastic weights. Interesting to see how old wooden clocks worked. \$8 Postpaid
MANTLE CLOCK (not shown)—Spring powered version of above clock that will sit on a shelf or mantle . . . \$8.
COLOR CLOCK—See through modern style clock that is a special delight for kids age 1 to nine. \$6.

CALDWELL INDUSTRIES

Box 170, Luling, Texas 78648

★★ BOOKS ON CLOCKS ★★

- Teach Yourself Horology \$ 4.50
- Clock Repairing as a Hobby 5.95
- The Science of Clocks
and Watches 7.95
- How to Make a Weight Driven
8 Day Wall Clock 12.00



Castrol Expertise in Lubrication

Remember when car owners drove their automobiles into early retirement? And it was customary for loan payment books to outlast the cars?

Times have changed!

So has thinking. Once, tough, protective lubrication was considered a special benefit. Reserved for record setters, competition drivers, vintage car collectors and sportscar owners. But today, the quality motor oil that was once one man's special benefit is now every man's necessity. Because it's more economical to buy a quality oil. For the bigger share of a century, fine quality lubrication has been Castrol's special field. Our research has helped develop many tough, protective motor oils, improving their performance through run up and breakout tests in the actual engines that will use them. We demand cleaner performance, more effective protection and hard working toughness from every Castrol oil. Starting with naked molecules — if need be — to achieve the exact product quality we demand. Castrol GTX motor oil evolved from our expertise.

Castrol GTX is our finest, all-season multigrade motor oil. It offers outstanding performance and protection for all makes and sizes of cars. In these times, every car owner should demand hard working Castrol. For cleaner, smoother operation and longer engine life. Next time, buy Castrol quality . . . try our expertise.

Burmah-Castrol Inc. Hackensack, N.J. Member Burmah Group

Discover Castrol GTX motor oil in the Automotive Section of your favorite department or Auto Parts store. Now available in SAE 10W/40, 10W/50, 20W/50.



***Inflationary times
demand tougher
motor oils...***

Castrol 10W-30
Motor Oil



Castrol 20W-40
Motor Oil



Castrol Heavy Duty
Motor Oil



Castrol GTX Motor Oil

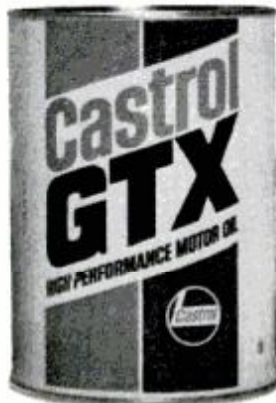

Castrol 2-Stroke
Motorcycle Oil



Castrol 4-Stroke
Motorcycle Oil



Castrol GT LMA
Brake Fluid



Castrol GP
Racing Motor Oil





Trim Time...

True Temper Cordless Electric Garden Tools put trimming work in its place: Out of the way! For example, the heavy duty Upright Cordless Electric Garden Shear (#3700) lets you walk through trimming jobs instead of crawling the length of your driveway on your hands and knees. The Heavy Duty Cordless Electric Garden Shear (#2720) makes quick work of hard to get spots like around trees and into corners. And the True Temper Cordless Electric Shrub Trimmer (#4700) cuts and sculpts shrubs and time down to size.

With True Temper Cordless Electric Garden Tools, trimming time is at a minimum, leisure time at a maximum.

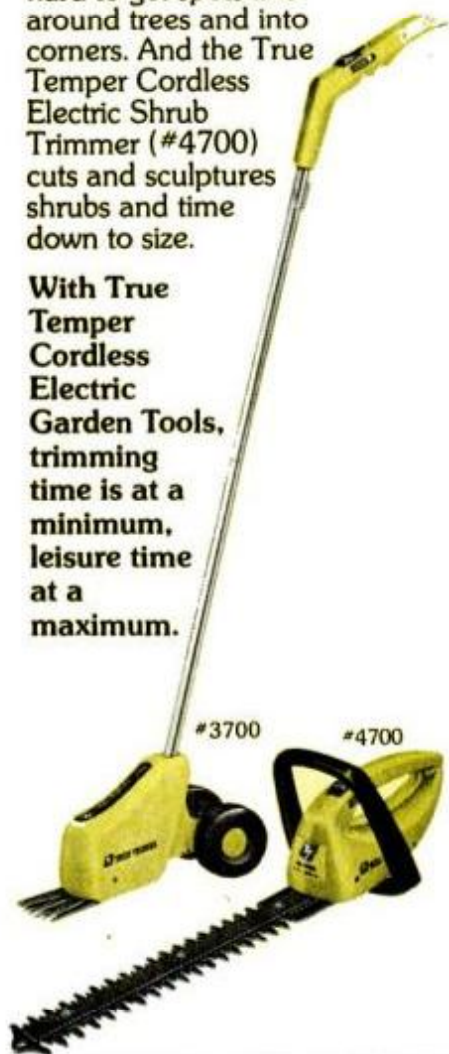

TRUE TEMPER
An Allegheny Ludlum Industries Company

Holographic movies viewed with white light

by Stephen Walton



3-D image of subject appears in center of drum-shaped multiplex hologram. Series shows motion of turntable used in original filming.

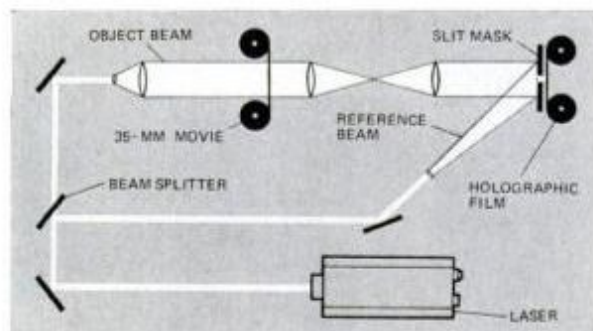
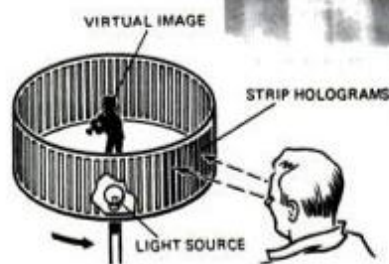

Each frame of movie of subject on turntable—for parallax between frames—is made into a strip hologram as shown schematically above. Viewer's two eyes see differently angled images—producing stereo effect.

The image you see is three-dimensional, contained within a plastic drum. It looks solid, but glows with its own light. As you watch, it both moves and revolves so that you see it from all angles.

What you're watching is a multiplex holographic movie, made by a process that requires no laser in the original filming of the subject or in playback. What you see is not a series of holograms of the subject—it's a holographic reconstruction of a 35-mm black-and-white movie shot with the subject on a turntable that makes one revolution in 45 seconds. With a laser, a white-light, image-plane hologram 9 inches high and just 3 mm (0.118 inch) wide is made of each frame of the movie. The film with these holograms is bent into a cylinder and the cylinder revolved (45 seconds per revolution) while illuminated from within and below. Each of the viewer's eyes sees the images produced by several of the strip holograms, but the two eyes see different sets, and the result is a moving stereoscopic image.

Holographic movies that are sequences of original holograms are also made, but are costly, and object-size limitations have so far restricted their use to microscopy. The new process was developed by Lloyd Cross and Dave Schmidt of the Multiplex Co. Their first holograms of this type, along with the one shown on this page, can be seen at the Museum of Holography, 120 West 20th St., New York, N.Y. 10011. ★★



WE LOOK FOR A FEW GOOD MEN.



AND WE FIND THEM.

MARINES

Quality, not quantity



Call 800-423-2600, toll free, for more information. (In California, call 800-252-0241.)

CAR CLINIC



BY MORT SCHULTZ

Diversionsary tactics

My 1972 Chevrolet Vega is driving me up the wall. I replaced the distributor cap, ignition wires, PCV valve and exhaust-system parts. I've set the carburetor to specification, but nothing has gotten rid of a back-firing out the exhaust when I decelerate. The noise sounds like fire-crackers. Please help.—Kenneth Muro, Elmont, N.Y.

I'll bet the diverter valve is bad. It's mounted on the air pump of the A.I.R. (Air Injection Reactor) system to control the airflow into the exhaust system. If the valve has failed, excessive pressure is building up that's relieved as air escapes from the tailpipe when you let up on the gas pedal.

Test the valve. With the engine idling, check to see that air is not escaping from the valve by placing your hand over the valve ports. Now, momentarily pinch the vacuum hose connected to the valve. Air should exhaust from the valve for about five seconds when pressure on the vacuum hose is released. Most times you will be able to hear the exhaust-ing air.

To replace a diverter valve that fails the test, disconnect the vacuum hose and the larger hose from the valve. Remove the two screws holding the valve to the A.I.R. pump. Remove the valve, and be sure to clean off all gasket material. Install a new valve using a new gasket.

Datsun doodles

At the 600-mile service on my '74 Datsun 610, I complained of a rear-end noise when cruising at 45 to 55 mph. It is a definite grind. At 2500 miles, my dealer finally received authorization to install a part that hasn't done one bit of good. Now I am told all 610s have this condition. Am I stuck?—Russel W. Knapp, Palm-dale, Calif.

I don't know whether you're stuck or not, but someone may be giving you a snow job. It's true that many 610s and Z model Datsuns with independent rear suspension have a "normal" whine. However, if the whine is objectionable, it can usually be reduced if the car has low mileage

by adjusting the clearance between the ring and pinion. If the car has high mileage, the ring and pinion should be replaced if you can't live with the noise.

But you speak of a grinding noise that occurs between 45 and 55 mph. That's a heck of a lot different than the whine I've been describing which occurs below 45 mph. I think you have a bad bearing in that rear end which should be replaced. I'll bet on the front pinion bearing, but whatever, your dealer should repair it under the warranty. If he doesn't want to, ask him to call in the Datsun field representative and let him judge the case.

Medical case

At 28,000 miles, the left rear bearing of my 1971 Toyota Corolla 1200 failed and was replaced. Less than 6000 miles later the new bearing and seal went bad. I've been riding on another new bearing for a while, and I may be getting paranoid, but I swear I'm hearing noise again. I don't do any unusual driving, and I don't carry heavy loads. I hope you can advise before I get an ulcer.—Dan Lawson, Flushing, N.Y.

I assume you are referring to the left rear-axle seal and bearing, Dan. If you are, then it is likely that when the bearing failed for the first time it seized and scored the axle housing. If so, replacing bearings and seals is fruitless. The scored housing will cause failure of new parts within a short period of time. Your logical solution is to replace the damaged housing.

Call the undertaker

For a long time my 1969 Ford pickup (360-cu.-in. engine) would suddenly gasp and die on a long, hard pull—just as if I had turned off the ignition. It got real hairy at times, because I haul a 7000-lb. camper on the pickup over some rough mountain passes. No mechanic could find the cause of the problem, because it just never occurred on the level. Then one day while searching for the source of a raw gasoline odor, I

found the trouble myself. With the engine under heavy load, torque would twist the fuel flex line just enough to open up a pinhole, allowing air to be sucked into the fuel line. A new piece of line and two hose clamps have corrected this long-standing problem.

I enjoy your column. Keep up the good work.—Al Jones, Fort Worth, Tex.

With guys like you feeding me stuff like this, I can't miss.

Shocking experience

On mornings when the temperature drops below 30° F., I get a stiff jolt when I put the key into the ignition of my 1973 Buick Century. What gives?—Mrs. Joan Metko, Linden, N.J.

Maybe your clothes, if you usually wear woollens in cold weather. Wool retains static electricity that "let's loose" when you touch the key to the switch.

Woollens or not, let's try a few things to solve the problem. The easiest attempt at a solution is to buy an antistatic electricity compound in an aerosol spray can that is sold by most auto supply and department stores. Spray it over the upholstery. If this fails to relieve the shock, buy a static strap and have it installed to a good ground in the rear of the car, such as where the bumper meets the frame.

Highway rodeo

My 1973 Plymouth Satellite starts with a bang and idles so fast I can hardly shift gears. It happens every morning, winter or summer, and continues until the engine warms up. I have to keep my foot on the brake pedal as I drive out of the garage and for the first few blocks. After it warms up, it runs like a top. When I get the car to the mechanic, it's warm and running beautifully, so he looks at me as if I've flipped. I'm no mechanic, so I don't need a big write-up. Just answer a question for me. Is this normal?—E.O. Hirt, Chicago.

You had better get that engine's
(Please turn to page 52)

He's just won \$25,000,
poured a bucket of champagne
over his head.
He's not going to follow all
that with a boring cigarette.



Warning: The Surgeon General Has Determined
That Cigarette Smoking Is Dangerous to Your Health.

King Size.
Super Longs.



Viceroy has full-bodied
flavor that doesn't flatten
out. Always rich...always
smooth...always exciting.
Get a taste of Viceroy.
Get a taste of excitement.

Viceroy. Where excitement is now a taste.

Kings, 16 mg. "tar," 1.1 mg. nicotine; Longs, 17 mg. "tar," 1.1 mg. nicotine, av. per cigarette, FTC Report Oct. '74



Ask your Ariens dealer why he sells Ariens

Your Ariens Dealer is an outdoor power equipment specialist. He has been selected because he has the knowledge, the experience, and the facilities to sell and service Ariens Tillers, Tractors and Riding Mowers in a thoroughly professional manner.

And your dealer chose to sell Ariens because his knowledge and experience told him that no other brand could exceed Ariens in excellence of design, quality of manufacture, or exceptional performance.

Your Ariens Dealer is eager to tell you about the ruggedness of Ariens Power Tillers, the superb handling of Ariens Lawn and Garden Tractors, the fine even cut you'll get from an Ariens Riding Mower with its "Flex-n-Float-Plus" mower suspension. That's the sort of thing that turns him on.

And, really, that's why he sells Ariens.

Ariens MAKING THE BEST

Ariens Company • 806 West Ryan Street • Brillion, Wisconsin 54110

To help stop Athlete's Foot more families buy Desenex[®] than any other remedy.

That's because anti-fungal Desenex contains a medically-proven formula that has successfully helped millions of sufferers. And the number gets bigger every year.

To help heal Athlete's Foot, use Desenex Ointment at night and Desenex Powder, or Aerosol, during the day.

When used routinely, Desenex provides continuing protection against fungous infection.



Also available in solution form.

©1974 Pharmacrast Consumer Products

A PRODUCT OF PENWALT CORPORATION

CAR CLINIC

(Continued from page 50)

fast idle and choke settings back on target before you wear out your brakes or run off the road.

SERVICE TIPS

■ **Chrysler's overheating problem.** In the August, 1974, *Car Clinic* we printed a service tip about overheating problems being experienced by many Chrysler Corp. cars. We have since received telephone calls and letters from Dodge, Plymouth and Chrysler owners who have taken their car back to dealer service shops for repair only to be met by skepticism. Service managers—some anyway—are actually disclaiming knowledge of the problem or of the *many* service bulletins which have been issued by Chrysler in an effort to solve it.

Well, enough of this nonsense. You take your car back to the service manager and defy him to tell you that the service bulletins I'm about to cite don't exist.

Let's start with service bulletin 09-13-73C (Chryslers and Plymouths), 09-13-73D (Dodge passenger cars) or 09-09-73T (Dodge trucks). Entitled "Engine Cooling—Severe Overheating," this bulletin is dated Aug. 27, 1973, and provides 28 pages of instructions on solving the problem.

The most important part of this bulletin is a lengthy questionnaire that you are asked to help fill out. Your answers to questions regarding your particular overheating condition will direct a good mechanic to the cause of the problem.

Another service bulletin that applies to overheating trouble is 07-01-73C for Chryslers and Plymouths, and 07-01-73D/07-01-73T for Dodge cars and trucks. This bulletin, dated Jan. 24, 1973, points out that overheating and coolant loss may be caused by solder corrosion products forming at the radiator core tube ends, causing a restriction. This bulletin explains how to solve the problem.

And still another bulletin you can quote to those "know nothing" service managers is 07-02-74C for Chryslers and Plymouths, and 07-02-74D/07-03-74T for Dodge passenger cars and trucks. Dated March 11, 1974, it expands on the bulletin discussed in the previous paragraph. It applies to vehicles that overheat after radiators have been rodded and freed of solder corrosion.

That's not all. There is still another service bulletin. It is 07-03-74C for Chrysler and Plymouth, and 07-04-74D/07-04-74T for Dodge cars and trucks. Date: Aug. 26, 1974. It explains how to make sure that the viscous fan drive is not causing overheating.

Now let's see some of those service managers try a cop-out! ★★★

GOT A PROBLEM WITH YOUR CAR?

Just ask Mort about it. Send your question to the Car Clinic, *Popular Mechanics*, 224 West 57th St., New York, N.Y. 10019. While letters cannot be answered individually, problems that are of general interest will be published in the column.

The man who'd rather drive a truck than a car.

He's got a nose for trucks.
 And a feel for trucks.
 Most of all, he's got a head for trucks.
 And he uses them all when he buys his Dodge.
 He opens up the hood and takes a long hard look inside. This man does a lot of his own work. And he wants to be sure he can get his hands on things.

Four-wheel drive. Good. Dodge is famous for that. Has been since World War II. And this man can make good use of it. For one thing, there's rarely a day when he does his driving all on a nice paved road. Some days there's no road at all.

He takes the measure of the payload. He'd better. A man who'd rather drive a truck than a car doesn't leave his wheels at some parking lot all day. He works his truck like he works himself. He spends a big chunk of his day in it. He grows attached to it almost by the seat of his pants.

So it counts that the payload is big. And it counts that Dodge has a tailgate that comes off easily.

Without a wrench.

Another thing. This man is rarely a desk jockey. If his truck doesn't work, neither does he.

So he finds a lot of comfort in the Electronic Ignition. What it does is very simple. It eliminates points and condenser. That means fewer tune-ups and surer starts.

The man who'd rather drive a truck than a car has another rare characteristic: he doesn't head for the highway to get away from his kids. He likes to have them around.

And he'll always be a little bit grateful to Dodge for the Club Cab... so he doesn't have to squeeze the family out.

Next time you're in some spectacular part of this country, keep an eye out for him.

The man who'd rather drive a truck than a car. We're proud so many of them would rather drive a Dodge.



DODGE PICKUPS '75



Extra care in engineering makes a difference.



CHRYSLER
 MOTOR CORPORATION

SIMONIZ

**HEAVY DUTY
AUTOMOTIVE
MOTORCYCLE
WORKSHOP
CAMPER
POWER TOOL
BICYCLE
MOTOR BOAT
SNOWMOBILE**

or just
about any-
thing
else you
have
'round the house
**CLEANER
DEGREASER**



Available in 28 oz. spray gun container
and 64 oz. refill wherever you buy auto
parts and accessories.

© MNP TEXIZE CHEMICALS COMPANY, DIVISION OF
MORTON-NORWICH PRODUCTS, INC., GREENVILLE, S.C. 29602

HINTS

FROM READERS



Soldering aid from socket

Remove the screw shell from a porcelain receptacle. Mount the socket on the wall of your workbench tool panel and fill it with steel wool. It will prove convenient for keeping the tip of your soldering iron or gun clean.—*H. Miller, Oroville, Calif.*



Renewing glove tips

Heavy welding gloves often wear out at the fingertips, while the rest of the glove remains serviceable. Coating the holes and tips with epoxy will more than double glove life and does not hinder their use.—*Tom McCanna, Woodstock, N.Y.*



Keeping lotion on hand

A bottle of hand lotion is always handy in your shop when kept on the tool panel, and a standard coat hook mounted horizontally makes a perfect holder for a 10-oz. bottle. A slight tug on the bottle frees it when needed. Two screws secure the hook.—*R. C. Rask, Denver*



Cord holder

To keep excess appliance cord coiled neatly, cut, notch and bend thin aluminum or plastic to shape shown (use escutcheon plate as a pattern). Round all edges. The existing mounting screw will hold the cord keeper in place behind the plate.—*M. G. McMullen, Santa Margarita, Calif.*

Chrysler: "The Great Getaway"

Pick yourself a spot where you can forget the everyday world and leave boredom behind.

And when you go take plenty of power to get you there and back. Like this Chrysler Funster powered by the famous Chrysler 60, with exclusive Magnapower II ignition. It's dependable. It's powerful. And it's designed simply — for ease of service. Let Chrysler take you out of the ordinary and power your Getaway with engines ranging from 3.6 to the 135. Take your choice and hang it on a Chrysler Hydro-Vee, Runabout, Cruiser, Bass Boat or Sailboat. See them at your Chrysler Crew dealers.



Two more ways to Getaway: Check your TV listing for Chrysler-sponsored "Fishin' Hole" and "Water World."

The whole neighborhood wondered what Frank Mallon was up to in his workshop.

Word had it he was up to something mighty peculiar. And when he didn't show up for bowling practice one Wednesday night, the Wabash Cannonballs (that was the name of his neighborhood team) began to wonder, too.

So it was that a bunch of the boys decided to pay their "star" a visit, and talk him out of his workshop and back into action.

It didn't happen that way, though.

Matter of fact, it was Frank Mallon who talked the Wabash Cannonballs out of their bowling night and down into his workshop. What was it... what could be exciting enough to keep a bunch of ten-pin tigers from their favorite pastime? One of the most fascinating learn-at-home programs in the world, that's what!

Actually build and experiment with the new generation color TV in Bell & Howell Schools' fascinating learn-at-home program. It will help you develop new occupational skills as an electronics troubleshooter.

You'll set up your own electronics laboratory to learn first-hand, the technology behind such innovations as digital-display wristwatches and tiny pocket calculators.

In fact, as part of the program, you'll actually build and experiment with a 25" diagonal color TV incorporating digital features.

But most important of all will be the new skills you'll develop all along the way... the kind of skills that could lead you in exciting new directions. While we cannot offer assurance of income opportunities, once you've completed the program you can use your training:

1. To seek out a job in the electronics industry.
2. To upgrade your current job.
3. As a foundation for advanced programs in electronics.

Go exploring at home, in your spare time. No traveling to class. No lectures. No one looking over your shoulder.

Bell & Howell Schools wants to introduce you to the modern way to learn. It means you'll be able to develop new skills in your own home—on whatever days and hours you choose. So you don't have to give up your present job or paycheck just because you want to learn new occupational skills.

What's more, we believe that when you're exploring a field as fascinating as electronics, reading about it is just not enough.

That's why you'll get lots of "hands on" experience with some of the most impressive electronic training tools you've ever seen.

No electronics background necessary.

That's one of the advantages of this program. We start you off with the basics and help you work your way up, one step at a time. In fact, with your first lesson you receive a Lab Starter Kit to give you immediate working experience on equipment.

You build and perform exciting experiments with Bell & Howell's Electro-Lab®, an exclusive electronics training system.

First comes the design console. After you assemble it, you'll be able to set up and examine circuits without soldering.

Next, you'll put together a digital multimeter. This instrument measures voltage, current and resistance, and displays its findings in big, clear numbers like on a digital clock.

Then comes the solid-state "triggered sweep" oscilloscope. An instrument similar in principle to the kind used in hospital operating rooms to monitor heartbeats. You'll use it to analyze the "heartbeats" of tiny integrated circuits. The "triggered sweep" feature locks in signals for easier observation.

You'll build and work with Bell & Howell's new generation color TV... investigating digital features you've probably never seen before!

This 25" diagonal color TV has digital features that are likely to appear on all TV's of the future.

As you build it, you'll probe into the technology behind all-electronic tuning. And into the digital circuitry of channel numbers that appear right on the screen! You'll also build in a remarkable on-the-screen digital clock that will flash the time in hours, minutes and seconds.

And you'll program a special automatic channel selector to skip over "dead" channels and go directly to the channels of your choice.

You'll also gain a better understanding of the exceptional clarity of the Black Matrix picture tube, as well as a working knowledge of "state-of-the-art" integrated circuitry and the 100% solid-state chassis.

After building and experimenting with this TV, you'll be equipped with the kinds of skills that could put you ahead of the field in electronics know-how.

We try to give more personal attention than other learn-at-home programs.

1. Toll-free phone-in assistance. Should you ever run into a rough spot, we'll be there to help. While many schools make you mail in your questions, we have a toll-free line for questions that can't wait.

2. In-person "help sessions". These are held in 50 major cities at various times throughout the year, where you can talk shop with your instructors and fellow students.

So take a tip from Frank Mallon. Find out more about the first learn-at-home program that could stir up your neighborhood!

Mail this postage-paid card today for full details, free!

Taken for vocational purposes, this program is approved for Veterans' Benefits.

If card has been removed, write:

An Electronics Home Study School
DeVRY INSTITUTE OF TECHNOLOGY



ONE OF THE
BELL & HOWELL SCHOOLS

4141 Belmont, Chicago, Illinois 60641

Electro-Lab is a registered trademark of the Bell & Howell Company.

696 R2



On-screen digital clock



Channel numbers that flash on the screen



Automatic pre-set channel selector

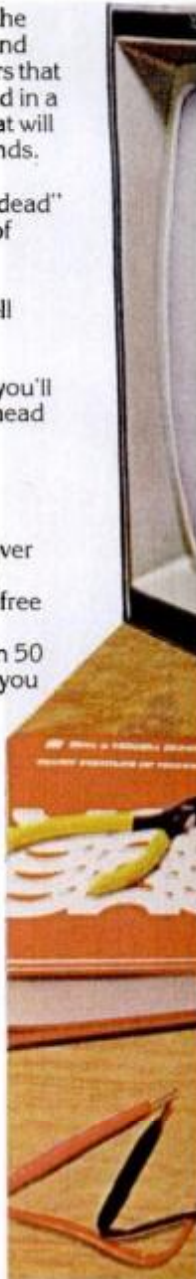

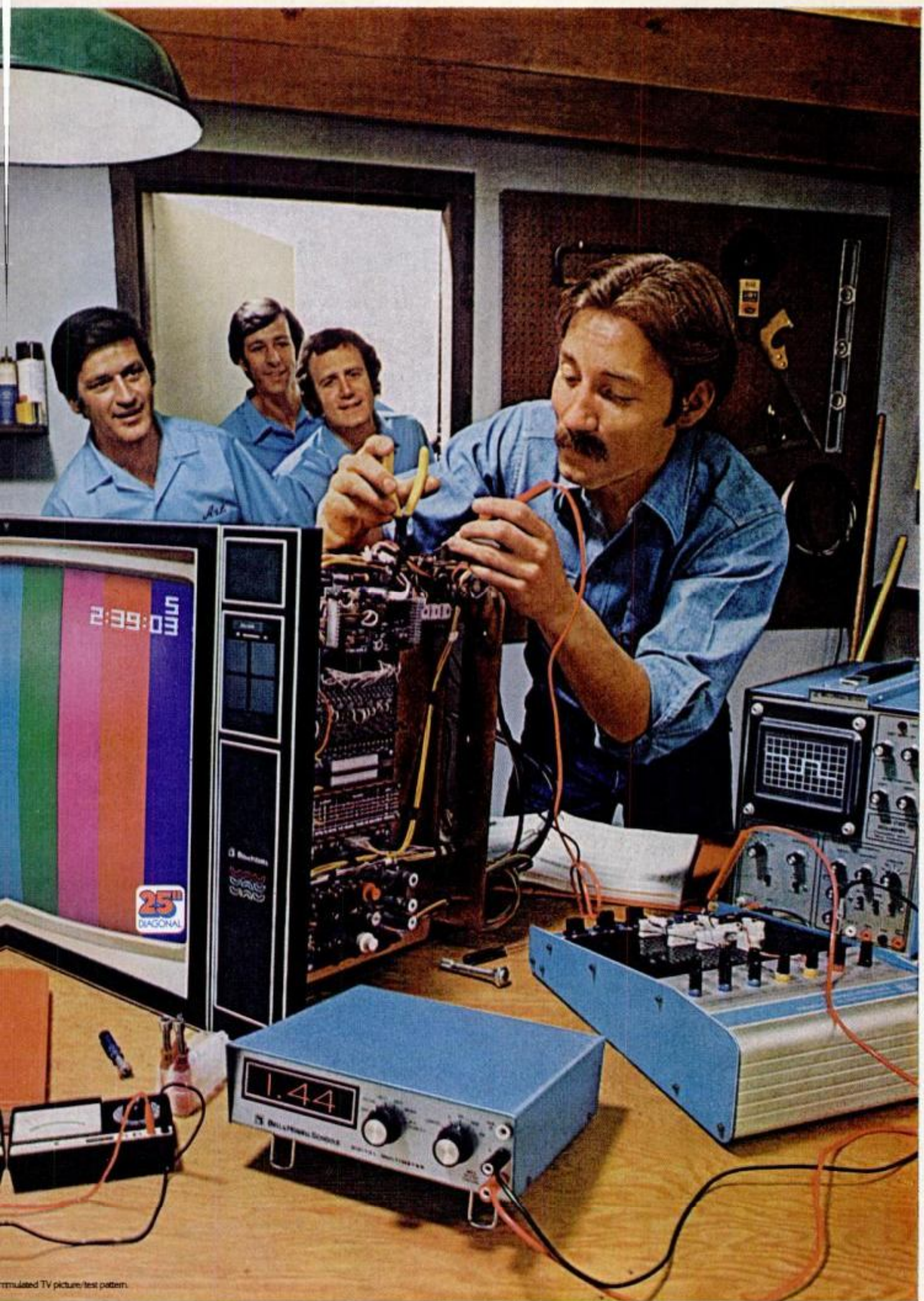

Simulated TV picture/test pattern.

who says
the shortest
distance between
two points
has to be
a straight line?



INSTALL YOUR OWN SPIRAL STAIRS!

It's fun to put
together in less
than 2 hours!

- COMPLETE INSTRUCTIONS INCLUDED
- NO SPECIAL TOOLS OR SKILLS NEEDED

STOCK KITS
AVAILABLE
FROM \$295.00

SEND FOR BROCHURE

SHOWROOM OPEN 9-5
—EXCEPT SUNDAY—

DESIGN SERVICES AVAILABLE

Mylan

INDUSTRIES

650 W WASHINGTON STREET
PEEKSKILL, N.Y. 10566

212-LU 5-6767 914-739-8486

QUESTIONS ANSWERED BY W. CLYDE LAMMEY



HOMEOWNERS' CLINIC

Puffing fireplace

I have a natural fireplace in a basement recreation room. When my gas furnace kicks on, the fireplace smokes—that is, a puff of smoke enters the room each time the gas burner starts its cycle. The fireplace upstairs is unaffected. What's the cause of this? And the remedy?—Lester Towns, Troy, N.Y.

Your basement must be nearly airtight. When the burner kicks on, warm air rises in the furnace flue by convection. Air pressure in the basement is equalized by air drawn down the fireplace flue, forcing smoke and gases from the natural fire into the room.

Opening a basement window slightly or leaving the door to the basement stair open should cure or at least minimize the problem.

Two stories or one?

I live in an older home and plan to build a new one on property I own in a better section of town. I'm inclined toward a two-story house but am still undecided; the split-level type is not very much to my liking. What is your opinion?—J. Horowitz, Pittsburgh.

Your local architect and builder are in a better position to advise you. If present-day construction costs are not a limiting factor, I would prefer the two-story house with traditional architectural lines to the seemingly more popular low-profile structure. In some localities it is cheaper to build a second floor than to spread out to obtain equal floor area. Two-story houses are also more economical to heat.

Will insulation harm shingles?

I've built up the insulation in my attic from 3 to 7 in., the original 3 in. being batts. Now I'm told that this will greatly accelerate the deterioration of the composition roof shingles. If this is so, how?—Gene Cowdry, Dubuque, Iowa.

If I were you, I would continue to sleep soundly. Your attic will be colder in winter and perhaps hotter in summer without added ventilation, and there is an opinion that this will

tend to shorten shingle life, but I doubt that this reduction would be more than three years on the average, if that much.

Condensation woes

Despite storm sash on all windows in my home (all storm windows are on hangers with hook closures), some windows sweat while others stay clear. On some the storms sweat; on others the inner glass is fogged. Why is this, and what can I do about it?—Robert Mayer, Northfield, Mass.

If the inner sash leak warm air, then the outer ones sweat, as you say. If the reverse is true, then the inner ones sweat. The remedy is a tighter fit of either the inner or the outer sash on each sweating window. Weatherstripping on the inner sash and turnbuttons on the outer ones will usually do it, or at least reduce condensation to the point where it is no longer objectionable.

Clock running wild

What's wrong with an electric clock that gains as much as an hour or two in a day? It's a battery-driven type, and I was told that the battery should last a year. But I've only had the clock a few months.—Miles Osborne, San Francisco.

The battery is nearly exhausted. This type of clock will become inaccurate as the battery nears total failure. Most clock batteries will last a full year, but have a limited shelf life, and it's possible that yours was old and was not tested before it was placed in the clock. Install a fresh battery—have it tested—and then see how the clock runs. If it needs regulation, look for a tiny exposed screw on the back of the movement and adjust this screw until the clock keeps good time. ★★★

Do you have a home maintenance or repair problem? Send it to Homeowners Clinic, Popular Mechanics, 224 West 57th St., New York, N.Y. 10019. Letters cannot be answered individually, but problems of wide interest will be discussed in this column. For more home repair and maintenance help, get PM's Home Care Guide, \$4.45 postpaid. Send orders to PM, Dept. HC5, Box 1014, New York, N.Y. 10019.

Warning: The Surgeon General Has Determined That Cigarette Smoking Is Dangerous to Your Health.



Start fresh with Belair.

Just the right touch of menthol.

Travel free and easy with this nylon weather-proofed Coleman day pack with zippered pouch and 2 side pockets. Yours for free B&W coupons, the valuable extra on every pack of Belair.

To see over 1000 gifts, write for your free Gift Catalog: Box 12, Louisville, Ky. 40201.



Kings, 16 mg. "tar," 1.1 mg. nicotine; Longs, 17 mg. "tar," 1.2 mg. nicotine, av. per cigarette, FTC Report Oct. '74



SCIENCE WORLDWIDE

The man is for burning

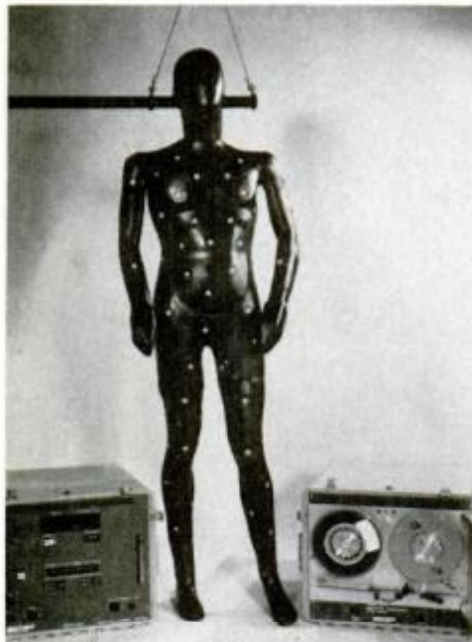

A life-sized, highly instrumented mannequin is now being used by Du Pont Co. researchers to measure the probable extent and severity of burn injury in tests of garment and fabric flammability. Called Thermo-Man, the mannequin is equipped with 114 heat-sensing devices (indicated by white rings in photo). Electronic gear, some of which is contained within Thermo-Man's abdomen, is capable of recording about 20,000 temperature measurements a minute. Computers in the system translate readings into a record of skin surface and tissue temperatures and damage at varying depths and over precise areas of the body. Originally, the mannequin was constructed by the Acurex Corp. for an Air Force study of protective clothing.

Easy on the chow!

Many dog owners may be injuring their pets by giving them too much food containing calcium, according to a Cornell University veterinarian. "Excess quantities of calcium, often found in nutrient supplements, can result in severe skeletal deformation in large dogs," says Dr. Lennart Krook. "Overnutrition can be as dangerous as undernutrition."

In one study reported by Dr. Krook, "overfed" Great Danes were found to be suffering from excessive

bone formation, retarded maturation of cartilage and decreased resorption of bone, a process normally needed to accommodate the changing structure of growing skeletons. The dogs suffered from lameness, moved clumsily and were sensitive to manual examinations.

Basis for new engine?

A virtually pollution-free engine that runs on "cool burning" fuel may result from designs now under development at laboratories of the General Electric Co. Such an engine could be built around the concept of burning fuel in a device called a "transpiration burner," developed originally as a tool for research in combustion processes.

A premixed flow of fuel and air is fed through a flat, porous plate in which cooling coils are embedded. A flat sheet of flame burns steadily above the plate, and the flame's temperature is reduced below what it would normally be as heat is absorbed by water in the coils. Reduction of flame temperature is vital to reducing pollutants, particularly oxides of nitrogen. The transpiration burner creates about 15 parts per million of nitric oxides while the

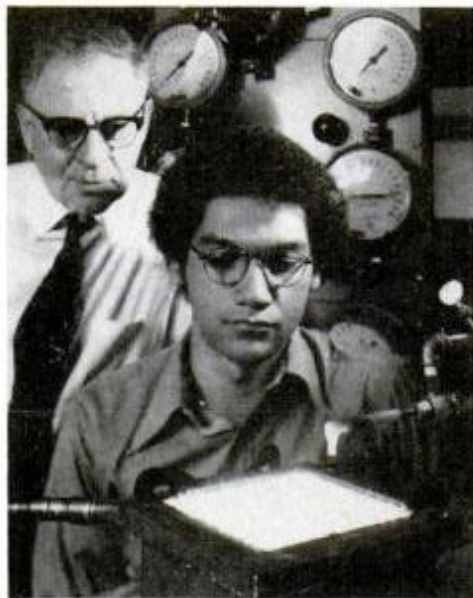

typical, hot-burning auto engine produces about 600 parts per million, according to GE researchers. Studies are being made into possible use of the transpiration burner as the basis

for an automotive steam engine or gas turbine.

Rare beefalo steaks

The "beefalo," bred from a buffalo and a cow, is being hailed by some cattlemen as the animal that will save the industry in years to come. The hybrid—first successfully bred in 1970 by a Californian—reportedly has twice as much protein and about 30 percent less fat than today's beef cattle. The animal does not need expensive grain but can get all his food in a pasture, cutting expenses significantly. It will be several years, however, before the supermarket will offer beefalo steaks because only a few hundred of the critters exist—and they are breeding stock. The meat reportedly is similar to beef, but dryer.

New diagnostic tool

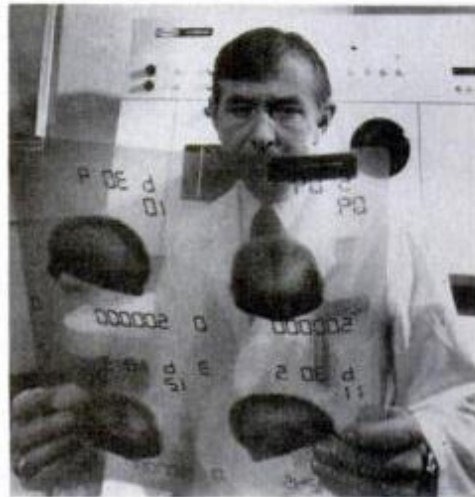

Standard X-ray has its limitations: It can't provide good detail of some organs and parts of the body. Researchers recently have come up with other methods of getting pictures. One is a gamma camera developed by the Raytheon Co. to detect organ damage, blood clots, tumors and other abnormalities. A radioactive substance is injected, then the organ under study is scanned by the camera, recording gamma-ray radiation. Result: a clear, detailed picture. Photo shows technician examining two brain scans made by the new instrument. ★★★

Speed. Control. Power.
Quick response. Everything you want
when you cruise, fish or ski.
We call it MerCruiser confidence.
Performance so worry-free
you take it for granted.
With quiet Jet-Prop™ exhaust
for economical operation.



And Power Trim for quick getaways,
safer shallow-water running,
and a smoother ride under varying
load and water conditions.

When it comes to performance,
other stern drives just don't
add up to MerCruiser.

We outsell all the others combined.

MerCruiser confidence. It starts with performance.

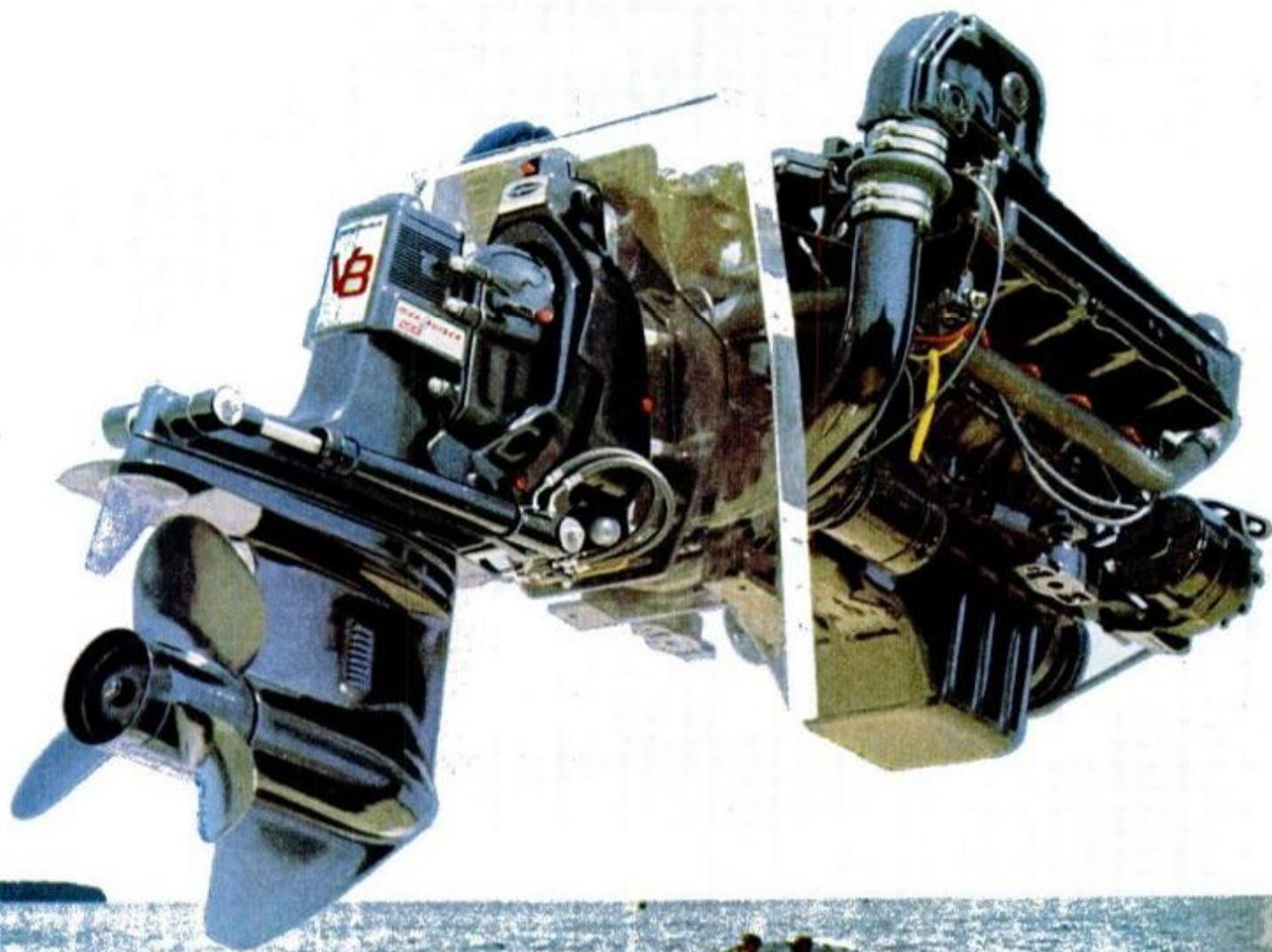

MERCUISE
STERN DRIVE POWER

Mercury Marine/Division of Brunswick Corporation,
Fond du Lac, Wisconsin/Canada/Australia/Belgium



Full Power Lineup for 75: MerCruiser 120, 140, 165, 688, 233, 265, 280.
For nearest MerCruiser dealer, see the yellow pages under "Outboard Motor."



New value. Now you have a whole new set of facts to consider in choosing your next van. Ford's new generation of vans creates room and comfort inside, new servicing ease outside... it's a lot of van. Shown with optional Chateau trim, radio, wheel covers, mirrors, whitewall tires, Tu-tone paint.

Ford redesigns the van.

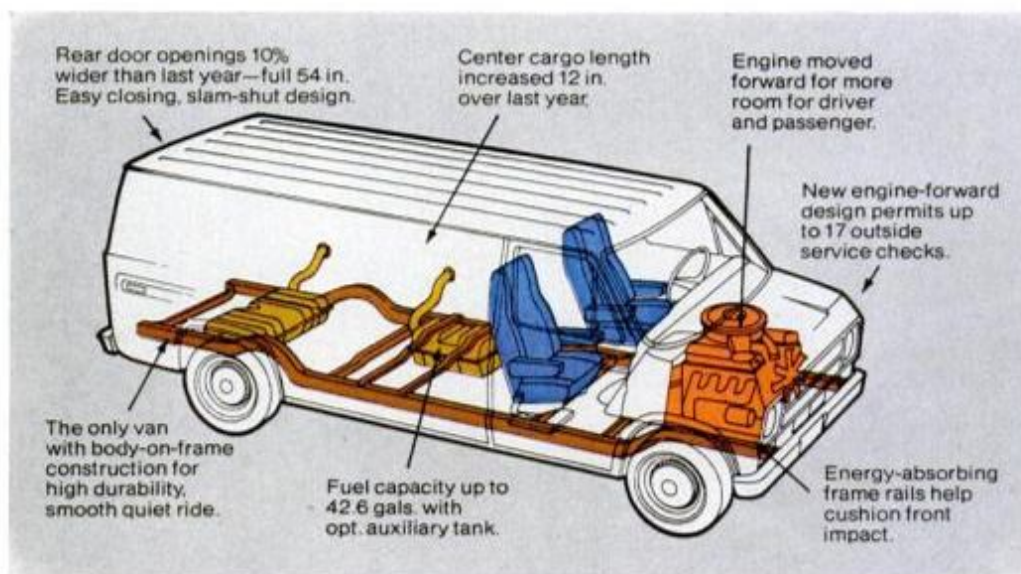

**Introducing '75 Ford Econolines
with basic advances in room,
comfort, durability
and all-around usefulness.**

A new generation of van value.



New comfort. Econoline '75 establishes a new standard of van comfort, both for business and personal use. Move-around room for feet and legs is increased over last year... on the passenger side, too. Van interior shown with optional Chateau trim, radio, Captain's Chair, air conditioner, automatic transmission.

New comfort

Econoline '75 is a whole new money's worth for the van buyer. It is designed as much for people as for things... brings you a new level of driving comfort. Engine and front axle have been moved forward, wheelhousings are out of your way, door openings are taller. The driver area is more spacious, with ample move-around room and seating comfort.

It's easier for the driver to step in and out on the wide step, to move from his seat to the load area, to step across to the passenger side, or to use the passenger-side door.

And Ford offers new options to the driver who wants to outfit his van... who "lives" and works in it all day, or uses it for pleasure.

Examples: woodtone finishes, cut-pile carpeting, one-way glass for privacy in rear doors and in Window Vans, sidewall-mounted auxiliary air conditioning/heater system, wide range of Tu-tone paints.

You'll find the Econoline '75 has a new "command" feeling—in ride, in road-hugging stability, in handling ease—and the quiet that says quality. It's the kind of quiet you get with an out-front engine and vibration-dampening body mounts.

Compare the '75 Ford Econoline with your van. Or any other van. Compare value for your dollar...compare on any basis you wish.



Standard seat is full-foam, contoured for all-day driving comfort. Optional passenger seat offered. Easy to step into cargo or passenger area.



New easy entry. Econoline '75's door openings are taller than last year—wheelhousing is moved forward out of the way. New wide step. Optional Captain's Chairs pivot both ways, have fold-down arm rests.



▲ New driving ease starts with well-designed instrument panel: New optional integrated air conditioner/heater system is built into dash. Note utility pockets molded into engine cover.

◀ New roominess. Ford has moved engine forward nearly 18 in. You enjoy new freedom of movement. Driver can use either door

New Durability, New Choices ▶

New durability

Econoline '75 is the only American van to have a separate frame and body. This type of construction makes for rugged strength... and permits a solid ride because the body is mounted to the frame on strategically-placed rubber mounts. These mounts are designed to isolate the body, driver and load from the frame.

To help protect the regular van and wagon bodies from the effects of time and weather, key body components are galvanized, and the entire body is primed by a deep-dip electrocoat process. Econoline '75 is built to keep its value.

Durability under the hood: Econoline '75's standard engine is a 300-cu. in. Six, for performance with economy...big 11-in. clutch, standard. Two V-8's available, 351- and 460-cu. in.

Also standard: Power front disc brakes for good control with low pedal pressure. Improved Twin-I-Beam front suspension, still a Ford exclusive, contributes to front-end toughness and stable ride.



18% bigger windshield area than last year.

Bolt-on front fenders for easy repair.

Power front disc brakes standard.

Improved Twin-I-Beam suspension for front-end strength.

The bigger, higher windshield of Econoline '75 provides improved visibility. Better to see traffic lights overhead, both fenders down in front. Washer jets are right on wiper arms for effective spray.

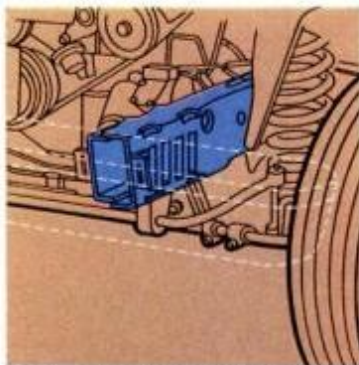

Energy-absorbing frame rails help cushion front impact.

Deep-dip electrocoat priming for complete coverage.

Zinc-rich primer on lower body panels.

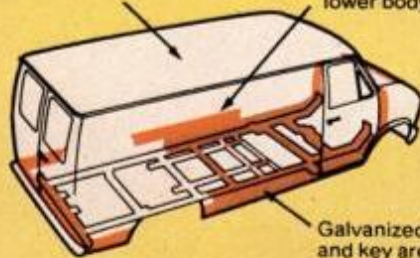

Galvanized steps and key areas.

Ford's anti-corrosion measures promote long life, help protect your investment in the new Econoline '75.

New choices

New power choices: 300-cu. in. Six is standard. Options: 351- or 460-cu. in. V-8.

New model choices: Now four series of Regular Vans, with new wheelbases, 124- and 138-in.... greater GVW's, to 10,000 lbs. Also offered as Window Vans. Club Wagons to 8,750 lbs. GVW. Cutaway chassis, 138- and 158-in. wheelbase, have GVW's to 11,000 lbs. with dual rear tires.

- Ford Parcel Delivery Vans now offer stand-up bodies 12 or 14 ft. long, 7 or 8 ft. wide. Single or dual rear tires.

- Cutaway chassis now take mini-motorhome bodies up to 21 ft.

New options: Tailor your new '75 Ford Econoline to your needs and tastes:

- An auxiliary fuel tank increases total fuel capacity up to 42.6 gallons.
- Auxiliary air conditioning/heater system has outlets along the sidewall.
- One-way glass for privacy in rear doors and in Window Van, AM/FM/MPX stereo, radial tires, Speed Control.
- Choice of hinged or sliding side cargo doors.
- Front stabilizer bars for improved handling.

See your local Ford Dealer. Look close at the new '75 Econoline...the all-new van, today's big van value.



New Ford Parcel Delivery Vans. Up to 40% more cube than last year. 12-, 14-ft. bodies.



Mini-motorhome chassis. GVW's to 11,000 lbs. Single or dual rear tires. For bodies to 21 ft.

New '75 Ford Club Wagons. 5-, 8-, 12-passenger. Optional Chateau Trim Package shown, with radio, wheel covers, whitewalls, mirrors, Tu-tone paint. 3 trailer towing packages, for GCW's to 16,300 lbs.



FORD ECONOLINE VANS

FORD DIVISION



VACATION HOMES

10 great designs
for leisure living

by Harry Wicks, WORKSHOP EDITOR



Despite cries of tight mortgage money, as many as 300,000 Americans are expected to take ownership of vacation homes this year. We've rounded up 10 typical homes that they will be moving into—prefabs, a condominium and three built from stock plans. The comfortable house here is an economical route to second-home ownership. If you want to finish the interior yourself, you can have a livable shell erected for about \$18,500.

For more details on any of these homes, write the manufacturers.



American Barn, 123 Elm St., South Deerfield, Mass. 01373

UPPER LEVEL

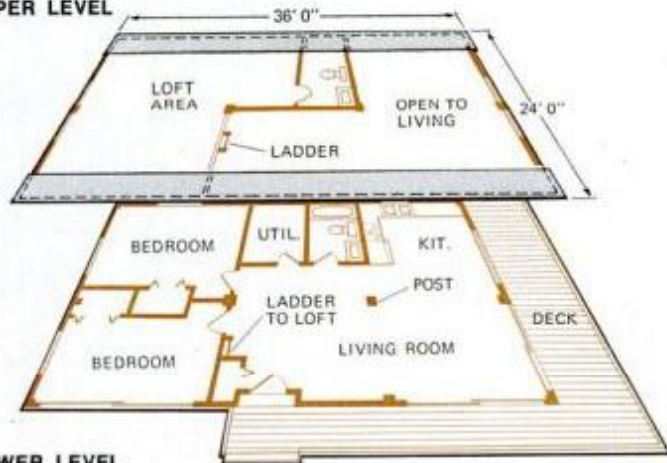

LOWER LEVEL



American Barn IV has the warm characteristics of a renovated barn with features found in today's better contemporary homes.

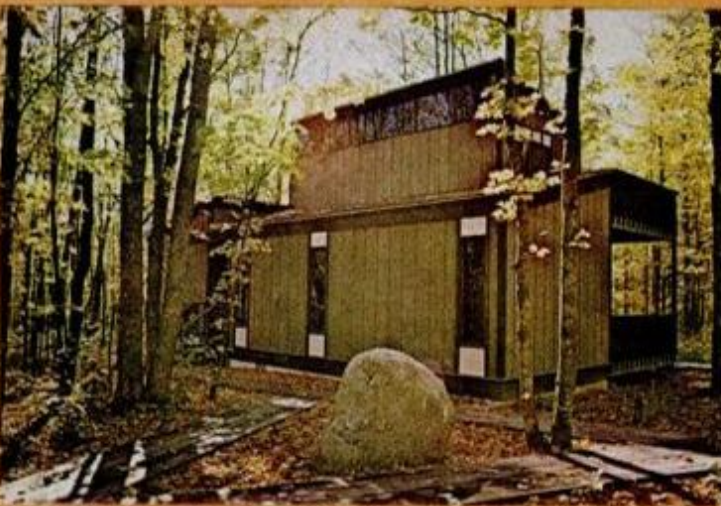

UPPER LEVEL



LOWER LEVEL



A country hideaway

This complete family-sized house with two large bedrooms and a bunk room is cozy enough for two or can be arranged to sleep up to 10 comfortably. Just one of 30 designs offered by the manufacturer, the Nutshell 900 features a balcony which overlooks a cathedral-ceilinged living room with 16 feet of glass. The glass opens on a spacious deck to let you view your lake, mountain or surf.

House size is 24x28 ft. with 912 sq. ft. of good living distributed over two levels. On your lot, the cost is about \$15,000 for a shell or \$24,000 complete.

Acorn Structures, Inc., Box 250, Concord, Mass. 01742

All fun and no work

Owning a condominium is the ideal way for many to have a second home. You can enjoy provided recreational facilities—such as swimming, hiking, fishing and golf—full time because condominium programs usually include exterior maintenance of your property. Sunriver, located on 5500 acres of unspoiled Oregon landscape, permits buyers the choice of either multi or single-residence dwellings. Environmental protection occupies a position of top priority in all planning. For example, the housing is grouped and contained within the timberline, and the golf courses are laid out to serve as green-belt buffer zones between the activity and wildlife areas.

Sunriver Properties, Inc., Sunriver, Ore. 97791
Photos: Western Wood Products Assn.

Rustic, contemporary and spacious

Mountain Haus design lets youngsters take over the upstairs to make it their domain while you remain down. The floor plan is clutterfree and features three bedrooms, two baths and a roomy 14x24-ft. living room. The pre-constructed module design lets you build up or out as lot size permits; units can be put together in a variety of bilevel and ground-level patterns. You can arrange modules to build a home of from one to five bedrooms, and the dwelling can be purchased as a shell if you opt to finish the interior yourself. Total living space of the four-module unit shown is about 1250 sq. ft.

Vacation Land Homes, Inc., Box 292, Bellaire, Mich. 49615

Custom designs with a natural look

If money abounds, you can indulge yourself by custom building the house of your dreams with the help of a reputable architect. The three ski cabins shown—far left in Utah, the other two in Colorado—were designed to blend harmoniously with surroundings, and cedar shingles used on the exteriors were left to weather naturally. The pair on the facing page have steeply sloped mansard-type roofs to shed snow loads quickly. The house at the near left is structurally designed to adequately support the heaviest of snowfalls.

Red Cedar Shingle & Handsplit Shake Bureau,
5510 White Building, Seattle, Wash. 98101

**Think big—
but start small**



Building a five-stager is a good way to have a vacation home fast. Plan 890-1E provides almost immediate living quarters because you first build the kitchen-bath-family room module (left). The four remaining stages can be erected in any order you prefer; the set of plans for this house contains one copy of each stage. When completed, the all-on-one level home boasts three bedrooms, two baths and a two-car garage. Note that each of the three independent decks at the rear is accessible to the room it abuts through a pair of sliding glass doors to provide outdoor living space. The family room doubles as a dining area with an open counter between it and the kitchen serving as a snack bar. Plan-ordering information for the three built-on-site homes shown on the facing page appears below.

**Carefree and casual
by the beach**

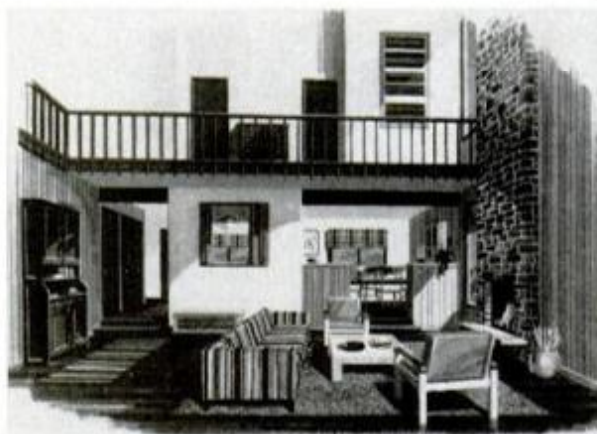

Impressive contemporary is a good choice for a summer home now and a retirement home later. The exterior is finished with maintenance-free materials which will take the abuse of high winds and salty ocean spray at the seaside; the surrounding terrain is left as undisturbed as possible. A second level balcony overlooks the living room with its glassed wall to the patio and view beyond. Whether he or she handles the kitchen chores when entertaining, neither one will feel left out of the activity taking place in the living room—a wall cutout (see left) is provided between these areas to keep both host and hostess in touch with their guests and good times.

**For ski buffs
and snow-country lovers**

After an exhilarating day on windswept slopes, skiers will happily return to your spacious, but cozy, modern chalet. The design here meets the demands of what skiers expect in a leisure home. Since most skiers prefer their activity in a group, sleeping accommodations for an almost unlimited number of guests is possible—the balcony can simply be furnished with dormitory-style bunks. Those who prefer to rest for the next day's activities won't be kept awake by evening revelry because the rec room is in the basement, well away from the sleeping quarters. Generous decking at the front and rear provides more than enough space for parking ski gear; ample storage room is tucked into the attic so that ski equipment can be safely hidden between seasons.

HOW TO ORDER PLANS

Plans for each of the three homes on the opposite page are available from Home Building Plan Service, Dept. PM, 2235 N. E. Sandy Blvd., Portland, Ore. 97232. Prices are \$35 for one complete set or \$50 for four sets of the same plan (except the five-stager—Plan 890-1E—which can be purchased for \$75). A plumbing and wiring diagram is available from the same source for \$10 and a materials list costs \$5. When ordering, make certain that you specify the plan number and the number of sets you want.

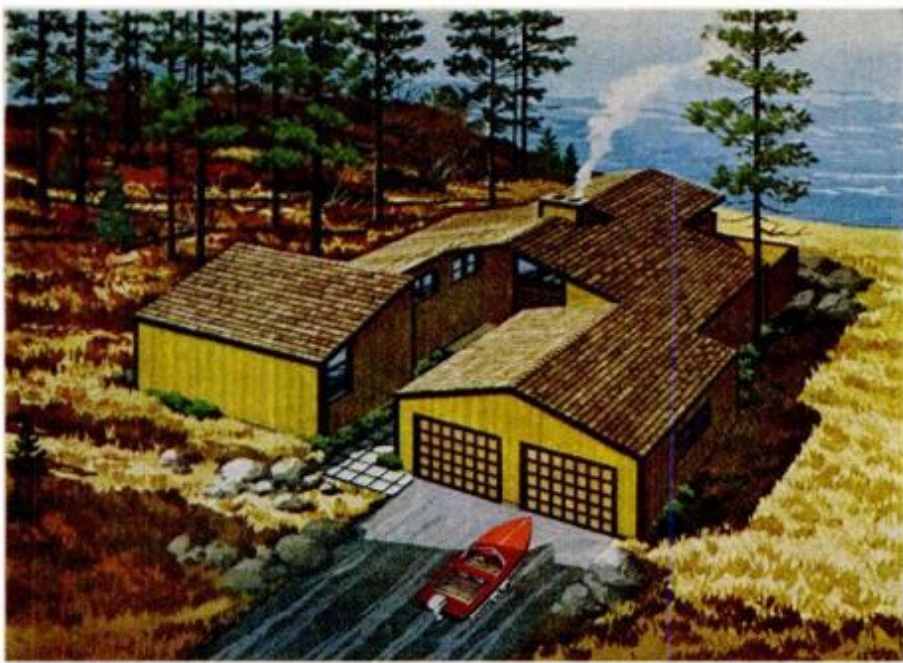

PLAN 890-1E



Living area: 1520 sq. ft.

Garage area: 484 sq. ft.



PLAN 889-1A



SECOND FLOOR PLAN

FIRST FLOOR PLAN

Living area: 598 sq. ft.
Storage area: 160 sq. ft.

Living area: 1155 sq. ft.
Garage area: 450 sq. ft.



PLAN 895-1



FIRST FLOOR PLAN

Living area: 1440 sq. ft.

Living area: 312 sq. ft.

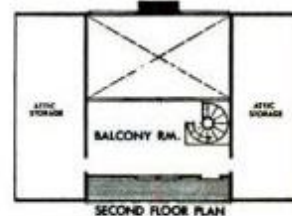

SECOND FLOOR PLAN



BASEMENT PLAN

Grow a vegetable bonanza in a small plot

by James Dwyer and John Albert

With food prices climbing faster than Jack's beanstalk, more and more homeowners are converting lawn areas into vegetable gardens. Not only can a home garden help ease the food budget, but your own produce will have a lot more freshness and flavor than anything you're likely to buy at the supermarket. If you have a spacious freezer or are good at canning, your vegetables can add zip to meals all winter.

It may be years since you tried your hand (or green thumb) at raising food for the table, so you may have questions: How big a plot do I need? How often is fertilizer required? When should I plant which vegetable? What sprays do I use?

These and other questions are answered by our two authors. James Dwyer is assistant editor of the *Garden Journal*, published by the New York Botanical Garden, and the author of numerous articles on horticultural subjects. John Albert heads a Botanical Garden program in which 200 New York children learn how to grow vegetables in their own miniature garden plots.—*The Editor*

In gardening, the magic words are *sunlight* and *nutrients*. Your first step is to pick a spot for the garden in full day-long sun, where the roots of large trees are not consuming the lion's share of the soil's nutrients and moisture. A plot of only 6 by 15 feet—basic size discussed in this article—can produce plenty of food for your table. If you have more area, better still.

Fertilizers

Today's vegetables, hybridized for rapid growth and high yield, need help in the form of extra nutrients. You give them the needed boost with a complete fertilizer, formulated for vegetables. Most garden stores have

such fertilizers in five-pound boxes carrying designations such as 5-10-5, 5-10-10, 10-15-10.

The numbers denote percentages of nitrogen, phosphate and potash (in that order). Normally, before planting you'll want to work into the soil about five pounds of 5-10-5 per 100 square feet after each four weeks of growth. Use smaller amounts if you're working with a fertilizer of higher concentration.

In the growing season, never let fertilizer remain on leaves or within an inch of plant stems. It's wise to rake the soil lightly after each application and then give the whole garden a good watering.

Fertilizers that are completely sol-

Hoe handle pressed into ground (right) makes trench for planting seeds. Most seeds require half-inch-deep trench.

Cold frame for protection and propagation of plants should be placed against a south wall or tight fence. Since frame usually is without bottom, drainage must be good.

Good way to start seeds is in peat pellets. When sprouts are ready to be put out, you plant the entire pellet. Peat breaks down in ground.

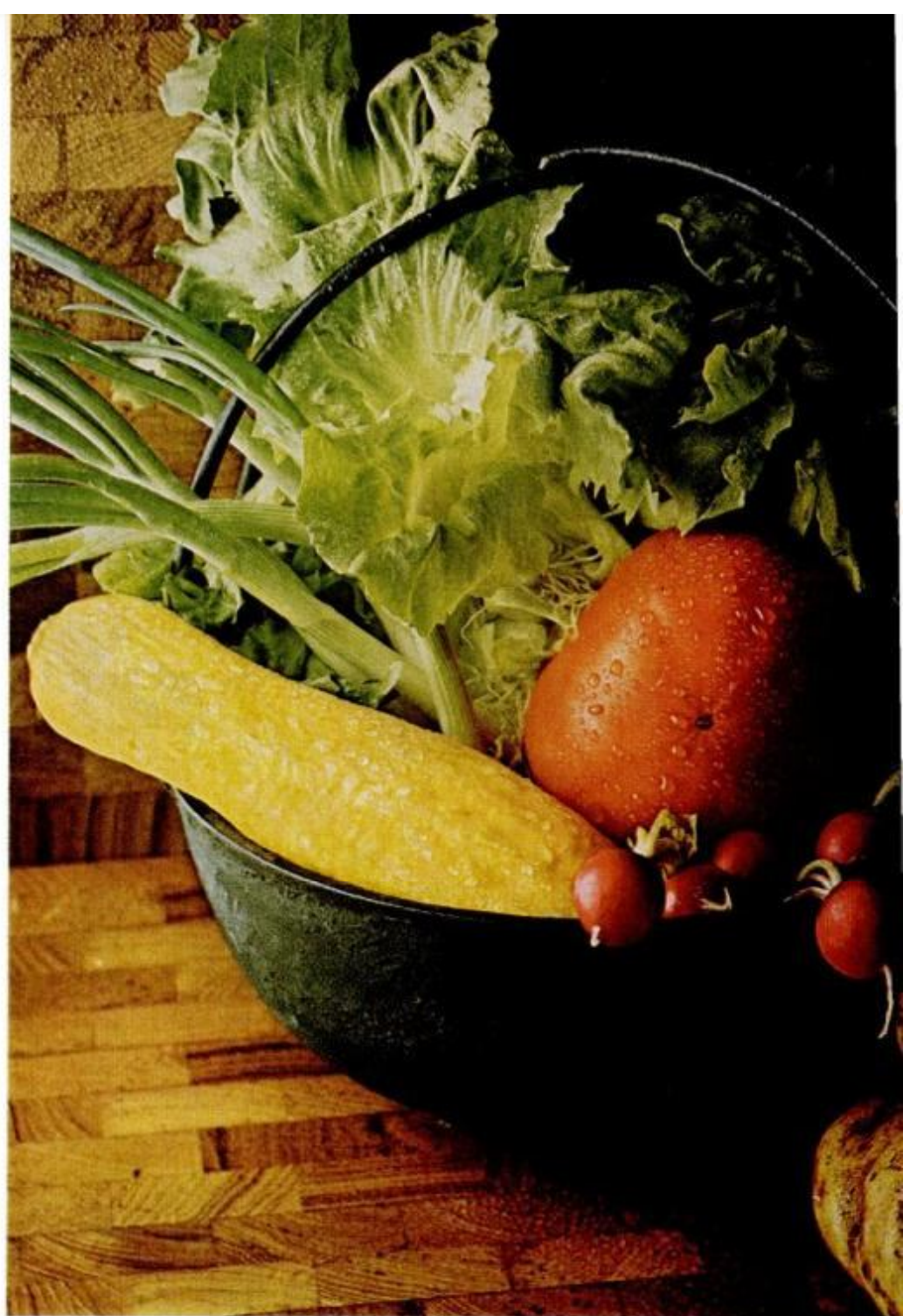

uble in water are excellent for use during the growing season. Used as directed, they will not burn leaves.

Compact soil

Soil too tightly packed inhibits root development. During rainy periods it will waterlog, cutting off normal aeration both to the roots and to beneficial microorganisms. In dry periods, it will cake on top so that water from the hose runs off or forms puddles while the soil beneath remains dry. Eventually, the soil may crack under the hot sun and cause damage to tender root growth.

The remedy is to work into the soil (up to one-third the volume of the soil in your garden) compost mixed with sand or perlite. This will allow drainage.

Loose soil

Sandy soil is structurally the best for good root development, but if it is too sandy, it doesn't retain much moisture or nutrients. Solve the problem with compost or manure (again, one-third of the volume) along with peat moss. Since compost and manure break down to provide nourishment for plants, they should be replaced each year. Peat moss, while of no direct nutritive value, will remain in the soil for a long time, serving as a storehouse of water and fertilizer.

Acid or alkaline?

Soil pH is the measure of hydrogen ion concentration in the soil, which is, in turn, a measure of soil acidity. It can be determined to a fair degree



Fencing can be used to support cucumbers and melons, and let them climb. Tomatoes (right) should be staked when planted to avoid root injury later. Stakes up to seven feet high are recommended. Inverted paper cup at base of the plant will hold off hungry cutworms.

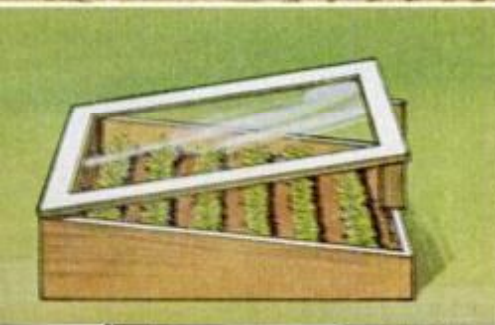
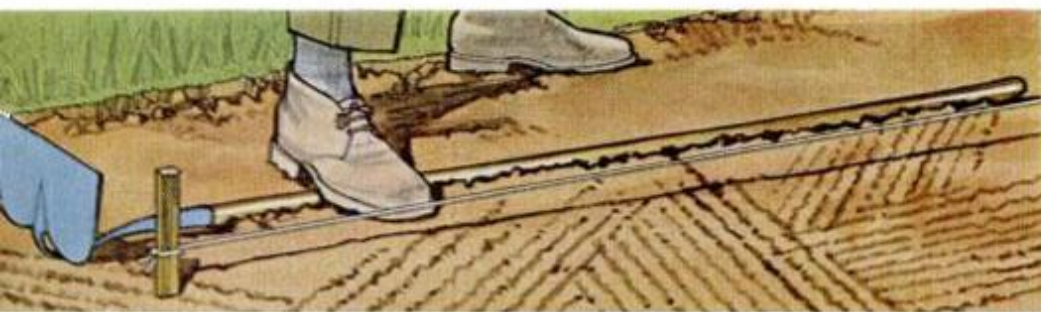
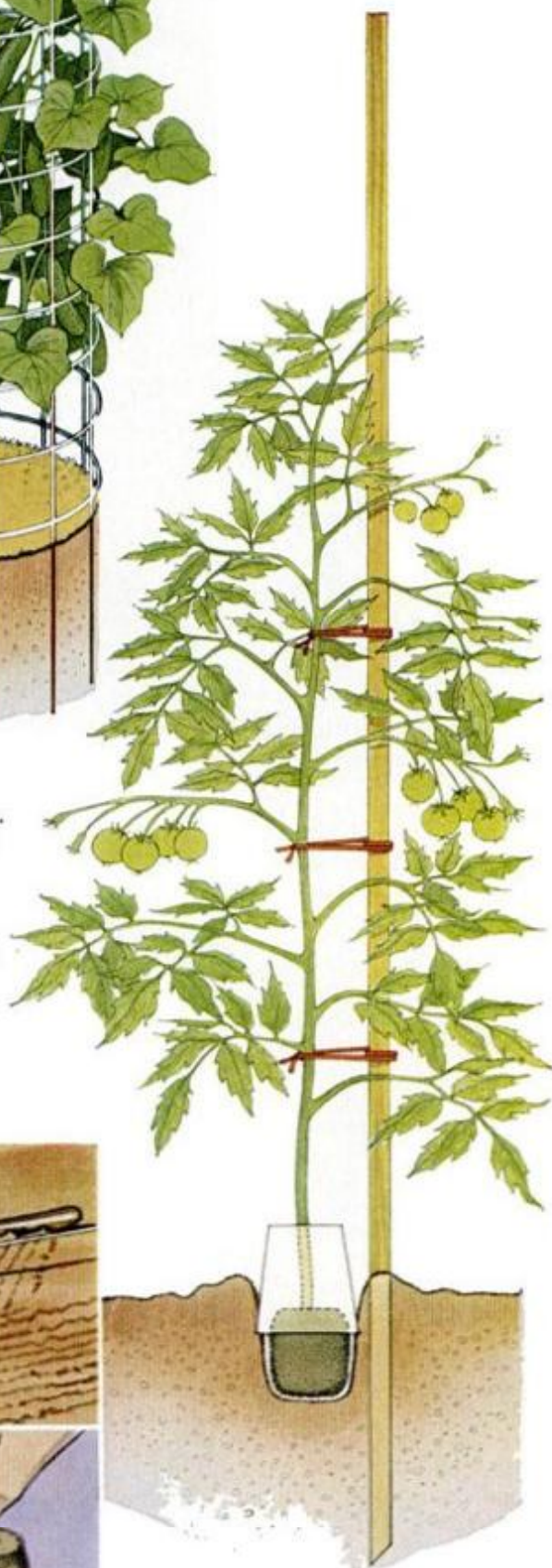



Before fall frost hits, cut off tomato vines at base and hang plants upside-down to force ripening of the remaining fruit. Onions will store well if hung in a dark, cool place.

of accuracy with a simple soil-test kit, obtainable for less than \$5 at a garden-supply store.

A pH reading of 1 is acid to the extreme, a pH 14 is as alkaline as you can get, and pH 7 is neutral soil. Most vegetables grow in slightly acid soil (pH 6 to 6.5). Much more acidity can be toxic to many plants, while very alkaline soil makes many trace elements unavailable to them.

The usual problem is acidity. If pH is below 5, add 10 pounds of ground limestone for each 100 square feet of garden. If it's only slightly low, make it 5 pounds. You can add it in the fall as a top dressing, giving you the chance to double check the reading in the spring, or put it on in the spring after having worked in the fertilizer. Rake it gently into the top inch of earth. Recheck the pH each year as lime is slowly leached out by rain.

If you live in an area rich in limestone, your soil problem is probably alkalinity. Fork in compost, manure, or peat moss to acidify. If the imbalance is extreme, say pH 8 or 9, add finely ground sulphur or aluminum sulfate.

Designing the plot

Maximum use of space is the keynote. Remember that space is three-

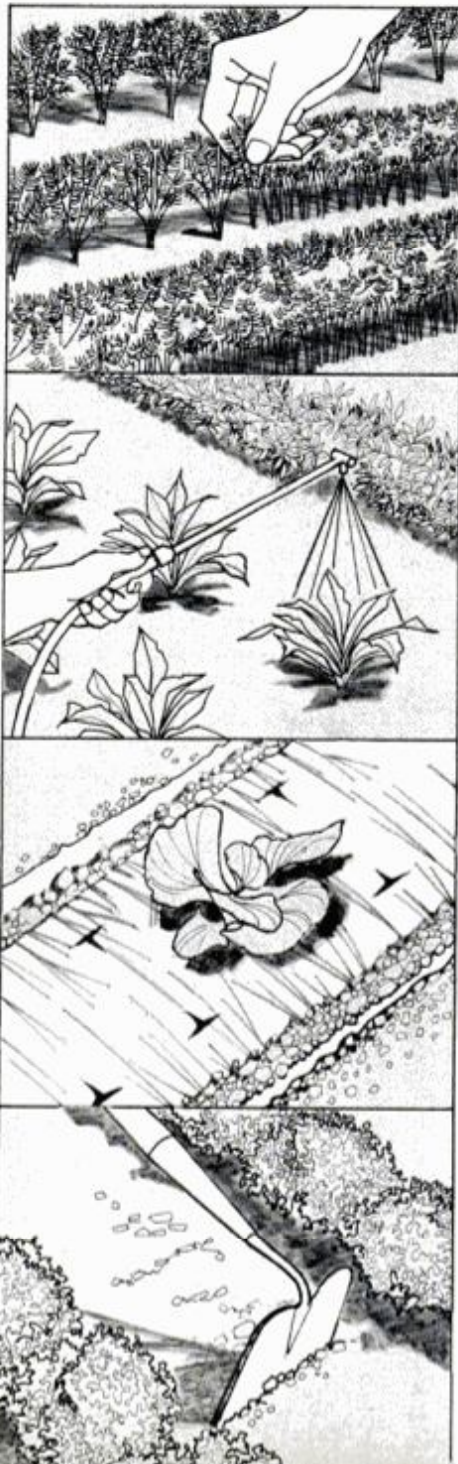

dimensional, and that sun in the northern hemisphere comes from the south, particularly in early spring and late fall. This means that plants should be arranged not only as closely together as their well-being permits, but with the taller ones to the north so they won't shade the others.

Plant tomatoes in a line along the northern edge, about a foot apart and tied up on stakes or cattle fencing. Pinch off side shoots during early growth. Today's varieties are very fruitful, so it doesn't take many plants for a good crop.

Cucumbers and melons should also be allowed to climb, but no staking for them—they need cattle fencing or chicken wire. Cucumber vines easily support their fruit this way, but you may have to rig cloth slings to support canteloupe and other melons as they get fully ripe.

Sweet peppers may need staking. The branches are quite brittle and crack easily under the weight of today's large peppers.

Plant cabbage and lettuce in twos or threes at close spacings. Head sizes won't be as large as they could be, but overall yield will be greater and be spread over a longer period. Harvest by pulling up an alternate plant every two or three days, as soon as the heads are developed enough to be edible. By the time you get back to the beginning of the row, the remaining plants should have nearly filled in the spaces. Don't let your lettuce harvest go into hot weather, as the heads will "bolt"—grow into stalks.

Beets, radishes, all the root vegetables, will benefit from the same alternating harvest principle, but practiced more extremely. Sprinkle seeds generously into a very straight, half-inch-deep trench—straightness will prove important when you're weeding the garden later—and let nature

When seedlings of root vegetables appear, thin out the weaker ones (left, top) until there are but three or four plants to the inch. This allows remaining plants to grow to a good size.

Though the best defense against disease and pests is to maintain strong growth in plants, you may have to resort to sprays. There is a wide variety of chemical agents available on the market.

A good "instant" mulch is provided by plastic covering. It holds in heat, discourages weeds. Plants grow through cutouts; slits provide ample drainage.

If you have planted crops in straight rows, cultivating with hoe (left) is easy. A good time to weed is when the ground is moist from rain or watering.



SPRING

In spring, seedlings must be "hardened off"—gradually acclimated to outside temperatures—before planting in ground. Crops shown here can be planted well before the last frost of spring, just about the time ground is workable. Care must be taken with cabbage. If a cold spell hits and plants are subjected to a week or more of daytime temperatures below 50°F., heads will begin to form prematurely.

- | | |
|---------------------------|----------------------|
| 1 Spinach | 6 Early cabbage |
| 2 Beets | 7 Radishes |
| 3 Broccoli or cauliflower | 8 Early head lettuce |
| 4 Onions | 9 Peas |
| 5 Spinach | |

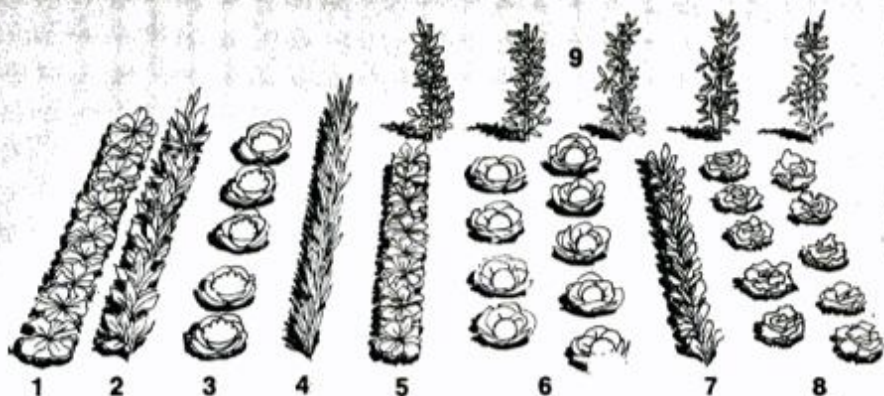

SUMMER

To give beans head start—and avoid possible frost injury—soak seeds indoors until almost germinated before planting in garden during a mild spell. Put in tomatoes, peppers and eggplant seedlings after all danger of frost is past. Follow in about a week with seed plantings of cucumbers, melons, pumpkins and squash.

- | | |
|---|-----------------|
| 1 Leaf lettuce | 6 Sweet pepper |
| 2 Carrots or parsley | 7 Zucchini |
| 3 Beets or kohlrabi | 8 Bush pumpkins |
| 4 String beans | 9 Eggplant |
| 5 Onions (from spring planting, harvest July) | 10 Tomatoes |
| | 11 Cucumbers |

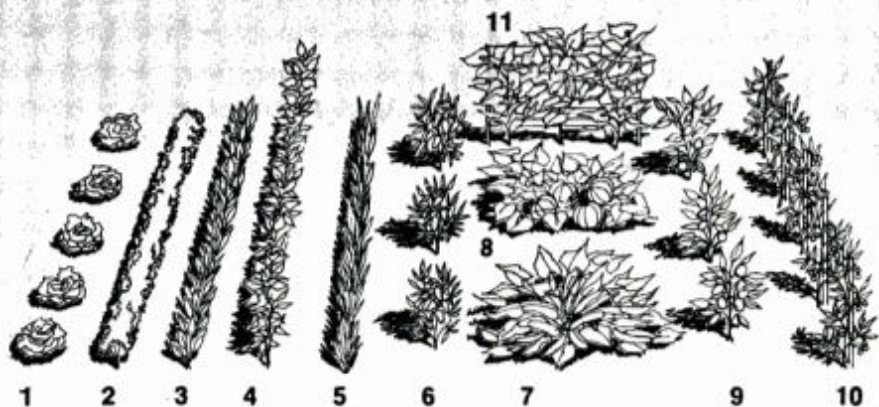

FALL

Lettuce, cabbage, beets, radishes, carrots, spinach and peas can all be planted in August or even September, depending on your area's climate. Again, planting seedlings will mean more of a harvest before winter. In all but the coldest climates, you can plant leaf lettuce, beets, carrots, onions and spinach in the fall and allow them to winter over for an exceedingly early harvest next spring. During the coldest of winter weather, you should cover crops with good mulch.

take its course. When the seedlings have appeared, thin out the weaker ones until you're left with three or four plants to the inch.

- | | |
|------------|--------------------------|
| 1 Radishes | 5 Cabbage |
| 2 Parsley | 6 Head lettuce seedlings |
| 3 Spinach | 7 Peas |
| 4 Radishes | |

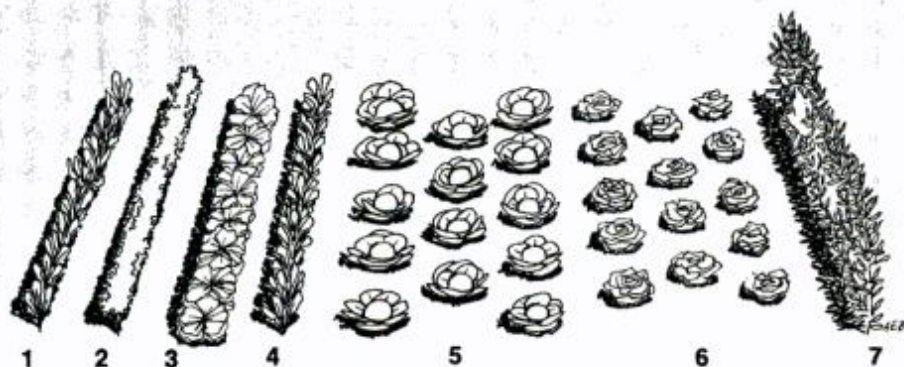

Allow plants to grow to a point where fruit formation is evident. Now thin out sparingly. Though fruit may not be large, it certainly will be edible. From then on, you'll be able to gather a small bunch of vegetables every week or two, taking them alternately from the row. Tiny at first, they'll get bigger as the season advances.

Onions are particularly good to

grow in abundance. They can be stored by hanging them on a string in a dark, cool place, and will last all winter. You can buy onion "sets" (bulbs) at some garden shops for spring planting.

Starting seedlings

You can extend the productive life of much of your garden by starting seedlings in flats or pots. Tomatoes, eggplants and peppers will begin producing earlier and thus will last longer. Head lettuce will have time to head completely before the heat of

summer causes bolting (growing into stalks). For the cabbage family, transplanted seedlings mean an earlier harvest.

Sow seeds near the surface in flats containing about two inches of loose, well-drained soil, six to eight weeks before you plan to put plants in the ground. Maintain a temperature of 70° to 75° F. until the seeds germinate. When the young sprouts have produced their first set of real leaves, they are ready to be transplanted to small pots, to other flats or to a cold

(Please turn to page 130)

The tiller— a backsaver for busting sod

by Glenn Hensley



MAKE/MODEL	HP	TRANSMISSION	TILLER WIDTH	TILLER WIDTH WITH TINE EXTENSIONS	SPEEDS	
ALLIS-CHALMERS	3	Worm Gear	21½"	31½"	Forward	
	5	Worm Gear	22½"	33½"	Forward, Reverse	
	8	Worm Gear	23½"	35"	Forward, Reverse	
AMF	1346	4	Worm Gear	26"	32"	Forward, Reverse
	1349	5	Worm Gear	28"	36"	Forward, Reverse
ARIENS	3205	3	Worm Gear	20"	28"	Forward
	4205	4	Worm Gear	20"	28"	Forward
	424SR	4	Worm Gear	24"	36"	Forward, Reverse
	524SR	5	Worm Gear	24"	36"	Forward, Reverse
	624SR	6	Worm Gear	24"	36"	2 Forward, 2 Reverse
	424CD	4	Chain Drive	24"	36"	Forward
	720SR	7	Worm Gear	20"	28"	2 Forward, 2 Reverse
	720ER	7	Worm Gear	20"	28"	2 Forward, 2 Reverse
BOLENS	2135	3.5	Worm Gear	17"	38"	Forward
	2150	5	Worm Gear	21"	46½"	Forward, Reverse
GILSON	51073	3	Chain Drive	26"	40"	Forward
	51075	5	Chain Drive	26"	40"	Forward
	51080	3½	Worm Gear	26"	40"	Forward
	51084	3½	Worm Gear	26"	40"	Forward, Reverse
	51081	5	Worm Gear	26"	40"	Forward, Reverse
	51082	5	Worm Gear	26"	40"	Forward, Reverse
	51083	8	Worm Gear	26"	40"	4 Forward, Reverse
	51085	8	Worm Gear	26"	40"	2 Forward, Reverse
	51005	8	Worm Gear	26"	40"	2 Forward, Reverse
HUFFY	H160	3	Worm Gear	24"	No Extension	Forward
	H170	5	Worm Gear	26"	40"	Forward, Reverse
JOHN DEERE	324	3½	Worm Gear	24"	No Extension	Forward, Reverse
	624	6	Worm Gear	24"	34"	Forward, Reverse
SIMPLICITY	1003	3	Worm Gear	22½"	33½"	Forward
	1005	5	Worm Gear	22½"	33½"	Forward
	1008	8	Worm Gear	23½"	35"	Forward
TORO	58013	3	Worm Gear	26"	38"	Forward, Reverse
	58114	4	Worm Gear	26"	38"	2 Forward, Reverse
	58125	4	Worm Gear	26"	38"	2 Forward, Reverse
	58220	5	Worm Gear	26"	38"	2 Forward, Reverse
	58231	5	Worm Gear	26"	38"	2 Forward, Reverse
WHITE	Roto Boss 350	3.5	Worm Gear	26"	40"	Forward, Reverse
	Roto Boss 500	5	Chain Drive	26"	40"	Forward, Reverse
	Roto Boss 800	8	Chain Drive	26"	40"	4 Forward, Reverse
YARD-MAN	5020	4	Worm Gear	26"	36"	Forward, Reverse
	5030	5	Worm Gear	26"	36"	Forward, Reverse
	5120	4	Chain Drive	26"	36"	Forward
	5130	5	Chain Drive	26"	36"	Forward



Heavy-duty tiller with rear-mounted tines (upper left) is one of seven models offered by Ariens. Powered by a 7-hp Tecumseh engine, it has two forward, two reverse speeds. The 8-hp Simplicity unit (above) has 35-inch tilling width with tine extensions. The 5-hp Gilson (left) cultivates an area as narrow as 12 inches, a useful capability in a small garden.



Putting in a garden can be a sweat-and-blister chore if you have to turn and pulverize the earth with spade or digging fork. A power tiller makes the job almost fun.

A relatively simple machine, the tiller is powered by a gasoline engine—of from 3 to 8 hp—that drives a set of rotary tines. The tines chop and pulverize the soil, making it ready as a bed for seeds or seedlings. When plants are growing, the tiller is also used for cultivating between rows.

There are two major types of tillers. In one, the tines are in front and are powered by the engine. They pull the machine along as they bite into the soil. In the other configuration, the tines are at the rear and a set of powered wheels are up front. This design usually is found only in the larger machines.

The front-tine tiller is designed for the average garden, where clearances are small. With this type of unit you can get within a few inches of a walk or shrub, an impossible maneuver with a rear-tined machine.

Normal tilling widths range from 17 to 28 inches. Many machines are adjustable, a handy capability when you want to cultivate between narrow rows. One Bolens unit, for example, will cultivate a swath as narrow as 9½ inches.

Most machines permit stretching tilling width by adding extension tines. By adding a "bolo" tine extension to a Toro tiller, tilling width is increased to 38 inches.

Bolo blades are good for cultivating and are designed to clean themselves. Some units are equipped with "slasher" tines to chew through tough turf and tangled roots. The average machine will pulverize soil up to a depth of eight inches.

The typical tiller is equipped with worm-gear drive, recoil starter and weighs about 130 pounds.

Increased emphasis on safety features is apparent among the 1975 machines. For example, many have safety clutches that must be gripped in order to operate the machine. Control panels have been redesigned in a number of instances to add to ease of operation. Most machines have clearly labeled controls as an added safety feature.

As it is with other outdoor power hardware, the more horsepower you opt for, the more you pay. The smallest White unit, for example, a 3.5-hp job, sells for \$265. Move up to 8 hp and the price is \$444.

If these typical prices seem steep, you might consider chipping in with neighbors to buy a machine. Unlike a mower, a tiller isn't used every week.

Because of space limitations, the chart accompanying this article does not include every make available. The chart is intended to show a selection of the units dealers are offering. ★★★

Composting the easy way

Though composting is as old as the hills, new wrinkles have been added. University of California researchers claim the process need not take months, but can be accomplished in only 14 days.

They advise mixing leaves, stalks and other waste with manure, commercial fertilizer or other material containing nitrogen, and then shredding the mix. This produces a larger surface-area-to-volume ratio, giving bacteria a chance to work faster. Finally, you build the pile in six-inch layers, wetting down each layer. Keep the pile moist, turn it a few times during the next 14 days—and you'll have a rich, soil-building humus for flower bed or vegetable garden.

If you want to skip the task of building a compost bin, you can buy a lightweight, adjustable type made by the Judd Ringer Corp., Eden Prairie, Minn. As photos below show, the bin is of a grid design, permitting good aeration of the pile. For \$13.98 you get the bin, water-soluble tablets containing microorganisms that promote decomposition, and an instruction booklet.

A pamphlet describing the University of California method is available free from the Kemp Shredder Co., 1003 Kemp Building, Erie, Pa. 16512.



PM OWNERS REPORT: CHEVROLET MONZA 2+2



Monza 2+2 owners in our survey bought their cars during the month of October 1974, when it first went on sale as a brand new 1975 model. This month, the hatchback 2+2 is joined in the lineup by a formal hardtop version called the Monza S (see *Detroit Listening Post* for a picture of the new model).

The fun and spunk of an import— with a few domestic bugs

A nationwide survey based on 197,000 owner-driven miles

by Michael Lamm
WEST COAST EDITOR

What makes people buy Monzas? "I always liked foreign sports cars—their styling, handling, etc.—and finally America has come around." Those are the words of a New York restaurateur. He's got a lot of company in that statement. A lot of people feel the same way.

Styling stands out as the car's No. 1 buying point—no fewer than 78 percent of Monza owners put it at the top of their *like* list. No one had bought the Monza *despite* its looks; something we find occasionally among buyers of certain imported cars.

Lots of people called the car "sporty." One fellow referred to his Monza as "my little 'Vette." Another called it "a miniature Z-28," and a third, "poor man's Pantera."

Chevrolet's new Monza comes with an overhead-cam Four as standard equipment—the same aluminum-block engine as in the Vega. But hardly anyone orders the Four. Instead, 97 percent of those in our survey went for the 262-c.i.d. V8. This engine is the same size outside and weighs as much as Chevy's 350-c.i.d. V8, yet it has smaller bore and stroke.

Even with the more powerful V8, very few owners complained of poor gas mileage. The V8, according to those we asked, averages just short of 20 mpg on long trips and 16.4 mpg around town.

(At this writing, the V8 isn't available for sale in California; yet only three percent of our respondents owned Fours. This represented too few replies from four-cylinder owners to tabulate for realistic mileage figures. Also, at the time we sent out our questionnaires, the only transmission Chevrolet offered in V8-engined Monzas was the Turbo Hydra-Matic. So we have no figures or comments on cars with four-speeds.)

What are some of the points owners particularly like about their Monzas? Says a Michigan parts manager, "I owned a Camaro 350, and the Monza feels like a lot more car. It handles better, gets better mileage, and is very comfortable. I also currently own a Vega GT that's nice but no comparison. The company car I drive—a Buick—isn't so comfortable although it's better equipped."

"It's a fantastic automobile," exudes a New Jersey machinist, "... the cornering, the smooth ride and smoother lines, and there's ample front legroom."

An Alabama engineer: "Concerning the gas mileage, on a recent trip to New Orleans, driving 50-60 mph, I consistently got over 22 mpg. We've all heard that the '75s were going to

Low is right—only 4.9 inches at the catalytic converter, so you have to be careful on potholed roads.

It's a mini-ponycar all right, especially with the peppy V8.

Standard rear axle ratio is a long-legged 2.56:1. Chevy listened to all those import owners who complain of buzzy "sewing machine" engines.

She might have a point on those rotten eggs. I got a whiff of them, too!

He likes it better than his Camaro or the company Buick.

Rear passengers gripe about scant headroom due to the sloping roof. But there's a big cargo deck for hauling things.

get better gas mileage, but I never expected this. I think the Chevrolet people should get a well deserved hurrah this time!"

"A nice, longer interval between oil changes and tune-ups, thanks to unleaded gasoline," observes a Michigan dental lab owner, and he's right—it's 7500 and 22,500 miles respectively.

"Handles like a 914 Porsche," comments a North Carolina beautician. "It's low to the road and has lots of V8 power."

Detroit nurse: "Good, secure feeling when driving, quiet inside, terrific body styling, great interior with cloth seats, satisfactory gas mileage. I only wish unleaded gas were more readily available in Canada."

Praises predominated by an overwhelming margin, but as in all cars—especially new ones—there were a few complaints. An Alabama electrical contractor mentioned hard starting on cold days. An Oregon piano salesman grouched, "Lousy workmanship—one week old and the paint's peeling, the taillight is split, the chromed plastic is starting to come off, and the lack of insulation in the roof makes it sound like a tin can in the rain."

"I hate catalytic converters," shrilled a Wisconsin housewife, "because the sulfur dioxide exhaust comes in through the open windows and makes me sick. It smells like rotten eggs. Just think what it's going to smell like when a lot of 1975 cars with catalytic converters get on the road together!"

Chicago bus driver: "Either the doors don't fit right or the rubber weatherstripping is messed up, but there's cold air coming in through the door."

Michigan computer operator: "The fake mag (plastic) wheelcovers fit very poorly and have come off a few times while driving. Also the doors fit poorly at the bottom, so they sound like they're not shut tight."

How about the Monza's comfort? Fully 81.2 percent rated comfort *good to excellent*, and that's high praise indeed for a car of this size. A Florida telephone cable splicer summed it up when he said, "The bucket seats up front are comfortable, but rear legroom and headroom are too cramped." And a Michigan electrician adds, "Comfortable, yes, but the rear seat never gets used; cargo space is used continually."

The Monza drew mild grumbles for less than perfect make-ready. Some 63 percent said they'd had to take their cars back to the dealer for repairs and adjustments. That's an especially high incidence considering how

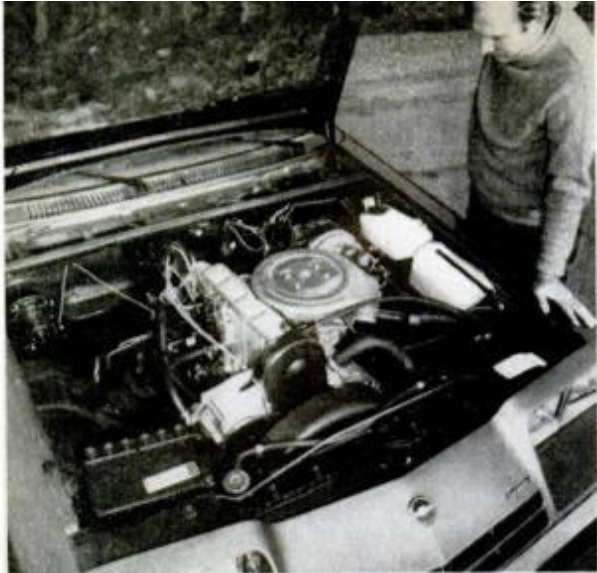

Four-cylinder engine has plenty of workroom around it. The V8, however, has a problem: One of the eight plugs is almost inaccessible without jacking engine.

The four-speed is presently available with V8-engined Monzas; some owners are now clamoring for a five-speed, soon to be available.

Actually the rectangular headlights give no more light intensity than round sealed beams.

wheels and silence the exhaust." "The car needs a four-speed with the V8." "The standard spare tire cuts down all that cargo room Chevy brags about." "Better brakes, heavy-duty suspension, and more inches from the V8."

Standard appointments were judged good in general, with the tachometer and full set of gauges drawing genuine appreciation. In addition, a college maintenance supervisor confided that, "... the saddle tan vinyl upholstery has fooled a lot of people into thinking it's real leather." "The rectangular headlights give a lot more light," thinks an Indiana trucker.

Most Monza owners are young—in their 20s and early 30s. Many are unmarried or newlyweds, and for 45.1 percent the Monza made up the total family stable of cars. Asked whether they'd buy another Monza next time, 27 percent of our respondents said no. One 18-year-old bank teller from Liverpool, N.Y. said she wasn't sure about buying a Monza next time. "I'll have to see how mine holds up. But I will say this. My father wants one now that he's driven mine." ★★★

short a time these people had owned their cars. Even so, the problems were mostly minor.

Heading the list of mechanical complaints was the carburetor, notably poor performance when cold, plus a high, rough idle. Brakes, too, came in for some gripes. People said the brakes were "squishy" and that the front discs squeaked.

Commenting on the Monza's handling: "Good stability, easy to park in the city with [optional] power steering."—California trucking clerk. "Sports-car-like handling, and a great amount of quickness from the V8."—Indiana soda salesman. "Handling has to be the greatest point. It handles like a car should handle: firm and steady. The power is there, but it's not overpowering."—New York restaurant manager.

And workmanship? Very few frowns here. Nearly 75 percent gave workmanship a rating of *good* to *excellent*. That's right up there with the best.

Dealer service fared less well; 55.5 percent considered it *average* to *poor*, with 22.2 percent saying *very poor* and *terrible*.

We asked Monza owners to suggest improvements, and we got plenty. Here's a smattering: "Needs a lockable compartment under the cargo deck." "Get rid of the 13-inch

These are exactly the same brakes as the Vega's, but the Monza V8 weighs nearly 1000 pounds more.

Skimpy rear legroom and sloping roof relegate the rear seat to short trips, but for small fry it's perfect.

It takes about 13 seconds for the V8 to get the over-3000-pound Monza up to 60 mph

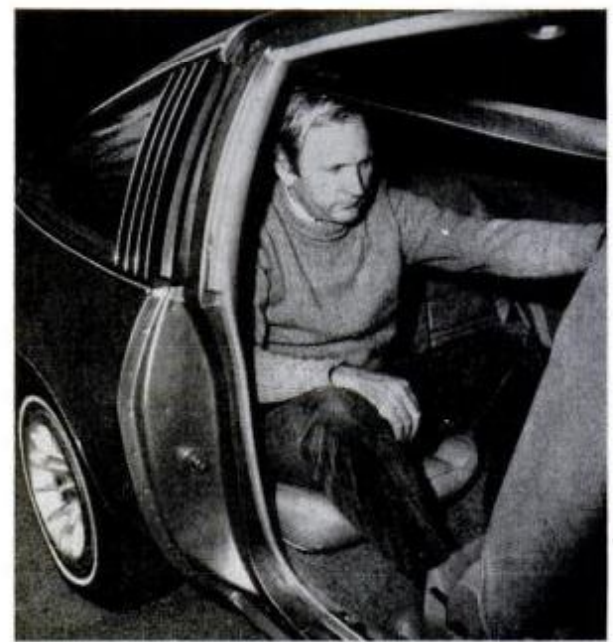

Summary of 1975 Monza 2+2 Owners Reports*

Total miles driven197,676	Performance 19.7	Other cars owned:	Alignment 11.6
Average miles per gallon:	Ride 18.2	Chevrolet 23.7%	Transmission 11.6
Local driving 16.4	Specific dislikes:	Volkswagen 15.8	Did you repair it yourself?
Long trips 19.9	Quality of materials 11.9	Pontiac 13.2	No 95.3%
Engine:	Rattles 9.0	Ford 13.2	Yes 4.7
2.3-liter Four 3.0%	Lack of room 9.0	Comfort opinion:	Dealer repairs satisfactory?
262-cu.-in. V8 97.0	Gas mileage 9.0	Good to excellent 81.2%	Yes 67.5%
Transmission:	Tire quality 9.0	Average to poor 17.3	No 32.5
Automatic 100.0%	Cold starts 7.5	Workmanship opinion:	Age distribution of owners:
Why the Monza 2+2?	Dealer service 7.5	Good to excellent 74.6%	15-29 years 60.5%
Styling 78.3%	What changes would you like?	Average to poor 25.4	30-49 years 26.7
Economy 30.4	More legroom 11.3%	Dealer service opinion:	50 plus 12.6
Size 26.1	Better tires 9.7	Good to excellent 44.5%	Family size:
Handling 13.0	Styling 6.5	Average to poor 55.5	1-2 people 61.4%
Specific likes:	Spare tire (type and location) 6.5	Had any mechanical trouble?	3-4 people 32.9
Styling 75.8%	Number of vehicles owned:	Yes 63.2%	5-6 people 5.8
Handling 69.7	Monza 2+2 only 45.1%	No 36.8	Would you buy another Monza 2+2?
Economy 34.8	Two cars 37.4	What type of trouble?	Yes 73.0%
Comfort 30.3	Three cars 11.3	Carburetor 20.7%	No 27.0
	Four or more cars 4.2	Brakes 20.9	

*Percentages might not equal 100% due to rounding or insufficient data.

The FTC makes amplifiers grow more 'honest'—and more fins

by Ivan Berger
ELECTRONICS EDITOR

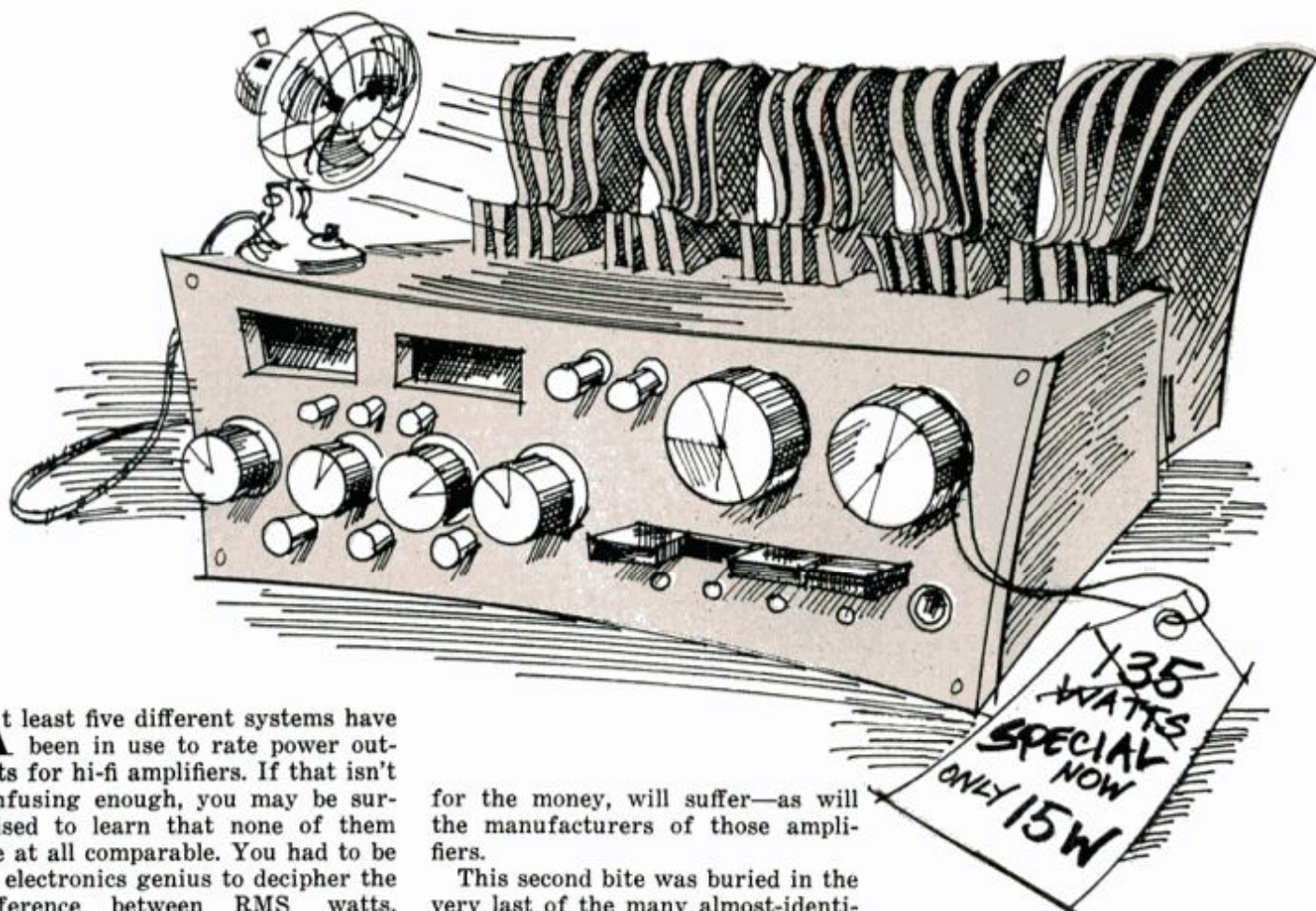

At least five different systems have been in use to rate power outputs for hi-fi amplifiers. If that isn't confusing enough, you may be surprised to learn that none of them are at all comparable. You had to be an electronics genius to decipher the difference between RMS watts, music power, peak power, continuous power, IHF watts, IPP watts, watts ± 1 db, and so on.

But now the Federal Trade Commission is changing all that. In a recent crackdown, the FTC ordered that all home amplifiers now be rated by one formula—continuous power or RMS watts—a most stringent rating method.

What does this mean to you? It means that no longer will one manufacturer rate his amplifier at "135 watts" while another, more accurate, maker would rate the same unit at "15 watts per channel."

So the hi-fi buyer is now the beneficiary of a consumerism with teeth in it.

But these teeth, unfortunately, bite in two ways. Those consumers who might formerly have been taken in by the inflated power-rating game will save a lot of money. But others, buying some of the amplifiers that now offer the most legitimate power

for the money, will suffer—as will the manufacturers of those amplifiers.

This second bite was buried in the very last of the many almost-identical drafts of the proposed FTC rule. It looked modest enough: A requirement that amplifiers be run at one-third power for an hour before their power test, presumably to simulate the warm-up they'd get in extended use at home.

But this requirement is not as modest as it looks. One-third power is very close to the point at which today's transistor amplifiers run hottest—hotter, in fact, than they do at full power. Unless some way is found to carry the heat away, an amplifier's output transistors may, if unprotected, cook—or circuits that have been designed to prevent their cooking may shut the amplifier down.

For makers of low-power equipment, this doesn't seem to be a problem. Most such amplifiers and receivers use their chassis as heat sinks to conduct heat away from the transistors. Those chassis are more than big enough to dissipate modest amounts of heat.

But as power goes up, so does heat. That's why medium-power amplifiers sport ruffles of fins on their rear panels, while big amplifiers positively bristle with them. Other methods of dissipating heat are also used: More output transistors, for instance, mean less heat per transistor—and it's the temperature of the transistor, not that of the heat sink, that counts. A few amplifiers even have built-in fans, while one, the Dynakit 400 (page 126, April '74), offers one as an option.

All these cooling measures cost money, but the manufacturers gladly spend enough to take care of the heat of normal operation. They have to—otherwise their amplifiers would come bouncing back to them as fast as flipping flapjacks.

But during that hour of one-third-power operation, the amplifiers will heat up more than they do in normal use. And handling that extra heat

(Please turn to page 144)

Easy riders

The grand touring motorcycles for '75
by Jake Grubb



Big-displacement bikes are coming on strong and becoming more civilized. The machines featured here are the superbikes of cycledom, and range from \$2000 to \$4000. The type of ride you get ranges from soft to sporty, but either way, one you won't forget. Here's a closer look at the big bikes.

BENELLI 750 SEI. Rare to U.S. superhighways, the Benelli 750 Sei is a familiar sight on the Auto-



Ducati 750 Sport, with its clip-on handlebars and racing setup, is for those who want to do their touring stretched out prone! Engine is a longitudinal V-twin.

stradas of suburban Italy. Six-cylinder overhead-cam format with fuel from three carburetors gives the Benelli 76 hp at 9000 rpm.

The Sei is considered by many the smoothest of all European tourers. Power impulses every 120° give a power overlap of 60°, eliminating the effects of inertia at the start of each stroke. Rigid all-tube frame provides low center of gravity, ample ground clearance and light weight for excellent handling. Hydraulic front and rear suspension complements Pirelli "high speed" radial tires for sure road-holding and comfort. All-modular instrumentation is styled for efficiency and modern appearance. *Cosmopolitan Motors, Jacksonville and Meadowbrook Rds., Hatboro, Pa. 19040.*

BMW R90/S. Continued refinement of a proven design supports BMW's long success as a maker of top

touring motorcycles. Culminating 52 years' production of Teutonic, twin-cylinder tourers, the R90/S offers a combination of performance, smooth ride and road handling to make it a classic in its own time.

Basic specifications offer a quick perspective: 898 cc, 9.5:1 compression ratio, opposed twin cylinders with 38-mm carburetors, 75 hp at 7300 rpm, five-speed transmission, .924-g braking force, 498 pounds ready to ride. As for comfort and luxury, the R90/S is paramount among all other tourers. Telescopic



BMW R90S is the Mercedes-Benz of motorcycles. Top-of-the-line 900-cc model features a racy touch with streamlined fairing, comprehensive instrument panel.

front forks with 8-inch travel complement hydraulic rear shock absorbers with soft springs and gentle damping. Together, these provide an ideal ride for the long-distance cyclist.

Dimensions between handlebars, seat and footpegs have been carefully calculated for comfortable posture. The seat is soft, yet resilient, and the fiberglass nose fairing provides additional comfort by cutting drag.

Mounted inside the cowling is an "information explosion" consisting of tachometer, speedometer, trip-meter, voltmeter and electric clock. Also included are colored wink-lights for generator, oil pressure, directional signal, high-beam and brake failure. *Butler & Smith, Inc., Walnut St. and Hudson Ave., Norwood, N.J. 07648.*

DUCATI SPORT. The 750-cc Sport is a bike for high-pressure accelera-



Benelli 750 Sei is powered by a Six—a six-cylinder, overhead-cam engine displacing 750-cc; hp is 76 at 9000 rpm.



Photos: David Gooley

tion and acrobatic cornering. Ducati's newest 750 is a Spartan mixture of hard ride, healthy exhaust note, impressive power and superb handling.

The Sport is racy in appearance with short, low set "clip-on" handlebars, one-man seat, elongated gas tank, nose-fairing and lengthy exhaust megaphones. The unique 90° longitudinal V-engine produces enormous low and mid-range torque with smooth acceleration. Durable five-speed constant-mesh transmission is precise and clunk-free. Cosmetic details such as paint, chrome plating and nameplate decals are abbreviated—if not carelessly applied. Creature conveniences such as electric starting and turn indicators are nonexistent. Handlebar-seat-footpeg layout is

awkward for long-distance touring—effective for riding in short, fast jaunts. *Berliner Motor Corp., Plant Rd. and Railroad St., Hasbrouck Heights, N.J.*

HARLEY-DAVIDSON FLH 1200. The "Harley" is the last of a small handful of motorcycles born in the United States before World War I. Affectionately nicknamed "Harley Hog," the 74-cu.-in. (1200 cc) Harley is perhaps the most classic of all. Having gone through model updates since 1921, the "Hog" exists today in the form of the FLH-1200—the bike most used by law-enforcement agencies in this country.

Despite thousands of improvements built into the engine over the years, the big 45° V-twin has

- 1 **Suzuki RE 5 Rotary** is hot setup for '75. Engine is a two-rotor Wankel.
- 2 **Styling** of 500-pound machine is by world-reknoned designer, Giugiaro.
- 3 **The rotary engine** is water-cooled using a large radiator up front.
- 4 **Automatic electric fan** assists cooling job. It cuts in when necessary.
- 5 **Power comes on strong** with an eerie smoothness; best of all, it's quiet.
- 6 **Instrument pod** or module is cylindrical. It's strange but efficient.

changed little in appearance. It is not uncommon to put 50,000 miles on the big V-twin before major engine maintenance is necessary. The FLH is able to take unusual punishment, as is so well exhibited by the pressures of police service.

About performance, torque is fan-



Harley-Davidson FLH-1200 is the Grand Daddy of all the big touring bikes. The Harley "Hog" sports a 1200-cc V-Twin.



Kawasaki Z-1 is a four-cylinder, 900-cc, double-overhead-cam machine, with positive crankcase ventilation (PCV).

Honda GL-1000 Gold Wing is a breathtaking new bike from the manufacturer that put respectability back in motorcycling.



tastic, but speed leaves something to be desired. The Harley is a chugger: It can climb hills, carry a sidecar or even tow an automobile, but passing performance is poor.

Though operation of the brakes and clutch is smooth, the noise from the transmission and vibration from the engine can be disconcerting at speed—something enthusiasts simply learn to accept. Peculiar features are instruments located on top of the gas tank and a throttle that has no automatic return spring.

Across the country, there are over 650 dealers, at least 2500 working Harley mechanics and a full line of factory-installed options available. It's a convenient tourer for an American to own. But compared with its

newest competitors, it can affectionately be called a living anachronism. *Harley-Davidson Motor Co., 3700 West Juneau Ave., Milwaukee, Wis. 53201.*

HONDA GL-1000. Finally unveiled after two years of rumor, the new GL-1000 carries on Honda's reputation as an innovative contributor to motorcycle touring. The GL has clean lines and a surprising lack of clutter despite its mass. A horizontally opposed four-cylinder engine, similar in appearance to that of a Volkswagen, is placed low and nearly midway within the wheelbase dimensions. This creates a low center of gravity—already the basis for good handling.

What appears to be the gas tank, mounted above the engine, is actually an empty compartment designed for touring gear. Fuel is stored in a tank of deceptively large dimensions located behind the engine. Liquid cooling is incorporated with a compact radiator, mounted in front of the engine between the two main frame downtubes. Power is put to the rear wheel through a compact, low-maintenance shaft drive. Brakes are hydraulic disc-type: twin disc up front, single disc in the rear. Instrumentation is typically Honda: Comprehensive, easy to learn and easy to operate.

Little is yet known of the performance characteristics unique to the GL-1000: At this writing, only

a half-dozen engineering prototypes are in the country. The model will be available at Honda dealers in late spring. *American Honda Motor Co., 100 West Alondra Blvd., Gardena, Calif. 90247.*

KAWASAKI Z-1. The 900-cc Kawasaki Z-1 has comfort, reliability, looks, handling ease, economical gas mileage, simple maintenance and high-performance power—all at a very competitive price.

Norton 850 Commando is sporty model. Interstate 850 version has a huge fuel tank offering greater touring range.

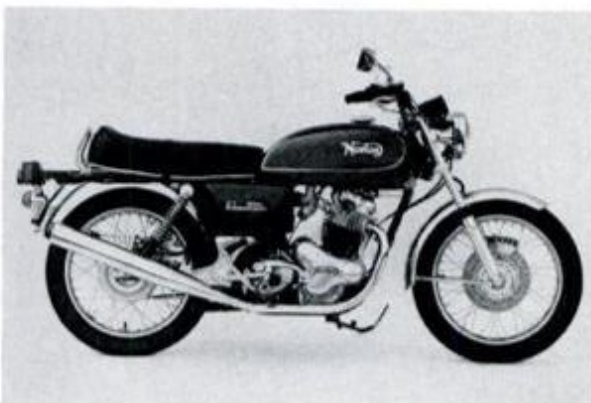

Moto Guzzi 850 T uses the famous V-twin in a freshly restyled bike that's sporty and a practical tourer as well.

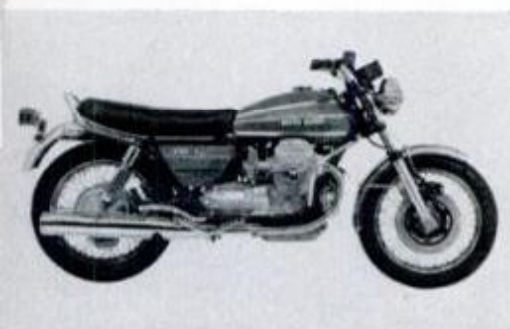

The transverse four-cylinder engine has a double-overhead-cam setup, wet-sump lubrication and fuel intake via four 28-mm Mikuni concentric carburetors. It even has a PCV system. Blow-by gas, normally expelled through the engine breather into the atmosphere, is returned through a system of channels (to separate oil and other elements) to an inlet manifold, through the carburetors and back into the combustion chamber to be reburned. Relatively low compression ratio of 8.5:1 lets the engine run with full efficiency on low-lead gasoline, and Z-1 gets a dependable 45 miles per gallon.

Noise level at 82 dBA is below that of current federal standards. Double-cradle tube steel frame of thick-walled 1.26-inch-diameter tubing insures against flexing under riding stress. Competition-bred chassis design and construction make the Z-1 stable and predictable. Suspension is comfortable but firm—less cushy than some tourers but more suited to a wide variety of riding styles. Large-diameter brakes—hydraulic disc in the front and drum in the rear—make for safe, effective

stopping. *Kawasaki Motors Corp., 1062 McGaw Ave., Santa Ana, Calif. 92705.*

LAVERDA 1000-cc DOHC. Laverda is a name synonymous with motor-cycle endurance competition throughout Europe. Though not unknown in the United States, the fabulous Laverda 1000-cc DOHC triple is only beginning to gain proper recognition. With double overhead camshafts and a light alloy cylinder head,

the 1000-cc engine has a 9:1 compression and develops over 80 bhp at 7300 rpm. A buttery-smooth five-speed gearbox offers ratios that comply with a wide variety of road conditions. The engine-gearbox unit is carried in a light but rigid double-cradle frame.

Ceriani telescopic forks with 280-mm twin disc brakes up front complement Ceriani shock absorbers and a large twin-shoe drum brake on the rear. This combination provides first-class ride and stopping power. Handling is sensitive but stable. Replacement parts and service centers are not plentiful for this rare machine. The Laverda is mystique as much as it is motorcycle. *Continental Motorcycles, Inc., 150 Ludlow Ave., Northvale, N.J. 07647.*

MOTO GUZZI 850T. The mere sight of a Moto Guzzi conjures thoughts of luxurious cruising to exotic destinations. Factory designers have taken the best technical features of the bearlike touring models which have made Guzzi a long-distance champion and combined them with the chassis and suspension of the V7 Sport to create the new 850T. An 850-cc, 90° transverse V-twin engine produces 68 hp at 7000 rpm. Power is transmitted to the rear wheel by a high-tensile steel driveshaft through a constant-velocity U-joint system. It's safer, surer and more durable than a common chain drive—also maintenance-free.

The Guzzi takes some getting used to. Quick acceleration must be attempted carefully, since it brings on

an instant torque reaction from the V-twin that tends to make the bike lean sideways. It is a characteristic of opposed twin-cylinder engines, however, something to which owners become accustomed. Once under way, sideways quaking smooths out, as does low rpm vibration from the long-stroke pushrod powerplant. Highway cruising becomes ultra-smooth and comfortable. Soft suspension with firm damping plus a low profile, rigid cradle frame make for excellent handling. Sound is low-pitched, quiet; stopping power, sensitive and secure. *Premier Motor Corp., Railroad and Plant Rds., Hasbrouck Heights, N.J. 07604.*

MV AGUSTA GT. Steeped in the rich tradition of European Grand Prix road racing, the MV Agusta GT is certainly the most exotic and exclusive tourer in motorcycling. The four-cylinder MVGT is a direct derivative of the 500-cc factory racer that has carried Italian riders to repeated world championships since the early 1950s.



Yamaha XS 650B gets power from a single overhead-cam, vertical-twin, four-stroke engine; you get 46 hp at 7000 rpm.

Each MV is hand-built at the factory. Engine cases are of sand-cast aluminum. Each of four cylinders is fueled with a concentric carburetor tuned so precisely that the engine needs no choke. Telescopic front suspension is by Ceriani; enormous double-disc front brakes by Scarab. The chassis, heavily gusseted for strength and yet lightweight for good handling, are carefully built, one at a time. Special cylinder heads with double overhead cams and four valves per cylinder play a large part in the MV's 80-hp muscle.

At nearly \$5000, the MVGT is not only the most exotic but also the most expensive tourer known to motorcycling. *Christopher Garville,*

(Please turn to page 126)



The shop that became a family fun center

Multipurpose hobby room is most-used in the house

by Harry Wicks WORKSHOP EDITOR

Though an avid workshopper, when David Warren of northern Illinois recently wanted to do something with his basement, he decided against using that space strictly for a workshop. Instead, he wanted a room that the entire family could use and enjoy. The six Warren children agreed enthusiastically, and plan-

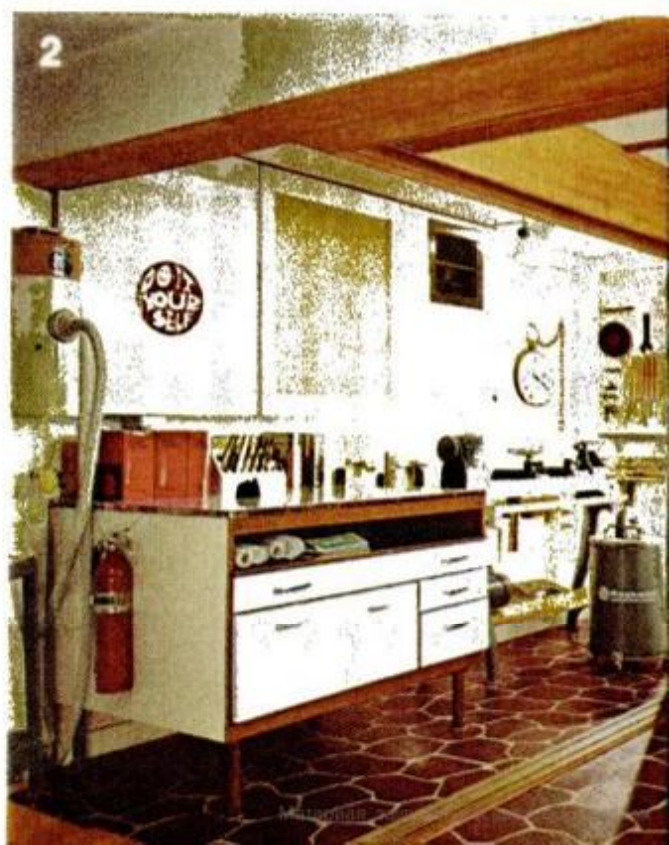



Owners: Mr. and Mrs. David Warren

Color photos: Bill Hedrich, Hedrich-Blessing

Elegant and organized, this hobby center has something for every member of the family. **1.** Work counter features a Corning Counter Saver for soldering and cutting; skylight above gives the room a studio look. The pair of sturdy benches in the center were purchased for less than \$5 at a garage sale. **2.** Barn doors, which separate the shop from the rest of the basement room, slide away to expose a corner that has been set aside for lathe work. **3.** Tools are displayed on Peg-Board, which was installed with a slight backward tilt to prevent tools from falling. Orientation of tools and work center can be seen in the floor plan; because of sliding panels (see photos on next page) the family room can be readied instantly for a party—the workshop is simply hidden from view.



Layout of the Warren's hobby room

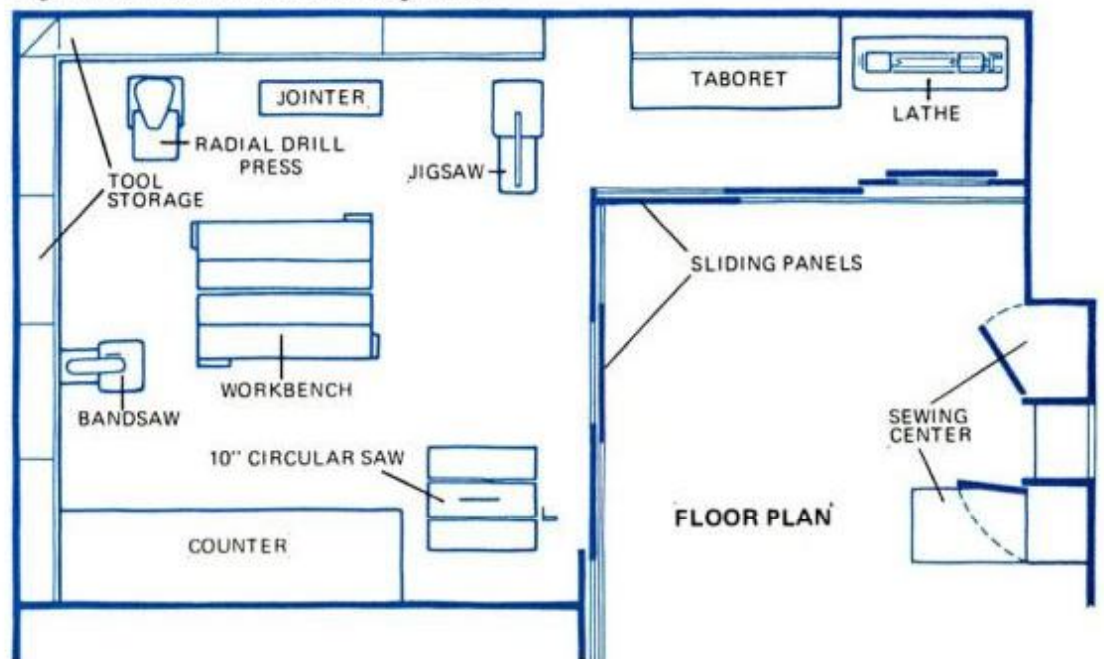

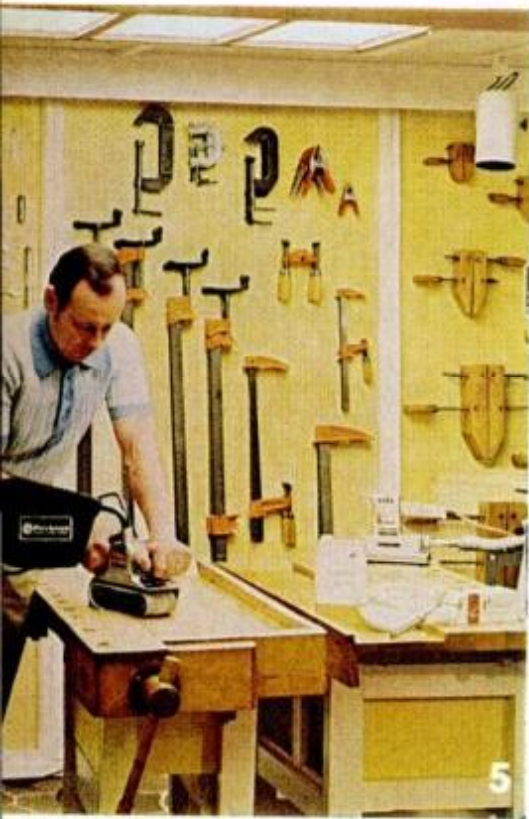

4. Barn doors are shown partially open. When they are closed, the doors meet at the corner (notice track on the floor) to form a right-angle wall that will conceal the shop area. 5. Warren sands bench surfaces; next, he coats the tops with wax for protection. 6. Cutting table in the sewing center swings on a pivot and gets its support from folding legs. When not in use, the table flips up into a closet for out-of-sight storage.

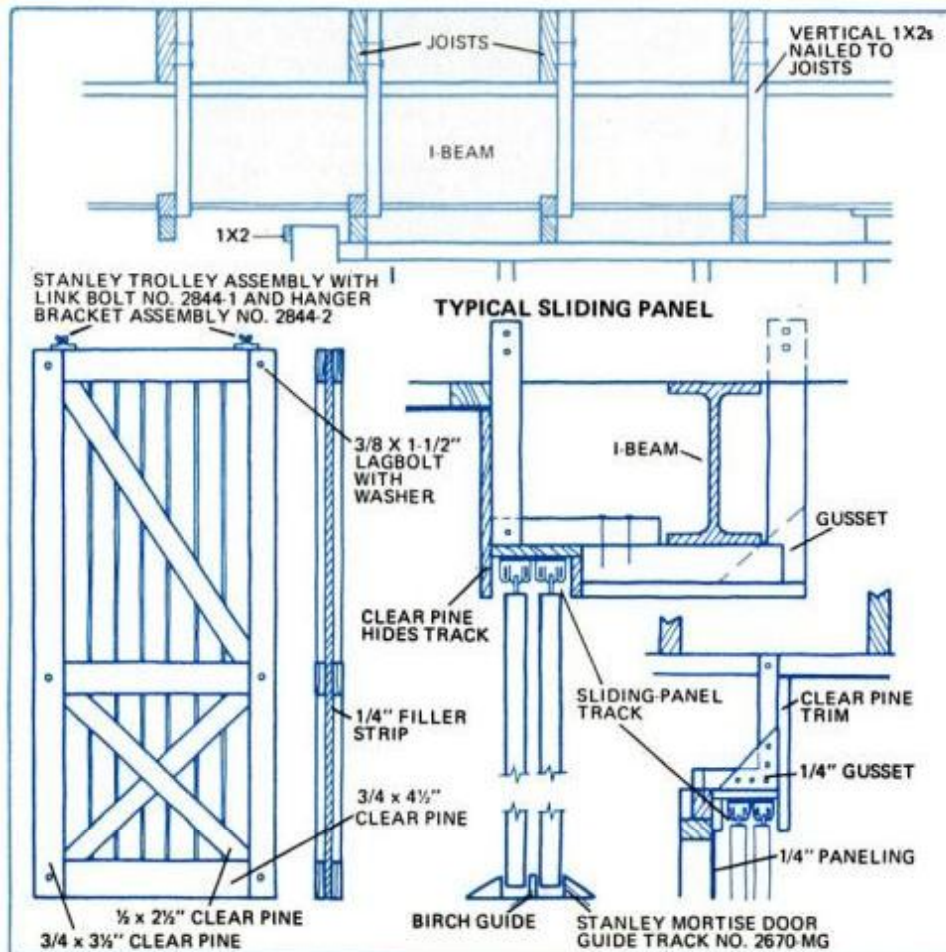

ning commenced on what was to become the most-used room in their house. The need was for a room that could serve several purposes: It had to be a work center all could use to pursue hobbies, special interests and homework projects, plus a family room for entertaining and games. To get what they wanted, Dave came up with the idea of installing a wall of sliding panels which would separate or open up the room as the moment required.

The panels are built to resemble barn doors; each is a full 4 feet wide and as tall as the ceiling height permits. Though originally the Warrens assumed that the rooms would be partitioned off most of the time, Dave says that "it turned out that the doors are almost always open. If one



7



8

Overall view of sewing center 7. Notice sewing-machine niche in closet at left. **8.** Doors slide easily because they are carefully constructed and mounted on good-quality sliding-door hardware. **9.** Valance over shop work counter conceals roll of photo-background paper. When it's needed for tabletop photography, it's simply pulled down and taped to the counter. ★★★



9

of our teen-agers has a gang over for a rap or rock session, and one of his brothers or sisters is in the shop, the doors are quickly closed to assure privacy for all. But, Dave adds, "lately, the kids and their friends seem to be more interested in workshoping than rapping." He added that "sometimes this place looks busier than the school shop."

For looks, the walls are clad with Masonite's Coach House White hard-board paneling. In the shop area, Peg-Board panels are framed with moldings and painted a bright yellow semigloss enamel.

Perhaps the singular most striking feature in the room is the skylight which Warren created to avoid the dark, cavelike look so common in basement family rooms. For continuity of design, the skylight treatment is repeated on the ceiling in the family room (in which the sewing center is located).

To get this outdoors effect, Dave lined the underside of the subflooring and joist sides with reflective aluminum foil before installing the six pairs of fluorescent fixtures. The light fixtures were then framed as shown below. Translucent sheet-acrylic plastic hides the fixtures but lets the light through; pecan stain on the wood gridwork supplies a touch of elegance. ★★★

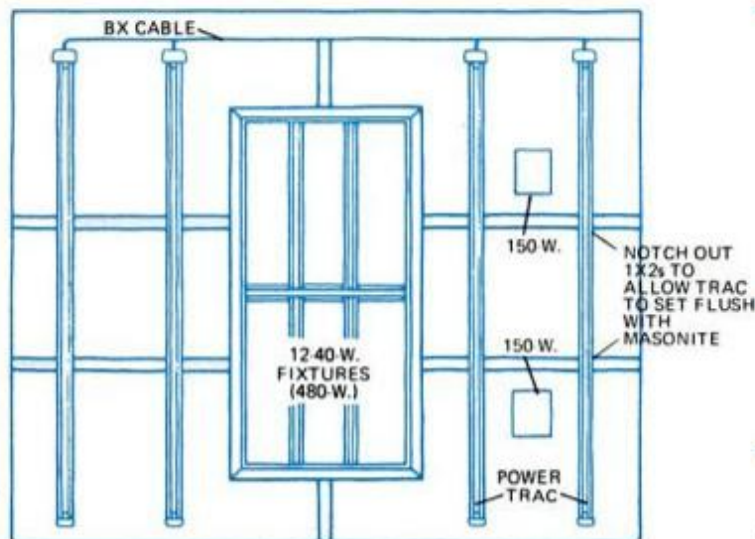

"SKYLIGHT" FIXTURE

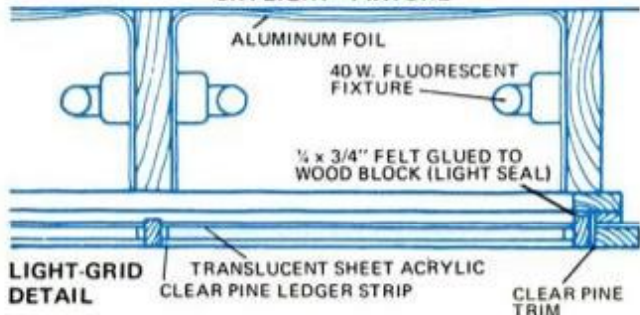

LIGHT-GRID DETAIL

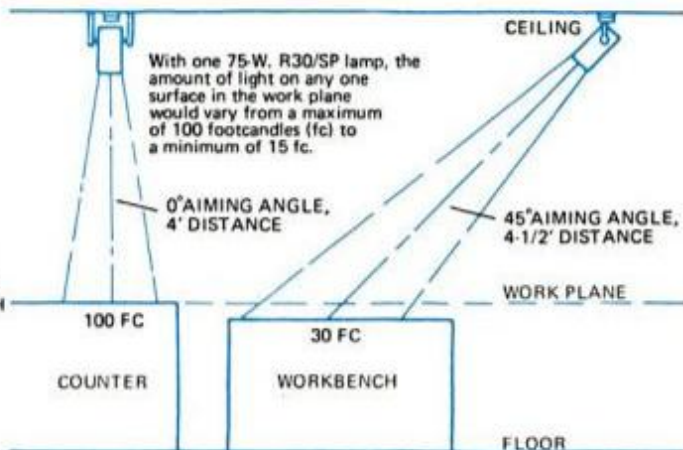

POWER-TRAC LIGHTING

Details in the Warren hobby center: Far left: Sliding barn doors were created with paneling which sandwiches 1/4-in.-thick pine fillers. Frames and diagonal bracing are of clear pine finished with pecan oil stain. I-beam was widened by boxing it in with 2x2 stock that, in turn, was covered with 1/4-in. hardboard. Clear pine at the front gives appearance of a beam and serves to hide the track. Near left: Another impressive feature of the basement room is the skylight Warren created using fluorescent lighting; 12 fluorescent fixtures were fastened to joists and concealed using the framing details shown. Above: The skylight is flanked by two pairs of Halo's Power-Trac lights which can be aimed in many directions for maximum efficiency.

Serve your guests with a dash of elegance

by Rosario Capotosto

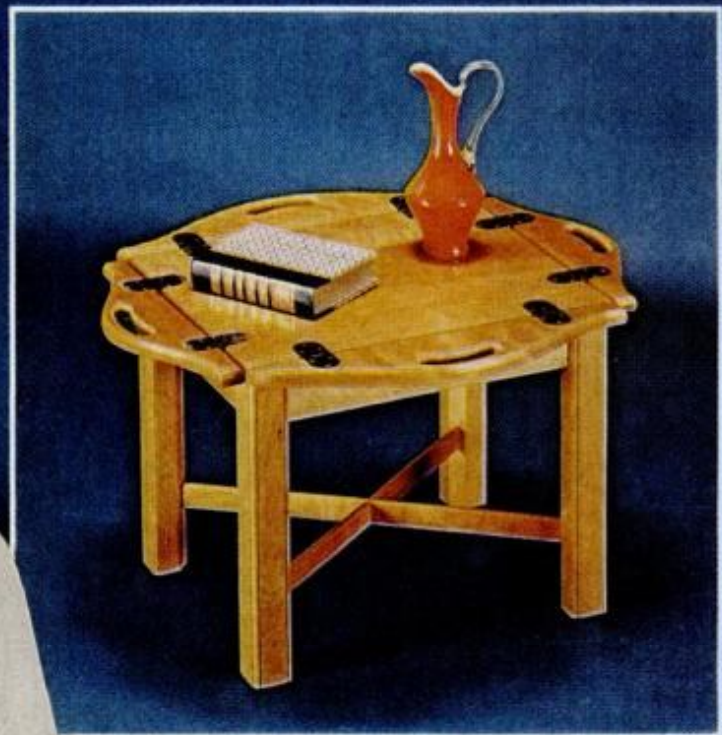

Make this butler's table with a lift-off top, and you'll always be ready to serve coffee or tea to guests. With the top in place, it's a handsome coffee table.



Photo: Stephen Fay

Материал защищенный авторским правом

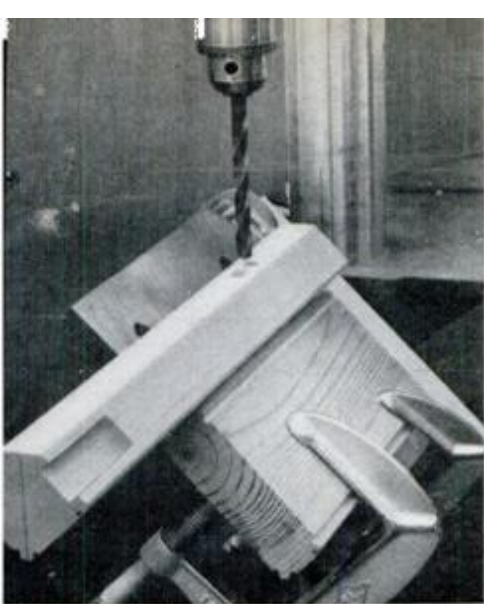

You'll have both a coffee table and a serving tray when you make this attractive butler's table. Its top lifts off for serving, then fits back firmly on the leg assembly when you use it as a table.

Friction hinges let you position its four leaves at any angle from horizontal to vertical to convert it to a tray with built-in handles. Cleats on the underside cleverly position the tray/top on its four legs so it can't slide off.

I made my table smaller than store-bought ones (usually 33x44 in.) for I found the bigger size and greater weight made it impractical for a woman to use the top as a tray.

It's no difficult job, but neither is it a hammer-and-saw project. A router will form the semicircular hinge mortises and round the edges. A table saw and molding cutter will form the decorative corner bead-

ing on the legs, a sabre saw will cut the tray leaves and hand grips and a drill press will form the stretcher mortises.

In the drawing below, note that all four legs are made alike; the inner corners are first beveled 45°, then mortised at the top for the aprons and 3 in. up from the bottom for the stretchers. I ripped the leg squares from a glued-up slab consisting of three 3/4 x 12 x 16-in. pieces, then dressed them four sides to 2 in. square.

Since the legs are not set in a square relationship but rather rectangular, the cross stretchers must enter the legs at a corresponding angle. To determine the correct angle for the stretcher mortises, number the legs and stand them upright on a flat surface the proper distance apart. Place a straightedge diagonally across the center of the bevels

(Please turn to page 145)

Tilt drill-press table so pencil line on leg and drill bit are vertical, then clamp.

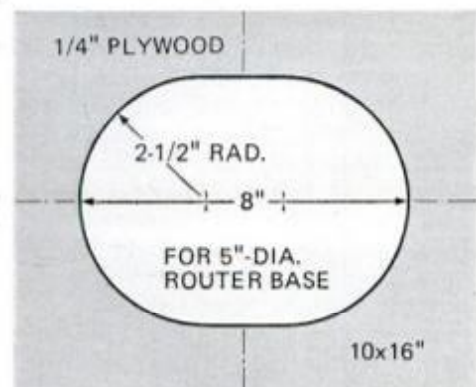

Template forms mortises for both leaves of hinges in one router operation.

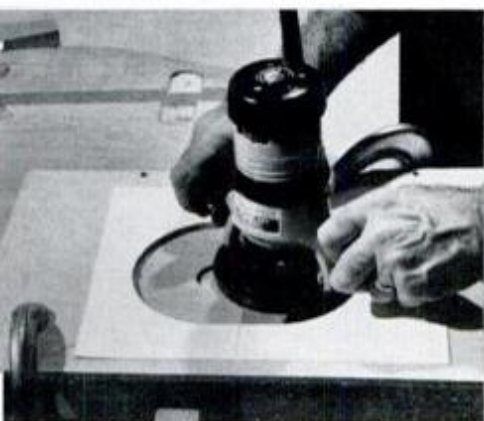

Use plywood template to guide router base for cutting semicircular hinge mortises.

Shim hinge mortises in table leaves to make up for single-thickness hinge leaf.

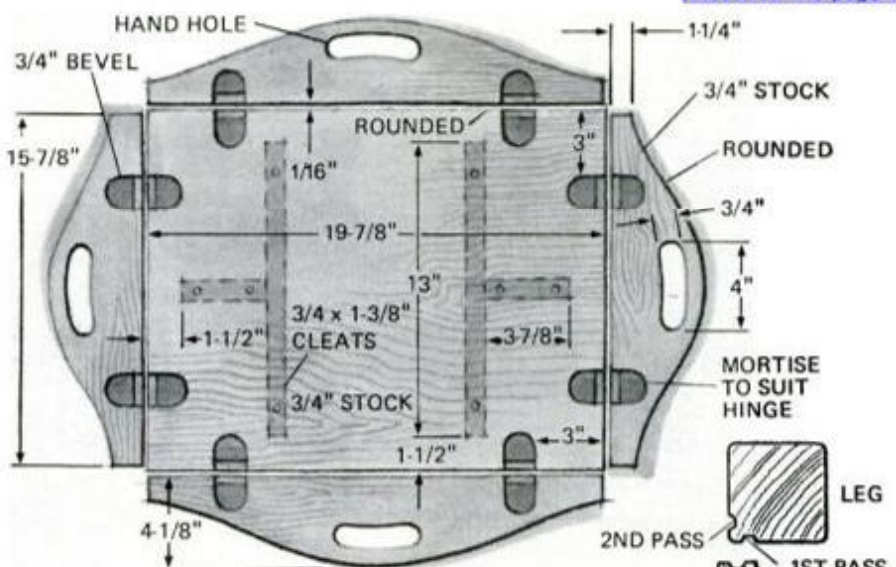
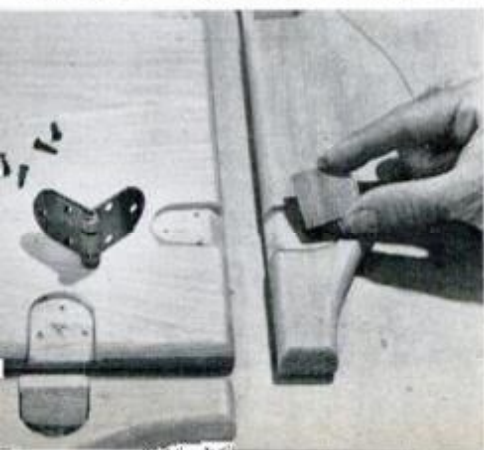

TRAY TOP

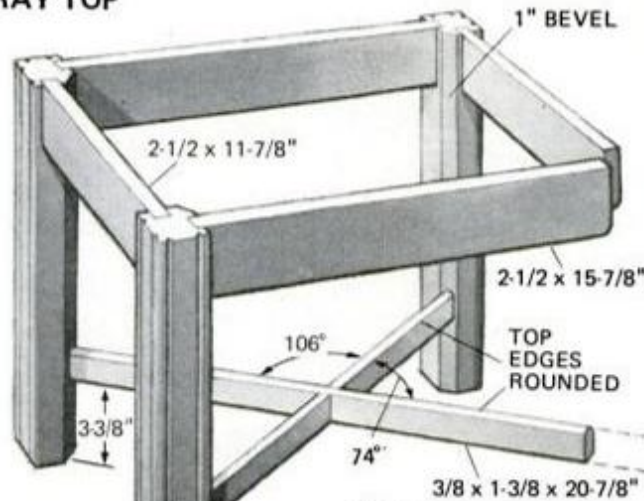

BASE

2x2x16" LEG

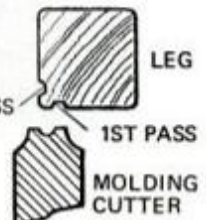
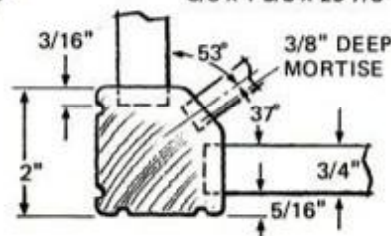

1/4 x 3/4" MORTISE

To buy the best battery, ask what it's going to run

by Rudolph F. Graf and George Whalen



In these days of universal portability, it sometimes seems as if the whole world runs on batteries, all going dead on you at unpredictable intervals—usually when you need them the most.

Why did your portable recorder die just as Junior gurgled his first words? Or why didn't the flashlight in the basement work when the power went off?

Even more baffling is the problem of which replacement batteries to buy: Transistor? Heavy-duty? Alkaline? Mercury? . . . the list is almost endless. One manufacturer alone of-

fers 13 different D-size cells. So which is best?

The answer depends on the kind of use you're going to give the battery you buy. What will it power? How often will you use it, and how long will it be stored before and between uses, and at what temperature? How low can voltage drop before the battery becomes unusable? And which counts most with you: Lowest price, lowest cost per hour of use, or longest time between replacements?

Obviously, there's a lot more to it than just picking a cell of the right

shape and size. But it's not really as complicated as it sounds.

To begin with, there are just four types of batteries in common home use: carbon-zinc, alkaline, mercury and nickel-cadmium, though there are several variations on a few of them.

The *carbon-zinc* is commonest and cheapest, but not always the most economical. Sometimes called the "Leclanché" cell, after its inventor, it's the standard old flashlight battery—and that's mostly what it's recommended for: flashlights.

Flashlights demand only moderate current, and they're usually used fairly frequently but just for a few minutes at a time. That's a perfect combination for the standard flashlight-type Leclanché cell. If you use your flashlight frequently, you'll wear out the battery long before it runs down by itself, even though its shelf life is poorer than that of most other types (capacity drops about 1 to 1½ percent per month at room temperature, even faster when the temperature is high—but slower at low temperatures, which makes refrigerating unused batteries a good idea).

Short shelf life, by the way, is why the carbon-zinc cells provided with many imported radios, recorders and other gadgets die so soon after you get them. They've already spent months in transit from the battery factory to the radio factory, then across the ocean by ship to a warehouse and on to your store.

A carbon-zinc cell's voltage drops rapidly with use (see chart, next page); but using it a few minutes at a time, you're unlikely to get enough voltage drop to dim your flashlight noticeably—and with the long rest periods typical of flashlight use, your battery will bounce back to full voltage before you use it again.

Heavy-duty or *industrial* cells have the same basic properties, but are designed for longer continuous use that would soon dim a standard flashlight cell. Though formerly a variety of carbon-zinc, these cells now commonly are zinc-chloride types.

Transistor batteries are also carbon-zinc types, but designed to give extra-long life under the low current drains typical of transistor radios.

Photoflash batteries (a fairly rare type, nowadays) are just the opposite of transistor batteries. While still carbon-zinc, they're built with a large internal contact area so that they can deliver heavy jolts of current fast, for flashbulbs and electronic flash.

Ready for more? *None* of the preceding types are strong performers in any motor-powered device. Unlike lamps and transistors, d.c. motors have voracious appetites for current at start-up and when slowed down under load. Unlike flashguns, they present a continuous drain to the battery. Cassette recorders that stop in mid-reel (or, worse, that slow down, unnoticed, in recording, to make later playback at normal speed sound like the gabbling of a demented duck), motorized toys that gasp to a stop in minutes, and portable shavers that groan through your stubble like a lawnmower in swamp grass are all typical results of using a carbon-zinc battery where another type would operate more efficiently.

The *alkaline* battery (or manganese-alkaline, to give it its full name) is designed for high-drain uses. A cousin of the carbon-zinc cell, the alkaline has a large reserve for peak current demands, making it a good choice for motor-powered applications. It's even better for photoflash use than the carbon-zinc photoflash types—one reason the carbon-zinc photo batteries are so hard to find.

Alkalines are markedly superior to carbon-zincs in other ways, too. In addition to much longer life when used continuously or in high-drain applications, the alkaline recuperates faster when used intermittently, holds its charge nearly twice as well in storage, has a much longer shelf life, works better at low temperatures (though still not as well as at

room temperature), and voltage drop isn't as much in use as that of a carbon-zinc cell.

On the other hand, while alkalines can deliver current at a higher rate than carbon-zincs, they do it at a slightly lower operating voltage; so an alkaline could drive some motorized devices more slowly, though for a longer time than a carbon-zinc.

Though alkalines are less likely to leak when dead, they do tend to "salt" over a long period of time, forming

Alkalines are markedly superior to carbon-zincs in longer life, faster recuperation after use.

a whitish powder at their terminals or, at the least, insulating the cell from whatever it's supposed to power. And the electrolyte paste, if it ever does leak out, is corrosive, too.

While it's good that an alkaline battery's voltage doesn't decline as steadily as that of carbon-zinc cells, the sudden drop in voltage at the end of the battery's useful life can take you by surprise. Carbon-zincs, by contrast, start warning you of their eventual demise almost from the first time you use them.

Alkalines cost more than carbon-zincs—about two or three times as much. If you should use them where the current drain or temperature dictate their use, alkalines are more economical in the long run. But when used in low-current applications such as flashlights or transistor radios, or in intermittent use, they offer little economic advantage over carbon-zincs, and may even cost more per hour of use. Still, if you find frequent

replacement a nuisance, or need to be sure that the batteries you haven't used in some time will still be good when you need them, then alkalines may be worth your while even in applications where their cost per hour is higher.

And it does make sense to try squeezing a bit more life from your alkalines by using them in your transistor radio when they no longer can power your motor-driven portables properly. With some radios, or sufficiently discharged batteries, the sound may be distorted, but with other radios, or only moderately weakened batteries, you may gain a few hours of "free" extra use.

So, while there's no such thing as a universal battery, the alkaline probably comes closest.

Rechargeable alkalines, chiefly offered by Mallory and RCA, have most of the standard alkalines' advantages—plus rechargeability. This greatly reduces their cost per hour even though they cost about twice as much as regular alkalines (not counting the cost of the special charger, now about \$21).

Alkaline rechargeables cost considerably less than the better-known rechargeable nickel-cadmium types and, while idle, don't lose their charge quite as quickly as nickel-cadmiums do.

But they can take only about 35 to 60 recharge cycles before failure (far fewer than nickel-cadmiums), and failure will occur much sooner if you drain them too deeply before recharging. Battery authorities suggest recharging before voltage drops below 1.2 volts from its initial 1.5-volt charge. If these batteries are drained until their voltage drops as far as 0.9 volts, they'll suffer irreparably.

Mallory, for just that reason, doesn't especially encourage home

SERVICE LIFE: 1-1/2 VOLT PENLIGHT CELLS

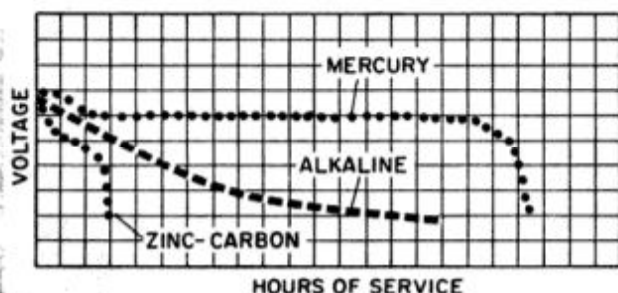

SHELF-LIFE

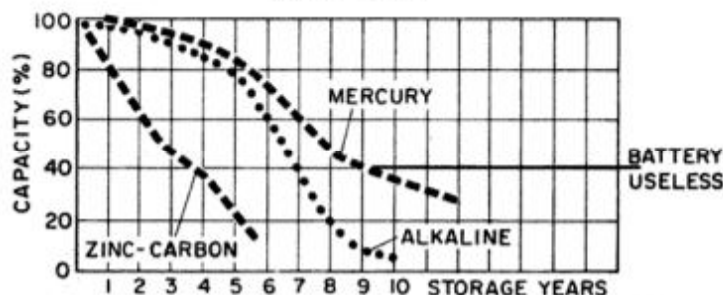

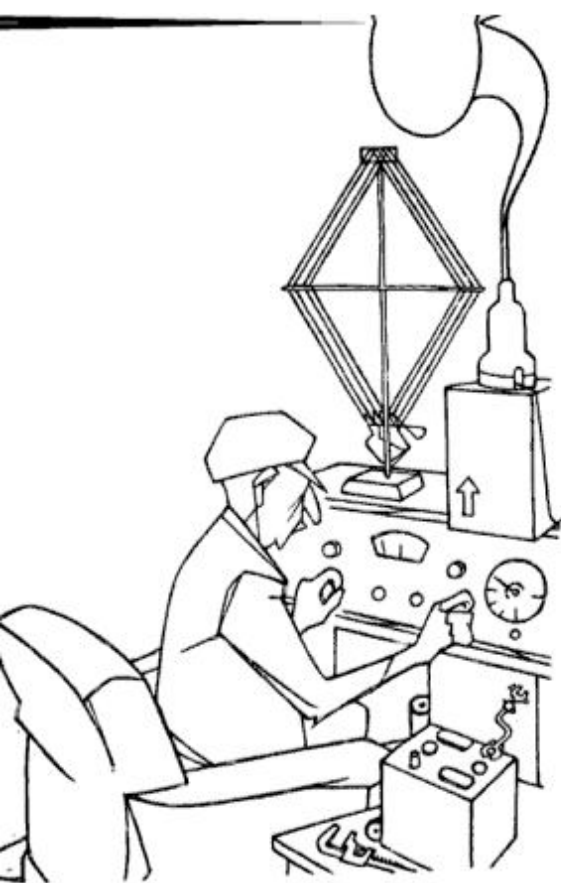

use of these rechargeables—most people tend to use them as they do regular flashlight batteries, running them down until they're practically dead, then wondering why they won't recharge back to normal again.

Mercuric oxide batteries—"mercury" cells, for short—cost about two to two-and-one-half times as much as alkalines, and are hard to find in the standard flashlight, penlight or transistor sizes (though they're quite common in the small wafer types used in cameras or hearing aids).

Like alkalines, mercury batteries have a long shelf life with a very low voltage drop, and long life at almost full initial voltage before a sudden voltage drop at the end of their useful lives. But mercury cells outperform alkalines substantially in both these areas (see chart, previous page), enough so that mercury cells are used as voltage references. Besides the great amount of power they pack in a minute space, this is just another reason why the mercury cells are used in camera light-meter systems.

In other ways, though, mercury cells react quite differently. Where alkalines thrive on delivering a lot of power at once, mercuries can take such loads only quite briefly before their efficiency and voltage suffer. Though they bounce back rapidly from brief overloads (even from brief short-circuiting), under normal drains they require no rest and can be discharged continuously with little or no loss of useful capacity.

Though mercury cells work well at high temperatures, their perfor-

mance degrades sharply at low temperatures where alkalines still keep going.

The voltage of mercury cells is constant, though it's lower than that of alkalines or carbon-zinc types: 1.4 or 1.35 volts instead of the standard 1.5. As our graph demonstrates, this difference can be more illusory than real, since the nominal "1.5-volt" batteries quickly drop off to well below the mercury's 1.35 or 1.4-volt level. (The 1.4-volt mercuries also drop off, but just to 1.35 volts; only the 1.35-volt type is used for voltage reference purposes.)

Mercury cells aren't completely interchangeable physically with the standard batteries they resemble. Running slightly smaller than alkaline or carbon-zinc types, they may not make firm (or any) contact in some battery-run devices.

Lithium batteries aren't too likely to show up in the battery bins of your supermarket, hardware store or electronics dealer for a while, but you can expect to see them there eventually. They pack incredible amounts of power for their size—but they cost accordingly. And since they deliver 2.8 volts per cell instead of the 1.5 volts of standard types they're unlikely to become exact replacements for the traditional cylindrical C, D, AA and AAA cells. You're likely to see them first in the same configuration as the familiar 9-volt, snap-contact "transistor" battery. (Strictly speaking, the word "bat-

Nickel-cadmium cells are costly, but in the long run recharging can make them the most economical types.

tery" applies only to units made up of several cells: the 9-volt type, for instance, is made up of 6 cells, delivering 1.5 volts each, in series.) But, like the mercury battery, the lithium "9-volt" size delivers an actual 8.4 volts.

When portable gadgets designed to work on 2.8-volt lithium cells in the standard cylindrical sizes are available, users will have to make doubly sure they replace a lithium cell only with its exact equivalent—devices made for 1.5-volt cells may react quite unfavorably to getting nearly twice the voltage they're designed for.

Nickel-cadmium cells differ in one basic way from most of the battery types we've discussed so far. Instead of being "primary" cells, which generate electricity from chemical ac-

tion nickel-cadmiums ("Nicad" is not a nickname, but a trademark) store and release electricity just as your car battery does. Initial cost is very high, but if they're properly recharged (and they can be subjected to hundreds of recharges), they can become the most economical batteries of all.

And a well-charged nickel-cadmium battery is a very good battery indeed: It's light, rugged, can take high discharge rates (though with severe reduction of power and capacity if drained critically at low temperatures), holds its voltage fairly constant in use (though the shelf life of its charge is only moderate), and can be used over a wide voltage range (though it's no match for an alkaline cell below freezing).

However, proper recharging is critical. Discharging it below 1.1 volts can reduce the cell's capacity—and so can recharging too soon, before any appreciable amount of power has been drawn from the cell. Overcharging, or charging too fast, can also cause cell damage, though special chargers with complex and expensive circuitry to reduce current as the cell recharges can be used to bring the cell back to full charge in just a few hours rather than the overnight periods simpler chargers require.

Nickel-cadmiums are perfect for emergency, standby power in case the main power-line supply fails. Plugged in to trickle-charge from the power line between uses, they'll maintain full charge almost indefinitely. But where access to power lines or rechargers is limited, nickel-cadmiums, with their short shelf life, per charge, make poor standbys.

Recharging primary cells can't really be done, despite the claims of the companies that sell the chargers. What a primary-cell "recharger" does is actually best called "rejuvenation," bringing back only a portion of the battery's original utility. At best the number of charge/recharge cycles and the capacity per charge is very limited—and then only if the battery is not deeply discharged, is placed on charge very soon after removal from service, is charged with about 1½ times as much as was originally drawn from it, with the charge spread over about 12 to 16 hours, and if it's put back into service quickly, before the rejuvenated cell can discharge itself. That's hardly worth the trouble, considering how little you save.

There are hazards, too: a cell recharged too fast or too long may explode—especially with mercury cells or new alkalines that haven't been recharged yet. ★★★

How to install a coolant recovery system

It's simply a see-through container that catches overflow from your car radiator. If you have one you take it for granted. If you install it following instructions, you'll wonder how you ever got along without it.

The container is essentially an expansion tank. It is mounted near the radiator and is connected by the radiator overflow hose. It makes a sealed system of your cooling system.

As your engine heats up, expansion takes place in the system and coolant is forced into the tank rather than lost on the road. As your engine cools, temperature and pressure are reduced and coolant is drawn back into the radiator from the tank.

Consider the many advantages:

- You can visually check the coolant level. You don't have to remove the radiator cap and peer inside.
- You eliminate the danger of removing the radiator cap and receiving a possible scalding.
- You save costly antifreeze, now at record high prices.
- A sealed system keeps air out of your cooling system, reducing corrosion, and bubbling that impairs heat transfer.—*Bill Hartford, Automotive Editor*



2. Hose clamps should be used at both ends of the radiator overflow hose. Find the hose, which usually runs down side of the radiator, and free it for next step.

3. Overflow hose is placed over flange on the bottom of the bottle. First slip a clamp over the hose, then slide it down into place to secure the hose.



4. Tighten clamp that holds the overflow hose in place on the bottle. Also tighten clamp on radiator end. Ready sheet-metal screws for the next step.

5. Overflow bottle, with hoses in place, is positioned and secured with sheet-metal screws. When drilling holes for sheet-metal screws don't make them too big.



6. Rubber seal on new radiator cap that comes with the overflow bottle is necessary to seal the cooling system. Make sure the rubber seal is in place on the cap.

7. New radiator cap is put in place after radiator is filled to top with a 50/50 mixture of ethylene glycol antifreeze and water. Fill overflow bottle next.



8. Fill the overflow bottle half full with antifreeze, or between the "Min" and "Max" marks if the bottle has these markings on the side. Check level as below.

9. Level will rise as engine warms up. If you've overfilled bottle, remove excess coolant with syringe or a pump of type used with hand lotion or glass cleaner.



1. Overflow bottle, which can be bought in most auto-parts stores, should be mounted high in the engine compartment near the radiator. Find a spot ahead of the radiator, possibly inside a front fender.

IT'S NEW NOW



First look at world's mightiest bomber—the B-1

Surprisingly small for the big job it will do, the much-heralded B-1 bomber makes its first public appearance recently at Wright-Patterson Air Force Base in Ohio. Though only two-thirds the size of the B-52 it replaces, it will carry nearly twice the payload and fly at better than twice the speed of sound. Its variable-sweep "swing" wings retract for high-altitude supersonic flight, extend for low-speed, short-field landings and takeoffs. Expected to be our chief nuclear deterrent for 30 years, the B-1 was jointly developed by Boeing, Rockwell International, GE and Cutler-Hammer.



'Barnyard boat' finally makes it to water

When 65-year-old retired Iowa farmer Bill Bodisch began building a 58-foot yacht in his barnyard, people smiled (see *A Dreamboat Takes Shape in a Barnyard*, page 96, Dec. '74). Now Bodisch has the last laugh. His 22-ton, all-steel cruiser is trailered (left) to the Mississippi River and finally launched (above). Bodisch plans a world-wide voyage.



Simple-to-install filter protects hot-water heater

Easy-to-add water filter not only prevents mineral deposits from forming in your hot-water heater, but even loosens hardened scale already built up in the tank. It dissolves harmful mineral residue that fouls lines and can lead to heater failure. AP400 Lime-Aid Water Conditioner inserts in cold-water inlet and has replaceable filter cartridges you can change without tools. AMF Cuno Div., AMF, Inc., Meriden, Conn.

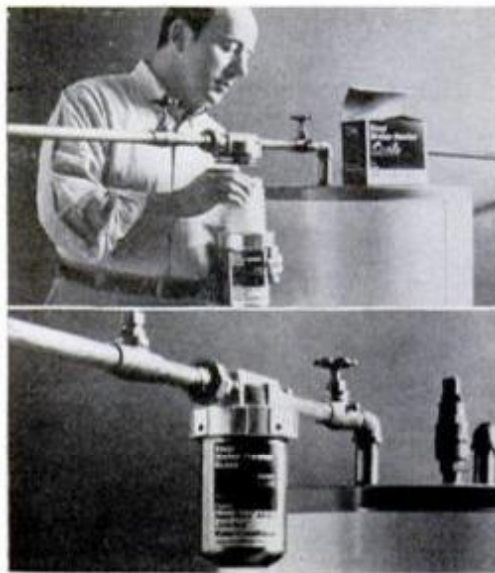



**Pretty shark bait
now sharkproof**

When beautiful "Sea Maids" at Florida's Sea World tourist attraction go down to feed fish, they have one problem—sharks like to eat, too. Now this plastic-sided "shark cage" allows spectators to view the feeding while protecting the pretty feeders from any overanxious man-eaters—or girl-eaters—that may be in the area. The cage, of GE's Lexan plastic, has made more than 5000 dives in the past year.

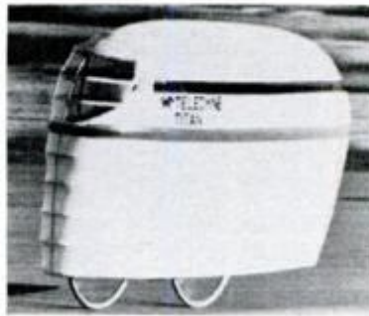

**It may not look like it,
but—yup—it's a bicycle**

Shrouded in a streamlined shell to cut wind resistance, bike racer Ron Skarin sets a new world speed record for two-wheelers at nearly 41 mph for the mile distance. He also hit 43 mph for the 200-meter run. (Bicycles have traveled faster, but only by following a "pace" car.) Bike was designed by Teledyne, shell by Dr. Richard Kyle of California State Long Beach College.



Walking wastebaskets eat trash and like it

Sheep may soon become living wastebaskets. Research in Australia shows the animals can exist on a diet of 60-percent waste paper, greatly reducing the cost of feed as well as providing a handy way to get rid of trash. Photo at left, above, is a gag shot—the sheep don't eat the paper "raw." It's ground up with minerals and other nutrients and formed into pellets (right), which then become fodder.

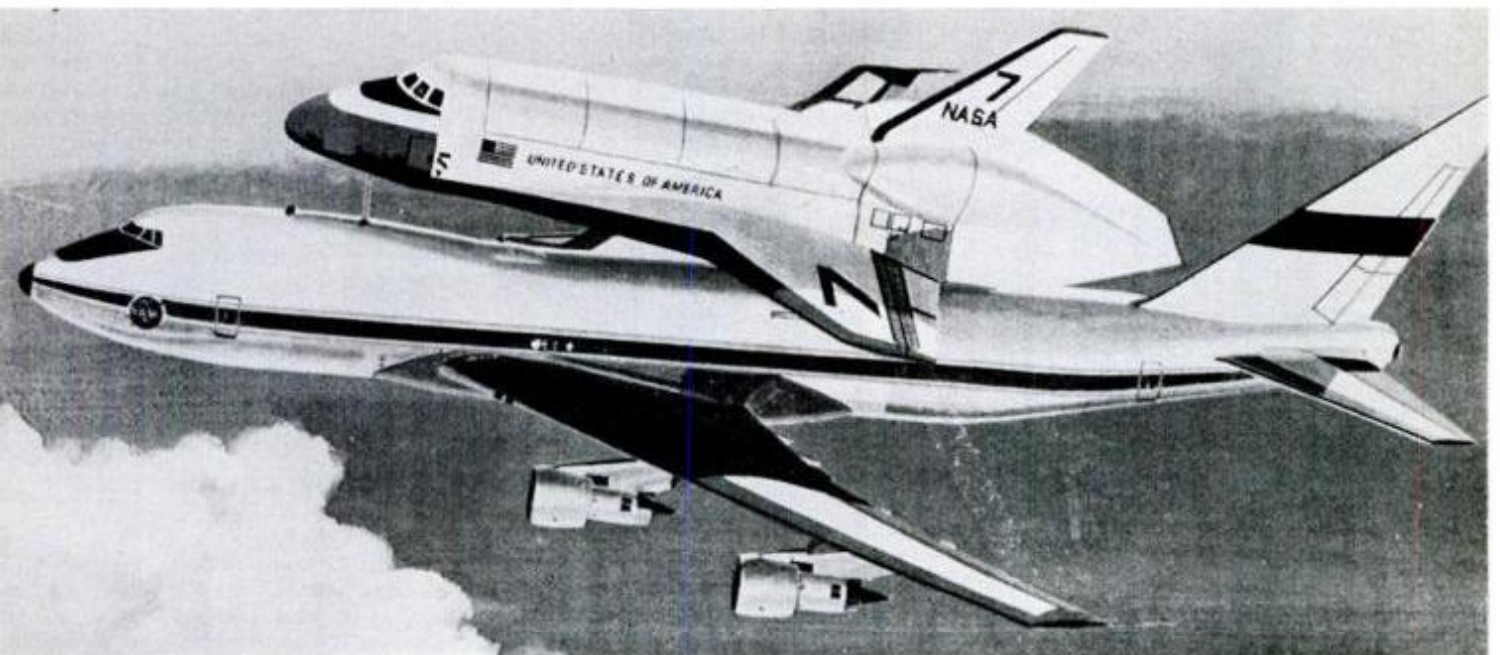

World's biggest piggyback ride!

Riding piggyback-style, a prototype of our Space Shuttle Orbiter gets a lift on top of a Boeing 747 jetliner in this artist's concept showing how the two will fly together during prelimi-

nary shuttle flight tests. NASA space technicians will use the jumbo jet to simulate landing approaches with the Orbiter and also to transport the shuttle from one NASA base to another.

Movie camera's built-in titler lets you zoom through slides

A unique "optical bypass" system on this new Elmo Super 204T super-8 movie camera lets you superimpose close-ups of title slides with live action—and get as close as the front of the lens without blocking subject illumination. The accessory slide-holding titler fits a special shoe on the camera. Lens is an 8.5-34-mm, f/1.8 zoom. Other features include a shutter release that folds out of the way when not in use, preventing accidental exposure, and an exposure compensation button for backlighting. Elmo, 32-10 57th St., Woodside, N.Y. 11377.



Speed ratchet for electric drills

Accepting standard-drive sockets and screwdriver attachments, Tight-N-Fast fits into any $\frac{3}{8}$ or $\frac{1}{2}$ -inch portable electric drill chuck to tighten bolts, nuts, drive screws. It has adjustable torque feature to prevent thread stripping and head shearing. With magnetic sockets, sheet-metal screws can be seated without starter holes. \$19.95 postpaid from Nebraska Machine Products, Box 12214, Omaha, Neb. 68112.



Well, it's one way to cross a river

Proving that a motorcycle can go just about anywhere, Greg Rodda of South Perth, Australia, emerges from the Canning River after crossing it underwater. Long "snorkel" tubes connected to the cycle's exhaust and carburetor intake kept the engine breathing, while scuba gear did the same for the watery rider.

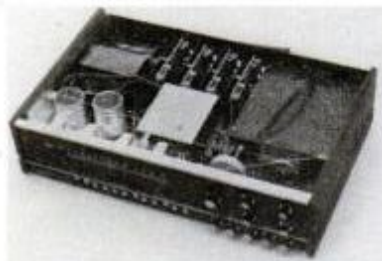

Kit-built four-channel receiver



It took us 32 hours to build this Heath 15-watt-per-channel, quadraphonic, FM/AM receiver. It was basically easy, except for a few too-short wires and a knuckle-busting transformer installation. Performance is good, controls convenient, and we liked such details as the deep-finned speaker terminals (left) that prevent shorting. The Heathkit AR-2020 receiver kit is \$260; an amplifier-only version is \$200.



Studio-type mike mixer comes in a kit

Gately, maker of the first professional microphone mixer kit (see *Homebuilt Kits for 'Professional' Recording*, page 136, Aug. '74), now has a second model. The Prokit II has slider input controls, front-panel switches for bass roll-off and mike gain, panpots to "place" any mike wherever desired between the two channels and LED indicators that flash when a pre-selected overload is reached. Kit, \$589; wired, \$889.



Look, Ma, no boat—a robot tow for water skiers

You don't need a towboat to water-ski with this remotely controlled robot to pull you. The 6-foot-long fiberglass mini hull has a 40-hp jet drive capable of better than 30 mph. Start, stop, throttle and steering are all controlled by skier through a 35-foot cable containing electrical and hydraulic connections. Called Ski-Whee, it fits in a station wagon, is said to eliminate cost of ski boat and trailer, plus need for a crew. About \$1300 from Ski-Whee Distributors, Inc., 1841 Wambolt St., Jacksonville, Fla. 32202.

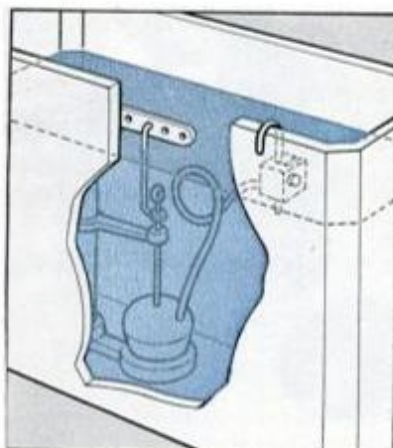

Water-saver for toilet tanks gives you flush choice: Full or half

To cut water use in toilets, Dual Flush System lets you flush bowl with half-tank of water for liquid waste, full tank for solid. Air valve (cube) lets ball reseal after half-tank is discharged; handle is held down for full flush. Device is \$4.98 postpaid from Savway Co., 52 Copley St., Staten Island, N.Y. 10314.



New high-speed train may rival air travel

Striking along at up to 120 mph, this sleek Canadian-designed express may be the answer to high-speed rail transportation between cities, making it possible for trains to compete with airliners on some routes. Called the LRC (for Lightweight Rapid Comfort), the diesel-electric-powered train uses a system of centrifugal-force sensors that provide automatic banking on curves to maintain comfort and safety at high speeds.

Gas-saving street buggy gives good speed, mileage

You get 55 miles to the gallon and speeds up to 50 mph in this trimly styled three-wheeler. Street-legal, the Exalter sports a 12-hp Tecumseh engine with electric start, independent front and rear suspension, disc brakes and all accessories required for road operation. Models range from \$439 to \$1299. Owosso Explorer Corp., Box 177, Owosso, Mich. 48867.



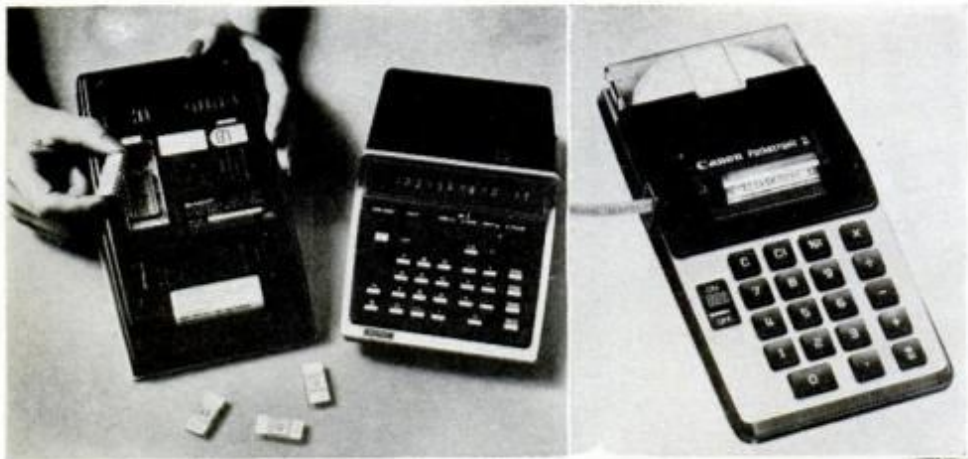

New calculators: One doesn't just calculate, it almost schemes

Sharp's PC-1002 scientific calculator (left) takes plug-in, integrated-circuit programs of 256 steps each, controlled by four special keys, and can be temporarily programmed for up to 64 steps through the keyboard. Statistical, math, metric and surveying plug-ins and others to come cost \$75; custom programs will also be available. The PC-1002, with one plug-in, is \$645. Canon's latest (right) is a large-type portable printing calculator with percentage key, \$160.

Lossless lens cap makes photographers flip

Tired of the old "is-my-lens-cap-in-my-pocket-or-did-I-lose-it-in-the-long-grass" blues? This lens cap flips open and shut, so you can't lose it. Available so far for lenses with 55-mm front threads, it's \$5; combined with a lens hood, \$6. Have your photo dealer order it from Kalt, Santa Monica, Calif. 90404.



Sensuous shower head: Get a massage while you bathe

Take the intermittent-spray principle of a Water Pik, put it in a shower head and you have Shower Massage that lets you dial fast or slow pulsed spray, plain spray or a combination. Idea is to clean thoroughly while giving you a pleasant sensation—in fixed or hose models. Teledyne Aquatec, 1730 East Prospect St., Fort Collins, Colo. 80521.



Bike lock comes with own pouch

All-Safe bike lock stores in its own saddle-mounted pouch when not in use, has 5-foot, 3500-pound-test, vinyl-coated aircraft cable. Pouch has reflective Scotch-lite strip. Suggested retail price is \$8.95 at bike shops, hardware stores. Clyde T. Johnson Associates, Lock Div., 520 South 15th St., Escanaba, Mich. 49829.



Man, when this thing dumps, look out!

So big it makes a regular truck look like a toy, this monster dump truck, said to be the world's largest, is 67 feet long and 25½ feet wide, can carry more than 350 tons and is powered by a 3300-hp locomotive engine. Called the Terex Titan, it was developed by General Motors to haul ore at mining sites.



Diving helmet—new fun from an old idea

With this simple plastic diving helmet, you can enjoy underwater fun without costly scuba gear. Aqua Bell comes with 35 feet of air hose and can be operated with hand pump or small compressor. Helmet, \$49.95; pumps, \$10.95 to \$109.95. Aqua Bell Corp., Box 221, Windsor, Wis. 53598.



Convertible caddy is dolly and hand truck, too

All-steel folding caddy stores in 6 x 16 x 18-inch space, has adjustable handle, solid-rubber ball-bearing wheels, 250-lb. capacity. Wingnuts lock caddy in shape desired. \$39.95; \$42.95 with swivel wheels. Caryall Products Co., Box 35072, Normandale Branch, Minneapolis, Minn. 55435.



Deluxe changer with turntable quality

If \$349.95 seems a lot to pay for a record changer, this Technics by Panasonic offers a lot. It represents the first application of the company's direct-drive turntable to an automatic changer for minimum distortion. A built-in strobe lamp permits precise checking and adjusting of speeds. The SL-1350 takes 4-channel CD-4 cartridges, also functions as a single-play turntable.

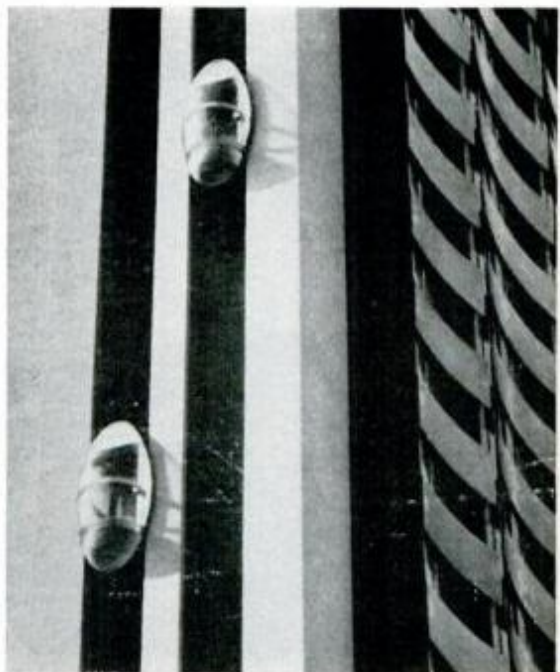

The view's fine—but don't look down

Looking like giant raindrops, these streamlined transparent elevators scoot up and down the outside of a new 23-story hotel near Paris. Designed by Ascinter Otis, French affiliate of the U.S. Otis Elevator Co., the see-through cars save valuable interior space and give passengers a spectacular view of the countryside to boot—so long as you're not squeamish about heights.

Seven tips for better boating

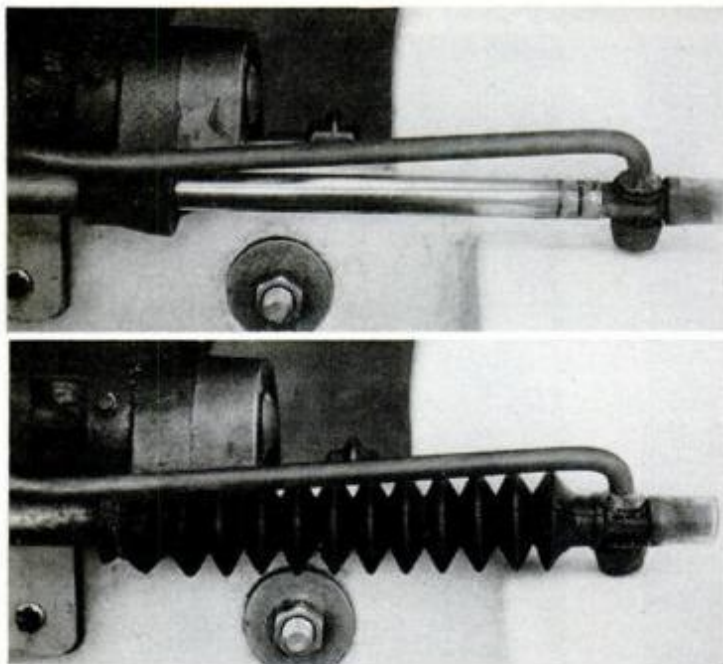

Slicker steering

Boats weren't built to travel on land, but many do behind a car. The dust and grime collected while trailing down a dirt road to a fishing hole can join up with salt spray to freeze up your steering. But the exposed shaft (top) can be easily covered with a corrugated rubber sleeve: Ford P/S Kit C60Z-3C651-A, from your auto parts store for just over a dollar. Install sleeve as shown.



Sparkle plenty

Night travel, afloat and (particularly) ashore, requires good visibility that can be helped with applications of reflectorized tape. The powerhead of the outboard motor above, wrapped with a strip of tape, helps show the overall length of your car-plus-trailer rig, especially when the trailer's taillights are not visible from the side. Spot-wrap the trailer frame as well.

by Bob Stearns

Trailer boats are much improved with a few simple changes.

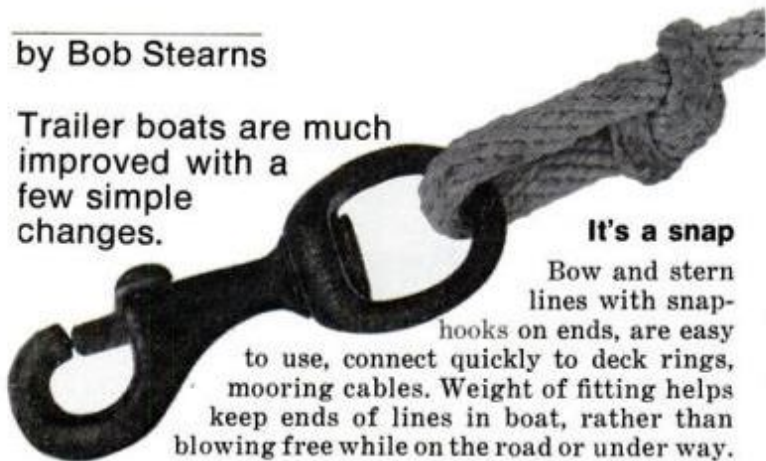

It's a snap

Bow and stern lines with snap-hooks on ends, are easy to use, connect quickly to deck rings, mooring cables. Weight of fitting helps keep ends of lines in boat, rather than blowing free while on the road or under way.

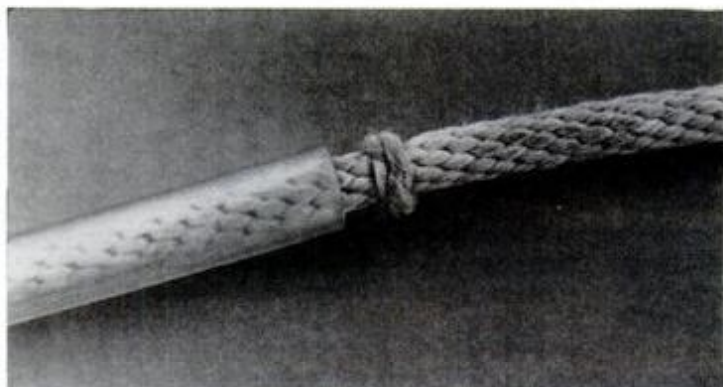

Under wraps

Vinyl tubing is particularly easy to install on a length of line that may chafe on a coaming or through a chock. A stopknot of light line, as shown, can hold it in place, or it may be left free to slide into the best position. For heavier anchor rodes and mooring lines, garden hose can be cut in a spiral, rewound on line—which makes chafing gear that's easy to remove.



In the clear

From a heavy sheet of clear plastic, a number of protective covers and flaps can be cut. The tab above, useful to keep spray and rain out of an ignition switch, was secured by loosening the panel's mounting screws, sliding the top of the plastic under the panel, then tightening screws. Along the bottom, splitshot sinkers are crimped on to weight it down over the instruments.

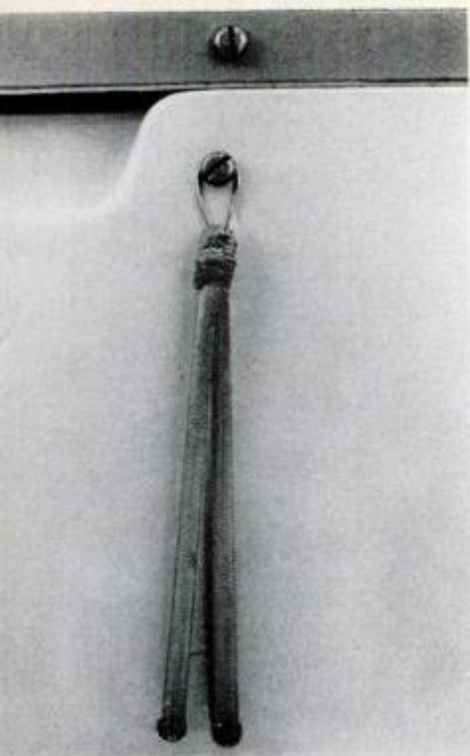

Shock treatment

The many uses of elastic shock cord are no secret to boatmen, but there are always additional ones. A locker lid that rattles and blows open can be secured with a shock cord and a wire loop that fits over a screw in the lid's edge. Lower screw holds loop in place when it's unhooked.

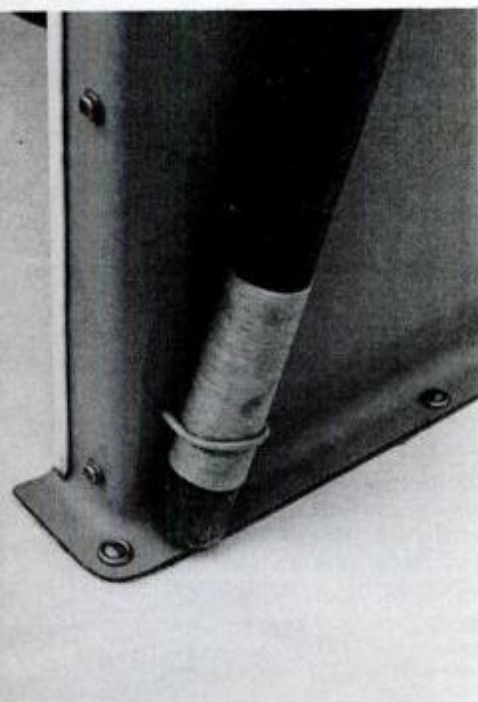

Standing the gaff

When you need a gaff, boat hook, fender or paddle, you need it now—and in place rather than under foot or in a locker. Small shock-cord loops can hold cockpit essentials ready and waiting, and also anchor down batteries, rods, binoculars, radio and other gear.

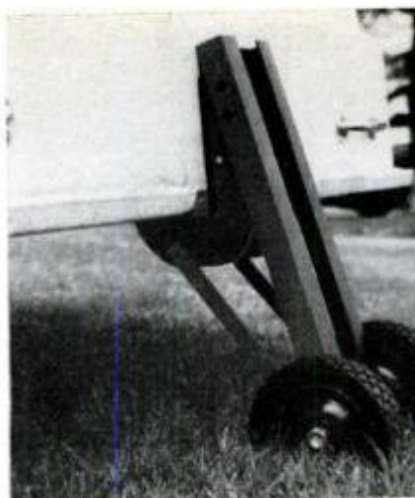

Roller tote for launching



You can buy a ready-made lightweight rig like this with thin doll-carriage wheels for \$20 and up, or use the transom clamp from a junked outboard motor and build a really sturdy tote of your own for half the price. This mini-dolly makes it possible for you to single-hand fishing boats of up to 200 pounds.

Wheels are the most important parts. They should be of the ball-bearing type, 1½ x 6-inch with treaded rubber tires and should cost less than \$2 each. Use four, two on each side, for sandy soil, and a 12-inch-axle bolt instead of an 8. Other materials include one 4-inch length of ¾-inch gas pipe, one 36-inch length of ⅛ x 1¼-inch angle iron and the same length of ⅛ x ¾-inch flat iron (these you will cut in half), eight ⅜ x 1-inch bolts, two 7/16-inch washers. Assemble as shown and spray with a rust-resistant paint.—John Aarav

Use transom clamp from a junked motor

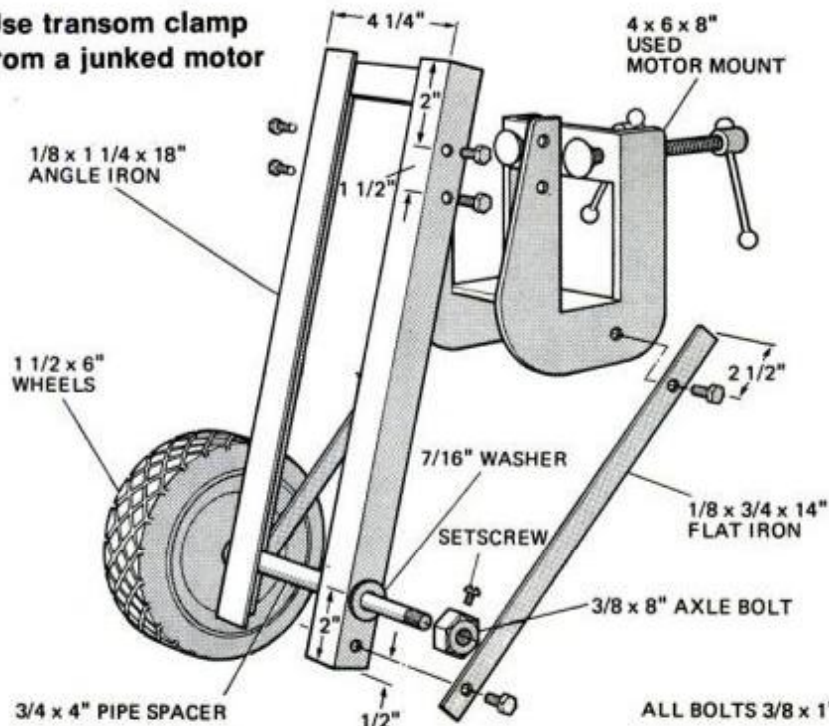

Service your own ignition system—and save up to \$40

by Mort Schultz

Ignition system tune-up includes replacing sparkplugs, reconditioning the distributor and setting dwell and timing. This service is essential to avoid problems such as hard starting, missing and excessive fuel consumption.

Done professionally, the cost would be \$40 to \$60 for an eight-cylinder engine. Done by you, the savings will be \$20 to \$40.

Parts and labor

Here's a specific example: A Buick dealer told me that he now charges \$29 for parts and \$30 for labor—a staggering total of \$59. Someone servicing his Buick himself would have to spend only \$23 for parts.

The owner would save \$36 just by doing about one hour's worth of work.

Costs can be cut even more by shopping for parts. The prices I've given have been for GM replacement parts, but you don't have to use those bearing a car manufacturer's name. Good quality parts are manufactured by many reputable independent companies.

Another way to save money is to

buy your parts from discount stores.

Instruments and tools

The cost of the very first service you do will probably be higher than succeeding services, because you may have to buy instruments you don't have. You will need a timing light, dwellmeter/tachometer, feeler gauge set, sparkplug gapping tool, distributor-tower brush, distributor-point file, distributor wrench and sparkplug wrench.

Cost of these tools, though, is a one-shot deal that will be written off with each service you perform.

With the exception of the dwellmeter, feeler gauge and distributor-point file, which are not needed for servicing electronic ignition systems, the tools I've listed are required for servicing both electronic and conventional systems.

Basically, conventional ignition systems use contact points and condensers, while electronic ignitions don't. This article concerns conventional ignition service; next month we'll discuss electronic systems.

Follow the numbers

Here is the essential procedure,

by the numbers on how to service a conventional ignition system:

1 After cleaning and regapping sparkplugs (or replacing them if they are badly worn or damaged), wipe off the coil and examine it. If the case is cracked, replace the coil.

Replace primary circuit wires if insulation is frayed or cracked, making sure they are attached tightly to terminals.

Remove the secondary cable from the coil tower by twisting and pulling the boot—not the cable. Replace a cable having damaged insulation or a badly eroded terminal.

Clean out the coil tower with the distributor-tower brush and reseal the secondary cable firmly.

2 Disconnect the coil-to-distributor secondary cable at the distributor. Uncover the metal terminal and hold it $\frac{1}{4}$ inch from a clean ground on the engine. Use a clip-type wooden clothespin clipped to the cable to hold the cable during the following test. Don't grasp the cable itself. You may get a shock.

If the terminal is covered by a molded-on boot that can't be pulled

Ignition wires in the primary circuit should be checked carefully to see if they're attached tightly to the terminals on the coil. Also check to make certain that the insulation is sound.

Coil tower and distributor tower should be checked for cleanliness. They should be free of deposits. To clean them, use a professional distributor-tower brush or improvise a tool to do the job.

Distributor cap is removed for ignition service and the inside of it is too often overlooked. Check for damage and deposits, and wipe it clean. Internal damage can cause hard starting and missing.

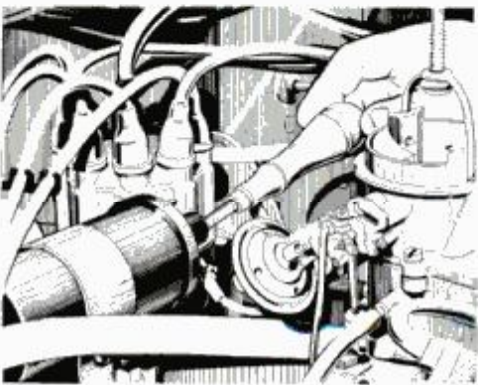

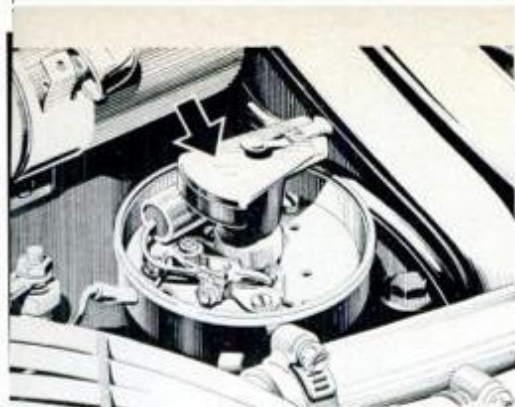

Distributor rotor conducts high current from the coil to sparkplug wires. Inspect it carefully, and always carry a spare.

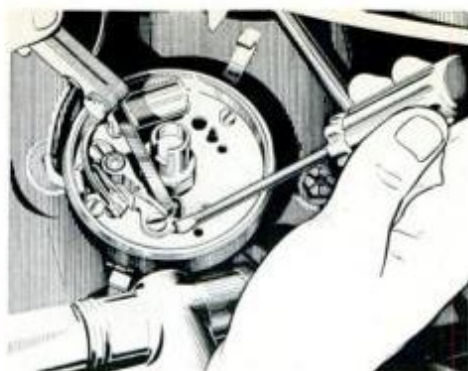

Distributor points are adjusted in a variety of ways. You can adjust this set by twisting a slot near mounting screw.



Cam lobe lubrication requires a steady hand: Place one drop on one cam lobe only. Take care not to overlubricate.

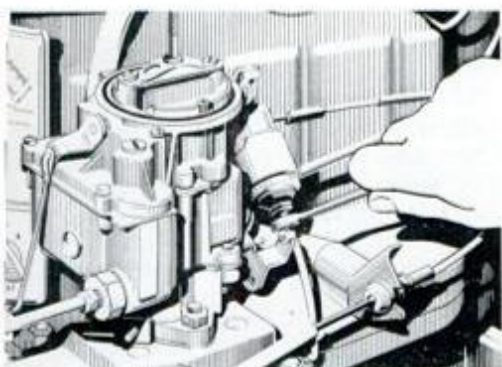

Slow idle speed should be set at the carburetor before you set the dwell angle at the distributor. Here, this is done at the idle-stop solenoid.



Dwell angle on some cars can be set without removing the distributor top. You open an access door and insert an Allen wrench to make this adjustment.

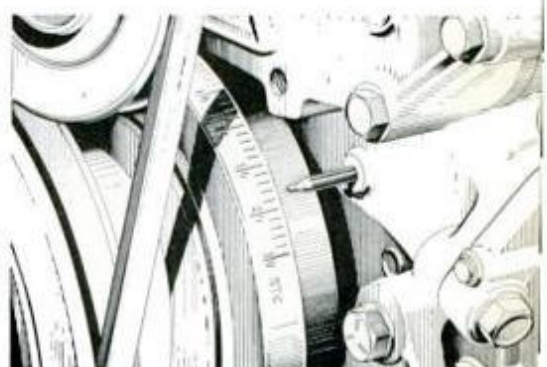

Timing mark and pointer are often in a hard-to-see spot. It helps to use white paint on the pointer and on the degree mark used to set your timing to spec.

back, insert a screwdriver having an insulated handle into the boot so it makes contact with the terminal, and hold the screwdriver $\frac{1}{4}$ inch from ground.

Have someone crank the engine. A strong blue spark should jump the gap. If the spark is yellow and weak, service the distributor and retest. If the spark is still weak, the coil has probably lost its punch and should be replaced.

3 Unclip or unlatch the distributor cap. Wipe it clean and look for cracks, chips, carbon tracks and broken or eroded terminals. Replace a damaged cap. If terminals are simply blackened, clean them with a piece of fine sandpaper.

Remove one secondary cable at a time and check towers for cracks and breaks. If towers are okay, clean them out with the distributor-tower brush.

Be sure cables are returned to their proper towers to prevent the firing sequences from being thrown out of whack, which could cause serious engine damage.

4 Pull or unscrew the rotor from the distributor shaft, and replace it if it's damaged. If there's a radio frequency shield over the

distributor, which prevents ignition-induced radio noise, unscrew it and lay it aside.

Now turn the distributor shaft in the direction of rotation and release it. If it doesn't snap back, the distributor should be removed and new springs and counterweights installed.

A distributor's direction of rotation can be determined by having someone in the car crank the engine as you watch the shaft. The way it rotates is the direction of rotation.

5 Sometimes it's difficult to adequately inspect points located in the distributor. To remove the breaker-point assembly, unscrew the clips holding the distributor primary wire and condenser pigtail wire. Make sure these wires aren't dam-

aged. Unscrew the point assembly and lift it from the distributor.

If the points have a grayish tint or are slightly rough, pass the distributor-point file between them once or twice at most. Moisten a cloth with mineral spirits or alcohol and wipe points clean. Reinstall them.

If points are badly worn or burned, install a new set.

Set point gap to specification, which can be determined by consulting the service decal in the engine compartment, your owner's manual or a service manual. Place the rubbing block of the movable breaker point on a lobe of the cam by having someone crank the engine in brief spurts.

Some distributor points are set by turning an adjusting screw with an Allen wrench. Others are gapped by loosening the mounting screw and twisting the slot near the screw.

Hold the feeler gauge straight, and make sure it's clean. Dirt transferred to points will cause fast failure.

Gap is set correctly when the feeler gauge offers slight resistance as you move it between points.

6 If the distributor has a wick lubricating pad resting on the cam, replace it with a new one. If

Tools pay for themselves in a few tune-ups

not, apply one drop of cam lubricant equal to the size of a match head to one cam lobe. Overlubrication causes points to burn. Reassemble the distributor.

7 Now set dwell to specification. Dwell refers to the amount of time that points are closed. Setting points with a feeler gauge brings dwell inside the ball park—setting points with a dwellmeter brings dwell home more precisely.

The dwellmeter measures dwell angle, which is the distance in degrees that the distributor cam rotates while points are closed. If points remain closed too long, arcing could occur—that reduces point life. If points stay open too long, missing at high speed could occur.

A dwellmeter is usually combined with a tachometer in a single instrument since dwell angle is usually measured at the engine slow-idling speed, and it's easier to check idle and dwell by switching from one mode to another than by hooking up two instruments.

Connect the dwell/tach's black lead to a clean ground, and the red lead to the distributor primary terminal on the coil. Set the meter to give engine rpm and start the engine. Let it warm up.

If the specified rpm reading is not recorded on the meter, set idle speed by adjusting the idle-speed screw or idle-speed solenoid on the carburetor.

Switch the instrument to "dwell." If the recorded dwell angle reading is not to specification, fine-tune the point gap.

If the distributor has an access door on the side of the housing, keep the engine idling, open the door and adjust the gap by inserting an Allen wrench into the adjusting screw. Turning the screw counterclockwise increases dwell angle. Be sure to close that access door after making the adjustment. Dirt and moisture can enter the distributor and cause damage.

If there is no access door, turn off the engine, remove the distributor cap and rotor, and reset the point gap as described earlier. If the dwell angle recorded on the dwellmeter is too great, set points farther apart—if too small, set points closer together.

Reassemble the distributor and check dwell angle again. You may have to readjust points several times

before hitting the correct setting.

8 Adjust ignition timing to specification, which refers to the position of a timing mark engraved on the crankshaft pulley, engine block or flywheel, to an index pointer. Timing the ignition is one of the most important services to perform, because faulty timing creates more pollution, leads to poor performance and may cause damage.

Connect the timing light. If necessary, the heavily insulated lead is attached to the No. 1 sparkplug by means of an adapter. The adapter is placed between the sparkplug cable and sparkplug terminal. The other two leads of the timing light are attached to the battery terminals—black lead to negative and red to positive.

Locate the correct timing mark. Timing marks of American-made cars are usually at the front of the engine on the crankshaft pulley or block. Timing marks of some imported cars—Opel and BMW, for example—are on the flywheel at the rear of the engine and can be observed through a peephole on the flywheel housing. You can make the

Timing light is connected to the No. 1 sparkplug and car battery (unless it gets power from garage line voltage). When you shine it on the timing mark, always sight down in a straight line.

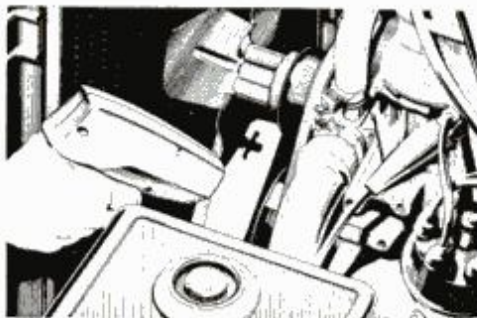

Vacuum advance is removed by unscrewing it from the breaker plate in the distributor. Arrow points to lubricating wick.

timing mark and pointer stand out by coating them with white paint or chalk.

Pull the vacuum advance mechanism hose off and plug its end with a pencil. Start the engine and keep the transmission in PARK or NEUTRAL. The engine has to idle at the specified slow-idle setting.

Aim the timing light straight down at the timing marks and pointer. See if the pointer aligns itself with the specified timing mark each time the light flashes, making both appear stationary. If the pointer aligns itself with other than the specified timing mark, timing has to be adjusted.

Turn off the engine and loosen the distributor hold-down bolt with the distributor wrench. Start the engine again, and aim the timing light at the timing marks. Grasp the vacuum advance mechanism and slowly rotate the distributor to get the proper timing.

Turning the distributor counterclockwise advances timing; rotating the distributor clockwise retards timing. Remember that if the index pointer moves farther away from the correct timing mark as you rotate the distributor, turn it the other way.

When you've got timing right on, turn off the engine and tighten the distributor. Recheck the timing and repeat the procedure if necessary.

9 Now check the functioning of the distributor's centrifugal and vacuum-advance mechanisms. Aim the timing light at the timing mark and advance the throttle until the engine is running at 1500 rpm (hook up your tach). The timing mark should advance as engine speed increases and drop back to its original setting when you allow engine speed to fall back to idle. If not, the distributor should be overhauled.

Reconnect the vacuum-advance hose. Again, aim the timing light at the timing mark and increase engine speed to 1500 rpm. The timing should advance itself farther than it did when you checked the centrifugal advance. If it doesn't, replace the vacuum advance.

10 The last thing you can do for your car's ignition system is to find and replace faulty secondary cables. See *How to Test and Replace Ignition Cables*, page 134, July '74. ★★

Exotic materials make easy-going, superlight bike frames



This Teledyne bike has a titanium frame that weighs only 3.6 pounds. Maker is Teledyne Linair Engineering, 651 West Knox St., Gardena, Calif. 90248.



The stainless-steel frame of this Crescent bike will never rust or corrode. Monark-Crescent is in Varberg, Sweden.



Flyweight frames are strong, make pedaling extra easy and give racing cyclists a boost—but cost a mint.

by Eugene A. Sloane

How would you like an 11-pound track bike you can lift with one finger . . . an 18-pound road racing machine that lets you take off like a banshee . . . or a 20-pound flyweight touring bike that flattens hills and cuts fatigue on long-distance trips? Thanks to space-age materials and new ways to join them, such ultralightweight bikes are now available, but at a price. You can buy a stainless-steel bike for around \$650, a titanium-frame bike for around \$900 and a graphite-fiber-frame bike for \$1300.

If you're a real bicycle nut (like me) who wants the ultimate in a light touring bike, then the high price is worth it. And the envious head-turning of real bike freaks is worth almost any price. If you're a racing

(Please turn to page 152)



Note steep frame angles and sloping fork crown of Teledyne bike (above). Stainless steel frame of the Crescent bike (above right) is hand silver brazed into handsome scrolled steel lugs. Mossberg's fiber frame tubes (right) are glued into specially designed steel lugs.

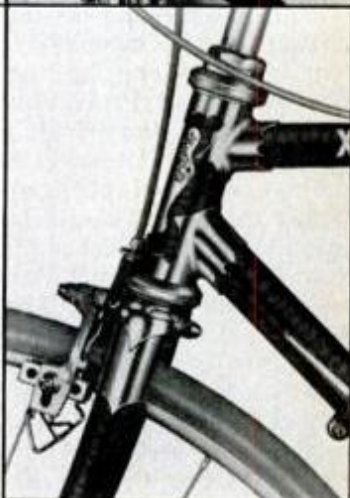

Track-racing version of the graphite-fiber bike weighs only 11 pounds. Maker is O.F. Mossberg & Sons, Inc., 7 Grasso Ave. North Haven, Conn. 06473.

How to keep your drinking water safe

Reports of contaminated water supplies have been alarming. Here's how to tell if you have a problem—and what to do if you have.

by Mort Schultz

Several months ago, New Orleans got the scare of its life: It learned its drinking water might be causing cancer. The traditionally fun-loving, high-living resort city on the banks of the Mississippi was shocked, but bravely tried to laugh it off. There were jokes about bourbon-and-water drinkers switching to soda, while anxious mothers bought bottled water for their babies.

Still, it was—and is—no laughing matter. In two completely independent studies, one by the Federal Environmental Protection Agency and another by the privately financed Environmental Defense Fund, the findings were frighteningly similar—they showed a "significant" correlation between incidence of cancer in New Orleans and pollutants found in its drinking water. The EPA in its study identified 66 organic contaminants in the water supply, 38 of which are known to be toxic and some of which have caused cancer in laboratory tests on animals. Moreover, the New Orleans area represents only one of nine Louisiana counties known to be among the highest in the nation in cancer deaths—and all draw their drinking water from the Mississippi River.

While both agencies were cautious



Trim and handy, home purifiers like compact kitchen unit above can do much to help safeguard your drinking water from contamination. This model, by Culligan,

works by reverse osmosis, will remove inorganic pollutants and some organic ones. For deadly bacteriological contamination, however, additional equipment is required.

in announcing the results of their investigations, the implication was ominously clear: The dread possibility that drinking water can kill did, indeed, exist.

New Orleans is not alone in its problem. Other reports of contaminated water supplies—some causing severe illness—have been coming in from all over the country at an alarming rate. Consider these recent events:

- In Ohio, several communities were found to have a cancer rate 20 to 50 percent higher than other communities. All these towns draw their drinking water from the Ohio River into which a nearby nuclear power plant discharges effluents.

- In Miami, 176 field workers were stricken with typhoid fever after drinking water contaminated with sewage.

- In Duluth, Minn., high concentrations of asbestos were found in drinking water drawn from Lake Superior. The dangerous pollutant was discovered to come from industrial wastes dumped into the lake.

- In Perham, Minn., 13 people became critically ill from water contaminated with arsenic. The poison came from a well in a new housing development built on what had for-

merly been farmland. Almost unbelievably, the source was traced to a farmer who had discarded a pesticide in a nearby trench back in 1933—more than 40 years ago.

- In Bound Brook, N.J., a woman was hospitalized in serious condition after drinking water containing gasoline. The fuel had seeped into her well from a ruptured tank at a nearby service station.

- In Evansville, Ind., 40 organic pollutants, two of them highly toxic, were found in the water supply, and in Ames, Iowa, 15 industrial chemicals were discovered in that city's water system.

- Out of 2600 samples of drinking water tested by the EPA across the nation, 996—more than one-third—were found to contain unsafe amounts of chemical and/or bacteriological contaminants. Known or suspected cancer-causing agents detected in such water samples include asbestos, arsenic, benzene, cadmium, carbon tetrachloride, cyanide, lead and mercury. These and other substances are also suspected of causing heart disease, liver and kidney disorders and birth defects.

What all this adds up to is simply that millions of Americans are now drinking water that can no lon-

ger be assumed safe. According to an EPA spokesman, "If we don't act soon to halt the contamination of our waterways, a major crisis, which could be the most serious in our history, can strike within five years."

Increased dumping of industrial wastes into lakes and rivers, the rapid rush to the country to convert previously contaminated farmland into residential developments, and ineffective water-control measures are all helping to worsen the water crisis. The incident in Perham, Minn., in which a farmer's long-discarded poisonous pesticide turned

But this doesn't mean you should rush right out and buy such equipment—it may be costly, it may be the wrong type for the job, or it may not be needed at all. The first thing is to determine whether you have a problem, then select the correct type of equipment to combat that particular problem.

To begin with, it's important to recognize that there are three general classifications of toxic agents that can contaminate water: inorganic substances, organic substances and microorganisms (harmful bacteria known as pathogens).

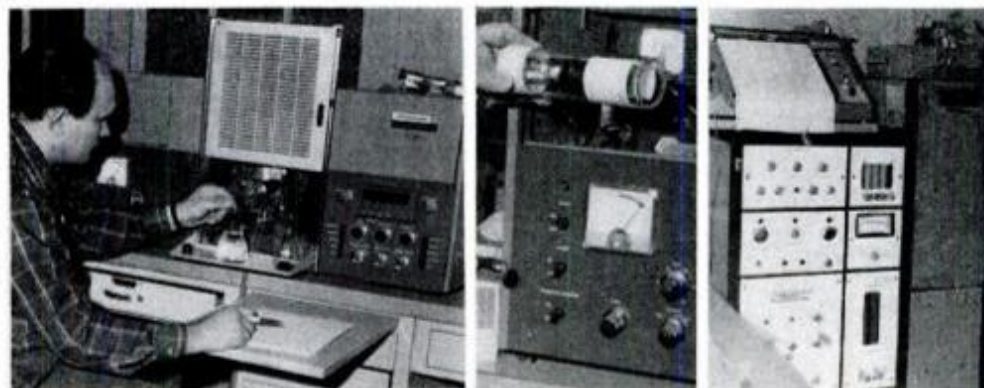

Complexity of apparatus required for proper water analysis indicates why such tests are costly, also why you should be wary of outfits that claim to use portable field testers—such equipment is not portable. At left, a Rutgers lab technician

checks water sample using atomic absorption spectrophotometer (AAS). Cathode tube (center) reveals presence of trace metal. A different tube is needed for each metal test. At right is gas/liquid chromatograph (GLC) to detect organic contaminants.

up in a newly dug well proves dramatically that chemical pollutants don't lose potency with age and can come back to haunt a water supply many years later.

The lack of competent water-control technicians and inadequate governmental authority are also contributing to the problem. In one study, the EPA found that 77 percent of the people who operate water-purification systems are not properly trained in the fundamentals of water microbiology. Under present law, the federal government has jurisdiction over only interstate transportation of water. When typhoid struck in Miami, the government immediately stopped planes, trains and buses from carrying Florida water to other states. But it had no control over handling of the outbreak locally.

Thus, until stronger laws are passed, it's more than ever up to the individual to check his own drinking water and, if necessary, take steps to assure a safe supply. Fortunately, this is easier to do than you may think. Unsafe amounts of every known toxic substance found in water—excepting radioactive fission material—can be eliminated by suitable home water-purification equipment.

Toxic inorganic substances that get into water include arsenic, asbestos, barium, cadmium, cyanide, lead, mercury and selenium. But trace metals, as these are called, permeate our water supply by natural means because they're contained in the soil. There's always bound to be a certain amount in the water you drink. Thus their presence is not as important as their amount. When the quantity of natural trace metals in water is increased by additional amounts from industrial runoff, the combination can reach hazardous toxic levels.

Toxic organic substances, on the other hand, are not a natural phenomenon. Such contaminants, which include pesticides, gasoline and phosphates in detergents, get into water supplies through indiscriminate use or by accident. Termite eradication agents injected into the ground around a foundation are a good example. The EPA has found such agents have accidentally contaminated water drawn from nearby wells.

As with inorganics, small amounts of toxic organic substances in water may not be harmful—the question is how much is too much. To establish safe limits of normal water im-

purities, the EPA has proposed a set of drinking-water standards that cover a variety of both organic and inorganic pollutants. The list of maximum allowable limits is shown on page 110. While it does not include all possible contaminants, it can help you determine the quality of your drinking water should you decide to have it analyzed.

Unlike organic and inorganic substances, there's no such thing as a "safe" limit for dangerous pathogens. These are the most likely to cause serious illness, even death, quickly. Bacteriological contamination can result in typhoid, infectious hepatitis, dysentery and cholera.

While pathogens can strike any water system, their greatest threat is to the 50 million or so Americans who draw their water from private sources rather than public supplies. Such sources are not regularly monitored by public health officials and are rarely protected by water-purification equipment. Pathogen-laden sewage can get into well water from too close or damaged septic systems. Where water is drawn from a surface source, such as a pond or stream, contamination can come from animal droppings.

How do you determine if your drinking water is safe? This calls for some careful thought. You could have a so-called "carte blanche" or complete analysis performed by a private laboratory, but the cost is prohibitive, ranging from \$500 to \$1000 or more. The reason for the high cost is that each substance must be tested for individually and often

TYPICAL HOME WATER FILTER

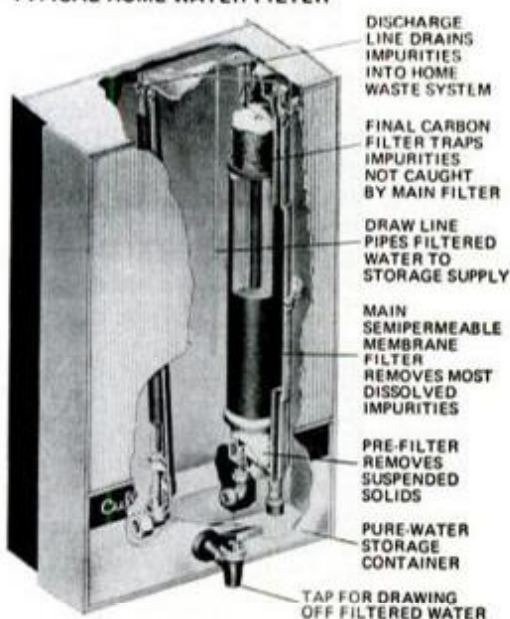

Reverse-osmosis purifier (same Culligan unit as shown on facing page) contains three filters—a prefilter to remove solids, semipermeable membrane to remove dissolved impurities and final carbon filter. Purified water is tapped off at bottom.

Checking for the right pollutants is the name of the game



Pathogenic pollutants can't be filtered, must be killed by disinfecting chemicals or germicidal ultraviolet light. Above is a typical home chemical-treatment system.

by different equipment, so the procedures are long and complicated when scores of possible pollutants may be involved.

Wise planning can reduce the expense, since there's no point in having water samples tested for substances not likely to be present. Test only for those you have reason to believe may exist. First, there's no need to employ a private laboratory to make a pathogenic analysis. All states and many local health departments have facilities for performing bacteriological studies and will usually do so either free or for a nominal fee. If you draw water from a private well or other local source, by all means have such a study made.

And remember that water that gets a clean bill of health one year may not necessarily be pure the next. Animal contamination or a suddenly malfunctioning septic system could cause pollution in the meantime, so it's wise to have bacteriological tests made periodically. They will cost little or nothing.

When it comes to checking on organic and inorganic substances, that's another story. Most public health departments are not equipped to handle such sophisticated analyses. Here's where you have to decide whether to go to a private laboratory and, if so, what to have them test for. If you draw water from a private supply and live within 30 miles of an industrial area, contamination by inorganic substances is possible. To find out the substances

Safe limits of inorganic and organic contaminants

Chemical	Limit (Milligrams per Liter)
Arsenic	0.1
Barium	1
Cadmium	0.010
Chromium	0.05
Cyanide	0.2
Fluoride	1.2 to 1.5*
Lead	0.05
Mercury	0.002
Nitrate	10 (1 for infants)
Pesticides:	
Aldrin	0.001
Chlordane	0.003
DDT	0.05
Dieldrin	0.001
Endrin	0.0005
Heptachlor epoxide	0.0001
Lindane	0.005
Methoxychlor	0.1
Toxaphene	0.005
Selenium	0.01
Silver	0.05

*NOTE: Amounts vary according to temperature and decrease as temperature increases. 1.2 is maximum permissible where average annual temperature is 80° F. or higher; 1.3 where temperature ranges from 66° F. to 79° F.; 1.5 where temperature is 65° F. or below.

most likely to be present, check with your state and local health authorities for a report on what trace metals are being used by plants in your area. Another source of information is your state department of industry and business.

If your home is located on or near land that was or is farmed, you may want to have your water analyzed for pesticide contamination. Another possibility is that organic phosphates from detergents used in your home may be polluting your well. However, there's no need to worry about phosphates if your septic system's drain fields and your well are far enough

Wise planning can reduce the expense. Test only for contaminants you have reason to believe exist.

apart. A safe distance is 100 feet or more.

If you're served by a public water supply, deciding whether to have private tests made—and what for—is a trickier matter. Theoretically, public water departments are carefully regulated, make their own water analyses periodically, and employ water-purification techniques when necessary. However, as evidence indicates, not all water-control systems are perfect and mistakes do occur.

One way to check the condition of

your drinking water is to contact the U.S. Environmental Protection Agency, 401 M St. S.W., Washington, D.C. 20460; the U.S. Geological Survey, C St. between 18th and 19th Sts. N.W., Washington, D.C. 20240; and your own state department of environmental protection (usually in your capital city). Request from each an analysis report on the water being supplied by your particular water company. If the reports are consistent, if they seem complete, including all three forms of pollution analysis—organic, inorganic and pathogenic—and if the levels of contaminants reported fall within the allowable limits set forth in the EPA table shown here, you can at least be reasonably sure your drinking water is being made as safe as possible.

But if the reports are incomplete, inconsistent or not forthcoming, you may well have reason to want to do some checking on your own by employing a private laboratory to make tests. To keep costs down, limit the tests to those pollutants most likely to be found in your particular water supply. As with a private water supply, try to find out from local authorities what trace metals are being used in your area. Also, in choosing a laboratory try to find one that has had experience testing water samples in your locality. It should know what pollutants are the most prevalent and may be able to help guide you in determining which ones to test for. You can get the names and addresses of private laboratories from the laboratory services division of your state department of health. Selecting the right laboratory is very important. Here are some additional pointers:

1. The service offered by the laboratory should be primarily water-oriented to assure you the best personnel, equipment and experience in water testing.

2. The laboratory should be equipped with an atomic absorption spectrophotometer (AAS) and a gas/liquid chromatograph (GLC). The AAS detects which trace metals are present and measures quantity. The GLC extracts organic substances and determines volume.

3. Don't patronize a laboratory that wants to visit your home and make "inexpensive" analyses using portable field kits. You'll waste your money. An AAS and GLC are essential for proper contamination detection—and they are *not* portable.

4. Remember not to hire a private

(Please turn to page 146)

How to get your power mower ready for the season

If you simply pushed your power mower into a corner of the garage last fall after its last mowing session, it's time to be thinking about a spring-cleaning job to ready the machine for the season ahead. Overheating, hard starting, internal engine wear and other serious problems will result if dirt trapped under, on and inside your power mower isn't cleaned away. It takes some effort to have a mower that's ready for use any time: The information on these pages will make

that task less troublesome because it covers the nitty-gritty of spring tune-ups.

Start inspection with the blade. A common problem is vibration caused by unbalanced blades. To check balance, remove blade and insert a screwdriver in the mounting hole. Hold the screwdriver vertically; if blade is unbalanced, blade will tip. Using a fine-grit grinding wheel, remove a little metal from the heavy end. If grinding doesn't balance the blade, replace it.

Clean cooling fins

The engine of a power mower is cooled by circulating air through fins inside the blower housing. If these fins become clogged and the airflow is blocked, the cooling process will be impeded or stopped completely. Overheating and damage to the internal parts can and will result. To clean the cooling fins, remove the blower housing and use a clean, dry paintbrush to brush dirt from between the fins. Packed-in dirt can be first loosened with an old screwdriver.

If dirt is stubborn, use a commercial degreaser and a narrow, stiff-bladed scraper to clean out the fins. Fins should be cleaned periodically during the season.

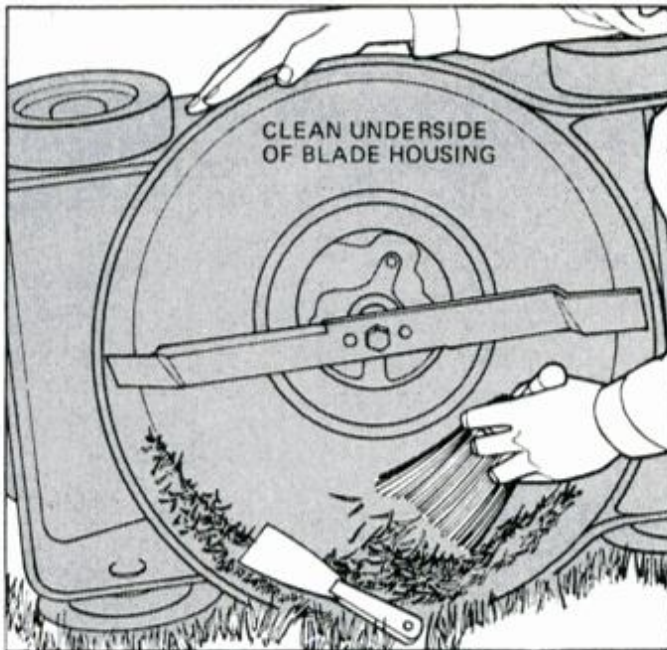
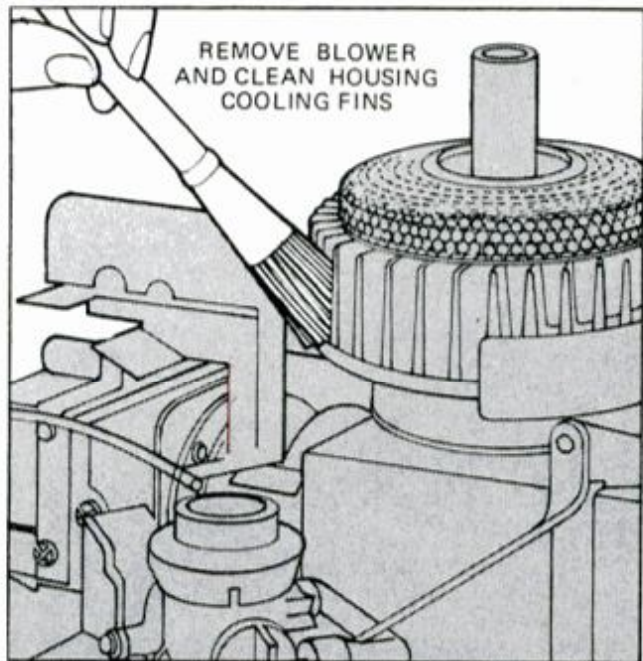

Then clean underside of blade housing

Often, because grass is moist when cut, the underside of the blade housing becomes clogged with layers of dried-on grass. If you failed to turn the mower over and clean the blade housing with a putty knife and whiskbroom after each cutting session, the task will be somewhat harder now. After each cleaning, also turn the machine right-side up and wipe the body exterior with a soft, clean cloth. A spray automotive-engine degreaser can be used to dissolve stubborn dirt and grease.

Now pay special attention to the carburetor linkage and choke-plate pivots. To clean these units, use a spray-type automotive-carburetor cleaner that's available at auto supply outlets. Then apply a drop of oil to the moving parts. Finally, remove the wheels, thoroughly clean the hubs and axles, and then coat the axles with a light layer of an all-purpose grease.

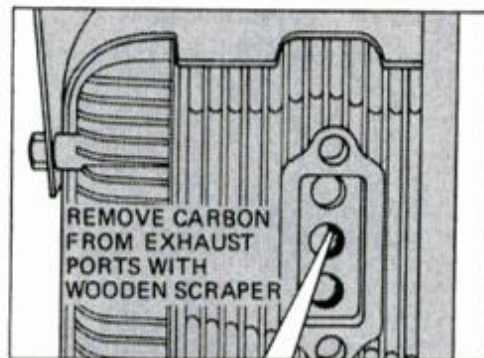

Exhaust ports

Carbon is also a form of dirt, and an accumulation of it in the exhaust ports of power-mower engines (two-cycle engines, in particular) will reduce the power output appreciably. Before scraping off the carbon, exercise the precaution of first removing the sparkplug from the engine (to prevent the engine from starting). Then remove the muffler.

Next, turn the crankshaft slowly by means of the starter cord or self-starter until the lower part of the piston covers the ports. In this way, carbon will be kept out of the cylinder when its scraped loose.

While you're at it you should scrape the carbon from the muffler and inspect the muffler gasket. If you discover that either part has been damaged, replace it promptly.

Correct oil-gas mix necessary for proper operation of two-cycle engines

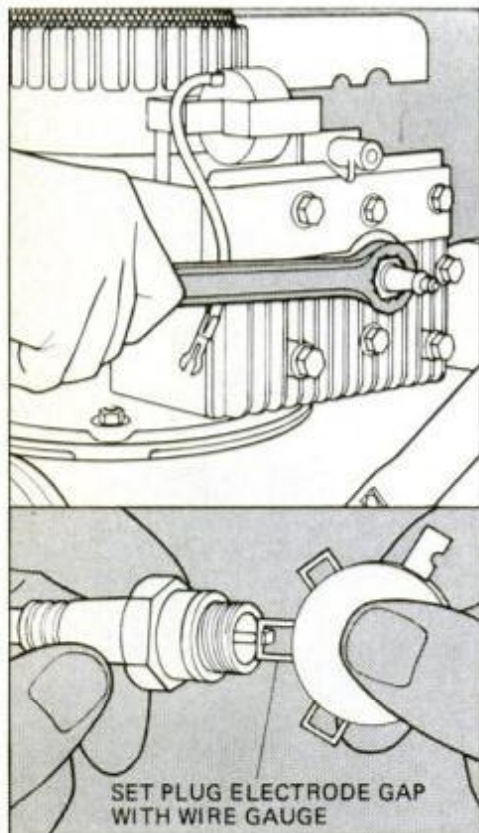

Sparkplug checkout

Remove the sparkplug and examine it carefully. If the electrodes are burned away or pitted, or if the porcelain is cracked, discard the plug and get a new one of the same designation. You will find the designation printed on the plug. Generally, 100 operating hours should be considered as maximum life for a plug.

If the plug looks fine, use a penknife or small wire brush to scrape dirt from around the electrodes. If you have a compressor, complete the cleaning with a blast of air. Lacking this equipment, blow out particles by mouth.

Whether the plug is new or not, set the electrode gap to the manufacturer's specification with a wire-type, sparkplug gauge like the one shown above. If you've lost the owner's manual and don't know the gap specification, for two-cycle engines gap is set at .028 to .033 in.; for four-cycle, it's .025 to .028. Insert plug and finger-tighten. Then, give it an additional half turn or so with a wrench.

Inspect the sparkplug lead wire. If it is not too badly frayed or damaged, you might be able to patch it with insulating tape. Otherwise, you will have to get at the coil to replace it; in some machines, this means removal of the flywheel—a job best left to a professional. Sometimes, the lead wire is connector-fastened to coil so that it can be replaced with coil left in place.

In other mowers, the wire is molded to the coil: To make the change, both wire and coil must be replaced.

Fuel-oil mixture

If your power-mower engine is four-cycle, warm it up, then shut it off. Remove the oil drain plug and drain the dirty oil into a waste pan. Replace drain plug and fill the crankcase through the oil filler to the level mark. Use the type and weight of oil specified in your owner's manual.

In two-cycle engines, a mixture of oil and gasoline is used in the fuel tank. Improper fuel-oil mixture is the main cause of operational problems with two-cycle engines, so check the owner's manual for the correct ratio. (The correct mixture is usually ½ pint oil to 1 gallon gasoline.) The oil should be of the type and weight specified in the owner's manual or of the type made especially for two-cycle engines (available at hardware and auto parts stores as well as at gasoline stations).

Insufficient oil in the mixture means that engine parts will be improperly lubricated, resulting in overheating and seizure. Too much oil causes engine smoking, loss of power and sparkplug clogging.

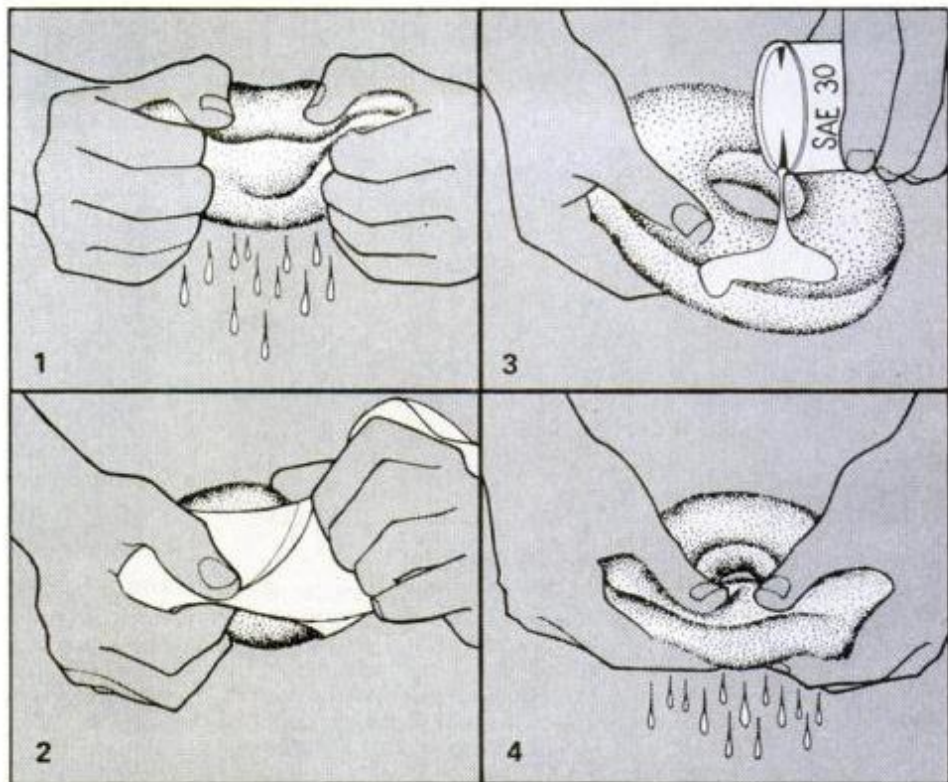
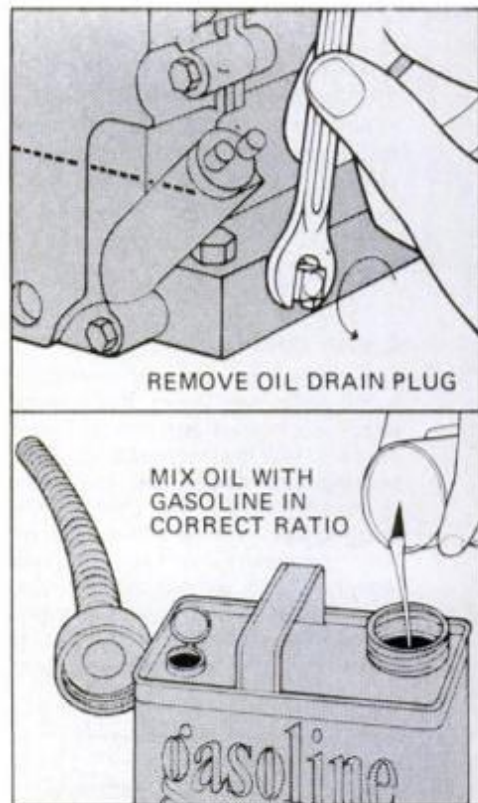

Polyurethane-sponge air cleaner

An air cleaner is the primary protection a power mower engine has from dust particles that can get inside to clog moving parts. One common type of air cleaner has a polyurethane-sponge element as shown above. To clean it, (1) wash element in liquid detergent and warm water, (2) wrap in a cloth and squeeze dry, (3) saturate with SAE 30 engine oil and (4) squeeze to remove excess oil. Clean container that holds element, replace element and cover tightly.



CLEAN OIL-BATH-TYPE AIR CLEANER IN KEROSENE

Oil-bath air cleaner

This type of air cleaner comes with a container that uses a layer of oil to trap dirt and dust particles.

To clean it, remove air cleaner from the engine and disassemble. Dump out the dirty oil and wash all the parts thoroughly in a solvent such as kerosene. Let these parts air-dry; then reassemble them and fill the cleaner to the level mark with a clean SAE engine oil.

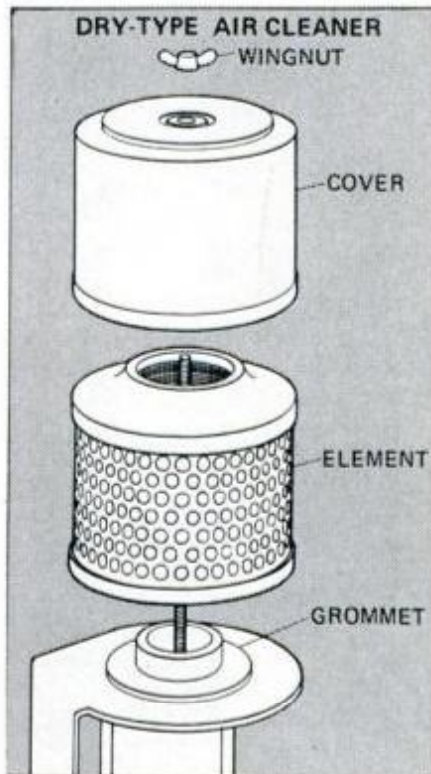

Dry-type air cleaner

With this type of air cleaner, unscrew the cover as shown above, take out and examine the filter element. If the element is paper, replace it. If it is metallic, carefully tap it on a flat surface to loosen dust and dirt. Then wash it thoroughly. Finally flush the element (from the inside out) with water until the water that comes out of the sides of the element looks clean. Allow the element to air-dry before replacing it on the mower.

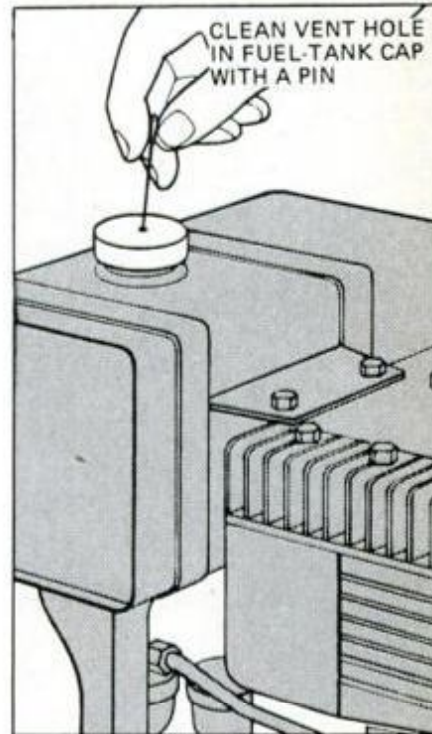

Fuel-tank cap

Some fuel-tank caps have a small vent hole. If it becomes plugged, a vacuum is created that will stop the flow of fuel and the engine will stall. Remove cap and clean out dirt in hole with a pin. *Take care not to enlarge hole.* In addition, be sure that only proper fuel is poured into fuel tank (pure gasoline or correct mixture of oil and gasoline). Use a clearly marked can for gasoline; many tanks and carburetors have been fouled up by kerosene, paint thinner or other liquid poured in by mistake.

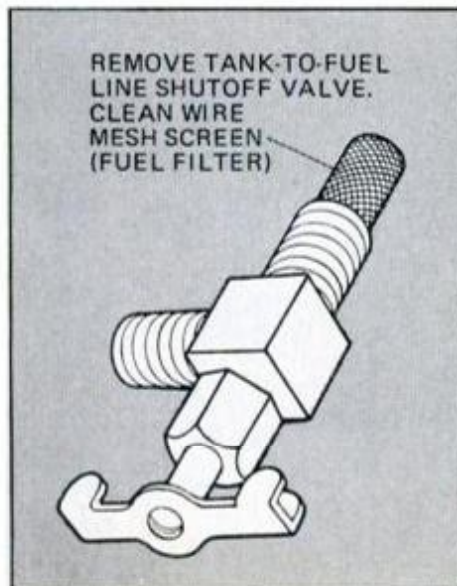

REMOVE TANK-TO-FUEL LINE SHUTOFF VALVE. CLEAN WIRE MESH SCREEN (FUEL FILTER)

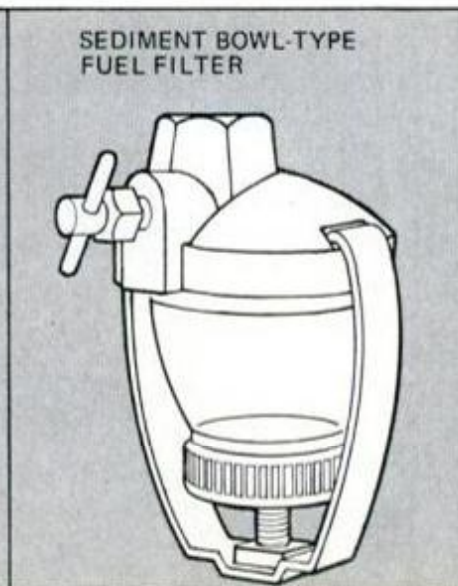

SEDIMENT BOWL-TYPE FUEL FILTER

Fuel filter

Remove the fuel filter from your power mower and wash it thoroughly in kerosene, or let it soak in engine degreaser. The filter in many small engines is located in the tank-to-fuel line shutoff valve. Remove the valve to get at the filter (far left).

Other engines have a sediment-bowl-type fuel filter that houses a ceramic element. Remove the bowl. If there is gasoline in the tank, be sure to first turn off the shutoff valve. Disassemble the filter and wash the parts in kerosene. If you're using engine degreaser, soak all parts for an hour or two; then wash in water and dry with an air-pressure hose which also blows away dirt.

All that remains for you to do is to tighten all body bolts and fasteners on your mower. Your clean machine is now ready for use. ★ ★ ★

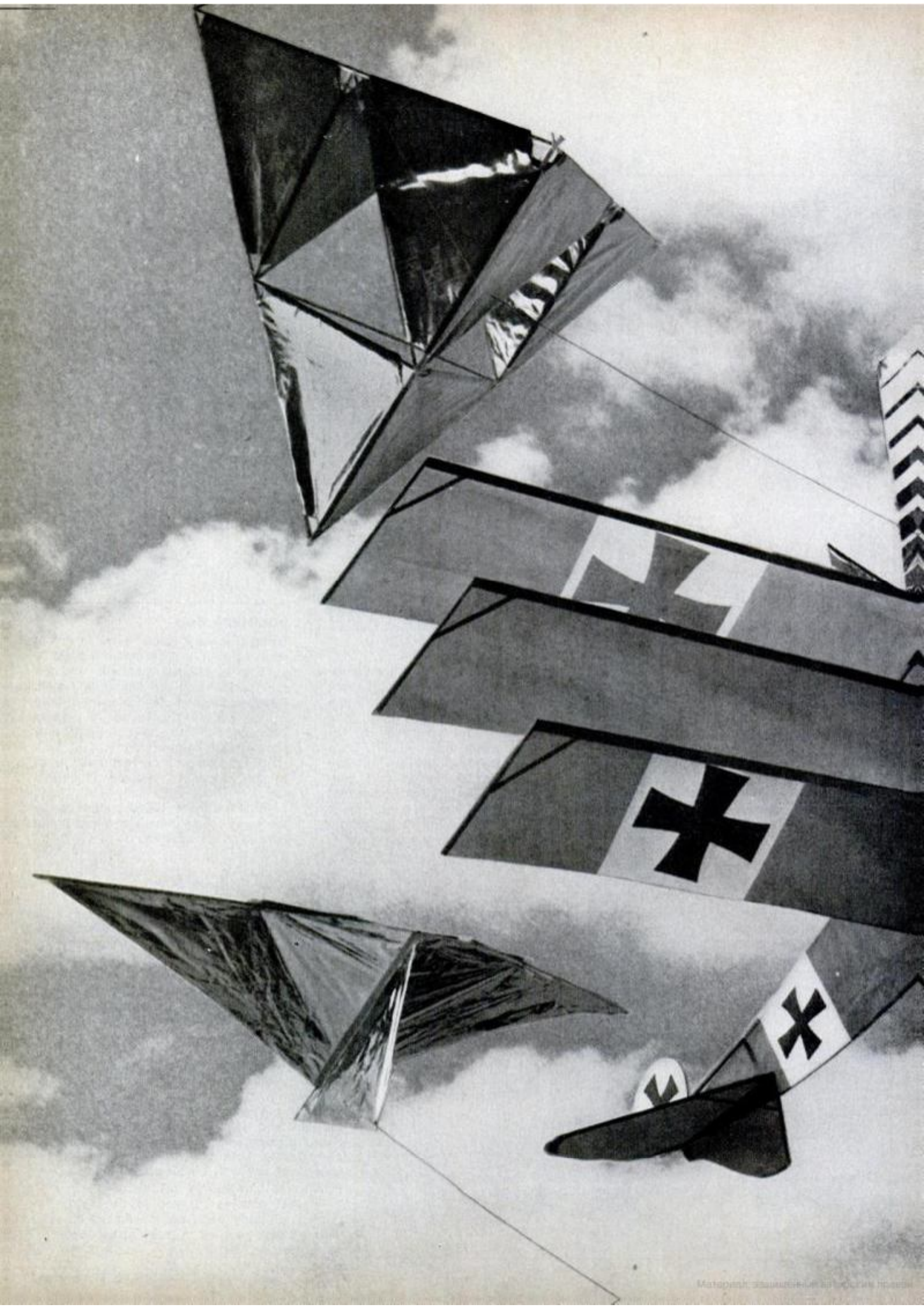



Go build a kite

Make one of these fancy flyers—
from a kit or from scratch—to take
advantage of March winds.

by Stephen Walton
ASSISTANT EDITOR, HOME AND SHOP

Some great kites come in kit form these days. The pyramid-shaped Tetra and the versatile Skylinks, shown in its catamaran-like, stunt-kite configuration, are easy to assemble from their plastic components. The Red Baron at center, patterned after a World War I Fokker triplane, is a different story—all its parts except plastic wing roots must be cut to shape from stock supplied, and a neat job may take you all of the 14 hours it took me. At lower left is a scratch-built delta kite in metallized Mylar—but you could make

[\[Please turn to page 136\]](#)



CAMPING GOES COMPACT . . . MORE CONVENIENCE, LESS COST

Fresh air is still free, and new gear to help you enjoy it is being made smaller, better.

by Bill McKeown
OUTDOORS EDITOR

More for your money—in fun, relaxation, change of scene, adventure—is waiting outdoors for this year's camper. Gear is getting lighter, better, simpler to set up and use. Fit out now for a bargain vacation and you can make "roughing it" an option instead of an essential. And a

lot of campers are turning turtle—and picking new equipment that's easy to pack on a back, a bike, a small boat or car.

While price tags on quality sleeping bags, knapsacks, tents and trailers have not come down, many outdoorsmen outfit for less cost with less elaborate, more compact equipment—or rent the necessary gear at additional savings.

As always, hoofing it is the cheapest way to go, and all that's necessary are comfortable clothes, shoes and rucksack. Lashing sleeping gear to a backpack or bike stretches your

radius of action. But many campers this year won't be planning a cross-country trip, and instead will stay closer to home. That can mean a choice of simple shelter gear with little fear of week-long rains for the Southwest camper, or high-altitude cold for a hiker in the East. Today's shopper will save by buying a sleeping bag or tent that's suitable for nearby conditions rather than the budget-breaking ultimate gear to handle everything from the tropics to the arctic.

Light daypacks, frameless or with the stiffening inside, are becoming

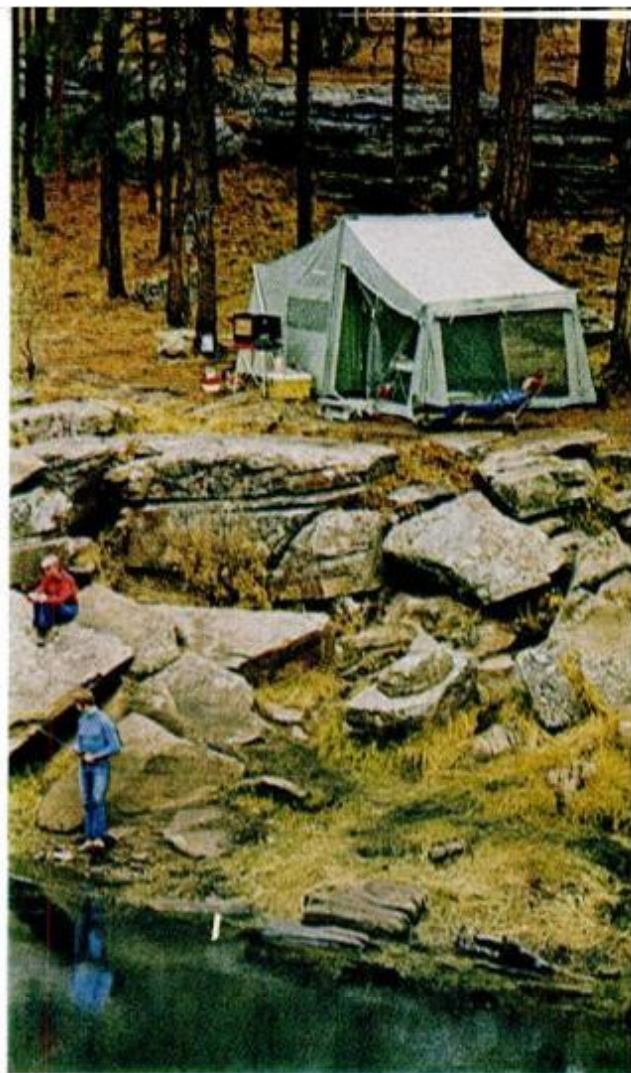

Easy-going gear will include the low-profile camp trailers, backpacks in many sizes, tents smaller or bigger, cars and vans that can be converted for bargain camping.

the sensible choice for short trips where a cargo portage model is not required.

A better quality of metal backpack frames is now contoured to fit the back, with shoulder and hip straps that balance and divide the load. The short foam pad has become the new mattress choice for light-gear camping.

Fill comprising synthetic insulation proves to be a worthwhile rival for the down lofting in clothing and sleeping bags.

Pack and touring tents are lighter, more durable and flame-retardant,

with wall-slot or outside suspension that keeps poles out of the middle of the interior or doorway. Floors and mosquito netting are now standard, and an additional fly cover to ward off driving rain and blazing sun is no longer an odd extra. Mountaineering tents have been redesigned to cut down the wind resistance during heavy storms.

Larger family cabin models show the best of European influence with screened-in outer areas that divide the tent into separate living room and bedroom. Camping in one spot becomes more pleasant, without the

restless need to move on every night.

Camping trailers with canvas or solid sides, and small and light enough to be towed by compacts, have showed popularity. Some small travel trailers are now designed to sleep large families. Vans and panel trucks have become favorites of younger campers, while van conversions that provide raised tops for standing headroom and added cooking and bathroom facilities, have increased in sales.

Luxury motor homes and trailers are available, but there are many cheaper ways to go as well. ★★★



Sew—

Several hours of easy work can cut your costs in half.

by Bill McKeown

How would you like a 50-percent discount on camping gear that you need? Not cheap equipment, either, but the very best obtainable—finely made and probably better than any you could order anywhere.

Nor is your choice limited to a handwoven belt or watch band. Look over the list below and see if there isn't an item—or, more likely, many—that you wish you had:

Down-filled sleeping bag

Bag liner

Bivouac cover

Down jacket

Parka

Ski coat

Down vest

Down sweater

Down pants

Gaiters

Poncho

Booties

Overboots

Chaps

Rain gear

Hood

Tent

Stuff sack

Backpack

Bike bag

Many of these come in assorted sizes, types and colors, while the variety of items offered is growing all the time.

At first glance, a price tag of \$100 for a sleeping-bag kit or tent kit can seem steep, especially since you still have to put it together. But if you don't enjoy working with your hands, you probably wouldn't take up camping, and the kit manufacturers have found their customers already know about but don't want the flimsy cut-rate items available from some surplus outlets. For example, if you buy a Carikit Polar sleeping-bag kit for \$83.50—rated for -20° F.—and then add the optional \$21 worth of "expedition down fill" for even more insulation, it's obvious you want the best. Or perhaps you select Frost-



Turning parts into a pack took an evening, Virginia Hricko (top) found after following kit's complete instructions and using all the comprehensive enclosures. Fabrics, goosedown packs and thread were in the boot and bootie kits (center). Final reward of a little needlework (bottom) is a bargain in quality gear.



you can save with camp-gear kits

Kit manufacturers

CARIKITS

Holubar, Box 7, Boulder, Colo. 80302.

EMSKITS

Eastern Mountain Sports, Inc., 1041 Commonwealth Ave., Boston, Mass. 02215.

FROSTLINE

Frostline Kits, 452 Burbank, Broomfield, Colo. 80020.

MAKIT

Mountain Adventure Kits, Box 571, Whittier, Calif. 90608.

line's Cougar model at \$58. It weighs five pounds, 10 ounces, but you sew the special full length foam pad right into the down bag, where it is always ready for use.

Because you or your wife do the sewing, you can be sure that no one took shortcuts on inside seams that don't show, and you can also double stitch or lock stitch spots where you know from experience a zipper can tear or a D-ring pull loose when you're miles from nowhere. Basic sewing experience is helpful, though not essential, and these kits could be sewn by hand rather than machine if you had a lot of time. According to the EMSkit division of Eastern Mountain Sports, "Novices seem to understand the instructions more easily than experienced seamstresses, and the most satisfied customers are those who enjoy making their own equipment rather than those who try to save money." And any man who thinks that only women can sew has never been a bachelor very long, or hasn't visited a sail loft recently.

To test kit instructions and materials, and because they looked great, we first selected down booties, \$5.95, and overboots, \$4.95, available in blue, green or orange. They are new items from Frostline, largest of the camping-kit manufacturers. Both came with all the materials—thread, elastic, cord and laces—plus illustrated instructions so explicit that someone who had never sewn before could have worked them out. Frostline and others also have a customer service representative who can answer any questions by mail or telephone.

Even after years of sewing, Virginia Hricko had never edge-seared fabric, but the instructions made it easy. You carefully pass a flame along the edge of the Ripstop Nylon without touching it. The heat seals the edge so that it will never ravel apart during wear, washing or cleaning. It is easy to see why in normal factory assembly there's no time to spare for refinements such as this.

Many products in Frostline's assortment of 46 kits come in a variety of sizes, ranging down to clothing for children and pack carriers for babies. Their Add-On sleeping bag starts with a 42-inch length, and can later be extended with 12-inch sections as the youngster grows. Both Frostline and Carikit, the sew-it-yourself division of the famous Holubar line, provide in small plastic packs the down you will use to fill their insulated clothing and bags. These, we found, make a neat and easy way to handle the very fluffy feathers.

And even if you have no plans for camping or cool-weather sports, the kit makers' catalogs deserve study for their versatile bargain travel packs and bags. We test-constructed kits from each, and found them uniformly well designed. They were complete with all necessary parts, and with instructions that told both the how and, reassuringly, the why of each succeeding step.

Cross-country and downhill skiers, hunters, bicyclists and travelers using almost any other means of getting around are likely to find kits designed especially for them. Quick orders can be placed by telephone and credit card.

Though it would be hard to select our favorite kit to sew up and use, our best bag-title award would certainly go to Eastern Mountain Sports for their \$16 model in navy or orange. It's the EMSkit Knapsack-snackpack Rucksack. It proved to be easier to sew than to say. ★★★

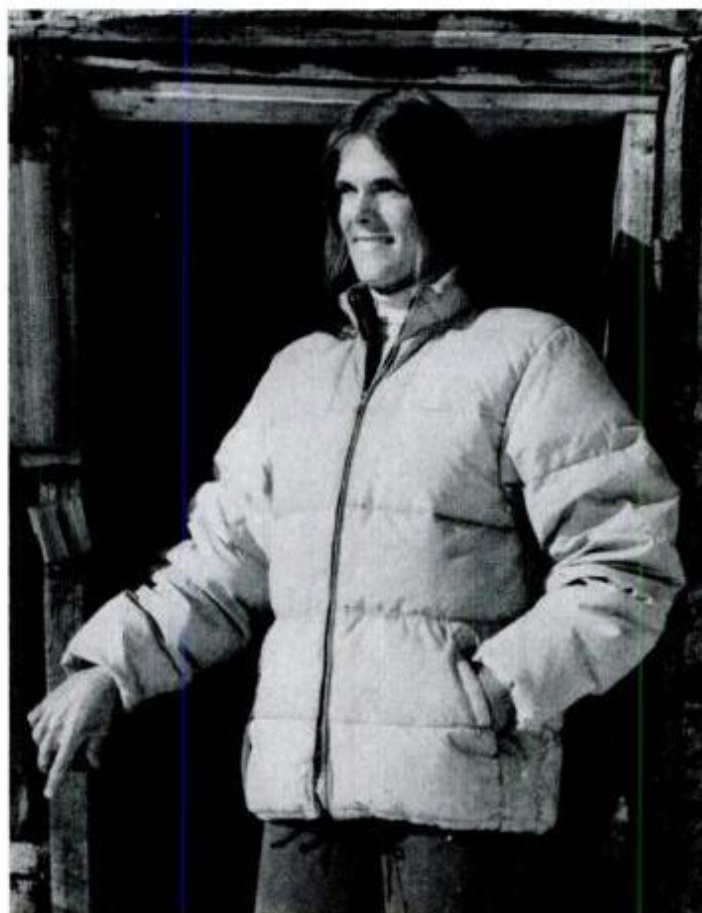

Sew-it-yourself Aspen jacket comes in kit from Frostline for \$26. A few hours' work converts pieces in package into quality down-filled coat that could cost \$49 or more ready-made.



Though somewhat narrow with no shoulders, highway was easy to drive, neverthe-

less, by author and his wife in 20-foot Winnebago Minnie Winnie van conversion.

New road to Old Mexico

No longer a challenge for only off-road four-wheel-drives, the Baja is becoming a magnet for self-contained RV families.

by Bruno Michetti

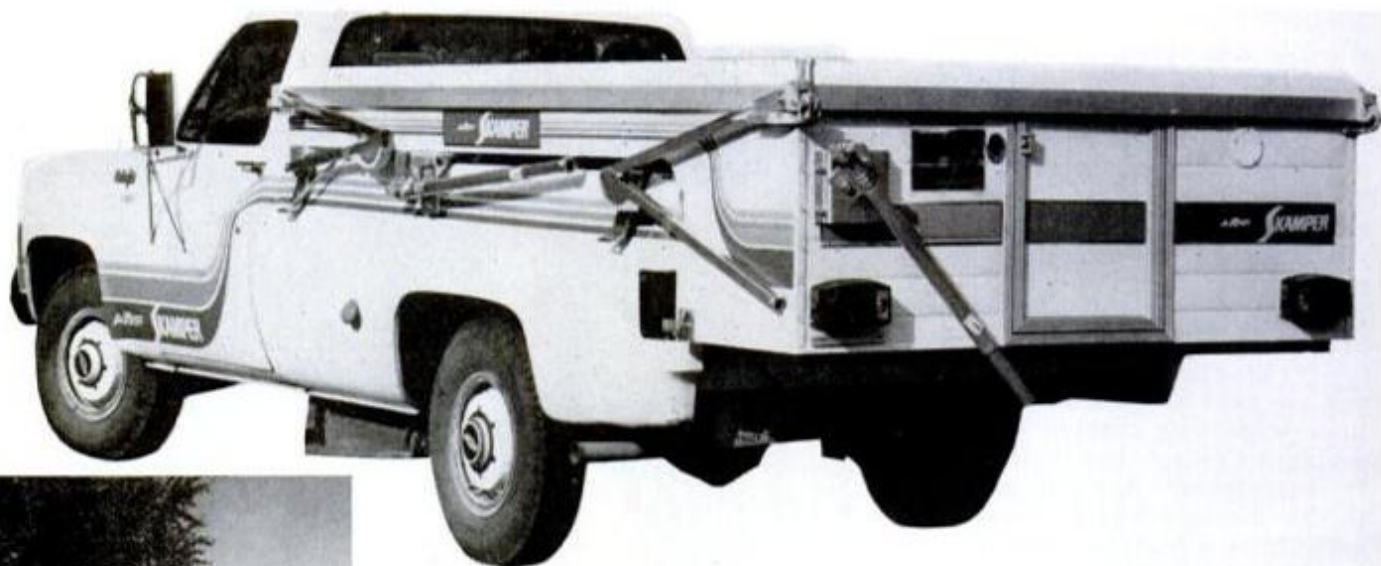

New RVs for the road

Larger assortments of accommodations are found in rigs that roll for fun in '75.

by Bill McKeown

“More into less for the same,” is the recreational vehicle formula for 1975.

That translates into bigger and

better accommodations in smaller travel rigs at prices not much higher than last year. And with a buyer's market in the works, the careful RV



Low in profile and wind resistance, high in headroom, new 6-sleeper SK-101S with lift roof and fold-out sides (folded in top view) joins wide AMF Skamper fold-up line.



Barren landscapes are part of the appeal for Baja campers. Cactus and palms edged this plateau swimming hole lagoon.



Fishing, snorkeling, clamming, swimming, total relaxing in lukewarm waters of Laguna Santispac were daily activities.

Adventure in your recreational vehicle is waiting just south of San Diego, Calif., at the Mexican border. There the new Baja Transpeninsular Highway starts at Tijuana and runs south for 1050 newly paved miles. A few years of tourist travel will change it, but right now it offers an unspoiled glimpse of the past.

Our vacation was scheduled for mid-summer and we knew we needed an airconditioned self-contained traveling home big enough for our family of four, yet small and rugged enough to turn off the 19-foot wide ribbon of

pavement. Winnebago's Minnie Winnie proved an ideal answer. Our two boys—Mark, 9, and Matt, 8—slept over the cab up in a queen-sized bed. We never needed to convert the double berth dinette, but made up the rear sofa into another queen-size bed for my wife and myself each night. The Winnie's 20-foot length and moderate rear overhang handled rutted-trail turnoffs with ease.

After skirting the Pacific, the road swings along the Sea of Cortez. We found our favorite camping spot on a curve of white sandy beach, called

Laguna Santispac, on the Bay of Concepcion between Mulege and Loreto. Swimming, fishing and clamming were exceptional, but bring your own gear and lures. (We found room for six rods in our hollow rear bumper.)

Getting gas, distilled water and American canned foods is not difficult, but take along guide books, Mexican car insurance, complete first-aid kit, snorkel gear, small-denomination travelers checks, and little bags of Mexican and American coins for change. You'll find many new sights and much enjoyment. ★★★



Need to sleep six in a 19-footer, and want one with a real bathtub? New Nineteen by Shasta II, one of 10 redesigned travel trailers, offers more standard equipment.



Designed for small-car towing, new Trail Star XL for '75 from Starcraft has 960-pound curb weight, added safety catch on lifter system, 110/12-v. converter.

shopper should find bargain selections.

This year's strong trend is toward vehicles that can do double and triple duty—family car, business van or truck, travel bus and summer camp cottage. Add a preference for compact rigs with modest cost and gas consumption and you can see reasons for the swing to the RVs we show here.

A number of companies are now turning out production-line conversions of panel trucks with the jazzed-up interiors that are currently popular. Murals on the outside and deep-

pile carpeting on the inner walls as well as on the roof are the trademarks of these carefree successors to the beach buggies that used to be home-built products.

Fold-up compacts cost less, which may account for the recent growth of tent and hard-side camping trailers, plus pop-up tops for pickups and vans. Lower wind resistance plus easier towing and garaging are added advantages.

Travel trailers, van conversions, and mini motor homes all pack in more accommodations in the form of beds and baths. Full bathtubs are

(Please turn to page 128)



Chateau Club Wagons and Econoline vans from Ford have higher gross weights, larger load and towing capability, longer front-end design, easier engine access.

Rancho poncho: a quick-change bivouac bag

by E. P. Haddon



Two ponchos—one hood inside the other and zipped together along bottom and side—look like only one (at left) when worn.

Tenting between twin ponchos can be easy with pole rigged in corner and top hood guyed up and open for through ventilation or closed with drawstring to keep out wind, rain.



TRIMMED MINI-TENT FLOOR PONCHO

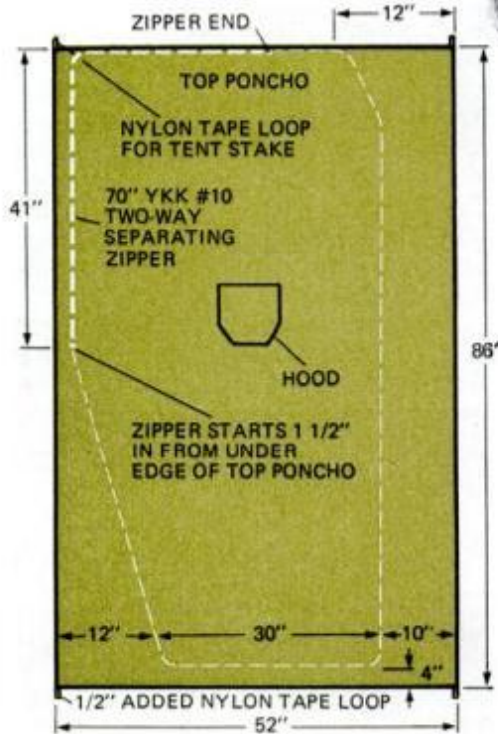

Sewn together as shown at left, ponchos form a bivouac bag shelter with pocket for mummy-shaped sleeping bag and room beside it for sleeper's clothes as well. Ensolite foam mattress also fits inside; pack or stuff sack becomes a pillow.

allow staking down with tent pegs or holding the front open using a line to a tree or with short poles. An outside A-frame can be made with two 22-inch sections of aluminum poles to support the closed end of the top poncho. A single 22-inch pole section supports the front corner of the tent over your head and is guyed with a short nylon line.

For more compact packing, shorter aluminum poles from Gerry or Eastern Mountain Sports will provide 12-inch fitted sections when used. Poles and screw-threaded aluminum spike tent stakes add only one-half pound to your pack.

When used as a bag or tent, the drawstring of the bottom hood can be drawn tight to make the floor moistureproof. Raise the top hood with a guy line and leave it open for added ventilation and space within the bivouac bag.

To complete my own extra-light pack, I use a North Face Superlight down sleeping bag, half-pound Ensolite 21x42-inch mattress pad, extra socks and a down vest, GI canteen cup with a plastic mug stowed inside. These go in a Cannondale Mountain Tour Pack with an aluminum handle that is compact enough to fit under an airline seat. My Heatab stove and enough fuel pellets for three days fit in a shirt pocket.

With gear this light I find that I require but four ounces of dehydrated or quick-freeze foods plus high-energy supplements per meal. Lightweight camping indeed has come a long way in the last few years. ★★★

For really lightweight wilderness backpacking, you can easily convert a couple ponchos into a triple-duty accessory that will keep you dry during a rain along the trail, make a neat bivouac bag at night for your sleeping bag, and stake out into a mini-tent with guy lines or small poles for support.

A friend in Sante Fe, N.M., designed it from two 52x86-inch Kelty urethane-coated waterproof ponchos, stitched it up on his ancient portable sewing machine, and appropriately dubbed it a "rancho-poncho."

I first tested mine on a hike of several days through the rugged Big Bend Country of west Texas that I had first covered 48 years ago. This region is sometimes buffeted by strong winds, and nighttime temperatures can drop below freezing.

I often pack without a tent, but something is needed here to break the wind. Anchored on exposed ledges of the Chisos Mountain South Rim, the rancho-poncho shed winds that would have pounded a good expedition tent.

To assemble, two ponchos are fitted together with one hood inside the other. A small portion of the lower or floor poncho is trimmed away and shaped to hold the foot of a mummy-type sleeping bag, as shown in the diagram. The two are then sewn together with a machine using 100-percent nylon thread, and the seams are waterproofed by applying a urethane-base seam sealant.

I added a two-inch-wide strip of ripstop repairing adhesive tape on the topside of seams for absolute waterproofing.

A zipper is worth adding, starting 41 inches from the top on one side and extending up and partially across the head of the tent. A 70-inch YKK Delrin No. 10 two-way separating zipper was my choice. Attach a nylon loop to both the inside and outside zipper pulls to avoid fumbling in the dark.

Two nylon tape loops are on Kelty ponchos at the front bottom corners. Sew on two more loops of 1/2-inch tape at the other two corners. These

\$2,899*

For the tough Marina.
The family sedan
with the gas-saving
MGB engine.
It's a tough deal to beat.



You're probably wondering how a car with so much going for it can go for such a price.

Here's the answer: we continued the production of 1974 Marinas.

The result: a tough deal to beat.

The Marina has the strong heart of a true sports car. The gas-saving, single carburetor version of the MGB engine. A dependable four cylinder 1800 cc engine that's good for over 20 miles per gallon according to 1974 Federal government tests that simulated city-type stop-and-go driving.

What's more, the Marina has responsive rack and pinion steering. Four-on-the-floor synchromesh transmission. Fade-resistant disc brakes. Gas-saving and long-lasting radial-ply tires. Tinted glass. Torsion bar suspension. Reclining bucket seats up front. A full rear seat with a padded fold-down center armrest. And 13 cubic feet of usable trunk space.

It all adds up to the kind of family car you're looking for. At a price that's tough to beat.

Prove it to yourself. Take a Marina for a test drive and compare its value,

roominess, and performance with any car in its price range. For the name of your Austin MG dealer, dial (800) 447-4700. In Illinois, (800) 322-4400. Toll free.

British Leyland Motors Inc., Leonia, New Jersey 07605.

*Manufacturer's suggested retail price P.O.E. Does not include inland transportation, local taxes, preparation charges and optional wheel trim rims.



austin
Marina

POPULAR MECHANICS MASTER WORKSHOP ORGANIZERS

DRILL-MATE^{T.M.}

Keeps drill and accessories handy!

DRILL-MATE eliminates forever the annoyance of misplaced, lost and disorganized drill accessories—a problem familiar to most hobbyists and craftsmen.

This versatile organizer can be used at the work bench or taken on the job.

Features:

- 25 hole drill bit index — $\frac{1}{16}$ " to $\frac{1}{2}$ "
- Handy pockets for tools, discs and accessories
 - 2 spill-proof utility drawers
 - Holds any $\frac{1}{4}$ " or $\frac{3}{8}$ " drill
 - Retractable handle
- Molded slots for wall or pegboard mounting
 - Preassembled, hi-impact polystyrene
 - Attractive two-tone Charcoal Grey-Blue

Dimension: 10"H x 12"W x 9"D.

Shipping Weight: 3 lbs. Price: **\$7.95** postpaid (delivered)

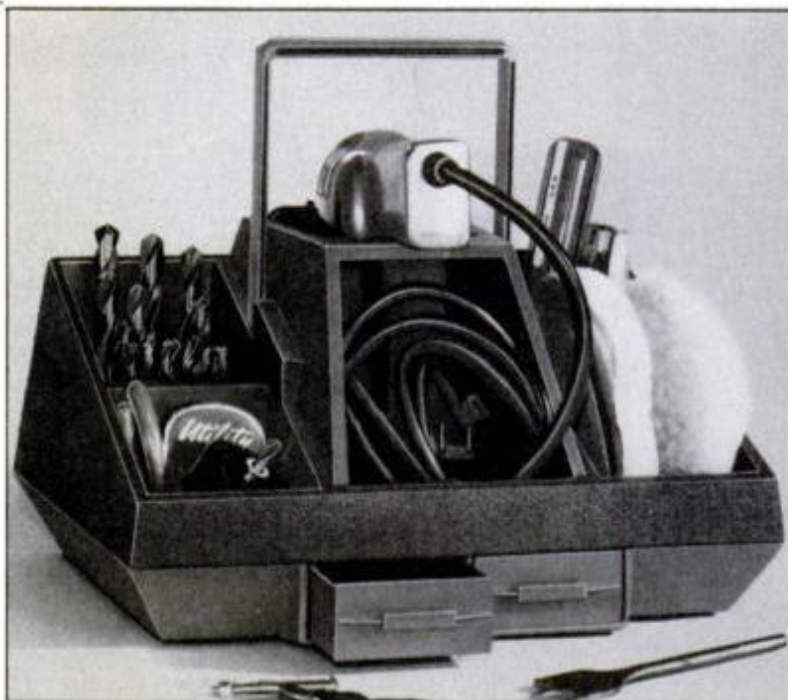

TOOL-MATE

Keeps tools and parts handy!

This unique tool organizer is actually a portable workshop at your fingertips. Molded of durable Hi-Impact, heavy duty Styrene, it stores everything in an upright, easy-to-use position.

Keeps hand tools and small parts handy and organized.

Features:

- 39 different tool holding slots
- 2 jumbo storage wells for large items
- 4 dust free drawers for nails, screws, etc.
 - Quick, easy assembly
- Attractive two-tone Beige and Brown

Dimensions: 11 $\frac{1}{2}$ " H x 14" L x 7" W.

Shipping Weight: 3 lbs.

Price: **\$7.95** postpaid (delivered)



Order yours today! Use the handy order form on the opposite page.
Satisfaction guaranteed.
Shipped promptly via UPS.

FOUR OF THE MOST USEFUL, PRACTICAL WORKSHOP AIDS WE'VE SEEN!



QUIK-PIK^{T.M.}

The 50 drawer organizer cabinet!

QUIK PIK is the king of storage organizing cabinets because of quality, good looks and a self stacking frame designed to "add 'n stack" more cabinets as needed.

Efficiently stores, organizes and protects hardware, small parts, hobby materials, household items. Keeps everything neat and handy at your fingertips.

Features:

- 50 see-thru Styrene drawers
- Drawers dividable into subcompartments
- "Unitized" steel frame
- Blue chip-proof enamel finish
- Key hole slots for wall mounting

Dimensions: 16"H x 15"W x 6½"D.

Drawer size: 2¾"W x 1¼"H x 5¾"D. Shipping Weight: 12 lbs.

Price: \$19.99 postpaid (delivered)



BENCH-MATE

The compact "supply room"!

This multi-purpose organizer and storage unit is "just what the doctor ordered" for that common workshop malady: "sloppy work bench"!

BENCH-MATE hangs on the wall or sits on the work bench and stores tools, paint, nails, nuts, bolts—everything within easy reach. Spillproof drawers too!

Features:

- 20 "see thru" Styrene drawers
- Two sizes (10 compact, 10 deep)
- 3 big 7"x30" shelves
- Formed steel construction
- Baked metallic blue finish
- Quick, easy assembly

Dimensions: 22½"H x 30"W x 7¼"D.

Shipping Weight: 13 lbs.

Price: \$16.98 postpaid (delivered)

Popular Mechanics Master Workshop Organizers,
Box 1014, Radio City, N.Y. 10019

Please ship me the MASTER WORKSHOP ORGANIZERS checked below. I have enclosed my check or money order for the amounts indicated. All orders are shipped postpaid.

- TOOL-MATE @ \$7.95 DRILL-MATE @ \$7.95
 BENCH-MATE @ \$16.98 QUIK-PIK @ \$19.99

Name _____

Address _____

City _____

State _____

Zip _____

(Please make checks payable to Popular Mechanics)

HM Specialties

EASY RIDERS

(Continued from page 85)

120 Wall St., New York, N.Y. 10005.

NORTON 850 INTERSTATE. The Norton 850 is to motorcycling as Bobby Riggs is to the game of tennis: Getting old and a little stiff in the knees, but still able to blitz many of the hot newcomers. Vertical twin engine format with twin Amal carburetors, twin exhausts, non-unit four-speed transmission, chain-driven all-metal plate clutch and double downtube cradle frame make Norton the most straight-forward, conventional tourer in motorcycling. The 850 Interstate continues to rate among the five or six most powerful and best handling "big bikes" currently in production.

The overhead-valve, pushrod engine delivers 56 foot-pounds of torque at 5000 rpm and 60 bhp at 6200 rpm. This translates into tremendous low and mid-range steam that continues to give Norton a "hot" reputation. Vibration below 3000 rpm is quite noticeable, but at highway cruising speeds, it stops almost completely due to Norton's unique "isolastic" construction. Large 7.2-gallon gas tank provides a 300-mile touring

range. But a rather poorly padded seat tends to make those 300 miles less comfortable than they might be.

Safety and convenience improvements include: Redesigned instrument cluster with special fingertip controls for horn, lights and blinkers, hydraulic chain adjuster, rear disc brake and electric starting. Norton Villiers Triumph Corp., 2767 East Huntington Dr., Duarte, Calif. 91010.

SUZUKI RE 5 ROTARY. The new Suzuki RE 5 Rotary is the first and only tourer designed with NSU-Wankel power. It was slightly more than three years ago that Suzuki obtained license to design an engine based on the patented Wankel format. By 1973, a working prototype motorcycle was undergoing testing at the Suzuki factory in Japan.

The RE 5 is just under 500 pounds (dry), its wheelbase stretches 59 inches and seat is 32 inches high. Displacement rating is 500 cc.

The motorcycle has tremendous power. Performance from a standing start is deceptively sluggish due to inertial flywheel effect from the engine's rotor. But speed accumulates quickly, smoothly and sound-

lessly with a bewildering—almost scary—momentum because there is no noticeable change in vibration and very little sound. Highway cruising is smooth and effortless, power is always on tap and the seat-footpeg-handlebar arrangement is extremely comfortable.

Handling is predictable and secure. The bike steers precisely and tracks with accuracy. Brakes, consistent with those of other Suzuki road machines, are sensitive to the touch and have strong stopping power. Twin discs on the front complement a large single drum-type on the rear.

Suzuki engineers have designed the single-rotor Wankel for easy servicing and have also succeeded in tucking it into a fairly compact cradle area. Liquid cooling is provided by a somewhat bulky radiator, mounted at the front of the chassis.

Economy was developed through much research. Air/gas mixture is lean and a special two-stage Mikuni carburetor has two throats—one fuels combustion below 1700 rpm; the other opens when a generous throttle is applied. Intense heat created by the lean mixture is controlled through the liquid cooling system assisted by an electric cool-

Elmer's new Contact Cement doesn't burn.

New Elmer's® Contact Cement contains no flammable solvents and has no harmful fumes. So you needn't worry about ventilation. Or "sniffing." And you needn't worry about spills, because you can just wipe away with a damp cloth before it sets.

Most important, you get a strong bond.

Strong and safe. New Elmer's Contact Cement—an effective cement you can use on wood, plastic laminates, and leather.

It's one of the new line of strong, safe cements and sealers from Elmer's.



ing fan that operates automatically. Built-in reliability is achieved by limiting the engine to a low, maximum redline of 6500 rpm. A special hardness coating protects the rotor housing from wear and insures long engine life.

A five-speed transmission with wide-spaced gearing makes the bike convenient in town and exciting on the open road. Styling by Italy's famous Giugiaro makes an otherwise bulky cycle look surprisingly lean and appealing. Finally, Suzuki's 12-month/12,000-mile guarantee supports its faith in what appears to be a versatile tourer with an entire style of its own. *U.S. Suzuki Motor Corp., 13767 Freeway Dr., Sante Fe Springs, Calif. 90670.*

TRIUMPH TRIDENT. First introduced in 1969, the latest version of the British-built Trident is a handler. Its single-downtube, twin-loop cradle frame has long since been proven for stability and balance on racetracks and expressways the world over. Girling shock absorbers are the pillars of good suspension in motorcycling, as are the Triumph's Lockheed disc brakes for stopping and the Dunlop K-100 tires for road holding. The 750-cc vertical OHV three-cylinder engine has smooth power. With an electric starter, left-side shift-lever, special fingertip controls and smart new styling for 1975, the new Trident—even in view of minor faults of its forebearers—has the earmarks of a winner. *Norton Triumph Villiers Corp., 2767 East Huntington Dr., Duarte, Calif. 91010.*

YAMAHA XS 650B. Simplicity is the basis for continued popularity of the "650" Yamaha. The XS 650B is a lean, clean touring machine.

The single overhead-cam, 650-cc engine has a compression ratio of 8.4:1—suitable for low-test gasoline. A healthy 40.1 foot-pounds of torque at 6000 rpm with an estimated 46 bhp at 7000 rpm highlight a high-revving engine that has strong pull from below 25 mph right on up through the 100-mph barrier. Riding comfort does not fess up to standards of such tourers as the BMW R90/S or Kawasaki Z-1. Neither is it as harsh as that of the Ducati Sport.

Brakes are excellent. Both front disc and rear drum are effective, fade-free and do not grab. The five-speed constant-mesh transmission is precise but not particularly smooth or quiet. Hand controls, switches and instrument console are thoughtfully designed for safety. *Yamaha International Corp., 6600 Orangethorpe Blvd., Buena Park, Calif. 90620. ★★*

Richard Petty says:

"NRI has the most up-to-date complete courses in Auto Mechanics I've ever seen."

Let them show you how you can become a professional automotive mechanic . . . learning at home in your spare time

When your life depends on the mechanical performance of a car, you get to know and appreciate good mechanics. And believe me, they're few and far between. If there ever was a field where opportunity is knocking, this is it.

I'm sure glad to see home training like the two NRI courses come along. With NRI training, you can keep your present job while you learn, and you get the kind of hands-on experience that pays off under the hood. It's a lot of training for a very few dollars.



Here's how to get real pro training

Take NRI's complete 70 lesson Master Automotive Technician Course and you'll get all of the essential training and diagnostic equipment you need. The equipment includes a dwell tachometer, AC power timing light, complete set of tools, a volt-amp tester, an ignition-analyzer scope, and assorted gauges. You pay nothing extra for the tools and they're yours to keep.

You learn step by step, just as if you had a master mechanic at your elbow showing you the way. The texts are "bite-size", fully-illustrated, and easy to

follow. I've gone over the course and I can tell you . . . it's a winner.

If you want to work on your own car

Take NRI's 30 lesson Tune-Up Course. It's a basic repair course for the homeowner and it can save you a bundle on car upkeep. Being your own mechanic can save you money on gas and on repair bills. The Tune-Up Course includes eight important service items, including a dwell tachometer, volt-amp tester, and tune-up tool kit.

Train with the leaders . . . NRI and McGraw-Hill

Never settle for second best. Look to the guys out in front. And in home study training, that's NRI and McGraw-Hill. No other school can match them in experience or teaching methods. More than a million students have trained at home the NRI way . . . so they must be doing something right. **NRI AUTOMOTIVE DIVISION, 3939 Wisconsin Avenue, Washington, D.C. 20016.**

RUSH FOR FREE CATALOG

NO SALESMAN WILL CALL



Richard Petty, America's Winningest Stock Car Driver and NRI Automotive Consultant

NRI
McGraw-Hill

NRI SCHOOLS
McGraw-Hill Continuing Education Center
3939 Wisconsin Avenue, Washington, D.C. 20016
Check below for your free Automotive catalog. Or select one of the other courses instead.

AUTOMOTIVE MECHANICS COURSES TV/Audio, Communications, and Computer Electronics Courses Air Conditioning, Refrigeration, and Heating Courses

Name _____ Age _____
(Please Print)
Address _____
City _____ State _____ Zip _____

Approved for career study under GI Bill. Check for details.
Accredited Member National Home Study Council.

NEW FOR THE ROAD ... AND RV ACCESSORIES

(Continued from page 121)

to be found in a number of rigs less than 20 feet long.

And for campers who like a lot of room, there are the new park models. With tipout rooms, they can be set for a week's stay, or for a year. ★★



RVs with a new name from a standard in RV industry, Winnebago, are the 25 and 27 Itasca motor homes on Chevy chassis.



With new look and streamlining for familiar Winnebago, Custom 29, 27 and 25 have first major style change in seven years.



Motorizing for a line that used to be all trailers, Holiday Rambler now has mini-motor home models with beds for up to 6.



More passenger room in the cab, and more cargo capacity, are available with three Dodge D200 Club Cab camper packages.



Families up to seven can sleep in new 1975 JS-715 Serro Scotty 15-footer with overhead bunk/storage compartment.



Fabric-covered and weighing 30 pounds, Kenco's aluminum-framed Porta Kap for pickups has screens, Fastak tie-downs.

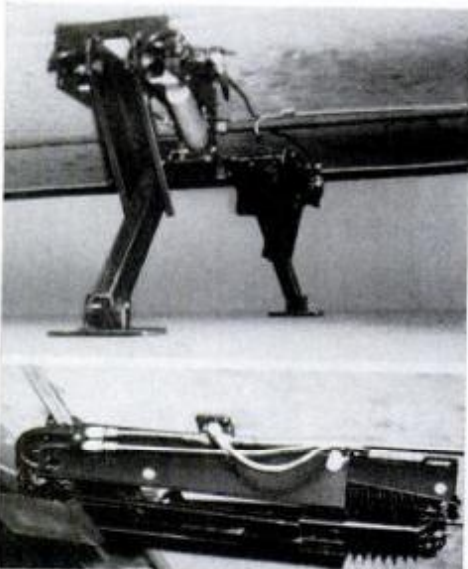

Hydraulic power lifts installed at front of trailer lower for leveling (top) or retract up in Prestolite's prototype system.



Pickup covers are more popular this year, and Super Kap from Winnebago has sliding screened windows, locking rear door.



Bolt-on under-car receivers for Class 3 frame or load-equalizing hitches come in Valley Tow-Rite kits, need no welding.



Ladder for roof racks has been designed to fit doors of Chevy, Dodge or Ford van conversions by Kenco Engineering.



Fifth-wheel trailering with passenger car is possible with Winter Welding's Ace hitch adapter, shown with Blazon Elite.



Awning in self-contained automatic roll-up box for vans, campers, travel trailers is named Shadow Box by Carefree of Colo.



Cross-leveling of recreational vehicles is aided by device with 10-inch lift travel made by Drier Leveler, Cortland, N.Y.

The Great ★ American Dream ★ ★ Machine ★ ★

*You've always wanted to own a helicopter,
but you never could . . . UNTIL NOW!*

For the price of a two-seat sports car you can have a two-seat helicopter parked in your garage. The Scorpion Too is everyman's helicopter. It can carry a salt block, a camera, a tool box, a piston drill, or a passenger where you need it, when you need it. RotorWay's Scorpion has a history of proven performance and versatility. *It's not just a dream . . . it's a dream come true.*



You've always wondered what makes a helicopter tick.



Learn about the Scorpion by sending in for Phase I of our *get acquainted* program. We know that the purchase of a Scorpion requires careful consideration, and that's why this \$6 package has been specially prepared. It will spare you the time and inconvenience of researching on your own.

You will receive essential information on how to judge the validity of the Scorpion and gain valuable insight into rotorcraft operation and usage. In addition to becoming an armchair helicopter expert you will really enjoy the enclosed 33-1/3 sound track recording of a Scorpion Too as its pilot explores old ghost towns and gold mines on a flight through the Mohave Desert.

SEND \$6 NOW . . .

*. . . for our illustrated
information package!*

ROTORWAY, INC.
Dept. B6/14805 S. Interstate 10
Tempe, Arizona 85281

Name _____

Address _____

City _____ St. _____ Zip _____

RotorWay
INCORPORATED

... here Today!

"IGNITION OF THE FUTURE" ALLISON "OPTO-ELECTRIC"

★ The BEST...the ULTIMATE...
of ALL the Ignition Systems!

● (We challenge ANYONE
to dispute this Fact).



● Never wears out or needs any Maintenance!



● Does more than Pay for itself in
GAS SAVINGS

...it gives you Maximum Power
with continuous PEAK PERFORMANCE

...while reducing Maintenance
and Operating Costs!



● The Allison OPTO-ELECTRIC System eliminates the Points and Condenser, replacing them with an OPTO-ELECTRONIC TRIGGER, using a Light-Emitting Diode and Photo transistor. As there are NO moving parts in rubbing contact...Timing adjustments are PERMANENT. The only "TRUE" Electronic Ignition...that you can buy for under \$100.

● Gives 40-Times more Timing Accuracy than ANY system using "Mechanical" Breaker-Points! UNLIMITED RPM! "Electronically-Controlled" DWELL automatically supplies HIGHEST Performance at both Low and High speeds. Spark strength does not fall off at high RPM. POSITIVE SPARK helps eliminate "Misfire" for faster acceleration and improved Engine Performance! Smoother running (No timing fluctuation as with Magnetic Units). Easier Starting under any condition! Sparkplugs LAST 3 to 10-Times LONGER.

All SOLID-STATE Components. UNAFFECTED By Temperature, Moisture, or Vibration! Highest grade materials Guarantee you solid, Dependable Performance.

★ Perfect Timing and Dwell never change.

Pays for itself! Eliminates Ignition Tune-Ups forever!
"INFINITE LIFE"...Once installed...Never needs replacing.

● PERFECT TIMING INCREASES Engine Efficiency and Gas Mileage. SAVES Precious Fuel! Allison gives you MAXIMUM Engine Efficiency 100% of the time...and that's the name of the game for BETTER Gas Mileage and Economy.

★ PROVEN RELIABILITY!
Dyno Tested up to 15,000 RPM.
Road and Race Proven.
(Opto-Electric Systems won at
INDY Two years in a row!)

● QUICK AND EASY INSTALLATION

★ If you want the BEST, and SAVE! This is IT!

● ORDER with CONFIDENCE...
SATISFACTION GUARANTEED!
1-YEAR FACTORY WARRANTY. Only \$49.95
COMPLETE.

● As you can see, you're not taking any
chances at all...Send your Order Today.

State Make, Year, Engine Size. (Calif. Res. add Tax).
● (So New...it's Sold ONLY FROM FACTORY DIRECT).

You may use your MASTER CHARGE or BANKAMERICARD.
Send us (1) Your Number, (2) Interbank No., (3) Exp. Date.

● Before buying any other Type Ignition system...

Send Postcard for our FREE BROCHURE.

★ If you have already installed a C-D ignition system,
Modernize and Increase its Efficiency...
CONVERT YOUR "C-D" UNIT TO BREAKERLESS!
Opto-Electric "TRIGGER UNIT"...Only \$34.95

● Our BEST Salesmen are the owners
and users of our ALLISON System!



ALLISON
AUTOMOTIVE COMPANY

1269-X, East EDNA PL., COVINA, CAL. 91722

GROW A VEGETABLE BONANZA

(Continued from page 75)

frame. In frame or flat, allow two inches between plants.

Seedlings should be sprayed with Maneb to prevent "damping off"—a fungus that attacks the stems. Also, give the seedlings as much light as possible and guard against extreme humidity.

A simpler propagation method is to use peat pellets, sowing several seeds in each pellet and letting the strongest sprout remain. At the proper time, plant them in the ground, pellet and all. Easiest way is to buy seedlings ready for planting.

When to plant

The sample plot designs presented with this article allow for consecutive spring, summer and fall plantings, making the small garden as productive as possible. Harvest times of each season's plants roughly coincide with the times of planting of new crops.

The timetable reflects conditions of the lower New York State area, a moderate climate typical of much of continental U.S.A. Of course, growing seasons are shorter farther north and longer in the South. The fall planting schedule presented here applies only to areas where the first frost comes no earlier than the latter part of October or the fall season continues to be relatively mild even after a frost.

Remember that all seedlings must be "hardened off"—they must have a week's exposure to gradually lower temperatures in making the transition from greenhouse warmth (or the sunny southern window where they've been kept) to outdoor temperatures.

Extra care should be taken with some crops. Cabbage, for example, should not go through a 7-to-10-day period of daytime temperatures consistently below 50° F. or heads will form prematurely.

Choosing varieties

Another result of the sophisticated hybrids developed is that there is a variety of every vegetable especially suited to nearly every specific locality. This is particularly true of tomatoes, eggplant, peppers and lettuce—in some cases a difference of 50 miles can call for two varieties. Most state agricultural colleges publish annual lists of recommended varieties by locality. These are available by mail. Your local agricultural agent will also have this information.

Diseases and pests

The best defense against diseases and pests in the small garden is pre-

vention. Maintain the plants in vigorous growth, remove all weeds from the plot and the close surroundings, and choose resistant strains of vegetables adapted to your region. To prevent cutworms from decapitating young seedlings, protect them with paper cups, the bottoms of which have been removed, when you put them in the ground.

Beyond this, weekly sprays or dustings of a pyrethrum-rotenone mixture can be very effective against a wide range of pests. Both substances are natural derivatives of plants and have a low toxicity to mammals. Caterpillars can be discouraged quite effectively with bacillus thuringiensis (sold under the trade names Dipel WP, Biotrol XK, and Thuricide HPC), which is nontoxic to mammals and other insects. This will prevent most of the damage done to members of the cabbage family.

Cabbages, brussels sprouts, cauliflower and kale also may suffer from maggots attacking their root stems. Onions and radishes may also be maggot victims. Use Malathion, a systemic spray that enters the plant's tissues. Malathion is also effective against leaf miners, a real problem in beets, turnips and leafy vegetables. These insects enter the leaf, leaving a telltale line of dead tissue to mark their paths as they eat it away. Malathion is one of the least toxic of the systemics, but that's not saying a lot. Follow directions and use with care.

Corn will almost certainly be attacked by many pests. Two of the worst, corn borer and earworm, can be prevented by applications of Sevin. This has a low toxicity to mammals, but is deadly to bees and many beneficial insects, so don't use it on anything in flower.

Most fungus diseases can be controlled by selecting resistant strains of vegetables and maintaining the garden properly. In case of "club root," a fungus that greatly enlarges parts of the roots of cabbage, raising the pH of the soil to neutral is a good preventive.

Other likely fungus victims are the leaves of cucumbers and melons. Use Maneb, as directed, but only if you have to. Difolatan, Phaltan and Bravo are also very effective.

Probably the best preventive is also the simplest: Water in the morning rather than late in the day. Fungus likes it best when the soil is dark and damp at the same time.

Well, there you have it—a down-to-earth approach to the home vegetable garden. But before you begin, make sure there's room in the freezer for those late crops of beans, squash and other goodies. ★★

HERE ARE REAL PEOPLE WHO BECAME REAL LOCKSMITHS!

Learning quickly, easily
at home, from the one and only
LOCKSMITHING INSTITUTE

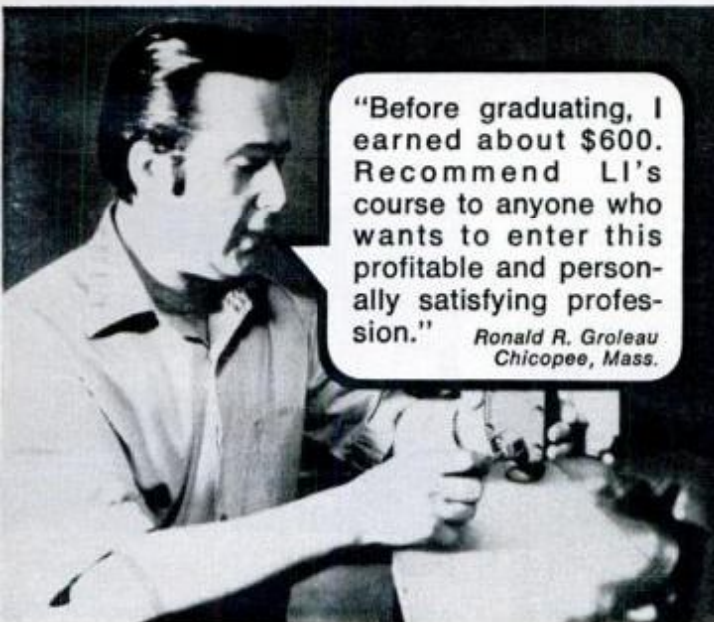

"Before graduating, I earned about \$600. Recommend LI's course to anyone who wants to enter this profitable and personally satisfying profession." *Ronald R. Groleau
Chicopee, Mass.*

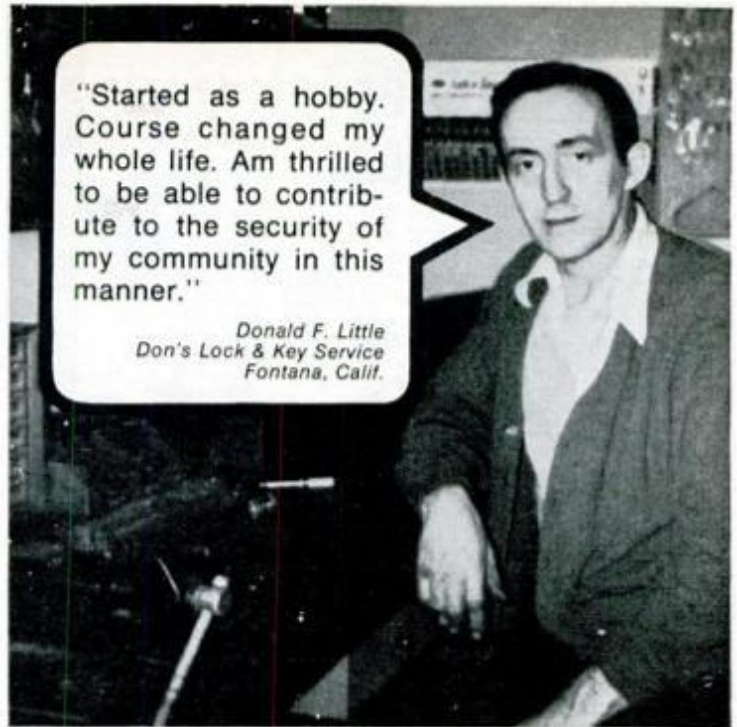

"Started as a hobby. Course changed my whole life. Am thrilled to be able to contribute to the security of my community in this manner."

*Donald F. Little
Don's Lock & Key Service
Fontana, Calif.*

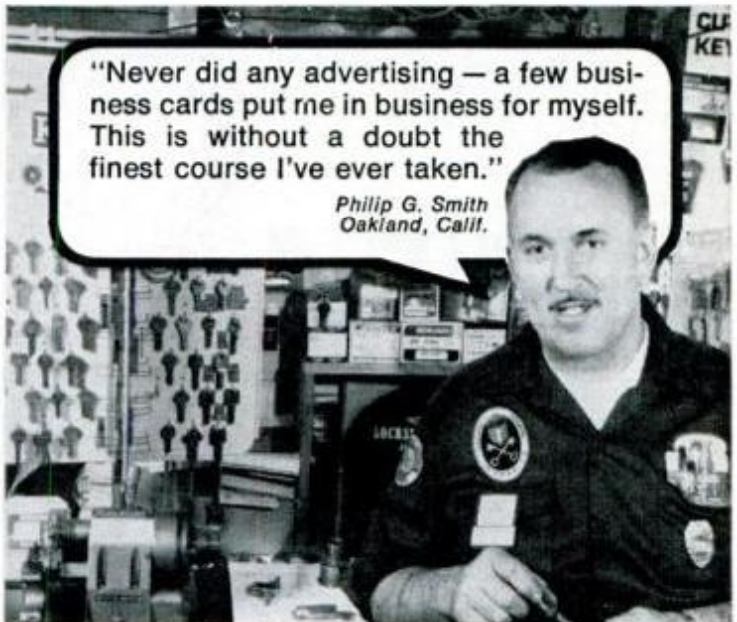

"Never did any advertising — a few business cards put me in business for myself. This is without a doubt the finest course I've ever taken."

*Philip G. Smith
Oakland, Calif.*

**You can have equal success —
Locksmithing Institute can be the key
to a highly paid successful future!**

LOCKSMITHING is truly the "neglected profession." Opportunities for big cash earnings, spare time or full time, exist in all parts of the country. Almost regardless of age or education, even with minor physical handicaps, you can acquire professional status in an enjoyable trade where work is fun. You can be your own boss—in your own business!

Let us send you sample lesson pages, full details of the home training, and, most important, complete

information on the glorious opportunities for locksmiths now that the nation is so security conscious.

See for yourself the list of more than 300 parts, tools and pieces that we furnish with the course. All your files, tweezers, cylinders, assemblies, extractors, plus locks, keys and door handles are included—EVEN A FULL SIZE ELECTRIC KEY MACHINE with which you can make money at once.

Write today... no obligation.

LOCKSMITHING INSTITUTE

Division of Technical Home Study Schools

Dept. 1110-035

Little Falls, New Jersey 07424

Licensed by State of New Jersey. Accredited Member National Home Study Council.
State Approved Diploma. Approved for Veterans Training.



**NO OBLIGATION —
NO SALESMAN WILL CALL!**

We'll mail you full information so that you can examine it, without obligation, in the privacy of your home, at your leisure.

LOCKSMITHING INSTITUTE

Dept. 1110-035
Div. of Technical Home Study Schools
Little Falls, New Jersey 07424

YES, rush me your free "Opportunities in Locksmithing," plus full details on money-making opportunities, key machine and tools, sample lesson pages, tuition and easy payment plans.

Name _____

Address _____

City _____

State _____ Zip _____

Check here for information on Veterans Benefits.

Handy little Devils for nasty little jobs.

Inside the house or out . . . whatever the job, top-quality Red Devil tools and chemicals make it easy!



For the best paint job, prepare surface first! Scrape, patch where needed, then paint. And use Red Devil Brushes. They're Bristle Blend Tested for paint distribution.



For sealing openings around door and window frames, use Red Devil Caulk. Unlike oil-base caulk, it flows on smoothly — and may be used under any paint without staining, bleeding-through or cracking. It requires no priming, and stays flexible for years.

It's easy . . . with the Devil!

Red Devil



Red Devil Inc.
Union, N.J. 07083

Learn CUSTOMIZING

at HOME in Your SPARE TIME!

Send for Career Kit—ALL FREE!



We Teach You Everything You Need to Know to...

CUSTOMIZE VANS, CARS, BUGGIES, CHOPPERS INSIDE & OUT for Yourself or Others!

FLAMES
FADING
FOGGING
SCALLOPS
LACE
COBWEBS
MURALS
PINK STRIPING
FUNKY LETTERING
PORT HOLES
MOON ROOFS
SCOOPS
SIDE-PIPES
SPOILERS
FLARES
CARPETING
UPHOLSTERY
PANELLING
DRAPES
HIGH-BACKS
BUILT-INS
ETC.

For the first time! A Home-Study Plan that puts it all together! No special talent needed,

because we teach you the professional secrets, short-cuts and easy ways to handle air-brushing, decals, screen-prints, striping, murals, upholstery, carpeting, metal-work, woodwork, etc.

NOT A "BOOK"! This is a "do-it-yourself," home study plan that teaches you step-by-step. You are guided all the way by our experienced counselors.

TOOLS & SUPPLIES INCLUDED! Not theory—but real learning through practice! You get tools and supplies like air-brush, stencils, decals, screens, brushes, metal-working, carpentry and upholstery tools. *Nothing else to buy!*

FREE "Customizing Career Kit" Shows You How Easy It Is How Fast You Can Start! Write for It Today!

How to *\$* Make Money CUSTOMIZING VANS, CARS

SAVE BY CUSTOMIZING YOUR OWN VAN OR CAR . . . Start Earning Good Money Customizing for Others in Your Spare Time . . . Even before You Finish Your Course!



CUSTOMIZING CENTER
4401 Birch St., Dept. PB025
Newport Beach, CA 92663

Rush me my personal copy of your "Customizing Career Kit." I understand it is absolutely free, and that no salesman will call.

Name _____ Age _____
Address _____
City _____ State _____ Zip _____

HINTS

FROM READERS

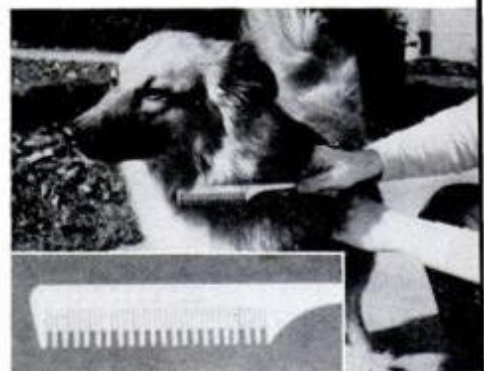

Pet-grooming aid

A lady's metal teasing comb, like the one shown, helps in grooming long-haired pets; it works out the undercoat that other combs seem to miss.

—Charles F. Dayton, Akron, Ohio

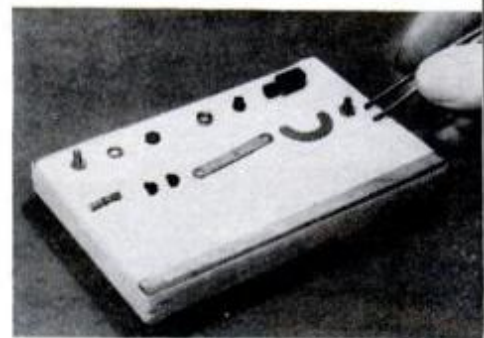

Parts holder

Small parts can be protected against loss and kept in proper assembly order by pressing them onto masking-tape strips fastened sticky side up to a piece of wood.

—William Swallow, Brooklyn, N.Y.

Itching, chafing, rash, irritation, excessive perspiration in the groin area could be

Jock Itch

Whether you're suffering from the bothersome symptoms, or Jock Itch (Tinea cruris), you should be using Cruex® Medicated Spray Powder.

Cruex soothes itchy, inflamed skin. Absorbs perspiration. Helps cushion against further irritation. And, medicated Cruex is strong enough to help prevent the fungous infection that can develop.

Since Cruex is a spray powder, it penetrates into hard-to-reach places, without mess, without pain. Get relief—fast. Avoid embarrassing itch, too. With Cruex. Soothing, cooling Cruex.

So good it has this guarantee: if not totally satisfied, just return the unused portion to manufacturer for full refund.

Cruex

Guaranteed to work or your money back.

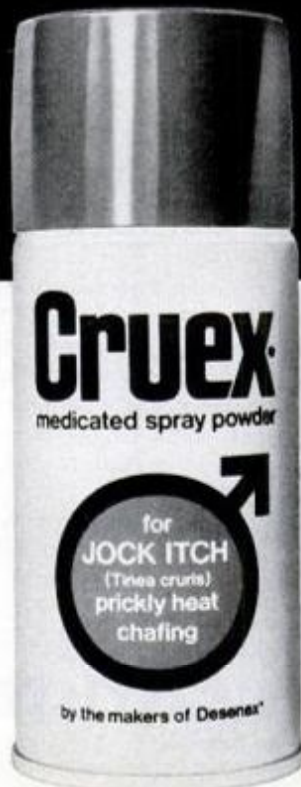

A PRODUCT OF PENNAC CORPORATION

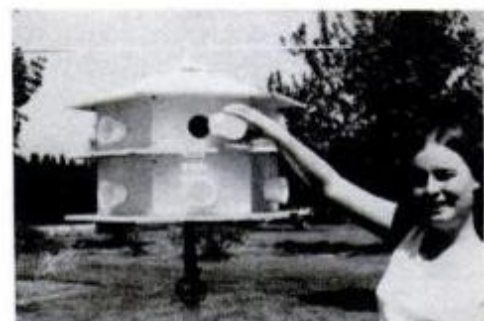

Plugging birdhouse holes

To keep less desirable birds out of a martin house before the martins' arrival, plug entrance holes with 7-oz., foam-plastic hot drinking cups.

—Charles F. Dayton, Akron, Ohio

Материал, защищенный авторским правом

If this isn't one of the most incredible tool inventions of the century, our name isn't Black & Decker.

It's called the Workmate™. It's part bench, part vise. It's lightweight, portable and remarkably strong.

It holds up to 350 lbs. of dead weight, it's got an incredible variety of clamping positions and it folds up to the size of a suitcase, so you can tuck it away when you're not using it.



From the top of its laminated birch-ply work surface to the bottom of its sturdy steel legs, it stands practically unrivaled in ingenuity and cleverness of design.

The Vise Jaws and Clamps

The top of the Workmate is, in effect, a giant 29"-long vise. The jaws are controlled by two separate clamps that work

independently. This means you can open one end wider than the other to hold an irregularly shaped object, like a bicycle. An extremely handy feature. (Another handy feature is the V-groove in the vise jaws, for firmly clamping pipes.)



The Swivel Pegs

There are 20 holes in the Workmate's top. These holes are "stops" in which swivel pegs are placed. Because the pegs turn to grip at any angle, you get an adaptability of clamping positions most regular workbenches don't have.

The Frame

The Workmate's frame is a combination of steel and die-cast aluminum. Its skeletal quality gives it great strength, but surprising lightness in weight. It can be easily carried from job to job. The bottom legs fold in or out, giving you a choice of two working heights. And, of course, the whole frame folds up completely, for amazingly handy storage.

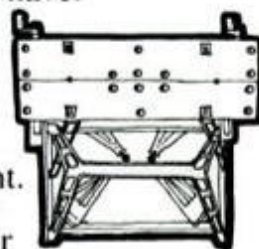

The incredible Workmate. Only from Black & Decker.



A tool you can work with at a price you can work with.  **Black & Decker.**
For your nearest Black & Decker dealer, call 800-243-6000 FREE, day or night. In Connecticut, call 1-800-882-6500.

FREE auto body repair booklet

AUTO REPAIRS YOU CAN MAKE
Illustrated How-To-Do-it Instructions
Featuring

BOND TITE

Tells you how to make body repairs yourself like the pros... with Bond Tite pro-quality materials.



Save hundreds of dollars by doing it yourself with famous Bond Tite auto body products & fiberglass repair kits.

Send self-addressed and stamped envelope today to:

Oatey Co. CONSUMER PRODUCTS DIV.
DEPT. P, CLEVELAND, OHIO 44135

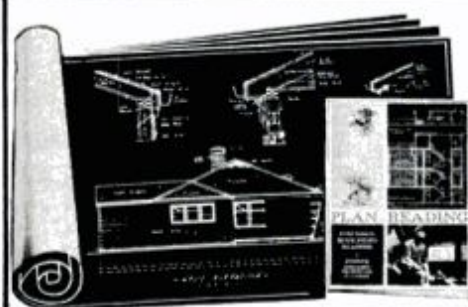

FREE BLUEPRINTS and TRIAL LESSON

—for your greater success in Building

Beginners, craftsmen, even foremen and superintendents, have sent for these free blueprints and trial lesson in Plan Reading as a means of trying out Chicago Tech's home-study Builders training. Learn how you can master Plan Reading—Estimating—and the practical details of all types of construction in your spare time at home. Mail coupon below today—see how you, too can prepare for a better job—higher income, or start your own contracting business.

CHICAGO TECHNICAL COLLEGE/School for Builders
2000 S. Michigan Avenue, Chicago, Ill. 60616

CHICAGO TECHNICAL COLLEGE Veterans Check Here
Dept. PM-35, 2000 S. Michigan Ave., Chicago, Ill. 60616

Please mail me a Free Trial Lesson, Blueprints and Builders Catalog. I understand there is no obligation—no salesman will call.

NAME _____ AGE _____
ADDRESS _____
CITY _____ STATE _____ ZIP _____

GO BUILD A KITE

(Continued from page 115)

an equally airworthy version using polyethylene trash bags for sail material.

The TetraKite, by Synestructics, Inc., takes its name from its tetrahedral shape, the shape favored by Alexander Graham Bell (the same one) during his kite research. Since tetrahedrons pack together just as neatly in space as equilateral triangles do on a plane surface, a tetrahedral kite can have as many cells or lifting units as desired, each a tetrahedron with two sides covered with sail material—Bell built one with 3393 cells that lifted a man. A SuperTetraKite that's made up of four TetraKites is also available; 5½ ft. on an edge, it's too big to fit through most doors, and so requires final assembly outdoors.

From the same manufacturer, Skylinks is a kite system based on triangular box-kite modules. These can be flown separately or in train, or assembled into larger kites like the one shown on page 114, a kite designed for dual-line stunt flying.

The Red Baron is one of four airplane-style kite kits made by Straton Air Engineering. It flies with a high angle of attack, its wings acting as sails, not airfoils. The dihedral angle of the wing-sails gives stability; in

principle, it's not too dissimilar to three tetrahedral cells stacked vertically.

Flight tests were incomplete at press time, and the flying weather available was generally gusty. Hard landings (resulting from the attempt to fly in unreliable wind) broke a couple of the Tetra's spars. On a day with very little wind, the Red Baron proved itself a stable flyer. Its apparent fragility was no drawback, since—in a steady breeze—it was easy to fly to soft landings, both on the ground and to the hand.

The delta-wing kite is easy to build. Make a full-size pattern on newspaper or wrapping paper from the pattern below, then cut ½-mil Mylar to it. Use a razor blade for the smoothest possible edge—ragged edges tear. Fold the main-sail tabs over and glue them down with rubber cement. Attach wing spars and spine to the sail with rubber cement and strapping tape.

Fold the keel into a single triangle, closing its open sides with strapping tape. Attach the keel to the under side of the sail with a strip of strapping tape along either side of the long edge. Holes for the spreader bar and bridling holes get double patches of tape—with grain perpendicular—on either side of the Mylar, and eyelets for further pro-

(Please turn to page 138)

DELTA-WING KITE

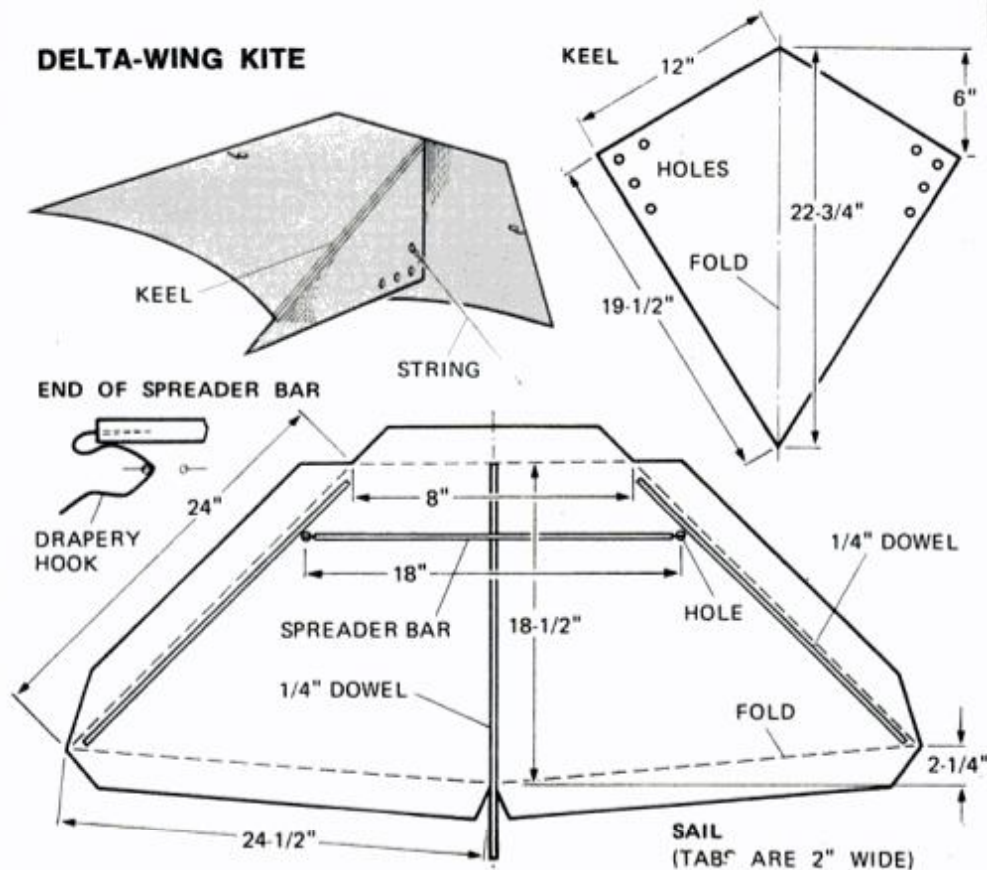

Frame parts—wing spars, spine and spreader bar—of delta-wing kite are all ¼-in. dowel. Material for sail and keel is ½-mil metallized Mylar.

The day Bill told off his boss

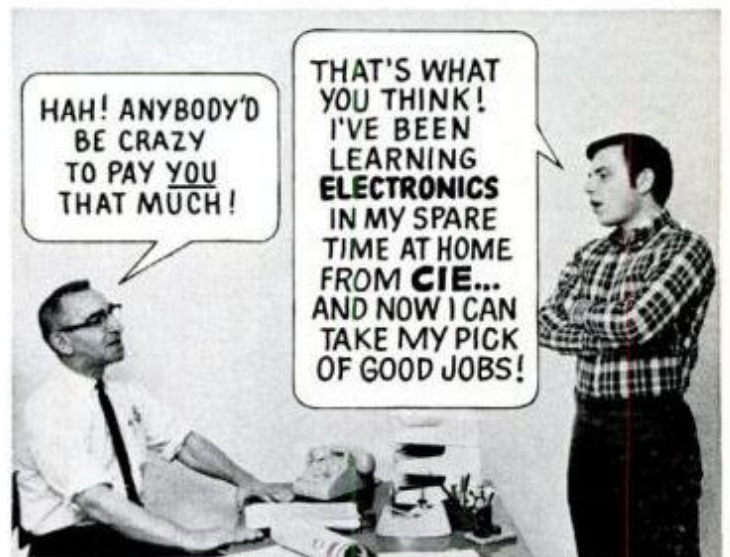
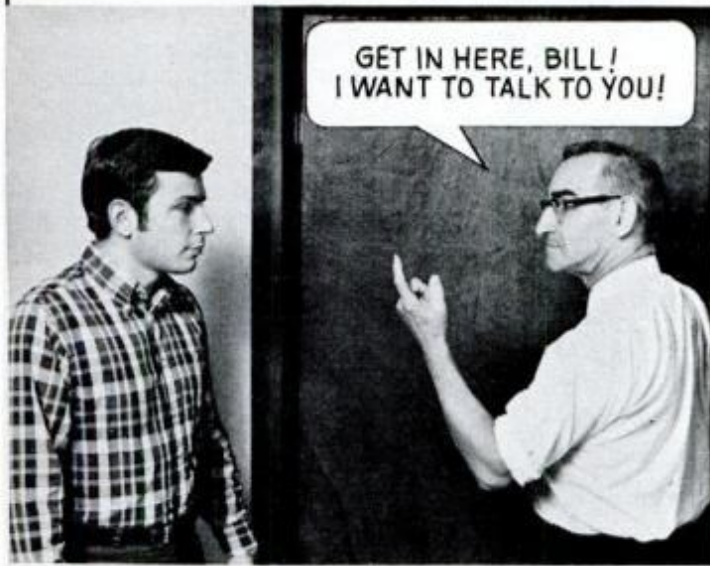

ARE YOU WORKING FOR PEANUTS IN A DEAD END JOB? GET SMART. SEND FOR 2 FREE BOOKS LIKE BILL DID!

Be sure to send for your 2 FREE books today. For your convenience, we will try to have a representative call. If coupon has been removed, write to Cleveland Institute of Electronics, Inc., 1776 East 17th Street, Cleveland, Ohio 44114.

IF CARD IS MISSING, MAIL THIS COUPON

CIE
Cleveland Institute of Electronics
1776 East 17th Street, Cleveland, Ohio 44114

Please send me your 2 FREE BOOKS describing the opportunities in Electronics and how to prepare for them.

Name _____
(Please print)

Address _____

City _____

State _____ Zip _____ Age _____

Veterans and Servicemen:
Check here for G.I. Bill information.

Accredited member National Home Study Council



PM-99

These 3 BIG DRAFTING KITS GIVEN TO YOU ...



when you train with us for a **HIGH PAY JOB IN DRAFTING!**

Take your pick of 1000s big salary jobs open to Draftsmen. U.S. Labor Dept. reports "42% more Draftsmen needed in next 10 years—not enough applicants to fill jobs available now." Easy home-study plan has helped 100s beginners toward \$5555, security, prestige as Draftsmen—many with only grade school training. Others report good earnings drafting part time while still learning. Why not you?

RUSH COUPON FOR FREE KIT!

Mail coupon for FREE "DRAFTING CAREER KIT," Sample Lesson, Drafting Aptitude Test including new 5-Way Drafting Instrument & 20-Page Book, "Your Future in Drafting" — ALL FREE.



G.I. Bill approved. Write today.

NORTH AMERICAN SCHOOL OF DRAFTING, Dept. PB025
 4500 Campus Dr., Newport Beach, Calif. 92663
 Rush "DRAFTING CAREER KIT," including Book, Sample Lesson, Aptitude Test & Drafting Instrument—ALL FREE!

NAME _____ AGE _____
 ADDRESS _____
 CITY _____ STATE _____ ZIP _____

See SUPER GLUE® and me, Jesse White, on TV. Just one drop holds 5,000 pounds. Bonds in seconds. Super fast. Super strong. SUPER GLUE®.



For sale wherever fix-it products are sold.
Duro Woodhill Chemical Sales Corp.
 Cleveland, Ohio 44128
 World's Finest Fix-it Products

GO BUILD A KITE

(Continued from page 136)

tection against rips. Putting more than one bridling hole in the keel will allow you to make adjustments for best flying characteristics. The spreader bar has drapery hooks set into dowel ends; pointed end hooks can be hammered in without splitting the dowel, but they should be secured with a dab of epoxy to be sure they won't come out.

If you are making the kite with polyethylene, use cellophane tape instead of strapping tape, skip the rubber cement and hold tabs down with tape, and omit the folded-up tap on the main sail's trailing edge.

Normally it shouldn't be necessary to run to get a kite into the air. In brisk winds, most kites will take off from your hand; if such a launch is not possible, there are two ways to go: One is to set the kite on the ground in something as close as possible to its flying position, back off about 100 ft., then when you feel a puff of wind, tug to lift off and start hauling in line as fast as you can. The other is to have a helper, about 100 ft. downwind, toss the kite gently into the air; you then haul in until the kite finds a steady breeze aloft and starts to pull. A faltering kite can often be made to resume climbing by tugging once or twice on its line; hauling in is the more drastic way to get a sinking kite back up.

Part of the skill involved in kite-flying is getting a kite to go higher and farther under less than ideal conditions. You acquire the knack by practice but it helps to use equipment giving you maximum control.

This means using a reel and rod. A good baitcasting reel works well; your thumb on the spool lets you feed line at just the right rate to a pulling kite. A rod not only gives you a place to mount the reel, making it easier to use, but provides increased leverage for line movement. Don't use a full-length rod, of course, just the bottom part of a sectional rod or a telescoping rod in closed position. Rod and reel also give much more control for landings.

Biggest book bargain on the subject is Wyatt Brummitt's Golden Handbook Guide, *Kites*, published by Golden Press at \$1.50. All the kite kits as well as the Brummitt book (\$1.70 by mail) and the Mylar used for the Delta kite, are available by mail from Go Fly A Kite Store, Inc. 1434 Third Ave., New York, N.Y. 10028. Postpaid prices are \$6 for the TetraKite, \$9.50 for Skylinks 4, \$7.50 for the Red Baron; Mylar is \$1 per yard. ★★★

muscle

The new **Powerwinch Jr.** is a rough and ready power tool that you carry anywhere, any time—as easily as a bowling ball! It's powered by a 12 volt car battery, operated by a remote control cord.



muscle ... 1500 pounds of pull, plenty of power to pull stumps, move trees and rocks, boxes, bales, crates, fencing, lumber, building materials—any heavy or bulky objects.

The **Powerwinch Jr.** comes complete with cable and mounting hardware, costs only \$119.95*. For the name of your nearest dealer, write: Powerwinch Div./Scott & Fetzer Co., 184 Garden St., Bridgeport, Ct 06605.

muscle ... to load equipment, appliances, machinery, barrels, drums, small tractors, snowmobiles, anything that can be winched up a plane ... muscle to handle a hundred jobs!

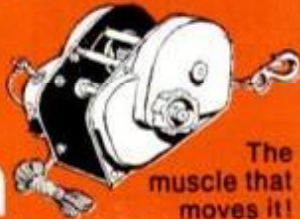

The muscle that moves it!

Powerwinch

*Manufacturer's suggested retail price.

"War injuries left me severely handicapped, but I'm making a very good living in Locksmithing, thanks to your course. Word of mouth advertising has been enough to make my business a financial success from the start. Besides, I'm my own boss doing something I thoroughly enjoy."

says Glen Johnson,
Larned, Kansas.



Earn More Enjoy Life – Be a... LOCKSMITH like I am!

Train FAST at Home – Earn While Learning
Get into this booming high-profit business that's
Easy to learn – Easy to do – Easy on You!

Never before have money-making opportunities been so great for qualified Locksmiths. Now, lucrative regular lock and key business has multiplied a thousandfold as millions seek more protection against ever increasing crime. Yet there's only one Locksmith for every 17,000 people! No wonder the money can roll in so FAST!

**Start collecting cash profits
right away – Up to \$12.50 an hour!**

You're "in business" ready to earn up to \$12.50 an hour a few days after you begin Belsaw's shortcut training. Special tools, equipment and supplies plus a professional Key-Making Machine help make your special knowledge bring in CASH FEES even while learning. Many students cover the full cost of their training and SHOW A SUBSTANTIAL PROFIT long before they finish. So can YOU.

Learn at home this shortcut way

Prepare yourself to take advantage of this tremendous money-making opportunity for steady, year-round EXTRA INCOME in your spare time or financial independence in a fulltime, high-profit business of your own. Perfect for retirement! You don't have to be an expert

mechanic to be an ace professional in this field. Once you know Locksmithing all your worries about a job, more income, layoffs, inflation, recession, too many bosses will be gone forever.

**Yours FREE – A burglar alarm
and security systems course**

Not for sale separately, but included with your training at No Extra Cost!

You receive the full course plus all special tools and equipment. Instructions and pictures are so clear you can't go wrong. This rapidly expanding field goes hand-in-hand with Locksmithing. It can add even more to your profits.

**Find out all about it
No Obligation –
NO SALESMAN WILL CALL**

Discover what's in Locksmithing for YOU. Find out how Belsaw's Master-Locksmith Approved training has helped hundreds of men to EARN MORE – ENJOY LIFE MORE.

RUSH COUPON TODAY FOR

FREE BOOK



Tells how to Make Money in Locksmithing – Spare Time or Full Time – Almost from the Start. Mail Coupon NOW!

**THIS
PRO KEY MACHINE**

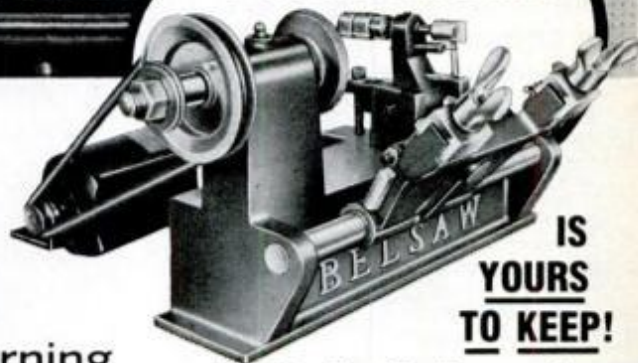

**IS
YOURS
TO KEEP!**

This Pro Key Machine can alone add up to \$200 a month to your income... and it won't cost you a penny extra with your training.

**PLUS THESE TOOLS AND MATERIALS ...
ALL YOURS AS PART OF YOUR TRAINING!**



BELSAW INSTITUTE

105M Field Bldg., Kansas City, Mo. 64111



Approved for all Veteran Training.

Accredited Member
National Home Study Council.

MAIL THIS COUPON – NO SALESMAN WILL CALL

BELSAW INSTITUTE, 105M Field Bldg., Kansas City, Missouri 64111

Please send me free of cost or obligation your publication "Keys to Your Future" on how Belsaw can train me to quickly make money in Locksmithing and how all tools and Key Machine are given me to keep.

Name _____

Address _____

City _____ State _____ Zip _____

Check here if eligible for Veteran benefits.

**Belsaw Started Me Making
Money FAST as a LOCKSMITH**

"I'm MAKING OVER \$300 A MONTH in my spare time with the Belsaw Locksmith Course. Yours is the best training in America."

Henry Rivas, Los Angeles, Calif.

"I CLEARED \$110 LAST SATURDAY! I am doing a wonderful business thanks to your course in Locksmithing. It's a great business."

R. W. Davis, St. Louis, Missouri.

"I HAVE ALL THE LOCKSMITH WORK I CAN HANDLE. Business is so good I'm expanding to fulltime."

Ed Boyle, Pittsburg, Penna.

Sun seats add style to your runabout

Build these recliners that can convert from seats to bunks, add storage below.

by Dan Dreyer

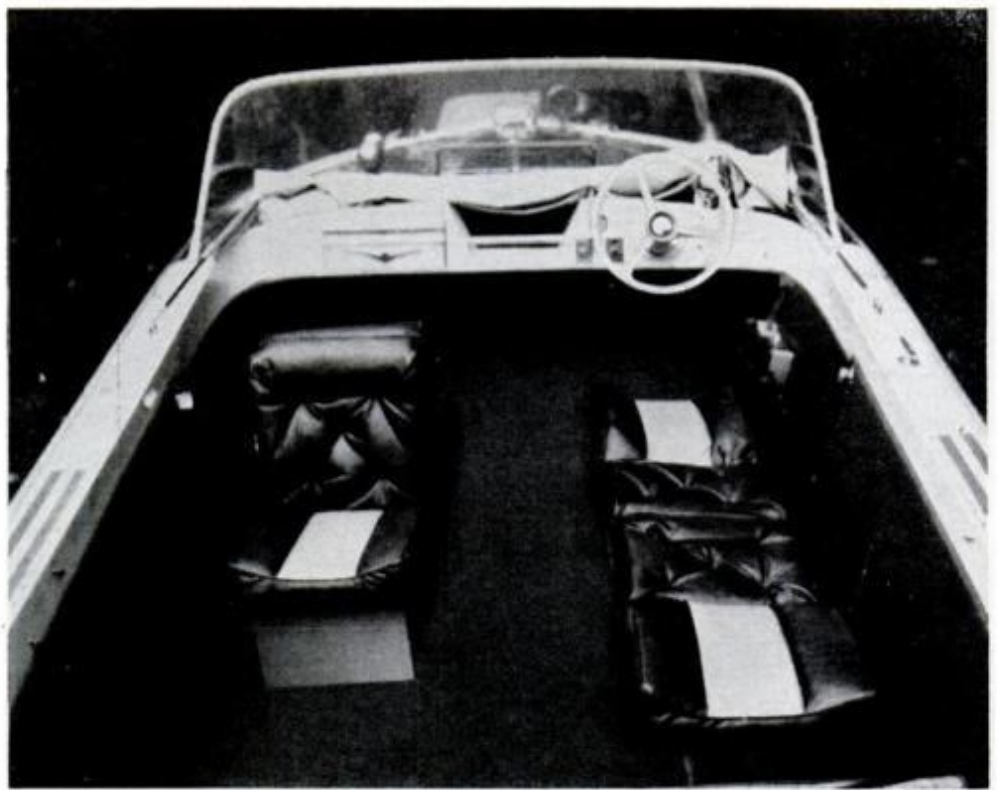

If you can find ready-made sun-lounger seats for your boat, they may cost \$150 or more per pair. You can build them for about \$25 each. Mine cost \$18.20 each, are like new after a season's use, and provide bonus storage space below that is accessible from front or back.

Naugahyde can be bought from upholstery supply, surplus and awning stores. Sometimes they have seconds

at considerable savings. Use marine plywood or painted exterior grade. Rust-free brass or aluminum hinges, screws, staples and hardware are preferred. Firm polyurethane foam is advised for seats, fiberfill sheeting or 1/2-inch foam for back. You can get 1/2-inch conduit pipe at electrical supply houses.

The 10-inch-high seats can be raised by adding to the 8-inch base;

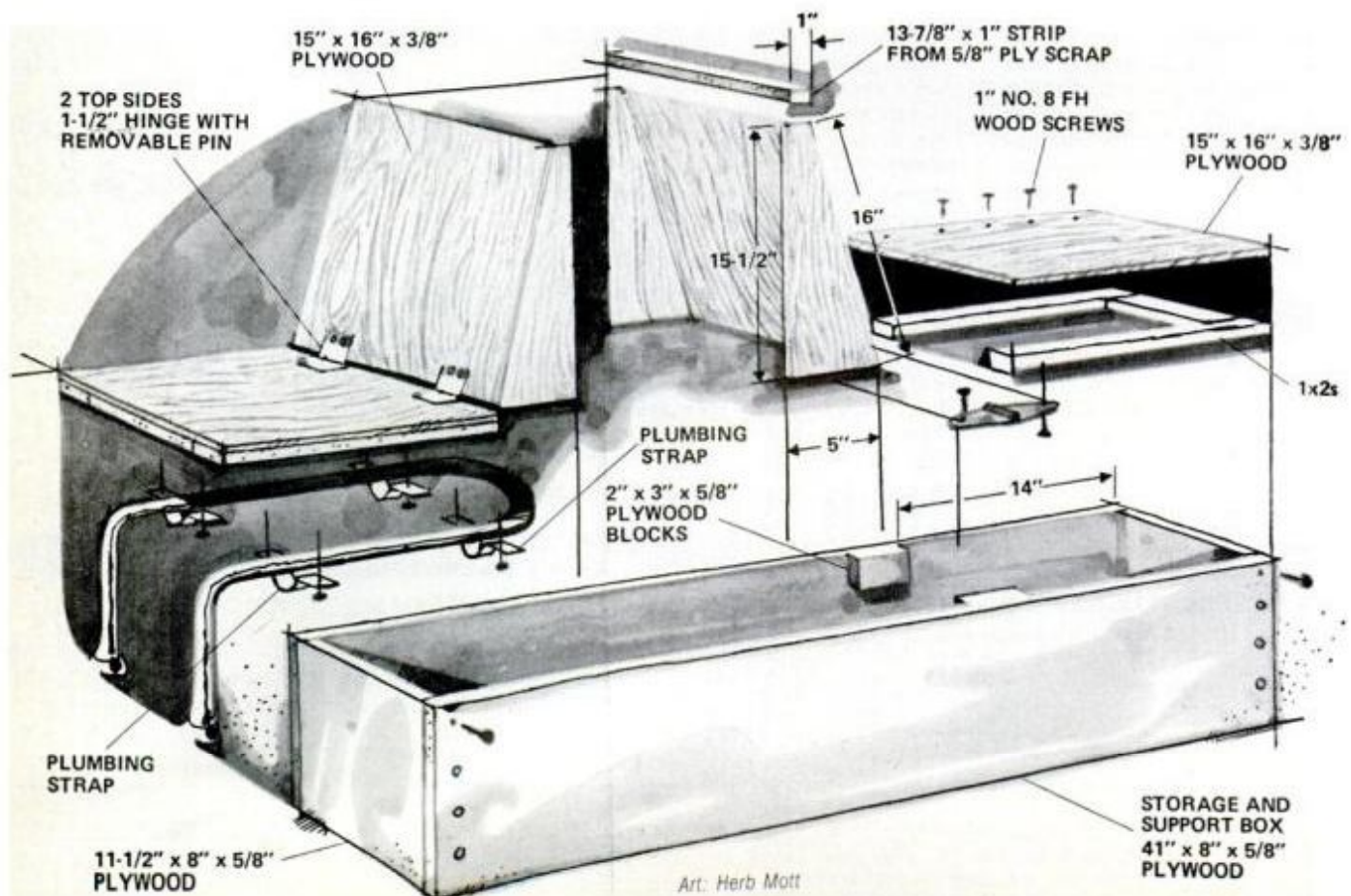

four more inches allow room for a standard metal gas tank. The storage box is glued and screwed together as shown. Seats and backs are joined with removable pin hinges, with pins replaced after upholstering.

Most sewing machines will sew several thicknesses of Naugahyde with heavy No. 16 needle and strong polyester thread. For thick sections, turn the machine by hand and pull the material through the machine. Cut material as shown and mark sew lines (usually 1 inch in) on back with a soft pencil. With zipper foot, sew welt cord or 1/4-inch rope into at least 100 inches of 3-inch stripping for bead around seat. Tape thin foam layer around edges of seat.

Cut foam in shapes shown with sabre saw, scissors or serrated knife. Assemble with foam glue or rubber cement. Turn upholstery right side out after sewing; staple edges to underside of seats, back and inside storage box base. ★★★

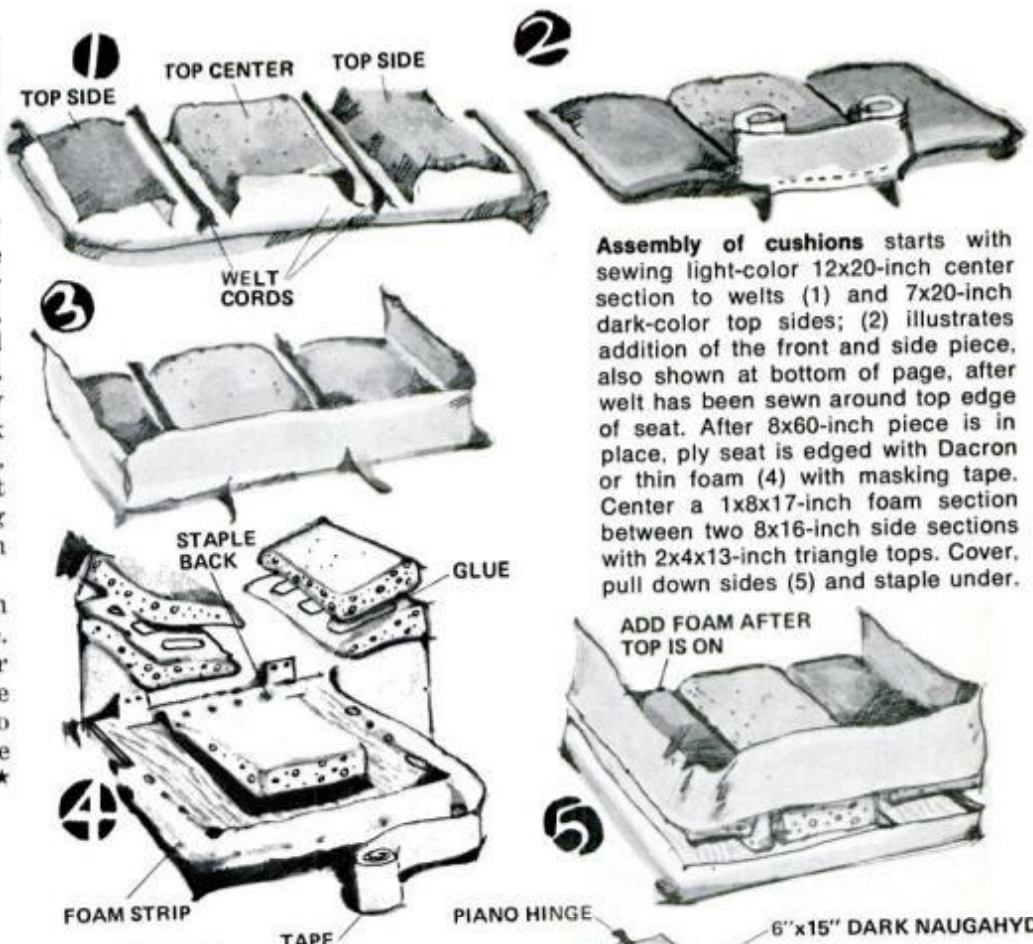

Assembly of cushions starts with sewing light-color 12x20-inch center section to welts (1) and 7x20-inch dark-color top sides; (2) illustrates addition of the front and side piece, also shown at bottom of page, after welt has been sewn around top edge of seat. After 8x60-inch piece is in place, ply seat is edged with Dacron or thin foam (4) with masking tape. Center a 1x8x17-inch foam section between two 8x16-inch side sections with 2x4x13-inch triangle tops. Cover, pull down sides (5) and staple under.



Backrest, with 2 1/2 x 7 1/2 x 17 1/2 x 18-inch cover, has pocket.

Cushion dimensions are below. Place button tufts by eye.

Plywood base of seats is connected to backs with hinges bolted to each, covered piano hinge between front and back. Front seat is hinged to base blocks; back slides aft.

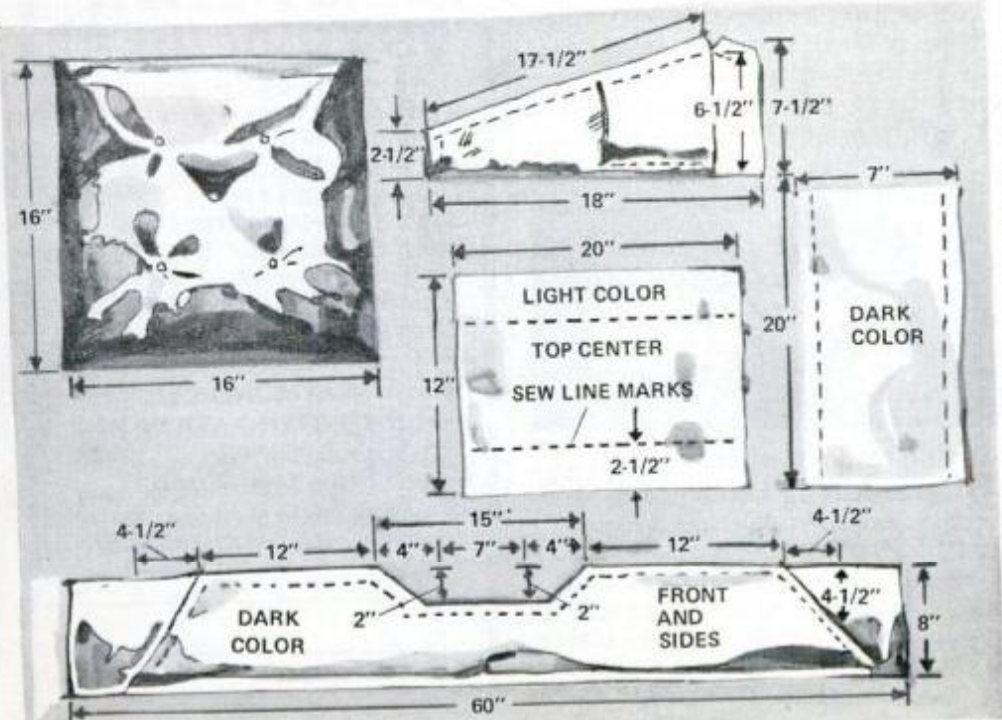

MATERIALS LIST—SUN SEAT

- | Amt. | Size and Description (Use) |
|---|---|
| 4 pcs. | 1x8x16" polyurethane foam (seat sides) |
| 2 pcs. | 3x4x13" polyurethane foam (cut four wedges) |
| 2 pcs. | 1x7 1/2 x 16" polyurethane foam (seat centers) |
| Darker Naugahyde, 5 yds. x 60" or 6 yds. x 45" | |
| 2 pcs. | 25x30" (back) |
| 4 pcs. | 7x20" (seat-top sides) |
| 2 pcs. | 8x50" (seat sides) |
| 1 pc. | 6x15" (piano-hinge cover) |
| 2 pcs. | 8x10" (pockets)
several long 3"-wide pieces (welt) |
| Lighter Naugahyde, 3 yds. | |
| 2 pcs. | 12x20" (seat-top center) |
| 1 pc. | 15x108" (support-box cover) |
| 4 pcs. | 3/8 x 15 x 16" plywood |
| 2 pcs. | 5/8 x 8 x 41" plywood |
| 2 pcs. | 6/8 x 8 x 11 1/2" plywood |
| 4 pcs. | 5/8 x 15 x 15 1/2 x 16" plywood, first cut 6-18 x 15 1/4" in 2 pcs., then cut diagonally |
| 1 pc. | 1x2x96" framing lumber |
| 1 pc. | 1/2"-dia. x 6' electrical conduit |
| 4 | 1/2" plumbing pipe straps |
| 2 | 3" strap hinges |
| 4 | 1 1/2" hinges with removable pins |
| 2 | 2 1/2 x 12" piano hinges |
| 2 | 3/8" rubber feet (pipe) |
| 8 | 1/2" No. 8 sheet-metal screws |
| 50 | 1" No. 8 flathead wood screws |
| 32 | 6-32 x 3/4" screws, lockwashers, nuts |
| Misc. | 1 lb. Dacron fiberfill, 1 can Sears polyurethane cement or 1 pint rubber cement, 1 small can waterproof wood glue, screws as needed to mount piano hinge and support box to boat. |

RUST AND CORROSION
A PROBLEM? Reach For

LIQUID WRENCH®

REGULAR NO. 1

The super-penetrating rust solvent that loosens rusted nuts, bolts, parts in seconds!



LIQUID WRENCH®

NEW! NO. 2

Quickly cleans and lubricates... stops squeaks, protects metal, dries wet engines!



RADIATOR SPECIALTY CO.
CHARLOTTE, N. C. 28237

HINTS

FROM READERS



Keeping paint from skinning

For skinless paint leftovers, try this oldtimers' trick: Take a deep breath, exhale into the can, then quickly close the lid. Carbon dioxide in your breath halts skin formation.—*Harry J. Miller, Sarasota, Fla.*

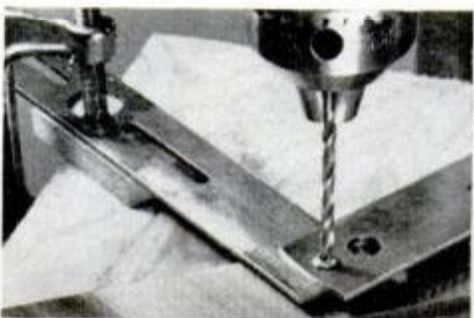

File helps in rivet removal

Removing a rivet by drilling out peened-over end can be a problem because rivet will revolve with the drill bit. What works for me is backing the rivet with a fine, flat file—being careful, of course, not to drill into it.—*B. F. Borsody, Palmetto, Fla.*



Ending rattle in wheel covers

After a few thousand miles, two-piece wheel covers with plastic centers can develop annoying noises at low speeds. Eliminate them permanently with a bead of silicone rubber sealant around each center on the inside, coating spring clips at all pressure points.—*Parry C. Yob, Fair Oaks, Calif.*

INVENTORS WANTED

IF YOU HAVE AN IDEA...

for a new product—or a way to make an old product better, contact us, "the idea people". We'll develop your idea, introduce it to industry, publicize it, negotiate for a cash sale or royalty licensing.

SUCCESS HAS MANY FACES



"CAROUSEL" FIREPLACE

Over \$50,000.00 in royalties already paid to inventor for invention RLO licensed to industry.



"TWIST-OFF" CAP

Trademark and cash payment negotiated by Raymond Lee with manufacturer.



LAWN ROLLER

Invention helped publicize inventor's crane repair business.

TAKE ACTION ON YOUR IDEA!

If you want recognition, financial reward or just credit for having "invented it first", write for our FREE "Inventor's Kit." It tells how your idea may become a reality. It includes a special "Invention Record Form", an important brochure—"Your Invention... Its Development, Protection & Marketing", and a Directory of 500 Corporations Seeking New Products.

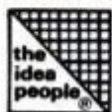

**RAYMOND LEE
ORGANIZATION, INC.**

230 Park Avenue,
New York, N. Y. 10017

Yes, I'd like to find out how to take action on my idea. Rush your FREE "Inventor's Kit No. A-129"

Name Please Print

Address

City

State

Zip

HINTS

FROM READERS



Soldering-iron support

Spring lamp-shade clip and base from a discarded iron, bolted together, make a rest for a hot soldering iron. Threaded part of clip was just right size for hole in base plate.—*Ken Patterson, Regina, Sask.*



Cleaning aerosol valves

Even the smallest needle or pin is too big to clear the tiny port of an aerosol valve, and ordinary wire is too limp. But a bristle snipped from a common wire brush is the right size (about .015 in. dia.) and stiff enough.—*W.G. Tilsher, Rosemead, Calif.*



High-visibility house number

A lighted house number is easily made by fastening metal numerals to a piece of translucent white plastic, which is hung from cup hooks. Number on white background is lit from behind by porch light at night.—*T. J. Gray, Springfield, Mo.*

144 Pages 3500 Items

Send for our New 1975

WOOD and woodshop supplies CATALOG

Fine domestic and imported Hardwoods... dimensions, blocks, plywoods. Everything for your shop... hand and power tools, upholstery and lamp supplies, cabinet hardware, clock and inlay picture kits, much more - in stock. For catalog send 50¢ for handling, postage to:

CRAFTSMAN WOOD SERVICE Dept. A-35, 2729 South Mary Street Chicago, Illinois 60608

SEND FOR THIS CATALOG

100's of illustrations & 1000's of bargains in hydraulics, electrical, marine, automotive, hardware items... and more! A must for hobbyists, sportsmen, machinists, inventors, just about everybody! Airborne's 30th Anniversary Surplus Guide is our best ever! Send 50c to cover postage & handling. In a hurry? Send \$1 for air-mail. Must include zip.

AIRBORNE SALES CO.
8501 Steller Dr. Dept. PM75
P.O. Box 2727
Culver City, Ca. 90230

Satisfying customers since 1945.

SAVE UP TO 90% ON GOVT. SURPLUS



Weld it yourself with a Lincoln AC-225

You can save a lot of money and time by handling repair jobs yourself. Lincoln's AC-225 makes weld-it-yourself easy.

Many uses: You can make welding repairs on cars, trucks, trailers, farm equipment, any metal assembly. Also fabricate your own equipment. Or do jobs like hard-surfacing or heating metal for bending.

Easy to operate: You don't have to go to welding school to use this Lincoln, just follow the simple instruction book furnished. You set a single dial to select current. Follow electrode selection guide on top of the machine. Unit plugs into standard 230 volt, single phase power source.

Dependable: Unit is built by Lincoln Electric, world's foremost welding equipment producer. Lincoln experience makes it dependable and long lasting. It's rugged and mobile (wheels optional). Top value for an economical price.



The Lincoln Electric Company

Dept. PM3-5, Cleveland, Ohio 44117

- Send free description bulletin
 Send price information

Name _____

Address _____

City _____ State _____ Zip _____

HINTS

FROM READERS



Ice-cube tray sorter

When an assembly or disassembly job involves a number of small parts, a plastic ice-cube tray with large compartments will keep them organized. —*B.W. Erwin, Kent, Ohio*



Cutting dowels safely

Dowels cut "loose" on the table saw can chatter, split off or be thrown toward the operator. They're cut safely when held in a grooved block (groove slightly larger than dowel size) clamped to the miter gauge. After each pass of the saw, the cut dowel is pushed out of the block as the other end is pushed in. —*William B. Eagan, Maceo, Ky.*

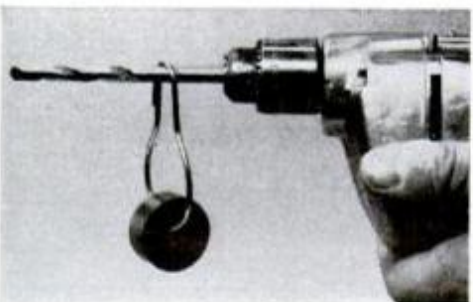

Hand-drill level indicator

At times it is necessary to drill a hole perfectly level. A weighted shower-curtain hook on the bit will serve as an indicator. With drill running and bit level, hook will stay in one place. When bit is tilted, hook will move forward or backward. Weight keeps hook from spinning with bit. —*Ken Patterson, Regina, Sask.*

"ME?"



Yes, you can install McGraw-Edison Central Air Conditioning in your home and save hundreds of dollars!

- Enjoy cool, whole-house comfort
- Increase the value of your home

If you are able to do simple "fix-it" jobs around the house, you can add central air conditioning to your forced air furnace and save hundreds of dollars by eliminating today's high installation cost. All you need are a few common hand tools and one of our complete kits. We help you select the right size unit, and provide step-by-step installation instructions. Mail coupon today for free illustrated brochure.



McGraw-Edison Company—Air Comfort Division
756A N. Clark Street—Albion, Mich. 49224

Okay, I want to know more. Please send me your brochure on Do-It-Yourself Central Air Conditioning Kits.

Name _____

Address _____

City _____ State _____ Zip _____

Fast Track to a Cool Job!

★ TRAIN AT HOME TO BE A
Motorcycle Mechanic



If you like to ride a cycle for fun... learn how to fix it for profit! Can you imagine a better way to earn your living? And to make it even better, the pay is great... whether you choose to work in a cycle shop for someone else or decide to start your own cycle repair business. Now, thanks to North American, there's a fast, easy way to get the training you need... **at home in your spare time.** No need to quit school or your job. Experts show you step-by-step everything from minor tune-ups to major overhauls.

CYCLES ARE BIG BUSINESS... AND SO IS FIXING THEM!

There are more than 3 million cycles registered in the U.S. today. Plus an estimated 3 million more dirt bikes. But there are fewer than 10,000 motorcycle mechanics available to repair them. (Imagine only one mechanic for every 600 motorcycles!) No wonder career opportunities are so great... and getting better every day. The door is open to you now. Rush coupon for FREE "Motorcycle Mechanic Career Kit."

SPECIAL CYCLE TOOLS & TEST INSTRUMENTS INCLUDED TO START YOU FAST!

Professional tools plus your North American "know-how" turn you into a skilled mechanic. We teach you how to use wrenches, sockets, impact screwdrivers, timing lights, electrical test instruments, compression gauges, vacuum gauges, degree wheels, soldering irons, ignition wrench sets, dial indicators and much, much more! We even include a set of special cycle tools and instruments to get you started fast! Find out all about it now. Send for FREE "Motorcycle Mechanic Career Kit." No cost, no obligation... now or ever! Rush coupon today.

NORTH AMERICAN SCHOOL OF MOTORCYCLE REPAIR
4500 Campus Drive, Dept. PM025, Newport Beach, CA 92663
Rush FREE "CAREER KIT" on how I can become an expert motorcycle mechanic.

NAME _____ AGE _____
ADDRESS _____
CITY _____ STATE _____ ZIP _____



energy savers

cut home fuel cost as much as 30%

You can easily apply M-D sealants and caulking around your doors and windows and stop costly drafts!



M-D CAULKING COMPOUND. Highest grade, oil base caulk. Use around wooden doors and windows.



M-D BUTYL RUBBER SEALANT. Ideal for sealing around masonry, aluminum doors and windows, gutters, flashing. Great flexibility, sets quickly, long lasting.



M-D LATEX ACRYLIC CAULK. Ideal for oil or latex paints. Won't stain, bleed. Fast drying. Paint can be applied within 30 minutes.

Stop those costly drafts around your house now. Use M-D caulking and sealants. Available at hardware, building supply and home center dealers.

Ask for M-D by name.

Macklanburg-Duncan Co.
P. O. BOX 25188 OKLAHOMA CITY, OKLA. 73125



I'd like to give this to my fellow men... while I am still able to help!

I was young once, as you may be—today I am older. Not too old to enjoy the fruits of my work, but older in the sense of being wiser. And once I was poor, desperately poor. Today almost any man can stretch his income to make ends meet. Today, there are few who hunger for bread and shelter. But in my youth I knew the pinch of poverty; the emptiness of hunger; the cold stare of the creditor who would not take excuses for money. Today, all that is past. And behind my city house, my

summer home, my Cadillacs, my winter-long vacations and my sense of independence—behind all the wealth of cash and deep inner satisfaction that I enjoy—there is one simple secret. It is this secret that I would like to impart to you. If you are satisfied with a humdrum life of service to another master, turn this page now—read no more. If you are interested in a fuller life, free from bosses, free from worries, free from fears, read further. This message may be meant for you.

By Victor B. Mason

I am printing my message in a magazine. It may come to the attention of thousands of eyes. But of all those thousands, only a few will have the vision to understand. Many may read; but of a thousand only you may have the intuition, the sensitivity, to understand that what I am writing may be intended for you—may be the tide that shapes your destiny, which, taken at the crest, carries you to levels of independence beyond the dreams of avarice.

Don't misunderstand me. There is no mysticism in this. I am not speaking of occult things, of innumerable laws of nature that will sweep you to success without effort on your part. That sort of talk is *rubbish!* And anyone who tries to tell you that you can *think* your way to riches without effort is a false friend. I am too much of a realist for that. And I hope you are.

I hope you are the kind of man—if you have read this far—who knows that anything worthwhile has to be *earned!* I hope you have learned that there is no reward without effort. If you have learned this, then you may be ready to take the next step in the development of your karma—you may be ready to learn and use the secret I have to impart.

I Have All The Money I Need

In my own life I have gone beyond the need of money. I have it. I have gone beyond the need of gain. I have two businesses that pay me an income well above any amount I have need for. And, in addition, I have the satisfaction—the deep satisfaction—of knowing that I have put more than three hundred other men in businesses of their own. Since I have no need for money, the greatest satisfaction I get from life is sharing my secret of personal independence with others—seeing them achieve the same heights of happiness that have come into my own life.

Please don't misunderstand this statement. I am not a philanthropist. I believe that charity is something that no proud man will accept. I have never seen a man who was worth his salt who would accept something for nothing. I have never met a highly successful man whom the world respected who did not sacrifice something to

gain his position. And, unless you are willing to make at least half the effort, I'm not interested in giving you a "leg up" to the achievement of your goal. Frankly, I'm going to charge you something for the secret I give you. Not a lot—but enough to make me believe that you are a little above the fellows who merely "wish" for success and are not willing to sacrifice something to get it.

A Fascinating and Peculiar Business

I have a business that is peculiar—one of my businesses. The unusual thing about it is that it is needed in every little community throughout this country. But it is a business that will never be invaded by the "big fellows." It has to be handled on a local basis. No giant octopus can ever gobble up the whole thing. No big combine is ever going to destroy it. It is essentially a "one man" business that can be operated without outside help. It is a business that is good summer and winter. It is a business that is growing each year. And, it is a business that can be started on an investment so small that it is within the reach of anyone who has a television set. But it has nothing to do with television.

This business has another peculiarity. It can be started at home in spare time. No risk to present job. No risk to present income. And no need to let anyone else know you are "on your own." It can be run as a spare time business for extra money. Or, as it grows to the point where it is paying more than your present salary, it can be expanded into a full time business—overnight. It can give you a sense of personal independence that will free you forever from the fear of lay-off, loss of job, depressions, or economic reverses.

Are You Mechanically Inclined?

While the operation of this business is partly automatic, it won't run itself. If you are to use it as a stepping stone to independence, you must be able to work with your hands, use such tools as hammer and screw driver, and enjoy getting into a pair of blue jeans and rolling up your sleeves. But two hours a day of manual work will keep your "factory" running 24 hours turning out a product that has a steady and

ready sale in every community. A half dollar spent for raw materials can bring you six dollars in cash—six times a day.

In this message I'm not going to try to tell you the entire story. There is not enough space on this page. And, I am not going to ask you to spend a penny now to learn the secret. I'll send you all the information, free. If you are interested in becoming independent, in becoming your own boss, in knowing the sweet fruits of success as I know them, send me your name. That's all. Just your name. I won't ask you for a penny. I'll send you all the information about one of the most fascinating businesses you can imagine. With these facts, you will make your own investigation. You will check up on conditions in your neighborhood. You will weigh and analyze the whole proposition. Then, and then only, if you decide to take the next step, I'll allow you to invest \$15.00. And even then, if you decide that your fifteen dollars has been badly invested I'll return it to you. Don't hesitate to send your name. I have no salesmen. I will merely write you a long letter and send you complete facts about the business I have found to be so successful. After that, you make the decisions.

Does Happiness Hang on Your Decision?

Don't put this off. It may be a coincidence that you are reading these words right now. Or, it may be a matter that is more deeply connected with your destiny than either of us can say. There is only one thing certain: If you have read this far you are interested in the kind of independence I enjoy. And if that is true, then you must take the next step. No coupon on this advertisement. If you don't think enough of your future happiness and prosperity to write your name on a postcard and mail it to me, forget the whole thing. But if you think there is a destiny that shapes men's lives, send your name now. What I send you may convince you of the truth of this proverb. And what I send you will not cost a penny, now or at any other time.

VICTOR B. MASON
1512 Jarvis Ave., Suite M-2-EC
CHICAGO, ILLINOIS 60626

Unadorned power tools ...they do the same job as tools costing up to 5 times as much.

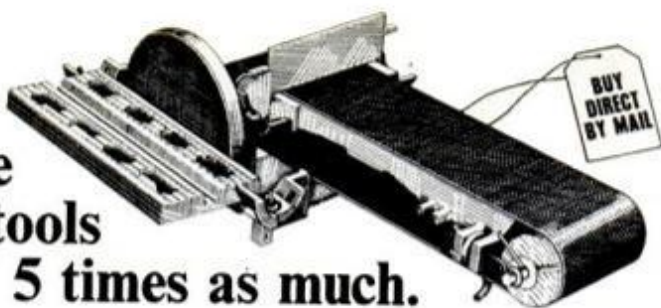

We skipped the chrome to save you money... but we did not skip anything on performance. Actually, we skipped more than just chrome, we cut out every costly frill that wasn't absolutely needed.

Our tools are not exactly flashy. We are the first to admit it. But in articles covering test results on AMT tools, written by leading publications such as Popular Science, our tools have been praised over and over again. In spite of their low prices, our tools are full scale and offer full performance and precision.

HERE'S HOW WE DO IT... First, we don't claim our tools should sell for five times the price! Just that our tools do the same job... with the same accuracy, ease and speed... and will last at least as long. AMT tools cost less to make and are sold direct. They are bona fide quality power tools used by serious amateurs and professionals alike and if sold in retail stores would be much higher in price. We use no magic, let's be specific:

SIMPLICITY... AMT tools are soundly engineered to eliminate every frill and gimmick—to minimize material and production costs. Machined parts are used only where they're needed. Unadorned cast iron and aluminum save you a fortune.

DIRECT-FROM-FACTORY SAVINGS... You save a bundle, yet we offer a double guarantee backed by a 45-year-old company with millions of satisfied customers... and hundreds of orders pour in daily. **LARGE VOLUME...** Our own foundry and large mass production facilities plus large buying power all work to keep costs down.

STANDARD PARTS... Our designs use standard hardware items wherever possible. By avoiding custom-made parts we pass on tremendous savings to you.

If you are looking for power tools that perform like units costing many times our low prices, order today and you'll be one step closer to many hours of woodworking satisfaction.

Bill Morley

JOINTER-PLANER 4 1/4" x 22". Cast iron and steel, precision ground adjustable tables. For planing, joints, bevels. Cuts to 1/4" depth. Fence adjustable 0° to 50°. Steel Knives, dual guards. Use any motor. Precision ball bearing industrial model, \$10.00 add'l. Wt. 19 lbs., f.o.b. factory.



\$3780

TWO GUARANTEES

10-DAY MONEY BACK GUARANTEE
Try any of these power tools and compare it with any similar machine at any price. If not satisfied, return it for prompt, no questions asked refund. We pay the return shipping charges.

10-YR. FULL SERVICE GUARANTEE
Any part or parts of these AMT power tools (except motor which carries a one year guarantee) which become inoperative for any reason within ten years after purchase date will be repaired or replaced by the factory with no cost to the purchaser other than postage.

AMERICAN MACHINE & TOOL CO.
4th & Spring St., Royersford, Pa. 19468

AMERICAN MACHINE & TOOL CO., Dept. PM35, Royersford, Pa. 19468

Please send me the units checked. Payment in full enclosed \$_____ or \$5 deposit each item enclosed, balance C.O.D. I must be fully satisfied or will return unit within 10 days for full refund. No questions asked.

- 8" Power Saw at \$29.95
- Standard Rip Fence at \$4.50
- Long Cabinet Rip Fence at \$5.50
- Ball Bearing Spindle at \$7.50
- Belt Sander at \$28.00
- Disc Sander Attachment at \$7.95
- Mitre Gauge for Sander at \$1.95
- Drill Press at \$48.80
- G.E. Motor \$24.90 (with other item)

- Jointer Planer at \$37.80
- Ball Bearing Spindle at \$10.00
- Wood Shaper Kit at \$25.95
- Opt. Hold Down Assembly at \$3.95
- 6" Swing 3' Lathe at \$19.80
- 12" Swing 4' Lathe at \$39.10
- Face Plate \$2.50 (either Lathe)
- Turning Chisels \$6.95 (either Lathe)
- \$29.85 (purchased separately)

NAME _____

ADDRESS _____

CITY _____

STATE _____

ZIP _____

BUY DIRECT
...USE THIS HANDY
ORDER COUPON
NOW



Brand new electric motor developing full 1 h.p. 17 lbs. (Purchased separately, \$29.85). With any AMT machine here. **\$24.90**

POWER SAW 8" tilt arbor saw... cross-compound angles, dados, coves, moldings. Completely assembled with ground cast iron table, safety guard, splitter, mitre gauge. Less blade, motor. Rip fence for easier work alignment. \$4.50 add'l. Ball bearing model. \$7.50 add'l. Takes 1/3 h.p. motor or larger, standard blades, attachments. Wt. 26 lbs., f.o.b. factory



\$2995



FREE OFFER, cabinet base plans... with one piece of 3/4" plywood, convert your \$29.95 saw into a floor model with a huge 27" x 24" top. Takes cabinet rip fence, \$5.50 add'l.

BELT SANDER A precision unit. It changes from horizontal to vertical in seconds. Heavy, sander includes 4" x 36" sanding belt. Uses 1/3 h.p. or larger motor. V-pully drive and multi-purpose drive spindle. Disc sander accessory, \$7.95 add'l. Mitre gauge, \$1.95 add'l. 15 lbs., f.o.b. factory



\$2800

3' WOOD LATHE ...6" swing. Same precision and speed as \$40 units. Sturdy cast iron with tubular steel bed. Lever action tail stock, two-speed pulley, fits any motor. Set of 3 high speed turning chisels, \$6.95 add'l. 4" face plate, \$2.50 add'l. 15 lbs., f.o.b. factory

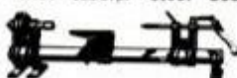

\$1980

4' WOOD LATHE ...12" swing. Industrial size, does the same job as \$75 units. Tubular steel bed rails, screw action tail stock, three-speed pulley. Use any motor. 3 high speed turning chisels, \$6.95 add'l. 4" face plate, \$2.50 add'l. 30 lbs., f.o.b. factory



\$3910

DRILL PRESS Precision 32" radii, unit has standard features and many extras. Depth of throat up to 16". Head tilts and table stays level. Drills to center of a 32" circle. All cast iron and steel. Takes standard motor. 32 lbs., f.o.b. factory



\$4880

WOOD SHAPER KIT Makes beads, coves, and-groove joints, etc. Accurate cuts at high speeds. Sealed greased-for-life ball bearings. Less wood. Takes 1/4 h.p. motor or larger, standard cutters. Optional hold down assembly, \$3.95 add'l. 9 lbs., f.o.b. factory



\$2595

PHOTO HINTS

FROM READERS

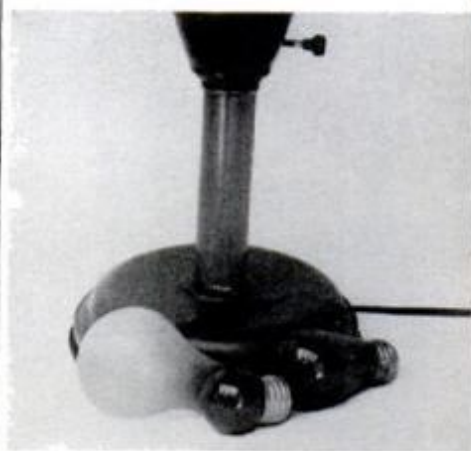

Dirt-cheap safelight

A standard 7 1/2 or 10-watt red bulb will turn just about any lamp into a safelight for pennies. But make sure the bulbs you use are safe by covering a strip of enlarging paper with a coin; then exposing paper to the safelight for five minutes. If the coin's outline is visible, safelights are too close, too bright or the wrong color and will cause fog.—Gary Cosand, San Bernardino, Calif.



Sliding shelves for big blowups

Sliding shelves under your enlarging table are handy for big blowups from small enlargers. Just reverse your enlarger (with its baseboard weighted, as shown, or clamped to prevent tipping) to project onto a shelf. Distance between shelves should be less than height of enlarger's column to permit full image-size adjustment. If shelves are 20 inches wide, they'll store two boxes of 8x10 paper side by side.—William M. Phillips, Tallahassee, Fla.

COUNTERFEIT GUNS

Authentic machined metal replicas of famous firearms disassemble like originals.

Precision machined metal models look, feel, weight, disassemble like real guns—Over 30 hand finished parts. Perfectly legal—CANNOT be fired. Great for decorating den, office, rec. room. Send for free color brochure of 28 models of famous historical to modern military firearms.



U.S. .45
#300
\$28.95

REPLICA MODELS Inc.
Dept. PM-3, 610 Franklin St., Alexandria, Virginia 22314
Send #300 Add \$1.25 postage per model.
Enclosed \$

NAME _____
ADDRESS _____
CITY _____ STATE _____ ZIP _____
 PLEASE SEND FREE FULL COLOR CATALOG.

FLUSH-UP

BASEMENT TOILET
Flushes up to existing sewer or septic tank by powerful self-contained pump. No digging up floors, etc. Clog resistant. Make basement into game room, bar, guest room, etc. with private bath.



Write for FREE LITERATURE
DOSS MFG. CO., Dept. J-25
Box 10947, Houston, Tex. 77018

U.S. Labor Dept. reports "openings for 26,000 Surveyors next 10 years." Easy home-study plan guides you. Send for FREE "Surveying Career Kit."

SURVEYING PAYS BIG

APPROVED FOR VETERANS
Name _____ Age _____
Address _____
City _____ State _____ Zip _____

NORTH AMERICAN SCHOOL OF SURVEYING
4500 Campus Dr., Dept. P-11023, University Plaza, Newport Beach, CA 92663

Just Pick the Kind of Body You Want... and you can have it almost overnight.

FREE BOOK

Here's the kind of body I want:

- Broad chest,
- Big shoulders,
- Powerful arms, grip,
- Powerful legs,
- Slimmer waist, hips,
- More weight, solid.

Send your name and address for Free Book to:
CHARLES ATLAS, Dept. C8, 49 West 23rd St., New York, N.Y. 10010

HOW TO BECOME A LOCKSMITH

COMPLETE BOOK OF INSTRUCTIONS How To Fit Keys, Change Combinations, Master Key Locks, Keys By Number, Tools To Use, etc. Detailed illustrations. Satisfaction guaranteed. Get started! Order today.

Only **\$3 ppd**

A.V. Ancele, P.O. Box 69234, Los Angeles, Ca. 90069

A Family Heirloom That's A True Bargain

Collecting back issues of Popular Mechanics has never been more worthwhile. Thousands of libraries and schools have extensive collections, many dating back to 1902, our first year.

An issue from the 20's or 30's is fascinating. You see a clear image of the era that vividly communicates the technology and quality of life perhaps better than any other periodical. Your collection of PM will become a family heirloom that will give the same joy of discovering the past to your grandchildren that a 1920's issue of PM gives to you.

The annual Index-Shelf Wrapper is an inexpensive aid to the serious collector of PM and one of the few true bargains in publishing. Take advantage of it.

Index-Wrappers are available for 1974, 3, 2 & 1 @ \$2.69 per year postpaid. Make check payable to "Popular Mechanics", specify years desired and mail with name and address to: PM INDEX, Box 1014, Radio City, N.Y. 10019

Now you can buy a '74 Hertz used car.

Call 800-654-3131 for the nearest Hertz corporate sales location and the name and location of participating Hertz system licensee.

Save \$100⁰⁰

Bring in this ad and get \$100 off the retail list price of any Hertz used car at Hertz corporate sales locations and at those of participating Hertz system licensees. Offer expires March 31, 1975. Good only in U.S.A. One coupon per purchase. All sales taxes paid by customer. Offer void where restricted or prohibited by law. Subject to state and local regulations.

ALL CARS FROM THE RENTAL FLEET



© HERTZ SYSTEM INC. 1975

Print Your Own

Cards, Stationery, Advertising, labels, tickets, announcements, QSL cards, greeting, sympathy, prayer cards, etc. Save money. **Print for others, good profit.** Have home print shop. Pays for itself in a short time. Sold direct from factory. Easy rules sent. We supply everything. Send \$2 for catalog. **KELSEY PRESSES** Meriden, Conn. 06450

MAIL THIS COUPON TODAY **Kelsey Presses Dept. 75-8P Meriden, Conn. 06450**

I enclose \$2 send big catalog and free samples.

Name _____
Address _____
City _____ State _____ Zip _____

WHAT'S HE DOING!

Making a Concrete Flower Pot! ... and **SO CAN YOU!**

Make and sell your own Ornamental Concrete items. **Rush \$3.00 for Book** about Aluminum Molds with prices and production trade secrets direct from world's largest mold manufacturer. Over 350 designs to select from.

Send **\$3.00** **CONCRETE MACHINERY COMPANY**
Today To ➔ P.O. BOX A99 - HICKORY, N.C. 28601

RONSON

Multi-Fill fuels most butane lighters

From **65¢**

The clean quality butane that won't clog.

FLEXI-FIRE

the versatile, easy-to-use propane torch with exclusive up-front flame control valve.

FLEXI-FIRE USES include auto body repair, metal sculpture, removing paint, soldering tubing, removing nuts, bolts, repairing utensils, thawing pipes, drying spark plugs. Hundreds of uses for home, garage, farm, laboratory, hobby, boat, auto, etc.

The Flexi-Fire kit contains

- Up-front flame control valve with molded grip
- 4 ft. flexible hose
- fuel cylinder
- wire form support
- metric thread pencil point tip
- brass adapter for standard thread tips

only \$15⁹⁵ each

Cal. residents add 6% sales tax

- Check enclosed for _____ Flexi-Fire kits. Ship postpaid.
- Send C.O.D. Deposit of \$5.00 per kit is enclosed and I'll pay postage.
- Send information about Flexi-Fire and the latest Solidox Braze/Weld Torch.
- Also info on other brass tips (pinpoint to blowtorch).

Name _____
Address _____
City/state/zip _____
Mail to: **CLEANWELD PRODUCTS, INC.**
4000 Medford St., L.A., Calif. 90063

Free!

'75 SPRING KIT CATALOG

72 color illustrated pages of back-packing and camping equipment. In either ready-made items or sew-it-yourself **HOLUBAR EQUIPMENT KITS.**

Choose from:

- Sleeping Bags
- Sweaters
- Tents
- All-Purpose Bags and many more!

IN MONEY SAVING SEW-IT-YOURSELF KIT FORMS!

Send for your FREE copy today!

Holubar

Dept. 3-123C Box 7 Boulder, Colo. 80302

A great time to save!

TAKE BOTH FREE

with membership in the POPULAR SCIENCE BOOK CLUB

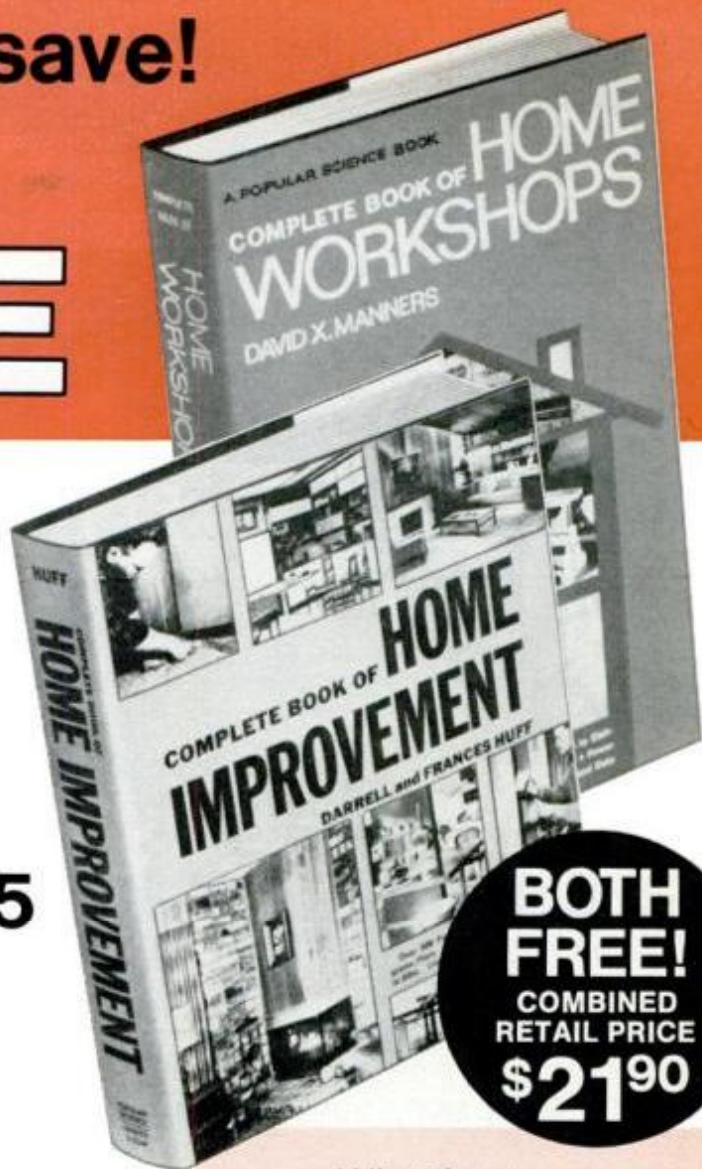

with your
first
Selection
for **\$5⁹⁵**
only

470 pages.
Reg. \$9.95

You get this book free:

The Complete Book of Home Improvement — all the practical, step-by-step guidance you need to turn an empty space into a useful one or make an old room new again. Hundreds of up-to-the-minute ways to improve your floors and walls . . . add a skylight . . . modernize your kitchen and bathroom . . . add a fireplace . . . add living space and more. Ways to save money while adding to the livability and value of your home.

And you get this book free:

The Complete Book of Home Workshops. With over 750 illustrations, plus floor plans for ingenious new shop layouts, whether it's shop-in-the-box or the most lavish setup. All the information you need to make your job easier: choosing the best tools (from drills to lathes, vises to stud drivers), advice on building your own equipment and more — a storehouse of knowledge you'll turn to for years to come!

And you save \$4.00 on this book:

The Homeowner's Complete Outdoor Building Book — your first Selection — for only \$5.95 (Reg. \$9.95). Helps you to look at your yard with new eyes . . . gives you lots of ideas for outdoor woodworking and masonry projects . . . with easy plans for building everything for your yard from a birdhouse to a garden house. Over 265 projects: trellises, fences, shelters, tool sheds, outdoor furniture, garden steps, terraces, pools, and so much more.

Imagine — three essential volumes — selling for \$31.85 — all yours for just \$5.95 with membership.

Start saving on the books that will help you save by doing it yourself. Just mail the postpaid card today!

**BOTH
FREE!**
COMBINED
RETAIL PRICE
\$21⁹⁰

What happens when you join the POPULAR SCIENCE BOOK CLUB

- First, you get *THE COMPLETE BOOK OF HOME IMPROVEMENT* and *THE COMPLETE BOOK OF HOME WORKSHOPS* (worth \$21.90) free! Plus, your first Club Selection, *THE HOMEOWNER'S COMPLETE OUTDOOR BUILDING BOOK* (a \$9.95 value) for only \$5.95.

- Then, about every four weeks, you'll receive a Club bulletin describing the coming selection and alternate selections. If you want the selection, do nothing; it will be sent to you automatically. If you don't want the selection or want alternate books, simply indicate your wishes on the card provided and return it by the date indicated. To maintain all membership privileges, you need only buy two discount-priced books per year. You may cancel your membership at any time after buying just two selections in the first year.

- Remember, as a Club member, you'll be offered the best books available on home improvements and repairs, house building, how things work, appliance repairs, science, cars, math, mechanics, engineering, electronics — a broad range of practical and technical subjects. All at savings of 25% to 60%!

- And, even after examining the book, if you're dissatisfied for any reason, you may return it within 10 days for a full credit.

MAIL ATTACHED CARD TODAY or write to **Popular Science Book Club** 44 Hillside Avenue
Manhasset, N.Y. 11030



Build strong hands as you fight strong odors.

Propellant makes up a large part of aerosol anti-perspirants. With Mennen non-aerosol anti-perspirant, you're the propellant. So you get only what you pay for — anti-perspirant spray.

Squeeze on Mennen Anti-perspirant Spray.



AMPLIFIERS GROW MORE HONEST—AND MORE FINS

(Continued from page 81)

will add an extra cost to many amplifiers.

Amplifier size will go up, too, if amplifier makers choose to use more and larger fins for cooling, rather than adding fans or extra output transistors.

How much will this cost increase? Estimates differ from a low of about 10 percent to a high of more than 50 percent. But some amplifiers already incorporate the heavy, conservative construction that's necessary to pass the FTC's test—and the one 400-watter which will pass it with flying colors now is priced about one-third higher than a couple of very good 400-watters which won't.

The question is: Who's right—the manufacturers of the amps that flunk, or makers of the heavy-duty amplifiers and the FTC? If an hour of hot, one-third-power operation really corresponds to home use, then the new FTC requirement should have been imposed years ago. But if this, in fact, was a reality, then, the amplifiers that flunk the FTC test would have been flunking out in home use, too. Their protective

circuits would have switched them on and off as heat overloads occurred.

Of the manufacturers and engineers PM polled for this article, only one could recall a case of an amplifier coming back to his factory because it cycled on and off that way—"and that was an amp whose bias had been misadjusted."

Dynaco points out that though they offer an optional fan for extra cooling, very few users have felt the need to order one. And, says Dyna's Bob Tucker, some amplifier makers are moving their protective heat sensors farther from the output transistors to delay shutdown—which improves their amp's ability to pass the test, but also reduces somewhat the sensors' margin of protection against damage to the amplifier.

Yet only one manufacturer could even conceive of a home user running his amplifier at its least efficient, hottest power point: "Under normal conditions in a well-designed system, an amp usually delivers 10 percent of its power. But when a nut takes inefficient speakers, turns the bass up, and turns the volume up to clip-

ping, he drives the amp to about 40 percent power."

So maybe the makers of at least some amplifiers that won't pass the preconditioning test are right. That means the FTC is wrong—but not the makers whose high-power amplifiers will pass. There's nothing wrong with buying a more robust amplifier than you need, so long as you're willing to pay the extra price for it. But buying a battleship instead of a powerboat of equal speed should be *your* choice—not one that's foisted on you.

Not that a "battleship" amplifier is an entirely unjustified expense. As BGW's Brian Wachner points out, the smaller the temperature increase between room temperature and the operating temperature of an

How to uprate a 15-watt amplifier—the old, now illegal, way

1. Start with a stereo amplifier delivering, per channel, at 1-percent distortion, 15 watts.
2. Double it for total power of both channels: 30 watts.
3. For "music power," add 30 percent.
4. For EIA ratings (at an implicit 5-percent distortion), add 20 percent.*
5. For maximum power at unlistenable distortion levels, add about 35 percent.*
6. For " ± 1 db," add 25 percent.
7. For "peak" power, add 100 percent.
8. For "Maximum IPP (Instantaneous Peak Power) watts ± 1 db" power, add all the above (except No. 4) to get: 132 watts.

*Exact values will vary from one amplifier design to another.

amplifier's output transistors, the longer those transistors will last; each 10° reduction roughly doubles their lives. But other sources say other factors cause the major limits to transistor life.

Even Wachner agrees that the one-third power test "wasn't the greatest thing to pick." But he feels that, had he written the standard, he would have included "some test of amplifier thermal capacity; thermal design has lagged behind circuit design, so far. In our amplifiers, we think every 2° or 3° is worth fighting for."

Power ratings into 4-ohm loads can cause another problem under the new FTC rule. Transistor amplifiers mostly deliver more power into 4-ohm loads than into 8 ohms, and more still into 2-ohm loads. But since more power means more heat, even an amplifier or receiver that could run cheerfully forever at one-third its 8-ohm power might sizzle at one-third of its higher, 4-ohm power potential.

From the standpoint of amplifier makers, the simplest solution would be not to list a 4-ohm power rating:

"We don't rate power at 4 ohms," says Radio Shack engineer Frank Roberts, "because we don't sell any 4-ohm speakers."

But though the rule, as written, is ambiguous, there are rumors the FTC will insist on 4-ohm ratings, too. Even though most speakers are 8-ohm models, there are a lot of 4-ohm models. And even 8-ohm speakers will present a 4-ohm load if you run one main and one remote speaker in parallel.

It's also possible simply to claim less power at 4 ohms than the amplifier can actually deliver, and precondition at one-third of this lower level. "Ironically, though," adds Don Merryman, an engineer at H. H. Scott, "our amps deliver as much power at 4 ohms as they ever did, under music listening conditions—more power, in fact, than they do at 8 ohms. Only now we can't say so."

If power at 4 ohms is understated, or unstated (which could lead buyers to assume it's the same as at 8 ohms), the hi-fi buyer with 4-ohm speakers can get more than he bargained for.

That's not entirely an advantage, Dynaco's Bob Tucker points out: "If the FTC rule forces amp manufacturers to, in effect, underrate 4-ohm power, you could buy an amplifier rated well under your speakers' maximum rated power-handling capacity and then blow out your speakers anyway with the power you didn't know was there."

"And if manufacturers stop stating 4-ohm power at all, speaker makers might conceivably list their 4-ohm speakers as 8-ohm models (the impedance of a speaker rated at 4 ohms is 8 ohms or higher at some frequencies, and maybe 3 ohms or less at others, so the rating is more or less nominal). That means a consumer could wire up two, or even three, '8-ohm' speakers in parallel and have the amp go crazy looking at a load that could be less than 2 ohms at some frequencies."

What is the hi-fi industry doing about the new FTC rule? Some, chiefly Phase Linear, Dynaco and *Stereo Review* magazine, are protesting it. Others, chiefly those who bring out new models each year anyway, are welcoming it. Still others aren't paying it much attention, either because their products have no problems with the rule or because they haven't yet grasped the fact that they have a problem.

As one maker of low-priced equipment stated candidly, "I don't think the FTC intends to enforce the rule literally. They're reasonable people. But if they did, we'd definitely have to change our designs." ★★★

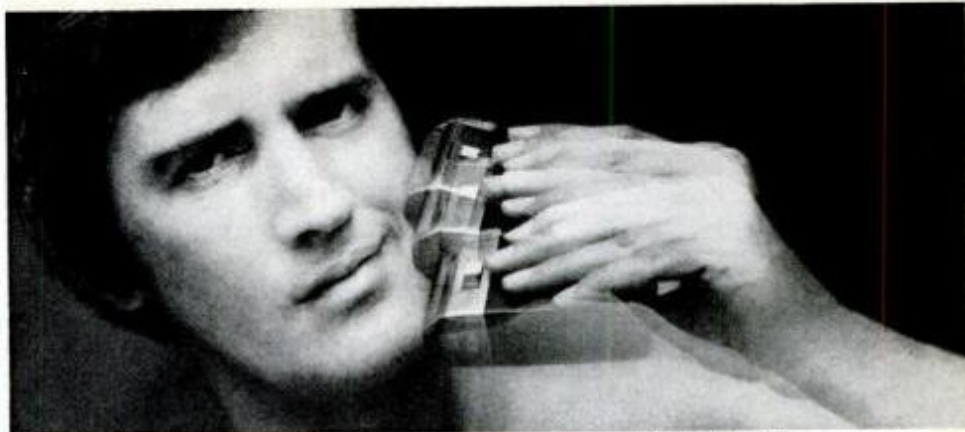

It's tough to cut a whisker when it's down.

Mennen Prop: Cool, refreshing electric pre-shave that props-up your beard and conditions your skin for closer, smoother shaves.

Prop-up your whiskers.



SERVE YOUR GUESTS WITH A DASH OF ELEGANCE

(Continued from page 91)

of two facing legs and draw a line across the tops. Do the same with the other two legs. Now tilt your drill-press table to correspond with the cross lines on the legs, and drill a series of $\frac{3}{8}$ -in. holes $\frac{3}{8}$ in. deep in one pair of legs. Do this for the others, tilting the table the other way.

To build the top, you'll have to edge-glue several boards and join them with dowels. Each butler-table hinge has a single-thickness leaf and a double-thickness one. It's standard to rout both mortises to suit the thicker leaf, then shim under the thin leaf. A bevel will have to be hand-chiseled at the outer edge of each mortise for hinge clearance.

If your router has a 5-in.-dia. base (most do), you can make your plywood hinge-mortising template the size given; if not, cut it to suit. Use the template's centerlines to position it over the hinge locations and place cardboard between the top and tray leaf for clearance. Then hold template, plus top and leaf, with C-clamps. The eight hinges can be purchased from Armor Co., Box 290, Deer Park, New York 11729, for \$16 postpaid. ★★★



Edges of built-in tray handles are rounded with router after forming curved openings with a $\frac{3}{4}$ -in. drill bit and sabre saw.

Cleats on underside of the tabletop fit inside aprons to register top automatically with the base when placed in position.



KEEP DRINKING WATER SAFE

(Continued from page 110)

laboratory to make a pathogenic survey, which can be done cheaply by your local public health department.

5. The laboratory should be supervised by a graduate chemist.

Once you have selected a laboratory, you will be told how to draw water samples properly for testing. Some laboratories don't leave this critical task to homeowners, but will send out experts to assure that the samples are not accidentally contaminated in the process.

If the lab report comes back indicating you have a problem, the first thing to do is study the type or types of contamination present, then pick the proper water-purification equipment suited to the condition. Don't be fooled by gadgets billed as "purifiers" that, in fact, are merely intended to remove certain minerals that make water "hard." Dangerous pollutants need specialized treatment. Inorganic and some organic chemicals can be removed by reverse osmosis. Organic substances can be eliminated by carbon filtration. Harmful bacteria (pathogens) can be killed by chemical or ultraviolet disinfecting. You may need

one, two or all three of these depending on the condition of your water.

A reverse-osmosis purifier uses a thin plastic semipermeable membrane resembling ordinary plastic wrap. The membrane is wound spirally around a central core and rejects dissolved inorganic substances and organic matter, while allowing purified water to pass through. Water entering the purifier receives a prefiltering through porous cellulose to remove turbidity and solid suspended matter that might clog the reverse-osmosis membrane. It also passes through a final filter of carbon after flowing through the membrane.

Such a reverse-osmosis unit is connected into the household water supply and uses normal water pressure to force the water through the membrane. Impurities trapped by the various filters drain into the home's sewage system, while purified water flows into a storage reservoir ready for use. A small home-type reverse-osmosis unit provides three to five gallons of purified water a day—enough for drinking and cooking. Your regular water supply is used for bathing, toilet-flushing and other nonconsumptive functions.

Where only toxic organic pollu-

ants are present, an activated carbon filter can be used. The carbon works by adsorption—dissolved impurities (or gas or odors) adhere to its pores, allowing purified water to pass through. Besides removing harmful organic contamination, a carbon filter is also excellent for eliminating hydrogen sulfide (so-called sulfur water that emits a rotten-egg smell), chlorine and other nontoxic matter that gives water an unpleasant taste or odor, but is not necessarily dangerous.

In time, the pores in a carbon filter clog up and can no longer adsorb impurities. When this happens, the element must be discarded and replaced with fresh carbon, usually once a year. To prolong the life of a carbon filter and keep it functioning efficiently, modern filter tanks are equipped with timing devices that provide automatic backwashing. During backwashing, water is forced through the carbon bed in reverse direction to flush accumulated waste matter down the drain. Normally, backwashing is set to occur once a week for about an hour. Without backwashing, a carbon filter would fail long before its usual one-year life expectancy, so be sure to look for

(Please turn to page 148)

RONII™...the disposable butane lighter by RONSON

Has at least **20%** more butane than other leading disposables... and gives many more lights.

- Expertly designed by Ronson, RONII holds at least 20% more butane to give you many more lights.
- Safe, Reliable, Durable.
- Fuel supply window tells you at a glance how much butane is left.
- Fingertip adjustable flame... low for cigarettes, medium for cigars, high for pipes.



- Attractively styled with stainless steel windscreen, in four exciting colors: black, red, blue and yellow.
- Guaranteed by Ronson, World's largest manufacturer of lighters and lighter accessories.

RONSON
DIFFERENT BY DESIGN AND BETTER BECAUSE OF IT

AND MORE

Earn Up To \$8 an Hour

In A Service Every Community Needs...

NEW
Weekend
or
Spare time
Business
of your own

Sharpen Saws and other tools for home and industry the easy **Foley** way



Now's the time to cash in on the huge demand for professional saw sharpening service. With Foley Saw and Tool Sharpening equipment you can sharpen regular saw blades, carbide tipped and high speed steel blades, as well as router bits and other tools—and do a perfect job every time! You need no experience or training.

Profitable Business of your Own with Minimum Investment Needed

There's no need to make a big investment or tie yourself down to long hours of work when you're "business for yourself" with Foley Sharpening equipment. You can set up for business anywhere: in your own basement, garage, tool shed or work room. Best of all, there is *no* stock to carry, *no* selling, *no* canvassing. Ninety cents out of every dollar you take in with Foley Saw Sharpening Equipment is *pure profit!* Takes only a few minutes to sharpen a regular saw for which you can charge \$2.00, and only 15 minutes to sharpen a carbide tipped blade for which you can charge \$8.00. And Foley wants you to be successful so we help you with minimum investment.

No Experience Needed—Start Making Money At Once

It used to take years to become a saw sharpening professional when the work was done by hand. But with Foley equipment, *anyone* can precision sharpen saws and other tools *every time* because the Foley equipment is built for accuracy—it does the job for you—and you reap the profits. If you are handy with your hands, this is an ideal business for you to get started in. You set the amount of extra money you want to earn. You are your own boss.



Town of 150 Supports Profitable Business

Even small towns are profitable. Dick and Jo Ann Koester were in business less than a year when they told Foley: "We have acquired another Foley Saw Filer and for the past two months we have been in full-time operation. As we live in a small town of 150 population in a farm area, we use our truck to pick up saws in five nearby towns. We already sharpen an average of 15-20 saws a day. Business for the future looks even better as good machine filing is our best advertising."



Growth of Carbide Tipped Saws Bonanza to Saw Sharpening Shop

Manufacturing firms of all sizes are switching to the new carbide tipped blades and that means an extra bonus to saw sharpening shops using Foley's special Carbide Grinding Equipment. The Foley Carbide Grinder precision sharpens dozens of different carbide tipped saws and tools. And with the average charge for resharpening a carbide tipped saw blade at a U. S. average of \$8, that's a tremendous bonanza to those who have the proper equipment.

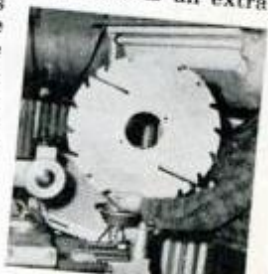

Saw Sharpening Is Needed Everywhere!

People all over the country, just like yourself, are earning excellent money in the saw sharpening business—because it's growing every day. Beginners in their first week can earn \$8 an hour. Many find their sparetime idea blossoms into very profitable full time service business. You can do it, too! Find out how today!



RETURN
this coupon
for full
details:

Foley Manufacturing Company

316-5 Foley Building,
Minneapolis, Minn. 55418

Foley

Yes, I want to find out more about the profits in the Saw and Tool Sharpening business. I understand that there is no obligation

Name _____

Address _____

City _____

State _____ Zip _____

KEEP DRINKING WATER SAFE

(Continued from page 146)

this feature when purchasing a unit. Be sure, too, that the unit you buy is specifically designed to remove *toxic* pollutants—not just odors and bad taste, as some simple filters do. Reliable makers of filters—both the carbon and reverse-osmosis kind—will gladly specify exactly what impurities their units will eliminate, so check on this when deciding which type you need or whether a particular model will satisfy your requirements.

Bacteriological pollutants cannot be filtered out of water—they must be killed before they reach the tap with disinfecting chemicals or ultraviolet light. Chemical treatment is the oldest and most common method. The agent used is usually chlorine, but iodine, bromine, potassium permanganate and other chemicals may also be employed. The chemical in solution form is fed into the water supply by automatic pumps programmed to inject just the right amount to destroy pathogens.

While the method is effective, chemical disinfecting has some

drawbacks. The chemical must be carefully monitored to make certain excess amounts do not get into the water as it could then become poisonous itself. Also, there is some suspicion in medical circles that chemical disinfecting can have a long-range adverse effect on health, even in small quantities. Finally, the chemicals used can give water a bad taste.

The more modern ultraviolet light method avoids these problems. Ultraviolet germicidal lamps are available in cylindrical units with standard plumbing fittings at the ends. The cylinder is simply cut into the water intake line. As water flows through it, the ultraviolet light kills any pathogens it may contain. Such units have their own disadvantages, however. One is cost. Each fixture sells for about \$200 and unfortunately must be replaced approximately once

MAN-SIZE **ECONOMY** TRACTOR

No-nonsense power for the serious gardener

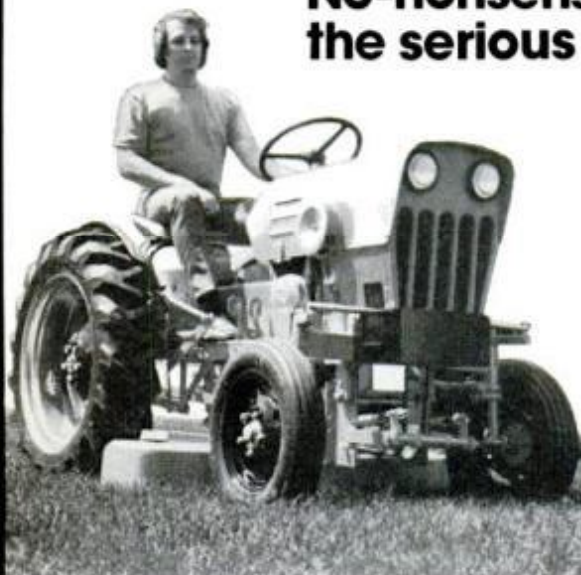

If you grow more than just a lawn on one to 20 acres, you need a tractor that will do more than just mow. You need the versatility and power of an Economy.

Not a toy, this rugged tractor has extra weight and traction to give you more push and pull-power, yet uses less gas per job. Automotive all-gear drive converts nearly 100% horsepower to workpower. Electromagnetic clutch gives you full control of powered attachments simply by pushing or pulling the dashboard switch. And for added safety, an electric interlock prevents tractor starts while attachments are clutch-engaged.

Mount attachments easily with new quick-hitch. Plow with ease. Prepare seed beds with 32" tiller. Plant, cultivate, fertilize and spray. Mow 2 to 3 acres an hour with the 60" rotary mower. Bulldoze with the 48" angling blade. Load gravel or dirt with the ½-ton bucket. Or cut a path through deep snow with the 42" snowblower. Handle all your garden and yard chores with over 20 attachments.

Write today for free color catalog.

c-29

ECONOMY TRACTOR

1005 K-3 Anoka Avenue
Waukesha, Wis. 53186

Bacteriological pollutants cannot be filtered out of water—they must be killed before they reach the tap . . .

a year at the same cost. In addition, such units are not effective if your water is turbid or contains iron salts as the light rays can't penetrate the particles to kill the pathogens. This means your checking should include tests for iron salts and turbidity if you decide on using ultraviolet disinfecting. If either cost or your water condition rules out the ultraviolet method, you can always fall back on chemical treatment.

One caution: Home water-purification systems are designed primarily to combat *mild* and *nonlethal* forms of contamination. If you find your water supply seriously polluted, such as with sewage, don't fool around with home remedies. Report the condition immediately to your local health department (if they made the original survey, they will, of course, know about it already and presumably will take action). In any case, be sure that action is taken to correct the condition at its source—not in your home. If your water is polluted, your neighbors' may well be, too, especially if they draw from the same or similar source as you. Raw sewage seeping into a water supply is too deadly to take chances with and must be stopped before it reaches your home.

Otherwise, you can be relieved to know that water impurities can be eliminated—and quite easily—a comforting thought in this increasingly polluted world. ★★★

YOUR OWN "REFERENCE LIBRARY" FOR ONLY \$2.45 A YEAR

**Popular
Mechanics**

1974 Index

The 1974 Popular Mechanics *Index-Shelf Wrapper* actually converts your '74 PM issues into a formidable "reference library." That's right, over 5,000 entries have been indexed and cross referenced.

The index is built-in to a handsome shelf wrapper of sturdy, high gloss lacquer board designed to withstand years of use. Precisely encasing twelve issues, it's an attractive addition to the most tasteful book shelf arrangement.

As years pass, your PM issues will increase in value. You'll enjoy the satisfaction of retrieving articles, as you need them, from a growing *information bank*.

Needed information "jumps out" of back issues at your beck and call—A Cartop Penthouse For VW Beetles; 16 Ways To Hide Ply-wood Edges; How To Build Custom Camera Bags, and hundreds more, all at your finger tips! Or you can find *all* the articles on broad categories such as auto repair, aviation, basements, batteries and beds. Why wait? Start your "reference library" now!

(A limited supply of 1971, 2 & 3 Index-Shelf Wrappers are still available.) Please clip and mail with check or money order.

TO: PM INDEX-SHELF WRAPPER,
Dept. C5 Box 1014, New York, N.Y. 10019

Please rush me the Index-Shelf Wrappers for the years checked below. I enclose a check or money order for \$2.45 plus 25¢ shipping for each.

1974 1973 1972 1971

Name _____

Address _____

City _____

State _____

Zip _____

HM SPECIALTIES

SAND-O-FLEX®

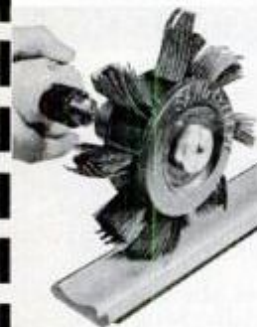

**Eliminates
tedious
hand
sanding**

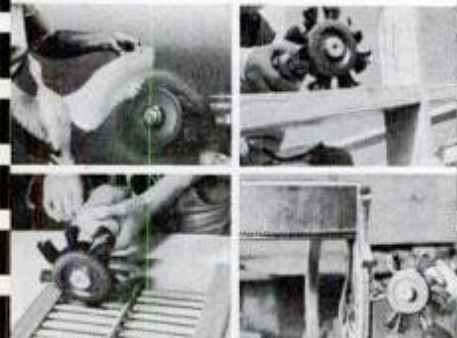

Why rub your fingers to the bone? A Sand-O-Flex Wheel gives you thousands of flexible sanding "fingers" for fast, professional sanding of wood...paint...ceramics...metals. For use on all surfaces—curved or flat. Save hours refinishing furniture, sanding wood carvings and driftwood, preparing shutters prior to painting. Hundreds of uses: Boats, frames, molding, fishing gear, patio furniture, shop and garden tools.

If not available at your lumber yard, hardware or hobby stores, **ORDER SANDER KIT BY MAIL** \$24.85 value. 8 brush 6" wheel and 3 abrasive refill coils. Adapters fit 1/4" drill \$21.95 or bench motor. No C.O.D.'s. Add \$2.00 for postage.

Write for FREE Home Workshop Brochure on sanding hints.

MERIT ABRASIVE PRODUCTS, INC.
201 W. Manville, Compton, California 90224

The kite that soars.

You wouldn't expect an eagle to just fly, would you? Amazingly life-like golden brown/black eagle printed on transparent plastic. 48" x 30"; 500 ft. of nylon string included. \$7 ppd. We have kites from all over the world. Kite poster catalog, 25¢.



go
fly a
kite

1434 THIRD AVE., N.Y.C. 10028, DEPT. D

Planer Molder Saw 3 Power TOOLS in 1 Feed

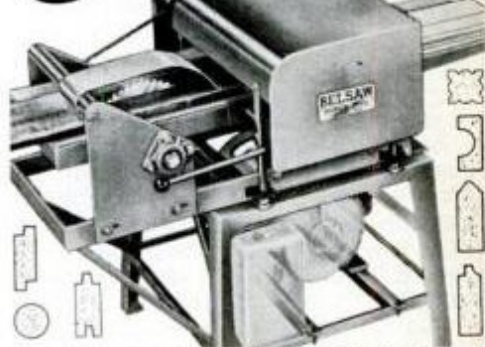

Now you can use this ONE power-feed shop to turn rough lumber into moldings, trim, flooring, furniture—ALL popular patterns. RIP-PLANE-MOLD . . . separately or all at once with a single motor. Low Cost . . . You can own this power tool for only \$50 down.

30-Day FREE Trial! SEND FOR EXCITING FACTS
NO OBLIGATION—NO SALESMAN WILL CALL
RUSH COUPON BELSAW POWER TOOLS CO.
TODAY! 905M Field Bldg.
Kansas City, Mo. 64111

BELSAW POWER TOOLS
905M Field Bldg., Kansas City, Mo. 64111

YES Please send me complete facts about PLANER—MOLDER—SAW and details about 30-day trial offer.

Name _____

Address _____

City _____

State _____ Zip _____

Stop paying hundreds of dollars a year for home and auto repairs you can easily do for yourself!

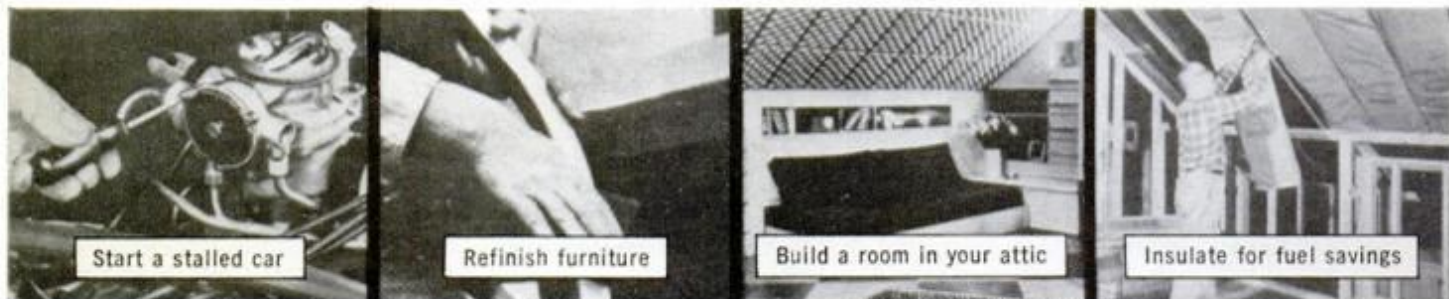

Start a stalled car

Refinish furniture

Build a room in your attic

Insulate for fuel savings

Take this \$3.49 volume
ABSOLUTELY FREE
 and let **POPULAR MECHANICS**
DO-IT-YOURSELF ENCYCLOPEDIA
show you how!



Today, a plumber gets \$10, \$15 or even \$20 to fix a stopped-up drain. TV repairmen charge \$7.50 for a house call, and parts are extra. The price quoted recently for painting a 4-room apartment: \$700! And all the while, inflation keeps cutting deeper into your paycheck.

You can't do without food—whatever the prices—and you have to pay the rent. But you can do something about the money that goes for repairs and improvements. Now, even if you're a beginner, you can do them yourself and save hundreds of dollars a year, with the help of the new **POPULAR MECHANICS DO-IT-YOURSELF ENCYCLOPEDIA!**

Take Volume 1 FREE and start saving right away!

We offer you this \$3.49 volume FREE so you can see how easy it is to be your own home handyman with clear step-by-step pictures and the advice of experts to guide you!

Browse through your FREE book and you'll discover how to cure 8 common car ailments yourself, with simple tools. Also how to burglar-proof your home . . . soundproof a room . . . decorate a child's room . . . and save \$1,000 or more. And that's just a small part of what's in your FREE volume . . . and in the complete set!

Turn to this complete ready reference library the moment your TV or toaster fails . . . chances are you can fix it. Build a Hi-Fi center . . . "antique" a chest . . . cane a chair . . . improve insulation to heat your home with less fuel!

You'll learn techniques for building, painting, soldering; for using power tools. You'll find detailed diagrams for cabinets, bunk beds, closets, kitchens, wiring and lighting. You even learn how to build model cars, model planes, soundtrack your own movies.

There's all this and much more in the set . . . 16 volumes . . . 3,136 pages . . . over 10,000 illustrations . . . bound in sturdy, washable bindings to last a lifetime.

Mail the NO RISK coupon today!

We'll rush you Volume 1—absolutely FREE to keep forever—with no obligation to buy any volumes. Read details in the coupon—and mail it today!



Exclusive Bonus With FREE VOLUME PROJECT-A-PLANS

Included in your FREE volume, Project-a-Plan lets you take even small-scale plans and, using your own projector, blow them up to full-scale working plans right in your own living room or workshop!

MAIL THIS COUPON TODAY

Popular Mechanics Books, Box 2315, K701 F.D.R. Station, New York, N.Y. 10022

This certificate entitles you to a free gift—Volume 1 of the 16-volume Popular Mechanics Do-It-Yourself Encyclopedia.

As a subscriber in good standing, you'll enjoy free examination of the additional volumes as you receive them. In about 6 weeks we'll send you Volume 2, and 4 weeks later Volume 3. After that, at approximately monthly intervals we'll send you shipments of Volumes 4-6, 7-9, and 10-16. (Also, you'll receive annual supplementary volumes as they are published on free 14-day approval with no purchase obligation.) This way you'll be able to complete the set in 6 months, and keep it up-to-date. You may cancel at any time or return any volume within 14 days for full credit and no more will be sent. Take as many volumes as you like—or none at all. For each volume you keep, you'll be billed just \$3.49 plus postage and handling. But you need never pay for more than 1 volume per month no matter how many you received.

Name _____ (Please print)

Address _____

City _____

State _____ Zip _____

Signature _____

This offer available in Canada at a slightly higher price. Canadian residents mail coupon to New York address. Shipment of books and all services will be handled within Canada. **H. M. BOOKS**

Now. Everything you need to shut John up once and for all.

Our Fluidmaster Ballcocks have been shutting up leaky Johns for 16 years. Now we're introducing our new Flusher Fixer™ Kit to stop his other noisy complaint. The weeping of a leaky flush valve.

The Flusher Fixer™ Kit is a combination flapper and sealant-mounted stainless steel replacement seat. It eliminates leaky flush valve seats, outdated tank balls, flabby flappers, tangled lift wires, and misguided guides. With the Flusher Fixer™ Kit, the captive flapper and seat always stay in perfect alignment, to finally put an end to handle jiggling.

No tools are required to install it. And because you don't need to remove the tank from the bowl, there's no risk of cracking your toilet.

You'll find the Flusher Fixer™ Kit wherever Fluidmaster Models 100, 200, and 400 Ballcocks are sold.



FLUIDMASTER, INC.
1800 Via Burton, P.O. Box 4264
Anaheim, California 92803

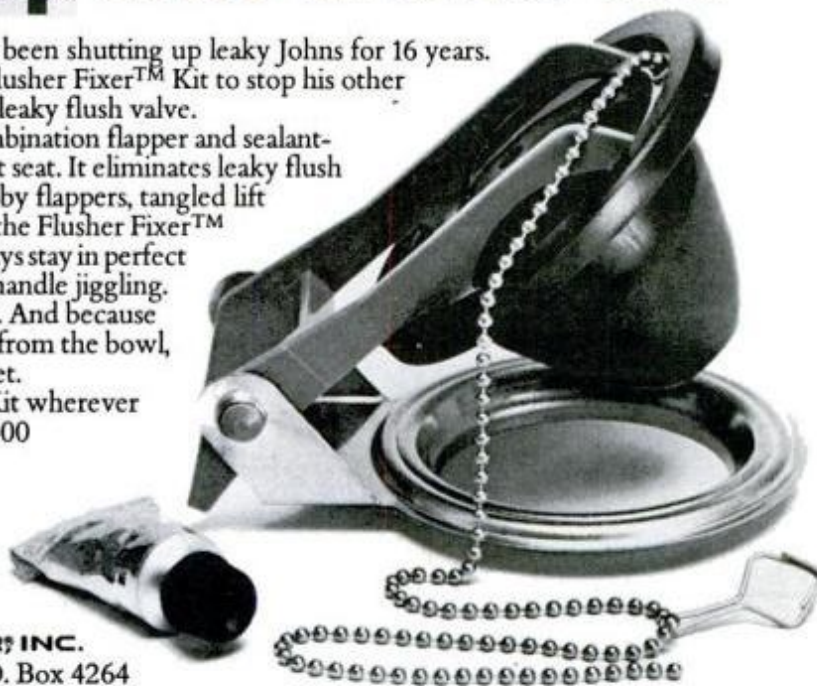

John never had it so good.

TURBO BLAST

Get Up To 50,000 Miles
On Your Spark Plugs

- Cleans all types of plugs in seconds
- Requires no compressed air

- Supply of glass bead abrasive for cleaning 250 plugs. Additional beads available

- Rugged, long life without maintenance

- Powered by rugged 12,000 RPM 120V motor



NEW



JAYCRAFT CORP. DEPT. PM-3
760 North Marshall Ave., El Cajon, Calif. 92020

Name _____
Address _____
City _____ State _____ Zip _____

\$19.95 Plus \$1.55 for shipping and handling
SATISFACTION GUARANTEED or your money refunded in 30 days
California Residents Add State Sales Tax

BUILD THE GREENWICH HALL CLOCK



Build this beautiful straight-sided hall clock from our completely cut-out cherry wood kit. Finest materials are used. Front and side frame, door, and break-arch are all factory assembled and sanded. Hardware is included. Purchase glass locally or order glass kit listed below.

K-6004 Greenwich Hall Clock Kit \$157.50
GL-6004 Glass (plain side glass and bevelled front glass) \$ 31.50

Shipped freight collect
Send 50¢ and select movement or dial from our illustrated 90-page Clock Book showing largest selection of movements and dials in the U.S. at reasonable prices. Clock patterns, moldings, barometers, and music boxes are also pictured.

CRAFT PRODUCTS

Dept. I,
Elmhurst, Ill. 60126

BURIED TREASURE

Locate from a LONG DISTANCE!
with Ultra-Sensitive **DIRECTIONAL** Locator
SEND FOR FREE INFORMATIVE BROCHURE

RESEARCH PRODUCTS
BOX 13441-AM TAMPA, FLORIDA 33611

FIND BURIED TREASURE!
DETECTS COINS, RINGS, GOLD, SILVER Dealers Wanted

Send for FREE Catalog
white's electronics, inc.
Dept. PA5C Phone
1011 Pleasant Valley Rd. Sweet Home, Oregon 97386 (503) 367-2138

BUILD A GENUINE ANTIQUE HEIRLOOM TRUNK FOR LESS THAN \$90.



FACTORY DIRECT PRICES

- Do-it-yourself kit, all parts pre-cut
- Solid brass exterior sheeting, lid and tray bottom velvet lined, tray and interior aromatic cedar, solid hardwood exterior banding
- Easily assembled
- Finished models available
- Money back guarantee

FREE
COLOR BROCHURE

Master Charge
BankAmericard
Southern Mobile Industries
Dept. 20
P. O. Box 360
Bay Minette, Al. 36507

Learn at home and at famous York Institute...

when you take NRI's Home Study Course in Air Conditioning, Refrigeration & Heating.

What's the best way to break into the booming field of air conditioning? Hold onto your present job and enroll in NRI's home training program—a comprehensive career course designed with the technical assistance of the York Division of the Borg-Warner Corporation.

You learn at your own speed, in your spare time, on such advanced training devices as the NRI Circuit Demonstrator; NRI Control Simulator; tubing and joint-making demonstrators; and a window air



All tuition and instruction material for the one week of resident training at York Institute are included at no extra charge as part of your course.

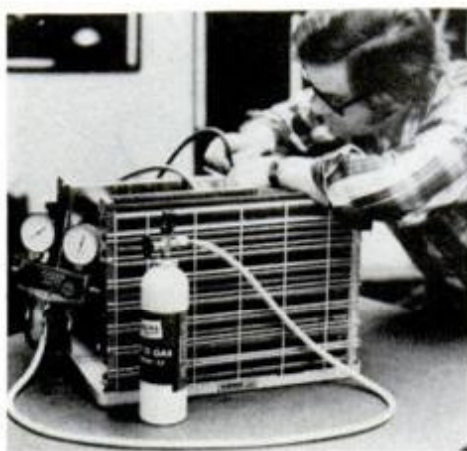

conditioner working unit for troubleshooting experiments.

Graduates of the NRI Master Course can then take optional resident training at the world-famous York Institute. Here you will receive practical experience equal to months of on-the-job work.

SEND FOR A FREE CATALOG. Get full details on this unique career opportunity. Find out why more than a million students have come to NRI for training.



NRI SCHOOLS
McGraw-Hill Continuing Education Center
3939 Wisconsin Avenue,
Washington, D.C. 20016

513-035

Rush me the NRI Catalog checked below. I understand NO SALESMAN WILL CALL.

- Air Conditioning and Refrigeration Master Course in Air Conditioning, Refrigeration & Heating

Name _____ Age _____
(Please print)

Address _____

City _____ State _____ Zip _____

Approved for career study under GI Bill. Check for facts.

Accredited Member National Home Study Council

EXOTIC, SUPERLIGHT BIKES

(Continued from page 107)

cyclist, anything that wins races worth the investment.

The three unique bikes are a Teledyne Titan titanium frame machine, a Mossberg graphite fiber frame bike and a Monark-Crescent stainless-steel frame road bike.

The Teledyne and Mossberg frame sets can be made up into an 11-pound track bike, an 18-pound road racer or a 20-pound touring machine. At the moment, I prefer the Teledyne because I have put a couple thousand miles on it. Soon as I road-test the Mossberg I'll report how it rides.

Teledyne's frames weigh 33 pounds in the 21-inch size, 39 pounds in the 24-inch size. This bike's short wheelbase of only 39.5 inches gave me a very quick-responding ride which took some getting used to. At first I thought, too, that this light bike would be unstable. Not so. I tracked as surefootedly on fast downhill runs over rough roads as it did on a smooth road on turns.

Teledyne frames are in 21, 22, 23 and 24-inch sizes, with the same 39.5-inch wheelbase in all sizes held by varying the frame angles. The 21-inch frame has 74° 30'/30°; the 22 and 23-inch frames have angles of 75° 30'/74° and the 24-inch frame has angles of 74° 30'/75°. These rather severe frame angles coupled with the short wheelbase gave me a fairly stiff ride for a touring bike. But when I shifted from high to low flanged hubs with crossed four spokes (longer spokes mean a more flexible wheel) and a well-broken-in 50,000-mile Brooks Pro leather saddle, most of the road shock disappeared. I found the 20-pound Teledyne Titan far easier up hills than my old 26-pound touring bike.

Titanium is extremely corrosion resistant, and the hard anodized finish of the Teledyne frame stays cleaner. The frame only, with fork and headset, sell for around \$450 through bike shops. If you use good components, you can come up with a complete bike for about \$900.

Mossberg has made a real breakthrough with its unique graphite fiber tubing frame. This frame, with a 100,000-p.s.i. tensile strength, is stronger than the titanium or conventional Reynolds "531" manganese molybdenum frames at 80,000-p.s.i. yield strength. However, you will never come close to breaking the titanium or "531" tubes unless you run into a truck. Replacing a graphite tube could be a problem, though.

Mossberg furnishes graphite fiber frame sets with a very short-rak-

(Please turn to page 154)

MAKES LOCKS WORK EASIER!



Provides maximum protection against freezing, sticking. Seals out moisture and dirt from all locks.

BELTS SLIP-SQUEAK?

Crystal-clear and clean... Best for automotive fan, V-belts, snowmobile drive belts, blowers, appliances, power equipment, air conditioners. Aerosol spray—works upside down, too.



AGS AMERICAN GREASE STICK CO.
Muskegon, Michigan 49443

PRESCRIPTION EYEGLASSES BY MAIL

direct from manufacturer

Your own doctor's prescription will be filled, or your present lenses duplicated. The latest fashions. All types of lenses available. Accuracy and perfect fit absolutely guaranteed.

SEND FOR FREE FAMILY CATALOG. TODAY!

Est. 1959

PRISM OPTICAL INC.

Dept. M-30 135 West 41st St., N. Y., N. Y. 10036

FIX LAWN MOWERS FOR FUN & PROFIT



Fascinating new Handbook by F. Peterson gives you the knowledge skilled mechanics learn.

OVER 125 ILLUSTRATIONS show how to trouble shoot, repair carburetors, engines, balance and sharpen blades, etc. Exploded drawings are extensively used.

INSTRUCTIONS COVER reel, rotary and rider mowers, preventive and routine maintenance, how to identify brand names, where to obtain replacement parts. How to buy and use a lawn mower. Friends gladly pay \$10 to \$50 to fix their lawn mowers. Try the HANDBOOK OF LAWN MOWER REPAIR. Rush only \$6.95 plus 50¢ handling on 10-day money-back guarantee.

EMERSON BOOKS, INC. Dept. 124B
Buchanan, New York 10511

BUILD YOUR OWN CAMPER!

SAVE UP TO 50%



SEND 25¢ FOR DETAILS



- 5th Wheel Plans.....\$12.95
- Cover basic frame, electric, plumbing, (general construction)
- Camper Plans.....5.95
- Pickup Cover.....3.95
- Travel Trailer.....4.95
- Econoline Type Van.....4.95
- Pass. Bus or Delivery Van.....4.95

EQUIPMENT CATALOG

Send \$1.00 postage, handling (Refundable)

VIKING CAMPER SUPPLY INC.

99-8P Glenwood Ave.
Minneapolis, Minn. 55403
Please send _____ for which I enclose \$_____
NAME _____
ADDRESS _____
CITY _____
STATE _____ ZIP _____

NEW RUBBER STAMP BUSINESS PAYS BEGINNERS UP TO \$16.50 AN HR.

START AT HOME IN SPARE TIME with Table Top Machine!

We Help Finance You... at less than bank rates!

The multi-million dollar Rubber Stamp business—once controlled by a few big companies—is now being taken over by small operators—one in each community throughout the United States. Men and Women who have this inexpensive machine can turn out huge quantities of Rubber Stamps with special wording that buyers once were forced to buy from big cities. Material costing only 27¢ makes a stamp that sells for \$2.75. The machine that does the work is simple and easy to operate and it turns out as many as six Rubber Stamps at a time, each with different wording such as names, addresses, notices, stock numbers, prices and other "copy" needed by offices, factories and individuals. Working full capacity, it can earn as much as \$33.00 an hour for the operator! Now you can get into the big-pay business yourself, with your own home as headquarters. You don't need experience. We supply everything, including complete instructions and eight ways to get business coming in fast. We even help finance your start! Start making up to \$16.50 an hour from the very beginning! Cash in on the profitable Rubber Stamp business in your community right away. We'll mail full particulars FREE and no salesman will call. Be first in your locality. Rush coupon today or send your name and address on postcard to:

RUBBER STAMP DIV., Dept. R-2-EC
1512 Jarvis, Dept. R-2-EC Chicago, Illinois 60626

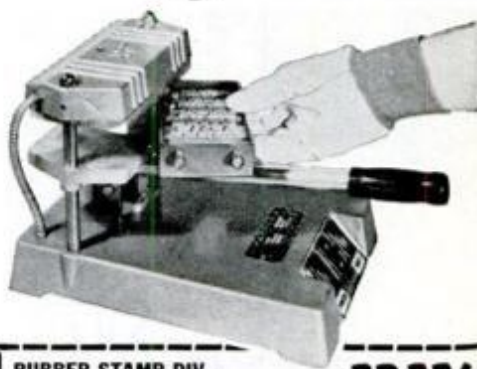

RUBBER STAMP DIV.
1512 Jarvis Ave., Dept. R-2-EC
Chicago, Illinois 60626

FREE!

Please rush full particulars about your financing plan and the little machine that can get me started in the profitable Rubber Stamp business at home in spare time. Everything you send me is FREE and no salesman will call.

Name.....

Address.....

City..... State..... Zip Code.....

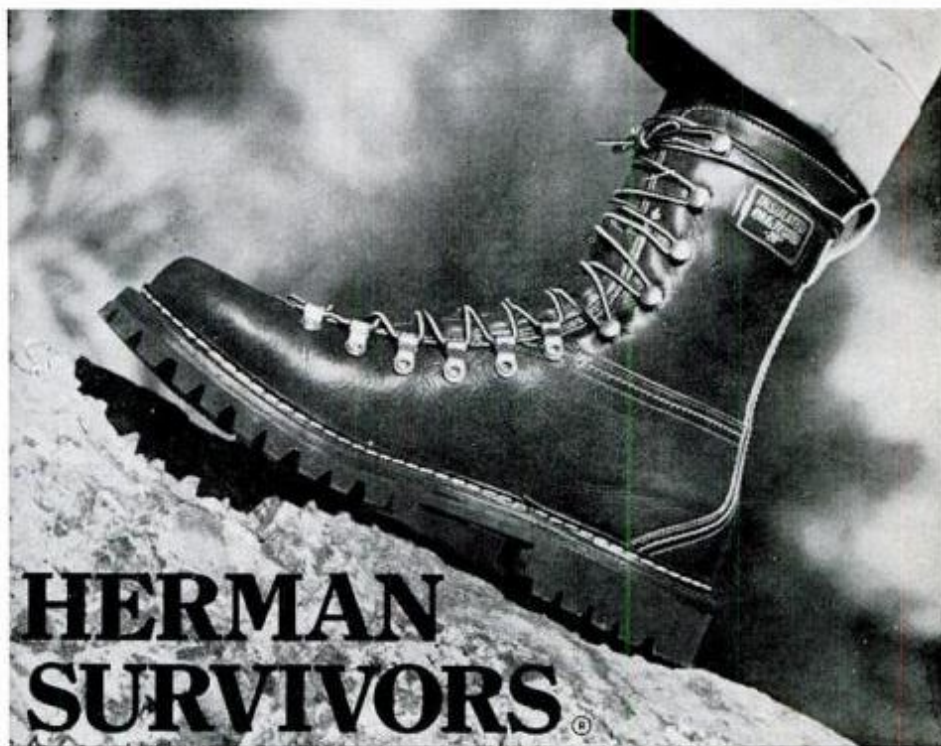

HERMAN SURVIVORS

In New England, where we build Herman Boots, most things are made a little better. Partly, it's pride in craftsmanship. But mostly, it's because things up here have to be made a little better. That's why we build Herman Mountaineers out of the best materials we can find. Tough green pebblegrain full grain rawhide vamps and quarters for long wear. Soft full grain shafts and tongue for suppleness. Ensolite® insulation for warmth. Even at -20°. Tan full grain cowhide lining... right down to the cushioned insole. And once the upper is built, we lock it to the surest footing you'll find: The Vibram® sole and heel. 8" boot—#7197. 6½" boot—#7197-6. Mountain Shoe—#4606. All in green rawhide with Vibram® sole and heel. When you're looking for the best, look up a pair of Hermans.



FREE CATALOG

J. M. HERMAN SHOE COMPANY, DEPT. 34, MILLIS, MASS. 02054
I'd like to try a pair of Survivors for myself. Send me your catalog and the name of my nearest Herman dealer.

PM-MB-5-3

Name.....

Address.....

City..... State..... Zip.....





CARPET DETERGER



UPHOLSTERY DETERGER



WALL DETERGER

Use your **SPARE TIME** beat inflation with added income

You offer a service everybody needs . . . work part time or full time . . . own your equipment . . . keep all you earn . . . start with just a small investment . . . and we help you every step of the way!

Have your own money-making business and make the kind of income you probably thought impossible. You can when you clean carpeting or upholstery or walls with Von Schrader professional cleaning equipment. Every home, every building are potential customers. And every customer can become repeat business. The demand for on-location cleaning is growing so fast that how much you earn depends solely on just your time and effort.

Moreover, we help you every step of the way . . . just as we have helped thousands of others build money-making businesses for 40 years. Typical comments: "Cleaning is a very good business—have been most grateful for your advice and help. You have fine machines—can recommend them to anyone."—*R. Herbst*. "Never have we made this good a living and been so

content and happy."—*N. Hanna*. "Have all 3 machines and very pleased with each one."—*C. Reiner*. "You people sure helped me and I'll never forget it."—*H. Kendall*.

There are three easy-to-use Von Schrader machines. You need no special skills or education to operate them. (1) CARPET DETERGER®. Its performance cannot be duplicated by any other cleaning machine. (2) UPHOLSTERY DETERGER®. Using dry foam, cleans fabrics beautifully and safely. (3) WALL DETERGER®. Washes walls and ceilings 5 times faster than by hand—no dripping or streaking.

You can start with just one machine. Then, as your business keeps growing, you may want to add the other two and thus offer a complete cleaning service.

You pay no fees, royalties, sign no contracts. You own your equipment, the finest of its kind. Keep all you earn. And your investment is so small you may find it hard to believe. For complete information—without any obligation—send for booklet.



"Let me send you our free booklet that gives all the facts"

—Francis von Schrader, President

Read about the big demand for on-location cleaning, see why Von Schrader Detergers are the finest of their kind, how easy they are to operate. Learn how other men have become financially independent, how Von Schrader helps you every step of the way. Fill in the coupon and send for booklet. **Extra! Special Recorded Message included with booklet.** Listen as Francis von Schrader talks to you personally about your growing future using Von Schrader Detergers.



Take the 1st step Mail coupon

VON SCHRADER company

40 years of helping people earn good money
1035 Place, Racine, Wisconsin 53403
Please send complete information on Von Schrader Detergers. No salesman will call.

Name _____
Street _____
City _____
State _____ Zip _____

**JEEP OWNERS
PICK UP OWNERS
FISHERMEN
HUNTERS**

FREE 116 page CATALOG

BAJA-PROVEN™ FLOTATION TIRES & WHEELS
UNIQUE CAMPING OFF ROAD & EQUIPMENT!

Honest tire information you can trust plus 100's of things you've been looking for and some you've never seen!

SET OF 4 TIRES & SUPER WIDE CEPEK WHEELS only \$199.95

ARMSTRONG **CEPEK**

SEND TODAY. INCLUDE ZIP CODE! FOREIGN CANADIAN & AIRMAL REQUESTS!

Dick CEPEK® 9201 CALIFORNIA AVE. Dept. PM
SOUTH GATE, CA 90280
© COPYRIGHT 1975 DICK CEPEK, INC.

At Last a New Amazingly Simple GAS TURBINE JET ENGINE



Build from easy to follow plans. Length 15".
Dia. 8 1/2". Wt. 15 lbs. Fuel: Gasoline/Kero.
"Screaming Demon" develops 20 H.P. Ideal project for serious-minded hobbyists, students; scientific and industrial arts classes. Make on 9" metal cutting lathe with milling attachment. For use on small racing boats, midget cars, etc. Full size assembly drawings with critical dimensions, bill of materials and photos. Price \$5.00. No C.O.D.
SAVOY SCIENTIFIC, BOX 1398, SANTA MONICA, CALIF. 90408

WHY BE FOOLED BY FAKES? Use the Flea Market Shopper!

Avoid bad or questionable items and recognize potentially valuable ones. 390-page volume (16 pages in full color) is a complete encyclopedia of American memorabilia from Superman Comics worth \$40 to Mickey Mouse clocks valued at \$500, plus thousands of others. Get this complete and comprehensive guide to Flea Market Shopping.

\$4.95 PHIL-JAC ENTERPRISES, Dept. C
plus 50¢ 3405 Cedar Hill Rd.
postage Canal Winchester, OH 43110

EXOTIC SUPERLIGHT BIKES

(Continued from page 152)

steel fork which in my opinion would give a ride too stiff for comfortable touring, though okay for racing. The firm says you can order the frame without a fork. If so, I'd ask for at least \$75 off the frame list price of \$600, and use a Reynolds "531" fork with 2 3/8-inch rake.

Frame tubes are joined into special steel lugs with an "aircraft" adhesive. Complete bike is \$1200 for the road and \$1300 for track. Frame sizes are 20, 22 and 24 inches. Frame weight is 3.1 pounds for the 20-inch frame. Frame finish is hard, very scratch and corrosion-resistant. Double seat stays add strength, rigidity.

A stainless-steel bicycle, not as lightweight as the Teledyne or Mossberg bikes, is made in Sweden by Monark-Crescent. I saw this bike frame being hand-silverbrazed last year and was impressed with the accuracy of alignment and craftsmanship. The 21-inch frame weighs only 22 pounds, light for a touring bike of more or less conventional design. Frame sizes are 21, 22, 23, 24 and 25 inches, which should fit 95 percent of us. I like this bike. It will never rust or need refinishing; it has the finest of component parts. Frame material is 302 or similar austenitic stainless steel with a yield point of around 40,000 p.s.i. Sweden's professional bike-racing team has won important European races on M-C stainless-steel bikes. You can buy this complete bike for around \$650 from U.S. dealers. ★ ★ ★



Extra tube in Mossberg graphite fiber frame runs from top tube to rear stay lug.

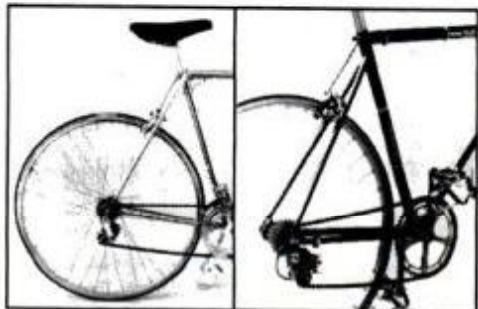

Crescent (left) has conventional frame angles; Teledyne, extreme rear stay angle.

PART TIME or FULL TIME SHARPENING BUSINESS!

YOU Can Earn Up To
\$800 An Hour
In
YOUR OWN

No Selling, No Inventory...Year Round
Cash Profits and YOU Set The Hours!

Yes, there's a lot of business waiting
for the man who can sharpen saws, planer
knives, jointer blades, wood chisels, scis-
sors, axes and other garden, shop and
home tools.

Belsaw SHARP-ALL does all these jobs
quickly with precision and at a big profit
for YOU. You can become Sharpening
Headquarters for carpenters, builders,
lumber yards, factories, home workshop
enthusiasts. And, you can start this Money-
making business for less than \$50.
FREE BOOK tells how to start your own
part-time business while you are still
working at your regular job. People bring
their work and pay Cash—over 90c of
every dollar you take in is cash profit.



Does The Belsaw Pay?
YOU BET!

JOIN THESE SUCCESSFUL
SHARP-ALL OPERATORS—

\$4,000 a Year

"Think the world of my SHARP-ALL. Am now
grossing about \$4,000 a year part time, and hope
to expand shortly. Now doing work for the State
of New York, Carrier Corp., and General Motors."
Lawrence Stevenson
E. Syracuse, New York 12057

Wanted to Retire

"I had dreamed of retiring for years, but was
afraid to quit my salaried job. I had never used
this type of equipment, but the SHARP-ALL was
so easy to learn. I sharpened 30 blades my first
week — without advertising at all. Now, for the
first time in my life, I can say that I am content."
Farris Cornelius
Wellington, Texas 79095

\$5.36 an hour

"On Saturdays, my big day, I take in \$45 to \$65.
Other days I average less, but I figure I make
between \$5 to \$6 per hour... and sometimes more.
I am presently enlarging my shop, and thank
BELSAW and their fine equipment for making it
possible."
V. O. Miller
Hubert, North Carolina 28529

Had to Quit His Job

"Bought my SHARP-ALL four years ago, and it
has done everything (and more) than you said it
could. I never sharpened a saw in my life, but
when I had to quit my regular job, I knew I had
something to do. Now I have more work
than I am able to do — I have as many as 100
saws ahead of me at a time."
Frank Sartis
Grandview, Washington 98920

100% Disabled

"I was disabled by an accident while employed
as an iron worker. They declared me 100% dis-
abled and said I'd never work again. I don't think
I could work for anyone else but I started my
sharpening business part-time and now it's turned
into a full-time job with more work than I can do."
Rez Stage
Tampa, Florida 33614

Let Belsaw prove
YOU can do it — On our
30-DAY FREE TRIAL OFFER

You risk nothing by accepting this offer to see how easily you
can turn your spare time into Big CASH Profits with your own
Complete Sharpening Shop. Send coupon or mail postcard for
full details on our exclusive 30-Day Free Trial Offer!



Our Free Book tells
how to start a profit-
able, lifetime home
sharpening business,
how we help you grow,
how we'll finance you.

BELSAW SHARP-ALL CO.
715M Field Building
Kansas City, Mo. 64111

RUSH COUPON TODAY FOR FREE BOOK

No obligation . . . No salesman will call

BELSAW SHARP-ALL CO.
715M Field Building
Kansas City, Mo. 64111

Please send my FREE copy of your book
"Lifetime Security" and full details on
your 30-Day Free Trial Offer!

Name _____
Address _____
City _____ State _____ Zip _____



SCAMP
FOR THE FIRST TIME
A DO-IT-YOURSELF KIT!



Water and dustproof, hail and corrosion
proof, maintenance free. The aerodynamic
and lightweight design makes trailer tow-
ing a real pleasure. Comfortable in any
climate, Scamp sleeps four and is fully
guaranteed. Send for your brochure. We'll
show you how you can make it happen.

Self contained unitized fiberglass
travel trailer designed especially for
compacts and foreign cars.

EASE OF ASSEMBLY



With the pre-moulded and finished fiber-
glass components, Scamp can be completed
for relaxation in forty hours of sparetime
with minimum tools.

IT'S SURPRISINGLY EASY AND THERE'S
NO WELDING. YOUR SCAMP KIT IN-
CLUDES ALL THE PARTS YOU NEED
AND A FULLY-ILLUSTRATED STEP-BY-
STEP ASSEMBLY MANUAL.

**HUNTING
FISHING
CAMPING**

Clip and mail to: PM-2

SCAMP
Division of Evelands Inc.
Manufacturers of Reinforced
Fiberglass Products
Backus, Minnesota 56435
Call Collect: 218-947-4932

Enclosed is \$ _____. Please rush me
 Brochure and complete information (\$1.00)
 Assembly Manual (\$7.00)

Name _____ Age _____

Address _____

City _____

State _____ Zip _____

Business Phone _____

Home Phone _____

THE BARGAIN HUNTER

GRANDFATHER CLOCKS

SAVE 50%

BUILD YOUR OWN FROM OUR SEMI-ASSEMBLED CASE KITS

We are the ONLY producer of COMPLETELY HANDCRAFTED semi-assembled clock kits! Major assemblies carefully fitted and joined by experienced cabinetmakers. (No power tools required.)

- Highest quality imported German movements
- Tubular or rod chiming
- Moving moon dials
- Kits for wall & mantel clocks available
- Templates & case plans

Send 50¢ for complete catalog

H. DeCOVNICK & SON,

P.O. Box 68, Dept. M-35
Alamo, Calif. 94507



PLAY GUITAR IN 7 DAYS OR MONEY BACK



In this Special Introductory offer you get all this: TOP GUITARIST ED SALLER'S famous Deluxe Secret System worth \$1.00 which shows you how to play a beautiful song the first day and any song by ear or note in seven days; contains 32 photos, 47 finger placing charts, etc., plus 110 popular and western songs, (words and music); a \$1.00 C.P.U. Finder of all the chords used in popular music; a \$3.00 Guitarist Book of Knowledge; and the extra special \$1.00 value NEW wallet size Tuning Device for tuning any guitar by ear.

Total Value \$9.00—Now \$3.98 SEND NO MONEY!

Just send your name and address. On delivery pay postman \$3.98 plus C.O.D. postage. Or send \$3.00 plus 50¢ shipping and handling charges with order to save C.O.D. risk, sorry, no C.O.D. outside Continental U.S.A.—omit with order. Money Back Guarantee.

ED SALE Studio 134-B, Avon By the Sea, N.J. 07717

KARATE

JUDO-SAVATE
JIU-JITSU

THE GREATEST SELF-DEFENSE SYSTEM KNOWN TO MAN!



FREE!

Learn-At-Home-Course reveals hundreds of deadly self-defense secrets, which will enable you to protect yourself from any attacker! Easy to learn! FREE COLORFUL BROCHURE REVEALS SELF-DEFENSE TECHNIQUES.

Send to: UNIVERSAL, Dept. M
BOX 39303 DETROIT, MICHIGAN 48239

woodworking benches woodcrafting tools

Danish crafted SOLID Danish Beech woodworking benches ruggedly made and finished like fine furniture. Built-in vertical and horizontal vises and adjustable surface dogs hold any shape workpiece. Available in 49", 60" and 80" models. One even folds for easy storage.

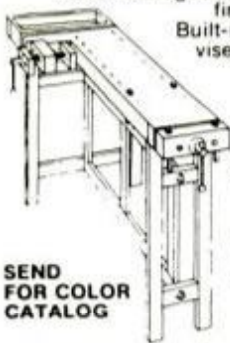

HAND FORGED turning gouges, chisels and sculptor's gouges, carving tools, handsaws and uniquely styled woodscrew drivers from Europe's finest tool-makers. The best the world can offer.

SEND FOR COLOR CATALOG

Name _____
Address _____
City _____ State _____ Zip _____

LEICHTUNG & GALMITZ, INC.

5187 Mayfield Rd. Cleveland, Ohio 44124

SILVO (BRAND NAME) TOOL CATALOG

Thousands of exciting tool values!



Stanley, Skil, Thor, Wen, Daston, Wiss, Wellsaw, Dremel, Plumb, Huot, Kennedy, Channellock, Rockwell, Holois, Vise-Grip, Crescent, Rigid, Pony Clamps, Unimat, Foredom and many other Nationally Advertised brands of Tools & Supplies. We ship Coast to Coast at prices Hard to Beat. Send \$1.00 for our big 196 page tool catalog today.

Silvo Hardware Co., PM-75
107 Walnut St., Philadelphia, Pa. 19106

IDEAL SHOP TOOL!

Popular Mechanics said: "Handiest Tool You Can Have in Your Shop"



It sands, grinds, polishes, sharpens. It's portable. Use with any 1/4 hp motor. Model 165. Factory direct special.

\$31.00 less motor

Other tools available, 2", 4", 6" sanders, power hacksaw.

1" Quik-Sand

ARCO MFG. CO. OF RACINE
1501 Clark St. Racine, Wisconsin 53403

GATEWAY TO ADVENTURE
QUALITY CANOES SINCE '32

TRAILCRAFT CANOE & KAYAK KITS
BUILD YOUR OWN FROM WOOD-CANVAS OR FACTORY MOLDED FIBERGLASS - BIG SAVINGS
MANY MODELS BOX 8012 FREE CATALOG
913-243-1213 - CONCORDIA, KANSAS 66901

DRILL YOUR OWN WATERWELL



With this low-priced outfit you can drill your own water well at a cost of about 12¢ per foot! Also, this unit can be operated horizontally to drill free-flowing springs in hillsides. A big, fact-filled package and 24-page book "How to Drill Your Own Water Well" is just \$1.00 PPD. (Refundable) "WRITE TODAY"

DEEPROCK MFG. CO.
1001 Lafayette Pkwy., Opelika, Ala. 36801

TWO GREAT NEW BOOKS FOR HOMEOWNERS

THE COMPLETE HANDBOOK OF LAWNMOWER REPAIR—Here's everything you need to know to keep your lawn equipment in tip-top shape. Beginning with basic 2-cycle and 4-cycle theory, you'll be taken through every part—carburetors, fuel systems, manual and electric starters and charging systems, etc.—of your lawnmower, system-by-system, and learn how to repair it without getting hurt. Hints on the tools you'll need will get you started without going broke. Includes latest data on Wankel-powered equipment & the latest electric models. A one-book library of practical dollar-saving know-how. 434 pgs., 392 ill. Hard. No. 767...only \$9.95

THE COMPLETE HANDBOOK OF HOME PAINTING—Here's modern, practical, comprehensive advice on all phases of home painting (even including painting swimming pools & boats). Clear and easy-to-read text covers choosing paints, preparing surfaces, paint problems, eqpt., interior and exterior painting, masonry and basement walls, floor refinishing, shingles, finishing techniques and how to hang wall coverings. Chock-full of unique ideas on decorator touches, plus clever applications that can make a room appear changed in size & shape. Really shows how to obtain those professional results! 210 pgs., 96 ill. Hard. No. 762...only \$7.95 SEND NO MONEY! We'll invoice on 10 DAY FREE TRIAL. Clip entire ad together. 100% guaranteed TAB BOOKS Dept. PM-35 Blue Ridge Summit, Pa. 17214

MAKE \$25 to 100 PER HOUR



BADGE-A-MINIT, a complete badge making system lets you make permanent metal pin back badges for fun or profit.

Money Back Guarantee

Badge parts cost pennies, you sell slogan buttons for up to 75¢ each, photo buttons for up to \$2.50 ea. Get FREE illustrated money making plans by return mail, or send \$34.95 plus \$1.75 for shipping to RPM Assoc. Ltd., Box 618, Dept PM-35, LaSalle, Ill. 61301

MAKE TIFFANY-TYPE LAMPS

Revolutionary new method. Cartoon design printed on molded form, matching paper patterns, instructions. Many old designs.. At most stained glass dealers. Information:

H. L. WORDEN, Granger, WA 98932



AMAZING NEW ELECTRIC ARC WELDER \$14.95

Twice as big-better-more power welds, brazes, solders, cuts all metal! Use any 110 volt house plug-in! Multitheat. Build-repair, most anything for cars-factory-home. Complete ready to use with kit of steel, bronze, carbon welding rods—flux-cored-automatic arc torch, scolding instructions—no experience needed!

SEND ONLY \$2.00 (cash, Ck, Mo.) and pay postman \$12.95 plus COD postage or send \$14.99 PPD in U.S.A. Lifetime burnout guarantee—10 day money back free trial! Now, save and make money. Order yours today! Midway Welder Dept. KPM-3, Kearney, Nebr. 68849

PLANS AND INSTRUCTIONS FOR

Go Kart	\$2.00
Mini Bike	\$2.00
Mini Car	\$3.00
Pedal Boat	\$4.00
12" Sail Boat	\$4.00
Snowmobile Sleigh	\$3.00
Mini Jeep	\$3.00

Mini Vehicles Plans Dept.-C
Chazy, N.Y. 12921

ClassMansShip

from Elite Enterprises
690 East Third Street
Cokato Minnesota 55301 Dept. PM375

Laser 917

The ultimate in a GT sports car kit. Take a VW chassis, combine it with your choice of motor, VW, Porsche, or GM, and on the -ASR-917 kit of your choice and drive away in the most uniquely styled street sports car of the times.

Fly to Me, St. Paul FREE* to place your order

Name _____
Address _____
City _____ State _____ Zip _____

* Enclosed is \$2.00 for your catalog
* Enclosed is \$10.00 for catalog and assembly manual
* Refundable on purchase of kit
* This information included with \$10.00 catalog and manual

DISCOUNT SALE \$9.95

AIR PISTOL \$7.95

(WITH FREE CAN OF PELLETS) PPD
IMPROVED MODEL. Built to last a Lifetime. Shoots both pellets and darts. This fine, well made .177 cal. German air pistol is just the ticket for target or Varmints. Accurate. No CO2 cartridges to replace, either. Once in a lifetime bargain. Order several. Only \$7.95 Secret Leather Holster, \$2.95 ppd. • 600 Deluxe Pellets, \$2.40 ppd. 20 Deluxe .177 cal. Steel Darts, \$2.00 ppd.
AIR PISTOL, Dept. PM-3
4535 Huntington Dr. So., Los Angeles, Calif. 90032

Sports Afield... Where the Action is Always Great now has more excitement than ever...even a new name...

Sports Afield with
ROD & GUN

No other outdoor magazine informs you, with articles by top experts the way SPORTS AFIELD WITH ROD & GUN does — through word, photograph and drawing on:

camping, shooting, fresh and saltwater fishing, trap and skeet, angling, hunting, wilderness savvy, dogs, boating and special equipment you'll need.

PLUS, detailed information on exciting places to go, how to get there, hundreds of useful tips, and new and regular monthly features like *Almanac*, *Travel Guide*, *Report Afield* and big bonus specials on every outdoor sport from bass fishing to deer hunting.

SEE IT AT YOUR
NEWSSTAND NOW!



ALL TO BRING YOU ACTION-FILLED EXCITEMENT AND ADD TO YOUR FUN IN THE GREAT OUTDOORS!

On the newsstand now—

The March 1975 issue of SPORTS AFIELD WITH ROD & GUN A CELEBRATION OF FISHING, with more information and ideas on fishing than ever before assembled in one issue of a magazine.

Feature articles on Bluegills—How to catch 'em; All About Hooks—The Most Details Ever; Tackle Craft—Great Ideas on Taking Care of Your Gear; How To Read a Trout Stream; Tuna—Problems and Fun of These Big-game Giants; Stripers and Weakfish—The Big Comeback, New Methods That Really Get Them; Bluefish—More of Them and Bigger than Ever; Salt-Water Fly Fishing; and The Most Useful Ideas in Fishing—By the Score.

And much more, including the monthly Editor's Reports from experts such as Homer Circle and Tom Paugh on fresh and salt-water fishing, John Jobson on camping, Jerome Robinson on trap and skeet, Jack Seville on recreational vehicles, Zack Taylor on boating, and Grits Gresham on shooting.

Pick up your copy of the March issue now, before it's sold out.

If you'd like to subscribe to SPORTS AFIELD WITH ROD & GUN, simply fill in the order form and mail it to Sports Afield with Rod & Gun, 250 West 55th Street, New York, N.Y. 10019.



Sports Afield with
ROD & GUN

250 West 55th Street, New York, N.Y. 10019

YES! Please enter my subscription for SPORTS AFIELD WITH ROD & GUN

- 1 year \$5.97 (save \$3.03 from the single-copy cost)
 2 years \$10.97 (save \$7.03 from the single-copy cost)

Name _____ please print

Address _____

City _____ State _____ Zip _____

Payment enclosed (or) Bill me _____ initial here
 New renewal WPM5C1

Your first copy will arrive in about 8 weeks. Watch for it! Sports Afield with Rod and Gun 75¢ a copy. Regular subscription prices in U.S. and possessions: 1 yr. \$5.97, 2 yrs. \$10.97. Canadian and foreign prices on request.



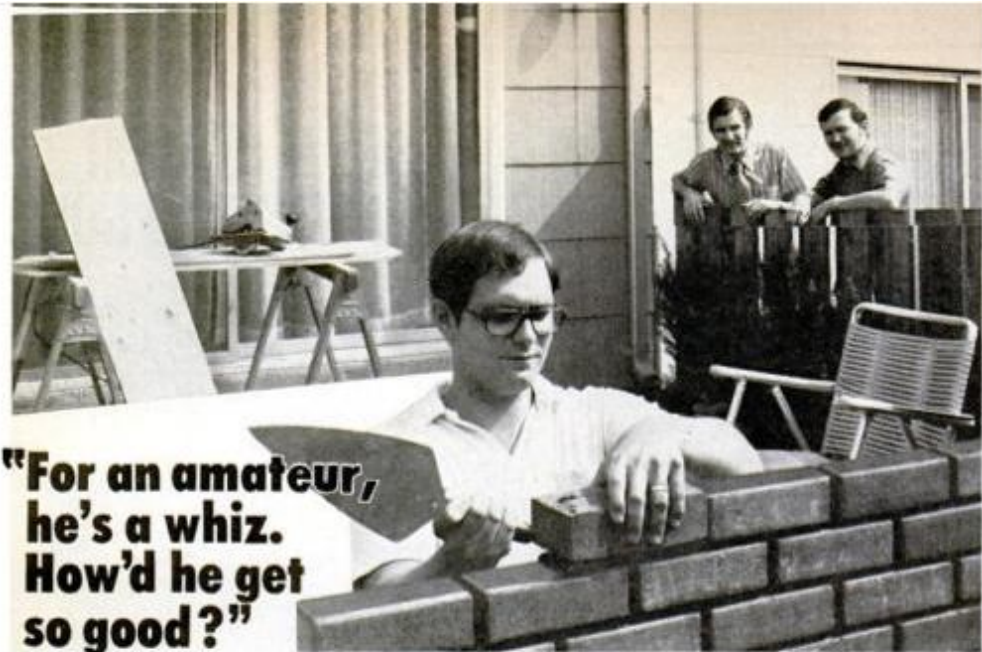

**"For an amateur,
he's a whiz.
How'd he get
so good?"**

Whatever practical skills you've been wanting to develop, Audel has comprehensive, step-by-step Guides to help you. They show you all the professional tricks of the trades

in clearly diagrammed and illustrated "how-to" steps. They can save for you, over and over. Here are four of Audel's many fields...



CARPENTERS AND BUILDERS LIBRARY

1490 pages of the latest information on modern construction in four volumes. They cover every phase of carpentry from foundations to finishing with easy-to-grasp, step-by-step instructions... all illustrated with thousands of diagrams, charts and photos. No. 23169—4 Volumes—\$21.25



MASONS AND BUILDERS LIBRARY

Two illustrated volumes on the science of masonry and bricklaying. Packed with how-to information and directions, rules, processes, definitions, formulas, diagrams, tables, estimating. A complete and authentic trade reference library. 752 pages. No. 23185—2 Volumes—\$12.75



PLUMBERS AND PIPEFITTERS LIBRARY

A valuable 3-volume guide to the principles, methods and short cuts of modern plumbing. Tools, fittings, fixtures, installation, drainage, welding and much more are all covered in these fully illustrated, easy to understand volumes. No. 23155—3 Volumes—\$15.50



MACHINISTS LIBRARY

Three books covering the entire field—1216 profusely illustrated pages on practical fundamentals of basic machine shop operations, setup and operation of spot machines, down-to-earth data on toolmaking procedures, layouts, jigs and fixtures, etc... equally valuable for beginners and experienced men alike. No. 23174—3 Volumes—\$19.50

MONEY BACK GUARANTEE

Send no money! We'll send you any Audel Guides for 10-day FREE EXAMINATION. If you keep them, you may use our easy payment plan. If not completely satisfied, return them for refund.

THEODORE AUDEL & CO.
Division of
Howard W. Sams & Co., Inc.
Indianapolis, Indiana 46206

SEND NO MONEY—10-day FREE EXAMINATION

Theodore Audel & Co.—Self Improvement Publishers since 1879
4300 West 62nd Street, Indianapolis, Indiana 46206

Please mail me for 10 days' FREE EXAMINATION the books I have checked at right. I agree to mail \$3 in 10 days for each set ordered and to further mail 1/2 of the purchase price 30 days later, with balance plus shipping costs to be mailed within another 30 days. I may return the books for refund if not completely satisfied.

Save shipping costs. Check here if you enclose full payment (plus sales tax, if any). We will pay postage charges. You have same return privilege.

Name _____

Address _____

City _____ State _____ Zip _____

23169
 23185
 23155
 23174

Woodcrafting Is Easier, Quicker with These Top Quality Benches

Whether you're a hobbyist, craftsman, cabinetmaker, or wood sculptor, experienced or beginner, The Yankee Wood Craftsman's wide selection of superb European workbenches offers you the exact features you need to do your finest work precisely, quickly. Solid kiln-dried European hardwood construction; pre-mounted specialized vises for horizontal and vertical hold; some models feature

world's finest Sheffield steel vises, provide unique swivel nylon shoulder vise face for firm holding of unusually shaped objects, bench stops, up to 5 drawers, ability to work on 3 or even 4 sides of bench. Large tool tray.

Largest choice in U.S. of amateur and professional models, 5' to 7' 1/2". One even folds to store — perfect for apartments. Also world's finest line of hand-forged European carving tools, clamps, and steel and exceptional wooden body planes available nowhere else in the U.S.



SEND TODAY FOR FREE CATALOG AND WOODCRAFTING MANUAL

Garrett Wade Company, Inc.
302 Fifth Ave., New York 10001

I want The Yankee Wood Craftsman catalog and woodcrafting manual.

Name _____

Address _____ City _____ St _____ Zip _____

PROTECT YOUR HOME

It's your biggest investment. Our combination burglar and fire alarm lets you sleep in peace. If someone tries to break in or a fire starts, the screeching siren alerts you and scares off most intruders. The slightest disturbance of the door trips the alarm. The built-in heat sensor triggers at 135°. Solid silver contacts. This compact alarm is 5 1/2" x 3" x 1 1/2" and runs off 2 "C" batteries (not included). Attractive beige case. Complete with switch and connector that can be used on a door or a window. Simple to install. 30 day money back guarantee.

MAC SECURITY, Dept. M1,
16643 Whitby Drive,
Livonia, Mich. 48154

Mac, send me _____ combination fire and burglar alarms

\$5.50 for one. \$10.00 for two. \$14.00 for three. I understand I can have my money back within 30 days if I am not satisfied.

NAME _____

ADDRESS _____

CITY _____ STATE _____ ZIP _____

Please add 50 cents for postage and handling. Mich. residents add 4% sales tax.

THE ORIGINAL IMPORTED
SWITCH-BLADE COMB
with replaceable blades



9" overall length
5 1/4" closed

- FUN
- PRACTICAL
- GUARANTEED

Spring action comb snaps into place at push of button. Locks shut to avoid opening in pocket. Perfect for conversation piece and practical use. Replaceable comb blades 50 cent each. Money back not completely satisfied.

Send \$4.75 plus 25c postage and handling to:
EXECUTEK
777 South Central Expressway
Richardson, Texas 75080

110 VOLT "PLUG-IN" YOUR TRUCK OR CAR

Mounts Under Dash or Hood in 10 Minutes—Has Off-On Sw.-Voltage Int. Light Up To 4000 Watts—110 Volt DC Power from car Alternator. Runs Carpen-ter - Farm - Builders - Tools - Lights - Heaters - Drills - Saws. Starts Cars, Quik Charges - Welds - Brazes, Solder, (cash, Ck., M.O.) and pay postman \$12.99 plus COD postage, or send \$14.50 for Paid Del. in USA. Complete Ready To Use With Speed Control—Full Instructions. One Year New Warranty—10 Day Money Back Trial—Ideal for pickup All Cars-Campers—Illush order.
WESTERN ELECTRONICS, Dept. PM-3, Kearney, Nebr. 688

INSTANT SPRING POLES

.....from 2 x 3's or round poles with TIMBER TOPPERS for shelves, room dividers, jurgyms, studs for solid walls. No fastenings walls, floors or ceilings. \$3.00 ea. postage. Specify round or square. Send for free id folder. Brewster Corporation, Dept. 47, Old Sa- brook, Ct. 06475

DETROIT APPROVED PICKUP TANKS

Original equipment type poly, now available in auxiliary tanks for pickups. Increase gas capacity 40 gals. Far superior to metal, complete hidden, no body work necessary. Easy 1 hour installation—Truck discounts pay for tanks in a short time. Two tanks, brass valve, hose, complete. Meets Federal Regulations.

PICKUP EQUIPMENT CO. INC.
Dept. PM-375, P.O. Drawer C, Hewitt, Texas 76710 CALL TOLL FREE 800-433-2386

EXTRA MONEY

'30 to '50
A DAY
Operate a community sharpening service with an investment of \$150. Work from your basement or garage. Our manual guides you in professional methods of grinding, of business promotion and in pricing your work.

- Hand Saws • Circular Saws • Knives • Chain Saws
- Scissors • Pinking Shears • Clipper Blades
- Planer and Dado Blades • Mower Blades

John Rodock says: "Thanks for shipping Model 331. It has paid for itself many times since I purchased it. Please send latest price list on grinding wheels."

TREYCO P.O. Box 216-A
North Tonawanda, N.Y. 14120

START NOW...WRITE TODAY

VENTRILOQUISM!

FREE INFORMATION!
Easy to learn in 60-90 days with our Home Study Course. RESULTS ARE GUARANTEED! Vent supplies include professionally handcrafted vent figures FULL COLOR dummy catalog: 50¢

MAHER: Box 420P; Littleton Colo 80120

FREE WINDPOWER HEAT

Cuts fuel bills, beats shortages. Encyclopedic windmill/generator report gives sources, costs, instruction capacities, specifications.
NOW \$2.98.

ENERGY UNLIMITED
Dept. 503
219 Thorndike St. Palmer, MA 01069

**IMPORTED
LOCK BLADE
KNIFE**

ONLY \$275 each
9" Overall Length
5" When Closed

- Opens instantly
- Sharp and Tough
- Stainless Steel Blade



Flips open instantly and locks automatically to prevent accidental closing. Razor sharp tough stainless blade for reliable use and hard, long service. Money back in 5 days if not satisfied. Send \$2.75 plus 25¢ to cover postage and handling.

WESTBURY SALES CO.
P.O. BOX 434, WESTBURY, N.Y. 11590
DEPT. L-3-PM

HEARING AIDS

SUPER SAVINGS! Newest, Finest. All types. Buy DIRECT & save up to HALFI No salesmen. Sold by AIR MAIL on HOME TRIAL. FREE Catalog. Write: **MONSIEUR HEARING AIDS**, Dept. PM-ID, 9530 Langdon Ave., Sepulveda, Cal. 91343

SAVE 1/2!
FREE CATALOG—WRITE!

"OUR FOUNDRYETTE" BLAST FURNACE

SINCE 1935
Hobbyists, Schools, Inventors, etc. Make your own castings of any metal from cast iron, down to lead and zinc. Available in sizes from 1 1/2 to 285 lbs. **RED BRASS**. Complete units furnished with all sizes. Send 25¢ for circular.
KANSAS CITY SPECIALTIES CO., INC.
Dept. P-3, P.O. Box 193, Middleton, Wisconsin 53562

RV KITS!

BUILD YOUR OWN & SAVE \$\$\$
CAMPERS, COVERS, VANS, TRAVEL TRAILERS AND 5th WHEELERS
Plans & Full Size Patterns Write for FREE CATALOG
GLEN L RVs
9152P Rosecrans, Bellflower, Ca 90706

LOCKSMITHING & Key Making

PRACTICAL UP-TO-DATE COURSE — ONLY \$7.95
Teaches you how to pick locks, de-code, make master keys, repair, install, service, etc. New self-instruction lessons for every handyman, homeowner, carpenter, mechanic, service station operator, fix-it shop, hardware dealer, gunsmith. 53 easy, illustrated lessons. Full price only \$7.95 postpaid. Satisfaction or refund guaranteed. Mail order today!
Nelson-Hall Co., Dept. 6CT-2
325 W. Jackson Blvd., Chicago 60606

LEARN UPHOLSTERY AT HOME... FOR FUN OR PROFIT!

NEW FURNITURE FOR OLD!
Turn cast offs into chairs, sofas worth \$100's. No experience needed. We show you how... supply all tools and furniture kits to get started! Fascinating, creative... ideal for spare or full time business.
MODERN UPHOLSTERY INSTITUTE
Box 16, PPM Orange, Calif. 92669

HYDRAULIC JACK REPAIRS

Earn While You Learn In Your Spare Time
Trained and qualified mechanics needed NOW to service interoperative hydraulic jacks. BIG opportunity for ambitious men. We show you HOW — in your basement or garage to earn spare time cash in an expanding industry. Don't wait, ACT NOW! Get the facts.
Write for folder No. PM-3, and free bonus offer.
Hydraulic Jack Repair Manual Co., Inc.
P.O. BOX 3 • STATE ISLAND, N.Y. 10314

Repair any watch

... LEARN AT HOME
Unique Sweeney System develops your watch repair skills step by step at home in spare time. No previous experience needed. Low tuition. Free sample lesson and full information.
CHICAGO SCHOOL OF WATCHMAKING
Dept. 135, Fox River Grove, Ill. 60021

WINDWATCH™ \$2295
ANEMOMETER—WIND VANE



Neon lights in indoor indicator show wind speed and direction. Decorative indicator with gold dial in dark mahogany case. Designed for desk or wall mount. Outdoor instruments of durable aluminum with electrical parts enclosed in rigid vinyl housings. Easy to assemble and install. Attach direct to roof or pole. Comes with wire and materials for installation up to 60 feet. Uses regular 120V AC. Unique low amp circuit assures absolute safety. A fascinating addition to any home. Five years guarantee. 15 day trial. Satisfaction or money back. Only \$22.95 postpaid.

WINDWATCH Dept. F2 104 Heimann San Antonio, Texas 78205

PROTECT YOUR CHILD PROTECT YOUR VALUABLES
Stainless Steel Dog Tags, 26" Chain and Clip. Great for luggage—Cameras—Pets—Etc. Send Name, Address, Phone Number and \$2.00 for each Tag to:
Futura Enterprises
Dept. PM-MD, 602 Syracuse Ave., N. Massapequa N.Y. 11758

PORTABLE STEAM CLEANER
Steam in 60 seconds

CLEAN: Engines, Air Filters, Lawn mowers, 3 year guarantee on fire box, coils. Uses liquid soap, propane fired. Weight 120 lbs. Auxiliary pump required on low water pressure.
WEDCO MFG. INC., Dept. M-5,
Box D, Jackson, Wyo. 83001

110 VOLT A.C. GENERATORS

60 cycles, 3000 watts. Wt. 27 pounds, 5"x10" Fanbelt driven from car or pickup. Operates T.V. All power tools. Over 13,000 in service. This is our 25th year. Guaranteed 6 months. \$115.50 Postpaid while supply lasts. Our 11200-watt generator needs no battery. Special price—\$95.00 Postpaid.
Virden Perma-Bilt, P.O. Box 7160 PM,
2821 Mays, Amarillo, Texas 79109

THROTTLE-SPEED CONTROL \$18.95 P. PD.

A quality manual speed control at the lowest prices. You can enjoy luxury driving and benefit from a terrific 15% saving on gas. Safe, system will not operate if electrical system or stoplights burnout. Just a touch of the illuminated switch turns it on. A touch of the brake pedal releases it. 45 min. installation time, out of the way on engine-side firewall. Guaranteed. Fits all 12V. cars and trucks. Send to **PERFORMANCE**
Box 129 Westport, Mass. 02790

BLACKJACK PLAYERS

Use my unbeatable, quickly-learned system to earn over \$50.00 an HOUR in any casino. Play relaxed. No cards or charts to memorize, and IT WORKS!
• **30-DAY FREE HOME TRIAL** •
You must be satisfied 100%. No obligation. Get a deck of cards and try it. You'll be amazed.
FREE DETAILS VIA AIRMAIL
MEL GRANT, Dept. 269
324 So. First Street Alhambra, CA 91802

Drivers and Pilots Sunglasses

"SKYMASTERS", the sunglasses that went to the moon on the Apollo missions. Military issue, made by **American Optical Co.** "True-Color" neutral-grey ground and polished impact-resistant lens. 1/10 12k gold filled frame, comfort contour earpieces. With case. Sugg retail \$20.25. Order now at discount prices. Only \$14.95 for 1 pair, or \$27.95 for 2. Postpaid. For Air Mail add 60 per pair. Most orders shipped within 24 hrs. under our 30 day no-risk money-back guarantee.
HIDALGO SUPPLY CO.
Dept. PM, 11505 Chimney Rock
HOUSTON, TEXAS 77035

U.S. Surplus High Speed Rotary Files. Hardened Steel.

For filing, drilling, milling, carving, routing any metal or wood. Cutting edges from 1/4" to 1", shanks all 3/8". Brand new, in air-tight G.I. packs. Export order. Add \$1.00
32 Tool Sets, G.I. cost \$265.00, now \$18.00
14 Tool Set, G.I. cost \$109.00, now \$12.00
Save Even More. Both Sets, now \$25.00
100% Guaranteed. We Pay the Postage.
Texas orders add 5% tax.
U. S. SURPLUS CENTER, Dept. 503
715 Camden, San Antonio, Texas 78215

Learn CUSTOM PICTURE FRAMING

For Fun Or Profit! Let Professionals show you the trade secrets of custom portrait and picture framing. It's a fascinating, satisfying craft — yet a Framers skills are worth \$8 to \$10 an hour or more!
Start a clean, quiet business you can easily manage from home in part time — we'll show you how, help you every step. Write for complete details — no obligation and no salesman will call.
SEND FOR DETAILS!
FRAMECRAFTERS, Dept. PPM P.O. Box 16 1205 W. Barkley, Orange, CA 92666



FREE POWERFUL MUSCLES FAST!
Fantastic New Discoveries in the science of bodybuilding. Our method will add inches of powerful muscles to arms, chest, shoulders & legs. Learn secrets on trimming the waist with ultra-modern methods—fast! Results Guaranteed! Send for free brochure.

Universal Bodybuilding Box 485
Dearborn, Michigan 48121
Dept. M
NAME _____ AGE _____
PLEASE PRINT
STREET _____
CITY _____ STATE _____ ZIP _____

BUILD YOUR OWN PORTABLE SANDBLASTER!

Easy to build from easy to find parts. Variable output, to work with large or small compressors.
PLANS AND SPECIFICATIONS \$400
ORDER TODAY FROM:
WILSON PLANS
P.O. BOX 340
KERNERSVILLE, NC 27284

APPROVED FOR VETERANS EDUCATION

LEARN TO BE A DENTAL MECHANIC

SECURITY • PRESTIGE • GOOD PAY
Learn at home, in your spare time, to make Crowns, Plates, Bridgework, etc. Dental Mechanics are employed by Dentists, Dental Laboratories or open your own shop, full or spare time. **FULL EQUIPMENT OF TOOLS AND MATERIALS INCLUDED WITH COURSE.** Low tuition. Easy Terms. Write for **FREE BOOK** about this money-making profession that's not affected by automation.
THE MCCARRIE SCHOOLS, INC.
132 N. 12th St., Dept. PM-35, Phila., Pa. 19105

"LISTEN IN" TO POLICE-FIRE RADIO CALLS IN YOUR CAR!

WORKS WITH ANY CAR—Portable or HOME RADIO! Just PLUGS IN—No wiring—3 minute hookup. SW T— instantly from regular radio to ALL **POLICE-FIRE-EMERGENCY-TAXI-STATE-GOV'T** 2 way radio on 1st Works Everywhere—AnyTime! Dual Band 36-49 & 150-175 MHz. Includes 1/2" postman \$12.99 COD post- age or send \$14.99 for PPD Del in USA. **COMPLETE** with Antenna and Plug-in to use with ANY Home or Portable Radio! Full instructions—**SOLD ONLY** Direct from Factory—**WESTERN RADIO DEPT. BPM-3 KEARNEY, NEBR. 68847**

the Invader GT

is the buildable VWsports car kit. Write for free color brochure.
AUTOKIT
Department P3
Post Box 1073
Alameda, CA 94501

APPLIANCE REPAIR BOOKS

Written in easy-to-understand language by experts with illustrations & diagrams. Acclaimed by instructors & professionals. How to diagnose & repair air conditioners, refrigerators, vacuum cleaners, ranges, washers, dryers, steam irons, portable kitchen appliances, water heaters; plus how to set up a shop, using test instruments and more. Only \$2.65 to \$4.90 each!
SEND FOR FREE DESCRIPTIVE PRICE LIST
CHAROUS & NIEBERGALL INC., 3841 MONTROSE, CHICAGO 60634

LEARN MEAT CUTTING

Train quickly in 8 short weeks at Toledo for a bright future with security in the vital meat business. Big pay. Full-time job. **HAVE A PROFITABLE MARKET OF YOUR OWN!** Time payment plan available. Diploma given. Job help. Thousands of successful graduates. **OUR 32nd YEAR!** Send **careful graduates FREE catalog**. No obligation. **NOW** for big new illustrated **FREE** catalog. **NATIONAL SCHOOL OF MEAT CUTTING NO. 0197** G.I. approved. **NATIONAL SCHOOL OF MEAT CUTTING NO. 0197** Dept. 50-N Toledo, Ohio 43004

CLASSIFIED ADVERTISEMENTS

Rate: \$2.65 per word payable in advance each insertion. Bold face capitalized words—75¢ per word additional (First word set in Bold Face at no extra charge, Zip Code Free). Minimum insertion ten words. To be inserted under proper classification, copy must be in our office by the 10th of the second month preceding date of issue. The next available issue to place an advertisement in America's No. 1 Classified Section is May. The closing date is March 10th. Send remittance and order to H. E. Kappel, Popular Mechanics, 224 West 57th Street, New York, New York 10019

Please make remittance payable to Popular Mechanics. . . . When answering advertisements please use the zip code number

AUTOMOBILES

SPECIAL Ten Automotive Products Formulas \$2.00. Muller's, R.D.4, Chestertown, Md. 21620.

SAVE GAS. 2-4 miles more per gallon. Simple adjustment. \$1.00. Andrew Di Santo, 9641 Avenue M, Chicago, 60617.

ELECTRIC CAR Building Instructions. Free Information, Iott Engineering, 4660 73rd, La Mesa, Cal. 92041.

33% OFF Delta Capacitive Discharge Ignitions. High Intensity Headlights. Other Savings. Free Catalog. Time Machines Inc., 29M Falmouth St., Brooklyn, N.Y. 11235.

AUTOMOBILE Repairs: Learn Making Them Yourself. \$1.95. Collie Compound, 806 Firnat, Houston, Texas 77022.

AUTOMOBILE SIXTY SECOND TIRE FIXER. No Tools—No Jack—Dealers Invited. Sample And Details \$4.98. Trial Case \$35.00. Postpaid, Warne, 6922 Congress, Detroit, 48207.

SAVE up to \$1000 DOLLARS or more on new cars. **GET DEALER COST** and buying guide. List car and options, all Amer. make cars. Send \$2.00 to **DAMIK, Inc.**, P.O. Box 2248, Melbourne, Florida 32901.

STOP: Don't drive your car another mile without patented Autotark protection. \$3.95 for set of 6. Alspott, (IA3), Box 176, Island Ave., Buckhannon, W. Va. 26201.

SAVE Big Money On Cars. Retired Auto Dealer Tells How. \$1.00. Poco Associates, Box 6691, San Antonio, Texas 78209.

MARK Ten B Ignitions, Assembled, Postpaid, \$40.25. Galt Services, 3533 Duke St., College Park, Md. 20740.

☆☆☆ **GOD BLESS THIS CAR** ☆☆☆ Rich and elegant metallic 3-toned dashboard mini-plaque with adhesive back. Every driver needs God's help. \$1.00 ppd. Mize Distributors, #18PM, POB 50394, Chicago, Ill. 60650.

DRAGSTER GO-KART Plans; Children's Fun Kart Remembers The Big Dragsters. Great Father-Son Project. Send \$2.00 Check/M.O. **PLANS**, 6 Craig Drive, Springfield, Illinois 62704.

SANDBLASTERS, \$32.50—\$749.50. Free Catalog—Truman, 1330 Market, Youngstown, Ohio 44507.

SHUT OFF UNNECESSARY V8 CYLINDERS. Save 15% gasoline. EPA Tests, Patent disclosures and trial kit. \$7.50 Box 545, Springfield, Virginia 22150.

MIDGET CARS

YOUR AD IN POPULAR MECHANICS WILL BE SEEN By More than 8,000,000 active buyers for your products and services. It costs only \$2.65 per word. And, if you wish to run all or part of your ad in bold capital letters—you can do so for as little as 75¢ per word additional. Act now! Send your Classified ad to: **POPULAR MECHANICS, CLASSIFIED DEPARTMENT, 224 WEST 57TH STREET, NEW YORK, N. Y. 10019.**

AUTO SUPPLIES & EQUIPMENT

NEW, Siphon Pump, Safe, Easy, only \$1.00. Brazier, 27675A Santa Clarita, Saugus, Calif. 91350.

BOOK of Alternator/Generator Rebuilding. Write Hedlund Engineering, P.O. Box 5777, Las Vegas, NV. 89102.

UNBELIEVABLE Results!! **GAS—OIL** Saver! \$6.50 postpaid. . . . (Two—\$12.00) . . . Established 1951, guaranteed! . . . **MOTALOY**, Grantham, Penna. 17027.

MAP HOLDER Ends "Foldditis," Keeps Entire Route in View Beside You. Great For Driver and Passengers. Only \$2 Postpaid, Add Applicable Tax. H. F. Smith, 770 "B" Street, Suite 402, San Diego, Ca 92101.

MOTALOY Ring Valve Job while you Drive. Only \$6.50 postpaid—Two \$12.00—Guaranteed. Andris, Box 34237, Dept. 391A, San Francisco, Cal. 94134.

IGLIT Continuously Indicates Ignition Performance. Helps Tune too. Q-ARC, Box 47876, Los Angeles, Calif. 90047.

RUN Automobiles on Charcoal, Coal, Etc. Details: 25¢. Ames, Box 9B, Dearborn Hts., Mich. 48127.

REVOLUTIONARY Auto Air Conditioner You can build For About \$50. **SAVE GAS.** FREE Detailed Information. Space Age Research Co., Dept. PM3, Box 770, Columbus, Indiana 47201.

WATER VAPOR INJECTORS Do Perform. Increased Power and Gas Mileage. Completely Assembled. Simple installation—\$14.95. 30 day money back guarantee. **RAD-AR** Products, Box 203, Farmingville, New York 11738.

HYDRAULIC Jack repair kits parts and supplies. Catalog 50¢ (in coin). Hydraulic Jack Packing & Tool Co., Inc., General P.O. Box 3, Staten Island, N.Y. 10314.

SYNTHETIC GASOLINE! Make it Yourself From Common Trash! Chemist's Complete, Simplified Instructions \$2.00. Also, Instructions on how you can "Make Natural Gas From Wastes"; "Reclaim Your Own Motor Oil"; "Test and Reclaim Old Gold"; "Chrome Plate at Home"; "Rejuvenate Auto Battery"; Only \$2.00 Each. Burchette, Box 1114-PM, Spring Valley, California 92077.

GASOLINE MILEAGE COMPUTER. Quick-Accurate-Compact. **BONUS:** "Tips to Improve Gasoline Mileage." \$1.00 postpaid. Dickson, Box 1135, San Rafael, California 94902.

AUTO Accessories at Jobber cost. Write Michael's, P.O. Box 588, Buford, Georgia 30518. Free Catalog.

HOMEMADE Vapor Injector Increases Mileage. Instructions \$2.00. Vidmar Crafts, Freeburg, Ill. 62243.

RACING Cylinder Heads Automotive and Motorcycle. Catalog \$1.00. Competition Heads, 27554 Wick Road, Romulus, Mich. 48174. 313-946-9850.

AUTOMATIC TRANSMISSIONS ELIMINATE 99% of trouble explained in my book. Twenty years exp. \$5.00 Guaranteed all cars. A A Transmission, 901 E. Vernon, Nevada, Missouri 64772.

GAS Mileage Figured Immediately with At-A-Glance Gas Mileage Chart. Fits on Car Visor. Only \$1.00. A & R Enterprises, 354 Joris, Waukesha, Wis. 53186.

VINYL TOP RESTORER Restore your vinyl top to its original luster and beauty. Money back guarantee with unused portion. Specify color. Send \$2.00 plus 50¢ postage and handling to: Imperial Motors, 5900 Eastern Avenue, Baltimore, Maryland 21224.

PARTS: Army jeep and truck parts. Spare Parts & Equipment Co., P.O. Box 751, Lexington, Kentucky 40502.

GAS MILEAGE CALCULATOR And car trouble-shooting guide. Great for trips or the wife. \$1.75. **REMCO**, Box 667, Santa Rosa, Ca. 95406.

BRAKE-A-THIEF! Most Tamperproof Anti-theft device invented now available to do-it-yourselfers with kit to fit any car. Send \$1.00 (refundable) for brochure, instructions, etc. B.X.&L., 17905 Sky Park, Irvine, Calif. 92707.

PLASTIC Guard Super High Lustre Car Finish. Protects Full Year! \$6.50 postpaid two \$12.00 Guaranteed. Andris, Box 34237, Dept. 113, San Francisco, Calif. 94134.

DUPLICATE Most Popular Battery Additive. Easy Sell. Stamped Envelope; 35¢. Box 654, Mineola, New York 11501.

MOTORCYCLES, BICYCLES, MOTORSCOOTERS, & SUPPLIES

AMERICAN INDIAN MOTORCYCLE COMPANY. WORLDS LARGEST Supply of Parts for **AMERICAN INDIANS.** 213-447-4078, 119 East Huntington Drive—Monrovia, California 91016.

HONDA, \$25.00. Other Bargains. Send \$1.00 (Refundable). Motorscooter, P443, Bend, Oregon 97701.

MOTORIZED BICYCLES—PLANS!!!! Electric, \$2.00 . . . Gasoline, \$2.00 . . . Both, \$3.00 . . . Guaranteed . . . Britt, 956 Springdale, Atlanta, Ga. 30306.

BICYCLE Parts. The "Handbook of Cycl-ology". 160 pages—5000 items. Foreign and domestic parts, tools, and accessories and gear tables and instruction. Send \$3.00 to: Wheel Goods, Dept. J, 14524-21st Ave. North, Minneapolis, Minnesota 55441.

GO-KARTS Factory direct low as \$19.95. Send \$1.00 for catalog and complete set of plans and drawings. Schmieder Motors, RD #1, Doylestown, Pa. 18901.

ILLUSTRATED Catalog, 25¢. Parts and Accessories. Custom and Stock. For Most Makes and Models. Motorcycle Supply, Box 159M, Fairbury, Illinois 61739.

MINI-BIKES. Go-Karts. Engines. Clutches. Discount Catalog 25¢. Lorenzo, Danville, Illinois 61832.

CONVERT Bicycles To Electric, Gasoline Powered. Plans \$2.00—Guaranteed. "Dixie", Box 90463, Houston, TX. 77090.

SPACE, ROCKETS, ASTRONAUTS

MOON PHOTO'S Other Space Souvenirs World's Largest Catalog. Free. Astroland Products, Box 234, Merritt Island, Florida 32952.

SHORT COURSES—Atom Bomb, Lasers, Moon Colony 2001, others. Catalog 50¢. P.O. Box 3028, Walnut Creek, Cal. 94598.

AVIATION

BUILD TEENIE TWO AIRPLANE. Information \$5.00-Deductible When ordering Plans. \$45.00. C. Y. Parker, Box 181, Dragoon, Ariz. 85609.

BUILD—One-Man Jet helicopter. Easy inexpensive. Detailed plans, drawings—\$5.00. Helicraft, Box 7153, Baltimore, Maryland 21218.

HANG GLIDING Handbook. 200 Pages. \$5.95 postpaid. Poynter, Box 4232-S, Santa Barbara, CA. 93103.

AIRBOAT Propellers, Engines, Hubs, Mounts, Supplies. Corvair. V-W Conversions. Removable Airdrives. Catalog \$1.00. Banks-Maxwell, Box 3301E, Ft. Worth, Texas 76105.

All About Ballooning. Handbook \$3.00. Aerostation, Box 141, Long Sault, Ontario, Canada K0C 1P0.

ULTRA-LIGHT HANG GLIDERS From world's largest manufacturer. Unsurpassed quality & safety. Rogallo plans—\$5.00. Kits, Complete gliders. Free Rogallo & Icarus information. Free-Flight, 12424 Gladstone, Sylmar, California 91342.

KITE, gigantic JFK prizewinner, tearproof, 5½ ft., heavy 500 ft. cord, winding reel, for adults, \$10.98. Children's 4 ft., \$6.98 postpaid. K&L Gifts, 115 9th St. S.E. Dept. 3, Washington, D.C. 20003.

HOVERCRAFT

HOVERCRAFT Plans. All sizes; Tested designs. Photos. Information: \$1.00. Universal Hovercraft, 2611 182nd Place, Redondo Beach, California 90278.

AERO-CAR Amazing Hovercraft built easily with ordinary tools. Lawnmower engine power. Carries one man plus. Hovers, flies forward, backward. Sideways over land/snow/water. Complete construction plans and brochure. \$5.95. Aero-Projects, Box 5118PM, Clinton, New Jersey 08809.

BOATS AND TRAILERS

BOAT KITS, HULL KITS, FRAME KITS, PLANS & PATTERNS. World's largest catalog, over 300 modern designs for the amateur in fiberglass, plywood, strip planking, steel, aluminum, cement, from 7 to 70 feet. **SAIL**—Prams, Day Sailers, Motor Sailers, Ocean Racers, Trimarans, Catamarans. **POWER**—Cruisers, Trawlers, Run-a-bouts, Fishing Boats, Kayaks, Inboard & Outboard Hydroplaners, Tunnel Boats. Also complete boatbuilding materials, sails, fiberglass, plywood, etc. Send \$1.00 for catalog or \$2.00 for catalog plus boatbuilding guide to Clark Craft, 16-P Aqua Lane, Tonawanda, New York, 14150.

FIBERGLASS BUILDER'S MATERIALS. Lowest factory prices in cloth, mat, roving, resin, epoxy, foam, bronze nails, plywood, mahogany. Send \$1.00 for literature or \$2.00 for literature plus booklet on mold making and "How to" fiberglass. **CLARK CRAFT**, 16-P1 Aqua Lane, Tonawanda, New York, 14150.

KAYAK KITS—Moulded Fiberglass—Wood, Canvas. Parts Precut. Complete Kits \$39.95 up. Free literature. Dedham Kayaks, Dept. PM8, Box 207, W. Lynn, Ma. 01905.

BOAT Kits. Molded Fiberglass. Save money—assemble yourself. Factory molded sections bond into one-piece craft. 20 models—14' to 32' Cruisers, Runabouts, Sailboats, Accessories, motors, trailers, Easy terms, Free catalog. Luger, Dept. BC-75, 3800 West Highway 13, Burnsville, Minnesota, 55337.

BOAT PLANS, FRAME KITS, FULL SIZE PATTERNS Especially for amateurs. Easy, proven methods, step-by-step pictorial instructions. All boat types 8' to 49'. Sail - Power - Inboards - Outboards - Jets - Houseboats - Cruisers - Hydroplaners - Trawlers - Catamarans - Ski Boats - Tunnel Hulls. Also fastenings, fiberglass, rigging, hardware, sails, spars, boat trailer plans. "How-to" Books. Send \$1.00 for **HUGE NEW** 120-page catalog plus **FREE** "Boatbuilding Supplies" brochure. Glen L, 9152MP Rosecrans, Bellflower, CA 90706.

CANOE'S! Kayaks! Factory Direct quality kits, from \$30.00. Many different models. Canvas, hulls. Strongest construction materials. Free literature. Sportscraft, Box 636-P, Allentown, New Jersey 08501.

FIBERGLASS Cloth and resin. World's finest cloth and non-run resin, at direct mill prices. Complete line of plastics, silicon bronze and brass screws, save 60%. No sales tax. Boat Plans. Catalog 25¢. Freight prepaid. Stiles Boat Supply, Box 11P, Linden Ave., Mantua Heights, N.J. 08051.

(Continued on next page)

BOATS AND TRAILERS (Continued from preceding page)

NEW From QUICK DESIGN. Quick Cat 16' CATAMARAN. Plywood with 190 Square Foot Sail. Cost under \$250.00. Plans \$8.00. 12' under \$100.00, plans \$5.00. Air Cushion TABLE HOCKEY plans \$3.00. Box 404E, Grand Haven, Mich. 49417.

FIBERGLASS Canoes, Kayaks, and Duckboats. Many exciting models. Easily assembled kits. \$49.95 up. Free Literature. Riverside Canoes, Box 5595P, Riverside, Calif. 92507.

CANOE Kilt-Wood Canvas, Molded Fiberglass—Free Catalog. Trailcraft, Inc., Box 60686, Concordia, Kansas 66901.

BUILD Your Own Pontoon. Lightweight, Maintenance, Free. Send \$1.00 For Information. Widmar, Box 54, Gra.ston, Minn. 55030.

NEW 1973 Outboards . . . Top Brands 6 H.P. \$288 . . . 18 5418 . . . 40 \$565 . . . 50 \$728 . . . 65 Electric 1958 . . . 85 Electric \$1,098 . . . **ALL SIZES** . . . Scott-McCulloch-Evinrude Parts . . . Handling 50¢ . . . Electra Marine, 610 Merrick Rd., Lynbrook, New York 11563.

FREE Catalog, Kayaks, Canoes, Sailboats, Pirogues, Fishing Boats, Duckboats, Plans, Patterns, 41 Models. Outdoor Sports, Box 1213-P, Tuscaloosa, Alabama 35401.

STOP Trailer theft with amazing Hitch-Mate-low cost insurance against loss of boat, trailer, etc., Only \$2.49 PP from GBJ Inc., Dept. PM, Box 321, Keenah, WI. 54956.

PROPELLER Maintenance And Repair Do It Yourself Manual \$4.00. Pitch And Balance Kit \$20.00. Vast Products, P.O. Box 6034, Bakersfield, Calif. 93306.

BUILD your own boat the simple foam-fiberglass method. Work from any plans, any size boats. \$3.00 for easy step by step method. Handcrafters Press. 9 Clintwood Gate. Unit 10, Don Mills, Ontario, Canada M3A 1M3.

WILDWOOD Tents, Camping, Boating Supplies. Free Catalog. Laacke & Joys, 1439 N. Water, Milwaukee, Wisconsin 53202.

CAMPERS AND TRAILER KITS—PLANS

BUILD YOUR OWN RV with GLEN L Component Kits. Plans and Full Size Patterns. **FREE CATALOG**, Campers, pickup covers, fifth wheel trailers for domestic and import trucks. Travel Trailers, camping trailers, van conversions. **SAVE! PREPAID FREIGHT SPECIAL!** GLEN-L, 9152P, Rosecrans, Balflower, California 90706.

MARINE EQUIPMENT & SERVICES

MARINE Engines, conversions, parts, equipment. Catalog Free! Stokes Marine Industries. Coldwater, Michigan 49036.

CONVERT Auto engines to marine. 68 Page Catalog, 50¢. Lehman Manufacturing Company, 800 Elizabeth Avenue, Linden 4, New Jersey 07036.

ATHLETIC AND BODY BUILDING COURSES

WEIGHT Exercising Equipment, send 25¢ to cover postage for illustrated catalog. Exercising Equipment, P.O. Box 662, Holyoke, Mass. 01040.

DYNAMIC Muscles Fast! No Gimmicks. Free Illustrated Brochure. Inquire: Goliath Enterprises, Box 933F-MI, Wheeling, Illinois 60090.

ARMS, 18+ Inches in 90 days or Refund!! Revolutionary Arms Specialization. \$3.00-Complete! also, Dynamic **KARATE!!** Black Belt Completeness in months or Refund!! Mind Technique. \$2.50-Complete. Phenoministics, Box 281E, Gresham, Oregon 97030.

SUPERHUMAN STRENGTH. Free Details, Madison, P.O. Box 206PM, Berea, Kentucky 40403.

KARATE "How To Train At Home" Step by Step, Action Packed Detailed Photographs Amazing Results, Make Your Own Equipment. Send \$3.98—Fully Guaranteed—Karate, Box 1182-A, Eugene, Oregon 97401.

KUNGFU, Karate, Judo, Giant-Book, Equipment, Collector's Weapons, Film Catalogue—\$2.00. Tiger, Cobra, Crane, Leopard, Praying Mantiss, Bruce Lee Information. East-Orient Importers, 2036 North Larrabee, Room 8026, Chicago, Illinois 60611.

SPORTING GOODS & EQUIPMENT

ARCHERY Lowest Discount Prices. All top brands. Orders shipped same day received. Money-back guarantee. World's Largest Supplier. Free catalog. Anderson Archery Corporation, Grand Ledge, Michigan 48837.

FREE CATALOG. Fishing Tackle, Archery, Hunting and Camping Equipment. Lowest Prices. Cabela's Inc., Dept. S32, Sidney, Nebraska 69162.

HUGE Sportsmans Catalog low direct factory prices, fishing, Hunting, Archery, reloading Camping. Send \$1.00 Refundable. Herters Inc., Dept. CPM, Waseca, Minn. 56093.

KARATE Uniform Sale! Price List From: Uniform, 424 Messner, Salisbury, North Carolina 28144.

POCKET BILLIARDS—'Inside Secrets' Revealed. Details—Mulhall, Sharon, New Hamp. 03458.

BOOMERANG — Beautifully Handcrafted \$9.50. Photos and Literature 3.00. County-Line, Box 11, Atlas, Mich. 48411.

FISHING, FISHING

"HOOK-RE-MOV-R"—Never Touch Fish, They Come Off Easy! Only \$1.00 postpaid. Poco Enterprises, Box 6691, San Antonio, Texas 78209.

FISHING SECRETS REVEALED 36-page 1975 Fisherman's Guide. Many hot tips, top spots, much more. Plus exciting new facts about fishing with Mepps spinners, world's most popular lure. 50¢ value. Send 25¢ with name and address to Sheldons', Inc., Box 7533, Antigo, WI 54409.

STOP Wasting Time! Lure Fish with Sounds of Insects. Send for Krafty Fish Caller. Only \$9.95—Guaranteed! Unique Enterprises, Box 9802, Birmingham, Alabama 35215.

EARTHWORMS, LIVE BAIT

HOW To Make Money Raising Fishworms. Details Free. Gloworm, 3910 Elfin, Louisville, Kentucky 40207.

EARN Money raising fishworms for us! Exciting details free! Oakhaven—56, Cedar Hill, Texas 75104.

HYBRID Redworms. 5000-\$15.00, 20,000-\$30.00 Postpaid with Raising Instructions. Brazos Worm Farms, Box 4185, Waco, Texas 76705.

FREE Literature. Profitable Business Raising Fishworms. Crickets. We Teach you how to Raise and Sell. Write today. Carter Fishworms, Plains, Georgia 31780.

SOILLESS Method Raising Worms. Garage Basement, Three Oaks, Dresden, Tenn. 38225.

FROGS, FISH, REPTILES

\$20,000 POSSIBLE RAISING BULLFROGS! Exciting Details Free! Bravo-A3, Box 696, Temple, TX. 76501.

HUNTING, GUNS, DECOYS

PELLET GUNS And Accessories. Sensible, Enjoyable Shooting Anywhere. Finest Adult Models; Satisfaction Guaranteed. Free Catalog. Write: Air Rifle Headquarters, Grantsville, WV 26147.

DOGS AND KENNELS

OBEDIENCE train your dog—15 min. a day. \$2.00. Broken H Kennels, Northfork, Cody, WY. 82414.

POULTRY & GAME BIRDS

QUAILS, Incubators, cages, supplies catalog. Marsh, 14216 Brookhurst, Garden Grove, Calif. 92643.

RABBITS, CHINCHILLAS, FUR BEARING ANIMALS

RAISE Chinchillas. Guaranteed income. Illustrated catalog \$3.00. Refundable. DeShon Chinchilla, Route 2H, Roanoke, Indiana 46783.

\$500-\$1000 MONTH Plan raising rabbits for us. Free details. White's Rabbitry-PM, Hudson, Ohio 44236.

AMAZING PROFITS!! \$10,000 Yearly Raising Rabbits for Wool and Breeding. Send \$1.00 for Details. American Angora, Malta 12, Montana 59538.

RAISE Rabbits successfully by knowing facts. 25 cents for 64 page illustrated book describing 25 breeds, housing, breeding, feeding, markets and marketing. American Rabbit Association 36 ARBA Building, Bloomington, Illinois 61701.

PETS—BIRDS, CATS, HAMSTERS, ETC.

VETERINARIAN Explains pet reproductive habits. Interesting and informative new booklet. Send \$2.00. Mar-Su Enterprises, Dept. M854, Mattoon, Illinois 61938.

999 PICTURE COLOR PET CATALOG \$1.00. "Everything—You Name It!" Rabbits, Bantams, Peacocks, Swans, Zebra, Stromberg's Pets Unlimited, Fort Dodge 59, Iowa 50501.

PETS, Reptiles, raccoons, skunks, squirrels, Catalogue 25¢. Trails End Zoo, St. Stephens, S.C. 29479.

HORSES, LIVESTOCK

"HOW TO TRAIN HORSES"—FREE Book tells how to break, train, make money with horses, Beery School, 1103 Pleasant Hill, Ohio 45359.

ELECTRICAL SUPPLIES

ELECTRIC MOTOR SUPPLIES! Equipment Plans! Modequip, Box 7266, Kansas City, Missouri 64113.

ELECTRONICS

FREE! Bargain Catalog—i.C.'s, LED's, readouts, fiber optics, calculator parts & kits, semiconductors, parts. Poly Paks, Box 942PM, Lynnfield, Mass. 01940.

BATTERIES, GENERATORS

BATTERY Reconditioning Kit, includes molds, material, instructions. Apex Engineering, 3100 Ramona, Atascadero, California 93422.

ENGINES, MOTORS, MAGNETS

STANLEY STEAMER MINI ENGINE BLUEPRINTS \$10.00 To: W. J. RYAN, 1912 Sunset Avenue, Waukegan, Illinois 60085.

WINDING Data. 275 motors, \$1.25. Data Company, 512 Kensington, Kansas City, Mo. 64124.

REWIND Car Generator for 110 VAC. Power Plant Plans \$2.00. Schmauss, 1228 East Cass, Tampa 33602.

Solar Panels \$9.00 each. Convert Three Phase Motors to Single Phase, AC Motors to Generators \$2.00 Each, Complete Plan and Kit list 50¢. DanRan, Box D, Reno, Nevada 89506.

TOOLS FOR SALE

DREMEL, Atlas, Maximat, Unimat, Toolkraft, X-acto, Freedom, etc. Priced For Your Pocket. Catalog \$1.00 Refundable. Visit our Showroom. Tools Unlimited Inc., 2106 Union Boulevard, Bayshore, New York 11706.

MACHINERY, TOOLS, & SUPPLIES

SMALL FOUNDRY furnaces. Supplies. Free literature. Pyramid Products, 3736 South 7th Avenue, Phoenix, Arizona 85041.

1400 CATALOGS Listed and Described! Sources for EVERYTHING Imaginable! Rush \$2.00. **MASTERLOG**, Box 24413-VO, Oakland, California 94623.

4" METAL Cutting Lathe \$47.40. Taig Tools, 15048 Proctor, Industry, Calif. 91746.

BANDSAW BLADE Complete. Welded to fit your saw. **COMPETITIVE** Free Literature. Tom Parker, R4-B735 Sonora, Cal. 95370.

PLANS, Tube bender, Press, Break. Info., P.O. Box 56, Campo, Calif., 92006.

PORTABLE Sandblaster—Free brochure. Billy D. Bass, 1179 Belvedere, Gallatin, Tenn. 37066.

MAXIMAT, Unimat Lathes, Attachments, Metals, Cutters, Micrometers. Catalogue \$1.00. Campbell, 1424 Barclay, Springfield, Ohio 45505.

MILLING Cutters, lathe milling attachments. Catalog \$1.00. Potter, Box 73, Cedar Rapids, Iowa. 52406.

12 GROSS Small Machine Screws Mixed-\$6.95 Nuts, Bolts, Screws, Washers, Assortments, Catalog 50¢, Nutty Co., 1576SMS, Fairfield, Conn. 06430.

CHAIN SAW CHAIN—Save to 40% on first-quality, fully-guaranteed Chain, Bars, Parts, Sharpening Equipment for all makes saws. Free Catalog. Write today. Zip-Penn, Box 43073-A77, Middletown, Ky. 40243.

CUSTOM BEARINGS. Sleeve and flange. From oilite, bronze, etc. Oil grooving available. Send print (including tolerances and material type) for quote. Burck Custom Machining, 24860 Audrey, Warren, Michigan 48091.

PORTABLE BAND SAW! 50 pound convertible metal cutting 3 1/2x6 inch capacity. Write: Halcyon Industries, P.O. Box 9644, St. Louis 63122.

WOODCARVERS Supply Catalog-75¢. Free on ordering Blandford's Woodcarving Book—\$2.00. 3112 West 28th, Minneapolis, MN 55416.

THREAD RESTORERS Renew rusted or damaged threads on 1/4" to 12" bolts and shafts. Buckingham, Box 1690, Binghamton, New York 13902.

WELDING, SOLDERING, PLATING

WELDERS. Convert To Heliarc. High Frequency Unit 0-225AMP. Plans \$4.00. Convert To DC Plans \$3.00. Information Supply Co., Box 166, College Park, MD. 20740.

ELECTROPLATING Equipment, Portable Platers, Supplies, and "Know-How." Build your own tanks for nickel, chrome, etc. Easy-to-install PVC liners. Rectifier components—all sizes. Schematics, parts lists, formulas, operating instructions for all-plating. Guaranteed to save you 25%-75%. Some good used units for sale. Free Details. Platers Service Company, 1511-PM Esperanza, Los Angeles, California 90023.

GOVERNMENT SURPLUS

GOVERNMENT LANDS . . . From \$7.50 Acre! Vacationing, Farming, Investment! Exclusive "Government Land Buyer's Guide" . . . plus "Land Opportunity Review" listing lands throughout U.S. Send \$2.00. Surplus Lands, Box 6588-AZ, Washington, D.C. 20009.

GOVERNMENT SURPLUS. How and Where to Buy in your area. Send \$2.00. **SURPLUS**, 30177PM HEADQUARTERS BUILDING, Washington, D.C. 20014.

1975 SURPLUS Army, Navy Store, 52 Page Illustrated catalog. Send \$1.00. Ruvel, 3037 North Clark, Dept. 3-J, Chicago, Illinois 60614.

JEES \$52.40. Airplanes \$75.01. Typewriters \$6.70. Boats \$7.50. Typical Bargains Available Nationwide. Sales Directory And Surplus Catalog \$1.00 (Refundable). Midwest Surplus, Box 401-PM, Dayton, Ohio 45401.

JEES!!! PICKUPS!! 100,000 items direct from government. Your area. Latest information & surplus categories: \$2.00 **MONEYBACK GUARANTEE.** Order manual #146, from "Dependable Products", Box 113, Vista, California. 92083.

"U.S. GOVERNMENT SURPLUS Directory." How, Where to buy 100,000 items (including Jeeps) . . . low as 2¢ on dollar! Most complete information available . . . \$2.00. **SURPLUS DISPOSAL, BOX 6586-AC, WASHINGTON, D.C. 20009.**

GOVERNMENT SURPLUS. How And Where To Buy In Your Area. **WRITE TODAY! NATIONWIDE AUCTIONEERS,** Box 872-PM, Anoka, Minnesota 55303.

(Continued on next page)

GOVERNMENT SURPLUS

(Continued from preceding page)

SURPLUS BARGAINS—War, government. Industrial surplus at savings to 80%! Clothes, boots, coats, tents—ba.gains for farm, home, outdoors. **SEND FOR FREE CATALOG**—must give zip code. **SURPLUS STORE**, Sioux Falls, S.D. 57102.

JEeps From—\$52.50; Typewriters from—\$4.15; Cars from—\$31.50. Walkie-talkies, motorcycles, airplanes, boats. Typical "As Is" bid bargains from Uncle Sam. Tremendous variety. Exciting free list. Write Enterprises, Box 402-X110, Jamaica, New York 11430.

SURPLUS Buyers Handbook. Military-Civilian. \$1.00. General Surplus Co., Box 915, Dept. 4PM2, Rochester, MN 55901.

GOVERNMENT SURPLUS How And Where To Buy In Your Area. **SEND \$2.00 TODAY**. Western Surplus, Box 198A, Tiburon, CA. 94920.

TREMENDOUS BARGAINS!! Buy Direct From Government. Complete Guide \$1.00. Informagency, Box 108, Brooklyn, New York 11219.

HOBBIES AND COLLECTIONS

HANDICRAFTERS—Old Horseshoes, \$2.35; Iron Novelties. Flying D Ranch, 10555 4th, Alameda, New Mexico 87114.

COLLECT MILITARY MEDALS. List 50¢. Vernon, Box 387PM, Baldwin, N.Y. 11510.

AUTOGRAPHS—Letters, Documents of Famous People, Bought and Sold. Monthly Catalogues issued. Neale Lanigan, Box 133, Fairview Village, Pa. 19409.

VENEER Bargain! 25 Square Feet Walnut \$7.00, 30 Samples 4"x9" \$4.95, Postpaid. New Exciting Simplified Instruction Manual/Catalog 25¢. Morgan, Box 18169, PO1K19, Louisville, Kentucky 40218.

ACTUAL Photographs of Buffalo Bill, Mark Twain, Geo. Westinghouse made from original glass plates. Mtd. \$9.50 PP. Picturesk Originals, Oakhurst, N.J. 07755.

READ "Country Americana Magazine". It's New, Different. Copy 35¢. Country Americana, Washington, N.J. 07882.

DECALS, EMBLEMS, PATCHES

CUSTOM Designed Embroidered Emblems, Decals. Inexpensive. Free Catalog, details. Southern Emblem, Box 8PMB, Toast, North Carolina 27049.

DECALS—Wildlife—Dogs—Horses. Send—10¢ for Free Folders. PM, Tyler, 1301 Methuen Street, Dracut, Mass. 01826.

4 EMBROIDERED Adhesive Patches \$3.00. Traffic Signs 3 inch. Garda, 371 Fifth Ave., Paterson, N.J. 07514.

BUMPER STICKERS, from your sketch. Sell or give to friends. 25 for \$10.00. Van Rhyne, Green Lake, Wis. 54941.

YOUR NAME IN GOLD on 15 pencils. \$5.00. White & Sons, P.O. Box 403, Elmhurst, Ill. 60126.

FREE For the Asking: Your Name in one-inch **CHROMED** Letters. Weatherproof. Adhesive-backed. \$1.00+ Value! No Obligation; only stamped, addressed envelope. Grifco Incorporated, Baldwin, Mississippi 38824.

STAMP COLLECTING

75 DIFF. CHINA—Only 10¢! Scarce, genuine postage stamps (Catalog Price Guaranteed Over \$6.00!) from all 3 Chinas: pre-1950, Nationalist China (Taiwan), plus Communist China. Ancient mysteries, modern marvels, Mao, Great Wall, etc.—this valuable collection only 10¢! Also, other exciting stamps to examine free. Buy any or none, return balance, cancel service anytime. Plus Wonderful Illustrated Catalog! H. E. Harris, Dept. A-248, Boston, Mass. 02117.

YOURS FREE! 40 RED CHINA Postage Stamps banned to American collectors for a generation by U.S. Gov't. Now at last you can legally own them; and these stamps are so worth having that experienced and beginning collectors alike want them—so act fast, because supplies are strictly limited! You also get 110 other stamps from Britain's Lost Empire plus illustrated Album to keep as a Bonus should you buy \$1.00 from our Approval Selection. Or return Album and 110 stamps with selection and buy nothing. Cancel service anytime. But Red China stamps are yours to keep! Send 10¢ for mailing while supplies last. Kenmore, Milford RC-817, New Hampshire 03055.

FREE! \$10.00 Giant Stamp Collection of 300 all different colorful, valuable postage stamps from Africa—Europe—Asia—British Empire—Worth \$10.00—\$12.00 at catalogue prices. Also money-saving Booklet. All yours as a Get-Acquainted Gift. Adults only. Other fine stamps enclosed for your inspection. Frasek Co., Inc., PM-3, White Plains, New York 10601.

NOW 50 IRAQ 10¢ with Approvals. Box 307, Goshen, N.Y. 10954.

35 HUNGARY: Send 25¢. Approvals Sent. Lee Stamp Co. P.O. Box 461, Cudahy, Wisconsin 53110.

FREE Mammoth Collection, Scott's or Master Global Albums given when you buy Approvals. Bargain Service, Box 5345, Santa Ana, Cal. 92704.

JAPANESE COMMEMORATIVES—pictorials. Mint complete sets cataloging over \$10.00 only \$2.00 with accompanying mint approvals. Satisfaction guaranteed. Pagoda, Box 132P, Sidney, Ohio 45365.

162 POPULAR MECHANICS

FREE! BIG Bargain Catalog—New Edition listing thousands of bargains including U.S. & B.N.A. stamps, packets, albums, accessories and supplies. Also, fine stamps from our approval service which you may return without purchases and cancel service at any time. Jamestown Stamp, Dept. E35PM, Jamestown, New York 14701.

35 STAMPS of Hungary! Send 25¢. Approvals Sent. Lee Stamp Company, P.O. Box 461, Cudahy, Wisconsin 53110.

WOW! 110 ALL Different Germany 10¢ Commemoratives, Airmails, High Values, Big Catalog, bargain lists. Also, fine stamps from our approval service, which you may return without purchases and cancel service at any time. Jamestown Stamp, Dept. A35PM, Jamestown, New York 14701.

FOREIGN Approvals! Gigantic values! 3¢ each. ABC, Dept. 3301-A, Box 6000, San Francisco 94101.

FRANCE #1100—\$4.95 each. Israel—1974 Jerusalem Exhibition—3-S/\$4.00 Set. Limited Quantity. Want Lists Solicited Europe 1964 to date. Mint only. Franklin, P.O. Box 467-PM3, Jamaica, New York 11434. Money Order Only.

20 HISTORICAL U.S. Commemoratives 10¢. U.S. Approvals accompany. **PINTO STAMP CO.**, Box 111, Park Ridge, Ill. 60068.

"EXOTIC Set"—10¢ with Approvals. Gorliz, Box 76457PM, Atlanta, Georgia 30328.

FREE 25 Worldwide stamps. Request Approvals. Approvals Contain Singles, Full, Short Sets. ACE, Box 315, Lafayette, Tenn. 37083.

1500 FOREIGN \$2.00; 5000 \$4.00; 9000 \$6.00. 1000 pre-1939 USA, contains dues, revenues, commemoratives, presidentials, order issues, etc. \$4.00. 4000 \$12.00. 300 USA high values \$2.00; 700 \$4.00. No approvals. Meyers, 5321 Fleming, Richmond, Calif. 94804.

FROM FIVE CONTINENTS 110 Different Stamps, All Yours for Only a Dime! Packages of Beautiful Approvals to Buy or Return. Send 10¢ to Stampac, Box 12005, San Francisco, California 94112.

NEW! 100 spectacular stamps from romantic Europe, exotic Orient, angry Africa, everywhere. Scarce Shan of Iran, Kennedy memorial, Space, many other issues from great empires and tiny republics. Plus stamp selections to examine. Buy any or none, return balance. Cancel service anytime. Rush 10¢. Garceion Co., 8PMA, Calais, Maine 04619.

FREE. U.N. Mint Set. Approvals. Hildebrand, Box 5645, Redwood City, California 94063.

50 YEARS Old, fifteen different United States, over fifty years old—10¢ with approvals. Jaxon, Box 145-P, Brooklyn, New York 11230.

SINGLE STAMPS 2¢ and up. Mounted in books. **TRUST STAMP COMPANY**, P.O. Box 100-P, Jamaica, New York 11435.

U.N. 9 Different Mint Sets \$1.00! U.S. 6 Different Commemorative Plate Blocks \$1.00! 30 Different Mint Commemoratives \$1.00! Approvals. Gordon Davison Hillsboro, New Hampshire 03244.

FREE surprise collection sent with approvals. Gould, 1784 Union, San Francisco 94123.

FREE Worldwide Packet. Penny Approvals. Froehlich, Box 412-A, Morton Grove, Ill. 60053.

PENNY! Approvals! Regardless catalogue! Kloster 4164 52nd St., San Diego, Calif. 92105.

65 DIFFERENT NUDES \$2.00. No Approvals. **KEMP**, 9952 Tamarack, Pacoima, California 91331.

50 DIFFERENT U.S. COMMEMORATIVES 25¢ Fine Used U.S. Approvals Accompany. Craig Stamps, Box 425-N, Bellmore, New York 11710.

315 DIFFERENT Stamps From Over 30 Countries, Including Special Selection From Wild, Mysterious Mongolia. Colorful, Fascinating Stamps Picturing Animals, Sports, Flowers, Paintings, Space And Much More. Only 25¢ . . . A Fabulous Bargain. Other Exciting Stamps Enclosed For Sale On Approval . . . Buy Some Or None, Return Balance, Cancel Anytime. The 315 Stamp Special Offer is Yours to Keep Regardless. Send 25¢ Today! JGS, Inc., Dept. C-35, Box 525, Merrifield, Virginia 22116.

BUILD Large U.S. Collection Economically. Sherman, Box 15355G, Philadelphia, Pa. 19111.

MYSTERY Packet. \$9.00 Catalog Value. Only 35¢. Stamps, Box 27, Fremont, Michigan 49412.

BECOME Mailorder Stamp Dealer. (Home Goldmine!) **FREE** Details. Nationwide, Box 355, Greenville, South Carolina 29602.

SPECIALS no approvals US Commemoratives 225 different \$1.00, 300 \$2.00, 400 \$4.00, 500 \$8.00, 600 \$16.00, airmails, 35 \$1.00, 59 \$5.00, Regency Stamps, Box 8854, Pittsburgh, Pa. 15221.

500 DIFFERENT Stamps, \$1.25. Smith, 508-A Brooks College Station, Texas 77840.

50 DIFFERENT Argentina—10¢. Approvals. Gobestamps, Box 402, Biddeford, Maine 04005.

100 Old United States between 1861 and 1839. \$1.00. Ed Roush, 423 Shepard, Mansfield, Ohio 44907.

U.S. BARGAIN, 50 Different 25¢, with beautiful worldwide, approvals. Stamp Center, Kennebunk, Maine 04043.

CANADA Sports Complete 10¢. Canadian Approvals. Harley Boardman, Little Valley, New York 14755.

RUSSIAN Space Collection 35¢, including Russian Approvals. Snedco, Waldwick, New Jersey 07463.

APOLLO 11 MOONLANDING. Complete set, fourteen multicolored giants, from Guinea (Scott #541-7a), only 50¢—catalog value \$6.82. Topical Approvals. LeBlanc, Box 110-P12, Glen Cove, New York 11542.

TEN Different Nudes: 20¢. Approvals. Stamp Farm, 2M76, Oxford, Wis. 53952.

225 DIFFERENT Worldwide: 25¢. Approvals. Tibbets, 8675 Meadow, Downey, California 90242.

100 DIFFERENT United States Commemorative, 50¢ with Discount Price List. Shelron, Box 547C, North Miami, Fla. 33161.

BETTER GRADE U.S., Canadian Stamps for advanced collectors. Borgen, Box 645, Seiad Valley, Calif. 96086.

SCARCE Guinea UN Airmails \$2.25, catalog 25¢. Approvals. Stamphaus, Box 533, Salisbury, Mass. 01950.

U.S. MINT Specials! Flag Set complete \$1.50. 1¢, 2¢, 3¢ Famous Americans (21 different) \$1.50. Free List. Brooks, 2601 Avenue "U", Brooklyn, N.Y. 11229.

100 DIFFERENT British Empire 10¢. Approvals. Gibson, Box 34, Lansdowne, Pa. 19050.

"INVERTED Error" Dag Hammarskjold, 10¢ with approvals. Belmont Stamps, Washington, D.C. 20015.

VIETNAM 25 Different 10¢ approval. Sam Chazen, Box 95, Ozone Park, N.Y. 11417.

FREE Catalog: 3,000 different stamp collections, packets; countries, topicals. Ullery, 1016 Meridian, Mishawaka, Indiana 46544.

110 DIFFERENT U.S. Commemoratives. \$1.00. Stamps, 7607 Larchview Drive, Dallas, Texas 75240.

50 DIFFERENT Old U.S. Revenue Stamps \$1.00. Winchester Stamps, Box 3592, Mansfield, Ohio 44907.

FREE Duplicate Exchange. 2¢ Approvals. Belden, Box 4175, Dearborn, Michigan 48126.

SOUVENIR Sheet Free with Approvals. Lee Hoover, Box 3594, Portland, Oregon 97208.

U.N. MINT 25 Different \$1.00. Philpot, Box 111, New Berlin, Wis. 53151.

2 NUDES Sets Plus 100 Others Only 35¢. Approvals. Paschall, Agnew, Box 56, Santa Clara, Calif. 95054.

OLDER U.S., POSSESSIONS, CANADA, ON APPROVAL. ADULTS ONLY, PLEASE. SURPRISINGLY GOOD. RIVERTOWN, BOX 188P, LOWELL, MICH. 49331.

50 DIFFERENT U.S. Stamps. Includes 1943 flag stamp of occupied nations. Only 25¢. Approvals included. Willett Co., Box 338-C, Yorktown Heights, N.Y. 10558.

WORLDWIDE Commemoratives. 25 Different 25¢. Approvals. Wilson, Box 116, Dollard des Ormeaux, Quebec, H9G-2H5 Canada.

COLLECT STAMPS FOR PROFIT. How To Start. Where to Sell. Complete Guide to America's most Popular Hobby. Only \$1.50, add 50¢ Postage and Handling. C. Ripley, 115 Myrtle, Pitman, New Jersey 08071 Dept. A.

PHILATELIC property remainder clearance! \$40.00 worth of fine high value stamps, plus 1000 different miscellaneous unpriced postage stamps. All for only \$10.00. Order Now! Shipped first class registered. Money back guaranteed. Eric's Stamps, Box 1444-B, Kitchener, Ontario, Canada.

WHOLESALE PRICES! World-wide approvals. To one-tenth catalog! Deposit \$2.00—Refundable. Floyd Gaines, Box 788, Mattoon, Ill. 61938.

FREE British with approvals. Stamps Unlimited. Box 2295, Kalamazoo, Michigan 49003.

WORLDWIDE Collection over 150 interesting stamps 10¢. Approvals Accompany. Casto, Box 927, La go, Florida 33540.

TOPS! 100 Popular Poland Stamps (all different) only 25¢. Mystic, Dept. PS 1, Camden, New York 13316.

PLASTIC Stamps! Moulded portraits of Kennedy, Churchill, Gandhi. Complete Mint postage set from Bhutan, only 25¢. Topical approvals. LeBlanc, Box 110-P7, Glen Cove, New York 11542.

FIVE Guinea Nudes, 5¢. Approvals. Summit, 1146-A-49th, Brooklyn, New York 11219.

WORLD Stamps. 3¢ to 10¢ each. Write for approvals today. Thousands to choose from. Continental, 20929 Ventura Blvd. #20, Woodland Hills, CA 91364.

INTRODUCTORY Offer. World Wide Stamps Over \$10.00 Value For \$1.00 with Approvals. Continental, 20929 Ventura Blvd. #20F, Woodland Hills, CA 91364.

UNITED STATES Commemorative Plate Blocks. 25 Different 3¢ - \$7.00, 4¢ - \$8.00, 5¢ - \$9.00. Village Stamps, 20929 Ventura Blvd. #20G, Woodland Hills, CA 91364.

BRITISH EMPIRE. 100 different 15¢ with packet approvals. Denali, 4122-PM Woodbridge, Lansing, Michigan 48910.

SENSATIONAL Clearance Offer. Forty different Packets \$1.00. Norge, Wyckoff, N.J. 07481.

FREE U.S. Used. Approvals Accompany. Chapmans, Box 487-S, Galesburg, Michigan 49053.

"WHOLESALE" U.S.—Foreign Pricelist and catalog Free! Everything Guaranteed. Schneider, Box 1240, Grand Rapids, Michigan 49501.

(Continued on next page)

Материал защищен авторским правом

STAMP COLLECTING

(Continued from preceding page)

101 WORLD WIDE STAMPS. Each from a different Country. 25¢ with request for Approvals. **HOBBY ASSOCIATES**, P.O. Box 2869, San Francisco, CA 94216 (Dept. PM).

EISENHOWER, TRUMAN or LYNDON B. JOHNSON Memorial Stamp on lovely, official, First Day Cover addressed any name of your choice. 60¢ each—all 3 for \$1.50. **K. M. WALSH**, Box 308AA TUCKAHOE, N.Y. 10707.

OWN a stamp business!!! Write: International, 6767LX, South Atlanta, Tulsa 74136.

RARE Stamp Free! Also new packet Aden to Urundi, with Kennedy, Triangles, Space, Sports, Ships, Dogs, Cats, Reptiles, plus others. All free. Send 10¢ for mailing. **Empire Stamp Co.**, Dept. 1, Toronto, Canada.

TREES ON STAMPS: Topical collection Free with Approvals. The stamp tree, 350 Foresthill Ave., Auburn, Cal. 95603.

FREE Mint British Colonials from Antigua, St. Christopher, Nevis, Sarawak, Turks, Caicos, Tristan Caymans, St. Vincent. Free with approvals. **Viking**, Great Neck, N.Y. 11021.

GIANT COLLECTION—213 STAMPS, ALL Complete sets including Space sets, Famous Paintings, Olympics, Wild Animals, Exotic Birds, and many more exciting sets. This bargain from London—yours for 25¢ in used stamps! To introduce approval-bargains. **B** oadway Approvals, Dept. TC6, 50 Denmark Hill, London S.E. 5, England.

VAN GOGH Gold-Framed Paintings, Multicolored, complete postage Free is your ask for approvals. **E. Frija**, R 1, B 157A, Red Hook, N.Y. 12571.

FREE Gift with quality approvals. **Lassen**, Box 877-PM, Chico, Cal. 95926.

COLLECT STAMPS FOR PROFIT! How to start, Where to sell. Complete guide to America's most popular hobby. Only \$1.50. **The Chalet**, Dept. PM3, Swiss Colony, Franklin, N.C. 28734.

14 DIFFERENT miniature sheets of Wild Animals, Butterflies, Fish, exotic Birds (192 stamps) only \$1.00 postpaid. **Albert Enterprises**, Box 15186M, Seattle, Wash. 98115.

RUSSIA! 30 Different! All Large Commemoratives! Only 25¢ with approvals. **Stamps**, 634-M Station A, Richmond, Calif. 94808.

15 BEAUTIFUL Stamps **FREE**. Worldwide Stamp Values, Box 1202, Waukesha, Wis. 53186.

215 WORLDWIDE Exciting, Bargain Approvals . . . Gifts. 25¢. **Grimco**, 4294 B. nnington PM, Brunswick, Ohio 44212.

COLLECT - Stamps for profit! How to Start, Where to Sell. Complete Guide to America's Most popular hobby. Only \$1.50. **McClense**, 1285 Boulevard, New Haven, Conn. 06511.

SERIOUS Collectors: \$1.50 Packet - Free! Approvals? **Rose**, 104-68 Roslyn, Winnipeg, R3L 0H7.

400 MIXED U.S. 25¢ Approvals, **Wright**, Box 753-M, Hagerstown, Maryland 21740.

SENSATIONAL Worldwide Collections: 870 Different —\$1.00. Breathtakingly Beautiful! **Andrew Veres**, Sagamore Hills, Ohio 44067.

FREE POCKET MAGNIFIER Sent With Our Beginner's Unusual Approvals. **Studio of Philately**, Hecker Pass, Watsonville, California 95076.

APPROVALS, Pennies, Regardless Of Value. **National**, Box 7037, Arlington, Va. 22207.

PICTORIALS Collection! Fifty Different, 10¢, Approvals. **Ross**, Box 564-M, Yonkers, New York 10702.

ICELAND volcanoes catalogue \$1.50 only 50¢. Approvals. **Sandell**, 701 Sherwood, St. Paul, Minnesota 55106.

U.S. COMMEMORATIVE PLATE BLOCKS—10 different: 3¢-\$2.95, 5¢-\$3.95, 6¢-\$5.95, 8¢-\$4.95, 10¢-\$5.75; list 10¢. **Hoecker**, Box 8943(P), Portland, Oregon 97208.

100 WORLDWIDE 10¢. Worldwide Approvals. **Seaside**, 6545 Camino Venturoso, Goleta, Calif. 93017.

"AROUND The World in 80 Stamps." 25¢. App. ovals. **Centennial**, Dept. A, Box 17630, Philadelphia, Pa. 19135.

COLLECT STAMPS For profit! How to start where to Sell Complete Guide to America's most Popular Hobby only \$1.50 Plus .50 Postage and Handling **GOLDEN BOOK HOUSE** Dept. 102, 8701 Kinmore, Dearborn Ht's., Mich. 48127.

50 SPORTS PICTORIALS. 25¢ with approvals. **Arbour**, 3727 Downey Dale, Randallstown, Maryland 21133.

"SUBMARINES, Destroyers, Battleships" - Russia's latest Gigantic Commemoratives - Free! Approvals plus 101 Bonus Sets. **William Deems**, 226 Race, Ravenswood, West Virginia 26164.

LOOK: 300 Worldwide Stamps, 25¢ with Approvals. **Scenic Stamps**, Box 1973G, Vancouver, Wash. 98663.

ABSOLUTELY free Foreign pictorials with approvals. Low prices. **Tom & Jerry**, Box 5052PM, Mission Hills, CA 91345.

FREE BARGAIN LISTS! U.S. Plates-Singles. **Scotco**, Box 470855-PM3, Miami, Fla. 33147.

WOW! 9 Beautiful Hungarian Aviation Stamps—35¢. Request approvals. **Sylvia Beatty**, Dept. 176 PM3, Eau Claire, Pa. 16030.

PAINTINGS! Twenty-five Different Masterpieces! 35¢. Approvals. **Stump**, Box 21245 Rosedale, New York 11422.

FREE New used Congo animal set. Approvals included. **Alpaugh**, Box 225, Hightbridge, N.J. 08829.

FREE U.S. price lists. No approvals. **Applied Concept**, Box 17185, Dulles, Washington, DC 20041.

FREE "Space". With packet approvals. **Sunset Stamps**, 33 Majorca Drive, Rancho Mirage, California 92272.

FREE Watermark Detector, Perforation Gauge, 100 Different Stamps, Packet of Things. State Collecting interest for Approvals. Mail a quarter for Handling. **H and L Stamp Company**, Box 3090 Station B, Calgary, Alberta, Canada T2M 4L6.

10 QUATAR Stamps Free—Approvals, W-B Stamps, **Wilkes-Barre**, Pa. 18703 Dept. PM

COINS, TOKENS, CURRENCY

HISTORIC BRITISH PENCE!! (Jumbo-Size Pennies). Mintage and Circulation Discontinued. \$1.00 Sample Packet (3). **FREE** Brochure. **Britannia, Ltd.**, 19CP, Kensington, Bronxville, New York 10708.

GRAB Bag U.S. Coins \$5.00, Double Value! Bargain Lists Free. **Sayers**, 1000 Unaka, Johnson City, Tennessee, 37601.

COINS at Discount Prices! Free Brochure. **Gene Carlton**, Chandler, Okla. 74834.

SILVER DOLLARS Uncirculated, 1880-81—1883-84-85 \$10.00 Ea. Catalogue 50¢. **Shultz**, Salt Lake City, Utah 84110.

CATALOGUE 3 Lincolns \$1.10—1928S-1938S—1939D—Rongo, 1265 81 Street, Brooklyn, New York 11228.

UNCIRCULATED Silver Dollar \$8.95. \$2 Bill \$3.95. Oz. Silver Bar \$6.95. Catalog 25¢. **Coin Pocket**, 342 S Central, Lawrence, N.Y. 11559.

"S" MINT Lincoln Cents. All Wheat Backs. Not Picked. 50-\$3.75, 100-\$6.90, 500-\$29.00. "S" Mint Nickels Before 1955 50-\$7.50, 100-\$13.00. **Village Coin**, 20929 Ventura, Woodland Hills, CA 91364.

FREE: Lists of Thousands of Stamp and Coins. No Approvals. **Bryson**, 612M White, Toledo, Ohio 43605.

SCARCE 1974-S Uncirculated Cent, Coin List 20¢. **Economy**, Box 92, Buzzard's Bay, Massachusetts 02532.

10 DIFFERENT Indian Pennies, \$8.75. Free Coin Catalogue. **Village Coin Shop**, Dept. P, Plaistow, N.H. 03865.

ANCIENT Roman Coin, 2,000 years old. Guaranteed Genuine, \$3.95. **Coins Ltd.**, Box 143-P, Canton, N.C. 28716.

GOLD AND SILVER! Bullion type coins. Wholesale systematic monthly investments. **Mexican coin experts**. Brochure free. **Colonial Coins**, 909 Travis, Houston, Texas 77002.

BRILLIANT Uncirculated 1950D Nickel \$11.48; Crisp New \$2.00 Bill \$6.89; 1973S, 1974S Proof Sets - Each \$15.78; Super-Bargain Lists 30¢. **Bebee's, Inc.**, Omaha, Neb. 68111.

GOLD COINS Of the World. Beautiful Low Prices. Plus thousands of United States Coins. Free price list. Please send long, airmail envelope. Self-addressed, stamped. **Silver Center**, Box 22171-M, San Francisco, California 94122.

GOLD Bullion Coins. Mexican 2 Pesos \$11.75. Mexican 50 Pesos \$256.50. **Kruggerand** \$222.50. 1/2 ounce Gold Bar \$100.00. Free Brochure. **Atlantic Wholesale**, Box 1091-C, Florence, S.C. 29501.

SPECIAL! Ten Buffaloes \$3.95 Coins Wanted! **Nelson**, 306-Z, Chappaqua, New York 10514.

HOW TO COLLECT COINS For Fun and Profit! How To Start, Where To Sell. Lists Of Valuable Coins. Send \$1.00. **Marbil Co.**, Box 177, Shamokin Dam, Pa. 17876.

INDIANHEAD & Lincoln Cents 1883-1949 33 different \$2.99. Catalog 25¢. **Edel's**, Carlyle, Illinois 62231.

CANADIAN Pennies Before 1936—Ten Different, Plus Giant Catalogue, \$2.00. **Niagara Coins**, P.O. Box 783, Pt. Huron, Michigan 48060.

ANTIQUES, RELICS, INDIAN GOOD AND CURIOS

INDIAN Relic list. Arrowheads \$4.00, doz. **Folsom**, \$5.00 each. **C. Secrist**, Deerfield, Missouri 64741.

SELLING 10,000 Indian Relics, Arrowheads, Knives, Spearheads, Scrapers, Etc. List Free. **Lear's**, Glenwood, Ark. 71943.

10 BEAUTIFUL Arrowheads \$2.00. **Guajardo's**, 8713 Shaver, El Paso, Texas 79925.

EVERYBODY LIKES DIXIE GUN WORKS

TONS of antique gun parts and supplies. All reproduction muzzle loading guns. Send \$2.00 for enlarged illustrated catalog No. 123A. **Dixie Gun Works**, Union City 12, Tennessee 38261.

MODELS—CARS, SHIPS, TRAINS, PLANES, ETC.

NEWEST, GREATEST FLYING HOBBY—ROCKETS! Zoom from Realistic Electric Launch Systems to 2,500 Feet on Safe, Thrifty, Solid-Propellant Power. Gentle Parachute Recovery For Over-and-Over-Again Flights. Tracking, Experiments, Real Miniaturized Still and Movie Cameras. Build your Own Exciting, Low-Cost Space-Age Adventure—Starting With a Big, New Full-Color Catalog of Over 80 Models (Including Ready-to-Fly). Send 25¢ to **ESTES INDUSTRIES**, Dept. 7G, Penrose, Colorado 81240.

SHIP Model Kits, fittings, plans, books, tools, engines, motors. Illustrated catalog 75¢. **Mats**. residents add 3% tax. **James Bliss & Co.**, Dept. 5M, Route 128, Dedham, Mass. 02026.

SHIP And Yacht model fittings: Pine construction hull kits: blueprints. Send \$1.00 for illustrated catalog. **A.J. Fisher, Inc.**, 1002 Etowah Avenue, Royal Oak, Michigan 48067.

MODEL Airplanes—Big 220 Page Catalog \$1.00. **Sig Company**, Montezuma, Iowa 50171.

SHIP MODEL Kits, Plans, Fittings from our own Workshop. Big Illustrated Catalog: 75¢. **Bluejacket Shipcrafters**, 145-V. Water Street South, Norwalk, Conn. 06854.

SHIP And Airplane Model Kits Catalog 25¢. **Scientific Inc.**, 340 Snyder, Berkeley Heights, N.J. 07922.

BUILD your dream home in miniature with wood, choose from: 1/2", 3/4" or 1" scales. Write: **Survival Systems**, 1804 #D Iris Avenue, Sacramento, California 95815.

GAMES, TOYS, PUZZLES, NOVELTIES

BE A Rebel. Play Chess by Color. (Patent) Info: **Iris**, Box 5092, Cleveland, Ohio 44101.

MINIATURE Charms — Trinkets — Toys. (3) **FREE** Samples. **TREASURE CHEST**. 9321 PM Capeview Ave., Norfolk, Va. 23503.

WHIZZEE BOSS BOX KITE. Giant 60" high. \$3.00 each, 2 for \$5.00. **Whizzee**, Box 764, West Fargo, N. Dak. 58078.

MAGIC TRICKS, JOKES, VENTRILOQUISM

SPOOKS, Mindreading, Crystal Gazing. **Mentalist's** catalogue free. **Magnuson**, 1446—4th Ave., Rockford, Ill. 61108.

MAGIC! Amaze. Mystify. Entertain! Large Catalog 25¢. Hundreds of Best Tricks for Stage, Pocket, Parlor. **Jeffries Magicland**, Dept. 11, Dallas, Texas 75201.

BEST Close-Up Magic! 25¢. **Conjurers Craft**, Box 65-M, New Hyde Park, N.Y. 11040.

MAGIC MAGAZINE. Tricks, News, Dealers Offerings. Monthly Since 1936. 2 sample Copies \$1.00. **Genii**, P.O. Box 36068M, Los Angeles, California 90036.

FABULOUS MAGIC! New 1974 Catalogue 50¢. Our Specialty Orders Shipped Same Day. No Substitutes. **Fabulous Magic**, 3319 East Charleston, Las Vegas, Nevada 89104.

NEW 68 Page Magic Magazine teaches Magic, Mind-reading, Illusions by World Famous Magicians. Sample copy \$1.00, 1 year (12 issues) \$10.00. **THE MAGIC MAGAZINE**, Dept. PM, 20 E. 46 St., New York, N.Y. 10017.

FREE! World's leading novelty catalog. 1600 Fun-makers, Jokes, Tricks, Science, Sports, Hobbies, Jewelry, Psychedelia. **Johnson-Smith**, C-10, Mt. Clemens, Mich. 48043.

VENTRILOQUISM! Information free. **EXCITING FULL COLOR DUMMY CATALOG**—25¢. **Maher**, Box 420PM, Littleton, Colorado 80120.

TWO! Different Magic Catalogs 25¢. **Miami Magic**, 9734 Bird Road, Miami 33165.

COMPLETELY illustrated catalog. 84 pages, 25¢. **Manhattan Magic**, Box 334-M, N.Y.C. 10011.

WORLD'S Finest professional magic tricks. **Joker's** Novelties. Giant illustrated catalog 25¢. **Top Hat**, Evanston, Illinois 60204.

WOW! Magic, jokes, Largest selection. Amaze, mystify friends. **Super Giant Catalog** 25¢. **Abracadabra-MP**, Colonia, New Jersey 07067.

MAGICIANS—Fantastic Magic! Catalog 50¢. (Deductible from first order.) **Conjurer's Cabinet**, Dept. 1613, Box 7, Old Bridge, NJ 08857.

VENTRILOQUISM Courses, Dummies, Marionettes. Catalog 50¢. **Izzy's Ventriloquism School**, 6034 South Pulaski, Chicago, Illinois 60629.

DOLLAR gets \$2 trick and exclusive catalog. **Magic**, 1218 Westcott, Syracuse, N.Y. 13210.

BOOKS WANTED

OUT Of Print Bookfinder. Box 663PM, Seaside, Calif. 93955. Send Wants.

BOOKS, CATALOGS, NEWSPAPERS

UNUSUAL Book Sale!! 40 for \$3.00. Free Brochure. **Susco**, POB 328-B, Oakland, Calif. 94604.

NATIONAL Geographic Magazines, 1888-1971, any issue. **Buxbaum**, Box 465-PM, Wilmington, Delaware 19899.

PUBLISH Your book. Join our successful authors: publicity, advertising, promotion, beautiful books. All subjects invited. Send for Free manuscript report and detailed booklet. **Carlton Press**, Dept. PMO, 84 Fifth Ave., NY, NY 10011.

FREE Book. Prophet Elijah Coming Before Christ. **Megiddo Mission**, Dept. 63, 481 Thurston Road, Rochester, N.Y. 14619.

INSTRUCTIONAL Mail-Order Publications. Free Catalog. **Kulis**, Box 9003, Maple Heights, Ohio 44137.

(Continued on next page)

NEWSPAPERS

(Continued from preceding page)

"BRAINPOWER" Send \$1.00 to Curtis HOOKS, Sr., P.O. Box B, Lebanon, Illinois 62254.

GIGANTIC BOOK SALE! Huge Selection, Free Catalogs. Write: Salter-B, 162 Calvert, Tonawanda, New York 14150.

1001 THINGS You Can Get FREE. Book shows how. Only \$1.00. Robert L. Buckman, 4808 W. Barry Ave., Chicago, IL 60641.

306 FREE magazines. Details 25¢. Custom House PM, Patterson, New York 12563.

BACK ISSUE MAGAZINES, 200 Titles 1890-1974. Everybody's, 317 West Sixth Street, Los Angeles, California 90014.

BEST "How to" Books/Manuals. Free general catalog. Write: Oak, Box 1488D, Oak Brook, IL 60521.

GREATEST Book Bargains ever—40 for \$3.00. List 25¢. Gunning, Box 457PM, RD 8, York, Penna. 17403.

HOBBY HOMESTEADER'S Manual Covers Well Drilling, Cheap Buildings, Free Power, Soils, etc. Free Details. Ajan Books, Box 239-P, Evansburg, Alberta, Canada. TOE OTO.

FRAUDS, SWINDLES, SCHEMES Revealed. Learn how to avoid them. Revealing Manual tells how. Send \$3.00. Frank's Sales, Box 14674, Phila., Pa. 19134.

FORTY Books for \$3.00—Yes, 40! Free Details from: Tamar-Kadesh Industries, P.O. Box 374, Bronx, N.Y. 10462.

AMAZING BOOK SALE Famous Blue Books, 600 Titles. Free Brochure. Bomart, Box 16313, Portland, Oregon 97233.

SELF Improvement books. Free details. Enterprises, Box 712, St. Thomas, V.I. 00801.

DISCOUNT BOOK CATALOG - Save money - Fiction, mystery, how-to. Send 25¢ to Phil-Jac, 3405 Cedar Hill Rd., Dept. B, Canal Winchester, OH 43110.

BIG Profits in Real Estate. How and Where To Buy Land. \$1.50 plus 50¢ for postage and handling. Steward Sales Company, 806 Massey Avenue, Durham, North Carolina 27701.

DEPRESSION, Inflation, Unemployment! Write for: "How You Can Survive a Depression" \$2 Postpaid. Pridemark Publishing Co., Box 109M, Glyndon, Maryland, 21071.

FREE Catalogs, 1000's of items. Information and directory \$1.00. Potpourri, Box 88, Kevil, Ky. 42053.

FREE CATALOG! Hundreds of popular books at huge discounts. Banner, Box 6724, Glendale, California 91205.

CLOCK And watch repairing books, tools, materials. Free catalog. North American, Box 77ACA, Fox River Grove, Illinois 60021.

"UNUSUAL" Books! Catalogue Free! International Imports, Box 7798PM, Atlanta, Georgia 30309.

HOW TO BEAT INFLATION—More Money, Happiness, Success. Free Details. C. Enterprises, Box 376PM, Walnut Creek, Calif. 94596.

HOW TO PREPARE FOR THE COMING CRASH. 122 page book gives program to survive greatest depression nation has known. Send \$3.95 plus 25¢ postage. MBM Distributors, 13297 Coyle, PM3, Detroit, Mich. 48227.

SALESMEN Increase Your Sales. New Book Tells How. Write For Information. Halls, 957-P La Fiesta Way, Lake San Marcos, Calif. 92069.

FREE List! Hundreds of Books—all kinds. Kirk Enterprises, 108-A W. Monroe, Salisbury, N.C. 28144.

EXPAND YOUR MIND. Inexpensively! Send Now! For free self improvement Catalogue, Palafin House, P.M.C. 52 Sidney, Buffalo, New York 14211.

HUGE—5—Pound Grab-bag of Books, interesting titles, damaged, hurry, limited supply. Send \$4.00. Wilson's, 6732 Jackson Dr., San Diego, Calif. 92119.

SERVICE YOUR OWN CAR! BUY POPULAR MECHANICS CAR REPAIR ANNUALS. There editions still available 1971 and 1973 and 1974. Price, \$1.00 each. Send Order to: Popular Mechanics, Dept. HE, Box 1014, Radio City, New York, N.Y. 10019.

PLAYS, SONGS, MANUSCRIPTS

SONGS-POEMS Wanted for Publishing-Recording at Our Expense. Authors of Accepted Songs Pay \$8.75 for One Hand-Cut Record. Monthly Awards. Fabulous Offer. Talent, 17 (PM) Longwood Road, Quincy, Mass. 02169.

SONGWRITERS LOOKING for CO-WRITERS on 50-50 basis. HAS songs recorded by BRENDA LEE, EDDY ARNOLD, and others. SEND lyrics to: NASHVILLE CO-WRITER PLAN, BOX 1152, NASHVILLE, TENNESSEE 37202.

BUSINESS SERVICES

PROFITS FROM CLASSIFIED ADVERTISING! Booklet shows you how to start your own business with Classified Advertising. Only \$1.00 (Refundable with first order.) H. E. KAPPEL, POPULAR MECHANICS, DEPT. P, 224 WEST 57TH STREET, NEW YORK, N.Y. 10019.

BUSINESS OPPORTUNITIES

IMPORT-EXPORT Opportunity, Profitable World-Wide, Mail Order Business From Home, without Capital or Travel Abroad. We Ship Plan for No Risk Examination. Experience Unnecessary. Free Report. Mellinger, Dept. A2703, Woodland Hills, California 91364.

HOW To Straighten Bicycle Wheels for Fun and Profit. Send \$2.00 to: Gillies Enterprises, 605A, Skyline Dr., Harrison, Ark. 72601.

BELOW Wholesale. Watches, Radios, Jewelry, carded goods, novelties. For resale. Hundreds items. Write Marco, PM-3, Ashburn, Georgia 31714.

INSTAMAIL'S Magic Mailer program makes \$100 weekly—dealership. Information: Instamail, Box 427, New Castle, Pa. 16101.

STUFF Envelopes \$500.00. Thousand FREE Details Send Stamped Addressed Envelope. Mantor House, Dept. 8, P.M.S. MINOA, N.Y. 13116.

SELL Books by Mail. Complete Dealer Set-Up 25¢. Ulis Distributors. Box 34029-PM Los Angeles, California 90034.

HOW to start a publishing house in your spare room. Publish books, courses, newsletters inexpensively. Amazing profits! Information free. Floyd-6C5, Box 653, Newberry, South Carolina 29108.

\$200.00 WEEKLY Possible Mailing Circulars. Send Stamped-Addressed Envelope. Mearian, 3565-P Albatross, San Diego 92103.

\$1000.00 MONTHLY! Become our mailorder distributor. Everything supplied—circulars, mailing lists. Write: Enterprise, Box 1296-B7, Newport News, VA 23601.

STUFF Envelopes. Earn \$5.00 per thousand. Free Supplies. Send Stamped Addressed Envelope. Godanovic, 160 Banner Way, Pittsburgh, Pa. 15201.

\$30.00 PER HUNDRED addressing envelopes. Immediate earnings. Beginners Instructions \$1.00 (Refundable). Park, Box 20401, Los Angeles, Calif 90006.

IMPROVE MAIL ORDER Skills With Professional Guidance. Easy To Read Reports Provide Hard And Fast Facts—Formulas. Free Details. Triandye, Box 2102, Great Falls, Mont. 59403.

MAILORDER PROFITS! BUSINESS SUCCESS! Inexpensive Books Show How! Free Details! Stratford House, Box 870, Department PM3, Wantagh, New York 11793.

MAILORDER—Nationally known MILLIONAIRE will teach you personally. Write for Informative Book, Gift Catalog, and Complete Details. EVERYTHING FREE. No Obligation. Mail Order Associates, Dept. 15, Montvale, NJ 07645.

MAIL ORDER SECTION AD SPACE! CONSUMER tabloid. Low rates; proven results. Copy, rates \$1.00. Liebig, Cold Springs Road, Huntingdon, Pennsylvania 16652.

UNBELIEVABLE Profits Without Investment? How? \$1.00 (Refundable)—Gift World, 157 Widmer Rd., Wapp's Fall's, New York 12590.

\$2,000 MONTHLY in fabulous new business. FREE DETAILS: NEESE, BOX 4243, MOBILE 36604.

300 WAYS TO MAKE EXTRA MONEY, Fascinating book gives practical ways to expand your income. \$6.95. R. C. Hamilton, 604C East Main St., East Alton, Illinois 62024.

ABANDONED INDUSTRIAL SILVER—yours for taking. Easy \$24,000 yearly! Free information: Silverman B-13, Box 548, Woodville, Texas 75979.

COMPLETE MAIL ORDER BUSINESS \$5.00. Enough starting supplies to NET you \$100 PROFIT. Liebig, Cold Springs Road, Huntingdon, Pennsylvania 16652.

\$2000. MONTHLY In Fabulous New Business Rush for Free Details. Staro Co., 33 Kelley St., Taunton, Mass. 02780.

\$400+ WEEKLY! Financial Breakthrough!! Free Details. Aware, Box 1248-PM2, Pacifica, Calif. 94044.

\$1000 MONTHLY Mail. Details. Nichols, Box 167A, Conowingo, Md. 21918.

FREE List! America's Best Moonlighting Business Opportunities. OKBC, Box 2506, Santa Rosa 95405.

\$70 TO \$200 WEEKLY—Home, Spare Time Simplified Mail Bookkeeping. Immediate Income. Easy. Auditax, Box 34741A, Los Angeles, Calif. 90034.

FREE! "Turn \$10 into Fortune!" Hotline, Box 3155-P, Springfield, Missouri 65804.

VENDING Machines. No selling. Routes earn amazing profits. Big catalogue free. Parkway Corporation, 715PM Ensor Street, Baltimore, Maryland 21202.

MAKE DOLLARS, 5000 per Month from Your Own Home. New Business. VEUTHEY HOUSE, Box 38477, Los Angeles, Cal. 90038.

EARN Money raising fishworms for us! Write: Oakhaven-38, Cedar Hill, Texas 75104.

BECOME Our Mail Order Distributor with \$150 Investment. Free Brochure. Audit Controls, 40 Brookside Ave., Fair Lawn, New Jersey 07410.

INSTANT Money! Plastics are the wave of the future. Big profits now! At home! Spare time! Materials costing 11¢ bring back \$2.58 profits immediately! Free information. Rush name on postcard to: Warner, Room LC-2-EC, 1512 Jarvis, Chicago, IL 60626.

VINYL'S Where The Money Is! Invisibly repair, re-finish, recolor furniture, luggage, car tops. Quick, easy. Two small \$20 jobs a day earn you \$1,000 a month. Homes, cars, offices, restaurants, unlimited customers. Start earning after an hour's practice. Sensational details Free. VIP, 2035 Montrose, Chicago, 60618.

ADVERTISING BUSINESS—You Own It! \$400 first week or money back. Action Ad Clock, Room AC-2-EC, 1512 Jarvis, Chicago, IL 60626.

\$400.00 MONTHLY Raising giant fishworms. Soilless method. Charlie Morgan, Bushnell, Florida 33513.

BECOME Mailorder Stamp Dealer. (Home Goldmine!) FREE Details. NPC, Box 355, Greenville, South Carolina 29602.

\$12.50 HOUR Spare Time—With Your Own Easy Vacuum Cleaner Repair—Rebuilding Business! Small Investment, "Results Guaranteed." Details Free! Baron, Box 863AB3, Portales, New Mexico 88130.

MAKE \$92.00 FROM Square Foot Plywood (Jigsaw or Bandsaw necessary). (Proof), details 25¢. (Refundable). Woodart, Bridgewater, Mass. 02324.

FREE 100-Page Catalog waiting to bring you Big spare-time cash commissions. Sell Advertising Book Matches. Every business a prospect... complete selling instructions furnished. Steady, repeat business. Dept. MX375, Superior Match Company, 7530 South Greenwood Avenue, Chicago, Illinois 60619.

MAKE MAGNETIC SIGNS. BIG PROFITS. FREE information. Universal, Lenora, Kansas 67645.

MAKE \$7.50 to \$15.00 hourly building portable custom cases in your home. Huge demand. Get orders by mail. We supply materials, instructions—everything. Free details. Customcase, 6075 De Soto, Dept. C-20-27, Woodland Hills, California 91365.

MAILORDER Opportunity. Beginners. Established. Every business uses. Elco, 181-M, Sylvania, Ohio. 43560.

EARN \$80.00 Daily Manufacturing Concrete Bricks-Tiles-Wooden Molds. Send Stamped Envelope, Hilmar, Route One, Box 347-DH, Valrico, Florida 33594.

PORTABLE Sandblaster \$29.95. Distributor wanted. Free Brochure. Inka, Box 66573-A, Houston, Texas 77006.

\$1.00 LISTS You year sent to 1000 Importers, Jobbers, Mailers, our mailing year. Dixie, King, North Carolina 27021.

\$200.00 SPARE Time earnings with your Tablesaw. Write: Workshop Five, 3800 Harney, Vancouver, Washington 98660.

\$100.00 DAY. Manufacturing Concrete Blocks, Posts. Semi-Automatic Block Machines. Mold Equipment Catalog, over sixty items, \$2.00 refundable. Carlayne, Route One, Box 95, Rapid City, South Dakota 57701.

SELL Books by mail. Complete dealer set-up—25¢. Midwest Mail Sales, Box 44R2-PM, Shawano, Wisconsin 54166.

WORLD'S Largest supply, Merchandise 25% to 40% under wholesale. Bankrupts. Closeouts 10¢ on dollar imports. Hong Kong clothes. Automobile discounts. Free details. International Buyers, Box 16386 MM, Portland, Oregon 97233.

PIANO Tuning Quickly learned with home study course. Diploma granted. American Tuning School, 17050 Teller Dr., Morgan Hill, Calif. 95037.

\$200.00 DAILY In Your Mailbox! Opportunity To Follow Mailorder Experts. Free Details. Associates, Box 136-A, Holland, Mich. 49423.

BECOME "Mortgage Broker." Lucrative! Capital Sources. Box 640099, Uleta, Florida 33164.

FREE COLLECTION AGENCY Details!! \$1000.00 Monthly Possible. Master-PM, Dawsonville, Georgia 30534.

HOW TO RAISE \$100.00 to \$1,000,000.00! Write: Capital-PM, Dawsonville, Georgia 30534.

START Mail Order. New Product. Fun, interesting, profitable. Free information. Toadstools, POB 1044-M3, Mason City, Iowa 50401.

MAILORDER Millionaire helps beginners make \$500 weekly. Free report reveals secret plan! Executive (1A3), 333 North Michigan, Chicago 60601.

MAILORDER BEGINNERS LIBRARY, Learn Professional Secrets Inexpensively! Write: HOW, Box 4457-PM3, Downey, California 90241.

I MADE \$40,000.00 Year by Mailorder! Helped others make money! Free Proof! Torrey, Box 318YY, Ypsilanti, Michigan 48197.

MAIL Baby Catalogs to New Mothers for Big Profits! Details 25¢. Volz-PM, Ypsilanti, Michigan 48197.

WHERE To Buy 750,000 Products Wholesale. Howard, 340-PM, Belton, South Carolina 29627.

RECEIVE \$250.00 Per Thousand—stuff Envelopes—Earn Immediately—Details 25¢. Saffar, Box 1956-PM18, Atlanta, Georgia 30301.

EARN \$60.00 Daily manufacturing Concrete Fence Posts. Practically no investment. Send stamped-addressed envelope. American, Excelsior Springs, Mo. 64024.

1000% PROFIT Bronzing Baby Shoes At Home. FREE LITERATURE NBCPM, Gower, MO. 64454.

HOLLYWOOD CEMENTCRAFT: Offers Highly Profitable Home Business. Experience Unnecessary. Unlimited Unique Pottery Designs Easily Made Without Moulds. Birdbaths, Fountains, Wishing-Well, Waterfalls, etc. Chemical Coloring Formulas. Marble-glazing. FREE Illustrated Brochure. CONCRETE FACTS, 602 Athens Street, Altadena, California 91001.

NEW, Compact fire extinguisher. Fantastic profits. Exclusive territories. Norwich Chemical, Norwich, Connecticut 06397.

(Continued on next page)

BUSINESS OPPORTUNITIES

(Continued from preceding page)

RECEIVE Mail Galore! National Listing. \$1.00. Sullins, 1313-M, Brunswick, GA 31520.

FREE NEWSLETTER. SELL BOOKS BY MAIL. We Wholesale, Dropship. National Publishers, Box 1355-C, Sioux Falls, South Dakota 57101.

FREE SECRET BOOK "2042 Unique Proven Enterprises." Tiny businesses but huge profits! How Little Felows beat inflation. Work home! Haylings, T51, Carlsbad, California 92008.

WATCH REPAIR. Learn this cash business at home. \$5 monthly. Free details. Chicago School of Watchmaking, YPA, Fox River Grove, Illinois 60021.

MAILORDER BEGINNERS—Read "Starter's Guide" first! Helpful, often overlooked information. Details sent FAST! Adams, Room 683, 12128 West 70th, Arvada, Colorado 80304.

TAKE Catalog orders. We drop-ship 1001 best selling specialty products. Lowest below wholesale prices. Immediate Delivery Spectacular home business opportunity. Free Book. Specialty Merchandise, Dept. 20-27, Woodland Hills, California 91365.

MAILORDER Dealers Wanted! Proven Executive Type Program! Details 25¢. P.W., Box 562, Royal Oak, Mich. 48073.

\$200 WEEKLY! Make, Sell Bricks! Free information! Xcito Bricks, 5715 N. Mozart, Chicago, Ill. 60659.

MAILORDER DEALERS. Your Own Business Immediately, Everything Supplied. Free Catalog, Details. Dunes, 310-IC Southeast Parkway, Richmond, Indiana 47374.

VALUABLE Mail Order Information, Write: Capital, Dept. PM3, Box 60538, Nashville, TN 37206.

COUPLES, \$300.00 Weekly Possible working 3 hours daily. Details \$3.00. Head, Route 4, Box 38, Owensboro, Ky. 42301.

MAILORDER Dealers wanted. Earn outstanding profits using tested promotions! Executive Type Business. Rutward-PP, Georgetown, Conn. 06829.

REPAIR Hydraulic Jacks—Details Free. Write: Hydraulic Parts Supply, Box 295, Port Isabel, Texas 78578.

CALIFORNIA MANUFACTURER NEEDS MAN to assemble our product and be local agent, experience unnecessary. May start while presently employed. Five-figure income for responsible applicant. S.K.R.M. Manufacturers, 2115 Torrance Blvd., Torrance, California 90501.

STUFF ENVELOPES, \$250 Per Thousand, Free Supplies, Send Stamped Addressed Envelope. C and L Distributors, Dept. 101, Box 30-1, Cincinnati, Ohio 45230.

MAKE MONEY Clipping Newspaper Items. \$2.00-\$10.00 Each . . . Details Free. Clippings, Box 10344-PM11B, Palo Alto, California 94303.

HOMEWORKERS—Mailables Wanted! Free Information, A. Allen, 2418 Lori, Santa Ana, California, 92706.

MAKE Years Income in 8 Weeks Camping. No Selling Capital or Land Necessary. Enclose Stamp Edru's, Box 46A, Gig Harbor, Wash. 98335.

OPPORTUNITY Knocks!! Everybody in Mail Order Needs the Real Secret of Making a Fortune! We Finally Reveal It! Our Book Included, Guaranteed . . . \$2.00. Items Associates, 1712 Cummings Street, Dept. 1G3, Thunder Bay, Ontario, Canada P7C 1P8.

SECRETS Revealed! Easy Money in Homework, Mail-order, Importing, Etc. Report: \$2.00. Guaranteed. Albers, Box 17052-PM, Minneapolis, Minnesota 55417.

FREE GIFTS, Catalogs! National Listing. \$1.00. Mele, 1400 Fifth Street, North Bergen, N.J. 07047.

FINALLY, Proven, Profitable, HOME BUSINESS you can buy Complete! Make 3-Dimensional vacuum formed wall, window, or magnetic car-truck advertising signs. \$2.50 material brings \$35.00 profit. Newspaper ad, yard sign, repeat customers, word of mouth does selling for you. Business includes large 28"x28"x15" vacuum forming machine—makes signs up to 24" sq., letter dies, inks, enough plastic-magnetic tape to make 20 sets of signs which would bring back full investment of \$695 F.O.B. Information write-VAC-U-FORM, 10077 Edison, Osceola, Ind. 46561.

\$\$\$ MACHINE! REPRODUCES! CARVES! ENGRAVES! Wood, Metal. Cheap, Easily Built. Economy Enterprises, Box 23-P, Highland, Maryland 20777.

\$500.00 WEEKLY in Mailorder. Expert's System, FREE Report. Clark, Box 80521-D Atlanta, Georgia. 30341.

HOUSE PAINTING, profitable one man business, Hand-book \$2.00, Sattler, 13 Balfour, Valley Stream, N.Y. 11580.

28 YEAR GUARANTEED INCOME! Writing Few Simple Pages at home. Economy Enterprises, No. 23-P Highland, Maryland 20777.

GET RICH BY MAIL! Free sample of product. Loran, Box 9194-M, Glendale, Calif. 91206.

\$178.00 WEEKLY. Spare Time. Guaranteed. Free Brochure. FAS, Box 13703, San Antonio, Texas 78213.

\$8,000 MONTHLY Spare Time! No Selling! Start immediately! Free proof! Owco, Box 665-A, Inglewood, Cal. 90307.

SEVEN Complete Mailorder Opportunities. Details Free! AM Sales, 31-14 94 St., East Elmhurst, NY 11369.

DROPSHIP To Mailorder Fortune! Free Details! Drake, 6233 Palo Alto, El Paso, Texas 79912.

50 Firms listed Information: Rush 25¢, Stamped, Addressed Envelope. ADZ, 6730 Adaridge, Ada, Michigan 49301.

HOW TO OPERATE a Profitable Bookkeeping Service For Small Businesses. R.I. Systems, Co. 1645-A Warwick Avenue, Warwick, R.I. 02889.

\$18,000 YEAR With Television Related Advertising Business. Operates In Any Size Town. Expands Rapidly. Relatively New Idea. Details, Sample \$1.00. TVSM, P.O. Box 2223, Montgomery, Ala. 36103.

LIVE LIKE A MILLIONAIRE WITHOUT MONEY! Free Proof. Century, Box 2127, Inglewood, Calif. 90305.

Earn \$30.00 per Hundred Stuffing Envelopes. Immediate Earnings. Beginner's Kit \$1.00 (Refundable). Mary Mott, 5944 Long Meadow, PM2, Nashville, Tenn. 37205.

"START YOUR OWN Janitorial Service. Free Details. Pioneer, Box-77, Howes-Cave, New York 12092.

START Your Own Correspondence School United Career Schools, 209 S. Citrus, Suite 7, Covina, Ca. 91723.

MAILORDER—Establish own business. Everything supplied—catalogs, ads, mailing lists. Merchandise dropshipped. Gift-Guide, 1137 Crenshaw, Dept. 445, Los Angeles 90019.

\$750.00 PER THOUSAND! STUFFING ENVELOPES! Details 25¢. ROSS, 7401 Walkermill, District Heights, Maryland 20027.

\$250.00 +/THOUSAND Immediately, Stuffing Envelopes! Free Supplies, Rush Stamped, Addressed Envelope!! Davis, Dept. 1A3, 1433 South Newkirk St., Philadelphia 19146.

NEWSPAPER CLIPPING, STUFFING ENVELOPES up to \$500/Thousand. Stamped, Address envelope. D. Erion, Route 1, Utica, Minn. 55979.

PROFITS FROM CLASSIFIED ADVERTISING! Booklet shows you how to start your own business with Classified Advertising. Only \$1.00 (Refundable with first order.) H. E. KAPPEL, POPULAR MECHANICS, DEPT. P, 224 WEST 57TH STREET, NEW YORK, N.Y. 10019.

FANTASTIC MAILORDER OPPORTUNITY! Unique proven program brings \$2000.00 per month . . . Guaranteed. Unique Ideas, Box 1121-C3, Belleville, Ont. Canada.

SECRETS! Mail Order Success. Internationally famous expert reveals how to make home business fortunes. Beginners: Get Free report "Make Money By Mail". Discloses free advertising, profitable products. Mailco, Dept. AC703, Woodland Hills, California 91364.

FREE! Just examine my home/business Protection Plan—I'll send you Burglar Alarm free! Beginners start earning big money fast spare time, full time! No experience or costly equipment needed. Write Nasco, Dept. A2703, Woodland Hills, California 91364.

SELL How-To Books!! Big Profits. Complete ready to use program. Instructions, sample catalog 25¢. Konkel, Department A3, 21288 Marie Park, Albuquerque, New Mexico 87112.

\$500.00 THOUSAND Stuffing Envelopes—Start immediately! Beginner's Kit, \$1.00. Guaranteed! FOATS, Box 1144, Forest Park, GA 30050.

NEW! Professional Mailorder plan—Satisfaction Guaranteed. Complete details free. Write: Arden, Dept. 114, 1912 Sussex, Sacramento, California 95815.

MAKE MONEY IN MAILORDER. Expert Reveals How. 40 Years Success! Write: Barclay, Box 45PC, Halesite, N.Y. 11743.

HOW & WHERE TO GET CAPITAL. Helped thousands get \$500 to \$2 million. Free offer. Capital-17, Kerrville, Texas 78028.

FREE MONEYBOOK "990 Successful, Little One-Man Businesses", plus cash loans. Start home! Small Business Index, Dept. 7, Kerrville, Texas 78028.

FREE WEALTH BOOK: "2100 Unique Ways To Make Money!!" Worlds Biggest Collection of Home Businesses!! Success-M, 26903 West Eight Mile, Detroit, Michigan 48240.

COMPREHENSIVE Guide to Government oil Lease Lotteries. Free details. "Guide", Box #4222-P, Long Beach, Calif. 90804.

PLAY SAFE. Use "Combination Mailorder Income Tax Record and Bookkeeping System." Only \$1.25 including wonderful dropship proposition. Neil H. Tasker, Shamokin, Pennsylvania 17872.

MAKE money fast!!! Get 2 to 3 times your cost on over 1,000 items. Gifts, novelties, jewelry. Send for free details. J and J Enterprises, Dept. 311E, 6217 W. 76th Place, Prairie Village, Kansas 66208.

MAKE 2 to 3 Times your Cost on Hundreds of Products. Gift Items, Novelties, Toy's - carded merchandise, 1001 others. \$2.00 brings giant catalog refundable on first order. M. Conley Co., 508 Ohio St., Akron, Ohio 44304.

PREPARE Tax Returns—Housewife Jo Ann Netzley made \$5,500 last season. Train at home. VA Approved. National Tax School, Monsey 2CF, New York 10952.

\$300-\$700 MONTHLY. Raise Rabbits, Laboratory, Meat Animals for us. Supplies available. Details 25¢. Rabbits of Michigan, Countyline Road, Pentwater, Michigan 49449.

ADDITIONAL INCOME: \$3.00 Brings mens wear sample and details. Money refunded on return of kit. Ideal part time family business. Brittany Limited, 8708 Brittany Drive, Cincinnati, Ohio 45242.

Write: Shurlaine Sales, 1939P, Guernsey, Beaverton, Mich. 48612.

PROFITS ZOOM up to 3000% on investments as LOW as 50¢. RUSH \$2.00 for COMPLETE details. When, where, how: KATHY ENTERPRISES, P.O. Box 62, Lantzville, B.C. V0R-2H0.

HOMEWORKERS—Mailables, addressers, newspaper clippers, envelope stuffers needed! Send 25¢ stamped, addressed envelope. Armondo De Carlo, 1473 Fern Avenue, Schenectady, N.Y. 12306.

AMAZING profits using proven mailorder secrets. Free Details. Amazing, Box 543, Fort Lauderdale, Florida 33302.

MAKE BIG MONEY. Complete Mail Order Course Tells All! Send \$6.95 to: ERH Enterprises, 5201 Cneebro, Agoura, Calif. 91302.

MAILORDER BEGINNERS LIBRARY, Inexpensive Source of Professional Secrets! Details FREE! Write: Ulrich, Box 8207-PM2, Lexington, Kentucky 40503.

MAKE \$2,000.00 Monthly. Spare time. Unique proven enterprise. No Selling. No Capital to start. Free Brochure. Kashbuilder-2, P.O. Box 1132 Indianapolis, Indiana 46204.

MAKE 2 to 3 Times Your Cost on Hundreds of Products, Gift items, Novelties, Toys, Carded Merchandise, 1001 Others. \$2.00 Brings Giant Catalog, Refundable on First order. Nevins World Gifts, 25700 6th. Street, Hemet, Cal. 92343.

\$1,000 WEEKLY - MAILORDER!!! Proven Dealership - No stock! Free Details! Millerprises (4A35), 55 Stadiy Rough, Danbury, Conn. 06810.

1000% PROFIT POSSIBLE. PART-FULL TIME. Operate from home. No inventory investment. Double your income in 5 months! Details free. Olympic, 744-S Broad, Newark, N.J. 07102.

STUFF Envelopes. \$250.00/thousand, Free Supplies, Rush Stamped, Addressed Envelope. Continental Business Service, 5157 North New Jersey, Indianapolis, Ind. 46205.

\$250/THOUSAND STUFFING ENVELOPES! Free Supplies, Rush Stamped, Addressed Envelope. Tori, Box 245, Socorro, New Mexico 87801.

MAILORDER!!! \$10.00 PROFIT each \$15.00 Sale!!! Free details! Millerprises (3A35), 55 Stadiy Rough, Danbury, Conn. 06810.

BUILD \$3,000.00 Foam Plastic Home, One Week. Sell For \$50,000.00. Costs 66% Less To Heat, Cool. Patent Pending. Drawings, Details, \$10.00 Refundable. ARK, (X), Box 16046, Kansas City, Missouri 64112.

\$10 to \$20 Hourly Possible Installing Security Devices. Experience Unnecessary. Full or Part Time. Details Free. Lugash, 13455 Ventura #234, Sherman Oaks, Ca. 91423.

\$250.00 WEEKLY Possible Spare Time. Start Home Plastic Laminating Business. \$15.00 Investment. Materials locally available. Excellent Opportunity for Handicap, Invalids. Full details, Samples \$3.00 ppd. FLOMAR, Box 13006-A, Pittsburgh, Pa. 15243.

NEW Report: "Easy Money . . ." Make \$1,000 Weekly. Information \$1.00 (Deductible). Joseph Bonsignore, 186 First Avenue, New York, N.Y. 10009.

ESTABLISH Successful mailorder business. Free samples! Mears-PM, 5363 Essex, Alexandria, Virginia 22311.

BEAT INFLATION, Own Business, Part/Fulltime Mail-order: Crockett Enterprises, 5469 Kirby Avenue, Cincinnati, Ohio 45223.

CONTRACTORS, EQUIPMENT RENTERS, MANUFACTURERS. Franchises offered on 1974 patented construction device. Unique, one of a kind; No Competition. Crozier, Box 7575, Postal Station E, Calgary, Canada T3C3M3.

\$1875 MONTHLY Second income. Free details. Star Enterprises, 5936 Silver Star, Orlando, Fla. 32808.

PROFITABLE Ways to make money at home. Write for details. Coach Publishers, Box 834M, Bangor, Maine 04401.

SELL Ordinary Sand \$5 Pound. I Do It, So Can You! Details Free! Sandco, Ceres, Calif. 95307.

FANTASTIC PROFITS!!! Start Wholesale Business From Home!! 1001 Best Sellers! Instructions Plus Giant Catalog \$2.00 (Refundable). Dickerson Company, Route 1-PM, Bridgeville, Delaware 19933.

RECRUIT Commission Salesmen! Free details!—Success Co., 256 Interlachen Lane, Excelsior, Minnesota 55331.

BECOME A Money Broker, Large Commissions, Send \$10.00 for details. D.R. Slater, P.O. Box 6606, Dept. PM1, W. Palm Beach, Fla. 33405.

HOW To Start a typewriting service at home. Free details. Coach Publishers, Box 834P, Bangor, Maine 04401.

ADDRESSERS—Mailables—Homemakers Needed! 50 Firms listed. Rush 25¢, stamped addressed envelope. D. Nones, 642-B N. 11th Ave., Phoenix, Ariz. 85007.

(Continued on next page)

BUSINESS OPPORTUNITIES

(Continued from preceding page)

RECEIVE 100 Envelopes Daily each containing \$1.00. Will send complete plan plus six formulas, only \$1.00. Enterprises, Box 27403, West Allis, Wisc. 53227.

IMPORTS—MAILORDER—WHOLESALE BUSINESS Free information. Maynard Imports, 942 Whitecliff, Corona, Calif. 91720.

YOU Choose—Your own business Send \$1.00. Receive a 16 page catalog Over 1000 profitable home operated businesses. R-n-R Enterprises, Box 9018-B, Lancaster, Ohio, 43130.

START Profitable Limited Production Factory. Write. Business Research, Box 5658C1, San Antonio, 78201.

"HOW to start your own mailorder business." Send \$1.00 to Mosco, Box 15497-BZ, Salt Lake City, Utah 84115.

TEN Years MAIL ORDER Experience in one evening. No-Quibble. Guaranteed. Free Details. Accredited Press, Box 6038, Jacksonville, Fla. 32205.

MANUFACTURING Business, \$50,000.00 with 10% Down. Excellent Territories Left On East Coast. E.R.E., P.O. Box 46, East Rochester, N.Y. 14445.

NEED EXTRA CASH—Earn it part time. Rush 10¢, Self Addressed Envelope; Herzog's, P.O. Box 4044, Reading, Pa. 19606.

ABSORB! TEN YEARS MAILORDER "KNOW-HOW" OVERNIGHT! Details. Fortune D. World, Box 4012, Foster City, California 94404.

START your own store WITHOUT CAPITOL. Send 30¢ for letterpress. Georgeco, PMB, 3834S, Military Highway, Chesapeake, Virginia 23321.

WE NEED GINSENG GROWERS! \$3,000-\$30,000 annually! We Buy Your Crop. Send \$2 for seed sample and information. Glass's Ginseng Exchange, Box 336, Rockdale Station, Jamaica, NY 11434.

BECOME A Millionaire! Your Own Business. Success, Box 9869-B, Phila., Pa. 19140.

MAKE \$40,000 YEARLY Using Our Exciting Money Making Plan. Details. BiMill, P.O. Box 8-PM, College Place, Washington 99324.

HOW TO MAKE MONEY Mailing Commission Circulars! Information Free. Smith, 1157-A Saratoga, San Jose, California 95129.

INCOME APARTMENTS Make Money. Free information. Sullivan (PM53), 252 Lenox, Albany, New York 12208.

BIG MONEY OPPORTUNITIES WITH ANTIQUES AND JUNGLE. New book gives trade secrets—Fulltime/Spartime—\$3.00. (Guaranteed) Stelco, Box 963, Oakbrook, Ill. 60521.

PIANO Tuning Learned Quickly at home! Tremendous field! Musical knowledge unnecessary. GI approved. Information free. Empire School, Box 450327, Miami, 33145.

\$200 WEEKLY spare time selling carpet. Buy wholesale. Carpet your own home for one third. No investment. Free sample. Money-making facts—write: Carpets, 248P, Resaca, GA 30735.

FLYING Saucer That Works, Simplified Fusion Power, Levitation-Gravity Motor, Permanent Magnet Self Powered Motor, Expansion-Contraction Motor, 1000 Horsepower Wind Motor, 1000 Horsepower Solar Free Motor, 1000 Horsepower Water Motor, Make Car Get 100 Miles Per Gallon, Run Car On Alcohol-Water 12¢ Gallon. Patents Pending. Drawings. Details \$10.00 Each. All \$29.00 Refundable. Miracle Science (G), Box 16046, Kansas City, Missouri 64112.

\$1.60 ASSURED EACH Envelope You Mail. Hunt-MD, 1340 Rice, Yellow Springs, Ohio 45387.

\$\$\$-\$\$\$ \$\$\$-\$\$\$ \$\$\$-\$\$\$ \$\$\$-\$\$\$ \$\$\$-\$\$\$ \$12,000,000,000 Carpet Business. You can get your year. No investment. No stock. Free sample—Information: Carpets, 248P2, Resaca, GA 30735.

MAKE FANTASTIC PROFITS! . . . FAST! AND EASY! Eagle, Drawer C-4, Belleview, Florida 32620.

PROVEN Successful Mailorder Imprint Catalog Program. Free Details. Allen, 544PM3, Spruce, Garwood, New Jersey 07027.

EARN \$2,000 Monthly in amazing, interesting Businesses. Free details—send self-addressed envelope: Box 282, Kingston 5, Jamaica W. I.

ORIGINAL Invention, For Sale, Fuelless Engine Originator, Owner, Albert L. Lanham, 914 Ash St., Louisville, Ky. 40208. 634-8977.

EARN \$10,000 to \$20,000 Stripping Furniture, Antiques etc. Part or Full Time. 300 Shops in U.S.A. Free Details: Amity, 2315 S. Stoughton, Madison, Wisc. 53716.

\$15,000 + ANNUALLY. IMPORT MAILORDER OPPORTUNITY. One year risk free trial basis. Details: Northeast Imports, Box 121M3, Fremont, NH 03044.

CLIP Newspaper Items. \$500 Monthly Possible. Information: Send Stamped, Addressed Envelope. News Clip, P.O. Box 402, 310 Franklin Street, Boston, Massachusetts 02110.

COPY Success! Use Mr. Rich Mark's amazing money-making system to earn a fast or slow fortune. Confidential report is filled with plans, businesses, and ideas you can use to swell your bank account . . . plus more! Free details: Scott Publishing Co., (102-H1) Lupine Lane, Penns Grove, NJ 08069.

FREE!—Big Mails From Wholesalers Jobbers Dealers Listing—\$1.00 Year —5 Years \$3.00. Superioer, Box 19, Avon Lake, Ohio 44012.

EARN Immediately Stuffing Envelopes. \$25.00 Hundred. Send Stamped Envelope. United, Box 492PM, San Diego, Cal. 92112.

MAKE Durable building plastic easily. Waterproof, fireproof, economical. Bays Laboratory, Cedaredge, Colo. 81413.

LAZY! Produce oil portraits in seconds! Details 25¢. JiffyPortrait, 2830PP - Gaffey, San Pedro, Calif. 90731.

MONEYMAKING OPPORTUNITIES

SPARE TIME CASH. Sell famous Hanover Shoes. Samples, sales kit free. No experience needed. No age limit. Big commissions. Hanover Shoe, Dept. 1290, Hanover, Pa. 17331.

STUFF Envelopes \$500.00/Thousand. FREE Details Send Stamped Addressed Envelope. Mantor House, Dept. 8-P.M.5, MINDA, N.Y. 13116.

TOTAL OUTLAY \$6.00. Immediate profitable income. Easy light assembly work in your home. Sample materials, instructions \$3.00 postpaid. Walmsley's Box 1187, Blaine, Wash. 98230.

\$250/THOUSAND STUFFING ENVELOPES IMMEDIATELY EXPERIENCE UNNECESSARY FREE SUPPLIES Rush stamped envelope. JETCO, Rt3-38P3, New Sharon, Iowa 50207.

\$2,000 MONTHLY Selling Information By Mail Complete Beginners Kit \$1.00. (Refundable) or Send Stamped Addressed Envelope For information: R. Fischer, Corner Colby & Regulus St., Pittsburgh, Pa. 15214.

STUFF ENVELOPES. \$25.00 HUNDRED IMMEDIATE EARNINGS. SEND ADDRESSED, STAMPED ENVELOPE. PALMER-C, P.O. Box 20028, El Cajon, Calif. 92021.

GET RICH! I'll help you! For free information write Key to: Riches, Box 118, Correll, Minn. 56227.

ABANDONED INDUSTRIAL SILVER—yours for taking. Easy \$24,000 yearly! Free information: Silverman B-13, Box 548, Woodville, Texas 75979.

MONEY-MASTER'S MANUAL reveals secrets of the insiders. Write: Fulton Systems, Box 476, Canton, Ill. 61520.

CLIP Newspaper Items, \$2.00-\$15.00 each. Details free. Rotunda (A3), 1021 Birchmount Rd. Toronto, Canada. MIK-IS2

SMALL Investors, How Can They Make Money in Silver? Free! Stagecoach, 1124 NW 49 Ave, Gainesville, Fla. 32601.

TROPHIES And Engraving \$20.-Hour or more. Free Catalogue. SKILL-Craft, P.O. Box 13201-PM, Columbus, Ohio 43213.

VENDING Machines. No selling. Routes earn amazing profits. Big catalogue free. Parkway Corporation, 715PM Ensor Street, Baltimore, Maryland 21202.

VINYL'S Where The Money Is! Invisibly repair, re-finish, recolor furniture, luggage, car tops. Quick, easy. Two small \$20 jobs a day earn you \$1,000 a month. Homes, cars, offices, restaurants, unlimited customers. Start earning after an hour's practice. Sensational details free. VIP, 2062 Montrose, Chicago, 60618.

FREE—Easy Ways to make money selling exciting new products—Full—spare time. Send name, age for 5 months free subscription. Salesman's Opportunity Magazine, 1460 Hancock Center, Dept. 335, Chicago 60611.

MONEY Rolls in from everywhere. No merchandise to handle. Instructions \$1.00. Charles Co., 42-PM, Norwood, Ohio 45212.

WORLD'S Leading Contest Magazine, 50¢ Prize-winner, 1315 Central, St. Petersburg, Fla. 33705.

SWEEPSTAKES Contests. How to Win. Write for Free Information. General Contests, 1609-18 East 5th., Duluth, Minnesota 55812.

MAILORDER There is Money in It. BUT—Before You Invest Investigate. \$3.00 Refundable. Prince Specialties, 9 Roberts, Farmingdale, N.Y. 11735.

SCIENTIFIC MESSAGE: Big Earnings; uncrowded profession. Learn spare time at home. Diploma awarded. Free Catalog. Write: Anderson School, Dept. C-1C, Princeton, Illinois 61356.

HORSEPLAYERS—Free!!!! How Turfwin Won \$300 Weekly. Guaranteed! Turfwin, Box 581 PM, Port Washington, NY 11050.

SELL Sensational Low-Cost Burglar Alarm. Exceptional Margin. Samples for trial. Northwest Electric, Ave.926, Mitchell, South Dakota, 57301.

HOW To Make Money Writing Short Paragraphs. Information Free. Barrett, Dept. C-27-X1, 6216 N. Clark, Chicago 60660.

CLIP Newspaper Items, \$1.00-\$5.00 each. Details free. Walter, Box 1360-PA, Erie, Pa. 16512.

MAKE Big Money. We furnish everything. For details send self-addressed envelope. Enterprises, Box 4516-Z, Compton, Calif. 90224.

LEARN, EARN Mail Order from Home Spare Time. Been telling how since 1929. Facts, Stories, Sources, Thousand Offers, Complete Course in Mail Order. Sample Copy 50¢; Year \$12. Mail Trade Magazine, Box 1302, Springfield, IL 62705.

HOMEWORERS. Receive \$100.00 weekly lifetime income mailing six envelopes daily. Setup \$2.00. Gemco, B-21244A, Indianapolis, 46221.

BORROW Your way to great riches. Free data. IWSP, Bank Plaza, Merrick, New York 11566.

STUFF Envelopes \$250/Thousand Immediately. Free Supplies! Details 25¢. Shorvue, Drawer 2256-P, Salisbury, Maryland 21801.

MAIL LETTERS Featuring Real Merchandise. \$12.00 Orders Every Mail, \$8.00 Profit! Write: The A. & L. Company, P.O. Box 653-A, Owosso, Mich. 48867.

250/THOUSAND IMMEDIATELY, STUFFING ENVELOPES. Free Supplies, Send Stamped-Addressed Envelope, Henriksen, Box 6080, Minneapolis, Minn. 55406.

\$40 DAILY Possible tying fishing flies at home. Details 50¢. Flyco, Box 946-P, Albany, Oregon 97321.

ADDRESSERS-MAILERS-HOMEWORERS NEEDED! 50 firms listed, Rush 25¢, Stamped, Addressed envelope. JW Sales, R3-192, Neosho, Mo. 64850.

ADDRESSERS-Mailers-Homeworkers-Needed! 50 Firms Listed. Rush 25¢, Stamped, Addressed Envelope. Cannon Enterprises, Box 34057, Bethesda, Md. 20034.

MAKE Statuettes, novelties, imitation marble. Sell to stores or start gift shop. Free details. Marbleizing, 41 Waverton, St. Louis, Mo. 63124.

FREE SECRET BOOK "2042 Unique, Proven Enterprises." Largest successful collection! Fabulous "Little Knowns." Work home! Haylings-T-50, Carlsbad, Calif. 92008.

\$175.00 WEEKLY Correcting Pupils' Lessons! Samples, \$1.00! Castle's, 507-LP Fifth, NYC 10017.

LEARN The secrets of repairing junk batteries. "Fabulous Profits" at home. Apex Engineering, 3100 Ramona, Atascadero, California 93422.

NEED MONEY? MAKE MONEY!! Moneybooks Show You How! Catalog, 25¢. Moneybooks, Box 192PM3, Griffith, Indiana 46319.

\$200.00 FROM Sheet 1/4" plywood (scrap). Details 35¢. Novelties, 610 So. 24th, Elwood, Indiana 46036.

FREE! LATEST DIRECTORY OF 500 CORPORATIONS SEEKING NEW PRODUCTS! If you have an idea for a new product—or a way to make an old product better, send for our FREE INVENTORS KIT NO. A-85. It gives vital information on developing and marketing your invention/idea for Cash/Royalty Sales to corporations nationwide. Raymond Lee Organization, 230 Park Avenue, New York, N.Y. 10017.

EARN \$500.00 a Week with amazing new Mailorder Money-maker Program. Free Details Write: Robeck, 868 Park Street, Hartford, Conn. 06106.

\$CASH \$1.00 Per Sale!!! Sample, Details 50¢. Tony Bernatek—1774 Riverbank, Lincoln Park, Mich. 48146.

MAKE MONEY Clipping Newspaper Items. \$2.00-\$10.00 Each . . . Details Free. Clippings, Box 10344-PM11A, Palo Alto, California 94303.

500,000 BARGAINS—3 Fabulous Catalogs Listing Amazing Below Wholesale Products For Home, Business—Many Free Items. Send \$2.00; Bargainhunters, Box 730-PM2, Holland, Michigan 49423.

GET World's Biggest Wholesale Import Catalog. Write: Wor-d, Medina, Washington 98039.

WE Buy Newspaper Clippings of Wedding Announcements for \$1.00 each. Instructions \$1.00. Clippings, Box 741PM, Gatesville, Texas 76528.

WILL You actually (really & truly) address, stuff and mail 20 envelopes a day? Then don't let's mess around. Send \$3 and we'll show you how to make up to \$1,000 monthly and even much more. **GUARANTEED!** Contractual Arrangements. Habersham-Hall, Box 613-F, San Pedro, CA 90733.

\$60 PER Evening Addressing Envelopes, Homework Guaranteed. Free Details. Sterim, Box 23E, Sterling Heights, Mich. 48078.

ADDRESSERS-mailers-homeworkers needed! 50 firms listed. Information: rush 25¢, stamped, addressed envelope. Paulamende, PM3, Box 2392, Hot Springs, Ark. 71901.

SEVEN-SUPER MONEY MAKING PLANS. Rush \$1.00 to: Jeff High, P.O. Box 44047, Chicago, Ill. 60644.

MAKE MONEY AS AN INVENTOR. Booklet shows how to turn your ideas into Profitable Inventions. Send \$1.50. Thompson, 203 Eden Dr., No. 116, Dept. 375PM, Longview, TX 75601.

BIG PROFITS! SELL "PERSONALIZED" SOCIAL SECURITY PLATES! FREE SALES KIT! KERN, 246PM RICHMOND, N. MASSAPEQUA, NEW YORK 11758.

STUFF ENVELOPES \$250/THOUSAND! Free Supplies! Send Stamped Addressed Envelope. Oriol, 50-58 47th St., Woodside, New York 11377.

\$800 MONTHLY—Addressing Envelopes. Details 25¢. Wanco, Box 3271-PM, Columbus, Ohio 43210.

ADDRESSERS-MAILERS-HOMEWORERS NEEDED! 50 Firms Listed. Information: Rush 25¢, Stamped, Addressed Envelope. Dennis, 243 Glenn Ave., Canonsburg, Pa. 15317.

\$250 WEEKLY possible! mailorder beginners- Homeworkers. Information Send self addressed stamped envelope. Foster's-IM, 36 14th Avenue SW, Birmingham, Alabama 35211.

FREE! Exciting details! Where to pan gold throughout U.S.! Amazingly widespread! Moran Publishing, 2-T Van Buren Road, Scotia, New York 12302. Enclose stamp.

EARN extra money sell victory miracle polishing cloths. The wonder cloth that cleans and polishes everything. Send \$1.00 for sample and details to: Vending, 76 Dewey St., Dept. P.M., Manchester, N.H. 03103.

(Continued on next page)

MONEY MAKING OPPORTUNITIES

(Continued from preceding page)

HOW TO APPLY FOR \$500 in money gifts, aids & free offers. Write: Moneytree-5, Kerrville, Texas 78028.

EARN AT HOME MAILING OUR CIRCULARS! EXPERIENCE UNNECESSARY! Send stamped addressed envelope. Wright, 949 Broadway, 602-PM, New York City 10010.

FREE WEALTH BOOK: "2100 Unique Ways To Make Money!" World's Biggest Collection of Home Businesses! Success-M, 26903 West Eight Mile, Detroit, Michigan 48240.

MAILORDER PRODUCTS, ideas reported regularly in newsletters for members only. Annual membership, \$18, brings you product sources, news, government actions, other benefits. Details free. National Mail Order Assn., 429 S. Western, Dept. A-15, Los Angeles 90020.

MAKE MONEY IN SPARE TIME. Earn generous commissions as a subscription representative for leading magazines. For free details, send this ad with your name and address to: **POPULAR MECHANICS**, Room 11075, 250 W. 55th St., New York, N.Y. 10019.

MEN-Women. Make Money Part Time. No Investment Necessary. Amrose, Box 8282MM, Richmond, Va. 23226.

NEED MONEY? Unlimited Earnings with Sensational Money-making Methods. Guaranteed Complete Details \$2.00. GMB, Dept. 205, 1576 Midgard Ave., Victoria, B.C. V8P 2Y1.

MAKE MONEY as an inventor. Booklet shows how to turn your ideas into profitable inventions. Send \$1.50 plus 50¢ handling. Rancon Enterprises, 1160 West Friesen, Reedley, Calif. 93654.

FORTUNE From Old Books. \$2.00 shows how. 2517 West 71st St., Chicago, Ill. 60629.

WOULD You like to receive 100 letters a week, each containing \$1.00? Plan plus 6 Formulas for \$1.00. Ellis Enterprises, P.O. Box 8503, Capitol Heights, Md. 20027.

50% PROFIT. Free Details. AED, #303, 3100 S. Michigan, Chicago 60616.

MAKE money with your camera. How and where to sell your photos, color slides. \$1.00. Morris, 298PM Como Dr., Lake Como, Fla. 32057.

99 MONEY-MAKERS in Hard Times. Guaranteed. \$2.00. Grimco, 4294 Bennington-PM, Brunswick, Ohio 44212.

MAKE a stepladder planter. 11 1/2" x 9" x 7 1/2". Plans \$1. VHC, Box 128, Wilmington, Mass. 01887.

WIN at any casino! Amazing new system! Free details. Northwind, Box 46407-M, Seattle, Washington 98146.

\$250.00/THOUSAND STUFFING Preaddressed Stamped ENVELOPES. Send 25¢, Stamped, self-addressed envelope. Donner, Box 133, Ely, Mn. 55731.

HOW to make money with your camera. Send \$1.00 for booklet. **COLUMBIA GIFTS**, 10534 Morning Wind, Columbia, Md. 21044.

EARN CASH Royalties for your ideas. Details \$1.00. Calcraff Publications, Box 20391, Charlotte, NC 28282.

SILVER Start Silver Reclaiming Business For Under \$50.00 Manual \$2.00. Globe Labs, Box 802, Solana Beach, Ca. 92075.

MANUFACTURING Our New Electro-Mechanical Device Can Alone Mean \$60 Per Hour To You! We Offer National Sales Promotion. \$5.95 Investment Brings Complete Assembly Set Up. Details \$2.00. Full-Part Time. ElectroLite, Box 608, Lorain, Ohio 44052.

NEED Capital for any proposition? Write for free information on our new manual "Best Ways to Raise Capital." Brondyke, 40-P Farr Road, Muskegon, Mich. 49444.

HOW To Get 100% Loans. Free details, OHG Company, P.O. Box 2901, Chicago, Illinois 60690.

AMAZING Highly Profitable Businesses. Details: A. Ca.o. 68-35 Harrow Street, Forest Hills, N.Y. 11375.

I'LL Help You let inflation fatten your wallet 101 easy ways. 30¢ shows how. Barbara, 514PM Orchard, Avalon, Pa. 15202.

FREE list of moneymaking opportunities. Inexpensive booklets give details. **RUSH** self addressed stamped envelope to: The Hutch Cupboard, Dept. PM-35, 185 East Walnut St., Westerville, Ohio 43081.

JEWELRY DISTRIBUTOR Make \$100 Daily. \$5.00 Brings You Complete Kit. N. Dirato, 134 Benart Place, Middlesex, New Jersey 08846.

ADDRESSERS - Mailers - Homeworkers Needed! 50 Firms Listed. Information: Rush 25¢, Stamped, Addressed Envelope. JOR Enterprises, Box 2204, Victoria, Texas 77901.

FREE Details! Win lifetime income from Dice, Roulette, Thoroughbred, Harness, Dog Racing. Guaranteed! Research, Box 551PM, Minola, N.Y. 11501.

INTERESTING BOOKLETS Make Money Collecting Stamps. Big Profits in Real Estate. Play winning Backgammon. Make money as an inventor. Make money with your ideas. Each booklet \$1.50 plus 50¢ postage. Oakland Gifts, 412D Stratford Drive, Harahan, Louisiana 70123.

\$1,000 MONTHLY! Stuffing Envelopes and Clipping Newspapers: Send Stamped Addressed Envelope . . . JOY, Box 936-C, Hyattsville, Maryland 20783.

CATALOGS OF MAIL ORDER, Self-Improvement and Money Making Opportunity Books, 25¢. Cazin, 526 Maple, Redwood City, CA. 94063.

SELL CALENDARS, SPECIALTIES Repeat Business - Free Details - FASCO, 6535 Cottage Grove, Chicago 60637.

AMAZING Tiny Fire Alarm—Every Home A Prospect, Fantastic Seller. Easterly Enterprises, Dept. PM375, Box 31128, Temple Hills, Md. 20031.

HOW To Earn at Home Addressing Envelopes, send Stamped Addressed Envelope to: R. H. M. Productions, 11 Willard Avenue, Mt. Vernon, New York 10553.

MAIL Selling is BIG MONEY BUSINESS. A Few Pages Tells All. Send \$1.00: Ba.ry Jay, 161 East Houston St., New York, New York 10002.

\$300.00 WEEKLY POSSIBLE Working At Home. Information Rush 50¢, stamped, addressed envelope. Profits, 4236 N. Troy, Chicago, Ill. 60618.

MAKE MONEY WITH YOUR IDEAS. Booklet Shows How. Just \$1.50 . . . Laugh 'N House, 6990 Lake Ellenor, Suite 122B, Orlando, Fla. 32809.

\$1,000 MONTH Mailing Letters. Guaranteed. Free Details. Sandco, Ceres, Calif. 95307.

INTERESTING Money-making Opportunities. Details 10¢. Monohon, Box 99697, PM3, Tacoma, Washington 98499.

PHOTOGRAPHERS—"75 Ways to Make Money at Home" \$2. Floyd, Rt. 1, Fayetteville, Tenn. 37334.

NEW Money in Action; Gold Supply, Economics, must for Successful People. Send \$2.98, Receive Complementary Book Free. P.O. Box-A 14625, Houston, Tx. 77047.

FOOTBALL FANS—Cash in on Enthusiastic Fans. Details \$1.00. VAB Enterprises, Box 6264, New Orleans, La. 70114.

PROFITS AT HOME! Booklet describes 50 simple plans, instruction books. \$1.00. Wesco, Box 891-A2, Michigan City, In. 46360.

\$1000 GUARANTEED at the Race track Free information. Howell's, 736 Carter, Owensboro, Ky. 42301.

FREE Circular. Money making Books. Self Improvement Books. Inexpensive. CPM, Box 284A, Cleveland, Ohio 44121.

GET RICH With secret law that smashes debts and brings you \$500 to \$2 million cash. Free Report! Credit (6A3), 333 North Michigan, Chicago 60601.

FANTASTIC Money-makers: Colorful T-Shirt Ironons. Samples \$1.00. Toledo, Micanopy, Florida 32667.

\$250/THOUSAND, Stuffing envelopes! Free Supplies. Rush stamped, addressed envelope. John C. Whitaker, Skyline Drive, Harrison, Arkansas 72601.

500 MONEYMAKING IDEAS. Free details. Fortune E. World, Box 4012, Foster City, California 94404.

REPAIR Washing Machines, Dryers, Dishwashers. **SAVE!** Repair Yours. **MAKE MONEY!** Repair Others. Manuals for all Makes. \$5 each. **QUALITY PRODUCTS**, 2988 Marengo Ave., Altadena, Calif. 91001.

FREE Carpet Sample. You Can Earn \$1,000 Month Spare Time Selling Carpet For Half Price—Information: Carpets, 248P3, Resaca, GA 30735.

AMAZING PROFITS Clipping Newspaper Items. Free Details. Raritan House, 115A Cindy Street, Old Bridge, New Jersey 08857.

HOW TO GET RICH PLAYING BLACKJACK! Secrets revealed. Amazing, simplified method. Get \$25.00 in fifteen minutes! Free details or send \$7.95 for powerful, new book. Money back guarantee. **REMC0**, Box 667, Santa Rosa, California 95406.

WIN Contest Prizes. Expert reveals professional methods. Newest book. \$1.00. American Books, Box 842, Corona, Cal. 91720.

CLIP Newspaper Items. \$1.00-\$10.00 Each. Free Details. Harris, Box 90463, Houston, TX. 77090.

CARPETS—Rugs Wholesale. You Can Buy One Rug Or Carpet Your Home For One Third. Earn Big Money Selling To Friends. Free Sample—Information—Carpets, 248P4, Resaca, GA. 30735.

SPEEDOMETER REPAIR, Fascinating, Profitable! Free Brochure. Instrument Training School, Box 1361, Muskogee, Oklahoma 74401.

HOW To Play Winning Bingo. Send \$1.00. Tongpioneer, Box 3273, Santa Monica, Calif. 90403.

SELL JUNIOR GRANDFATHER CLOCKS 16" high. Solid woods. Fun, easy. Wood Works, 1821 West Wilson Ave., Chicago, Illinois 60640.

NEVER WON ANYTHING? Anyone can win Sweepstakes contests! Free details. Services, Box 644-PCC, Des Moines, Iowa 50303.

PERSONALIZED PHOTOSTAMPS Make High Profits! Mail Order. Complete literature package free. Photo Postermaker, East Providence, R.I. 02914.

I MADE \$3,000.00 in one week reselling scrap X-Ray Film. Details. Where to locate Film, and who buys it. \$2.00. Jim, 3610 Glenwood, Wichita Falls, Texas 76108.

PROFITABLE OCCUPATIONS

SELL YOUR PHOTOS. Report tells how and where. Color slide markets. Only \$1.00. Westford Enterprises, 664 Trapelo Rd., Waltham, Ma. 02154.

RECYCLE newspapers! Inexpensive art. \$3.00. Kinney, 105 Filmore, Endicott, New York 13760.

FREE Catalogs. Repair air conditioning refrigeration. Tools, supplies, full instructions. Doolin, 2016 Canton, Dallas, Texas 75201.

BAKE new greaseless doughnut in kitchen. Sell stores. Free recipes. Michael Ray, Waseca, Minn. 56093.

HOW TO MAKE MONEY Writing Short Paragraphs. Information Free. Barrett, Dept. C-27-X2, 6216 N. Clark, Chicago, 60660.

FT. SMITH Auction School, Ft. Smith, Ark. 72901. Resident & Home study. Veteran approved.

\$100.00/DAY POSSIBLE!!! Buy Scrap Gold . . . Easy . . . Complete manual, \$4.00 Satisfaction Guaranteed . . . brown, 956 Springdale, Atlanta, Ga. 30306.

PLASTERCRAFT!!! Profitable home business. Molds available. Details: Lynnette, 6251C Mentor Park, Mentor, Ohio 44060.

BECOME A Mortgage Broker. Highly respected, interesting, lucrative prestige business. For complete information write: United, Box 6284-F, Marietta, Georgia 30060.

CREATE Ideas—Unique Mind Opener. Instructions \$1.00. Logication, 4712 W. Magnolia, Burbank, CA. 91505.

SHARPEN—Scissors, Pinkers. Light, compact equipment. Supplies. Blackhawk's, Sheldahl, Iowa 50243.

PICTURE Framing—Profitable full or spare-time business. Easy to learn with handbook-course "Guide To Picture Framing Profits." \$2.00 Guaranteed. Free framing-supplies catalog included. Japs, 126-PM Seventh North, Hopkins, Minnesota 55343.

RAISE CAPITAL With A \$15 Investment. Get \$500 to \$2 million. Helped thousands. Free details. Capital-25, Kerrville, Texas 78028.

DOLLS! DOLLS! DOLLS! Make DOLLS! For fun, profit! Complete instructions! \$3.00. Gua.anteed! CAM, Box 16930, Wilmington, Del. 19899.

METALIZE BABY SHOES! Etc. Easy Processes. Send \$2.00 to: PER, 15 Riverside, Saginaw, Michigan 48602.

\$12 HOUR Making Ordinary Potholders. Free Details! Sandco, Ceres, Calif. 95307.

BIG CASH from Junque/Antiques. Little known methods—\$1.00 (Satisfaction Guaranteed) Stelco, Box 963, Oakbrook, Ill. 60521.

SALESMEN—DISTRIBUTORS

WORLD'S most powerful flashlight \$12.95 Gantner Enterprise, Dept. 55, Granton, Wisc. 54436.

MAKE MORE MONEY in 1975. Start now on a full or part time basis. Show our new 1976 Line of Calendars, Promotional Advertising and Gifts to local Business Firms. No investment, collections or District Managers. Many promotions to help you get started. Prompt, friendly service with 66 year old firm rated AAA-1. Weekly commissions and liberal bonus. Write John McNeer, Dept. PM3, **NEWTON MFG. CO.**, Newton, Iowa 50208.

HOUSEHOLD PRODUCTS ROUTE. EARN \$25 or more daily. Also Party Plan opportunities for men, women full, part time. McNess, Freeport (2625), Illinois 61032.

AUTOMATIC Fishhooks. Profitable Samples, \$2.00 (refundable). Aron, 61-PM, Mastic Beach, New York 11951.

SELLING KNAPP SHOES IS EASY. HIGHEST Cash commissions immediately. Enjoy a steady income with satisfied repeat customers. Your own hours. No investment. Free Sales Kit. Irwin Margolis, 612 Knapp Centre, Brockton, Massachusetts, 02401.

MAKE Extra \$25 to \$75 Spare Time! Double Air Cushion Shoes. Men's, Women's Line. Dress, Work, Play. Highest Commissions. Shoes for Yourself. Outfit Free. Bronson, Dept. HX-35, Minneapolis, Minnesota 55408.

HERTEL Exclusive reference Bible! Big profits! Startling 3-dimension cover! Demonstrator, supplies furnished. Top commissions plus extra bonus earnings! Free outfit. International Book, Dept. PM, Box 118, Wichita, Kansas 67201.

EARN Big Commission Full or Part Time. Show America's largest line low Priced Business Printing and Advertising Specialties Plus Calendars in season. No experience. No investment. No collections or Deliveries. On-the-spot commissions. Big Free Sales Kit Samples hundreds items used daily by businessmen. Merchandise bonuses for you. Build profitable repeat business. Start now. National Press, Dept. 5BB, North Chicago, Ill. 60064.

SELL CALENDARS, SPECIALTIES Repeat Business - Free Details - Fleming, 6535 Cottage Grove, Chicago 60637.

STOPS Bad Check Losses. Chemically Treated Pressure Sensitive Identification Labels. Shows Positive Fingerprint on Label but Leaves No Stain on Finger. Every Merchant Accepting Checks is a Potential Repeat Customer. No Minimum Investment. Send \$10.00 for Sample Dispenser Kit & 500 Labels. Literature Available Free. Print-Gard, Inc., 327 S. LaSalle St., Chicago 60604 (312) 922-8895.

AGENTS WANTED

SPARE TIME CASH. Sell famous Hanover Shoes. Samples, sales kit free. No experience needed. No age limit. Big commissions. Hanover Shoe, Dept. 1292, Hanover, Pa. 17331.

PART Time Help Needed. Crystal Palace, Box 111, Roseville, Calif. 95678.

"SELL" Lifetime Metal Social Security Plates. Big Profits! Free Sales Kit! House Of Plates, 1806 Dallas, Modesto, Calif 95351.

(Continued on next page)

AGENTS WANTED

(Continued from preceding page)

EVERY Man a prospect. Refundable sales kit offer showing line belt buckles, tie clasps, money clips, cuff links, lapels, identification badges, individualized with customer's name and emblems. Cap badges for trucking, bus, taxi, police, firemen. Also postal, letter carriers and heavy construction emblems. Choice 5000 emblems. Hook-Fast, Box 1088-PM, Providence, R.I. 02901.

YOUR Own business. Used Suits \$1.50; Overcoats 65¢; Mackinac 35¢; Shoes 12½¢; Ladies' Coats 30¢; Dresses 15¢. Enormous profits. Catalog Free. Nathan Portnoy Associates, 2109-AA Roosevelt Road, Chicago, Illinois 60608.

PRINTING Advertising Salesmen—Excellent money-making sideline selling Decalcomania Name Plates, small quantities. Advertising Specialties, sign letters. Free Samples. Raico XL, Boston, Mass. 02119.

FABULOUS New Beauty Mask. Earn Fantastic Profits Part Time. Also Party Plan—Crew Manager Opportunities. Barnes, Box 759-H, Portsmouth, Va. 23705.

BEAT High Living Cost—Take orders for America's finest shoes from friends, neighbors! Easy. Profitable. No experience needed. Selling outfit Free! Mason Shoes, K-125, Chippewa Falls, WI 54729.

\$600.00 PER DAY With one order selling replacement windows to home owners. Details free. Write: Replacement Window Corporation, Dept. 22, Rose City Industrial Park, North Little Rock, Arkansas 72117.

EMPLOYMENT INFORMATION

AUSTRALIA . . . NEW ZEALAND NEED YOU!! 47,000 Jobs!!! Free transportation! Complete information and forms \$1.00. Careers, Dept. PM-3 Box 623, South San Francisco, Ca. 94080.

MEN! Women! Jobs on Ships. American, Foreign. Guide \$3.00. Seafax, Dept. W-5, Box 2049, Port Angeles, Wash. 98362.

OVERSEAS Bulletin of specific openings published monthly for professionals, military, craftsmen. Complete information, guaranteed. Current issue \$5. Not post office box operation. Trans-Global Overseas Network, 301 E. Franklin, Richmond, Va. 23219 (804) 644-0351.

AUSTRALIA—NEW ZEALAND WANT YOU!!! 50,000 Jobs! Paid Transportation! Latest information and forms. \$1.00 Austco, Box 3623-E, Long Beach, California 90803.

OVERSEAS JOBS—Now Hiring, 103 Countries, All Occupations, High Pay, Free Transportation, Tax Benefits. Latest Computerized Reports—\$2.00. **TRANSWORLD**, International Airport, Box 90802-E, Los Angeles, California 90009.

FLORIDA Employment Information Booklet. \$1.00! Sunshine, 4512N Jamaica, Tampa, Florida 33614.

HAVE WORKED SUCCESSFULLY 20 yrs. overseas with world's leading contractors. You can too! who to contact, send \$2.00. PEC, Box 3248, Amarillo, Texas 79106.

OVERSEAS Opportunities. General Survey \$2.00 prepaid. RSVP, Box 1786, New York, New York 10001.

AUSTRALIAN Employment—American Associated Firms. All Skills! Australian Handbook Explains: Government Transportation, Grants, Housing, Social Life, Taxes, Plus Immigration Form. Send \$1.00. National Benefit, Box 2244-3, Highland, Ca. 92346.

HOW TO GET THE JOB YOU WANT. Amazing Detailed Booklet Reveals Success Secrets. Plus Forms, Examples. \$3.00. Aitnet, Box 2171B, Des Moines, Iowa 50310.

AUSTRALIA WANTS YOU!!! Thousands of Jobs! Free Transportation! Plus Giant Employers List and Forms! \$1.00. Creative Concepts, Box 13A, Kalamazoo, Mich. 49002.

AUSTRALIA Needs You! Many Jobs!—Free Transportation! Complete details about salaries, schools, rents, farming, taxes, social life, immigration requirements and forms . . . plus giant employers list! Guaranteed! Send \$1.00 to C.B. Distributors, Box 30507, Seattle, Wash. 98103.

AUSTRALIA NEEDS YOU!! Jobs! Paid Transportation! Information plus immigration form. **GUARANTEED**—\$1.00. Stovers, Box 23592A, Tampa, Fla. 33622.

AUSTRALIA Needs You!!! Thousands of Jobs. All skills. Australian Opportunities fact book explains Rents, Farming, Social life, Salaries, Schools, Taxes. Big Employers List, Satisfaction Guaranteed. \$1.00. Bilmor Sales, 8225 Encino, Northridge, Calif. 91324.

AUSTRALIA NEEDS YOUR SKILL - Paid Transportation - Employers List - Housing - Taxes - Latest Information. Complete \$3.00. Profit Language, Box 2421, Sierra Vista, Arizona 85635.

HELP Rebuild Australia - She Needs Your Skills Now - Immigration Forms and Requirements Sent Fast. \$2.00 to Universal Enterprises, 687 Watkins Street, Box #2, Brooklyn, N.Y. 11212.

AUSTRALIA, New Life For You, \$1.00 For Details, Refundable, SCS Enterprises, 285 New Conley Road, Suite-2, Conley, Georgia 30027.

AUSTRALIA NEEDS YOU!!! All skills needed, Paid transportation. Fact book lists salaries, schools, farming, recreation, giant employers list, immigration requirements. Guaranteed. Send \$1.00 to Austra, Box 662-A1 Tulsa, Okla. 74152.

AUSTRALIA Needs Workers!! Thousands of Jobs—Jobs Now Available. Government Passage, Employers Gigantic List: Housing, Recreation, Etc. \$1.00. Liberty Enterprises, Box 1241-A3, Rochester, New York 14609.

AUSTRALIA EMPLOYMENT * Paid Transportation - Salaries - Housing - Forms - **EMPLOYERS LISTS** * \$1.00 Mailhouse, Box 737-83, Nampa, Idaho 83651.

HOW TO GET THE JOB YOU WANT! Amazing booklet! Complete instructions. Guaranteed! \$1.00. Mid-Am. Enterprises, Box 9503P, Minneapolis, Minnesota 55440.

AUSTRALIA-NEW ZEALAND NEEDS YOU!!! 40,000 Jobs! Free transportation! Current information and forms. \$1.00. The Winfred Co., Box 444-Z, Euless, Texas 76039.

AUSTRALIA Needs You! Employment directory, Forms, Transportation, Information Guaranteed—\$1.00. Wallace, 2499 Fairway Drive, Costa Mesa, CA. 92627.

AUSTRALIA—Big Decision! Understand before You Go . . . Complete details . . . Employers write to: Immigrations Form—guaranteed. \$1.00, Mseco Sales, Box 2187A1, Peabody, Mass. 01960.

AUSTRALIA, Unlimited Jobs, Free Transportation— Complete Details plus Employers List. \$1.00 (Guaranteed) Anderson Co. Box 87369, College Park, Ga. 30337.

AUSTRALIAN . . . OPPORTUNITIES SKILLED . . . UN- SKILLED DIRECTORY . . . **PASSAGE IMMIGRATION RE-** QUIREMENTS.

SUPERB HOME WINES AND CHAMPAGNE RECIPES \$1.50 EACH. REFUND GUARANTEED. Ranger Publications, Box 6400, Baltimore, Maryland 21230.

CANADIAN Jobs—Big Employment Opportunities Research Publication and how, when, where to apply—\$2.00. National Advertiser, Box 2541, London, Canada.

HELP WANTED

OVERSEAS EMPLOYMENT . . . Australia, Europe, South America, Asia! All Occupations! \$700-\$3,000 monthly! Write: Employment International, Box 29217-AC, Indianapolis, Indiana 46229.

EARN At Home Addressing Mail. Details 25¢ and Stamped Envelope. Deeco-151, Box 9308, North Hollywood, Cal. 91609.

FLORIDA Employment and Living Information. Write; Reports, Box 14625-P, North Palm Beach, Fla. 33408.

TEXAS REFINERY CORP. Offers **PLENTY OF MONEY** Plus cash bonuses, fringe benefits to mature individual in your area. Regardless of experience, airmail Y. M. Pate, Pres., Texas Refinery Corp., Box 711, Forth Worth, Texas 76101.

REAL ESTATE & FARMS

NEW! FREE CATALOG! Exciting **SPRING** edition of country property! Over 5,400 NEW properties described, pictured—Land, Farms, Homes, Businesses—Recreation, Retirement. Selected Best throughout the U.S.! 75 Years' service—670 Offices, 41 states Coast to Coast. Mailed Free from the World's Largest! Strout Realty, Inc. 60-MX E. 42nd St., NY, NY 10017; 7-MX S. Dearborn, Chicago, Ill 60603; 150-MX N. Santa Anita, Arcadia, Ca 91006.

CANADIAN LAND FROM \$35.00 AN ACRE CHOICE. Properties available across Canada. Low monthly payments. Ideal for farming, cottages, hunting, fishing. Free Catalogue. Canadian Estate Land, Dept. PMC-3, 286 Lawrence Ave. West, Toronto, Ont., Canada M5M 1B3.

\$5 ACRE, Canadian Border—hundreds campsites, islands, farmlands, directly from tax authorities. (Non-profit). Lists, photographs mailed. Register, Room 10, 110 Church Street, Toronto 1, Ont. Canada

\$1.00 ACRE! USA and Canada. Lists, photographs mailed. Government Lands, 220-PM Delaware, Buffalo, New York 14202.

"CANADIAN Country Acres and Lots." Our 60th year. Free catalogue. Tax Sale Service, Room 301-PM, 85 Bloor Street, East, Toronto, Ontario M4W 1B5.

CENTRAL Ontario—Choice 640 acre Sportsmen's paradises still available—\$20.00 plus \$6.50 taxes yearly. Maps, pictures, \$2.00 (Refundable). Information Bureau, Norvai 4, Ontario, Canada.

GOVERNMENT LANDS FROM \$7.50 ACRE! Vacationing, Farming, Investment! Exclusive "Government Land Buyer's Guide" . . . plus "Land Opportunity Review" listing lands throughout U.S. Send \$2.00. Surplus Lands, Box 6588-AC, Washington, D.C. 20009.

EXCEPTIONAL 5-ACRE RANCH. Lake Conchas, New Mexico. Only 5995 per acre. Vacation Paradise. Good long term investment. Easy Terms. Free brochure. Ranchos, Box 2010PM, Alameda, California 94501.

BIG . . . FREE . . . CATALOG! 272 pages! Over 2,500 top values in 40 states coast to coast! **UNITED FARM AGENCY**, 612-PM West 47th St., Kansas City, Mo. 64112.

CANADIAN Land: \$285.00, \$10.00 month. Free information. Vacation Acres, 7771-A Bernard, LaSalle, Canada, H8N 1V8.

FOR NORTH ARKANSAS LAND DON MOORE IS YOUR MAN DON MOORE REALTY P.O. Box 1072, Harrison, Ark. 72601. Phone 501-365-9416.

BIG Profits in Real Estate. New Report tells How and Where to Buy Land—\$1.50. Canada Sales Division, 280-P Nelson, Ottawa, Ontario, Canada K1N 7S2.

FORTUNE in Delinquent tax properties. Booklet \$3.00. Land, 296PM, Port Richey, Fl. 33568.

FARM & GARDEN EQUIPMENT

VETERINARY Guide to Farmers. The only book of its kind. Send \$6.95 to: **POPULAR MECHANICS**, Dept. VG, Box 1014, Radio City, New York, N.Y. 10019.

FLOWERS, PLANTS, & NURSERY SUPPLIES

LEARN Landscaping and the growing of plants. Start a profitable business part or full time. Free information without obligation. Lifetime Career Schools, Dept. A-829, 2251 Barry Avenue, Los Angeles, California 90064.

GINSENG Bringing \$35 Pound. Have Seeds, Roots, Goldenseal. Full Information. K. Collins, Viola, Iowa 52350.

VERTICAL GARDEN 120 Plants in 3 sq. ft. **PLANTS GROW UP AND DOWN**, not along the ground. Copy-righted plans \$2.00. **JAMDEN**, Rm. 21, 6720 Calista, Orangevale, Ca. 95662.

PLASTIC Flower Pot Sale! Free Information. Floripot, Box 34, Bethel, Minn. 55005.

GROW SUPER VEGETABLES without Weeding or Cultivating. Trial Tested Method. **COMPLETE** Information. Send \$2.00 to "WORK NO MORE GARDEN" Box 165, Groveland, New York 14462.

BEST Fastest Growing Shade Tree. Details: Gallant Green, 42 Morton, NYC 10014.

CONSTRUCTION PLANS, BLUEPRINTS

HOUSE EXPANSION PLANS And detail instruction book provide anything from an extra room to 1000 s/f addition. Build what you need at big do-it-yourself saving. Book with 1 set working blueprints \$14.50! With 4 sets (required by contractors) \$20.00. Money-Saver Projects, Box 303-44B, Chappaqua, New York 10514. Information available.

CHALETs, CHATEAUS STUDY Plans 5 Different Sets- \$2.00 Each 2-\$3.50 3-\$5.00, 4-\$6.50 5-\$8.00. Parlee Arts, Box 27717, Tempe, Arizona 85282.

INSTA - HOUSE Pat. Pend. designed to fit the ecology. Amazing new concept for Fast Economical Housing. **DESIGNER'S** illustrated **PLANS \$7.50**. 7887 Riverside Drive, Dublin, Ohio. 43017.

LOG CABINS, "A" FRAMES

BUILD Log Cabins, Rustic furniture, Fireplaces!! Complete manual \$3.00 . . . "A" Frame plans, \$2.00 . . . Guaranteed. . . Beels, 956 Springdale, Atlanta, Georgia 30306.

YOUR pioneer log cabin! Detailed plans and method. Adaptable to any woodland retreat. Minimum cost. Manual \$3.00. Handcrafters Press. 9 Clintwood Gate. Unit 10, Don Mills, Ontario, Canada M3A, 1M3.

HOME CRAFTSMAN

101 PATTERNS of smart Gifts, Novelties, Shelves, Action Windmills, plus "Make Money Jig Sawing." \$2.00. Mastercraft, 35M, 7041 Olcott, Chicago 60631.

CATALOG FULL SIZE FURNITURE PLANS—\$1.00 Refunded with first order. Traditional Early American, over 150! Furniture Designs, 1425 Sherman, Dept. CP-75, Evanston, Illinois 60201.

BRIAR, MEERSCHAUM, Smoking Pipe Materials. Pimpop, Box 59211, Chicago, Illinois 60659.

BARN PLANS, Gambrel roof. Simplified plans and material list. Garage and utility. 20' x 24' or 24' x 28' \$5.00. Utility 16' x 20' or 12' x 16' \$4.00. Modular Designs, 216 Garver, Elkhart, Ind. 46514.

CABINETMAKING MADE EASY AND "How to Make Formica Counter Tops." Two excellent guides let you build kitchen cabinets and counter tops like professionals. Extraordinary guides bring master craftsmen's shortcut methods. Satisfaction guaranteed. Write: Japs, 126-P Seventh North, Hopkins, Minn. 55343.

PICTURE Framing—Profitable full or spare-time business. Easy to learn with handbook-course "Guide To Picture Framing Profits." \$1.50 Guaranteed. Free framing-supplies catalog included. Japs, 126-PM Seventh North, Hopkins, Minnesota 55343.

PLANS for low Cost thickness planner \$2.00. Woodcraft, 49 Downing St., Fall River, Mass. 02723.

WOOD—Domestic and imported Hardwoods! 3500 Items! Clock, Musical Instrument Kits. Tools . . . Discount Prices! Hard-To-Find Hardware. 144 page Catalog, 50¢. Craftsman, Dept. AX-35, 2729 Mary, Chicago, Illinois 60608.

VENEER Bargain! 25 Square Feet Walnut \$7.00, 30-Samples. 4"x9" \$4.95, Postpaid. New Exciting Simplified Instruction Manual/Catalog 25¢. Morgan, Box 18169, POK18, Louisville, Kentucky 40218.

BATTERY-OPERATED WESTMINSTER CHIME, pendulum (from 4" to 40" lengths), conventional clock movements, hands, weights, clock accessories. **KLOKIT**, P.O. Box 629, Lake Geneva, Wisconsin 53147.

TRIPLE-Sided ant farm. Plans \$3.00. S-P Enterprises, Box 8529, Parkville, Maryland 21234.

FUEL SHORTAGE BURN HYDROGEN From Water. One Day Work. Use Existing Fuel System. Cheap. Send \$3.00 to: Plans, Box 8279, North Royalton, Ohio 44133.

GREENHOUSE. Build a nontaxable greenhouse for under \$50.00. Plans for 8' X 8' X 7½' unit \$3.00. Thermal Research, Box 761-PM, Station A, Eatontown, New Jersey 07740.

WOODEN Tavern Lantern plan—\$1.00. P.O. Box 74, Langhorne, Pa. 19047.

(Continued on next page)

HOME CRAFTSMAN

(Continued from preceding page)

TOY plans—eight wooden vehicles—\$2.00. Things Americana, Box 918, Pilgrim Station, Warwick, R.I., 02888.

FREE PLAN For Making Sir Isaac Newton's swinging-ball cradle which he used to demonstrate his theory of motion. Makes Science Conversation piece for Coffee Table, great science-fair project for school shop. Way-Mar, 58 Underhill Road, Scarsdale, New York 10583.

BUILD A HOUSE BOAT FOR LESS THAN \$1000. It's a 25 Footer with a graceful vee bow. Best of all, with its 8 Ft. beam it's trailerable. Plans \$24.50. Send to: Popular Mechanics, Dept. HE, Box 1014, Radio City, New York, N.Y. 10019.

DO-IT-YOURSELF

MESSY Attic? How To Organize Your Attic—\$1.00. Frye, Box 65B, Royalston, Mass. 01368.

MECHANICAL Trash smasher under \$20.00 to make, plans \$2.50, 4023 Southwest 12th St., Plantation, Fla. 33317.

MAKE Wine & Champagne using Kitchen Equipment. Recipes Guaranteed \$2.50. Louise Enterprises, Box 14752, Cincinnati, Ohio 45214.

NEW Illustrated Manual Teaches Simple Home Repairs. Free Information; Duval Publishing, 908 Rhawn, Philadelphia, Pa. 19111.

BURGLAR-FIRE Alarm Supplies and Information. Free Catalog. Protecto Alarm Sales, Box 357A, Birch Run, Michigan 48415.

SOILLESS Year-Round Gardens. Illustrated Guide, Adaptable Plans, Bibliography, Sources, Helps—\$3.00. Nutrient (Makes 100 gallons)—\$4.00. Hydroponic, Drawer 260M, Corona, CA 91720.

ELECTROPLATING. Complete amateur's textbook All metals Electroplate metallic/nonmetallic items \$7.00. Details free. Tropic, Box 95P3, Palm Bay, Fla. 32905.

CONVERT MOWER Engines i.to air compressors. Write: Showwater, Box 409, Abilene, Kansas 67410.

1400 CATALOGS Listed and Described Sources for EVERYTHING Imaginable! Rush \$2.00. MASTERLOG, Box 24413-YO, Oakland, California 94623.

BASIC Gas Range, Water Heater, House Heater Repair. \$1.95. Basic, Box 325, Idyllwild, Ca. 92349.

PIC-YO Guide. Do-It-Yourself Wiring Handbook. Non-technical. Guaranteed. \$1.95. Suburban Business, Northboro, Mass. 01532.

PERSONALIZED STENCILS: 1-16 Bold 1/2 inch letters or numbers Cut to your order \$2.00. Complete alphabet \$3.00. Print Message Clearly. Jantoe Products, Box 209, Hasbrouck Heights, N.J. 07604.

DO-IT yourself tax guide: W-2 People. Sample Filled in Forms. Deductible. \$1.95. Suburban Business, Northboro, Mass. 01532.

STOP USING the kitchen table for a workbench. Easy-to-follow \$1.00 plan shows how to build a dandy 5-ft. bench and tool panel from lumberyard material. Way-Mar, 58 Underhill Rd., Scarsdale, N.Y. 10583.

BEST "How to" Books/Manuals. Free general catalog. Write: Oak, Box 1488C, Oak Brook, IL. 60521.

INCOME TAX—Don't pay others to figure it. Send \$2.00 for #1040 TAX KIT. Simonds, Box 3387, Lake Wales, Florida 33853.

BUILD stereo center for under \$15.00. Use simple hand tools. Holds 300 albums, stereo and speakers. \$2.00 White-Plans, Box 10037, Kansas City, Missouri 64111.

VODKA, Bourbon, Gin, Rum, Plans directions, only \$2.00. Vineyard Hills Rt. 1 Fleming, Ohio 45729.

MAKE Cheese, Yogurt, Sausage at Home. Brochure plus potpourri offers free. WATSONS, 156 John Street, Hauppauge, New York 11787.

TURQUOISE JEWELRY Less Than Wholesale. Indian Style Ring Kits, Includes: Guaranteed Genuine Turquoise Stone, 10 Carats or Larger, Polished, Ready to Mount. All Silver. EASY Assembly Instructions. \$7.00 Each-Two For \$13.50. South-West Kits, 1602 Velta Dr., Belen, New Mexico 87002..

WINDTURBINE, Several Kinds, 12v-110v, \$5.00. Solar Heating, Cooling, \$3.00. Power Motor Tree Limb Shredder, \$2.00. Free House Heating, cooling, \$2.00. Automobile Battery Power, \$3.00. All Illustrated Instructions Guaranteed. Energycraft, 2350 W47AP, Denver, Colo. 80211.

BEAT INFLATION! Slash utility bills 20-40%. Unique report discloses 140 simple tricks energy experts use at home. 40 pages explain practical savings for every room appliance. Guaranteed. Send \$3.00 today. Brothers Research, Box 19234-P, Sacramento, California 95819.

NOW! End expensive auto repairs. Save hundreds of dollars on costly labor charges. Excellent book shows how easy it can be done. Send \$1.95. Aldor House, Dept. 3PM75, 162 Belmont Blvd., Elmont, New York 11003.

MAKE Radiator Anti-Freeze. Information, \$2.00. Palmer, P.O. Box 1244, Phenix City, Alabama 36867.

TELEPHONES Unlimited, equipment, supplies. Catalog 50¢. Box 1654-B, Costa Mesa, California (92626).

MAKE champagne, wine on beer budget, \$2.50. Guaranteed. Touchstone, Box 346B, Clyde, Kansas 66938.

ELECTRIC MOTOR Repair Guide & Catalog for Air Conditioning & Heating Fan Motors. New Motors, Parts & How To Repair Data. Send \$3.00, EMS, 1308 North 14th, Kingsville, Texas 78363.

WINDMILL Generators, Plans, \$5.00. Solar Heating, \$5.00. Energy, 1158, Lancaster, S.Car. 29720.

FREE Hot Water, Solar Systems Plans and specs with instructions. Send \$10.00. D.R. Slater, P.O. Box 6606, Dept. PM2, W. Palm Beach, Fla. 33405.

TV PROBLEMS Diagnosed By Mail. Free Details. Stanley Studio, Box 1783-D3, Riverton, Wyo. 82501.

END carrying water to humidifier. Automatic float kit \$18.00. Plans \$3.00. Tidewater, 30 Stephen Rd., Kingston, New York 12401.

CUT Heating Costs by 75%. Convert your fireplace to heat entire home using your present heating system. Plans: hot air systems \$6.50. Thermal Research, Box 761-PM, Station A, Eatontown, New Jersey 07724.

SAVE 90% Costly TV Repair Bills. Free Details. Stanley Studio, Box 1783-B3, Riverton, Wyo. 82501.

REPAIR MINIBIKES, LAWNMOWERS, BICYCLES, Sewing Machines, Auto Engines, Mazda/Wankel, Motorcycles, Magic boats. Over 100 How-To-Books. Free Brochure. **BEAT THE RECESSION.** Sincere, Box 10422, Phoenix, Arizona 85064.

WATERPROOF, Repair, build with bulk epoxy adhesive. Free literature. Construction Chemicals, 257-G, Monroe, CT. 06468.

SIMPLE Develop Color Slides Without Darkroom. Free Details. Stanley Studio, Box 1783-P3, Riverton, Wyo. 82501.

DAMP BASEMENT? Book shows you how to fix it yourself. \$3.00 postpaid, Box 662, Elyria, Ohio 44035.

SOLAR Science Projects by Halacy cooker, still furnace, oven, water heater, motor, radio. Includes plans, bills of materials, written instructions. \$3.00. Centerline 401G South 36th Street, Phoenix, Arizona 85034.

OUTWIT Burglars-Practically Infallible, inexpensive, simple construction and installation. Send \$3.00. Alarm Plans, Box 691, Fremont, Ohio 43420.

POPULAR MECHANICS HOME BOOK OF REFINISHING FURNITURE. Covers all the tricks of the trade. Only \$4.95. Send to: POPULAR MECHANICS, Dept. HE, Box 1014, Radio City, New York, N.Y. 10019.

REPRODUCTION MOLDS

MOLDS For Ornamental Concrete. Our Catalog Contains Over 700 rubber and fiberglass molds. Catalog \$2.00. Plycrete Mold Co., Elk Rapids, Mich. 49629.

ARTS & CRAFTS

GLASS BLOWING Kits and Supplies—Literature Upon Request—Willis Glass, P.O. Box 3460, Anaheim, California 92803.

MAKE Figurines, plaques, lawn ornaments. Molds, plastercraft kits, liquid rubber. Sample and catalogue 25¢. Wooley Company, Box 29-B, Peoria, Illinois 61601.

"GETTING Started in Stained Glass" 25¢. Whittemore, Box 2065Y, Hanover, Mass. 02339.

LARGEST HANDICRAFTS SUPPLY DIRECTORY \$3.00. R.P.H. Manufacturing Co., 24 Winter Street, Stamford, Conn. 06905.

BINOCULARS, TELESCOPES, MICROSCOPES, MAGNIFIERS

FREE Binocular, Rifle scope catalog. Discount sale. Save 50%. Free gift with order. Write: United Binoculars, BN-9308, 9043 So. Western, Chicago 60620.

"AN EXPERT'S Advice on Binoculars." Write: Tele-Optics, 5514 Lawrence, Chicago, Ill. 60630.

CAMERAS AND EQUIPMENT

FREE! FREE! BARGAIN BOOK. Central Camera Co., Dept. 3151, 230 S. Wabash, Chicago, Ill. 60604.

BARGAIN BOOK FREE—Jimco Specialty, Dept. 7532, 30 E. Jackson Blvd., Chicago, Ill. 60604.

GAF Products. Factory Shipped; Big Money Savings. 25¢ Details. Consumer's Delight, 216 Jackson, Suite 612P; Chicago, Illinois 60606.

PHOTO & PHOTO SUPPLIES

SHOOT WEDDINGS Like The Pro's, 150 Pictures that make money for Professional Photographers. Earn \$300.00 on a Weekend. Information, Tips Booklet \$1.00. Studio WM, 6713 Wildwood, Westland, Michigan 48185.

COLOR SLIDES

GAF Color Slides. 12,500 all nations. Catalog 25¢. Worldwide PMJ, 7427 Washburn, Minneapolis, Minn. 55423.

FREE 35MM Color Slide Encyclopedia. Same slides used in TV, national magazines. 126-pages individual listings. Write Wolfe Worldwide Films, Dept. 14-35, Los Angeles, Ca. 90025.

MOTION PICTURES & SOUND EQUIPMENT

175-FT. 8MM, CLASSIC SAMPLER . . . ONLY \$1.99. Highlights from heyday of the silents! Chaplin, Laurel & Hardy, Fairbanks, Keystone Kops, Gish, Pickford, Chaney, the first Indianapolis 500 and more. Order today . . . specify standard or super-8. Free catalog: 8MM. & 16MM. movies & 35MM. 2" x 2" color slides. Blackhawk Films, 491 Eastin-Phelan Bldg., Davenport, Iowa 52808.

UNUSUAL Movie supplies. Free circular. Esor, 47th Holly, Kansas City, Missouri 64112.

8MM—SUPER 8—16MM MOVIES! Biggest Selection! Lowest Prices! Free Catalog! Cinema Eight, Box 14M, Chester, Connecticut 06412.

SUPER 8MM, 16mm, 8mm silent and sound film classics. Free catalog. NILES, 1141PM Mishawaka, South Bend, Ind. 46615.

SUPER 8, 8mm, 16mm, 35mm, B&W and Color Film, Supplies, Processing Equipment. Send 25¢ for 84-page catalog refundable with order. Superior, 448 N. Welis, Chicago 60610.

8 MM SOUND - Silent Films Steiglitz Corp. - Box 127 - Brooklyn, N.Y. 11220.

COLUMBIA Home Movies - Free Catalog - G & G Films, Box 321, Syosset, N.Y. 11791.

RADIO, TV & HAM EQUIPMENT

TOWERS—For TV, Radio, Ham. Beautiful Aluminum, Quality Made. Telescoping or Fixed. Buy Direct—Save. Box 158PM, Wyckoff, N.J. 07481.

CANADIAN Catalogs—Giant Savings, Surplus, Clear-outs, Bankruptcy Stocks, Factory Deals. Rush \$1.00. Etco-PM, Box 741, Montreal "A".

GOVERNMENT Surplus receivers, transmitters, sniperscopes, parts. Catalog 25¢. Meshna, Nahant, Mass. 01908.

36¢ RADIO & TV Tubes. Free catalog. Cornell, 4213-17 University, San Diego, California 92105.

ELECTRONIC TV ANTENNA Brings in every channel sharp and clear. \$2.95. Locke Enterprises, 3609 Stag Run, Dept. C23, Huntsville, Ala. 35810.

"CRYSTAL Set Handbook"—50¢. Catalog 25¢. refundable. Laboratories, 1477C, Garden Grove, Calif. 92642.

HIFI, TAPES, & RECORDS

OLDIES 45 RPM Original Hits—Catalog 50¢. C&S Record Sales, Box 197, Wampsville, New York 13161.

FREE Catalog—Electronic Kits—Amplifiers—Pre-amplifiers—Psychedic Strokes—SCA Adaptors—Color Organs—Digital Instruments—Guitar Amplifiers. **FREE** Subscriptions. SWTPC, Box PM32040, San Antonio, Texas 78284.

FREE Catalogues, 2000 hard to find unusual records. Rose's Records, Box 7216, Louisville, Ky. 40207.

OLDIES 45RPM. Free Catalog. Corry's Record Shop, Box 166B, Mason, Ohio 45040.

8-TRACK Fidelity Stereo Tapes. Any Top Rock, Oldies, Radio Shows, Humor, Party. \$3.50 you name it. List 50¢ (refundable). DiWan Company, Box 1302, Springfield, IL 62705.

GOLDEN Age Radio. Complete taped Shows. Box 25215-M, Portland, Oregon 97225.

SOUNDTRACK-Record-Albums, Mail-Auction-, Free-List-, Whalon-, 2321P Hill, Redondo Beach, California 90278.

CASSETTES. Labels. Free Samples. 638 Muskogee Avenue, Norfolk, Virginia 23509.

SAVE 50% ON STEREO EQUIPMENT. Details \$1.00. Actonco, 3 Putting Green, Penfield, New York 14526.

GENE AUSTIN—A Cassette Tape of this pioneer Crooner's Best Records: 1925-1931; Ramona, 19 Selections. \$5.00—Wetzell's Cassettes, 523 DuBois, Barrington, N.J. 08007.

MUSIC & MUSICAL INSTRUMENTS

UKULELE Solos by "Heeday" Kimura on cassette tape. 25 minutes of strictly uke artistry. \$4.95. Maui Mail, 434-A Maalo, Kahului, Hawaii 96732.

LEARN to Play Piano—Guitar—Accordion My Way. Write: Hall's, Box 181PM, Lynwood, California 90262.

ACCORDIONS Manufacturing, 6846-P North, Chicago 60635. Concertinas - Chromatics - Heligons - Hohners - New - Used - Repairing - Wholesale Catalogs Free.

LEARN Banjo, 5-String Bluegrass. No music. Makes learning easy. Free details. Blaylock, Box 25-M, Marietta, Georgia 30060.

POEMS Wanted for songs. Nashville Music Productions, Box 40001-P, Nashville, Tennessee 37204.

WHOLESALE! Professional Guitars, PA Systems, Altec Speakers, 240W RMS Amplifiers. Free Catalog. Carvin, Escondido, Calif. 92027.

GUITAR, Banjo, Violin, Mandolin Making Materials, Accessories, Books. Catalog 25¢. Guitar Center, Box 15444, Tulsa, Oklahoma 74115.

EASY to Play And Make, Quality Dulcimers, Banjos, Thumb Pianos; Instruments And Kits. Can Be Profitable Hobby. **HERE,** Inc. #P, 410 Cedar Avenue, Minneapolis, Minn. 55404.

KITS! Build Dulcimers, Guitars, Balalaikas, Thumb Pianos, Harps. From \$2.95. Finished Dulcimers from \$19.95, 8665 West 13th Avenue-PM, Denver, Colorado 80215.

VIOLIN And Guitar makers—send for latest Free Catalogue of woods & accessories. International Violin, PM1, 414 East Baltimore St., Baltimore, Md. 21202.

POEMS Songs wanted. Recording. Publishing guaranteed. Royalties. Radio-TV release. Broadway Music, Box 11647-PM, Sarasota, Fla. 33578.

PLAYER PIANOS: PUMP ORGANS—books; repair manuals. Catalog \$1.00, refundable first order. Vestal Press, Box 97, Vestal 11, NY 13850.

(Continued on next page)

MUSIC & MUSICAL INSTRUMENTS

(Continued from preceding page)

ACCORDION Top Brands. Cordovox, Buy direct. Tremendous discounts. Trades accepted. Free brochure PM. Accordion-O-Rama, 874 Broadway, N.Y.C. 10003.

STRINGS OUR SPECIALTY! Accessories, Books. Catalog 25¢. Stringking, M3 Box 5444, Lindenhill, Flushing, N.Y. 11354.

30% TO 50% DISCOUNT! Any Model: Guitar, Amp, Drum, Banjo, Dobro! Free Catalog! Warehouse P55, Box 11449, Fort Worth, Texas 76109.

WHOLESALE. Musical Instruments—Accessories. Allied, 573 Route 17, Paramus, New Jersey 07652.

ACCORDIONS—Famous makes. 40 models. 5 Day Home Trial. Easy terms. Trades. Free Catalogs! Money saving Importer-to-You Price List. Write: Accordion Corporation, Dept. R, 5535 Belmont, Chicago 60641.

LEARN TO Play Piano In One Hour. Free Details. Correlation, Box 751-M, La Canada, Calif. 91011.

COUNTRY MUSIC LOVERS. Write for free sample copy of **MUSIC CITY NEWS**, Box 975-PM, Nashville, TN. 37202.

ELECTRIFY Player Pianos, Pump Organs Quickly, inexpensively with Lee Silent Suction Units. Write: Lee Music, 525F Venezia Avenue, Venice, California 90291.

PLAY PIANO IN 60 MINUTES! Simple! Great for beginners! Proven results! No musical experience necessary. Satisfaction guaranteed! 3333. Barmel Enterprises, Box 8132-A, Van Nuys, Calif. 91409.

REPLACE Piano Ivories and Refinish Sharps Easily. Supplies and Instructions Only \$24.00. Write: Piano Repair, Box 2204, Melfort, Sask., Canada, SOE 1A0.

PIANO Tuning Made Easy. Manual and all necessary tools, only \$24.95. Ten-day moneyback guarantee. Utaris free. Stamm Industries, 471 W. South Blvd., Kalamazoo, MI 49006.

NEW PLAYER PIANO ROLLS. Free Catalog. Dupree, 2940-DE Grace, Costa Mesa, California 92626.

UP TO 60% Discount Name Brand Instruments. Catalog. Freeport Music, 455F Route 110, Melville, N.Y. 11746.

EDUCATION & INSTRUCTIONS

WELDING TRAINING Basic and Advanced Training for Major Processes—Arc, Gas, Pipe, TIG, MIG, Plasma. Hobart, a non-profit school, is accredited member NATE. Approved Ohio 70-12-0064 NT. Write for school bulletin and course schedule. **HOBART SCHOOL OF WELDING TECHNOLOGY**, Box 75, Troy, Ohio 45373.

ACCOUNTING CAREER. Many make \$1,200 monthly. You start, only 20 lessons, \$5.00 each. Pay as you learn and earn. State approved. Certificate. Start by mailing \$5.00 for first lesson. Jenkins, Box 571, Taft, California, 93268.

CASSETTES! Christian Way Out—\$1.00. List available. Twin Tier Tapes, Pine Valley, NY 14872.

UNBELIEVABLE But True! Call Strangers by Name. Tell Age, Occupation, More. Free P.O. of Magnuson, 1446c—4th Ave., Rockford, Ill. 61108.

RADIESTHESIA, Radionics, Dowsing, E.S.P. Courses and Equipment. Illustrated Catalog \$1.00 (refundable) Established 27 years. Dept. PM/R Bruce Copen. Highfield, Danehill, Sussex, England RH17 7EX.

NOW! YOUR OWN BURGLAR/FIRE ALARM BUSINESS OR Alarm installation position through training at home. Great demand, rapidly expanding field. Full information by mail, no salesmen. Security Systems Management School (homestudy) Dept. 7310-025, Little Falls, N.J. 07424.

AUCTIONEERING, Resident or home Study Course. Free Catalog, Nashville Auction School, 1921 West End, Nashville, Tennessee 37203.

AUTOSUGGESTION. Sleep-learning headquarters! Tapes, records, books. Gigantic catalog free. Research Association, Box 24PM, Olympia, Washington 98501.

UNLOCK Your Future. Become professional Locksmith by spare time homestudy. \$13 in an hour possible. All tools, equipment included. Facts FREE. Send name. Locksmithing Institute (homestudy), Dept. 1310-035, Little Falls, New Jersey 07424.

DETECTIVE—Training Course. American Detective Institute, Box 418-A, Fairfield, Alabama 35064.

LEARN TO Fix Typewriters and Office Machines. Many Trained Men Needed. Make up to \$25 in one hour on overhaul. Learn at Home in Spare Time. Facts FREE. Send Name. Typewriter Repair School (homestudy), Dept. 3310-035, Little Falls, New Jersey 07424.

RELIGIOUS VOCATION? Write: Church of Holy Light Inc., P.O. Box 4478, Pittsburgh, Pa. 15205.

USED Courses! Books! List 10¢. Smith's, 124 Marlborough, Salem, Massachusetts 01970.

COMPLETE YOUR HIGH SCHOOL At home in spare time. Texts furnished. No classes. Our diploma awarded. Our 78th year. Free Brochure. American School, Dept. X345, Drexel at 58th, Chicago 60637.

OWN Collection agency. "Little Gold Mine!" Franklin Credit, Roanoke, Virginia 24004.

LEARN Flower Arranging and Floristry. Start business or hobby. Free information on home study course. Lifetime Career Schools, Dept. B-265, 2251 Barry Avenue, Los Angeles, California 90064.

PIANO Tuning quickly learned with home study course. Diploma granted. American Tuning School, 17050 Teller Dr., Morgan Hill, California 95037.

DETECTIVE Profession. Easy home study; free tie-tack or lapel pin, certificate, future. GI approved. Professional Investigators. Box 41345. Dept. CP, Los Angeles, Calif. 90041.

LEARN Auctioneering. Term soon. Free Catalog. Reich World Wide College of Auctioneering, Inc., Box 949, Mason City, Iowa 50401.

AVIATION JOBS—Train at one of nation's largest aeronautics schools for pilot license, helicopter pilot, aviation technician, maintenance, power-plant, airframe technician, aviation electronics or instrument technician. Indicate if eligible for G.I. Benefits. Write for Free "Career Kit". Spartan Airschool, International Airport, Dept. PBCC4, Tulsa, OK. 74151.

EARN ELECTRONICS DEGREE by correspondence. Free brochure. Grantham, 2004 Stoner, Los Angeles, California 90025.

LEARN Sewing Machine Repairing. Men, Women. Lucrative profits. Profession with bright future. Gresslin Correspondence School, Box 927, Spencer, Iowa 51301.

PROBLEMS? There's an Answer! Free Home Study by Mail in the Torah or Confraternity New Testament. Please state your Religion. Lamplight Studies, Box 88-D, Brooklyn, New York 11229.

EXTENSION And Post-Graduate Awards in Philosophy, Art, Sciences, Botanic Medicine, Homeopathy, Radionics and others. 30 subjects. Curricular free (airmail \$1.00 refundable). Registrar, Sussex College of Technology, Highfield, Danehill Sussex, England.

LEARN Asleep or awake! Records, tapes, equipment! Free catalog! Drawer PM-400, Ruidoso, New Mexico 88345.

USED Courses! Books Catalog 10¢. (Courses Bought). Lee Mountain, Pisgah, Alabama 35765.

INSTANT MEMORY. . . . New way to remember. No memorization. Release "photographic" memory. Forget nothing! Liberates extraordinary knowledge talents, ESP. Immediate results! Free information. Institute of Advanced Thinking, Box 606-PM, Pacific Palisades, California 90272.

SURVEYING PAYS BIG!! United States Department of Labor reports "openings for 26,000 Surveyors in next ten years." Easy home-study plan guides you. Send for free "Surveying Career Kit." North American School of Surveying, Dept. PBCC4, Newport Beach, California 92663.

DETECTIVE Course. Free information. Universal Detectives, Box 8180-F, Universal City, California 91608.

PARAPSICOLOGY. Complete Study Course, Certificate. Details. American Parapsychological Research Foundation, Box 5395-B, Sherman Oaks, Calif. 91413.

BARTENDING Course Professional/Home Use \$9.95 Money Back Guarantee. 701 N. Birch, Coquille, Ore. 97423.

MAKE Money Writing Articles Professionally. Free Proof. Goliath Distributors, Box 1073PM, Arlington Heights, Illinois 60005.

PIANO Technology—Electronic organ servicing, learned easily at home. G.I. Approved. Free booklet. Niles Bryant School, Dept. P, 3631 Stockton, Sacramento, California 95820.

FREE Book tells how you can learn camera repair and service. Home study or classroom. Write today! National Camera, Dept. EAD, Englewood, Colorado 80110.

FINGERPRINTING—Investigation. Exciting, secure career. Learn at home. Free book. State age. Institute of Applied Science, 1920 Sunnyside, Dept. 163, Chicago, Illinois 60640.

BEST JOB FOR YOU. Computerized analysis after testing. Satisfaction guaranteed. Free details. W.B. Heidemann, 540 Clifford, Loves Park, Illinois 61111.

CUSTOMIZE VANS, Trucks, cars. Learn big profit home business in spare time. Materials, tools included. Exteriors, interiors—painting, upholstery, special fittings. **FREE** Career Plan. Customizing Center, Dept. PBC25, Newport, California 92663.

COLOR TV. Learn career Electronics by mail. Build, keep 25" diagonal color TV. FCC License prep. More. G. I. Bill. **FREE** school catalog. School rep will try to call. Write CIE, Dept. PM, 1776 East 17th St., Cleveland, Ohio 44114.

ORDINATIONS, Lifetime! Church chartered 1887! Write! 708 Bragg, Monroe, North Carolina 28110.

OUTSTANDING Photographs Made Easy. Cusmano, 247 East Alice, Phoenix, Az. 85020.

WATCH REPAIRING. 35 Lesson Home Study Course. Free sample. Diploma awarded. Chicago School of Watchmaking, Dept. YP, Fox River Grove, Illinois 60021.

METRICS MADE EASY CALCULATOR. Slim pocket pull tab guide with eight charts. \$1.75. REMCO, Box 667, Santa Rosa, Calif. 95406.

PENMANSHIP Corrector. Improve poor penmanship quickly. Details Free. Thurmon, Box 824, Stinnett, Texas 79083.

HAPPINESS Is A Skill. Learn it from one book, \$3.25. Satisfaction Guaranteed. Rempe, Box 1014M, Lomita, CA 90717.

FREE Lifetime Ordination. Become Chaplain Missionary. Bishop, Box 744, McKeesport, Pa. 15134.

COLLEGE Degrees at home. Choice of subjects. Easy tuition. Free inf. Elyson College, B. C. Box 909, San Ysidro, Cal. 92173.

FOR INVENTORS

LEARN To Write Your OWN Patent Application Market Your OWN Ideas Worldwide. Comprehensive Valuable Home Study Course. Information: IPD, 812 North Highland Avenue, Los Angeles, Calif. 90038.

PATENT Application Financing. Free patent search plan. Global Patent Division, 139-G Lake Merced Hill South, San Francisco, California 94132.

MR. INVENTOR: Manufacturers need inventions. For development assistance, patent searches, sales for cash or royalties, free "Proof of Invention" forms and other important information, write: Charles S. Prince, Invention Consultant, 509-A 5th Avenue, NYC, 10017.

INVENTORS—UNITED STATES PATENT OFFICE SEARCHES. PATENT DEVELOPMENT Engineering and MARKETING of your inventions, ideas with MANUFACTURER CONTACTS. Send for **FREE INVENTION CERTIFICATES** and Invention Information. Serving inventors since 1948. **GEORGE SPECTOR, LICENSED PROFESSIONAL ENGINEER—PATENT ENGINEER.** Former UNITED STATES PATENT OFFICE EXAMINER—3615 Woolworth Building, New York, New York 10007.

U.S. PATENT Office Searches, 234 Broadway, Room 3615, New York 10007. Free invention certificates.

INVENTORS: Your ideas and inventions (patented/unpatented) expertly searched, developed for commercial appeal and cash/royalty sales to manufacturers by professional Invention Developer with excellent record of experience. B. S. Industrial Engineering; United States Patent Office former Patent Examiner; United States Government former Patent Advisor. Second decade reliable service! Member: United States Council International Chamber Commerce. Free "Invention Record" and "Recommended Protection Procedure." Airmailed! Write: Raymond Lee, Invention Developer, 230P-Park Ave., New York, New York 10017.

FREE PAMPHLET: "Tips on Safeguarding Your Invention." Write: United States Inventors Service Company, 501-P Thirteenth Street N.W., Washington, D.C. 20004.

INVENTIONS Needed Immediately for manufacturers. For additional information write Kessler Corporation, C-53-F1, Fremont, Ohio 43420.

DON'T spend any money on your invention before you read this book by a successful inventor. How to make, evaluate, protect, develop and sell your invention. For more information without obligation write: Goldschmidt Associates, Box 2167, Menlo Park, California 94025.

NEW Idea Show Coming! Spring-Fall Shows. All inventions Welcome. Free Details. Application, No Obligation. Write: Paul Paulsen, Jr., 401 So. Columbia St., Frankfort, Ind. 46041.

ROYALTY Money Paid For Inventions. American Square Factory, Jamestown, N.C. 27822.

INVENTORS! Expose your invention to over 1,000 potential buyer/manufacturers in "The Inventors' Digest." For particulars write: 209 Calle Dorado, San Clemente, Cal. 92672.

PATENT Specifications Typed. Drawings. Reasonable. Landon ID. 108-02, 72 Avenue, 11375.

SEARCHES \$10.00 Invention Evaluated, developed and marketed. **FILING** YOUR OWN APPLICATION and other helpful Guides. Free literature. Professional Engineer, Box 8001 JFK, P.O. Boston, Mass. 02114.

INVENTIONS WANTED

CASH—Royalties for patented, unpatented inventions. Global Marketing Service, 139-G Lake Merced Hill South, San Francisco, California 94132.

INVENTORS! Protect your ideas! Free "Recommended Procedures." Washington Inventors Service, 422F Washington Building, District of Columbia 20005.

FREE! LATEST DIRECTORY OF 500 CORPORATIONS SEEKING NEW PRODUCTS! If you have an idea for a new product—or a way to make an old product better, send for our **FREE INVENTORS KIT NO. A-84.** It gives vital information on developing and marketing your invention/idea for Cash/Royalty Sales to corporations nationwide. Raymond Lee Organization, 230 Park Avenue, New York, N.Y. 10017.

INVENTIONS MARKETED Cash, Royalties **FREE INVENTION PROTECTION CERTIFICATES** George Spector Manufacturers Representative, Woolworth Building, New York, N.Y. 10007.

INVENTIONS IDEAS WANTED Developed, Marketed by leading professional organization for Cash/Royalty sales. **FREE EXAMINATION and CONFIDENTIAL REPORT** of the Commercial Features of Your Patented/Unpatented Invention. **FREE COPY** "How to Safeguard and Market your Invention to Industry" Write or Call: **LAWRENCE PESKA ASSOCIATES**, Dept. C, 500 Fifth Ave., N.Y.C. 10036. (212)354-9696, 150 S. Wacker Dr., Chicago, Ill. 60606, (312)346-1172, 1 Biscayne Tower, 2 So. Biscayne Blvd., Miami, Florida 33131. (305)358-1366, 44 Montgomery St., San Francisco, Calif. 94164 (415)956-1212, 1888 Century Park East, Los Angeles, Calif. 90067 (213)552-2020.

INVENTORS—If you have an invention for sale, patented or unpatented, write for free brochure outlining manufacturers requirements, royalty rates. Kessler Corporation, C-53-IW, Fremont, Ohio 43420.

HONGKONG factory needs 10-15 new products every month to satisfy their overseas buyers and to keep the factories running. Particularly interested in household items, toys, games and gadgets. Please send sketches or detailed explanation for our evaluation and cash/royalty purchase. Hongkong Plastic & Metal Products Company, P.O. Box 9627, Kwun Tong, Hongkong.

MANUFACTURING

INVENTORS Ideas Developed. Research. Models. Manufacturing. Sales. Free Brochure. Since 1942. William Parker, Box 6305, Orlando, Fla. 32803.

BUY IT WHOLESALE

WORLD'S Largest Wholesale Supply. 7853 American, European, Japanese wholesalers. Hongkong clothes. Rockbottom prices. Automobile discounts. Free Details. International Buyers, Box 16386-M, Portland, Ore. 97233.

HEARING Aids, batteries, Wholesale. Catalog 25¢. Fiston, Box 1444, New Preston, Conn. 06777.

PLASTIC Bags, Film, Tubing. Wholesale Price List 20¢. Milvan, 7799 Enterprise, Newark, Calif. 94560.

400,000 BARGAINS Below Wholesale: Many Free Liquidations . . . Closeouts . . . Job Lots . . . Single Samples. Free Details. Bargainhunters Opportunities, Box 730-A, Holland, Michigan 49423.

166 FREE WHOLESALE CATALOGS. 165,000 Products. 600 Suppliers, Dropshippers, Importers. Free Details. Worldwide Marketing, Box 1355-PM, Sioux Falls, South Dakota 57101.

OVER 4,000 items wholesale, Catalog \$2.00, Refundable. T-P Wholesale, Box 97, West Paducah, Ky. 42086.

CARPETS—RUGS WHOLESALE. No Minimum Order. Samples—Information, \$3.00. Refundable. Owen, 248A, Resaca, GA. 30735.

EXPORT-IMPORT

ORIGINAL Oil Paintings \$96 Dozen. Color Brochure 25¢. McDaniel, 3632 Topax, Claymont, Delaware 19703.

JAPAN: 1200 Products directory. Illustrated Manufacturers' names, addresses, \$5.00. Send cash. Yamagata Office, 814 Tugin Bldg., Marunouchi, Tokyo.

FOR THE HOME

SAVE HUNDREDS OF DOLLARS on a new roof! Free proof! Send self-addressed stamped envelope to: Roofs, Box 387, So. Bethlehem, N.Y. 12161.

VICTORY MIRACLE Wonder Cloth! Cleans, polishes Gold, Silver, all other metals. Removes scratches, stains, leaves furniture glossy. Lasts until fabric wears out. Send \$1.00 (refundable). GENEROSO, Box 961, Lomita, Calif. 90717.

OF INTEREST TO ALL

CRIME FIGHTERS! Police—Detectives—Investigators—Information—\$1.00 (Refundable) Don-Q, Box 548-PMO, Seattle, Wash. 98111.

\$500 MONTHLY Possible clipping items from your newspaper. Experience unnecessary. Details, send stamped addressed envelope, American, Excelsior Springs, Mo. 64024.

"GET Everything Your Government Has to Give." Details 25¢. Custom House, Patterson, New York 12563.

SCATTERED YOUR KEYS LATELY? Send \$1.00 for unbreakable Key Chain to: Dia-man Jim, Box 28027, Dallas, Tex 75228.

FREE PUBLICITY For Individuals, Businesses, Teams, Clubs. Simple guide with many sample stories. Rush \$3.00. Publicity, 3520 Madison, Dearborn, Michigan 48124.

DELUXE Folding Scissors—Send \$1.00 to: MJB Enterprises, 175 5th Avenue, NYC 10010.

LOSING HAIR? BALDING? DANDRUFF? Doctor's Authentic, Copyrighted Booklet with proprietary offerings \$1.00. Dr. Shiffer Laboratories, Box 398 PM, Punta Gorda, Florida 33950.

OF INTEREST TO WOMEN

BEAT THE HIGH COST OF LIVING! Buy Clothing, Furniture, etc. at up to 90% off retail price! New cars \$125.00 over Dealer's cost! Many amazing budget stretchers! Completely legal. Astounding Report \$2.98. Satisfaction Guaranteed. Progress Reports, Box 66-A, Denham Springs, La. 70726.

\$500 MONTHLY Possible clipping items from your newspaper. Experience unnecessary. Details, send stamped addressed envelope, American, Excelsior Springs, Mo. 64024.

HOW TO MAKE MONEY Writing Short Paragraphs. Information Free. Barrett, Dept. C-27-X3, 6216 N. Clark, Chicago, 60660.

VINYL'S Where The Money Is! Invisible Repair, re-finish, recolor furniture, luggage, car tops. Quick, easy. Two small \$20 jobs a day earn you \$1,000 a month. Homes, cars, offices, restaurants, unlimited customers. Start earning after an hour's practice. Sensational details Free. VIP, 2034 Montrose, Chicago, 60618.

ADDRESSES MAILERS HOMEWORKERS needed 50 Firms listed rush 50¢ Stamped envelope. FLO-TONE ENTERPRISES, 228 LIVINGSTON STREET, NORTHVALE, NEW JERSEY 07847.

500 BUTTONS Plastic Assorted sizes, colors, styles \$2.50 ppd. Erlichman, 103 Hedgerow, Morrisville, Pa. 19067.

WEAVE RUGS — Make Good Profits! No experience necessary! For complete catalog, samples, and low prices on warps, fillers, looms, parts, etc. send 25¢. If you have loom — advise make, weaving width please. **OR. RUG COMPANY**, Dept. 2545, Lima, Ohio 45802.

GIFT SHOPPING

SELECTED UNIQUE GIFT IDEAS. Exclusive Items. FREE catalog. Multi Service Association, 1119 Foster Street, Franklin Square, New York, 11010.

FREE GIFT CATALOG! Bargain prices, great selection. C&J Enterprises, 7000 Chestnut Oak Ct., Grove City, Ohio 43123.

MINIATURE Charms—Trinkets—Toys. (3) FREE Samples. **TREASURE CHEST**, 9321 PGM Capeview Ave., Norfolk, Va. 23503.

JEWELRY! Gift Catalog Free! Randolph, Dept. PM7, P.O. Box 146, Nebo, N.C. 28761.

FREE Catalog. Bonus. Sperry Gifts, Box 441, Virginia Beach, Virginia 23458.

GIFT SHOPPING? Free beautifully illustrated catalog. 300 gift ideas! Village Gifts, Box 352, Clemmons, N.C. 27012.

Free Catalog! Bargains are our Business, also wholesale catalog \$2.00. Refundable. Alicia Company, Pelzer, S.C. 29669.

CLOCKS, WATCHES, OLD GOLD, JEWELRY

HIGHEST CASH Immediately for Old Gold, Jewelry, Gold Teeth, Watches, Diamonds, Spectacles, Silver, Platinum. Free Information. Rose Industries, 29-A East Madison, Chicago 60602.

JEWELRY Sample \$10.00. AED, #303, 3100 S. Michigan, Chicago, Ill. 60616.

WANTED—Gold, silver, platinum (any form). Coins. Information free. Wilmot's, 345 South Glassell, Orange, Calif. 92666.

CLOCK Repairing Parts, Tools, Supplies. Catalog, \$1.25. G/M, 22627 Berdon, Woodland Hills, California 91364.

BUYING Jewelry, Precious Metals! Write! Metallurgy, Box 33009-PM, Charleston, S.C. 29407.

WATCH and Clock repairing books, tools, materials. Free catalogs. North American, Box 77-AC, Fox River Grove, Illinois 60021.

HEARING AIDS

HUGE SAVINGS. Eliminate dealer mark-ups. Free Trial. Batteries Wholesale. Terms arranged. Lloyds-PMC, Rockford, Ill. 61104.

HEARING Aids, Batteries, Discount Prices. Free Trial. Write: Rhodes, Brookport, Illinois 62910.

FREE HEARING AID CATALOG—Save by mail. Write: "MONEYSAVERS", 9530-PM-3, Langdon, Sepulveda, California 91343.

HEARING AID BATTERIES Largest Selection * * * Lowest Prices Free Catalog * * * Write * * * WYATT, 501 Ivey Street, Grass Valley, Calif. 95945.

WHOLESALE Discounters! Famous Aids! Batteries! Repairs! AidMart, Drawer Z-2, St. Petersburg, Florida 33731.

HEARING Aids—Huge savings on tiny, all in the ear, eyeglass, behind the ear and body models. Free home trial. Low as \$10 monthly. Write for free catalog. Prestige, Dept. R-6, Box 10947, Houston, Texas 77018.

TOBACCO

HANDCARVED Meerschaum Pipes Wholesale Catalog. Nichols, Box 3144, Enid, Oklahoma 73701.

MEERSCHAUM Pipes—Free Catalog. Conner Imports, Box 9574-PM3, San Jose, Calif. 95157.

DO YOUR pipe a flavor. Factory-fresh, pure tobacco. Natural and aromatic custom blends. For free sample write: Green River Tobacco, Box 1313-PMT, Owensboro, Ky. 42301.

HAND Blended Pipe Tobaccos, Mild Rich Flavored, finest available, Send \$3.00 for Eleven Samples or write for Free Catalogue only. R.K. Williams Co. Ltd., Dept. P3, 6316 Winthrop Ave., Indianapolis, Indiana 46220.

HAND Carved MEERSCHAUM Pipes, free catalog. Bacchus Imports, 1570 Sanders, Northbrook, Illinois 60062.

WALL PIPE RACK WITH HUMIDOR, Make your own. Photocopy of article shows all details. Price 45¢. Send order to: **POPULAR MECHANICS**, Dept. HE, Box 1014, Radio City, New York, N.Y. 10019.

FREE Sample of our best selling tobacco. Bradley's Smokers News, 170 Cypress, Abilene, Texas 79601.

SCIENCE & CHEMISTRY

SCIENCE EXPERIMENT KITS, for youngsters—8-14, information, Schubel & Son, Box 214848-N, Sacramento, CA 95821.

FREE chemicals, apparatus. Details for stamp. Ervin, B21, Monroe, Ohio 45050.

AMAZING! Scientific-Apparatus-Glassware-Chemicals. Catalog-50¢. Hagenow Laboratories, 507-A Huron Street, Manitowoc, Wisconsin 54220.

CATALOGUE Of Those Very Hard-To-Find Chemical Products, 500 How-To-Books, Laboratory Experiments, Supplies, Information. Special Attention to Beginners. Formulas Of Every Conceivable Mixture in Science and Industry. 75¢. Kennus-C, Box 205, Staten Island, New York 10306.

DISCOUNTED! Laboratory Chemicals, Glassware-Apparatus. Catalog-50¢. Deluxe Scientific, 507 Huron, Manitowoc, Wisconsin 54220.

FORMULAS, PLANS, ETC.

ANY Formula \$5.00. Catalog - Manufacturing Treatise \$1.00. Belfort, 192 N. Clark, Chicago 60601.

AUTOMATIC GARAGE Door Closer. Free Details. AED, #303, 3100 S. Michigan, Chicago 60616.

PLASTICS

CASTOLITE Pours like water, hardens like glass without heat. Crystal clear, colors. Embed flowers, seashells, mementos, anything. Make fine gifts. Form flexible molds over patterns of any shape, size. Reproduce your own designs in plastics, candlewax, metal, plaster, cement. Free Brochure. Or send \$1.00 for illustrated Manual Catalog. Profitable. **CASTOLITE**, Dept. 75C/PM, Woodstock, Ill. 60098.

LUCITE—Plexiglas acrylic cut-offs 10-lb. boxes—1/16" to 1/4" thick—minimum dimensions. Each piece 2" maximum dimension 12". All clear, paper masked—\$7.50. Mixed clear and colored—\$8.50. Craftics, Inc., 2301 N. Pulaski Rd., Chicago, Ill. 60639, (312) 235-3307.

PLASTIC LAMINATES. How to work with! You can turn out elegant finished products just by using hand or power tools. Resurface kitchen countertops. Correct countertop bubbles. Shows you laminating tricks you should know about. Photocopy of PM article. Price \$1.80. Send order to: Popular Mechanics, Dept. HE, Box 1014, Radio City, New York, N.Y. 10019.

TREASURE FINDERS

TIRED OF DIGGING UP TRASH? The All New "Coin-Shooter" Rejects Bottle Caps, Tin Foil, Nails and Shallow Trash. Detects Gold, Silver Coins and Jewelry. Free Literature. **D-TEX ELECTRONICS**, Box 451-U, Garland, Texas 75040.

POWERFUL Metrotec locator detect gold, silver, coins, relics. Moneyback guarantee, terms. Free information. Underground Explorations, Dept. A, Box 793, Menlo Park, California 94025.

BURIED TREASURE—Locate up to Quarter Mile away with Ultra-Sensitive Directional Locator. Send for free, informative pamphlet. Research Products, Box 13441-AMC, Tampa, Florida 33611.

FREE FACT-FILLED Catalog! World's largest selection! Metal detectors starting at \$79.50. Two year guarantee! Three factories, U.S.-Canada. 1,200 dealers—Service Centers nationwide. Finest instruments at any price! Budget terms. Dealer inquiries invited. Write: White's Electronics, Inc., Dept. PASQ, 1011 Pleasant Valley Road, Sweet Home, Oregon 97386.

TREASURE FINDER Locates buried gold, silver, coins, treasures. 6 powerful models. Instant financing available. Write or call for free catalog. Phone (713) 682-2728 day or night. Dealer inquiries invited. Relco, Dept. AA21, Box 10839, Houston, Texas 77018.

FREE! Exciting details! Where to pan gold throughout U.S. Moran Publishers, 2 Van Buren Road, Scotia, New York 12302. Enclose stamp.

FIND Buried treasure with patented metal detectors that distinguish Metallic trash from treasure, have push button and automatic tuning, ground pickup eliminate feature, great range, etc. Free catalogue. Gardiner Electronics, Dept. 9, 4729 N. 7th Avenue, Phoenix, Arizona 85013.

DON'T DIG TRASH! Owners report our "Selectmatic" Detector best. Differentiates treasure faster, deeper. Patented against imitations. Treasure Electronics, Rt. 1, Box 56MN, Benton, La. 71006 **CALL** 318-965-0277.

GOLD

LARGE GOLD NUGGETS Panned from Goldbearing Streams: 3 for \$9.95, 10 for \$29.95. Excellent investment! Money Back Guarantee. Tannenbaum, Dept. M, 6 Fiesta Court, Hewlett, New York 11557.

GOLD PROSPECTING GUIDE, Assay Gold, Find treasures. Free information. Dave Hunt, Rt. 1, Roosevelt, Utah 84066.

PRECIOUS STONES & MINERALS

OPALS, Australian Black Opals at genuine bargain prices, stones \$10, rings \$15, many others available. Kookaburra Opal Trading, Box 414, Hawthorn, Victoria, Australia.

GET Free catalog no serious rockhound, gem cutter, jewelry maker, hobbyist or craftsman can be without. Full of bargains, exclusive items, low prices from largest suppliers and authorities in the field. Free new catalog just off the press, yours for the asking. Write: Grieger's, Dept. C-12, 900 South Arroyo Pkwy., Pasadena, California 91105.

500 POLISHED Gemstones \$5.00. Tumblecraft, 5401 James North, Minneapolis, Minn. 55430.

PLASTIC Casting Supplies, Molds, Jewelry Mountings, Cut Stones. Wholesale Catalog 25¢. Etoixite, 806B 10th St., Wheatland, Wyo. 82201.

CARTOONING, COMMERCIAL ARTS, SHOWCARD & SIGN PAINTING

LEARN Sign painting at home. Free Talent test. Ben Kerns, Box 812-PM, Greenville, S.C. 29601.

SIGN Painting—\$1000 per Month Part-Time. Free Catalogue. Kaufmann Supply, Centertown, Missouri 65023.

MODERN Cartooning taught by mail. Write for free brochure. Cartoonrama—Box 263-PMC, Branford, Conn. 06405.

(Continued on next page)

CARTOONING, COMMERCIAL ARTS, SHOWCARD & SIGN PAINTING

(Continued from preceding page)

COMPACT 23 lesson Cartoon Course and Cartoonist's Magazine. \$2.00. Hartman, Box 30367, Lincoln, Nebraska 68510.

FASCINATING Systems. Sign Painting-Cartooning. Straley, 1704 South Center, Springfield, Ohio 45506.

ADVERTISING AGENCIES, ADV. SERVICES MAILING LISTS

ADVERTISING Ratebook leading newspapers, magazines. \$1.00. Chicago Advertising Agency, 28-E Jackson, Chicago 60604.

MAILING List. Most all Kinds, \$10.00 per M, 500 Circulars mailed \$7.00, Dixmailers, King, NC 27021.

MAILORDER ADVERTISERS!! CLASSIFIED ADVERTISING CAN BE MOST PROFITABLE AND REWARDING. PROBLEM IS TO KNOW WHAT TO DO, WHAT NOT TO DO. COLUMBIA CAN HELP YOU WITH YOUR MAILORDER PROGRAM. OVER 20 YEARS CLASSIFIED ADVERTISING EXPERIENCE, KNOWLEDGE OF BEST PULLING PUBLICATIONS, EXPERT COPY SERVICE IS ALL YOURS AT NO INCREASE OVER PUBLISHER'S STANDARD RATES. CHANCES ARE YOU WILL SAVE MONEY. WRITE TODAY FOR FREE DETAILS PLUS YOUR FREE COPY OF "MAILORDER ADVERTISER'S RATE GUIDE". COLUMBIA ADVERTISING AGENCY, BOX 1258CAR, RICHMOND, INDIANA 47374.

RUBBER STAMPS

CUSTOM Made Stamps. Free Catalog. ALLEGHENY, Box 14C, East McKeesport, PA 15035.

3-LINE Stamps, \$2.50. Signature Stamps, \$5.95. Tabco, Tomkins Cove, New York 10986.

FREE catalog—Rubber Stamps—Signature Stamps—Business Cards. Youngers Stamp Shop, Princeton, Iowa 52768.

QUALITY RUBBER STAMPS 3 Lines \$2.50. Cloverleaf Service, Box 49, Selbyville, Del. 19975.

CUSTOM Made Stamps, Unique Cartoon stamps, quality, low prices, Catalog \$1.00 refundable, Bradley Stamp, 9117 Walton, Indianapolis, Indiana 46231.

OFFICE SUPPLIES

MAILORDER RECORDS Help get increased business! Complete 32 Page Record Book shows your inquiries, orders, advertising, expense, etc. Only \$1.00. H. E. KAPPEL, POPULAR MECHANICS, DEPT. R, 224 WEST 57TH STREET, NEW YORK, N.Y. 10019.

SELF-CORRECTING TYPEWRITER RIBBON! Simply backspace, shift ribbon selector, and retype error. Only \$3.50! Specify make/model (standard, electric, portable). The Source, Box 306-P3, Buena Park, Calif. 90621.

PRINTING PRESSES, RUBBER STAMP OUTFITS

SIMPLE-X RUBBER STAMP PRESSES, Hydraulic operated, electrically heated. Sizes 5" x 8", 8" x 12", 10" x 15". Starting outfits. Orders for presses, supplies shipped day received. Send \$2.00 for Catalog and brochure. Custom Manufacturers, 2251-P N. Golden, Springfield, Mo. 65806.

PRINTING MACHINES. Offset, Mimeograph, Typewriters, Composing, Machines, Digraph, King, North Carolina 27021.

NEW Catalog No. 13, 120 Pages, hand printing presses, type fonts, supplies. Send \$1.00 deductible first order. Acme Type, 732 Federal, Chicago, Illinois 60605.

RUBBER Stamp manufacturers supplies. Presses, starting outfits. Best prices, service. Catalog. Jackson Supply, Box 443A, Franklin Park, Ill. 60131.

SAME Day shipment on rubber stamp supplies. Revised wholesale price list No. 11 free. Star Stamp Supply, 732 Federal, Chicago, Ill. 60605.

PRINT YOUR OWN—Printing Presses, type, supplies direct from factory. Send 25¢ for catalog and samples to: Kelsey Co., DM, Meriden, Conn. 06450.

PRINTING Presses, type, Supplies Lists, 10¢. Turnbaugh Service, Mechanicsburg, Pennsylvania 17055.

RUBBER Stamp Presses, Starting Kits, Type, Supplies. Barco Type Founders, 237 S. Evergreen, Bensenville, Ill. 60106.

RUBBER Stamp Supplies; Starting Outfits. Martin, 1432 Major, Jefferson City, Mo. 65101.

PRINTING AND SUPPLIES

CUSTOM PRINTING ON T-SHIRTS AND SWEAT SHIRTS. HILDEN'S, ONTONAGON, MICHIGAN 49953.

NOVELTY Business cards. Free sample. Empire-PM, 1916 Fifth, Sacramento, California 95814.

FREE Literature, Business Cards, Letterheads, Labels, Rubber Stamps. Geer's, 111 North Drive, Ottawa, Ohio 45875.

SHIPPING LABELS, gummed mailing, \$5.00 per 1,000 prepaid. Halderman's, Girard, Kansas 66743.

\$7.90 YOUR COPY Reverse of 1000, 8 1/2 x 11 Circulars, your copy black ink. Mailtrade, Box 1302, Springfield, IL 62705. Samples 20¢ stamps.

200 BUSINESS Letterheads, 200 envelopes! BOTH! \$9.00 Total! Halderman's, Girard, Kansas 66743.

FREE Literature: Rubber Stamps, Books, Business Cards, Printing, Labels. Jordan's, 552 West O'Connor, Lima, Ohio 45801.

DISTINGUISH Embossed Letterheads, Envelopes, inexpensive. Postpaid. Universal, 226M, Myrtle, Scotch Plains, New Jersey 07076.

PRINTING and Rubber Stamps for Small Businesses. Free Samples. Watson's, Phillips, Neb. 68865.

DISCOUNT PRICES . . . Printing, Rubber Stamps, Labels. Longwood Press, Fort Johnson, NY 12070.

45% OFF Printing: 100-\$3.50; 1000-\$6.95; 1000 Envelopes \$11; 500 Business Cards \$5; 2000 Booklets \$87; 500 Letterheads Envelopes \$16.95. Overnight Shipping. Free Price List, "Avoid 27 Mistakes When Buying Printing." Speedy Offset Printers, 23968 Aurora, Bedford, Ohio 44146.

QUICK Copy Offset Printing. Free Introductory Offer, Nationwide Printing, 614 North Main, Bloomington, Illinois 61701.

EMBOSSED Business Cards \$6.10. Agents Wanted. Printers, Box 2426, Alderwood Manor, Wa. 98036.

50% OFF Printing Stationery, Envelopes, Business Cards, etc. Free Literature. D & G, 5269 Belclare, Cincinnati, Ohio 45239.

"**QUALITY** Stamps - 3 lines - \$2.50 - Business Cards - Labels - Free Catalog." Stamps, 1737 W. Coolidge, Phoenix, Az. 85015.

QUALITY Shipping Labels, Stationery, Forms, Cards. Reasonable. Burnhn, Weaubleau, Mo. 65774.

SMALL Quantity Business Printing. Graphic., Dept. PM35, 604 Marlborough Road, Brooklyn, N.Y. 11226.

FAST Business Printing, regular or carbonless forms, etc. Free Brochure. Aurora Graphic, P.O. Box 36, Montgomery, Illinois 60538.

GUMMED LABELS

1000 NAME address Labels 95¢. Ellis, 615A West College, Bainbridge, Ga. 31717.

1000 GUMMED Address Labels \$1.00. Wait's, Box 960A, South Bend, Indiana 46624.

1,000 GUMMED ADDRESS LABELS \$1.00. FREE LITERATURE, Acme, 1238 Voskamp, Pittsburgh, Pennsylvania 15212.

1000 ADDRESS Labels \$1.00. Kelly, P.O. Box 14195, Dept. PM-GL1, Okla. City, Okla. 73114.

1,000 ILLUSTRATED Address Labels . . . 75¢, "Presti-Labels", 617 Fifth-T, Baraboo, Wisconsin 53913.

REMAILING SERVICE

TOLEDO, OHIO REMAILS 25¢, Monthly \$3.00. BENJY, Box 345, Toledo, Ohio 43691.

SASKATCHEWAN Canada and Montana Remailing 50¢ Each or Monthly. Clark, 411 Timmons, Scobey, Mont. 59263.

MIAMI 25¢. Letters remailed from 130 foreign cities. 300 U.S. cities. Marie, Box 1266, Miami, Florida 33134.

CONFIDENTIAL California Address. Receiving-Forwarding. Single Remails 25¢—Business—Personal. MERLIN Remail Service, Suite 318, 206 West 4th Street, Santa Ana, California 92701.

NEW YORK, New Jersey, Remails, 25¢, Fahey, Box 159, Matawan, N.J. 07747.

TRAVEL, Change Jobs, Relocate, Never Lose Mail. Complete Mailing Service. Member IRFA. Free Brochure. Westcoast Mailers, 1323-M15 Euclid Ave., Bellingham, Washington 98225.

SECRET. Receiving—forwarding. Discreet and confidential. Remail 25¢ single. Mail Forwarding Service, 8050 S. Main, Houston, Texas 77025.

YOUR Mail Received-Forwarded. Hedgpath, 324-M South First, Alhambra, Calif. 91802.

CALIFORNIA Remails 25¢. Monthly \$3.00. (No Limit). Beemal. P.O. Box 82. Campbell, Cal. 95008.

LOUISVILLE, Derby City Remails 25¢. Grayce, Box 7232A, Louisville, Ky. 40207.

REMAILS 10¢ Big Mails 10¢. Smith, 817 S.E. 67th, Oklahoma City 73149.

REMAILS—LOS ANGELES, 25¢. Lessman, 169 South St. John, Pasadena, California 91123.

HAWAII Confidential Remailing 25¢. Bator, PO Box 8821-84, Honolulu, Hawaii 96815.

WINSTON-SALEM or Clemmons remails. Mail received and forwarded. Singles 25¢. Douglas, Box 352, Clemmons, N.C. 27012.

DEPENDABLE, Confidential, Free information. Harding, 642 LaBrook Drive, Richmond, Virginia 23225.

DEPENDABLE California Remails 25¢. \$3.00 Monthly. CFS, POB 59, Canyon, Calif. 94516.

PROMPT Confidential Mail Receiving-Forwarding Service. Write: National, Box 587-PM, St. Petersburg, Florida 33731.

CONFIDENTIAL Remails 25¢. Canadian 50¢. Phillip's, Box 647, Buffalo, N.Y. 14205.

CONFIDENTIAL New York Mail Address \$5.00 Month. Telephone service \$5.00 Remails 25¢. Call Director, 1540 Broadway, Suite 303, New York 10036 212-221-1246.

REPAIRS & SERVICING

CALCULATORS, Pocket repaired. \$14.95. Major parts extra. Ship prepaid to: RAINBOW ELECTRONICS, 4158 Greeby Street, Philadelphia, Pa. 19135.

COMPLETE Hydraulic Jack Repairing Manual \$3.00. Ironclad Moneyback guarantee. Bayerco, 938-KH Betty Avenue, Neenah, Wisconsin 54956.

SPECIAL SERVICES

INFORMATION On anything. Ferguson Research Specialists. 72-25 Woodside, Woodside, New York 11377.

BEST IDEAS MONTHLY. Newsletter of useful information for home, businesses, work and auto. New products, reports and plans. \$1.00. Best Ideas, Box 246, San Antonio, Texas 78291.

PROFITS FROM CLASSIFIED ADVERTISING! Booklet shows you how to start your own business with Classified Advertising. Only \$1.00 (Refundable with first order.) H. E. KAPPEL, POPULAR MECHANICS, DEPT. P, 224 WEST 57TH STREET, NEW YORK, N. Y. 10019.

BETTER HEALTH

HOW To Stop Smoking!! Complete Guide!! Rush \$2.00—Paulamende-PM2, Box 2392, Hot Springs, Ark. 71901.

FREEZE DRIED FOODS, details, \$1.00. 494 N.W. 22nd Avenue, Canby, Oregon 97013.

STOP SMOKING—EASY WAY To Stop! Send \$1.00. Jimco, Box 186MP, Garden Grove, California 92642.

TOO FAT? Get doctor's proven and most effective reducing program. Healthful menus. Thousands already benefited. Send \$4.50 refundable. I. Henry, Safe Diet, Box 282, Kingston 5, Jamaica, W.I.

ASTHMA AGONY—RUPTURE MISERY I ended both—quickly, easily, permanently. Drugless home treatment. Free facts airmailed—please say wnic. John Mortimer, Box 608, Victoria, B.C., Canada V8W 2P3.

ARTHRITIS?—PROSTATE? Sensational botanicals. Information \$3.00. Unconditionally guaranteed. Poppel, Box 16312, San Diego, Calif. 92116.

STOP SMOKING!! My "Copyrighted" booklet shows you how. Simple . . . Safe . . . Effective. (GUARANTEED). Send \$3.00. Quality Book, Box 332PM, Kensington, Connecticut 06037.

NERVOUSNESS could lead to insanity. Amazing booklet Reveals How to Conquer Nervousness. Just \$2.00. Loeber Enterprises, 9945 3rd Ave., Brooklyn, New York 11209.

"**HOW** To Stop Smoking"; Free Details; This Way Works; Lamb, Box 13647-EP, St. Louis, Missouri 63138.

LOANS BY MAIL

BORROW By Mail! Up to \$3,000.00. Convenient Terms. State Licensed. Postal Finance, Dept. 17-01 6018 Military Ave., Omaha, Nebraska 68104.

PERSONAL

MIND-STIMULATOR Develops Personality, Inner Power! Tibolt, 2819M3 Carmel, Glenside, Pa 19038.

STOP SMOKING! INGENIOUS. 4-EASY STEPS. BOOKLET \$1.00. ROBERT BYRNES, BOX 652, DEARBORN, MICHIGAN 48121.

BECOME An ordained minister. Free ministerial credentials legalize your right to the title "Reverend." Write Church of Gospel Ministry, 486-PM Skyhill Court, Chula Vista, Calif. 92010.

PSORIASIS SUFFERERS: DISCOURAGED? Write for Free important information that is helping thousands. Pixacol, Box 29277-PM, Parma, Ohio 44129.

TWO WILL FORMS—Instructions—Extras. \$1.00. PoCo Associates, Box 6691, San Antonio, Texas, 78209.

NEED Money—Debts Too Big? Consolidate Bills. "Quick-Cash" Emergency Loans Available. Helped Thousands since 1936. Free Application. Interstate, 28 E. Jackson, Suite 1204-X3, Chicago 60604.

"**GAIN WEIGHT**" fast and easy. Free information. Unique Advisors, Box 668, Dept. C, Sparks, Nevada 89431.

INVESTIGATORS. Latest electronic Aids. Free Literature. Clifton, 11500-P NW 7th Ave., Miami, Florida 33168.

BIBLE Questions answered. Stamped envelope. Bylon, 17167 Bentler, Detroit, Michigan 48219.

RECORD Telephone Calls Automatically! Unattended Operation. Auto-Cord, Box 192-PM3, Griffith, Indiana 46319.

ESCAPE From debts and bill collectors! Have AAA-1 credit everywhere. Free report reveals secret plan! Credit 4A3, 333 North Michigan, Chicago 60601.

STOP SMOKING NOW! Guaranteed. Personally Autographed Book Leads You Step By Step From Slavery To Freedom! \$2.00. Edwards, Box 4059, KA3, Dallas, Texas 75208.

STOP SMOKING! Guaranteed Results! Send Stamped Envelope for FREE information To Church Entr., Box 508A, Millers Creek, N.C. 28651.

TROUBLES? The Mynah Bird will Bring You Luck. Send \$1.00. Don Murphy, Box 141C, Keewatin, Minn. 55753.

STOP Smoking!—Guaranteed Program Helped Others . . . Why Not You?—Free Proof—Aaron, Box 1587-P, Marietta, Georgia 30060.

\$300.00 WEEKLY Possible—Stuffing envelopes. Start Immediately! Details, \$1.00, refundable. Royal-PM1, Box 36643, Los Angeles 90036.

RECORD Telephone Conversation automatically. Leave Recorder Unattended. Robert's, Box 49-PM3, Parkridge, Illinois 60068.

PERSONAL

(Continued from preceding page)

HOW TO WIPE OUT YOUR DEBTS. Get relief up to \$25,000 in as little as 90 minutes. Free details. Counselor-7, Kerrville, Texas 78028.

SECRET LOANS By Mail. Borrow \$100 to \$3000 for any good reason in absolute privacy. No interviews, no endorsers, no co-signers. Fast service. Write Dial Finance, Dept. 3047, 340 S.W. Eighth Street, Des Moines, Iowa 50309.

HOW INTELLIGENT are you? Self-scoring test reveals I.Q. in 45 minutes! Send \$2—guaranteed!! Tests, 13900 S.W. 152 Street, Department 809, Miami 33177.

STOP SMOKING—GUARANTEED, or your money back. Send \$1.00. N.D. Phillips—8661-A Lathorn Drive. Huntington Beach, Calif. 92646.

PERSONAL PROTECTION!! Electronic-Burglar-Fire Alarm. Easy Portable or Permanent Installation. Only \$9.95—GUARANTEED!! AMA Products, Box 3814 Dept.-184, Amarillo, Texas 79106.

STOP Smoking—!! Guaranteed easy method booklet. \$1.00. Lemar, Box 63-C, Dayton, Ohio 45419.

WILL KIT! 4 Forms, Attorney's Booklet! . . . \$2.00—Nan Gauger, 807 Stinson, Rockwall, Tx. 75087.

SAVE money. Ten tax tips for small investors, entrepreneurs, business owners. \$2.00. Dee, 4013 Guadalupe, Austin, Texas 78751.

HANDWRITING COURSE—Complete, Over 200 Pages. Analysis, Medical Studies, Graphoguides, Party fun. \$2.00. House of Seven, 8990 Eastern, Byron Center, Michigan 49315.

SAVE ON FOOD!!! Cut grocery bills up to 60%. Anyone can. Proven inflation beating secrets. Guaranteed. Rush \$3.98 today. Save tomorrow. William Lilling, 1312 N. Curson, Suite 5, Hollywood, California 90046.

FEEL Healthier—Live Longer. Slow Down Body Aging. Long Life Secrets Revealed. Complete Report \$1.00. Herb Williams, 1728-PM3 Ixora Drive West, Melbourne, Florida 32935.

INSTANT Debt relief. Use little known law. Also procedure to have A-1 Credit in 30 Days. Send 3.00 to: Davidson, 3815 Kings Highway, Kansas City, Mo. 64137.

STOP-OR REDUCE PROPERTY TAXES. Be President of your own Tax-exempt church or other non-profit corporation. FINANCE YOUR DREAMS. Get Foundation grants. Free details. TOU-PM3, 6311 Yucca, Hollywood, California 90028.

WIPE out debts, without borrowing . . . Method guaranteed . . . \$1.98 Clay Enterprises, 7307 East Riverside, 32-B, Austin, Texas 78741.

'INEXHAUSTABLE Wealth' Live life to the fullest . . . Complete step by step plan. \$3.00. Son, Box 5006-D, Florence, S.C. 29501.

BLANK Will Forms! Now 2 for only \$1.75! 4- \$3.00! Farrington Enterprises, 5350 Angus Avenue, Orlando, Florida 32810.

YOUR Inheritance Lost? We Will Buy And Settle Complicated Estates. Free Forms, Write: Heirfinders, P.O. Box 187, Elgin, Oregon 97827.

LOOK younger than your age, my secrets of health write for free information. "Secrets", P.O. Box 711, Metairie, Louisiana 70004.

WRITE Your Will Quick Easy. 4 Will Forms. Instructions. Moneyback Guarantee. \$2.00. Marion, 2609PM6 Tilbury, Pittsburg, Pa. 15217.

SPENDING more than your income? Avoid financial embarrassment!! "Personal Budget Planner" will help you gain control. Imaginative, uncomplicated new concept. Mail \$3.95 today! Money back guarantee. Sunnyside, Box 8153, Dept. PP3, Jacksonville, Florida 32211.

ACNE SCARS, pits. New home French herbal skin planing treatments. PREVENT BALDNESS. Herbal hair-pulling scalp stimulant. Hebs for Youth, Box 943C, Dana, Florida 33004.

SOCIAL SECURITY PLATES

PERSONALIZED Metal Social Security Plate, \$1.50. Send Name, Number. Personalized Engraving Sales, 45 Tilt Street, Enfield, Connecticut 06082.

WANTED MISCELLANEOUS

MERCURY Gold, Silver, Platinum: Ores assayed. Wholesale Terminal, Norwood, Mass. 02062.

WINEMAKING & OTHER RECIPES

WINEMAKERS FREE ILLUSTRATED Supply catalog of yeast, equipment. Continental, Box 18223-PM, Indianapolis, Ind. 46218.

WINEMAKING, Yogurt, Cheesemaking. Free catalog. Arbolyn, Box 663, West Columbia, S.C. 29169.

AMAZING!! Make delicious wine and champagne at home. Using everyday kitchen utensils. Complete instructions. Economical & easy. Send \$1.98 to R&G Distributors, Box 10836, Dept. A, Jackson, Miss. 39209.

DELICIOUS Champagne and Wine, using Kitchen Utensils only. Seven Tested Recipes. \$2.00. Moore, 8190 West 8th, Lakewood, Colorado 80215.

WINEMAKER'S Supply Catalog—Free. Bacchanalia, 273 Riverside Ave., Westport, Conn. 06880.

WINEMAKER'S! Free Illustrated Catalogue of Quality Products. Brant's Wine Rack, Box 3256-PM, Orange, California 92665.

WINEMAKING Supplies and Equipment—Largest stock. Free Catalog. Jim Dandy Wine Supplies, 8454 Beechmont, Cincinnati, Ohio 45230.

WINEMAKERS. Free illustrated catalog of yeasts, equipment. Simplex, Box 12276R, Minneapolis, Minn. 55412.

WINEMAKING Made Easy. Simple instructions using kitchen utensils. Money Back Guarantee. \$1.00. Jim, Box 1026, Blythe, Cal. 92225.

BEAT RISING COSTS, MAKE YOUR OWN Liqueurs, Wine, Champagne. Amazingly Easy, Guaranteed. Complete instructions. Free Details. C. Enterprises, Box 376M, Walnut Creek, Ca. 94596.

WINEMAKERS Free Informative Catalog, Yeast Equipment, Ingredients, DANENBERGER'S, Box 276-M, New Berlin, Ill. 62670.

NEW! . . . FREE CATALOG . . . 30 VARIETIES FRUIT & GRAPE CONCENTRATES . . . 100 WINE & LIQUEUR FLAVORS. Complete line of Winemaking Supplies. Kraus, Box 451-L, Nevada, Missouri 64772.

GOLDEN DYNAMITE. A Very Potent and Powerful Wine! Use Kitchen Utensils. Ingredients at grocers. Amazing Results! Recipe \$2.00. Stevens Enterprises, Box 3693-PM, Philadelphia, Pa. 19125.

HOW TO MAKE WINE AND CHAMPAGNE! Complete instructions with six recipes. Use regular kitchen equipment. Money back GUARANTEE. \$1.00. Stovers, Box 23592A, Tampa, Fla. 33622.

MAKE JERKY!!! Amazing new formula—use standard kitchen items. Guaranteed delicious or money back. \$3.00 for spices and instructions. Jerky, 617 West Vandalia, Greensboro, N.C. 27406.

WINEMAKERS it is unlawful to make wine for home consumption unless you file form 1541-\$1.00 for instructions. elGordo Enterprises, Box 301, Pinole, Calif. 94564.

MAKE delicious wine, champagne! Inexpensive, proven recipes. Simple directions; kitchen utensils. \$1.00. Golden State Marketing, Box 33363-B, San Diego, Ca. 92103.

HOW To make Wine and Champagne at Home, simple method no special equipment needed, Eight amazing recipes, Guaranteed delicious or Money Back, Send \$2.00. Book Market, Box 16313B, Portland, Oregon 97233.

FIGHT INFLATION Make your own wine, champagne, creme-de-menthe, kahula. No special equipment, complete instructions including LEGAL Requirements \$2.00. elGordo Enterprises, Box 301, Pinole, Calif. 94564.

"HOW to make delicious wine and champagne. Also free german beer recipe included \$2.00." Schwenke, Box 425, Minot, North Dakota 58701.

76 DELICIOUS Beer and Wine Recipes for Beginners and Experts. Completely foolproof instructions! Guaranteed \$2.00. Beachco, Box 4421-A, Long Beach, Cal. 90804.

FREE BEER Recipe with Purchase of Wine Recipes \$3.00. Also 2 Free Publications Rod-Mar, Box 261, Loran, Ohio 44052.

MAKE DELICIOUS WINE, CHAMPAGNE AT HOME. Use standard kitchen equipment. Recipes. Send \$2.00. Penwines, Box 588, Monroe, Louisiana 71201.

AMAZING!! How to Make Delicious Wine and Sparkling Champagne—at Home—only Pennies a Bottle—Complete instructions—Easy Recipes. \$1.98. Guaranteed. O'Brien's Galleries, Box 34566-A, Parma, Ohio 44134.

PURE CORN WHISKEY—How it was made in the kitchen. Free information. David Owen, 248, Resaca, GA 30735.

YOU CAN MAKE WINE—CHAMPAGNE—BEER At Home. Easy Method. Free Details. Gamma, Dept. 133, Box A, Sharon Hill, Pa. 19079.

FREE . . . FREE . . . FREE—Real German Beer home recipe, with the Purchase of our famous home Wine and Champagne recipe booklet. Satisfaction Guaranteed . . . Send \$2.00 check or money order to Altec Associates, P.O. Box 70A, Robbinsville, New Jersey 08691.

MISCELLANEOUS

HORSEPLAYERS—fantastic new handicapping method! Please write for more information. Box 157, Broomall, Pa. 19008.

HOW To Pan Gold! Book explains equipment used simple panning method \$1.00. The Olympic's Enterprise, 108 West 3rd Street, Port Angeles, Wa. 98362.

SURVIVAL Food—Freeze Dried Storage, By the Case. Menu Planner and Price List—25¢. Hate Supply Company. (K-50), McDonald, Ohio 44437.

PRESCRIPTION EYEGASSES. Free Catalog. A-Z Optical Company, Box 175, Dept. R26, Bay Station, Brooklyn, New York 11235.

LOSE Weight Permanent. No Dieting, Guaranteed. Send for Information: Wheatpm, 3311 S. Hooper Ave., Los Angeles, Ca. 90011.

CLARETTES at half the cost. Roll plain, filtertip or king with our rollers and blended tobaccos. Free Sample. Write Green River Tobacco, Box 1313PM, Owensboro, Ky. 42301.

Will Kit Forms, Asset List, Instructions, \$2.00. Futura, Dept. 2PM3, 602 Syracuse Ave., N. Massapequa, New York 11758.

LARGE SELECTION & BIG DISCOUNTS—Books, Merchandise, Catalogs and Samples \$1.00 VAZER, Box 10055, Phoenix, AZ 85064.

ORNAMENTAL Iron designs, Book of 1600 beautiful, practical designs for railings, columns, etc. Free literature. Cunningham, 3881 South 3200 West, Box 20005, Salt Lake City, Utah 84120.

BOOKS On antiques and their prices. Free circular!! P. Warman Publishers, Uniontown, Penna. 15401.

HOW TO SAVE on Fresh Vegetables, Fruit. Send \$2.00—Informative Booklet. Box 141-P, North Salt Lake, Utah 84010.

IDENTIFICATION CARDS. Send stamped self-addressed envelope for samples. NIPCOM, 727 North Main, Las Vegas, Nevada 89101.

WIN! Casino Games! Free Details! Xcito Games, 5715 N. Mozart, Chicago, Illinois 60659.

HEARING Aid batteries wholesale. Free list. Habs, Box 51, York, Penna. 17405.

SAUSAGE Making 50 Recipes. Curing Smoking Hams Bacon Pouilly Fish Venison. Premixed Spices Cures Casings Smokehouse Ideas. Free Catalog. RAK, Dept. 9, Box 4155, Las Vegas, Nevada 89106.

AMAZING Secrets Revealed Galiano, Kahlua type liquors, easily made. \$3.00. Jenco, 7525 Florence, Downey, Calif. 90240.

BIG PROFITS in REAL ESTATE. New report—sound procedures; use other people's money. \$1.50 plus 30¢ postage. SHELCO, 12417 Sandal Lane, Bowie, Maryland 20715.

MAGNETS. All Types. Specials-20 Disc. or 10 Bar, or 2 Stick, or 8 assorted Magnets, \$1.00. Magnets, Box 192-A, Randallstown, Maryland 21133.

CHESSPLAYERS! Play by mail! Information: Chessnuts, 25-PB Mount Vernon, Saugus, Mass. 01906.

U.S. IS GOING METRIC! "METRIVERTOR" Pocket Slide-Rule converts ALL Metric Measurements to U.S. and vice versa at a glance. No skill required! Money back guaranteed. ORDER NOW! \$3.95 plus 50¢ handling. Excellent Gift! Save this ad. "GUIDE-KIT" Publications, Dept. GK111, Box 332, Rialto, California 92376.

STILL BUILDING BOOK, 57 Drawings, 6 Models, All sizes from Stovetop to Mountaintop! 100 pages, \$3.75. DOCUMENTED, Box 1004, Fostoria, Ohio 44830.

PHOTOSTAMPS—Posters—For Samples—Send 10¢ Stamp to: Richard Daube PM, Box 3043, Falls Church, Va. 22043.

FREE Miracle Polishing cloth with Purchase of Automatic Alarm. 10 year Guaranteed. Send \$2.98. Trades Hawaii, 216T1 W. Jackson Blvd. #612, Chicago, Ill. 60606.

ROACH-PROOF Your home permanently with "Unroach." \$3.95 - guaranteed! Star, 5936 Silver Star, Orlando, Fla. 32808.

NEED \$25,000.00 Loan By Mail? Unlimited Business Capital? Details \$1.00. Griffin, Box 826PM, Keystone, FL 32656.

DON'T DIE Without A Will! Blank Will Forms and Instructions. Only \$1.75—Guaranteed! Order Today!! Seque, Box 15455, Dept. 1A3, Lakewood, Colorado 80215.

IS BANKRUPTCY THE ANSWER? Stop your frustration—4000 word booklet simply written, answers questions about bankruptcy and methods of avoiding it. Any wage earner or small businessman can benefit by this report. Send \$3.00. Solutions, 6577 North 44 Ave., Glendale, Arizona 85301.

AMAZINGLY tasty wines and champagne made in your home . . . Recipes . . . easy to follow instructions. Send \$1.00 . . . Dale Co., Box N, Dept. 1C, Osseo, Minn., 55369.

WHY Pay Doctor Bills!! Proven home cures only \$2.95 - Guaranteed. Order today. Gregory, 320 Frandsen, Box 36, Independence, Missouri 64050.

SEE Without being seen!! Secret two-way mirror lets you see through walls, doors!! Easily concealed!! Giant 80 square inch mirror, only \$2.00—Four mirrors for \$5.00. Seven day guarantee!!! Mailway, Box 234-P3, Luverne, MN 56156.

AT LAST! Complete guide to Fica Market Shopping. 320 pages. Value for thousands of Antiques. . . . Collectibles. Send \$3.98. Osage, 2616 Twin Hills, PM3, Jefferson City, Missouri 65101.

BURGLAR ALARMS & HOME PROTECTION

'DOUBLE-DUTY ALERT ALARM' Burglar/Fire Protection Anywhere, Portable! Heat Sensor! Penetrating Siren! Mounts Top Inward! Outward Doors, Moneyback Guaranteed. Send \$8.95—2—\$7.95. "Protecto" IPM3, Box 4266, Fort Lauderdale, Florida, 33304.

FREE Catalog on Burglar-Fire Alarm Accessories. Vancor Security Systems, Box 438-M, Boston, Massachusetts 02144.

LOCKSMITHING Supplies—Buyers Guide \$1.00. Despuhs, Box 22005H, Phoenix, Arizona 85028.

FREE Catalog on Burglar-fire Alarm Equipment. Protecto Alarm Sales, Box 357-D Birch Run, Michigan 48415.

PERSONAL BODY GUARD AND HOME BURGLAR ALARM! Usable everywhere. Pocket size convenience. \$7.00. Morrow Products, Box 147-A, Fairport, N.Y. 14450.

DIALING Unit automatically calls Police. \$29.95. Free Literature. S&S Supply, Box 12375B, North Kansas City, Mo. 64116.

CHAIN Burglar Alarm install on Windows or Doors, \$3.75. James E. Dow, Sr., P.O. Box 2342, S. Hackensack, N.J. 07606.

NOW AVAILABLE! Wholesale, Professional, Burglar-Fire Alarm Equipment for the Do-It-Yourselfer. Free Catalog! Emel Electronics, Dept. PM3, Box 509, Flushing, N.Y. 11365.

SAFEGUARD Family Home against Burglary/Fire . . . excellent protection, siren-like sound. \$8.95 . . . Satisfaction guaranteed. Clay Enterprises, 7307 East Riverside 32-A, Austin, Texas 78741.

MOTOR's easy "2-step" repair method helps you FIX ALMOST ANY PART OF ALMOST ANY CAR...FAST

So clear, you'll breeze through tune-ups, engine overhauls, air conditioning, brake jobs—practically any repair on cars listed.

You just can't make mistakes with the "2-step" method in the new 1975 MOTOR AUTO REPAIR MANUAL. First the special "Trouble Shooter" section helps pinpoint in a flash the cause of trouble. Next, over 3,000 "How-To-Fix-It" close-up pictures (and plain-talk directions) show how to lick repair problems—fast and right! Even green beginner mechanics find the MANUAL so clear and easy to follow, they speed through the toughest jobs like pros!

Auto Repairman's "Bible"

Every job, from installing distributor points to front end jobs, is covered in minute detail for 2,300 U.S. car models, 1969-1975. The over 1,300 oversize pages of the giant MANUAL contain 55,000 specifications, thousands of illustrations, diagrams and charts — the "meat" of 300 official shop manuals.

You get service data on Transmissions, Steering, Brakes, Universals, Alternators, Fuel Pumps, Ignition Systems, much more! It's no wonder this illustrated MOTOR MANUAL is called the auto repairman's indispensable "Bible." It's no wonder that 7,000,000 copies have been purchased by repairmen, service station operators, the U.S. Armed Forces, schools and students all over the world. Here is the help every beginner or "pro" needs to fix almost any part of any car right the very first time. And save time, work, money!

Learn all about the 1975 cars and in addition see how Detroit's 1975 specs and procedures affect your older car. Auto makers continually up-date and improve past model adjustment specs on older cars as new road test data comes in. That's why you'll need this new 1975 MOTOR MANUAL to get the best performance out of your car—even if you already own an earlier edition.

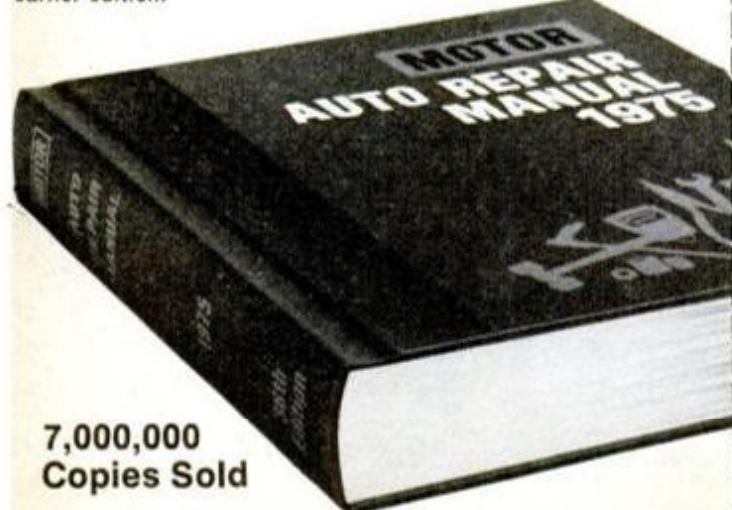

7,000,000
Copies Sold

Motor Books, Publisher's Office, 250 West 55th Street, New York, N.Y. 10019

1. Spot trouble fast



2. Fix it fast



1975 edition covers all these makes

Toronado	Buick Special	Pinto
Mustang	Barracuda	Maverick
Mustang II	American	Vega
Chevy II	Falcon	Nova
Pontiac	Oldsmobile F-85	Gremlin
Thunderbird	Ford Fairlane	Buick
Buick	Tempest	Century
Imperial	Corvette	Cutlass
Cadillac	Valiant	Monte Carlo
Lincoln	Mercury	Matador
Dart	Cougar	Skylark
Continental	Camaro	LeMans
Mercury	Front-drive	Skyhawk
Ford	Cadillac	Starfire
Chevelle	Javelin	Monza 2+2
Chevrolet	Montego	Monarch
Chrysler	Torino	Granada
Plymouth	Mark IV	Cordoba
Dodge	AMX	Grand AM
Oldsmobile	Hornet	Astre
Comet	Challenger	

Same Free 10-Day Offer on MOTOR's Auto Engines & Electrical Systems



1,300 big pictures, over 700 pages. Clear how-to text explains how parts work, principles involved, design, construction maintenance, etc. Covers all parts of engines and electrical system. High performance hints. For FREE trial, check box in coupon.

FREE WITH YOUR ORDER

MOTOR's Hi-Performance Tuning Guide, a \$2.95 value.

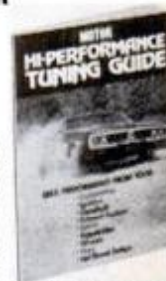

This 68-page Guide tells you all you need to know about getting the most performance out of any car. Covers carburetion, ignition systems, compression ratios, camshafts, exhaust systems, gear ratios, suspension systems and much more. Yours to keep free even if you're not completely satisfied with the Motor Manuals — it's our way of saying "thanks."

Send no money

The MANUAL costs \$12.95, but we'll send it to you for 10 days FREE trial, so you can see for yourself how it makes auto repairs go quick and easy. Use it for 10 days. If it doesn't give you complete satisfaction, return it and owe nothing. Mail the coupon today.

Order the New 1975 Edition now and try it FREE for 10 days

Mail to: MOTOR Books, Shipping Service

P.O. Box 2316, F.D.R. Sta., New York, N.Y. 10022

Please send me the Manuals checked below for ten days free examination:

- 11148 MOTOR Auto Repair Manual, \$12.95
 12534 MOTOR's Auto Engines & Electrical Systems, \$12.95
 If I am not fully satisfied, I will return the shipment promptly and owe nothing. Or I will keep it and pay the total price in three monthly installments, plus shipping.

NOTE: The MOTOR Auto Repair Manual is also available in a DeLuxe edition with heavy duty fine grain bindings, thumb indexing and woven page marker. Check here if you'd prefer this version at \$17.95. **10546**

I want to save shipping charges.

I am enclosing payment for \$_____ in full. MOTOR will pay shipping charges. (Same return privileges, refund guaranteed.)

Print Name _____

Address _____

City _____ State _____ Zip _____

Signature _____ Tel. No. _____

Offer available only in the Continental United States. Allow 3-4 weeks for delivery.

K-306

Hitch your wagon to a star.



If you haul or
pull heavy loads
you need
Gabriel Hi Jackers.

Gabriel Hi Jackers, the air adjustable shock you fill like a tire to lift up to a 1,000 pound load. Whether you drive a camper, wagon or tow a trailer, you need Hi Jackers. They carry their maximum load more than twice as long as the nearest competitors. Loaded or unloaded, Hi Jackers can be adjusted to give you a safe, comfortable ride.

Heavy duty Hi Jackers contain all of Gabriel's exclusive features including pre-assembled air fittings, a free-floating outer can and enclosed diaphragm. These features combine to make Gabriel Hi Jackers the best selling air shock of its kind.

Look for Hi Jackers and hitch your wagon to our star.

Gabriel

Engineers of the shocking difference.

For complete test results, write Hi Jackers Gabriel, 168 N. Michigan, Chicago, Ill. 60601

Материал, защищенный авторским правом



Colorado River at Lava Falls. A drop of one foot per second.

**TOUGH POWER.
YOU REALLY
NEED IT HERE.**

**THAT'S WHY A
MERC POWERS
THEIR TRIP.**

One brief loss of power here can send this raft slamming into a solid rock wall! That's why Mercury outboards are used exclusively by the guides with Grand Canyon Expeditions, Inc. On the Colorado River, they depend on 20-hp Mercs to power their 7000-lb. rafts through the rapids. They know the Merc is built tough enough to bound over underwater obstacles and grind through sandbars. Power is smooth and sure with the Mercury sealed Thunderbolt® ignition system and preset carburetion. The Mercs used on the Colorado River are no different from the ones at your dealer. So you know you can depend on a Merc—every one—from 4.5 to 150 hp. For rugged, trouble-free outboard performance, see your Mercury dealer soon.



MERCURY. PERFORMANCE AND POWER YOU CAN DEPEND ON.

