

DEC. 1973 60 CENTS

CHRISTMAS  
IDEAS  
20 PAGES

# Popular Mechanics

**BUILD THIS  
VW-POWERED PLANE  
and be flying in  
six months** Page 160

**World's first  
solar-powered  
watch** Page 172

## CLIP-AND-SAVE

**KNOW-HOW:** Starts page 78

- How to fix a gas clothes dryer
- How to pick the right paint roller
- How to sharpen almost anything
- What you should know about fuses

**Make your own digital clock from a kit** Page 127



**AMC  MATADOR**  
**NEWEST MID-SIZE**  
**FOR 1974**

This is one mid-size car you've never seen before. The roomy AMC Matador coupe.

With sweeping, clean lines. Low profile. And plenty of window area for all-around vision. Test drive the new Matador. And see why experts are already calling it America's sportiest new car.



# AMC BUYER PROTECTION PLAN MORE THAN JUST A GUARANTEE

To us at American Motors, and to our dealers, the exclusive AMC Buyer Protection Plan means a commitment to our customers. A commitment to stand behind every single car we build.

## A GUARANTEE YOU CAN UNDERSTAND.

When you buy a new 1974 AMC car from an American Motors dealer, American Motors Corporation guarantees to you that, except for tires, it will pay for the repair or replacement of any part it supplies that is defective in material or workmanship. This guarantee is good for 12 months from the date the car is first used or 12,000 miles, whichever comes first. All we require is that the car be properly maintained and cared for under normal use and service in the fifty United States or Canada, and that guaranteed repairs or replacement be made by an American Motors dealer.

At AMC we expect every part in every car to last for at least 12 months or 12,000 miles under normal use and service.

And that's why we back our cars with this simple, strong guarantee. A guarantee that covers every part—except tires—even those annoying little things that occasionally wear out like spark plugs, wiper blades and light bulbs.

## PLUS A BUYER PROTECTION PLAN THAT DOES MORE.

AMC is the only manufacturer with a program to provide a free loaner car should guaranteed repairs take overnight. And a special trip interruption plan that pays up to \$150 for food and lodging if guaranteed repairs have to take place more than 100 miles from home.

We even have a toll-free hotline to Detroit for you to call if you ever feel we aren't living up to our promises.

And let's face it, when you make this kind of commitment to stand behind your cars, you have to build them better.

## AMERICAN MOTORS CORPORATION

We back them better because we build them better.



Z3LT-K1R-1G1L

DECEMBER 1973

1



Only  
**DREMEL**<sup>®</sup>  
 puts it all  
 together!

*the complete MOTO-SHOP...:*

... for EVERYONE ... young, old, in-between, he or she — fun for avid hobbyists, pride for the skilled craftsman and creative buff, and fixing it power for the do-it-yourselfer ... EVERYWHERE. ... in your camper; at your office; in the kitchen, basement, rec. room, or attic; in school — the Dremel shop sets up anywhere there's an electrical outlet. (stores away in a 2 sq. ft. space) ... for EVERYTHING ... sawing, sanding, drilling, grinding, polishing, routing, sharpening, buffing, carving, engraving, deburring, trimming, you name the power tool job.

Dremel, putting together better ideas in compact packages for over 40 years!

**DREMEL**<sup>®</sup>  
 creative power tools

Dremel Manufacturing Co.  
 Dept. 903L, Racine, WI 53406



• MOTO-SHOPS<sup>®</sup> • MOTO-TOOLS<sup>®</sup> • ENGRAVERS • SHOE POLISHERS

# How to put your hands to work making money

Do you remember what you paid the repairman, the last time you had trouble with your TV, Air Conditioner, or Automobile? Do you know how much it would cost today—to fix your roof, install new kitchen appliances, or change the electrical wiring in your home?

Now, turn it around—and look at it this way: do you realize how much money you could earn today if you were a trained Electrician, Auto Mechanic, or Electronics Technician? And do you realize how many job openings exist in these fields... either full or part time?

Suddenly, it's a wide-open world of opportunity, if you're one of those fortunate people who enjoy working with their hands. If you can choose one of the high-paying fields where your talents are needed and appreciated. And if you can get the kind of career training that today's employers and consumers are willing to pay big money for.

To help you select a field that's right for you, we've listed 14 opportunities on the coupon below. And you are invited to find out what you should know about the field you like best, by simply mailing the coupon.

## Free Guidance Booklet

In return, you will receive a free Career Guidance Booklet that describes the opportunities, income, and job security you might expect in your newly chosen field. It will also explain how

ICS can help you get the training you need to break into this new career field...right in your home...during your spare time...without losing a single day's pay from your present job...and without ever setting foot in a classroom.

## Free "Demonstration Lesson"

In addition, you'll receive a free "Demonstration Lesson" that lets you see for yourself why picking up the job skills you need—the ICS way—may be easier than you think.

## Major Corporations Use ICS Career Training

Please bear in mind, as you fill in the coupon below, that more than 8,500,000 men and women have turned to ICS for career training since 1890. And some 2,000 American firms and government agencies are also using ICS training programs to upgrade their employees. (Among these firms are such names as *Ford, U.S. Steel, Chrysler, Mobil, 3M Company, Alcoa, Pan Am, GE, Motorola, and RCA.*)

ICS career training is Approved for Veterans, and is Accredited by the Accrediting Commission of the National Home Study Council. Now it's your turn to discover how ICS can start you in a rewarding new career. Just mail the coupon for your free guidance materials to: ICS, Scranton, Pa. 18515.

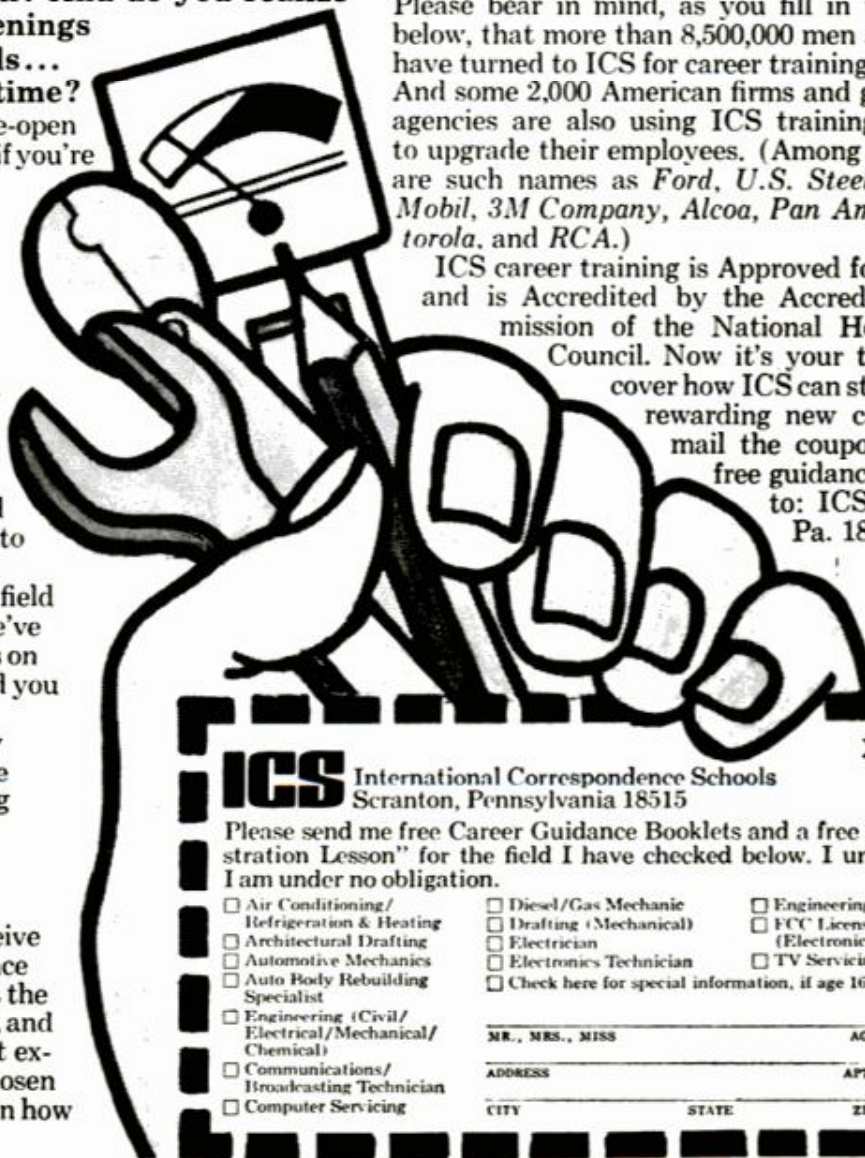

**ICS** International Correspondence Schools  
Scranton, Pennsylvania 18515

XA693R

Please send me free Career Guidance Booklets and a free "Demonstration Lesson" for the field I have checked below. I understand I am under no obligation.

<input type="checkbox"/> Air Conditioning/Refrigeration & Heating	<input type="checkbox"/> Diesel/Gas Mechanic	<input type="checkbox"/> Engineering Technician
<input type="checkbox"/> Architectural Drafting	<input type="checkbox"/> Drafting (Mechanical)	<input type="checkbox"/> FCC Licensing (Electronics)
<input type="checkbox"/> Automotive Mechanics	<input type="checkbox"/> Electrician	<input type="checkbox"/> TV Servicing & Repair
<input type="checkbox"/> Auto Body Rebuilding Specialist	<input type="checkbox"/> Electronics Technician	
<input type="checkbox"/> Engineering (Civil/Electrical/Mechanical/Chemical)	<input type="checkbox"/> Check here for special information, if age 16 or under	
<input type="checkbox"/> Communications/Broadcasting Technician		
<input type="checkbox"/> Computer Servicing		

MR., MRS., MISS \_\_\_\_\_ AGE \_\_\_\_\_

ADDRESS \_\_\_\_\_ APT. \_\_\_\_\_

CITY \_\_\_\_\_ STATE \_\_\_\_\_ ZIP \_\_\_\_\_

Approved for Veterans' Training. Approved for Federally Insured Loans. Accredited Member National Home Study Council. Canadian residents use this address for service from ICS Canadian, Ltd. In Hawaii: 931 University Ave., Honolulu, Hawaii 96814

## AUTOMOBILES, DRIVING

- [30](#) Detroit Listening Post
- [57](#) Imports and Motorsports
- [102](#) Don't let winter stop your four-wheel-driving fun!
- [122](#) The diesel: New future for an old engine
- [146](#) Saturday Mechanic: How to stop wind noise and water leaks

## SHOP AND CRAFTS

- [16](#) Hints from readers
- [34](#) Hints from readers
- [67](#) Spellbinders: optical fibers
- [70](#) Free-form, one-of-a-kind candles are molded in snow
- [140](#) Your own business at a price you can afford
- [150](#) Six quick-and-easy projects
- [170](#) Hobby kits that add fun to Christmas . . . and the rest of the year

## HOME AND YARD

- [72](#) Yule tree—from tin cans
- [78](#) How to fix a gas clothes dryer
- [84](#) How to pick the right paint roller
- [86](#) How to keep cutting edges sharp
- [88](#) How to handle an electrical emergency

## BOATING, OUTDOORS

- [74](#) New gear for the snow season
- [76](#) Old boats
- [77](#) New boats
- [90](#) New guns and gear for shooters
- [94](#) New meters for finding fish
- [101](#) New for snowmos

## SCIENCE, INVENTION

- [96](#) For that needed energy: Pour on the coal!
- [106](#) Firemen with fins
- [120](#) Atomic pollution: A whopping fish story?
- [172](#) World's first solar-powered watch

## AVIATION

- [143](#) New build-your-own copters: More power, looks, convenience
- [160](#) Build your own VW-powered biplane from PM plans

## ELECTRONICS, RADIO, TV

- [127](#) Digital clock kits: fun to build, fun to watch—and oh, yes, they keep time
- [134](#) New in home electronics

## PHOTOGRAPHY

- [48](#) Photo hints
- [130](#) Pocket Super-8s: Home movie cameras you won't leave home

## EVERY MONTH

- [8](#) Letters
- [22](#) Appliance Clinic
- [40](#) Car Clinic
- [52](#) The Bicycle Shop
- [55](#) Science Worldwide
- [59](#) All Outdoors
- [64](#) Homeowners' Clinic
- [108](#) It's New NOW: Latest products and developments (A 12-page roundup)

# Popular Mechanics

DECEMBER 1973 • Vol. 140 No. 6

### INTERNATIONAL EDITIONS

Australia, Caribbean, Denmark, Mexico, Southern Hemisphere, Sweden



[Build-your-own copters . . . . . 143](#)



[Pocket movie cameras . . . 130](#)

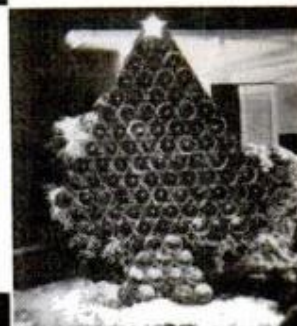

[Yule tree—from tin cans . . . . . 72](#)



[Weight bench: one of six quick projects . . . 150](#)

ON THE COVER: The Scamp, Designer Harris "Woody" Woods' new VW-powered, all-metal low-cost biplane. You can build it from PM plans. Photo: Howard Levy

AS A SERVICE TO READERS, *Popular Mechanics* publishes newsworthy products, techniques and scientific and technological developments. Due to possible variance in the quality and condition of materials and workmanship, *Popular Mechanics* cannot assume responsibility for proper application of techniques or proper and safe functioning of manufactured products or reader-built projects resulting from plans published in this magazine.

# Your son could get a lot more than enjoyment from a Daisy B-B Gun.



A Daisy is a gun, not a toy. And they are made for boys who are ready to treat them like guns.

If you have a son who wants a Daisy, there are two questions we'd like you to ask yourself.

First, is he ready for it?

Second, what will you and your son get out of it?

You're the only person who can answer the first question. But we'd like to answer the second one.

With your help, your son can get a lot out of a Daisy.

He can start with one of our lighter models. Then move up to a larger model that resembles a big-game gun or western carbine.

Later he may want to move up to a pump-up air rifle, or CO<sub>2</sub> Gun.

A Daisy is the best way in the world for a boy to learn the lessons of marksmanship and proper gun handling. Lessons that also teach patience, responsibility and respect.

You'll get something out of it, too: the pleasure of watching your son learn and grow with his Daisy.

Think about it.

If your son is ready for a Daisy, we'll have a Daisy ready for him.

**Daisy**  
SINCE 1886

**The B-B Gun every boy dreams about.**

Division Victor Comptometer Corporation, Rogers, Arkansas 72756

# You Can Cut It...

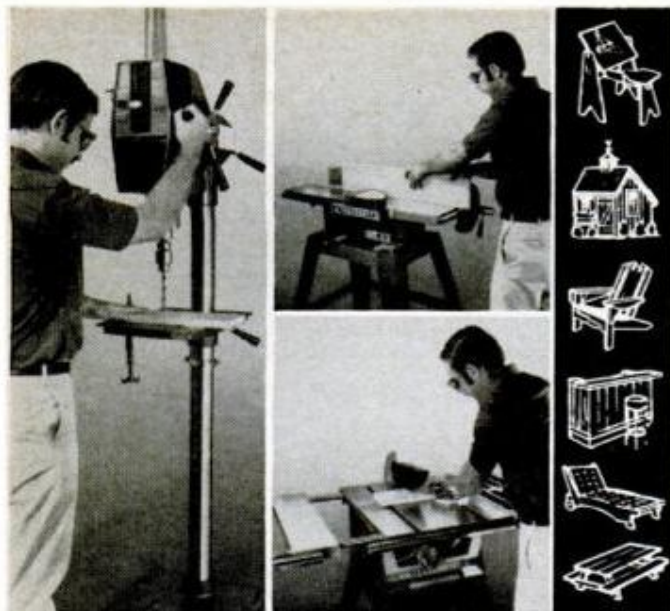

*and Drill it... Sand it... Plane it... Bevel it...  
Mortise it... Rabbet it... Dado it... Rout it... etc.*

## Toolkraft's Basic Home Workshop

All the tools you need to do the job yourself. The TOOLKRAFT Basic Home Workshop packs all the performance you need to tackle any woodworking project. The TOOLKRAFT big capacity 10" Tilting Arbor Circular Saw, the husky 4 1/8" Jointer and the versatile Drill-Router make the perfect combination of quality power tools for every home craftsman.

It's the TOOLKRAFT quality extras, like sturdy construction, precision accuracy, ease of operation and safety that make home repairs and maintenance work a breeze. Whether building or repairing furniture, finishing an attic or recreation room or even building a garage, you'll be surprised at how easy the job can be because all the skill is built into the tools. Not only will you have a feeling of pride and satisfaction showing off your accomplishments, but savings on repairs in just a few weekends will more than pay for the investment.

**And Now . . . A Word About Safety:** TOOLKRAFT. Every TOOLKRAFT power tool features the latest, most advanced safety features for peace-of-mind operation. Safety features engineered in . . . not just added on. Safety features that meet or exceed the standards of the industry. Safety features that make TOOLKRAFT the safest name in power tools.

**See Them . . . Try Them.** Visit your hardware or building supply dealer for a free demonstration . . . see how easy you can cut it with the TOOLKRAFT Basic Home Workshop.



## TOOLKRAFT CORPORATION

Plainfield St. • Chicopee, Ma. 01013

Send for the 48-page Power Tool Handbook . . . "How to" information for more effective use of your power tools. (Enclose 50c for your post-paid copy.)

Toolkraft Corp., Dept. PM-12 Plainfield St. • Chicopee, Mass. 01013

- Please send me 48-page Power Tool Handbook. I enclose 50c.
- Please send me catalog of Toolkraft Quality Power Tools and the name of my nearest dealer.

Name .....

Address .....

City ..... State ..... Zip .....

# Popular Mechanics

JIM LISTON, Editor

SHELDON M. GALLAGER, Executive Editor

JOHN A. LINKLETTER, Managing Editor

WAYNE C. LECKEY, Home and Shop Editor

ALVIN KIETZ, Art Director

BILL HARTFORD	Automotive
JOHN F. PEARSON	Science and Engineering
WM. T. McKEOWN	Boating and Outdoors
IVAN BERGER	Electronics and Photography
HARRY WICKS	Home Workshop
STEPHEN WALTON	Assistant, Home and Shop
MICHAEL LAMM	West Coast
ROBERT LUND	Detroit Automotive
GARRY WINTER	Copy Chief
RICHARD H. FUNK	Production
ALFREDO VEGA	Assistant, Production
DON EVANS	Technical Art Director
DAVID KOMITAU	Assistant Art Director
IRA HERRICK	Assistant Art Director
DON L. MANNES	Assistant Art Director
CLIFFORD B. HICKS	Special Projects
SOPHIE GRONOWICZ	Director, Bureau of Information
EVERETT JOHNSON	Cabinetmaker

DANIEL J. COLEMAN, Director of Advertising

**ADVERTISING OFFICES:** New York: 224 West 57th St., 765-6850; Chicago: 520 N. Michigan Ave., 527-2400; Detroit: General Motors Bldg., TRIMNY 5-8711; Cleveland: 20310 Chagrin Blvd., Shaker Heights, 283-7788; Los Angeles: 601 North Vermont Ave., 606-6263.

JOHN A. REGINA, Advertising Production Manager

Published by The Hearst Corporation

FRANK MASSI  
President

JOHN R. MILLER  
Executive Vice President

RANDOLPH A. HEARST  
Chairman

RICHARD E. DEEMS  
President, Magazines Division

JOSEPH F. KERN  
Publisher

**ADDRESS ALL EDITORIAL COMMUNICATIONS TO:** 224 West 57th St., New York, N.Y. 10019. For additional sources of information on the articles and products in this issue, write to Bureau of Information, Popular Mechanics, for free "Where-to-Find-It" list.

**SUBSCRIPTION SERVICE:** Mail all subscription orders, changes of address, correspondence concerning subscriptions, and Postmaster notices of undeliverable copies to Popular Mechanics, Box 646, New York, N.Y. 10019. Please enclose your latest address label for quickest service when writing about your subscription.

**POPULAR MECHANICS IS PUBLISHED MONTHLY** by The Hearst Corporation, 224 West 57th Street, New York, N.Y. 10019, U.S.A.; Frank Massi, President; John R. Miller, Executive Vice President; Randolph A. Hearst, Chairman; Harrison A. Mitnick, Treasurer; Harvey L. Lipton, Vice President and Secretary; Hearst Magazines Division; Richard E. Deems, President; Raymond J. Petersen, Executive Vice President; William S. Campbell, Vice President and General Manager; John F. D'Avolio, Vice President and Resident Controller; Albert A. Rachoi, Vice President and Director of Circulation; Joseph F. Kern, Vice President for Popular Mechanics. Single copy in the United States and Canada, 60 cents. Subscription prices: United States and Possessions, \$5.97 for one year; \$10.97 for two years; \$14.97 for three years. Canada, add \$2.00 for each year. All other countries, add \$4.00 for each year. When changing address, give old address as well as the new, with zip code, and allow six weeks for change to become effective. Second-class postage paid at New York, N.Y., and at additional mailing offices. Authorized as second-class mail by the Post Office Department, Ottawa, and for payment of postage in cash. Registered as second-class matter at the Post Office at Mexico D.F., Mexico, June 20, 1950. © 1973 by The Hearst Corporation. All rights reserved. Printed in U.S.A.



# 6 Grow with the future in any one of big-money careers

Send postpaid coupon below for FREE booklet of your choice.

For over sixty years LaSalle has been helping ambitious men start new and profitable careers. We can help you too. LaSalle's practical home study program lets you learn at your own pace. Experienced instructors supervise your work by mail every step of the way. You receive individual assistance whenever you need it. Send for FREE booklet on the field you like best. Mail coupon below. No stamp needed. There is no obligation. LaSalle, 417 S. Dearborn St., Chicago, Illinois 60605.



## DIESEL Mechanics

Called one of the best non-college careers by U.S. Department of Labor. Big field where even newcomers earn good pay.

## AIR CONDITIONING & Refrigeration

Short supply of trained men to service and install commercial and home equipment. Wide-open field.

## DRAFTING

Enjoy good pay as a draftsman in construction, manufacturing, many other industries. No drawing skill required to learn.

## COMPUTER Programming

High-pay, prestige field. All it takes to start training is a high school education and a logical mind. Technical experience not needed.

## AUTOMOTIVE Mechanics

Uncrowded field with great opportunities to earn a high income. 150,000 more trained mechanics needed.

## ELECTRONICS Technician

Earn a big pay in TV and radio broadcasting, automation, industrial electronics. Training for FCC license available.



### MAIL THIS POSTAGE PAID ENVELOPE

Cut coupon along dotted lines, fill in your name and address ... fold, seal (tape, paste or staple) and mail. No stamp or envelope is necessary.

Dept. 96-063

Please rush me, without obligation, the free booklet and full information on the field I have checked below:

- |   |   |
|---|---|
| <input type="checkbox"/> Diesel Mechanics     | <input type="checkbox"/> Air Conditioning and Refrigeration |
| <input type="checkbox"/> Drafting             | <input type="checkbox"/> Computer Programming               |
| <input type="checkbox"/> Automotive Mechanics | <input type="checkbox"/> Electronics Technician             |

Name ..... Age .....

(please print)

Street ..... Apt. No. ....

City .....

State ..... Zip .....

13R

FOLD HERE ↓ (DO NOT CUT) SEAL AND MAIL TODAY - NO STAMP NEEDED.

FIRST CLASS  
PERMIT NO. 27  
CHICAGO, ILL.

BUSINESS REPLY MAIL

No postage stamp required if mailed in the United States

Postage will be paid by

**LA SALLE EXTENSION UNIVERSITY**  
*A Correspondence Institution*  
**417 S. DEARBORN STREET**  
**CHICAGO, ILLINOIS 60605**

DECEMBER 1973

7

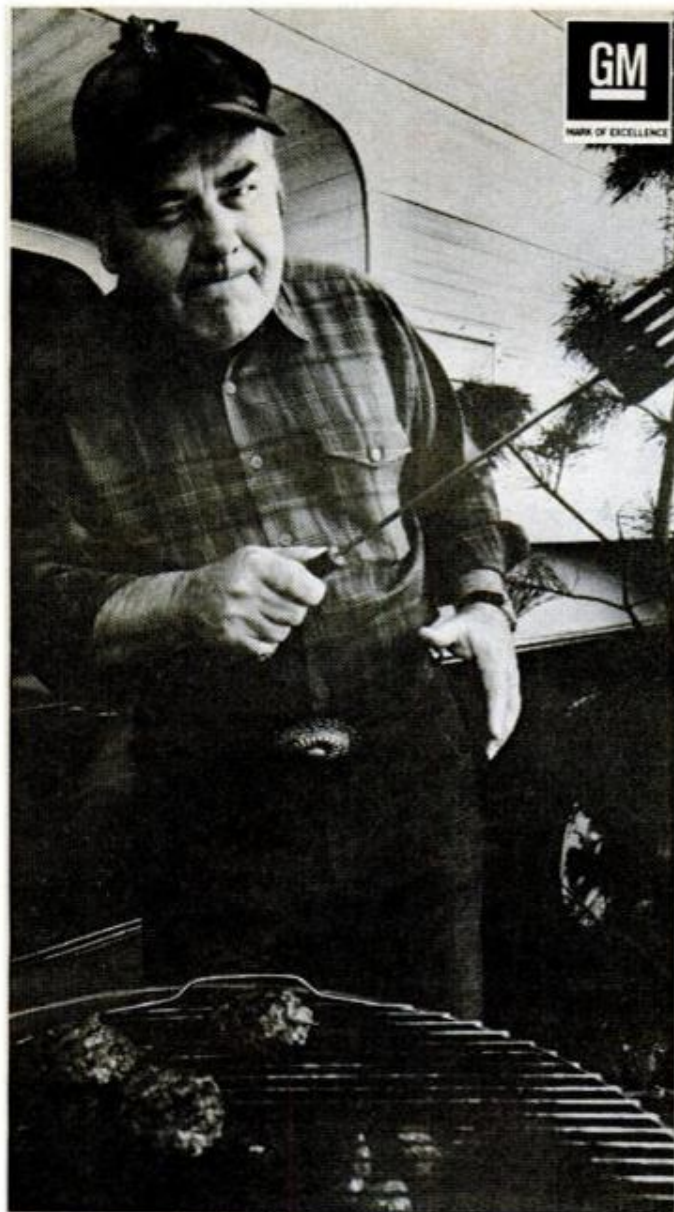

Jonathan Winters as the well traveled Ozzie Outdoors

**"Give me the broiling sun.  
Give me the scorching heat.**

**But first, give me  
Harrison Air Conditioning."**

"I like roughing it. But the summer sun can make it a little too rough. So I never go camping without Harrison Air Conditioning in my cab. Keeps me cool, summer after summer. And even though I'm virile (feel my muscle?), I'm bothered by dust, pollen and excess humidity. But Harrison removes all that. See your Chevrolet or GMC Truck dealer for a demonstration of GM-Harrison Truck Air Conditioning. Because broiling is for steaks, not for people."

**Let Harrison Air Conditioning  
make you a cool camper!**

Turn on "The Wacky World of Jonathan Winters" on local television.

## LETTERS

### TO THE EDITOR

#### More fun to drive old cars

I enjoyed the three viewpoints on beating the new-car game (*Should You . . . Trade In? Hang On? Cop Out?* page 124, Oct. PM). I, too, own a Volvo 145, a 1970, and we love it dearly. And the '52 Hudson owner can't be right in my opinion.

My second car has been a series of no-depreciation, *interesting* cars; a 1936 Ford pickup with '59 Olds engine (bought it for \$400, sold it for \$500); a 1929 Chev coupe (bought it in a basket for \$400, sold it for \$500 when I admitted I never had time to restore it); a 1965 Sunbeam Alpine for which I bought a parts car and scrounged a good engine, hardtop, etc.; and now a 1960 Austin Mini-Cooper, which is a hell of a lot of fun to drive, beats new Detroit monsters and gets 35 miles to the gallon. I don't think I'll ever buy a new car—no fun.

LOS ALTOS, CALIF.

STEVE FRY

I couldn't have been more delighted with Michael Lamm's article about his 1952 Hudson.

I have *not* had to scrounge for parts or even do more than normal upkeep and repairs on my '55 Buick (which also had 76,000 miles at purchase).

I think that many consumers simply cut down on the normal care they give new cars as they grow older (or if they buy an older car cheaply). Their mistake is in valuing the car by its current market value. So Mr. Average Guy says, "Why should I pay more for repairs or new tires than the car is worth?"

My \$150 Buick is better than a new car with problems. So am I foolish to buy a good battery or wide radial tires? Or to service it as regularly as a new car?

PACIFIC PALISADES, CALIF.

ROGER VIVIAN

#### Waiting for answer paid off

You answered my question about an "Un-agitated Agitator" on a Maytag washer in the September *Appliance Clinic* (see page

*(Please turn to page 10)*

# TOM McCAHILL SAYS:

**“You can pocket \$5 to \$7 an hour if you're good enough to fix these things.”**

The coming of the automobile built a multimillion dollar service industry in a few, short gas-eating years. The same thing has happened in the electrical appliance field. Manpower is desperately needed now to repair appliances.

But there is one big difference. Anybody with a few simple tools can get started in appliance repair. No expensive equipment is needed.

What is needed is the right kind of training. You can't strike it rich in today's job market with nothing more than muscle. Nor can you hang onto an old-time job skill while an electronic monster with buttons replaces men around you. It's like driving a buckboard down the Jersey Turnpike. The fuzz would locate you fast and send you out to pasture.

If you want an up-to-date job skill with good opportunity—why not take a look at the Electrical Appliance Repair field?

This field is loaded with opportunity because every house in our high speed land is loaded with appliances. There are about four times as many appliances as we have men, women, children and babies in the good old U.S.A. There are over a billion of these electrical gadgets being used, abused and broken. If you know how to do fast repair jobs on them, how much you can earn can well depend on how much you want to earn.

The opportunities in this field are all the better because you can prepare for them fast. There's one short, sweet course you can take right in your own home and it covers everything. I'm referring to a home-training course offered by the Appliance Division of National Radio Institute—one of the biggest and oldest home study schools of its kind.

NRI gives you the whole works. Their training covers basic electricity and how to use test instruments. They cover the electrical and mechanical operation of every type of appliance from toasters and coffee-makers to dishwashers; from vacuum cleaners and automatic laundry equipment to air conditioners and refrigerators. They even show you how to fix farm and commercial appliances and small one-lung engines.

The training is designed to be interesting, practical and fast. You can make \$5 to \$7 an hour extra fixing

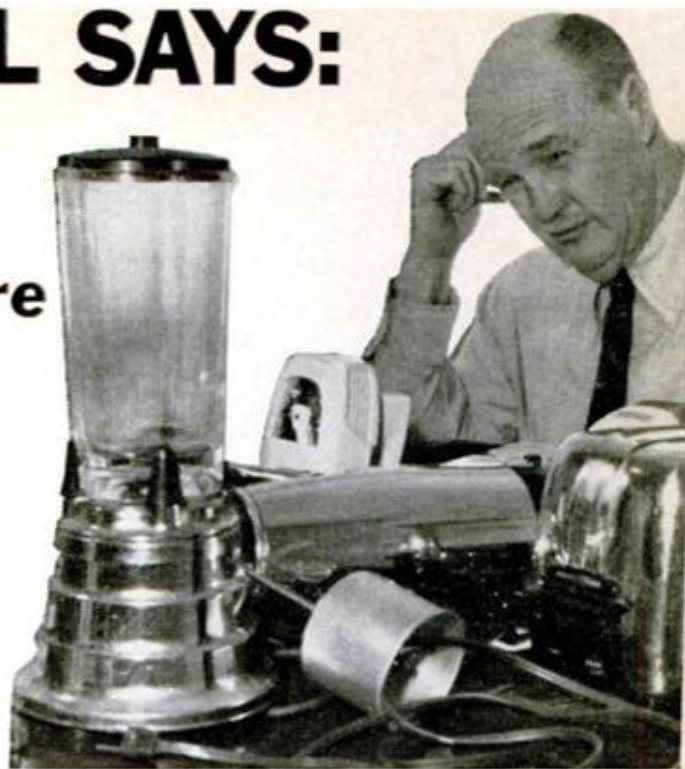

appliances in spare time starting soon after you enroll. They give you all you need to know to do fast, profitable repair service. They even include equipment without charging you extra. And the full cost of the training is surprisingly low.

If you are driving a buckboard in today's job market, at least find out what the Appliance field can do for you. NRI sends you a fancy, illustrated book about their training so you can judge for yourself. There's no obligation and they don't send a salesman to pressure you. All I say is get the facts and see for yourself. Send the coupon today while you are thinking about it.

*Tom McCahill*

**AVAILABLE UNDER NEW GI BILL**  
If you served since January 31, 1955 or  
are in service, check GI line below.

**APPLIANCE DIVISION, NATIONAL RADIO INSTITUTE 600-123**  
3939 Wisconsin Avenue, Washington, D.C. 20016

- OK—I want to see for myself. Send me the free book on Professional Appliance Servicing.
- Check for facts on new GI Bill.

**NO SALESMAN WILL CALL.**

Name \_\_\_\_\_ Age \_\_\_\_\_

Address \_\_\_\_\_

City \_\_\_\_\_ State \_\_\_\_\_ Zip Code \_\_\_\_\_

**ACCREDITED MEMBER**  
**NATIONAL HOME STUDY COUNCIL.**

## LETTERS

(Continued from page 8)

62). Things turned out just as author Paul Mann said: It was the nylon rollers.

I got the parts for \$3 and one hour later I had the job done. While I was at it, I asked the appliance repair company how much it would cost to have them installed; it would have been about \$22. So waiting for my answer in *PM* paid off—almost \$20 worth.

Thank you for the detail and space you used to answer my question.

WATERBURY, CONN.

ALBERT DALTON

### Good guess, says Gillespie

It is easy to see what type of shotgun author Gary Gillespie grew up with (*How to Select a Modern Scattergun*, page 134, Sept. *PM*). It was most probably a pump shotgun, but clearly a 12-gauge.

I grew up shooting a 20-gauge double-barrel. I have used my 20-gauge for all types of upland game and waterfowl, including pass shooting with good success.

My selection for a "best buy" is an American 20-gauge double-barrel, chambered for three-inch shells with barrels choked, improved cylinder and modified.  
SUNBURG, MINN.                      ROGER L. JONES

*Author Gillespie says that you made a good guess—and he still has the gun. As for your choice of a best buy, he won't argue with it.*

### Easy fix for a water heater

As a property owner, I appreciated your article, *How to Troubleshoot a Water Heater* (page 84, Sept. *PM*). However, I feel you have not mentioned a problem that is fairly common and relatively easy to solve. Many times the dip or drop tube itself becomes deteriorated to the point that the incoming cold water does not reach the bottom of the tank, and a shortage of hot water then exists.

The correct way to fix it is to disconnect the cold-water line, remove the old dip tube and insert a new one. This assures that cold

*(Please turn to page 13)*

**The Duster Coupe is more car than the Maverick Coupe.  
It has room for one more passenger.  
And it has half again as much trunk space.  
It offers more options.  
It gives you more weight, which you'll notice at freeway speeds.  
It has more width.  
Duster's price is more, but not that much more.  
So, of course, this year, we've been selling more.  
Small wonder.**

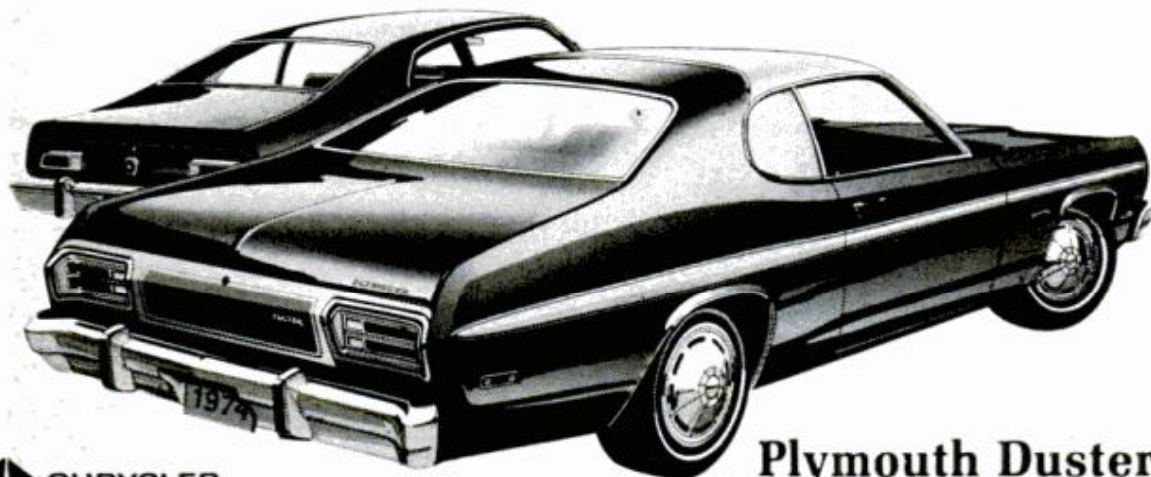

**Plymouth Duster.**

Extra care in engineering . . . it makes a difference.

# nothing compares



## The Atlas 6" back-gear lathe

Here's the low-priced screw-cutting lathe with high-priced lathe features, versatility and precision. You save money when you buy it . . . make money and develop skills as you use it. Handles the full range of lathe operations: turning, boring, threading and milling. Look at these features: precision ground bedways, lifetime lubricated spindle ball bearings for radial and thrust loads, 8 spindle speeds, wide thread cutting range . . . and many more. Write for free catalog.

### ATLAS PRESS CO.

12-24 N. Pitcher St., Kalamazoo, Mich. 49001

## START A MONEY-MAKING BUSINESS FOR LESS THAN \$50!



You can have your own lifetime business right at home . . . work in spare time . . . and make up to \$200 a month CASH! My FREE PLAN gives you all the facts: How to start, how to grow. You don't need previous experience. You don't have to sell. I'll even finance you. People bring you the work and pay cash. Over 90¢ of every dollar you collect is clear cash profit. And you work when you want to. Let me prove you can't find a more certain, lower cost, higher paying business of your own.

Just Mail Coupon—No Salesman Will Call

BELSAW SHARP-ALL CO., Stan Field, Pres.  
714Z Field Bldg., Kansas City, Mo. 64111

Name \_\_\_\_\_

Address \_\_\_\_\_

City \_\_\_\_\_ State \_\_\_\_\_ Zip \_\_\_\_\_

FREE BOOK

# HERMAN SURVIVORS®



We build Herman Survivors® to do two things well: Cover a lot of territory in great comfort. And stand up to the kind of punishment outdoorsmen give them. In any kind of weather. That's why we build the uppers of soft, durable burgundy full-grain glove leather, line them with Ensolite® for warm feet right down to -20°, then line the whole upper and soft padded cushion insole with saddle tan full-grain cowhide for even greater comfort. After that we stitch the boot down to resilient, oil-resistant Neoprene® crepe soles and heels. These Hermans come in two styles: 8" insulated boot, #7192, and 6" insulated shoe, #7192-6. They're tough. And they're comfortable. Like all our boots. When you're looking for quality in an outdoor shoe, hunt up a pair of Hermans.



FREE CATALOG

NAME \_\_\_\_\_

ADDRESS \_\_\_\_\_

CITY \_\_\_\_\_ STATE \_\_\_\_\_ ZIP \_\_\_\_\_

J. M. HERMAN SHOE COMPANY,  
DEPT. 34, MILLIS, MASS. 02054

That sounds like my kind of boot.  
Send me your catalog and the name  
of my nearest Herman dealer.

PM-BGL-3-12

# Just pick up this movie camera once. That's all we ask.



Reach for that easy-to-handle, professional pistol grip. You're holding the Bell & Howell 672/XL low-light camera.

Just aim it at your subject and our Focus-Matic® feature measures the proper distance — at the push of a button.

No guesswork. No calculating.

One quick lens setting and sharp, clear movies are yours. And what you see in that viewfinder is what you'll see on your film. Our exposure indicator will warn you if there's not enough light for good movies.

And if you aren't hooked already, check the 672/XL's fast f/1.3 lens and our 2.8-to-1 power zoom control.

Now you know what we mean when we say that the Bell & Howell existing light movie cameras provide a better way to take home movies indoors and outdoors.

**The 672/XL  
Movie Camera**

**BELL & HOWELL**

## Irwin workshop special



The workshop set you've been wanting. Get 6 precision-engineered Irwin Speedbor® "88" wood bits with 1/4" electric drill shank, sizes 3/8, 1/2, 5/8, 3/4, 7/8, 1". Plus an all metal storage rack. Specially priced for home, farm, factory, school workshop. Bits forged from finest tool steel. Heat tempered full length. Machine-sharpened for fast, clean, accurate cutting power. Irwin 13 bit set with rack also available, 1/4 to 1". Both sets gift boxed. Buy from your Irwin hand tools dealer.

**Irwin Screw Starter.** Marks hole, starts hole, threads hole for screw to easily enter wood and non-metal materials. Handiest tool in years for home and job. Get one soon.

© Registered U.S. Patent Office



**IRWIN**® every bit as good  
as the name  
at Wilmington, Ohio 45177, since 1885

New Tool  
Works Wonders  
With Wire!

## WIREFORMER

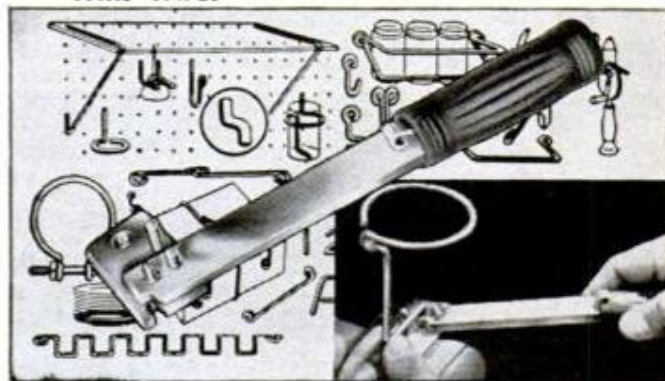

**IT BENDS! IT CUTS! IT STRAIGHTENS!**

WIREFORMER is a simple, precision made, vise-held tool of innumerable uses. Make your own peg board hooks, clamps, handles, braces, brackets, etc. — any shape you want. Forms an eye of 3-16" inside diameter (just right for any nail, screw, or bolt up to that size). Even uses coat hanger wire. No pliers needed. WIREFORMER does the work with the pressure of one finger. Straightens the wire if you make a mistake. Cuts the wire just where you want it. Forms any angle, arc or circle. Bends both right and left. Tool is case hardened, plated, with a plastic handle. Fits in your pocket. Complete instructions, illustrated brochure showing many things to make.

SOLD ONLY BY MAIL. MONEY BACK GUARANTEE. Four dollar bills will get you one, or send check or money order for just \$3.98 We pay postage and handling charges.

**VINKEMULDER TOOL CO. Dept. PM12**  
2223 Estelle Dr., S.E. Grand Rapids, Mich. 49506

## LETTERS

(Continued from page 10)

water will reach the bottom of the tank instead of neutralizing the hot water at the top of the tank.

WICHITA, KANS.

KEVIN KIMMEL

### Needs help on the hills

Reading your articles on bicycles in recent issues gives me an idea. Why not make a bike motor for aiding in climbing hills? The main reason I can't ride a bike to work is up-and-down hills. If a battery-powered electric unit could be mounted on the front wheel to pull up the hills, I could easily pedal across the flats.

OCEANSIDE, CALIF.

DUWAYNE A. PHILO

*We've received a couple of news releases recently describing power units for bicycles, though we've never tried one so we don't know how well they work. One Chicago firm offers plans for three different electric-motor setups. For information, contact Sheldon Shacket, The Flying Zeemo Electric*

*Bicycle Co. of America, 2239 North Lincoln Ave., Chicago, Ill. 60614.*

*There's also a new gasoline-powered auxiliary motor called "Chicken Power." It weighs only seven pounds and "adds the power of one full horse (or an estimated 650 chickens) to a bicycle." You can get information from O & R Engines, Inc., 3340 Emery St., Los Angeles, Calif. 90023.*

### Small projects? We still have 'em

I realize that the majority of your readers are experienced craftsmen, but there are a lot of us who don't have the money or tools required for most of your projects. For example, your dry sink (*Little Colonial Charmer*, page 138, Feb '72 PM) and *An Early American Hutch-Table* (page 96, July '73 PM). You have published a few small projects before, but you seem to have quit. I would appreciate it if you would start publishing such articles again.

FULTONDALE, ALA.

PAUL DOWNS

*We really haven't quit. You must have*

*(Please turn to page 14)*

**There are a lot of big reasons for buying a Duster instead of a Pinto.**

**Duster has room for five. Pinto has room for four.**

**Duster's trunk is almost three times bigger than Pinto's.**

**Duster's engine offers half again as much horsepower.**

**And Duster has a wider stance.**

**Of course, Duster's price is more.**

**But not that much more.**

**So there's little reason to buy a Pinto when you know the big advantages of Duster.**

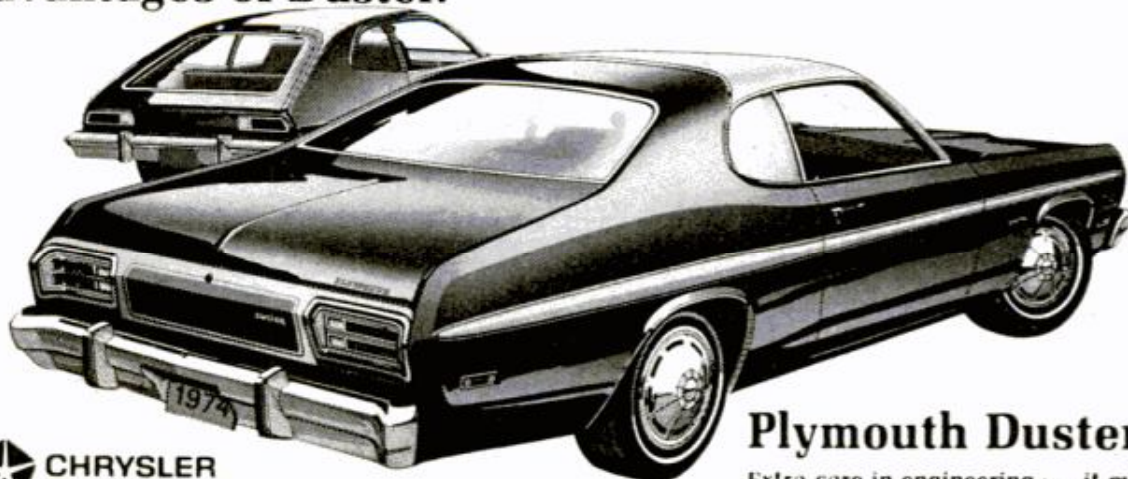

CHRYSLER

Plymouth

**Plymouth Duster.**

Extra care in engineering . . . it makes a difference.

## LETTERS

(Continued from page 13)

liked the 21 pages of Christmas Gifts You Can Make in the November issue (page 89) and you'll also find more small projects on page 150 of this issue.

### Stop short for better joint

In a May 1973 *Hints From Readers* page, the item "Joint-Gluing Trick" (page 161) suggested that shallow saw kerfs be cut in the lap faces for better gluing of a half-lapped joint. The problem is that if the frame is exposed, the kerf holes must be

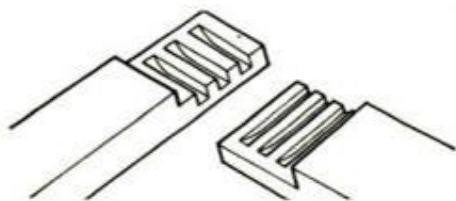

filled and sanded. This could be eliminated by stopping the kerf grooves short of breaking through, as shown in the drawing. I think the original idea is great, but this suggestion would save a little work later.  
WARREN, MICH. JOHN C. MEISSNER JR.

### Still doesn't believe it

Thanks to you, I am not afraid of my circular power saw any more. *Benchtop Saw Table Converts Portable to 'Radial'* (page 170, Sept. *PM*) has got to be one of the best articles *PM* ever did.

I work it, but I still don't believe it. This saw table does it all—and if it's any news to the people who introduced this wonder, you can adapt a router and jigsaw with very little effort using the right accessories. Instead of moving the tool, you move the work; it's that simple.

LOS ANGELES

HERMAN MARTIN

### Sand for a whetstone

In the October *Homeowners' Clinic* (page 82), Leroy Hoadley asks about "trueing up" a whetstone or oilstone.

For the home-workshop mechanic, the practical and safe way to resurface or "joint" an oilstone is to use very fine sifted sand on a level base of concrete (such as a cellar floor).

Rub the stone about on this fine sand, preferably in a figure eight. As the sand breaks down, use the finest of this to finish the job. It is safe and easy and if carefully done will give perfect results.

BURLINGTON, VT.

L. C. BEAUREGARD

### PM Christmas-display builders

My Christmas yard display (*Build PM's 'Sequence Santa' Electric Greeting Card*, page 172, Nov. '70 *PM*) was an enjoyable and satisfactory project. One problem I had was that the lights did not go off



simultaneously. I corrected it by changing the wiring so the first switch became the on-off switch for all other switches.

WATERBURY, CONN.

HANK RONCARTI



My Santa (*Hi, There!* page 109, Nov. '72 *PM*) turned out very well. My special thanks to *PM* for a good Christmas display for my porch.

NEW CARROLLTON, MD.

PETER KUCYK

I made the Santa Claus with the moving arm and put it up on my lawn. It turned out great, and I got many comments.

BROOKFIELD, WIS.

RONNIE DERRWALDT

Photocopies of the original articles can be ordered for 20 cents per page plus 25 cents postage from *Popular Mechanics*, Dept. JL, Box 1014, Radio City, N. Y. 10019. ★★★



# FREE GAS

AMAZING DEVICE INCREASES GAS MILEAGE UP TO 22%

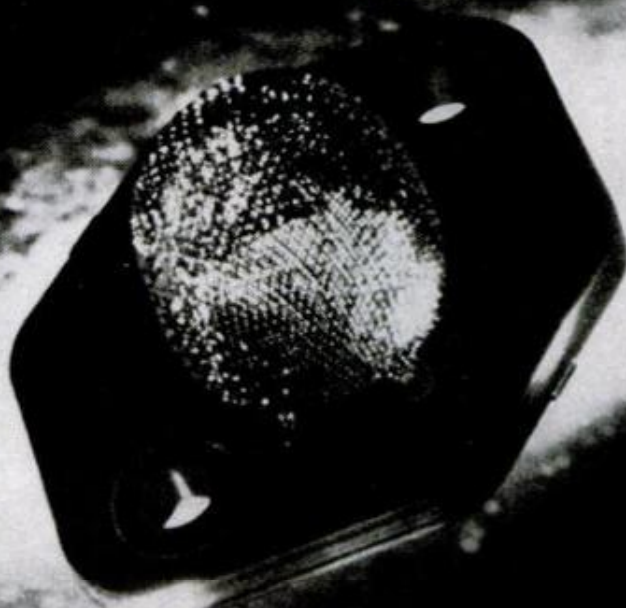

## EASY DO-IT-YOURSELF INSTALLATION

- ELIMINATES CAR POLLUTANTS
- INSURES PASSING COMPULSORY INSPECTIONS—MAKES CARS LEGAL
- GUARANTEED FOR LIFE OF CAR
- MEETS FEDERAL & LOCAL EMISSIONS CODES—EPA TESTED
- RESTORES POWER DEPRIVED BY OTHER ANTI POLLUTION EQUIPMENT



ENDORSED BY  
FAMOUS RACE  
CAR DRIVER  
MARIO ANDRETTI

The Tungsten Hydro Catalyst is a pre-combustion carburetor device that restores the power and gas economy robbed by other anti pollution equipment. And by changing the molecular structure of the gas/air mixture the Hydro Catalyst allows a clean burn, eliminating carbon monoxide up to 97%, hydrocarbons and nitrogen oxides up to 50%. Even your spark plugs will last up to 50% longer. Stalling, hesitation and diesling will cease. And you will get premium performance on regular gasoline. The Tungsten Hydro Catalyst makes cars legal and insures passing compulsory inspections. Famous race driver, Mario Andretti says "It really works to improve fuel economy and solve the pollution problem for a lot less money than even car manufacturers thought possible."

To get yours right away fill out this coupon and send check or money order for \$24.95 plus \$1.00 for postage and handling. Or charge to credit cards listed. New Jersey residents add 4% tax. Order now and receive your FREE Clean Air Kit which includes a Pollution Control Valve (PCV Valve) and Air Filter Breather.

An exclusive product of Tungsten Contact Mfg. Co., Inc.

## THE TUNGSTEN HYDRO-CATALYST

Tungsten Contact Mfg. Co., Inc.  
c/o Mario Andretti  
P.O. Box 146, North Bergen, N.J. 07047

Gentlemen:

Please rush me \_\_\_\_\_ Tungsten Hydro Catalyst(s) and my FREE Clean Air Kit(s) at \$24.95 each. ADD \$1.00 for postage and handling.

Name \_\_\_\_\_

Address \_\_\_\_\_

City \_\_\_\_\_ State \_\_\_\_\_ Zip \_\_\_\_\_

Enclosed is: Check \_\_\_\_\_ Money Order \_\_\_\_\_

Charge to:

American Express # \_\_\_\_\_

Diners Club # \_\_\_\_\_

Master Charge # \_\_\_\_\_

Bank Americard # \_\_\_\_\_

Carte Blanche # \_\_\_\_\_

Expiration date \_\_\_\_\_

Sign Here \_\_\_\_\_

NOTE: Please do not send cash!

**IT MAKES  
CARS  
RUN  
BETTER**

**PROBABLY  
YOURS,  
TOO**

**TEST DRIVE IT  
YOU'LL LIKE IT!**



**SPECIAL OFFER**

Rislone National Championship Racing Jacket only \$7.95 prepaid. Durable nylon-cotton Rislone yellow with red, black racing stripes. S, M, L, XL. Send check or money order to: Rislone National Champion Jacket, P.O. Box 457, Bonner Springs, Kansas 66012.



**THE SHALER CO.**

Waupun, Wisconsin 53963  
In Canada: The Canadian Shaler Products Co. Ltd. Ontario

**HINTS**

**FROM READERS**



**Holding odd diameters in lathe collets**

Lathe collets will hold between-size diameters if you use simple bushings made from sheet-metal strips of uniform thickness. Each strip is rolled into a tube that fits over the workpiece, with a small gap between strip ends; position the gap near or in line with one of the collet's slots. If necessary, two thicknesses can be used, or the bushing can be machined from tube or bar stock.

—B. W. Erwin, Kent, Ohio

**MEET LULU...the incredible electric lure with a motor for a heart and you for a brain!**

**THE IDEAL GIFT!**

Satisfaction Guaranteed or Money Back

You're not seeing things...that's a propeller on Lulu's nose. Behind it is an electric motor in a watertight compartment. On the power of a night battery, she can swim around lily pads, logs and weeds for up to an hour...side up to a big one 300 feet away. Your rod tip directs her. The whine of her motor is a siren's song to every lunger around. Lulu's \$6.50 pstd. in a choice of colors: Blk, Red & Wht, Grey & Blk, Yellow Perch, Green & Yellow, Green & Silver, Blue & Black, Green & Blk, and Black & White Stripes. State preference.

Send check or money order, name and address to:

**CAPTIVATED LURES INC., P.O. Box 16875 Jacksonville, Florida 32216**

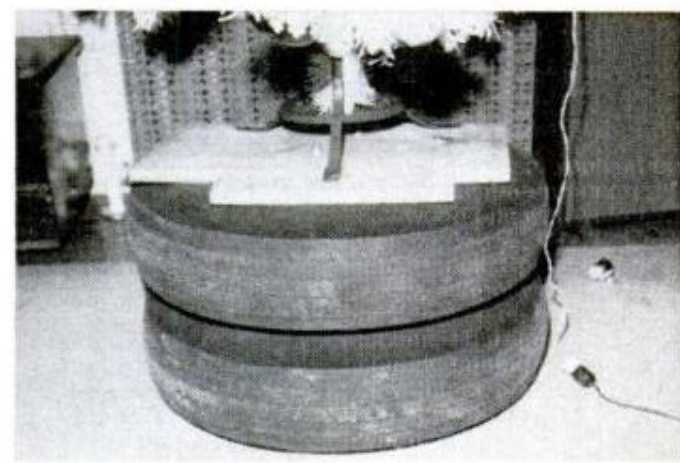

**Tires make Christmas-tree base**

I found that rim-mounted tires (off car while snows are used) and a piece of plywood bolted to the rims made a solid base for a small Christmas tree. Bring wiring through center before base is draped.

—Stanley R. Pennington, Fairview, N.J.

# Grande Canadian.

We wish you a Grand Holiday Season  
from the last North American frontier.

**Made smooth  
from selected  
Canadian Whiskies.**  
Gift wrap at no extra cost.



From the pride  
of a rugged land, from  
rich Canadian grains,  
from glacier-pure water,  
comes Grande Canadian.

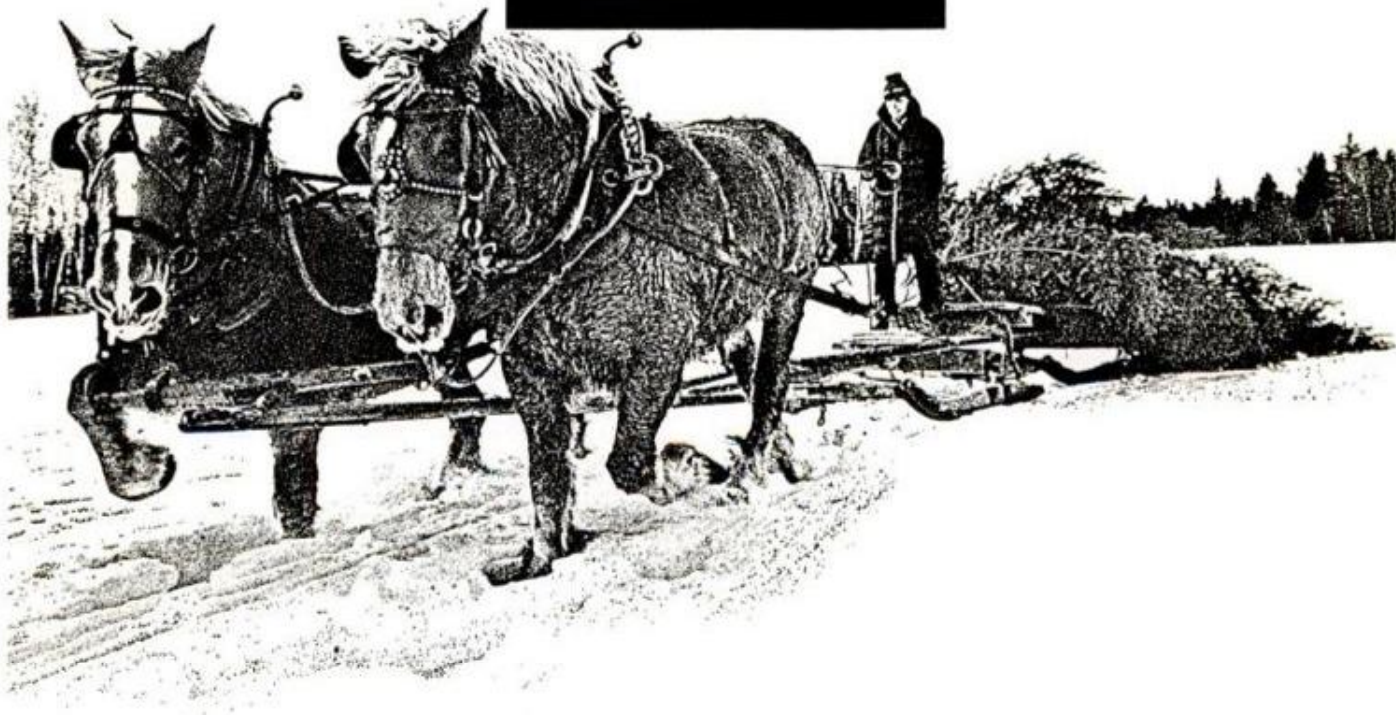

# Here it is!

# Popular Mechanics

# COMPLETE GARDENING GUIDE

All the basic information on home gardening at your fingertips!



### Partial list of contents:

- Landscaping
- Garden surfaces
- Gardening in your climate
- How to improve your soil
- Starting seeds
- Trees
- All kinds of transplanting
- Shrubs
- All about pruning
- Flowers
- Lawn care
- Vegetables
- Garden pools
- Fruits, nuts and herbs
- Container gardening
- Outdoor play areas
- Storage structures

FIRST WE assembled every bit of information you need to know to make your lawn and garden the most beautiful in your neighborhood. We condensed *these* basics to *their* essentials. Then we added more than 20 fact-packed tables and charts, and scores of show-how drawings. Finally, we printed this vital material on heavy plastic-coated cards, and spiral-bound them together.

*You'll be amazed at the vast amount of information packed into your COMPLETE GARDENING GUIDE!* Planting dates and depths for all kinds of seeds and bulbs; when to prune what, and how; information on the 56 most popular shrubs, and the 21 best hedges; all about ground covers; the shapes and heights of the 52 most popular tree species; how to select evergreens; how to lay flagstone, patio blocks, bricks; how to build decks; all about air-layering, whip-grafting and other ways of starting plants; how and when to transplant almost anything; all about lawn renovation; and much, much more. *You can have all this basic gardening know-how at your fingertips!*

*No gardener can be a complete gardener without the COMPLETE GARDENING GUIDE! Order your copy today!*

**POPULAR MECHANICS, Box 1014 (Dept. GG) Radio City, New York 10019**

Enclosed is my check for \$3.95.

Send my PM GARDENING GUIDE to:

Name \_\_\_\_\_

Address \_\_\_\_\_

City \_\_\_\_\_ State \_\_\_\_\_ Zip \_\_\_\_\_

# KEEP THIS EQUIPMENT AND PUT YOUR HANDS TO WORK MAKING MONEY

© 1973 ICS

## 25" Motorola Quasar II®

**Color TV.** Get experience handling a name-brand, professionally built set—and, at the same time, enjoy your favorite TV shows in full color on a huge 25-inch screen. Famous Motorola "Works In A Drawer" model lets you slide out the main chassis from front of cabinet for easy study, adjustment or repair. And it's yours to keep—at no additional cost—when you complete your training.



**LEARN  
TV SERVICING  
& REPAIR  
(AT HOME)  
THE ICS WAY**



**Electronic Measurement Lab**, helps you make the right repairs, quickly and efficiently. Includes fully assembled HEATHKIT Oscilloscope and EICO Volt-Ohm Milliammeter.

**Convergence Generator, High Voltage Probe, and Hex Alignment Tool.** For perfect TV tuning.

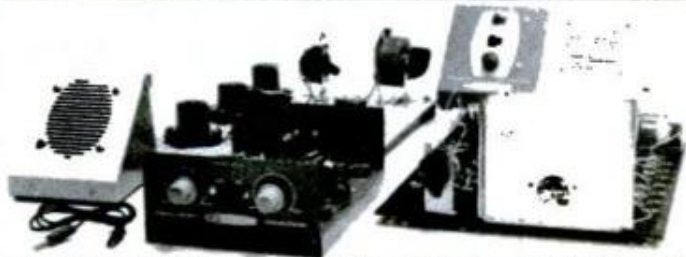

**TV Training Lab**, for testing, evaluating circuits and systems. Start earning money repairing TV's, radios, hi-fi's, etc.. even while you learn.

**Let ICS send you a free "Demonstration Lesson" that could start you on the road to success in this rewarding career field. Mail the attached card or coupon today.**

You need experience using this kind of equipment to really make money as a TV Repairman. ICS will give you that experience. In the privacy of your own home, during your spare time. And when you complete your training, all this equipment will be yours to keep—at no additional cost. So you can start using it on the job

(where trained technicians now get anywhere from \$3.50 to \$6.50\* an hour). Or open a shop of your own, and earn even more, working full or part-time. Get started now. Just mail the postpaid card (or coupon below) for your free "Demonstration Lesson" and free Career Guidance materials. There's no obligation.

\*U.S. Labor Department

YES, send me full details plus a free "Demonstration Lesson" that could start me on the road to success as a TV Service and Repair specialist. I understand that I am under no obligation.

Name \_\_\_\_\_ Age \_\_\_\_\_

Address \_\_\_\_\_ Apt. No. \_\_\_\_\_

City \_\_\_\_\_

State \_\_\_\_\_ Zip \_\_\_\_\_

**ICS** International Correspondence Schools  
Scranton, Pennsylvania 18515

Note: Check below only if you prefer to receive free information about these related career fields.

- Electronics     CATV/MATV     Engineering  
 Electrician     Computer Servicing  
 FCC License     Communications/Broadcasting  
 Air Conditioning, Heating & Refrigeration  
 Check for special information if 16 or under.

APPROVED FOR VETERANS TRAINING. APPROVED FOR FEDERALLY INSURED LOANS. ACCREDITED BY NATIONAL HOME STUDY COUNCIL.

There's a lot of good

KING SIZE

Winston

FILTER · CIGARETTES

FULL · RICH  
TOBACCO FLAVOR

Warning: The Surgeon General Has Determined  
That Cigarette Smoking Is Dangerous to Your Health.

between "Winston...

and should."

Winston tastes good GOOD, like a cigarette should.

© 1975 R.J. REYNOLDS TOBACCO CO.  
20 mg. "tar", 1.3 mg. nicotine av. per cigarette. FTC Report SEPT. 1971  
Материал, защищенный авторским правом



**FREE**  
1974 LAFAYETTE  
CATALOG 740  
*Ready Now!*

### Your Complete Electronics Buying Guide

- Stereo/Hi-Fi Components • CB Transceivers & Walkie-talkies • PA Systems • Tools & Test Equipment
- Police/Fire Monitor Receivers • Antennas • Photography Equipment • Ham Gear • Books, Parts, and More!

**Send Today!**

Lafayette Radio Electronics  
P.O. Box 10, Dept. 15123  
Syosset, L.I., N.Y. 11791

15123

NAME \_\_\_\_\_

ADDRESS \_\_\_\_\_

CITY \_\_\_\_\_

STATE \_\_\_\_\_

ZIP \_\_\_\_\_

## MAKE BIG MONEY IN EITHER OF THESE TWO FIELDS



### TRACTOR-TRAILER DRIVER

We can train you to operate the big diesel rigs. Study at home followed by practical training at school-owned facilities in Miami, Fla. Accredited Member NHSC. Home Office—Miami, Fla.

APPROVED FOR VETERANS AND INSERVICE PERSONNEL

### HEAVY EQUIPMENT OPERATOR

Learn to operate cranes, draglines, scrapers, clamshells, bulldozers, backhoes, trenchers. Study at home followed by practical training at school-owned facilities in Miami, Fla. Accredited Member NHSC. Home Office—Miami, Fla.



UNIVERSAL TRAINING SERVICE, Dept. PM  
1901 N.W. 7 St., Miami, Fla. 33125 • Phone: (305) 642-0800

- TRACTOR-TRAILER DRIVER  
 HEAVY EQUIPMENT OPERATOR

PLEASE PRINT

Name \_\_\_\_\_

Address \_\_\_\_\_

City \_\_\_\_\_ State \_\_\_\_\_

Zip \_\_\_\_\_ Phone \_\_\_\_\_ Age \_\_\_\_\_

BY PAUL MANN

## APPLIANCE CLINIC

### Won't hold water

The problem with our Maytag automatic clothes washer, model A-702, is that during the wash-rinse cycle, water drains out of the tub. The unit doesn't fill. The only way to get water into the tub is to advance the timer to SPIN DRY and recycle to the beginning. Help!—R. Wong, Concord, Calif.

The cause of your problem is probably that the end of the unit's drain hose is below the level of the water in the tub, creating a siphon effect. It is the same as siphoning a fuel tank by dropping a hose below the level of the fuel. The drain hose of an automatic washer should terminate at a point that is above the tub water line, or at least level with it. This may not be possible in some installations. For this reason, some automatic washers have an anti-siphon device built into them that interrupts the flow of air which creates the siphoning action. If you can't raise the end of the drain hose, you should install an antisiphon device. Maytag makes one, part No. 2-1112. Get it from a Maytag dealer.

### Sticks fix

Because our summer home is in the "sticks," I can't get a refrigerator serviceman to come and fix a Hotpoint refrigerator, model EB 87, which was manufactured in 1954. The only problem I have with this excellent unit is that it won't go back to REFRIGERATE after it has been on AUTOMATIC DEFROST unless I jump the circuit. What do you suggest I do?—Daniel Cody, Union, N.J.

I suggest that you contact the right people at the right place. They will see to it that an authorized serviceman is made available. If there were just one component that could cause this problem, I would outline the way to fix it and the services of a technician would be unnecessary. But there are several possible reasons for this condition, and indiscriminate replacement of parts could cost you a good deal of money for nothing. For

(Please turn to page 24)



**The Air Force offers a 30-day paid vacation in your first year—and that's only the beginning.** The benefits start the second you start with us. Benefits that make your starting salary (over \$300) worth much, much more.



Like free dental and medical care. Money-saving buys at our commissaries and exchanges. Wide-open opportunities to continue your education—for free. Low-cost travel on commercial airlines, or free on Air Force planes that happen to be going your way. Free food, clothing and housing. And no worries about business setbacks that could eliminate your job. As for your job...

**You choose it—we guarantee it before you enlist!** What are you most interested in? Mechanics? Dentistry?

Electronics? Choose one from any one of our over 100 jobs.

We'll train you. And pay you while you learn.

You'll wind up with a rewarding job. With real responsibilities. With skill and experience that civilian employers prize.

**Want more reasons to join?** You can get them all, right down to the nitty-gritty, if you contact your local Air Force Recruiter. Or call 800-447-4700, toll free (in Illinois call 800-322-4400). Or just send in the coupon.

And start planning those 30-day paid vacations.

Air Force Opportunities, Box A  
Randolph AFB, Texas 78148

1-PM-123

Name \_\_\_\_\_  
(Please Print)  
High School \_\_\_\_\_  
Address \_\_\_\_\_  
City \_\_\_\_\_ County \_\_\_\_\_  
State \_\_\_\_\_ Zip \_\_\_\_\_  
Soc. Sec. # \_\_\_\_\_ Age \_\_\_\_\_

**Find yourself  
in the Air Force.**

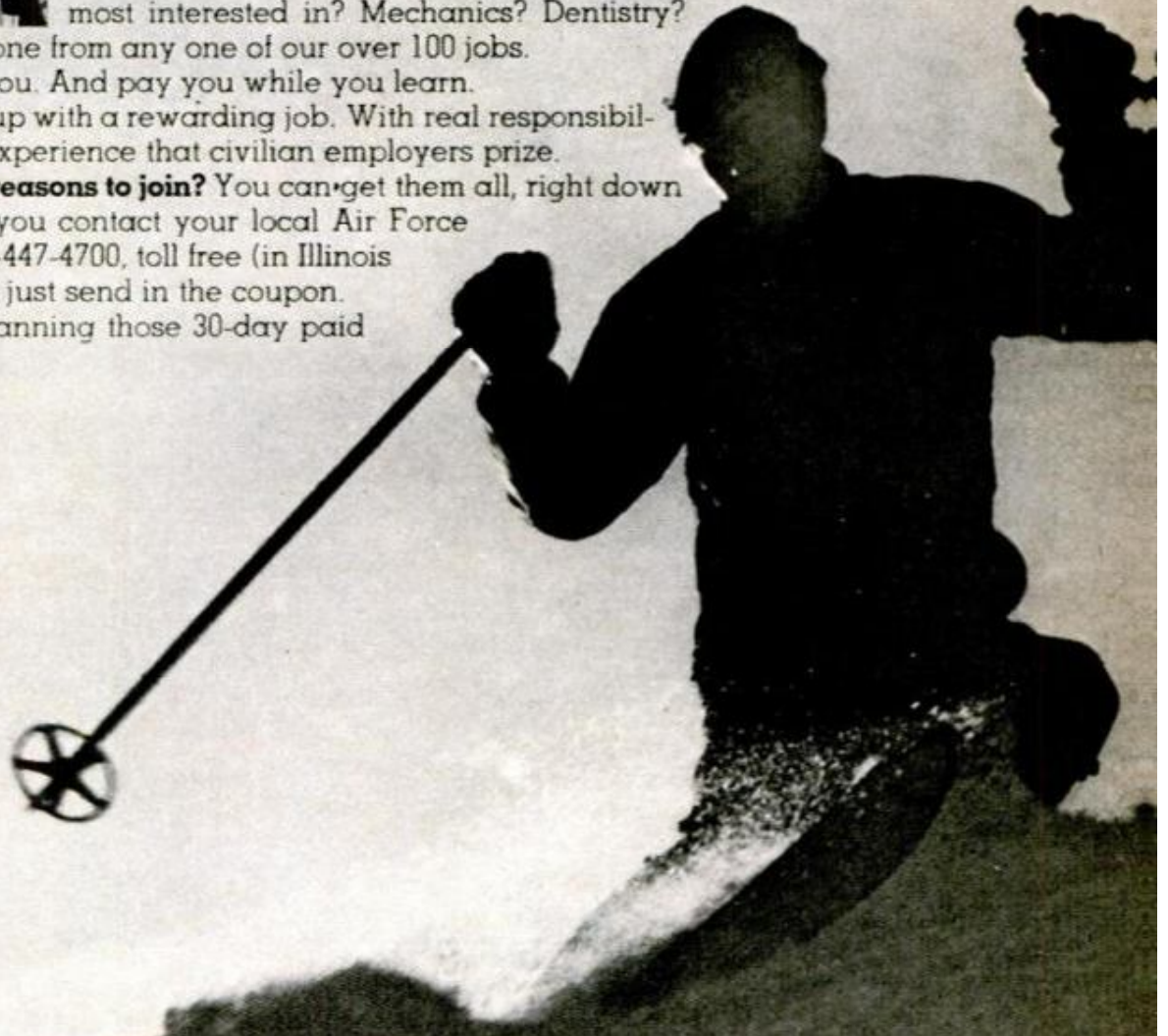

**If nobody's offered you a job  
with a 30-day paid vacation,  
read this.**

# Last year's hottest selling lightweight: The Poulan XXV. \$119<sup>95</sup>\*

You're looking at a winner. The Poulan XXV. With a 14-inch bar and chain, not 12 inches. A tough all-magnesium housing, not plastic. A Tillotson all-position carb (so it even cuts upside-down). And power that cuts through an 8-inch log in 4 seconds flat. It's less than 10 pounds. Less than \$120.

And more than any other saw for the money.



\*Manufacturer's Suggested Retail Price.

## APPLIANCE CLINIC

*(Continued from page 22)*

example, the trouble could be caused by a bad defrost timer that allows the refrigerator to kick into defrost but doesn't let it kick out of defrost automatically. Or the cause could be a weak heater that is taking several hours to defrost the refrigerator, when defrost should take only about 10 to 15 minutes.

Hotpoint reports it has authorized servicemen going to any location where there is a Hotpoint appliance. I suggest that you get in touch with the field service supervisor at the technical service department of Hotpoint in North Caldwell, N.J. The telephone number is (201) 256-8770.

### Water gate

*Water keeps running into my GE dishwasher even when the unit is not being operated. The only way to halt the flow is to close off the valve on the water line. What's wrong?—Felix F. Gines, Alhambra, Calif.*

There is something wrong with either the

machine's water valve or its timer. If the unit is an under-the-counter model, take off the bottom control panel. If the unit is a portable model, remove the front panel. This reveals the water valve. Remove the wires from the valve, disconnecting it from the timer. If water now flows into the dishwasher, the unit has a bad valve. If no water flows, the timer should be replaced.

### Not seeing red

*Our Tappan electric stove is 13 years old. Because its four surface units wouldn't turn red when on HIGH, I jumped the gun and purchased four new units. They don't get red hot either. Why?—E. J. Bussey, Hartford, Conn.*

There are several possible reasons. The first thing you should do is push each unit completely home to make sure it's firmly in its socket. If this doesn't make you see red, find the terminal block at the rear of the range. A voltmeter reading at this block should be 230 v. If it is not, then the terminal block may be burned (look for blackness) and will have to be replaced. Damaged wires

are another possible cause of the problem. Shut off power, remove the front panel and examine wiring. If it is broken, the range will have to be rewired. Since few servicemen do this, you should then contact Frank Stevens, Technical Service, Tappan, 101 Kuller Rd., Clifton, N.J. 07015—telephone (201) 881-7966.

### Noisy disposer

*We recently purchased a GE food waste disposer which works fine, except that it is very noisy. I investigated by turning off the switches and putting my hand inside the unit. One of the spinners is so loose that I can lift it up. The other spinner can't be lifted, although it does spin around. Is this a normal situation?—Mrs. Stanley Nosko, Manchester, Mass.*

Both spinners (impellers) should be held fast to the flywheel, although both should revolve. The job of the impellers is to throw waste against the shredding ring. Impellers are usually riveted to the flywheel. (In some disposer models, they are held by bolts and nuts).

If a rivet has failed, the flywheel should be replaced. I would get in touch with the dealer or with a GE service center. If the unit is still under warranty, the repair should be free.

### Open and shut case

*Our Westinghouse refrigerator-freezer frequently doesn't turn itself off when it should. If we turn it off manually and immediately turn it back on, it will remain off until it's supposed to go back on again. We thought the problem was a faulty control, so we had that replaced, but the trouble continues. Can you suggest a cure?—E. F. Dailey, Freeport, Fla.*

If the trouble isn't being caused by a bad thermostat, then chances are it's a faulty control relay on the motor that should be replaced. ★★★

*If you have a question about any appliance, send it to Appliance Clinic, Popular Mechanics, 224 West 57th St., New York, N.Y. 10019. Sorry, but letters cannot be answered individually. Problems of wide interest will be answered in this column.*

## Next year's hottest selling super-lightweight: The new Poulan XX. \$99<sup>88\*</sup>

Introducing another sure winner. The brand new Poulan XX, weighing under 8 pounds, is now available.

With the same tough all-magnesium body (so it performs like a machine, not a toy). A 12-inch bar and chain, instead of the usual 10-inches you find on other super-lightweights. And get this: automatic chain oiling is standard. (For extra heavy cutting, the XX has a manual override oiler.) The whole package sells for less than \$100. A good lightweight chain saw has many of these features.

But the Poulan XX has all of them.

Check the yellow pages for dealer nearest you or call toll free (800) 551-8989. In Louisiana the number is (800) 282-8803.

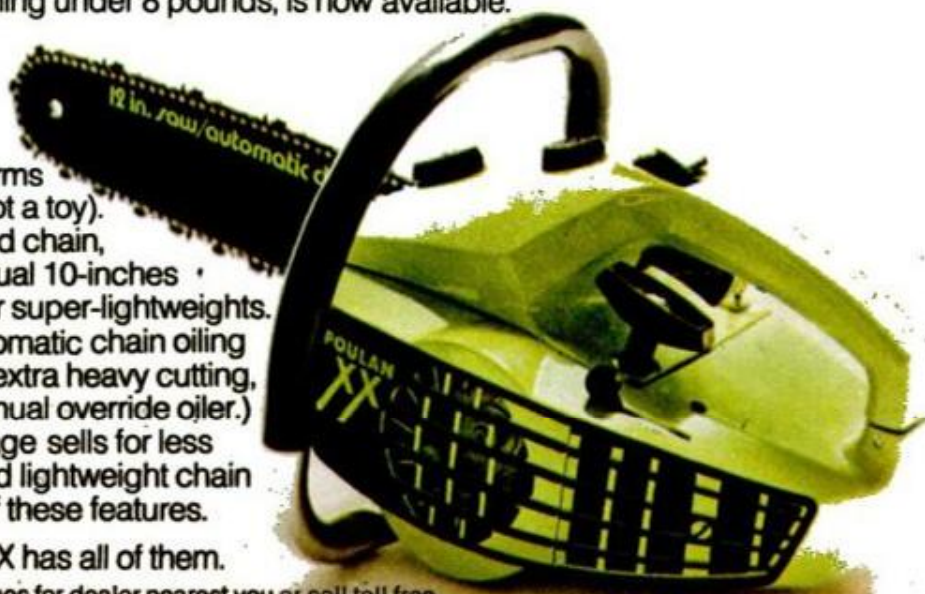

\*Manufacturer's Suggested Retail Price.

# Let MOTOR's new 1974 Auto Repair Manual show you HOW TO FIX ALMOST ANY PART OF ALMOST ANY CAR

Shows you where to start ...  
which tools to use ...  
exactly what to do!  
quickly ... easily ... right!

Here—in one giant volume—is the "meat" of over 300 factory manuals, brought together for you in the most complete, up-to-date auto repair guide ever prepared! Here are the easy directions and "see-how" pictures that help you sail through virtually every auto repair ... from a simple carburetor adjustment to a complete transmission overhaul! Here are over 1,000 almost-foot-high pages that can lick your toughest problems—quickly, easily, right the first time!

Yes—fix practically any part of any car! This revised, improved 1974 edition immediately identifies 2,300 models (1968-1974) for you. Just look up make, model, and repair in the handy Instant-Reference Index—and go to it!

MOTOR takes you all the way—shows where the trouble is, which tools to use what to do to fix it fast. Over 3,000 pictures and diagrams detail the parts ... clear, simple language puts over 225,000



service and repair facts at your fingertips!

Special Trouble-Shooter section and detailed trouble-shooting information thruout help pinpoint in a flash over 4,200 causes of car trouble: transmission, brakes, engines, electrical systems.

#### Saves You Time, Money, Work

You get hundreds of compact tables ... over 55,000 essential specifications and dimensions ... tune-up and adjustment charts ... tables of measurements and clearances ... overhauling and replacement facts ... adjusting and servicing guidance, and much, much more!

Here is the step-by-step help every beginner needs. And here are the labor-saving methods and shortcuts that get old pros over the "tight spots" and save time and money.

Learn all about the 1974 cars and in addition see how Detroit's 1974 specs and procedures affect your older car.

"I always rely on my MOTOR Books. They're well illustrated—and complete and simple."—Mr. Erve Jones, Minnesota (Garage Owner)

"The MOTOR Auto Repair Manual is invaluable to me. I depend on it for all makes and models."—Mr. W. W. Forlines, Virginia (mechanic)

Auto makers continually up-date and improve past model adjustment specs on older cars as new road test data comes in. That's why you'll need this new 1974 MOTOR Manual to get the best performance out of your car—even if you already own an earlier edition.

MOTOR's is so comprehensive, no wonder it's a 6.5 million copy bestseller with students, professional mechanics, and car buffs.

#### Send No Money — Mail Coupon Today!

We don't want you to send a penny now. Just mail the coupon below and we'll rush a copy of the new, most up-to-date 1974 MOTOR Auto Repair Manual to your home or shop. TRY this brand new edition, which contains the new 1974 models, for 10 full days—at our risk—FREE!

See for yourself what a time-saver and a work saver this manual is. If this book doesn't pay for itself in the first 10 days, just return it and pay nothing, owe nothing.



#### Same Offer on MOTOR's Auto Engines & Electrical Systems

1,300 big pictures. Clear text explains how parts work; principles involved; design; construction; maintenance. Covers all parts of engines & electrical system. For FREE trial, check box in coupon below.

Fix all these cars — 1968-1974			
Mustang	Chevrolet	Corvair	Front Drive
I and II	Chrysler	American	Cadillac
Chev II	Plymouth	Oldsmobile	Mark III
Ford	Lincoln	F85	AMX
Thunderbird	Nova	Falcon	Javelin
Buick	Vega	Fairlane	Montego
Imperial	Pinto	Tempest	Torino
Cadillac	Gremlin	Corvette	Barracuda
Continental	Hornet	Valiant	Rambler
Mercury	Dodge	Cougar	Mark IV
Ford	Oldsmobile	Toronado	Challenger
Chevelle	Comet	Maverick	... and more.

Mail coupon today and try the New 1974 Edition FREE for 10 days

**MOTOR**  
**AUTO REPAIR**  
**MANUAL**  
1974

Mail to: MOTOR Books, Shipping Service, P.O. Box 2316, F.D.R. Sta., New York, N.Y. 10022

Please send me the Manuals checked below for ten days free examination:

11148 MOTOR Auto Repair Manual, \$10.95

12534 MOTOR's Auto Engines & Electrical Systems, \$10.95

If I am not fully satisfied, I will return the shipment promptly and owe nothing. Or I will keep it and pay the total price in three monthly installments, plus shipping.

**I WANT TO SAVE SHIPPING CHARGES.**

I am enclosing payment for \$..... in full and MOTOR will pay shipping charges. (Same return privileges, refund guaranteed.)

Offer available only in the Continental United States and Canada. Prices slightly higher in Canada. Delivery will normally be 3-4 weeks in Eastern U.S. and slightly longer West of the Mts.

611X

Print Name .....

Address .....

City .....

State .....

Zip .....

Please Initial .....

(M. Books)

6.5 Million Copies Sold

MOTOR BOOKS, PUBLISHER'S OFFICE, 230 WEST 50 ST., NEW YORK, N.Y. 10019

# Jobs open up for Technicians with down-to-earth training!

Opportunities are everywhere and the pay is excellent in the technical service industries. But it takes the right training to get a man started: **NTS Project-Method Home Training!**

You learn by building the latest equipment and test instruments (which are included in your tuition). You're guided every step of the way by easy-to-read NTS Lessons.

When you graduate, you know service and repair from the bottom up, inside-out!

You have answers on the tip of your tongue. Know-how at your fingertips. You have the down-to-earth training experience employers are willing to pay good money for!

Find out. Send card today. No obligation. No salesman will call.



Solid-State Color TV  
315 Sq. In. picture

## ELECTRONICS DIVISION

NTS offers a wide-range of training with solid-state equipment (almost all of it commercially available). Build a solid-state 315 sq. in. Color TV; solid-state B&W TV; solid-state FM multiplex Receiver and Speakers; solid-state Oscilloscope; solid-state Compu-Trainer. Plus, Amateur Phone Transceiver, FET Volt-Ohmmeter, Electronic Tube Tester, Signal Generator, and more! Get valuable experience in the latest electronics technology. Read details in catalog.



## AIR CONDITIONING/ REFRIGERATION & HEATING DIVISION

NTS provides you with the important tools of the trade! Courses include specially-designed Hermetic Unit Analyzer — a tester with multiple applications; Leak Detector-Soldering Kit — with hundreds of uses; Charging-Testing-Purging Manifold Set with dispensing and piercing valves. Plus, Socket, Wrench, Open-End Wrench, Tube Bender Sets, and more!



## MECHANICS DIVISION

NTS includes professional tools and test equipment. Earn as you learn. Make money even before you graduate! Big 109 piece Socket Wrench and Tool Set — all American made! And a Performance Kit — Timing Light, Smog Valve Tester, Compression Tester, Remote Starter Switch, Dwell Tach, Alternator-Generator-Regulator Tester. Also, "Speed Shop" lessons and diesel training.



## HOME APPLIANCE DIVISION

Multiply your experience with appliance circuitry through the exclusive NTS Circuit Trainer. Eliminates the need to buy dozens of appliances for training purposes. The 4-in-1 Appliance Tester performs many troubleshooting tasks. It includes an Ohmmeter, Voltmeter, Ammeter, and Wattmeter; measures both AC and DC currents; it will be valuable to you during training and on the job!

## APPROVED FOR VETERAN TRAINING

Accredited Member: National Association of Trade & Technical Schools; National Home Study Council.

## CLASSROOM TRAINING AT LOS ANGELES

Train in sunny Southern California. NTS occupies a city block with over a million dollars in training facilities. Check box.

## NATIONAL TECHNICAL SCHOOLS

WORLD-WIDE TRAINING SINCE 1905

Resident & Home Study Schools  
4000 So. Figueroa St., Los Angeles, CA. 90037

## NATIONAL TECHNICAL SCHOOLS

WORLD-WIDE TRAINING SINCE 1905

Resident & Home Study Schools

4000 So. Figueroa St., Los Angeles, CA. 90037

Send for color Catalog and Sample Lesson — both FREE! Check below. No salesman will call. No obligation.

- Electronics Division       Mechanics Division  
 Air-Conditioning, Refrigeration, Heating Division       Home Appliance Division

NAME \_\_\_\_\_ AGE \_\_\_\_\_

ADDRESS \_\_\_\_\_

CITY \_\_\_\_\_ STATE \_\_\_\_\_ ZIP \_\_\_\_\_

- Check for Veteran Training under G.I. Bill  
 Check if interested in information on Classroom Training in Los Angeles

Dept. 201-123

## DETROIT LISTENING POST

### GM orders: Make 'em small

Five new cars from GM! All mid-sizers or minis. The mid-sizers will be within an inch or two of GM's current X-body cars: Chevrolet Nova, Pontiac Ventura, Oldsmobile Omega and Buick Apollo. The minis will be smaller than today's Vega. When? As soon as GM can rev up to produce them. The Cadillac and Pontiac cars will be out a year from now—next fall or as mid-year introductions in the spring of 1975. The Buicks, Olds and Chevys will follow a year later.

GM has reluctantly confirmed smaller cars are coming from Cadillac and Pontiac. Reluctantly because there's a rule at GM that you don't take the shine off this year's cars by talking about what you plan to bring out next year or the year after. But the general managers of all five GM car divisions have said, either at press conferences or in private conversations I've had with them, that small is the only way to go "and we intend to compete in that market."

### Overdrive for Vega Wankel

Standard or as an option, one way or the other, overdrive will be used on the Wankel-powered Vega coming from Chevrolet next

year. But GM won't call it overdrive. It'll be known as the "fifth gear" and there will be an extra slot on the gearshift. GM's been running comparison tests of Wankel engine cars with and without the fifth gear and has achieved fuel economy results with overdrive equal to or surpassing mpg with piston engine cars.

### Chapter II on Mustang II

Part of Ford's pitch for Mustang II is that it was time to come up with a new car because the original Mustang had become too big, overblown and expensive. But Ford doesn't add that Mustang II was launched on the same course of bigger and better before the first II came off the line. The car will stay the same size for the next few years, but it will obviously cost more when V8 engine and performance driveline are added next year.

### Pontiac pedals to proliferate

Pontiac isn't going to have an exclusive on its adjustable foot pedals very long. (The brake and accelerator pedal can be moved

*(Please turn to page 32)*

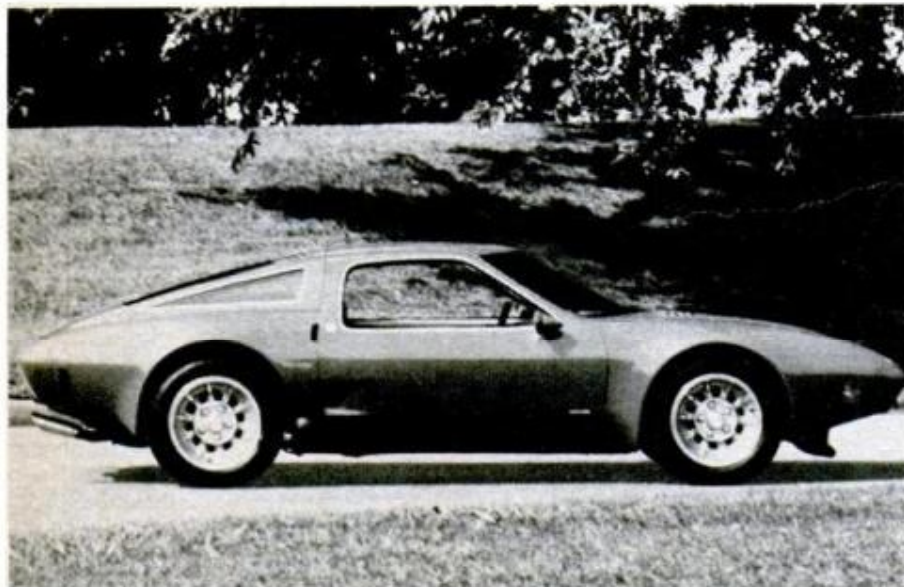

From Detroit with style. The long-anticipated mid-engine Corvette has arrived—not with trumpets and fanfare, but with utmost secrecy: It was whisked off to the European auto shows before we could do anything more than get a quick picture. This is the Corvette Two Rotor. It's only one of at least two models that'll be used to test public reaction before one of them becomes the '75? '76? production model. In the Two Rotor, the GMRE (General Motors Rotary Engine) mounts transversely ahead of the rear axle. It displaces 4.4 liters and is coupled with a three-speed automatic transmission. This hatchback is shorter and lower than the current Corvette, yet has better space utilization. Styling was done at the GM Tech Center; body is metal.

# TRY KOOL MILDs.

And taste the difference  
extra coolness makes in a  
lowered tar cigarette.



14 mg. tar,  
1.0 mg. nicotine

Kool Milds.  
We lowered the tar  
but didn't touch  
the unique taste of  
extra coolness  
that made Kool  
America's #1 selling  
menthol cigarette.

Discover a cooler kind of mild.

Warning: The Surgeon General Has Determined  
That Cigarette Smoking Is Dangerous to Your Health.

# Gift idea...



## freedom from flat tire worries!

Every auto, motor home, trailer, boat or truck should carry a 12-volt Auto-Flator for convenience and emergency. Plugs into car lighter to inflate any size tire in minutes. Easily inflates air mattresses, boats, rafts, pools, air jacks, etc. Only 6½" long yet amazingly produces up to 60 lbs. pressure. With air hose, plug and inflator attachments. 10-day moneyback guarantee. Send check or P.O.

**\$29.95**  
(plus \$1.00 shipping)

*Speedy* auto-flator.

Compressed Air From Car Lighter

W. R. BROWN CORPORATION

2773 N. Normandy Ave., Chicago, Ill. 60635

## DETROIT LISTENING POST

(Continued from page 30)

up or down, depending on how tall you are.) Other GM divisions are already lined up to pinch the idea next year. Cadillac's almost a shoo-in to have the item on its '75s and there's a fair chance Chevrolet will latch on to the feature for its top-priced cars. Ford also thinks well of the idea and is working on a me-too version.

The movable pedals make sense for a reason that won't become apparent for a couple years. The government is talking about a standard that would require seats to be bolted down in a fixed position. No more adjustable seats. This wouldn't present a problem for tall drivers, because they can cock their legs at the knee. It's not a comfortable way to drive, but you can do it. But if the seat is nailed down—permanently anchored to the frame—the under-average-size driver is going to have a tough time stretching to reach the pedals. That's no problem if the pedals can be moved up to compensate for what the driver lacks in length.

## Why BENJAMIN'S

NEW SUPER SINGLE SHOT AIR RIFLE

is just the Ticket for Plinkers Who Don't Want to Play Second Fiddle to Their Shootin' Pals.

The more you shoot this Super Single Shot, the more you'll appreciate what a rewarding companion it is to those who want top performance and versatility. One of the chief reasons many shooters put their confidence in Benjamin is the fact our new gun remains unchanged in basic design since 1908. And when you have been making anything as long as we've been building air rifles, you learn how to make them right. Of course, this new version is so strikingly different from older models you'd never know they had anything in common. Just the same, all the things we've learned over the years are embodied in our new pump-up. We're proud of this Benjamin and the fine reputation it has earned for Power, Accuracy, Dependability.

Besides these credentials and our insistent use of the best materials and workmanship, here are other features that have made Benjamin the great gun it is: reliable, time-tested action; adjustable firing force. Ramp-type front sight; adjustable stepped leaf rear sight. Thumb operated safety behind breech. Walnut Monte Carlo stock and pump handle. Safe, quiet, lightweight, odorless. It's a joy to shoot indoors or out—nails targets, tin cans, small game with amazing accuracy. 3 calibers. Reasonably priced. At your dealer's.

Use Benjamin H-C Pellets—Sized & Lubricated for greater accuracy. 177 & 22. 250 or 500 per can.

BENJAMIN AIR RIFLE COMPANY **FREE CATALOG**  
896 Marion St., St. Louis, Mo. 63104

YOU CAN DEPEND ON BENJAMIN

## Detroit to nullify gas stickers

Auto manufacturers apparently have a tacit understanding they won't try to cut each other up by using the fuel consumption labels on the '74 cars to claim one make is superior to another because it gives better mileage. The companies are putting the mileage stickers on at the urging of the Environmental Protection Agency. But they aren't happy about it. What happens if one company decides to promote its mileage figures by downgrading a competitor's car? It could happen, but it isn't likely.

As Chrysler said in a statement to EPA, it's common knowledge that small, light cars use less fuel than big, heavy cars. If you want to play the numbers game, Chrysler adds (as a threat?), "the chances of serious injury and death increase dramatically as the weight of the car decreases." In other words, if anybody builds a sales pitch around the gas numbers, they can expect a counter blast relating death statistics to vehicle size and weight. That ought to cool off any name-calling based on mileage claims. But that doesn't stop you from making the rounds of dealers and checking the mileage labels. ★★



# "I lost 5<sup>3</sup>/<sub>4</sub> inches off my waist, 25 pounds of excess weight... and shaped up... in just 14 days!"

One 5-Minute exercise, twice daily, lying on my back, without giving up the foods I love... Did It!"



Gordon as he looked the day he started.

After 7 Days — A remarkable transformation — pot almost gone — revitalized.

After 14 Incredible Days — Slimmed, reshaped, looking 15 years younger, feeling 25 years younger

## SEE AND FEEL AMAZING RESULTS IN JUST 3 DAYS!!

### WHAT IS THIS INGENIOUS PLAN?

The Weider "5" Minute Body Shaper Plan is based on doing ONE CONTINUOUS RHYTHMIC CO-ORDINATED EXERCISE while still eating the foods you like. That's all you do! This one five-minute exercise is designed to attack the Waist and Hips (where fat accumulates quickest, giving your body a flabby, weak and distorted look) — as well as burn off excess body fat fast by speeding up your metabolism, burning up stored calories and releasing excess water—while reshaping your chest, abdomen, firming up your legs and arms — your total body!

It's safer than strenuous workouts, beats the time consumption and dangers of gym workouts....or any other vigorous sport.

The unit weighs about 16 oz. and fits any wallet-sized case. You can carry it and use it wherever there's floor space — anytime. Even while watching television.

### WHAT COMES OFF IN 14 DAYS?

Individual results vary, but during an average 14 day period, you can expect to lose up to four inches from your waistline and up to ten pounds off your present weight. It strengthens your heart and lungs, increases stamina and endurance, improves your digestive function and general health. IT TOUGHENS YOU UP. For a "5-Minute Exerciser" — it sure does a lot!

### WHAT SATISFIED CUSTOMERS SAY:

Results vary depending on how much overweight each of our students is. Nevertheless, this is a sampling from the impressive letters we receive: Willie Ellis — "I lost 3 inches off my waist and 9 pounds in 7 days." Kent Christensen — "I lost 5 1/2 inches off my waist and 20 pounds in 10 days." Marino Zoller, M.D. — "I lost 2 inches off my waist in 14 days." Michael Benedict — "I lost 6 inches off my waist and 22 pounds in 21 days." Ken Waller — "I lost 3 inches off my waist in 5 days."

### WHAT THE EXPERTS SAY:

Medical Doctors, Chiropractors, Osteopaths, Athletic Coaches....agree its the most successful Waistline-Weight Reducer and Shaping Up Plan ever invented!

Patent Pending. Copyright Joe Weider, 1973

"Doctors have always known, exercise done while lying on the back virtually eliminates strains while slimming and reshaping the body. Yours is the finest Body Shaper Program on the market."

RICHARD TYLER, D.C.

"Beats jogging and working out in gyms — and much safer. I lost 4 1/2 inches off my waist in 14 days." — JIM HANLEY, famous athletic coach.

"Based on sound physiological and medical knowledge, it burns fat and shapes the body without strain to the heart or other organs. I lost 12 lbs. of excess weight using it." DR. ANITA D. SANTANGELO, Chiropractic Orthopedics

### \*EXPOSING EFFORTLESS EXERCISERS

Reader's Digest (Sept. 1971), New York Times and Good Housekeeping, among others, exposed sauna wraps, inflated belts, weighted belts and effortless exercisers as frauds. Scientific researchers, medical and fitness experts all agree...there is only one way to firm, shape and trim up your body... you must work the inches off!

## NO GIMMICKS, NO CATCHES MONEY BACK GUARANTEE OFFER

Because this isn't a "gimmick" plan — and you have been fooled in the past by "effortless exercisers" — I make you this UNCONDITIONAL GUARANTEE: "GET IT OFF FAST" — and see measurable and firming results in three days or return the exerciser for a full 100% refund! Proven results are already verified. The guarantee is in writing. Now, can you think of a reason for not ordering your "5-Minute Total Body Shaper?"

## FREE TRIAL OFFER!!

See your exciting new body begin to take shape in 3 days or every penny back!

**SEND TODAY**

Weight Just 16 oz.

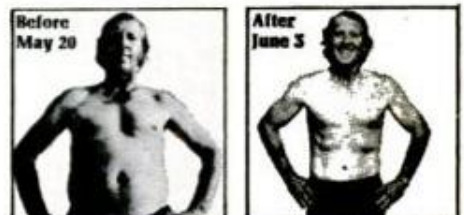

14 days shaped me up in the privacy of my home!

# '5' MINUTE BODY SHAPER

We Care About The Shape  
You're In — DON'T YOU?

**SEND TODAY** COMPLETE KIT \$9.95 ONLY

Joseph Weider, Dept. BR/L  
Trainer of Champions with Over 2,750,000  
Successful Students  
"5" MINUTE BODY SHAPER PLAN  
21100 Erwin Street, Woodland Hills, Calif. 91364

Prove to me I can see results and start shaping up in 3 days!  I enclose \$9.95 for "5" Minute Body Shaper & Slimming Course, plus \$1.00 for shipping and handling.  SAVE! Order TWO for only \$17.95, plus \$1.00 for shipping and handling. (No C.O.D.'s please). Enclosed is  check or  money order or  cash for \$..... (Calif. residents add 6% sales tax.)

Name ..... Age .....

Address .....

City .....

State ..... Zip .....

(Please print clearly)

IN CANADA: "5" Minute Body Shaper Plan, 2875 Bates Road, Montreal, Quebec.

# HINTS

## FROM READERS

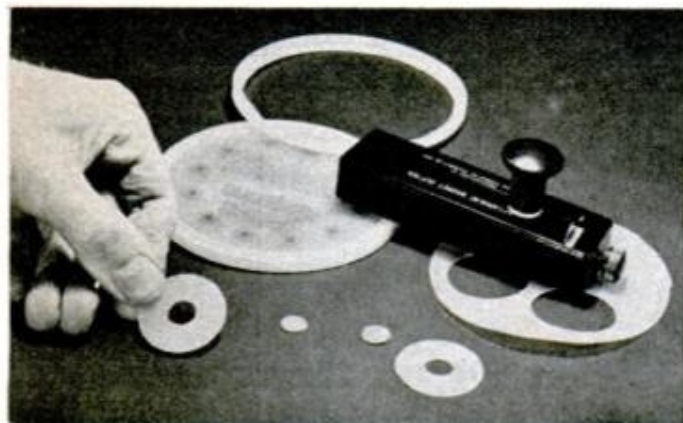

### Plastic washers

If you need resilient plastic washers, try cutting them from the polyethylene covers of food containers, such as those in which soft margarine is packed, or from the lids supplied with cans of ground coffee. You can form the washers with punches, a gasket cutter or a sharp knife.

—Walter E. Burton, Akron, Ohio

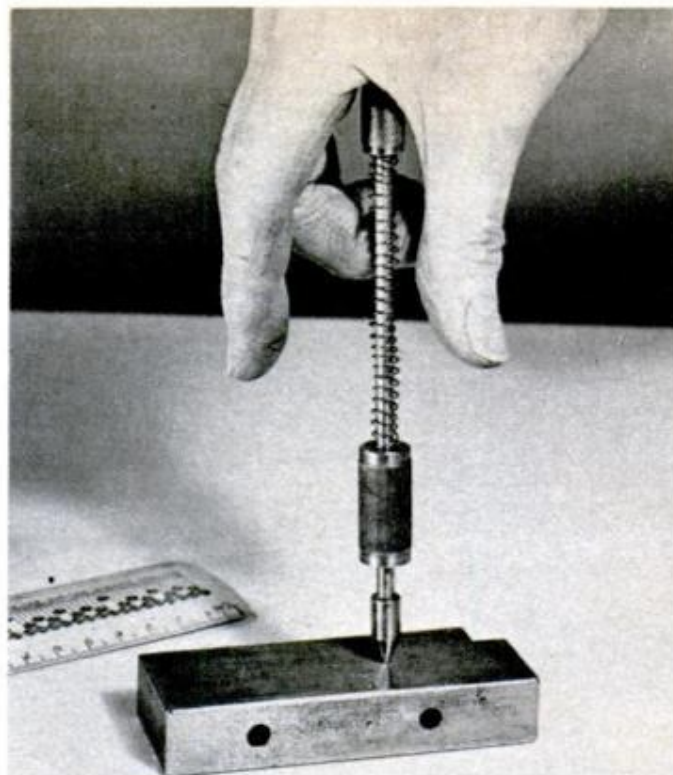

### Spring-driven punch

A sliding-hammer prickpunch that usually requires two hands to use can be adapted for one-hand operation. Slip a light compression spring onto the shaft between hammer and punch handle, then replace punch head. Hold tool on the spot to be marked, lift and release hammer with a snap.

—Peter Legon, Malden, Mass.



### Nonmarring twist-drill stop

To limit penetration of a drill bit through sheet metal when making holes for self-tapping screws, a stop can be made from an empty fountain-pen cartridge (Sheaffer) and a piece of  $\frac{3}{8}$ -in. o.d. aluminum tubing. About  $\frac{1}{8}$  in. of cartridge projects past tubing, acting as a cushion to reduce marring of the work.—E. B. Walters, Chicago

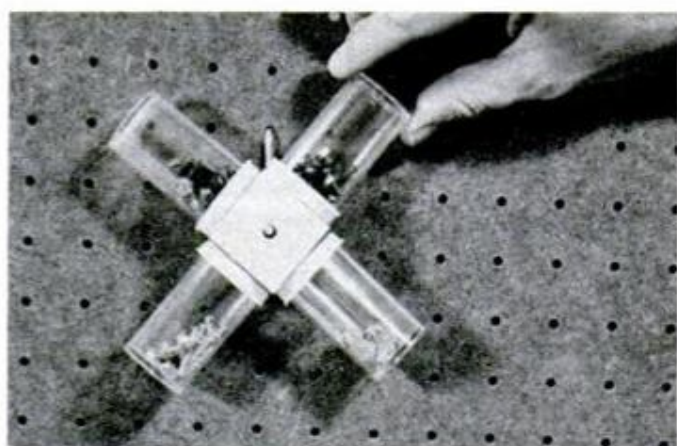

### Small-parts containers

Pill bottles are excellent containers for small parts in the workshop. They are even more useful when grouped as shown here. The caps are fastened to a cube of wood, through which a hole has been drilled, allowing it to be hung on a standard hook for perforated hardboard.

—Ken Patterson, Regina, Sask.

# WHILE YOU'RE WARMING UP YOUR CAR, YOU COULD BE WEARING OUT YOUR ENGINE.

You've probably heard many times that you should warm up your car engine a little before driving off, but a lot of people have a tendency to overdo it.

They let the car run while they're having their morning coffee and figure that when the seat is warm enough to sit on, the engine is warm enough to start traveling.

It's a very comfortable misleading myth. And we'd like to explain why.

When you start cold, extra fuel is delivered to the cylinders because the automatic choke provides a rich mixture of gasoline and air.

The extra gasoline washes some of the protective oil off the cylinder walls and piston rings. As this continues to happen, you get more and more wear on these parts. And the oil in your crankcase is diluted with gasoline.

The right idea is to get the engine up to a normal operating temperature as quickly as possible, after a brief idle period to assure that engine oil pressure is normalized. The automatic choke will then turn off and the engine will get to a normal, leaner mixture sooner.

This getting to a normal operating temperature is best done by driving. Not by standing still.

Of course, there are other ways of minimizing wear. One of them is by choosing the proper grade of a high-quality motor oil to put in your crankcase.

We at Gulf take great pride in the quality of motor oils we produce. In fact, our top line oils are named Gulfpride. If you stop at one of our Gulf dealers, he'll be happy to tell you about them or anything else you'd like to ask about your car.

Or send your questions direct to: Gulf Consumer Information, Box 1519-H, Houston, Texas 77001.

You see, at Gulf, we'd like you to learn all you'd like to know about your car. And our products. That way we can keep you on the road. And us, too.

**GET TO KNOW GULF AND YOU'LL GET TO KNOW YOUR CAR.**



GULF OIL CORPORATION

# IF YOU CAN USE ANY OF THESE TOOLS...

... you can build yourself a Bell & Howell  
solid-state 25-inch diagonal color TV...  
and maybe build a whole new future  
while you're at it!



"Electro-Lab" is a registered trademark of the Bell & Howell Company.

If you're already handy with a set of tools, here's a way to pick up a pretty thorough knowledge of electronics: build yourself a solid-state color TV as part of a complete learn-at-home program from Bell & Howell Schools.

This important project gives you valuable "hands on" experience with solid-state circuitry—the kind of *practical* experience you'll need to build a successful career. It's a vital part of your total electronics education.

Once you've completed your program from Bell & Howell Schools, you could have an exciting career opportunity waiting for you in the growing field of home entertainment electronics. You might even end up with a business of your own in color TV servicing.

#### Fix stereo systems... FM-AM radios... phonographs... tape recorders

With your new skills, you can build and service stereo-hi-fi systems—including FM-AM radios... phonographs... open reel tape recorders and cassette or cartridge player/recorders. You could even build yourself a complete "home entertainment communications center"—complete with the new gadgetry of cartridge television when it comes out. The skills you build by following this unique program are more than enough to service almost any type of home entertainment electronics device.

#### A complete at-home learning program in home entertainment electronics

Your color TV project is probably the best way for you to learn the most advanced "state of the art" concepts of sophisticated electronics circuitry. It's part of a complete at-home learning program prepared by skilled instructors at Bell & Howell Schools. Mail the postage-free card today so that our representative can bring you all the facts at no obligation.

It doesn't matter if you've never had any training in electronics before. Nobody's going to start throwing "diodes" and "capacitors" at you right off. You start with the basics. You take it one step at a time. You walk before you run. And you'll be amazed at how quickly you start to feel comfortable with things that seemed complicated at the beginning.

#### Attend special "help sessions" if you like

In case you run into a sticky problem—or you want to discuss your project with an instructor—come in and see us. We've scheduled special "help sessions" regularly at the Bell & Howell Schools and in many other cities throughout the U.S. and Canada. Drop by. Meet an expert instructor in person. Talk over any rough spots with him—and with other students. You'll enjoy the chance to "talk shop."

#### Master the most up-to-date solid-state circuitry

Solid-state is here to stay. Not just color TV but almost every type of electronic device will eventually move farther and farther in the direction of *total* solid-state circuitry. Get to know the most advanced "trouble-shooting" techniques for these sophisticated circuits. You'll find an almost irresistible demand for your skills.

#### Why you should know electronics

No matter where you look, the amazing technology of electronics is becoming a bigger and bigger part of the picture. More and more automotive parts and diagnostic instruments are electronic. Many large manufacturing plants use sophisticated electronic systems—controlled by a few skilled electronics technicians. The increasing use of two-way radio... the huge promise of cable television... the astonishing growth of electronic data processing all open doors to exciting new career opportunities for the man with thorough training in electronics. In fact, the day may come when the man who does *not* have electronic skills will be severely handicapped in many industries.

#### Why you should get your training from Bell & Howell Schools

Skilled instructors at Bell & Howell Schools—carefully selected for their knowledge, experience and teaching ability—plan each program with the utmost care and attention. Each year, they spend over \$200,000 improving programs to keep them up-to-date with the latest technology. Many Bell & Howell Schools graduates have used their home study training to get started in exciting new careers or businesses of their own in electronics. You could too!

#### With your first lesson you get...

... the Laboratory Starter Kit! A volt-ohm-meter (VOM) with design panels, modular connectors, experimental parts and battery power source. Gives you *immediate* "hands on" experience with your very first lesson.

#### You also build and keep the exclusive Bell & Howell Schools Electro-Lab® electronics training system

To make sure you get practical experience with instruments used daily by professionals, you build yourself a Design Console, an Oscilloscope and a Transistorized Meter (see details at right). These are the three instruments you'll work with constantly—both during your program and thereafter.

#### CONSIDER THESE ADVANTAGES:

**Help Sessions** We've scheduled special "help sessions" regularly at the Bell & Howell Schools and in many other cities throughout the U.S. and Canada. Top instructors give you expert advice and you meet other students, too.

#### National Career Placement Center

When you complete your course, we will help you in your search for a job in a field of electronics that fits your background and interests. Although we cannot guarantee jobs to our graduates, this placement service is available at any time after you graduate.

**Veterans' Benefits** We are approved by the state approval agency for Veterans' Benefits. Check the box for details.

**Student Financial Aid** We are an eligible institution under the Guaranteed Student Loan Program. Check the box for details.

#### For Free Information, Mail Card Today!

If card has been removed, write:

An Electronics Home Study School  
DeVRY INSTITUTE OF TECHNOLOGY

ONE OF THE  
**BELL & HOWELL SCHOOLS**

4141 Belmont, Chicago, Illinois 60641

Detach postage-paid  
reply card and  
mail today for Free  
Information!



25-inch  
picture  
(measured  
diagonally)

■ **Bell & Howell Solid-State 25-inch color TV.** Ultra-rectangular tube... 25-inch picture measured diagonally... full 315 square inch viewing area. Solid-state modular circuitry... 4 advanced IC's... 100 transistors... 72 diodes... individual plug-in circuit boards. Special UHF/VHF tuning features... built-in self-service components.

■ **Design Console** Use this to rapidly "breadboard" circuits without soldering. Equipped with built-in power supply... test light... speaker... patented plug-in modular connectors.

■ **Oscilloscope** Portable 5-inch wide-band oscilloscope offers bright, sharp screen images... calibrated for peak-to-peak voltage and time measurements... 3-way jacks for leads, plugs, wires.

■ **Transistorized Meter** Combines most desired features of vacuum-tube voltmeter and quality multimeter. Registers current, voltage and resistance measurements on a large, easily-read dial. Features sensitive, 4-inch, jewel-bearing d'Arsonval meter movement.

528R

## CAR CLINIC

BY MORT SCHULTZ

### Racked up

*Because of limited trunk space, I would like to install a luggage rack on the roof of my 1972 Comet. However, there is no rack made specifically for this car. A visual check suggests that the rack made for the Pinto Runabout might fit. The dealer can't tell me for sure and says that he won't make the attempt unless I agree to buy the rack whether it fits or not. I would like to have some assurance before spending \$50, so I'm turning to you.—Glenn Murphy, Frankfort, Ky.*

The luggage rack made for the Pinto Runabout will fit your Comet if your Comet is a two-door model. Another possibility you might consider in order to increase the car's luggage capability is to install a rear-deck luggage rack rather than a roof rack. A rear-deck rack is made for your car and is labeled part No. C9AZ6255100A.

### Toss-up

*I have heard that riveted brake linings are superior to bonded brake linings. Is this true?—W. A. Lee, San Francisco, Calif.*

Quality brake linings are superior to inferior brake linings, and here the difference ceases. However, it's my opinion that riveted linings do provide one advantage. They issue a "warning" in the form of a squeal when lining wear is approaching the critical stage. This noise is produced when protruding rivets rub against the brake drum. With a bonded lining, squeal indicates the lining wear has proceeded beyond the warning stage and the webbing is striking the brake drum. This may cause drum distortion.

### Water torture

*My car, a 1971 Plymouth with 318-cu.-in. engine and dual exhaust, expels a substantial amount of water from both tailpipes in cold and warm weather. This has resulted*

*in two mufflers and a tailpipe rusting out in one year. Please help.—R. L. Williams, Jacksonville, Fla.*

Chrysler Corp. advises that this is not an unusual occurrence with a car that isn't driven "extensively." However, you might have a bad head gasket. Coolant can leak past a bad gasket and be expelled through the exhaust system. Check the gasket by putting the cooling system under pressure overnight with a cooling system pressure tester. Next morning remove sparkplugs and check for moisture at the tips. The presence of moisture verifies a bad gasket.

### Hub-cap hubbub

*The hub caps of my 1973 Chevelle are too loose. How can they be tightened?—Glen Remington, Denver.*

Owners of 1973 Chevilles, Monte Carlos and Camaros with this problem will be happy to learn that hub caps may be tightened by bending the retaining tabs (four small projections) slightly. Only a slight holding force is needed to keep hub caps gripped securely, so don't overdo it. Bending a tab too much will snap it. Test to see if a hub cap is tight enough by trying to rotate it on the wheel. If there's sufficient friction, the hub cap is secure.

### Glowing report

*The alternator indicator light of my 1971 Ambassador began to glow three months ago and hasn't gone out. The alternator has been checked, and output is 60 amps. The regulator has been replaced, but that didn't extinguish the glow. The battery has not lost its full charge either. In other words, the car is operating perfectly except for that menacing glow. How do I get rid of it?—Arthur Saumier, Detroit.*

Probably by replacing the triode plate (also called the diode trio) in the alter-

*(Please turn to page 42)*

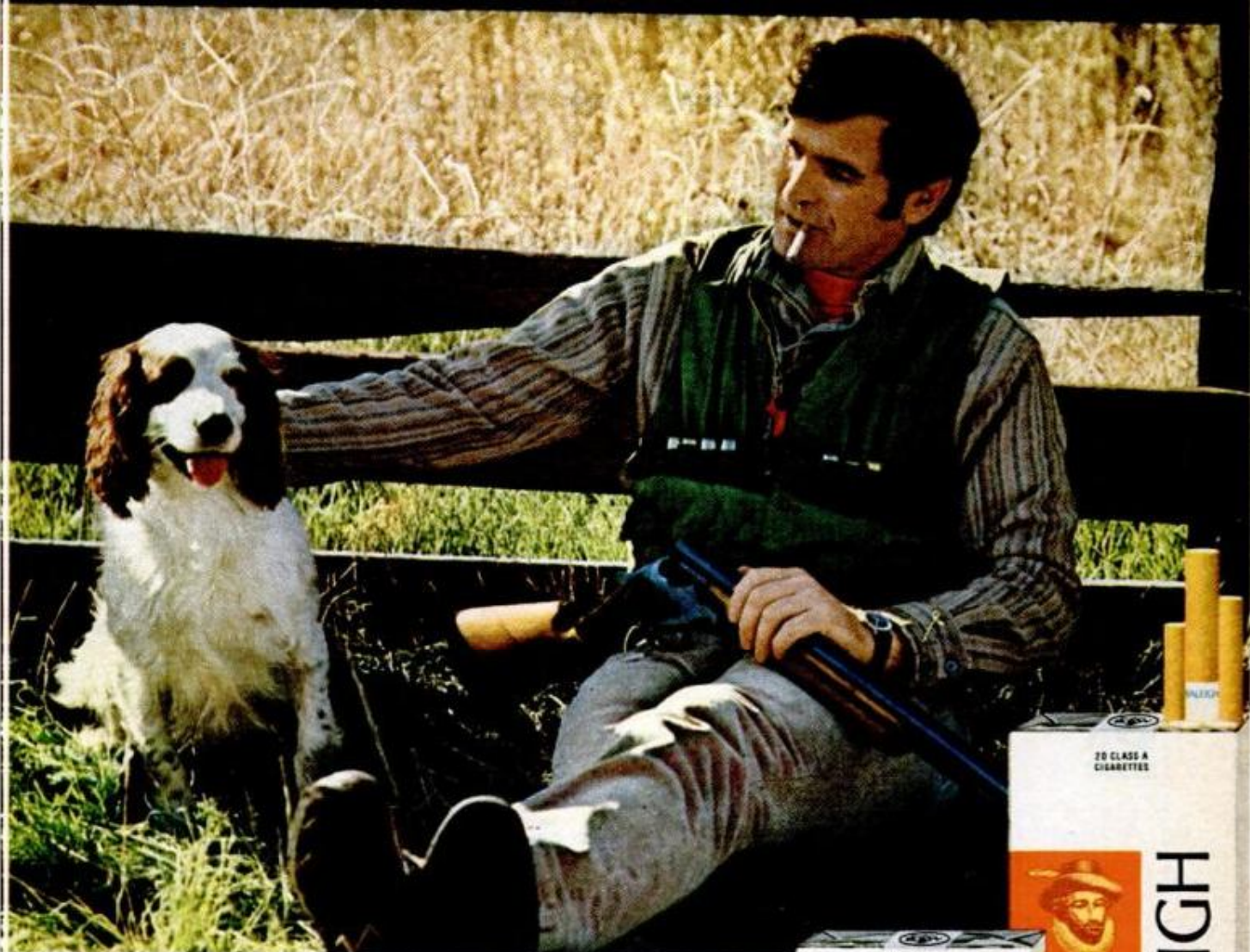

# Spend a milder moment with Raleigh.

A special treatment softens the tobaccos for a milder taste.



Trustworthy. You can always depend on this Mercury calendar watch by Timex. Sweep second hand. Chrome-plated case, stainless steel back. Yours for free B&W coupons, the valuable extra on every pack of Raleigh.

To see over 1000 gifts, write for your free Gift Catalog: Box 12, Louisville, Ky. 40201.

© BROWN & WILLIAMSON TOBACCO CORP.

Filter Kings, 16 mg. "tar," 1.2 mg. nicotine; Longs, 18 mg. "tar," 1.3 mg. nicotine, av. per cigarette, FTC Report February 73

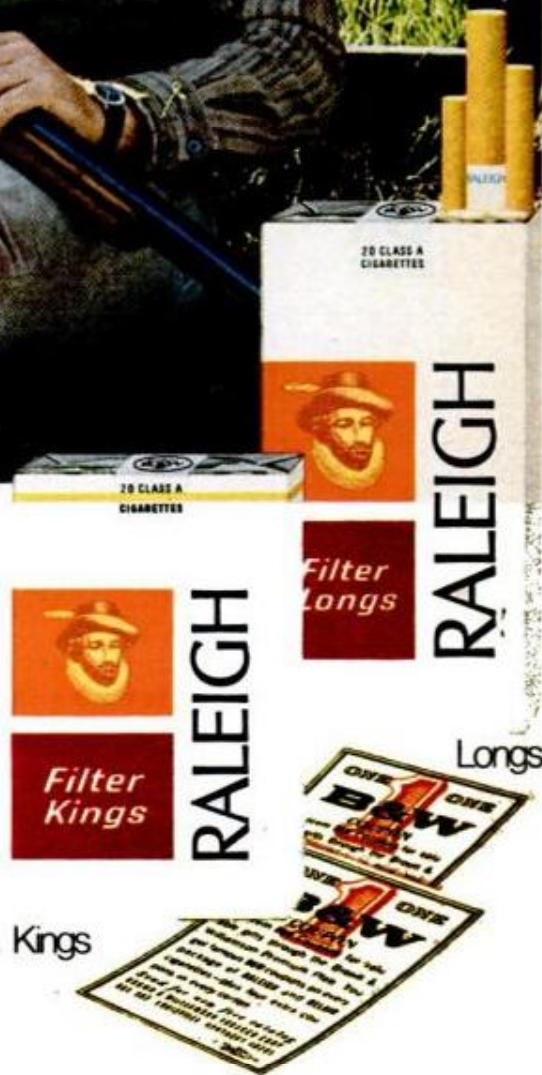

Warning: The Surgeon General Has Determined That Cigarette Smoking Is Dangerous to Your Health.

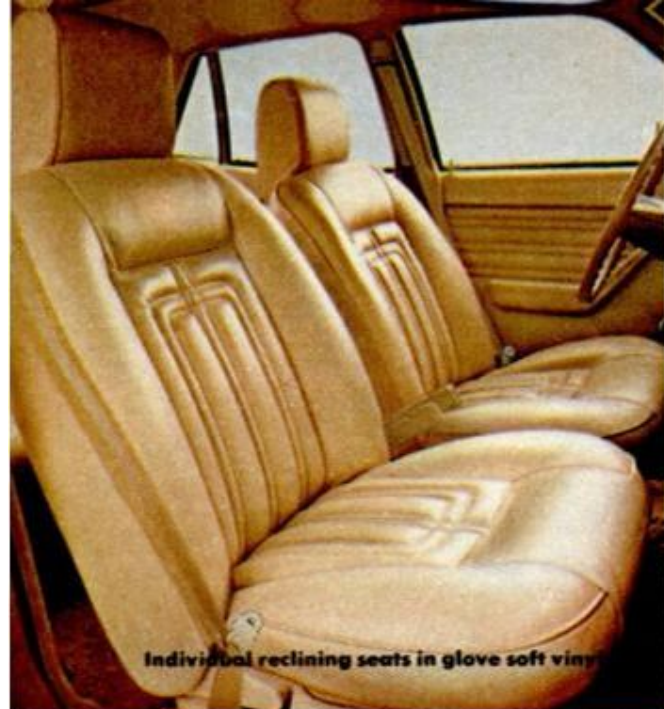

Individual reclining seats in glove soft vinyl.



Grained vinyl roof.



Family-size back seat.

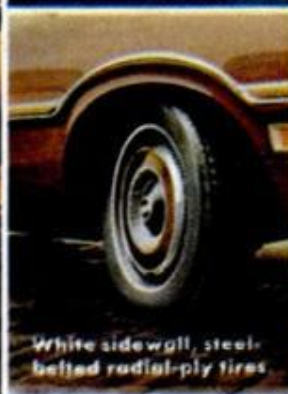

White sidewall, steel-belted radial-ply tires.



Plenty of room for a family of five.

## Surprising luxury and comfort in an

### CAR CLINIC

*(Continued from page 40)*

nator. The triode provides a sensing voltage to the alternator regulator. The indicator light receives current from the triode. If there is an imbalance in voltage resulting from a faulty triode, the indicator light will begin to glow.

To find the problem, connect a voltmeter between the output terminal and the regulator terminal of the alternator with engine running and lights and heater blower motor turned on. A reading of over 0.6 volt indicates a faulty triode.

If you don't want to replace the triode, which costs about \$25, no harm will be done. You can get rid of the glowing light by installing a heavy-duty bulb and socket adapter contained in a kit (part No. 3207588).

### Hunting down a hum

*A hum from the rear of my 1971 Pontiac Ventura occurs between 50 and 60 mph. The dealer has told me to live with it—that*

*there is nothing wrong. Is he telling me the truth?—Matthew Korecki, Philadelphia*

There definitely should not be a noise. However, it is very difficult for someone to pin down the cause without at least being able to drive the car. Several things may cause a noise—a bad bearing, for example. Unfortunately, determining whether there is a bad bearing in the rear entails disassembly of the differential and examination of each bearing for damage.

There is one way you can try to pinpoint the problem area. Inflate the rear tires to 50 p.s.i. and road-test the car. If the character of the noise is changed, then noise is probably being caused by tires.

I have consulted Pontiac about this problem, and the company has told me to tell you that you should have your dealer contact the customer service department at the company's Philadelphia zone office if he can't resolve the problem.

### Hard to resist

*The problem I'm having with a 1969 Nova, 250-cu.-in. engine, is really baffling. I am*





## economical family car. Ford Maverick for 1974.

Ford Maverick has always been an inexpensive car to run with a reputation for good gas mileage. Now Maverick with Luxury Decor Option also offers many appointments you'd expect on a luxury car. It's the economical family compact that doesn't ask you to give up luxury. See it now at your Ford Dealer's. The closer you look, the better we look.

## FORD MAVERICK

FORD DIVISION 

*now on my third coil. Checking at the coil positive with the engine running, I find that the coil is receiving 12 volts when it should be getting only a maximum of 8. With the resistance-wire bypass at the starter solenoid disconnected, I still get 12 volts at the coil positive. The ignition system seems to be wired correctly if one is to believe color coding.*

*In other words, it seems that the resistance wire has failed and is allowing too much juice to flow; which is hard to believe. I would expect a failure either by grounding, or by complete or partial breakage, which would give too little juice. What do you think?—William Vosseller, Perth Amboy, N.J.*

Try this theory. Just suppose that someone replaced that resistor wire with a wire having no resistance. What would you get at the coil positive? Right—12 volts.

Add a resistor or a resistor wire rated at 1.80 ohms.

### SERVICE TIPS

**Sticking key?** If you have trouble getting the key out of the door or trunk-lock cylinder, the problem may be insufficient lubrication inside the lock cylinder. Inject some silicone lubricant, such as Dow Corning 4X, into the cylinder. Insert and withdraw key a few times to disperse lubricant.

**Ford** advises that 1971-73 models with C-6 automatic transmission may lose transmission fluid through the vent if operated at 70 mph or more when air temperature is 80° F. or higher. The company suggests you judge your driving conditions and if they meet these criteria that you reduce the transmission fluid to the "Add" mark on the dipstick after the car has been driven sufficiently to bring the fluid to operating temperature. It's at this temperature when the dipstick is too hot to hold at the shaft.

**Olds owners:** Windshield-wiper blade chatter with 1971-73 Oldsmobile 88s, 98s and Toronados may be a thing of the past. Dealers now have a new shroud top vent screen (part No. 9688242) to reduce pressure on wiper-blade inserts. ★★

**GOT A PROBLEM WITH YOUR CAR? Ask Mort about it. Send your question to Car Clinic, Popular Mechanics, 224 West 57th St., New York, N.Y. 10019. Letters cannot be answered individually, but problems of general interest will be published in the column.**



1933



1973

Loctite Lock n'Seal is a revolutionary liquid material that hardens in the *absence* of air. It fills the gap between threaded assemblies to make them vibration proof. Lock washered assemblies can vibrate loose. Assemblies treated with Lock n'Seal can't. Yet disassembly's just as effortless. Use it on auto engines, power mowers, cycles, outboard motors, bicycles . . . wherever a loose bolt or screw can cause problems. Ask for Lock n'Seal at your hardware or auto supply store.



Loctite Corporation — Newington, Connecticut 06111



Give old John something to shut him up.

Leaks. Squeaks. Whistles. Chances are, your toilet is trying to tell you it has a serious problem. Simple, but serious. An out-dated, corroded ball cock that leaks.

There are different ways to deal with toilet noise. Pretend to ignore it. Have some sleepless nights. Fuss and cuss a lot (not recommended where children are present).

Or, stop toilet noise once and for all. With Fluidmaster.

Fluidmaster eliminates the old-fashioned tank float and arm. And, because Fluidmaster operates hydraulically, it works with water pressure, for fast, positive shut-off.

Write today for full details.

And give John the silent treatment.

Manufacturer of the Model 100, 200 and 400.



FLUIDMASTER, INC.  
1800 Via Burton  
Anaheim, Calif. 92805

SPECIAL OCT. 15 - DEC. 31 ONLY!

# FREE!!! \$37.<sup>95</sup> LATHE CHUCK

With your order for the UNIMAT 5-in-1 Metal Machine Shop



precision lathe

UNIMAT changes in seconds from a precision lathe to vertical miller, drill press, surface grinder, polisher.

UNIMAT is designed for the serious modelmaker, hobbyist and gunsmith who is satisfied with nothing less than professional accuracy in everything he creates. More than 100,000 UNIMATS in use all over the world.

This offer good from Oct. 15 thru Dec. 31 only. See your participating dealer now. If he cannot supply use handy order form to mail your order today. Prompt shipment.

only **\$199.<sup>50</sup>**  
F.O.B. TENAFLY, N. J.



DRILL PRESS



SURFACE GRINDER



VERTICAL MILLER

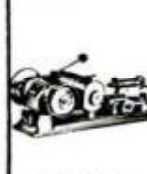

POLISHER

Now, from Oct. 15 thru Dec. 31 only, get a heavy duty 3-jaw chuck, that regularly sells for \$37.95, FREE with your purchase of a complete UNIMAT, the bench machine shop every home mechanic or hobbyist wants to own.

A wonderful Christmas gift for the model builder, the gunsmith and for any hobbyist who wants to make his own small metal, plastic or wood parts in a hurry. Famous self-powered UNIMAT, the precision lathe only 17" long, is also a vertical miller, drill press, surface grinder and polisher. Handles all machining operations including threading and boring. Change from one operation to another in seconds. Buy your UNIMAT during this special promotion period from your nearest participating dealer, and get this versatile chuck that also serves as a milling bed vise. Precision ground and balanced, reversible jaws, accurate to .003".

Use this coupon to send your order with check for immediate shipment. Order must be postmarked on or before Dec. 31, 1973.

AMERICAN EDELSTAAL, INC./ BL-3 /Tenafly, N. J. 07670

Rush complete catalog and list of participating Dealers

Here is my check (money order) for \$199.50 for a complete UNIMAT in its own carrying case. I understand I am to receive as a FREE bonus a 3-jaw Universal Lathe Chuck, that regularly sells for \$37.95. I further understand that UNIMAT carries a six month guarantee against defective parts and workmanship. (This special bonus offer expires Dec. 31, 1973)

Charge my purchases through:

Am. Exp.  Diners Club  Bank Americard  Master Charge

My Act. # is \_\_\_\_\_ Expiration date \_\_\_\_\_

Master charge Interbank (4 numbers over your name) \_\_\_\_\_

Signature \_\_\_\_\_

Name \_\_\_\_\_

Address \_\_\_\_\_

City \_\_\_\_\_ State \_\_\_\_\_ Zip \_\_\_\_\_

Here is \$2 for UNIMAT 44-pg. Handbook, "Miniature Machining Techniques"

## Protect your valuables & lovable with the Archer® Photoelectric Warning System.



27<sup>95</sup>

Guards any area or entrance with a beam of light! Use it as an intruder alarm or to announce visitors.

Sounds a siren or bell either of two ways: 1) Continuously, once beam is broken. 2) Only during time beam is broken. Easy setup — just aim light beam at "eye" of receiver. AC powered for low-cost 24-hour protection. #275-489.

**ARCHER**  
by  
**Radio Shack®**

and ALLIED RADIO STORES 304

A TANDY CORPORATION COMPANY

P. O. Box 1052, Fort Worth, Texas 76107

FREE '74 CATALOG

AT YOUR NEARBY STORE OR MAIL COUPON

180 Pages . . . Full Color! Hi-Fi, Recorders, Radios, CB, Kits, Antennas, Parts, More!

Name \_\_\_\_\_ Apt. # \_\_\_\_\_

Street \_\_\_\_\_

City \_\_\_\_\_ State \_\_\_\_\_ ZIP \_\_\_\_\_

Prices may vary at individual stores.

Accessory Bell  
#273-020  
4<sup>95</sup>

Accessory Siren  
#275-497  
2<sup>95</sup>

Place light source & receiver up to 50' apart!

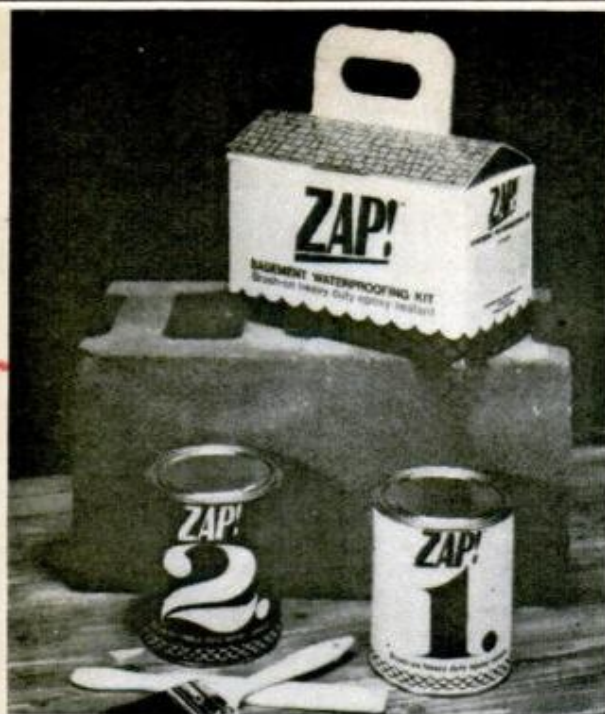

### New epoxy sealant ends basement leaks

Zap, a two-part formula used by professional waterproofers, is now packaged for home use. It brushes on, dries quickly, withstands water pressure of two tons per sq. ft. Great for licking leaks in basement walls and swimming pools. Half-gallon kit (\$13.95) covers 100 sq. ft. Construction Chemical Corp., Dept. M, Box 257, Monroe, CT, 06468

### WHAT DO YOU REALLY WANT FOR CHRISTMAS

Another Tie, a Shirt, how about after-shave? When you are asked that question, think about these books.



#### PAPERBOUND FROM ENGLAND, \$2.00 EACH

**LATHE ACCESSORIES**—how to make and use them.  
**FOUNDRY WORK FOR THE AMATEUR**—from pattern-making to building your own furnace in your backyard.

**HARDENING & TEMPERING ENGINEERS TOOLS**—chisels, taps, lathe tools, equipment needed.

**MILLING IN THE LATHE**—including how to mill without attachments and how to build your own.  
**HOW TO WORK SHEETMETAL**—with a minimum of equipment.

**SOLDERING & BRAZING**—from fixing the coffee pot to installing plumbing or building a model boiler.

**GEAR WHEELS & GEAR CUTTING**—including how to cut gears on a lathe and the design of gears.

**MICROMETERS, SLIDE GAUGES & CALIPERS**—their selection and use in the home shop by amateurs.

**SHARPENING SMALL TOOLS**—drills, screwdrivers, knives, scissors, drawing instruments, saws, etc.

The **BEGINNERS GUIDE TO THE LATHE**—an introduction to using the small lathe in the home shop.

FREE with an order of 3 books, the **CRAFTSMANSHIP CATALOG**, normally \$1. And if you order all 10, you receive **ELECTROPLATING FOR THE AMATEUR** absolutely FREE!



**CALDWELL INDUSTRIES**

Box 170

Luling, Texas 78648

### PRESCRIPTION EYEGLASSES BY MAIL

direct from manufacturer

Your own doctor's prescription will be filled, or your present lenses duplicated. The latest fashions. All types of lenses available. Accuracy and perfect fit absolutely guaranteed.

**SEND FOR FREE FAMILY CATALOG. TODAY!**

Est. 1959 in a hurry to receive a catalog? . . . add 25¢ for 1st class mail.



**PRISM OPTICAL INC.**

Dept. M-22 135 West 41st St., N.Y., N.Y. 10036



### BUILD THESE BEAUTIFUL CLOCKS



**NOW AT BIG SAVINGS!**

Send just \$1 for plans & instructions to build choice of: (A) Grandfather, (B) Steeple, (C) Grandmother—plus information-packed catalog of movements, dials, parts & kits to build these & 16 other fine clocks. All 3 plans—\$2.50. Catalog alone—25¢.

**MASON & SULLIVAN**  
 Dept. PM, Osterville, MA 02655  
 IN CANADA: COLONIAL TIMES  
 Box 2 Stn S Toronto, Ontario M5M466

## SUBSCRIBER'S

### Change of Address Form

Please use this form to notify us at least six weeks before you move to your new address.

**1. Present address:** Attach address label from a recent issue, or print your name and address exactly as shown on the label.

NAME _____
ADDRESS _____
CITY _____ STATE _____ ZIP _____

**2. Fill in new address:**

NAME _____
NEW ADDRESS _____
CITY _____ STATE _____ ZIP _____

**3. Mail this form to:**

**POPULAR MECHANICS**  
 Subscription Service Dept.  
 Box No. 646  
 New York, N.Y. 10019

# Who made the difference between oil that poops out and oil that protects?

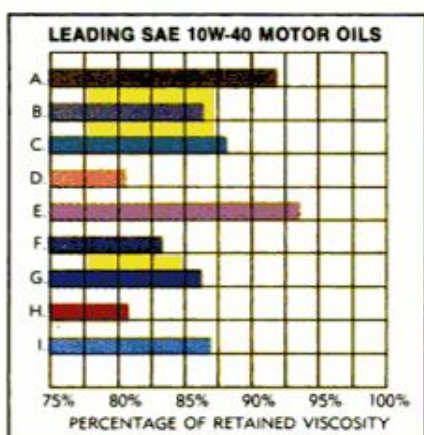

Shear stability chart of the leading SAE 10W-40 motor oils.

(Shear stability — the ability of an oil to retain its viscosity after use.)

Viscosity loss begins almost immediately during use. Several of these oils no longer retain their SAE 40 viscosity characteristics.

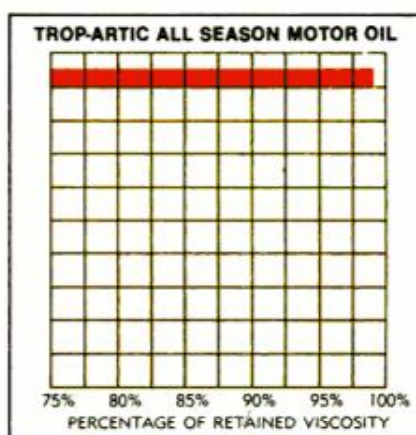

Shear stability chart of Trop-Artic All Season motor oil.

Trop-Artic retains nearly all its viscosity during use. Remaining more like a new oil mile after mile. And providing superior lubricating properties for a wide range of operating conditions over a long period of time.

The difference. Special additives that made this multi-grade retain its original characteristics longer.

And who makes Trop-Artic All Season motor oil? The same company that makes other



fine products for your car.

The Performance Company: Phillips Petroleum Company. Surprised?



**The Performance Company**

Test conducted in accordance with American Society for Testing and Materials (ASTM), Method D 2603-70. For a summary of the test write Phillips Petroleum Company, Manager Lubricant Sales, Bartlesville, Oklahoma 74004.

# Find the answers to 1001 workshop questions

## quickly, easily with the **POPULAR MECHANICS MASTER SHOP GUIDE**

24 hangup boards, coated with wipe-clean plastic keep vital how-to-do-it information always at your finger tips.

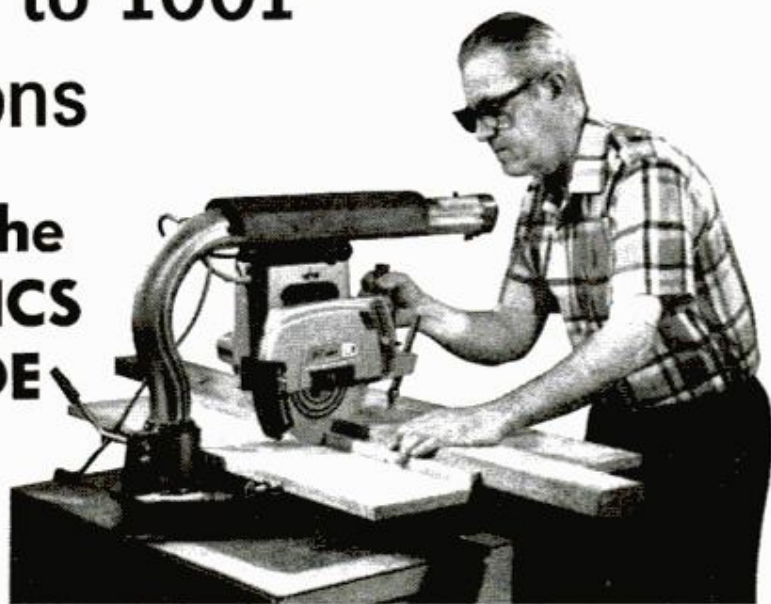

Here in an easy to use, last-forever format are the answers to everything you'll ever need to know about: nails, screws, bolts, wall-fasteners, drills, abrasives, lumber, hardwoods, moldings, plywood, hardboard, gypsum, adhesives, plumbing, electrical work, floor and wall tile, glass. Facts on remodeling measurements, gutters, concrete, garden chemicals. Plus—all on one board—a ruler, protractor, 45-degree triangle, and compass for accurate circles! You'll reach for the **MASTER SHOP GUIDE** for every job you tackle!

What nail should you use? How many pounds will a 1/4-inch toggle bolt hold? How can you save money ordering lumber? What size quarter-rounds are available? How do you bleach close-grained hardwoods? What glue is best?

Repairs, too! Illustrations on plumbing, electrical, floor or wall tile, plastic laminates, glass, remodeling. All the basic dimensions you'll need!

By the editors of *Popular Mechanics*—order yours now—you'll use it the rest of your life!

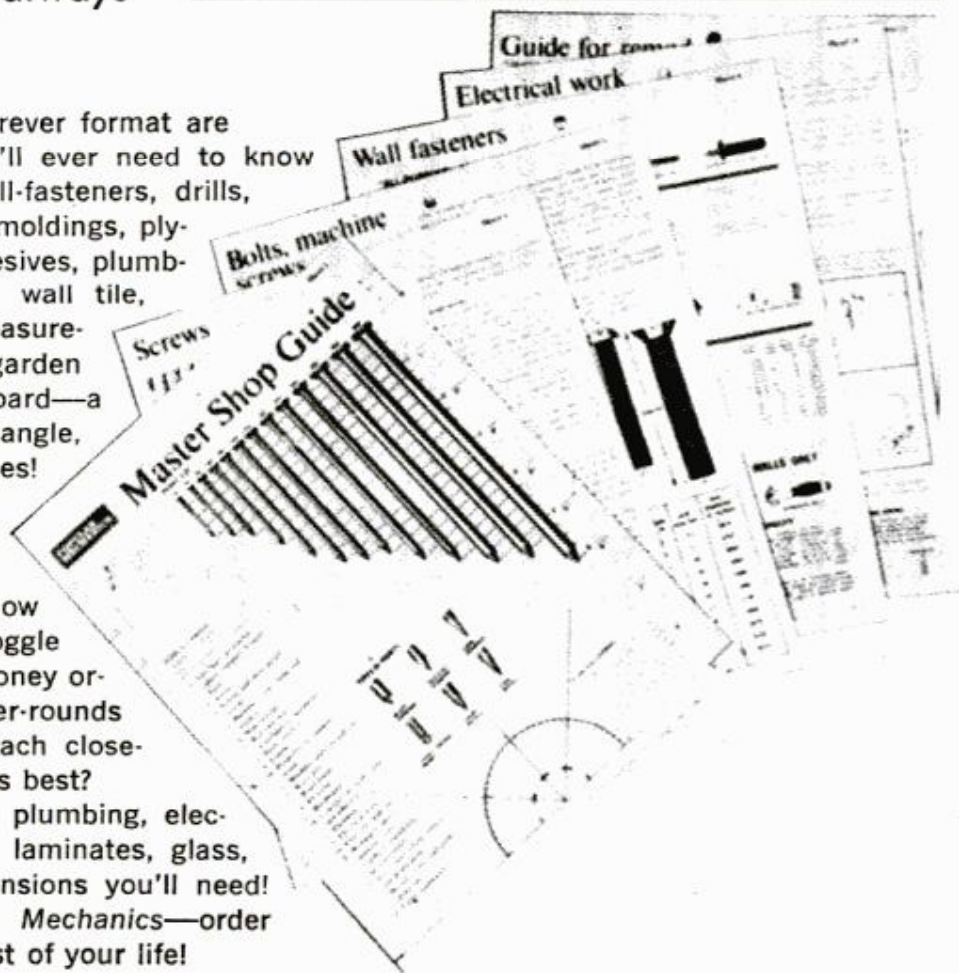

Popular Mechanics  
P.O. Box 1014 Dept. SG  
Radio City, New York 10019

Rush me \_\_\_\_\_ sets of the  
**MASTER SHOP GUIDE.**

I enclose check or money order  
for \$3.95 for each set ordered.

NAME \_\_\_\_\_

ADDRESS \_\_\_\_\_

CITY \_\_\_\_\_ STATE \_\_\_\_\_ ZIP \_\_\_\_\_

# "THE EASY WAY TO RICHES"

## Recreation-Oriented Catalog Mail-Order Business

SPORTING GOODS, FIREARMS, FISHING TACKLE, WATER SPORTS EQUIPMENT AND MARINE PRODUCTS.

Less than \$300.00 for everything!

You read right! For less than \$300 you can have your own catalog mail-order business in this exciting, fascinating and profitable field. You could handle one of the largest, most diversified and most desirable lines of famous namebrand merchandise available from any mail-order firm.

And now we're going to make you a most unusual offer. You don't have to spend anywhere near \$300 to see what we're talking about. Send only \$10 for our "Easy Way to Riches" and learn everything. . . all the secrets on how to have your own business, and have it operating within 45 days.

We absolutely guarantee you that you can have such a business, including everything you need to run it, all for less than \$300 and in 45 days, or we'll immediately refund your \$10. We won't even deposit your \$10 payment until 30 days after we mail you your material.

That'll give you plenty of time to get it, look it over, and talk it over with your friends.

If you don't agree that it's worth at least a hundred times what you invested, send it back. Your uncashed check or money order will be returned.

The only reason we won't send it to you and bill you or send it C.O.D. is because both these methods involve more time and money. We're already going to give you the biggest bargain of your life.

We are going to show you how to do something that cost us tens-of-thousands of dollars to learn, and more tens-of-thousands of dollars to put into practice.

We are offering to show you how you can have an account established for the wholesale supply of the best known names in guns, ammo, fishing tackle, sporting goods, watersports equipment and marine products.

We'll show you how your supplier will package, label, insure and drop-ship your customers orders. . . orders that were pre-paid so you don't tie up your money.

You'll have your own custom printed catalogs.

All this, and complete, step-by-step instructions on how to accomplish the whole thing in 45 days.

It doesn't require education.

It doesn't require lots of capital.

It doesn't require luck.

It doesn't require talent or special qualifications.

It doesn't require experience.

Your age makes no difference.

What does it require? BELIEF! Enough to take a chance. Enough to absorb what we send you. Enough to put into action, a plan that could put you on the road to riches.

Have you ever thought what it would be like if you opened your mail each morning — in your own home — and money fell out! **YOUR MONEY!**

Imagine being able to afford the things you've always wanted. . . Being able to "take off" and go fishing, hunting or anything you desired whenever you wanted to. And, be secure in the knowledge that your business would keep running in your absence.

Just imagine what it would be like to be your own boss. Set your own hours. Work as little — or as much — as you please, realizing that the more you worked, the richer you'd become.

Sound like the impossible dream? It's not. . . We guarantee it!

PLEASE. . . Believe what we are telling you. To the best of our knowledge,

**THERE HAS NEVER BEEN SUCH AN OFFER!**

**THERE HAS NEVER BEEN SUCH AN OPPORTUNITY!**

Remember. . . you don't have to give up your present job. You don't need any special permits or licenses. And, you can work out of your home.

Now, the rest is up to you. Make us prove every statement we have made here. Send us the attached coupon now. We are not asking you to blindly believe us. **JUST TRY IT.** You have only an eight cent stamp to lose. But. . . what if we are right. Look what you could gain.

-----THIS COUPON WORTH \$10.00\*-----

**RECREATION ENTERPRISES, Dept. 57**

**657 West 19th Street, Suite I, Costa Mesa, California 92627**

Okay fellows. . . it sounds impossible, but I've got nothing to lose. Send me your "EASY WAY TO RICHES" I've enclosed \$10 payment, but don't deposit my check until 30 days after you mail my material.

If I return all the material — for any reason — within that time, I understand you'll immediately return my un-cashed check.

Name \_\_\_\_\_

Address \_\_\_\_\_

City \_\_\_\_\_ State \_\_\_\_\_ Zip \_\_\_\_\_



**SPECIAL OFFER.** If you mail this coupon within one week of the date at the top of this page — even if you decide to return all of the material for a refund, you'll receive a \$10.00 credit towards sporting goods of your choice. Complete details enclosed with your material.

# PHOTO HINTS

## FROM READERS

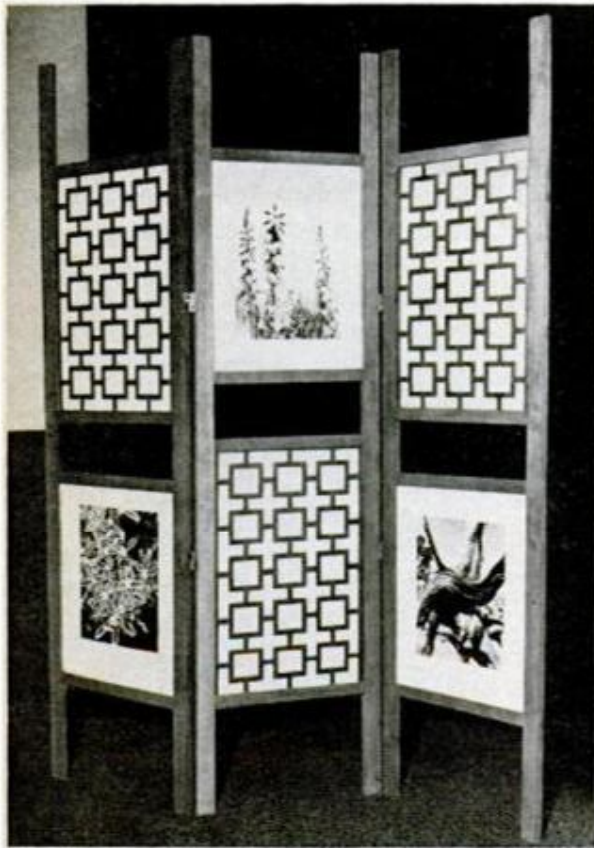

DETAIL OF CROSSPIECE

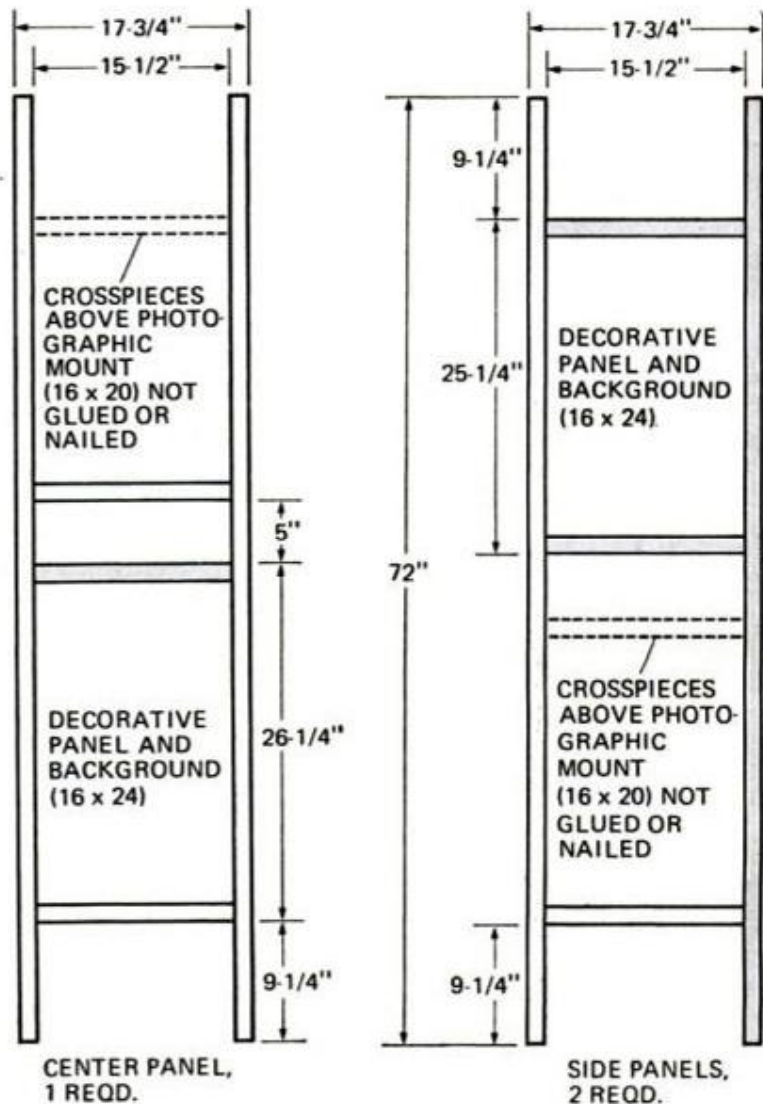
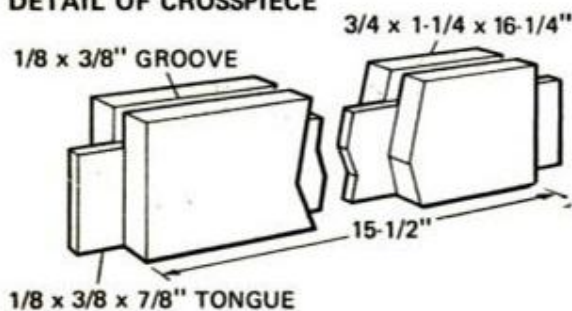

### Folding screen displays photographs

This folding screen serves as both a room divider and a display for photographs—and the photos are easily changed.

Construction is simple, with each section built individually, then attached with folding screen hinges. Materials are readily cut from 1x2 stock, and can be cut for you by a lumberyard. Both the vertical and horizontal pieces have grooves  $\frac{1}{8}$  in. wide by  $\frac{3}{8}$  in. deep along one edge to hold the panels; the horizontal pieces also have  $\frac{3}{8} \times \frac{1}{8} \times \frac{7}{8}$  in. tongues to fit grooves of vertical supports.

Each section was assembled with glue and small brads, but the horizontal pieces above the photos were not glued or nailed, so the photos could be changed easily. Decorative panels are of  $\frac{1}{8}$ -in. plywood or hardboard filigree, stained or painted before the watercolor-board backing is applied. Photo panels used are the standard-size 16x20-in. print mounts, and the prints are attached either by dry mounting or through the use of print-mounting adhesives.

—Ben Pilcher, Abilene, Tex.





### Film-type reminder holds film box lid

Trace a film box's end flap on a scrap of aluminum flashing, and cut with metal snips (or scissors), leaving enough metal around the outline to allow three bent edges as shown (box end flaps slip in the open end). Bend with pliers, sand and glue or epoxy on. —George Daniels, Danbury, Conn.

## Minolta helps you bag the one that got away.



Minolta puts over twenty years of little-camera making experience into every Pocket Autopak® 70.

So you'll be able to show your nine-pound bass in all its glory, even if you didn't bring it home.

An electronic shutter sets the camera automatically for beautiful pictures with 110-cartridge film. A signal in the finder tells you when you need a Magicube.

Minolta includes an optical-glass lens, and there's an exclusive built-in lens for dramatic close-ups.

For more information, visit your Minolta dealer or write Minolta Corporation, 200 Park Avenue South, New York, N.Y. 10003. In Canada: Anglophoto Ltd., P.Q.



**Minolta Pocket Autopak 70. Fine pocket photography.**

# IT'S ALL HERE! Phones that Save You Money!

OWN YOUR OWN READY-TO-USE PHONE! SAVE MONEY ON PHONE BILL EVERY MONTH!



## MODERN COLOR PHONE

**\$19<sup>95</sup>** With ringer, dial, plug & cable

Attractively designed American phone in a choice array of decorator colors: white, black, beige, blue, green, ivory, pink, red, yellow. Shatterproof plastic, lightweight. Ready to be plugged in and used.



## DIAL PHONE

ASSORTED STYLES **Black only**

With ringer, dial, plug & cable **\$9<sup>95</sup>**

Plug in an extra phone wherever wanted, without adding to phone bill.



## PRINCESS-Style TELEPHONE

**\$19<sup>95</sup>** With dial, plug and cable

Sleek and low design. Colors: white, beige, blue, pink. Buzzer, if needed, at \$10 add'l.



## UPRIGHT PHONE

With buzzer, dial, plug and cable **\$54<sup>95</sup>**

Most popular style — right out of the "speak-easy era". Stands 1 foot high with dial in base. Original black. Brass finish at only \$5 add'l.



## TRENDLINE TELEPHONE

**\$59<sup>95</sup>** With ringer, dial, plug & cable

The trimmest design and the newest trend in phone glamor! Colors: white, ivory, green, blue, beige, pink, red.



## Ericofon SCULPTURED TELEPHONE

**\$49<sup>95</sup>** With dial, plug, Buzzer & cable

Swedish beauty winner of ultra-contemporary design, stands like a statue; rests horizontally for easy dialing. Coordinate color: white, green, blue, red, ivory, yellow, pink.



## FRENCH CRADLE TELEPHONE

Genuine authentic elegance for home or office. Fully equipped and ready for use; just plug in. Ivory with gold trim and black with gold trim. **\$59<sup>95</sup>** With ringer, dial, plug & cable

## 25 FOOT PHONE EXTENSION CORD \$2<sup>99</sup>

Make your phone reach every part of your room. Save steps and energy! Off-white color.

Add 60¢ pstg.



METROPOLITAN TELETRONICS CORP  
Dept. P12, 35 WEST 35th ST, New York, N.Y. 10001

Please send me.....phones as follows:

..... Add \$1.50 pstg/hdlg charge for each phone. (\$2 pstg/hdlg west of Mississippi)

Mail \$1 for our illustrated Catalog. Full refund with 1st order.

Include applicable sales tax.

Name \_\_\_\_\_

TOTAL COST \$ .....  
Shipping Chg .....  
Tax, if any .....

Address \_\_\_\_\_

City \_\_\_\_\_ State \_\_\_\_\_ Zip \_\_\_\_\_

AMOUNT ENCLOSED \$

Send check or money order for prompt delivery. Add proper sales tax.



## COMPACT WALL PHONE

Designed to hang compactly in small space areas. Ready for use. Black. **\$8<sup>95</sup>** With ringer, dial, plug & cable

# LOCKHEED P-38 LIGHTNING

**BUILD AND FLY THIS FAMOUS WW-2 FIGHTER!**

**Guillow's**

3/4" SCALE  
40" WING SPAN

Many operational features including retractable landing gear, moveable flying surfaces, hinged canopy and droppable bombs. For static display, .09 U-Control or .049 free flight.

**\$18**  
KIT 2001  
No liquids or engines included in kit



*Balsa flies BETTER*

Check "Yellow Pages" under "Hobby Stores" for nearest Guillow model dealer. SEND 25¢ for catalog and "How to Build Balsa Model" booklet.

**PAUL K. GUILLOW, INC., Wakefield, Mass. 01880**

**HELPMATE**

- OPENS & CLOSES
- ILLUMINATES
- SECURELY LOCKS



... ANY GARAGE WITH UPWARD ACTING DOORS

- Wood, Metal, Fiberglass
- Sectional or one piece
- Up to 20 feet wide

**THOUSANDS IN USE!**

Shipped PP or UPS



GARAGE DOOR **OPERATOR** RADIO CONTROLLED **\$99<sup>95</sup>!**

- SAFETY night and day year 'round
- SECURITY door positively locked when closed
- CONVENIENCE in-car control of door
- EASY INSTALLATION in two hours
- SAVE up to 50% direct factory purchase
- GUARANTEED one year

Free Brochure HELPMATE Equipment Co., Box 217 PM, Baroda, Mich. 49101

**GET UP TO 50,000 MILES ON... YOUR SPARK PLUGS!**



**OWN YOUR OWN SPARKPLUG CLEANER**

- Cleans all types of plugs in seconds
- Requires no compressed air
- Powered by rugged 12,000 RPM motor
- Designed for long life without maintenance
- Supply of abrasive for cleaning 250 plugs
- Long life, maintenance free design

**SATISFACTION GUARANTEED**

Or your money refunded in 30 days

JAYCRAFT CORP., DEPT. 12  
760 North Marshall Avenue  
El Cajon, CA 92020

Name \_\_\_\_\_

Address \_\_\_\_\_

City \_\_\_\_\_

State \_\_\_\_\_ Zip \_\_\_\_\_

California Residents Add State Sales Tax

**\$19<sup>95</sup>**  
Ppd.

## THE BICYCLE SHOP

BY EUGENE A. SLOANE

### Will it work?

*I would like to install a wide-range freewheel (13 to 31 teeth) on a Gitane that has Simplex dropouts, using a Campagnolo Nuovo Record derailleur. I have been told by the dealer that Campy derailleurs won't work on Simplex dropouts. Is this true? If so, what derailleur would you recommend for use with the wide-range freewheel gear cluster?—Ernst Ginkel, Glendora, Calif.*



First of all, the Nuovo Record derailleur is designed to handle gears from 13 to 28 teeth only. I have seen it used on up to 34 teeth, but the shifting is erratic; sometimes it will get up to the bigger gears, sometimes it won't (usually when you need it most). I recommend the new Shimano Crane GS wide-range derailleur (photo), which is lighter and works better than the Campagnolo Gran Turismo wide-range derailleur. You should be able to buy it in your bike shop. This derailleur should work on the Simplex dropouts.

### Bike for a heavyweight

*I am six-feet-six and weigh 300 pounds and would like to bicycle. Is there a bike built for me?—Glenn Vernor, New York.*

You can buy a conventional 10-speed bicycle with a good chrome molybdenum or manganese steel alloy frame, such as one of the better Schwinns or Raleighs, that will be plenty strong for you. But you may have spoke breakage, in all probability on the rear wheel, particularly if you do much touring over long distances and carry baggage. (Of course, if you ride like that, you'll drop some of those 300 pounds along the way.)

I would suggest you have your dealer re-

move the rear 36-spoke rim and hub and lace up a 40-spoke rim and hub to handle the greater load. He might use heavier tandem spokes, too. I would think that the front wheel with a 36-spoke hub and rim would hold up.

You could also lace and true the wheel yourself (see [The Bicycle Shop](#), page 21, March PM, and page 40, April PM).

### Derailleur-chain master link

*Can a master link be put on the chain of a five-speed derailleur bicycle?—John Austin, Greenwich, Conn.*

No, because these narrow 3/32-inch-wide chains would then be too wide to fit over freewheel gears if equipped with a master link. The chain would rub if so equipped. I suggest you buy a chain rivet remover



(photo) and learn how to use it (see [The Bicycle Shop](#), page 31, April '72 PM) so you can take your chain off for cleaning. Carry this tool with you on trips because you can break a chain link, and the chain rivet remover makes it easy to repair the chain in minutes.

### Wants 28-inch tires

*Where can I buy 28 x 1 3/8 and 28 x 1 5/8-inch tires and tubes?—H. True Hill Jr., Safford, Ala.*

If your Raleigh dealer can't supply them (Raleigh makes a 28-inch bike that's sold in

[\(Please turn to page 54\)](#)

# 2 well-paid skills in demand

## NRI can teach you at home in your spare time



### 1 AUTOMOTIVE SERVICING

Save dollars servicing your own car, or prepare for a top-paying job as a master mechanic. You learn step-by-step with bite-size, fully illustrated texts that combine practical service work with top

quality professional testing equipment that you keep. NRI offers a complete Master Automotive Technician Course which includes—at no extra cost—your own ignition analyzer scope (an NRI exclusive) and 9 other essential servicing items. NRI also offers a shorter Tune-Up and Electrical

Systems program with 8 important servicing items.

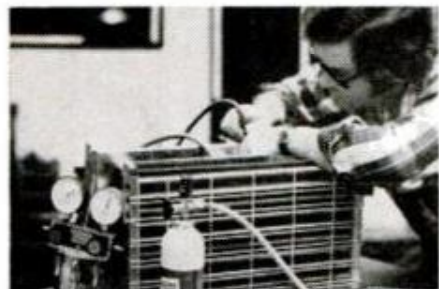

### 2 AIR CONDITIONING, REFRIGERATION, AND HEATING

Move into the "boom" industry of the '70s, where tens of thousands of technicians are needed. NRI courses were developed with the technical assistance of the York Division of

the Borg-Warner Corp., world leader in air conditioning. Training units include a *Circuit Demonstrator* for circuit studies; a *Control Simulator* for learning the fundamentals of electric controls; and with the Master Course a complete window air conditioner for troubleshooting. Optional resident training at York Institute is available at no extra charge.



**"Hands-On" Training Pays Off . . .** NRI was first to supply home training students with custom-designed training kits combined with bite-sized texts to make learning at home exciting, fast and profitable. Tens of thousands of NRI graduates are proof it is practical to learn at home in your spare time.

**Earn \$5 to \$7 an Hour, Starting Soon . . .** Keep your present job while preparing for a top-paying job, or business of your own. With NRI's professional testing equipment (provided at no extra cost) you can earn good money making repairs for your friends and neighbors.

**Train with the Leader—NRI . . .** The same training innovations which have made NRI the leader in technical education at home are now available to you. You'll proceed at your own pace, guided and assisted by your own NRI home training expert.

**NO SALESMAN WILL CALL**

APPROVED UNDER G.I. BILL Check G.I. line in coupon.

**RUSH Coupon for ONE FREE Catalog**



**NRI TRAINING**  
3939 Wisconsin Avenue  
Washington, D.C. 20016

Please rush me ONE FREE catalog checked below. I understand NO SALESMAN will call. Check Only One.

- Automotive Catalog 946-123     Air Conditioning, Refrigeration & Heating Catalog 513-123  
 Send me facts on G.I. Bill

Name \_\_\_\_\_ Age \_\_\_\_\_  
(Please Print)

Address \_\_\_\_\_

City \_\_\_\_\_ State \_\_\_\_\_ Zip \_\_\_\_\_

Accredited Member National Home Study Council

## THE BICYCLE SHOP

(Continued from page 52)

the United States), you can get them from a bicycle mail-order house such as Wheel Goods Corp., 2737 Hennepin Ave., Minneapolis, Minn. 55408. These tires are listed on page 109 of their \$2 catalog.

### Direct-drive bicycle

*I heard that someone has made a bicycle without a chain but with direct shaft drive. Have you ever heard of such a bicycle?—Steve Butler, Rapid City, S.D.*

A number of firms made such a bicycle around the turn of the century. One such bike is shown in the photos below. Other



makes hid the shaft in the right-hand stay. This transmission system was abandoned because it was less efficient than chain drive and a lot heavier.

### Tools for a crank

*I have a bicycle with a Nervar cotterless crankset. Where can I find tools to remove it? What do you think of this crankset?—James Langley, Concord, N.H.*

If you can't find a Nervar cotterless crank remover, the Campagnolo crank puller will fit the Nervar crank. But the Campagnolo nut wrench is too big. The Nervar crank locknut is either 13 or 14 mm, and any thinwalled box wrench that size will fit. I suggest you review crank removal and disassembly instructions in the May '72 *Bi-*

*cycle Shop* (page 67) or page 293 of my book, *The Complete Book of Bicycling* (Trident Press, \$9.95). It's easy to ruin these cotterless cranks unless you know how to take them apart properly.

### How good is 'good'?

*Do you think a 10-speed bicycle for \$62 is a good buy?—Kenny Bachman, New York.*

No, because a bicycle at that price will have heavy, cumbersome, awkward components and frame. This will be a heavy clunker that will be hard to pedal, hard to repair and hard to have fun on. Of course, such bikes have their uses. If you need it to ride to school where it might be stolen, it would be a good buy. Or for strictly utility use, a few miles at a time, it would be okay.

### Cinderella conversion

*I would like to change the frame of a Schwinn Varsity 10-speed for a lighter frame of Reynolds '531' or Columbus tubing. Is this possible, and how much would it cost?—Anthony Orrico, Jersey City, N.J.*

You could, but it would be like hanging low-cost parts on a Rolls Royce. I recently bought a '531' frame made in England, and even with a friendly dealer discount I still paid \$175 for the frame only. The Varsity is a good, sturdy utility bike that will take a lot of abuse, but it's not in the same class as a bike with a '531' frame. If you want a good bike, why not buy a good bike (see *Eugene Sloane Picks the Best Bikes for Your Family*, page 98, June *PM*). You can buy a good bike with a '531' frame for around \$250.

### About self-addressed envelopes

Many readers send me questions with self-addressed, stamped envelopes so I can answer them directly. I regret that the volume of these queries makes individual answers impossible for me; there are just not enough hours in the day. (I probably never will get hardened enough not to regret being unable to give individual replies to those who ask for them.)

I'll continue to answer all the letters I can in this column. ★ ★ ★

## SCIENCE WORLDWIDE



### Curing a cast with light

A new type of cast for broken bones—said to be 50 percent lighter and three times stronger than the conventional plaster of paris cast—has been developed by Merck Sharp & Dohme Orthopedics Co., West Point, Pa. A cast is made by slipping a polypropylene stockinet over a broken arm or leg, then wrapping it with an open-weave fiberglass tape impregnated with a photosensitive plastic resin. The cast is cured by putting it under a special lamp that generates light of a frequency near the ultraviolet part of the electromagnetic spectrum. The light causes the resin to harden, a process that takes about five minutes.

### Football helmet: dangerous weapon?

Though protective equipment for football has been improved in recent years, the helmet could be made safer. That's the view of Dr. Richard W. Corbitt, chairman of a sports committee of the American Medical Assn.

"The hard plastic covering of the helmet and shoulder pads is a significant source of injury, in terms of its impact on an opposing player," says Dr. Corbitt. "The more

so because many coaches today still teach players to use the head when hitting." Dr. Corbitt's committee recommends a soft outer covering for pads and helmets.

### Coming: close-ups of Mercury

Next March, a Mariner spacecraft equipped with TV cameras is scheduled to fly within 600 miles of Mercury, a planet difficult to observe from Earth because of its extreme closeness—36 million miles—to the sun. The purpose of the flyby is to determine the orientation of the planet's spin axis and to obtain information for making maps. Earth-based telescopes can distinguish only gross characteristics of Mercury.



### A quick way to 'shovel' snow

Snow accumulations could cause the collapse of an air-supported structure used at the University of Alaska to house a hockey rink and tennis courts. In the past it was necessary to deflate the bubble to allow workmen to clear it by hand—a slow and costly process. But now the job is done cheaper and faster by a small helicopter equipped with floats. The downdraft from

*(Please turn to page 56)*

LIVE IN THE WORLD OF TOMORROW . . . TODAY!

# UNUSUAL BARGAINS

NEW PRODUCTS • NEW MATERIALS • NEW IDEAS

## SEE AN ACTUAL WANKEL WORK!



Build the real thing, watch it work with nearly 40% fewer parts than conventional engines. Use it to power a model plane! Learn first-hand why Wankel is so great. No pistons to pollute, almost vibrationless, powerful quiet air-cooled single-rotor engine w/30 cu. in. displ. Has glow-plug ignition system, throttle-type carb, runs on std. methanol-based model fuels; 1/2 hp; 16,000 rpm. Precision German made. Incl. see-thru demonstrator, propeller.

No. 71.860H (31/2x23/4" dia.) ..... \$99.50 Ppd.

## "FISH" WITH A MAGNET



Go treasure hunting on the bottom! Fascinating fun & sometimes profitable! Tie a line to our powerful new specially designed 150 lb. pull Magnet—drop it overboard in bay, river, lake or ocean. Trawl it along bottom—your "treasured" haul can be outboard motors, anchors, other metal valuables. Has 6 stacked ceramic magnets. Lifts more than 150 lbs. under water!

No. 71.135H (31/4x37/8") \$16.50 Ppd.  
75-LB. PULL (1 LB.) W/ 3 CERAMIC MAGNETS

No. 71.150H (1-11/16x31/4") ..... \$10.25 Ppd.

## ACTUAL WORKING SOLAR HOME PLANS



Learn all about the most fascinating possible home of the future. It can be your "now" answer to today's energy crisis in housing. Expert Dr. Harry E. Thomason tells advantages, problems, savings, and more in this important 20-pg fact-filled booklet. Also includes 8-page oversize insert of basic, actual solar home plans, a valuable guideline to you and your architect in fitting space requirements, design ideas, and local area building codes.

No. 9440H (Solar House Plans) ..... \$10.00 Ppd.

## GIANT WEATHER BALLOONS—8' or 25' DIAMETER



"Balls of fun" for kids, traffic stoppers for stores, terrific for amateur meteorologists. Create a neighborhood sensation. Great for decorations, launching radio controlled airplanes, scuba diving markers, etc. Amateur meteorologists use to measure cloud heights, wind speed and temperature. Made of thin neoprene designed to burst at high altitudes. Inflate carefully with vacuum cleaner or auto air hose; or locally available helium for high rise.

Stock No. 60.568H (8' size) ..... \$2.50 Ppd.  
..... \$13.95 Ppd.

Stock No. 60.632H (25' size) ..... \$13.95 Ppd.

## AMERICAN MADE OPAQUE PROJECTOR



Projects illustrations up to 3" x 3 1/2" —enlarges them to 35" x 30" if screen is 6 1/2 ft. from projector. Larger pictures if screen is farther away. No film or negatives needed. Primarily intended for children. Projects charts, diagrams, color or black-and-white in darkened room. 115 v. A.C. . . . 6 ft. cord and plug included. Size 12" x 8" x 4 1/2" wide. Weight 1 lb. 2 ozs. Plastic case.

Stock No. 70.199H ..... \$8.75 Ppd.

'Bright Ideas' in Unique Lighting Big, new 100-page handbook packed with facts, loaded with illustrations. All latest developments, applications, equipment. 8 1/2" x 11" looseleaf paper to fit 3 rings. Stock No. 9100 H ..... \$3.00 Ppd.



## MAIL COUPON FOR GIANT FREE CATALOG!

164 PAGES • MORE THAN 4,500 UNUSUAL BARGAINS!

Completely new 1974 Catalog. Packed with huge selection of telescopes, microscopes, binoculars, magnets, magnifiers, prisms, photo components. Ecology and unique lighting items, parts, kits, accessories—many hard-to-get surplus bargains. 100's of charts, illustrations. For hobbyists, experimenters, schools, industry.

**EDMUND SCIENTIFIC CO. 300 Edscorp Building, Barrington, N. J. 08007**  
Please rush Free Giant Catalog "H"

Name \_\_\_\_\_  
Address \_\_\_\_\_  
City \_\_\_\_\_ State \_\_\_\_\_ Zip \_\_\_\_\_

**EDMUND SCIENTIFIC CO.** MONEY BACK GUARANTEE  
**300 EDSCORP BLDG. BARRINGTON, NEW JERSEY 08007**  
ORDER BY STOCK NUMBER - ADD \$1 HANDLING CHARGE - SEND CHECK OR MONEY ORDER

## SCIENCE WORLDWIDE

(Continued from page 55)

the rotor is powerful enough to blow away loose accumulations. The copter's floats are used to crunch down on—and break apart—patches of snow that have crusted over.

## Fish tag transmits temperatures

A temperature-sensitive, ultrasonic fish tag has been developed by environmental scientists at the Oak Ridge (Tenn.) National Laboratory. The device can be surgically implanted to measure fish body temperature, or attached to the skin to measure water temperature.

Powered by small batteries, the tag transmits readings by acoustic energy. The signals are received on shore or in a boat by means of a hydrophone system.



## Bugler brings in the herd

Soviet researchers are slowly domesticating a herd of 45 elk on a farm some 60 miles west of Moscow. Over a period of years, the elk have overcome their fear of humans, the females even allowing themselves to be milked. The animals have been conditioned to respond to the sound of a bugle, gathering at a clearing where they are rewarded with salt and bread. The successful domestication of a cold-region animal like the elk could mean more protein for Alaska and Canada as well as Russia. ★ ★ ★



## IMPORTS AND MOTORSPORTS

### Volvo in Virginia

When the 1977 Volvos start coming off the assembly line at Chesapeake, Va., in the fall of 1976, Volvo officially will be the only foreign car manufacturer building cars in the United States. The Swedish company will break ground for the \$100-million plant next month. Among the innovations to be used for production is the "tipper trolley" shown below.

It was feedback from assembly-line

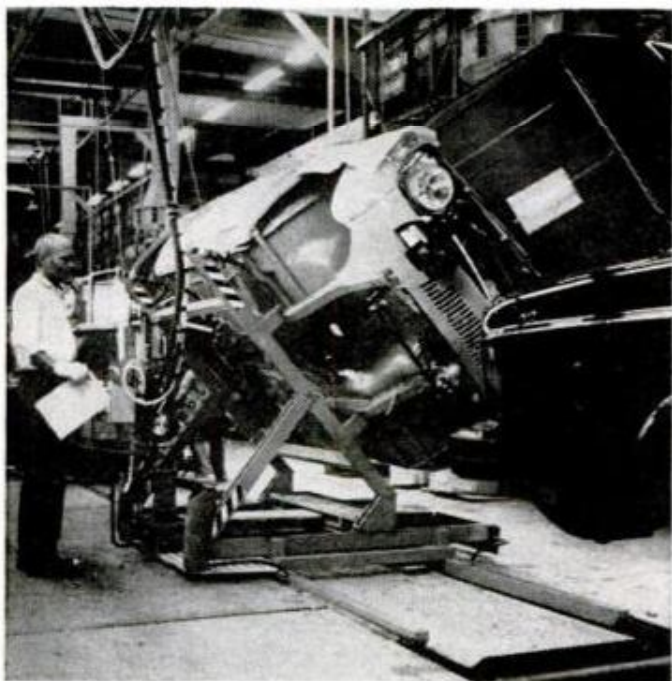

workers at Volvo's plant in Sweden that led to development of the trolley. This allows heavy components like fuel tanks and exhaust systems to be fitted from the side rather than from a pit below.

The decision to build here reflects a continuing commitment to the American market where Volvo sells 25 percent of its passenger-car production. The plant will employ about 3000 workers and all cars produced there will be sold in the United States. Capacity is planned to be 100,000 cars annually by the late '70s.

Parts for the cars will come from American and European suppliers and production at the plant will include body assembly, surface finish and final assembly.

### Saab in '74



A new model from Saab will be available in the spring. The 99 LE Hatchback version of the 99 has a redesigned back end with a hatch that may be bigger than any you've seen. A couple of years ago we suggested to the Saab engineers in Trollhattan that America needed the likes of a 99 station wagon—sensibly sized, safe and economical—but they showed no interest. Now we know why: They had something much better in mind than a box of a wagon!

The Combi Coupe, as it's called in Europe, and all the other two-liter 99s for '74 are now fuel-injected. Other features for '74 include redesigned front seats, improved flow-through ventilation and, on automatic transmission models, the power steering owners said was needed (See *PM Owners Report*, page 106, Aug. '72 *PM*).

And since it's about time we started "thinking metric," because the United States is in the process of switching, Saab

*(Please turn to page 58)*

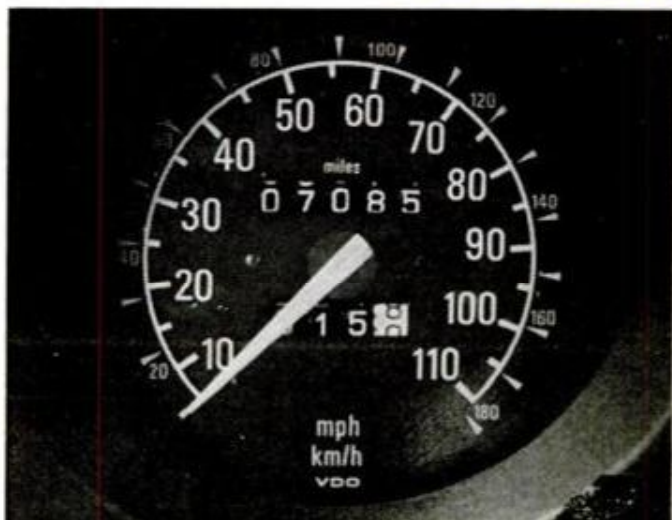

## FIRE ALARM

The Crestalarm, early warning of home fires, incorporates a quality brass diaphragm air horn triggered by heat and sounded continuously 5-8 minutes by pressurized container. Model M-100 for bedrooms, etc. enclosed in attractive neutral color plastic case for wall mounting—\$9.95. Model M-101 (higher activation temperature) with wall clamp for furnace room, attic—\$9.50. Prices include tax and parcel post delivery.



**CRESTWOOD PRODUCTIONS**  
POST OFFICE BOX 60  
DARLINGTON, S.C. 29532

Please ship: ( ) M-100's @ \$9.95—\$ \_\_\_\_\_  
( ) M-101's @ \$9.50—\$ \_\_\_\_\_

Name \_\_\_\_\_

Address \_\_\_\_\_

City, State, Zip \_\_\_\_\_

## Are you missing half the joy of your guitar?

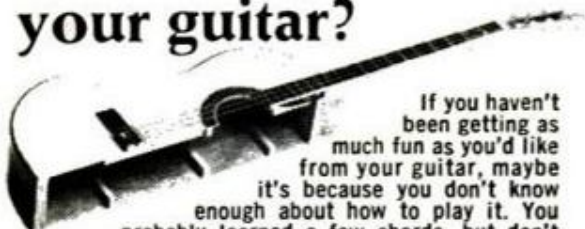

If you haven't been getting as much fun as you'd like from your guitar, maybe it's because you don't know enough about how to play it. You probably learned a few chords, but don't know how to go further. If so, let us help you. We'll teach you to read music and play pick style with both notes and chords—the way a teacher would. The difference is we teach with lessons by mail, and it costs a lot less. Courses in other instruments too—piano, spinet organ, accordion, violin, saxophone. If 17 or over, write for free booklet with more details. Send your name, address, zip code and list instrument you want to learn. Write U.S. School of Music, Studio 24-605, 417 South Dearborn Street, Chicago, Illinois 60605. ACCREDITED MEMBER NATIONAL HOME STUDY COUNCIL © 1973 U.S. SCHOOL OF MUSIC 444

**OUT NOW—1974 edition of POPULAR MECHANIC'S CAR REPAIR ANNUAL.** The big bonus in this edition is the 92 page Car Care Guide that leads you step by step through the basics of car repair. A thorough discussion of all the maintenance jobs you can do yourself. This manual is a dollar saving guide for all mechanics. Buy it from your local newsstand dealer or send \$1.00 plus 15¢ for postage to, **Popular Mechanics Dept. FA Box 1014 Radio City, New York, N.Y. 10019.**

## IMPORTS AND MOTORSPORTS

(Continued from page 57)

has both kilometers/hour and mph scales on its speedometer. One kilometer equals .6214 miles, so a speed of 100 km/h is equal to 62.14 mph. Got it?

### Audi outfoxed

It started out as an Audi 80, or the Fox as it's called here, before Karmann and Ital-Design gave it a new shape for the Frankfurt International Auto Show. The wedge-styled four-seater is a one-off show car, of course, but incorporates ideas that



may find their way into production. Most unusual inside the car is the instrument display. Gauges and indicator lights are in a big, cylindrical, bolster-like dash with viewing apertures for the driver.

### Beat frostbite

They're fleece-lined pockets with heavy outer shells and are called "Hippo Hands." The left one even has a little pouch in it for toll change. If you want to ride all winter, write Vetter Fairing Co., Box 927, Rantoul, Ill., for more information. ★★★



## ALL OUTDOORS

BY BILL McKEOWN

Here is our year-end selection from the mountain of sports items now available—a few of the essentials we'd want to take along to a desert island or anywhere else. Our choices have been field-tested from the near-arctic regions to the tropics—and many camp spots in between. Several are new or improved; others have been durable companions over a number of years. They have earned their keep and carrying weight on ski and snowmobile safaris, backpack, RV, hunting and fishing trips, inland floats and offshore cruises. Reliability and exceptional performance were requirements for top rating. All are available by mail order or from local outlets.

A new down sweater, which is actually a jacket that compresses tightly into a stuff sack, we find useful under a ski parka, beneath foul-weather gear in a blind, or offshore during a winter norther in the Caribbean. Ours came by mail from Recre-

ational Equipment Co., the Seattle campers' co-op. This all-purpose item gets squeezed into our backpack or baggage for every trip and is now available from a number of mail-order suppliers and sports outfitters.

The Thermos Pop Tent has been around a number of years. Many tents are lighter and smaller, but when out camping by car, recreational vehicle, ATV, 4WD mountain goat or boat, we like to have one. It can hold a camp spot if you must drive away, will store excess equipment or kids, add a room to a larger tent or smaller RV or boat, pop up or take down in minutes in a rain-storm. For backpacking, our selection is Camp Trails' remarkable four-pound Chaparral with waterproof condensation-controlled roof that needs no fly. But for fast general use, a vote here for the Pop.

**Modern outdoorsmen** know enough to come in out of the rain, but when that gets

*(Please turn to page 60)*

**VW is more money than Duster.**

**Duster is considerably more car than VW.**

**VW seats four.**

**Duster seats five.**

**Duster has three times as much trunk space as VW.**

**Duster delivers about twice as much horsepower as VW.**

**And it has more weight, wheelbase and width.**

**So, when you buy a Duster instead of a VW you get more.**

**And pay less.**

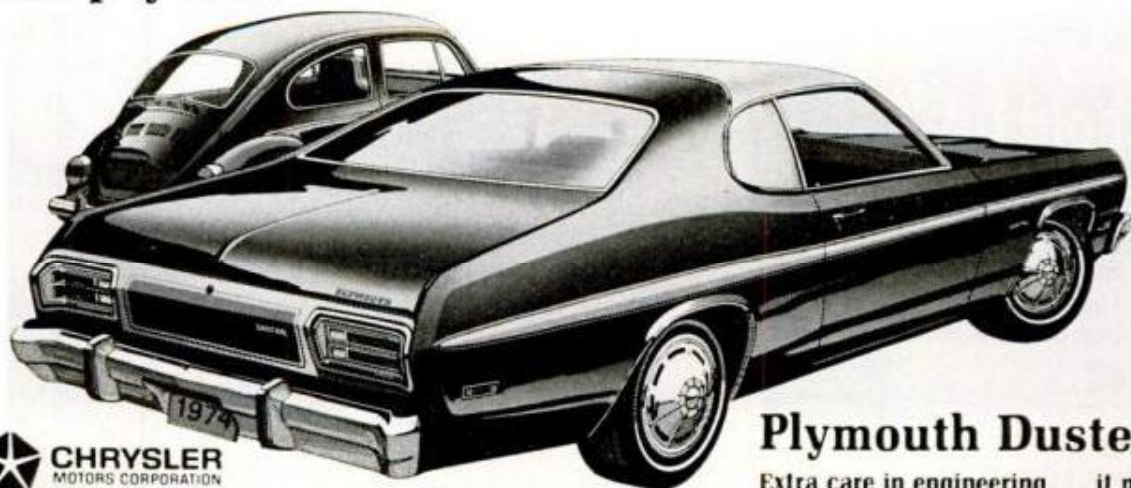

**Plymouth Duster.**

Extra care in engineering . . . it makes a difference.



**CHRYSLER**

*Plymouth*

# START A BUSINESS

in your neighborhood

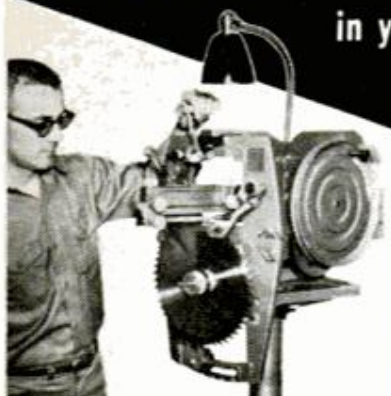

Sharpen Hand or Power  
Saws with the

## FOLEY SAW FILER

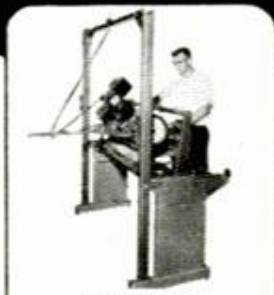

### MOWER SHARPENER

Precision-grind all  
hand and power lawn  
mowers—a perfect job  
every time.

Start your business in sparetime and make CASH PROFITS right away. No stock to carry, no selling involved, no experience needed—the Foley Saw Filer does every sharpening job **automatically!** Earn \$3 to \$6 an hour sparetime in your own garage or basement. Profit 90c on every dollar.

Best of all, every saw you sharpen, will be resharpened again and again—watch your repeat business grow! Add cash to your income now, while you build retirement security with the Foley Saw Filer.



**FREE BOOK** shows how you can make money as thousands of others have. Send coupon today. There's no obligation, and no salesman will call—so write today!

Foley Manufacturing Co.  
1216-3 Foley Bldg., Minneapolis, Minn. 55418  
Send for **FREE** book on Money-Making facts about the sharpening business.

NAME \_\_\_\_\_  
ADDRESS \_\_\_\_\_  
CITY \_\_\_\_\_ STATE \_\_\_\_\_ ZIP CODE \_\_\_\_\_

**ARROW**  
All-Purpose  
**STAPLE GUN**

SHOOTS A STAPLE

Uses 6  
Staple Sizes  
1/4" to 9/16"  
including  
Ceitile.

WHEREVER YOU'D DRIVE A NAIL!

At Hardware, Lumber & Building Supply, Stationery, Variety and other retail outlets.

**ARROW FASTENER COMPANY, INC.**  
271 Mayhill Street, Saddle Brook, N. J. 07663

## Makes Household Oil Old-Fashioned

- Stops squeaks
- Protects metal
- Loosens rusted parts
- Frees sticky mechanisms

Aerosol **WD-40** lubricates as it cleans to protect metal

### TRY A FREE SAMPLE

Send 25c to cover handling to:  
WD-40, 5390 Napa St. San Diego, CA 92110



## ALL OUTDOORS

(Continued from page 59)

difficult, high-quality foul-weather gear is the answer. A season-long test of parka-style Ted Williams-brand storm suits has failed to tear or poke holes in the rubberized nylon. Sears stores and catalog also list cheaper models, and drug-store plastic cheapies are less than \$1, but for a suit to fit comfortably over fishing clothes, ventilate without letting water in and last and last, we have found nothing better at anywhere near the \$16 price. And after fishing and shooting with perfectionist Ted Williams, it's easy to see why his approval carries such weight with Sears customers.

Sunsensor is the name Corning Glass gives its new updated lenses ground to a sportsman's prescription that automatically darken in bright light to a protective comfortable density. We find them particularly useful around water, but they rate as a bonus this year for any outdoor activity.

Short-section fishing rods that can take down to fit into a backpack, knapsack or glove compartment are now well enough made to rival the action of one or two-piece models. Fine fitted cases slide them easily and safely into almost any size luggage. A Zebco Travel-Pak rod-reel combination has been touring successfully with us by boat, air and RV for several years, and we have seen excellent new models from Berkley, Shakespeare, Orvis, Martin, True Temper, Daiwa, Heddon, Sears, and Garcia as well. Eagle Claw even has an eight-piece spin, cast or fly rod that fits inside its tackle box. Handy encased pack rods are one of the best trends of the year.

The Swiss Army knife earns its top rating partly by performance, partly by its finish as a fine instrument. None of its parts—scissors, screwdrivers, saws, even blades—are as rugged or easy to use as the full-size tools, but it is remarkably compact and handy, though expensive. Fine specialty knives that rate high are the Finnish Rapala filet models and the Normark Swede 45 that comes apart for easy cleaning.

Shoes for general outdoor wear now come from the best makers. We would top-rank our Herter's Hudson Bay Two-Point high shoe, but special conditions often require favorites like L.L. Bean's Maine Hunting Shoe, Herman Survivors and others.

Combining the old-time hard-to-start charcoal fire and flavor with easy-to-start LP-gas, Primus has come up with a fine

new barbecue stove called a Campacue, that uses permanent ceramic coals. More improved LP models for full-size pots or backpacking come from Coleman, Gerry, Bernz-O-Matic, Zebco and others, improving campfire in every way except appearance.

There is no all-purpose outdoorsman's camera—or pack, gun or fishing lure—but the Nikonos underwater model can certainly survive more moisture and hard knocks out of water than most and still bring back fine pictures. We bought the first model, the Calypso, in France, and wore it for years through offshore races when we came back with broken bones, but camera and photos were undamaged. While not very light or small, the Nikonos is certainly a most durable outdoor camera.

Savage calls its over-and-under rifle/shotgun that folds into a canvas case a Campers Companion, and that's just what it is. With .22-cal. on top and 20-gauge shot or slug shell below, it's suitable for plinking on up. Regular shooters will choose one or more specialty models from top makers, but for a multipurpose single-shot just to have along, we'd pick this one.

That's 10 top items to take outdoors, and any, incidentally, would make good Christmas gifts for a sportsman. But we've tested or noted many other outstanding products and trends this past year. Outstanding outboard motor of this and many other years may be the Outboard Marine rotary which Evinrude and Johnson are expected to market some year soon. Top sports plane of the decade is our rating for the Pitts Special. Leading offshore high-performance powerboat, *Cigarette*, has an unrivaled win record. Fine for special purposes are Glastron Campers, Boston Whalers, Hewes Bonefishers, Aquasports and Terry bass boats.

Clothing for outdoorsmen introduced in 1973 has been outstanding, with much more variety and adaptability available than before. A camper can keep warm with gear like Eddie Bauer's down cap and mittens while packing along a Gerry Mini-Stove or a Kangaroo Cooker. We're glad to see large parachute-type bags available from Beckel Canvas Products and P & S Sales. First-aid pocket-size packs now come from Cutter. Bass fishermen can now buy the "Big O" and similar successful lures from several makers. Graflite carbon-filament extra-strength rods hold promise and are available from Fenwick and Shakespeare. Sportsmen seeking the best can find a lot to choose from this year's crop. ★★★



**Winnie Wagon** is latest in extensive Winnebago RV line. Van conversion raises roof for headroom, lowers it for garaging. Thermo-steel bodied unit will cost \$6915.



**Go-Joe**, a new four-wheeler from Rupp Industries, is claimed to be part motorbike, dune buggy, snowmobile, with speeds to 40 mph from a 2-cycle 8-hp Chrysler.



**Extension Step Bumper** for Chevy, Ford, Dodge, GMC and International pickups bolts on without welding, extends with camper mounted. From Kenco Engineering.

(More photos on page 62)

## ALL OUTDOORS

(Continued from page 61)



**Newest tent from Coleman** is Villa Del Mar with side-door entrance, seven large nylon-screened windows, three-color European look. The 9x12-footer sleeps five.



**Instant buoyancy for flies** results from new aerosol Dry Fly Spray LT 100 from Scientific Anglers, maker of Air Cel, Wet Cel fly lines and a new division of 3M.



**A workhorse** now available in seven colors, the 1974 International Scout with two-wheel or four-wheel drive can tow trailers to 5000 lbs. with equalizer hitch.

62 POPULAR MECHANICS

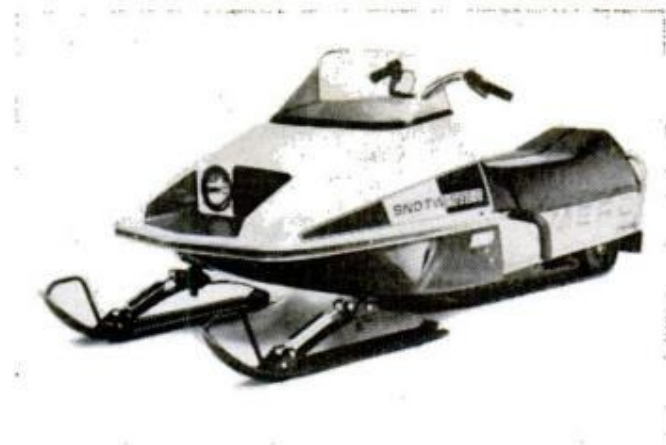

**Merc Sno-Twister 400-D**, newly added to Mercury Marine's snowmobile line, is high-performance 398-cc machine with slide-rail suspension designed for racing.



**Waving an orange flag** at fishermen when a fish strikes, the Pop-Up magnetic tip-up from the Worth Co., Stevens Point, Wis., is easy to set up on ice over fish hole.

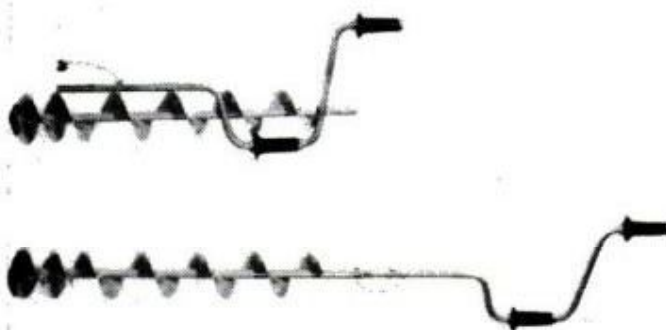

**Cutting a five-inch** or seven-inch-diameter hole for ice fishing is easier with Jiffy Hand Ice Drill from Feldman Engineering, Box 153, Sheboygan Falls, Wis.

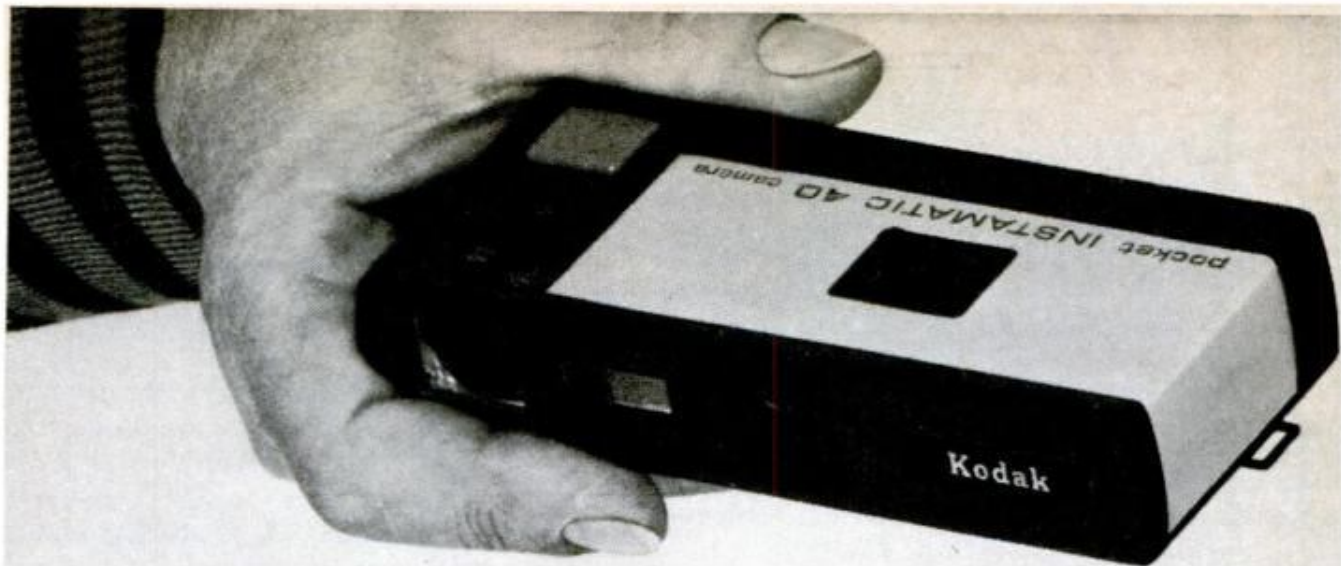

## Be prepared. Put a Pocket in your pocket.

The little Kodak pocket Instamatic 40 camera is always ready to take big beautiful pictures. It has an action-stopping electronic shutter (1/225 of a second in bright sunlight), a lens that focuses as close as three feet, and a CdS electric eye.

Pocket a Pocket 40 for less than \$68. Other Pockets from less than \$23. Prices subject to change without notice.

**Kodak pocket Instamatic® cameras.**



## MAKE EXTRA \$\$\$ EVERY DAY!

Get into the big, year-round  
**EXTRA MONEY BUSINESS**  
that's EASY to learn—EASY to  
do—and EASY ON YOU!

# Be a LOCKSMITH!

You Can Make Up to \$10 an Hour—even while learning!  
Train FAST at Home!

Never before have money-making opportunities been so great for qualified Locksmiths. Now lucrative regular lock and key business has multiplied a thousandfold as millions seek more protection against zooming crime. Yet there's only one Locksmith for every 17,000 people!

Start Collecting CASH PROFITS Right Away

You're "in business" ready to earn \$5 to \$10 an hour a few days after you begin Belsaw's shortcut training. Take advantage of today's unprecedented opportunities in Locksmithing for year-round EXTRA INCOME in spare-time—or fulltime in a high-profit business of your own. Hundreds we've trained have done it. So can YOU! All tools plus professional Key Machine given you with course. These plus practice materials and equipment,

**THIS PRO  
KEY MACHINE—  
YOURS TO KEEP—**

can add \$25 to \$40 a week to your income . . . and it won't cost you a cent with your training.

**ALL TOOLS, MATERIALS AND PRACTICE  
EQUIPMENT COME TO YOU WITH YOUR COURSE.**



**FREE**



Tells how to make money in Locksmithing almost from the start!

"War injuries left me badly handicapped, but now I'm a financial success as a Locksmith, thanks to your training. Besides, the work is fascinating. If I can do it anybody can." — Glen Johnson, Larned, Kan.



plus simple, illustrated lessons, plus expert supervision, plus business-building guidance will enable you to KEEP THE MONEY COMING IN! Ideal for retirement—good jobs, too.

**SEND FOR EXCITING FACTS—No Obligation**

Discover what's in Locksmithing for you—how Belsaw's master-locksmith-approved training can give you the skill you can depend on to EARN MORE—ENJOY LIFE MORE. Just fill in and mail the coupon below to receive full information by return mail. Do it TODAY!

**BELSAW INSTITUTE, 1042 Field Bldg., Kansas City, Mo. 64111**  
Accredited Member National Home Study Council  
Approved for all Veteran Training

**MAIL THIS COUPON—NO SALESMAN WILL CALL**

**BELSAW INSTITUTE, 1042 Field Bldg.  
Kansas City, Missouri 64111**

Please send me free of cost or obligation your publication "Keys to Your Future" on how Belsaw can quickly train me to make money in Locksmithing and how all tools and Key Machine are given me to keep.

Name \_\_\_\_\_

Address \_\_\_\_\_

City \_\_\_\_\_ State \_\_\_\_\_ Zip \_\_\_\_\_

Check here if eligible Veteran.

## HOMEOWNERS' CLINIC

BY W. CLYDE LAMMEY

### Peeling under windows

*Although I seem to have no such trouble elsewhere, the outside paint persists in peeling under several windows. I've done these areas over several times, but the paint still peels. What's the cause and remedy?—Harry Osbourne, Springfield, Mass.*

If you remove the trim pieces (aprons) under the stools (sometimes mistakenly called window sills), you will likely see a narrow crack or opening. Moisture from inside the room is forced through this opening by vapor pressure into the space between the inside and outside walls. From here it gets under the paint film and eventually lifts it. Brush the dust from the opening and fill it with spackling compound, forming a fillet with your finger. When the compound is dry, prime it with aluminum paint, then apply a coat of oil-base paint or enamel. This usually cures the trouble.

### Loose at the edges

*Vinyl tiles in my kitchen have loosened and turned up at the edges. Can I restick 'em or must I replace?—Robert Marion, Chicago.*

You might try running an iron, set on low heat, over the edges. If there is no accumulation of dust or wax under the edges, this can work. Be careful not to overheat and damage the tiles.

If the iron doesn't do the trick, you'll have to lift the edges, clean out dust and debris with a wire brush and work vinyl adhesive underneath. Wipe up any excess adhesive and weight the treated joints until the adhesive has set. This is the sure cure, but the job won't be quite as neat as it was originally—some of the turned-up edges may show in oblique light.

### Splintered tread

*One of my basement-stair treads is splintered at the edge. I don't know how it hap-*

*pened; the splinter just suddenly appeared. It's about two-thirds the length of the tread with one end still holding. Can it be repaired some way or should I replace the tread?—R. M. Desmond, Austin, Tex.*

Before replacing the tread I'd try a repair. If the splinter is still intact, it should fit back in place with little if any offset. Mix a small amount of waterproof glue; then pry the splinter up very carefully, just enough to work in the glue between the meeting surfaces. Cover as much of each surface as possible without breaking the splinter off entirely. Force it back into place and hold it there with strips of adhesive tape. Wipe away any excess glue. When the glue dries, sand the area smooth and repaint in matching color.

### Cove correction

*A short section of the cove base in my bathroom has loosened and won't stick back in place. I've tried twice; the cement hardens but won't hold. This section is about 18 in. long and at the side of the toilet bowl. What to do now?—H. Cole, Redwood City, Calif.*

It seems as if you didn't do a very thorough job of cleaning behind the cove. Usually the top end of the cove will loosen first, admitting dust and other debris. Unless this dirt is removed first, the cement just won't stick.

Do an all-out job of cleaning both the cove (scrape the old cement off the back, too) and the surface, then spread cove base adhesive (of a type appropriate for your cove material) as uniformly as possible with a notched trowel. Replace the cove and apply pressure if possible or use well set 4d finishing nails where required. ★★

*Do you have a home maintenance or repair problem? Send it to Homeowners' Clinic, Popular Mechanics, 224 West 57th St., New York, N.Y. 10019. While letters cannot be answered individually, problems of wide interest will be discussed in this column.*



© BROWN & WILLIAMSON TOBACCO CORP.

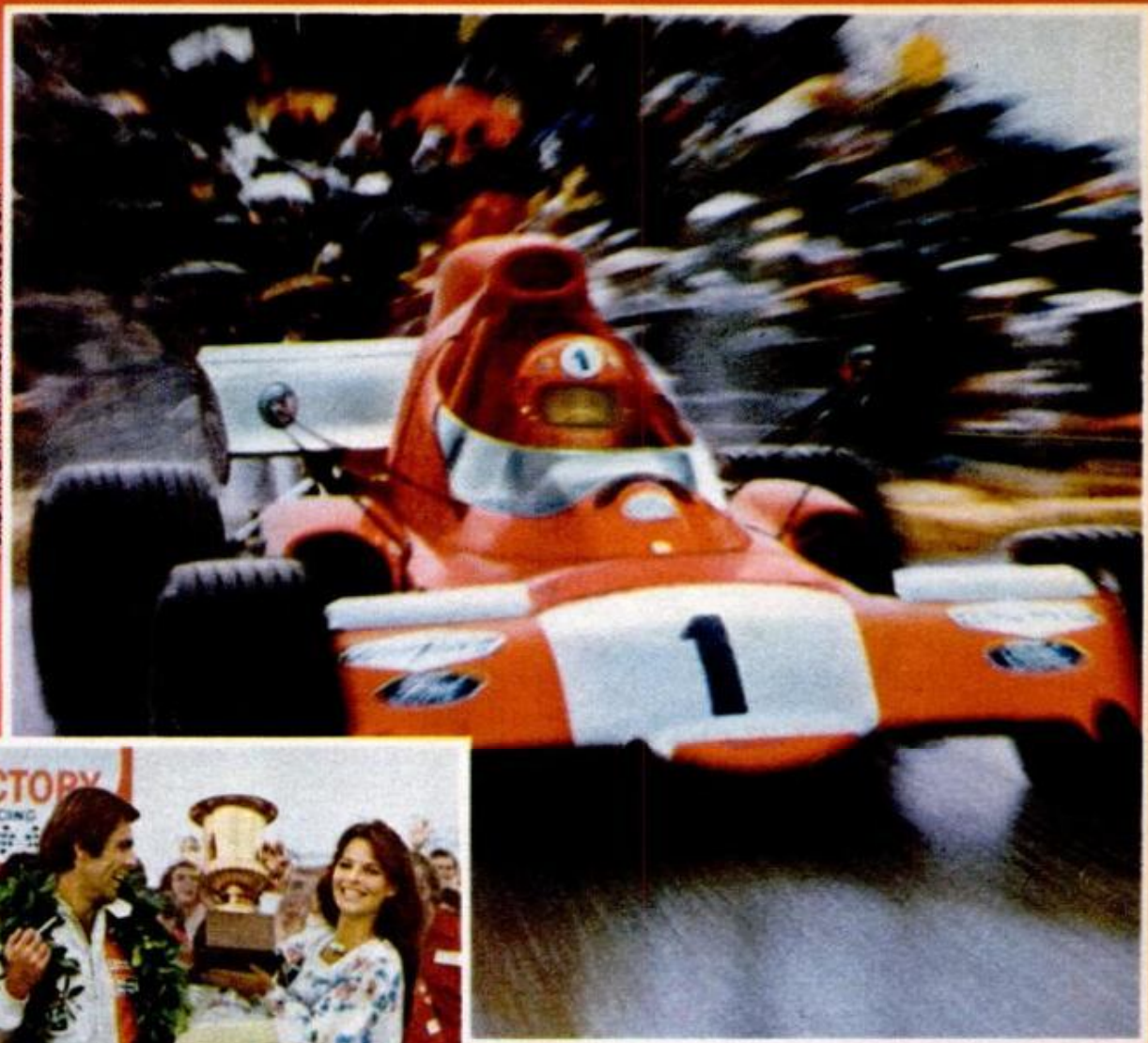

# Taste it all in Viceroy.

Get a taste of excitement. Viceroy excitement. Full flavor that comes on rich and smooth from start to finish.

Warning: The Surgeon General Has Determined That Cigarette Smoking Is Dangerous to Your Health.

King Size.  
Long Size.



Kings, 16 mg. "tar," 1.1 mg. nicotine,  
Longs, 17 mg. "tar," 1.2 mg. nicotine,  
av. per cigarette, FTC Report Sept. '73

# Share America's Whiskey.



It's Christmas in the country, and the more snow, the merrier.

It's a time when old friends make new friends, and everyone shares the joy of the season. They also share the friendly taste of Seagram's 7 Crown.

It's America's favorite whiskey. Especially at America's favorite time of year.



**Give Seagram's 7 Crown.  
It's America's favorite.**

SEAGRAM DISTILLERS CO., N.Y.C. AMERICAN WHISKEY—A BLEND. 86 PROOF.



GIFT-PACKAGED AT NO EXTRA COST.

# Spellbinders: optical fibers

**G**littering pinpoints of lights cascading from the tips of hundreds of optical fibers turn these unique table lamps into fountains of breathtaking beauty. Like so many tiny "weeping" straws bunched together at one end, the synthetic, tubular optical fibers have a special coating which keeps the light from "leaking" out the

side. The high-intensity light travels the full length of the core and spills out the ends.

Designed to enhance home decor, whether traditional, contemporary, Oriental, Mediterranean or Early American, these mood-setting lamps are great as TV lights and night lights and, when battery operated, they can be used as dramatic dining-table



**Table Tree** adds colorful, decorative holiday touch at Christmas time when fitted with a red or green filter; 14 in. tall, it's priced at \$9.99.



**Called Essence**, this beauty combines wood, acrylic and chrome with five light sprays, \$100

## Soft, delicate points of free-form light



**Dream Tree** is weeping willow with hundreds of tiny lights emanating from its realistic tree-like branches. Available in a put-it-together-yourself kit, it sells for \$17.50.

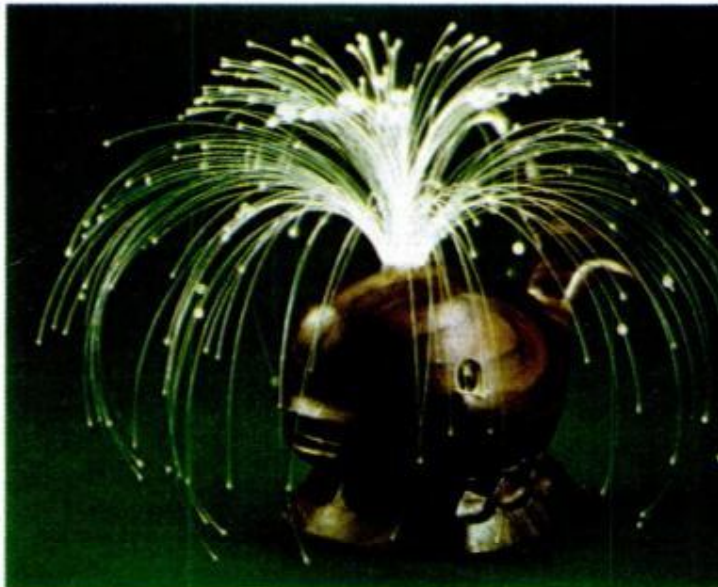

**Moby Glo**, a wood-tone ceramic whale, spouts spray of glimmering lights. For nautically inclined. About 8½ in. high, it costs \$25.

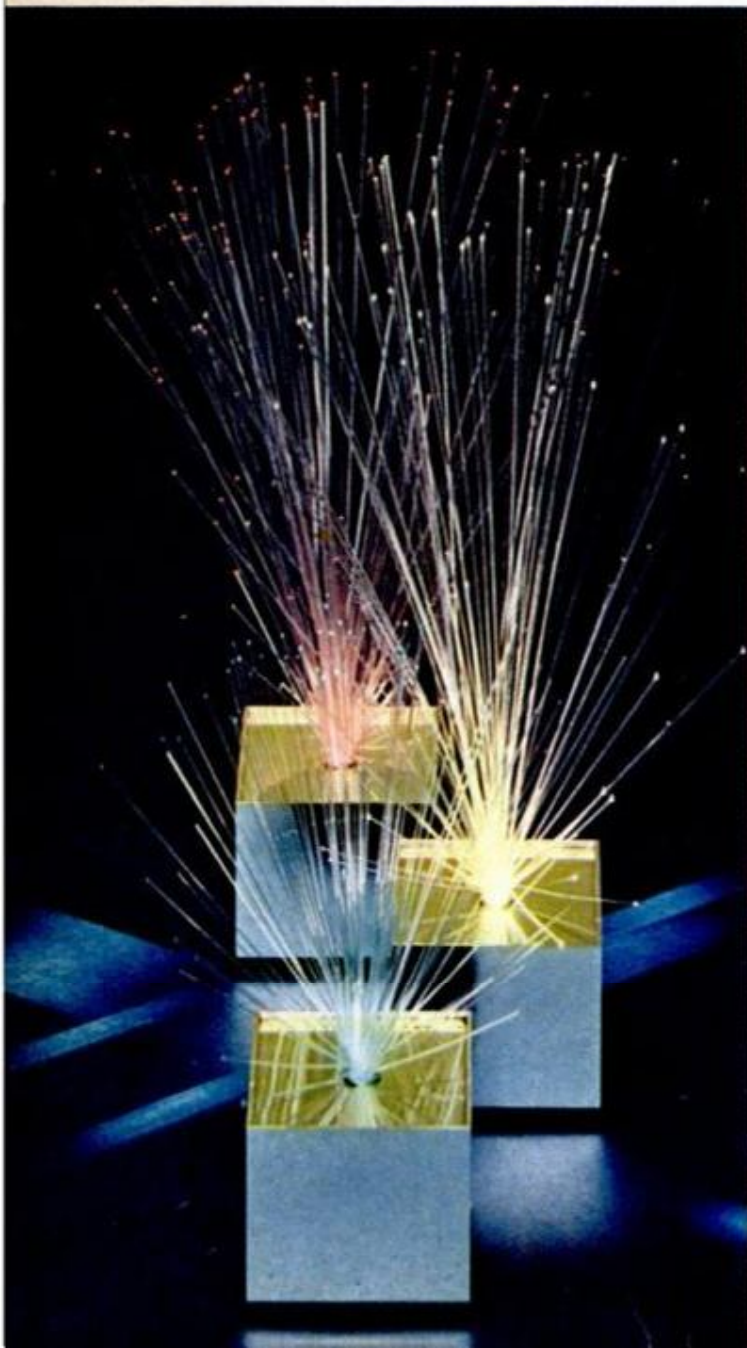

centerpieces. Manufactured by Poly-Optic, Inc., of Santa Ana, Calif., the lamps are available as complete ready-to-plug-in units or as kits in both plug-in and cordless types. The parts also can be purchased as individual components for anyone who wants to create his own designs.

The optical fibers come in two forms—loose and as complete sprays—in a variety of colors, lengths and thicknesses. Loose fibers are made into sprays by simply epoxying a metal collar to the bunched ends, and are easily trimmed to the desired lengths with scissors. Other components include a high-intensity light source and reflector, separating tubes, color filters and a transformer plug which reduces 115-v. house current to 7 volts. Illuminated by a No. 55 auto headlight bulb, the lamps cost about the same to operate as an electric clock. Cordless lamp kits are available, too, using two D-size batteries. ★★★

Photo at left: Ben Rose

**Star like** and bursting from silvered box vases, sprays of handsome cordless lamps are ideal for contemporary dining table. Named **Reflections**, about 15 in. tall, \$17.50 each.

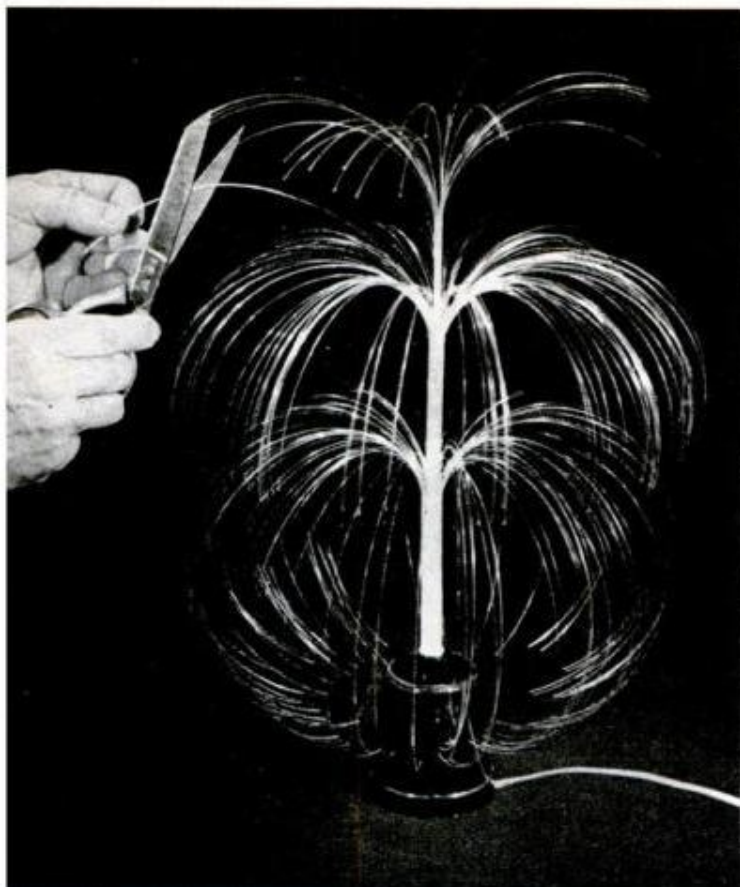

**Fountain Glo lamp** uses one complete spray which is divided into three separate sprays by "soda straw" slip-over tubes. Optical fibers are trimmed to the desired length with ordinary household scissors.



**This 24-page booklet** contains basic information on how to work with optical fibers and components. Can be obtained by sending \$1.50 to Poly-Optics, Inc., 1815 East Carnegie St., Santa Ana, Calif. 92705.

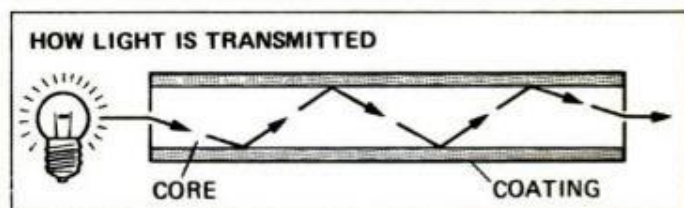

Like water passing through a hose, light travels through core of fiber strands and out the ends in form of tiny starlike dots. Special coating prevents light from "leaking" out through the sides.

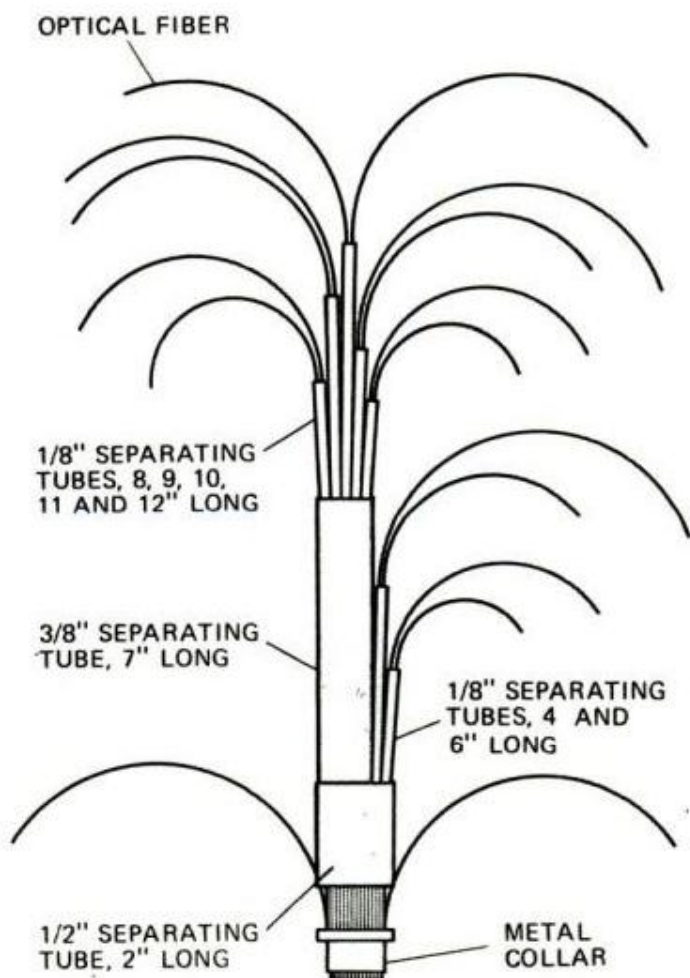

BASE



REFLECTOR



BULB AND SOCKET



TRANSFORMER PLUG

**Basic components of hobby kits** (above) also include complete spray already attached to metal collar. Electric kits have transformer plug to reduce house current to 7 volts. Two "D" batteries run cordless lamps.

**Drawing** shows use of separating tubes to produce various spray heights and tiered effects. Here, up to eight tubes are used to create complex sprays. Fountain Glo lamp (above) uses only three tubes.



**Delicate, frosty look** is special feature of snow-molded candles. One above was made with two pours of different wax colors.

**Each of the three candles** at right was made with a single pour of wax. Pink and green ones are "upside down" candles.

**Another two-pour candle**, below, shows the delicacy—and unpredictability—of results. No two snow candles can be alike.



# Free-form, one-of-a-kind candles are molded in snow

by Doug Dill

Photos by the author

Snow can be the mold you use to create candles that take on a frosty appearance, yet provide a warm glow for winter nights. Hot wax melts and changes its snow molds as it solidifies, producing unusual textures and shapes.

Snow candles are made with your favorite brands of candle wax, colors, scents and wicks. (For sources of supply and basic instructions on handling wax, see *Fancy Candles: Colorful Christmas Gifts*, page 114, Nov. '72 PM.) Snow becomes the mold. The process is like making sand candles except that the snow molds are not as predictable as sand and can result in pleasant surprises for the candlemaker.

If you live in snow country you can melt the wax in the normal fashion on your home stove. If you have to travel to the snow, a campstove makes a fine source of heat. In either case, use a double boiler, never direct heat.

Start making your molds in the snow while the wax is melting. Simply create a depression that wax can be poured into. Dangle a wick into the depression from a stick placed across its rim; the wick should be coated with melted wax and allowed to dry thoroughly before being placed in the mold. Wire-core wicks seem to work best.

There are two basic types of snow candles. The "upside down" candle is made by sculpting a design in the bottom of your depression in the snow. After the wax is poured and set, the candle is removed and turned upside down for use.

More unpredictable designs happen with the two-pour candle. After one pour has



Unique candles are created by pouring wax into snow "mold." Resulting designs are as varied as snowflakes.

solidified completely, more wax, usually of a second color, is poured into the mold. Results can be surprising. Instead of filling the mold to the top, the second pour will run to the bottom of the mold and harden under the first, making its own design. This candle is not inverted, but used in the position in which it is formed. Usually some wax must be removed from the bottom to make it sit flat; use a hot knife and be careful not to break off delicate parts. Sometimes the second pour will go deeper than the wick and another must be inserted; use a heated icpick to make a tiny hole, place the new wick and pour melted wax around it.

It takes about an hour for wax to harden enough for removal from the snow. Be very careful when digging out the candle—parts may spread far from the original mold.

Snow characteristics will affect candles. Try molds made in new or soft snow, both packed and unpacked. Crusty or melting snow makes interesting but generally more predictably shaped candles. ★★★

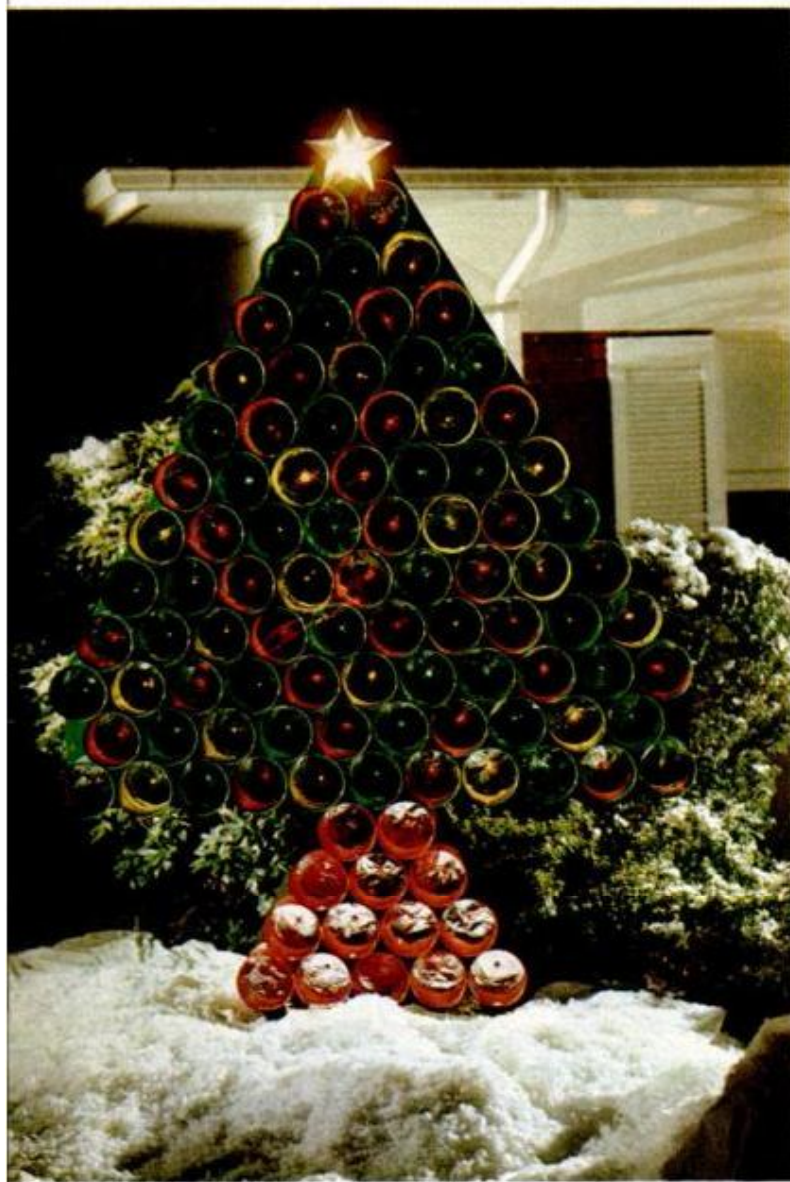

# Yule tree— from tin cans

by Wayne C. Leckey

HOME AND SHOP EDITOR

You'll not only have the most dazzling yard decoration you ever saw, but you'll be helping out with ecology in rounding up the 101 tin cans required to make this 8-ft.-tall Christmas tree.

Serving as reflectors for 101 miniature tree lights, the one-gal. institutional-size cans appear as a pyramid cluster of 6-in.-ball ornaments when lights are turned on.

A brainchild of Oren A. Glatt of Abilene, Kans., the tree is the kind of entry which can easily cop first prize in any local lighting contest—it's that spectacular!

Good sources for the cans are school cafeterias and local restaurants. After washing the cans and removing the labels, drill two holes in the bottom of each—a 1/2-in. hole in the center for a miniature tree bulb, and a 3/16-in. hole for a 1/2-in. wood screw. A swinging support for the can, such as the one shown in the photos on page 73, automatically centers the can on the drill press and makes the drilling go faster. A neater 1/2-in. hole in thin sheet metal results when you start with a 1/8-in. bit and work up to the final size with progressively larger bits. In each case, you should not ram the bit through, but drill slowly.

After all holes are drilled, 87 of the cans are sprayed green on the inside 1 1/2-in. or so down from the top. It's not too necessary to paint the outside of the cans although it will make the tree look better in the daytime, and, of course, prevent rusting. Finally, clear spray is applied to the remainder of the interior of the cans to add additional "sparkle." The same is done to the remaining 14 cans (the trunk of the tree) except they are painted red.

The cans are attached to a 3/4-in.-plywood

*(Please turn to page 176)*



**Daytime look of tree (left)** is improved when plywood and cans are painted green. Prop holds tree upright.



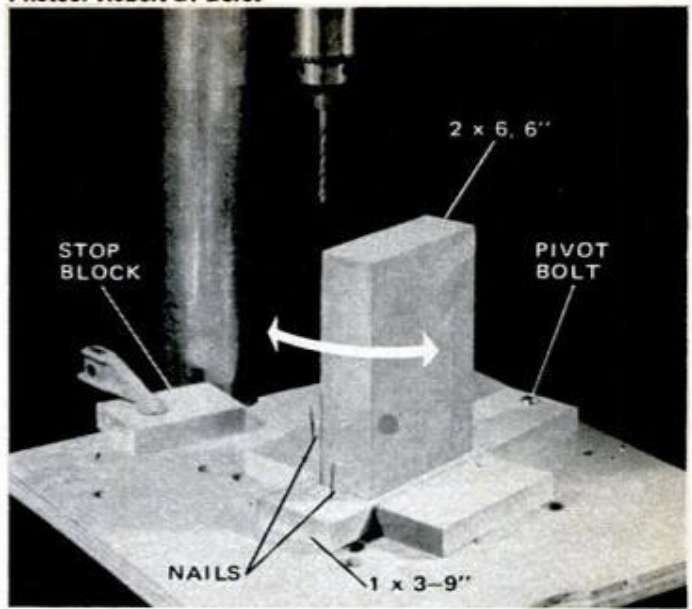
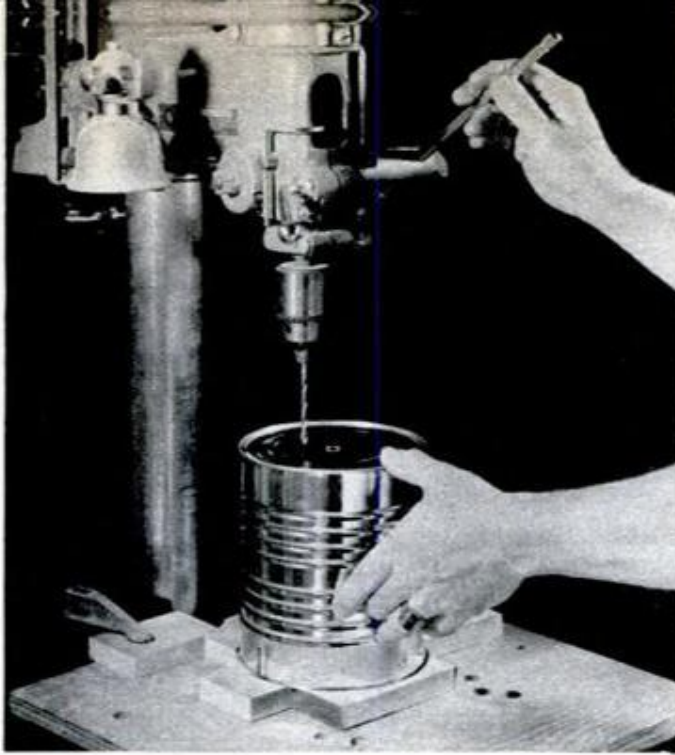

Jig support for drilling holes in bottom of cans (above right) is improvised from scrap blocks and pivoted to wood drill-press table so jig can be swung out and tin can placed over top. Nails automatically center can on jig and stop block centers jig under drill for fast and accurate drilling. True holes result in the thin metal when  $\frac{1}{2}$ -in. holes are started with  $\frac{1}{8}$ -in. bit. Spray paint (right) is used to coat inside of cans  $1\frac{1}{2}$  in. down from rim. This is done primarily for looks. Drawings (below) show how three parts of tree are laid out on 4x8-ft. sheet of fir plywood and how 1x3 cleats are placed on back to hold these parts together. Star is cut from foil pizza pan.

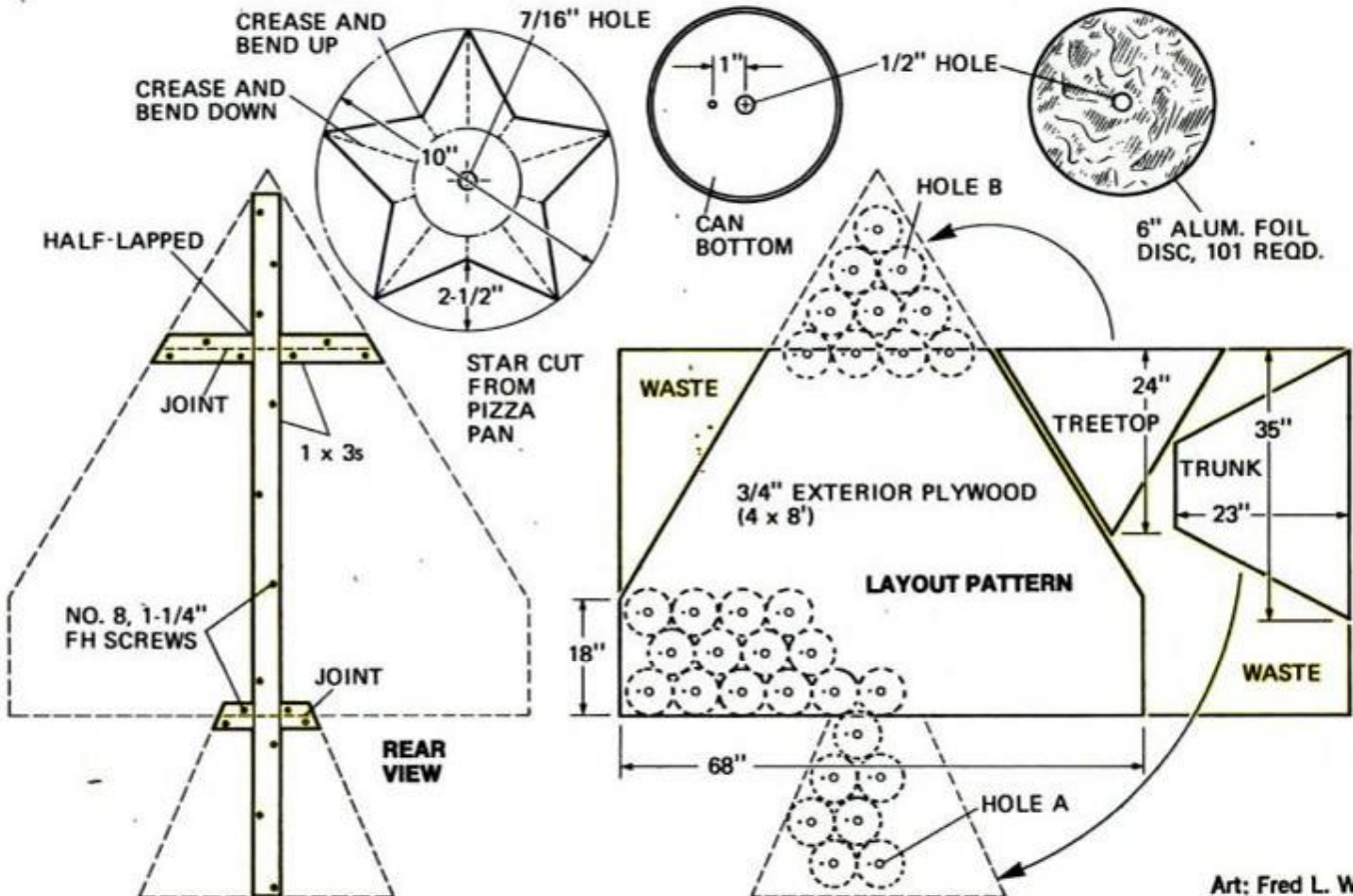

Art: Fred L. Wolff

# New gear for the snow season

Cold weather clothes this coming winter are likely to look wet and colorful, feel warm, comfortable.

by Bill McKeown  
OUTDOORS EDITOR

Winter wear warmth for snowmobilers includes matching suits, some with a "wet look," like these from John Deere made to match the manufacturer's machines.

Winter outdoorsmen—whether enjoying the action or watching it—have a lot of extras going for them this year. Clothes and accessories that can keep you warm have turned on the off-season for sportsmen and spectators alike.

Much thanks goes to the snowmobile. Skiing helped develop light stretchable clothes and unbendable boots. But it was the snow-going machines that required the wind-resistant padded suits and boots that now keep out the cold when you're in the driver's seat, on the sidelines and in the stadium, out ice fishing, off mountain camping, or just while doing chores, hunting, or mushing through drifts.

Goose down, DuPont's Dacron Fiberfill II, PolarGuard fabric and Thermos Space Blankets are among innovations that insulate to keep body warmth in where it belongs. And for face, eye, ear, nose, finger and toe protection, there are new goggles, gloves, face masks, helmets, thermal wear, socks and survivor boots—some electrified.

For appearance, far-out colors and wet-looks will be brightening the black and white of snowscapes. But the big bonus is cool season warmth and comfort from outdoor gear to keep winter in its place. ★★





Matching new Polaris white and blue machines are red and blue, wet-or-dry-look one-piece suits or jacket and pants sets that are easier to remove.



Uvex Sound System from Garcia Ski & Tennis has goggles, earphones to hear downhill music, radio tips from instructor, belt pouch for receiver, tape.



Racing stripes are feature of Mercury's four snowmobile models and jackets of their two-piece suits. Take-off jackets make lodge warm-up stops easier.

Microlouv goggles, new from 3M and about \$15, have tiny horizontal louvers that don't show to viewer but shadow eyes, reduce fatigue from glare.



Formerly all-yellow Ski-Dos now are many colors from Bombardier. Even wider assortment of match or contrast drive and lounge suits are being offered.

# Old boats



Pleasure-boat buffs visit the new Shipyard Museum year-round at Clayton, N.Y., but crowd into this pleasant Thousand Island stretch of Canadian border on the St. Lawrence river in August for the only antique boat show afloat. Judges see their reflection in mirror coats of varnish and polished engines; spectators ashore and on the water watch ancient narrow-beamed beauties glide by at up to 40 mph. Keeping fine old St. Lawrence skiffs, plus rowing craft, canoes, guide boats, launches, runabouts and cruisers alive and well is becoming another art. ★★★

Antique outboards, left, are viewed by visitors, judges during annual display during in-the-water parade and contest for best restored craft. Classic ACF cruiser Vagabond, below, still used by Jim and Tony Lewis of Beaver Falls, N.Y., has 1930s date but modern look.

Photos: Lorraine McKeown



Shipyard Museum at Thousand Islands, Clayton, N.Y., is only collection specializing in antique and classic (pre-1940) power craft. Exhibits include old outboard motors, inboard steam, naphtha and gasoline engines; classic launches like three-cockpit Snark on trailer.



Fawn, a treasured 19-foot launch built sometime prior to 1888 in Skaneateles, N.Y., once was powered by a steam engine, now uses an old 3-hp Buffalo. Classic mahogany Wild Goose of 1915, shown at left, daily cruises her old Chrysler engine at 30 mph.

# New boats

**P**re-boat-show previews of the newest in pleasure craft indicate more outside styling and inside space. Bass boats are still growing in popularity, size, electronic gadgets and horsepower.

Runabouts are making room for more passengers, with opened-up foredecks, and should be even more seaworthy as new safety requirements for flotation, plaques for cargo weight and power recommendations go in effect. Stern steps make boarding easier for skiers or a man overboard. Boatmen are demanding smoother rides as they learn how a good hull should perform. ★★★

**High-style sportsters** in the '74 Glastron line, right, will be the CV-19 S/S, top, and the 18-foot CV-18 S/S. A stern swim platform is a feature of the 19 jet from the Glastron/Carlson division, while the CV-18 will have jet or stern-drive power, full cockpit handrails.



**Runabout speedster** with the additional open space of a foredeck cockpit is this model from Crestliner's updated line. New Ted Williams 14-foot Gamefisher bass boat from Sears, bottom, has optional controls available, with power up to 25 hp.



**Catamaran sailing** may be an ancient art, but it's showing modern popularity. Chrysler's new Musketeer, above, is 16½-foot day sailer designed by British champion cat sailor Rod Macalpine-Downie. Paceboat to windward is Chrysler C-486 cruiser, 23-foot hardtop.



# How to fix a gas clothes dryer

Data: Ed Franzese

A gas clothes dryer, like an electric dryer, is designed to remove moisture from damp clothes by passing hot air over and through them. In place of a simple heating element, a gas dryer has a burner with complex controls and safety devices. While controls and ignition systems vary from one manufacturer to another, there are few basic types and troubleshooting charts on the next five pages will tell you how to deal with the most common problems that may

arise. Gas problems more complicated than those covered in the charts should be handled only by a qualified serviceman.

Many electrical and mechanical functions of a gas dryer are the same as those of an electric model and many of its problems are handled the same way—these are also covered in the charts. But the electronic dampness sensors found on many newer gas and electric dryers are delicate devices best left to the serviceman. ★★★

## Typical gas dryer components

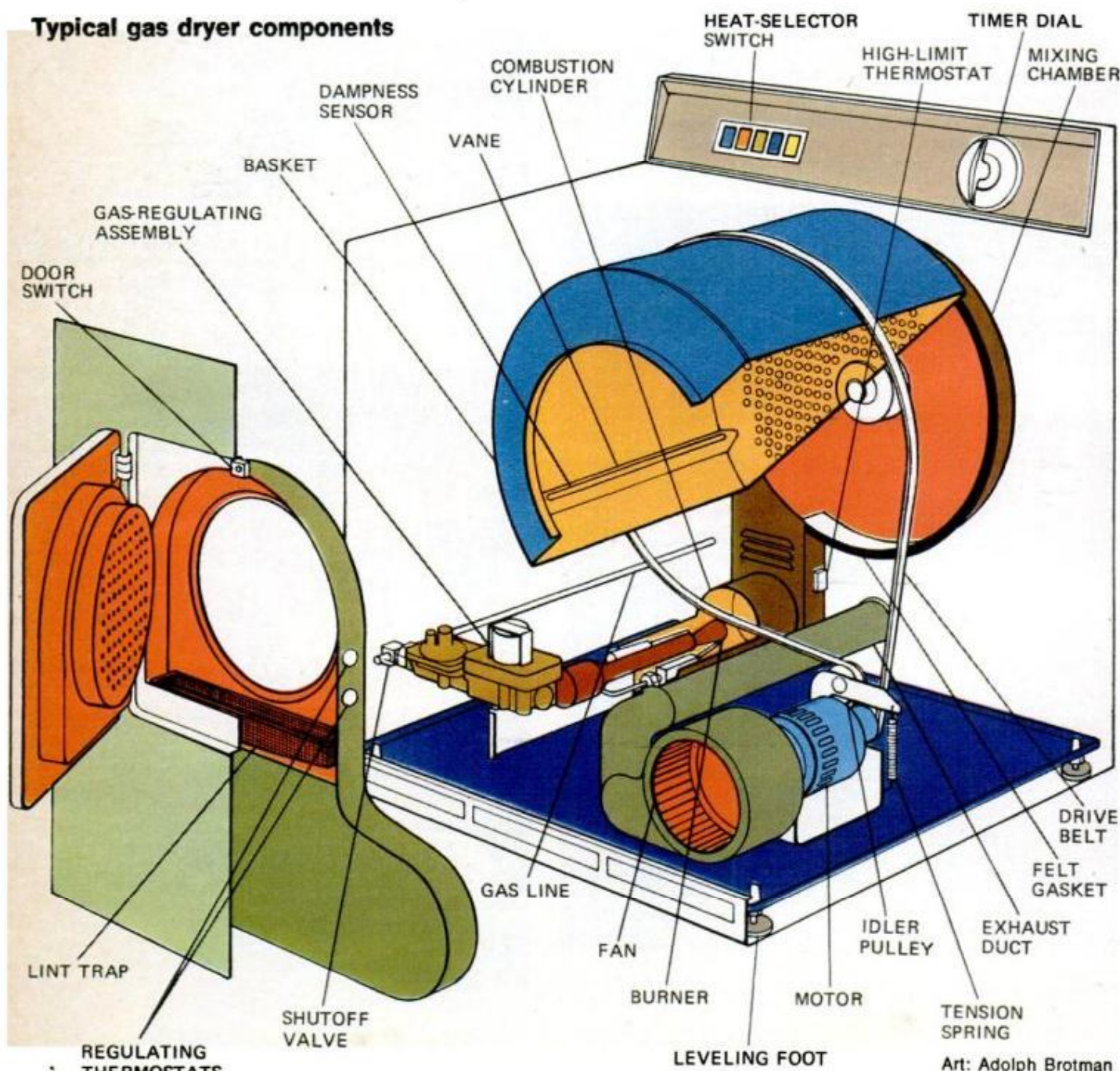

Art: Adolph Brotman

**Motor does not start**

POSSIBLE CAUSES	WHAT TO TRY
1. Fuse blown.	Replace fuse (or reset circuit breaker).
2. Door open.	Close door tightly.
3. Timer defective.	Check the line voltage at timer. Turn timer on and place 115-v. test lamp across its terminals. If you get a reading, it indicates open contacts. Replace contacts or timer.
4. Door switch defective.	Remove wires from the door switch, then place continuity tester across the switch terminals and press button. No reading indicates a defective switch. Replace.
5. Motor wiring loose or disconnected.	Tighten or reconnect loose or disconnected wires.
6. Centrifugal switch defective.	Refer to the manufacturer's schematic diagram for switch terminals on the motor; place continuity tester across terminals. If you get no reading, replace switch or motor.
7. Motor defective.	Direct-test motor with test jumper. If motor still fails to run, replace.

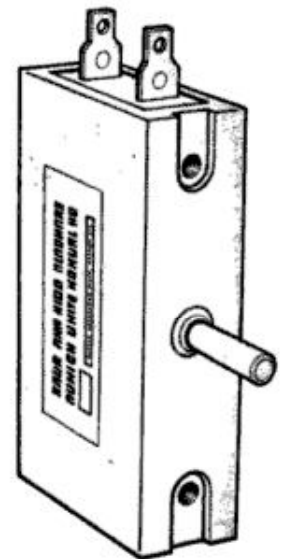
**DOOR SWITCH****Motor hums**

POSSIBLE CAUSES	WHAT TO TRY
1. Centrifugal switch in motor stuck.	Remove both motor and switch. Grease the shaft, clean the contacts and reassemble. If the switch still sticks, replace it.
2. Basket binding or idler wheel broken.	Check the basket while turning it by hand. Replace any worn or broken idler wheels. Check leveling of machine.
3. Motor defective.	Direct-test motor with test jumper. Replace motor if it fails to operate properly.

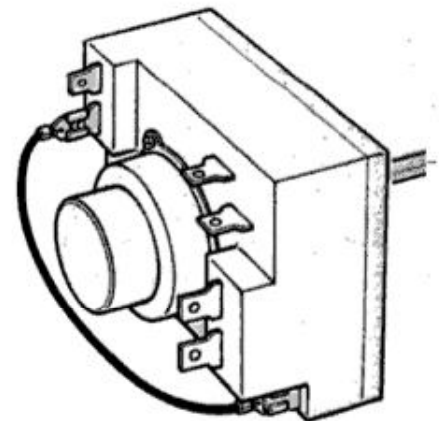
**TIMER****Motor runs, basket does not rotate**

POSSIBLE CAUSES	WHAT TO TRY
1. Broken belt.	Remove back of dryer and replace any broken belts you find.
2. Loose pulley.	Check setscrews in all pulleys. If pulleys are slipping on their shafts, realign them first and then tighten setscrews.
3. Tension spring broken.	Replace broken tension spring.
4. Basket binding or idler wheel broken.	Check the basket while turning it by hand. Replace any worn or broken idler wheels. Check leveling of machine.

## Noisy operation

POSSIBLE CAUSES	WHAT TO TRY
1. Loose fan.	Retighten fan-blade setscrew on motor shaft.
2. Loose objects caught in basket.	Remove all loose objects from basket.
3. Loose motor pulley.	Retighten motor-pulley setscrew.
4. Worn belt.	Replace any worn or frayed belts.
5. Basket binding.	Turn basket by hand to locate the point of binding. Check felt gaskets, wire harnesses and leveling of the unit.
6. Vibration.	Check for a loose fan blade, an out-of-balance fan blade, also for worn basket bearings and motor mounts. Tighten any loosened parts and replace worn parts.

## TIMER

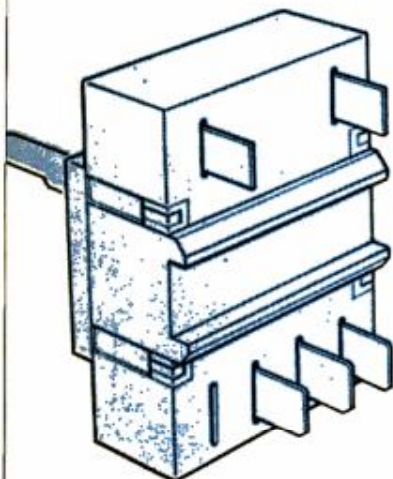

Pattern of airflow in most gas dryers is as shown below—air is mixed with hot flue products behind basket, sucked through it and through lint trap to fan; then it's forced out through exhaust duct and hose. Below, right, is the type of basket-drive system generally found in dryers that do not use the single-belt drive shown on page 78.

## Dryer does not shut off

POSSIBLE CAUSES	WHAT TO TRY
1. Timer defective.	Check for a stuck timer or welded contact points. Replace.
2. Door switch defective.	Remove wires from the door-switch terminals; then place continuity tester across terminals. If there is a reading before the switch button is pressed, replace switch.
3. Operating thermostat defective.	Check thermostat against the manufacturer's specifications with a thermometer in the exhaust duct. If defective, replace.
4. Motor grounded.	Remove wires from motor terminals. Touch one lead of the continuity tester to a terminal and the other lead to the motor housing. If you get a reading on the tester, the motor is grounded. Replace.

## AIRFLOW IN DRYER

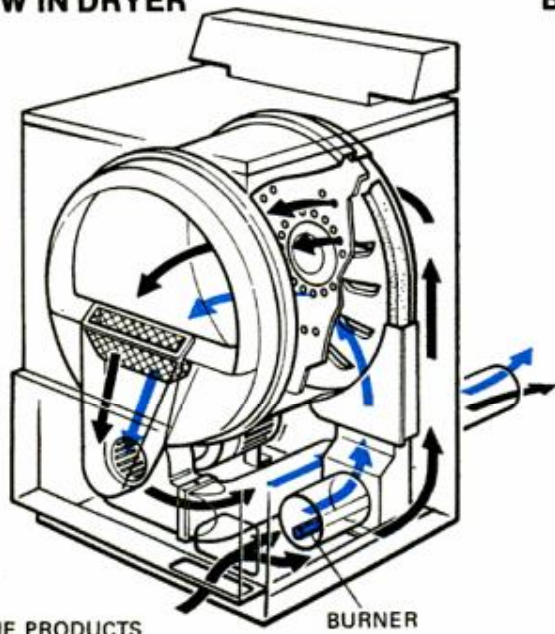

## BASKET DRIVE WITH REDUCTION PULLEY

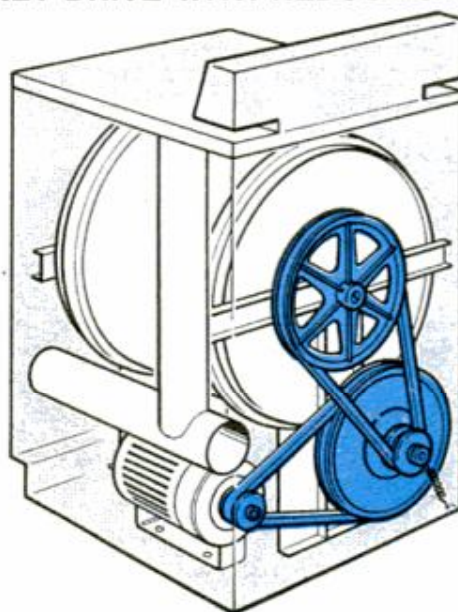



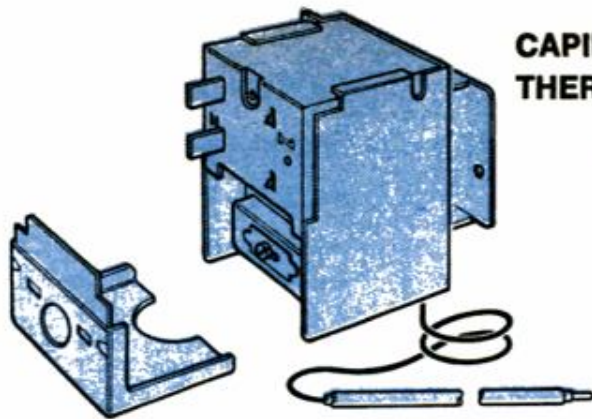

## CAPILLARY THERMOSTATS

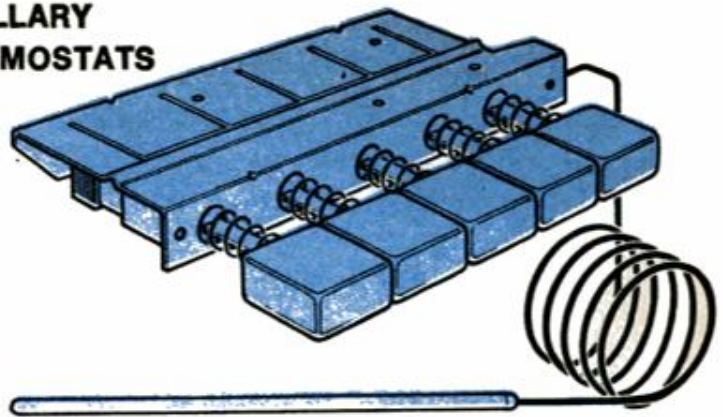

### Clothes dry slowly or not at all

POSSIBLE CAUSES	WHAT TO TRY
1. Basket overloaded.	Check size of load. Refer to manufacturer's minimum and maximum standards.
2. Operating thermostat defective.	Check thermostat against the manufacturer's specifications with a thermostat in the exhaust duct. Replace thermostat if it does not operate at correct temperatures.
3. Lint trap clogged.	Clean lint trap thoroughly.
4. Exhaust hose clogged.	Clear exhaust hose.
5. Main burner orifice too small.	Check size of orifice (usually stamped on fitting) against manufacturer's specifications. Replace if incorrect.
6. Timer set too low.	Check owner's operating manual and increase the timer setting.
7. Ignition assembly defective.	Refer to following charts that cover pilot and ignition problems.

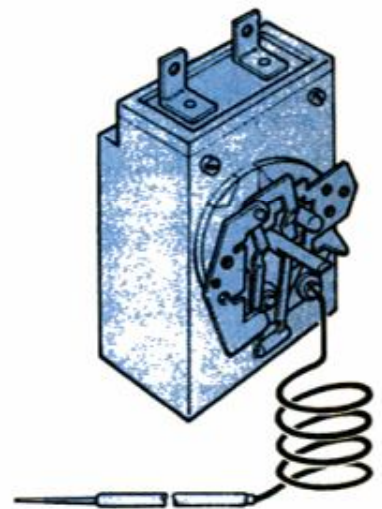

### Pilot will not light or goes out

POSSIBLE CAUSES	WHAT TO TRY
1. Loose connections in thermocouple circuit.	Check thermocouple fittings and tightness of screws on terminal leads.
2. Vent pipe off fan housing; draft blows pilot out.	Check position of the vent pipe (exhaust duct). Reposition it if necessary and secure it with a retaining clip.
3. Pilot burner or orifice dirty.	Check and clean pilot burner and orifice. Do not ream orifice.
4. Filter clogged.	Clean or replace pilot line filter.
5. Thermocouple defective.	Check thermocouple voltage with pilot on. Reading should be between 10 and 18 millivolts. Check against manufacturer's specifications.
6. Magnetic (Baso) valve defective.	Check thermocouple voltage as above. If okay, replace Baso valve.
7. Low gas pressure.	Pressure after regulator should be 2 to 3 ounces per square inch, or show a 3½-in. water column in a U-tube manometer, with the main burner operating. Check with gas company if low.

## BIMETAL THERMOSTATS



## Pilot burning high, low or erratically

POSSIBLE CAUSES	WHAT TO TRY
1. Orifice clogged.	Clean orifice—do not ream.
2. Pilot out of adjustment.	Adjust pilot by means of screw on Baso valve to raise or lower flame.
3. Orifice wrong size.	Check orifice size against the manufacturer's specifications. Replace if wrong.
4. Filter clogged.	Clean or replace pilot line filter.
5. Gas pressure too high or too low.	See "Low gas pressure" in preceding chart.
6. Yellow-tipped flame.	Open air shutter or use smaller orifice. Clean orifice—do not ream.
7. Orange flame.	Clean orifice, surrounding area—do not ream.

**Caution:** Be sure power is turned off before you handle components. Make all continuity tests with power off. When using a test lamp, keep power off while connecting and disconnecting the lamp. Use your manufacturer's manual to locate components, and use only replacement parts that meet his specifications.

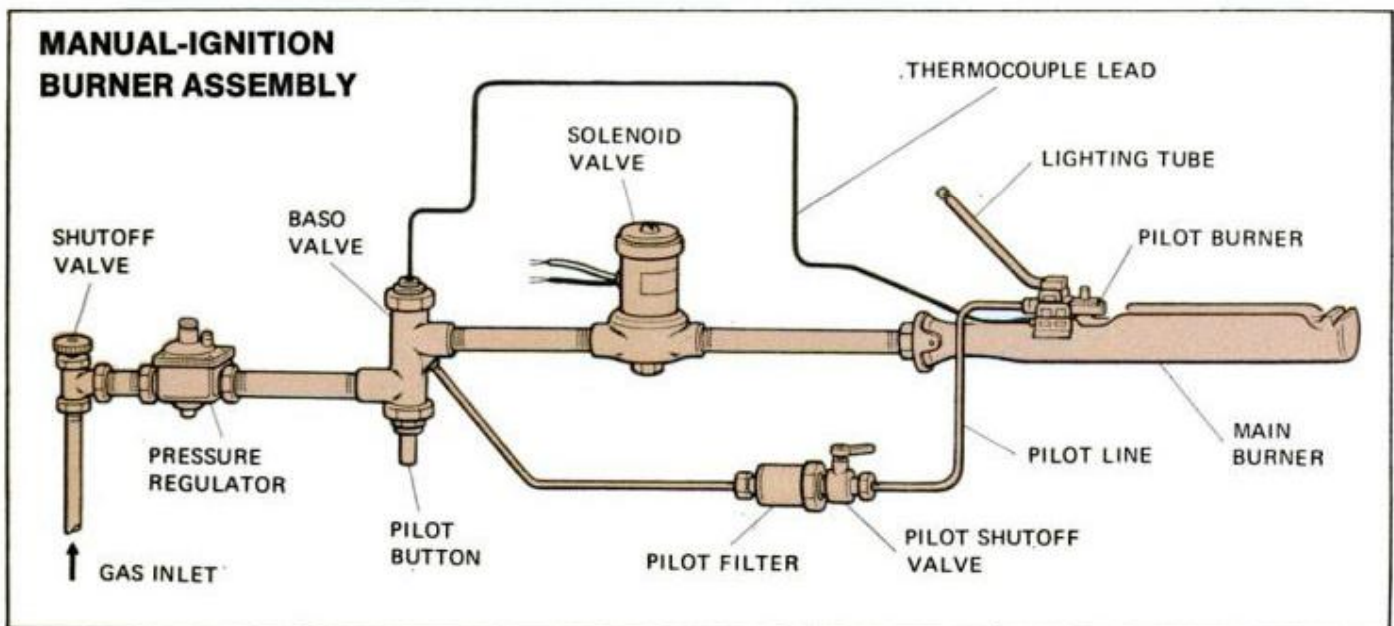

## MANUAL-IGNITION BURNER

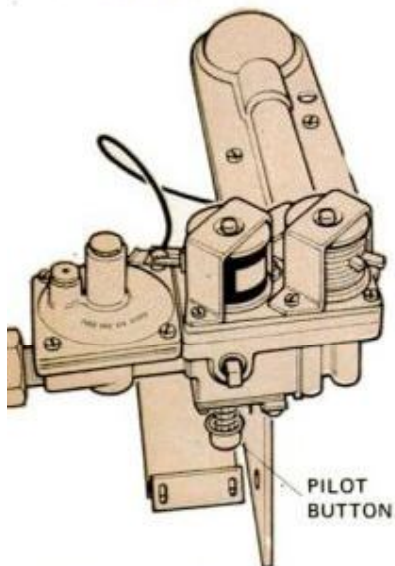

## Pilot lights; main burner does not light

POSSIBLE CAUSES	WHAT TO TRY
1. Orifice plugged.	Clean main burner orifice.
2. Main solenoid coil defective.	Disconnect power and remove leads from solenoid coil. Place continuity tester across terminals. No reading indicates a defective or open solenoid. Replace.
3. Open circuit to main solenoid.	Disconnect power. Check continuity of circuit through pilot switch, door switch, thermostats and line fuse. Correct wherever circuit is open.
4. Timer defective.	Turn timer on. Check voltage at the solenoid with 115-v. test lamp. No voltage indicates a defective timer. Replace.
5. Valve closed.	Open valve in line to main burner.
6. Centrifugal switch in motor defective.	See "Centrifugal switch defective" in chart titled "Motor does not start" (page 79).

## Glow coil does not heat

POSSIBLE CAUSES	WHAT TO TRY
1. Broken or damaged coil.	Replace coil.
2. Leads broken or shorted to housing.	Replace broken leads; remove leads from shorted points. Check transformer secondary voltage.
3. Open circuit in transformer	Disconnect power and check transformer windings for continuity. If open, replace transformer.
4. Open circuit between timer and transformer.	Disconnect power; check continuity through warp-switch (bimetal) contacts, fuses, safety pilot contacts, timer contacts. Correct wherever open.

## ELECTRIC-IGNITION ASSEMBLY

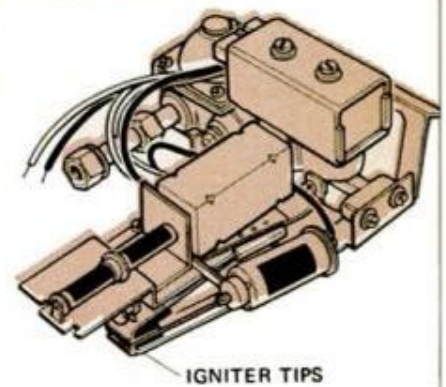

## GLOW-COIL ASSEMBLY WITH PILOT

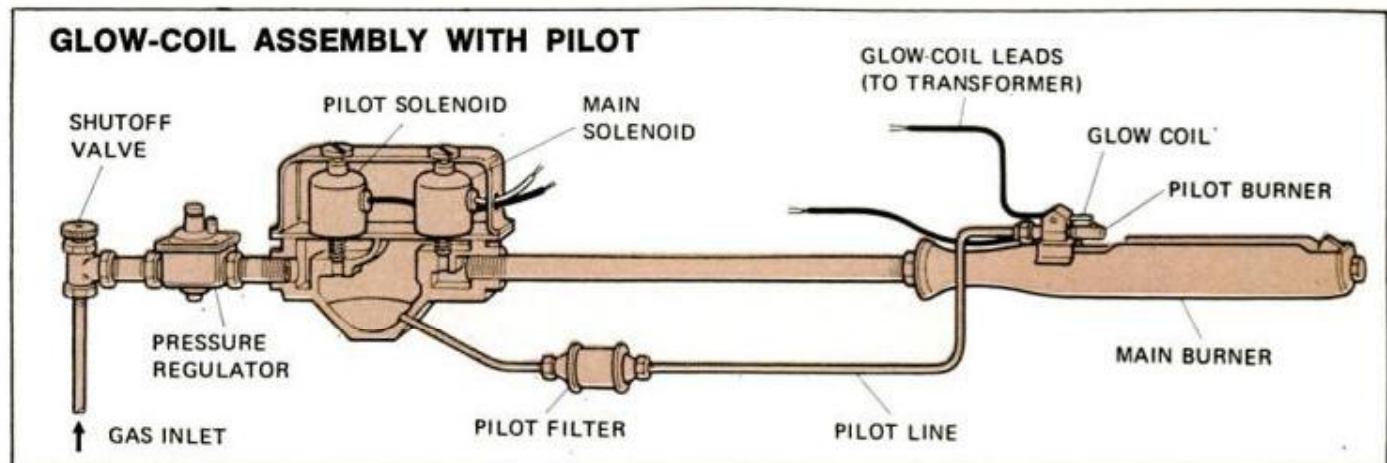

## Glow coil heats; pilot does not ignite

POSSIBLE CAUSES	WHAT TO TRY
1. Orifice plugged.	Clean pilot orifice—do not ream.
2. Valve shut.	Open gas valve.
3. Pilot solenoid defective.	Disconnect power and solenoid leads. Test for continuity across terminals. No reading indicates a defective solenoid. Replace.
4. Vent pipe off fan housing causing draft across pilot.	Check position of the vent pipe (exhaust duct). Reposition it if necessary and secure it with a retaining clip.
5. Coil not hot enough.	Glow coil should be white hot. Refer to the following chart.

## GLOW-COIL BURNER ASSEMBLY

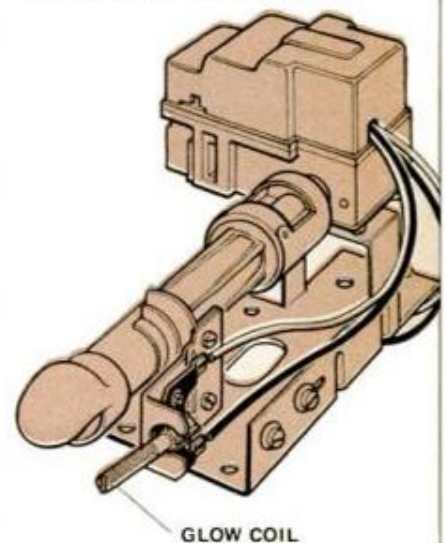

## Glow coil not hot enough

POSSIBLE CAUSES	WHAT TO TRY
1. Loose connection or short circuit.	Check and tighten all connections in the circuit. Reposition leads to avoid shorting them to bracket or housing.
2. Low voltage.	Check the line voltage, then check the voltage on both sides of the transformer against the manufacturer's specifications. If low, replace the transformer.

# How to pick the right paint roller



## Quality paints deserve quality rollers

The typical paint applicators shown above make painting today easier than ever. Care should be taken to select roller covers that best suit the type of paint to be used. Basically, covers to be used for latex paints should not be made of rayon or lamb's wool (water causes softening and matting of the fibers). Oil and alkyd paints (thinned with mineral spirits or turpentine) will not affect most rollers. See the chart on the opposite page for the correct cover to use for most home paint jobs.

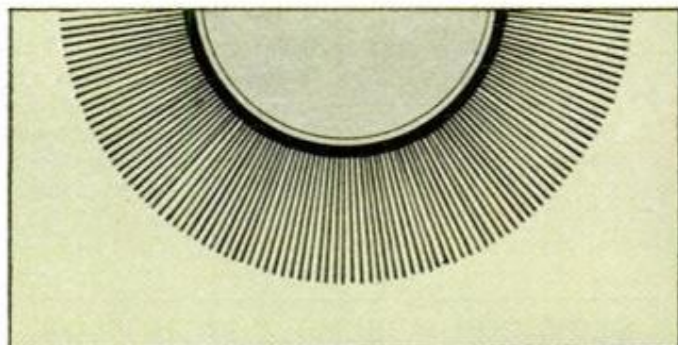

### Too dense roller covers

The number of fibers per square inch in a roller is a critical factor. If they are too dense, they will cut down the paint-holding capacity of the roller. They will also interfere with the roller's ability to meter out paint evenly on the surface.

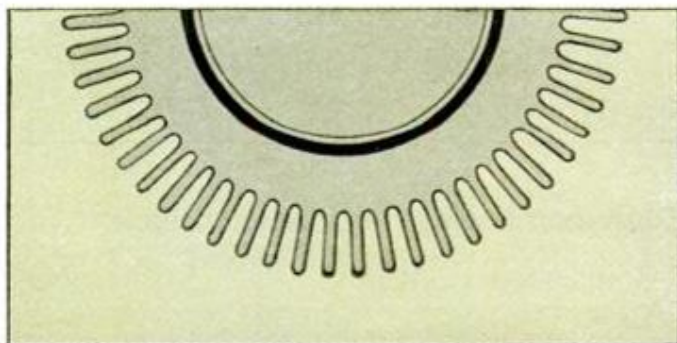

### Sparse-density roller covers

When too few fibers are distributed over a roller surface the result is just as bad as if the roller had too many fibers. Having an insufficient number of fibers, a roller lacks capacity to flow paint on the surface evenly. Result: a spotty paint job.

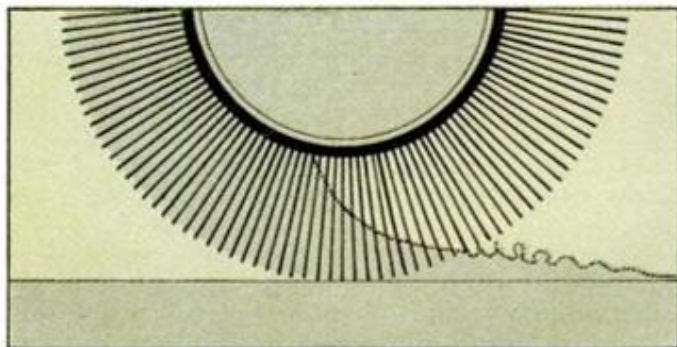

### Correct density

The proper number of fibers on a roller will distribute a uniform coat of paint that is relatively smooth as it goes on. Such a roller also carries a good paint load and cuts down the number of passes between the surface and the paint tray.

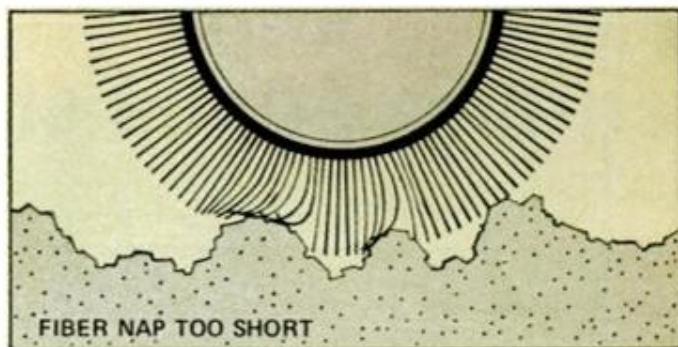
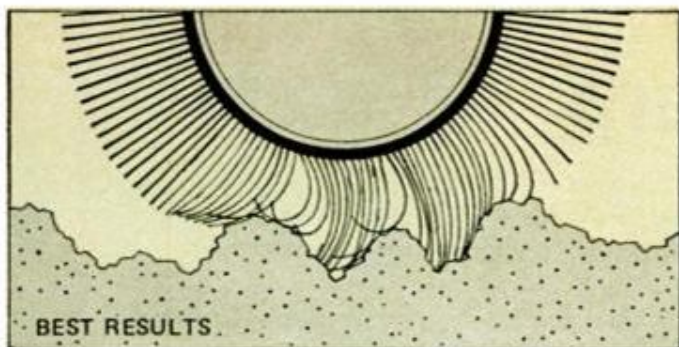

### Rough surface takes longer nap

Basically, the rougher the surface, the longer the nap length of roller cover should be. When fiber length is correctly matched to surface, a smooth, uniform coat without "show-through" is possible.

### Nobody needs a 'holiday'

If fiber length is too short for surface texture, roller cover will fail to reach bottoms of valleys in rough surface like stucco. Result: a paint job with show-throughs, commonly called holidays.

## GUIDE TO PAINT-ROLLER SELECTION

CODE FOR CHART BELOW	SIZE (Number)	CORE (1st letter)	FABRIC (2nd letter)	NAP LENGTH (3rd letter)	
				S-1/4"	E-1"
	9-9"	J-Jumbo	A-Lamb's wool	1-1/2"	X-1 1/4"
	12-12"	F-Fiber	C-Carpet	L-3/4"	U-1 1/2"
	18-18"		K-Textfab		
			M-Mohair		
			P-Pronel		

Chart information: EZ Paint Corp.

PAINT OR COATING MATERIAL	SMOOTH SURFACE <sup>1</sup>	SEMIROUGH <sup>2</sup>	ROUGH <sup>3</sup>	EXTRA ROUGH <sup>4</sup>
<b>Primers, Metal</b>				
Chlorinated rubber	9FP, 9JP	9FPI, 9JPI		
Epoxy	9FAS	9FA, 9JA		
Oleo-resinous	9FAS	9FA, 9JA		
Red lead or tinner's red	9FP, 9JP, 9FA, 9JA	9FPI, 9JPI, 9FA, 9JA		
Vinyl	9FAS	9FA, 9JA		
Wash coat	9FP, 9JJP	9FPI, 9JPI		
Wetting oil	9FAS	9FA, 9JA		
Zinc chromate	9FP, 9JP, 9FA, 9JA	9FPI, 9JPI, 9FA, 9JA		
<b>Primers, Wood</b>				
Oil and alkyd	9FP, 9FPS	9FPI, 9JPI, 9FA, 9JA		
Enamel undercoat	9FM, 9FPS, 9JM	9FPI, 9JPI		
<b>Primers, Masonry</b>				
Block fillers, oil or latex				9FPX, 9JPX
Silicone water repellent		9FA, 9JA	9FAL, 9JAL	9FAX, 9JAX
Sealer, clear		9FA, 9JA	9FAL, 9JAL	9FAE, 9JAE
Oleo-resinous		9FPI, 9JPI	9FPL, 9JPL	9FPE, 9JPE
<b>Primers, Wallboard</b>				
Emulsion or latex	9FP, 9JP	9FPI, 9JPI		
Oil and alkyd	9FP, 9JP, 9FA, 9JA	9FPI, 9JPI, 9FA, 9JA		
<b>Exterior Wood Finishes</b>				
Oil and alkyd paints	9FPS	9FPI, 9JPI, 9FA, 9JA	9FPL, 9JPL, 9FAL, 9JAL	
Latex house paints	9FPS	9FPI, 9JPI	9FPL, 9JPL	
Oil stains	9FA, 9JA	9FAL, 9JAL	9FAE, 9JAE	9FAX, 9JAX
Wood preservatives	9FA, 9JA	9FAL, 9JAL	9FAE, 9JAE	9FAX, 9JAX
<b>Floor Coatings</b>				
Alkyd	9FM, 9JM, 12JM, 18JM	9FP, 9LP, 12JP, 18JP		
Chlorinated rubber	9FM, 9JM, 12JM, 18JM	9FP, 9LP, 12JP, 18JP		
Epoxy	9FM, 9JM, 12JM, 18JM	9FA, 9JA, 12JA, 18JA		
Latex	9FM, 9JM, 12JM, 18JM	9FP, 9JP, 12JP, 18JP		
Sodium silicate (water glass)	9FM, 9JM, 12JM, 18JM	9FP, 9JP, 12JP, 18JP		
Urethane	9FPS, 9FM, 9JM, 12JM, 18JM	9FA, 9JA, 12JA, 18JA		
Seamless flooring system	9FPL for base, chip coats 9FPS for glaze coats			
<b>Interior Flat Finishes</b>				
Oil and alkyd flat	9FP, 9JP, 9FA, 9JA	9FPI, 9JPI, 9FA, 9JA	9FPL, 9JPL, 9FAL, 9JAL	9FPE, 9JPE, 9FAE, 9JAE
Latex	9FP, 9JP	9FPI, 9JPI	9FPL, 9JPL	9FPE, 9JPE
<b>Masonry Paints</b>				
Alkyd	9FP, 9JP, 9FA, 9JA	9FPI, 9JPI, 9FA, 9JA	9FPL, 9JPL, 9FAL, 9JAL	9FPE, 9JPE, 9FAE, 9JAE
Latex	9FP, 9JP	9FPI, 9JPI	9FPL, 9JPL	9FPE, 9JPE
Styrene-butadiene	9FP, 9JP	9FPI, 9JPI	9FPL, 9JPL	9FPX, 9JPX
<b>Stipple Paint</b>	9FC	9FC		
<b>Texture Paint</b>	9FK	9FK		
<b>Varnishes</b>				
Alkyd	9FPS, 9FM			
Phenolic	9FPS, 9FM			
Urethane	9FPS, 9FM			
<b>Wire-Fence Paints</b>		9FAL, 9JAL	9FAE, 9JAE	9JAU

Footnotes: 1—smooth wallboard, putty coat plaster, sanded wood, smooth metal; 2—sand-finished plaster or drywall, metal, poured concrete; 3—textured plaster, light stucco, wood shakes, filled block; 4—raw block, brick, heavy stucco.

# How to keep cutting edges sharp

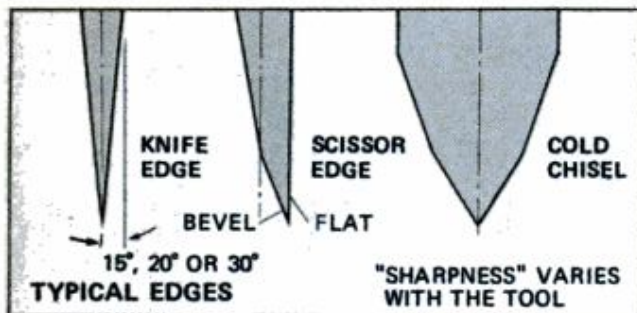

## The how and why of sharpening

It won't take you long to discover that you'll get twofold benefits from keeping all cutting edges of your various tools sharp. First, your skills with chisels, knives, gouges and the like will increase because you will have better control over the tool. Second, since a dull cutting tool is far more dangerous to work with than a sharp one, you'll minimize the chance of unfortunate accidents. (A dull chisel, for example, forces you to do the work that the tool should be doing, by applying extra pressure. A chisel should cut effortlessly so there is no possibility of the tool skipping or jumping and nicking your free hand.)

Though most beginning workshoppers believe that efficient sharpening is beyond their skills, the opposite is true. Almost anyone can obtain, and keep, a sharp cutting edge rather than be forced to work with a ragged one—if he follows the basics listed on these pages.

Two sharpening rules of thumb you should always keep in mind:

□ *Sharpen cutting tools regularly;* don't wait until they are dull and nicked because the cutting edge will then have to be reshaped on the grinding wheel.

□ *Maintain the tool's original cutting-edge shape* (see examples above) *when sharpening.* Various tools call for specific degrees of bevel and shape: These shapes (degree of bevel) have proven to be the best for the particular job for which the tool is intended.

Any cutting tool that has been abused—lost its shape or nicked in its cutting edge—requires two steps for reconditioning: reshaping and sharpening. The reshaping may be done on a grinder, or with files if the tool is "soft" enough (of low carbon steel). To reshape, use coarse-grit grinding stones or files. The object of reshaping is to true a tool's edge, restore proper bevels and remove all nicks. Sharpness is *not* obtained with the coarser grits. Sharpening differs from reshaping in that only the edge requires work—removal of small particles of metal to achieve a razor edge.

## Grinding and grinding wheels

There are two principal types of grinding wheels: natural and man-made. The first are of fine grit and are used in water at relatively low speeds for sharpening and fine honing. To reshape an edge, switch to one of the man-made stones (available in fine, medium-fine, medium-coarse and, occasionally, in coarse). Though several types are made, best for all-around use are long-wearing bonded and vitrified aluminum-oxide abrasive wheels. Grinding generates heat; stop frequently and water-cool the tool so its temper is not drawn. If tool becomes bluish, it's too hot and has lost its hardness. After frequent use, metal particles may fill (load) the stone's pores. To dress a stone, use a steel wheel dresser; to dress natural stones, use a stone or a chunk of concrete.

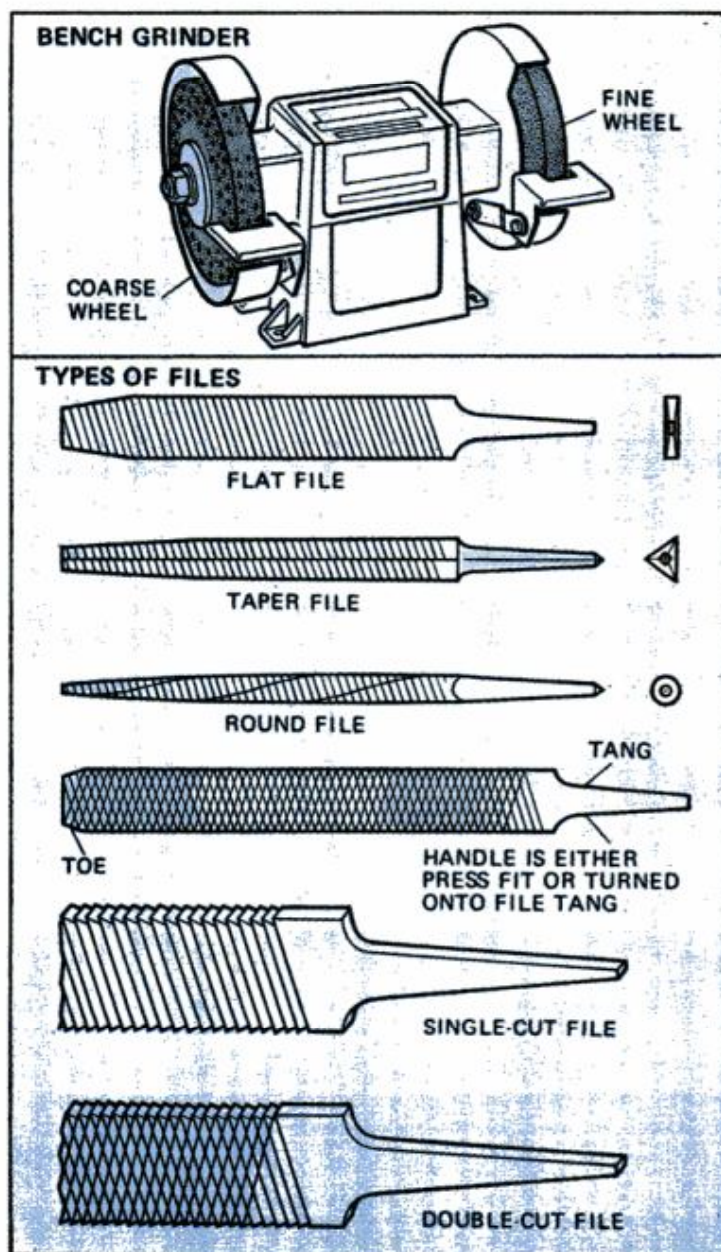

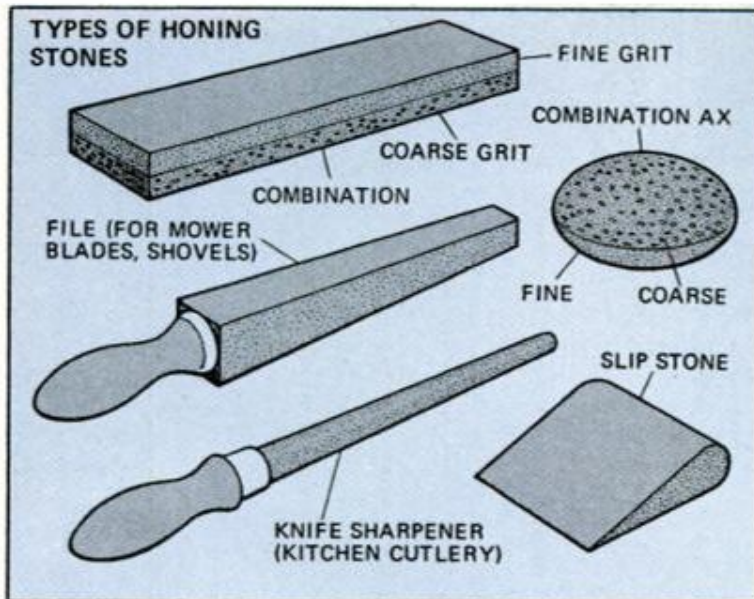

### How-tos of honing

Like grinding wheels (natural and man-made), stones must be lubricated during use, either with water or a couple of drops of fine-grade machine oil. The lubricating agent is a matter of personal preference, but most pros prefer to use oil. Oilstones are probably the most commonly used honing stone; these are flat and may be of one grit throughout, but the combination type (see drawing above) is more practical to own.

The idea of honing is to feather the cutting edge as fine as possible. To do it, alternately stroke each side with progressively lighter pressure and finer grit abrasive. It is important that every stroke be delivered in the right direction and at the right pressure. Once you have achieved a feather edge, stop. Additional honing can be, in fact, damaging because there is good chance that you will change the tool's edge shape. The tool will be sharpened properly if, when passed lightly across your thumbnail, its edge delicately removes a scant amount of nail.

Honing stones should also be redressed occasionally and stored in a covered box.

### Using files

Low-carbon cutting edges can be reshaped and sharpened with one of the files shown at left on facing page. The bottom edge of the cutter bar on a reel-type mower, for example, can be touched up using a flat metal-cutting file. (Never attempt to sharpen the reel blades unless you have the special equipment such sharpening requires.) When using files to sharpen a plane iron or chisel, support tool in vise so bevel edge is horizontal and cutting edge is facing away from you. File toward the edge. For straight-edge chisels, use mill files; for gouges, round files. Follow filing with a honing. ★★★

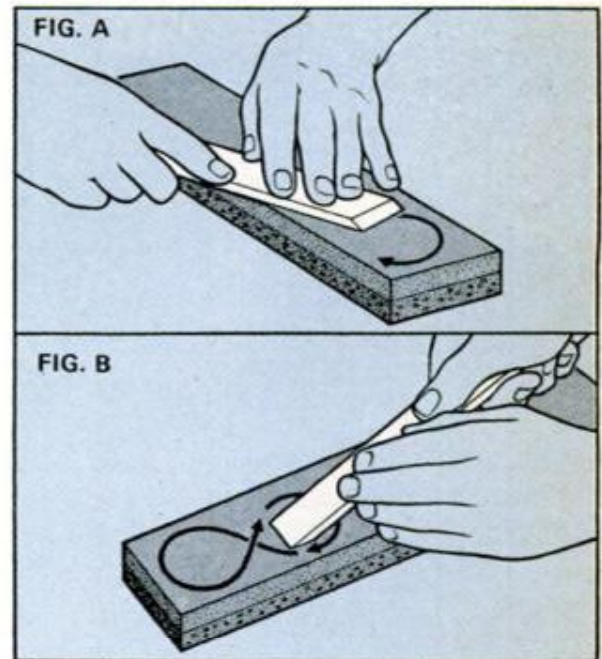

### Honing a chisel

To stone an edge without rounding it, use one hand to control the angle and the other to apply uniform downward pressure. In Fig. A above, burrs are removed using a circular motion. To hone bevel edge (Fig. B), keep wrists rigid and move the blade in a *continuous* figure-8 pattern. To maintain an edge which is started right, it must be occasionally whetted. In A (below), the blade needs attention all around; bevel must be taken all the way down as in B and then feathered to a razor edge as shown in C.

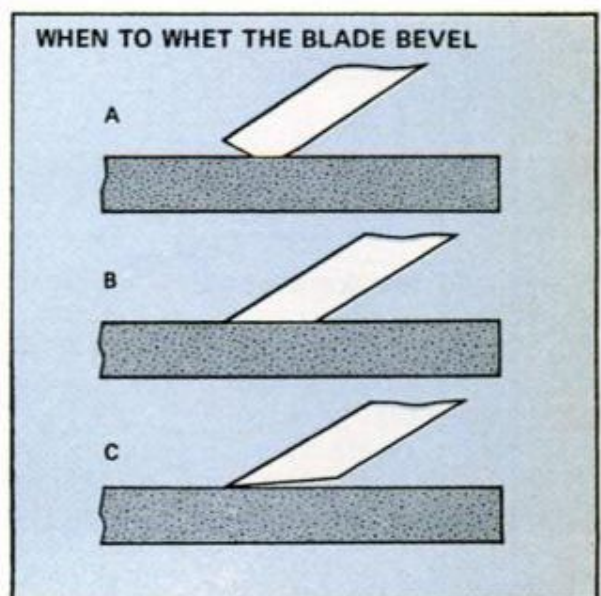

# How to handle an electrical emergency

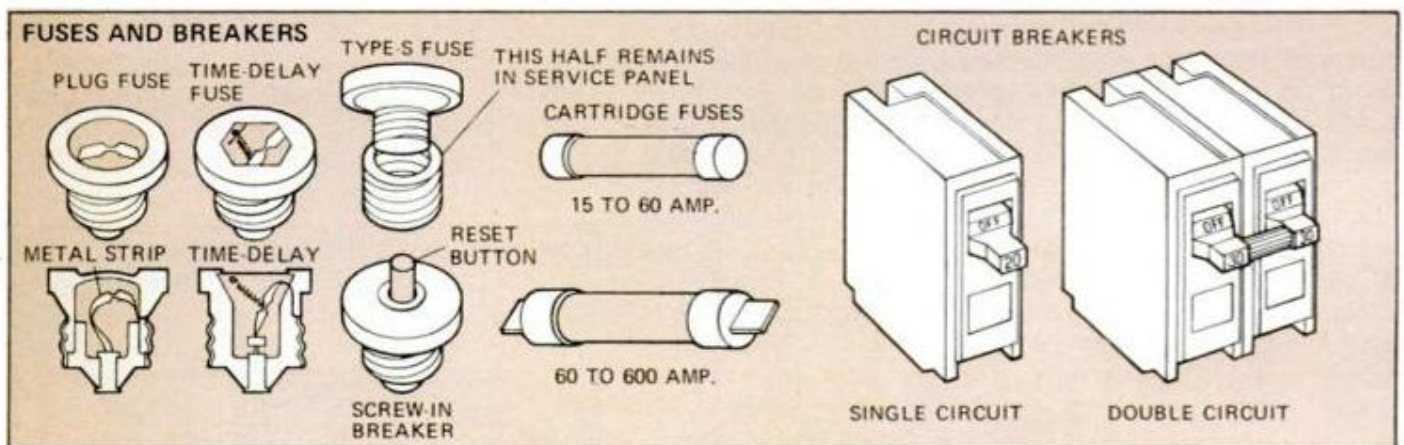
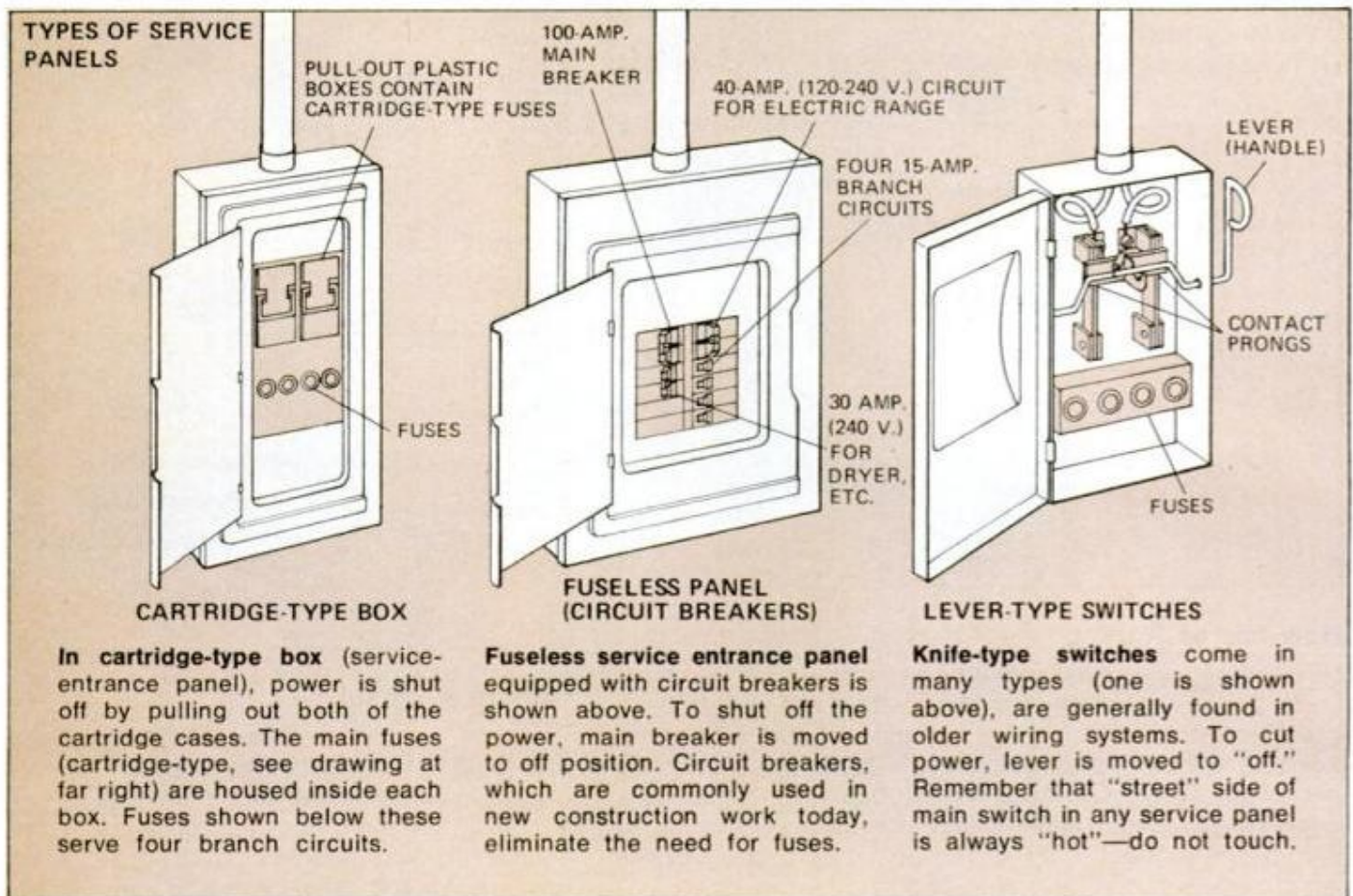

## Fuses and breakers—built-in safety

Electricity entering your service panel from the street is divided into what are called branch circuits that feed various outlets, switches and electrical equipment. Each circuit (cable) branching out from the service panel is connected to a fuse or circuit breaker, which, in turn, completes the connection with the electrical source (or main).

Fuses and breakers are designed to prevent fire hazard. If a line (circuit) becomes overloaded (hot)—whenever its capacity is exceeded by current

demand—the fuse controlling that line will "blow." This breaks the link with the main fuse—and the line goes dead. Several fuses are shown above. Cartridge and plug screw-in types must be replaced with new ones when they blow. Circuit-breakers do not blow, but "throw" a switch to off when overloaded—they are simply reset to the on position. Equipment on a branch circuit should be turned off prior to reactivating its circuit breaker or replacing its fuse.



### HOW A FUSE WORKS

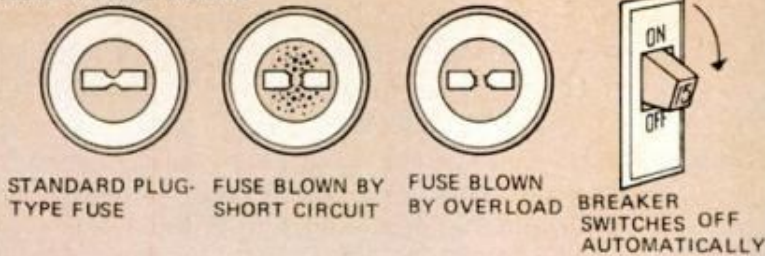

### How an ordinary fuse works

The standard plug-type fuse shown above is designed to protect an electrical circuit from overloading. Current passes through the metal strip running across the face of the fuse. If a circuit goes dead, a quick check of the service panel will let you know which fuse controls that circuit. If the fuse was blown by a short circuit, the metal strip would have been heated instantly to such high temperature that it vaporized, resulting in a discolored fuse window. If an overload was the cause, the strip would have overheated and melted, and broken at its weakest point—visible through a clear fuse window. In each case, the flow of current through the circuit was stopped and can be restored only by substitution of a new fuse. If you have a fuseless panel and a circuit goes dead, a breaker will have been tripped to "off." If problem is a short, an electrician should be called to trace the cause and make the repair.

### UNDERWRITERS KNOT

1. TO PROTECT LINE CORD FROM STRAIN, LOOP CORDS...

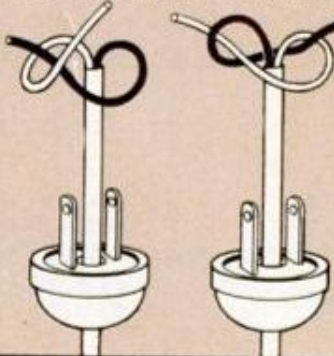

2. PULL DOWN INTO RECESS

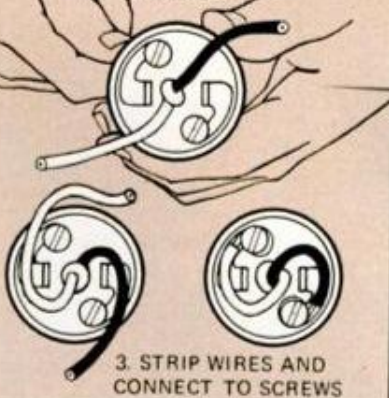

3. STRIP WIRES AND CONNECT TO SCREWS

### How to prevent cord pullout

Because most people mistakenly remove a line cord from a receptacle by pulling the cord instead of its plug, even molded plugs occasionally need replacing. To relieve the cord from such a strain, always make the new connection with an Underwriters knot as shown. If a cord is pulled from its plug, turn off the power for that circuit at the service panel before removing plug from the receptacle. Rewire cord with Underwriters knot to avoid recurrence of pullout.

### PUSHBUTTON FUSE

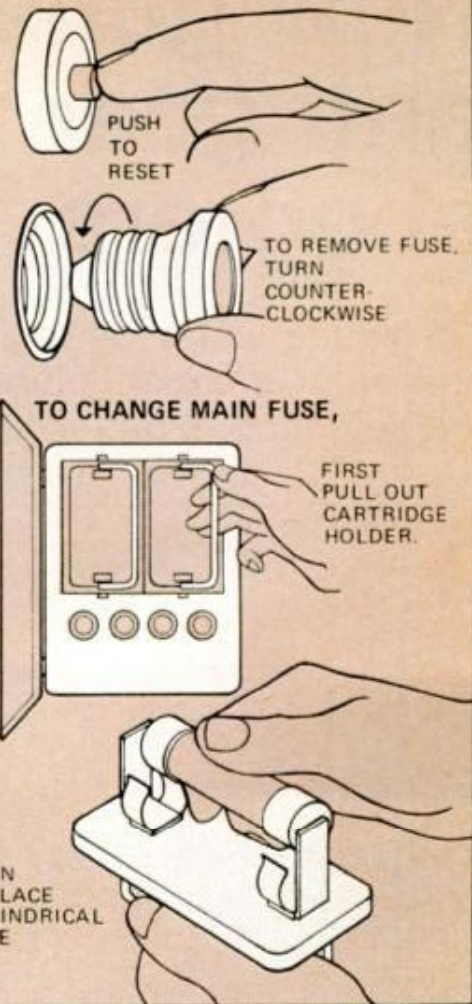

# New guns and gear for shooters

For young would-be marksmen and older sharpshooters as well, the selection is better than ever.

by Gary Gillespie

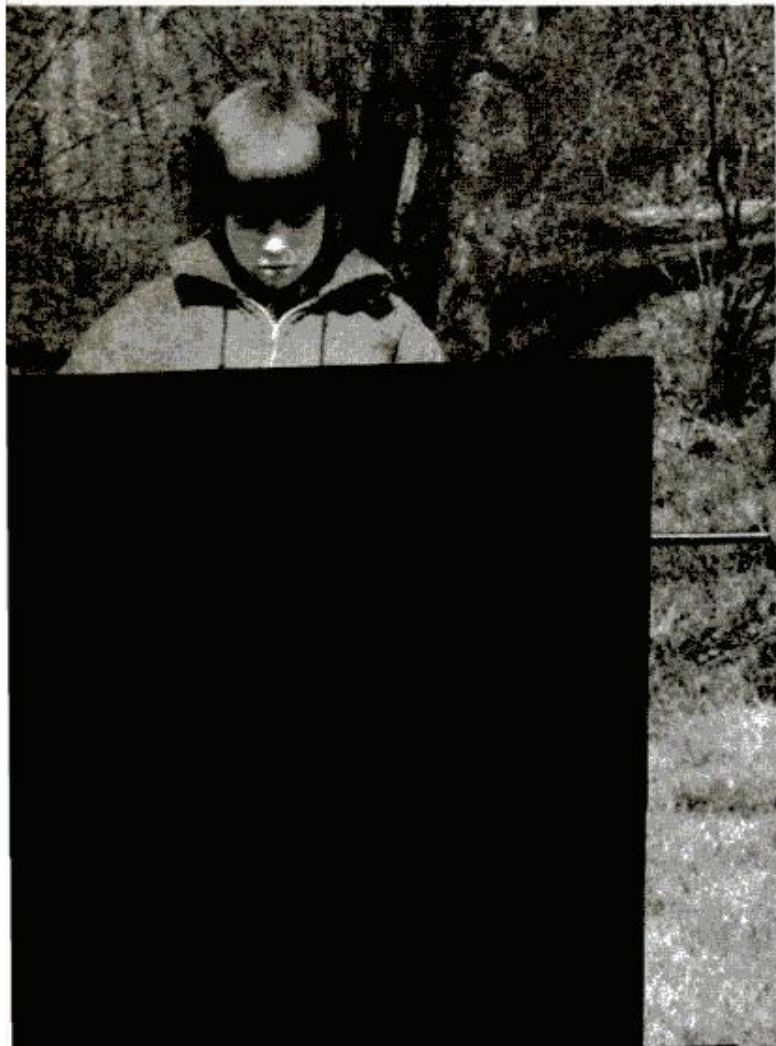

Many youngsters will be getting their first guns this month as Christmas gifts. Proper choice of gun and training of the young marksman are important. The appropriate selection doesn't have to be expensive, with the fancy elaborate engraving that delights an experienced collector, but it should be made with quality by a reputable manufacturer to insure safe and accurate performance.

For more experienced outdoorsmen, there is a tremendous variety of items they need, or think they need. To select a gift, you should begin with knowledge of the individual's specialty—range, benchrest, trapshooting, skeet, duck, deer or varmint hunting among others. Then, two sources of advice are available: your local sporting goods store or section of a department store, plus your reading.

At a well-established store, an experienced clerk can give good advice about arms, ammo and accessories. Taking along an expert friend is also worthwhile. One word of caution: Hunters and target shooters develop some very specific preferences, so you should know about his favorite makes and models, specifics of gauge and choke for shotguns and caliber for rifles, or else rely on a gift certificate. Shop early; a dealer can usually order exactly what you want if he has the time.

Second source for information and equip-

**El Dorado BB gun**, \$26, is new to Sears store and catalog line. Tested here by marksman Vinnie Shaw, it has look and feel of larger standard-size rifle.

## Gift selections for shooters of all ages

First gun for Jimmy (7): Daisy 102 Cub BB.

Training rifle for Bobby (10): Remington Model 580 Boy's Rifle with shortened stock.

Introductory skeet gun for Jill (13) and Mom: Remington 1100 28-gauge skeet gun.

Indoor practice handgun (teens and adults): Crosman Mark I pellet pistol.

Team competition for Bill (15): Savage/Anschutz 64 match rifle.

All-around plinker for summer cabin trips:

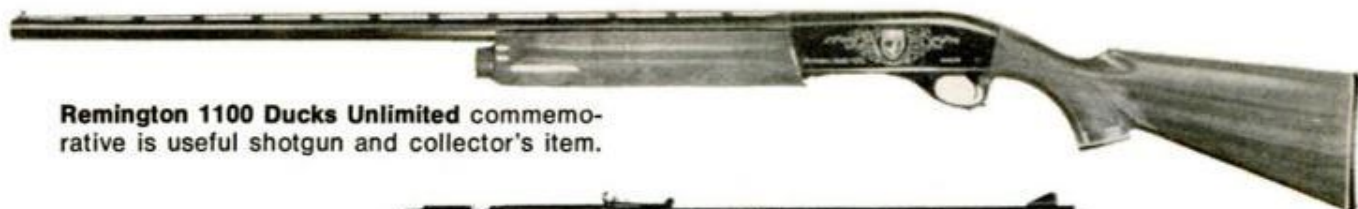

**Remington 1100 Ducks Unlimited** commemorative is useful shotgun and collector's item.



**Sheridan Blue Streak**, a \$48.25 pellet pneumatic, has sharpshooting accuracy.

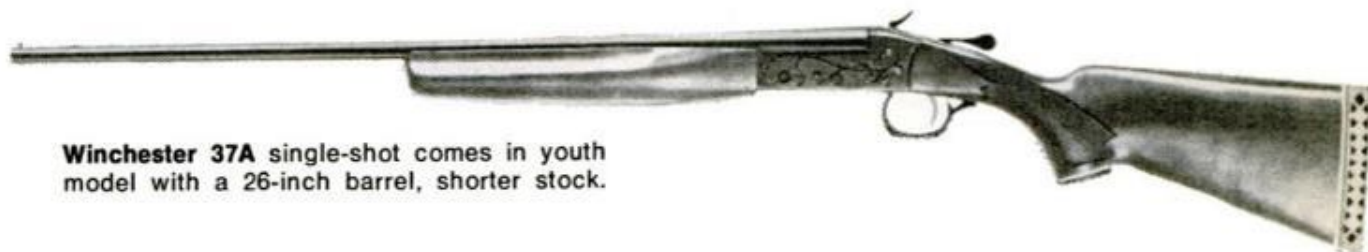

**Winchester 37A** single-shot comes in youth model with a 26-inch barrel, shorter stock.



**Shotguns** make versatile gifts. Crosman CO<sub>2</sub> skeet set (right) includes trap with foot release, Trapmaster gas-powered shotgun, targets, shells. Hand-engraved receiver (far right) is feature of new imported over/under from Sears at less than \$200. Mauser-Bauer's Italian Model 610 skeet gun (below) with .12, .20, .28 and .410 Purbaugh Tubes for the dedicated skeet competitor, is about \$1300.

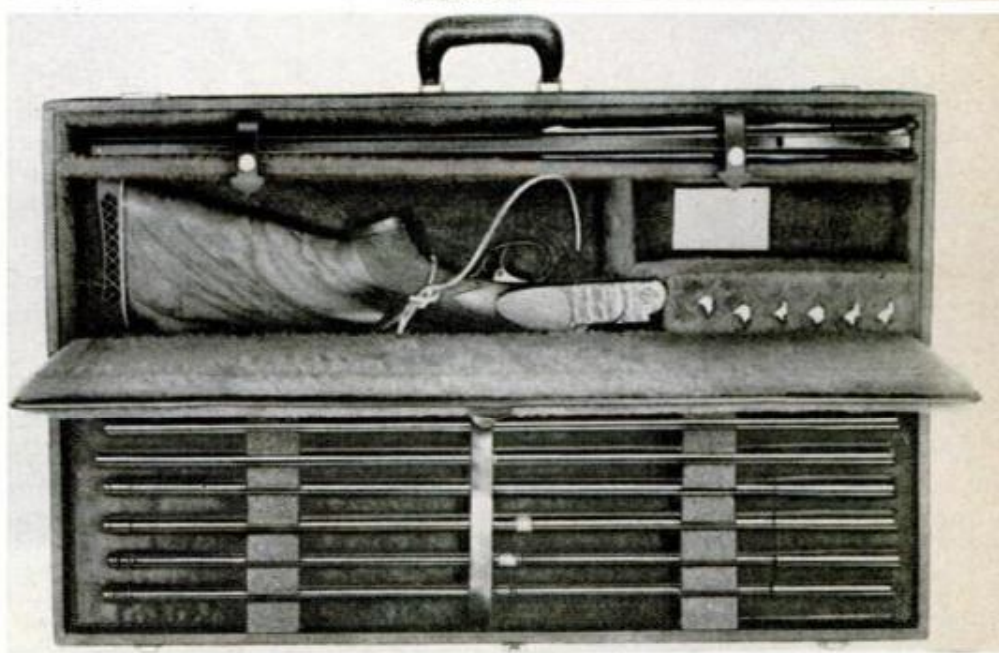

## New arms range from BB plinkers to big-game rifles



Old-time look for a rim-fire rifle, the .22 Ithaca Model 72 Saddlegun lever-action is \$80.



Muzzle loader like \$175 Hawken Hurricane from Navy Arms is for hunters, collectors.



Powder horn, \$6.55 from Numrich Arms is another favored item for black-powder man.



Deer rifle with Old West look, the Mossberg Model 472 lever action is \$100 6-shot 30-30.

ment are the pages of a magazine such as *PM* plus the excellent mail-order catalogs specializing in equipment for outdoorsmen. A list of some of the best-known houses are on the last page of this article. You can order from them while sitting at home.

*Air guns* can be a source of fun for the entire family, youngsters and adults alike. An indoor shooting range, where you use CO<sub>2</sub> or pump-up air guns, is quiet and requires little space in a basement or garage. It can provide hours of enjoyment as well as good safety and marksmanship training, plus sharper eyes and steadier hands for the bigger guns used afield.

Daisy has a complete BB Gun Range that includes four Model 99 Daisy Champion BB guns, 6000 rounds of BB shot, 400 paper targets and two BB backstop target holders—all for \$40. Crosman and Winchester also have a wide selection of pneumatic rifles

and pistols including highly sophisticated target types. Crosman offers a complete CO<sub>2</sub>-powered skeet kit with shotgun, trap, targets and reloadable shells for less than \$90. One of the most versatile indoor-outdoor pellet guns is the Sheridan "Blue Streak" with adjustable power—enough for outdoor hunting of small pests, and less than \$50. Benjamin is another famous quality manufacturer.

*Rim-fire .22-caliber rifles* are a step up the ladder for young family marksmen. Two new high-quality lever action models with the flair of the Old West are the Ithaca Model '72 Saddlegun for \$80 and the Winchester Model 9422 for about \$100. For less experienced beginners, don't overlook the many single-shot bolt action .22s at economy prices.

*Gun collector gift?* How about a commemorative that can combine distinctive

appearance, usefulness afield and growing collector value. Two recent issues of note are the Harrington & Richardson 1873 Springfield Commemorative Rifle with trapdoor single-shot action in 45-70 cal., and the Remington Model 1100 shotgun in a special Ducks Unlimited version.

*Left-hander in the family?* For years, southpaw shooters had to make do with guns made for the right-handed majority. No more. Now there are "lefty" versions of the Savage Model 110 or Remington Model 700 bolt-action rifles, or Remington Model 1100 or 870 pump-action shotguns and Model 581 bolt-action rim-fire rifle.

Shooters' extras certainly include clothing. Outdoorsmen don't enjoy getting wet or cold anymore than anyone else. Nothing beats expensive goose down, but you can save money by wearing a down underjacket like Eddie Bauer's \$32 Trail Shirt under less expensive outer wear. Pick footwear like Bean's famous rubber-leather boots for warm, dry feet. Hunting binoculars, spotting scopes, shooting glasses, rangefinders and assorted camping gear are also recommended items.

Books always make the off-season seem shorter. Recommended new volumes include *New England Grouse Shooting*, latest edition of a classic; *Gone for the Day*, a treasury of outdoor lore that's only \$2 by mail from the Pennsylvania Game Commission, Harrisburg, Pa. 17120; *Wild Game Cookbook* and *The Practical Hunter's Dog Book*, timely gifts; for the weathered-in shooter, sample *A Hunter's Fireside Book*. ★★★

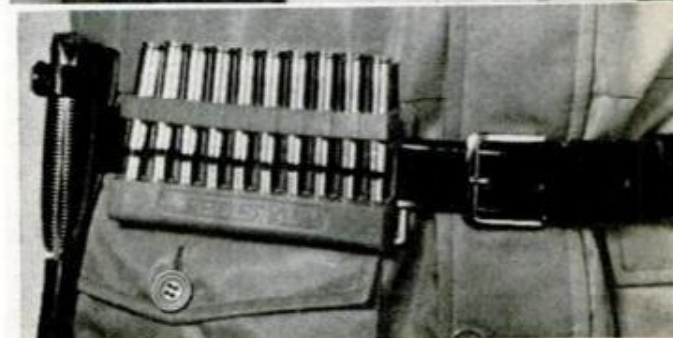

### Gear and equipment catalogs

Eddie Bauer, 1737 Airport Way South,  
Seattle, Wash. 98134.

L. L. Bean Inc., Freeport, Me. 04032.

Browning Arms, Rt. 1, Morgan, Utah 84050.

Gander Mountain Inc., Box 248, Wilmot, Wis. 53192.

Herter's Inc., RR 1, Waseca, Minn. 56093.

Montgomery Ward (available at local retail stores).

The Orvis Co., Manchester, Vt. 05254.

Parker Distributors, 40 Industrial Place,  
New Rochelle, N.Y. 10805.

Recreational Equipment Co., 1525 11th Ave.  
Seattle, Wash. 98122.

Sears, Roebuck (available at local retail stores).

Norm Thompson, 1805 N.W. Thurman St.  
Portland, Ore. 97209.

**Accessories make good gifts** for the hunter. A Thermos Space Blanket (top) can help ward off cold and rain in deer stand or duck blind while Rangematic distance finder shows true distances. L.L. Bean 7-inch Lounger Boots and Orvis "chamois cloth" shirts are outdoor favorites. Federal's new Cartridge Carrier fits belt.

# New meters for finding fish

Electronics now can note a lunker's favorite depth, bottom, temperature, light level and even oxygen supply.

by Bill McKeown  
OUTDOORS EDITOR

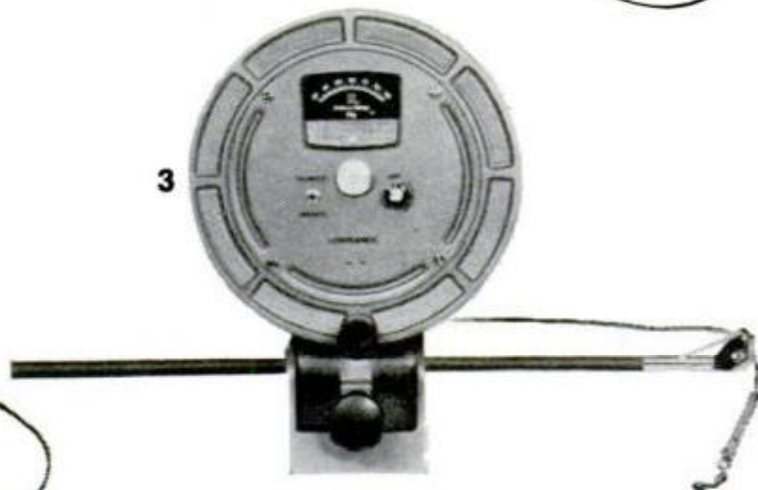
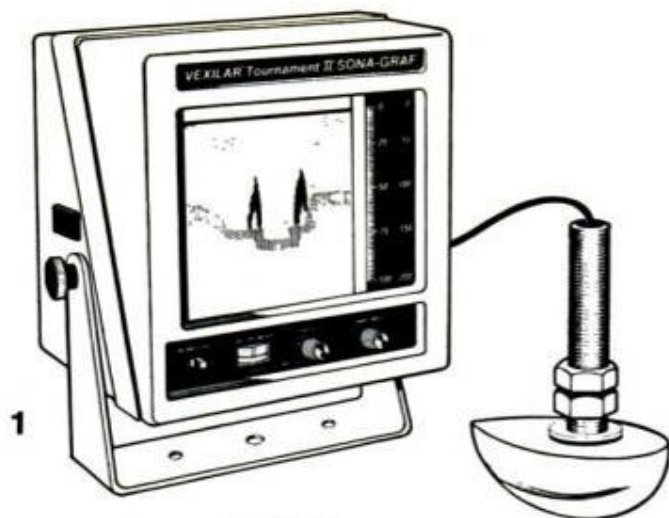

1. Vexilar's new Tournament II Sona/Graf 510 is now reported sensitive enough to indicate microorganism concentrations at thermocline or deep scattering layer, plus fish, making other measurements unnecessary.
2. Waller Fish Hawk 550 can give digital readings of oxygen ratio in the water, temperature, light density and depth at any probe sounding to 100 feet.
3. Lowrance LTG-200 Fish-N-Temp Rig, latest addition to Fish Lo-K-Tor line, is self-contained deep trolling system that also measures temperatures to 200 feet.

New fish-finding gadgets have gotten so sophisticated they now do everything except lower a questionnaire to ask lunkers what they'd like for lunch. Gone are the days when an angler measured the water depth with a sinker on a string, then dangled a worm or floated a fly—and hoped.

In 1924 Raytheon started marketing its famous Fathometer with electronic reading of distance from boat to bottom. (Since the sinking of the *Titanic* Raytheon had been trying to develop an iceberg warning device but found the echoes coming back showed where the bottom was instead.) Today's dedicated fishermen are familiar with the well-known Lowrance Fish Lo-K-Tor and similar small sonar sounders. These show bottom contour depths plus fish concentrations in between by neon flashes on the dial.

Last year Bass-Ox, Inc., of Dallas introduced a hand-held meter to measure the depths where oxygen in the water is from five to 13 parts per million, the content that fish prefer. A new model, Sentry II, reads underwater temperatures as well.

Garcia and others have now developed oxygen-ratio meters for 1974 fishermen, and the most elaborate is likely to be Waller's forthcoming Model 550 Fish Hawk. For about \$210 this one will give a digital depth reading as a probe is lowered that sends back oxygen, light density and temperature readings. Select from its front panel the kind of fish you want and its favorite temperature range, lower the probe to find the depth of that temperature, verify adequate oxygen content and then read the light density measurement to see which color lure

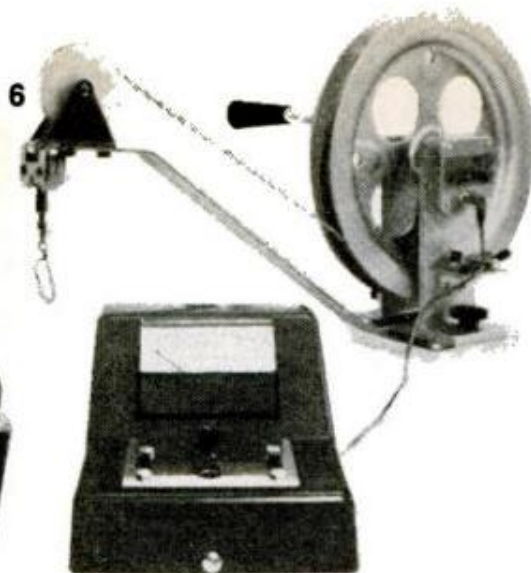

4. Garcia is introducing new O.T.P.-8500 Oxygen-Temperature Probe to locate optimum conditions.
5. Ray Jefferson Beeper 6010 shows bottom structure, fish; sounds alarm if fish or obstruction below.
6. Riviera Temptroll 1300 holds lure at selected depth to 200 feet while giving temperature readout.
7. Fishmaster Products Scuba Eye is diver's meter to show fish, caves, bottom distance, surface boats.
8. Waller Fish 600, \$60, is hand-held depth finder.
9. Lowrance Flasher-Graph LRG 600 shows bottom and fish on printout recorder or dial light.
10. Sea Deep Sounder/Locator, \$160, gives straight-line bottom, fish readings to 25, 50, or 200 feet.
11. Depth-O-Lite DL-30 at \$35 from Fishmaster indicates percentage of light penetration.

## THERMAL LAYERS IN A TYPICAL LAKE

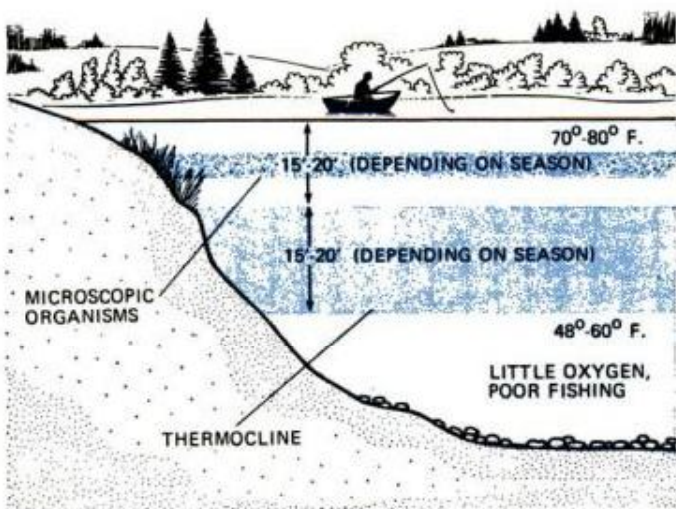

Thermocline varies with water depth, but rapid drop of temperature usually indicates poor oxygen and fishing.

brightness will look most enticing down there!

A different approach, at \$399, is Vexilar's new Tournament II Sona Graf Model 510. With both vertical flasher in 100 and 200-foot ranges plus a straight-line chart recording graph, the instrument is reported to be so sensitive it can register not only individual fish but also, under optimum conditions, the microorganisms that form a layer above the thermocline at the major breaking point of the temperature pattern. They also react to light penetration, and oxygen so that these individual readings may not be necessary. This new Vexilar and other models have tested out at boat speeds above 40 mph.

Soon scientists may be able to out-think fish. Now if they can only persuade the fish to bite! ★★

# For that needed energy: Pour on the coal!

Our gas and oil reserves are running out. Nuclear power is slow in developing. But coal is still there for the taking.

---

by M.F. Holbein

**The Geysers** produces electrical power for some northern California communities. It is the nation's only powerplant that uses natural steam to turn its generators.

Whether you call it a pinch, crunch or crisis, the fact is that we're running out of the stuff that makes everything go: jets in the sky, industrial machines, your auto, the furnace in your home, the toaster on the breakfast table. They all take their large or small bite out of the energy pie.

The average American is the world's greatest consumer of energy, according to statisticians at the Department of the Interior's Office of Coal Research. They figure it this way: Divide the total energy used in the United States on a per capita basis and you get 390 million B.T.U.s (British thermal units) consumed annually per person. (The energy involved equals 15 tons of coal.)

In contrast, the average Briton "consumes" 170 million B.T.U.s annually; the West German, 140 million, and the Brazilian only about 20 million.

Basic energy sources being tapped today include the fossil fuels—oil, coal and natural gas—and several of lesser importance. These include hydropower, nuclear power (uranium) and geothermal energy.

Natural gas, cleanest of fuels, is running out fast. If we don't find new reserves within the United States, we could burn up what we have in only 12 years. That's the estimate of Philip N. Ross, manager of

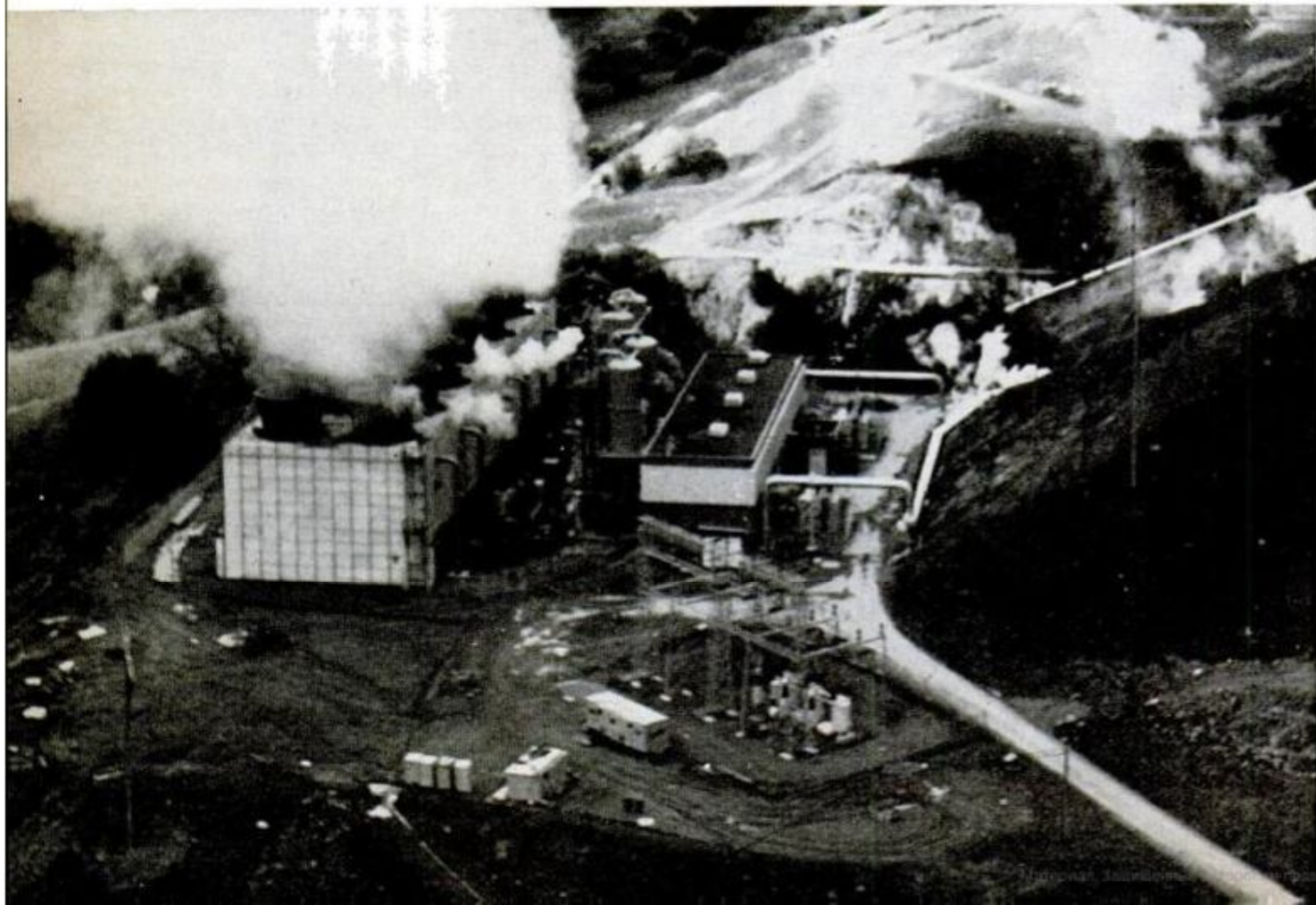



power systems planning at Westinghouse Electric Corp. Natural gas makes up only 3 percent of our energy supply but accounts for 32 percent of our use.

Mr. Ross also contends that the United States would be out of oil by 1995 if forced to depend solely on her domestic supplies. By importing oil, he says, we can extend the oil-burning age an additional 25 years. Then the entire world will be out of oil. At current usage rates, which are bound to rise, the world's oil will be totally consumed by the year 2021.

Not since 1967 has the United States been able to get along solely on the oil within her borders. Today, we import 24 percent of our oil. It's estimated that by 1985 our energy needs will be double those of 1970. By then, according to the Department of the Interior, we may have to import as much as 65 percent. That's the kind of thing calculated to give military men the shudders.

Some power experts say we might as well write off oil and turn to coal—the ancient fuel that's earned such a dirty name.

"We should place essentially no dependence on oil and natural gas in the long run," says Philip Ross. "Coal I foresee as being an increasingly precious commodity. Through its synthesis into petroleum and gaseous forms, it must furnish the needs of



Since the Department of the Interior has a wide responsibility in the energy area, PM submitted some key questions to Interior Secretary Rogers C. B. Morton. The questions and his answers appear below:

**In the immediate years ahead will the energy pinch get worse than it is now?**

In the near term, yes. The reason quite simply is that our domestic supply capacity from natural gas, oil, and refinery production has failed to match the increases in energy consumption.

**Do you foresee a time, then, when gasoline, natural gas, or electricity will be rationed to the consumer?**

It's possible, but I certainly don't see it in the near term. What the government will try to do, however, is to see that shortages, when they do occur, are shared equitably.

**How much of a contribution will the Trans-Alaskan Pipeline make to meeting our national energy needs?**

If we can start construction this year, the first oil from Alaska's North Slope will arrive by 1976 or 1977, and at full production it will bring 2-million barrels a day to the lower 48. That's equal to about a third of this year's oil imports.

**Do we know the potential value of oil and gas deposits on the continental shelf off the East Coast?**

Not really, because no one has actually undertaken drilling operations. The Geological Survey and private industry, however, have made some rough estimates based on surface core samples. These estimates suggest there are probably significant deposits there.

**What kind of a contribution can energy conservation make in meeting America's energy needs?**

Simply increasing our energy supply is not enough. Energy conservation—and I mean reducing our total energy usage by only about 7 percent—must become a national habit.

**What about other new energy technologies?**

We are still sorting out the dimensions of oil shale and geothermal leasing programs on the federal lands. If we can minimize the environmental impacts and refine the technical advances we have made in these areas, there is no reason why both can't absorb a greater portion of the market by the end of the decade. That also applies to the breeder reactor.

Wide-scale applications of solar and fusion technology, however, are still many years in the future.

**ENERGY USE IN THE UNITED STATES**

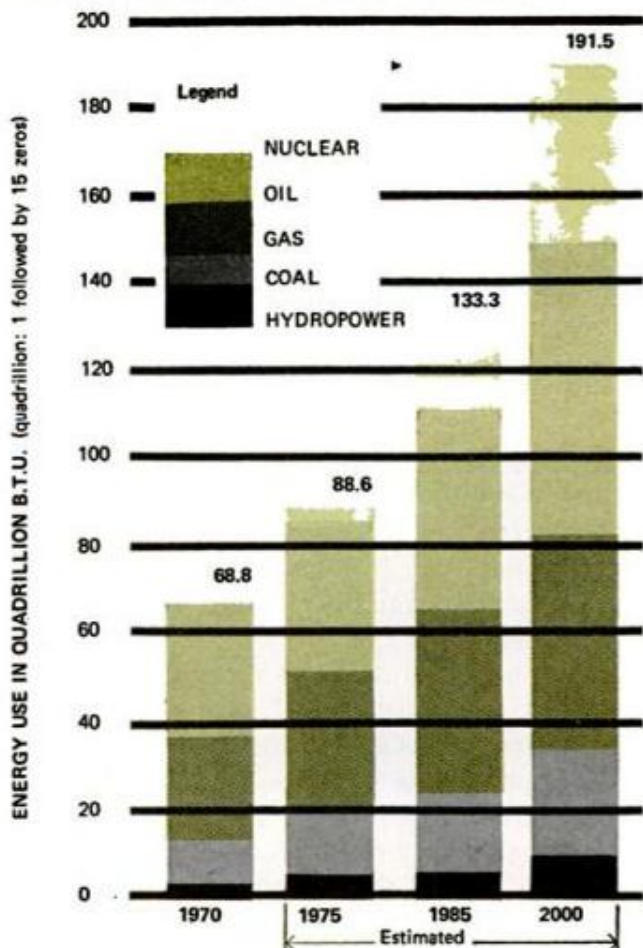

# Coal gasification system

The HyGas process takes a coal-oil slurry and its resultant gases through a complex series of steps. The original heat source is electricity. Many of the later steps refine the final products—a char with appreciable heating values retained and a gas said to be of pipeline quality.

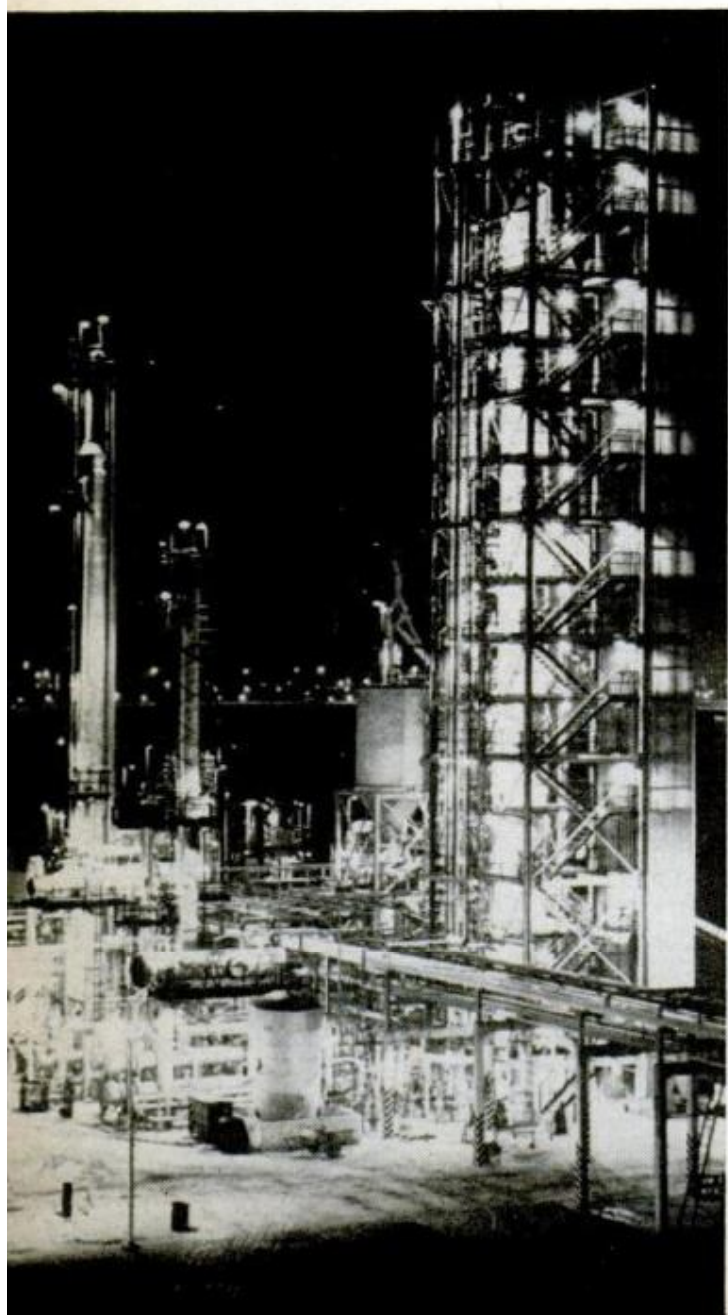
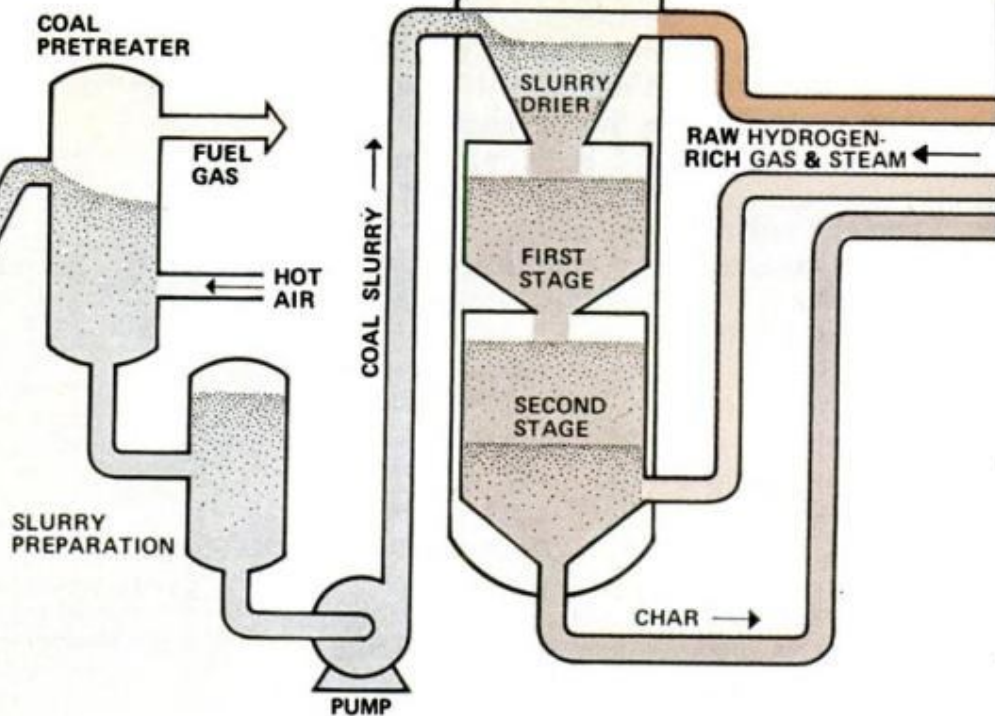

the petrochemical industry and the fuel for trucks and aircraft.

"The critical position coal holds in this nation's energy future cannot be over-emphasized, for . . . it is also the energy source upon which we will lean most heavily to effect the difficult transition from where we are today to the ultimate nuclear energy economy."

Secretary of the Interior Rogers C.B. Morton observes: "Coal is clearly our greatest asset in the intermediate term. Over 90 percent of America's fossil fuels is coal, compared to about only 4 percent oil and 3 percent natural gas.

"Using much of that coal, however, especially low sulfur coal in the Great Plains states, will mean more strip mining. But with mined land reclamation and new technologies like coal gasification, there is no reason why coal can't be environmentally more acceptable. I personally expect to see several of the new coal technologies under investigation today in the commercial market place by 1980." (More of Secretary Morton's views on the current energy situation appear on page 97.)

The United States has more coal deposits than any other country. Some 3 trillion tons lie buried beneath American soil, two-

**The \$7 million HyGas facility in Chicago is said to be the farthest along of all coal-gasification plants.**

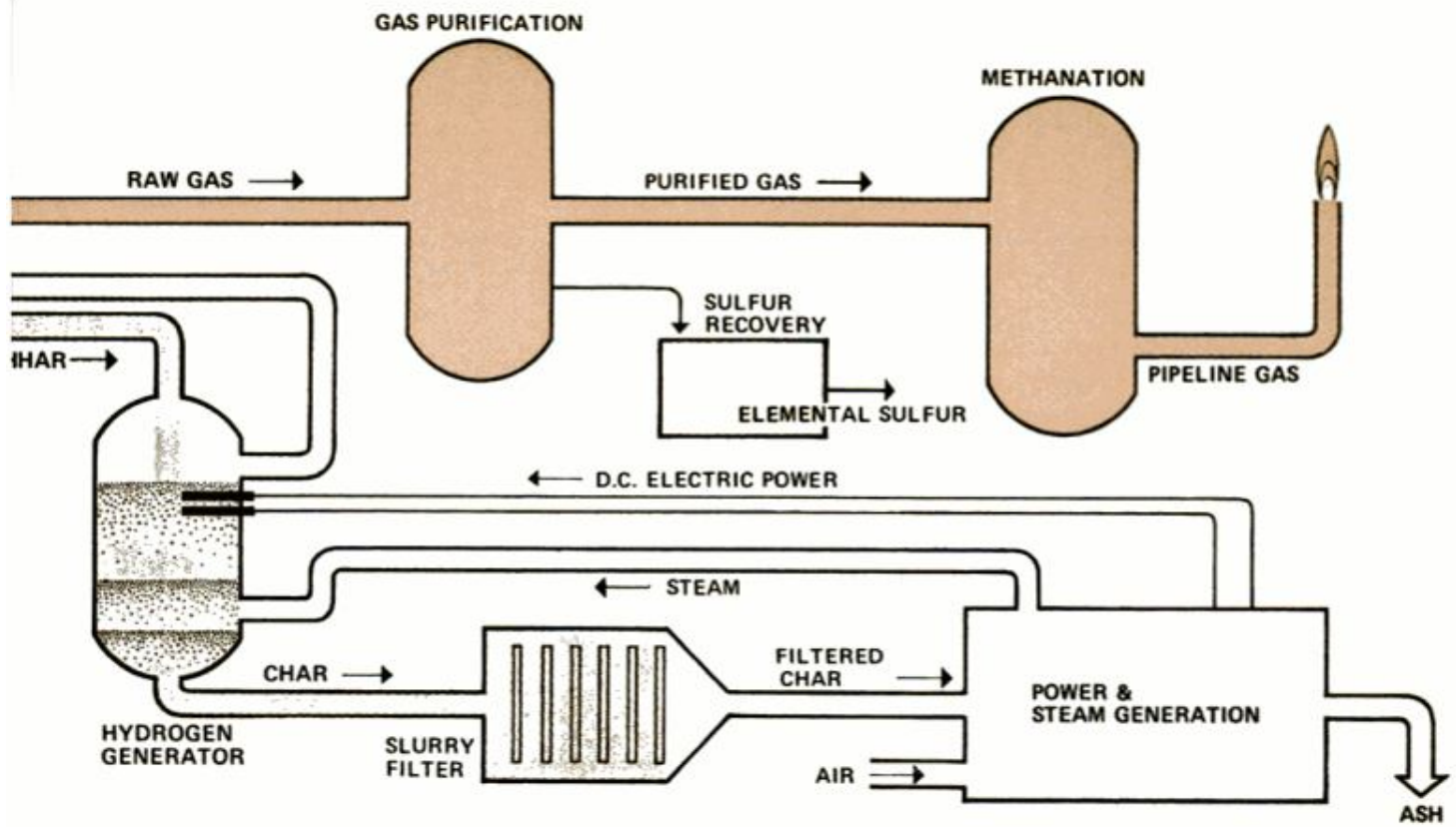

thirds of it said to be recoverable by current methods.

The Office of Coal Research, in cooperation with private power companies and research organizations, is pushing various programs for the development of efficient ways to convert coal into pipeline quality gas, into an industrially useful oil, and into a "cleaner" solid that can be used directly as a fuel. The gas could be piped to factory and the home. Or, like the oil and the solid fuel, it could be used to generate electricity, the form of energy that's vital to a society such as ours. The problem is that electrical generation is very inefficient. Some 60 percent of the energy value of a fossil fuel is lost in the conversion process.

Farthest along of the new coal gasification methods is that used in the HyGas plant in Chicago (the process diagrammed on these pages). The plant is designed to convert 75 tons of coal a day to 1.5-million cu. ft. of high-quality gas.

In this process, coal is mixed with a light oil (a byproduct of the process) and this slurry is heated in a reactor. Chemical reactions and heat exchanges cause the coal to give off most of its gases. Refining removes sulfur in its elemental form—not as a gas but a nonpolluting and valuable solid.

Another pilot plant, in Rapid City, S.D., is designed to test a conversion system called the "Carbon Dioxide Acceptor Pro-

cess." The chemical reaction between a form of lime and carbon dioxide creates the heat needed to achieve coal gasification. The process is designed to convert lignite—a carbonaceous fuel more like peat than coal—into a sulfur-free pipeline gas.

There are experimental systems that convert coal to a high-grade synthetic crude oil. A pilot plant in operation for three years at Princeton, N.J., uses a fluidized-bed system to produce a gas, a solid char and a synthetic crude. Even the char can be used as a boiler fuel.

A fluidized-bed setup is also the basis for a method of burning coal to extract its heat energy directly. Small pieces of coal are mixed with an inert ballast material, which serves to prevent the coal particles from sticking together and forming a slag.

The coal-ballast mix is kept in motion around an array of water-filled pipes by a blast of air from below—that is, particles "float" on a bed of air. Heat from the burning coal particles converts water in the pipes to steam, which, in turn, drives turbogenerators that produce electricity.

Unlike conventional coal-burning powerplants, the fluidized bed can burn any type of coal and yet keep pollutants such as sulfur dioxide down to low levels. A pilot plant at Alexandria, Va., reportedly passed Bureau of Mines pollution tests with ease. Large plants like this could be in operation

as early as 1976, according to the designers of the Alexandria facility.

Though our coal resources could last several hundred years, many experts continue to look toward nuclear energy as the ultimate solution to our problems. They expect to see a big boost in the output of conventional nuclear plants, which today represent but 4 percent of our electrical generating capacity. According to an Atomic Energy Commission projection, this could be raised to 30 percent by 1985.

This would be an intermediate stage. Philip Ross and other experts look to the breeder reactor to carry us far into the 21st century. This type of reactor not only provides power by producing energy in the form of heat, but it also "breeds" new fuel. It converts a nonfissionable form of uranium into plutonium 239, a highly fissionable fuel.

This is of critical importance because conventional reactors, using uranium-235, are even more inefficient than fossil generating plants in providing energy for the production of electricity. They waste such large amounts of fuel (in the form of heat) that in a few decades we might run out of easily mined uranium.

Other energy sources are either limited or far out of reach now. Hydroelectric power can only make a limited contribution. Geothermal energy, obtained by tapping the heat of the Earth itself, is a subject of controversy. There are researchers who says its contribution will always be limited. There is one geothermal plant in operation, The Geysers in California. It

uses natural steam to generate electricity.

Other sources of oil are the very large deposits contained in the mountains of shale found principally in Colorado, Utah and Wyoming. One problem is how to "boil off" the oil in an economical way. Another problem is ecological—what to do with the hills of spent shale.

Though some experts are pessimistic about the possibilities of shale, men like Harry Johnson, deputy oil shale coordinator for the Department of the Interior, are very optimistic. He says: "Most people think commercial oil shale is 10 years away and not competitive. We think it is three years away—and competitive at today's prices."

Solar power is in a similar state of development. Though its potential is great—it's a source of energy that will last as long as the sun—we're only beginning to develop systems to capture its energy on a large scale. (See *Will Solar Farming Solve Our Power Crisis?* page 90, July 1972 PM.)

The ultimate energy, say many scientists, is thermonuclear fusion. Its promise has been evident ever since the first hydrogen bomb was exploded—an uncontrolled fusion reaction. The problem, which some of the best scientific brains are working on, is how to control a fusion reaction.

This energy source is virtually limitless. Fusion uses heavy water, which can be extracted from the sea. Using fusion power, we can then take more energy from the sea in the form of hydrogen. Who knows—maybe 50 years from now Americans will drive cars powered by a nonpolluting "tiger in the tank" called hydrogen. ★★★

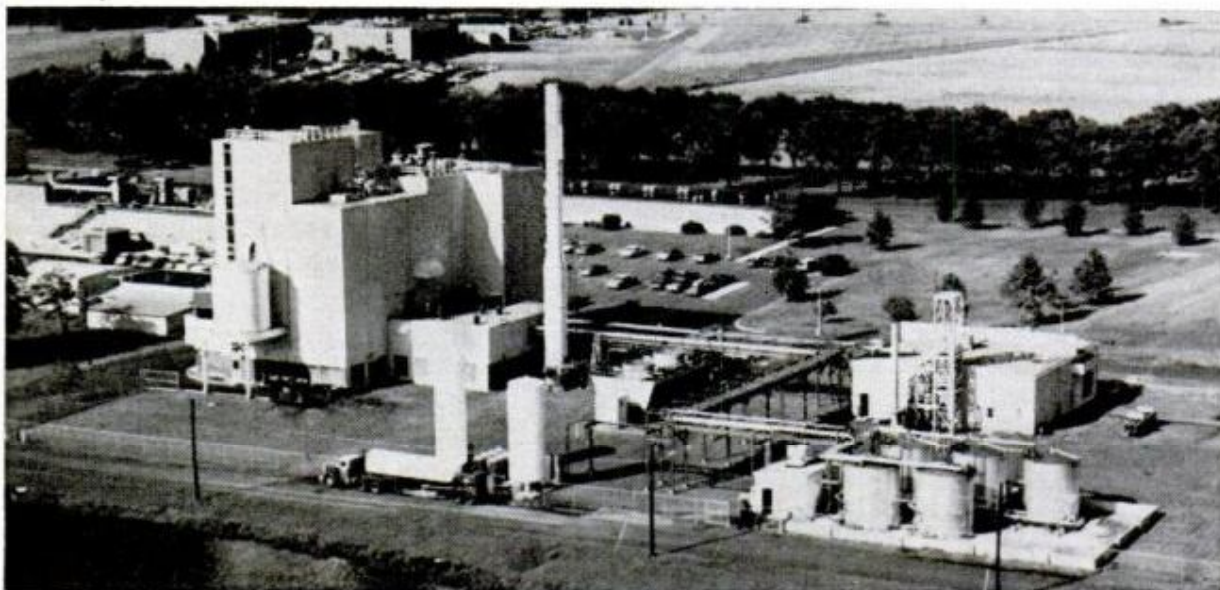

A pilot plant in Princeton, N.J., has been operational since 1970. It uses fluidized beds to produce a gas, a char and a crude oil. The results are called "encouraging."

# New for snowmos

A growing assortment of add-ons and accessories is arriving each year for snow-country speedsters. Rear-view mirrors for handlebars and mittens, roll bars, track cleats and ski keels, plastic snowshoes, emergency flare and survival kits, front wheels for off-season running, speed kits for better performance and canvas cab covers for warmth are among the new extras.

For cold-weather campers who take their machine along, there are travel trailers with rear garage door so the snowmo can stow aboard. The latest gadgets make travel to new trails easier and safer. ★★★

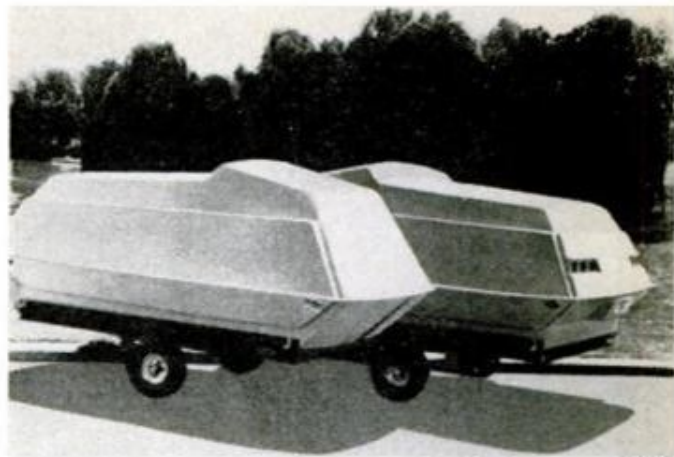

Protection of machines from slush, gravel and theft is claimed for VersaCap (above). \$340 from Lakeland Mfg., Box 223, Manchester, Mich., 48158. Assorted colors are available. Its TrailAir-Foil is a clamshell shield for front of a trailer. Vinyl-covered \$23 chain and lock set (left) is from Master Lock, Milwaukee, Wis.



Even tie-down straps now come in matching colors. Six choices in nylon webbing are offered by AGM Cargo-Ties through snowmobile dealers. After adjusting for fit, a KevLok cam lever tensioning fastener secures machine to trailer, is reported unaffected by ice or mud. Two-corner tie-downs are \$7; four-corner, \$10.



Pickup portage of a snowmobile becomes easy with a slanted drive ramp from Pepper Engineering, 4093 Carpenter Rd., Ypsilanti, Mich. 48197. Their portable aluminum two-section Porta-Ramp, 3x9 feet and \$65 f.o.b., weighs 35 pounds and assembles in a minute. Other widths for lawnmowers, garden tractors, ATVs.

Emergency snowmobile tow strap is recommended accessory. Eight-foot, 2500-lb.-capacity nylon webbing strap (below) has noncorrosive hooks, comes in seven colors from AGM Cargo-Ties, Tucson, Ariz. Useful for pulling disabled vehicle with driver. Tow sled with passengers, cargo should use bar to prevent overrunning.





## Don't let winter stop your four-wheel-driving fun!

You'll have roads and back country to yourself: no crowds, noise or insects. The scenery is even more spectacular under a snow blanket!

by Barry Lopez

Photos: Barry Lopez and Donald Johnson

Even a dedicated four-wheeler can't quite follow the snowmobiles and ATVs, but you can go farther than you thought.

Running in the winter requires a little more attention to the operation of your four-wheel drive than in the summer. Number one on a prewinter check is a look at the battery. Even a brand-new battery will deliver only 65 percent of its power at 32° and even less, about 45 percent, at 0°. So keep it charged and keep connections clean.

Ignition components should be given a close going over. Gasoline doesn't vaporize as well in the cold so it requires a hot spark from the coil to ignite the fuel mixture.

The next item on your prewinter checklist should be fluids. A 1:1 mixture of permanent-type antifreeze in the radiator will protect you to about 30 below. A can of "dry gas" (an alcohol or acetone anticondensation mixture) to every three or four tankfuls of gas will sop up moisture in fuel lines and prevent icing there and in the carburetor. Keeping a full gas tank also reduces the moisture level. A final note on fluids: Don't forget to mix antifreeze 3:2 in your windshield washer bottle.

After your battery, tires are the next important consideration. You might get a set of full-fledged snow tires with an open-lug design. They'll not pack up with snow as easily as your modified snow tires and tend to be self-cleaning. They are usually noisy, don't wear well and are not safe at very high speeds, but the presumption is you'll be using them only during the winter.

Studs are terrific on ice and packed snow, but do tear up roads and are illegal in various states. If you opt for studs, check local ordinances and get them on all four tires for safety and to "balance" your vehicle's handling characteristics.

Before you hit the back roads, check some extra equipment. Your winter driving kit should include snow chains and chain tighteners with a box of extra links, heavy-duty jumper cables, flat-necked shovel, ax, high-lift jack with a 3/4-inch-thick, 2-foot-square plywood platform, and survival kit—space blanket, food, firestarter, and so on. This assumes you have a toolbox, electric tape, spare parts, flares, flashlight, tow chain, can of gas, first-aid kit and other four-wheeling necessities.

The chains and jumper cables explain themselves. The flat-necked shovel is to get between your vehicle and a low spot. It and a high-lift jack will get you out of a ditch

if you slip off an icy road crown. The ax is a major survival tool. You can cut logs to skid your vehicle over bad spots (mud, for example, which is worse than snow to drive in because you can't get a bite or even track straight). You can cut poles to serve as levers when you're stuck, to break through frozen earth to set a "deadman" for your winch, to construct an emergency shelter, and to attend to normal tasks like cutting firewood.

One extra piece of equipment especially helpful in the winter months is a set of driving lamps, one wide-beam and one narrow-beam. Their extra reach and brightness helps when braking distances become longer and poor visibility—snow, freezing rain, fog—occurs.

You should consider carrying various spray-on window de-icers, windshield defoggers, scrapers and other gadgets. I'm happy with an ice scraper and my standard defroster. I do keep a window cracked even in the coldest weather to lower the humidity (your rig's airconditioner will do the same thing; see the instruction manual). I also install a frost shield, an oblong of plastic

**At a backwoods crossroad** in Oregon's Cascades (top right) the author checks a detailed U.S. Forest Service map. Note his sunglasses. Don't forget them: In bright sun on a snowy day you would be quickly fatigued without them. If you have only one set of chains (right) put them on front where there's more weight. When going gets rough (below) stop and plan your next moves.





1



2



3



4

1. **One wheel spins** while other gets no power with conventional front axle. Use chains, rock or back up and take another run at it.

2. **With determination**, a four-wheel drive will buck through snow this deep. Check often to clear snow packed up under hood.

3. **Use vehicle-mounted winch** for drifts. With 150-foot cable you can usually find a tree, or use log buried in snow as "deadman."

4. **The problem of winching** the vehicle down the road in a straight line is solved by letting one end of tow chain center winch cable.

5. **Jack can lift you** out of ditches, over obstructions. Tip jack toward road and alternately "throw" front and rear back onto road.



5

with a rubber rim just smaller than the window glass on my rear window because I have no rear window defogger. The air trapped between the plastic and glass prevents frost and fog buildup.

Two winter-type gadget sprays I do keep around are a can of ether-base starting fluid to hit the carburetor on a cold morning and a can of Dow's Liquid Tire Chain.

Extreme cold takes the flex out of tires, stiffens grease in wheel bearings and slows down oils, so for the first half mile or so take it easy.

Once you're off the highway, check under your vehicle for ice buildup which will damage wiring and block steering. Lock up your front hubs if you have them and consider putting on your chains before you get into hub-level snow so you'll have room to work. Chains on the front are fine because that's where the weight is, but if you're out on the highway put the chains on the rear.

A limited-slip differential which delivers power to the wheel with the best traction is, of course, better than the slip differential which feeds power to the slipping wheel for winter driving. You may, if you spend a lot of time with your rig in bad traction



## Go when that fresh snow is packed in the mountains!

situations, want to get a limited-slip axle in the rear. They are not recommended for the front because they make steering very difficult. A manual transmission is also easier to get along with in the snow than the automatic which encourages wheel spin.

Once you take off over snow-covered roads, momentum is the key to your forward progress. How to get and keep that momentum is a much-debated topic. Some four-wheelers swear by the high-speed creep—low range and second gear. Others say the best is second gear in high range. There is no best. It depends on weight of vehicle, depth and type of snow, width and condition of tires, to note just a few things. You want to keep moving *steadily*, not as fast as you can, and don't want your tires to break away from the snow. Once you lose traction you lose both momentum and control of the vehicle.

Once you're rolling, here are things to remember about winter-driving back roads. First and foremost, stay on them: Offroad driving in winter is an invitation to fallen-through-the-creek disasters. Drive the crown of the road to keep from sliding into roadside ditches. When you come to a turn take it as high as you can and always stay on the high side of a banked road. When you see a hill ahead, begin building up steam immediately. Like a long-distance runner, you never want to break stride. If you stop, stop where you can get going again: at the crest of a hill, at a bare spot in the road.

One thing that makes snow-driving easy is that your vehicle will make its own tracks, so it's usually easy to back up if you get in trouble—unless you're headed downhill. Beware of a downhill run over fresh snow.

If you're bucking deep drifts, check under the hood for snow buildup that can choke your engine. When snow gets wet, however, it can be very rough to buck through. Wind-crusting snow presents more of a problem: Your wheels will break through but your frame may not and this will leave you high-centered. Solution? Have a buddy walk out in front breaking trail—always an excellent idea when you are on a road and in a terrain you are unfamiliar with.

If you get stuck, get out and take a good look at the situation. Are you high-centered? Spinning? Which wheel? Where are your wheels pointing? Which direction do you want to go when you get out? Your answers will tell you in part what to do. This may be the time to put on the chains. Foot your high-lift jack on a suitable platform, jack it up and slap on the chains. If you're high-centered, go to work under the vehicle with your shovel and/or cut poles. If you've slid off into a ditch, your high-lift jack, tow chain and various lengths of tree poles will lever, push, lift, slide, pull and shove you out. The situation will determine the combination.

If it's only a spinning wheel and you have no chains, you should be carrying sand to throw down (rock salt for ice), a gunny sack to stuff with snow and wedge under the wheel, or strips of carpet or metal lath. Or, again, take that ax and cut some heavy brush to wedge under the wheel.

An obvious aid for back-road winter travel is a vehicle-mounted winch. Set up properly, it will pull you out of awful situations. Snow, especially if wet, can create terrific resistance, as can your vehicle if you're pulling it sideways. For these reasons it's a good idea to purchase and use a snatch block—a pulley mounted in a steel housing. You anchor it at the base of a tree, say, run your winch line through it and dead-end your winch line back on your vehicle. This doubles your mechanical advantage. Before you winch out, clear a path for your wheels and vehicle so they don't snowplow.

Other things to keep in mind in the snowy woods: never set a parking brake in freezing weather; *drive* down hills, don't coast or slide; always make slow, clean, deliberate moves on ice; if you're headed uphill and start to lose traction, turn the steering wheel from side to side to help you "walk" up—each turn of the wheels will give your tires a new bite up front.

If you're driving a road that hugs the side of a hill, especially on a southward facing slope, you run a danger of the road giving way; melting and refreezing may have opened cracks. Creeks may lie hidden at the bottom of a hill or at the head of a draw under a thin layer of ice and snow in

*(Please turn to page 182)*

# Firemen with fins

by S. M. St. Germain

**Fog nozzles** spew plumes of spray as firefighting frogmen at right swim in under an otherwise inaccessible pier.



**Relaxing after a tough siege**, an underwater fireman doffs his gear and prepares to stow it aboard a specially equipped tender filled with diving apparatus.

**Y**ou expect firemen to know all about working with water, but not to have to swim in it. Yet that's exactly what many firemen are now doing in such harbor cities as Los Angeles and San Francisco. Water-front pier fires have long been considered among the most treacherous because most of the burning occurs underneath, inaccessible to land-based crews on top. The highly flammable creosoted timbers create a raging inferno that spreads quickly with blistering heat and thick, black, poisonous smoke, making the fire difficult to approach. Not even fireboats with their turret-mounted deck nozzles can reach in under such blazing structures to get at the flames.

But scuba divers, trailing hoses in the water, can swim in under a burning pier and

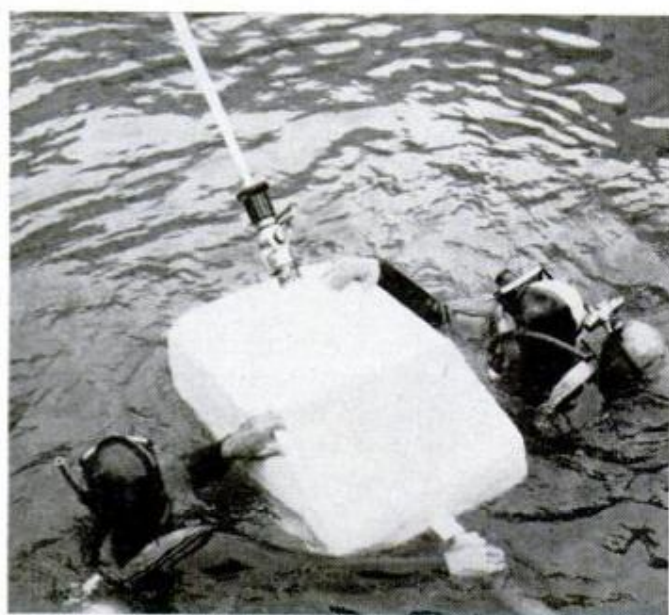

**Heavy hose lines** are supported on foam-filled fiberglass floats with molded-in handles that permit fire divers to "steer" the water stream in any direction.

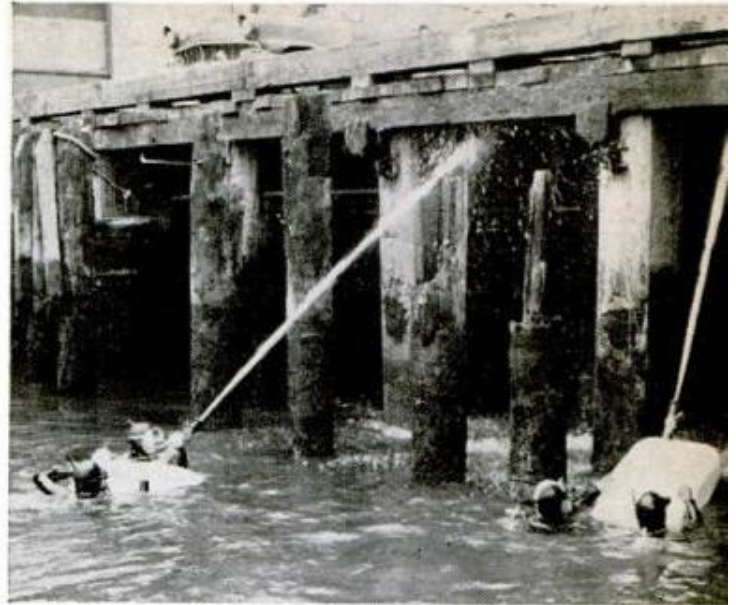

**Directing streams upward** from underneath, firemen in water can get at burning dock timbers that can't be reached by fireboats or conventional land equipment.

attack the fire from below, right at its heart. It all started when a few Los Angeles firemen, skilled in scuba diving as a hobby, volunteered to try the technique. With some reluctance, they received permission. When their efforts paid off in helping to stop a particularly stubborn multimillion-dollar dock fire a few months later, the fire-diver program was officially born.

At first, the heavy, water-filled hoses tended to sink, so plastic floats were designed to support them. The divers work in teams of two to a float, one on each side to guide it. Each fireboat can supply up to five float-mounted hose lines at a time. The nozzles swivel for shooting straight upward and can be adjusted to give either a solid stream or fine-mist spray. Fog sprays are frequently used because they blanket a large area, cool down the intense heat and help to shield divers from falling embers.

The men wear full scuba gear—wet suit, swim fins, helmet, face mask, snorkel and backpack air tank. They breath through the snorkels when surface air permits, then switch over to their air tanks if the smoke becomes too dense. This enables them to remain almost completely submerged for protection against heat and flames. The technique has proved so successful that Los Angeles already has more than 100 specially trained firefighting frogmen, and San Francisco has about 35—ample proof that fighting fire *underwater* can be as effective as fighting it with water. ★★★

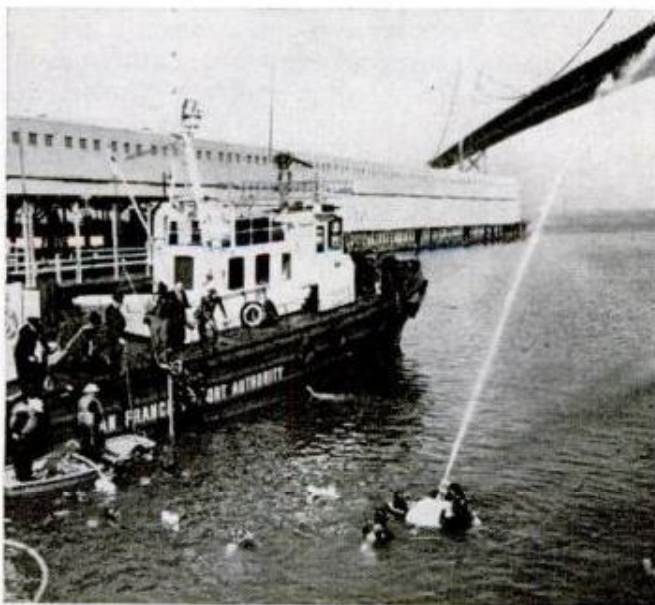

**In a practice session**, fire divers demonstrate long reach of their waterborne jet streams. Nozzles can be swiveled to point straight up as well as forward.

# IT'S NEW NOW

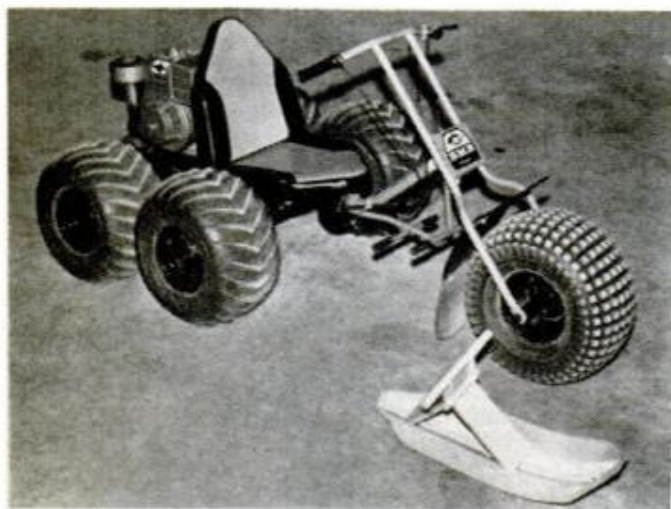

## Tough new buggies for land or snow

Two new tri-wheelers have joined the growing fleet of rugged, go-anywhere ATVs. One at upper left, BMB's Dragst'r, is actually a five-wheeler, having four-wheel rear drive for added traction. It's powered by an 8-hp engine, can hit up to 40 mph. Below, BGW's Tri-Rod comes with a choice of 5, 8 or 16-hp mills. Both can be fitted with front-wheel skis for use in snow. Further information on specs and prices can be obtained from BMB Co., Holton, Kans. 66436 and BGW Ind., Box 1683, Mansfield, Ohio 44907.

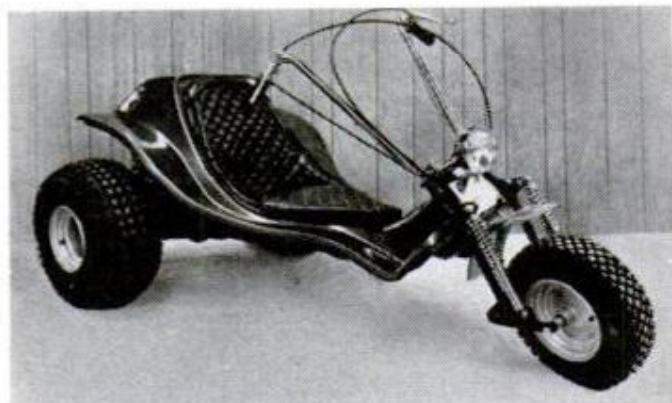

## Invisible hearing aid hides in glasses



You can't tell the man at left is wearing a hearing aid because the microphones and electronic circuitry are embedded in his eyeglass frames. Besides being inconspicuous, system is said to provide improved binaural hearing with a mike for each ear (diagram below) and better directional sound pickup because mikes face forward. Made in men's and women's styles by Dunshaw, Inc., 130 West 42nd St., New York, N.Y.

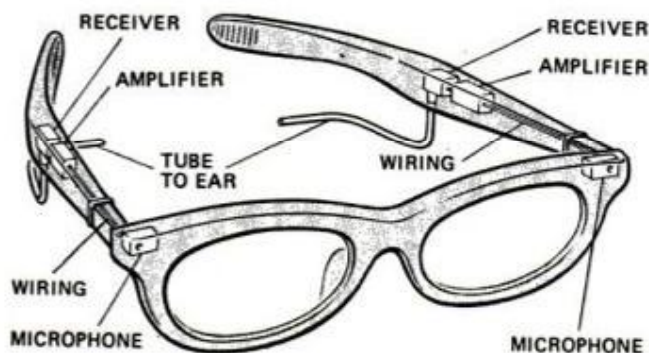



**Lighted Christmas tree**

Instant holiday decoration for window, wall or doorway, GE's Merry Midget Lighted Tree comes ready to plug in. The green tinsel tree is 18 inches tall with 9 red and 11 green bulbs and a red brick-patterned base. Covered back conceals wiring. Price is about \$6.



**Self-contained smoke alarm gives early warning of fire in the home**

Pyro-Guardion, compact and designed for surface mounting, has ionization detector that responds to combustion products, sounding a high-pitched alarm. UL-listed unit is available in two versions, for new construction and for existing buildings. Each is \$79.95. Pyrotronics Div., Baker Industries, 8 Ridgedale Ave., Cedar Knolls, N.J. 07927.



**High-style night light**

Colonial Night Light gives Early American touch to any room or hallway. Light has switch, 3000-hour, 7-watt bulb and virtually unbreakable polypropylene lamp-post shade, according to manufacturer. UL-listed light, made by General Electric, sells for \$1.29.



**Table saw's features include low price**

New 9-inch table saw has 1½-hp motor with thermal overload protector, ball-bearing construction, self-aligning rip fence, see-through blade guard with splitter and antikick-back attachments. At \$129.99, maker says it's the lowest priced saw of its kind. Power Tool Div., Rockwell International, 400 North Lexington Ave., Pittsburgh, Pa. 15208.



## Cartridge-loading Rollei pops up from pocket size

Pull the two ends of that compact, featureless box in the lower left photo, and out pop lens and viewfinder of Rollei's new A-26 camera. Pocket-sized, the A-26 takes standard 126 film cartridges. Its CdS light meter gives automatic exposures from 1/30 second at f/3.5 to 1/250 at f/22 and warns of low light levels. Attach the matching C-26 flash, and the aperture is automatically set to match flash output and film speed. Popping the camera closed again protects the lens, meter, finder and soft-touch electronic shutter release.

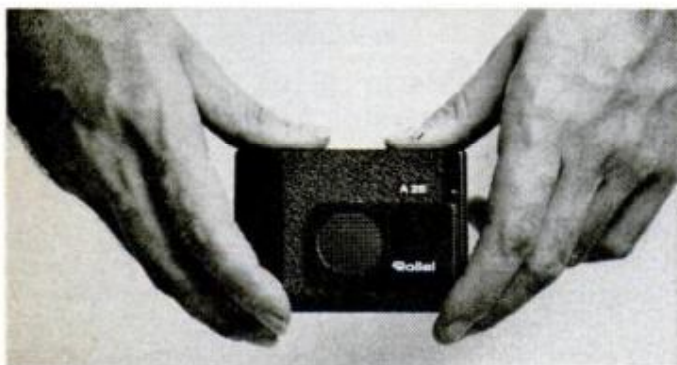

## Bed of plastic foam stops crash-landing jet—without a scratch

Kicking up a frothy spray, a British Comet jet simulates a crash landing on a bed of plastic foam designed to keep runaway aircraft from overshooting a runway. The foam strip, developed for emergency use at British airports, stopped the ship in 250 feet without brakes—a fraction of the distance normally required with brakes.



## Pocket 110 camera has built-in electronic flash

First 110 instant-load pocket camera with 1/1000 second strobe flash built in, Keystone's Pocket Everflash has self-contained lens cover, tripod socket, flash ready-light. Model 120, with f/8 lens, is \$54.95; electric-eye, \$69.95 Model 130 has f/5.6 lens; \$89.95 Model 140 is similar, with rechargeable batteries.

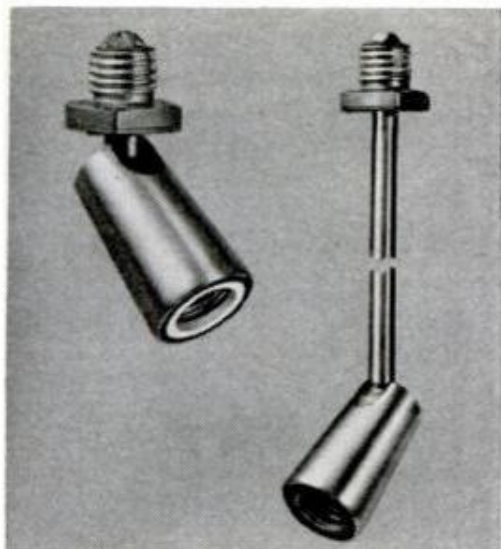

### Point-anywhere lighting screws into any socket

Light goes where it's needed with fixtures that angle and swivel, screw into any medium-base receptacle. With 5-inch extension, fixture is \$5.50; without, \$3.75. Double, deluxe versions also available. Swivelier Co., Inc., Nanuet, N.Y. 10954.

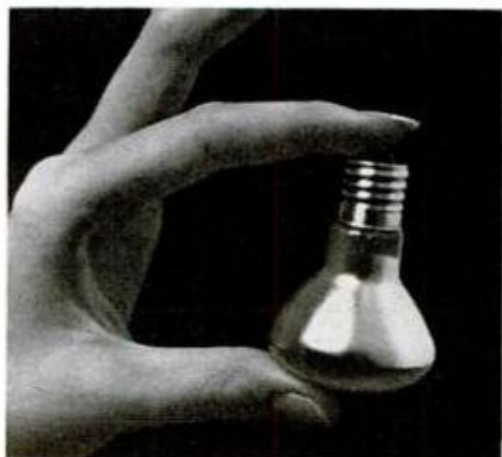

### Tiny bright bulb for high-intensity lighting

New bulb for use in high-intensity portable lamps, accent and display lighting is brighter, cooler, longer lasting than older 110-v. bulbs, uses only 25 watts. "Little R" from General Electric is \$1.75.



### Would you believe—now they're making warships out of plastic!

They're making everything else out of plastic these days—why not warships? First to try it is this experimental plastic-hulled British mine hunter, the HMS *Wilton*. Besides being easier to fabricate, the molded-fiberglass hull lessens the danger of triggering magnetic mines.

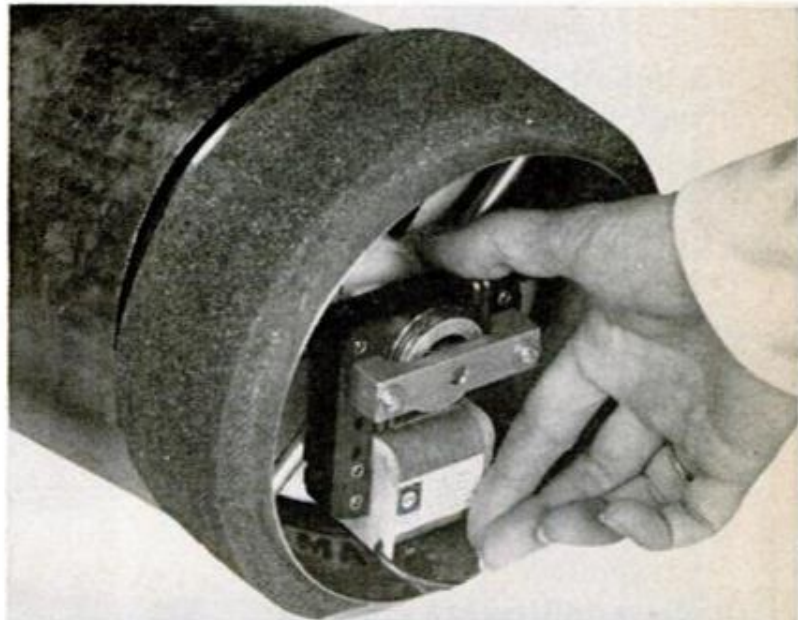

### Booster fans for heating, airconditioning ducts

For rooms that are hard to heat or cool, booster fans may make the difference. Permanently lubricated fan cartridge fits standard 6-inch ducts, is held and insulated by a foam-rubber cuff, can be controlled by thermostat or run continuously. \$14.95 at building supply outlets. Airtrol Corp., 203 West Hawick St., Rockton, Ill. 61072.



## New 'little' Leica has through-the-lens meter

Leitz's latest rangefinder camera is nearly as compact as its tiny prewar models. But it incorporates a through-the-lens light meter like its big brother, the Leica M5, and sells for \$600—about half the M5's price. Lenses bayonet in and out of the CL's "M" mount quickly, and the 90, 50 and 40-mm sizes automatically bring the right finder frame into view as they're mounted. Camera is made by Minolta; lenses by Leitz.



## Highway marker bounces back after impact

Widely used in Europe, Flexopost is an extruded polyethylene highway marker that can bend under repeated high-speed impacts, spring back and stay in service, without damaging vehicles. U.S. distributor is the Rodgers Co., Inc., 29-33 Lodi St., Hackensack, N.J. 07602.

## Cordless drill has low price tag

For power where there is none, cordless 1/4-inch electric drill from Black & Decker weighs less than 3 1/2 pounds with self-contained power pack, drills at 800 rpm. Charging unit included gives batteries full charge in 16 hours. Drill lists at \$49.99, 33 percent lower than firm's previous cordless drill model.







**'Apartment-on-wheels' gives husband-wife truckers the comforts of home**

Carl and Sally Shankle, a husband-and-wife team of long-haul truckers for Mayflower, don't have to leave home when they leave home. Many household comforts go along with them in a special "room" behind the cab of their tractor-

trailer. Paneled and carpeted, it contains such luxuries as hot and cold running water, sink, refrigerator, oven, electric heat, hi-fi and color TV. The Shankles, of Battle Creek, Mich., travel 70,000 miles a year in their apartment-on-wheels.



**World's biggest penguin?**

It isn't alive, but it seems to fool its smaller real-life cousin at the Belle Vue Zoo in Manchester, England. The huge 8-foot-tall stuffed penguin was made by a toy company for use in a British movie.

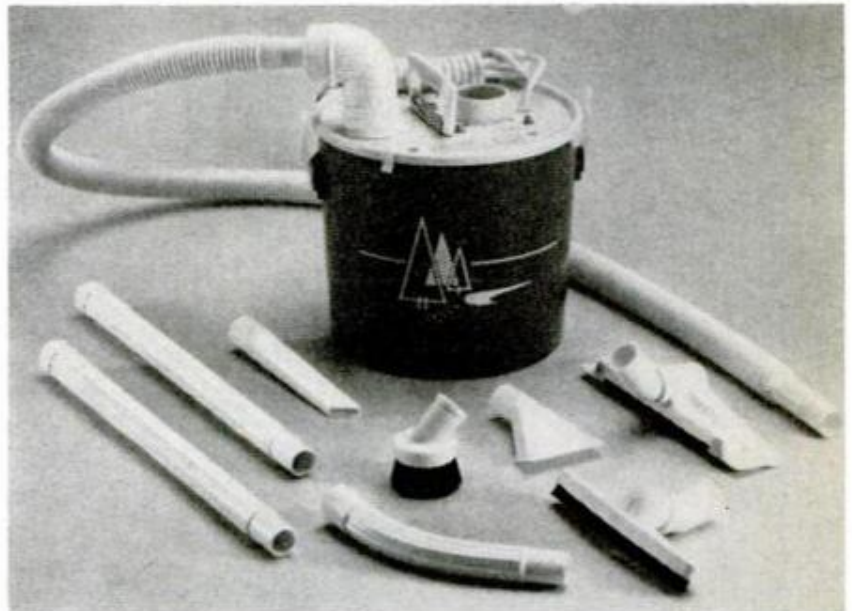

**Portable/built-in vacuum for RVs**

Compact vacuum with 1-hp motor runs on 110-volt a.c. or d.c., holds 3½ gallons dry measure, is designed for use as a built-in unit in RV or boat, yet remains usable as a portable vacuum. Tools and accessories include a shag-rug head, hoses up to 14 feet long. Prices start at \$29.95. At RV suppliers or from M-V Industries, Box 482, Palatine, Ill. 60067.

# NOW

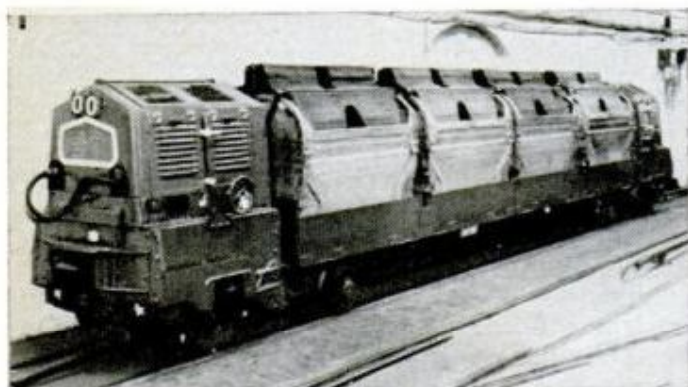
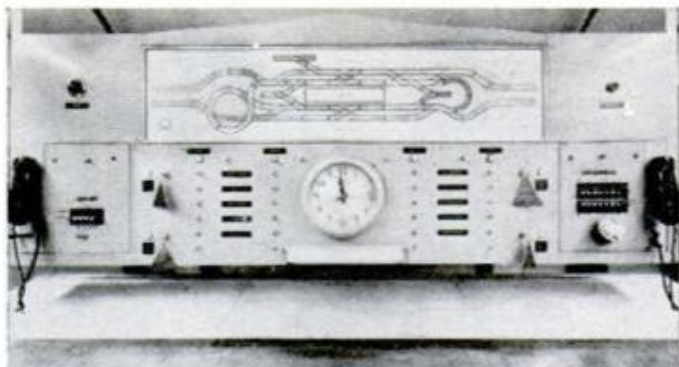

## Letters ride faster than people do in London's rapid-postal system

When they say "fast mail" in London, they really mean it. To avoid delays caused by traffic congestion and ever-present fogs that slow surface travel, the British postal system has its own underground railway—the only one of its kind in existence—to speed mail throughout the city. Electric-powered cars like the one at lower left above whisk mail sacks through subway-like tunnels (upper left), shuttling back and forth between central London and six suburban sorting stations

in outlying areas. The tracks run 70 feet below street level and handle an average of 40 trains an hour carrying 40,000 bags of mail. The bags are packed into hoppers (lower right), which then ride conveyors for automatic loading onto the rail cars. The cars are unmanned and operated entirely by remote control from electronic consoles like the one at upper right. Result: London can sort, process and deliver more mail faster than any other city in the world.



## Puck slides on cushion of air for fast action in home hockey game

Fast-moving, friction-free puck floats on a cushion of air forced through 2000 holes in this playing table's surface, while players try to score and defend by hitting it with their "goalies." Air Hockey operates on 115-volt house current, turns into side table or buffet with optional top. Suggested retail price is \$299 at department and sporting-goods stores. Brunswick Div., Brunswick Corp., Skokie, Ill. 60076.



### Forgotten warbirds still fly

Restoring old aircraft is becoming a popular hobby, but British World War II pilot Douglas Bianchi goes a step farther than most. He finds and rebuilds many lesser-known, almost forgotten vintage warbirds no longer thought to be in existence. Some examples, top to bottom above, are early German Fokker E-III, German Storch and Russian YAK-11. Many of Bianchi's restorations have appeared in movies such as the *Blue Max* and *Those Magnificent Men and Their Flying Machines*. His hobby is now a full-time business: Personal Plane Service, Ltd., Wycombe Airpark, Marlow, England.



### Personalize your Pentax? Honeywell will do it for you

Telling your Pentax from anybody else's—and making it a lot harder for a thief to sell—is easier now with a new service from Honeywell. For \$10, it will engrave up to 20 characters in black on a chrome Pentax, or in white on a black one; for \$2 additional, it will do this in the color of your choice. Write Honeywell, Box 1010, Littleton, Colo. 80120.

# NOW

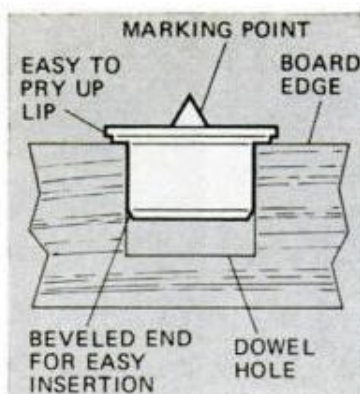

## Centers for locating dowel holes

Dowel centers make it easy to transfer dowel-hole locations from one mating part to another accurately. This set has beveled ends that go into holes easily, extra lip for quick removal without gouging wood, includes pairs of centers in five sizes from 1/4-in. to 1/2-in. dia. Plated steel, set is \$1.40 plus shipping from Brookstone Co., Peterborough, N.H. 03458.

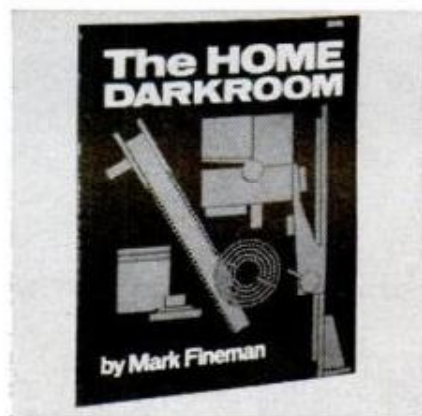
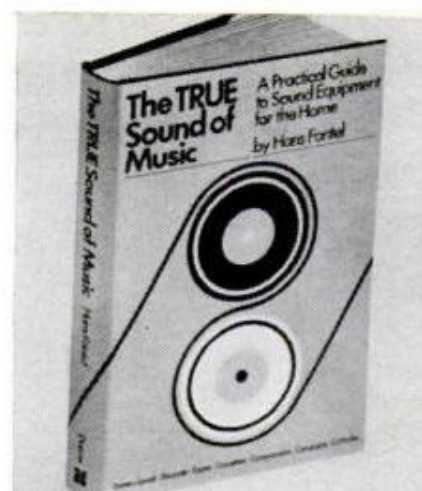

## Good books to read or give

*The True Sound of Music*, by PM author Hans Fantel (assisted by PM's Electronics Editor) covers hi-fi and quad sound literately and in depth. From Dutton, \$7.95 at bookstores. *The Home Darkroom* by Mark Fineman (Amphoto) is basic, \$2.95 at photo stores.



## Sparkling bell for seasonal cheer

Merry Midget Lighted Tinsel Bell from General Electric (left) has a dozen gold bulbs on a background of gold noncurl tinsel, a lighted red clapper, green tinsel leaves and a bright red bow. Wiring is concealed by covered back. UL-listed for indoor use, the bell retails for about \$6.

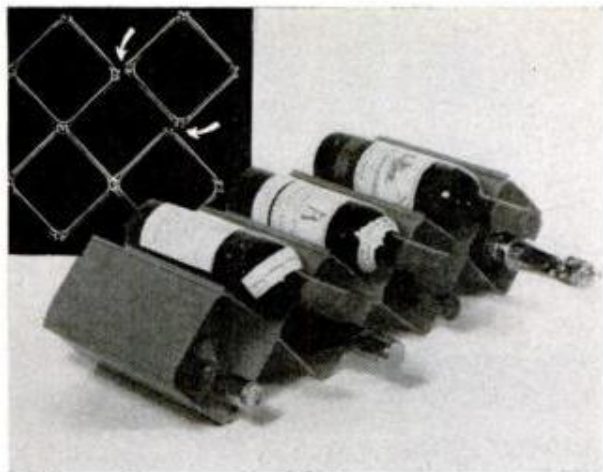

**Wine rack that grows with collection stores bottles the way they should be**

Add A Rack cradles bottles in a position that keeps their corks wet—essential for safe wine storage—and protects them from light. The compact rack system (left) can be adapted to space of any shape, expanded in all directions, will hold bottles of all sizes from 6-ounce split to magnum. Available in black, red and yellow, racks can be color-coded to indicate the types of wines they hold. Prices start at \$4.98 for a seven-bottle rack. Add A Rack, Box 30230, Cincinnati, Ohio 45230.

**Toolkits for Christmas have identifying shapes**

You won't have any trouble telling what each of these toolkits is for—the shape of the package gives it away. Motorcycle, boat and auto toolkits have suggested retail prices of \$11.97, \$9.97 and \$8.97 respectively. Other outfits in line are a family toolkit, a trailer toolkit and a household screwdriver set. Stanley Tool Div., The Stanley Works, 195 Lake St., New Britain, Conn. 06050.

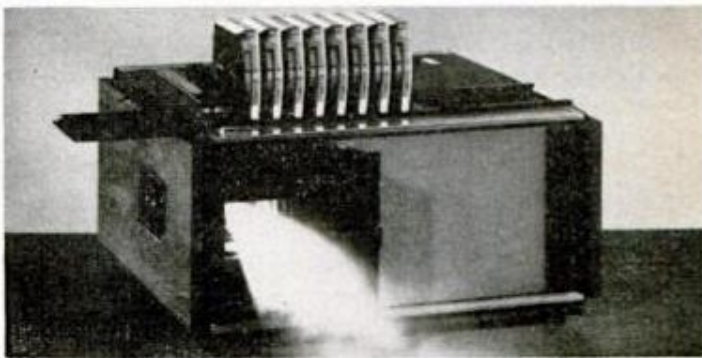
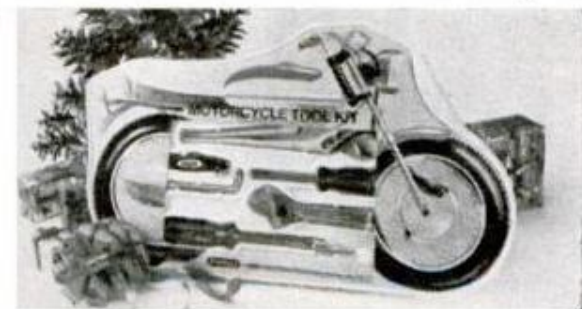

**'Double-feature' Super-8 projector shows up to eight film cassettes on free-standing or built-in screen**

Furniture-styled so you can leave it out on a shelf between shows, Bell & Howell's new Double Feature movie projector has a TV-like screen of its own built in, but can also project on walls or bigger screens. Loaded with up to eight 50-foot cassettes of 8-mm or Super-8 film, the Double Feature rewinds automatically at each cassette's end, changing to the next cassette when you punch a button. An "Instant Replay" button rewinds rapidly when held, resumes projection when released. Single-speed projector will be \$189.95; Multi-Motion version (with 6 f.p.s. slow motion and 2 f.p.s. stop-motion), \$219.95.

# NOW

## Ingenious old 'gravity clock' runs downhill to tell the time, but never runs down itself

This clock runs down, but not the way most timepieces do—it runs down an inclined plane. The inner mechanism and clock face are pendulum-weighted to keep them vertical, while the outer rim rotates as it rolls slowly down the slope, providing power to drive the works. The ramp is marked off in days of the week so the clock's position automatically shows what day it is. At the end of each week, the clock is moved back up to the starting point at top. The unusual timepiece is a replica of a clever 17th-century "gravity clock" recreated by E. Dent & Co., famous maker of London's Big Ben. Its price: about \$1300 from Diners Club, 214 Oxford St., London, England. At right is clocks' test rack.

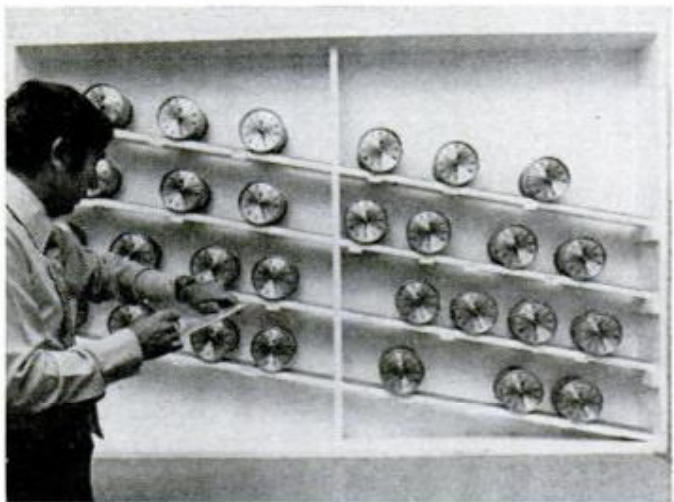
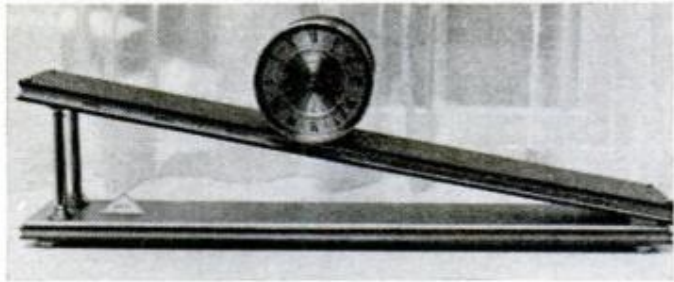

## Versatile fixture for variety of outdoor lighting uses

Portable outdoor spot and floodlight holder can be used with detachable ground spike, mounted permanently with base plate on outlet box, or screwed or nailed to post or wall as a hang-up light. Made by GE, porcelain fixture with bulb is \$7.25 (clear) or \$7.89 (colored) in lighting, department stores.

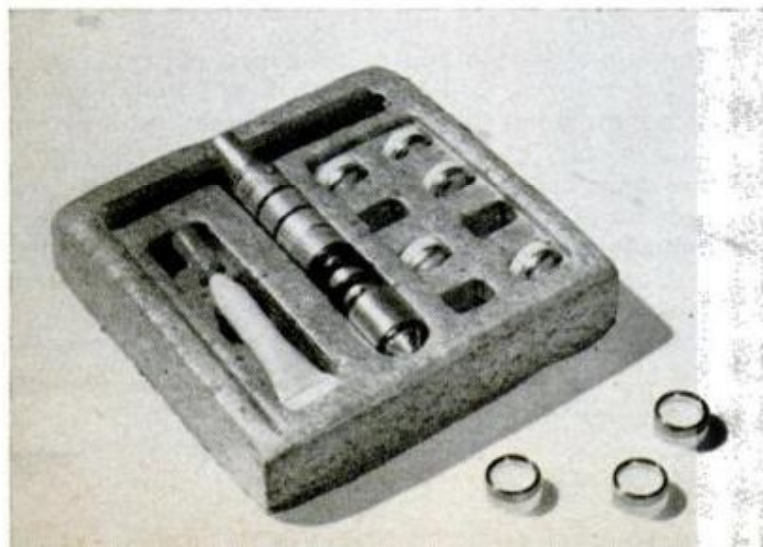

## Faucet repair kit includes seats, cutting tool

You can install a new seat and washer in virtually any faucet with the Vulcan Universal Faucet Repair Kit. Package includes eight seat and washer sets, adhesive, cutting tool. Kit is \$6.95 plus 50 cents for postage and handling. Vulcan Manufacturing Co., Box 33, Grand Valley, Colo. 81635.

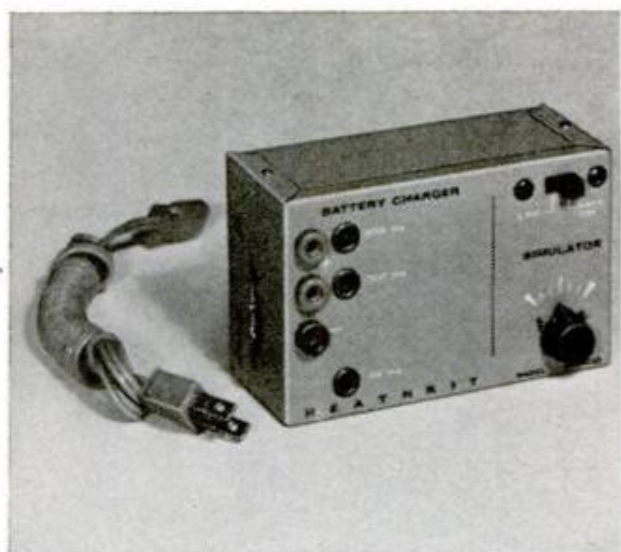

### Handy servo simulator speeds job of adjusting R/C models

New Heathkit servo simulator replaces transmitter and receiver when making fine adjustments on radio-controlled models. Works on all Heath servos and many others, doubles as battery charger. Runs on a.c. or optional battery pack. GD-1053, \$19.95; battery pack, \$9.95. Heath Co., Benton Harbor, Mich. 49022.



### Anticorrosion treatment turns rust into protection

To neutralize rust instead of covering it, Kurust combines chemically with it to form a tough coat that's bonded to the metal surface, keeps water out to prevent formation of new rust. At auto-supply outlets, Kurust is \$2.50 for a 5-ounce can. A. R. Fisher Products, 5-49 48th Ave., Long Island City, N.Y. 11101.



### Saw stores in carrying case

Saw kit from Skil Corp. includes 7¼-inch circular saw with burnout-protected 1¼-hp motor delivering 5700 rpm, safety guard stop and automatic blower to clear sawdust from line of cut. Heavy-duty carrying case stores saw, rip fence, blade wrench, extra blades. Model 574-3 Port-A-Pak is \$34.99.

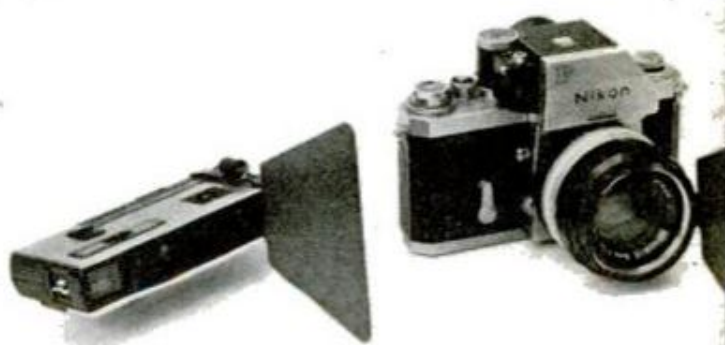

### Reflection shield saves window shots

Adaptable to most cameras, Flec-Shield blocks reflections when shooting through windows of tour buses, planes, trains, cars or buildings. Made of vinyl-padded aluminum, it slips on and off in seconds, won't interfere with camera settings. It's \$3.95 postpaid from Pantec, 917 Carillo Rd., Santa Barbara, Calif. 93103.

# Atomic pollution: A whopping fish story?

Fears that atomic wastes will kill marine life may prove unfounded, claim British ecologists in this surprising report.

by David Lampe

Photos: Michael Wood

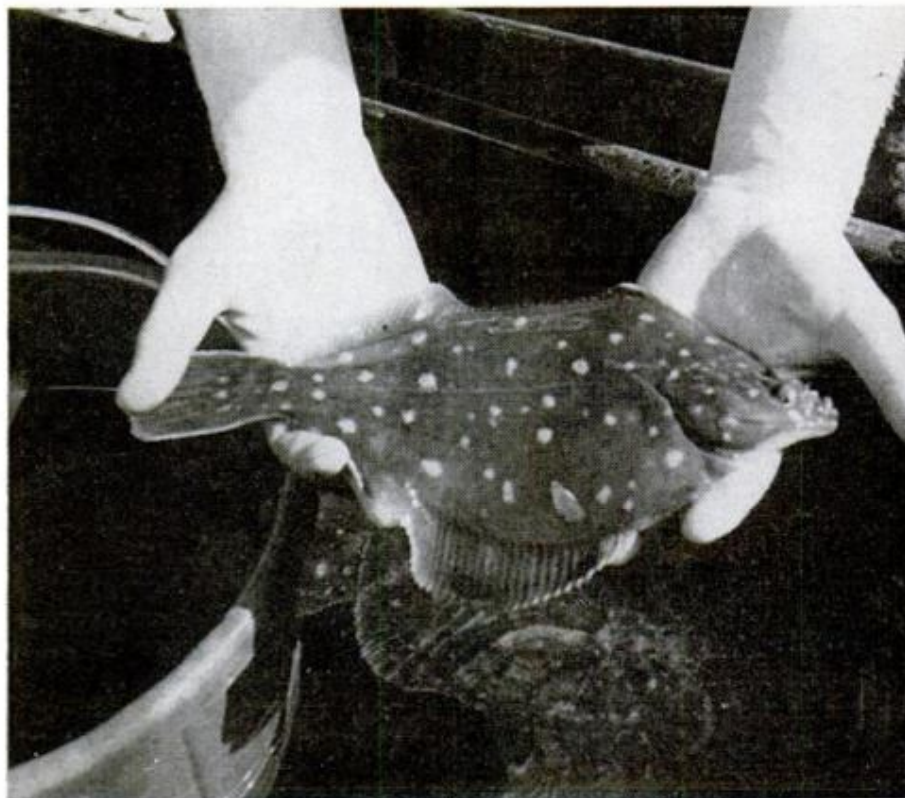

A yearling plaice, healthy and larger than normal for its age, is one of many test fish successfully reared in atomic-effluent waters by British scientists. At left, experimental fish-breeding areas are constantly checked for salinity, temperature, radioactivity and chlorine content. Though abnormally warm and heavily chlorinated, waters were not found to be radioactive.

All over the country, ecologists are screaming about the pollution effects of atomic powerplants being built on our lakes, rivers and coastal shores. It's been assumed that the soup-warm, chlorinated, mineral-dosed water spewing from the massive cooling systems of such generating plants would destroy marine life or at least make fish poisonous with radioactivity. But before these well-meaning dissenters yell too loud, they should know the astonishing results obtained by British marine researchers worried about the same thing.

To sea-bound Britons, good, healthy fish are a vital need, both as a basic food staple in the daily diet and as a major national industry. Thus fishing to the English is as important as corn, wheat and potatoes are to American farmers. In an attempt to increase fish production, British breeding experts recently set up an experimental





fish-farming station at Port Erin on the Isle of Man in the relatively warm, sheltered waters off England's northwestern coast. To their surprise, such succulent species as sole and plaice—ordinarily accustomed to much colder waters—not only thrived there, but grew to maturity in half the usual time, produced greater numbers than expected and were far healthier to boot. Could the warmer-than-normal waters be the answer?

To find out, the researchers set up two more fish-breeding farms, this time deliberately located in inlets heated by the effluence from giant power-generating stations. One was at Ardtoe, the other at Hunterston, both along the southwestern coast of Scotland. Coolants discharged from the huge powerplants kept these inlets as much as 45° F. warmer than water in the open sea nearby. To prevent mussels and other sea organisms from breeding in the power systems' plumbing, all cooling water was heavily chlorinated and treated with minerals. To complicate matters even more, the generator at Hunterston was of the atomic-powered type. Would the 840 gallons it dumped into the inlet every minute of the day and night be radioactive?

But again the same amazing results: Fish grew within less than two years to a size that would customarily take four years. Because of their rapid growth rate, fewer were subjected to diseases and more of the young survived. What's more, not a trace of radioactivity was found in any of them.

While the tests are still continuing, the



**Measuring a turbot** (lower photo above) indicates unusually rapid growth rate in waters warmed by the effluence from powerplant cooling systems—long thought to cause thermal pollution harmful to marine life. At top is one of the dammed-off inlets along the Scottish coast used to test the effects of atomic effluence on fish breeding. The experiments are being conducted by Britain's White Fish Authority, an agency of the government's Ministry of Agriculture and Fisheries.

outlook is extremely encouraging. Scientists theorize that atomic effluence, far from destroying marine life, actually helps to accelerate healthy growth because fish in the unnaturally warm water tend to feed continually throughout the year. In their normal breeding grounds, fish such as sole feed only six months at a time, going into a kind of hibernation during the coldest part of the year. If the British findings hold up, they may lay to rest fears of thermal and radioactive pollution, opening the way at last to uncontested expansion of our much-needed power sources. ★★★

# The diesel: new future for an old engine

Its low emissions and excellent fuel economy make the diesel a promising alternative to the gasoline engine; and now with Peugeot joining Mercedes-Benz in the American market, there's a choice of diesel-powered passenger cars.

by Joseph P. Zmuda

The diesel is the most reliable, long-lasting, economical-to-operate and basically clean engine now, or ever before, built for passenger car use. Many foreign countries have translated the superior economy of the low-pollution diesel into plus factors for themselves and the environment.

Heavy-duty diesel engines are used to economical advantage here in large trucks and buses. But precisely in these applications the idea of clean motive energy is distorted by the image of a dirty, noisy, smoke-belching, foul-smelling engine.

Actually the odor and visible smoke from these large diesel powerplants have obscured the fact that their emissions are less harmful than the more invisible emissions from conventional gasoline internal-combustion engines. Recognition of this fact and diesel economy has led to a re-evaluation of the diesel's role as a powerplant at a time when clean air and conservation of fuel are of prime concern. Consider that:

- Early this year the Environmental Protection Agency (EPA) produced its Request for Proposal No. WA73-R176, *Study of the Problem Areas and Impact of the Diesel as a Light-Duty Powerplant*. When awarded, the study will cover the effects of increased diesel passenger-car applications.

**More people are on the waiting list for a Mercedes-Benz 220D than for any other M-B model. Note: For 1974 the diesel will be the 240D (2.4 liters) and the gasoline model, the 230.**

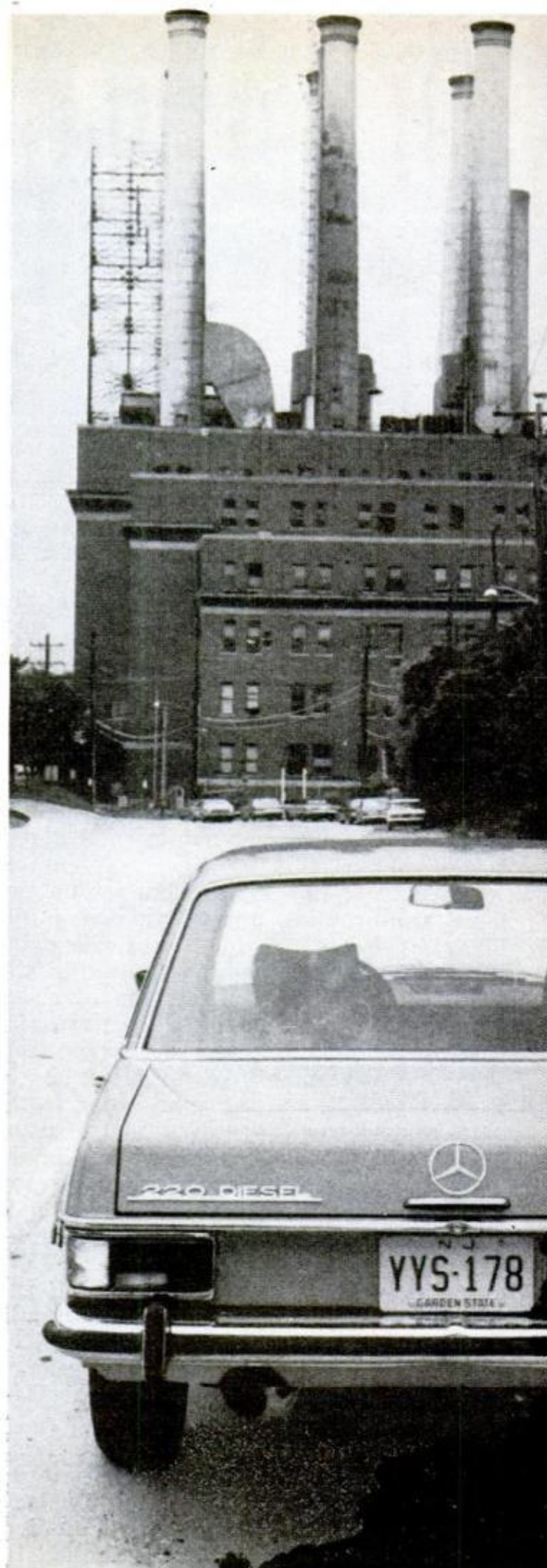

□ Last February, the prestigious and highly publicized Report by the Committee on Motor Vehicle Emissions of the National Academy of Sciences (contracted by EPA) indicated that the diesel was one of only four types of powerplants to satisfy 1975 model-year emissions requirements. It added that the diesel, unlike the Wankel or conventional internal-combustion engine with their increasingly wasteful fuel consumption, will offer improved fuel economy "competitive with 1970 gasoline engines" and without need for costly smog controls.

□ Peugeot, the biggest manufacturer of passenger diesels, has begun importing its diesel-powered 504 model. Next month this will be available in sedan and station-wagon versions. The 504D is one of six diesel passenger-car models made by Peugeot for sale in Europe.

□ Mercedes-Benz, up until now, has offered the only diesel passenger car available here. Its waiting list is longer than that for any other model in the M-B line.

□ Opel of West Germany, a subsidiary of General Motors, has just begun offering a four-cylinder, four-stroke cycle, diesel-engine option for its two and four-door Rekord and Rekord L sedans. GM obviously feels the diesel has a future, if only in Europe.

□ In the 81 years since Rudolph Diesel patented the first compression-ignition engine that made his name famous, the diesel has won recognition as the only prime mover capable of providing long-lived and reliable service in engines ranging from a few horsepower to more than 40,000 bhp. At the same time it exhibited consistently flat load-efficiency curves, high thermal efficiency and superior fuel economy, even with varying loads and speeds.

Whatever the diesel has going for it, you still might wonder what chance it has of competing with the Wankel, stratified-charge and piston engines. Diesel experts and even the pessimistic-though-honest auto manufacturers make no secret that we have the technology and basic engine types now to produce highly-economical, performance-competitive diesel passenger cars that meet 1976 emissions requirements. Unfortunately, we will not see such cars in general U.S. production for many years. Again, as in the past for small economy cars, we must turn to Europe to meet what is bound to be a growing market for diesel passenger cars.

How about emissions standards beyond

## Driving the 504D Peugeot Diesel



The Peugeot 504 isn't new to American roads but a diesel engine option in four-door-sedan and station-wagon models will be when they go on sale next month.

Driving a diesel can be an adventure—just finding fuel. But then, owners of gasoline-powered automobiles didn't have it too easy either at the time we were looking for fuel for a preproduction 504D that just arrived here from France.

With a diesel, once you've scouted your area for diesel pumps and noted their business hours, there's no inconvenience in keeping the tank topped off. And if you're going to venture far afield, the oil companies publish a nationwide list of diesel dealers. Price per gallon of No. 2 diesel fuel compares to a gallon of regular gasoline these days, but it'll take you two or three times as far as your Gas Gulper V8.

We picked up the four-door 504D in Clifton, N.J., after we had returned a 220D to Mercedes in nearby Montvale. The starting procedure for the Peugeot differs a little from the 220D. In both cars there's an ignition switch, cold-start switch to heat the glow plugs and cutoff control for the fuel-injection pump. In addition to these three controls for starting and stopping the engine, there's an idle-speed adjuster. Peugeot hopes to automate the action of these controls in its production models.

The 504, like its gasoline-powered equivalent, is a very comfortable and well-appointed automobile. It's well built and nicely finished and worth the \$6000 that, in round figures, we guess it will cost in 1974.

The 504D is a bit faster getting up to speed than the 220D (still, both are in the 25 to 30-second range for 0 to 60 mph), but both cars have top speeds in the mid 80s and are at their best in terms of comfort and driving pleasure at turnpike cruising speeds.

Because of the diesel's high compression ratio (22.2:1 for the 504D) and peak rpm that is limited by metering of the fuel, throttle pressure and shift points take some getting used to—otherwise acceleration through the gears will be anything but smooth. What is smooth is getting close to 30 mpg. Even better is the European Peugeot 204 with the 1.3-liter diesel: 40 mpg! But that car isn't "safe" enough for us, says Big Brother. Never mind that it would be one the average man or woman could better afford.—*Bill Hartford*

1975? Can a diesel really "come clean" for 1976? J.I. Miller, board chairman at Cummins Engine Co., Inc., appearing at EPA light-duty vehicle hearings in May 1971, indicated that the diesel has the potential to meet future light-duty vehicle (LDV) emission standards. Except for excessive nitrogen oxides (NOx) due to high peak temperatures, diesels produced today can meet even the 1976 requirements. But Cummins and other diesel firms are proposing LDV engine design unlike that popular now: a low-compression-ratio, indirect engine that would achieve a high specific output at low-peak cylinder pressures.

N.J.E. Hartwell, ecological engineering manager at Perkins Engines, Inc., believes "the diesel engine—lightweight, high speed, with indirect injection system, possibly lightly turbocharged—can be a very serious contender in the LDV field. It has proven so for taxicab and light van delivery service throughout Europe and the United Kingdom. It has found its place in the Middle East. Israel particularly has found it to be advantageous. In fact, America is the last country to be converted to the cause. We have lightweight diesels running in European cars which meet the U.S. 1975 emission requirements without any alteration from the standard production specification."

The only barrier to the 1976 standards, according to Hartwell, is the 0.4 grams/mile NOx requirement that most authorities consider unreasonable. It is not a scientifically-derived standard, but only a gross percentage (10 percent) of the average levels of uncontrolled 1971 vehicles. In April, EPA indicated this 90 percent reduction "not necessary" and that NOx is

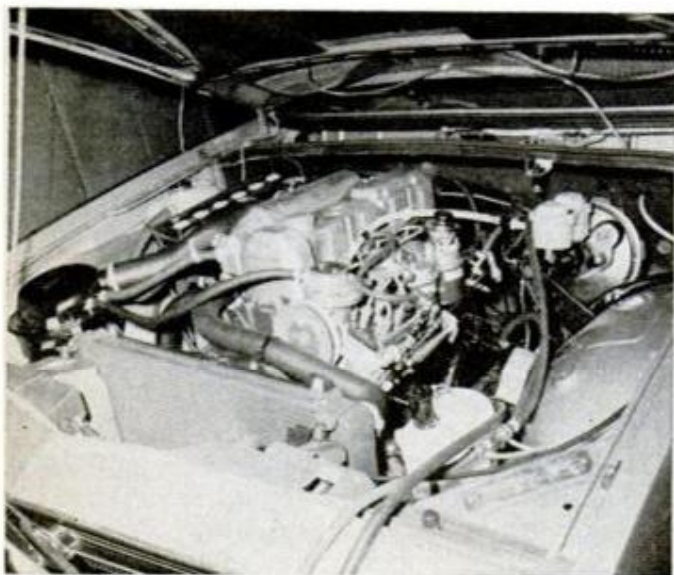

124 POPULAR MECHANICS

"not the problem" EPA and Congress thought it was.

Despite the future certainty of relaxing NOx requirements, Hartwell feels that technology still can get the diesel down to 0.8 grams/mile by combustion system and fuel-injection system redesign alone. There are more decisive changes in the offing.

By resorting to late injection timing, a more constant-pressure cycle-type diagram would be substituted for the typical high-pressure rise (diesel knock) characteristic. Not only would the lower temperatures and pressures bring NOx to below 1976 levels, the engine would be quieter and could be made lighter and, therefore, cheaper.

How much fuel economy can we really expect from future diesels? Hartwell cited a comparison of 1969 taxicabs in which diesel units gave double the hours of operation per gallon of fuel of gasoline units.

"Theoretically, therefore by inference in 1976, the diesel version should be giving at least three times the economy of the gasoline version," he emphasized, "and that's without the additional cost of maintenance of catalysts, afterburners, EGR systems, and so on."

These characteristics of low specific fuel consumption and fewer exhaust emissions are inherent to the diesel cycle. Unlike a

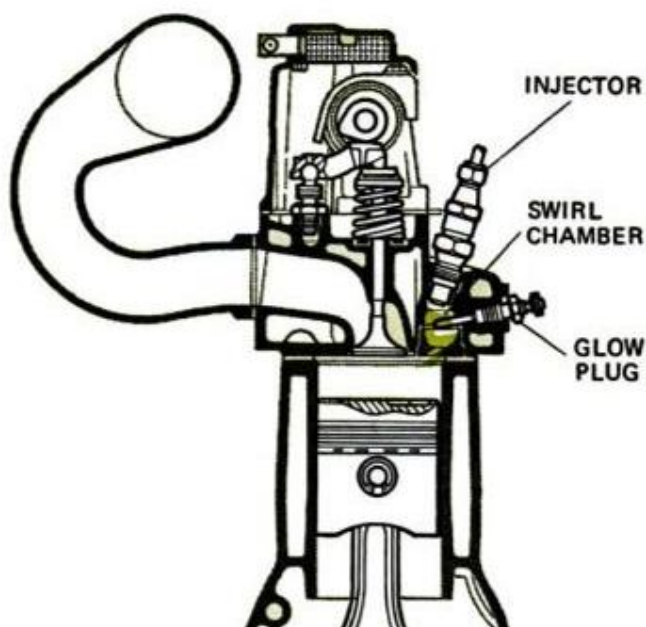

Diesel engines for passenger cars use either a swirl chamber or prechamber above the cylinder. Combustion starts here and spreads down. For cold starts a glow plug heats the chamber.

Diesel engine in the Opel Rekord is, like the M-B and Peugeot powerplants, four cylinders displacing just over two liters. GM does not offer the car for sale in the United States.

gasoline engine that uses an electric spark to ignite the fuel, air in the diesel cylinder is heated by compression so gas temperature alone causes ignition. Instead of using a fixed proportion of fuel and air, diesels run with a precise amount of injected fuel and usually with more air than necessary to support combustion.

Such abundant air assures more complete burning, reducing the production of unburned hydrocarbons (HC) and oxygen-starved carbon monoxide (CO) while at the same time boosting fuel economy. Even the air not used in combustion serves to dilute the exhaust gas, further decreasing the concentration of pollutants.

Besides its strong points, the diesel has its drawbacks: malodorous exhaust, smoking, excessive weight and poor acceleration. But even today's diesels are decidedly improved in those areas.

**Odor:** While the cause of diesel odor is not precisely known, reducing the amount of fuel held in the tip of the injectors was found to work wonders for human sniffers at Detroit Diesel. And engineers at GM found that a simple switch to needle-valve injectors from crown-valve injectors minimized the fuel held below the control valve and reduced odor substantially.

**Smoke:** Black smoke seen when a truck or bus accelerates or climbs a steep grade (lugging down) is actually harmless soot particles produced by increased fuel injection to supply temporary high power at lower air-fuel ratios. By sticking to good engine designs that do not stress overly-high performance, smoking can be avoided during much of the driving mode.

Another smoke-reducing feature involves burning injected fuel in a small precombustion chamber and then discharging the atomized fuel into the main cylinder. Compared to direct injection, burning starts sooner and lasts longer, reducing smoke to below visual level in the lug-down mode.

Smoke reduction means cleaner emissions. For example, Caterpillar Tractor Co. began producing prechamber diesels for various reasons over 40 years ago. Now its latest 1600 series engines meet stringent 1976 standards for CO along with combined HC-NOx standards for 1975.

**Noise:** Noise reduction can be achieved by shielding, powerplant redesign or a combination of both. While total shielding is impossible because of cooling needs, partial shields were introduced with good results

## Driving the 220D Mercedes Diesel



Mercedes-Benz has had a diesel-powered passenger car in the American market for years. I never drove the early 180D, but recently did take out this 1973 220D.

If I wrote about 220D after driving it for an hour, I'd say it couldn't get out of its own way. But after a week I found that even I adjusted to waiting half a minute to get up to 60 mph, changed my driving habits and got a new perspective on the jackrabbit-start syndrome. Reluctantly, after the week, I surrendered the Mercedes, got back in my own car and nearly snapped my neck when I let out the clutch.

Recent experiments with turbocharging passenger-car-size diesels have resulted in impressive acceleration, but such hop-ups will, at least for now, not be done at the factory. So, for between \$7000 and \$8000 you have a choice between the 220D and a faster 220 gasoline (240D and 230 for '74). Fuel economy, simplicity of maintenance and longer engine life dictate the D, not to mention environmental dictates.

Apparently these are the reasons Mercedes has such a waiting list for the diesel and why owners willingly pay a couple hundred more for it. I would seriously consider doing the same.

Advantages of the diesel have seemed more obvious to Europeans, and many Americans have had their first fast, luxurious, diesel-powered ride going to a European airport in a Mercedes taxi.

The 220D is indeed luxurious and, at the same time, a terrific handling car with excellent braking capabilities. Some consider this aspect of its performance a waste—especially when coupled with the diesel's low power output and the fact that the car is so popular among older, retired people. To me the rationale is simple: As aging shaves fractions of a second off your reaction time, the incredible brakes will shave feet off your stopping distance!—Bill Hartford

in the 1950s. Engines now are being re-designed for noise control, and totally new configurations based on low-noise requirements will prevail in the future.

Turbo supercharging, another method of noise reduction, increases the mass of air handled by a given swept volume in the cylinders through the use of compressors driven by exhaust-gas turbines. Combustion noise is reduced along with smoke and gas emissions.

Turbocharging also results in a lower engine speed with a higher specific power and a lower specific weight because smaller cylinder bores—which restrain noise—can be used for a given horsepower. For example, the Perkins six-cylinder diesel normally develops 120 bhp. Turbocharging raises this figure to 155 bhp.

One more diesel high point: McCulloch Corp. is working on a 180-hp, four-cylinder diesel that cuts weight and NOx significantly by reducing internal pressures. Although the project is under tight wraps, automakers are interested in it.

With such present progress and implied future improvement, the only sour note is the unwillingness of the auto industry to launch a time-specific program for diesel LDV development. Industry executives and corporations that work closely with them display evidence of disinterest . . . at least outwardly. Here are some comments:

Morris G. Garter, technical and product information, Ford Motor Co.: "Personally I wouldn't look on the diesel as a replacement for the conventional engine."

J.H. Pitchford, chairman of the directors, Ricardo & Co. Engineers, Ltd., England: "I personally do not see the smaller size of automotive diesel engine, as we know it in Europe today, really replacing the gasoline engine in the ordinary privately owned automobile to any significant extent, but I do see its use in what may be termed the utility class of vehicle."

Sydney L. Terry, vice-president of environmental and safety relations, Chrysler Corp.: "The engineering, development and tooling of several sizes of diesel engines to power all of our cars would take a minimum of five years and would cost in the hundreds of millions of dollars. Since the diesels still can't meet 1976 emission levels and cost substantially more per car than gasoline engines, we do not feel that a massive engineering development program on diesels is justified at this time."

## Results of EPA diesel tests

	EMISSIONS, GRAMS/MILE		
	HC	CO	NOx
1976 NATIONWIDE STANDARDS	0.41	3.4	0.4
1975 NATIONWIDE STANDARDS	1.5	15.0	3.1
1975 CALIFORNIA STANDARDS	0.9	9.0	2.0
MERCEDES 220D	0.34	1.42	1.43
OPEL REKORD 2100D	0.40	1.16	1.34
PEUGEOT 504D	3.11	3.42	1.07

**Low-emissions characteristics** of Mercedes, Peugeot and Opel diesel-powered passenger cars are revealed in tests by the Environmental Protection Agency.

Fred W. Bowditch, director of automotive emission control, General Motors: "I am sorry to be unable to perpetuate an exciting rumor, but I believe you will agree . . . that in their present state of development, diesel passenger-car engines would indeed have difficulty in competing with U.S. gasoline-powered automobiles."

There is an interesting footnote to the official GM stand. One recently-retired, high-echelon GM staff member whose adherence to facts has won out over his commitment to the company line assessed the situation as it concerned the Opel Rekord diesel: "EPA provided me with their figures on its emissions. Although the car is not sold in the U.S.A.—yet—HC and CO are one-third of the 1976 standards! The NOx is high, but no work has been done on NOx and besides, there is no claptrap on the engine."

"What this means is that 'they' can't keep the modified diesel—which we began developing almost 10 years ago—under the rug any longer. GM now has a car on the European market which should embarrass them here in the States."

With today's energy crisis forcing curtailment of fuel consumption, it would be surprising if the Federal government and domestic automakers did not combine efforts to accelerate diesel research and development. Meanwhile, you have a choice between the 220D and 504D. ★★★

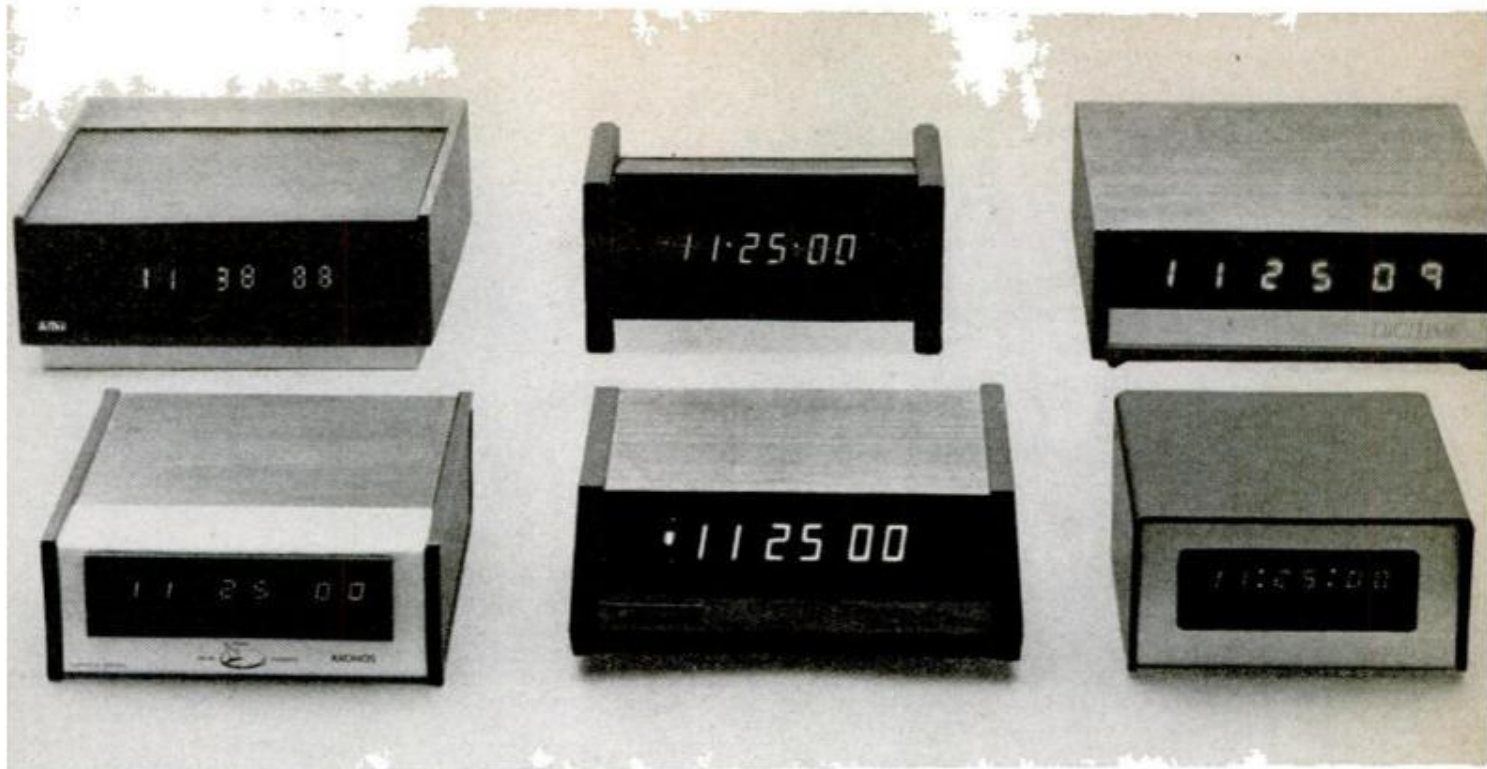

# Digital clock kits: fun to build, fun to watch—and oh, yes, they keep time

by Andy Santoni

Photos: Peter Schneider

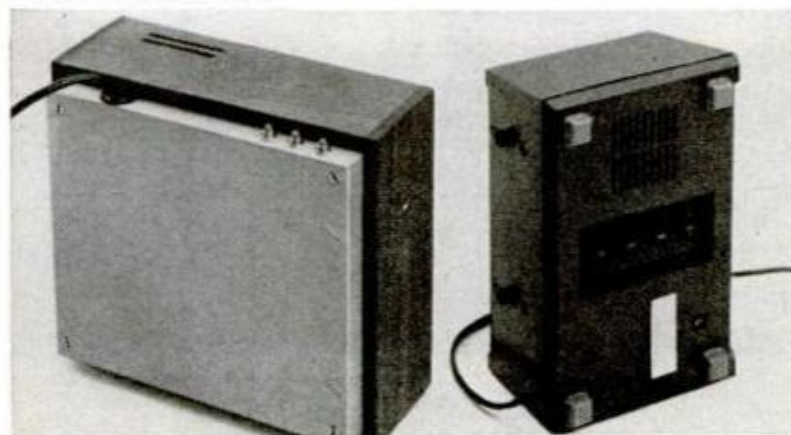

Six all-electronic clocks you can build from kits, left to right: (back row) Aries, Huntcutt, ESE Digitime; (front row) Poly-Paks Kronos, Heathkit alarm, MITS. Kits range in cost from \$47 to \$59.95. Time to build them varies from 4 to 10 hours.

Every generation is convinced that the next one will have a softer life. Now they're even making that childhood bugaboo, the "big-hand, little-hand" method of time-telling, obsolete. Digital clocks, displaying the time in large, clear numbers, are beginning to supplant the old, two-handed "analog" models. Already, silent, all-electronic digitals are replacing the not-so-old mechanical drum and flip-chart types. And many of these are now available as kits.

Like run-of-the-mill electrics, the six kits I built and checked used 115-volt, 60-Hz. line current both for power and as a frequency reference to determine the correct time. All featured six-digit, hour-minute-second displays and used seven-segment readouts. But aside

Time-setting pushbuttons are unmarked on most clocks, as on Aries (far left). Heath (left) has incomplete markings on bottom setting switches, none for rear-panel alarm shutoff and snooze-delay switches.

from those basic similarities, each took a different design approach.

The simplest, most basic model, was the ESE Digitime ES-112, using incandescent displays and TTL-type, medium-scale integrated circuits instead of the new displays and MOS large-scale integrated circuits used in the other clocks.

Actually, this approach has its advantages: Using medium-scale TTL circuitry, while it increases the number of ICs used, decreases the number of discrete resistors, transistors and such to be wired (the ES-112 was the fastest unit of the group to wire, taking just four hours), and the ready availability of TTL ICs simplifies repair, should that ever be necessary. Price of the ES-112 kit is \$46.95, plus \$12 for the attractive wood case or \$7.50 for the aluminum case (which I haven't seen), plus about \$2 for shipping from ESE, at 506 Main St., El Segundo, Calif. 90245.

The Hunicutt NC-247, another TTL type, uses larger, more legible Sperry gas-discharge displays, and its metal cabinet can be tilted within its wooden end panels for the best viewing angle. The clock takes about eight hours to build and costs \$59.95 plus shipping from Hunicutt Digital Electronic, Box 9793, Fort Worth, Tex. 76107. An \$18 accessory kit will convert it to a timer.

The more sophisticated approach, using a single, large-scale integrated (LSI) chip containing all the clock circuitry, actually increases the number of parts to assemble. That's because the LSI chips are MOS (metal-oxide semiconductor) circuitry that can't drive the illuminated displays directly. This means you have to mount about 19 extra transistors and several resistors. But the advantages of this approach include smaller power supplies (MOS chips consume much less power than TTL) and the options of wiring for either 50 or 60-Hz. operation and for either conventional 12-hour or military-style 24-hour readout.

With all that extra wiring required, the Aries AR-730K MOS-chip clock took 10 hours to build. It was also the most attractive of the six, though its fluorescent display was the least legible (and the only audible one, ringing faintly as the time changed). It's available for \$47.50 from Aries, Box 808, Peabody, Mass.

The MITS DC-6K, on the other hand, though it shared the Aries's high parts count due to its MOS circuitry, took only

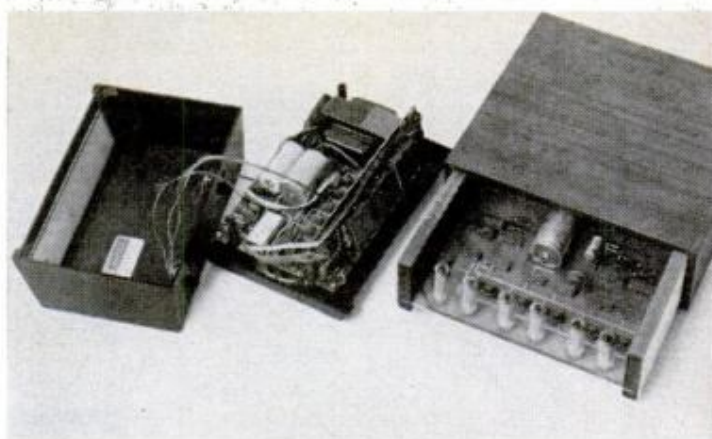

Kits with all clock circuitry on one MOS chip (like Heath, above left) take longer to build than the kits using older TTL chips (like ESE, above right) which require more ICs, but a lot fewer, smaller components.

about six hours to build, thanks to its clearly written manual. I wasn't too happy with this clock's red LED (light-emitting diode) readouts—they're bright, but their segments are distracting rows of dots instead of the continuous bars of the other displays.

The MITS's engineers must have been trained in military electronic design and engineering, judging from their use of very high quality printed circuit boards with plated-through holes and clearly marked component locations, a sturdy aluminum cabinet, and split-ring lockwashers instead of the star-washer types more commonly used in consumer products. The MITS manual was a marvel of clarity, with a delightful component-installation coding system: On each page, components to be installed are clearly designated, while components which have already been installed are blacked in, with outlines showing components to be mounted later. It's one of those simple but effective ideas that always makes you surprised someone hadn't thought of it years ago. The MITS DC 6K is \$58.50 with case, \$49.50 without. If you don't like to see the seconds zipping by, a four-digit (hours and minutes only) version is available for \$10 less. Shipping is \$3 additional. MITS is at 6328 Linn Ave. N.E., Albuquerque, N.M. 87108.

Similar to the MITS is the Kronos MAN-1 from Poly-Paks (Other models are also available). The case is quite attractive, with walnut-finish side and top panels, adding up to a small, neat unit for \$47 plus \$1.50 postage. Building time was nine



hours. Poly-Paks' ordering address is Box 942, Lynnfield, Mass. 01940.

Then, saving the best for last, there's the Heathkit GC-1005. It has all the best features of the other clocks including big bright Sperry displays and the option of wiring it for either 12 or 24-hour operation. But it also incorporates an alarm and a unique power-off warning.

The alarm works on a 24-hour cycle, so it won't go off in the PM when you want it to go off in the AM, and it has a snooze switch that lets you sneak an extra seven minutes' sleep before the alarm goes off again. But both the snooze switch and the alarm shutoff are identical-looking, identical-feeling switches on the back of the clock, so it's possible to confuse them in your morning fog.

Interrupting the power makes the other clocks display random, and possibly confusing, times when they start up again. The Heath's display shows all eights, instead, as a warning. But I would have liked to have the alarm sound, too: then, if power failed during the night, I'd wake up to reset the clock. Still, at \$54.95 and 10 hours' building time, I liked it best.

Setting a digital clock takes three buttons. On all but the Hunicutt and Heath, one button moved the time ahead quickly for hour setting, one moved it ahead slowly to set minutes, and a "hold" froze the time on the clock; you just set the clock a few minutes fast, then hold it till time catches

up with you. The Hunicutt had a variation; its hold button also set the seconds to "00," which I found less convenient. Having to start at 00 seconds every time meant that if I was a bit slow or fast in releasing the hold button, I'd have to wait a full minute to reset the clock accurately. Heath uses still another variation: Instead of a hold button like the Hunicutt's, it has a switch that holds until you click it off again. Also, the Heath's "minute" switch sets only the individual-minute column; to set the tens-of-minutes column, you have to hold both the minutes and hours switches.

These procedures take a bit of getting used to; but of the clocks tested, only the Poly-Paks Kronos and the MITS had clearly marked time-set controls. Heath marked all but the alarm on-off and snooze switches, but had no indication that two switches had to be coordinated to set the minutes. And though the Hunicutt instruction book mentioned a designation label for the buttons, none was included with my kit.

As to time accuracy, though I worried that power-line surges might throw the clocks off (the inertia of a normal electric clock's motor smooths out these noise spikes), I've had them running in my house for a few months, and they haven't gained or lost enough time to notice, even during brownouts. Most important, they tell me the time clearly, even in the dark. And it's been fun building them and talking about them with my curious friends. ★★★

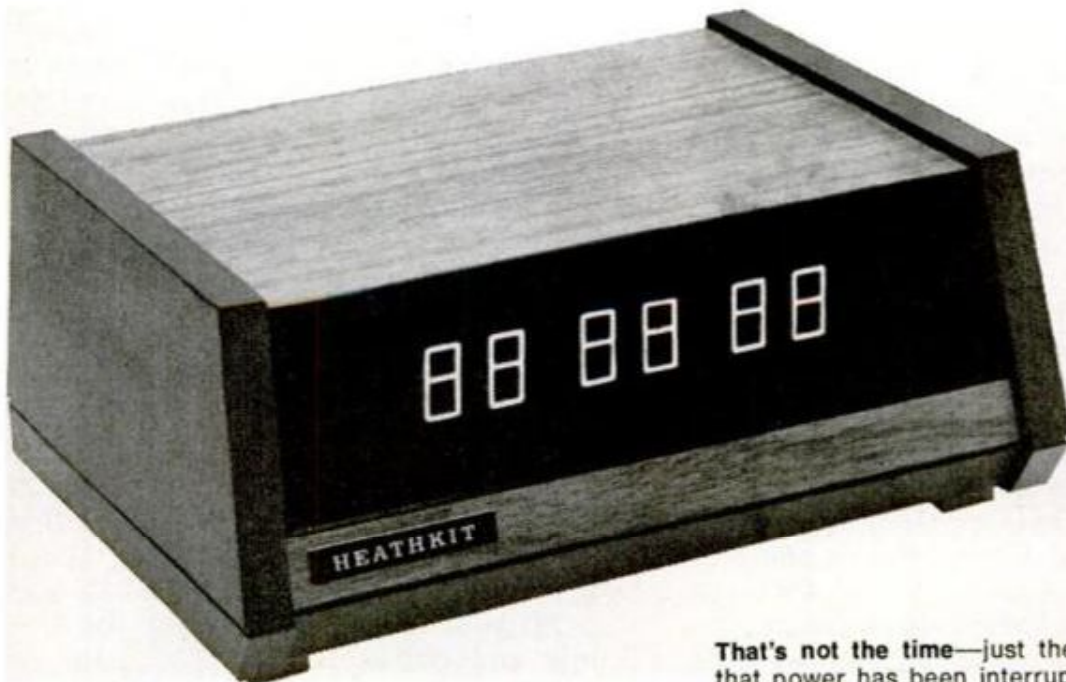

That's not the time—just the way the Heathkit warns that power has been interrupted since you last looked at the clock. Random times that are shown by other clocks after power interruptions might be close enough to the right time to be confusing.



# Pocket Super-8s: Home movie cameras you won't leave home

by Peter and Susan Schneider

Photos: Peter Schneider

**N**ext time you go on a trip and can't find room for a movie camera in your camera bag, try slipping one into your pocket. Now there's a whole new breed of versatile Super-8s small enough to whip out of a pocket when the action breaks.

The advantages are obvious. But what about the limitations? If you can't live without features like 8X or 10X power zoom lenses, in-camera dissolves and so on, you'll just have to lug around a full-sized Super-8 camera. And the pocket models are often a bit harder to hold comfortably and steadily. But that's about it.

All 10 of the cameras we tried took sharp, steady, well-exposed films, indoors and out. However, we had some difficulty focusing them accurately at telephoto settings, because of their clear viewing screens. We'd rather see ground-glass, microprism or rangefinder screens, where the image snaps more positively into focus. Of course, there

is ample depth of field to cover focusing errors at normal and wide-angle zoom settings; but if you plan to do a lot of telephoto shooting, you should try focusing any camera in the store before you buy it.

The same holds true for a camera's general "feel" and the way it fits your hands while you're working the controls. Pistol grips are a big help, though they're literally a snag when it comes to putting the camera in your pocket. Three of the cameras tested had such grips: a removable grip with a built-in trigger for the Argus Cosina, a neatly-folding (but awkwardly-angled) grip on the GAF, and a trigger grip that folded back around the camera (making it a bit long for most pockets) on the Nizo. Accessory grips are also available for the Bolex, Eumig and Bell & Howell.

Cameras whose triggers are just beneath their lenses, like the Eumigs and Bolexes, are especially awkward without a grip—

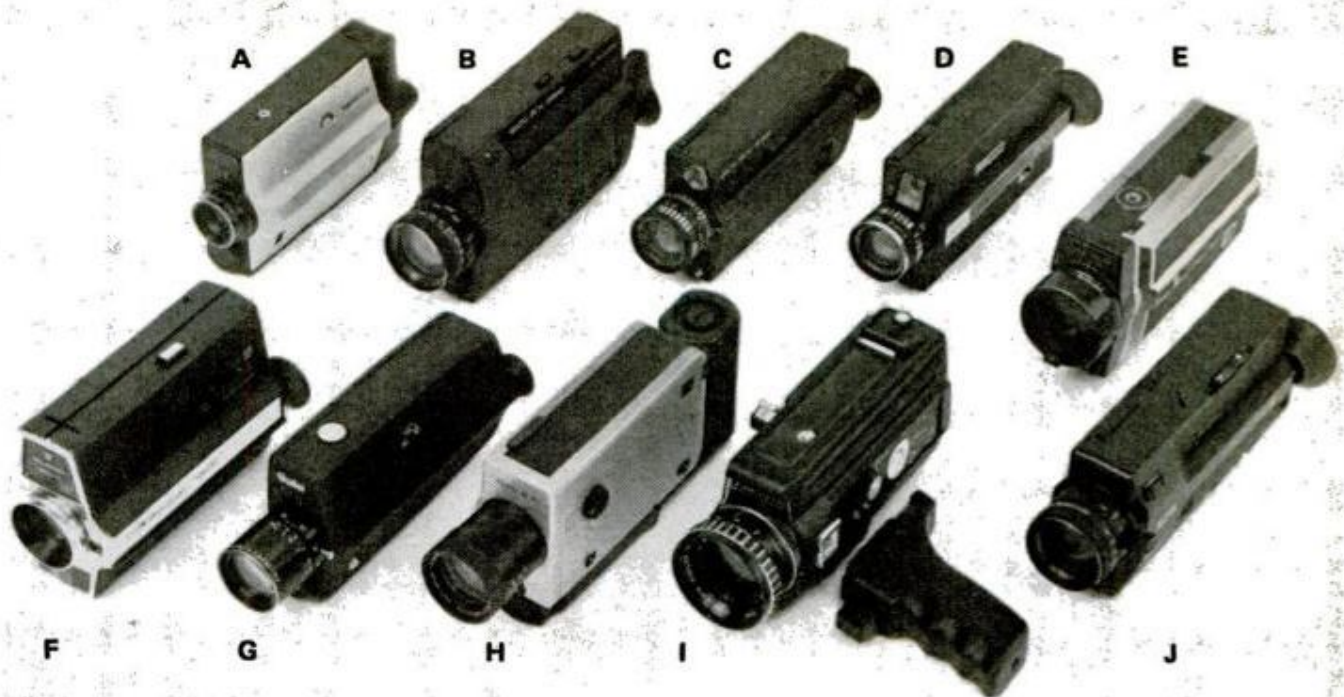

**Pocket Super-8s include** (A) Bauer Star XL, (B) Bolex 350 Macro Compact, (C) Bolex 233 Compact S, (D) Eumig Mini 3, (E) GAF Compact 400, (F) Bell & Howell 670/XL, (G) Rollei SL 86, (H) Braun Nizo S30 (with handle folded back), (I) Argus Cosina 735 (with detachable trigger grip) and (J) Eumig Mini 5. Not quite hip-pocket size, jacket pockets (opposite page) almost swallow smallest camera, the Bauer Star XL (top), easily accommodate even biggest of the group, the Argus Cosina 735. Good things available in these small packages include power zoom lenses, macro focusing, single-framed animation, manual exposure override, mild slow motion (details in chart, page 132).

**Handles help you keep a steady grip.** Three cameras came with them (below): GAF's folded flat, Nizo's folded back and Argus Cosina's was removable.

even more so if you want to zoom or focus while shooting (but on the bigger Bolex and Eumig, power zoom helped). The only one I really liked using without a grip was the Rollei, with its trigger on top.

For tripod use, all of the cameras except the Bauer, Bell & Howell and the Rollei had cable releases, and the Argus Cosina and Braun Nizo had electrical remote-control sockets as well.

Optically, the most versatile cameras were the Bolex 350 and the Eumig Mini 5, both of which had 8-40-mm 5X power-zoom f/1.9 lenses that focused to three feet (close enough to fill the screen with a large butterfly, at the 40-mm telephoto setting), plus a macro range that lets you focus to within a few millimeters of the lens. Other power zooms were the Argus Cosina's 8-40-mm f/1.8, the GAF's 4X, 7-28-mm f/1.9, and the Nizo's 3X, 10-30-mm f/1.8.

Manual zooms, which take some practice

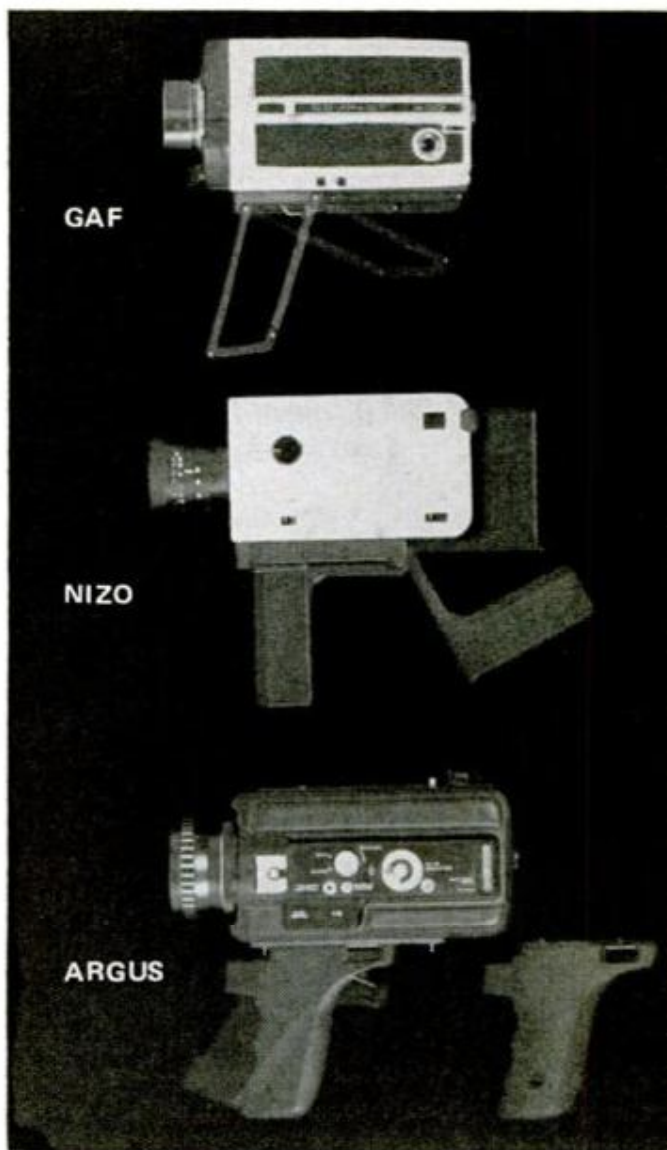

## QUICK GUIDE TO POCKET MOVIE CAMERAS

Camera	Price	Weight (with batteries)	Height, Width, Length (plus Lens)	Lens Focal Length, Aperture	Zoom Range, Type	Closest Focusing Distance	Exposure- Meter Type
Argus Cosina 735	\$239.95	2 lb., 2 oz.	3 $\frac{3}{4}$ x 2 x 5 $\frac{1}{4}$ " (+1 $\frac{3}{8}$ ")	8-40 mm, f/1.8	5X, P	4'	TTL
Argus Cosina 755 XL	269.95	2 lb., 2 oz.	3 $\frac{3}{4}$ x 2 x 5 $\frac{1}{4}$ " (+1 $\frac{3}{8}$ ")	9-27 mm, f/1.2	3X, P	4'	TTL
Bauer Star XL	139.95	15 oz.	3 $\frac{3}{8}$ x 2 x 5 $\frac{1}{4}$ " (+3 $\frac{3}{8}$ ")	9 mm, f/1.2	None	Fixed	TTL
Bell & Howell 670 XL	119.95	1 lb., 1 oz.	3 $\frac{3}{4}$ x 2 $\frac{3}{8}$ x 5 $\frac{1}{2}$ " (+3 $\frac{3}{8}$ ")	9 mm, f/1.2	None	Fixed	EE
Bolex 233 Compact S	136.00	1 lb.	3 x 1 $\frac{3}{4}$ x 5 $\frac{3}{4}$ " (+1 $\frac{1}{8}$ ")	9-30 mm, f/1.9	3.3X, M	4'	EE
Bolex 350 Macro Compact	264.50	1 lb., 10 oz.	3 $\frac{7}{8}$ x 1 $\frac{7}{8}$ x 6" (+1 $\frac{1}{8}$ ")	8-40 mm, f/1.9	5X, P	3' and macro	TTL
Braun Nizo 530	225.00	1 lb., 12 oz.	3 $\frac{3}{4}$ x 2 x 7 $\frac{1}{4}$ "* (+1 $\frac{3}{4}$ ")	10-30 mm, f/1.8	3X, P	3'	TTL
Eumig Mini 3	119.95	1 lb.	3 $\frac{1}{8}$ x 1 $\frac{5}{8}$ x 5 $\frac{7}{8}$ " (+7 $\frac{1}{8}$ ")	9-28 mm, f/1.9	3X, M	"Servo"	EE
Eumig Mini 5	279.95	1 lb., 8 oz.	3 $\frac{1}{4}$ x 2 x 6 $\frac{5}{8}$ " (+1")	8-40 mm, f/1.9	5X, P	3' and macro	TTL
GAF Compact 400	184.50	1 lb., 9 oz.	3 $\frac{3}{4}$ x 2 $\frac{1}{8}$ x 6 $\frac{1}{4}$ " (+1 $\frac{1}{2}$ ")	7-28 mm, f/1.9	4X, P	3'	TTL
Rollei SL 86	156.00	1 lb.	3 $\frac{3}{8}$ x 2 x 6 $\frac{1}{4}$ " (+1 $\frac{1}{2}$ ")	12-30 mm, f/1.9	2.5X, M	5'	TTL

\*Measured with handle folded

Key to abbreviations: BL, backlight EE, meter with separate window; M, manual zoom;

to use smoothly, were found on the smaller cameras: a 3.3X, 9-30-mm f/1.9 on the Bolex 233; a 2.5X, 12-30-mm f/1.8 on the Rollei; and on the Eumig Mini-3 a 3X, 9-28-mm f/1.9 that's equipped with a unique "Servofocus" system which keeps the lens focused for the maximum depth of field at any focal length.

The Bauer Star XL and the Bell & Howell 670/XL both had fixed-focus, nonzoom lenses with ultrafast f/1.2 maximum apertures for shooting in a dim light. As additional aids to low-light shooting, both of the XL models had nonreflex finders, which don't rob light from the taking lens; for the same reason, the Bell & Howell's meter read through a separate window instead of through the lens.

Actually, all of the cameras could shoot indoor films without movie lights at least some of the time, since all are adapted to the new ASA 160 Ektachrome film, all have reasonably fast lenses, and several have extra-large shutter openings to let in more light. In addition, the Eumig Mini 5 and Bolex 350 can run at 9 frames per second (f.p.s.) to admit twice as much light as they would at the normal 18 f.p.s. rate (and in the process doubling the apparent speed of on-screen action).

About half the cameras also offered one

faster filming speed, for a mild slow-motion effect—more pronounced on the Argus and GAF, with 32 f.p.s. than on the Bolex 350, Eumig Mini 5 and Braun Nizo, with 24. All cameras except the GAF and Bell & Howell also allowed single-frame exposures for animation or time-lapse work, and the Argus even had electronic flash synch (with both hot-shoe and PC-cord connections) for easier single-frame work.

Electric-eye meters in all of these pocket cameras control the exposure automatically, reading through the lens for greater accuracy (and so you can't unwittingly cover the meter with your finger) on all but the Bell & Howell, Bolex 233 and Eumig Mini-3 models.

All of these cameras except the Bauer, Bell & Howell and Rollei also allow some manual exposure control—either a compensator for back-lighted subjects that opens the lens about one stop, a lock that lets you move in close for a meter setting and then hold that setting as you move back, or a full manual override that lets you fade in and out or underexpose for "moonlight" effects in daylight.

Reflex viewfinders that see through the lens were the rule in all but the two XL cameras. All cameras had eyepiece focusing designed to compensate for individual eye-

Meter Override	Battery No., Type	Battery Test	Eyepiece Signals	Cable-Release Socket	Single-Frame Release	Speeds (frames per sec.)	Remarks
L, manual	4 AAA	Yes	f/stop, U	Yes	Yes	18, 32	"Left-eyed" design, flash synch on single frame, remote-control socket, detachable trigger-grip filter switch
L, manual	4 AAA	Yes	f/stop, U	Yes	Yes	9, 18	"XL" version of above (new, not tested by PM)
lone	2 AA	No	f/stop, run	No	Yes	18	Smallest
lone	4 AAA	Yes	Battery, run, U	No	No	18	Filter switch, socket for accessory trigger grip
L	2 AA	No	Run, U, BL	Yes	Yes	18	
L, Lock	2 AA	Yes	Battery, f/stop, U, O, run, end, BL	Yes	Yes	9, 18, 24	Accepts accessory battery chargers for 110-v. a.c. and 12-v. d.c.
l manual	4 AA	Yes	Battery, f/stop, U, O	Yes	Yes	18, 24	Folding grip, filter switch, remote-control socket
L	2 AA	No	Run, U, BL	No	Yes	18	"Servofocus" keeps lens focused for max. depth of field at all focal lengths
L, Lock	2 AA	Yes	Battery, f/stop, U, O, run, end, BL	Yes	Yes	9, 18, 24	
L	4 AAA	Yes	Film reserve, run, U, O	Yes	No	18, 32	Removable folding handle, retracting lens hood
lone	2 AA	No	f/stop, run	No	Yes	18	Filter switch

l, overexposure indicator; P, power zoom; TTL, through-the-lens meter; U, underexposure indicator

sight variations, and all but the Argus Cosina had eyepieces on their left side, for more convenient right-eye viewing (for left-eyed viewers, the Argus will probably be the first choice).

Additional indicators in the finders (some of them were hard to see) showed, variously, whether the film was running, had stopped or was about to end; whether the film was being over or underexposed or whether the backlight compensator was on and, in some cases, which f-stop was in use. (For details, see the chart above.)

Batteries are penlight size (AA) in some cameras and size AAA in others. They required replacement after about every eight rolls, on the average. The Bolex 350 has a socket for use with an optional recharger and nickel-cadmium batteries. Few of the cameras had removable battery cases, which prevent permanent damage if batteries leak, and we found battery-changing much more difficult on models using the smaller, harder-to-find AAA batteries.

From the smallest camera (the Bauer Star XL), to the biggest (the Argus Cosina and Bolex 350), we found the pocket Super-8s easy to carry with us and hard to leave home. Whether you want to take one home in the first place—and which one you'll want to take—is up to you.

You won't get all the features you'd get from a full-sized camera, but you may get all those that interest you. And a big camera you've left at home might as well have no features at all. ★ ★ ★

**Macrofocusing capability of Eumig Mini 5 (below) and Bolex 350 Macro** allowed close-ups only millimeters from lens. Most minis made respectable nonmacro close-ups at maximum telephoto setting and minimum focus distance; even in normal ranges, Bolex 350 and Eumig 5 were champs, focusing to 3 feet at 40 mm.



# New in home electronics

There's always something new in home electronics. But this year, though there was a bit less excitement in four-channel products (lots more of them, though), there was a great deal more in other areas than we've been seeing lately. TV innovations included lots of simplified tuning systems (even a prototype that would switch channels for you at preprogrammed times) and more new picture tubes. Car stereo equipment, now tending more and more to in-dash tape/FM/AM combinations, included one such combo that could record cassettes off the air, and a modular component setup (both from Metrosound).

Weather bands showed up on car and portable radios, while Sanyo portable came with an FM wireless microphone, and one Yamaha receiver has a mixing control for wireless mikes. In phonographs, round shapes abounded. Component hi-fi innovations ran mainly to four-channel gear combining *both* matrix and CD-4 discrete disc circuits, more and better cassette decks (including JVC's four-channel one), and more and more self-equalized speakers.

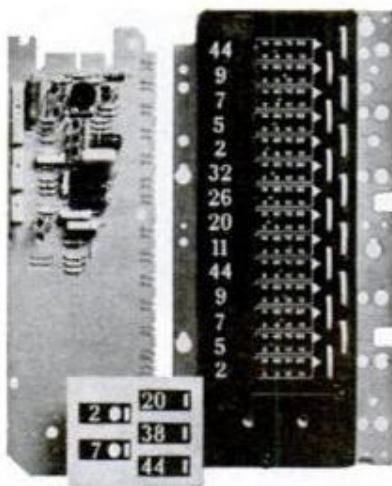
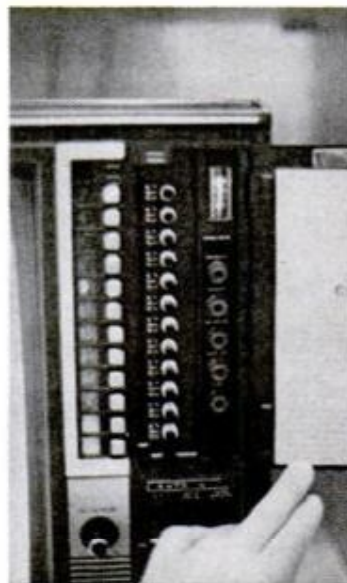
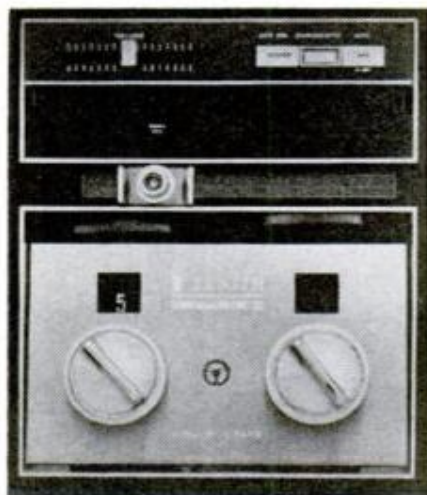

**Easier tuning** is a major feature of forthcoming TV sets. Some Zenith sets have a single control (top, left) that handles the functions of seven knobs. Varactor tuning systems from Sanyo (top right), Zenith (above, left) and others have pushbutton "dials," with one button preset to each station. Sylvania's version makes tuning the only accessible control (above, right); after setting once, all subsidiary controls are swung back in and locked with a key.

**Remote control for any TV**, new Daltone Channel changer slips over tuning knob, lets you change VHF channels and turn set on and off with a wireless hand control provided. No special tools are required. \$39.95. Dalamal, 107 Franklin St., New York, N.Y. 10013.

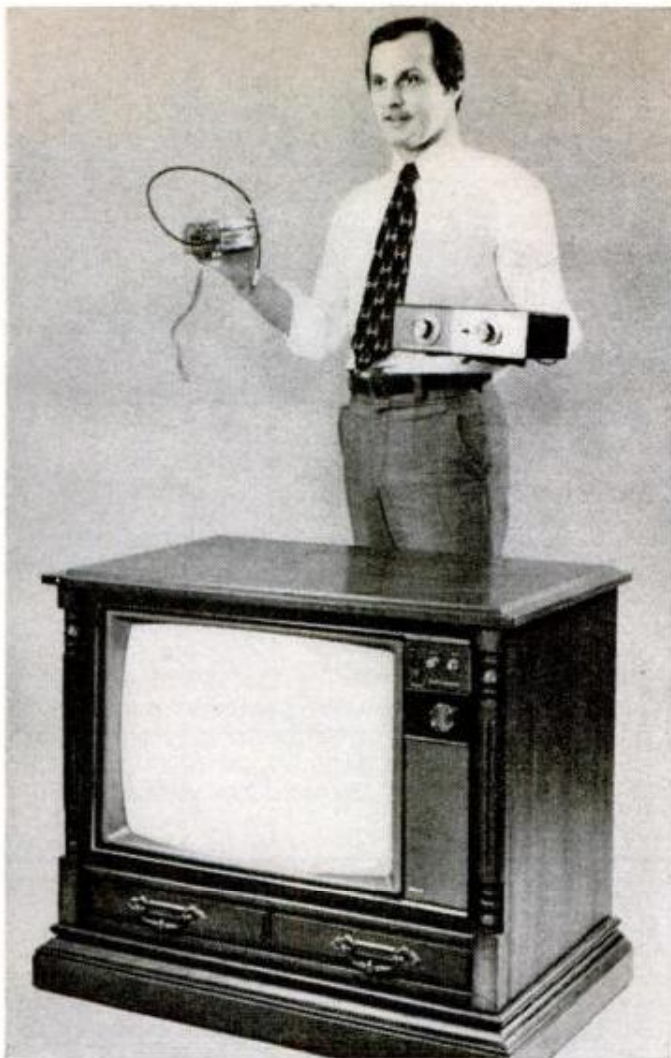

**Camera for RCA's SelectaVision video tape cartridge system weighs about 2¼ pounds, has a 3-to-1 zoom lens with a through-the-lens finder, and will cost about \$300. RCA also announced 100 prerecorded TV programs. Selectavision will be available "in early 1974."**

**24-channel cable TV capability is built into this new RCA color set, so you don't need to use an unsightly converter and can still change channels with the set's wireless remote control. CableGuard shielded tuning system is found in all-new RCA "XL-100" 21 and 25-inch color sets, which also get off-the-air signals.**



**Superslim 5-inch TV, shown in prototype by Panasonic, uses wide-deflection tube to make a cabinet only 5½ inches deep, 12¾ in. wide, 7¾ in. high.**

**A TV that runs on D-cell flashlight batteries, another Panasonic prototype, runs more than eight hours on nine, readily-available alkaline D batteries, as well as operating from a.c. power or car batteries.**

## Car radios and tape players

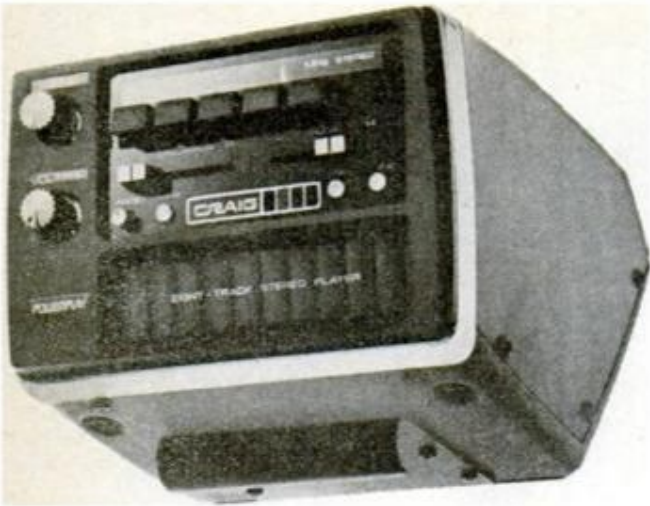

Cutting through wind and traffic noises, these new car stereos can bring you clearer sound. Craig's 3139 (above, left) with pushbutton FM-stereo tuner, puts out a hefty 24 watts *continuous* (rms) power; when it does, the Craig badge lights up. The 3139 is \$159.95;



without FM, it's available as the \$99.95 Model 3138. Panasonic's CX-475 (above, right) has a Dynamically Boosted Sound (DBS) button to bring volume up to its 12-watt music-power maximum, also boosting those lows and highs easily drowned by noise. \$69.99.



"Now you see it, now thieves don't," should be the motto of Invis-A-Dek. Push an 8-track tape against it, and the controls come into view. Pull out the tape, and it disappears. Car Tapes, Inc., 9180 Kelvin, Chatsworth, Calif. 91311



How's the weather up ahead? This Sanyo Weathermatic car radio will tell you. Two buttons can be preset for FM, two for AM, and the fifth button gets you the weather band, for official U.S. government weather reports, 24 hours a day. Model F8572 is \$89.95; stereo Model F8574, \$129.95. Information (on request) from Sanyo Electric, Inc., 1200 West Walnut St., Compton, Calif. 90220



# Phonographs and receivers

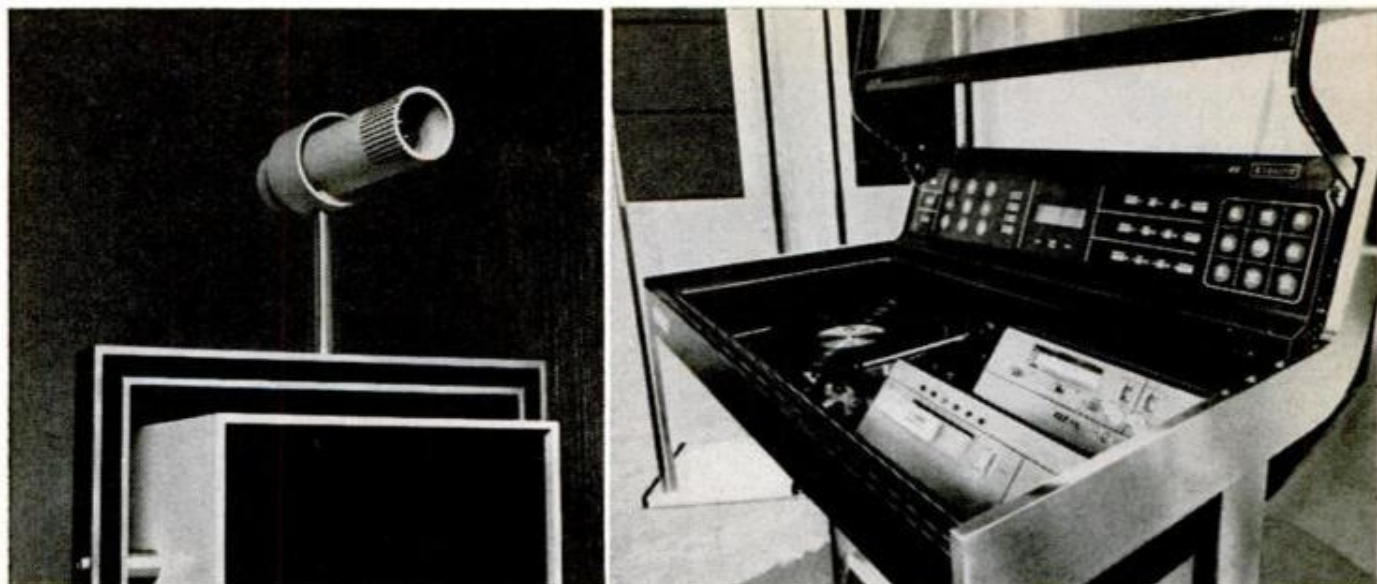

A system of the future from Zenith, the Concept 4X transmits sound to the rear speakers via infrared light beamed from atop front speakers (left, above), has "touch-plate" controls for radio, tape, volume.

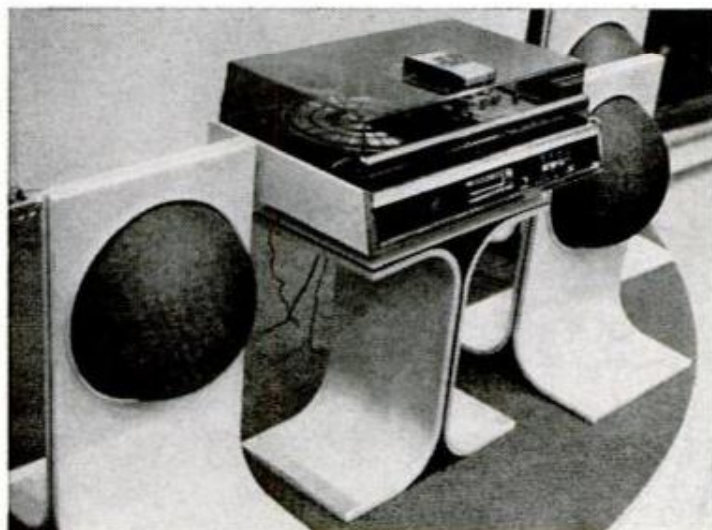

Novel styling highlights Electroponics "Apollo" compacts, equipped with curvilinear stands to echo the lines of the omnidirectional speaker spheres.



Hear TV on the run, even if you can't watch it, with GE's new P4930 radio. It picks up FM, AM and the audio portions of TV channels 2 through 13. Other features include a.c. and battery operation. \$42.95.



Panasonic's experimental RF-7000 24-band portable radio picks up AM, FM and SSB from 160 kHz to 230 MHz., with a motor-driven band selector and a world clock. It runs on battery, car battery or 100-240-v.a.c.

# Turntables, receivers and tape



**New version of the AR turntable, AR-XB** adds cueing lift lever, more low-slung base, to AR's well-known superstable suspension. AR-XB costs \$99.95, Acoustic Research, 10 American Drive, Norwood, Mass. 02062.



**Zero tracking error** isn't yet available at zero price, but Garrard's new Zero 92 model brings it a little closer: just \$169.95, instead of the \$209.95 price of the variable-speed Zero-100-C model.



**Voice-operated tape recorders** tend to chop off the first syllable while they come up to speed. Panasonic's RQ-110S uses a "bucket-brigade" delay to hold the signal back until the tape's moving properly.

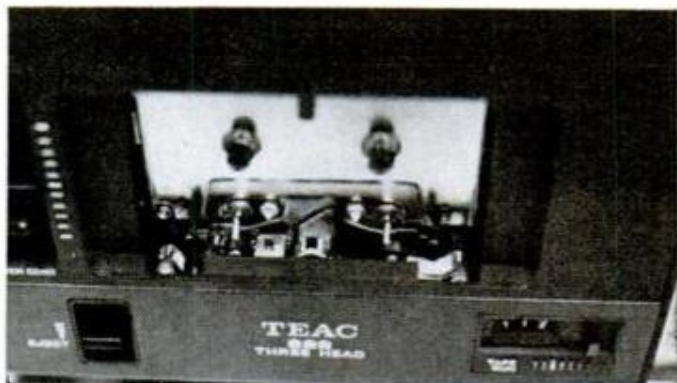

**Two heads? No, three:** Second head on TEAC's new 850X (and on cassette decks from Technics and Nakamichi) has separate record and playback gaps, for off-the-tape monitoring, and wider-range response.



**Four-channel receiver** from Onkyo automatically is set to match CD-4, SQ or QS (RM) four-channel records played in any sequence. TS-500 costs \$729.95.



**Dolby noise reduction** is showing up in receivers from Akai (left), Marantz and others, for use in FM listening as well as in tape recording and playback.



**Most powerful four-channel receiver** we've seen yet is this Sylvania RQ3748, delivering 4x50 watts continuous power in quadraphonic mode, 125x2 watts in stereo. Price is \$549.95, less speakers. Features include orientation control to rotate sound field.

## Speakers and headphones



**That end table's a speaker**—Mexico's Romex-Vega three-way system has speakers on adjacent sides for broader dispersion. About \$350. Marketing World, 2280 Grand Ave., Baldwin, N.Y. 11510.

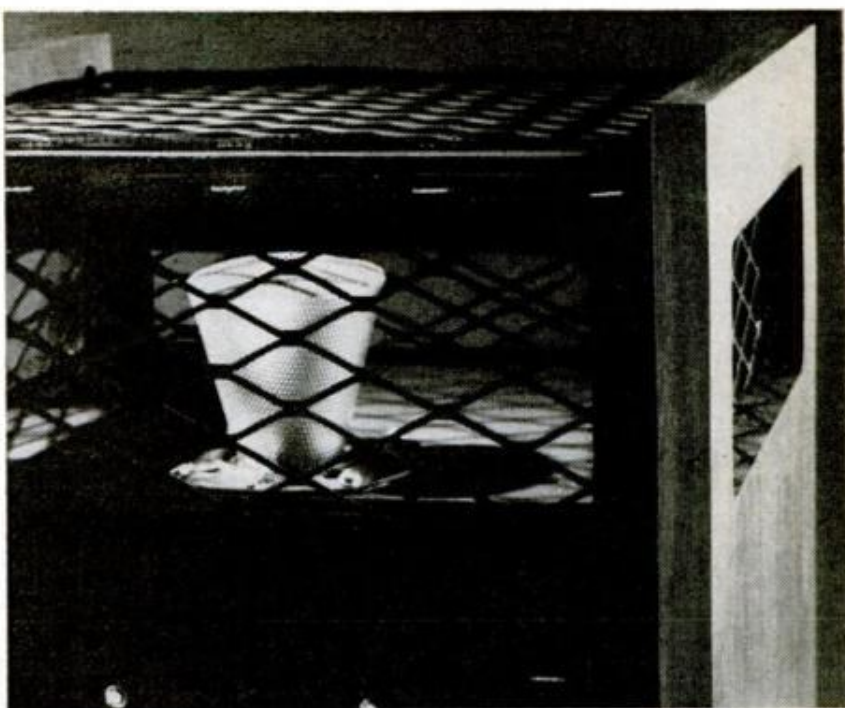

**"Transmission-line" tweeter** on new Infinity Monitor speaker is made under license from Ohm Acoustics, which also makes a full-range version. Signal travels up the cone's steep sides, radiating sideways 360° as it goes. Infinity, 9001 Fullbright, Chatsworth, Calif. 91311. Ohm, 241 Taaffe Pl., Brooklyn, N.Y. 11205.



**Headphones that float atop the head**, instead of hugging the ear, come with new Janszen/Jecklin which has electrostatic speakers, costs \$300. Janszen Electronic Industries, 7516 42nd Ave. North, Minneapolis, Minn. 55427.



**Headphone listening** make you want to close your eyes and lie back on a pillow? Hear-Muffs have pillow built in. Several stereo and four-channel models, from \$30. Hear Muffs, Rogers St., Downers Grove, Ill. 60515.



**Folding headphones**, Koss's new little Travlers snug together for compact storage or traveling. Price is \$29.95, complete with storage/travel pouch. Koss, 4129 North Port Washington, Milwaukee, Wis. 53212.

# Your own business at a price you can afford

by Mort Schultz

**"D**ull, repetitive, seemingly meaningless tasks, offering little challenge or autonomy, are causing discontent among workers at all occupational levels," states a report by the U.S. Department of Health, Education and Welfare. Union and even industry spokesmen voice similar views.

Workers, especially those on assembly lines, complain of boredom on the job. Even increased leisure time doesn't seem to lessen the feeling of drudgery.

"There is very little evidence to suggest that a reduction in working time will increase employee satisfaction while at work," says Sidney McKenna, industrial relations director for the Ford Motor Co.

Of some 50 New Jersey factory workers interviewed by this reporter, 40 expressed dissatisfaction with their work, saying they felt trapped in a dead-end job. Many expressed a yearning to be "my own boss."

If you're dissatisfied with your job and also long to do something worthwhile with your spare time, you might consider starting a part-time business in your home. There are a number of reputable companies that can help you do just that. The "directory"

(see below and next two pages) describes some of them. Incidentally, veterans may be reimbursed for costs under the GI Bill of 1966.

The small business opportunities presented here have been restricted to those which meet the following requirements:

- A business that can be started in your spare time, so you won't have to give up your full-time job.
- A business that can be operated from your home, so you won't have to rent space.
- One that requires little, if any, previous training or education.
- One that can be started with a relatively small investment, so you won't have to dip into savings.

(Franchise operations are not included because they tend to be full-time ventures from the start and usually require a substantial investment.)

Like others that have started as small, part-time businesses, yours may grow to such an extent that it will require full-time effort. You will then be your own boss; you will have other problems, but boredom won't be one of them.



## CUSTOM CLEANING SERVICE

**Description:** Cleaning tacked-down carpeting or large-size area rugs; cleaning upholstered furniture; cleaning walls and ceilings of homes, offices, and motels, as well as of other commercial and public buildings.

**Business potential:** According to the company that provides cleaning equipment and supplies, it's possible to earn "between \$200 and \$1000 a week."

**Company to contact:** Von Schrader Co., Dept. of Information, 1600 Junction Ave., Racine, Wis. 53403.

**Company provides:** All equipment, supplies, accessories, instructions.

**Your investment:** Carpet cleaning machine, \$750; upholstery cleaning machine, \$578; wall and ceiling cleaning machine, \$350.

## LOCKSMITH

**Description:** Installing and repairing locks, making keys, picking locks, changing combinations, installing alarm systems. Customers are homeowners, auto owners, offices, factories, apartment buildings, hotels, hospitals, other institutions.

**Business potential:** According to the *Locksmith Ledger*, a trade publication, locksmiths earn an average of \$12.50 per hour.

**Companies to contact:** Belsaw Institute, Information Bureau, 315 Westport Rd., Kansas City, Mo. 64111; Locksmithing Institute, Training Information, 1500 Cardinal Dr., Little Falls, N.J. 07424.

**Companies provide:** At-home study course, plus equipment and tools.

**Your investment:** \$275 (Belsaw); \$270 (Locksmithing Institute).



## UPHOLSTERING

**Description:** Custom furniture upholstery for homes and businesses.

**Business potential:** Company claims that you can earn from \$6.50 to \$15.60 per hour.

**Company to contact:** Training Dept., Modern Upholstering Institute, Box 899, Orange, Calif. 92669.

**Company provides:** At-home study course; kit of upholstery tools and supplies.

**Your investment:** \$255 for course, tools and furniture kit.



## TOOL SHARPENING

**Description:** Sharpen knives, saws, scissors, shovels, mower blades, ice skates, hedge trimmers and other household, garden and shop implements.

**Business potential:** According to a company supplying equipment and instructions, you can make "\$5 an hour in your spare time."

**Companies to contact:** Belsaw Machinery Co., Information Bureau, 315 Westport Rd., Kansas City, Mo. 64111; Information Dept., Foley Saw and Tool Maintenance School, 3300 Fifth St. N.E., Minneapolis, Minn. 55418.

**Companies provide:** Belsaw Sharp-All machine and operator's manual; Foley offers five-day training program at Minneapolis facility (no training by mail) and wide variety of machines.

**Your investment:** Belsaw machine and manual cost \$279; cost of Foley course (\$195) includes instructional materials, food, lodging and local transportation, but no machines; Foley machines start at \$125 and average about \$500 in price.

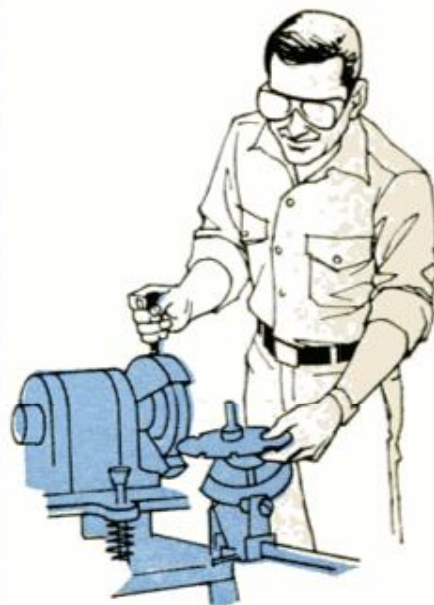

## MAKING VINYL REPAIRS



**Description:** Repairing, recoloring and renewing items covered with vinyl—auto interiors and tops, furniture, camping equipment, sporting goods.

**Business potential:** Company that provides instructions and equipment says earnings of from \$25 to \$35 per hour are possible.

**Company to contact:** Utility Color Labs, Inc., Special Information Bureau, 17301 Edwards Rd., Cerritos, Calif. 90701

**Company provides:** Instructions plus starter kit of tools and equipment.

**Your investment:** \$249 for starter kit comprising both tools and instructions.

## CUSTOM CASEMAKING

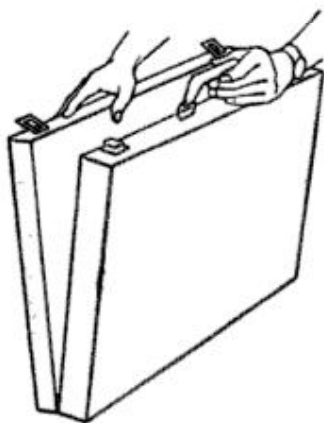

**Description:** Making custom cases for individuals whose work requires them to carry samples or equipment. Photographers, salesmen and repairmen are among potential customers.

**Business potential:** No figures available. Company that provides instructions states: "Because every job you do is 'special' and different, you can name a top price for your time, your services and your materials."

**Company to contact:** Custom Case Supply Co., Office of Training, 6075 DeSoto Ave., Woodland Hills, Calif. 91364.

**Company provides:** At-home study course. Materials for making cases are sold to you "at discount."

**Your investment:** \$59.95 (for study course only).

## MAKING RUBBER STAMPS

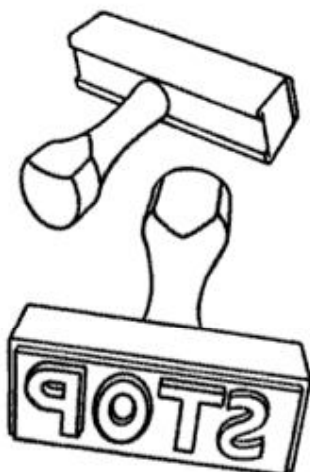

**Description:** Making and selling standard and made-to-order rubber stamps for individuals, firms, hospitals and other organizations.

**Business potential:** According to the company that supplies this equipment and instructions, "your possible profit per hour is \$22.65."

**Company to contact:** Rubber Stamp Div., Warner Electric Co., Inc., Information Center, 1512 Jarvis Ave., Chicago, Ill. 60626.

**Company provides:** Instructional material and Shop B—rubber stamp vulcanizing press, type faces and various other supplies; or instructional material and Shop A—rubber stamp vulcanizing press, greater selection of type faces and more extensive supplies.

**Your investment:** \$499.95 (Shop B); \$745.35 (Shop A). ★★ ★



First twin-prop mini copter is this Bensen B-16S powered by two 45-hp Kiekhaefer snowmobile engines. Nose cowling is also from snowmobile.

## New build-your-own copters: More power, looks, convenience

By Sheldon M. Gallager and Howard Levy

PHOTOS BY HOWARD LEVY

Those tiny one-man "back-yard helicopters," once considered curiosities in the aviation world, have come a long way since their introduction 20 years ago. Highly refined, sturdily powered and slicked up in appearance, the latest models offer low-cost fun and thrills to countless numbers from those who never dreamed of getting off the ground at all to seasoned pilots who find the mini whirlybirds an exciting change from conventional flying. At a Midwest air show this past summer, a Bensen Gyrocopter put



Fitted with floats, this amphibious autogyro can operate from land or water, was modified from a standard Bensen B-8M single-seater Gyrocopter kit by J. Hasselfeldt of Royal Oak, Mich. Cost, including the engine, fiberglass hull and outboard sponsons, came to \$3200.

on an aerobatic demonstration that left crowds breathless. Another Bensen recently set a world's distance record making a 3400-mile cross-country flight from California to North Carolina. The day of the personal helicopter as a sure, safe, serious form of sport flying has arrived.

The two leaders in the field, Bensen's Gyrocopter and RotorWay's Scorpion, both have innovations for the coming year. Bensen is pioneering a twin-prop version designated the B-16S—the first multiengine

## Twin tails, engines, seats



**Latest addition** to the growing fleet of build-your-own copters is this sleek single-seater Gyro-Falcon autogyro featuring a fully enclosed fiberglass cockpit. The twin-tailed, pusher-prop ship is powered by a 90-hp McCulloch engine, has a rotor diameter of 22 feet. It hits a top speed of 90 mph, climbs 950 feet a minute, can land in 20 feet. Other features include a mechanical spin-up system for the rotor and hydraulic disc brakes. Construction plans are \$35 from Rotor-Hawk Ind., 9007 Henderson Rd., Goodrich, Mich. 48438.

craft of its type. It also features a semi-enclosed cockpit, providing added warmth and security for those who may feel a bit exposed at 3000 feet in Bensen's traditional bare-seat models. RotorWay's newest offering is a two-seater called the Scorpion Too—the first midget copter to carry a pilot and passenger. This has a fully enclosed, smartly styled, cab-type cockpit that gives the ship a sleek appearance as well as all-weather protection. As with their predecessors, both the new Bensen and Scorpion models can be scratch-built from plans or assembled from prefabbed parts available in kit form.

Technically, there's an interesting distinction between the two types of ships. The Bensen is an autogyro with a free-turning, nonpowered rotor for lift and pusher props for forward thrust. The Scorpion is a true helicopter with a powered rotor and no independent propeller. It gets both lift and forward motion from its rotor. To avoid confusion, the two are loosely referred to simply as "rotorcraft" or "rotary wing" craft. Each has its proponents. The Scorpion, with its powered rotor, is capable of vertical takeoffs and landings just like its bigger cousins. The Bensen requires a take-off run of about 500 feet to accelerate the rotor up to lift speed. Once the ship is aloft, however, the rotor autorotates for long

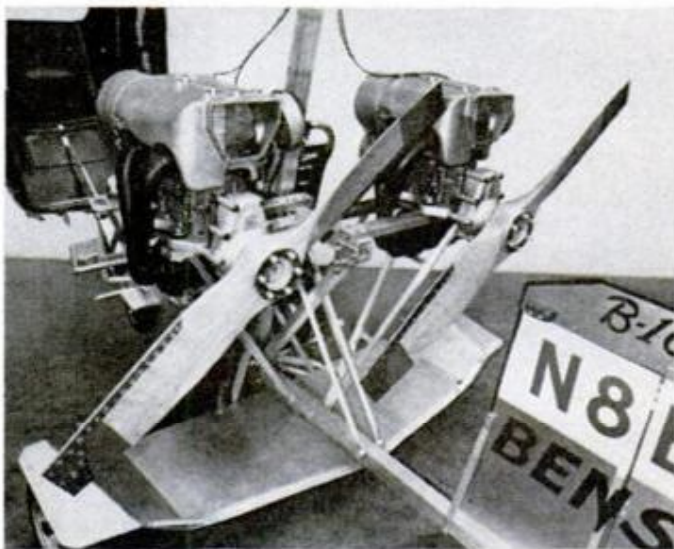

**Beefed up with twin props** and sporting a streamlined cockpit cowling, new Bensen B-16S (top photo above) takes on a slicker, more modern appearance than its traditionally sparse predecessors. The closely spaced side-by-side props (center photo) overlap each other, but are offset just enough to provide safe clearance. Engines are dual 45-hp Kiekhaefer Aeromarine powerplants delivering a total of 90 hp. Like the basic Bensen single-engine B-8M, the B-16S is an autogyro, using a free-turning rotor for lift with prop power for forward thrust. Cruising speed is 75 to 80 mph. Semi-enclosed nose cowling tilts forward (bottom photo) for easy access to cockpit, is actually a snowmobile hood. Landing gear includes steerable nose wheel, can be replaced with floats for water use, skis for snow.



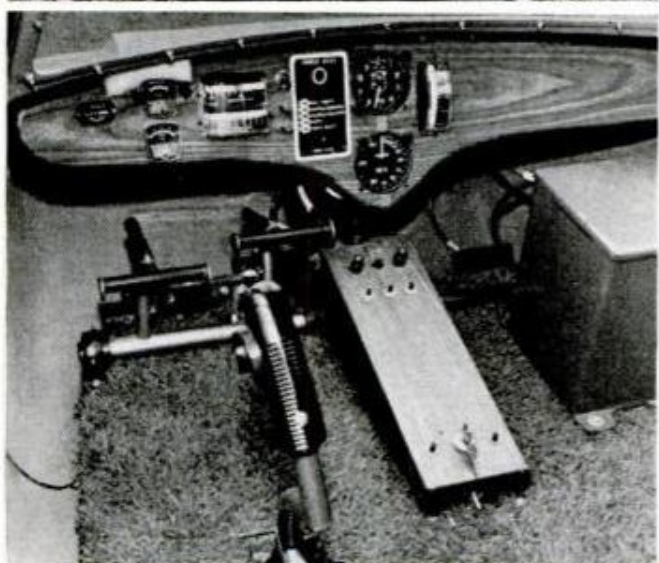

**Two-place version** of RotorWay's Scorpion is new for '74. Like its single-place forerunner, it's a true helicopter with powered main and tail rotors, cyclic pitch and collective controls. Called the Scorpion Too, it has a 140-hp Vulcan V4 engine, cruises at 75 mph, climbs 1000 feet a minute. Rotor diameter is 24 feet; range, 125 miles on standard 10-gallon fuel supply. Payload is 435 pounds—ample for a hefty pilot and passenger. Ship shown here was customized by builder Charles Murphy of Hastings, Mich., to include such extra features as a retractable landing light and elaborate electronic control console (bottom photo above). Basic plans for the Too are \$75 from RotorWay, Inc., 14805 South Interstate 10, Tempe, Ariz. 85281. Partially prefabbed parts are also available in kit form.



**He's sitting on his gas tank**—in fact, the whole seat is a one-piece molded fiberglass fuel supply designed to save space and weight. One of the newest wrinkles in rotorcraft equipment, the seat tank, developed by Ken Brock, is available as an accessory at rotorcraft dealers. Here, it's been incorporated into a standard Bensen B-8M Gyrocopter built from plans by Russell W. Jansen of Ridott, Ill. The Bensen plans sell for \$35.

glides and safe power-off landings in a small space.

As advantages of the autogyro design, Bensen claims lower cost, less power requirement and easier construction. Since the free-turning rotor exerts no counter torque on the ship, the need for a stabilizing tail rotor is eliminated and controls are simplified. The Scorpion uses a reversible-pitch tail rotor to control yaw, while the Bensen is steered by a conventional rudder. Power is 90 hp for the Bensen, 140 hp for the Scorpion. Both ships cruise at 75 to 80 mph. Rotor diameter is 24 feet for the Scorpion Too, 22.7 feet for the Bensen B-16S.

The reason for going to twin props in the new Bensen B-16S is that the two 45-hp engines, while providing the same total power as the single 90-hp engine normally used, actually produce increased thrust because of their greater combined prop-disc area. The engines are also smaller, easier to maintain and offer backup safety—should one fail, the ship can operate on the other.

Prices for plans have not yet been established for the Bensen B-16S, but are \$75 for the Scorpion Too. Further information on other models and kit prices can be obtained from Bensen Aircraft Corp., Box 2746, Raleigh-Durham Airport, Raleigh, N.C. 27602; RotorWay, Inc., 14805 South Interstate 10, Tempe, Ariz. 85281. ★★★

# How to stop wind noise!

Here are the surefire ways to keep out the wind and the rain.

by Mort Schultz

**Y**ou don't have to endure irritating wind noise while driving. Nor do you have to take a chance of getting wet because of a leak into your car when it's raining. Just use the same techniques that the pros use to find and fix these problems.

There are two kinds of wind noise: that caused by air leaks and that by turbulence.

Air leaks occur when weatherstripping around doors and windows wears out, wasn't installed properly to begin with or doesn't seal for some other reason. Turbulence—the interruption of airflow around the outside of a car—is caused by the shape of the body, or a protruding or loose part.

You can often trace an air leak with the car parked in your driveway. Troubleshooting noise caused by turbulence usually requires on-the-road testing.

## Tracing an air leak

Noise caused by an air leak occurs frequently when air leaks *out of* rather than into a car, because air pressure becomes greater inside the car than outside. This happens when you drive with doors and windows closed, and air vents open, or the heater or air conditioner turned on.

Higher in-the-car air pressure forces the top edges of door glass outward. If glass loses contact with weatherstripping, the air leak that results will produce an annoying noise.

Air leaks that cause noise are normally confined to the upper part of a car to about a foot below the bottom of windows. Leaks lower down cause drafts, and may let dust and water into the car, but they seldom produce noise.

To troubleshoot a noise created by an air leak, proceed as follows:

Examine all weatherstripping for worn-out spots, tears and looseness. Reglue loose weatherstripping, using rubber cement. Worn-out weatherstripping can often be salvaged by inserting some roll-type caulking beneath the worn spot. If weatherstripping is torn or badly damaged, replace it.

Inspect each door for holes in the sheet-metal joints and for rotted-out spots. Remove rust and seal holes with auto-body caulking compound.

The bottom of each door has drain holes that allow water getting inside the door to run out. This prevents rusting.

Door drain holes must *not* be sealed. In fact, you should make sure they are free. Use an awl, icepick or some such tool to clean them out.

Examine door-opening surfaces for solder lumps and other uneven spots that are preventing full contact of weatherstripping with the door frame. Solder lumps should be filed off or cut off with a hammer and metal chisel. Weatherstripping must have an even surface against which to seat firmly if air leaks and the noise they produce are to be prevented.

Since the most minor irregularity may allow air to leak and could escape detection, your inspection to this point may not have produced results. So, roll up all windows and shut fresh air inlets. The inside of the car must be completely closed off.

Start the engine and set heater or air-conditioner controls to admit air into the car. Place the blower at top speed.

Get out of the car. Check that doors and windows are tightly shut, and allow pressure to build up inside several minutes.

Take a length of hose, hold one end to your ear and pass the other end slowly around the edges of doors and glass. Even the hiss of a small air leak will be audible.

The hose method of finding a leak is almost as reliable as modern electronic air-leak detectors used by some auto body and glass shops. The usual electronic detector consists of two components.

One component is a signal generator that

# and water leaks

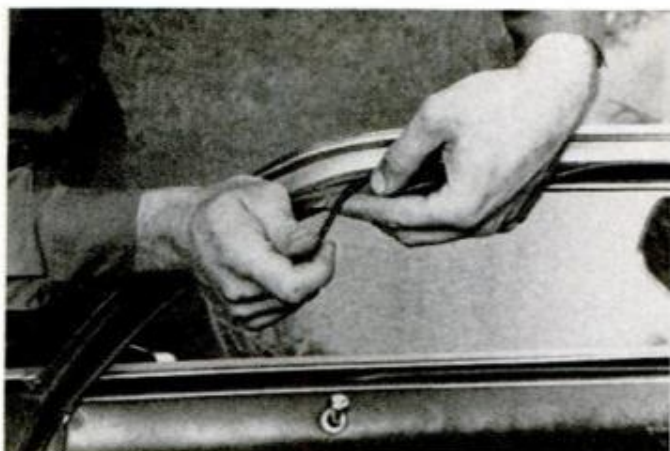

**Weatherstripping is shimmed** by pulling the seal away from the frame and placing roll-type caulking under it.



**Small construction imperfections** such as solder lumps can be the cause of annoying noise around windows.



**Solder lumps and high spots** can be chipped off with a hammer and chisel. Take care not to nick surfaces.

is placed inside the closed car. The other is a detecting unit held outside the car to pick up the generated tone signal. The signal can't be heard unless it is "leaking" from the car.

If you took your car to a shop that uses an electronic leak detector, the manager might not charge you for finding the leak. However, he would expect to make repairs, and they aren't free. Managers of other shops tell us that they charge up to \$10 for tracing air leaks.

Up to now, we've been dealing with noise made by air from inside of the car leaking out. However, air can leak into the car from the outside as well, creating noise.

To determine if a leak exists because of a bad weather seal around the door, place a strip of paper between the weatherstripping and door frame. Do this around the perimeter of the door, making sure you test every section of weatherstripping.

Pull the paper out. If it comes easily, without resistance, the weatherstripping should be shimmed or replaced. However, if weatherstripping doesn't seem worn or loose, the door may be misaligned and require tightening of hinges, repositioning of the striker or some other adjustment.

Air can also leak into a car from around windows. Close each window tightly and



**Air leaks can be detected** with hose used as stethoscope. Car is closed tight with fan blower running.

# Window molding strips are main cause of turbulence noise



**Check weatherstripping** by closing the doors on strips of wrapping paper to see how snugly they're held.

blow tracing powder or chalk in along the edges. Check for traces of powder or chalk on the inner side of the window. If dust shows up on the inside, the window seal may have to be replaced or the window may have to be readjusted.

## Tracing noise created by turbulence

You won't be able to get rid of all noise made by turbulence. There will always be some because of the design of the car.

A perfectly streamlined car wouldn't create turbulence. But it wouldn't provide much room for comfort either.

So, although some turbulence noise will be heard, you don't have to stand for noise produced by a loose or protruding part. But you have to find it. Here's how:

For your road test, select a route in an open, low-traffic area which will allow you to drive at cruising speed and to pull safely off the road to make adjustments. Equip yourself with a roll of masking tape and strips of automotive caulking. Close all windows and doors tightly. Make sure the blower is off, fresh air vents are closed, and heater and airconditioner controls are off.

Drive at the speed at which the noise annoys you. If the noise seems to be outside the car, it is being caused by turbulence. If the noise sounds to be in the car, you may have an air leak that was unnoticed during the driveway test.

Using masking tape, cover each part of the car's body that may create turbulence and noise. Molding strips are prime candi-



**Window seals can be checked** using a marking chalk that comes in a squeeze-type container (see text).

dates. Cover a small section at a time. When the noise disappears during a particular phase of the road test, it means you have found the offending area.

Quite often, noise created by turbulence occurs when wind whips beneath a strip of molding and rushes through the "hollow." This can be corrected by removing the molding strip, filling the space with automotive caulking and replacing the strip.

Another part creating noise is the weatherstrip around the outside of vent windows, especially at the lower front corner. The weatherstrip here may be distorted and pulled away from the body. Called a pucker, this could have been caused by overtravel of the vent. If weatherstrip is rubber, get rid of distortion by softening it with a heat source, such as a propane torch. When the material becomes pliable, smooth out the pucker and work the weatherstrip into shape as it cools. The distorted spot may need a few heat applications before it is finally smooth.

Another source of turbulence noise is roof railings. These, too, should be taped one small section at a time until the road test demonstrates that the noise disappears, revealing the offending section. If rails are rusted or have pulled away from the body of the car, they should be repaired if noise is to be eliminated.

## Tracing water leaks

There are several spots through which water can leak into a car, but the front and



**Rubber seals** will most often "pucker" in the corners. Remedy is to carefully heat and smooth the rubber.

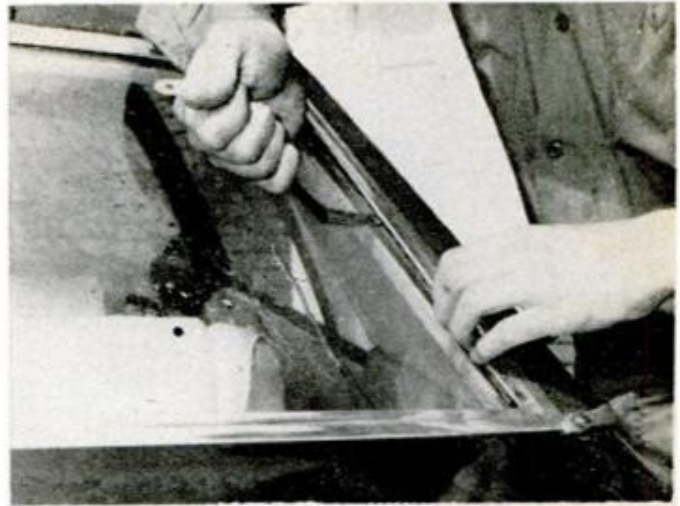

**Special clip tool** is used to remove windshield molding without cracking glass so caulking can be applied.

rear windshields are always prime candidates. Concentrate on the front one if water has appeared in the front of the car. Test the rear windshield if water has leaked onto the rear deck or into the trunk.

Tape a garden hose, minus a nozzle to the top of the car and place a can in front of the snout. When you turn on the water, see to it that water disperses itself over the entire surface of the windshield.

Keep water flowing for at least 30 minutes; it may take this long for water to show up inside the car. Every several minutes, rock the car from side to side. Water occasionally accumulates in a seam along the windshield and will leak into the car only when the car corners.

Resealing a front or rear windshield is no easy task. You shouldn't apply sealing compound right over molding. It often won't provide an adequate seal, and if the windshield ever does have to be removed, your chances of breaking the glass will be increased.

Molding should come off, but don't use a screwdriver or some other common tool. You could crack the glass. Instead, get a windshield clip tool (it costs about \$2) from a dealer of auto supplies. Slip the tool beneath the molding and slide it along until it touches each molding clip (see photo above, right). Twist the tool to pop the molding loose from the clips.

Buy new molding clips (same kind as the old clips) from an auto glass dealer and insert them into place along the glass. Now,

apply a liberal bead of windshield sealer around the entire circumference of the windshield. Reattach the molding by pressing it onto clips.

If a water leak up front isn't uncovered by hosing down the front windshield, apply a heavy flow of water from a hose (no nozzle) for several minutes on each spot up front that may be leaking. These include every bolt and seam along the firewall, drip rails, and the A-post (the part of the body on each side of the windshield).

Have someone in the car yell when water begins to leak. When this leak is revealed, seal the weak area with silicone rubber caulk.

If water is leaking into the trunk by some other way than through the rear windshield, the location of the leak can be found by having someone crawl into the compartment with a flashlight. Close the lid and play a heavy stream of water from a hose (no nozzle) along each part through which water can leak—including the trunk-lid seam, stop and backup-light seams, and rear body seams. Be sure to concentrate a heavy flow of water on one section at a time for a long enough period. When your friend in the trunk sees water starting to drip in, he can yell or tap on the lid to tell you to open up.

A leaking trunk lid can often be repaired by prying off the gasket, repositioning it and gluing it back into place. Leaky seams around the lights and body can be sealed with automotive blind side so that patching material won't show. ★★★

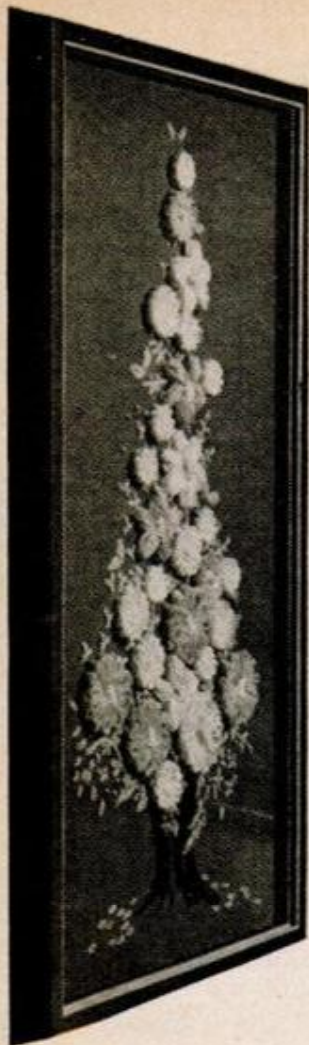

## 2 Deep needlework frame

(See page 154)

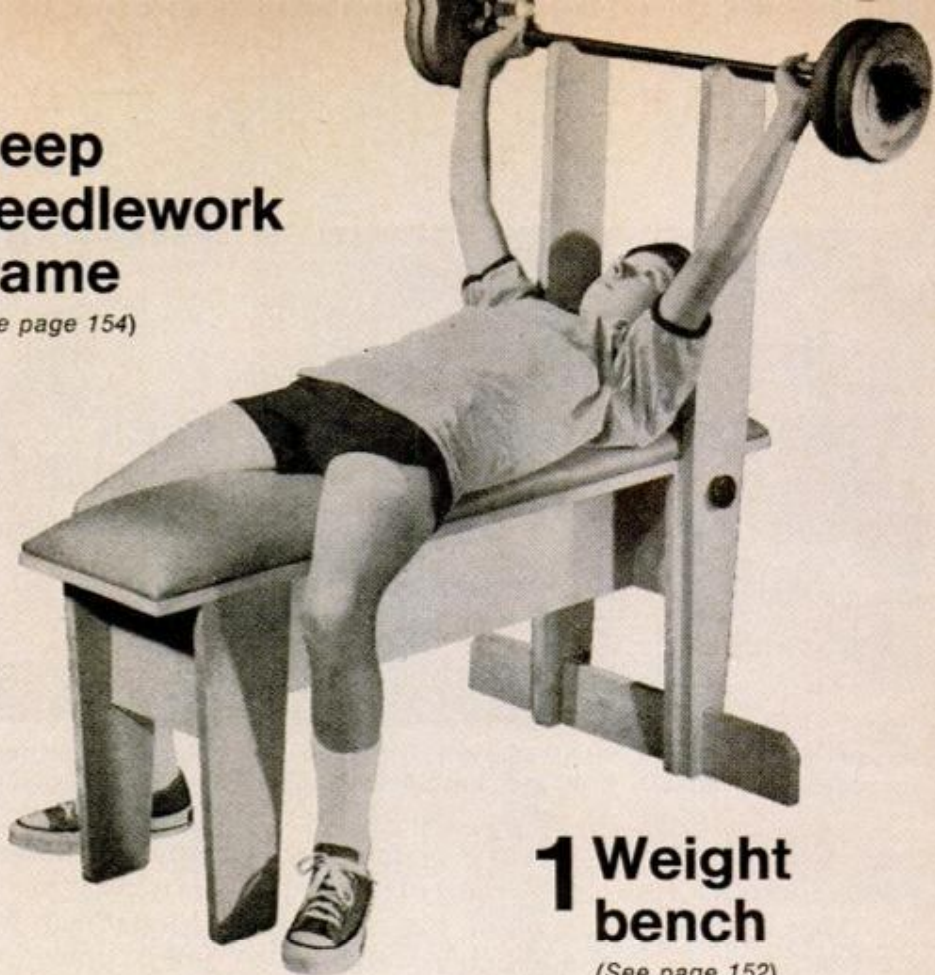

## 1 Weight bench

(See page 152)



## 3 Shuffle-board table

(See page 154)



## 4 Wall-mounted message center

(See page 156)



## 5 Musical crèche

(See page 157)



## 6 Bumblebee pull toy

(See page 166)

# Six quick-and-easy projects

You'll have time to make them for Christmas if you start now.

Now is the time—before you're caught in the crush of last-minute Christmas shopping—to give serious thought to making some of the presents yourself. There are two good reasons for wanting to give a gift you have created with your own hands:

- You'll save money. An item of a quality comparable to any project shown here cannot be bought for what it will cost you to build.
- Your gifts will be treasured. A toy you make for your child will be, more likely than not, passed along to a grandchild.

The projects are all relatively easy to make (although the level of woodworking sophistication varies slightly from one to another). The most difficult project shown is the shuffleboard table, but even this can be simplified, if desired, by using butt corners on the rails instead of the interlocking type shown on page 155. (It should be noted, however, that the latter is stronger.) And on the weight bench, for looks and practicality—resistance to scuffs and bumps from youngsters—we used Johns-Manville Melamite birch plastic laminate on all exposed parts. The cost could be lowered by painting or staining and varnishing. But the beauty of the laminate is that once it's done, there is no periodic refurbishing. However many projects you decide to build between now and Christmas, you're sure to find it a rewarding way to spend evenings over the next few weeks. To make it easy, complete plans for all projects follow.

# 1 Weight bench

One of the best ways for an athlete to ready himself for an upcoming sports season is to follow a daily program using a weight bench and barbell. The bench shown is based on a design by high-school teacher and coach Jack Fisher of Newark, N. J. The stabilizer foot at the head end of the bench makes it as rigid as expensive commercial benches you'll find in sporting-goods stores.

The original bench was made entirely of  $\frac{3}{4}$ -in. fir plywood and covered with plastic laminate for durability and looks. This step, of course, is not necessary, but since little laminate is required, is worth considering. All four short legs are alike except that only two are notched; the two tall legs are identical. A handscrew turned into a tee nut embedded in each rear short leg is used to attach the tall legs to the bench and makes it simple to remove them when desired. Both crosspieces are the same size, but you'll notice that the rear one is notched to provide clearance for the threaded hand-screws. If you have difficulty obtaining the 2-inch-thick cushion foam and handscrews,

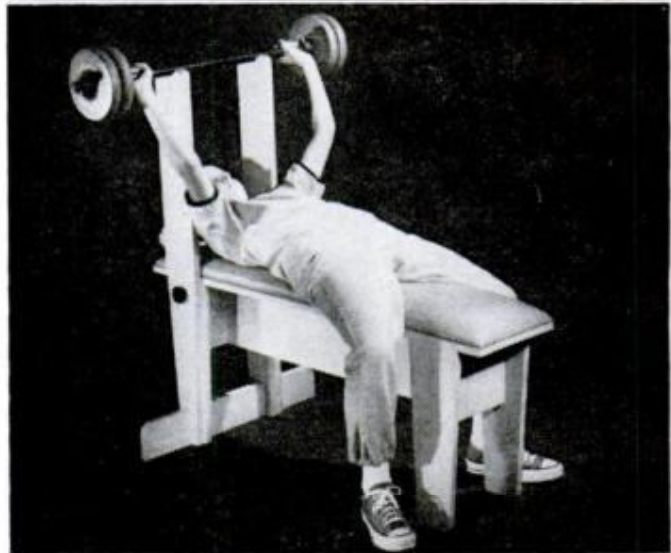
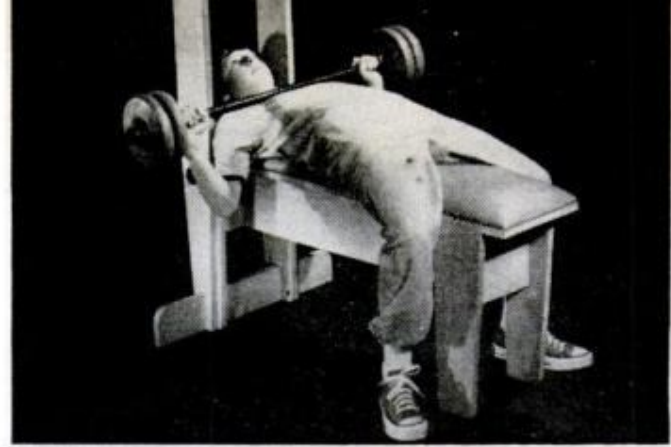

**Weight bench** can be used to develop tricep and bicep muscles. For correct bench use, see facing page.

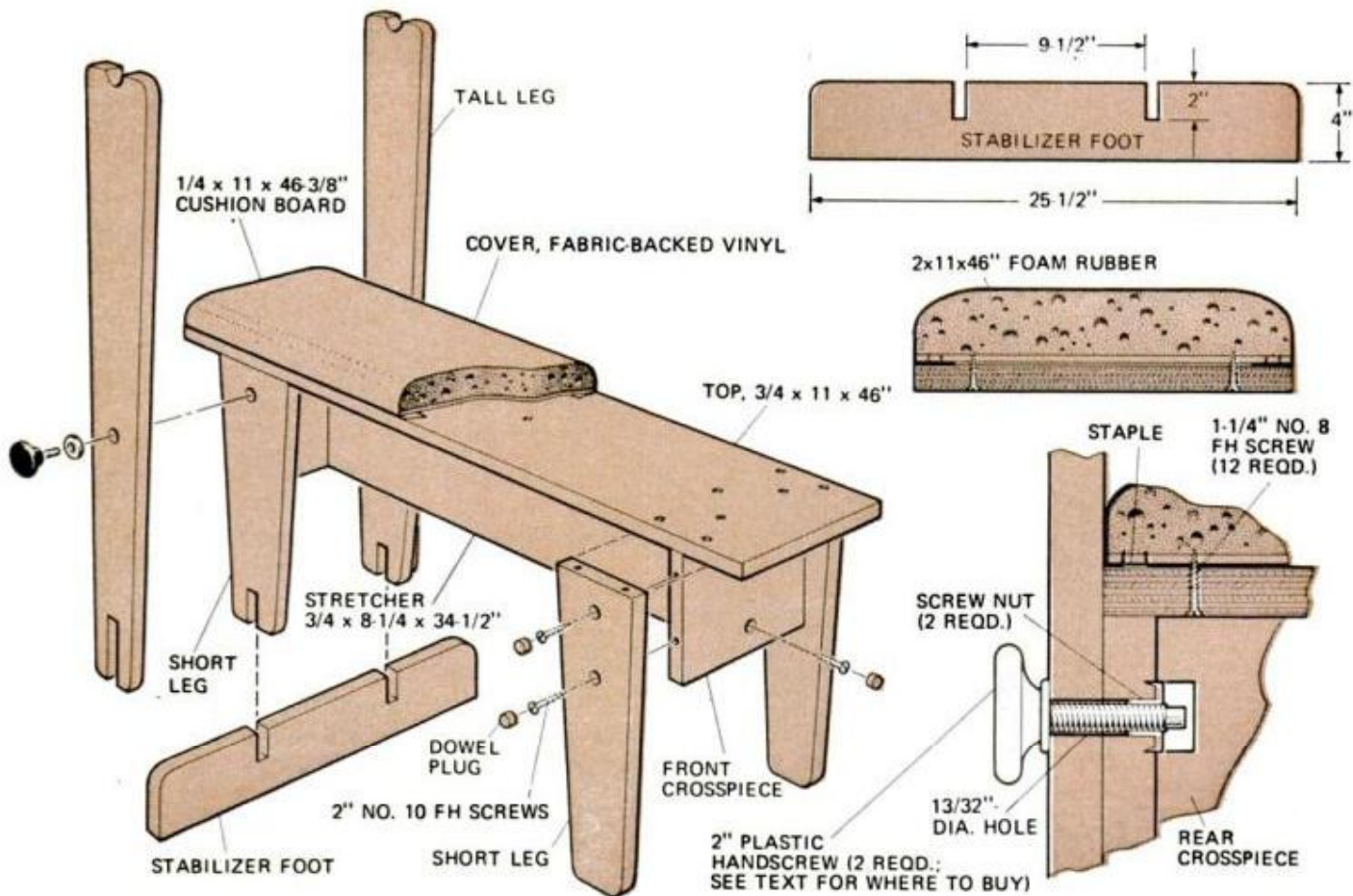





Nails are used to assemble bench temporarily, but for strength and rigidity, finish with screws and glue.

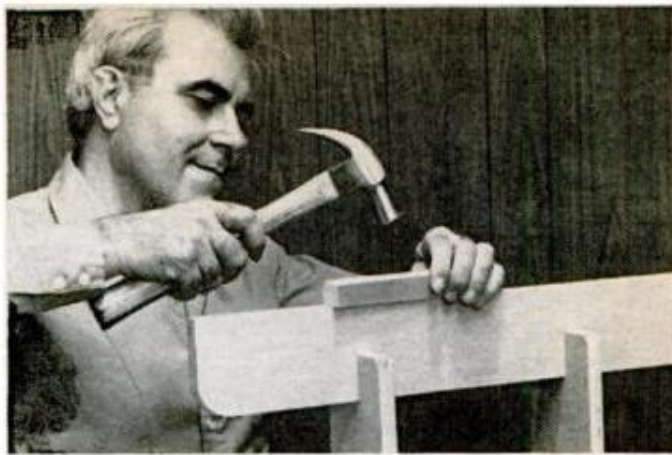

Notched stabilizer foot should have a snug fit with mating notches on two short, nonadjustable legs.

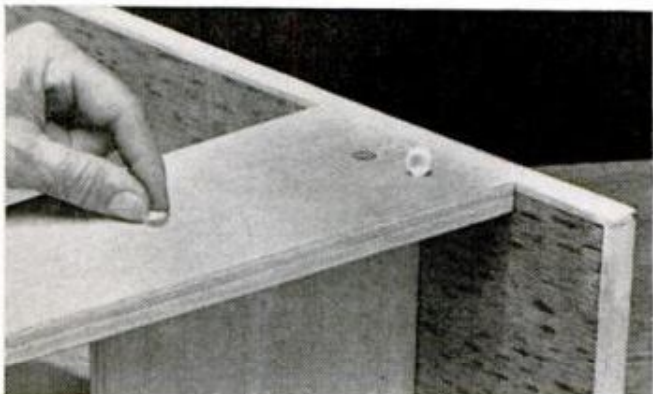

Screwheads are plugged if bench is to be stained or painted. For laminated bench, simply fill and sand.

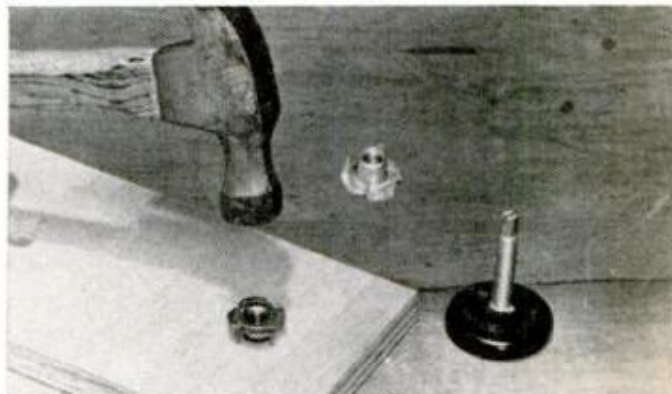

After boring 1/2-in. clearance hole, tee nut for hand screw is driven home with a couple of hammer blows.

Armor Co., Box 290, Deer Park, N. Y. 11729, will supply the cushion for \$2 and the handscrew set for \$4.50, both postpaid.

If working with plastic laminate is a new experience for you, refer to *How to Work With Plastic Laminate* (page 154, March '70 PM).

Once the bench is built, it is important that it be used properly. A quickie use-course is given below; serious students should consider buying a weight-lifting book.—*Harry Wicks and John Capotosto*

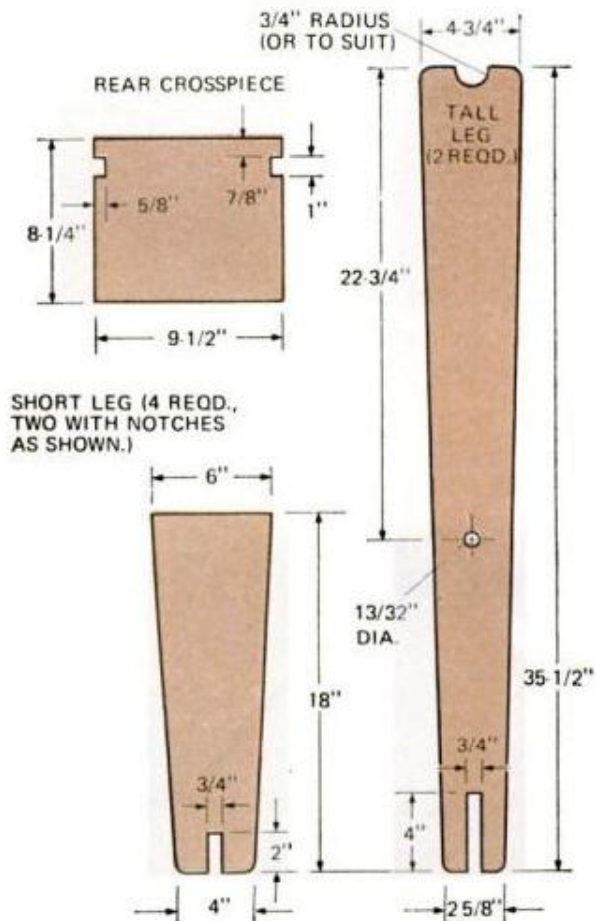

#### How to use a weight bench

1. Always stretch and loosen up before lifting.
2. Position: Lie on back, feet flat on floor with eyes directly under bar. Hands in wide position to work on chest (pectoralis); hands close to work on arms (strength).
3. Straighten arms to clear bar off support, then bring bar forward over chest. Lower bar to chest while inhaling. Raise bar to full extension while exhaling. Complete desired number of repetitions and replace bar on the support.

*In general.* Weight to use depends upon individual strength; use weight that is heavy for you (one you can't lift more than 10 times). For strength, increase weight as your strength increases. For endurance, use weight you can lift 15 to 20 times each session.

## 2 Deep needlework frame

Though some needlework can be considered two-dimensional because the surface design is made up of thread and there is no appreciable depth, many pieces are really three-dimensional with deeply piled flowers and figures. The latter cannot be framed with an ordinary picture frame unless the picture glass is removed. This, of course, is undesirable because the piece is then exposed to dust, fingers and other possible sources of damage which will shorten its life.

The custom frame shown at right solves this problem and adds to the visual effect of the hanging. The design permits use of ready-made hardwood molding; this simplifies the project considerably. The cross section shown will accommodate a workpiece of  $\frac{1}{2}$ -in. thickness. If yours is deeper, sim-

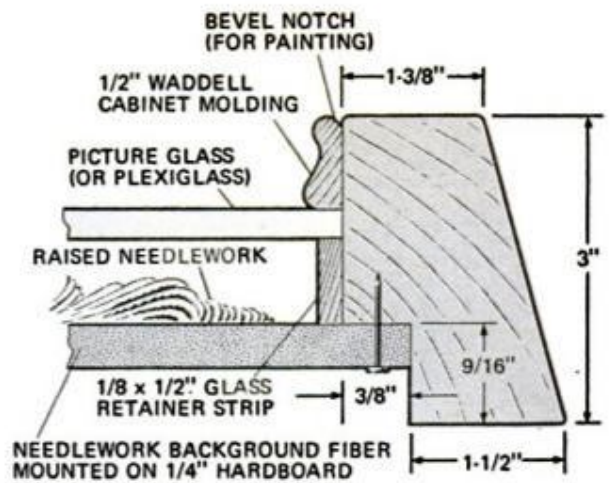

ply increase the dimension of the shoulder. Rip the outside bevel cut on four lengths of stock, then clear out the rabbet. Glue the molding to the individual strips before mitering the corners. Assemble frame with white glue and finishing nails.

—Rosario Capotosto

## 3 Shuffleboard table

Here's a gift the whole family can enjoy—a table shuffleboard. The waxed bed is of solid-core birch plywood with the scoring zones inlaid with strips of  $\frac{1}{8}$  x  $\frac{1}{8}$ -in. walnut. The grooves for the inlays are saw kerfs made on the bench saw.

The 1x3 birch rails have interlocking joints at the corners. To make such joints, you first groove the end rails to the depth shown. Then you cut the  $\frac{1}{8}$ -in. slot and tab with one cut at right angles to the groove. To make the side rails, after cutting a  $\frac{1}{8}$ -in. notch in the end of the rail as shown, you turn the rail over and make a second cut to create a  $\frac{1}{8}$ -in. tab. Finally, a  $\frac{1}{8}$ -in. slot is made to the depth shown.

The 12 weighted pucks are mass-produced from  $\frac{5}{8}$ -in.-thick wood in the following manner. First the wood is clamped to the drill-press table and a  $\frac{3}{4}$ -in. hole is bored completely through the wood. Then, without unclamping the work, the  $\frac{3}{4}$ -in. bit is replaced with a hole saw and a 2-in. plug is cut completely through the wood. This produces a doughnut shape. Next a same-size Formica disc is cut with the hole saw and cemented to the bottom of the puck. Now the outer edge of the puck is smoothed by

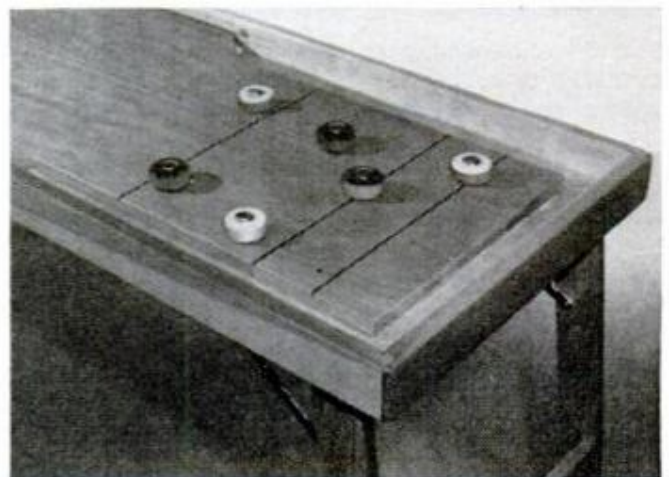

Game can be played by two, three or four persons. For game rules, see instructions on opposite page.

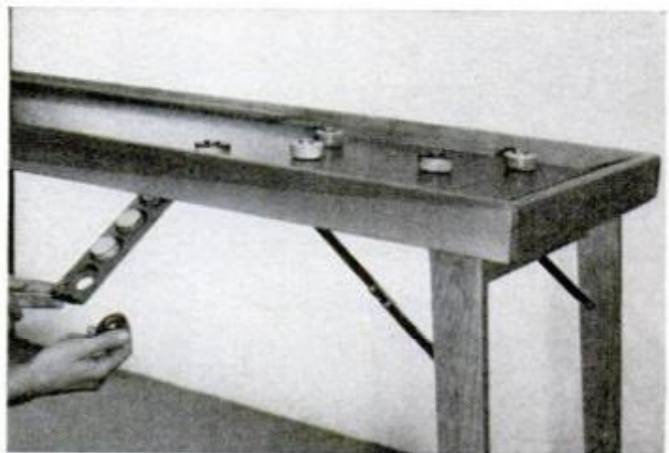

Shuffleboard weights (pucks) are stored in hinged rack beneath table. Each rack will hold six weights.

holding it lightly against a disc sander, after which the top and bottom edges are chamfered slightly by hand with a flat file. Finally, each puck is weighted by filling the center hole with molten lead and capping with a metal chair glide. Each set of three pucks is color-coded by painting the tops.

A hole saw is also used to form the storage wells for the pucks. First 2-in. holes are bored completely through the  $\frac{3}{4}$ -in. thickness. Then  $\frac{1}{8}$ -in. tempered hardboard is glued to the underside and 1-in. finger holes are bored in the center of the 2-in. holes.

—Carroll G. Hakenson

### Rules for Shuffleboard

Number of players: Two, three or four.

Object of game is to slide weight down the table, with one rebound off side bumper, and have it land in one of three zones. Nearest zone counts one point, middle zone two points, end zone three points, overhanging weight four points. Score goes to player who has weights ahead of his opponent's. Only weights ahead of the opponent's weights are counted when you're scoring.

Each player has three weights per turn; first player to score 21 wins. Players alternate shots, scorer shoots first on next round.

Art: Fred L. Wolff

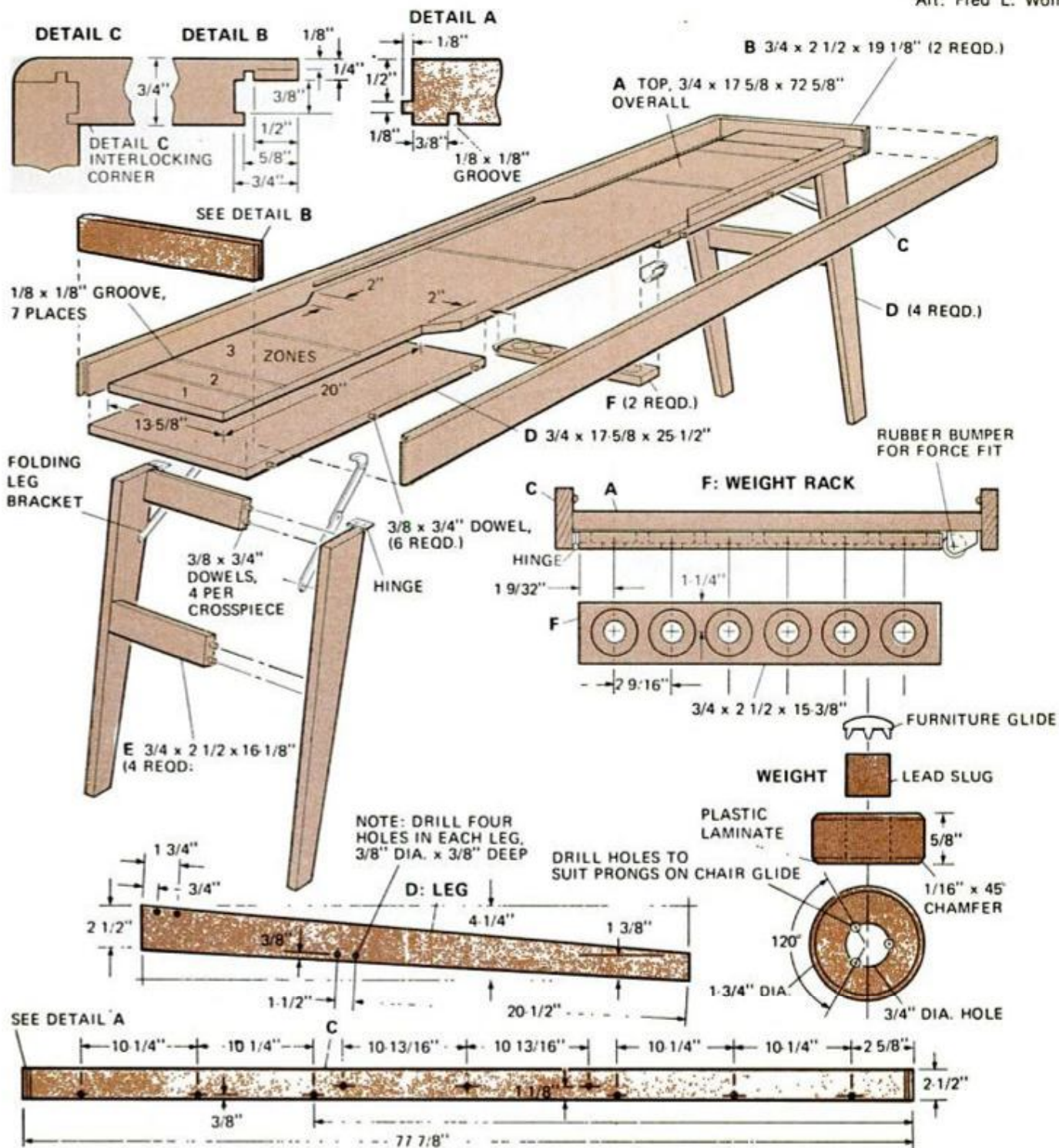

## 4 Wall-mounted message center

This efficient, neat-looking message center will be welcome in any active household. Simplicity of design makes it particularly easy to build, although the finished piece has the look of painstaking craftsmanship. The unit provides an on-the-spot place for recording telephone messages before they can be forgotten, a telephone surround that gives the center a built-in custom look and a place behind the bulletin board for convenient storage of pencils, pads, Yellow Page directory and the like. When the board is flipped down, two brass chains hold it so you can use it as a table while using the directory.

The center shown was constructed of  $\frac{3}{4}$ -in. cabinet-grade birch plywood, but if preferred, the unit can be made up using a solid soft or hard wood. If you do use plywood, remember to order a roll of matching flexible wood tape for concealing all exposed plywood edges. To finish the piece, apply

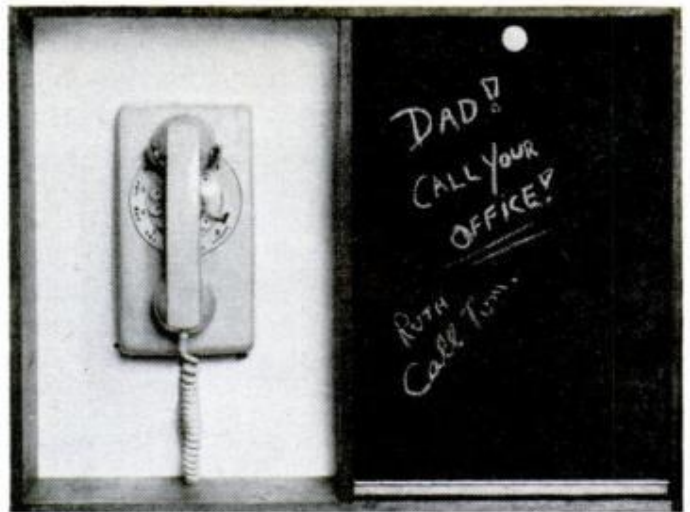

Center surrounds wall telephone, provides convenient chalkboard for messages and directory storage.

stain and allow to dry overnight. When dry, apply several coats of stain-finish varnish, sanding between coats. Use chalkboard paint on the bulletin board.—Gary Gerber

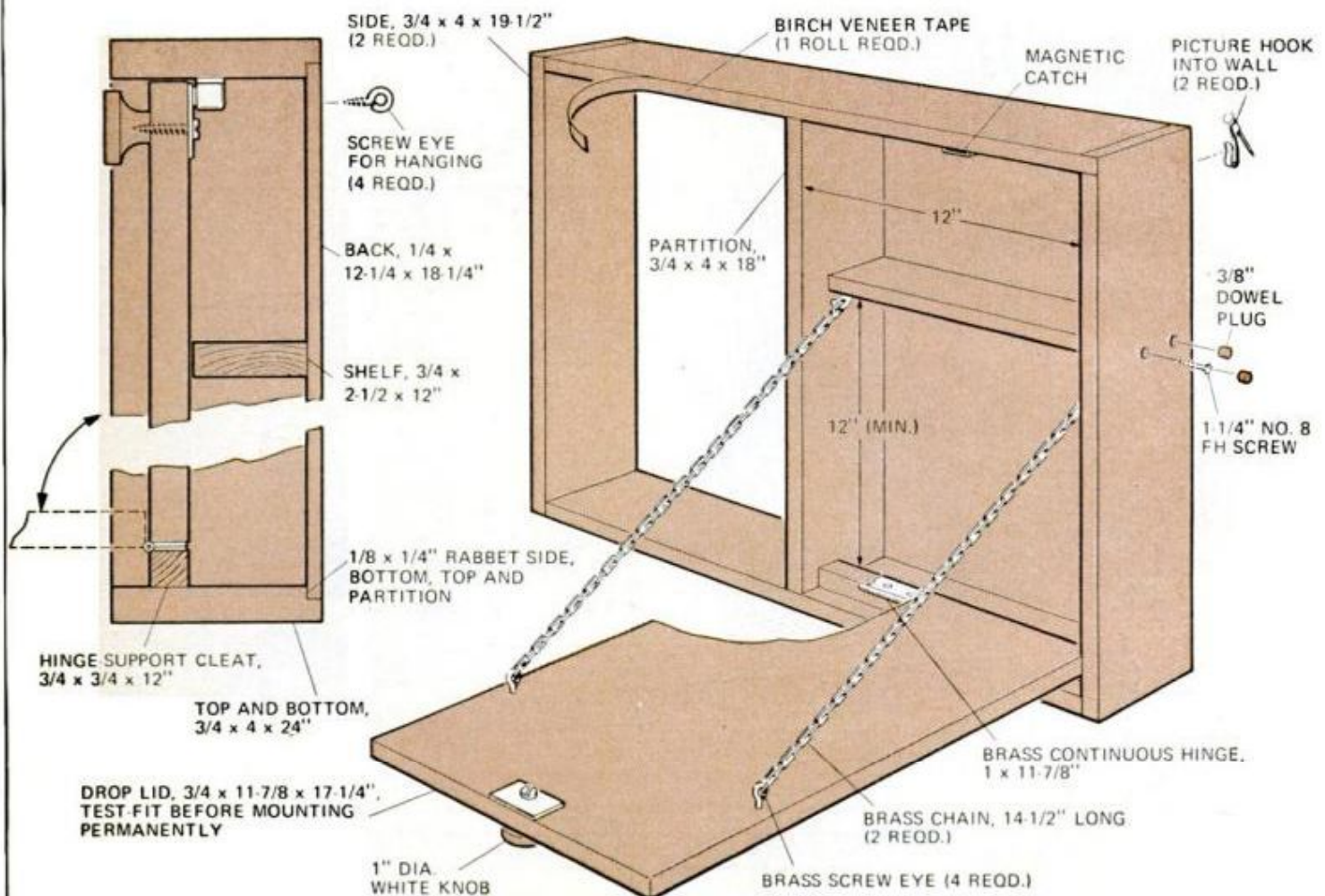

# 5 Musical crèche

Marching 'round and 'round to the accompaniment of a Christmas carol, three kings come "from the East" in search of the Christ Child who, with Mary and Joseph, occupies the second tier of this musical crèche. On the top tier are a shepherd and sheep. This model crèche is a handsome decoration for a mantel, or perfect for a centerpiece setting when surrounded with boughs of evergreen. It's a good project even for those who feel that carving is beyond their skills as commercial figures of all types are available that will work just as well as the handcarved ones. But if you want to try your hand at "whittling," front and profile views shown will give you a head start on the carving.

For this crèche,  $\frac{7}{8}$ -in.-thick birch was used for the platforms. To make the base, glue and clamp two thicknesses to create a  $1\frac{3}{4}$ -in.-thick block. Lay out an 8-in. circle and divide the circumference into six equal

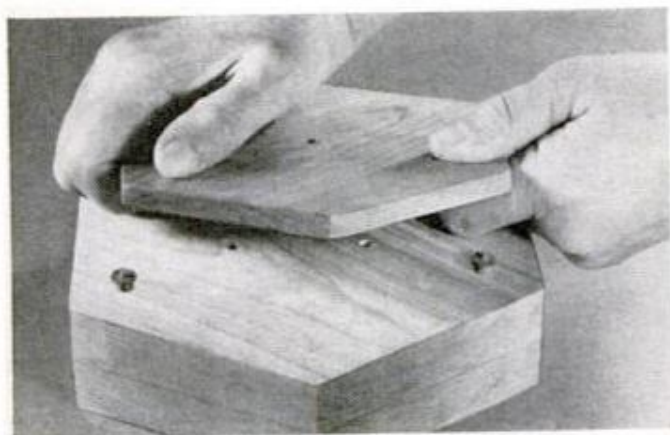

Platform B is centered on base. Dowel centers are used to mark locations for boring dowel holes.

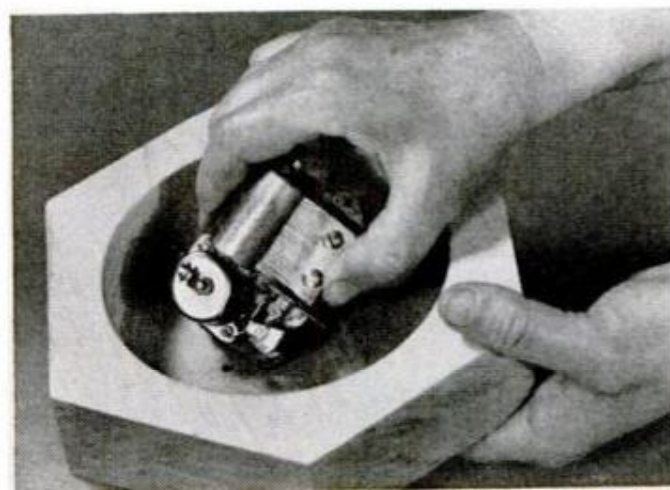

Movement was purchased from Walters Modern Hobby Shop, 207 French Rd., Utica, N.Y. 13502. Cost: \$4.50.

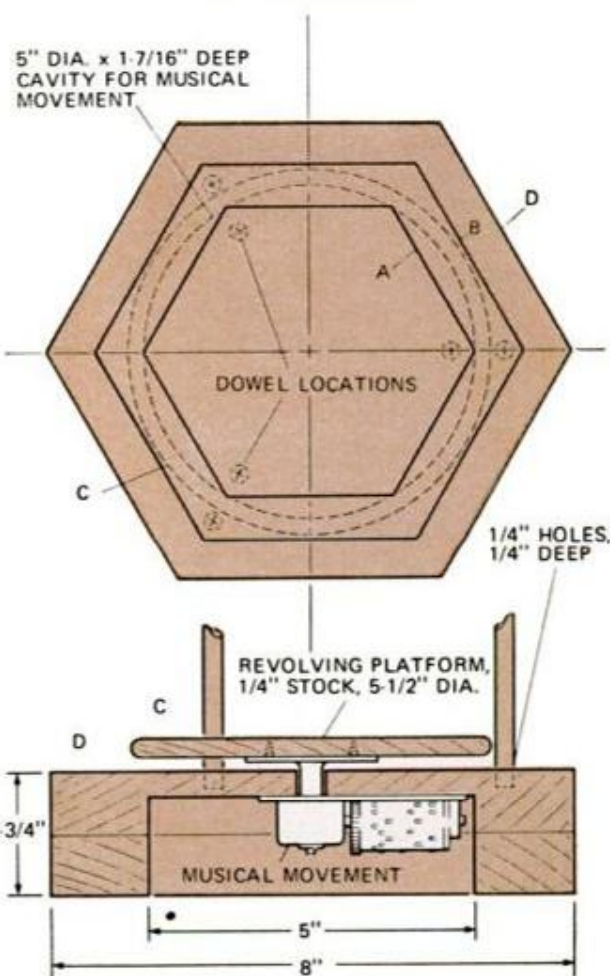
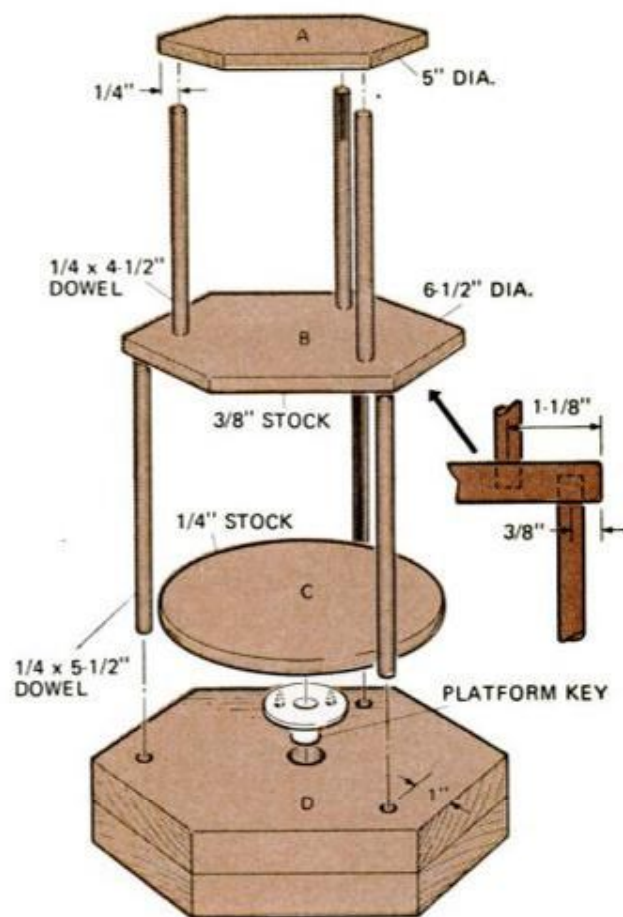

parts to create the hexagon. After cutting out the hexagon, mount the block on your lathe faceplate and turn out the cavity shell to accommodate the platform winding key. Sand the base smooth.

Cut and sand the other two hexagons using  $\frac{3}{4}$ -in.-thick birch. Bore  $\frac{1}{4}$ -in.-dia. holes  $\frac{1}{4}$  in. deep into the top side of the base platform as shown. Place dowel centers into holes and mark the locations for the underside of platform B for  $\frac{1}{4}$ -in.-deep blind holes for the dowel top ends. Repeat the procedure to locate dowel centers exactly between platforms A and B. With tier assembled, fasten the musical movement in place with screws. The revolving platform for the kings is turned from  $\frac{1}{4}$ -in. stock. The rest of the project is the carving of the figures. These can be left natural, varnished, or if you have the skill, realistically painted.—*Elma and Willard Waltner*

*(Please turn to page 166)*

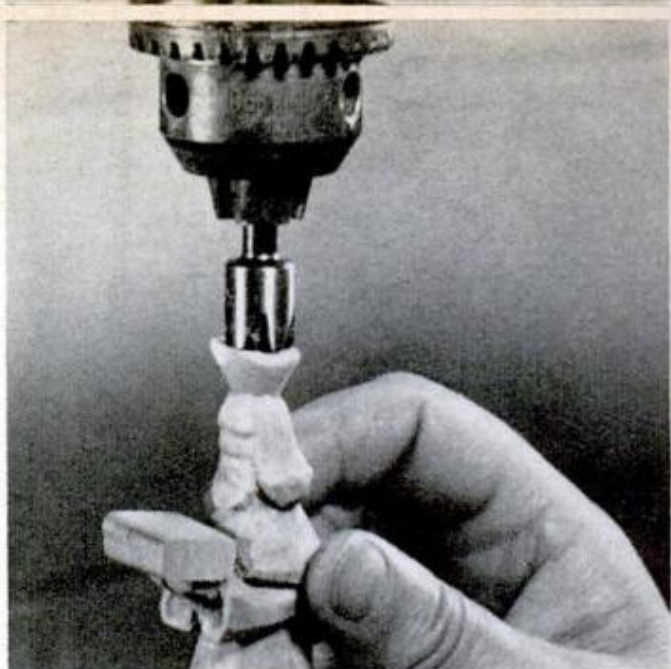

Countersink chucked in a drill press works well for drilling out the top of one king's crown.

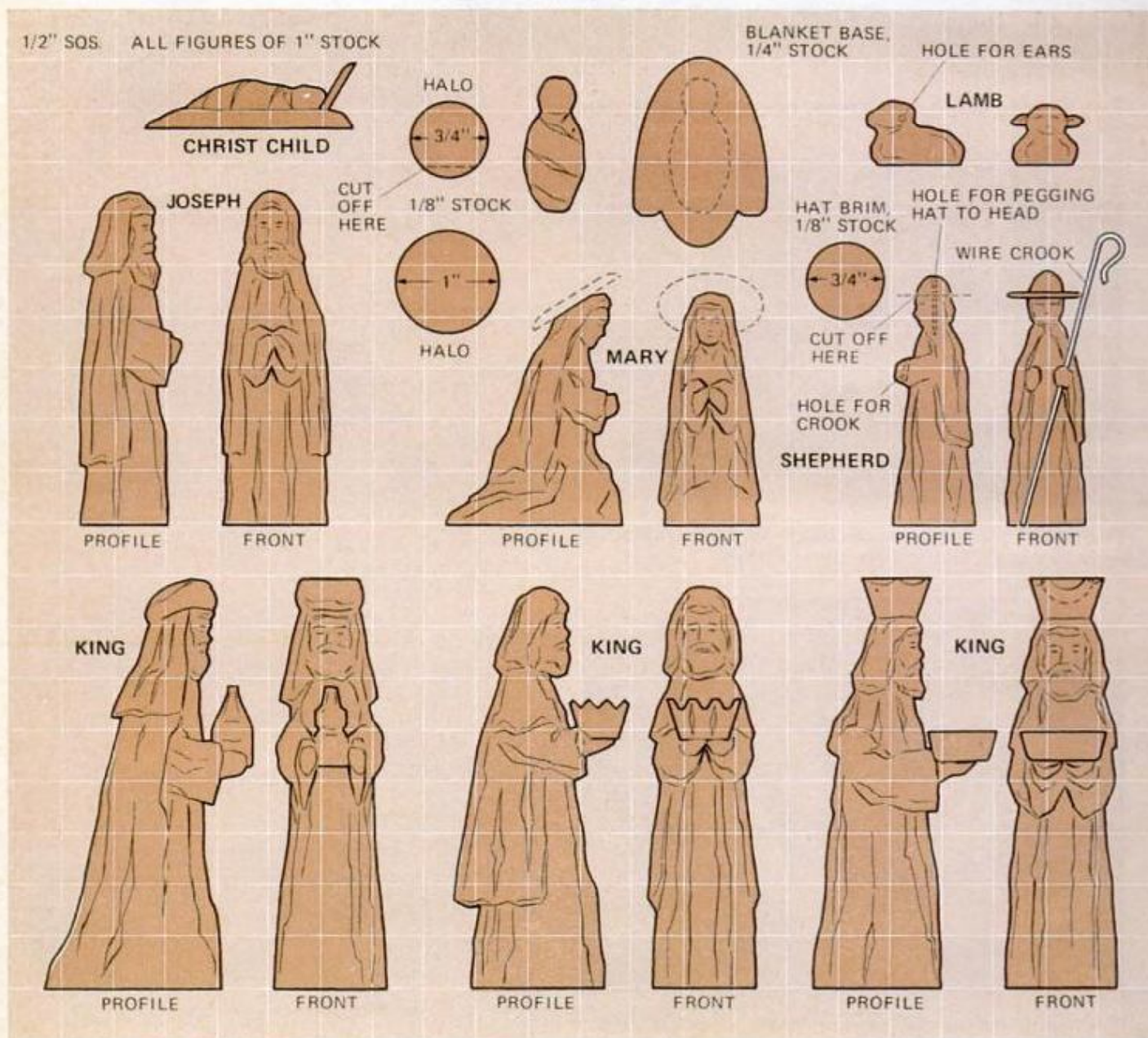

# Salem refreshes naturally!

- Naturally grown menthol.
- Rich natural tobacco taste.
- No harsh, hot taste.



King or Super King

Warning: The Surgeon General Has Determined That Cigarette Smoking Is Dangerous to Your Health.

KING: 19 mg. "tar", 1.3 mg. nicotine,  
SUPER KING: 21 mg. "tar", 1.5 mg. nicotine, av. per cigarette, FTC Report FEB. '73.

# Build your own VW-powered

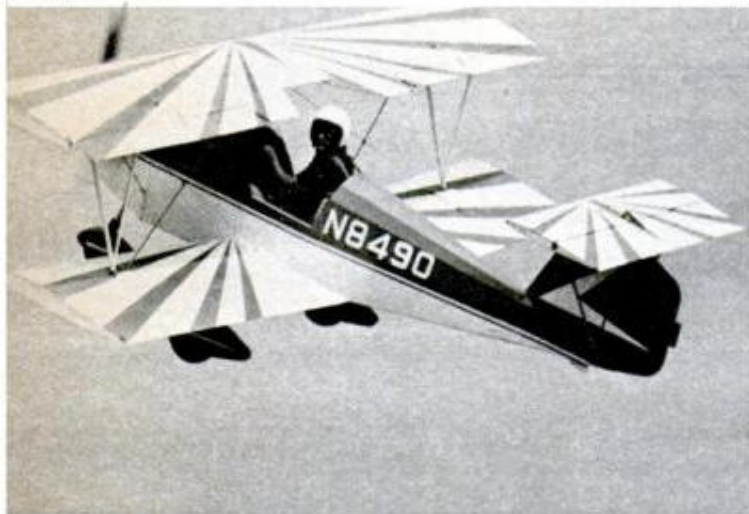

The last word in simple construction, this mini aerobatic sport plane can be completed in as little as six months. You can even buy the parts in kit form to speed the job.

by Sheldon M. Gallager  
and Howard Levy

PHOTOS BY HOWARD LEVY

Ever since Harris "Woody" Woods designed a strange-looking craft called the "Rail," he's been intrigued with the idea of single-beam construction for airplanes. The Rail was just what its name implies—a long stick with wings, tail, two engines and a seat for the pilot stuck on. It was breezy and primitive, but proved so simple to build and fly it became an instant favorite of many beginning pilot-builders.

Now Woody has applied the same basic rail principle to a full-fuselage configuration and the result is the Scamp—a scrappy little low-cost, single-seater, open-cockpit, all-metal biplane that brings the exciting world of sport flying to virtually anyone with ordinary home-shop tools and skills. Powered by a VW engine, it offers simplicity of construction for the first-time builder and safe, easy handling for the low-time flier. At the same time, it's hot enough to supply the thrills sought by more advanced pilots. Stressed for 6 Gs positive and 3 Gs negative, it's capable of most aerobatic maneuvers except snap rolls.

Like the Rail, the Scamp is built around a 2x5-inch extruded box beam that runs the full length of the airframe. This forms the plane's backbone, like the keel of a ship. Wings, tail, fuselage bulkheads, landing gear and all other major structural members are anchored to the beam. A second beam or "mast" extends vertically to support the upper wing. It's this combination of central

rail and mast that gives the Scamp its tremendous strength. It also acts as an automatic alignment guide, eliminating the need for jigs normally required for proper positioning of fuselage parts.

The Scamp is the crowning point in a long career of impressive achievements by Woody. A design engineer for such well-known aircraft companies as Piasecki, McDonnell, North American, Lockheed and Bell, he's turned out more than a dozen homebuilts in the past decade—all highly successful. By special arrangement, his plans for the Scamp are being made available to PM readers. As an additional aid to the home builder, Woody will also supply parts for the Scamp in complete or partial kit form. With the help of these, it's possible to build the ship in as little as six months for less than what most people spend on a family car. For those who prefer closed-cockpit comfort, a single-wing cabin version, called the Quail, is also available.

The rail is not the only innovation Woody has brought to his homebuilts. In the Scamp, the ailerons are in the upper instead of lower wing—unusual in biplanes. This gets them up into "clean air," away from propwash turbulence, for better control. The same is true of the high-mounted "T-tail," which improves spin and stall control. Wing spars are stock metal tubes for high

(See drawing on following page,  
[text continues on page 164.](#))



# biplane from PM plans



**Pair of flying midgets:** Above, high-wing, enclosed-cockpit Quail; below, biwing, open-cockpit Scamp. Basically similar in construction, both are powered by VW engines, can be built from either plans or kits. Scamp is high-performance ship stressed for most aerobatic maneuvers.



# Build-it-yourself VW-powered biplane

*(Continued from page 161)*

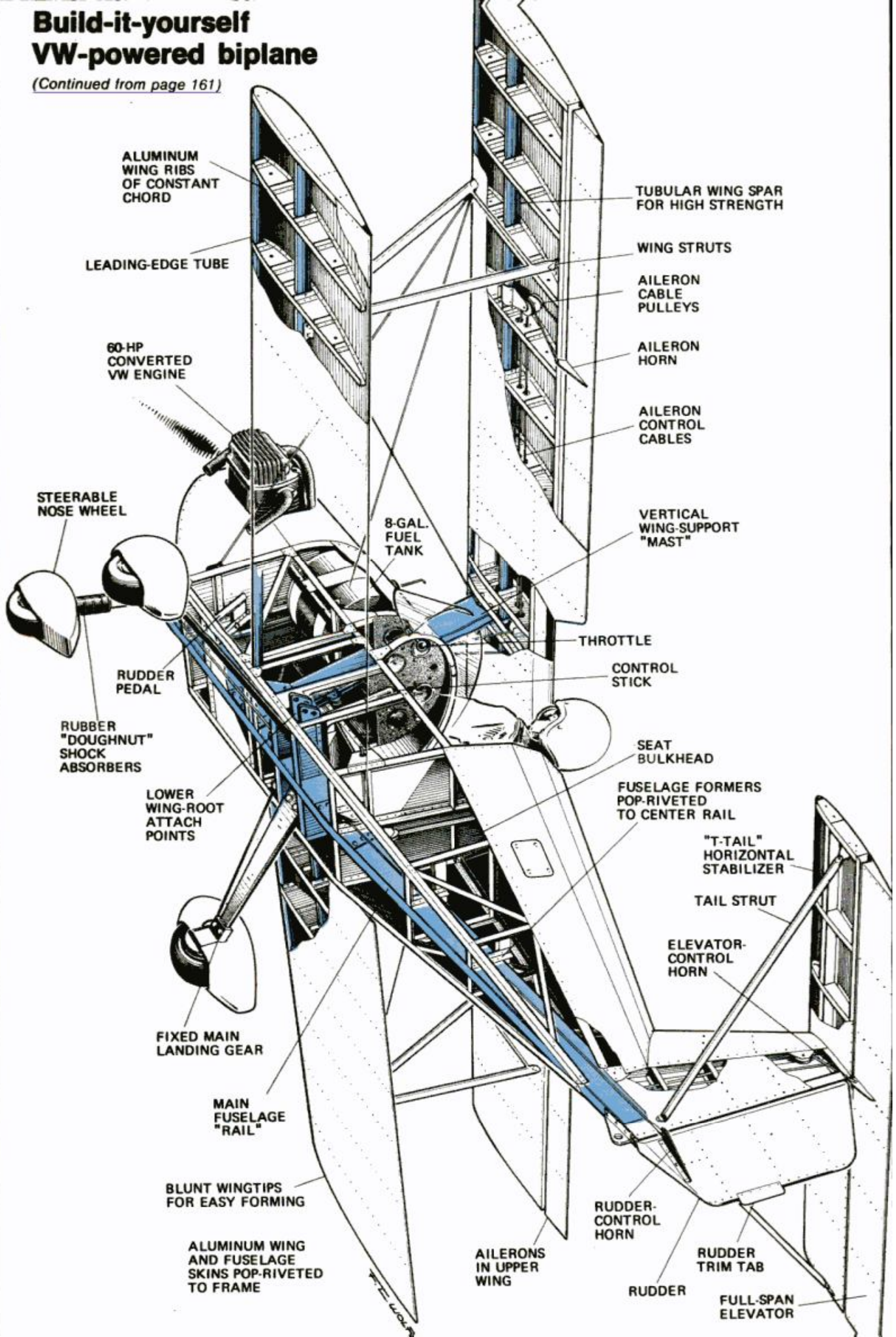

ALUMINUM  
WING RIBS  
OF CONSTANT  
CHORD

TUBULAR WING SPAR  
FOR HIGH STRENGTH

LEADING-EDGE TUBE

WING STRUTS

60-HP  
CONVERTED  
VW ENGINE

AILERON  
CABLE  
PULLEYS

AILERON  
HORN

AILERON  
CONTROL  
CABLES

VERTICAL  
WING-SUPPORT  
"MAST"

STEERABLE  
NOSE WHEEL

8-GAL.  
FUEL  
TANK

THROTTLE

RUDDER  
PEDAL

CONTROL  
STICK

RUBBER  
"DOUGHNUT"  
SHOCK  
ABSORBERS

SEAT  
BULKHEAD

LOWER  
WING-ROOT  
ATTACH  
POINTS

FUSELAGE FORMERS  
POP-RIVETED  
TO CENTER RAIL

"T-TAIL"  
HORIZONTAL  
STABILIZER

TAIL STRUT

ELEVATOR-  
CONTROL  
HORN

FIXED MAIN  
LANDING GEAR

MAIN  
FUSELAGE  
"RAIL"

RUDDER-  
CONTROL  
HORN

RUDDER  
TRIM TAB

BLUNT WINGTIPS  
FOR EASY FORMING

ALUMINUM WING  
AND FUSELAGE  
SKINS POP-RIVETED  
TO FRAME

AILERONS  
IN UPPER  
WING

RUDDER

FULL-SPAN  
ELEVATOR

# Does More Than Help Shrink Swelling Of Hemorrhoidal Tissues Due To Infection

Also gives Prompt, Temporary Relief in Many Cases from Pain, Itching in Such Tissues.

Doctors have found a remarkably successful medication that actually helps shrink swelling of hemorrhoidal tissues when infected and inflamed. And it *does more*. In many cases it gives relief for hours from pain and itching in

these tissues. Tests by doctors proved this true in many cases.

The medication used in these tests was Preparation H. And no prescription is needed for Preparation H<sup>®</sup>. Ointment or suppositories.

## "GROUNDED" OUTLET TESTER



New GT-20 Tester tells if your AC outlets are safely grounded. Amber lights show if power is OK. Red indicates reverse polarity, faulty connections or absent grounds. Simple to use & carry, hi-impact. Ideal for home, shop, campers, electricians, maintenance men, etc. \$7.95 PREPAID. Two prong adapter 75¢.

**ALCO** BOX 1348-PM-1  
Lawrence, Ma. 01840

## I-N-V-E-N-T-O-R-S WE NEED INVENTIONS

Sell your invention for cash—good money for Patent?—Are technical problems holding you back? Universal Inventions has helped inventors all over the world—just like yourself—why not you? Inventions provide the magic spring-board to sudden riches. REMEMBER, we either sell your invention or pay you a cash bonus. Write for details. UNIVERSAL INVENTIONS, Dept. 13, Marion, Ohio 43302

## RONSON

Multi-Fill  
fuels most  
butane  
lighters



From  
49¢

The clean  
quality butane  
that won't clog.



## HEAVY DUTY WELDER

with special \$7.00 gift offer to Popular Mechanics Readers  
**10-DAY FREE TRIAL**  
Lifetime Guarantee

Buy Factory Direct and Save **18.95** POST PAID

Fits ordinary 110V outlet  
Not one • but 6 welding heats

Weld, braze, solder or cut most anything made of metal. No experience necessary. Follow simple instructions to make repairs on cars, trailers, farm and lawn equipment, bicycles, appliances, etc. Make campers, boats, furniture, hundreds of valuable items. **NOTHING ELSE TO BUY!** Comes complete with full face shield, pack of welding and brazing rods, heavy duty power cables, special electric torch attachment, ground clamp, flux, easy-to-follow illustrated instructions, rod holder, etc. Uses standard 1/8" rods to weld iron, steel, brass, bronze, aluminum, other metals. New improved HEAVY DUTY circuit gives more welding power. Gives 4 times the heat needed to melt toughest iron. Plugs into ordinary 110V outlet. 6 WELDING HEATS for professional quality welding of "tough" to "light-weight" metals. 10 day MONEY BACK GUARANTEE. Lifetime parts and service guarantee. An excellent gift for any occasion. **FREE!** Mention you saw this ad in Popular Mechanics and receive a \$7.00 gift pack of welding rods free. For same-day C.O.D. shipment just call (713) 682-5681 or send only \$2.00 and pay postman \$18.95 plus small C.O.D. when delivered or charge to your BankAmericard or Master Charge card or for postpaid shipment send \$18.95 check or M.O. to WEL-DEX, Dept. W-203, Box 10776, Houston, Tex. 77018.

## WHITE'S METAL DETECTORS

WHITE'S ELECTRONICS, INC. manufacture the World's Largest and Finest Line of Mineral and Metal Detectors. Ghosttowing, beachcombing, bottle hunting, coin hunting—all types of TREASURE HUNTING or PROSPECTING, amateur or professional. Detect conductive metals—Gold, Silver, Copper Nuggets—Coins—Rings—Jewelry, etc. Underwater or on the land. "There are no finer at any price" 25 production models to choose from—T.R. or B.F.O.

Priced from \$75.00 up  
—Always specify the Blue & Gold  
ASK FOR WHITE'S BY NAME

—Free Literature—  
WHITE'S ELECTRONICS

Rm. No. 512  
1011 Pleasant Valley Rd.  
Sweet Home, Oregon  
33784 Hazel Street  
Abbotsford, B.C., Canada  
Elk-Air Industrial Park  
Dexter Drive, East  
Elkhart, Indiana 46514



**ON S** FREE Color Catalog

• Discount Prices • 42 Models

Accordian Corp. of America—Dept. R-123, 5535 W. Belmont Ave., Chicago, Ill. 60641

Send FREE accordian catalogs and discount prices. Include special information checked:

Accordian Amplifiers  Button Accordions

Name \_\_\_\_\_

Address \_\_\_\_\_

City \_\_\_\_\_ State \_\_\_\_\_ Zip \_\_\_\_\_

## BUILD YOUR OWN VW-POWERED BIPLANE FROM PM PLANS

(Continued from page 160)

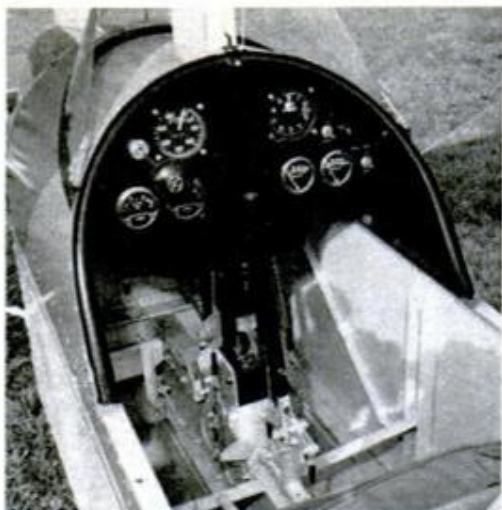

High-mounted T-tail (left above) improves stability, permits full-span elevator for ease of construction and good control. Rudder trim tab is simply small metal strip hand-bent to proper trim. Cockpit view (cen-

ter) shows portion of "mast" protruding up behind instrument panel to support upper wing. Unusually wide offset wing stagger (right) gives easy access to cockpit, also good ground visibility ahead of lower wing.

strength and easy fabrication. Rolling the sheet-metal wing skins around tubes at the front produces neat, smoothly rounded leading edges—a clever dodge. All skins and most frame members are simply Pop-riveted in place. Fuselage contours avoid tricky compound bends, yet provide a trim, sporty look.

The Scamp uses a fixed tri-gear with steerable nose wheel. Recommended engines are VWs in the 1600-1800-2100-cc range. The prototype is powered by an 1834-cc developing about 60 hp. Performance and weight vary somewhat with engine choice, but cruising speeds are typically 90 to 95 mph, with a top of 125 mph. Stall speed is a tame 42 mph, making the Scamp a ship you can fly in and out of pasture strips. Rate of

climb is 650 to 900 feet per minute; range, 250 miles on an eight-gallon fuel supply. Overall length is 14 feet; wingspan, 17½ feet.

Plans for the Scamp are \$49.98 (see instructions for ordering below). Parts are available directly from Woody at Aerosport, Inc., Box 278, Holly Springs, N.C. 27540. The complete construction kit, less engine, sells for \$2245. Partial kits—there are six—range from \$280 for the landing gear assembly to \$550 for fuselage bulkheads and skins. Plans and kits for the Quail are also available from Aerosport. Woody does not supply VW engines himself, but warns it is *absolutely essential* that they be properly converted for aircraft use. Some VW-powered planes have failed, he points out, because their builders attempted to use the engine as it came right from the car—a highly dangerous practice. Reliable VW conversions can be obtained from outfits like Barker and Revmaster for \$700 to \$1400. ★★



Blunt nose cowling is cleverly shaped to give pleasing appearance without requiring tricky compound curves. Engine heads are exposed—also for simplicity.



**Come to where  
the flavor is.**



18 mg. "tar," 1.3 mg. nicotine av. per cigarette, FTC Report Feb '73

Warning: The Surgeon General Has Determined  
That Cigarette Smoking Is Dangerous to Your Health.

Материал, защищенный авторским правом

(Continued from page 158)

## 6 Bumblebee pull toy

As this toy is pulled along by a youngster, the smiling bee "buzzes" around the petal continuously, "alighting" only when the pulling stops. While sure to delight toddlers, this pull toy will make parents happy as well because the "buzzing" is silent—no clacking or quacking to annoy parents.

As can be seen in the drawing at right, the toy is far easier to make than one would suppose when watching the finished toy in action. Parts are easy to make and assemble; no sophisticated tools, techniques or knowledge are called for in the making. In fact, the project can be completed entirely with handtools using a coping saw for shaping petals and bee, brace and bit for all necessary boring. The rest of the job calls for gluing, sawing, nailing and finish-painting with nontoxic paint.

The wheels on the toy shown were cut from 1/2-in.-thick plywood. If you lack a jigsaw or holesaw—either of which must be used to cut perfect circles—buy a length of 2-in.-dia. hardwood dowel, and cut off 1/2-in.-thick pieces like slices of bologna.

It is best to tack-assemble the toy before finishing to assure that moving parts work as they should. When satisfied, disassemble the piece, do the finish painting and permanently assemble.—*Merton H. Slutz*

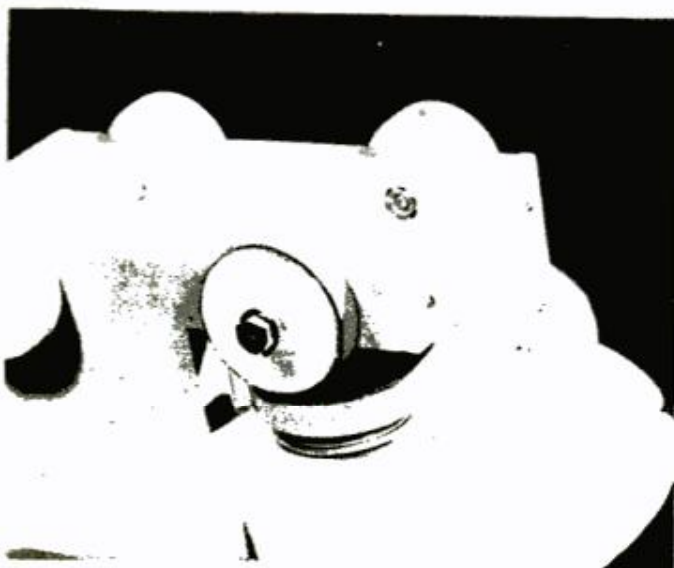

Upside-down view shows what makes bee buzz—rubber gasket on drive wheel rides atop right rear wheel.

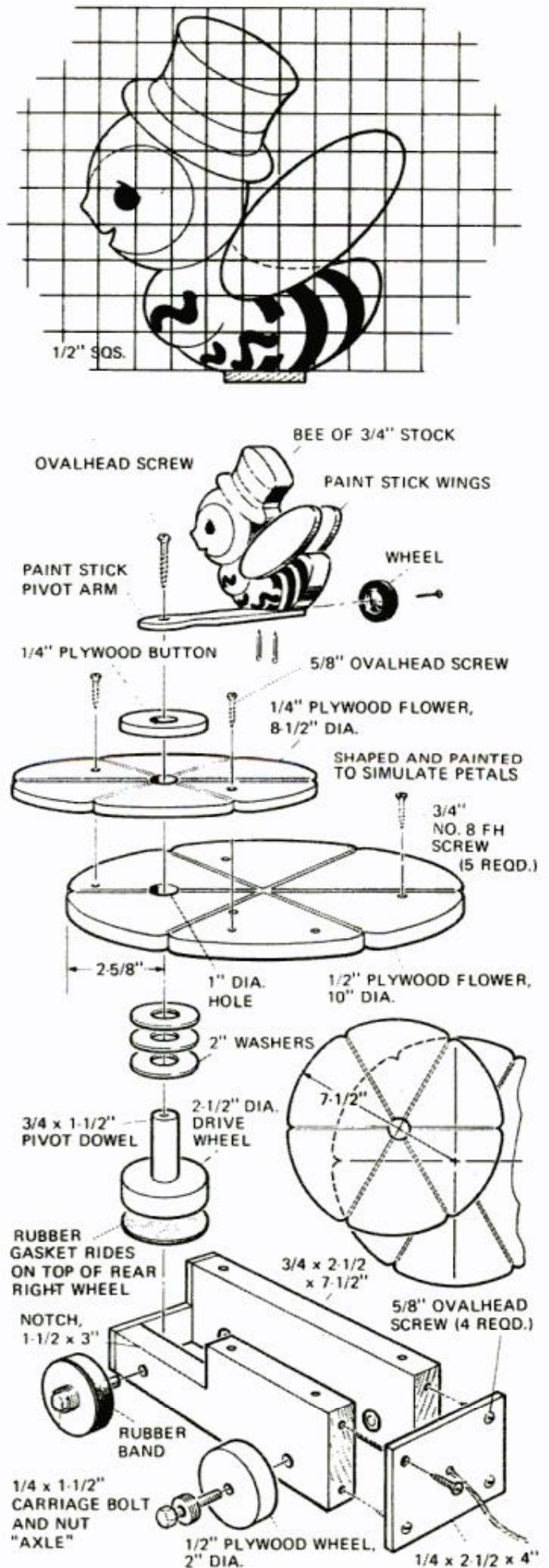



**IF YOU HATE  
SHOVELING SNOW  
FOR HOURS...**

**HERE'S HOW TO  
HATE IT FOR  
ONLY MINUTES!**

The Ariens Sno-Thro! When winter's at its worst, this rugged, powerful SNO-THRO will muscle its way through the heaviest snowfalls and knee-deep drifts with ease. Frankly, it makes snow removal almost fun.



Easy to maneuver, the Ariens Sno-Thro has four speeds forward and reverse. Cuts a clean swath with its two-stage, self propelled action. The 240° swing around discharge chute throws the snow up to thirty feet. Waist high, finger-tip controls ensure quick response. Available in 4 HP, 5 HP, two 6 HP and two 8 HP models with auger widths from 20" to 32" to suit your needs.

Why not join the thousands of discriminating owners who have made Ariens the industry's biggest seller. Check the Yellow Pages for your nearest Ariens dealer.



**A CUT ABOVE THE REST!**  
**Ariens**

Ariens Company 811 West Ryan Street Brillion, Wisconsin 54110 Phone 1 (414) 756-2141

DECEMBER 1973 166A

# Announcing

## Popular Mechanics Picture-Tools - the handiest shop-organizers ever designed

POPULAR MECHANICS PICTURE-TOOLS are a great new idea to take the confusion out of *what goes where* on workshop tool panels.

The complete PM PICTURE-TOOL KIT consists of seven big sheets (9¾ x 11¾ in.) of a special heavyweight paper with a pressure-sensitive adhesive on the back. On each sheet are beautiful drawings of hand tools and portable power tools—all (74 in total) you're likely to have in your shop. Most are full size; the others, only slightly reduced.

Also enclosed in the kit is a blank sheet of the same special paper, printed in an overall color to match the tools. This sheet enables you to design your own drawings or silhouettes of any special tools you have.

Each of the PM PICTURE-TOOLS is carefully die-cut. You simply peel it off the backing paper and apply it to the proper spot on your panel. You can apply PICTURE-TOOLS to any painted or unpainted wood, plywood, hardboard and even perforated-hardboard surface.

Later if you want to move a few tools or rearrange the entire panel, you can peel off

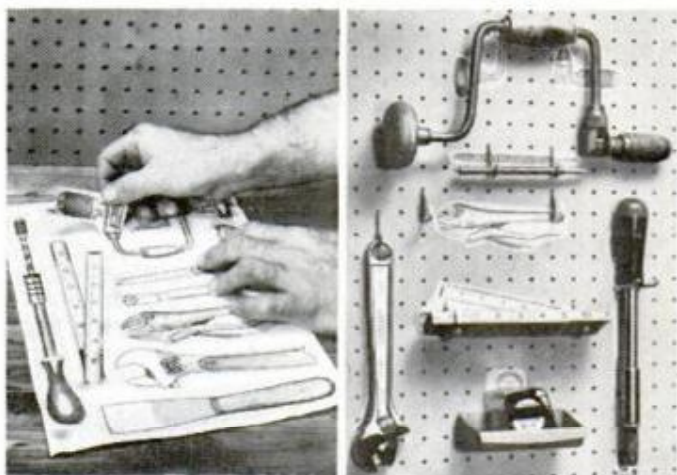

the PM PICTURE-TOOLS and move them to new locations. They are reusable!

Once your PICTURE-TOOLS are in place, you'll know at a glance exactly where each tool in your shop belongs. You'll also know—again at a glance—what tools are missing.

Best of all, you'll be surprised how PM PICTURE-TOOLS will instantly and dramatically enhance the appearance of your shop!

**Order your PM PICTURE-TOOL KIT today!**

Only  
**\$3.95**

**Popular Mechanics, Box 1014 (Dept. PT), Radio City, N.Y., N.Y. 10019**

Enclosed is my check or money order for \$3.95.

Send my PM PICTURE-TOOL KIT to:

Name \_\_\_\_\_

Address \_\_\_\_\_

City \_\_\_\_\_

State \_\_\_\_\_

Zip \_\_\_\_\_



# You get more for your money from NRI



**SOLID STATE TRAINING**—Learn-by-doing with NRI equipment. TV-Radio Servicing course includes 25" diagonal color TV, with handsome woodgrained cabinet at no extra cost; wideband service type oscilloscope, color bar crosshatch generator, transistorized volt-Ohm meter, and solid-state radio kit. Other courses equally complete.

## NRI Programmed Equipment Gives You Priceless Confidence, Makes Learning TV-Radio, Electronics Fast and Fascinating

NRI pioneered the idea of supplying home-study students with custom designed training kits to give practical on-the-job experience as you learn. Today, NRI's "3-Dimensional" training can't be equalled. You get more value—from the exclusive Achievement Kit sent the day you enroll, to "bite-size" texts and custom training equipment. Learning TV-Radio, Electronics or Communications at home is easy, exciting, the NRI simplified, dramatized way.

### BE A SKILLED TECHNICIAN IN AMERICA'S FASTEST GROWING INDUSTRY

Regardless of your educational background, you can learn the Electronics field of your choice the practical NRI way. The NRI color catalog, sent to you free and without obligation, tells you how you can qualify quickly to be a part of the fast growing Electronic Age; about engineering jobs in business, industry, broadcasting, government, now offered to men without college degrees. It will open your eyes to the great number of success opportunities available right now in the high-pay world of TV-Radio Servicing, Broadcasting-Communications and Industrial-Military Electronics. With NRI technical training, you can take your choice of a wide variety of career

openings or have a business of your own. And if you choose one of five NRI courses that include FCC License preparation, you must earn your FCC License or NRI refunds your tuition!

### MAKE \$5 TO \$7 AN HOUR EXTRA IN SPARE TIME STARTING SOON

Tens of thousands of NRI graduates are proof it is practical to train at home in your spare time. Keep your present job while preparing for a better one, and earn \$5 to \$7 an hour extra in spare time while you train, fixing sets for friends and neighbors. NRI shows you how. Equipment you build and keep becomes useful in your work.

### STEP UP TO BETTER PAY, A BRIGHTER FUTURE

NRI can help you, but the decision to act must come from you. Decide now to move ahead . . . mail the postage-free card today for your FREE NRI color catalog. No obligation. No salesman will call. NATIONAL RADIO INSTITUTE, Electronics Division, Washington, D.C. 20016.

#### APPROVED UNDER GI BILL

If you served since January 31, 1955, or are in service, check GI line on postage-free card or in coupon.

### CASH IN ON THE BOOM IN COLOR TELEVISION



The NRI TV-Radio Servicing course includes your choice of black and white or color TV training equipment. Color TV needs thousands of trained men to keep pace with millions of sets being sold every year. NRI prepares you quickly. Cash in on the boom.

Mail insert card for your **FREE NRI color CATALOG**

No salesman will call



# Hobby kits for fun at Christmas



## Shaker Maker switchables

The Flintstones and Buggles join the rest of the hairy bunch of people, picture, animal and bird sets by Ideal Toy Corp. Without electricity, heat or hot water, youngsters can cast an endless number of miniature figures with interchangeable molds having three front pieces and a back. Thus a cowboy can be cast with a monkeys' body and a woman's feet, or 27 other variations. The Flintstones include Fred, Wilma and Dino; the Buggles are wiggly bugs, with elastic cord. About \$6.



## Flower-shaped candlemaker

A new special wax lets you make delicate flower leaves and petals without heat with Skilcraft's Candle Maker kit. Combining regular wax for bases and flexible wax for petals, the kit contains 2 lbs. of flexible wax in slab form, 1 lb. regular wax, 8 chips of nontoxic colors, melting pot, petal and leaf-pattern sheet, 3 candle center/base molds, aluminum-foil tray, 6 ft. of wicking material, gold glitter, wax-cutting tool, floral scent and full instructions. About \$8, in department-store toy centers.

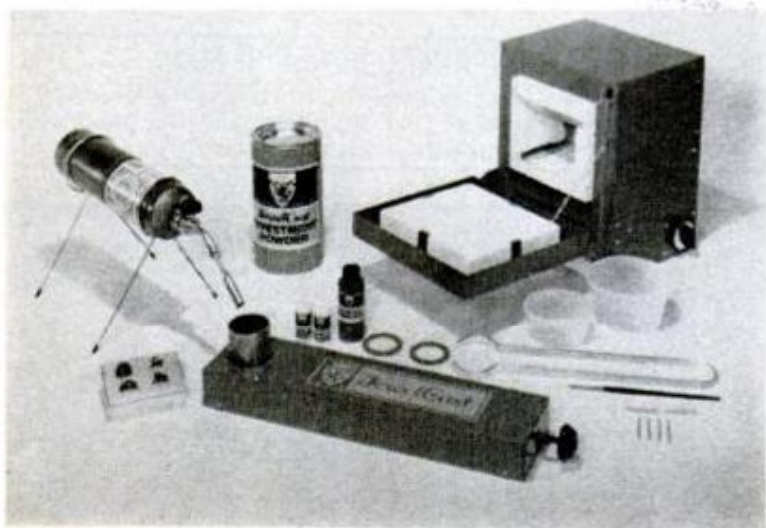

## Precious-metal casting kit

Employing the lost-wax process, you can make beautiful professional-quality jewelry with Jewel-Cast kit from Classic Industries, Culver City, Calif. 90230. Complete instructions take you through the five basic steps: attaching sprue, investing, burn-out, casting and polishing. Kit includes vacuum caster, kiln, jeweler's torch, tongs, mixing bowls, debubblizer, casting powder, flasks, special alloy metal, sprue wax, sticky wax for attaching sprues and four wax patterns. It sells for \$99.50.

# .. and the rest of the year

## Handcrafted ceramics kit

Using clay which air-dries, no baking or firing is required to make hand-thrown ashtrays, candlesticks, vases, bowls, flowerpots and other ceramic pieces with Gilbert Industries' Potterycraft. An electric, benchtop potter's wheel features variable-speed drive: fast for throwing or slow for decorating. Kit also contains nontoxic glaze and water-soluble paints, shaping tools, artist's brush, potter's sponge, 3 lbs. of air-dry clay and a step-by-step instruction booklet. Price about \$30.



## Aeronautics lab kit

With this kit, your youngsters can study the history of flight, learn about aerodynamics, experiment with the nature of flight and propulsion, construct a helium balloon, aileron-controlled glider, rocket with automatic parachute recovery and others. Kit contains all parts for making over 100 experiments in a 159-page manual and it also includes a free membership in the Logix Science Club. It's \$15.95 postpaid from Edmund Scientific Co., Edscorp Building, Barrington, N.J. 08007.



## Moby Dick scrimshaw kit

Widely regarded as America's most authentic folk art, scrimshaw is the carving of a design on whale's teeth and bone that was practiced by men who sailed whaling ships in the 1800s. While the Moby Dick scrimshaw kit does not include real whale ivory, it provides a three-piece polystyrene form which, assembled, simulates a 7-in. whale's tooth. Kit has everything needed to etch and antique the tooth. Made by Whiting, a division of Milton Bradley Co.; under \$7 at hobby/toy stores.



# World's first solar-powered watch

This fascinating quartz watch runs virtually forever, even has a calendar good for the next 126 years.

by Stephen Walton

**Silicon solar cells** on top give watch cobra-like look. Light-emitting diodes on edge facing the wearer display time, date, seconds count. Dots between numerals are binary code for year in leap-year cycle.

Quartz watches are almost commonplace by now, but this one has plenty of new features that make it special:

- It draws its power from the sun (or ambient room light), using silicon solar cells like Skylab's to keep nickel-cadmium batteries charged.
- It incorporates a true calendar—not just a day-counting mechanism—that keeps track of the number of days in the month and allows for leap years as well. It won't need resetting until the year 2100.
- It has a digital display of light-emitting diodes and automatically adjusts the display's brightness to the light it's viewed in—it's claimed to be the first LED watch display visible in full sunlight.
- Its working parts are sealed into a module that can stand 5000-G shocks and boiling and freezing temperatures. Neither the watch module nor its case includes a single threaded fastener.

Heart of the watch is a quartz crystal vibrating at 32,768 Hz. This frequency is

*(Please turn to page 174)*



**PUMP** DRAINS pools, cellars, laundry tubs  
IRRIGATES — CIRCULATES — SPRAYS



Heavy duty ball bearing pump. All metal, rust-proof Type XB. Stainless shaft. Use 1/4 HP or larger. 1 HP 1,200 GPH 60' high or 3,000 GPH 25' well. 5,200 GPH max. 1 1/4" in; 1" out. Belt or direct drive. \$17.95  
Type P won't rust or clog. Bronze bearing. To 2,400 GPH. 1" in; 3/4" out. \$11.95  
p'pd cash with order. Money back Guarantee.

LAWACO, Box 40, Belle Mead, N.J. 08502

HEADQUARTERS FOR EVERY TYPE & SIZE AT REAL DOWN-TO-EARTH MONEY SAVING PRICES!

**TIRES!**

ALL FAMOUS BRANDS! AUTO TRUCK SPORT CAR FARM TRAILER

TREMENDOUS SAVINGS!  
LET US PROVE IT TO YOU!  
... WRITE US TODAY ...

Send for your FREE catalog!

RELIABLE TIRE CO. 1111 Chestnut St. Camden, N.J. 08103

**AAMCO® And You Can Make It!**

The world's largest transmission chain is still growing strong after nine years. Over 500 of our franchises located from coast to coast. New openings in some markets mean you too might qualify. For further information write:

**AAMCO Transmissions, Dept. D-7**  
408 E. Fourth St., Bridgeport, Pa. 19405

**BASEMENT TOILET**

Flushes up to existing sewer or septic tank by powerful, self-contained pump operated by normal water pressure. No digging up floors. Clog resistant, easily installed. Make basement into game room, den, apartment with private bath. Financing available. Dealer inquiries invited. Write for free catalog.



**DOSS, Dept. J-25, Box 10947, Houston, Tex. 77018**

**BLAST FURNACE—FOUNDRYETTE 2400 F**



Since 1935  
Hobbyists • Schools • Inventors, etc.  
Make your own castings of any metal from cast iron, down to lead and zinc. Available in 6 sizes, 1 1/2 to 50 lbs. Complete units from \$50.40 to \$162. Send 25¢ for circular—refundable.

**KANSAS CITY SPECIALTIES CO.** Dept. P-12  
P.O. Box 193  
Middleton, Wis. 53562

**WRIST ROCKET™**

AMERICA'S HARDEST HITTING SLING

Range 225 yd. — 232 fps.  
Matched replacement rubbers and LEATHER pouch assembly \$1.00  
At dealers or order direct.



WRIST ROCKET™ Mfg.  
P.O. BOX 471-B  
Columbus, Nebraska 68601

**\$3.00** Post. Pd. in USA. No C.O.D.'s  
Orders outside U.S.A. add \$1.00 for postage and handling.

**LEARN UPHOLSTERY AT HOME!**



Men & Women All Ages! Send for free book on learning to reupholster chairs, divans, footstools, all furniture for BIG MONEY in spare or full time. No experience needed, no age or educational limits. We show you how and provide EVERYTHING needed to start: (1) Home training covering all phases, (2) all tools and 6 big furniture kits for practice, (3) free supplies, frames & materials to build \$300 worth of furniture, yours to keep or sell. Write TODAY for big free upholstery career book. No obligation, no salesman will call. Veteran Approved.  
Modern Upholstery Institute  
Box 899-ZPM, Orange, Calif. 92669.

**\$12.95 BLACK DIAL TELEPHONES**

Complete



add \$2.00 for color  
Factory rebuilt Western Electric in white, beige, ivory, pink, green or blue. If 4 prong plug is required add \$2.00. Fully guaranteed.

Designs may vary.

Write for free list. All shipments F.O.B.

**SURPLUS SAVING CENTER**

DEPT. PM-123, WAYMART, PENNA. 18472

**inventors**

if you have a better idea...

for a new product, or a way to improve an old product, contact us — "the idea people".

We will develop your idea, introduce it to industry, negotiate for a cash sale or royalty licensing!

Send for our FREE "Inventor's Information Kit". It has a special "Invention Record" form, an important brochure: "Inventions—Their Development, Protection & Marketing", and a Directory: "500 Corporations Seeking New Products". (It also tells you why we're known as "the idea people".)



**RAYMOND LEE ORGANIZATION**

230 Park Ave., New York, N. Y. 10017  
(212) 686-8500

Yes, I'd like to find out how to take action on my idea. Please send me your FREE "Inventor's Kit" A-12

Name \_\_\_\_\_ (Please Print)

Address \_\_\_\_\_

City \_\_\_\_\_ State \_\_\_\_\_ Zip \_\_\_\_\_  
NEW YORK BOSTON CHICAGO GENEVA SAN FRANCISCO TORONTO  
MONTREAL LOS ANGELES VANCOUVER DALLAS KANSAS CITY

**MAN-SIZE TRACTOR**  
does tough jobs faster



More pull-power, more tool-power with 14 hp and all-gear drive (no belts, no fluid power loss). Bigger frame, bigger wheels, more weight and traction. 20 big attachments—32" tiller, 48" snow blow, 48" and 60" mowers, loader, dozer, plow, harrow, seeder, etc. More for your money. Write for free catalog.

**ECONOMY TRACTOR**

1005K-12 Anoka Avenue  
Waukesha, Wis. 53186

**U.S. Surplus High Speed Rotary Files. Hardened Steel.**  
For filing, drilling, milling, carving, routing any metal or wood. Cutting edges from 1/4" to 1", shanks all 1/4". Brand new, in air-tight G.I. packs.



36 Tool Set, G.I. cost \$265.00, now ..... \$15.00  
16 Tool Set, G.I. cost \$109.00, now ..... \$10.00  
Save Even More, Both Sets, now ..... \$22.00  
100% Guaranteed. We Pay the Postage. Order Now!

U. S. SURPLUS CENTER, Dept. 503  
715 Camden, San Antonio, Texas 78215

**2,000**

**WOOD**  
CATALOG & MANUAL

Hard-to-find PRODUCTS for easier...better woodworking!

Discover! Enjoy! Benefit from newest products and ideas in Constantine's big picture-packed Manual. Wood headquarters since 1812. Largest selection of world's most beautiful cabinet lumber, veneers, plywood, inlays, moldings. Woods in natural color. Tool bargains. Furn. hdwe. Finishing & upholstery supplies. Fabulous glue that needs no clamps! Instructions. Everything. Unsurpassed values.



**CONSTANTINE**

2051 Eastchester Road, Bronx, N.Y. 10461

Enclosed 50¢ for Giant 96-page Catalog



Name \_\_\_\_\_

Address \_\_\_\_\_

Zip \_\_\_\_\_

DECEMBER 1973

173

## SOLAR-POWERED WATCH

*(Continued from page 172)*

turned into time and date-keeping information by a complementary MOS (metal-oxide semiconductor) integrated circuit with more than 4 trillion different logic states. According to the watch's inventor, Roger Riehl of Troy, Ohio, the circuit is a breakthrough in the number of components used—about 1100—to achieve its functions. An equivalent circuit would require about 4500 transistors. Timekeeping accuracy within a minute a year is claimed.

Wearing the watch, you don't have to roll up your sleeve and go outdoors once a day. A total of 14 hours of sunlight takes the nicad batteries from dead to full charge, which will give six months of normal use. This amounts to an average of about 10 or 15 minutes' exposure a day, and the watch will also charge, although more slowly, in room light. Left in a drawer, with no drain from the LEDs, the watch will run for a year on a full battery

charge. Nickel-cadmium batteries have a limited life, however, and will have to be replaced—perhaps once a decade.

Replacing batteries will require opening the module into which all the watch's operating components are sealed. This is an injection-molded Lexan jacket filled with a jelled epoxy. Placed in a stainless-steel shroud, the module is held in the watch case by overrides on the pins that also attach the watchband. Tested to withstand pressures equivalent to 300 ft. of water, the watch was undamaged after being subjected to sustained temperatures of 180°F., being placed in boiling water and frozen into a block of ice.

In addition to three output brightness levels and a switch for setting time-zone changes without changing the calendar, the watch offers a choice of 12-hour or 24-hour time readout and carries a 3-year guarantee. The Synchronar solar wristwatch is made by Ness Time, 3780 Fabian Way, Palo Alto, Calif. 94303, and retails for \$500.

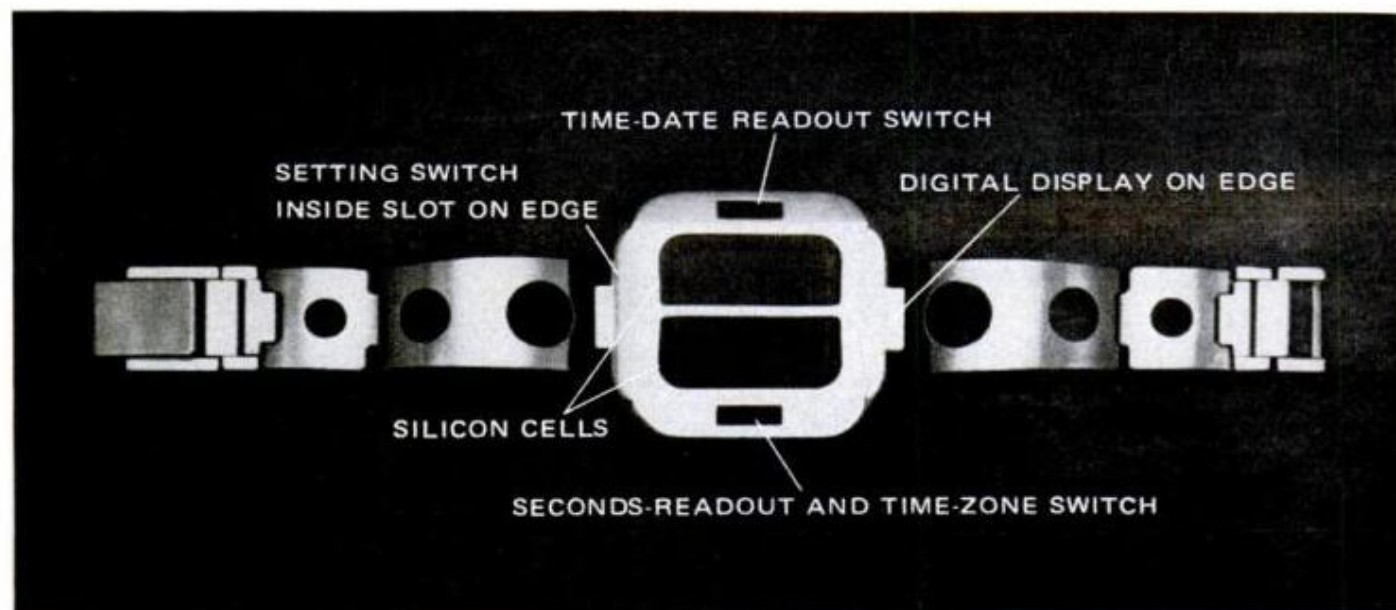

**Controls** have no electrical connection to sealed watch module. Slide "switches" on case move magnets that actuate reed switches inside module. To read the time, move upper switch (on right-hand side from wearer's point of view) toward display, away from display for date. Moving lower (left-hand) switch toward display starts count of seconds; moving it away (against a stronger spring) resets hour for time-zone change, but does not affect calendar. Setting switch is located inside slot to prevent accidental movement; when used (e.g., after crossing the international dateline) it can be operated with a toothpick or paper clip.



# BASEMENT TOILET FLUSHES UP



TO OVERHEAD SEWER OR SEPTIC TANK. NO DIGGING UP FLOORS. INSTALLS EASY. Write McPHERSON, INC., BOX 15133, TAMPA, FLORIDA 33614

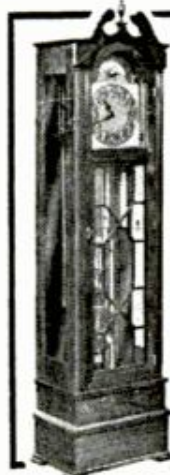

## BUILD YOUR OWN GRANDFATHER CLOCK

Save over 50% by building your own grandfather clock. Stately, straight-sided "AMERICAN CLASSIC" with beveled plate glass sides. Narrow waist designs: "SPIRIT OF '76" with finely sculptured crown and brass-tipped pillars; or easy to build, always popular "SPIRIT OF THE CENTURY." Our kits are Red-i-Kut, semi-assembled, hand-crafted of solid 3/4" kiln-dried mahogany, cherry or walnut. Tubular bell or Westminster rod chimes. Moving moon dials painted by our own artists, and our own original Goddess Diana or Lady Florentine pendulums. Gorgeous solid bronze dials with raised numerals and corners. Send \$3.75 for all three plans, plus description of kits and movements, as folks have for more than fifty years.

KUEMPEL CHIME CLOCK WORKS & STUDIO  
Route 3, Box 240-D, Excelsior, Minnesota 55331

# EARN MONEY FAST!

## REPAIR HYDRAULIC JACKS

Earn while you learn at home. Millions of jacks in gas and auto service stations, trucking firms, body shops, riggers, factories and farms need servicing... most of which you can learn to repair. We show you HOW. Start spare time in your basement or garage. Big opportunity for mechanics. ACT NOW!

Write for folder PM 12, and free bonus offer



HYDRAULIC JACK REPAIR MANUAL CO., INC.  
G. P. O. BOX 3 • STATEN ISLAND, N. Y. 10314

# MOLDS

for making Ornamental Concrete Items...



Book about Aluminum Molds with prices and production trade secrets direct from world's largest mold manufacturer.

SEND \$3.00

CONCRETE MACHINERY COMPANY, INC.

P. O. BOX A99 - HICKORY, N. C. 28601

# HOW TO GET RICH



Have you ever thought of operating a little mail order business of your own. There is no other business like mail order. Start on a shoestring in your spare time and make a fortune fast. It strikes like a bolt of lightning! Millions read your ad and suddenly you are swamped with cash orders from all over the country. MORE MONEY in 60 days than you could earn in a lifetime! Let us help you get started. To receive a free book and complete details just fill out the coupon and mail to:

Mail Order Associates, Inc., Dept. 508, Montvale, N.J. 07645

Name \_\_\_\_\_  
Address \_\_\_\_\_  
City \_\_\_\_\_ State \_\_\_\_\_ Zip \_\_\_\_\_

**1/2 OFF** 100% legal SURVIVAL HUNTING **BLOW-GUN** UNAVAILABLE ELSEWHERE USA made lifetime weapon IMMEDIATE DELIVERY

**100 FREE STEEL DARTS** BONUS OFFER .38 caliber Reusable Tempered **GUARANTEED 10 YEARS** NOW ONLY **\$6.88** ~~\$12.95 list~~

SILENT, POWERFUL, ACCURATE, HITS LIKE A RIFLE BULLET. Improved version of most effective native weapon—Malaysia's hunting blowgun. Thrilling sport! Kills varmints, pests. Tranquilizes. Survival. Defense. Ideal gift. Compressed breath gives amazing power. 200 ft. range. Astound friends! Rugged .38 cal. precision aluminum. Pierces 1/2" plywood. Speed 300 ft./sec. Not a toy! Has 100-5" & 8" steel darts (kit) targets, instructions. Compact 4 1/2 Ft. model \$6.88! Popular 5 1/2 Ft. \$7.88! Magnum 6 1/2 Ft. \$8.88! Extra darts \$2.50 per 100! \$10 per 500. BUY 2 GUNS GET 500 "BONUS" DARTS FREE (\$10 value)! BUY 3 GUNS GET 1000 DARTS (\$20 value)! BUY 4 GET 1600! (\$32 value) Add .65c postage EACH gun. IF BROKEN WITHIN 10 YEARS WE WILL REPLACE AT NO CHARGE! Use 30 days. Money back if not delighted.

HOUSE OF WEAPONS, Box 7285-V5, Univ. Sta., Provo, Utah 84601. Send cash, check or money order.



GERSTNER CHESTS are for the FEW TRUE Craftsmen

GERSTNER TOOL CHESTS  
Dept. L-3 20 Cincinnati Street  
Dayton, Ohio 45407

Send 25¢ for Catalog

## SOUND ACTIVATED ELECTRIC SWITCH

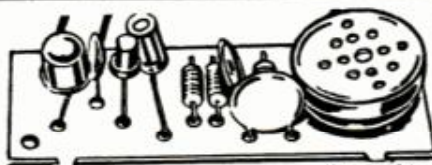

SURPLUS BARGAIN! ONLY \$1.95. Turns on lights, bells, horns, sirens, alarms, tape recorders, wireless mikes, etc. Operates by voice, whistle or any sound from across room. Hundreds of fun & practical uses. Do mysterious tricks & stunts. Great for experimenters, electronic bugs. NOT A KIT. Completely assembled, wired. Includes sensitive switch which receives sonic signal, transistorized relay circuit & electronic switch, crystal mike. Regular value to \$10. Limited quantity electronics surplus, \$1.95 each, 2 for \$3.00. Add 35c handling. Johnson Smith Co., 1012 Auto. St. Mt. Clemens, Mich. 48043.



You can make money in

# WATCH REPAIR

## Learn at home the low cost Sweazey Way

Develop your skill step by step in your spare time at home. Chicago School of Watchmaking's exclusive Sweazey System shows you how to repair all types of Swiss and American watches. Practical shop training. No previous experience needed. Age no barrier. Diploma awarded. Send today for free information and sample lesson. No obligation. No salesman will call.

CHICAGO SCHOOL OF WATCHMAKING  
Dept. 1123 Fox River Grove, Illinois 60021

## FREE BOOK and SAMPLE LESSON

CHICAGO SCHOOL OF WATCHMAKING  
Dept. 1123, Fox River Grove, Illinois 60021  
Please rush FREE BOOK and Sample Home Study Lesson.

Name \_\_\_\_\_ Age \_\_\_\_\_  
Address \_\_\_\_\_  
City \_\_\_\_\_ State \_\_\_\_\_ Zip \_\_\_\_\_

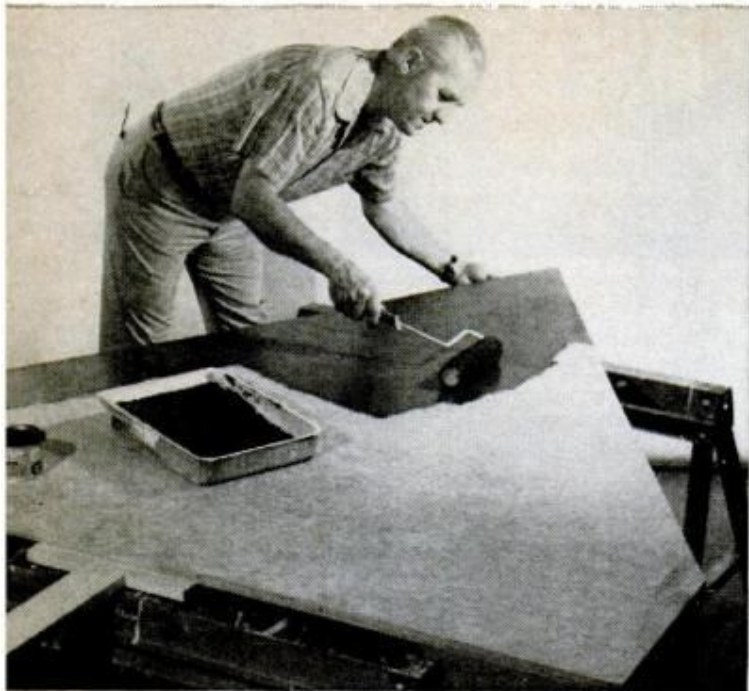

Front and back of tree are given two coats of latex enamel to improve looks, help waterproof the plywood.



The 1/2-in. holes in bottom of cans are used as guide for drill when boring 1/2-in. holes through plywood.

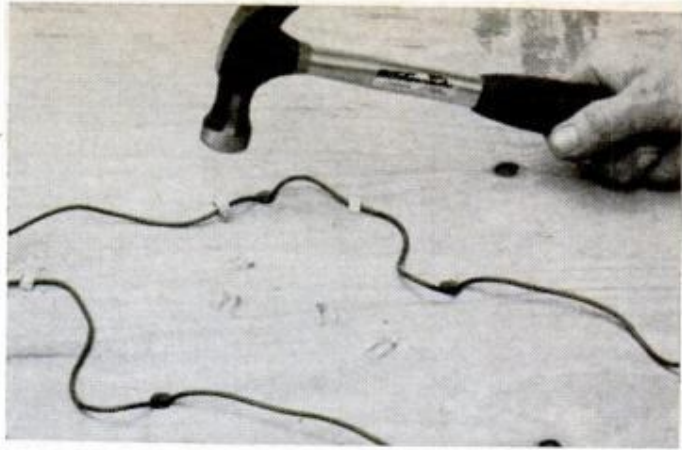

After outdoor light sockets have been inserted through holes from the back side, the socket wires are secured flat against the plywood with insulated staples.

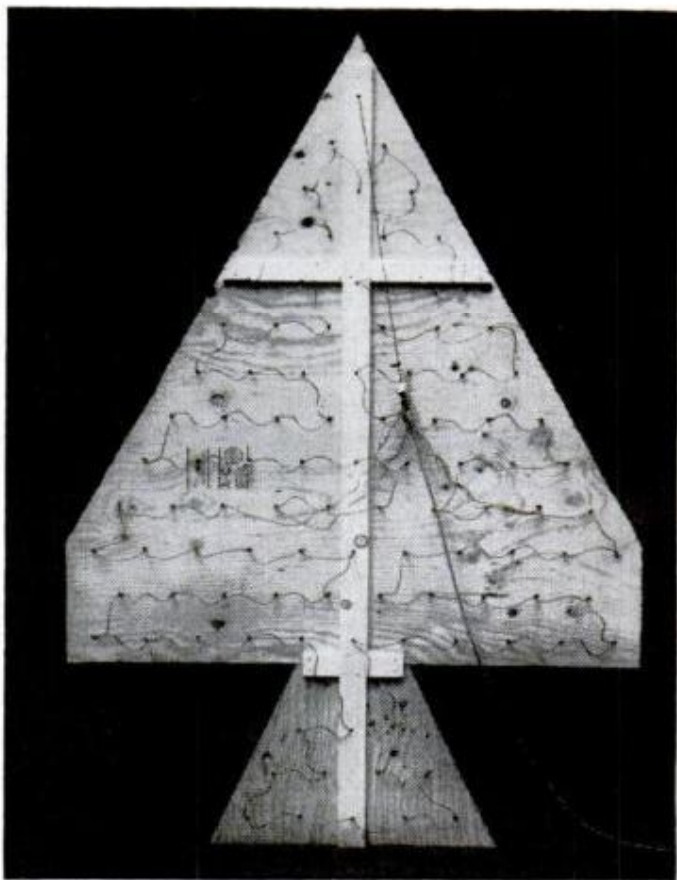

Separate socket in top can (cut from old tree-light string) is fitted with short line cord and plug.

## YULE TREE—FROM TIN CANS

*(Continued from page 72)*

tree, built up from a single 4x8-ft. sheet. Three separate pieces are joined together from the back with 1x3 cleats and screws. Then two coats of forest-green latex enamel are rolled on the front of the plywood  
*(Please turn to page 182)*

Two 50-socket sets of miniature lights are required. The GE Merry Midgets are available in assorted colors and cost approximately \$6.50 per set.



## MAKE UP TO \$12 AN HOUR AT HOME

Let Me Prove It To You FREE!

I'll show you how Plastic Laminating at home, spare time, can give you as much as \$12 each hour you operate. Table-top machine sets up anywhere. Easy. Fun. No experience needed. We furnish everything. We'll even help finance you. No house-to-house selling. Orders come by mail. Write for facts FREE. No salesman will call.

WARNER ELECTRIC, Dept. L-2-CP, 1512 Jarvis, Chicago, IL 60626



## HOME-WORKSHOP ELECTRIC ARC WELDER \$9.99!



WELDS—BRAZES—SOLDERS—CUTS—ALL METALS! Plugs into ANY 110 volt socket. MAKE—REPAIR most anything for CAR—HOME—BUSINESS. Lifetime BURNOUT GUARANTEE. 10 day money back trial (if retnd). HEAVY DUTY Design. No experience needed—FREE WELDING LESSONS!

(cash, ck. M.O.) and pay postman \$7.99 COD postage or send \$9.99 plus \$2.00 for postage—packing in U.S.A. COMPLETE READY TO USE—Includes BIG pack steel, Brazing, Solder, Carbon "touch" rods & ELECTROFLAME ARC TORCH! OFFER LIMITED—Order TODAY! MIDWAY WELDER, Dept. EPM-12, Kearney, Nebr. 68847

SEND \$2.00

ONLY postage or send \$9.99 plus \$2.00 for postage—packing in U.S.A. COMPLETE READY TO USE—Includes BIG pack steel, Brazing, Solder, Carbon "touch" rods & ELECTROFLAME ARC TORCH! OFFER LIMITED—Order TODAY! MIDWAY WELDER, Dept. EPM-12, Kearney, Nebr. 68847

## REWCO CENTER FINDER

Locates the precise center of dowels and any size square, round, octagonal and rectangular stock.

Stainless Steel—Professional Accuracy—No Adjustments

Woodworkers: Use My Tool. Then if You Can Do Without it, Return For Refund.

REWCO, Box 567,

Rogers, Arkansas 72756

SEE PAGE 136 PM NOV. 73



(\$2.00 ppd.)

## 150,000 Candlepower "FLAMETHROWER" Sealed Beam Headlights

Over 2 1/2 times as bright as stock high beams. Lets you see whats ahead. (at 60 mph. you overdrive your present lights). No alterations, fit bright sockets on quad (4) light 12V systems. Be Safe not sorry, Satisfaction guaranteed.

\$11.95/pair, ppd. USA no c.o.d. please.

Extend your safe driving line of SIGHT

Warren Enterprises, Box 563m, Skokie, IL 60076



## TELLS HOW TO SELL YOUR INVENTION

If you have an invention that you believe has merit, write us at once for copy of copyrighted booklet "How to Go About Selling Your Invention." We work with manufacturers, and booklet reveals present markets, qualities of a saleable invention, current royalty rates being paid by manufacturers. Booklet is FREE, is offered to encourage new ideas we might submit to manufacturers. Just send name (no drawings, please) to Kessler Sales Corp., Dept. D-512, Fremont, Ohio 43420

## FIND BURIED TREASURE

Powerful electronic detector finds buried gold, silver coins, etc. Write or call for free catalog. Dealer inquiries invited.



Financing Available 19.95

Phone day - night (713) 682-2728

RELCO, Dept. D-3 198.50

BOX 10839, HOUSTON, TEX. 77018

## LEARN MEAT CUTTING



Train quickly in 8 short weeks at Toledo for a bright future with security in the vital meat business. Big pay, full-time jobs—HAVE A PROFITABLE MARKET OF YOUR OWN! Time payment plan available. Diploma given. Job help. Thousands of successful graduates, OUR 60th YEAR! Send illustrated FREE catalog. No obligation. No. 0197T

NOW for big new illustrated FREE catalog. G.I. approved. NATIONAL SCHOOL OF MEAT CUTTING Dept. 50-D, Toledo, Ohio 43604

## BUILD, FLY YOUR OWN COPTER!

It's great sport to fly a Bensen Gyrocopter — lowest cost, too. Fly high or low, fast or slow. Adapts to skis. Pilot ages range from teens into 60's. Enjoy flying this easy way! Plans, parts and factory kits available. Get colorful info packet with photo, specs, 3-View Drawings. Send \$5 today!

BENSEN AIRCRAFT CORP., Dept. PM-123 RDU Airport, Raleigh, N. C. 27602



NAME \_\_\_\_\_

ADDRESS \_\_\_\_\_

## Muzzle Loading KITS



Complete with all parts needed to make a handsome, fully shootable Muzzle Loading Pistol. .44 cal. precision rifled, octagonal barrel, front and rear sights. Stock fully contoured and Semi-inletted. All

holes drilled and tapped. Illustrated instructions. Available in Percussion and Flintlock Models. Model KA702 (pictured) \$19.95 + \$1 Shipping.

Complete Kentucky Rifle Kits available from only \$57.45 (Percussion) and \$61.45 (Flintlock) plus postage.

CONNECTICUT VALLEY ARMS, INC.

Dept. PM Higganum, Conn. 06441

Enclosed is a self-addressed, stamped envelope. Please send FREE Brochure on CVA Muzzle Loading Kits.

Name \_\_\_\_\_

Address \_\_\_\_\_

City \_\_\_\_\_

State \_\_\_\_\_

Zip \_\_\_\_\_



CONNECTICUT VALLEY ARMS, INC.

## miniWINCH

Pulls In Excess Of 1 Ton - Weighs Only 12 Pounds

\* Simple to operate \* Attaches to any popular chain saw

Powerful help for Homeowners — Sportsmen — Contractors — Snowmobiles — Campers — Boatowners — Builders — Farmers — Rescue Units



BUY IT FROM YOUR LOCAL CHAIN SAW DEALER OR DISTRIBUTOR

TRIWAY MANUFACTURING, INC. \*

P.O. BOX 37 MARYSVILLE, WASHINGTON 98270

## locksmithing and key making

PRACTICAL UP-TO-DATE COURSE — ONLY \$7.95

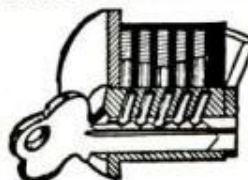

Teaches you how to pick locks, de-code, make master keys, repair, install, service, etc. New self-instruction lessons for every handyman, homeowner, carpenter, mechanic, service station operator, fix-it shop, hardware dealer, gunsmith. 53 easy illustrated lessons. Full price only \$7.95 postpaid. Satisfaction or refund guaranteed. Mail order today!

NELSON-HALL CO., Dept. 6MX-2 325 W. Jackson Blvd., Chicago 60606

DECEMBER 1973

177

## OF POPULAR MECHANICS

**Alaskan oil** will help ease the fuel shortage—but will the pipeline wreck the wilderness? Next month's cover story examines a bold engineering proposal that promises good ecology and oil, too. A 789-mile bridge would carry highway-rail traffic as well as the pipe 30 feet above the tundra and wildlife. . . . The wide, wonderful world of **motorcycle competition** offers something for everyone: dirt-track racing, friendly hill climbs, muddy struggles, hairy motocross events. . . . **Is airline safety slipping?** PM reviews some of the worst recent accidents. We go to the hangars to see what's done before the big jets take off.

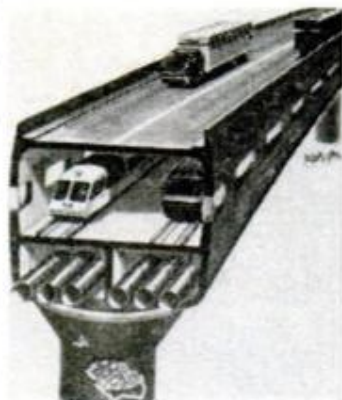

save know-how features include such familiar (or not so familiar) jobs as **How to Fix a Freezer**, **How to Hang Wallpaper**, **How to Work With Plastic Pipe**.

Our **Camper top for compact pickups** is just what hunters and fishermen have been



waiting for. You can build it on a weekend for under \$150. . . .

Teen-age mechanics winning **Plymouth's Trouble Shooting Contest** get scholarships, tools. We tell how to enter; what it takes to win. . . . **Simulators teach old salts new tricks:** Merchant seamen learn how to navigate automatic ships electronically. . . . PM's photo editor shows you cures for **muddy prints** and how to make a **custom camera bag**. . . . **Electronic synthesizers** that reproduce any musical-instrument sound and create never-before-heard sounds are available at electronic-organ prices. . . . All this and much more in the exciting January issue.



We show you how to build five units of **modular furniture**—desk, bar, sewing center, dressing table and bookcase-room divider—in handsome modern and sharing a common construction technique. . . . First sign of spring for boatmen is a January boat show. We bring you **the best new boats for '74**, a preview of new models you'll see at shows and marinas this year. . . . Clip-and-



**Buy it on your newsstand. Better yet, make sure you'll keep getting this kind of exciting fare. Send this coupon with your check to:**

**POPULAR MECHANICS**  
250 West 55th Street  
New York, New York 10019

Please enter my subscription for  1 yr. \$5.97 or  2 yrs. \$10.97

Name \_\_\_\_\_ (Please print)

Address \_\_\_\_\_

City \_\_\_\_\_ State \_\_\_\_\_ Zip \_\_\_\_\_

Payment of \$\_\_\_\_\_ is enclosed.  New  Renewal

On new subscriptions, first copy will arrive in about 8 weeks.

(Above prices apply in U.S. and Possessions only. Canada, add \$2 per year. All other countries, add \$4 per year.)

WPM3L1

# POPULAR MECHANICS

## HOLIDAY SHOPPING GUIDE



**SAVE 40%**

**CAR MODELS, TRAINS,  
ROAD RACE SETS**

\$2.25 models \$1.35; \$118 train set \$70.91; \$40 road race set \$24; \$22 Cox gas-powered buggy \$13. Send \$1 for membership catalog.

Hundreds of Other Models

DISCOUNT CLUB, Box 697P, Bethany, IL 61914

**HEX NUT-SIZE  
RE-THREADER**

**DIES**

Run on and off with regular wrench to renew bad threads! 7 Piece Die Set in Plastic Case works on sizes: 1/4", 5/16", 3/8", 7/16", 1/2", 9/16" and 5/8"



C7=Coarse F7=Fine Threads \$3.25 Set, Get Both for \$6 Ppd.

Satisfaction Guaranteed

JAW MFG. Box 213 Reading, Pa. 19603



**FREE!!! POWERFUL MUSCLES FAST!**

Fantastic New Discoveries in the science of bodybuilding. Now, in the privacy of your bedroom, our method will add inches of powerful muscles to arms, chest, shoulders & legs. Learn secrets on trimming the waist with ultra-modern methods—fast! Results Guaranteed! Send for free brochure, Universal Bodybuilding, Box 485-M1, Dearborn, Mich. 48121.

**WHO'S MAKING  
A BUNDLE?**

How much profit does Joe's business make (exactly)? Any business? Costs? Cash needed? Knowledge needed? How to start? Case history details on every profitable business around.

**INSIDER'S REPORT 3K**

Box 90954, Los Angeles 90009

**DIGITAL: THEORY. DESIGN,  
CONSTRUCTION**

**LOGIC**

**NEWSLETTER** ©

SAMPLE COPY \$1.00  
LOGIC NEWSLETTER  
POB 252  
WALDWICK, N.J. 07463

Worked 16 hours  
a day  
AGAIN? **FOR  
WHO?**

Be a Fox Swimming Pool Dealer. If you qualify you'll get in on the ground floor of the booming billion dollar leisure-time market and run a rewarding, stimulating business-of-your-own.

You'll be part of Fox Pool Corp.—a solid, long-established growth company with a national network of successful builders. We will set you up, train you, guide you. We back you up with national advertising, leads, sales promotion aids, technical assistance and Field Reps. to support your efforts.

You'll offer the **best** packaged in-ground swimming pool in the world. **The best.** It installs in just days! Result: more pools in less time for more profits.

If you're tired of making others rich, invest in a phone call or 8c stamp and get complete details. Call Don Dahowski (717)-764-8581 or write, Fox Pool Corp., P.O. Box 549, York, Penna. 17405.

**FOX**

THE STRONGEST NAME IN POOLS



Easy to Build **PLANS  
AND INSTRUCTIONS** for

Go Kart .....	\$2.00
Mini Bike .....	\$2.00
Three Wheeler .....	\$2.00
Three Wheeler A.T.V. ....	\$5.00
Mini Car .....	\$3.00
Pedal Boat .....	\$4.00
12' Sail Boat .....	\$4.00
Sail Board .....	\$2.00
Pontoon Boat .....	\$1.00
8' Hydroplane .....	\$2.00
Two People Mini Jeep .....	\$3.00
Snowmobile Sleigh .....	\$3.00



Two People Mini Jeep .....\$3.00  
Snowmobile Sleigh .....\$3.00



**MINI VEHICLES PLANS**

"DEPT. C"—P.O. Box 92  
Chazy, N.Y. 12921

**KEEP  
WARM**

**WITH PAULIN'S 8,000 B.T.U.  
INFRA-RED HEATER**

Hottest heater  
anywhere, for its size.

Instant heat • No waiting.

Easy to operate and light.

Operates up to 4 hrs. on 14

oz. cylinder

Stands upright or hangs on wall.

Guaranteed 3 yrs.

Comes complete with wall

bracket, 14 oz. cylinder and

stand.

Order by mail, postpaid \$21.95

dept. PM



MODEL  
690100

**PAULIN**

30520 Lakeland Bl., Willowick, O. 44094

**KUNG FU Training Disk**

Acquire the speed of a master with amazing, special metal disks. Its timing, velocity and distance never twice the same. Safe self-training in: Breath, Throw, No-blink, Grasp, Hit, Kick, Jump & Sixth sense, step by step. For health & self-protection. \$2.00 a kit. Your money back guaranteed. Free training lessons included, offer once only.



**MR. C. YANG, 2402 St. Charles,  
Cinnaminson, N.J. 08077**

**SAVE! BUILD YOUR OWN  
POWER TOOLS**



**METAL PARTS KITS AT  
FACTORY DISCOUNT PRICES**

- 10-in. TILT/ARBOR SAW
- 6-in. BELT SANDER
- SPINDLE SHAPER
- 9-in. TILT/TABLE SAW

- 18-in. BANDSAW • 12-in. BANDSAW
- COMB. DRILL PRESS-LATHE

**SAVE \$50 OR MORE** with **PLANS, \$200** FULL-SIZE PATTERNS per Plan Deductible

**Kits from \$19.99 to \$59.99** Featured in Popular Science, Mechanix Illustrated. Sold for 27 years. Thousands in use. Satisfaction guaranteed. Send \$2 each for Plans (state tools wanted), Catalog included. Or send 25c for Catalog!

**GILLIOM MFG. CO.**  
Dept. PMT-12 St. Charles Mo. 63301



**SILVO**  
(BRAND NAME)  
TOOL  
CATALOG  
Thousands  
of exciting  
tool values!

Stanley, Skil, Thor, Wen, Disston, Wiss, Wellsaw, Dremel, Plumb, Huot, Kennedy, Channellock, Rockwell, Helois, Vise-Grip, Crescent, Rigid, Pony Clamps, Unimat, Foredom and many other Nationally Advertised brands of Tools & Supplies. We ship Coast to Coast at prices Hard to Beat. Send \$1.00 for our big 196 page tool catalog today.

Silvo Hardware Co., PM-73  
107 Walnut St., Philadelphia, Pa. 19106

**Want to make some easy money?**

Let us show you how to begin AT ONCE...full or spare time. Many report \$10 to \$50 PROFIT FIRST HOUR! Nothing to buy...no salesman will call. EVERYTHING NEEDED SENT FREE including BEAUTIFUL SAMPLE!

Write: Russell Products Co.  
DEPT. K25, COLUMBIA, TENN. 38401



**DETROIT APPROVED  
PICKUP  
TANKS**



Original equipment type poly, now available in auxiliary tanks for pickups. Increase gas capacity 40 gals. Far superior to metal, complete hidden, no body work necessary. Easy 1 hour installation—Truck discounts pay for tanks in a short time. Two tanks, brass valve, hose, complete. Meets Federal Regulations.

**PICKUP EQUIPMENT CO. LTD.**  
Dept. PM-1273, P.O. Box 7635  
WACO, TEXAS 76710  
CALL TOLL FREE 800-433-2386

**DUNE-BUG**

Complete plans & specs on how to build or buy - disc. prices on parts, kits, engines, & raw material.



Send \$1 for DUNE-BUG pkg. to:  
Box 987P12, Azusa, Ca. 91702,  
Ph (213) 334-0334

**NEW! PROTECTIVE GLASSES**  
FOR FOG—RAIN—BLINDING HEADLIGHTS!

Now—first time in USA  
Sensational self-adjusting glasses prevent any glare—without impairing vision.

In rain and fog field of vision remarkably enlarged—diminishes blurs—improves definition and contrast. Prevent fatigue and headache. New safety for long hour driving. Tested and recommended by optometrists. An optic quality product. (Pat. in West Germany) Also available in clip-ons to be worn over prescription glasses.

Send \$15.95 + 50¢ postage  
Money Order or Check to

Galvani Imports Dept. 133  
82-90 Broadway,  
Elmhurst, N.Y. 11373

**WOODCARVING**

SIGNS, PLAQUES, GIFT ITEMS ETC. IS EASY AND PROFITABLE WITH OUR 3-D CARVING MACHINES. SEE YOUR LOCAL MACHINE DEALER OR SEND FOR FREE BROCHURE.

**MARLIN INDUSTRIES**  
7351 Adams Street, Dept. PM-12  
Paramount, California 90723

**FACTORY CLOSEOUT!**  
**AIR PISTOL \$6.95**

(with Free can of pellets) 6 ppd.

Shoots both pellets and darts. This fine, well made .177 cal. German air pistol is just the ticket for target or Varmints.

Accurate. No CO2 cartridges to replace, either. Once in a lifetime bargain. Order several. Supply limited. Only \$6.95 ppd.

(Secret leather holster, \$2.95 ppd.)  
600 Deluxe Pellets, \$2.40 ppd.  
20 Steel Darts, \$2.00 ppd.

**AIR PISTOL, Dept. PM-12**  
4535 Huntington Dr. South  
Los Angeles, Calif. 90032



**PORTABLE STEAM CLEANER**  
Steam in 60 seconds



**CLEAN:** Engines—Air filters—lawn mowers—trucks—tractors

"Big enough to do the job, small enough to get there."

Fast, economical, ruggedly built. 3 year guarantee on coils & firebox. Propane fired. Weighs 120 lbs.

Auxiliary pump required on water pressures below 60 lbs. or on well systems.

**WEDCO MFG. INC., Dept. M-4,**  
Box D, Jackson, Wyo. 83001

**AUTOMATIC SAW SET**

Set saw teeth automatically—400 per minute without effort. Perfect hammer and anvil action sets teeth uniformly—no tooth breakage.



**FOR HAND SAWS AND BAND SAWS**

Write for details  
**BURR MANUFACTURING CO.**  
8931 Venice Blvd.  
Los Angeles, Calif. 90034

**BUILD AN ELECTRIC BIKE!**

Recycle an old bicycle this winter. Build an inexpensive, quiet, 27 m.p.h. electric bike. Easy-to-follow illustrated plans. Send \$3.95 to:

**ZEEMO ELECTRIC BICYCLES**  
Dept. B, 2239 N. Lincoln, Chicago, Ill. 60614

**THE ALL NEW KITE!**

FUN FOR EVERYONE.  
COMPLETE—READY TO FLY. LOOPS—DIVES.  
IDEAL FOR CHRISTMAS



**F. T. SADA MFG. CO.**  
7113 BANDERA RD.  
SAN ANTONIO, TEXAS 78228

**FIGHTING KITE**  
2.95 EA. P.P.D.

**FIX LAWN MOWERS**  
FOR FUN & PROFIT!



Fascinating new Handbook by F. Peterson gives you the knowledge skilled mechanics learn. **OVER 125 ILLUSTRATIONS** show how to trouble shoot, repair carburetors, engines, balance and sharpen blades, etc. Exploded drawings are extensively used.

**INSTRUCTIONS COVER** reel, rotary and rider mowers, preventive and routine maintenance, how to identify brand names, where to obtain replacement parts. How to buy and use a lawn mower. Friends gladly pay \$10 to \$50 to fix their lawn mowers. Try the **HANDBOOK OF LAWN MOWER REPAIR**. Rush only \$6.95 plus 50¢ handling on 10-day money-back guarantee.  
**EMERSON BOOKS, INC., Dept. 112A**  
Buchanan, New York 10511

**WE DARE TO MAKE THIS SHOCKING OFFER!**

**4 HEAVY DUTY SHOCK ABSORBERS \$36.00**  
Lifetime Guarantee

Make check or money order payable to Bristol Auto Parts. No C.O.D.'s. Send order to Special Mail Order Offer, Bristol Auto Parts, 21 North St., Bristol, Conn. 06010. Include make of car, model, year, No Cyl. & Eng. size. Catalog on other Discount Auto Parts available for \$1.00.

**PLASTIC CUTTER**

CUT SHEET PLASTIC, MICA, TILE, EASILY

AMAZING NEW TOOL



Save hundreds of dollars remodeling kitchen cabinets, ceilings, floors, etc. with this new cutter

ORDER NOW AND INSTRUCTIONS ON CUTTING WILL BE INCLUDED  
Satis. Guar. No C.O.D.'s  
Add 50¢ Handl. & Post.  
Dealership inq. invited Only

**\$4.98**

**TOLCO** 930 N.W. 27th AVE.  
MIAMI, FL.

**Fantastic Swiss Measuring Tool**



**Model 70-D DIAL CALIPER**  
5" range  
ONLY \$9.95  
Add \$1.00 postage

Measures 3for inside, outside, depth & step readings. \$26.00 Dial graduated in .001" unbreakable. Includes rust proof, patented construction. case, & 500 pg catalog \$1.00 -free with order. shipping

**SCHLESINGERS FOR TOOLS LTD.**

1020 East 54th Street,  
Brooklyn, N.Y. 11234

## GODESIC DOME!



21 Ft. DIA.  
LESS  
THAN  
\$850.00

HOUSE!  
SHOP!  
GREENHOUSE!

Kit includes metal frame kit and metal cover with all hardware, excluding door and glass. Or buy the frame kit and cover it with glass or plastic for a low cost greenhouse. **FREE DETAILS!**

Write: **TRAMSPAN**  
300 Greenville St., Newnan, Ga. 30263

IMPORTED

## LOCK BLADE KNIFE

ONLY \$275 each

9" Overall Length  
5" When Closed

- Sharp and Tough
- Stainless Steel Blade



Locks into position to prevent accidental closing. Razor sharp tough stainless steel blade for reliable use and hard, long service. Money back in 5 days if not satisfied. Send \$2.75 plus 25¢ to cover postage and handling.

**WESTBURY SALES CO.**  
P.O. Box 434, Westbury, N.Y. 11590  
Dept. L-12-PM

CANOE KITS Since 1962

## BUILD YOUR OWN CANOE

WOOD & CANVAS KITS \$59.00  
MOLDED FIBERGLASS KITS

FREE CATALOG (A Complete Canoe Kit)

**TRAILCRAFT** INC.

Ph. 913/243-1313 P.O. Box 60679 Concordia, Kans. 66901

## KARATE

JUDO • SAVATE • JIU-JITSU

The Greatest Self-Defense System Known to Man! FREE Brochure reveals Self-Defense Techniques.

Send to: **Universal, Dept. M**  
Box 39303, Detroit, Mich. 48239 **FREE**

## 110 Volt A.C. GENERATORS

60 cycles. Fanbelt driven from car or gas engine. Operates T.V., refrigerators, radios, all power tools, projectors, P.A. systems and fluorescent lights. Over 12-000 in service. Guaranteed six months. 1500-watt \$85.00 postpaid. 3000-watt \$105.50 postpaid. Special X-1000 watt self-excited generator \$85.00 postpaid.

**TOOL POWER™ patent pending**

115 volts D.C. 5000-watts. 50 amps from your car's alternator. **Guaranteed 20 years.** Install in ten minutes. Operates all power tools, electric motors up to 2 h.p. Arc welding, fast battery charging. Any like device by any name is an infringement of our patent pending. All copiers are notified. Be safe, buy from the inventor and developer. \$25.00 postpaid. Attractive dealer plan.

**VIRDEN PERMA-BILT CO.,**  
P.O. Box 7160PM

2821 Mays, Amarillo, Texas 79109

The  
do-it-all  
portable radio...  
8 bands plus  
automatic weather!

only  
\$89.95

Here's the most useful, most unusual portable multi-band radio you've ever seen, engineered by Triumph Electronics, Division of General Time. Convenient push-button selectors bring in AM, FM, FM-AFC, Aircraft Weather, Ship-to-Shore, Hi-Band and Low-Band Short Wave, Aircraft and Public Service Broadcasts. *Plus*—there's an instant U.S. Weather Service band you switch on without disturbing other settings. Unique world-time map and dial lets you calculate the time anywhere in the world quickly. Operates on household current or batteries. Telescoping FM antenna and separate weather-band antenna. Slide controls for tone and volume. **Hurry!** This special mail order price may have to be increased soon!



**Clocks 'N Stuff**  
P.O. Box 184, Dept. TPM  
Spring Valley, Illinois 61362

Please send my Portable AM/FM/SW Radio immediately.

- My check or money order for \$89.95 is enclosed. (Ill. residents add 5% sales tax.)
- Charge to Master Charge \_\_\_\_\_ number

Signature \_\_\_\_\_

Name \_\_\_\_\_

Address \_\_\_\_\_

City \_\_\_\_\_

State \_\_\_\_\_ Zip \_\_\_\_\_

## YOUR OWN RADIATOR BUSINESS

"\$70,000  
LAST YEAR"

says D. Carter,  
Lemoine, Pa.



Complete turn-key package: training school in radiator repair technology and business management plus special power-equipped auto radiator shop.

Don Carter writes: "Averaging \$30 an hour, expect to hit \$80,000 next year." Mail this coupon for complete story.

NAME \_\_\_\_\_

ADDRESS \_\_\_\_\_

CITY \_\_\_\_\_ STATE \_\_\_\_\_

ZIP \_\_\_\_\_ PHONE \_\_\_\_\_

**INLAND MFG. CO. Dept. PM-12**  
1108 Jackson Street • Omaha, Nebr. 68102

## BEST LEARN-IT-YOURSELF BOOKS

- Guide to Auto Tuneup & Emission Control Svcs. \$8.95
- Everyman's Guide to Auto Maintenance. 192p. \$7.95
- The Complete Mini-Bike Handbook. 320 pps. \$8.95
- Electrical Wiring & Lighting Home & Office \$7.95
- Basic Electricity & Beginning Electronics. \$7.95
- Profes. Picture Framing for Amateurs. 224pp. \$5.95
- How to Repair Small Gas Engines. 288 pps. \$8.95
- Small Appliance Repair Guide. 224pp. \$7.95
- Using Electronic Testers for Auto Tuneup. 256p. \$6.95
- Electric Motor Test & Repair. 140pp. \$6.95
- Major Appliance Repair Guide. 288pp. \$7.95
- Cassette Tape Recorders / Care & Repair \$7.95
- 4-Channel Stereo. From Source to Sound. 174p. \$6.95
- How to Repair Home & Auto Air Conditioners \$7.95
- Introduction to Medical Electronics. 372p. \$9.95
- Landsailing-From RC Models to the Big Ones. \$7.95
- How to Become a Radio Disc Jockey. 254pp. \$8.95
- Basic Radio Course. 224 pages. \$4.95
- 44 Hobby Projects for Home & Car. 192pp. \$7.95
- Refrigeration. 160 pps. 53 illus. \$4.95
- Beginner's Guide to TV Repair. 176pp. \$4.95
- How to Read Electronic Circuit Diags. 392pp. \$7.95
- Understanding & Using the VOM & EVM. 192 p. \$7.95
- Marine Electronics Handbook. 192pp. \$7.95
- Fire & Theft Security Systems. 174 pps. \$7.95

SEND NO MONEY! We'll invoice you on 10-DAY FREE TRIAL. Clip entire ad to order. 100 percent guaranteed—used by hundreds of thousands to learn. Same day shipment. **TAB BOOKS, Dept. PM-123 Blue Ridge Summit, Pa. 17214**

## BUILD YOUR OWN MINI-CAR

Easy to read plans and specifications make this a great father and son project. Mini-Car can handle 8 to 14 h.p. engine. It bolts together. Designed for 4 wheel brakes. All parts can be purchased from any auto supply dealer. Send \$5.00 for plans and specs. to:

**C.S.C. Engineering Co.**  
P.O. Box 5095, Garden Grove, Calif. 92645

## BIG PROFITS ELECTRONIC ASSEMBLY BUSINESS

Start home, spare time. Investment, knowledge or experience unnecessary. **BIG DEMAND** assembling electronic devices. Sales handled by professionals. Unusual business opportunity.

FREE: Complete illustrated literature  
BARTA, Box 248HZ  
Walnut Creek, Calif. 94597

## Build This All-Wooden Clock

Complete plans for building this unique clock. 100% wood. All moving parts visible. No special tools required. Separate

hour, minute, and second hands, weight driven, keeps perfect time. May be mounted in large grandfather case or displayed on pedestal or shelf. A simple project for the woodwork hobbyist or clock enthusiast. Plans only, \$4.00 plus 50¢ handling. **R. D. Thomas, 1412 Drumcliffe Rd., Winston Salem, N. C. 27103**

**GOVT. SURPLUS**

and other bargains  
**SAVE to 90%**

Send for this catalog

The world-famous Airborne Catalog. Fully illustrated. Contains 1000's of bargains in hydraulics, electrical, marine, automotive & hardware items . . . and more! A must for mechanics, machinists, hobbyists, sportsmen, inventors, etc. Send 35¢ to cover postage & handling. In a hurry? Send \$1 for airmail delivery. Must include zip.

**AIRBORNE SALES CO.** Dept. PM73  
8501 Steller Dr., Box 2727, Culver City, Ca. 90230  
Satisfying world-wide customers since 1945



## YULE TREE—FROM TIN CANS

(Continued from page 176)

tree and two coats of white (or green) are rolled on the back.

After all the cans are fastened to the plywood, 1/2-in. holes are drilled through the wood using the holes in the bottoms of the cans to center the drill.

Not all miniature tree lights can be used since some brands do not have enough wire between sockets to reach from hole to hole. (Be sure lights are rated for outdoor use.)

Two General Electric 50-light Merry Midget sets were used in the original tree, mixing red, green, blue and yellow bulbs and using red alone in the trunk cans. The bulbs and sockets are inserted in the cans through the holes in the back. Count off the 24th socket in the string and use it to start hole A in the vertical cleat. Work outward in each direction and upward. Do the same with the second string, inserting socket 24 in hole B and working downward. The two strings are plugged together and the wires stapled here and there to the plywood. A separate bulb and socket are used to top-out the tree since two 50-light sets leave one light short. This can be cut from an old regulation-size light string and plugged into the other light sets. Use a white bulb for the top one and center it in a star reflector cut from an aluminum-foil pizza pan.

Finally a 6-in. disc of common kitchen foil, with a hole in the center, is rubber-cemented to the bottom of each can. The shiny foil reflects light against sides of the cans to provide added sparkle. ★★★

## FOUR-WHEEL-DRIVING FUN IN WINTER

(Continued from page 105)

a channel that's deep enough to hang you up.

If hopelessly stuck, you should be prepared with your emergency kit to await rescue, usually a safer action in bad weather than walking out. This presumes you left word before you departed about where you'd be. You should always be carrying the clothing, implements and supplies necessary to keep warm, dry and fed, and to signal for aid.

If you're desperate, a spare tire full of gas laced with oil makes a dense and effective smoke signal.

Once you're out of the woods, off snowy highways and back home, clean your vehicle, so you'll be ready to go out again while all that fresh, white snow is packed in the mountains! ★★★

STATEMENT OF OWNERSHIP, MANAGEMENT AND CIRCULATION (Act of August 12, 1970; Section 3685, Title 39, United States Code). 1. Title of publication: Popular Mechanics. 2. Date of filing: October 1, 1973. 3. Frequency of issue: Monthly. 4. Location of known office of publication: 224 West 57th Street, New York, N.Y. 10019. 5. Location of the headquarters or general business offices of the publishers: 959 Eighth Avenue, New York, N.Y. 10019. 6. Names and addresses of publisher, editor, and managing editor. Publisher: The Hearst Corporation, 959 Eighth Avenue, New York, N.Y. 10019. Editor: James Liston, 224 West 57th Street, New York, N.Y. 10019. Business Manager: Joseph F. Kern, 224 West 57th Street, New York, N.Y. 10019. 7. Owner: The Hearst Corporation, principal office, 100 West Tenth Street, Wilmington, Delaware 19801—Stockholders owning or holding 1 percent or more of total amount of stock of The Hearst Corporation are: William Randolph Hearst, Jr., Randolph Apperson Hearst, David Whitmire Hearst, George Hearst, (deceased), The Hearst Foundation, Inc. and the Trustees of Trusts created under the Will of William Randolph Hearst, Deceased, namely: Richard E. Berlin, Franklin C. Snyder, Richard E. Deems, David Whitmire Hearst, John R. Hearst, Jr., George Hearst, Jr., Randolph Apperson Hearst, William Randolph Hearst, Jr., Harold G. Kern, Frank Massi, John R. Miller, Raymond J. Petersen, J. Kingsbury-Smith, the address for all of the foregoing being 959 Eighth Avenue, New York, New York 10019, and the William Randolph Hearst Foundation, 811 West Seventh Street, Los Angeles, California 90017. Those having a beneficial interest in the Trusts mentioned above are: William Randolph Hearst, Jr., Phoebe Hearst Cooke, George Hearst, Jr., Randolph Apperson Hearst, David Whitmire Hearst, John Randolph Hearst, Jr., William Randolph Hearst, II, Joanne Hearst Tarafa, Deborah Hearst and The Hearst Corporation. 8. Known bondholders, mortgagees, and other security holders owning or holding 1 percent or more of total amount of bonds, mortgages or other securities (if there are none, so state) None. 9. For optional completion by publishers mailing at the regular rates (Section 132.121, Postal Service Manual). 39 U.S.C. 3626 provides in pertinent part: "No person who would have been entitled to mail matter under former section 4359 of this title shall mail such matter at the rates provided under this subsection unless he files annually with the Postal Service a written request for permission to mail matter at such rates." In accordance with the provisions of this statute, I hereby request permission to mail the publication named in Item 1 at the reduced postage rates presently authorized by 39 U.S.C. 3626. (Signature and title of editor, publisher, business manager, or owner) Joseph F. Kern, Business Manager. 10. For completion by nonprofit organizations authorized to mail at special rates (Section 132.122, Postal Manual) (Check one) The purpose, function, and nonprofit status of this organization and the exempt status for Federal income tax purposes  Have not changed during preceding 12 months  Have changed during preceding 12 months (If changed, publisher must submit explanation of change with this statement.) 11. Extent and nature of circulation. A. Total no. copies printed (Net Press Run). Average no. copies each issue during preceding 12 months, 1,947,800; Actual number of copies of single issue published nearest to filing date, 2,054,900. B. Paid circulation, 1. Sales through dealers and carriers, street vendors and counter sales; Average no. copies each issue during preceding 12 months, 380,171; Actual number of copies of single issue published nearest to filing date, 340,800. 2. Mail subscriptions; Average no. copies each issue during preceding 12 months, 1,380,954; Actual number of copies of single issue published nearest to filing date, 1,476,298. C. Total paid circulation: Average no. copies each issue during preceding 12 months, 1,761,125; Actual number of copies of single issue published nearest to filing date, 1,817,098. D. Free distribution by mail, carrier or other means: 1. Samples, complimentary, and other free copies; Average no. copies each issue during preceding 12 months, 9,886; Actual number of copies of single issue published nearest to filing date, 10,443. 2. Copies distributed to news agents, but not sold; Average no. copies each issue during preceding 12 months, 176,456; Actual number of copies of single issue published nearest to filing date, 227,200. E. Total distribution (Sum of C and D): Average no. copies each issue during preceding 12 months, 1,947,467; Actual number of copies of single issue published nearest to filing date, 2,054,741. F. Office use, left-over, unaccounted, spoiled after printing; Average no. copies each issue during preceding 12 months, 333; Actual number of copies of single issue published nearest to filing date, 159. G. Total (Sum of E & F)—should equal net press run shown in A): Average no. copies each issue during preceding 12 months, 1,947,800; Actual number of copies of single issue published nearest to filing date, 2,054,900. I certify that the statements made by me above are correct and complete. Joseph F. Kern (Signature of editor, publisher, business manager, or owner).

# CLASSIFIED ADVERTISEMENTS

Rate: \$2.20 per word payable in advance each insertion. Capitalized words—75¢ per word additional. Minimum insertion ten words. To be inserted under the proper classification, copy must be in our office by the 10th of the second month preceding date of issue. The next available issue to place an advertisement in America's No. 1 Classified Section is February. The closing date is December 10th. Send remittance and order to H. E. Kappel, Popular Mechanics, 224 West 57th Street, New York, New York 10019. Please make remittance payable to Popular Mechanics.

POPULAR MECHANICS

WHEN ANSWERING ADVERTISEMENTS PLEASE USE THE ZIP CODE NUMBER

## CHRISTMAS GIFT SHOPPING

**FREE CATALOG! SEIKO WATCHES.** Low Price. Dickson Company, Box K-3979, Kowloon, Hong Kong.

**KITES!** Quality Action Styles! Brochure 10¢. Hutchinson, PM12, 83 Tremont, Barre, Vermont 05641.

**DISTINCTIVE** Gift Ideas. Catalog 25¢. Gifts 'n Gadgets. (1A12), Box 312, Carrollton, Texas 75006.

**PERSONALIZED** Book Matches. Any Color. 20 or 30 Strike. \$3.50 Carton of 50. Maximum 3 Lines Printing, 18 Letters/Spaces per Line. Skinner Bros. Imprinters, Box 2171C, Anaheim, Calif. 92804

**COLORFUL** Gift Catalog Free Plus Bonus Offer. Mariners Trading Post PM, 275 Summit St., Norwood, New Jersey 07648.

**GEMSTONE** Trees in Kits easy to make 8 inches high. Beautiful inexpensive gifts. Free Literature. Grayling Gemcraft, Box 613AP, Grayling, Michigan 49738.

**SPACE SAUCER RADIO!** New Space-Age Combination Radio and Desk Pen. Complete with Pen, Holder and Batteries. Send \$18.95 To: Lynann Enterprises, Dept. PM, Box 5704, Fort Lauderdale, Fla. 33310.

**SPORTSMEN—ELECTRIC BUNK WARMER** for RECREATIONAL VEHICLES. Ideal Gift. Free Details. Greatbasinco, 110 Quincy, Ogden 84404.

## AUTOMOBILES

**ELECTRONIC IGNITION** means increased engine performance, gas economy. **Magna DWELL** fits most cars, negative ground. Installs in minutes. On off switch and test post. For additional information write **MAGNA DWELL P.O. BOX 2171, ABILENE TEXAS 79604.** State make, model, year, CID. \$44.95 each. Quantity Discounts Available.

**CAPACITIVE DISCHARGE IGNITIONS. DISCOUNTED.** Rodgers, Son (PM), Box 3583, Anaheim, Calif. 92803.

**GAS MILEAGE INCREASED—Seven Proven** Techniques all legal—rush \$1.00 to—Millers, Box 141, Elbridge, New York 13060.

**SPORTSCAR REMOVABLE CARTOPS** for USA and Foreign-shipped insured anywhere. Illustrated order information \$1.00, airmailed with credit good on order or phone (213) 393-9840. **RUSH SERVICE.** Fiats, Datsuns, TRS, M. Benzs, 190-350 SL's, Corvette 53-73, T Bird 55-7 etc. **SHELL'S** 1452 2nd, Santa Monica, Cal. 90404, Box 767PM

## MIDGET CARS

**YOUR AD IN POPULAR MECHANICS WILL BE SEEN** By More than 5,000,000 active buyers for your products and services. It costs only \$2.20 per word. And, if you wish to run all or part of your ad in bold capital letters—you can do so for as little as 75¢ per word additional. Act now! Send your Classified ad to: **POPULAR MECHANICS, CLASSIFIED DEPARTMENT, 224 WEST 57TH STREET, NEW YORK, N. Y. 10019.**

## AUTO SUPPLIES AND EQUIPMENT

**SELL** \$2.50 Can Guaranteed. Weldite Transmission Conditioner, 120 North Fourth Street, North Wales, Penna. 19454.

**TOWING** Rig Complete \$295.00. Jeep Winches \$95.00. **BEJAY**, 4085 Lincoln, Venice, Calif. 90291.

**ALTERNATORS.** Rebuilt. For American Cars. Guaranteed. Write Car Model, Year, Air cond. \$17.95 plus \$2.85 delivery. Juno Electric. 4808 1/2 West 19 Street, Cicero, Illinois 60650.

**ALTERNATOR/Generator** Rebuilder's Course: includes Tooling & Test Equipment: Write: Hedelund Engineering, P.O. Box 2127, Sepulveda, California 91343.

**RING-Valve** Job while driving. \$6.50 postpaid. (Two-\$12.00). . . . Established 1951. . . . Results Guaranteed!! Motaloy. Grantham, Penna. 17027.

**AIRMASTER** Gas Saver Fits All Cars. \$14.95. Airmaster, Lenora, Kansas 67645.

**UTILIZE** AC Motors as AC generators—three phase motors on single phase—auto generator to DC motor—\$1.50 each. DanRan, Box D, Reno, Nevada 89506.

**NOVEL** Inexpensive Glowing Gage Continuously Checks Ignition Performance. **QARC.** Box 47876, Los Angeles, Calif. 90047.

**PARTS:** Army jeep and truck parts. Spare Parts & Equipment Co., P.O. Box 751, Lexington, Kentucky 40502.

**ANTIQUE FORD PARTS.** Illustrated Catalogue \$1.00. Mark Auto, Layton, NJ 07851.

**SAVE** Money! Buy from Manufacturer. Car Electricity Adapter \$10.95. Battery Additive \$1.95. Information Free. Venture, Box 7431-PM, Baltimore, Maryland 21227.

**NEW** Economical Multi-Purpose Auto Jack on Wheels. Great for VW Engine removal and installation. Ideal for Home Auto Repair Projects. Free Details . . . Blazer Jacks, Box 15311 (A), Tulsa, Okla. 74112.

**AMAZING CLOTH** Cleans Your Car Without Soap or Water \$2.98 postpaid. Satisfaction Guaranteed. Daube's, 4335 Frank Street, Pittsburgh, Pa. 15227.

**KEEP** Radiators Working like new! 5 minute filter installation. Guaranteed! Scumskimmer, Box 7414, Spreckels, Cal. 93962.

**MIRACLE** Cloth-Dry Cleans, Waxes Automobile in Minutes! Lasts 50-100 Cleanings!! \$2.98. McCater (P12), 317 Grand, National Park, New Jersey 08063.

**BEST** Little Automotive Burglar Alarm Around. Ten Minute Easy Installation. One Car Stolen Every 25 Seconds in the U.S.A. Don't Let Your Car Be Next. Send \$8.95 Plus 55¢ Delivery Charges. Ideal Xmas Present. Hal Mac Associates, Village Plaza, Marble Head, Mass. 01945.

## SNOWMOBILES

**ELECTRIC** Starter Kit \$29.95 Less Battery. Money Back if not Satisfied. Advise Make & Model of Engine. Surplus City, 4802 Nicollet, Minneapolis, Minn. 55409.

**KID'S SNOWMOBILE \$75.00;** Plans \$5.95. Information 35¢ (Refundable) Albar Sales, M-12-Box 386, Yarmouth, Maine 04096.

## MOTORCYCLES, BICYCLES, MOTORSCOOTERS AND SUPPLIES

**ATV'S** Motorcycles! Clothing! Shoes! Wholesale Catalog 25¢. Lorencio, Danville, Illinois 61832.

**AUTOMATIC KILL SWITCH—Easily Build** Your Own—Very Simple—Try My Design—Plans \$1.00. Rebell-PM, P.O. Box 487, Princeton, Indiana 47670.

**MAKE** Your Bicycle Electric, Plans \$2.95. Kielian, 130 Drake, South San Francisco, Calif. 94080.

**HONDA.** \$25 Other Bargains. Send \$1.00. (Refundable). Motorscooter, P443, BEND, Oregon 97701.

**ILLUSTRATED** Catalog, 25¢. Parts And Accessories. Custom And Stock. For Most Makes and Models. Motorcycle Supply, Box 159M, Fairbury, Illinois 61739.

**GO-KART—MINI-BIKE** Plans. Easy to follow. **SAVE MONEY.** Build your own. Go-Kart plan \$2.00. Mini-Bike plan \$2.00. Both plans \$3.00. **GUARANTEED.** RWM Sales, P.O. Box 660A3, Belleville, Illinois 62222.

**GO-KARTS** Factory Direct Low As \$19.95. Send 35¢ for Catalog. Schmieler Motors, RD #1, Doylestown, Penna. 18901.

**BICYCLE PARTS CATALOG.** Gold mine for hard to get foreign and domestic parts, tools and accessories. Send \$2.00 for this big 8 1/2 x 11 inch 160 page catalog. Refundable if not completely satisfied. Wheel Goods, Dept. J, 2737 Hennepin, Minneapolis, Minnesota 55408.

(Continued on next page)

## MOTORCYCLES, BICYCLES, MOTORSCOOTERS AND SUPPLIES

(Continued from preceding page)

**BICYCLES**—Quality 3, 5, 10, 15 speeds Specialty Components, Tools, Clothes, Shoes, Etc. Send \$2.00. **WARES** Catalog, Department P.M., 2656 N. 76th, Milwaukee, Wisconsin 53213 (Since 1939)

## SPACE, ROCKETS AND ASTRONAUTS

**ANTIGRAVITY DEVICE.** Brochure rushed free. AGD, Box 3062 PM, Bartlesville, Oklahoma 74003.

**MODEL ROCKETRY SURPRISE PACK.** Three Fantastic Assortments of Components for Designing and Building Custom Rockets. **BEGINNER PACK:** \$4.50 value; \$2.29. **MASTER PACK:** \$11.00 value; \$4.89. **ADVANCED PACK:** \$27.00 value; \$9.89. Color Catalog; 25¢. **AVI.** Astroport, Mineral Point, Wisc. 53565.



## AVIATION

**BUILD**—One-Man jet helicopter. Easy Inexpensive. Detailed plans, drawings—\$5.00. Helicraft, Box 7153, Baltimore, Maryland 21218.

**BE A** Government licensed aviation mechanic. Practical training. Free Information. Aero Mechanics School, Dept. PM-Municipal Airport, Kansas City, Missouri 64116.

**AIRBOAT** Propellers, Engines, Hubs, Mounts, Supplies, Corvair, V-W Conversions. Removeable Airdrives. Catalog \$1.00. Banks-Maxwell, Box 3301E, Ft. Worth, Texas 76105.

**HANG GLIDERS.** Proven Rogallo Design. Plans—\$5.00. Kits, Accessories, Complete Kites. Compare Quality And Price Before You Buy. Free-Flight Systems, 10730 Whiteoak, Granada Hills, California 91344.

**FLY ICARUS II** The Universal **HANG GLIDER.** The Fantastic Performing Biplane you've seen on T.V. Information including Action Poster \$2.00. **ULTRALIGHT FLYING MACHINES.** Box 59P, Cupertino, Calif. 95014.

**HELICOPTER** Kits. VW Powered, Inflight Photos and information 50¢. Drawings \$5.00. Weilage Helicopters, Box 1267, Redwood City, California 94064.

## HOVERCRAFT

**HOVERCRAFT** Plans. All sizes; Tested designs. Photos. Information: \$1.00. Universal Hovercraft, 2611 182nd Place, Redondo Beach, California 90278.

**INSTALL** Kart, Lawnmower, Snowmobile Power On This Hovercraft. Plans, Instructions, \$6.00. Airboat Plans Instructions, \$5.00. Design Book for Homebuilders, \$5.00. Palmer Aerosystems, P. O. Box 1891M12, Coral Gables, Florida 33134.

**AERO-CAR** Amazing Hovercraft built easily with ordinary tools. Lawnmower engine power. Carries one man plus. Hovers, flies forward, backward, Sideways over land/snow/water. Complete construction plans and brochure, \$5.95. Aero-Projects, Box 5118PM, Clinton, New Jersey 08809.

**HOVERLOG '73**—Most Complete Hovercraft Catalog Available. JLO Engines, Multi-Wing Fans, Plans, Kits. "Hoverbugs". Complete Catalog \$2.00. Venture, Dept. 505, Box 5273, Akron, Ohio 44313.



## BOATS AND TRAILERS

**BOAT** Kits. Molded Fiberglass. Save money-assemble yourself. Factory molded sections bond into one-piece craft. 20 models-14' to 32' Cruisers, Runabouts, Sailboats, Accessories, Motors, Trailers. Easy terms. Free catalog. Luger, Dept. BC-73, 3800 West Highway 13, Burnsville, Minnesota, 55337.

**CANOE** Kits—Wood Canvas, Molded Fiberglass—Free Catalog. Trailcraft, Inc. Box 60686, Concordia, Kansas 66901

**FIBERGLASS BUILDERS MATERIALS** Lowest factory prices in cloth, matt, roving, resin, epoxy, foam, nails, fittings. Send \$1.00 for literature (refundable) or \$2.00 for literature plus booklet on Mold-making and "How to Fiberglass". Clark Craft, 16-P1 Aqua Lane, Tonawanda, N.Y. 14150.

**FIBERGLASS** Cloth, matt, polyester and epoxy resins. Wholesale catalog 25¢. Boat Molding book 30¢. Seifert's, Box 1206-M, Green Bay, Wis. 54305.

**BOAT KITS-PLANS AND PATTERNS-FRAME KITS.** World's largest catalog. Over 300 top designs from 7-77' in plywood, ferro cement and fiberglass. Sailboats include: Windmill, Snipe, Motor Sailer, Trimarans, Catamarans. Powerboats include: Cruisers, Houseboats, Deep V's, Fishin'ski, Runabouts, Hydroplanes, Canoes, Kayaks, inboards, outboards. Send \$1.00 for large catalog or \$2.00 for catalog plus "Boat Builders Guide". Clark Craft, 16-P Aqua Lane, Tonawanda, N. Y. 14150.

**BOAT PLANS, FULL-SIZE PATTERNS, FRAME KITS** With step by step written and pictorial instructions especially for amateurs. Easy to build. Send \$1.00 for **HUGE 100 PAGE** Illustrated Catalog. Over 125 modern designs from 8 to 49'. Includes Sail, Jets, Inboards, Outboards, Cruisers, Houseboats, Hot Boats, Catamarans, Hydros. Also available—"Boat Building With Plywood" Hard cover—219 pages \$7.50. **GLEN L.** 9152 MP Rosecrans, Bellflower, Calif. 90706.

**FIBERGLASS** Cloth and resin. World's finest cloth and non-run resin, at direct mill prices Flotation foam. Complete line of plastics, silicon bronze and brass screws, save 60%. No sales tax. Boat Plans. Catalog 25¢. Freight prepaid. Stiles Boat Supply, Box 11P, Linden Ave., Mantua Heights, N.J. 08051.

**CANOE!** Kayaks! Factory-direct quality kits, from \$25.00. Many different models. Canvas hulls. Strongest construction materials. Free literature. Sportscraft, Box 636-P, Allentown, New Jersey 08501.

**FREE** Catalogue—plans, patterns: Canoes, sailing canoes, kayaks. 14-17' trailable cruising sailboats. Quicksilver. 255A Shamrock Blvd., Venice, Florida 33595.

**KAYAKS,** Canoes, Plans, Kits, Finished Craft, Books. Free Catalog. Outdoor Sports, Box 1213P, Tuscaloosa, Ala. 35401.

**NEW 1973** Outboards . . . Top Brands 6 H.P. \$288 . . . 18 \$418 . . . 40 \$565 50 \$728 65 Electric \$958 . . . 85 Electric \$1,098 **ALL SIZES** . . . Scott-McCulloch Parts . . . Handling 50¢ . . . Electra Marine, 610 Merrick Rd., Lynbrook, New York 11563.

**FIBERGLASS** Canoes, Kayaks, and Duckboats. Many exciting models. Easily assembled kits. \$44.95 up. Free Literature. Riverside Canoes, Box 5595P, Riverside, Calif. 92507.

**LIGHTS "THOUSAND-LIVES"**. Battery powered Cordless, RECHARGEABLE. Table-lites, Lanterns, Flashlites. Use Nickel-Cadmium "LIFETIME" ("Never buy Batteries again") Free Literature. Heydecker, 500 G West End Avenue, New York, New York 10024.

**FIBERGLASS** Canoe Kit Literature 25¢. Fiberglass Material, Resin, and Supplies Catalogue 50¢. Spearcraft, Box 600-PM, Mount Juliet, Tennessee 37122.

**300 BOAT** Plans, Patterns, Some Kits. Catalogs: Powerboat, 170 Pages, \$1.50; Sailboat, 70 pages, 75¢. Marinecraft, Box 161-M, Brighton, Mass. 02135.

## CAMPERS AND TRAILERS— KITS—PLANS—

**CABOVER** Campers & Pick-Up Covers for Compact & Standard Trucks, 16 & 20 Trailers. Build and Save. Large scale plans and full-size patterns with written & pictorial instructions. Complete accessory and aluminum covering kits. Free literature. **Glen L.** 9152MP Rosecrans, Bellflower, California 90706.

**CAMPER** Module, Easily Removable, for all Vans—Make your Hauler a Weekender Plans \$5.00—Korski, Box 3394P, San Diego, Calif. 92103.

## MARINE EQUIPMENT AND SERVICES

**MARINE** Engines, conversions, parts, equipment. Catalog Free! Stokes Marine Industries, Coldwater, Michigan 49036.

**MARINE** Supplies, Ignition Parts. Free literature. Michael's, 991 Broadway, Bayonne, New Jersey 07002.

**CONVERT** Auto engines to marine. 68 Page Catalog, 50¢. Lehman Manufacturing Company, 800 Elizabeth Avenue, Linden 4, New Jersey 07036.

## ATHLETIC AND BODY BUILDING COURSES

**POWERFUL** Muscles fast! Free brochure. Universal Bodybuilding, Box 4327-C, Dearborn, Michigan 48126.

**"GIANT** Arms." Dr. Young. Revolutionary discovery. Inquire. Gaucho, Box 1769-A7, Chicago 60690.

**MIGHTY** BODY YOURS IN MINUTES A DAY. \$2.00 FULL COST. **CHAMPAGNE'S,** BOX 15322, BATON ROUGE, LOUISIANA 70815.

**KUNG-FU** Secrets. 350 Photos. Complete, Easy Instructions, \$1.95 + 30¢. Johnson-Smith, 10 Auto., Mt. Clemens, Mich. 48043.

**ARMS,** 18-20 Inches in 90 days or Complete Refund!! Miraculous Revelation! \$3.00. Phenominists, Box 281, Gresham, Oregon 97030.

**FREE** Self-Defense Informative Literature. Men, Women, Teenagers. Judo, Kungfu Books. Jorgensen, Box 70482-11273, Seattle, Washington 98117.

**THREE** "Mutual Massage Muscles" Courses, Illustrated \$10.00. Buddy System, (L), Box 16046, Kansas City, Missouri 64112

## SPORTING GOODS AND EQUIPMENT

**FREE** Catalog low direct factory prices, fishing, Hunting, Archery, reloading Camping supplies. Send today. Herters Inc., Dept. CPM, Waseca, Minn. 56093.

**FREE WHOLESALE CATALOG.** Lure parts, Molds, Rod Blanks, Reels, Archery, Metal Detectors, Rare Hardwoods. Finnsports (ME), Toledo, Ohio 43614.

**ARCHERY** Lowest Discount Prices. All top brands. Orders shipped same day received. Money-back guarantee. World's Largest Supplier. Free catalog. Anderson Archery Corporation, Grand Ledge, Michigan 48837.

**FREE CATALOG.** Fishing Tackle, Archery Hunting and Camping Equipment. Lowest Prices. Cabela's, Inc., Dept. S-24, Sidney, Nebraska 69162.



## FISHING, TACKLE, LURES

**MOLDS**—For casting your own fishing sinkers. Free illustrated booklet. Reading Instrument Co., Box P-78, Reading, Pa. 19603.

**FISHERMAN'S DREAM BOOK**—FREE, 170 page catalog just loaded with Hard-To-Find Fishing Tackle Specialties and Do-It-Yourself Goodies. Our 29th year. **NETCRAFT** Inc., Box 5510, Dept. PM-12, Toledo, Ohio 43613.

## EARTHWORMS, LIVE BAIT

**HOW** To Make Money Raising Fishworms! Details Free. Gloworm, Department P.O. 189, 3910 Elfin, Louisville, Kentucky 40207.

(Continued on next page)



## EARTHWORMS, LIVE BAIT

(Continued from preceding page)

**EARN** Money raising fishworms for us! Exciting details free! Oakhaven—56, Cedar Hill, Texas 75104.

**FREE** Literature. Profitable Business Raising Fishworms, Crickets. We Teach you how to Raise and Sell. Write today. Carter Fishworms, Plains, Georgia 31780.

**BIG** Profits Raising Worms Soilless Method. Three Oaks, Dresden, Tennessee 38225.

## FROGS, FISH, REPTILES

**\$20,000 POSSIBLE RAISING BULLFROGS!** Free Information! BRAVCO-A, 122 Ottoway, Temple, Texas 76501

## AQUARIUM SUPPLIES

**AQUARIUMS.** Filters. Fishfoods. Air-pumps. World-champion Guppies. 448-page Fishbook. \$3.95. Catalog 25¢. Aquatic-Discount, Ortonville, Mich 48462

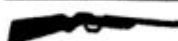

## HUNTING, GUNS, DECOYS

**PELLET GUNS** For Fun or Serious Target Shooting Anywhere. Giant Selection. Finest Models. Satisfaction Guaranteed. New 100 Page Catalog Free (\$1 value). Write: ARH, Dept. 15, Grantsville, West Virginia 26147.

**DUCK** And Goose Decoys. Buy direct and save. Send for free catalogue to: Decoys, Rt. 11, Box 229-B, Houston, Texas 77050.



## POULTRY & GAME BIRDS

**QUAILS.** Incubators, cages, supplies catalog. Marsh, 14216 Brookhurst, Garden Grove, Calif. 92643.

## RABBITS—CHINCHILLAS—FUR BEARING ANIMALS

**\$500-\$1000 MONTH** Plan raising rabbits for us. Free details. White's Rabbitry-PM, Hudson, Ohio 44236.

**RAISE** Rabbits Successfully by knowing Facts. 48 Page Illustrated Book describing 25 Breeds. Housing, Breeding, Feeding, Markets, Marketing, etc. 25 cents. American Rabbit Association, 36 Arba Building, Bloomington, Illinois 61701.

**EARN** \$10,000 Yearly Raising Angora Wool and Breeding Stock. Details 25¢ coin. American Angora, Malta 12, Montana 59538.

**TOPLESS INCOME RAISING** Mutation chinchillas. 25¢: Bulletin \$1.00. Chinchilla, 11PM12, Port Richey, Florida 33568.

**RAISE** Chinchillas. Guaranteed Income. Catalog \$1.00. DeShon Chinchilla, Route 2H, Roanoke, Indiana 46783. Missouri Agent, Rudolph Eggemann, 9615H Tocan Court, Affton, Missouri 63123.

**\$30,000 YEAR.** Mink, Otter—many Kinds. Details—send \$25.00 self addressed envelope. Farmers or city. Fur Animals, Box 236, R-1, Milford, Indiana 46542.

## PETS—BIRDS, CATS, HAMSTERS, ETC.

**PETS,** Reptiles, raccoons, skunks, squirrels. Catalogue 25¢. Trails End Zoo, St. Stephens, S.C. 29479.

**LIVE** Seahorses, marine specimens, aquarium supplies. Illustrated catalog 35¢. Marine, Box 23158-S, Ft. Lauderdale, Florida 33307.

## CAMPING EQUIPMENT AND TENTS

**FREE** 112-page Camping. Marine Color Catalog. Laacke & Joys, 1439 N Water, Milwaukee, Wisconsin 53202.

## ELECTRICAL SUPPLIES

**ELECTRICAL SUPPLIES** Do It Yourself. **SAVE** Enormous Electrician prices. Illustrated Catalog, \$1.50 Refundable. EVN, Box 5564, Ft. Lauderdale, Florida 33310.

## HORSES, LIVESTOCK

**"HOW TO TRAIN HORSES"—FREE** Book tells How to Break, Train, make Money with Horses. Beery School, 11012, Pleasant Hill, Ohio 45359.

## BATTERIES, GENERATORS

**BATTERY** Reconditioning Kit, includes molds, material, instructions. Apex Engineering, 3100 Romona, Atascadero, California 93422.

## ENGINES, MOTORS

**FANTASTIC!** Electric Motor Without Windings! Complete details on Theory of Operation and Construction. \$5.00. BEL Enterprises, Box 381M, Bellflower, Calif. 90706.

**WINDING** Data, 275 motors, \$1.25. Data Company, 512 Kensington, Kansas City, Mo. 64124.

**STEAM** Engine Kits, Catalog-Handbook \$1.00. Reliable Industries, New Baltimore, Mich. 48047.

**MOTOR REWINDING SUPPLIES!** Equipment plans! Modequip, Box 7266, Kansas City, Mo. 64113.

**REWIND** Car Generator for 110 VAC. Power Plant Plans \$2.00. Schmauss, 1228 East Cass, Tampa 33602.

## TOOLS FOR SALE

**METRIC** Ruler Measures Inches/Centimeters. 6' Retractable Steel. Included, "Conversion Chart". \$2.00. "Chart" Alone, \$1.00. Atterbury, 3974-E Malibu Road, Malibu, California 90265

## MACHINERY, TOOLS AND SUPPLIES

**ASSEMBLE** In One Hour. Ball Bearing 4" Metal Cutting Lathe Kit \$32.70. Design Machine, 15048 Proctor, Industry, Calif. 91746.

**SANDBLASTERS,** \$32.50—\$749.50. Free Catalog—Truman, 1330 Market, Youngstown, Ohio 44507.

**MICRO** Lathe including 5 pc collet set 3 1/4" 3 Jaw Chuck and 6 Speed Pulley set, 2 Year Warranty \$79.50 Postpaid. Taig Tools, 15048 Proctor, Industry, Calif. 91746.

**SMALL** Foundry furnaces. Supplies. Free literature. Pyramid Products, 3736 South 7th Avenue, Phoenix, Arizona 85041.

**MAXIMAT,** Unimat Lathes. Metals. Micrometers. Catalogue 50¢, Industrial \$2.00. Campbell (PM), 1424 Barclay, Springfield, Ohio 45505.

**1400 CATALOGS** Listed and Described! Sources for EVERYTHING Imaginable! Rush \$2.00. MASTERLOG, Box 24413-(VL), Oakland, California 94623.

**END** Mills. Lathe Milling Attachments: Information. Potter, Box 73, Cedar Rapids, Iowa 52406.

**TOOLS,** Metal, Woodworking, Shop, Power, Hand, LATHES and Accessories. Catalog \$1.00. Refundable. Tools Unlimited, Inc., Box 7PM, Brentwood, New York 11717.

**SINGLE** Phase Runs Three Phase Motors. Secure Electronics, 32 Warren, Waban, Mass., 02168.

**FINEST** Tools—Catalog 50¢. Woodcarvers Supply, 3112 West 28th, Minneapolis, Minnesota 55416.

**BUILD** This Traveling Flip-Up Lathe Safety Shield for about \$4.00. Complete Drawings \$1.50. Jim Berger, 429 Clinton Ave., Tiffin, Ohio 44883

**"ATTACHALL"** The Steel Motor Arbor holds 33 different turning-type tools to fractional HP Motor (1/2" Shaft). Changes Tools in Seconds. Now greatly improved with Steel Hand Chuck. Send \$4.25 post paid. Money-Back Guarantee. Buy "Attach-all," we'll sell cheapest motor USA. ShopAider Tool Co., 233M12 East 77 Street, NYC 10021.

**SCREWS,** Bolts, Nuts Assortments, Cotter Pins, List 35¢. Nutty Co., 1576SMSP, Fairfield, Conn. 06430.

**SEND** For Complete Catalog of Maintenance Free Stainless Steel Nuts, Bolts, Washers, Etc. \$1.25. Summit Fasteners, Box 183A, Lansdale, Pa. 19446.

## WELDING, SOLDERING, PLATING

**WELDERS.** Convert To Heliarc. High Frequency Unit 0-225AMP. Plans \$4.00. Convert To DC Plans \$3.00. Information Supply Co., Box 166, College Park, MD. 20740.

**ELECTROPLATING** Equipment. Portable Platers, Supplies, and "Know-How." Build your own tanks for nickel, chrome, etc. Easy-to-install PVC liners. Rectifier components—all sizes. Schematics, parts lists, formulas, operating instructions for all-plating. Guaranteed to save you 25%—75%. Some good used units for sale. Free Details. Platers Service Company, 1511-PM Esperanza, Los Angeles, California 90023.

**TURN** Your Workshop into Plating Shop for \$6.95! **GUARANTEED** kits, manuals, supplies, **FREE** details! QREW, Box 8-PK, Bourbonnais, Illinois 60914.

## GOVERNMENT SURPLUS

**FREE!** Nationwide Surplus List. Write today. Auctioneers, Box 872-P, Anoka, Minnesota 55303.

**FREE** Catalog Government Surplus and Sporting Goods. Enclose 8¢ Stamp. Bonanza Surplus, Box 725-PM, Grand Haven, Michigan 49417.

**SURPLUS BARGAINS**—War, government. Industrial surplus at savings to 80%! Clothes, boots, cots, tents—bargains for farm, home, outdoors. **SEND FOR FREE CATALOG**—must give zip code. **SURPLUS STORE,** Sioux Falls, S.D. 57102.

**JEEPS!!! PICKUPS!!!** 100,000 items direct from government. Your area. Latest information & surplus categories: \$2.00 **MONEYBACK GUARANTEE.** Order manual #131, from "Dependable Products", Box 113, Vista, California, 92083.

**NO CATCHES.** Buy any surplus direct from U.S. gov't. All information \$2.00. Bridgewater, P.O. Box 2292-C, Vancouver, Washington 98661.

**1973 SURPLUS** Army, Navy store, 52 Page illustrated catalog. Send 50¢. Ruvel, 3037 North Clark, Dept. 12-J, Chicago, Illinois 60614.

**GOVERNMENT SURPLUS,** How and Where to buy in your area. Send \$2.00. **SURPLUS INFORMATION,** 30177PM **HEADQUARTERS BUILDING,** Washington, D. C. 20014.

**"U.S. GOVERNMENT SURPLUS Directory."** How, Where to buy 100,000 items (including Jeeps) . . . low as 2¢ on dollar! Most complete information available . . . \$1.00. **SURPLUS DISPOSAL,** Box 6586-AL, WASHINGTON, D.C. 20009.

**JEEPS** From—\$52.50; Typewriters from—\$4.15; Cars from—\$31.50. Walkie-talkies, motorcycles, airplanes, boats. Typical "As Is" bid bargains from Uncle Sam. Tremendous variety. Exciting free list. Write: Enterprises, Box 402-X95, Jamaica, New York 11430.

**JEEPS, TRUCKS,** Cars From \$31.50 . . . Airplanes, Boats, Typewriters, Clothing, Camping, Sporting, Electronics, Photographic Equipment . . . 100,000 Surplus Bid Bargains Direct From Government Nationwide Typically Low as 2¢ on Dollar! Complete Sales Directory and Surplus Catalog \$1.00 (Deductible First \$10 Order From Included Catalog). U. S. Surplus Disposal, 2200 Fuller 601B-PPM, Ann Arbor, Michigan 48105.

**JEEPS** \$52.40, Airplanes \$75.01, Typewriters \$6.70, Boats \$7.50, Typical Bargains Available Nationwide. Sales Directory And Surplus Catalog \$1.00 (Refundable). Midwest Surplus, Box 401-PM, Dayton, Ohio 45401.

(Continued on next page)

## HOBBIES AND COLLECTIONS

**COLLECT** Military Medals, list 25¢. Vernon, Box 387PM, Baldwin, N.Y. 11510.

**NAZI** Medals, Photos, and Jewelry. Also War Mementos from Other Countries. Catalog and War Poster, 25¢. Hutchinson House, Box 6411, Chicago, Illinois 60680.

**WOODCARVING**—Complete line of three dimensional carving machines for home hobbyist and professional carvers. New models from 1 to 4 spindles. Patterns, workblanks and supplies. Write for "How to Make Quality Wood Carvings" booklet—25¢. Hobbi Carve, 930 Duluth Street, Dept. PM, St. Paul, Minn. 55106.

**NATURE SPECIMEN** Of the Month Club. Free Membership Details. Collectors' Wonderland, Box 1170, New York 10008.

## DECALS, EMBLEMS, PATCHES

**CUSTOM** Designed Embroidered Emblems, Decals. Inexpensive. Free Catalog, details. Southern Emblem, Box 8PMB, Toast, North Carolina 27049.

**EMBLEMS** Embroidered to your own design. Leading manufacturer offers custom emblems in any quantity. Send sketch for firm quote or write for free Design-An-Emblem Guide and literature. A-B Emblem, Box 5695, Weaverville, North Carolina 28787.



## STAMP COLLECTING

**FREE!** Big Bargain Catalog—New Edition listing thousands of bargains including U.S. & B.N.A stamps, packets, albums, accessories and supplies. Also, fine stamps from our approval service which you may return without purchases and cancel service at any time. Jamestown Stamp, Dept. E123PM, Jamestown, New York 14701

**225 STAMPS** For only 10¢! Airmails. Pictorials: stamps from strange countries cataloging up to 25¢ each! Plus unusual stamps to examine. Buy any or none return balance, cancel service anytime. Mystic Stamp Co., Camden 80, New York 13316.

**WOW!** 110 All Different Germany 10¢. Commemoratives, Airmails, High Values. Big Catalog, bargain lists. Also, fine stamps from our approval service, which you may return without purchases and cancel service at any time. Jamestown Stamp, Dept. A123PM, Jamestown, New York 14701.

**TRADE** Your Duplicates! (Foreign) New "Free Bonus" Plan: NFK, Box 98-P, Newton Highlands, Mass. 02161.

**MAGNIFICENT PAINTINGS!** 25 Different Breathtaking Beauties for only 25¢ with Approvals. RIX, Box 250-BB, Station "P", Toronto, Canada. M5S 2S8.

**BE A Stamp Dealer!!** Write: International, 6767L South Atlanta, Tulsa 74136

**FREE.** Worldwide or Canadian with approvals. New issue service available. Stamps Unlimited, Box 2338, Kalamazoo, Michigan 49003.

**U. N. 9** Complete Mint Sets \$1.00! Approvals Gordon Davison, Hillsboro, New Hampshire 03244.

**BE A STAMP DEALER!** Sell by Mail. 20-000-Word Instruction Manual, Exciting Supplements, only \$1 (gift stamp set included too). Extra Income from working with Stamps! Howland Services Inc., Box 159, Lee's Summit, Mo. 64063.

**SCANDINAVIA**—40 Colorful 10¢! Approvals. Belke, 1824 Gates, Brooklyn, New York 11227

**SENSATIONAL** Clearance Offer. Fifty Different Packets \$2.00. Norge, Wyckoff, New Jersey 07481.

**FREE** Worldwide Packet. Penny Approvals. Froelich, Box 412A, Morton Grove, Ill. 60053.

**FREE 50** Worldwide Approvals. University Stamps, P.O. Box 1471, Lake Worth, Florida 33460.

**AMAZING** Value—Enormous Worldwide Collection! Hundreds of Colorful Stamps—Airmails, Commemoratives, Strange Countries, Nature's Wonders. Catalog over \$10.00, only 10¢. Approvals. Buy Any or None. Cancel Anytime. Daniel Healy, Box 1164PM12, Arlington Heights, Illinois 60006.

**CANADA**, 25 Different Commemoratives, 25¢. Approvals. Wilson, Box 116, Dollard des Ormeaux, Quebec, Canada.

**FABULOUS** Collection! 107 different stamps from all seven continents. Get Q.E.-II Silver Wedding (bound to be a classic), giant Mongol horseman, many other new, old issues from Asia, Africa, Europe, North, South America, Australia, Antarctica. Also stamp selections to examine. Buy any or none, return balance. Cancel service anytime. Send 10¢ now. Williams Co., PM87, St. Stephen, N.B., Canada.

**200 WORLDWIDE** 25¢ To Approval Applicants. Polze, Box 5215, Milwaukee, Wisconsin 53204.

**SINGLE STAMPS** 2¢ and up. Mounted in books. **TRUST STAMP COMPANY**, P. O. Box 100-P, Jamaica, New York 11435.

**100 DIFFERENT** United States Stamps, 25¢ With U.S. Foreign Approvals. ShelRon, Box 547C, North Miami, Fla. 33161.

**50 DIFFERENT** Old U.S. Revenue stamps \$1.00. Winchester Stamps, Box 3592, Mansfield, Ohio 44907.

**TEN** Different Nudes: 20¢. Approvals. Stamp Farm, 2M61, Oxford, Wis. 53952.

**FOREIGN** Approvals! Gigantic values! 3¢ each. ABC, Dept. 3301-A, Box 6000, San Francisco 94101.

**U.S. MINT** Specials! Flag set, complete \$1.00. 1¢, 2¢, 3¢ famous Americans (21 different) \$1.00. Free list. Brooks, 2601 Avenue "U," Brooklyn, N.Y. 11229.

**"AFRICA"** 25 Beauties, 15¢. Approvals, Gorliz, Box 28765 PM, Memphis, Tennessee 38128.

**PENNY!** Approvals! Regardless catalogue! Kloster, 4164 52nd St., San Diego, Calif. 92105.

**FREE** Surprise collection sent with approvals. Gould, 1784 Union, San Francisco 94123.

**ABSOLUTELY** Free United States Mint Souvenir Sheet When Requesting United States Approvals. K&B, Box 70, Brooklyn, N.Y. 11223.

**500 DIFFERENT** Stamps, \$1.25. Smith, 508-A Brooks, College Station, Texas 77840.

**100 DIFFERENT** British Empire 10¢. Approvals. Gibson, Box 34, Lansdowne, Pa. 19050.

**100 OLD** United States between 1861 and 1935. \$1.00. Ed Roush, 423 Shepard, Mansfield, Ohio 44907.

**20 HISTORICAL** U.S. Commemoratives 10¢. Bargain U.S. Approvals. PINTO, Box 111, Park Ridge, Illinois 60068.

**80 DIFFERENT** U.S. Stamps. Includes 1943 flag stamp of occupied nations. Only 25¢. Approvals Included. Willett Co., Box 338-M, Yorktown Heights, N.Y. 10598.

**50 YEARS** Old, fifteen different United States, over fifty years old—10¢ with approvals. Jaxon, Box 145-P, Brooklyn, New York 11230.

**U.S. BARGAIN**, 50 Different 10¢, with beautiful worldwide, approvals. Stamp Center, Kennebunk, Maine 04043.

**210 DIFFERENT** U.S. Commemoratives \$1.00. Stamps, 7607 Larchview, Dallas, Texas 75240.

**RUSSIAN** Space Collection 25¢, including Russian Approvals. Snedco, Waldwick, New Jersey 07463.

**LIECHTENSTEIN #356-\$19.00:** France #1100-\$4.00; UN 29-30-\$15.00; NH. CWO. Submit Lists Western Europe Only. All N. Franklin, Box 467P, Jamaica, 11434.

**1500 FOREIGN** \$2.00; 5000 \$4.00; 9000 \$6.00. 1000 pre-1939 USA, contains dues, revenues commemoratives, presidentials, high values, older issues, etc. \$3.00; 5000 \$12.00. 300 pre-1940 USA commemoratives \$2.00; 700 \$4.00. No approvals. Meyers, 5321 Fleming, Richmond, Calif 94804.

**GET** Scarce Kennedy memorial, Red China, Vietnam stamps plus new countries, topicals, commemoratives, many more! Valuable collection of 100 different stamps from the world over. Colorful new and old issues—wild animals, famous people, far places, others! Also stamp selections to examine. Buy any or none, return balance. Cancel service anytime. Rush 10¢ today. Garcelon Co., 8PMA, Calais, Maine 04619

**FREE**, Mint Worldwide Packet. Approvals. Hildebrand, Box 5645, Redwood City, California 94063.

**PICK** And Choose from Thousands of Stamps 3¢ Each. Continental, Box 9384M, N. Hollywood, Calif. 91609.

**THOUSANDS** Of Stamps 3¢ each. Pan Pacific Stamp Co., P.O. Box 9413, No. Hollywood, Calif 91609.

**UNITED STATES** 5¢ Plate Block, 25¢, With Discount Price List. Stevens, Box 546D, North Miami, Fla. 33161.

**SPECIAL Offer!** 100 Unusual Stamps 10¢ with Request for Approvals and Bargain List. Continental, Box 9384P, No. Hollywood, Calif. 91609.

**U.N. MINT** Six Sets \$1.00. Philpot, 119 Chateau, Milwaukee, Wisconsin 53217.

**COVERS** U.S. 25 Different \$1.00. Free Gold List. Superior, Avon Lake, Ohio 44012.

**TREMENDOUS** Savings on Complete Sets. Stan's, Box 546, Silverdale, Washington 98383.

**FREE** British Colonies With Approvals. Chapmans, Box 487-B, Galesburg, Michigan 49053.

**FREE** 25 Different Canada. Joseph Myers, 633 W. Michigan, Marshall, Michigan 49068.

**60 DIFFERENT** United States (30 Commemoratives) 25¢. Seidenberg, Salem 169, Oregon 97308.

**3¢ PLATE** Block—Complete 1974 U.S. Stamp and Supply Catalog 25¢. Schultheis, Box 2151S, New Hyde Park, New York 11040.

**BREATHTAKINGLY BEAUTIFUL** 50 Different mint Monaco Multicoloured Pictorial Commemoratives only \$1.00 with accompanying mint complete set approvals. Pagoda, Box 132P, Sidney, Ohio 45365.

**OLDER** U.S. stamps, covers, on approval to adults only. Surprisingly good. ENGLE, Box 208P, Lowell, Michigan 49331.

**2-D SPACE STAMPS!** Incredible! Spectacular Mint Set (6 Magnificent Stamps!) and **SURPRISE PACKET!** Yours, with Colorful, Exciting, Adventure—Filled Approvals, Rush 25¢ Today. APOLLO, Box 1417PB, Idaho Springs, Colorado 80452.

**75 DIFFERENT** Canada 25¢, Approvals. Oroszky, P.O. Box 1, Sarnia, Ontario, Canada.

**50 DIFFERENT** U.S. COMMEMORATIVES 25¢ Fine Used U.S. Approvals Accompany. Craig Stamps, Box 425-N, Bellmore, New York 11710.

(Continued on next page)

## STAMP COLLECTING

(Continued from preceding page)

**\$35.00 CATALOG** Value! 1000 Different Worldwide. \$2.00. with profit-sharing approvals. Universal, Box 6D, Kenosha, Wisconsin 53141.

**255 DIFFERENT** Worldwide :15c. Approvals. Tibbets, 8675 Meadow, Downey, California 90242.

**U.S. CHRISTMAS COMMEMORATIVES**—2 Stamps on two Different beautiful First Day covers addressed to any name your choice. 50c each both for \$1.00. from K. M. WALSH, Box 308L, Tuckahoe, New York 10707.

**"INVERTED Error"** Dag Hammarskjold, 10c with approvals. Belmont Stamps, Washington, D. C. 20015.

**CANADA** Sports Complete 10c. Canadian Approvals. Harley Boardman, Little Valley, New York 14755.

**CANADA** Terrific Lot of 30 different, including Commemoratives, 15c to Approval Applicants. Lewis, 339 Beaconsfield Cres. Saint John W., New Brunswick, Canada.

**SENSATIONAL Penny Approvals!** Pictorials, Topicals, Etc.! Write Today! Schmidt, 634-M Station A, Richmond, Calif. 94808.

**FASCINATING** Pick-and-choose packet approvals. Bargain hunter's Delight. Rivertown, Box 188P, Lowell, Mich. 49331.

**FREE** New used Congo animal set. Approvals included. Alpaughco, Highbridge, N.J. 08829.

**FREE!** 10 African Beauties! 30 Others! Approvals. Cambridge, Box 2311, Heath, Ohio 43055

**NEW 15 MOVIE STARS** On Stamps. 10c. Worldwide Approvals. Kenos, Box 1092-A, North Miami Beach, Florida 33160.

**BRITISH EMPIRE.** 100 Different, 10c. Country Packet Approvals. Denali, 1836-PM Water, Port Huron, Michigan 48060

**50 DIFFERENT** British Commonwealth Foreign Many Pictorials, Commemoratives, 10c Approvals Included. City Stamp Co., Box 216, Station W., Toronto, Canada M6M-422.

**GUIDE** For Stamp Dealers: "Secrets of Successful Stamp Dealing." Plus Wholesale Lists. Both \$2.00. Campbell Hall Company, Box 295, East Northport, New York 11731

**\$5.28 CZECHOSLOVAKIA** Buildings set only 25c when requesting our foreign approvals. D & E Enterprises, P.O. Box 570, Santa Rosa, Cal. 95402

**U.S. PRESIDENTIAL** Issue 15 Varieties for 10c to Approval Applicants. Russell Stamp Company, Box 42, Hickory Withe, Tenn. 38043.

**RARE** Foreign Collection! Just 10c. Approvals Upon Request. Mile High, P.O. Box 1716, Denver, Colorado 80201.

**FREE**—Dollar Stamp Packet. Approvals. Gains, Box 788-D, Mattoon, Ill. 61938

**SEND** Only 10c for nice collection of U.S. stamps including "\$5.00" Issue and scarce mint SipeX Souvenir Sheet. You will also receive the most wonderful catalogue of stamp offers in America. Littleton Stamps, Dept. SS1, Littleton, New Hampshire 03561.

**OUR PLEDGE TO YOU!** Quality approvals at fair prices. Bonus set with first \$2.00 purchase. P. E. Roy, Box 9723, Dept. C, Quebec G1V 4C3, Canada.

**FREE** Stamps Send 10c. APPROVALS Uxco. 320 Congress, Austin, Texas 78701.

**SEND** Only 5c for Worldwide Collection of over 50 different Singapore, Grenada, Chad, etc. Contains old and new Issues, sports, animals, etc. You will also receive interesting lists and a certificate worth 50c toward purchases. Goliath Co., Dept. TP-1, Bethlehem, New Hampshire 03574.

**SWASTIKA AND EAGLE** On Genuine Cover Mailed By Member of Hitler's Wehrmacht! Cacheted 1930's First Flight! Cacheted Block of Four FDC! 7 More Exciting Covers and Cards. Only \$10.00. Money Back Guarantee. FISHER, Box 61, Vineland, New Jersey 08360.

**307 DIFFERENT** Triangles, Sports, Topicals, etc. Value \$8.00. Only 25c. Bargain approvals. Free Catalog and Coupon worth \$1. Jayto Stamps, East Syracuse, New York 13057.

**FREE.** United Nations Stamps Brochure. 10c Mailing. Frankel, P.O. Box 87, Brooklyn, New York 11229.

**BETTER GRADE** U. S., Canadian Stamps for Advanced Collectors. Borgen, Box 645, Seiad Valley, Calif. 96101.

**FREE LISTS!** Discount prices. U.S. Singles-Plate Blocks. Moneyback guarantee. Scotco, Box 855-PMP, Miami, Fla. 33147.

**FOURTEEN CHRISTMAS ISSUES** of New Zealand only 50c with pictorial approvals. Robert Hedges, Route 3, Hagerstown, Maryland 21740.

**50 DIFFERENT** Argentina—10c. Approvals. Gobestamps, Box 402, Biddeford, Maine 04005.

**EXOTIC** Collection Free with Approvals. C. Stump Stamps, Box 212-A, Rosedale, New York 11422.

**"SKYLAB** Space Launch", Dominica's latest Commemoratives—Free! Approvals plus 101 Bonus Sets. William Deems, 226 Race, Ravenswood, West Virginia 26164.

**U.S.A. \$1.50 BUYS** Fine Mint Air, #C119 Approvals accompany. WHITON PAINE, Westport, Connecticut 06880.

**10,000 U.S.A.** \$8.00 Commemoratives Galore. Treasure, Box 28613-P, Memphis, Tenn 38128

**UNITED STATES**—200 Different \$1.50 Friend. 304 Main, Beacon, N.Y. 12508.

**PNCOVERS** send SASE for list of FDC with combination STAMP and COIN. Ed Parma, Box 5011M, Irving, Texas 75062.

**WORLD WIDE.** All DIFFERENT, 500 \$1.25, 1000 \$2.75, 2000 \$5.95, 3000 \$9.50, 5000 \$28.00, 10,000 \$79.95. Price List Available. Olympic, Box 639, Novi, Michigan 48050.

**SURPRISE** Collection! Exotic mint British Colonials absolutely free with approvals. Viking, Great Neck, N.Y.

**FIRST DAY COVER** Mailing Service. Next Issue and Details FREE. Whelplev. 7530 Robin Rest N-1, San Antonio, Texas 78209.

**WATERMARK** Detektor. Perforation Gauge, 100 Different Stamps, Packet of Hinges, all for 25c to Approval Applicants, State Preferences. H & L Stamp Company, Box 3099 Station B, Calgary, Alberta, Canada T2M 4L6.

**FREE** Mystery Lot Plus Approvals, Price Lists, Etc. Sherwood Enterprises, Dept. PM, P.O. Box 102, Syosset, New York, 11791.

**WOW!** 14 Different Complete Sets From Poland only \$1.00. Boudreau, Box 275D, St. Lambert, Quebec, Canada.

**WORLD'S LARGEST STAMP**—Tremendous Investment Potential. \$4.95 Each. 10, \$39.50. Satisfaction Guaranteed. United, Oakton, Virginia 22124

**FREE** World Collection. Over 100 stamps. Approvals. Global. Box 792, Livermore, Cal. 94550.

**QUALITY AND LOW PRICE. EXCELLENT** For advanced or beginner. Mounted approvals 2c up, all countries in Scott's Order. Preview Stamps, P.O. Box 20667, San Diego, California 92120.

## COINS, TOKENS, CURRENCY

**FREE** Rare Coins from Giant Catalog. Send 25c. Allen's, 5674-PM Beacon, Pittsburgh, Pa. 15217.

**INDIANHEAD** Cents, V-Nickels 5 Different \$1.98. Catalog 25c. Edel's, Carlyle, Illinois 62231

**MEXICO:** Silver Dollars Dated 1957 To 1967 in Nice Condition. Ten For \$3.95 Delivered Postpaid. El Paso Coin Co. Inc., Suite 108, El Paso National Bank Bldg., El Paso, Texas 79952.

**39 COIN** Uncirculated Lincoln Set 1956-1973, \$2.00. Ed Frederick, Rte. 3, Mountain Home, Arkansas 72653.

**50 DIFFERENT** Foreign Coins, \$3.00. Hoffman, Box 98-M, Clarence, New York 14031.

**USA SILVER** Dollars Nice Condition 10 Different Dates Only \$39.95 post paid. El Paso Coin Co., P.O. Box Q, El Paso, Texas 79952.

**1909-VDB** Lincoln Cent. Fine. \$1.50. Free Catalog. Village Coin Shop, Dept. P, Plaistow, New Hampshire 03865.

**SILVER DOLLARS** Uncirculated. 1880-81—1883-84-85 \$8.00 Ea. Catalogue 50c. Shultz, Salt Lake City, Utah 84110.

**MEXICO** Revolutionary "Pancho Villa" 10 and 5 Centavos Copper Coins Dated 1915 Nice Condition only \$2.95 each. Delivered Postpaid. El Paso Coin Co., P.O. Box Q, El Paso, Texas 79952.

**COINS** At Discount Prices! Free Brochure. Gene Carlton, Chandler, Okla. 74834.

**FREE:** Lists of Thousands of Stamps and Coins. No Approvals. Bryson, 612M White, Toledo, Ohio 43605.

**22 "S" LINCOLNS** Including 1955S, \$1.75. 24 1909-1939, \$1.75. 10 "S" Jeffersons, \$1.75. All different. All three \$5.00. HARRIS, 3350 P, El Camino, California 95051.

**\$1000.00 BANKNOTE**—Complete 1974 U.S. Coin and Supply Catalog 25c. Schultheis, Box 2151C, New Hyde Park, New York 11040.

**COIN** Bargain Lists, 8c Stamp. Nayko, Box 233, Kennedy Airport, New York 11430.

**SET (SILVER)** War Nickels \$2.95; Silver Certificate \$2.25; Bargain Listing 25c. Fairway, Box 685-K, White Plains, New York 10602.

**SEND** 10c for new edition valuable Guidebook "HOW TO COLLECT COINS." Also included 5 foreign coins from Turkey, Spain, etc., and best coins and supplies catalog in America. Littleton Coin Co., Dept. XB-1, Littleton, N. H. 03561

**15 COINS** From 15 Countries \$1.00 WILLIAM GETTS, 4 QUARROPAS ST., WHITE PLAINS, NEW YORK 10601.

**"1800's"** Indianhead + Rare 1909 VDB Penny, \$2.10. Lad, Box 3095, Daly City, Cal., 94015.

**FOREIGN** Coins. Free Lists. Limarc, Box 1142, Langley Park, Maryland 20787.

**4 BUFFALOS** \$1.20. 1929S—1930S—1937S—1938D. Ronro, 1265-81 Street, Brooklyn, New York 11228.

**FIFTEEN** Different Indian Cents \$7.48; Crisp New \$2.00 Bill \$7.28; Uncirculated 1950-D Nickel \$11.88. Bargain Lists 25c. Bebee's Incorp., Omaha, Nebraska 68111.

**CABLE** Car Centennial Coin In Bronze \$3.00 postpaid. Sterling Silver \$12.00. Sea Captain's Chest, 211 Jefferson, San Francisco, Cal. 94133.

**JEFFERSON NICKELS** 1938-D, 1938-S, 1939-D, 1939-S, all 4 VG/F \$5.95. 1950-D Uncirculated \$8.50. 1973-74 Catalog 50c. Jake's, 5521 Belmont, Chicago, Illinois 60641.

(Continued on next page)

## COINS, TOKENS, CURRENCY

(Continued from preceding page)

**INVESTMENT** Specials: Uncirculated Silver Dollars \$6.95 Each, Five Different \$33.95. One Ounce Pure Silver Bars \$4.95, Five For \$23.95. Coin Investments, 342 Central, Lawrence, NY. 11559

**XMAS SPECIAL** Starter Sets. Indians or Buffalo's Ten for \$4.95. Sylvia Novack, P. O. Box 729, San Bernardino, California 92402.

**BARGAIN** Coin List, 10¢. Economy Sales, Box 92, Buzzard's Bay, Massachusetts, 02532.

## ANTIQUES, RELICS, INDIAN GOODS & CURIOS

**WHOLESALE** Advertising Collectibles! Stamp for list, Freeman's, Box 128M, Park Forest, Ill. 60466.

**APACHE ARROWHEAD COLLECTIONS**—Perfect, 25—\$5.00, 100—\$15.00. **GERONIMO**, PMD1239, Apache Junction, Arizona 85220.

**FREE!!** Lists Antiques, Indian Relics, 10 Arrowheads \$4.00. Hyde's, Box 2304, Santa Fe, New Mexico 87501.

**INDIAN** Relic list, Arrowheads \$4.00. doz. Folsom, \$5.00 each. C. Secrist, Deerfield, Missouri 64741.

**SELLING** 10,000 Indian Relics. Arrowheads, Knives, Spearheads, Scrapers, Etc. List Free. Lear's, Glenwood, Ark. 71943.

## MODELS—CARS, SHIPS, TRAINS, PLANES, ETC.

**SCALE** Model Cannons, Ships, Tanks, Airplanes, Autos, Trains and Accessories. New Catalog \$1.50. Frontier Models, 1583 West Washington Blvd., Los Angeles, Calif. 90007.

**SHIP** Model Kits, Fittings, Plans, Books, Tools, Engines, Motors. New Illustrated Catalog 75¢. Mass. residents add 3% tax. James Bliss & Co., Dept. SM, Route 128, Dedham, Mass. 02026.

**SHIP MODEL** Kits, Plans, Fittings from our own Workshop. Big Illustrated Catalog: 50¢. Bluejacket Shipcrafters, 145-V Water Street, South Norwalk, Conn. 06854.

**SHIP** And Airplane Model Kits Catalog 25¢. Scientific, Inc., 340 Snyder, Berkeley Heights, N.J. 07922.

**MODEL** Airplanes—Big 220 Page Catalog \$1.00. Sig Company, Montezuma, Iowa 50171.

**SHIP** And Yacht model fittings: Pine construction hull kits: blueprints. Send 75¢ for illustrated catalog. A.J. Fisher, Inc., 1002 Etowah Avenue, Royal Oak, Michigan 48067

**LIVE** Steam powered backyard railroads! All sizes. Complete "bolt-together kits," and rough castings. Excellent drawings. 100 page catalog \$2.00. Little Engines, Lomita, California 90717.

**MINIATURE** Screws, Size 1-72 X 3/16. Straight Slot Flathead Package, 200 For \$1.00 Postage Paid. 3 Packages For \$2.50. Write: A. H. Edelen, 2562 Calle Narcisco, 1000 Oaks, California 91360. List Sent.

**LIVE** Steam Engine Kits. Fascinating Hobby for Model Mechanics. Boilers, Fittings, Accessories. Pictured Catalog \$1.00. H.P.K. Models, Centuck 34, Yonkers, "V" New York 10710.

## GAMES, TOYS, PUZZLES, NOVELTIES

**KIDS!** 8-80. Puzzles: \$2 00; \$1.25; Both \$2.25. Heyl, 266 Belvidere, Grayslake, Illinois 60030.

**PARTY** Fun! Mating Game Compares Handwriting, reveals Personality, Predicts Future Relationships! \$5.95 Guaranteed. The Mail Plaza, Box 412, Thermal, Calif. 92274.

**FUN!** 8 Unusual Pocket Games for Two. \$1.25. H&R Associates, Box 212, Hinsdale, Illinois 60521

**HOUSEFLY PISTOL/Rubber Gun/Not Quite Raid/But lots more fun.** Kit \$1 49. Dual Design, Box 3828, Granada Hills, Calif. 91344.

**BIBLE** Verse Cards 100 from Catholic, Protestant, Jewish Bibles. \$2.00. Scriptures, 5837 Stewart, Sylvania, Ohio 43560.

**NOVELTY UNIVERSITY DEGREES, HIGH SCHOOL, Marriage, Divorce, and Many Others.** Send \$2.00 Sample of your Choice. P. O. Box 50, Franklin, La. 70538.

## MAGIC TRICKS, JOKES, VENTRILOQUISM

**HOUDINI'S** Greatest Magic! You can do them all!! Giant Illustrated Catalog 25¢ House of 1000 Mysteries, P.O. Box 5007P, Ft. Lauderdale, Florida 33310.

**VENTRILOQUISM!** Learn at home. Guaranteed. Information **FREE!** Dummy Catalog 25¢: Maher, Box 9037PM, Denver, Colorado 80209.

**FREE!** World's leading novelty catalog. 1600 Funmakers, Jokes, Tricks, Science, Sports, Hobbies, Jewelry, Psychedelia. Johnson-Smith, C-10, Mt. Clemens, Mich. 48043.

**COMPLETELY** Illustrated catalog. 84 pages. 25¢. Manhattan Magic, Box 334-M, N.Y.C 10011.

**MAGIC MAGAZINE.** Tricks, News, Dealers Offerings. Monthly Since 1936. 2 sample Copies \$1.00. Genii, P.O. Box 36068M, Los Angeles, California 90036.

**WORLD'S** Finest professional magic tricks. Joker's Novelties. Giant illustrated catalog 10¢. Top Hat, Evanston, Illinois.

**FABULOUS MAGICS** New 1973 catalogue 25¢. Our specialty orders shipped same day no substitutes. Fabulous Magic, 3319 East Charleston, Las Vegas, Nevada 89104.

**BE A Magician!** Two booklets explaining 156 tricks plus large professional catalog. \$1.00. Magic, Inc., 5082 Lincoln, Chicago, Illinois 60625.

**MAGIC!** Amaze, Mystify, Entertain! Hundreds Of Newest Tricks For Pocket, Parlor, Stage. Complete Catalog Only 25¢. Jeffries Magicland, Dept. 11, Dallas, Texas 75201.

**TWO!** Different Magic Catalogs. 25¢. Miami Magic, Box 1047, Miami 33133.

**LEARN VENTRILOQUISM! GUARANTEED.** Information Free. Dummies, Courses, Puppets Catalog 25¢. Izzy's Ventriloquism School, 3746 West 63rd Street, Chicago, Illinois 60629.

**WOW!** Magic, jokes. Largest selection. Amaze, mystify friends. Super Giant Catalog 25¢. Abracadabra-MP, Colonia, New Jersey 07067.

## BOOKS, CATALOGS, NEWSPAPERS

**OPERATION SUCCESS** Book and Chart based on 25 years of research. Send \$2.95 To: **ALADDIN'S**, 311 St. Charles Ave., New Orleans, La. 70130.

**LATEST** Military/Survival Books/Manuals Catalog 25¢. Hillcrest Publications (K-18), McDonald, Ohio 44437

**OUT** of Print Bookfinder. Box 663 PM, Seaside, Calif. 93955 Send Wants.

**FREE VENTRILOQUIST NEWSPAPER!** Fascinating, Informative, Profitable! No obligation. Maher, Box 9037PB, Denver, Colorado 80209.

**WIRETAPPING EXPOSE**—Your Privacy Invaded—Details \$1.00. Refundable. Don-Q, Box 548, Dept. PMO, Seattle, Wa. 98111.

**FREE BOOK.** Prophet Elijah Coming Before Christ. Megiddo Mission, Dept. 63, 481 Thurston Road, Rochester, N.Y. 14619.

**NATIONAL** Geographic Magazines, 1888-1971, any issue. Buxbaum, Box 465-PM, Wilmington, Delaware 19899.

**HIGHER INCOME,** Security and Power. 256 page Book "Thinking Big" reveals secrets that make men rich. Send \$2.00 Kinney (B-12)—1846 Baird, Madison, Wisconsin 53713.

**FREE** Catalog. Blue Books. How-to-Books Bargain Guides. Elston House, Centerville, Mass. 02632.

**FREE BOOK DISCOUNT CATALOG** Listing over 600 Books—Moneymaking Opportunities, Personal Improvement, Astrology—other titles. Pickwick House, Dept. P112, 62 Park Avenue, Verona, New Jersey 07044.

**FREE!** Current Magazines. Details: Dept. PML, 2004 Mackay, Redondo Beach, Calif. 90278.

**BOOK SALE!** Great Buy. 40 Family Books. \$3.00. Winchester Enterprises, 2807PM Hargrave Street, Philadelphia, Penna. 19136.

**FREE MAGAZINES!** Huge Selection, latest issues. Guaranteed. Complete Details. Send \$2.00—Ableco, 935 Rosewood, Inglewood, Calif. 90301.

**VEGETARIANISM**—"We Vegetarians Look Younger and Live Longer". Beautiful Scientific Quotations \$2.00. Model Francis Lighttown Model, 4210 Collins Avenue, Miami Beach, Florida 33140.

**GOOD BOOKS ABOUT MAIL ORDER BUSINESS.** Free Information. Queens Enterprise, Box 1607-K, Grand Central, New York 10017.

**BARGAIN** Book Catalog 25¢. Heinz von Kaenel, 1084 Bahama Dr., Marion, Ohio 43302.

**BOOK** Club. Discounts! Premiums! Join Now! Membership Fee 25¢. Distributors, Box 5067-P, Mission Hills, Calif. 91345

## PLAYS, SONGS, MANUSCRIPTS

**SONGS SONGPOEMS** Wanted For Radio Show. Hollywood Music Productions, 6425-PM, Hollywood Boulevard, Hollywood, California 90028.

**SONGPOEMS, SONGS!** Urgently Needed. Possible Recording/Publishing, 50-50 Agreement, Betty's Music Makers, 1417B Park Bldg., Pittsburgh, Pennsylvania 15222.

**WANT** Your book published? Learn how—we publish, advertise, promote, distribute. Many successes. Free booklet **PM**. Vantage, 516 W. 34th Street, New York City.

**SONGS,** Poems Wanted for publishing, recording! (Publishing contracts issued upon author's request.) Talent, 17-PM Longwood Road, Quincy, Mass. 02169

**SONGWRITERS!** Poets! We need new song material for immediate publishing, recording consideration! Accepted songs recorded, published at our expense! Author pays cost of only one handcut record! (Publishing contracts issued upon author's request.) Grand Recording, 1354-PM Hancock Street, Quincy, Mass. 02169. (A Talent Company.)

## BUSINESS SERVICES

**PROFITS FROM CLASSIFIED ADVERTISING!** Booklet shows you how to start your own business with Classified Advertising. Only \$1.00 (Refundable with first order.) **H. E. KAPPEL, POPULAR MECHANICS, DEPT. P, 224 WEST 57 STREET, NEW YORK, N.Y. 10019.**

**JAPAN** SOURCING for mail order promotions. Friedman, Shiba P.O. Box 234, Tokyo, Japan 105.

**INFLATION** Got You? Earn \$20-2000 Monthly!!! Full—Part Time\*\* Service Business\*\* No Investment!!! Be Your Own Boss\*\* Complete Proven Simple Instructions\*\* \$4.98\*\* Hathaway (1-E-12), 8681 Viscount, Huntington Beach, California 92646\*\*.

(Continued on next page)

## BUSINESS OPPORTUNITIES

**BOOKKEEPERS** Operate Profitable Bookkeeping Service. Earn \$10.00-\$20.00 hour. Details free. Universal Bookkeeping, Box 664-M, Springfield, Missouri 65801.

**PREPARE** Tax Returns—Policeman Albert Myers made \$2000 his very first season. Train at home. VA Approved. National Tax School, Monsey, 2XD, N.Y. 10952.

**SECRETS!** Mail Order Success. Internationally famous expert reveals how to make home business fortunes. Beginners: Get free report "Make Money By Mail." Discloses free advertising profitable products. Mailco, Dept. GC, 70C, Woodland Hills, California 91364.

**BIG PROFITS** Selling Nameplates, Custom Engravings. Largest Catalogue \$1.00 (Refundable). R.P.H. Manufacturing—249H-Winter, Stamford, Connecticut 06905.

**DON'T** Die without a will! Blank Will form protects your family. Only \$2.00. Guaranteed! Don't Delay!! Guy's, Room 8, 40 Sturtevant St., Norwich, Conn. 06360.

**\$2000 MONTHLY** Selling information By Mail. Free Details: Clark, Box 80521-M, Atlanta, Georgia 30341.

**LIBERATE YOURSELF.** Become Our Distributor Making Highest Profits On 1001 Products. We Drop-Ship Novelties, Gifts, Toys. \$2.00 Brings 150 Page Catalog (Refundable With First Order). **ALLEN WHOLESALE COMPANY**, 12135 Mitchell Avenue 220-P2, Mar Vista, California 90066.

**\$26.00 HUNDRED** Addressing Envelopes. Details. Send \$1.00 and Stamped Addressed Envelope. Keen, Box 9995PM, San Diego, Cal. 92109.

**500% PROFIT** Possible Novelties. General Merchandise, Specialties. Wholesale Catalog \$2.00 (refundable). Imperial Gifts, 621 Tucson, Lexington, Kentucky 40503.

**REPAIR TYPEWRITERS:** Book \$3.00. United Typewriters, 12429 Southeast Stevens, Portland, Oregon 97233.

**MAILORDER DEALERS WANTED** 50 to 400% profits. Details 25¢. Silva-PS, 467 Shears St., Wrentham, Mass. 02093.

**IMPORT OPPORTUNITY** Free at our Risk and Expense for One Full Year. Earn \$15,000 or Pay Nothing. Detail's: Northeast Imports, World Trade Division, Box 111M11, Fremont, New Hampshire 03044.

**\$25.00 HUNDRED** Stuffing Envelopes. Instructions \$1.00. Amsen, 2614XB Weisman, Wheaton, Maryland 20902.

**BIG** Money, Abandoned Land. Helped others. Free information. Tax Sales, Box 3-A, Montreal, Canada H4E 4H4.

**START** Your Own Business with Part Time Earnings of \$75.00 to \$250.00 weekly. Grow into Full Time Big Business in Six Months. Act Now, Offer Limited. Send \$2.00 for Complete Details. Carlisle Industries, Box 10997, St. Petersburg, Fla. 33733.

**BOOKLETS** Make Money on Government Surplus, How and Where to Buy. Stop Smoking Step by Step Method. \$10 Daily Writing Short Articles at Home. Mailorder Imports Drop Ship Sources. \$1.00 Each. The Red Gift House, 7716 Oak Ave., Gary, Ind. 46403.

**FREE MONEYBOOK** "990 Successful, Little One-Man Businesses", plus money loans. Work home! Small Business Index, Dept. 7, Kerrville, Texas 78028.

**ADVERTISING BUSINESS—YOU** Own it. \$400 First Week or Money Back. Electric Ad Clock, Room AC-2CP, 1512 West Jarvis, Chicago, Illinois 60626.

**SEE** How Mail Order Fortunes Are Made. Keystone, P.O. Box 106-PM, Rockaway, New Jersey 07866.

**\$700 MONTHLY** Immediate Income. Stuff envelopes at home. Information, send self-addressed stamped envelope. Cottage, Box 25053-CAJ, Los Angeles, Calif. 90025.

**HOW TO EARN AT HOME** Addressing Envelopes. Rush Self-Addressed, Stamped Envelope. Jotti, (P121M), Box 449, Hawthorne, Calif 90250.

**COMPLETE QUESTIONS & ANSWERS ON MAILORDER.** \$1.25 to: Scott Schwartz, 590 Whitenack Road, Rivervale, N.J. 07675.

**HOW AND WHERE TO GET CAPITAL.** Get \$500 to \$2 million. Free information. Counselor-17, Kerrville, Texas 78028.

**SELL** Music Books, Mailorder—300% Profit!! Circulars, Ads Available. Dropshipments. Free Details. Shoneco, Box 192, Medford, Oregon 97501.

**\$25,000 + YEARLY**—Sparetime, guaranteed mailorder system! Start with \$7.00. Rush 25¢ (refundable) Mears, 5363 Essex, Alexandria, Virginia 22311.

**\$250.00 PER** Thousand stuffing envelopes! Unconditional Money-Back guarantee! Complete Starters Kit \$1.00. **HOMEWORKERS**, Box 24413-NL, Oakland, Cal. 94623.

**I MADE** \$2,000.00 Monthly by Mailorder . . . Evenings Only! You Can Too—Free Proof! Asbury, Box 161-D, Madison, Ohio 44057.

**FREE** Newsletter! "Selling Books By Mail". (Wholesale. Dropship, Imprints). Mailco, Box 1355, Sioux Falls, South Dakota 57101.

**RECEIVE** \$250.00 Per Thousand—stuff Envelopes—Earn Immediately—Details 25¢. Saffar, Box 1956PM3, Atlanta, Georgia 30301.

**NEW!** Profitable Mail Order Business! Free Details! Xcito Businesses, 5715 N. Mozart, Chicago, Illinois 60659.

**CLAIM ABANDONED SILVER**—\$20,000 Secret Revealed! Free Information: Silverman 4A-13, Box 548, Woodville, Texas 75979.

**START** Your Own Correspondence School. United Career Schools, 5820P Imperial Hyway, South Gate, Calif. 90280.

**HERBALISM!** The Home Gold Mine! **FREE LESSON, SEEDS!** Herbalism Institute-B, Box 968, Glendora, California 91740.

**BIG PROFITS!! SELL ENGRAVED, METAL, SOCIAL SECURITY PLATES. FREE SAMPLE KIT!** MYERS, 928-PM CRESCENTHILL, NASHVILLE, TENNESSEE 37206.

**MAILORDER** Dealers Wanted. Earn outstanding profits using tested promotions! Rutward-PD, Georgetown, Conn. 06829.

**PIANO** Tuning Learned Quickly at Home! Tremendous field! Musical knowledge unnecessary. GI Approved. Information Free. Empire School, Box 327, Miami, 33145.

**WORLD'S** Largest supply. Merchandise 25% to 40% under wholesale. Bankrupts. Closeouts 10¢ on dollar. Imports. Hong Kong clothes. Automobile discounts. Free details. International Buyers, Box 16386 MM, Portland, Oregon 97233.

**SELL** Books by mail. Complete dealer set-up—25¢. Midwest Mail Sales, Box 44R2-PM, Shawano, Wisconsin 54166.

**MAKE** A Years Income in 8 weeks Camping. No selling, Capital or Land necessary. Write: Edru's, Route 5, Box 5733, Gig Harbor, Washington 98335.

**BECOME** "Mortgage Broker." Lucrative! Capital Sources, Box 99-A, Uleta, Florida 33164.

**MAKE** Magnetic signs. Machineless method. Profits enormous. Write: R1B49APM, Bardstown, Ky. 40004.

**HOLLYWOOD CEMENTCRAFT:** Offers Highly Profitable Home Business. Experience Unnecessary. Unlimited Unique Pottery Designs Easily Made Without Moulds. Bird-baths, Fountains, Wishing-Wells, Waterfalls, etc. Chemical Coloring Formulas. Marble-glazing. **FREE** Illustrated Brochure. **CONCRETE FACTS**, 602 Athens Street, Altadena, California 91001.

**COPUBLISH** "Mail Sale Advertiser," leading mailorder paper. Copy and details 25¢. U.S.A. only. Vanroy Shirk, Lebanon, Pa. 17042.

**FREE** Catalogs. Repair air conditioning refrigeration. Tools, supplies, full instructions. Doolin, 2016 Canton, Dallas, Texas 75201.

**\$70 TO \$200 WEEKLY**—Home, Spare Time Simplified Mail Bookkeeping. Immediate Income. Easy. Auditax, Box 34741A, Los Angeles, Calif. 90034.

**VENDING** Machines. No selling. Routes earn amazing profits. Big catalogue Free. Parkway Corporation, 715PBM Ensor Street, Baltimore, Maryland 21202.

**\$60.00 DAY.** Manufacturing Concrete Posts. Blocks. Mold Equipment Catalog \$1.00 refundable. Carlayne, Route One, Box 95, Rapid City, South Dakota 57701.

**SELL** Books by mail. 400% profit. Royal, Box 450-X, Cleveland, Ohio 44127.

**MAILORDER** Records help get increased business! Complete 32 page Record Book shows your inquiries, orders, advertising, expense, etc. Only \$1.00. **H. E. KAPPEL, POPULAR MECHANICS, DEPT. R, 224 WEST 57TH STREET, NEW YORK, NEW YORK 10019.**

**REPAIR** Hydraulic Jacks—Details Free. Write: Hydraulic Parts Supply, Box 295, Port Isabel, Texas 78578.

**EARN** \$60.00 Daily manufacturing Concrete Fence Posts. Practically no investment. Send stamped-addressed envelope. American, Excelsior Springs, Mo. 64024.

**\$50.00 PLUS 50% COMMISSION** Stuffing 200 already stamped, addressed envelopes, our circulars. Information 25¢ with stamped, self-addressed envelope. Brewster-PB, Clearwater, Florida 33517.

**\$400.00 MONTHLY** Raising giant fishworms. Soilless method. Charlie Morgan, Bushnell, Florida 33513.

**EARN** Money raising fishworms for us! Write: Oakhaven-38, Cedar Hill, Texas 75104.

**WATCHMAKING** Makes every day a payday. Learn this cash business at home. Free details. Chicago School of Watchmaking, YZA, Fox River Grove, Illinois 60021.

**\$1.00 LISTS** You year sent to 1000 Importers, Jobbers, Mailers, our mailing year. Dixiem, King, North Carolina 27021.

**\$200.00 SPARE** Time earnings with your Tablesaw. Write: Workshop Five, 3800 Harney, Vancouver, Washington 98660.

**\$200 WEEKLY!** Make, Sell Bricks! Free Information! Xcito Bricks, 5715 N. Mozart, Chicago, Ill. 60659.

**I MADE \$40,000.00** Year by Mailorder! Helped others make money! Start with \$15.00—Free Proof. Torrey, Box 318-Y, Ypsilanti, Michigan 48197.

**SELL** New Sensational Car Thief Signal. Lightning Seller, Samples for trial, Northwest Electric Ave. 183, Mitchell, S. Dak. 57301.

**BECOME** Our Mail Order Distributor with \$150 Investment. Free Brochure. Audit Controls, 40 Brookside Ave., Fair Lawn, New Jersey 07410.

**PORTABLE** Sandblaster \$29.95. Distributor wanted. Free brochure. INKA, Box 66573—A, Houston, Texas 77006.

**MAILORDER** Millionaire helps beginners make \$500 weekly. Free report reveals secret plan! Executive (1A12), 333 North Michigan, Chicago 60601.

**FREE SECRET BOOK** "2042 Unique, Proven Enterprises." Tiny businesses but huge profits! How Little Fellows beat inflation. Work home! Haylings, T27, Carlsbad, California 92008.

(Continued on next page)

## BUSINESS OPPORTUNITIES

Continued from preceding page.

**SECRETS** of getting rich with other people's money. \$5000 + possible in one day. Free details. JPA, Dept. 308, Box 101, Park Ridge, N.J. 07656.

**\$200.00 DAILY** In Your Mailbox! Opportunity To Follow Mailorder Experts. Free Details. Associates, Box 136-A, Holland, Mich. 49423.

**\$25,000.00 GUARANTEED** Income. Mail-order Business. Information 25¢. International, Box 217, Madison, Wisconsin 53701.

**SELL** Books!! Complete Mailorder Plan. Vikari's, Box 1312PM2, Salt Lake City, Utah 84110.

**ADDRESSERS.** Homeworkers Needed! Info. 35¢. Bitonti, 5225 Pattison, St. Louis, Mo. 63110.

**TAKE** Catalog orders. We drop-ship 1001 best selling specialty products. Lowest below wholesale prices. Immediate Delivery. Spectacular home business opportunity. Free Book. Specialty Merchandise, Dept. S-P-12, Woodland Hills, California 91364.

**STUFF** Envelopes. \$25 Hundred. Immediate Earnings! Beginner's Kit \$1.00 (Refundable) MLFlores, 785-A San Pierre Way, Mountain View, Calif. 94043.

**\$500.00 WEEKLY.** Most Profitable. Mail Order. Sell Information. Details. Smith, Box 176, Corona, California 91720.

**\$25.00 HUNDRED** Addressing possible year round. Special information 25¢ with self-addressed stamped envelope. Cove-B, 627 Franklin, Clearwater, Florida 33517.

**\$1000 MONTHLY** from your own home. Write: Jordan, Box 884, Dept. PM12, Visalia, Calif. 93277.

**DO SIMPLE ADDRESSING**—Mailing. Receive \$12.95 orders. Keep \$8.00 profit. Details Free! Quality, Box 9-P, East Rockaway, N.Y. 11518.

**MEN**—Women! Fill out income tax forms at home in own business. We show you how. Simple, easy to learn. \$700 per month earnings possible. Details mailed free. No salesmen. Hurry. Federated Tax Home Training School, 2065 Montrose, Chicago 60618

**MAKE** \$7.50 to \$15.00 hourly building portable custom cases in your home. Huge demand. Get orders by mail. We supply materials, instructions—everything. Free details. Customcase, 6075 De Soto, Dept. C-P12, Woodland Hills, California 91364.

**HOW TO MAKE MONEY ADDRESSING, MAILING LETTERS. OFFER DETAILS 10¢.** Lindbloom, 3636 West Peterson, Chicago 60659.

**MAIL** Baby Catalogs Imprinted with your address to New Mothers for Big Profits! Details 25¢. Volz PM, Ypsilanti, Michigan 48197.

**CALIFORNIA MANUFACTURER NEEDS** Man to assemble our product and be local agent, experience unnecessary. May start while presently employed. Five-figure income for responsible applicant. S.K.R.M. Manufacturers, 2347 West 238 Street, Torrance, California 90501.

**MAILORDER BEGINNERS LIBRARY.** Learn Professional Secrets Inexpensively! Write: HOW, Box 4457PM12, Downey, California 90241.

**RAISE** Rabbits, other Laboratory animals for us. We supply equipment, breeders and instructions. Details 25¢. Rabbits of Michigan, MP-11 Countyline Road, Pentwater, Michigan 49449.

**HOW TO RAISE** \$100.00 to \$1,000,000.00!! Write: Capital-PM, Dawsonville, Georgia 30534.

**FREE COLLECTION AGENCY** Details!! \$1000.00 Monthly Possible. Master-PM, Dawsonville, Georgia 30534.

**SUBSTANTIAL PROFITS.** Own your own business. Quickly learned. Operate from your home while continuing present job. Little over \$1,400.00 starts your own nationally and locally advertised business. Investigate immediately before your territory is taken. Free Literature. Send today. Thixo-Tex, Inc., 5757 Lincoln Avenue, Dept. PM-3, Chicago, Illinois 60659.

**START Profitable Home Mailorder Business** with Proven. Tested Baby Gift Catalog. Imprinted. Complete Profit Details. Sample Catalog 25¢. Langford, 600 National Drive, Grafton, Ohio 44044.

**HIGH** Profit Potential from Plastic Engraving! Ideal Home Business. Trend Craftsmen, 4901P Perrine, Midland, Michigan 48640.

**YOUR** Own Mailorder Catalog Business. No Merchandise Investment. Details 25¢. AM Sales, 31-14 94 St., East Elmhurst, New York 11369.

**RAISE** Capital without collateral or credit. Unique plan assures success. Enterprises, Box 247-M, Columbus, Georgia 31902.

**1000% PROFIT** Bronzing Baby Shoes At Home. Free Literature. NBC-PM, Gower, Missouri 64454.

**FINDER'S FEES?** Turn Contacts into Cash. Two Survey Reports, Trial Membership Kit. Send \$2. Finderhood, (PM-74), 15 West 38th St., New York, N.Y. 10018.

**MONEY EVERYDAY** IN YOUR MAILBOX. Free Details. Jaycee Barnes, Box 913, Glens Falls, New York 12801.

**NEED MONEY?** Stop Looking! Start small, at home, grow at your own pace. Men and Women equally successful. Details 25¢. Reliable, Dept. 1012, 28 East Jackson Blvd., Suite 1204, Chicago, Ill. 60604.

**AUTO PARTS STORES FOR SALE!** For Locations and Information Write: G. A. Millinger, 2754 Quincannon Lane, Houston, Texas. 77043.

**GOOD PROFITS** In Your Own Business. Designed to Fit you Alone. Start in Spare Time. Small Investment. Trauhau-53, Box 3004, Duluth, Minnesota 55803.

**FREE Literature**—Start Your Own Mail Order Business At Home. The Tomlyn Co., Box 614 (L-3), Clifton, N.J. 07012.

**ELECTRONIC** Assembly Business. Big profits. Start home, spare time. Investment, knowledge, experience unnecessary. Free illustrated literature. Barta, Box 248GZ, Walnut Creek, Calif. 94597.

**NEW.** Compact fire extinguisher. Fantastic profits. Exclusive territories. Norwich Chemical, Norwich, Connecticut 06397.

**SELL** Books By Mail. Dealership Information 25¢. House of Better Books, 33 Stonycliff Road, Centerville, Mass. 02632.

**\$\$\$\$\$ MACHINE!** Reproduces, Carves, Engraves! Cheap, Easily Built. Economy Enterprises, Box 23-P, Highland, Maryland 20777.

**"MAILORDER Course! Home Study".** 24 Easy Lessons. \$2.00. "Bill" Lambertson, 132 Tamiami Station, Dept. PM123, Miami, Florida 33144.

**"MAKE \$2000 Monthly** in Fabulous New Business. Write: Bradshaw's, Burgin 1, Kentucky 40310."

**RECEIVE** Big Mails! Free Details! Kennedy, Box 351, Selma, Alabama 36701

**SELL BURGLAR ALARMS.** Set of Five Warning Stickers \$1.00. Lee Specialties, Box 32P, Dobbs Ferry, New York 10522.

**LET** others make money for you. Start home business. Full or part time. I show you how. Free Report. Morgan, Dept. G270C, 6100 Variel, Woodland Hills, California 91364.

**FREE**—166 Wholesale Catalogs and FREE bookmarkers. Finest Mailorder Information!—Jay's Mail Order Sales, 2208 Hermitage Avenue, Wheaton, Maryland 20902.

**RECEIVE** Mail Galore! Your name on our national mailing lists, \$1.00. Sullins, Box 1313, Brunswick, Georgia 31520.

**REPAIR** Hydraulic Jacks—Details Free. Write: Hydraulic Parts Supply, Box 295, Port Isabel, Texas 78578.

**IMPORT-EXPORT** Opportunity, profitable world-wide, mail order business from home, without capital or travel abroad. We ship plan for no risk examination. Experience unnecessary. Free Report. Mellinger, Dept. G270C, Woodland Hills, California 91364.

**FREE** Details and Catalog to Begin a Profitable Mailorder Business. Yvon Patraulea, 173 West 78th Street, New York, New York 10024.

**MAKE EXTRA MONEY.** Copyrighted Report Shows how you can turn a Hobby into Money Making Venture. Common and /or Unusual Household Articles may be worth Hundreds of Dollars. Booklet HH65M. \$1.00. Hallen House, 10632 Pedro Way, Rancho Cordova, Calif. 95670.

**\$500 MONTHLY POSSIBLE** Clipping newspaper items—at home, spare time. Details free. Clippings, Box 10343—PM3B, Palo Alto, California 94303.

**INSTALL** Burglar alarms without previous experience or costly equipment. Big profit. Free details. Nasco, Dept. G270C, Woodland Hills, California 91364.

**EXTRA INCOME** In 1974. Start Now! Pleasant Work, Small Investment. Gerald D. Foster Co., Box 161, Dept. PM123, Baldwinville, New York 13027.

**INTERESTED** In Mail Order? **START RIGHT!** We have the Programs, Small or Large. Write: TURNACO A50, 2201 Bonita Way So., St. Petersburg, Florida 33712.

**MAKE** durable building plastic easily. Waterproof, fireproof, economical. Bays Laboratory, Cedaredge, Colo. 81413.

**MAKE \$92.00 FROM** Square Foot Plywood (Jigsaw or Bandsaw necessary). (Proof), details 25¢. (Refundable). Woodart, Bridgewater, Mass. 02324.

**BECOME** Notary. Free particulars. Smidts, 405 Richardt Avenue, Evansville, Indiana 47711.

**BE YOUR** Own Boss! Read, "How To Start Your Own Business." Only \$1.00. Associates, 113031 Community, Shillington, Pennsylvania 19607.

**YOUR** Name Placed Directly with 100's of Mailers, Publishers, Importers, Exporters. Mail \$1.00. Jemco, Box 6428, Fort Worth, Texas 76115.

**\$1000.00 IN ONE WEEK**—I made it in Home Security Business. Free Details. Security Systems, 6 Manor View Drive, Greenville, Pennsylvania 16125.

**\$2,500 WEEK** Profit! New—first major change in carpet cleaning for decades! Superior to any other method! Start your own carpet cleaning business—easy! Every household your customer. Beat all competition! Rent out equipment. Have your own name brand cleaning solutions! Fantastic Sales Plan can make you \$30,000 monthly! Free—complete, exciting details. Miraclean International, 1265PZ E. La Habra, La Habra, Calif. 90631.

**CASH** In on the Crying Need for Clean Water. Distribute our Water Purifier. Rare Opportunity. Popular Price. Timely. Write Hurley, A Name Known Since 1910. 3172 Sheridan, Chicago 60657.

**1000 FRESH MAILING LISTS** Perforated for \$1.00 bill (REFUNDABLE) AIRMAIL ORDER to: R. RAJGOPAL, POST BOX 16629, BOMBAY 19, INDIA.

(Continued on next page)

## BUSINESS OPPORTUNITIES

(Continued from preceding page)

**MILLIONS Possible.** Gravity Amplifies Power, Details \$50. Refundable. Spaceman, (M), Box 16046, Kansas City, Missouri 64112

**\$19.95 INVESTMENT** = \$40,000 return. No selling, age limit, diploma. Your own fascinating business. Complete information, postage, handling—\$1.00. Satisfaction guaranteed. Composite Designs Inc., Mancelona, Michigan 49659

**HOMEWORKERS**—Mailers Wanted! Free Information. A. Allen, 2418 Lori, Santa Ana, California, 92706.

**EARN \$2000.** Monthly Amazing, Interesting Businesses, Free Details. Simmons Enterprises, 11A Kiely Place, Brooklyn, New York 11208

**EARN More than many professional men!** \$1000. Month Mail Order Collection Agency, Continental, Box 2023-A, Des Moines, Iowa 50310.

**\$100,000 MONTHLY Possible.** Double Gas Mileage. Details \$39.00 Refundable. Ark, P. O. Box 8170, Kansas City, Missouri 64112

## MONEYMAKING OPPORTUNITIES

**BIG Profits** in becoming a supplier to major industry through electroplating small parts and metallizing non-metallics. Write for free particulars: Mason, Room MC-2-CP, 1512 Jarvis, Chicago, Illinois 60626.

**MAKE \$200** this weekend installing burglar-fire alarm systems. No experience. Instruction kit/manual, parts cat., prices, \$5.00 PPD. Guaranteed L.D. Oliss Publishing, 810 31st St., Union City, N.J. 07808

**PENNY STOCKS** Have Profit Potential. Free information. Analyst-PM, Box 534, Camino, California 95709

**\$6,000.00-\$12,000.00** Raising Rabbits. 400,000 Books Sold. Free Details. Vidikapa, Box 1543-PM12, Tampa, Florida 33601.

**MAKE MONEY** With Your Camera! Booklet \$1.00 Guaranteed. Owl's Nest, 3330 Lockheed Boulevard, Alexandria, Virginia 22306.

**HOW To Make Money in Real Estate.** Write: Howard, Box 577-B, Bozeman, Mont. 59715.

**POTENTIAL WRITERS:** 3 Steps to Successful Novels: **STEPS**, \$1.50. **Writer's Aid**, **SPEEDWRITING**. Original! \$1.00. Both, \$2.00. Specific, P.O. Box 2070, San Jose, California 95109

**200% PROFIT** Selling Rings. Triple Money in 30 Days or Money Back. Free Details. Anka, P.O. Box 8036-PM, Cranston, Rhode Island 02920.

**LEARN Sign Painting**—\$1000 Monthly, Part-Time. Free Catalogue. Kaufmann Company, Centertown, Missouri 65023.

**\$100.00 EXTRA WEEKLY EASY! SPARE TIME! DETAILS, BEAUTIFUL SAMPLE FREE.** **RUSSELL PRODUCTS, DEPT. P41, COLUMBIA, TENNESSEE 38401.**

**MAKE Statuettes, novelties, imitation marble.** Sell to stores or start gift shop. Free details. Marbleizing, 41 Waverton, St. Louis, Mo. 63124.

**HOW To Make Money Writing Short Paragraphs.** Information Free on "Home Studies in Writing" Barrett, Dept. C-27-C1, 6216 N. Clark, Chicago 60660.

**\$2.40 HOURLY** Making simple wood novelties. Free details! Gene's, 55 Boxwood, Falmouth, Mass. 02540.

**PYRAMID** Anything worth \$10.00 into \$100,000.00 without work—risk. Absolute Proof-Free. COSCO, Box 9007, Santa Rosa, CA 95405.

**NATURE LOVERS** Fantastic **NEW Opportunity EASY \$200-\$300** per outing possible Complete Instructions. **RUSH \$4.00.** Mother Nature's Workshop, 17706 Bay Circle, Fountain Valley, Calif 92807.

**HOW TO MAKE MONEY** Clipping newspaper items. \$2.00—\$10.00 each. . . . Details free. Clippings, Box 10343—PM3A, Palo Alto, California 94303.

**YOU Earn Your Living.** Let Us Help You Make Your Fortune. **FREE DETAILS.** Write: Acme Management Company, P.O. Box 20268, Chicago, Illinois 60620.

**FAILING** At mail order? Tired of the gimmicks, read all the books, mailed catalogues and still losing your shirt? Before you quit, write us for success details of making money at mail order. Information free. Write Home Publishing Company, 786 Laurel Lane, Wayne, Pennsylvania 19087.

**MAILER'S NEWSLETTER!** Over 50 firms listed. \$1.00, stamped addressed envelope. Pat Richardson, Box 4097, Yuma, Arizona 85364.

**FANTASTIC Seller** 5 electrically lighted roses. Red, Yellow or Pink. Sample \$3.00 Post Paid. Doz. Assorted—\$30.00. Sell for \$4.98. Collier, Box 306A, Yucca Valley, Cal. 92284.

**CHRISTMAS MONEY** Earn \$400 in 2 weeks. Work 3 hours nightly. A Christmas Service which requires no selling. Complete instructions \$2.00 **HURRY!** J. Beach, 1412 Miller Avenue, Winter Park, Florida 32789.

**NEVER** Pay another phone bill. Let others pay it for you. **HOW?** Find out **FREE.** Send \$1 to cover postage and handling. Bryan, 613 Oakley, Jacksonville, Ark. 72076.

**LOTTERIES, IRISH SWEEPSTAKES. HOW TO WIN.** Stop Buying Tickets At Random. For Detail: Necaca, P.O. 851-P, Philadelphia, Pa. 19105

**HIGHER INCOME, Security and Power.** 256 Page Book "Thinking Big" Reveals Secrets That Make Men Rich—\$2.00. Thermal Bent Distributors, Box 746, Tryon, North Carolina 28782.

**STUFF ENVELOPES.** \$250 thousand. Immediate earnings. Supplies furnished free. Send stamped, self-addressed envelope NRG, 271 Vanburger Rd., Owego, New York 13827.

**MAKE MONEY IN SPARE TIME.** Earn generous commissions as a subscription representative for leading magazines. For free details, send this ad with your name and address to: **POPULAR MECHANICS**, Room 1107S 250 W. 55th St., New York, N.Y. 10019.

**HOW TO GET RICH!!** Free "Money-making Brochure"! Success International, Box 2447-C, Livonia, Mich. 48151.

**VENDING Machines.** No selling. Routes earn amazing profits. Big catalogue Free. Parkway Corporation, 715PMM Ensor Street, Baltimore, Maryland 21202.

**\$40 DAILY** Possible tying fishing flies at home. Details 25c. Flyco, Box 946PM, Albany, Oregon 97321.

**EARN MONEY,** learn mailorder, spare-time, at home, reading leading (since 1929) trade magazine, product sources, stories, tips. Sample 50c, year \$5. Mail Trade, Box 1302, Springfield, Illinois 62705.

**FREE**—Easy Ways to make money selling exciting new products—Full—spare time. Send name, age, for 5 months free subscription. Salesman's Opportunity Magazine, 1460 Hancock Center, Dept. 17-MM, Chicago 60611.

**ADDRESSERS**—50 Companies want Addressers. Send self-addressed envelope. Cal Enterprises, Box 4516-X, Compton, Calif. 90224.

**SWEEPSTAKES** Contests. How to win. Write for free information. General Contests, 1609-18 East 5th., Duluth, Minnesota 55812.

**FREE SECRET BOOK** "2042 Unique, Proven Enterprises." Largest successful collection! Fabulous "Little Knowns." Work home! Haylings-T26, Carlsbad, Calif. 92008.

**\$200.00 FROM** Sheet 1/4" plywood (scrap). Details 25c. Novelties, 610 So. 24th, Elwood, Indiana 46036.

**GET** World's Biggest Wholesale Import Catalog. Write: World, Medina, Washington 98039.

**ADDRESSERS** And Mailers Needed! Free Details! Splendid Opportunity! Delta, Box 24-P, Chalmette, Louisiana 70043.

**SPARE** Time Cash. Sell Famous Hanover Shoes. Actual Samples and sales kit Free. No experience needed. No age limit. Lowest prices for highest quality makes selling easy. Every man a prospect. Big daily commissions. For full details, write: Hanover Shoes, 1041 Carlisle, Hanover, Pa. 17331.

**\$250.00 PER** Thousand stuffing envelopes! Unconditional Money-Back guarantee! Complete Starters Kit \$1.00. **HOMEWORKERS**, Box 24413-ML, Oakland, Cal. 94623.

**LEARN** The secrets of repairing junk batteries. "Fabulous Profits" at home. Apex Engineering, 3100, Romona, Atascadero, California 93422.

**PROVEN** Successful Mailorder Imprint Catalog Program. Everything Tested, Available. Free Details, Sample Catalog. Allen, 554CS-7 Spruce, Garwood, New Jersey 07027.

**WORLD'S** Leading Contest Magazine, 50c. Prizewinner, 1315 Central, St. Petersburg, Fla. 33705.

**NEVER WON ANYTHING?** Anyone Can Win Sweepstakes Contests! Free details. Services, Box 644-PCN, Des Moines, Iowa 50303.

**3000% PROFIT** Preserving Baby Shoes In Chinakote. Free Literature. NBC-PM-1, Gower, Mo. 64454.

**HIGHER INCOME, Security and Power.** 256 page Book "Thinking Big" Reveals Secrets that Make Men Rich! Send \$2.00. The Variety House, PM123, 1414 South 120th Street, Seattle, Washington 98168.

**WIN** Sweepstakes, Skill Contests—Now!! Free information. Wiemels, 325-L, Elmwood, Bay Village, Ohio 44140.

**GUARANTEED** Homework! Write us first for free details. Troy Company, Desk 810, Bayonne, New Jersey 07002.

**START** Small, Highly Profitable Electronic Production in your Basement. Investment, Knowledge unnecessary. Postcard brings facts. Barta-FZ, Box 248, Walnut Creek, Calif. 94597.

**I DIDN'T** Get Rich In Mail Order! My Story—\$2.00—Will save you Money and Frustration. Jon-Jon, 7160 Northwoods Station, Jacksonville, N. C. 28540.

**INCREASE** Your Income! Make Money with Your Camera. Informative Booklet Shows How, Where To Sell Your Photos. Act Now! Send \$1.00. Glory Hill, PM1273, Atlanta, Missouri 63530.

**400% PROFIT** From Square Foot 1/4" Plastic. Details Free Jo-Mar-Ko, POB A34893, Detroit, Mich. 48234.

**\$2,000 MONTHLY** In **ASTONISHING** Spare Time Business. Free Details. S. Branch, 1290 Lafayette Avenue, New York, New York 10459.

**HOW** To Make Money Writing for Magazines. Inquire: Sunrise, 25P Lake Street, White Plains, New York 10603.

**FREE**—Money-making Tips for fun and profit. Aneva's—1P1, 4221 S. 6th-A39, Milwaukee 53221

(Continued on next page)

## MONEYMAKING OPPORTUNITIES

(Continued from preceding page)

**\$800/MONTH Possible!!** Distribute Exciting Monthly Newsletter Featuring Latest Money Making Opportunities. Fantastic Subscriber Guarantee. Free Details. Business Opportunity Enterprises, 1576 Cicotte, Lincoln Park, Michigan 48146.

**\$100.00 WEEKLY** addressing—\$50.00 weekly homeworking, \$150.00 weekly collecting names.—Big money with **TELEPHONE, TYPEWRITING, SEWING** or mail-order. Details-stamped self-addressed envelope—.25¢ (refundable) to: **WJAS** Company, 8457 Aster, Oakland, California 94605

### PROFITABLE OCCUPATIONS

**MEN—Women!** Start money-making Plastic Laminating business at home in spare time. Material costing 11¢ brings back \$2.58. No canvassing or selling but mail orders bring in \$20 a day. Write for full particulars free. Rush name on postcard to: Warner, Room LC-2-CP, 1512 Jarvis, Chicago, Illinois 60626.

**LEARN GUN REPAIR, GUNSMITHING** In spare time. Books, details 10¢. Modern Gun Repair School, Dept 2217, 4225 N. Brown, Scottsdale, Arizona 85251.

**FT. SMITH** Auction School, Ft. Smith, Ark. 72901. Resident & Home study. Veteran approved.

**BECOME A Mortgage Broker.** Highly respected, interesting, lucrative prestige business. For complete information write: United, Box 6284-F, Marietta, Georgia 30060.

**PLASTERCRAFT!!!** Profitable home business. Molds available. Details: Lynnette, 6251C Mentor Park, Mentor, Ohio 44060.

**SHARPEN—Scissors, Pinkers, Light, compact equipment.** Supplies. Blackhawk's, Sheldahl, Iowa 50243.

**HOW To Make Money Writing Short Paragraphs, Information Free on "Home Studies in Writing".** Barrett, Dept. C-27-C2, 6216 N. Clark, Chicago 60660.

**BAKE** New greaseless doughnuts in kitchen. Sell Stores. Free Recipes. Michael Ray, Waseca, Minn. 56093.

### SALESMEN—DISTRIBUTORS

**PUBLICATIONS** for local wholesale distribution, higher profits. Details, sample, \$1 refundable. Publisher, 404 West Jefferson, Springfield, Illinois 62702.

**AUTOMATIC Fishhooks.** Free details. Samples, \$2.00. Aron, 61PM, Mastic Beach New York 11951.

**SELL Advertising Ball Pens, Calendars, Ad-Specialties—Build Own Repeat Business—Free Details—Fleming, Dept. A, 6535 Cottage Grove, Chicago 60637.**

**EARN MONEY IMMEDIATELY.** Sell nationally-famous Knapp Shoes part-time or full time. High cash commissions immediately plus bonuses monthly, benefits. Your own hours, your own business. No investment. Free selling and training kit. Lowell Harris, Dept. PM-12, Knapp Centre, Brockton, Mass. 02401.

**HERTEL** exclusive reference Bible! Make biggest profits with world's best seller! Startling 3-dimension cover! Demonstrator, supplies furnished. Top commissions plus extra bonus earnings! Write International Book, Dept. PM, Box 118, Wichita, Kansas 67201.

**TEXAS Refinery Corp.** offers opportunity for high income plus cash bonuses, convention trips and fringe benefits to mature individual in your area. Regardless of experience, air mail V.L. Pate, Pres., Texas Refinery Corp., Box 711, Fort Worth, Texas 76101.

**LONG** Needed Invention. Want man contact service stations. Full or part time. Huge Profits. Write Cyclo, 3816 Dahlia, Dept. 105, Denver, Colo. 80201.

**\$100.00 EXTRA** A week easy! Spare time! Double Air Cushion shoes. Men's, women's line. Dress, work, play. Highest commissions. Shoes for yourself, Outfit Free. Bronson, Dept. H-123, Minneapolis, Minnesota 55408.

### AGENTS WANTED

**EVERY** Man a prospect. Refundable sales kit offer showing line belt buckles, tie clasps, money clips, cuff links, lapels, identification badges, individualized with customer's name and emblems. Cap badges for trucking, bus, taxi, police, firemen, also postal, letter carriers and heavy construction emblems. Choice 5000 emblems. Hook-Fast, Box 1088-PM Providence, R.I. 02901.

**PRINTING, Advertising Salesmen—Excellent** moneymaking sideline selling Decalcomania Name Plates, small quantities. Advertising Specialties, sign letters. Free samples. Ralco XL, Boston, Mass 02119.

**YOUR** Own business. Used Suits \$1.50; Overcoats 65¢; Mackinaws 35¢; Shoes 12½¢; Ladies' Coats 30¢; Dresses 15¢. Enormous profits. Catalog Free. Nathan Portnoy Associates, 2109-AA Roosevelt Road, Chicago, Illinois 60608.

**INTRODUCE** Fast Selling Auto Products. Giant Profits. Big Market. Dealers Invited. McCarthy, 317 Grand, National Park, New Jersey 08063.

### EMPLOYMENT INFORMATION

**OVERSEAS JOBS—Now Hiring, 103 Countries, All Occupations, High Pay, Free Transportation, Tax Benefits. Latest Computerized Reports—\$2.00. TRANSWORLD, International Airport, Box 90802-E, Los Angeles, California 90009.**

**SEAGOING JOBS** Adventure Travel High pay & Rm & Board Guaranteed Methods for shipping with or without Seaman's Papers Specific Info Send \$3.00. Maritime Service, PO Box 228, Venice, Ca. 90291.

### HELP WANTED

**OVERSEAS** Jobs—Europe, South America Australia, Far East, etc. 2000 openings all trades. Construction, Office, Engineering Sales, etc. \$700 to \$3,000 month. Expenses paid. Free Information. Write: Overseas Jobs, International Airport, Box 536-M, Miami, Florida 33148.

**EARN** At Home Addressing Mail. Details 25¢ and Stamped Envelope. Deeco-151, Box 9308, North Hollywood, Cal. 91609.

**OVERSEAS EMPLOYMENT** . . . Australia, Europe, South America, Asia! All Occupations! \$700-\$3,000 monthly! Write: Employment International, Box 29217-AL, Indianapolis, Indiana 46229.

**OVERSEAS** Jobs—Australia, Europe, South America, Far East openings in all trades and professions. New listings; send \$5.00. Foreign Jobs Co., Box 2235AMF, Miami, Florida 33159.

**QUIT? We Dare You!** The Job Campaign helps you get better employment. Free Details. Life Encounters Kits, 91 Market Street, Annapolis, Maryland 21401.

### REAL ESTATE AND FARMS

**FREE CATALOG!** Giant Fall-Holidays edition of country property! Over 5,200 New properties described, pictured—Land, Farms, Homes, Businesses—Recreation, Retirement. Selected Best thruout the U.S.! 73 Years' service—670 Offices, 41 STATES Coast to Coast. Mailed FREE from the World's Largest! **STROUT REALTY, Inc.,** 60MX E. 42nd St., NY, NY 10017 7-MX Dearborn, Chicago, Ill. 60603 150-MX N. Santa Anita, Arcadia, Ca. 91006.

**CANADIAN LAND FROM \$25.00 AN ACRE CHOICE.** Properties available across Canada. Low monthly payments. Ideal for farming, cottages, hunting, fishing. Free Catalogue. Canadian Estate Land, Dept. PMC12, 286 Lawrence Ave. West, Toronto, Ont., Canada M5M 1B3.

**FREE. . . BIG** 264-page catalog. Hundreds of top real estate values coast to coast! **UNITED FARM AGENCY, 612-PM** West 47th St., Kansas City, Mo. 64112.

**CANADIAN** Land. Full Price \$285.00. \$10.00 Down. \$10.00 Month. Ideal Vacation. Hunting, Fishing. Free information. Vacation Acres, 7771A, Bernard, LaSalle 660, Canada.

**CENTRAL** Ontario—Choice 640 acre Sportsmen's paradises still available—\$20.00 plus \$6.50 taxes yearly. Maps, pictures. \$2.00 (Refundable). Information Bureau, Norval 4, Ontario, Canada.

**FREE** Catalog! **PHOTOS!** Coast to coast farms, business, retirement. All types, sizes & prices. **SAFE-BUY** Real Estate, Box 589-PM, Little Rock, Ark. 72203.

**\$1 ACRE—Canadian border—hundreds** campsites, islands, farmlands, directly from tax authorities. (Non-profit). Lists, photographs mailed. Register, Room 10, 110 Church Street, Toronto 1, Canada.

**BOILING** Spring Lakes—America's Greatest Real Estate Value. 1/3 acre vacation or retirement homesites only \$995 cash price. Ten-year terms available. Money-back inspection guarantee. Carolina coast multi-million dollar, 14,000 Acre development. 50 fresh water lakes, private ocean beach, golf course, motel, and country club. Free literature. Dept. 1-R, Boiling Spring Lakes, North Carolina 28461. (Registered under Federal Land Sales act but not offered to residents of states requiring separate registration.)

**CANADIAN** Vacation lands: Full price \$385.00. 40 acres. \$10 month. Suitable cottage sites, hunting, fishing, investment. Free information. Land Corporation, 3768-C Bathurst, Downsview, Ontario, Canada.

**\$1.00 ACRE!** USA and Canada. Lists, photographs mailed. Government Lands, 220 Delaware Ave., Buffalo, New York 14202.

**GOVERNMENT LANDS FROM \$7.50 ACRE!** Vacationing, Farming, Investment! Exclusive "GOVERNMENT LAND BUYER'S GUIDE" . . . plus "LAND OPPORTUNITY REVIEW" listing lands throughout U. S. Send \$1.00. Surplus Lands, Box 6588-AL, Washington, D. C. 20009.

**SURPLUS** Forest, Mountain, Desert, Waterfront Land. Neglected Estates, Farms, Groves, Cabins. Throughout United States, Canada, Mexico. Low prices. Easy terms. Free list. Box 6272, Dept. 46, Santa Ana California 92706.

**IDEAL 5-ACRE RANCH.** Lake Conchas, New Mexico. \$4,975. No Down. No Interest. \$30/mo. Vacation Paradise. Good Investment. Free Brochure. Ranchos: Box 2006GB, Alameda, California 94501.

**INVEST** In Southern California Real-Estate. Beach, Mountain, Ranch Property go into Foreclosure Daily (Owner not making their payments). Deal Direct with the Owners, it's possible to buy their Equity for Pennies on the dollar. For Full Information on how to, Send \$1.00 to: California Notice of Default Service, P.O. Box 269, Alhambra, California 91802

### FARM AND GARDEN EQUIPMENT

**BUCKET HOLDER** For holding 10 quart galvanized bucket to chain link fence post or wood fence. \$2.98 Quantity discounts available. Microfab Inc., 127-B Brook Ave., Deer Park, N.Y. 11729



### FLOWERS, PLANTS & NURSERY SUPPLIES

**LEARN** Landscaping and the growing of plants. Start a profitable business part or full time. Free information without obligation. Lifetime Career Schools, Dept. A-369, 2251 Barry Avenue, Los Angeles, California 90064.

**LEARN** Flower Arranging. Start business or Hobby. Free information on home study course. Lifetime Career Schools, Dept. B-774, 2251 Barry Avenue, Los Angeles, California 90064.

(Continued on next page)



## CONSTRUCTION PLANS, BLUEPRINTS

**HOUSE EXPANSION PLANS** And detail instruction book provide anything from an extra room to 1000 s/f addition. Build what you need at big do-it-yourself saving. Book with 1 set working blueprints \$14.50! With 4 sets (required by contractors) \$20.00. Money-Saver Projects, Box 303-44B, Chappaqua, New York 10514. Information available.

**HOME** Building secrets exposed by professional engineer and builder. Booklet \$3.00 postpaid. Moesel Enterprises, Frenchtown, N.J. 08825.

### LOG CABINS

**"A" FRAME** Study Plan 50¢. Family House, Box 251, Westfield, New Jersey 07091.

**BUILD** Log Cabins. Rustic furniture, Fireplaces!! Complete manual \$3.00 . . . "A" Frame plans, \$2.00 . . . Guaranteed. . . Beels, 956 Springdale, Atlanta, Georgia 30306.

**"A" FRAME CABIN.** \$500. Material. Purchase locally. Completely illustrated instruction manual & material list: \$2.00. Moneyback Guaranteed. Order Plan #1926. from "Dependable Products", Box 113, Vista, California 92083.

**"A" FRAME** Cabin. 1184 square feet: \$1950. material. Purchase locally. Complete plans, illustrated instruction manual & material list: \$5.00. Moneyback guarantee. Specify plan #1601. "Reliable Products", Box 597, San Marcos, California 92069.

### HOME CRAFTSMEN

**WOOD**—Domestic and Imported Hardwoods! 3500 items! Clock, musical instrument kits Tools . . . discount prices! Hard-to-find hardware. 144 page catalog, 50¢. Craftsman, Dept. AX-123, 2729 Mary, Chicago, Illinois 60608.

**CLOCK** Kits, Movements, Catalog 25¢. Newport, Box 6848A, Burbank, Calif. 91510

**101 PATTERNS** of Smart Gifts, Novelties, Shelves, Action Windmills, plus "Make Money Jig Sawing." \$2.00. Mastercraft, 125M, 7041 Olcott, Chicago 60631.

**POPULAR MECHANICS MASTER SHOP GUIDE.** Greatest product offered to a man with a workshop. All information printed on heavy boards, punched and ready to hang above his workbench. Covers wall fasteners, nails, screws, bolts, twist drills, abrasives, lumber, moulding patterns, plywood grades, hardboard, dry-wall plumbing supplies, electrical supplies. Plus information on score of other subjects. Send \$3.95 to: **POPULAR MECHANICS**, Dept. HE, 224 West 57th Street, New York, New York 10019.

**CABINETMAKING MADE EASY** And "How to Make Formica Counter Tops." Two excellent guides let you build kitchen cabinets and counter tops like professionals. Extraordinary guides bring master craftsmen's shortcut methods. Satisfaction guaranteed. Write: Japs, 126-P Seventh North, Hopkins, Minn. 55343.

**CATALOG FULL SIZE FURNITURE PLANS** —\$1.00 Refunded with first order. Traditional. Early American, over 150! Furniture Designs, 1425 Sherman, Dept. CP-123, Evanston, Illinois 60201.

**ORNAMENTAL IRON WORK.** Beautiful scrolls with inexpensive professional bender. Modular segments. Details Free. Fuschlin, Box 472, Woodland, California 95695.

**WORKBENCH** And tool panel anyone can build. Complete with material list. \$1.00. Way-Mar, 58 Underhill Road, Scarsdale, New York 10583.

**PICTURE** Framing—Profitable full or spare-time business. Easy to learn with handbook-course "Guide To Picture Framing Profits." \$1.50 Guaranteed. Free framing-supplies catalog included. Japs, 126-PM Seventh North, Hopkins, Minnesota 55343.

**BIRD HOUSES** For Fun and Profits. 20 Projects And Plans. \$1.00. Infoco-P12, Box 34260, Washington, D.C. 20034.

**IDENTIFICATION** Name Plates. Gold Stamped. Free sample. Doorposter, Box 30502, New Orleans, La. 70190

**UNIQUE** Ecology Boxes. Plans, Instructions. Material List. \$1.00. Blanco, 9403 Aspen, Shreveport, Louisiana, 71108.

### HOME REMODELING

**BUILD THIS ALL-IN-ONE DIVIDER.** Hi-Fi, storage and seating all combined in this handsome home entertainment center. Photocopy of article as it appeared in P.M. shows you how. Price 85¢. Send orders to Popular Mechanics, Dept. HE, Box 1014, Radio City, New York 10019.

### DO-IT-YOURSELF

**COMPLETE** Plans for Miniature Santa's Sleigh. 50¢. Itens, 1500 Wellington, Faribault, Minn. 55021.

**AMAZINGLY** Handy PURSE-LITE. Great Gift. Plans \$1.00. A1, 18711 Saticoy, Reseda, California 91335.

**MEAT EATERS** Make Your Own Sausage, 7 Delicious Kinds, Using Pork or Beef, Venison Etc. Complete Instructions & Formulas. Send \$2.25. Formulas-A, Box D, Forest Lake, Minn 55025.

**STEAM** Engines. Flash, Watertube Bailleurs, Burners Pictures, Descriptions Drawings. Send \$2.00. Now we can supply 17 castings to make The Old Steam Popcorn Steam Engine. Travis Tool Co., Sidney, Iowa 51652.

**CONVERT** Any Television to Sensitive, Big-Screen Oscilloscope. Only minor changes required. No electronic experience necessary. Illustrated plans. \$2.00. Relco, Dept. A-201, Box 10563, Houston, Texas 77018.

**BURGLAR-FIRE** Alarm Supplies and Information. Free Catalog. Protecto Alarm Sales, Box 357A, Birch Run, Michigan 48415.

**CONVERT** MOWER Engines into air compressors. Write: Showalter, Box 409, Abilene, Kansas 67410.

**1400 CATALOGS** Listed and Described Sources for EVERYTHING Imaginable! Rush \$2.00. MASTERLOG, Box 24413-YL, Oakland, California 94623.

**CONVERT** TV to 6-ft. wide screen! B & W/Color. Do-It-Yourself—easy! Kit, instructions, lens, \$12.95 PPD. Free illustrated details, MACROCOMA, PM-12, Washington Crossing, Penna. 18977.

**D.C. ARC WELDER** From YOUR AUTO and 12 Volt Battery! Efficient D.C. Welding to 200 AMPS! No Modification to your Auto! Use Anywhere you Drive your Auto! Detailed Instructions \$2.00. Basic Welding Kit \$19.00, Instructions Included (12V. Battery not included). Bitek Industries, Dept. C, Box 404, Inyokern, Calif. 93527.

**"CREATE** Custom Fireplace Tool Sets for Profit. Elegant Wooden Designs. \$3.00 for plans and sales information. Hearthmates, 1860 Polk Street, Concord, Cal. 94521."

**WIND** Turbine Electric Power 110V. \$500.00. Illustrated Instructions, \$5.00. Guaranteed. Homecraft, 2350 W 47th, Denver, Colorado 80211.

**RUSTIC COCKTAIL TABLE AND CANDLE CHANDELIER** made from Inexpensive Materials. Illustrated Plans 50¢. Rustic Designs, Box 35304, Houston, Texas 77035.

**HOW** To Install Forced Air Furnace In Your Home. Free Details on Book, Jim Webb, Rt. 1, Box 566, Fayetteville, W. Va. 25840

**PROTECT** Valuables from Loss or Theft. Amazing Engraving Tool writes on Glass, Plastic, Ceramics, Metals. \$2.98. Maylor House, 5511 South 93rd Street, Omaha, Nebraska 68127.

**REPAIR** MINIBIKES, LAWNMOWERS, BICYCLES, Sewing Machines, Auto Engines, Mazda/Wankel, Motorcycles, Magic, boats. Over 100 How-To-Books. Free Brochure. Mastercharge accepted. Sincere, Box 10422, Phoenix, Arizona, 85064.

**RID YOUR HOME** Completely of pests, bugs Yourself. Save. Details \$2.00. Casno, 1944 N. Kildare, Chicago, Illinois 60639

### ARTS AND CRAFTS

**"GETTING** Started in Stained Glass" 25¢. Whittemore, Box 2065Y, Hanover, Mass. 02339.

**FREE LITERATURE** For sculptors showing how to make molds, cast plastics. Adhesive Products Corporation, 1660 Boone Avenue, Bronx, N.Y. 10460.

**FREE:** New handicraft catalog. Supreme Handicrafts, Box 395-PM, Sioux Falls, South Dakota 57101.

**LEARN** Arts & Crafts at home. Excellent full or part time business opportunities. or hobby. Free booklets. Lifetime Career Schools, Dept. E-808, 2251 Barry Avenue, Los Angeles, California 90064.

**MAKE** Figurines, plaques, lawn ornaments. Molds, plastercraft kits, liquid rubber. Sample and catalogue 10¢. Wooley Company, Box 29-B, Peoria, Illinois 61601.

### BINOCULARS, TELESCOPES, MICROSCOPES, MAGNIFIERS

**FREE** Binocular, Riflescope catalog. Discount sale. Save 50%. Free gift with order. Write: United Binoculars, BN-7408, 9043 So. Western, Chicago 60620.

**MAGNIFIER SET,** Plastic. Includes 2X-5X Combination, 3X, 4X, Bug-box, 5X, 10X and 15X Loupes. Many uses. \$3.95 check or money order. Plastecs, Box 188-M, Webster, Mass. 01570. Mass. Residents Add 3% Tax.

**TELESCOPE** (reflectors) complete kits. Other accessories, request free literature. Criterion Manufacturing, Dept. PM 47, Hartford, Connecticut 06101.

### CAMERAS AND EQUIPMENT

**NEW** Konica, Nikon, Seiko, Rolex—Others. 50% off Local Prices. Guaranteed. Information \$3.50. Beukema, 220 S.W. 64th Way, Pembroke Pines, Florida 33023

**FREE CATALOG!** Cameras, Lenses, Binoculars, Dickson Company, Box K-3979, Kowloon, Hong Kong. Air Mail US \$1.00

**WOW!** Film At Wholesale Plus 5%. Free Catalog. Diamond, Box 15473D, San Diego, California 92115.

**POLAROID OWNERS!** New lens adaptor doubles picture taking capacity. Pays itself on first film. **SAVE.** Buy direct from manufacturer. Send camera type and \$2.75 to: Syntex, Box 223, Redmond, Wash. 98052.

**FREE! FREE! BARGAIN BOOK.** Central Camera Co., Dept. 3121, 230 S. Wabash, Chicago, Ill. 60604.

### PHOTOS AND PHOTO SUPPLIES

**SELL YOUR PHOTOS.** Report tells How, Where. Color Slide Markets. Only \$1.00. Free Catalog. GienGarry Gifts, Dept. MR, 341 84th Street, Brooklyn, New York 11209.

### PHOTO FINISHING

**CAMERA FANS!** Expert photofinishing by one of Country's largest labs at lowest prices. Fast service and free "Foto-Fan" Stamps you quickly redeem for valuable Photo Supplies. 8MM Kodachrome \$1.29; 8 Exp. Kodacolor \$1.79; 35MM Kodachrome 20 Slides \$1.39; 8 Exp. Black White 69¢. Satisfaction guaranteed. Send exposed film or request free mailers. complete Price List and Gift Catalog. Direct Mail Photo, Box 8352-PM, Pittsburgh, Pa. 15218.

(Continued on next page)

## COLOR SLIDES

**35MM COLOR Slides.** 10,671 Individually sold. Described, Encyclopedia catalog 10c. Wolfe Worldwide, Dept. 14-123, Los Angeles, Calif. 90025.

**GAF COLOR Slides** 10,000 U.S. and foreign subjects. Catalog 25c. **WORLDWIDE SLIDES** (PM-1) 7427 Washburn So., Minneapolis, Minn. 55423.

## MOTION PICTURES AND SOUND EQUIPMENT

**CLASSIC 8MM. MOVIES . . . 35MM, 2"x2" Color Slides.** . . . largest selection anywhere! Silent classics, comedy, history, sport, news, documentaries, features, others! 16MM films also Free catalog. Blackhawk Films, 690 Eastin-Phelan Bldg., Davenport, Iowa 52808.

**FREE!** 64-Page catalog. 8-16MM film supplies, processing equipment. Superior, 448 N. Wells, Chicago 60610.

**8MM—SUPER 8—16MM MOVIES!** Biggest Selection! Lowest Prices! Free Catalog! Cinema Eight, Box PM, Chester Connecticut 06412.

**FREE Catalog—8mm-16mm—Top Manufacturers—G & G Film Library.** Box 321, Syosset, New York 11791.

**UNUSUAL Movie supplies.** Free circular. Esor, 47th Holly, Kansas City, Missouri 64112.

**SUPER 8MM, 16MM, 8MM Sound and Silent Classic Films.** Free Catalog. Niles, 1019-PM, So. Michigan, South Bend, Indiana 46618.

## RADIO, TELEVISION AND HAM EQUIPMENT

**SAVE Money on parts and Transmitting—receiving tubes.** Foreign—domestic. Send 25c for giant catalog. Refunded first order. United Radio Company, 56-PM Ferry Street, Newark, N.J. 07105.

**36c RADIO & TV Tubes.** Free catalog. Cornell, 4213-17 University, San Diego, California 92105.

**GOVERNMENT Surplus receivers, transmitters, snooperscopes, parts.** Catalog 25c. Meshna, Nahant, Mass. 01908.

**GIANT Canadian Electronics Surplus Catalog.** \$1.00. Etco PM, Box 741, Montreal.

**RESISTOR Color Coder** 50c. Norvex Co., 3920 Larkin St., Norfolk, Va. 23513.

**HEAR Police/Fire Dispatches.** Catalog Shows Receivers; Exclusive Directories of "Confidential" Channels. Send 8c Stamp. Communications, Box 56-PM, Commack, New York 11725.

## HIFI TAPES, RECORDS AND ELECTRONICS

**OLD Radio Programs On Tape.** Thousands Available. Top Quality. Lowest Prices. Catalogue 25c. Nostalgic Radio, Box 29, Peoria, Illinois 61601.

**OLDIES 45 RPM Original Hits—Catalog** 50c. C&S Record Sales, Box 197, Wampsville, New York 13161.

**FREE Catalogues.** 2000 hard to find unusual records. Rose's Records, Box 7216, Louisville, Ky. 40207.

**FREE Catalog—Electronic Kits—Amplifiers—Preamplifiers—Psychedelic Strobes—SCA Adaptors—Color Organs—Digital Instruments—Guitar Amplifiers.** FREE Subscriptions. SWTPC, Box PM32040, San Antonio, Texas 78284.

**TAPES—8-Track—Low as \$1.10 Each.** Free Catalog—800 Top Titles. Send Postcard. GemTone Industries, Box 57220, Dept. PM, Los Angeles, Calif. 90057.

**NEW 45'S 69c each-5 for \$3.45.** Free list. TOP 100. Box 176, 2138 E. 75th Street, Chicago, Illinois 60649.

**FREE CATALOG—Tremendous Electronic Bargains.** American, Box 4188P, Mountain View, California, 94040.

**ORIGINAL RADIO BROADCASTS** Catalog. \$1.00. Radio Vault, Box 9032, Wyoming, Michigan, 49509.



## MUSIC AND MUSICAL INSTRUMENTS

**ACCORDIONS And Amplifiers! New—Used.** Cordovox, Excelsior—Top Makes! Save to 50%. Direct factory dealer. Terms. Trades accepted. 5 day home trial. Free catalog—Discount prices. Write: Accordions Unlimited, Dept R, 3147 North Luna, Chicago 60641.

**30% + DISCOUNT.** Name Brand Musical Instruments. Free Catalog. Continental Music, P. O. Box 3001, Dept. D, Garden City, New York 11530.

**SWISS Finest Music Boxes, Movements.** Spielman, 55 West 42nd, New York 10036.

**LEARN To read music in one evening.** Free brochure. Jordan, 27495 Road 176 Dept. PM-12, Exeter, Calif. 93221.

**EASY To Play And Make.** Quality Dulcimers, Banjos, Thumb Pianos: Instruments And Kits. Can Be Profitable Hobby. HERE, Inc., #P, 410 Cedar Avenue, Minneapolis, Minn. 55404.

**ELECTRIFY Player Pianos, Pump Organs** Quickly. Inexpensively with Lee Silent Suction Units. Write: Lee Music, 525F Venezia Avenue, Venice, California 90291.

**30% TO 50% DISCOUNT!** Any Model: Guitar, Amp, Drum, Banjo, Dobro! Free Catalog! Warehouse-P40, Box 16399, Fort Worth, Texas 76133.

**POEMS Wanted** for songs. Nashville Music Productions, Box 40001-P, Nashville, Tennessee 37204.

**VIOLIN And Guitar makers—send for** latest Free Catalogue of woods & accessories. International Violin, PM1, 414 East Baltimore St., Baltimore, Md. 21202.

**WHOLESALE!** Professional Guitars, PA Systems, Altec Speakers, 240W RMS Amplifiers. Free Catalog. Carvin, Escondido, Calif. 92027.

**RECONDITIONED Accordions for sale—Save \$\$\$.** Top Brands. Write for free descriptive folder. A-1 Rebuilt Accordions, 31 E. 18th St., N.Y.C. 10003.

**ACCORDION Top brands.** Buy direct. Tremendous discounts. Trades accepted. Free brochure PM. Accordion-O-Rama, 874 Broadway, N.Y.C. 10003.

**GUITAR, Banjo, Violin, Mandolin Making** Materials, Accessories, Books. Catalog 25c. Guitar Center, Box 15444, Tulsa, Oklahoma 74115.

**LEARN Banjo.** 5-String Bluegrass. No music. Makes learning easy. Free details. Blaylock, Box 25-M, Marietta, Georgia 30060.

**30% DISCOUNT** Name Brand Musical Instruments. Free Catalog. Freeport Music, 455F Route 110, Melville, N.Y. 11746.

**ACCORDION Manufacturing** 6846-P North Avenue, Chicago, Illinois, 60635. Concertinas, Chromatics, Heligons, Hohners, Guitars, Drums, New, Used, Tuning, Repairing. Wholesale Catalogs Free.

**BAND INSTRUMENTS. NAME BRANDS.** Discount Prices. Free Catalog. Musical Instrument Wholesalers, Drawer 5370. Ft. Worth, Texas 76108.

**KITS!** Build Dulcimers, Guitars, Balalaikas, Thumb Pianos, Harps. From \$2.95. Finished Dulcimers from \$19.95, 8665 West 13th Avenue-PM, Denver, Colorado 80215.

**PIANO TUNING** Made Easy. Manual and all Necessary Tools, only \$22.50. Ten-Day Money-Back Guarantee. Details Free. Stamm Industries, 813 West Lovell, Kalamazoo, Michigan 49007.

**WHOLESALE.** Musical Instruments—Accessories. Allied, 573 Route 17, Paramus, New Jersey 07652.

**FREE—Fully Illustrated Music Catalog.** Accessories, Instruction Books, Repair Parts. Marina Music, Box 718-C, Marina Del Rey, California 90291.

**FREE CATALOG—30% DISCOUNT.** Best Names In Musical Instruments. Dial For Music, 7 Crescent Drive, Spring Valley, N.Y. 10977.

**GUITAR MAKING BOOK & TOOLS.** Overholtzer, 618 Orient St., Chico, Cal. 95926.

**PLAYER PIANO ROLLS,** 704 East Douglas, Wichita, Kansas 67202. Free Catalog.

**PLAYER Piano Rebuilding—get details** from: Vestal Press, Vestal 11, N.Y. 13850.

**PIANO Cassette Chord Formulae Les-** sons. Refundable \$7.95. Music, Box 128, Milford, Ohio 45150.

## EDUCATION AND INSTRUCTIONS

**WELDING TRAINING** Basic and advanced training for major welding processes—Arc, Gas, Pipe, TIG, MIG, plasma. Hobart, a non-profit school, is accredited by NATTS. Approved Ohio 70-12-0064 HT. Write for school bulletin and course schedule. **HOBART SCHOOL OF WELDING TECHNOLOGY,** Box 73, Troy, Ohio 45373.

**VETERINARY ASSISTANT—Train at home** for exciting animal care career. Send for **FREE "Career Kit"**. North American School of Animal Sciences, Dept. PBCC3, Newport Beach, California 92663.

**FREE Brochure Self-Improvement Books.** Covers Financial Opportunities, Marriage, Hobbies, Health, Personality, Numerous Subjects. Cliftons', Box 2550A, Schenectady, N.Y. 12309.

**DEGREE Program in Electronics Engi-** neering. Our 27th Year! Free Literature. Cook's Institute, Dept. 10, Box 10634, Jackson, Miss. 39209.

**MISSOURI Auction School.** Veteran Approved. Free catalog. 1600-03 Genesee, Kansas City, Missouri 64102.

**LEARN Auctioneering.** Term soon. Free catalog. Reisch Auction College, Box 850, Mason City, Iowa 50401.

**EXTENSION And Post-Graduate Awards** in Philosophy, Art, Sciences, Botanic Medicine, Homeopathy, Radionics and others. 30 subjects. Curricular free (airmail \$1.00 refundable). Registrar, Sussex College of Technology, Highfield, Danehill Sussex, England.

**VENTRILOQUISM—Profitable Hobby or** Career! **FREE** newspaper and Home Course Scholarship. Maher, Box 9037PI, Denver, Colorado 80209.

**RELIGIOUS VOCATION? Write:** Church Of Holy Light Inc., P.O. Box 4478, Pittsburgh, Pa. 15205.

**USED Courses! Books** Catalog 10c. (Courses Bought). Lee Mountain, Pisgah, Alabama 35765.

**AUTOSUGGESTION.** Sleep-learning headquarters! Tapes, records, books. Gigantic catalog free. Research Association, Box 24PM, Olympia, Washington 98511.

**AUCTIONEERING.** Resident or home Study Course. Free Catalog. Nashville Auction School, 1921 West End, Nashville, Tennessee 37203.

**PERFECT Husband-Wife Business.** Learn Upholstery at home. Make \$10 an hour. Buy—repair—sell for even bigger profits. Kits, tools, included. Free Booklet. Upholstery & Decorating School, (homestudy), Dept. 5310-123, Little Falls, New Jersey 07424.

**DETECTIVE Course.** Free Information. Universal Detectives, Box 8180-F, Universal City, California 91608.

**LEARN To Fix Typewriters.** Desperate shortage trained men. Hundreds needed. Make up to \$25 in one hour. Learn at home in spare time. Industry Approved course. Facts Free. Send name. Typewriter Repair School, (homestudy), Dept. 3310-123, Little Falls, New Jersey 07424.

**PIANO Tuning** quickly learned with home study course. Diploma granted. American Tuning School, 17050 Telfer Dr., Morgan Hill, California 95037.

**SHORTCUTS To Success! Highly Effective, Profitable Short Courses.** (75 Choices). Study At Home. Diploma Awarded. Our 27th Year. Free Literature CIEE-25, Box 10634, Jackson, Miss. 39209.

(Continued on next page)

## EDUCATION AND INSTRUCTIONS

(Continued from preceding page)

**WATCH REPAIRING.** Learn at home in spare time. Diploma awarded. Free sample lesson. Chicago School of Watchmaking, Dept. YZ, Fox River Grove, Illinois 60021.

**SERVE God's Ministry.** Free Ordination. Bible Institute, Box 744, McKeesport, Pa. 15134.

**LEARN Asleep or awake!** Records, tapes, equipment! Free catalog! Drawer PM-400, Ruidoso, New Mexico 88345.

**USED Courses! Books! List 10¢.** Smith's, 124 Marlborough, Salem, Massachusetts 01970.

**UNLOCK Your Future.** Become professional Locksmith by spare time home study. Make up to \$6 per hour. All tools, equipment inc. Facts free. Send name. Locksmithing Inst. (Homestudy), Dept. 1310-123, Little Falls, New Jersey 07424.

**DETECTIVE Profession.** Easy home study; free tie-tack or lapel pin, certificate, future. GI approved. Professional Investigators, Box 41345, Dept. CP, Los Angeles Calif. 90041.

**COMPLETE YOUR HIGH SCHOOL** at home in Spare Time. Texts furnished. No Classes. Diploma. Our 76th year. Free Brochure. American School, Dept. X945, Drexel at 58th, Chicago 60637.

**COLLEGE Degree** at home. Your choice of subjects incl. Law. Easy tuition plan. Williams College, 915 Cerrillos Road, Santa Fe, New Mexico 87501.

**ACUPUNCTURE TRAINING MANUALS AND SUPPLIES CATALOG!** Wong, Box 219W, Toronto, Canada M6M 4Z2.

**"LEARN Fast as Geniuses!"** Eleven Books, \$3.95! Castle's, 507-M Fifth, New York 10017.

**JUMP On To-morrow—Know All About Metric** by Home Study with Certificate. **METRIC CONSULTING INTERNATIONAL**, Box 167C, Ligonier, Pennsylvania 15658.

**ORDINATIONS, Lifetime!** Church chartered 1887! Write! 708 Bragg, Monroe, North Carolina 28110.

**KNOW More, Make Better Decisions.** Earn More. Remarkable new methods. Details, 25 Pages, \$2.00. Alsson Press, 689-E Hunt, Alcoa, Tennessee 37701

**LEARN Sewing Machine Repairing.** Men, Women. Lucrative profits. Profession with bright future. Gresslin Correspondence School, Box 927, Spencer, Iowa 51301.

**OWN Collection agency.** "Little Gold Mine!" Franklin Credit, Roanoke, Virginia 24004.

**GAME WARDEN, Government Hunter, Forestry, Park & Wildlife Service** announce job openings regularly. Prepare at home for outdoor work, good pay, security. Approved for Veterans! **FREE!** "Conservation Career Kit." North American School of Conservation, Dept. PBCC3, Newport, California 92663.

**TRIGONOMETRY IN ONE DAY!** No Algebra, Geometry or Square Root Required. Free Brochure: Trig System, Box 1624-PM123, Bellevue, Wash. 98009.

**HIGH SCHOOL Equivalency Diploma Fast!** Simple home study GED Preparation. Details: Bright Futures, Box 514PMC, Jackson Heights, New York 11372.

**METRIC SYSTEM EXPLAINED!!—500 Physical Measurements Converted!**—Guaranteed Booklet!—\$2.00—Kulchar Studio, Box 1992A, Philadelphia 19105.

**MIND STIMULATOR** (original) helps thousands Succeed. Unique message that helped Millions Free! Frank Tibolt, 2819M Mt. Carmel, Glenside, Pa. 19038.

**CHILDREN Quickly Taught Mathematics** Facts With Amazing Teaching Invention. Price \$1.25. Literature Free. Bodega, Box 83, San Leandro, Calif. 94577.

**SUPERIOR Auction School—Free Catalog**—Term Soon. Box 1281, Decatur, Illinois 62525

**PIANO Technology—Electronic organ servicing, learned easily at home.** G. I. Approved. Free booklet. Niles Bryant School, Dept. P. 3631 Stockton, Sacramento, California 95820.

**FREE Book** tells how you can learn camera repair and service. Home study or classroom. Write today! National Camera, Dept. EAD, Englewood, Colorado 80110.

## FOR INVENTORS

**INVENTIONS** Needed immediately for manufacturers. For additional information write: Kessler Corporation, C-512F1, Fremont, Ohio 43420.

**IDEAS, INVENTIONS AND PATENTS.** An Easy to Read Book That Tells You in Plain Language How To Get a Patent. Complete Information, Including Sample Patent. Send \$4.95 Plus 60¢ Postage and Handling To: Pioneer Press, Dept. PM12, P.O. Box 76025, Atlanta, Georgia 30328.

**INVENTORS! FREE BROCHURE LISTING 1,000 CORPORATIONS** which may be interested in your invention. Many well-known Manufacturers have engaged us to locate new products. For FREE brochure and information regarding the promotion of your invention, contact Wall Street Invention Brokerage, 79 Wall St., New York, N.Y. 10005.

**PATENT Information \$4.00—Martin, P.O. Box 1412, Tustin, Calif. 92680.**

**U.S. PATENT Office Searches, 234 Broadway, Room 3615, New York 10007.** Free invention certificates.

**PATENT Application Financing.** Free patent search plan. Global Patent Division, 2420 77th, Oakland, Calif. 94605.

**PATENT Searches** including maximum speed, full airmail report and closest patent copies. Quality searches expertly administered with complete secrecy guaranteed. Free Invention Protection Form and "Patent Information." Write: Dept. 15, Washington Patent Office Search Bureau, Benjamin Franklin Substation, P.O. Box 7167, Washington, D.C. 20044.

**PROSECUTE Your Own Patent Application.** All Material Necessary—Write: Inventors Service, Box 3574, Washington, D.C. 20007.

**FREE PAMPHLET:** "Tips on Safeguarding Your Invention." Write: United States Inventors Service Company, 501-P Thirteenth Street N.W., Washington, D.C. 20004.

**INVENTORS:** Your ideas and inventions (patented: unpatented) expertly searched, developed for commercial appeal and cash/royalty sales to manufacturers by professional Invention Developer with excellent record of experience. B. S. Industrial Engineering; United States Patent Office former Patent Examiner. United States Government former Patent Advisor. Second decade reliable service! Member: United States Council International Chamber Commerce. Free "Invention Record" and "Recommended Protection Procedure." Airmailed! Write: Raymond Lee, Invention Developer, 230P-Park Ave., New York, New York 10017.

**NEEDING Assistance? INVENTION DEVELOPMENT FOUNDATION, 155 Kent Street, Ottawa, Canada K1P 5P3.**

**ANOTHER XEROX?** Your idea or invention might be. Let our expert staff try to make it another Xerox. We will expertly Search, Develop, and Market for Cash/Royalty Sales to Manufacturers, your Idea and Inventions (Patented/Unpatented). Free "Invention Record" and Valuable Information. Reasonable Fee. Financing Plan Available. The **IMPACT** Company, Invention Investment Intermediates, Inc., Box 7, North Hackensack Station, Hackensack, New Jersey 07601

**MR. INVENTOR:** Inventions needed by manufacturers. Development assistance and patent searches. Free "Proof of Invention" forms and other important information. Write: Charles S. Prince, Invention Consultant, 509-A 5th Avenue, New York City 10017.

**INVENTORS—United States Patent Office Searches, Patent Development Engineering, marketing of inventions—ideas by Licensed Professional Engineer—Patent Engineer and United States Patent Office Former Examiner, Inventions developed for patenting and marketing. We are contacted by many manufacturers seeking to purchase appropriate new products invented by our clients. Send for Free Invention Certificate and Invention Information. Serving Inventors since 1948. George Spector, Licensed Professional Engineer—Patent Engineer—3615 Woolworth Building, New York, New York 10007.**

**SAVE Hundreds.** How To File Your Own Patent Application. Write: Inventor's Guide, 468-G Goodspeed Road, Virginia Beach, Virginia 23451.

## INVENTIONS WANTED

**INVENTORS—If you have an invention for sale, patented or unpatented, write for free brochure outlining manufacturers requirements, royalty rates.** Kessler Corporation, C-512IW, Fremont, Ohio 43420.

**INVENTORS! Protect your ideas! Free "Recommended Procedures."** Washington Inventors Service, 422F Washington Building, District of Columbia 20005.

**FREE "Directory of 500 Corporations Seeking new Products."** For information regarding developments, sale, licensing of your patented/unpatented inventions. Write: Raymond Lee Organization, 230-N Park Avenue, New York, New York 10017.

**CASH-Royalties** for patented, unpatented Inventions. Global Marketing Service, 2420-G 77th, Oakland, California 94605.

**WE EITHER** sell your invention or pay cash bonus. Write for details. Universal Inventions, 28E, Marion, Ohio.

**INVENTORS! Don't sell or license your Invention until you receive our offer.** Eagle Development Company, Dept. H, 83 Wall Street, New York City 10005.

**NEW PRODUCTS—INVENTIONS—IDEAS** Researched/Developed/Marketed by Professional Organization for Cash/Royalty Sales. **FREE EXAMINATION and CONFIDENTIAL REPORT** of the Commercial Features of your Patented/Unpatented Invention. **FREE COPY** "How to Safeguard and Market Inventions to Industry." Write: **LAWRENCE PESKA ASSOCIATES**, 500-C Fifth Avenue, New York City 10036.

**INVENTORS! Either we will sell your Invention before you or anyone else does, or we will pay you a cash bonus.** Get Free Invention Evaluation and information write: Gilbert Adams Organization, Invention Brokerage, Dept 15, 81 Wall St, New York, NY 10005.

**INVENTORS** With production capability, strong desire for commercial success, and risk capital to invest in their own business might be helped by writing: Philip A. Goutell, 175 Fifth Avenue, New York, New York 10010.

## PATENTS FOR SALE

**AUTOMATIC Saw Sharpener.** P.O. Box 119, Portsmouth, Rhode Island 02871.

## BUY IT WHOLESALE

**FANTASTIC Free catalog—Watches, general merchandise Department Forty, 100 North Greene Street, Baltimore, Md. 21201.**

**400,000 BARGAINS** Below Wholesale! Many Free! Liquidations . . . Closeouts . . . Job Lots . . . Single Samples, Free Details, Bargainhunters Opportunities, Box 730-A, Holland, Michigan 49423

**HEARING Aids, batteries, Wholesale, Catalog 25¢.** Fiston, Box 1444, New Preston, Conn. 06777.

(Continued on next page)

## BUY IT WHOLESALE

(Continued from preceding page)

**165 FREE Wholesale Catalogs!** Mailorder Dropshippers. Your Business Imprint, Automobile Discounts. Free "Digest." Vault International, Box 7284W, Lexington, Kentucky 40502.

**DISCOUNTS** Famous Brands. Free Catalog. National Sales Co., 2P Timber Ridge, Mt. Airy, Maryland 21771.

**WORLD'S** Largest Wholesale Supply. 7853 American, European, Japanese wholesalers. Hongkong clothes. Rockbottom prices. Automobile discounts. Free Details, International Buyers, Box 16386-M Portland, Oreg. 97233.

**FREE** Catalog. Gifts, Specialties, Toys, Below Wholesale. Delphian, 5275 DeLongpre, Hollywood, Calif. 90027.

**SAVE TO 400%** on Imported Products. Recently Compiled List of 30 Foreign Companies and Their Products. Great Help for Mail Order Beginners. Send \$2.00 to "Addresses", Dept. PM, P.O. Box 24, San Luis Obispo, Ca. 93406

### EXPORT-IMPORT

**JAPAN:** 1200 Products directory. Illustrated Manufacturers' names, addresses. \$5.00. Send cash. Yamagata Office, 814 Togin Bldg., Marunouchi, Tokyo.

### FOR THE HOME

**NEW MIRACLE CLOTH** Cleans—Polishes—Restores. Metals. Furniture. Instruments. Guaranteed! \$1.00. Prize Products, Dept. PM12, 89 Cedar Ave., North, Fargo, North Dakota 58102.

**TWO-WAY** Mirror—See thru walls and doors!! View others without being seen!! Instructions—Send \$2.00—Guaranteed—Hvatfco, Dept. 1B12, Standish, Calif. 96128.

### OF INTEREST TO WOMEN

**LADIES:** \$6.00 dozen paid lacing Baby Boots! This is our 20th year! Write: Cowboy-9, Warsaw, Indiana 46580.

**\$25.00 DAILY** Possible Addressing-Staffing Envelopes. Typewriter-Longhand, also Clipping News Items at Home. Information; Send Stamped Addressed Envelope. Ame-38, Box 310, Le Mars, Iowa 51031.

**PLASTERCRAFT!!!** Profitable Home Business. Molds Available. Details: Lynnette, 6251CW Mentor Park, Mentor, Ohio 44060.

**STUFF ENVELOPES!** \$50.00 per hundred! Guaranteed earnings! Details 25c. Smith's, Box 2469-PM, Newark, New Jersey 07114.

**\$500 MONTHLY** Possible addressing—stuffing envelopes (longhand—typing) at home. \$500 monthly Clipping news items from your newspaper. Information: Send stamped self-addressed envelope. American, Excelsior Springs, Missouri 64024.

**NEW** magazine, foods, decorating, household tips, family living. Sample 25c Homemaker Magazine, 404 West Jefferson, Springfield, Illinois 62702.

**WANT** A new car, color TV, new clothes? Learn hundreds of ways to make money. 5 month subscription FREE. Write: Salesman's Opportunity Magazine, Dept. 17-MO, 1460 Hancock Center, Chicago 60611.

**DO SIMPLE** Addressing—Mailing. Receive \$12.95 Orders. Keep \$8.00 Profit. Details Free! Quality, Box 9—PW, East Rockaway, N.Y. 11518.

**HOW TO MAKE MONEY ADDRESSING, MAILING LETTERS. OFFER DETAILS 10c.** Lindbloom, Dept PM, 3636 Peterson, Chicago 60659.

**\$57 DOZEN** Possible Showing Beautiful Handicrafts. No Gimmick. Details 35c. Trolltown, Box 744, Clinton, Miss. 39056.

**EARN** \$25.00 Hundred Stuffing Envelopes. Instructions \$1.00 (Refundable). Belmont, 4711-R Linden, Lincoln, Nebraska 68516.

**EARN** Up to \$150.00 weekly—home addressing for us. Details 15c. Lily, Box 4967-P12, NYC 10017

**\$600 MONTHLY** Possible Addressing at Home, Longhand or Typed. \$600 Monthly Possible Clipping News Items. Send \$1.00 (Refundable) and Stamped Self-Addressed Envelope. DJ's Services, Box 564, Franklin, Michigan 48025.

**MAILER'S NEWSLETTER!** Over 50 firms listed. \$1.00, stamped addressed envelope. P. Richardson, Box 4097, Yuma, Arizona 85364.

### GIFT SHOPPING

**BEAUTIFUL** Mexican Purses, Wallets, Etc. Impress your Friends 40% Savings Free Catalog. Write: Best Leather, 859-A Corvina, Imperial Beach, California 92032.

**FREE!** Gift Catalog. Wide Appeal, Something for Everyone. Write To: Advance, 1101-S East Six Court, Hialeah, Florida 33010.

**DISTINCTIVE GIFTS** by Mail. Free Catalog. Kinney, (B12), 1846 Baird, Madison, Wisconsin 53713.

**"OVER 100** Distinguished Gifts Mail Ordered. Satisfaction Guaranteed. Write: HORESH, 105-24 64 Rd., Forest Hills, New York 11375.

**FREE** 32 Page catalog. Distinctive Gifts By Mail. Harlow Enterprises, 70 Highland Street, Hyde Park, Mass. 02136 PM-2.

**FREE SILVER DOLLAR BONUS GIFT. FREE GIFT CATALOGUE. TREASURE CHEST, 9321-A CAPE VIEW AVENUE, NORFOLK, VA, 23503.**

### WATCHES, OLD GOLD, JEWELRY

**HIGHEST CASH** For Gold, Jewelry, Gold Teeth, Rings, Diamonds, Watches, Silver, Platinum. Mail Articles Today: Free gift with information. Chicago Gold & Precious Metals, 6 E Monroe, Dept. 458, Chicago 60603.

**CASH** Immediately for Old Gold, Jewelry, Gold Teeth, Watches, Diamonds, Spectacles, Silver, Platinum, Mercury. Free information. Rose Industries, 29-A East Madison, Chicago 60602.

**WATCH** And Clock repairing books. Free List. North American, Box 77-AM, Fox River Grove, Illinois 60021.

**CLOCK,** Watch Repairing Tools, Supplies. Catalog, \$1.25. G/M, 1521-A West Magnolia, Burbank, California 91506.

**WANTED . . .** Gold, Silver, Platinum (any form). Coins. Information Free. Wilmot's, 1067 Bridge, Grand Rapids, Michigan 49504.

**FREE** Gift Case! Mother's Rings. Lifetime guarantee! Sterling Silver! . . . Gold! 1-7 Stones! Even sizes 5-10. \$18 plus \$1 each Stone. Send Birthday Month. Size. Hurry! Moenter, Box 47, Dept. 12A1, East Detroit, 48021.

### HEARING AIDS

**HUGE SAVINGS.** Eliminate dealer mark-ups. Free Trial. Batteries Wholesale. Terms arranged. Lloyds-PMC, Rockford, Ill 61108.

**WHOLESALE** Discounters! Famous Aids! Batteries! Repairs! AidMart, Drawer Z-2, St. Petersburg, Florida 33731.

**HEARING** Aids, Batteries, Discount Prices. Write: Rhodes, Box 518 PM, Paducah, Ky. 42001.

**FREE**—Hearing Aid Catalog. Save half! Write: "MONEYSAVERS", 9530-PMJ, Langdon, Sepulveda, California 91343.



### SCIENCE AND CHEMISTRY

**DISCOUNTED!** Laboratory Chemicals, Glassware-Apparatus. Catalog-50c. Deluxe Scientific, 507 Huron, Manitowoc, Wisconsin 54220.

**CATALOGUE** Of those ver-ry hard-to-find chemical products, things that go boom, multi-stage rockets, 500 How-To books, 10,000 formulas of every conceivable mixture in science and industry. 50c. Kenrus-C, Box 205, Staten Island, New York 10306.

**CHEMISTRY** And Biology Catalog 35c. Boulevard Laboratories, Suite 302, 3114 E. 83rd St., Chicago, Ill. 60617.

**AMAZING!** Scientific-Apparatus-Glassware-Chemicals. Catalog-50c. Hagenow Laboratories, 507-A Huron Street, Manitowoc, Wisconsin 54220.

**WHAT IS BIOFEEDBACK?** Discover the Modern Method of Relaxation in this Informative Report; Includes Easy to Follow Directions. Assemble your own at a Fraction of Cost. \$2.00. Padula Electronics, Dept. 27-P, Box 184, Marlboro, Mass. 01752.

**COMPLETE** Catalog 35c. Specials List. Laboratory Sales, Box 161-A, Brighton, Mass. 02135.

### FORMULAS, PLANS, ETC.

**ANY** Formula \$5.00. Catalog—Manufacturing Treatise 25c. Belfort, 192 N. Clark, Chicago 60601.

### PLASTICS

**CASTOLITE** pours like water, hardens like glass without heat. Crystal clear, colors. Embed flowers, seashells, mementos, anything. Make fine gifts. Form flexible molds over any pattern, size. Reproduce your own designs in plastics, candlewax, metal, plaster, cement. Profitable. Illustrated Manual and Catalog Only \$1.00. CASTOLITE, Dept. 73P/PM, Woodstock, Ill. 60098.

**LARGEST** Handicrafts and Candlecrafts Catalogue \$1.00. (Refundable). R.P.H. Manufacturing-248-M-12, Winter, Stamford, Connecticut 06905.

### TREASURE FINDERS

**GOLD & Silver**—Locate up to ¼ mile away with my sensitive locator. Send for my free, informative pamphlet. Carl Anderson, P.O. Box 13441-AMC, Tampa, Florida 33611.

**TREASURE** Finder locates buried gold silver, coins, treasures. 6 powerful models. \$19.95 up. Instant financing available. Write or call for free catalog. Phone (713)-682-2728 day or night. Dealer inquiries invited. Relco, Dept. A-40, Box 10839, Houston, Texas 77018.

**FREE 156** Page Detector Catalog. General Electronic Detector Co., Box 67, Bellflower, California 90706.

**FIND** Buried treasure with revolutionary patented, analytical metal detector. Features push button and automatic tuning, negligible ground pickup, greatest range. Free catalogue. Gardiner Electronics, Dept. 9, 4729 N. 7th Avenue, Phoenix, Arizona 85013.

**POWERFUL** Metrotech locator detect gold, silver, coins, relics. Moneyback guarantee, terms. Free information. Underground Explorations, Dept. A, Box 793, Menlo Park, California 94025.

**GOLDAK** Treasure locators—Pleasure and profit in a hobby you'll enjoy. Find coins, relics, gold, silver. Charge on Bank-American. GOLDAK, Dept. PM, 1101-A Air Way, Glendale, California 91201.

**TIRED OF DIGGING UP TRASH?** The All New "Coinshooter" Rejects Bottle Caps, Tin Foil, Nails and Shallow Trash. Detects Gold, Silver Coins and Jewelry. Free Literature. D-TEX ELECTRONICS, Box 451-U, Garland, Texas 75040.

**FREE FACT-FILLED CATALOG.** World's largest line of metal detectors. Models as low as \$49.50 and up. Two year Guarantee. Three factory locations, U.S. and Canada, plus over 1,000 dealers and 35 Service Centers from coast to coast. No finer instruments made at any price. Budget terms. Write: WHITE'S ELECTRONICS, INC., RM #381 1011 PLEASANT VALLEY ROAD, SWEET HOME, OREGON 97386.

(Continued on next page)

## TREASURE FINDERS

(Continued from preceding page)

**FISHER DETECTORS.** You deserve the best. Free literature. FRL, Dept. PM-12, P.O. Box 490, Belmont, California 94002.

**FREE—VALUABLE TREASURE FINDER** catalog sent by return mail. Find Coins, Rings, Gold, Silver, Metals, Relics. Write today. JETCO, Dept. CPM, Box 26669, El Paso, Texas 79926.

## PRECIOUS STONES & MINERALS

**500 POLISHED Gemstones \$5.00.** Tumblecraft, 5401 James North, Minneapolis, Minn. 55430.

**GET** Free catalog no serious rockhound, gem cutter, jewelry maker, hobbyist or craftsman can be without. Full of bargains, exclusive items, low prices from largest suppliers and authorities in the field. Free new catalog just off the press, yours for the asking. Write: Grieger's, Dept. C-12, 900 South Arroyo Pkwy., Pasadena, California 91105.

**COLLECTORS!!** Expand. Improve Your Collection! Crystals, Minerals, Rocks, Geological Oddities. Illustrated (215 photographs) Catalog \$1.00 (Refundable). Excellent reference book. Filer's, Box 372 M2, Redlands, California 92373.

## CARTOONING, COMMERCIAL ARTS, SHOWCARD & SIGN PAINTING

**"HOW TO MAKE MONEY WITH SIMPLE CARTOONS"**—Informative Book sent FREE Tells Way to Big Income. Cartoonists' Exchange, 912 Pleasant Hill, Ohio 45359.

**BOB HALE'S CARTOON COLLEGE** 24 Lessons from one of America's top Cartoonists. \$1.00 FIRST 3 LESSONS or \$4.95 for the full course. Bob Hale, Box 1671, Hesperia, California 92345.

**SIGN Painting**—\$1000 per Month Part-Time. Free Catalogue. Kaufmann Supply, Centertown, Missouri 65023.

**COMPACT** 23 lesson Cartoon Course and Cartoonist's Magazine. \$2.00. Hartman, Box 30367, Lincoln, Nebraska 68510.

**MODERN** Cartooning taught by mail. Write for free brochure. Cartoonorama—Box 263-4M, Branford, Conn. 06405.

**CARTOON** For Money!! Big Free Book: Success, Box 885-C, Dearborn, Mich. 48121.

**LEARN** Sign painting at home. Free Talent test. Ben Kerns, Box 812-PM, Greenville, S.C. 29601.

**FASCINATING** Systems. Sign Painting-Cartooning. Straley, 1704 South Center, Springfield, Ohio 45506.

**EASY** Method Sign Painting. Free Information. Corson Ellis, 10533 121 Ave. Largo, Florida 33540.

**LEARN** Cartooning at Home. Approved for Veterans. Free Bulletin. Cartooning, Box 70690, Colorado Springs, Colorado 80933.

## ADVERTISING AGENCIES, ADV. SERVICES, MAILING LISTS

**OPPORTUNITY** Seekers—Ambitious individuals seeking additional income. Gummed 33-up labels—\$25/1000. Merchandisers, 1137 Crenshaw, Los Angeles 90019.

**MAILING** List, Most all Kinds, \$9.00 1000 Gummed, Circulars mailed \$5.00 1000. Dirmailers, King, North Carolina 27021.

**ADVERTISING** Ratebook leading newspapers, magazines, 25¢. Chicago Advertising Agency, 28-E Jackson, Chicago 60604.

**\$1.00 LISTS** You Year sent to 1000 Importers, Jobbers, Mailers. our mailing year Activ-Graph, Box 1252, Williamsport, Pa. 17701.

**ADVERTISE** Timely Tips, Mailorder Magazine. SAMPLE 35¢. Lyke, 3042 Sherwood, Markham, Illinois 60426.

## TYPEWRITERS, DUPLICATORS, OFFICE EQUIP.

**PROFITS FROM CLASSIFIED ADVERTISING!** Booklet shows you how to start your own business with Classified Advertising. Only \$1.00 (Refundable with first order.) H. E. KAPPEL, POPULAR MECHANICS, DEPT. P, 224 WEST 57TH STREET, NEW YORK, N. Y. 10019

## RUBBER STAMPS

**FREE** Catalog—New Self Inking Stamps, Marking Equipment. Rush Stamps, 132 Farmcrest, Rush, New York 14543.

**FREE** Catalog—Rubber Stamps, Business Cards, Labels, Printing. Youngers Stamp Shop, Princeton, Iowa 52768.

**POCKET** Stamp \$1.00. Handle Stamp \$1.50. 1000 Labels \$1.00. Martinhouse, 2052-O East 24th, Brooklyn 11229

**FREE** stamp catalog. 45 type styles. Fast Service, low prices. Jackson's, Box 443A, Franklin Park, Ill. 60131.

**FOUR** Lines Walnut Knob Handle Two Dollars Postpaid. Mesabi Mimeo, 2224M First Avenue, Hibbing, Minnesota 55746.

## OFFICE SUPPLIES

**MAILORDER RECORDS** Help get increased business! Complete 32 Page Record Book shows your inquiries, orders, advertising, expense, etc. Only \$1.00. H. E. KAPPEL, POPULAR MECHANICS, DEPT. R, 224 WEST 57TH STREET, NEW YORK, N. Y. 10019.

## PRINTING PRESSES, RUBBER STAMP OUTFITS

**SIMPLE-X RUBBER STAMP PRESSES.** Hydraulic operated, electrically heated. Sizes 5"x8", 8"x12", 10"x15". Starting outfits. Orders for presses, supplies shipped day received. Free catalog low supply prices. Send \$1.00 for postage and handling (refundable on first order). Custom Manufacturers, 406-P East Elm, Springfield, Missouri 65801.

**PRINTING** Presses, type, Supplies Lists, 10¢. Turnbaugh Service, Mechanicsburg, Pennsylvania 17055.

**NEW** Catalog No. 13, 120 Pages, hand printing presses, type fonts, supplies. Send \$1.00 deductible first order. Acme Type, 732 Federal, Chicago, Illinois 60605.

**PRINTING MACHINES.** Offset, Mimeograph, Typewriters, Composing, Machines. Dixgraph, King, North Carolina 27021.

**SAME** Day shipment on rubber stamp supplies. Revised wholesale price list No. 9 free. Star Stamp Supply, 732 Federal, Chicago, Ill. 60605.

**RUBBER** Stamp outfits, supplies. Kiewiet, 2025 Barney Road, Kalamazoo, Michigan 49007.

**PRINT YOUR OWN**—Printing Presses, type, supplies direct from factory. Send 25¢ for catalog and samples to: Kelsey Co., DM, Meriden, Conn. 06450.

**LOW** Priced Rubber Stamp Manufacturing Supplies, Starting Outfits. Martin, 1432 Major, Jefferson City, Missouri 65101.

**RUBBER** Stamp manufacturers supplies. Presses, starting outfits. Best prices, service. Catalog. Jackson Supply, Box 443A, Franklin Park, Ill. 60131.

**MAKE** Your Own Self-Molding Rubber Stamps and Printing Cuts. Plexirubber, Argyle A, Wisconsin.

## PRINTING AND SUPPLIES

**BUSINESS CARDS** Raised Letters \$5.65 Thousand. Like Engraved. Free Samples. Kavanagh, Box 1222, Brooklyn, N.Y. 11202.

**PRINTING** Supermarket Short Run Specials. 1000-\$4.75, 5000-\$22. 1000 Envelopes \$8. Shipping 9 hours. Get Free Printing Specials Price List "Do You Make These 18 Mistakes When You Buy Printing." Speedy Offset Printers, 23806, Aurora, Bedford, Ohio 44146.

**1000 EMBOSSED** Business Cards \$5.25 Postpaid. Agents Wanted. Elco, 181-A, Sylvania, Ohio 43560.

**FREE** Literature, Business Cards, Letterheads, Labels, Rubber Stamps. Geer's, 111 North Drive, Ottawa, Ohio 45875.

**QUALITY** Printing. Novelty and Imported Items. Catalog 25¢. John G. Robeson, Box 2316, Hyattsville, Maryland 20784.

**PRINTING** Reasonable Prices. Samples Free. FOWLCO, 3515 Walnut, Muncie, Indiana 47302.

**QUICK** Copy Offset Printing. Free Introductory Offer. Nationwide Printing, 73 E. University, Champaign, Ill. 61820.

**FREE** Literature: Business Cards—Rubber Stamps, Address Labels, Printing. Jordan's, 552 West O'Connor, Lima, Ohio 45801.

## MULTIGRAPH, MIMEOGRAPH

**PROFITS FROM CLASSIFIED ADVERTISING!** Booklet shows you how to start your own business with Classified Advertising. Only \$1.00 (Refundable with first order.) H. E. KAPPEL, POPULAR MECHANICS, DEPT. P, 224 WEST 57TH STREET, NEW YORK, N. Y. 10019.

## GUMMED LABELS

**1000 GUMMED** Address Labels \$1.00. Wait's, Box 960A, South Bend, Indiana 46624.

**1,000 GUMMED ADDRESS LABELS \$1.00** FREE CATALOG, Acme, 1238 Voskamp, Pittsburgh, Pennsylvania 15212.

## REMAILING SERVICE

**YOUR** Mail Received—Forwarded. Hedgpath, 324-M South First, Alhambra, Calif. 91802

**PROMPT!** Confidential!! Remails!!! 25¢. Gallagher, 420 High Street, Phoenixville, Penna. 19460.

**HAWAII** Remails 25¢. Monthly \$3.00 Walker, Box 147, Wailuku, Hawaii 96793.

**CONFIDENTIAL**—Receiving-Forwarding. Remails 25¢. Hillegas, Box 169-P Hainesport, New Jersey 08036.

**CONFIDENTIAL:** Receiving—Forwarding—Remailing. A. Nails, Box 3021, Noroton, Connecticut 06820.

**SECRET.** Receiving—forwarding. Discreet and confidential. Remail 25¢ single. Mail Forwarding Service, 8050 S. Main, Houston, Texas 77025.

**MIAMI** Remails 25¢—Monthly rates. Remails—view cards from 80 Foreign cities. Marle, Box 1266, Coral Gables, Florida 33134.

**CONFIDENTIAL** New York Mail Address \$3.00 Month. Telephone Service \$5.00. Re-mails 25¢. Details Free. Birnhan, 152 West 42, New York 10036.

**PONY-EXPRESS** Your Mail, received-forwarded. Davis, 1391 Archer, Live Oak, Calif. 95953.

**WHATEVER** Your Reasons for Remailing. Confidential Service. 35¢ each. Three for \$1.00. We pay Postage. Ray, Box 781, Sherbrooke, (Que.), Canada J1H 5K7.

**BALTIMORE** Remails, 25¢ Single. Woodway Services, Box 8509, Baltimore, Maryland 21234.

**JAPAN REMAILING** anywhere \$2.00/letter. Friedman, Shiba P.O. Box 234, Tokyo, Japan 105.

**OZARK** Remails 25¢. La Trasse, Box 52, Fairdealing, Mo. 63939.

**CONCEAL** Your Location: use our address. Wright, CN-2112, Asheville, N.C. 28802.

**FIRST MONTH FREE.** World Mail Bag, Drawer 568E, ANAHEIM, CALIFORNIA 92805.

**CANADA** Remails \$1.00 Receiving-Forwarding. King, Box 5662, "A", Toronto, Canada M5W1N8.

(Continued on next page)

## REPAIRS AND SERVICING

**PROFITS FROM CLASSIFIED ADVERTISING!** Booklet shows you how to start your own business with Classified Advertising. Only \$1.00 (Refundable with first order.) **H. E. KAPPEL, POPULAR MECHANICS, DEPT. P, 224 WEST 57TH STREET, NEW YORK, N. Y. 10019.**

**APPLIANCE PARTS:** Buy at 20-50% discount. For complete list of parts catalogs, troubleshooter's handbooks, repair Manuals, send \$1.00. API, Box 3844, Shreveport, Louisiana 71103.

**NEW SOLID STATE COMPRESSOR PROTECTION—Air Conditioning-Refrigeration—YOU Can install. Dealerships—\$1.00—Refundable. Associated Service, Ltd. P.O. Box 5053, Irving, Texas 75062**

## SPECIAL SERVICES

**POPULAR MECHANICS INDEX AND SHELF WRAPPER** 1971 and 1972 editions now available. You will be able to find any article that appeared in P. M. covering those years in seconds. These annual indexes will make your copies of P. M. even more valuable! Each \$1.49. Send checks to: Popular Mechanics, Dept. HE, Box 1014, Radio City, New York, New York 10019.

**INFORMATION** On anything. Ferguson Research Specialists, 72-25 Woodside, Woodside, New York 11377.

## TOBACCO

**BRIAR PIPES.** Discount Prices. Write: Maxima, Box 26-D4, Vails Gate, New York 12584.

**ORIENTAL Turkish—Domestic Tobaccos For Do-It-Yourself Blending.** Tobacco Blenders Supply, 1237 1/2 Cook, Denver, Colo. 80206.

**DO YOUR pipe a flavor.** Factory-fresh, pure tobacco. Natural and aromatic custom blends. For free sample write: Green River Tobacco, Box 1313-PMT, Owensboro, Ky. 42301.

**MEERSCHAUM Pipes—Free Catalog.** Conner Imports, Box 9574-PM2, San Jose, Calif. 95157.

## BETTER HEALTH

**WORLD'S Most Outspoken Publication.** Natural Health, Healing, Organic Gardening. Free Copy. Provoker Press, St. Catharines 102, Ontario.

**LIVE LONGER!** Booklet reveals the secrets of a long and healthy life. Send \$1.00 Pennley Gifts, 71 West 47 Street, Room 1306, New York, New York 10036.

**NOW!** Look better, feel better, lose weight. Workable plan includes: delicious menus, recipes, even tasty snacks. Rush \$1.00 To: Advance, 1101 East Six Court, Hialeah, Fla. 33010.

**LIVE LONGER!** Booklet Reveals the Secrets of a Long and Healthy Life. Send \$1.00. Coral Reef Enterprises, 5407 Florida Ave., Tampa, Fla. 33604.

## PERSONAL

**BORROW** By Mail! Up to \$1500.00. Convenient terms. State Licensed. Postal Finance, Dept. 17-T, 6018 Military Ave., Omaha, Nebraska 68104.

**I HELPED** Thousands Wipe Out Debts. Clear credit. Immediate relief to \$25,000. Free details. Counselor-7, Kerrville, Texas 78028.

**INSTANT DEBT RELIEF** Without borrowing. Without Bankruptcy. Have excellent credit in 45 days. Free!!! Wealth Building, Box B-12, 1996 Hoyt Street, Lakewood, Colorado 80215.

**NEED Money-Debts Too Big?** Consolidate Bills. Free Emergency Loans. Write: Interstate, 28 E. Jackson, Suite 1204-X3, Chicago 60604.

**PSORIASIS** Sufferers: Discouraged? Write for Free important information that is helping thousands! Pixacol, Box 38-PM, Avon Lake, Ohio 44012.

**BIBLE** Questions answered. Stamped envelope. Bylon, 17167 Bentler, Detroit, Michigan 48219.

**INVESTIGATORS.** Latest electronic Aids. Free Literature. Clifton, 11500-P NW 7th Ave., Miami, Florida 33168.

**RECORD** Telephone Conversation automatically. Leave Recorder Unattended. Robert's, Box 49-PM12, Parkridge, Illinois 60068.

**RECEIVE** Phony State Chartered University Degrees immediately. Box 11516, Tucson, Arizona 85706.

**CASH LOANS** by mail! Up to \$2,500 on signature alone. No collateral! Secret! Union Finance Company, 3608 No. 16th St., Dept. PM, Phoenix, Ariz. 85011.

**SEE THRU WALLS!** New Secret Two-Way Super Spy Device, instructions included. Guaranteed only \$2.00. World-12C20, 3047 University, San Diego, Cal. 92104.

**TELL** Fortunes accurately—Immediately! ESP Aids, Box 21-PM, Olympia, Washington, 98501.

**TATTOO** Removing—Chemical Do-It-Yourself Method—Free Details: Atlanta, 907P Beachpoint, Pickering, Ontario, L1W 2A4

**"RULE** Others With Thoughts." (Telepathy). Write: Clarion, Box 1769-A7, Chicago 60690.

**CREDIT** Cards . . . loans . . . no credit investigation!!! Guaranteed Free report. Continental-23, Nicerville, Florida 32578.

**SECRET LOANS BY MAIL.** Borrow \$100 to \$3000 for any good reason in absolute privacy. No interviews, no endorsers, no co-signers. Fast service. Write: Dial Finance Co., Dept. 3626, 418 Seventh Street, Des Moines, Iowa 50309.

**LIVE SECURELY!** Protect Your Family with a LEGAL Will. Complete Instructions, Samples, and Forms. Only \$1.95—Fully Guaranteed! Act Now! Basics-12A,—903 Parkside, Elmhurst, Ill. 60126.

**NONRESIDENT DEGREES!** Nationwide Faculty. Catalog \$3.00. UNITED STATES UNIVERSITY OF AMERICA. Box 4552, Washington, D.C. 20017.

**LOOKING FOR SOMEBODY?** Do it yourself and save—instructions \$2.00. Wood, Box 533, Hillsboro, Ohio 45133.

**HOW** Intelligent are you? Self-scoring test reveals IQ in 45 minutes. Send \$2 today—guaranteed! Shackles, Box 44742, Dept. PM-1273, Los Angeles 90044.

**HEALTH** Problem? Sensational New Discoveries About Mind-Body Relationship Improvement Guaranteed. Absolutely No Risk. \$2.00. ALTA Products, P.O. Box 1293, Moncton, New Brunswick, Canada

**LEGAL WILL FORMS** Six for \$1.00. Guaranteed. Colossi, 1433M 61 Street, Brooklyn, New York 11219

**LOSING HAIR? BALDING? DANDRUFF?** Free copyrighted booklet. Dr. Shiffer Laboratories, Dept. 536, Box 398, Punta Gorda, Florida, 33950.

**ELECTRONIC DEBUGGING.** Other Security Equipment. Top Quality. Lowest Wholesale Prices. Viking International, Box 632, Newhall, California 91321.

## WANTED-MISCELLANEOUS

**MERCURY,** Gold, Silver, Platinum: Ores assayed. Wholesale Terminal, Norwood, Mass. 02062.

## WINEMAKING & OTHER RECIPES

**SIMPLE** Recipe—Pineapple Champagne—Send \$2.00 to: George's, Box 592, Yemassee, S. C. 29945.

**MAKE** Your own Wine—using equipment you have in your own kitchen. Recipes and complete instructions. \$3.00. MAR-KER Enterprises, P.O. Box 5061, Evansville, Indiana 47715.

**MEAD WINE.** Excellent, referred to in the Bible. Proven recipe \$1.00. Honey in bulk, wholesale, 5 lbs. up. Inquire: Keller, Box 6197-PM, San Jose, California 95150.

**CONCENTRATE** Catalog. 60 Varieties. Vendramino Wine Co., Dept. A, 13273 Michigan Ave., Dearborn, Mich. 48126.

**WINEMAKERS** FREE Supply Catalog. Excellent Selection of Fruit & Grape Concentrates. Kraus, Box 451-L, Nevada, Missouri 64772.

**WINEMAKERS.** Free illustrated catalog of yeasts, equipment. Semplex, Box 12276R, Minneapolis, Minn. 55412.

**WINEMAKER'S** Supply Catalog—Free. Bacchanalia, 273 Riverside Ave., Westport, Conn. 06880.

**HOMEWINE MAKING SEND** For FREE Informative CATALOG OF RECIPES, EQUIPMENT, and INGREDIENTS. Brewer's Yeast Dry Malt, Crystal Malt, Bottle Caps, Barrels, Chemicals, Concentrates, Over 250 Items. Winemaking Is A Fascinating Hobby. Write To: Danenberger's, Box 276-M, New Berlin, Ill. 62670.

**WINEMAKER'S!** Free Illustrated Catalogue of Quality Products. Brant's Wine Rack, Box 3256-M, Orange, California 92665.

**WINEMAKERS . . .** Free Illustrated Supply Catalog of Yeast, Equipment, Recipes. Continental, Box 18223-PM, Indianapolis, Ind. 46218.

**WINEMAKERS:** Free Catalog. Fast Service. Arbolyn, Box 663, West Columbia, South Carolina 29169.

**OAK** Barrels—Round and Oval. All Sizes. Barrel Winery, 1201 University Avenue, Berkeley, California 94702.

**LARGEST** Stock Supplies and Equipment. We have the Know-How. Write for Catalog, Advice, Consultation . . . Jim Dandy Wine Supplies, 8454 Beechmont, Cincinnati, Ohio 45230.

**FREE** Winemakers Comprehensive Supply Catalog. Winecrafters, Box 24, Abington, Pa. 19001.

**WINEMAKERS.** Tremendous selection. Fast service. Free catalog. Winecraft; Columbia Mall; Columbia, Maryland 21043.

## MISCELLANEOUS

**ANIMAL** coat-of-arms!!! Full color 8x10 plaque. History of breed on back. Personalized—Your pets name. Unusual gift!! Only \$3.25. Satisfaction guaranteed. Give pets name and breed. J and J Enterprises, Dept. 4E12, 6217 W 76th Place, Prairie Village, Kansas 66208.

**FUN** Projects For Dad And The Kids. A Book With Hundreds Of Ideas, Club House, Sailboats, Swing Dollhouse—Only \$2.95. Lawrence Lombardi, 15 West 44th Street, New York, New York 10036.

**DON'T DIE** Without A Will! Blank Will Form protects your family Only \$2.00—Guaranteed! Order Today!! FORMS, 1925 Harrison St., Div. 102P-12, Evanston 60201.

**TV PICTURE TUBES** manufactory direct, easy installation. Write: Ehes Co., 405 E. Jefferson, Cheyenne, Wyo. 82001.

**BOOKS** On antiques and their prices. Free circular!! P. Warman Publishers, Uniontown, Penna. 15401.

**PRE-PACKAGED** Toys complete with free self-selling display rack. Free Details. Toys, 1916 Fifth, Sacramento, California 95814.

**SLEEPATRON.** New device for inducing sleep. Gardiner Electronics, Dept. C, 4729 North 7th Avenue, Phoenix, Arizona 85013.

**IDENTIFICATION CARDS.** Send stamped self-addressed envelope for samples. NIPCOM, 727 North Main, Las Vegas, Nevada 89101.

**EYEGLASSES** wholesale—Free Catalog. A-Z Optical Company, Box 175, Dept. R26, Bay Station, Brooklyn, N.Y. 11235.

**1400 CATALOGS** Listed and Described! Sources for EVERYTHING imaginable! Rush \$2.00. MASTERLOG, Box 24413-(UL), Oakland, California 94623.

(Continued on next page)

**MISCELLANEOUS**

(Continued from preceding page)

**CREDIT Cards** . . . loans . . . no credit investigation!!! Guaranteed Free report. Continental-24, Nicerville, Florida 32578.

**ORNAMENTAL Iron designs.** Book of 1600 beautiful, practical designs for railings, columns, etc. Free literature. Cunningham, 3881 South 3200 West, Box 19005, Salt Lake City, Utah 84119.

**HOBBY CRAFT SALES, YOU MAKE IT, WE SELL IT.** Information 50¢. P.O. 893, League City, TEXAS 77573.

**WIN Contests, Prizes, Money.** We show you how. Send \$1.00 to Jan-Dar, Box 948, Mobile, Ala. 36601.

**TATTOOING:** Complete Inventory of Equipment and Supplies for Professional and Amateur. Transistor Driven Machines. Illustrated Information. Paul's, Box 8073, LaCrescenta, California 91214.

**HOW INTELLIGENT Are You?** Self-Scoring Test Reveals I.Q. in 45 Minutes! Send \$2.00 today—Guaranteed!! Leonard Kelleher, Dept. 1A12, 37 17th Avenue, Coatesville, Pennsylvania 19320.

**DON'T DIE Without A Will!** Blank Will form protects your family. Only \$2—Guaranteed! Order today!! MJS Associates, Dept CA12, Box 347, Clementon, N.J. 08021

**HOW Firearm Permit Application For Sport or Protection.** Only \$1.00. G. S.'s, Dept. PM., 3215 Macland Rd., Powder Springs, Ga. 30073.

**CIGARETTES** at half the cost. Roll plain, filtertip or king with our rollers and blended tobaccos. Free Sample. Write Green River Tobacco, Box 1313PM, Owensboro, Ky. 42301.

**MINIATURE 1" Flashlight** only \$1.00. AMERICAN-CA, 1 Riverside, Riverside, Illinois 60546.

**"HOW TO PREPARE FOR THE COMING CRASH!"** Protect your Family from Inflation! Survive coming Worldwide Depression! Paperback Book \$2.00 +25¢ Mailing. Calico Enterprises, 200112 California Ave., Palo Alto, Calif. 94306.

**SAVE TAXES.** Booklet explains many common deductions often overlooked. Valuable! Send \$2.00 today! Tax Consultant, 47-P Seward Street, Dansville, New York 14437.

**ONE DROP Room Deodorizer.** Destroys Odors for 24 Hours. 500 Drops in Bottle. Powerful!! Guaranteed—\$2.49. Turman's, PM-12, 2317 North Shannon, Sherman, Texas 75090

**MAKE Delicious Homemade Sausage and coldcuts.** Free Illustrated Catalog—seasonings, casings, equipment, recipes. Stuff 'n' Serve, Box 8009-65, Rochester, New York 14606.

**BETTER Than Metal!!! Lifetime Plastic Social Security Card!** Guaranteed! Free Case! . . . Identification Card! Send Name . . . Number . . . \$2.50 . . . Moenter, Dept. 12B2, Box 47, East Detroit, 48021.

**BLANK FORMS—Birth Certificate, Baptism, Marriage, Divorce, High School, College, Driver's License, General Agreement, Power Attorney, Lease, Building Contract, Karate Expert, Press Correspondent, Investigator.** Any 3—\$1.00 . . . 7—\$2.00. (Catalog 25¢, applies next Order.) Legal Forms, Department 290, Box 554, Farmington, Michigan 48024

**NOW! WORLD'S SMALLEST FIRE ALARM!** Low cost, high quality fire protection where you need it! Just plug in any outlet. Ultra alert sensor activates buzzer in time for effective action! Great for kitchen—bedrooms! Take travelling—plug in hotel/motel room outlets! Moneyback guarantee. Order today! ONLY \$10.95! SHEPHERD'S, 7463 LATHERS, WESTLAND, MICHIGAN 48185.

**HEARING Aid batteries wholesale.** Free list. Habs, Box 51, York, Penna. 17405.

**BURGLAR ALARMS & HOME PROTECTION**

**FIRE?? Save Lives!! Small Alarm Sounds Loud Warning! Plugs in anywhere!! \$10.95**—Guaranteed. Park Products, Box 197, West Hartford, Connecticut 06107.

**LOCKSMITHING Supplies—Buyers Guide \$1.00.** Despubs, Box 22005H, Phoenix, Arizona 85028.

**FREE Catalog on Burglar-fire Alarm Equipment.** Protecto Alarm Sales, Box 357-D, Birch Run, Michigan 48415.

**BURGLAR ALARM Do It Yourself.** Prevent Theft and Break-ins of Automobiles, Boats, Trailers etc. Can be Seen and Heard 1/4 Mile. Easy to Follow Plans \$3.00. EVN, Box 5564, Ft. Lauderdale, Florida 33310.

**NEW Heavy Chain Burglar Alarm** makes entry impossible and alerts you. Guaranteed. \$6.95. Donald Johnson, Wilson Road, Kittery, Maine 03904.

**WORLDS Smallest Fire Alarm!!! Plugs in Anywhere.** Sounds at 135° take anywhere. Only \$10.95 Guaranteed. Universal Products, Dept. CA12, 603 East Oak Grove Street, Juneau, Wisconsin 53039.

**EARLY WARNING OF HOME FIRES—NO ELECTRIC POWER REQUIRED.** The Crest-alarm incorporates a quality brass diaphragm air horn triggered by heat and sounded continuously 5-8 minutes by pressurized container. Model M-100 for bedrooms, etc. enclosed in attractive neutral color plastic case for wall mounting \$9.95—**HANG ONE NEAR YOUR CHRISTMAS TREE!** Model M-101 with wall mount clamp (higher activation temperature) for furnace room, attic \$9.50. Prices include tax and Parcel-Post delivery. CRESTWOOD PRODUCTIONS, P. O. BOX 60, DARLINGTON, S. C. 29532

**BIG MONEY**

- LIGHTNING TECHNOLOGY
- GET IN ON GROUND FLOOR
- BE YOUR OWN BOSS
- LEARN AT HOME

WRITE:

Lightning Protection Institute School  
122 W. Washington Ave.  
Madison, Wis. 53703

No obligation.



**SPECIAL OFFER! Molykote® 557 all-purpose spray lubricant**

Nonstaining, nonflammable; dries quickly to clear, slippery, dust-free coating. Countless uses in home, yard, shop, garage. For example, aluminum windows in home or camper, sticky drawers, doors, tools, etc. Works on metals, wood, rubber, plastics. 16-oz. economy can lasts months, only \$4.95 post-paid. Check or money order to Dow Corning Corp., P.O. Box 2024, Midland, Michigan 48640.

**"LISTEN IN" TO POLICE-FIRE RADIO CALLS IN YOUR CAR!**

WORKS with ANY CAR—Portable or HOME RADIO! Just PLUGS in—No wiring—3 minute hookup! Switch instantly from regular to ALL POLICE - FIRE - EMERGENCY - COMMERCIAL - TAXICAB-STATE-CITY-GOV'T 2 way Radio calls in YOUR AREA. DUAL-HI-LOW BANDS TUNES 36-49 & 150-175 MHS. USE Everywhere—anytime—always works.

**SEND ONLY \$2.00** (cash, Ck., M.O.) and pay post-man \$9.99 plus COD post or send \$11.99 for ppd Del in USA. COMPLETE, ready to use with instructions. One Year Service Warranty—10 DAY MONEY BACK TRIAL (if rtd). Sold Only—DIRECT FROM FACTORY at this LOW Price! WESTERN RADIO BPM-12 KEARNEY, NEBR. 68847



**Print For Profit**

Cards, Stationery, Envelopes, Advertising, labels, tickets, announcements, Q.S.L. cards, greeting, sympathy, prayer cards, tags, etc. Good Profits. Pays for itself in a short time.

**Own a Printing Business**

We supply everything direct from factory only. Easily followed rules. Also raised printing like engraving. Have home shop. Add to income. Send 25¢ for catalogue. **KELSEY PRESSES Meriden, Conn. 06450**

MAIL THIS COUPON TODAY!

KELSEY PRESSES, DEPT. 73-A1, Meriden, Conn. 06450

I enclose 25¢ send big catalog and samples.

Name \_\_\_\_\_

Address \_\_\_\_\_

City \_\_\_\_\_ State \_\_\_\_\_ Zip \_\_\_\_\_

**ENJOY YOUR OWN BUSINESS**

Start earning at once—No special experience required

A SHOP  
IN ITSELF  
AUTOMATIC  
FOOLPROOF

**STAND-ALL Model 7**

Sharpens & Retoots Hand Saws 3 point through 16 point. SHARPENS—BAND SAWS—HACK SAWS—WOOD AND METAL CUTTING SAWS with straight back and identical tooth profile.

CROWNS—adjusts to any standard crown.

HOOKS—5° to 21° BEVELS—0° to 30°

SMITH-NIELSEN EQUIPMENT CO.

P-73 Mfg. of Saw Grinders—Distributor of Complete Saw Shop Equip. Box 2505 Terminal Annex, Spokane, Washington 99220 509-535-9811



# Unadorned power tools ... they do the same job as tools costing up to 5 times as much.

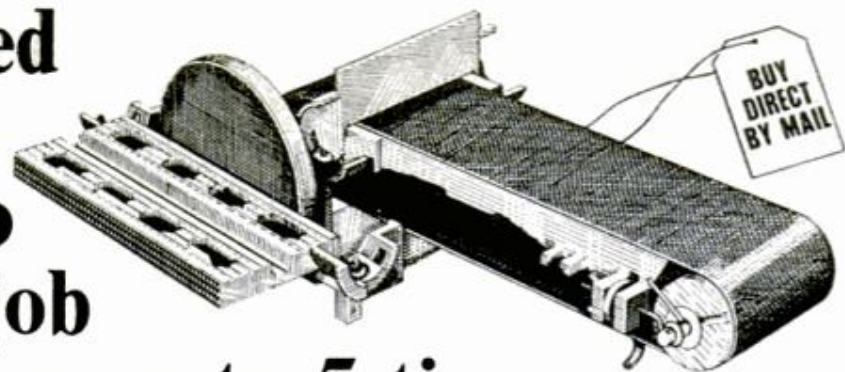

We skipped the chrome to save you money... but we did not skip anything on performance. Actually, we skipped more than just chrome, we cut out every costly frill that wasn't absolutely needed.

Our tools are not exactly flashy. We are the first to admit it. But in articles covering test results on AMT tools, written by leading publications such as Popular Science, our tools have been praised over and over again. In spite of their low prices, our tools are full scale and offer full performance and precision.

**HERE'S HOW WE DO IT . . .** First, we don't claim our tools should sell for five times the price! Just that our tools do the same job . . . with the same accuracy, ease and speed . . . and will last at least as long. AMT tools cost less to make and are sold direct. They are bona fide quality power tools used by serious amateurs and professionals alike and if sold in retail stores would be much higher in price. We use no magic, let's be specific: **SIMPLICITY . . .** AMT tools are soundly engineered to eliminate every frill and gimmick—to minimize material and production costs. Machined parts are used only where they're needed. Unadorned cast iron and aluminum save you a fortune.

**DIRECT-FROM-FACTORY SAVINGS . . .** You save a bundle, yet, we offer a double guarantee backed by a 45-year-old company with millions of satisfied customers . . . and hundreds of orders pour in daily.

**LARGE VOLUME . . .** Our own foundry and large mass production facilities plus large buying power all work to keep costs down.

**STANDARD PARTS . . .** Our designs use standard hardware items wherever possible. By avoiding custom-made parts we pass on tremendous savings to you.

If you are looking for power tools that perform like units costing many times our low prices, order today and you'll be one step closer to many hours of woodworking satisfaction.

*Bill Morley*

## POWER SAW 8" tilt arbor saw ... crosscuts, rips,

mitres, cuts compound angles, dados, coves, moldings. Completely assembled with ground cast iron table, safety guard, splitter, mitre gauge. Less blade, motor. Rip fence for easier work alignment, \$3.50 add'l. Ball bearing model, \$5.00 add'l. Takes 1/3 h.p. motor or larger, standard blades, attachments. Wt. 26 lbs., f.o.b. factory



**\$19.95**



**FREE OFFER, cabinet base plans, . . .** with one piece of 3/4" plywood, convert your \$19.95 saw into a floor model with a huge 27" x 24" top. Takes cabinet rip fence, \$4.50 add'l.

## BELT SANDER A precision unit. It changes from horizontal to vertical in seconds. Heavy, sander includes 4" x 36" sanding belt.

Uses 1/3 h.p. or larger motor. V-pulley drive and multi-purpose drive spindle.



Disc sander accessory, \$7.95 add'l. Mitre gauge, \$1.95 add'l. 15 lbs., f.o.b. factory

**\$19.95**

## 3' WOOD LATHE . . . 6" swing. Same precision and speed as \$40 units. Sturdy cast iron with tubular steel bed.

Lever action tail stock, two-speed pulley, fits any motor. Set of 3 high speed turning chisels, \$5.95 add'l. 4" face plate, \$2.50 add'l. 15 lbs., f.o.b. factory



**\$14.95**

## 4' WOOD LATHE . . . 12" swing. Industrial size, does the same job as \$75 units. Tubular steel bed rails, screw action tail stock, the speed pulley.

Use any motor. 3 high speed turning chisels, \$5.95 add'l. 4" face plate, \$2.50 add'l. 30 lbs., f.o.b. factory



**\$29.95**

## JOINTER-PLANER 4 1/8" x 22". Cast iron and steel, precision ground adjustable tables. For planing, joints, bevels, Rabbits to 3/8" depth. Fence adjustable 0 to 50.

Steel knives, dual guards. Use any motor. Precision ball bearing industrial model, \$10.00 add'l. Wt. 19 lbs., f.o.b. factory



**\$29.95**

## DRILL PRESS Precision 32" radial unit has standard features and many extras. Depth of throat up to 16". Head tilts and table stays level. Drills to center of a 32" circle. All cast iron and steel. Takes standard motor. 32 lbs., f.o.b. factory.

**\$39.95**

## WOOD SHAPER KIT Makes beads, coves, moldings, tongue-and-groove joints, etc. Accurate cuts at high speeds. Sealed greased-for-life ball bearings. Less wood. Takes 1/4 h.p. motor or larger, standard cutters. Optional hold down assembly, \$2.95 add'l. 15 lbs., f.o.b. factory



**\$19.95**

### TWO GUARANTEES

**10-DAY MONEY BACK GUARANTEE**  
Try any of these power tools and compare it with any similar machine at any price. If not satisfied, return it for prompt, no questions asked refund. We pay the return shipping charges.

**10-YR. FULL SERVICE GUARANTEE**  
Any part or parts of these AMT power tools (except motor which carries a one year guarantee) which become inoperative for any reason within ten years after purchase date will be repaired or replaced by the factory with no cost to the purchaser other than postage.

AMERICAN MACHINE & TOOL CO.  
4th & Spring St., Royersford, Pa. 19468



**Brand new electric motor** developing full 1 h.p. 17 lbs. (Purchased separately, \$24.85). With any AMT machine here. **\$19.90**

**BUY DIRECT . . . USE THIS HANDY ORDER COUPON NOW**

AMERICAN MACHINE & TOOL CO., Dept. PMD3, Royersford, Pa. 19468  
Please send me the units checked. Payment in full enclosed \$ or \$3 deposit each item enclosed, balance C.O.D. I must be fully satisfied or will return unit within 10 days for full refund. No questions asked.

- |   |  |
|---|--|
| <input type="checkbox"/> 8" Power Saw at \$19.95          | <input type="checkbox"/> Jointer Planer at \$29.95             |
| <input type="checkbox"/> Standard Rip Fence at \$3.50     | <input type="checkbox"/> Ball Bearing Spindle at \$10.00       |
| <input type="checkbox"/> Long Cabinet Rip Fence at \$4.50 | <input type="checkbox"/> Wood Shaper Kit at \$19.95            |
| <input type="checkbox"/> Ball Bearing Spindle at \$5.00   | <input type="checkbox"/> Opt. Hold Down Assembly at \$2.95     |
| <input type="checkbox"/> Belt Sander at \$19.95           | <input type="checkbox"/> 6" Swing 3' Lathe at \$14.95          |
| <input type="checkbox"/> Disc Sander Attachment at \$7.95 | <input type="checkbox"/> 12" Swing 4' Lathe at \$29.95         |
| <input type="checkbox"/> Mitre Gauge for Sander at \$1.95 | <input type="checkbox"/> Face Plate \$2.50 (either Lathe)      |
| <input type="checkbox"/> Drill Press at \$39.95           | <input type="checkbox"/> Turning Chisels \$5.95 (either Lathe) |
| G.E. Motor \$19.90 (with other item)                      | \$24.85 (purchased separately)                                 |

NAME \_\_\_\_\_  
ADDRESS \_\_\_\_\_  
CITY \_\_\_\_\_ STATE \_\_\_\_\_ ZIP \_\_\_\_\_



# Every man wants Black Velvet in his stocking..

Give the smooth, imported whisky from Canada.  
And for the holidays, give Black Velvet in the attractive drums.  
Every man wants Black Velvet. And every woman too.



BLACK VELVET® BLENDED CANADIAN WHISKY, 80/86 PROOF, IMPORTED BY ©1973 HEUBLEIN, INC., HARTFORD, CONN.

Материал, защищенный авторским правом

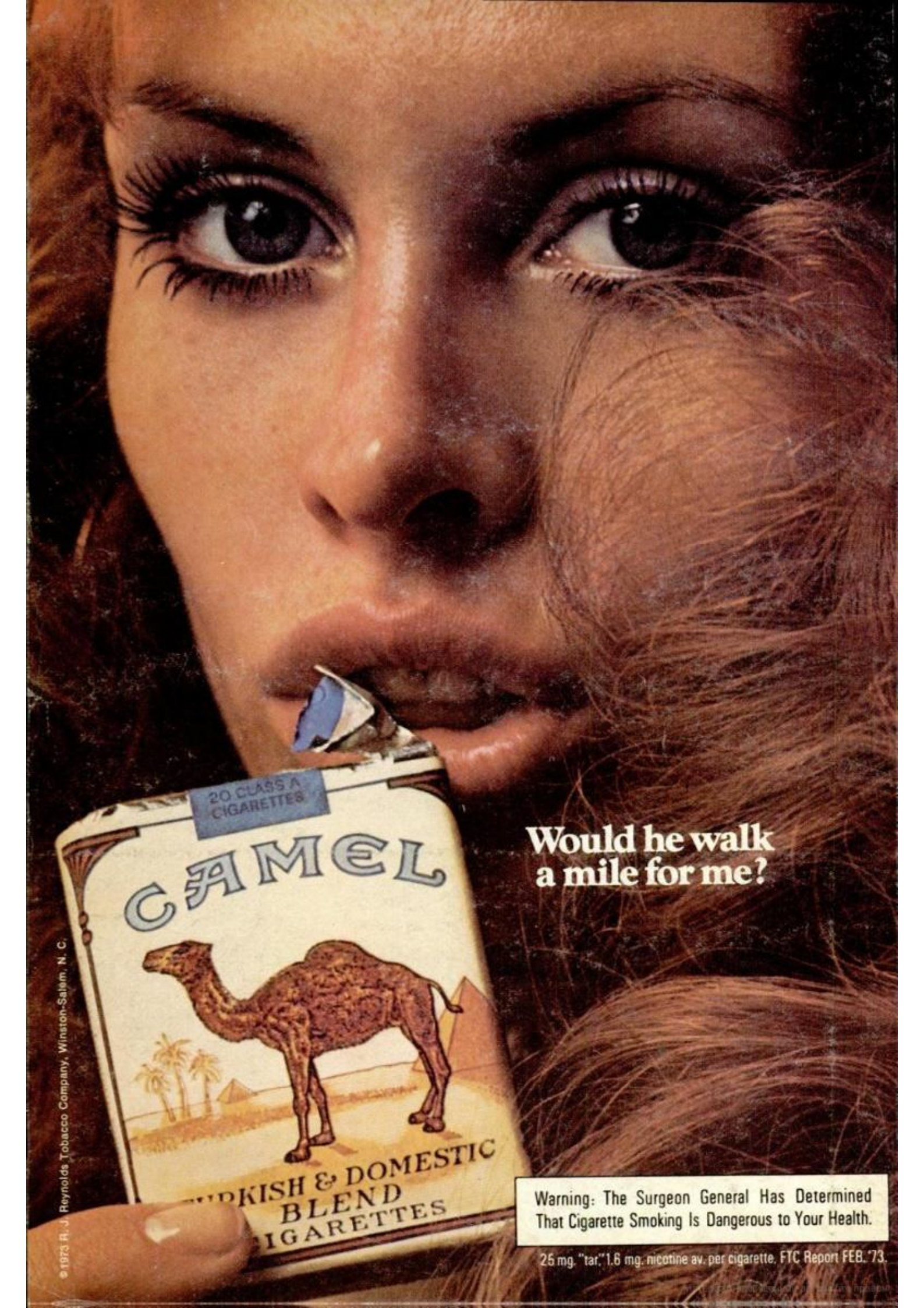

20 CLASS A  
CIGARETTES

CAMEL



TURKISH & DOMESTIC  
BLEND  
CIGARETTES

**Would he walk  
a mile for me?**

Warning: The Surgeon General Has Determined  
That Cigarette Smoking Is Dangerous to Your Health.

25 mg. "tar," 1.6 mg. nicotine av. per cigarette. FTC Report FEB. '73.