

# Popular Mechanics

## CHRISTMAS GIFTS YOU CAN MAKE

21 pages Starts page 89

**BEDE 5J:**  
First homebuilt jet  
for private pilots  
Page 192

**CLIP-AND-SAVE  
KNOW-HOW:**  
Starts page 92

- How to fix a clothes dryer
- How to unclog drains
- How to cut heat loss
- How to fix furniture mars



PIPE RACK

BOOK ENDS



DESK ORNAMENTS



CARVED JEWELRY



PULL-TOYS



# There's coolness in your future.



© BROWN & WILLIAMSON TOBACCO CORP.

## Come all the way up to KOOL

Warning: The Surgeon General Has Determined  
That Cigarette Smoking Is Dangerous to Your Health.

17 mg. "tar," 1.4 mg. nicotine; av. per cigarette, FTC Report Feb. 73.

Материал, защищенный авторским правом



# How to beat the odds on the long shots.

Here's why many of the people who know rifles best put their money on the Remington Model 700.

When you finally get a bead on the big one—a trophy ram, or goat, or pronghorn—you know how many shots you're going to get.

One. Making that kind of long shot takes a lot of practice. It also takes a lot of rifle.

The Remington Model 700 bolt action is a lot of rifle. That's why so many people with gun savvy recommend it for long-range shooting.

Ask a veteran hunter—a guy who's bagged the big ones time and time again. The Model 700 is so accurate we used its design as the basis for our classic 40XB Bench Rest competition model. Before we ship a 700, we test it carefully for accuracy. If it doesn't measure up, it never leaves the factory.

Ask a gunsmith. He knows gun design inside and out. He can tell you that our Model 700 has one of the strongest center fire bolt actions ever made. The cartridge head is surrounded by three rings of solid steel. And there are no extractor cut-aways to weaken this critical area. The bolt lugs are machined from steel every bit as strong as the steel around the cartridge head.

Ask a dealer. He probably sells hundreds of rifles a year. You might find out from him that the variety of

the Model 700's caliber selection sets it apart from any other bolt action rifle. It comes in 17 different calibers, for every kind of hunting, every kind of game.

Beyond accuracy. Accuracy and versatility are only a part of the 700 story. Because we know a sportsman

takes special pride in owning a finely crafted firearm.

The Model 700 BDL "Custom Deluxe" is a finely crafted firearm. And it looks it.

Its classic Monte Carlo stock is made of select American walnut. We bring out the rich grain with Du Pont RK-W, a high-lustre finish that's also scratch- and water-resistant.

We've given it deep, traditional checkering to accent the natural beauty of the wood. And added white line spacers and a black fore-end tip to set it all off.

The BDL also has a hinged floor plate, "jeweled" bolt, and a sling strap with quick-release swivels. A real buy with prices starting at \$174.95\*.

The Model 700 ADL "Deluxe" offers, among other features, a Monte Carlo stock, skip-line checkering, and Du Pont RK-W wood finish. It's priced from \$154.95\*.

**One more thing you ought to know:** Once you've picked the right rifle, pick the right ammunition to go with it.

Remington ballistics know-how and top-quality components make Remington "Core-Lokt" center fire cartridges the logical choice. They're made for your Model 700. In fact, each 700 is tested with them before it leaves the factory.

The Remington Model 700 and "Core-Lokt" cartridges. Put them together and you've got a shooting system that's hard to beat for reliability and accuracy.

Remington Reports are based on information direct from the Remington experts who design and engineer our products. For more details and a free copy of our full-color catalog, send a postcard to: Remington Arms Company, Inc., Dept. 100, P.O. Box 218, High Wycombe, Conn. 066

MODEL 700 CALIBERS
17 Rem.
22-250 Rem.
222 Rem.
223 Rem.
25-06 Rem.
6 mm Rem.
243 Win.
270 Win.
30-06
308 Win.
7 mm Rem. Mag.
264 Win. Mag.
6.5 Rem. Mag.
350 Rem. Mag.
300 Win. Mag.
375 H & H Mag.
458 Win. Mag.
Left Hand Version
270 Win.
30-06
7 mm Rem. Mag.

This One



RQ4S-0S9-W11Z

**Remington**®

Great guns deserve great ammunition. ↘

"Remington" and "Core-Lokt" are trademarks registered in the U. S. Patent Office. \*Prices shown are suggested minimum prices. Subject to change without notice.



# Sub-compact. Full size. Which demands more from its motor oil?

At today's expressway speeds, little car engines strain to keep up with the big guys. That raises the oil temperature. Today's big cars are usually loaded with power options that also raise the oil temperature. And heat is the main reason oil deteriorates. Today you have to name your oil. By type. By S.A.E. grade. By brand.



Ten years ago, you rarely had to think about oil temperatures. Today you do. Thinking about it may help prevent an unnecessary repair bill.

It doesn't matter what size car you're driving. Even with a modest number of power extras, your new little car can generate some severe crankcase temperatures. Emission controls are one reason. Also the strain of high speeds on little engines, especially on a hill. The harder an engine works, the hotter the oil gets.

**Full-size cars run hotter, too.** They're loaded with heat-raising options. Some examples: Automatic transmission ups oil temperatures by 10-15° F. Air conditioning adds about 10° F. Power steering, about 10° F. Plus, in new cars, a 15-20° F. boost from emissions systems. And if you're hauling a trailer, change the oil even more often.

What all this means is that your engine oil temperature may be running close to or over 300° F., compared to about 180° F. 10 years ago.

In short, heat is now an oil's worst enemy. So what should you do?

**First, read your owner's manual.** And change oil just as

frequently as it says to. Also note the cautions about severe operating conditions such as dusty areas and short trips in extreme cold.

**Second, have your oil level checked more often.** Every time you fill up with gas, in fact. Some oil burn-off is normal—but the amount

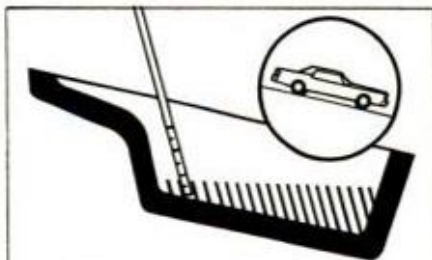

### When you check and add oil yourself:

1. Choose a level spot—not a sloping driveway.
2. Turn the engine off. Wait a few minutes.
3. Fill to the full dipstick mark, but not beyond.

varies from car to car, even when they're the same size and the same year. And keeping the crankcase full helps keep the oil cool.

**Quaker State your car to keep it running young.**

**Third, watch your oil warning light.** At start-up, it flickers on for a moment or so, until the oil flow is normal throughout the engine. If the light stays on, switch your ignition off immediately and get help. If the light goes on when you're driving, pull over as soon as it's safe. Maybe it's just your oil that's low. Or there may be a more serious problem. Answer: Wait for a professional to get you going again.

**Fourth, be sure to use a premium oil.** An oil that's fortified to handle this severe heat. For your peace of mind, ask for Quaker State Motor Oil. Quaker State is refined only from 100% Pure Pennsylvania Grade Crude Oil, the world's choicest. And Quaker State is fortified with a blend of additives, scientifically selected to retard oxidation, clean and disperse harmful deposits and to neutralize harmful acids.

Just ask for Quaker State Motor Oil by name. For your peace of mind.





# CHANNELLOCK

Gives You More In Hand Tools Including  
Handcrafted...High Polished  
**PRECISION PLIERS**  
(wonderful for fine work)

**Beautiful?** They'd grace a jeweler's window.

**Practical?** Thousands of precision work craftsmen—professionals and hobbyists alike—buy them every year and swear by them.

**Precision made** of high grade drop forged steel. Beautiful polished finish. Blue dipped plastic comfort grips.

Ask for CHANNELLOCK Little Champ precision pliers. You'll like 'em.

LET US SEND YOU OUR CATALOG showing Little Champs and their equally fine big cousins.

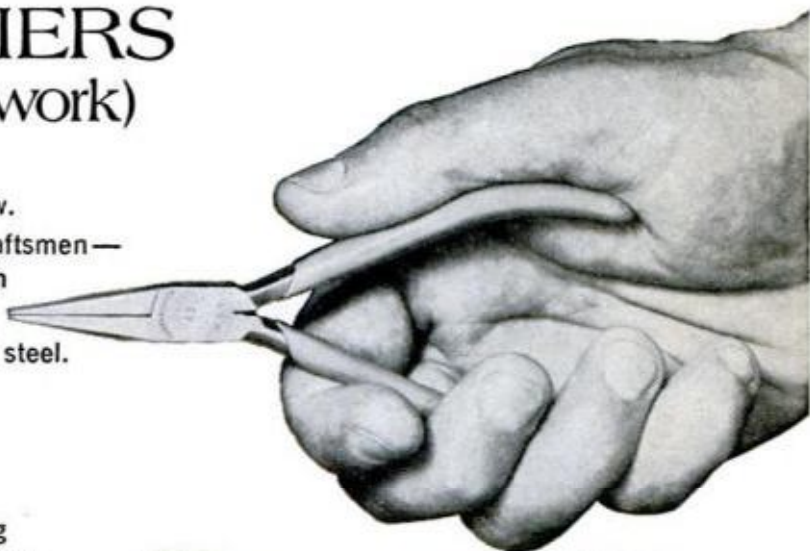

TOOLS BY  
**CHAN NEL LOCK**<sup>®</sup>

MEADVILLE, PA. 16335



## AUTOMOBILES, DRIVING

- [28 Drive to South America? How to go by family car](#)
- [40 Detroit Listening Post](#)
- [62 Imports and Motorsports](#)
- [109 Motor homes built the way they ought to be](#)
- [114 When we really had a mini-car!](#)
- [117 '74 Snowmobiles: New styling, new power](#)
- [128 PM owners report: Buick Apollo](#)
- [146 Saturday Mechanic: Get set for a cold-weather starting emergency!](#)
- [154 Up periscope? Your next car may have one](#)

## SHOP AND CRAFTS

- [89 Christmas gifts you can make](#)
  - [89 Jewelry you can carve in a jiffy](#)
  - [161 Initial bookends](#)
  - [162 One-piece plastic beauties](#)
  - [166 Animal pull toys](#)
  - [169 Blockmobiles](#)
  - [172 Kitchen play appliances](#)
  - [175 Teaching box](#)
- [176 Belt sander becomes edge sander with new quick-change attachment](#)
- [178 Rapid travel for drill-press attachment](#)
- [179 Hints from readers](#)
- [180 Jaw stretchers give your lathe chuck a bigger bite](#)

## HOME AND YARD

- [92 How to fix an electric dryer](#)
- [98 How to unclog drains](#)
- [100 How to minimize heat loss](#)
- [102 How to repair scratches in furniture](#)
- [182 Outdoor greeting card with a new twist](#)

## AVIATION

- [122 World's hottest homebuilt: The famous Pitts Special](#)
- [192 Bede 5J: First build-it-yourself jet](#)

## BOATING, OUTDOORS

- [109 Motor homes built the way they ought to be](#)
- [117 '74 Snowmobiles: New styling, new power](#)

## SCIENCE, INVENTIONS

- [104 Who's ahead in the superstadium game?](#)
- [196 From wood to paper—now it's back again to wood](#)

## ELECTRONICS, RADIO, TV

- [150 Four-channel headphones: Here's how they sound on two ears](#)

## PHOTOGRAPHY

- [84B Photo hints](#)
- [198 Compact 300-mm tele at a comfortable price](#)

## EVERY MONTH

- [8 Letters](#)
- [20 All Outdoors](#)
- [49 Car Clinic](#)
- [70B Science Worldwide](#)
- [70F Appliance Clinic](#)
- [74 The Bicycle Shop](#)
- [86 Homeowners' Clinic](#)
- [132 It's New NOW: Latest products and developments \(A 14-page roundup\)](#)

# Popular Mechanics

NOVEMBER 1973 • Vol. 140 No. 5

### INTERNATIONAL EDITIONS

Australia, Caribbean, Denmark, Mexico, Southern Hemisphere, Sweden



[Four-channel headphones . . . 150](#)



[Rapid travel for drill-press table . . . . . 178](#)



[Christmas gifts you can make 89-91, 158-175](#)



[Cold-weather starting tips 146](#)

ON THE COVER: A generous sampling from [21 pages of fascinating Christmas gifts](#)—jewelry, pull toys, household accessories—you can make from wood and sheet plastic. Photo by George Ratkai

AS A SERVICE TO READERS, *Popular Mechanics* publishes newsworthy products, techniques and scientific and technological developments. Due to possible variance in the quality and condition of materials and workmanship, *Popular Mechanics* cannot assume responsibility for proper application of techniques or proper and safe functioning of manufactured products or reader-built projects resulting from plans published in this magazine.



# Make your own furniture with Stanley's Electrichisel.™

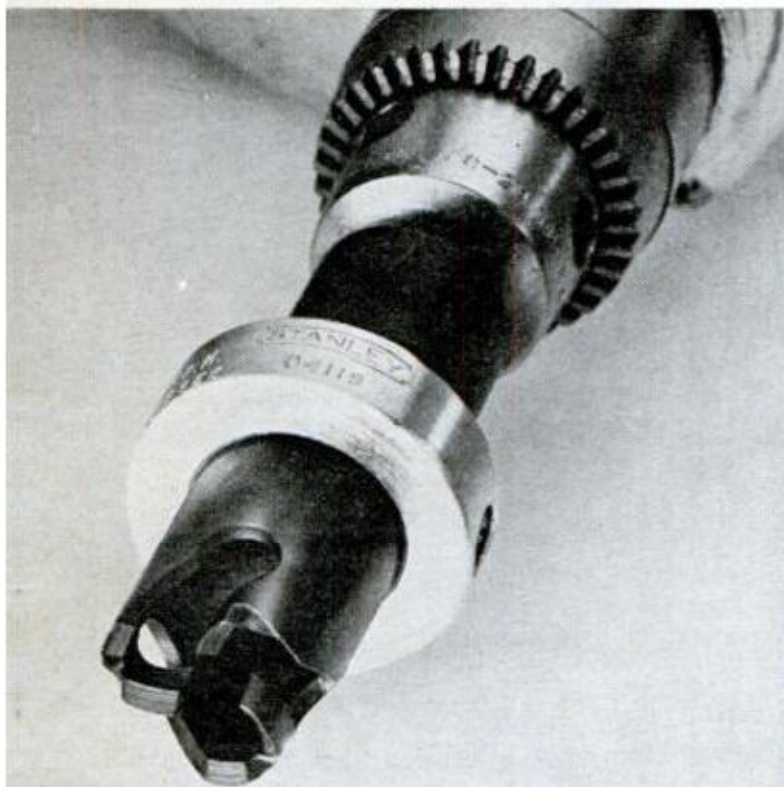

Stanley's remarkable new Electrichisel™ tool works with any electric drill. Makes dado, rabbet and mortise cuts in wood.

As cut deepens, work drill to 90° angle with ring resting on guide to attain desired depth.



Just clamp a guide to the wood. Set depth ring. Start cut at 45° angle and work Electrichisel back and forth along guide.

**STANLEY**  
helps you do things right

The Electrichisel attachment is a must for your portable electric drill. In two sizes: 1/2" size about \$5.25; 3/4" size about \$5.50.

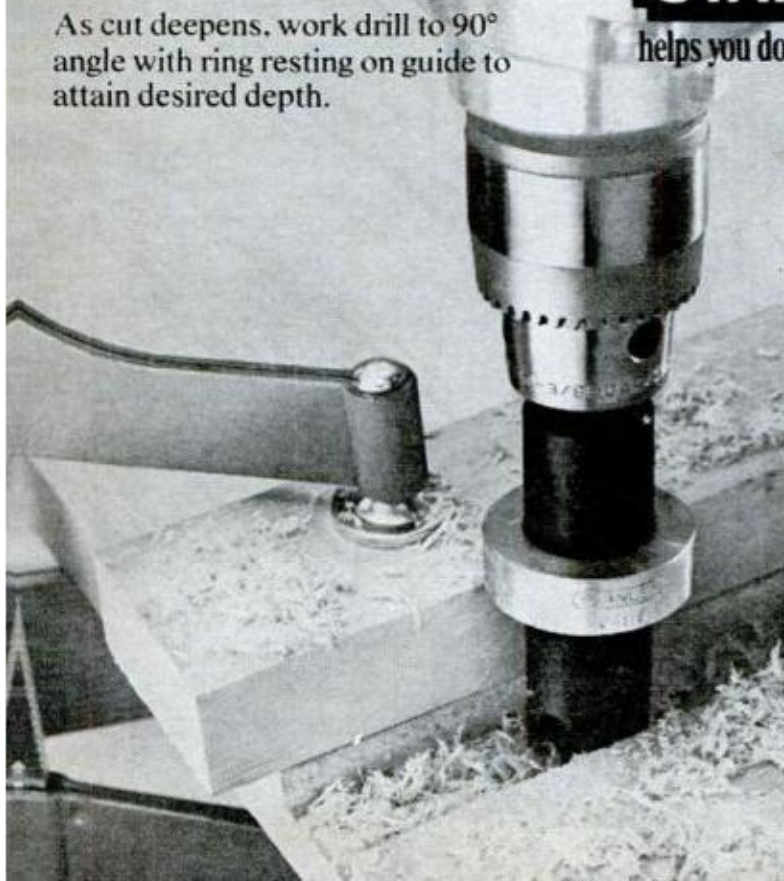



# Popular Mechanics

**JIM LISTON**, Editor

**SHELDON M. GALLAGER**, Executive Editor

**JOHN A. LINKLETTER**, Managing Editor

**WAYNE C. LECKEY**, Home and Shop Editor

**ALVIN KIETZ**, Art Director

<b>BILL HARTFORD</b>	Automotive
<b>JOHN F. PEARSON</b>	Science and Engineering
<b>WM. T. McKEOWN</b>	Boating and Outdoors
<b>IVAN BERGER</b>	Electronics and Photography
<b>HARRY WICKS</b>	Home Workshop
<b>STEPHEN WALTON</b>	Assistant, Home and Shop
<b>MICHAEL LAMM</b>	West Coast
<b>ROBERT LUND</b>	Detroit Automotive
<b>GARRY WINTER</b>	Copy Chief
<b>RICHARD H. FUNK</b>	Production
<b>ALFREDO VEGA</b>	Assistant, Production
<b>DON EVANS</b>	Technical Art Director
<b>JOSEPH P. BEATON</b>	Assistant Art Director
<b>DAVID KOMITAU</b>	Assistant Art Director
<b>IRA HERRICK</b>	Assistant Art Director
<b>CLIFFORD B. HICKS</b>	Special Projects
<b>SOPHIE GRONOWICZ</b>	Director, Bureau of Information
<b>EVERETT JOHNSON</b>	Cabinetmaker

**DANIEL J. COLEMAN**, Director of Advertising

**ADVERTISING OFFICES:** New York: 224 West 57th St., 765-6850; Chicago: 520 N. Michigan Ave., 527-2400; Detroit: General Motors Bldg., Trinity 5-8711; Cleveland: 20310 Chagrin Blvd., Shaker Heights, 283-7788; Los Angeles: 601 North Vermont Ave., 666-6261.

**JOHN A. REGINA**, Advertising Production Manager

Published by The Hearst Corporation

**FRANK MASSI**  
President

**JOHN R. MILLER**  
Executive Vice President

**RICHARD E. DEEMS**  
President, Magazines Division

**JOSEPH F. KERN**  
Publisher

**ADDRESS ALL EDITORIAL COMMUNICATIONS TO:** 224 West 57th St., New York, N.Y. 10019. For additional sources of information on the articles and products in this issue, write to Bureau of Information, Popular Mechanics, for free "Where-to-Find-It" list.

**SUBSCRIPTION SERVICE:** Mail all subscription orders, changes of address, correspondence concerning subscriptions, and Postmaster notices of undeliverable copies to Popular Mechanics, Box 646, New York, N.Y. 10019. Please enclose your latest address label for quickest service when writing about your subscription.

**POPULAR MECHANICS IS PUBLISHED MONTHLY** by The Hearst Corporation, 224 West 57th Street, New York, N.Y. 10019, U.S.A. Frank Massi, President; John R. Miller, Executive Vice President; Harrison A. Mitnick, Treasurer; Harvey L. Lipton, Vice President and Secretary, Hearst Magazines Division; Richard E. Deems, President; Raymond J. Petersen, Executive Vice President; William S. Campbell, Vice President and General Manager; John F. D'Avolio, Vice President and Resident Controller; Albert A. Rachol, Vice President and Director of Circulation; Joseph F. Kern, Vice President for Popular Mechanics. Single copy in the United States and Canada, 60 cents. Subscription prices: United States and Possessions, \$5.97 for one year; \$10.97 for two years; \$14.97 for three years. Canada, add \$2.00 for each year. All other countries, add \$4.00 for each year. When changing address, give old address as well as the new, with zip code, and allow six weeks for change to become effective. Second-class postage paid at New York, N.Y., and at additional mailing offices. Authorized as second-class mail by the Post Office Department, Ottawa, and for payment of postage in cash. Registered as second-class matter at the Post Office at Mexico D.F., Mexico, June 29, 1950. © 1973 by The Hearst Corporation. All rights reserved. Printed in U.S.A.

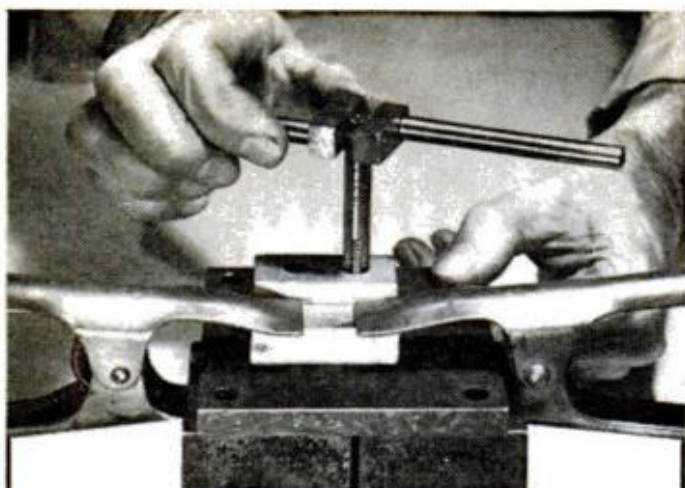

## For the man who likes to do-it-himself.

With money-saving, "do-it-yourself" tips—more than in any other magazine—on how to maintain and repair your home, your car, your boat, your power mower, your TV and nearly everything that breaks down, wears out and needs fixing.

Plus feature articles on Automobiles and Driving, Shop and Crafts, Science and Inventions, Boating and Outdoor Recreation, Home and Yard, Electronics, Radio and TV, Photography...and much, much more!  
**ENTER YOUR SUBSCRIPTION NOW.**

## POPULAR MECHANICS

Simply fill in the form and mail it promptly.

**POPULAR MECHANICS**  
250 West 55th Street  
New York, New York 10019

Please enter my subscription for

1yr. \$5<sup>97</sup> or  2yrs. \$10<sup>97</sup>

Name (please print)

Address

City State Zip

Payment of \$\_\_\_\_\_ is enclosed.

New  Renewal

On new subscriptions, first copy will arrive in about 8 weeks.

(Above prices apply in U.S. & Possessions only. Canada add \$2 per year. All other countries add \$4 per year.)

WSF3K1



# Explore the exciting world of Electronics.

## It's easy as 1-2-3

1. Print your name here .....Age .....
2. Print your address .....Apt. No.....  
City..... State..... Zip.....
3. MAIL THIS COUPON FOR FREE INFORMATION

We will rush you, without obligation, a FREE sample lesson in Electronics to demonstrate LaSalle's home study method — plus 2 illus-

trated booklets, "Your Place in the World of Electronics" and "How to Obtain Your Commercial FCC License."

### LASALLE EXTENSION UNIVERSITY

A Correspondence Institution • 417 S. Dearborn Street, Dept. 95-097, Chicago, Illinois 60605

05B

© 1973 LaSalle Extension University.

Find out how to take the important step from a dead-end job to an exciting future in electronics. LaSalle's free sample electronics lesson demonstrates how you can train at home for entry into the field of electronics. Send for this free lesson. There's no obligation.

#### Thousands of Technicians in demand!

Each year the electronics field continues to grow, revolutionizing industry and communications, developing new applications that reshape our lives. "The world of tomorrow" is here . . . with electronic crime detectors, electronic traffic control, electronic factory automation, electronic medicine . . . and with TV-radio broadcasting reaching new peaks of development. No wonder there are so many opportunities at all levels for the man who knows electronics. Why not get started now? With LaSalle training and subsequent on the job experience, you'll have every chance to move ahead in this exciting field.

#### Let LaSalle teach you at home

You don't need previous technical knowledge for LaSalle training. You learn the basic principles of electronics under the guidance of experienced instructors. Lessons in this up-to-date course are simply

presented, easy to understand. You are led step-by-step into practical applications — with emphasis on modern techniques. You actually build your own electronic equipment with parts supplied to you. You receive individual attention and you can have additional help by mail whenever you need it. When you have satisfactorily completed your studies, you are awarded the LaSalle diploma, a respected credential.

#### Training for FCC License Included

If you decide to go into electronics communication you will need the Government FCC (Federal Communications Commission) License. LaSalle training in communications fully prepares you to pass the FCC's first class radio-telephone operator license exam. LaSalle has enrolled more than 2,000,000 men and women in its many career programs. It gives you a great feeling of confidence to know that your training is in the hands of a leader in home study.

#### Send for FREE sample lesson right away

You owe it to yourself to find out how LaSalle can prepare you for a future in electronics. Mail the coupon today. Send now for your free sample lesson. There's no obligation. LaSalle, 417 South Dearborn Street, Chicago, Illinois 60605.

## ALL 3 FREE!

Sample Lesson in Electronics, "Your Place in the World of Electronics," "How to Obtain Your Commercial FCC License."

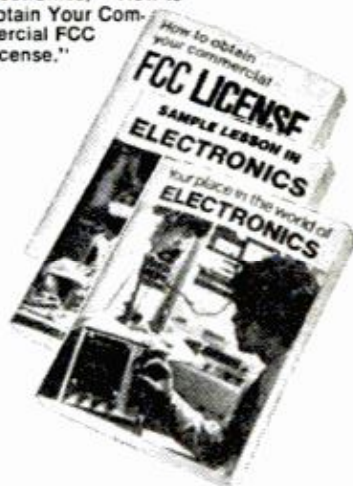

NOVEMBER 1973

7



# LETTERS

## TO THE EDITOR

### Train has right-of-way

*Grade Crossings Take a Deadly Toll* (page 138, Sept. PM) by Jack Harrison Pollack is well-written and timely. He could have let the last line say: "Remember, the train has the right-of-way and can always prove it." I read this somewhere years ago and have never forgotten it. Make school bus drivers memorize it.

BELLAIRE, TEX.

JACK BARKER

### Carbon copy in the Bahamas

In the August *Detroit Listening Post* (page 32) you stated that General Motors in 1975 will be introducing "Vega carbons" bearing the Pontiac and Olds nameplate.

On a recent trip to the Bahamas I saw what appeared to be a Vega with a different grille and taillight treatment. On closer

examination of one of these cars, I noticed the Pontiac nameplate. Is this the same car mentioned in the column? If so, why will it not be available here until 1975?

TAMPA, FLA.

ALAN SOLOWITZ

*Yep, same car. Pontiac's already producing a derivative of Vega in Canada. It's called the Astre. It's sold in the Bahamas, but not in the United States. GM doesn't have the manufacturing capacity to produce the car here yet, but that problem should be solved by next summer.*

### Woodchopper's maul

I disagree in part with *How to Fell, Buck and Limb a Tree* (page 90, Sept. PM). I have had many years' experience in tree harvesting, so I believe I can make the following comments as an expert.

When you're splitting a large-diameter log for fireplace use, it should be done when the log is green—not after it has dried out. Hickory, for instance, cannot be split when dry.

Second, when you're splitting with a steel

*(Please turn to page 10)*

***This little Pocket can stop  
a backhand, a sidestroke, leaps,  
bounds, even a gallop.***

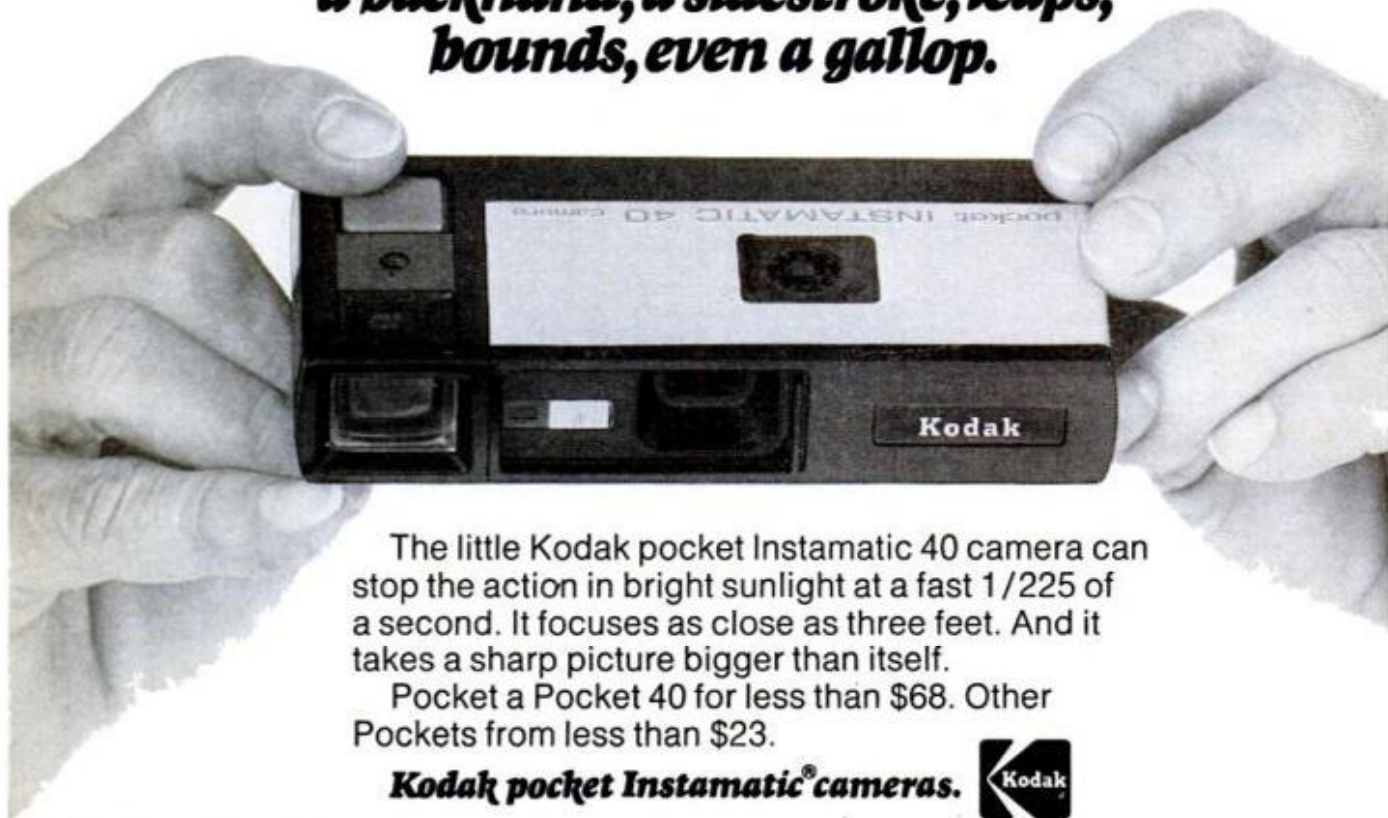

The little Kodak pocket Instamatic 40 camera can stop the action in bright sunlight at a fast  $1/225$  of a second. It focuses as close as three feet. And it takes a sharp picture bigger than itself.

Pocket a Pocket 40 for less than \$68. Other Pockets from less than \$23.

**Kodak pocket Instamatic® cameras.**



Prices subject to change without notice.



# HOLD



# IT

**POWER GUN 1000 STAPLE GUN  
FASTENS MOST EVERYTHING**

There's nothing like it. Here's the staple gun with the power lever for extra heavy duty drive. Powerful enough to do any stapling job because it even drives through hardwoods (like oak) better than other staple guns. Ceiling tile, paneling,



upholstery, fencing, insulation, name it — the Powergun 1000 does it.

Easily. Uses 5 staple sizes. Sold separately or as a kit with staples plus wire, shade, screen attachments. Handsome carrying cases, too. Pick one up. It's easy to use. Hard to put down.



**EXCEPT WHAT RIVET-IT  
RIVETING PLIER FASTENS!**

It fastens anything to anything professionally — the way the factory does and you've always wanted to! Ideal for autos, boats, appliances, cycles, sleds, toys, gutters and spouts, pots, pans, etc. Holds tight. Better than nuts, bolts, screws or solder. Rivets don't come loose.



You fasten from one side. Perfect for can't get to it places.

Rivet-It riveting plier!  
Try it!

**Swingline®**  
32-00 Skillman Avenue Long Island City, N.Y. 11101



## LETTERS

(Continued from page 8)

wedge, never use a steel sledge; the sledge steel, being softer than the wedge, will splinter and fly off in all directions. A maul should be used for this purpose. Make it from a six or eight-inch-diameter hickory tree cut close to the ground in the fall and

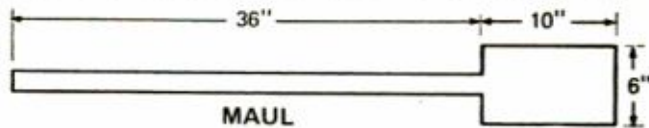

shaped as shown. It should dry out in the summer and be used the following fall.

COLUMBUS, GA. LESLIE W. BLOOMFIELD

### Oil, too, heats water

*How to Troubleshoot a Water Heater* (page 84, Sept. PM) failed to mention the fact that water heaters are also oil-fired.

As a matter of fact, we in the business feel that an oil-fired water heater represents the best value because of its low operating cost and better recovery rate.

CENTRAL ISLIP, N.Y. GENE GIFFORD

On page 89 you state that a water-heater tank is made of copper or glass. Copper, maybe, but glass, never! Surely you meant glass-lined. An all-glass tank would probably burst from water pressure or crack from the heat of the burner flame.

SWISHER, IOWA

ROBERT D. SMITH

### Still good after 40 years

Congratulations on your consistently concise, informative articles on practical home-built planes.

I should say, also, that I enjoy your magazine as much as, or more than, I did 40 years ago.

ASHLAND, VA.

D. WALTER McDOUGALL

### Rx for red eye

I was surprised by your report that the new Keystone Everflash camera does not help solve the red-eye problem (*Pocket Cameras Become Big Business*, page 128, Sept. PM). According to Keystone, the

## True Grit. When ordinary blades can't cut it.

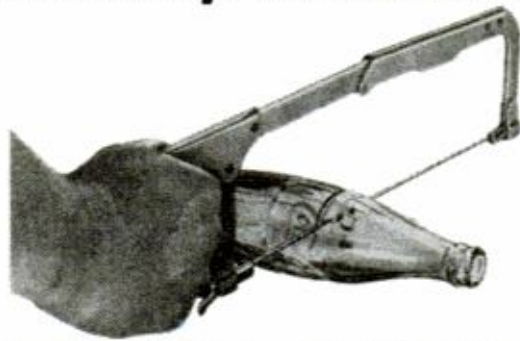

**GRIT  
EDGE**

When ordinary blades can't do the job, Remington "Grit-Edge" blades take over. They take the tough out of tough jobs, saw through "unsawable" materials.

How? Hundreds of tungsten carbide particles permanently bonded to the blades make them a match for materials that usually call for expensive diamond or solid tungsten carbide toothed blades. And if that isn't true grit, what is?

Remington "Grit-Edge" blades are available for Hack-saws, Saber Saws, Circular Saws, Bandsaws, and as a Rod Saw. The only thing ordinary about them is their low cost, which is a bargain considering their long life and the jobs they do.

For more information, see your hardware dealer or write: Grit-Edge Products, Dept. 400, Remington Arms Company, Inc., Bridgeport, Connecticut 06602.

**Remington.** 

"Remington" is a trademark registered in the U. S. Patent Office.  
"Grit-Edge" is a trademark of the Remington Arms Company, Inc.

### RECOMMENDED CUTTING APPLICATIONS FOR "GRIT-EDGE" BLADES

Material	Rod Saw	Hack-saw	Saber Saw	Circ. Saw
Ceramic Tile	X	X	X	
Slate	X	X	X	
Marble	X	X	X	
Flagstone	X	X		
Brick	X	X		
Glass	X	X		
Fiberglass	X	X	X	X
Tempered Hardboard			X	X
Asbestos Cement	X	X	X	X
Composition Board			X	X
Synthetic Marble	X	X	X	X
Plywood			X	X
Plaster			X	X
Counter Top Material	X	X	X	X
Hardwood Flooring			X	X
Stranded Cable	X	X		
Spring Steel	X	X		
Hardened Chain	X	X		
Stainless Steel	X	X	X*	
Tailpipe Bolts	X	X		
Cast Iron	X	X		

\*requires coolant and variable speed machine.

(Please turn to page 13)





# What it didn't have... held it all together...



We ran this Kawasaki 900Z 200 miles at 130.423 mph. The bike was perfectly stock, except it was missing all nine gaskets and 355 lock washers? How did our driver, champion Tom Rockwood react? Like you will. With amazement.

Permatex Gel Gasket replaced those conventional soft gaskets, and Permatex Lock-Nut the lock washers; two revolutionary products that do a better job than the parts you use now.

Permatex Gel Gasket was used

instead of gaskets on the Crankcase Split, Oil Pan, Cylinder Base, Valve Cover, Cam Chain Tensioner Housing, Kickstart Cover, Breaker Housing, Clutch Cover, and Transmission Cover—all with predicted success. We just squeezed it on, bolted it tight, and drove away.

We applied Permatex Lock-Nut instead of lock washers on 165 engine parts and 190 frame locations with equally remarkable success: a smooth steady ride,

safe, sound, sure. One drop of Permatex Lock-Nut will keep any threaded connection together, and even works in the presence of grease and oil—so you don't have to worry about any special cleaning. And with over 800 applications in one handy bottle, that's a lot of extra room in your tool box.

Permatex Gel Gasket and Permatex Lock-Nut. Performance you can depend on. Our name is our bond.



PERMATEX COMPANY, INC., P.O. Box 1350, West Palm Beach, Florida 33402 • 305/686-0880 • Telex 513-417



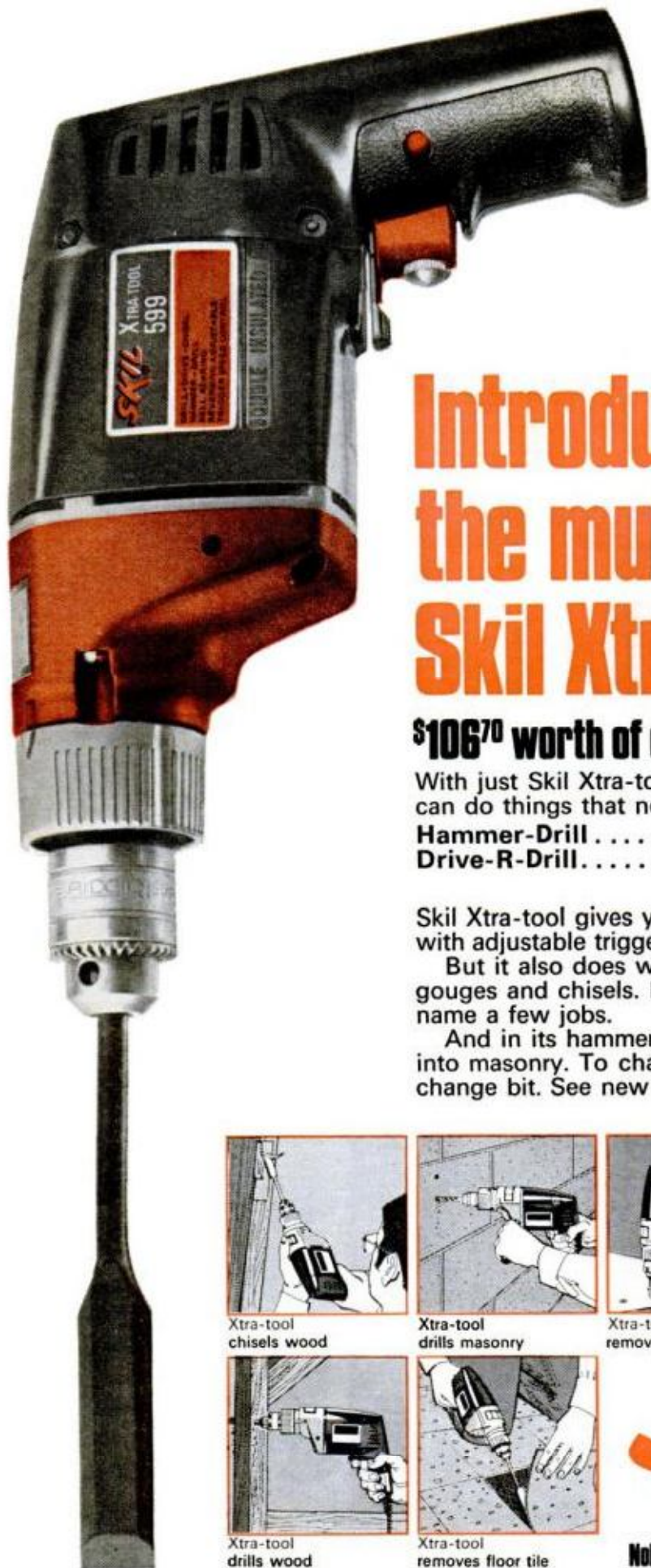

# Introducing the multi-purpose Skil Xtra-tool.

**\$106<sup>70</sup> worth of capabilities for just \$49<sup>99</sup>.**

With just Skil Xtra-tool and available accessories you can do things that normally require two different tools.

Hammer-Drill .....	\$ 66.75 *
Drive-R-Drill .....	39.95 **
	<u>\$106.70</u>

Skil Xtra-tool gives you all the capabilities of a  $\frac{3}{8}$ " drill with adjustable trigger speed control, forward and reverse.

But it also does what no drill can do. It scrapes, gouges and chisels. Removes paint, putty, rust. Just to name a few jobs.

And in its hammer-drill mode, Xtra-tool drills quickly into masonry. To change mode, just rotate collar and change bit. See new Skil Xtra-tool. A drill. A hammer-drill.

All for just \$49.99.

\*Price based on averaging of retail prices for suggested competitive products.

\*\*Price based on Skil suggested retail price. Details available on request.



Xtra-tool  
chisels wood



Xtra-tool  
drills masonry



Xtra-tool drives,  
removes screws



Xtra-tool  
drills wood



Xtra-tool  
removes floor tile

# SKIL

**Nobody was ever sorry he bought the best there is.**



## LETTERS

*(Continued from page 10)*

distance between lens and flash unit is sufficient to reduce the red-eye problem substantially. This is one of the camera's big advantages.

On the other hand, you might have tested a Pocket Everflash and come up with different results. Was this the case?

NEW YORK

SAUL BENNETT

*You're right, we were talking about the Pocket Everflash—as we thought was made clear in the context.*

### Now Olds is quiet as a graveyard

I can't tell you how grateful I was to find the solution to an annoying rattle in my 1972 Olds Delta 88 in your July *Car Clinic* ("Nesting Birds," page 32). This noise had been driving me up a wall for nearly three months, and once I had the parking brake cables lubricated it stopped entirely.

Now my Olds is quiet as a graveyard.

JOHN B. HASTINGS

GROSSE POINTE WOODS, MICH.

### Likes Teenie better

There is a homebuilt design which years ago met and exceeded most of the design and flight criteria outlined in your article on the Pazmany PL-4A (*Breezy Little Homebuilt: A Beginner's Dream Plane*, page 127, June PM).

The Teenie Two was designed by Calvin Parker for the first-time builder. It requires only the most basic tools. It is all metal, pop-riveted, has a single seat and tricycle landing gear and is direct-drive Volkswagen powered. The original Teenie Two has been flying since 1969. There are several Teenie Twos flying or under construction. My own is 50 percent complete.

On several occasions I've had the pleasure of flying the Teenie Two. It offers the first-time builder a safe, easy-to-fly airplane

*(Please turn to page 14)*

# HERMAN SURVIVORS®

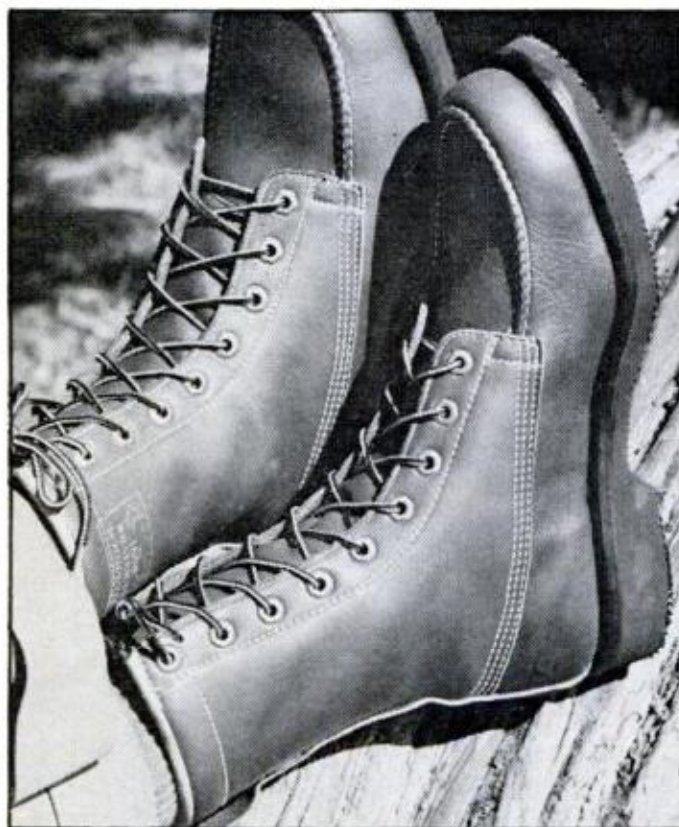

We build Herman Survivors® to do two things well: Cover a lot of territory in great comfort. And stand up to the kind of punishment outdoorsmen give them. In any kind of weather. That's why we build the uppers of soft, durable burgundy full-grain glove leather, line them with Ensolite® for warm feet right down to  $-20^{\circ}$ , then line the whole upper and soft padded cushion insole with saddle tan full-grain cowhide for even greater comfort. After that we stitch the boot down to resilient, oil-resistant Neoprene® crepe soles and heels. These Hermans come in two styles: 8" insulated boot, #7192, and 6" insulated shoe, #7192-6. They're tough. And they're comfortable. Like all our boots. When you're looking for quality in an outdoor shoe, hunt up a pair of Hermans.



FREE CATALOG

NAME \_\_\_\_\_

ADDRESS \_\_\_\_\_

CITY \_\_\_\_\_

STATE \_\_\_\_\_

ZIP \_\_\_\_\_

J. M. HERMAN SHOE COMPANY,  
DEPT. 34, MILLIS, MASS. 02054

That sounds like my kind of boot.  
Send me your catalog and the name  
of my nearest Herman dealer.

PM-BGL-3-11



# SUPER CAULK™

## Guaranteed for 20 Years

- Macco Acrylic Super Caulk will not lose adhesion, crack, bleed, stain or discolor
- Adheres to all common building materials
- May be painted within 30 minutes with oil base or latex paints
- Resists dirt pickup
- Easy to apply
- Hands and tools clean up quickly with soap and water
- For use inside or outside the home



**Guarantee:** Macco Adhesives guarantees that if Macco Acrylic Super Caulk is used as directed and fails within 20 years after application, Macco will replace an equal amount of material at no cost after inspection, and upon submission of proof of purchase to Macco. This guarantee applies to residential use only.

**MACCO ACRYLIC SUPER CAULK.**  
IT'S CALLED SUPER FOR A REASON.

**SCM MACCO ADHESIVES**  
SCM CORPORATION, WICKLIFFE, OHIO 44092

## SHIP MODELS



From our own workshop: finest quality wood ship kits—clippers, schooners, frigates, tankers, freighters—39 in all. Beautiful fittings; no lead or plastic. Also plans, books, whales, marine prints and decoration. At better dealers or send 50¢ for big illustrated catalog.

**BLUEJACKET**  
SHIP CRAFTERS

145-D Water St. S. Norwalk, Ct. 06854

## Mini-Kites

Mini-kites are only 6 inches high. These small box kites done in bright colors are remarkable fliers. Interesting and attractive conversation pieces too; and because of their small size, high angle of flight and ease of flying, they are especially suitable for children and congested areas. Excellent gifts and for year round flying. Come sturdily packaged and ready to fly on 125 yards of string, included.

Each prepaid in U.S.A.—\$3.00  
Two for \$5.00

MINI-KITE COMPANY

Satellite Beach, Florida 32937

Box 2067

14 POPULAR MECHANICS

## LETTERS

(Continued from page 13)

with a minimum of work, in a minimum of time and with a minimum expenditure.  
EL CAJON, CALIF. RICHARD W. SEVERSON

*We were pretty sure that Teenie Two is a good airplane, too, back when we printed an article about it (Now: Teenie Two, page 94, May '71 PM) and offered plans. They are still available for \$35. Order plan No B1270 from Popular Mechanics, Dept. CO, Box 1014, Radio City, N.Y. 10019.*

## Prizewinner

Following plans in *This Christmas Wish the World Peace* (page 152, Nov. '71 PM) I built the poster with some minor modifications. I attached a small rubber-tired wheel to each leg of the frame for rolling it in and out of the garage and suspended the whole thing from the overhead beam across the front of my garage.



The poster won third prize in the 1972 Newport Christmas decorating contest with hardly any additional decoration—only a few strings of colored lights around the garage door and front windows. I hope to shoot for another prize next Christmas!  
NEWPORT, ORE. CLYDE SLOAN

## Car Care Guide again available

I would like to know if I can obtain a copy of the May 1973 issue of *PM* containing the *Car Care Guide*. Or is a reprint available?  
READING, PA. VINCENT GRUPI

*The Car Care Guide is included in the 1974 Car Repair Annual, which went on sale recently. If you can't find the annual on your newsstand, order it for \$1 from Popular Mechanics, Dept. JL, Box 1014, Radio City, New York, N.Y. 10019. ★★★*



# SIX REASONS WHY YOU SHOULD PUT FIRESTONE STEEL RADIAL 500 TIRES ON YOUR CAR VERY SOON.

- 1 They will put steel between you and tire trouble.** Two strong belts of brass plated high tensile steel cord are under the tread to stand up to chuckholes, curbs and roadjunk.
- 2 They are guaranteed for 40,000 miles.** When you think most people drive about 12,000 miles a year, imagine how long these tires should last.
- 3 They will give you better handling, more precise steering than any conventional tire we've ever made.** The steel belts stabilize the tread, help hold it to the road to deliver better handling and better cornering.
- 4 They are the quiet radials.** Compare the radials — you'll find Firestone has a computer designed, logarithmic tread pattern specially designed for quiet running and quiet cornering.
- 5 Firestone gives you 7 days to test the ride.** If you're looking for a smooth-riding radial, read our offer below.
- 6 We'll help you out when it comes to paying for them.** Your Firestone Revolving Charge, Master Charge, BankAmericard, Carte Blanche, Diners Club and American Express Card are good at most Firestone Dealers and stores.

#### OUR 40,000 MILE GUARANTEE

The Steel Radial 500 by Firestone is guaranteed to give you 40,000 miles of treadwear in normal passenger use on the same car. If it doesn't, take your guarantee to any Firestone Store or participating Dealer. He'll replace the tire with a new one and give you credit for the mileage not received based on the then current adjustment price (approximate national average selling price) plus Federal Excise Tax. A small service charge may be added.

#### OUR 7 DAY TEST RIDE

Trade in your old tires on a set of Firestone Steel Radial 500's at any Firestone Store or participating Dealer. Drive on them for seven days. If you don't like the way they handle—or ride—return them within seven days and they'll put your old tires on again and refund your money in full.

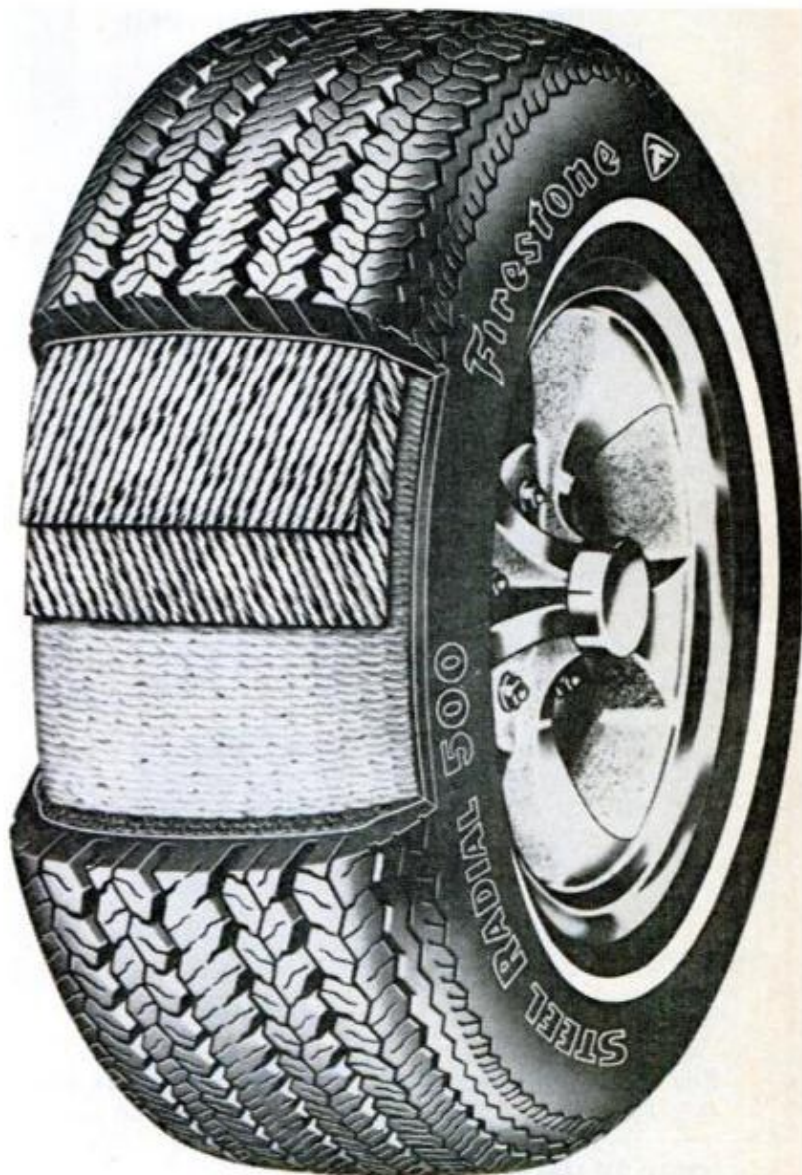

## Firestone

The people tire people



# DECEMBER PREVIEW

## OF POPULAR MECHANICS

What's new and different in Christmas decorations: Best of what's new is what *you* create with your hands and ingenuity,

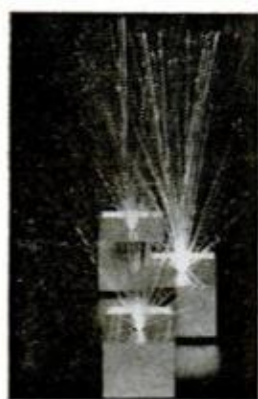

so we suggest: **Optical fibers** made of flexible hollow plastic transmit light and let it spill out of the end like water. These are now available in kits and PM shows you how to use them to make handsome Yuletide and year-round gifts. . . .

**Snow candles** are made by pouring molten wax into snow. The technique is simple; the results simply beautiful. . . . **Outdoor decorations** include a tree you can make from painted cans which are illuminated from within by miniature bulbs. The tree appears to be made of large colored spheres.

Two new VW-powered planes that can be built from plans and kits are shown



for the first time. The Scamp, a biplane, and the Quail, a monoplane, are single-seaters that are designed for easy construction by the home-builder and for flying out of pasture strips. The Scamp can be built within six months—you can get started now and be flying it next summer.

What's new under the sun? A **solar-powered watch** that's a spin-off from space research. . . . **New winter gear and snow glasses** that evolved from snowmobiling.



. . . **New winter driving techniques** for four-wheel drive vehicles. . . . **New meters** that help fishermen find fish. . . . **New guns, new boats, new radios, new digital clock kits, new hobby kits, new light on the energy crisis and a new way you can go into business for yourself.**



Plus the know-how that will make your around-the-house jobs easier: **How to repair a gas clothes dryer • How to sharpen almost anything • The choice and care of paint rollers • What you should know about fuses.**

**Buy it on your newsstand. Better yet, make sure you'll keep getting this kind of exciting fare. Send this coupon with your check to:**

**POPULAR MECHANICS**  
250 West 55th Street  
New York, New York 10019

Please enter my subscription for  1 yr. \$5.97 or  2 yrs. \$10.97

Name \_\_\_\_\_ (Please print)

Address \_\_\_\_\_

City \_\_\_\_\_ State \_\_\_\_\_ Zip \_\_\_\_\_

Payment of \$ \_\_\_\_\_ is enclosed.  New  Renewal

On new subscriptions, first copy will arrive in about 8 weeks.

(Above prices apply in U.S. and Possessions only. Canada, add \$2 per year. All other countries, add \$4 per year.)

WPM3K1



New square-cornered Sylvania picture tube

Handsome woodgrain cabinet, at no extra cost. (Offered only by NRI)

6-position detented UHF channel selector

Modular construction with plug-in circuit boards

Automatic color control

Automatic degaussing

Automatic tint control

100% solid state chassis

Automatic fine tuning



## NOW... learn color TV servicing while building this NEW 25" DIAGONAL SOLID STATE SET created by NRI for home training

NRI wanted more than a hobby kit TV . . . so we built one from the circuits up, specifically for teaching advanced electronics. You can only get this superb set from NRI . . . it's exclusive with NRI Color TV Servicing Course.

NRI was first to supply home study students with custom-designed training kits to give practical hands-on experience as you learn. Now NRI scores another first . . . with the exclusive 25" diagonal picture tube, solid chassis, color TV set designed-for-learning. You build it yourself with NRI's TV-Radio Servicing Course.



*Kit for kit, dollar for dollar, you get more for your money from NRI.*

The TV-Radio Servicing Course includes a wide-band service type oscilloscope and a color bar cross-hatch generator . . . along with

other valuable equipment you will use to perform experiments and make repairs on your own and other sets.



You'll soon find yourself earning \$5 to \$7 an hour, in your spare time . . . even before the course is completed.

Learning at home is easy . . . the simplified NRI way. Texts are "bite-size" and fully-illustrated, leading you step by step, stage by stage, to a thorough

knowledge of electronics. You can introduce defects into circuits, perform experiments, and discover the how and why of circuitry and equipment operation.



### Train with the Leader—NRI.

The same training innovations which have made NRI the leader in career training at home are now available to you. Mail the insert card for a free full-color catalog which spells out the NRI "discovery" method of learning. There's no obligation. NO SALESMAN WILL CALL.

**APPROVED UNDER NEW GI BILL.** If you have served since January 31, 1965, or are in service, check GI line on reply card.



**NRI TRAINING**  
3939 Wisconsin Avenue, N.W.  
Washington, D.C. 20016





## ALL OUTDOORS

### Endangered

Animals threatened with extinction receive a great deal of their protection from our leading conservationists: the hunters, target marksmen, arms and ammunition companies. An excellent 28x43-inch poster in color illustrating 26 species on the endangered list is offered for \$1 by Crosman Arms, the maker of BB and pellet rifles. Write Endangered Species Poster, Crosman Arms Co., Box 355P, Newark, N.Y. 14513.

Snowmobilers endangered by weather, lack of maintenance, handling techniques or their own carelessness can now get good instruction from many safety education programs. Arctic Cat has prepared a new student manual for drivers taking Snowmobile Operator Responsibility Training, a course that provides basic instruction for owners. Groups may obtain information about the program from local dealers and Arctic Enterprises, Thief River Falls, Minn. Scorpion, Polaris and Bombardier Ski-Doo also offer training aids.

### Preserved

With urban sprawl encroaching on hunting areas, a handy answer for many sportsmen this time of year is the shooting preserves in the United States, Canada and Mexico. A listing of hundreds of public daily-fee preserves, giving season dates and cost of non-

*(Please turn to page 24)*



**Chevrolet's recreational lineup for '74 has 14 station wagons and trucks. K-20 pickup (top) has full-time four-wheel drive. Center is dual-rear-wheel pickup crew-cab model. New Cutaway Van (above) offers either dual or single rear wheels for popular mini-motor home "chopped van" vehicle conversions.**

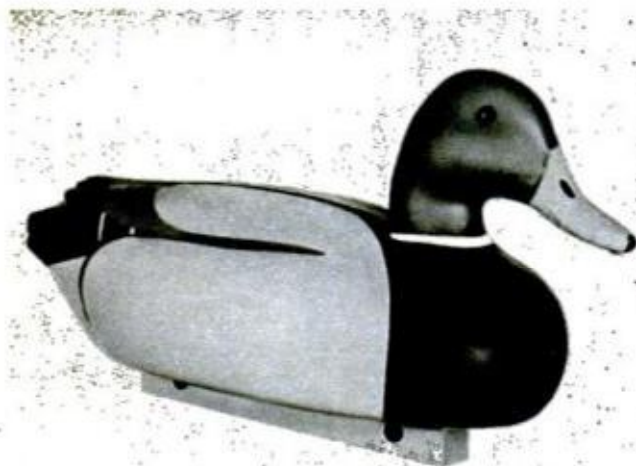

**Decoys of a dozen mallards or black ducks (six drakes, six hens) can be made from finish-it-yourself kit for \$26.95. Included are 12 solid foam-plastic bodies, hand-blown glass eyes, mahogany keels, epoxy, sandpaper, paint kit (10 colors for mallards). Keyser Decoys, Industrial Hwy, Southampton, Pa. 18966.**





There's a lot of good  
between "Winston..."



and should."

Winston tastes good **GOOD**, like a cigarette should.

Warning: The Surgeon General Has Determined  
That Cigarette Smoking Is Dangerous to Your Health.

© 1973 R.J. REYNOLDS TOBACCO CO.  
20 mg. "tar", 1.4 mg. nicotine av. per cigarette, FTC Report FEB. '73.

Материал распространяется авторским правом.



# EMPEROR GRANDFATHER CLOCK

## DO-IT-YOURSELF CASE KIT

MODEL 120 IN SOLID 3/4 INCH CHERRY

SALE  
PRICED **89.50**  
REGULARLY  
\$129.50

Finished Model 120 in cherry shown

All pieces pre-cut and pre-sanded at the factory. Breakfront swan neck crown and finial, waist and dial doors, dial frame and sculptured base-front factory assembled by skilled cabinetmakers. Complete hardware and assembly instructions furnished. Each piece may be re-ordered separately. No woodworking experience necessary.

## NOW A FIRST FROM EMPEROR

### FOR THE VERY FIRST TIME . . . IN CHERRY

Since colonial days cabinetmakers and woodworkers have chosen cherry for its distinctive natural color and beautiful, close grain. Now you can share in this American heritage of craftsmanship. Emperor's stately Model 120 (America's most popular grandfather clock) is now available in lustrous cherry. The rich look and resonant quality of this fine hardwood enhances the desirability of this elegant timepiece. Build it yourself, and enjoy that rare feeling of self-accomplishment that comes from one's own workmanship. The Model 120 Do-It-Yourself Case Kit is easy to assemble and contains all the wood parts you need. The movement is ordered separately from Emperor.

### ENJOY DOUBLE SAVINGS

You save on this beautiful cherry grandfather clock because you build it yourself. And you save even more now, because the Model 120 solid cherry case kit is sale priced at just \$89.50. Save \$40.00 from the regular price of \$129.50. Install the movement and save hundreds from the price of comparable grandfather clocks retailing up to \$600. There is no better reason to order this beautiful clock now, adding "the final touch of elegance" to your home, while creating an heirloom for generations to come.

#### MONEY BACK GUARANTEE

If not completely satisfied, return in original shipping carton within thirty days for complete refund. No questions, no excuses.

**ORDER NOW . . . IN TIME FOR CHRISTMAS**— Emperor Grandfather Clocks are a pleasure to give . . . a joy to receive. By ordering now, your kit will arrive in time to build for yuletide enjoyment.

SEND FOR FREE COLOR BROCHURE  
OF COMPLETE EMPEROR LINE

OFFER GOOD THROUGH DEC. 31, 1973



Model 120, Solid 3/4" Cherry  
74"x16 3/4"x10"



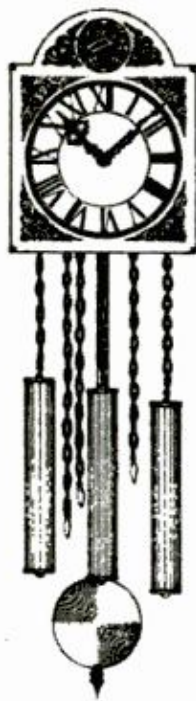

100-M Movement  
with Tempus Fugit  
Dial  
**\$89.50**

# EMPEROR MOVEMENT FOR MODEL 120

**WEIGHT-DRIVEN—EIGHT-DAY—WESTMINSTER CHIMES**

Emperor's 100-M grandfather clock movement is produced in West Germany by proud clocksmiths who, for over a century, have been manufacturing the world's finest movements.

Embossed overlays surround the solid brass dial. The face has a high, permanent polish and serpentine hands. In the arch above the dial is a shaped aluminum world with the words "Tempus Fugit" (Time Flies) inscribed in black enamel. Or, if you prefer, the classic moving moon with lunar calendar.

The completely weight-driven movement strikes the famous, melodious Westminster chimes on four musically-tuned rods; four notes on the quarter-hour, eight on the half-hour, twelve on the three-quarter hour, and sixteen on the hour. The hour is struck on four additional tuned rods. The Emperor movement includes weights, solid brass weight shells, brass bob, pendulum and chimes. All plates are solid brass, and pinions are hardened steel. Installation and adjustment of the movement is simple, following the step-by-step instructions.



100-M Movement  
with Moving Moon  
Dial  
**\$99.50**

**ONE YEAR UNCONDITIONAL GUARANTEE**

## MERRY CHERRY AT CHRISTMAS SAVINGS!

**ORDER NOW!... DIRECT WITH THIS FORM!**  
**OFFER GOOD THROUGH DEC. 31, 1973**

CLOCKS, KITS, MOVEMENTS SHIPPED 2 TO 3 WEEKS, SHIPPING CHARGES COLLECT  
WORLD'S LARGEST MANUFACTURER OF GRANDFATHER CLOCKS

TO: **EMPEROR CLOCK COMPANY, Dept 39**  
Emperor Industrial Park, Fairhope, Alabama 36532

Please Check:  
New Customer   
Previous Customer

QUANTITY	DESCRIPTION	WEIGHT	REG. PRICE	SALE	EXTENSION
	Model 120-K Do-It-Yourself Case Kit, Cherry, w/o movement	53	\$129.50	<b>\$89.50</b>	
	Model 100-M movement complete with Tempus Fugit dial, Westminster Chimes for Model 120	32	\$89.50		
	Model 100-M movement complete with moving moon dial, Westminster Chimes for Model 120	32	\$99.50		

We accept personal checks.

ENCLOSED: ( ) CHECK ( ) MONEY ORDER \$ \_\_\_\_\_

CHARGE TO MY ( ) BANKAMERICARD ( ) MASTER CHARGE

Card number \_\_\_\_\_

Expiration date \_\_\_\_\_

NAME \_\_\_\_\_

ADDRESS \_\_\_\_\_

CITY \_\_\_\_\_

STATE \_\_\_\_\_

ZIP \_\_\_\_\_

TOTAL \$ \_\_\_\_\_

Alabama Residents

ONLY Add 4% \$ \_\_\_\_\_

GRAND TOTAL \$ \_\_\_\_\_



Please send FREE color brochure on complete Emperor line

VISIT OUR FACTORY SHOWROOMS MON.-FRI., 8 AM to 5 PM, EMPEROR INDUSTRIAL PARK, FAIRHOPE, ALA.

NOVEMBER 1973

23



## ALL OUTDOORS

(Continued from page 20)

resident hunting licenses as well, is found in the *1973-74 North American Shooting Preserve Directory*, 25 cents from the National Shooting Sports Foundation, 1075 Post Rd., Riverside, Conn. 06878.

### Coming events

Nov. 9-18, Southern California Boat Show, Los Angeles Convention Center; Nov. 10, Hennessy Key West Offshore Race, Key West, Fla.; Nov. 10-11, Regional Pistol Championships, Tampa, Fla.; Nov. 12-23,

(Please turn to page 26)

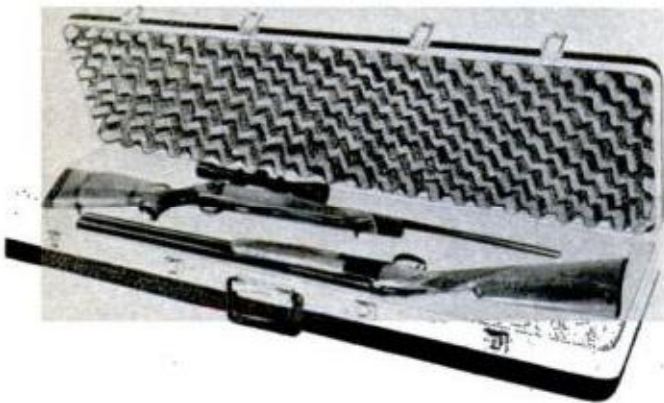

### Polyfoam protection

Grand National gun case, 54x12x5½ inches, is large enough for scoped rifles or shotguns on bed of foam for full protection. Brown or black case is \$45 from Olympic Luggage, Box 161, Kane, Pa. Pistol case is \$20.



### Hunting stand

Apache Port-A-Stand rides into the woods on hunter's back and assembles quickly for lookout set 10½ feet high. Stand can even be used as game litter to carry out trophy. Weighing less than 17 pounds, it's available for \$65 from Sporting Products, West Monroe, La.

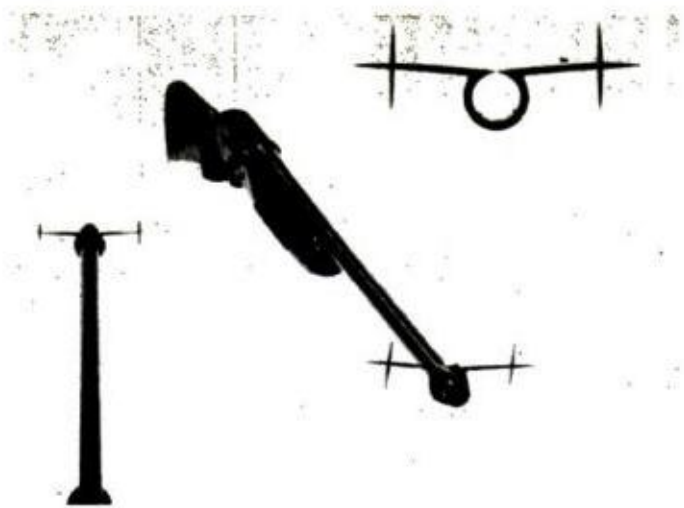

### Shotgun sight

Duk Hit, a new shot-shooter accessory, slips on 12 and 16-gauge single-barrel guns without tools and is claimed to give 80 percent improvement in figuring lead. D.D. Ritter, 22244 Archwood, Canoga Park, Calif., \$5.

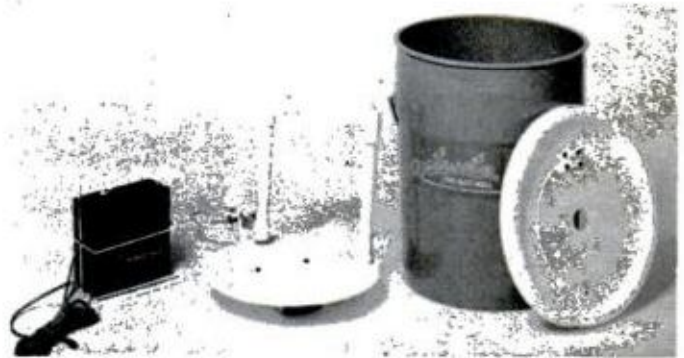

### Live bait well

Water-ator, operating from 12-volt d.c. car or boat battery or rechargeable power pack, also comes as ice chest aerator. Sportsraft, Chelsea Place, Houston.



### Lantern reflector

Generations of outdoorsmen have suspected the Coleman lantern couldn't be improved, but now a heat-resistant plastic and aluminum reflector aims the light while protecting hands. Fits 220 and 228 model lanterns.



## THE '74 VEGA GT. EVERYBODY LOVES A WINNER.

In three short years Vega has won more automotive honors than any other American-built economy car, and has become one of the best selling cars made.

So what do we do? We change it.

But not without darn good reasons.

We reshaped the front end with the intention of making Vega stronger, not prettier. With tougher bumpers. And cooling slots in place of a grille.

Instead of grasshopper legs to support the hatch, you get hydropneumatic arms for easier opening.

On the lighter side, you also get nicer carpeting, and a bigger selection of available fabrics and colors and vinyl

roofs and stripes and that sort of thing.

But, more than ever you want economy, of course. So we've improved the Vega overhead cam engine with modifications in the carburetor linkage, the inlet manifold and so on. And we've even increased the size of the fuel tank—so you can go farther between stops.

Vega honors include: *Car & Driver* Readers' Choice, Best Economy Sedan, '71, '72, '73. *Motor Trend*, Car of the Year, '71. Economy Car of the Year, '73 Vega GT. *Motor Service & Service Station Management* mechanic survey, Easiest Subcompact to Service, '72.





## ALL OUTDOORS

*(Continued from page 24)*

World Moving Target Championships, Melbourne, Australia; Nov. 21-25, St. Petersburg Sailboat Show, Bayfront Yacht Basin, St. Petersburg, Fla.

---

### Ready to tow

Dodges for '74 can be ordered fully factory equipped with hitch or hitch platform, dual battery charging system circuitry, electric wiring harness and connector, trailer brake provision—all set for trailer hookup. ★★★



### Convertible chest

On its side this new oversize ice chest can serve as a 2.7-cu.-ft. vertical refrigerator. Back down as top opener, Covey Convertible is heavy-duty 80-quart chest, seat, live-bait tank. From Covey Corp., Houston.

---



### Underwater detector

Keys, valuables dropped overboard can be located by diver with new Goldmaster Amphibian from White's Electronics, Sweet Home, Ore. Optional headphone and hood, shown, is used instead of built-in speaker.



### '74 outboard

Expanded line of outboard motors from Sears has been announced with introduction of this 15-hp unit. Others include twin-cylinder 9.9 hp, 7.5-hp water and air-cooled motors, plus new air-cooled 5 and 3-hp sizes.

---

### Hunting coat

New with full back covering of blaze fabric for high visibility, Sears jacket is about \$18 from catalog and stores. Also available is special Winter Sports Catalog offering skis, skates, cold-weather clothing.





# Switch from what you're used to.



Would you like to become less dependent on cigarettes? Would you like to smoke less? Or inhale less?

Then you ought to think about switching to new Dutch Treats. The filtered little cigar with a taste that's different from cigarettes but very satisfying.

**Dutch Treats**  
could change the way you smoke.





# Drive to South America?

Here's how to go  
all the way by family car.

---

by Ernst Jahn

**Recreational vehicle** owners who follow the Pan American Highway will find photo subjects like this Andean girl, plus mountain villages and ancient ruins.





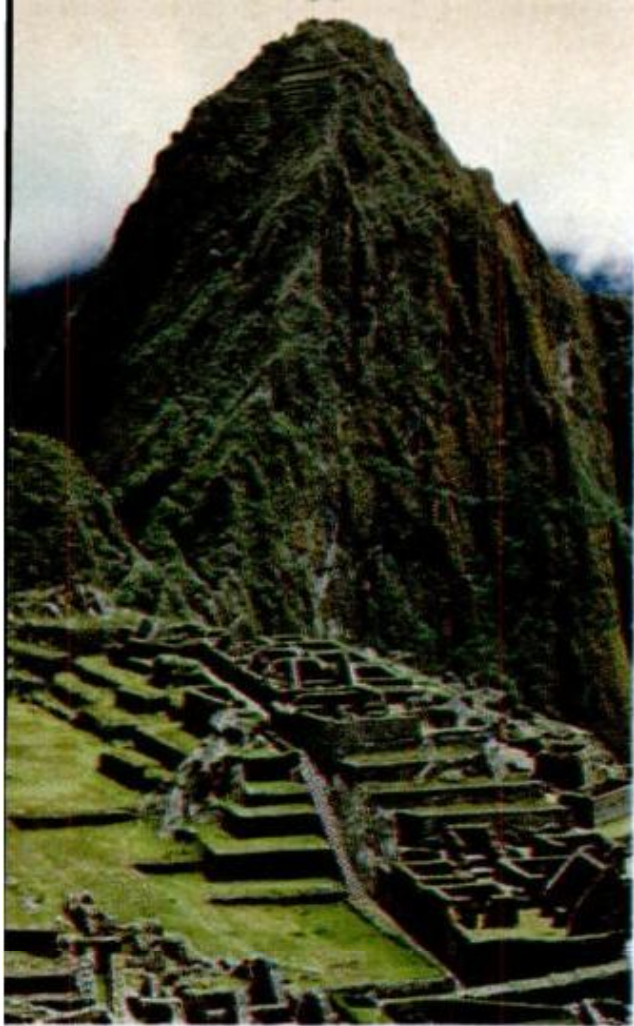

**High above Sugarloaf and Copacabana beach** of Rio de Janeiro, a trip can begin or end if you drive halfway and then trade off with friends who have flown down to complete the trip by land while you return by air.

**Machu Picchu**, ruins of the lost city of the Incan civilization, is a side trip when you leave the Pan American Highway at Lima, Peru, and drive high into the Andes. The city is reached by 3000 hand-hewn steps.

**T**he Pan American Highway is no longer a dream. Today 92 percent of it is paved and South American border procedures are much easier than a few years ago. On a recent return tour of this vast, amazing continent, my wife and I had to open the doors of our camper only once for customs inspection during 26 border crossings.

Living costs are still remarkably low. A filet mignon dinner with a bottle of wine in Rio de Janeiro was just one dollar, and two pounds of well-aged steak at a butcher store in Argentina cost 80 cents. Gasoline in Colombia averaged 15 cents a gallon for standard and 21 cents for premium. It was even less in Venezuela.

Jungle animals are no problem: The jaguars, poisonous snakes, anacondas, crocodiles and man-eating piranha you hear about keep their distance if you keep yours. You have to go far off main routes to find them. But along the highway we saw llama, vicuna, deer, sea lion, fox, ostrich, rhea, penguin and a lot of wild fowl.

On our latest trip we flew to Rio to pick up the camper of stateside friends who had driven it down. Most people on their first excursion begin in Mexico and head south. From the United States, the Pan American Highway crosses Mexico to Guatemala, El Salvador, Honduras, Nicaragua, Costa Rica and Panama. Through Central America it winds along, below, around and through the mountains that are the backbone of the Americas.

Beyond Panama is the only break in the highway. Here the road is under construc-



**Native market shopping** keeps costs low for the RV tourist. In Cuzco, the ancient capital of Peru, poncho-clad Indians display their wares. Beyond, the road leads up to Lake Titicaca, at a 12,600-foot elevation, and Bolivia.



## One-fifth of highway is above 10,000 feet



High suspension bridges swing Pan American Highway across Peruvian valleys between passes through Andes, make easy grades for camper driving. Approaching a narrow bridge, first car to blink headlights has the right-of-way.



Car ferry across the Straits of Tiquina on Lake Titicaca, elevation 12,600 feet, uses an outboard motor for power. Route is a side-trip to Cuzco, Peru, and La Paz, Bolivia.

tion and will require 130 bridges before it is completed through the Darien jungle several years from now. At present, your car goes by boat to Cartagena, Barranquilla, or Buenaventura in Colombia, or La Guaira, Venezuela. Shipping cost for an average camper plus two passengers is \$200.

From these ports the Pan Am Highway heads south through spectacular Ecuador and Peru. A side trip from Lima, up into the Andes, leads to Cuzco, ancient capital of Peru. Beyond, on the road to La Paz, Bolivia, you can cross the world's highest navigable lake, Titicaca, at 12,600 feet. An outboard-powered ferry takes you and your car across the Strait of Tiquina for \$2.

A branch of the highway goes east from Bolivia across Paraguay, through Asunción to Argentina. An alternate route south through Chile first crosses hundreds of miles of the Atacama Desert, then goes through valleys of the mountains surrounding Santiago. From here the route east swings upward through the Bermejo Pass over the Andes; during heavy winter snows you can drive through the international rail-

*(Please turn page for map of Pan American highways; text continues on page 34)*



# CHEVY

Our Cheyenne Camper Special

# CAMPER TAMER



## Pickups engineered with campers in mind

Underneath, there's an improved brake system because front disc/rear drum brakes are computer-matched to truck GVW rating. A massive Girder Beam front suspension and Load Control rear leaf springs to help smooth the ride. Tough double-wall construction in the cab and body.

Inside, there's a foam-padded seat cushion almost 7 inches thick. Insulation in the cowl, floor and roof. You can order power steering and Turbo Hydra-matic transmission. And Chevy's remarkable Elimipitch camper stabilizer system that dramatically reduces camper body surge and chucking.

Another result of all this built-in toughness and comfort is built-in value. Value you can appreciate day in, day out, day off.



## Camper Special Package

On  $\frac{3}{4}$ - and 1-ton Chevy pickups equipped with a 350 or 454 V8, larger tires, and Turbo Hydra-matic or 4-speed manual transmission, you can order the Camper Special equipment package that includes heavy-duty suspension, a camper wiring harness and front stabilizer.

## Deluxe Camper Special Package

In addition to the Camper Special equipment, this package includes camper Elimipitch shock absorbers, camper tie-downs and a rear stabilizer bar.

Building a better way

**Chevrolet**

to see the U.S.A.



# Colorful weeks or months can be spent on route

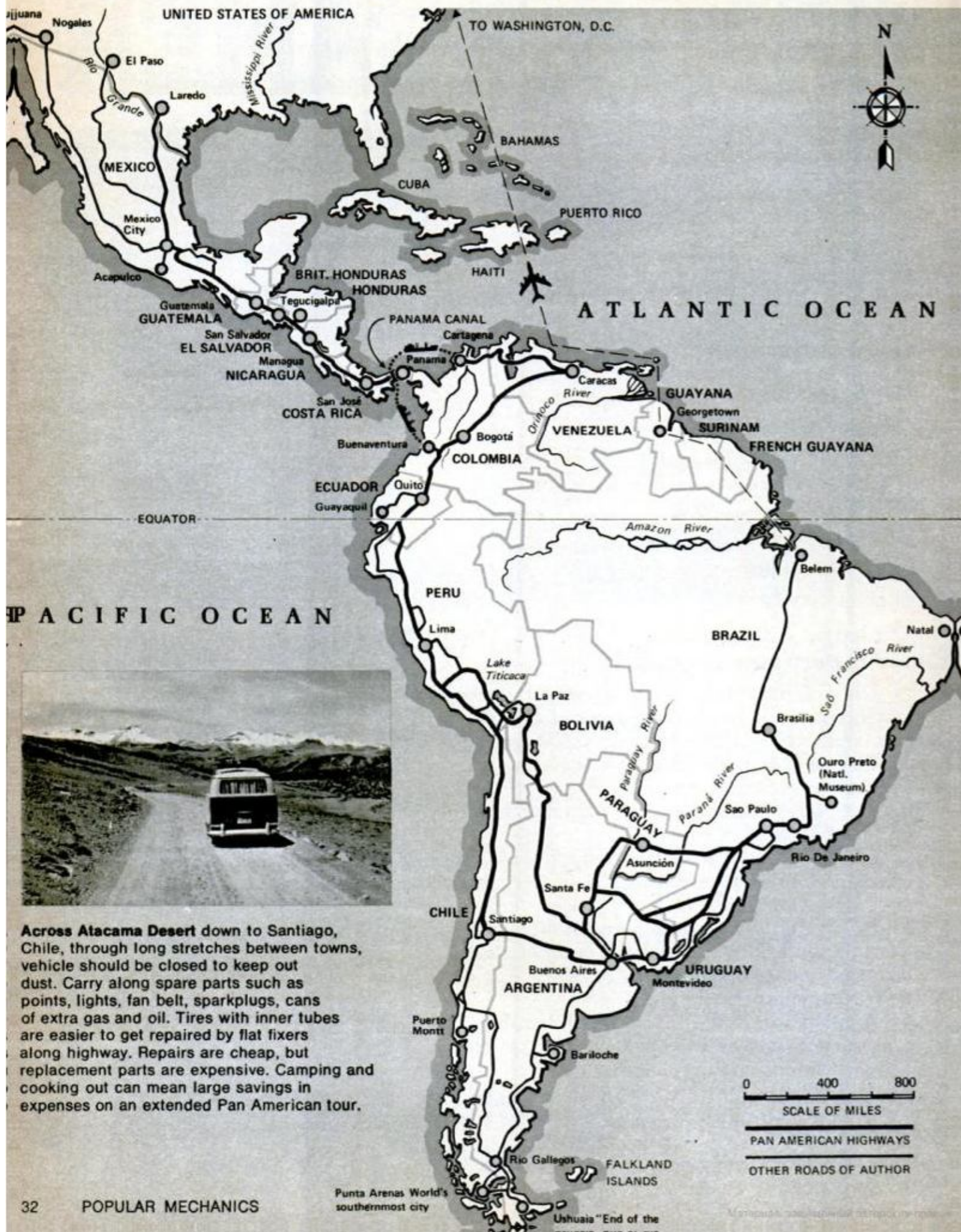

Across Atacama Desert down to Santiago, Chile, through long stretches between towns, vehicle should be closed to keep out dust. Carry along spare parts such as points, lights, fan belt, sparkplugs, cans of extra gas and oil. Tires with inner tubes are easier to get repaired by flat fixers along highway. Repairs are cheap, but replacement parts are expensive. Camping and cooking out can mean large savings in expenses on an extended Pan American tour.

Punta Arenas World's southernmost city

Ushuaia "End of the world"



# Have one of mine.

Get hold of  
honest taste..

Have an  
Old Gold.



Warning: The Surgeon General Has Determined  
That Cigarette Smoking Is Dangerous to Your Health.

20 mg. "tar," 1.3 mg. nicotine  
av. per cigarette, FTC Report Feb. '73



## Cheap repairs, expensive parts, are available

way tunnel instead. A two-day run through the Pampas brings you to Buenos Aires.

The highway turns north through Uruguay to Brazil and Rio de Janeiro, the "marvelous city" as it's called in Portuguese by Brazilians. Mountains and jungle slope steeply down to the beaches of Copacabana and Ipanema. Inland several hundred miles, Brasilia, the new capital city, marks the end of the Pan American with ultramodern skyscrapers and architecture.

To complete a circuit of South America the Brasilia-Belém Highway stretches 1300 miles north through the Mato Grosso region and Amazon Valley jungles. It is gravel surfaced but continually maintained for the never-ending flow of truck traffic. Pavement is scheduled for 1974 completion, and there is twice-a-week bus service. Overnight accommodations at local inns on the way are 15 cents for a hammock, 25 cents for a bed. To keep costs down, the secret is travel by camper, motor home or trailer, eliminating hotel and restaurant expense. Campgrounds are becoming increasingly available, (one Brazilian chain now has 42), but on our most recent trip from Rio de Janeiro to La Guaira, Venezuela, we parked instead at picturesque shoreside or mountain spots off the highway. In large cities, for a few cents a night, we parked at truckers overnight filling stations or in hotel parking lots with the permission of the manager. Meals averaged \$1.35 per day for food bought in local markets. Total gasoline bill was \$250; car repairs including flats were \$68. Expenses for four months along the highway came to \$480, and \$380 more shipped the

camper from La Guaira back to New York.

Before starting, you'll need a passport for every country except Mexico. A tourist card can be obtained from the consulate of the country you are about to enter. Required Inter-American Registration and Driving Permits are \$5.50 from the American Automobile Assn. (AAA) and a Carnet de Passage en Douanes is \$35.

Most cities and towns have servicing facilities for any car. Repair shops are efficient and cheap; spare parts are generally available, but expensive. It's well to carry sparkplugs, points, condensers, fan belt, wire, headlights, several feet of garden hose, spare cans of gas and oil, and inner tubes. Tires with tubes are easier to patch and there are plenty of "vulcanizadores" (flat fixers) along the way. If your engine is a high-octane, high-compression job have it tuned down for the low-test you're more likely to find. Try to seal your vehicle from inside; in some remote areas, dust may become unbearable.

Best months for driving the highway are January through April (South American autumn) to avoid the rainy season, and the best hours are during daylight. At night pedestrians may be walking the roadway or cattle sleeping on the warm pavement. But the highway is well built and wide with gradual inclines, and any recreational vehicle can travel its entire length successfully. Complete details are given in the author's *Latin American Travel & Pan American Highway Guide*, \$7.35 postpaid from Compsco Publishing, 663 Fifth Ave., New York, N.Y. 10022. ★★★

**Brasilia**, supermodern capital of Brazil, marks the end of the present highway after it turns inland at Rio de Janeiro. From Brasilia, gravel road extends north 1300 miles through Mato Grosso and Amazon Valley jungles to Belém. Paving of this stretch is scheduled for 1974.





**“Buy 12 Craftsman panels,  
get this jig saw free.**

**That’s some deal from The Paneling People.”**

“One of the best deals I’ve ever heard of for home handymen.” That’s what Wally Bruner, of the TV show “Wally’s Workshop”, says about this offer.

Here’s the deal: U.S. Plywood will give you a Rockwell® Model 67 USP Jig Saw absolutely free, when you buy 12 Craftsman® panels. This saw lets you cut panels face-side up, and sells in stores for \$19.99.

Choose from ten different looks in our Craftsman line, from formal to rustic. Or get the free saw with 12 panels from our new Weldwood® Collection.

Call toll-free 800-447-4700 (in Illinois, 800-322-4400) for the name of your nearest participating dealer. Offer ends December 31, 1973. (Or such earlier date as supply is exhausted.)

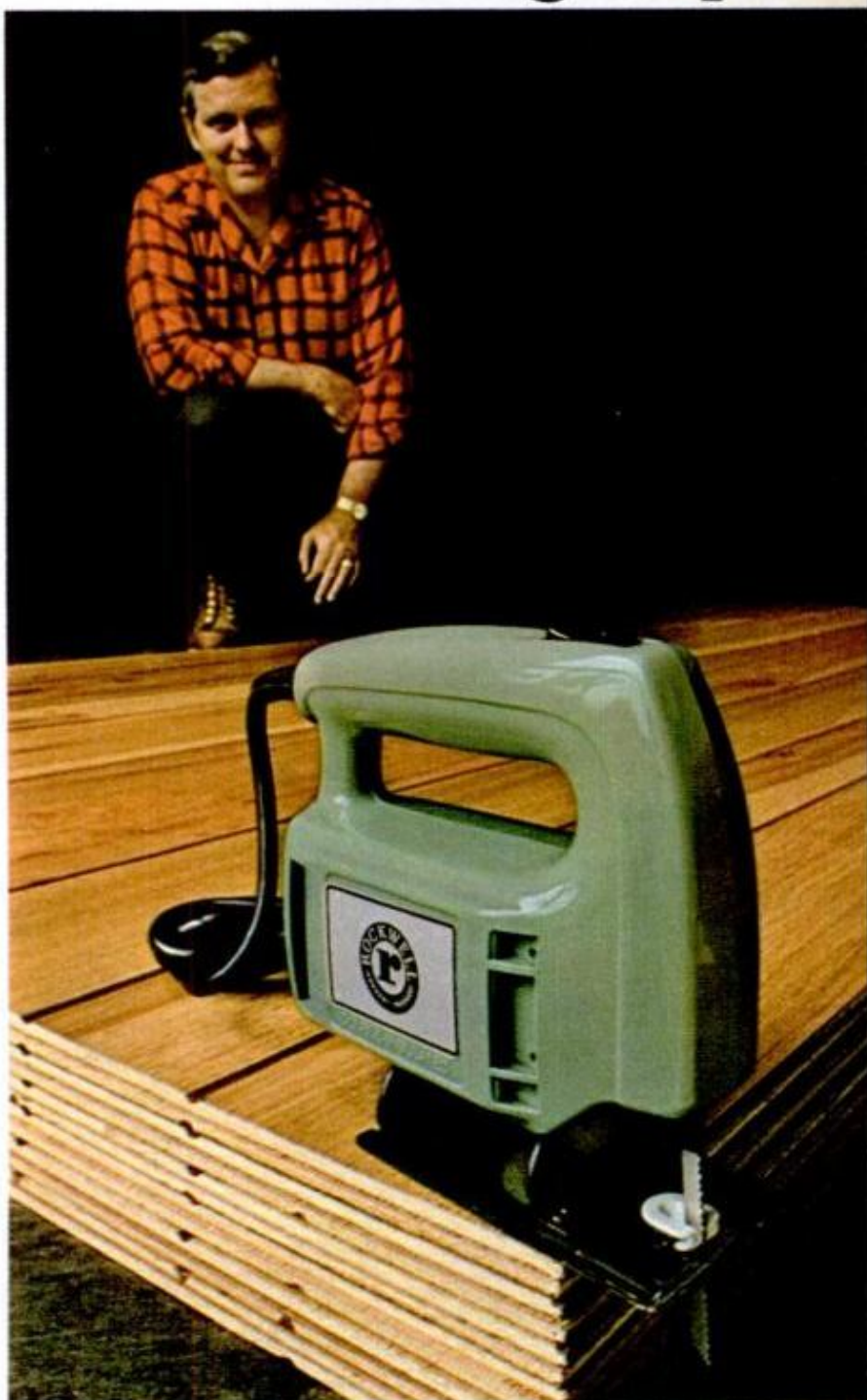

**The Paneling People.**

**U.S. Plywood**



Today's Winchester Model 94 brings you real walnut, a cold-forged chrome molybdenum steel barrel, deep rich blueing, a steel finger lever with smoother, easier action, and a rugged steel carrier... all at a price you want to pay.

More than 3,500,000 Model 94s in the hands of hunters for the last 79 years have earned for it the well-deserved title: "The Deer Rifle."



**Cold-forged chrome molybdenum steel barrel:** Twenty inches of tough, accurate barrel come on the business end of every Winchester Model 94 we make. The size gives you a gun that snaps to your shoulder perfectly, in any cover, and then lays the Super-X right where you

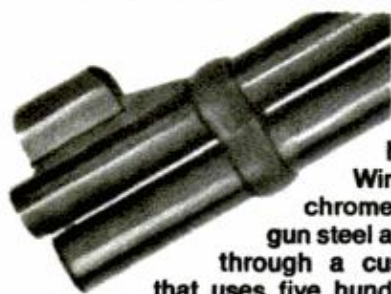

put your sights. But the way we make these barrels today would make old-timers scratch their heads in admiration.

Winchester takes a blank of chrome-moly steel . . . the best gun steel around . . . and then puts it through a custom-designed machine that uses five hundred tons of pressure to cold forge Winchester Proof Steel barrels of excellent strength and accuracy. Time-tested design, with the modern precision of chrome-moly steel. The best combination you can have come buck season.

**Walnut stock and forend:** The quality of Winchester chrome-molybdenum steel calls for the traditional finishing touch of solid American walnut, made with Winchester craftsmanship for a fine wood-to-metal fit.

The handsome, dark wood tones of the finish give the experienced hunter an unobtrusive brush-buster of a deer gun that's all business as it waits for the big ones. The weather-resistant satin finish shrugs off snow and rain . . . and then shines up to give you a fine looking Winchester you'll show proudly alongside your trophies.



**Steel carrier:** One important thing that hunters have found about the Model 94 is its safety. Exterior hammer. And

if you open the action a crack, you can tell at a glance if there's a round in the chamber. However when you re-close the action, you place a lot of pressure on the carrier. The Model 94 has a heavy, all-steel carrier that's made to keep your repeater in business year after year.

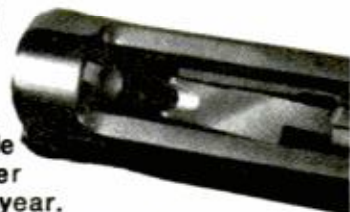

That's Winchester the way you want it.



**Smoother lever linkage:** Hunters who appreciate a well-made rifle will do themselves a favor by opening up the new Model 94's lever action, and taking a good look at how it goes together. If you know your 94s, you'll notice a brand-new, re-designed camming slot in the lever. It's curved. The result is an action that opens more easily and smoothly than ever before . . . and a Model 94 that lets you reload in a flash if you have to, without taking your attention from your target. The lever is steel, rugged enough to take all the manhandling you can dish out . . . but polished and blued for a sharp appearance that says "pure Winchester."

**New rich blueing:** The Model 94 receiver is another tough customer. Its one-piece construction is 20% stronger today than previously. But on the outside, the receiver is a real smooth operator, finished with a unique, rich blueing process newly developed by Winchester. Men who know guns can tell with one look whether a blueing job is right or not. Take a look at our new 94.

**New loading port cover:** Designed to make loading a snap, the new Model 94 loading port cover is a one-piece unit that works better, and looks better. We blue it on the regular 94, but if you're the kind of hunter who wants a little more, take a look at the Winchester Model 94 Antique. Marbled, case-hardened receiver, and a brass-plated loading gate. Works just like the regular Model 94, though. Very accurately.



**Most popular deer cartridge . . . 30-30.** Over the years, we've chambered this old buck-buster for a lot of different loads. And even today we'll read where some hunter who understood quality when he bought it has bagged a good-sized White Tail or Muley with his 32-40 or 38-55 Winchester Model 94. Today we've settled on just one caliber for the Model 94. The famed 30-30 holds 6 rounds in the

tube magazine under the barrel. You can find 30-30 Winchesters everywhere you find deer as legal center fire game . . . and where there are men who like prime venison. Always ask for Winchester Super-Speed or Western Super-X, in your choice of Silvertip or Power-Point bullets.

**Biggest-selling deer rifle ever made.** A deer hunter is a no-nonsense kind of guy who goes into the woods for just one reason: to bring home the venison. For success, he relies on doing the basics just a little bit better than the buck he's after. When it comes to selling this deer hunter a sporting arm, you can forget all about the frills and fancy stuff. He knows what he wants and goes after a fast-aiming repeater that can do the fundamentals just as well as he can. And for more than three quarters of a century his consistent first choice has been the Winchester Model 94. To prove that, we've sold more than 3,500,000 over the last three-quarters-of-a-century-plus. There's got to be a reason why. Find out what it is for yourself, today, at your Winchester dealer's. **WINCHESTER.**, 275 Winchester Avenue, New Haven, Connecticut 06504.

**MADE IN U.S.A.**



**Proven design:** hunters that the best way to improve the Model 94's appearance was to

**Winchester** Since 1894, have agreed

leave it alone. We have. And today the Model 94 still has all the crisp, lean Western styling it had when we shipped the first ones out of the factory. It's a style that's been imitated often. But even the sincerest form of flattery from our good competitors can't match Model 94 performance that's given the name "Winchester" a definition all its own in Webster's dictionary. First of all the 94 is a carbine. That means it's a compact design . . . less than seven pounds that you can carry all day in one hand. It comes to your shoulder quickly and naturally in brush or open country . . . anywhere, anytime you have to make snap shots count. The straight-grip, high-comb stock is a pleasure to look at, and fits you like a glove. The slim carbine-style fore-arm gives a feel of accuracy and precision. Top ejection means the Model 94 works equally well with either left- or right-handed shooters. The hooded front sight and sporting rear sight are made to line up in a big hurry. But the option of a side scope mounting lets you have pinpoint longer-range accuracy too. Put it all together and you'll know why "Model 94" means "Winchester" . . . and why "Winchester" means "Rifle" to sportsmen and peace officers all over the world.

 **winchester**  
the way you  
want it



# The nice little things you



An interior in Custom Cruiser that's a lot like a luxurious sedan.



A tailgate on the Custom Cruiser that disappears into the floor.



Lots of room to haul lots of things.



A front center armrest in Cutlass Supreme Cruiser and Vista-Cruiser.



A Vista Vent on the Vista-Cruiser to let smoke out and sun in.



Tailgates that swing up and out of the way on Cutlass Supreme Cruiser and Vista-Cruiser.

You get some nice things because our wagons are Oldsmobiles: things like thick cut-pile carpeting, woodgrain vinyl inlays, and beautiful upholstery. Seats with up to six inches of foam. The equipment to make your wagon drive like an Olds: power steering, power front disc brakes, Turbo Hydra-matic transmission, and a Rocket V8.

You get other nice things because our wagons are wagons: things like cargo space—Custom Cruiser has up to 106 cu. ft., Cutlass Supreme Cruisers and Vista-Cruisers each have up to 85 cu. ft. Each wagon is available in 2-seat and 3-seat models.

Finally, you get other nice things because you order them extra: like GM steel-belted radial tires, power windows, luggage rack, stereo radio, and many other features to make your wagon all the Oldsmobile you want it to be.

**1974 Oldsmobile station wagons.**  
*Many nice things make a difference.*



# can have with an Olds wagon.

Cutlass Supreme Cruiser



Vista-Cruiser

Custom Cruiser





## DETROIT LISTENING POST

---

### Ford readying new mini

Ford has still another new car in the works, but you may never see it unless you're a world traveler. It's Ford's version of the ultimate small car. Ultimate if you want a rear seat, which the car has, but not the smallest car the company could put out if it decided to dispense with the back seat and build a two-passenger one-seater. While solid information is hard to come by at this early stage, indications are the car is intended for markets outside the United States. But if the trend to small, smaller, smallest cars continues in this country, a domestic version could be in the offing. When? Two years from now at the earliest, but more likely late 1976.

---

### Chrysler thinking small

Is Chrysler thinking small car again? It's either that or the company is on a miniaturization kick. Engineers assigned to component development projects for '74-and-beyond cars who thought they had their work all locked up have been given new orders: redo it on a smaller scale. Design engineers are really sweating on some parts—shrinking the steering column, for example, while still allowing enough room for stowing an air bag behind the center of the horn ring.

---

### Better idea for boosting belts

Engineers are looking at an idea that may overcome Detroit's main objections to the ignition interlock system. This is the device that requires the driver and right front passenger to buckle the combination seat belt-shoulder strap before the car can be driven. The auto companies are very much in favor of force feeding people to wear belts and shoulder straps. But they don't like the idea of making the car undrivable until the belts are buckled.

There may be a way around this. If the government would allow it—which seems

unlikely at this point—the belts could be hooked up to the speedometer, rather than the ignition, so it would be possible to start and drive the car at very low speeds, say up to 10 mph, without buckling the belts. To kick the car above 10 mph, the belts would have to be fastened.

This would overcome the nuisance objections to the ignition interlock—situations where a stalled car has to be moved or when a parking lot attendant wants to shuttle a car a short distance. The idea is feasible, but Detroit isn't very hopeful about selling it to the government unless there are massive failures of the ignition interlock.

---

### Ghia to be Ford trend car

Mustang Ghia, highest priced version of the new Mustang II, will apparently become the try-it-on-for-size car at Ford, taking over that role from T-bird and Continental. When a new idea comes along, the big, expensive cars get first crack at it. Then, after a year or two, a whittled-down version is developed for the smaller, less expensive cars. This is true at all the companies.

Ford has reportedly sent word to suppliers that if they have any promising ideas for comfort and convenience add-ons, the company is interested in looking at the items for future editions of Mustang Ghia. This makes sense if Detroit is really going to smaller cars. Try it on the small cars first, rather than on the low-volume big jobs.

---

### No more oil changes?

Automakers are weighing the advantages versus disadvantages of using more sophisticated oil filters as a means of reducing oil changes, thereby conserving oil. Both auto engineers and petroleum engineers say the usable life of oil could be extended thousands of miles by going to a more advanced filtration/purification system. Car-

*(Please turn to page 46)*



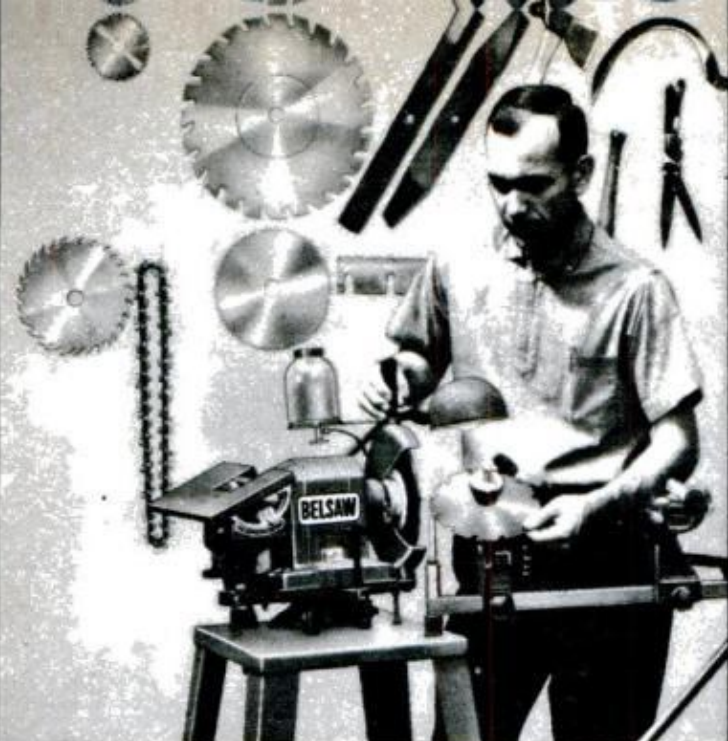

**Makes Over \$60.00 EXTRA  
a Week In His Spare Time  
Sharpening Shop!**

**"My Belsaw Sharp-All made me  
an extra \$3,500 last year.  
Now I am going full time.  
It's great to be your own boss."**

**DAVID SWANSON—Utica, Michigan**

**Let Belsaw prove  
YOU can do it, too! On our  
30-DAY FREE TRIAL OFFER**

**SEND FOR FREE FACTS!**

You risk nothing by accepting this offer to see how easily you can turn your spare time into big Cash Profits with your own Complete Sharpening Shop. No selling . . . no previous experience needed. Our famous Sharp-All and show-how instruction set you up to make \$200, \$500, \$700 a month CASH sharpening Saws, Knives, Scissors, Lawnmowers, Shop and Garden Tools . . . all cutting edges.

**Does The Belsaw Pay?  
YOU BET!**

**JOIN THESE SHARP-ALL  
MONEYMAKERS**

**"I average \$5.00 an hour part  
time and business gets better  
all the time."**

*Robert Barrett, Jr.  
W. Springfield, Mass.*

**"My Sharp-All shop is now  
averaging me \$300.00 a month."**

*Roy Jennings  
Sandwich, Illinois*

**"There's excellent profit in  
sharpening . . . we now do  
about \$600.00 a month."**

*Ed Kistler, Jr.  
Sarasota, Florida*

**No Selling, No Inventory...Year Round  
Cash Profits and YOU Set The Hours!**

**Our Free Book tells  
how to start a profit-  
able, lifetime home  
sharpening business,  
how we help you grow,  
how we'll finance you.**

**MAIL THIS HANDY POSTAGE-  
PAID COUPON ENVELOPE...**

**BELSAW SHARP-ALL CO.  
714V Field Bldg.  
Kansas City, Mo. 64111**

**CUT ALONG DOTTED LINES... FOLD IN HALF... SEAL AND MAIL**

**No Stamp Needed—Mail Today!**

**No Obligation . . . No Salesman Will Call**

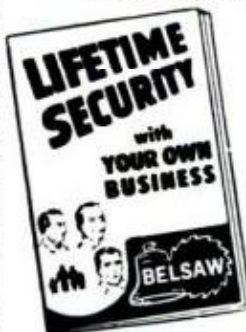

**Please send my FREE copy of your book  
"Lifetime Security" and full details of  
your 30-Day Free Trial Offer!**

Name \_\_\_\_\_

Address \_\_\_\_\_

City \_\_\_\_\_ State \_\_\_\_\_ Zip \_\_\_\_\_

**FOLD IN HALF HERE**

**FIRST CLASS  
PERMIT NO. 1014  
KANSAS CITY, MO.**

**BUSINESS REPLY MAIL**

No Postage Stamp Necessary if Mailed in the U.S.

Postage will be paid by—

**BELSAW SHARP-ALL CO.  
714V Field Building  
Kansas City, Missouri 64111**

**CUT ALONG DOTTED LINES**



# You were born smart.





# Make it pay off in the Navy.

Get advanced technical training in electronics or nuclear power.

If you're a high school graduate who can meet our qualifications, the Navy will offer you over \$17,000 worth of advanced technical training in our Advanced Electronics or Nuclear Power Programs.

These are very special programs, and the academic schedule will be tough . . . calling for plenty of concentration and honest effort. It'll take more than a good mind to make it. You'll need a strong desire to learn and achieve. And a willingness to do your share of the house-keeping chores. But any man who learns to operate or

repair the Navy's sophisticated electronic systems or nuclear power plants, guarantees himself a firm foot-

hold in the future, whether he stays in the Navy or not.

For more details, talk to your local Navy Recruiter. Or mail the coupon below. Or call toll-free, anytime, 800-841-8000.

**Be someone special  
in the New Navy.**

TO: U.S. NAVY—Capt. Robert W. Watkins 422  
NAVY OPPORTUNITY INFORMATION CENTER  
P.O. Box 2000  
Pelham Manor, N.Y. 10803

Please send more information on:

- Advanced Electronics Program
- Nuclear Power Program
- Other Navy career opportunities.

If you really don't want to wait, call 800-841-8000 toll-free (24 hours a day, seven days a week). In Georgia, call 800-342-5855. Call collect: In Alaska—272-9133, in Hawaii—533-1871.

Name \_\_\_\_\_ Date of Birth \_\_\_\_\_  
Address \_\_\_\_\_  
City \_\_\_\_\_ Phone \_\_\_\_\_  
State \_\_\_\_\_ Zip \_\_\_\_\_







# I'd like to give this to my fellow men... while I am still able to help!

I was young once, as you may be—today I am older. Not too old to enjoy the fruits of my work, but older in the sense of being wiser. And once I was poor, desperately poor. Today almost any man can stretch his income to make ends meet. Today, there are few who hunger for bread and shelter. But in my youth I knew the pinch of poverty; the emptiness of hunger; the cold stare of the creditor who would not take excuses for money. Today, all that is past. And behind my city house, my

summer home, my Cadillacs, my winter-long vacations and my sense of independence—behind all the wealth of cash and deep inner satisfaction that I enjoy—there is one simple secret. It is this secret that I would like to impart to you. If you are satisfied with a humdrum life of service to another master, turn this page now—read no more. If you are interested in a fuller life, free from bosses, free from worries, free from fears, read further. This message may be meant for you.

By Victor B. Mason

I am printing my message in a magazine. It may come to the attention of thousands of eyes. But of all those thousands, only a few will have the vision to understand. Many may read; but of a thousand only you may have the intuition, the sensitivity, to understand that what I am writing may be intended for you—may be the tide that shapes your destiny, which, taken at the crest, carries you to levels of independence beyond the dreams of avarice.

Don't misunderstand me. There is no mysticism in this. I am not speaking of occult things, of innumerable laws of nature that will sweep you to success without effort on your part. That sort of talk is *rubbish!* And anyone who tries to tell you that you can *think* your way to riches without effort is a false friend. I am too much of a realist for that. And I hope you are.

I hope you are the kind of man—if you have read this far—who knows that anything worthwhile has to be *earned!* I hope you have learned that there is no reward without effort. If you have learned this, then you may be ready to take the next step in the development of your karma—you may be ready to learn and use the secret I have to impart.

## I Have All The Money I Need

In my own life I have gone beyond the need of money. I have it. I have gone beyond the need of gain. I have two businesses that pay me an income well above any amount I have need for. And, in addition, I have the satisfaction—the deep satisfaction—of knowing that I have put more than three hundred other men in businesses of their own. Since I have no need for money, the greatest satisfaction I get from life is sharing my secret of personal independence with others—seeing them achieve the same heights of happiness that have come into my own life.

Please don't misunderstand this statement. I am not a philanthropist. I believe that charity is something that no proud man will accept. I have never seen a man who was worth his salt who would accept something for nothing. I have never met a highly successful man whom the world respected who did not sacrifice something to

gain his position. And, unless you are willing to make at least half the effort, I'm not interested in giving you a "leg up" to the achievement of your goal. Frankly, I'm going to charge you something for the secret I give you. Not a lot—but enough to make me believe that you are a little above the fellows who merely "wish" for success and are not willing to sacrifice something to get it.

## A Fascinating and Peculiar Business

I have a business that is peculiar—one of my businesses. The unusual thing about it is that it is needed in every little community throughout this country. But it is a business that will never be invaded by the "big fellows." It has to be handled on a local basis. No giant octopus can ever gobble up the whole thing. No big combine is ever going to destroy it. It is essentially a "one man" business that can be operated without outside help. It is a business that is good summer and winter. It is a business that is growing each year. And, it is a business that can be started on an investment so small that it is within the reach of anyone who has a television set. But it has nothing to do with television.

This business has another peculiarity. It can be started at home in spare time. No risk to present job. No risk to present income. And no need to let anyone else know you are "on your own." It can be run as a spare time business for extra money. Or, as it grows to the point where it is paying more than your present salary, it can be expanded into a full time business—overnight. It can give you a sense of personal independence that will free you forever from the fear of lay-off, loss of job, depressions, or economic reverses.

## Are You Mechanically Inclined?

While the operation of this business is partly automatic, it won't run itself. If you are to use it as a stepping stone to independence, you must be able to work with your hands, use such tools as hammer and screw driver, and enjoy getting into a pair of blue jeans and rolling up your sleeves. But two hours a day of manual work will keep your "factory" running 24 hours turning out a product that has a steady and

ready sale in every community. A half dollar spent for raw materials can bring you six dollars in cash—six times a day.

In this message I'm not going to try to tell you the entire story. There is not enough space on this page. And, I am not going to ask you to spend a penny now to learn the secret. I'll send you all the information, free. If you are interested in becoming independent, in becoming your own boss, in knowing the sweet fruits of success as I know them, send me your name. That's all. Just your name. I won't ask you for a penny. I'll send you all the information about one of the most fascinating businesses you can imagine. With these facts, you will make your own investigation. You will check up on conditions in your neighborhood. You will weigh and analyze the whole proposition. Then, and then only, if you decide to take the next step, I'll allow you to invest \$15.00. And even then, if you decide that your fifteen dollars has been badly invested I'll return it to you. Don't hesitate to send your name. I have no salesmen. I will merely write you a long letter and send you complete facts about the business I have found to be so successful. After that, you make the decisions.

## Does Happiness Hang on Your Decision?

Don't put this off. It may be a coincidence that you are reading these words right now. Or, it may be a matter that is more deeply connected with your destiny than either of us can say. There is only one thing certain: If you have read this far you are interested in the kind of independence I enjoy. And if that is true, then you must take the next step. No coupon on this advertisement. If you don't think enough of your future happiness and prosperity to write your name on a postcard and mail it to me, forget the whole thing. But if you think there is a destiny that shapes men's lives, send your name now. What I send you may convince you of the truth of this proverb. And what I send you will not cost a penny, now or at any other time.

VICTOR B. MASON

1512 Jarvis Ave., Suite M-2-CM  
CHICAGO, ILLINOIS 60606



# "How I rewired my taillights with a plastic straw and Dow Corning Bathtub Caulk."



We knew our silicone rubber bathtub caulk was good for a lot more things than bathtubs, and when we heard how Larry Oswald of Sewickley, Pa., used it, our opinion was confirmed.

"When my taillights started getting dimmer and dimmer, I took them apart and found that the sockets, wires, everything, were all corroded.

"So I cleaned everything up, bought two new sockets, and decided this time that they weren't going to corrode.

"I had a tube of Dow Corning® Bathtub Caulk lying around the house, so I figured why not, and caulked up the sockets.

"Then I figured that if it'd work on the sockets, it'd work on the splices.

I cut two small pieces off a plastic drinking straw, slid one over each set of wires to keep them from getting stuck together, tied the wires together, and then pumped them full of caulk.

"It's been six months now, and my taillights are still brighter than ever."

Next time you're faced with a plumbing leak, broken gasket, or

almost any fix-it job around the house, get the Dow Corning Silicone Bathtub Caulk out of the bathroom and put it to work.

You'll find it in white and pastel decorator colors in the hardware or paint department of your favorite store. Look for Dow Corning Silicone Sealer in clear, black, or aluminum in tubes and cartridges, too.

Dow Corning Corporation, Dept. D-3102, Midland, Michigan 48640.

**DOW CORNING**



MODEL  
CD-5

**GARAGE DOOR OPERATOR**  
**RADIO CONTROLLED**



Buy Mail Order And Save

ONLY... **\$134.95!**

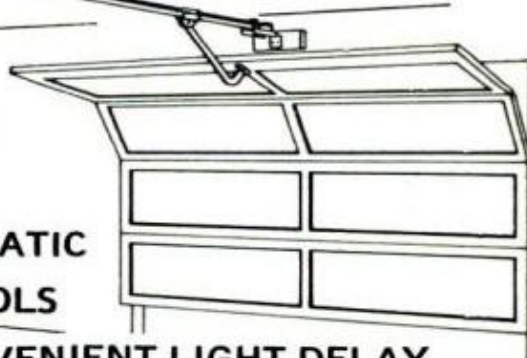

- 1/3 HP HEAVY DUTY • FULLY AUTOMATIC
- INTERFERENCE FREE RADIO CONTROLS
- INSTANT SAFETY REVERSE • CONVENIENT LIGHT DELAY

NOW you can buy the most POWERFUL DEPENDABLE garage door operator available anywhere DIRECT from the factory by mail and SAVE up to \$100! IMMEDIATE shipment NO WAITING Home delivery in 3 days via UPS. The HELPMATE opens and closes, illuminates and securely locks any garage with wood, metal or fiberglass doors up to 20' wide whether sectional or 1-piece. Requires but 1-3/4" clearance and 2 hours to install using our exclusive Homeowners Guide. Guaranteed 1 year. Choice of 4 models from \$99.95 budget unit to \$149.95 premium 1/3 HP screw drive system. Free brochure with limited time special offer sent promptly. HELPMATE Equipment Co. Box 14, Michigan 49101, Telephone (616) 422-2311



## NEW FREE BOOK DISCUSSES

# HOW TO SELL YOUR INVENTION

If you have an invention (whether patented or unpatented) that you believe has commercial value, our Free Booklet entitled "How to Go About Selling Your Invention" may help you save time and money.

We are specialists in representing inventors and submitting their inventions to manufacturers. We work with scores of manufacturers who are seeking new products or new product ideas, and we therefore know which firms may be interested in your particular invention. Our service is designed to do all those things the average inventor lacks the knowledge or facilities for doing, or does not have time to do. We prepare your sales letters, folios, duplicate drawings, handle correspondence, select the firms.

We charge the standard commission (on sales) and a modest fee for the submitting service. This fee is refunded if a manufacturer buys your invention through our efforts. We are a nationally known concern with an impeccable reputation for ethics and integrity.

The Free Booklet we have prepared especially for inventors contains such information as current royalty rates being paid by manufacturers, discusses many types of inventions, the possible market for them, tells the effective methods of presenting your invention for sale, whether you employ us or do it yourself, and outlines how we may be able to help you.

You can obtain this booklet "How to Go About Selling Your Invention" by mailing the coupon below. And if you wish to write us for comments on your invention, please do so. We make no charge for consultation. But please do NOT send drawings or models. Just describe the purpose and nature of your invention. Mail the coupon to K. O. Kessler, Pres., Kessler Sales Corporation, Dept. D-511, Fremont, Ohio 43420.

You are welcome to ask your lawyer, local Bank, Chamber of Commerce to carefully check on our reputation for honesty and fair-dealing.

### MAIL THIS COUPON

Mr. K. O. Kessler, President, Dept. D-511  
Kessler Sales Corp., Fremont, Ohio 43420

Please mail me a copy of your Free Booklet "How to Go About Selling Your Invention." It is understood that this does not obligate me in any way to use your Service.

My Name .....  
Street Address .....  
City ..... State ..... Zip .....

## DETROIT LISTENING POST

(Continued from page 40)

makers are weighing the pros and cons—cost, availability and reserves of oil measured against a much more complicated and costlier filtering system.

### AMC to get GM Wankel

Although no contract has been signed, GM has agreed to sell American Motors rotary engines "as available." This means AMC has an understanding to obtain Wankels from GM, but the deal doesn't specify how many or when they will be delivered.

### Bad news for car strippers

During the past four or five years, Detroit has made a real effort to build cars easy to service—so you can do your own servicing, so parts are easy to get at, remove and install. That trend may stop, at least on the prime targets for thieves—tape players, for example. A plan being discussed would fasten certain accessories down so they can't be removed with anything less than a blowtorch, stethoscope and sledge hammer.

The car companies are looking for ways to thwart thieves, not only those who make off with the whole car, but also strippers who peel off parts and fence them through bootleggers. If your car is pinched, you have a fair chance to get it back. About four out of five stolen cars are recovered. But if a heister takes your tape player, mag wheels or radial tires, you can just about kiss them goodbye.

There's a way of discouraging the strippers, if not outwitting them completely, and automakers are examining the idea. It consists of locking in parts so you have to go through a long, involved procedure to remove them. There's no easy way to get the gear off—you have to know the exact removal sequence—in the same way you must know the order of numbers to open a combination lock—to pull the parts out. A stripper could still take your tape player, but he would need time to disassemble it. He couldn't grab-and-run, as he can now.

But there's a drawback for the car owner. If Detroit goes to "nailed in" parts, the owner will have to pay the mechanic for the extra time it will take to remove parts when an item needs service. ★★★



THE MORE YOU KNOW, THE MORE YOU'LL WANT

# DELCO

## HOW TO SPOT A FRESH BATTERY.

Start by looking for the red, white, and blue Delco sign. You'll find it on service stations, independent garages and tire stores just about anywhere.

Then look for Delco Energizer batteries. You'll know they're fresh because

they're vacuum sealed at the factory to help give you the power you pay for. The seals aren't broken or the activator fluid added until the battery is ready to be installed in your car.

That's nice to know. And it's nice to know that years of GM engineering, testing and experience are built into every

Delco battery to give you that burst of power you need for start after start, time after time.

Next time you need a new battery, make sure you get a new battery.

Delco. It's a fresh start to go with.





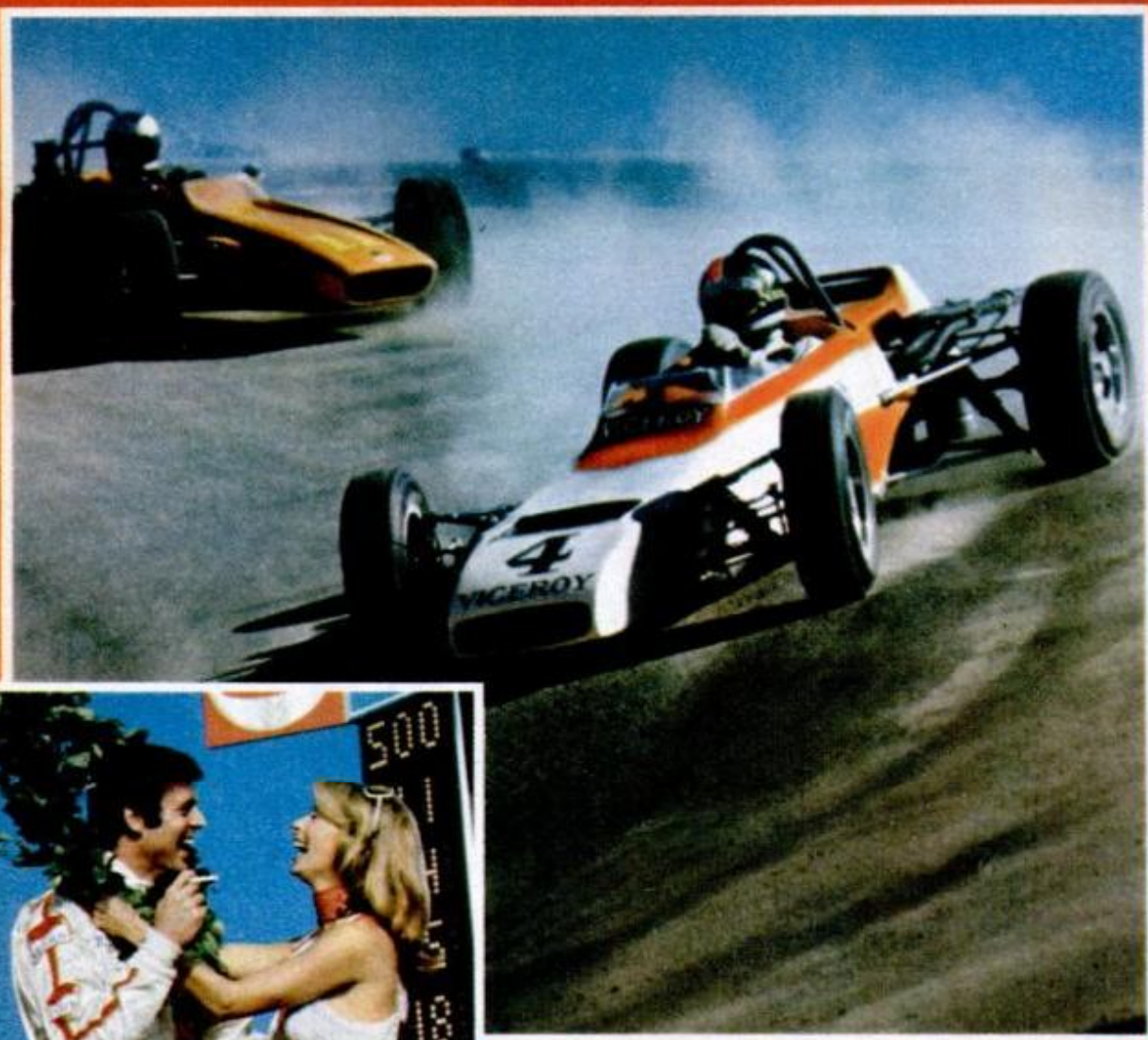

King Size. Long Size.

# Taste it all in Viceroy.

Get a taste of excitement. A taste worth smoking for. That's Viceroy. Full flavor that comes on rich and smooth from start to finish. Viceroy. Taste what smoking's all about.

**Warning: The Surgeon General Has Determined That Cigarette Smoking Is Dangerous to Your Health.**



King Size, 17 mg. "tar," 1.2 mg. nicotine.  
Long Size, 18 mg. "tar," 1.3 mg. nicotine  
av. per cigarette, FTC Report Feb. 73

© BROWN & WILLIAMSON TOBACCO CORP.



## CAR CLINIC

BY MORT SCHULTZ

### The horn blows at midnight

*Recently, the horn of my parked 1971 Ford LTD started blowing in the middle of the night. It is now disconnected, awaiting your diagnosis. Whats wrong?—Harold C. Kopp, Nashville, Tenn.*

The horn contact in the steering wheel of several Ford models has plastic inserts beneath the contact pads. These inserts have expanded, forcing the contacts to close. The problem has been recognized, and a new type of horn contact has been issued. Consult a Ford dealer. Replacing the horn contact should solve the problem.

### Obstinate Opel

*I have a problem that is common among Opel owners. My particular car is a 1971 1900 station wagon. Because of a poor carburetor, the car is hard starting, has poor power, and pings when most brands of gasoline are used. These conditions are getting more pronounced as the car logs more mileage. I would like to replace this carburetor, which I have already rebuilt once, for another. What make do you suggest?—Melvin O. Brown Jr., Rome, N.Y.*

Sorry, Mr. Brown, but if there is another make of carburetor which you can use in place of this two-barrel Solex, I don't know what it is. The problems that you and others have experienced are real enough, but there have been several modifications and advisories issued by the factory to Buick-Opel dealers that have helped iron out some of the difficulties. Rebuilding the carburetor without applying these modifications is akin to doing half a job. One advisory, for example, warns of the harm that loose manifold bolts will cause and the necessity of tightening them often. One modification calls for installation of a heat shield between carburetor and manifold to offset percolation. There are others, and you should check with a Buick-Opel dealer or write the technical publications department of Buick Motor Div., General Motors, 902 East Hamilton

Ave., Flint, Mich. 48550, for an explanation of what they are.

### How to get Subaru parts

*I own a 1972 Subaru 1300G EFI sedan and am experiencing difficulty getting parts. Most parts stores don't stock supplies for Subaru. What should I do?—L. Rubin, Washington, D.C.*

Parts should pose no problem if you request them from a Subaru dealer. According to Subaru of America, master parts depots in California and New Jersey supply western and eastern distributors. There are 14 distributors in the country, and they in turn supply Subaru dealers. If you cannot obtain parts from a local Subaru dealer, contact the distributor for your region: Mid-Atlantic Subaru Star, Ltd., 17450 Indian Head Hwy., Accokeek, Md. 20607. Any other Subaru owner reading this who needs help in locating a place to get parts may call a toll-free number, 800-447-4700, in every state other than Illinois. In Illinois, call toll-free 800-332-4400.

### Needs a break

*I service a 1972 Chevelle Malibu with a six-cylinder engine. The engine starts immediately, but stops after a few revolutions and requires restarting four or five times before it finally catches. I found that the choke plate closes fully when the throttle is depressed prior to cranking, but that it flies open halfway when the engine starts. This is causing the trouble, I'm sure, but the Chevrolet service shop tells me this is the way it's supposed to be because of anti-pollution measures and that I'd be subject to a \$10,000 fine if I tampered with the setup. What do you have to say?—Stamm's Garage, Middletown, Pa.*

It isn't printable. Undoubtedly, that Chevy shop hasn't heard of a choke vacuum-

*(Please turn to page 52)*



# AMC MATADOR

# NEWEST MID-SIZE FOR 1974

This is one mid-size car you've never seen before. The roomy AMC Matador coupe.

With sweeping, clean lines. Low profile. And plenty of window area for all-around vision. Test drive the new Matador. And see why experts are already calling it America's sportiest new car.





# AMC BUYER PROTECTION PLAN MORE THAN JUST A GUARANTEE

To us at American Motors, and to our dealers, the exclusive AMC Buyer Protection Plan means a commitment to our customers. A commitment to stand behind every single car we build.

## A GUARANTEE YOU CAN UNDERSTAND.

When you buy a new 1974 AMC car from an American Motors dealer, American Motors Corporation guarantees to you that, except for tires, it will pay for the repair or replacement of any part it supplies that is defective in material or workmanship. This guarantee is good for 12 months from the date the car is first used or 12,000 miles, whichever comes first. All we require is that the car be properly maintained and cared for under normal use and service in the fifty United States or Canada, and that guaranteed repairs or replacement be made by an American Motors dealer.

At AMC we expect every part in every car to last for at least 12 months or 12,000 miles under normal use and service.

And that's why we back our cars with this simple, strong guarantee. A guarantee that covers every part—except tires—even those annoying little things that occasionally wear out like spark plugs, wiper blades and light bulbs.

## PLUS A BUYER PROTECTION PLAN THAT DOES MORE.

AMC is the only manufacturer with a program to provide a free loaner car should guaranteed repairs take overnight. And a special trip interruption plan that pays up to \$150 for food and lodging if guaranteed repairs have to take place more than 100 miles from home.

We even have a toll-free hotline to Detroit for you to call if you ever feel we aren't living up to our promises.

And let's face it, when you make this kind of commitment to stand behind your cars, you have to build them better.

## AMERICAN MOTORS CORPORATION

We back them better because we build them better.



## CAR CLINIC

(Continued from page 49)

break adjustment, so let me give you the procedure and you can pass it on. It calls for proper adjustment of the vacuum-break diaphragm to insure correct initial choke-plate opening after the engine starts.

First, remove the air cleaner and plug the "Therm AC" sensor vacuum-takeoff port if the car is equipped with a "Therm AC" air cleaner. Apply vacuum to the vacuum-break diaphragm with an external vacuum source until the plunger is fully seated. Now, push the choke plate closed and place a gauge between the lower edge of the plate and the air-horn wall. If the car is equipped with automatic transmission, the size of the gauge should be .225 inch. Bend the vacuum-break rod at the elbow to adjust to the correct specification.

By the way, at present, according to federal law, only franchised dealers and manufacturers are subject to the \$10,000 fine for tampering with emission controls. State laws on emissions vary. As an independent garage owner, you might contact the motor vehicle department in Harrisburg to determine the nature of Pennsylvania law.

### Cranky speedometer

*My 1968 Chevrolet Nova makes a whining noise that is accompanied by the speedometer needle jumping. The manual is rather vague on how to lubricate the cable, and it seems to me that the radio has to be removed, steering post dropped and instrument cluster pulled out. Is there an easier way?—Harry Simmons, Brooklyn.*

I agree that space is kind of tight, but you can work on this speedometer without taking any of the vehicle apart.

I doubt, though, if lubrication alone will solve your problem. Experience has shown that oscillation of the speedometer needle and/or a whining noise is caused most often by a kinked or sharply bent cable. The problem can usually be corrected by following this procedure:

1. Examine the speedometer cable for kinks and sharp bends at the speedometer

head, firewall and transmission. If the cable is kinked or bent, it should be removed and straightened out or replaced.

2. Disconnect the cable from the speedometer by unscrewing the coupling nut. About 1000 Novas in 1969 were built with a push-on connector that held the cable to the head. To remove the cable, pull it away from the head as you depress the connector.

3. Pull the shaft part of the cable from the casing and straighten or replace it. Reinsert shaft in casing and reconnect cable.

### More light on 'blackout'

*Your answer to Hugh Lewis of Coshocton, Ohio, regarding headlight dimming with his 1968 Oldsmobile ("Blackout," Car Clinic page 22, June PM) overlooked one probable cause. I had the same problem with a 1967 Pontiac LeMans. In addition to what you suggested to check (drive belt, carburetor idle adjustment, grounding of the regulator and condition of regulator and alternator), I think he should check the BATT wire going to the regulator. In my car, the wire comes off the starter solenoid and is difficult to reach, but when it was replaced and contacts cleaned, the problem cleared up.—Kenneth K. Rosenthal, Austin, Minn.*

Thanks for the valuable addition, Mr. Rosenthal.

## SERVICE TIPS

**The U.S. Department of Transportation** warns car buyers to beware of dealers who substitute undersized tires for those supplied by the vehicle's manufacturer. The department's National Traffic Safety Administration says it has received "numerous reports" of undersized tires being installed by new-car dealers. The department suggests that you check the designation on tires against manufacturer's specification in the owner's manual and on the placard that is usually put into the glove compartment to make sure they match. Don't fail to check, especially if you have the dealer substitute an optional tire for original equipment. Substituting inadequate tires is a violation of federal safety law.

**Sparkplugs fouling** at low speeds with a 1973 Chrysler Corp. car having a 340-cu.-in. engine? Switch from an N9Y to an N12Y sparkplug. ★★

**GOT A PROBLEM WITH YOUR CAR?** Ask Mort about it. Send your question to Car Clinic, Popular Mechanics, 224 West 57th St., New York, N.Y. 10019. Letters cannot be answered individually, but problems of general interest will be published in the column.



# It pays to go by the book.

## **Chilton's Auto Repair Manual, 1973.**

(American cars 1966-1973)

This is easily the best book of its kind  
ever assembled.

**Comprehensive.** No other manual comes close. Either in our detailed coverage of just about every repair job, or in our special sections on trouble-shooting, tune-ups, engine rebuilding, emission controls, windshield wipers and the Wankel engine. In scope, detail and clarity they're unequalled.

**Understandable.** You don't have to be a professional. We use simple, everyday vocabulary, and go through each job methodically, step by step. (There's even a special section that tells you how to use the book.)

**Loaded.** There are tables, charts, drawings, diagrams and exploded views galore. Over 4,000. There are almost 1500 pages. And we cover every popular American car from 1966 through 1973. (Including Jeep and the new Olds Omega.)

Chilton's Auto Repair Manual, 1973. Get it now at your local bookstore or automotive department. Or return the coupon below.

## **CHILTON BOOK COMPANY**

Radnor, Pa. 19089

Chilton Book Company  
Dept. PM 1173  
Chilton Way, Radnor, Pa. 19089

Please send me CHILTON'S AUTO REPAIR MANUAL, 1973, for which I enclose check/money order for \$10.95, plus any applicable tax. If not satisfied with this book, I may return it postpaid, in clean saleable condition, within 10 days for full refund.

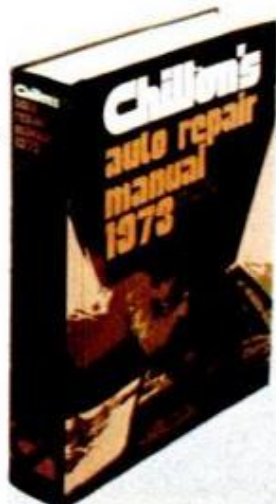

Name \_\_\_\_\_

Address \_\_\_\_\_

City \_\_\_\_\_

State \_\_\_\_\_ Zip \_\_\_\_\_



If you've ever said...

# "There must be a better

Send for a free Career Guidance Booklet that could start you on the road to success in a rewarding new career.

It happens to all of us, sooner or later. No matter what kind of job we have.

One day, it suddenly strikes home that we're going to have to work for a living, the rest of our lives. And most of us are horrified at the thought of forever being locked into the jobs we now hold.

"Surely," we tell ourselves, "there must be a way to earn enough extra dollars each month to balance the family budget. Surely, there must be

a way to get the kind of position where you don't have to worry about job security."

"Surely," in other words, "there must be a better way to earn a living!"

If you, too, have been thinking these same thoughts, you'll find one of our free Career Guidance Booklets very helpful at this time. We invite you to send for one.

Your free booklet will describe the opportunities for higher income and greater job security you might ex-





# way to earn a living.."

pect in one of the career fields listed on the coupon below. It will also explain why ICS can prepare you for this new career field...right in your own home...in your spare time...*regardless of your education or past experience.*

In addition, you will receive a free "Demonstration Lesson" that lets you see for yourself why preparing for a more rewarding career—the ICS way—may be a lot easier than you think.

Please bear in mind, as you check off your career choice on the coupon below, that ICS has a long and distinguished record of success. In fact, more than 8,500,000 men and women have turned to ICS for career training, since 1891.

## Major corporations use ICS Career Training

ICS has provided training programs for various divisions and branches of companies like Ford; U.S. Steel; Chrysler; Mobil; DuPont; etc.

ICS Career Training is approved for Veterans and Servicemen under the new G.I. Bill, and is Accredited by the Accrediting Commission of the National Home Study Council.

Now it's your turn to discover how ICS training can start *you* in a rewarding new profession. Just fill in the postpaid card or coupon below and mail it today for your free Career Guidance Booklet and free "Demonstration Lesson."



## Mail attached card or coupon for Free Career Guidance Booklets and Free "Demonstration Lesson."

These free Career Guidance Materials are yours without obligation. They will help you find out what you should know about the career field of your choice. They will also let you see for yourself why preparing for a more rewarding career—the ICS way—may be easier than you think.



Mail attached postage-free card today. If card is missing, please mail coupon to: ICS, Scranton, Pa. 18515.

## ICS International Correspondence Schools Scranton, Pennsylvania 18515

Please send me a free Career Guidance Booklet, and a free "Demonstration Lesson" for the field I have checked below. I understand that I am under no obligation.

- |  |   |
|--|---|
| <b>1. ACCOUNTING</b><br><input type="checkbox"/> Business Accounting<br><input type="checkbox"/> Bookkeeping <input type="checkbox"/> CPA Training<br><input type="checkbox"/> Income Tax Specialist   | <b>8. DRAFTING</b><br><input type="checkbox"/> General Drafting <input type="checkbox"/> Specialized Training (Arch., Mech., Struct., Electrical, Aircraft, Electronics)  |
| <b>2. BUSINESS MANAGEMENT</b><br><input type="checkbox"/> Business Administration<br><input type="checkbox"/> Executive Management<br><input type="checkbox"/> Industrial/Production Mgt.<br><input type="checkbox"/> Marketing/Advertising/Sales Management | <b>9. AUTOMOTIVE</b><br><input type="checkbox"/> Master Mechanic<br><input type="checkbox"/> Air Conditioning Specialist<br><input type="checkbox"/> Body Rebuilding Specialist<br><input type="checkbox"/> Diesel/Gas Mechanic                                       |
| <b>3. MOTEL/HOTEL MANAGEMENT</b><br><input type="checkbox"/> Motel Management<br><input type="checkbox"/> Club/Restaurant Management<br><input type="checkbox"/> Resort Manager <input type="checkbox"/> Hotel Executive                                     | <b>10. ENGINEERING</b><br><input type="checkbox"/> Mechanical <input type="checkbox"/> Civil <input type="checkbox"/> Chemical<br><input type="checkbox"/> Industrial <input type="checkbox"/> Electrical-Electronics<br><input type="checkbox"/> Surveying & Mapping |
| <b>4. COMPUTER PROGRAMMING</b><br><input type="checkbox"/> Programming Concepts<br><input type="checkbox"/> COBOL <input type="checkbox"/> System 360<br><input type="checkbox"/> Fortran IV   | <b>11. ELECTRONICS</b><br><input type="checkbox"/> Electronics Technician<br><input type="checkbox"/> Specialized programs in Computer Servicing, Communications/Broadcasting, CATV<br><input type="checkbox"/> FCC Licensing   |
| <b>5. INTERIOR DECORATING &amp; DESIGN</b><br><input type="checkbox"/> Interior Decorator<br><input type="checkbox"/> Interior Designer<br><input type="checkbox"/> Advanced Interior Designer   | <b>12. TV SERVICING</b><br><input type="checkbox"/> Color TV Technician<br><input type="checkbox"/> Stereo/Hi-Fi Specialist<br><input type="checkbox"/> CATV/MATV Specialist  |
| <b>6. ELECTRICIAN</b><br><input type="checkbox"/> Master Electrician<br><input type="checkbox"/> Practical Electrician   | <b>13. AIRCONDITIONING/HEATING</b><br><input type="checkbox"/> Air Conditioning/Refrigeration Technician <input type="checkbox"/> Heating Specialist  |
| <b>7. SECRETARIAL</b><br><input type="checkbox"/> Medical <input type="checkbox"/> Legal <input type="checkbox"/> Executive  | <b>14. HIGH SCHOOL</b><br><input type="checkbox"/> For those who want to earn an ICS High School Diploma  |

Check here for special information, if age 16 or under XA638S

Miss \_\_\_\_\_  
Mrs. \_\_\_\_\_  
Mr. \_\_\_\_\_ Age \_\_\_\_\_

Address \_\_\_\_\_ Apt. \_\_\_\_\_

City \_\_\_\_\_ State \_\_\_\_\_ Zip \_\_\_\_\_

Approved for Veterans Training. Approved for Federally Insured Loans.  
Accredited Member National Home Study Council.

Canadian residents use this address for service from ICS Canadian, Ltd.  
In Hawaii: 931 University Ave., Honolulu, Hawaii 96814





## Print For Profit

Cards, Stationery, Envelopes, Advertising, labels, tickets, announcements, Q.S.L. cards, greeting, sympathy, prayer cards, tags, etc. Good Profits, Pays for itself in a short time.

### Own a Printing Business

We supply everything direct from factory only. Easily followed rules. Also raised printing like engraving. Have home shop. Add to income. Send 25c for catalogue. **KELSEY PRESSES Meriden, Conn. 06450**

MAIL THIS COUPON TODAY!

**KELSEY PRESSES, DEPT. 73-AF, Meriden, Conn. 06450**

I enclose 25c send big catalog and samples.

Name \_\_\_\_\_

Address \_\_\_\_\_

City \_\_\_\_\_ State \_\_\_\_\_ Zip \_\_\_\_\_

## HOW TO GET RICH



Have you ever thought of operating a little mail order business of your own. There is no other business like mail order. Start on a shoestring in your spare time and make a fortune fast. It strikes like a bolt of lightning! Millions read your ad and suddenly you are swamped with cash orders from all over the country. **MORE MONEY** in 60 days than you could earn in a lifetime! Let us help you get started. To receive a free book and complete details just fill out the coupon and mail to:

**Mail Order Associates, Inc., Dept. 507, Montvale, N.J. 07645**

Name \_\_\_\_\_

Address \_\_\_\_\_

City \_\_\_\_\_ State \_\_\_\_\_ Zip \_\_\_\_\_

GET INTO **\$4.95**  
THE STEAM  
OF THINGS



This steam engine kit is an ideal project for the coming winter. Pull that UNIMAT out of the closet and get some use out of it. This kit has all the parts you'll need including complete drawings and instructions. You can build it on your kitchen table. At only **\$4.95** it makes a good answer to that approaching question, "What do you want for Christmas?".

Two good books on steam are: **MODEL STATIONARY & MARINE STEAM ENGINES, \$5.50. MODEL BOILERS & BOILERMAKING, \$6.00.**

FREE with any order from this ad, a copy of the **CRAFTSMANSHIP CATALOG** usually sold for \$1.



**CALDWELL INDUSTRIES**  
Box 170 Luling, Texas 78648



## HEAVY DUTY WELDER

with special \$7.00 gift offer to

Popular Mechanics Readers  
**10-DAY FREE TRIAL**  
Lifetime Guarantee

Buy Factory Direct  
and Save **18<sup>95</sup>**  
POST PAID

Fits ordinary 110V outlet  
Not one - but 6 welding heats



Weld, braze, solder or cut most anything made of metal. No experience necessary. Follow simple instructions to make repairs on cars, trailers, farm and lawn equipment, bicycles, appliances, etc. Make campers, boats, furniture, hundreds of valuable items. **NOTHING ELSE TO BUY!** Comes complete with full face shield, pack of welding and brazing rods, heavy duty power cables, special electric torch attachment, ground clamp, flux, easy-to-follow illustrated instructions, rod holder, etc. Uses standard 1/4" rods to weld iron, steel, brass, bronze, aluminum, other metals. New improved HEAVY DUTY circuit gives more welding power. Gives 4 times the heat needed to melt toughest iron. Plugs into ordinary 110V outlet. **6 WELDING HEATS** for professional quality welding of "tough" to "light-weight" metals. 10 day **MONEY BACK GUARANTEE.** Lifetime parts and service guarantee. An excellent gift for any occasion. **FREE!** Mention you saw this ad in Popular Mechanics and receive a \$7.00 gift pack of welding rods free. For same-day C.O.D. shipment just call (713) 682-5681 or send only \$2.00 and pay postman \$16.95 plus small C.O.D. when delivered or charge to your BankAmericard or Master Charge card or for postpaid shipment send \$18.95 check or M.O. to **WEL-DEX, Dept.W-203 Box 10776, Houston, Tex. 77018.**

make  
**\$10**  
to  
**\$30**  
an hour!

## PREPARE TAX RETURNS

### Spartime-Fulltime

Fees of \$10, \$25, \$50 per return can add up to \$3,000 and more **EXTRA CASH!** All in your own business in just 3 months of the tax season. Thousands more operating year 'round tax services. Booming field—big repeat business. Learning easy, quick thru low-cost home training course. Complete help on how to start, grow fast. No bookkeeping or accounting needed. Write for **FREE** facts. No salesman will call.

**NATIONAL TAX TRAINING SCHOOL,**  
Monsey, 20WD, N.Y. 10952 • Accredited Member  
NHSC Approved For Vet Training



## BUILD THESE BEAUTIFUL CLOCKS



**NOW AT BIG SAVINGS!**

Send just \$1 for plans & instructions to build choice of: (A) Grandfather, (B) Steeple, (C) Grandmother—plus information-packed catalog of movements, dials, parts & kits to build these & 16 other fine clocks. All 3 plans—\$2.50. Catalog alone—25¢.

**MASON & SULLIVAN**  
Dept. PM, Osterville, MA 02655  
IN CANADA: COLONIAL TIMES  
Box 2 Stn S Toronto, Ontario M5M466

## WHAT'S HE DOING!

Making a Concrete  
Flower Pot! ... and  
**SO CAN YOU!**

Make and sell your own  
Ornamental Concrete items.  
**Rush \$3.00 for Book**  
about Aluminum Molds  
with prices and production trade secrets  
direct from world's largest mold manufacturer.  
Over 350 designs to select from.



Send **\$3.00** **CONCRETE MACHINERY COMPANY**  
Today To ➔ P. O. BOX A99 - HICKORY, N. C. 28601



SPECIAL OCT. 15 - DEC. 31 ONLY!

# FREE!!! \$37.<sup>95</sup> LATHE CHUCK

With your order for the UNIMAT 5-in-1 Metal Machine Shop

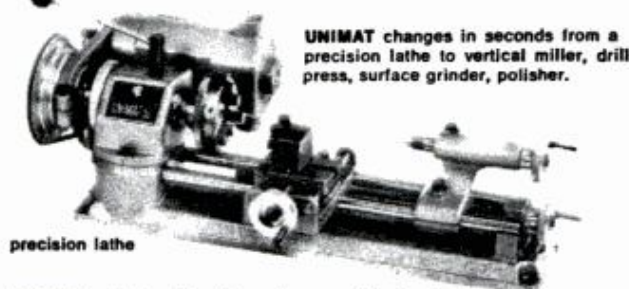

precision lathe

UNIMAT changes in seconds from a precision lathe to vertical miller, drill press, surface grinder, polisher.

UNIMAT is designed for the serious modelmaker, hobbyist and gunsmith who is satisfied with nothing less than professional accuracy in everything he creates. More than 100,000 UNIMATS in use all over the world.

This offer good from Oct. 15 thru Dec. 31 only. See your participating dealer now. If he cannot supply use handy order form to mail your order today. Prompt shipment.

only **\$199.<sup>50</sup>**

F.O.B. TENAFly, N. J.



DRILL PRESS



SURFACE GRINDER



VERTICAL MILLER

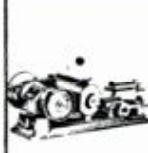

POLISHER

Now, from Oct. 15 thru Dec. 31 only, get a heavy duty 3-jaw chuck, that regularly sells for \$37.95, FREE with your purchase of a complete UNIMAT, the bench machine shop every home mechanic or hobbyist wants to own.

A wonderful Christmas gift for the model builder, the gunsmith and for any hobbyist who wants to make his own small metal, plastic or wood parts in a hurry. Famous self-powered UNIMAT, the precision lathe only 17" long, is also a vertical miller, drill press, surface grinder and polisher. Handles all machining operations including threading and boring. Change from one operation to another in seconds. Buy your UNIMAT during this special promotion period from your nearest participating dealer, and get this versatile chuck that also serves as a milling bed vise. Precision ground and balanced, reversible jaws, accurate to .003".

Use this coupon to send your order with check for immediate shipment. Order must be postmarked on or before Dec. 31, 1973.

AMERICAN EDELSTAAL, INC./ BK-3 /Tenafly, N. J. 07670

Rush complete catalog and list of participating Dealers

Here is my check (money order) for \$199.50 for a complete UNIMAT in its own carrying case. I understand I am to receive as a FREE bonus a 3-jaw Universal Lathe Chuck, that regularly sells for \$37.95. I further understand that UNIMAT carries a six month guarantee against defective parts and workmanship. (This special bonus offer expires Dec. 31, 1973)

Charge my purchases through:

Am. Exp.  Diners Club  Bank Americard  Master Charge

My Act. # is \_\_\_\_\_ Expiration date \_\_\_\_\_

Master charge Interbank (4 numbers over your name) \_\_\_\_\_

Signature \_\_\_\_\_

Name \_\_\_\_\_

Address \_\_\_\_\_

City \_\_\_\_\_ State \_\_\_\_\_ Zip \_\_\_\_\_

Here is \$2 for UNIMAT 44-pg. Handbook, "Miniature Machining Techniques"

## the 3,000 lb. LIGHTWEIGHT

The Slaymaker Lock'n Cable Kit will give you the year-round protection, durability, and lightweight convenience you need.

**The CABLE:**

- 3,000 lbs. of break strength.
- six feet of tough, galvanized aircraft steel.
- vinyl coated.
- flexible, easy to carry —lock and cable weigh only 1 lb.

**The LOCK:**

- laminated steel body, case-hardened steel shackle.
- rust and corrosion-proof solid brass cylinder.
- special pin-tumbler mechanism that retains key until lock is securely closed.

# Slaymaker

LOCK COMPANY

Lancaster, Pennsylvania 17604



# FREE

1974 LAFAYETTE CATALOG 740

*Ready Now!*

### Your Complete Electronics Buying Guide

- Stereo/Hi-Fi Components • CB Transceivers & Walkie-talkies • PA Systems • Tools & Test Equipment
- Police/Fire Monitor Receivers • Antennas • Photography Equipment • Ham Gear • Books, Parts, and More!

**Send Today!**

Lafayette Radio Electronics  
P.O. Box 10, Dept. 15113  
Syosset, L.I., N.Y. 11791

15113

NAME \_\_\_\_\_

ADDRESS \_\_\_\_\_

CITY \_\_\_\_\_

STATE \_\_\_\_\_ ZIP \_\_\_\_\_



# SOLID FORD

**With a new  
young look and a  
smooth  
and steady ride.**

There's more excitement than ever in the solid mid-size.

Outside, the Gran Torino's been restyled, with a gleaming new front end, a new rear end design and even an optional opera window. (Standard on Gran Torino Brougham.)

Inside, the Gran Torino Brougham's split bench seats (seen here) add a touch of luxury and convenience.

And while you can love Torino for



1974 Gran Torino Brougham shown with optional deluxe bumper group, electric rear window defroster and convenience group.



# TORINO '74



its looks, you can trust it because it's solid. Torino's suspension, wide track and long wheelbase help give it a smooth and steady ride that spells quiet comfort and confidence on the road. As do Torino's optional steel-belted radial ply tires and power front disc brakes.

See the complete Torino line at your Ford Dealers.

The closer you look, the better we look.



The solid mid-size.

## FORD TORINO

FORD DIVISION





## IMPORTS AND MOTORSPORTS

### Spridget kit



Pack up your troubles with your old kit car and try this brand-new one from England. We found out about it too late for last month's kit car story (See *Drop a New Body on the Old Buggy*, page 110, Oct. '73 PM). Most kit conversions use a VW chassis, but this kit turns any Spridget (Sprite or Midget model) made since 1958 into a very British sports car. The fiberglass front and rear sections give Spridgets the appearance of a combination of the Morgan, Triumph TR series and Lotus Seven. The photo below shows before and after views of a converted MG Midget. The kit car is called the Arkley SS after the village in Hertfordshire where the kits are made. Designer is John Britten, a British club-racing driver, who wanted to market a "typically English sports car" at an affordable price. His solution is this modification of the Spridgets which retain their twin-carb, 1275-cc engine and drive-line components. For more kit information, write to John Britten at Arkley Engineering, John Britten Garages, Ltd., Barnet Road, Arkley, Hertfordshire, England.

### Superstar car

Buried for 42 years in the sand on the coast of Wales, a famous land-speed record car runs again! It was in 1927 that driver Parry Thomas cranked over the 500-hp machine, nicknamed Babs, and ran it up to speed—almost 170 mph—in an attempt to shatter the land speed record of 174 mph, which was then held by Sir Malcolm Campbell. When the drive chain snapped, the car somersaulted, killing Thomas. The crashed car was left behind and was soon covered by the drifting sands. It was resurrected by a mechanical engineer, Owen Wyn Owen, who found it with the help of old maps and photos (and shovels). With the 27-liter Liberty aero engine roaring, he drove it for all to see last summer, following a four-year task of restoration.

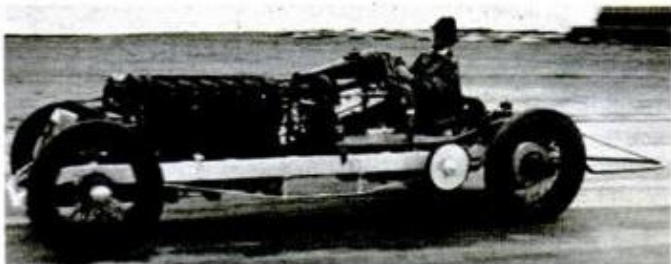

### Adam's apple

The General Motors subsidiary in West Germany, Adam Opel A.G., has a smart-looking new car that was just introduced at the

*(Please turn to page 64)*







## We'll pay you \$61.08 a weekend, or more, now. And pay you for life when you retire.

The money's important—but it's only one reason for prior-service men and women to join the Air Force Reserve. You've already invested a certain number of years. Put in time against your 20-year retirement benefits. Benefits civilian employment will hardly match. It's your insurance policy against the years coming. Why give it up?

For two days a month, plus two weeks a year, you can keep the investment you made, add to it, and reap the benefits.

And all the while, there's added income. Plus a chance to learn a new skill or improve your present one. Plus travel. Plus limited exchange privileges. Plus that feeling you've become so familiar with when you know you're doing a great job for your country.

All the reasons benefit you. Call 800-525-9984, toll free. (In Colorado call 800-332-9952.) Or send in the coupon. We'll give you the location of your nearest Air Force Reserve Unit.

**Air Force Reserve.  
Your Local Air Force.**

Air Force Reserve 3-PM-113

Box A  
Randolph AFB, Texas 78148

Please send me more information. I understand there is no obligation.

Name \_\_\_\_\_ Sex (M) (F)  
(Please Print)

Address \_\_\_\_\_

City \_\_\_\_\_

State \_\_\_\_\_ Zip \_\_\_\_\_ Phone \_\_\_\_\_

Soc. Sec. # \_\_\_\_\_ Date of Birth \_\_\_\_\_

Former Grade \_\_\_\_\_ Former Specialty \_\_\_\_\_



# free! 1974 Olson CATALOG



SAVE ON THE BEST  
AND NEWEST IN  
ELECTRONICS

- Stereo / 4 - Channel Systems
- Tape Recorders
- Radios • Phonos • Kits
- Amateur/Shortwave Gear
- CB • Antennas • Police/Fire Radios
- Calculators, Timepieces • Security
- Test Equip. • Parts, Tubes, Batteries, Wire, Hardware

**Olson** Electronics Dept. JM  
260 S. Forge St., Akron, Ohio 44327

Send My FREE 1974 Olson Catalog

**free!  
MAIL  
TODAY**

Name \_\_\_\_\_

Address \_\_\_\_\_

City \_\_\_\_\_ State \_\_\_\_\_

Zip

## Gift idea...



**freedom from  
flat tire worries!**

Every auto, motor home, trailer, boat or truck should carry a 12-volt Auto-Flator for convenience and emergency. Plugs into car lighter to inflate any size tire in minutes. Easily inflates air mattresses, boats, rafts, pools, air jacks, etc. Only 6½" long yet amazingly produces up to 60 lbs. pressure. With air hose, plug and inflator attachments. 10-day money back guarantee. Send check or P.O.

**\$2995**  
(plus \$1.00 shipping)

**Speedy auto-flator.**

Compressed Air From Car Lighter

**W. R. BROWN CORPORATION**

2773 N. Normandy Ave., Chicago, Ill. 60635

## IMPORTS AND MOTORSPORTS

(Continued from page 62)

Frankfurt International Auto Show. The new model is still called the Kadett, a name that has dropped from our vocabulary here since Opel has gone to the 1900 and Manta logos. It's a small, practical car, but GM Overseas Operations says there are no plans to bring it in at U.S. ports of entry.



### Citroen hum-m-ms a pas de deux

If you're a Wankel fan, the new Citroen GS Birotor will double your pleasure and double your hum-m-m. The new GS, introduced at the Paris Auto Show, mounts a two-rotor Wankel from the European Comotor engine works. Comotor is a joint venture of NSU and Citroen that was formed in the late '60s to develop and produce Wankels for passenger-car use. The GS Birotor displaces 1900 cc and goes on sale in France early next year.



### Shoehorned V8

The MGB GT V8 sounds impossible, but it's been done. In England, British Leyland Motors markets the GT with two heads under one bonnet: They've stuffed the Rover 3.5-liter V8 in the engine compartment and performance is incredible. You can't buy the V8 version here, but now that you know it's possible you can do it yourself. ★★★



# IF YOU'VE NEVER OWNED A CHAIN SAW, YOU NEED ALL THE HELP YOU CAN GET.

With literally hundreds of chain saws to choose from, how in the world are you supposed to know which one will end up being right for you?

That's exactly what we at Homelite had to ask ourselves when we set out to design your first chain saw.

## SHOULD YOUR FIRST CHAIN SAW HANDLE LITTLE JOBS? OR BIG JOBS?

Chances are you're going to use your chain saw for little jobs. Like pruning trees and clearing brush.

And big jobs. Like cutting trees and firewood.

So to make both jobs less like jobs, we designed your first chain saw with a separate trigger for each of them.

For the little jobs, the XL2 has a trigger up front.

This lets you get right up on top of your work, when you need really tight control.

And we put a second trigger in the rear for the big jobs.

Which gives you greater leverage and a fantastic sense of power.

## HOW LIGHT SHOULD YOUR FIRST CHAIN SAW BE?

We weighed the Homelite XL2 in at 7¼ pounds.\*

Light enough to make it easy to handle. Heavy enough so it doesn't feel like a toy.

## HOW CHEAP SHOULD YOUR FIRST CHAIN SAW BE?

In designing your first chain saw, we at Homelite had to decide whether to give you an extremely low price and very little chain saw. Or a lot of chain saw and sell it at a price we could both live with.

This will give you an idea of what we decided:

Your first chain saw has a 12" guide bar with the same Power-Tip® sprocket nose that professional

loggers use to boost their cutting power.

Your first chain saw has an all-weather ignition so that it starts when you want it to start.

Your first chain saw has an automatic chain oiler.

Your first chain saw has a rugged carbon steel saw chain and die cast magnesium housing.

And it has all these things at a price we think is rather irresistible.

**\$119.95.**

After all, what would be the point of designing your first chain saw if we couldn't first lure you into buying it.

**HOMELITE® XL2**  
WITH TWO TRIGGERS.  
A FRONT TRIGGER FOR LITTLE JOBS.  
A BACK TRIGGER FOR BIG JOBS.



**BUY THE XL2 NOW  
AND GET THIS  
\$9.95 CARRY CASE FREE.**

\*Less bar and chain.  
Carry case offer expires Dec. 31, 1973

HOMELITE A  DIVISION - FORT CHESTER, N.Y. 10673 SUGGESTED RETAIL PRICE \$119.95. For the Homelite dealer nearest you, check the Yellow Pages under Saws.



# IF YOU HAVE STEREO, YOU ALREADY OWN HALF A 4-CHANNEL SYSTEM! ADD THE 2nd HALF FOR 164.95. BY REALISTIC®.

Save 17.45 off our "each" prices for everything you need to move up to true quadraphonic sound!

Your stereo components are ready and waiting for easy updating to 4-channel. Our SQ-II Decoder unscrambles all matrixed 4-channel records, tapes and FM broadcasts and even adds a 4-channel effect to regular stereo. Add it, and our SA-175B Amplifier plus two deluxe Baffle/Speakers to your system, and hear sound from front and rear, left and right — the way you hear actual "live" music. Simple hookup, no internal rewiring. Get a demonstration at any of 2000 Radio Shack stores in all 50 states!



SQ-II Decoder Alone **39<sup>95</sup>**

Price may vary at individual stores.



**FREE '74 CATALOG** 274  
AT YOUR NEARBY STORE OR MAIL THIS COUPON

180 Pages . . . Full Color! Hi-Fi, CB, Kits, Recorders, Antennas, Parts, More!

PLEASE PRINT CLEARLY

Name \_\_\_\_\_ Apt. # \_\_\_\_\_  
Street \_\_\_\_\_  
City \_\_\_\_\_ State \_\_\_\_\_ ZIP \_\_\_\_\_

## REALISTIC

Now Playing at Over 2000 Stores in ALL 50 States

# Radio Shack®

and ALLIED RADIO STORES  
A TANDY CORPORATION COMPANY

P.O. Box 1052, Fort Worth, Texas 76107

## MAKE BIG MONEY IN EITHER OF THESE TWO FIELDS



### TRACTOR-TRAILER DRIVER

We can train you to operate the big diesel rigs. Study at home followed by practical training at school-owned facilities in Miami, Fla. Accredited Member NHSC. Home Office — Miami, Fla.

APPROVED FOR VETERANS AND INSERVICE PERSONNEL

### HEAVY EQUIPMENT OPERATOR

Learn to operate cranes, draglines, scrapers, clamshells, bulldozers, backhoes, trenchers. Study at home followed by practical training at school-owned facilities in Miami, Fla. Accredited Member NHSC. Home Office — Miami, Fla.



UNIVERSAL TRAINING SERVICE, Dept. PM  
1901 N.W. 7 St., Miami, Fla. 33125 • Phone: (305) 642-0800

- TRACTOR-TRAILER DRIVER  
 HEAVY EQUIPMENT OPERATOR

PLEASE PRINT

Name \_\_\_\_\_  
Address \_\_\_\_\_  
City \_\_\_\_\_ State \_\_\_\_\_  
Zip \_\_\_\_\_ Phone \_\_\_\_\_ Age \_\_\_\_\_

# SUBSCRIBER'S

## Change of Address Form

Please use this form to notify us at least six weeks before you move to your new address.

1. **Present address:** Attach address label from a recent issue, or print your name and address exactly as shown on the label.

NAME \_\_\_\_\_  
ADDRESS \_\_\_\_\_  
CITY \_\_\_\_\_ STATE \_\_\_\_\_ ZIP \_\_\_\_\_

2. **Fill in new address:**

NAME \_\_\_\_\_  
NEW ADDRESS \_\_\_\_\_  
CITY \_\_\_\_\_ STATE \_\_\_\_\_ ZIP \_\_\_\_\_

3. **Mail this form to:**

**POPULAR MECHANICS**  
Subscription Service Dept.  
Box No. 646  
New York, N.Y. 10019





**"For an amateur,  
he's a whiz.  
How'd he get  
so good?"**

Whatever practical skills you've been wanting to develop, Audel has comprehensive, step-by-step Guides to help you. They show you all the professional tricks of the trades

in clearly diagrammed and illustrated "how-to" steps. They can save for you, over and over. Here are four of Audel's many fields . . .



**CARPENTERS AND BUILDERS LIBRARY**

1612 pages of the latest information on modern construction in four volumes. They cover every phase of carpentry from foundations to finishing with easy-to-grasp, step-by-step instructions . . . all illustrated with thousands of diagrams, charts and photos. No. 23169 — 4 Volumes — \$18.50

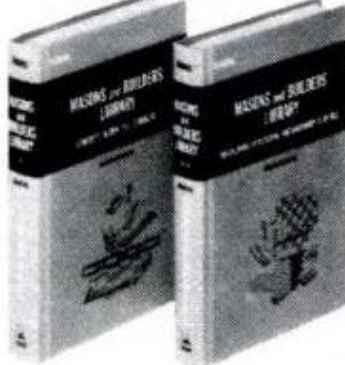

**MASONS AND BUILDERS LIBRARY**

Two illustrated volumes on the science of masonry and bricklaying. Packed with how-to information and directions, rules, processes, definitions, formulas, diagrams, tables, estimating. A complete and authentic trade reference library. 752 pages. No. 23185 — 2 Volumes — \$11.25



**PLUMBERS AND PIPEFITTERS LIBRARY**

A valuable 3-volume guide to the principles, methods and short cuts of modern plumbing. Tools, fittings, fixtures, installation, drainage, welding and much more are all covered in these fully illustrated, easy to understand volumes. No. 23155 — 3 Volumes — \$13.50

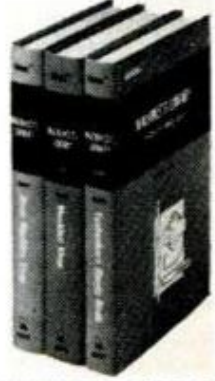

**MACHINISTS LIBRARY**

Three books covering the entire field—1216 profusely illustrated pages on practical fundamentals of basic machine shop operations, setup and operation of spot machines, down-to-earth data on toolmaking procedures, layouts, jigs and fixtures, etc. . . . equally valuable for beginners and experienced men alike. No. 23174—3 Volumes—\$16.95

**MONEY BACK GUARANTEE**

Send no money! We'll send you any Audel Guides for 10-day FREE EXAMINATION. If you keep them, you may use our easy payment plan. If not completely satisfied, return them for refund.

**THEODORE AUDEL & CO.**  
Division of  
Howard W. Sams & Co., Inc.  
Indianapolis, Indiana 46268



**SEND NO MONEY—10-day FREE EXAMINATION**

Theodore Audel & Co.—Self Improvement Publishers since 1879  
4300 West 62nd Street, Indianapolis, Indiana 46268

Please mail me for 10 days' FREE EXAMINATION the books I have checked at right. I agree to mail \$3 in 10 days for each set ordered and to further mail 1/3 of the purchase price 30 days later, with balance plus shipping costs to be mailed within another 30 days. I may return the books for refund if not completely satisfied.

Save shipping costs. Check here  if you enclose full payment (plus sales tax, if any). We will pay postage charges. You have same return privilege.

Name \_\_\_\_\_  
Address \_\_\_\_\_  
City \_\_\_\_\_ State \_\_\_\_\_ Zip \_\_\_\_\_

- P-113
- 23169
  - 23185
  - 23155
  - 23174



# EXTRAORDINARY OFFER!

To Help You Start

## YOUR OWN BUSINESS



### No Money Down

Start in sparetime; build a money-making full-time business in your garage or basement. We'll start you in business with No Money Down. Your earnings easily cover the low monthly payments. Sharpening saws is an important service in any neighborhood or small town—You can earn \$3 to \$6 an hour sharpening hand, band or circular saws.

### No Experience! No Selling

The easy-to-operate Foley Saw Filer is automatic—it does the job for you. You can be doing business the day after you receive your machine. And with a saw filing business customers will come to you. No door to door selling! You are supplying a service they need. If you'd like more information about this unique business opportunity, return coupon (no salesman will call) and we'll send you our fact-filled

#### MONEY-MAKING BOOKLET FREE!

Foley Manufacturing Co.  
1143-3 Foley Bldg., Minneapolis, Minn. 55418  
Send for FREE book on Money-Making facts about the sharpening business.

NAME \_\_\_\_\_

ADDRESS \_\_\_\_\_

CITY \_\_\_\_\_ STATE \_\_\_\_\_ ZIP CODE \_\_\_\_\_



## GRIND-O-FLEX FLEXIBLE

### ABRASIVE WHEEL REMOVES RUST

Thousands of abrasive cloth flaps per minute remove rust and polish — old tools, gutters, sash, antiques... any flat or contoured surfaces. Removes paint too. Fits 1/4" drill or bench motor.

**MERIT ABRASIVE PRODUCTS, INC.**

201 W. Marville, Compton, Ca. 90224

ORDER YOUR 6" DIA. WHEEL BY MAIL \$7.95

Price includes all postage and handling. No C.O.D.s

FREE Home Workshop Brochure PM



### "GROUNDED" OUTLET TESTER



New GT-20 Tester tells if your AC outlets are safely grounded. Amber lights show if power is OK. Red indicates reverse polarity, faulty connections or absent grounds. Simple to use & carry, hi-impact. Ideal for home, shop, campers, electricians, maintenance men, etc. \$7.95 PREPAID. Two prong adapter 75¢.

**ALCO** BOX 1348-PM-1  
Lawrence, Ma. 01840



## Solve Your HANG-UPS

Magnabar Mark XII. Lifetime guarantee, convenient, practical, versatile, trouble-free. Fashioned in 12" hardwood, singly boxed. Mounts quickly on any surface. Excellent gift. Model SS-12: \$4.95 p.p. each.



**Phelon Magnagrip Company, Inc.**

East Longmeadow, Mass. 01028

Send check or M.O. to Dept. A119

## FLAMETHROWERS



**STOP DRIVING BEYOND YOUR LIGHTS**  
150,000 candlepower sealed beams. Over 2½ times as bright as stock high beams. No alterations, fit bright sockets on quad (4) light 12 volt systems. \$11.95/pair  
Cash, check or M.O. no c.o.d. please  
Warren Enterprises, Box 563 M  
Skokie, Illinois 60076

EXTEND YOUR DRIVING LINE OF SIGHT



WHITE'S METAL DETECTORS

WHITE'S ELECTRONICS, INC. manufacture the World's Largest and Finest Line of Mineral and Metal Detectors. Ghosttowning, beachcombing, bottle hunting, coin hunting—all types of TREASURE HUNTING or PROSPECTING, amateur or professional. Detect conductive metals—Gold, Silver, Copper Nuggets—Coins—Rings—Jewelry, etc. Underwater or on the land. "There are no finer at any price" 25 production models to choose from—T.R. or B.F.O.

Priced from \$250 up  
—Always specify the Blue & Gold  
ASK FOR WHITE'S BY NAME

—Free Literature—  
WHITE'S ELECTRONICS

Rm. No. 512  
1011 Pleasant Valley Rd.  
Sweet Home, Oregon  
23784 Hazel Street  
Abbotsford, B.C., Canada  
Elk Air Industrial Park  
Dexter Drive, East  
Elkhart, Indiana 46514



# FREE BURPEE SEED CATALOG

Newest Hybrids • Exclusive Varieties

The newest Burpee catalog has over 600 photos, 175 in color, featuring dozens of exciting new hybrid flowers and vegetables. It contains over 1400 flowers, vegetables, fruits, shrubs, trees and garden aids. Many new plants and famous favorites are available only from Burpee, America's leading breeder of flowers and vegetables for the home gardener. Send for your free copy today.

W. ATLEE BURPEE CO., 5074 Burpee Bldg., Phila., Pa. 19132 • Clinton, Iowa 52732 • Riverside, Cal. 92502.



# People pay a lot of money to these men. You can be one of them soon.



**Electronics Technician.**



**Automotive Technician.**



**Air Conditioning  
Refrigeration Technician.**



**Home Appliance  
Technician.**

You know what technicians charge to repair your TV set, your car, refrigerator or washing machine. The men who can do the job — and do it right — get paid very well indeed.

**Join** them! Be a technician and let people pay **you** for a change.

National Technical Schools will train you at home the professional way — with profes-

sional instruction, tools and test equipment, the kind of equipment you'll be using on actual jobs. It makes home training practical and more fun. And you get to **keep** all of the tools and equipment.

Choose the kind of technician you want to be. **Then** mail the card for free color catalog. No obligation. No salesman will call.



### NTS Electronics Division

Multiply your income with space age skills in Computer Electronics. Color TV & Radio Servicing, Automation/Industrial Electronics or Electronic Communications. Courses include valuable kits such as 315 sq. in. Solid State Color TV, Solid State B&W TV, 2-way Radio Transceiver, Compu-Trainer, Oscilloscope, and more. Check card for new **FREE** Color Catalog, complete details.



### NTS Mechanics Division

NTS puts you into America's #1 industry fast. Start earning almost as soon as you begin. You get 109-piece Socket Wrench & Tool Set with case and professional 8-unit diagnostic test equipment, yours to keep. Plus bonus Speed Shop lessons. Check card for new, free color catalog and complete details on all four courses and equipment.



### NTS Air-Conditioning/ Refrigeration, Heating Division

Install and maintain today's complex air-conditioning, refrigeration, and heating systems. As an NTS master technician you can handle any job. Or you can go into your own business. "Project Method" makes your training interesting with all new Hermetic Analyzer, tester, and other valuable instruments. Send for new catalog. Check card today.



### NTS Home Appliance Division

Boost your income, build a new career, start a business of your own. Learn the professional way to service ranges, washing machines, dryers, home air-conditioners, and other appliances. We'll supply everything you need, including the New Exclusive Circuit Trainer, 4 in 1 Appliance Tester and complete set of fine hand tools. Check Card.

**MAIL CARD NOW  
FOR FREE  
CATALOG &  
SAMPLE LESSON**



**APPROVED FOR VETERAN TRAINING**

### Classroom Training at Los Angeles.

Train in sunny Southern California. NTS occupies a city block with over a million dollars in training facilities. Check special box on card.

## NATIONAL TECHNICAL SCHOOLS

WORLD-WIDE TRAINING SINCE 1905

Resident & Home Study Schools

4000 So. Figueroa St., Los Angeles, Calif. 90037

Accredited Member: National Association of  
Trade & Technical Schools,  
National Home Study Council.



## SCIENCE WORLDWIDE



### Lab hailstones test windshields

Some crashes that defy explanation may be caused by hailstones smashing an airplane's windshield or penetrating its skin. That's the thinking of British researchers who use a helium-powered gun to fire man-made hailstones at airplane windshields of different types of composition. Projectiles of frozen distilled water are fired at speeds up to 1700 mph. In size, they match hailstones encountered between 10,000 and 30,000 feet, and are as large as two inches in diameter.

Object of the tests is to find airplane components that will stand up to the icy projectiles in the sky.

### No mums for mom if she's allergic

If you give your wife a bouquet of fall flowers and she breaks out in a rash, chances are she's allergic to chrysanthemums. This popular flower is one of the most common causes of skin rash, according to a recent report in *Archives of Dermatology*, a professional journal. The potency of mums was established in tests with human subjects known to be allergic to certain substances. Researchers gave the offensive ingredient in mums the forbidding name "sesquiterpene lactones"—a substance that is also found in tulip bulbs.

### How do green plants do it?

The ability of green plants to convert sunlight into chemical energy is under study by University of Michigan scientists. Their goal: to find a new approach in the design of a device that will collect sunlight and convert the energy to electricity. "Ideally, we would like our device to be both small enough and economical enough for the home," say the scientists.

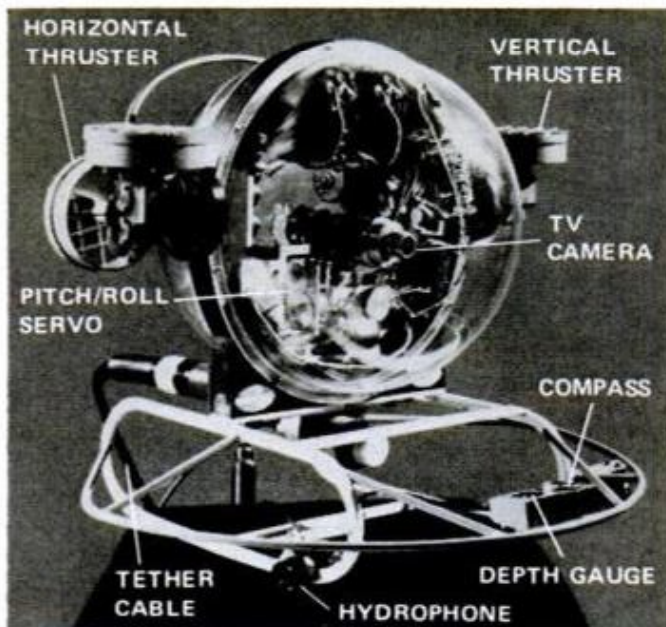

### TV eye for underwater work

A new device for underwater inspection work is Anthro, a remotely controlled submersible with a 20-inch-diameter plastic bubble for a hull. A television display and propulsion controls—on board ship or on dry land—are connected to the vehicle by an umbilical. Anthro's TV camera is electronically "slaved" to the operator's head. As he moves his head, the scene he views is moving in exact synchronization. Headphones provide binaural sound—transmitted from hydrophones aboard Anthro—as an additional aid in orienting the vehicle. (If Anthro bumps into anything, the bump

(Please turn to page 70D)



# LIVE IN THE WORLD OF TOMORROW...TODAY!

**A BETTER LIFE  
STARTS HERE**

## ACTUAL WORKING SOLAR HOME PLANS



Learn all about the most fascinating possible home of the future. It can be your "now" answer to today's energy crisis in housing. Expert Dr. Harry E. Thomason tells advantages, problems, savings, and more in this important 20-pg fact-filled booklet. Also includes 8-page oversized insert of basic, actual solar home plans, a valuable guideline to you and your architect in fitting space requirements, design ideas, and local area building codes.

No. 9440H (Solar House Plans) \$10.00 Ppd.

## "FISH" WITH A MAGNET

Go treasure hunting on the bottom! Fascinating fun & sometimes profitable! Tie a line to our powerful new specially designed 150 lb. pull Magnet—drop it overboard in bay, river, lake or ocean. Troll it along bottom—your "treasured" haul can be outboard motors, anchors, other metal valuables. Has 6 stacked ceramic magnets. Lifts more than 150 lbs. under water!

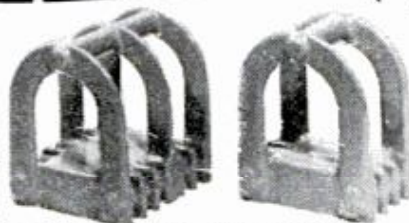

No. 71,135H ..... (3 1/4 x 3 3/8") ..... \$16.50 Ppd.  
75-LB. PULL (1 LB.) W/ 3 CERAMIC MAGNETS  
No. 71,150H ..... (1-11/16 x 3 1/4") ..... \$10.25 Fpd.

## GIANT WEATHER BALLOONS— 8' or 25' DIAMETER

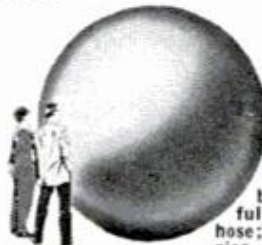

"Balls of fun" for kids, traffic stoppers for stores, terrific for amateur meteorologists. Create a neighborhood sensation. Great for decorations, launching radio controlled airplanes, scuba diving markers, etc. Amateur meteorologists use to measure cloud heights, wind speed and temperature. Made of thin neoprene designed to burst at high altitudes. Inflate carefully with vacuum cleaner or auto air hose; or locally available helium for high rise.

Stock No. 60,568H (8' size) . . . \$ 2.50 Ppd.  
Stock No. 60,632H (25' size) . . . \$13.95 Ppd.

(And our FREE CATALOG is packed with exciting and unusual ecological & physical science items—plus 4,500 finds for fun, study or profit . . . for every member of the family.) Great for unusual Christmas gifts!

## 3" ASTRONOMICAL TELESCOPE



See moon shots, orbits, stars, phases of Venus, planets close up. 60 to 180 power. New improved aluminum, overcoated 3" diam. f/10 primary mirror, ventilated cell. Equatorial mount with locks on both axes. 60x eyepiece and mounted Barlow lens. 3x finder telescope, hardwood tripod. FREE: "Star Chart," "How To Use Your Telescope" book.  
Stock No. 85,050H ..... \$34.95 Ppd.  
DELUXE 3" REFLECTOR TELESCOPE \$62.50 Ppd.  
Stock No. 80,162H ..... \$145.00 Ppd.  
4 1/4" Reflector Telescope with Clock Drive  
Stock No. 85,107H ..... \$110.00 FOB  
4 1/4" REFLECTOR TELESCOPE (45x to 270x)  
Stock No. 85,105H ..... \$110.00 FOB  
6" REFLECTOR TELESCOPE Stock No. 85,187H ..... \$215.00 FOB  
6" REFLECTOR W/ (ELECTRIC) CLOCK DRIVE  
No. 85,086H ..... \$249.50 FOB

## RESTORE MOST METAL SURFACES

. . . in minutes with ingenious Electroplating Kit. Brush on or dip for durable finish on 1000's of things: jewelry, guns, antiques, cameras, silver, printed circuits, parts of car bumpers, scopes. Safe, non-cyanide process makes objects like new almost instantly. Kit has all you need except 2 AA batt for up to 100 sq. in. instr.



No. 61,003H ..... (SILVER) ..... \$11.00 Ppd.  
No. 61,004H ..... (GOLD) ..... \$28.00 Ppd.  
No. 61,005H ..... (CHROME LIKE) ..... \$5.00 Ppd.  
No. 61,009H ..... (BLACK VELVET) ..... \$10.00 Ppd.

## TERRIFIC BUY!

### AMERICAN MADE! OPAQUE PROJECTOR



Projects illustrations up to 3" x 3 1/2" - enlarges them to 35" x 30" if screen is 6 1/2 feet from projector. You get even larger pictures if screen is farther away. No film or negatives needed. Primarily intended for children, this unit projects charts, diagrams, in color or black & white. 115v A.C. . . . 6-foot cord and plug are included. Size is 12" x 8" x 4 1/2" wide. Weighs just 1 lb. 2-ozs. Comes with a sturdy plastic case.

Stock No. 70,199H . . . \$8.75 Ppd.

**MAIL COUPON FOR  
GIANT FREE  
CATALOG!**

164 PAGES • MORE THAN  
4500 UNUSUAL BARGAINS!

Completely new Catalog. Packed with huge selection of telescopes, microscopes, binoculars, magnets, magnifiers, prisms, photo components, ecology and Unique Lighting items, parts, kits, accessories . . . many hard-to-get surplus bargains. 100's of charts, illustrations. For hobbyists, experimenters, schools, industry.

**EDMUND SCIENTIFIC CO.**  
300 Edscorp Building, Barrington, N. J. 08007  
Please rush Free Giant Catalog "H"

Name \_\_\_\_\_  
Address \_\_\_\_\_  
City \_\_\_\_\_ State \_\_\_\_\_ Zip \_\_\_\_\_



**ORDER TODAY! COMPLETE AND MAIL**

**EDMUND SCIENTIFIC CO.**

300 Edscorp Building, Barrington, N.J. 08007

How Many	Stock No.	Description	Price Each	Total

PLEASE SEND  GIANT FREE CATALOG "H" **MERCHANDISE TOTAL**  
**ADD HANDLING CHARGE\*** \_\_\_\_\_  
**TOTAL** \_\_\_\_\_

I enclose  check  
 money order for \$ \_\_\_\_\_

NAME \_\_\_\_\_

ADDRESS \_\_\_\_\_

CITY \_\_\_\_\_ STATE \_\_\_\_\_ ZIP \_\_\_\_\_

\*\$1.00 ON ORDERS UNDER \$5.00  
\*50¢ ON ORDERS OVER \$5.00





# COLLECTOR CLASSICS

**Authentic! Full Size Machined Metal Models  
Disassembles Like Originals — Over 30 Parts**

Museum quality precision machined metal classics look, feel, weigh like real guns. Will fool experts. Perfectly legal—**CANNOT BE FIRED**. Blued and disassembles like originals. Decorate your den, office rec-room. Send for free color brochure of 35 famous historical to classic military firearms. Each model made of over 30 blued, hand-finished parts—delivered fully assembled.

**METAL MODELS FOR DISCRIMINATING COLLECTORS**  
(Money back guarantee.)



**Model 1776 Flintlock Pistol**  
Carried by Continental soldiers in Revolutionary War—A classic reproduction of old world craftsmanship—#830 ONLY \$39.95.

**U.S. Model 1851 Navy Colt**  
Used by Union & Confederate troops in U.S. Civil War—#400 ONLY \$26.95.



**U.S. Model 1873 Western Peacemaker**  
Legendary firearm of old west. Choice of frontier sheriffs & Texas Rangers—#101 ONLY \$24.95.



**U.S. cal. 45 Service Automatic**  
Trusted sidearm of U.S. troops in W.W. I, W.W. II & Korea—Rated best military pistol in the world. #300 ONLY \$24.95.

**German P-08**  
By Geo. LUGER—German officer pistol—Prized souvenir in W.W. I & W.W. II #200 ONLY \$26.95.

**MADE OF OVER 30 PARTS AND CAN BE DISASSEMBLED.  
ALL MODELS ARE SAME SIZE & WEIGHT AS ORIGINALS**

## COLLECTOR CLASSICS, LTD.

Dept. PM-11 610 Franklin St., Alexandria, Virginia 22314

Send #101  #200  #300  #400  #830

Enclosed \$..... Add \$1.25 postage per model

Charge to my:  BankAmericard  Mastercharge

Am. Ex. #.....

Name .....

Address .....

City/State/Zip .....

SEND FREE CATALOG OF OVER 35 MODELS.

## MAN-SIZE TRACTOR

**Works faster, saves you time**



Whiz through tough jobs with this big, powerful tractor. Mow 3 acres an hour; plow, till, bulldoze, remove snow fast with 21 big attachments. 14 H.P. More work-power with all-gear drive (no fluid power loss), automotive clutch, transmission and differential. Free catalog, prices.

**ECONOMY TRACTOR**  
1005 K-11 Anoka Avenue  
Waukesha, Wis. 53186

## locksmithing and key making

**PRACTICAL UP-TO-DATE COURSE — ONLY \$7.95**



Teaches you how to pick locks, de-code, make master keys, repair, install, service, etc. New self-instruction lessons for every handyman, homeowner, carpenter, mechanic, service station operator, fix-it shop, hardware dealer, gunsmith. 53 easy illustrated lessons. Full price only \$7.95 post-paid. Satisfaction or refund guaranteed. Mail order today!

**NELSON-HALL CO., Dept. 6LX-2**  
325 W. Jackson Blvd., Chicago 60606

70D POPULAR MECHANICS

## SCIENCE WORLDWIDE

(Continued from page 70B)

is heard topside.) Movement of Anthro—forward, reverse, up and down—is by hand controls. Device was developed by Hydro Products, San Diego.

## A real wet spot in sunny Hawaii

Though a number of areas in the Hawaiian Islands suffer from drought, Mount Waialeale, a 5148-foot peak, is the wettest known spot on Earth, according to the U.S. Geological Survey. Located near the center of the island of Kauai, Mount Waialeale is oriented in such a way that its sheer walls tend to pull in prevailing trade winds and “wring” moisture from them.

The peak is a unique laboratory, say Geological Survey scientists, allowing them to study the complexities of the hydrology of Pacific Island environments. Hydrologists have been measuring rainfall on Mount Waialeale for the past 62 years.

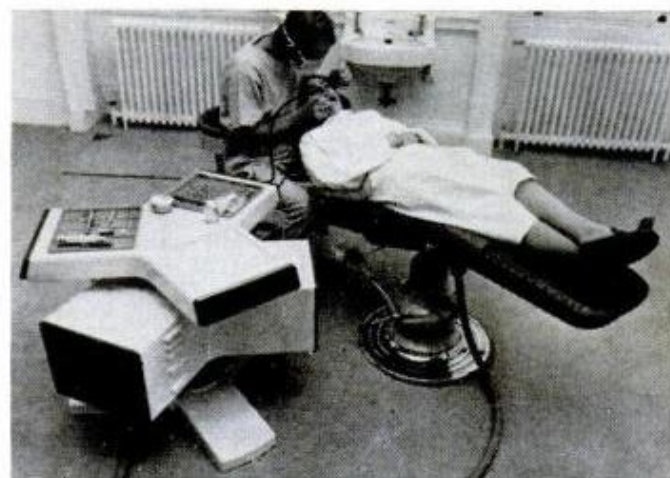

## Dental equipment goes modern

There's little resemblance between the conventional dental chair and a new dental system created by a British designer. The main component is a service module containing just about everything a dentist needs—instrument trays, X-ray unit, high-speed drill, and air, water and suction lines. A hydraulic umbilical connects the service module with the patient's chair; any adjustment in chair height is relayed to the module, which automatically moves up or down so that it remains at a comfortable working height. The system is not yet on the market.

★★★





CARPET DETERGER



UPHOLSTERY DETERGER



WALL DETERGER

# PART TIME or FULL TIME

*have your own  
money-making  
business*

**You offer a service everybody needs . . . work part time or full time . . . own your equipment . . . keep all you earn . . . start with just a small investment . . . and we help you every step of the way!**

Have your own money-making business and make the kind of income you probably thought impossible. You can when you clean carpeting or upholstery or walls with Von Schrader professional cleaning equipment. Every home, every building, are potential customers. And every customer represents repeat business.

Moreover, we help you every step of the way . . . just as we have helped thousands of other Von Schrader Associates build money-making businesses for almost 40 years. Here are some comments. Carpet: "You people sure helped me and I'll never forget it. I'm averaging about \$18,000 a year."—*H. Kendall*. "During first 2 months made \$2500 net."—*R. Pflong*. Upholstery: "One day I did a \$135 job. Best week was \$500."—*C. Lambert*. "We passed over the

\$450 mark in five days."—*T. E. Baylor*. Wall: "I work just 2 or 3 days a week. Best month was \$1200."—*J. R. Johnson*.

There are three easy-to-operate Von Schrader Detergers. You need no special skills. Each offers a proven way to a growing income. (1) Von Schrader Carpet Deterger gives deep-level cleaning to carpeting. (2) Von Schrader Upholstery Deterger cleans fabrics and synthetics beautifully. (3) Von Schrader Wall Deterger cleans walls (and ceilings) five times faster than by hand.

You can start with just one Deterger. Then, as your business keeps growing, you may want to add the other two and thus offer a complete cleaning service.

There are no fees, royalties, or contracts. There's no franchise involved to shackle you with giving up part of your income. Instead, you own your equipment, keep all you earn. Cost of the equipment is so small you may find it hard to believe. What's more, we help you get started and continue to help afterwards. For complete information—without any obligation—send for the interesting free booklet.

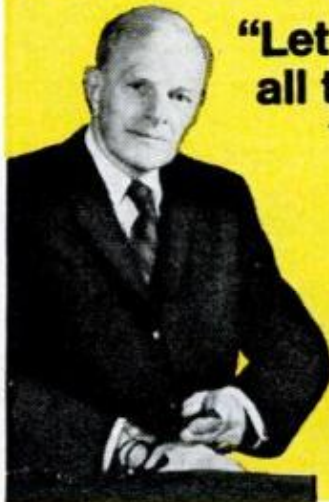

**"Let me send you our free booklet that gives all the facts"**

—Francis von Schrader, President

Read about the big demand for on-location cleaning, see why Von Schrader Detergers are the finest of their kind, how easy they are to operate. Learn how other men have become financially independent, how Von Schrader helps you every step of the way. Fill in the coupon and send for free booklet.

**Extra! Special Recorded Message included with booklet.** Listen as Francis von Schrader talks to you personally about your growing future with Von Schrader Detergers.



These proven ways to your own profitable business with Von Schrader Detergers

39 years of helping people earn good money

**VON SCHRADER company**

10114 Place, Racine, Wisconsin 53403

Please send complete information on Von Schrader Detergers.

Name \_\_\_\_\_

Address \_\_\_\_\_

City \_\_\_\_\_

State \_\_\_\_\_ Zip \_\_\_\_\_



# APPLIANCE CLINIC

BY PAUL MANN

## Selecting the right refrigerator size

I have received a number of letters from readers asking for guidelines to use in determining what size they need when purchasing a new refrigerator. The chart below provides average figures that should prove helpful. It is based on information supplied by the General Public Utilities Corp.

Size of Family	Shopping Frequency	Refrigerator Space Needed (cu. ft.)	Freezer Space Needed (cu. ft.)
1	Once or more a week	8	3
	Twice a month	9	4
	Once a month	9	5
2	Once or more a week	10	4
	Twice a month	10	4
	Once a month	10	6
3	Once or more a week	11	4
	Twice a month	12	5
	Once a month	12	6
4	Once or more a week	11	4
	Twice a month	12	6
	Once a month	12	8
5	Once or more a week	12	4
	Twice a month	12	6
	Once a month	14	10
6	Once or more a week	13	6
	Twice a month	13	6
	Once a month	14	11
7	Once or more a week	15	6
	Twice a month	15	7
	Once a month	16	12

## Dispenser replacement

*I have a Whirlpool front-loading portable dishwasher that needs a new detergent dispenser. Can I replace it myself?—Vincent Cellucci, Philadelphia.*

I don't see why not. Your first task is to get new parts. These come in a detergent-dispenser replacement kit, which can be obtained from a Whirlpool dealer. The part number of the kit for your portable machine is 569383. It costs \$3.08. If you can't get the kit from a dealer in your area, write the Customer Assurance Dept., Whirlpool Corp., St. Joseph, Mich. 49085, and you'll get assistance.

To remove the old detergent dispenser and replace it with the new one, disconnect the dishwasher from its power source and remove the front panel. Disconnect the wiring harness lead to the dispenser coil at the molded connector. Now, simply remove the four screws holding the dispenser assembly to the interior door panel, open the door and lift the dispenser out.

Reverse the procedure to install the new dispenser, making certain that the detergent-dispenser gasket is seating squarely when you secure the dispenser to the interior door panel.

## No-defrost warning

*Our Frigidaire refrigerator-freezer, about 15 years old, is supposed to be self-defrosting. However, the freezer compartment no longer self-defrosts. The unit has served us well, and we hate to part with it if it can be repaired. Please advise.—E. T. Dahlin, Fort Wayne, Ind.*

It can be repaired, but this will be expensive. What probably happened is common in machines that have seen long service. The freezer compartment is supposed to begin self-defrost at about minus 5° F. If the inside of the compartment doesn't reach this temperature, the unit will continue to freeze food satisfactorily, but won't kick into self-

(Please turn to page 70H)





**NRI Appliance Training Division**  
 3939 Wisconsin Avenue  
 Washington, D.C. 20016

600-113

Send me your illustrated **FREE CATALOG** that tells about opportunities in Servicing Electrical Appliances, and gives details of NRI's low-cost training plan. I understand there is no obligation. No salesman will call.

Name \_\_\_\_\_ Age \_\_\_\_\_

Address \_\_\_\_\_

City \_\_\_\_\_ State \_\_\_\_\_ Zip \_\_\_\_\_

**CHECK HERE FOR FACTS ON GI BILL**

If you have served since January 31, 1955,  
 or are in service now, check box above.

MAIL COUPON ABOVE FOR THIS

**FREE NRI  
 CATALOG**

# Learn professional methods of appliance repair

**Refrigeration and Air Conditioning included.** Save on your own repairs, learn a skill in demand, earn extra income or start your own business.

**Short, easy course trains you at home to make \$5 to \$7 an hour starting soon.**

Mail the coupon above for your **FREE NRI Catalog**. Find out how you can prepare quickly at home to do professional appliance servicing.

After only a few lessons, you can be ready to start servicing your own appliances or start earning \$5 to \$7 an hour fixing appliances for friends and neighbors. The entire training can be finished in a few months.

NRI Appliance training is the fastest way to a new job or skill or extra income in a spare time or full time business of your own. Wherever you live or want to live, you'll find a demand for top-notch appliance servicemen.

With a billion appliances in use, there are probably thousands needing repair right in your own neighborhood. They mean



**NRI APPLIANCE TRAINING DIVISION** • Washington, D.C. 20016  
 Accredited Member National Home Study Council

cash profits for you starting soon. Put your spare time to good use. Appliance servicing can give you the extra cash you may be seeking to do and buy the things you've always wanted.

- Low-cost NRI training covers —
- Small and large home appliances
  - Air conditioning
  - Refrigeration
  - Portable electric tools
  - Small gasoline engines
  - Farm and commercial equipment

Professional appliance testing equipment is included in your NRI course at no extra cost — to help you speed troubleshooting and repair jobs. Mail coupon now for your **FREE NRI Catalog**. No salesman will call. National Radio Institute, Appliance Training Division, Washington, D.C. 20016.



# The famous Lincoln AC 225-amp welder is your best buy



Thousands of home handyman, farmers and shop fabricators buy the Lincoln AC-225 every year for these reasons.

**Hundreds of Uses.** Lincoln AC-225 welders give the ideal arc for fabrication and repair welding. Build your own tools and equipment. Fix cars, trailers, boats, farm machinery quickly. Rebuild or hardsurface worn parts. Heat metal for bending, straightening. Thaw frozen water pipes.

**Versatile.** Weld heavy plate or sheet metal, Lincoln ampere selection is right for both. Current capacity and duty cycle let you weld without delays. Use low hydrogen, stainless and mild steel electrodes with excellent arc striking and arc stability. Solder, braze, or weld copper and aluminum with the arc torch.

**Easy to Operate.** Single range control, no cranking or plug changes necessary. Electrode selection guide on top of machine.

**Long Life, Dependable Performance.** No controls to creep or wear out. Transformer is extra dipped for weather protection. Bottom screen makes the welder verminproof. Built by Lincoln Electric... world's foremost producer of arc welding equipment and supplies.

**Easy to Install.** Plug into standard 230-volt, single-phase current, just like an electric range. NEMA rated. UL approved at 230 volts, 60 hertz. Will also operate on 208 volts.

**Mobile, Lightweight.** Easy to move. Wheels optional.

**Ready to Use.** Price includes accessories, sample electrodes, power cable, instruction book.

(Suggested Zone 1 list price only \$95, subject to change without notice. Optional features, taxes, local delivery and Zone 2 freight charges may alter this price.)

SEND THIS COUPON TODAY!

**LINCOLN  
ELECTRIC**

The Lincoln Electric Company  
Dept. PM-4, Cleveland, Ohio 44117

- I am interested in a 225 AC welder  
 Send free copy of bulletin E320

Name \_\_\_\_\_

Address \_\_\_\_\_

City \_\_\_\_\_ State \_\_\_\_\_ Zip \_\_\_\_\_

## APPLIANCE CLINIC

(Continued from page 70F)

defrost. The reason for the problem in a unit this old is a weakened compressor that isn't operating at full capacity. You'll have to replace the compressor, and this will cost about \$150. The job should be done by a qualified refrigerator serviceman. If not replaced, the compressor will get progressively worse and ultimately fail completely—possibly causing a freezer-load of food to spoil.

### What happened to combinations?

*For years I was more than satisfied with a washer-dryer combination. Now I am ready for another such unit, but have been told that no company manufactures them any more. Is this true? If so, why?—Ms. Roberta Bobba, San Francisco.*

Yes, it is true. I haven't been able to find a company that presently manufactures washer-dryer combinations. But I have found retail outlets that still have some in stock, so I suggest you shop more appliance stores in your area.

Why have washer-dryer combinations been discontinued? I've gotten several stories. The one that some appliance manufacturers would like you to believe is that the market has been saturated, but this is not really the case. There are consumers like you who would buy a combination. The story that sounds more plausible is that some major problems with these units—such as leakage of water into the dryer fan and motor—could not be solved. For most small-space installations, stacked washer-dryer pairs are now the rule. You might consider one.

### Trucking

*I have to truck a refrigerator several miles, but have been told that damage could occur if I lay the unit on its side. Is this correct?*

—Peter W. Busch, Phoenix, Ariz.

No, it's not correct. Truck away. ★★★

*If you have a question about any appliance, send it to Appliance Clinic, Popular Mechanics, 224 West 57th St., New York, N.Y. 10019. Sorry, but letters cannot be answered individually. Problems of wide interest will be answered in this column.*



# The day Bill told off his boss

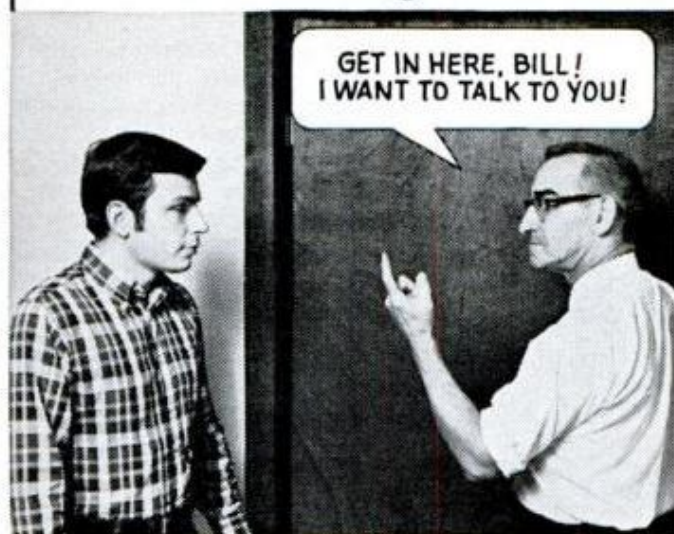

GET IN HERE, BILL!  
I WANT TO TALK TO YOU!

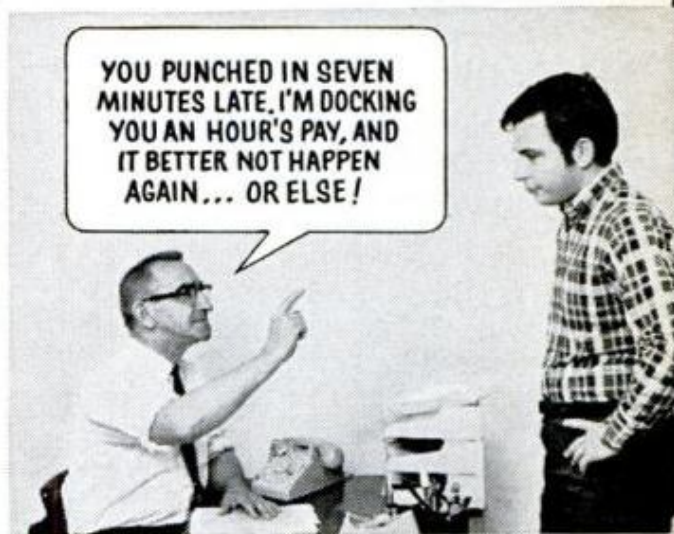

YOU PUNCHED IN SEVEN  
MINUTES LATE. I'M DOCKING  
YOU AN HOUR'S PAY, AND  
IT BETTER NOT HAPPEN  
AGAIN... OR ELSE!



OH, YEAH? I'VE GOT NEWS  
FOR YOU, MR. BEMIS.  
I'VE GOT A NEW JOB  
OFFER WITH A REAL  
FUTURE... AT TWICE  
THE MONEY!



HAH! ANYBODY'D  
BE CRAZY  
TO PAY YOU  
THAT MUCH!

THAT'S WHAT  
YOU THINK!  
I'VE BEEN  
LEARNING  
**ELECTRONICS**  
IN MY SPARE  
TIME AT HOME  
FROM **CIE**...  
AND NOW I CAN  
TAKE MY PICK  
OF GOOD JOBS!



YOU GOTTA BE  
KIDDING! YOU?  
IN **ELECTRONICS**!

YES! NOW I'VE GOT A CAREER.  
**CIE** MADE IT EASY. SO GOOD-BY  
TO YOU AND YOUR CRUMMY JOB!

ARE YOU WORKING FOR PEANUTS IN A DEAD END JOB?  
GET SMART. SEND FOR **2 FREE BOOKS** LIKE BILL DID!

Be sure to send for your 2 FREE books today. For your convenience, we will try to have a representative call. If coupon has been removed, write to Cleveland Institute of Electronics, Inc., 1776 East 17th Street, Cleveland, Ohio 44114.

**CIE** Cleveland Institute  
of Electronics, Inc.

1776 East 17th Street, Cleveland, Ohio 44114  
Accredited Member National Home Study Council

Please send me your **2 FREE BOOKS** describing the  
opportunities in Electronics and how to prepare for them.

Name \_\_\_\_\_  
(Please print)

Address \_\_\_\_\_

City \_\_\_\_\_

State \_\_\_\_\_ Zip \_\_\_\_\_ Age \_\_\_\_\_

APPROVED FOR TRAINING UNDER G. I. BILL

Veterans and Servicemen:  
 Check here for G. I. Bill information.



PM-85



## THE BICYCLE SHOP

BY EUGENE A. SLOANE

You can ride your bicycle for exercise or commuting all winter. Here are tips for preparing your bike, and yourself, for the cold.

**I** ride my bicycle all year round, and so can you. All you need to know is how to prepare your bike for winter, how to ride safely (even in two or three inches of snow) and how to keep warm.

First, the bicycle. Fall is a good time to do your annual overhaul, because if you ride much in winter, it's easy to get water in bearings that will wash grease out. And in the North, a lot of slush that gets into bearings has corrosion-causing road salt along with it. The last thing you want to happen to your good bike is to have rust in your bearings, which could mean expensive bearing replacement (balls and cups, for example). So take apart all bearing parts, including headset, bottom bracket, pedals and hubs (see illustrations, right).

For lubrication, I like the new Phil Woods grease which has excellent low-temperature rolling characteristics and water repellency. As the temperature drops, ordinary grease gets stiffer, makes pedaling harder and can be washed out of bearings by water. The Phil Woods grease costs about \$1.25 for a three-ounce tube. Another good product is Lubriplate Low Temp grease, also sold as Lubriplate Snowmobile grease. It gives excellent running characteristics down to minus 60°. It's \$1.55 for a pound can.

If you ride a fine bike through slushy streets that have been salted, you'll find the fine polish of aluminum cranks, chainwheels, hubs, rims and even handlebars will be pitted or seriously marred by the salt. You can protect these parts by removing all grease with a solvent (such as any dry-cleaning fluid), then spraying the parts with a clear acrylic coating. I use Rustoleum No. 2500 water white clear acrylic lacquer that comes in a spray can for \$1.25. If the

*(Please turn to page 76)*

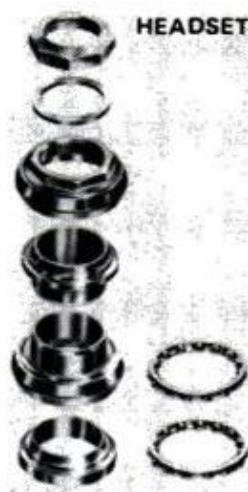

HEADSET

Take apart and relube all bearing surfaces for winter cycling. These include headset (left), bottom bracket, pedals and hub (below). You will find instructions for these jobs in past *Bicycle Shop* columns. For headsets, see page 38, Sept. '72; bottom brackets, see page 67, May '72; pedals, see page 34, July '72; and hubs, see page 31, April '72.

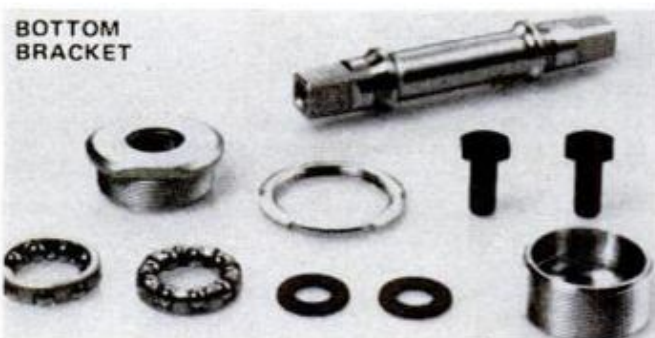

BOTTOM BRACKET

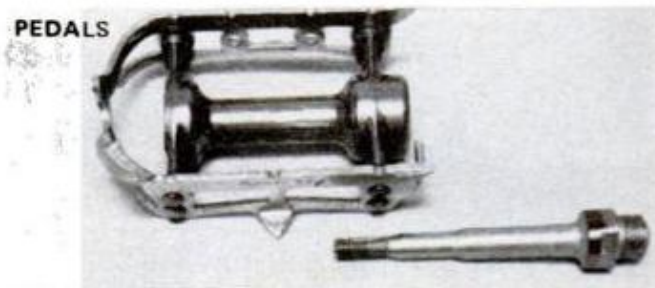

PEDALS



COMPLETE REAR HUB



COMPLETE QUICK-RELEASE UNIT



COMPLETE AXLE UNIT



# AC goes to great length to protect your car's engine

AC Oil Filters provide up to 12 feet of filtering surface to help keep your car's oil and engine running clean.

That's 12 feet of tough, polyester-reinforced filter material. A lot of material. A lot of protection.

How does AC pack it all in? With a unique "W-Fold" in the filter material. (The additional folds provide the additional filtering surface area.)

There is a difference in oil filters. Go to any length necessary to get a new AC Oil Filter with your next oil change.



AC's unique "W-Fold" construction. More folds provide more filter surface.

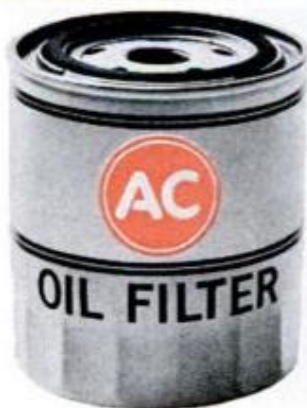

AC SPARK PLUG DIVISION

AC helps keep your engine running clean

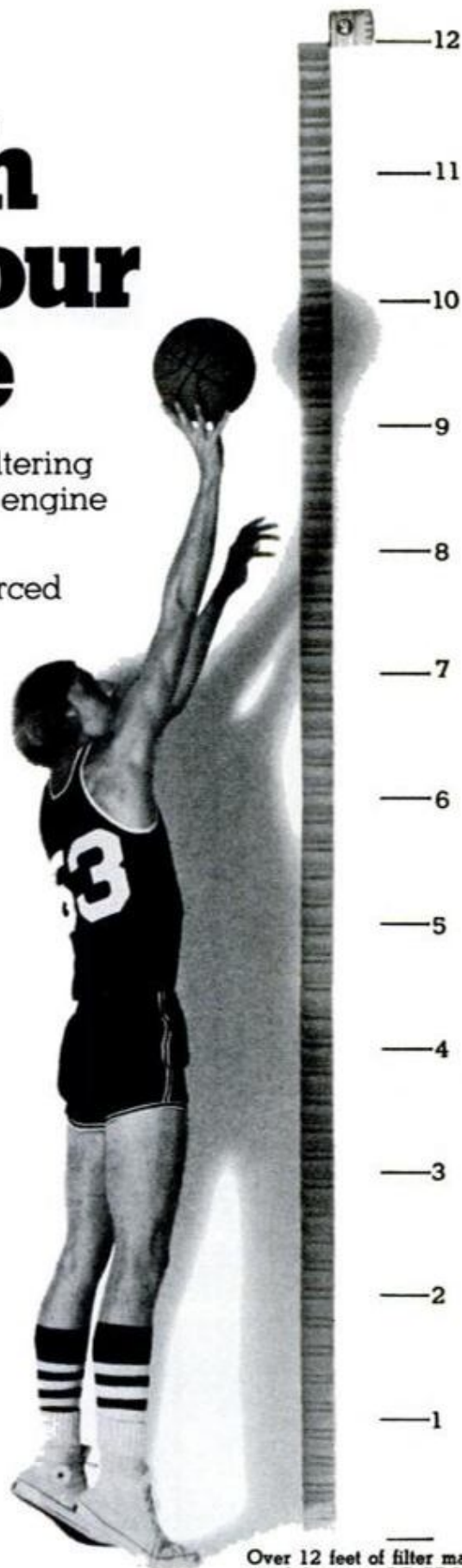

Over 12 feet of filter material from an AC PF-30 Oil Filter stretched full length.



## THE BICYCLE SHOP

(Continued from page 74)

lacquer won't adhere, remove it with methyl ethyl ketone (MEK), available in hardware stores. Then brush on one coat of Rustoleum clear blue (*very* light blue transparent coating) undercoating paint. Allow it to dry for at least 30 minutes, then spray on the lacquer. When winter is over, these coatings can be removed easily with MEK.

You might also dab or spray a few drops of graphite oil into your bike lock to keep it from "freezing" in cold weather.

You can successfully ride in snow up to about three inches deep. However, if you have fenders, you'll probably have to stop occasionally to unclog the snow packed between fenders and tires. For slippery conditions, when roads are snow-covered, try cyclo-cross tires (drawing) if you use tubular tires; otherwise try the knobbyest wired-on tires you can buy.



New Goodyear and Firestone wired-on tires have a highly visible reflective ring on each side which makes the tires glow like neon hoops when auto headlights reach them—a vital addition to safety for nighttime riding.

Speaking of night riding, I never go out without some kind of light so motorists can

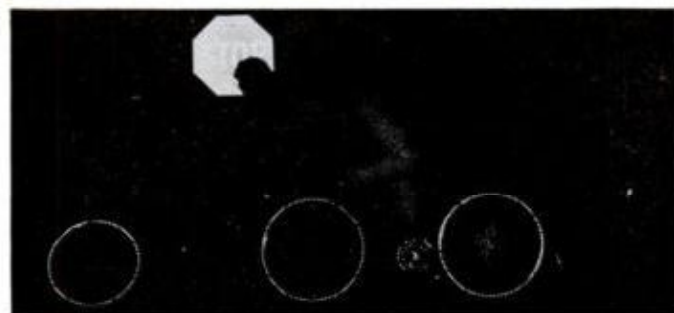

All six bicycle tires visible in top photo look alike—until night. Then even a distant light reflects from three Goodyear Glowall tires (bottom photo).

see me—not so I can see where I'm going. Streetlights, or the light of the moon on snow, give me all the light I need. A good light is one you can strap on your left leg, with amber or red beam facing rear, white beam facing front. Most bike shops sell them for around \$3, with batteries. The light makes you quite visible as your leg moves up and down.

I'd also add a set of reflectors visible

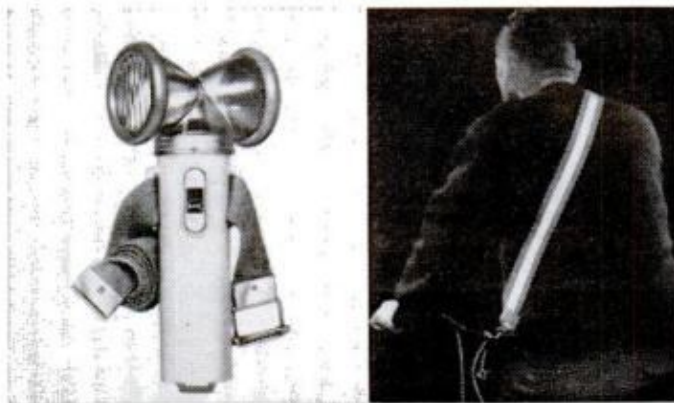

from all sides, such as red facing rear, amber both sides and white facing front. A reflective belt, like this Gladd model (around \$1.75), adds nighttime visibility.

A hard hat of some sort is very important at any time—and especially needed in win-



ter when roads may be slippery. I've had two bike accidents recently (both my own fault) which resulted in two totally wrecked bike frames and a dislocated shoulder in one instance and a sprained wrist in the other. Either one could have easily resulted in a fatal head injury; I was very, very lucky. I now have religion, and in summer I wear a hockey helmet, and in winter, a trooper cap (actually a hard hat in disguise). My hockey helmet is the Cooper SK16 for about \$10; the trooper cap is made by G&R Distributors, 3015 California Ave., Chicago 60618, for around \$15.

In general, you should be able to ride until the air temperature drops to about 15°F. To keep warm, I suggest wearing layers of clothing. Start with thermal under-

(Please turn to page 78)



For  
easier  
starting,  
lower  
emissions,  
smoother  
idling,  
no stalling,  
faster  
take-offs and  
better mileage.

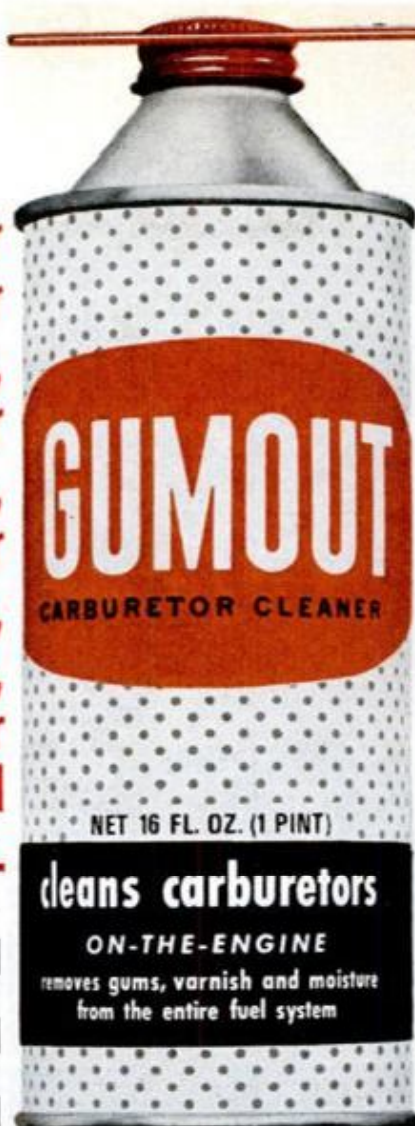

# THE CARBURETOR CLEANER.



**Inside.** Just pour a pint of GUMOUT into your gas tank. It cleans out all the jets and passages, removes the gum and varnish while you drive.



**And out.** It takes less than a minute to clean the outside of your carburetor with Jet Spray GUMOUT. Throat, automatic choke, linkage, throttle plate—all clean like new.

**GUMOUT** Division, Pennsylvania Refining Company, Cleveland, Ohio 44104



## THE BICYCLE SHOP

(Continued from page 76)

wear, slacks, a sweater and windbreaker. As the temperature falls, replace slacks with goose down-filled or heavy lined pants, keep the sweater, but add a heavy jacket, preferably down filled. Forget electrically heated socks and gloves; they just don't work. Use a good grade of double ski sock. For shoes, I like fleece-lined winter booties made for bicycling. If your bike shop doesn't carry them, you can order them directly from W. F. Holdsworth Ltd., 132 Lower Richmond Rd., Putney, SW15, England, for about \$15. Be sure to send your U.S. shoe size, which is the same as British size. Bike shoes are important because they have a steel plate in the sole which distributes pedaling pressure evenly over the foot, instead of letting it concentrate in one spot.

As for winter-cycling gloves, the only ones that keep my hands warm in below-freezing temperatures are ski mittens with a wool liner. Buy them big enough to add your own liner if they don't come that way.

Remember, if you have layers of clothes instead of one thick set of pants or slacks

or one heavy jacket, you can peel off a layer as you warm up.

There's really nothing like getting out in the crisp, cold air on a bike to make you really feel alive. But be careful. In late fall, when roads are leaf-covered, remember that wet leaves are as slippery as ice.

If you ride over snow, be sure you know there's no ice under the snow that can cause you to skid and perhaps fall under a passing car. Snow itself is surprisingly unslippery if you don't try to take corners too sharply or too fast. Don't ride on ice or snow over ice. And stay on flat ground; it's almost impossible to climb steep, snow-covered hills, and it's downright dangerous to come down them at anything like high speed. You may not make fast time in winter, but you can get a lot of healthful outdoor exercise on your bike, yet remain warm and comfortable while others are shivering. ★★★

*Gene answers letters of general reader interest in every third or fourth Bicycle Shop column. However, it is impossible for him to give individual responses to your letters, so please do not enclose a stamped envelope for a reply. Letters should be addressed to The Bicycle Shop, Popular Mechanics, 224 West 57th St., New York, N.Y. 10019.*

**Now, this is all you need  
to stain and finish furniture  
in just one day...**



Staining and finishing furniture *used to be* a slow, messy, smelly job. But Deft has changed all that. Just apply Deft *Vinyl Wood Stain* as it comes from the can — needs no solvents, clean up with water. Then 60 minutes later brush on Deft *Clear Wood Finish* as it comes from the can — won't brush mark or sag. Dries in 30 minutes, recoat in 2 hours. 3 coats give a deep, rich, alcohol and water resistant finish. Staining and finishing furniture is rewarding, and now it can be done all in one day!

**FREE BOOKLET "Wood Staining and Finishing Made Easy."** Send self-addressed envelope stamped with 16¢ postage to Deft, Inc. Dept. PM11, Box 3669, Torrance, CA 90510.



"the wood finish people"

**OUT NOW—1973 edition of  
POPULAR MECHANICS IN-  
DEX AND SHELF WRAPPER.**

Index is bound into a handsome wrapper made of heavy boards and encloses the 12 issues which are cross referenced in the Index. Also available 1971 and 1972 eds. Price \$1.49 each. If back issues are missing covering these years enclose 60¢ for each year needed. Send orders to: **Popular Mechanics Dept. FA, Box 1014 Radio City, New York, N.Y. 10019.**



Only  
**DREMEL**<sup>®</sup>  
puts it all  
together!

*the complete MOTO-SHOP:..*

... for EVERYONE ... young, old, in-between, he or she — fun for avid hobbyists, pride for the skilled craftsman and creative buff, and fixing it power for the do-it-yourselfer ... EVERYWHERE.

... in your camper; at your office; in the kitchen, basement, rec. room, or attic; in school — the Dremel shop sets up anywhere there's an electrical outlet. (stores away in a 2 sq. ft. space) ... for EVERYTHING ... sawing, sanding, drilling, grinding, polishing, routing, sharpening, buffing, carving, engraving, deburring, trimming, you name the power tool job.

Dremel, putting together better ideas in compact packages for over 40 years!

**DREMEL**<sup>®</sup>  
creative power tools

Dremel Manufacturing Co.  
Dept. 903K, Racine, WI 53406



• MOTO-SHOPS<sup>®</sup> • MOTO-TOOLS<sup>®</sup> • ENGRAVERS<sup>®</sup> • SHOE POLISHERS<sup>®</sup>



# LET'S DO LEATHERCRAFT



## Send Today For Your **FREE** TANDY LEATHERCRAFT CATALOG

New Leathercraft Catalog features more Kits and Supplies than ever before!

Send today for the latest jam-packed Tandy Leather Company Catalog. 92 pages listing and showing the world's greatest collection of leather, leathercraft tools, leathercraft kits. Included are new clog sandal kits, belts, handbag kits, billfold kits, plus patterns and leather for making your own leather garments. Over 1200 different items! Includes addresses of over 220 Tandy Stores nationwide where you can shop in person or by mail. Just send us your name and address today and your new Tandy Catalog will be sent to you immediately.



Dept. PM1173 **1001 Foch Street**  
Fort Worth, Texas 76107

## WAIST-AWAY™ Helps Trim Stomach Bulges the scientific way

Reducing belts may come and belts may go, but our WAIST-AWAY belt that started it all, continues to trim bulging waistlines long after the imitators have fallen by the wayside. That's because the WAIST-AWAY method is a basically sound, scientific method that works for everyone. The WAIST-AWAY belt was the first with the tested and proved reducing principle that athletes have used successfully for years.

It took a champion athlete to develop the WAIST-AWAY Belt. Athletes in training have used rubber "sweat suits" to lose bulk fast. All that was needed was to find a way to concentrate the body's heating effect on the area bulging with fat.

### ALL BELTS ARE NOT THE SAME

ALL "reducing belts" are not made with the same materials and design as the WAIST-AWAY. Some imitate, but none can duplicate the original WAIST-AWAY design. Note these important differences:

WAIST-AWAY is made of the same soft, rubber-like composition that the athletes use. This is the most effective material to make your body heat sweat away the excess moisture that adds to bulky fat. And it's the most comfortable to wear next to your body. Not a cheap elastic or cloth.

### REDUCES—DOESN'T JUST HOLD IN

Some belts just hold you in like a corset while you wear them. Waist-Away Belt plus our exercise program actually trims down the bulge; doesn't just squeeze it in.

WAIST-AWAY's special construction creates a soothing massage effect that relieves back and waist tensions. The heating effect developed by WAIST-AWAY helps ease backache and stiffness.

The WAIST-AWAY Belt works on a simple, scientific principle. You don't have to wear cumbersome weights. WAIST-AWAY is perfectly safe. There are no vibrating devices in WAIST-AWAY. Do the Waist-Away exercise, then you do whatever you wish while you wear it; do housework, jog or just sit and watch TV.

### 10-DAY MONEY-BACK GUARANTEE

Whatever method of reducing you have tried without success, don't give up. Order a WAIST-AWAY belt today on our money-back guarantee. You risk nothing.



### VIBRA SALES INC.

Dept. PM-11, 342 Madison Ave., New York, N. Y. 10017

Send me the following belts (indicate quantity):

..... men's WAIST-AWAY Belts (waist measurement ".....") at \$9.95 ..... \$ .....  
 ..... women's WAIST-AWAY Belts (waist measurement ".....") at \$9.95 ..... \$ .....

Shipping & Handling ..... \$1.00

Total Price ..... \$ .....

N.Y. State residents add local sales tax (New York City 7%) \$ .....

(No. C.O.D.) I enclose  
 check  money order for \$ .....

NAME \_\_\_\_\_

STREET \_\_\_\_\_

CITY \_\_\_\_\_ STATE \_\_\_\_\_ ZIP \_\_\_\_\_



# I LIVED LIKE A KING ... AFTER I LEARNED HOW TO MAKE \$2,000 A DAY ... YOU CAN TOO!



My Castle high atop my own mountain

## IF YOU WANT TO BE RICH!



My dream came true by Copying Success

## I WILL TEACH YOU MY SECRET OF COPYING SUCCESS!

**THERE ARE 3 WAYS TO BECOME RICH.** One is to be born rich, two is to have wealth thrust upon you and three is to achieve wealth. If you were not born rich, forget it, wishful thinking won't help. Some hope for a rich uncle to remember them in a will. There is also the Lottery Ticket Type who reads travel folders while waiting for his number to be called. Waiting for wealth to fall on you is one of the most popular yet least successful ways of becoming rich. If this is your present system, forget it. **STOP DREAMING, WAKE UP, YOU MUST MAKE IT HAPPEN!**

### YOU MUST COPY SUCCESS!

I have proven that a fortune can be made in a brief period if a person knows how. I can show you how to do it too. Why would I share my secret to success? Simply because it gives me a great feeling of satisfaction helping others to find their fortunes as I did. I will also probably make another fortune myself from these ads that are appearing all over this great country.

### STOP USING EXCUSES NOW

Age, education, capital are unimportant in this system of making money. There are no degrees needed to be rich. I was going nowhere for years, then the opportunity to copy success came and I grabbed it, then my success story unfolded. I had problems too. I was born poor, quit school, washed dishes for 3 months and daydreamed about how to make a better life. I got married and had children and worked selling everything from garbage cans to correspondence courses. I even worked on the side as a mechanic and painter. I worked 60 hrs. a week but ended up with so many debts and loans it seemed hopeless. We even took in boarders to make ends meet. I'm not talking about the depression years, I'm talking about just twelve years ago. I'm sure there are many going through the same thing, right now.

### OPPORTUNITY UNFOLDED

right before me, just as this page is unfolded before you, not by plan but by chance. I was out selling and stopped into a man's office just at a moment when he was

counting what looked like thousands of dollars right there in front of my eyes. I just stood there in awe for a couple of minutes just looking at all that money. It wasn't bundled like from a bank, just loose bills crumbled on a desk in a pile about a foot high. The longer I stared the bigger that pile looked. I'll never forget that day because it was the beginning of the change I needed and wanted in my life. That man was making thousands of dollars a day and he had been doing it for years. He was a millionaire. I had to find out how he was doing it. I made up my mind to copy his secret or method or whatever it was that made him rich. I went to work for that man the next day. For 6 months I watched, listened and studied everything that man did. I learned the secrets this man developed in ten years of success. I put these methods to work on a limited basis at first because I had only limited money.

### THEN IT STARTED WORKING FOR ME

I got out of debt and before I knew it I had made a fortune, more money than I imagined even in my day dreams.

Almost overnight people were calling me a genius. I was written about on the front page of the Wall St. Journal. People were coming to me for advice. I had a mansion in town. I owned buildings with rents coming in. I even bought a 55 room castle atop my own mountain with swimming pool, tennis court and gardeners. I owned Lincolns and Cadillacs. My family and I traveled. We were suddenly financially successful and we did it by our secret of copying success.

### I OFFER YOU OPPORTUNITY

even greater than my own. I offer to share with you my secrets for success that I have proven can work. Now I am going to ask you to send me ten dollars for sharing this way to wealth. The information I mail will cost me less than ten dollars and I hope to make a profit (less the cost of this ad). I am sure you will not begrudge me making a profit, after all, it might make you rich. I would gladly have paid a thousand dollars 12 years ago for the key to success. You should never expect something for nothing. If you are not satisfied I will return your payment. Never give away ideas, they may be worth millions. Start thinking right now about making money and stop worrying about losing ten dollars. Ten dollars won't even pay for a parking ticket in some cities. By the way, you can examine the information I send you for ten days and return it for a full refund if you are not completely satisfied. All your risk is really an eight cent stamp.

### NOT A BOOK OR FRANCHISE

I'm not offering you a stock scheme, merchandise or equipment. You won't have to leave your job, knock on doors or get your friends to do it for you. No working in a cellar either. This is excellent for women too. It's possible to make more money at home than their husbands make at work.

**I will not just tell you about my success story, but rather ... I will introduce you to your own!**

You can have cash coming in every day even when you're sick or on vacation. Even holidays can't stop the cash flow of my system. Sound exciting? You bet it is. You will need lots of confidence in my system and very little money to get started. People with little capital

must have daring and be willing to take a chance if they want to make lots of money. If you have ten dollars worth of daring after reading this offer, I strongly urge you to put it in an envelope and I promise to show you how to change your life.

**OTHERS GOT BACK THOUSANDS BECAUSE THEY BELIEVE IN ME AND MY SYSTEM NOT ONE LOST.**

One man made \$30,000 in just six months using my secrets. I taught him what I will teach you and now he is independent. People from all walks of life have used my idea: A teacher, janitor, lawyer, housewife, chemist, salesman, secretary and even a policeman. **NOT ONE EVER LOST A PENNY.** I cannot promise you will make as much money as I but then again you may make more.

**OPPORTUNITY IS NOT JUST KNOCKING AT YOUR DOOR ... IT'S ALMOST KNOCKING YOUR DOOR DOWN!!!**

This is the chance you have been dreaming about ... **NOW TAKE IT!** Your risk is only a stamp, your money is refunded if you find I'm wrong. **BUT, . . . . .**

**\$ \$ WHAT IF I'M RIGHT \$ \$**

It might make you rich. **RUSH ORDER FORM**

**MAIL THIS COUPON and \$10.00**

To: M.O.I. Incorporated Dept. 00  
Suite 1002  
500 5th Ave.  
New York, N. Y. 10017

Please send your offer on a ten day trial. I understand that I may return for refund if not satisfied.

Name \_\_\_\_\_

Address \_\_\_\_\_

CITY \_\_\_\_\_ State \_\_\_\_\_ Zip \_\_\_\_\_



# Triumph FM Stereo Headhugger Radio

**The private stereo radio you can enjoy anytime, anywhere.**

Triumph Headhugger, the self-contained cordless headset radio, has gone stereo. Gives you full-range FM stereo radio pleasure anywhere—at work, in a crowd, on a train or bus—anywhere. Without Martian-like antennas. Doesn't disturb those around you while you listen to your own private world of sealed-in stereo sound. Yours for less than \$60.00, it's one of the great Christmas-season ideas you'll find at your Triumph dealer. ■ There are more. Like the new Triumph digital clock/timer capable of turning on or off the heaviest appliances or the biggest color tv's automatically. Triumph multi-band portable radios. The first digital clock radio designed for feminine tastes, the Triumph Princess. Plus, of course, a complete selection of AM and FM Headhugger radios. ■ Whether you're shopping for someone else or for yourself, try a new adventure in home entertainment: ■ Write today for the name of your nearest Triumph dealer.

 TRIUMPH

Triumph Electronics Division, General Time Corporation / 599 South Wheeling Road, Wheeling, Ill. 60090



A Talley Industries, Inc. Company



PM'S PICTURE-TOOLS are a great new idea to take the confusion out of *what goes where* on workshop and tool panels.

The complete PM PICTURE-TOOL KIT consists of seven big sheets (9¾ x 11¾ in.) of a special heavy-weight paper with a pressure-sensitive adhesive on the back. On each sheet are beautiful drawings of hand tools and portable power tools—all you're likely to have in your shop (74 in total). Most are full size; the others nearly so.

Also enclosed in the kit is a blank sheet of the same special paper, printed in an overall color to match the tools. This sheet enables you to design your own drawings of special tools.

Each of the PM PICTURE-TOOLS is carefully die-cut. You simply peel off the backing paper and apply it to the proper spot: on painted or unpainted wood, plywood, hardboard and even perforated-hardboard surface.

Later, if you want to move a few tools or rearrange the entire panel, you can peel off the PM PICTURE-TOOLS and reuse them in new locations!

Once your PICTURE-TOOLS are in place, you'll know at a glance exactly where each tool belongs.



# ONE-HALF INCH AND A CLOUD OF DUST. FROM BLACK & DECKER.

The Black & Decker 1/2" reversing drill. A big, tough drill that's at its best where the jobs are toughest. In masonry. *Heavy* masonry. Like cement blocks. Or concrete slabs. Or fire-hardened brick.

It's got a strong, burnout-protected 1/3 HP motor. With a high-torque gearing system that'll drive through just about anything. And since it's *reversing*, you can get out of the work as easily as you got in.

It's got a two-position end handle that'll give you extra control and leverage for tough jobs. And it's removable, for

close-quarter work.

It's also a good choice for home drill-press work. With the proper bit, it'll bore a hole up to 1/2" in diameter in steel and a full inch in hardwood.

Chuck in a hole saw and you can cut a clean hole up to 2 1/2".

No doubt about it. This Black & Decker 1/2" reversing model is the perfect "second drill" for your workshop.

Because when the job gets tough, it gets the job done.

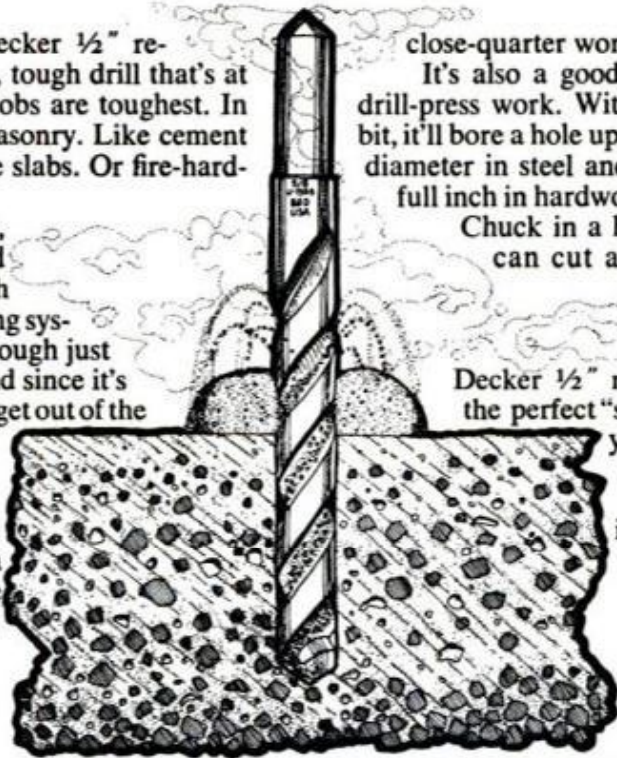

7250 1/2" REVERSING DRILL

**29.99**

Expect the best from Black & Decker, for less than you'd expect. **Black & Decker**  
For your nearest Black & Decker dealer, call 800-243-6000 FREE, day or night. In Connecticut, call 1-800-882-6500.



# "THE EASY WAY TO RICHES"

Recreation-Oriented Catalog Mail-Order Business

SPORTING GOODS, FIREARMS, FISHING TACKLE, WATER SPORTS EQUIPMENT AND MARINE PRODUCTS.

Less than \$300.00 for everything!

You read right! For less than \$300 you can have your own catalog mail-order business in this exciting, fascinating and profitable field. You could handle one of the largest, most diversified and most desirable lines of famous namebrand merchandise available from any mail-order firm.

And now we're going to make you a most unusual offer. You don't have to spend anywhere near \$300 to see what we're talking about. Send only \$10 for our "Easy Way to Riches" and learn everything. . . all the secrets on how to have your own business, and have it operating within 45 days.

We absolutely guarantee you that you can have such a business, including everything you need to run it, all for less than \$300 and in 45 days, or we'll immediately refund your \$10. We won't even deposit your \$10 payment until 30 days after we mail you your material.

That'll give you plenty of time to get it, look it over, and talk it over with your friends.

If you don't agree that it's worth at least a hundred times what you invested, send it back. Your uncashed check or money order will be returned.

The only reason we won't send it to you and bill you or send it C.O.D. is because both these methods involve more time and money. We're already going to give you the biggest bargain of your life.

We are going to show you how to do something that cost us tens-of-thousands of dollars to learn, and more tens-of-thousands of dollars to put into practice.

We are offering to show you how you can have an account established for the wholesale supply of the best known names in guns, ammo, fishing tackle, sporting goods, watersports equipment and marine products.

We'll show you how your supplier will package, label, insure and drop-ship your customers orders. . . orders that were pre-paid so you don't tie up your money.

You'll have your own custom printed catalogs.

All this, and complete, step-by-step instructions on how to accomplish the whole thing in 45 days.

It doesn't require education.

It doesn't require lots of capital.

It doesn't require luck.

It doesn't require talent or special qualifications.

It doesn't require experience.

Your age makes no difference.

What does it require? BELIEF! Enough to take a chance. Enough to absorb what we send you. Enough to put into action, a plan that could put you on the road to riches.

Have you ever thought what it would be like if you opened your mail each morning — in your own home — and money fell out! YOUR MONEY!

Imagine being able to afford the things you've always wanted. . . Being able to "take off" and go fishing, hunting or anything you desired whenever you wanted to. And, be secure in the knowledge that your business would keep running in your absence.

Just imagine what it would be like to be your own boss. Set your own hours. Work as little — or as much — as you please, realizing that the more you worked, the richer you'd become.

Sound like the impossible dream? It's not. . . We guarantee it!

PLEASE. . . Believe what we are telling you. To the best of our knowledge,

THERE HAS NEVER BEEN SUCH AN OFFER!

THERE HAS NEVER BEEN SUCH AN OPPORTUNITY!

Remember. . . you don't have to give up your present job. You don't need any special permits or licenses. And, you can work out of your home.

Now, the rest is up to you. Make us prove every statement we have made here. Send us the attached coupon now. We are not asking you to blindly believe us. JUST TRY IT. You have only an eight cent stamp to lose. But. . . what if we are right. Look what you could gain.

THIS COUPON WORTH \$10.00\*

RECREATION ENTERPRISES, Dept. 57

657 West 19th Street, Suite I, Costa Mesa, California 92627

Okay fellows. . . it sounds impossible, but I've got nothing to lose. Send me your "EASY WAY TO RICHES" I've enclosed \$10 payment, but don't deposit my check until 30 days after you mail my material.

If I return all the material — for any reason — within that time, I understand you'll immediately return my un-cashed check.

Name \_\_\_\_\_

Address \_\_\_\_\_

City \_\_\_\_\_ State \_\_\_\_\_ Zip \_\_\_\_\_



**SPECIAL OFFER.** If you mail this coupon within one week of the date at the top of this page — even if you decide to return all of the material for a refund, you'll receive a \$10.00 credit towards sporting goods of your choice. Complete details enclosed with your material.



# Let's Make You A Winner! Astounding Method to beat the Dice Tables.

**DOUBLE YOUR MONEY BACK GUARANTEE**

Play in all Legalized Casinos:

**LAS VEGAS, RENO, BAHAMAS, PUERTO RICO,  
LONDON, MONTE CARLO!**



**"ACTION ON EVERY ROLL"**

**BET LIKE THE PROFESSIONAL INSIDERS DO**

**By placing only 5 bets, and having all numbers in your favor . . . including the 7**

The Most Talked About Dice Instructions in America

Put This New Knowledge To Immediate Use For Astounding Results

**PLAN 1:** After making his point and your 5 bets are placed, any number that comes out in each roll 2, 3, 4, 5, 6, 7, 8, 9, 10, 11; 12. **YOU WIN!** Only if the shooter's point comes back in two rolls, you don't win. You play two rolls after making his point and make \$10 to (approx.) \$200 (according to the amount bet).

**NOW YOU SAY PROVE IT! O.K.**

Get a pair of dice. Play for as many shoots as you like, and you be the judge. Make your point on the 1st roll, then see if you can repeat the same back in 2 rolls. If you don't, **YOU'RE A WINNER EVEN IF YOU HIT A 7.** Keep track of the score you make, then see your results after 40 or 50 shoots or more.

**WHEN WINNING WITH YOUR 10 NUMBERS, EVEN IF A 7 HITS!**

When winning, many players keep playing after two rolls because they have 10 out of 11 numbers in their favor, **INCLUDING THE 7**, so that when shooter has a **LONG ROLL**, hitting "lots of numbers" with the **7** in their favor, **THEY CLEAN UP A BUNDLE . . . THEN QUIT!** For only \$25 we will send you this fascinating money-maker with complete instructions, **NEVER BEFORE DISCLOSED.**

**WHEN DICE ARE "HOT OR COLD"**

As an added introductory "bonus special," we will include our \$25 Plan 2 for only \$10. You place your bets in only 4 different positions, **ALSO HAVING 10 OUT OF 11 NUMBERS** in your favor every roll. Win between \$10 and over \$500 in 2 rolls (according to the amount bet) and use as an alternate method of playing with Plan 1 when dice are "Hot" or "Cold." **WE GUARANTEE DOUBLE YOUR MONEY BACK ON PLAN 1 AND PLAN 2 IF EITHER PLAN DOES NOT PROVE RESULTS AS DESCRIBED. EVEN BEGINNERS . . . ARE WINNERS.**

**BET ON IT! MAKING MONEY IS EASY . . . WHEN YOU KNOW HOW.**

**GET THE SOURCE THE EXPERTS USE . . . "ACTION ON EVERY ROLL"**

Allow 2 to 3 weeks for Delivery.  
Send Money Order plus 80¢  
for Overnight Delivery!

**ORDER AT ONCE!**  
©MURRAY C. CORBIN

Make Dough  
Like a Pro

Please send me PLAN 1 for \$25 and as an optional introductory "Bonus Special" include Plan 2. I am **GUARANTEED DOUBLE MY MONEY BACK** if either plan does not prove results as described.

Enclosed is my check or money order for \$25 . For Both Plan 1 and 2 \$35

**MAIL TO: MURRAY C. CORBIN DEPT. MGPM11  
P.O. Box 869, Radio City Station, New York, N.Y. 10019**

Name (Print clearly) \_\_\_\_\_

Address \_\_\_\_\_

City \_\_\_\_\_ State \_\_\_\_\_ Zip \_\_\_\_\_

Executive Offices: 221 W. 57 St.

New York, N.Y. 10019



# PHOTO HINTS

## FROM READERS

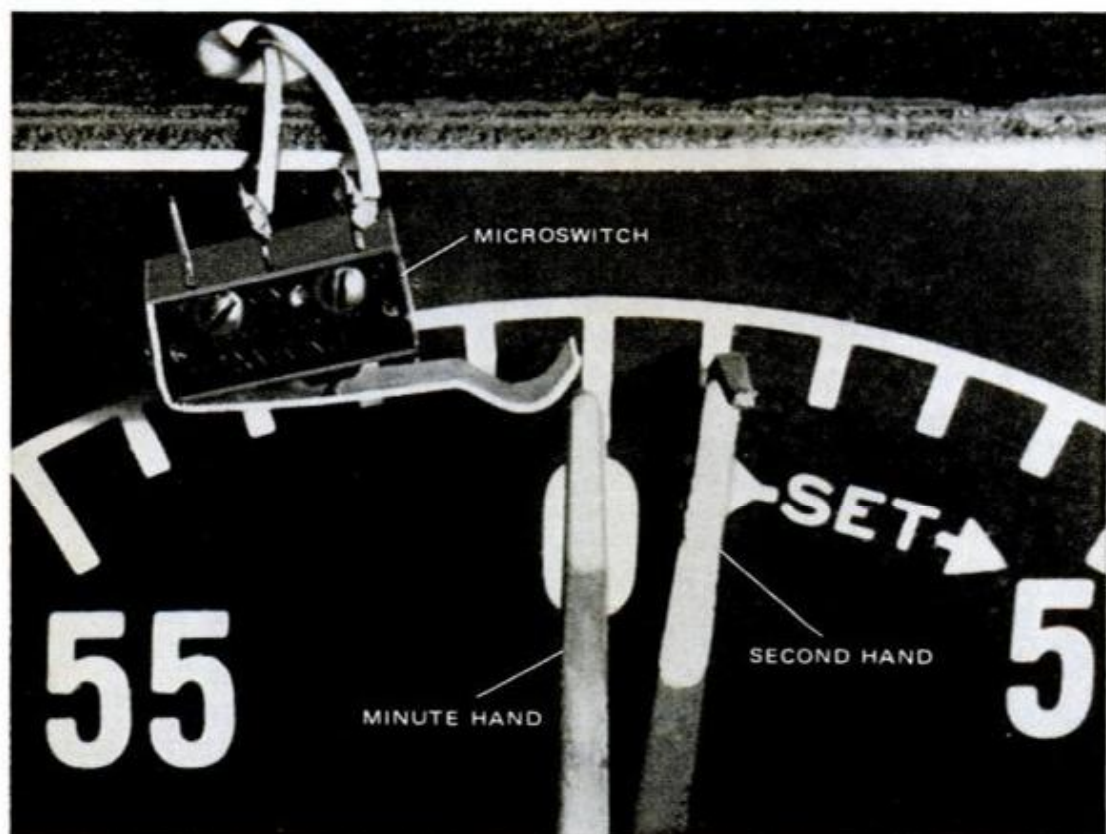

Microswitch contacts second hand once per minute, to activate "beep" oscillator and speaker added inside case.

### Beeper improves darkroom timer

I use my Gra-Lab timer for both printing and film developing. Since I can't always look up to see when I should agitate the film or paper, I added a "beeper" to sound off once per minute while the timer hands are moving. Parts I used were a lever-type microswitch, mounted to contact the second hand as it passed the 60-second mark, a small speaker, and a Radio Shack code oscillator module with its battery taped on; but any equivalent parts should do. The oscillator is mounted inside the timer case with aluminum brackets, and the speaker is epoxied directly to the case (I get adequate sound without baffle holes). The microswitch is mounted on a small wood spacer, so it won't interfere with the minute hand's operation.

—Douglas Blodgett, St. Charles, Mo.

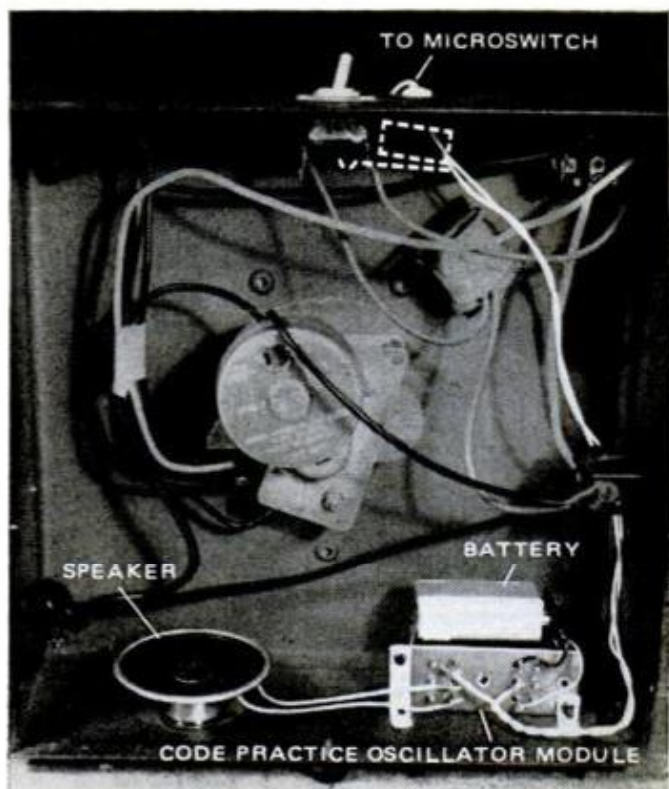



### Photos make personalized note cards

Turn your favorite photos into photo notes, and you'll get a lot more mileage from them. Cut 8x10 single-weight, matte paper into 5x8-inch halves (double-weight or glossy papers are more likely to crack), and print your picture as a vertical or horizontal on the right half of the sheet, so that it makes the front of the note when folded; mask off the unexposed half of the paper during exposure, to avoid fogging it. If it's a shot

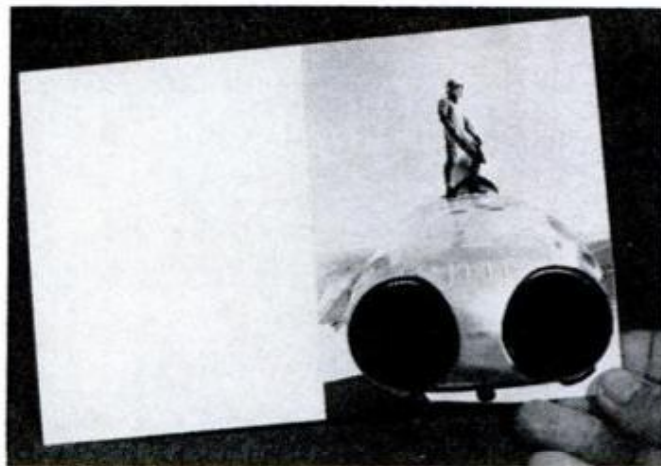

Print on the right half, leave the left half blank, and fold the paper on the centerline.

you're especially proud of, you can print it across the entire sheet and fold the picture in the middle; the recipient can fold it out again.

Since unmounted, single-weight paper has a tendency to curl, use print-flattening solution (or print on Kodak's "RC" resin-finished papers) and keep your finished note cards flattened between blotters until you use them.—Arthur L. Schoeni, Dallas.



Emulsion on the outside carries the picture, while paper's back surface, inside, is easy to write on.

## Minolta helps you get close to nature.



You can shoot a nature film in your own backyard with a Minolta Autopak® movie camera.

Power zoom in for those close-ups, zoom wide for the big panoramas. The Autopak will adjust itself automatically and instantly for perfect exposure. And the bright viewfinder shows the exact image you'll get on film.

With the Autopak's optional remote control you can get close to the wildlife without getting close. Time lapse photography is possible too. So you can make flowers bloom before your eyes.

For more information, see your photo dealer or write Minolta Corp., 200 Park Ave. So., N.Y., N.Y. 10003. In Canada: Anglophoto Ltd., P.Q.

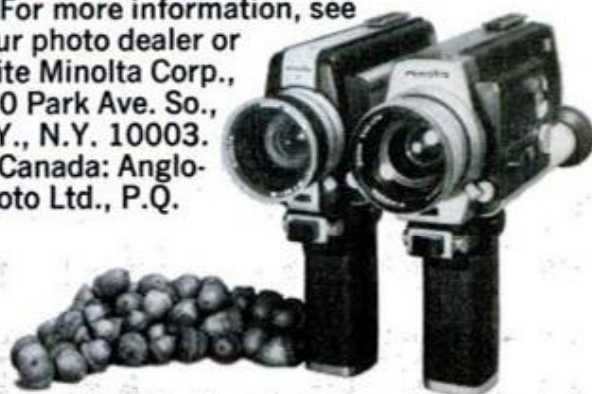

**Minolta Autopak**



# How to fix almost any part of almost any car.

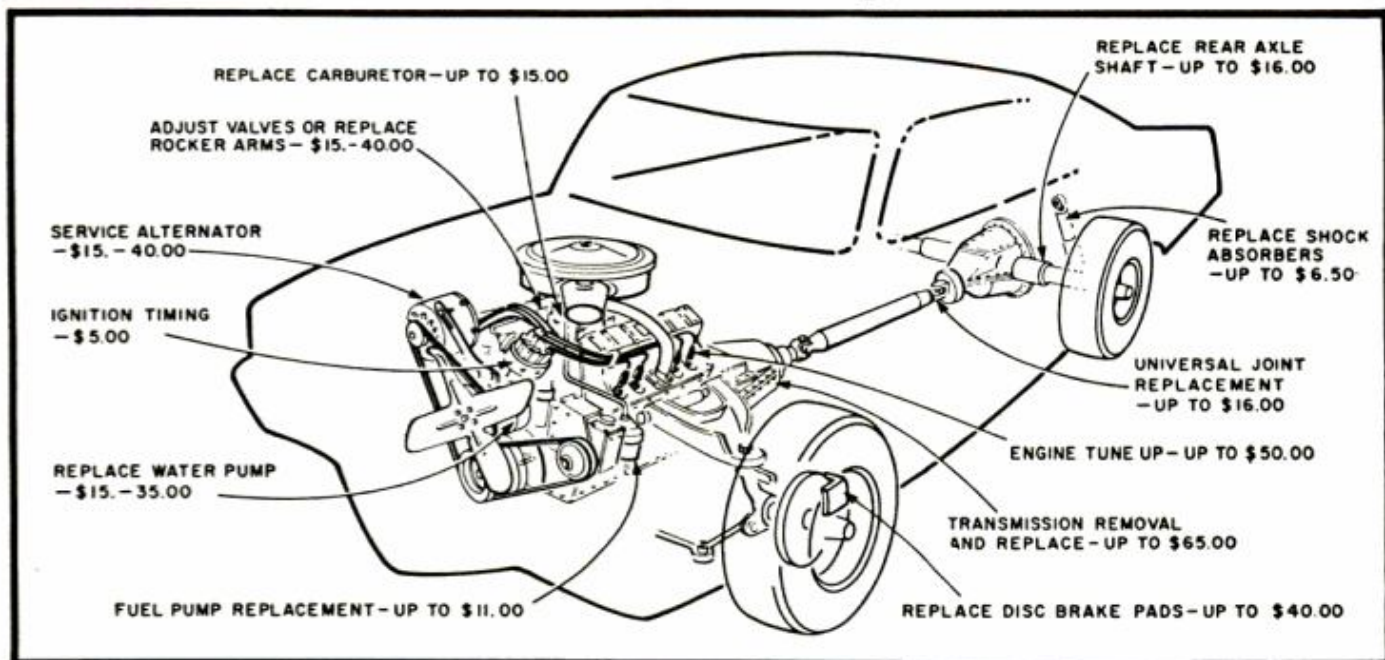

Even a beginner can tackle these repair jobs and save hundreds of dollars a year.

Whether you're a backyard tinkerer or a seasoned mechanic, MOTOR's new 1974 Auto Repair Manual will help you breeze through almost every repair you'll ever have to make. And on almost every model of every car made in the U.S. between 1968 and 1974.

Quickly and easily you'll replace your carburetor (and save up to \$15 in labor), tune up your own engine (and save up to \$50), even do complete overhauls (and save hundreds of dollars).

No matter what the repair job, there's no guesswork. The 1974 MOTOR Auto Repair Manual starts from scratch—leads you through the entire job with easy step-by-step directions, clear how-to pictures. Tells you where to start, which tools to use, and exactly what to do.

**Over 1,000 Big Pages**  
**Over 3,000 Pictures**

This new 1974 edition is like having a factory trained expert at your side, guiding your every move. There are over 1,000 pages. Over 3,000 pictures. Hundreds of "Quick-Check" charts, 55,000 essential repair specifications. Over 225,000 service and repair facts.

Plus Adjustment Tables, Tune-Up Charts,

Tables of Measurements and Clearances, Overhauling and Replacement facts. A special Trouble-Shooter Section helps you pinpoint the cause of 4,200 car troubles fast—and then steers you to the section that shows you how to solve your trouble.

### Fix all these cars . . . and more

Chevrolet	Chrysler	Tempest
Mustang I & II	Plymouth	Corvette
Barracuda	Oldsmobile	Cougar
Chevy II	Rambler	Toronado
Pontiac	Dodge	Valiant
Thunderbird	Mark III & IV	Dart
Buick	Checker	Javelin
Imperial	Lincoln	Montego
Cadillac	Buick Special	AMX
Continental	Comet	Pinto
Mercury	Corvaire	Hornet
Ford	American	Maverick
Vega	Olds F-85	Falcon

### The "Meat" of 300 Shop Manuals

Even professional mechanics find this Giant Manual shows them many new time-saving and work-cutting procedures. The reason is MOTOR's editors have "boiled down" into one fully-illustrated, easy-to-understand guide, the "know-how" from 300 Official Shop Manuals and hundreds of factory service bulletins.

Learn all about the 1974 cars and in addition see how Detroit's 1974 specs and procedures affect your older car. Auto makers continually improve past model adjustment

#### "Single most useful reference available"

"I'm most impressed with the clear presentation of what I've found to be complete and correct information. Certainly recommended for the home mechanic."—William E. Lohne, New Hope, Pa.

#### "Clears up mysteries"

"I always rely on Motor when I do a repair I am not familiar with. Well illustrated, complete, simple."—E. Jones, Minnesota

### Same Free Trial Offer on MOTOR's Auto Engines & Electrical Systems

Over 700 pages. 1300 big pictures. Clear text explains how parts work; principles involved; design, construction, maintenance. Covers all parts of engines & electrical systems.



specs on older cars as new road test data comes in. That's why you'll need this new 1974 MOTOR Manual to get the best performance out of your car—even if you already own an earlier edition.

### Send No Money

See for yourself—at our risk—why more than 6,500,000 copies of the MOTOR Manual have been sold. Just mail the Reservation Certificate today and as soon as the new, most-up-to-date 1974 MOTOR Auto Repair Manual comes off press, we'll rush a copy to your home or shop. If it doesn't pay for itself in 10 days, return the book and you owe us nothing.

**Reserve The New 1974 Edition**  
**Now and try it Free for 10 days.**

### RESERVATION CERTIFICATE

Mail to: MOTOR Books, Shipping Service  
P.O. Box 2316, F.D.R. Station  
New York, N.Y. 10022

Please send me the Manuals checked below for ten days free examination:

- 11148 MOTOR Auto Repair Manual, \$10.95  
 12534 MOTOR's Auto Engines & Electrical Systems, \$10.95

If I am not fully satisfied, I will return the shipment promptly and owe nothing. Or I will keep it and pay the total price in three monthly installments, plus shipping.

I want to save shipping charges. I am enclosing payment of \$\_\_\_\_\_ in full and MOTOR will pay shipping charges. (Same return privileges, refund guaranteed.)

G110

Print Name \_\_\_\_\_

Address \_\_\_\_\_

City \_\_\_\_\_

State \_\_\_\_\_ Zip \_\_\_\_\_

Signature Please \_\_\_\_\_ Age \_\_\_\_\_

Prices slightly higher in Canada. Offer available only in continental United States. Delivery will normally be within 3-4 weeks in Eastern U.S. Please allow longer west of the Mississippi.

(M.M. Books)

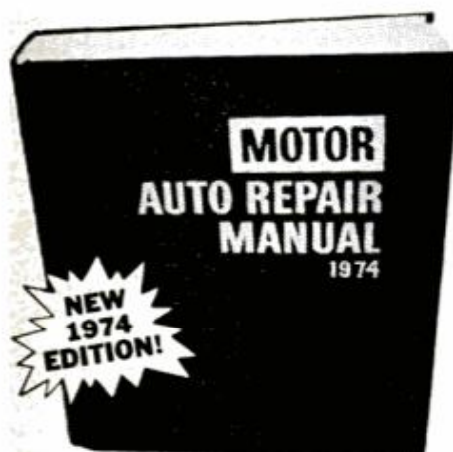

MOTOR BOOKS, PUBLISHER'S OFFICE,  
250 WEST 55 ST., NEW YORK, N.Y. 10019



**In the last three years, over a quarter million people switched from other makes of cars to our Satellite. That was only the beginning.**

**This year, we're out to win you over.**



## **Announcing the 1974 Plymouth Satellite Wagon.**

For three years now, our Plymouth Satellite Wagons have had more cargo room than any other mid-size wagons in the country. And for three years, people have been switching from other cars and wagons to Plymouth Satellite.

This year, we expect our '74 Satellite Wagon to win you over.

Maybe it'll be the fact that our wagon is big enough to carry 4' x 8' paneling on the rear floor even with the tailgate closed. (Compare that to other

mid-size wagons.)

Maybe it'll be the three-way tailgate itself, which makes it easy to load either things or people.

Or maybe it'll be the way we engineered this wagon. With a torsion-bar front suspension. A body made strong by more than 4,000 welds and quieted by more than 95 individual components to reduce noise.

Maybe it'll be the Electronic Ignition System with no points or

condenser to replace. It virtually eliminates ignition tune-ups. And helps spark plugs last as much as 18,000 miles.

Or maybe we'll win you over with the fact that all our engines run on regular gas.

You see, getting a quarter of a million people to switch from other cars and wagons to our Plymouth Satellite in the last three years was only the beginning.

Whatever it takes... this year we're out to win you over.

Watch AFC Football, Championship Baseball Playoffs and the World Series on NBC-TV. Brought to you by Chrysler Corporation.

**Mid-size Plymouth Satellite.**  
Extra care in engineering...it makes a difference.

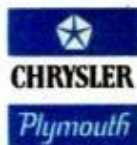



## HOMEOWNERS' CLINIC

BY W. CLYDE LAMMEY

### Balky garage door

*It's getting almost impossible to raise and lower my sectional garage door. It even binds and sticks at several points coming down. What could be wrong and how do I fix it?—Howard Weist, Gary, Ind.*

Sounds to me as though the parts need oil badly, or the torsion spring is out of adjustment, or both. I'm assuming that no parts have been damaged or are out of original alignment. The ball-bearing rollers at each end of such a garage door will run dry of lubricant in time, sometimes to the point where they will not be able to rotate. This alone could cause the trouble you describe. Clean each roller with a solvent and stiff brush, then apply a few drops of light oil.

The torsion spring on the support shaft at the top of the door is designed to provide part of the "lift." This spring is adjustable. Tighten it a little at a time until the door raises easily and requires a slight pull to lower. Clean and oil this spring in the same manner as the rollers.

### Clock origin

*I acquired an old clock that caught my eye because of its unusual ornamentation. It has a long door veneered in a beautiful curly wood and a door panel consisting of nine pieces of beveled glass set in brass framing. It strikes on a long chime rod, has Arabic numerals, a brass and silvered dial and is driven by two brass weights. It's a hanging clock, about 35 in. tall and 12 in. wide. The question is, who made it and where? No one I've contacted seems to know.—George Hyde, Atlanta.*

It's not possible to give you a positive answer without seeing it, but I'm guessing—and this is strictly a guess—that the clock was made in either Germany or Austria. The strike on a single chime rod and the multipaneled glass door in brass framing would seem to indicate this origin.

### Refinishing benchtop

*I've just bought a nice cabinet workbench for my basement shop. It's used, of course, and the top has chisel marks, digs and gouges—none very deep—and several small holes. How do I go about smoothing it up?—Bill Fredricks, Baltimore.*

With some doing you can make it look almost, but not quite, like new. Use a wire brush first to remove dirt and any other debris. Then buy a cabinet scraper (if you don't already have one) and scrape the top until you get down to clean wood. Drive short lengths of dowels into the holes, cut them off flush and sand the entire top smooth. If some of the gouges are too deep to reach bottom with the scraper, or a hand plane, chisel a diamond-shaped recess and fit a patch of the same wood. Glue this in place and sand flush. Then give the top several coats of boiled—not raw—linseed oil, or any prepared oil finish.

### Skin on paint leftovers

*I buy a quart of paint, use a part of it, put the cover back on tightly. Yet when I open it again there's a thick coating or "skin" over what's left. How does one prevent this?—Ralf Mayer, El Paso, Tex.*

The best way I know of salvaging paint leftovers is to pour what remains after use into a glass jar with a screw top that can be closed tightly. The trick is to select a jar of a size just large enough to hold the leftover paint with little space remaining between the paint and the underside of the lid. As a rule, paint leftovers will keep in such a container for long periods of time without "skinning." But make sure that lid is turned down tightly. ★★★

*Do you have a home maintenance or repair problem? Send it to Homeowners' Clinic, Popular Mechanics, 224 West 57th St., New York, N.Y. 10019. While letters cannot be answered individually, problems of wide interest will be discussed in this column.*



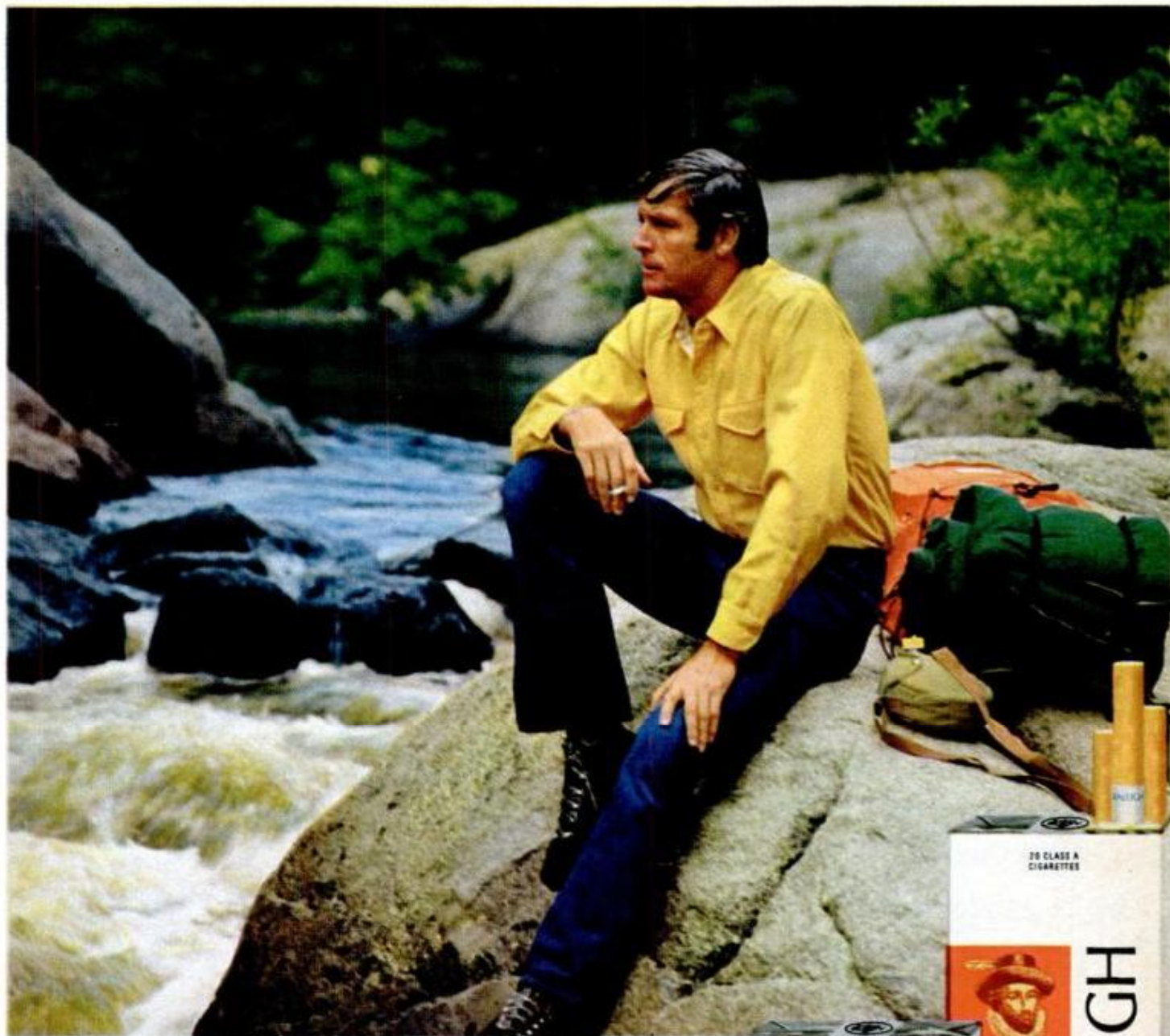

# Spend a milder moment with Raleigh.

A special treatment softens the tobaccos for a milder taste.



Quench your thirst anytime, anywhere, from this sturdy 2-qt. aluminum canteen by Mirro. It's yours with removable duck cover and adjustable shoulder strap for free B&W coupons, the valuable extra on every pack of Raleigh.

To see over 1000 gifts, write for your free Gift Catalog: Box 12, Louisville, Ky. 40201.

© BROWN & WILLIAMSON TOBACCO CORP.

Filter Kings, 16 mg. "tar," 1.2 mg. nicotine; Longs, 18 mg. "tar," 1.3 mg. nicotine, av. per cigarette, FTC Report February 73



Warning: The Surgeon General Has Determined That Cigarette Smoking Is Dangerous to Your Health.



# A man likes to come home to Black Velvet.

Every man wants to feel the smooth, imported whisky from Canada.  
And every woman, too.



BLACK VELVET® BLENDED CANADIAN WHISKY 80-86 PROOF, IMPORTED BY ©1973 HEUBLEIN, INC., HARTFORD, CONN.

Материал, защищенный авторским правом



# Christmas gifts you can make

**Popular  
Mechanics**

## Jewelry you can carve in a jiffy

You can create these personalized, easy-to-make gifts in time for them to be found under the Christmas tree

---

by John Gaynor and Harry Wicks

**T**hese miniatures can be carved, from start to finish, on a kitchen table, so you won't need a king-sized workshop for the project. And the nature of the job requires just a small amount of material—even scraps which you probably have on hand can be used. Further, the tools that

make it all possible are available at reasonable cost.

Mini carving is a wise choice for beginners. Unlike sculpture, you needn't be either an artist or an advanced craftsman to try your hand at it. As can be seen in the step-by-step photos showing the crea-

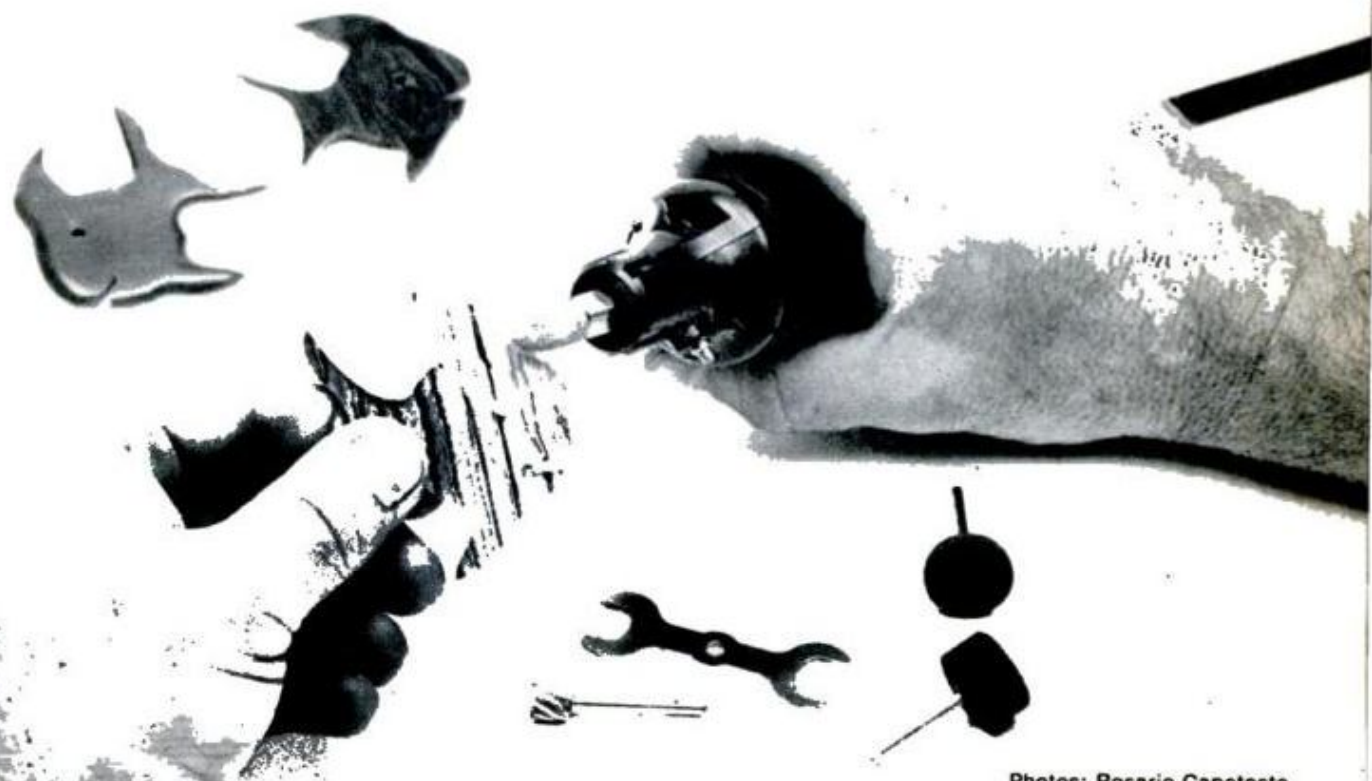

Photos: Rosario Capotosto









- 1 Peace dove pendant is of white plexiglass on tinted plastic suspended from a rawhide thong.
- 2 Whale tie tack was created using two woods. The rounded-off edges reveal lighter backup piece.
- 3 Same carving of the whale in red plexiglass is particularly well suited for teen-ager's earrings.
- 4 Masculine cuff links were "carved" on a jigsaw, sanded smooth, then glued to jewelry hardware.

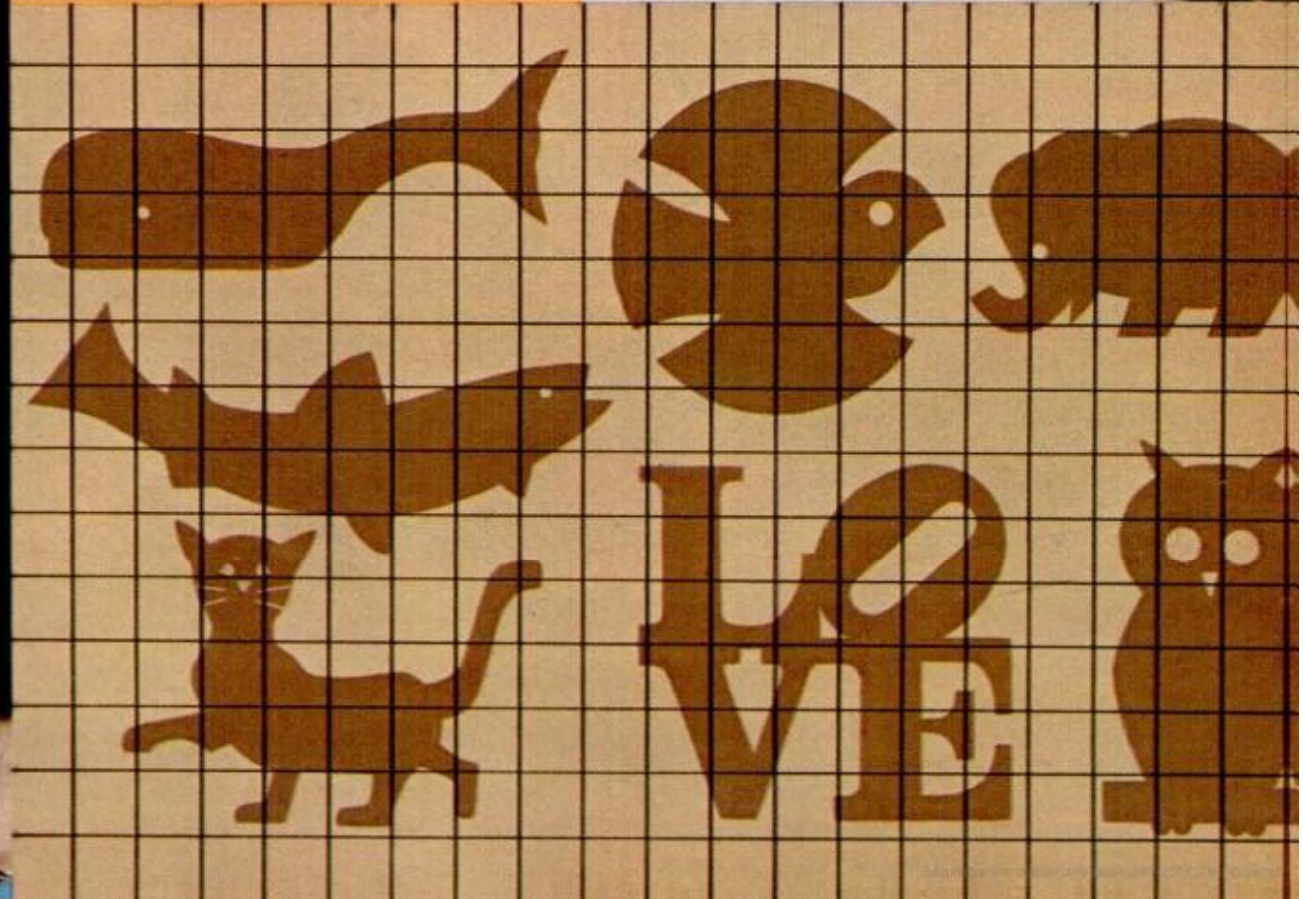
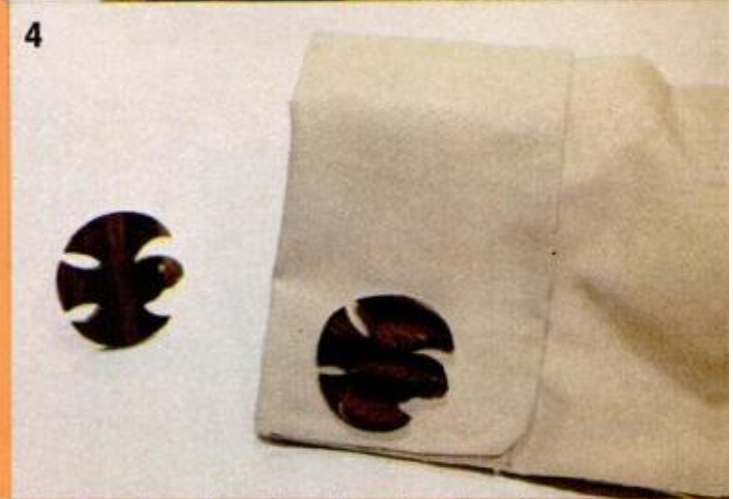



# How to fix an electric dryer

Data: Ed Franzese

An automatic clothes dryer is probably the simplest of major appliances: Basically, its function is to pass hot air across and through wet clothes to evaporate moisture from them.

The major components of an electric dryer are a basket to hold the clothes, fan or blower to move the air, motor to turn both basket and fan, resistance-wire heating element to heat the air, and controls for motor and heating element.

An electric dryer is normally run on a

30-amp., 220-v. circuit, with the heating element operating on a full 220 v. and the motor on 110 v. Some dryers are designed to run on 110-v. circuits as well. But, while this is perfectly safe, the heating element is less efficient at the lower voltage and drying time is considerably longer.

Nearly all electric dryers work like this: Air at room temperature is drawn into the appliance at the bottom or through front or rear openings. It is passed to the heating element, heated and drawn into the clothes

## Typical dryer components

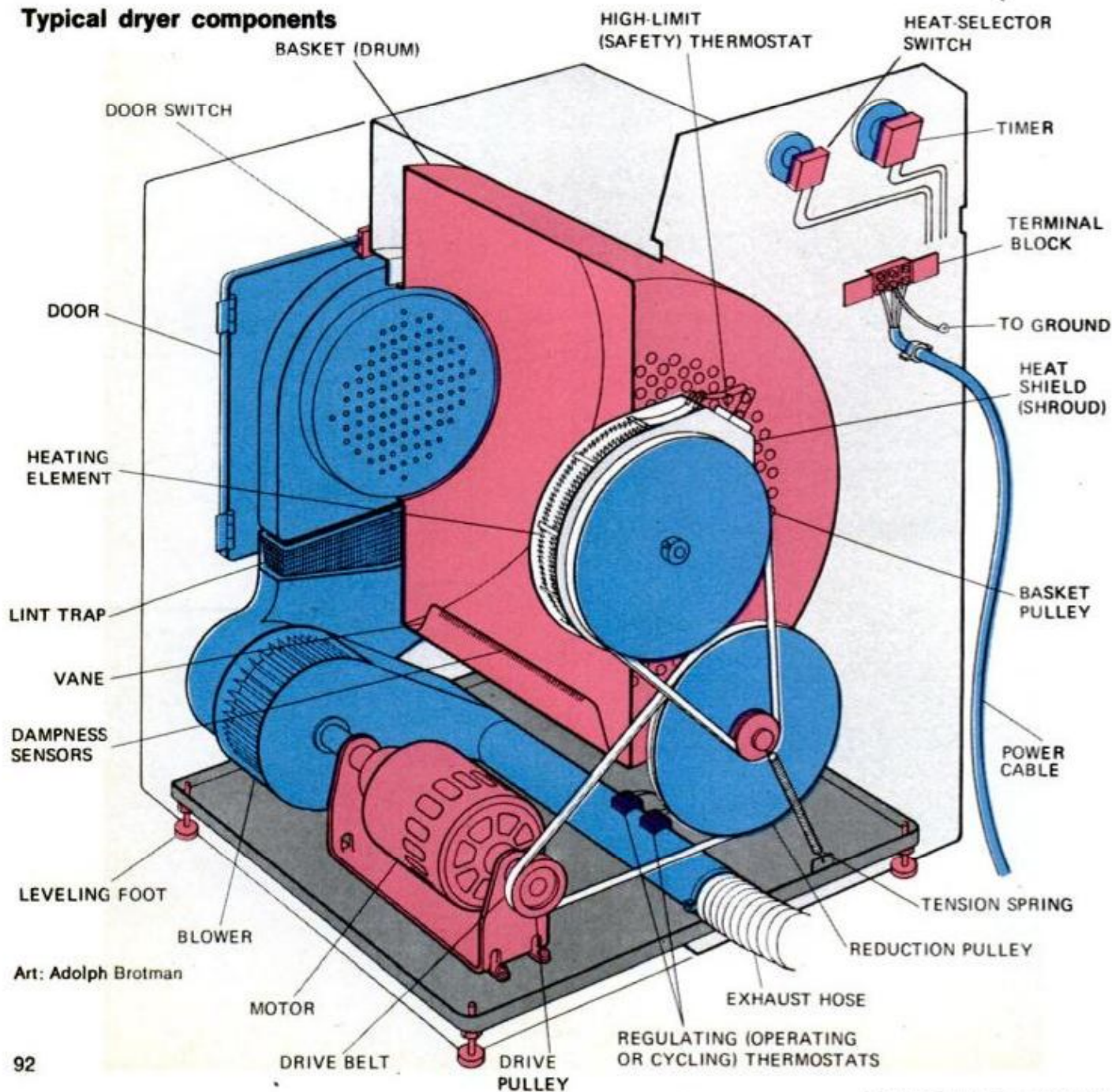

Art: Adolph Brotman



basket. In dryers with unshrouded baskets, hot air enters through holes at the rear of the basket; in dryers in which the basket is shrouded, hot air is drawn into the shroud and enters the basket through holes around its side. Passing over and through tumbling clothes in the basket, the hot air picks up moisture and lint (a result of normal wear) from them. When it leaves the basket at the front through ducting built into the door assembly, the air passes through a screen lint trap, usually just below the door.

The air then is sucked into the blower, and forced through a duct to an exhaust hose that leads outdoors.

Motor and heating element are controlled by a timer, a heat-selector switch, two or more thermostats, a door switch, and, in newer machines, an electronic dampness sensor. The thermostat located near the heating element, called a high-limit thermostat, is a safety device and will not trip if the machine is operating normally. One or more regulating thermostats govern the

*(Text continues on page 96)*

## TIMERS

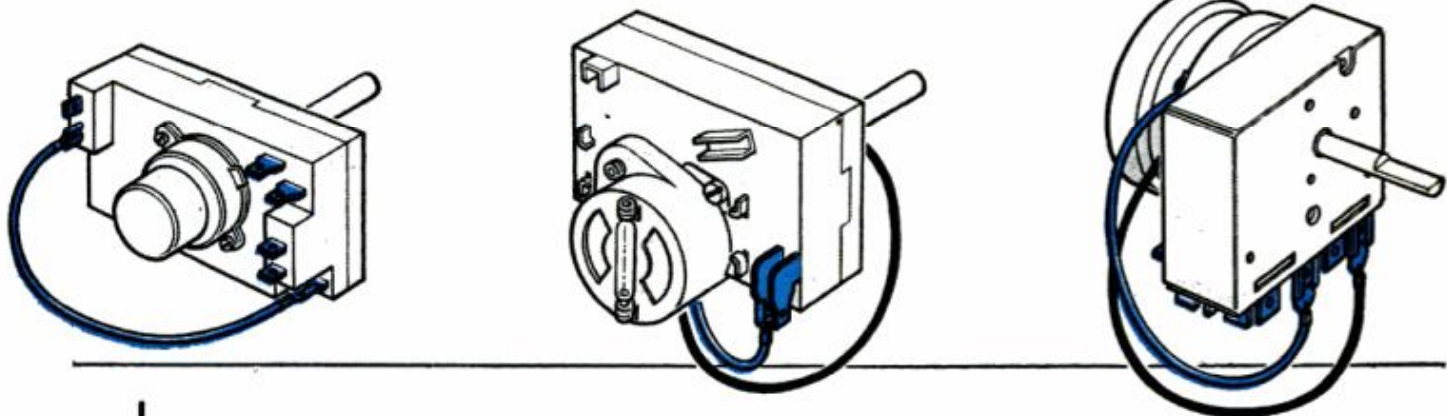

Art: Peter Trojan

## Motor does not start

POSSIBLE CAUSES	WHAT TO TRY
1. Line fuse blown.	Replace fuse (or reset circuit breaker).
2. Door open.	Close door tightly.
3. Timer defective.	Check the line voltage at timer. Turn timer on and place 115-v. test lamp across its terminals. If you get a reading, it indicates open contacts. Replace contacts or timer.
4. Door switch defective.	Remove wires from door switch, place continuity tester across terminals and press button. No reading indicates a defective switch. Replace.
5. Motor wiring loose or disconnected.	Tighten or reconnect loose or disconnected wires.
6. Centrifugal switch defective.	Refer to the manufacturer's schematic diagram for switch terminals on the motor; place continuity tester across terminals. If you get no reading, replace switch or motor.
7. Motor defective.	Direct-test motor with test jumper. If motor still fails to run, replace.

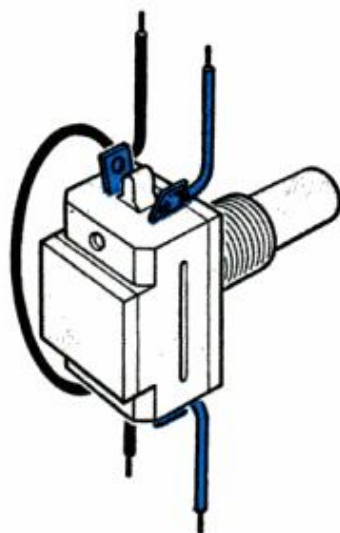

## DOOR SWITCHES

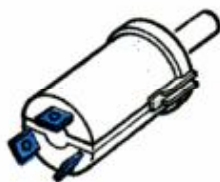



## Motor hums

POSSIBLE CAUSES	WHAT TO TRY
1. Voltage too high or too low.	Check panel fuses or circuit breakers. Check voltage at dryer line or terminals. Any variation greater than 15 percent from normal can cause hum. Notify power company.
2. Centrifugal switch in motor stuck.	Remove both motor and switch. Grease shaft, clean the contacts and reassemble. If the switch still sticks, replace it.
3. Basket binding or idler wheel broken.	Check the basket while turning it by hand. Replace any worn or broken idler wheels. Check leveling of machine.
4. Motor defective.	Direct-test motor with test jumper. Replace it if it fails to operate properly.

### MOTOR AND MOUNT

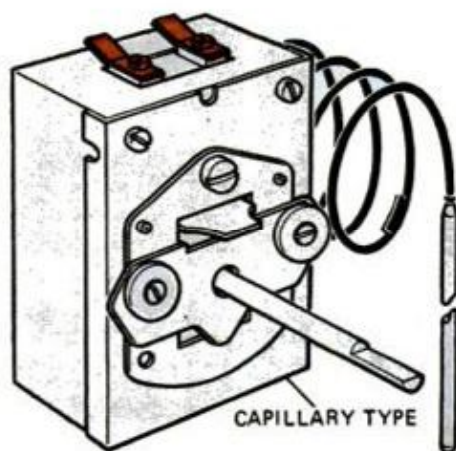
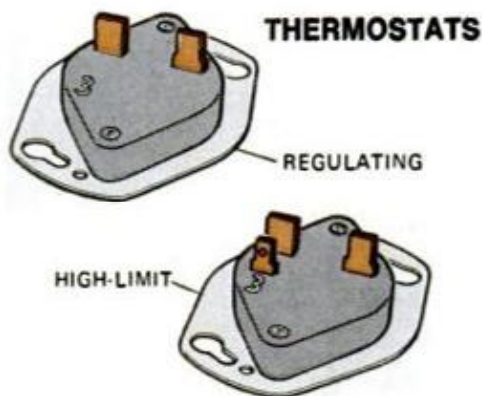
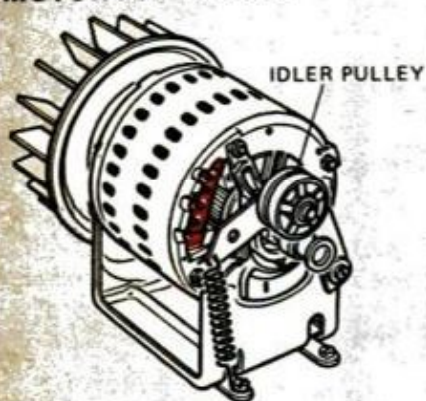

## Motor hums; basket does not rotate

POSSIBLE CAUSES	WHAT TO TRY
1. Broken belt.	Remove back of dryer and replace any broken belts you find.
2. Loose pulley.	Check setscrews in all pulleys. If pulleys are slipping on their shafts, realign them first and then tighten setscrews.
3. Tension spring broken.	Replace broken tension spring.
4. Basket binding or idler wheel broken.	Check the basket while turning it by hand. Replace any worn or broken idler wheels. Check leveling of machine.

### BASKET DRIVE WITH REDUCTION PULLEY

EXHAUST FAN PULLEY

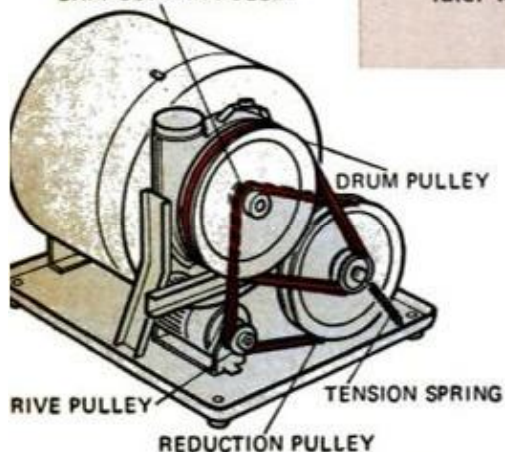



## Noisy operation

POSSIBLE CAUSES	WHAT TO TRY
1. Loose fan.	Retighten fan-blade setscrew on motor shaft.
2. Loose objects caught in basket.	Remove all loose objects from basket.
3. Loose motor pulley.	Retighten motor-pulley setscrew.
4. Worn belt.	Replace any worn or frayed belts.
5. Basket binding.	Turn basket by hand to locate the point of binding. Check felt gaskets, wire harnesses and leveling of the unit.
6. Vibration.	Check for a loose fan blade, an out-of-balance fan blade, also for worn basket bearings and motor mounts. Tighten any loosened parts and replace worn parts.

Quick, corrective action—when dryer runs noisily—is the best insurance against more serious damage to the dryer later.

## Clothes dry slowly or not at all

POSSIBLE CAUSES	WHAT TO TRY
1. Drum overloaded.	Check size of load. Refer to the manufacturer's minimum and maximum standards.
2. Operating thermostat defective.	Place a thermometer in an exhaust duct, then record the temperatures at which the dryer heat is turned on and off. Check these figures against the manufacturer's specifications. If they should be out of the suggested range, replace the thermostat.
3. Lint trap clogged.	Clean lint trap thoroughly.
4. Heating element open.	Place a continuity tester across the heating-element terminals. If there is no reading, an open coil is indicated. Replace.
5. Exhaust hose clogged.	Clear exhaust hose.
6. Timer set too low.	Check your owner's operating manual; then increase the timer setting.
7. Blown panel fuse or tripped circuit breaker.	Check fuse or circuit breaker at the panel; then replace or reset it. If fuse or breaker should blow or trip again, then check for a short circuit in the heating element.
8. 110-v. operation.	If possible, change to 220-v. operation. Clothes take 2½ to 3 times longer to dry on 110-v. line.
9. Clothes excessively wet when placed in the dryer.	See that clothes are spun-dry or wrung out—not dripping wet—before they are placed in dryer.

Too often, slow drying will occur because the maker's instructions are not followed to the letter. First step is to reread operating instructions, make certain that they are followed.

MOI



heating element in normal operation. In old dryers, these may be of the adjustable, capillary type (you should *not* attempt to adjust one of these). Simple bimetal thermostats are more common. Regulating thermostats are usually located in the door assembly or on the exhaust duct, one for each heat setting for which the dryer is designed.

A dryer with a permanent-press cycle may have a "cool-off" regulating thermostat to run the motor with heat off until clothes cool to about 115°F.

Operation of electronic dampness sensors is based on the fact that the electrical resistance of clothing increases as it dries. Damp clothes complete a circuit across sensor elements located on or near the basket vanes. By measuring their resistance in this circuit, the sensor determines whether or not a desired dryness has been reached, and shuts off the dryer when it has. Repair

of these sophisticated electronic controls should also be turned over to a qualified serviceman.

A dryer basket may be driven by a belt that passes around it and also passes over a pulley on the motor shaft. Where the dryer is equipped with a shrouded basket, that basket is usually driven through two belts and a reduction pulley.

A dryer motor has two windings—one for starting and one for running. It is shifted from the former to the latter winding by a centrifugal switch. The motor terminals and their corresponding wires are usually coded with matching colors. Refer to the manufacturer's schematic diagram for correct terminals when you test your equipment.

The troubleshooting charts on these pages should help you correct most common electric dryer problems. Gas dryers will be the

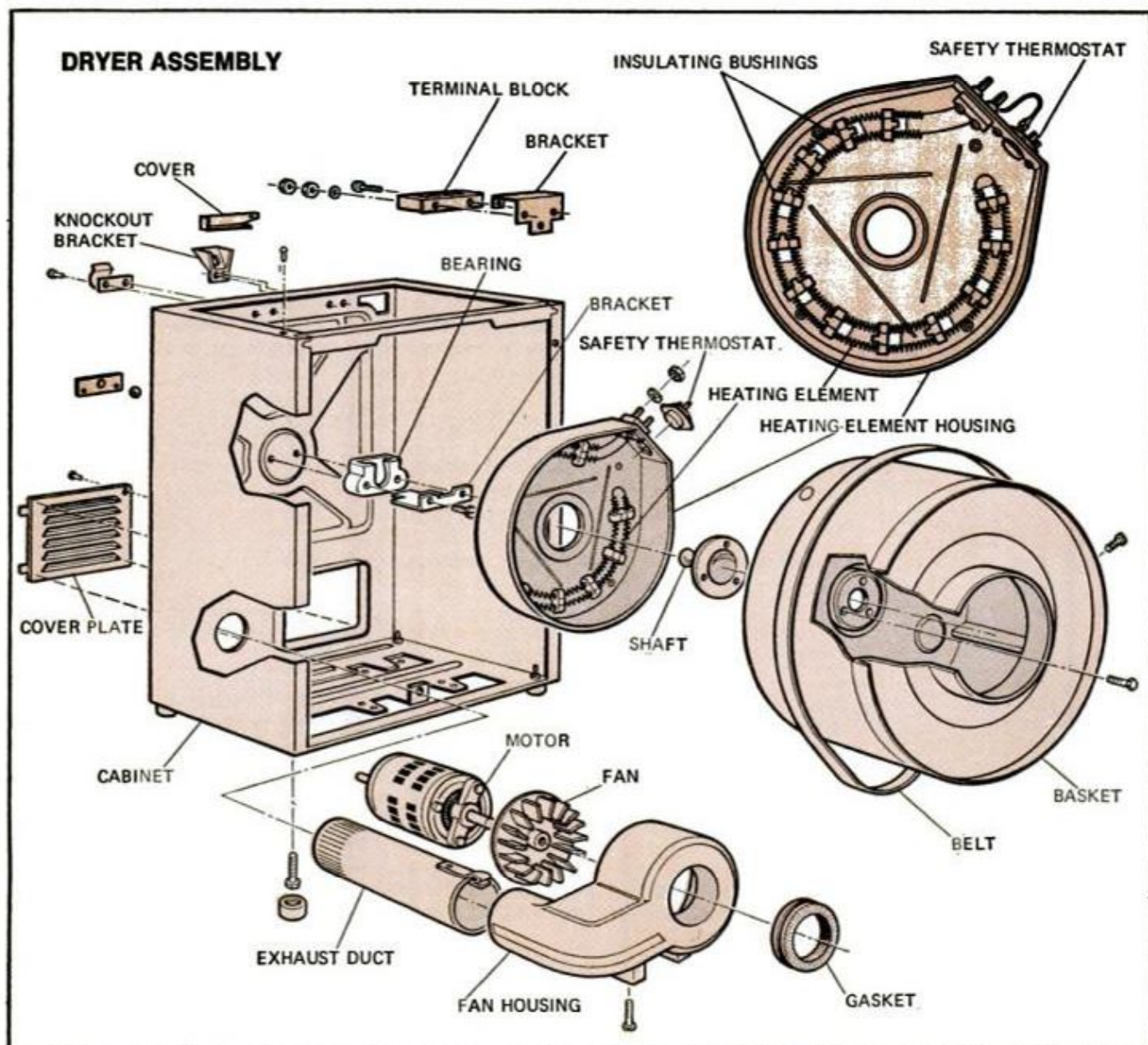



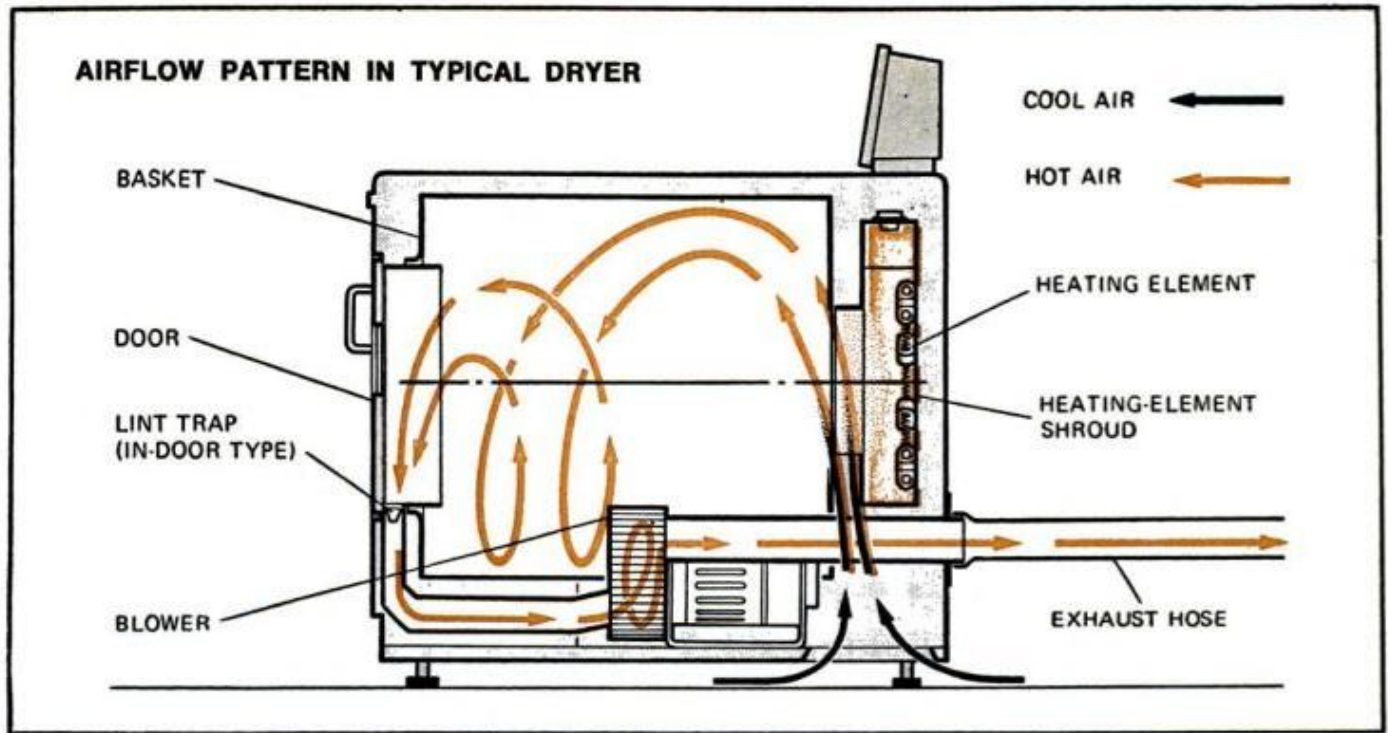

subject of a **CLIP-AND-SAVE KNOW-HOW** article in next month's *PM*. When working on your electric dryer, or any other appliance, follow these safety precautions:

- Refer to your manufacturer's manual to locate components.
- Be sure that power is *turned off* before you handle components.
- Make all of your continuity tests with *power off*.
- When making tests with a 115-v. lamp, turn power off first, connect the lamp, turn power on again, observe the result, then turn power off again and disconnect the lamp.

- Make sure that the appliance is properly grounded, in accordance with your local electrical code.

- Use replacement parts that meet factory specifications; those that are made by the manufacturer of the appliance are your best bet.

*Extra tips:* Before replacing an electrical part you believe to be faulty, make sure that the problem isn't caused by a loose connection. Tighten all connections after replacing an electrical part. Use new parts, not rebuilt ones, unless your appliance is so old that you can expect little further service from it. ★★★

### Dryer does not shut off

POSSIBLE CAUSES	WHAT TO TRY
1. Timer defective.	Check for a stuck timer or welded contact points. Replace.
2. Door switch defective.	Remove wires from the door-switch terminals; then place continuity tester across terminals. If there is a reading before the switch button is pressed, replace switch.
3. Operating thermostat defective.	Check thermostat against the manufacturer's specifications with a thermometer in the exhaust duct. If defective, replace.
4. Motor grounded.	Remove wires from motor terminals. Touch one lead of the continuity tester to a terminal and the other lead to the motor housing. If you get a reading on the tester, the motor is grounded. Replace.



# How to unclog drains

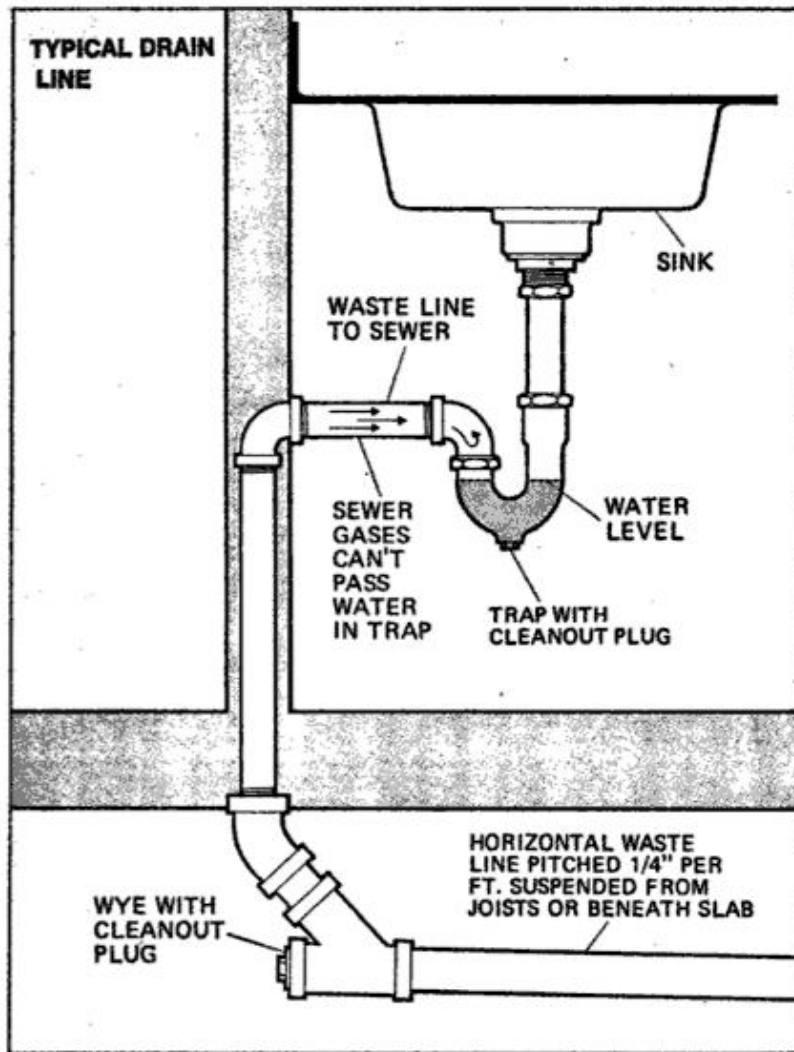

Art: Adolph Brotman

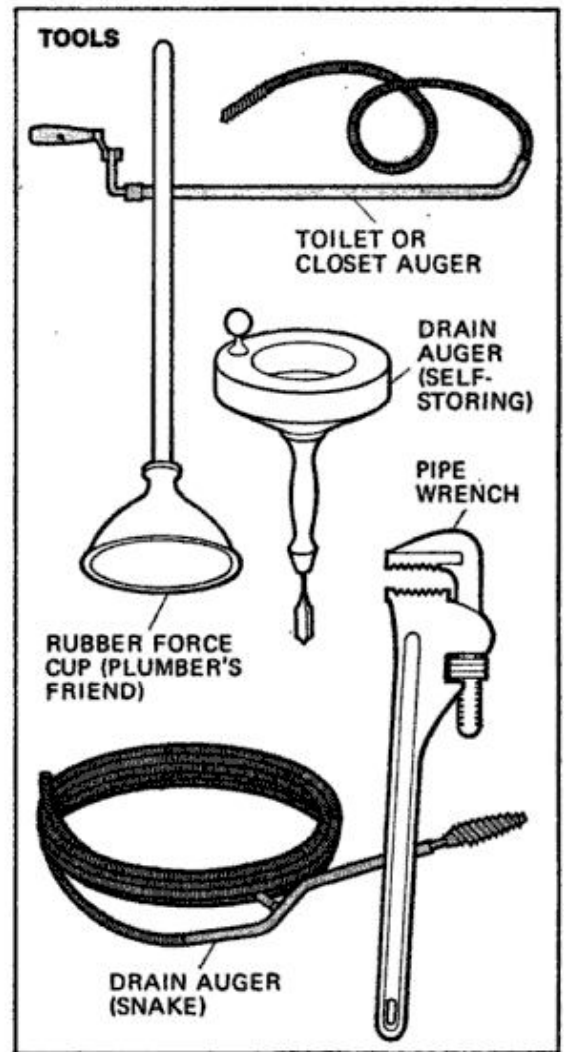

## Blocked drains—a common problem

Drain blockage (after dripping faucets) is probably the most frequently encountered home-plumbing problem. The first step to take when a drain has clogged is to check other drains in the house to determine whether the main waste line itself is blocked. A typical drain is shown above. Notice that between the sink basin and waste line horizontal run, there are two places where the line can be cleaned out—at the trap and at the wye. There should also be a cleanout at every angle (turn) in the waste line. The five tools shown at right above will let you handle most emergencies when the obstruction is in the fixture or reachable area of the waste line. If blockage is caused by tree roots outside, your best bet is to call in a pro with his equipment for clearing the line. To free a stopped-up sink (right), plug fixture's overflow vent and use a force cup. Remove stopper, cover force cup with water and stroke with up-and-down motion. Particles drawn up into sink should be removed and operation continued until line is running freely. If this doesn't work, try chemical cleaners; first scoop out all water in sink.

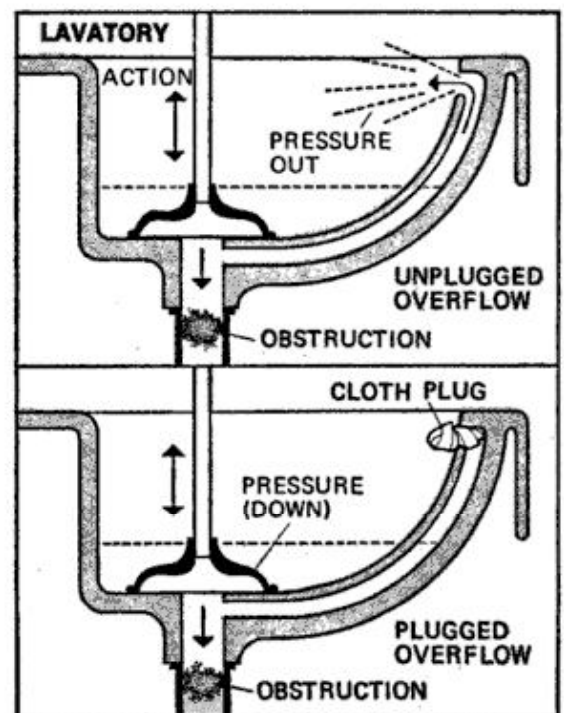



## Clogged toilet

If just one toilet is clogged, it means that the problem is in the toilet itself and not in the drain line. Generally, a number of energetic thrusts with the force cup will free the obstruction. If this fails, try removing the obstruction using a bent wire coat-hanger or toilet auger. (Removal of the obstruction is better than pushing it along where it may clog further along the line.)

The toilet auger is a flexible wire encased in a metal tube. When the handle is cranked, the flexible wire is forced out of the tube and into the trap. Though a good tool for clearing toilet obstructions, its effectiveness is limited by length—usually 3 to 4 ft. If the auger won't reach the obstruction, try using a drain and trap auger. If this fails, the toilet will have to be removed so clearing of line can be accomplished.

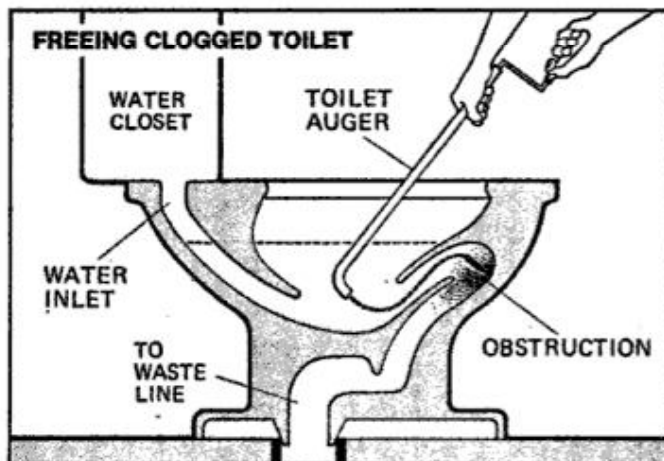

## When all else fails

If you've tried all methods without success, the obstruction is in the main sewer line. In this event, a professional is required; he has the tools and the specialized know-how for clearing clogged lines (usually tree roots) with a minimum of fuss and inconvenience for the family.

## Chemical cleaners

To avoid clogged drains, chemical cleaners should be used at the first sign that water drainage is slowing down in fixtures. Make certain you read and follow the manufacturer's instructions on the container, paying particular attention to the safety precautions (and antidotes). When using chemical cleaners, wear rubber gloves, protect your eyes and make certain you *never use a force cup immediately after using chemicals*; your skin can be severely burned by liquids that may splash back. Give cleaner time to do its job (following maker's instructions), then flush out drain with cold water.

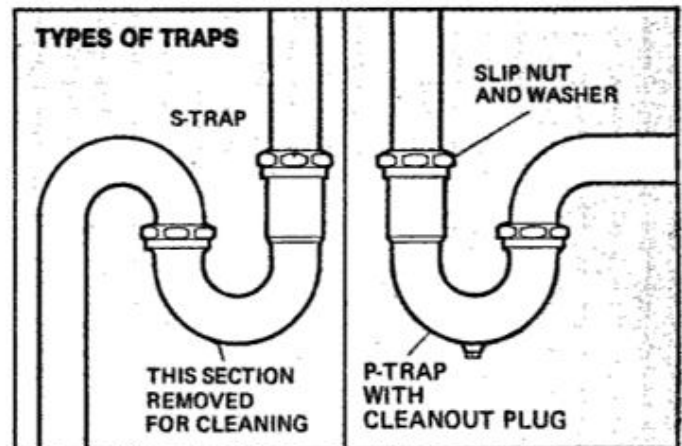

## Cleaning out the trap

The primary function of the trap in a waste line is to prevent the odor of sewer gases from entering the house via the fixture. Water, which is always in the trap, prevents this from happening. If the force cup or chemicals won't clear the line, the third step is to clean out the trap. S-traps must be removed entirely for cleaning by loosening two slip nuts. However, most traps have a cleanout plug at the bottom. Here, simply place a pail beneath the trap and back out the cleanout plug. Then the obstruction usually can be washed out with tap water or snaked out with a drain auger. When line is clear, *carefully* replace the plug or slip nuts. They have very fine threads that are easily stripped if not started right. At this time, check washers on the slip nuts for resiliency. If they show signs of wear, they should be replaced.

## General facts about clogged drains

By conscientiously performing a few maintenance chores every few months, you can probably avoid clogged drains to begin with (except for root problems in the main sewer line). Periodically back out the clean-out plug (or remove S-trap) and flush out all sludge, hair and the like. Make certain you have a pail handy as you remove the plug—remember it is always filled with water. Second, periodically use a chemical cleaner. One type of "clogging" occurs in winter only: Freezing. Here, you must first locate the frozen section of pipe—usually in an unheated attic or crawl space. If water lines are in an outside wall, in some cases the freezing will be where you can't directly reach it. Here, heat applied lower on the line will eventually reach and thaw out the frozen section. Apply heat to pipes using flameless heater, hair dryer, or warm air from the exhaust outlet of a vacuum cleaner. If you use a propane torch, keep flame moving and remove flame from pipe every few minutes or steam might develop to explosive pressure.



# How to minimize heat loss

For months, there has been growing concern over the amount of heating fuel that will be on hand for the cold months ahead. Because of probable limited availability and increasing cost, it makes good sense for every homeowner to cut down fuel consumption wherever possible. After the basics (see *How to Cut Fuel Bills*, page 70, Jan. '73 PM), the best way to do this is by reducing the amount of heat lost through

cracks around windows and doors. Whether your home is new or old, chances are a careful inspection of these areas will reveal places where you can reduce or completely eliminate drafts to save fuel and money.

Storm windows should be used in *all* cold climates. In particularly cold areas, it even makes sense to use them over double-glazed (insulated) windows to create, in effect, triple glazing.

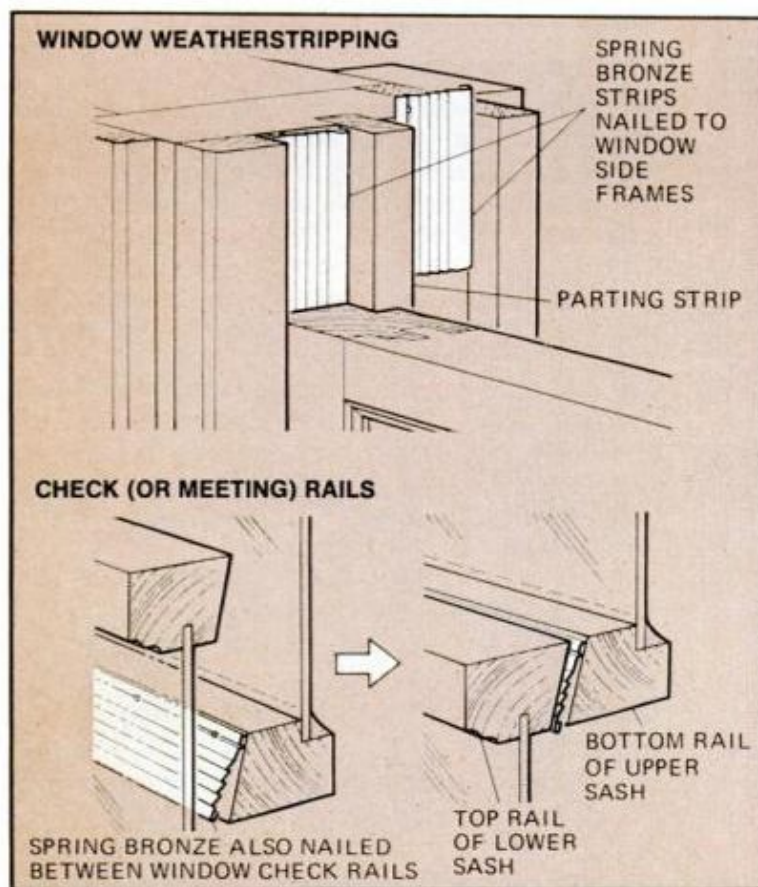

Art: Peter Trojan

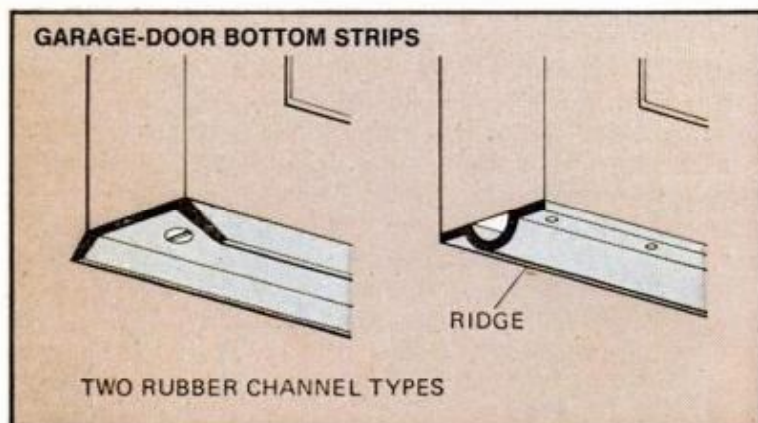

## Drafty windows

If you have neither the desire nor cash to replace a drafty window, you should consider installing spring-type weatherstripping as shown in the drawing at left. Minor drafts can be corrected with such weatherstrip, but for very poor-fitting windows, your best bet is to call in a pro for an estimate on what it would cost to replace the window with a factory-weatherstripped and double-glazed new one.

To weatherstrip a double-hung sash, raise the bottom sash all the way and nail the stripping to the channels (track) where the sash runs, on both sides. Next, lower the bottom and top sashes and install the stripping in the top-sash tracks. Also apply the stripping to the top rail of the upper sash and the bottom rail of the lower one. (This way, it is less conspicuous than if nailed to the head and sill.) Finally, where top and bottom sash meet—the check rails—install stripping.

On steel casement windows, several coats of paint will eventually produce mating shapes on the frame and sash that will form an almost airtight joint.

## Treating garage doors

The chief source of garage-door drafts is at the bottom. Several types of rubber or vinyl channels (drawing, left) available for sealing this joint are simply nailed to the door bottom. If drafts exist around side and head, typical weatherstrip stop cannot be used; friction created by the sliding door will soon wear it out. There is, however, a product available for draftproofing these areas which is nailed on—instead of replacing—existing stop. Made of white vinyl, it comes packaged to suit the opening.



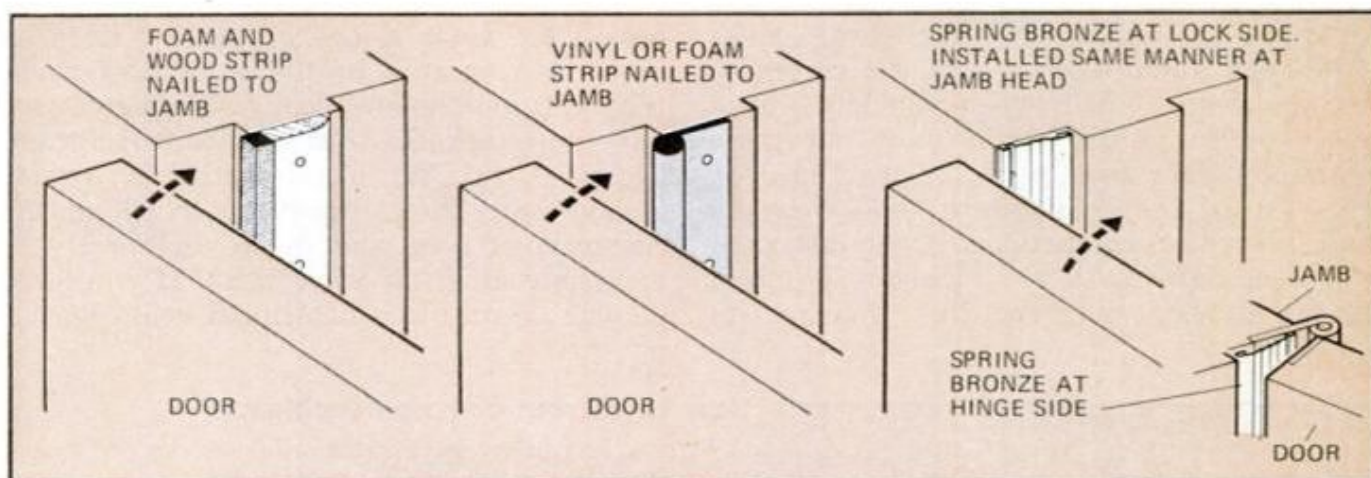

### Exterior doors

Wide gaps around an exterior door can usually be corrected using one of the three types of weatherstripping shown above. One of the best methods for doors is the spring-metal type discussed for windows. Here the strips are nailed to the door jamb close to, but not touching, the door stop. (If the metal touches the stop, the spring action will

not function efficiently, and there is good chance the door will not open and close properly.) The two other types are applied to the stop (rabbeted jamb shown). If the jamb is nonrabbeted, the old stops can be replaced entirely with clamshell or colonial stop which comes with the weatherstripping applied to its edge (foam and wood strip). These stops come in packages of two 7 and one 3-ft. lengths of stop and the necessary nails.

To install stop, close the door and position the stop so it exerts a slight force against the door—so it won't rattle in stiff breezes—and nail it in place. Do the two verticals first, and the head stop last using coped cuts on both ends for neat, tight joints.

Since most exterior doors must be trimmed on the bottom to clear carpeting inside, the largest draft-producing gap is usually at the bottom. Thus, all exterior doors should be fitted with a weatherstrip threshold. These are commonly used in new construction, but if your door has a wood saddle beneath it, consider replacing this saddle with a method shown at left. To install any of these thresholds, door must be taken down and refitted.

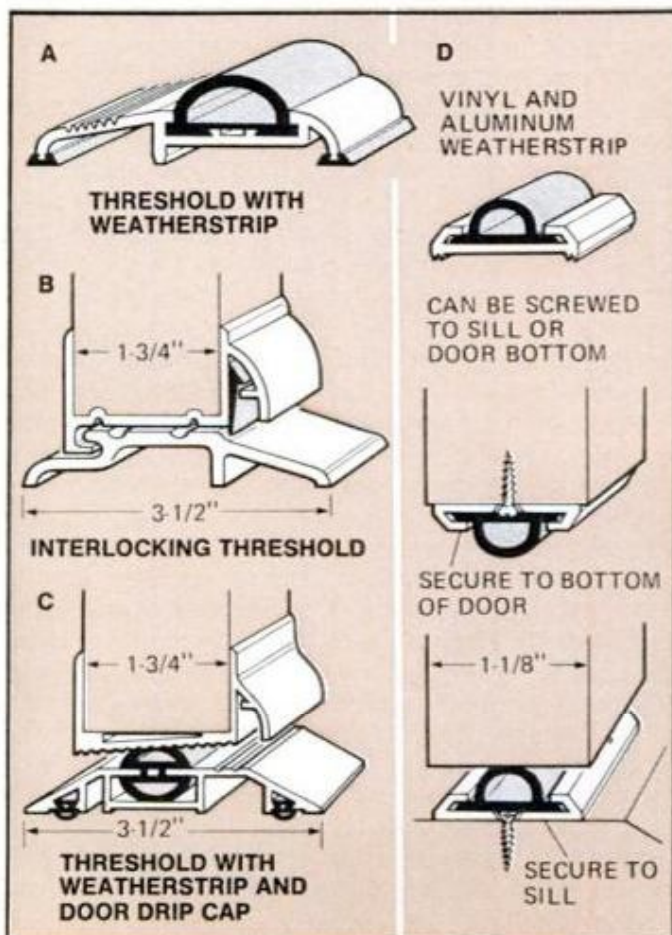

### Don't overlook exterior cracks

Instead of minimizing the importance of "those two or three windows that need a caulk job," think of the size crack or opening around each window or door. Multiply it by the number of windows and exterior doors in your house and you might well end up with the equivalent of a 2x2-ft. opening in your wall. Also, bear in mind that caulking can become useless with age due to exposure to sun and house settling. Check all openings where siding meets casings, scrape out any loose caulk and replace with new. And, though a cheap compound may spell a saving initially, in the long run you will come out ahead with high-quality latex or butyl caulks because they will last longer.



# How to repair scratches in furniture

Mars in furniture—scratches, nicks and dents—often can be corrected by the owner. First, when you buy a new piece of furniture, you'll find that most manufacturers give specific instructions for the care of the finish. Save these booklets and follow the instructions. If you lack such aids, the information on these pages will help you keep your furniture looking its

best, allowing it to age gracefully. Keep in mind that because of the variety of ways that different finishes can be damaged, you have no guarantee that results will always be successful. When attempting a repair, always test the planned repair on an inconspicuous area and make certain treatment is compatible with finish. If you have doubts, consult a professional refinisher.

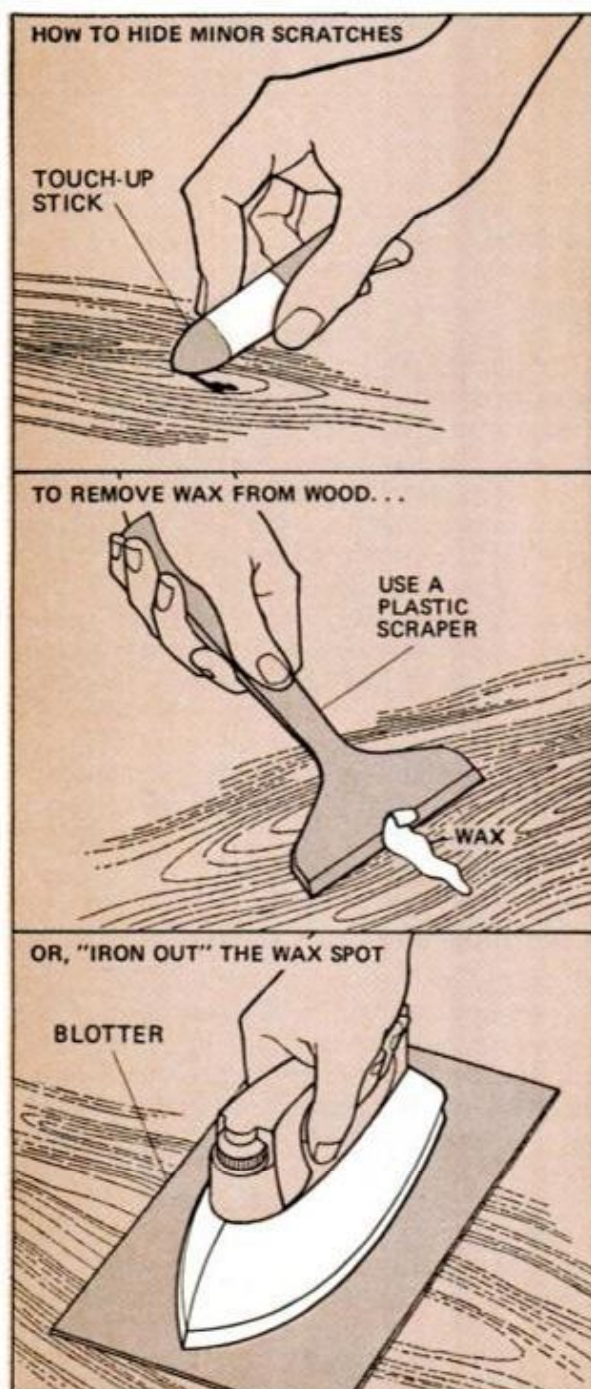

## How to correct common problems

□ *Alcohol and other liquids* such as perfumes and medicines should be wiped up immediately. If the liquid remains on for a period of time, the finish may soften. Allow spot to dry, then use a staining polish of a shade close to the finish. If this doesn't do the job, try rubbing liquid or paste wax into the wood, using your fingers. For oil finishes, make a paste of finely powdered rottenstone and boiled linseed oil and apply it to the damaged area, using a piece of felt or cotton swabs and rubbing lightly with grain. Then wipe the area dry with a clean cloth and polish the surface.

□ *Minor nicks and scratches* that have not penetrated the surface are called blemishes by professionals. These are more easily repaired. Your first try should be with a scratch-concealing (tinted) polish. If unsuccessful, apply a touch-up stick to the area (see top drawing). These are available in a variety of colors; if you cannot find a stick that comes close to the furniture color, try using a combination of two or more sticks to mix desired shade. Fill the scratch with this and rub well. Finally, polish with wax and a soft cloth. A couple of "home remedies" that work: shoe polish applied with a cotton swab and buffed dry. On cherry or mahogany pieces, iodine will sometimes conceal scratches.

□ *Minor burns* are a little more difficult to repair. Sometimes these can be hidden by rubbing with a poultice (paste) consisting of lemon juice and cigaret ashes. Apply with a gentle, circular rubbing motion and wipe clean. When dry, apply scratch-concealing polish. For major burns call in an expert.

□ *Candle wax* can be removed by carefully chipping off as much as possible with a plastic scraper (center drawing). Follow by wiping with a cloth dampened with mineral spirits. On stubborn wax spots, place an ice cube over the spot for a few seconds to harden the wax, and repeat scraping step. Frequently, a spot of wax can be ironed off. Place a heavy blotter on the spot and press with an iron set on "warm." The blotter absorbs the wax. Finish with liquid polish and a brisk rubbing. Water spots can usually be removed using same technique. To remove white rings, rub with a thin paste consisting of wax and mineral spirits. When dry, apply a thin coat of cleaning polish or paste wax.



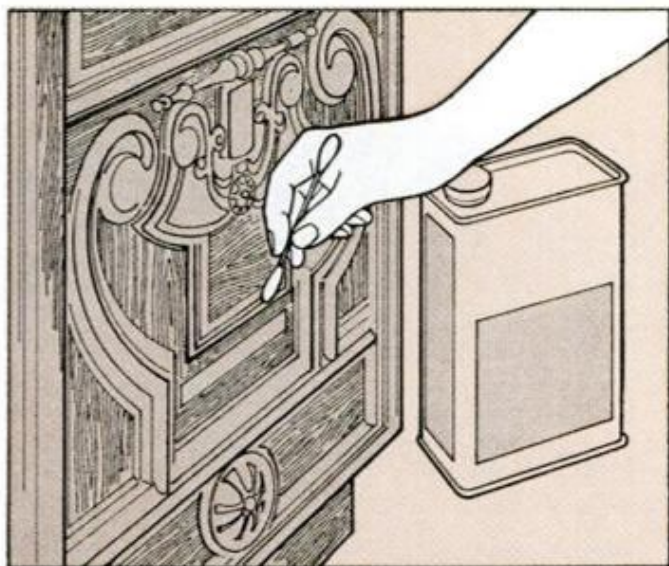

### Care of plastic-laminate furniture

There are now available easy-to-use commercial plastic-laminate cleaners. Sold in a pressurized can, the cleaner is simply sprayed on the laminate and wiped with a clean, soft cloth. Before applying the cleaner/polish, first wash the surface using a mild soap or detergent and water solution to remove spots. Allow surface to dry before applying the polish. Although many homeowners mistakenly believe that plastic laminates are virtually indestructible, remember that they are not. Take precautions. Protect surface from hot vessels with trivets; do not use a kitchen countertop for slicing vegetables. Do your cutting on a cutting board.

### Routine furniture care

Routine care means frequent dusting, occasional washing, periodic cleaning and waxing, and making minor repairs. *Dusting.* Should be done several times a week using a clean, lint-free absorbent cloth. *Washing.* At least annually use a mild, sudsy soap-and-water mix. Dip rag and wring out well. Take care so you do not overwet joints or glued parts will loosen. Work fast. Wash, rinse and dry a small area at a time; make certain you overlap washed areas. *Complete cleaning.* At least once a year, before applying a new coat of wax, give the wood finish a thorough cleaning. First remove old wax film with a clean cloth dampened with mineral spirits or, even better, a *synthetic turpentine* with an oily base. (Turpentine can leave a sticky residue.) Mineral spirits and synthetic turpentine are available at most paint stores. If many layers of wax have accumulated, use a cleanser-conditioner to completely remove dirt buildup. Do a small area at a time, drying worked areas as you go. To clean out crevices, such as in carvings, wrap absorbent cotton around a pointed stick (drawing, above left). Dampen cotton with mineral spirits and clean out desired areas. Wipe and dry the crevices as you proceed. Finish with a thin coat of liquid wax; rub thoroughly with piece of flannel.

### Some furniture dos and don'ts

*Do* immediately remove spilled liquids using a blotting rather than wiping action.

*Do* lift objects to move them. Lamps and ashtrays should not be dragged across a surface.

*Do* use trivets or pads to avoid burns.

*Do* use only polishes recommended for furniture. A self-polishing floor wax, for example, could soften and damage a wood finish.

*Do* use only soft, lintfree cloths for polishing. If using old shirts, remove all buttons and seams. Since some contain an abrasive starch, *do not* use cheesecloth to polish.

*Do* work *with* the grain of the wood whether washing, cleaning, polishing or waxing.

*Don't* use a new polish or cleaning agent without first testing on an inconspicuous area.

*Don't* use nail-polish remover on furniture.

*Don't* attempt the repair of badly damaged surfaces yourself. If you create a large damaged area, the inevitable calling-in of a pro will just up the cost of repair.

*Don't* place rubber and vinyl products (mats and coasters) on furniture surfaces unless the manufacturer states that they are intended for such purpose. Lacking this assurance, place a piece of felt under each lamp, ashtray and the like to serve as a protective pad for the furniture.

*Don't* wash painted furniture too frequently. Repeated washings or heavy scrubbing will eventually change the color.

*Don't* wax or polish a painted piece of furniture unless the product you plan to use is guaranteed not to discolor paint finishes.



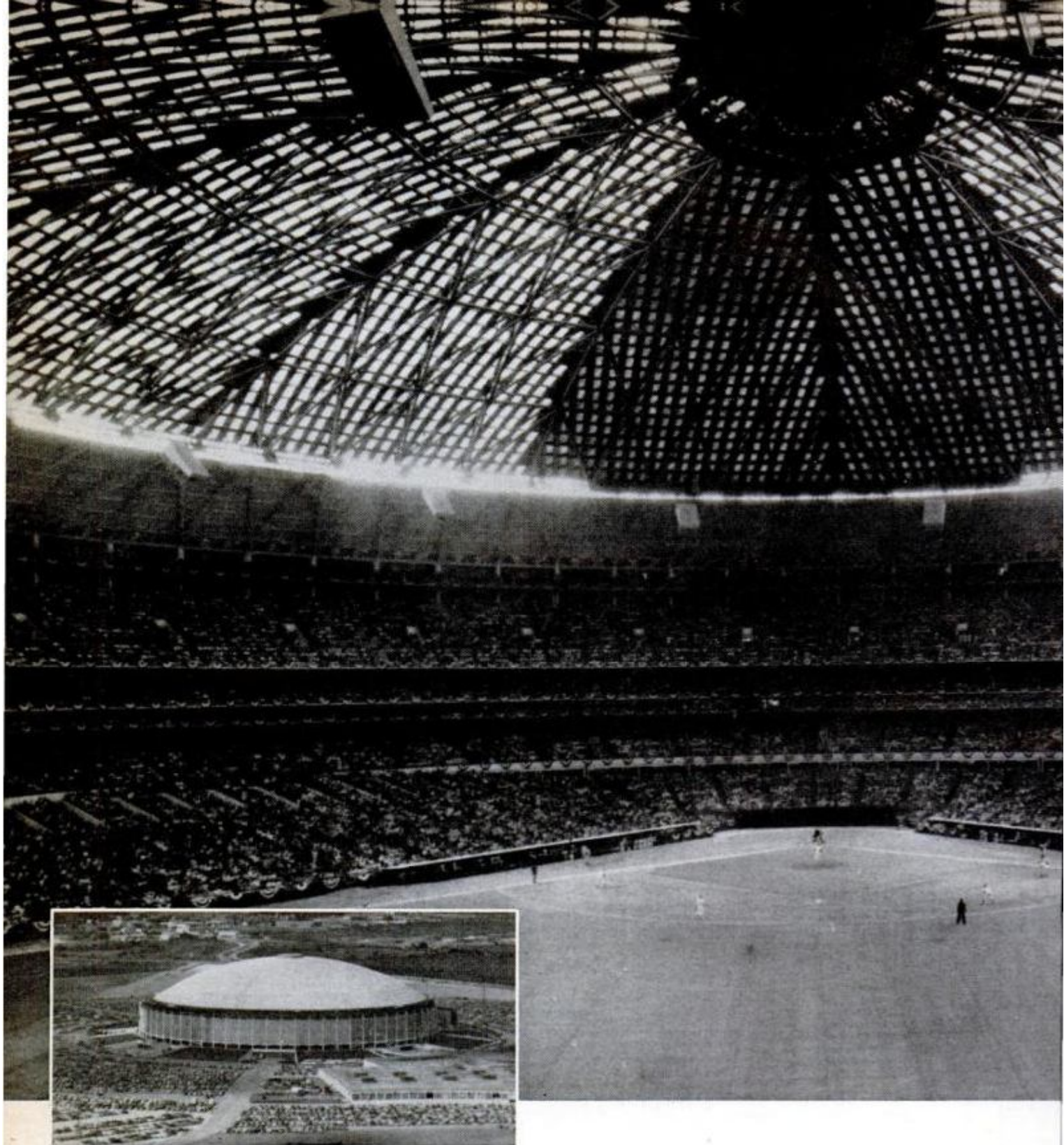

## Who's ahead in the superstadium game?

by Ed Nelson

The downtown skyscraper is no longer the proudest structure of the American city. Today, the chamber of commerce is more apt to roll out the superlatives for the new stadium, especially if it's topped with a dome.

New stadiums—some more “super” than others—have sprouted in or near cities like Houston, San Diego, Dallas, Buffalo and Kansas City. Late starters, but coming up fast in this newest of competitions, are Seattle, New Orleans and an area in New





## Louisiana superstadium

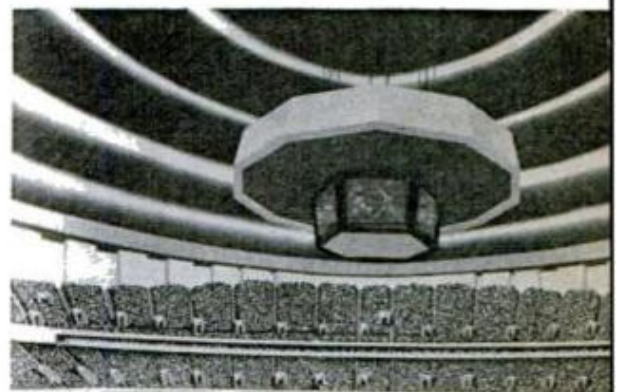

Jersey known as the Hackensack Meadows.

Rivalry is keen. In a brochure, publicists proclaim the Houston Astrodome as the "eighth wonder of the world," an assessment they attribute to evangelist Billy Graham. Not to be outdone, the builders of the Louisiana Superdome in New Orleans created a drawing showing how the entire Astrodome could fit inside their stadium—and with room to spare.

Scheduled to open in the fall of 1974, the Superdome bids to become the new

The "age" of the domed sports arena got its start with the Houston Astrodome (left), completed in 1965. Artificial turf was another first. Now the Louisiana Superdome (above) bids to take over the top spot among superstadiums. Located in downtown New Orleans, it will be bigger than the Astrodome and will boast a TV gondola suspended from its huge dome. Six screens, each measuring 26 by 22 feet, will provide spectators with instant replays. The stadium will cost \$154 million.



## A university stadium designed for versatility

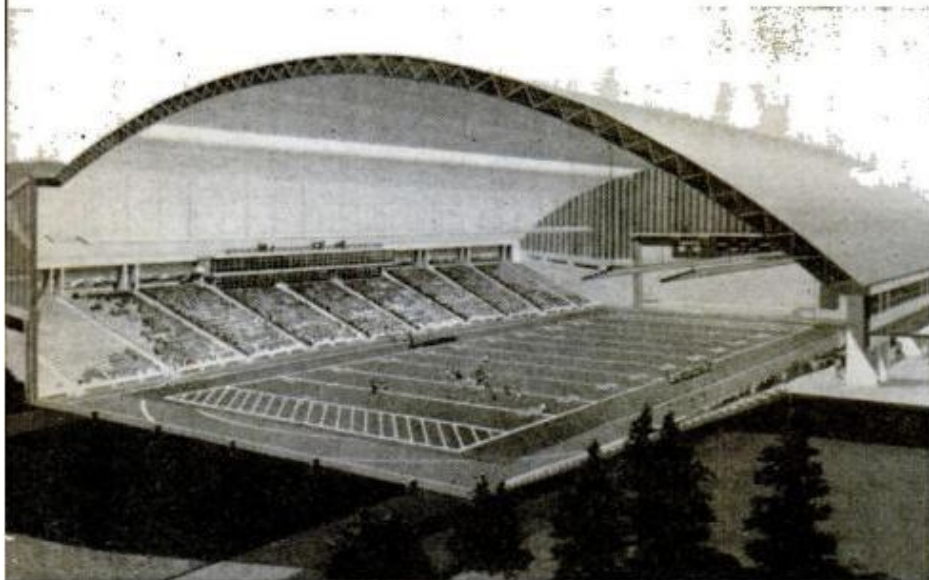

champ—the largest enclosed stadium in the world. It will have a dome 680 feet in diameter and 273 feet high, and a seating capacity of 75,000 for football. By contrast, Astrodome sports a 642-foot-diameter roof, is 208 feet high and seats 52,000 football fans.

Superdome will be equipped with a system of motorized stands to allow ground-level seats to be moved for different seating configurations for various types of events. The wheeled stands will roll on recessed tracks. Thus, Superdome will have 18,886 seats for basketball, 60,543 for baseball and 97,465 when used as an auditorium.

Versatility is not unique to Superdome. Like other modern stadiums, it will owe a debt to Rome's Colosseum, a multipurpose arena that even had a system for flooding the field for minor "naval battles." It seated 50,000, putting it in the same league with many of today's stadiums.

But Superdome's TV array, a "gondola" of six screens suspended from the dome, will be a feature no Caesar could watch. Hanging high in the center of the stadium, the TV screens will provide the crowd with instant replays and close-ups of the action on the field. All this suggests that you'll be able to see as good a show at the game as you would have by staying home in front of the tube. This may be a crowd pleaser, but one wonders how baseball umpires and football officials, who must make many split second judgment calls, view this bit of technological legerdemain.

Superdome beats out the Astrodome in another way, too. The Houston facility cost a mere \$38 million. Superdome had an initial price tag of \$35 million, a total that since has mushroomed to \$154 million.

The inflated price didn't faze at least one state official. "We're not gonna let a couple of million dollars stop us," he said. Needless to say, the state government is backing the project to the hilt.

The daddy of the superstadiums is the Astrodome, the "world's first airconditioned domed stadium." The guiding genius behind it is Judge Roy Hofheinz, a portly, cigar-smoking Houston businessman who claims Rome's Colosseum gave him his inspiration. But the ground-breaking ceremony, in January, 1962, was strictly Texas-style. In addition to wielding shovels, public officials and chamber of commerce people fired .45 Colts into the ground.

Today, the Astrodome is the major structure of what has become known as the Astrodomain. Other facilities include Astrohall, a huge exhibition hall; Astroworld, an amusement park; four Astroworld hotels and motels.

It's Judge Hofheinz's habit to think big and do things with a flourish, prompting one admirer to comment: "I fully expect to read some morning that Roy Hofheinz has booked World War III."

You might think that Seattle, located in the cool, sober precincts of the Northwest, would handle its project—the King County Multipurpose Stadium—with a minimum of



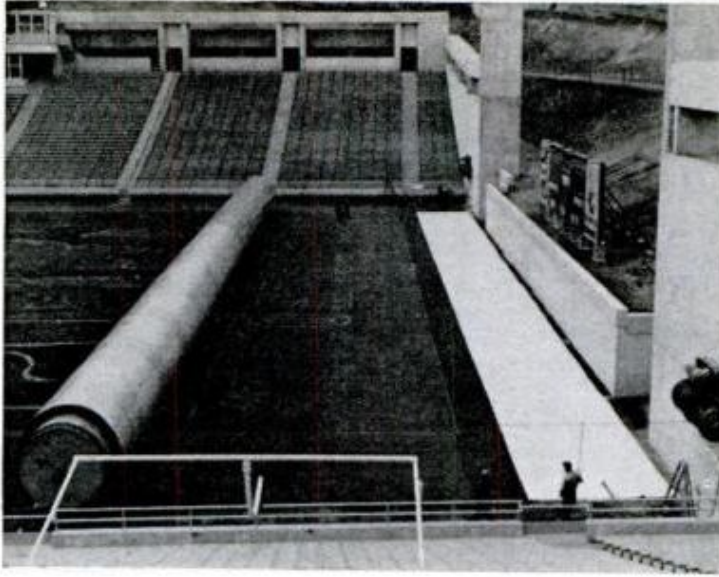

**University of Idaho's** new 21,000-seat stadium was not designed as competition for the domed palaces. But it's an innovative facility that will—after a second phase of construction—sport an arched roof. When the Tartan Turf gridiron (extreme left) is rolled up, other sports (center) can be played on the permanent floor. Photo shows the system of cables and winches used to roll up the synthetic gridiron.

fuss and confusion. Not so. Seattle voters twice rejected stadium proposals. When they finally okayed a revised proposition, location became a problem.

Professional consultants told a commission—composed of political and business leaders—that the three best available sites were in the suburbs. Each would be cheaper than a downtown site under consideration, and each would be readily accessible to cars.

But the commission wanted a downtown site. A local paper joined in the flap with an editorial calling for the firing of all the consultants.

When the dust finally settled, the site chosen was 37 acres of abandoned rail yards at the edge of town. A 65,000-seat stadium, as is planned, would normally require 10,000 parking spaces, perhaps more. But only 2400 are planned. Officials say that other downtown space will take up the slack—and many fans will come by bus, they hope.

Necessary ramps from a nearby freeway and other highway improvements could cost an extra \$6.5 million. The stadium itself is tabbed at \$43 million.

And the sad part is that the stadium can't lay claim to a major-league football or baseball team, a caliber of tenant that stadium builders dote on. What may have been Seattle's best chance for big-league football vanished when the Buffalo Bills announced they were staying put. The Bills had threatened to call a moving van when



**Texas-style opulence and comfort** are seen in these two private boxes at Texas Stadium, outside Dallas. To obtain a 40-year lease on a box, you have to purchase \$50,000 worth of stadium bonds and buy a dozen \$120 season tickets. Box shown at top, leased by an oil and gas company, features blue velvet chairs and a crystal chandelier. Gridiron, where Dallas Cowboys do their stuff, is behind and to left of camera. Bottom photo shows modern decor favored by a cement company.





New home for the Buffalo Bills is a relatively modest, no-dome structure. Like other stadiums, it did not come into being without controversy about location.



Instead of a single, multipurpose facility, the new Harry S. Truman Sports Complex in Kansas City, Mo., boasts separate football and baseball stadiums.

Buffalo, too, came down with a fairly serious case of stadiumitis.

Local folks had generally agreed that a new stadium would be nice. But sharp disagreement developed over location: city or suburbs. For a while there also was talk of building a domed stadium.

Finally, conflicts were resolved and the Erie County Football Stadium became reality—in a suburban location. The community had sold \$23.5 million bonds for financing but—wonder of wonders—the stadium was completed at a cost of only \$21.5 million. One reason for the low price tag: no dome. The Bills are playing in the new stadium this season.

Buffalo's modest approach was patterned, to some degree, on Schaeffer Stadium, a no-

frills structure erected in Foxboro, Mass., outside Boston, at a cost of but \$6.2 million.

The stadium was opened in 1971. A crowd of 60,423 watched the New England Patriots beat the New York Giants. But this artistic success was somewhat dimmed by a traffic jam that the *Boston Globe* termed historic. More embarrassment came from Foxboro's sewer system, which simply wasn't up to opening-day demands. Before the end of the game, washrooms were awash.

The visiting team that day—a New York fixture for decades—will not be based in the nation's largest metropolis much longer. Soon they'll be playing out of New Haven, Conn. (location of the Yale Bowl) while waiting for their new home to be built in the Hackensack Meadows, near Rutherford, N.J., and across the Hudson River from New York.

The Giants were lured into the Meadows by a gentleman who could easily give Judge Hofheinz a run for his money. Though less flamboyant than the judge, David A. (Sonny) Werblin is his match when it comes to big thinking and doing.

After years as a leading show-biz executive, Sonny became president of the New York Jets. He quickly turned them into a top attraction by signing on Joe Namath—for a princely sum—as quarterback.

Sonny left the Jets in '68. He is now the chairman of the New Jersey Sports & Exposition Authority and the driving force behind the development of a sports and exposition center in what is now a rubble-strewn marshland.

The main facility will be Giants Stadium, an open, three-tiered structure that will accommodate "more than 75,000 persons in self-rising, armchair seats," according to publicity literature. The stadium will be ready by August, 1975, says Sonny.

The complex will also include a track for horse racing, an exposition "arena," hotel and other impressive facilities.

At groundbreaking ceremonies on a snowy November day, Sonny Werblin spoke in the true spirit of the stadium builder as he surveyed the expanse of garbage-littered marsh: "We will stand here again someday and marvel together at what men of determination, good will and strong faith can achieve. The Good Lord willing, we will transform what is before you today into an area of beauty, excitement and pleasure for you, your children and generations still to come." ★★★



# Motor homes built the way they ought to be

by Jim Liston

EDITOR

Picture this: You're at the wheel of a motor home rolling at 70 mph. It's so quiet you can easily talk with people seated at the dinette behind you without raising your voice; so quiet you need to check the tachometer against the speedometer. You hear the whiz of the tires and the swish of the wind. But engine noise is more than 20 feet away, sealed off in a rear compartment.

The coach is eager on the hills, never slows to less than 50—in second—on the steepest; it glides down the highway, smoothing out the dips and rough stretches with a pleasant, easy stride. The accelerator is responsive; the power steering has a good, positive feel. A truck pulls onto the highway and you hit the brakes at 70 and there's no sweat, no squeal, no fade. When your freeway exit takes you by surprise, you zip into the tight curve of the off ramp faster than you think you should with a vehicle of this type. There's no lean, no sway; the coach tracks like a sports car.

There's a wonderfully secure, solid feeling to the vehicle, and the more you drive it the more aware you become of the complete control you have. This is the way motor homes *should* handle; this is the way they'll have to perform and handle if they're to come up to this pace-setter recently introduced by the FMC Corp.

FMC is a worldwide manufacturer of diversified machinery, chemical, fiber and film products. It had been known for some time that General Motors' GMC Truck and Coach division was planning to enter the motor-home field as a producer. But FMC's 2900 R (29 feet; R for rear engine) entry came as a surprise. The prototype first appeared at the Family Motor Coach Assn. convention at Burlington, Vt., July, 1972, and all but stole the show.

It was the kind of vehicle coach fans knew from experience would be an ideal highway cruiser. And with its price of about \$30,000, which included *everything*, it was considered a real bargain by coach



**FMC 2900R** (top) is 29 feet long, 8 wide, with 81-inch track, built-in airconditioner, TV antenna on roof. GMC's 26-footer has sleek, aerodynamic styling.

buyers accustomed to prices that start at \$35,000. A short distance away the GMC was attracting big crowds with its front-wheel drive, low roofline and floor, and air springs mounted between tandem rear wheels.

As two different engineering approaches to a design problem the FMC and the GMC offer an interesting comparison.

From their beginning, 15 years ago,



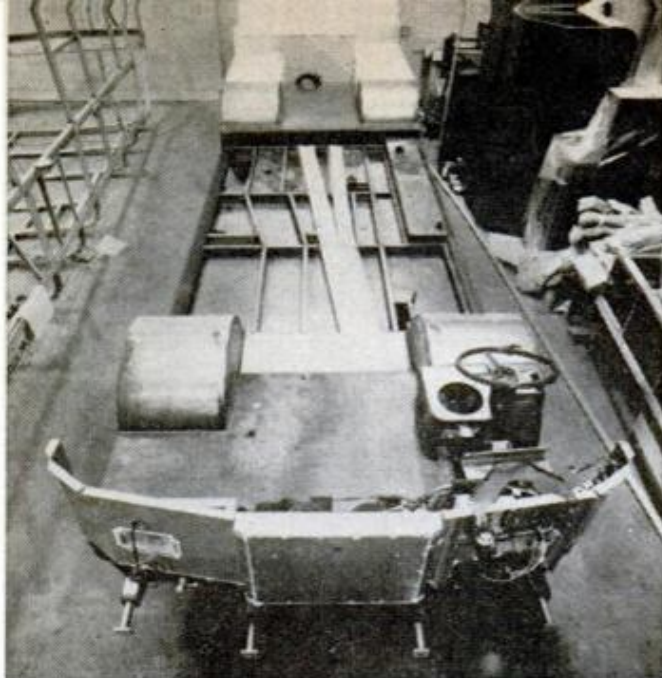

**FMC starts by welding** its own steel chassis, to which aluminum frame (left) is welded. Plastic conduits in center carry accelerator, brake and gear selector cables and heater hose. All joints on underbelly are sealed to prevent corrosion. Cockpit of FMC has good instrument array with panel at right supplying a digital readout on the coach's domestic equipment.

most motor homes have been built on truck chassis. The adaptation results in several things that are less than ideal—a high center of gravity with poor lateral stability (sway on turns and in crosswinds), hard-riding truck suspension, poor acoustical and thermal insulation—and, in many instances, insufficient power.

Truck manufacturers whose chassis are used by motor-home builders have lately improved suspension systems and braking power and lowered the high center of gravity. But engineers have long contended that the right way to build a motor home is from the ground up, with body and chassis engineered as a unit.

The engine of the FMC is in the rear to eliminate a long drivetrain and to make possible a radically lower center of gravity. Noise and heat are behind, and mechanics never have to enter the living quarters to tune the engine. A Chrysler 440-cu.-in. engine is coupled to a heavy-duty, three-speed transmission, and oil pan capacity has been increased to insure adequate cooling without adding transmission coolers.

FMC uses four-wheel independent-suspension-type chassis. Front suspension is an 11-leaf transverse spring with "A" arms; the rear suspension is a torsion-bar system.

On the rear wheels a trailing arm is welded to a tube held in rubber bushings and clamped in brackets. In the middle of this assembly, which is bolted to the frame, is a torsion bar. This is the same torsion bar FMC developed for military personnel carriers which have been torture-tested from the Arctic to Panama.

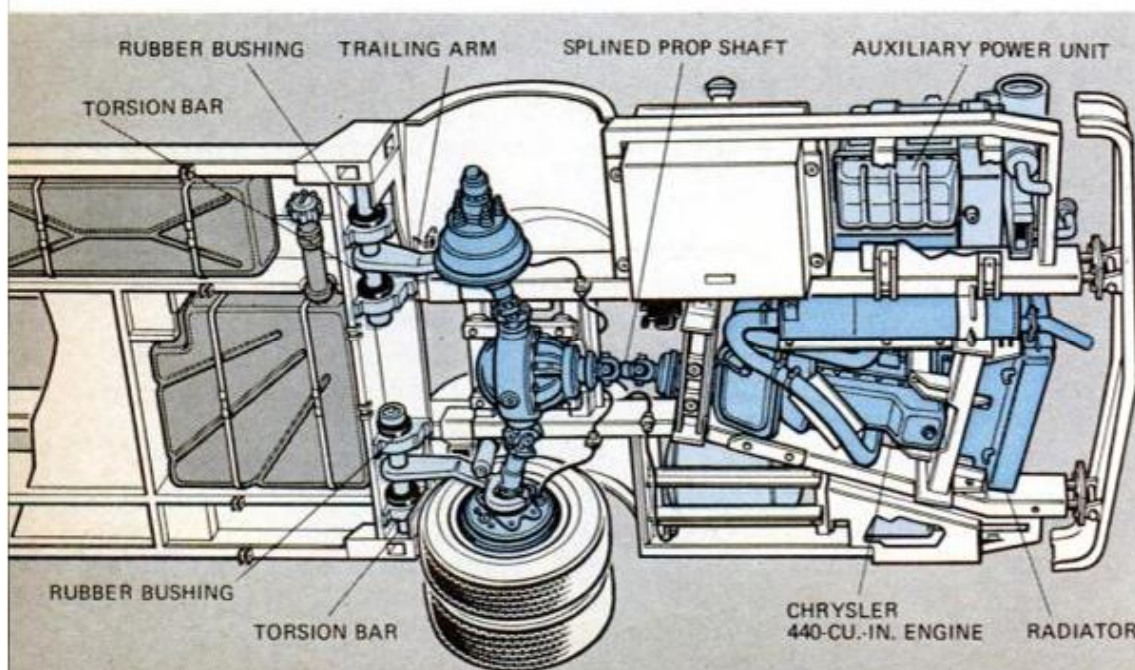

**Torsion-bar suspension** accounts for coach's remarkably quiet, smooth ride. The tube to which the trailing arms are welded passes through heavy rubber bushings that eliminate lubrication, noise and vibration. Engine compartment affords good access and is vented on three sides.



The differential is mounted on the chassis frame with a sliding spline shaft so the drive wheels can bounce and the shaft merely gets longer or shorter. This substantially reduces the unsprung mass.

Motor homes built on truck chassis have Ackerman steering. Alec Turner, chief engineer, maintains that FMC's three-piece automotive-type track rod is superior to the one-piece track rod used on trucks. The turning radius is a remarkable 31 feet. A 14 $\frac{1}{8}$  x 3 $\frac{1}{2}$ -inch brake lining is used on all four wheels.

The exterior of the coach is gold and white, colors molded into the fiberglass shell. A clean roof (one-piece molded fiberglass with no joints) with vent stacks, auto airconditioning condenser and TV antenna concealed, reduces air drag and wind noise. Two 115-volt off-road airconditioners, that get power from a land line or the 6500-watt Onan generator, are concealed beneath the closet of the vehicle and are exhausted under the coach.

The combination of a steel frame and welded aluminum upper cage gives the FMC full roll-over strength. Legislation requiring this and other safety features was anticipated by FMC to avoid costly design changes later.

It's easy to step aboard the FMC; there are no steps to climb. The flat floor extends all across the interior width in front, so in addition to the driver, two passengers can share the view and they can stand erect

when getting in or out of the seat. In addition to the passenger door, there's a driver's door—something *every* motor home could use.

The instrument panel gives the driver solid information with calibrated water temperature, oil pressure and amperage gauges and a tachometer. A "domestic panel" gives a readout on the amount of water in the water tank, the amount of fluid in each of two holding tanks; battery condition, waste destruct system and vehicle leveling indicator. The latter is a camping convenience; it shows which wheels are low; when the coach is leveled within two degrees, panel lamps go off. This system is soon to be coupled to an automatic self-leveling device.

The FMC's interior closely resembles a well-appointed commercial jetliner. Vinyl-clad aluminum walls, wood-grained Formica cabinets, and molded fiberglass bathroom fixtures make it a beautiful, easily-maintained vehicle. The galley, bath and bedroom/living room are well planned and—there's only one word for it—"restful" after a day behind the wheel.

Originally, the 2900 R had a base price of \$22,958 with optional features available. But it soon became clear that those who were interested in this coach—third and fourth-time purchasers of motor homes—wanted everything. The present price of about \$30,000 is for a single design with everything "standard." To list only a few: 60-gallon fuel tank; 60-gallon fresh water tank; 65-gallon dual waste holding tanks: AM-FM radio, stereo tape deck, front and rear 28,000-B.T.U. auto airconditioning,

**Well-lighted bath** has skylight and window, molded plastic vanity sink, tub-shower, marine toilet. Galley's wide window, eye-level oven, 8-cu.-ft. refrigerator, ample cabinet space make cook happy.





**GMC's 26-foot model** sleeps six; 23-footer sleeps two less for about \$1000 less. When open, bath and closet doors divide vehicle into two private compartments. Coach is only one step off ground but the driver sits above the engine with an excellent view of the road.

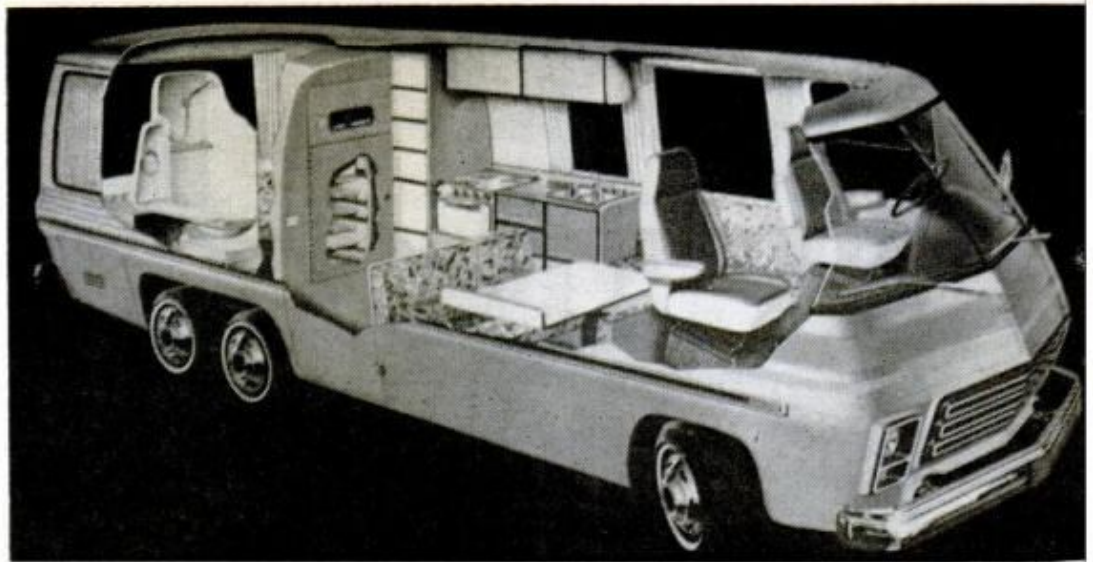

22,000-B.T.U. household airconditioning, 6.5-kilowatt auxiliary generator, Thermasan waste destructor, Michelin tires, TV antenna.

We drove the FMC from San Diego to San Jose, Calif., a distance of 468 miles in

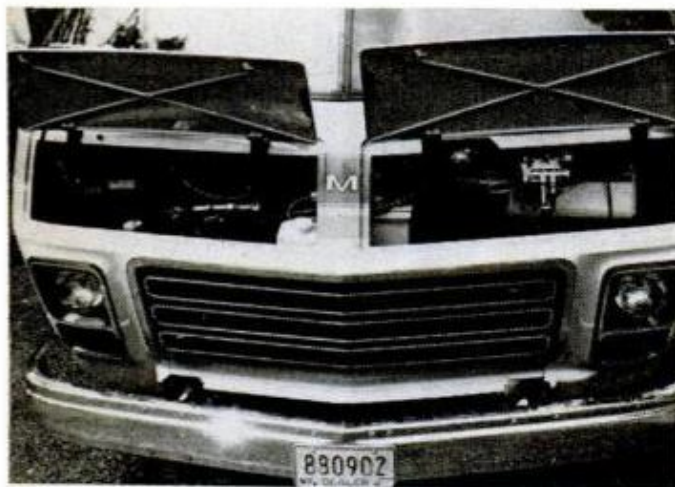

**Doors on front of GMC** give access to cooling system, brake master cylinder, battery, oil dipstick.

**Dinette converts** to double bed; couch back raises to make double berth. Main bedroom/lounge is at rear.



eight hours. We chose U.S. 5 through the San Joaquin Valley because it's notorious for its strong crosswinds. We knifed through them without effort, cruising steadily at a legal 70 mph. Despite the winds, L.A. freeway traffic, and 100° temperatures which required full airconditioning all day, we got 6.9 miles per gallon at an average speed of 58 mph. At the end of the day we knew FMC had here a whole new dimension in motor homing—an express cruiser (60-gallon fuel tank) capable of biting off at least 360 miles without a gas stop and with very little wear and tear on the driver. That comes pretty close to low-level aviation.

With all the good features in the 2900 R there are a few faults that are surprising oversights. The owner of a \$30,000 rig will want a better bed for his guests than is provided by converting the dinette. Likewise, the driver's seat and front passenger seat will, we're sure, have to be redesigned. The brake pedal is not directly across from the accelerator; you have to draw your foot *back* about four inches and raise it to land on the brake. Too slow in an emergency.

**I**f you've ever wondered what it would be like to boss a big transcontinental bus on the highway or slip into the pilot's seat of a commercial airliner—you'll get a pretty authentic answer when you climb into the "cockpit" (that's what they call it) of the GMC.

GMC gets rid of the long drivetrain and lowers the center of gravity by using an Oldsmobile front-wheel-drive unit with 455 cu.-in. engine, four-barrel carburetor and three-speed automatic transmission. The floor of the vehicle is only 15 inches off the



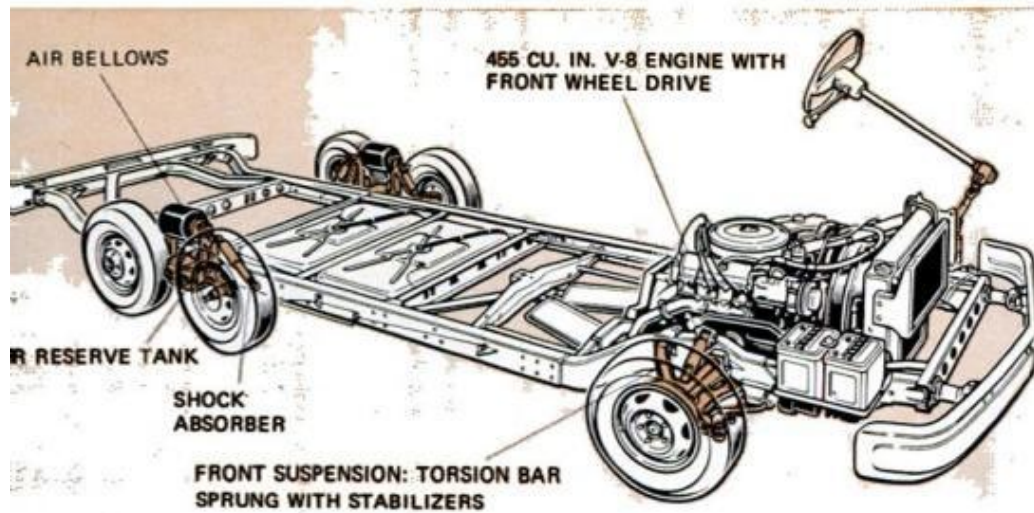

**Low-slung chassis** puts floor of GMC only 15 inches above ground. Low center of gravity gives the vehicle its stability. Rear wheels, cushioned by air springs, are in tandem and mounted outboard of the body for wider stance. Rear track of GMC is 82 inches. Wheel bases available are 140 in. and 160 in.

ground; the "flight deck" over the engine is 21½ inches above that so the view is high, wide and handsome. No motor home offers a more unobstructed view. The windshield wraps completely around to the pillar behind the driver's seat. (The big windshield wipers have the washers built into the arms so the fluid hits where it should.)

GMC licks the ride problem with "air springs," air-inflated rubber bags, mounted between independently suspended wheels in tandem. The air-cushion unit includes an automatic leveling valve that maintains a constant ride height at the rear tandem suspension. An optional Power Level System that overrides the automatic leveler lets you trim the rig at a campsite; it raises or lowers the vehicle as much as four inches.

The front wheels are independently suspended with torsion bars and stabilizers. GMC uses tandem rear wheels instead of duals, claiming that: (1) placed outboard, they provide a wider stance, hence greater stability (the GMC rear track is 82 inches) and, (2) the wheel wells do not intrude on passenger space.

The body of the vehicle is shaped like an aircraft fuselage—and built like one, with a cage of aluminum ribs and stringers. The roof and upper side panels are aluminum; the nose and rear and lower panels are molded fiberglass to resist corrosion.

The glass areas are generous; windows in the living area are each 32 x 57 inches; the rear window is 32 x 66. Overhead cabinets in the galley are kept to a minimum to lend spaciousness. But there is plenty of storage under the sink and adjoining the

*(Please turn to page 208)*



**Air bellows is not concealed,** is displayed as distinctive feature. Rear adjusts automatically to load under way, can be leveled at your campsite.

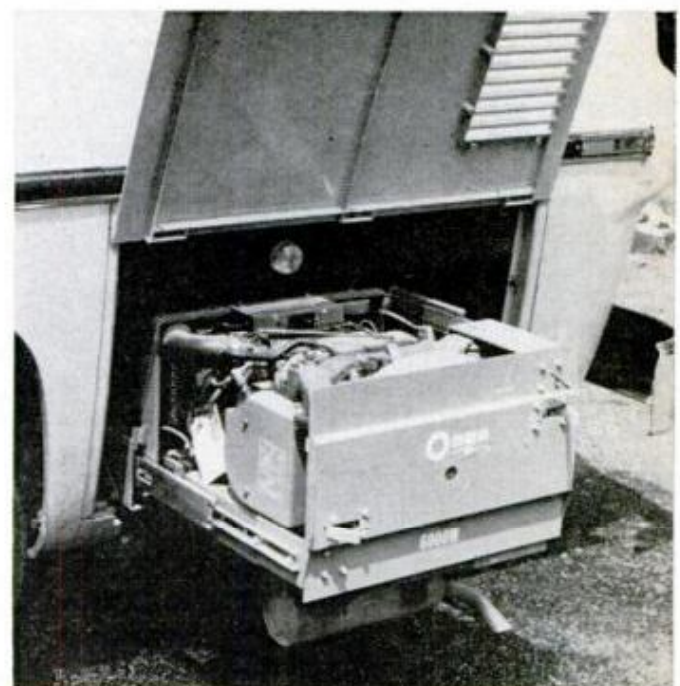

**Motor generator, in left rear compartment,** glides out on ball-bearing tracks for easy servicing.



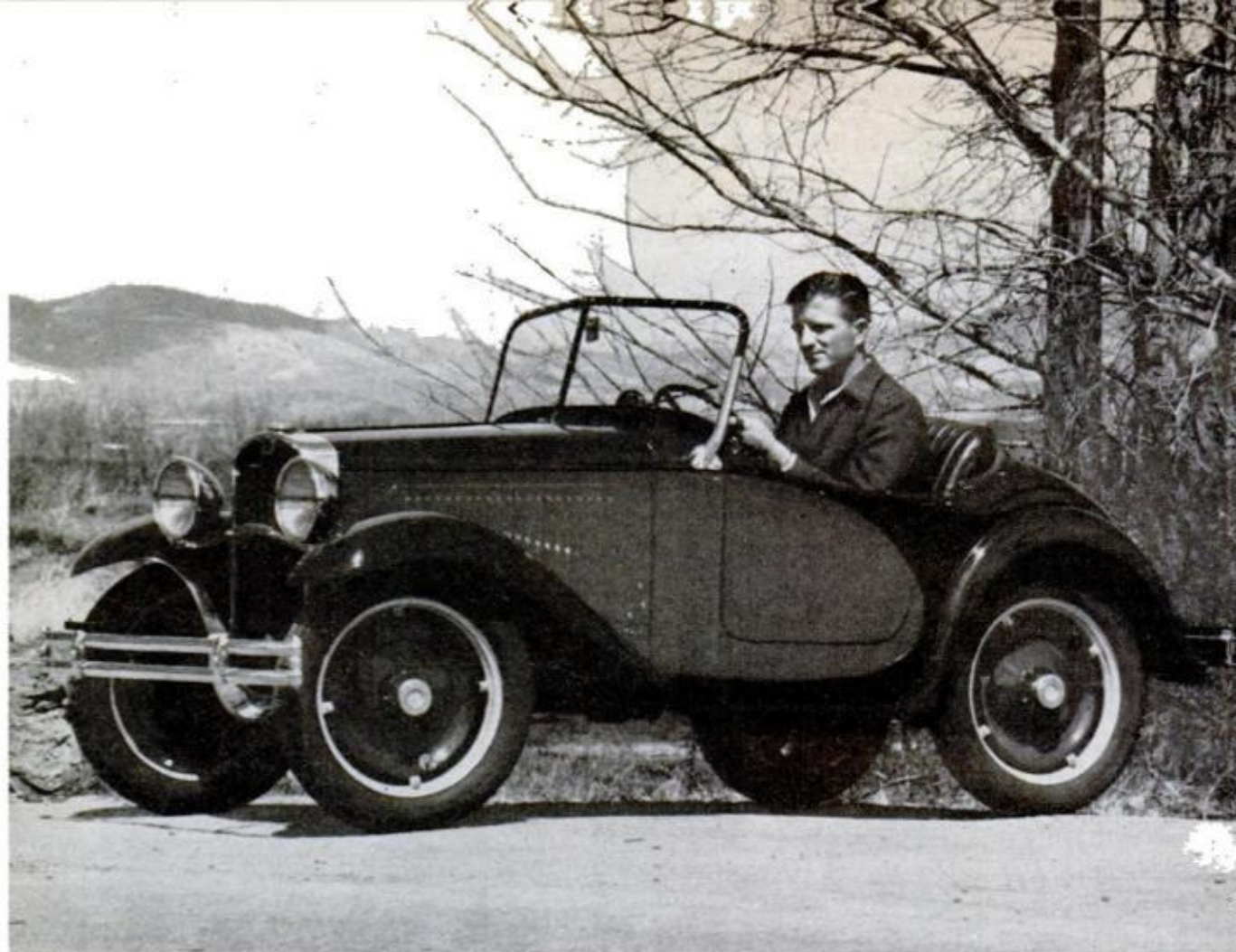

Photos taken at Harrah's Automobile Collection, Reno, Nev.

**1933 Austin roadster**, the "American Austin," is built on wheelbase of 75 inches and has overall length of 122.5 inches! This perfectly restored example is from Harrah's in Reno, Nev.

# When we really had a mini-car!

Dozens of makes of small cars once scooted around towns in the United States and were regarded as just whimsical—but now we need 'em!

by Michael Lamm  
WEST COAST EDITOR

**W**hat ever happened to Baby Austin? For that matter, what ever became of all those little roller skates—the Crosley, Bantam, Metropolitan, Davis, Playboy and similar wee ones, their names dim now or forgotten completely?

With consumer pressure—and conceivably even future legislative pressure on Detroit—the automakers are spawning a whole new crop of small cars. As the small-car boom gets in full swing, a brief look at some subcompacts of the past might prove interesting. Because every one of them failed!

Before World War I, a craze for so-called cyclecars swept this country. Cyclecars were one and two-passenger jobs, usually powered by motorcycle engines, many with belt drive and flimsy wooden or wicker bodies. They sold for around \$350 at a time when normal motor cars were rich men's toys. The craze lasted until 1914, when Henry Ford undercut cyclecar prices with his Model T. Before that, though, some 300 manufacturers





**"Perpendicular parking only!"** Ten-foot-long cars, 49 inches wide like the American Austin, would easily triple the number of parking places available along Main Street, U.S.A.

**No cosmetic continental kit,** the rear-mounted spare tire is a real one and is easily accessible for changing. Tires are 3.75x18, and the wheels are disc type with demountable rims.

**Not up to current safety standards,** the Austin has a three-speed stick and is fun to drive. The automobile of the future will also be small and a joy to drive, agrees automotive researcher Dr. Nathaniel H. Pulling, who is auto safety project director for Liberty Mutual. He sees the trend definitely heading toward smaller cars again, "like we had in this country in the 1920s and '30s and still are predominant in Europe. I have little doubt that cars will be a joy to drive by the 1980s." But the most important changes will be in safety improvements, and therefore any update of the Austin would have a far different interior than that shown here!



of cyclecars had jumped right into the fray.

No significant small-car developments happened again until the late 1920s, when a group of U.S. businessmen took out a license to build an American version of the highly successful British Austin Seven. This became the American Austin. Production began in Butler, Pa., in 1930—just in time for the Depression. It looked like perfect timing—a cheap, economical midget for an impoverished people. But do you think Americans were sensible enough to actually buy the little Austins? Not on your life. And why not? Opinions vary, but most of the reasons were considered to be emotional.

The American Austin came in cute roadster, coupe and commercial body styles. It was powered by a two-main-bearing, four-cylinder engine about the size of a six-pack of soda pop. The whole car was supersimple to work on. Power was rated 13 bhp at 3200 rpm, giving a cruising speed of about 45 mph and 45 mpg. Not bad, especially considering the f.o.b. price of only \$395 in 1930, dropped to \$315 by 1933.

Photos are of Harrah's wonderfully restored 1933 American Austin roadster, a car I had occasion to drive not long ago. It's sheer delight—highly maneuverable, responsive, comfortable, and a bigger crowd-gatherer than any brand-new Lamborghini. The Austin is shorter than a VW Beetle by exactly three feet, so it'll park in the maneuvering space between two standard-sized cars that are parallel-parked. Its major drawback proved to be a congenital lack of power. Thirteen horses just aren't enough to





to keep up with traffic as it exists today.

Austin's slogan, "... not too small, others too large," convinced too few Depression buyers. Then, too, for another \$150 (lots of money in those days), you could buy a new Ford, Chevrolet, or Willys 77. So in 1934, the American Austin Car Co. went into receivership, emerging again the next year as the American Bantam Car Co. (same factory, same British patents, essentially the same engine and running gear). Bantams were restyled in 1938 and lasted through 1941. With a dying gasp, Bantam engineers designed the first acceptable military Jeep in 1940, but the company was too weak to build Jeeps, so the contract fell to Willys.

Another small-car adventurer, Powel Crosley, began building midgets in 1939, which again seemed a fortuitous time because war was coming, with tire and gas rationing right behind. These factors would



Front track of the roadster is 42.5 inches, and rear is 44.0 inches. The car sold for \$315 in 1933.

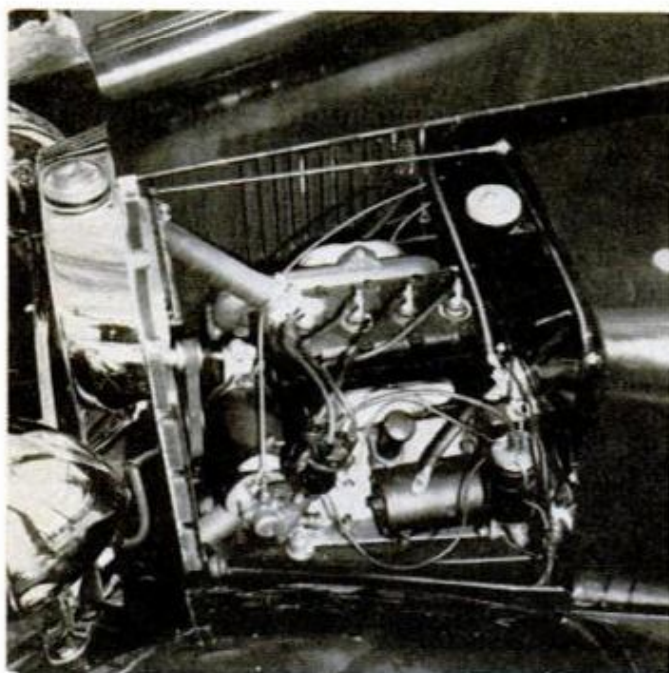

The four-cylinder engine has a cast-iron block and displacement of 45.6 cu. in.; hp is 13 at 3200 rpm.

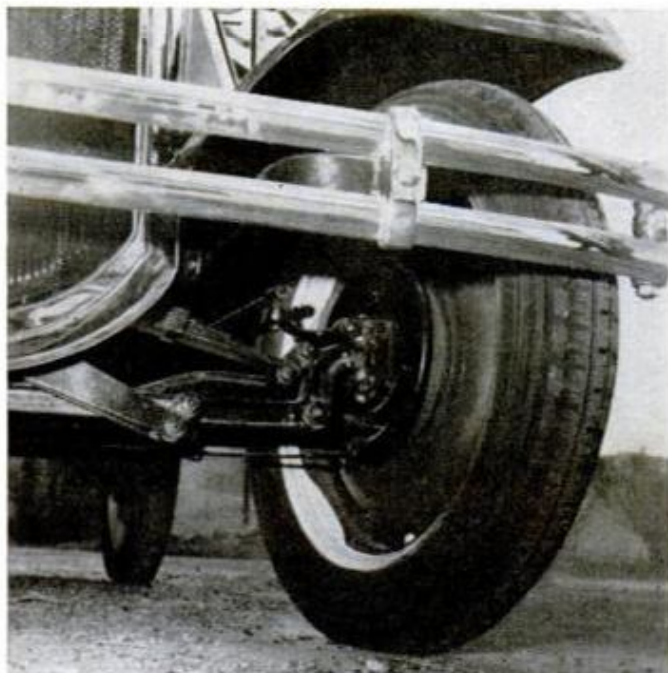

The 1020-pound car has 8 $\frac{3}{4}$ -inch ground clearance, drum brakes, transverse leaf-spring front suspension.

put Austins, Bantams and Crosleys in great demand during WW II. I remember people swearing by their Austins during the war, because they'd run forever on the same tires—and the same tank of gas, some of them said.

After the war, these dutiful cars inevitably ended up on some wrecking yard roof as sort of a symbol, like the pawnbroker's three globes.

Anyway, just after war's end, another rash of little cars with names like Bobbi, Keller, Del Mar, Gregory, Airway and Pup

popped up briefly. The thinking was that America needed new cars—any new cars—preferably cheap and quickly made. What these builders didn't realize is what all small-car makers before them had also miscalculated: the fact that most Americans simply didn't like little cars. It's an emotional business.

This time around, though, there's no room for emotion. There are pressing reasons for cars to get smaller. They'll be getting smaller, still. Maybe as small as an American Austin. ★★★



# '74 snowmobiles: new styling, new power

Cold-weather customers may call this the winter of the hot bargains.

by Bill McKeown  
OUTDOORS EDITOR

After last year's scant snow supply, Skiroule drivers and all others are hoping for white hillsides once again.



**T**his winter's bigger and better snowmobiles will come from an industry that's smaller and better. More models are being offered by fewer companies, with 30 or so builders turning out machines that are stronger and safer, more durable and easier to service—plus some that are lighter, quieter and faster.

Three years ago more than 100 companies were in the snowmo business, but over-estimated markets and under-average snowfall have settled things down, and 95 per-

**Mirage II** is Ski-Doo's name for its experimental version of side-by-side seater for four, enclosed and heated. Prototype mounts rear 1600-cc water-cooled engine, reports speeds to 50 mph.

More new snowmobiles on following pages:  
[text continues on page 120](#)



## More color and less noise for '74 snow trails



**Ski-Doo will offer** (from left) Elan 294 SS, Elan 250 Deluxe, Elan 250 E, Olympique 340, Olympique 300, T'NT Free Air, T'NT, T'NT Everest and (at back) Elite, Nordic and Alpine.

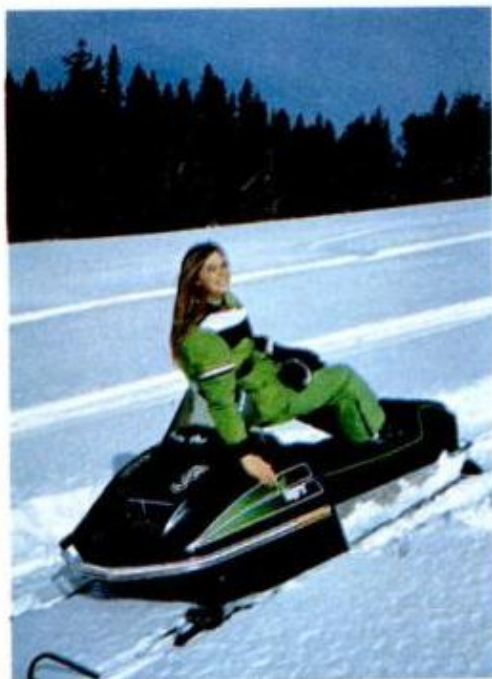

**Arctic Cat's hot El Tigre** with 440 cc tops line that includes Puma, Cheetah, Panther and Lynx.



**John Deere** offers an expanded line of seven models including 600 (at right) and matching clothing.





**Polaris lineup** (front to rear) features new Electra, Custom II, women's champ Dorothy Mercer with Colt, and Colt S/S.

**Evinrude's** (below) will come in wide-track Trailblazers using 35 and 45-hp rotary engines plus narrow-track Skimmers to 50 hp.



**Mercury Trail Boss models**, the Mark II, 440 Max and 440 S/R, will have bogies and slide rails, torsion-bar ski suspension.



**Johnson JX 650** (left) will supply 50 hp, with other options of 400 cc/35 hp and 440 cc/40 hp plus wide-track, quiet, rotary models.



**Skiroule's RTW** has a rotary Wankel engine and a new orange look for the noted green line. Kohler powers a new 50-hp Laser 440.



MORE  
→





**Massey-Ferguson** will offer seven Ski Whiz models this winter from 21.5 to 40 hp in Sport Track and wide track, optional electric start, shocks.



**Chaparral Firebird**, from Armco, has 22, 28 and 32-hp engine options. Liquid-cooled engines will be feature of new SSX 40 and 50-hp models.



**Suzuki XR 440** tops five-model line with 432-cc, 37-hp engine, disc brake, slide rail, hydraulic shocks, dual rear mirrors.



**Deere JDJ models** are "blitz-black" with 340-cc displacement for JDJ4 Special, 400 for JDJ6, 440 in JDJ8, slide rails, "grouser-bar" track.

cent of machines now produced come from the 19 members of the International Snowmobile Industry Assn. Sleds left over from last year should provide bargains for buyers and make the market more competitive.

Engine noise, chronic complaint of the nonrider, has been reduced 75 percent in the last five years. Since 1970, sound levels are down from 88 decibels on the A scale to 82 dBA, a 50-percent reduction using the dB logarithmic measurement. Goals for April 1975 are 78 dBA ratings and 73 after April 1978. Evinrude and Johnson already have machines at this level. Rapid development of snowmobile trails away from settled areas should also help quiet critics.

Power trends continue to go up, with displacement nearing 800 cc for some free-air racing rigs. Liquid cooling, so well established with four-cycle automotive engines, may bring its stable temperatures and easy silencing possibilities to snow-time travel:





**Raider, from Leisure Vehicles, has rear-mounted Canadian Curtiss-Wright engine, twin tracks, Double Eagle, Eagle and Hawk bucket-seat models.**



**Moto-Ski Grand Sport has 399-cc and 436-cc models with slide rails, speedo and tach. Other machines include Cadet, Capri, Chimo, 295, 340, 440 Futuras.**



**Boa-Ski 440 SS has hydraulic disc brakes, pop-up headlamp, automotive instrument panel, front shocks, Kohler 440-cc engine.**



**Rupp Nitro II provides 336-cc or 438-cc engines, twin carbs, CD ignition, aluminum rails.**

Chaparral will have a new liquid-cooled SSX of 40 and 50 hp, Brut introduced one last winter, and Kiekhaefer Aeromarine's new high-performance snowmobile mill, possibly for some Ski-Doo models, is reported to have liquid cooling as well. Both Evinrude and Johnson offer optional U.S.-made rotary combustion engines up to 10 hp to 45 this year. Their new narrow (15-inch) track Evinrude Skimmer and Johnson JX will mount up to 650-cc 50-hp engines.

The top 25 machines of 1973-74 could include Alouette, Arctic Cat, Auto-Ski, Boa-Ski, Chaparral, Columbia, John Deere, Evinrude, Harley-Davidson, Herter's Husky, Johnson, Mercury, Moto-Ski, Northway, Polaris, Raider, Rupp, Scorpion, Ski-Doo, Skiroule, Massey-Ferguson Ski Whiz, Sno-Jet, Speedway, Suzuki, Viking and Yamaha. Many models have color-matched clothing.

Snow-season shoppers should have a lot to select from this year. ★★★



**Scorpion Super Stinger 440 has Rockwell Twin 434-cc power, front shocks, speedometer, tach, flecked red styling, Para-Rail suspension, Power-Bite track.**



# World's hottest homebuilt

The famous Pitts Special is considered the finest aerobatic plane around, yet oddly enough is a home-grown creation. You can build one like it yourself from plans or from a new kit of parts soon to be available.

by Harvey Shaman

Go to any air show, stunt-flying exhibition or competition event and you're likely to see more Pitts Specials performing than any other aerobatic aircraft. The U.S. team that took top honors in last year's International Aerobatic Championship did it in—guess what?—yes, the Pitts. Over the years, this tough, lovable little biplane has become a favorite of crack pilots the world over and is generally considered the finest aerobatic performer around.

What's so astonishing about the Pitts is





that it's basically a homebuilt—not mass-produced on assembly lines, not costing hundreds of thousands of dollars, not reserved for the wealthy few—but lovingly handmade from plans in back-yard barns and garages all over the country. Until recently, the plane was not even certificated by the FAA, but had to be licensed in the experimental category. So popular has the Special become that well over 3000 sets of plans have already been sold to prospective builders. More than 300 completed Pitts are flying; another 400 are under construction.

While the Pitts does require some special skills to fly it aerobatically, it is by no means limited to professionals. Any reason-

**Peeling off in a smart bank** (far left) is colorfully striped Pitts, its sunburst design a trademark of world-famous stunt pilot Bill Thomas who flew plane exclusively for PM pictures. Below, Thomas and PM Outdoors Editor Bill McKeown (left in photo) roll out a two-place version of the Pitts for an exciting test ride. McKeown, a World War II fighter pilot, reports his experiences with the Pitts on page 125. At bottom, Curtis Pitts, designer of the vaunted Special, stands by one of his creations.



Photos by the author



ably well experienced sport pilot can handle it successfully—and have a ball in the process. More than anything else, the Pitts is a fun plane to build and fly. It is small, light, extremely sensitive on the controls and incredibly strong. While its designer, Curtis Pitts, only claims it meets minimum FAA aerobatic stress specifications of 9 Gs positive and 4 Gs negative, competition pilots regularly pull much more than this—and miraculously the wings stay on. The twin wings give the ship a high degree of lift, good stability and a relatively low, safe stall speed of 62 mph. This combination of sure-footed stability, easy handling and quick responsiveness makes the Pitts a strange cross between a Sunday pilot's dream and a wild man's adventure. You can fly it with conservative care or all-out abandon—either way, the thrills and excitement it offers are hard to beat. The Special is, indeed, something *really* special.

In its classic form, the Pitts is a single-place, open-cockpit biplane reminiscent of the helmet-and-goggles, scarf-flying, wind-in-the-face early days of aviation. For those preferring companionship and/or instruction while flying, a two-place version—the S-2A—is also available. Both have remarkable performance characteristics. The single-place Special—three decades in development and refinement—is powered by a 180-hp

Lycoming engine. It has a top speed of 176 mph and a phenomenal rate of climb of 2600 feet a minute. Its power loading is so low—only six pounds per horsepower—it can fly straight up, performing intricate antics as it goes, without stalling.

What makes the Pitts so maneuverable are its small size, dual ailerons and symmetrical wing shape. Overall length is only 15 feet, 4 inches, and the wings span less than 17½ feet. The dual ailerons—two on each side—are ganged together to provide large control surfaces for quick turns and rolls. These, combined with the short wing-span, give the ship a tremendously fast roll rate of 180° per second. The symmetrical wings—having the same curvature on both top and bottom—enable the plane to fly equally well upside down as right side up

**Rolling a Pitts** is simple because the ship is so responsive and easy to control. In series of photos at right, aerobatic champion Bill Thomas demonstrates this graceful and spectacular maneuver. Main trick is to keep tail straight as plane rolls on its axis.







**At midpoint in roll** (above), plane is upside down, showing vivid checkerboard markings on underside of wings. Wings have symmetrical airfoil shape, enabling them to fly equally well inverted as right side up—important in aerobatic flying. Note very slight aileron deflection due to ship's sensitivity.



**Report from the cockpit:** PM Outdoors Editor test-flies the two-place Pitts S-2A.

Some people go to Mecca, dive through underwater canyons or climb mountains for an ultimate adventure. I found mine about 3000 feet above Miami Everglades in the front cockpit of a Pitts S-2A—two-holer model of the world's most responsive airplane.

Bill Thomas, perhaps the greatest of aerobatic instructors, was in the back seat, following me through on stick and rudder. The controls had the clean, crisp feel that showed no hint of mush or vicious reaction, just as Thomas had described back in his Fly for Fun office at New Tamiami Airport. The Pitts is a plane you have to fly to believe.

Through stalls, straight and inverted tailspins, loops, Cuban eights on to hammerhead stalls, slow rolls and snaps, Immelmans, Olympic routines, lomcováks—I tried to remember any plane like it I had flown during my test pilot days or in fighter combat. None compare in feel or could have completed all the maneuvers. If I had the time, I'd buy the plans and parts today from Pitts and build one. If I had \$20,000, I'd buy a completed Pitts from Thomas. That's not much to pay these days for perfection.

—Bill McKeown



**Featherlike wing section** is all wood with open-truss rib construction for maximum strength, minimum weight.



—particularly important in aerobatic flying where many of the most exotic maneuvers are performed in an inverted position.

Basic construction is fabric over a welded-tube fuselage and all-wood wing sections. Pitts believes the wood wings provide high strength without the danger of fatigue that metal might be subjected to under the constant flexing of aerobatic stress. Empty weight is 720 pounds, gross 1150. Fuel capacity is 20 gallons. Landing gear is fixed to save weight and simplify construction. Wheels, wing struts and engine cowling are all smoothly faired to minimize drag.

Plans for the Pitts Special, including detailed instructions and many full-size patterns, are \$150 a set. As an additional aid to home builders, Pitts will supply many of the parts ready-made. He is also preparing a complete kit of parts, which, when properly assembled and FAA-approved, will result in a fully certificated aircraft. The plans-built version will remain an experimental-class ship. And if you have about \$20,000 to spare, you can buy the plane ready to fly. So there are many ways to have a Pitts if you want it. For more information, write Pitts Aviation Enterprises, Box 548, Homestead, Fla. 33030. ★★★

**Smiling from cockpit,** aerobatic ace Bill Thomas (left, below) prepares to put Pitts through its paces for PM. Dual ailerons in upper and lower wings (center photo)—rare in biplanes—are one reason why Pitts is so maneuverable. Lower ones are controlled by stick, while upper ones are "slaves" operated by connecting rods. At right is cockpit—unusually roomy for such a small plane.

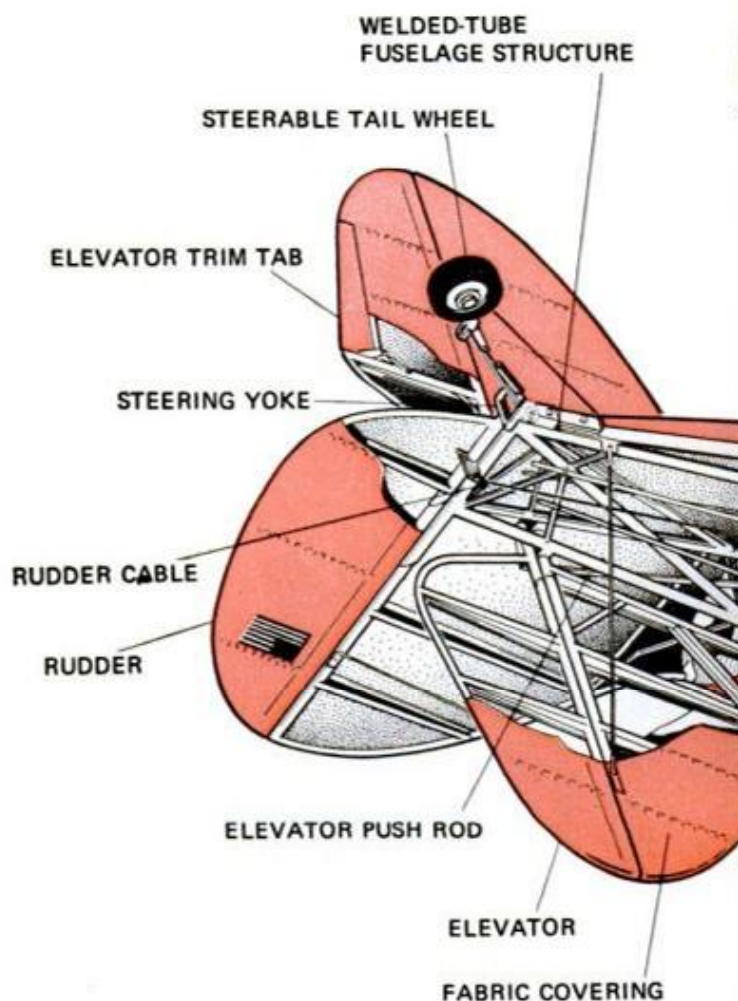



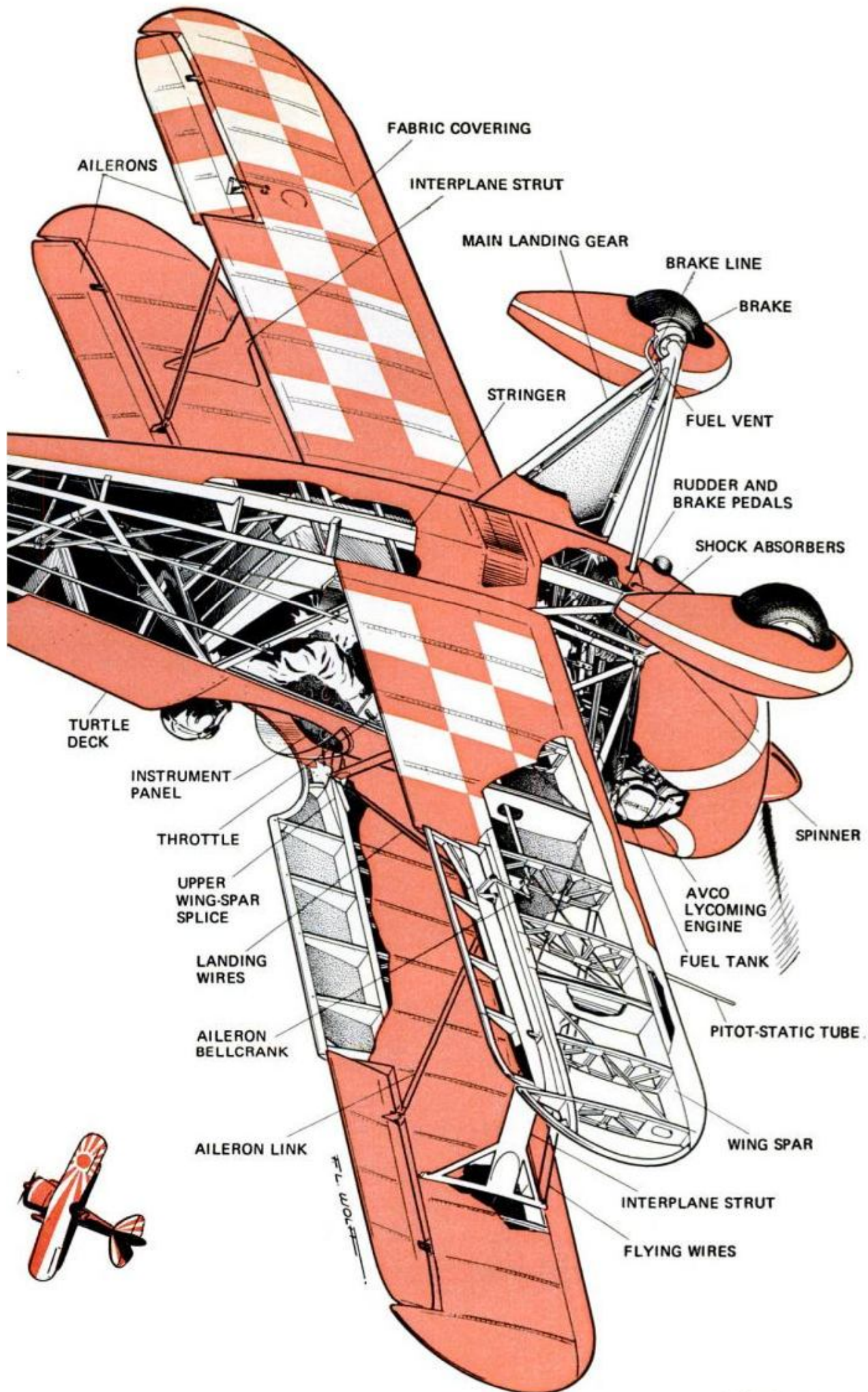





PM OWNERS REPORT: **BUICK APOLLO**

# Easy rider, good handler;



Apollo uses GM's X-body, same as Nova, Ventura and Omega, but Buick-ish grille and portholes give it the Flint look.



Owners report good roadholding, cornering and ride. Rattles, wind roar in hatchback were noted by a few.



# but rough on gas!



A nationwide survey based on 700,000 owner-driven miles.

by Michael Lamm  
WEST COAST EDITOR



Photos by the author

**I**t's a great road car, corners better than other makes I have driven, and doesn't creep sideways going around curves." That's the way a Minneapolis food-store manager sums up his new Apollo.

"It's built on GM's small body, but the Apollo drives and handles like a much larger car," says a Texas lab technician.

Handling came in as the Apollo's best liked feature. Fully 52.8 percent of our respondents listed handling as their primary "specific like." Yet handling didn't emerge as a major reason for buying the car initially. Size and styling led that parade, and it wasn't until after most of the owners had lived with their Buick compacts that they discovered just how well they handled. The good handling came as an unexpected bonus.

Among other reasons for buying the Apollo: "Since we already have a 1965 Skylark with 155,000 miles that's still going strong, we were glad when Buick came out with a smaller car—but not *too* small"—



**Drastic body tuck** lets tires kick mud and stones onto rockers. Size and styling played major roles in buying decisions.



**'I'm short . . . Apollo was the one I could see out of best.'**



Give us back our quarter windows, say many owners. Apollo's gas mileage with the V8 is only two mpg better than big Electra's. A Six is available, but so few people buy it we couldn't tabulate it in our sampling. Hatchback owners praise space and convenience, but would like a regular spare and a method of holding the hatch up in any given position.

tribute from a New Jersey department-store manager.

An Ohio laborer confessed, "I was driving past the Buick dealership when I saw this car. I said to myself, 'That's a sharp car,' and I bought it right then and there." An Indiana teacher gave this reason for choosing the Apollo: "I'm short-statured. After checking out several imports and small cars, the Apollo was the one I could see out of best."

Buick's Apollo is the latest in a series of GM compacts built on the X-body shell. It shares basics with Chevrolet's Nova, Pontiac's Ventura and the Olds Omega. The Apollo's engine is by Buick, and so are quality control and identifying trim (such as the grille). A few owners noted that the car looked too much like other GM compacts and should be altered to make it more definitely Buick.

Nearly 20 percent of our owners selected the hatchback coupe over the two other body styles available—four-door sedan and a regular pillared coupe. Most liked the hatchback's easy access and ample storage. A 62-year-old retiree wrote, "I even slept in the back once and found it perfectly comfortable in my sleeping bag in the hatch." Noted an Indiana housewife, "The hatchback trunk is deep enough to carry grocery bags upright."

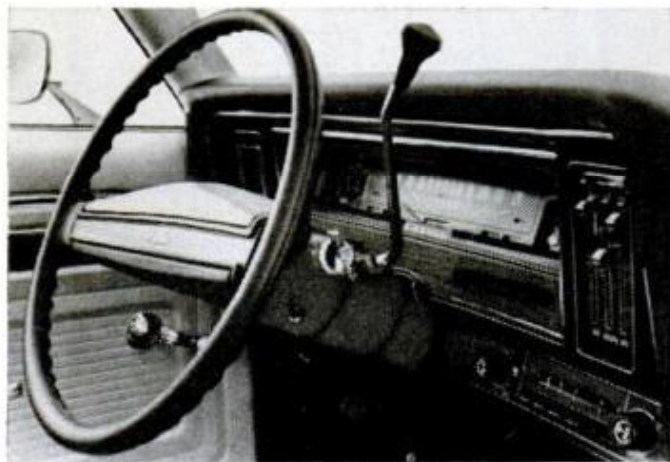

Apollo's dashboard looks much like all other X-bodied GM compacts. Airconditioning/heater controls take figuring out, but otherwise it's an easy car to drive. Most owners optionalized to the hilt, with sunroofs cropping up as one of the most popular extras.

However there were a few complaints. A Wisconsin welder: "The rear seatback isn't held down firmly enough, so it rattles. And the rear glass fogs easily." An Ohio printer: "The hatchback leaks." Several owners also mentioned short legroom in the rear seat of the hatchback, and a New York contractor sighed, "I wish they'd given me a real spare instead of this deflated eraser. Also there ought to be a way to hold the hatch up in any given position."

Now what about that famous Buick workmanship? "All good except the inside trim, which fell off when I brushed against it," said a Colorado tool and diemaker. "Seems to be very good," commented a Texas retiree. A New Hampshire accountant with tiny handwriting: "Generally good, but some minor spots of glue and blemished paint on close



inspection." Over half of our owners rated workmanship "good to excellent."

Apollo buyers tend to be middle-aged or beyond, and many had owned Buicks before. For instance, "I've bought Buicks since 1934 and have always been satisfied—sure didn't want to switch after 39 years."

And about their dealers, nearly 80 percent rated them "good to excellent" on sales and general policies, but when we asked for a service rating, the percentage dropped to 50/50. "I call their service manager a mental incompetent," growled one testy Apollo owner.

The biggest gripe, though, as usual, was poor gas mileage. Our sampling averaged between 12 and 15 mpg, which is only two mpg better than we reported for the 1973 Buick Electra (page 130, June *PM*). A Muskegon Mich., day-care director speculated: "Antipollution controls make for added fuel consumption and cause rough running when cold." His point about surging when cold was echoed by a number of respondents.

What changes would Apollo owners suggest, given free license? "Move shoulder harness hook at roof so belts don't strangle people getting in and out of rear area." "Too much body tuck lets mud and rocks mar fender areas." "I'd like a small vent window up front," suggested a North Carolina bank clerk, and she had plenty of company. "More room in the rear seat of my

sedan." "Better gas mileage [over and over]." "Fewer gaps in body sheet-metal to cut wind noises at speed."

This last came from an Ohio real estate broker, and on the same point a Massachusetts lab assistant mused, "The Buick dealer should have charged me more for my Apollo because I have a perpetual hurricane outside the window. With all windows closed, this noise starts at about 40 mph and gets louder as I go faster." Wind roar bothered quite a number of people.

Apollo owners generally find their cars comfortable to drive and ride in. Most are pleased and even impressed with the 350 V8's power, although a handful note an initial sluggishness just above idle. This they blame on smog equipment.

Among minor complaints, the horn ring seems a bit touchy, and not everyone has mastered the airconditioning/heater system. "I've read the instructions at least a dozen times, but I still don't think a Philadelphia lawyer could figure them out."—Virginia supervisor.

Mostly, though, owners feel the same way as this Indiana telephone operator: "I looked at a lot of cars before the Buick. The minute I spotted the Apollo and sat in it, I knew this was my car. I didn't even have to drive it, and I bought it before the official show date. I wouldn't want any other car. I really do enjoy it. It's great." ★★★

## Summary of 1973 Buick Apollo Owners Reports\*

Total miles driven .....732,675

### Body styles:

Two-door coupe .....50.0%  
Four-door sedan .....30.1  
Hatchback coupe .....19.9

### Engines:

350-cu.-in. V8 .....97.5%  
250-cu.-in. Six .....2.5

### Transmissions:

Automatic .....99.3%  
Manual ......7

### Average miles per gallon:

Local driving .....12.0  
Long trips .....14.8

### Why the Apollo?

Size .....38.6%  
Styling .....36.5  
Economy .....11.6  
Good price .....10.5  
Previous Buick ownership .....4.6

### Specific likes:

Handling .....52.8%  
Styling .....35.7  
Comfort .....24.5  
Ride .....21.9  
Size .....16.0

### Specific dislikes:

Poor gas mileage .....26.5%  
Poor workmanship .....10.4  
Rattles .....5.6  
Harsh ride .....4.5

### What changes would you like?

Better gas mileage .....14.0%  
More legroom .....9.3  
Different styling .....7.0  
Bigger trunk .....5.6  
Better workmanship .....5.6

### Had any mechanical trouble?

No .....52.6%  
Yes .....47.4

### What type of trouble?

Transmission .....15.4%  
Electrical .....14.0  
Airconditioner .....10.3  
Carburetor .....8.1  
Alternator .....6.6  
Brakes .....5.9

### Did you repair it yourself?

No .....97.7%  
Yes .....2.3

### Dealer repairs satisfactory?

Yes .....61.5%  
No .....38.5

### Dealer service opinion:

Good to excellent .....50.0%  
Average to poor .....50.0

### Workmanship opinion:

Good to excellent .....55.6%  
Average to poor .....44.4

### Is the Apollo your only car?

Yes .....52.8%  
No .....47.2

### Other cars owned:

Other Buicks .....34.6%  
Chevrolet .....20.6  
Ford .....10.3  
Pontiac .....7.4  
Oldsmobile .....4.4

### Age distribution of owners:

15-29 years .....19.3%  
30-49 years .....29.1  
50-plus .....51.7

### Would you buy another Apollo?

Yes .....72.7%  
No .....27.3

\*Percentages might not equal 100% due to rounding or insufficient data.



# IT'S NEW NOW

## A strange new sight: Floating cities looming out of the sea

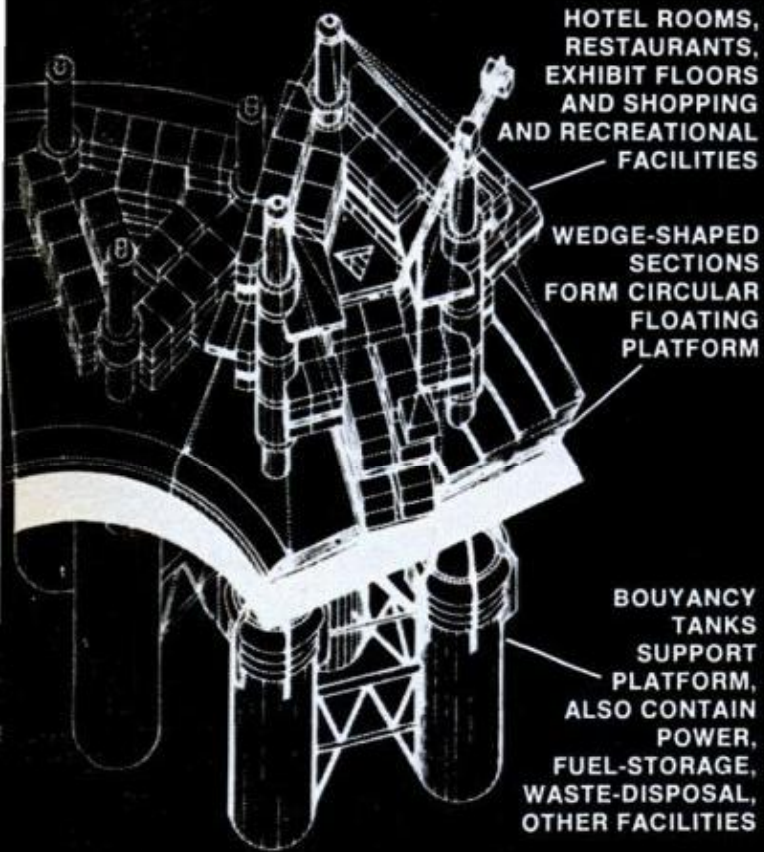

The answer to our overcrowded land may be man-made islands—huge floating cities in the sea to create more living space. To find out, scientists at the University of Hawaii are planning a pilot project, a mini city on sea legs to be stationed off Honolulu. The novel structure is expected to be completed in time to serve as an exposition center to commemorate two bicentennial anniversaries—the American Revolution in 1976 and the discovery of the Hawaiian Islands in 1978. The floating city will consist of wedge-shaped platform sections joined together to form a ring 1000 feet in diameter. The ring will be supported on bottle-like buoyancy tanks extending 370 feet deep. A 1/20th-scale model of these columns is shown in photo below. The tanks narrow at the neck to minimize the force of wave action. Towering buildings on top of the circular platform will house exhibit areas, living quarters, restaurants and shopping facilities. With water covering 70 percent of the Earth's surface, expanding into the sea may well be man's solution to the problem of finding space for a growing population.

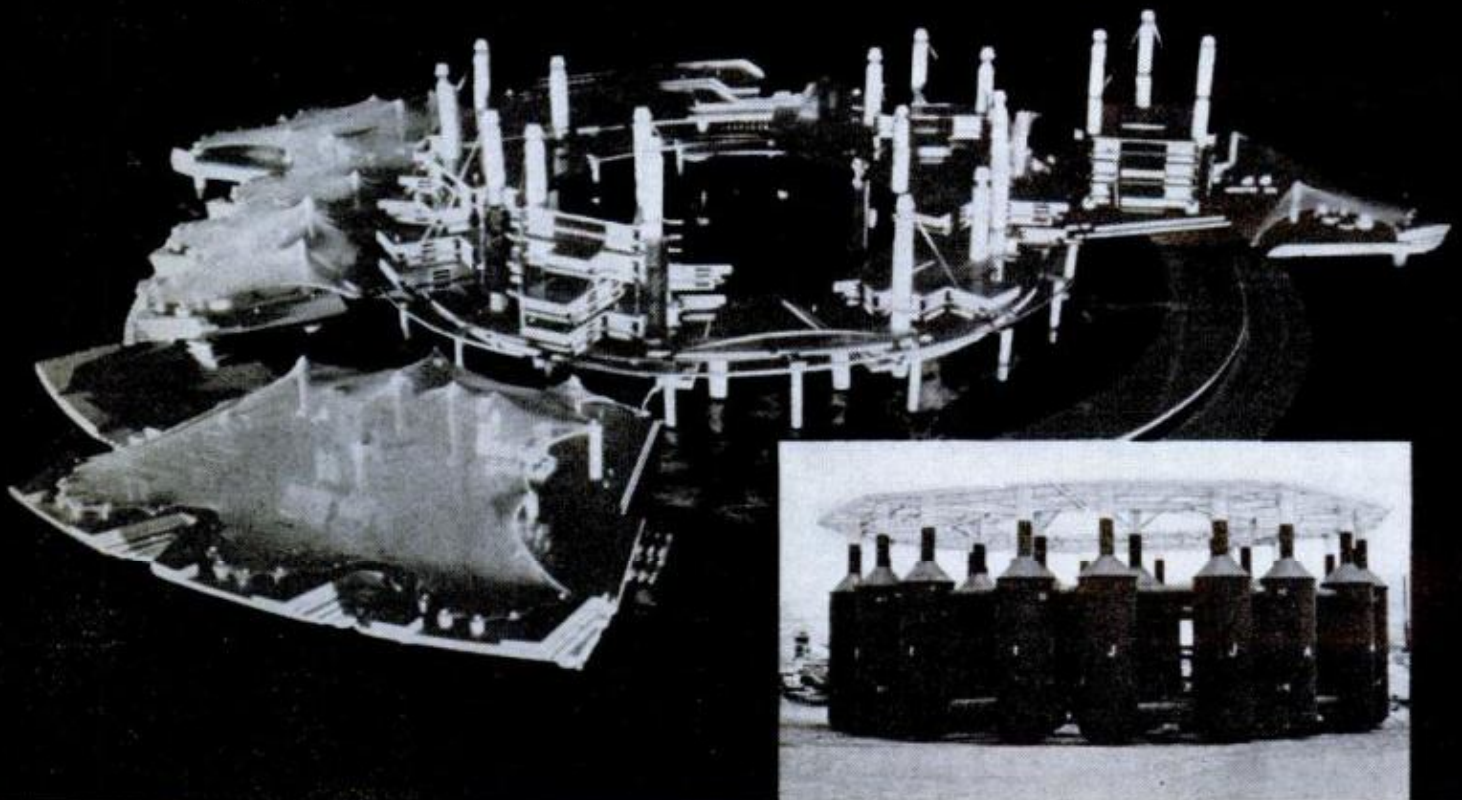





**Corral for trash cans**

Clean-Way shelter for trash cans is mobile, animalproof, prevents rusting. Sells for \$29.95 (stationary model \$24.95) plus collect shipping charges. Environmental Products, Inc., Box 672, Alexandria, Minn. 56308.



**Emergency compressor for road use**

Thomas First Air Kit is based on a small but powerful compressor that plugs into your car's cigaret lighter, pressurizes up to 60 pounds per square inch, and can inflate a flat tire so you can drive on it to permanent repair facilities. The outfit weighs 4 pounds, includes 10 feet of power cord and 3 feet of air hose, nozzles for tire valves, toys and sporting goods and air cleaning. It's \$24.95 from Thomas Power Air Div., Thomas Industries, 1419 Illinois Ave., Sheboygan, Wis. 53082.



**Suspended ceilings with hidden support**

Ceilings with no visible means of support—and without visible bevels between tiles—are the result with Armstrong Cork Co.'s Integrid Ceiling System. Metal grid runners are hidden above 1x4-foot acoustical tiles, available in three patterns. Ceilings can also be installed directly under exposed wood joists or they can be attached to existing suspended-ceiling grids. A special recessed lighting fixture can be obtained as part of the system.



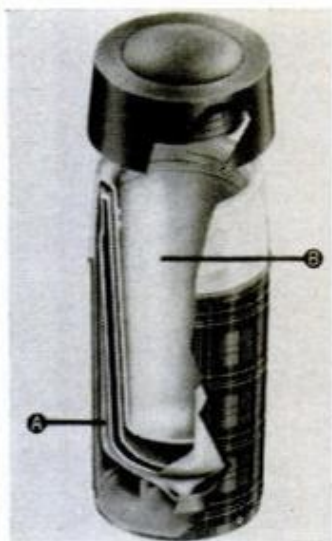

## Safety vacuum bottle for youngsters

Safety-Sealed vacuum bottle from Aladdin has glass vacuum-insulated filler (A) sealed between walls of plastic case (B) so that even if the filler breaks, no glass comes out. Reduced bulk of glass filler makes bottle easy for child's hand to hold; wide mouth makes it easy to drink or spoon from. It's made by Aladdin Industries, Inc., 703 Murfreesboro Rd., Nashville, Tenn. 37210.



## Genuine fake antiques custom-made



## Squadron of Messerschmitts—cars, that is

Gathered together for their annual outing are these old-time Messerschmitt cars produced by the same German firm that turned out the famous World War II Messerschmitt fighter. The nine shown here at Rickmansworth, England, are believed to be the only still-operating models remaining from the many that were imported by Britain up to 1964, the last year the midget side-hinged, hatch-door cars were made.

The nearest thing to a real antique is one made by British silversmiths Eric Pollard and Frederick Neale of Southwick. Their reproductions are so authentic—right down to scratches in the original—that only chemical analysis can tell the difference. A genuine antique is first disassembled and a mold made for each part. Duplicate parts are then cast in the molds and assembled into replicas selling for up to \$1000.



## Soldering with a match

Want to solder a couple of wires together but don't have a soldering gun handy or a place to plug one in? With this Archer tape solder, you don't need a gun. You just twist the wires together (photo 1 at left), wrap the tape around the splice (2) and hold a match underneath (3). The flame melts the solder and out comes a perfect joint (4). Handy for emergency use when traveling, boating or camping, the solder comes in 100 pre-cut pieces for 89 cents. At Allied and Radio Shack stores.

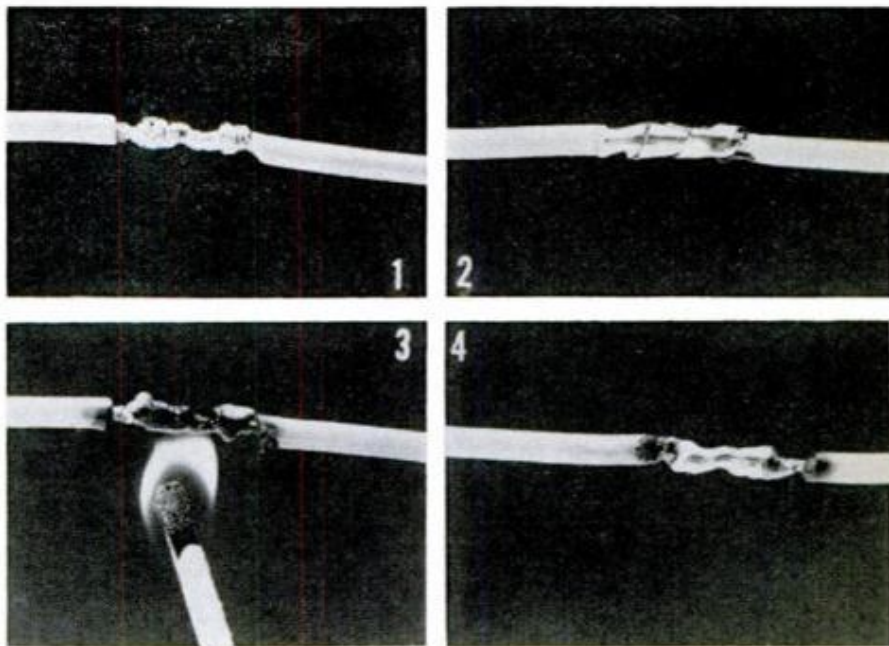

## Quartz-lamp sauna heater

Compact Vega Sauna Heater has high-intensity quartz-lamp heating that gives fast warm-up and produces a soft light. Three safety devices are incorporated in the heater and controls. Heaters are \$450 and \$550 f.o.b. Denver; prefab sauna rooms start at \$550. Write Vega Sauna Co., 2301 South Delaware St., Denver, Colo. 80223.

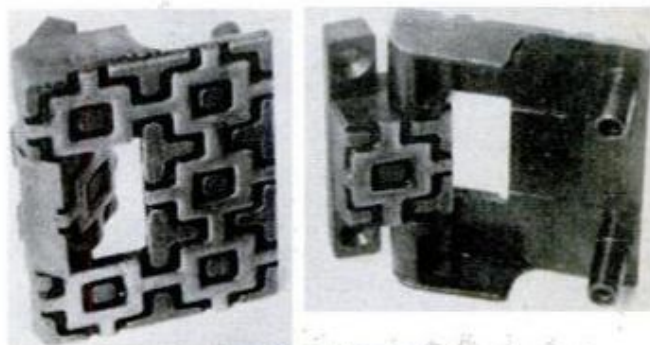

## Handsome hinge hides its works

New decorator hinge is unusual because it has no visible screws, barrel or pin. Designed for use on  $\frac{3}{8}$ -inch offset (lipped) cabinet doors, the deeply carved hinges are called Sculptura V, come in five different patterns, each available in antiqued brass and antiqued silver. For nearest supplier, write to Gries Reproducer Co., Dept. PM, 400 Beechwood Ave., New Rochelle, N.Y. 10802.



# NOW

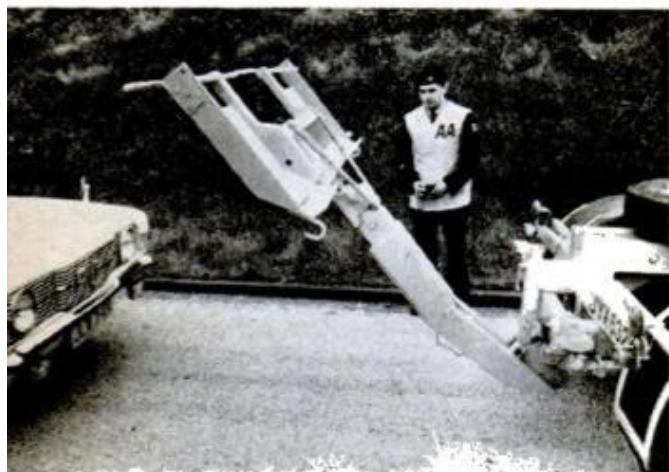

## Quick lift for stranded motorists

The hydraulic lift on this new British tow truck can pick up a disabled vehicle and have it on its way to a repair shop in less than a minute. The lift arm is rolled under the stranded car's front wheels, then raised. The wheels hook into pockets, locking the car to the tow truck without other fastening. Much faster and safer than conventional methods, the system is under study by the British Automobile Assn.



## Mini airliner to go where only copters dare

Designed for quick takeoff (top photo) and short landings on rough terrain (bottom), this new Australian "bush" transport can venture into rugged jungle and mountain areas where formerly only helicopters could operate. The twin-engine, turboprop Nomad can take off in 400 feet and land in 200—without a paved runway. Seating 12, it's being considered for use both as a military troop carrier and small civilian airliner. A special wing-flap system gives the ship its unusual slow-flying STOL capabilities.

## Center-finding tool

Locating the center of a length of dowel or of a piece of any round, square, octagonal or rectangular stock is a snap with the Rewco Center Finder. The device is placed over edge or end of workpiece and a line drawn along the diagonal. Tool is then rotated and second line drawn. Center is at intersection. Made of a stainless steel, the tool is \$2 postpaid from Rewco, Box 567, Rogers, Ark. 72756.

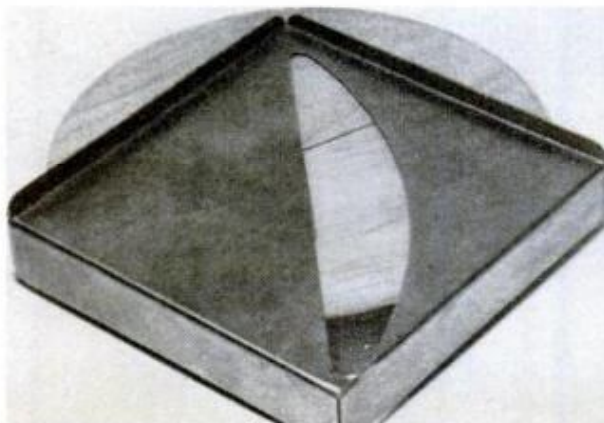





### Instant tire-pressure indicators

You can check your tire pressure at a glance with these screw-on indicators, one for each wheel. Each gauge attaches to the tire valve and registers pressure on a pop-out stem as you press a sleeve. Releasing the sleeve retracts the stem. The gauges do not interfere with tire filling and can be left on permanently. Set of four, \$2.98 postpaid. Schmuckle's, Box 2278, Encinitas, Calif. 92024.



### Chair back adjusts to you instead of you to it

You can tailor this backrest to suit your own personal comfort merely by turning a small wheel at the side. The cushion clamps to most home or office chairs. Turning the wheel varies curvature to desired contour for maximum seating ease. Not yet marketed, the device was invented by Dr. Muller-Limmroth, Munich, Germany.

### Flameless flying model rockets

Convertible Cold Power line of flying model rockets from Estes uses freon gas propellant for flameless operation, with provision for conversion to standard model-rocket engines. Each kit includes model, launcher, launch-control system, propellant and converter. Rockets are from 17 to 19½ inches in length. All feature parachute recovery. Kits are \$6.95 each at hobby, toy and department stores, discount centers, or by mail directly from Estes Industries, Inc., Box 227, Penrose, Colo. 81240.





## Paper bricks



Recycled paper may soon be used to make building blocks for homes. The process, developed by chemical engineer Robert Matteson (left), is currently being put to the test by elementary school children in Orinda, Calif. Old paper is shredded and mixed with chemicals, then compacted in a hand press (bottom) to form "bricks." The method was used to erect a 6x10-foot toolshed (center photo).

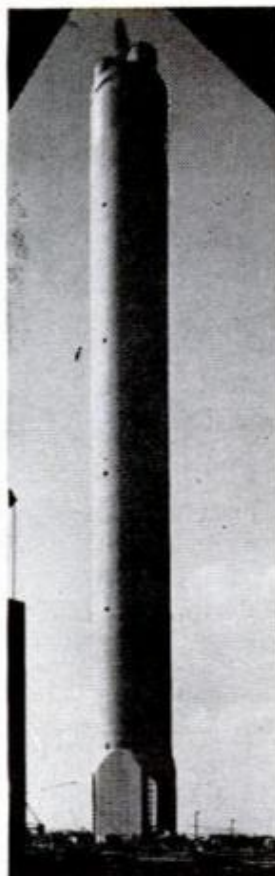
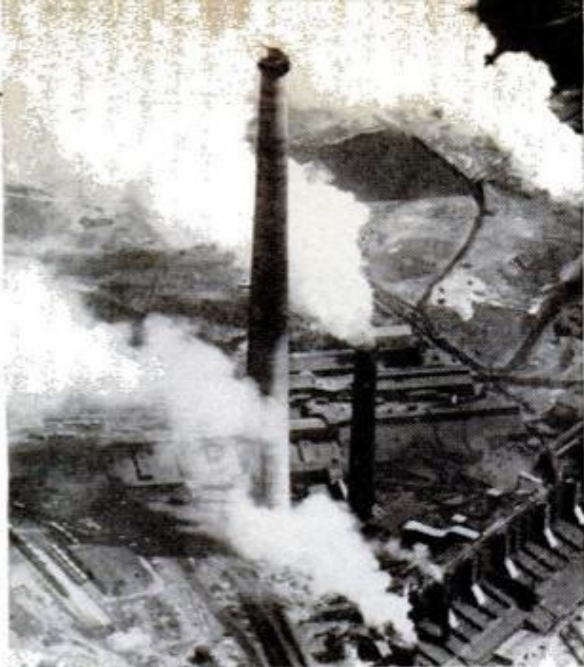

## World's tallest chimneys

Industrial chimneys are getting taller every day in an effort to spew polluting fumes higher into the atmosphere. International Nickel's at Sudbury, Ont. (top) is said to take the record at 1250 feet. At Drax, England, Britain's Central Electricity Generation Control Board boasts the biggest. While shorter at 850 feet, the mammoth tower (lower left) is 87 feet in diameter. In Japan, Mitsubishi's unusual four-legged stacks (lower right) top out at 722 feet. The design is said to withstand wind stress better than a single straight chimney.





### Space trackers—junior style

For several years now, students at Kettering Grammar School in Northamptonshire, England, have been scooping the world in reporting Russian space launches. Their tracking station, part of a physics course, has proved so successful they often beat Tass and NASA to the news.

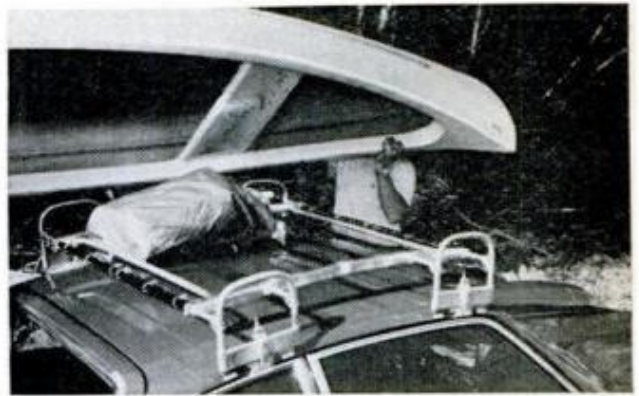

### Convertible cartop carrier

All-purpose cartop carrier has a system of adjustable crossbars and tiedowns that permit it to tote a variety of loads from luggage, camp gear and canoes (top photo) to small items like skis, oars and fishpoles (bottom). The Hema rack telescopes to fit all cars from compacts to full-size wagons and can carry up to 440 pounds. Easily attached, it quickly fastens to a car's rain gutters with clamps. \$39.95 from ICM Marine Products, Ltd., 1140 West 15th St., North Vancouver, B. C., Canada.



### Hot-glue gun puts the heat on repairs

Bond, caulk and seal wood, tile, leathers, plastic with The Little Red Fixer, Swingline's automatic-feed electric glue gun kit. FixStix adhesive bonds in 60 seconds. UL-listed gun has contour grip, thermostatic control, long nozzle for tight spots, automatic trigger for one-hand operation—glue feeds as you squeeze. Kit includes gun, 29 glue and caulk sticks, instructions, molded plastic carrying case. Suggested retail price is \$11.98.





## Automated bartender

Slip in a programmed punch card (top photo) and this automated bar will turn out any drink you want, premixed and ready for use. Up to 50 selections of ingredients are possible from which hundreds of drinks can be made. Liquors and mixes, kept in pressurized containers (left), are fed in precise amounts to a mixing spout. \$700 to \$1400. Leisure Products Corp., 1717 Dallas N. Parkway, Plano, Tex. 75074.

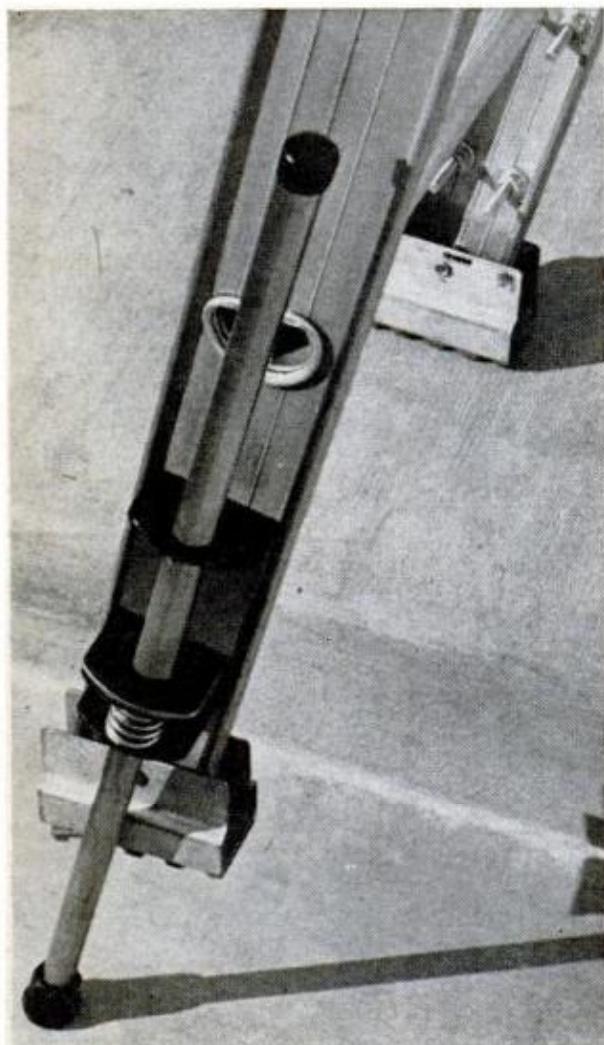

## Leg lengtheners for safer ladders

For working more safely on a ladder on uneven ground, Xtenda-Leg adds up to 16 inches of length to a ladder leg. The infinitely adjustable steel extenders mount on both wood and metal ladders. They're \$9.95 per pair, including freight, from K. O. Industries, 12968 Greenleaf St., Studio City, Calif. 91604.

## Big-job portable drill

McCulloch's new Mini Mac All Purpose Drill weighs 23 pounds, is powered by a 1.8-cubic-inch two-cycle engine, has two-speed-plus-neutral gearbox. Supplied with a 1-inch wood auger, it accepts augers and drill bits up to 8 inches in diameter. Suggested retail price is \$269.95. For more information, write McCulloch Corp., 6101 West Century Blvd., Los Angeles, Calif. 90045.





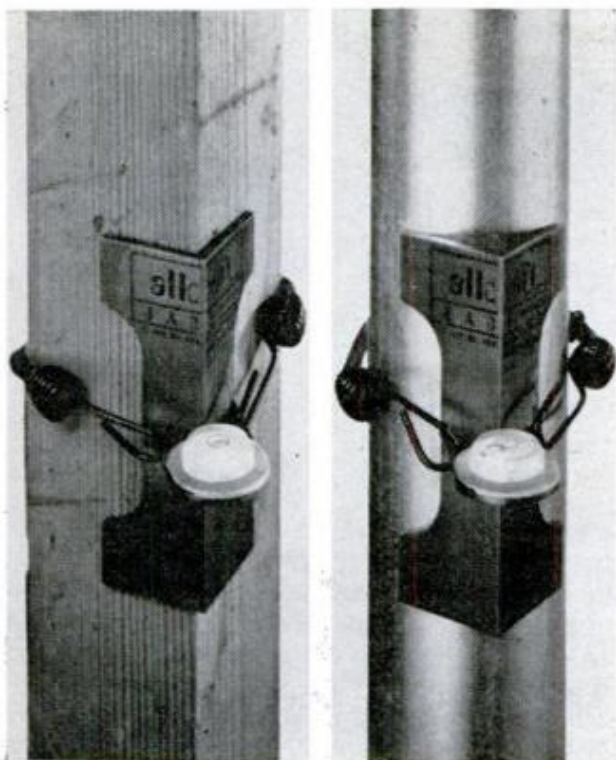

### Strap-on vertical level

Lev-All is a vertical level that leaves hands free. It straps to any round, square or rectangular pole, post or rod, has bull's-eye bubble level that allows leveling in all directions at once, using both hands for adjustments. Maker suggests using it on fenceposts, television antennas and wall studs. The tool is available for \$8.95 postpaid from Cedar Hill Service, Dept. PM, Foristell, Mo. 63348.

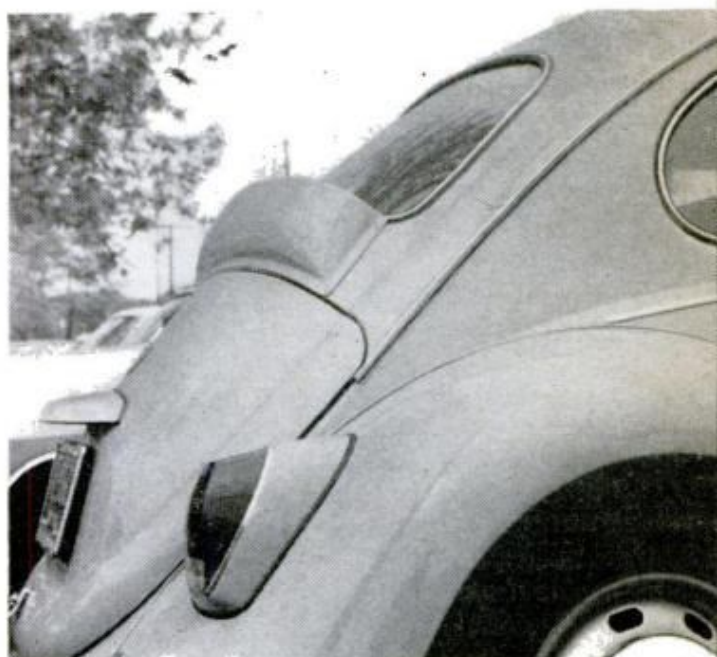

### Better breathing for the VW Beetle is said to improve engine performance

Made especially for the Volkswagen Beetle, this trim-looking molded-plastic air scoop is said to improve engine breathing and cooling, resulting in better performance, increased gas mileage and lower oil temperatures. The accessory fastens to the rear deck, channeling ram air to the engine compartment, and can be spray-painted to match existing body color. For additional information on price and local sources, write the maker, Amroc Co., Box 242, Smithtown, N. Y. 11780.

### Piggyback house trailer

This new experimental British house trailer isn't really a trailer at all but is coupled rigidly to the car so both operate as a single unit. Called the "Caraboot," it's said to be easier and safer to handle than conventional trailers because turning, backing and jackknifing problems are eliminated. Also, the trailer's wheels connect to the car's brakes to give added stopping traction. The fiberglass body, housing the kitchen, bath and sleeping quarters for four persons, is waffle-ribbed for strength.





# NOW

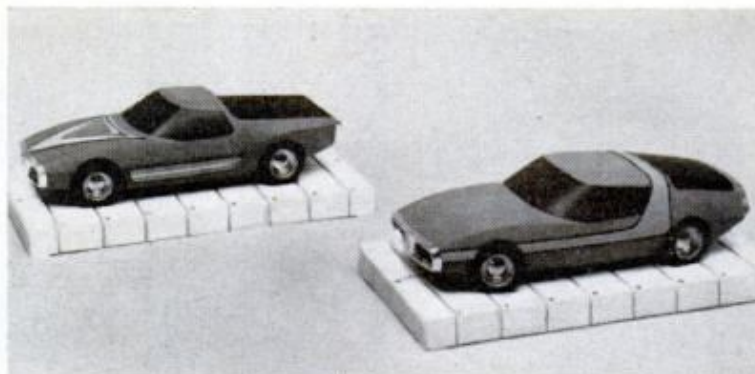
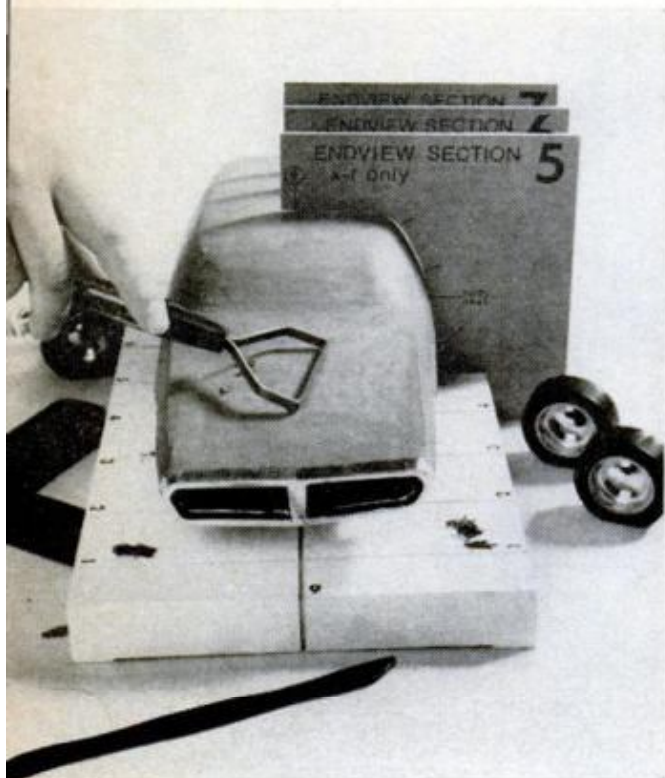

## Model-car styling kit

Use the same materials, tools and techniques the pros do with the Detroit Car Styling Kit. Apply clay to a foam-plastic buck and shape it using templates provided to make a sleek fastback or pickup—or a model of your own design. Each kit includes wheels, bumper-grilles and decals for finishing. Made by Whiting, a division of Milton Bradley Co., Springfield, Mass., the kit sells for about \$9 in hobby and department stores.



## Pocket calculator travels anywhere

This kit-built pocket calculator runs on rechargeable batteries and comes with a charger that can be wired for either 120 or 240-volt operation so you can use it virtually anywhere in the world. A special "battery-saver" circuit turns off the display after 15 seconds, but stores the information so you can reactivate it any time later. The IC-2009 kit has 8-digit display, floating decimal, constant key, can be built in two or three evenings. \$92.50, Heath Co., Benton Harbor, Mich. 49022.

## A paint job that 'sparkles'

Glitter is sprayed on right along with the paint using Glitter Brite Flake Finish. The initial coat is then followed with a clear coat of a shiny, weather-resistant finish. Available in many colors, the paint is about \$3.28 for a 16-ounce can. Order from Growco, Inc. Box 3285, Tampa, Fla. 33601.





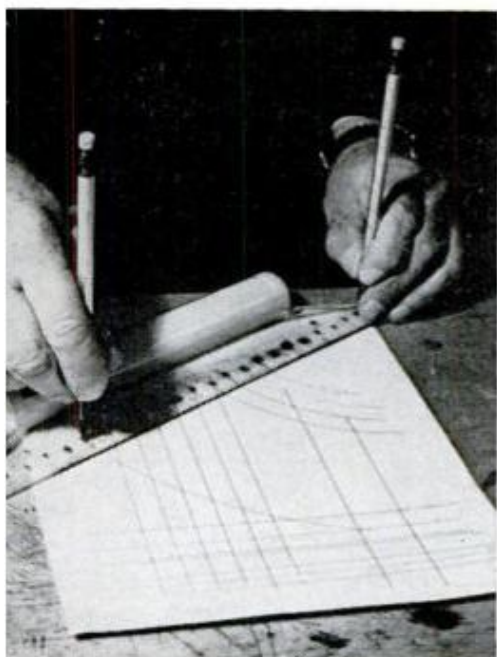

**Rolling ruler does tricks**

Drawing parallel lines is easy with this novel ruler. One edge is fitted with a roller that permits the ruler to slide smoothly over the paper. The opposite edge has a series of spaced holes. You just place two pencil points in the holes the desired distance apart and roll the ruler along to get two perfectly spaced lines. By pivoting the ruler at one end and swinging the other, you can also draw arcs and circles. \$6.95, Rol-Ruler Co., Riegelsville, Pa. 18077.



**Finger saver**

This handy nail starter makes it easy to work in hard-to-reach places and will keep you from rapping fingers. The nail or tack is snapped into slotted jaws at the tip, and the tool is pulled free after starting. Made of tough Cyclocac plastic, the starter features a 4-inch ruler, a nail penny (d) gauge and a hole for hanging on a tool-board. Made by The Raylar Co., Box 8366, Long Beach, Calif. 90808. Available by mail for \$1 plus 10 cents for postage and handling.



**His roof's growing fine**

No, you're not seeing things. The man above is actually mowing grass on a rooftop. He's John Campbell, caretaker of a home for handicapped children in Symington, Scotland. The idea for the turf-covered roof came from the home's founder, Isabel Murdoch, who felt it would give the structure a natural, pleasing appearance. It provides a tough and weather-proof covering and never wears out or blows off like shingles.



**Quick-check anti-skyjacking system**

Passengers and luggage are screened simultaneously in this two-in-one airport security system designed to speed up anti-skyjacking measures. As passengers walk through a tunnel-like magnetometer to detect metal, their baggage rides along beside them on a conveyor for checking by X-ray inspection. Side-by-side system, used by TWA at LaGuardia and other major U.S. air terminals, can process 720 passengers and pieces of luggage an hour.





## At last, a move to standardize slide trays

First non-Kodak slide projector to take circular Kodak Carousel slide trays is this Keystone made by Berkey Photo. It features rangefinder focusing, also accepts other Kodak accessories such as supplementary lenses and stack loaders. Three models range from \$114.95 to \$179.95. Keystone Div., Berkey Photo, Inc., Keystone Pl., Paramus, N.J. 07652.

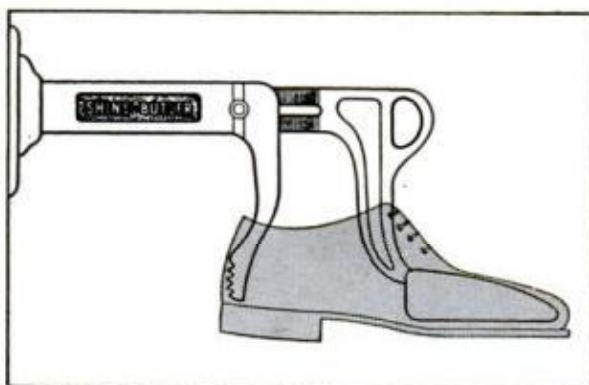

## Shoeshine parlor on the wall

No-stoop shoeshines are possible when the shoe is held at a convenient height on the wall by Shine Butler. The device saves wasted motion and leaves both hands free to use polishing cloth the way a professional does. Shakeproof and self-storing, the bracket mounts on any solid vertical surface and holds shoes of all sizes—men's, women's and children's. Shine Butler sells for \$4.95 postpaid from David Lash, Dept. PM, Box 464, South Norwalk, Conn. 06856.

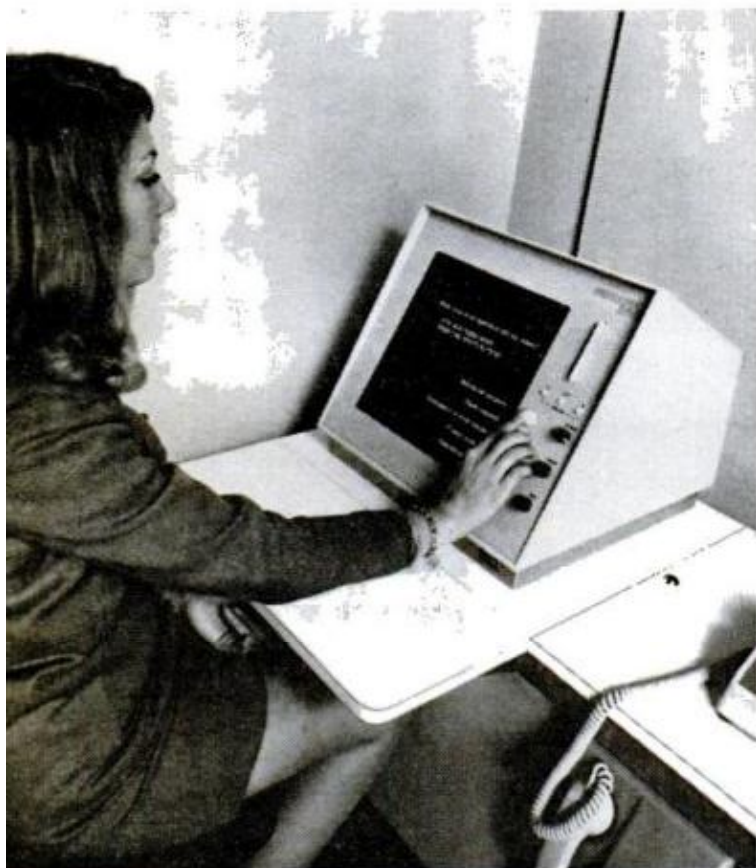

## Electronic 'doctor'

Busy doctors can now interview patients electronically to save time. Questions flash on a TV-like screen, and the patient replies by pressing buttons. The answers then appear on a printed readout that gives a doctor a medical "profile" of the patient's general condition and symptoms to aid diagnosis. The Searle Medi-data Profile 320 can be linked by phone to a central computer so physicians in different locations can simultaneously study the results.



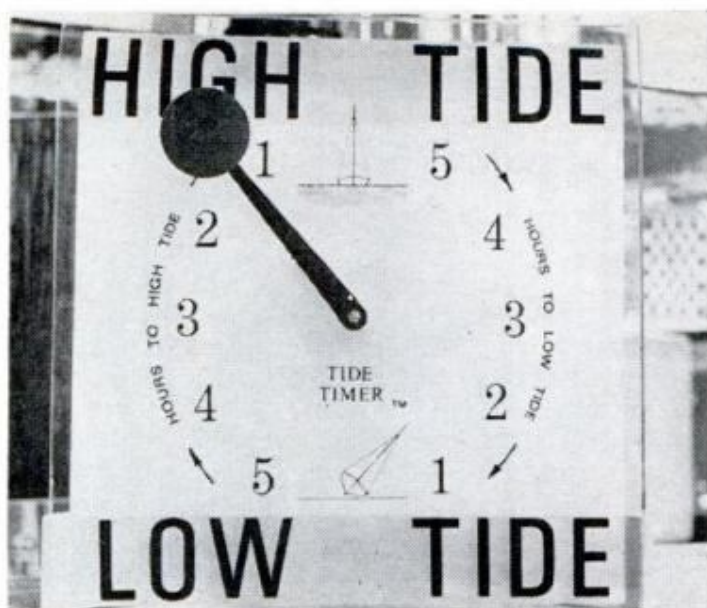

**Automatic tide timer**

Swimmers and boaters can tell tide time at a glance with this clock. Unlike indicators that must be manually adjusted, it revolves once every 12 hours and 25 minutes, automatically compensating for daily variations. Two models are \$30 and \$60 from Hammacher Schlemmer, 147 East 57th St., New York, N.Y. 10022.

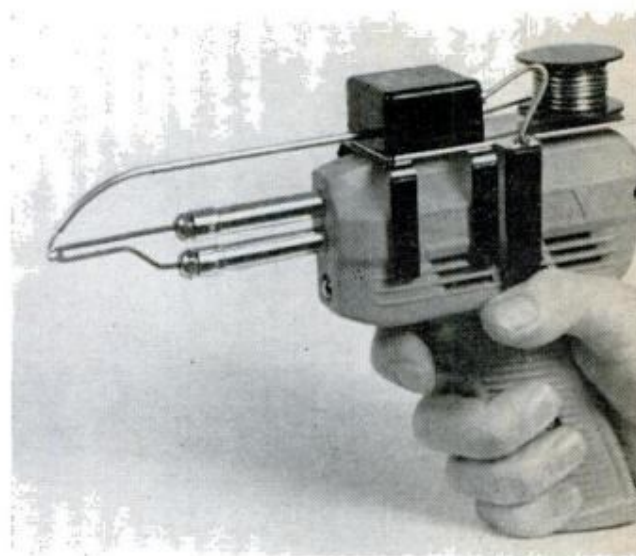

**Feeder for one-hand soldering**

Thumb trigger of "Freehand" solder feeder gives  $\frac{1}{4}$  inch of solder with each squeeze and can be positioned on gun for either right or left-hand use. Feeder holds 20 feet of solder, weighs 5 ounces loaded. Upside down it's a solder-gun stand. Available for most popular guns (specify make and model) for \$8.95 postpaid (plus applicable tax) from Schurman Products, Dept. G-PM, Box 13, Weymouth, Mass. 02188.

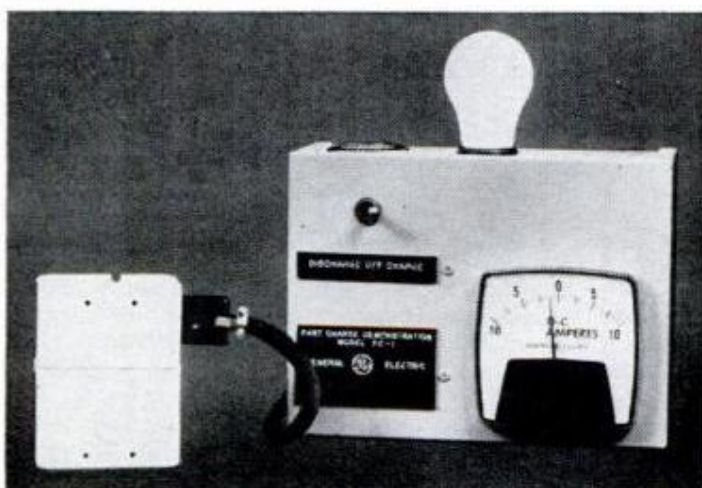

**New 'instant charge' reusable batteries**

New line of GE nickel cadmium batteries can be recharged in as little as 15 minutes. What's more, they can be left on charge indefinitely without harm as a sensing circuit automatically cuts off power as capacity is restored. Called Powerup 15, the new cells are available in all popular household sizes.



**Pruner has blunt nose for safety**

Pocket pruner stays handy while blunt nose protects pockets and user. Highly polished stainless-steel pruner is  $4\frac{1}{4}$  inches long, has serrations on one jaw to prevent slipping; \$3.85 plus shipping from Brookstone Co., Peterborough, N.H. 03458.



# Get set for a cold-weather starting emergency!

by Mort Schultz

Suppose you find yourself stranded late one night in the middle of winter, because your car won't start. Help is miles away, and the thought of trudging through ankle-deep snow in near-zero weather is chilling. But what choice do you have?

Just this: By considering the facts and using everything at your disposal, your chances of getting the car started and keeping it running long enough to reach help are pretty good.

Think a moment. Does the engine crank normally? Does it start but fail to keep running? Does it crank sluggishly or not at all?

Each condition reflects a different set of circumstances. For example, if the engine turns briskly but doesn't fire or starts but fails to keep running, a careless starting procedure could be causing fuel flooding or starvation.

Place the selector lever of an automatic transmission in P or N. If the car has a manual transmission, press the clutch pedal to the floor. Late-model cars with manual transmissions are equipped with a starter interlock which prevents cranking if the clutch isn't fully depressed.

If the engine is still warm, keep the gas pedal depressed one-third to one-half as you crank, but don't pump the pedal.

If the engine is cold, depress the gas pedal to the floor once only and release it

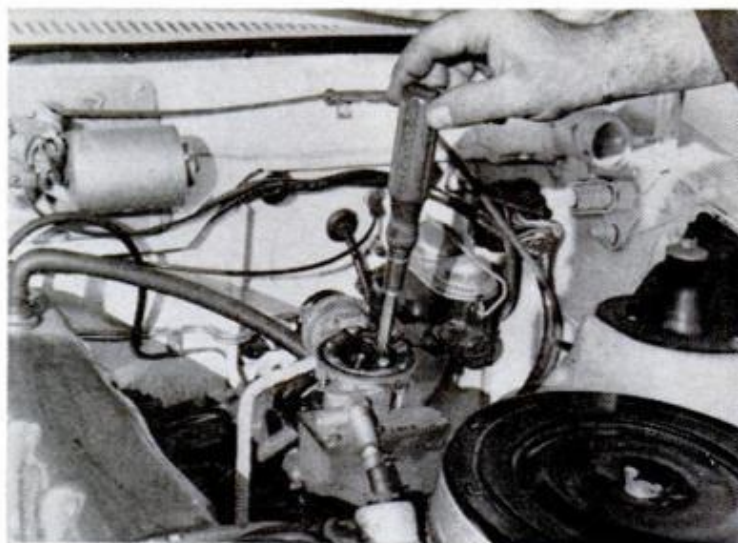

**Choke-plate operation** affects proper starting and running. Plate should be closed starting a cold engine, but should open gradually as engine warms. If it is stuck in closed position try to free it or prop it open.

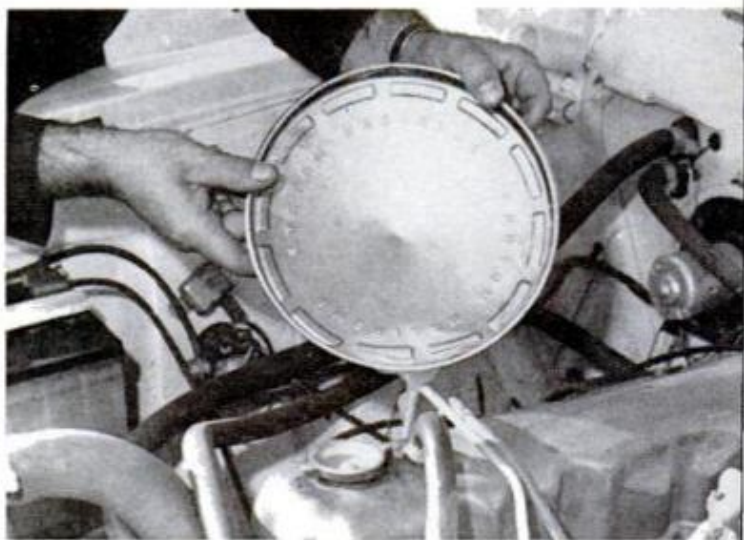

**Water in your gas** can freeze in winter and block fuel lines, especially at bends. Hot liquid poured over the lines will get fuel flowing again so you can start. If you need a pail or container, a hubcap makes a good one.

slowly. With your foot *off* the pedal, crank the engine. If it starts but fails to keep running, repeat the procedure.

In very cold weather (0° or below) with a cold engine, fully depress and release the gas pedal slowly two or three times before cranking. Keep your foot off the pedal as you crank.

If the engine won't start, it may be flooded. Press the gas pedal right to the floor and keep it there as you crank. When



the engine fires, keep holding the pedal to the floor until engine speed increases.

If correct starting procedure doesn't produce results after a couple of attempts, don't keep at it. You'll just kill the battery. Instead, remove the carburetor air cleaner and look at the choke plate. If the engine is cold, the choke plate should be closed so an enriched fuel mixture will be available for easy starting.

Close a choke plate that is stuck in the open position by pushing it closed with your finger. If it fails to stay in place, prop it closed by wedging a screwdriver between the carburetor air cleaner holding bracket and the carburetor.

If the choke plate sticks in the closed position and won't open as the engine warms up, flooding will occur, causing the engine to stall. Release the choke arm from the fast idle cam, which opens the plate, and keep it open by wedging it with a scrap of wood or anything else that will fit snugly between the plate and carburetor.

Suppose starting procedure and choke plate operation are okay, but the engine still won't start although it cranks briskly—what then? As long as the carburetor air cleaner has been removed for examination of the choke plate, determine if fuel is getting to the carburetor.

Operate the throttle once or twice by hand. A strong spray of fuel should squirt

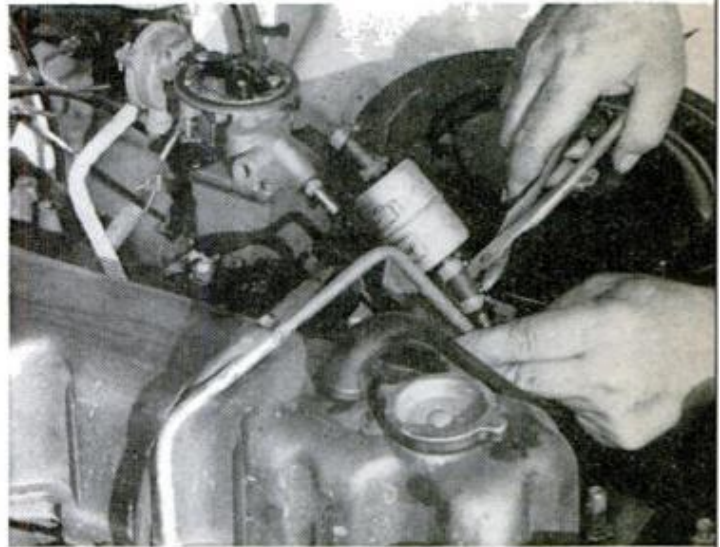

**A fuel filter that's clogged with ice or dirt will cut off fuel. Remove it from the fuel line.**

into the venturi. If not, maybe a sliver of ice is blocking the flow of fuel.

If you have a thermos of coffee, slowly pour it over the fuel pump, fuel line, fuel filter and carburetor fuel bowl. Or if the engine is still warm, open the radiator drain plug slightly and drain some coolant from the radiator. Use a hubcap to catch it if no other receptacle is available.

What can you do if the engine is ice cold? Gather snow in a receptacle or hubcap and start a fire with paper and other flammable material. This is an emergency. Use whatever is available.

Melt the snow and get water as hot as you can. Pour it over the fuel pump, fuel line, fuel filter and carburetor bowl.

The fuel filter can be troublesome, and it might prove fruitful to take it off to see if the engine will start without it.

Some cars have an external filter, while others have filters inside the carburetor intake port. Check the fuel line. If the filter is external, slip clamps off the line and pull the filter off.

The only drawback to having an external fuel filter during an emergency is that you must replace it with a piece of hose when you remove it. If you have spare hose of suitable size in the trunk, you're in good shape. If not, look beneath the hood for a piece of hose of suitable size that won't prevent the engine from starting and running

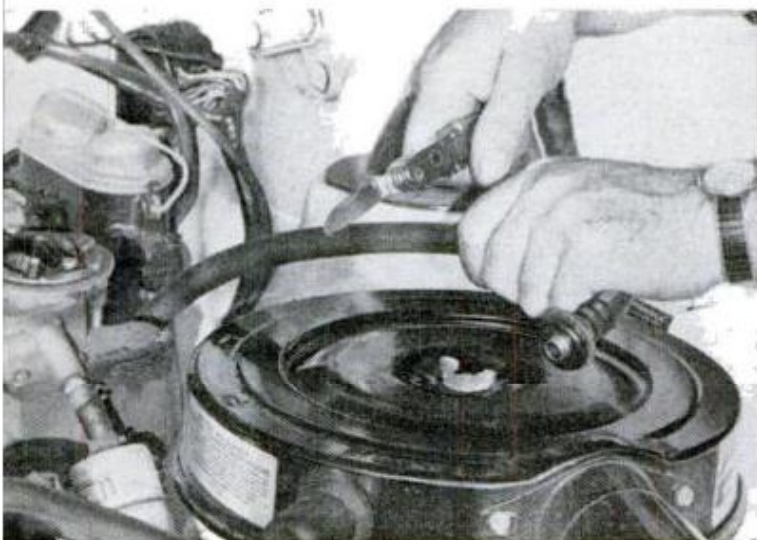

**Length of hose from your PCV system will serve as an emergency bypass for fuel filter that's been removed.**





**Check inside of distributor cap** for moisture, and wipe thoroughly. Make sure cables are tightly in place.

if it is removed. One such piece may be the windshield washer hose.

You can also cut off a piece of PCV hose. Although there will be a tremendous loss of vacuum, the engine will start and keep running until you reach help. Connect the hose, but drive slowly so it won't slip off.

If the fuel filter is internal, you have to unscrew the fuel line at the carburetor. Remove the filter from the intake port and reconnect the fuel line at the carburetor. You can run the engine without the filter or a substitute.

One more thing in the fuel system should be checked: a piece of ice or dirt may be keeping the needle valve off its seat. Tapping the fuel inlet of the carburetor with a tire wrench or any other suitable tool will often cause the obstacle to dislodge itself.

If fuel is getting to the carburetor, but the engine won't start although it cranks freely, an ignition failure is indicated. Perhaps snow has blown onto ignition parts, dampening out the spark. This is a good possibility if dirt has built up on ignition parts. Dirt retains moisture.

Wipe off each sparkplug. Wipe out the distributor cap and coil towers, and wipe off each high tension cable and its terminal.

Be sure terminals are firmly replaced into towers and onto sparkplugs.

Suppose that instead of cranking freely, the engine emits disheartening grunts. Chances are that the battery has failed suddenly or a combination of cold weather and dirty battery cable terminals has increased resistance in the starter circuit.

To verify this possibility, switch on the headlights and operate the starter. Battery failure or troublesome cables cause the lights to go out or dim considerably.

Remove the cables from the battery posts; scrape the insides of the terminals with a knife, screwdriver or piece of sandpaper; scrape off the battery posts; and tighten terminals firmly to the posts.

Disconnect the ground cable first and reconnect it last to avert a short.

No luck? Maybe one of the cables has failed. If you have battery jumper cables in the trunk, use them as a substitute by hooking them to the battery posts, and connecting the ground cable to ground and the "hot" cable to the starter switch. If the engine starts, drive slowly—jumper cable clamps may slip off from vibration.

Many jumpers sold today have soft aluminum wiring that will overheat to the point of failure if used for any length of time. A sturdy set of cables with strong copper wiring that can withstand emergency service is better. It costs about \$10.

To be safe, stop frequently and check cables for overheating. If they are hot, stop the engine and let them cool.

If your problem is a dead battery and you have a manual transmission you can be

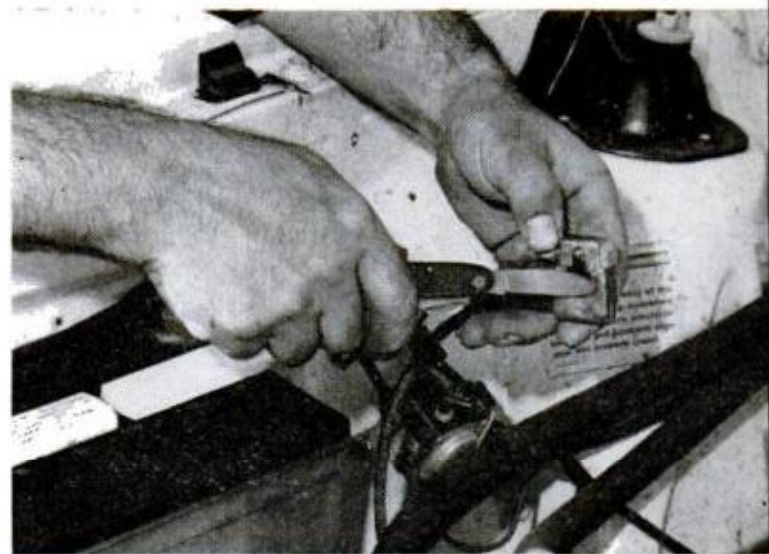

**Corrosion on battery terminals** and posts will boost circuit resistance and could cause a cranking problem. In emergency, scrape both with knife if your wire-brush cleaning tool is home in the garage.



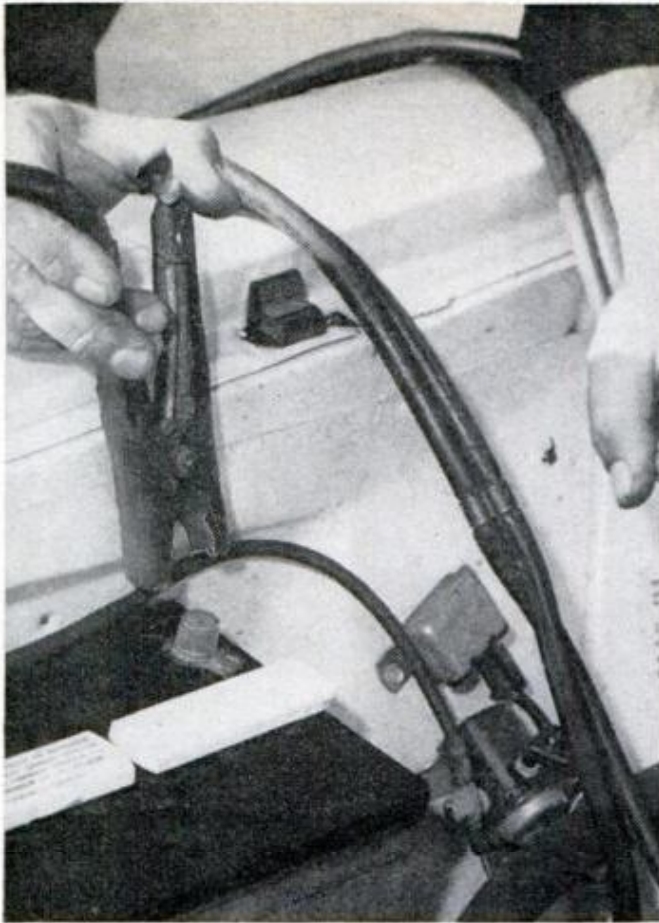

**Ingenious emergency trick:** If your battery cables have failed, use your jumper cables to make the circuit.

push-started. Switch on the ignition key, shift into second gear and depress clutch. When the car is rolling at about 10 mph, let out the clutch.

Your chances of starting a car having an automatic transmission by pushing are slim. The oil circuits in most are such that the engine can't be driven through the transmission. If you can push start, place the transmission selector lever at N and turn on the ignition key. When the car is rolling at the speed specified for your car, shift to the specified gear range.

Since battery failure causes more winter emergencies than anything else, carry a set of jumper cables so you can jump your battery with that from another car.

If you want to be 100 percent equipped for winter driving—in remote areas, especially—keep a booster battery in the trunk, too, but make sure it is charged.

It is very important to connect a booster battery properly to avoid damaging diodes in the alternator. Connect the positive post of the booster battery to the positive of your car battery using the red jumper cable. Connect the negative posts of the two batteries with the negative (black) jumper cable. ★★★

## New for road emergencies



### Portable charger gets you started

You'd never be stranded with a dead car battery with this portable charger along. The 28-pound gas-powered generator recharges 6 or 12-volt batteries in 10 minutes, was developed by William Lear, designer of the Lear Jet. \$279 from Lear Avia Corp., Box 10825, Reno, Nev. 89510.



### Gasoline substitute keeps you going

Out of gas? Just pour in a can of this nonflammable substitute and you're on your way. Eliminating the hazards of carrying spare gasoline in a trunk, Rescue mixes with the gas remaining in an "empty" tank and raises the level enough to get you to a gas station. Cristy Chemical Corp., 405 Grove St., Worcester, Mass. 01605.



# Four-channel headphones: Here's how they sound on two ears

by Robert Angus



“If God had meant us to have four-channel headphones,” quipped an audiophile friend of mine the other day, “He would have given us four ears.” But since we have just two, do four-channel headphones (which have been with us almost since the first four-channel amplifier appeared) do any good? Or are they merely a gimmick to part us from \$50 or so of our hard-earned cash?

One acoustical engineer, at least, thinks they're a gimmick. Peter Tappan, of Bolt, Beranek and Newman (acoustical consultants for New York's Philharmonic Hall), after lengthy experiments with quadraphonic headphones, told last year's Audio Engineering Society convention: “Most of the clues necessary for four-channel perception—those provided by involuntary head movements and others—are missing in four-channel earphone listening, because the phones are directly coupled to the ear. The



**Fixler headphones**—the only ones we've found that really reproduce the four-channel speaker experience—will be coming soon from Teledyne and other manufacturers. These are preproduction prototypes; final versions may look slightly different, as each manufacturer has his own ideas on styling.





**Inside a quadraphonic** headphone like this Superex model, you'll usually find two small speakers angled slightly toward each other and facing the head: angles and the distance between speakers control sound perspective, construction of speakers; earcup controls sound quality. Fixler phones (facing page) are designed differently, have speakers aimed along axis parallel to the head's.

result is a narrow band of four-channel perception inside the head between the ears."

If that's the case, why have thousands of audiophiles listened, then laid down hard cash for quadraphones? To find out, *PM* tried several of the more popular four-channel models, including Koss's 2+2, Lafayette Radio Electronics's F-4400, David Clark's CH4/A, the Superex QT-4B and the Mura four-channel phones. We tried them with different types of music, on different types of four-channel recordings, and tried some of Tappan's test procedures, too. In addition, we took apart the Superex to see how a four-channel phone is constructed.

Our listening tests showed Tappan's observation that most of the quadraphonic activity takes place along a narrow band between your ears to be essentially correct, particularly with SQ or QS matrixed four-channel records. The newer phones—the David Clark and Lafayette models—seemed to provide a greater spread between front and rear than did models like the Koss and Superex which have been available on the market for some time. But that "spread"—at least with the test records that we used—often made pianos and violins sound larger than life.

The piano in Philippe Entremont's recent Columbia SQ recording of the Khatchaturian Piano Concerto, for instance, seemed 50 yards wide when heard through quadra-

phonic headphones. Yet when heard through speakers, the piano was of normal size. A Khachaturian violin concerto recorded by JVC on a CD-4 discrete disc positioned the violin to the listener's left, with speakers, but squarely in the middle of the headphone listener's head. (Nonetheless, CD-4 discs do let the listener place instruments more precisely than he can with either SQ or QS matrix discs—and CD-4's stereo spread is greater, regardless of which phones you choose).

The paradox is that stereo listening has conditioned us to expect more drama and dimension from headphone than from speaker listening, while four-channel phones so far have given us a little less. But four-channel phones do add *something*—shifting the switches on my Koss and Clark units from four-channel to stereo did cause a definite collapse of the acoustic "space" I heard, and reduced presence and brilliance a bit, too (but doubling up the speakers on each channel also gave stereo listening better bass response and less distortion). The Lafayette's "two-channel" position switches in a simple matrix, adding quadraphonic ambience to stereo material.

To understand what four-channel phones do, it helps to have some understanding of how they're put together. Usually, both front-channel and rear-channel reproducers are mounted at equal angles to the head; but because of the ear's shape, the front-



## Sampling of four-channel phones 1



Four-channel phones vary in shapes, features. Rectangular David Clark phones (1) come with plug-in matrix box to add ambience to stereo material; Koss KO-747Q (2) and PRO-5Q (3) have quad/stereo switches, volume-balance controls.



Lafayette F-4400 phones (4) have switch-selected matrix for quad listening to stereo; Stanton 65/4C (5) has external switch.





channel reproducer feeds directly into the ear, while the rear-channel reproducer fires across the bumps and ridges of the outer ear. As a consequence, you will hear less treble from the rear channels—but then, you also hear less treble from the rear in real life.

Obviously, the outer ear is much more than just a simple sound funnel into the eardrum. Acoustical engineers are only now becoming aware of the significance of the ear's whorls, ridges and valleys, and their influence on directional hearing. Scientists at the Massachusetts Institute of Technology several years ago made a synthetic ear which could be slipped over a microphone.

When the bare microphone was placed in the midst of a group of students who were all talking at once, it was impossible to distinguish what any one voice was saying in the babble. But when the "ear" was slipped over the mike, the voices became more distinct, and it was possible to pick out a single speaker and follow what he said. This phenomenon forms part of the four-channel headphone experience.

But it's obvious that quadraphonic earphone listening is not an attempt to recreate reality, or even to reproduce inside headphones what takes place acoustically in your living room. Quadraphones seem to be designed for a totally different kind of listening effect than either that of loudspeaker four-channel or two-channel headphone listening—an effect which, though unreal, is rather pleasurable and quite exciting in itself.

Does it have to be unreal? One man who says no is Philadelphia inventor John Fixler, who's come up with a four-channel headphone that really seems to work. The Fixler phone resembles conventional quadraphones in most respects—look-alikes, with two drivers in each earpiece. But the

*(Please turn to page 209)*



**Teledyne PH-220 (6)** comes with stereo adapter plug. **Superex QT-4B (7)** and **Realistic Nova 44 (8)** have stereo/quadraphonic selector switches.



In the first Indy 500 a rear-view mirror was used by the winner to keep an eye on all the cars behind. "Sitting alone in the narrow cockpit of the Wasp and trusting to an adjustable mirror placed just in front of his eyes to warn him of the approach of any of his rivals from the rear, Harroun drove a masterly race." That's how the periodical, *The Automobile*, described the event in 1911.

Since then we've trusted to the rear-view mirror to warn of other "rivals from the rear"—cars racing for the same hole in traffic that we're heading for!

Relying on the rear-view mirror standard, with its limited angle of rear vision, too many drivers have missed cars in the "blind spots" and the accident statistics have climbed: A recent estimate lays the cause of at least six million vehicle accidents last year to inadequate rear vision. Average drivers are oriented toward vision in the front hemisphere of the vision arc and even the best of us have some difficulty, for example, backing a small tandem trailer into a driveway.

At best, the current system of rear-view mirrors, inside and out, have provided only a 30 percent rear-view arc. This isn't much better than it was back in 1911. Attempts to improve the viewing arc with rear view mirrors since then have been many. Outside mirrors have expanded the rear-viewing angle, but have always been subject to the elements, of course, not to mention the carstrippers' art. Aftermarket manufacturers have devised mirrors of all sorts, some of them adding a couple of degrees of view to give the average motorist a fair break in his attempts to negotiate today's 100-million-car traffic on high-speed roads with multilane challenges from sideswiping lane changers.

Some motorists have bought larger mirrors that mount in place of the original-equipment mirror, but many became disenchanted and discarded them after a period of straining their necks to see over or under them in order to catch changing traffic signals.

Convex mirrors, popular on some European sports models, have had their own disadvantages in mass usage. The convex curve of the mirrors, while it expands the field of rear viewing, does so at the expense of clarity of the image reflected. And the danger of misjudging the distance and speed of the car coming up behind can

## Up periscope?

The trick of seeing behind you has always been done with simple mirrors, but if they can't measure up to stricter rear-visibility standards, your next car will have a periscope.

by Ed Janicki

Among experimental periscopes being tested in real-life driving situations are several that have been installed in auto-racing pace cars. This Javelin pace car at Michigan International Speedway mounts a Parascope designed by Para-Vue. Another system designed by Donnelly Mirror Co. makes use of electric defrosting and has been installed in a fleet of General Services Administration cars for purposes of testing and evaluation.





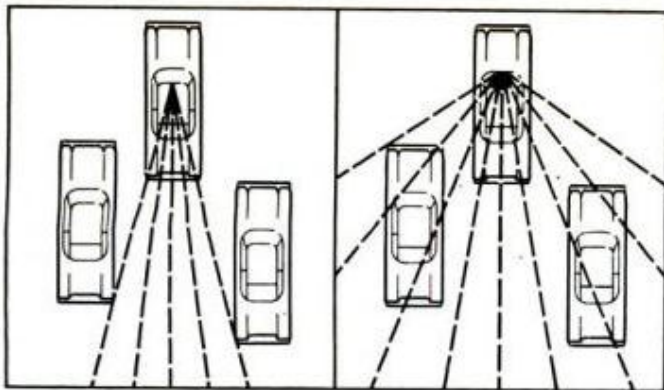

**Wide-angle mirror** systems may be able to meet future standards for rear visibility. New systems are being researched by auto companies as a more cost-effective approach to indirect rear visibility than periscopes. Shown here is the view afforded by one of the aftermarket wide-angle mirrors that are available. This one, called WINK, greatly expands rear viewing angle as shown in drawings and photos. Costing about \$15, this system mounts five mirrors in one frame to provide the panorama. Each separate mirror is set at a precise angle to provide the distortion-free view. Another wide-angle mirror available is approximately 30 inches wide and is of single-piece construction. Disadvantage of these systems, of course, is the extent to which they intrude on forward visibility.



make this alternative to the flat image mirror a very dangerous one.

While the problem of providing simple and effective rear-viewing systems would seem anything but insurmountable at first glance, designers who have tried to do so have the problems of cost and car designs to reckon with. Fastbacks, for example, practically, shut out the whole world behind the car, and the huge fins of the 1950s were nightmares all their own.

The rear-visibility problem, being one of safety, drew the attention of the Department of Transportation. A few years ago, the DOT underwrote a study by the California firm of Dunlap and Associates. The Dunlap report on motor vehicles rear vision was completed in August 1969 and it told the government and the industry what everyone knew. But it did so in convincing language and with convincing evidence, including a survey of driver views on rear vision. Not surprisingly, a high percentage of those surveyed felt the system could stand some improvement.

Results of the Dunlap study called for an



## Early inventors saw a need for a better rear vision

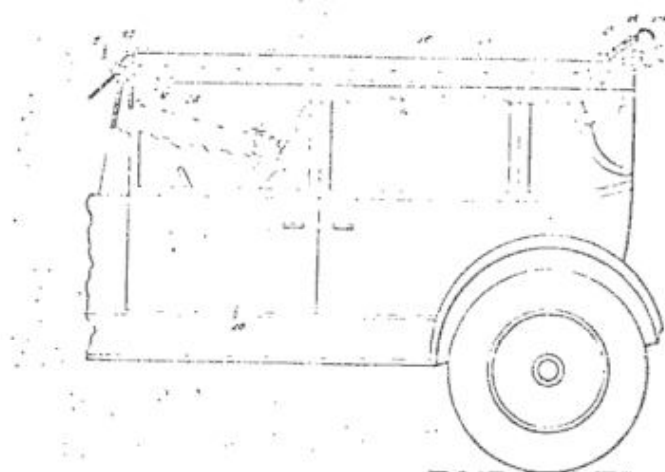
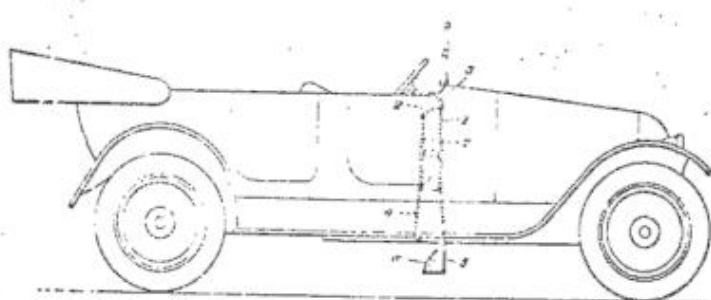

**Automotive periscopes** are not a new idea! Shown here are patent drawings from early in the century. At top is an idea from 1919 for a "vehicle reflector." Filed by F. Schmid and F.E. Thomas, the idea was to pick up the image of traffic behind in a mirror under the car and reflect the image up to the dashboard. Another idea, as shown above, was to enclose the "automobile mirror system" in a tunnel in the roof of the car. Filed in 1926 by C.W. Paul, the drawing's plan view showed the rear opening running the entire width of the car. The deflector at the rear appears to be the first rear spoiler on an automobile—unintentional, of course!

over-the-roof system as the best for rear view. This, to many in the field, means the periscope.

The federal government has equipped a group of cars with improved mirrors, hoping to arrive at standards for increased "indirect vision." The ultimate goal of the project is a system that uses a single device to provide five-lane rear vision. It's still not known whether any system of mirrors, inside or outside, or in combination, will be able to meet this requirement and that is why new systems such as the periscope are being looked at and checked out by the manufacturers.

To provide a single display point within the automobile, either the periscope or some

other more sophisticated system will be needed. Television scanning and even fiber optics—bands of optic material that can bend light around corners—are not to be ruled out entirely, except that the costs of such systems would be prohibitive, and there's a limit to what the motorist can afford to get a "safe" car. The periscope may be the most cost-effective solution providing the greatest safety for the least dollars.

The automobile periscope has been a traditional area of tinkering for American inventors, with a file of patent art alone gathering dust a foot thick in patent offices. Some of the early attempts are curious tinkering with the basic problems of bending light.

A pair of inventors named Schmid and Thomas came up with one of the earliest attempts, a system of periscopes that gave a rear view from under the chassis (shown in the drawing, top left). That happened in 1919.

By 1923, a W.A. Doble devised a double periscope system, with one scope for the driver and one for the back-seat driver. C.W. Paul designed a periscope in 1926 that involved a tunnel running the length of the car just under the roofline (drawing at bottom, left).

The trouble with most of such attempts was that, while some looked good in theory, application involved a grappling with cumbersome boxes. The three-mirror approach of the time created a problem in the bending of light and ended with requirements for very awkward systems.

In 1960 Karl E. Smith began working on a panoramic three-mirror system and after three years of experimenting came up with a scope which he mounted onto the roof of a Chevrolet Corvette. It consisted of one mirror as wide as the car and mounted on the roof. This mirror projected an unobstructed view of the rear and sides and transmitted it via two mirrors to the driver's front line of sight.

The Dunlap report was high in praise of the Smith system.

There are about a dozen firms trying to get there first with the most flexible and adaptable periscope system. Among them is Para-Vue, a small company headquartered in Roseville, Mich.



Its periscope system operates with only two mirrors, a trick made possible by use of a see-through mirror. Previously three mirrors were required simply because a conventional two-mirror system left the driver with a useless, inverted image in front of him.

Para-Vue calls its system the Parascope and its claim for it a doubling of viewing arc over present mirror systems.

The Parascope has a 22-inch-wide mirror encased in a hermetically sealed covering that protrudes four inches above the roofline on the driver's side. The display mirror inside is located just above the front windshield header.

Para-Vue says its unit will be available through retail outlets it is starting to franchise around the country. The cost, which includes the installation, will be less than \$100, according to the company. In assembly-line mass production the Para-Vue unit would cost out at less than \$25, it is claimed.

And there are still some unanswered questions in the whole field of car-mounted periscopes. Para-Vue has the devices mounted on company-owned Camaros and has installed them on pace cars at two of Michigan's speedways.

The differential in vibrations between cars and from the outside mirror and the inside mirror can raise problems and even though hermetically sealed, such mirrors

might become encrusted with freezing rain just as any mirror will. For this reason, Donnelly Mirror Co. in Holland, Mich., has built an electrical defrosting system into its periscope.

Would the old adjustable interior window in tandem with a rear window defrosting system, despite its inherently narrow viewing arcs, be as acceptable the best of all possible systems? It may be.

Carmakers have greatly improved rear visibility in recent years. Greenhouses are bigger, there's more glass area and the wide C pillars have been narrowed to block as little of the traditional blind spot as possible, and rear-window defrosters are proliferating.

If Detroit can meet stringent indirect visibility standards for the late '70s with \$5 worth of mirrors they'll be home free. They'll beat the problems of cost, styling—even car washing—associated with periscopes. That's why they are researching advanced applications of conventional mirrors with top priority.

GM is rumored to have received favorable results with a two-mirror system for the left side of the car. One mirror is wider than the other to obtain a greater viewing angle.

If there's a more economical way to see as much behind without the problems and cost of a periscope, they'll find it. Otherwise it's . . . up periscope! ★★★



**Experimental Safety Vehicle (ESV)** from Fairchild prepared for the Department of Transportation includes a periscope installation that is aerodynamically integral with the roofline of the sedan.



**ESV from AMF** uses a periscopic rear-viewing system that protrudes several inches from the roof. Its height enables it to provide the driver with a better viewing angle for objects close behind the car.



Christmas gifts  
you can make  
(Starts on page 89)

## How to carve the mini jewelry

*(Continued from page 90)*

Cement worked best. Apply cement liberally to surfaces to be joined and clamp the piece overnight between two pieces of wood. Make certain the wood is separated from workpiece with wax paper because glue oozes out as clamp pressure is increased.

Next day, remove hardened excess glue using a sharp knife. The flat is now ready to saw to shape. After sawing, sand and

buff edges smooth. Drill the hole for the hanger if the carving is to be a necklace or simply glue the carving to the appropriate jewelry finding with Super Strength Adhesive. For a hand-rubbed look, we found that a clear plastic coating, the type which comes in an aerosol container, works best. Three light coats are better than one thick one. It is also best to spray flat pieces with them lying down rather than suspended—



**Basic tool used for carvings** is Dremel Moto-Tool which comes in 34-piece kit including wrench. Tungsten carbide bits are extras, but well worth the investment.



**Other tools which will speed work:** 1. variable-speed control; 2. drill-press accessory; 3. Moto-Shop jigsaw and 4. flexible shaft (used with jigsaw).

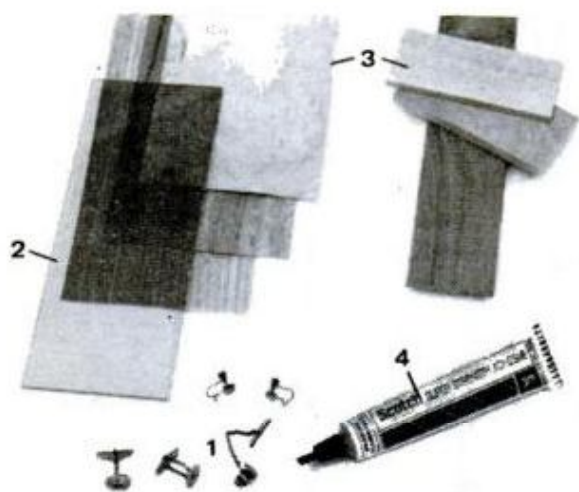

**Materials used:** 1. jewelry findings (cuff links, earrings, tie tack shown); 2. plexiglass; 3. veneers, solid wood and 4. glue to affix carvings to hardware. For sources of the materials, see page 160.



**Carvings shown above** are examples of plastic glued to plastic (top), wood to plastic and plastic glued over veneer. Daybond Thickened Cement (Rohm and Haas) works best for these applications.



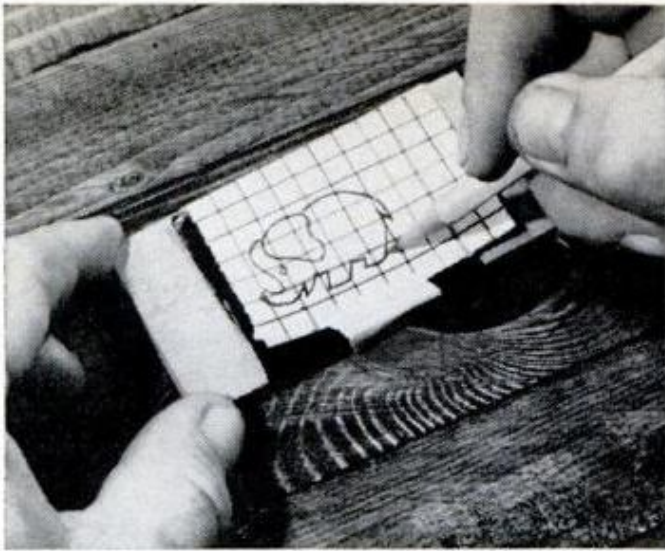

1. Design is transferred from grid paper to wood block using carbon paper beneath drawing. Tape carbon and drawing so they can't shift while you trace.

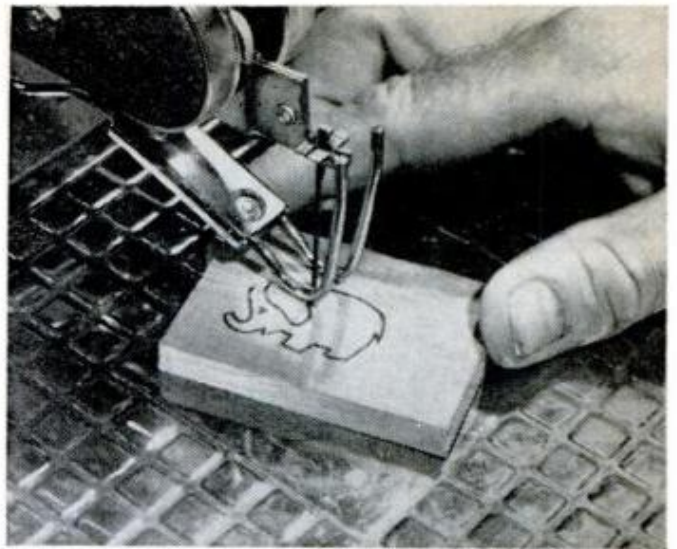

3. Figure is then cut out using the jigsaw. Stock used to create elephant shown is  $\frac{3}{16}$ -in.-thick cherry. Blade guard minimizes chatter and protects fingers.

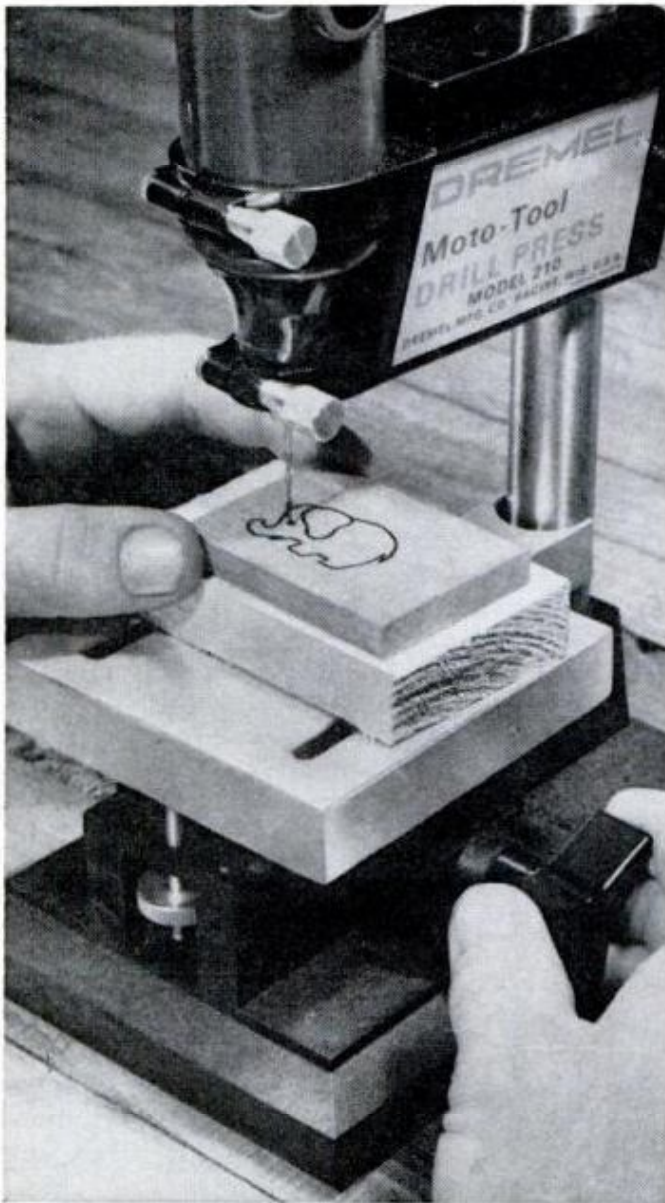

2. Carving tool is mounted in drill-press accessory and eyehole is drilled. Unlike large presses, this head remains stationary; worktable is raised to drill by turning knob to right of and below platform.

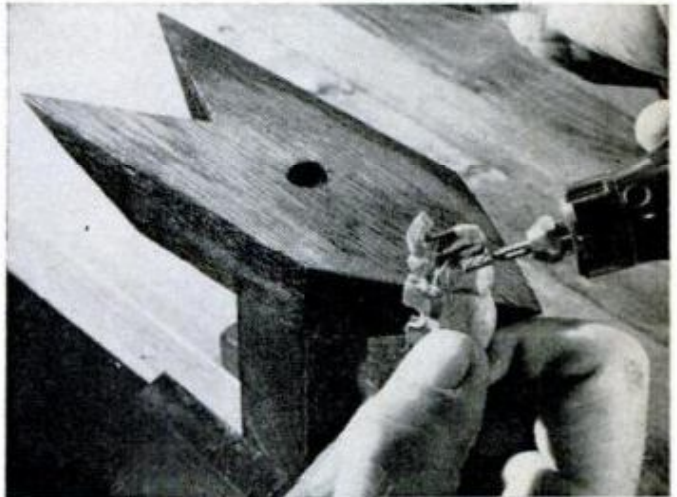

4. Carving starts with knurled cutter (No. 194 shown). Shop-built work jig facilitates maneuvering and handling small piece. Jig (below) is gripped in bench vise.

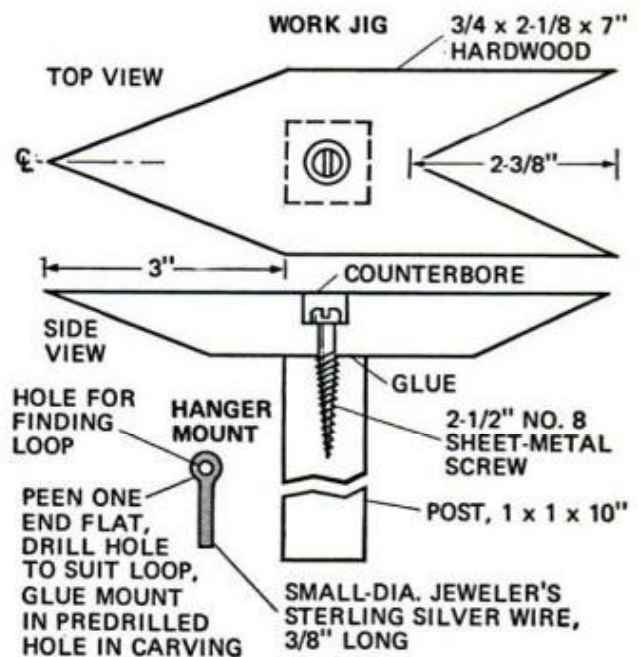



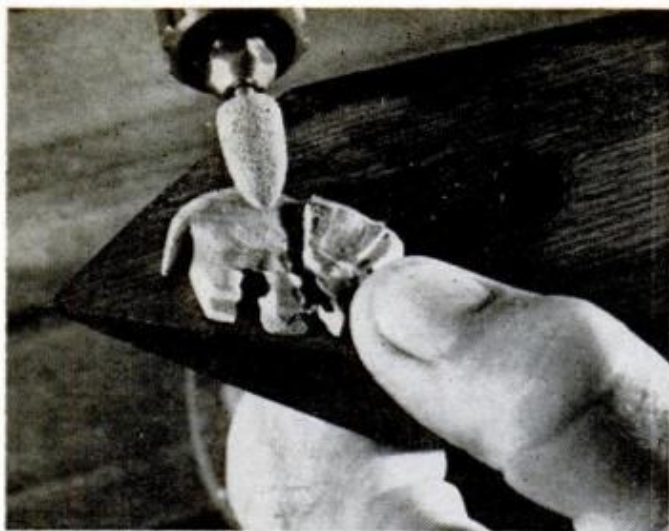

5. After rough shaping, carving is ground smooth with emery-point dressing wheel. Since tiny form is finger-held, carving with power calls for extra care.

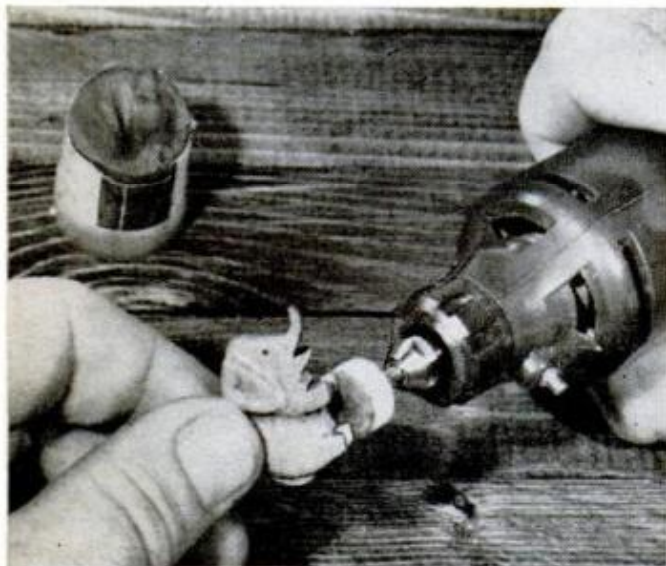

6. To finish, carving is polished with buffing rouge and cloth pad chucked in tool. Pad is recharged by periodically dipping spinning pad in the rouge.



7. Finished gift from the workbench is ready to be wrapped and placed under tree. For looks, box can be lined with black velvet around tissue as shown.

## Manufacturers of Materials

**Tools:** Moto-Tool kit No. 281 (\$49.95), Moto Shop No. 571 (\$39.95), and accessories, Dremel Mfg. Co., Dept. PM, Box 518, Racine, Wis. 53401.

**Jewelry findings:** American Handicrafts Co., Dept. PM, 1011 Foch St., Fort Worth, Tex. 76107.

**Wood and veneers (by mail order):** Albert Constantine and Sons, 2050 Eastchester Rd., Bronx, N. Y. 10461. Also, Craftsman's Wood Service, 2727 South Mary St., Chicago, Ill. 60608.

**Plexiglas and Daybond Cement:** Rohm and Haas Co., Dept. PM, Philadelphia, Pa. 19105.

**Super Strength Adhesive:** Adhesives Div., 3M Center, St. Paul, Minn. 55101.

**Clear plastic coating:** No. 1301, Krylon Div. of Borden, 50 West Broad St., Columbus, Ohio 43216.

**Note:** All items listed above, except for woods and veneers, are available at hobby, hardware and department stores. If you have difficulty obtaining a product, to locate nearest source write direct to the manufacturer at address given above.

when the first side is dry, flop the piece and spray the second side.

*Carving in the round.* Though three-dimensional carving is slightly more difficult than flat carving, it is also more satisfying. For these carvings, use thicker stock— $\frac{5}{16}$  to  $\frac{3}{8}$  in. Steps for carving in the round are shown in the photos. After cutting out the shape, use the powered carver and various cutters to begin rough shaping to give the piece form in the third dimension. Although cutter No. 194 is not included in the kit, we found it best for this stage of carving.

Keep in mind that the Moto-Tool's cutter rotates at 30,000 rpm. And since the carving is small, thus fingertip held, care should be taken to keep fingers clear of the cutter's path. Never start a cut from the end and work toward the middle; always start a cut in a "meat" portion of the wood and progress shaping toward an end. If you start a cut at the end grain, the tool may jump in the opposite direction. Also, don't try to cut away too much wood in one pass. A series of light passes is easier to control and permits more graceful shaping.

With the piece roughed out, start smoothing using a grinder such as No. 992 or 997. For this step, using the variable-speed control, adjust the tool speed to lower rpm. High rpm will leave burn marks on wood and plexiglass. To sand hard-to-get-at spots, trim an emery board to a point. When satisfied with smoothness, spray the piece with a clear plastic coating. When completely dry, polish the piece with the buffing wheel and polishing rouge as shown in Step 6. ★★★



Christmas gifts  
you can make

# Initial bookends

by U. R. Ittman

Here's a gift that is as personal as it can be—bookends of a friend's first and last initials. Letters C, O, U, J and V must be altered a bit to provide flat bottoms for attaching sheet-metal bases. The project provides a good way to use up scrap wood and pieces of plastic laminate.

Formica's English Oak was used on the face of the letters shown and the rest was painted (see cover). Cement the laminate to the wood and tape a paper pattern of the initial (enlarged from the drawing below) to the laminate before bandsawing. ★★★



**Sanding** the bandsawed edges of the letters goes a lot faster with a band sander, of course, but it can be done by hand with the sandpaper wrapped around a dowel and narrow wood block.

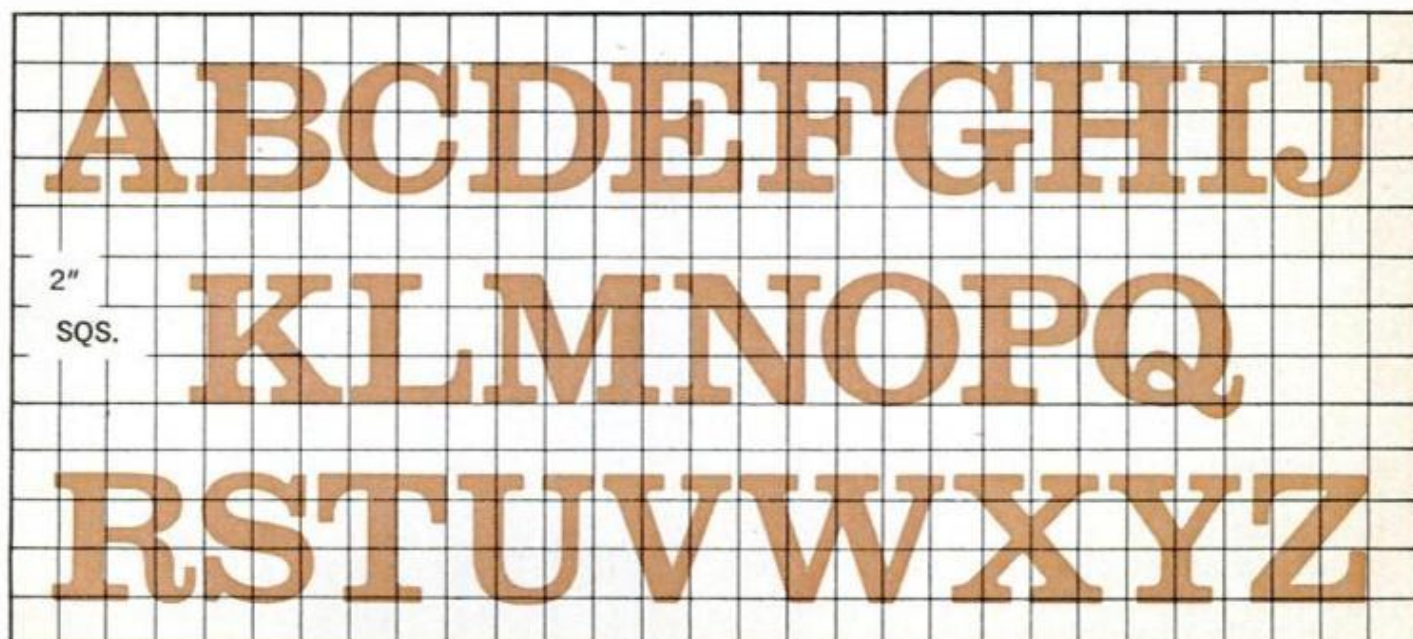
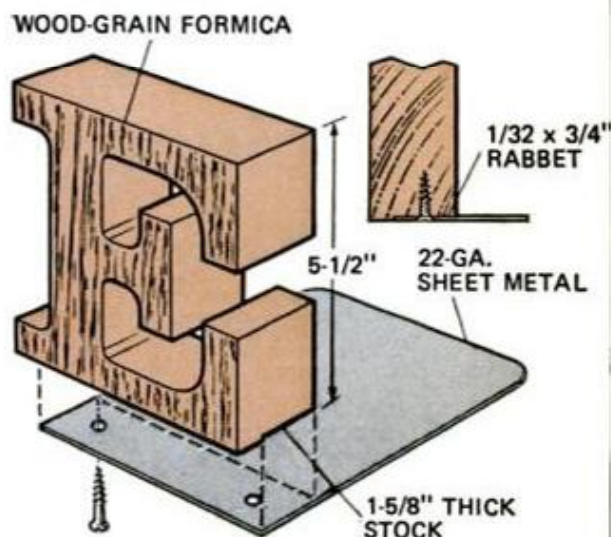



## Christmas gifts you can make



### King-size book rack

This handsome book rack is made from a sheet of  $\frac{1}{8}$ -in. black plastic measuring 14 x 18 in. When cut out and the edges polished, four 90° bends complete it.

## One-piece plastic beauties

by Michael Shook

Any time you can make a project from a single piece of wood, the simpler it is. That holds true with sheet plastic when messy cements are not required. One advantage of rigid acrylic plastic like plexiglass over wood is that it can be bent like butter merely by heating it. Consequently, corners and joints are integral and exceptionally strong.

There are any number of handsome and useful glasslike projects you can make from a single piece of translucent, opaque or transparent plastic as you can see from the five examples shown here. Aside from needing a saw or pointed tool to cut the material and a drill to drill it, bending is most easily done with a strip heater. This can be a homemade affair as shown on page 165 which makes use of a heating-tape element sold at most stores that sell sheet plastic.

Normally, the protective paper covering

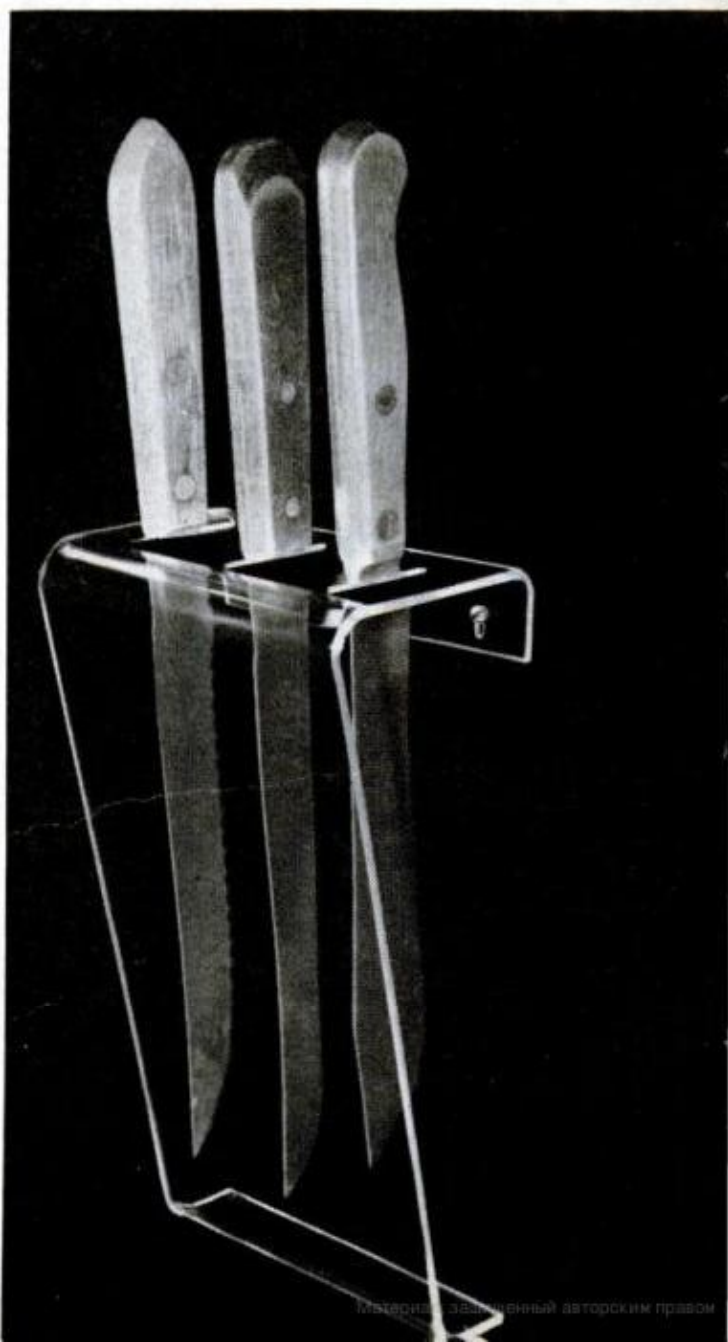



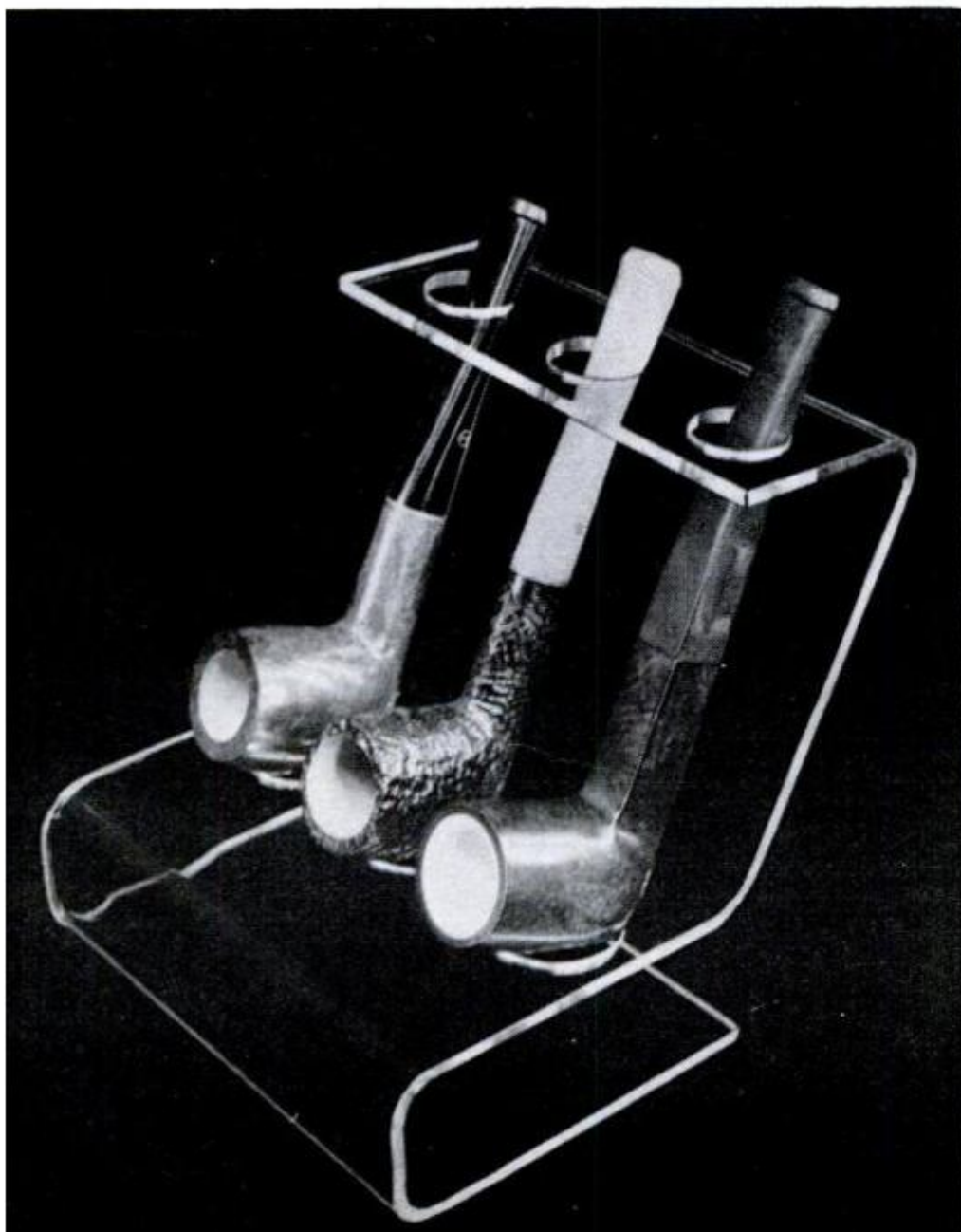

### Magazine rack

Shaped like a huge "W," this modern, roomy magazine holder (left, above) lets you see each periodical at a glance.

### Letter/stamp holder

Serving to hold both letters and a roll of stamps, this simple-to-make gift (right, above) makes an unusual desk accessory.

### Knife rack

Looking like glass, this three-knife holder (far left) is formed from  $\frac{1}{8}$ -in. clear plastic and hangs on wall by two keyhole slots.

### Pipe holder

A relief from the common wood pipe rack, this beauty (left) holds three pipes, with their bowls cradled in polished holes.



## Bends and holes required for five projects

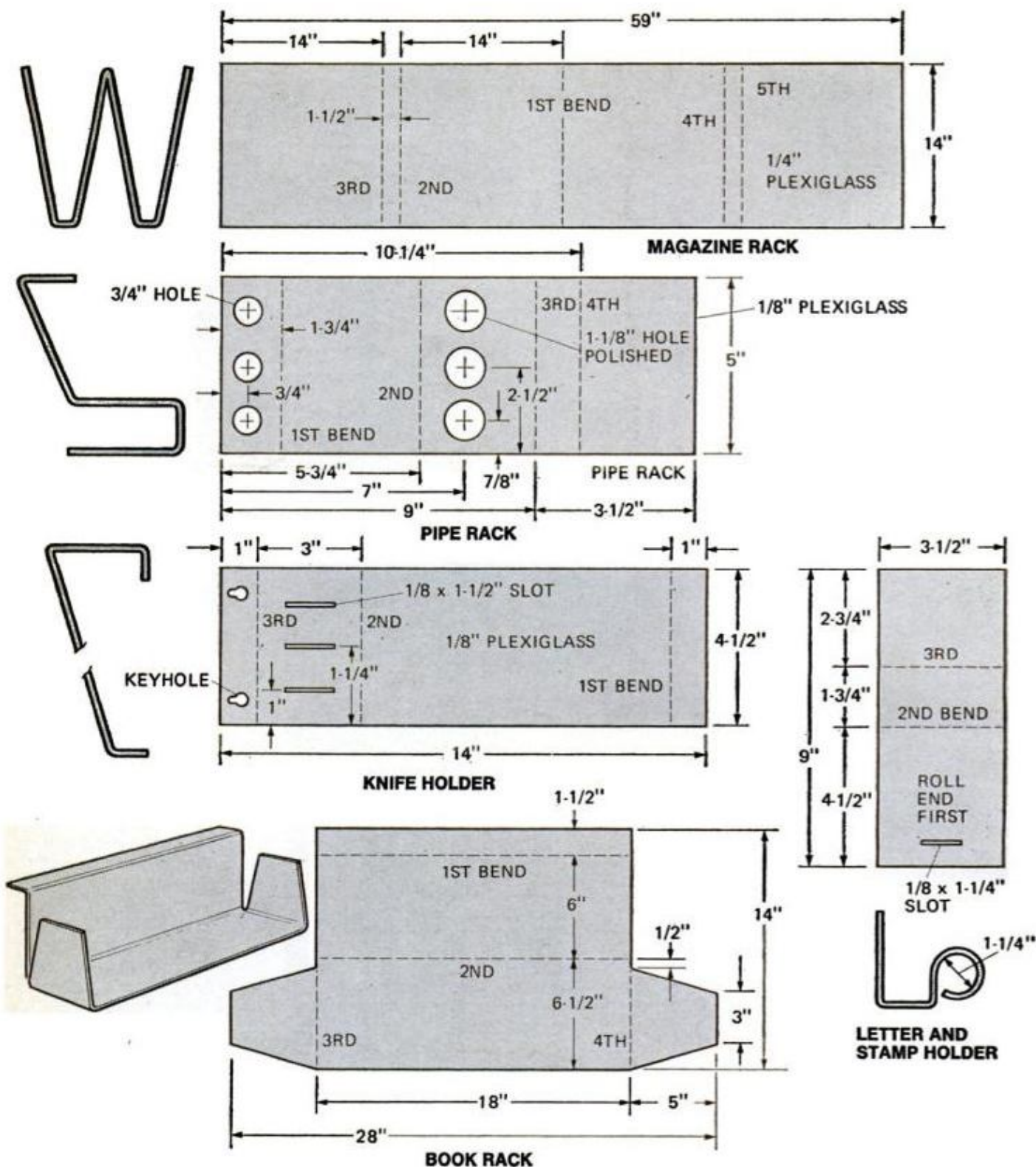

on plastic is left intact while you're working it, but when you're ready to bend it, the paper must be peeled off. A grease pencil is used to mark the line of bend.

To use the heater, plug it in about 15 minutes to get the tape hot (about 290° F.) Place the plastic across the heater so the line of bend is over the tape and leave it for another 15 minutes or until the plastic has

softened sufficiently. Now gently bend it along the pencil line while the sheet is still on the heater to the angle of bend you want. Then lift it off to cool. Since the bend has a tendency to spring back slightly upon cooling, make the bend a bit greater than you want and continue to hold it until the softened plastic cools and hardens. It will harden in a minute or two.



## Details for making strip heater

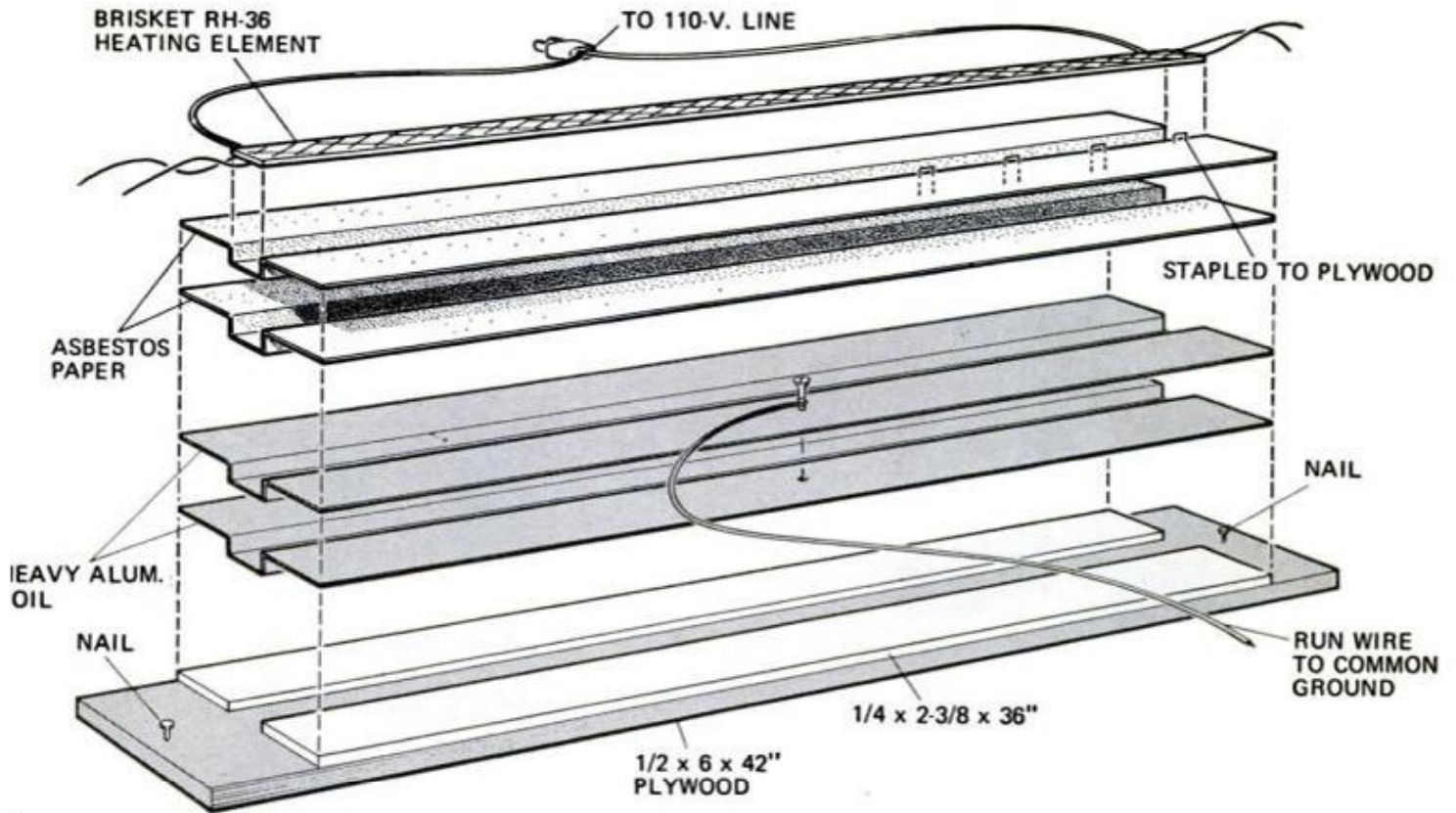

## Plans available for additional projects

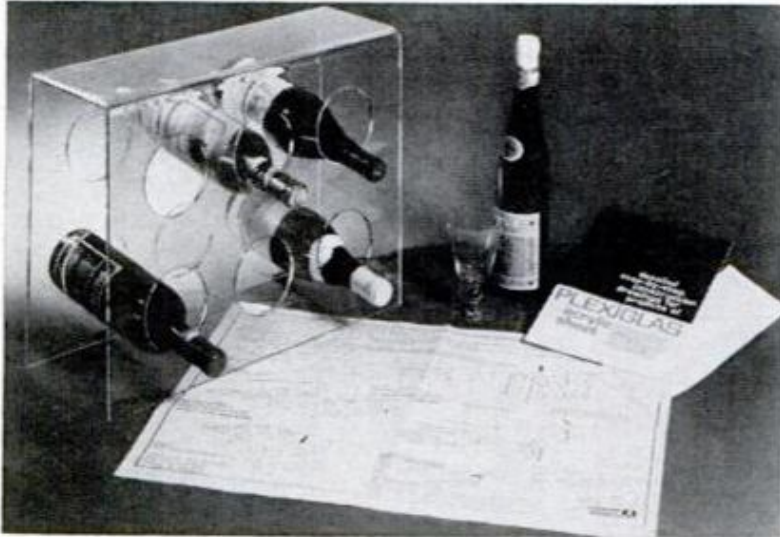

How-to plans for this handsome one-piece wine rack, plus some 20 others such as coffee tables, tic-tac-toe game and lamp are now available to PM readers from Plexiglas dealers or by mail from Rohm and Haas Co., Box 9730, Philadelphia, Pa. 19140. Measuring 17 x 22½ in., each plan provides step-by-step instructions and sells for 50 cents. Readers also can get from dealers for 25 cents a colorful 16-page booklet, *Do It Yourself With Acrylic Sheet*, with photos of 40 project ideas, fabrication information and lists of project plans available.



Christmas gifts  
you can make

# Animal pull toys



Mom Duck and kids

by Elma Waltner

Toddlers like toys they can pull, and if they are noisy, so much the better. Mom Duck and her kids waddle along quacking merrily, and Danny Dachshund makes himself heard as he is pulled. Off-center wheels provide the waddle, and compression-spring necks make the heads bob.

Both ducks and dog have the same voices, produced by pieces of clock spring being snapped against sounding boxes by hardwood ratchets.

The series of photos on the opposite page shows how the ducks are made. In each case, the voice-box holes are bored before

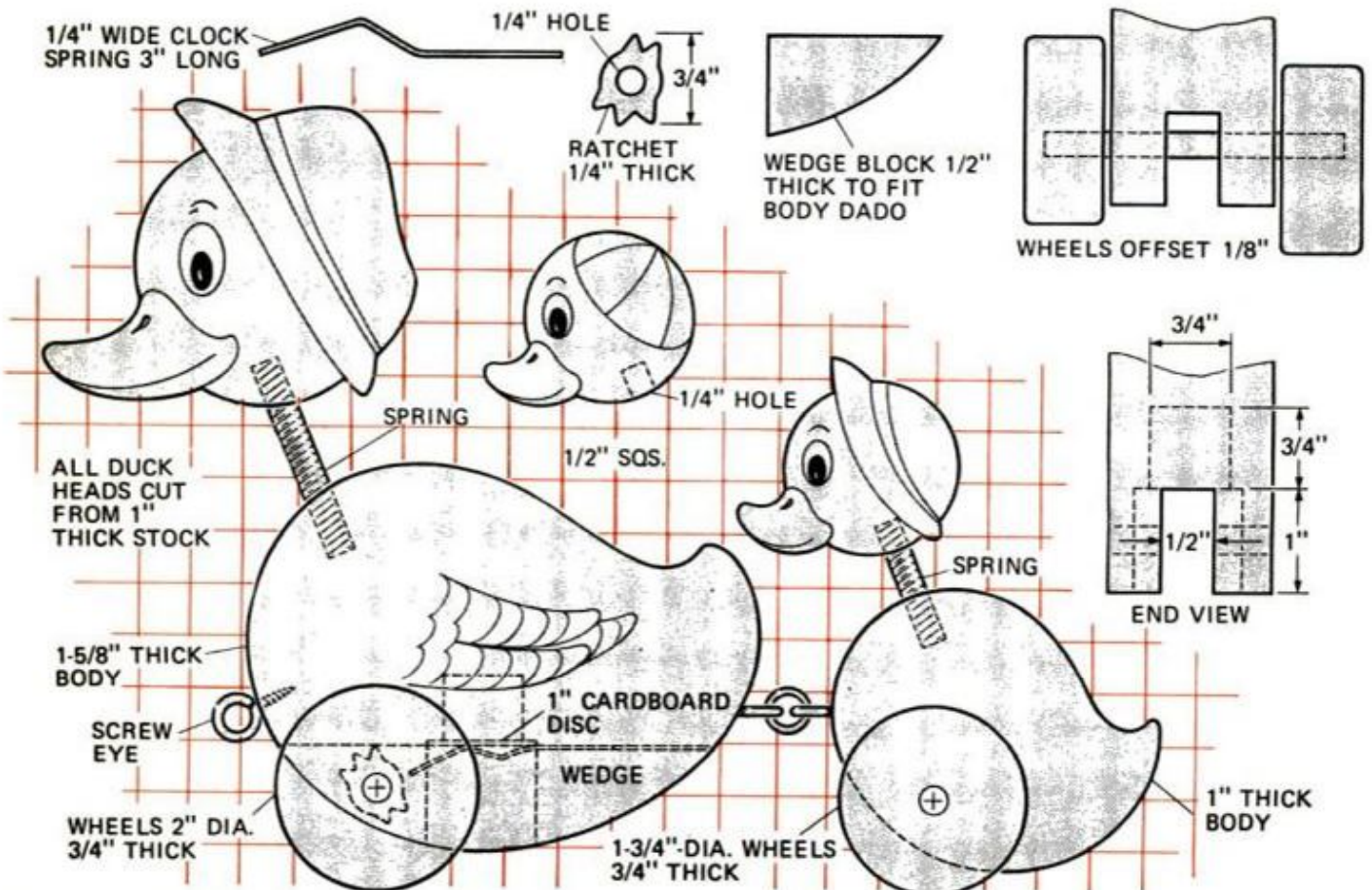



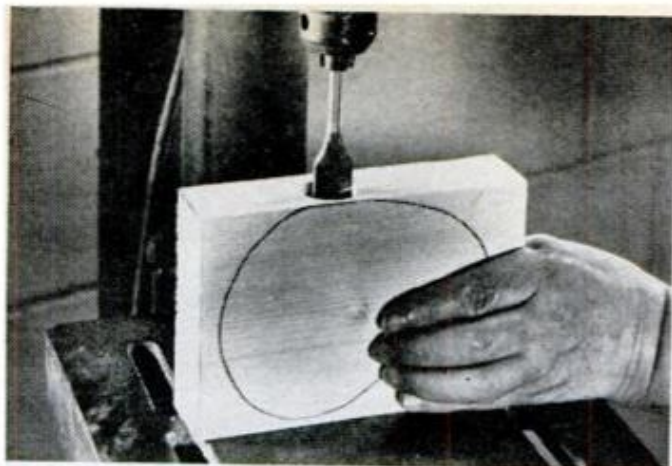

Sounding-box holes are bored in block before body is cut out. Drill 1-in. hole first, then  $\frac{3}{4}$  in.

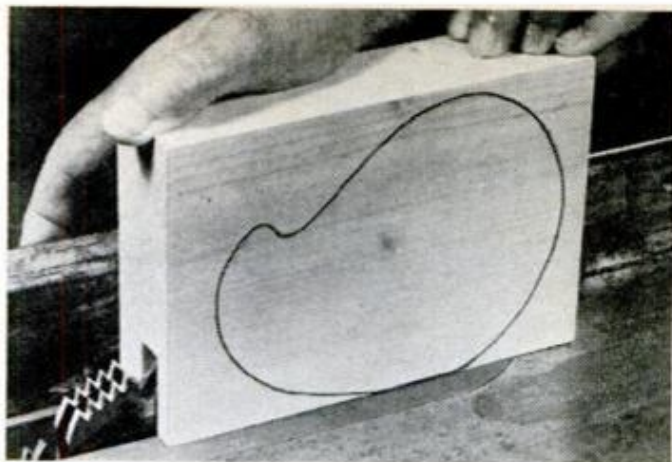

Block is passed over dado saw to form  $\frac{1}{2}$ -inch.-wide slot in bottom edge, drilled for axles, then sawed.

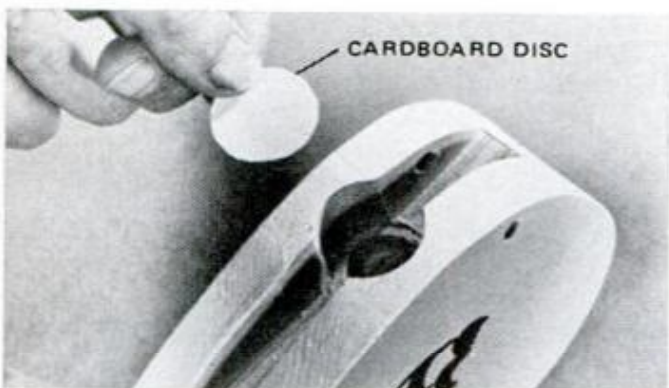

Thin cardboard disc is glued to ledge formed by large hole to cover the  $\frac{3}{4}$ -in. sounding-box hole.

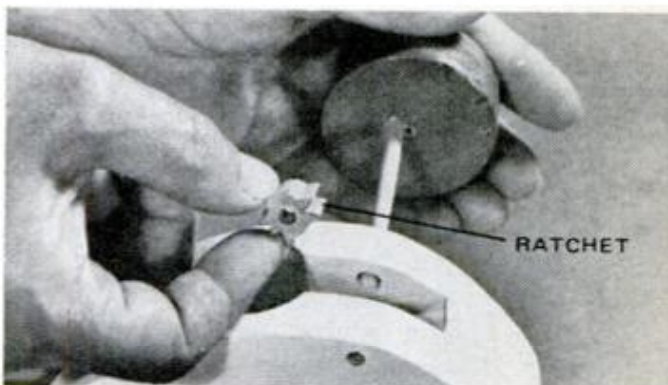

Ratchet is slipped over axle as it's passed through slot. Glue on each side holds ratchet on axle.

## Duck assembly

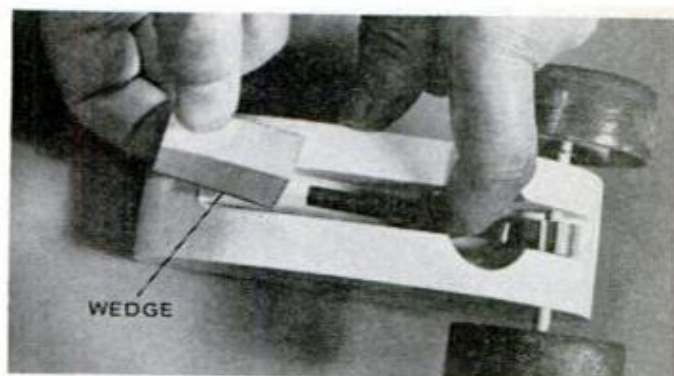
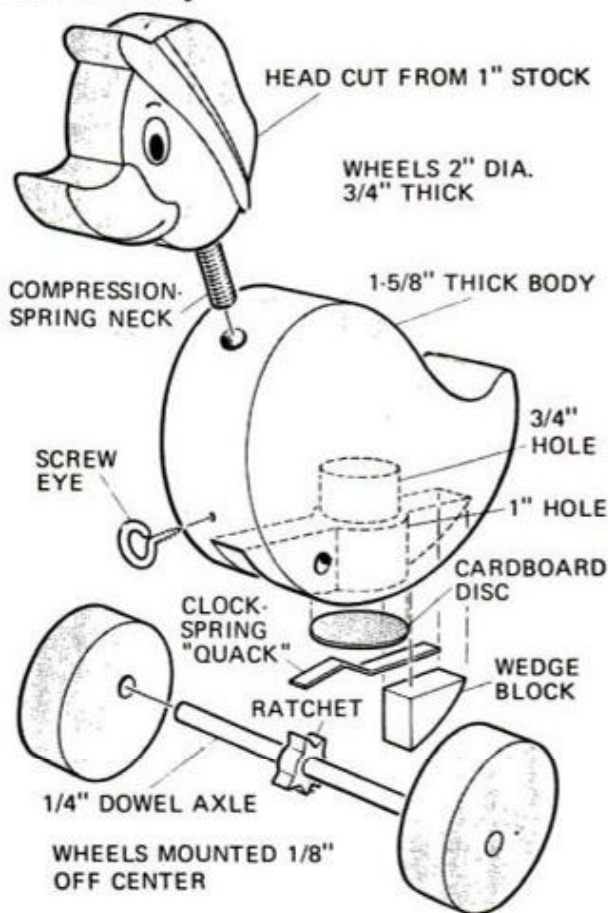

Apply glue to wedge block, then insert block in slot to hold spring against cardboard and ratchet.

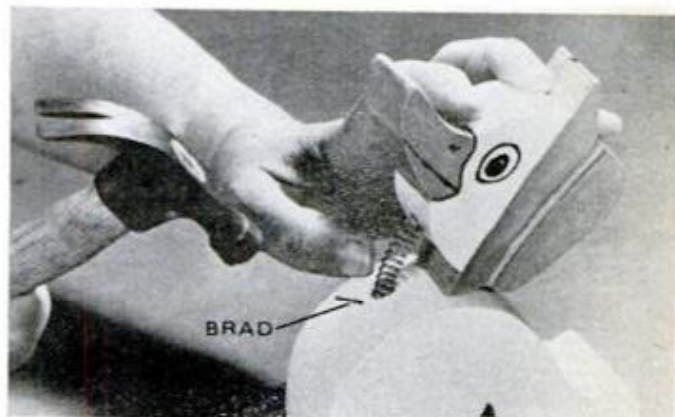

Small finishing nails, plus glue, are used to anchor neck springs in holes. Nails are driven crosswise.





Danny Dachshund

the blocks are slotted and sawed out. Postcard stock is just right for the cardboard sounding-box discs; a dab of glue holds the ratchet (clacker) on the axle and in center of the slot.

Basically, Danny is made the same way, the exception being that only his rear wheels are placed off center. Waddle is produced by attaching his hind quarters with a nail in an oversize hole. His head is lathe-turned and then cut off at an angle to form nose and mouth. Wheels can be cut quickly with a hole cutter. Sand all parts smooth and paint with a nontoxic enamel. ★★★



Attach ears to head by driving nails through oversize holes in ears, then through wooden beads.

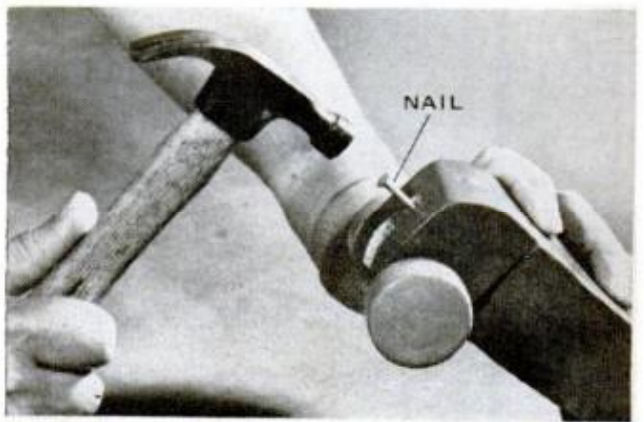

Attach hind quarters to front section with washer between by driving nail through loose-fitting hole.

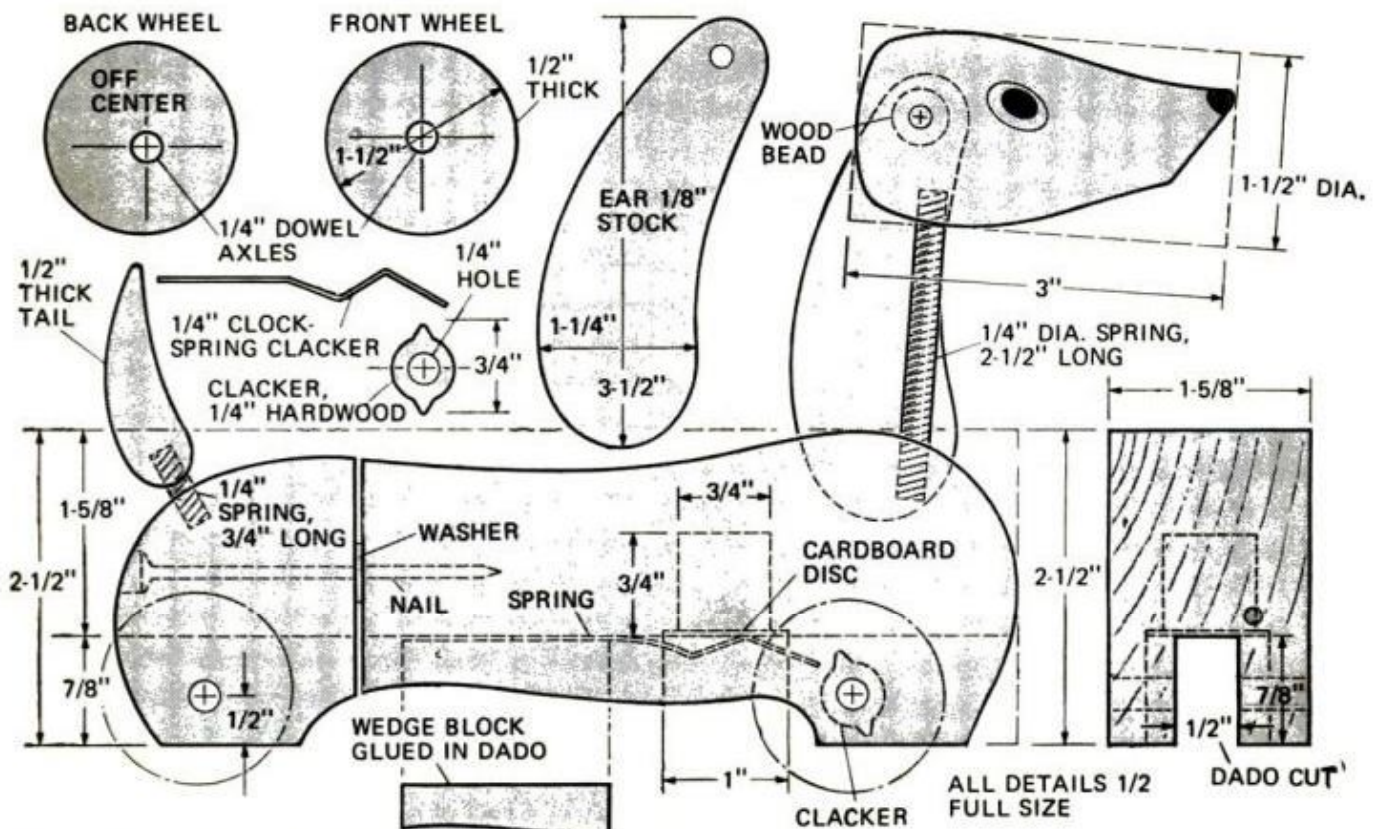



# Blockmobiles

Christmas gifts  
you can make

by Willard Waltner

A fleet of these classy blockmobiles will provide hours of fun for a 4-year-old, and they can be made for practically nothing from scraps of  $\frac{3}{4}$  and  $1\frac{1}{2}$ -in. pine found in your woodbox. They are also practically unbreakable.

All are made by first gluing up blocks of

varying thicknesses after precutting them to shape. All fender "wells" are bored  $\frac{1}{2}$  in. deep with a  $1\frac{3}{8}$ -in. spade power bit. Then  $\frac{5}{16}$ -in. holes are drilled from each side for free-turning axles of  $\frac{1}{4}$ -in. dowel rod.

The wheels are easy to make if you own

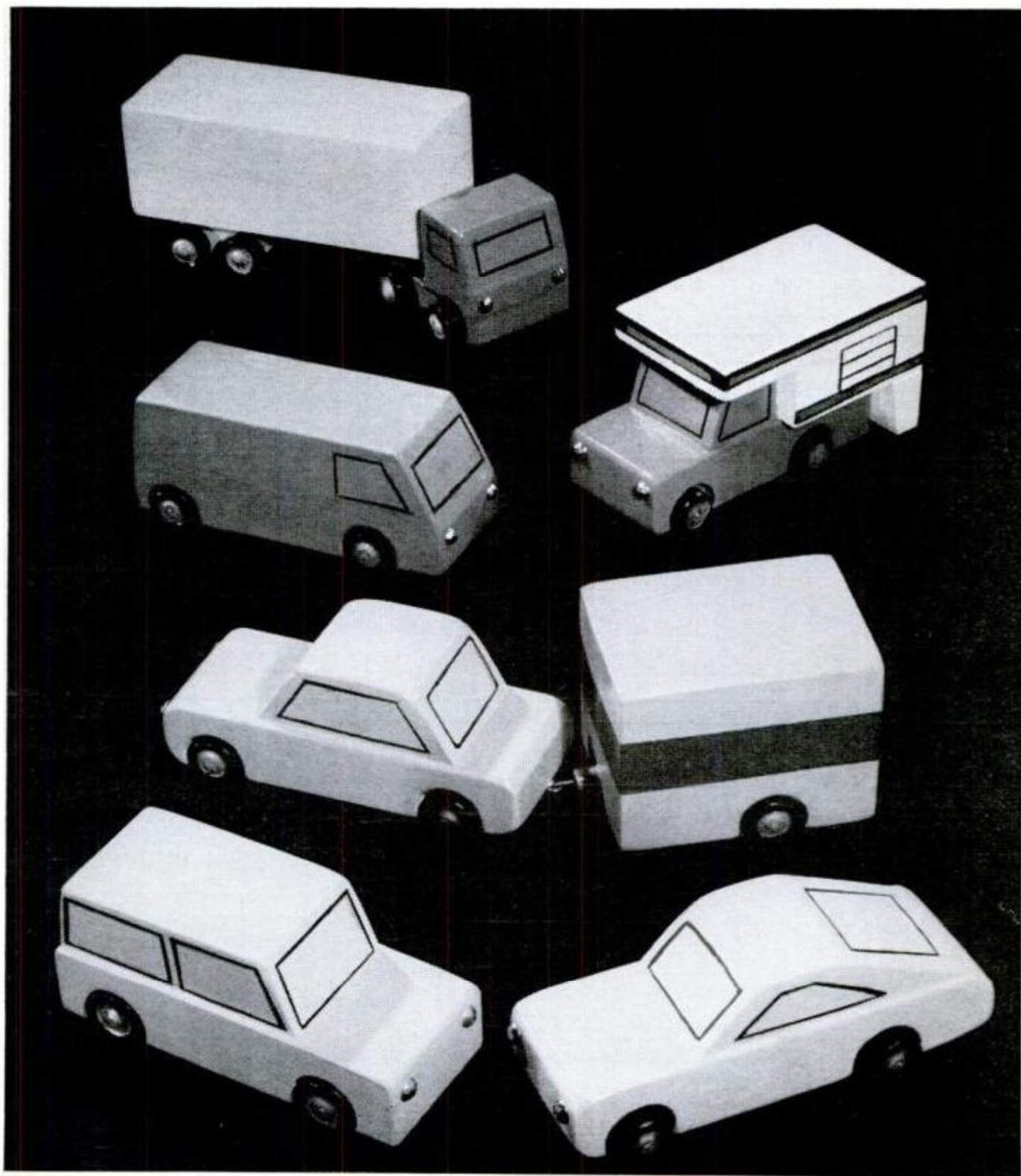



# Fun fleet for toddlers

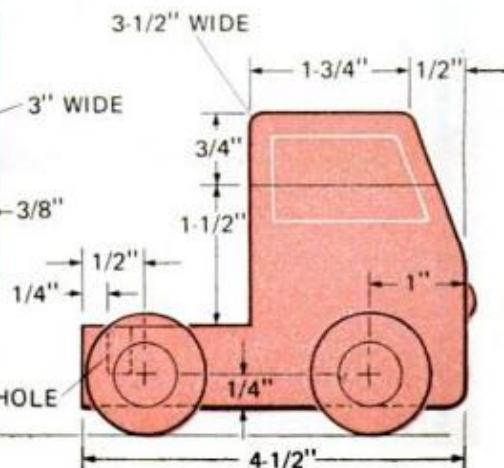
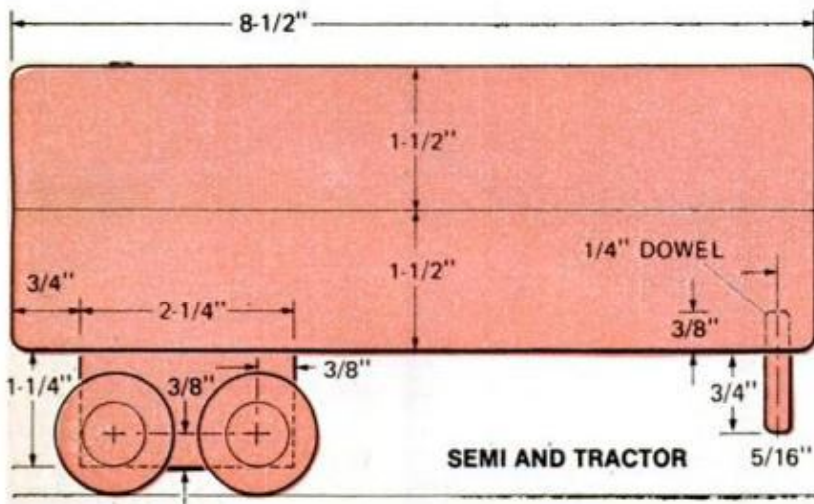
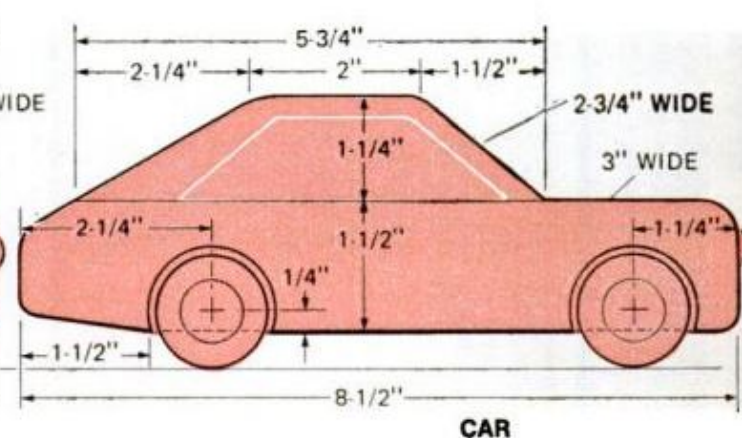
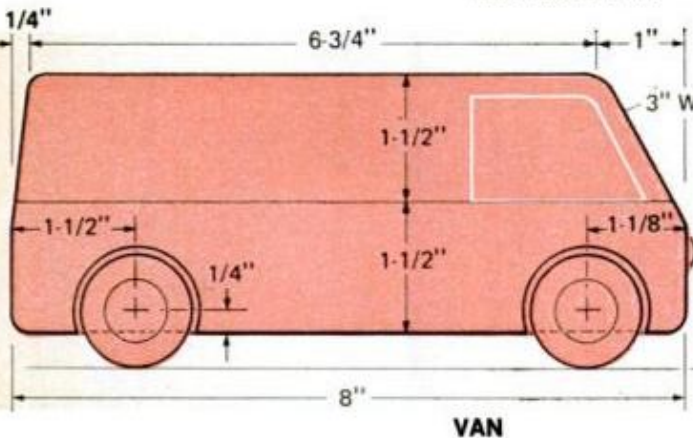
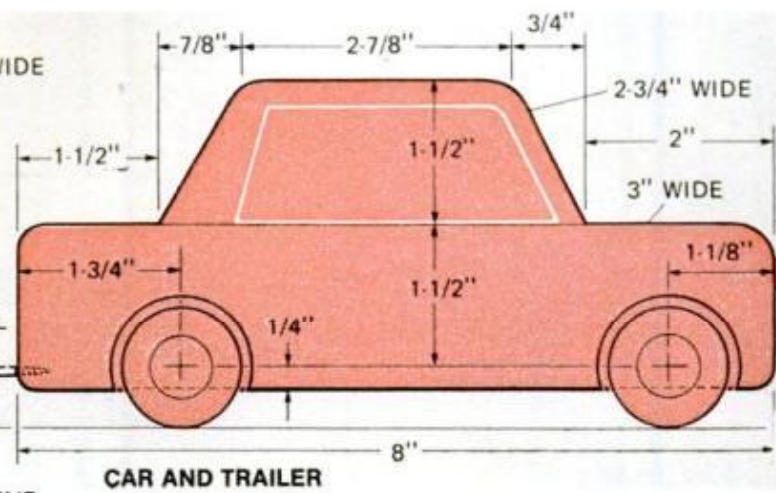
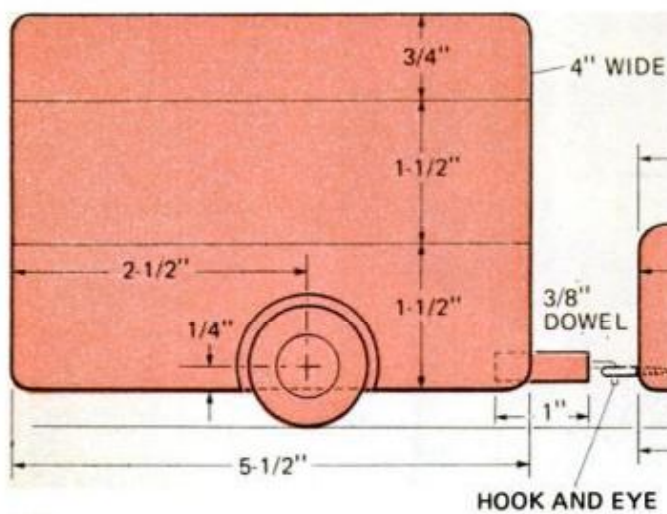
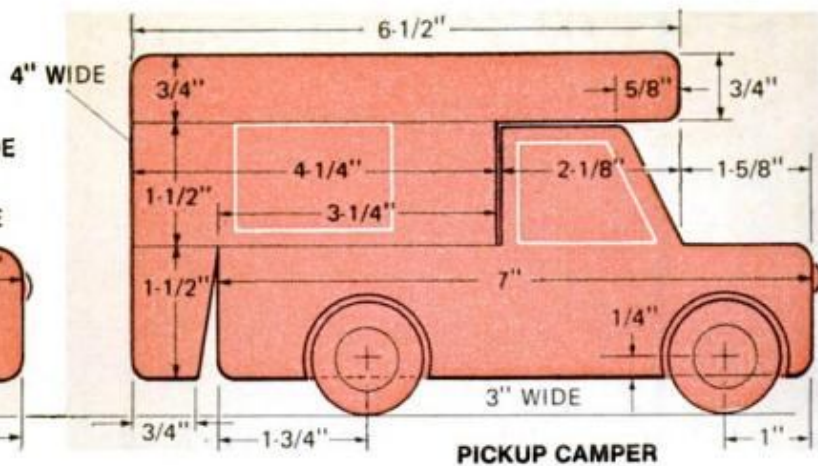
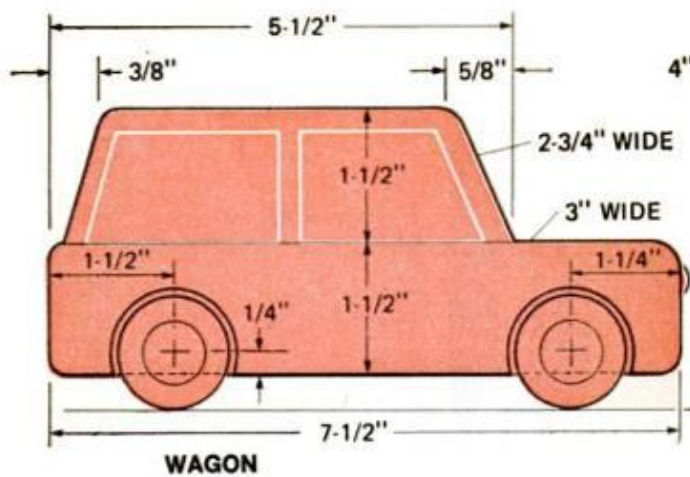



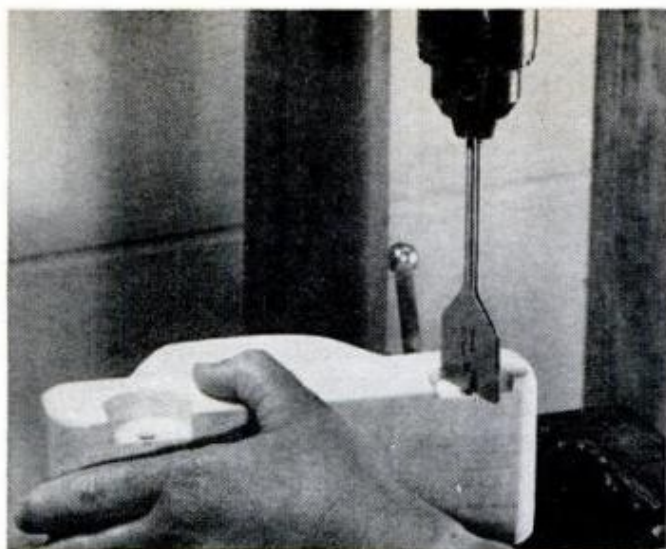

Fender wells for wheels are made  $\frac{1}{2}$  in. deep with  $1\frac{3}{8}$ -in. spade-type bit chucked in drill press.

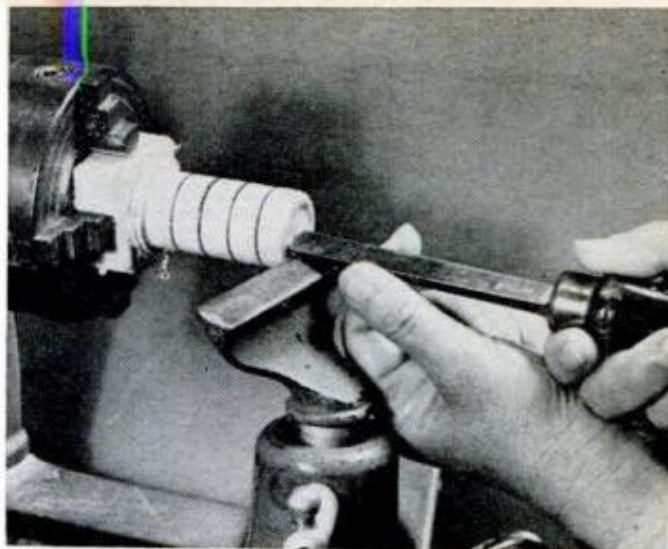

Wheels are turned one at a time from chucked turning. Shape hub and tire first, then cut off.

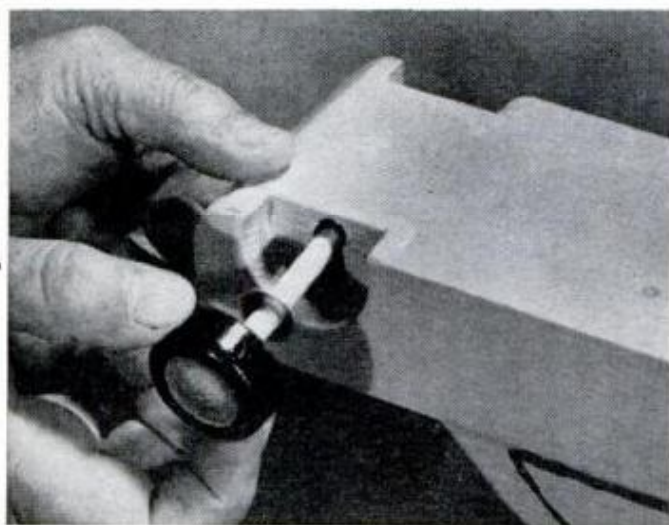

Glue wheels to dowel axles after inserting axles in their holes and slipping washers over the ends.

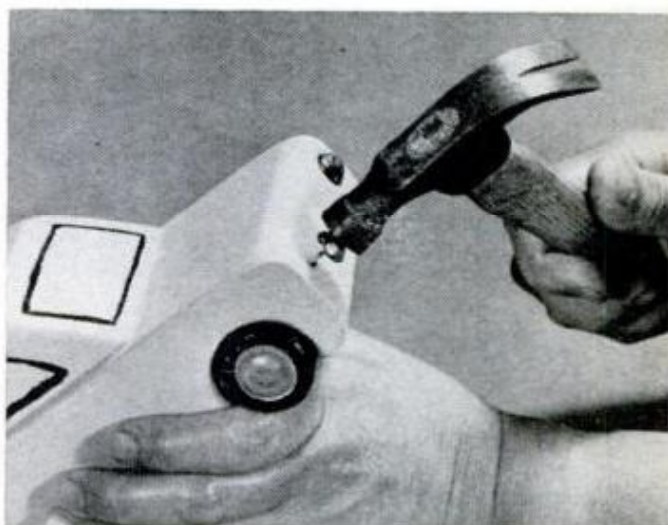

Fancy-head upholstery nails make perfect headlights. Wooden screw-hole buttons, painted, can also be used.

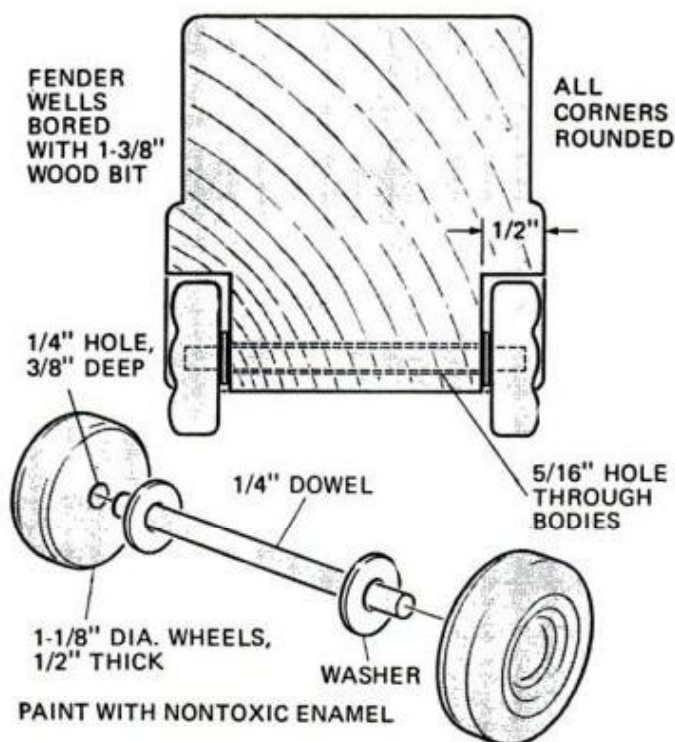

a lathe, but there are other ways to make them. One way is with a hole cutter in a drill press; another is with a pivot jig clamped to the table of a disc sander. In a pinch, checkers could be used for wheels.

The best way to turn the wheels is to gang-turn them from a single turning as shown in the photo above. Here the wheels are cut off one by one after you form a hub on the face of the wheels and round the edges to form a tire. The wheels are glued onto the ends of the dowel axles after being drilled  $\frac{3}{8}$  in. deep from the inside. Washers keep the wheels from rubbing and sticking. It's best to paint the wheels beforehand.

It's important, of course, to round all sharp edges, sand the wood smooth and paint the vehicles with a nontoxic paint.

Upholstery tacks are used for headlights, and a small L-hook and screw eye are used as a hitch for the car and trailer. ★★★



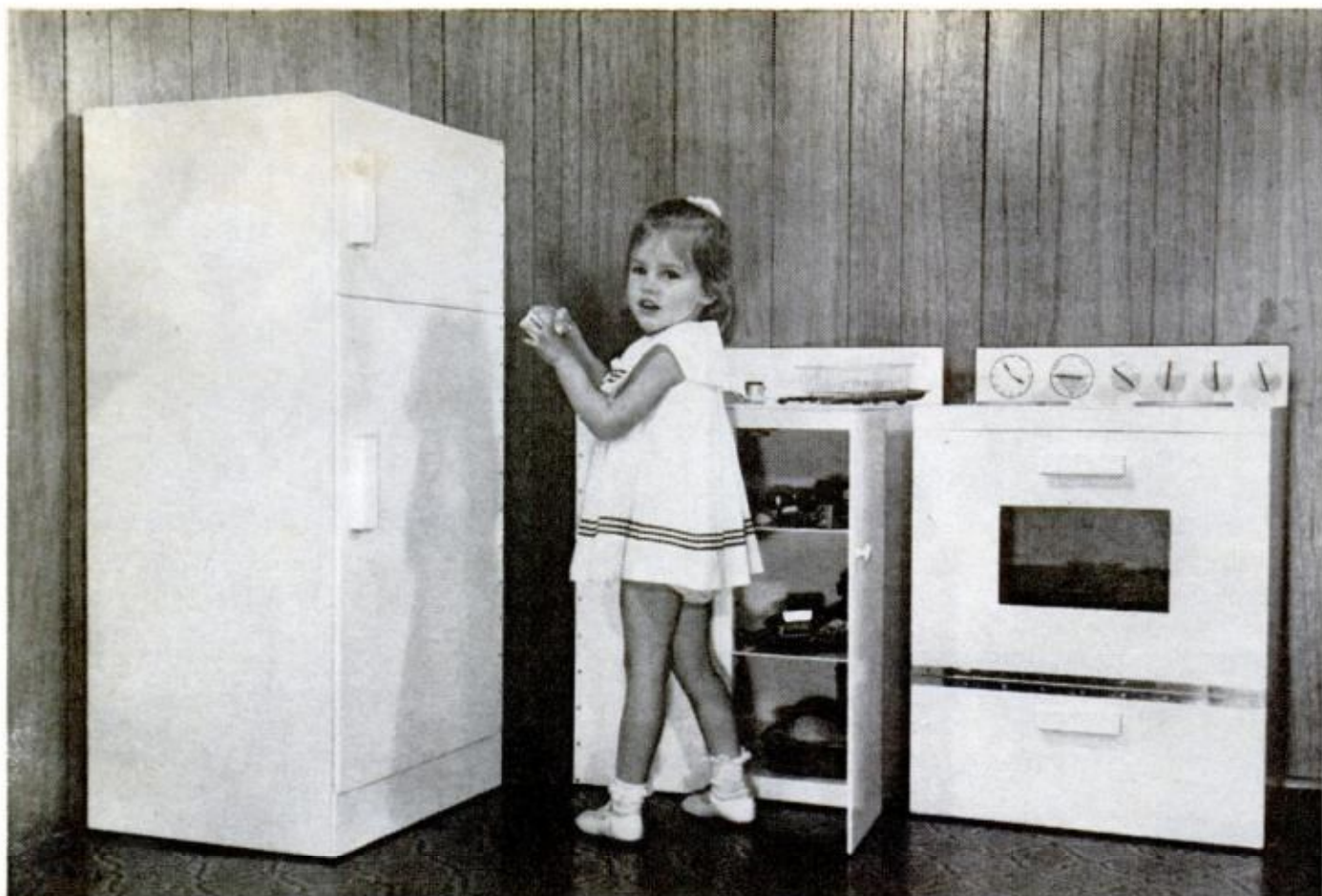

Christmas gifts  
you can make

## Kitchen play appliances

by Terence E. Hogan



**Miniature kitchen furniture** consists of two-door refrigerator, sink with faucet, and stove with play dials and oven. All are constructed alike— $\frac{1}{4}$ -in. chipboard over  $\frac{3}{4}$  x  $1\frac{1}{4}$ -in. framework. Appliances can be painted to match Mommy's; paint should be lead-free.

**S**turdy, realistic-looking and sure to please your little "doll" is this set of pint-sized kitchen appliances you can build in a weekend or two. Unlike the flimsy metal or corrugated cardboard counterparts available commercially, these scaled-down versions of Mommy's appliances have enough movable parts to keep the youngest lady of the house occupied for months.

Because the units are constructed of pine stock and skinned with just  $\frac{1}{4}$ -in. chip and hardboard, they are light enough to be easily moved, yet rugged enough to take the punishment small fry can dish out. All units were assembled using glue as well as nails. To fasten the outer covering, also use white glue and  $\frac{3}{4}$ -in. finishing nails.

Since the three units are basically alike, you can save time by using jigs, gang-cutting and other production-like methods wherever possible. For example, after roughing out the hardboard and chipboard, all frame pieces of a given dimension can be clamped together and cut simultaneously on the table saw. To avoid confusion, mark all pieces as they are cut. With all pieces of the frames cut, these parts can be sanded and prime painted prior to assembly. But make certain you do not prime those areas that will be glue-joined.

**Range.** To mark the range for the clocks



# Mini appliances you can't buy

## REFRIGERATOR DETAILS

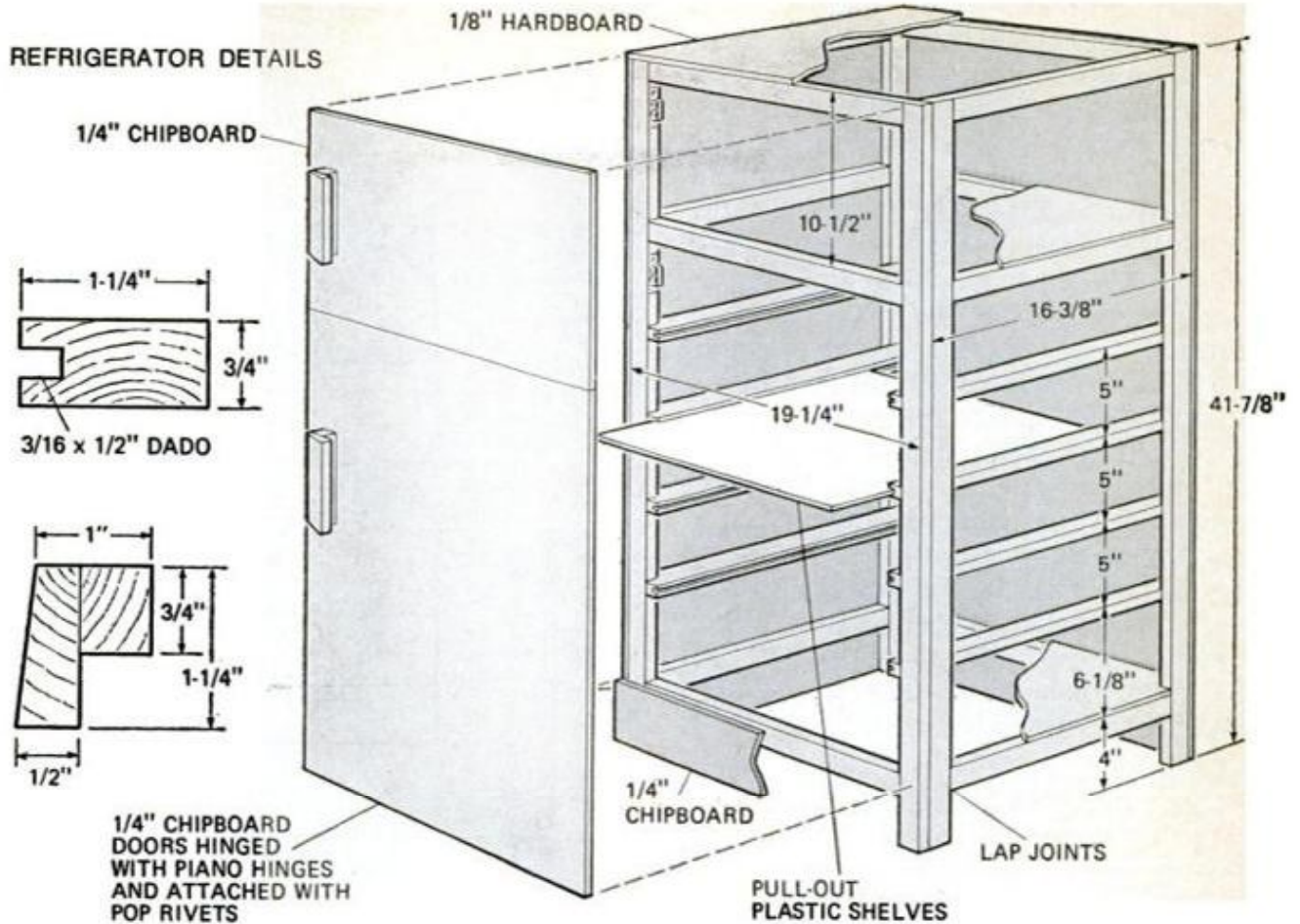

## SINK DETAILS

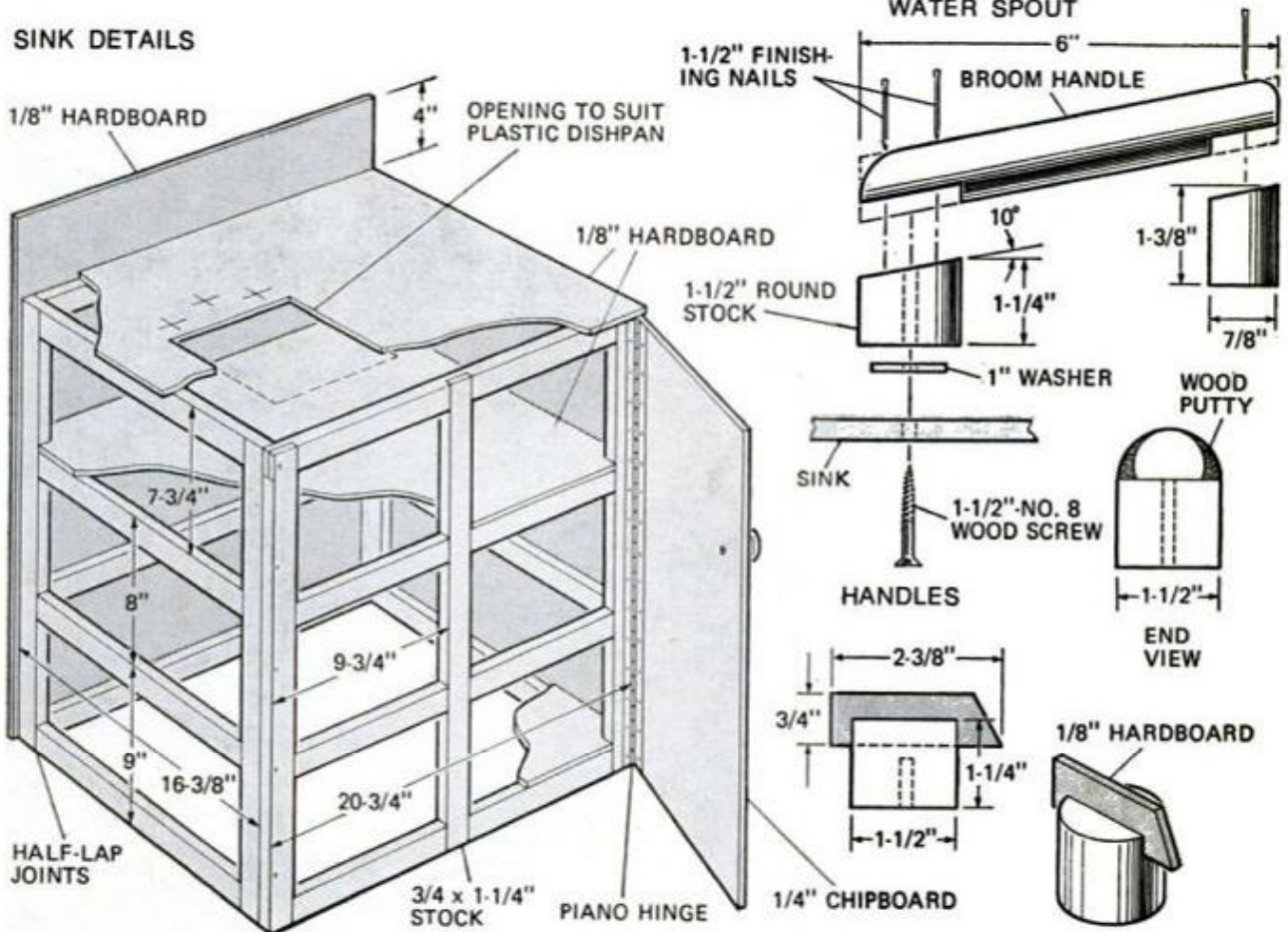

## FAUCET DETAILS

### WATER SPOUT

### END VIEW



and dials as shown, use a center punch to locate exact centers. After painting the front, the circles, clock dials and other details can be applied using India ink and an artist's brush. When this "artwork" is dry, apply clear varnish. The window on the chipboard door is simply a piece of plexiglass set in the rabbet with bathtub caulk.

**Sink.** On the unit shown, the sink is a  $2\frac{1}{4} \times 7\frac{1}{2} \times 7\frac{1}{2}$ -in. bowl that came with a 19-cent vegetable grater. Before cutting out your sinktop, have your "sink" on hand to assure a neat fit. The sink trim requires a little effort using a chisel and coping saw to do the notching. After assembling these parts, fill any voids with a wood filler and sand smooth. Trim can be finish-painted with aluminum paint for realism.

**Refrigerator.** This is the easiest unit to construct because it is really just a box with two doors. As with all units, sand all surfaces and edges absolutely smooth before applying a nontoxic paint. ★★★

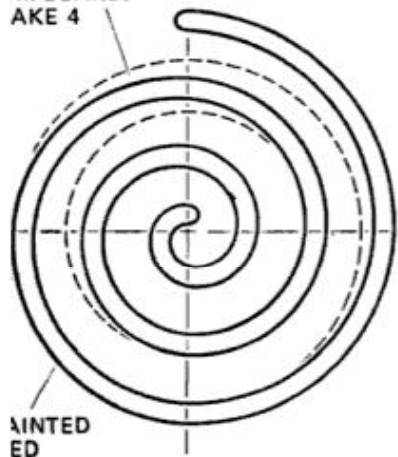
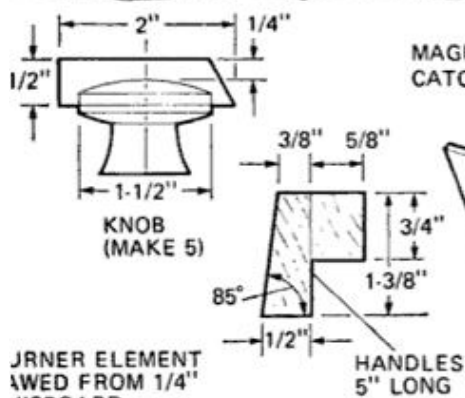
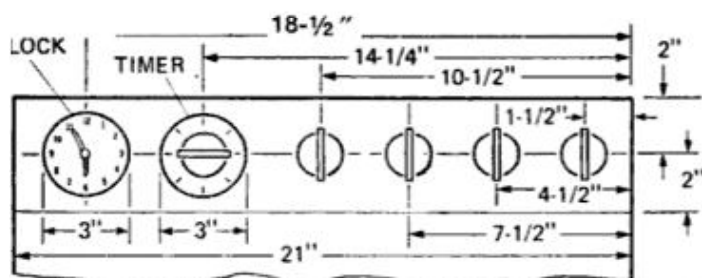
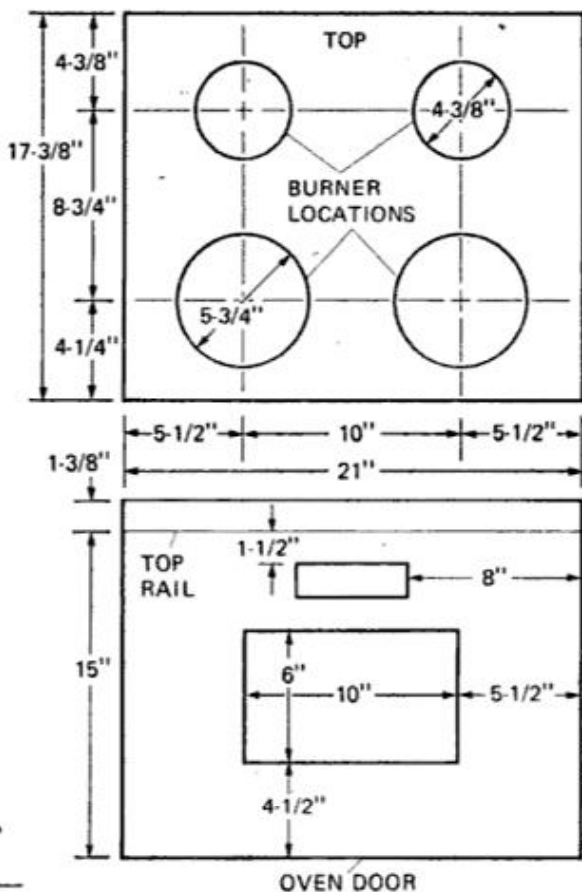

#### RANGE DETAILS

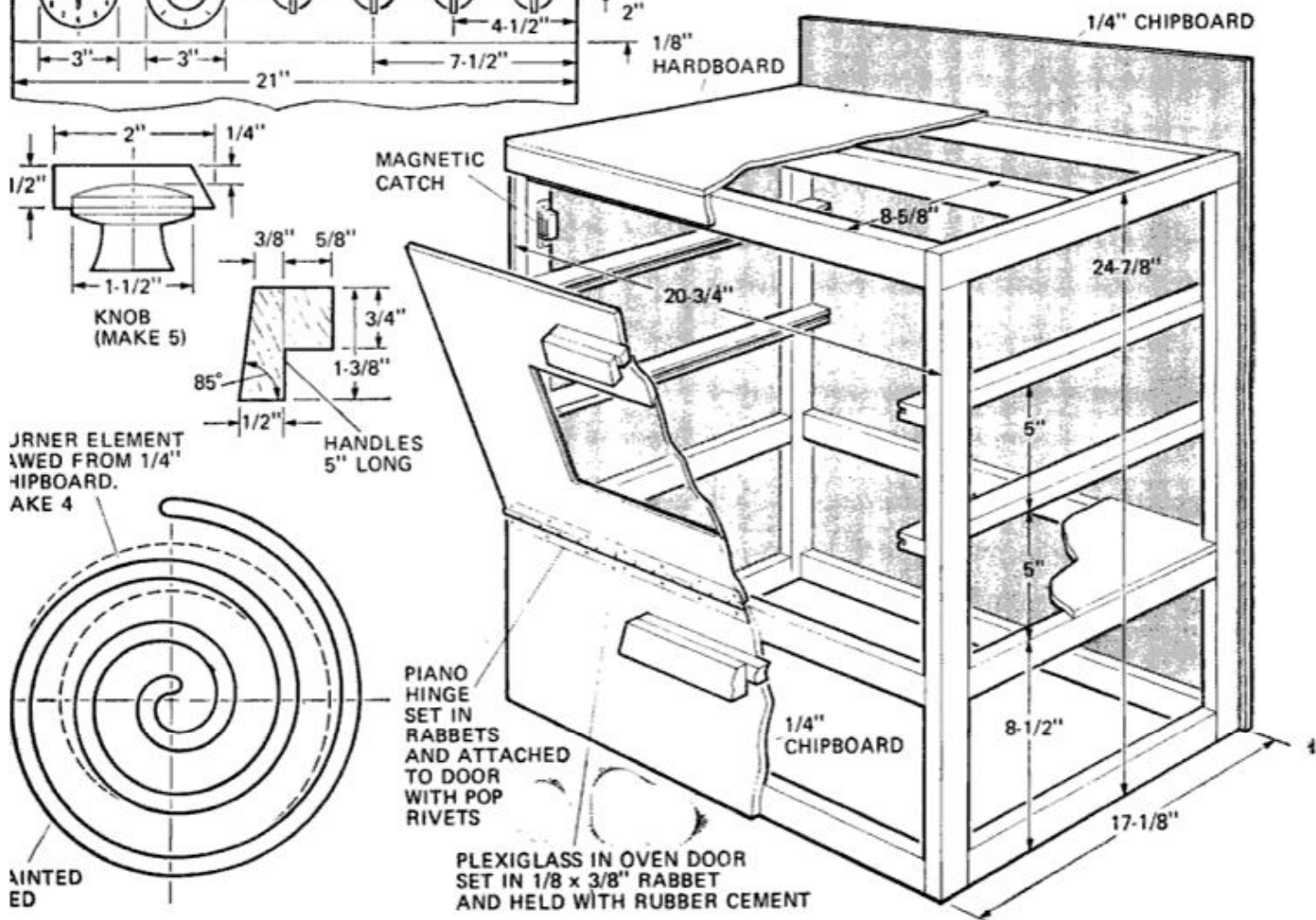



# Teaching box

by Douglas Santy

By teaming up colors with numbers, learning to count from 1 to 5 becomes both fun and easy for any preschool tyke with this plug-in, pushbutton teaching box. Jigsawed numerals in the top of the box are illuminated from below by five Christmas-tree lights when refrigerator-door-type switches are depressed and held. Each switch is numbered and color-coded—red, white, blue, yellow and green—and each controls a bulb of the same color. The child learns to count quickly by associating a certain color with each lighted number. ★★

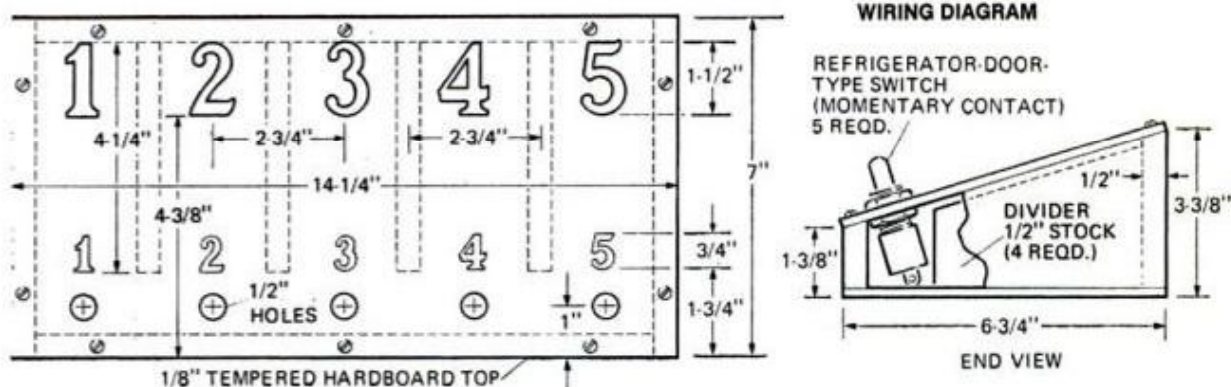
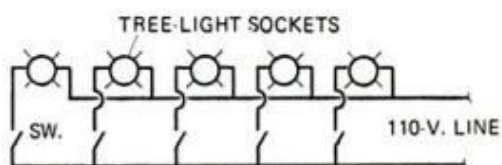

Sockets are cut apart from the light string, stuck to the bottom of the box with hot glue and the wires soldered to the switches following the diagram. A 2-in.-wide strip of 1/8-in. clear sheet plastic is cemented to the underside of the jigsawed numerals. The center

piece of the figure 4 is cemented to the plastic backing. The spring-loaded switches are identical to refrigerator-door switches except that they work just the opposite. The light goes on when the button is pushed in. Sold by Lafayette and Radio Shack.

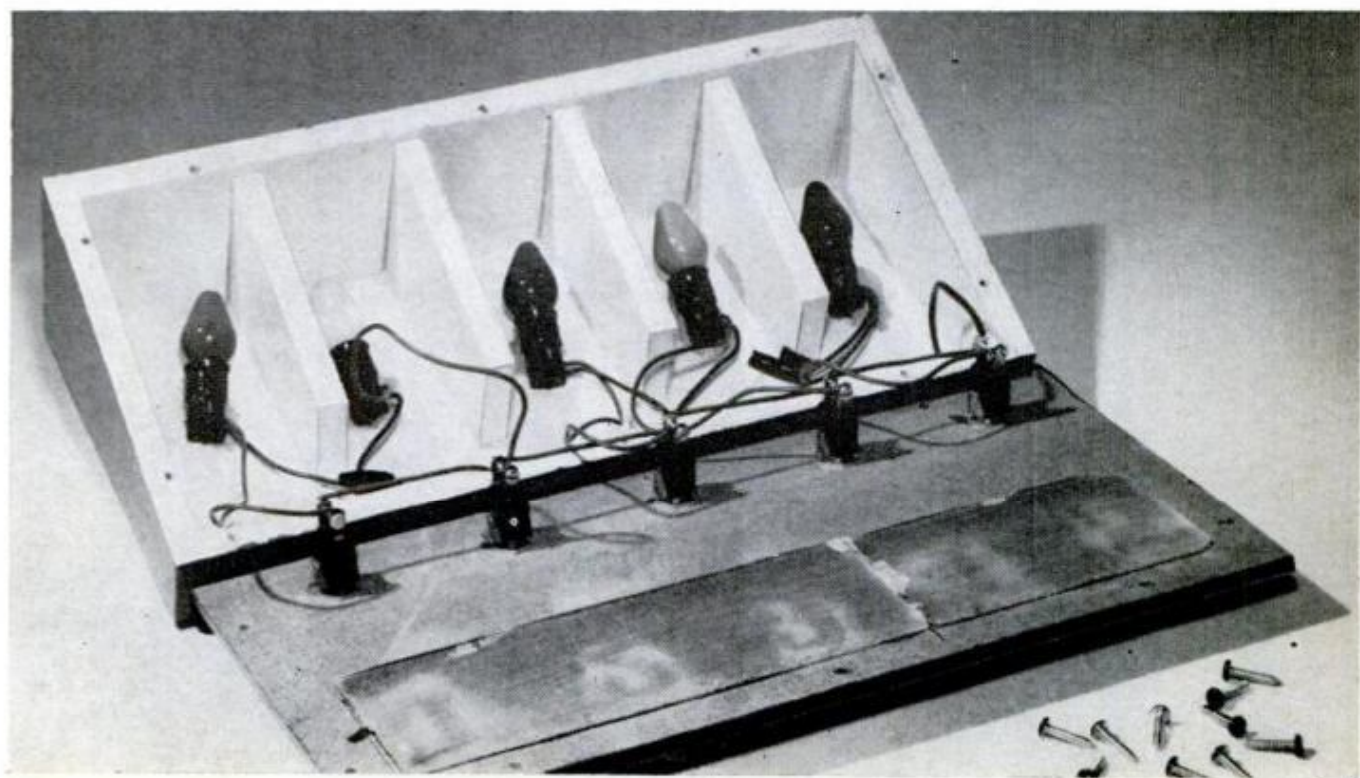



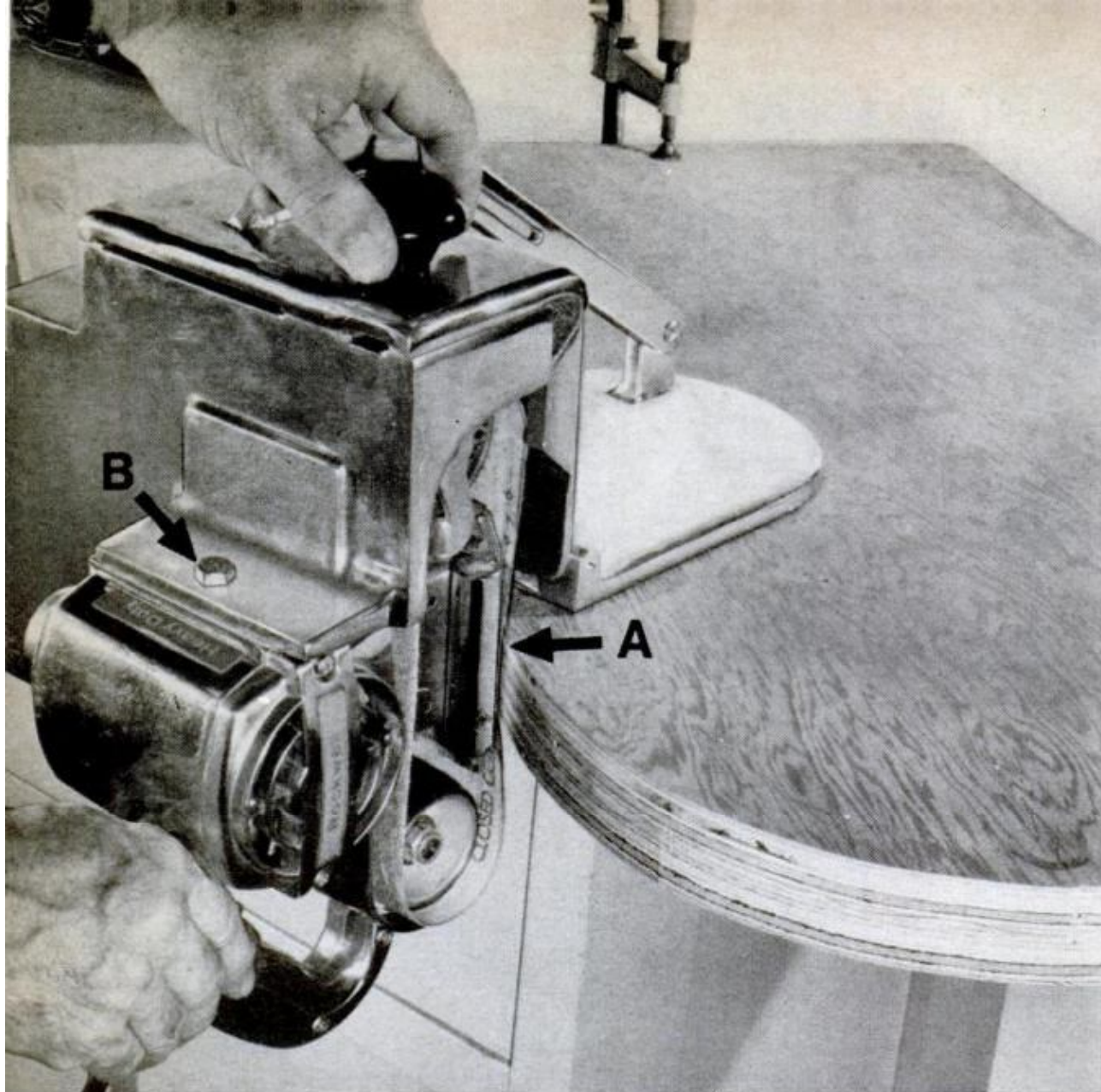

Round rod added to sander's shoe (A) supports belt when sanding inside radius as small as  $\frac{3}{4}$  in. Single capscrew (B) in original knob-mounting hole bolts attachment to sander. Below: Attachment is adjustable for sanding edges at angle.

#### SHOP TEST REPORT

## Belt sander becomes edge sander with new quick-change attachment

by Wayne C. Leckey  
HOME AND SHOP EDITOR

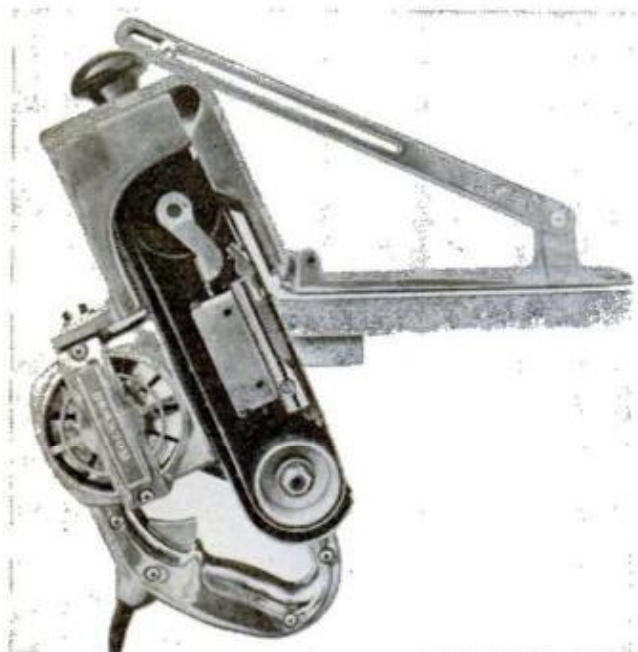



**Attachment is designed** to fit most any 3x21-in. belt sander (right), can be quickly detached when sander is needed for surface sanding.

**Bolted to workbench** (below), attachment converts sander to handy stationary bench model for edge sanding at various angles.

**Sander's position** can be switched from vertical to horizontal (below, right) by bolting attachment to the side of the sander.

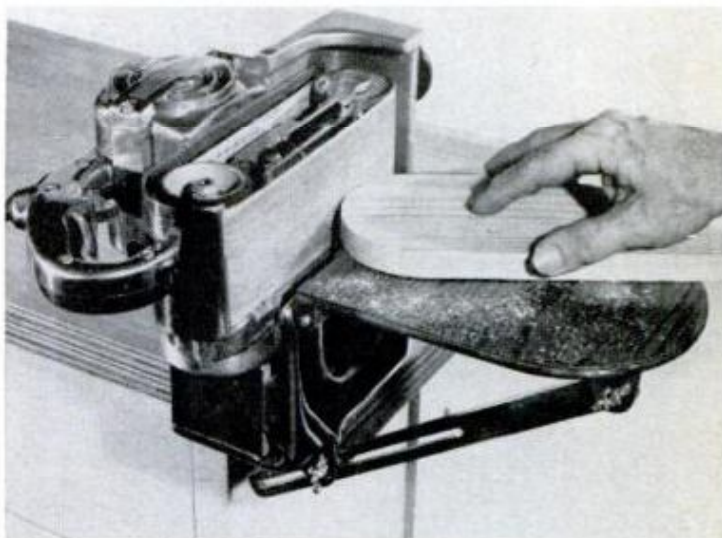
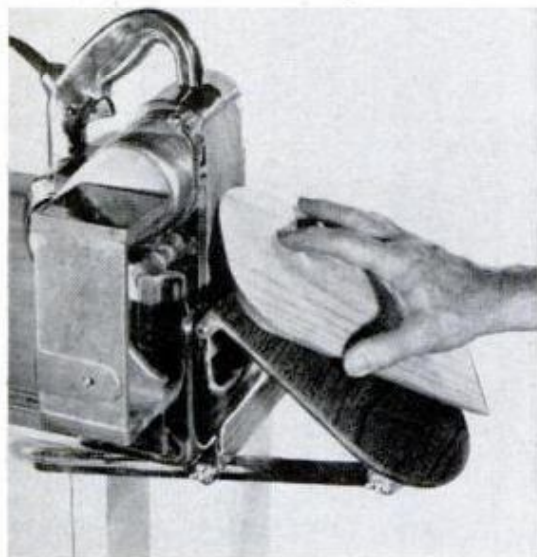
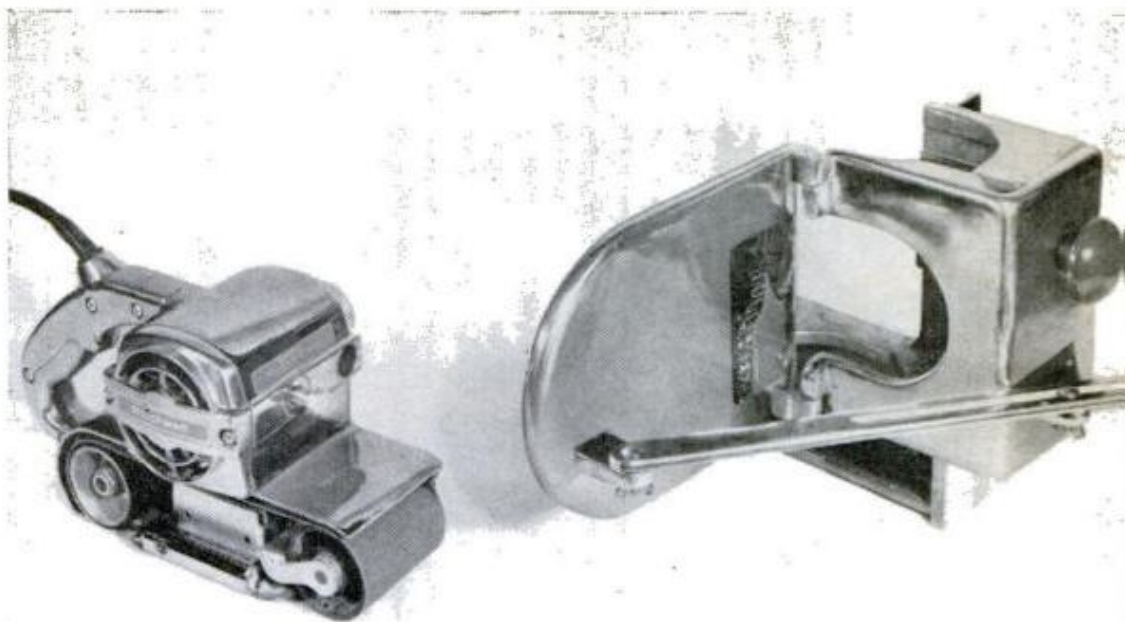

**O**f all portable power tools, the belt sander is probably the least versatile. For the most part, it can do little more than sand plain flat surfaces. Now, thanks to an attachment called Edge-a-neer, I found the belt sander takes on new importance and usefulness, both in the shop and on the job.

Consisting of a two-piece aluminum casting, the attachment quickly converts an ordinary surface sander into an efficient edge sander in a matter of seconds. In use, a flat plate or fence rides the work surface and supports the sander at the desired angle as the machine is moved along the edge of the work. When the sander is supported vertically as shown in the upper photo at the left, you can sand the edges of irregular-shaped countertops or other thick work having inside radii as small as  $\frac{3}{4}$  in. This

is possible by the addition of a short section of round rod to the edge of the sander's shoe. By adjusting the belt so it tracks and overrides the shoe  $\frac{3}{4}$  in. or so, contact with the work causes the belt to conform to the curvature of the rod. To sand a bevel on irregular-shaped work, a wingnut and slotted bar let you adjust the plate angle.

When you wish to sand with the grain the edges of exterior doors or other thick straightedge work, you can quickly change belt rotation from vertical to horizontal by switching the attachment from the front of the sander to its side.

The attachment can be used with most any 3x21-in. sander; here it's with a Rockwell No. 153. The original sander knob is used to hold the two attachment parts to-

*(Please turn to page 206)*

NOVEMBER 1973 177



# Rapid travel for drill-press table

by R. K. Pedersen

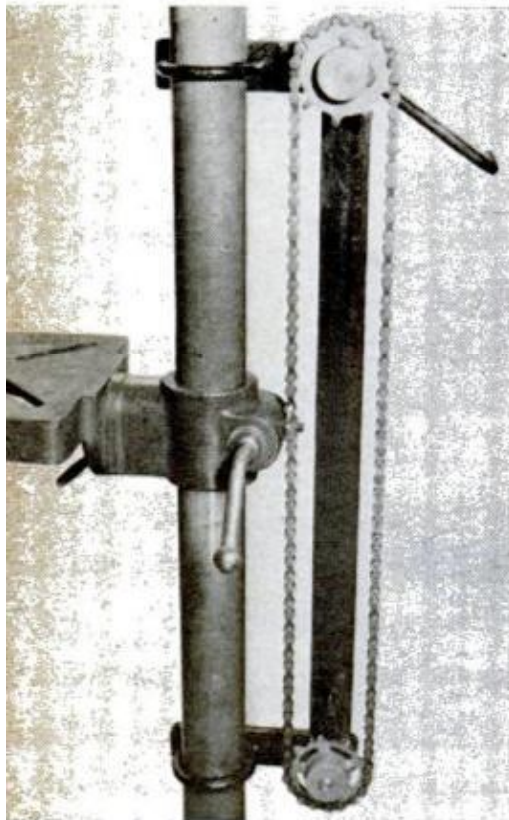

Simple winch, using bicycle chain and sprockets, makes it easy to move heavy drill-press table up and down.

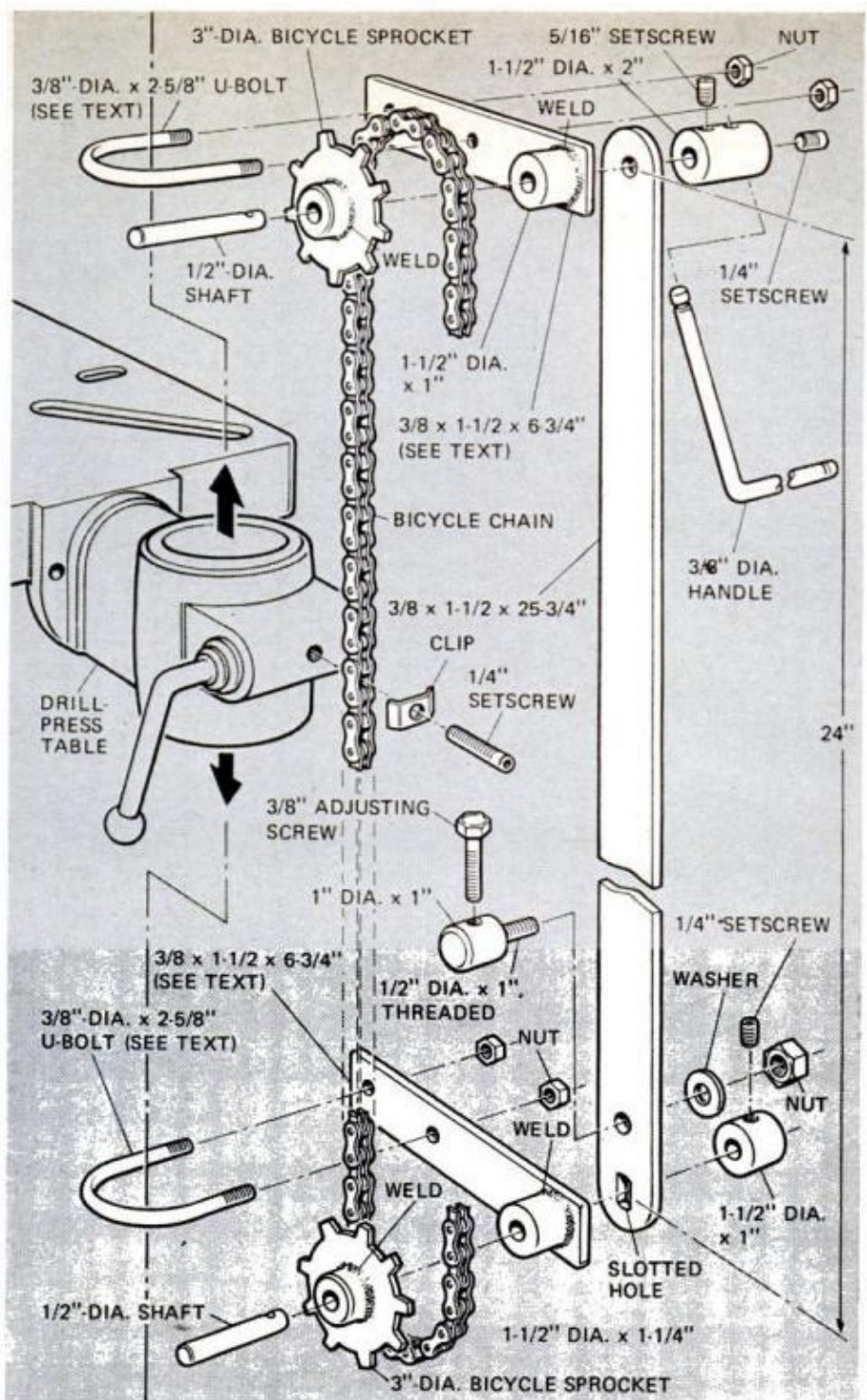

Art: Peter Trojan

To provide a solid work surface, a drill-press table has to be heavy. But because it's heavy, it can be difficult to lift—and too easy to drop. Add this chain winch, and you can crank your table up and down fast and with little effort.

Use the dimensions shown above, with these possible variations: Length of the two horizontal crossbars must depend on the rearward extension of your table clamp. U-bolts should fit your drill-press column as closely as possible; U-bolts  $2\frac{5}{8}$  in. wide center-to-center were ideal for a  $2\frac{1}{4}$ -in.-diameter column. And you may need or wish to vary the nearly 24-in. travel indicated above.

A certain amount of play is normal in a bicycle chain. The adjusting screw and the slotted hole in the vertical bar will let you keep it at the right tension. ★★★



# HINTS

## FROM READERS

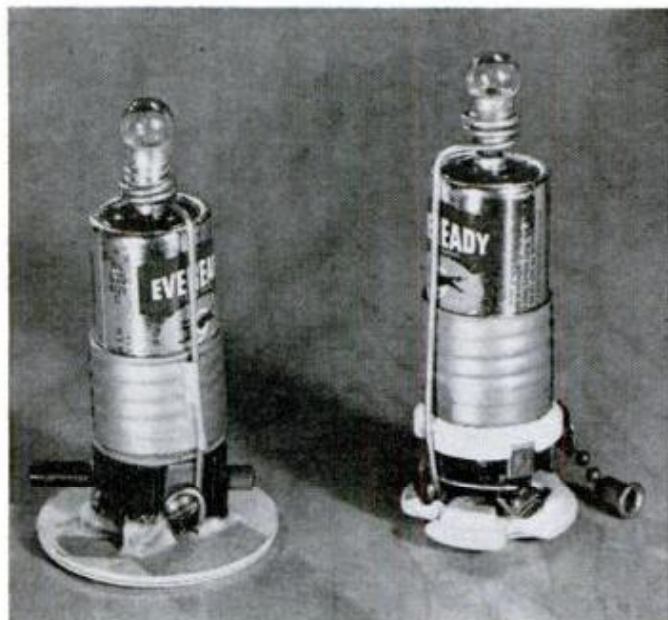

### Emergency night light

Handy night light is a C-cell in a push-button or pull-chain socket, its outside taped. Wire connected to terminals holds 1½-v. flashlight bulb, soldered to battery post. Cardboard base is added with hot-glue gun.—Wallace H. McClay, Pasadena, Calif.



### Widening spring clamps

Adapt spring clamps for wide work by making extension jaws of heavy-gauge aluminum or sheet steel, bent as shown. Mount by drilling and tapping extensions and original jaws for 8-32 machine screws. Dimensions depend on size of work to be clamped.—Louis Hochman, Sherman Oaks, Calif.

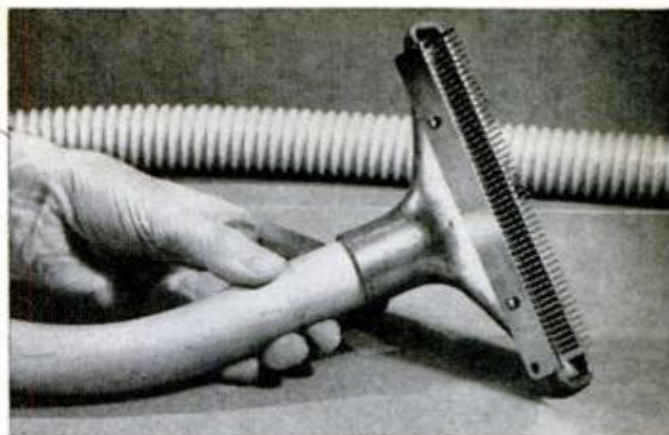

### Canine grooming aid

A metal pet comb attached with screws to a shop-vacuum nozzle makes it easy to remove loose hair and dirt from your dog's coat.—Charles Dayton, Akron, Ohio.



### Fabric hinges

Vinyl upholstery fabric, fastened with wood or metal strips and nails or screws, makes a continuous hinge—here on insect-collecting cage.—E. B. Walters, Chicago.



### Taking pinch out of vise

Wrap rubber bands at each end of the handle on a machinist's vise and you needn't worry about pinching fingers when handle drops.—Leonard Witkovsky, Avenel, N.J.



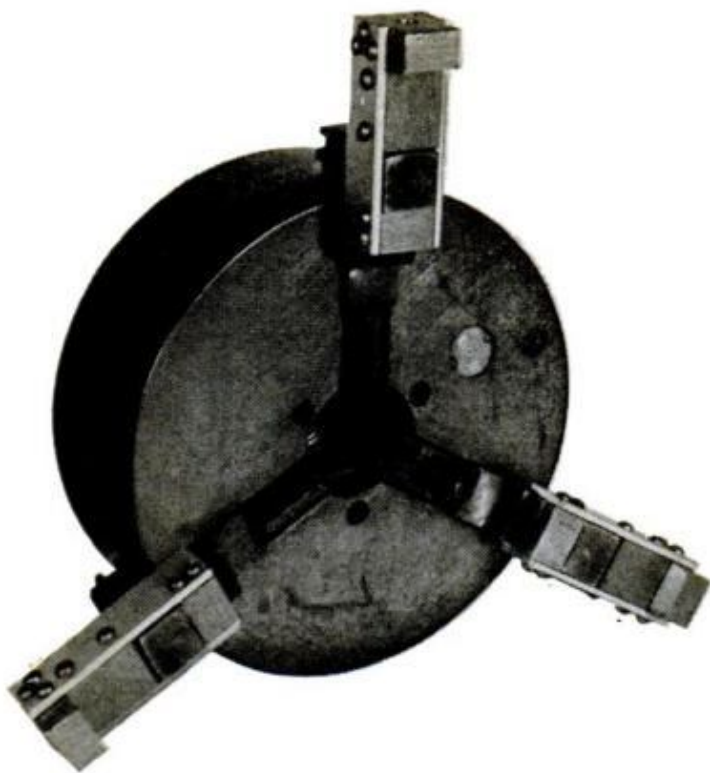

# Jaw stretchers give your lathe chuck a bigger bite

by Philip Duclos

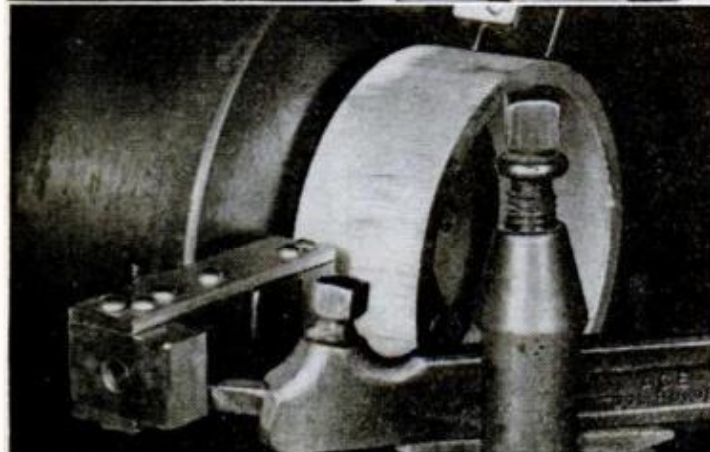
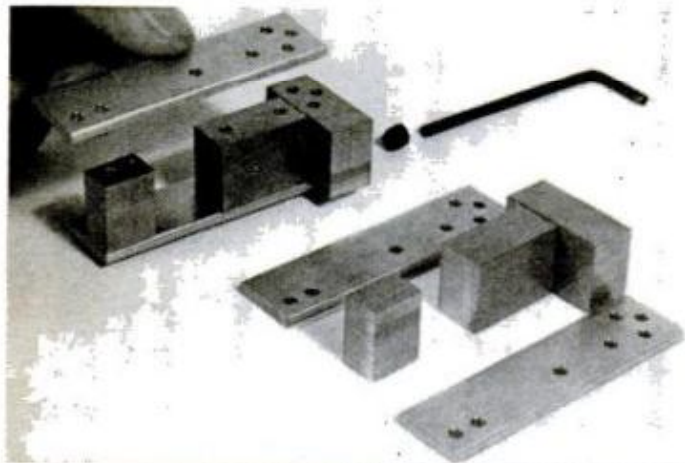

Here's a handy set of jaw stretchers for any lathe chuck. They will work on either a three or four-jaw chuck and let you handle large-diameter work. With them, my 6½-in. chuck now holds work up to 10 in. in diameter.

I used 5/16-in. No. 6 type-U, hardened drive screws to pin the stretcher parts together. These drive screws are easier to use than ordinary machine screws—because they require no tapping and are installed with a hammer—but if you cannot obtain them in local stores, you will have to tap (thread) each hole for a bolt or machine screw.

The stretchers are clamped to the chuck jaws with ¼-20 Allen setscrews. As the setscrew holes are deep (nearly equal to the distance the extensions give), it is advisable to counterdrill with a tap-clearance drill to about three-fourths the depth of each hole—otherwise, it may be too deep for a standard tap. ★★★

Because chuck sizes vary, the stretcher dimensions must be made to suit the chuck being used. Parts are cut from bar and sheet stock, drilled for hammer-driven, type-U self-tapping screws. Photo second from bottom shows how stretcher fits chuck jaw. At bottom, stretchers are clamped to jaws and a light cut is taken on them to make them run true; jaws are held rigid with a large piece of round scrap (a short section of large-diameter pipe was used here). Matching numbers should be scribed on stretchers and jaws to assure correct replacement each time.



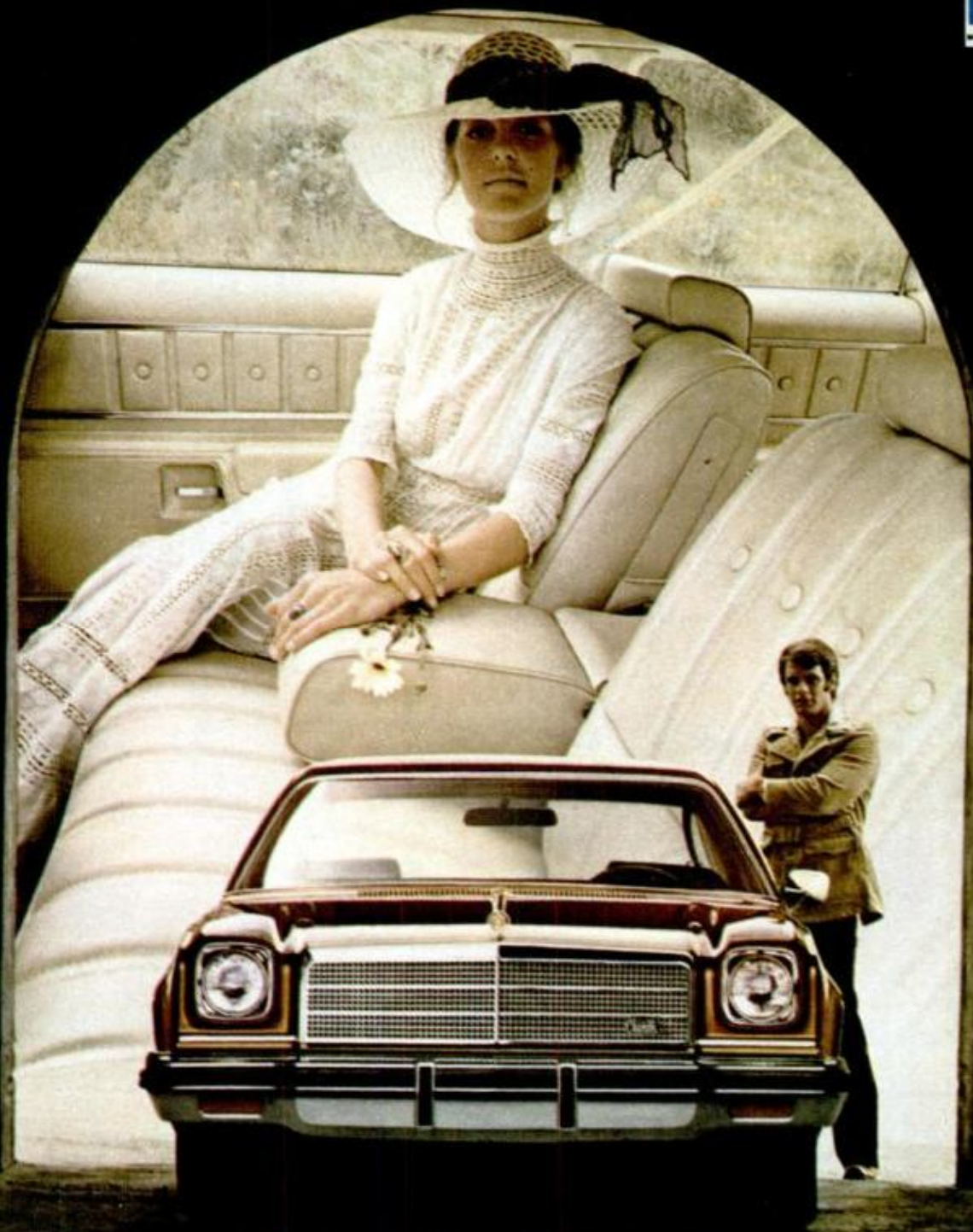

## Introducing the Chevelle Malibu Classic inside out.

### Malibu Classic.

A luxury Chevelle, new this year.

Full foam seats. Fold-down front seat armrest. Tasteful fabrics. Cut-pile nylon carpeting. Wood-grain vinyl accents. Even the inner door panels are elegant.

And look at the exterior. Look carefully, so you can sense the character of the car. In the lines. The stance. The detail. It's as classic outside

as it is inside.

Yet, so importantly, it remains mid-size. It remains mid-priced. It remains Chevelle, a truly fine-handling automobile.

The very new, very luxurious Chevelle Malibu Classic. Now that you've looked, come and see.

At your Chevrolet dealer's.

*Chevrolet. Building a better way to see the U.S.A.*

**Chevrolet**



SEASON'S GREETINGS

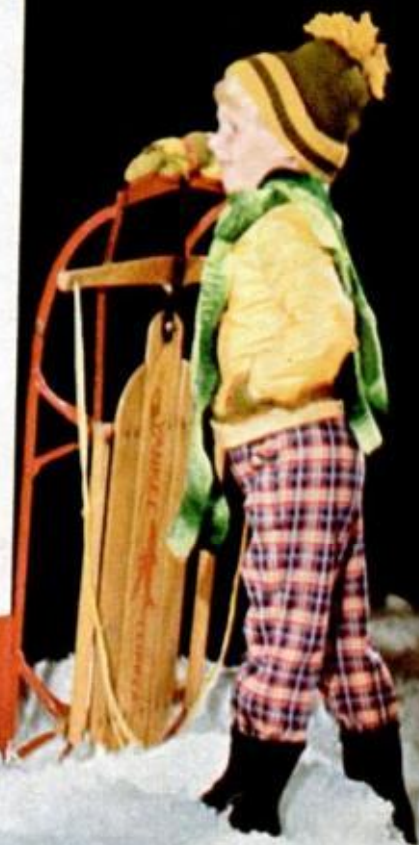

## Outdoor greeting card with a new twist

Three merging posters provide endless action as triangular columns slowly rotate.

by Rosario Capotosto

A comical Christmas mouse gorging himself on a candy cane, a lost Santa and reindeers frantically looking at a road map and a quaint drummer boy and lamb are three ever-changing holiday scenes that will make passersby stop and take a second look at PM's outdoor greeting card for 1973.

Each scene, a 42x54-in. colorful poster, is mounted on five three-sided vertical columns that rotate simultaneously and continuously. As one scene comes into view, it slowly fades into another, then another. The sequence is repeated over and over as long as the unit is plugged in. The changing scenes are fascinating to watch.

A 7-rpm geared motor turns the five columns by a chain-and-sprocket drive that keeps them turning in perfect alignment.



## How the three scenes change from one to another

First, full Drummer Boy scene appears.



Then, turning slowly, scene starts to merge . . .

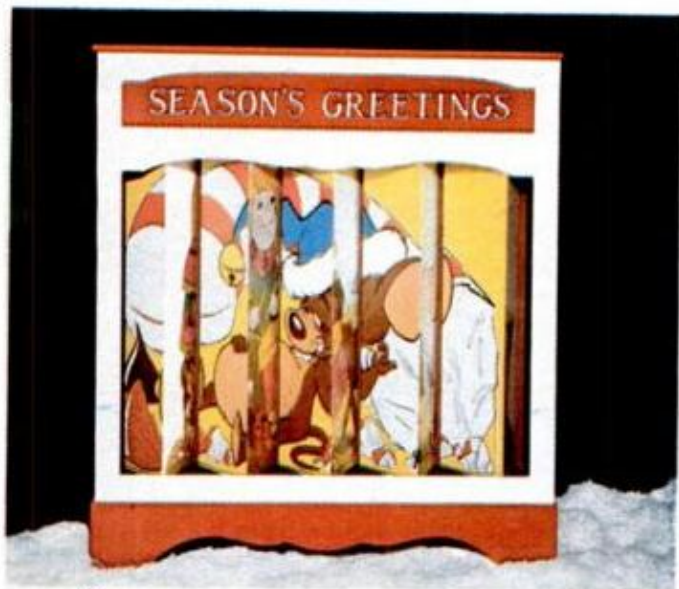

. . . with oncoming Myron Mouse scene.



Mouse scene comes into full view . . .

The columns turn freely in ball bearings at top and bottom.

Start with the column corner posts, using four 8-ft. lengths of 2x4. Pick straight ones with minimal knots. Cut them in half and rip them down the middle so you have eight 4-ft. 2x2 pieces. Tilt the saw blade to 30°. Rip a bevel cut on one side of all the pieces. Use one of the angled cutoffs to help cut the other bevel. Nail the waste about 12-in. offset to the rear and flush to the bottom edge of the workpiece. This does two things: It provides a handle with which to push the work so the cut is complete while your hand is still at a safe distance. And the waste rides firmly against the rip fence

*(Please turn page for construction photos;  
text continues on page 186)*

. . . and goes on to merge with Santa scene.





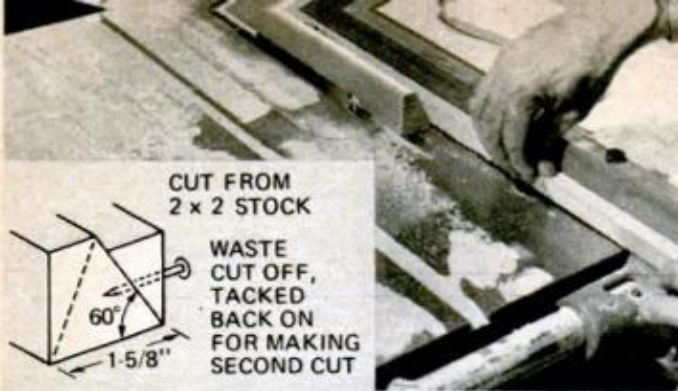

Blade is tilted 30° to cut triangular posts. For safety, tack on waste piece to push work for second cut.

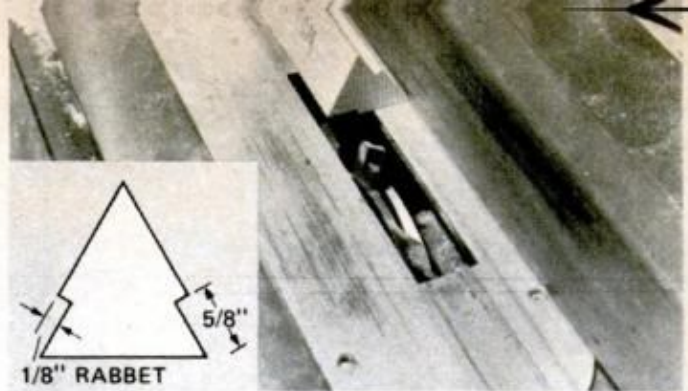

Wide rabbets are cut 1/8 in. deep along both sides of posts. Use push stick, mark "bottom" to avoid error.

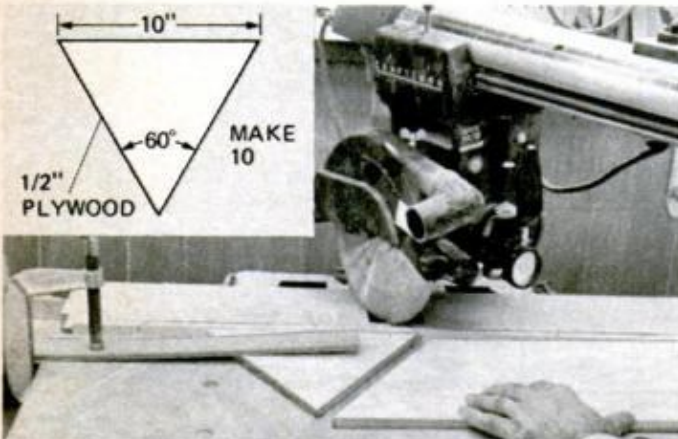

Triangular sample of column bases is clamped to saw table, used as stop for cutting nine more duplicates.

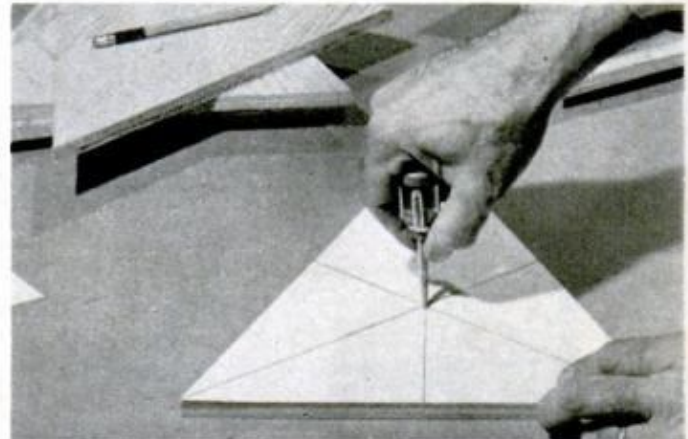

All axis holes must be bored dead-center in triangular pieces. Best to use template for accuracy in marking.

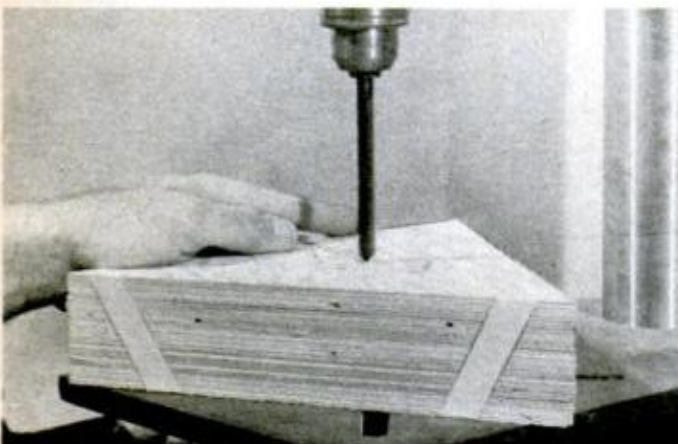

Triangular column pieces are stacked and taped together for gang-drilling five at a time on drill press.



Two finish nails and glue are used to anchor bases to corner posts. Check for alignment before applying glue.

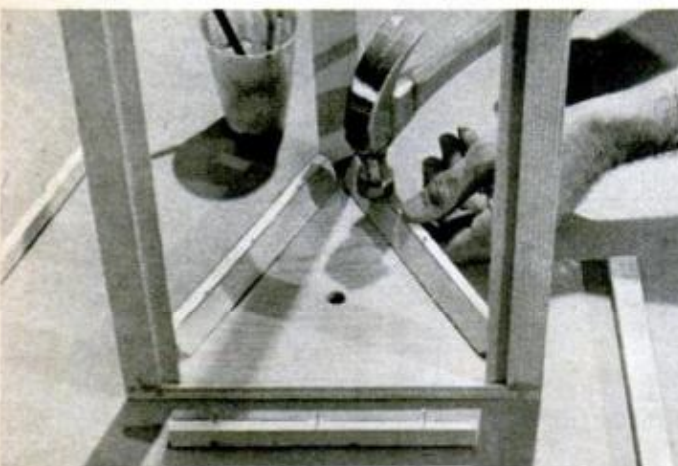

Nailing cleats for hardboard panels are set even with setback of post rabbets, anchored with glue and nails.

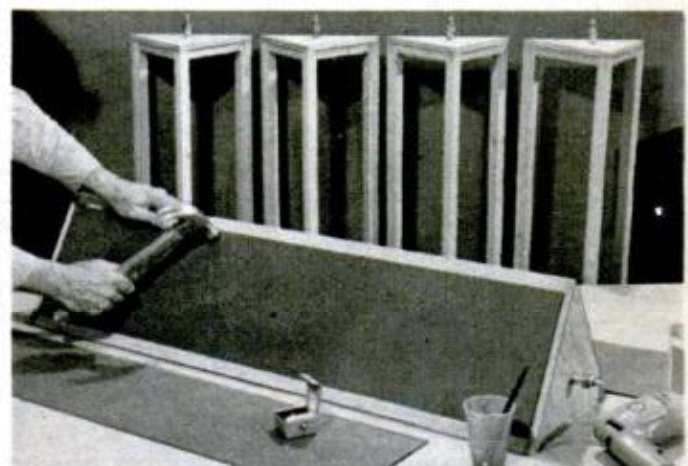

Bolt axes are installed before tempered hardboard panels are added. Use plastic resin glue, small nails.



# Can you spot the Camel Filters smoker?



© 1973 R. J. Reynolds Tobacco Co.

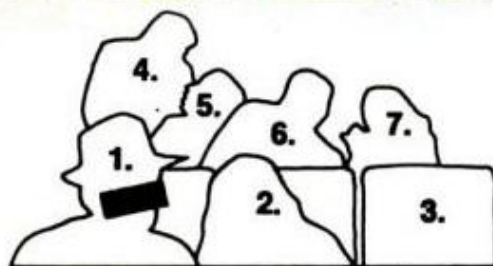

Everybody aboard this jet plane has a gimmick . . . almost everybody. Pick the one who doesn't. **1.** Nope. He's Húgo Slavia, impoverished secret agent. Gimmick: Sells "hot" watches as a sideline. His cigarettes smoke even hotter.

**2.** Mike L. Angelow. Gimmick: Artist who draws everything but attention. At last sidewalk exhibition he got a ticket for littering. Smokes decorator pack cigarettes.

**3.** No. Ralph Knoshow (not pictured). Transistor radio salesman. Resigned when given new territory . . . Japan. His cigarette's taste is missing too. **4.** Right. Wherever he goes, he leaves the far-out gimmicks to others. Likes his cigarette no-nonsense too. Camel Filters. Honest.

Good tasting. **5.** Charles Chizlar. Gimmicks: 5 overcoats, 4 sweaters, 3 pairs of pants. Saves on overweight luggage. Drains tap in men's room for his water-filtered cigarettes. **6.** He's Vaseli Overaidt, wrestler. Gimmick: Demonstrating arm wrestling techniques to strangers. **7.** Helen Back, stranger. Also black belt karate expert.

**Camel Filters.**  
**They're not for everybody**  
(but they could be for you).



**CAMEL**

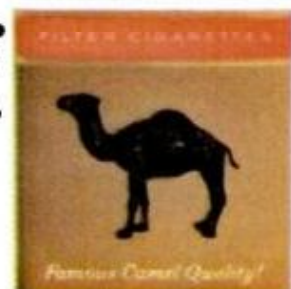

Warning: The Surgeon General Has Determined  
That Cigarette Smoking Is Dangerous to Your Health.

20 mg. "tar", 1.3 mg. nicotine av. per cigarette, FTC Report FEB. '73.

Материал, защищенный авторским правом







## Dodge is America's Number 1 Builder of Mini Motor Home Chassis.

Dodge pioneered the development of the cutaway mini motor home chassis. Dodge offers all these benefits: dual rear wheels, the longest wheelbase—145," power front disc brakes, 360 V8 engine, Electronic Ignition, and "thumpless" polyester RV tires.



## The Club Cab. The Number 1 idea in pickups.

The exclusive Dodge Club Cab pickup gives you over 34 cubic feet of extra storage space inside for the things you don't want to leave outside. The Club Cab Camper Specials are equipped to accommodate most slide-on campers to haul you and your friends to your favorite snow trails.

# Turn to Dodge for leadership in Recreational Vehicles.

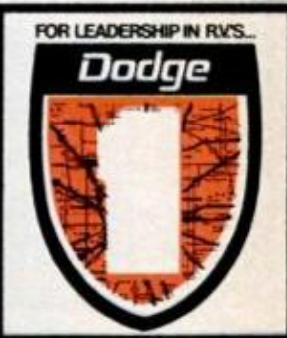



SPRING-CLIP  
CONNECTING  
LINKS (3 SETS  
EQU.)

ROLLER CHAIN  
10 FT. 1/4" PITCH

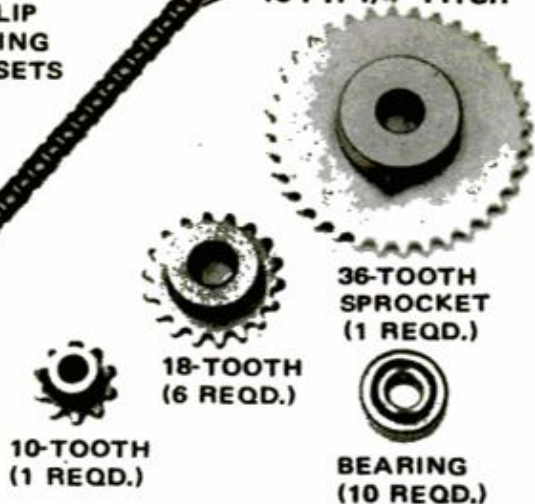

### COLUMN PIVOTS DETAIL

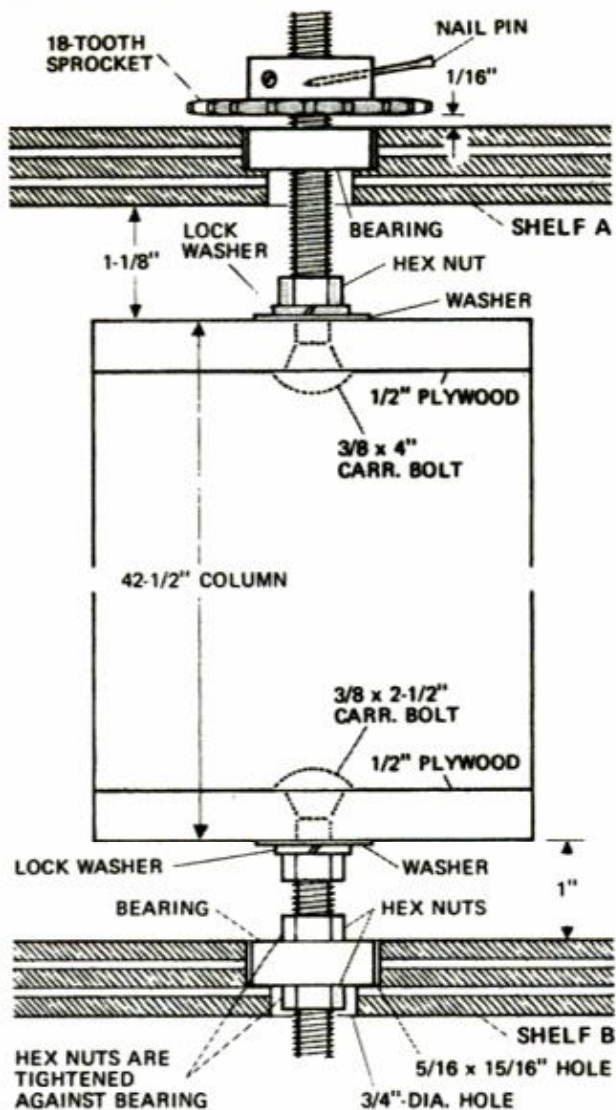

### WHERE TO BUY PARTS

Sprockets, bearings and chain (shown above) obtainable as a kit from The Armor Co., Box 290, Deer Park, N.Y. 11729. \$67 ppd.  
Posters of the Drummer Boy, Myron the sweet-toothed Christmas mouse and Lost Santa available from U-Bild Enterprises, Box 2383, Van Nuys, Calif. 91409. \$10 ppd. per set.  
Gear motor, 7 rpm, The Way-Mar Co., Box 164, Hartsdale, N.Y. 10530. \$15.50 ppd.

### OUTDOOR GREETING CARD

(Continued from page 186)

bored holes. Bore the larger holes first or you won't be able to center the drill for the second hole.

Glue and screw the sides to the bottom shelf and temporarily screw in the top to

(Please turn to page 202)

### BEARING AND IDLER LOCATIONS

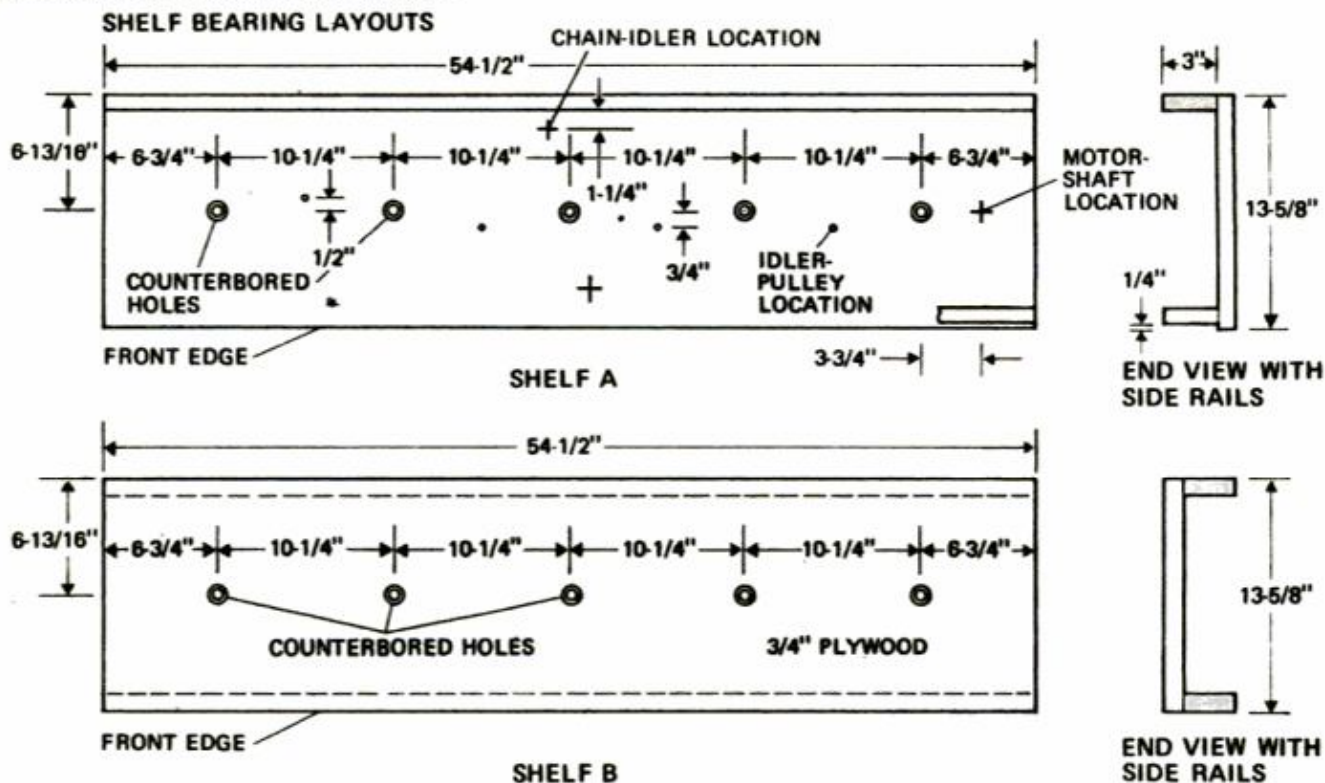



# the FREE 1974 Heathkit catalog-

courtesy of the world's largest  
fraternity of electronic enthusiasts.

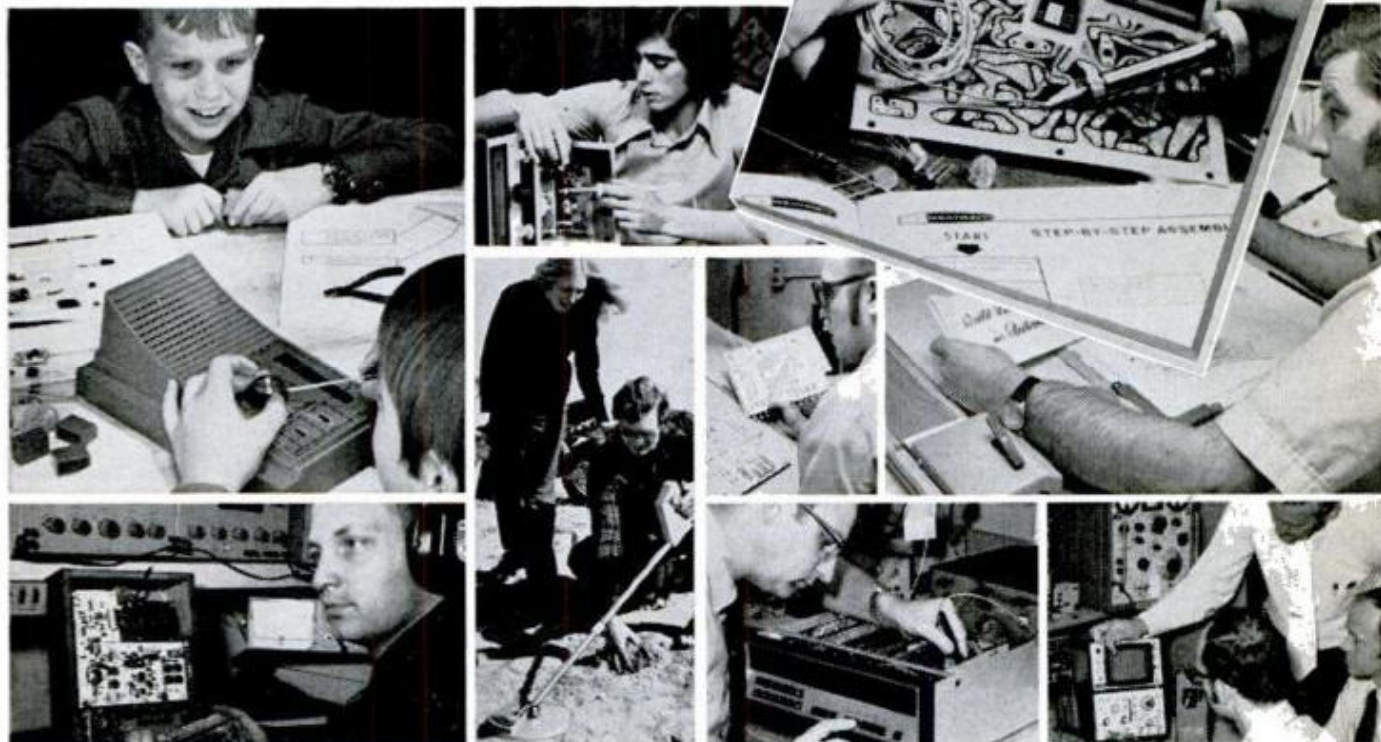

Pride of accomplishment. It begins in our design labs with the creation of new kit. It carries through to a cozy basement workshop where a customer's hand reaches to press the power button on a just-finished color television, digital calculator or home intrusion alarm. The inanimate device comes to life just like the assembly manual said it would. And at that moment another Heathkit builder feels the same thrill felt by the design engineer when he hit the switch on this piece of circuitry that up till then had worked only in his mind.

The engineer will experience a similar "kick" once again — when he reads the handwritten letter that says:

"Wow! You guys sure have great kits. Mine worked on the first try, with no hitches. Keep up the good work."

The creative bond between Heath employees and Heathkit builders forms a proud fraternity. Ask around, there's probably a member in your neighborhood.

The coupon below gets you your free 1974 Heathkit Catalog. Your first Heathkit project gets you into the club.

**Attention: U.S. Military Personnel in W. Germany:**  
All Heathkit products and catalogs are available at your nearest Audio Club.

- Color TV
- Stereo & 4-Channel Equipment
- Amateur Communications Gear
- Home Protection Devices
- Auto Tune-up Instruments
- Calculators
- Electronic Organs
- Marine Electronics
- Educational Kits
- Service & Lab Instruments

**HEATHKIT ELECTRONIC CENTERS**—ARIZ.: Phoenix; CALIF.: Anaheim, El Cerrito, Los Angeles, Pomona, Redwood City, San Diego (La Mesa), Woodland Hills; COLO.: Denver; CONN.: Hartford (Avon); FLA.: Miami (Hialeah); GA.: Atlanta; ILL.: Chicago, Downers Grove; IND.: Indianapolis; KANSAS: Kansas City (Mission); MD.: Baltimore, Rockville; MASS.: Boston (Wellesley); MICH.: Detroit; MINN.: Minneapolis (Hopkins); MO.: St. Louis; N.J.: Fair Lawn; N.Y.: Buffalo (Amherst), New York City, Jericho; L.I.: Rochester; OHIO: Cincinnati (Woodlawn), Cleveland; PA.: Philadelphia, Pittsburgh; R.I.: Providence (Warwick); TEXAS: Dallas, Houston; WASH.: Seattle; WIS.: Milwaukee.

<b>HEATH</b>	
<b>Schlumberger</b>	
Heath Company, Dept. 17-11 Benton Harbor, Michigan 49022	
<input type="checkbox"/> Please send FREE Heathkit Catalog.	
Name _____	
Address _____	
City _____ State _____ Zip _____	
*Mail order prices; F.O.B. factory. <span style="float: right;">CL-482R</span>	



You expect a jet to be fast, but when it's a tiny blur streaking over the field at better than 300 mph, the sight is almost unbelievable. When it pulls up in a screaming vertical climb, then flips over into a series of corkscrew rolls, you rub your eyes in wonder—is it for real?

This remarkable little ship is the BD-5J, newest of several spectacular homebuilts by the famous Jim Bede and the first jet-powered craft designed especially for sport use and build-it-yourself construction. Less than 12½ feet long with a wingspan of 17 feet, the 5J is incredibly small. The top of the canopy barely comes up to your waist. To fit into the cockpit, a pilot must almost lie down. You don't just get into the plane—you put it on and wear it!

The BD-5J has the same sleek, bullet-nosed lines as its prop-driven cousin, the BD-5 (*Bullet-Nosed Beauty*, page 174, Nov. '72 PM), but beyond that the similarity ends. Powered by a 200-pound-thrust turbojet engine, it has a top speed of more than 330 mph, a phenomenal rate of climb of 2400 feet a minute, a service ceiling of 30,000 feet and a range of 550 miles. Yet stall speeds are surprisingly low for a jet—60 mph with flaps, 70 mph without flaps. Take-off run is 1100 feet, landing roll 800—also low by jet standards. Fully aerobatic, the ship is stressed for a whopping plus or minus 9 Gs. Special air brakes, called "thrust reversers," enable you to reduce flying speed without cutting engine power below a safe level. These clamshell plates close around the jet port on landing approaches to decrease thrust. If emergency "go-round" power is suddenly needed, plates can be quickly opened to give full thrust.

Despite its small size, the BD-5J does not feel cramped or confining. Visibility is excellent because your line of sight is well ahead of the wing line. Landings are easy because the ship is built so close to the

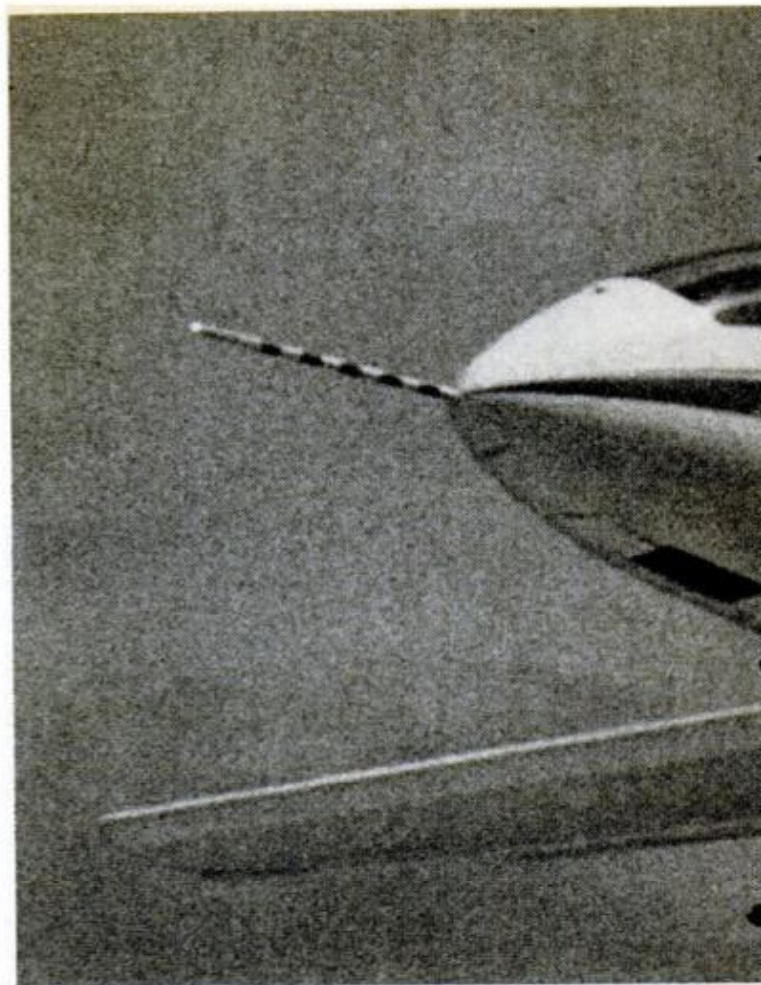

## Bede 5J: First

by Sheldon M. Gallager  
and Howard Levy

PHOTOS BY HOWARD LEVY

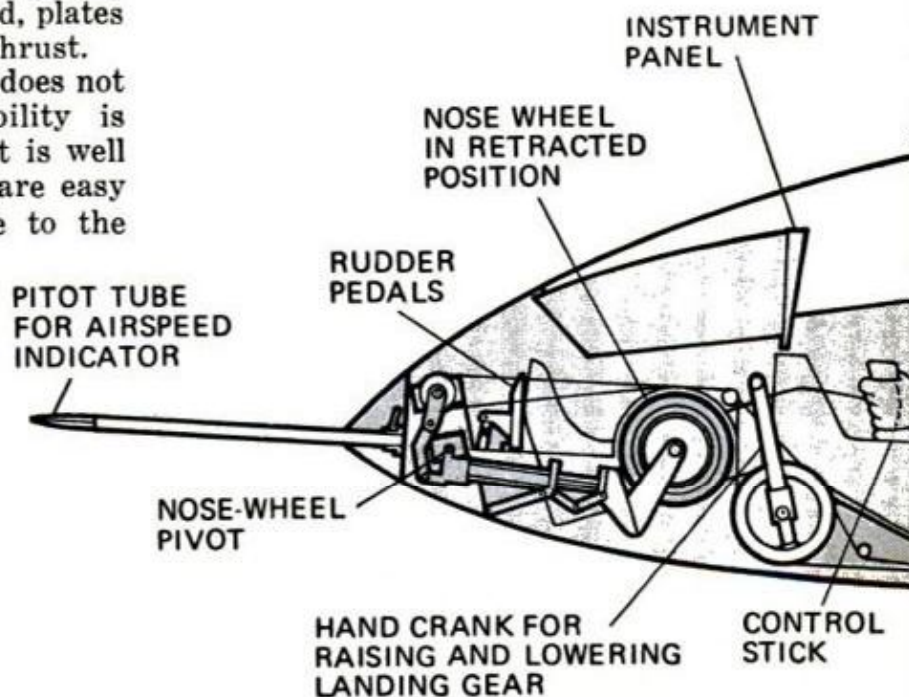

**Cutaway view** of BD-5J at right shows pilot snugly shoehorned into cockpit in reclining position similar to that of a Formula One racing driver. Nose wheel actually retracts up in space between pilot's feet. Space behind seat is taken up by main fuel tank and engine. To save weight and complexity, all controls are manually operated by hand crank or cable without hydraulics.



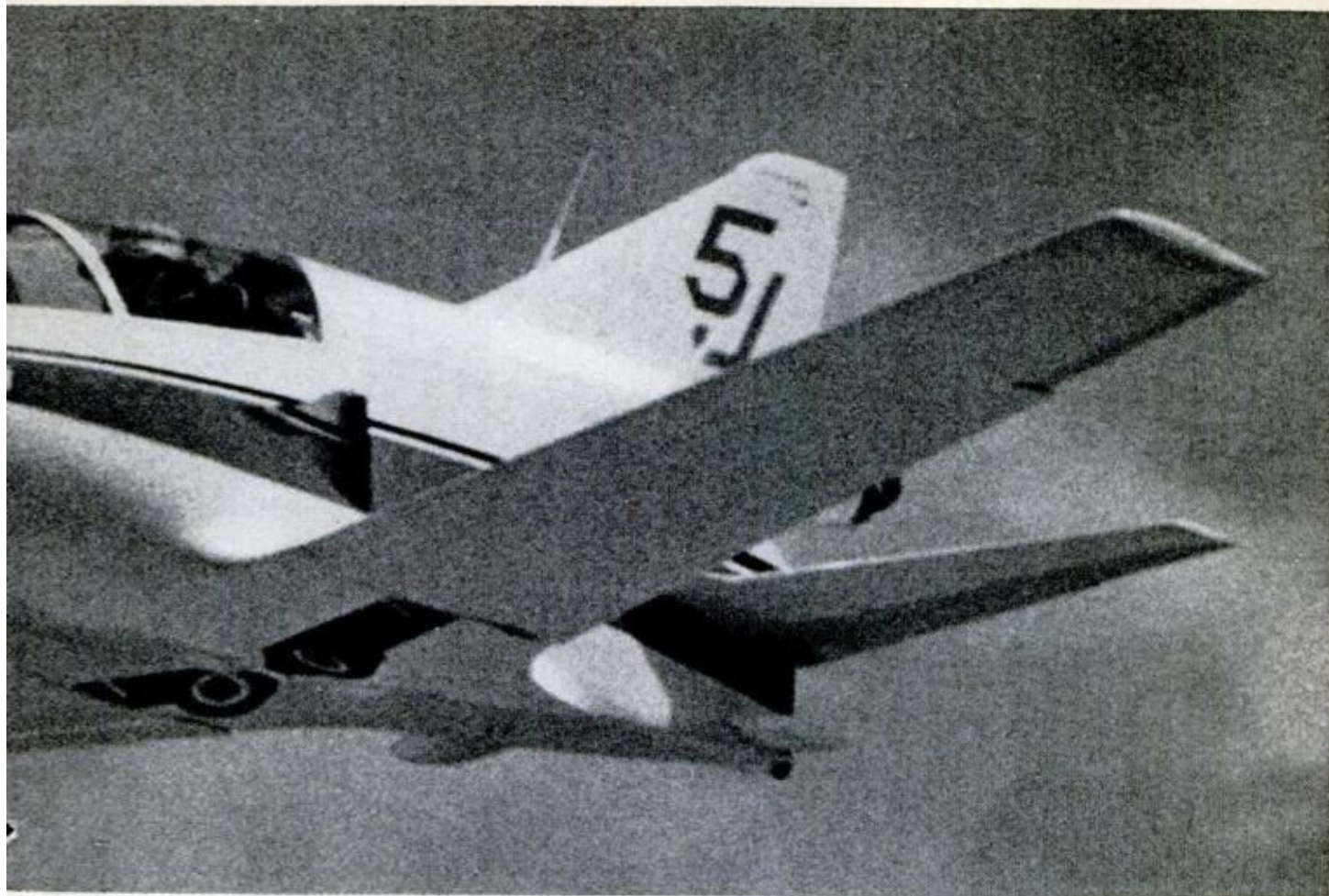

# build-it-yourself jet

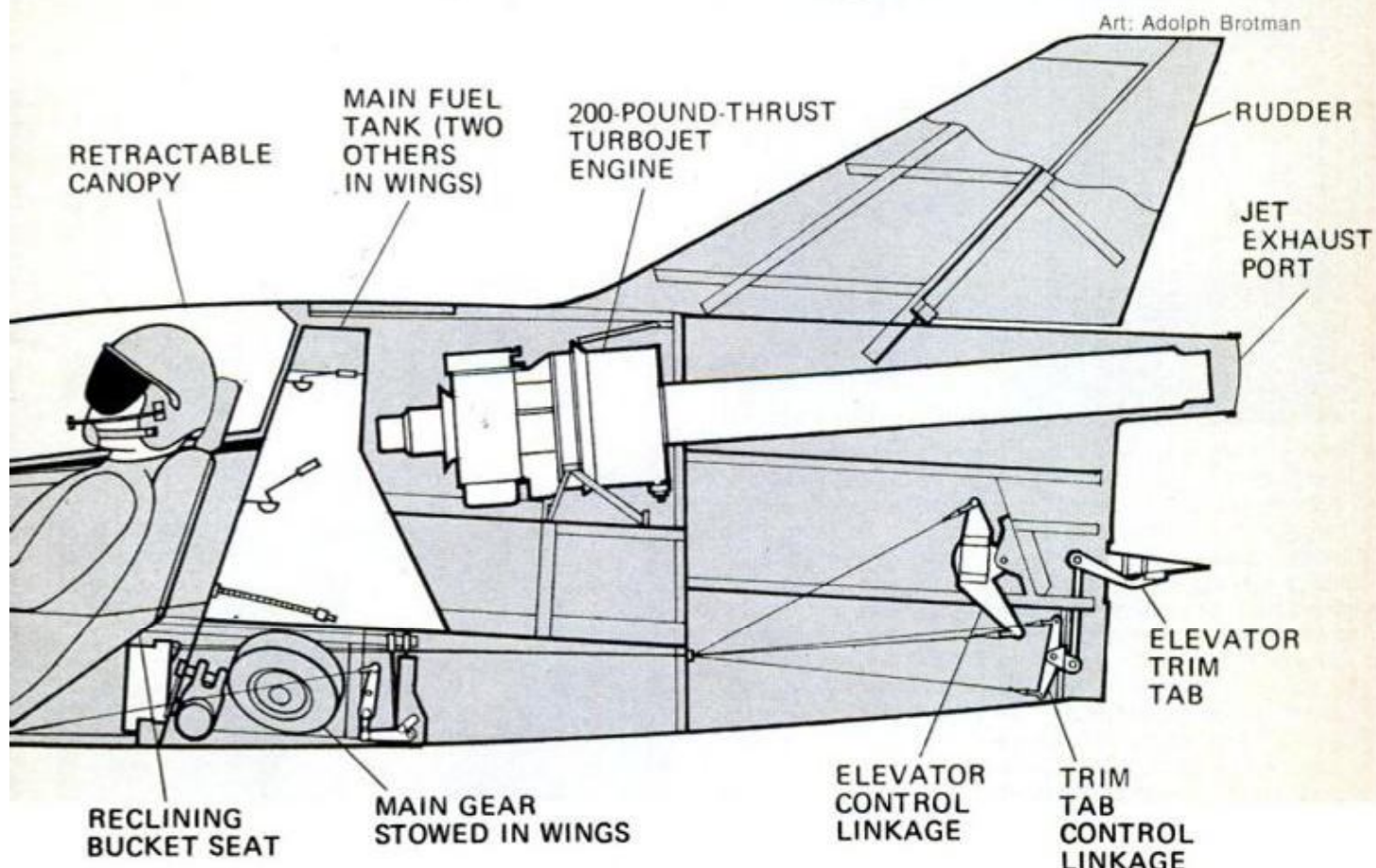



ground you always know exactly where the runway is as you come in—you can almost reach out and touch it. Complete kits for building the 5J will be available for \$21,400. Production models will also be sold ready to fly for \$29,000. At these prices, the midget jet is obviously not a “cheapie.” Nor is it intended for the inexperienced beginner. A high-performance ship requiring a skilled hand at the controls, it will appeal mainly to the advanced amateur who’s had considerable time in prop jobs and is now looking for something a bit hotter to try. But whatever its future, the Bede jet represents a bold new advance in sport aviation. ★★

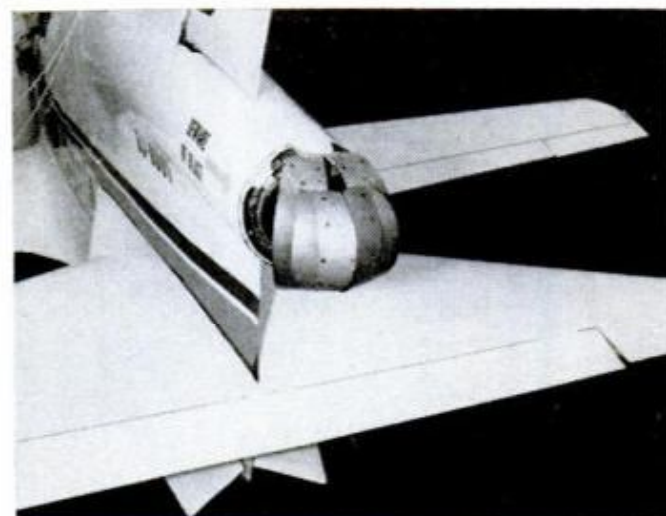
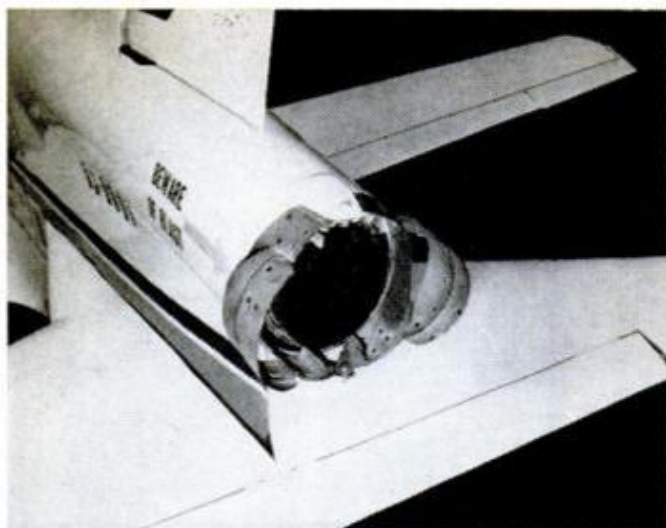

**Clamshell thrust brakes** partially close off jet port on landing approaches to reduce speed by channeling some of thrust around to front like reversers on big jets. Brakes are shown open at top, closed at bottom.

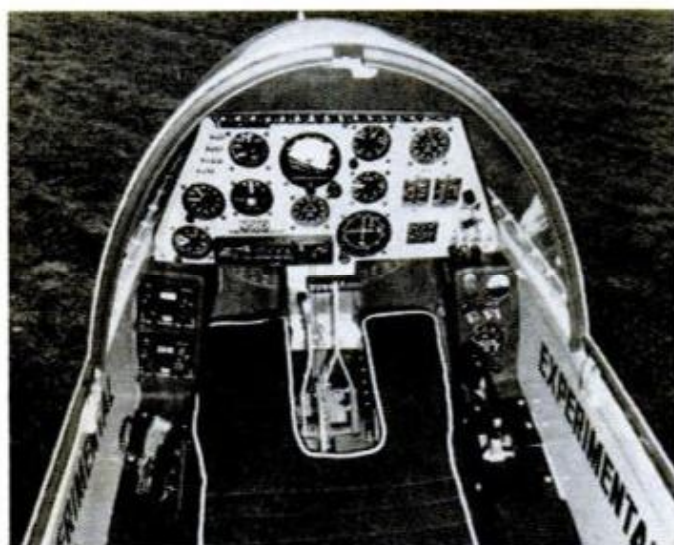

**Entire horizontal stabilizer** (right) tilts on central pivot, serving as one-piece elevator. Called “all-flying tail,” it makes ship extremely responsive because of its large surface area—an important aid in executing quick aerobatic maneuvers. Narrow control surface along trailing edge functions as trim tab. Wings are fitted with both flaps and ailerons. Canopy, shown retracted above, swings up and backward for access to cockpit. Closed, it clears pilot’s head by a scant few inches. Cockpit view (top) shows sophisticated control panel including full instrumentation for IFR flying as well as VFR. Unusual offcenter control stick is stubby handgrip at right, located at side of cockpit instead of between pilot’s legs. Gear-retract handle is at center where stick would normally be, is merely pushed or pulled to raise and lower wheels.





## BURIED TREASURE



Locate from a LONG DISTANCE!  
with Ultra-Sensitive **DIRECTIONAL** Locator  
SEND FOR FREE INFORMATIVE BROCHURE  
**RESEARCH PRODUCTS**  
BOX 13441-AM TAMPA, FLORIDA 33611



## Repair any watch

### ... SWISS OR AMERICAN

Unique, modern Sweazey System starts you making repairs right away. Develops skill step by step at home in spare time. Diploma awarded. Free sample lesson. No obligation.

**CHICAGO SCHOOL OF WATCHMAKING**  
Dept. 1113, Fox River Grove, Ill. 60021

## HOME-WORKSHOP ELECTRIC ARC WELDER \$9.99!



WELDS—BRAZES—SOLDERS—CUTS  
—ALL METALS! Plugs into ANY  
110 volt socket. MAKE—REPAIR  
most anything for CAR—HOME—  
BUSINESS. Lifetime BURNOUT  
GUARANTEE 10 day money back  
trial (if retrnd). HEAVY DUTY De-  
sion. No experience needed—FREE  
WELDING LESSONS!

(cash, ck, M.O.) and pay postman \$7.00 COD  
postage or send \$9.99 plus \$2.00 for postage-  
packing in U.S.A. COMPLETE READY TO USE—  
Includes BIG pack steel, Brazing, Solder, Carbon "touch" rods &  
ELECTROFLAME ARC TORCH! OFFER LIMITED—Order TODAY!  
MIDWAY WELDER, Dept. EPM-11, Kearney, Nebr. 66847

## PUMP DRAINS pools, cellars, laundry tubs IRRIGATES — CIRCULATES — SPRAYS



Heavy duty ball bearing pump. All metal, rust-  
proof Type XB. Stainless shaft. Use 1/4 HP or  
larger. 1 HP 1,200 GPH 60" high or 3,000  
GPH 25" well. 5,200 GPH max. 1 1/4" in;  
1" out. Belt or direct drive. \$17.95  
Type P won't rust or clog. Bronze bear-  
ing. To 2,400 GPH. 1" in; 3/4" out. \$11.95  
P'pd cash with order. Money back Guarantee.

LAWACO, Box 40, Belle Mead, N.J. 08502

## FREE Big New 1974 Catalog 1,600 Jokes, Tricks, Novelties



Send today for FREE World Famous catalog of hard-  
to-get novelties, gadgets, hobbies, sports, science,  
electronics, mod & psychedelic, jewelry, guns, fun-  
makers, timesavers, banks, school-office-artist items,  
photo-optical, motors/engines, auto/bike items, books,  
magic & occult, bargains, jokes & tricks, etc. No letter  
necessary. Send name & address to: JOHNSON-  
SMITH, C103 Auto St., Mt. Clemens, Mich. 48043

## BASEMENT TOILET FLUSHES UP



TO OVERHEAD SEWER OR SEPTIC TANK.  
NO DIGGING UP FLOORS. INSTALLS EASY. Write

McPHERSON, INC., BOX 15133, TAMPA, FLORIDA 33614

## 1¢ SALE

GUARANTEED  
10 YEARS



The knife for hunting, fishing and all around use. Mirror polished, imported stainless steel blade honed to a razor's edge. Rugged. Opens quickly, easily. Locks into position. Blade will not close when in use. Press button in handle to close. Safety finger guard. Sure-grip handle. Balanced for target throwing. IF BROKEN WITHIN 10 YEARS WE WILL REPLACE AT NO CHARGE! Use 30 days. Money back if not pleased. Special 1¢ sale. REG. PRICE \$2.50. Send \$2.51 & receive 2 knives. Add 49¢ postage, handling. Remit TOTAL \$3.00 for 2 knives. ORDER NOW! Midwest Knife Co., 9043 S. Western Ave., Dept. UDK-7708, Chicago, Ill. 60620. Est. 1936.

USE ZIP CODES  
WHEN ANSWERING ADS

## EARN \$20<sup>00</sup> PER HOUR by Assembling

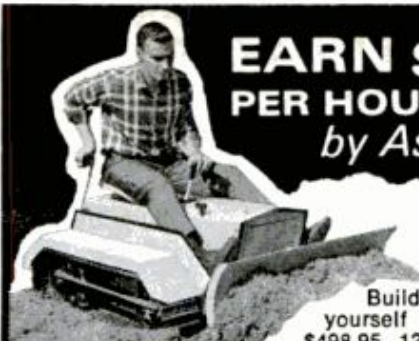

## MINI- DOZER

Build crawler tractor for yourself or resale. 7 hp. kit, \$498.95. 12 hp. kit, \$748.95. 20 attachments — loader, blade, mower, snowblower, garden implements. Send \$1 for "tell-all" brochure or \$5 for Build-It-Yourself Plans (\$ refunded on any purchase). Struck Corp., Dept. PM113 Cedarburg, Wis. 53012.



## BIG MONEY

- LIGHTNING TECHNOLOGY
- BE YOUR OWN BOSS
- LEARN AT HOME

Lightning Protection Institute School  
122 W. Washington Ave.  
Madison, Wis. 53703

## SAVE MONEY ON CAR REPAIRS!

1001 Questions and Answers About Your Car by M. Schultz. Simple, how-to-do-it directions—over 600 photos—show you how to operate, maintain and repair your car. Tells what tires and gas to buy, why your car stalls, how to prevent oil leaks and increase battery life, much, much more. For 10-day FREE examination copy send \$7.95 plus local tax to McGRAW-HILL BOOK Co., Dept. PM, 1221 Ave. of the Americas, New York, N.Y. 10020. Offer good only in U.S.

## FREE PLAN How to Start Your Own Business



Start a steady repeat CASH business in your basement or garage. Earn \$3 to \$6 an hour in your sparetime! Excellent profits in saw sharpening business! Automatic Foley Saw Filer, easy to operate, files combination saws, hand, band, and circular saws. No experience needed. H. C. Delbert wrote us: "Since I got my Foley Filer 5 years ago, I have averaged 4 1/2 saws each day since I started."

Every saw you sharpen brings you more customers. "I rented a two-car garage and have all the work I can do," writes Charles H. Smith.

## FREE BOOK Shows How to Start

Fact filled booklet tells you how to start a sparetime business immediately; how to get new business, how to advertise. Rush coupon now; get "Money Making Facts" and details on Easy Payment Plan. No Salesman will call.

Send Coupon for FREE BOOK Money Making Facts

FOLEY MANUFACTURING CO.  
1116-3 Foley Bldg. Minneapolis, Minn. 55418

Send FREE BOOK—"Money Making Facts",  
and Time Payment Plan.

Name \_\_\_\_\_

Address \_\_\_\_\_





# From wood to paper—now it's back again to wood

Your next home may be built of old newspapers, magazines and telephone books. What's more, it may even be better than one constructed of conventional materials—its parts won't rot, leak, warp or burn.

After hundreds of years of making paper from wood, science is now finding a way to turn all that paper back into wood again—or at least a product very much like wood. The process is being developed by Meyer Steinberg, a research chemist at Brookhaven National Laboratory in Upton, N.Y. Used paper, like the telephone book in the upper photo at right, is first soaked in a chemical containing petroleum derivatives known as "monomers." It's then put under tremendous pressure in a hydraulic press and cured in an oven at high temperatures. During the pressure and curing treatments, the monomers fill the pores of the paper and are converted into a superhard, plastic-like substance called a polymer. The result is a product that saws and nails like wood, as shown in the lower photos at right, yet is much tougher and more stable than wood. It's impervious to rot and weathering, won't shrink or warp and can easily be made fireproof with noncombustible additives.

The paper can be compressed into slabs of any thickness—thin sheets for paneling, planks for decking, heavy timbers for structural use. A \$20,000 grant has already been received from the Federal Railway Administration to see if railroad ties can be produced by the method—ties that would be virtually indestructible. If the process proves practical on a large-scale commercial basis, it may succeed in getting rid of the millions of tons of paper waste produced annually in this country, while at the same time providing a usable substitute for our dwindling supplies of natural lumber, a neat ecological trick.—*Bernard Bard.*

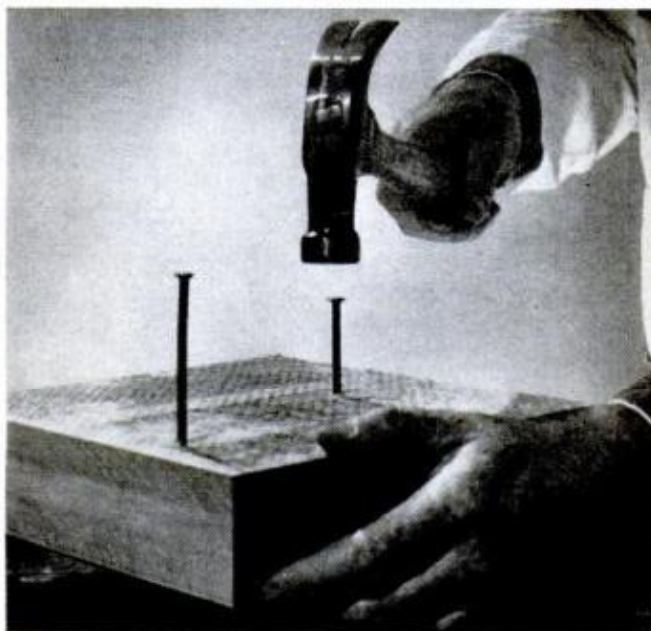



# "I lost 5<sup>3</sup>/<sub>4</sub> inches off my waist, 25 pounds of excess weight... and shaped up... in just 14 days!"

One 5-Minute exercise, twice daily, lying on my back, without giving up the foods I love... Did It!"



Gordon as he looked the day he started.

After 7 Days — A remarkable transformation — pot almost gone — revitalized.

After 14 Incredible Days — Slimmed, reshaped, looking 15 years younger, feeling 25 years younger

## SEE AND FEEL AMAZING RESULTS IN JUST 3 DAYS!!

### WHAT IS THIS INGENIOUS PLAN?

The Weider "5" Minute Body Shaper plan is based on doing ONE CONTINUOUS RHYTHMIC CO-ORDINATED EXERCISE while still eating the foods you like. That's all you do! This one five-minute exercise is designed to attack the Waist and Hips (where fat accumulates quickest, giving your body a flabby, weak and distorted look) — as well as burn off excess body fat fast by speeding up your metabolism, burning up stored calories and releasing excess water—while reshaping your chest, abdomen, firming up your legs and arms — your total body!

It's safer than strenuous workouts, beats the time consumption and dangers of gym workouts... or any other vigorous sport.

The unit weighs about 16 oz. and fits any wallet-sized case. You can carry it and use it wherever there's floor space — anytime. Even while watching television.

### WHAT COMES OFF IN 14 DAYS?

Individual results vary, but during an average 14 day period, you can expect to lose up to four inches from your waistline and up to ten pounds off your present weight. It strengthens your heart and lungs, increases stamina and endurance, improves your digestive function and general health. IT TOUGHENS YOU UP. For a "5-Minute Exerciser" — it sure does a lot!

### WHAT SATISFIED CUSTOMERS SAY:

Results vary depending on how much overweight each of our students is. Nevertheless, this is a sampling from the impressive letters we receive: **Willie Ellis** — "I lost 3 inches off my waist and 9 pounds in 7 days." **Kent Christensen** — "I lost 5<sup>1</sup>/<sub>2</sub> inches off my waist and 20 pounds in 10 days." **Marino Zoller, M.D.** — "I lost 2 inches off my waist in 14 days." **Michael Benedict** — "I lost 6 inches off my waist and 22 pounds in 21 days." **Ken Waller** — "I lost 3 inches off my waist in 5 days."

### WHAT THE EXPERTS SAY:

Medical Doctors, Chiropractors, Osteopaths, Athletic Coaches... agree its the most successful Waistline-Weight Reducer and Shaping Up Plan ever invented!

Patent Pending. Copyright Joe Weider, 1973

"Doctors have always known, exercise done while lying on the back virtually eliminates strains while slimming and reshaping the body. Yours is the finest Body Shaper Program on the market."

RICHARD TYLER, D.C.

"Beats jogging and working out in gyms — and much safer. I lost 4<sup>1</sup>/<sub>2</sub> inches off my waist in 14 days." — JIM HANLEY, famous athletic coach.

"Based on sound physiological and medical knowledge, it burns fat and shapes the body without strain to the heart or other organs. I lost 12 lbs. of excess weight using it."

DR. ANITA D. SANTANGELO, Chiropractic Orthopedics

### EXPOSING EFFORTLESS EXERCISERS

Reader's Digest (Sept. 1971), New York Times and Good Housekeeping, among others, exposed sauna wraps, inflated belts, weighted belts and effortless exercisers as frauds. Scientific researchers, medical and fitness experts all agree...there is only one way to firm, shape and trim up your body... you must work the inches off!

## NO GIMMICKS, NO CATCHES MONEY BACK GUARANTEE OFFER

Because this isn't a "gimmick" plan — and you have been fooled in the past by "effortless exercisers" — I make you this UNCONDITIONAL GUARANTEE: "GET IT OFF FAST" — and see measurable and firming results in three days or return the exerciser for a full 100% refund! Proven results are already verified. The guarantee is in writing. Now, can you think of a reason for not ordering your "5-Minute Total Body Shaper?"

## FREE TRIAL OFFER!!

See your exciting new body begin to take shape in 3 days or every penny back!

**SEND TODAY**

Weight just 16 oz.



IN CANADA: "5" Minute Body Shaper Plan, 2875 Bates Road, Montreal, Quebec.

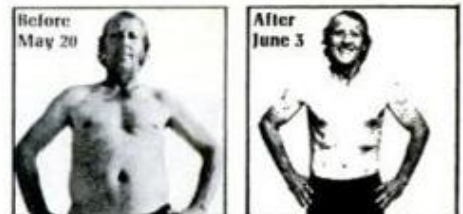

14 days shaped me up in the privacy of my home!

# '5' MINUTE BODY SHAPER

We Care About The Shape You're In — **DON'T YOU?**

**SEND TODAY COMPLETE KIT \$9.95 ONLY**

Joseph Weider, Dept. BR/K  
Trainer of Champions with Over 2,750,000 Successful Students  
"5" MINUTE BODY SHAPER PLAN  
21100 Erwin Street, Woodland Hills, Calif. 91364

Prove to me I can see results and start shaping up in 3 days!  I enclose \$9.95 for "5" Minute Body Shaper & Slimming Course, plus \$1.00 for shipping and handling.  SAVE! Order TWO for only \$17.95, plus \$1.00 for shipping and handling. (No C.O.D.'s please). Enclosed is  check or  money order or  cash for \$..... (Calif. residents add 6% sales tax.)

Name ..... Age .....

Address .....

City .....

State ..... Zip .....

(Please print clearly)



# Compact 300-mm tele at a comfortable price

by Ivan Berger  
PHOTOGRAPHY EDITOR

Three hundred millimeters is a useful length for a telephoto lens—it brings you six times “closer” to your subject than a 50-mm normal lens, more than twice as close as a 135-mm telephoto, and it’s about the longest focal length you can shoot handheld. The trouble with most 300-mm telephotos is that they’re big, heavy, slow and expensive. Not this new Spiratone 300-mm, though: It’s comparatively small (7 inches), light (24 ounces) fast (f/4) and cheap, (\$119.95 for most popular SLRs, \$129.95 for electric-eye reflexes and the Canon F1 and FTb), and it’s given me good results during a month or two of shooting.



Interchangeable mounts (arrow) allow automatic diaphragm action on most popular reflex cameras; “T” mount adapters also fit, for preset use on other reflexes.

Accessories, of course, come extra: lens-hood (\$10), lens case (\$10.75), 77-mm filters (\$15), a case to hold a camera with the 300-mm and other lenses (\$15), and a pair of “FocusXtenders” which bring the lens’s minimum focusing distance from 15 feet to 3½ feet. ★★★

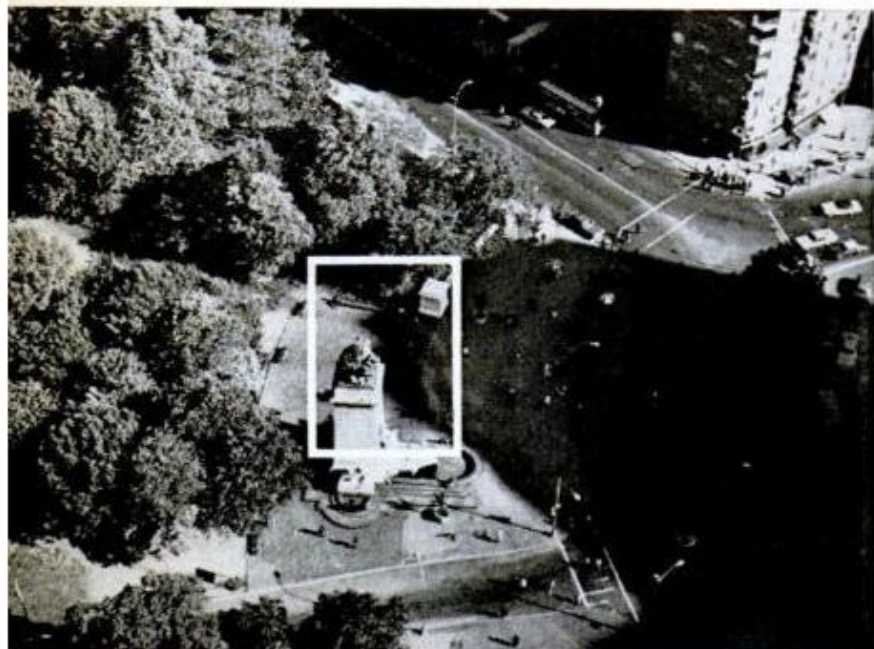

Multiply a lens’s focal length six times, as you do when switching from a 50-mm normal to a 300-mm telephoto lens, and it’s like moving six times closer; 300-mm shot (right) gives “close-up” view, compared with 50-mm shot (above). Equivalent area (box) of 50-mm shot would show same perspective if blown up to same size as 300-mm shot, but would also have less sharp detail and six times as much grain.





Get a small fortune in books  
on your favorite workshop subjects for only \$1!

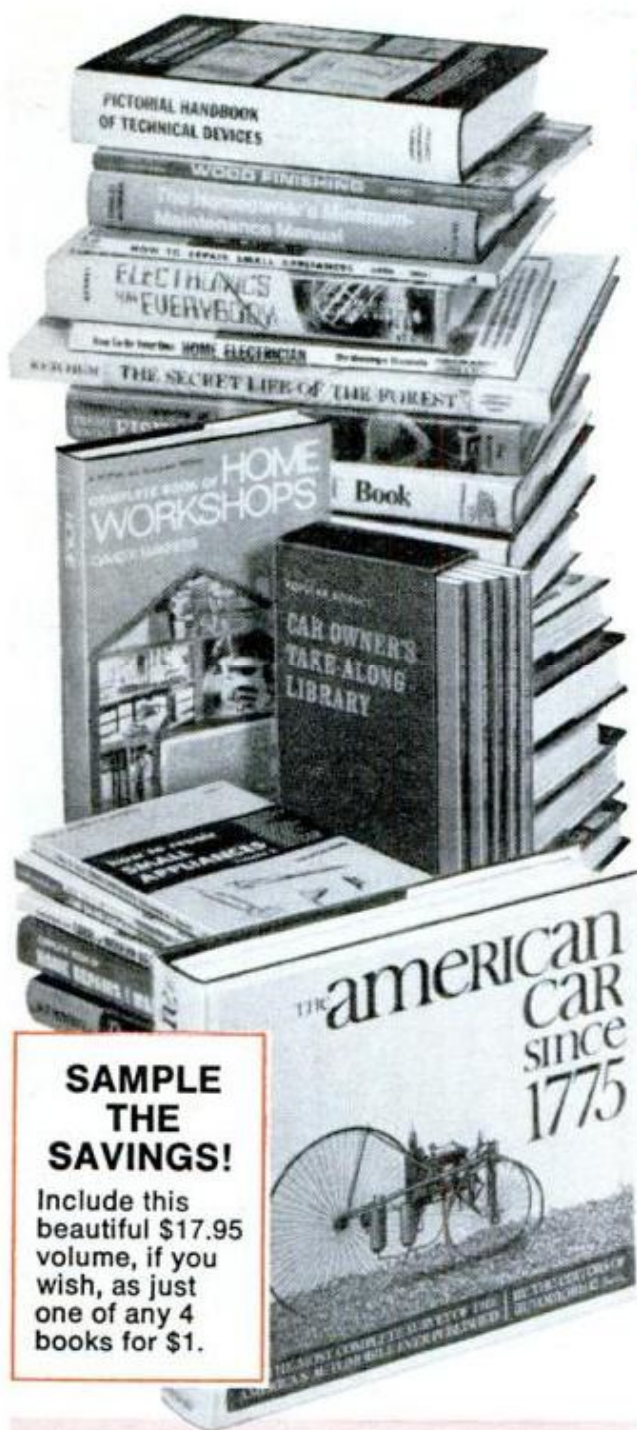

**SAMPLE  
THE  
SAVINGS!**

Include this beautiful \$17.95 volume, if you wish, as just one of any 4 books for \$1.

Just look at these books! They're the best available on your favorite subjects. And they're even more exciting when you check the retail values. There's one on this page worth \$20.00! Another retails for \$17.95. Yet, you may take any four (that's up to \$57.90 worth of books) for only one dollar. And as a member, you can continue to save **BIG** on the books you want—from 30% to 60%! And you need buy *only one* selection per year to stay a member. Start saving now—take four books for \$1!

Mail the postcard today or write to  
**POPULAR SCIENCE BOOK CLUB**  
44 Hillside Avenue, Manhasset, N.Y. 11030

TAKE

**any 4 books  
for only \$1** [up to \$57.90  
worth  
of books]

when you join the  
**POPULAR SCIENCE BOOK CLUB**

- 340. THE AMERICAN CAR SINCE 1775. Hundreds of rare photos. Retail: \$17.95
- 050. COMPLETE BOOK OF HOME REPAIRS AND MAINTENANCE. Retail: \$8.95
- 324. HOMEOWNER'S MINIMUM MAINTENANCE MANUAL. Hundreds of easy maintenance procedures. Retail: \$6.95
- 661. ALIVE IN THE WILD. Fascinating stories of 35 wild animals, and the writer's experiences with them. Retail: \$9.95
- 018. HOW TO BE YOUR OWN HOME ELECTRICIAN. Covers everything you need to know. Retail: \$1.95
- 007. COMPLETE BOOK OF CAMPING. Equipment data, skills, maps, trip planning, etc. Retail: \$5.95
- 1038. HOW TO REPAIR SMALL APPLIANCES. Cords, plugs, attachments, heating elements, motors, diagnosing problems. Retail: \$5.90
- 027. HOW TO DO YOUR OWN WOOD FINISHING. Antiques, marred surfaces, much more. Retail: \$1.95
- 026. HOME GUIDE TO PLUMBING, HEATING & AIR CONDITIONING. Step-by-step instructions. Retail: \$1.95
- 038. ELECTRONICS FOR EVERYBODY. Illustrated how-to's of do-it-yourself electronics. Instructions for 4 projects, all under \$15. Retail: \$6.95
- 1016. CAR OWNER'S TAKE-ALONG LIBRARY. Five "how-to" paperbacks. Retail: \$5.95
- 292. AMATEUR ASTRONOMY. Lively, informative, nontechnical. Retail: \$6.95
- 329. COMPLETE BOOK OF FURNITURE REPAIR & REFINISHING. How to restore all kinds of furniture. Illustrated. Retail: \$8.95
- 044. COMPLETE BOOK OF HOME WORKSHOPS. How to build or expand your workshop. Retail: \$8.95
- 057. DO-IT-YOURSELF HOME PROTECTION. How to build or install a home (or auto) security system. Retail: \$7.95
- 014. HOW TO BUILD YOUR OWN CABIN OR MODERN VACATION HOME. Hundreds of hints to save you money. Retail: \$1.95
- 349. WOODWORKING MADE EASY. 250 illustrations. Complete handbook on fundamentals, techniques. Retail: \$6.95
- 326. PICTORIAL HANDBOOK OF TECHNICAL DEVICES. Easy-to-read detailed construction designs. Retail: \$12.50
- 647. SECRET LIFE OF THE FOREST. How plants and wildlife interact in the cycle of life. Retail: \$7.95
- 335. A CENTURY OF WONDERS. Magnificent volume covering last 100 years of technological growth. Retail: \$20.00

Here's what happens when you join the  
**Popular Science Book Club**

1. You get up to \$57.90 worth of books for only \$1 (plus postage and handling) when you start your club membership.
2. Every four weeks you'll receive an interesting, informative and colorful Club bulletin fully describing the coming selection and alternates available, which you may accept or reject. If you want the selection, do nothing. It will be sent to you automatically. If you don't want the selection, or want alternate books, or no books, simply indicate your wishes on the card provided and return it by the date indicated.
3. To retain all membership privileges you need buy only one book per year. You may cancel your membership any time you wish after buying only one regular selection.
4. You will be offered the best books available on home improvements and repairs, how things work, appliance repairs, science, cars, math, mechanics, engineering, electronics — a broad range of practical and technical subjects.
5. You save from 30% to 60% on every Club selection. Yet virtually all PSBC books are identical to publisher's editions.
6. If, after examining a book, you are dissatisfied for any reason, you may return it within 10 days without obligation.



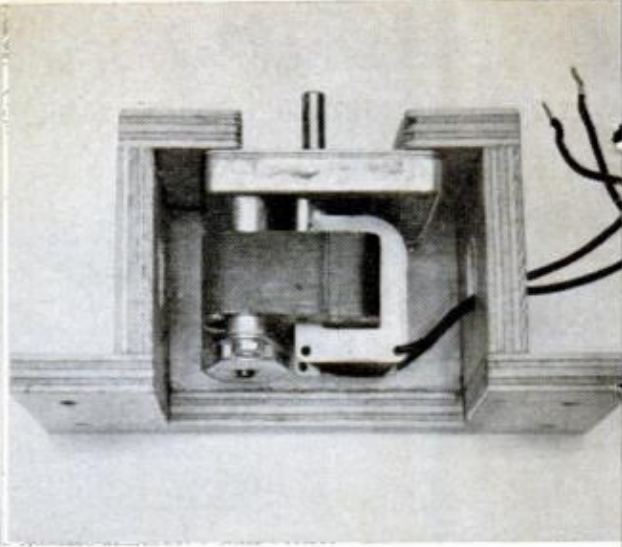
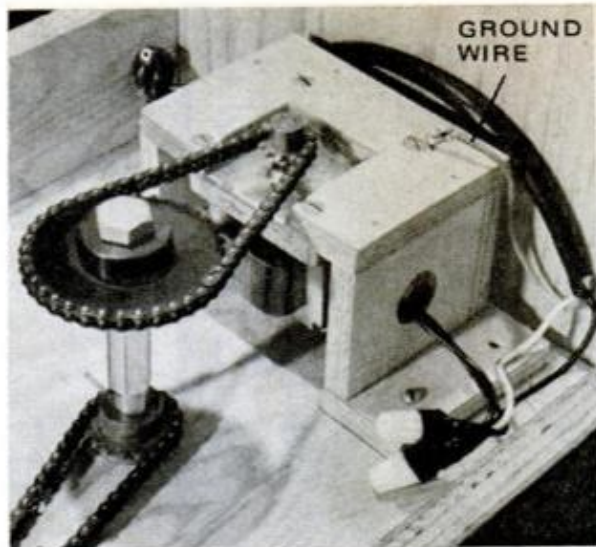
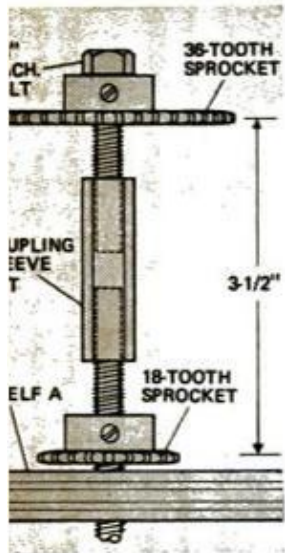

Extension on axle of first column is fitted with 36-tooth sprocket to reduce motor speed, column rotation.

The 7-rpm motor is suspended in wooden holder by inserting four screws in tapped holes in gearbox frame.

## OUTDOOR GREETING CARD

(Continued from page 188)

steady the unit. Attach cleats to the inside of the frame. Paint the inside walls black before inserting columns. To install the columns, you need only to drop the lower bolts with bearings secured into the recess.

The top shelf is then lowered into place over the upper bolts and upper bearings dropped into place.

The sprockets have setscrews that will grip the threaded surface of the bolts adequately for the initial setup, but for continued running it will be necessary to pin

(Please turn to page 204)

## MOTOR SUPPORT

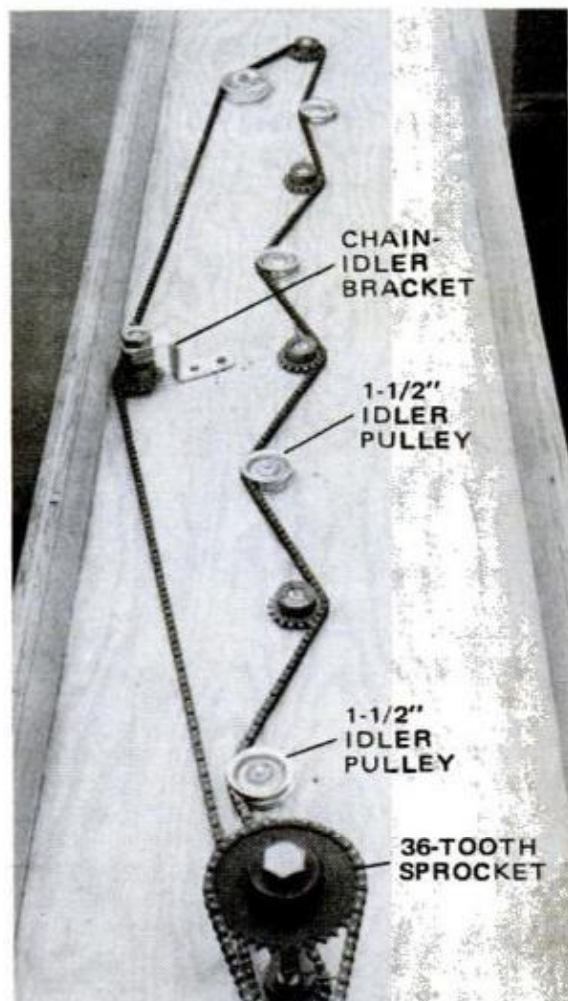
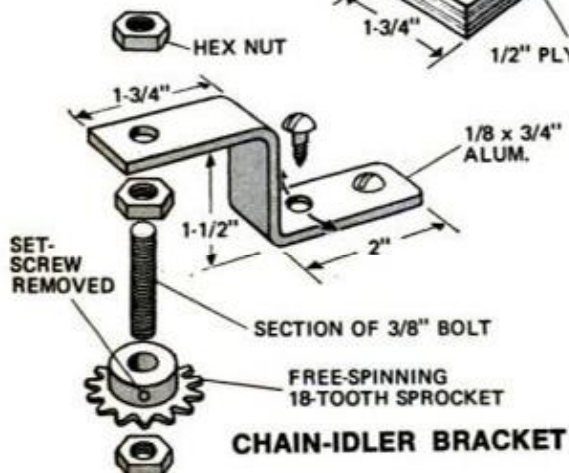
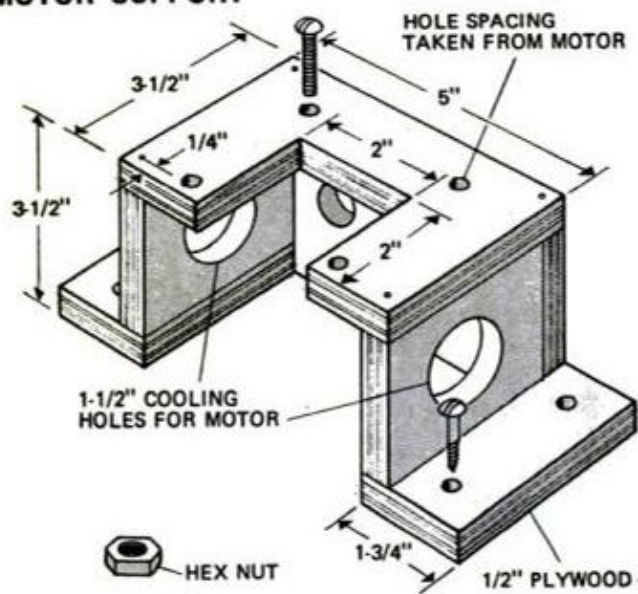

Idler pulleys keep chain in place on sprockets. Idler sprocket on bracket controls chain tension.



# NEW RUBBER STAMP BUSINESS PAYS BEGINNERS UP TO \$16.50 AN HR. START AT HOME IN SPARE TIME

The multi-million dollar Rubber Stamp business—once controlled by a few big companies—is now being taken over by small operators—one in each community throughout the United States. Men and Women who have this inexpensive machine can turn out huge quantities of Rubber Stamps with special wording that buyers once were forced to buy from big cities. Material costing only 27c makes a stamp that sells for \$2.75. The machine that does the work is simple and easy to operate and it turns out as many as six Rubber Stamps at a time, each with different wording such as names, addresses, notices, stock numbers, prices and other "copy" needed by offices, factories and individuals. Working full capacity, it can earn as much as **\$33.00 an hour for the operator!** Now you can get into the big-pay business yourself, with your own home as headquarters. You don't need experience. We supply everything, including complete instructions and eight ways to get business coming in fast. **We even help finance your start.** Start making up to \$16.50 an hour from the very beginning. Cash in on the profitable Rubber Stamp business in your community, right away. We'll mail full particulars FREE and no salesman will call. Be first in your locality. Rush coupon or send your name on postcard now to:

**RUBBER STAMP DIV., Dept. R-2-CM**  
1512 Jarvis Ave. • Chicago, Illinois 60626

THIS LITTLE TABLE TOP MACHINE  
MAKES EVERYTHING SIMPLE & EASY



MAIL  
THIS

## RUBBER STAMP DIV. FREE!

1512 Jarvis Avenue Dept. R-2-CM, Chicago, Ill. 60626

Please rush full particulars about your financing plan and the little machine that can get me started in the profitable Rubber Stamp business at home in spare time. Everything you send me is FREE and no salesman will call.

Name \_\_\_\_\_  
Address \_\_\_\_\_  
City \_\_\_\_\_  
State \_\_\_\_\_ Zip \_\_\_\_\_

# I-N-V-E-N-T-O-R-S WE NEED INVENTIONS

Sell your invention for cash—need money for Patent?—Are technical problems holding you back? Universal Inventions has helped inventors all over the world—just like yourself—why not you? Inventions provide the magic spring-board to sudden riches. REMEMBER, we either sell your invention or pay you a cash bonus. Write for details. UNIVERSAL INVENTIONS, Dept. 13, Marion, Ohio 43302

## NEW Chairs, Sofas, FURNITURE FROM OLD



• LEARN RE-UPHOLSTERY AT HOME... FOR FUN OR PROFIT!  
Turn cast-offs into \$100's. No experience needed. We show you how... get you started fast!

Send for FREE BOOK

Name \_\_\_\_\_ Age \_\_\_\_\_  
Address \_\_\_\_\_  
City \_\_\_\_\_ State \_\_\_\_\_ Zip \_\_\_\_\_

MODERN UPHOLSTERY INSTITUTE, Box 899-YPMORANGE, CA. 92669

USE ZIP CODES WHEN ANSWERING ADS

# FINISH CORNERS • CUT MOULDING WITH ANY ELECTRIC DRILL

NO \$50 ROUTER  
OR \$6 BITS NEEDED!

You don't have to buy an expensive Router to finish corners, moulding & trim. ARCO Corner Finishing & Moulding Cutters do the work at a fraction of the cost. Simply slip the Cutter's 1/4" shank in any drill chuck and it's ready to produce! Special Dual Guides assure accurate cuts along entire length & width of workpiece. Cuts wood, plastics, soft metals. Quality-made in U.S.A. of hardened steel. These Cutters will fit & work with all Electric Routers.

## No. 6—3 PIECE CUTTER SET CUTS 3/4" CONTOURS \$495

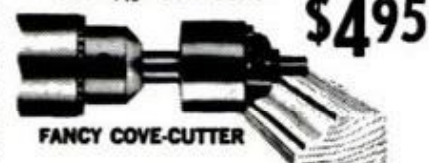

FANCY COVE-CUTTER



ROMAN OGEE-CUTTER

RABBET-CUTTER

## No. 7—3 PIECE CUTTER SET CUTS 3/4" CONTOURS \$495

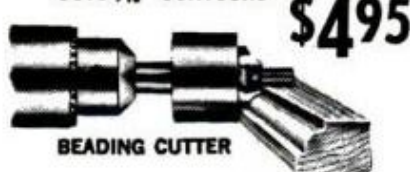

BEADING CUTTER



COVE-CUTTER

OGEE-CUTTER

### SPECIAL SAVING!

Order all of above 3 Sets at our Special Money-Saving Price. No. 6715, total of 10 Cutters, only **\$1395**

These & over 300 other Arco Tools available at Hardware Depts. everywhere, or order direct on 20-day Money Back Guarantee

## No. 15—4 PIECE RADIUS & BEVEL CUTTER SET \$650



ADJUSTABLE BEVEL-CUTTER cuts 45° bevels 1/2" to 3/4" wide.

RADIUS CUTTERS 3 SIZES for 1/8", 3/16", 1/4" Radius Cuts.

## MAIL THIS COUPON TODAY!

ARCO TOOLS, INC. Dept. PM-11  
421 West 203rd St., N.Y., N.Y. 10034

Ship on your 20-day Money Back Guarantee:

- No. 6, 3-Piece Cutter Set ... \$4.95  
 No. 7, 3-Piece Cutter Set ... 4.95  
 No. 15, 4-Piece Cutter Set ... 6.50  
 No. 6715, All 10 Cutters ... 13.95  
 I enclose Check. M.O.—SHIP PPD. (No C.O.D.'s)

Name \_\_\_\_\_  
Address \_\_\_\_\_  
City \_\_\_\_\_ State \_\_\_\_\_ Zip \_\_\_\_\_



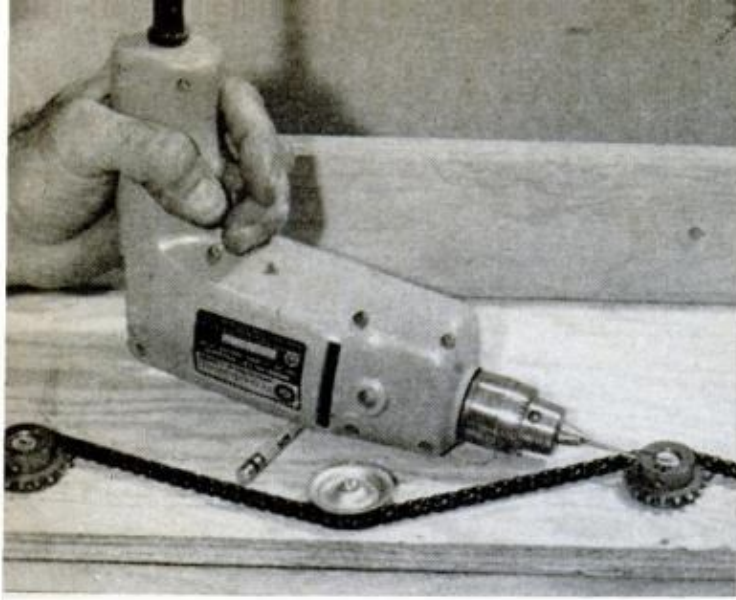

When columns are lined up "in phase," a hole is bored in each sprocket and bolt, then locked with nail pin.

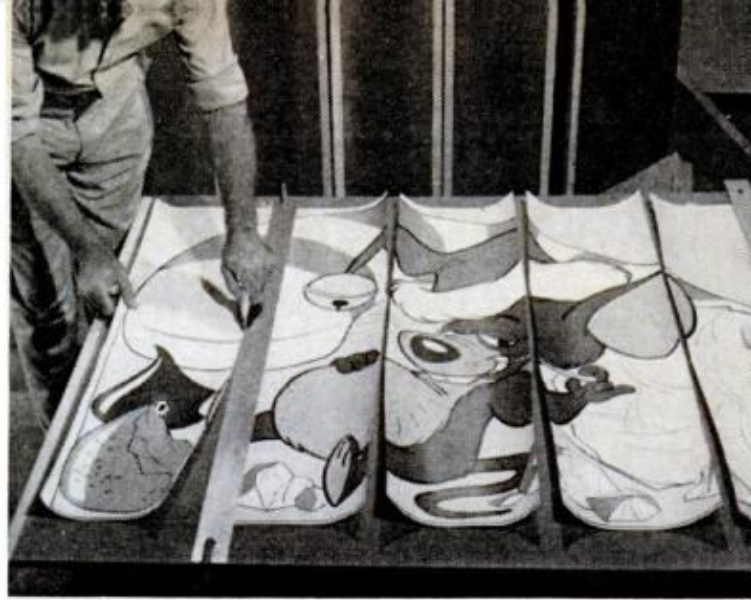

Posters are cut in 10-in.-wide strips on flat surface by running knife along clamped metal straightedge.

## OUTDOOR GREETING CARD

*(Continued from page 202)*

the sprockets to the bolts. This can be done with nails. Predrill  $\frac{1}{16}$ -in. holes in the sprocket hubs at a slight upward angle, using the drill press for best control. The angle is necessary to permit clearance for the portable drill which must be used to continue the holes "on location."

Use pressed metal pulleys for idlers which are removed from the casing of ordinary clothesline pulleys, obtainable at hardware stores. Try to get  $1\frac{1}{2}$ -in.-dia. pulleys; however, the size is not critical. The groove width must be large enough, though, so the chain will ride inside (about  $\frac{3}{8}$  in. will do). Weave the chain over and under as indicated, then grind off the rivet at one link to allow use of a connecting link. Set up the idler sprocket bracket with one screw temporarily to let the bracket swing in an arc for adjusting chain tension.

Line up all columns with one face parallel and hold them in place by resting a straight board against them. Tighten the setscrew on each sprocket. Test the column rotation by driving the chain by hand. If they check out okay, drill the pin holes through the sprockets into the bolts. Use a dab of thread-locking fluid or some adhesive to prevent loosening. Insert pins (nails are fine) of the proper size. Incidentally, the sprockets should not rest directly on the wood shelf surface; allow a space of at least  $\frac{1}{16}$  in.

Install the motor in its wood support box and attach the box with one screw temporarily to allow shifting while proper chain tension is achieved. The 10-tooth driver sprocket is available only with  $\frac{1}{4}$ -in. bore so you'll have to rebores the hole to  $\frac{3}{16}$  in. so it'll fit over the motor shaft. (I added a



Work carefully but quickly when applying strips to columns. Press out bubbles, wrinkles in paper as you go.

setscrew at right angles to the original one in the sprocket to prevent loosening.)

Since the 7-rpm motor is a bit too fast, a 36-tooth driven sprocket is utilized to further reduce rotation speed of the columns. This is connected to the shaft of the first column with the use of a coupling nut which allows insertion of an additional bolt. As an option, you can use a long piece of threaded rod for the first column.

The motor has two leads. For safety, connect these to a three-wire power cord with grounding plug. Connect the third wire to one of the motor mounting screws. Plug it in and test run the unit while observing the motions. If the movement is strained, the chain tension may be too tight. Adjust the idler sprocket to relieve it. If rocking occurs between columns, the

*(Please turn to page 206)*





For **TOOLMAKERS**  
who use the  
**FINEST . . . . .**

**GERSTNER TOOL CHESTS**  
Dept. K3, 20 Cincinnati Street  
Dayton, Ohio 45407

Send 25¢  
for Catalog

**\$12.95 BLACK DIAL TELEPHONES**

Complete



add \$2.00 for color  
Factory rebuilt Western Electric in white,  
beige, ivory, pink, green or blue. If 4  
prong plug is required add \$2.00. Fully  
guaranteed.

Designs may vary.  
Write for free list. All shipments F.O.B.

**SURPLUS SAVING CENTER**  
DEPT. PM-113, WAYMART, PENNA. 18472

**HYDRAULIC JACK REPAIRS**



**Earn While You Learn at Home**

Earn while you learn at home. Millions of jacks in gas and auto  
service stations, trucking firms, body shops, riggers, factories  
and farms need servicing . . . most of which you can learn to  
repair. We show you HOW. Start spare time in your basement  
or garage. Big opportunity for mechanics. ACT NOW!  
Write for folder No. PM-111 and free bonus offer.

**HYDRAULIC JACK REPAIR MANUAL CO., INC.**

G.P.O. BOX 3 • STATEN ISLAND, N.Y. 10314

**instant teflon surface**



Apply A SURFACE OF TEFLON\* IN-  
STANTLY with Self Sticking Teflon  
Film. Slippery nonstick Teflon has  
scores of uses in home, shop, indus-  
try. Send \$0.25 for four page authori-  
tative Popular Science reprint.

\*tm DuPont

CONNECTICUT HARD RUBBER CO.  
407F East St., New Haven, Ct. 06509

**USE  
WHAT THE  
PROS USE!**



- LUBRICATES
- PENETRATES
- PREVENTS RUST

Available wherever  
automotive products  
are sold.

**CRC CHEMICALS**  
Div. C. J. Webb Inc.  
Dresher, Pa.

**BASEMENT TOILET**

Flushes up to existing sewer or septic tank  
by powerful, self-contained pump operated  
by normal water pressure. No digging up  
floors. Clog resistant, easily installed. Make  
basement into game room, den, apartment  
with private bath. Financing available. Dealer inquiries  
invited. Write for free catalog.



**DOSS, Dept. J-25, Box 10947, Houston, Tex. 77018**

**AAMCO® And You Can Make It!**

The world's largest transmission chain is still growing  
strong after nine years. Over 500 of our franchises located  
from coast to coast. New openings in some markets mean  
you too might qualify. For further information write:

**AAMCO Transmissions, Dept. N-30**  
408 E. Fourth St., Bridgeport, Pa. 19405



**5 DAY  
HOME  
TRIAL**

**DISCOUNT BREAKTHROUGH ON  
ACCORDIONS**

SAVE 1/2 OFF retail prices of comparable accordions.  
Buy direct from world's largest dealer. Over 40 models  
for Student, Teacher, Professional. Electronic,  
Standard & Button Models—Amplifiers too! All Big  
Names. Try before you buy. Free accessories. E-Z  
Terms. Trades. Lifetime Performance Policy. FREE  
Color Catalogs/Discount price list. Rush coupon.

**Own 5 Acres of  
Prime Vacation Land**



Scene at  
Lake Conchas

**\$30 per month. No down payment, interest or finance  
charge. Total price \$4,975.**

Enjoy your next vacation on land you own . . . at Conchas Lake in  
unspoiled Northeastern New Mexico. Great year-round fishing,  
camping, boating. Excellent hunting in season for wide variety of  
game. Enjoy unlimited use while you buy. Build if you wish . . .  
or park your trailer or camper. Easy monthly payments of \$30  
for 165 months, plus one payment of \$25 . . . no hidden charges.  
Other Ranchos available from \$3975 to \$5975.

**Don't Wait. For your free Portfolio containing property descrip-  
tion, photos, maps, warranty, contract, write to: Ranchos Lake  
Conchas, Administration Center, Box 2005EP, Alameda, Calif. 94501**

Offering statement available from subdivider. Filing with New York  
Department of State is not approval of merits of offering. NYA-73-908.

**BUILD, FLY YOUR OWN COPTER!**

It's great sport to fly a Bensen  
Gyrocopter — lowest cost, too. Fly  
high or low, fast or slow. Adapts  
to floats. Pilot ages range from  
teens into 60's. Enjoy flying this  
easy way! Plans, parts and factory  
kits available. Get colorful info  
packet with photo, specs, 3-View  
Drawings. Send \$5 today!

**BENSEN AIRCRAFT CORP., Dept. PM-113**  
RDU Airport, Raleigh, N. C. 27602

NAME \_\_\_\_\_

ADDRESS \_\_\_\_\_



**LEARN  
MEAT CUTTING**



Train quickly in 8 short weeks at Toledo  
for a bright future with security in the vital  
meat business. Big pay, full-time jobs—  
**HAVE A PROFITABLE MARKET OF YOUR  
OWN!** Time payment plan available. Diplo-  
ma given. Job help. Thousands of suc-  
cessful graduates. **OUR 50th YEAR!** Send  
illustrated FREE catalog. No obligation,  
G.I. approved. No. 0197T

**NATIONAL SCHOOL OF MEAT CUTTING**  
Dept. 50-C, Toledo, Ohio 43604

**FIND BURIED TREASURE**

Powerful electronic detector finds buried  
gold, silver coins, etc. Write or call for  
free catalog. Dealer inquiries  
invited.



Financing Available 19.95  
Phone day-night (713) 682-2728 to

**RELCO, Dept. D-3 198.50**  
BOX 10839, HOUSTON, TEX. 77018

**FREE  
Color  
Catalog**

**Discount  
Prices**

**42  
Models**

**Accordion Corp. of America—Dept. R-113,**  
5535 W. Belmont Ave., Chicago, Ill. 60641

Send FREE accordion catalogs and discount prices.  
Include special information checked:

Accordion Amplifiers  Button Accordions

Name \_\_\_\_\_

Address \_\_\_\_\_

City \_\_\_\_\_

State \_\_\_\_\_

Zip \_\_\_\_\_



# 20 WOOD SAMPLES with woodworkers Catalog

ENJOY woodworking more! Let Constantine's big picture-packed Catalog-Manual help you build new furniture — refinish, restore beat-up cabinets, chairs, chests, tables, etc. Find instantly whatever you need. Buy at money-saving prices from world's largest catalog source for imported and domestic woods. Cabinet lumber, carving blocks, veneers, plywood, pipe briar, inlays and more!

Newest Catalog features new tools, materials, shop devices. Fabulous all-purpose clear finish. Glue that needs no clamps. Inlay picture kits, 99¢. Needed products found nowhere else. Plus wood-working instructions, plans, patterns!



**2,000**

PRODUCTS FOR SHOP & HOME  
Woods — Veneers — Finishes  
Furn. Hardware — Lamp Parts  
Cane — Upholstery — Tools  
Picture Molding — Clock Kits

**FREE WITH CATALOG**  
"101 PROJECT IDEAS"

Catalog & Wood Samples Only \$1

Dollar Fully Refunded on First Order  
Accept this offer to own fascinating set of 20 2x4 specimens of world's glamorous veneers — Rosewood, Satinwood, Lacewood, Teak, etc! Compare! Then instantly identify finest woods wherever you go. Send only \$1 for Wood Samples and Woodworkers Catalog. Dollar refunded on first order.

**CONSTANTINE**

2051 Eastchester Rd., Bronx, N.Y. 10461

Enclosed \$1 for Wood Samples & Woodworkers Catalog. (\$1 refunded)

96 GIANT PAGES

Catalog only 50¢



Name \_\_\_\_\_  
Address \_\_\_\_\_  
Zip \_\_\_\_\_

**RONSON**

**Multi-Fill**  
fuels most  
butane  
lighters



From  
49¢

The clean  
quality butane  
that won't clog.

**ORDER FROM THE  
ONE-STOP CLOCK SHOP**



Concord  
Grandmother  
Clock Kit  
(Walnut, Cherry)



School Clock Kit  
(Oak, Walnut,  
Cherry)



Double Steeple  
Clock Kit  
(Cherry,  
Walnut, Maple)

23 Fine Wood Kits & Finishes  
Full Size Patterns  
100 Different Clock Movements  
Selection of Hands  
50 Different Dials  
Brass Hardware  
Hardwood Moldings  
Barometers & Music Boxes

Send 25¢ for New  
100-page catalog

**CRAFT PRODUCTS**

Dept. 1, Elmhurst, Ill. 60126

## OUTDOOR GREETING CARD

(Continued from page 204)

cause is most likely insufficient tension. There is a happy medium and you will find it only by experimentation. Too much tension puts a strain on the motor. When tension is corrected, insert the second screw and fix the position of the idler bracket.

Cut and mount the posters next. Since the width of the combined picture area of the columns is 50 in., you'll need the posters cut into five 10-in. strips. The Drummer Boy Poster is a bit taller and wider than the others; trim off the excess white on the top and bottom so it, too, measures 42½ in. high. To get the 50-in. width, you'll be cutting off about an inch of the scene at each end. Clamp a metal straightedge and cut the strips continuously. Do not remove any paper between strips!

The posters can be mounted as per the manufacturer's instructions using plastic resin glue. Line up the strips along one edge of the column, then press to make contact, working gradually toward the other end. Work out any wrinkles or bubbles with a padded cloth as you go along.

To finish the project, you'll need a facing frame which can be made in one piece with lap joints. Glue and nail this into place leaving 2¼ in. of the base exposed at the bottom. A strip of hardboard with message spelled out (or cut from posters) can be inserted while the top is removed. Replace top, then add the hardboard back panels, one piece for the large area, a separate one across the top. These are screw-fastened. The base is also made as a separate unit and attached with screws. ★★★

## BELT SANDER BECOMES EDGE SANDER

(Continued from page 177)

gether; a single ⅜-in. capscrew is used to mount the attachment to the sander.

The attachment also lets your sander perform as a stationary edge sander. Here you simply bolt the casting to one end of your workbench in an upside-down position. The fence becomes a work table that can be adjusted up or down to sand edges from 90° to 45°. Here, too, you can switch the sander from a horizontal to vertical position.

Complete with belt sander, the attachment sells for \$174.95. If you already have a sander, you can buy the attachment alone for \$79.95 from C. B. Enterprises, 7701 Telegraph Road, St. Louis, Mo. 63129. ★★★



# POPULAR MECHANICS

## HOLIDAY

### SHOPPING GUIDE

**DETROIT APPROVED PICKUP TANKS**



Original equipment type poly, now available in auxiliary tanks for pickups. Increase gas capacity 40 gals. Far superior to metal, complete hidden, no body work necessary. Easy 1 hour installation—Truck discounts pay for tanks in a short time. Two tanks, brass valve, hose, complete. Meets Federal Regulations.

**PICKUP EQUIPMENT CO. LTD.**  
Dept. PM-1173, P.O. Box 7635  
WACO, TEXAS 76710  
CALL TOLL FREE 800-433-2386

**PERMANENT MATCH**

AMAZING INVENTION SELLS LIKE MAD!



Lights up to 15,000 times. Pull this ingenious metal winder out of its case, strike on side, and presto—it's lit. Amazes everyone who sees it. **MAKE BIG PROFITS.** Show to friends, fellow-workers, in stores, offices, taverns, factories. Sells on sight for \$1.00. Order at low wholesale prices ONLY \$5.90 per doz.; \$16.50 for 3 doz.; \$57.00 for 12 doz. (2 samples \$1.25). Catalog of 100 other fast sellers included free! Lakeside Company, Dept. PP-113, 6800 N. Campbell Ave., Chicago, Ill. 60645.

**SAVE GAS SCIENTIFICALLY**



NEW MILES PER GALLON METER MEASURES GAS MILEAGE AT ALL SPEEDS

Monitor gas mileage with Spacekom's new mpg meter, and you can reduce gas consumption, detect problems, and increase engine efficiency. The meter uses patented photo-electronic flow and speed sensors, and a miniature computer for instantaneous mpg readout on a 2 3/4-inch meter. Quick and simple to install, it fits all U.S. and most foreign cars and trucks.

Order a meter and examine it 14 days. Money refunded if not satisfied. \$34.50 postpaid. (California residents add sales tax.)



P.O. Box 10/Dept. PM  
Goleta, California 93017  
Phone: (805) 967-7114

**SAVE 40%**

CAR MODELS, TRAINS, ROAD RACE SETS

\$2.25 models \$1.35; \$118 train set \$70.91; \$40 road race set \$24; \$22 Cox gas-powered buggy \$13. Send \$1 for membership catalog.

Hundreds of Other Models

DISCOUNT CLUB, Box 697P, Bethany, IL 61914

**EXTRA MONEY**

\$30 to \$50 A DAY



Operate a community sharpening service with an investment of \$150. Work from your basement or garage. Our manual guides you in professional methods of grinding, of business promotion and in pricing your work.

- Hand Saws • Circular Saws • Knives • Chain Saws
- Scissors • Pinking Shears • Clipper Blades
- Planer and Dado Blades • Mower Blades

John Rodock says: "Thanks for shipping Model 331. It has paid for itself many times since I purchased it. Please send latest price list on grinding wheels."

**TREYCO** P.O. Box 216-A  
North Tonawanda, N.Y. 14120

**START NOW...WRITE TODAY**

**WATER WATER WATER WATER WATER**

"HOW TO DRILL YOUR OWN WATER WELL"

**\$1.00 ppd**

SATISFACTION GUARANTEED

DEEPROCK CO.  
OPELIKA, ALA. 36801

**FACTORY CLOSEOUT!**

**AIR PISTOL \$6.95**  
(with Free can of pellets) 6 ppd.

Shoots both pellets and darts. This fine, well made .177 cal. German air pistol is just the ticket for target or Varmints. Accurate. No CO2 cartridges to replace, either. Once in a lifetime bargain. Order several. Supply limited. Only \$6.95 ppd. (Secret leather holster, \$2.95 ppd.) 600 Deluxe Pellets, \$2.40 ppd. 20 Steel Darts, \$2.00 ppd.



**AIR PISTOL, Dept. PM-11**  
4535 Huntington Dr. South  
Los Angeles, Calif. 90032

**GRANDFATHER CLOCKS**

SAVE 50% BUILD YOUR OWN FROM OUR SEMI-ASSEMBLED CASE KITS



We are the ONLY producer of COMPLETELY HAND-CRAFTED semi-assembled clock kits! Major assemblies carefully fitted and joined by experienced cabinet-makers. (No power tools required.)

- Highest quality imported German movements
- Tubular or rod chimes
- Moving moon dials
- Kits for wall & mantel clocks available
- Templates & case plans

Send 50c for complete catalog

**H. DeCOVNICK & SON,**  
P.O. Box 68, Dept. M113  
Alamo, Calif. 94507



**BELSAW** PLANER • MOLDER • SAW



**30-DAY FREE Trial!**

Now you can use this ONE power-feed shop to turn rough lumber into moldings, trim, flooring, furniture... ALL popular patterns. RIP... PLANE... MOLD—separately or all at once with a single motor. Free 30-Day Trial. Low Cost—only \$35 down.  
Send Postcard Today—No Salesman Will Call  
**BELSAW POWER TOOLS 904V Field Bldg., Kansas City, Mo. 64111**

**MOTOR HOMES**

(Continued from page 113)

range. The refrigerator is all-electric a.c./d.c. There is a 25x25-inch closet and three good-size wardrobe drawers. The molded fiberglass bath is 37 x 44 inches with a 42-inch vanity sink. The rear bedroom which converts to a dinette, has a 6-foot 6-inch bed, which is 48 inches wide (6 inches shy of standard double width.)

The GMC Motorhome comes in 23 and 26-foot models, six exterior colors, 15 different floor plans and a choice of four interior decors.

The base price for the 23-foot model is \$13,545; \$14,545 for the 26-footer. There is a long list of options, (most of which are "standard" on the FMC) but according to GMC "a very well-equipped" 26-footer costs about \$19,000.

We didn't have the GMC long enough to test it in anything but moderate crosswinds, but established that it doesn't shudder or wander when blasted by passing trucks and buses.

Averaging 50 mph on a windless day, but with the airconditioner running constantly we showed gas consumption of 10 mpg—by no means a bad showing since we had been accelerating freely on a number of steep grades without giving a thought to economizing on fuel.

Six-wheel braking—discs on the front, drums on the rear—makes this a sure-footed rig. The 455 engine makes it nimble and quick; the low center of gravity and suspension makes it stable—all in all, a delight to drive for hours at a time.

We found that the GMC has excessive rear overhang (technically, an acute angle of departure) that will cause a lot of scraping on parking-lot ramps and driveway entrances. The lowest point is the exhaust pipe of the motor generator; a lot of these will be dinged.

The bath lacks a skylight and is vented by a single fan. It may give some people a sauna, others claustrophobia.

Standard-size people will not be completely happy with the 48-inch-wide double bed.

But the shortcomings of both the FMC and GMC are few and easily corrected. Both have set new standards of performance and safety for the industry. It is to be hoped that both will soon produce smaller, lower-priced models that maintain these standards. ★ ★ ★

**• Muzzle Loading KITS •**



Complete with all parts needed to make a handsome, fully shootable Kentucky Rifle. .44 cal. precision rifled octagonal barrel, front and rear sights. Stock is fully rifled and Semi-inletted. All holes drilled and

tapped. Illustrated instructions. Available in Percussion and Flintlock Models. Model KA705, Percussion (pictured) \$57.45 + \$2 Shipping.

Complete Kentucky Pistol Kits available from \$19.95 (Percussion) plus postage.

**CONNECTICUT VALLEY ARMS, INC.**  
Dept. PM  
Higganum, Conn. 06441  
Enclosed is a self-addressed, stamped envelope. Please send FREE Brochure on CVA Muzzle Loading Kits.

Name .....  
Address .....  
City ..... State ..... Zip .....



**CONNECTICUT VALLEY ARMS, INC.**

**REAL ESTATE**  
*BE A BROKER*

**PAYS BIG! SEND FOR BIG FREE CATALOG NOW!** Graduates report making substantial incomes. Operate your own business quickly. Men, Women, all ages, learn easily. Course covers Sales, Appraising, Loans, Mortgages, & related subjects. **STUDY AT HOME** or in classrooms in leading cities. **Diploma Awarded. Write Today for FREE Book!**



Accredited Member National Home Study Council. Approved Veteran Training.  
**WEAVER SCHOOL OF REAL ESTATE**  
3521-K7 Broadway (EST. 1936) Kansas City, Mo. 64111

**At Last a New Amazingly Simple**  
**GAS TURBINE**  
**JET ENGINE**



Build from easy to follow plans. Length 15", Dia. 8 1/2", Wt. 15 lbs. Fuel: Gasoline or Kero.  
"Screamin Demon" develops 20 H.P. Ideal project for serious-minded hobbyists, students, scientific and industrial arts classes. Make on 9" metal cutting lathe with milling attachment. For use on small racing boats, midget cars, etc. Full size assembly drawings with critical dimensions, bill of materials and photos. Price \$5.00. No C.O.D.  
**SAVOY SCIENTIFIC, BOX 1398, SANTA MONICA, CALIF. 90406**

**BLAST FURNACE—FOUNDRYETTE 2400 F**



Since 1935  
Hobbyists • Schools • Inventors, etc.  
Make your own castings of any metal from cast iron, down to lead and zinc. Available in 6 sizes, 1 1/2 to 50 lbs. Complete units from \$50.40 to \$162. Send 25c for circular—refundable.

**KANSAS CITY SPECIALTIES CO.** Dept. P-11  
P.O. Box 193  
Middleton, Wis. 53562



## FOUR-CHANNEL HEADPHONES

(Continued from page 153)

speakers are mounted facing each other instead of aimed directly at the ear; and Fixler has included some electronic circuitry which produces a definite four-channel effect, including the location of instruments behind the listener. In fact, in a listening comparison between the Fixler phones and a good four-channel speaker setup, we found the placement of instruments virtually identical—well outside that narrow band inside one's head. The sensation was exactly that of listening to a good four-channel speaker array.

Fixler has no plans to manufacture the phones himself. Instead, he's been talking to most of the major headphone manufacturers about licensing them to produce their own models using his patents. One of the first to accept is Teledyne, whose product shortly will be available from Olson Electronics for about what you'd expect to pay for any other four-channel phones.

Are the four-channel phones worthwhile? Before laying down your hard-earned cash we'd suggest you try a listening test or two of your own. Find a dealer who's able to demonstrate the phones both with matrixed four-channel (Columbia or Vanguard SQ, or QS discs from Project 3, Command, Dunhill, Impulse and other labels) and CD-4 (RCA and Warner-Elektra-Atlantic). Pick a type of music with which you're familiar, if possible, and make sure that the CD-4 and matrix discs are of the same type. (For example, don't compare classical music on CD-4 with matrixed rock.) Don the headphones and listen. If there's a two-channel/four-channel switch, flip it once or twice to compare.

Can you locate the various instruments? Is there more spaciousness and life in four-channel than when the same music is heard in two-channel? How wide and how deep does the quadrasonic stage seem to be? Is the bass clean and natural, and is there plenty of it? Are the midrange and high frequencies clean and crisp? Finally, how does the headphone experience seem to compare with listening to the same music through four loudspeakers in the dealer's listening room?

Whether it's to your taste, or whether you demand something "more natural" or "less theatrical" is for you to decide. But listen first, and listen carefully. ★★★

**GOVT. SURPLUS**  
and other bargains  
**SAVE to 90%**



Send for this catalog

The world-famous Airborne Catalog. Fully illustrated. Contains 1000's of bargains in hydraulics, electrical, marine, automotive & hardware items... and more! A must for mechanics & machinists, hobbyists, sportsmen, inventors, etc. Send 35¢ to cover postage & handling. In a hurry? Send \$1 for airmail delivery. Must include zip.

**AIRBORNE SALES CO.** Dept. PM73  
8501 Steller Dr., Box 2727, Culver City, Ca. 90230  
Satisfying world-wide customers since 1945

## Are you missing half the joy of your guitar?

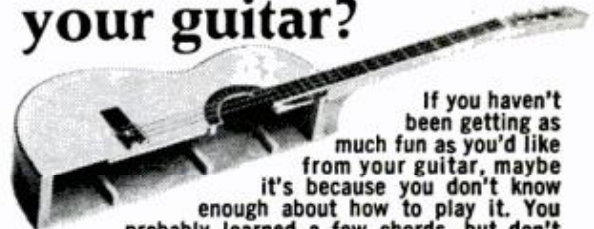

If you haven't been getting as much fun as you'd like from your guitar, maybe it's because you don't know enough about how to play it. You probably learned a few chords, but don't know how to go further. If so, let us help you. We'll teach you to read music and play pick style with both notes and chords—the way a teacher would. The difference is we teach with lessons by mail, and it costs a lot less. Courses in other instruments too—piano, spinet organ, accordion, violin, saxophone. If 17 or over, write for free booklet with more details. Send your name, address, zip code and list instrument you want to learn. Write U.S. School of Music, Studio 23-610, 417 South Dearborn Street, Chicago, Illinois 60605. ACCREDITED MEMBER NATIONAL HOME STUDY COUNCIL © 1973 U.S. SCHOOL OF MUSIC 444

## inventors if you have a better idea...

for a new product, or a way to improve an old product, contact us — "the idea people".

We will develop your idea, introduce it to industry, negotiate for a cash sale or royalty licensing!

Send for our **FREE "Inventor's Information Kit"**. It has a special "Invention Record" form, an important brochure: "Inventions—Their Development, Protection & Marketing", and a Directory: "500 Corporations Seeking New Products". (It also tells you why we're known as "the idea people".)



**RAYMOND LEE ORGANIZATION**

230 Park Ave., New York, N. Y. 10017  
(212) 686-8500

Yes, I'd like to find out how to take action on my idea. Please send me your **FREE "Inventor's Kit" A-12**

Name (Please Print)

Address

City State Zip  
NEW YORK BOSTON CHICAGO GENEVA SAN FRANCISCO TORONTO  
MONTREAL LOS ANGELES VANCOUVER DALLAS KANSAS CITY



## SAVE! BUILD YOUR OWN POWER TOOLS



### METAL PARTS KITS AT FACTORY DISCOUNT PRICES

- 10-in. TILT/ARBOR SAW
- 6-in. BELT SANDER
- SPINDLE SHAPER
- 9-in. TILT/TABLE SAW
- 18-in. BANDSAW
- 12-in. BANDSAW
- COMB. DRILL PRESS-LATHE

SAVE \$50 OR MORE

PLANS, with FULL-SIZE PATTERNS \$200 per Plan Deductible



Kits from \$19.99 to \$51.99  
Featured in Popular Science, Mechanix Illustrated. Sold for 27 years. Thousands in use. Satisfaction guaranteed. Send \$2 each for Plans (state tools wanted), Catalog included. Or send 25¢ for Catalog!

GILLIOM MFG. CO.

Dept. PMT-11 St. Charles, Mo. 63301

DIGITAL: THEORY, DESIGN, CONSTRUCTION

## LOGIC NEWSLETTER

SAMPLE COPY \$1.00  
LOGIC NEWSLETTER  
POB 252  
WALDWICK, N.J. 07463



### Build This All-Wooden Clock

Complete plans for building this unique clock. 100% wood. All moving parts visible. No special tools required. Separate

hour, minute, and second hands, weight driven, keeps perfect time. May be mounted in large grandfather case or displayed on pedestal or shelf. A simple project for the woodwork hobbyist or clock enthusiast. Plans only, \$4.00 plus 50¢ handling. R. D. Thomas, 1412 Drumcliffe Rd., Winston Salem, N. C. 27103

## make your own Solid-State

# CLOCK

It's easy with the Isotron 100 battery clock movement kit we'll send you.



Make your own cordless clock from a picture, model, needle-

point, planter or make a built-in clock behind paneling, wallboard or plastic. Just use your imagination and the complete General Time clockmaker kit we'll send. Includes precision solid state Isotron 100 jeweled movement made in the U.S.A. complete with 2 sets of decorative hands, and easy-to-follow instructions. No special tools needed. Make clocks for your own use, for unique gifts, for fund raising, or to sell at a big profit. Send only \$9.50 ea., 4 for \$36, plus \$1 shipping cost. It's FUN! Get started now—ORDER TODAY.



**GENERAL TIME SERVICE**  
A TALLEY INDUSTRIES COMPANY  
(Send check or m.o. to Dept. PM-11, nearest service center. Include local tax, where applicable.)  
AKRON 25 Ghent Rd., Ohio 44313  
CHICAGO 206 N. Michigan, Ill. 60601  
DALLAS 400 S. Ervay St., Tex. 75201  
LOS ANGELES 5404 Wilshire Blvd., Cal. 90036  
NEW YORK 150 E. 47th St. N.Y. 10017  
PHILADELPHIA 1214 Walnut St., Pa. 19107  
PHOENIX 2047 E. Camelback Rd., Ariz. 85016  
SAN FRANCISCO 540 Mission St., Cal. 94105

## KARATE

JUDO • SAVATE • JIU-JITSU  
The Greatest Self-Defense System Known to Man! FREE Brochure reveals Self-Defense Techniques. Send to: Universal, Dept. M Box 39303, Detroit, Mich. 48239 **FREE**

### WE DARE TO MAKE THIS SHOCKING OFFER!

4 HEAVY DUTY SHOCK ABSORBERS \$36.00  
Lifetime Guarantee

Make check or money order payable to Bristol Auto Parts. No C.O.D.'s. Send order to Special Mail Order Offer, Bristol Auto Parts, 21 North St., Bristol, Conn. 06010. Include make of car, model, year, No Cyl. & Eng. size. Catalog on other Discount Auto Parts available for \$1.00.

## 100 SHOE STYLES FOR WIDE FEET and HIGH INSTEPS

EE to EEEEE Only  
Sizes 5 to 13

Men only. Casual, dress, work shoes that really fit. Top quality, popular prices. Money-back guarantee.

Write Today for FREE CATALOG

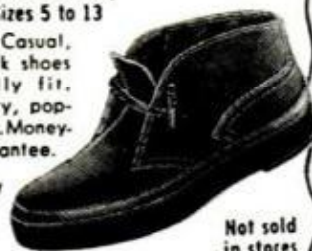

Not sold in stores

HITCHCOCK SHOES, INC.  
Hingham 28-H, Mass. 02043



### FREE!!! POWERFUL MUSCLES FAST!

Fantastic New Discoveries in the science of bodybuilding. Now, in the privacy of your bedroom, our method will add inches of powerful muscles to arms, chest, shoulders & legs. Learn secrets on trimming the waist with ultra-modern methods—fast! Results Guaranteed! Send for free brochure. Universal Bodybuilding, Box 485-M1, Dearborn, Mich. 48121.

## "NU-THRED" FILES

\$3.50 ea. ppd.

No. 1 for 11, 12, 13, 14, 16, 18, 20 and 24 T.P.I.  
No. 2 for 9, 10, 12, 16, 20, 27, 28 and 32 T.P.I.

This is the original 8 in 1 rethreader tool. Renews damaged, right or left-hand threads of any diameter fast!

No. 8 Metric \$4 ppd.

Satisfaction Guaranteed  
Order now! Get Both for \$6.50 Ppd.

JAW MFG. CO. Box 213, Reading, Pa. 19603



### Easy to Build PLANS AND INSTRUCTIONS for

- Go Kart .....\$2.00
- Mini Bike .....\$2.00
- Three Wheeler ....\$2.00
- Three Wheeler A.T.V. \$5.00
- Mini Car .....\$3.00
- Pedal Boat .....\$4.00
- 12' Sail Boat .....\$4.00
- Sail Board .....\$2.00
- Pontoon Boat .....\$1.00
- 8' Hydroplane .....\$2.00
- Two People Mini Jeep .....\$3.00
- Snowmobile Sleigh .....\$3.00

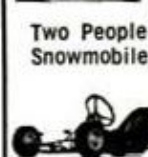

### MINI VEHICLES PLANS

"DEPT. C"—P.O. Box 92  
Chazy, N.Y. 12921

## BIG PROFITS ELECTRONIC ASSEMBLY BUSINESS

Start home, spare time. Investment, knowledge or experience unnecessary. BIG DEMAND assembling electronic devices. Sales handled by professionals. Unusual business opportunity.

FREE: Complete illustrated literature  
BARTA, Box 248HY  
Walnut Creek, Calif. 94597

## PLASTIC CUTTER

CUT SHEET PLASTIC, MICA, TILE, EASILY

AMAZING NEW TOOL

Save hundreds of dollars remodeling kitchen cabinets, ceilings, floors, etc. with this new cutter  
ORDER NOW AND INSTRUCTIONS ON CUTTING WILL BE INCLUDED  
Satis. Guar. No C.O.D.'s  
Add 50¢ Handl. & Post.  
Dealership Inq. invited Only

\$4.98

TOLCO 930 N.W. 27th AVE.  
MIAMI, FL.



IMPORTED  
**LOCK BLADE KNIFE**

ONLY \$275 each

9" Overall Length  
5" When Closed

- Sharp and Tough
- Stainless Steel Blade



Locks into position to prevent accidental closing. Razor sharp tough stainless steel blade for reliable use and hard, long service. Money back in 5 days if not satisfied. Send \$2.75 plus 25¢ to cover postage and handling.

**WESTBURY SALES CO.**  
P.O. Box 434, Westbury, N.Y. 11590  
Dept. L-22-PM

**FIX CLOCKS, WATCHES**

FOR FUN & PROFIT! Fascinating new Handbook by master craftsman H. Harris gives you the knowledge skilled watchmakers learn.

OVER 200 ILLUSTRATIONS show how to install hands, dials, crystals, main-springs, stems—re-house old movements in modern cases—clean timepieces, etc.

INSTRUCTIONS COVER every popular watch and clock, chimes, grandfather, cuckoo, everyday alarm and electric clocks. Handbook tells you where to buy parts . . . where to send "overflow" work for repairs at wholesale prices as business expands!

Friends gladly pay \$5 to \$50 for restoring cherished timepieces. Try the HANDBOOK OF WATCH AND CLOCK REPAIRS. Rush only \$5.95, plus 30¢ handling, on 10-day money-back guarantee. EMERSON BOOKS, Inc., Dept. 48A, Buchanan, N.Y. 10511

**CHIPPED WINDSHIELD?**

Here's a complete kit to fix those stone "chips" on cars and trucks. Looks like new. Save \$5 for new windshield. Includes tools, chemical, complete instructions. Used by fleet owners and car dealers, now available to you. Satisfaction guaranteed or money back. Send check or M.O. for **BULLSEYE GLASS CO., INC.** 4275 South 27th St., Greenfield, Wisc. 53221 **495** ppd.

**CONVERT TO JET POWER**

NEW BREAKTHRU IN SMALL JET-ENGINE DESIGN! POWER YOUR GLIDER, SMALL PLANE, HELICOPTER, HANG-GLIDER, HOVERCRAFT, ICE SLED, BOAT, & GO-KART.



REVOLUTIONARY NEW JET: ALL WHO SEE IT MARVEL AT ITS POWER, SIMPLICITY, PUSH-BUTTON STARTING, FINGER-TIP CONTROL, 100% THROTTLEABLE, SAFE, RELIABLE, ECOLOGICALLY CLEAN EXHAUST, NO SMOKE, NO VISIBLE FLAME, 15 & 75 LB. THURSTS, WT. - 5-12 LBS.

DO-IT-YOURSELF JET ENGINE CONSTRUCTION PLANS, KITS, AND ASSEMBLED JETS. FREE \$3 DISCOUNT COUPON ON PLANS

SEND \$5 #1. BOOK ON G8-2 JET USES. #2. TECHNICAL HANDBOOK WITH PHOTOS, GRAPHS, POWER CURVES, DIAGRAMS, COMPARISON TO OTHER JETS, SMALL HELICOPTER LIFT CURVE AND GUIDE TO POWER, BROCHURES & CATALOG LIST.

SEND \$1 #3. 8X10 PHOTO OF G8-2-15 JET ENGINE, BROCHURES & CATALOGUE LIST

\$12.00 G8-2-15 JET ENG. CONSTRUCTION PLANS

**EMG ENGINEERING CO.**  
18518-N 50 BROADWAY, GARDENA, CAL. 90248

POPULAR MECHANICS PM-BEE! Plan for a radio-controlled model that flies on CO<sub>2</sub>. Fuel is nonflammable and odorless. Sophisticated and simple to build! To obtain full-scale pattern from which you can trace off the parts directly, send \$3.49 to POPULAR MECHANICS Dept. FA, Box 1014 Radio City, New York, N.Y. 10019.

**NEW!**

Thumb Control 8-Inch Open End Wrench \$795 Plus 32c Tax For Mo. Residents

- Faster, more accurate
- Exceeds federal specifications
- Drop-forged steel-chrome vanadium
- Automatically self-locking

Now, an open end adjustable wrench that anyone can use with ease. New thumb control works smoother and faster with more accuracy than conventional adjustable open end wrenches.

ORDER YOUR NEW WRENCH N-O-W!

**Guarantee**  
Manufacture guaranteed from shipment of any QUALICRAFT tool returned because of tool failure during normal use and service.

**Helix International Inc.**  
P. O. Box 424  
Neosho, Mo. 64850

Distributors Wanted!

**SECRETS!**

GODHAM HUNTER

Trapping secrets, that is! Lots of 'em! . . . They're in that fascinating, unusual book—the HAVAHART Trapping Guide. All about animals and things animals do. It tells how to trap 'em humanely, too . . . Price list for traps, cages 'n everything is included . . . This great book is FREE and we'd like you to get your copy at once. Write for it today. Address—

**HAVAHART, 136-N Water St., Ossining, N.Y. 10562**

Please send free trapping guide and price list.

Name \_\_\_\_\_

Address \_\_\_\_\_

City \_\_\_\_\_ State \_\_\_\_\_ Zip \_\_\_\_\_

**SILVO**  
(BRAND NAME) TOOL CATALOG

Thousands of exciting tool values!

Stanley, Skil, Thor, Wen, Distan, Wiss, Wellsw, Dremel, Plumb, Huot, Kennedy, Channellock, Rockwell, Holois, Vise-Grip, Crescent, Rigid, Pony Clamps, Unimat, Foredom and many other Nationally Advertised brands of Tools & Supplies. We ship Coast to Coast at prices Hard to Beat. Send \$1.00 for our big 196 page tool catalog today.

**Silvo Hardware Co., PM-73**  
107 Walnut St., Philadelphia, Pa. 19106

**KEEP WARM**

WITH PAULIN'S 8,000 B.T.U. INFRA-RED HEATER

Hottest heater anywhere, for its size. Instant heat • No waiting. Easy to operate and light. Operates up to 6 hrs. on 14 oz. cylinder

Stands upright or hangs on wall. Guaranteed 3 yrs.

Comes complete with wall bracket, 14 oz. cylinder and stand.

Order by mail, postpaid \$21.95 dept. PM

MODEL 690100 **PAULIN**

30520 Lakeland Bl., Willowick, O. 44094

**HEARING AIDS**

UP TO **50% OFF** COMPARABLE AIDS

BUY DIRECT • 20 DAYS FREE TRIAL Body Aids \$49.95 up. Tiny All-in-the-Ear: Behind-the-Ear; Eye Glass Aids. No salesman will call. Write **LLOYDS** \* Dept. PM, 905 9th St., Rockford, Ill. 61108 \*

**110 Volt A.C. GENERATORS**

60 cycles. Fanbelt driven from car or gas engine. Operates T.V., refrigerators, radios, all power tools, projectors, P.A. systems and fluorescent lights. Over 12,000 in service. Guaranteed six months. 1500-watt \$63.00 postpaid. 3000-watt \$105.50 postpaid. Special X-1000 watt self-excited generator \$85.00 postpaid.

**TOOL POWER™ patent pending**

115 volts D.C. 5000-watts. 50 amps from your car's alternator. **Guaranteed 20 years.** Install in ten minutes. Operates all power tools, electric motors up to 2 h.p. Arc welding, fast battery charging. Any like device by any name is an infringement of our patent pending. All copiers are notified. Be safe, buy from the inventor and developer. \$25.00 postpaid. Attractive dealer plan.

**VIRDEN PERMA-BILT CO.,**  
P.O. Box 7160PM  
2821 Mays, Amarillo, Texas 79109

**PORTABLE ELECTRIC POWER**

BUILD-UR-OWN 110-volt plant from used parts and our PLANS. Also PLANS AVAILABLE for ALT-POWER. 110 volt power on your car, single TWIN JET outboard motor for small boats and LIL BASS BOAT. Send \$2 for complete INFO PACKET on all plans (refundable). **ELECTRIC POWER PLANT** (shown) Plans \$5 ppd. B-UR-O Co. 34161-B Coast Hwy. Dept. PY, Dana Point, Calif. 92629

**Want to make some easy money?**

Let us show you how to begin AT ONCE...full or spare time. Many report \$10 to \$50 PROFIT FIRST HOUR! Nothing to buy...no salesman will call. EVERYTHING NEEDED SENT FREE including BEAUTIFUL SAMPLE!

Write: **Russell Products Co.**  
DEPT. K25. COLUMBIA, TENN. 38401

**FREE**



**IT'S EASY TO INSTALL YOUR OWN VINYL TOP.** Kit comes in white, black, brown, green or blue factory type vinyl. Vinyl, glue, moldings and complete instructions supplied. We show you how, takes only a few hours for a "new look". Complete \$24.95 ppd. Send check or M.O. to **UNITOP DISTRIBUTORS, INC.** 339 East Stewart, Milwaukee, Wisc. 53207

**HOBBYIST VIEWER**



See your hobby or work magnified bigger than life with the new Doublex Viewer. Eliminate work and eyestrain. Free standing and only 3 1/2" high. Used by Artists, Numismatists, Engravers, Philatelists, Photographers and many others. \$1.95 postpaid. 3 for \$4.95!

UNUSUAL DEVICES Box 1348, Lawrence, Mass.

**BEST LEARN-IT-YOURSELF BOOKS**

- Everyman's Guide to Auto Maintenance. 192p. \$7.95
- The Complete Mini Bike Handbook. 320 pps. \$8.95
- Electrical Wiring & Lighting-Home & Office \$7.95
- Basic Electricity & Beginning Electronics. \$7.95
- Profes. Picture Framing for Amateurs. 224pp. \$5.95
- How to Repair Small Gas Engines. 288 pps. \$8.95
- Small Appliance Repair Guide. 224pp. \$7.95
- Using Electronic Testers for Auto Tuneup. 254p. \$7.95
- Electric Motor Test & Repair. 140pp. \$6.95
- Major Appliance Repair Guide. 288pp. \$8.95
- Cassette Tape Recorders / Care & Repair \$7.95
- 4-Channel Stereo. From Source to Sound. 174p. \$6.95
- How to Repair Home & Auto Air Conditioners \$7.95
- Introduction to Medical Electronics. 272p. \$9.95
- Landsailing From RC Models to the Big Ones. \$7.95
- How to Become a Radio Disc Jockey. 254pp. \$7.95
- Basic Radio Course. 224 pages. \$8.95
- 64 Hobby Projects for Home & Car. 192pp. \$6.95
- Refrigeration. 160 pps. 53 illus. \$7.95
- Beginner's Guide to TV Repair. 174pp. \$6.95
- How to Read Electronic Circuit Diags. 192pp. \$7.95
- Understanding & Using the VOM & EVM. 192 p. \$7.95
- Marine Electronics Handbook. 192pp. \$7.95
- Fire & Theft Security Systems. 174 pps. \$7.95

SEND NO MONEY! We'll invoice you on 10-DAY FREE TRIAL. Clip entire ad to order. 100 percent guaranteed—used by hundreds of thousands to learn. Same day shipment. **TAB BOOKS, Dept. PM-113 Blue Ridge Summit, Pa. 17214**

**WINDWATCH™ ANEMOMETER—WIND VANE \$22.95**



Neon lights in indoor indicator show wind speed and direction. Decorative indicator with gold dial in dark mahogany case. Designed for desk or wall mount. Outdoor instruments of durable aluminum with electrical parts enclosed in rigid vinyl housings. Easy to assemble and install. Attach directly to roof or pole. Comes with wire and materials for installation up to 60 feet. Uses regular 120V AC. Unique low amp circuit assures absolute safety. A fascinating addition to any home. Five years guarantee. 15 day trial. Satisfaction or money back. Only \$22.95 postpaid.

**WINDWATCH** Dept. F 1104 Heimann San Antonio, Texas 78205

**NEW SUPER TRYKE**

KIT PRICE \$369.95



YEAR ROUND FUN

**HEALD'S NEW "SUPER TRYKE"** Has full suspension front and rear, large 21" dia. x 12" wide ATV tires and 8 H.P. 306 cc, Tecumseh Engine. Torque Converter drives differential rear axle through #40 chain. Options include electric start, front ski, lights, roll bar, spark arrester muffler. Tryke comes in easy-to-build semi-kit form. Base kit price \$369.95. Ideal for farm or recreational use on snow, sand or trails.

FOR MORE INFORMATION WRITE **HEALD INC., Dept. PM-11, P.O. Box 1148, Benton Harbor, Michigan 49022**

**FREE CATALOG**

**"LISTEN IN" TO POLICE-FIRE RADIO CALLS IN YOUR CAR!**

WORKS with ANY CAR—Portable or HOME RADIO! Just PLUGS in—No wiring—3 minute hookup! Switch instantly from regular to ALL POLICE - FIRE - EMERGENCY - COMMERCIAL - TAXICAB-STATE-CITY-GOV'T 2 way Radio calls in YOUR AREA. DUAL-HI-LOW BANDS TUNES 36-49 & 150-175 MHS. USE Everywhere—anytime—always works.



SEND ONLY \$2.00 (cash, Ck., M.O.) and pay postman \$9.99 plus COD post of send \$11.99 for ppd Del in USA. COMPLETE, ready to use with instructions. One Year service Warranty—10 DAY MONEY BACK TRIAL (if rtdn). Sold Only—DIRECT FROM FACTORY at this Low Price! **WESTERN RADIO BPM-11 KEARNEY, NEBR. 68847**

**OUT NOW—1974 edition of POPULAR MECHANIC'S CAR REPAIR ANNUAL.** The big bonus in this edition is the 92 page Car Care Guide that leads you step by step through the basics of car repair. A thorough discussion of all the maintenance jobs you can do yourself. This manual is a dollar saving guide for all mechanics. Buy it from your local newsstand dealer or send \$1.00 plus 15¢ for postage to, **Popular Mechanics, Dept. FA, Box 1014 Radio City, New York, N.Y. 10019.**

**Own Your Own SPARKPLUG CLEANER**

**TURBO BLAST CLEANER INCREASES PLUG LIFE UP TO 50,000 MILES**  
**CLEANS ALL TYPES OF PLUGS IN SECONDS**  
**REQUIRES NO COMPRESSED AIR**  
**POWERED BY RUGGED 12000 RPM 110 V MOTOR**  
**DESIGNED FOR LONG LIFE WITHOUT MAINTENANCE**  
**SUPPLY OF ABRASIVE FOR CLEANING 250 PLUGS**

**19.95**  
ppd



**JAYCRAFT CORP., DPT. 11 \$19.95 PPD.**  
760 North Marshall Ave.  
El Cajon, CA. 92020

Name \_\_\_\_\_  
 Address \_\_\_\_\_  
 City \_\_\_\_\_  
 State \_\_\_\_\_ ZIP \_\_\_\_\_

California Residents Add State Sales Tax

**SATISFACTION GUARANTEED**  
**OR YOUR MONEY BACK WITHIN 30 DAYS**



# CLASSIFIED ADVERTISEMENTS

Rate: \$2.20 per word payable in advance each insertion. Capitalized words—75¢ per word additional. Minimum insertion ten words. To be inserted under the proper classification, copy must be in our office by the 10th of the second month preceding date of issue. The next available issue to place an advertisement in America's No. 1 Classified Section is January. The closing date is November 10th. Send remittance and order to H. E. Kappel, Popular Mechanics, 224 West 57th Street, New York, New York 10019. Please make remittance payable to Popular Mechanics.

POPULAR MECHANICS

WHEN ANSWERING ADVERTISEMENTS PLEASE USE THE ZIP CODE NUMBER

## CHRISTMAS GIFT SHOPPING

**KITES!** Quality Action Styles! Brochure 10¢. Hutchinson, PM11, 83, Tremont, Barre, Vermont 05641

**DISTINCTIVE** Gift Ideas. Catalog 25¢. Gifts 'n Gadgets. (1A11), Box 312, Carrollton, Texas 75006.

**ANCIENT** Roman Chess Sets & Beginners to Strategic Chess Books. Ideal for Gifts. Other Style Sets Available. Free info. Write: Hinsdale House, Dept. AT, 9117 Hasty Ave., Downey, California 90240.

**USEFUL** Gifts! Reasonable! Illustrated Catalogue 25¢. S&E Sales Co., Box 48PM, Brooklyn, N.Y. 11226.

**FREE** Gift Catalog—Order yours Now for Xmas Shopping. Rush Postcard to Clinton A. Archer, P.O. Box 115, Orleans, Indiana 47452

**FREE** Gift Catalog. Attractive Gifts for all seasons. Mark Anthony's. 3841 Hammel, Los Angeles, California 90063.

**GIFTIME CATALOG!** Featuring Corningware, 17 Jewel Watches as Bonus Gifts. Remit 50¢, Refunded first Order. Smart Mart, 152 West 42nd, New York City, 10036.

**UNUSUAL** Christmas Gifts. Free Catalog. Eastern Summit, Florida, Mass. 01247.

**UNIQUE** Exciting Gift Ideas 10¢. Zodiac, Box 2006, LaMesa, Calif. 92041.

**BOOZE** Bags! Ideal for Quart Bottle Gifts. Beautiful Holiday Patterns. Strong! Practical! Convenient! Eliminates tiresome Wrapping. Set of Four \$1.89. LAVOR House Products, Suite 2B, 148 West 67th, New York, New York 10023.

## AUTOMOBILES

**CAPACITIVE DISCHARGE IGNITIONS. DISCOUNTED.** Rodgers, Son (PM), Box 3583, Anaheim, Calif. 92803.

**AUTOMOBILE SIXTY SECOND TIRE FIX.** No Tools—No Jack-Dealers Invited. Sample. And Details, ppd. \$3.98—Warne, 6922 Congress, Detroit 48207.

**VOLKSWAGEN** Parts Mail Order at Discount Prices. Send 35¢ for Catalog. Masonville Garage, Box 57PM, Masonville, Iowa 50654.

**OUTWIT VASCAR** Speedtraps. Booklet \$1.00. Box 6537A, Station "B", Evansville, Indiana 47712.

**"WARNING . . . Protected by Electronic Burglar Alarm" DECALS** 35¢ Each, 4/\$1.00. Protect your Car, Boat, Cycle, Office, Apartment, Home, etc. from would-be Thieves. Authentic—used by Actual Security Firms. Dramatic Shield Design with Three Bold Colors, full 2½" X 3". Stick Anywhere, from Front or Back. Full Money-Back Guarantee. Order Now. Benci, Dept. 1A, 42 McKee, Floral Park, New York 11001.

**FREE** Cataloge. Auto Book Service, P.O. Box 12091, San Diego, California 92112.

**ELECTRONIC** Ignition. Do Yourself; Instructions. \$39.95 PPD. Guaranteed. Write Tatra, Bedminster, New Jersey 07921.

**RING-VALVE** Job While Driving, \$6.00 Postpaid (Two-\$11.50)—Established 1951—Guaranteed Results—Motaloy, Box 6615, St. Louis, Missouri 63125.

**WANTED** To Buy: Old Automotive Literature, 1900-1955. David Ficken, Box 11, Babylon, New York 11702.

**AUTOBOOKS CATALOG CONTAINS OVER 1000 BOOKS.** Covering Repairs, Tuning and Maintenance for Foreign and American Cars and Motorcycles plus Racing and Design. Also Back Issues Motoring Magazines. Send 25¢ To: **AUTOBOOKS**, 2900 Magnolia, Burbank, California 91505.

## MIDGET CARS

**YOUR AD IN POPULAR MECHANICS WILL BE SEEN** By More than 5,000,000 active buyers for your products and services. It costs only \$2.20 per word. And, if you wish to run all or part of your ad in bold capital letters—you can do so for as little as 75¢ per word additional. Act now! Send your Classified ad to: **POPULAR MECHANICS, CLASSIFIED DEPARTMENT, 224 WEST 57TH STREET, NEW YORK, N. Y. 10019.**

## AUTO SUPPLIES AND EQUIPMENT

**PREVENT** Auto Theft Auto-Guard protects Cars, Trucks, Hot Wiring, master keys useless. Solid State Circuitry. Guaranteed! \$6.95. New World Products, PM01, 2707 Lucinda, Perry, Iowa 50220

**REPAIR YOUR OWN CAR FOR PENNIES . . . IT'S EASY!** Complete 144-page, illustrated auto repair guide shows how to diagnose any car problem, breeze through repairs. Takes mystery out of tune-ups, brake repair, body work, carburetor, shocks, muffler, much more. Also, where to buy tires, batteries, parts at discount. Send \$1.95 plus 25¢ postage To: Consumers Digest Library, Dept. PM-1, 6316 N. Lincoln Ave., Chicago, Illinois 60659. Moneyback if not satisfied.

**THIEVES CAN'T** Drive your car when this easily installed system is used. Plans \$1.00-kit \$3.50. Farleys, Box 285, King of Prussia, Pa. 19406.

**ALTERNATOR/Generator** Rebuilder's Course; includes Tooling & Test Equipment. Write: Hedelund Engineering, P.O. Box 2127, Sepulveda, California 91343.

**RING-Valve** Job while driving, \$6.50 postpaid. (Two-\$12.00). . . . Established 1951. . . . Results Guaranteed!! Motaloy, Grantham, Penna. 17027.

**SAVE \$\$\$\$\$ MOTALOY** Ring-Valve Job \$5.95. AIRMAILED!! With FREE GIFT!! Guaranteed!! Free Information. Flewellings! Box 21-PM11, Tustin, California 92680.

**AIRMASTER** Gas Saver Fits All Cars. \$14.95. Airmaster, Lenora, Kansas 67645.

**UTILIZE** AC Motors as AC generators—three phase motors on single phase—auto generator to DC motor—\$1.50 each. DanRan, Box D, Reno, Nevada 89506.

**NOVEL** Inexpensive Glowing Gage Continuously Checks Ignition Performance. **QARC**, Box 47876, Los Angeles, Calif. 90047.

**HYDRAULIC** Jack repair kits parts and supplies. Catalog 50¢ (in coin). Hydraulic Jack Packing & Tool Co. Inc., General P.O. Box 3, Staten Island, N.Y. 10314.

**CANADIAN** Automotive Trade Tests **MOBELEC** Breakerless C.D. Ignition with Good Results! Write for Reprint. Mobelec, 1512 Bexley, Austintown, Ohio 44515.

**30 9x12" CAR POLISHING CLOTHS . . .** \$1.49 . . . Guaranteed! PSP (A11), Box 275, Pella, Iowa 50219.

**AUTO-GUARD** Prevents Theft Electronically. Simple To Install! For Cars And Trucks. Only \$7.95 Guaranteed!! Dept. 1PM11, Henderson Enterprises, 3115 Stonewall, Houston, Texas 77020.

**"FREE INFORMATION"** Aire Puffed Plastic Seat Covers. For All Cars. Alpine Sales, 5213-B Alpine St., Fayetteville, N. Car. 28301.

**DUITSMAN DRIVE WAY CHIMES.** Chimes ring in your home as cars drive in. Complete unit \$39.95 plus 5% Illinois sales tax. Order from L. H. Duitsman Mfg., Ogden, Illinois 60859.

**MIRACLE CLOTH**—dry cleans, waxes automobile in minutes! Lasts 50-100 cleanings!! \$2.98. McCater, 317 Grand, National Park, New Jersey 08063.

**PARTS:** Army jeep and truck parts. Spare Parts & Equipment Co., P.O. Box 751, Lexington, Kentucky 40502.

**110 VDC** 3000 Watts from Car Alternator. Adapter Only \$10.95. Plans \$3.50. Details 25¢. Venture, Box 7431-PM, Baltimore, Maryland 21227.

**GREASY, Oily, Inky Hands Cleaned Fast.** Reusable Miracle Cloth. 100% Guaranteed. Only \$1.89. Order Now. Hopro. Box 129-AA Selden, New York 11784.

**NO-WELD TOWBAR—E-Z** Plans—\$3.00. **HUSKY** Enterprises, P.O. Box 13404, Spokane, Washington 99213.

**LIKE NO OTHER CAR POLISH EVER SEEN.** Brings out the best on any body finish and gives A deep glow of elegance. Unconditionally guaranteed if not satisfied in every way with formula 2. Return unused portion for money back guarantee. Send \$4.98 to: Elegant House, 155 Head Street, Manchester, N.H. 03102.

(Continued on next page)



## AUTO SUPPLIES AND EQUIPMENT

(Continued from preceding page)

**ANTIQUE FORD PARTS.** Illustrated Catalogue \$1.00. Mark Auto, Layton, NJ 07851.

## SNOWMOBILES

**MAKE YOUR OWN SNOWMOBILE.** Propeller driven by a Continental aircraft engine. Drives over snow and ice. Becomes a "self contained" trailer in 15 min. when necessary to transport snowmobile over dry highways. Buy a photocopy of article as it appeared in P.M. for \$1.25. Send orders to: Popular Mechanics, Dept. HE, Box 1014, Radio City, N.Y. 10019.

**ELECTRIC Starter Kit \$29.95** Less Battery. Money Back if not Satisfied. Advise Make & Model of Engine. Surplus City, 4802 Nicollet, Minneapolis, Minn. 55409.

**KID'S SNOWMOBILE \$75.** Rotary lawn mower engine powered. Track from used snowtire treads. E-Z Plans \$5.95. Information \$.35 refundable. Albar Sales M11 RR Box 386, Yarmouth, Maine 04096.

## MOTORCYCLES, BICYCLES, MOTORSCOOTERS AND SUPPLIES

**MAKE Your Bicycle Electric.** Plans \$2.95. Kielian, 130 Drake, South San Francisco, Calif. 94080.

**HONDA, \$25** Other Bargains. Send \$1.00. (Refundable). Motorscooter, P443, BEND, Oregon 97701.

**BOLT-ON TORQUE CONVERTER** Makes out-dated, out-classed, mini-bikes competitive, mean machines. More low end muscle—more high end hustle. Fits B&S, Tecumseh, most engines. 35 minute installations. \$34.95 ppd. No C.O.D. Information + decal 25¢. MAX-TORQUE, Inc., 7300 Monticello, Skokie, Illinois 60076.

**ILLUSTRATED Catalog, 25¢.** Parts And Accessories. Custom And Stock. For Most Makes and Models. Motorcycle Supply, Box 159M, Fairbury, Illinois 61739.

**GO-KART—MINI-BIKE** Plans. Easy to follow. **SAVE MONEY.** Build your own. Go-Kart plan \$2.00. Mini-Bike plan \$2.00. Both plans \$3.00. **GUARANTEED.** RWM Sales, P.O. Box 660A3, Belleville, Illinois 62222.

**GO-KARTS** Factory Direct Low As \$19.95. Send 35¢ for Catalog. Schmieder Motors, RD #1, Doylestown, Penna. 18901.

**BIKE AND MINI-BIKE GOGGLES.** All Purpose, Well Padded, \$1.00 P.P. Phillips-Wilson, P.O. Box 3125 Augusta, Ga. 30904.

**BICYCLE PARTS CATALOG.** Gold mine for hard to get foreign and domestic parts, tools and accessories. Send \$2.00 for this big 8½ x 11 inch 160 page catalog. Refundable if not completely satisfied. Wheel Goods, Dept. J, 2737 Hennepin, Minneapolis, Minnesota 55408.

**ATV'S! TRAIL-CYCLES!** Trailers! Kits. Discount Catalog 25¢. Lorenzo, Danville, Illinois 61832.

**AMAZING Electric Bicycle, 10¢ A Day.** Complete Illustrated Plans. \$2.00. MR. WIZZARD, P.O. Box 204, Roselle, Ill. 60172.

**FAST ELECTRIC BICYCLE** Illustrated Super Plans—\$3.95. ZEEMCO, 2239 Lincoln, Chicago, Illinois 60614.

**BUILT In An Hour!** The World's **CHEAPEST** Gasoline Motorbike. Illustrated plans: \$3.95. ThriftyZeemo, 2239 Lincoln, Chicago, Illinois 60614.

**BIKE AND MINI-BIKE GOGGLES.** All Purpose, Well Padded, \$1.00 P.P. Phillips-Wilson, P.O. Box 3125, Augusta, Georgia 30904.

## SPACE, ROCKETS AND ASTRONAUTS

**ANTIGRAVITY DEVICE.** Brochure rushed free. AGD, Box 3062 PM, Bartlesville, Oklahoma 74003.

**MODEL ROCKETRY SURPRISE PACK.** Three Fantastic Assortments of Components for Designing and Building Custom Rockets. **BEGINNER PACK:** \$4.50 value; \$2.29. **MASTER PACK:** \$11.00 value; \$4.89. **ADVANCED PACK:** \$27.00 value; \$9.89. Color Catalog; 25¢. AVI, Astroport, Mineral Point, Wisc. 53565.



## AVIATION

**BUILD—One-Man jet helicopter.** Easy Inexpensive. Detailed plans, drawings—\$5.00. Helicraft, Box 7153, Baltimore, Maryland 21218.

**ALL About Ballooning.** Handbook \$3.00. Aerostation, Box 141, Long-Sault, Ontario, Canada. KOC 1PO.

**BE A Government licensed aviation mechanic.** Practical training. Free Information. Aero Mechanics School, Dept. PM-Municipal Airport, Kansas City, Missouri 64116.

**AIRBOAT** Propellers, Engines, Hubs, Mounts, Supplies. Corvair, V-W Conversions. Removeable Airdrives. Catalog \$1.00. Banks-Maxwell, Box 3301E, Ft. Worth, Texas 76105.

**HELICOPTER Kits.** VW Powered, Inflight Photos and information 50¢, Drawings \$5.00. Weilage Helicopters, Box 1267, Redwood City, California 94064.

**HANG GLIDING, Self-Soar, Skysurf:** Free Information Kit. Service to Students, Instructors, Business. All Top Plans Available; Books Too. Sample **LOW & SLOW Magazine, \$1.00.** Send To: **SELF-SOAR Association,** Box 1860, Santa Monica, California 90406.

**HANG GLIDERS.** Proven Rogallo Design. Plans—\$5.00. Kits, Accessories, Complete Kites. Compare Quality And Price Before You Buy. Free-Flight Systems, 10730 Whiteoak, Granada Hills, California 91344.

## HOVERCRAFT

**HOVERCRAFT Plans.** All sizes: Tested designs. Photos. Information: \$1.00. Universal Hovercraft, 2611 182nd Place, Redondo Beach, California 90278.

**INSTALL Kart, Lawnmower, Snowmobile Power On This Hovercraft.** Plans, Instructions. \$6.00. Airboat Plans Instructions, \$5.00. Design Book for Homebuilders, \$5.00. Palmer Aerosystems, P. O. Box 1891M11, Coral Gables, Florida 33134.

**AERO-CAR** Amazing Hovercraft built easily with ordinary tools. Lawnmower engine power. Carries one man plus. Hovers, flies forward, backward. Sideways over land/snow/water. Complete construction plans and brochure. \$5.95. Aero-Projects, Box 5118PM, Clinton, New Jersey 08809.

**HOVERLOG '73—Most Complete Hovercraft Catalog Available.** JLO Engines, Multi-Wing Fans, Plans, Kits, "Hoverbugs". Complete Catalog \$2.00. Venture, Dept. 504, Box 5273, Akron, Ohio 44313.



## BOATS AND TRAILERS

**CANOE Kits—Wood Canvas, Molded Fiberglass—Free Catalog.** Trailcraft, Inc. Box 60686, Concordia, Kansas 66901

**KAYAK KITS—Moulded Fiberglass—Wood, Canvas, Parts Precut.** Complete Kits 39.95 up. Free literature. Dedham Kayaks, Dept. PM1, Box 207, W. Lynn, Ma 01905

**BOAT Kits.** Molded Fiberglass. Save money—assemble yourself. Factory molded sections bond into one-piece craft. 20 Models—14' to 32' Cruisers, Runabouts, Sailboats, Accessories, Motors, Trailers. Easy terms. Free catalog. Luger, Dept. BC-73, 3800 West Highway 13, Burnsville, Minnesota 55337.

**FREE 112-Page Camping, Marine Color Catalog.** Laacke & Joys, 1439 N. Water, Milwaukee, Wisconsin 53202.

**FIBERGLASS BUILDERS MATERIALS** Lowest factory prices in cloth, matt, roving, resin, epoxy, foam, nails, fittings. Send \$1.00 for literature (refundable) or \$2.00 for literature plus booklet on Mold-making and "How to Fiberglass". Clark Craft, 16-P1 Aqua Lane, Tonawanda, N.Y. 14150.

**FIBERGLASS Cloth, matt, polyester and epoxy resins.** Wholesale catalog 25¢. Boat Molding book 30¢. Seifert's, Box 1206-M, Green Bay, Wis. 54305.

**BOAT KITS-PLANS AND PATTERNS-FRAME KITS.** World's largest catalog. Over 300 top designs from 7-77' in plywood, ferro cement and fiberglass. Sailboats include: Windmill, Snipe, Motor Sailer, Trimarans, Catamarans. Powerboats include: Cruisers, Houseboats, Deep V's, Fishin'ski, Runabouts, Hydroplanes, Canoes, Kayaks, inboards, outboards. Send \$1.00 for large catalog or \$2.00 for catalog plus "Boat Builders Guide". Clark Craft, 16-P Aqua Lane, Tonawanda, N. Y. 14150.

**BOAT PLANS, FULL-SIZE PATTERNS, FRAME KITS** With step by step written and pictorial instructions especially for amateurs. Easy to build. Send \$1.00 for **HUGE 100 PAGE** Illustrated Catalog. Over 125 modern designs from 8 to 49'. Includes Sail, Jets, Inboards, Outboards, Cruisers, Houseboats, Hot Boats, Catamarans, Hydros. Also available—"Boat Building With Plywood" Hard cover—219 pages \$7.50. GLEN L, 9152 MP Rosecrans, Bellflower, Calif. 90706.

**FIBERGLASS Cloth and resin.** World's finest cloth and non-run resin, at direct mill prices Flotation foam. Complete line of plastics, silicon bonze and brass screws, save 60%. No sales tax. Boat Plans. Catalog 25¢. Freight prepaid. Stiles Boat Supply, Box 11P, Linden Ave., Mantua Heights, N.J. 08051.

**CANOE! Kayaks!** Factory-direct quality kits, from \$25.00. Many different models. Canvas hulls. Strongest construction materials. Free literature. Sportscraft, Box 636-P, Allentown, New Jersey 08501.

**FREE Catalogue—plans, patterns:** Canoes, sailing canoes, kayaks. 14-17' trailable cruising sailboats. Quicksilver, 255A Shamrock Blvd., Venice, Florida 33595.

**KAYAKS, Canoes, Plans, Kits, Finished Craft, Books.** Free Catalog. Outdoor Sports, Box 1213P, Tuscaloosa, Ala. 35401.

**NEW 1973 Outboards . . . Top Brands 6 H.P. \$288 . . . 18 \$418 . . . 40 \$565 . . . 50 \$728 . . . 65 Electric \$958 . . . 85 Electric \$1,098 . . . ALL SIZES . . . Scott-McCulloch Parts . . . Handling 50¢ . . . Electra Marine, 610 Merrick Rd., Lynbrook, New York 11563.**

**FIBERGLASSING? Complete Instructions!** "Craftsmans Fiberglass Manual." Only \$2.00 Postpaid! Edryn Corporation, Box 537-PG, Cocoa Beach, Florida 32931.

**FIBERGLASS Cloth, mat, resin, Flotation foam.** Complete supplies. Catalog 25¢. Kick-Shaw, Inc., 3511 Hixson Pike, Chattanooga, Tenn. 37415.

**FIBERGLASS Canoes, Kayaks, and Duckboats.** Many exciting models. Easily assembled kits. \$44.95 up. Free Literature. Riverside Canoes, Box 5595P, Riverside, Calif. 92507.

**POWERBOAT Handling instruction.** \$2.00 postpaid. Dasher, A912 Main, Hebron, Ohio 43025.

**CATAMARAN 45 Foot Fiberglass Hulls—Info.** \$1.00—Int. Cat., POB 16185, Tampa, Florida 33617.

**LIGHTS "THOUSAND-LIVES".** Battery powered Cordless. RECHARGEABLE. Table-lites, Lanterns, Flashlites. Use Nickel-Cadmium "LIFETIME" ("Never buy Batteries again") Free Literature. Heydecker, 500 H West End Avenue, New York, New York 10024.

(Continued on next page)

Материал, защищенный авторским правом



## CAMPERS AND TRAILERS—KITS—PLANS—

**CABOVER Campers & Pick-Up Covers** for Compact & Standard Trucks, 16 & 20 Trailers. Build and Save. Large scale plans and full-size patterns with written & pictorial instructions. Complete accessory and aluminum covering kits. Free literature. Glen L. 9152PM Rosecrans, Bellflower, California 90706.

## MARINE EQUIPMENT AND SERVICES

**MARINE Engines, conversions, parts, equipment.** Catalog Free! Stokes Marine Industries, Coldwater, Michigan 49036.

**MARINE Supplies, Ignition Parts.** Free literature. Michael's, 991 Broadway, Bayonne, New Jersey 07002.

**CONVERT Auto engines to marine.** 68 Page Catalog, 50¢. Lehman Manufacturing Company, 800 Elizabeth Avenue, Linden 4, New Jersey 07036.

## ATHLETIC AND BODY BUILDING COURSES

**BARBELL Course \$1.00. Booklet 10¢.** Good Barbell, B-542, Seneca, Missouri 64865

**POWERFUL Muscles fast!** Free brochure. Universal Bodybuilding, Box 4327-C, Dearborn, Michigan 48126.

**KUNGFU, Illustrated instructions.** \$2.00 complete. RSH, 5834 Manton, Chicago, Illinois 60646.

**"GIANT Arms."** Dr. Young. Revolutionary discovery. Inquire. Gaucho, Box 1769-A7, Chicago 60690.

**KUNG-FU, Karate, Judo Books, Fighting Weapons, Films.** Giant Brochure-\$2.00. Green Dragon Fighting Society, Dept.-PM, 4350 N. Cicero, Chicago, Illinois 60641.

**"GIANT Arms". American Indian Hand Wrestling Kit!!!!** Junior—\$7.98, Adult—\$12.98. Moneyback Guarantee. Modern Enterprises, Dept. A11, Santa Anna, Texas 76878.

**KUNGFU Manual on Poison-Hand, Death-Touch \$2.29.** Manual on Fighting Like Cobra, Tiger, Dragon, Leopard, Snake—\$6.25. Green Dragon KungFu Fighting Society, 4350 N. Cicero, Chicago, Illinois 60641.

**MIGHTY BODY YOURS IN MINUTES A DAY. \$2.00 FULL COST. CHAMPAGNE'S. BOX 15322, BATON ROUGE, LOUISIANA 70815.**

**KUNG-FU Secrets.** 350 Photos. Complete, Easy Instructions. \$1.95 + 30¢. Johnson-Smith, 10 Auto., Mt. Clemens, Mich. 48043.

**ARMS, 18-20 Inches in 90 days or Complete Refund!!** Miraculous Revelation! \$3.00. Phenominists, Box 281, Gresham, Oregon 97030.

**KUNGFU Self-Defense Illustrated Instructions, complete \$2.00.** Satisfaction guaranteed. Jorgensen, Box 70482-11173, Seattle, Washington 98117.

**SHORT STATURED? Growth, Height Increase Facts, Medical Details.** Adults Youngsters. 25¢ to: Physical Culture, Box 1548-PM11, Pompano Beach, Florida 33060.

## SPORTING GOODS AND EQUIPMENT

**FREE Catalog low direct factory prices,** fishing, Hunting, Archery, reloading Camping supplies. Send today. Herters Inc., Dept. CPM, Waseca, Minn. 56093.

**FREE WHOLESALE CATALOG.** Lure parts, Molds, Rod Blanks, Reels, Archery, Metal Detectors, Rare Hardwoods, Finnsports (ME), Toledo, Ohio 43614.

**ARCHERY Lowest Discount Prices.** All top brands. Orders shipped same day received. Money-back guarantee. World's Largest Supplier. Free catalog, Anderson Archery Corporation, Grand Ledge, Michigan 48837.

**FREE CATALOG.** Fishing Tackle, Archery Hunting and Camping Equipment. Lowest Prices. Cabela's, Inc., Dept. S23, Sidney, Nebraska 69162.

**MINI EMERGENCY KIT** Over 50 Emergency Items. Handy, Compact, Waterproof. For every Outdoorsman. Send \$1.00 to: P.O. Box 6426, Ft. Myers, Florida 33901.

**PELLET GUNS** For Fun or Serious Target Shooting anywhere. Giant selection. Finest Models. Satisfaction Guaranteed. New 100 Page Catalog Free (\$1 value). Write: ARH, Dept. 15, Grantsville, W. Va. 26147.

**GOLFERS, Better Than Lesson. Stick INSTANT REPLAY** on Club. Compare with Furnished Analysis. Satisfaction Guaranteed. Only \$1.00. Instant Replay, 10806 Yolanda, Northridge, California 91324.

**BOY Scout 4 Blade knife \$2.49** pstpd. G. M. Robinette & Co., 420 S.E. Grand, Portland, Oregon 97214.

## AQUARIUM SUPPLIES

**AQUARIUMS, Filters, Fishfoods, Air-pumps, World-champion Guppies.** 448-page Fishbook, \$3.95, Catalog 25¢. Aquatic-Discount, Ortonville, Mich 48462



## FISHING, TACKLE, LURES

**MOLDS—**For casting your own fishing sinkers. Free illustrated booklet. Reading Instrument Co., Box P-78, Reading, Pa. 19603.

**FISHERMAN'S DREAM BOOK—FREE,** 170 page catalog just loaded with Hard-To-Find Fishing Tackle Specialties and Do-It-Yourself Goodies. Our 29th year. NETCRAFT Inc., Box 5510, Dept. PM-12, Toledo, Ohio 43613.

## EARTHWORMS, LIVE BAIT

**HOW To Make Money Raising Fishworms!** Details Free, Gloworm, Department P.O. 188, 3910 Elfin, Louisville, Kentucky 40207.

**EARN Money raising fishworms for us!** Exciting details free! Oakhaven—56, Cedar Hill, Texas 75104.

**FREE Literature.** Profitable Business Raising Fishworms, Crickets. We Teach you how to Raise and Sell. Write today. Carter Fishworms, Plains, Georgia 31780.

**BIG Profits Raising Worms Soilless Method.** Three Oaks, Dresden, Tennessee 38225.



## HUNTING, GUNS, DECOYS

**DUCK And Goose Decoys.** Buy direct and save. Send for free catalogue to: Decoys, Rt. 11, Box 229-B, Houston, Texas 77050.

## DOGS AND KENNELS

**FULLY Guaranteed, Hounds Trained and Cattle Dogs—on Trial** Guardians. State Requirements. C. Zeron, Morrisburg, Ontario.



## POULTRY & GAME BIRDS

**QUAILS, Incubators, cages, supplies** catalog. Marsh, 14216 Brookhurst, Garden Grove, Calif. 92643.

## RABBITS—CHINCHILLAS—FUR BEARING ANIMALS

**\$500-\$1000 MONTH Plan** raising rabbits for us. Free details. White's Rabbitry-PM, Hudson, Ohio 44236.

**RAISE Rabbits Successfully** by knowing Facts. 48 Page Illustrated Book describing 25 Breeds, Housing, Breeding, Feeding, Markets, Marketing, etc. 25 cents. American Rabbit Association, 36 Arba Building, Bloomington, Illinois 61701.

**EARN \$10,000 Yearly Raising Angora Wool and Breeding Stock.** Details 25¢ coin. American Angora, Malta 12, Montana 59538.

**TOPLESS INCOME RAISING** Mutation chinchillas. 25¢: Bulletin \$1.00. Chinchilla, 11PM11, Port Richey, Florida 33568.

**RAISE Chinchillas.** Guaranteed Income. Catalog \$1.00. DeShon Chinchilla, Route 2H, Roanoke, Indiana 46783. Missouri Agent, Rudolph Eggemann, 9615H Tocan Court, Affton, Missouri 63123.

## PETS—BIRDS, CATS, HAMSTERS, ETC.

**PETS, Reptiles, raccoons, skunks, squirrels.** Catalogue 25¢. Trails End Zoo, St. Stephens, S.C. 29479.

**LIVE Seahorses, marine specimens, aquarium supplies, illustrated catalog** 35¢. Marine, Box 23158-S, Ft. Lauderdale, Florida 33307.

## HORSES, LIVESTOCK

**"HOW TO TRAIN HORSES"—FREE Book** tells How to Break, Train, make Money with Horses. Beery School, 11011, Pleasant Hill, Ohio 45359

**DO YOU Want to Know how to Break, Train, Ride, Care for Horses and Make Money?** Write: Box 559-B, Monticello, Ind. 47960.

## CAMPING EQUIPMENT AND TENTS

**FREE Outdoorsman's Catalog.** Features Outdoor clothing, boots, tents, packs, hunting, fishing, hiking equipment, government surplus etc. Satisfaction Guaranteed. Write for free copy today. P & S Sales, Dept. P-11, Box 45095, Tulsa, Okla. 74145.

## ELECTRICAL SUPPLIES

**EXTENSION CORD WINDER.** Ends tangling. Two 15 AMP Grounded Outlets. Holds 100 Feet 7/16" Cord. (Not Included). **LASTS LIFETIME.** \$6.95 (Postpaid U.S. Only). WM. B. CAMERON, 4300 Soquel Dr., Soquel, Calif. 95073.

**ELECTRICITY FROM BACTERIA.** The Biolec Corporation introduces pollution free, long life, low cost, self-contained electrical power. The Biolec current cell . . . Send for a demonstration Science Kit \$29.95 postpaid. Biolec Corporation, PO Box 13377, Houston, Texas 77019.

## BATTERIES, GENERATORS

**BATTERY Reconditioning Kit,** includes molds, material, instructions. Apex Engineering, 3100 Romona, Atascadero, California 93422.

## ENGINES, MOTORS

**WINDING Data,** 275 motors, \$1.25. Data Company, 512 Kensington, Kansas City, Mo. 64124.

**STEAM Engine Kits, Catalog-Handbook** \$1.00. Reliable Industries, New Baltimore, Mich. 48047.

**MOTOR REWINDING SUPPLIES!** Equipment plans! Modequip, Box 7266, Kansas City, Mo. 64113.

**REWIND Car Generator for 110 VAC.** Power Plant Plans \$2.00. Schmauss, 1228 East Cass, Tampa 33602.

**REPAIR Your Own Electric Motors.** Copyrighted book moneyback guarantee. \$4.95. The Gift House, Blacksburg, S.C. 29702.

## MACHINERY, TOOLS AND SUPPLIES

**COMPLETE 4" Metal Cutting Lathe** \$89.50. Machined Parts Kit Less Motor and Accessories \$29.50. Taig Mfg., Dept. T, 15048 Proctor, Industry, California 91746.

**SMALL Foundry furnaces.** Supplies. Free literature. Pyramid Products, 3736 South 7th Avenue, Phoenix, Arizona 85041.

(Continued on next page)



## MACHINERY, TOOLS AND SUPPLIES

(Continued from preceding page)

**MAXIMAT**, Unimat Lathes, Metals, Micrometers. Catalogue 50¢. Industrial \$2.00. Campbell (PM), 1424 Barclay, Springfield, Ohio 45505.

**1400 CATALOGS** Listed and Described! Sources for EVERYTHING Imaginable! Rush \$2.00. **MASTERLOG**, Box 24413-(VK), Oakland, California 94623.

**END Mills**, Lathe Milling Attachments: Information. Potter, Box 73, Cedar Rapids, Iowa 52406.

**SANDBLASTERS**, \$32.50—\$749.50. Free Catalog—Truman, 1330 Market, Youngstown, Ohio 44507.

**TOOLS**, Metal, Woodworking, Shop, Power, Hand, **LATHES** and Accessories. Catalog \$1.00. Refundable. Tools Unlimited, Inc., Box 7PM, Brentwood, New York 11717.

**SINGLE Phase** Runs Three Phase Motors. Secure Electronics, 32 Warren, Waban, Mass., 02168.

**ASSORTMENTS**, Nuts, Bolts, Screws. List 25¢ Coin. Nutty Co., Box 1576, SMS, Fairfield, Conn. 06430.

**"ATTACHALL"**, The engineered threadless super-motor-arbor holds 33 different turning-two tools to fractional HP Motor (1/2" shaft). Changes tools in seconds. It's even for Professionals! Makes super-mini-home-workshop. Send \$2.50 postpaid. Price includes 25¢ Catalogue listing attachments, other inexpensive critical tools. Money back guarantee. Buy "Attachall", we'll sell cheapest used Motor USA, ShopAider Tool Co., 233M11 East 77th Street, NYC 10021.

**FINEST Tools**—Catalog 50¢. Woodcarvers Supply, 3112 West 28th, Minneapolis, Minnesota 55416.

## WELDING, SOLDERING, PLATING

**WELDERS**. Convert To Heliarc. High Frequency Unit 0-225AMP. Plans \$4.00. Convert To DC Plans \$3.00. Information Supply Co., Box 166, College Park, MD. 20740.

**LEARN COMPLETE PLATING BUSINESS**. Metals, Plastics, Baby-Shoes, Make Your Own Equipment Fiberglass Tanks Over 30 Years Experience. \$5.00 Will Start You In Business. NU-Lite Platers Research, Inc., 72-32 Calamus Ave., Woodside, N.Y. 11377.

**ELECTROPLATING** Equipment, Portable Platers, Supplies, and "Know-How." Build your own tanks for nickel, chrome, etc. Easy-to-install PVC liners. Rectifier components—all sizes. Schematics, parts lists, formulas, operating instructions for all-plating. Guaranteed to save you 25%—75%. Some good used units for sale. Free Details. Platers Service Company, 1511-PM Esperanza, Los Angeles, California 90023.

## GOVERNMENT SURPLUS

**FREE!** Nationwide Surplus List. Write today. Auctioneers, Box 872-P, Anoka, Minnesota 55303.

**FREE** Catalog Government Surplus and Sporting Goods. Enclose 8¢ Stamp. Bonanza Surplus, Box 725-PM, Grand Haven, Michigan 49417.

**SURPLUS BARGAINS**—War, government. Industrial surplus at savings to 80%! Clothes, boots, cots, tents—bargains for farm, home, outdoors. **SEND FOR FREE CATALOG**—must give zip code. **SURPLUS STORE**, Sioux Falls, S.D. 57102.

**JEeps!!! PICKUPS!!!** 100,000 items direct from government. Your area. Latest information & surplus categories: \$2.00 **MONEYBACK GUARANTEE**. Order manual #130, from "Dependable Products", Box 113, Vista, California, 92083.

**NO CATCHES**. Buy any surplus direct from U.S. gov't. All information \$2.00. Bridgeworth, P.O. Box 2292-C, Vancouver, Washington 98661.

216 POPULAR MECHANICS

**1973 SURPLUS** Army, Navy store, 52 Page illustrated catalog. Send 50¢. Ruvel, 3037 North Clark, Dept. 11-J, Chicago, Illinois 60614.

**GOVERNMENT SURPLUS**, How and Where to buy in your area. Send \$2.00. **SURPLUS INFORMATION**, 30177PM HEADQUARTERS BUILDING, Washington, D. C. 20014.

**"U.S. GOVERNMENT SURPLUS Directory."** How, Where to buy 100,000 items (including Jeeps) . . . low as 2¢ on dollar! Most complete information available. **\$1.00. SURPLUS DISPOSAL**, Box 6586-AK, WASHINGTON, D.C. 20009.

**JEeps** From—\$52.50; Typewriters from—\$4.15; Cars from—\$31.50. Walkie-talkies, motorcycles, airplanes, boats. Typical "As Is" bid bargains from Uncle Sam. Tremendous variety. Exciting free list. Write: Enterprises, Box 402-X94, Jamaica, New York 11430.

**JEeps, TRUCKS**, Cars From \$31.50 . . . Airplanes, Boats, Typewriters, Clothing, Camping, Sporting, Electronics, Photographic Equipment . . . 100,000 Surplus Bid Bargains Direct From Government Nationwide Typically Low as 2¢ on Dollar! Complete Sales Directory and Surplus Catalog \$1.00 (Deductible First \$10 Order From Included Catalog). U. S. Surplus Disposal, 2220 Fuller 601B-PPM, Ann Arbor, Michigan 48105.

**JEeps** \$52.40. Airplanes \$75.01. Typewriters \$6.70. Boats \$7.50. Typical Bargains Available Nationwide. Sales Directory And Surplus Catalog \$1.00 (Refundable). Midwest Surplus, Box 401-PM, Dayton, Ohio 45401.

**GOVERNMENT SURPLUS!!** Detailed information: How to Buy, Nearest Outlets, Timing. Everything you need to Buy, \$2.00. DeMuir Surplus, 38 Franklin Ave., 2A11, Lockport, N.Y. 14094.

**JEep** and Gov't. Surplus Buying Manual (Jeeps Pictured) 75¢. Surplus Bargain Catalogue 60¢. Both \$1.00. Surplus Bargains, Box 789PM3, York, Pa 17405.

**AMAZING BARGAINS!** Jeeps! Automobiles! Tools! Official guide tells How? Where? Money back Guarantee. \$2.00. Connell, 1804 Savannah Hwy., Dept. A4, Charleston, South Carolina 29407.

## HOBBIES AND COLLECTIONS

**COLLECT** Military Medals, list 25¢. Vernon, Box 387PM, Baldwin, N.Y. 11510.

**NAZI** Medals, Photos, and Jewelry. Also War Mementos from Other Countries. Catalog and War Poster, 25¢. Hutchinson House, Box 6411, Chicago, Illinois 60680.

**#1:00 SURPRISE: SKYLAB** Official Emblem—Foreign Medal—Catalog: Insignias, Box 71 M, Rockaway, New York 11694.

**GEORGIA RED CLAY** Authentic, One Ounce \$1.00. Hobnob, 201 Marray, Atlanta, Georgia 30341.

**COPIES** Of Original Bill of Rights, Constitution, and Declaration of Independence. Perfect for Library, Den, Office or Gift. \$3.00 Each or All 3 for \$7.00. Please Include 50¢ for Handling. Cris Sales, 23 Munchausen Avenue, Bristol, Connecticut 06010.

**NAZI** War Souvenirs Free Illustrated catalog. Delta, Box 361PS, Lafayette, Calif. 94549.

**ANTIQU** OLD MONEY SETS. **FREE SAMPLE**. Zent Distributing, Box 589, Dickinson, N.D. 58601.

**SEASHELL-Of-The-Month Club**. Receive Exotic Seashells inexpensively. Continuing enjoyment. Fabulous Christmas Gift. Post Office Box "T", Honolulu, Hawaii 96815.

**WOODCARVING**—Complete line of three dimensional carving machines for home hobbyist and professional carvers. New models from 1 to 4 spindles. Patterns, workblanks and supplies. Write for "How to Make Quality Wood Carvings" booklet-25¢. Hobbi Carve, 930 Duluth Street, Dept. PM, St. Paul, Minn. 55106.

**CURIOS** And Collectibles. Where to Buy and Sell. Old Comic Books, Medal Buttons, Toys and other Valuable Objects. Send \$1.95 for Illustrated Book. Jackson Mail Order Sales, Coleman, Crothersville, Ind. 47229.

## DECALS, EMBLEMS, PATCHES

**CUSTOM** Designed Embroidered Emblems, Decals. Inexpensive. Free Catalog, details. Southern Emblem, Box 8PMB, Toast, North Carolina 27049.

**EMBLEMATIC** Fraternal Emblems. Free Brochure. Porter Specialty, P.O. Box 1568, Tampa, Florida 33601.

**EMBROIDERED** Emblems, Quotes Your Design. Emblems, 9L, Littleton, New Hampshire 03561.



## STAMP COLLECTING

**88 COUNTRIES—ONLY 10¢!** Worth \$5.00 at catalog prices!! Incredible collection of genuine postage stamps from 88 different countries—from Afghanistan to Zambia, North to South Pole! British, French, Portuguese, Spanish Colonies, Old 19th Century, New Issues, Moon and Outer Space stamps, etc. All for only 10¢! Also, other exciting stamps to examine free. Buy any or none, return balance, cancel service anytime. Plus Wonderful Free Catalog! H. E. HARRIS, Dept. SS-63, Boston, Mass. 02117.

**YOURS FREE! 40 RED CHINA** Postage Stamps banned to American collectors for a generation by U.S. Gov't. Now at last you can legally own them; and these stamps are so worth having that experienced and beginning collectors alike want them—so act fast, because supplies are strictly limited! You also get 110 other stamps from Britain's Lost Empire plus illustrated Album to keep as a Bonus should you buy \$1 from our Approval Selection. Or return Album and 110 stamps with selection and buy nothing. Cancel service anytime. But Red China stamps are yours to keep! Send 10¢ for mailing while supplies last. Kenmore, Milford RC-430, New Hampshire 03055.

**FREE!** \$10.00 Giant Stamp Collection of 300 all different colorful, valuable postage stamps from Africa—Europe—Asia—British Empire—Worth \$10.00—\$12.00 at catalogue prices. Also money-saving Booklet. All yours as a Get-Acquainted Gift. Adults only. Other fine stamps enclosed for your inspection. Frasek Co. Inc., PM-11, White Plains, New York 10601

**FREE!** Big Bargain Catalog—New Edition listing thousands of bargains including U.S. & B.N.A. stamps, packets, albums, accessories and supplies. Also, fine stamps from our approval service which you may return without purchases and cancel service at any time. Jamestown Stamp, Dept. E113PM, Jamestown, New York 14701

**SENSATIONAL Clearance Offer**. Fifty Different Packets \$2.00. Norge, Wyckoff, New Jersey 07481.

**FREE** Worldwide Packet. Penny Approvals. Froelich, Box 412A, Morton Grove, Ill. 60053.

**APACHE ARROWHEAD COLLECTIONS**—Perfect, 25—\$5.00, 100—\$15.00. **GERONIMO**, PMD1239, Apache Junction, Arizona 85220.

**LOOK** US Commemoratives 225 Different \$1.00, 300—\$2.00, 350—\$3.00, 425—\$5.00, 525—\$10.00, 575—\$20.00. No Approvals. Regency Stamps, Box 8854, Pittsburgh, Pa. 15221.

**WOW!** 110 All Different Germany 10¢. Commemoratives, Airmails, High Values, Big Catalog, bargain lists. Also, fine stamps from our approval service, which you may return without purchases and cancel service at any time. Jamestown Stamp, Dept. A113PM, Jamestown, New York 14701

(Continued on page 219)

Материал защищен авторским правом



## STAMP COLLECTING

(Continued from page 216)

**RARE Stamp Free!** Also new packet Aden to Urundi, with Kennedy, Triangles, Space, Sports, Ships, Dogs, Cats, Reptiles, plus others. All free. Send 10¢ for mailing. Empire Stamp Co., Dept. 1, Toronto, Canada.

**GRAB BAG** of over 100 unsorted stamps. Contains new issues, Asia, South Seas, Africa, etc., plus copy of most wonderful Catalog of Stamp Offers in America All for only 10¢. Littleton Stamps, Dept. BB-1, Littleton, N.H. 03561.

**FREE BARGAIN LISTS!** U.S. Mint Singles-Plate Blocks. Scotco, Box 855PMO, Miami, Fla. 33147.

**FREE 50 Worldwide Approvals.** University Stamps, P.O. Box 1471, Lake Worth, Florida 33460.

**FREE Surprise Gift Sent With Approvals.** Boudreau, Box 275, St. Lambert, Quebec, Canada.

**\$30 CATALOG VALUE!** All different stamps catalog to dollars each. Enormous value. Just \$3.00. Postage Paid by Airmail. D. & E. Enterprises, P.O. Box 570, Santa Rosa, Cal. 95402.

**"WHOLESALE" U.S.—Foreign Pricelist and catalog Free!** Everything Guaranteed. Schneider, Box 1240, Grand Rapids, Michigan 49501.

**107 EXCITING British Colonials 25¢.** Approvals. Castle, Box 15-PM14, Flushing, New York 11352.

**U. S. PLATE Blocks 7 Different 3¢ Commemoratives \$1.00!** Approvals. Gordon Davison, Hillsboro, New Hampshire 03244.

**AMAZING Value—Enormous Worldwide Collection!** Hundreds of Colorful Stamps—Airmails, Commemoratives, Strange Countries, Nature's Wonders. Catalog over \$10.00, only 10¢. Approvals. Buy Any or None. Cancel Anytime. Daniel Healy, Box 1164PM11, Arlington Heights, Illinois 60006.

**ISRAEL Pictorials, commems galore.** 25 different, only 10¢ with low price U.S. and Foreign approvals. KAYCO, P.O. Box 437, Flushing, N.Y. 11367 Dept. M.

**CANADA, 25 Different Commemoratives, 25¢.** Approvals. Wilson, Box 116, Dollard des Ormeaux, Quebec, Canada.

**FABULOUS Collection!** 107 different stamps from all seven continents. Get Q.E.-II Silver Wedding (bound to be a classic), giant Mongol horseman, many other new, old issues from Asia, Africa, Europe, North, South America, Australia, Antarctica. Also stamp selections to examine. Buy any or none, return balance. Cancel service anytime. Send 10¢ now. Williams Co., PM87, St. Stephen, N.B., Canada.

**200 WORLDWIDE 25¢ To Approval Applicants.** Polze, Box 5215, Milwaukee, Wisconsin 53204.

**SINGLE STAMPS 2¢ and up.** Mounted in books. TRUST STAMP COMPANY, P. O. Box 100-P, Jamaica, New York 11435.

**LOOK! 100 Beautiful Romania Pict, 25¢ Approvals.** Scenic Stamps, Box 1973-B, Vancouver, Wash. 98663.

**100 DIFFERENT United States Stamps, 25¢ With U.S., Foreign Approvals.** Shelron, Box 547C, North Miami, Fla. 33161.

**50 DIFFERENT Old U.S. Revenue stamps \$1.00.** Winchester Stamps, Box 3592, Mansfield, Ohio 44907.

**TEN Different Nudes; 20¢.** Approvals. Stamp Farm, 2M60, Oxford, Wis. 53952.

**FOREIGN Approvals! Gigantic values!** 3¢ each. ABC. Dept. 3301-A, Box 6000, San Francisco 94101.

**U.S. MINT Specials! Flag set, complete \$1.00.** 1¢, 2¢, 3¢ famous Americans (21 different) \$1.00. Free list. Brooks, 2601 Avenue "U," Brooklyn, N.Y. 11229.

**"AFRICA" 25 Beauties, 15¢.** Approvals, Gorliz, Box 28765 PM, Memphis, Tennessee 38128.

**PENNY! Approvals! Regardless catalogue!** Kloster, 4164 52nd St., San Diego, Calif. 92105.

**FREE Surprise collection sent with approvals.** Gould, 1784 Union, San Francisco 94123.

**ABSOLUTELY Free United States Mint Souvenir Sheet When Requesting United States Approvals.** K&B, Box 70, Brooklyn, N.Y. 11223.

**500 DIFFERENT Stamps, \$1.25.** Smith, 508-A Brooks, College Station, Texas 77840.

**100 DIFFERENT British Empire 10¢.** Approvals. Gibson, Box 34, Lansdowne, Pa. 19050.

**100 OLD United States between 1861 and 1935.** \$1.00. Ed Roush, 423 Shepard, Mansfield, Ohio 44907.

**225 STAMPS For only 10¢!** Airmails. Pictorials: stamps from strange countries cataloging up to 25¢ each! Plus unusual stamps to examine. Buy any or none return balance, cancel service anytime. Mystic Stamp Co., Camden 80, New York 13316.

**20 HISTORICAL U.S. Commemoratives 10¢.** Bargain U.S. Approvals. PINTO, Box 111, Park Ridge, Illinois 60068.

**80 DIFFERENT U.S. Stamps.** Includes 1943 flag stamp of occupied nations. Only 25¢. Approvals included. Willett Co., Box 338-M, Yorktown Heights, N.Y. 10598.

**50 YEARS Old, fifteen different United States, over fifty years old—10¢ with approvals.** Jaxon, Box 145-P, Brooklyn, New York 11230.

**QUALITY AND LOW PRICE. EXCELLENT** For advanced or beginner. Mounted approvals 2¢ up, all countries in Scott's Order. Preview Stamps, P.O. Box 20667, San Diego, California 92120.

**U.S. BARGAIN, 50 Different 10¢,** with beautiful worldwide, approvals. Stamp Center, Kennebunk, Maine 04043.

**210 DIFFERENT U.S. Commemoratives \$1.00.** Stamps, 7607 Larchview, Dallas, Texas 75240.

**HITLER, 100 Germany 10¢!** Approvals. White Rock Stamps, 13125 24th M Avenue, Surry, B. C., Canada.

**RUSSIAN Space Collection 25¢,** including Russian Approvals. Snedco, Waldwick, New Jersey 07463.

**LIECHTENSTEIN #356-\$19.00; France #1100-\$4.00; UN 29-30-\$15.00; NH. CWO. Submit Lists Western Europe Only.** Ali N. Franklin, Box 467L, Jamaica, 11434.

**1500 FOREIGN \$2.00; 5000 \$4.00; 9000 \$6.00.** 1000 pre-1939 USA, contains dues, revenues commemoratives, presidentials, high values, older issues, etc. \$3.00; 5000 \$12.00. 300 pre-1940 USA commemoratives \$2.00; 700 \$4.00. No approvals. Meyers, 5321 Fleming, Richmond, Calif 94804.

**GET Scarce Kennedy memorial, Red China, Vietnam stamps plus new countries, topicals, commemoratives, many more!** Valuable collection of 100 different stamps from the world over. Colorful new and old issues—wild animals, famous people, far places, others! Also stamp selections to examine. Buy any or none, return balance. Cancel service anytime. Rush 10¢ today. Garcelon Co., 8PMA, Calais, Maine 04619

**FREE Canadian.** Approvals. Stamps Unlimited, Box 2338, Kalamazoo, Michigan 49003.

**FREE, Mint Worldwide Packet.** Approvals. Hildebrand, Box 5645, Redwood City, California 94063.

**PICK And Choose from Thousands of Stamps 3¢ Each.** Continental, Box 9384M, N. Hollywood, Calif. 91609.

**THOUSANDS Of Stamps 3¢ each.** Pan Pacific Stamp Co., P.O. Box 9413, No. Hollywood, Calif 91609.

**UNITED STATES 5¢ Plate Block, 25¢.** With Discount Price List. Stevens, Box 546D, North Miami, Fla. 33161.

**SPECIAL Offer! 100 Unusual Stamps 10¢ with Request for Approvals and Bargain List.** Continental, Box 9384P, No. Hollywood, Calif. 91609.

**FREE Twelve New Africa, Rwanda etc., Approvals included.** Alpaughco, Highbridge, N.J. 08829.

**VIETNAM 25 Different 10¢ approval.** Sam Chazen, Box 95, Ozone Park, N.Y. 11417.

**50 DIFFERENT Argentina—10¢.** Approvals. Globestamps, Box 402, Biddeford, Maine 04005.

**U.N. MINT Six Sets \$1.00.** Philpot, 119 Chateau, Milwaukee, Wisconsin 53217.

**COVERS U.S. 25 Different \$1.00.** Free Gold List. Superior, Avon Lake, Ohio 44012.

**40 DIFFERENT NUDES \$1.00.** No Approvals. Kemp, 9952 Tamarack, Pacoima, California 91331.

**TREMENDOUS Savings on Complete Sets.** Stan's, Box 546, Silverdale, Washington 98383.

**BETTER GRADE U. S., Canadian stamps on approval.** Borgen, Box 502, Alturas, Calif. 96101.

**25 US Commemoratives, Magnifier—10¢.** Approvals. Mixdrak, 5630 Wilson, Chicago 60630.

**FREE Duplicate Exchange, 2¢ Approvals.** Belden, Box 4175, Dearborn, Michigan 48126.

**FREE British Colonies With Approvals.** Chapmans, Box 487-B, Galesburg, Michigan 49053.

**2 NUDE Sets Plus 100 Others.** Only 25¢. Approvals. Paschall, Box 331, Kosciusko, Miss. 39090.

**SUMMER Clearance \$50.00 Catalog Value USA Foreign Stamps just \$5.00.** Hetricks, 39 East Main, Brookville, Pa. 15825.

**FREE 25 Different Canada.** Joseph Myers, 633 W. Michigan, Marshall, Michigan 49068.

**FREE Collection—Colonials! Worldwide Approvals.** Gains, Box 788-C, Mattoon, Ill. 61938.

**LOCOMOTIVES—1973 Liberia Complete—25¢ with pictorial approvals.** Robert Hedges, Route 3, Hagerstown, Md. 21740.

**60 DIFFERENT United States (30 Commemoratives) 25¢.** Seidenberg, Salem 169, Oregon 97308.

**NUDES, 25 LARGE glossy pictorials, 25¢!** Approvals. White Rock Stamps, 13125-24th N-M Ave, Surrey, British Columbia, Canada.

**FREE 77 Different Stamps.** James Cash, Box 63, Nineveh, Indiana 46164.

**3¢ PLATE Block—Complete 1974 U.S. Stamp and Supply Catalog 25¢.** Schultheis, Box 2151S, New Hyde Park, New York 11040.

**SAVE! Send \$2.00 for \$5.00 Assortment.** No Approvals Sent. Gallery, Box 35291, Los Angeles 90035.

**MAGNIFICENT PAINTINGS! 25 Different Breathtaking Beauties for only 25¢ with approvals.** Rix, Box 248-BA, Station "T", Toronto, Canada M6B-4A1.

**BREATHTAKINGLY BEAUTIFUL 50 Different mint Monaco Multicoloured Pictorial Commemoratives only \$1.00 with accompanying mint complete set approvals.** Pagoda, Box 132P, Sidney, Ohio 45365.

**VALUABLE Stamp Packet Only 10¢ with Approvals.** Marquardt, Box 4503, Milwaukee, Wisconsin 53207.

(Continued on next page)



## STAMP COLLECTING

(Continued from preceding page)

**400 MIXED U.S. 25c.** Approvals. Wright, Box 753-M, Hagerstown, Maryland 21740.

**OLDER U.S. stamps, covers, on approval to adults only.** Surprisingly good. **ENGLER, Box 208P, Lowell, Michigan 49331.**

**GOODIES!** Pick and Pay 1¢ to 5¢. Return remainder. World-wide Selections. Free \$1.00 credit. Henry Oudolf, 96 Woodland, River Edge, New Jersey 07661.

**COMMEMORATIVES: U.S.A. 100 Different large \$3.00.** No Approvals. The Stamp Box, Anchor Lane, Southold, New York 11971.

**2-D SPACE STAMPS!** Incredible! Spectacular Mint Set (6 Magnificent Stamps!) and **SURPRISE PACKET!** Yours, with Colorful, Exciting, Adventure—Filled Approvals. Rush 25¢ Today. **APOLLO, Box 1417PA, Idaho Springs, Colorado 80452.**

**100 U.S. OVER 25 Years Old.** Commemoratives, Airmails, Regulars. \$1.00. Bob Barrett, 5730 Muddycreek, Cincinnati, Ohio 45238.

**FREE!** Illustrated Bargain List plus Surprise Gift. Eckert, Box 205, Clifton, New Jersey 07015.

**JUMBO Approvals.** 30,000 Different 1-3¢ Each. Covey, Box 1137, Anna Maria, Florida 33501.

**200 WORLDWIDE Stamps 10c.** Approvals. White, 6808-E Chrysanthemum, Indianapolis, Indiana 46224.

**"SKYLABS",** Poland's Latest Honors U.S.-Russia Experimental "Space Stations"—Free! Approvals Plus 101 Bonus Sets. William Deems, 226 Race, Ravenswood, West Virginia 26164.

**FREE Gift with Approvals.** Stamp Stamps, Box 212, Rosedale, New York 11422.

**75 DIFFERENT Canada 25c.** Approvals. Oroszky, P.O. Box 1, Sarnia, Ontario, Canada.

**50 DIFFERENT U.S. COMMEMORATIVES** 25¢ Fine Used U.S. Approvals Accompany. Craig Stamps, Box 425-N, Belmore, New York 11710.

**2¢ AND UP.** Packet Approvals. Dean, 508 Snow, Richland, Washington 99352.

**\$35.00 CATALOG Value!** 1000 Different Worldwide. \$2.00. with profit-sharing approvals. Universal, Box 6D, Kenosha, Wisconsin 53141.

**255 DIFFERENT Worldwide :15c.** Approvals. Tibbets, 8675 Meadow, Downey, California 90242.

**SENSATIONAL!** Handsome Mint Collection of Red China, Cataloging Over \$30.00 for Only \$5.00!! Bergman, Box 231, Weymouth, Massachusetts 02188.

**U.S. CHRISTMAS COMMEMORATIVES—2** Stamps on two Different beautiful First Day covers addressed to any name your choice. 50¢ each both for \$1.00. from **K. M. WALSH, Box 308K, Tuckahoe, New York 10707.**

**U. S. MINT: 1943-44 Flag Set Complete \$1.25, S. P. A. S Sheet Mint: 50¢.** Reliable, Box 1553, Bristol, Connecticut 06010.

**SENSATIONAL WORLD MIXTURE "ELITA": BIG THREE POUND PARCEL CONTAINS ABOUT 7000 STAMPS, THOUSANDS OF PICTORIALS, YOURS FOR JUST \$25.00 DELIVERED, DUTY FREE (HALF POUND SAMPLE \$5.00) LIST FREE WITH 200 STAMP OFFERS. B. SCHULZE STAMPS LTD., 139A ESTELLINE, VICTORIA, B.C., CANADA.**

**FREE World Collection.** Over 100 stamps. Approvals. Global, Box 792, Livermore, Cal. 94550.

**"INVERTED Error"** Dag Hammarskjold, 10¢ with approvals. Belmont Stamps, Washington, D. C. 20015.

**OUTSTANDING Collection:** \$24.23 Catalogue Value: \$1.00. Veres, 753 Pipe's, Sagamore Hills, Ohio 44067.

**WATERMARK Detektor, Perforation Gauge, 100 Different Stamps, Packet of Hinges, all for 25¢ to Approval Applicants, State Preferences. H & L Stamp Company, Box 3099 Station B, Calgary, Alberta, Canada T2M 4L6.**

**CANADA Sports Complete 10c.** Canadian Approvals. Harley Boardman, Little Valley, New York 14755.

**CANADA Terrific Lot of 30 different, including Commemoratives, 15¢ to Approval Applicants. Lewis, 339 Beaconsfield Cres. Saint John W., New Brunswick, Canada.**

**15 MOVIE STARS On Stamps United Nations Set 25c.** Approvals. Kenos, Box 1092-A, No. Miami Beach, Florida 33160.

**500 DIFFERENT Worldwide Stamps.** \$1.00. Gifts, Bargain Pricelist Sent with Charming Approvals. **PUBEST, Zaragoza 297B, Ocotlan, Jal, Mexico.**

**SENSATIONAL Penny Approvals!** Pictorials, Topicals, Etc.! Write Today! Schmidt, 634-M Station A, Richmond, Calif. 94808.

**FASCINATING Pick-and-choose packet approvals.** Bargain hunter's Delight. Rivertown, Box 188P, Lowell, Mich. 49331.

**307 DIFFERENT Triangles, Sports, Topicals, Etc.** Worth Near \$8.00. Only 25¢. Bargain Approvals. Free Catalog And Coupon Worth \$1.00. Jayto Stamps, East Syracuse, New York 13057

**PERSIA 20 Different, 10c.** Approvals. Gant, Box 1385, Shreveport, La. 71164.

**FREE!** 55 Different, Including Triangles, Space, Others! Nice Low Cost Approvals. L. Baird, PM-36, Box 8128, Portland, Oregon 97207.

**25 STAMPS ONLY 10¢** to introduce Our Inexpensive used British Commonwealth Approvals. Indicate Interests. McQuain Stamps, P. O. Box 1885, Warner Robins, Georgia 31093.

### COINS, TOKENS, CURRENCY

**SEND Only \$1.00 for Coin Collecting Outfit.** Contains 25 new coins from 25 countries, PLUS magnifier, wooden nickel, "HOW TO COLLECT COINS" booklet, special coin envelopes, foreign banknote and big catalog of coins, paper money, collectors supplies. Littleton Coins, Dept. GH-1, Littleton, New Hampshire 03561

**MEXICO: Silver Dollars Dated 1957 To 1967** In Nice Condition. Ten For \$3.95 Delivered Postpaid. El Paso Coin Co. Inc., Suite 108, El Paso National Bank Bldg., El Paso, Texas 79952.

**39 COIN Uncirculated Lincoln Set 1956-1973, \$2.00.** Ed Frederick, Rte. 3, Mountain Home, Arkansas 72653.

**50 DIFFERENT Foreign Coins, \$3.00.** Hoffman, Box 98-M, Clarence, New York 14031.

**USA SILVER Dollars Nice Condition 10** Different Dates Only \$39.95 post paid. El Paso Coin Co., P.O. Box Q, El Paso, Texas 79952.

**1909-VDB Lincoln Cent. Fine, \$1.50.** Free Catalog. Village Coin Shop, Dept. P, Plaistow, New Hampshire 03865.

**SILVER DOLLARS Uncirculated, 1880-81—1883-84-85 \$8.00 Ea.** Catalogue 50¢. Shultz, Salt Lake City, Utah 84110.

**MEXICO Revolutionary "Pancho Villa"** 10 and 5 Centavos Copper Coins Dated 1915 Nice Condition only \$2.95 each. Delivered Postpaid, El Paso Coin Co., P.O. Box Q, El Paso, Texas 79952.

**COINS At Discount Prices!** Free Brochure. Gene Carlton, Chandler, Okla. 74834.

**FREE:** Lists of Thousands of Stamps and Coins. No Approvals. Bryson, 612M White, Toledo, Ohio 43605.

**BARGAIN Coin List, 10c.** Economy Sales, Box 92, Buzzard's Bay, Massachusetts, 02532.

**GOLD—(1865) Mexican Maximilliano** Peso, Bu \$2.95. Northwoods, Bigfork, Minn. 56628.

**22 "S" LINCOLNS** including 1955S, \$1.75. 24 1909-1939, \$1.75. 10 "S" Jeffersons, \$1.75. All different. All three \$5.00. **HARRIS, 3350 P, El Camino, California 95051.**

**1939-S NICKEL** Nice Circulated, 75¢ Three for \$2.00. **FREE Price List.** Reitmair, 916 Crawford, Bethlehem, Pennsylvania 18017.

**COLLECT Coins!** Catalogue 35¢. Raibl, 2355 Scenic Highway, Pensacola, Fla. 32503.

**UNCIRCULATED 'S' Lincolns,** three different, 10¢ Bargain lists included. Farley Coins, Metamora, Illinois 61548.

**\$1000.00 BANKNOTE—Complete 1974** U.S. Coin and Supply Catalog 25¢. Schultheis, Box 2151C, New Hyde Park, New York 11040.

**COIN Bargain Lists, 8¢ Stamp Nayko,** Box 233, Kennedy Airport, New York 11430.

**UNIQUE BANKNOTE REPLICAS** Look, Feel Old! Exclusive Process—Not Merely Printed Sheet! Free Sample. Haynesco, 15101 San Jose, Mission Hills, California 91345.

**\$10 PER POUND!** My trunkful of Indian & Lincoln Cents from 1880's thru 1930's. Sample Sent—\$3. Mrs. Penny Fisher, Box 1778-CC, Encino, Calif. 91316.

**100 LINCOLNS BEFORE 1959, \$8.25.** Satisfaction Guaranteed, Postpaid. Free Price List. The Penny People, Box 31131, Temple Hills, Maryland 20021.

**"S" MINT Lincoln Hoard.** Not picked. Lots of Old Ones. 50-\$1.50, 100-\$3.00, 500-\$15.00. Tim Frein, Box 9384, North Hollywood, California 91609

**GOLD COINS** Of the World. Beautiful Low Prices. Plus thousands of United States Coins. Free price list. Please send long, airmail envelope, Self-addressed, stamped. Silver Center, Box 22171-M, San Francisco, California 94122.

**SET (SILVER) War Nickels \$2.95; Silver Certificate \$2.25; Bargain Listing 25¢.** Fairway, Box 685-K, White Plains, New York 10602.

### ANTIQUES, RELICS, INDIAN GOODS & CURIOS

**FREE!!** Lists Antiques, Indian Relics, 10 Arrowheads \$4.00. Hyde's, Box 2304, Santa Fe, New Mexico 87501.

**INDIAN Relic list, Arrowheads \$4.00.** doz. Folsom. \$5.00 each. C. Secrist, Deerfield, Missouri 64741.

**SELLING 10,000 Indian Relics.** Arrowheads, Knives, Spearheads, Scrapers, Etc. List Free. Lear's, Glenwood, Ark. 71943.

**AUTHENTIC WESTERN ARROWHEADS—** Perfect, 25-\$5.00, 100-\$15.00. **BROKEN ARROW, PMD1208, Scottsdale, Arizona 85252.**

**FROM Florida!** Oldest Antique-Taken From Phosphate Mines, Genuine Shark's Tooth, Claimed by Scientists 10 Million Yrs. Old! Send \$1.00. Covers Mailing and Story of Antiquity. **HOUSE OF KATHLEEN, Box 295, Kathleen, Florida 33849.**

**10 BEAUTIFUL Arrowheads \$2.00.** Guajardo's, 8713 Shaver, El Paso, Texas 79925.

**ANTIQUES—List 50¢.** Dept. P1, Box 153, Quantico, Va. 22134.

### MODELS—CARS, SHIPS, TRAINS, PLANES, ETC.

**SHIP Model Kits, Fittings, Plans, Books, Tools, Engines, Motors.** New Illustrated Catalog 75¢. Mass. residents add 3% tax. James Bliss & Co., Dept. SM, Route 128, Dedham, Mass. 02026.

**SHIP MODEL Kits, Plans, Fittings** from our own Workshop. Big Illustrated Catalog: 50¢. Bluejacket Shipcrafters, 145-V Water Street, South Norwalk, Conn. 06854.

**SHIP And Airplane Model Kits Catalog** 25¢. Scientific, Inc., 340 Snyder, Berkeley Heights, N.J. 07922.

(Continued on next page)



**MODELS—CARS, SHIPS,  
TRAINS, PLANES, ETC.**  
(Continued from preceding page)

**MODEL Airplanes**—Big 220 Page Catalog \$1.00. Sig Company, Montezuma, Iowa 50171.

**SHIP And Yacht model fittings:** Pine construction hull kits: blueprints. Send 75¢ for illustrated catalog. A.J. Fisher, Inc., 1002 Etowah Avenue, Royal Oak, Michigan 48067

**LIVE Steam Engine Kits.** Fascinating Hobby for Model Mechanics. Boilers, Fittings, Accessories. Pictured Catalog \$1.00. H.P.K. Models, Centuck 34, Yonkers, "T" New York 10710.

**LIVE Steam powered backyard railroads!** All sizes. Complete "bolt-together kits," and rough castings. Excellent drawings. 100 page catalog \$1.00. Little Engines, Lomita, California 90717.

**STUART Steam Engines, Castings, Catalog 75¢.** Carolus Models, P.O. Box 6070, Salt Lake City, Utah 84106.

**DEFY GRAVITY Build Soaring Rockets or Stable Airplanes, Moderate Cost Plans \$1.00.** Tom's Hobbies, 4457 Wadmill, Hamilton, Ohio 45014.

**MODEL Ships and Cannons. Catalog 20¢.** Studio House, Dept-1113, Box 185, Deer Park, New York 11729.

**700 AUTHENTIC Model Airplane Plans.** 25¢-\$25.00. Thrilling Antique Pictorial Catalog, 2 yrs. \$1.00. Clevemodells, 10307CPM Detroit, Cleveland, Ohio 44102.

**GAMES, TOYS, PUZZLES,  
NOVELTIES**

**KITES! Quality Action Styles! Brochure 10¢.** Hutchinson, PM11, 83 Tremont, Barre, Vermont 05641.

**MINIATURE CHARMS Make Fascinating Party Favors, Fantastic Assortment of 25 \$1.00. TREASURE CHEST, 9321 PM11 Cape View Avenue, Norfolk, Virginia 23503.**

**PARTY Fun! Mating Game Compares Handwriting, reveals Personality, Predicts Future Relationships! \$5.95 Guaranteed.** The Mail Plaza, Box 412, Thermal, Calif. 92274.

**TWELVE DIFFERENT \$1.00. Free Catalog.** Gregory's, 6539 Emhouse, Dallas, Texas 75232.

**MAGIC TRICKS, JOKES,  
VENTRILOQUISM**

**PROFESSIONAL Magical Effects.** Ideal for the Beginner or Serious-Minded Magician! Catalog 50¢. Super Service! Midnight Magic Mfg. Co., 110-M Proctor, Revere, Massachusetts 02151.

**VENTRILOQUISM! Learn at home. Guaranteed. Information FREE! Dummy Catalog 25¢.** Maher, Box 9037PM, Denver, Colorado 80209.

**FREE! World's leading novelty catalog.** 1600 Funmakers, Jokes, Tricks, Science, Sports, Hobbies, Jewelry, Psychodelia. Johnson-Smith, C-10, Mt. Clemens, Mich. 48043.

**COMPLETELY Illustrated catalog.** 84 pages. 25¢. Manhattan Magic, Box 334-M, N.Y.C 10011.

**MAGIC MAGAZINE.** Tricks, News, Dealers Offerings. Monthly Since 1936. 2 sample Copies \$1.00. Genii, P.O. Box 36068M, Los Angeles, California 90036.

**WORLD'S Finest professional magic tricks. Joker's Novelties.** Giant illustrated catalog 10¢. Top Hat, Evanston, Illinois.

**FABULOUS MAGICS New 1973 catalogue 25¢.** Our specialty orders shipped same day no substitutes. Fabulous Magic, 3319 East Charleston, Las Vegas, Nevada 89104.

**BE A Magician! Two booklets explaining 156 tricks plus large professional catalog.** \$1.00. Magic, Inc., 5082 Lincoln, Chicago, Illinois 60625.

**FREE Trick and Magic Catalogue 35¢.** Magic House, 531-A East-78th Street, Brooklyn, N.Y 11236.

**MAGIC! Amaze, Mystify, Entertain! Hundreds Of Newest Tricks For Pocket, Parlor, Stage. Complete Catalog Only 25¢.** Jeffries Magician, Dept. 11, Dallas, Texas 75201.

**TWO! Different Magic Catalogs. 25¢.** Miami Magic, Box 1047, Miami 33133.

**LEARN VENTRILOQUISM! GUARANTEED.** Information Free. Dummies, Courses, Puppets Catalog 25¢. Izzy's Ventriloquism School, 3746 West 63rd Street, Chicago, Illinois 60629.

**HOUDINI'S Greatest Magic! You can do them all!!** Giant Illustrated Catalog 25¢ House of 1000 Mysteries, P.O. Box 5007P, Ft. Lauderdale, Florida 33310.

**BOOKS: "Magic in Your Mind"—"Magic Made Easy"—"Magic of Thinking Big"—"Magic Power of Your Mind"—Magician".** \$2.25 each. Cazim, 526 Maple, Redwood City, Cal. 94063.

**WOW! Magic, jokes. Largest selection.** Amaze, mystify friends. Super Giant Catalog 25¢. Abracadabra-MP, Colonia, New Jersey 07067.

**FREE!! Outstanding Novelties Catalog.** Ekstrom, 427 Stockton-707, San Francisco California 94108.

**BOOKBINDING**

**REBIND YOUR DAMAGED BOOKS.** With a few common tools and a homemade book press (plan included) you'll be able to handle anything from a torn hinge to a complete rebinding. Photocopy of article as it appeared in P.M. available for \$1.75. Send orders to Popular Mechanics, Dept. HE, Box 1014, Radio City, New York 10019.

**BOOKS, CATALOGS,  
NEWSPAPERS**

**PUBLISH Your Book! Join our successful authors: All subjects invited.** Send for free appraisal and detailed booklet. Carlton Press, Dept. PMW, 84 Fifth Avenue, New York 10011.

**UNUSUAL Books!! 40 for \$3.00. Catalogue 10¢!** International, Box 7798PM, Atlanta, Georgia 30309.

**AMAZING Offer! Hundreds Unusual Books! Details 25¢. (Refundable).** Vanhook's, Etna Green, Indiana 46524.

**FREE VENTRILOQUIST NEWSPAPER! Fascinating, Informative, Profitable! No obligation.** Maher, Box 9037PB, Denver, Colorado 80209.

**WIRETAPPING EXPOSE—Your Privacy Invaded—Details \$1.00. Refundable.** Don-Q, Box 548, Dept. PMO, Seattle, Wa. 98111.

**FREE Book locating. Send wants. Bazaar Book Search, Box 496, Chico, California 95926.**

**LATEST Military Manuals/Books Catalog 25¢.** Hillcrest Publications (K-18), McDonald, Ohio 44437.

**FREE BOOK. Prophet Elijah Coming Before Christ. Megiddo Mission, Dept. 63, 481 Thurston Road, Rochester, N.Y. 14619.**

**NATIONAL Geographic Magazines. 1888-1971, any issue.** Buxbaum, Box 465-PM, Wilmington, Delaware 19899.

**HIGHER INCOME, Security and Power. 256 page Book "Thinking Big" reveals secrets that make men rich.** Send \$2.00 Kinney (B-11)—1846 Baird, Madison, Wisconsin 53713.

**FREE Information on "How Mail Order Fortunes Are Made".** Robson's, 415 Ed. Fort Walton Beach, Florida 32548.

**FREE Catalog. Blue Books. How-to-Books Bargain Guides.** Elston House, Centerville, Mass. 02632.

**FREE List Low Cost Books. Happiness, Health Success, Confidence Astrology, Dreams, Bowling, Horses.** Send Post Card, Tracy Ann Boutique, Room 111, 281 Cumberland, Buffalo, New York 14220.

**FREE Brochure. Christmas Projects, Decorating, Designs, Artcrafts, Low Cost Family Books.** Winchester Enterprises 2807PM Hargrave Street, Philadelphia, Penna. 19136.

**SMALL STOCK MAGAZINE: Learn about rabbits, goats, poultry, other livestock, gardening and small farming in general.** \$5/yr. COUNTRYSIDE, Rt. 1 Box 239-U, Waterloo, Wis. 53594.

**HEALTH BOOKS—FREE ILLUSTRATED CATALOG—2,000 Books about Organic Foods, Nutrition, Herbalism, Nature-Cure, Vegetarianism, Etc.** Send name and address to: "Catalog", Box 5852, Denver, Colo. 80217.

**FREE Catalog 200 exciting self-improvement books \$1.00 and \$2.00.** Frazier's Forum, P.O. Box 1511, Annex Sta., Providence, R.I. 02901.

**PLAYS, SONGS, MANUSCRIPTS**

**SONGWRITERS! Spirited, religious poems, songs wanted for FREE publishing, recording consideration by Chapel Orchestra-Choir. CHAPEL RECORDING, P.O. Box 162-PM, Wollaston, Mass. 02170.**

**SONGS SONGPOEMS Wanted For Radio Show.** Hollywood Music Productions, 6425-PM, Hollywood Boulevard, Hollywood, California 90028.

**PUBLISHING Contract Guaranteed on selected songs and poems. Free evaluation Hollywood Songwriters'. 6253 Hollywood, 1117-PM, Hollywood, California 90028.**

**RECORDS Made. Publishing Contract Guaranteed On Accepted Songs, Poems. Send: Talent Searchers Of Hollywood, 6311-X Yucca, Hollywood, Calif. 90028.**

**SONGS, POEMS WANTED! For publishing, recording at our expense! TALENT, 17-PM, Longwood Road, Quincy, Mass. 02169.**

**SONGS, Poems Needed. New Songs recorded. Publishing Guaranteed. Musically Yours, Box 606PM, Laurel, Florida 33545.**

**POEMS Songs wanted. Recording. Publishing guaranteed. Royalties. Radio-TV release. Broadway Music, Box 11647-PM Sarasota, Fla. 33578.**

**SONGPOEMS, SONGS! Urgently Needed, Possible Recording/Publishing. 50-50 Agreement, Betty's Music Makers, 1417B Park Bldg., Pittsburgh, Pennsylvania 15222.**

**WRITE The Music for Your Poems. COUNTRY WESTERN SONGWRITERS WORK-BOOK Tells How. HAMMONDS, 3 Baemar, Wheeling, West Virginia 26003 Only \$3.49.**

**WANT Your book published? Learn how—we publish, advertise, promote, distribute. Many successes. Free booklet PM. Vantage, 516 W. 34th Street, New York City.**

**BUSINESS SERVICES**

**PROFITS FROM CLASSIFIED ADVERTISING! Booklet shows you how to start your own business with Classified Advertising. Only \$1.00 (Refundable with first order.) H. E. KAPPEL, POPULAR MECHANICS, DEPT. P, 224 WEST 57 STREET, NEW YORK, N.Y. 10019.**

**BUSINESS OPPORTUNITIES**

**BECOME Tax Consultant. Our students earn \$1,000-\$3,000 every tax season preparing returns evenings, State approved. National Tax School, Monsey 2WD, New York 10952.**

**YOUR Name on our Mailing List. Free Details. Kennedy Mailing Service, Box 351, Selma, Alabama 36701.**

**START Your Own Business at Home. Earn \$20,000 Year. Learn from Experts. Full Information \$3.00. Stemmermann, Box 277, Oyster Bay, New York 11771.**

(Continued on next page)



## BUSINESS OPPORTUNITIES

(Continued from preceding page)

**ADDRESS.** Envelopes. \$100.00 Weekly Possible. For Details. Send \$1.00 And Stamped Addressed Envelope. Keen, Box 9995PM, San Diego, Cal. 92109

**CASH** For Newspaper Clippings. Royce, 14603 Dorchester, GC-113, Dolton, Illinois 60419.

**SELL** Music Books, Mailorder—300% Profit! Circulars, Ads Available. Dropshipments. Free Details. Shonoco, Box 192, Medford, Oregon 97501.

**INSTALL** Burglar alarms without previous experience or costly equipment. Big profit. Free details. Nasco, Dept. G270B, Woodland Hills, California 91364.

**HOW AND WHERE TO GET CAPITAL.** Get \$500 to \$2 Million. Free information. Counselor-17, Kerrville, Texas 78028.

**\$25,000 + YEARLY**—Sparetime, guaranteed mailorder system! Start with \$7.00. Rush 25¢ (refundable) Mears, 5363 Essex, Alexandria, Virginia 22311.

**\$250.00 PER** Thousand stuffing envelopes! Unconditional Money-Back guarantee! Complete Starters Kit \$1.00. **HOMEWORKERS**, Box 24413-NK, Oakland, Cal. 94623.

**SECRETS!** Mail Order Success. Internationally famous expert reveals how to make home business fortunes. Beginners! Get free report "Make Money By Mail" Discloses free advertising profitable products. Mailco, Dept. GC70B, Woodland Hills, California 91364

**ENGRAVE ELECTRIC SIGNS!** Plus build. Electrify, Plastic, (magnetic) Signs! Economy Enterprises, Div. 23, Highland, Maryland 20777.

**FREE MONEYBOOK** "990 Successful, Little One-Man Businesses", plus money loans. Work home! Small Business Index, Dept. 7, Kerrville, Texas 78028.

**\$2,000 MONTHLY** In Fabulous New Business. Write: Nance, Box 25035-E, Cincinnati, Ohio 45225.

**IMPORT-EXPORT** Opportunity, profitable world-wide, mail order business from home, without capital or travel abroad. We ship plan for no risk examination. Experience unnecessary. Free Report. Mellinger, Dept. G270B, Woodland Hills, California 91364

**SILVER RECOVERY** Dealers **WANTED!**—Earn \$24,000.00 By Second Year!—No Investment! No Risk! Equipment Provided!—Our Manual "How to Start and Operate Your Own Silver Recovery Business" Gives Complete Details—Manual Only \$9.95—Limited Offer!—Creative Products, 8415 Lofland, Dept. 113, Houston, Texas 77055.

**I MADE \$2,000.00** Monthly by Mailorder . . . Evenings Only! You Can Too—Free Proof! Asbury, Box 161-D, Madison, Ohio 44057.

**FREE** Newsletter! "Selling Books By Mail". (Wholesale, Dropship, Imprints). Mailer, Box 1355, Sioux Falls, South Dakota 57101.

**\$500.00 MONTHLY!** Two Hours Per Day! Mail Order! Complete Instructions \$3.00! Hilmar, Box 347-DH, Valrico, Florida 33594.

**RECEIVE \$250.00** Per Thousand—stuff Envelopes—Earn Immediately—Details 25¢. Saffar, Box 1956PM2, Atlanta, Georgia 30301.

**FREE** Book! How to Sell Successfully by Mail Without Inventory. Write: AIDS, Route 5-A, Jefferson City, Missouri 65101.

**NEW!** Profitable Mail Order Business! Free Details! Xcito Businesses, 5715 N. Mozart, Chicago, Illinois 60659.

**50-400% PROFIT!** Sell Tested, Proven, Legitimate, Moneymaking Publications by mail. Complete Details 25¢. PAIT, 140T South B, Tustin, California 92680.

**BIG** Business in Vinyl Repair. Sensational process repairs, refinishes, recolors vinyl, leather, naugahyde furniture, car tops. One 20 minute job puts \$20 in your pocket. Make \$600 a month spare time. Homes, restaurants, offices, cars, unlimited customers. Easy to learn and do. Details Free. VIP, 2007 Montrose, Chicago, 60618.

**BIG** Profits selling Nameplates, Custom Engraving—Free Details, R.P.H. Manufacturing, 249-G Winter, Stamford, Conn. 06905.

**\$2000, MONTHLY** Selling Information By Mail; Free Details: Clark, Box 80521-M, Atlanta, Georgia 30341.

**CLAIM ABANDONED SILVER**—\$20,000 Secret Revealed! Free Information: Silverman 4A-13, Box 548, Woodville, Texas 75979.

**START** Your Own Correspondence School. United Career Schools, 5820P Imperial Hyway, South Gate, Calif. 90280.

**HERBALISM!** The Home Gold Mine! **FREE LESSON, SEEDS!** Herbalism Institute-B, Box 968, Glendora, California 91740.

**BIG PROFITS!!** **SELL ENGRAVED, METAL, SOCIAL SECURITY PLATES. FREE SALES KIT!** MYERS, 928-PM CRESCENTHILL, NASHVILLE, TENNESSEE 37206.

**MAILORDER** Dealers Wanted. Earn outstanding profits using tested promotions! Rutward-PD, Georgetown, Conn. 06829.

**PIANO** Tuning Learned Quickly at Home! Tremendous field! Musical knowledge unnecessary. GI Approved. Information Free. Empire School, Box 327, Miami, 33145.

**WORLD'S** Largest supply, Merchandise 25% to 40% under wholesale. Bankrupts. Closeouts 10¢ on dollar. Imports. Hong Kong clothes. Automobile discounts. Free details. International Buyers, Box 16386 MM, Portland, Oregon 97233.

**SELL** Books by mail. Complete dealer set-up—25¢. Midwest Mail Sales, Box 44R2-PM, Shawano, Wisconsin 54166.

**MAKE** A Years Income in 8 weeks Camping. No selling. Capital or Land necessary. Write: Edru's, Route 5, Box 5733, Gig Harbor, Washington 98335.

**BECOME** "Mortgage Broker." Lucrative! Capital Sources, Box 99-A, Uleta, Florida 33164.

**MAKE** Magnetic signs, Machineless method. Profits enormous. Write: R1B49APM, Bardstown, Ky. 40004.

**ADVERTISING BUSINESS—YOU** Own it. \$400 First Week or Money Back. Electric Neon Action Ad Clock, 229 W. Illinois, Chicago 60610.

**HOLLYWOOD CEMENTCRAFT:** Offers Highly Profitable Home Business. Experience Unnecessary. Unlimited Unique Pottery Designs Easily Made Without Moulds. Bird-baths, Fountains, Wishing-Wells, Waterfalls, etc. Chemical Coloring Formulas. Marble-glazing. **FREE** Illustrated Brochure. **CONCRETE FACTS**, 602 Athens Street, Altadena, California 91001.

**COPUBLISH** "Mail Sale Advertiser," leading mailorder paper. Copy and details 25¢. U.S.A. only. Vanroy Shirk, Lebanon, Pa. 17042.

**FREE** Catalogs. Repair air conditioning refrigeration. Tools, supplies, full instructions. Doolin, 2016 Canton, Dallas, Texas 75201.

**\$70 TO \$200 WEEKLY**—Home, Spare Time Simplified Mail Bookkeeping. Immediate Income. Easy. Auditax, Box 34741A, Los Angeles, Calif. 90034.

**VENDING** Machines. No selling. Routes earn amazing profits. Big catalogue Free. Parkway Corporation, 715PBM Ensor Street, Baltimore, Maryland 21202.

**\$60.00 DAY.** Manufacturing Concrete Posts. Blocks. Mold Equipment Catalog \$1.00 refundable. Carlayne, Route One, Box 95, Rapid City, South Dakota 57701.

**SELL** Books by mail. 400% profit. Royal, Box 450-X, Cleveland, Ohio 44127.

**MAILORDER** Records help get increased business! Complete 32 page Record Book shows your inquiries, orders, advertising, expense, etc. Only \$1.00. **H. E. KAPPEL, POPULAR MECHANICS, DEPT. R, 224 WEST 57TH STREET, NEW YORK, NEW YORK 10019.**

**REPAIR** Hydraulic Jacks—Details Free. Write: Hydraulic Parts Supply, Box 295, Port Isabel, Texas 78578.

**EARN** \$60.00 Daily manufacturing Concrete Fence Posts. Practically no investment. Send stamped-addressed envelope. American, Excelsior Springs, Mo. 64024.

**\$50.00 PLUS 50% COMMISSION** Stuffing 200 already stamped, addressed envelopes, our circulars. Information 25¢ with stamped, self-addressed envelope. Brewster-PB, Clearwater, Florida 33517.

**\$400.00 MONTHLY** Raising giant fishworms. Soilless method. Charlie Morgan, Bushnell, Florida 33513.

**EARN** Money raising fishworms for us! Write: Oakhaven-38, Cedar Hill, Texas 75104.

**WATCHMAKING** Makes every day a payday. Learn this cash business at home. Free details, Chicago School of Watchmaking, YYA, Fox River Grove, Illinois 60021.

**\$1.00 LISTS** You year sent to 1000 Importers, Jobbers, Mailers, our mailing year. Dixie, King, North Carolina 27021.

**\$200.00 SPARE** Time earnings with your Tablesaw. Write: Workshop Five, 3800 Harney, Vancouver, Washington 98660.

**STUFF** Envelopes. \$25 Hundred. Immediate Earnings! Beginner's Kit, \$1.00 (refundable). Lewcard, P392M, Brea, Calif. 92621.

**\$200 WEEKLY!** Make, Sell Bricks! Free Information! Xcito Bricks, 5715 N. Mozart, Chicago, Ill. 60659.

**\$2000.00 MONTHLY** Selling Information By Mail. Ropchan, Box 5341P, Sherman Oaks, Calif. 91413

**I MADE \$40,000.00** Year by Mailorder! Helped others make money! Start with \$15.00—Free Proof. Torrey, Box 318-Y, Ypsilanti, Michigan 48197.

**SELL** New Sensational Car Thief Signal. Lightning Seller, Samples for trial, Northwest Electric Ave. 182, Mitchell, S. Dak. 57301.

**BECOME** Our Mail Order Distributor with \$150 Investment. Free Brochure. Audit Controls, 40 Brookside Ave., Fair Lawn, New Jersey 07410.

**PORTABLE** Sandblaster \$29.95. Distributor wanted. Free brochure. INKA, Box 66573—A, Houston, Texas 77006.

**MAILORDER** Millionaire helps beginners make \$500 weekly. Free report reveals secret plan! Executive (1A11), 333 North Michigan, Chicago 60601.

**FREE SECRET BOOK** "2042 Unique, Proven Enterprises." Tiny businesses but huge profits! How Little Fellows beat inflation. Work home! Haylings, T25, Carlsbad, California 92008.

**SECRETS** of getting rich with other people's money. \$5000 + possible in one day. Free details. JPA, Dept. 307, Box 101, Park Ridge, N.J. 07656.

**\$200.00 DAILY** In Your Mailbox! Opportunity To Follow Mailorder Experts. Free Details. Associates, Box 136-A, Holland, Mich. 49423.

**RECEIVE** Mail Galore! Your name on our national mailing lists, \$1.00. Sullins, Box 1313, Brunswick, Georgia 31520.

(Continued on next page)



## BUSINESS OPPORTUNITIES

(Continued from preceding page)

**\$25.00 HUNDRED** Addressing possible year 'round. Special information 25¢ with self-addressed stamped envelope. Cove-B, 627 Franklin, Clearwater, Florida 33517.

**\$1000 MONTHLY** from your own home. Write: Jordan, Box 884, Dept. PM11, Visalia, Calif. 93277.

**DO SIMPLE ADDRESSING**—Mailing. Receive \$12.95 orders. Keep \$8.00 profit. Details Free! Quality, Box 9-P, East Rockaway, N.Y. 11518.

**MEN**—Women! Fill out income tax forms at home in own business. We show you how. Simple, easy to learn. \$700 per month earnings possible. Details mailed free. No salesmen. Hurry. Federated Tax Home Training School, 2065 Montrose, Chicago 60618

**MAKE \$7.50 to \$15.00** hourly building portable custom cases in your home. Huge demand. Get orders by mail. We supply materials, instructions—everything. Free details. Customcase, 6075 De Soto, Dept. C-P11, Woodland Hills, California 91364.

**TAKE** Catalog orders. We drop-ship 1001 best selling specialty products. Lowest below wholesale prices. Immediate Delivery. Spectacular home business opportunity. Free Book, Specialty Merchandise, Dept. S-P-11, Woodland Hills, California 91364.

**HOW TO MAKE MONEY ADDRESSING, MAILING LETTERS, OFFER DETAILS 10¢.** Lindbloom, 3636 West Peterson, Chicago 60659.

**MAIL** Baby Catalogs Imprinted with your address to New Mothers for Big Profits! Details 25¢. Volz PM, Ypsilanti, Michigan 48197.

**CALIFORNIA MANUFACTURER NEEDS** Man to assemble our product and be local agent, experience unnecessary. May start while presently employed. Five-figure income for responsible applicant. S.K.R.M. Manufacturers, 2347 West 238 Street, Torrance, California 90501.

**MAILORDER BEGINNERS LIBRARY.** Learn Professional Secrets Inexpensively! Write: HOW, Box 4457PM11, Downey, California 90241.

**PLAN** Ahead "1974's Greatest Mailorder Opportunities." Absolutely free. Neil H. Tasker, Shamokin, Pennsylvania 17872.

**\$150 WEEKLY** Possible Addressing, Stuffing Envelopes. Information Send 25¢ Stamped, Addressed Envelope To: D & M Advertising, Box 4347—M, Colorado Springs, Colorado 80930.

**EARN** Thousands at home. How to sell books by mail. Free details. Wisdom House, Box 1106P, Largo, Florida 33540.

**RAISE** Rabbits, other Laboratory animals for us. We supply equipment, breeders and instructions. Details 25¢. Rabbits of Michigan, MP-11 Countyline Road, Pentwater, Michigan 49449.

**HOW TO RAISE \$100.00 to \$1,000,000.00!** Write: Capital-PM, Dawsonville, Georgia 30534.

**FREE COLLECTION AGENCY** Details!! \$1000.00 Monthly Possible. Master-PM, Dawsonville, Georgia 30534.

**BECOME** a Mail Order distributor with small investment. No inventory catalogs. Full Profit. Free details. Queens Enterprise, Box 1607-A, Grand Central, N.Y. 10017.

**SUBSTANTIAL PROFITS.** Own your own business. Quickly learned. Operate from your home while continuing present job. Little over \$1,400.00 starts your own nationally and locally advertised business. Investigate immediately before your territory is taken. Free literature. Send today. Thixo-Tex, Inc., 5757 Lincoln Avenue, Dept. PM-3, Chicago, Illinois 60659.

**START** Profitable Home Mailorder Business with Proven, Tested Baby Gift Catalog. Imprinted. Complete Profit Details, Sample Catalog 25¢. Langford, 600 National Drive, Grafton, Ohio 44044.

**SEE** How Mail Order Fortunes Are Made. Keystone, P.O. Box 106-PM, Rockaway, New Jersey 07866.

**HIGH** Profit Potential from Plastic Engraving! Ideal Home Business. Trend Craftsmen, 4901P Perrine, Midland, Michigan 48640.

**YOUR** Own Mailorder Catalog Business. Merchandise Investment. Details 25¢ AM Sales, 31-14 94 St., East Elmhurst, New York 11369.

**FABULOUS** Spare-Time Earnings — Burglary Prevention. Details 25¢. Sample \$3.00. Marside, 115 Paloma, San Antonio, Texas 78212.

**RAISE** Capital without collateral or credit. Unique plan assures success. Enterprises, Box 247-M, Columbus, Georgia 31902.

**NEW EXCITING BUSINESS.** Free Details. T. Pearson, 787 Haight, San Francisco, Calif. 94117, Dept. 109.

**\$10,000 MONTHLY** Possible! Fantastic secret carpet cleaning formula revealed! Costs little—huge profits! Professional results guaranteed! Learn how to start your own cleaning business—easy! Every household your customer. Beat all competition. Sell formula/cleaning course by mail. Have your own name brand cleaning solutions. Complete, exciting details, \$1—refundable. Tower Carpets, Box 1066-H11P, La Habra, Calif. 90631.

**BEGINNER'S** Mail Order Business Secrets. Details. Al's, PM, Atalissa, Iowa 52720.

**8 TRACK** Tapes. \$24.00—Dozen. Rock, Soul, Country, Spanish. Free Catalog. Victor's, Box 10215, Cleveland, Ohio 44110.

**SELL** BURGLAR ALARMS. Set of Five Warning Stickers \$1.00. Lee Specialties, Box 32P, Dobbs Ferry, New York 10522.

**EARN** More than many professional men! \$1000. Month Mail Order Collection Agency. Continental, Box 2252-A, Des Moines, Iowa 50310.

**"MAILORDER** Course! Home Study". 24 Easy Lessons. \$2.00. "Bill" Lambertson, 132 Tamiami Station, Dept. PM113, Miami, Florida 33144.

**ADDRESS** Envelopes. Good money available from Mail Order Firms. Send self-addressed stamped-envelope. COLUMBIA, Box 24413-M, Oakland, California 94623.

**1000% PROFIT** Bronzing Baby Shoes At Home. Free Literature. NBC-PM, Gower, Missouri 64454.

**1000 SUCCESSFUL** Home Businesses Described. Bakers, 313 Harrison, Sullivan, Illinois 61951.

**FINDER'S FEES?** Turn Contacts into Cash. Two Survey Reports, Trial Membership Kit. Send \$2. Finderhood, (PM-74), 15 West 38th St., New York, N.Y. 10018.

**HOMEWORKERS**—Mailables Wanted! Free Information. A. Allen, 2418 Lori, Santa Ana, California, 92706.

**FREE**—166 Wholesale Catalogs and FREE bookmakers. Finest Mailorder Information!—Jav's Mail Order Sales, 2208 Hermitage Avenue, Wheaton, Maryland 20902.

**MONEY EVERYDAY IN YOUR MAILBOX.** Free Details. Jaycee Barnes, Box 913, Glens Falls, New York 12801.

**HOW** To Make \$30,000 net yearly. Complete Program \$2.00. Fuller, 228-B Lemmon, Sumter, South Carolina 29150.

**INEXPENSIVE INVESTMENT**—Profitable Returns with Magnetic Sign Machine. \$1,000 Machine can be Built for Under \$75.00. Detailed Blueprints \$14.95 or Information 25¢. Vac-U-Form, 10077 Edison, Osceola, Ind. 46561.

**OPERATE** MAIL ORDER BUSINESS. Profitable spare time opportunity. Free details. Wilfert Co., 7580 Clough, Cincinnati, Ohio 45244.

**SELL** Books!! Complete Mailorder Plan. Vikari's, Box 1312PM2, Salt Lake City, Utah 84110.

**SMALL BUSINESS OPERATORS.** Learn how to increase your Profits and Operate more Effectively. Big Business Techniques Exposed. Subscribe to the "Small Business Reference Letter." 3 months trial (New Subscribers) ONLY \$2.00. One Year \$18.00. FREE Bonus Copy of "Analyzing Your Investment Opportunities" for Prompt Action. Guaranteed Fascinating and Informative. Hamilton Publications, Dept. PMB, Box 156, Stratford, Conn. 06497.

**BIG** Money Abandoned Land. Helped others. Free Information. Tax Sales, Box 3-A, Montreal, Canada 206.

**MAKE** Your Fortune with Mail Order Imports. Work at home, no Investment in Merchandise. Exciting New Method of Starting in this Profitable Business Revealed. Send \$1.00. Raintree House, Dept. PM, 53 Circuit Ave., Tuckahoe, New York 10707.

**WHO'S MAKING A BUNDLE?** How Much Profit does Joe's Business Make (Exact-ly)? Any Business? Costs? Cash needed? Knowledge needed? How to Start? Case History Details on every Profitable Business Around. Write Free, **INSIDERS REPORT 2K**, Box 90954, Los Angeles 90009.

**"HOMEWORKERS** \$25.00 Hundred Stuffing Envelopes. Details 10¢ Save-Rite Sales PM, P.O. Box 81, Morton Grove, Illinois 60053.

**100 BUSINESSES YOU CAN START FOR LESS THAN \$100.** Free Report. EDUCATIONAL, Box 3133M, Santa Rosa, California 95403.

**"YOUR** Name Placed Directly—with 100's of Mailers, Publishers, Importers, Exporters. Mail \$1.00. Jemco, Box 6428, Fort Worth, Texas 76115."

**LET** Others make money for you. Start home business. Full or part time. I show you how. Free Report. Morgan, Dept. G270B, 6100 Variel, Woodland Hills, California 91364.

**\$5,000.00 WEEKLY** Possible. Very Simply Change Refrigerators, Air Conditioners to Use 1/3 Less Electricity. Details \$40.00. Refundable. Spaceman, Box 16046 Kansas City, Missouri 64112.

**MONTHLY** \$1500—From Your Home, Easily!! Write: E. Enterprises (P11), 1019 Hillside, Valdosta, Georgia 31601.

**NEED MONEY?** Stop Looking! Start small, at home, grow at your own pace. Men and Women equally successful. Details 25¢. Reliable, Dept. 1011, 28 East Jackson Blvd., Suite 1204, Chicago, Ill. 60604.

**MAKE** \$92.00 From Square Foot Plywood with Jigsaw or Bandsaw; Revealing details 25¢. Woodat, Bridgewater, Mass. 02324.

**BECOME** A Millionaire. How? Member Kit. \$2.00. Rainbow, Elkin, North Carolina 28621.

**MAKE** durable building plastic easily. Waterproof, Fireproof, Economical. Bays Laboratory, Cedaredge, Colorado 81413.

**SUCCEED!** Your Own Mail Order Business. Start Now! Pamphlet 50¢. Guaranteed! Lynco, Dept. 1613, Box 7, Old Bridge, New Jersey 08857.

**\$150 WEEKLY** In Your Own Business, Repairing Books At Home. Details Free. PBC Bookbinding, Box 10, Bonham, Texas 75418.

**WE NEED GINSENG GROWERS!** \$3,000-\$30,000 Annually! We Buy Your Crop. Send \$2.00 for Seed Sample and Information. Glass's Ginseng Exchange, Box 336, Rochdale Station, Jamaica, New York 11434.

(Continued on next page)



## BUSINESS OPPORTUNITIES

(Continued from preceding page)

**LEARN AUTO UPHOLSTERING & vehicle interior customizing. Save BIG MONEY, EARN BIG MONEY!** Start with your own car, learn at home, spare time, through A.U.I. proven home instruction course. Includes custom and standard cars, boats, campers, trailers, bucket and standard seats, tops, headliners, auto glass, carpeting, diamond tufting, tuck & roll—everything to make you a real auto trim expert in few short months! Tools & do-it-yourself kits included. Send for FREE facts and auto trim career booklet. **AUTO UPHOLSTERY INSTITUTE, BOX 64-YPM, ORANGE, CALIF. 92669.**

**YOUR GREATEST OPPORTUNITY:** Work less, earn much more money, enjoy easy life, achieve your goals. Free details. Orben PY-11, 33 Parkview Ave., White Plains, N.Y. 10604.

**SELL Books by Mail 400% Profit!** Associated, Box 123 PM, Wenonah, New Jersey 08090.

**ROBOTS:** Rea' Talking. Sales Promotional money-makers. Free Details, Orben PR-11, 33 Parkview Ave., White Plains, N.Y. 10604.

**HOW TO EARN AT HOME ADDRESSING ENVELOPES.** Rush addressed/stamped envelope. Midland Gifts, 2047 East Main St., Billings, Montana 59101.

**GREAT NEW GOLDEN OPPORTUNITIES:** Goals getting success kit. Free Details. Orben PK-11, 33 Parkview Ave., White Plains, N.Y. 10604.

**AUTO PARTS STORES FOR SALE!** For Locations and Information Write: G. A. Millinger, 2754 Quincannon Lane, Houston, Texas. 77043.

**\$6,040.00 MONEY BACK PROGRAM.** Details 25¢. Wis. Box 188-PM, Birnamwood, Wisconsin 54414.

**SELL Simple Formula for Making One-Way Mirrors Via Cheap Classified Ads.** Big Orders From Men's Magazines. Formula: \$5.00. Lormail, 518 18th Street, Lorain, Ohio 44052

**"HOW To Start Your Own Business."** Read Before You Leap!!! \$1.00. Associates, 113D29 Community, Shillington, Pennsylvania 19607.

**GOOD PROFITS In Your Own Business.** Designed to Fit you Alone. Start in Spare Time. Small Investment. Trauhau-52, Box 3004, Duluth, Minnesota 55803.

**FANTASTIC Mailorder Business.** \$25,000.00 First Year Guaranteed. Details 25¢. International, Box 217, Madison, Wisconsin 53701.

**MERCHANDISE At Wholesale, Catalog \$1.00.** Edco Distributing, Box 49, Buffalo, New York 14224.

**FREE Literature—Start Your Own Mail Order Business At Home.** The Tomlyn Co., Box 614 (K-3), Clifton, N.J. 07012.

**DOUBLE Your Income.** Complete Formula Guarantees Success and Prestige. Book \$2.00. Imperial Gifts, 621A Tucson, Lexington, Kentucky 40503.

**SWIMMING Pools!** Be a Fox Pool Dealer. If you qualify you'll get in on the Ground Floor of the Booming Billion Dollar Leisure-Time Market and run a rewarding stimulating Business—of—your—own. You'll be part of Fox Pool Corporation—a solid long-established Growth Company with a National Network of Successful Builders. Fox will set you up, Train you, Guide you. We back you up with National Advertising, Supply Leads! Sales Aids and Technical Assistance. Field Reps support your efforts. You'll be Selling the Best Package in—Ground Pool made. It installs in just Days. If you're tired of making others rich, call Don Dahowski (717) 764-8581 or write: Fox, P.O. Box 549, York, Pennsylvania 17405.

**ELECTRONIC Assembly Business.** Big profits. Start home, spare time. Investment, knowledge, experience unnecessary. Free illustrated literature. Barta, Box 248GY, Walnut Creek, Calif. 94597.

**NEW.** Compact fire extinguisher. Fantastic profits. Exclusive territories. Norwich Chemical, Norwich, Connecticut 06397.

**SELL Books By Mail.** Dealership Information 25¢. House of Better Books, 33 Stonycliff Road, Centerville, Mass. 02632.

## MONEYMAKING OPPORTUNITIES

**BIG Profits in becoming a supplier to major industry through electroplating small parts and metalizing non-metals.** Write for free particulars: Mason, Room MC-2-CP, 1512 Jarvis, Chicago, Illinois 60626

**AMAZING PROFITS! NO RISKS!** Selling Jewelry By Mail. KIT \$1.00 (refundable). Fortune World, Box 4012, Foster City, California 94404.

**MAKE \$1.00 PER SALE** Selling engraved metal Social Security plates. **FREE SALES KIT.** Engravaplates, Box 10460-199, Jacksonville, Florida 32207

**HOW To Make Money in Real Estate.** Write: Howard, Box 577-B, Bozeman, Mont. 59715.

**POTENTIAL WRITERS:** 3 Steps to Successful Novels: STEPS, \$1.50. Writer's Aid. **SPEEDWRITING.** Original! \$1.00. Both, \$2.00. Specify. P.O. Box 2070, San Jose, California 95109

**200% PROFIT** Selling Rings. Triple Money in 30 Days or Money Back. Free Details, Anka, P.O. Box 8036-PM, Cranston, Rhode Island 02920.

**BUY BELOW WHOLESALE.** Make Big Profits. Gift Items, Carded Merchandise. Free Catalog. Little Town Products, 311 Cottage Morrisville, Vermont 05661.

**400% PROFIT** From Square Foot 1/4" Plastic. Details Free. Jo-Mar-Ko, POB A34893, Detroit, Michigan 48234.

**MAKE MONEY** Writing Fiction for Magazines. Complete Instructions \$5.00. Jeff Morris, 2320 Garland, Missoula, Montana 59801

**EARN Money by mail.** Free details. R. V. Heuvel, 2030 Roblane, Muskegon, Michigan 49442.

**YOUR Ideas are Worth Big Money.** Exciting new Book tells Secrets. Free Details. Neotek (PMA-M), 19309 Revere, Detroit, Michigan 48234.

**HOMEWORKERS.** Earn 25¢ Each, Stuffing Envelopes. Rush 10¢. Gemco, B-21244A, Indianapolis 46221.

**\$500.00 WEEKLY.** Most PROFITABLE. Mail Order, Sell Information, Details. Smith, Box 176, Corona, California 91720.

**LEARN Sign Painting—\$1000 Monthly, Part-Time.** Free Catalogue. Kaufmann Company, Centertown, Missouri 65023.

**CLIP Newspaper items.** \$1.00-\$5.00 each. Details free. Walter, Box 1360-PA, Erie, Pa. 16512.

**\$100.00 EXTRA WEEKLY EASY! SPARE TIME! DETAILS, BEAUTIFUL SAMPLE FREE.** RUSSELL PRODUCTS, DEPT. P41, COLUMBIA, TENNESSEE 38401.

**MAKE Statuettes, novelties, imitation marble.** Sell to stores or start gift shop. Free details. Marbleizing, 41 Waverton, St. Louis, Mo. 63124.

**HOW To Make Money Writing Short Paragraphs.** Information Free on "Home Studies in Writing" Barrett, Dept. C-27-C1, 6216 N. Clark, Chicago 60660.

**\$2.40 HOURLY** Making simple wood novelties. Free details! Gene's, 55 Boxwood, Falmouth, Mass. 02540.

**HOW TO GET RICH!!** Free "Money-making Brochure"! Success International, Box 2447-C, Livonia, Mich. 48151.

**VENDING Machines.** No selling. Routes earn amazing profits. Big catalogue Free. Parkway Corporation, 715PMM Ensor Street, Baltimore, Maryland 21202.

**PENNY STOCKS** Have Profit Potential. Free Information. Analyst P.M., Box 214 Redondo Beach, California 90277.

**\$40 DAILY** Possible tying fishing flies at home. Details 25¢. Flyco, Box 481PM, Albany, Oregon 97321.

**EARN MONEY,** learn mailorder, spare-time, at home, reading leading (since 1929) trade magazine, product sources, stories, tips. Sample 50¢, year \$5. Mail Trade, Box 1302, Springfield, Illinois 62705.

**FREE—Easy Ways to make money selling exciting new products—Full—spare time.** Send name, age, for 5 months free subscription. Salesman's Opportunity Magazine, 1460 Hancock Center, Dept. 17-LM, Chicago 60611.

**ADDRESSERS—50 Companies want Addressers.** Send self-addressed envelope. Cal Enterprises, Box 4516-X, Compton, Calif. 90224.

**SWEEPSTAKES** Contests. How to win. Write for free information. General Contests, 1609-18 East 5th., Duluth, Minnesota 55812.

**FREE SECRET BOOK** "2042 Unique, Proven Enterprises." Largest successful collection! Fabulous "Little Knowns." Work home! Haylings-T24, Carlsbad, Calif. 92008.

**\$200.00 FROM** Sheet 1/4" plywood (scrap). Details 25¢. Novelties, 610 So. 24th, Elwood, Indiana 46036.

**GET World's Biggest Wholesale Import Catalog.** Write: World, Medina, Washington 98039.

**ADDRESSERS And Mailers Needed!** Free Details! Splendid Opportunity! Delta, Box 24-P, Chalmette, Louisiana 70043.

**SPARE Time Cash.** Sell Famous Hanover Shoes. Actual Samples and sales kit Free. No experience needed. No age limit. Lowest prices for highest quality makes selling easy. Every man a prospect. Big daily commissions. For full details, write: Hanover Shoes, 1041 Carlisle, Hanover, Pa. 17331.

**\$250.00 PER Thousand** stuffing envelopes! Unconditional Money-Back guarantee! Complete Starters Kit \$1.00. **HOMEWORKERS,** Box 24413-MK, Oakland, Cal. 94623.

**ADDRESSERS And Mailers Needed...** Immediately Earning! Details 10¢. Lily, Box 4967-P11, NYC 10017.

**\$75 DAILY** showing car owners how to end Waxing-Polishing Forever. Samples details Free. International, 34 E. 12th Street, New York, N.Y. 10003. Dept. PMD-6.

**NEED Cash?** We Pay Cash for Newsclippings and Box Tops. Free Details. Troy Company, Dept. 611PM, Bayonne, N.J. 07002.

**LEARN The secrets of repairing junk batteries.** "Fabulous Profits" at home. Apex Engineering, 3100, Romona, Atascadero, California 93422.

**PROVEN Successful Mailorder Imprint Catalog Program.** Everything Tested, Available. Free Details, Sample Catalog. Allen, 554CS-7 Spruce, Garwood, New Jersey 07027.

**WORLD'S Leading Contest Magazine,** 50¢. Prizewinner, 1315 Central, St. Petersburg, Fla. 33705.

**"MILLION DOLLAR EXPORT BUSINESS"** I'm making mine! Are you? Details \$2.00 (refundable) To: World Trade, P.O. Drawer 2347, Sepulveda, California 91343.

(Continued on next page)



## MONEYMAKING OPPORTUNITIES

(Continued from preceding page)

**NEVER WON ANYTHING?** Anyone Can Win Sweepstakes Contests! Free details. Services. Box 644-PCM, Des Moines, Iowa 50303.

**WIN** In State Lotteries, Irish, Australian Sweepstakes! Don't buy tickets randomly. Give them a Chance. Information: Necaca, P.O. Box 851-P, Philadelphia Pa. 19105.

**STARTS WITH SMALL AD GETS \$85,019.23 FIRST YEAR. YOU CAN TOO LEWCO, BOX 4233 A, WICHITA, KANSAS 67204.**

**3000% PROFIT** Preserving Baby Shoes in Chinakote. Free Literature. NBC-PM-1, Gower, Mo. 64454.

**HIGHER INCOME, Security and Power.** 256 page Book "Thinking Big" Reveals Secrets that Make Men Rich! Send \$2.00. The Variety House, PM113, 1414 South 120th Street, Seattle, Washington 98168.

**\$10 DAILY WRITING** Short Articles At Home. Report tells How. Begin IMMEDIATELY. Send \$1.00. P-B Enterprises, 172 E. King St., Lancaster, Penna. 17602.

**YOUR Money Method.** Ask Total Research, Box 46011, Seattle, Wash. 98146.

**EARN Money at Home** Addressing Envelopes. Rush Stamped Self Addressed Envelope. Hall's Secretarial Service, 1580-A Neva Avenue, Colusa, Calif. 95932.

**MAILERS NEEDED!** List of Firms \$1.00, Stamped, Addressed Envelope. Pat Richardson, Box 4097, Yuma, Arizona 85364.

**WIN Sweepstakes, Skill Contests—Now!!** Free information. Wiemels, 325-K Elmwood, Bay Village, Ohio 44140.

**SPECIAL Offer** Assortment 36 Adjustable Ladies Rings, Display Box. \$2.00 Retail, \$1.95 PPD. Edwards, 18062 Hamann, Riverview, Mich. 48192.

**\$2,000 MONTHLY** Possible in Fabulous New Mailorder Business. Write: Dept. PM, P.O. Box 1534, Beaumont, Texas 77704.

**CHRISTMAS MONEY** Make \$400 in Two Weeks. A Christmas Service that Requires No Selling. Complete Instructions \$2.00. J. Beach, 2101 Byron Road, Winter Park, Florida 32789.

**THINK Money.** Earn Extra Income Writing Short Articles at Home. Booklet Tells How and What to Write. Includes Directory Telling Where to Sell Articles. \$1.00. Raintree House, Dept. PM, 53 Circuit Ave. Tuckahoe, New York 10707.

**GUARANTEED Homework!** Write us first for free details. Troy Company, Desk 710, Bayonne, New Jersey 07002.

**PHOTO BUTTON MACHINE** \$29.95, 8D Enterprises, 230-PM, Greenwood, Lepanto, Arkansas 72354.

**INVEST** In Worlds Fastest Growing Agribusiness—Hydroponic Agriculture. Very Small Investment Receives Very High Returns. For Detailed Information, Send \$1.50 To: USA HYDRO, P.O. Box 608, Concord, California 94522.

**HOW TO COLLECT COINS** For INVESTMENT AND PROFIT! One Roll of 1926S Buffalo Nickels are now Worth \$13,000.00. Where to Buy and Sell Coins. Become a Franchised Coin Dealer. How to Start. Booklet #PM-1 only \$1.00. I. Clarke, 101-D, Clark Street #8 Brooklyn, New York 11201.

**NEW Product** Turns Dimes into Dollars! Free Details. Ideaco, Box 69828PY, Los Angeles 90069.

**FREE Information** "Many Successful, Little-Known Businesses". Work Home! Seventh House—PM9-2, 2111 Sierra Drive, Kemah, Texas 77565.

**70 SOCIAL SECURITY PLATE STYLES!** FREE SAMPLES AND SALES KIT. SYSTEMS, DEPT. CN-19, BOX 341, NORTHFIELD, IL 60093.

**BIG Profits—Sell Lifetime Metal Social Security Cards.** Free Sales Kit. Sunshine, PM113—2228 Saul Drive, Jacksonville, Florida 32216.

**"SUCCESS Is Easier Than Failure!"** Informative, Inspiring Book. Details. Premier Enterprises. Box 10597-BL, Pittsburgh 15235.

**FORTUNES In Land!** Amazing Profits! Acreage, lots few dollars on signals. Five other fast \$100,000 Profit Plans. Mental Money-Machine Instruction. Easy Borrowing. Everything \$5.00. Fortune-Builders, FPBM-1 Box 25, Marshall, Texas 75670.

**CREATE YOUR OWN PROFITABLE BUSINESS FROM SCRATCH:** Free details. Orben PB-11, 33 Parkview Avenue, White Plains, N.Y. 10604.

**START Small, Highly Profitable Electronic Production** in your Basement. Investment, Knowledge unnecessary. Postcard brings facts. Barta-FY, Box 248, Walnut Creek, Calif. 94597.

**EARN MONEY, Part/Full Time.** Details 25c. Ayton, PM-11, 5506 16th Avenue, Brooklyn, New York 11204.

**GET RICH!!** Sell Books Mailorder! Executive-22, Box 383, Jacksonville, Florida 32201.

**RETIRE** Anytime in Luxury! Easy Legitimate! Details. Premier Enterprises, Box 10597-AL, Pittsburgh 15235.

**METRIC, S.A.E., U.S.S., Bolts and Nuts.** Also **KEY MACHINES** and Key Blanks. Become the Dealer in your area Details \$1.00. (Refundable). American Distributors, Box 12121, Tucson, Arizona 85732.

### PROFITABLE OCCUPATIONS

**MEN—Women!** Start money-making Plastic Laminating business at home in spare time. Material costing 11¢ brings back \$2.58. No canvassing or selling but mail orders bring in \$20 a day. Write for full particulars free. Rush name on postcard to: Warner, Room LC-2-CP, 1512 Jarvis, Chicago, Illinois 60626.

**LEARN GUN REPAIR, GUNSMITHING** In spare time. Books, details 10¢. Modern Gun Repair School, Dept 2211, 4225 N. Brown, Scottsdale, Arizona 85251.

**FT. SMITH Auction School, Ft. Smith, Ark. 72901.** Resident & Home study. Veteran approved.

**BECOME A Mortgage Broker.** Highly respected, interesting, lucrative prestige business. For complete information write: United, Box 6284-F, Marietta, Georgia 30060.

**PLASTERCRAFT!!!** Profitable home business. Molds available. Details: Lynnette, 6251C Mentor Park, Mentor, Ohio 44060.

**SHARPEN—Scissors, Pinkers.** Light, compact equipment. Supplies. Blackhawk's, Sheldahl, Iowa 50243.

**HOW To Make Money Writing Short Paragraphs,** Information Free on "Home Studies in Writing". Barrett, Dept. C-27-C2, 6216 N. Clark, Chicago 60660.

**BAKE** New greaseless doughnuts in kitchen. Sell Stores. Free Recipes. Michael Ray, Waseca, Minn. 56093.

**MAKE MONEY IN SPARE TIME.** Earn generous commissions as a subscription sales representative for leading magazines. For full details and instructions, send this ad with your name and address to: POPULAR MECHANICS, Room 1107M, 250 W. 55th St., New York, N.Y. 10019.

### SALESMEN—DISTRIBUTORS

**BIGGEST earnings ever!** Show famous Hertel fully referenced Bible on proved plan. Startling 3-dimension cover. Easy credit plan. No investment. Demonstrator furnished. Write International Book, Dept. PM, Box 118, Wichita, Kansas 67201

**MAJOR 43 Year Old Greeting Card Publisher—now seeking full or part-time salesmen to contact retail stores.** No experience necessary. Easy sales. Huge commission rate. Write today. Moderne Card Company, Dept. PM-11/3855 North Lincoln Avenue, Chicago, Illinois 60613.

**\$100.00 EXTRA** A week easy! Spare time! Double Air Cushion shoes. Men's, women's line. Dress, work, play. Highest commissions. Shoes for yourself. Outfit Free. Bronson, Dept. H-113, Minneapolis, Minnesota 55408.

**COLLECTION System.** Sample \$3.00. Dozen \$24.00. Sell \$15.00 Each, Creditors Service Company, Murphy, North Carolina 28906.

**HOUSEHOLD PRODUCTS ROUTE. EARN \$25 or more daily.** Also Party Plan opportunities for men, women full, part time. McNess, Freeport (26113) Illinois 61032.

**PUBLICATIONS** for local wholesale distribution, higher profits. Details, sample, \$1 refundable. Publisher, 404 West Jefferson, Springfield, Illinois 62702.

**AUTOMATIC Fishhooks.** Free details. Samples, \$2.00. Aron, 61PM, Mastic Beach New York 11951.

**SELL Advertising Ball Pens, Calendars, Ad-Specialties—Build Own Repeat Business—Free Details—Fleming, Dept. A, 6535 Cottage Grove, Chicago 60637.**

**EARN MONEY IMMEDIATELY.** Sell nationally-Famous Knapp Shoes part-time or full time. High cash commissions immediately plus bonuses monthly, benefits. Your own hours, your own business. No investment. Free selling and training kit. Lowell Harris, Dept. PM-11, Knapp Centre, Brockton, Mass. 02401.

**AN OHIO Oil Co.** offers opportunity for high income PLUS cash bonuses, convention trips and fringe benefits to mature individual in your area. Regardless of experience, air mail U.L. Read, Pres., American Lubricants Co., Box 696, Dayton, Ohio 45401.

### AGENTS WANTED

**EVERY Man** a prospect. Refundable sales kit offer showing line belt buckles, tie clasps, money clips, cuff links, lapels, identification badges, individualized with customer's name and emblems. Cap badges for trucking, bus, taxi, police, firemen, also postal, letter carriers and heavy construction emblems. Choice 5000 emblems. Hook-Fast, Box 1088-PM Providence, R.I. 02901.

**ESTABLISH** Your own business. Low prices on used clothing, shoes, household goods. Unlimited profits. Free catalog. Northwestern Distributors, 2129-31 North Western Avenue, Chicago, Illinois 60647.

**PRINTING, Advertising Salesmen—Excellent moneymaking sideline** selling Decalcomania Name Plates, small quantities. Advertising Specialties, sign letters. Free Samples. Raico XL, Boston, Mass 02119.

**DISTRIBUTORS, Vendors, and Flea Markets!** Send \$1.00 (refundable) for our Illustrated Wholesale Price List of Fast-selling Collectibles, Giftwares, Curios, and Novelties. **THE CONOY CORPORATION, 214 East King Street, Lancaster, Pennsylvania 17602.**

**EARN** Up to three times your cost on dozens and dozens of unusual, unique gift items. Receive catalogs imprinted with your name and address. Drop shipment available in any quantity of packages direct to your customers using your own labels. Order today and receive our catalog with confidential wholesale price list plus a beautiful sample gift. Send \$2.00 refundable on your first order. CDS Enterprises, Dept. PM-1123, Box 638, New York, N.Y. 10005.

(Continued on next page)



## EMPLOYMENT INFORMATION

**OVERSEAS JOBS**—Now Hiring, 103 Countries, All Occupations, High Pay, Free Transportation, Tax Benefits, Latest Computerized Reports—\$2.00. **TRANSWORLD**, International Airport, Box 90802-E, Los Angeles, California 90009.

**AUSTRALIA—NEW ZEALAND WANT YOU !!!** 50,000 Jobs! Paid Transportation! Latest Information and Forms. \$1.00. Austco, Box 3623-E, Long Beach, California 90803.

**GOVERNMENT** Jobs, easily without experience. Only \$1.00. G. S.'s, Dept. SM, 3215 Macland Rd., Powder Springs, Ga. 30073.

**BE A World Traveler.** Earn Good Money, Save Most of it. Send \$2.00, Complete Information on Merchant Seaman Career. P.O. Box 1718, Pasadena, Texas 77501.

## HELP WANTED

**OVERSEAS** Jobs—Europe, South America Australia, Far East, etc. 2000 openings all trades. Construction, Office, Engineering Sales, etc. \$700 to \$3,000 month. Expenses paid. Free Information. Write: Overseas Jobs, International Airport, Box 536-M, Miami, Florida 33148.

**EARN** At Home Addressing Mail. Details 25¢ and Stamped Envelope. Deeco-151, Box 9308, North Hollywood, Cal. 91609.

**OVERSEAS EMPLOYMENT** . . . Australia, Europe, South America, Asia! All Occupations! \$700-\$3,000 monthly! Write: Employment International, Box 29217-AK, Indianapolis, Indiana 46229.

## REAL ESTATE AND FARMS

**FREE CATALOG!** Giant Fall-Holidays edition of country property! Over 5,200 New properties described, pictured—Land, Farms, Homes, Businesses—Recreation, Retirement. Selected Best thruout the U.S.! 73 Years' service—670 Offices, 41 STATES Coast to Coast. Mailed FREE from the World's Largest! **STROUT REALTY, Inc.**, 60MX E. 42nd St., NY, NY 10017 7-MX Dearborn, Chicago, Ill. 60603 150-MX N. Santa Anita, Arcadia, Ca. 91006

**CANADIAN LAND FROM \$25.00 AN ACRE CHOICE.** Properties available across Canada. Low monthly payments. Ideal for farming, cottages, hunting, fishing. Free Catalogue. Canadian Estate Land, Dept. PMC11, 286 Lawrence Ave. West, Toronto, Ont., Canada. M5M 1B3.

**CENTRAL** Ontario—Choice 640 acre Sportsmen's paradises still available—\$20.00 plus \$6.50 taxes yearly. Maps, pictures. \$2.00 (Refundable). Information Bureau, Norval 4, Ontario, Canada.

**FREE** Catalog! **PHOTOS!** Coast to coast farms, business, retirement. All types, sizes & prices. **SAFE-BUY** Real Estate, Box 589-PM, Little Rock, Ark. 72203.

**\$1 ACRE**—Canadian border—hundreds campsites, islands, farmlands, directly from tax authorities. (Non-profit). Lists, photographs mailed. Register, Room 10, 110 Church Street, Toronto 1, Canada.

**BOILING** Spring Lakes—America's Greatest Real Estate Value, 1/3 acre vacation or retirement homesites only \$995 cash price. Ten-year terms available. Money-back inspection guarantee. Carolina coast multi-million dollar, 14,000 Acre development. 50 fresh water lakes, private ocean beach, golf course, motel, and country club. Free literature. Dept. 1-P, Boiling Spring Lakes, North Carolina 28461. (Registered under Federal Land Sales act but not offered to residents of states requiring separate registration.)

**CANADIAN** Vacation lands: Full price \$385.00. 40 acres. \$10 month. Suitable cottage sites, hunting, fishing, investment. Free information. Land Corporation, 3768-C Bathurst, Downsview, Ontario, Canada.

**\$1.00 ACRE!** USA and Canada. Lists, photographs mailed. Government Lands, 220 Delaware Ave., Buffalo, New York 14202.

**GOVERNMENT LANDS FROM \$7.50 ACRE!** Vacationing, Farming, Investment! Exclusive "GOVERNMENT LAND BUYER'S GUIDE" . . . plus "LAND OPPORTUNITY REVIEW" listing lands throughout U. S. Send \$1.00. Surplus Lands, Box 6588-AK, Washington, D. C. 20009.

**SURPLUS** Forest, Mountain, Desert, Waterfront Land. Neglected Estates, Farms, Groves, Cabins. Throughout United States, Canada, Mexico. Low prices. Easy terms. Free list. Box 6272, Dept. 46, Santa Ana California 92706.

**IDEAL 5-ACRE RANCH.** Lake Conchas, New Mexico. \$4,975. No Down. No Interest. \$30/mo. Vacation Paradise. Good Investment. Free Brochure. Ranchos: Box 2006GB, Alameda, California 94501.

**FLORIDA LOTS**—Investment, retirement. Low down payment. Easy terms. Free brochure. Owner, Box 825, Deland, Florida 32720.

**CANADIAN** Land. Full Price \$285.00. \$10.00 Down, \$10.00 Month. Ideal Vacation, Hunting, Fishing. Free Information, Vacation Acres, 7771 A, Bernard, LaSalle 660, Canada.

**FREE.** . . . **BIG** 264-page **FALL** catalog. Hundreds of top real estate values coast to coast! **UNITED FARM AGENCY**, 612-PM West 47th St., Kansas City, Mo. 64112.



## FLOWERS, PLANTS & NURSERY SUPPLIES

**LEARN** Landscaping and the growing of plants. Start a profitable business part or full time. Free information without obligation. Lifetime Career Schools, Dept. A-368, 2251 Barry Avenue, Los Angeles, California 90064.

**GINSENG BRINGING** \$30 Pound. Have seeds, roots, Goldenseal. Full information. K. Collins, Viola, Iowa 52350.

**LEARN** Flower Arranging. Start business or Hobby. Free information on home study course. Lifetime Career Schools, Dept. B-773, 2251 Barry Avenue, Los Angeles, California 90064.

## CONSTRUCTION PLANS, BLUEPRINTS

**HOUSE EXPANSION PLANS** And detail instruction book provide anything from an extra room to 1000 s/f addition. Build what you need at big do-it-yourself saving. Book with 1 set working blueprints \$14.50! With 4 sets (required by contractors) \$20.00. Money-Saver Projects, Box 303-44B, Chappaqua, New York 10514. Information available.

**HOME** Building secrets exposed by professional engineer and builder. Booklet \$3.00 postpaid. Moesel Enterprises, Frenchtown, N.J. 08825.

## LOG CABINS

**"A" FRAME** Study Plan 50¢. Family House, Box 251, Westfield, New Jersey 07091.

**BUILD** Log Cabins, Rustic furniture, fireplaces!! Complete manual \$3.00 . . . "A" Frame plans, \$2.00 . . . Guaranteed. Beels, 956 Springdale, Atlanta, Georgia 30306.

**"A" FRAME CABIN.** \$500. Material. Purchase locally. Completely illustrated instruction manual & material list: \$2.00. Moneyback Guaranteed. Order Plan #1925, from "Dependable Products", Box 113, Vista, California 92083.

**"A" FRAME** Cabin. 1184 square feet: \$1950. material. Purchase locally. Complete plans, illustrated instruction manual & material list: \$5.00. Moneyback guarantee. Specify plan #1601. "Reliable Products", Box 597, San Marcos, California 92069.

**6 VACATION HOMES** You Can Prefab From \$360: "A"—Frames—Gambrels—Mansards. Illustrated Booklet Features Pan-L-Fab Method, Floorplans, Elevations—\$3.50. Omnimarketing, Inc., 5444 Bay Center Drive, Tampa, Florida 33609.

## HOME CRAFTSMEN

**WOOD**—Domestic and Imported Hardwoods 3500 items! Clock, musical instrument kits. Tools . . . discount prices! Hard-to-find hardware. 144 page catalog. 50¢. Craftsman, Dept. AX-113. 2729 Mary, Chicago, Illinois 60608.

**MAKE** Toys Yourself! 1 1/2" Hardwood Wheels \$2.95/36. Cange, 24A Cedar, Caseyville, Illinois 62232.

**IDENTIFICATION** Name Plates. Gold Stamped—Free Sample. Doorposter, Box 30502, New Orleans, La. 70190.

**101 PATTERNS** of Smart Gifts, Novelties, Shelves, Action Windmills, plus "Make Money Jig Sawing". \$2.00. Mastercraft, 115M, 7041 Olcott, Chicago 60631.

**POPULAR MECHANICS MASTER SHOP GUIDE.** Greatest product offered to a man with a workshop. All information printed on heavy boards, punched and ready to hang above his workbench. Covers wall fasteners, nails, screws, bolts, twist drills, abrasives, lumber, moulding patterns, plywood grades, hardboard, dry-wall plumbing supplies, electrical supplies. Plus information on score of other subjects. Send \$3.95 to: **POPULAR MECHANICS**, Dept. HE, 224 West 57th Street, New York, New York 10019.

**CABINETMAKING MADE EASY** And "How to Make Formica Counter Tops." Two excellent guides let you build kitchen cabinets and counter tops like professionals. Extraordinary guides bring master craftsmen's shortcut methods. Satisfaction guaranteed. Write: Japs, 126-P Seventh North, Hopkins, Minn. 55343.

**CATALOG FULL SIZE FURNITURE PLANS** —\$1.00 Refunded with first order. Traditional. Early American, over 150! Furniture Designs, 1425 Sherman, Dept. CP-113, Evanston, Illinois 60201.

**ORNAMENTAL IRON WORK.** Beautiful scrolls with inexpensive professional bender. Modular segments. Details Free. Fuschlin, Box 472, Woodland, California 95695.

**WORKBENCH** And tool panel anyone can build. Complete with material list. \$1.00. Way-Mar, 58 Underhill Road, Scarsdale, New York 10583.

**PICTURE** Framing—Profitable full or spare-time business. Easy to learn with handbook-course "Guide To Picture Framing Profits." \$1.50 Guaranteed. Free framing-supplies catalog included. Japs, 126-PM Seventh North, Hopkins, Minnesota 55343.

**BRASS** Hardware—Pulls, Knobs, Latches, Hinges, Etc. Lamp Parts to Make, Repair, Convert Lamps. Catalog 75¢. Paxton, Dept. B24, Upper Falls, Maryland 21156.

**SEE "ATTACHALL"**—Super-Motor Arbor ad under "Machinery, Tools, Supplies".

**PROTECT YOUR TOOLS**, with new durable engraving tool. Write on any surface permanently. Only \$2.98. Variety House, 9108 Troy, Evergreen Park, Ill. 60642.

## HOME REMODELING

**BUILD THIS ALL-IN-ONE DIVIDER.** Hi-Fi, storage and seating all combined in this handsome home entertainment center. Photocopy of article as it appeared in P.M. shows you how. Price 85¢. Send orders to Popular Mechanics, Dept. HE, Box 1014, Radio City, New York 10019.

(Continued on next page)

Материал защищенный авторским правом



## DO-IT-YOURSELF

**LAWN SPRINKLER UNDERGROUND SYSTEM**, 60"x120' Lot \$75. Designs for different site into complete with instructions 50¢. Fountain Sprinkler Co., 2244 Osage, Bartlesville, Okla. 74003.

**SAVE** On your grocery bill. Grow your own. Four books tell how. Home vegetable growing. Home grown fruit. Rabbits Mean Meat. Chickens for eggs and meat \$1.00 each. Berryhill, PM-11, Violet Hill, Ark. 72584.

**CONVERT** Any Television to Sensitive. Big-Screen Oscilloscope. Only minor changes required. No electronic experience necessary. Illustrated plans, \$2.00. Reico, Dept. A-201, Box 10563, Houston, Texas 77018.

**PROFESSIONAL** Secrets Revealed. Concise Home Manuals. Furniture Refinishing—Furniture Repairs—Minor Upholstery. \$2.00 each. Lent Woodworking, Box 303, Sewickley, Pennsylvania 15143.

**BURGLAR-FIRE** Alarm Supplies and Information. Free Catalog. Protecto Alarm Sales, Box 357A, Birch Run, Michigan 48415.

**CONVERT MOWER** Engines into air compressors. Write: Showalter, Box 409, Abilene, Kansas 67410.

**ARTIFICIAL** Fireplace Cabinet for T.V., Stereo. Bar Built of Wood Material. List Instructions Plans \$4.00. MMP Fireplaces, Box 1069, San Fernando, California 91341.

**1400 CATALOGS** Listed and Described Sources for EVERYTHING Imaginable! Rush \$2.00. MASTERLOG, Box 24413-YK, Oakland, California 94623.

**CONVERT** TV to 6-ft. wide screen! B & W/Color. Do-It-Yourself—easy! Kit, instructions, lens, \$12.95 PPD. Free illustrated details. MACROCOMA, PM-11, Washington Crossing, Penna. 18977.

**HOW** To Antique New Wood Without Stains. Unusual, Simple Plans give full details \$2.00. Irvin, 102 Sunny Lane, Mt. Pleasant Mills, Penna. 17853.

**SHUFFLEBOARD** Table Plans, Complete Instructions 10 to 24". More Fun Less Space Than Pool. \$2.00. Wilson, Box 91426, West Vancouver, B.C., Canada.

**BUILD NEW FREE HEATING**—Lighting. Powerful—Perpetual Unit (Device) Wouldn't Cost Penny to Run. For Full Instruction \$10.00 M.O. "Kosmon" Company, P.O. Box 68, Victoria, B.C., Canada

**PERPETUAL**—Machine you can Build and Solve. Energy Shortage. Full Instruction \$10.00 M.O. M. S. Research, P.O. Box 23812, Oakland, Calif. 94623.

**NEW** Invention! Electronic Cigarette Lighter for your home. Never needs fuel. Plans \$2.00. Kit \$19.95. American, Box 159, Tacoma, Wash. 98491.

**LIFETIME** OUTDOOR INCINERATOR Build it yourself for less than \$20.00. Instructions \$5.00. Ebner, RD #1, Box 147, Williamsport, PA. 17701.

**BEAT INFLATION!** Make Artificial Face-bricks—Under 10¢ sq. Foot. Any Color, Style. Details: Wagner, 1349 Ayrault Road, A9B11, Fairport, N.Y. 14450.

**SAVE** Fuel. Sleep Better. Lower Thermostat 5-10-Degrees At Nite Without-Touching-Normal Before Arising—Automatically Easy Instructions—\$12.00. Williams Variant Heat, 5707 Tulip, Philadelphia, Penna. 19135.

**D.C. ARC WELDER** From YOUR AUTO and 12 Volt Battery! Efficient D.C. Welding to 200 AMPS! No Modification to your Auto! Use Anywhere you Drive your Auto! Detailed Instructions \$2.00. Basic Welding Kit \$19.00. Instructions Included (12V. Battery not include). Bitek Industries, Dept. C, Box 404, Inyokern, Calif. 93527.

**REPAIR MINIBIKES, LAWNMOWERS, BICYCLES** Sewing Machines, Auto Engines, Mazda/Wankel, Motorcycles, Magic, boats. Over 100 How-To-Books. Free Brochure. Mastercharge accepted. Sincere. Box 10422, Phoenix, Arizona, 85064.

**HOME PROTECTION**—Not Costly! Free Catalog. Home Products, Box 281, Plymouth, Michigan 48170.

## ARTS AND CRAFTS

**"GETTING** Started in Stained Glass" 25¢. Whittemore, Box 2065Y, Hanover, Mass. 02339.

**FREE LITERATURE** For sculptors showing how to make molds, cast plastics. Adhesive Products Corporation, 1660 Boone Avenue, Bronx, N.Y. 10460.

**FREE:** New handicraft catalog. Supreme Handicrafts, Box 395-PM, Sioux Falls, South Dakota 57101.

**LEARN** Arts & Crafts at home. Excellent full or part time business opportunities, or hobby. Free booklets. Lifetime Career Schools, Dept. E-807, 2251 Barry Avenue, Los Angeles, California 90064.

**MAKE** Figurines, plaques, lawn ornaments. Molds, plastercraft kits, liquid rubber. Sample and catalogue 10¢. Wooley Company, Box 29-B, Peoria, Illinois 61601.

**TERRARIUMS** Are Gardens in Glass Bottles, Decanters, Jugs. Easy to Make, Inexpensive, Beautiful Gifts. Profitable Too! Learn How \$2.00. Jeff Nelson, 531 West Vermont, Phoenix, Arizona 85013.

**JEWELLED** Beauties, Wonderful Rewarding Hobby Easily Made with our Inexpensive GEMsai Tree Kits. Free Literature. Grayling Gemcraft, Box 613—AN, Grayling, Michigan 49738.

**MAKE** Old Wax Letter Seal. Directions: \$1.00 to: MRB, 509 "C" Street, New Bern, North Carolina 28560.

## BINOCULARS, TELESCOPES, MICROSCOPES, MAGNIFIERS

**FREE** Binocular, Riflescope catalog. Discount sale. Save 50%. Free gift with order. Write: United Binoculars, BN-7308, 9043 So. Western, Chicago 60620.

**TELESCOPE** (Reflectors) Complete Kits. Other Accessories, Request Free Literature. Criterion Manufacturing, Dept. PM 46, Hartford, Connecticut 06101.

**MAGNIFIER SET**, Plastic, Includes 2X-5X Combination, 3X, 4X, Bug-box, 5X, 10X and 15X Loupes. Many uses. \$3.95 check or money order. Plastecs, Box 188, Webster, Mass. 01570. Mass. Residents Add 3% Tax.



## CAMERAS AND EQUIPMENT

**FREE CATALOG!** Cameras, Lenses, Binoculars! Dickson Company, Box K-3979, Kowloon, Hong Kong. Airmail U.S. \$1.00!

**FREE! FREE! BARGAIN BOOK** Central Camera Co., Dept. 3111, 230 S. Wabash, Chicago, Ill. 60604.

## PHOTOS AND PHOTO SUPPLIES

**DARKROOM SINK WITH A BUILT-IN PRINT WASHER.** Make it yourself, it's easy! For 75¢ you can buy a photocopy of the article as it appeared in PM. Send orders to POPULAR MECHANICS, Dept. HE, Box 1014, Radio City, N.Y. 10019.

## PHOTO FINISHING

**CAMERA FANS!** Expert photofinishing by one of Country's largest labs at lowest prices. Fast service and free "Foto-Fan" Stamps you quickly redeem for valuable Photo Supplies. 8MM Kodachrome \$1.29; 8 Exp. Kodachrome \$1.79; 35MM Kodachrome 20 Slides \$1.39; 8 Exp. Black White 69¢. Satisfaction guaranteed. Send exposed film or request free mailers, complete Price List and Gift Catalog. Direct Mail Photo, Box 8352-PM, Pittsburgh, Pa. 15218.

## COLOR SLIDES

**35MM COLOR** Slides. 10,671 Individually sold. Described. Encyclopedia catalog 10¢. Wolfe Worldwide, Dept. 14-113, Los Angeles, Calif. 90025.

## MOTION PICTURES AND SOUND EQUIPMENT

**CLASSIC 8MM. MOVIES . . . 35MM. 2"x2"** Color Slides. . . largest selection anywhere! Silent classics, comedy, history, sport, news, documentaries, features, others! 16MM films also Free catalog. Blackhawk Films, 690 Eastin-Phelan Bldg., Davenport, Iowa 52808.

**FREE!** 64-Page catalog. 8-16MM film supplies, processing equipment. Superior, 448 N. Wells, Chicago 60610.

**8MM—SUPER 8—16MM MOVIES!** Biggest Selection! Lowest Prices! Free Catalog! Cinema Eight, Box PM, Chester Connecticut 06412.

**FREE** Catalog—8mm-16mm—Top Manufacturers—G & G Film Library, Box 321, Syosset, New York 11791.

**"HANDBOOK FOR 16MM FILM COLLECTORS"** . . . FREE Descriptive Circular. P.S.F. Enterprises, Dept. PM-7, 4476 Kingspark Drive, San Jose, California 95136.

**UNUSUAL** Movie supplies. Free circular. Esor, 47th Holly, Kansas City, Missouri 64112.

**SUPER 8MM, 16MM, 8MM** Sound and Silent Classic Films. Free Catalog. Niles, 1019-PM, So. Michigan, South Bend, Indiana 46618.

## RADIO, TELEVISION AND HAM EQUIPMENT

**TV-FM ANTENNA** VHF-UHF-FM 12 db. gain. No SPLITTER needed. US Pat. 3577196 ROLLABLE design. Just unroll and stick on wall. Size 18"x48". Made of decorative plastic but rugged for yacht or R/V. Just \$10 postpaid. Order from Antenna Design Co., Albuquerque, New Mexico 87112.

**SAVE** Money on parts and Transmitting—receiving tubes. Foreign—domestic. Send 25¢ for giant catalog. Refunded first order. United Radio Company, 56-PM Ferry Street, Newark, N.J. 07105.

**36¢** RADIO & TV Tubes. Free catalog. Cornell, 4213-17 University, San Diego, California 92105.

**GOVERNMENT** Surplus receivers, transmitters, snooperscopes, parts. Catalog 25¢. Meshna, Nahant, Mass. 01908.

**GIANT** Canadian Electronics Surplus Catalog. \$1.00. Etco PM, Box 741, Montreal.

**RESISTOR** Color Coder 50¢. Norvex Co., 3920 Larkin St., Norfolk, Va. 23513.

**HEAR** Police/Fire Dispatches. Catalog Shows Receivers; Exclusive Directories of "Confidential" Channels. Send 8¢ Stamp. Communications, Box 56-PM, Commack, New York 11725.

## HIFI TAPES, RECORDS AND ELECTRONICS

**OLD** Radio Programs On Tape. Thousands Available. Top Quality, Lowest Prices. Catalogue 25¢. Nostalgic Radio, Box 29, Peoria, Illinois 61601.

**OLDIES** 45 RPM Original Hits—Catalog 50¢. C&S Record Sales, Box 197, Wampsville, New York 13161.

**8-Track** Tapes • Catalog free. C. Bolton, 1114 9th Ave., So. Sioux City, Nebraska. 68776.

(Continued on next page)



## HIFI, TAPES, RECORDS AND ELECTRONICS

(Continued from preceding page)

**YOUR FAVORITE RADIO** Programs from 1940's on Records and Tapes. Great Christmas Gift Ideas. Catalog 50¢. Words and Pictures, PO Box 130, Fairfield, Connecticut 06430.

**FREE Catalogues**, 2000 hard to find unusual records. Rose's Records, Box 7216, Louisville, Ky. 40207.

**TAPE RECORDER PARTS**, Belts, Heads, Etc. Catalog \$1.00 (deductible). Tapemech, Box 219, Fern Park, Florida 32730.

**FREE Catalog—Electronic Kits—Amplifiers—Preamplifiers—Psychedelic Strobes—SCA Adaptors—Color Organs—Digital Instruments—Guitar Amplifiers. FREE Subscriptions.** SWTPC, Box PM32040, San Antonio, Texas 78284.

**TAPES—8-Track—Low as \$1.10 Each.** Free Catalog—800 Top Titles. Send Postcard. GemTone Industries, Box 57220, Dept. PM, Los Angeles, Calif. 90057.

**FREE CATALOG—Tremendous Electronics Bargains.** American, Box 4192P, Mountain View, California 94040.

**SUSPENSE—Fibber—Benny; Others.** Cassette \$4.00/Hour. Free Catalog. Radio-Heyday, 8162 West Balmoral, Chicago, Illinois 60656.



## MUSIC AND MUSICAL INSTRUMENTS

**ACCORDIONS And Amplifiers! New—Used.** Cordovox, Excelsior—Top Makes! Save to 50%. Direct factory dealer. Terms. Trades accepted. 5 day home trial. Free catalog—Discount prices. Write: Accordions Unlimited, Dept R, 3147 North Luna, Chicago 60641.

**30% + DISCOUNT.** Name Brand Musical Instruments. Free Catalog. Continental Music, P. O. Box 3001, Dept. D, Garden City, New York 11530.

**SWISS Finest Music Boxes, Movements.** Spielman, 55 West 42nd, New York 10036.

**LEARN To read music in one evening.** Free brochure. Jordan, 27495 Road 176 Dept. PM-11, Exeter, Calif. 93221.

**EASY To Play And Make, Quality Dulcimers, Banjos, Thumb Pianos; Instruments And Kits.** Can Be Profitable Hobby. HERE, Inc., #P, 410 Cedar Avenue, Minneapolis, Minn. 55404.

**ELECTRIFY Player Pianos, Pump Organs** Quickly, inexpensively with Lee Silent Suction Units. Write: Lee Music, 525F Venezia Avenue, Venice, California 90291.

**30% TO 50% DISCOUNT!** Any Model: Guitar, Amp, Drum, Banjo, Dobro! Free Catalog! Warehouse P39, Box 16399, Fort Worth, Texas 76133.

**PLAYER Piano Rebuilding—get details** from: Vestal Press, Vestal 11, N.Y. 13850.

**POEMS** Wanted for songs. Nashville Music Productions, Box 40001-P, Nashville, Tennessee 37204.

**VIOLIN And Guitar makers—send for** latest Free Catalogue of woods & accessories. International Violin, PM1, 414 East Baltimore St., Baltimore, Md. 21202.

**WHOLESALE! Professional Guitars, PA Systems, Altec Speakers, 240W RMS Amplifiers.** Free Catalog. Carvin, Escondido, Calif. 92027.

**RECONDITIONED Accordions** for sale—Save \$\$\$, Top Brands, Write for free descriptive folder. A-1 Rebuildt Accordions, 31 E. 18th St., N.Y.C. 10003.

**ACCORDION Top brands.** Buy direct. Tremendous discounts. Trades accepted. Free brochure PM. Accordion-O-Rama, 874 Broadway, N.Y.C. 10003.

**GUITAR, Banjo, Violin, Mandolin Making** Materials, Accessories, Books. Catalog 25¢. Guitar Center, Box 15444, Tulsa, Oklahoma 74115.

**LEARN Banjo. 5-String Bluegrass.** No music. Makes learning easy. Free details. Blaylock, Box 25-M, Marietta, Georgia 30060.

**NEW GUITAR MAKING BOOK & NEW TOOLS.** Overholtzer, 618 Orient, Chico, Cal. 95926.

**30% DISCOUNT** Name Brand Musical Instruments. Free Catalog. Freeport Music, 455F Route 110, Melville, N.Y. 11746.

**ACCORDION Manufacturing** 6846-P North Avenue, Chicago, Illinois, 60635. Concertinas, Chromatics, Helligons, Hohners, Guitars, Drums. New, Used, Tuning, Repairing. Wholesale Catalogs Free.

**BAND INSTRUMENTS. NAME BRANDS.** Discount Prices. Free Catalog. Musical Instrument Wholesalers, Drawer 5370, Ft. Worth, Texas 76108.

**KITS! Build Dulcimers, Guitars, Balalaikas, Thumb Pianos, Harps.** From \$2.95. Finished Dulcimers from \$19.95, 8665 West 13th Avenue-PM, Denver, Colorado 80215.

**PIANO TUNING Made Easy.** Manual and all Necessary Tools, only \$22.50. Ten-Day Money-Back Guarantee. Details Free. Stamm industries, 813 West Lovell, Kalamazoo, Michigan 49007.

**BIG DISCOUNTS Wholesale.** Musical Instruments. Accessories. Free Catalog. Nationals Music, POB 27206, Tucson, Arizona 85726.

**WHOLESALE.** Musical Instruments—Accessories. Allied, 573 Route 17, Paramus, New Jersey 07652.

**FREE—Fully Illustrated Music Catalog.** Accessories, Instruction Books, Repair Parts. Marina Music, Box 718-C, Marina Del Rey, California 90291.

**NEW PLAYER PIANO ROLLS.** 3000 Selections. Free Catalog. David T. Dupree Piano Rolls, 2940D1 Grace Lane, Costa Mesa, California, 92626.

**FREE CATALOG—30% DISCOUNT.** Best Names in Musical Instruments. Dial For Music, 7 Crescent Drive, Spring Valley, N.Y. 10977.

## EDUCATION AND INSTRUCTIONS

**SURVEYING PAYS BIG!!!** United States Department of Labor reports Openings for 26,000 Surveyors in next ten years." Easy home-study plan guides you. Send for Free "Surveying Career Kit." North American School of Surveying, AZ, Newport Beach, California 92663.

**WELDING TRAINING** Basic and advanced training for major welding processes—Arc, Gas, Pipe, TIG, MIG, plasma. Hobart, a non-profit school, is accredited by NATTS. Approved Ohio 70-12-0064 HT. Write for school bulletin and course schedule. HOBART SCHOOL OF WELDING TECHNOLOGY, Box 73, Troy, Ohio 45373.

**STOCK MARKET Correspondence Course** for Beginners. Ten Lessons, \$42.50. Box 5095, Beverly Hills, Calif. 90210.

**ONLY You Can Improve Yourself.** Write for Self-Improvement Book List. Free. Clifton Park Gifts, Dept. 19, 2550 Upper Union Branch, Schenectady, New York 12309.

**FINGERPRINTING—Investigation.** Exciting, secure career. Learn at home. Free book. State age. Institute of Applied Science, 1920 Sunnyside, Dept.16B, Chicago, Illinois 60640.

**DEGREE Program in Electronics Engineering.** Our 27th Year! Free Literature. Cook's Institute, Dept. 10, Box 10634, Jackson, Miss. 39209.

**VETERINARY ASSISTANT—Train at home** for exciting animal care career. Send for FREE "Career Kit". North American Home-Study School of Animal Sciences, AZ, Newport Beach, California 92663.

**MISSOURI Auction School.** Veteran Approved. Free catalog. 1600-03 Genesee, Kansas City, Missouri 64102.

**LEARN Auctioneering.** Term soon. Free catalog. Reisch Auction College, Box 850, Mason City, Iowa 50401.

**LIVE, WORK, EARN OUTDOORS!** Be a Park Ranger. Train in spare time at home. Important, rewarding, respected work. Good pay now. Great future. Trained men in demand. Details Free. National School, Dept. 4-30, 2019 20th St., NW, Washington, D.C. 20036.

**EXTENSION And Post-Graduate Awards** in Philosophy, Art, Sciences, Botanic Medicine, Homeopathy, Radionics and others. 30 subjects. Curricular free (airmail \$1.00 refundable). Registrar, Sussex College of Technology, Highfield, Danehill Sussex, England.

**LEARN Sewing Machine Repairing.** Men, Women. Lucrative profits. Profession with bright future. Gresslin Correspondence School, Box 927, Spencer, Iowa 51301.

**VENTRILQUISM—Profitable Hobby or Career!** FREE newspaper and Home Course Scholarship. Maher, Box 9037P1, Denver, Colorado 80209.

**RELIGIOUS VOCATION?** Write: Church Of Holy Light Inc., P.O. Box 4478, Pittsburgh, Pa. 15205.

**USED Courses! Books Catalog 10¢.** (Courses Bought). Lee Mountain, Pisgah, Alabama 35765.

**AUTOSUGGESTION.** Sleep-learning headquarters! Tapes, records, books, Gigantic catalog free. Research Association, Box 24PM, Olympia, Washington 90851.

**OWN Collection agency.** "Little Gold Mine!" Franklin Credit, Roanoke, Virginia 24004.

**AUCTIONEERING.** Resident or home Study Course. Free Catalog. Nashville Auction School, 1921 West End, Nashville, Tennessee 37203.

**PERFECT Husband-Wife Business.** Learn Upholstery at home. Make \$10 an hour. Buy—repair—sell for even bigger profits. Kits, tools, included. Free Booklet. Upholstery & Decorating School, (homestudy), Dept. 5310-113, Little Falls, New Jersey 07424.

**DETECTIVE Course.** Free Information. Universal Detectives, Box 8180-F, Universal City, California 91608.

**LEARN To Fix Typewriters.** Desperate shortage trained men. Hundreds needed. Make up to \$25 in one hour. Learn at home in spare time. Industry Approved course. Facts Free. Send name. Typewriter Repair School, (homestudy), Dept. 3310-113, Little Falls, New Jersey 07424.

**PIANO Tuning** quickly learned with home study course. Diploma granted. American Tuning School, 17050 Telfer Dr., Morgan Hill, California 95037.

**SHORTCUTS To Success!** Highly Effective, Profitable Short Courses. (75 Choices). Study At Home. Diploma Awarded. Our 27th Year. Free Literature CIEE-25, Box 10634, Jackson, Miss. 39209.

**WATCH REPAIRING.** Learn at home in spare time. Diploma awarded. Free sample lesson. Chicago School of Watchmaking, Dept. YY, Fox River Grove, Illinois 60021.

**SERVE God's Ministry.** Free Ordination. Bible Institute, Box 744, McKeesport, Pa. 15134.

**LEARN Asleep or awake!** Records, tapes, equipment! Free catalog! Drawer PM-400, Ruidoso, New Mexico 88345.

**NOW! Your Own Burglar/Fire Alarm Business.** Train at home. Expanding field. Course includes professional tools Plus equipment, supplies for first job. Information by mail. Security Systems Management School (homestudy), Dept. 7310-113, Little Falls, N.J. 07424.

**USED Courses! Books! List 10¢.** Smith's, 124 Marlborough, Salem, Massachusetts 01970.

**UNLOCK Your Future.** Become professional Locksmith by spare time homestudy. Make up to \$6 per hour. All tools, equipment inc. Facts free. Send name. Locksmithing Inst. (Homestudy), Dept. 1310-113, Little Falls, New Jersey 07424.

(Continued on next page)



## EDUCATION AND INSTRUCTIONS

(Continued from preceding page)

**DETECTIVE** Profession, Easy home study; free tie-tack or lapel pin, certificate, future. GI approved. Professional Investigators, Box 41345, Dept. CP, Los Angeles Calif. 90041.

**LEARN ACCOUNTING!** U.S. Labor Department reports "33,000 NEW Accountants, 78,000 NEW Bookkeepers needed EACH YEAR for next ten years". Easy home-study plan prepares you. Approved for Veterans. Send for FREE "Accounting Career Kit". North American School of Accounting, AZ, Newport Beach, California 92663.

**JACK** Hudson made \$20,000 working just 6 months in Accident Investigation. Train at home in spare time. No college. No selling. Free placement service for jobs that furnish car and expenses. Huge, growing field. Men needed urgently. Details Free. Universal Schools, Dept. 1-21, 1129 20th St. NW, Washington, D.C. 20036.

**GRAPHOANALYSIS**—Learn scientific handwriting analysis for profit, pleasure. Free sample lesson, catalog, reveals plan. Write: IGAS Inc., 325 Jackson, Dept. JX-2, Chicago 60606.

**COMPLETE YOUR HIGH SCHOOL** at home in Spare Time. Texts furnished. No Classes. Diploma. Our 76th year. Free Brochure. American School, Dept. X845, Drexel at 58th, Chicago 60637.

**COLLEGE** Degree at home. Your choice of subjects incl. Law. Easy tuition plan. Williams College, 915 Cerrillos Road, Santa Fe, New Mexico 87501.

**LEGAL INVESTIGATION** Pays big! Work with trial lawyers. Fascinating, big pay career. Learn at home, spare time. No college. No experience. Details Free. Universal Schools, Dept. 3-21, 1129 20th St. NW, Washington, D.C. 20036.

**FREE** Book tells how you can learn camera repair and service. Home study or classroom. Write today! National Camera, Dept. EAD, Englewood, Colorado 80110.

**HIGH SCHOOL** Equivalency Diploma Fast! Pass GED. New-Type 5 Week Home Preparation. Simplified, Budget-Priced. Information Mailed Free: Bright Futures, Box 514PMB, Jackson Heights, New York 11372.

**ACUPUNCTURE TRAINING BOOKS AND SUPPLIES CATALOG!** Wong, Box 219W, Toronto, Canada M6M 4Z2.

**NEW SCIENCE MEASURES VALUES;** Defines Good, Bad; Methods, Applications; Comprehensive Booklet, \$2.00. Alsson Press, 689 East Hunt, Alcoa, Tennessee 37701.

**"LEARN** Fast as Geniuses!" Eleven Books, \$3.95! Castle's, 507-M Fifth, New York 10017.

**FREE BROCHURE—SELF IMPROVEMENT BOOKS.** Over 200 to Choose From, H&M Sales, Dept. M-1, Box 331, Fitchburg, Mass. 01420.

**JUMP** On To-morrow—Know All About Metric by Home Study with Certificate. **METRIC CONSULTING INTERNATIONAL,** Box 167B, Ligonier, Pennsylvania 15658.

**YOU CAN FIND YOURSELF** And Your Big Opportunity. My Mind-Stimulator Helps Thousands. Amazing Message That Helped 47 MILLION FREE! Frank Tibolt, 2819E Mt. Carmel, Glenside, Penna. 19038.

**HIGH SCHOOL**—Have your beautiful Diploma—Show your knowledge—Absolutely legal—Guaranteed—Order now. \$1.98. GB House, IA11, 3030 Prospect Street 5Q, Burlington, Ontario.

**ORDINATIONS.** Lifetime! Church chartered 1887! Write! 708 Bragg, Monroe, North Carolina 28110.

**1973 ELECTRONIC COMPUTER KNOWLEDGE • ELECTRONIC COMPUTER CODE—• ELECTRONIC COMPUTER MATH—• ELECTRONIC COMPUTER PUNCHED CARD FOR ONLY \$1.98 EACH. ALL 3 FOR \$3.98. C CODE, BOX 343, MOHEGAN LAKE, N.Y. 10547.**

**TECHNICIAN Training Difficult? TECHNOLOGY Mysterious? \$2.00 Explanatory Statement. \$5.00 Answers Reasonable Questions. Most Technical Subjects. STANTECH, Box 876, Lafayette, Indiana 47902.**

## FOR INVENTORS

**INVENTORS! FREE BROCHURE LISTING 1,000 CORPORATIONS** which may be interested in your invention. Many well-known Manufacturers have engaged us to locate new products. For FREE brochure and information regarding the promotion of your invention, contact Wall Street Invention Brokerage, 79 Wall St., New York, N.Y. 10005.

**IDEAS, INVENTIONS AND PATENTS.** An Easy to Read Book That tells You in Plain Language How to Get a Patent. Complete Information, Including Sample Patent. Send \$4.95 Plus 60¢ Postage and Handling To: Pioneer Press, Dept. PM11, P.O. Box 76025, Atlanta, Georgia 30328.

**PATENT** Information \$4.00—Martin, P.O. Box 1412, Tustin, Calif. 92680.

**INVENTORS** Seldom Make Money, but you can. Exciting new Book tells Secrets. Free Details. Neotek, (PMA-I), 19309 Revere, Detroit, Michigan 48234.

**INVENTORS**—If you have an invention for sale, patented or unpatented, write for free brochure outlining manufacturers requirements, royalty rates. Kessler Corporation, C-511FI, Fremont, Ohio 43420.

**U.S. PATENT** Office Searches, 234 Broadway, Room 3615, New York 10007. Free invention certificates.

**PATENT** Application Financing. Free patent search plan. Global Patent Division, 2420 77th, Oakland, Calif. 94605.

**INVENTORS**—United States Patent Office Searches, Patent Development Engineering, marketing of inventions—ideas by Licensed Professional Engineer—Patent Engineer and United States Patent Office Former Examiner. Inventions developed for patenting and marketing. We are contacted by many manufacturers seeking to purchase appropriate new products invented by our clients. Send for Free invention Certificate and Invention Information. Serving Inventors since 1948. George Spector, Licensed Professional Engineer—Patent Engineer—3615 Woolworth Bldg., New York, N.Y. 10007.

**PATENT** Searches including maximum speed, full airmail report and closest patent copies. Quality searches expertly administered with complete secrecy guaranteed. Free Invention Protection Form and "Patent Information." Write: Dept. 15, Washington Patent Office Search Bureau, Benjamin Franklin Substation, P.O. Box 7167, Washington, D.C. 20044.

**PROSECUTE** Your Own Patent Application. All Material Necessary—Write: Inventors Service, Box 3574, Washington, D.C. 20007.

**FREE PAMPHLET:** "Tips on Safeguarding Your Invention." Write: United States Inventors Service Company, 501-P Thirteenth Street N.W., Washington, D.C. 20004.

**INVENTORS:** Your ideas and inventions (patented/unpatented) expertly searched, developed for commercial appeal and cash/royalty sales to manufacturers by professional Invention Developer with excellent record of experience. B. S. Industrial Engineering; United States Patent Office former Patent Examiner. United States Government former Patent Advisor. Second decade reliable service! Member: United States Council International Chamber Commerce. Free "Invention Record" and "Recommended Protection Procedure." Airmailed! Write: Raymond Lee, Invention Developer, 230P-Park Ave., New York, New York 10017.

**NEEDING** Assistance? **INVENTION DEVELOPMENT FOUNDATION,** 155 Kent Street, Ottawa, Canada K1P 5P3.

**PATENTS**—Do It Yourself. Step by Step Detailed. Inventors Guide, 468 Goodspeed Road, Virginia Beach, Virginia 23451.

**NEW GOVERNMENT PROCEDURE** Lets you file your invention with U.S. Patent Office for only \$10. Full Details plus Honest, Experienced Information on Protection and Sales, Only \$2.98. Satisfaction Guaranteed or Immediate Refund. Invention Protection, 541 Commonwealth Ave., Boston, Mass. 02215.

**INVENTORS:** We Make Working Models and Prototypes! Blueprints Developed from your Sketches! Complete Machine Shop Facilities, all work Guaranteed. Free Information. Axial, 38 Franklin Ave., 3A11, Lockport, N.Y. 14094.

**PATENT** Searches. Lusk-Evans Limited, 1120 Connecticut Avenue, N.W. Suite 940, Washington, D.C. 20036.

**SPECIFICATIONS.** Drawings. Workmanship Guaranteed. Reasonable. PEN-INK, 50 E. 42, N.Y.C. 10017.

## INVENTIONS WANTED

**INVENTIONS** Wanted immediately for promoting on cash or royalty. Patented, Un-Patented. Free booklet outlines royalty rates, requirements. Write: Kessler Corporation, C-5111W, Fremont, Ohio 43420

**INVENTORS!** Protect your ideas! Free "Recommended Procedures." Washington Inventors Service, 422F Washington Building, District of Columbia 20005.

**FREE** "Directory of 500 Corporations Seeking new Products." For information regarding developments, sale, licensing of your patented/unpatented inventions. Write: Raymond Lee Organization, 230-N Park Avenue, New York, New York 10017.

**CASH**—Royalties for patented, unpatented inventions. Global Marketing Service, 2420-G 77th, Oakland, California 94605.

**WE EITHER** sell your invention or pay cash bonus. Write for details. Universal Inventions, 28E, Marion, Ohio.

**INVENTORS!** Don't sell or license your invention until you receive our offer. Eagle Development Company, Dept. H, 83 Wall Street, New York City 10005.

**NEW PRODUCTS—INVENTIONS—IDEAS** Researched/Developed/Marketed by Professional Organization for Cash/Royalty Sales. **FREE EXAMINATION and CONFIDENTIAL REPORT** of the Commercial Features of your Patented/Unpatented Invention. **FREE COPY** "How to Safeguard and Market Inventions to Industry." Write: **LAWRENCE PESKA ASSOCIATES,** 500-C Fifth Avenue, New York City 10036.

**INVENTORS!** Either we will sell your invention before you or anyone else does, or we will pay you a cash bonus. Get Free Invention Evaluation and information write: Gilbert Adams Organization, Invention Brokerage, Dept 15, 81 Wall St. New York, NY 10005.

**MR. INVENTOR:** Ideas and Inventions Urgently Needed by Manufacturers. Product Development Assistance and Quality Patent Searches. Financial Assistance Plan if Required. Write: Charles S. Prince, Invention Consultant, 509-A 5th Avenue, New York City 10017.

## PATENTS FOR SALE

**SUN HAT** Without Sweatband—Cooler, Cheap—Attractive. H. Kiefer, 222 Windermere, Wayne, Pennsylvania 19087.

## BUY IT WHOLESALE

**FANTASTIC** Free catalog—Watches, general merchandise Department Forty, 100 North Greene Street, Baltimore, Md. 21201.

**400,000 BARGAINS** Below Wholesale! Many Free! Liquidations... Closeouts... Job Lots... Single Samples. Free Details. Bargainhunters Opportunities, Box 730-A, Holland, Michigan 49423

**HEARING** Aids, batteries, Wholesale. Catalog 25¢. Fiston, Box 1444, New Preston, Conn. 06777.

(Continued on next page)



## BUY IT WHOLESALE

(Continued from preceding page)

**WORLD'S** Largest wholesale sources. U.S., foreign factory suppliers will dropship for you. 200 free catalogs. Get free samples. Your business imprint catalog. Free details. International Buyers, Box 16386-M, Portland, Oregon 97233.

**165 FREE** Wholesale Catalogs! Mailorder Dropshippers. Your Business Imprint, Automobile Discounts. Free "Digest." Vault International, Box 7284W, Lexington, Kentucky 40502.

**MILLIONS** Panty Hose. Now You Too Can Cash In On This Tremendous Market. By Taking Advantage of our Low Wholesale Prices. Sample and Details \$2.00. A&H Wholesale, P.O. Box 639M, East St. Louis, Illinois 62202.

**DISCOUNTS** Famous Brands. Free Catalog. National Sales Co., 2P Timber Ridge, Mt. Airy, Maryland 21771.

**FREE** Catalog. Gifts, Specialties, Toys, Below Wholesale. Newton, 5275 DeLongpre, Hollywood, Calif. 90027.

### EXPORT-IMPORT

**JAPAN:** 1200 Products directory. Illustrated Manufacturers' names, addresses. \$5.00. Send cash. Yamagata Office, 814 Togin Bldg., Marunouchi, Tokyo.

**ORIGINAL** Oil Paintings \$96.00 Dozen. McDaniel, 3632 Topax, Claymont, Delaware 19703.

**WORLDWIDE:** 1000 Products Directory. Manufacturer's Names, Addresses. Send \$5.00. Guy's, 40 Sturtevant St., Room 8, Norwich, Conn. 06360.

### FOR THE HOME

**HELP CURB CRIME**—Engraving Tool, Tungsten-Carbide Tip, Writes on Anything \$2.98. Billy Vaughn, 2035 Farnsworth Way, Rancho Cordova, Calif. 95670.

**EVERYTHING** Tool, cracks Nuts, Ice; Unscrews Tops, used as Pliers, Screwdriver. \$2.98. Mark Anthony's, 3841 Hammel, Los Angeles, California 90063. California Residents Add 18¢ Sales Tax.

**BEAUTIFUL WHISK BROOMS.** Hand made Whisk Brooms \$1.25 each ppd. E. Graves, Box 354, Campbellsport, Wisc. 53010.

### OF INTEREST TO WOMEN

**PLASTERCRAFT!!!** Profitable Home Business. Molds Available. Details: Lynnette, 6251CW Mentor Park, Mentor, Ohio 44060.

**STUFF ENVELOPES!** \$50.00 per hundred! Guaranteed earnings! Details 25¢. Smith's, Box 2469-PM, Newark, New Jersey 07114.

**\$6.00 DOZEN** Paid lacing baby boots! Cowboy, Warsaw 9, Indiana 46580.

**\$500 MONTHLY** Possible addressing—stuffing envelopes (longhand—typing) at home. \$500 monthly Clipping news items from your newspaper. Information: Send stamped self-addressed envelope. American, Excelsior Springs, Missouri 64024.

**NEW** magazine, foods, decorating, household tips, family living. Sample 25¢ Homemaker Magazine, 404 West Jefferson, Springfield, Illinois 62702.

**WANT** A new car, color TV, new clothes? Learn hundreds of ways to make money. 5 month subscription FREE. Write: Salesman's Opportunity Magazine, Dept. 17-LO, 1460 Hancock Center, Chicago 60611.

**DO SIMPLE** Addressing—Mailing. Receive \$12.95 Orders. Keep \$8.00 Profit. Details Free! Quality, Box 9—PW, East Rockaway, N.Y. 11518.

**HOW TO MAKE MONEY ADDRESSING, MAILING LETTERS. OFFER DETAILS 10¢.** Lindbloom, Dept PM, 3636 Peterson, Chicago 60659.

**MAILERS NEEDED!** List of Firms \$1.00, Stamped, Addressed Envelope. P. Richardson, Box 4097, Yuma, Arizona 85364.

**MAKE \$8 AN HOUR AT HOME** Repairing Doubleknit Suits, Dresses. New Method easily learned in Spare Hours. Details FREE. FabriCraft, Box 5274-YPM, Orange, CA 92669.

### GIFT SHOPPING

**BEAUTIFUL** Mexican Purses, Wallets, Etc. Impress your Friends 40% Savings Free Catalog. Write: Best Leather, 859-A Corvina, Imperial Beach, California 92032.

**EXCITING** Gift Catalog, Free Bonus Gifts. Send 25¢. Stan's Enterprises, 300 N. Rampart, 125PM, Orange, Calif. 92668.

**FREE!** Gift Catalog, Wide Appeal, Something for Everyone. Write To: Advance, 1101-S East Six Court, Hialeah, Florida 33010.

**FREE DISTINCTIVE GIFTS CATALOG.** Kaitells Import, 2564 Nottingham, Cincinnati, Ohio 45225.

**DISTINCTIVE GIFTS** by Mail. Free Catalog. Kinney, (B-10), 1846 Baird, Madison, Wisconsin 53713.

**FREE GIFT CATALOG.** Interesting and unusual items. Rainbow Products, 1410 S. 31st Street, Philadelphia, Pa. 19146.

**GENTLEMAN'S** Knife Sturdy Wafer Thin-3 oz. Leather Covered Made Of Top Quality Forged Steel-Includes Nail File, Bottle Opener, Scissors, Screw Driver. Great Gift-\$4.25 P.P. Satisfaction Guaranteed. F.J. Grant, B1114, Black Mountain, North Carolina 28711.

**FREE** Gift Catalog. Send Name and Address Now To: RAINIER ENTERPRISES, 453 Algonquin, Hampton, Virginia 23661.

**SELF-CORRECTING** Typewriter Ribbon Covers Mistakes Instantly, Permanently. Guaranteed 10 Days Full Refund. 1 Ribbon \$3.50. 2 Ribbons \$6.00. Give Brand Name of Typewriter. Give Model, Standard, Electric, Portable. Danas, Box 533, Petaluma, California 94952.

**CHRISTMAS PENDANTS!** Genuine Oriental Jade, with Treasured Emerald in Golden Horseshoe Mounting, Neckchain, Gift Case. Catalog. \$4.95 Prepaid. BISHIP'S GEMS, Box 38481, Dallas, Texas 75238.

**PERMANENT MATCH** Lights Up To 10,000 Times. Pu.1 this ingenious metal wonder out of its case, strike it on its side, Presto! it's lit. Amazes everyone who sees it. Guarantee! Order Now. Only \$1.10. Charlie's Enterprise, 11051-11PM Tiara St., North Hollywood, Calif. 91601.

**NEW** Mercury dime Necklace a Conversion Piece beautiful and decorative costume jewelry, an outlined silver dime cut from old United States dimes, will make a wonderful gift for the holiday Season. Order Now. #700—\$4.95 add. tax, 50¢. Receive free Catalog. Seville Gift Shoppe, Dept. PM, 507 First Avenue, Bayport, New York 11705.

**SEND FOR FREE 1974 GIFT CATALOG.** WILLIAMS, 1121 East 61st Street, Chicago, Illinois 60637.

**FREE** Gift Catalog—FANTASTICALLY LOW Prices. Rackliffe, Pondmeadow, Westbrook, Connecticut 06498.

**"OVER 100** Distinguished Gifts Mail Ordered. Satisfaction Guaranteed. Write: HORESH, 105-24 64 Rd., Forest Hills, New York 11375.

**FREE** 32 Page catalog, Distinctive Gifts By Mail. Hariow Enterprises, 70 Highland Street, Hyde Park, Mass. 02136 PM-1.

### WATCHES, OLD GOLD, JEWELRY

**HIGHEST CASH** For Gold, Jewelry, Gold Teeth, Rings, Diamonds, Watches, Silver, Platinum. Mail Articles Today: Free gift with information. Chicago Gold & Precious Metals, 6 E. Monroe, Dept. 358, Chicago 60603.

**CASH** Immediately for Old Gold, Jewelry, Gold Teeth, Watches, Diamonds, Spectacles, Silver, Platinum, Mercury. Free information. Rose Industries, 29-A East Madison, Chicago 60602.

**WATCH** And Clock repairing books. Free list. North American, Box 77-AL, Fox River Grove, Illinois 60021.

**CLOCK,** Watch Repairing Tools, Supplies. Catalog, \$1.25. G/M, 1521-A West Magnolia, Burbank, California 91506.

**WANTED . . .** Gold, Silver, Platinum (any form), Coins. Information Free. Wilmot's, 1067 Bridge, Grand Rapids, Michigan 49504.

**'EXOTIC** Sapphire Jewelry from mysterious Bangkok. Ideal investment or gift for less. Details, Pittman, 8285 Woodcrest, Westland, Michigan 48185.

### INDUSTRIAL SURPLUS CLOTHING

**BEAT INFLATED CLOTHING PRICES!** Buy Industrial Surplus Clothes. Pants (28-40 Waist) \$2.00. Shirt (S-M-L-XL) \$1.50. Pants/Shirt Set \$2.95. Colors—Grey, Green, Blue, White. Heavyweight Cotton-Polyester. American Made. Slightly Used. Freshly Cleaned-Pressed. We Pay Postage. Order Now. Send for **FREE CATALOG** of New & Slightly Used Clothing Bargains. Industrial Surplus, 133 West Tulpehocken, Philadelphia 19144.

### HEARING AIDS

**HUGE SAVINGS.** Eliminate dealer mark-ups. Free Trial. Batteries Wholesale. Terms arranged. Lloyds-PMC, Rockford, Ill 61108.

**HEARING** Aids—Huge savings on tiny, all in the ear, eyeglass, behind the ear and body models. Free home trial. Low as \$10 monthly. Write for free catalog. Prestige, Dept. R-6, Box 10947, Houston, Texas 77018.

**FREE**—Hearing Aid Catalog. Save half! Write: "MONEYSAVERS", 9530-PMN Langdon, Sepulveda, California 91343.

**WHOLESALE** Discounters! Famous Aids! Batteries! Repairs! AidMart, Drawer Z-2, St. Petersburg, Florida 33731.



### SCIENCE AND CHEMISTRY

**DISCOUNTED!** Laboratory Chemicals, Glassware-Apparatus. Catalog-50¢. Deluxe Scientific. 507 Huron, Manitowoc, Wisconsin 54220.

**CATALOGUE** Of those ver-ry hard-to-find chemical products, things that go boom, multi-stage rockets, 500 How-To books, 10,000 formulas of every conceivable mixture in science and industry. 50¢. Kenrus-C, Box 158M, Staten Island, New York 10309.

**CHEMISTRY** And Biology Catalog 35¢. Boulevard Laboratories, Suite 302, 3114 E. 83rd St., Chicago, Ill. 60617.

**AMAZING!** Scientific-Apparatus-G'ass-ware-Chemicals. Catalog-50¢. Hagenow Laboratories, 507-A Huron Street, Manitowoc, Wisconsin 54220.

### FORMULAS, PLANS, ETC.

**FORMULAS** For Making Imitation Stone For Outdoor Furniture, etc. Skin Food Cream For Removing Wrinkles. Cutting Glass With Scissors; Increasing Growth Of Hair. \$1.00 Each. T. Paulsen, Zoar Road, Rowe, Mass. 01367.

**ANY** Formula \$5.00. Catalog—Manufacturing Treatise 25¢. Belfort, 192 N. Clark, Chicago 60601.

### PLASTICS

**CASTOLITE** pours like water, hardens like glass without heat. Crystal clear, colors. Embed flowers, seashells, mementos, anything. Make fine gifts. Form flexible molds over any pattern, size. Reproduce your own designs in plastics, candlewax, metal, plaster, cement. Profitable. Illustrated Manual and Catalog Only \$1.00. CASTOLITE, Dept. 73M/PM, Woodstock, Illinois 60098.

(Continued on next page)

Материал защищенный авторским правом



## PLASTICS

(Continued from preceding page)

**LARGEST** Handicrafts and Candlecrafts Catalogue \$1.00. (Refundable). R.P.H. Manufacturing-24-M-11, Winter, Stamford, Connecticut 06905.

**PLASTIC LAMINATES.** How to work with! You can turn out elegant finished products just by using hand or power tools. Resurface kitchen countertops. Correct countertop bubbles. Shows you laminating tricks you should know about. Photocopy of PM ARTICLE. Price \$1.80. Send order to: Popular Mechanics, Dept. H-M, 224 W. 57th St., New York, N.Y. 10019.

## TREASURE FINDERS

**TREASURE** Finder locates buried gold silver, coins, treasures. 6 powerful models. \$19.95 up. Instant financing available. Write or call for free catalog. Phone (713)-682-2728 day or night. Dealer inquiries invited. Relco, Dept. A-40, Box 10839, Houston, Texas 77018.

**FREE 156** Page Detector Catalog. General Electronic Detection Co., Box 67, Bellflower, California 90706.

**FIND** Buried treasure with revolutionary patented, analytical metal detector. Features push button and automatic tuning, negligible ground pickup, greatest range. Free catalogue. Gardiner Electronics, Dept. 9, 4729 N. 7th Avenue, Phoenix, Arizona 85013.

**POWERFUL** Metrotech locator detect gold, silver, coins, relics. Moneyback guarantee, terms. Free information. Underground Explorations, Dept. A, Box 793, Menlo Park, California 94025.

**GOLDAK** Treasure locators—Pleasure and profit in a hobby you'll enjoy. Find coins, relics, gold, silver. Charge on BankAmericard. GOLDAK, Dept. PM, 1101-A Air Way, Glendale, California 91201.

**TREASURE** Locators. Most complete line. Free information. TESOROS, Apartado 7-905 Mexico 7, Mexico.

**TIRED OF DIGGING UP TRASH?** The All New "Coinshooter" Rejects Bottle Caps, Tin Foil, Nails and Shallow Trash. Detects Gold, Silver Coins and Jewelry. Free Literature. D-TEX ELECTRONICS, Box 451-U, Garland, Texas 75040.

**FREE FACT-FILLED CATALOG.** World's largest line of metal detectors. Models as low as \$49.50 and up. Two year Guarantee. Three factory locations, U.S. and Canada, plus over 1,000 dealers and 35 Service Centers from coast to coast. No finer instruments made at any price. Budget terms. Write: WHITE'S ELECTRONICS, INC., RM #381 1011 PLEASANT VALLEY ROAD, SWEET HOME, OREGON 97386.

**FISHER DETECTORS.** You deserve the best. Free literature. FRL, Dept. PM-11, P.O. Box 490, Belmont, California 94002.

**TREASURE HUNTERS!!** Receive Interesting, Valuable Minerals Monthly. Write Today!! Mineral of Month Club, Box 487MA, Yucaipa, California 92399.

## PRECIOUS STONES & MINERALS

**GOLD** 10 Small nuggets panned from Oregon Streams \$1.00. Robert Brandt, Sweethome, Oregon 97386.

**500 POLISHED** Gemstones \$5.00. Tumblecraft, 5401 James North, Minneapolis, Minn. 55430.

**GET** Free catalog no serious rockhound, gem cutter, jewelry maker, hobbyist or craftsman can be without. Full of bargains, exclusive items, low prices from largest suppliers and authorities in the field. Free new catalog just off the press, yours for the asking. Write: Grieger's, Dept. C-12, 900 South Arroyo Pkwy., Pasadena, California 91105.

**PLACER** Gold Samples \$5.00, refundable. Variety Bookshop, Box 140, Lewiston, Idaho 83501.

**FREE Information!!** Receive Interesting, Valuable Minerals Monthly! Write Today! Mineral of Month Club, Box 487M5, Yucaipa, California 92399.

**GOLD PANS** Nugget Trap Inserts. Also Use Dry. \$8.00, Postpaid. Complete Panning Instructions Free. Supra GoldPans, P. O. Box 30, Clarkston, Washington 99403.

**FOSSILS.** Ideal for Jewelry or Collection. Millions of Years Old. \$5.00, lb. or \$1.50 for Two Fossils. Box 45, Glen Lyn, Virginia 24093.

**COLLECTORS!!** Expand. Improve Your Collection! Crystals, Minerals, Rocks, Geological Oddities. Illustrated (215 photographs) Catalog \$1.00 (Refundable). Excellent reference book. Filer's, Box 372 M1, Redlands, California 92373.

**JEWELRY CASTING** Alloy Looks, Works Like Gold, Costs Pennies. Free Sample. P. O. Box 1451, Bellevue, Washington 98009.

## CARTOONING, COMMERCIAL ARTS, SHOWCARD & SIGN PAINTING

**"HOW TO MAKE MONEY WITH SIMPLE CARTOONS"**—Informative Book sent FREE Tells Way to Big Income. Cartoonists' Exchange, 911 Pleasant Hill, Ohio 45359.

**BOB HALE'S CARTOON COLLEGE** 24 Lessons from one of America's top Cartoonists. \$1.00 FIRST 3 LESSONS or \$4.95 for the full course. Bob Hale, Box 1671, Hesperia, California 92345.

**SIGN** Painting—\$1000 per Month Part-Time. Free Catalogue. Kaufmann Supply, Centertown, Missouri 65023.

**COMPACT** 23 lesson Cartoon Course and Cartoonist's Magazine. \$2.00. Hartman, Box 30367, Lincoln, Nebraska 68510.

**MODERN** Cartooning taught by mail. Write for free brochure. Cartoonorama—Box 263-3M, Branford, Conn. 06405.

**CARTOON** For Money!! Big Free Book: Success, Box 885-C, Dearborn, Mich. 48121.

**LEARN** Sign painting at home. Free Talent test. Ben Kerns, Box 812-PM, Greenville, S.C. 29601.

**FASCINATING** Systems. Sign Painting-Cartooning. Straley, 1704 South Center, Springfield, Ohio 45506.

**LEARN** Cartooning at Home. Approved for Veterans. Free Bulletin. Cartooning, Box 70690, Colorado Springs, Colorado 80933.

## ADVERTISING AGENCIES, ADV. SERVICES, MAILING LISTS

**ADVERTISE** Timely Tips, Mailorder Magazine. Sample, 35c. Lvke, 3042 Sherwood, Markham, Illinois 60426.

**MAILING** List, Most all Kinds, \$9.00 1000 Gummed, Circulars mailed \$5.00 1000. Dixmailers, King, North Carolina 27021.

**ADVERTISING** Ratebook leading newspapers, magazines, 25c. Chicago Advertising Agency, 28-E Jackson, Chicago 60604.

## TYPEWRITERS, DUPLICATORS, OFFICE EQUIP.

**PROFITS FROM CLASSIFIED ADVERTISING!** Booklet shows you how to start your own business with Classified Advertising. Only \$1.00 (Refundable with first order.) H. E. KAPPEL, POPULAR MECHANICS, DEPT. P, 224 WEST 57TH STREET, NEW YORK, N. Y. 10019

## RUBBER STAMPS

**FREE** Catalog—New Self Inking Stamps, Marking Equipment. Rush Stamps, 132 Farmcrest, Rush, New York 14543.

**FREE** Catalog—Rubber Stamps, Business Cards, Labels, Printing. Youngers Stamp Shop, Princeton, Iowa 52768.

**POCKET** Stamp \$1.00. Dealer's Wanted. Day's, 97 Stark Avenue, Dover, New Hampshire 03820.

**3-LINE** STAMPS, \$2.50. Signature Stamps, \$5.95. Tabco, Tomkins Cove, New York 10986.

**FREE** Stamp Catalog. 45 type styles. Fast Service, low prices. Jackson's, Box 443A, Franklin Park, Ill 60131.

**POCKET** Stamp \$1.00. Handle Stamp \$1.50, 1000 Labels \$1.00 Martinhouse, 2052 N East 24th, Brooklyn 11229

## OFFICE SUPPLIES

**MAILORDER RECORDS** Help get increased business! Complete 32 Page Record Book shows your inquiries, orders, advertising, expense, etc. Only \$1.00. H. E. KAPPEL, POPULAR MECHANICS, DEPT. R, 224 WEST 57TH STREET, NEW YORK, N. Y. 10019.

## PRINTING PRESSES, RUBBER STAMP OUTFITS

**SIMPLE-X RUBBER STAMP PRESSES.** Hydraulic operated, electrically heated. Sizes 5"x8", 8"x12", 10"x15". Starting outfits, Orders for presses, supplies shipped day received. Free catalog low supply prices. Send \$1.00 for postage and handling (refundable on first order). Custom Manufacturers, 406-P East Elm, Springfield, Missouri 65801.

**TYPE**, Presses, Supplies. Barco Type Mfg., 237 S. Evergreen, Bensenville, Ill. 60106.

**PRINTING** Presses, type, supplies. Lists, 10c. Turnbaugh Service, Mechanicsburg, Pennsylvania 17055.

**NEW** Catalog No. 13, 120 Pages, hand printing presses, type fonts, supplies. Send \$1.00 deductible first order. Acme Type, 732 Federal, Chicago, Illinois 60605.

**PRINTING** MACHINES. Offset, Mimeograph, Typewriters, Composing, Machines. Dixgraph, King, North Carolina 27021.

**SAME** Day shipment on rubber stamp supplies. Revised wholesale price list No. 9 free. Star Stamp Supply, 732 Federal, Chicago, Ill. 60605.

**MIMEOGRAPHS**, Duplicators Prints. Several Colors Without Extra Drums. Rollers. Write: AM Sales, 31-14 94, E. Elmhurst, NY 11369.

**RUBBER** Stamp outfits, supplies. Kiewiet, 2025 Barney Road, Kalamazoo, Michigan 49007.

**PRINT YOUR OWN**—Printing Presses, type, supplies direct from factory. Send 25c for catalog and samples to: Kelsey Co., DM, Meriden, Conn. 06450.

**LOW** Priced Rubber Stamp Manufacturing Supplies, Starting Outfits. Martin, 1432 Major, Jefferson City, Missouri 65101.

**RUBBER** Stamp manufacturers supplies. Presses, starting outfits. Best prices, service. Catalog. Jackson Supply, Box 443A, Franklin Park, Ill 60131.

**PRINTING AND SUPPLIES**

**BUSINESS CARDS** Raised Letters \$5.65 Thousand. Like Engraved. Free Samples. Kavanagh, Box 1222, Brooklyn, N.Y. 11202.

**FREE** Offset Catalog. Fast-Economical. Seaview, 212-26P 48th, Bayside, NY 11364.

**FREE** Literature: Business Cards, Rubber Stamps, Address Labels Printing Big Selection. Jordan's, 552 West O'Connor, Lima, Ohio 45801.

**PRINTING** Supermarket Short Run Specials. 1000-\$4.75, 5000-\$22; 1000 Envelopes \$8. Shipping 9 hours. Get Free Printing Specials Price List "Do You Make These 18 Mistakes When You Buy Printing." Speedy Offset Printers, 23893 Aurora, Bedford, Ohio 44146.

**1000** EMBOSSED Business Cards \$5.25 Postpaid. Agents Wanted. Elco, 181-A, Sylvania, Ohio 43560.

**DISTINCTIVE** Embossed Letterheads, Envelopes, Cards Inexpensive. Postpaid. Universal, 226-N Myrtle, Scotch Plains, New Jersey 07076.

(Continued on next page)



## PRINTING AND SUPPLIES

(Continued from preceding page)

**FREE Literature, Business Cards, Letterheads, Labels, Rubber Stamps.** Geer's, 111 North Drive, Ottawa, Ohio 45875.

**FREE Information About Personalized Business Printing.** Longwood Press, Fort Johnson, N.Y. 12070.

**PHOTOGRAPHIC Supplies—Business Cards—Send 10¢ for Catalog To:** Lutz Co., P.O. Box 156, Dewitt, New York 13214.

**QUALITY Printing, Novelty and Imported Items.** Catalog 25¢. John G. Robeson, Box 2316, Hyattsville, Maryland 20784.

**TAGFAST—Marking Tags, Strung, White 1000—\$4.95, Shipping Tags, White, 100—\$1.95.** Box 276, Placentia, California 92670.

**1000 QUALITY Business Cards \$4.83—2000 for \$8.14.** Two Day Service. Printers, 4616 N. Darin, Otis Orchards, Washington 99027.

**PRINTING Reasonable Prices. Samples Free.** FOWLCO, 3515 Walnut, Muncie, Indiana 47302.

**QUICK Copy Offset Printing. Free Introductory Offer.** Nationwide Printing, 73 E. University, Champaign, Ill. 61820.

### MULTIGRAPH, MIMEOGRAPH

**PROFITS FROM CLASSIFIED ADVERTISING!** Booklet shows you how to start your own business with Classified Advertising. Only \$1.00 (Refundable with first order.) **H. E. KAPPEL, POPULAR MECHANICS, DEPT. P, 224 WEST 57TH STREET, NEW YORK, N. Y. 10019.**

### GUMMED LABELS

**SPECIAL! 3000 ADDRESS LABELS \$2.00**—(same or different addresses). **IMPERIAL, Box 651PM, Westwood, N.J. 07675.**

**1000 GUMMED Address Labels \$1.00.** Walt's, Box 960A, South Bend, Indiana 46624.

**1,000 GUMMED ADDRESS LABELS \$1.00 FREE CATALOG.** Acme, 1238 Voskamp, Pittsburgh, Pennsylvania 15212.

**TALLMART Address Labels: Standard, 1000-\$1.00; Jumbo/Initial, 500-\$1.50.** Box 3361M, Tallahassee, Fla. 32303.

**1,000 ADDRESS Labels—78¢! FREE Catalog of EXCEPTIONAL Values!!** Rackliffe, Pondmeadow, Westbrook, Connecticut 06498.

**SPECIAL 3 Sets Deluxe Gummed Address Labels (3,000) Individually Gift Packed \$1.50.** Free Circular. DIK Smile Studios, Dept. 21, 1182 Broadway, New York, New York 10001.

**1000 NAME & Address Labels \$1.00** Postpaid. Glen Pancoma, 1205 Melrose Way, Vista, Calif. 92083.

### REMAILING SERVICE

**CONFIDENTIAL—Receiving-Forwarding.** Remails 25¢. Hilllegas, Box 169-P Hainesport, New Jersey 08036.

**CONFIDENTIAL: Receiving—Forwarding—Remailing.** A. Naols, Box 3021, Noroton, Connecticut 06820.

**SECRET. Receiving—forwarding. Discreet and confidential.** Remail 25¢ single. Mail Forwarding Service, 8050 S. Main, Houston, Texas 77025.

**MIAMI Remails 25¢—Monthly rates.** Remails—view cards from 80 Foreign cities. Marle, Box 1266, Coral Gables, Florida 33134.

**CONFIDENTIAL New York Mail Address \$3.00 Month. Telephone Service \$5.00.** Re-mails 25¢. Details Free. Birnhan, 152 West 42, New York 10036.

**EUROPEAN Confidential Remails. Singles \$1.25.** Receiving. Melody Taylor, 6520 Worms/Herrnsheim, Herrnsheimer 122, Germany.

### 232 POPULAR MECHANICS

**REMAILS 25¢. Monthly \$3.00.** Receiving. Forwarding. Box 412, Van Wert, Ohio 45891.

**KEEP Your location secret: Use our address.** Wright, BR-2112, Asheville, N. Car. 28802.

**PONY-EXPRESS Your Mail, received-forwarded.** Davis, 1391 Archer, Live Oak, Calif. 95953.

**CANADIAN Address. Letters Received—Forwarded 35¢.** Emkav, Box 5815-A, Toronto, Ontario, M5W1J2.

**FIRST MONTH FREE.** World Mail Bag, Drawer 568D, ANAHEIM, CALIFORNIA 92805.

**BOSTON Or PROVIDENCE Remailing.** \$3.00 Monthly, 25¢ Each. Eagle, Box 9, Randolph, Massachusetts 02368.

**WHATEVER Your Reasons for Remailing. Confidential Service.** 35¢ each, Three for \$1.00. We pay Postage. Ray, Box 781, Sherbrooke, (Que.), Canada J1H 5K7.

**CONCEAL Your Location: Use Our Address.** Wright, CN-2112, Asheville, N.C. 28802.

### REPAIRS AND SERVICING

**COMPLETE Hydraulic Jack Repairing Manual \$3.00.** Moneyback Guarantee. Bayerco, 938 FJ, Betty Avenue, Neenah, Wisconsin 54956.

**PROFITS FROM CLASSIFIED ADVERTISING!** Booklet shows you how to start your own business with Classified Advertising. Only \$1.00 (Refundable with first order.) **H. E. KAPPEL, POPULAR MECHANICS, DEPT. P, 224 WEST 57TH STREET, NEW YORK, N. Y. 10019.**

**APPLIANCE PARTS: Buy at 20-50% discount.** For complete list of parts catalogs, troubleshooter's handbooks, repair manuals, send \$1.00. API, Box 3844, Shreveport, Louisiana 71103.

### SPECIAL SERVICES

**INFORMATION On Anything.** Universal Information, Box 9131, Shreveport, La. 71109.

**POPULAR MECHANICS INDEX AND SHELF WRAPPER 1971 and 1972 editions now available.** You will be able to find any article that appeared in P. M. covering those years in seconds. These annual indexes will make your copies of P. M. even more valuable! Each \$1.49. Send checks to: Popular Mechanics, Dept. HE, Box 1014, Radio City, New York, New York 10019.

**INFORMATION On anything.** Ferguson Research Specialists, 72-25 Woodside, Woodside, New York 11377.

### TOBACCO

**PIPE SMOKING PLEASURE,** only as satisfying as the tobacco you put in it. Write for factory-fresh samples. Green River Tobacco, Box 991, Owensboro, Ky. 42301.

**BRIAR PIPES.** Discount Prices. Write: Maxima, Box 26-D3, Vails Gate, New York 12584.

**ORIENTAL Turkish—Domestic Tobaccos For Do-It-Yourself Blending.** Tobacco Blenders Supply, 1237 1/2 Cook, Denver, Colo. 80206.

### BETTER HEALTH

**HOME Flour Mills: Electric or Hand Operated and Breadmixers.** Write: Smithfield Implement Company, Box 66, Smithfield, Utah 84335.

**SLUGGISH? TIRED? Chinese Super-tonic \$9.95.** Health, Box 65976, Vancouver, Canada.

**SLEEP—Without pills! Simple exercises.** 164 page book only \$1.00. Handy Sandy Enterprises, 439 Windsor Ave., Windsor, Conn. 06095.

**NATURE'S Answer Against Cancer, Heart Attack, Arthritis, Diabetes, Cataract.** Free Information. Provoker Press, St. Catharines 202, Ontario.

**FREE Natural Vitamin Discount Catalog.** Top Quality. Big Savings! Westernco, Box 593-PM, Lakewood, California 90714.

## PERSONAL

**BORROW By Mail! Up to \$1500.00.** Convenient terms. State Licensed. Postal Finance, Dept. 17-T, 6018 Military Ave., Omaha, Nebraska 68104.

**SECRET PLAN Wipes Out All Debts.** \$500 to \$25,000 in as little as 90 minutes. Clear credit. Free details. Counselor-7, Kerrville, Texas 78028.

**SLEEP—WITHOUT PILLS!** Booklet tells how. \$1.00. The Trading Post, 18 Mont Blanc, Mt. Charleston, Nevada 89100.

**INSTANT DEBT RELIEF** Without borrowing. Without Bankruptcy. Have excellent credit in 45 days. Free!!! Wealth Building, Box B-11, 1996 Hoyt Street, Lakewood, Colorado 80215.

**NEED Money-Debts Too Big? Consolidate Bills. Free Emergency Loans.** Write: Interstate, 28 E. Jackson, Suite 1204-X3, Chicago 60604.

**LOSING HAIR? BALDING? DANDRUFF?** Free copyrighted booklet. Dr. Shiffer Laboratories, Dept. 536, Box 398, Punta Gorda, Florida, 33950.

**PSORIASIS Sufferers: Discouraged?** Write for Free important information that is helping thousands! Pixacol, Box 38-PM, Avon Lake, Ohio 44012.

**BIBLE Questions answered.** Stamped envelope. Bylon, 17167 Bentler, Detroit, Michigan 48219.

**INVESTIGATORS.** Latest electronic Aids. Free Literature. Clifton, 11500-P NW 7th Ave., Miami, Florida 33168.

**RECORD Telephone Conversation automatically.** Leave Recorder Unattended. Robert's, Box 49-PM11, Parkridge, Illinois 60068.

**RECEIVE Phony State Chartered University Degrees immediately.** Box 11516, Tucson, Arizona 85706.

**CASH LOANS by mail! Up to \$2,500 on signature alone.** No collateral! Secret! Union Finance Company, 3608 N. 16th St., Dept. PM, Phoenix, Ariz. 85011.

**SEE THRU WALLS!** New Secret Two-Way Super Sov Device. Instructions included. Guaranteed only \$2.00. World-11C20, 3047 University, San Diego, Cal. 92104.

**TELL Fortunes accurately—Immediately!** ESP Aids, Box 21-PM, Olympia, Washington, 98501.

**TATTOO Removing—Chemical Do-it-Yourself Method—Free Details:** Atlanta, 907P Beachpoint, Pickering, Ontario, L1W 2A4

**"RULE Others With Thoughts."** (Telepathy). Write: Clarion, Box 1769-A7, Chicago 60690.

**STOP SMOKING NOW!** Free details. Mark, Box 398X, Lewiston, Michigan 49756.

**CREDIT Cards . . . loans . . . no credit investigation!!!** Guaranteed Free report. Continental-23, Nicerville, Florida 32578.

**SECRET LOANS BY MAIL.** Borrow \$100 to \$3000 for any good reason in absolute privacy. No interviews, no endorsers, no co-signers. Fast service. Write: Dial Finance Co., Dept. 3625, 418 Seventh Street, Des Moines, Iowa 50309.

**LIVE SECURELY!** Protect Your Family with a LEGAL Will. Complete Instructions, Samples, and Forms. Only \$1.95—Fully Guaranteed! Act Now! Basics-11A, —903 Parkside, Elmhurst, Ill. 60126.

**NONRESIDENT DEGREES!** Nationwide Faculty. Catalog \$3.00. UNITED STATES UNIVERSITY OF AMERICA, Box 4552, Washington, D.C. 20017.

**EASY WAY Stop Smoking. No Pills—Guaranteed.** Send \$3.00: F&M Associates, Box 2136, Orem, Utah 84401.

**SELF-CONSCIOUS? Don't Be.** Pamphlet \$3.00. Robert de Jorio, 468 Bellevue Avenue, Yonkers, New York 10703.

(Continued on next page)

Материал защищенный авторским правом



## PERSONAL

(Continued from preceding page)

### YOUR QUESTIONS FULLY ANSWERED . . .

Regardless of your problem. Any Subject. Any Business. Reasonable fees. Prompt, reliable details guaranteed. Write today BerMal, Box 291PM, Mt. Vernon, New York 10551.

"MAKE Your Own Will" . . . **SIX** Forms, Information Booklet, \$2.00. **MONEY-BACK GUARANTEE!!!** Plato, Box 207-P11, Saint-Davids, Pennsylvania, 19087.

**JESUS** Books. The Metta Company (PM5), Box 932, Moorhead, Minnesota 56560.

**NEVER** Before So Much for so little. Buy everything you'll ever need below wholesale! Full particulars **FREE**. Write today. Warner, Room CC-2-CM, 1512 Jarvis, Chicago, Ill. 60626.

**MAKE YOUR OWN WILL** 64 Page Booklet, Four Forms, Personal History and Family Asset Sheet Included. Only \$1.98. **HALMAR HOUSE**, Dept. WK63, 19537 So. Redland Rd., Oregon City, Oregon 97045.

**STOP** Being Cheated! Our Complaint Kits guarantee results. \$5.00; Ren-Ton, 1602 Eton, Crofton, Maryland 21113.

**STOP SMOKING** New Automatic Method Guaranteed \$2.00. Colossi, 1433M 61 Street, Brooklyn, New York 11219.

**PROTECT** Your Loved Ones. Don't Die Without a Will. Two Blank Will Forms With **COMPLETE** Instructions. Order today! Guaranteed! Send Only \$2.00. T.J. Enterprise, Box 714, Port Huron, Michigan 48060.

**ELECTRONIC DEBUGGING**. Other Security Equipment. Top Quality. Lowest Wholesale Prices. Viking International, Box 632, Newhall, California 91321.

### WANTED-MISCELLANEOUS

**MOLDS** For Casting. Old lead Toys. Eccles, 1613 Dill, Burlington, Iowa 52601.

**MERCURY**, Gold, Silver, Platinum: Ores assayed. Wholesale Terminal, Norwood, Mass. 02062.

### WINEMAKING & OTHER RECIPES

**CANDIED FIGS**. Recipe \$1.00. Marys' Gifts, 913 N. School, Santa Maria, Calif. 93454.

**MEAD WINE**. Excellent, referred to in the Bible. Proven recipe \$1.00. Honey in bulk, wholesale, 5 lbs. up. Inquire: Keller, Box 6197-PM, San Jose, California 95150.

**CONCENTRATE** Catalog. 60 Varieties. Vendramino Wine Co., Dept. A, 13273 Michigan Ave., Dearborn, Mich. 48126.

**WINEMAKERS FREE** Supply Catalog. Excellent Selection of Fruit & Grape Concentrates. Kraus, Box 451-L, Nevada, Missouri 64772.

**WINEMAKERS**. Free illustrated catalog of yeasts, equipment. Semplex, Box 12276R, Minneapolis, Minn. 55412.

**WINEMAKER'S** Supply Catalog—Free. Bacchanalia, 273 Riverside Ave., Westport, Conn. 06880.

**HOMEWINE MAKING SEND** For **FREE** Informative **CATALOG** of **RECIPES, EQUIPMENT, and INGREDIENTS**. Brewer's Yeast Dry Malt, Crystal Malt, Bottle Caps, Barrels, Chemicals, Concentrates, Over 250 Items. Winemaking Is A Fascinating Hobby. Write To: Danenberger's, Box 276-M, New Berlin, Ill. 62670.

**WINEMAKER'S!** Free Illustrated Catalogue of Quality Products. Brant's Wine Rack, Box 3256-M, Orange, California 92665.

**WINE CELLAR**—New low cost interlocking units in traditional design, unlimited capacity. Start with 7 bottle rack \$4.98, postpaid. Free picture brochure. Winemaker's Catalog. **ADDARACK**, Box 30230M, Cincinnati, Ohio 45230.

**WINEMAKERS**. Tremendous selection. Fast service. Free catalog. Winecraft, Columbia Mall; Columbia, Maryland 21043.

**WINEMAKERS . . .** Free Illustrated Supply Catalog of Yeast, Equipment, Recipes. Continental, Box 18223-PM, Indianapolis, Ind. 46218.

**WINEMAKERS**: Free Catalog. Fast Service. Arbolyn, Box 663, West Columbia, South Carolina 29169.

**OAK Barrels**—Round and Oval. All Sizes. Barrel Winery, 1201 University Avenue, Berkeley, California 94702.

**BOURBON** Fruitcake Recipe. Information Stamp. Sample \$2.00, Satisfaction Guaranteed. Muller's, Chestertown, R.D. Maryland 21620.

**LARGEST** Stock Supplies and Equipment. We have the Know-How. Write for Catalog, Advice, Consultation . . . Jim Dandy Wine Supplies, 8454 Beechmont, Cincinnati, Ohio 45230.

### MISCELLANEOUS

**SAVE \$10,000** Buying A Home! Write Gray, 3611S Bridge Manor, Kansas City, Mo. 64137.

**SOS-LITE!!!** Ultimate Protection. New, Unique Long Distance Flashlight Combined With Loud Siren. Audible Quarter Mile. Descriptive Literature, Specifications Free. Write: Peterzell, Box 3658PM11, Rochester, New York 14609.

**MAGNETS**. All Types. Specials-20 Disc, or 10 Bar, or 2 Stick, or 8 assorted Magnets, \$1.00. Magnets, Box 192-A, Randallstown, Maryland 21133.

**HIGH** Quality Sports Glasses—Also Chained Burglar Door Alarm \$3.95 each. Blitzkrieg, Box 144, North Industry, Ohio 44707.

**PLAY** Chess by Mail! Names, Addresses—All Anxious To play! \$2.00. Lindo, DPM, Box 691, No. Hollywood, Cal. 91603.

**TV PICTURE TUBES** manufactory direct, easy installation. Write: Ehnes Co., 405 E. Jefferson, Cheyenne, Wyo. 82001.

**CUT** Cigarette costs in half with our custom-blended tobacco and rollers: filter or plain. Free sample: Green River Tobacco, Box 954, Owensboro, Ky. 42301.

**BOOKS** On antiques and their prices. Free circular! P. Warman Publishers, Uniontown, Penna. 15401.

**PRE-PACKAGED** Toys complete with free self-selling display rack. Free Details. Toys, 1916 Fifth, Sacramento, California 95814.

**SLEEPATRON**. New device for inducing sleep. Gardiner Electronics, Dept. C, 4729 North 7th Avenue, Phoenix, Arizona 85013.

**IDENTIFICATION CARDS**, Send stamped self-addressed envelope for samples. **NIPCOM**, 727 North Main, Las Vegas, Nevada 89101.

**EYEGASSES** wholesale—Free Catalog. A-Z Optical Company, Box 175, Dept. R26, Bay Station, Brooklyn, N.Y. 11235.

**1400 CATALOGS** Listed and Described! Sources for **EVERYTHING** imaginable! Rush \$2.00. **MASTERLOG**, Box 24413-(UK), Oakland, California 94623.

**CREDIT** Cards . . . loans . . . no credit investigation!!! Guaranteed Free report. Continental-24, Nicerville, Florida 32578.

**HEARING** Aid batteries wholesale. Free list. Habs, Box 51, York, Penna. 17405.

**ORNAMENTAL** Iron designs. Book of 1600 beautiful, practical designs for railings, columns, etc. Free literature. Cunningham, 3881 South 3200 West, Box 19005, Salt Lake City, Utah 84119.

**MUSTACHE N BEARD** Grooming Set Is for Any Man who wears a Mustache or Beard. Look Sharp—Set Includes Shears, Shaper, Brush, Comb, Mini Razor, Mustache Wax and Style Guide. Satisfaction Guaranteed. Send \$14.95. Merkler, Dept. 1PM11, Box 156, Defiance, Missouri 63341.

**MAKE** Delicious Homemade Sausage and coldcuts. Free Illustrated Catalog—seasonings, casings, equipment, recipes. Stuff'n'Serve, Box 8009-65, Rochester, New York 14606.

**HOBBY CRAFT SALES, YOU MAKE IT, WE SELL IT**, Information 50c. P.O. 893, League City, TEXAS 77573.

**WIN** Contests, Prizes, Money. We show you how. Send \$1.00 to Jan-Dar, Box 948, Mobile, Ala. 36601.

**PROTECT** Yourself and Equipment Inexpensively. Operation "Stop Thief" Kit Guaranteed Effective. Free Information and Proof. Odessa Company, Security Division 9, 4652 151st Ave. S.E., Bellevue, Washington 98006.

**NEW!!** Electronic Indoor TV-FM antenna. Plugs into wall outlet. Fantastic reception—Attaches in seconds . . . \$2.19 Guaranteed! Turman's, 2317 North Shannon, Sherman, Texas 75090.

**METRIC SYSTEM!—INFORMATIVE**, Detailed, Two-Way Conversion Booklet.—Satisfaction Guaranteed!—\$2.00—Alex Kulchar, Box 1992, Philadelphia, 19105.

**RECROOM LAMPS EXCITING**. Gogo girls in motion many more barlites in color. For free brochure and pricelist send self address large stamp envelope to: Magic Motion Lamps, 2617 E. Birchwood Ave., Cudahy, Wisc. 53110.

**WILLS**—How To **MAKE** and **BREAK** Them! Book Explains Law, Gives Examples. Make Sure Your Will is Valid!! Blank Will Forms Included! \$2.98. Guaranteed. DeMuir, Dept. 1A11, 27 Oak Terrace, Lakewood, N.J. 08701.

**BLANK WILL FORM** \$1.00 Guaranteed. Order today. RAP Enterprises, Dept. 7PM11, Box 35624, Houston, Texas 77035.

**UP 50%!!** Tapes \$1.50. Reels, Cassettes, "Panasonic TV's, Tape Players, Grandfather Clocks"! New Items 3 Catalogues \$1.00 United, 807, Roanoke Rapids, N.C. 27870.

**TATTOOING**: Complete Inventory of Equipment and Supplies for Professional and Amateur. Transistor Driven Machines. Illustrated Information. Paul's, Box 8073, LaCrescenta, California 91214.

**DON'T PAY INCOME TAX**. Legally. No Matter What Your Income. Rich Men's Methods Adapted For Anyone's Use. Free Details. Trauhaus-51, Box 3004, Duluth, Minnesota 55803.

**IMPROVE** Your Personality. Fascinating 110 Page Book "Dynamic Thinking" Shows How. Only \$1.00. Adair Enterprises, Dept. K2, 40 Longfellow, Mill Valley, Calif. 94941.

### BURGLAR ALARMS & HOME PROTECTION

**LOCKSMITHING** Supplies—Buyers Guide \$1.00. Despubs, Box 22005H, Phoenix, Arizona 85028.

**FREE** Catalog on Burglar-fire Alarm Equipment. Protecto Alarm Sales, Box 357-D, Birch Run, Michigan 48415.

**BURGLAR-PROOF YOUR HOUSE!!** Treasury. Intelligence Expert's Modernized "Home Security Manual" demonstrates economical do-it-yourself savings!! Guaranteed. **FREE** information. Sullivan House, Department 27-N, 2402 South 222nd, Seattle 98188.

**BURGLAR ALARM** Do It Yourself. Prevent Theft and Break-ins of Automobiles, Boats, Trailers etc. Can be Seen and Heard ¼ Mile. Easy to Follow Plans \$3.00. EVN, Box 5564, Ft. Lauderdale, Florida 33310.

**SECURITY!!!** Home, Business, Do-It-Yourself \$2.—Ernest, 922-24th St., Watervliet, N.Y. 12189.

**DOORMAT ALARM** Prevents Theft. Free Details. Ayton, P-11, 5506 16th Avenue, Brooklyn, New York 11204.

**DAY AND NIGHT PROTECTION AUTO BURGLAR ALARM**. Sounds Loud Warning. Prevents Theft. Easy Installation on any Car. Fits 6 or 12 Volts—\$4.98 Postpaid.

**MARDI GRAS** Imports, 9604 Jefferson Hwy., New Orleans, La. 70123.

(Continued on next page)



# Unadorned power tools ... they do the same job as tools costing up to 5 times as much.

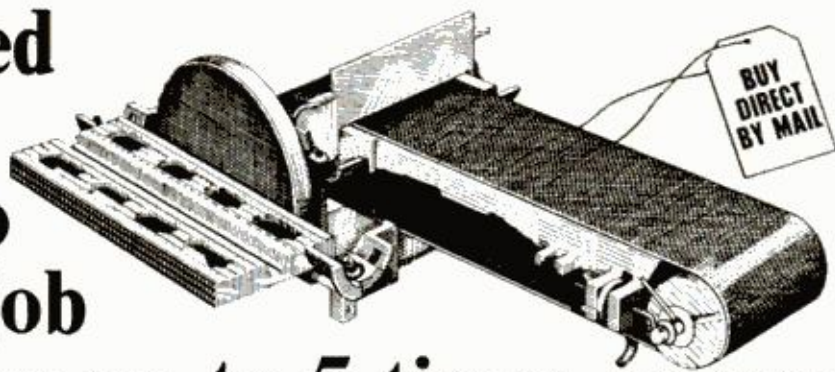

We skipped the chrome to save you money... but we did not skip anything on performance. Actually, we skipped more than just chrome, we cut out every costly frill that wasn't absolutely needed.

Our tools are not exactly flashy. We are the first to admit it. But in articles covering test results on AMT tools, written by leading publications such as Popular Science, our tools have been praised over and over again. In spite of their low prices, our tools are full scale and offer full performance and precision.



**HERE'S HOW WE DO IT**... First, we don't claim our tools should sell for five times the price! Just that our tools do the same job... with the same accuracy, ease and speed... and will last at least as long. AMT tools cost less to make and are sold direct. They are bona fide quality power tools used by serious amateurs and professionals alike and if sold in retail stores would be much higher in price. We use no magic, let's be specific: **SIMPLICITY**... AMT tools are soundly engineered to eliminate every frill and gimmick—to minimize material and production costs. Machined parts are used only where they're needed. Unadorned cast iron and aluminum save you a fortune.

**DIRECT-FROM-FACTORY SAVINGS**... You save a bundle, yet, we offer a double guarantee backed by a 45-year-old company with millions of satisfied customers... and hundreds of orders pour in daily.

**LARGE VOLUME**... Our own foundry and large mass production facilities plus large buying power all work to keep costs down.

**STANDARD PARTS**... Our designs use standard hardware items wherever possible. By avoiding custom-made parts we pass on tremendous savings to you.

If you are looking for power tools that perform like units costing many times our low prices, order today and you'll be one step closer to many hours of woodwork satisfaction.

*Bill Morley*

## POWER SAW 8" tilt arbor saw ... crosscuts, rips,

mitres, cuts compound angles, dados, coves, moldings. Completely assembled with ground cast iron table, safety guard, splitter, mitre gauge. Less blade, motor. Rip fence for easier work alignment, \$3.50 add'l. Ball bearing model, \$5.00 add'l. Takes 1/3 h.p. motor or larger, standard blades, attachments. Wt. 26 lbs., f.o.b. factory **\$1995**



**FREE OFFER, cabinet base plans**,... with one piece of 3/4" plywood, convert your \$19.95 saw into a floor model with a huge 27" x 24" top. Takes cabinet rip fence, \$4.50 add'l.

## TWO GUARANTEES

**10-DAY MONEY BACK GUARANTEE**  
Try any of these power tools and compare it with any similar machine at any price. If not satisfied, return it for prompt, no questions asked refund. We pay the return shipping charges.

**10-YR. FULL SERVICE GUARANTEE**  
Any part or parts of these AMT power tools (except motor which carries a one year guarantee) which become inoperative for any reason within ten years after purchase date will be repaired or replaced by the factory with no cost to the purchaser other than postage.

AMERICAN MACHINE & TOOL CO.  
4th & Spring St., Royersford, Pa. 19468

**Brand new electric motor** developing full 1 h.p. 17 lbs. (Purchased separately, \$24.85). With any AMT machine here. **\$19.90**

**BUY DIRECT**  
... USE THIS HANDY ORDER COUPON NOW

AMERICAN MACHINE & TOOL CO., Dept. PMN3, Royersford, Pa. 19468  
Please send me the units checked. Payment in full enclosed \$\_\_\_\_\_ or \$3 deposit each item enclosed, balance C.O.D. I must be fully satisfied or will return unit within 10 days for full refund. No questions asked.

- |   |  |
|---|--|
| <input type="checkbox"/> 8" Power Saw at \$19.95  | <input type="checkbox"/> Jointer Planer at \$29.95             |
| <input type="checkbox"/> Standard Rip Fence at \$3.50   | <input type="checkbox"/> Ball Bearing Spindle at \$10.00       |
| <input type="checkbox"/> Long Cabinet Rip Fence at \$4.50   | <input type="checkbox"/> Wood Shaper Kit at \$19.95            |
| <input type="checkbox"/> Ball Bearing Spindle at \$5.00   | <input type="checkbox"/> Opt. Hold Down Assembly at \$2.95     |
| <input type="checkbox"/> Belt Sander at \$19.95   | <input type="checkbox"/> 6" Swing 3' Lathe at \$14.95          |
| <input type="checkbox"/> Disc Sander Attachment at \$7.95   | <input type="checkbox"/> 12" Swing 4' Lathe at \$29.95         |
| <input type="checkbox"/> Mitre Gauge for Sander at \$1.95   | <input type="checkbox"/> Face Plate \$2.50 (either Lathe)      |
| <input type="checkbox"/> Drill Press at \$39.95   | <input type="checkbox"/> Turning Chisels \$5.95 (either Lathe) |
| G.E. Motor <input type="checkbox"/> \$19.90 (with other item) <input type="checkbox"/> \$24.85 (purchased separately) |  |

NAME \_\_\_\_\_  
ADDRESS \_\_\_\_\_  
CITY \_\_\_\_\_ STATE \_\_\_\_\_ ZIP \_\_\_\_\_

## BELT SANDER A precision unit. It changes from horizontal to vertical in seconds. Heavy, sander includes 4" x 36" sanding belt.

Uses 1/3 h.p. or larger motor. V-pulley drive and multi-purpose drive spindle. Disc sander accessory, \$7.95 add'l. Mitre gauge, \$1.95 add'l. 15 lbs., f.o.b. factory **\$1995**



## 3' WOOD LATHE ... 6" swing.

Same precision and speed as \$40 units. Sturdy cast iron with tubular steel bed. Lever action tail stock, two-speed pulley, fits any motor. Set of 3 high speed turning chisels, \$5.95 add'l. 4" face plate, \$2.50 add'l. 15 lbs., f.o.b. factory **\$1495**



## 4' WOOD LATHE ... 12" swing.

Industrial size, does the same job as \$75 units. Tubular steel bed rails, screw action tail stock, three-speed pulley. Use any motor. 3 high speed turning chisels, \$5.95 add'l. 4" face plate, \$2.50 add'l. 30 lbs., f.o.b. factory **\$2995**



## JOINTER-PLANER 4 1/8" x 22".

Cast iron and steel, precision ground adjustable tables. For planing, joints, bevells, Rabbits to 3/8" depth. Fence adjustable 0 to 50". Steel knives, dual guards. Use any motor. Precision ball bearing industrial model, \$10.00 add'l. Wt. 19 lbs., f.o.b. factory **\$2995**



## DRILL PRESS Precision 32" radial unit has standard features and many extras.

Depth of throat up to 16". Head tilts and table stays level. Drills to center of a 32" circle. All cast iron and steel. Takes standard motor. 32 lbs., f.o.b. factory. **\$3995**



## WOOD SHAPER KIT Makes beads, coves, moldings, tongue-and-groove joints, etc. Accurate cuts at high speeds. Sealed greased-for-life ball bearings. Less wood. Takes 1/4 h.p. motor or larger, standard cutters. Optional hold down assembly, \$2.95 add'l. 15 lbs., f.o.b. factory **\$1995**







# 1974 MERCURY COUGAR XR-7

**In size, this new breed of Cougar is like Grand Prix and Monte Carlo.  
In every other way, it's like nobody else's car.**

You're looking at the all new Cougar for '74. It's more than a new car. It's moved up one whole class. In fact Cougar is the only new choice among the mid-size personal luxury cars.

There's new styling, inside and out. New dash with tachometer and hooded gauges mounted in deeply padded vinyl. Elegant new opera window. Distinctive new Landau roof. Steel-belted radials. All standard. There's power steering. And front disc brakes, automatic floor shift and bucket

seats, also standard. Plus the same type suspension system as Lincoln-Mercury's most expensive luxury car. Other features shown are optional.

And along with Cougar's new size class comes a whole new class of comfort for you. Because we felt this much luxury deserved a little more room.

## MERCURY COUGAR

LINCOLN-MERCURY DIVISION





100 mm. long, yet  
**LOWER IN 'TAR'**  
than the best-selling 70 mm.

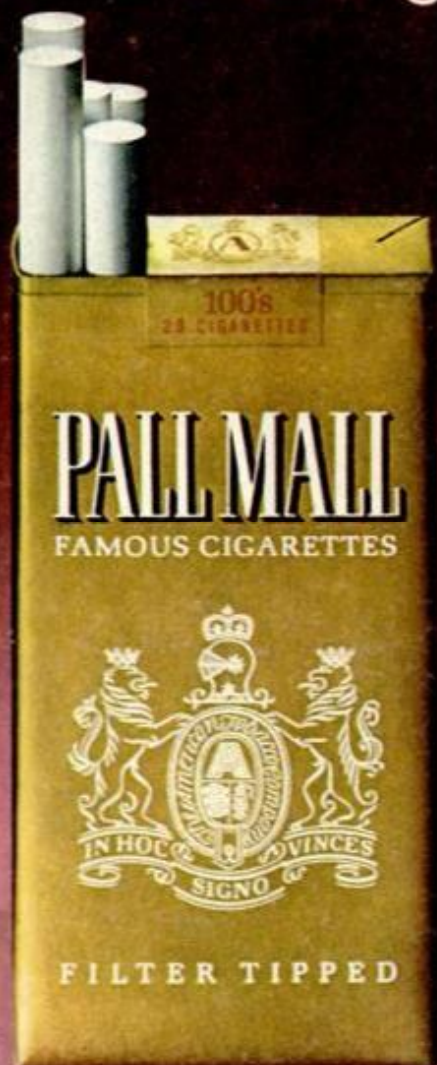

**PALL MALL**  
**GOLD 100's**

*The longer filter that's long on taste*

PALL MALL GOLD 100's	"tar" 20 mg - nicotine, 1.4 mg
Best-selling 70 mm.	"tar" 25 mg - nicotine, 1.6 mg
Of all brands, lowest	"tar" 1 mg - nicotine, 0.1 mg

Warning: The Surgeon General Has Determined  
That Cigarette Smoking Is Dangerous to Your Health.

20 mg. "tar" 1.4 mg. nicotine av. per cigarette, FTC Report FEB. '73.