

Popular Mechanics

'74 CARS

COMPLETE SPECS FOR ALL MODELS

starts page 110

Sporty, gas-saving compacts will soon be in short supply

Upstyle a VW with a bolt-on kit body like this Page 110

ADVANCE COPY
PRINTED WHILE MAKING
COLOR & REGISTER ADJUSTMENTS
FOR PUBLISHERS USE ONLY
This Is Not A Production Run Copy.

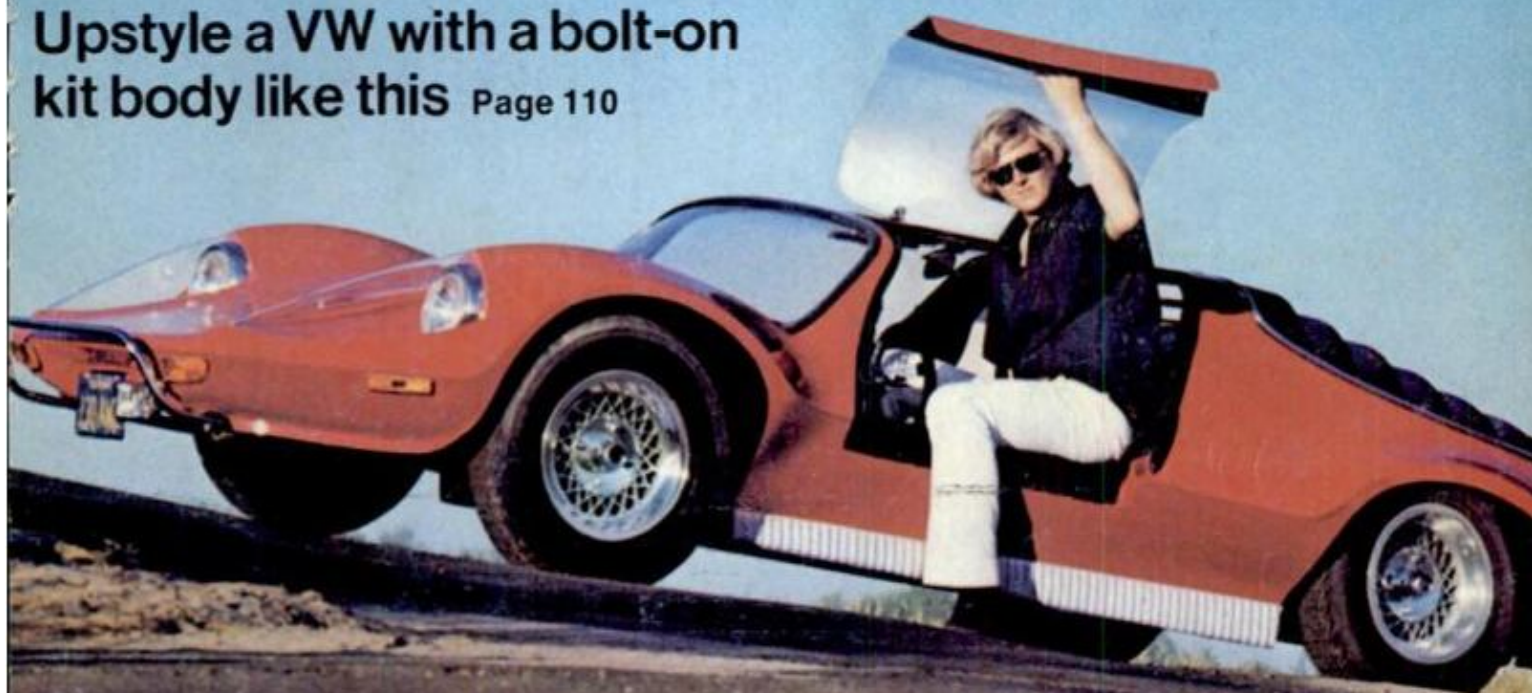

Autokit's Invader GT-IV hatchback

Clip-and-save know-how: Starts page 92

- How to waterproof a basement
- How to remove almost any stain
- How to put up TV antennas
- How to keep gutters and leaders clear

Half baths — for even smallest spaces Page 85

THE MORE YOU KNOW, THE MORE YOU'LL WANT

DELCO

YOU'LL FIND DELCO'S INSTANT STARTING POWER IN SOME OF THE DARNEDEST PLACES.

Battery trouble in any out-of-the-way place can be frustrating. We know. But it doesn't necessarily mean you have to get "stuck" either. There are thousands of Delco retailers across the country, in big cities, in small towns and sprinkled around the countryside. These service stations or garages

are ready to help you with a Delco battery. A battery designed to give you the full burst of instant power needed to start your car, start after start.

Most Delco replacement batteries are vacuum-sealed at the factory. The seals aren't broken until you buy your Delco battery. Then the activator fluid is added. So you get a fresh start and the power you pay for, right from the beginning.

The next time you need a new battery, get with Delco. The battery engineered, tested and built with years of GM experience. Just look for the red, white and blue Delco sign. There's probably one nearby, wherever you are.

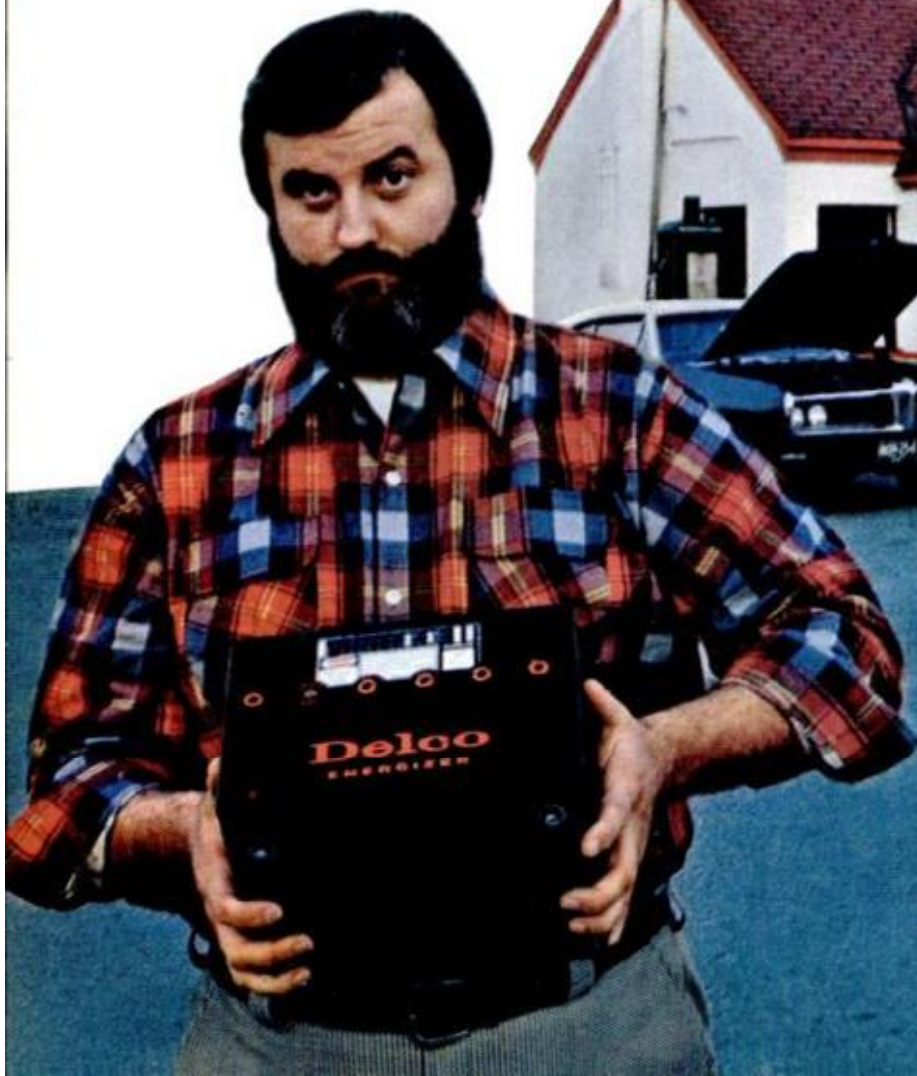



If two blades are better than one... try 18 of them.

Some blade-makers are saying that it takes more than one blade to get a close shave.

Norelco's known that for years. We've got 18. And they're not just 18 ordinary blades. They're surgical steel, self-sharpening rotary blades. They fit inside three super Microgroove™ floating heads that cling to every curve and crag of your face.

And they work together with nine closeness-comfort settings on the VIP™ Tripleheader to let you shave as close, as comfortably, as you like. So close, we dare to match shaves with a blade... or two...or three...



This One



1UCR-196-UYHD

The Norelco® VIP
We dare to match shaves with a blade.

TAKE A QUICK LOOK.

IT'S THE QUICKEST WAY TO IMPROVE YOUR SHORT-RANGE RIFLE SHOOTING.

Qwik-Point is an entirely new sighting concept. It's great when iron sights just aren't fast enough.

It's for superfast short-range shooting with center-fire rifles or 22's (or with shotguns). It's ideal for brush guns like the Winchester 94. It's accurate in dim light or heavy cover.

With one or both eyes open, just look at the target, move the blaze-orange dot to the target, and fire.

You see dot and target instantly in clear, sharp focus. No changing your point of focus. No lining up eye, bead, and target.

You can quickly improve your natural shooting skills with Qwik-Point.

IT'S EASY. IT'S FAST.

Look at your target with one or both eyes open. There's no magnification, no field of view. Focus is infinite. You see your target just like it is. And you see the blaze-orange dot out there on the target.

IT'S PRECISE.

Easy to sight in for your particular kind of shooting. Elevation and windage adjustments put the blaze-orange dot in the center of your shotgun's pattern. Set dead on at 40 yards for skeet or hunting. Set eight to ten inches high for trap shooting.

IT'S TOUGH.

Qwik-Point is recoil-proof and shock-proof. It's really tough. The body is lightweight aluminum finished with durable jet-black anodizing.

IT'S BRIGHT.

Qwik-Point's bright blaze-orange filament collects light and projects an intense dot into the optical system, which, in turn, puts it "out there" on your target. Excellent for dim light conditions. Unlike conventional sights, your target and the dot appear to be in the same place.

IT'S FOR 'MOST ANY RIFLE.

Model R-1 for center-fire rifles is complete with built-in mount (mount bases extra).

Model R-22 has built-in mount that fits factory-grooved receivers on most 22's.

Qwik-Point fits most pump and automatic shotguns, too, with built-in mount and base.

WEAVER

QWIK-POINT®

FROM THE GREAT AMERICAN SCOPE COMPANY.

Suggested retail price for all Qwik-Point Models is \$39.95. Bases extra for R-1.

Write for FREE all-new 1973 catalog.

W. R. Weaver Company,

Dept. 91,

El Paso, Texas 79915.



Any product that passes UL's safety tests deserves a medal.

The UL symbol on a product means the manufacturer cares about your safety by submitting his product to UL's impartial testing. UL's engineers put the product through normal-use tests, and tests far more rigorous. They want to determine if it is adequately safeguarded against electric shock, fire and casualty hazards. If a product meets our standards it deserves the right to wear our symbol.

But you must do your part for complete safety. Read the instructions, and use the product as intended. Heed the warning markings. Join the safety team.



UL examines and tests products and systems in these six areas.

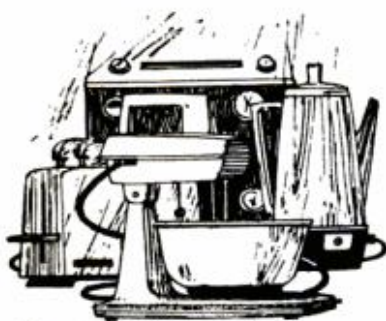

Electrical. All types of appliances and lighting equipment for home, school, business and industry, as well as electrical construction equipment... wire, conduit, switches, fuse boxes.



Heating, Air-Conditioning and Refrigeration. Most sizes of equipment in this field are examined and tested, from the smallest unit for homes or apartments, to giant equipment for industrial use.

Fire Protection. UL tests the design of fire extinguishers, fire and smoke detectors, sprinkler systems, and fire-fighting equipment.



Casualty and Chemical Hazards. Safety cans, ladders, and gasoline pumps, are just a few of the products and materials tested and evaluated in this area.



Burglary Protection and Signaling. UL field inspects and certifies burglar alarm signal systems and installations, evaluates burglary protection systems, and alarm devices... safes and bullet-resistant glass, too.



Marine. UL evaluates life preservers, boat electrical systems, marine fire extinguishers and other products relating to pleasure boat safety.

Underwriters  Laboratories, Inc.
Chicago and Northbrook, Ill., Melville, N.Y., Santa Clara, Calif., Tampa, Fla.

AUTOMOBILES, DRIVING

- [50 Detroit Listening Post](#)
- [60 Imports and Motorsports](#)

The '74 Cars

- [110 Drop a new body on the old buggy!](#)
 - [114 Something olé, something new from AMC!](#)
 - [116 Chrysler's new cars are designed for a quick fix](#)
 - [118 Ford's Mustang II: Best idea of the year](#)
 - [120 GM styling: Give safety the credit!](#)
 - [122 Specifications and comparisons of the 1974 cars](#)
 - [124 Should you . . . Trade in? Hang on? Cop out?](#)
-
- [152 How you pay for boredom on the assembly line](#)
 - [164 Saturday Mechanic: What you should know about fluids for your car](#)

HOME AND YARD

- [85 Half baths you can install just about anywhere](#)
- [92 How to waterproof your basement](#)
- [96 How to remove stains from almost anything](#)
- [100 How to keep your gutters and downspouts functioning](#)
- [104 How to put up TV antennas](#)
- [108 Rainproof cushions for outdoor furniture](#)

SHOP AND CRAFTS

- [64 Hints from readers](#)
- [162 A new, low-cost portable drill press \(PM shop test\)](#)
- [168 One man's incredible antique tool collection](#)
- [173 Hints from readers](#)
- [174 Make your oilstone self-lubricating](#)
- [176 Hints from readers](#)

BOATING, OUTDOORS

- [56 Tent-camping by ATV](#)
- [151 Overnight rod repair](#)
- [178 PM rotary outboard test tops 100 mph](#)
- [184 Next year's newest outboards](#)

SCIENCE, INVENTIONS

- [128 'Big iron' moves to the North Sea](#)
- [190 Switching on the sun \(first solar home to offer heat and electricity\)](#)

PHOTOGRAPHY

- [46H New: A Kodak Super-8 that talks](#)
- [74 Photo hints](#)
- [160 World's smallest full-size reflex camera](#)

ELECTRONICS, RADIO, TV

- [104 How to put up TV antennas](#)
- [156 How to buy the right antenna](#)

AVIATION

- [148 Fast, racy fun plane you can build yourself](#)

EVERY MONTH

- [8 Letters](#)
- [22 The Bicycle Shop](#)
- [30 Appliance Clinic](#)
- [39 Car Clinic](#)
- [46B Science Worldwide](#)
- [66 All Outdoors](#)
- [82 Homeowners' Clinic](#)
- [134 It's New NOW: Latest products and developments \(A 14-page roundup\)](#)

Popular Mechanics

OCTOBER 1973 • Vol. 140 No. 4

INTERNATIONAL EDITIONS

Australia, Caribbean, Denmark, Mexico, Southern Hemisphere, Sweden



[Fast, racy fun plane you can build . . . 148](#)



[Switching on the sun . . . 190](#)

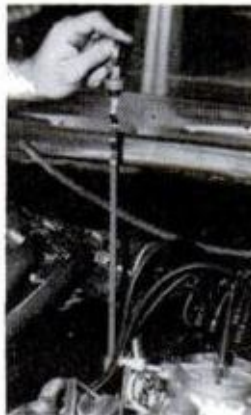

[Fluids for your car . . . 164](#)



[Half baths for small spaces . . . 85](#)

[Worth writing for: see page 72](#)

ON THE COVER: Designer-builder Bruce Weeks with Autokit Invader GT-IV hatchback, his car-body kit for a Volkswagen chassis. Photo: Michael Lamm, PM's West Coast Editor

AS A SERVICE TO READERS, *Popular Mechanics* publishes newsworthy products, techniques and scientific and technological developments. Due to possible variance in the quality and condition of materials and workmanship, *Popular Mechanics* cannot assume responsibility for proper application of techniques or proper and safe functioning of manufactured products or reader-built projects resulting from plans published in this magazine.

Make your own furniture with Stanley's Electrichisel.™



Stanley's remarkable new Electrichisel™ tool works with any electric drill. Makes dado, rabbet and mortise cuts in wood.

As cut deepens, work drill to 90° angle with ring resting on guide to attain desired depth.

STANLEY
helps you do things right



Just clamp a guide to the wood. Set depth ring. Start cut at 45° angle and work Electrichisel back and forth along guide.

The Electrichisel attachment is a must for your portable electric drill. In two sizes: 1/2" size about \$5.25; 3/4" size about \$5.50.

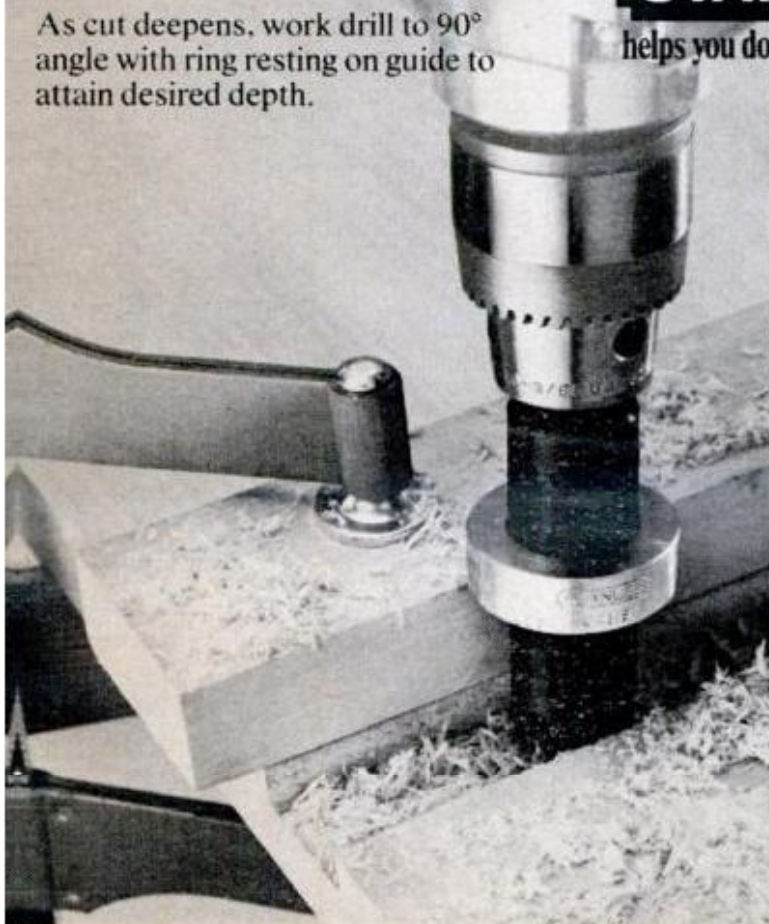

The famous Lincoln AC 225-amp welder is your best buy



Thousands of home handymen, farmers and shop fabricators buy the Lincoln AC-225 every year for these reasons.

Hundreds of Uses. Lincoln AC-225 welders give the ideal arc for fabrication and repair welding. Build your own tools and equipment. Fix cars, trailers, boats, farm machinery quickly. Rebuild or harden worn parts. Heat metal for bending, straightening. Thaw frozen water pipes.

Versatile. Weld heavy plate or sheet metal, Lincoln ampere selection is right for both. Current capacity and duty cycle let you weld without delays. Use low hydrogen, stainless and mild steel electrodes with excellent arc striking and arc stability. Solder, braze, or weld copper and aluminum with the arc torch.

Easy to Operate. Single range control, no cranking or plug changes necessary. Electrode selection guide on top of machine.

Long Life, Dependable Performance. No controls to creep or wear out. Transformer is extra dipped for weather protection. Bottom screen makes the welder verminproof. Built by Lincoln Electric... world's foremost producer of arc welding equipment and supplies.

Easy to Install. Plug into standard 230-volt, single-phase current, just like an electric range. NEMA rated. UL approved at 230 volts, 60 hertz. Will also operate on 208 volts.

Mobile, Lightweight. Easy to move. Wheels optional.

Ready to Use. Price includes accessories, sample electrodes, power cable, instruction book.

(Suggested Zone 1 list price only \$95, subject to change without notice. Optional features, taxes, local delivery and Zone 2 freight charges may alter this price.)

SEND THIS COUPON TODAY!

**LINCOLN
ELECTRIC**

The Lincoln Electric Company
Dept. PM-3, Cleveland, Ohio 44117

- I am interested in a 225 AC welder
 Send free copy of bulletin E320

Name _____

Address _____

City _____ State _____ Zip _____

Popular Mechanics

JIM LISTON, Editor

SHELDON M. GALLAGER, Executive Editor

JOHN A. LINKLETTER, Managing Editor

WAYNE C. LECKEY, Home and Shop Editor

ALVIN KIETZ, Art Director

BILL HARTFORD

JOHN F. PEARSON

WM. T. McKEOWN

IVAN BERGER

HARRY WICKS

STEPHEN WALTON

MICHAEL LAMM

ROBERT LUND

GARRY WINTER

RICHARD H. FUNK

ALFREDO VEGA

DON EVANS

JOSEPH P. BEATON

DAVID KOMITAU

IRA HERRICK

CLIFFORD B. HICKS

SOPHIE GRONOWICZ

EVERETT JOHNSON

Automotive

Science and Engineering

Boating and Outdoors

Electronics and Photography

Home Workshop

Assistant, Home and Shop

West Coast

Detroit Automotive

Copy Chief

Production

Assistant, Production

Technical Art Director

Assistant Art Director

Assistant Art Director

Assistant Art Director

Special Projects

Director, Bureau of Information

Cabinetmaker

DANIEL J. COLEMAN, Director of Advertising

ADVERTISING OFFICES: New York: 224 West 57th St., 765-6850; Chicago: 520 N. Michigan Ave., 527-2400; Detroit: General Motors Bldg., TRinity 5-8711; Cleveland: 20310 Chagrin Blvd., Shaker Heights, 283-7788; Los Angeles: 601 North Vermont Ave., 666-6263.

JOHN A. REGINA, Advertising Production Manager

Published by The Hearst Corporation

FRANK MASSI

President

JOHN R. MILLER

Executive Vice President

RICHARD E. DEEMS

President, Magazines Division

JOSEPH F. KERN

Publisher

ADDRESS ALL EDITORIAL COMMUNICATIONS TO: 224 West 57th St., New York, N.Y. 10019. For additional sources of information on the articles and products in this issue, write to Bureau of Information, Popular Mechanics, for free "Where-to-Find-It" list.

SUBSCRIPTION SERVICE: Mail all subscription orders, changes of address, correspondence concerning subscriptions, and Postmaster notices of undeliverable copies to Popular Mechanics, Box 646, New York, N.Y. 10019. Please enclose your latest address label for quickest service when writing about your subscription.

POPULAR MECHANICS IS PUBLISHED MONTHLY by The Hearst Corporation, 224 West 57th Street, New York, N.Y. 10019, U.S.A.; Frank Massi, President; John R. Miller, Executive Vice President; Harrison A. Mitnick, Treasurer; Harvey L. Lipton, Vice President and Secretary. Hearst Magazines Division: Richard E. Deems, President; Raymond J. Petersen, Executive Vice President; William S. Campbell, Vice President and General Manager; John F. D'Avolio, Vice President and Resident Controller; Albert A. Rachoi, Vice President and Director of Circulation; Joseph F. Kern, Vice President for Popular Mechanics. Single copy in the United States and Canada, 60 cents. Subscription prices: United States and Possessions, \$5.97 for one year; \$10.97 for two years; \$14.97 for three years. Canada, add \$2.00 for each year. All other countries, add \$4.00 for each year. When changing address, give old address as well as the new, with zip code, and allow six weeks for change to become effective. Second-class postage paid at New York, N.Y., and at additional mailing offices. Authorized as second-class mail by the Post Office Department, Ottawa, and for payment of postage in cash. Registered as second-class matter at the Post Office at Mexico D.F., Mexico, June 20, 1950. © 1973 by The Hearst Corporation. All rights reserved. Printed in U.S.A.

Big demand for trained AUTO MECHANICS

150,000 more needed right now. If you like cars, here's your opportunity of a lifetime to get started in a big-money field. Send for free booklet.

Do cars turn you on? Then turn your hobby into a high-pay career. *Become an auto mechanic.* The need is so great now that beginners are welcomed with open arms. Salaries are good. And with on-the-job experience your earnings will go up. Even back in 1969, the U.S. Department of Labor estimated average earnings of auto mechanics at \$5.16 per hour! They're much higher today.

Prepare in your spare time.

Wayne can help you get started by training you right at home in your spare time. Keep your present job as you learn. We'll teach you all you need to know about motors, (including the new Wankel engine!), transmissions, brakes, fuel and ignition systems — how to service every vital part of a car. Take this step toward big earnings. You might even want to open a profitable shop of your own someday.

FREE BOOKLET

To find out more about opportunities in this high-pay field that grows bigger every year, send for our FREE booklet, "Your Future in Automotive Mechanics." There's no obligation. Mail the coupon today. Wayne School, 417 S. Dearborn St., Chicago, Ill. 60605.

© 1973 LaSalle Extension University • A Correspondence Institution



WAYNE SCHOOL

A leader in home study
417 S. Dearborn Street, Dept. 94-091,
Chicago, Illinois 60605

YES, please rush me your FREE illustrated AUTOMOTIVE MECHANICS booklet without obligation.

Print Name Age

Address Apt. No.

City

State Zip

01T

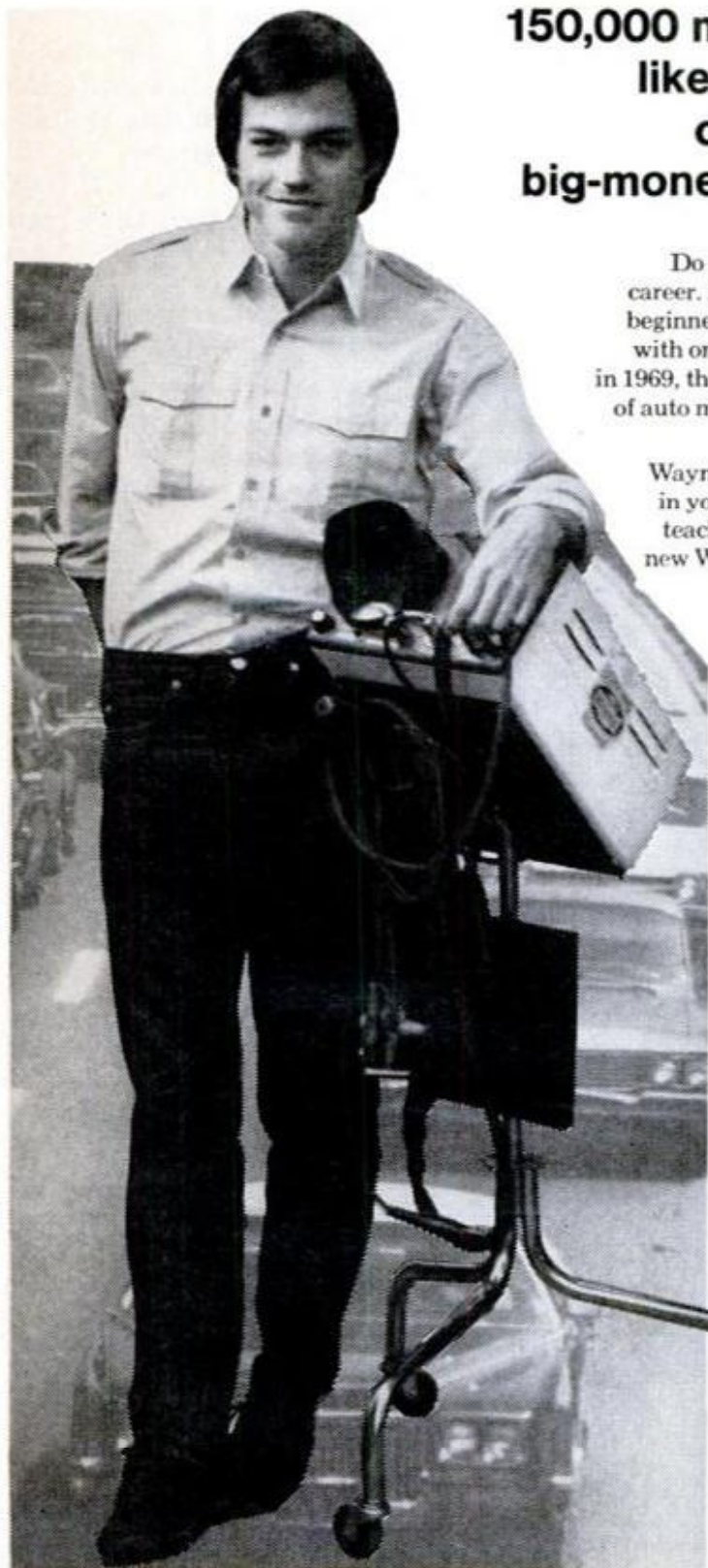

HANDY LITTLE DEVILS FOR NASTY LITTLE JOBS.

Scraping . . . caulking . . . whatever the job, top-quality Red Devil tools and chemicals make it easy!

To prepare a surface for painting, remove loose, flaking or blistering paint with a Red Devil **Paint Scraper**. Its precision-ground blades reach into tight corners.



For sealing openings around door and window frames, use Red Devil **Caulk**. Unlike oil-base caulk, it flows on smoothly — and may be used under any paint without staining, bleeding-through or cracking. It requires no priming, and stays flexible for years.

It's easy . . . with the Devil!

Red Devil

Red Devil Inc.
Union, N.J. 07083



NAVAL JELLY®

removes rust from
bicycles and roller
skates.

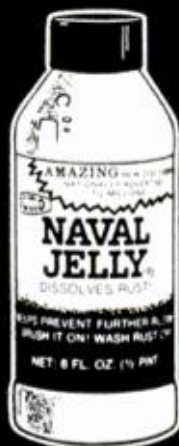

For sale wherever fix-it products are sold.
Woodhill Chemical Sales Corp., Cleveland, Ohio 44128
World's Finest Fix-it Products

LETTERS

TO THE EDITOR

No more radios for porpoises

In your August *Now* section, you have a picture entitled "Wired" Porpoise Tracks Tuna for Fishermen" (page 115).

Please be advised that as long ago as May, NOAA (National Oceanic and Atmospheric Administration—which was charged with carrying out the provisions of the Marine Mammals Protection Act of 1972, until such time as the permanent three-man commission was named) declared that even though the radio-equipped porpoises might have been taken accidentally, the spirit of the Act was being broached, and therefore it was illegal to attach radio transmitters to the cetaceans for the purpose of tracking the schools of tuna.

AMERICAN CETACEAN SOCIETY BEMI DEBUS
MARINA DEL REY, CALIF. EDITOR,

THE WHALEWATCHER

Unhook those wires

A word of warning to the boy working on the rocket (page 106) pictured in *Big-Scale Thrills at Small-Scale Prices* (page 102, Aug. *PM*): Do make sure that the wires are unhooked from the battery before you check the rocket. Otherwise, you risk a short-circuit launch and burns.

NORMAN, OKLA.

DAVE SWANK

The firing device shown has a safety arming feature that prevents accidental triggering, but you're right that care should be taken at all times.

New maturity for karting

Your colorful feature, *Karting: Everybody's Chance to Be a Race Driver* (page 69, July *PM*) should do much to increase interest in that sport. It should not be conceded that spectator appeal cannot be increased. The belated move to dignify the vehicle by encasing its skeletal frame and driver within a beautiful shell will draw

(Please turn to page 11)



Can you tell which pickup is overloaded?

(answer below)

If you *can't* tell, you've got a lot of company — because load weight climbs a lot faster than most people realize. *Both* trucks in our picture are overloaded for their standard tires, especially when you figure that both pickups will probably bounce those loads over fields and really rough roads.

When we hear from someone who says he's wearing out pickup tires too often, we often find he's running on passenger car tires, because he thinks they cost a lot less. When we tell him that some sizes

of our Firestone Transport, a real truck tire with a 6-ply load rating instead of a 4-ply load rating, actually cost less than passenger car tires — and are designed to take more punishment — he's usually surprised.

His last questions are often "how does it ride and how does it look?" When we tell him he probably won't be able to tell the difference in ride, and that many sizes come in whitewalls, he usually goes to see his Firestone Dealer or Store. We hope you will.



Firestone Transport®

CONVENIENT, ONE HAND EASE OF OPERATION



freed
other
hand
to hold
work
for a
neater
job!



IT'S A BREEZE—ONE SQUEEZE AND YOU'VE NAILED IT...

ARROW

HEAVY DUTY

STAPLE GUN

SHOOTS A STAPLE
WHEREVER YOU'D
DRIVE A NAIL!

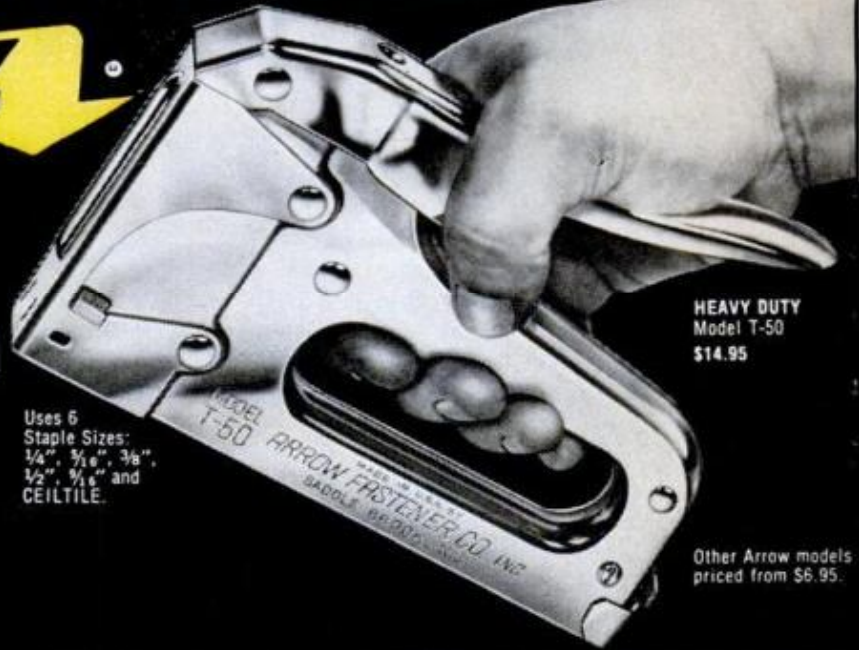

HEAVY DUTY
Model T-50
\$14.95

Uses 6
Staple Sizes:
1/4", 3/8", 1/2", 5/8", 3/4",
and CEIL/TILE.

Other Arrow models
priced from \$6.95.

FASTER! BETTER! CHEAPER!

Built of all-steel for rugged durability . . . with a patented jam-proof mechanism for smooth, trouble-free performance . . . the one-hand operated Arrow T-50 Staple Gun provides the versatility, power and convenience you need to perform 1,001 fastening jobs—Faster, better, cheaper than hammer and nails!

A HANDY CHECKLIST OF SOME OF THE MANY USES:

- Installing ceiling tile
- Insulating
- Weatherstripping
- Re-upholstering furniture
- Wire fencing
- Tacking carpet pads
- Repairing screens
- Electrical wiring
- Attaching window shades to dowels
- Tacking down linoleum
- Lining closets
- Installing wallboard and plywood paneling
- Covering valances
- Boat fiberglass insulation
- Kitchen shelf trimming
- Fastening decorations
- Securing burlap wrappings around tree trunks

LIMITED TIME
ARROW SPECIALS
FEATURED
AT YOUR
LOCAL DEALER
FOR FALL
HARDWARE WEEK



No. T-50FS SPECIAL



JT-21C SPECIAL



T-55FS SPECIAL

Available at
Hardware, Lumber,
Building Material,
Stationery,
Variety Stores
and other
Retail Outlets.

ARROW FASTENER COMPANY, INC./SADDLE BROOK, N. J. 07663/In Canada: Quebec Province

THE STANDARD OF EXCELLENCE BY WHICH ALL OTHERS ARE JUDGED

LETTERS

(Continued from page 8)

attention and add a new note of maturity.

The sport needs a racing course other than the snaky quarter-mile or the immensity of a three-mile circuit. Possibly one mile of roadway involving chicanes with more width and with less acute angles on the turns would be ideal.

ST. PETERSBURG, FLA.

F. P. SHERRY

Another way to tie ties

Regarding your otherwise excellent article on *How to Build Retaining Walls* (page 86, Aug. *PM*), my own experience with railroad ties suggests that 20d nails are very weak reeds upon which to depend for holding these very heavy timbers together. I have had excellent success using deformed steel bars, which are used as reinforcing in concrete, cut into lengths of about 15 to 18 inches. They are driven straight down from each strake of ties into the layer next below. Three per eight-foot tie are plenty. Half-inch diameter rod is fine.

Drill the holes with a power auger bit about 15 inches long, available at any decent tool department. The deformation of the bars holds the pins tightly in place. They must be driven in with a sledge. A "home workshop" electric drill won't do; use a heavy-duty slow-speed drill. It is important to pull the bit out every inch or two to clear the chips; otherwise you will never get the bit out of the hole. If this system is used, I don't think the use of pipe to anchor the ties is useful; I doubt they could be effective unless set in concrete and then, say, 1½ or 2 inches IPS (iron pipe size).

BETHESDA, MD.

ARTHUR ENDERLIN

We have no qualms about the holding power of 20d nails, but some readers might want to try Mr. Enderlin's reinforcing-rod technique for holding railroad ties.

Rapid transit? Not yet

The rapid-transit system at West Virginia University ("Private 'El' for College Students," page 111, *Now*, Aug. *PM*) does not

(Please turn to page 12)

HERMAN SURVIVORS®

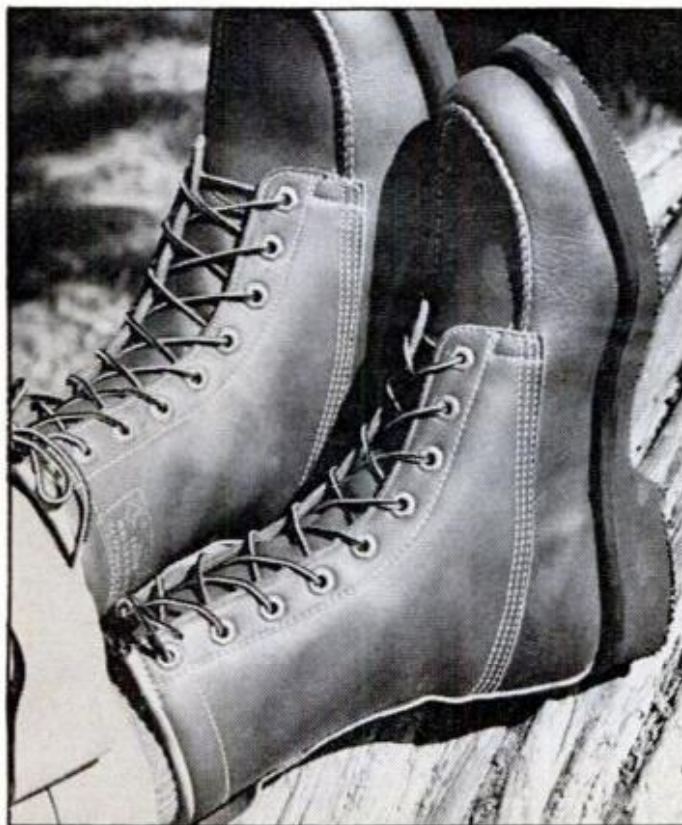

We build Herman Survivors® to do two things well: Cover a lot of territory in great comfort. And stand up to the kind of punishment outdoorsmen give them. In any kind of weather. That's why we build the uppers of soft, durable burgundy full-grain glove leather, line them with Ensolite® for warm feet right down to -20°, then line the whole upper and soft padded cushion insole with saddle tan full-grain cowhide for even greater comfort. After that we stitch the boot down to resilient, oil-resistant Neoprene® crepe soles and heels. These Hermans come in two styles: 8" insulated boot, #7192, and 6" insulated shoe, #7192-6. They're tough. And they're comfortable. Like all our boots. When you're looking for quality in an outdoor shoe, hunt up a pair of Hermans.



J. M. HERMAN SHOE COMPANY,
DEPT. 34, MILLIS, MASS. 02054

That sounds like my kind of boot.
Send me your catalog and the name
of my nearest Herman dealer.

PM-BGL-3-10

NAME _____

ADDRESS _____

CITY _____

STATE _____

ZIP _____

START A BUSINESS

in your neighborhood



Sharpen Hand or Power Saws with the

FOLEY SAW FILER

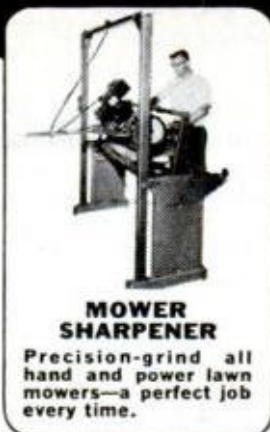

MOWER SHARPENER
Precision-grind all hand and power lawn mowers—a perfect job every time.

Start your business in sparetime and make CASH PROFITS right away. No stock to carry, no selling involved, no experience needed—the Foley Saw Filer does every sharpening job **automatically!** Earn \$3 to \$6 an hour sparetime in your own garage or basement. Profit 90c on every dollar.

Best of all, every saw you sharpen, will be resharpened again and again—watch your repeat business grow! Add cash to your income now, while you build retirement security with the Foley Saw Filer.

FREE BOOK shows how you can make money as thousands of others have. Send coupon today. There's no obligation, and no salesman will call—so write today!



Foley Manufacturing Co.
1043-3 Foley Bldg., Minneapolis, Minn. 55418
Send for FREE book on Money-Making facts about the sharpening business.

NAME _____

ADDRESS _____

CITY _____ STATE _____ ZIP CODE _____

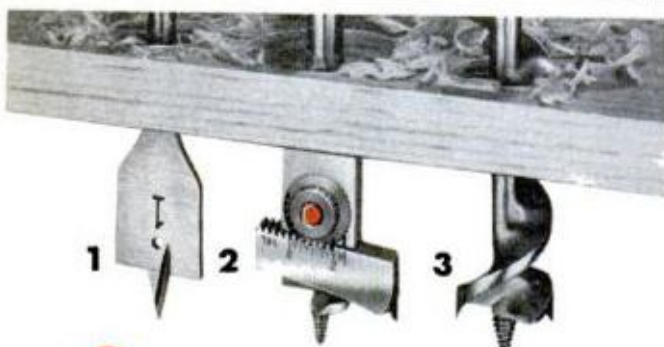

3 easy ways to bore holes faster

1. Irwin Speedbor "88" for all electric drills. Bores faster in any wood at any angle. 17 sizes, 1/4" to 1 1/2". Only \$.98 to \$1.70, depending on size. Also buy in sets.

2. Irwin No. 22 Micro-Dial expansive bit. Fits all hand braces. Just dial your size. Bores 35 standard holes, 7/8" to 3". Only \$6.30. No. 21 small size bores 19 standard holes, 5/8" to 1 1/4". Only \$5.60.

3. Irwin 62T Solid Center hand brace type. Only 16 turns to bore 1" holes through 1" wood. Double-cutter boring action. Sizes 1/4" to 1 1/2". 1/4" size only \$1.75.

EVERY IRWIN BIT made of high analysis tool steel, heat tempered, machine-sharpened and highly polished, too. Buy from your independent hardware, building supply or lumber dealer.

Strait-Line Chalk Line Reel Box

only \$1.50 for 50 ft. size

New and improved Irwin self-chalking design. Durable aluminum alloy box. Practically damage-proof. Fits pocket or hand. 50 ft. and 100 ft. sizes.



IRWIN every bit as good as the name
at Wilmington, Ohio 45177, since 1885

LETTERS

(Continued from page 11)

yet whisk any "lucky students" anywhere as it will not be operational for at least another year. As for not having to poke our noses outside, none of the PRT (Personal Rapid Transit) stations are connected to any other buildings by other than the usual sidewalks, and, in my opinion, these stations are much less conveniently located than the present bus stops.

MORGANTOWN, W. VA. JEAN F. STEWART

This article is far from the truth. I am very disappointed, as I have been a PM fan for years.

CHARLESTON, W. VA. DALE W. LOY

We're disappointed, too. Sorry. We relied on a news source that was overzealous in describing things that are yet to be.

Hutch-table measurement

In *An Early American Hutch Table You Can Build* (page 96, July PM), Harry Wicks says, "Thus we returned to the workshop for a second go-around on the project and here's the result."

Does he ever build one of these projects or does he take someone's word for facts and figures? He surely didn't build that table, because he would never have gotten part B fastened to part A without considerable hangover on part B. I question the length of 37 1/2 inches; the very longest that part B could possibly be is 34 3/4 inches, and that would have to be with a square-edged table.

TELL CITY, IND.

FOREST B. COOPER

That hutch table was built twice—once by Harry and once by our cabinetmaker. Unfortunately, the error was made when measurements were transferred to final art for presentation in the magazine. The length of part B should be 34 inches.

EPA and EV

Re your article, *Will Clean-Air Cops Confiscate Your Car?* (page 144, Aug. PM), there is a glimmer of hope that such a paralyzing act can be avoided. A study has

(Please turn to page 14)

TOM McCAHILL SAYS:

"The appliance repair field is so uncrowded it's almost lonely!"

Someone once said that if you build a better mousetrap, the world will beat a path to your door. In the home appliance business, a lot of enterprising companies have gotten rich peddling a list of handy electrical gadgets for the home longer than Wilt Chamberlain's arm. The trouble is, the dozen or more appliances in the average American home can go on the fritz, and men with the proper training to do repairs are as scarce as knee-length skirts on teen-agers.

Good Appliance Repairmen are a rare breed these days. Those with a little ambition are booked so solidly you can wait days to get somebody to fix a balky refrigerator or cantankerous toaster. Sometimes, you have to settle for a bum job from a guy who had no business calling himself an Appliance Repairman in the first place.

This brings me to my point. If you want to make money in a field that's begging for trained technicians, there's a fine, low-cost home-study plan available that teaches you how to handle every type of Appliance repair in detail—including refrigeration, air conditioners, and even small gas engines. The course was prepared by the instructors at National Radio Institute. This is the oldest and largest home-study school in the Electronics/Electrical fields with more than fifty years' experience training men like yourself for new careers or spare-time or full-time businesses of their own.

A few years ago, NRI recognized the increasing demand for trained Appliance Repairmen. They set about preparing well-illustrated, easy-to-understand lessons that teach you how to repair home, commercial and farm Appliances. NRI even added a professional Appliance Tester that's included in their low tuition. With the Tester and a few basic tools you probably already have,

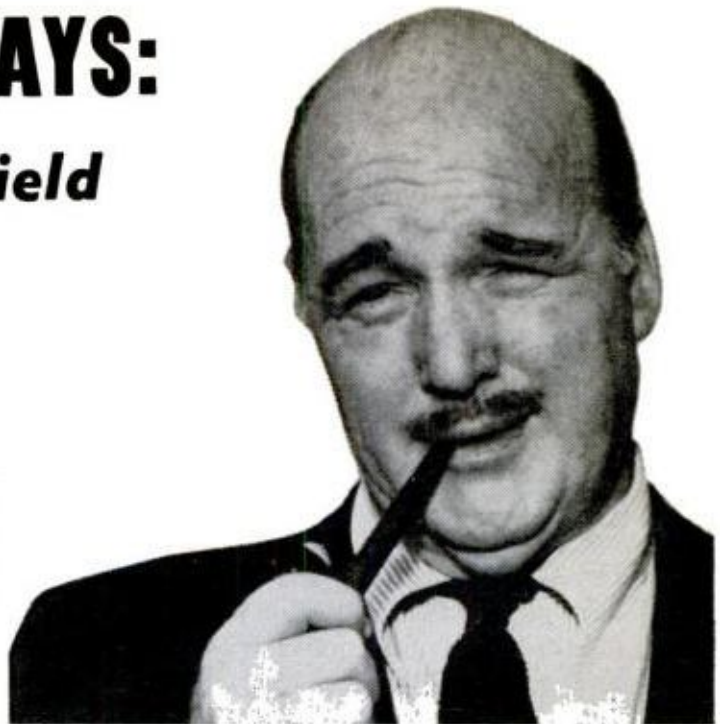

you're equipped to service most Electrical Appliances. If you aren't making as much as \$4 to \$6 an hour in spare time fixing Appliances for friends and neighbors within a few months after enrolling, my name isn't McCahill.

The reason I'm no doubting Thomas, is because the staff at NRI is composed of experienced instructors who guide you through the course with more personal attention than you'd get in many classrooms. With the kind of help they give a student and the kind of course they have, you can be the man in demand in this field—even if you've never tried to rewire a plug, or got fed up with school at the 9th grade.

The best advice I can give you is to clip the coupon below and send for the NRI Appliance Training Catalog. It's free, and there's no obligation. NRI doesn't employ salesmen, so nobody will be knocking at your door. All it will cost you is a postage stamp. Take it from Uncle Tom, the Appliance Repair field needs good men. Now.

Tom McCahill

TOM McCAHILL

APPLIANCE DIVISION, NATIONAL RADIO INSTITUTE
3939 Wisconsin Avenue, Washington, D.C. 20016

APPROVED UNDER NEW GI BILL.
If you served since January 31, 1955, or
are in service, check GI line below.

600-103

OK—I want to see for myself. Send me the free book on Professional Appliance Servicing. No salesman will call.

Name.....Age.....

Address.....

City.....State.....Zip Code.....

Accredited Member National Home Study Council.

Check for facts on new GI Bill.

LETTERS

(Continued from page 12)

just been launched by the Environmental Protection Agency to determine the impact which on-the-road electric vehicles might have if introduced in the Los Angeles region. The study, to be completed by mid-1974, reaches beyond mere reduction in air pollution. It deals with social and economic adjustments as well.

Although the Los Angeles area, due to great distances, is the toughest place imaginable to test EVs for general road use, the industry is betting on good results—if the test group remembers the limitations of EVs. A study concluded in 1971 showed that EVs could perform the same services demanded of internal-combustion vehicles—that better than 20 percent of the ICs could be replaced with EVs at that time, with no loss of mobility or service.

If this happened in the Los Angeles area it's very likely the traffic could keep moving very satisfactorily.

PORTER CORP.

G. ROGERS PORTER
PRESIDENT

WESTPORT, CONN.

Last October *PM* reported in *Detroit Listening Post* (page 51) that an *Electric Vehicle Council* survey showed 42 percent of Americans "would be interested in purchasing a short-range, limited-speed electric auto if it were available for under \$2000." So there appears to be plenty of interest in EVs. *PM* readers who are EV buffs will find good reading in a quarterly, *Electric Vehicle News*, sponsored by the *EVC* and published by the *Porter Corp.* It's \$8 per year. Box 533, Westport, Conn. 06880.

Pleased with grandfather clock

I was interested in *Charming Grandfather Clock From a Kit* (page 162, Aug. *PM*).

I purchased one last year and constructed it from a mahogany kit. I was very pleased with the attention and help given me by the Emperor Clock Co.

HARRY SCHMIDT
ONTARIO, CALIF.



Airconditioner know-how

Your outstanding article, *How to Troubleshoot Your Airconditioner* (page 72, July *PM*), proved to be very profitable. I had a broken one, just lying around the house until I read your article and found how easily it could be repaired. My family kept cool all summer.

SOUTH LYON, MICH.

CARL M. WILLIAMS

Two-door barrel bar

My barrel bar turned out to be everything you said it would be, and I'm proud of it. I made it from plans in *Roll Out the Barrel When the Gang's All There* (page 131, Jan. '72 *PM*).

I made a few changes. The top shelf rotates, as does the bottom shelf. The door shelves not only serve as shelves, but give

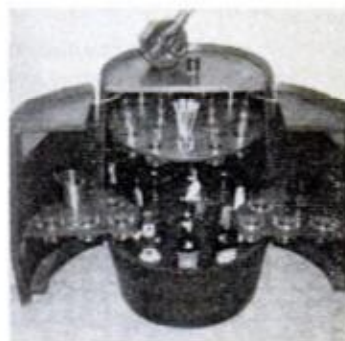

the doors a great deal of support. I made the shelves out of wood instead of the plastic laminate.

I tried for hours to hang the door as you have it, but it seemed impossible. That's when I got the idea of two doors, and it worked out beautifully.

FOND DU LAC, WIS.

WILLIAM GAU

Photocopies from old PMs

Many thanks for your prompt reply to my inquiry about an article from a 1959 *PM*. I am most happy you can make a photocopy of the article; my check is enclosed.

MOCKSVILLE, N.C. MRS. C.F. MERONEY JR.

Most any article back to about 1914 can be supplied in photocopy form for 20 cents per page plus 25 cents postage and handling. Order from the Reader Service Bureau, *Popular Mechanics*, 224 West 57th St., New York, N.Y. 10019. Be sure to include your complete address. ★★★

Why take a chance on a furnace you never heard of when General Electric has oil, gas and electric furnaces?

A furnace is a purchase you are going to have to live with and depend on for a great number of years. So, wouldn't it be foolish to buy one you never heard of when you can get a General Electric furnace with all of GE's quality for years of dependable service?

GE does have just about any kind of furnace you can imagine. Fifty-six gas-fired (natural or propane), 11 oil-fired, and 5 electric. Seventy-two different models in all.

You can choose from furnaces that fit into basements, utility rooms, crawl space, attics, alcoves, even closets. Upflow, Downflow, Horizontal furnaces, and Lo-boys, too.

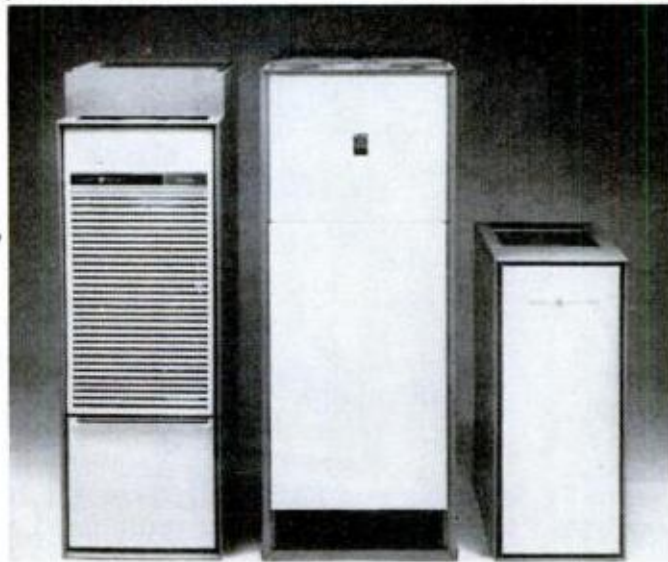

All of these have certain things in common. They're attractively and functionally designed, dependable, quiet, filter-fitted for clean air, convenient to service and to operate.

And every single one of them is eligible for the General Electric Central Air Conditioning National Service Contract Plan.

If you're in the market for a furnace now, or in the future, the man to talk to

is your General Electric Central Air Conditioning Dealer.

You'll find him in the Yellow Pages under "Furnaces, Heating; or Air Conditioning Equipment and Systems!"



GENERAL  **ELECTRIC**

KEEP THIS 25" MOTOROLA COLOR TELEVISION AND PUT YOUR HANDS TO WORK MAKING MONEY.



When you learn TV Servicing and Repair, at home, the ICS way... you get all the tools and equipment (shown here) that you'll need, at no additional cost.

You need the experience of handling a name-brand, professionally built color television to really start making money as a TV specialist. So ICS gives you a brand new Motorola Color Television that you can set up—and enjoy—in your own home. And it's yours to keep, at no additional cost, when you complete your training program.

Earn big money

What's more, you also get to keep all the other testing and troubleshooting equipment that ICS sends you. So you can start using them on the job (where trained technicians now earn anywhere from \$3.50 to \$6.50 an hour*). Or open a shop of your own—and earn even

more, working full or part-time.

Get everything you need

You can set up your new Motorola Quasar II® color TV in any room of your home. Enjoy your favorite TV programs in full color on a huge 25-inch screen. And, at the same time, use it as your testing laboratory.

This famous Motorola "Works In A Drawer" model makes it easy because you slide out the main components from the front of the cabinet—for easy study, adjustment or repair. And it's yours to keep—at no additional cost—when you complete your training. (You can place your Motorola TV chassis in a wall unit. Or select the cabinet of your choice at a special student discount.)

Ideal way to learn

As an ICS student you get all the working experience you need—in the privacy of your own home, during your spare time.

But you're not alone. Skilled instructors are always ready to help you. And you can even call ICS from anywhere, at any hour. Toll-free.

Free "Demonstration Lesson"

If you want a career that gives you more (more money, more day-to-day satisfaction, and more future) just mail the attached card for free career guide booklets and a free "Demonstration Lesson." Find out for yourself why getting started in this rewarding career field may be easier than you think.

KEEP THIS PHILCO-FORD AIR CONDITIONER AND PUT YOUR HANDS TO WORK MAKING MONEY.



When you learn Air Conditioning, Heating & Refrigeration, at home, the ICS way . . . you get all the tools and equipment (shown here) that you'll need, at no additional cost.

You need the experience of installing, testing and trouble shooting a name-brand air conditioner to really start making money as an air conditioning specialist. So ICS gives you a Philco-Ford air conditioner that you can install—and enjoy—in your own home. And it's yours to keep, at no additional cost, when you complete your training program.

Earn Big Money

What's more, you also get to keep all the other tools, testing and trouble-shooting equipment that ICS sends you. So you can start using them on the job (where trained technicians now get anywhere from \$3.25 to \$7.00 an

hour*). Or open a shop of your own and earn even more, working full or part time.

6,000 BTU's of cooling power

The styling of your Philco-Ford air conditioner is right for any room in your home. It has an adjustable automatic thermostat, 2-speed cooling, a stale-air exhaust, and No-Drip dehumidification. Plus a big 6,000 BTU's of cooling power that you'll really appreciate when the temperatures soar.

And, at the same time, this powerful air conditioner will also serve as your testing laboratory—for testing electrical circuitry, temperature control, refrigerant circuits, and mechanical operation.

Ideal way to learn

As an ICS student you get all the working experience you need—in the privacy of your own home, during your spare time.

But you're not alone. Skilled instructors are always ready to help you. You can even call ICS from anywhere, at any hour. Toll-free.

Free "Demonstration Lesson"

If you want a career that gives you more (more money, more day-to-day satisfaction, and more future) just mail the attached card for free career guide booklets and a free "Demonstration Lesson". Find out for yourself why getting started in this rewarding career field may be easier than you think.

EMPEROR'S GRANDEST GRANDFATHER CLOCK

MODEL 300 IN SOLID $\frac{3}{4}$ INCH CHERRY

DO-IT-YOURSELF CASE KIT

**SALE
PRICED**

149⁵⁰

REGULARLY
\$199.00

Finished Model 300 in cherry shown

All pieces pre-cut and pre-sanded at the factory. Breakfront swan neck crown and finial, waist and dial doors, dial frame and sculptured base-front factory assembled by skilled cabinet-makers. Complete hardware and assembly instructions furnished. Each piece may be re-ordered separately. No wood-working experience necessary.

NOW! EMPEROR'S FINEST IN

CHERRY THE AMERICANA WOOD

Emperor introduces America's most beautiful timepiece — Model 300 — in lustrous solid cherry, the finest tradition of craftsmanship and taste. Model 300 has a classic design that complements any decor. It stands tall and proud (82" high) to be admired by generations to follow. And now the beauty of this fine grandfather clock is further enhanced by the warmth of cherry . . . the preferred hardwood of expert cabinetmakers since colonial days. The fine close grain and natural resonance of cherry (utilized in many musical instruments) make it exceptionally desirable as a clock case. With Emperor's accurate and melodious clock movement, your Model 300 Grandfather Clock will become a treasured heirloom.

ENJOY DOUBLE SAVINGS

By building Model 300 yourself (from the Do-It-Yourself Case Kit), and adding a quality Emperor movement, you save hundreds of dollars from the price of comparable grandfather clocks retailing for as much as \$1200. You save even more, now, while this fine clock case kit is sale priced at \$149.50 — \$49.50 less than the regular price of \$199.00. This is your opportunity to "add the final touch of elegance to your home" — at great savings.

FACTORY-TO-YOU SAVINGS ON FINISHED CLOCKS

During this sale you can also buy Model 300 in cherry, completely finished with Westminster Chimes for \$499 (Reg. factory price \$695) and Model 300 in cherry completely finished with triple chimes for \$556 (Reg. factory price \$745).

MONEY BACK GUARANTEE

If not completely satisfied, return in original shipping carton within thirty days for complete refund. No questions, no excuses.

SEND FOR FREE COLOR BROCHURE
OF COMPLETE EMPEROR LINE

OFFER GOOD THROUGH DEC. 31, 1973



Model 300, solid $\frac{3}{4}$ " cherry
82" x 19 $\frac{1}{2}$ " x 13"

THE EMPEROR MOVEMENT FOR MODEL 300

WEIGHT-DRIVEN • EIGHT DAY • WESTMINSTER OR TRIPLE CHIMES

Emperor grandfather clock movements are produced in West Germany, the proud work of famous third-generation clocksmiths who have been manufacturing the world's finest movements for over a century.

Embossed overlays surround the brass dial. The face has a brilliant permanent polish with raised brass Arabic numerals and serpentine hands. In the arch above the dial face is displayed a moving moon with lunar calendar.

The Emperor movement strikes four notes on the quarter-hour, eight on the half-hour, twelve on the three-quarter hour, and sixteen on the hour. These notes are struck on four musically tuned rods. A Big Ben tone sounds the hour. Movement 200-M sounds the famous Westminster chimes. Movement 300-M features a selection of three melodious chimes: Whittington, St. Michael and Westminster. The Emperor movement includes weights, solid brass shells, brass bob, pendulum and chimes. All plates are solid brass, and pinions are hardened steel. Installation and adjustment of the movement is simple, following the step-by-step instructions.

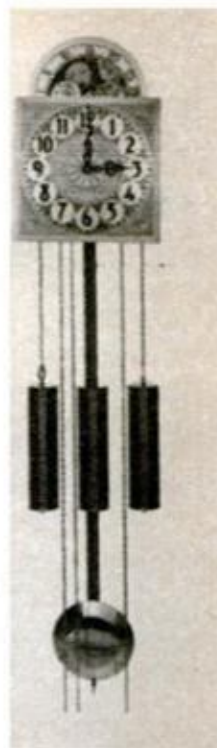

ONE YEAR UNCONDITIONAL GUARANTEE

200-300-M Movement
Westminster chimes
\$169.50

Triple chimes \$199.50

LUSTROUS CHERRY...A CHRISTMAS BONUS

**ORDER NOW!... DIRECT WITH THIS FORM
OFFER GOOD THROUGH DEC. 31, 1973**

CLOCKS, KITS, MOVEMENTS SHIPPED 2 TO 3 WEEKS, SHIPPING CHARGES COLLECT

TO: **EMPEROR CLOCK COMPANY, Dept. 39**
Emperor Industrial Park, Fairhope, Alabama 36532

Please Check:
New Customer
Previous Customer

QUANTITY	DESCRIPTION	WEIGHT	REG. PRICE	SALE PRICE	EXTENSION
	Model 300K Do-It-Yourself kit without movement, solid cherry	90	\$199.00	\$149.50	
	Model 300A completely finished clock solid cherry, Westminster chimes, moving moon dial	160	\$695.00	\$499.00	
	Model 300TA completely finished clock solid cherry, Triple chimes, moving moon dial	167	\$745.00	\$556.00	
	Model 200-M movement complete with Westminster chimes, moving moon dial, for Model 300	44	\$169.50		
	Model 300-M movement complete with triple chimes, moving moon dial, for Model 300	48	\$199.50		

We accept personal checks:

TOTAL \$ _____

ENCLOSED: () CHECK () MONEY ORDER \$ _____

Alabama residents only
add 4% sales tax \$ _____

CHARGE TO MY () BANKAMERICARD () MASTER CHARGE

GRAND TOTAL \$ _____

Card Number _____

Expiration Date _____



NAME _____

ADDRESS _____

CITY _____ STATE _____ ZIP _____

Please send FREE color brochure
on complete Emperor line

VISIT OUR FACTORY SHOWROOMS MON.-FRI., 8 A.M. to 5 P.M., EMPEROR INDUSTRIAL PARK, FAIRHOPE, ALA.

THE BICYCLE SHOP

BY EUGENE A. SLOANE

Once in place, this unit ends crank-assembly maintenance worries for years. You can install it in just 30 minutes.

The bottom bracket of a bicycle (the crank axle, bearings and cups) is close to the ground and exposed to dust and grit kicked up by the wheels. This assembly is also one of the most highly stressed parts of a bicycle. As a result, time-consuming maintenance of this vulnerable-to-wear component is required at least twice a year—and oftener if you do a lot of riding, especially over dusty roads. The bottom bracket is also expensive to replace should it wear out.

A new sealed bottom-bracket unit, incorporating the axle and precision ball bearings, is now on the market. Because it's sealed, it requires virtually no care. Although the unit costs around \$40 (and replaces your old axle and bearings), its low friction and maintenance-free advantages make it a worthwhile investment for any bicycle that has aluminum-alloy cotterless cranks. The sealed unit is also available for steel cotted cranks, but in my opinion, a bike with these cranks would not be good enough to justify the expense.

You will need a special ring wrench (above, right) to install the new sealed unit. The wrench costs \$12, so you may not want to buy it. Bike dealers who handle these units are generally willing to let you borrow this wrench—or your bike club or group of friends might want to buy one together. The sealed unit is made by Phil Wood & Co., and it's stocked, or can be ordered, by better bicycle stores.

The best way to order the new sealed bottom-bracket unit is to check by phone to see if your dealer has it, then take your bike down to the store to make sure the right unit is ordered or in stock. The dealer will need to know the make of your bicycle

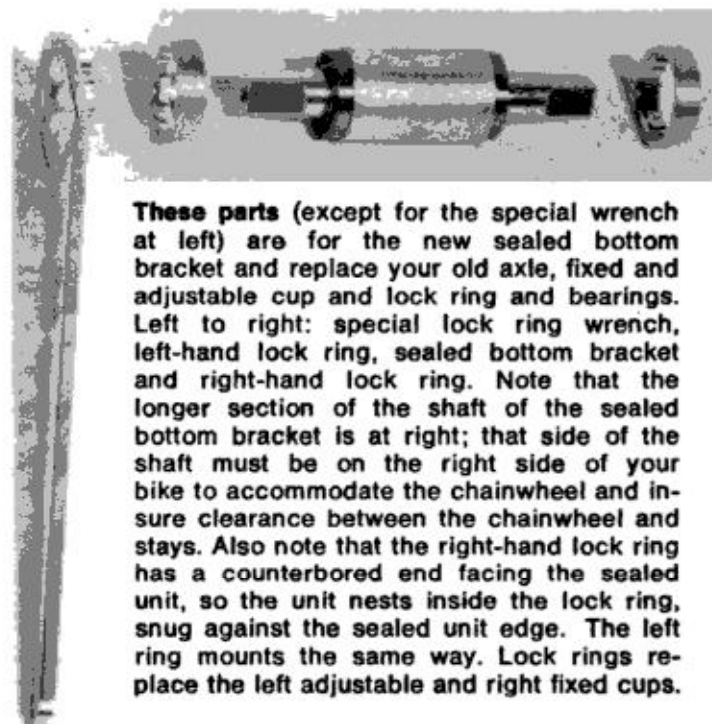

These parts (except for the special wrench at left) are for the new sealed bottom bracket and replace your old axle, fixed and adjustable cup and lock ring and bearings. Left to right: special lock ring wrench, left-hand lock ring, sealed bottom bracket and right-hand lock ring. Note that the longer section of the shaft of the sealed bottom bracket is at right; that side of the shaft must be on the right side of your bike to accommodate the chainwheel and insure clearance between the chainwheel and stays. Also note that the right-hand lock ring has a counterbored end facing the sealed unit, so the unit nests inside the lock ring, snug against the sealed unit edge. The left ring mounts the same way. Lock rings replace the left adjustable and right fixed cups.

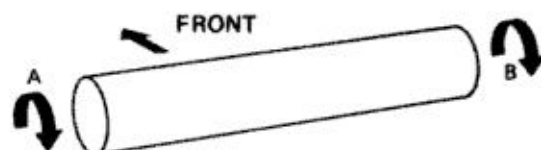

Some bicycles, such as Schwinn Paramount and those made in Britain, have crank hangers threaded so rings or cups thread on clockwise on left side, counterclockwise on right. "A" illustrates left-side threading; "B" illustrates right side. If right-hand ring on your bicycle threads on counterclockwise, pedaling tends to loosen it, so lock it on tightly.

and chainset and whether you have a single, double or triple chainwheel. Bikes made in England, Switzerland, Italy and France have different bottom-bracket threads, and in the case of British and Swiss hangers, the left-side thread is right-hand (threads on clockwise) and the right-side thread is counterclockwise. If, for some reason, your dealer can't guarantee he can order the correct size bottom bracket for your bike, find a dealer who can (and stick with him in the future).

Here are the steps for installing the sealed bottom-bracket unit:

(Please turn to page 24)

Salem refreshes naturally!

- Naturally grown menthol.
- Rich natural tobacco taste.
- No harsh, hot taste.



Warning: The Surgeon General Has Determined That Cigarette Smoking Is Dangerous to Your Health.

King or Super King

© 1973 R. J. REYNOLDS TOBACCO CO.

KING: 19 mg. "tar", 1.3 mg. nicotine, SUPER KING: 21 mg. "tar", 1.5 mg. nicotine, av. per cigarette, FTC Report FEB '73.

THE BICYCLE SHOP

(Continued from page 22)

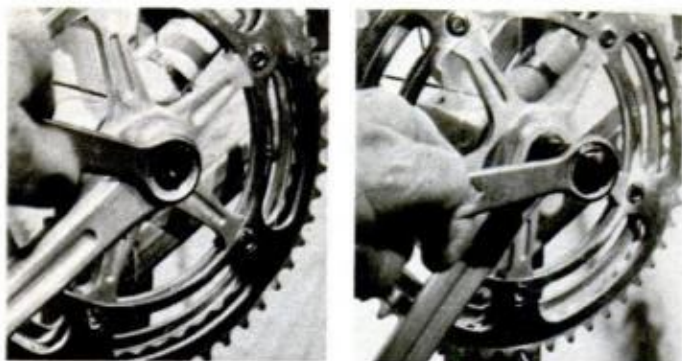

1. Remove dust cap, axle locknut and install crank puller in crank and remove both cranks. (You may want to review crank disassembly instructions in *The Bicycle Shop*, page 67, May '72 PM and page 52B, June '72 PM, or page 286 of my book, *The Complete Book of Bicycling* (Trident Press, New York).

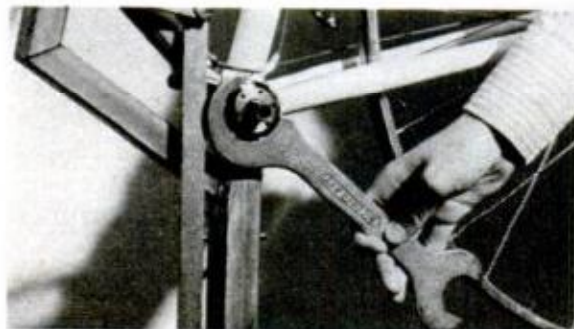

2. Remove left-hand lock ring and adjustable cup. They thread off counterclockwise. Remove the axle and bearings.

3. Remove both wheels. Make sure you know which way the right-hand fixed cup threads off. If your bike was made in England, Japan or Switzerland—or is a Schwinn Paramount—the fixed cup threads off clockwise. Your dealer *should* know. Holding the bike flat, fixed cup (right side) down, put the fixed cup flats in a sturdy machinist's vise and tighten the vise hard. Rotate bike frame in the correct direction to loosen the fixed cup, and, once it's loose, remove the bike and cup from the vise and complete fixed-cup removal with a monkey wrench. As noted, the fixed cup is on the right side of the bicycle.

4. Clean the bottom-bracket hanger inside, including the threads, and inside the squared hole in cranks. Put thread-mounting compound on the rings of the new sealed unit (the compound comes with the unit).

5. Slide sealed unit, long-shaft end first, into bottom bracket through left side. Long-shaft end should extend from right-hand side of hanger (photo, page 22).

6. Thread on both lock rings. Make sure lock rings have their counterbored ends facing *inward*, so shoulder of sealed bottom-bracket unit nests *inside* the lock

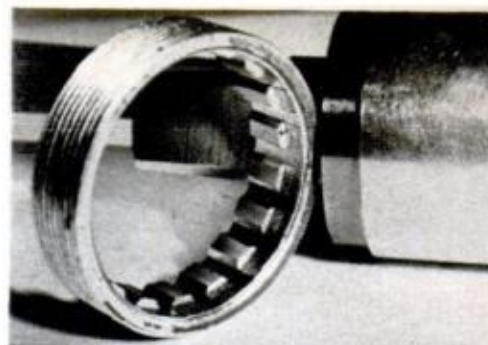

ring, as shown. If right lock ring threads on counterclockwise, it will be identified by a red stripe on the ring.



7. With the special wrench, tighten both lock rings so the same amount of threading shows on each side of hanger and the sealed unit is fitted tight between lock rings. Torque rings to about 25 pounds.

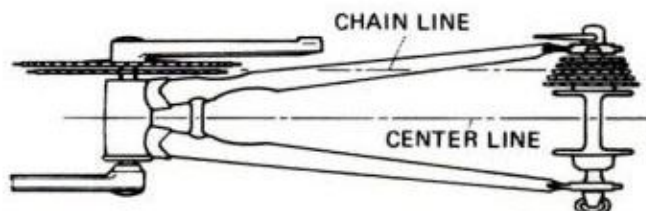

8. Put a thin layer of oil on bottom-bracket unit shafts and inside squared hole in cranks. Slide cranks on axle, insert locknut washer and locknut and tighten locknut snug but not tight. Check alignment of both cranks. Left crank should clear frame members. Chainwheel should clear frame members. Center between dual chainwheel should line up with center (third) gear of freewheel. Center chainwheel of triple chainwheel should line up with center freewheel gear.

9. If you need to move the bottom bracket left or right slightly to line up freewheel with chainwheel as in Step 8, remove cranks as in Step 1, loosen one lock ring a half turn or so, tighten the other lock ring the same amount, recheck alignment and tighten lock rings as in Step 7. Reinstall cranks and tighten crank locknuts well up. Retighten crank locknuts at 50 miles and at 100 to make sure cranks don't work loose. Cranks are softer aluminum alloy; if they get loose, they'll round the squared holes in the shank and you'll need new cranks. After two retightenings, cranks should stay tight till you want to remove them—which, with the new bottom bracket, should be unnecessary. ★ ★ ★

The 1974 Plymouth Duster. A lot of car for the money. Again.

Duster starts out as a basically good thing; with room for five, a huge trunk, a husky—but economy-minded—six-cylinder engine, and an Electronic Ignition System that cuts down on tune-ups.

But if you want to build onto a basically good thing, you can turn it into a Space Duster. It goes from a coupe to a mini-wagon, with 6½ feet of carpeted storage space, when you order the fold-down rear seat. And you can top it all off by ordering a crank-open sun roof.

You can also turn a good thing into the Gold Duster. (It comes in 15 other colors, too.) If you buy one with whitewalls, wheel covers, special trim and carpeting, you can get the vinyl roof at no extra charge. We don't charge the dealer for it, so he can pass the savings along to you.

Finally, if you're a performance buff, you can make your Duster into a

good thing for you. The Duster 360. Nice, fat tires you can order with raised white lettering and rallye wheels. Heavy-duty suspension. And 360 cubic inches running on regular gasoline.

The '74 Plymouth Duster. No matter how you order yours, it's a lot of car for the money. Again.



CHRYSLER

Plymouth Duster 

Extra care in engineering...it makes a difference.

1974 Plymouth Space Duster



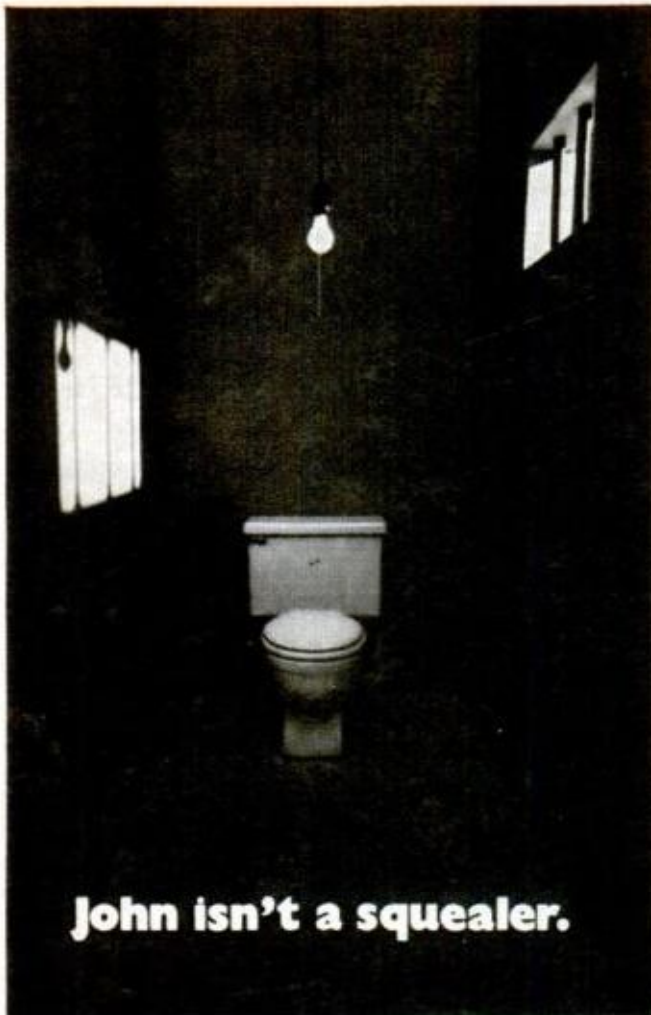

John isn't a squealer.

It's a crime the way some Johns operate. They leak, squeak, whistle and squeal. Usually due to out-dated ballcocks that are corroded and leaky.

But once Fluidmaster takes over, things really quiet down. Because unlike old-fashioned ballcocks with tank float and arm, Fluidmaster controls toilet tank water hydraulically. Working with water pressure, instead of against it. So shut-off is fast and positive. No leaks. No squeaks. No whistles or squeals.

Write today for full details. Before your John is found guilty of disturbing the peace.

Manufacturer of the Model 100, 200 and 400.



FLUIDMASTER, INC.
1800 Via Burton
Anaheim, Calif. 92805

**Why BENJAMIN'S
NEW SUPER
SINGLE SHOT AIR RIFLE**

**is just the Ticket for Plinkers
Who Don't Want to Play Second
Fiddle to Their Shootin' Pals.**

The more you shoot this Super Single Shot, the more you'll appreciate what a rewarding companion it is to those who want top performance and versatility. One of the chief reasons many shooters put their confidence in Benjamin is the fact our new gun remains unchanged in basic design since 1908. And when you have been making anything as long as we've been building air rifles, you learn how to make them right. Of course, this new version is so strikingly different from older models you'd never know they had anything in common. Just the same, all the things we've learned over the years are embodied in our new pump-up. We're proud of this Benjamin and the fine reputation it has earned for Power, Accuracy, Dependability.

Besides these credentials and our insistent use of the best materials and workmanship, here are other features that have made Benjamin the great gun it is: reliable, time-tested action; adjustable firing force. Ramp-type front sight; adjustable stepped leaf rear sight. Thumb operated safety behind breech. Walnut Monte Carlo stock and pump handle. Safe, quiet, lightweight, odorless. It's a joy to shoot indoors or out—nails targets, tin cans, small game with amazing accuracy. 3 calibers. Reasonably priced. At your dealer's.

Use Benjamin H-C Pellets—Sized & Lubricated for greater accuracy. 177 & 22, 250 or 500 per can.

BENJAMIN AIR RIFLE COMPANY **FREE CATALOG**
896 Marion St., St. Louis, Mo. 63104

YOU CAN DEPEND ON BENJAMIN

Model 340 BB. Model 342 Cal. 22
Pellet. Model 347 Cal. 177 Pellet.

**PRESCRIPTION EYEGLASSES
BY MAIL**

direct from
manufacturer

Your own doctor's prescription will be filled, or your present lenses duplicated.

The latest fashions. All types of lenses available. Accuracy and perfect fit absolutely guaranteed.

SEND FOR FREE FAMILY CATALOG. TODAY!

Est. 1959 in a hurry to receive a catalog?
... add 25¢ for 1st class mail.

PRISM OPTICAL INC.

Dept. M-21 135 West 41st St., N.Y., N.Y. 10036

**New Table Top Invention Puts You In ...
PROFITABLE RUBBER
STAMP BUSINESS**

**Home Operators now make
\$16.50 AN HOUR in Busi-
ness once monopolized by
a few big companies**

Special rubber stamps bring high prices—cost only pennies to make on new, low-cost table top machine. Take 27 cents worth of material, make perfect stamps, the kind businesses and offices now buy by the dozen at \$2.75 each. Make up to \$16.50 an hour. Start in spare time in your own home. Run machine on kitchen table using ordinary electrical outlet. Make any kind of stamp. We'll send you free information without obligation about this established, highly profitable business. **We'll even help finance your start.** For free information send name and address today on a postcard to:

Rubber Stamp Div., 1512 Jarvis, Dept. R-2-CL, Chicago, Ill. 60626



Great careers begin at home

Join the high-paid technicians who got their start through NTS Home Training

Build a new and successful career with a leading industrial company. NTS graduates have been employed by Burroughs, Sears, Carrier, Ford, and many others — and these men started at home.

NTS turns your home into your own private classroom-workshop. See your skills and confidence grow as you train at home on professional equipment we send you. Tools, test equipment, lessons and manuals are all included in your tuition, yours to keep. You test what you learn as you learn it on the same kind of equipment technicians use. You learn at your own pace, keep your own schedule, save precious time.

For the successful career you want, begin at home with NTS. Check coupon for the course that interests you, and we'll rush you a free color catalog. No obligation; no salesman will call.

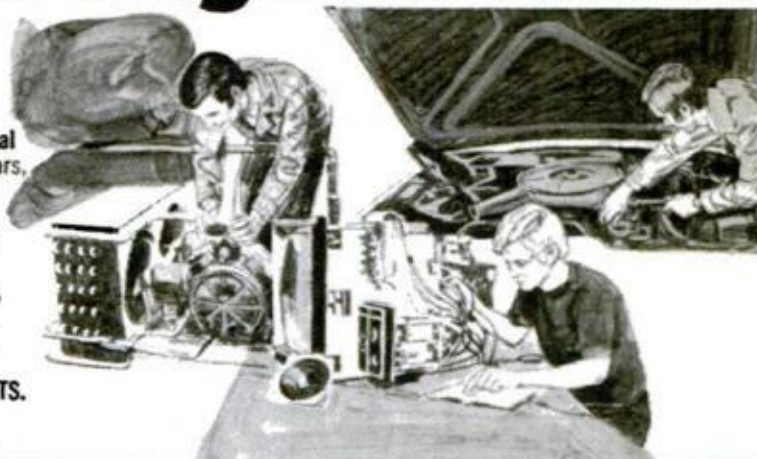

Solid-State Color TV
315 Sq. In. picture

Electronics Division

Cash in on the growing fields of Color TV & Radio servicing, Computer Electronics, Electronic Communications, Industrial & Automation Electronics, Audio Electronics. Courses include valuable Solid State equipment such as large-screen color TV, NTS Compu-trainer, Oscilloscope, FM Multiplex Receiver & Speakers, Test Instruments, and more. Check card or coupon today for FREE color catalog.



Air-Conditioning, Refrigeration, Heating Division

As an NTS master technician, you'll install and maintain today's complex air-conditioning, refrigeration, and heating systems. Earn high wages with a service company, or go into business for yourself! Receive tools, tester, gauges, and instruments, included in your tuition. Check coupon now for new, free color catalog.



Mechanics Division

America's largest industry pays top money for top skills — and NTS prepares you fast! Professional diagnostic test equipment and 109-piece Tool Set included in your tuition. Plus bonus "hot shop" lessons. Four big automotive fields to choose from. Check coupon for new, free color catalog, receive complete details.



Home Appliance Division

Start earning extra money even before you finish the course! Open your own shop, or join a first-class company. Service ranges, washing machines, dryers, home air-conditioners, and other major and small appliances. "Project Method" features exclusive Circuit Trainer, Appliance Tester, and tools. Check coupon for free color catalog!

Classroom Training at Los Angeles

You can take classroom training at Los Angeles in sunny Southern California. NTS occupies a city block with over a million dollars in training facilities. Check box in coupon.



APPROVED FOR VETERAN TRAINING

Accredited Member: National Association of Trade and Technical Schools; National Home Study Council.

SEND FOR FREE CATALOG & SAMPLE LESSON

NATIONAL TECHNICAL SCHOOLS

Resident and Home Study Schools
World-Wide Training Since 1905
4000 So. Figueroa St., Los Angeles, Calif. 90037



NATIONAL TECHNICAL SCHOOLS

Resident and Home Study Schools / World-Wide Training Since 1905.
4000 So. Figueroa St., Los Angeles, Calif. 90037

Please rush FREE CATALOG and SAMPLE LESSON for course checked below. No obligation. No salesman will call.

Electronics Division

- Master Course in Color TV Servicing
- Color TV Servicing (for Advanced Technicians)
- Master Course in B&W TV & Radio Servicing
- Practical TV & Radio Servicing
- FCC License Course
- Master Course in Electronic Communications
- Master Course in Electronic Technology
- Industrial Electronics
- Computer Electronics
- Basic Electronics
- Audio Electronics Servicing

Air Conditioning/Refrigeration/Heating Division

- Master Course in Air Conditioning, Refrigeration & Heating
- Air Conditioning & Heating
- Refrigeration

Mechanics Division

- Master Course in Auto, Truck & Diesel Mechanics
- Automotive Mechanics
- Truck, Heavy Duty & Diesel Mechanics
- Engine Tune-up & Electricity

Home Appliance Division

- Home Appliance Master Technician's Course
- Home Appliances Servicing
- Handyman Appliance Repair

CHECK ONE ONLY!

Name _____ Age _____
Address _____
City _____ State _____ Zip _____

Check here if interested in veteran training under new G.I. Bill.
 Check if interested ONLY in classroom training at Los Angeles.

Dept. 201-103

MAKE BIG MONEY IN EITHER OF THESE TWO FIELDS



TRACTOR-TRAILER DRIVER

We can train you to operate the big diesel rigs. Study at home followed by practical training at school-owned facilities in Miami, Fla. Accredited Member NHSC. Home Office—Miami, Fla.

APPROVED FOR VETERANS AND INSERVICE PERSONNEL

HEAVY EQUIPMENT OPERATOR

Learn to operate cranes, draglines, scrapers, clamshells, bulldozers, backhoes, trenchers. Study at home followed by practical training at school-owned facilities in Miami, Fla. Accredited Member NHSC. Home Office—Miami, Fla.



UNIVERSAL TRAINING SERVICE, Dept. PM

1901 N.W. 7 St., Miami, Fla. 33125 • Phone: (305) 642-0800

- TRACTOR-TRAILER DRIVER
 HEAVY EQUIPMENT OPERATOR

PLEASE PRINT

Name _____

Address _____

City _____

State _____

Zip _____

Phone _____

Age _____

THE SCOTT ENGRAVER Your spare time money-maker

Scott's SM100 turns 10¢ worth of plastic laminate into a product you can sell for 75¢ to \$1.00. Every business is a prospect. Make name plates, signs, plaques and more . . . in just minutes, using just one hand. A complete, ready-to-operate engraving shop to help you make big money in your spare time!

To find out more, send for free catalog, today.
Dept. 10051

SCOTT MACHINE DEVELOPMENT CORP.

P. O. Box 217
Walton, New York 13856

Scott fills every engraving need—
from stock to fonts.



BY PAUL MANN

APPLIANCE CLINIC

Nice and easy

We recently purchased a Hotpoint frost-free refrigerator for our mountain home. From the beginning, it has emitted an annoying vibration when the motor is running. However, the operation of the unit doesn't seem to be affected. I have called the place where we bought the refrigerator, but the man has put me off about coming out, probably because he has to travel 25 miles each way. I would appreciate your opinion as to whether I can get rid of the noise myself.—Charles Stewart, Morton Grove, Ill.

Analyzing noise without being able to listen to it is difficult, but from your description this seems like a fairly common problem: The cause of the noise may be an unseated drain pan. The pan may have been knocked out of position when the refrigerator was delivered to your home. The cure is to pop off the front cover at the base of the unit, revealing the pan, and to place the pan firmly back into its guide. Then replace the cover (this is easier to do with the refrigerator door open).

Slow, slower, slowest

We are having trouble with a Whirlpool dishwasher that is a number of years old. Our service costs have been considerable, including a new pump and timer. Now we notice a new problem—slowing down of the machine on the wash cycle. It seems to operate well on other cycles. What's wrong?—Ralph Stenerson, East Northport, N.Y.

Water and detergent in a dishwasher should circulate at the rate of about 60 gal. per minute. In most units, a revolving spray arm, which has holes in its upper surface, sprays water from below, and a fixed spray tower sprays water from above, so that all sides of the dishes are washed.

The revolving spray arm is driven by jet action caused by the force of water coming out of the holes—like the way a lawn sprinkler operates. When a jet of water is shot out of the slanted holes at

(Please turn to page 32)

Tobacco Grower - circa 1915 • 27 1/2" x 14 1/2"

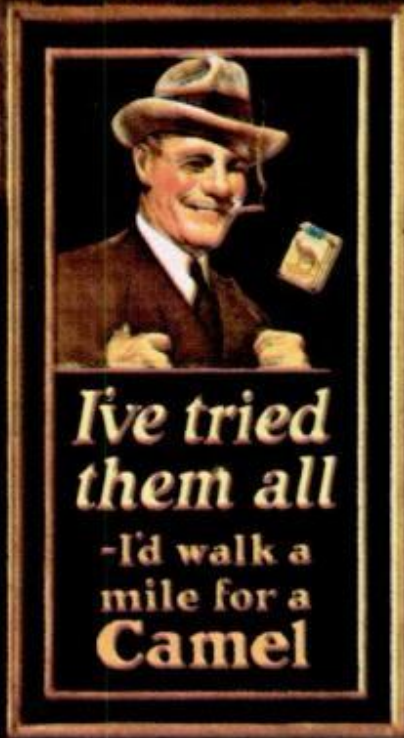
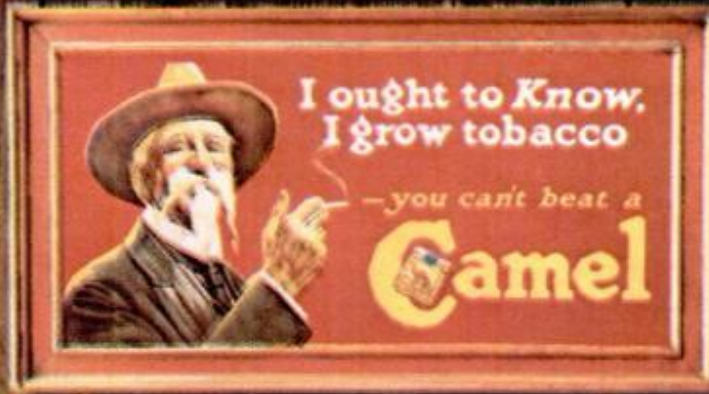

Clear Cut Merit - circa 1926 • 27 1/2" x 14 1/2"



Big Nostalgia Hang-up! Authentic reproductions of 3 vintage Camel Ads.

[All 3 for One Dollar*]

For the 80th Anniversary of Camel, we said, "Hang it all, let's celebrate!" So here's an Anniversary Offer nobody can resist. Three posters (frames not included) of three nostalgic Camel ads. It's our way of reminding you that the taste and quality of Camels have been worth walking a mile for since 1913. It's your way of decorating a game room, a playroom, a bar with handsome, authentic reproductions of these three Camel classics. *Plus 2 empty Camel packs.

Mail to: CAMEL Poster Offer P.O. Box 9126, St. Paul, Minnesota 55191

Please send me _____ CAMEL Poster Set(s). I enclose \$1.00 (no stamps) and 2 empty CAMEL REGULAR packages for each CAMEL Poster Set ordered.

I certify that I am 21 years of age or older.

Name _____ Please Print Plainly

Address _____ Phone No. _____

City _____ State _____ Zip _____ (Required)

Allow 4-6 weeks for delivery. Offer expires January 31, 1974. Offer is limited to U.S.A. and is not valid where prohibited by law.

Warning: The Surgeon General Has Determined That Cigarette Smoking Is Dangerous to Your Health.

25 mg. "tar," 1.6 mg. nicotine av. per cigarette. FTC Report 11/8, '73.

Last year's hottest selling lightweight: The Poulan XXV. \$119^{95*}

You're looking at a winner. The Poulan XXV. With a 14-inch bar and chain, not 12 inches. A tough all-magnesium housing, not plastic. A Tillotson all-position carb (so it even cuts upside-down). And power that cuts through an 8-inch log in 4 seconds flat. It's less than 10 pounds. Less than \$120.

And more than any other saw for the money.



*Manufacturer's Suggested Retail Price

APPLIANCE CLINIC

(Continued from page 30)

one end of the arm, it exerts a force on the arm in the opposite direction. Since the arm is mounted on a freely turning pivot, it rotates.

The wash cycle would be slow if the water pressure in your home were too low, but that would not be the fault of the dishwasher. The wash cycle also would be slower if the holes in the spray arm have become clogged with calcium deposits. Try cleaning out the holes with a piece of wire (after shutting off power to the dishwasher).

Furthermore, there could be calcium deposits on the bearing surface between the spray arm and hub that could slow down rotation. Clean off any you find.

Temperamental dryer

Our General Electric clothes dryer is four years old. After two or three large loads are done, for some reason the unit refuses to start again. We usually have to wait 30 minutes or so before it will work. What's wrong?—David W. Levy, Nashville, Tenn.

This problem is a recognized one. The motor is building up too much heat, causing the overload thermostat to open. When this built-in safety device kicks in, the motor can't start until it has cooled off.

A fan kit has been issued to provide adequate cooling for the motor, thus preventing this inconvenience. It can be purchased from a GE parts center as No. WE25X73. Work through the rear access panel to install the new part.

Pull the wall plug, take off the belt, and remove and discard the motor pulley. Using an Allen wrench, install the fan assembly on the motor shaft in place of the original pulley. Place the belt on the grooved hub provided for it on the fan assembly. The fan will operate as long as the motor is on and should solve your problem.

Frosty

My Westinghouse model DCM 14 refrigerator, which is supposed to be frost-free, occasionally freezes everything in the refrigerator compartment. If I turn it off for a while, the ice melts and the unit works

okay. This is not a new problem, but it has been happening since the appliance was bought 12 years ago. Why?—E. T. Crockett, San Gabriel, Calif.

For 12 years, you have been annoyed by nothing more serious than an erratic cold control. This control consists of a straight piece of tubing called a bellast, a spring and a set of contacts. As the temperature in the refrigerator drops, refrigerant expands and backs up into the bellast. This puts pressure on the spring, which in turn forces the contacts open. When the contacts open, the compressor is shut off, and defrosting takes place. As temperature rises, refrigerant contracts out of the bellast, taking pressure off the spring. Contacts close and the compressor starts.

Replace the cold control by removing the knob and unscrewing the plate. Unscrew the two nuts that hold the bellast (a 1/4-in. nut driver is ideal for this). The entire control, consisting of the bellast, contacts and spring, will come out. If the refrigerator still freezes up after a new control has been installed, replace the relay on the compressor that works with the control to govern compressor action. It's the only relay there.

Sometimes it will stick and not shut off the compressor.

Slow shave

My battery-operated Sears rechargeable razor has started to run slow, although I keep it charged and clean. If I remove the rotary heads and run it without a load, it runs pretty fast. Is there something inherently wrong with this model?—John F. Leahy, Gonzales, Calif.

Sears says it has had no sluggishness problem with this shaver. Possibly the rotary cutting heads have been damaged—perhaps dropped—causing them to bind. In any event, I've been advised to tell you to contact R. Hoeft, Dept. 1571, Sears Roebuck, 2650 East Olympic Blvd., Los Angeles, Calif. 90051. ★★★

If you have a question about any appliance, send it to Appliance Clinic, Popular Mechanics, 224 West 57th St., New York, N.Y. 10019. Sorry, but letters cannot be answered individually. Problems of wide interest will be answered in this column.

Next year's hottest selling super-lightweight: The new Poulan XX. \$99^{88*}

Introducing another sure winner. The brand new Poulan XX, weighing under 8 pounds, is now available.

With the same tough all-magnesium body (so it performs like a machine, not a toy). A 12-inch bar and chain, instead of the usual 10-inches you find on other super-lightweights. And get this: automatic chain oiling is standard. (For extra heavy cutting, the XX has a manual override oiler.) The whole package sells for less than \$100. A good lightweight chain saw has many of these features.

But the Poulan XX has all of them.

Check the yellow pages for dealer nearest you or call toll free (800) 551-8989. In Louisiana the number is (800) 282-8803.

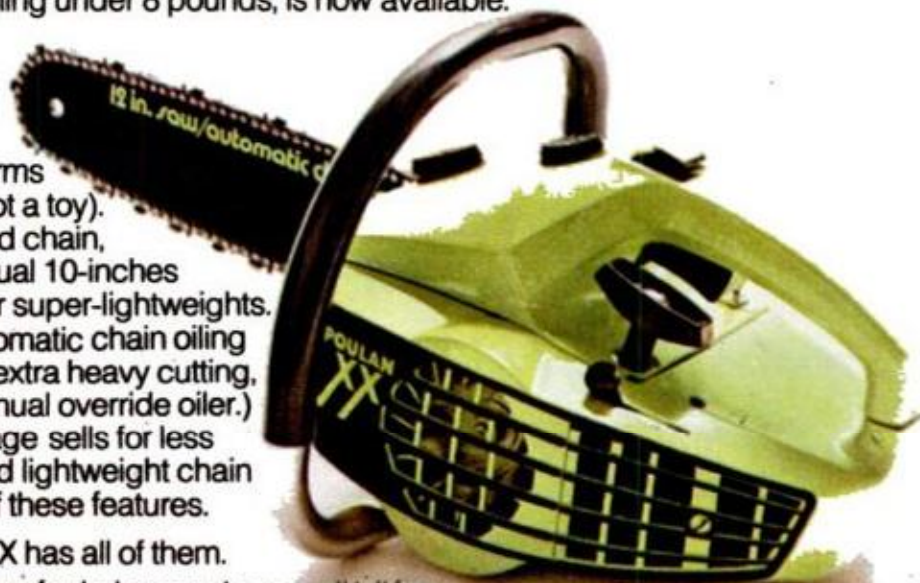

*Manufacturer's Suggested Retail Price.

12 things you should know about the '74 Ford before you buy any pickup.



1 Ford cabs are quiet, carlike, roomy. Inside width of 66 inches allows three big men to ride relaxed. Padded dash is standard; glove box is large and placed high for easy use.



2 Optional air conditioning is built right into the instrument panel to improve air circulation and give full legroom.



**Works like a truck.
Rides like a car.**

A better idea for safety: Buckle up.



3 Behind the seat is a hidden storage space 5½ feet wide. It's big enough to hold tool boxes, golf bags or other gear.



6 Ford took the gas tank out of the cab and put it in a protected position under the box, between the frame rails.



10 Front disc brakes are standard on 2-wheel-drive pickups; power brakes on those over 5,100 lbs. GVW



4 Only Ford pickups have Twin-I-Beam front suspension for truck strength plus carlike ride. Two axles let wheels step over bumps independently.

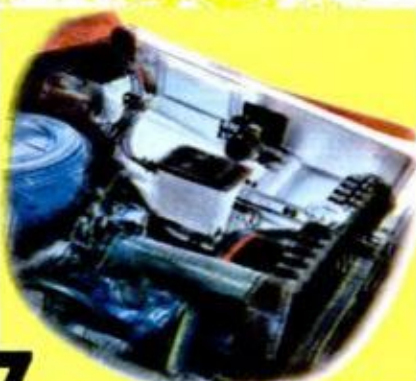

7 You can choose a Ford Six or, for heavy loads, V-8's up to 460 cu. in. Note galvanized splash shield.



11 Even the standard cab gives you the comfort of a full-foam seat 7 inches deep. Seat adjusts 5 inches.



5 Sides of the cargo box are double-wall their full depth. All told, over 200 sq. ft. of surface is zinc-coated to resist rust.



8 Ford pickups come big as 10,000 lbs. GVW, like this F-350 Super Camper Special, to meet all your pickup needs.

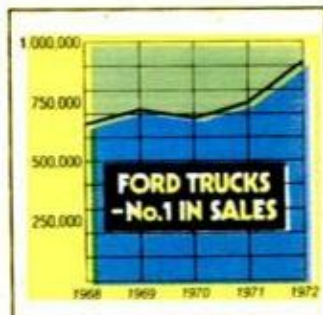

9 Official industry figures from R. L. Polk & Co. prove the durability of Ford trucks. For a long-term investment, see your Ford Dealer now.

12 Better ideas have put Ford trucks first in sales for five straight years through 1972. Industry records show Ford Dealers sold over 200,000 more trucks than the next make.

FORD

FORD DIVISION



"How I rewired my taillights with a plastic straw and Dow Corning Bathtub Caulk."



We knew our silicone rubber bathtub caulk was good for a lot more things than bathtubs, and when we heard how Larry Oswald of Sewickley, Pa., used it, our opinion was confirmed.

"When my taillights started getting dimmer and dimmer, I took them apart and found that the sockets, wires, everything, were all corroded.

"So I cleaned everything up, bought two new sockets, and decided this time that they weren't going to corrode.

"I had a tube of Dow Corning® Bathtub Caulk lying around the house, so I figured why not, and caulked up the sockets.

"Then I figured that if it'd work on the sockets, it'd work on the splices.

I cut two small pieces off a plastic drinking straw, slid one over each set of wires to keep them from getting stuck together, tied the wires together, and then pumped them full of caulk.

"It's been six months now, and my taillights are still brighter than ever."

Next time you're faced with a plumbing leak, broken gasket, or

most any fix-it job around the house, get the Dow Corning Silicone Bathtub Caulk out of the bathroom and put it to work.

You'll find it in white and pastel decorator colors in the hardware or paint department of your favorite store. Look for Dow Corning Silicone Sealer in clear, black, or aluminum in tubes and cartridges, too.

Dow Corning Corporation, Dept. D-3102, Midland, Michigan 48640.

DOW CORNING



MIGHTY MAC SHREDDER-CHIPPER MODEL 12-P



Process garden refuse material through a mighty Mac shredder-chipper for compost heaps or till directly into your soil. The model 12-P shown above will chip tree limbs up to 3" diameter for valuable mulch. Don't burn your refuse; recycle it back to the soil. Process corn stalks, manure, leaves, sod and flower stems. Write for free literature describing the Mighty Mac quality line. Amerind MacKissic Inc., Box 111, Parker Ford, Pa. 19457

SUBSCRIBER'S

Change of Address Form

Please use this form to notify us at least six weeks before you move to your new address.

1. Present address: Attach address label from a recent issue, or print your name and address exactly as shown on the label.

NAME _____

ADDRESS _____

CITY _____ STATE _____ ZIP _____

2. Fill in new address:

NAME _____

NEW ADDRESS _____

CITY _____ STATE _____ ZIP _____

3. Mail this form to:

POPULAR MECHANICS

Subscription Service Dept.

Box No. 646

New York, N.Y. 10019



Evinrude 1974

The exciting new world of boating escape power.

They're on the way to your dealer's now—22 escape-inspired new ways to enjoy life afloat. From 70 mph powerhouse V-4's to a tiny electric trolling motor.

New super sophisticated "135"—A distinctively styled, limited edition satin-silver V-4—with luxury features no outboard at any price ever had before.

New loop-charged "70"—Swift. Sleek. Strong. Loop-charged and pulse-tuned for performance and economy; power-g geared for torque and thrust.

New electric start "15"—All the features a fisherman could want, now, for the first time, in a motor he can carry. Electric and manual start models.

New low-profile 9.9—Even smaller than our classic low-profile 9½, and with all its great features plus exciting new ones. Electric and manual start.

New Sport Evinrudes—Now Evinrude performance motors come in Evinrude racing colors—with a "look" straight from the championship racing circuit.

Write for our escape literature, beautiful mood paintings, and complete specs on all 22 models. Evinrude Motors, P.O. Box 663, Milwaukee, Wisconsin 53201

EVINRUDE 
DIVISION OF OUTBOARD MARINE CORP.
first in outboards



USED CAR FOR SALE \$75,000

You can get last year's Viceroy racing car that was part of the Indianapolis 500 effort (original cost \$100,000) for \$75,000, and one Viceroy carton end panel.

And get a taste of what smoking is all about in every pack of Viceroy. For complete details, mail this coupon with one Viceroy carton end panel. Hurry! Only a few cars are available.

Race Car Offer Mail this coupon with one Viceroy carton end panel for complete details to:

Viceroy Used-Car Offer, P.O. Box 903 VUC, Louisville, Ky 40201

The carton end panel will be applied toward the purchase of the car.

NAME _____

I am over 21 years of age

ADDRESS _____

CITY _____ STATE _____ ZIP _____

Offer expires December 31, 1973

PM



Get a taste of what it's all about. It's all there in Viceroy.

KING SIZE AND LONG SIZE

Warning: The Surgeon General Has Determined
That Cigarette Smoking Is Dangerous to Your Health.

King Size, 17 mg. "tar," 1.2 mg. nicotine. Long Size, 18 mg. "tar,"
1.3 mg. nicotine av. per cigarette, FTC Report Feb. 73

CAR CLINIC

BY MORT SCHULTZ

Wood grain turns milky

Owners of Ford Country Squire station wagons (mine is a '70) in this area are all having the same problem. The wood-grain side panels are turning a milky color. Ford dealers offer no solution other than replacement, which would cost hundreds of dollars. Is there a better way?—Gene Matz, Woodland Hills, Calif.

You don't say whether you live or park your car near the sea, but the condition you describe is a problem particularly in saltwater areas. Ford advises that at present there is no way to fix faded wood-grain paneling "short of replacing the paneling itself." But Ford has asked me to relay a message. You will, if you haven't yet, be contacted by a company representative to see if Ford can be of assistance in resolving the problem.

Reverse flow

While my 1969 Dodge Coronet 318-cu.-in. (engine) is parked, gas drains out of the carburetor back toward the gas tank. The car is then hard to start until I can pump gas back into the fuel bowl. I have tightened everything in sight. What now?—E.L. Bedeski, Nanicoke, Pa.

Quite probably the diaphragm in the fuel pump has developed a pinhole that is making the pump lose its hold on gas when the car is parked. Or, a fuel check valve in the pump may be leaking. In any event, gas is draining back through the line, gas filter and fuel pump, leaving you dry for starting. I suggest you have the fuel pump tested.

Clicks at random

My 1973 Oldsmobile Cutlass with 350-cu.-in. engine has in its 1100 miles of life given forth a click from beneath the hood

that can be heard inside the car. It sounds like a pinball machine counting up a score. The noise occurs at random. The dealer tells me it's being caused by a relay on the fire-wall (a metal box about 1½ inches square.) He says he has worked on it, but the noise persists. I would like to know if (1) it is harming the car and (2) can I get rid of it?—H.L. Schierschwitz, Shiner, Texas.

If it's what I think it is—no, it's not harming the car, and yes, you should be able to get rid of it. The chattering may be coming from the heating and airconditioner relays which aren't properly grounded, or from a poorly grounded electric backlight if the car is so equipped. Ask your dealer to check these. I don't know exactly which relay your dealer has worked on, but I think it might be the relay on the fire wall into which the horn and buzzer circuits are connected. However, this relay functions only when the key is on, the door is open, and the horn is blown. If this is what's happening, remove the relay and place rubber insulation between it and the fire wall.

An exhausting story

I thought your readers would be interested in a problem my class and I had with the 1971 Buick of the school board president. I teach auto mechanics here at Mercer High School, and we are avid readers of Car Clinic.

The problem involved an engine having 30,000 miles that was losing power and missing. Following a valve job (a compression test had shown no compression in one cylinder), the engine refused to go over 30 mph without missing and sputtering. Checks and rechecks were made of all possibilities—timing, carburetor, fuel pump pressure, coil, distributor cap, sparkplugs. You name it, we did it.

Now, for the surprise. We finally cut into

(Please turn to page 42)

OCTOBER 1973 39

AMC  MATADOR
NEWEST MID-SIZE
FOR 1974

This is one mid-size car you've never seen before. The roomy AMC Matador coupe.

With sweeping, clean lines. Low profile. And plenty of window area for all-around vision. Test drive the new Matador. And see why experts are already calling it America's sportiest new car.



AMC BUYER PROTECTION PLAN MORE THAN JUST A GUARANTEE

To us at American Motors, and to our dealers, the exclusive AMC Buyer Protection Plan means a commitment to our customers. A commitment to stand behind every single car we build.

A GUARANTEE YOU CAN UNDERSTAND.

When you buy a new 1974 AMC car from an American Motors dealer, American Motors Corporation guarantees to you that, except for tires, it will pay for the repair or replacement of any part it supplies that is defective in material or workmanship. This guarantee is good for 12 months from the date the car is first used or 12,000 miles, whichever comes first. All we require is that the car be properly maintained and cared for under normal use and service in the fifty United States or Canada, and that guaranteed repairs or replacement be made by an American Motors dealer.

At AMC we expect every part in every car to last for at least 12 months or 12,000 miles under normal use and service.

And that's why we back our cars with this simple, strong guarantee. A guarantee that covers every part—except tires—even those annoying little things that occasionally wear out like spark plugs, wiper blades and light bulbs.

PLUS A BUYER PROTECTION PLAN THAT DOES MORE.

AMC is the only manufacturer with a program to provide a free loaner car should guaranteed repairs take overnight. And a special trip interruption plan that pays up to \$150 for food and lodging if guaranteed repairs have to take place more than 100 miles from home.

We even have a toll-free hotline to Detroit for you to call if you ever feel we aren't living up to our promises.

And let's face it, when you make this kind of commitment to stand behind your cars, you have to build them better.

AMERICAN MOTORS CORPORATION

We back them better because we build them better.

CAR CLINIC

(Continued from page 39)

the exhaust system inch by inch with a hacksaw and uncovered a constriction that had caused the problem to begin with. The exhaust system of this car in front of the muffler consists of a double-walled pipe. Although the outside of the pipe looked satisfactory, the inside pipe had wrinkled from heat and squeezed shut. How about them apples!—Brent Davis, Mercer, Wis.

Wow! Thanks to you and your class for this important tip!

Jittery hubcaps

I have noticed that all four hubcaps of my 1968 Pontiac LeMans rotate to the point of passing the valve stems so I can't reach them to check air pressure. Lately, I've been losing the front units. I've tried expanding grip points, but it's no use. Can you suggest a fix?—Jim Poulton, Casselberry, Fla.

Put tape at several points around caps where they snap to the wheels so that there will be more adhesion between cap and wheel. Place tape beneath the cap so it will be concealed from view. Tape may give caps just enough of a grip to keep them from taking a walk.

Hatching trouble

When I accelerate and then let up on the accelerator of my 1973 Vega Hatchback with the large-version engine and two-barrel carburetor, the accelerator seems to stick. If I push in on the clutch a little, the engine idles down normally. This is a problem in traffic, because I either have to ride the brake or keep pushing in on the clutch to keep speed under control. My dealer tells me this is normal because of the emission controls. What should I do?—Bruce Crow, Windsor, Mo.

Seems that everything gets blamed on emission controls. I doubt if the accelerator is really sticking. It sounds, instead, as if the antidieseling (idle stop) solenoid

on the carburetor is out of adjustment, creating a high rpm rate. Depressing the clutch pedal causes a drop in rpm, because a switch beneath the pedal allows the solenoid to disengage when the pedal is depressed. Have a mechanic adjust the idle-stop solenoid and readjust the rpm rate as described on pages 6 to 8 of the 1973 service manual.

Lockout

Last winter, the locks of my Datsun pickup had a tendency to freeze. Once frozen, they couldn't be unlocked even from inside. Can I prevent the trouble this winter?—Robert Taylor, Lynn Center, Ill.

Usually, shooting liquid graphite into the lock before winter starts will keep locks from freezing all winter. The cylinder part of the lock is probably the victim of cold. If the trouble happens anyway, heat the key with a match before inserting it into the cylinder. This should thaw out whatever's inside causing the freezeup.

SERVICE TIPS

□ **Studded snow tires:** At this writing five states have banned studded snows on their highways: Hawaii, Louisiana, Minnesota, Mississippi and Utah. The ban in Minnesota applies only to cars registered in that state, and not to drivers of cars registered in other states who are traveling through. After April 15, 1974, studded snows will be outlawed in Virginia.

□ **1973 Chevrolet owners** with V8 engines and two-barrel carburetors: If a high idle speed (even after the engine gets warm) is bugging you, check insufficient rotation of the fast-idle cam. There is a remedy outlined in technical service bulletin VI, calling for adjustment of the choke coil rod, so see your dealer.

□ **Some 1973 FoMoCo car lines** have been experiencing hard starting with the engine cold. These are Fords, Lincolns and Mercurys with 351, 429 and 460-cu.-in. engines and four-barrel carburetor. Your dealer has been advised what to do on page 8 of technical service bulletin 44. The fix calls for checking the choke from fore to aft and, if necessary, replacing a binding choke piston and link with a new one (part No. D3AZ-9840-A). ★★★

GOT A PROBLEM WITH YOUR CAR? Ask Mort about it. Send your question to Car Clinic, Popular Mechanics, 224 West 57th St., New York, N.Y. 10019. Letters cannot be answered individually, but problems of general interest will be published in the column.

Canada at its best.

Try the light, smooth whisky that's becoming America's favorite Canadian.
Imported Canadian Mist.



CANADIAN WHISKY - A BLEND - 40% ALC/VOL (80 PROOF)
BROWN-FORMAN DISTILLERS - IMPORT COMPANY, NEW YORK, N.Y.

© 1997 BROWN-FORMAN DISTILLERS

Here it is!

Popular Mechanics

COMPLETE GARDENING GUIDE

All the basic information on home gardening at your fingertips!



Partial list of contents:

Landscaping

Garden surfaces

Gardening in your
climate

How to improve
your soil

Starting seeds

Trees

All kinds of
transplanting

Shrubs

All about pruning

Flowers

Lawn care

Vegetables

Garden pools

Fruits, nuts
and herbs

Container gardening

Outdoor play areas

Storage structures

FIRST WE assembled every bit of information you need to know to make your lawn and garden the most beautiful in your neighborhood. We condensed *these* basics to *their* essentials. Then we added more than 20 fact-packed tables and charts, and scores of show-how drawings. Finally, we printed this vital material on heavy plastic-coated cards, and spiral-bound them together.

You'll be amazed at the vast amount of information packed into your COMPLETE GARDENING GUIDE! Planting dates and depths for all kinds of seeds and bulbs; when to prune what, and how; information on the 56 most popular shrubs, and the 21 best hedges; all about ground covers; the shapes and heights of the 52 most popular tree species; how to select evergreens; how to lay flagstone, patio blocks, bricks; how to build decks; all about air-layering, whip-grafting and other ways of starting plants; how and when to transplant almost anything; all about lawn renovation; and much, much more. *You can have all this basic gardening know-how at your fingertips!*

No gardener can be a complete gardener without the COMPLETE GARDENING GUIDE! Order your copy today!

POPULAR MECHANICS, Box 1014 (Dept. GG) Radio City, New York 10019

Enclosed is my check for \$3.95.

Send my PM GARDENING GUIDE to:

Name _____

Address _____

City _____ State _____ Zip _____

the FREE 1974 Heathkit catalog—

courtesy of the world's largest
fraternity of electronic enthusiasts.



Pride of accomplishment. It begins in our design labs with the creation of new kit. It carries through to a cozy basement workshop where a customer's hand reaches to press the power button on a just-finished color television, digital calculator or home intrusion alarm. The inanimate device comes to life just like the assembly manual said it would. And at that moment another Heathkit builder feels the same thrill felt by the design engineer when he hit the switch on this piece of circuitry that up till then had worked only in his mind.

The engineer will experience a similar "kick" once again — when he reads the handwritten letter that says:

"Wow! You guys sure have great kits. Mine worked on the first try, with no hitches. Keep up the good work."

The creative bond between Heath employees and Heathkit builders forms a proud fraternity. Ask around, there's probably a member in your neighborhood.

The coupon below gets you your free 1974 Heathkit Catalog. Your first Heathkit project gets you into the club.

Attention: U.S. Military Personnel in W. Germany:
All Heathkit products and catalogs are available at your nearest Audio Club.

- Color TV
- Stereo & 4-Channel Equipment
- Amateur Communications Gear
- Home Protection Devices
- Auto Tune-up Instruments
- Calculators
- Electronic Organs
- Marine Electronics
- Educational Kits
- Service & Lab Instruments

HEATHKIT ELECTRONIC CENTERS—ARIZ.: Phoenix; CALIF.: Anaheim, El Cerrito, Los Angeles, Pomona, Redwood City, San Diego (La Mesa), Woodland Hills; COLO.: Denver; CONN.: Hartford (Avon); FLA.: Miami (Hialeah); GA.: Atlanta; ILL.: Chicago, Downers Grove; IND.: Indianapolis; KANSAS: Kansas City (Mission); MD.: Baltimore, Rockville; MASS.: Boston (Wellesley); MICH.: Detroit; MINN.: Minneapolis (Hopkins); MO.: St. Louis; N.J.: Fair Lawn; N.Y.: Buffalo (Amherst), New York City, Jericho; L.I.: Rochester; OHIO: Cincinnati (Woodlawn), Cleveland; PA.: Philadelphia, Pittsburgh; R.I.: Providence (Warwick); TEXAS: Dallas, Houston; WASH.: Seattle; WIS.: Milwaukee.

HEATH
Schlumberger

Heath Company, Dept. 17-10
Benton Harbor, Michigan 49022

Please send FREE Heathkit Catalog.

Name _____

Address _____

City _____ State _____ Zip _____

*Mail order prices; F.O.B. factory. CL-482R

SCIENCE WORLDWIDE

Nuclear power capacity grows

Five percent of the total electric generating capacity in the United States is now nuclear, according to the Atomic Industrial Forum, an information agency. Thirty-six nuclear powerplants, with over 21 million kilowatts of capacity, are operable; 55 plants are under construction, and 82 reactors are on order. Ten new plants became operational in the first half of '73.

Flip-flop table for eye surgery

During crucial phases of surgery on the retina, it helps to have the patient in a face-down position. A motorized table that can rotate 360° facilitates the procedure for Dr. Hal M. Freeman, a Boston eye surgeon. The patient's eye can be seen between Dr. Freeman's hands. He wears a special examination light on his head. The table, said to be the only one of its kind in the world, was designed by the doctor.

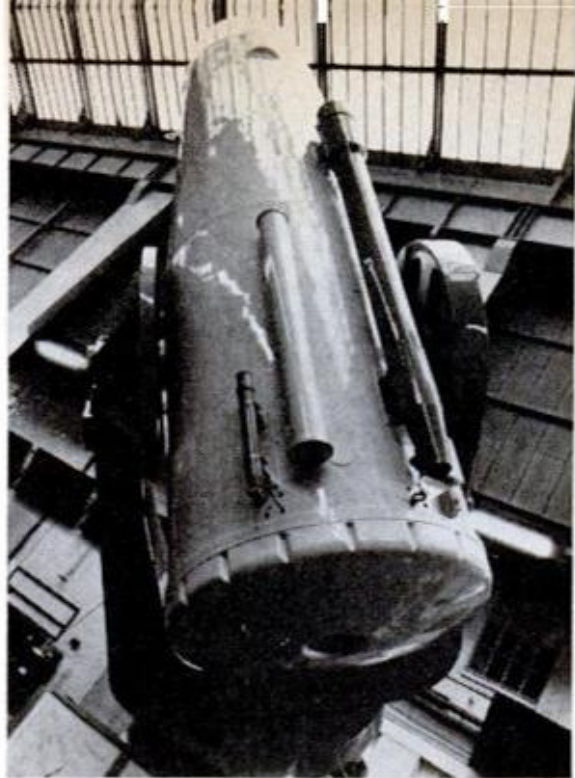
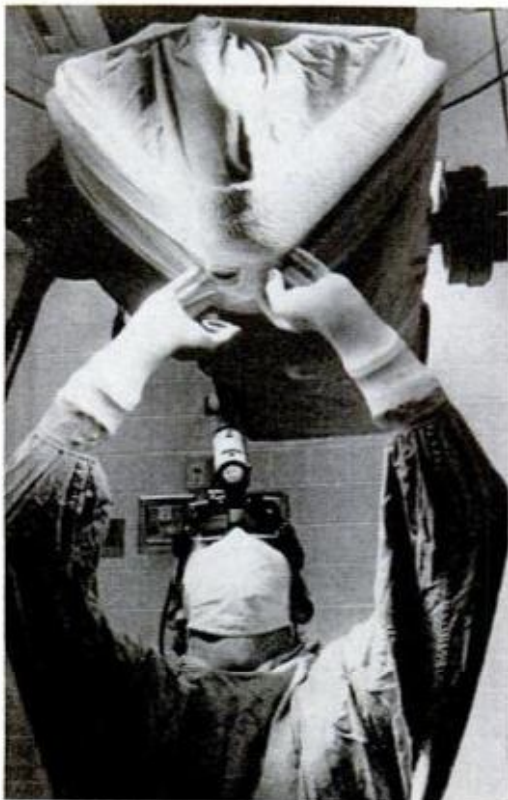

New telescope for Down Under

A 48-inch telescope, built in Great Britain and based on a German design, will be installed alongside a 150-inch instrument at an observatory in New South Wales, Australia. The new scope, which cost approximately \$1.25 million, will be used in the compilation of information for the first atlas of the southern skies.

Old rubber for cleaner water

Old auto tires, long a major environmental eyesore, may help solve another environmental problem: mercury pollution. Atomic Energy Commission researchers report that ground-up rubber from the tires can "capture" mercury from water and absorb it. The rubber contains sulfur, which readily combines with mercury. The experimental method proved to be successful in the elimination of mercury from a stream of heavy water, which is manufactured for use in atomic energy programs.

New item for table: minced fish

Minced fish is a new kind of fish product that will become increasingly available to consumers, according to the Department of

(Please turn to page 46D)

Want magnum performance from your standard 2³/₄ inch chambered shotgun?

What you get out of your shotgun depends on what you put into it. The shell on the left is a standard 2³/₄" long-range load. The shell on the right is a 2³/₄" magnum load (we call it our "baby magnum"), which delivers more pellets and a denser pattern at longer ranges. Both shells fit all standard 2³/₄" chambered shotguns.

Here's what a baby magnum can do for you: When you load up with Remington 2³/₄" magnum shells, you're putting in approximately 20% more shot than that carried in standard 2³/₄" shells. For example, 12 gauge baby mags carry 39 more pellets of #4 shot than standard field loads. (See chart below showing average pellet count.)

You waterfowlers can appreciate what a difference this can make. More shot, of course, means a denser pattern at the point of impact, and that's when the baby magnum earns its keep. How many times have all of us hunters sat in blinds hoping the geese would fly a little lower or ducks would pass closer? The standard-length magnum will increase your effective range by at least ten yards, and that can often mean the difference between a successful hunt and being skunked. Pellet count and pattern density are critical to your success when 40-yard shots are common and will help in reducing cripples, too.

12 Ga. Shot Size	# Pellets per Ounce	Standard 2 ³ / ₄ " 1 ¹ / ₄ oz.	Baby Magnum 2 ³ / ₄ " 1 ¹ / ₂ oz.	Pellet Increase	% Inc.
#2	87	109	130	21	19.2
#4	134	168	207	39	23.2
#6	221	276	331	55	19.9

Remington research and development have modified the base wad of the standard 2³/₄" hull to provide more internal volume. Heavier loads need a proportionate increase in powder for velocity and range. Remington 2³/₄" magnums contain

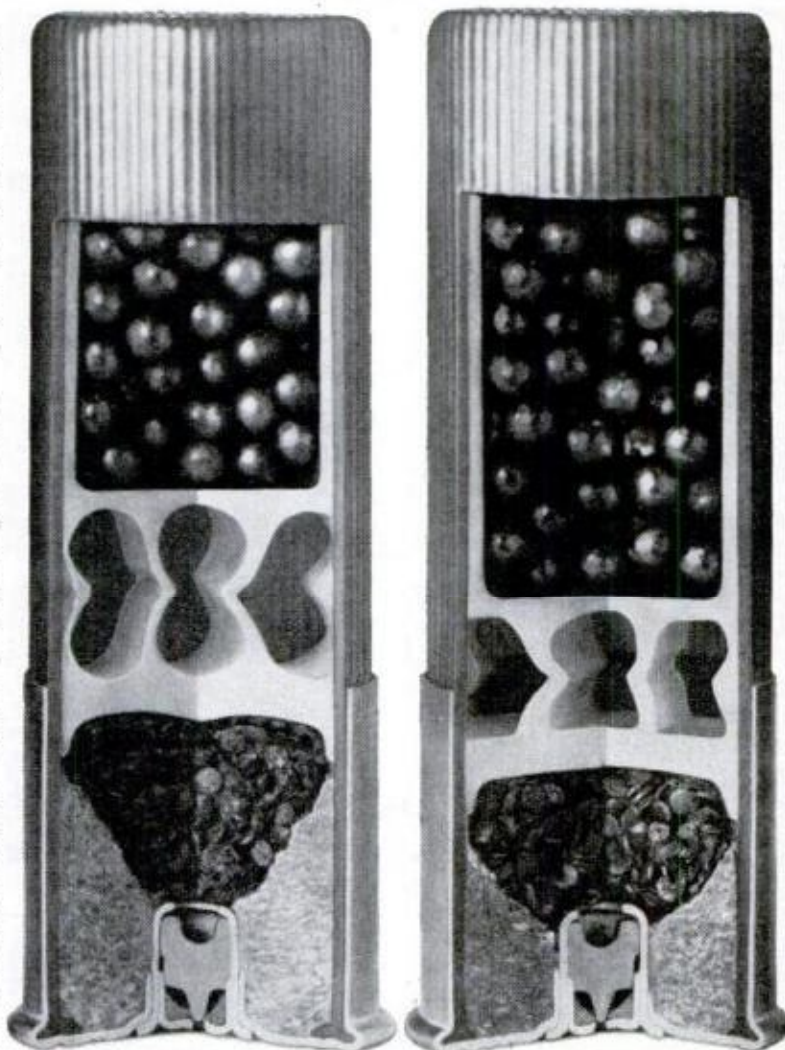

Standard 2³/₄" 12 Ga. load

Baby magnum 2³/₄" 12 Ga. load

five more grains of a slower-burning powder, which provides the necessary power to drive the heavier loads while maintaining sufficient chamber pressure.

Baby magnums are available in 12, 16 and 20 gauge and in a variety of shot sizes as well. (See chart below.) The 12 gauge 2³/₄" magnum and most other Remington shotgun shells are loaded with our famous "Power Piston" one-piece wad to help you get all the power you pay for. By helping to reduce pellet distortion, the "Power Piston" wad actually puts more shot in your pattern than other wads, and that will improve any hunter's chances. A specially designed plastic shot protector is used in 16 and 20 gauge baby magnums to allow for maximum pellet count and weight.

Now, doesn't it make sense to carry a supply of baby magnums the next time you go hunting? They're not only an excellent selection for waterfowl, but are recommended for pheasants, big western

grouse and the wily wild turkey. Baby magnums are real handy when shooting through heavy foliage, and if you tote a side by side or over and under to the field, a wise hunter will keep one in the choked barrel for that long second shot.

Baby Magnum Gauges	Shell Length Inches	Ounces of Shot	Shot Sizes
12	2 ³ / ₄	1 ¹ / ₂	2, 4, 5, 6
16	2 ³ / ₄	1 ¹ / ₄	2, 4, 6
20	2 ³ / ₄	1 ¹ / ₄	4, 6, 7 ¹ / ₂



Get "Know Your Ducks", a pocket-size reference booklet with illustrations of the 17 ducks most frequently found in the North American flyways. Printed on waterproof plastic.

Regularly a \$2.00 value, it's yours now for only \$1.00 and two box tops from any Remington "Express" or "Shur Shot" shotgun shell boxes when you send them to Remington Arms Company, Inc., Dept. 414, P.O. Box 9500, Bridgeport, Conn. 06602.

Remington. 

Great guns deserve great ammunition. We make both.

"Remington" and "Power Piston" are trademarks registered in the United States Patent Office.



There's more to a Winegard TV Antenna than shows on the price tag!*

Much more! Like the sophisticated electronic design that only an engineer could really appreciate . . . but you can see the results right on your TV screen.

Winegard's only business is TV reception, and that pays off for you. Winegard holds many basic patents for color TV antennas, and has an electronics research laboratory in Denver working full time on advanced TV reception products.

And naturally, Winegard's "state-of-the-art" antennas are backed up with unsurpassed construction: high tensile strength, weather-protected aluminum elements . . . precision alignment . . . heavy duty brackets . . . every feature for longer service and better reception on all your TV channels in color and black and white; FM and stereo too!

Choose the antenna the experts and surveys recommend: Winegard . . . because there's more to it than shows on the price tag!

* "My name, for one thing! When you put up a Winegard antenna, I know you'll be satisfied. If not, write me personally and I'll make sure you get the best possible reception for your location. And that's a promise!"

John Winegard
John Winegard



WINEGARD COMPANY

3000 Kirkwood Street
Burlington, Iowa 52601

Send me FREE

Facts on "Pay Cable TV and Winegard's CableMate TV Antenna."

"What you should know about color TV reception . . . and color TV antennas."

NAME _____

ADDRESS _____

CITY _____

STATE/ZIP _____

PM

SCIENCE WORLDWIDE

(Continued from page 46B)

Commerce. Said to be as pure and nutritious as other cuts, minced fish is made from edible flesh which formerly was wasted in processing. Improved techniques make the difference.

Pressed into large blocks for processing into a variety of items for frozen food counters, the minced fish is expected to be less expensive than other similar seafoods. According to the labeling requirements, the words "made from minced fish" must appear on the package.

Fantastic structure for North Sea

In a few years the North Sea may be dotted with gigantic steel-and-concrete islands like Condeep, a drilling-production platform that has been designed to withstand both

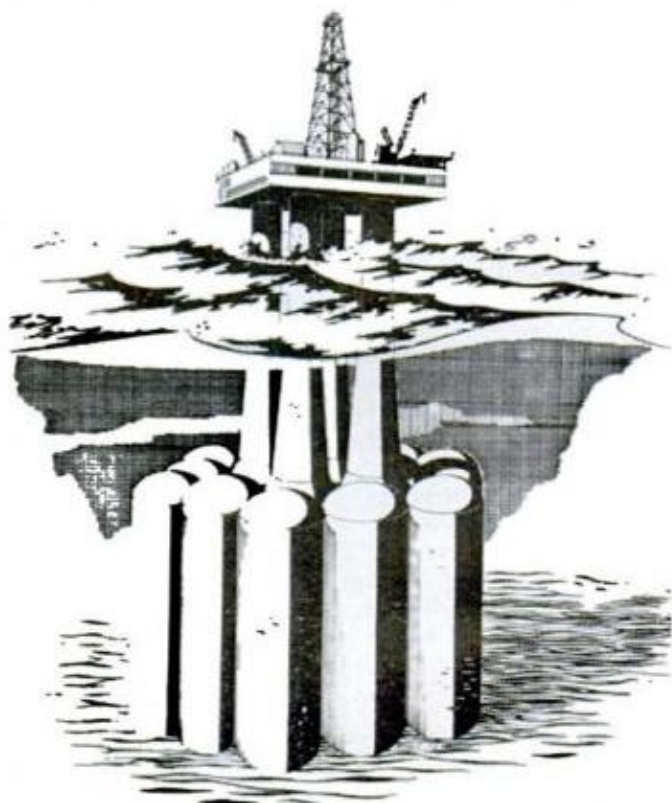

high winds and heavy seas. It would be towed to an oil field and sunk. Such an island would not be anchored with pilings, but would rest on the bottom, thus achieving stability through design and heft.

Other types of steel mammoths that are needed in the current off-shore oil boom are shown and described in 'Big Iron' Moves to the North Sea, which starts on page 128 of this issue. ★★★

Something good could happen to your son, when you put a Daisy B•B Gun in his hands.



A boy has a long way to go in this world before he can become a man. He needs help. He needs guidance. He needs you.

A Daisy B•B Gun can bring you both together and, at the same time, provide lessons in responsibility for him.

Because a Daisy is a B•B gun. It's not a toy. And it requires all the lessons of marksmanship and proper gun handling. Lessons that you can teach him yourself.

And while you're at it, it will provide valuable lessons in patience, responsibility, and respect.

Of course, your son will see his Daisy as something exciting. He can start with one of the lighter Daisy models, then move up to a bigger model that resembles a big-game gun or western carbine.

Later, he may want to have a Daisy pump-up, or CO₂ Gun from our Power Line series.

And while he's having all the fun, even if he doesn't know it, your son will be picking up valuable lessons in responsibility.

So if your boy is ready to learn those lessons, we have a Daisy B•B Gun ready for him.

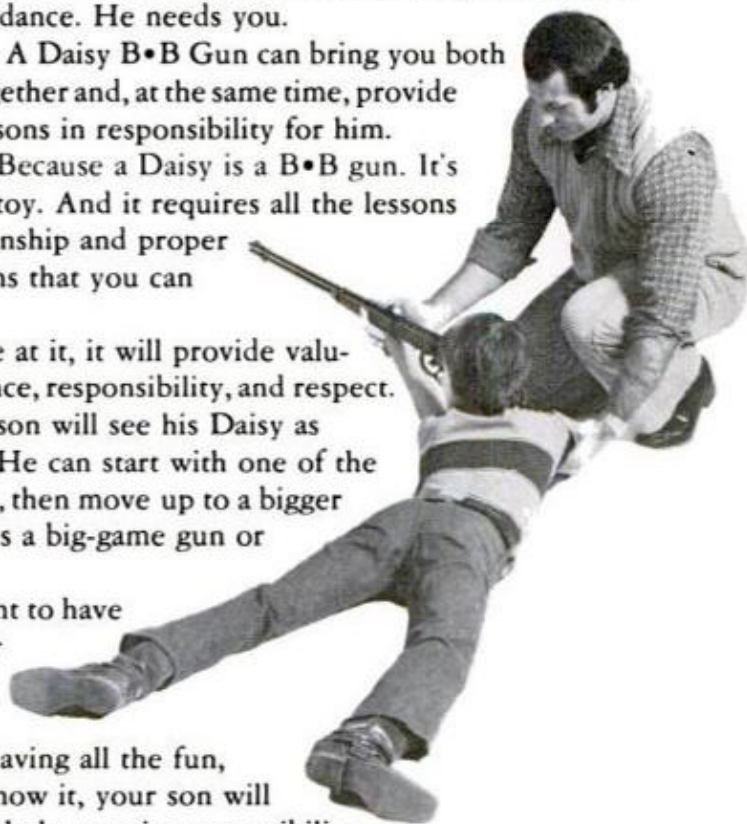

Daisy
SINCE 1886

The B•B Gun every boy dreams about.

Division Victor Comptometer Corporation Rogers, Arkansas 72756



WHY GEL GASKET MAY MAKE GASKETS OBSOLETE.

Ever since the invention of the internal combustion engine, people have been looking for a better way of holding it together. The problem is simple: keep what is in the engine, in the engine; keep what is not, out. Through the years, solutions to this problem have ranged from oakum, paint,  and a large variety of gaskets and sealants. Gel Gasket is the ultimate solution to this problem.



What is a gasket?

Theoretically, you don't need a gasket. If two surfaces were perfectly machined and put together, they would never leak. But there is no such thing as perfect machining. There are always gaps, scratches, unevenness  in machined parts. So the gasket was introduced. The idea was that a resilient material was squeezed between the two mating surfaces. It would fill in the gaps. And there would be no leaks.

What is wrong with gaskets?

Gaskets relax. They flex. They age. They have to be retorqued to keep them filling those microscopic irregularities. They have to be torqued carefully so that every part of the bearing surface has the same pressure.  A sealant helps. (We should know, we sell eight million tubes a year.) And when it is time to take it apart,  it's a tough, time consuming job to get the old gasket material off.

How does Gel Gasket work?

Gel Gasket is a product of eight years of laboratory work.  It has many remarkable properties. You squeeze it out of its tube in a thin (5/64) bead. It will stay in that gel form until energy is applied. This is in the form of bolting the parts together. It then flows into all the microscopic scratches and imperfections.  Then it changes its form into an extremely tough, extremely strong solid. Unlike other types of products, it does **not** shrink. It does not release solvents. So if you start with an ounce of gel, you end up with an ounce of gel gasket. You bolt the part together once, and forget it. No need to retorque. No need to wait. You can use the part immediately. Yet when it comes time to disassemble, you can remove it easily.  A finger nail will do.

Why is Gel Gasket better?

Using Gel Gasket actually makes a stronger engine. What you have, in effect, is millions of tiny keyways holding things together. It won't leak. There is no place for anything to go. In a sense, it makes the parts perfectly machined. You never have to retighten anything. You put it on, bolt it together, drive away and forget it.



How is Gel Gasket different from formed-in-place gaskets?

A formed-in-place gasket is a gasket.  It has the drawbacks of a gasket. It flexes. It relaxes. It does not contribute to the structural integrity of the part.







Where can Gel Gasket be used?

Anyplace you use a soft gasket or a paper gasket. The temperature range is from minus 40° to plus 350°F,  so you can use it just about anywhere at any time.

How is Gel Gasket applied?

Cut the tip at the mark.  That will give you the right size bead. That size bead is correct for any application. A little goes a long way. Just squeeze out a continuous bead, making sure there are no gaps. Naturally, you go inside of bolt holes.  Then just bolt the parts together  to the recommended torque settings. That's all there is to it. The part may be used as soon as you can turn the switch.

Will Gel Gasket make gaskets obsolete?

We think so. We've tried it on race cars,  motorcycles,  marine engines,  outboards,  lawnmowers,  and a motor home.  Why don't you try it yourself, and see?

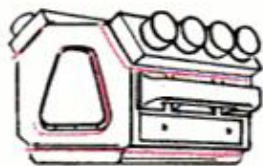

Permatex our name is our bond

New: A Kodak Super-8 that talks



by Ivan Berger
PHOTOGRAPHY EDITOR



Ektasound cameras shoot available-sound movies in available light. (They share the wide-open shutter, fast $f/1.2$ lens, and the viewfinder and exposure system of Kodak's XL low-light cameras.) Ektasound 140 shown has 9-21-mm zoom, costs \$275; nonzoom 130 costs \$190.

Ektasound projector (left) has mirror (arrow) next to lens that flips to project pictures from front or back of projector. This \$280 Model 245 records or plays sound tracks; \$220 Ektasound 235 has playback only. Both models show silent Super-8 films, too.

Your next birthday-party film can capture the whoosh as well as the flicker of the candles blowing out, with Kodak's new Ektasound Super-8 system. Just load one of the new Ektasound available-light cameras with magnetically-stripped Kodachrome II or Ektachrome 160 in a special sound cartridge (a bit deeper than a silent cartridge, to allow access for the camera's recording head and the capstan and pressure roller that move the tape past the head smoothly), plug in a microphone, and shoot. A light glimmers in the finder if the recording is okay. The cameras are designed for available-light filming with 160 film, like Kodak's XL cameras.

Ektasound films (which cost \$1.75 more per roll than silent Super-8, but cost no more to process) can be played on Ektasound or any other Super-8 magnetic sound projectors. Ektasound cameras and projectors take silent film, too. ★★★

INSIDE THE EKTASOUND CARTRIDGE

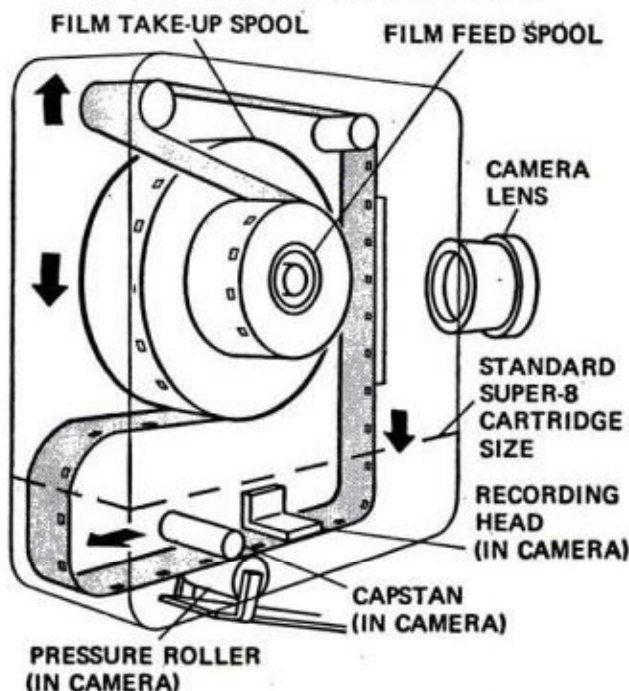

Art: Gerhard Richter

**“Buy 12 Craftsman panels,
get this jig saw free.**

That's some deal from The Paneling People.”

“One of the best deals I've ever heard of for home handymen.” That's what Wally Bruner, of the TV show “Wally's Workshop”, says about this offer.

Here's the deal: U.S. Plywood will give you a Rockwell® Model 67 USP Jig Saw absolutely free, when you buy 12 Craftsman® panels. This saw lets you cut panels face-side up, and sells in stores for \$19.99.

Choose from ten different looks in our Craftsman line, from formal to rustic. Or get the free saw with 12 panels from our new Weldwood® Collection.

Call toll-free 800-447-4700 (in Illinois, 800-322-4400) for the name of your nearest participating dealer. Offer ends December 31, 1973. (Or such earlier date as supply is exhausted.)

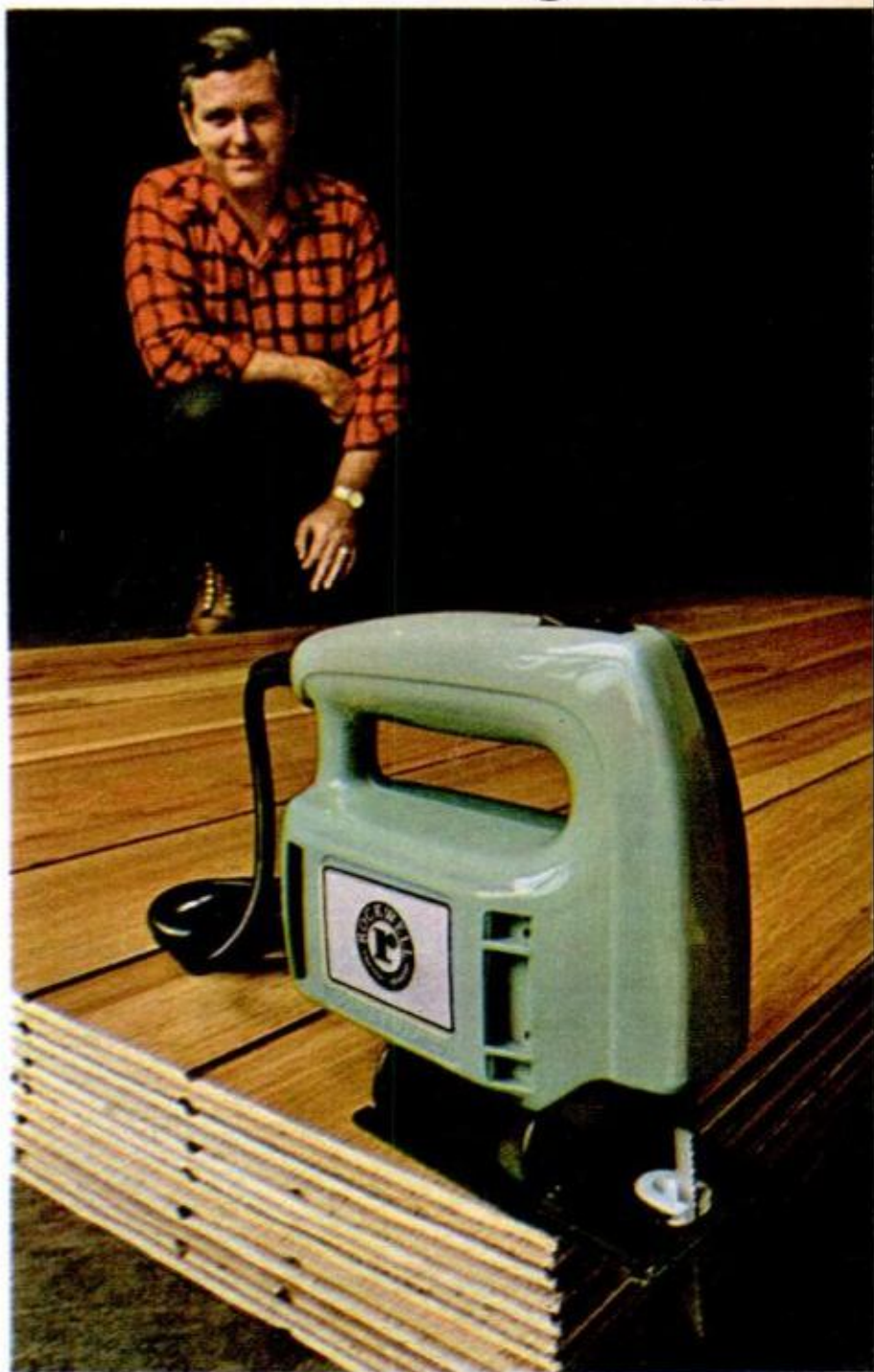

The Paneling People.

U.S. Plywood

Upland means different things to different people.



In New England, it's partridge and woodcock and "shot shells." In the Eastern and Northern tiers of states, upland shooting means fast, light-feathered birds and, usually, dense cover. Winchester or Western

UPLAND game loads deliver a pattern dense enough to chop its way through limbs, leaves and brush and yet remain even enough not to tear up the game. Partridge and woodcock are quick, tough and tricky. UPLAND is more than a match for them. After all, it's the name of the game. Shot sizes 8 and 9 recommended.



Down South, it's "birds," and that means quail and "bird shells." Kings of the South, quail hold tight under a good dog, break fast and demand a load that'll put a full, no-holes pattern right on 'em. Thanks to its Mark V collar, UPLAND shot doesn't scrub flat against the barrel but stays round, eliminating blown or patchy patterns. Quail aren't very big, and shooters need all the shot they can get. They can get it in UPLAND. Shot sizes 7½ and 8 recommended.



Out West, it's chukars, western grouse and "low base" or "low brass." Here's still another story. No short range shooting for these elusive, far-flushing twisters. To bring them down consistently takes power plus a full pattern 'way out there. UPLAND,

with its Sealed Gas Chamber, keeps all the power behind the shot, eliminating gas leaks that can diminish power and cause deformation. UPLAND — it's as good as the game it's named for. Shot sizes 6 and 7½ recommended.



Midwesterners who go after rabbits and quail, simply say "shells." He's where you find him, which is just about everywhere, and anybody who thinks he's an easy target hasn't been rabbit hunting. Hunted best ahead of an enthusiastic beagle, he's tough to stop and demands the

reserve power we put into UPLAND. All too often a rabbit hunter finds puffs of brown hair and no rabbit after a shot. Change to UPLAND and let the controlled power put rabbit in the stew. Shot sizes 5 and 7½ recommended for rabbit.

To all of 'em Upland is a triple-threat performer giving premium power, pattern and performance at no extra cost.

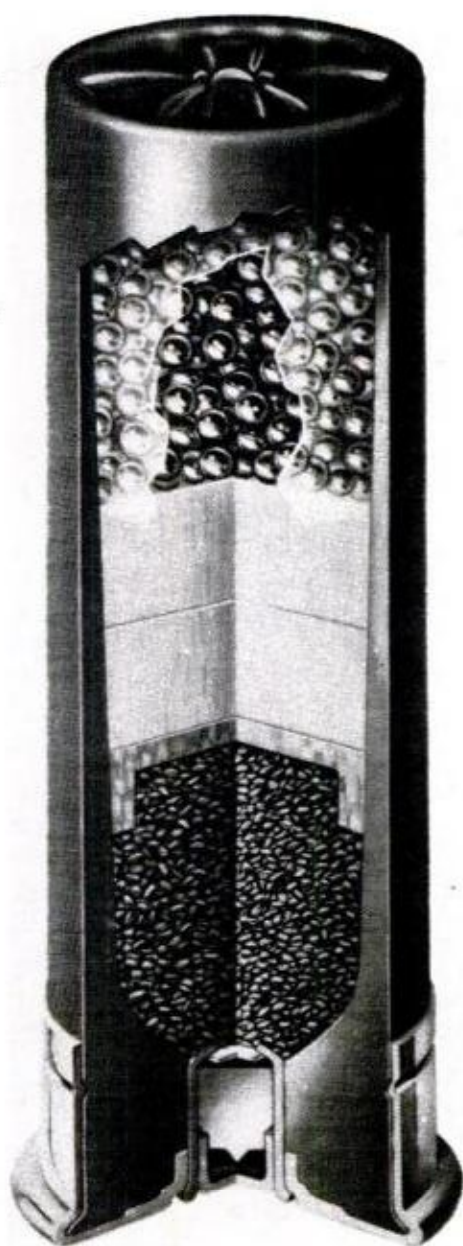

The one-piece case is strong enough to be shot without the brass head. We're not suggesting you try it, but it's true — the one-piece construction eliminates base wads and makes the entire case, from primer pocket to crimp, of one solid piece of strong forged plastic. The brass head is for ease of extraction and loading only.

Maximum reloadability. Many hunters are finding out what clay target shooters have known for years. The one piece hull in Upland is identical with the famous Winchester-Western AA target load and can be reloaded many, many times for more economical shooting.

Slick, scuff-proof handling. The smooth plastic of Winchester or Western Upland loads allows shooters to reload quickly, smoothly and also permits fast, easy extraction of the fired case from the chamber. Small details, perhaps, but indicative of the professional attention paid to such details at Winchester-Western.

Hard, polished shot. Containing just the right amount of antimony to harden the lead, the polished Upland shot retains its shape after hitting the game and drives home for the quick, clean kill sportsmen demand. Round pellets fly true, stay in the pattern.

Sealed Gas Chamber. The Upland flanged over-powder wad and solid base combine to form a gas-tight chamber that seals the power behind the shot column, eliminating blown patterns caused by hot gas leaking into the shot. The result is full, even patterns.

Mark V Collar. This Upland collar wraps around the shot during its passage down the barrel and takes the full abrasive effect of that trip. The collar falls away at the muzzle, leaving the shot full and round and — in the pattern.

Non-Corrosive Priming. Weather-proof Upland priming can never put corrosive salts in your shotgun barrel for a simple reason. We don't use any. The quick, hot flash Upland priming generates comes from the precise manufacturing technique used in making the primer cup and anvil together with completely up-to-date priming compound technology.

WINCHESTER-~~Western~~ 275 Winchester Avenue, New Haven, Connecticut 06504.

 | winchester
the way you
want it

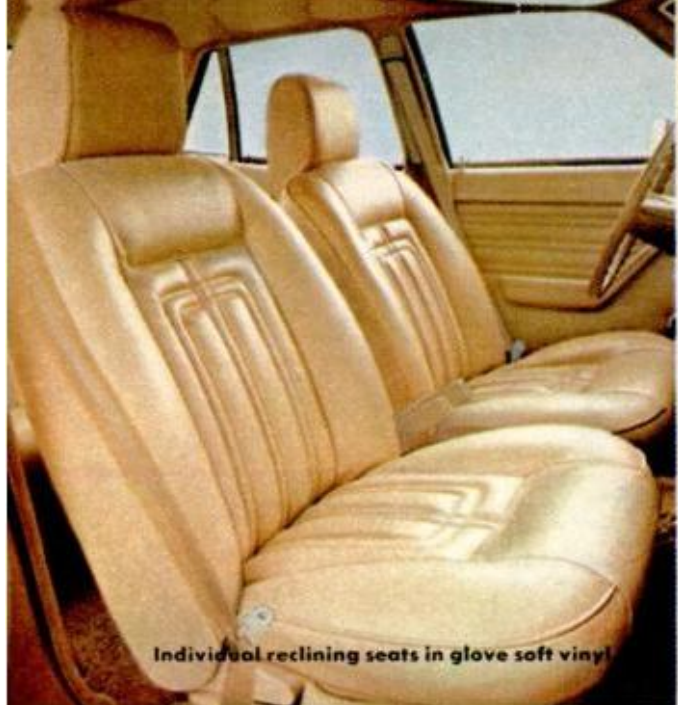

Individual reclining seats in glove soft vinyl



Grained vinyl roof.



Family-size back seat

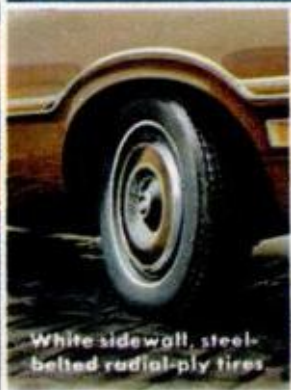

White sidewall, steel-belted radial-ply tires



Plenty of room for a family of five.

Surprising luxury and comfort in an

BY ROBERT LUND

DETROIT LISTENING POST

Surprise car coming from Olds

There's a fun and performance car coming from Oldsmobile, if General Motors will clear it for production. If a fun car from Olds sounds out of character, you're right, it is. Olds has a reputation for turning out solid, respectable cars, ranking with the best of them in engineering, but they aren't what you would call particularly imaginative automobiles. But the new one, tagged the "W," is an exciting car. "W" is an identifying nickname the car carried while in development. It will get a formal name when it goes on sale—if it goes on sale.

A flashy two-door, the "W" is the nearest thing to a track car Olds has ever worked up. The car started as a just-for-the-heck-of-it project in the company's engineering department. Every engineer on the staff was

invited to contribute to the car, modify it or suggest hang-on hardware. There were two restrictions: no hang-ons requiring special tooling and no modifications conflicting with government regulations on safety and emissions.

It may be a while before you see the "W" in action, because GM had not approved the car for production when this issue went to press.

New mid-sizer from Ford

Ford's pushing to have a new top-of-the-line mid-size car ready to preview at the Chicago Auto Show the end of February. The on-sale date will be a month or so later, about mid-April.



Energy absorbing bumper for '74.



economical family car. Ford Maverick for 1974.

Ford Maverick has always been an inexpensive car to run with a reputation for good gas mileage. Now Maverick with Luxury Decor Option also offers many appointments you'd expect on a luxury car. It's the economical family compact that doesn't ask you to give up luxury. See it now at your Ford Dealer's. The closer you look, the better we look.

FORD MAVERICK

FORD DIVISION 

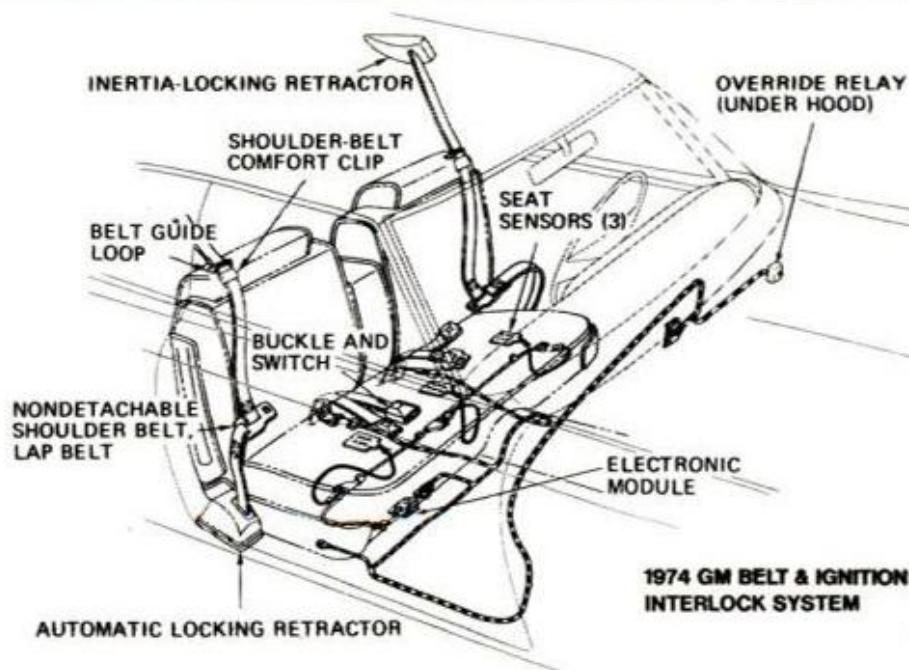

Just sit on the sensor and the sequential ignition interlock logic system will do the rest: It'll keep you from starting your 1974 car until you buckle up. There are sure to be a certain number of system failures, and for that eventuality there's an emergency override button under the hood so the engine can be started. The initiative to buckle up could have been provided by, say, losing all right to insurance collectability if involved in an accident and unbuckled, but now this complex system will guarantee responsible motoring. At least it's easy to use: One hand will buckle the combination lap/shoulder harness and it's on an inertia reel—a sensible system at last. This is GM's wiring drawing, but all '74s have a similar system. PM will not publish instructions for disconnecting the system.

Fixed glass for two-doors

Rear side windows you can roll up and down will disappear from all two-door cars within the next few years. The windows will be there, but they will be fixed—the so-called opera window pioneered by Cadillac. The auto companies will promote this as styling

elegance, but it's actually a way of cutting production costs because with a fixed window there's no concealed hardware to install. Chrysler, which now has permanent quarter windows on its big cars, will go to sealed side glass on its mid-size coupes in

(Please turn to page 52)

\$37.95 FREE LATHE CHUCK!

When you buy

UNIMAT



Oct. 15 - Dec. 31



Here's a machine tool bargain you won't want to miss: a FREE Universal Lathe Chuck with 3 reversible jaws regularly priced at \$37.95. Save almost \$38 when you buy world famous UNIMAT—the precision lathe that converts to vertical mill, drill press, surface grinder & polisher. Over 100,000 in use by R & D labs, inventors, hobbyists, precision machinists.

THIS OFFER AVAILABLE THRU HUNDREDS OF PARTICIPATING DEALERS THROUGHOUT THE USA!

Write today for full details.

edelstaal \$199.50
Job Tenally, N.J.

American Edelstaal, Inc.
Dept. BJ-3 / Tenally, N. J. 07670

DETROIT LISTENING POST

(Continued from page 51)

1975. Which brings to mind a conversation with a Ford v.p. several years ago. Ford had just deleted the vent window from Mustang. I like the vent window and asked why it was being dropped. "Just wait a few years," the Ford guy replied, "and somebody will 're-invent' the vent." Sure enough, it's back this year. But now you pay extra for it. Roll-down side windows will go the same route. They will be back in production in about four years—as an extra-cost option.

Price cut on antiskid

The first antiskid system priced under \$100 will be offered on standard and intermediate-size Ford products next year—the '75 cars. The two-wheel system (rear wheels only) will require only minimum service during the life of the car.

Slow down, automakers advise

Automakers are apparently on the verge of coming out in favor of reducing speed limits to 50 or 60 mph as a means of conserving fuel. The auto companies have been putting out feelers to test public reaction to the idea before advocating it openly. At GM, Buick ran a series of tests with three identical LeSabres over a route of 2700 miles. Car A, driven at 70 mph, got 15.3 miles to the gallon. Car B, cruising at 60, realized 17.6 mpg. Car C, loping along at 50, scored 18.8 mpg. There's no argument that you can stretch mileage by slowing down. But if Detroit is going to advocate a slowdown, carbuilders should be consistent and cut out the funny stuff with speedometers that give readings of 120 mph. Some GM divisions have done that with their '74 cars, cutting the meter back to a top of 100.

Speaking of the fuel shortage, if there is one, what are you paying for gas these days? A few stations in rural areas of Michigan, where it's a long haul between pumps, have socked the price up to 96 cents a gallon on holiday weekends and in the early morning hours when most stations are closed. That beats any argument the environmentalists have come up with for ditching cars in favor of horses. ★★

FREE

1974 LAFAYETTE CATALOG 740

Ready Now!

Your Complete Electronics Buying Guide

- Stereo/Hi-Fi Components • CB Transceivers & Walkie-talkies • PA Systems • Tools & Test Equipment
- Police/Fire Monitor Receivers • Antennas • Photography Equipment • Ham Gear • Books, Parts, and More!

Send Today!

Lafayette Radio Electronics
P.O. Box 10, Dept. 15103
Syosset, L.I., N.Y. 11791

NAME _____ 15103

ADDRESS _____

CITY _____

STATE _____ ZIP _____

SOONER OR LATER, YOU'RE GOING TO GET STUCK.



There's nothing more aggravating than having your car break down on the road. Except maybe paying a twenty-mile towing charge and finding out the trouble was just a loose connection, like a coil wire or a battery cable.

People have been going through this kind of aggravation for years. And we at Gulf think it's time something was done about it. We think that, in a country where people spend so much time behind the wheel of a car, they ought to know a little bit more about one.

That's why we've compiled a little 24-page booklet called "How not to get stuck when you get stuck."

In this little booklet we tell you the things to look for when your car breaks down. And we explain, in layman's terms, how a car works, how so many unexpected things can go wrong, and what can be done about them.

It covers everything from a loose electrical connection to a blown-out muffler.

Of course we're not suggesting that the booklet will make a master mechanic out of you. Some things you're going to have to leave up to someone who is. And that's also covered in the booklet.

You'll find chapters on starting, stopping, tune-ups, tires, fuel & oil, and all kinds of repairs and maintenance, and lots more.

It's clear, informative, up-to-date, useful and free.

If you'd like a copy just write to: Gulf Consumer Information, Box 1519-H, Houston, Texas 77001. We'll mail it to you right away.

It won't stop your car from ever breaking down. In fact, you're almost certain to get stuck sometimes. But when you do, at least you'll know your coil from your rear-end differential.

GET TO KNOW GULF AND YOU'LL GET TO KNOW YOUR CAR.



GULF OIL CORPORATION

You were born smart.



Make it pay off in the Navy.

Get advanced technical training in electronics or nuclear power.

If you're a high school graduate who can meet our qualifications, the Navy will offer you over \$17,000 worth of advanced technical training in our Advanced Electronics or Nuclear Power Programs.

These are very special programs, and the academic schedule will be tough . . . calling for plenty of concentration and honest effort. It'll take more than a good mind to make it. You'll need a strong desire to learn and achieve. And a willingness to do your share of the house-keeping chores. But any man who learns to operate or

repair the Navy's sophisticated electronic systems or nuclear power plants, guarantees himself a firm foot-

hold in the future, whether he stays in the Navy or not.

For more details, talk to your local Navy Recruiter. Or mail the coupon below. Or call toll-free, anytime, 800-841-8000.

**Be someone special
in the New Navy.**

TO: U.S. NAVY—Capt. Robert W. Watkins
NAVY OPPORTUNITY INFORMATION CENTER
P.O. Box 2000
Pelham Manor, N.Y. 10803

391

Please send more information on:

- Advanced Electronics Program
- Nuclear Power Program
- Other Navy career opportunities.

If you really don't want to wait,
call **800-841-8000** toll-free
(24 hours a day, seven days a week).
In Georgia, call 800-342-5855. Call collect:
In Alaska—272-9133, in Hawaii—533-1871.

Name _____ Date of Birth _____
Address _____
City _____ Phone _____
State _____ Zip _____

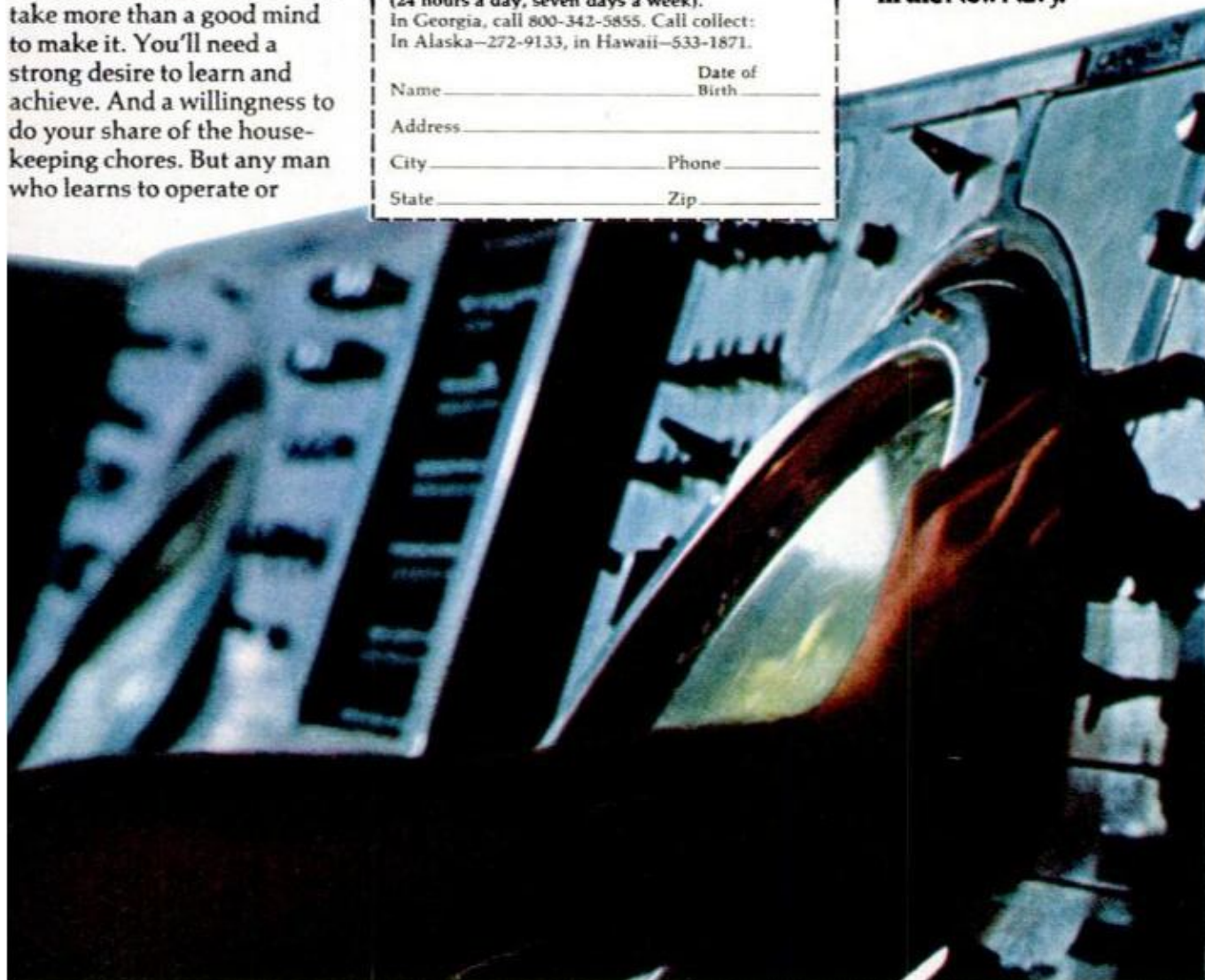

Tent-camping by ATV

Now a tiny tow-along offers summer sleep-out shelter or winter ice fishing.

by Bill McKeown
OUTDOORS EDITOR

More fun for less money is a camping trend and a challenge for recreational-vehicle designers. A recent answer is one of the smallest camp rigs made—a compact tent-trailer from Attex Manufacturing Co. of Glenshaw, Pa.

That company's all-terrain vehicle is well known: Attex may produce more than 50 percent of ATVs sold every year to civilians and the Army. Now the firm can equip you not only to drive far off the beaten track but to be ready to camp on arrival in the new mini-travel-camper.

In spite of early announcements a few years ago, ATVs can't go everywhere and do everything. So when this campsite son-of-ATV was announced, we wanted a practical and impartial trial. Our testers were outdoorsman Vin Shaw, a plastics engineer, and his son Vinnie in Latrobe, Pa. Rolling Allegheny hills surround the town and both Shaws had covered them by foot, car, bicycle, skis and snowmobiles. But they had never seen an ATV nor heard the claims that these little rigs could conquer cliffs or surf and were the greatest thing since bubble gum.

After Shaw junior and senior had tried out the vehicle's capabilities for a couple weeks, we found their appraisal interesting. Using a 34-hp Attex with a 398-cc JLO Rockwell engine, they found it more fun to drive than a snowmobile. Both had no trouble

(Please turn to page 56C)

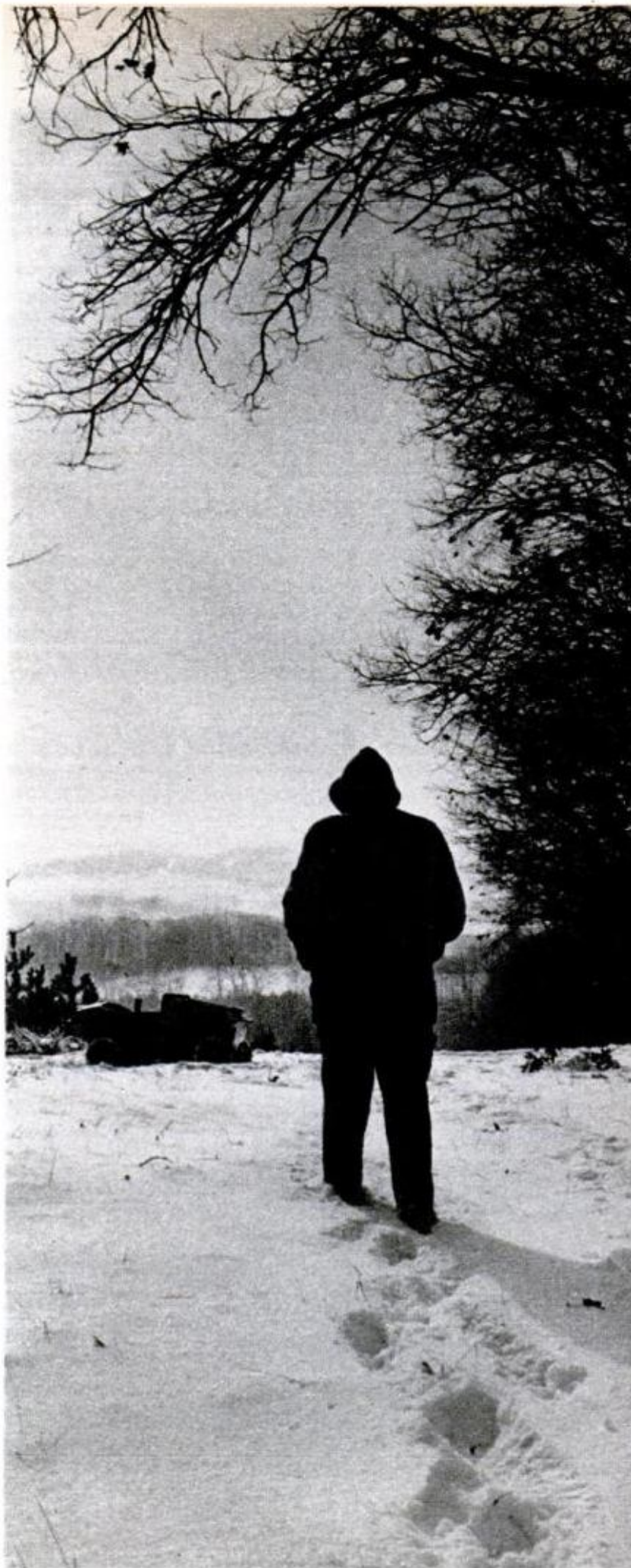

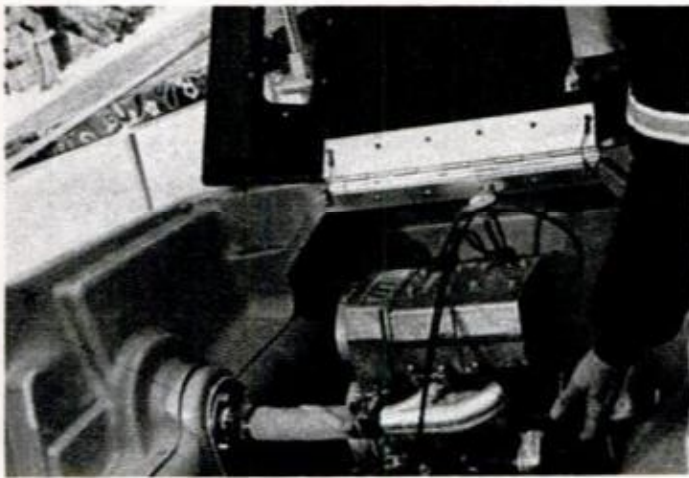

Photos: L. Laredo

Early snow added to test conditions for this Attex foldable compact base camp. Light weight of the tag-along proved no problem for the 34-hp, 398-cc engine. Tight turning radius of Attex Thunderchief, as shown by tread tracks (middle right) allows maneuvering camper trailer into small level clearings. Latrobe, Pa., campers Vin Shaw junior and senior plus test-camper McKeown found tent-trailer setup time averaged 10 minutes in cold conditions, slightly less during warmer weather. Plastic top is raised, double-bed platforms hinged out. Canvas curtains are stowed in top. Erection proved simple enough for night assembly by lantern light.



The Club Cab. Dodge, and only Dodge, has it.



Only Dodge gives you the Club Cab, with 34 cubic feet of extra storage space behind the seat.

Neither rain nor snow nor heat of day nor dust of road will touch your valuable belongings again. Because the Dodge Club Cab gives you 34 extra cubic feet of space behind the seat to keep all those things you don't want to leave outside, inside. Things such as expensive tools, or fishing tackle, or golf clubs. Even things such as kids, if you have the optional jump seats with seat belts for the back. Electronic Ignition and front disc brakes come standard, too. The versatile Club Cab—only Dodge has it.



EXTRA CARE IN ENGINEERING
MAKES A DIFFERENCE.

**DODGE TRUCKS.
DEPEND ON 'EM.**



You get this much extra space behind the seat. For extra things. For extra people.

TENT-CAMPING BY ATV

(Continued from page 56)

working out steering with the two upright levers, bulldozer-style. The speeds of nearly 40 mph racing up and down slopes proved exciting. And since no one had told them ATVs can climb Everest or cross the Pacific, they didn't try driving over fallen tree trunks or into deep rough water. All they found was a vehicle that could climb steep and stubbled fields with ease, handle narrow wooded trails and turn around in its own length. Deep drift snow, they suspected, might stop it, but moderate winter conditions were no problem.

They had practiced setting up the camper trailer several times before I arrived to join the test and had promised me a warm fall weekend. Overnight the mountains took a quick white cover, however, to add autumn hunting-season weather to the tent-trailer checkout. The woodland clearing we towed to for camping proved not as level as the top layer of snow appeared, but the adjustable legs of the rig leveled it.

The little camper-trailer, closed up, is 53 inches wide, 104 inches long, 40 inches high and weighs a light 550 pounds. It is rated to carry a load of 400 additional pounds at highway speeds up to 70 mph using on-road 4.80 X 8 tires, something we didn't test. With a total poundage of less than one-third of even a small tow car's weight, brakes are not required in some states but are available as an option. Camper weight is so light, in fact, that we found no trouble positioning it by hand.

When opened up, the trailer turns into a roomy enclosure 74 inches long, with 73-inch headroom and a total width of 148 inches. Double beds on each side mount three-inch-thick urethane-foam mattresses with sleeping space for four adults. Living space inside doesn't compare with the generous room aboard the deluxe large camping

(Please turn to page 56D)

Camping comfort, provided by foam mattresses stored amidships, can take rigors out of roughing it. Once double-bed side sections are unfolded (top), mattresses are positioned. Adjustable legs (center photo) allow leveling of camper body if site is uneven. Additional gear can be stowed under mattresses. Zippered enclosure in top of camper (right) opens to drop down side curtains. Window openings are screened and doorways at front and rear tie open for easy access or screened ventilation. Tent provides wind shelter and warmth when closed.

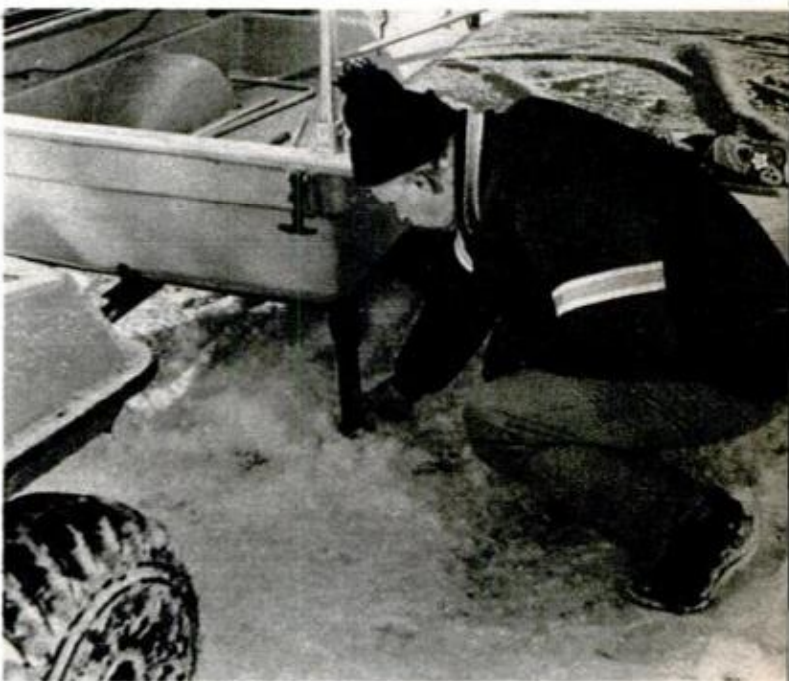

TENT-CAMPING BY ATV

(Continued from page 56C)

trailers now available, but neither does the price. The Attex camper-trailer lists for about \$695 f.o.b. Glenshaw, Pa. The trailer's bottom and hardtop are of wear-resistant ABS thermoplastic with color molded in. Tent sides are U.S. Army duck boat-shrunk canvas that is claimed to be water repellent and mildew resistant. The tent is stitched together with Dacron thread that is guaranteed for the life of the canvas. Zippers are of nylon, and the four canvas panels that make up the tent can, it's claimed, be replaced individually—and economically—if ever necessary. Fiberglass mesh screening in the windows should keep most bugs out where they belong. And with windows and doors closed, we found the small size of the enclosure made it easy to keep warm.

Setting up proved a simple procedure, and although, like most engineers, Vin Shaw had a running series of design improvement suggestions, I found the rig simpler than many and, even in the cold, we broke no fingernails trying to pull resistant canvas into place. That's something not every tent-camper can claim. First the roof is lifted, gear stowed inside repositioned out of the way, and uprights erected to hold the roof in place. Bases for the beds hinge out and

are supported by angle braces extending to the adjustable legs. Brackets that shape the side sections above the double bunks pivot up, and the double bed mattresses which have been stored in the center compartment are lifted onto the bunk boards.

All this time the tent itself has been out of the way, stowed up under the hardtop. Now a pull of the plastic zippers and it all drops down, hanging from the top, ready to be tugged into position. We found the complete procedure times out to 10 minutes or less.

For the camper who enjoys the gadgetry that can go with the sport, a number of new options are now available. Added to electric brakes for the camper are an enclosure of canvas and windshield for your ATV, studded tires for ice and snow, electric winch for extricating the rig from tight spots, outboard motor mount to rig power for offshore, snowplow, utility trailer to tow along gear, and a towing trailer the ATV and utility can ride down the highway behind your passenger car. High-performance additions include souped-up engines, roll bar, instrument panel, and even matching helmet and jump suit.

But camping seems like a more sensible use for this soft-footed vehicle. Now that the wild all-purpose claims are dwindling it may find a market for all-terrain campers, with its tent trailer in tow. ★★★

Fully erected, the tent proved strong and suitable for moderate conditions. At 550 lbs., it can be towed by ATV, smallest car, or into a tight space by hand. Used as a base camp for hunting, as at right, small hardtop can sleep four, provide shelter and weather protection. Long life is claimed for ABS thermoplastic and army-duck boat-shrunk canvas tent material, plastic zippers.



Ken Waller writes to tell us that...

CASE #136
(in a continuing series)

"I lost 3 inches off my waistline, 6 pounds...and shaped up—in 5 days!"

"I did it with one 5-minute exercise, twice daily, lying on my back—WITHOUT DIETING!"

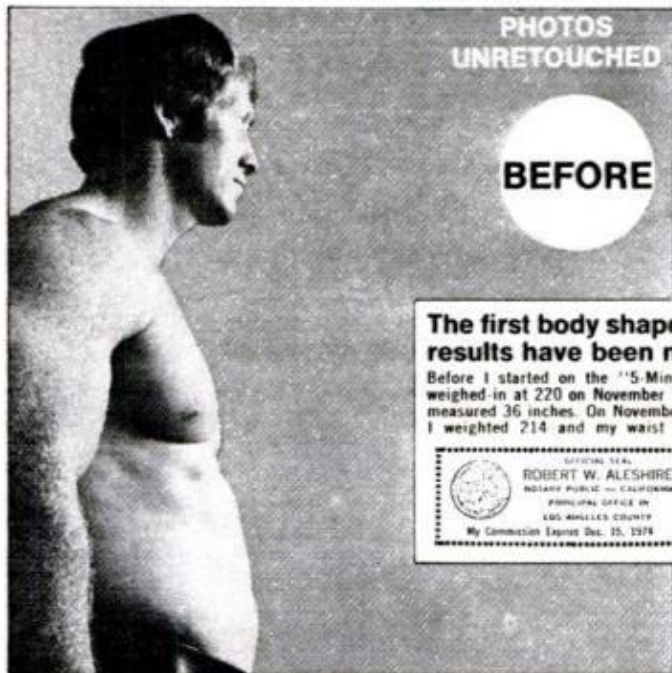

The first body shaper so effective— results have been notarized!

Before I started on the "5-Minute Body Shaper" Plan I weighed in at 220 on November 1st. On that date my waist measured 36 inches. On November 5th, just five days later, I weighed 214 and my waist measured 33 inches. I'd

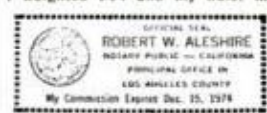

lost 6 pounds and 3 inches from my waist in just five days with no special dieting or exercise. Just the "5-Minute Body Shaper" Plan. **KEN WALLER**

Nov. 1st.
Weight 220
Waist 36"

"I'm usually in good shape, being a physical fitness buff, but when I moved from St. Louis to Los Angeles, I neglected my eating and fitness habits. I gained weight and softened up. I had no time to go to the gym, so I tried the "5-Minute Body Shaper" Plan. I was amazed at how fast I firmed, trimmed, tightened up my waist and got rid of extra body fat. It sure beats jogging and gym workouts for people who have little time to shape up! Thanks for your well thought out plan! Good luck with it!"

Nov. 5th
Weight 214 (lost 6 lbs.)
Waist 33" (lost 3 inches)

HERE'S WHAT THE EXPERTS SAY:

"Doctors have always known, exercise done while lying on the back, virtually eliminates strain while slimming and reshaping the body. Yours is the finest Body Shaper Program on the market." **RICHARD TYLER, Chiropractor**

"Beats jogging and working out in gyms—and much safer. I lost 4½ inches off my waist in 14 days."
JIM HANLEY, famous athletic coach

"Based on sound physiological and medical knowledge, it burns fat and shapes the body without strain to the heart or other organs. I lost 32 lbs. of excess weight using it."
PIERRE GRAVEL, President,
Canadian Council of Chiropractic Research

WHAT IS THIS INGENIOUS PLAN?

The Weider "5-Minute Body Shaper" plan is based on doing ONE CONTINUOUS RHYTHMIC CO-ORDINATED EXERCISE. That's all you do! This one 5-minute exercise is designed to attack the Waistline and Hipline (where fat accumulates quickest, giving your body a flabby, weak and distorted look)—as well as burn off excess body fat fast by speeding up your metabolism, burning stored calories and releasing excess water—while re-shaping your bustline, hipline, firming up your legs and arms—YOUR TOTAL FIGURE!

It's safer than strenuous gym workouts, beats the time consumption and dangers of gym workouts.... or any other vigorous sport.

The unit weighs about 8 ounces and fits any wallet-size case. You can carry it and use it wherever there's floor space—anytime. Even while watching television.

WHAT COMES OFF IN 14 DAYS?

Individual results vary, but during an average 14-day period, you can expect to lose up to 4 inches from your waistline and up to 10 pounds from your present weight. It strengthens your heart and lungs, increases stamina and endurance, improves your digestive function and general health. It also shapes you up—from head to toes. For a "5-Minute Exerciser—it sure does a lot."

Patent Pending. © Copyright Joe Weider, 1973

*EXPOSING EFFORTLESS EXERCISERS

Reader's Digest (September, 1971), New York Times and Good Housekeeping, among others, exposed sauna wraps, inflated belts, weighted belts and effortless exercisers as frauds. Scientific researchers, medical and fitness experts all agree... there is only one way to firm, shape and trim up your body... you must work the inches off!

NO GIMMICKS, NO CATCHES
MONEY BACK GUARANTEE OFFER
Because this isn't a "gimmick" plan—and you have been fooled in the past by "effortless exercisers"—I make you this
UNCONDITIONAL GUARANTEE.
"GET IT OFF FAST"—and see measurable and firming results in 3 days or return the exerciser for a full 100% refund!
Proven results are already verified. The guarantee is in writing. Now you can think of a reason not ordering your "5-Minute Total Body Shaper"?

'5' Minute BODY SHAPER

The Body Shaper that Works

FREE TRIAL OFFER!

Weight just 16 ounces!



See your exciting new body begin to take shape in 3 days or return lightweight Body Shaper (small enough to fit into pouch shown) for a full 100% refund!

**DISCOVER A NEW JOY
IN YOUR BODY —
GIVE IT SEX APPEAL**
COMPLETE KIT ONLY
\$995

JOE WEIDER, DEPT. BR/J
21100 Erwin Street, Woodland Hills, California 91364

Dear Joe: Rush me your 5 Minute Total Body Shaper and Slimmer Course in plain wrapper, with your money back guarantee offer!

I Enclose \$9.95 For The Above. Cash Check Money Order
\$1.00 extra for Air Mail. (No COD's Accepted). Calif. residents add 5% sales tax (10.50)

Name _____
Address _____
City _____ State _____ Zip _____

IN CANADA: "5" Minute Body Shaper Plan, 2875 Bates Road, Montreal, Quebec





engrave money (legally)

One dollar makes ten. Make profits up to ten times your cost—full or part time—right in your own home.

Engrave much needed nameplates, directories, signs, trophies, badges in plastic, metal and wood on the time-tested New Hermes Engravograph.

Simple to operate. It's tracer-guided.

Engraving is a permanent business — not a fad — with small investment of less than \$400; money back guarantee. Trained representatives at your service.

Write for free illustrated catalog 10.

**new
hermes
engravograph**

20 Cooper Square, New York, N.Y. 10003
World's largest engraving machine manufacturer.

MOLDS

for making
Ornamental Concrete
Items...

Book about Aluminum
Molds with prices and
production trade secrets
direct from world's larg-
est mold manufacturer.



SEND
\$3.00

CONCRETE MACHINERY COMPANY, INC.

P. O. BOX A99 - HICKORY, N. C. 28601

BUILD YOUR OWN CAMPER!

SAVE UP TO 50%



SEND
25¢ FOR
DETAILS



EQUIPMENT CATALOG

Send \$1.00 postage, handling.
(Refundable)

5th Wheel Plans ... \$9.95
Cover basic frame,
electric, plumbing,
(general construction)
Camper Plans 4.95
Pickup Cover 2.95
Travel Trailer 3.95
Econoline Type Van 3.95
Pass. Bus or
Delivery Van 3.95

VIKING CAMPER SUPPLY,
INC.

99-BP Glenwood Ave.
Minneapolis, Minn. 55403

Please send _____ for

which I enclose \$.....

NAME.....

ADDRESS.....

CITY.....

STATE..... ZIP.....

WHITE'S METAL DETECTORS

WHITE'S ELECTRONICS, INC. manufactures the World's Largest and Finest Line of Mineral and Metal Detectors. Ghosttowning, beachcombing, bottle hunting, coin hunting—all types of TREASURE HUNTING or PROSPECTING, amateur or professional. Detect conductive metals—Gold, Silver, Copper Nuggets—Coins—Rings—Jewelry, etc. Underwater or on the land. "There are no finer at any price" 25 production models to choose from—T.R. or B.F.O.

Priced from \$750 up

—Always specify the Blue & Gold
ASK FOR WHITE'S BY NAME

—Free Literature—
WHITE'S ELECTRONICS
Rm. No. 512
1011 Pleasant Valley Rd.
Sweet Home, Oregon
33784 Hazel Street
Abbotsford, B.C. Canada
Elk Air Industrial Park
Custer Drive, East
Earhart, Indiana 46514

Fine! 3-D Sight Magnifiers ENLARGES CLOSE WORK ONLY \$1.98 SMALL PRINT!

WORTH MUCH MORE!

See clearer, work faster, more accurately with less eye strain, less fatigue and tension with **HEAD BAND MAGNIFIER**. Wear like glasses, they'll magnify up to 3x and leave hands free to work.

Produces a 3-dimensional effect, where each detail appears to stand out. **FOR CLOSE WORK, REPAIRS, SEWING, HOBBIES, etc.** Sturdy, lightweight, adjusts to all sizes. With or without glasses. Fine, sharp prismatic polished lenses. Only \$1.98 + 50¢ for Post. and Hdg. PPD. (2 for \$3.50, 3 for \$5.00) **WORTH MUCH MORE! MONEY BACK GUARANTEE.**

Nu Find Products

Dept. HB210, 12 Warren Street, New York, N.Y. 10007

BUILD YOUR OWN

GRANDFATHER CLOCK

Save over 50% by building your own grandfather clock. Stately, straight-sided "AMERICAN CLASSIC" with beveled plate glass sides. Narrow waist designs: "SPIRIT OF '76" with finely sculptured crown and brass-tipped pillars; or easy to build, always popular "SPIRIT OF THE CENTURY." Our kits are Red-i-Kut, semi-assembled, hand-crafted of solid 3/4" kiln-dried mahogany, cherry or walnut. Tubular bell or Westminster rod chimes. Moving moon dials painted by our own artists, and our own original Goddess Diana or Lady Florentine pendulums. Gorgeous solid bronze dials with raised numerals and corners. Send \$2.50 for all three plans, plus description of kits and movements, as folks have for more than fifty years.

KUEMPEL CHIME CLOCK WORKS & STUDIO
Route 3, Box 240-O, Excelsior, Minnesota 55331

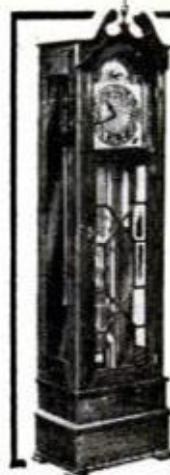

You get more for your money from NRI



SOLID STATE TRAINING—Learn-by-doing with NRI equipment. TV-Radio Servicing course includes 25" diagonal color TV, with handsome woodgrained cabinet at no extra cost; wideband service type oscilloscope, color bar crosshatch generator, transistorized volt-Ohm meter, and solid-state radio kit. Other courses equally complete.

NRI Programmed Equipment Gives You Priceless Confidence, Makes Learning TV-Radio, Electronics Fast and Fascinating

NRI pioneered the idea of supplying home-study students with custom designed training kits to give practical on-the-job experience as you learn. Today, NRI's "3-Dimensional" training can't be equalled. You get more value—from the exclusive Achievement Kit sent the day you enroll, to "bite-size" texts and custom training equipment. Learning TV-Radio, Electronics or Communications at home is easy, exciting, the NRI simplified, dramatized way.

BE A SKILLED TECHNICIAN IN AMERICA'S FASTEST GROWING INDUSTRY

Regardless of your educational background, you can learn the Electronics field of your choice the practical NRI way. The NRI color catalog, sent to you free and without obligation, tells you how you can qualify quickly to be a part of the fast growing Electronic Age; about engineering jobs in business, industry, broadcasting, government, now offered to men without college degrees. It will open your eyes to the great number of success opportunities available right now in the high-pay world of TV-Radio Servicing, Broadcasting-Communications and Industrial-Military Electronics. With NRI technical training, you can take your choice of a wide variety of career

openings or have a business of your own. And if you choose one of five NRI courses that include FCC License preparation, you must earn your FCC License or NRI refunds your tuition!

MAKE \$5 TO \$7 AN HOUR EXTRA IN SPARE TIME STARTING SOON

Tens of thousands of NRI graduates are proof it is practical to train at home in your spare time. Keep your present job while preparing for a better one, and earn \$5 to \$7 an hour extra in spare time while you train, fixing sets for friends and neighbors. NRI shows you how. Equipment you build and keep becomes useful in your work.

STEP UP TO BETTER PAY, A BRIGHTER FUTURE

NRI can help you, but the decision to act must come from you. Decide now to move ahead... mail the postage-free card today for your FREE NRI color catalog. No obligation. No salesman will call. NATIONAL RADIO INSTITUTE, Electronics Division, Washington, D.C. 20016.

APPROVED UNDER GI BILL

If you served since January 31, 1955, or are in service, check GI line on postage-free card or in coupon.

CASH IN ON THE BOOM IN COLOR TELEVISION



The NRI TV-Radio Servicing course includes your choice of black and white or color TV training equipment. Color TV needs thousands of trained men to keep pace with millions of sets being sold every year. NRI prepares you quickly. Cash in on the boom.

Mail insert card for your **FREE NRI color CATALOG**

No salesman will call



IMPORTS AND MOTORSPORTS

Comes the evolution

After 25 years of Beetle production, Volkswagen is about to begin importing some of the most changed cars in its history. The first will be the Passat (VW's version of the Audi Fox) in the four-door model



shown here, also in a two-door and a wagon. With a front-engine, water cooling and front-wheel drive, the Passat will replace the Squareback wagon and Fastback sedan in the VW lineup. The car is on a 97.3-in. wheelbase, is 165 in. long and it weighs just under 2000 pounds. Standard engine for the United States will be the 1.5-liter ohc Four. European versions are on sale now; we'll have it soon, and a name being considered for US is VW Dasher.

The second car, still on the drawing boards at Wolfsburg—probably on the test track by now—is a prototype small car. Small car is right. A little shorter than the Beetle, the car is a fwd mini resembling the Fiat 126 and 127. Will it replace the Beetle? Not right away—maybe another 25 years?

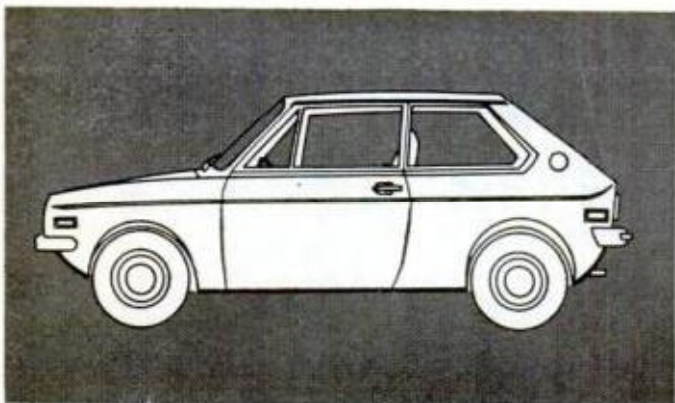

Save your neck

Conventional safety helmets protect the head, all right, but they'll get you in the neck. It's the back edge that does it when your head snaps back in a rear-ender, as shown in the drawing below.

A new helmet is designed to protect both the head and neck. The Saf-Tech helmet features a movable rear section called Nek-Gard. It absorbs the initial shock of col-

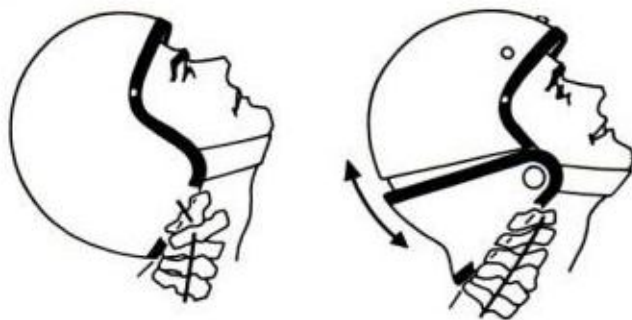

lision and distributes the forces over a larger area for a longer period of time than does the conventional helmet. For more information, write to Saf-Tech Inc., 211 Watson Blvd., Centerville, Ga. 31093.

Save your pennies

A free fact sheet listing more than 300 models of cars, both domestic and imported, and their miles-per-gallon ratings is avail-

(Please turn to page 62)

NO NONSENSE

SOME IDEAS FROM AC THAT MIGHT HELP IMPROVE YOUR GASOLINE MILEAGE

Spark Plug Misfiring Chart

Gasoline Mileage Loss (Test Results in Percentage When Spark Plugs Fail to Fire)		
Speed (m.p.h.)*	One Spark Plug Missing	Two Spark Plugs Missing
30	10.3% (loss)	34.6% (loss)
40	15.2% (loss)	36.7% (loss)

*Test conducted under simulated road load conditions on dynamometer stand

Yes, our spark plug engineers at AC have a number of "No Nonsense" ideas that may help improve your gasoline mileage.

1. It makes sense that generally you get better gasoline mileage if you drive at moderate speeds. Needless acceleration and jackrabbit starts can play havoc, too.
2. It makes sense to make sure your car is properly tuned according to factory specifications.
3. Whether you tune your car or have it tuned, we would like to recommend AC Fire-Ring Spark Plugs.

AC Spark Plugs are available most everywhere quality automotive parts are sold, so you'll have no trouble finding a set. And there's a set of ACs engineered to meet your car needs and driving conditions.

We believe our spark plug engineers' "no nonsense" ideas make a lot of sense. They're the experts who collected this test data to show the importance of spark plug performance and what can happen, should your spark plugs begin misfiring.



AC SPARK PLUG DIVISION

AC . . . for quick starts and a smooth-running engine

Special Limited Offer

Ending October 31st



A **FREE** gallon of Dacor Adhesive Mortar with every four-box purchase of high-quality Dacor Bricks . . . the original, beautifully authentic brick replicas, just $\frac{1}{4}$ -inch thick. Four boxes cover twenty square feet. Easy to apply. Work at your own pace... start and stop as you please. Six Dacor styles . . . See your authorized Dacor dealer. At leading building supply, home decorating and hardware centers.

Send 25¢ for booklet, "The Wonderful Things You Can Do with Dacor," to Dacor, Inc., Worcester, Mass. 01601.



IMPORTS AND MOTORSPORTS

(Continued from page 60)

able. The sheet is reprinted from Consumer News and the figures are based on EPA studies. Write Consumer Product Information, Pueblo, Colo. 81009.

Mystery vibrations

Race driver Dwight Mitchell was having handling problems when his Porsche 914 was set up for professional racing. He would lose traction in certain turns. It took another race driver and the head of Hewlett-Packard's dynamic analysis department, Hank Fallek, to find out that the problem was resonant vibration of the car frame. The rear wheels would lift almost an inch off the ground when the track surface



imparted vibrations to the car at the frame's natural frequency. H-P will soon be offering dynamic analysis to anyone who needs it. It's located at 1501 Page Mill Road, Palo Alto, Calif. 94304.

Speedy conversions

Speedwin Automotive Engineering is in the business of rally and race-car preparation. It does engine blueprinting and balancing, dynotunes engines and chassis, does custom machining and fabricates an extensive line of roll bars. It needed a quick reference for converting U.S., metric and Whitworth tool sizes and other metric values, so it printed one. You can get a copy by sending 50 cents to the company at 945 Motor Parkway, Hauppauge, N.Y. 11787. ★★★

You get a lot more out of Chilton's Auto Repair 1973...



Not just another how-to book, CARM '73 gives you all this . . . and much more.

In-depth coverage on new developments.

■ A separate section on troubleshooting all types of emission controls, to help you live within the standards. You test each system first, then isolate components one by one until trouble-spots are located. Tune-up procedures are explained in detail.

■ Special feature! A nontechnical discussion of the Wankel engine, describing its operating principles and comparing it with the present piston-type engines. Includes diagrams.

Special advantages.

■ Nearly 1500 pages, over 4000 illustrations . . . photos, exploded views; tables, charts . . . for all popular American cars, 1966-1973—including Jeep, and the new Olds Omega.

■ Information so comprehensive it helps you determine whether you should tackle the job, or have a garage do it . . . and helps you understand what the garage will have to do to correct the problem.

New feature! Complete section of Diagnostic Charts to help you check out each primary system and find where the problem is by a step-by-step process of elimination.

■ Both factory and "time-saver" procedures are given for certain jobs, so you have a choice.

■ Detailed instructions on components and subsystems, in a separate section.

■ Invaluable "cautions" and "notes" on possible problems . . . suggestions on special tools you may need to do some of the jobs.

■ Everything indexed. Color-coding throughout. Large, easy-to-read type.

■ Contents structured so you can find what you want at a glance.

...because we put a lot more into it.

We have a full-time staff of editors working on CARM the year round. Each one is not only thoroughly trained, widely experienced in all areas, he's also a specialist in one or more specific areas of automotive repair.

Our editors write CARM in its entirety, to make sure what you read is thoroughly proven, highly accurate. They apply common sense, and write in "people language." Basic information is selected carefully, expanded, and then interpreted . . . to make CARM '73 as useful as possible . . . to give you what you really need to know.

And best of all, CARM '73 costs no more than the usual how-to manual. You get all of CARM's exclusive advantages . . . for \$10.95.

Available now, at your local bookstore and automotive departments. Or mail the coupon with a check/money order to order your copy today.

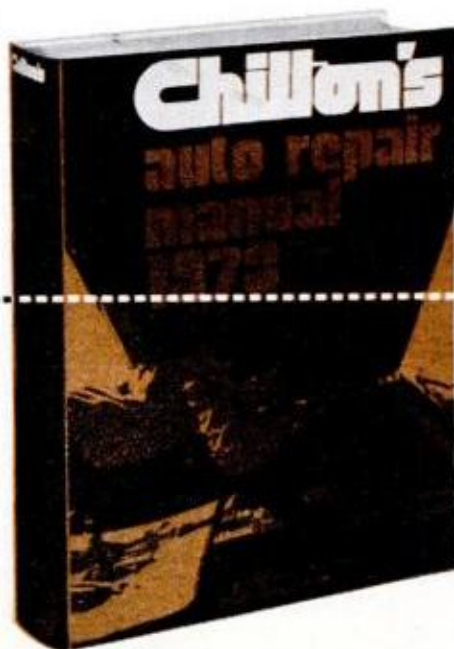

CHILTON BOOK COMPANY

Radnor, Pa. 19089

TO: CHILTON BOOK COMPANY
Dept. PM1073
Radnor, Pa. 19089

Please send me CHILTON'S AUTO REPAIR MANUAL 1973, for which I enclose check/money order for \$10.95, plus any applicable tax. If not satisfied with this book, I may return it postpaid, in clean, saleable condition, within 10 days for full refund.

Name _____
Address _____
City _____
State _____ Zip _____

HINTS

FROM READERS

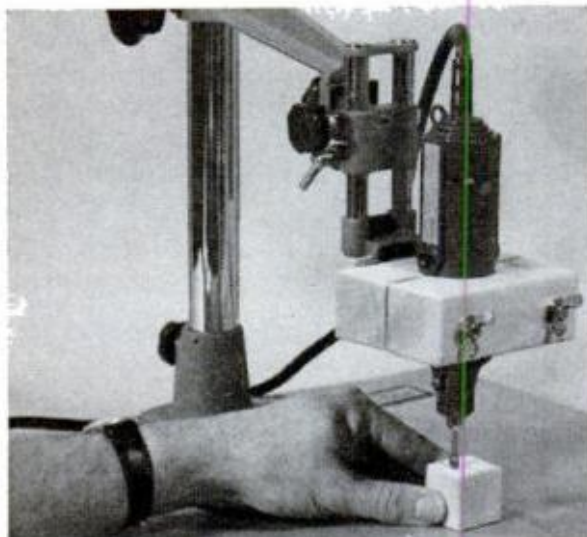

Copy stand makes drill press

I found that you can get double duty from a photographic copy stand if you equip it with blocks to hold a hand grinder. It not only becomes a miniature drill press, but also makes a dandy overarm router with fine adjustment for accurate work on small pieces.—*Ken Patterson, Regina, Sask.*



Painting furniture fittings

Drawer pulls, knobs and other furniture hardware are easier to paint when screwed to stiff cardboard that serves as a handle for them—and a convenient place for them to dry, too.—*William Swallow, Brooklyn.*

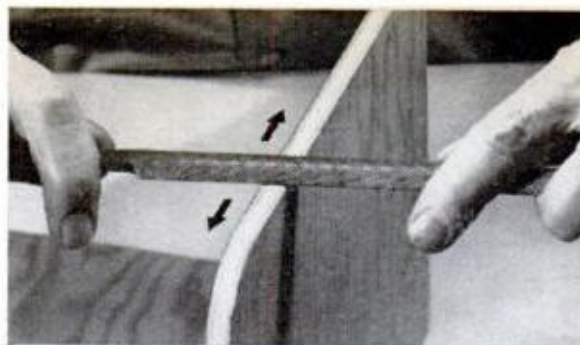

Smoothing plywood edges

To reduce splintering when smoothing the edge of a plywood panel with a wood rasp, use the rasp like a draw file. Hold it as shown above and move it back and forth parallel to the edge.

—*Walter E. Burton, Akron, Ohio*

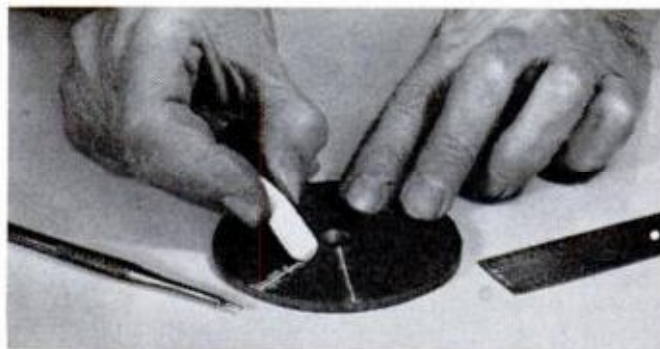

Making scribed lines visible

If layout lines scratched with a scribe on a dark-colored surface are difficult to see, try rubbing chalk crosswise into each line, removing excess with a finger.

—*W. B. May, Oak Park, Ill.*

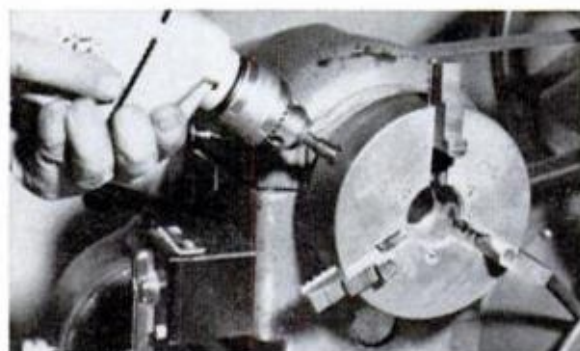

Speedy chuck operation

To save time opening and closing the jaws of my lathe chuck, I use a reversible variable-speed drill with a socket drive instead of the regular chuck key. Works on a four-jaw chuck as well.—*Wilson Moore, Lexington, Ky.*

100 mm. long, yet
LOWER IN 'TAR'
than the best-selling 70 mm.



PALL MALL
GOLD 100's

The longer filter that's long on taste

PALL MALL GOLD 100's... "tar" 20 mg. - nicotine, 1.4 mg.
Best-selling 70 mm. "tar" 25 mg. - nicotine, 1.6 mg.
Of all brands, lowest "tar" 1 mg. - nicotine, 0.1 mg.

Warning: The Surgeon General Has Determined.
That Cigarette Smoking Is Dangerous to Your Health.

20 mg. "tar" 1.4 mg. nicotine av. per cigarette, FTC Report FEB. '73.

ALL OUTDOORS

Shotshell efficiency

A definitive study has finally been made to examine alternatives to the lead shot found to be causing lead poisoning in ducks. In 1959, it was estimated that between two and three million waterfowl would die after eating lead shot scattered over their feeding areas from spent shells. Alternatives suggested have included steel and copper shot.

Now researchers at Nilo Farms, Winchester-Western's experimental and demonstration shooting preserve near Alton, Ill., have completed tests with 2400 pen-reared mallards under closely controlled conditions, working with conservation personnel and statisticians of the U.S. Bureau of Sport Fisheries and Wildlife, the University of Wisconsin, and wildlife conservation technicians from 10 states. Research confirmed the contention that shotshell effectiveness depends on the striking energy of each pellet, efficiency with which the pellet delivers energy, and the number of pellets striking vital areas on target.

Results indicate that, though the increase in barrel deformation caused by steel shot is minor, the shorter range of steel may cause fewer ducks to be bagged and create many more cripples—a projected number, in fact, as large as the estimated losses from lead ingestion. It would appear from this study that more research should be done before a decision is made to replace lead shot with a less effective substitute.

(Please turn to page 68.)



Jeep Renegade (top) is now a production model for 1974, and sports utility Cherokee (above) is new addition to the famous line. All models will be available in nine colors. Renegade features roll bar, heavy-duty cooling, padded instrument panel, forged aluminum wheels. Cherokee will offer Quadra-Trac full-time four-wheel drive, a 401-cu.-in. engine, stick shift or automatic transmission, front power disc brakes. Wagoneer and pickup are the other Jeep models.

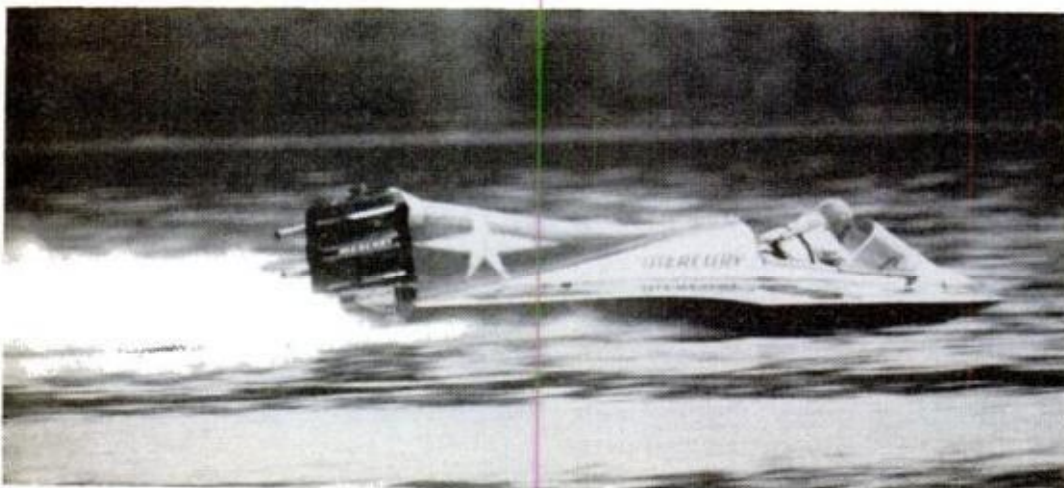

New world's record for outboards was set in August at 136.138 mph by a 100-cubic-inch Mercury, mounted on a Twister-craft three-point hydro driven by Jim Merten on the Fox River outside Kaukauna, Wis. The new record, totaled from two runs over a one-kilo course, tops Evinrude's 1966 record on Lake Havasu by more than five mph.



Great One George Bignotti says:
**"Save big money on S-K®
 Golden Warranty Specials"**

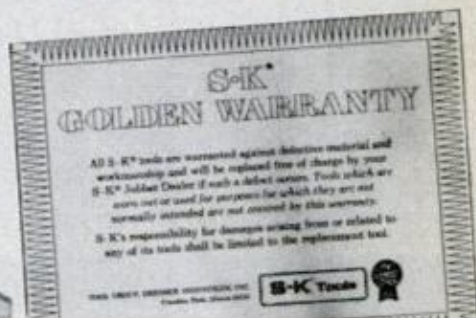

Mechanics like George Bignotti, winner of more Indy 500 races than any crew chief, uses S-K tools at the track. And at home for "fix-it" jobs.

Whether a professional or home handyman, you'll like the famous S-K reversible ratchet. Lets you at difficult-to-reach places . . . breeze through tough jobs.

As Great One, George Bignotti, says: "You can't buy better. The Golden War-

ranty is proof. And right now they're on sale at hardware and auto parts stores."

All American Made



TOOL GROUP, DRESSER INDUSTRIES, INC.
 Franklin Park, Illinois 60131



© 1973 Tool Group,
 Dresser Industries, Inc.

SAVE \$21.99

21 pc. 3/8" drive Socket Set with famous S-K ratchet, No. 4521-9. Includes 9 standard sockets; 8 deep sockets; 2 extensions; universal joint and reversible ratchet.

Separate purchase price: \$42.98

\$20⁹⁹*



*Suggested user price



SAVE \$14.70

14 pc. 3/8" drive Metric Socket Set with S-K ratchet, No. 14-9. Includes 10 metric size sockets; spark plug socket with neoprene insert; 2 extensions; S-K reversible ratchet.

Separate purchase price: \$29.69

\$14⁹⁹*

SAVE \$2.89

4 pc. Ratcheting Box Wrench Set, No. 340-9. Includes 4 wrenches in vinyl pouch.

Separate purchase price: \$16.87

\$13⁹⁸*



SAVE \$1.34

7 pc. 3/8" drive Hex Bit Socket Set, No. 19707-9. Includes 7 sockets. Replaceable hex bits.

Separate purchase price: \$11.83

\$10⁴⁹*



Our policy: complete satisfaction or return for free replacement (Warranty administered at point-of-sale)

ALL OUTDOORS

(Continued from page 66)



Fifth-wheel trailer towing with a passenger car is claimed for this new two-wheel \$545 hitch, reported to attach in minutes with ordinary tools, still allow trunk access. From Winter Welding, York, Pa.

Space-age fishing

A preview of new fishing gear for 1974 indicates the well-equipped angler may have along electronic equipment to measure bottom depth and structure, schooling depth, temperatures, oxygen content and light transmission from the surface. Lures smell and taste good, swim, shimmer and rattle.

Coming outdoor events

Oct. 1-4, Police Combat Pistol Championships, National Rifle Assn., Jackson, Miss.; Oct. 4-7, Midwest Powerboat Show, Mount Clemens, Mich.; Oct. 4-8, U.S. Sailboat Show, Annapolis, Md.; Oct. 6-7, Regional High Power Rifle Championships, N.R.A., Fort Riley, Kans.; Oct. 12, Miami-Nassau Power Race, Miami, Fla.; Oct. 11-14, U.S. Powerboat Show, Annapolis, Md.; Oct. 11-14, Great Lakes Sailboat Show, Mount Clemens, Mich.; Oct. 19-24, Miami Dinner Key Boat Show, Miami, Fla.; Oct. 20-28, Western Zone Confederation Rifle Championships, Mexico City. ★ ★ ★



Cool-weather coat designed for side-liner with clipboard, Coaching Jacket with front pocket big enough for boxes of shells or thermos of hot buttered Ovaltine is by Harvard of Hillsdale, Litchfield, Mich.

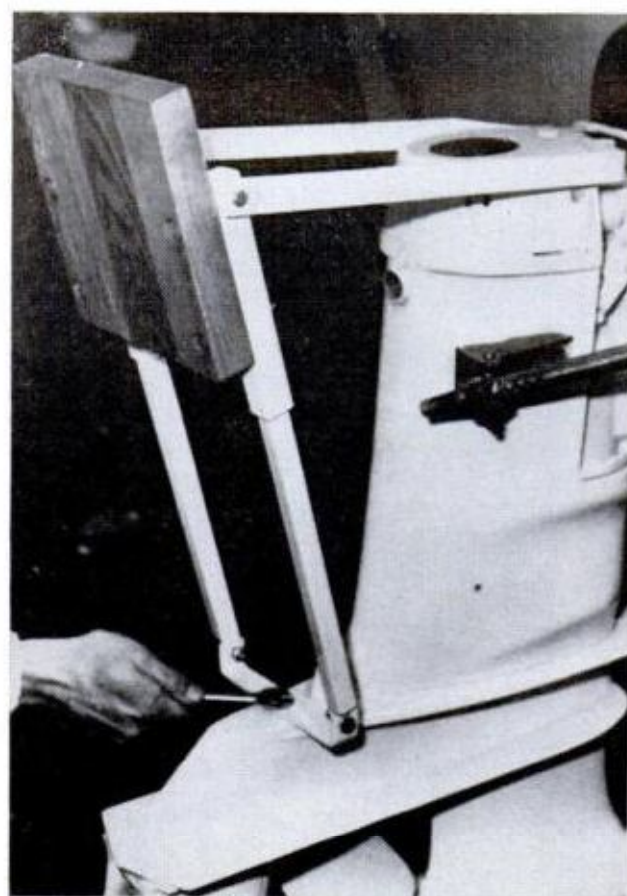

An outboard motor can piggyback aboard inboard/outboard for emergency use or inshore trolling with new bracket by N.A. Taylor, Gloversville, N.Y. Models fit standard stern drives, sailboats.



NRI gives you the professional testing equipment and tools you need. Illustrated is the equipment you get with the NRI Master Automotive Technician's Course. Equally complete materials come with the Courses in Air Conditioning, Refrigeration and Heating.

Now you can learn these two well-paid skills at home... in your spare time

1 NRI AUTOMOTIVE SERVICING
You get hands-on experience and the finest professional tools

Learning to service automobiles can be easy, exciting and profitable, the NRI way. You learn step-by-step proceeding at your own rate of speed and the courses are complete and professional in every way.



Richard Petty, America's winningest stock car racer and NRI Automotive Consultant, says, "NRI training gives you the kind of solid background you need to launch a career as a master mechanic, or to learn what you have to know to take good care of your own car. I especially like the "bite-size" lessons, and how NRI has covered practical service work... so a guy can learn with his hands."



Your choice of two courses...

NRI gives you a choice of Master Automotive Technician training or a shorter Automotive Tune-up and Electrical Systems course for the man seeking greater understanding of basic car repair. With the Master Course, you get—at no extra cost—your own ignition analyzer scope (an NRI exclusive!), as well as a dwell-tachometer, timing light, complete set of tools, volt-amp tester, and assorted gauges.

APPROVED UNDER GI BILL—If you have served since January 31, 1955 or are in the service now, check GI line in the coupon.



NRI TRAINING
3939 Wisconsin Avenue, NW,
Washington, D.C. 20016



2 NRI AIR CONDITIONING, REFRIGERATION & HEATING
Get in on the ground floor of a really growing industry

The NRI Air Conditioning, Refrigeration and Heating courses qualify you quickly to step into a high-paying career or part-time job. The programs were developed with technical assistance from the York Division of the Borg-Warner Corporation.



Enrollees in the Master Course may take an optional week of advanced laboratory work at the famous York Institute at no extra cost.

Exclusive Training Units

NRI training units include a Circuit Demonstrator for circuit studies, and a Control Simulator for learning the fundamentals of electric controls.

Window Air Conditioner

With the NRI Master Course, you receive a complete 5,000 BTU window air conditioner for system troubleshooting and your personal use.



NRI Training, 3939 Wisconsin Avenue, Washington, D.C. 20016

Please send me the free catalog I have checked below. I understand there is no obligation. **No salesman will call.**

I am interested in: CHECK ONLY ONE

- AUTOMOTIVE SERVICING 946-103
 AIR CONDITIONING, REFRIGERATION, 513-103 AND HEATING

Name _____ Age _____
(Please Print)

Address _____

City _____ State _____ Zip _____

Send me facts on GI Bill

Accredited Member National Home Study Council

RUSH COUPON FOR ONE FREE NRI CATALOG

No Salesman Will Call



GOOD FOR 10,000 BATHS

Rub-a-dub-dub, put GE Bath-tub Seal around your tub. It's made of silicone. So it's guaranteed for 10,000 baths or 10 years—whichever is longest. Permanently flexible, waterproof and mildewproof, it won't crack, dry or shrink. What's more, it adheres to most materials including ceramic, porcelain, metal, glass. So get a tube at your hardware counter. Squeeze it on and start counting baths. One, two, three, four, five, six, seven, eight, nine, ten.....

GENERAL  ELECTRIC

Sun 'n' Snow Tire.

The Seiberling Four Seasons, the original asymmetric snow tire. Powers through snow, hugs slippery surfaces. Yet runs like a whisper on dry pavement. As good a tire in summer as in winter. Drive in to your Seiberling dealer now, and drive out on a better road. Call toll-free for your nearest Seiberling dealer: 800-447-4700. (Illinois residents call 800-322-4400.)

NFL HAT \$1.99

For a limited time, your Seiberling dealer is offering an official NFL Action Hat—a washable, warm acrylic knit stocking cap. Official team colors and team insignias. Only \$1.99.



 **Seiberling. The Better Road.**

PUBLICATIONS WORTH WRITING FOR

PM'S PICTURE-TOOLS are a great new idea to take the confusion out of *what goes where* on workshop and tool panels.

The complete PM PICTURE-TOOL KIT consists of seven big sheets (9¾ x 11¾ in.) of a special heavy-weight paper with a pressure-sensitive adhesive on the back. On each sheet are beautiful drawings of hand tools and portable power tools—all you're likely to have in your shop (74 in total). Most are full size; the others nearly so.

Also enclosed in the kit is a blank sheet of the same special paper, printed in an overall color to match the tools. This sheet enables you to design your own drawings of special tools.

Each of the PM PICTURE-TOOLS is carefully die-cut. You simply peel off the backing paper and apply it to the proper spot: on painted or unpainted wood, plywood, hardboard and even perforated-hardboard surface.

Later, if you want to move a few tools or rearrange the entire panel, you can peel off the PM PICTURE-TOOLS and reuse them in new locations!

Once your PICTURE-TOOLS are in place, you'll know at a glance exactly where each tool belongs.

Order your PM PICTURE-TOOL KIT today. Simply send a check or money order for \$3.95 to Popular Mechanics, Dept. PT, Box 1014, Radio City, New York, N.Y. 10019. Be sure to enclose your name and address. ★★★

I LIVED LIKE A KING... AFTER I LEARNED HOW TO MAKE \$2,000 A DAY... YOU CAN TOO!

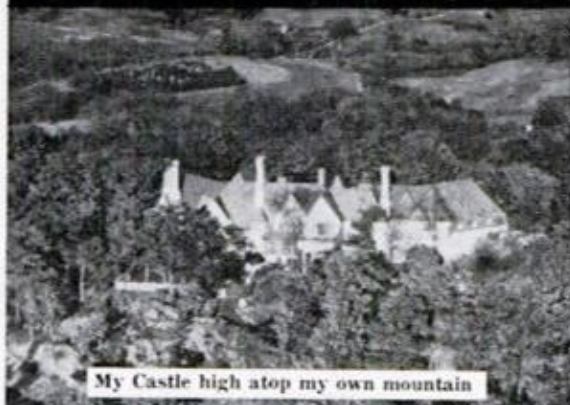

My Castle high atop my own mountain

IF YOU WANT TO BE RICH!



My dream came true by Copying Success

I WILL TEACH YOU MY SECRET OF COPYING SUCCESS!

THERE ARE 3 WAYS TO BECOME RICH. One is to be born rich, two is to have wealth thrust upon you and three is to achieve wealth. If you were not born rich, forget it, wishful thinking won't help. Some hope for a rich uncle to remember them in a will. There is also the Lottery Ticket Type who reads travel folders while waiting for his number to be called. Waiting for wealth to fall on you is one of the most popular yet least successful ways of becoming rich. If this is your present system, forget it. **STOP DREAMING, WAKE UP, YOU MUST MAKE IT HAPPEN!**

YOU MUST COPY SUCCESS!

I have proven that a fortune can be made in a brief period if a person knows how. I can show you how to do it too. Why would I share my secret to success? Simply because it gives me a great feeling of satisfaction helping others to find their fortunes as I did. I will also probably make another fortune myself from these ads that are appearing all over this great country.

STOP USING EXCUSES NOW

Age, education, capital are unimportant in this system of making money. There are no degrees needed to be rich. I was going nowhere for years, then the opportunity to copy success came and I grabbed it, then my success story unfolded. I had problems too. I was born poor, quit school, washed dishes for 3 months and daydreamed about how to make a better life. I got married and had children and worked selling everything from garbage cans to correspondence courses. I even worked on the side as a mechanic and joiner. I worked 60 hrs. a week but ended up with so many debts and loans it seemed hopeless. We even took in boarders to make ends meet. I'm not talking about the depression years, I'm talking about just twelve years ago. I'm sure there are many going through the same thing, right now.

OPPORTUNITY UNFOLDED

right before me, just as this page is unfolded before you, not by plan but by chance. I was out selling and stopped into a man's office just at a moment when he was

counting what looked like thousands of dollars right there in front of my eyes. I just stood there in awe for a couple of minutes just looking at all that money. It wasn't bundled like from a bank, just loose bills crumbled on a desk in a pile about a foot high. The longer I stared the bigger that pile looked. I'll never forget that day because it was the beginning of the change I needed and wanted in my life. That man was making thousands of dollars a day and he had been doing it for years. He was a millionaire. I had to find out how he was doing it. I made up my mind to copy his secret or method or whatever it was that made him rich. I went to work for that man the next day. For 6 months I watched, listened and studied everything that man did. I learned the secrets this man developed in ten years of success. I put these methods to work on a limited basis at first because I had only limited money.

THEN IT STARTED WORKING FOR ME

I got out of debt and before I knew it I had made a fortune, more money than I imagined even in my day dreams.

Almost overnight people were calling me a genius. I was written about on the front page of the Wall St. Journal. People were coming to me for advice. I had a mansion in town. I owned buildings with rents coming in. I even bought a 55 room castle atop my own mountain with swimming pool, tennis court and gardeners. I owned Lincolns and Cadillacs. My family and I traveled. We were suddenly financially successful and we did it by our secret of copying success.

I OFFER YOU OPPORTUNITY

even greater than my own. I offer to share with you my secrets for success that I have proven can work. Now I am going to ask you to send me ten dollars for sharing this way to wealth. The information I mail will cost me less than ten dollars and I hope to make a profit (less the cost of this ad). I am sure you will not begrudge me making a profit, after all, it might make you rich. I would gladly have paid a thousand dollars 12 years ago for the key to success. You should never expect something for nothing. If you are not satisfied I will return your payment. Never give away ideas, they may be worth millions. Start thinking right now about making money and stop worrying about losing ten dollars. Ten dollars won't even pay for a parking ticket in some cities. By the way, you can examine the information I send you for ten days and return it for a full refund if your not completely satisfied. All your risk is really an eight cent stamp.

NOT A BOOK OR FRANCHISE

I'm not offering you a stock scheme, merchandise or equipment. You won't have to leave your job, knock on doors or get your friends to do it for you. No working in a cellar either. This is excellent for women too. It's possible to make more money at home than their husbands make at work.

I will not just tell you about my success story, but rather... I will introduce you to your own!

You can have cash coming in every day even when you're sick or on vacation. Even holidays can't stop the cash flow of my system. Sound exciting? You bet it is. You will need lots of confidence in my system and very little money to get started. People with little capital

must have daring and be willing to take a chance if they want to make lots of money. If you have ten dollars worth of daring after reading this offer, I strongly urge you to put it in an envelope and I promise to show you how to change your life.

OTHERS GOT BACK THOUSANDS BECAUSE THEY BELIEVED IN ME AND MY SYSTEM NOT ONE LOST.

One man made \$30,000 in just six months using my secrets. I taught him what I will teach you and now he is independent. People from all walks of life have used my idea: A teacher, janitor, lawyer, housewife, chemist, salesman, secretary and even a policeman. **NOT ONE EVER LOST A PENNY.** I cannot promise you will make as much money as I but then again you may make more.

OPPORTUNITY IS NOT JUST KNOCKING AT YOUR DOOR... IT'S ALMOST KNOCKING YOUR DOOR DOWN!!!

This is the chance you have been dreaming about... **NOW TAKE IT!** Your risk is only a stamp, your money is refunded if you find I'm wrong. **BUT.....**

\$ \$ WHAT IF I'M RIGHT \$ \$

It might make you rich. **RUSH ORDER FORM**

MAIL THIS COUPON and \$10.00

To: M.O.I. Incorporated Dept. 82
Suite 1002
500 5th Ave.
New York, N. Y. 10017

Please send your offer on a ten day trial. I understand that I may return for refund if not satisfied.

Name _____
Address _____
CITY _____ State _____ Zip _____

WORTH WRITING FOR

LOOKING FOR IDEAS AND INFORMATION ON HUNTING, FISHING, CAMPING, BUILDING, TOOLS, ETC.? CHECK THESE LISTINGS, THEN USE THE COUPON BELOW.

200. THAT TIFFANY TOUCH!

Tiffany's 5th Ave. offers their new fall catalog. Beside jewelry, Tiffany's incomparable collections of watches, silver, china, crystal and stationery are illustrated in over 100 color pages. Unusual small gifts are featured, too, and don't think they all cost a million. Many are priced between \$5 and \$100. And all have that special Tiffany touch. \$1.00.

201. THE KEY TO LOCK BUYING

Illustrated pamphlet describes how to buy, choose, and install locks so that they can give you the maximum security. From Schlage Lock Co. Free

202. SCOPE THIS OUT

A full-color catalog that looks more like an expensive hunting and shooting magazine gives full details on entire line of Weaver Gun Scopes as well as instructions on their proper use. From W. R. Weaver Co. Free.

203. END NOISY TOILET TANKS

Full brochure gives complete details of revolutionary ballcock that checks all leaks, squeaks & whistles. And, you install it yourself. From Fluidmaster. Free.

204. HELP YOUR HI-FI

Excellent brochure gives you the facts about the advanced capabilities of the new Memorex Cassette Tape with MRX Oxide. Helps you understand why some recording tapes are noticeably better than others. From Memorex Corp. Free

205. "QUICK & EASY" VACATION HOMES

Planning Guide gives full details

and plans on how you can build the vacation home of your dreams! Excellent information kit shows you the way. From Wickes Lumber Div. \$1.00.

206. A BREAKTHROUGH IN THE BASEMENT!

Fully illustrated booklet gives full specifications and plans on how to break through the foundation wall and build a direct outside basement entrance. Opens up basement space for recreation and storage. From the Bilco Co. Free.

207. 1973 SPORTSMAN'S DISCOUNT CATALOG

Everything for the outdoorsman from fishing tackle and camping to backpacking at rock bottom prices. Sports Liquidators. Free.

208. HOW TO USE POWER TOOLS

This 48-page "Power Tool Handbook" is packed with useful information on how to get the most of your stationary power tools. Basic facts, short cuts, and practical suggestions. Packed with "How-to-do-it" illustrations. From Toolkraft Corp. 50¢.

209. A SHORT COURSE IN NATURAL WOOD FINISHES

Comprehensive, well-illustrated manual covers all phases of natural wood finishing—from kinds of wood to equipment to the actual finishing itself. From Pierce & Stevens Chemical Corp. 25¢.

210. HI FI KITS FOR THE PERFECTIONIST

Full-color 20-page brochure of easy-to-build hi fi components,

4-channel adapter which needs no new amplifier, and popular speaker systems. Plus 24-page booklet of published test reports. From Dynaco Dynakits. Free.

211. FUN-FILLED CATALOG

New, world famous catalog of 1,600 hard to get novelties, jokes, tricks, hobbies, sports, science, electronics, emblems, posters, bargains and many more. From Johnson Smith Co. Free.

212. HOW TO WORK WITH PLEXIGLAS

Useful booklet gives a world of information on every way you can work with Plexiglas. Includes cutting, drilling, routing, shaping and sanding. Highly recommended. From Cadillac Plastic Co. Free.

213. CRAFT FINISHES CATALOG

Beautiful catalog illustrates and describes full-line of craft finishes, new display units and several Judy Martin Craft Products. From Illinois Bronze. Free.

214. FISH THE EASY WAY

Find fish the way the experts do. Take the guesswork out of your weekend and put science on your side! Get all the facts on the "Sentry Oxygen Monitor". From Bass-Ox, Inc. Free.

215. GAS OIL ELEC.—TIME TO THINK OF HOME HEATING NEEDS

General Electric has specifications sheets available on three types of furnaces . . . gas, electric, and oil. Specify which one. Free.

POPULAR MECHANICS 1073
BOX 1718, SANDUSKY, OHIO 44870

This coupon expires December 31, 1973

Please see that I receive the items checked below. I have enclosed 35¢ for the overall service charge, plus remittance for any priced items.

- | | | | | |
|---------------------------------------|---------------------------------------|------------------------------------|------------------------------|-----------------------------------|
| <input type="checkbox"/> 200 (\$1.00) | <input type="checkbox"/> 204 | <input type="checkbox"/> 208 (50¢) | <input type="checkbox"/> 212 | <input type="checkbox"/> 215 GAS |
| <input type="checkbox"/> 201 | <input type="checkbox"/> 205 (\$1.00) | <input type="checkbox"/> 209 (25¢) | <input type="checkbox"/> 213 | <input type="checkbox"/> 215 OIL |
| <input type="checkbox"/> 202 | <input type="checkbox"/> 206 | <input type="checkbox"/> 210 | <input type="checkbox"/> 214 | <input type="checkbox"/> 215 ELEC |
| <input type="checkbox"/> 203 | <input type="checkbox"/> 207 | <input type="checkbox"/> 211 | | |

Total items requested _____ Total money enclosed _____

Name _____
(Please Print)
Address _____

Town _____ State _____ Zip Code _____

(Please send cash, check or money order made out to POPULAR MECHANICS. No stamps please.)

NOTE: POPULAR MECHANICS processes your requests for the above information and forwards these inquiries to the organization making the offer. Each company mails the material directly. Please allow 4-6 weeks for delivery. Unfortunately, we are unable to process requests outside of the U.S. and Canada.

- ★ *Family sedan*
- ★ *Pick-up truck*
- ★ *Mini-car*
- ★ *Motorhome*
- ★ *Power boat*
- ★ *Van*
- ★ *Tow vehicle*
- ★ *Camper*
- ★ *Station wagon*
- ★ *Off-road buggy*

**POPULAR
MECHANICS
PRODUCT FEATURE**

If you drive one of these ...you need an **EDELBROCK MANIFOLD.**

Performance improvements you can feel in the seat of your pants — easier starting, throttle response, overall smoothness and driveability — **without** sacrificing economy or increasing exhaust emissions... all of these result from installation of an Edelbrock intake manifold.

Regardless of vehicle type, you'll gain more useable power for passing, pulling, cruising, and climbing; and improved engine efficiency gives better gas mileage and lower emissions.

Edelbrock manifolds are easy to install; come with complete, bolt-on instructions; and accept all stock hardware and emission equipment.

See your local Edelbrock dealer, J.C. Penney, Sears, or Montgomery Ward or send \$1 for complete catalog.

Edelbrock
WHERE GREAT IDEAS TAKE SHAPE

411 Coral Circle, Dept. PM-1073, El Segundo, Calif. 90245



**JOIN THESE SHARP-ALL
MONEYMAKERS**

"I average \$5.00 an hour part time and business gets better all the time."

*Robert Barrett, Jr.
W. Springfield, Mass.*

"My Sharp-All shop is now averaging me \$300.00 a month."

*Roy Jennings
Sandwich, Illinois*

"Think the world of my Sharp-All. Am grossing \$4,000 a year on a part-time basis."

*Lawrence Stevenson
E. Syracuse, New York*

"There's excellent profit in sharpening... we now do about \$600.00 a month."

*Ed Kistler, Jr.
Sarasota, Florida*

**Makes Over \$60 EXTRA a Week In
His Own Sharpening Shop**

"My Belsaw Sharp-All made me an extra \$3,500 last year. Now I am going full time. It's great to be your own boss."

DAVID SWANSON — Utica, Michigan



Let Belsaw prove
YOU can do it, too! On our
30-DAY FREE TRIAL OFFER

You risk nothing by accepting this offer to see how easily you can turn your spare time into big Cash Profits with your own Complete Sharpening Shop. No selling... no previous experience needed. Our famous Sharp-All and show-how instruction set you up to make \$200, \$500, \$700 a month CASH sharpening Saws, Knives, Scissors, Lawnmowers, Shop and Garden Tools... all cutting edges.

**SEND FOR
FREE FACTS!**

Our Free Book tells how to start a profitable, lifetime home sharpening business, how we help you grow, how we'll finance you.

**BELSAW SHARP-ALL CO.
714T Field Bldg.
Kansas City, Mo. 64111**

RUSH COUPON TODAY!

No Obligation... No Salesman Will Call

BELSAW SHARP-ALL CO. 714T Field Bldg., Kansas City, Mo. 64111
Send details of FREE TRIAL OFFER and Free Book "Lifetime Security"

NAME _____
Address _____
City _____ State _____ Zip _____

PHOTO HINTS

FROM READERS

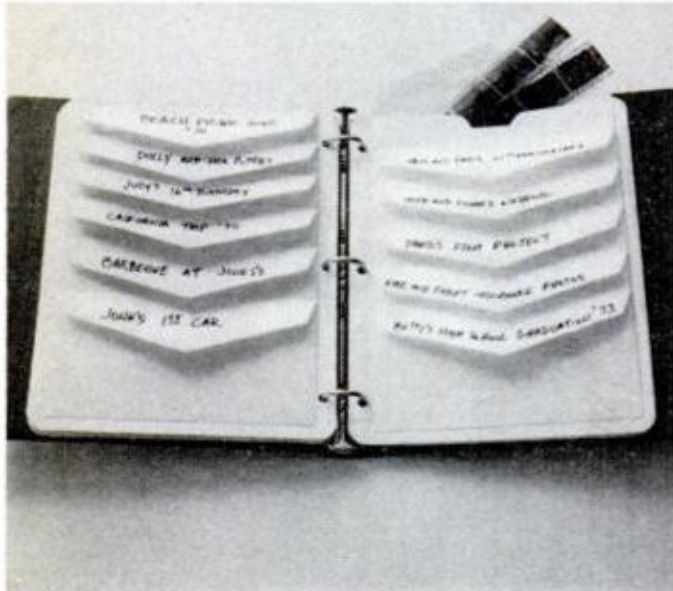

Envelopes make loose-leaf album for storing negatives

Here's an easy way to file your negatives where you can find them again. Glue No. 6- $\frac{3}{4}$ (3- $\frac{5}{8}$ x 6 $\frac{1}{2}$ in.) envelopes to loose-leaf notebook pages, four or five to each side of the paper, overlapping them so that only the flaps are visible. Identify the negatives in each envelope by writing the subject name or film number on the flaps. Then file in a ring binder. If you have a lot of negatives, you can restrict each page to negative subjects starting with the same letter, then file them between alphabetical index separator pages.—*Margaret Shauers, Great Bend, Kans.*

Easy, under-shelf enlarging-lens rack

If you use more than one size of film, you'll need more than one enlarging lens—and a place to store whichever lens isn't in use. Two slotted lumber scraps under a dark-room shelf will hold the lens handily, complete with lens board. The shelf will help keep dust off the lens; but if you have lens caps, use them.—*Val Hawes, Brea, Calif.*

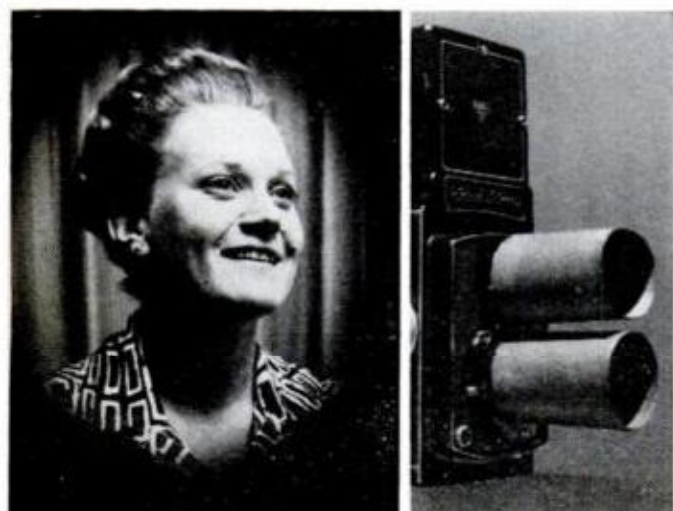
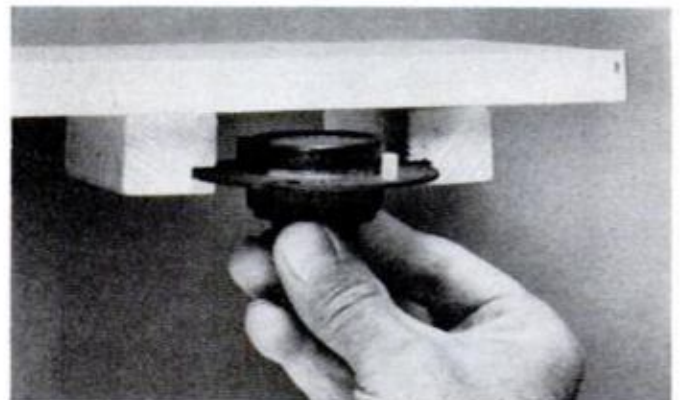

Cardboard tube makes simple vignetting device

A simple effective vignetter may be made by cutting a toilet paper roll in two, painting its interior flat black, and carefully slipping it over the lens (or into a filter adapter ring) of a reflex camera. For a twin-lens reflex, use two identical vignettors. To vary the effect, change tube lengths: a longer tube will vignette more, a shorter one will vignette less.—*Arthur L. Rouleau, Fullerton, Calif.*

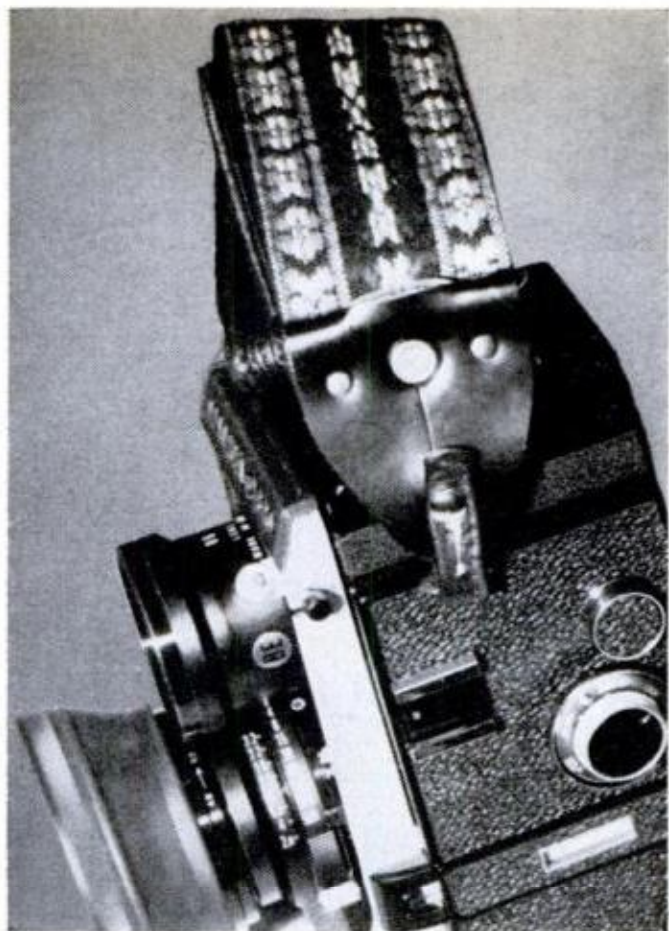

Guitar strap eases camera load

Ever need relief after carrying a camera and gadget bag around through a full day's shooting? Most weekend photographers overload themselves with gear, then suffer aches and pains from muscles they don't use during the week unless they're postmen. In my case, a touch of arthritis made me look for something easier on my shoulders than the narrow straps and pads now sold for photo use. I found the answer in colorful, extra-wide guitar straps—two-inch straps for my camera and three-inch for my gadget bag—distributing the equipment's weight over the largest possible body area, and relieving muscular strain. The straps are strong enough to carry your equipment safely, and they can cost less than a good strap pad.

To mount them, cut your camera and gadget-bag straps down to three-inch stubs, and have a shoe-repair shop stub-rivet the stubs to the guitar strap's leather tab end.
—Joseph F. Stoffel, Huntsville, Ala.

Minolta helps you spend more time with the baby and less time with the camera.

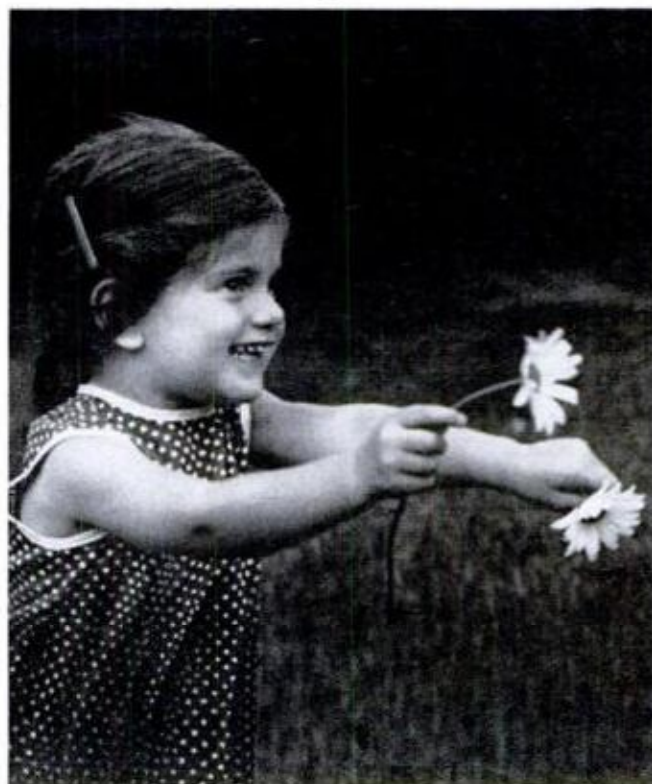

If you think babies are fun to photograph, but more fun to play with, try an electronic Minolta Hi-matic F.

With this 35mm camera, you never have to spend time making adjustments. Because the Hi-matic F sets itself automatically for one perfect picture after another. Indoors or out, with or without flash, all you do with a Hi-matic F is point, focus and shoot. Even time exposures are automatic.

Besides being easy to use, the Hi-matic F is easy to take. Just slip it in a pocket and you're ready whenever the baby is.

Try a Minolta Hi-matic F and start taking pictures for the fun of it. For more information, ask your dealer or write to Minolta Corp., 200 Park Ave. So., N.Y., N.Y. 10003. In Canada: Anglophoto Ltd., P.Q.



Minolta Hi-matic F. The pocketable electronic.

LIVE IN THE WORLD OF TOMORROW... TODAY!

A BETTER LIFE STARTS HERE

NEW! FORD TURBINE ENGINE KIT



Think Wankel's great? Build a 1/4 scale model of Ford's revolutionary, "better" answer for a clean-burning economy engine! Harnesses power prev. used in jets w/ ingenious engineering like exhaust regenerator, variable power turbine nozzle, electronic control system. Exact detail model shows actual working compressor, gears, turbine, regenerator, power output shaft; glowing combustion chamber. Batt. oper. (2 "AA" not inc.). Instruments, Stock No. 71,851H\$12.95 Ppd.

"FISH" WITH A GIANT MAGNET

Go Treasure Hunting On The Bottom! Fascinating fun, and sometimes very profitable! Tie a line to our 5-pound Magnet—drop it overboard in bay, river, lake or ocean. Troll it along the bottom. Your "treasured" haul can be outboard motors, anchors, other metal valuables. Five-pound Magnet is war surplus—Alnico V Type that cost the Government \$50. It lifts over 150 pounds on land—much greater weights under water!



Stock No. 70,571H\$14.00 Ppd.
Stock No. 70,570H... 3 1/2 lbs... \$8.75 Ppd.
Stock No. 60,215H... 1 1/2 lbs... \$5.75 Ppd.

GIANT WEATHER BALLOONS—8' or 25' DIAMETER



"Balls of fun" for kids, traffic stoppers for stores, terrific for amateur meteorologists. Create a neighborhood sensation. Great for decorations, launching radio controlled airplanes, scuba diving markers, etc. Amateur meteorologists use to measure cloud heights, wind speed and temperature. Made of thin neoprene designed to burst at high altitudes. Inflate carefully with vacuum cleaner or auto air hose; or locally available helium for high rise.
Stock No. 60,568H (8' size) \$ 2.50 Ppd.
Stock No. 60,637H (25' size) \$13.95 Ppd.

(And our FREE CATALOG is packed with exciting and unusual ecological & physical science items—plus 4,500 finds for fun, study or profit . . . for every member of the family.)

3" ASTRONOMICAL TELESCOPE



See moon shots, orbits, stars, phases of Venus, planets close up. 60 to 180 power. New improved aluminized, overcoated 3" diam. f/10 primary mirror, ventilated cell. Equatorial mount with locks on both axes. 60x eyepiece and mounted Barlow lens. 3x finder telescope, hardwood tripod. FREE: "Star Chart," "How To Use Your Telescope" book.
Stock No. 85,050H\$34.95 Ppd.
DELUXE 3" REFLECTOR TELESCOPE
Stock No. 80,162H\$62.50 Ppd.
4 1/4" Reflector Telescope with Clock Drive
Stock No. 85,107H\$14.00 Ppd.
4 1/4" REFLECTOR TELESCOPE (45x to 270x)
Stock No. 85,105H\$10.00 Ppd.
6" REFLECTOR TELESCOPE (ELECTRIC) CLOCK DRIVE
No. 85,086H\$215.00 FOB
.....\$249.50 FOB

RESTORE MOST METAL SURFACES

. . . in minutes with ingenious Electroplating Kit. Brush on or dip for durable finish on 1000's of things: jewelry, guns, antiques, cameras, silver, printed circuits, parts of car bumpers, scopes. Safe, non-cyanide process makes objects like new almost instantly. Kit has all you need except 2 AA batt for up to 100 sq. in. Instr.



No. 61,003H(SILVER)\$11.00 Ppd.
No. 61,004H(GOLD)\$8.00 Ppd.
No. 61,005H(CHROME-LIKE)\$9.00 Ppd.
No. 61,009H(BLACK VELVET)\$10.00 Ppd.

TERRIFIC BUY!

AMERICAN MADE! OPAQUE PROJECTOR



Projects illustrations up to 3" x 3 1/2" enlarges them to 35" x 30" if screen is 6 1/2 feet from projector. You get even larger pictures if screen is farther away. No film or negatives needed. Primarily intended for children, this unit projects charts, diagrams, in color or black & white. 115v A.C. . . 6 foot cord and plug are included. Size is 12" x 8" x 4 1/2" wide. Weighs just 1 lb 2-ozs. Comes with a sturdy plastic case.

Stock No. 70,199H\$8.75 Ppd.

MAIL COUPON FOR GIANT FREE CATALOG!

164 PAGES • MORE THAN 4500 UNUSUAL BARGAINS!

Completely new Catalog Packed with huge selection of telescopes, microscopes, binoculars, magnets, magnifiers, prisms, photo components, ecology and Unique Lighting items, parts, kits, accessories . . . many hard-to-get surplus bargains. 100's of charts, illustrations. For hobbyists, experimenters, schools, industry.

EDMUND SCIENTIFIC CO.

300 Edscorp Building, Barrington, N. J. 08007

Please rush Free Giant Catalog "H"

Name _____

Address _____

City _____ State _____ Zip _____



ORDER TODAY! COMPLETE AND MAIL

EDMUND SCIENTIFIC CO.

300 Edscorp Building, Barrington, N.J. 08007

How Many	Stock No.	Description	Price Each	Total

PLEASE SEND GIANT FREE CATALOG "H" **MERCHANDISE TOTAL \$**

HANDLING CHARGE \$1.00*

TOTAL \$

I enclose check
 money order for \$ _____

NAME _____

ADDRESS _____

CITY _____ STATE _____ ZIP _____



*50¢ ON ORDERS OVER \$5.00

NOW! FORGET GAS AND OIL SHORTAGES!



This Revolutionary, Low-Cost Electric Baseboard Heating System Provides ...



HOT WATER HEAT WITHOUT COSTLY PLUMBING

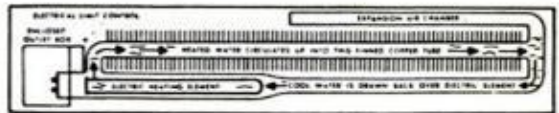

Tell your Electric Contractor, Builder or Architect you want INTERTHERM heating. It's available at leading Electrical Supply Houses.

MAIL COUPON FOR FULL INFORMATION!

INTERTHERM INC.; Dept. FF-103
3800 Park Ave.; St. Louis, Mo. 63110

Please send me FREE Brochure which gives full information and prices:

Enclosed are plans, or room measurements, of home I plan to build or remodel. Send me FREE, without obligation, a Factory-engineered Heating Layout.

Name Phone

Address Zip

Town State

Now—in spite of fuel shortages—your family can enjoy wonderful indoor comfort in coldest weather. Provided by INTERTHERM's soft, gentle, uniform, floor-to-ceiling hot water heat. Without cold floors, drafts or too-hot, too-cold periods. That's not only economical—but the safest, cleanest, most healthful heat on the market. Permanent systems for entire homes—portable models for single rooms.

INTERTHERM Costs Much Less to Install and Maintain than Central Heating Systems. Because it requires no boiler, furnace, pipes, ducts, flues, chimney, fuel storage. Heaters don't cause a fire, scorch drapes, burn child or pet. Don't carbonize lint and dust particles that dirty furnishings, irritate nose and throat—or burn plastic particles into toxic vapors. Recommended by many allergists. Almost one million installations. Available with INTERTHERM Whole-House Air Conditioning.

The INTERTHERM's Patented Inner Works, Shown By Diagram at Right, consists of a copper tube inside of which an electric heating element and a water and anti-freeze solution—which never needs replenishing—are permanently, hermetically sealed. Electricity heats the water solution. Then shuts off. The water continues giving off heat—maintaining temperature desired, while saving money.

Mail Coupon for FREE Brochure. And a FREE Factory-Engineered Heating Layout of home you plan to build or remodel, if desired—for which send us plans or room measurements. No obligation.

INTERTHERM INC.; 3800 Park; St. Louis, Mo. 63110

America's No.1 'holding' company.



No matter what Elmer's* you use, you can be sure it's going to hold.

Elmer's Glue-All: for wood, leather, paper and cloth. Even Styrofoam**.

Elmer's Epoxy: extra tough. For metals or bonds that need to be water-proof.

Elmer's Contact Cement: where you can't use clamps. Bonds instantly.

Elmer's. The glue that puts it all together. For good.



For Elmer's brand new handyman booklet containing ideas on how-to "make and fix" many things around the house, send 25c for postage and handling to Elmer's "Make-It & Fix-It" Booklet, Dept. MFM, Box 266, Medina, Ohio 44256.

*Registered Trademark of Dow Chemical Co.

NOVEMBER PREVIEW

OF POPULAR MECHANICS



Outdoor greeting card for your yard

This holiday display for your front lawn has three triangular-shaped posts that rotate. As each plane lines up, a different Christmas scene is displayed. The mechanism is ingenious but simple to build.



Superstadiums on the rise

New stadiums are rising all over America. Everything rises under the builders' magic touch—civic pride, costs and tempers.

Plexiglass novelties

A pipe rack, knife holder, magazine rack, letter holder, wine bottle rack—we show you how to make handsome gifts from translucent plastic.



Jewelry you can carve

Earrings, pendants, cuff links, desk ornaments—we show how to carve them from wood and plastic. These are novel, personalized gifts anyone can make.

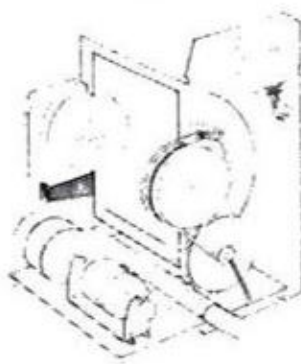

Dryer repair

Troubleshooting an electric dryer is not difficult with the aid of the easy-to-follow instructions and sketches we give you. It's money-saving know-how you can use.

PLUS

Bede 5J: First homebuilt jet for private pilots • '74 snowmobiles: new style, new power • Drive to South America? You can! • Four-channel headphones: How they sound to two ears • The Pitts Special—the flyer's airplane • Owners Report on the Buick Apollo • How to make child-size kitchen equipment • Sure ways to start a car.

Buy it on your newsstand. Better yet, make sure you'll keep getting this kind of exciting fare. Send this coupon with your check to:

POPULAR MECHANICS
250 West 55th Street
New York, New York 10019

Please enter my subscription for 1 yr. \$5.97 or 2 yrs. \$10.97

Name _____ (Please print)

Address _____

City _____ State _____ Zip _____

Payment of \$ _____ is enclosed. New Renewal

On new subscriptions, first copy will arrive in about 8 weeks.

(Above prices apply in U.S. and Possessions only. Canada, add \$2 per year. All other countries, add \$4 per year.)

WPM3J1

Want a job doing what comes naturally? Take this test.

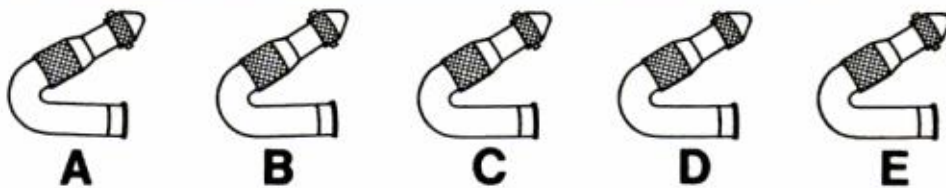

Think you're a "natural" technician? Then you should be a lot better than average at spotting the differences between similar objects. For example,

which part, A, B, C, D, or E has a visible defect? Answer: D

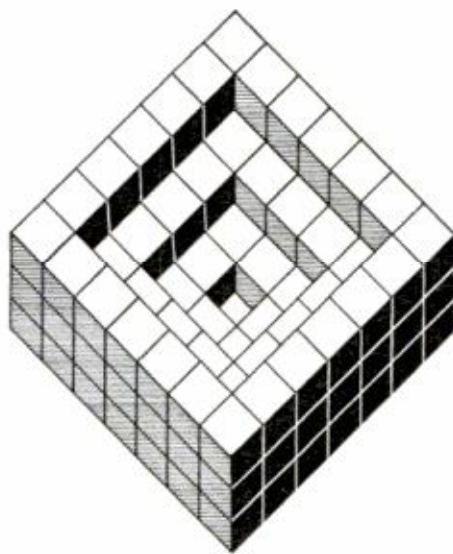

Here's a tougher one. Give us the right total of cubes in this figure. You'll be proving to yourself you have the kind of clear head and mechanical aptitude that really count for something in the Air Force. Answer: 112



Good imagination and deductive powers? They'll help you fly through the Air Force's many types of advanced technical training. Think—which ones

of cubes A, B, C, or D could be the same cube as the one on the left, only turned? Answer: A, B, C, D

Illustrations Courtesy of Arco Publishing Co., Inc.

Got them right? Then you might rack up high scores on the Air Force Aptitude Test. And that could do you a lot of good. Now, by qualifying you for outstanding technical training in one of over 100 Air Force jobs, from aircraft mechanic to medical specialist. And later, when you offer prospective employers a reusable skill.

Think it over. Mail in the coupon, or call 800-447-4700, toll free (in Illinois call 800-322-4400) for the nearest Air Force representative, and get the details. If you have natural mechanical talents, the Air Force will see to it those talents get

trained. Neither you nor the Air Force can afford to let them go to waste.

Air Force Opportunities	1-PM-103
Box A	
Randolph AFB, Texas 78148	
Name _____	
Address _____	(Please Print)
City _____	
State _____ Zip _____	High School _____
Soc. Sec. # _____	Age _____

Find yourself in the Air Force.

SAVE GASOLINE! Add the Archerkit™ Deluxe Electronic Ignition System Kit to Your Car

39⁹⁵

Price may vary at individual stores.



28-3203

Assemble this kit tonight and start getting its benefits tomorrow. Better gas mileage. Faster starts. Longer plug & point life. Less exhaust emissions. Capacitive-discharge design gives a hotter spark, complete combustion. Installs with no rewiring. For any 12 VDC neg. gnd. vehicle.

At 2000 Radio Shack stores in all 50 states!

Radio Shack®

and ALLIED RADIO STORES
A TANDY CORPORATION COMPANY

P.O. Box 1052, Fort Worth, Texas 76107



FREE '74 CATALOG
AT YOUR NEARBY STORE OR
MAIL THIS COUPON

256

180 Pages . . . Full Color! Hi-Fi, CB, Kits, Recorders, Antennas, Parts, More!

PLEASE PRINT CLEARLY

Name _____ Apt. # _____

Street _____

City _____ State _____ ZIP



PLANER • MOLDER • SAW

30-DAY FREE Trial!

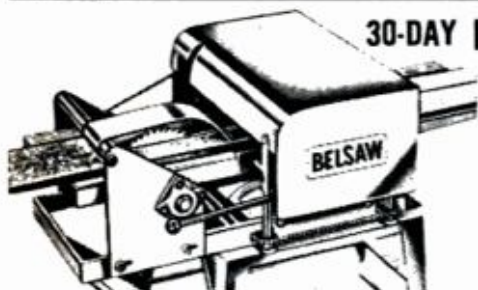

Now you can use this ONE power-feed shop to turn rough lumber into moldings, trim, flooring, furniture...ALL popular patterns. RIP...PLANE...MOLD—separately or all at once with a single motor. Free 30-Day Trial. Low Cost—only \$35 down. Send Postcard Today—No Salesman Will Call
BELSAW POWER TOOLS 904T Field Bldg., Kansas City, Mo. 64111

Makes Household Oil Old-Fashioned

- Stops squeaks
- Protects metal
- Loosens rusted parts
- Frees sticky mechanisms

Aerosol **WD-40** lubricates as it cleans to protect metal

TRY A FREE SAMPLE

Send 25¢ to cover handling to:
WD-40, 5390 Napa St. San Diego, CA 92110



WANT TO MAKE \$1,000,000?

I've invented several new products, one of which has done \$50 million. Want to know how it's done? Invest \$10 and I'll send you a complete course "FROM CONCEPT TO MARKET". Follow this course step by step and you could make up to \$1,000,000 or more. Here's the catch! I'll trust you to send me \$100 more when your idea hits the market. Rush check or money order for \$10

TO: INVENTIONS, P.O. BOX 1234, CANOGA PARK, CALIF. 91304.

RONSON

Multi-Fill
fuels most butane lighters



From 49¢

The clean quality butane that won't clog.

WOOD VENEERS • TOOLS
Shop Equipment • Supplies
POWER TOOLS
at Lowest Discount Prices!

SAVE MONEY on finest domestic and imported hardwoods . . . all dimensions. Over 1500 items for the home craftsman and woodworking hobbyist. Lamp parts, upholstery supplies, tile, power tools at discounts. **NEW CATALOG READY** 132 pages. Full Color. Send name, address and 50¢ to cover handling, and postage. Write...

CRAFTSMAN Wood Service Co. Dept. A103
2729 S. Mary, Chicago, Ill. 60608



CARPET DETERGER



UPHOLSTERY DETERGER



WALL DETERGER

PART TIME or FULL TIME

*have your own
money-making
business*

You offer a service everybody needs . . . work part time or full time . . . own your equipment . . . keep all you earn . . . start with just a small investment . . . and we help you every step of the way!

Have your own money-making business and make the kind of income you probably thought impossible. You can when you clean carpeting or upholstery or walls with Von Schrader professional cleaning equipment. Every home, every building, are potential customers. And every customer represents repeat business.

Moreover, we help you every step of the way . . . just as we have helped thousands of other Von Schrader Associates build money-making businesses for almost 40 years. Here are some comments. Carpet: "You people sure helped me and I'll never forget it. I'm averaging about \$18,000 a year."—*H. Kendall*. "During first 2 months made \$2500 net."—*R. Pilong*. Upholstery: "One day I did a \$135 job. Best week was \$500."—*C. Lambert*. "We passed over the

\$450 mark in five days."—*T. E. Baylor*. Wall: "I work just 2 or 3 days a week. Best month was \$1200."—*J. R. Johnson*.

There are three easy-to-operate Von Schrader Detergers. You need no special skills. Each offers a proven way to a growing income. (1) Von Schrader Carpet Deterger gives deep-level cleaning to carpeting. (2) Von Schrader Upholstery Deterger cleans fabrics and synthetics beautifully. (3) Von Schrader Wall Deterger cleans walls (and ceilings) five times faster than by hand.

You can start with just one Deterger. Then, as your business keeps growing, you may want to add the other two and thus offer a complete cleaning service.

There are no fees, royalties, or contracts. There's no franchise involved to shackle you with giving up part of your income. Instead, you own your equipment, keep all you earn. Cost of the equipment is so small you may find it hard to believe. What's more, we help you get started and continue to help afterwards. For complete information—without any obligation—send for the interesting free booklet.

"Let me send you our free booklet that gives all the facts"

—*Francis von Schrader, President*

Read about the big demand for on-location cleaning, see why Von Schrader Detergers are the finest of their kind, how easy they are to operate. Learn how other men have become financially independent, how Von Schrader helps you every step of the way. Fill in the coupon and send for free booklet.

Extra! Special Recorded Message included with booklet. Listen as Francis von Schrader talks to you personally about your growing future with Von Schrader Detergers.



Three proven ways to your own profitable business with Von Schrader Detergers.

39 years of helping people earn good money

VON SCHRADER company

10104 Place, Racine, Wisconsin 53403

Please send complete information on Von Schrader Detergers.

Name _____

Address _____

City _____

State _____ Zip _____

What Do Many Doctors Use When They Suffer Pain Of Hemorrhoidal Tissues?

Exclusive Formula Gives Prompt, Temporary Relief In Many Cases from Such Pain. Also Helps Shrink Swelling of Such Tissues Due to Infection.

In a survey, doctors were asked what they use to relieve such painful symptoms. Many of the doctors reporting said that they either use Preparation H themselves or in their office practice.

Preparation H gives prompt, temporary relief for hours in many cases from pain, itching in hemorrhoidal tissues. And it actually helps shrink painful swelling of such tissues when infected and inflamed. Just see if doctor-tested Preparation H® doesn't help you.

porary relief for hours in many cases from pain, itching in hemorrhoidal tissues. And it actually helps shrink painful swelling of such tissues when infected and inflamed. Just see if doctor-tested Preparation H® doesn't help you.

SANDING BELTS



	Per Doz.		Per Doz.
1x42 Mead, etc.	\$4.45	4x21 3/4 Skil, etc.	7.45
2-17 3/8 Burgess	4.45	4x24 Misc.	7.75
2x21 Porter Cable, etc.	4.45	4x27 Porter Cable etc.	7.95
2 1/4 x 21 5/16 Skil, etc.	5.00	4 1/2 x 26 Skil, Thor, etc.	8.45
3x18 Wen, etc.	5.00	4x36 Hammond, etc.	9.00
3x21 Porter Cable, etc.	5.45	4x37-13/16 Atlas, etc.	9.00
3x23 3/4 Skil, Thor, etc.	5.45	4x52 1/2 Walker Turner	10.95
3x24 Porter Cable, etc.	5.45	4x54 Porter Cable, etc.	10.95
3x27 Porter Cable, etc.	5.45	6x48 Delta-Sears, etc.	15.95

- 1—All belts cloth backed.
- 2—Please specify for wood or metal.
- 3—Will ship assorted or specify grits from 24-400.
- 4—**MONEY BACK GUARANTEE**
- 5—All other belt sizes available at lowest prices. Please inquire.

Include 75¢ for postage and handling. Send check or money order. DEALERS INQUIRIES INVITED.

JACKSON TOOL CORP., DEPT. FL
27-55 Jackson Ave., Long Island City, N.Y. 11101

Are you missing half the joy of your guitar?

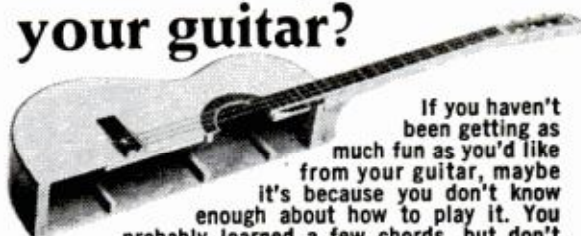

If you haven't been getting as much fun as you'd like from your guitar, maybe it's because you don't know enough about how to play it. You probably learned a few chords, but don't know how to go further. If so, let us help you. We'll teach you to read music and play pick style with both notes and chords—the way a teacher would. The difference is we teach with lessons by mail, and it costs a lot less. Courses in other instruments too—piano, spinet organ, accordion, violin, saxophone. If 17 or over, write for free booklet with more details. Send your name, address, zip code and list instrument you want to learn. Write U.S. School of Music, Studio 22-604, 417 South Dearborn Street, Chicago, Illinois 60605. ACCREDITED MEMBER NATIONAL HOME STUDY COUNCIL © 1973 U.S. SCHOOL OF MUSIC 444



Print For Profit

Cards, Stationery, Envelopes, Advertising, labels, tickets, announcements, Q.S.L. cards, greeting, sympathy, prayer cards, tags, etc. Save money. Pays for itself in a short time.

Own a Printing Business

We supply everything direct from factory only. Easily followed rules. Also raised printing like engraving. Have home shop. Add to income. Send 25¢ for catalogue. **KELSEY PRESSES 73-AC, Meriden, Conn. 06450**

HEAVY DUTY WELDER

with special \$7.00 gift offer to Popular Mechanics Readers
10-DAY FREE TRIAL
Lifetime Guarantee
Buy Factory Direct and Save **\$18.95** POST PAID
Fits ordinary 110V outlet
Not one • but 6 welding heats



Weld, braze, solder or cut most anything made of metal. No experience necessary. Follow simple instructions to make repairs on cars, trailers, farm and lawn equipment, bicycles, appliances, etc. Make campers, boats, furniture, hundreds of valuable items. **NOTHING ELSE TO BUY!** Comes complete with full face shield, pack of welding and brazing rods, heavy duty power cables, special electric torch attachment, ground clamp, flux, easy-to-follow illustrated instructions, rod holder, etc. Uses standard 1/8" rods to weld iron, steel, brass, bronze, aluminum, other metals. New improved HEAVY DUTY circuit gives more welding power. Gives 4 times the heat needed to melt toughest iron. Plugs into ordinary 110V outlet. 6 WELDING HEATS for professional quality welding of "tough" to "light-weight" metals. 10 day MONEY BACK GUARANTEE. Lifetime parts and service guarantee. An excellent gift for any occasion. **FREE!** Mention you saw this ad in Popular Mechanics and receive a \$7.00 gift pack of welding rods free. For same-day C.O.D. shipment just call (713) 682-5681 or send only \$2.00 and pay postman \$16.95 plus small C.O.D. when delivered or charge to your BankAmericard or Master Charge card or for postpaid shipment send \$18.95 check or M.O. to WEL-DEX, Dept.W-203, Box 10776, Houston, Tex. 77018.

ORDER FROM THE ONE-STOP CLOCK SHOP



Concord Grandmother Clock Kit (Walnut, Cherry)



School Clock Kit (Oak, Walnut, Cherry)



Double Steeple Clock Kit (Cherry, Walnut, Maple)

23 Fine Wood Kits & Finishes
Full Size Patterns
100 Different Clock Movements
Selection of Hands
50 Different Dials
Brass Hardware
Hardwood Moldings
Barometers & Music Boxes

Send 25¢ for New 100-page catalog

CRAFT PRODUCTS

Dept. 1, Elmhurst, Ill. 60126

THIS CAN BE YOUR "BIG BREAK"

if you're a man who doesn't want to be...

**"Ashamed
to go to his
class reunion!"**

REMEMBER, DEAR, OUR HIGH SCHOOL REUNION IS THIS WEEKEND.

DO WE HAVE TO GO, HONEY? SUPPOSE SOMEONE ASKS ME ABOUT THAT CRUMMY JOB OF MINE...?



PLEASE, JACK, I'M DYING TO SEE OUR OLD FRIENDS AGAIN.

OH, I GUESS SO — O.K.

LATER

JACK! WHERE HAVE YOU BEEN KEEPING YOURSELF?

OH, YOU KNOW— AROUND. LOOKS LIKE YOU'VE DONE ALL RIGHT, THOUGH.



ONLY SINCE I GOT SMART AND GOT INTO ELECTRONICS! IT'S A BIG "GROWTH" FIELD TODAY.

SOUNDS GREAT. BUT HOW'D YOU BREAK IN?



EASIER THAN YOU MIGHT THINK. I LEARNED EVERYTHING I NEEDED TO KNOW AT HOME, IN MY SPARE TIME... WITH CIE! THEY EVEN HELPED ME GET MY JOB, TOO!



HOW ABOUT YOU? WANT A GREAT JOB IN ELECTRONICS? GET FULL FACTS IN CIE'S 2 FREE SUCCESS BOOKS! SEND REPLY CARD OR COUPON NOW!



Be sure to send for your 2 FREE books today. For your convenience, we will try to have a representative call. If coupon has been removed, write to Cleveland Institute of Electronics, Inc., 1776 East 17th Street, Cleveland, Ohio 44114.

FILL IN COUPON AND MAIL TODAY

CIE Cleveland Institute of Electronics, Inc.
1776 East 17th Street, Cleveland, Ohio 44114
Accredited Member National Home Study Council

Please send me your two FREE books:

1. Your school catalog, "Succeed in Electronics."
2. Your book on "How To Get A Commercial FCC License."

Name _____ Age _____
(please print)

Address _____

City _____ State _____ Zip _____

APPROVED FOR TRAINING UNDER G.I. BILL

Veterans & Servicemen: Check here for G.I. Bill information PM-84

HOMEOWNERS' CLINIC

BY W. CLYDE LAMMEY

Cleaning a clock face

I want to clean an old clock dial, which is soiled and discolored. How do I go about it?—E. Edmund, Oakland, Calif.

Carefully—it's risky at best. If the dial is paper on metal or wood, one way to clean it is to flood it with naphtha—*caution*: Naphtha is flammable—and immediately sprinkle it with talcum powder, covering the whole surface uniformly. Wait a minute or two, then brush off the talc. If some discoloration still shows, the process may be repeated. If the dial is enamel on wood or metal, a light washing with mild soapy water, applied with a loose pad of clean cotton, is safest. Be careful not to over-wet the surface. Do not use naphtha or any other solvent, as it might soften or remove old enamel.

Removing decal residue

I've managed to scrape old decals off an enameled surface, but how does one remove the sticky residue? No solvent I've tried will touch it.—Edward Hosen, Utica, N.Y.

There is a remover specially made for this purpose. If you cannot obtain it locally, try rubber-cement thinner, available at art-supply and stationery stores. This will soften the residue of decal adhesive so that it may be scraped off, or rubbed off with a fingertip.

Remover doesn't

I always work with paint and varnish removers outdoors. Often the remover doesn't "remove." The residues seem to harden and dry up on the surface and won't strip off easily. I must be doing something wrong, but what?—Jerry Bates, Canton, Ohio.

You may be brushing the remover too thinly. It works best when laid on in a one-direction stroke, using a full brush at each sweep. Also, in the open on a dry

day, remover tends to evaporate more rapidly, even though a retarder is included in its formulation. Try laying a thickness of waxed paper over the surface immediately after applying remover.

Odor from crawl space

My home is built over a crawl space that is damp, but not wet, during the warmer months. A disagreeable odor persists in parts of the house. What can I do to eliminate this?—Edward Rees, Covington, Ky.

The odor probably is caused by fungi that will grow on joists and subfloor in the presence of continuing dampness. You may need to add perhaps 10 to 20 percent more area to the ventilating louvers in the foundation. Spreading chloride of lime on the earth in the crawl space will minimize the odor if not eliminate it entirely.

Truing a whetstone

I have an old whetstone that has become cupped by long use. How does one flatten the worn surface and make it usable again?—Leroy Hoadley, Dallas.

This is one of those things easier said than done. Rubbing the stone against another of coarser grade only improves the first by damaging the second. Rubbing the stone against concrete is better. But if you have a table saw and a worn disposable blade, turn the blade to run backward, with just a fraction of an inch of tooth projecting above the tabletop, and pass the higher portions of the stone over the blade. This will cut away the high spots quite effectively. Be sure to wear safety goggles.

Do you have a home maintenance or repair problem? Send it to Homeowners' Clinic, Popular Mechanics, 224 West 57th St., New York, N.Y. 10019. While letters cannot be answered individually, problems of wide interest will be discussed in this column.

There's coolness in your future.

© BROWN & WILLIAMSON TOBACCO CORP.



Come all the way up to KOOL

Warning: The Surgeon General Has Determined That Cigarette Smoking Is Dangerous to Your Health.

17 mg. "tar," 1.4 mg. nicotine av. per cigarette, FTC Report Feb. 73.

Материал, защищенный авторским правом

America's whiskey and how to enjoy it.

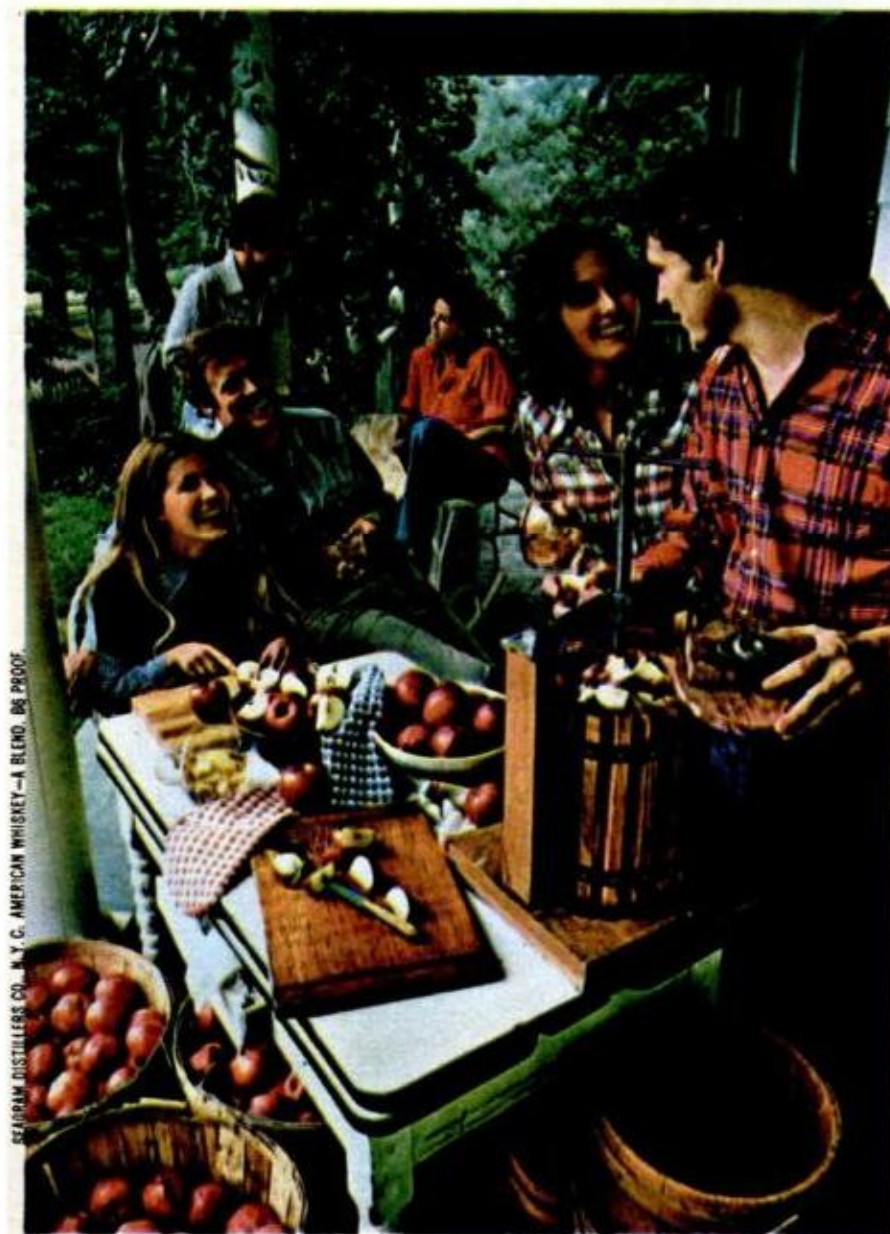

SEAGRAM DISTILLERS CO., N.Y.C. AMERICAN WHISKEY—A BLEND. 66 PROOF.

If you're lucky enough to have a cider press, you know what fun it is to make your own cider. And how great it tastes, right out of the bucket.

But you might not know how great it tastes another way—mixed with Seagram's 7 Crown, America's favorite whiskey.

It's the Seven 'n Cider, a perfect drink for lazy autumn afternoons on the old front porch.

Of course, your cider doesn't have to be home-made. Any good cider will do.

Just make sure the whiskey is Seagram's 7 Crown, with the unique light taste that goes so well, so many ways.

Seagram's 7 has versatility. That's what makes it America's



Seagram's 7 Crown.
It's America's whiskey.



**The Seven 'n Cider. 1½ ounces Seagram's 7 Crown.
6 ounces fresh, sweet apple cider. Stir over ice.**

Half baths you can install just about anywhere

If you have 15 sq. ft.
of space, you can add a
convenient powder room.

by Harry Wicks
WORKSHOP EDITOR

In most homes, 7:00 o'clock in the morning is a pretty hectic time. At that hour, everyone wants to shave, shower, put on makeup—all at one time—in the mad rush to get to school or work on time. The strain on everyone's nerves can be eased considerably by adding a half bath so that various members of the family can use the smaller facility to free the larger one for showers and baths. Surprisingly, a sink and toilet can be installed in a very small amount of space, as can be seen in the typical floor plans shown on the following pages.

If you do the carpentry yourself, you can probably keep the cost of a powder room somewhere around the \$600 mark. The most important factor in controlling costs is the location of the powder room. For example, if you can put the new fixtures on a wall next to the existing bathroom (or kitchen), plumbing will cost less because you can tie water and waste lines into these lines rather than having to snake entirely new lines up through the walls. No matter where you locate your half bath, proper venting (stacks) of the fixtures is a must. Your plumber or local building department can spell out local requirements. Here, to save ripping out and patching, it makes sense to install fixtures along a wall you

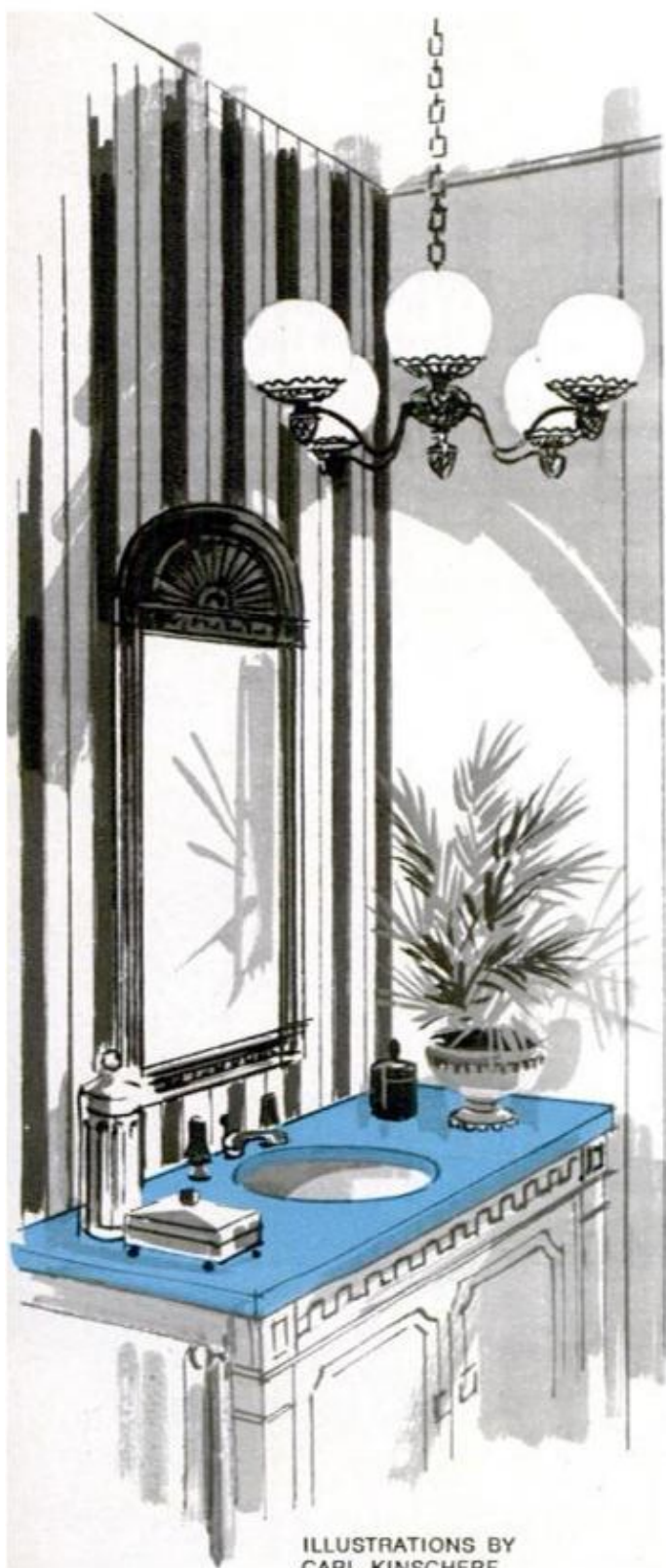

ILLUSTRATIONS BY
CARL KINSCHERF

**With imagination, you can
make new half bath charming
as well as convenient.**

Survey your home for wasted space

plan to erect; the vent stack can then be placed in the new wall.

Your first step is to survey your home for wasted space to find a logical location for the powder room. It could be in a little-used closet, under the stairs or in a corner taken from a large room by adding walls and a door. But, when you're picking a location, don't overlook or minimize the importance of convenience. Although it may cost slightly more initially to put the powder room by the back door or in a basement family room, the convenience of having this facility where it can be used by kids coming in via the back door or by guests at a family-room party could easily justify spending a few dollars more.

Adding a half bath is a sound investment, too. A powder room automatically adds to the value of your home. Real-estate experts will tell you that a home with a well-planned bath-and-a-half has a higher market value

than a comparable home with just a single bathroom. Thus, should you have to sell your home, the return of your investment is just about assured; you simply add the installation cost to your selling price. Realtors also say that a 1½-bath house is sure to sell faster, with less effort, than the same house with a single bath.

Don't automatically discard the idea of adding a half bath because, after a cursory inspection, you decide there is just no room for one. Make a thorough survey of your home and call in your plumber for his recommendations, too. He is very likely to suggest locations you might never have thought of in the first place. Chances are, there is space somewhere in your home where a powder room can be located—upstairs, downstairs or in the basement.

One good place to look is in the laundry room. In many tract homes these rooms are laid out and utilized inefficiently. By

CONTEMPORARY WALL VANITY

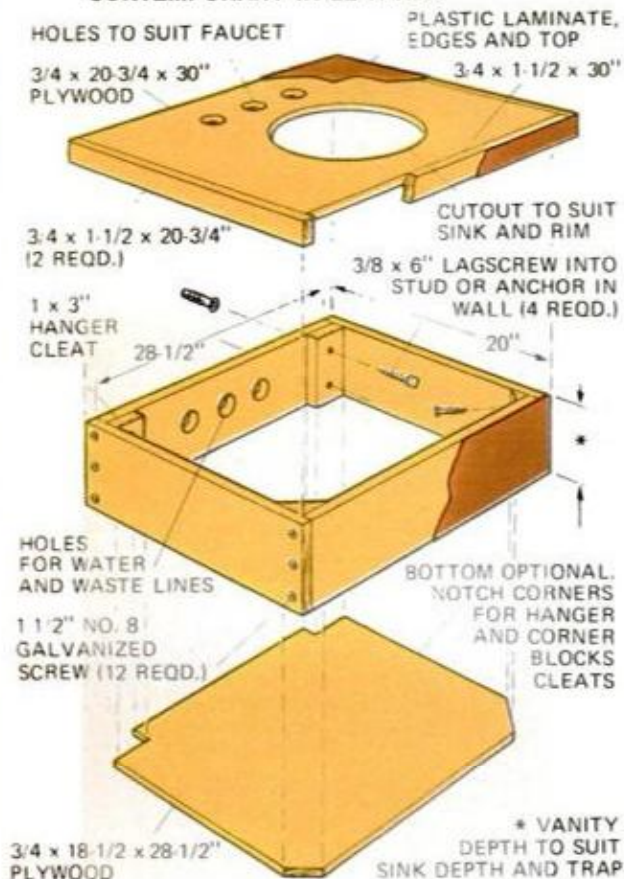

AMERICAN STANDARD PHOTO

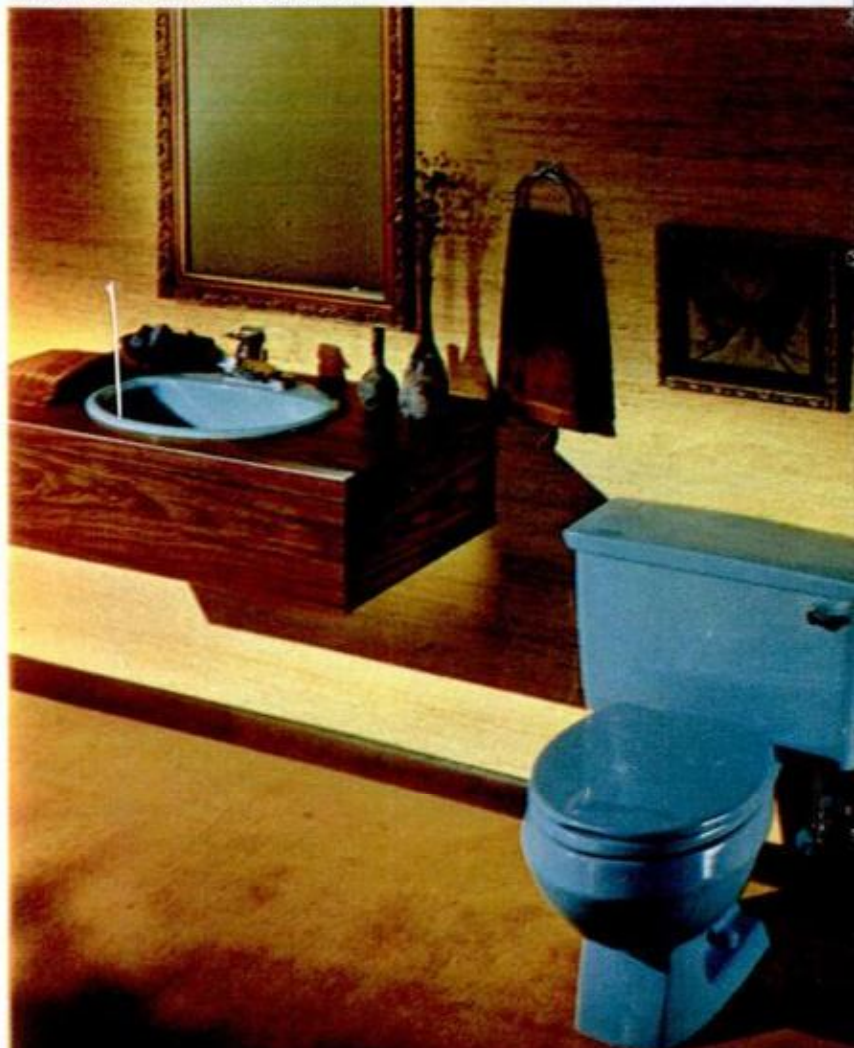

Vanity for sink in photo (right) is made of plywood, which is then covered with a wood-grain plastic laminate.



Small space can be converted easily into a half bath as shown in sketches and photos on this page. Powder room below has a compact 14x20-in. sink, fits in a 16-sq.-ft. area. Petite powder room (right, below) features unique wall-hung vanity with built-in lighting. Though small, powder rooms have an elegant look because of careful attention to choice of materials.

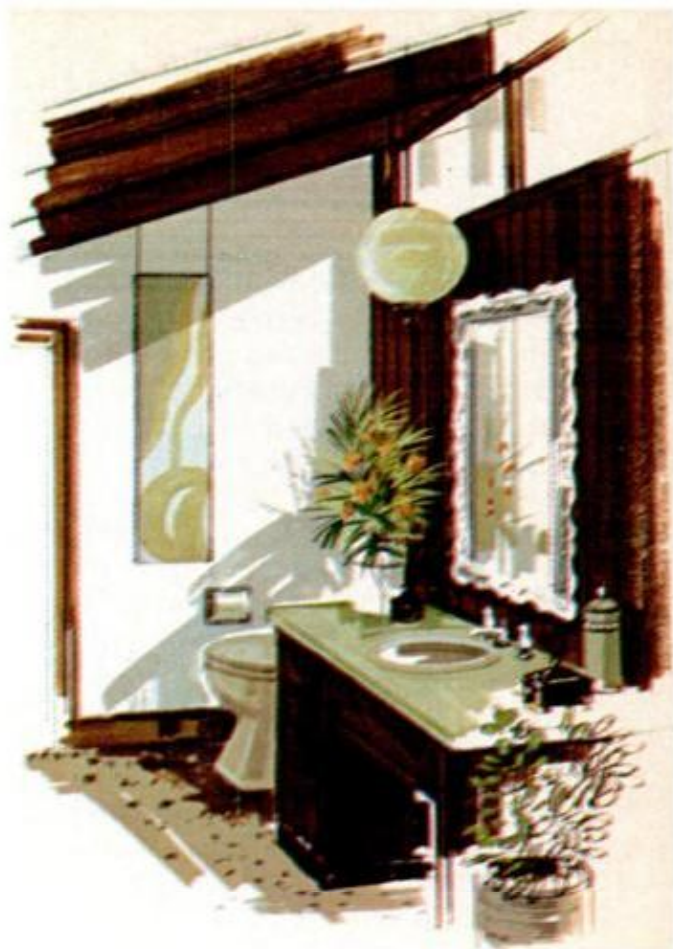

AMERICAN STANDARD PHOTO

ELJER PLUMBINGWARE PHOTO

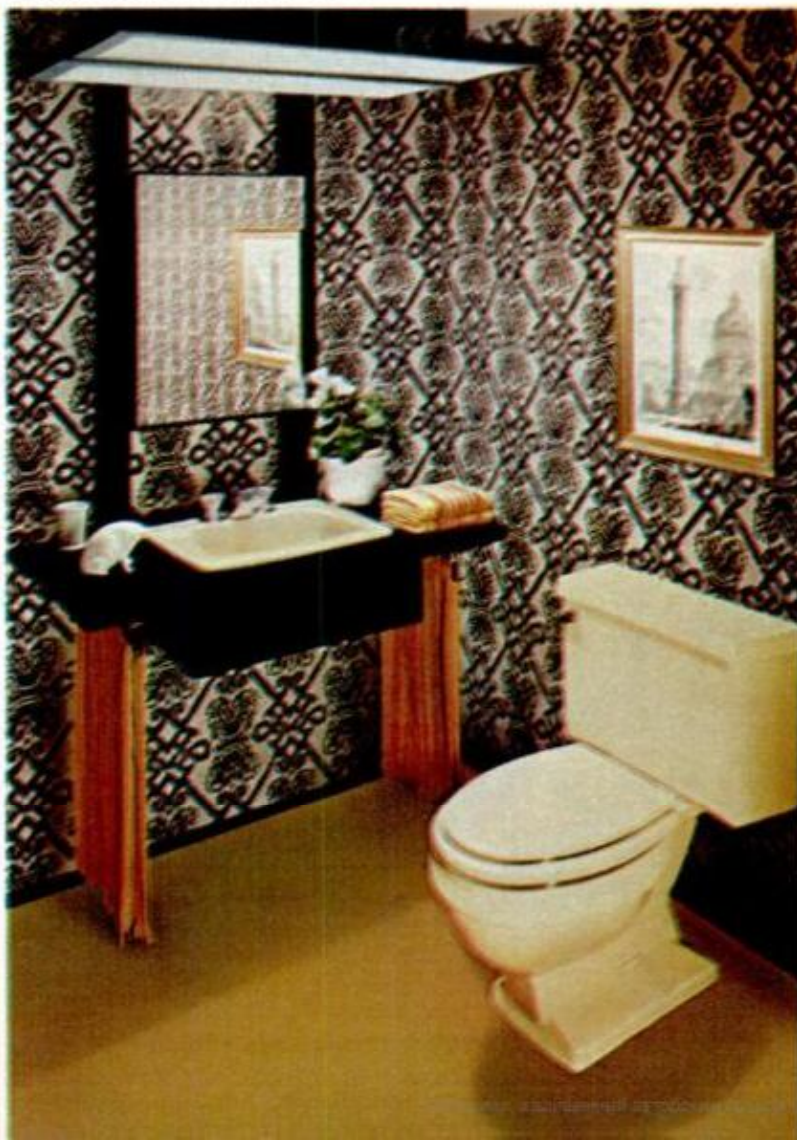

Careful planning pays off

doing some careful rearranging of appliances, and adding a wall or two, this location is generally extra convenient because of its location near the kitchen.

There are rules—functional as well as decorative—when installing a powder room. First, as mentioned before, try to locate the room as near as possible to existing plumbing lines to keep costs down. If you live in a climate subject to below-freezing temperatures, don't put the water lines in an outside wall where they could freeze and burst under severe weather conditions.

And, remember that a bathroom must have proper ventilation and light. (FHA standards are 10 percent of floor square footage for light, and 5 percent of operable windows for venting.) Thus, if the room is an interior one without a window, installation of adequate lighting and an exhaust fan is a must. A ceiling fan is most desirable, but if it must be placed on the wall, try to locate it as near to the ceiling

Rectangular area permits the use of a room vanity as shown below. When installing any bathroom fixture, follow as close as possible the architectural spacing standards shown in the sketches at the right. In an extra-tight space squeeze, consider hanging a sliding pocket door instead of the conventional hinged type.



BATH FIXTURE ARCHITECTURAL STANDARDS

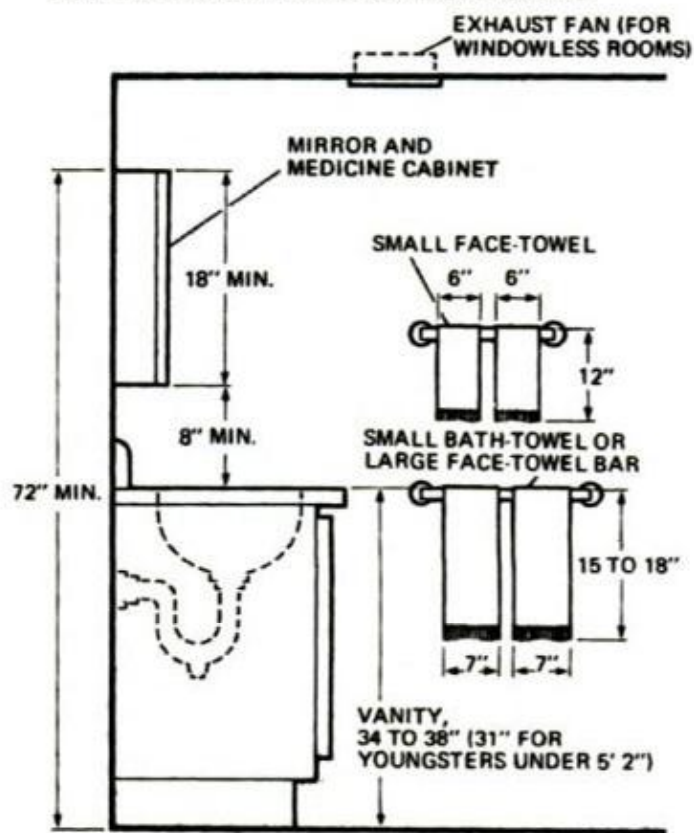

SPACE REQUIREMENTS FOR BATH FIXTURES

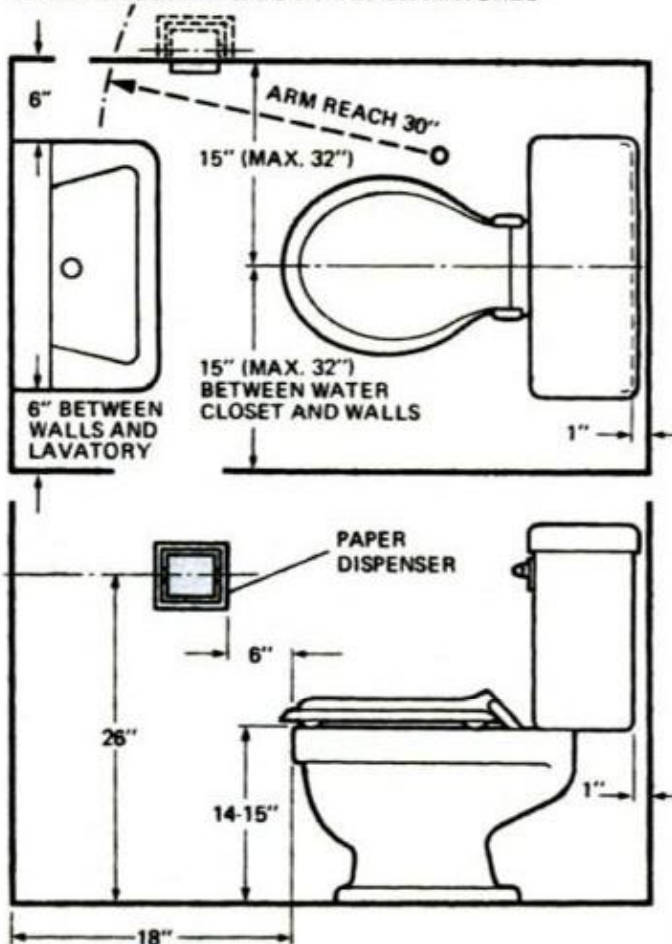

What shape will your powder room be?

PETER TROJAN

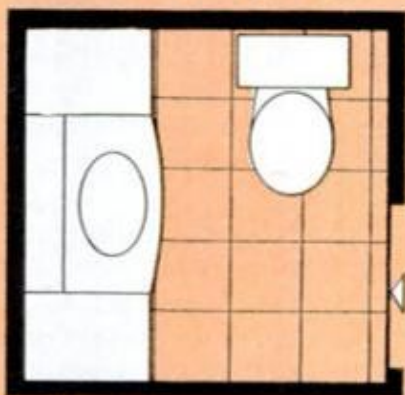

Luxury of having 25 sq. ft. to use permits installation of generous-sized wall-to-wall vanity.

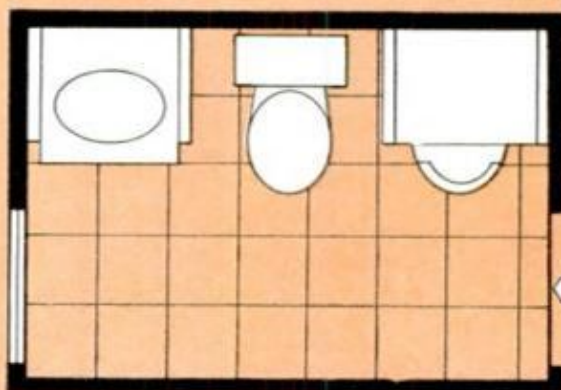

Rectangular room such as this gives plenty of space for separate vanity for guest's (and householder's) primping.

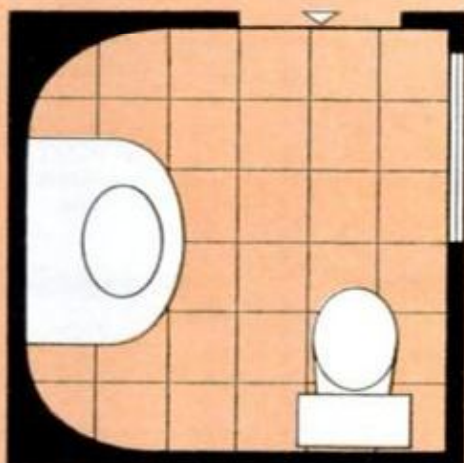

Dramatic look is created by building curved walls. To do this, use 3/16-in. plywood over studs.

SCALE: 1 SQUARE
EQUALS 1 SQ. FT.

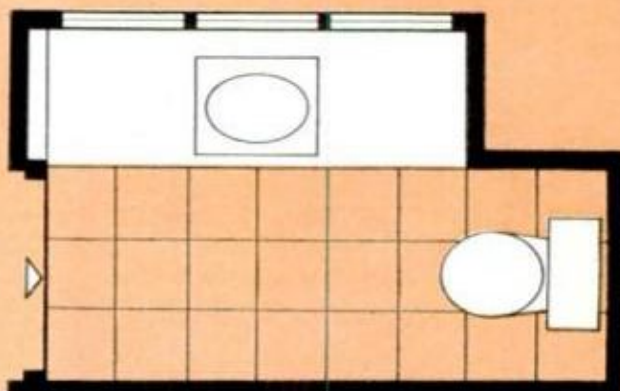

Irregular shape as above usually occurs when powder room is installed between bedroom closets. Use space for large vanity.

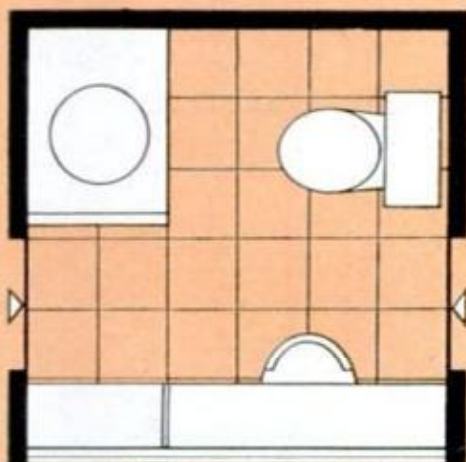

Large square room allows the use of one wall for a makeup area and floor-to-ceiling storage cabinets.

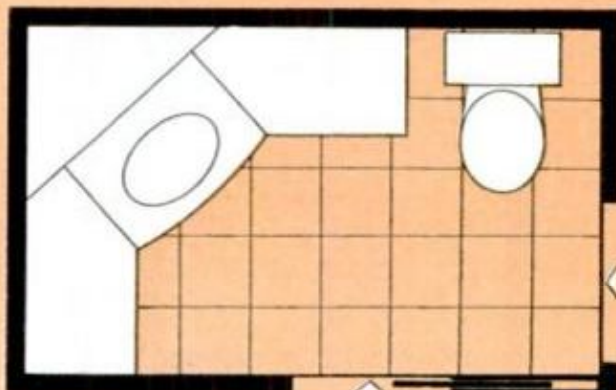

To gain storage space, you can use a corner for the lavatory and dressing table. Consider mirrors above all counter area.

Other floor plans you can use

as possible. The exhaust fan should be wired into the light so it goes on automatically when the lights are flicked on. And don't forget to allow for "makeup" air for such installations. Makeup air is that air which replaces the air drawn out through the fan. It is needed to maintain the flow of air to, and through, the fan. The usual procedure is to cut off the bottom of the bathroom door so there is a minimum of 1/2-in. space between the door and floor. Cold air drawn in through this opening exits via the fan.

There is no reason why a small powder room can't be comfortable, bright and cheerful. Accompanying sketches prove that.

There are decorating tricks you can use too. For example, to make the room appear

larger than it is, use light colors—whether applying paneling, wallpaper or paint. Another favored decorating stunt for visually enlarging space is to use mirrors to create the illusion of added area. If use of a conventionally hung door is less than desirable because of door swing, consider using a pocket door which slides into framing in the wall.

When choosing your toilet and sink fixtures, keep in mind that color fixtures cost only slightly more than white ones. Most bathroom fixture manufacturers offer both pastel and bright accent colors. Your aim should be to pick the color that best suits your overall home-decorating scheme.

The most important point to remember if

Under the stairs; in a closet

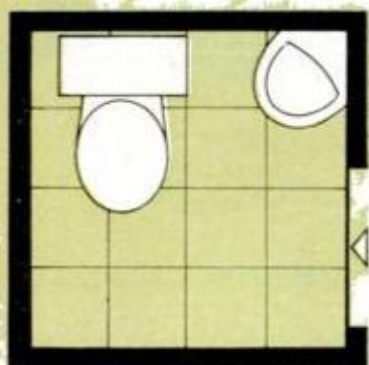

Lots of convenience in 16 sq. ft. Corner sink is efficient as well as space-saving.

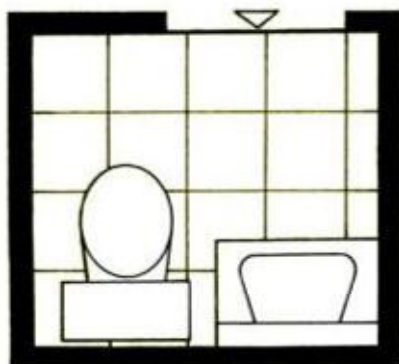

For plumbing economy, fixtures can be laid out to keep water and waste lines in one wall.

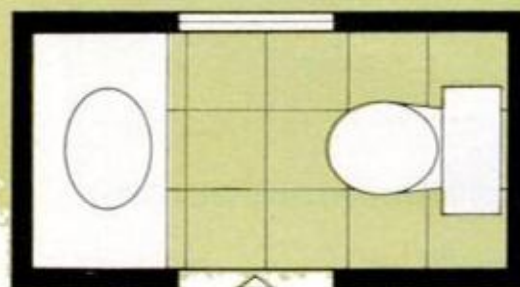

Narrow rectangular room is particularly well suited for pocket (sliding) door. See text.

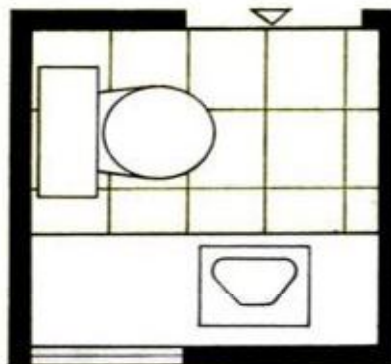

If space permits, add convenience of a countertop. Cabinet below sink provides needed storage.

SCALE: 1 SQUARE
EQUALS 1 SQ. FT.

you decide to use color fixtures is to make certain that they are all by the same manufacturer. Although the difference in color can be very subtle from one maker to the next, the variation can be quite obvious when the fixtures are placed side-by-side in the same room.

What about fixture cost? Generally, the appearance and performance of plumbing fixtures are in proportion to their cost. You get what you pay for. Considering that the powder room can only be as good as the fixtures it contains, stick with quality name brands to avoid disappointment. At that, top-quality manufacturers usually have at least one line in the lower cost ranks. Chances are, these are the makes that your

local reputable plumbing supplier will have on display. In general, shy away from the fast buck operators who, through newspaper ads and hand flyers, offer all sorts of "extras" in a package deal. Besides the appearance of the finished job, a poorly or improperly installed half bath can be a health hazard.

For other half-bath ideas, write to American Standard, Dept. PM—Communications, Box 2003, New Brunswick, N.J. 08903 and Eljer Plumbingware Div., Wallace-Murray Corp., 3 Gateway Center, Dept. PM, Pittsburgh, Pa. 15222. Both manufacturers offer half-bath plumbing booklets that are loaded with good ideas. The price of each booklet is \$1. ★★★

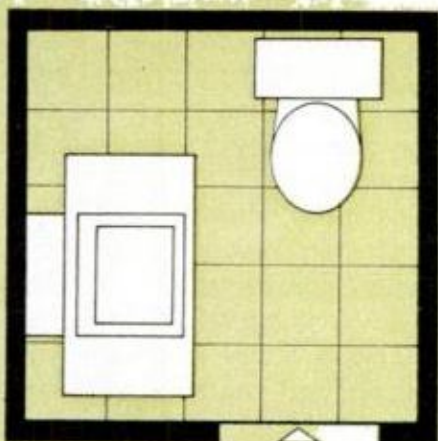

Freestanding vanity of non-conventional form adds look of luxury to this small half bath.

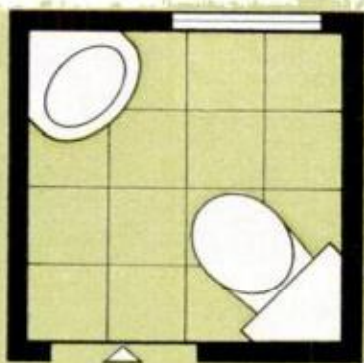

Utilization of corner toilet allows installation of wall grab bars—a must for the infirm.



Turn your imagination loose. Use louvered doors on vanity and gaily patterned wallpaper.

How to waterproof your basement

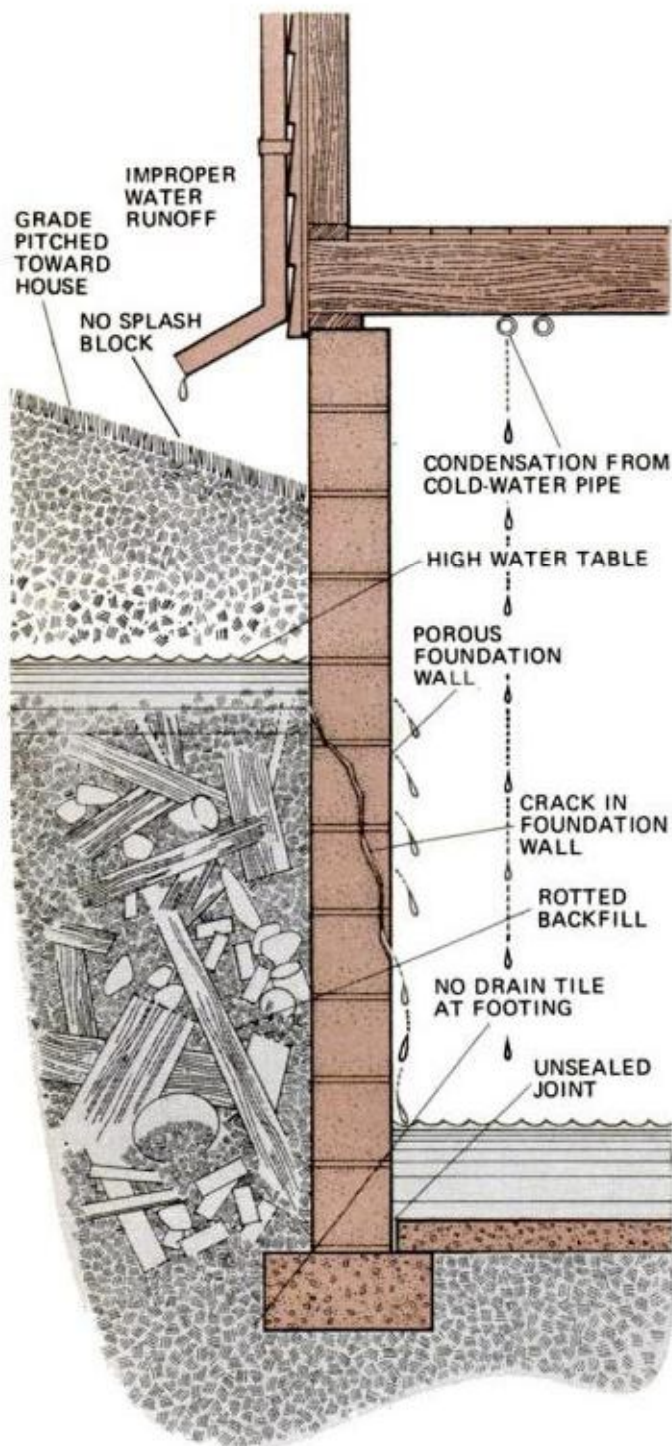

Why a basement isn't dry

Sketch above shows a number of problems that can contribute to making a basement wet. They include improper runoff, a high water table (prevailing level below which ground is saturated with water) and poor backfill with debris that decomposes to create water-retaining spaces in the ground.

When the need for extra living space involves the basement, one thing is certain—it had better be dry. Several inches of water won't help carpeting or wall paneling, and even when it comes to setting up a workshop, a damp musty basement can cause such problems as warped lumber, tool rust, sticking doors and windows.

These four pages show you what you can do about a damp or wet basement—from simple cures for condensation to a thorough job of foundation waterproofing from the outside. Not all problems will yield to these solutions, however. You may have to install a sump pump or consider having work done by commercial waterproofers.

Commercial firms use several methods, including application of water-repellent silicones to exterior foundation walls below grade without excavation. Since commercial waterproofing is not cheap, you should shop for it just as carefully as you would for any other home improvement of comparable cost.

Your first step, though, is to study the drawing at left. It may give you a clue to the cause of a basement problem that you can solve yourself. Simply pitching the grade away from a house, for example, has dried out many a wet basement.

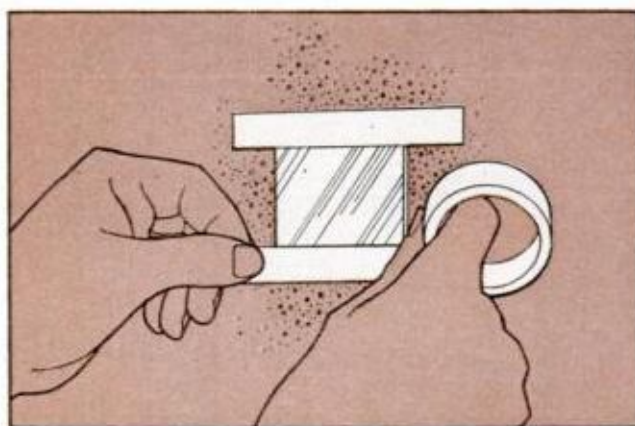

Checking for condensation

Test for condensation by taping a pocket mirror or scrap of shiny metal to dampest wall. If this is covered with mist or water droplets after 24 hours, condensation is the problem or is contributing to a wet basement.

What to do about condensation

Insulate all exposed cold-water pipes with a good quality wrapping—fiberglass insulation (near right) or foam plastic sleeves (far right), closing slits with tape. Replace any leaking plumbing. Ventilate basement well: Keep windows open day and night in fair weather, close them when outside air is moist. Prune or thin plantings to let a maximum of sunlight into basement. Other steps: Do not dry clothes on line in basement. Make sure clothes dryer is vented to outside. A window airconditioner will remove some moisture from air; some have dehumidifying cycles. Separate dehumidifiers are also available at appliance shops.

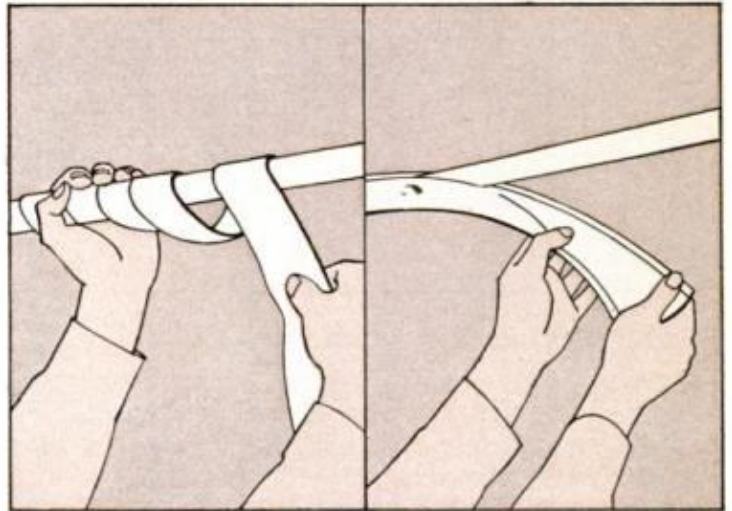

Repairing foundation cracks

Cracks in foundation walls most often occur along masonry-block joints, owing to settling. When inspecting for cracks, start at places where foundation receives most stress—around windows, doors, and pipe and cable entries. A crack inside may mean a crack outside as well, but interior cracks should be repaired in any case, and in many instances this will complete the repair. Using a masonry or cold chisel, begin repair by chipping out the crack, undercutting so that the crack is wider at the bottom than it is at the surface. Then rub briskly with a stiff wire brush to remove all loose particles of concrete and mortar.

With crack prepared, it can be patched with mortar or cement. Wet the crack first; this will retard hydration and assure a strong bond between patch and original material. Butter crack with patch mix, making certain that the patch is forced into every crevice. Allow patch to cure for 2 to 3 weeks; keep it damp for at least the first 24 hours. Where water is flowing from a crack or hole, patching with quick-setting mortar may be possible; it is held tightly in place against the leak, and sets in a few minutes. Epoxy patches, applied without moistening wall, cure in about 24 hours. With all patch mixes, follow maker's instructions.

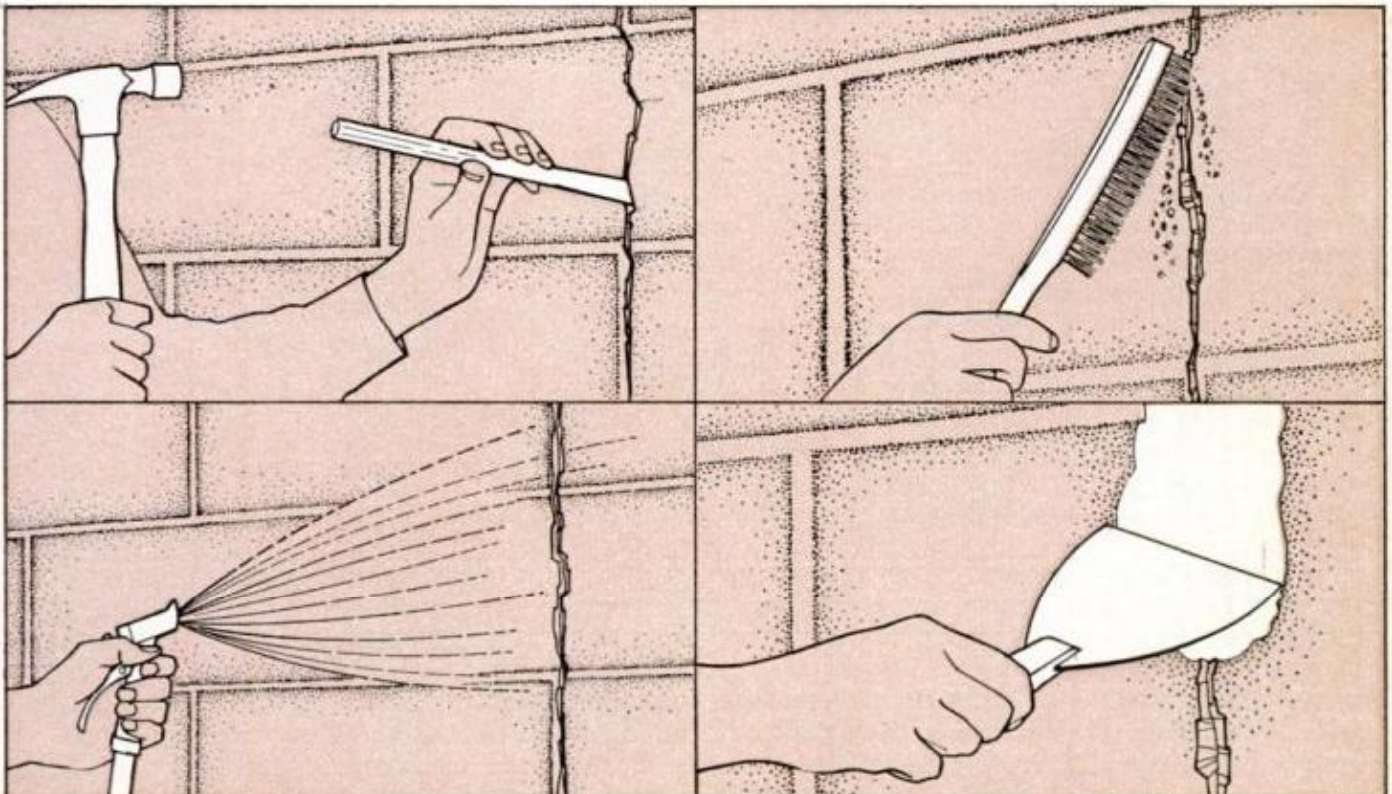

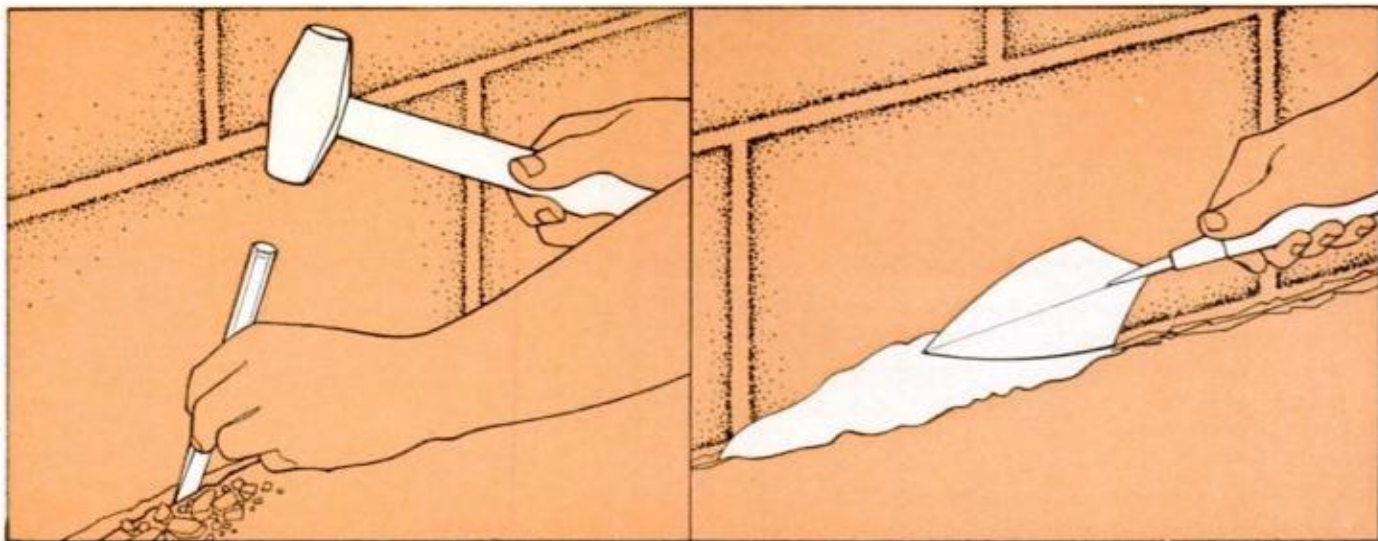

Check the wall-floor joint too

If an unsealed or cracked joint between wall and floor is a source of water, it can be sealed with epoxy mortar. Here, too, the area to be patched or sealed is chiseled out with undercut to key the mortar in place. Loose particles, dirt and chips should be completely removed—use a whisk broom

or vacuum-cleaner exhaust. Epoxy mortar is troweled on, smoothed with the oiled bowl of a cheap spoon. Hot tar is generally used to seal this joint in new construction, but it is extremely dangerous for the homeowner to attempt this indoors and is not recommended for a novice do-it-yourselfer.



Interior coatings

If wetness or dampness is not caused by condensation, and remains a problem after cracks have been repaired, suspect seepage through a porous foundation wall. This is usually the result of deterioration of concrete that included too much sand in the original mix. One or—better—two coats of an interior dampproofing or waterproofing material may arrest seepage, and, although applying it is not a small job, it is much less difficult and expensive than excavating and waterproofing from the outside (see next page). Commercially available coatings are of several types—mortar, epoxy, emulsified latex—and may be sold dry or premixed. Surface preparation requirements vary. Roughening the wall may be called for, or etching with muriatic (hydrochloric) acid—if you must do this, be sure to protect your eyes and skin. Follow coating manufacturer's directions, and allow ample curing time for any patches before applying the coating. Most interior coatings come in a variety of colors.



Assure good runoff

Gutters and downspouts are important protection for your basement as well as the rest of your home—see *How to Keep Your Gutters and Downspouts Functioning*, page 100. To divert water from foundation walls, use a commercial plastic extension or a splash block as above. Perforated with sprinkler holes near end, the extension carries the water to lawn or plantings where it will be absorbed.

Exterior waterproofing

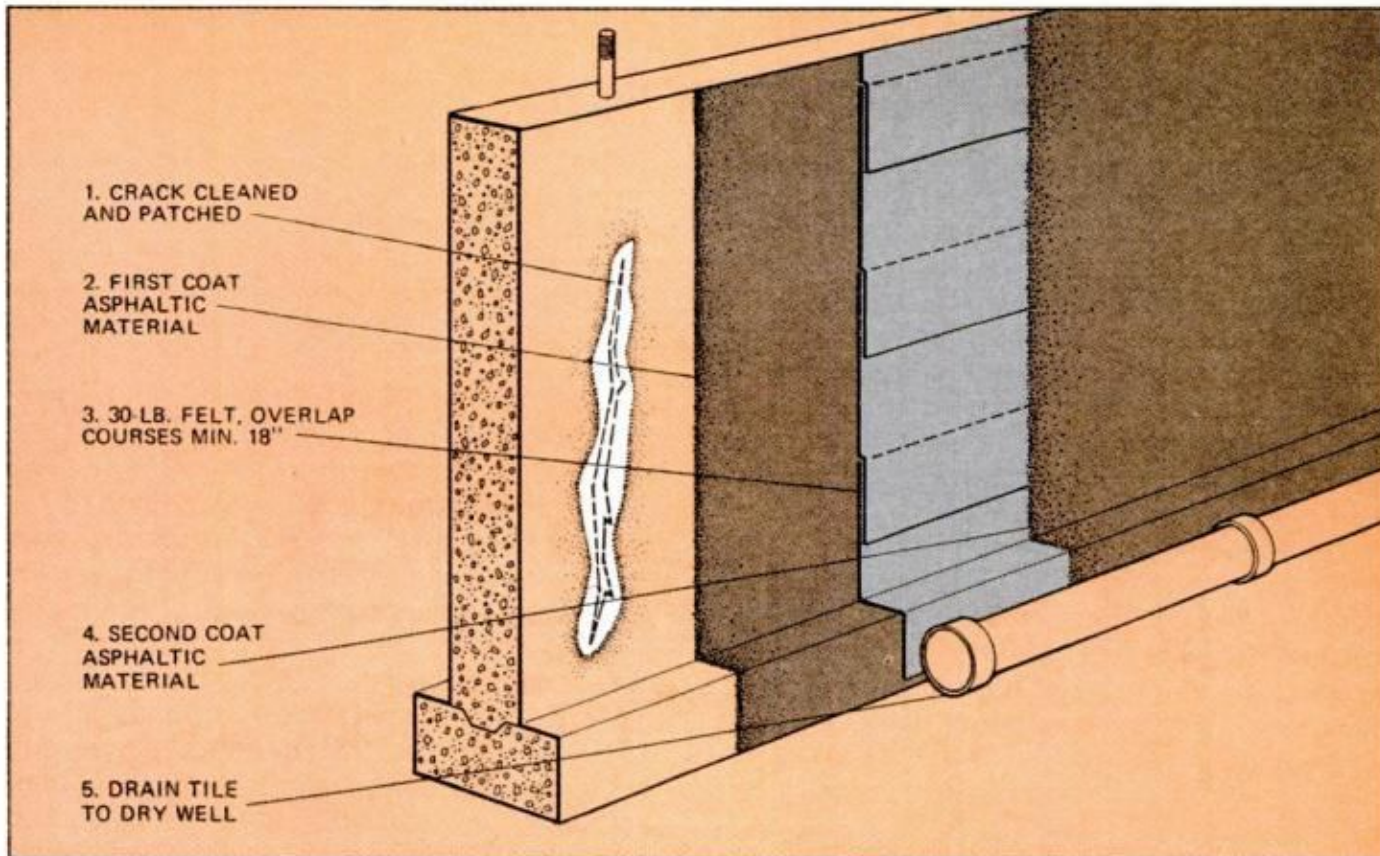

How to do exterior waterproofing

Most drastic but sometimes unavoidable is a complete exterior waterproofing job of the type that should always be part of new construction. Since this project requires excavation to the base of the wall footings, it's a lot of work, but it may also be the only effective way to correct basement wetness.

After excavation, all visible cracks must be cleaned out and patched. Masonry-block walls that do not already have such a coating are then "parged"—given two $\frac{1}{4}$ or $\frac{3}{8}$ -in. coats of a mortar made of 1 part portland cement, $2\frac{1}{2}$ parts sand. Masonry should be cleaned and moistened before parging. The first coat (often called scratch coat) is lightly roughened with a stiff brush and should not yet be firmly set when the second is applied. The second coat is steel-troweled to a smooth finish. Poured-concrete walls, like the one shown above, do not require parging.

Next, a coat of hot tar is mopped onto the wall and footing, followed by lengths of 30-lb. felt laid horizontally, each course overlapping the preceding one by a minimum of 18 in. A second coat of hot tar is then mopped on.

Drain tile should be laid along the footing, below the level of the bottom of the floor slab. Pitch the run toward a dry well, outfall or storm sewer (where permitted). Bell-end tiles shown above are used where water table is high to conduct water from downspouts away from house. Where water table is low, drain tile collects water from base of foundation and carries it off. For this purpose, short sections of tile are used, with $\frac{1}{4}$ -in. gaps between sections covered with 30-lb. felt. Open

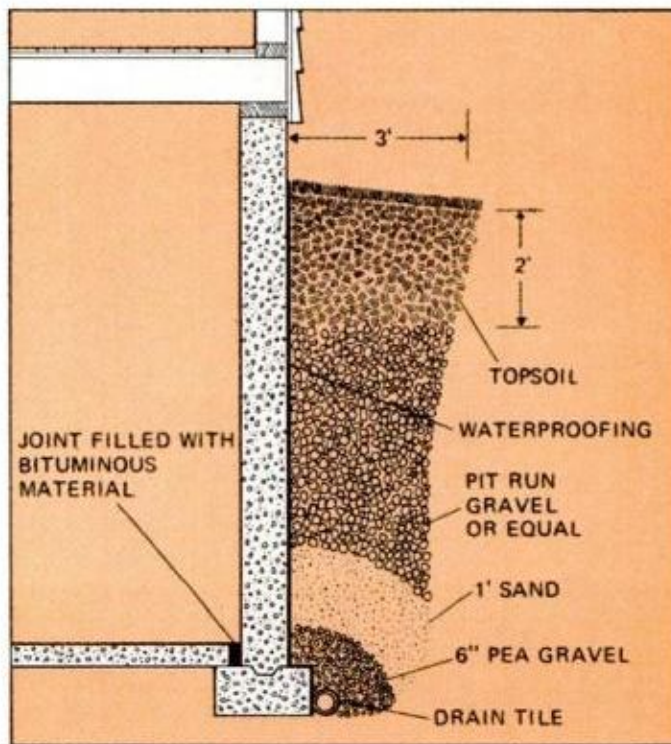

tile laid this way will, over its run, lose some water to the ground.

Backfill (replacement for excavated material) should be as shown above. Grade topsoil away from house, with a minimum of 8 in. between highest grade and top of foundation. Tamp fill at each stage to minimize later settling. Old fill removed in excavation may be useful for regrading another part of your property. ★★★

How to remove stains from almost anything

Almost anything can, or will, stain something. There are staining agents that can cause spots on synthetic and natural fabrics, painted surfaces, masonry, marble and other surfaces commonly found in any home. However, most stains can be classified by types—and for each type there is an effective solvent that will break down and remove the stain.

On these pages are several charts listing the most common household stains, the solvents to use on them and the best methods to use to remove them. When removing stains, it's important to remember that it is possible a spot may be a combination of more than one staining agent. (For example, a machine oil stain could include traces of metal.)

Also keep in mind that a solvent that won't harm one type of fabric may harm another. Because of this, the choice of solvent is determined by both the stain and the fabric. Generally, water or a combination of water and a second solution,

can be used on washable fabrics—but will not be effective on nonwashable fabrics.

Carbon tetrachloride, and other non-water solutions, are useful on both types of fabrics. *Caution: Regardless of the type of solution used, and with carbon tet in particular, take time to read the manufacturer's instructions for using.* Follow all safety instructions and work in a well-ventilated area. If possible, work outdoors when using carbon tet or naphtha.

How you treat stains on white or colored fabrics is important, too: Inert solvents such as carbon tet, benzol, alcohol and water can be used on both colored and white fabrics. But avoid using active solvents such as citric, tartaric acids, alkali (ammonia or borax), laundry bleaches and hydrogen peroxide on colored fabrics. These will generally change the colors of dyes. There are four ways of applying solvents to fabrics for removing stains: 1) soaking, 2) applying pressure, 3) front sponging, and 4) back sponging. Here's how:

Typical household stains on: A, brick floor; B, wood floor; C, floor tile; D, washable fabric; E, synthetic fabric; F, rug; G, wood; H, nonwashable fabric; I, plastic laminate; J, white fabric; K, painted surface.

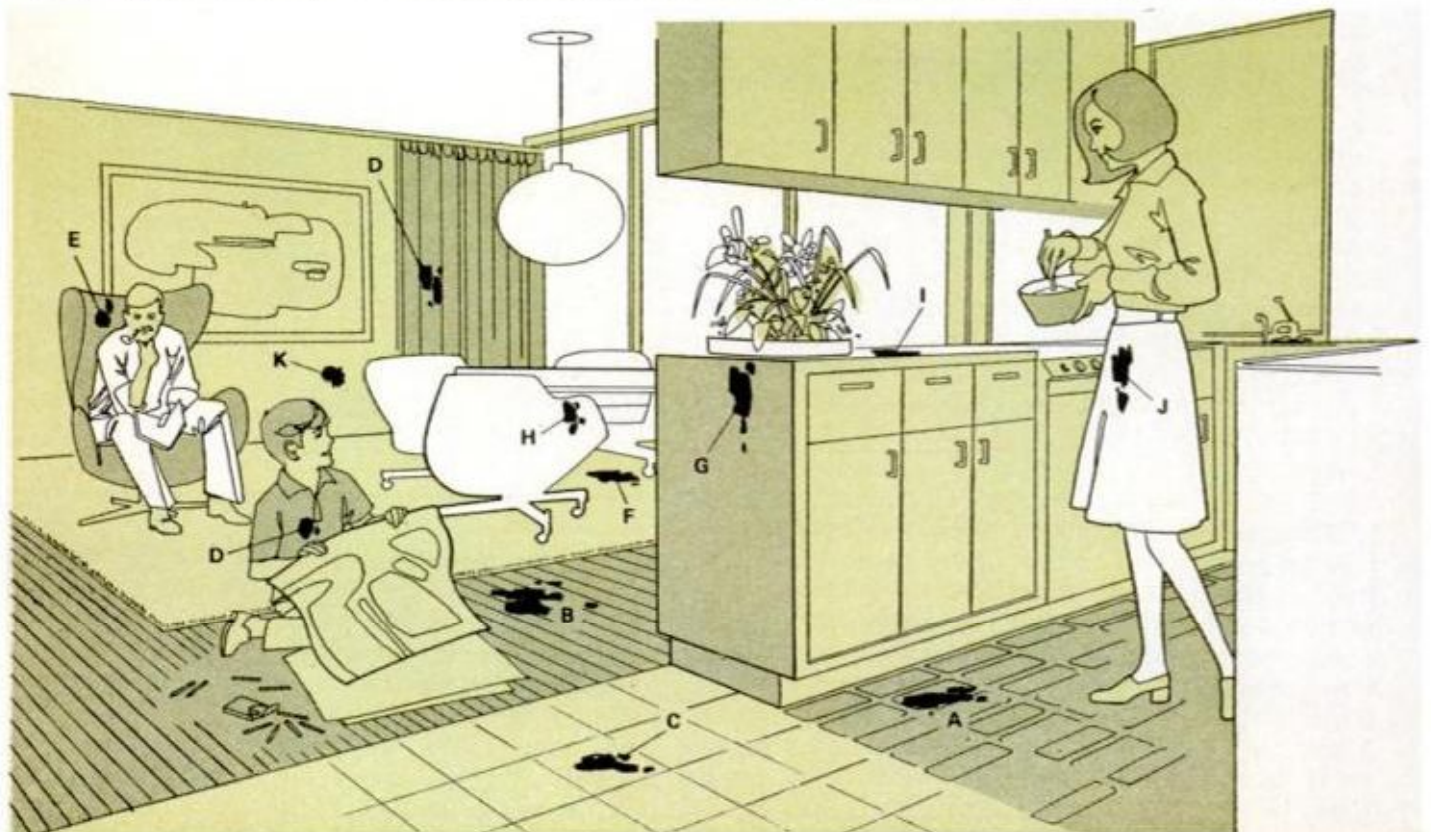

When to water-spray stains prior to using solvent

RESPOND TO WATER SPRAY

Alcoholic beverages	Mud (allow to dry first and brush)
Blood	Mustard (yellow stain often impossible to remove completely)
Candy	Perfume (wet immediately; may not be removable if set)
Catsup	Perspiration (wet immediately; may not be removable if set; may affect dyes)
Chocolate	Soft drinks
Cocoa	Sugar
Coffee	Tea (treat as soon as possible)
Egg	Tobacco
Fruits, fruit juice	Tomato juice
Gelatine	Toothpaste
Glue	Wine
Grass	Writing ink
Ice cream	
Iodine	
Meat juice	
Mercurochrome (may need chemical treatment)	
Mildew (may need chemical treatment)	
Milk	

DO NOT REQUIRE WATER SPRAY

Adhesive tape	Linseed oil (if set, almost impossible to remove)
Butter	Lipstick (some stains)
Candle wax (scrape off first)	Machine oil
Carbon paper	Mascara
Chewing gum (scrape off excess)	Mayonnaise
Cod liver oil	Petroleum jelly
Crayon	Rouge
Cream	Salad dressing
Fats	Shoe polish (may require chemical treatment)
Floor wax	Soot
Gravy (spray lightly to remove starch first)	
Grease, soil and tar	
Ballpoint-pen ink (may need chemical treatment)	
Lead pencil	

Stains listed above generally will respond to a water-spray treatment before dry cleaning with a solvent. Blood must be removed before dry cleaning.

Dry cleaning only is required by above stains. Some may call for special treatment—in some cases, with chemicals (refer to comments in parentheses).

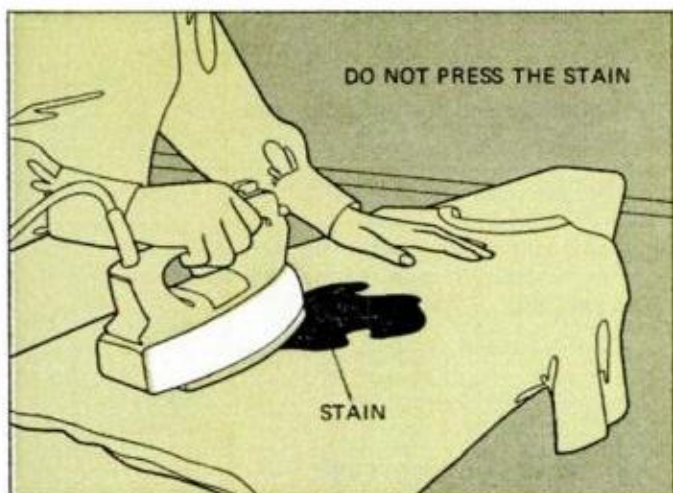

Don't set the stain

If a stain becomes set (fixed in the fabric), it can never be removed without some damage to the fabric. Thus, there are several rules of thumb you should follow to help safeguard against setting stains inadvertently:

1. Avoid heat. If a garment or slipcover becomes stained, *do not* press the stain, because heat sets stains.
2. Sponge stained areas as quickly as possible using lukewarm water.
3. *Don't* use home-spotting agents such as cleaning or lighter fluid. Check charts on these pages to determine which solvent and method to use.
4. *Don't* rub stain; sponge it as shown at right.

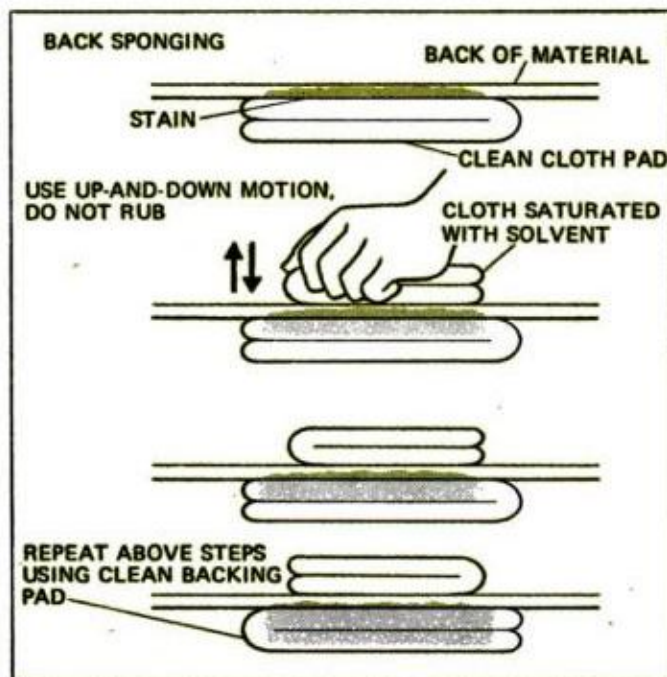

Art: Roy Grinnell

Back sponging

To back sponge, place stained side face down on clean, absorbent material. Then sponge the back of the stain with a pad saturated with solvent appropriate for both material and stain. Important: Do not rub; rather, use an up-and-down padding motion. Final step is to replace the cloth pad below with a clean one and repeat the padding to remove all traces of stain from the fabric.

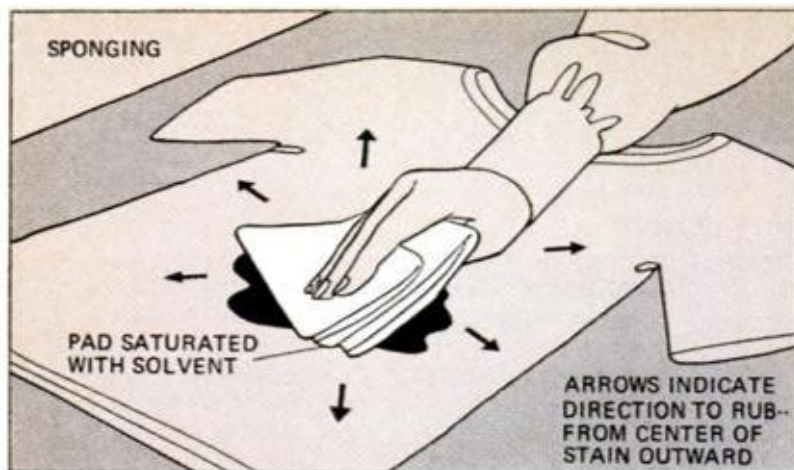

Front sponging

Sponging is probably the most frequently used method of removing stains from non-washable fabrics. Front sponging (applying solvent to the face of the fabric) works well with most grease solvents such as carbon tet. The stained fabric should be backed up with absorbent material or a blotter, and the rubbing strokes should be away from the center of the stain. Don't rub in circles over stained areas. This will only cause rings (of the stain) which will decrease in darkness as the circle, or stain, spreads.

Common stains and their treatment

STAIN	HOW TO REMOVE IT
Coffee	Hot water; if stain remains, use oxidizing solvent.
Gum	Scrape off as much as possible; then use carbon tet.
Ink	Apply citric acid or oxalic acid—or apply these alternately with laundry bleach. Some colored inks can be removed with water or alcohol.
Iodine	Use hot water or alcohol; on starched material, use hypo.
Latex paint (fresh)	Use water, detergent, ammonia.
Latex paint (old)	Soak in ammonia.
Lipstick	Rub with lard or petroleum jelly; use grease solvent, detergent.
Mildew	Detergent; then use a laundry bleach or hydrogen peroxide.
Oil paint (fresh)	Remove oil with turpentine or benzol; then launder. On nonwashables, use carbon tet.
Oil paint (old)	Soak in ammonia or borax; then launder.

NOTE: Before using any solvent on fabric, be sure it is safe. Test on scrap of same material if possible or try solvent on out-of-sight part (i.e. shirttail) of garment first.

Typical solvents

SOLVENT CLASS	NAME OF SOLVENT
Hot water	
Inert solvents	Carbon tetrachloride*, benzol, turpentine and alcohol.
Oxidizing solvents	Laundry bleach and hydrogen peroxide*.
Detergents	Detergent solution, soap in alcohol.*
Acids	Citric acid, oxalic acid, tartaric acid, acetic acid (vinegar).
Alkali	Ammonia water, borax solution.
Reducing solvents	Hypo solution.
Lacquer solvents	Acetone, lacquer thinner.

*Mildest solvent of its class; best for delicate materials.

Types of stains

TYPE	EXAMPLES	SOLVENT	
		Washable Material	Nonwashable Material
Protein*	Egg, meat, blood, milk, cream	Cold water, detergent	Cold water, inert solvent, detergent
Grease	Petroleum jelly, fats, oils, motor oil, tar	Grease solvent, detergent	Grease solvent
Water-soluble	Sugar, candy, syrup	Water, detergent	Cold water†, inert solvent, detergent
Dye‡	Fruit, grass, dyes	Hot water, oxidizing agent	Warm water, mild oxidizing agent
Starchy	Flour, starch	Hot water, detergent	Inert solvent, detergent, warm water
Iron (rust)	Rust	Acid	Acid‡
Solid soil	Mud, mud particles	Brush off, detergent, inert solvent	Brush off, detergent, inert solvent

* Do not use heat in any form or hot water.

† Sometimes usable by sponging; test before using.

‡ Do not use soap or alkaline substances.

Asphalt and vinyl-asbestos floor tiles

Stain-removal methods: A. Remove or wipe from floor. B. If freshly spilled, take up by blotting—don't rub; let dry. C. Wash with water-soaked rag. D. If dry, scrape off with putty knife. E. Wash with cloth dipped in liquid cleaner; rinse. F. Rub lightly with cloth dipped in alcohol and rinse. G. Rub with 00 steel wool dipped in liquid cleaner; rinse. H. If G fails, apply mild household cleaner rub with steel wool dipped in liquid cleaner, rinse thoroughly. I. Polish surface when completely dry.

STAIN	METHOD FOR REMOVAL
Asphalt adhesive	ADGHI
Alcoholic beverages	ACI
Blood	AGHI
Butter	DEI
Catsup	AEI or AGHI
Cement (household)	DGHI
Chewing gum	DGHI
Cigaret burns	GHI
Coffee	ACI
Detergents	ACI or GI
Dye	BGHI
Eggs	ACI
Foodstuffs	ADGHI
Fruit juice	AEI
Furniture polish	ADGHI
Grass stains	GHI
Grease (vegetable)	ADGHI
Ice cream	AEI
Lacquer	BEI or DGHI
Mercurochrome	BFI or BGHI
Mildew	GHI
Milk	AEI
Mucilage	BDEGHI
Mustard	AEI
Nail polish	BEI or DGHI
Oil (vegetable or petroleum)	AEI
Paint	BEI or DGHI
Rubber heel marks	GHI
Rust stains	GHI or A
Shoe polish	AGHI
Soft drinks	ACI
Solvents	BEI
Strong soaps	ACI
Tar	ADGHI
Tea	ACI
Varnish	BEI or DGHI



Brick and wood stains

Many types of stains on materials other than fabric can be removed by washing with a mild detergent. Where an oily substance has penetrated a wood (or concrete) floor, a poultice consisting of an oil solvent (such as turpentine) mixed with an absorbent agent—corn meal, for example—will usually do the stain-lifting job. Stains on marble tabletops can frequently be removed using this method. If the stain is still fresh, it is best to dust on the absorbent material, then apply a pad saturated with solvent. Ordinary stains that penetrate brick and stone masonry can usually be removed with this method, but in all likelihood, some degree of rubbing will be necessary. ★★★

How to keep your gutters and downspouts functioning

A thorough annual gutter and downspout inspection and maintenance program can add from 5 to 10 years of service to the gutters on your home. That's the kind of do-it-yourself work that keeps cash in your pocket instead of causing you to lay out large sums for new gutters.

Basically, gutter upkeep can be broken down into three categories: 1) cleaning, 2) repairing damaged and leaky areas and 3) preventive maintenance.

Keep in mind that clogged gutters, as well as leaky ones, can cause problems. Because clogged drains prevent proper water runoff, for example, water can back up under roof shingles or cause a damp or wet basement and unsightly stains on the house siding. You should also know whether your

house is adequately guttered. For an average rainfall, a gutter will perform well with approximately 1 sq. ft. of surface for each 150 sq. ft. of roof to be drained.

Typical gutter and downspout component parts are shown below. These are available in both metal and plastic types composed of preformed subassemblies that are easily slipped together to form a desired unit.

Gutter sections come in 8, 10 and 12-ft. lengths—the 10-footers are perhaps the most popular length and are easy to handle. The various fittings, connectors and the like must be ordered separately; make certain that you include enough hangers to do the job. Assemble sections on the ground; then, with help, hoist and fasten them in position.

Typical gutter and downspout parts

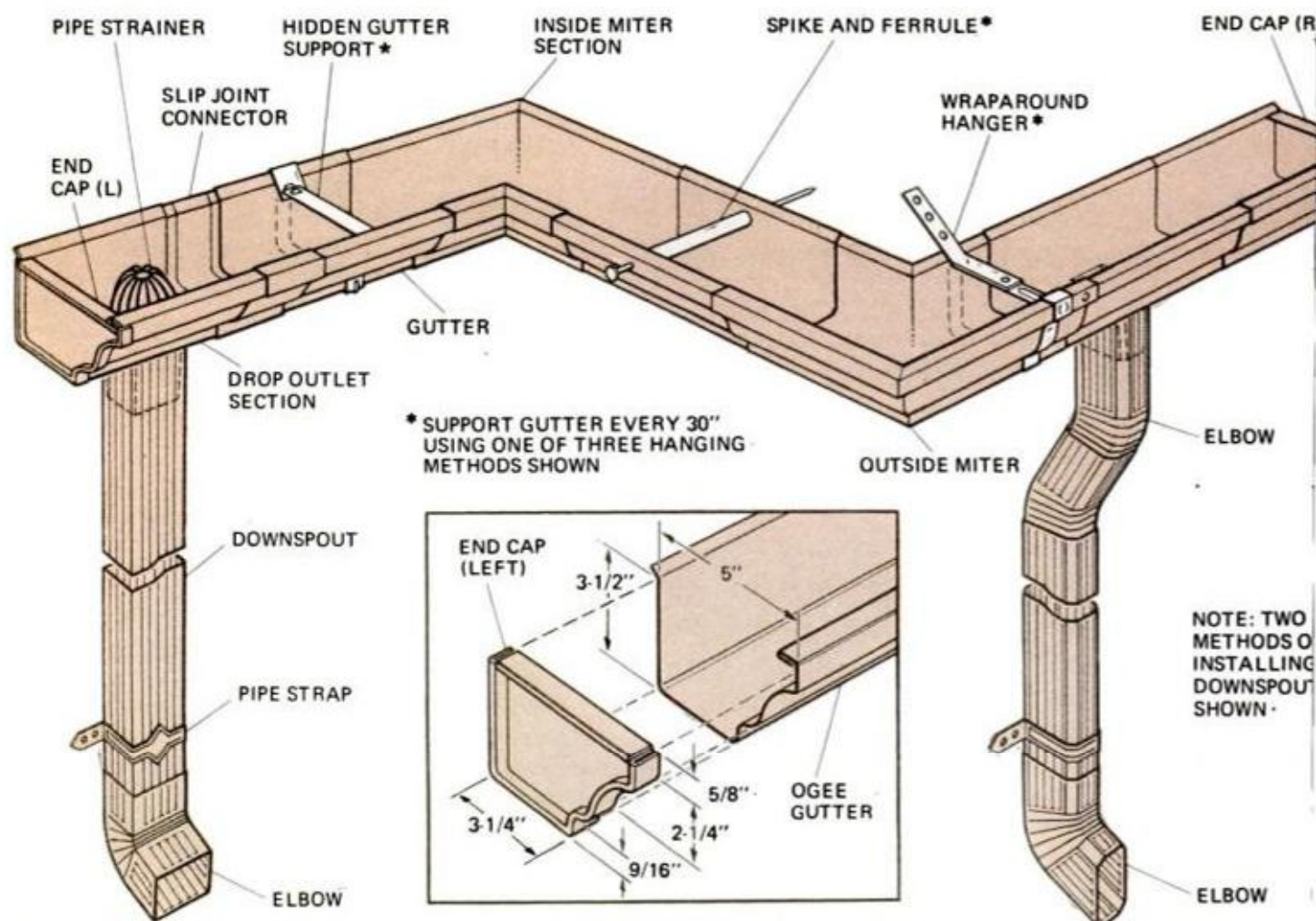

NOTE: TWO METHODS OF INSTALLING DOWNSPOUT SHOWN.

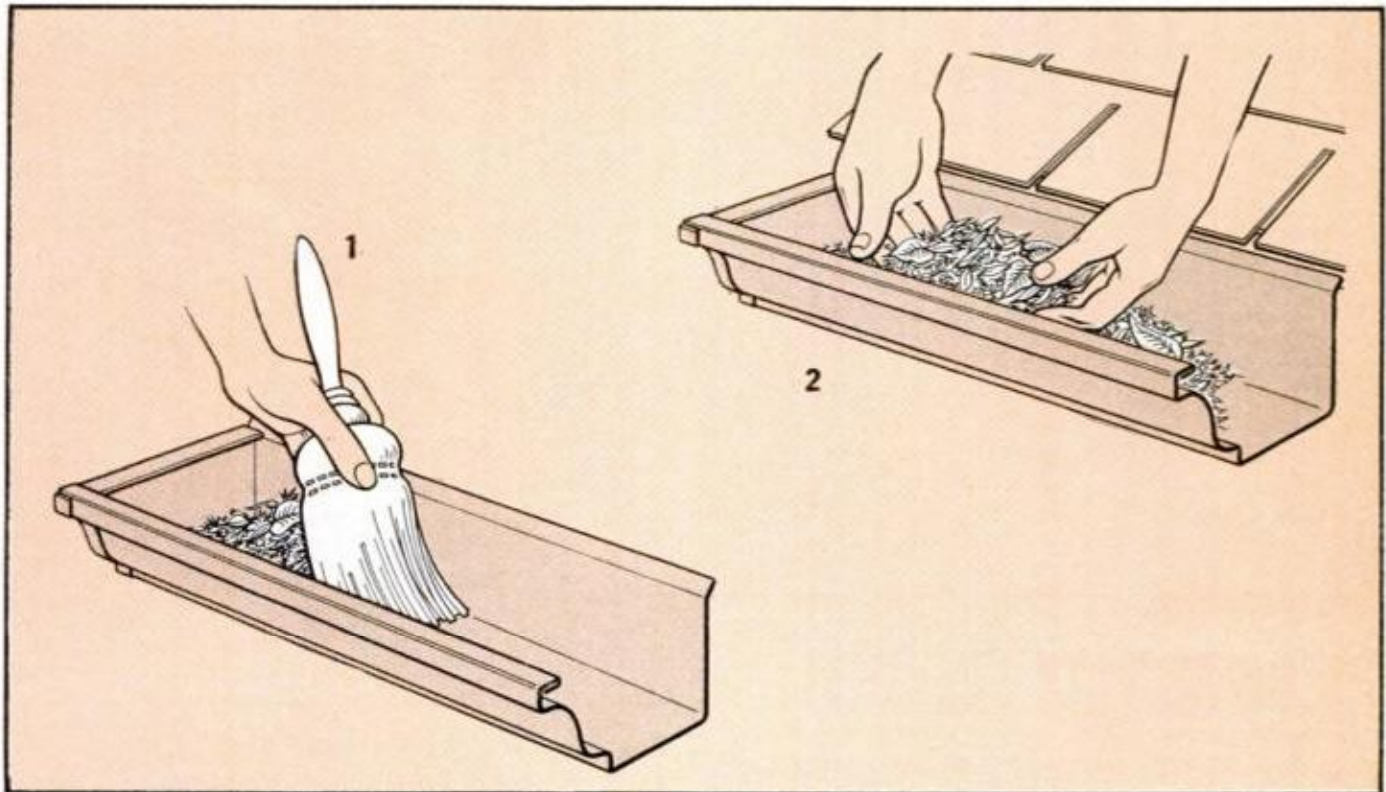

PETER TROJAN

When to clean the gutters

The logical time to give your gutters an annual cleaning is in autumn, after all leaves have fallen. You'll find minerals and grit from your shingles in gutters as well. A whisk broom (1) is a perfect "tool" for this chore. After all leaves and debris have been scooped out (2), flush out the gutter

using a garden hose. During this cleaning stage you can check for leaks and drainage pitch and make necessary corrections (see next two pages). Keeping gutters clean is extremely important; rotting leaves combined with soot and the like will form an acid that hastens rusting and corrosion.

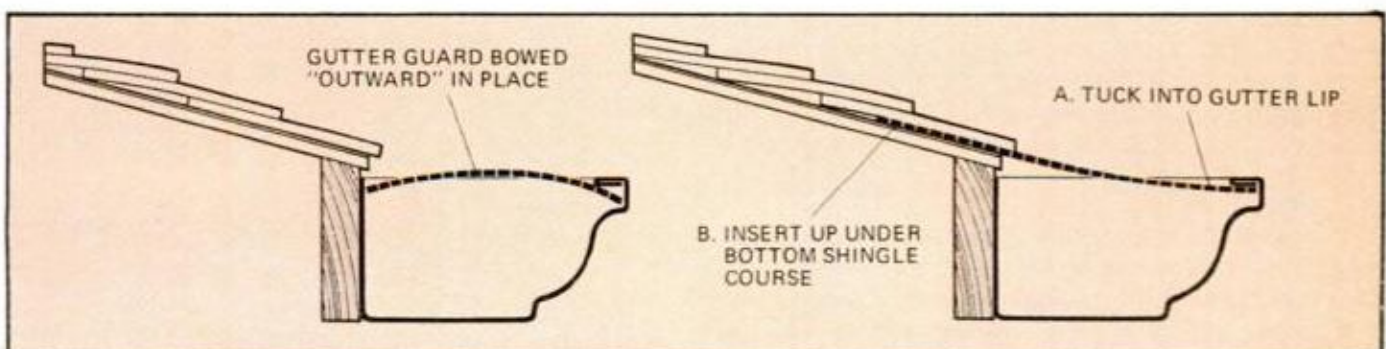

Consider installing gutter guard

Installation of plastic gutter guard takes a lot of the work out of keeping gutters clean. Using the screen doesn't completely eliminate the leaf-cleaning task, but it does minimize it. Most types of gutter screening come in rolls 6 in. wide by 25 ft. long. The guard can be installed using either method shown above: By tucking one edge up

under the bottom course of shingles with the other edge in the gutter lip, or by bending both edges into the gutter to create a pressure fit. Overlap end joints by at least 4 in. The only tool you'll need for this job is a pair of scissors for cutting the guard. In any event, the guard does not eliminate annual hosing down of gutters.

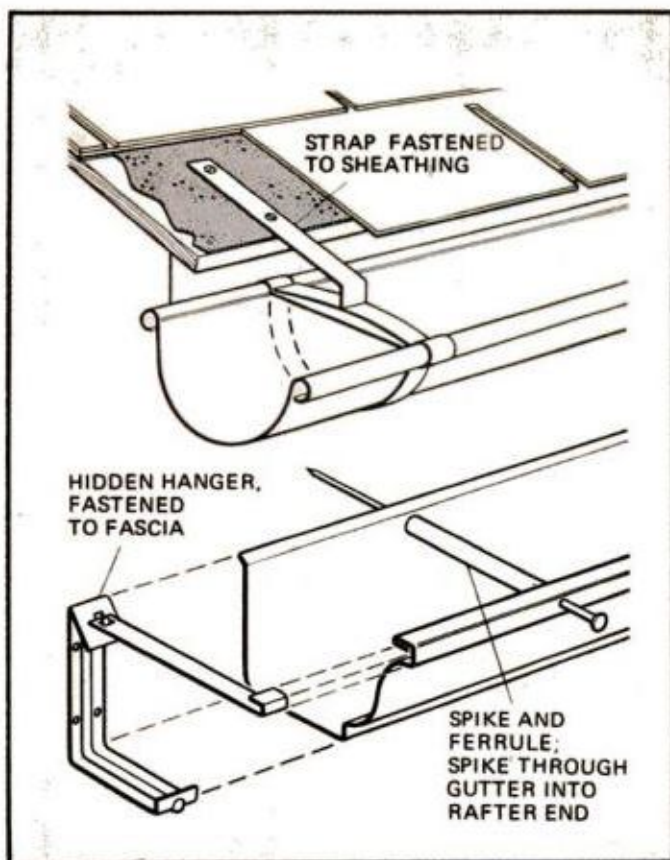

Typical gutter hangers

Your yearly inspection should also include checking for sagging gutters (where water will collect instead of run off). Sags will inevitably cause water to spill over the gutter during heavy rains. If you have water spills during a cloudburst, and your cleaning assured that there were no clogs, you can assume that the gutter is sagging because of a hanger problem.

A sag can be caused by a loosened hanger—usually created by excessive weight of ice formed in an improperly pitched gutter. There are other reasons for sag, too—a ladder placed improperly against the gutter, a stray basketball or a fallen tree limb, for example.

If your gutter is fastened with straps (top sketch), carefully lift the shingle to avoid cracking it and check the nail. If necessary, take up slack and replace the nail with a longer one. After replacing the nail, cover its head and the surrounding area with roof cement and lower the shingle into place.

If the gutter is supported by a hidden-type hanger, the gutter section may have to be removed for inspection. If the hanger is loose, chances are that either the nails have backed out or too few were used originally. Add longer nails and make certain *all* nails are driven home so the bracket is fully seated on the fascia board.

The third type of hanger is the spike and ferrule. Carefully remove the old spike. After determining that the fascia is sound, carefully drill a hole in the gutter at least 2 in. away from the spot where the old spike was. Insert the spacer (ferrule) and drive home the spike. Patch both sides of gutter where it was pierced by the original spike.

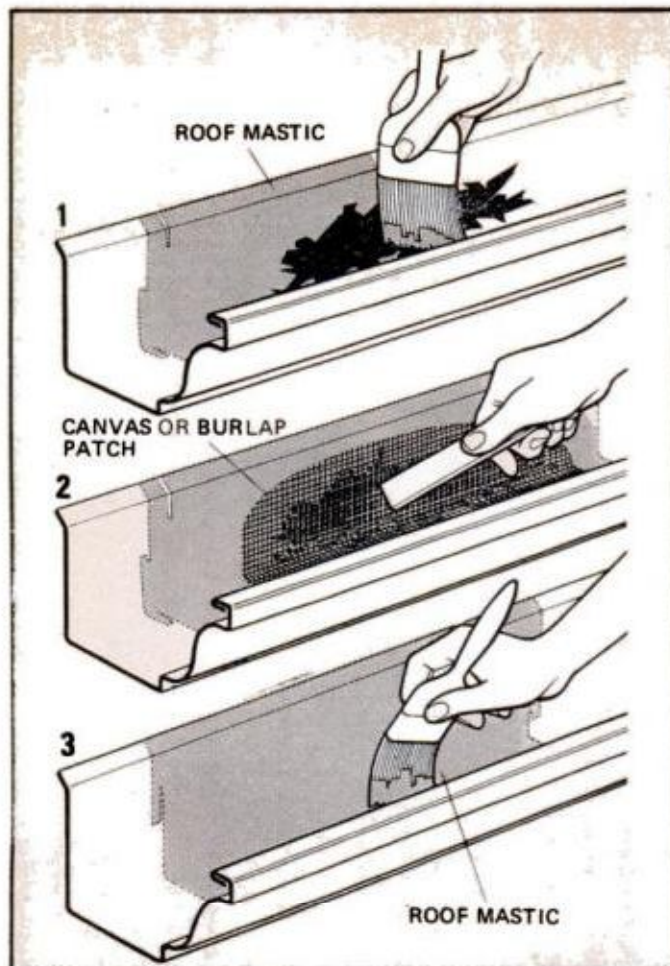

Patching small holes and breaks

Small holes in the metal can be closed using a fabric patch and roofing compound. First clean the area and go over it with a wire brush. After dusting, apply roof mastic (1). Then press in a patch of either fiberglass, canvas or burlap. Use a wood "spatula" to smooth out all wrinkles (2) and apply a top coat of the roof mastic compound (3). Do not build up the area too high or you may restrict the flow of water. These patches can add years of service life to a gutter.

If corrosive damage is extensive, an external patch may also be required. Your best bet is to use one of the fiberglass repair kits that are available at auto supply stores. Read the manufacturer's instructions before applying. However, before tackling a patch job of considerable size, give thought to replacing the damaged section of gutter entirely. In the final analysis, replacing the section may be cheaper, and accomplished with less time and effort.

Repairing holes in wood gutters

Wood-gutter repairs are similar to metal-gutter repairs except that a careful check should be made to assure that there are no soft spots under the surface of seemingly sound areas. Soft spots should be gouged out with a wood chisel and patched with a quality wood filler intended for outdoor use. When filler has hardened, proceed with the patching operation as described above for metal gutters.

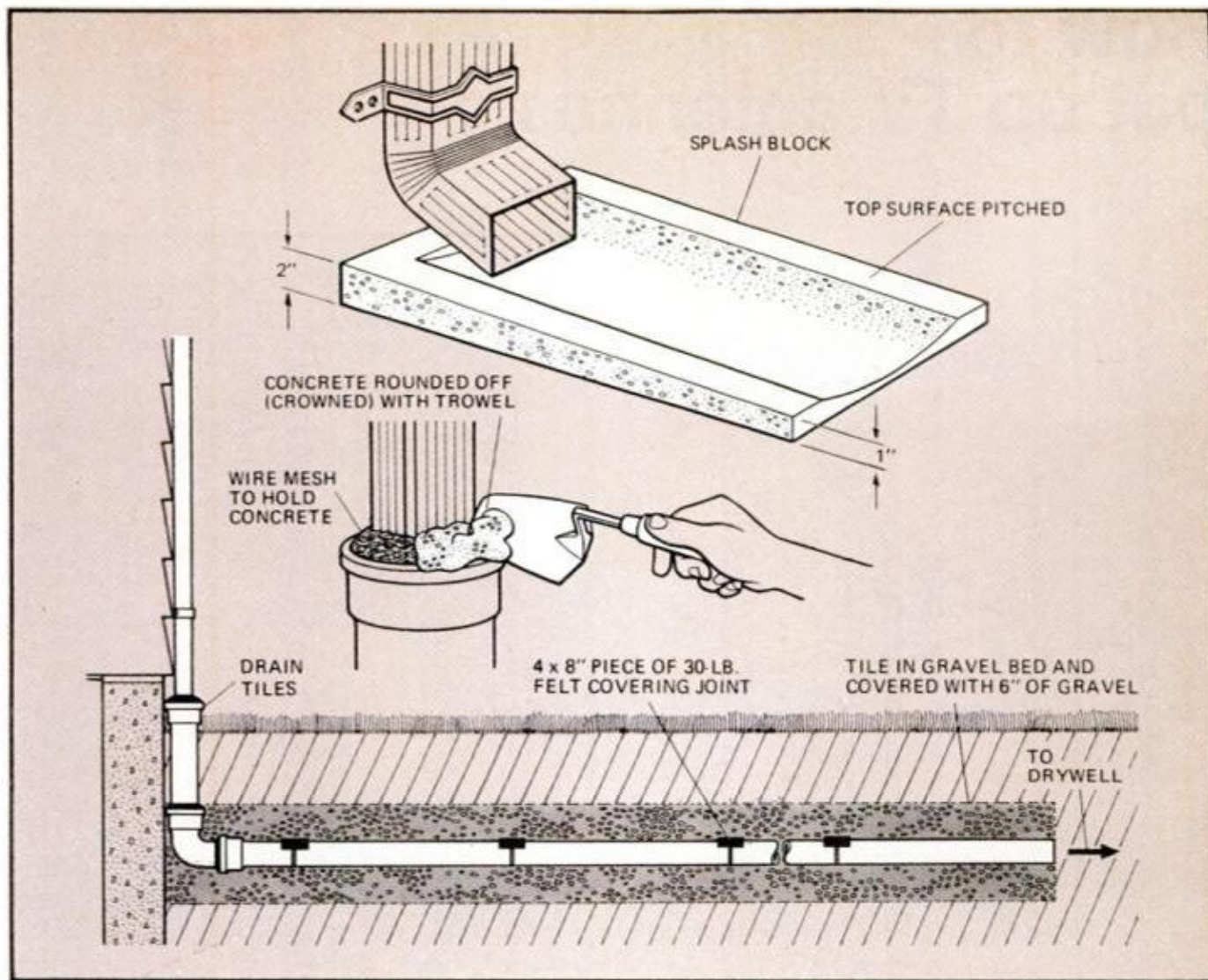

Installing splash blocks and drain tiles

Unless you provide for water discharge at ground level, soil will be washed away. And if drainage away from the foundation wall is poor, water may seep into the basement.

If there is good drainage away from your foundation, a flat stone placed beneath each downspout will do an adequate job of dispersing water. It is better, however, to install concrete or plastic

splash blocks; you'll have a more permanent job.

□ In some soils, a run of open-end drain tiles installed below grade as shown above will serve as an effective dispersal unit. If desired, drain tiles can be connected to a dry well filled with gravel and capped with concrete. On long runs, wells are usually not needed; water is adequately dispersed at joints along the length of the tiles.

Annual preventive maintenance

After gutters have been thoroughly cleaned and any necessary spot-patches completed, they should be given the appropriate annual maintenance. Follow these steps:

□ *Wood gutters.* Keep inside surfaces thoroughly coated with brush-on asphaltic cement.

□ *Metal gutters.* If of galvanized iron, they may show rust spots. After wire brushing and dusting off, apply a quality rust-preventing prime coat of paint. Consider painting the entire gutter lining, but make certain the surfaces are clean or the primer will peel off.

□ *Aluminum gutters.* Require minimal main-

tenance because they will not rust. Aluminum gutters provide their own oxidation which helps the paint to adhere. They are not as strong as steel however, and are more prone to damage from ladders, tree limbs and the like.

□ *Polyvinyl chloride (PVC) plastic gutters.* This type requires practically no upkeep (other than annual cleaning). It is not as strong as metal when used as a ladder support and has the disadvantage of great expansion and contraction in heat and cold. Thus, when you are installing PVC gutters be sure to use the prescribed connectors that allow for expansion at the joints. ★★★

How to put up TV antennas

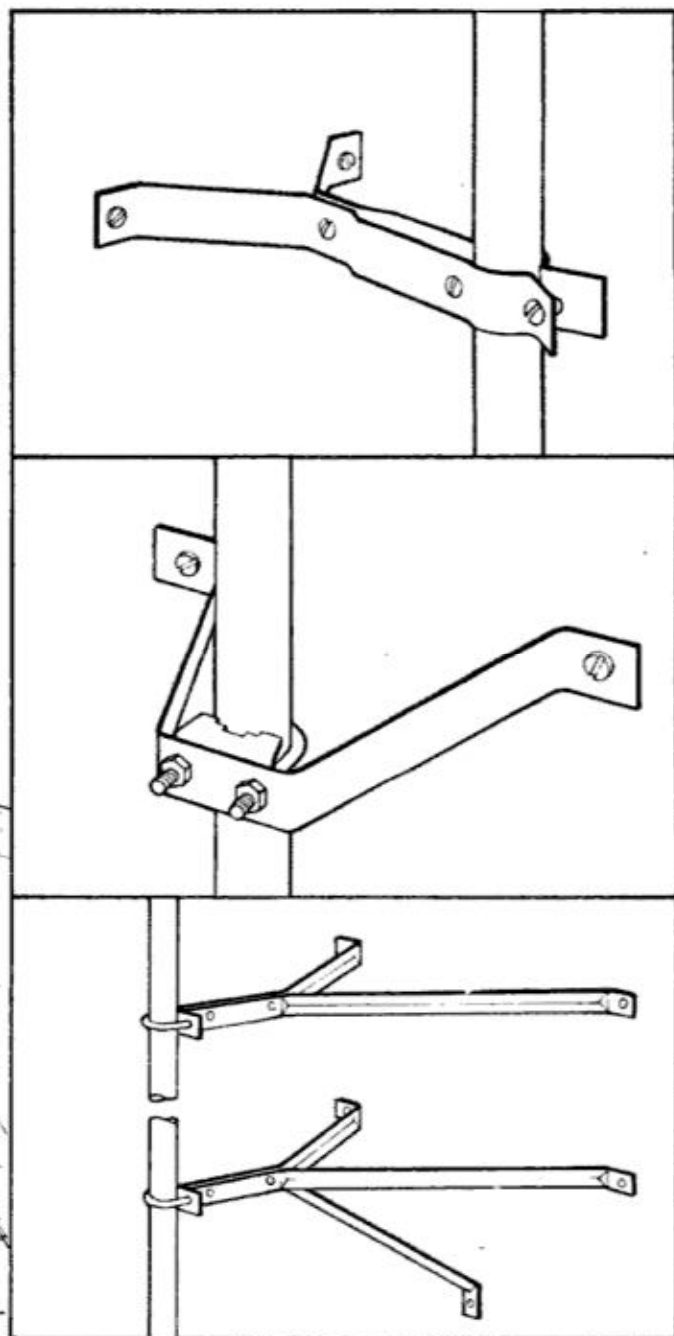
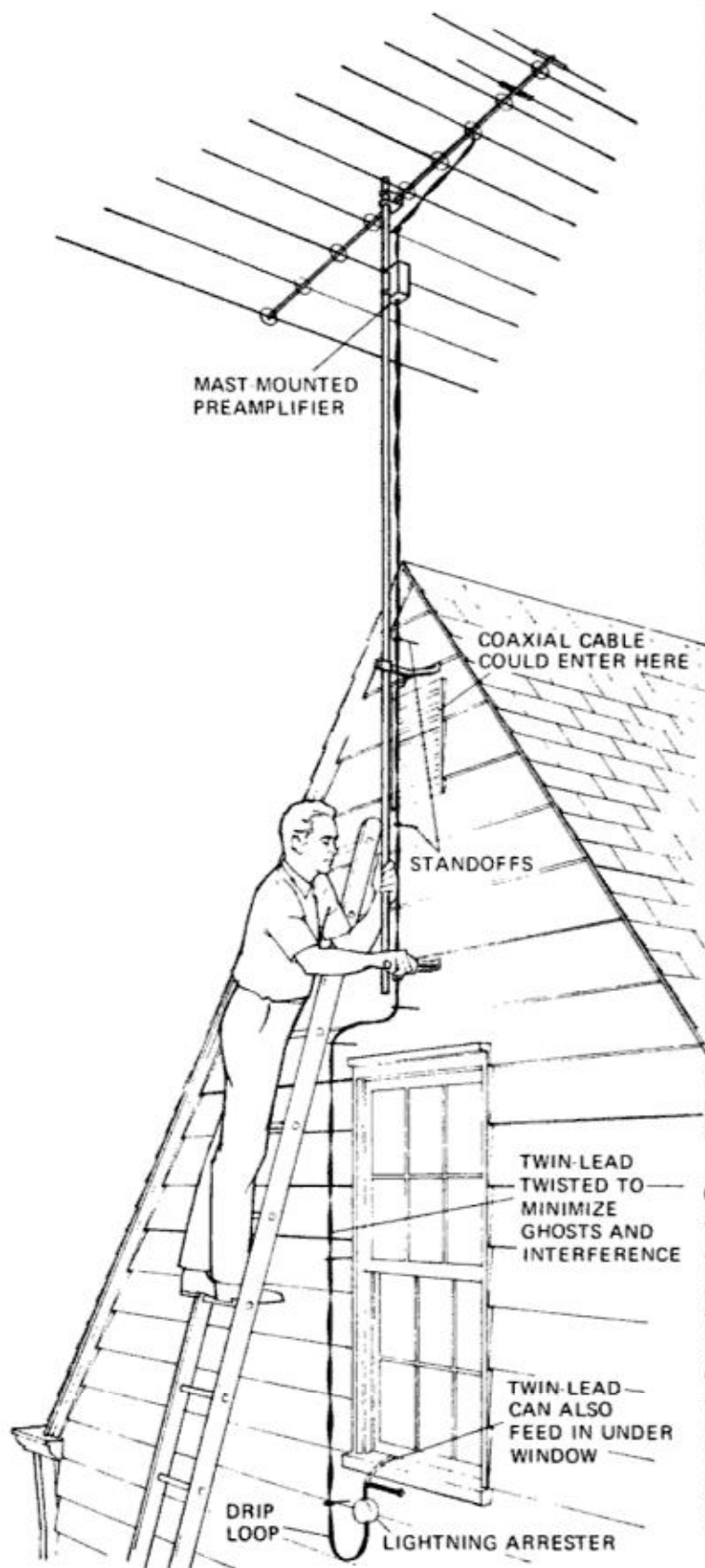

Gable mount must clear eaves

Techniques start with the right mount. Above: three types of wall mount; pick a pair deep enough to clear your eaves' overhang. Mount them at least 2 ft. apart for masts up to 10 ft.; for 15-ft. mast height, use three brackets, 2 ft. apart, and a 20-ft. mast. Coaxial cable is the best lead-in, unless you have very weak signals and no ghosts or interference; if you use flat twin-lead (it's cheaper), twist it once per foot to reduce ghost and noise pickup. Keep twin-lead well away from metal, or from surfaces which may get wet.

(For more on preamps, see page 198)

Chimney mounts avoid roof-walking

Chimney mount is popular and easy, if the chimney's at least 3 feet high, made of real brick, and in good condition. Check for loose bricks and chipped mortar. Use sturdy mounts, with heavy-duty, rustproof hardware and brackets, stainless-steel straps. Smoke corrodes, so if chimney is active, use color-anodized steel masts, 75-ohm antenna with screw-plug coaxial connections. Straps should be near top and bottom of chimney, 2½ to 4 ft. apart—the farther, the sturdier. Line up straps with brick rows to level them, attach mast brackets loosely before raising antenna to roof, align antenna mast with a level before tightening straps. No chimney? Use vent-pipe mount.

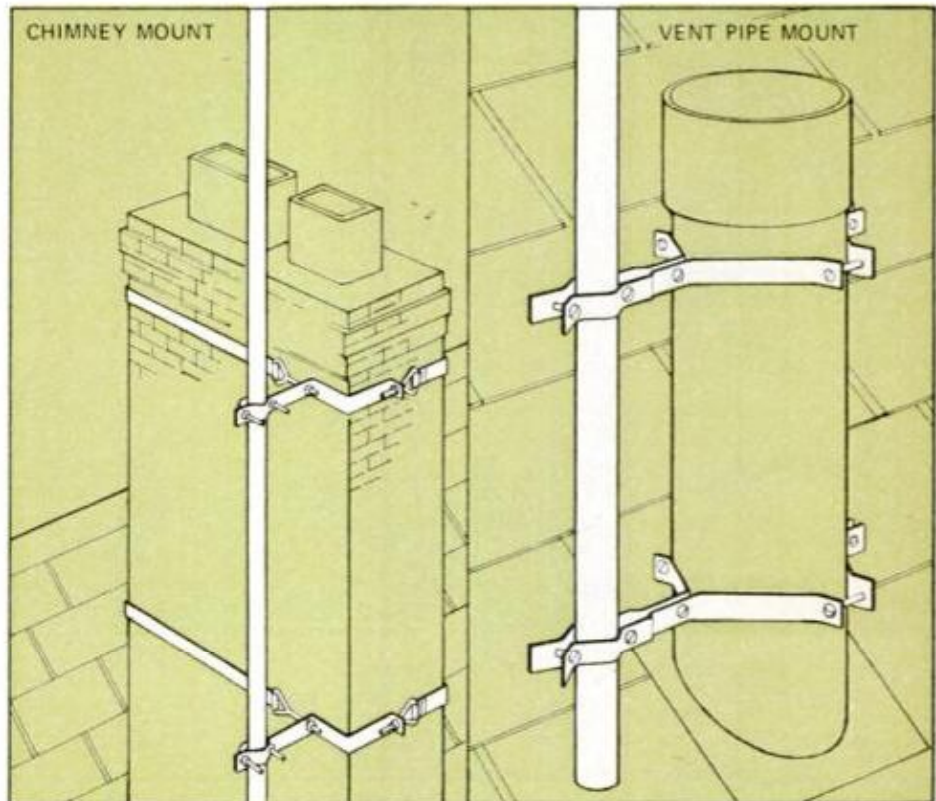

Tripods are the most rigid roof mounts

Tripod mounts, unlike other roof mounts, need no guy wires for masts up to 5 ft. high; for taller masts requiring guys, base mounts (next page) are easier to install, cheaper. Eave-mounting tripod (below, left) has swivel mast support, so mast can be attached, swung into place, then fixed. Tower type

(below, right) adjusts for flat or peaked roofs. All roof (and wall) mounts should be attached to beams or masonry—never into unsupported roofing or siding, or into mortar between bricks. To locate beams, tap with hammer, drive test nails where your roof feels most solid.

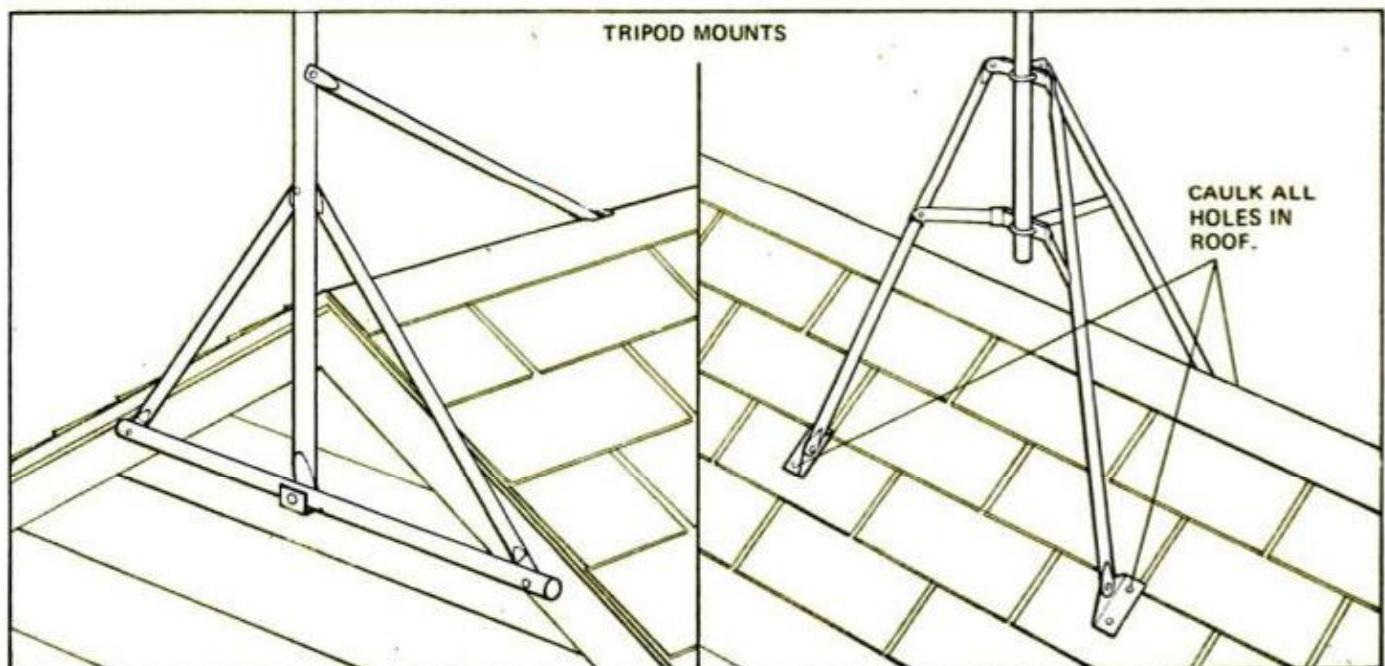

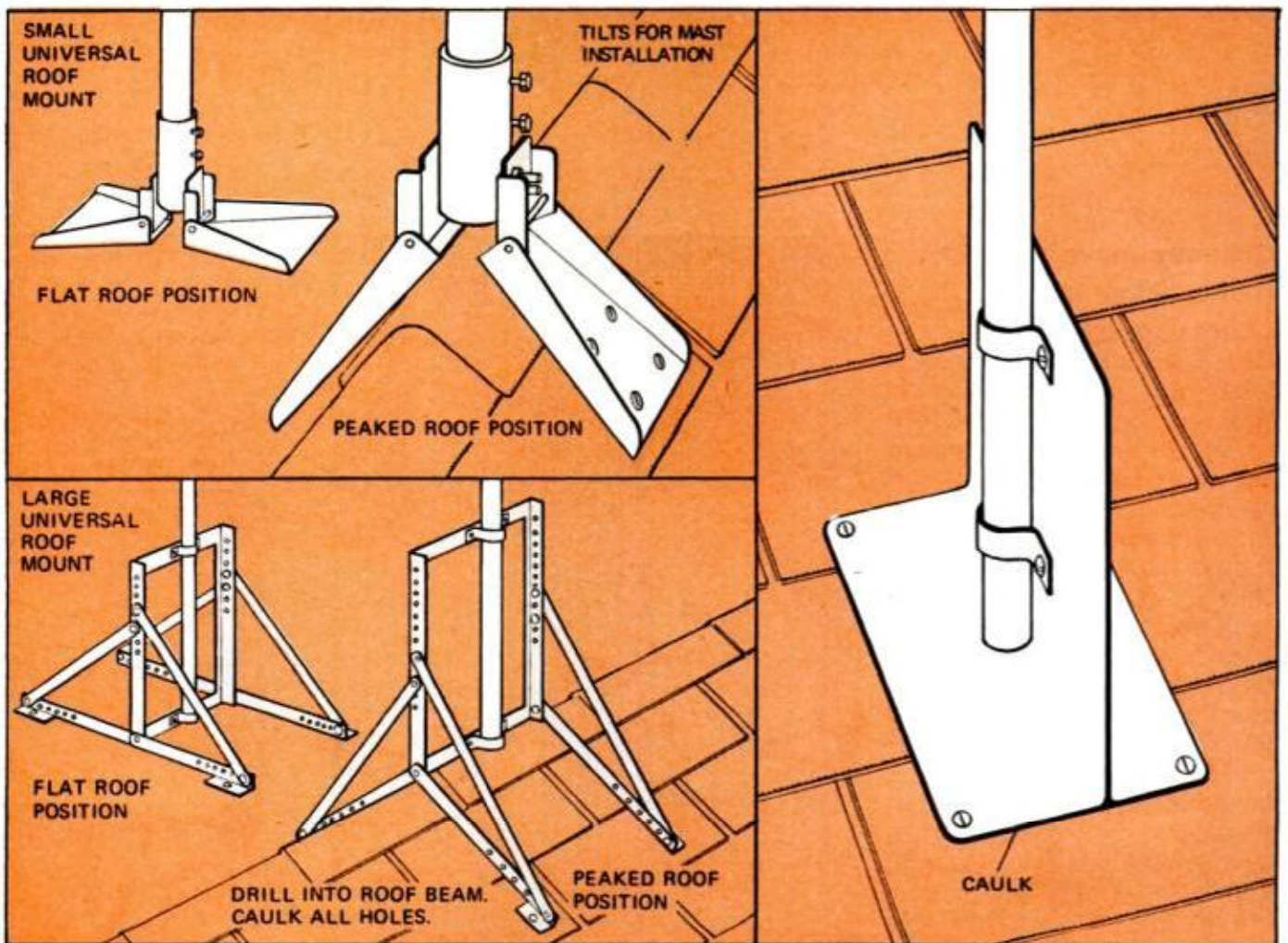

Three more types of roof mount

Saddle-type mounts for roof peaks usually adjust to fit steep or shallow roof pitches, flat roofs as well. Smaller type (top, left) tilts along roof ridge for easier mast installation; a lock screw holds it upright while you install the guy wires. Larger style (above, left) adjusts to peaks or flat roofs as shown, or to sloping roofs, can be used without guy wires if mast is short. T-girder roof mount (above, right)

fits flat or sloping roofs, always needs guys. To avoid leaks, never let mast stub touch roof, and caulk with asbestos roof cement in all screw holes, under the feet of roof mounts, and under and over screwheads. Again, make certain that all screws go into beams and not into unsupported roofing, so that high winds won't peel roof when they pull at antenna.

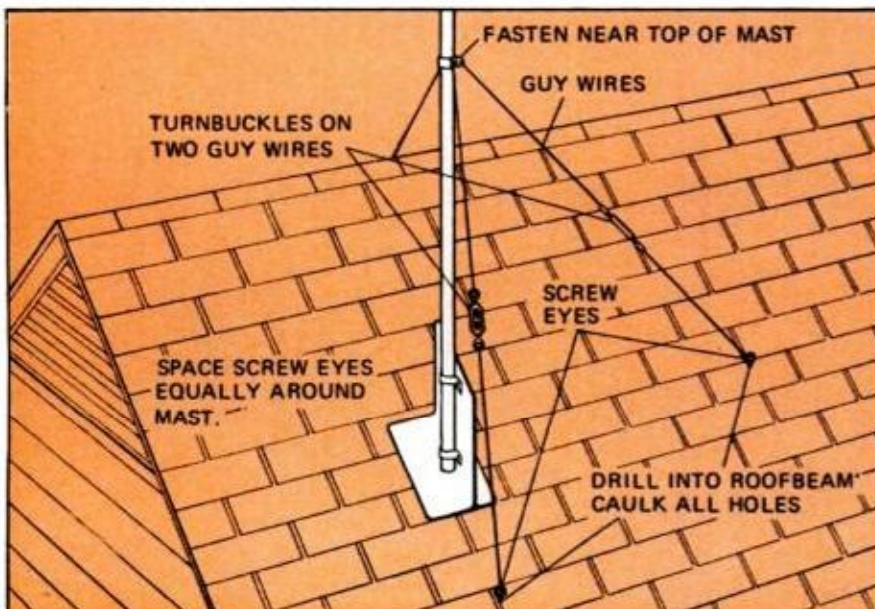

Guy wires: when and how

Use guy wires for all base-type roof mounts, masts over 10 ft. tall (one set of guys for each 10 ft. of mast), areas of heavy winds, snow, ice. Space screw eyes equally around mast, as far out as possible (ideal angle is 60° between mast and wires). On tall masts, use separate eyes for each guy, if possible. Anchor eyes in beams, caulk all holes. Don't guy to trees—they may bend and snap wires. Replace wires which kink during installation—kinks cause weak spots. Install one eye in direction prevailing wind comes from. Tighten turnbuckles evenly, so mast doesn't bow. Leave some slack; overtight guys may snap.

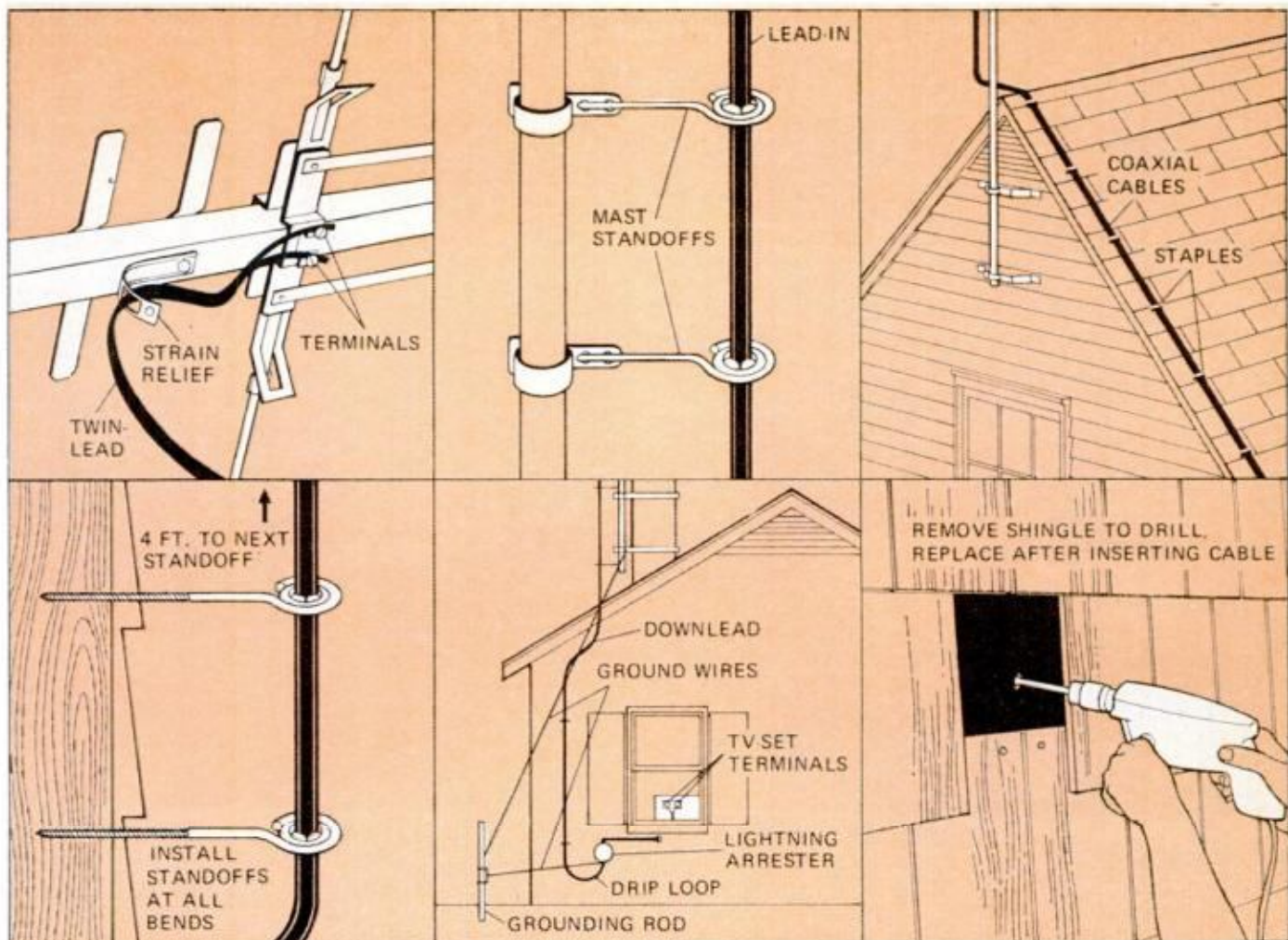

Wire it right for a better picture

Downlead should be wired to antenna and secured by a strain relief before antenna is raised. Flat twin-lead must be routed away from mast and building side with standoffs (leave enough slack between standoffs to allow for cold-weather contraction, wind, but not enough to let lead flap), and requires a lightning arrester where downlead enters house. Coaxial cables can be taped to mast, stapled to house (but be sure staples don't crush inner

shield). Masts, lightning arresters, shield of coax must be grounded for safety. To keep wire entrance from leaking, form drip loop below it, drill hole slightly upwards. Holes around a coaxial cable can be caulked, but waterproofing of twin-lead entrances requires special feedthrough hardware. To conceal and waterproof a hole in a shingle house, remove one shingle, drill the hole, then replace the shingle.

MORE TIPS:

- To aim antenna: (a) Use a compass and a pilot's map which shows antenna tower sites; (b) have someone watch set and report to you by walkie-talkie or "people chain" (easier if set is near a window); (c) put your set in the yard, where you can see it from your roof (but make sure set is grounded) (d) Take a battery-powered portable set (preferably color) to roof with you.
- If putting antenna on a rotor, leave enough slack in leads at the top for rotor to turn without breaking the downlead.
- Coaxial cable and quality twin-lead can last 10 years; cheap twin-lead can go in 2.

- Coaxial cable can be led from attic or basement via heating or airconditioning ducts—handy if set is on an inside wall.
- For inconspicuous entry, bring leads into house at baseboard level, in a closet, or just below a window.
- If you must staple twin-lead indoors, drive staples parallel to conductors, as closely centered between them as possible.
- Leave slack where the downlead meets the set, so you can move the set for cleaning, or repair. The slack in coaxial cable can be coiled—but twin-lead should never be coiled, just left slack.

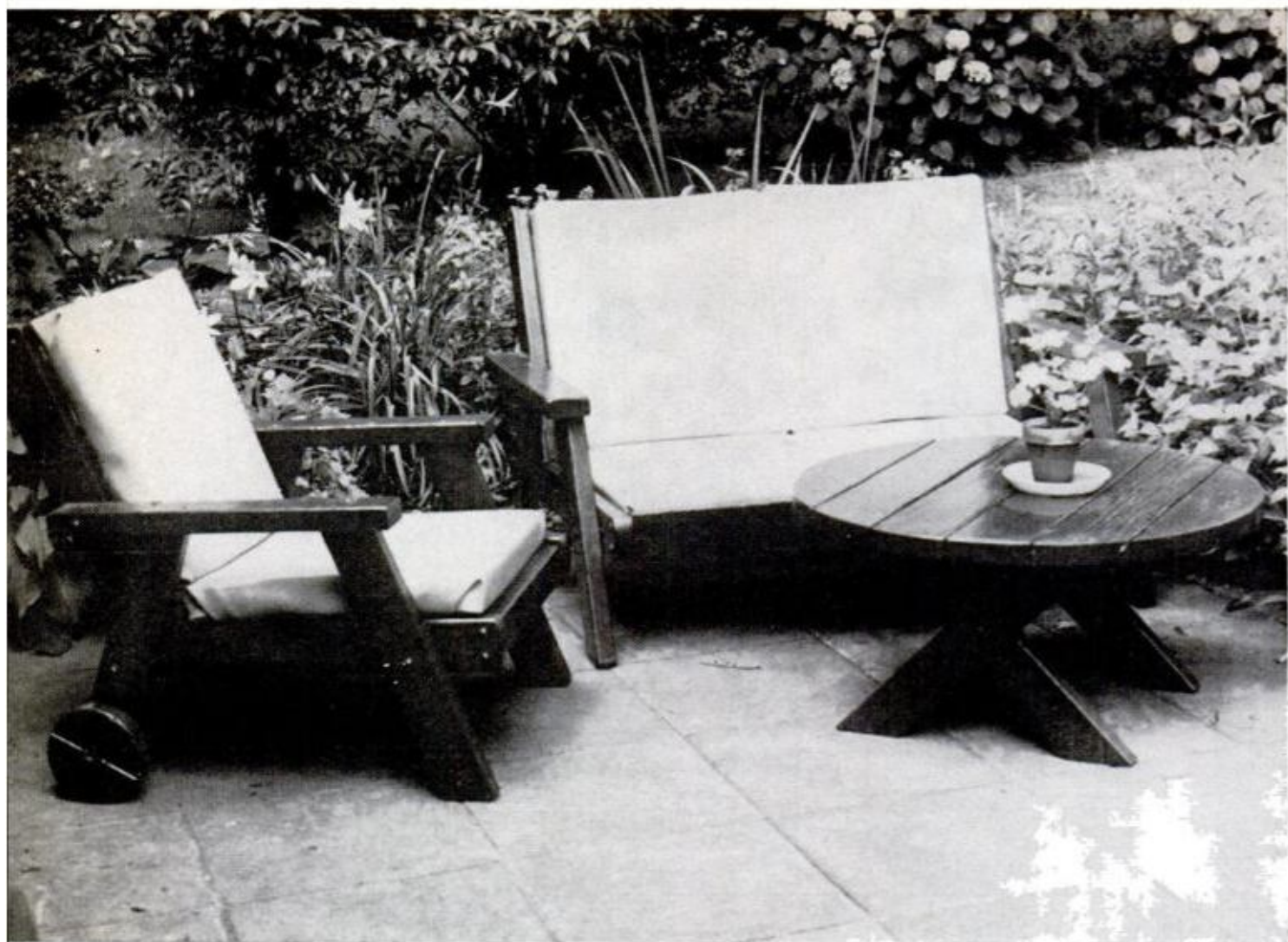

Rainproof cushions for outdoor furniture

by Robert Brightman

Are you tired of hauling in the cushions from your outdoor furniture every time it starts to rain or the weather looks threatening? Fed up with having to remove a protective cover every time you want to sit down? You can forget this annoyance if you replace the cushions with the waterproof type or recover the old cushions with plastic.

The secret is in enclosing polyurethane cushions in an envelope of vinyl upholstery fabric such as Naugahyde. Available in many colors, such material is usually 54 in. wide. A typical cushion for outdoor furniture is 3x21x21 in., requiring about one linear yard of covering. Most department stores sell both the vinyl and the polyurethane inner cushions. The cement used must be a waterproof type, such as 3M's Super Strength adhesive. Allow the cement to cure overnight before putting cushions in service. The ones shown above still look fresh after a summer's use. Occasional wiping keeps them clean. ★★★

Making the covers is like wrapping packages

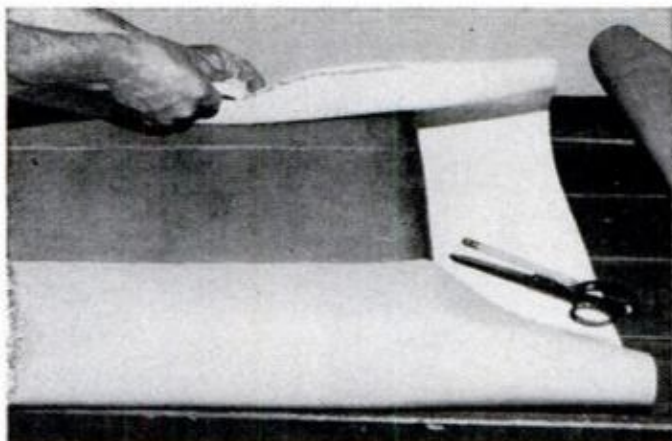

Each cushion takes two pieces of vinyl. Cut larger one big enough for generous overlap, lay face down with cushion on top. Apply cement to cushion and vinyl, let dry about 15 seconds before pressing together.

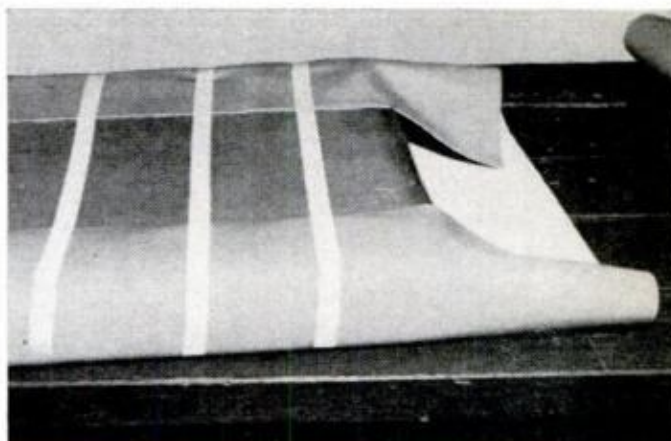

Second joint requires strips of masking tape to hold vinyl in place while cement sets—otherwise cushion's resilience will pull it apart. Position strips of tape so that they will not interfere with next step.

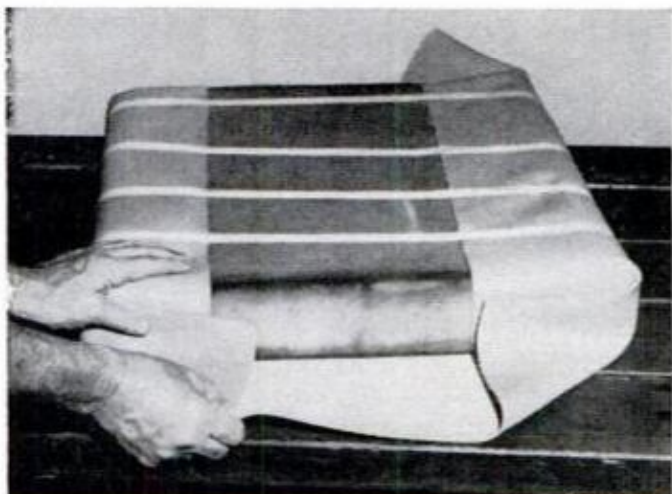

Loose ends of vinyl are folded upward, as paper would be when you gift wrap a package, and cemented. Loose corners will allow air to escape from finished cushions, keep them from coming apart when sat upon.

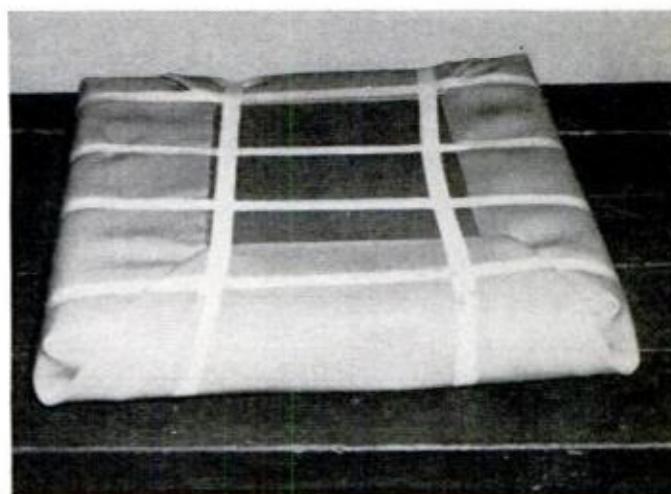

Masking tape holds vinyl "wrapping" in place while adhesive cures—about 24 hours for maximum strength. When making a pair or set of cushions, bring all to this stage and allow curing time before proceeding.

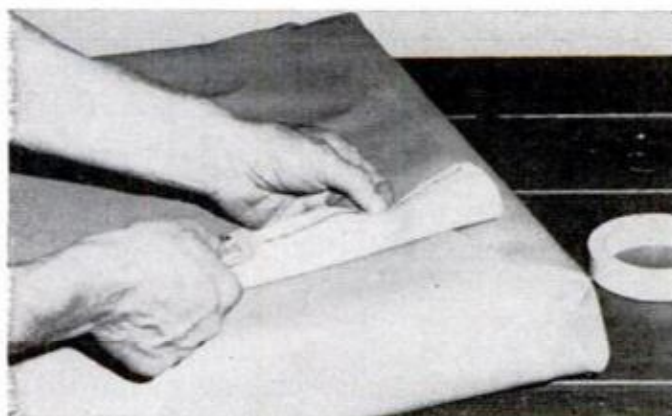

With tape removed, bottom square of vinyl is cemented in place, providing extra seal for joints already made. Apply cement to center of panel, as well as to edges, to bond it firmly to the cushion.

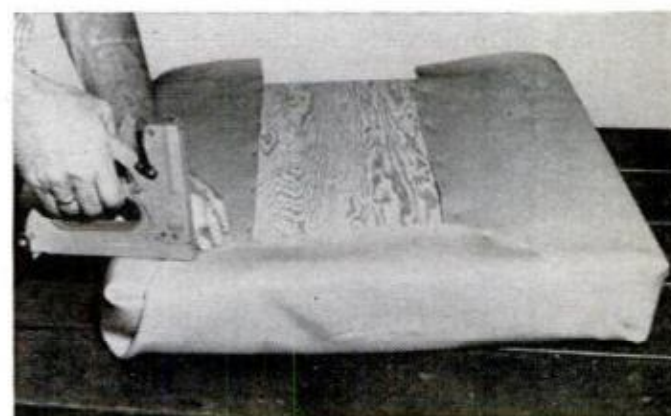

If desired—or required by construction of furniture— $\frac{1}{2}$ -in. plywood panel can be incorporated into cushion, with vinyl stapled to it. But bottom square still should be cemented, not stapled, into place.

'74 CARS

Drop a new body on the old buggy!

The race is on for small, sporty, economical cars, and to meet the demand, Detroit may have to do some quick gearshifting. Don't wait in line: Go ahead and assemble your own on a VW chassis!

by Bill Hartford and Michael Lamm
AUTO EDITOR WEST COAST EDITOR

Building his own house is probably the do-it-yourselfer's ultimate project. A good warm-up for that monumental undertaking is building your own car!

Well, let's say, *assembling* it, because these fiberglass cars are almost all built on existing Volkswagen chassis. Your work is similar to the "final assembly" step on any automobile mass-production line.

The result that you get, however, is far from a mass-produced automobile. Most are sleek, low machines like the sports prototypes in a World Championship of Makes event. Others are replicas of older, classic cars.

Whichever type suits your taste, you can pick a model from any number of kit cars

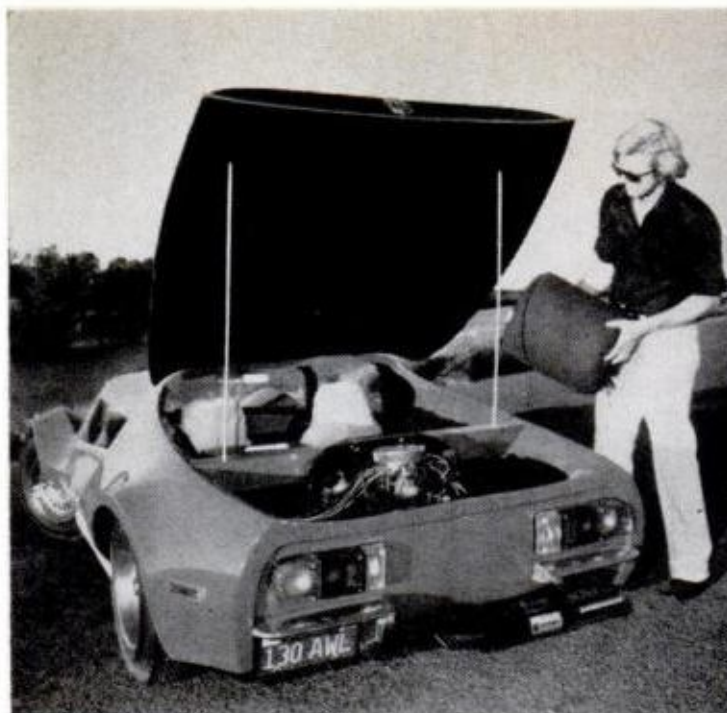

The Invader GT-IV hatchback kit car is \$900 in this deluxe version. You assemble it on an unshortened VW chassis and just add lights and a Karmann-Ghia windshield.

now available. One of the established makers in the kit-car field is Fiberfab, a company that will soon be 10 years old. Its first, racy Avenger model was introduced in 1966; an assembly project was even featured in *PM* (See *New One-Piece Body Turns 'Bug' Into a Beauty*, page 157, July '69 *PM*).

Today there are three models of the Avenger plus new models including the Liberty SLR on the opposite page.

One of the newer entries in the kit-car field is Autokit, a California company formed by a very enterprising young man, Bruce Weeks. Four years ago, Bruce, then aged 18, bought his dream car. He thought, "It came from a kit, and Bruce was this particular kit's fifth owner. The previous four

owners, he found out later, had given up trying to put that kit together.

Bruce couldn't assemble it either, so he took the kit back to the manufacturer which, among other things, assembled kits for customers. But the factory couldn't make it go together right either. So Bruce sold the kit to its sixth owner.

Figuring he could design a better car kit himself, Bruce Weeks had at it. After seven months of between-classes time at the College of Marin near San Francisco, Bruce came up with the Invader GT-I.

The GT-I wasn't flawless, but it beat his first kit in every way. Realizing he'd need formal training to improve the kit, Bruce enrolled in plastics technology at California State University at San Francisco (CSUSF) and began his Invader GT-II. CSUSF maintains a tremendous plastics workshop, and Bruce could count on good backup from his professors and classmates. By the semester's end, the GT-II emerged and was ready for marketing.

Weeks soon made a European version, the GT-III-E, and he's just begun building and selling Invaders in Spain. Meanwhile he's sold 230 kits to date in the United States. Today, at a ripe old 22, Bruce Weeks owns and operates Autokit, and he's still a full-time student at CSUSF. He's just taken out patents on a geodesic plastic vacation home which he plans to begin selling soon in kit form.

The Invader GT-IV kit comes in standard and deluxe versions. These sell for \$695 and \$895 respectively. The deluxe kit includes plexiglass gull-wing doors, uphol-

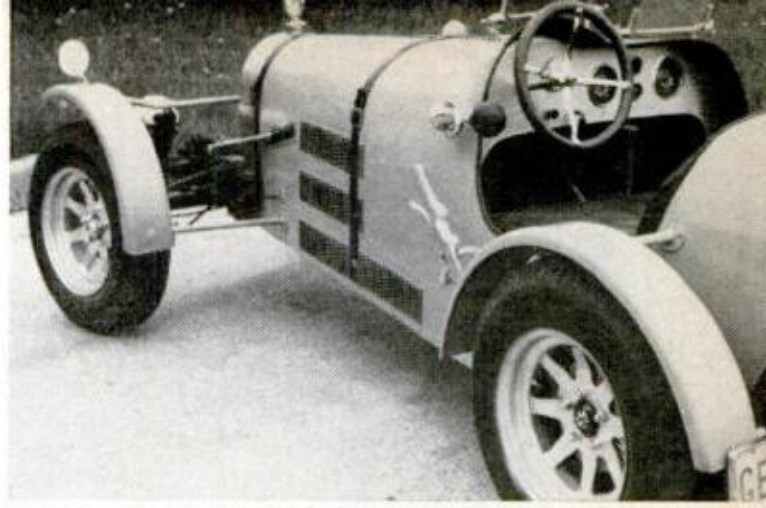

These new classics are kit cars with the romance of great cars of the past. The Targlia Mk V is a replica of the Type 35 Bugatti. The fiberglass body which bolts to a VW chassis is from Ye Olde Classic Cars. \$800.

Porsche 550/RSK kit is also from Ye Olde Classic Cars. A takeoff on the Porsche Spyder racing car of the '50s, the kit body allows room for fitting oversize wheels and tires to VW chassis. It, too, is priced at \$800.

Liberty SLR is styled after the European road racers of the '30s. This kit, from Fiberfab, is designed around the Mustang chassis and small-block V8 engine. The deluxe kit is \$1300, more if equipped as shown.

Maxi-Taxi II from Bremen Sport Equipment is a roadster designed for a VW chassis. Kit starts at \$850, but goes up to \$1500 for the metal-flake job with some of the many options available.

'74 CARS

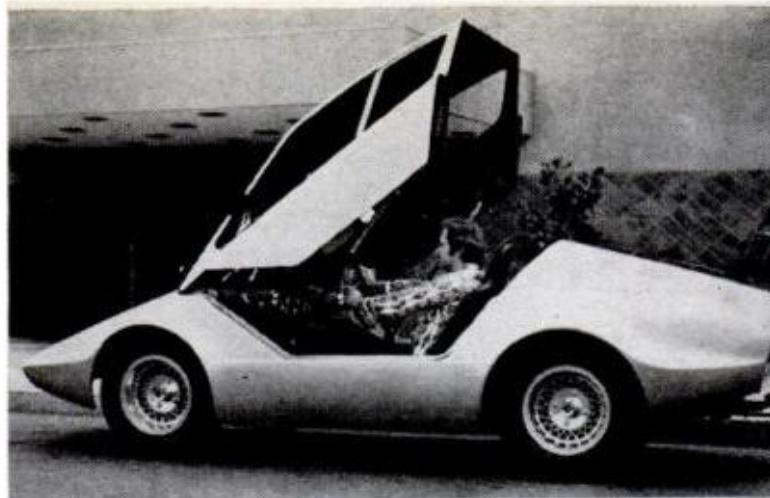

The Talon avoids bugaboo of fitting doors; canopy hinges up at the windshield. Starts at \$1000.

The ultimate project for an automotive do-it-yourselfer is building his own car!

stered seats, and all hinges and fasteners. The GT-IV body bolts to a steel subframe (supplied) that goes on an *unshortened* VW chassis platform. The only body parts not supplied are lights and a stock Karmann-Ghia windshield. Otherwise the kit arrives complete, and assembly takes common handtools plus a couple of weekends.

When you finish the project, the GT-IV or any one of the kits built on a VW chassis, you'll have a vehicle that is not only a unique, head-turner of a car, but is very economical to run—and that's more important than ever right now. With a VW-powered car you'll get VW economy and then some: The aerodynamic profile of these cars is sharper than the Beetle's and your fuel mileage will therefore be even better.

How do you get started? Usually when

you flip over one of the kit-car body designs! You can see what various manufacturers offer by writing them at the addresses listed below. As you find yourself getting in deeper, you might invest a few dollars in the construction manual that is usually sold separately from the kit itself. Gauge your own skills against the amount of work involved. Decide whether you want to spend the extra money for preassembled sections when they are available or whether you'll do the work yourself. Figure out where you are going to work. A two-car garage is ideal.

If you've gone this far, you'll next want to check your insurance company and state motor vehicle bureau for the licensing procedure. And when you're on the road, drop us a note and perhaps even a picture to let us know! ★★

KIT CARS—MANUFACTURERS AND DISTRIBUTORS

American Fiberglass and Fabrication, 2056 Clement Ave., Alameda, Calif. 94501.

Autokit, P.O. Box 1073, Alameda, Calif. 94501.

Bradley Automotive, 7669 Washington Ave. South, Edina, Minn. 55435.

Bremen Sport Equipment, Inc., U.S. 6 East, Box 221, Bremen, Ind. 46506.

Elite Enterprises, Inc., 690 East Third St., Cokato, Minn. 55321.

Fiberfab, 41060 High St., Fremont, Calif. 94538.

Lotus Central, 35093 Schoolcraft Rd., Livonia, Mich. 48150.

Marauder & Co., Route 1, Potomac, Ill. 61865.

Talon Automotive Products, Inc., 18744 Parthenia, Northridge, Calif. 91324.

Ye Olde Classic Cars, 7515 59th St., Summit, Ill. 60501.



The Talon is built on a shortened VW chassis, has a dramatic front end with quad headlights inserted.



Laser 917 is Elite Enterprises body for unshortened VW chassis. Kit prices start at \$1700.



Bradley GT is an easy-to-assemble kit that's available with a full range of accessories and over 50 metal-flake and solid colors. The basic kit is \$1500; the super kit version, which is more complete and requires less work, is \$2400. The fiberglass body is designed for the full-length VW chassis and the detailed assembly manual starts with complete information on locating an old Beetle, a list of chassis numbers representing the various model years and instructions for removing the body from the chassis.



Something olé, something new from AMC!

Obviously bullish on the intermediate-size cars for '74, American Motors has waved the designer's cape over the docile Matador and sired an aggressive new coupe—shown here in red, of course.

by Bill Hartford

AUTO EDITOR

For a while it looked as if American Motors Corp. might become the Counter Culture Car Company. Imagine. Blue denim in a Gremlin. It was a double affront to Detroit's cherished big-car caper.

And then, on top of that, a self-disparaging ad campaign! They turned the styling of anonymity into an asset: "What's a Matador?" A Detroit automaker was telling the world what it needed was a solid little car without all the flash. It was reminiscent of Volkswagen marketing "ugliness": In a world of slab-sided ships, their little car had real fenders over each wheel.

It appeared that AMC, the company in last place, planned to exploit its underdog status for all it was worth and zap the fat cats. I had visions of really little AMC station cars plugged into electrical outlets from one end of megalopolis to the other; of little, bullet-shaped transportation modules that *Popular Mechanics* in the '30s and '40s was predicting we'd have long before 1974; of . . . well, a Detroit automaker just can't turn around that fast. Even the smallest is too big. Maybe next year they'll have a new, little "peoples' car."

AMC's conventional surprise for 1974 is a new coupe in the intermediate line. The

company's design team put a marlinspike to the problem of satisfying two types of buyers and split the Matador into the sedate sedan and wagon on 118-in. wheelbase, and a brand-new sporty car on 114 inches.

The Matador coupe is smooth and slippery and actually competes with the Javelin for "boss" muscle-car styling. Various angles on the new car are shown in the pictures at right. AMC thinks of the car as being in the tradition of "European Gran Turismo road cars" but still meeting Americans' requirements for space and comfort. And appropriately, AMC has chosen it to get the fourth in its series of international designer touches. Oleg Cassini is the designer this time around, and the Cassini package includes interior and exterior marks of *haute couture*. Upholstery, panels and headliner are done in jet black with carpets and vinyl roof in a copper accent color. Outside, striping, rub rails, wheelcovers and a crest mark the Matador as Cassini's.

Powerplants include the entire range of AMC engines from the 232 Six to the 401 V8. The 232 is standard except in California (due to that state's stringent emissions standards); there the 258 Six is used. The 304 V8 is standard in the X coupe; and the 360 is an option, except in California where it's standard in the wagon.

There are many nice features; some standard, some optional. The lists only start with front discs and steel-belted radials. All makers have 5/5 for '74 (5-mph bumpers front and rear) and AMC's freestanding, energy-absorbing, recoverable system is especially simple and neat.

All cars in the line also have the required ignition interlock safety-belt system. It has shoulder and lap belt connected together for quick buckle up (See *Detroit Listening Post*, page 50, for a diagram of the system). It's such a simple, neat system that owners of pre-'74 cars should be indignant that it wasn't done sooner.

Going up the line, here are some of the changes for '74. Gremlin gets a new grille, quarter panel and minor changes for the 5/5 bumpers. A Rallye Pac option on the X

(Please turn to page 206)



Matador X is an all-new coupe in the intermediate lineup from American Motors. Available in three versions—standard, X (shown) and Brougham—the car is on a 114-in. wheelbase. The rakish new coupe replaces the staid two-door Matador hardtop. The four-door and station wagon models continue on a 118-in. wheelbase.

The coupe's aerodynamic lines were certainly drawn with one eye on winning buyers who like sporty passenger cars, and the other on having the slipperiest shape possible for winning races on the NASCAR circuit. The new Matador is s-m-o-o-t-h all over with the exception of those headlight pods. But, who knows, maybe admiring imitators are at work on their own versions right now.

On the practical side, safety and service are covered with nicely engineered bumper-systems fore and aft, three-point lap/shoulder belts and comprehensive Buyer Protection Plan.

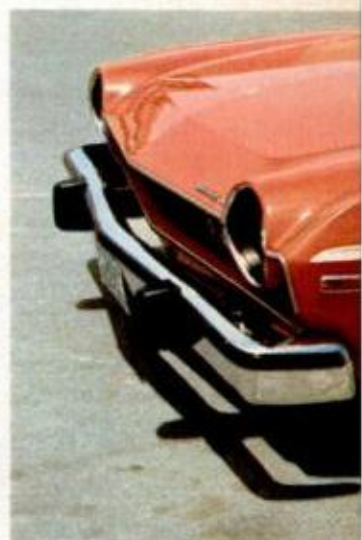

Chrysler's new cars are designed for a quick fix

Improved serviceability is built in, and all new styling is wrapped around the big cars in the lineup—but still no home-grown mini

by Robert Lund

DETROIT AUTO EDITOR

The big news from Big C is C cars. That's Detroit shorthand for saying Chrysler's full-size cars have new bodies this year. The auto companies designate bodies by the alphabet. It's a sort of code, so that even though the names of the cars may change, if you refer to an A body (compact), B body (intermediate) or C body (standard size), people on the inside know the package you're talking about.

Chrysler's C bodies are the big jobs—Dodge Monaco, Plymouth Fury, Chrysler Imperial, New Yorker, Newport and Town & Country. Those nameplates have new sheet metal.

All the C's have a lower belt line. About two inches lower than last year. This increases the glass area all around. If you're an average-size guy, you can see all four corners of the car from the driver's seat without craning your neck. Good feature. Chrysler says it used a new computer technique to design the windshield pillar and roof, so the roof's stronger than it used to be despite the wider expanse of glass.

Another neat item common to all full-sizers is an easy-service instrument panel.

Covers on the dash can be removed for quick access to radio speakers, defroster outlets, heater, airconditioning linkages and vacuum lines. The fuse block is hinged so it swings down from the instrument panel for checking the electrical system.

The C cars have a wider track than last year, 64.0 inches against a 62.1-inch spread on the '73s. This makes for more room in the engine compartment, because the frame side rails have been moved out. The radiator has been pushed forward four inches and the hood widened 6½ inches. On the big cars, Chrysler has also repositioned some underhood components. What it all adds up to is less crowding in the engine compartment and better accessibility.

Chrysler has been on a kick for a couple years to make its vehicles easier to service and repair and this is reflected in areas of the car other than the engine compartment and the zip-out dashboard. For example, door trim panels on the C cars are in two sections. The lower portion (with the arm rest) contains all the hardware. The upper portion conceals the glass. You can get in to work on the glass just by removing the lock button. Taillamp bulbs can be replaced from inside the trunk without using tools.

Cars with the new body also have the usual frosting stuff to avoid look-alike: grilles, front and rear light arrangements, side markings, even some hood ornaments.

If you pull a trailer, you can order any '74 Chrysler product with a factory-installed hitch or hitch platform. The factory will automatically build in whatever you need in the way of brakes, wiring harness, rim wheels and suspension, depending on the tow package specified.

There are no new engines from Chrysler this year, but the company has made modifications in its standard Sixes and Eights that are supposed to make them run better. External bowl vents have been eliminated from carburetors to improve cold starting. Snorkels on air cleaners are oval-shaped, instead of rectangular. Changing the shape of the snorkel reduces turbulence in incom-

(Please turn to page 208)



1



2



3



4



5

1. **Imperial LeBaron** comes on strong with a new front end and lowered beltline for more glass area. Grille is die-cast, lights hidden.

2. **Plymouth Fury Gran Coupe** is one model in broad Fury lineup. New body sheet metal is on a wheelbase increased to 122 inches.

3. **Dodge Charger** is charging strong with high owner loyalty. 360-cu-in. V8 replaces 340. Wheelbase is 115 in., Coronet's 118.

4. **Dodge Monaco** wagon is one of the restyled models in the Monaco line. Among its features are 40,000-mile radials standard.

5. **Chrysler New Yorker** shares grille with Brougham and Town & Country wagon. Under the new skin, serviceability is built in.

Ford's Mustang II: Best idea of the year

It arrives on the scene just in time. In the real world of shrinking space, limited energy and precious little clean air, dreamboat cars are out. Mustang II proves that the new breed of small cars can still be exciting!

by Michael Lamm

WEST COAST EDITOR

Last decade's milestone car had to be Mustang—THE influential car of the 1960s. It changed Detroit's thinking and launched the entire ponycar rage.

Ford introduced the original 1965 Mustang on Income Tax Day, 1964. It became an immediate, runaway bestseller—418,812 built and sold that year (admittedly a stretched year, though). Hot on its heels, as a direct result came Barracuda, Camaro, Firebird, Cougar, Javelin and Challenger.

So again, 10 years later: Ford's at the gate with a new Mustang. This one shares nary a nut nor bolt with any previous Mustang, and Ford insists the 1974 Mustang II is emphatically *not* just a dolled-up Pinto—it's a mini-ponycar in the original Mustang vein—basically inexpensive, yet chic, sporty, fun to drive, and with a long-as-your-arm option list. You don't have to put a lot of money into it, but if you want to, you can turn it into a small Mark IV—

or a miniaturized Pantera (well, almost).

Comparing the new Mustang II with its 1965 forebear, we see it's not really all that smaller. Wheelbase is down nearly a foot, yes, but overall it's only six inches shorter. It's two inches lower on the outside but has 0.3 inch more headroom. The '65 boasted more hip and shoulder space, but the two cars are equal on front legroom.

Mustang's base 1965 engine, the 170-c.i.d. in-line Six, was only 30 c.i.d. larger than the 1974 Mustang II's standard 2.3-liter ohc Four (140 c.i.d.). And the optional 1974 Cologne V6 at 170.4 c.i.d. (2.8 liters) matches the original Mustang Six almost inch for inch. (Of course, Ford's 1965 ponycar could be ordered with 260 and 289-cu.-in. V8s with up to 271 bhp.)

The 1974 Mustang II comes in five models and two body styles. As a two-door notchback, it's available as the posh Ghia or in plain-Jane basic form. As a three-door hatchback, you can have it as Ford's first production two-seater since the classic 1957 Thunderbird—or as a 2+2 or the Mach I. A fold-down rear seat is standard in the 2+2 and Mach I; optional in notchbacks.

Mustang II has much more standard equipment than the '65 model: front disc brakes, four-speed trans, tach, complete instrumentation (except oil-pressure gauge), and rack-and-pinion steering. It carries all required safety, impact and smog equipment.

Like other FoMoCo small cars, the Mustang II uses a unitized body/chassis, but unlike them, it has a subframe underneath the toeboard to isolate engine/transmission and suspension vibration. This subframe mounts via heavy, rubber-bushed bolts. Bolted to it in turn are front suspension struts and the rear engine mount. Harsh vibrations and hard road jolts are less likely to reach the passenger area, because they're absorbed in the subframe.

The rear suspension uses leaf springs with heavily bushed shackles and staggered shocks. Forged aluminum "mag" wheels, competition suspension, steel-belted radials, plus power steering, factory aircondition-

(Please turn to page 206)



When the dust settles and the secret '75 model prototypes roll onto the proving ground, Mustang II will be on sale. And what a sale it should be!

The body-style blitz includes three-door hatchbacks (above and left) and two-door notchbacks (below, right) with five models: Hardtop and Ghia in two-doors; Mach I, 2+2 and two-passenger in hatchback configuration. The two-passenger is the first two-seater since the original Thunderbird.

Ford makes no secret of European influence in design and styling ("European-type, amber turn-signal lens," "classic European look of the notchback," and so on). It'll be out to lasso the driver who might otherwise go import (just as Cosworth Vega's target is the 240Z, BMW and Alfa buyer).

Standard engine is 2.3-liter, ohc Four, first mass-produced American engine with metric measurements. Standard in Mach I, optional in other models, is Ford of Europe's 2.8-liter V6.

Standard equipment features, like front disc brakes, are many and there's wide range of options from competition suspensions to sunroofs.



'74 CARS

New noses of '74 could be a successful skit for federal safety officials by the GM styling staff. Hard-nose requirements for bumpers have been met with style. Below is the Pontiac Firebird Formula with cast urethane bumper system. Top right is the '74 Camaro and below it the Vega Estate Wagon—by Chevrolet.



Pontiac Catalina hardtop coupe is distinguished by fixed rear quarter window and Mercedes . . . er, all-new front end. Radial Tuned Suspension (RTS) is an option.

Buick Riviera scuttles the boattail in a major styling change for 1974. New grille, roofline and the high-level lamps just below backlight are easy to spot.



Chevelle by Chevrolet, this the Malibu Classic Wagon, also has a familiar touch of class in its redesigned grille. Imitation is the sincerest form of flattery.

Oldsmobile Cutlass Salon coupe is new model in the Salon lineup. Standard is a suspension package built around GM's steel-belted radial tires. It handles.

GM styling: Give safety the credit!

Federal bumper standards
have forced stylists
to redesign front ends
—for the better.

by Robert Lund

DETROIT AUTO EDITOR

The wailers and weepers in Detroit have been saying for years that government intervention discourages innovation.

That argument ain't necessarily so, as General Motors proves with its 1974 cars.

GM's '74 machines carry all the stock stuff the government says is good for you: The ignition interlock system (requiring you to buckle up before you can drive the car), rear bumpers that can take a five-mph nudge without crumpling, a fail-safe throttle, stronger roofs. But GM added a batch of build-'em-better features of its own.

Most GM improvements are hidden—you wouldn't call them major advances in auto-making but they add to the vehicle's durability so it should last longer, be easier to service and hold down on the repair bills. The improvements apply to most makes.

Here's what GM has done to improve the '74s over the '73s:

The company is using a new petroleum-base coating to cover frames and rear suspension lower control arms—areas exposed to a lot of corrosive road splash and grime. Frames will be less susceptible to rust-out.

Horn wiring has been put inside the passenger compartment—it used to be under the hood—to guard against corrosion.

On cars with power steering, a small magnet has been added to the pump to pick up metal impurities that might be in the fluid.

Battery vent caps have an antifire fea-

ture. The cap consists of a sintered carbide insert that disperses battery fumes and acts as a screen to protect the battery from catching on fire.

On V8s, the front cover on the engine has been redesigned to make it easier to remove. The cover can be pulled off without lowering the oil pan.

Two items GM introduced last year have been extended to nearly all cars for '74. One is a visual wear indicator on the lower ball joint. You can tell if the ball joint needs replacing just by looking at it. The second item is a built-in squeal in front disc brakes. Just before you need new pads, the brake starts to squeal, reminding you it's time for a brake check.

Finally, there's GM's new steel-belted radial tire, available for all GM cars.

Let's look at what's new by nameplates:

Chevrolet: There are 44 cars for 1974, down four from last year. The base coupe is dropped from the Monte Carlo "S" line. There are nine Chevelles, three less than in '73. Camaro is now a three-car line, down one from a year ago. That adds up to five deletions. But Chevy has added a new car, [the Cosworth Vega \(see Detroit Listening Post, page 32, Aug. PM\)](#).

Chevrolet's most changed cars are the Chevelles. The eye-grabbers are a new Laguna Type S-3 coupe and the Malibu Classic. Both have fixed opera windows, are about three inches longer than last year to accommodate tougher energy-absorbing rear bumpers.

On the big car line—Caprice, Impala and Bel Air—the six-cylinder engine has been eliminated. Base engine for Impala and Bel Air is a 350-c.i.d., two-barrel V-8. Standard Caprice engine is a 400-c.i.d. two-barrel.

New for the mid-size Nova is a sports package. This is primarily in the form of exterior trim and paint job, but includes a your-choice option on engines. The standard V8 for Nova is Chev's Turbo-Fire 350, replacing the 307 of the previous model year. A Six is also available.

A new option for the Corvette is a "Gymkhana" suspension package. The extras include stiffer front and rear springs

[\(Please turn to page 210\)](#)

SPECIFICATIONS AND COMPARISONS

Car— Series: Models, Options	Body Style	Wheel- base (in.)	Overall Length (in.)	Overall Width (in.)	Track f/r (in.)	Engines in Model Series* (Cu. In.— V8 except as noted)	1974 Changes (Not federally regulated)
AMERICAN MOTORS CORP.							
American Motors Gremlin: Levi's, X, Rallye X	2-dr. sedan	96.0	170.3	70.6	57.5/57.0	232-6, 258-6, 304	Refinements, new options
Hornet: Levi's, X, Rallye X, Sportabout	2-dr. sedan, 3-dr. hatchback, 4-dr. sedan, 4-dr. wagon	108.0	187.0	71.0	57.0/57.0	236-6, 258-6, 304, 360	Refinements, new options
Javelin: AMX, Rallye, "Go"	2-dr. hdtp.	110.0	192.3	75.2	59.3/60.0	232-6, 258-6, 304, 360, 401	Refinements, new options
Matador: X, Brougham	2-dr. coupe, 4-dr. sedan, 2&3-seat wagons	114.0 to 118.0	209.3 to 216.0	77.2	60.0/60.0	232-6, 258-6, 304, 360, 401	All-new coupe model, refinements, options
Ambassador: Brougham	4-dr. sedan, 2&3- seat wagon	122.0	218.8 to 219.4	77.2	60.0/60.0	304, 360, 401	Refinements
CHRYSLER CORP.							
Dodge Dart: Swinger, Custom, Swinger Spe- cial, 360 Sport, Sport Challenger	2-dr. hdtp., 2-dr. coupe, 4-dr. sedan	108.0 to 111.0	198.2 to 203.2	69.6 to 71.8	59.1/55.4	198-6, 225-6, 318, 360	Refinements, new options, 360 V8 replaces 340 (in all Dodge, Plymouth lines)
Charger: Charger S.E., Charger Coupe	2-dr. hdtp., 2-dr. coupe	110.0 115.0	198.6 214.0	77.4 77.0	60.2/60.7 61.9/62.0	318, 360 225-6, 318, 360, 400, 440	Refinements, new options Refinements, new options
Coronet: Custom, Crestwood	4-dr. sedan, 2&3-seat wagons	118.0	212.4 to 221.8	77.8 to 78.8	61.9/62.0	225-6, 318, 400	Refinements, new options
Monaco: Monaco Custom, Monaco Brougham	2-dr. hdtp., 4-dr. hdtp., 4-dr. sedan, 2&3-seat wagons	122.0 to 124.0	220.5 to 226.2	79.3 to 79.4	64.0/63.7	360, 400, 440	All-new styling, new options
Plymouth Valiant: Duster, Duster 360, Scamp	2-dr. hdtp., 2-dr. coupe, 4-dr. sedan	108.0 to 111.0	194.1 to 197.6	71.0 to 71.8	59.1/55.4	198-6, 225-6, 318, 360	111-in. wheelbase for sedan, refinements, new options
Barracuda: 'Cuda Satellite: Custom, Regent, Sebring, Sebring Plus, Road Runner	2-dr. hdtp., 2-dr. coupe, 4-dr. sedan, 2&3-seat wagons	108.0 115.0 117.0	195.6 208.9 217.1	75.6 78.6 79.2	60.2/60.7 61.9/62.0	318, 360 225-6, 318, 360, 400, 440	Refinements, new options Refinements, new options
Fury: I, II, III, Gran Coupe, Gran Sedan	2-dr. hdtp., 4-dr. hdtp., 4-dr. sedan, 2&3-seat wagons	122.0 to 124.0	219.9 to 223.3	79.4	64.0/63.7	360, 400, 440	All-new styling, 122-in. wheelbase, new options
Chrysler New Yorker: Brougham, Newport, Custom	2-dr. hdtp., 4-dr. hdtp., 4-dr. sedan, 2&3-seat wagons	124.0	224.7 to 225.0	79.5	64.0/63.7	400, 440	All-new styling, new options
Imperial: Le Baron	2-dr. hdtp., 4-dr. hdtp.	124.0	231.1	79.7	64.0/63.7	440	All-new styling, new standard equipment
FORD MOTOR CO.							
Ford Pinto: Runabout	2-dr. sedan, 3-dr. sedan, 2-dr. wagon	94.2	168.8 to 178.7	69.4 to 69.7	55.0/55.8	122-4, 140-4	New engine option, new standard equipment and options
Mustang II: Ghia, Mach I	2-dr. hdtp., 3-dr. fastback, 3-dr. 2- passenger	96.2	175.0	70.2	55.5/55.6	140-4, 171-V6	All-new car
Maverick: Grabber	2-dr. sedan, 4-dr. sedan	103.0 to 109.9	187.0 to 193.9	70.5	56.5/56.5	200-6, 250-6, 302	Refinements, new options
Torino: Gran Torino, Brougham, Squire, Sport	2-dr. hdtp., 4-dr. hdtp., 2&3-seat wagons	114.0 to 118.0	213.1 to 220.7	79.0 to 79.3	62.8/62.9	302, 351, 400, 460	Refinements, new standard equipment and options
Ford: Custom 500, Galaxie 500, LTD, LTD Brougham Thunderbird	2-dr. hdtp., 4-dr. hdtp., 2&3-seat wagons	121.0	222.5 to 225.2	79.5 to 79.9	64.2/64.4	351, 400, 460	Refinements, new standard equipment and options
Lincoln-Mercury Comet: Comet GT	2-dr. sedan, 4-dr. sedan	120.4	224.8	79.7	63.0/63.1	460	Refinements, new standard equipment and options
Cougar XR-7	2-dr. hdtp.	103.0 to 109.9	190.0 to 196.9	70.5	56.5/56.5	200-6, 250-6, 302	Refinements, new standard equipment and options
Montego: MX, MX Brougham	2-dr. hdtp., 4-dr. hdtp., 2&3-seat wagons	114.0 to 118.0	215.5 to 223.1	78.6 to 79.6	63.4/63.5	351, 400, 460	All-new styling, suspension and body/frame construction, new standard equipment and options Refinements, new standard equipment and options

OF ALL 1974 DOMESTIC MODEL CARS

Car— Series: Models, Options	Body Style	Wheel- base (in.)	Overall Length (in.)	Overall Width (in.)	Track f/r (in.)	Engines in Model Series* (Cu. In.— V8 except as noted)	1974 Changes (Not federally regulated)
Mercury: Monterey, Custom, Marquis, Brougham	2-dr. hdt., 4-dr. hdt., 2&3-seat wagons	121.0 to 124.0	225.7 to 226.8	79.6	64.1/64.3	400, 460	Refinements, new standard equipment and options
Lincoln Continental	2-dr. coupe, 4-dr. sedan	127.0	232.6	80.0	64.3/64.3	460	Refinements, new standard equipment and options
Continental Mark IV	2-dr. coupe	120.4	228.4	79.8	63.0/63.1	460	Refinements, new standard equipment and options
GENERAL MOTORS CORP.							
Chevrolet Vega: LX, Estate Kammback, GT Sport, Cosworth	2-dr. coupe, 3-dr. coupe, 2-dr. wagon 2-dr. panel	97.0	175.4 to 176.4	65.4	55.2/54.1	140-4, 122-4 with twin overhead cam	Refinements, new standard equipment and options, new special production model
Corvette Stingray	2-dr. coupe, 2-dr. convert.	98.0	185.5	69.0	58.7/59.5	350, 454	Refinements, new standard equipment and options
Camaro: LT, Rally Sport, Z28	2-dr. sport coupe	108.0	195.4	74.4	61.3/60.0 61.6/60.3 (LT Model)	250-6, 350	Refinements, new standard equipment and options
Nova: Custom, SS	2-dr. coupe, 4-dr. sedan, 3-dr. hatchback	111.0	196.7	72.4	59.8/59.6	250-6, 350	Refinements, new standard equipment and options
Chevelle: Deluxe, Malibu, SS, Classic, LaGuna, Type S-3	2-dr. coupe, 4-dr. hdt., 2&3-seat wagons	112.0 to 116.0	206.3 to 216.2	76.6	61.5/60.7	250-6, 350, 400, 454	Refinements, new standard equipment and options
Chevrolet: Belair, Impala, Caprice Classic	2-dr. coupe, 4-dr. sedan, 2-dr. convert., 2&3-seat wagons	121.5 to 125.0	222.6 to 228.1	79.5	64.1/64.0	350, 400, 454	Refinements, new standard equipment and options
Monte Carlo "S"	2-dr. sport coupe	116.0	213.1	77.6	61.9/61.1	350, 400, 454	Refinements, new standard equipment and options
Pontiac Firebird: Esprit, Trans Am, Formula	2-dr. coupe	108.0	196.0	73.4	61.9/61.1	350, 400, 455	Refinements, new standard equipment and options
Ventura: Custom, GTO	2-dr. coupe, 3-dr. hatchback, 4-dr. sedan	111.0	199.4	72.5	59.9/59.6	250-6, 350	Refinements, new standard equipment and options
LeMans: Luxury, Sport Coupe, GT	2-dr. hdt., 4-dr. hdt., 2&3-seat wagons	112.0 to 116.0	208.8 to 212.8	77.9	61.5/60.7	350, 400, 455	Refinements, new standard equipment and options
Grand Am	2-dr. hdt., 4-dr. hdt.	112.0 to 116.0	210.9 to 214.9	77.0	61.9/61.1	400, 455	Refinements, new standard equipment and options
Catalina: Bonneville, Grand Ville, Safari	2-dr. coupe, 4-dr. hdt., 4-dr. sedan, convert., 2&3-seat wagons	124.0 to 127.0	226.0 to 231.3	79.6	64.1/64.0	400, 455	Refinements, new standard equipment and options
Grand Prix: SJ	2-dr. coupe	116.0	217.5	77.9	61.9/61.1	400, 455	Refinements, new standard equipment and options
Buick Apollo	2-dr. coupe, 3-dr. hatchback, 4-dr. sdn.	111.0	200.2	72.7	59.1/58.8	250-6, 350	Refinements, new standard equipment and options
Century 350: Luxus, Regal, Gran Sport	2-dr. coupe, 4-dr. sedan, 2&3-seat wagons	112.0 to 116.0	209.5 to 218.2	79.0	61.5/60.7	350, 455	Refinements, new standard equipment and options
LeSabre: Luxus	2-dr. hdt., 4-dr. hdt., convert.	123.5	225.9	79.9	63.6/64.0	350, 455	Refinements, new standard equipment and options
Electra 225: Custom, Limited Estate Wagon	2-dr. hdt., 4-dr. hdt., 2&3-seat wagons	127.0	231.5	79.9	63.6/64.0	455	Refinements, new standard equipment and options
Riviera: GS	2-dr. coupe	122.0	226.4	80.0	63.6/64.0	455	All-new styling, new standard equipment, options
Oldsmobile Omega: Omega "S"	2-dr. coupe, 3-dr. hatchback, 4-dr. sedan	111.0	200.3	74.2	59.1/58.8	250-6, 350	Refinements, new standard equipment and options
Cutlass: "S," 4-4-2, Supreme, Salon, Vista Cruiser	2-dr. coupe, 4-dr. sedan, 2&3-seat wagons	112.0 to 116.0	210.6 to 220.0	76.2 to 76.8	61.4/60.7	350, 455	New coupe, refinements, new standard equipment and options
Delta 88: Royale	2-dr. hdt., 4-dr. sedan, convert., 2&3-seat wagons	124.0	226.9	79.5 to 79.6	63.7/64.0	350, 455	Refinements, new standard equipment and options
Ninety-Eight: Luxury, Regency	2-dr. coupe, 4-dr. sedan	127.0	232.4	79.6	63.7/64.0	455	Refinements, new standard equipment and options
Toronado: Custom, Brougham	2-dr. coupe	122.0	228.0	79.8	63.5/63.5	455	Refinements, new standard equipment and options
Cadillac: Calais, DeVille, 60 Special Brougham, Eldorado, 75 Sedan and Limo	2&4-dr. hdt., 4-dr. sedan, limousine	130.0 to 151.5	230.7 to 252.2	79.8	63.0/63.0	472, 500	Refinements, new standard equipment and options

*Not all engines available in all models

Should you... Trade in? Hang on? Cop out?

A-U-T-O!
PM catches the Auto Editors in New York, Detroit and California sometimes cursing and sometimes caressing the four-letter word in their lives. Their approach to automobiles may help you with the car-buying decisions you have to make.

FROM NEW YORK

by Bill Hartford

I drive a big car. That's why I get only 20 miles to the gallon, and I'm not happy about that. Of course, I could get better fuel economy with my Volvo 145 but I drive hard. I can't help it. I enjoy driving. I'll have to be content with 20 mpg.

Despite my unhappiness about mileage—premium fuel, at that—at least I do have the pleasure of owning a new car. I bought my wagon new in 1968, and now, 76,000 miles later, it's still new—because I've kept it that way. In some respects it's even newer than it was in '68: The original tires have been replaced with steel-belted radials, the

FROM DETROIT

by Robert Lund

My current car is a Mustang. Not the new Mustang II. The old one, a '73. I bought the car in July, so it's one of the last of the '73 Mustangs produced and one of the last of the old-size Mustangs.

I buy a new car every year and always at the end of the model run. I buy basic transportation. Not bottom-of-the-line basic, but just above that. The car I traded for the Mustang was a '72 Chevrolet Nova. I've also owned Chrysler cars. But more Ford products than others. And my cars are small or mid-size cars, because they are more maneuverable in city traffic—where I do

FROM CALIFORNIA

by Michael Lamm

Okay, so I'm a nut. A Hudsonut, to be specific. I drive a 1952 Hudson Hornet—drive it as everyday transportation, put about 15,000 miles a year on it.

I don't say everyone should own a 22-year-old car, but if you're the least bit mechanical, it's not a bad idea. I'm convinced that an older car can serve you as well as or better than your newer car, the one you're still and perennially paying for. That's because they don't depreciate.

But before I launch into my dollars-and-cents rationalizations for Hudsonuttiness, let's get the emotional side over with. First,



shocks with Konis, the exhaust system with a lifetime Abarth system and the original lights with an improved system. A remnant of indoor/outdoor carpeting has kept the original carpet in the cargo area in the condition it was the day the car was bought. The engine is now run in and I don't use enough oil to add any between oil changes every 2000 to 3000 miles. The twin S.U. carbs are fiddle-free and engine degreaser and body wax keep the car sparkling outside and under the hood.

Tender loving care will keep any car new for years. Naturally, proper maintenance



most of my driving—rather than big cars.

There's an old fiction that if you buy at the end of the model run, you automatically lose a year's depreciation as soon as the new cars come out. That's not true. You take a beating on depreciation whenever you buy. But if you trade every 12 months, the beating is the same whether you buy in September-October, at new model time, or June-July, during the build-out period.

There are a lot of good reasons for buying at the end of the model run. I figure by the end of the run they've learned how to put the pieces together and I'm less likely to get



I've always enjoyed older cars. I was 14 when I got my first car—a 1931 Hudson Greater 8 sedan. That was in 1950.

The little South Texas town I grew up in had only one new-car dealer. He sold Hudsons. My dad bought nothing but Hudsons from 1939 through 1954, same as everyone else in town.

So when I spotted my present Hudson Hornet, nostalgia and sentimentality overran all reason and I tortured and hounded its owner for three years until he finally relented and sold me the car. I paid \$350.

Now if you're thinking I'm driving a \$350

Bill Hartford

and repair has to be something of a hobby. It is for anyone who regards a car more than just a transportation device. Obviously, to me a car is much more than an appliance—even though some friends compare the Volvo's styling to that of a refrigerator.

This styling, of course, is one of the reasons that my car stays "newer" than many others. You can't convince the insurance company of this, and the market value of the car isn't much more than \$1000. To me it's worth \$4595. That's the price of a '73 Volvo 145. I couldn't afford that today. Mine was \$3400. Inflation and appreciation have

put many of us in a situation where today we couldn't afford the home we live in: For me it's the same with my car.

The 1973 model is a lot more car with improvements that I envy, but I've got essentially the same car and in future years when my engine needs work perhaps I'll just drop in a new one—the current two-liter, B20 with its fuel injection, alternator and other nice things my B18 does not have.

Now that the 1974 models are arriving, I'm happier than ever about owning the car that I do: My car has no buzzers, flashing lights and I can start it *before* I take one

Robert Lund

a lemon. It's rough driving in Michigan in winter and it gives me a good feeling to know I'm going into the snow-and-ice time of year with a new car that isn't likely to give me trouble.

Another advantage of being last in line is that you can listen to people who bought early in the year. As part of my job, I also have an opportunity to drive loaners the factories make available to reporters, so I have a chance to evaluate the next car I might want to buy before buying it. By the time I'm ready for a new one, I've got a pretty good idea of what car I want. Or

the other way around: what cars to avoid.

So much for how I buy cars. What do I expect out of them and what do I think of the current crop?

I have a love/hate attitude toward cars. I'm grateful to Detroit for automobiles, for the new model whoopee, for the ongoing search for something better, to improve them. Writing about cars enables me to make a living and it isn't an unpleasant way of earning your keep.

To earn a living writing about cars you need certain tools. Typewriter, pencils, paper, phone, tape recorder and, if you're

Michael Lamm

bargain, you're wrong. The car did cost me that initially, and it *was* in amazingly good condition when I got it—76,000 miles on the clock, no rust, very few dings. It did need work, though, for the sake of safety and reliability. Some of this work I did myself; some I farmed out. A friend and professional mechanic, Jim Holmes, helped me (or vice-versa) with the major repairs. All told, I put another \$934.82 into the Hornet before I began to drive it (see chart on page 205).

Are parts hard to get, you ask. No, but then I've bought and given away six parts cars over the last two years. None cost me

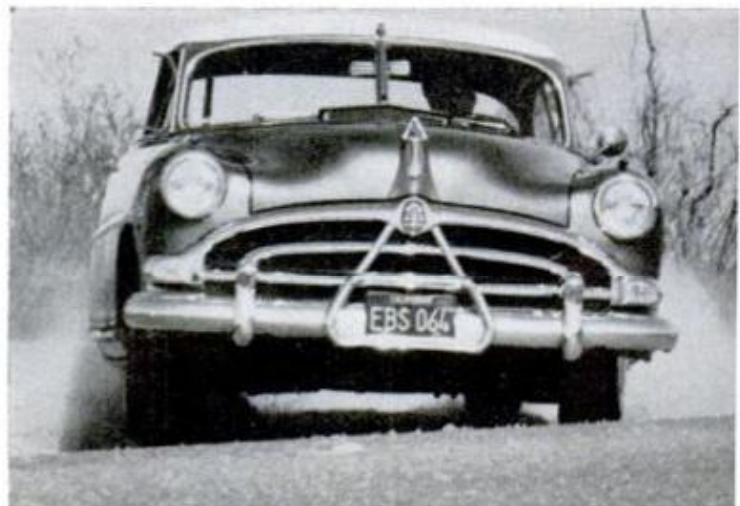



hand and click my three-point, lap/shoulder belt in place. It would be nice to have an inertia-reel system, but you couldn't get everything in 1968.

Obviously, I plan to keep my car for a long time, and I'm sure that more and more people are planning to do the same. I don't envy anyone who, right now, has to make a wise decision about which new car to buy, or for that matter, whether to buy one at all! People are finding new answers to the old problem of getting around—some of them ten-speed solutions. The highway trust fund has been busted and mass transit is

(Please turn to page 204)

covering Detroit, a car. Detroit is a sprawled-all-over-the-place town; you can't get around without an automobile.

But owning and operating a car is becoming more and more of a nuisance and burden.

First, there's initial cost. I used to be able to buy a car for something around \$2300 to \$2500. Now the price is around \$3100 to \$3300. Where I used to get 18 or maybe 20 miles to the gallon, now I'm lucky to get 11 to 12. Where I used to pay 32 or 33 cents a gallon for regular, I recently paid 44 for regular. Insurance costs twice what

I paid 10 years ago. And I'm a careful driver with a good record.

I used to be able to park all day for what I now pay for a few hours. When Chevrolet held a press conference at a downtown restaurant several months ago, I made the mistake of parking across the street—\$1.80 for 75 minutes of parking. When the Society of Automotive Engineers comes to town in February, I don't even take the car downtown. I take the bus, 40 cents each way. The last time I took the car to an S.A.E. convention, I drove around 40 minutes before I could find a place to park. I finally found a

(Please turn to page 204)

more than \$20, none was restorable, all had parts that I pirated.

Otherwise, parts are available through the Hudson-Essex-Terraplane Club (RFD 3, Warren, Ind. 46792) plus various other sources that every collector gets to know.

Is such an old car reliable? Well, frankly not so reliable as I'd hoped. I originally figured on no more downtime than with any newer car. But it hasn't worked out that way. In Nov. 1972, I had to have the Hydra-Matic overhauled to the tune of \$211.68.

And in June 1973, I did a valve job. The engine wouldn't normally have needed a

valve job, but when Jim Holmes and I overhauled the engine back in early 1972, we set the valves cold and never bothered to re-adjust them hot, so eventually No. 4 intake valve wouldn't seat. On a trip, it burned. But other than those two lapses, the car hasn't caused any more trouble than a newer one would. And emissions are low, too.

Is the Hudson cheaper or more expensive to operate than a newer car? Cheaper, overall, I believe, the main reason being no depreciation. If anything, the Hudson is appreciating, albeit slowly. In *Special-Interest*

(Please turn to page 205)

'Big iron' moves to the North Sea

by John F. Pearson

SCIENCE EDITOR

Even under the best of conditions, drilling for offshore oil is dangerous work—but in the North Sea it can be a wind-lashed nightmare.

In this small arm of the Atlantic—600 miles long and 400 broad at its widest latitude—you can encounter some of the most savage offshore weather in the world. It takes tough, capable men and the stoutest of vessels to stand up to the North Sea, especially in winter when storms bring 90-foot waves and 100-mph gusts, when air temperatures drop below freezing and water temperatures dip under 40° F. A swift change in

Oceaneer 1000 saturation diving system is installed in an enclosed space on the deck of the Sedco 702. Four divers live in the two deck decompression chambers (A), equipped with bunks, washbasins, shelves and lockers. They move into the diving bell (D) through the transfer chamber (B), which mates with the bell. The system is monitored and controlled from van (C). On sea bottom, diver moves from the bell to inspect blowout stack (E). The sophisticated system is designed to permit divers to work at depth of 1000 feet.

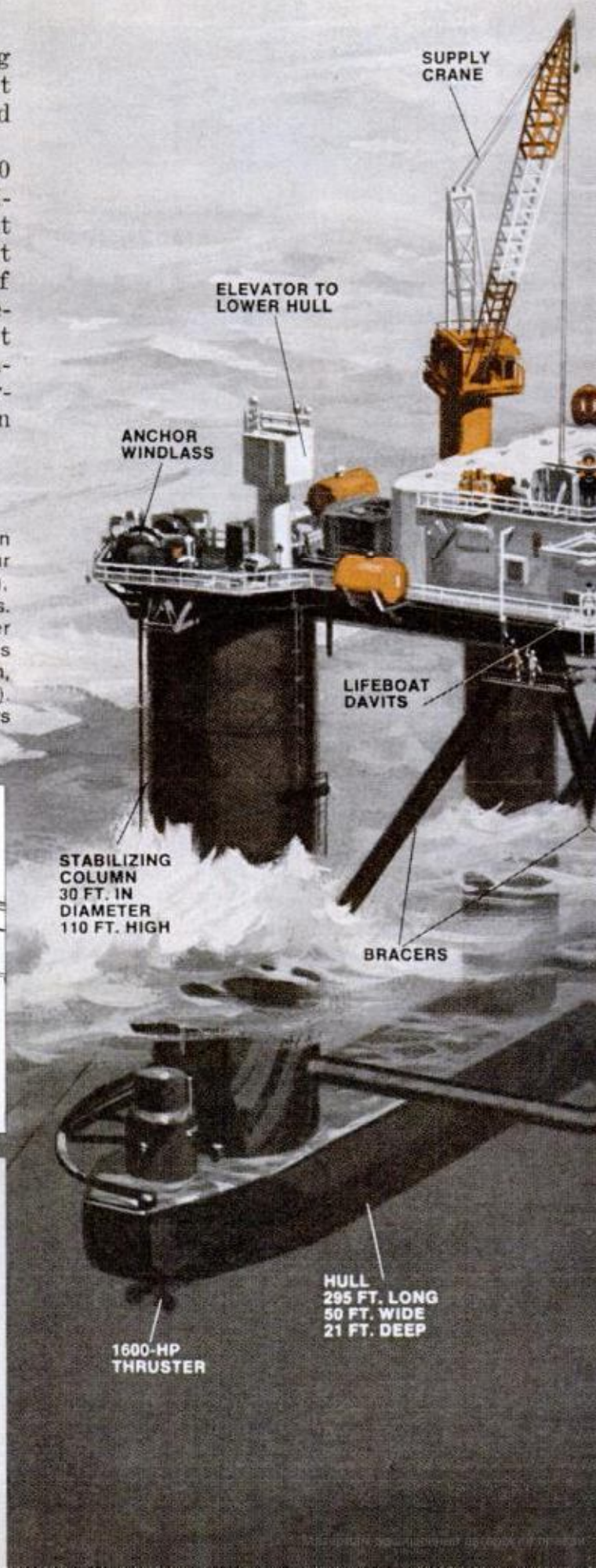
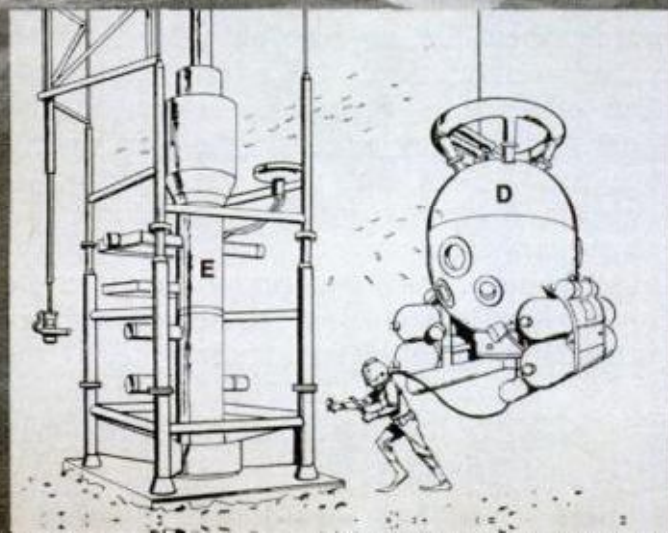
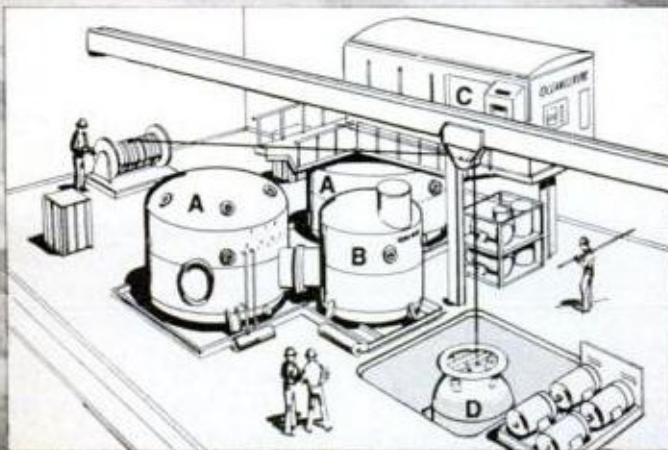

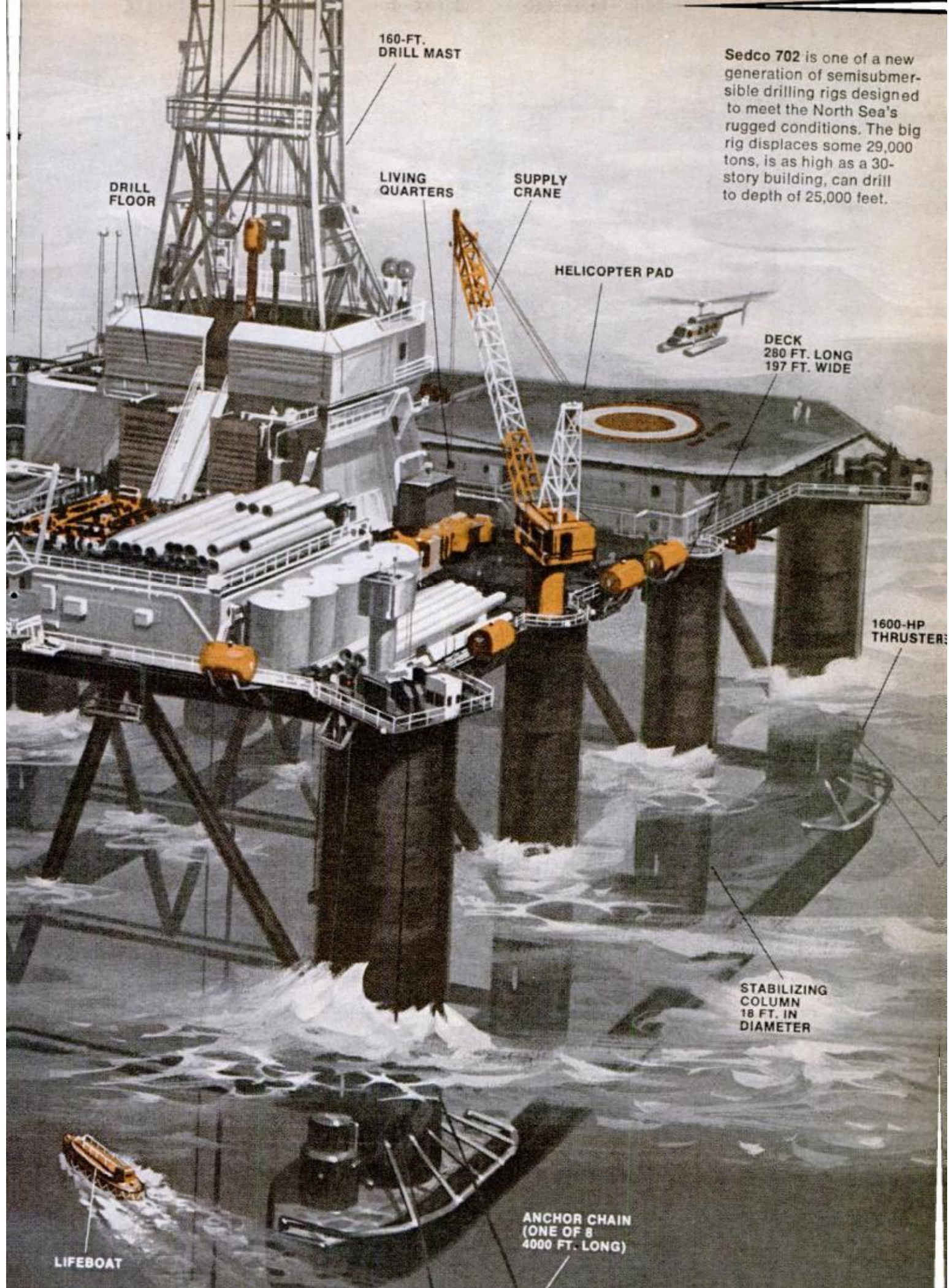

Sedco 702 is one of a new generation of semisubmersible drilling rigs designed to meet the North Sea's rugged conditions. The big rig displaces some 29,000 tons, is as high as a 30-story building, can drill to depth of 25,000 feet.

160-FT. DRILL MAST

DRILL FLOOR

LIVING QUARTERS

SUPPLY CRANE

HELICOPTER PAD

DECK
280 FT. LONG
197 FT. WIDE

1600-HP THRUSTER

STABILIZING COLUMN
18 FT. IN DIAMETER

ANCHOR CHAIN
(ONE OF 8
4000 FT. LONG)

LIFEBOAT

ILLUSTRATIONS BY ROY GRINNELL

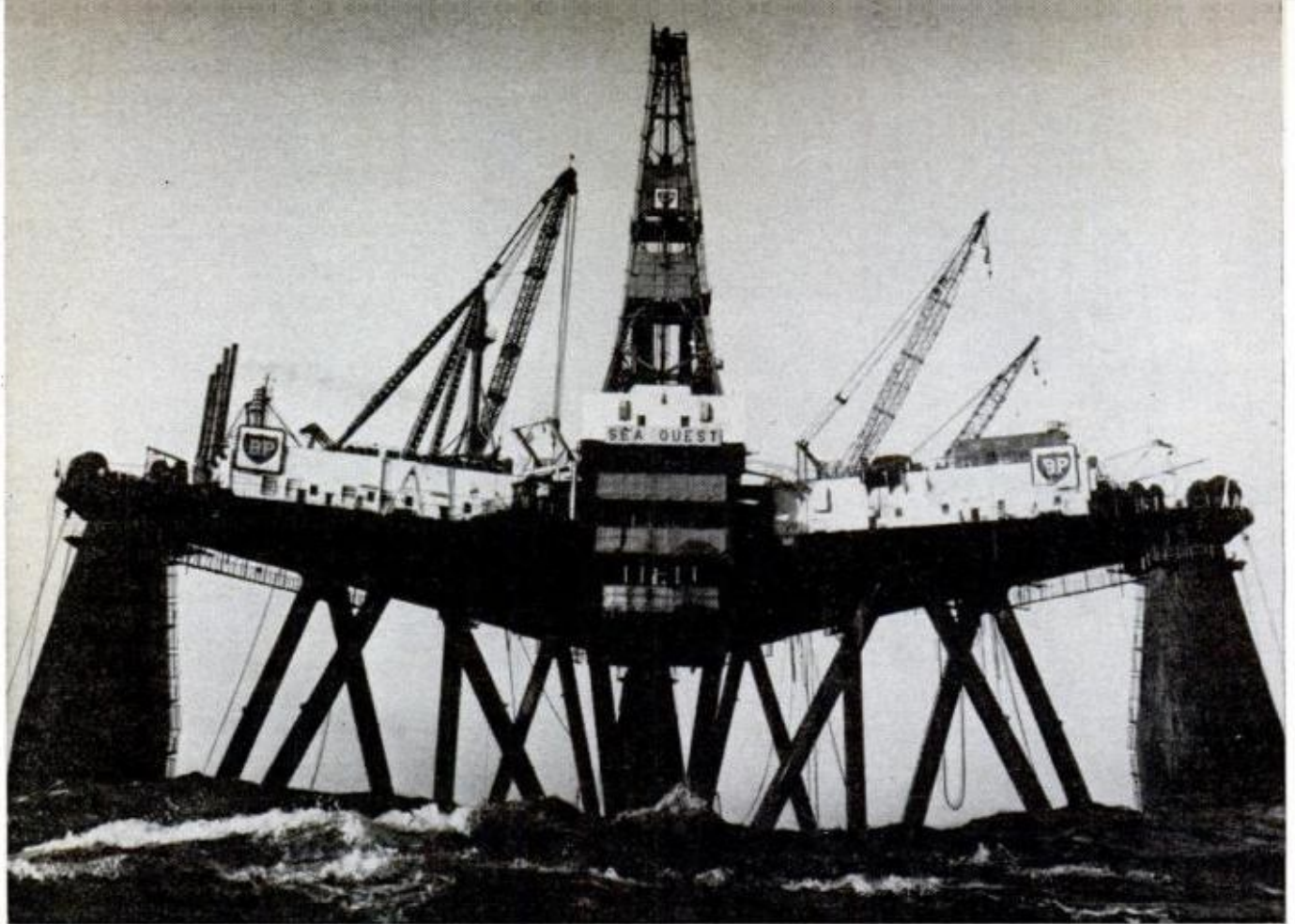

BRITISH PETROLEUM CO.

weather can bring fog or heavy rain that reduces surface visibility to zero.

It's one thing to simply navigate the North Sea and quite another to station a big drilling rig at a precise location and hold it there.

Last winter, a combined Shell-Esso effort off the Shetland Islands had only one dry hole to show for nearly five months' work. Because of rough seas it took a month just to set the drilling rig's anchors. After drilling started, a storm blew the rig off location. At a second site, after weathering other storms, the rig drilled a dry hole. This

BP's giant rig, the *Sea Quest*, drilled 115 miles off the coast of Scotland and discovered the "Forties" oil field. Its next assignment was a site above Aberdeen. Distortion is due to wide-angle lens.

frustrating venture cost the two oil companies about \$5 million.

During only a few years of exploration, three rigs have been destroyed—one with a loss of 13 lives—several others damaged, and four supply boats lost. None of the rigs was designed for the North Sea.

Despite tremendous engineering problems—and a cost 10 times that required to

North Sea oil boom



After tricky tow, 295-foot-high concrete tank (shown under construction) now rests in 230 feet of water at the Ekofisk field (cluster of three dots on map). It holds 1 million barrels of crude, collected from many wells. It's part of production center for piping oil to Britain and gas to West Germany.

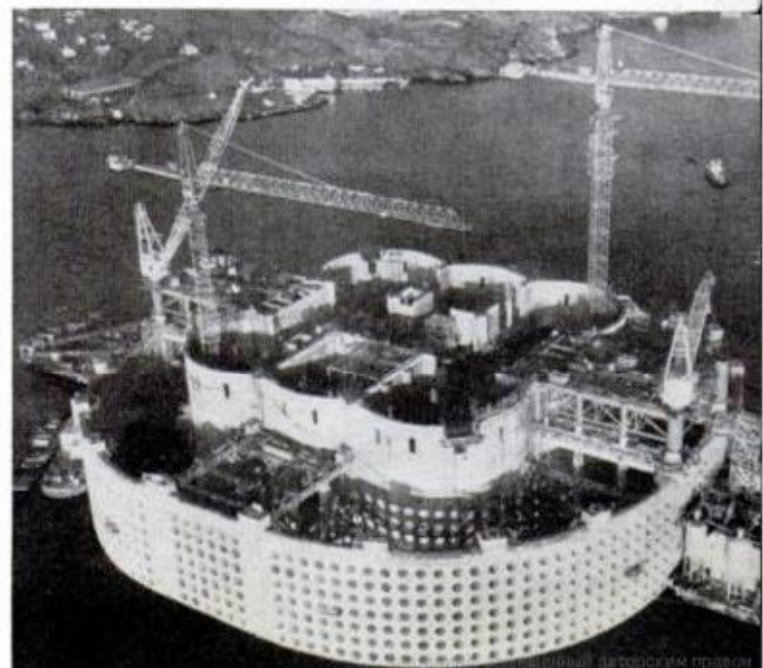

extract oil from Middle East sands—the North Sea is in the midst of an oil boom. This oil is especially valuable because it's found right on Europe's doorstep.

The first sign that there was more than herring and cod to be taken from the North Sea came with the discovery, in 1959, of a huge natural gas field in the northern region of the Netherlands. Six years later, exploration led to the discovery of a gas field off England's coast. Since then, several other fields have been found.

The first oil find was made off the Danish coast in 1967—three years after North Sea oil rights had been divided among Norway, Denmark, Britain, the Netherlands, Belgium and West Germany. Early exploration was carried out by some industry giants—Shell, Esso (still Exxon's name in Europe), Phillips, British Petroleum and Amoco.

It's estimated that North Sea oil reserves total about 12 billion barrels, a figure that could climb with further exploration. The potential stacks up well against Gulf of Mexico reserves (8 billion barrels) and Alaska's North Slope (10 billion barrels), but it's small potatoes compared with the 350-billion barrel bonanza of the Middle East.

By 1980, the North Sea may be producing about 3.5 million barrels of crude a day, filling about 15 percent of Europe's projected energy needs. North Sea oil is low in sulfur content and, thus, would be relatively nonpolluting.

North Sea gas reserves are estimated at 50 trillion cubic feet (about one-fifth of the reserves in the United States).

Exploitation of the North Sea's riches poses an unprecedented challenge to oil men. In addition to the persistently bad weather, drilling must be carried out far offshore—200 miles in some cases—and in deeper waters than rigs normally work. In the northern part of the sea, rigs will have to drill in 1000-foot depths.

Since there has been offshore drilling in the Gulf of Mexico for over 25 years, Houston, New Orleans and a host of other Texas and Louisiana towns boast of more rig builders, diving companies and other offshore specialists than any other area.

When the North Sea action began, it was natural that American know-how and equipment would play a major role. Companies like Sedco, in Dallas, and Oceaneering International, in Houston, were engaged to provide their expertise.

A drilling contractor, Sedco lays claim to having drilled some 500 wells in the waters of 20 countries. Thus, solid engineering experience went into the design of the 702, one of a series of new Sedco semisubmersibles slated for work in areas like the North Sea. The semisubmersible, like the drill ship (the famous *Glomar Challenger*, for one) is designed for deep water. In shallower water, to about 300 feet, a mobile jack-up rig can be used. It has long steel legs that are lowered to the seabed and a platform that can be jacked up above the water. (If oil is found, the usual procedure is to erect a fixed platform to drill development wells and handle production.)

Semisubmersibles come in various configurations, but all resemble overgrown Tinker Toys. They "ride" on huge buoyant hulls ballasted with seawater. When the 702's twin hulls are under 60 feet of water, 100-foot waves will pass under the rig's high deck, say Sedco engineers.

On site, the 702 is moored by means of

THE OFFSHORE CO.

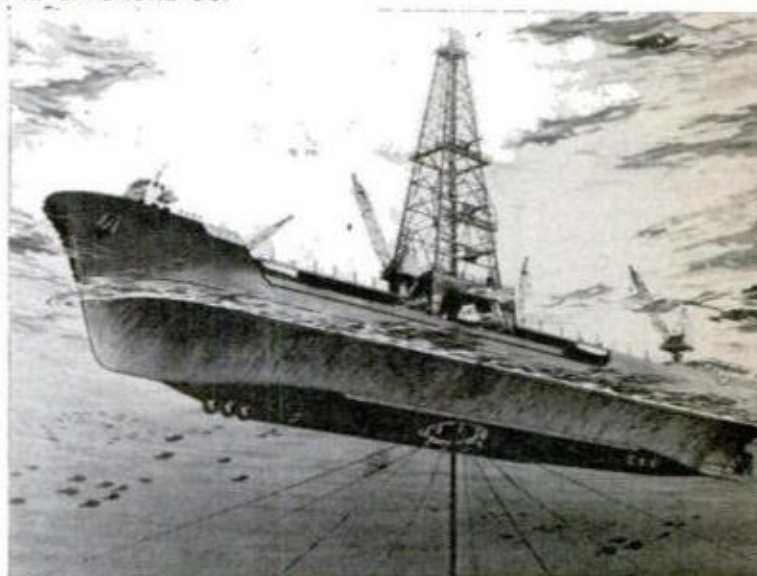

In very deep waters, drill ships such as the *Discoverer 534* are used for oil exploration. It uses anchors as well as thrusters to maintain position.

eight 30,000-pound anchors. Four 1600-hp thrusters, one at each tip of the two hulls, help to maintain exact position. They can propel the big rig at a speed of 8 knots—handy for survival in heavy seas or for moving the vessel to a new location.

The rig can operate in water as deep as 2000 feet and drill to a depth of 25,000 feet. With the addition of four more thrusters, for which provision has been made, the 702 will be able to drill in water 3000 feet deep.

At 25,900 long tons (about 29,000 tons),



Harding survival boat, made in Norway, would provide escape for crew of disabled rig. Worker (left) inspects 26-inch bit before it's lowered to seabed.

the 702 is what oil men refer to as "big iron." Despite its heft, it can be controlled with precision. Here's how exact position is maintained:

Two transducers—one fixed at the well-head, the other at a point along a pipe coming up from the seafloor—send signals that are picked up by hydrophones between the rig's submerged hulls. The signals are processed by a computer to determine movement of the drilling unit in relation to the drill hole. The results show on a scope in the rig's control room. Position adjustments are made by using the thrusters.

The living quarters on a big rig resemble those of a modern freighter: staterooms, offices, a rec room for movies and TV (distance from shore usually makes for poor reception, so video tapes get a big play), and a dining hall that serves huge meals and hot coffee at all hours. On location, a rig works 24 hours a day.

Crews work 14 days, then take 14 days off. They're usually flown ashore for relaxation and perhaps a nip or two. No liquor is permitted on the rig.

The 702 has accommodations for 102 personnel—geologists, roughnecks, drillers, barge engineers and other specialists. They have a common aim: to drill a hole in the ocean floor as quickly as possible. Big-league drilling comes at big-league prices. To operate a rig like the 702 costs about \$50,000 a day.

Built in a yard near New Orleans, the 702



Massive size of typical rig dwarfs divers being lowered by crane, evidently for shallow inspection dive.



Ironing out wrinkle in Oceaneer 1000 system are Mike Hughes (right), program manager Larry Cushman (center) and technical director Len Aaron. In control van (left photo), technician checks out decompression system. Van has communications links with divers and strategic areas of rig, and controls for underwater lights and TV. Below, diver is shown after test with helmet newly designed for work at 1000 feet. It is joined to neck ring of diving suit by means of two cams.

was commissioned last March 17. Using her thrusters plus a two-tug tow, the vessel moved from the Gulf to the North Sea. At this writing, the rig is doing exploratory drilling for Continental Oil (Conoco) at a site off the Shetland Islands.

Like the 702, the Oceaneer 1000 saturation diving system was designed in response to the need for deep-water work. The system was produced in record time—barely seven months from drawing board to installed hardware on the 702.

But that's the kind of accomplishment you might expect from young guys in a young industry. Mike Hughes, chairman of Oceaneering's board, and Lad Handleman, president of the corporation, are both still in their thirties. Both are former divers. Handleman started out as an abalone diver in California at the age of 17 and eventually got into oilfield work, chalking up some 10,000 hours underwater.

Hughes became interested in diving as a student at the University of Tennessee. When a diver was needed at a nearby TVA installation, Hughes showed up with his equipment. An on-site test was arranged.

"I had to prove I could dive as deep as the job required," he recalls. "They lowered me to the bottom, a depth of about 70 feet. Following instructions, I grabbed a handful of bottom mud to prove I'd actually made it. But on the way up the mud dribbled out between my fingers. When I surfaced and

(Please turn to page 202)



IT'S NEW NOW



Liberty Bells by the hundreds

The bells are smaller, but the order is bigger. Whitechapel Bell Foundry in London, which cast Philadelphia's famous Liberty Bell, is now making 2400 1/5th-scale replicas to commemorate the 200th anniversary of the American Revolution in 1976. The bells are faithful reproductions except for one detail—they don't have the notorious crack. Whitechapel says the original was not defective, but damaged in shipment.



World's biggest oil tanker

Said to be the largest moving object ever built by man, this giant oil tanker is nearly a quarter of a mile long and has a dead weight of 483,664 tons. Named the *Globtik Tokyo*, the \$58-million ship was built in Japan for Globtik Tankers of Britain and will transport crude oil from the Persian Gulf. It has a service speed of 15 knots.

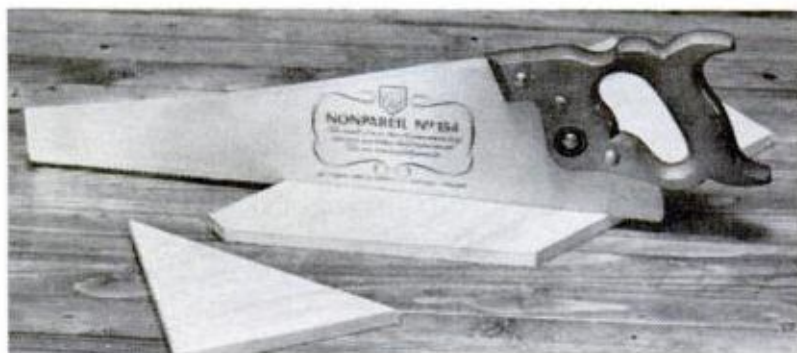

Fancy saws for fussy woodworkers

Fine English-made handsaws have polished blades, double-tapered for smooth working, but with cutting edges of unvarying width. Beechwood handles are attached with brass screws. Crosscut and rip saws available, \$14.95 to \$16.95 plus postage. Brookstone Co., Peterborough, N.H.

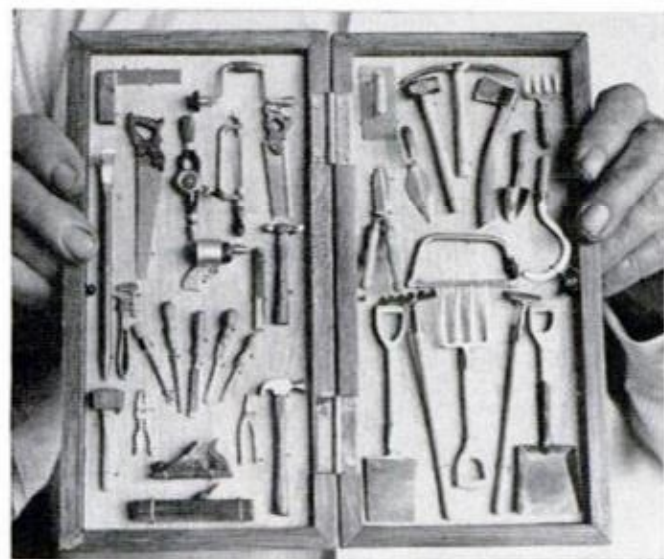
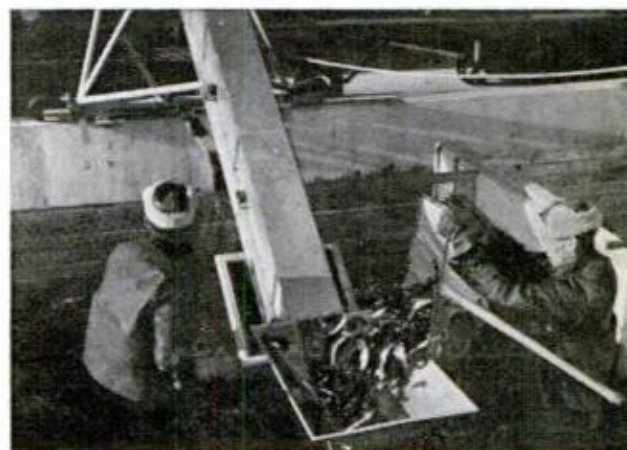
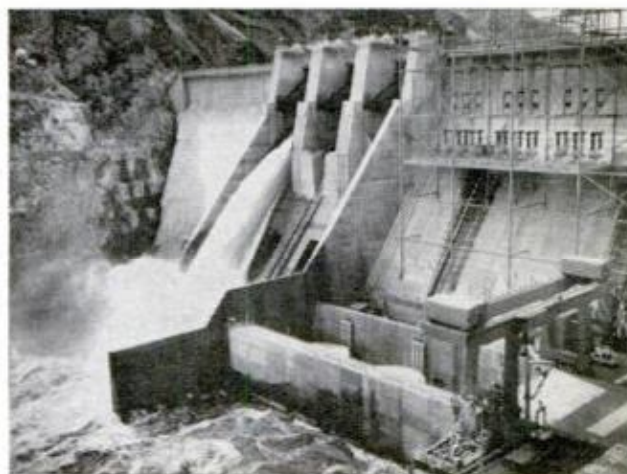

Tools for Tom Thumb

Collection of tiny shop, garden and construction tools made from scrap is the result of about 200 hours' work by Londoner Tom Williams, an ex-carpenter, joiner, builder and engineer. "All my life I wanted a lightweight toolkit that I could carry," he says, "and now I have it."

Salmon get a helpful lift upstream

When they built the 300-foot-high Hells Canyon Dam across Snake River in Idaho, they blocked the way for spawning salmon swimming upstream. The novel solution: Now the salmon get a lift around the dam in "fish taxis"—huge tanker trucks (top right)—and their eggs are hatched in special incubator trays (bottom). When the offspring grow to smolt stage, they're trucked back downstream for the long journey to the sea.



NOW



New aids for the handicapped take many strange and ingenious forms

Portable half-step at far left, top, eases stair-climbing for arthritic persons. Attached to a stick, it's pulled up a step at a time, making each one, in effect, half as high. At near left is sock-puller-upper for those unable to bend over. The combination fork-spoon in next photo down hooks over hand and can be manipulated by those who've lost the use of their fingers. Food "bumpers" clip to edge of plate to prevent spillage. Below, a crippled boy rides a battery-powered mini-car—more fun than a conventional wheelchair. Car was developed by Terry Gray, Surrey, England. At bottom, a telephone is activated as a young man, unable to use his hands, rolls his wheelchair over a plate in the floor. Warren Crapse, San Leandro, Calif., devised the no-hands phone.

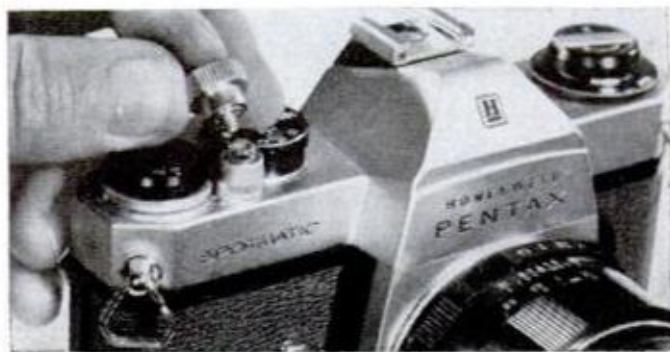

Shutter button stops accidental shots

Ever accidentally click off a wasted shot while closing your camera case or shoot the bottom of your nose? Not with this shutter button. A twist of its collar locks your shutter; twisting the other way frees it again. In addition to serving as a shutter lock, it also provides a comfortable finger release. It's \$1.25 from Spiratone, Inc., 135-06 Northern Boulevard, Flushing, N.Y. 11354.

'Sampler' of old-fashioned nails

Cut nails give an authentic Early-American look to woodwork of all kinds, are especially valuable in meticulous restoration work. And, according to their maker, they have 70 percent more holding power than conventional wire nails. Sample nail kit is \$3 from Tremont Nail Co., 21 Elm St., Wareham, Mass. 02571.



Climbing the Matterhorn—mini style

Look at the top photo above and you'd think a youthful mountain climber is about to scale the heights of a giant peak. The "mountain" is actually a 44-foot-tall scale replica of the Matterhorn's final 1800 feet used to teach mountaineering techniques at St. Peter's Preparatory School in Seaford, England.



Water 'mower' for clearing weeds

Ridding lakes and rivers of choking weed growth is becoming a major national problem, but Louisiana inventor Tom Kelpin now thinks he has the answer. It's a floating "mower" that chops out underwater weeds much like a lawnmower cuts grass. Powered by an air prop, the pontoon craft is fitted with a jawlike system of cutters on the bow. It can trim vegetation to a depth of four feet and cover two acres an hour.

Can 'flying trains' beat airliners in the coming battle for fast intercity travel?

Airliners have nearly put railroads out of business, but now the shoe may be on the other foot. New super-high-speed trains, skimming the rails almost like "airliners on wheels," may eventually make short-run domestic air travel obsolete. One of the most promising is Britain's Advanced Passenger Train or APT below. The streamlined diesel-electric can cruise at 155 mph on conventional roadbeds and up to 250 mph on new concrete-based track (top right). Its cab and control consoles (center photos) look like the cockpit of a giant jet. Special inertia-sensitive wheel trucks (bottom) automatically bank the train on curves to offset centrifugal force.

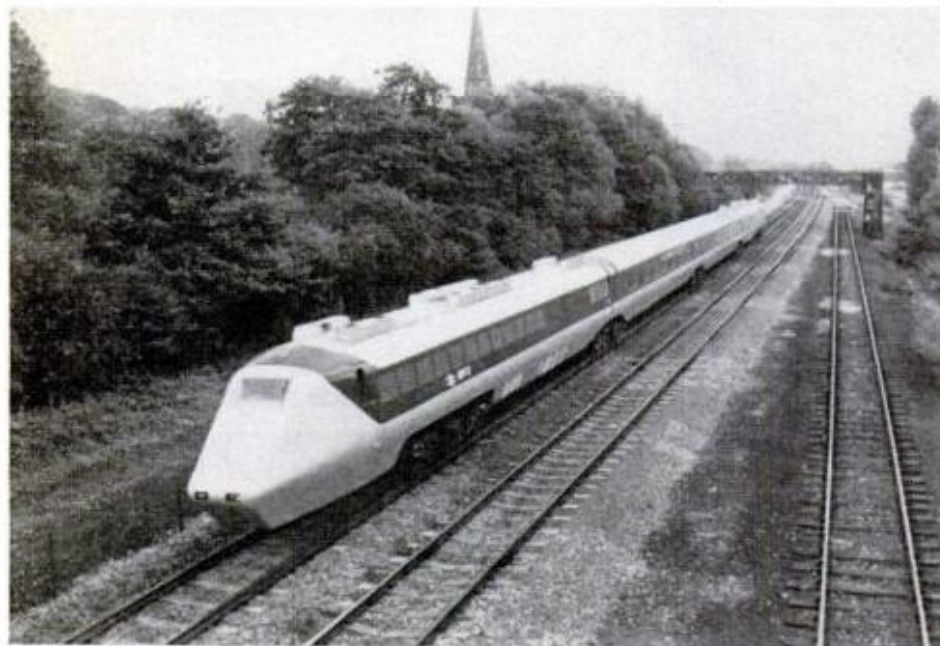
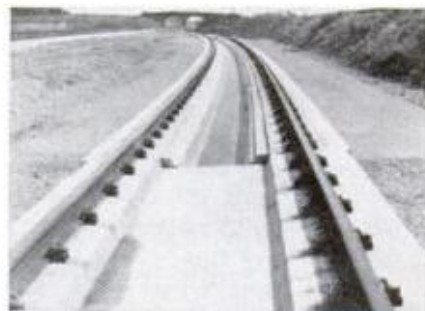

Recorder's Dolby works on FM, too

Even if your cassette recorder has a Dolby noise-reduction circuit, you still need another Dolby circuit if you want to get the most from FM programs broadcast with Dolby processing—unless the deck happens to be this new 3M/Wollensak 4765 model. Its Dolby circuit can be switched for use with external signals from an FM tuner or another tape deck. Its beltless drive system has a plus, too: a three-year warranty. \$329.95. 3M Co., Box 33600, St. Paul, Minn. 55133.

138 POPULAR MECHANICS

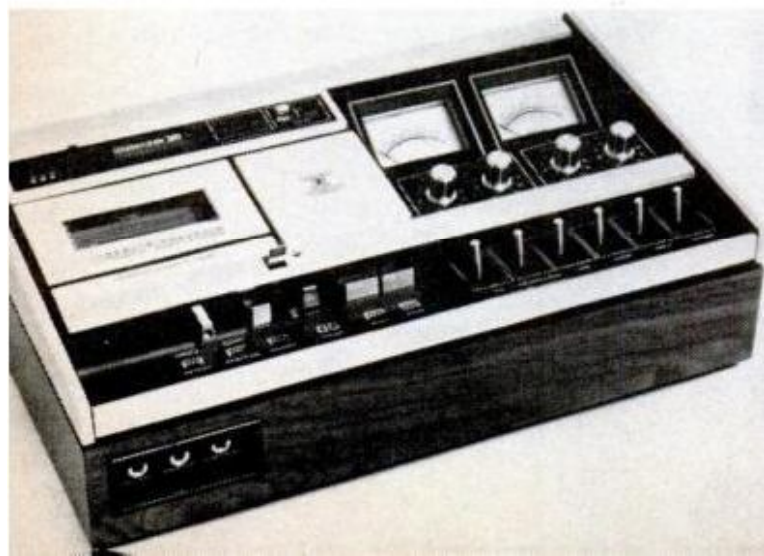



New bike styles—high and wide

The current boom in bike riding is bringing with it some unusual new styles, such as those above. One at top has its frame extended to raise the seat, pedals and handlebars. Why? Well, designer Malcolm Clark of Bugbrooke, England, lives in an area subject to frequent flooding and simply got tired of getting wet while riding through deep puddles. At bottom is a new version of the old bicycle-built-for-two but with side-by-side seating instead of the familiar tandem arrangement. One advantage: It can't tip over. Prices are \$225 to \$275 from Esse, Box 871, Tustin, Calif. 92680.



Jelly cleans sinks and tubs

This new cleaner for sinks, tubs, showers is in jelly form—ideal for vertical surfaces. Applied with brush or sponge, Duro Tub 'n Sink Jelly dissolves most stains in 5 to 10 minutes, then is rinsed away. An 8-ounce bottle is \$1.49. Woodhill Chemical Sales Corp., Box 7183, Cleveland, Ohio 44128.

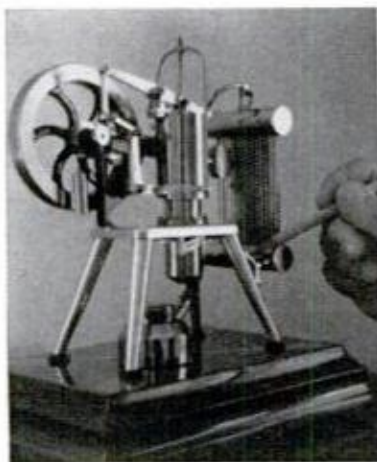

Specialist in scratch-built, working models

Sophus Johnson, 72, of Rhinelander, Wis., builds his operating scale-model engines entirely from scratch, machining all parts and some of his tools himself. All of them run—including gas engines made of plastic. Above, left, is his model of a turn-of-the-century warm air (Stirling cycle) engine; the original was used on farms to pump water.

Big mouth: Mighty British dragline has a 100-ton bite

Moving mountains is no exaggeration for this giant dragline excavator, the largest produced in England. Its bucket scoop is so wide it holds two cars side by side (lower photo at right) and can chew out a 100-ton mouthful with each bite. Dubbed "Big Geordie," the British-made monster can move 140,000 tons of earth and rock in a day's time—enough to sink the liner *Queen Elizabeth*. It has a 265-foot-long boom towering 190 feet above the ground, takes 8½-foot strides on huge "walking" legs, and is powered by two engines providing a total of 6250 hp. Big Geordie's time is so valuable the machine operates 23½ hours out of every 24, shutting down for only two 15-minute rest periods a day for servicing.



For do-it-yourselfers: Sing-along TV

Wish you could sing along with your favorite TV stars? You can with this new TV set introduced in Japan by Matsushita. A plug-in mike lets you channel your voice through the set's speaker along with regular broadcast sound. Exactly why the girl at left is singing to a blank screen isn't explained, but anyhow the TV sells in Japan for 87,800 yen—about \$250 in American money. Whether it will eventually hit U.S. markets has not yet been announced.



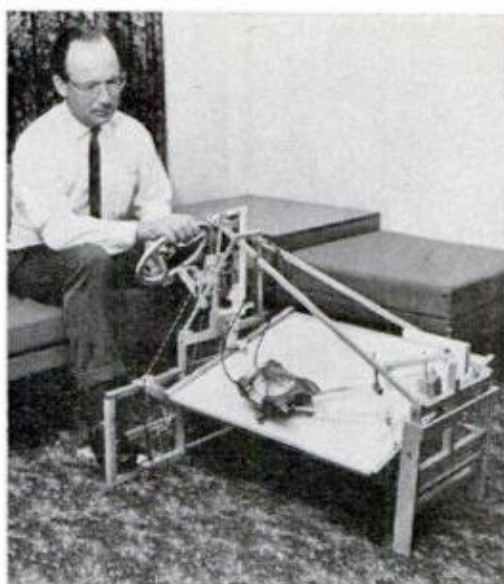

Skid simulator helps student drivers keep their cars on the road

Teaching skid control to student drivers is difficult without a professional road course to practice on. This scale-model simulator, however, is said to teach the same basic skills in a space no larger than that occupied by a coffee table. A model car, controlled by a full-sized steering wheel and foot pedals, rides on a pivoted platform. Tilting the platform simulates a skid. Proper reactions correct the skid, while wrong ones worsen it. The device was invented by Rolls Royce engineer George Whiston, 14 Appleby Gardens, Dunstable, England.

Bright eye in the sky

Tracking criminals by helicopter is relatively easy in daylight but tough at night in the dark. Not any more. Now police copters are getting a new 100-million-candlepower searchlight that turns night into day. The 1600-watt Xenon lamp is shown on the facing page on a Los Angeles Police chopper. Photo at far left shows how it illuminates a street scene almost as brightly as sunlight.

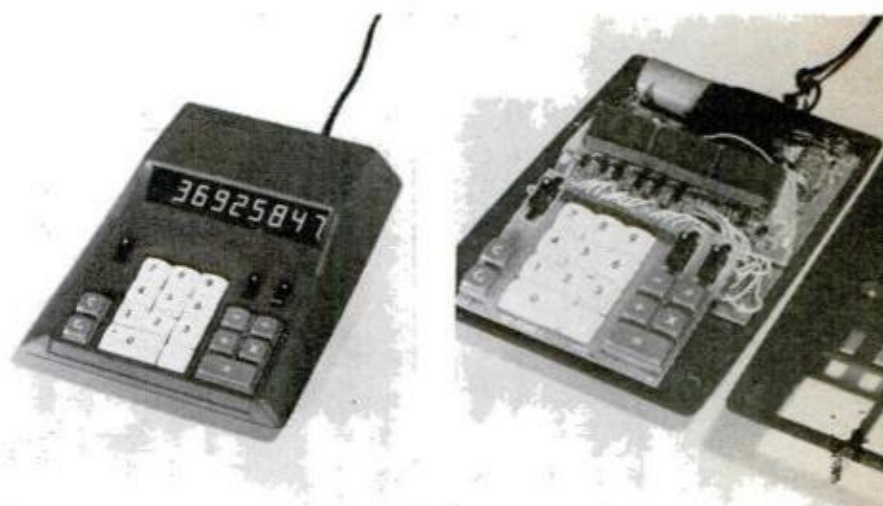

Eight-digit calculator kit takes three evenings to build

This new desktop calculator kit has an 8-digit display with big, bright, easy-to-read numerals 1/2-inch high. Features include four-function, color-coded keyboard, switchable constant key, fixed and floating decimal, separate equals key, and key to clear entries without disturbing prior calculations. IC-2108 kit is \$79.95, takes three evenings to assemble. Heath Co., Benton Harbor, Mich.

First cassette deck to top \$1000 has professional features and specifications to match its price

Designed to offer the ultimate in cassette recording, this new deck has third-head, off-the-tape monitoring, built-in mixing for two lines and three mikes, a limiter, both DNL and Dolby noise-reduction circuitry, memory rewind that returns to any predetermined spot, and auto rewind after each play, plus response from 35 to 20,000 Hz. Its price: \$1100. Nakamichi, 220 Westbury Ave., Carle Place, N.Y.



NOW

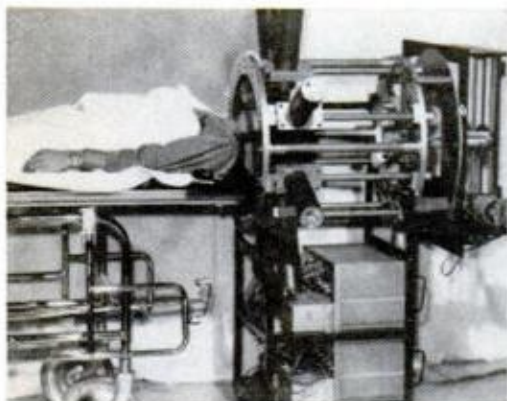

Now when you're sick, you may go to an engineer

One of these days when you visit a doctor, he may not be a doctor at all but an engineer. At Vanderbilt University in Nashville, Tenn., biomedical engineers have come up with ingenious solutions to once-tough medical problems. At top, an array of collimators around a patient's head pinpoints the exact size and location of a brain tumor through precise gamma ray measurements. This enables surgeons to remove the tumor with minimum danger. At bottom, sound waves detect bone healing that X-rays can't. Because the waves travel faster through solid bone than fractures, their speed gives an accurate indication of the mending process.



Flight simulator for young pilots

Realistic landings and takeoffs are possible with this toy flight simulator that duplicates the motions of full-size aircraft. U-Fly-It consists of control panel with yoke, 6-foot runway and 45-foot-long sloping line along which a model plane slides. The plane is catapulted up the line by a rubber-band launcher, then swivels around at the top and "glides" smoothly back to a landing on the runway. Moving the yoke causes the model to dip, climb or bank. For information on prices and accessories, write Cootie Co., South Shore Dr., Minneapolis, Minn. 55441.

'Available light' intrusion alarm

Sentray Photronic Alarm uses any available light source. Adjusted to light level by needle centered on meter at top, it sounds off when an intruder passes between it and the light. Used with a street light, Sentray can sound alarm before break-in occurs. Retail at \$19.95. Paragon Electric Co., 1600 12th St., Two Rivers, Wis. 54241.



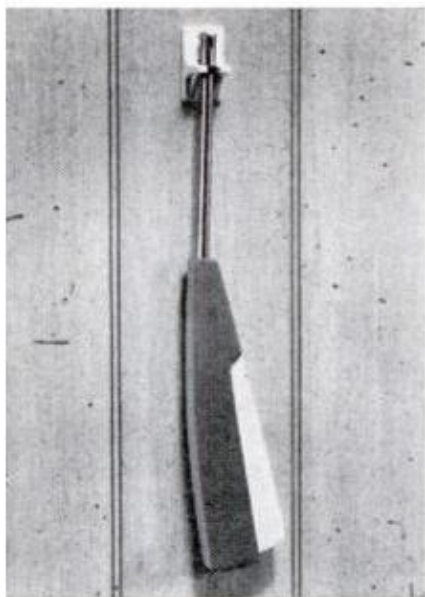

Perpetual gas lighter

Piezoelectric hand gas igniter from Panasonic uses man-made crystals to generate 13,000-volt spark for instant lighting of gas stoves, heaters and pilot lights. Model shown will sell for about \$10; a pistol-grip model will be available for about \$11. Manufacturer says tests have shown igniters should be good for more than 30,000 lights. Matsushita Electric Corp. of America, 200 Park Ave., New York, N.Y. 10017.

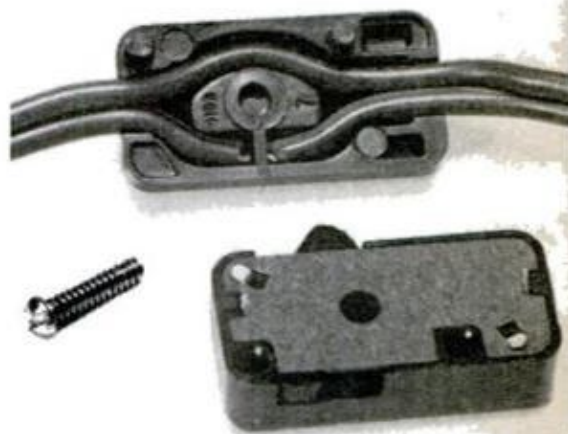

'Instant auditioning' from videotapes

Busy TV and movie producers don't have to take time to audition actors and actresses personally. At Utopia Talent and Tape Service in New York City, tryouts are videotaped individually (top photo below), then played back on a bank of monitor screens (bottom) for simultaneous viewing of a number of choices to speed selection.



Toggle-action cord switch

Line-cord switch has toggle instead of wheel action. Push one side for On, other for Off. Ball-bearing action is spring-loaded. Unit installs anywhere on standard No. 18 parallel wire. Jiffy Cord Switch is UL-listed, sells for 49 cents through most electrical merchandisers. Eagle Electric Manufacturing Co., 45-31 Court Sq., Long Island City, N.Y. 11101.

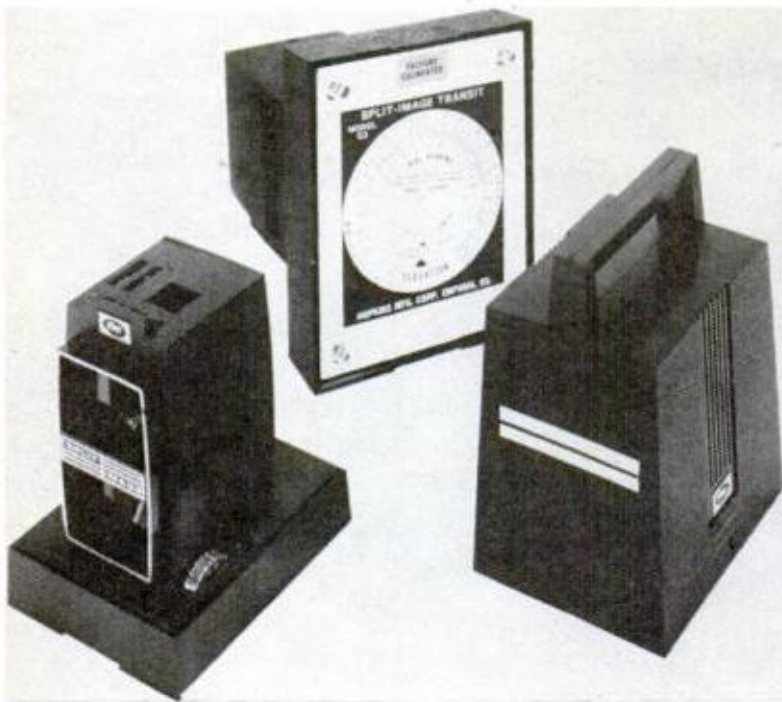

One-man transit levels, measures inclines

This split-image transit makes most leveling and incline measuring one-man work. Transit is adjusted until split image of target, on cover, appears in alignment. Then bubble level is centered and numerical reading obtained. Dial calculator on transit base computes difference in elevation between transit and target from their distance apart and the numerical reading. Inclines small as thickness of a dime at 25 feet can be read. \$16.95 plus \$1 postage from J. W. Holst, Inc., 1005 East Bay St., East Tawas, Mich. 48730.



Mini greenhouses give anyone a year-round garden

The growing popularity of do-it-yourself greenhouses is indicated by these three unusual new mini models. One at upper near left comes in basic 4-foot-long modules each 6 feet wide by 8 feet high. It can be expanded up to 20 feet long by adding extra sections as your garden grows. Each module is \$99 from American Mobile Vehicles, Inc., 9489 Dayton Way, Beverly Hills, Calif. 90210. At far left is a 12-foot model that can also be expanded by adding sections. It's \$119.95 with polyethylene covering, \$189.95 with fiberglass. Maker is Peter Reimuller/Greenhouseman, Box 2666, Santa Cruz, Calif. 95063. At bottom is a novel fold-out greenhouse with hinged doors that swing open to 8-foot width (far left). Closed (near left), unit is only 3 feet wide. Harrods, Ltd., Knightsbridge, London S.W. 1, sells it in the United States for about \$155 plus shipping.



Thiefproof car 'key'

No thief can run off with your car so long as you have this pocket-sized computer with you. Pressing a button sends out a coded signal that unscrambles a similarly coded receiver in your car. Only then will the car start. Code is automatically changed each time car is used so thief can't duplicate it. \$89.95 from TMX Data Code 2000, 666 Fifth Ave., New York, N. Y. 10019.



Huge tents and domes beat rising building costs

When a new group of buildings is completed this fall at La Verne College near Pomona, Calif., the campus will look like a collection of giant Indian tepees. The tent-like structures, said to be the largest requiring no air pressure for support, consist of plastic skins held up by center poles and cables. Standing 68 feet high and covering 1½ acres, they'll house a new student union, gym, drama theater and other recreational facilities. At top is an artist's concept of the finished project, while photo at bottom shows the buildings under construction, with circular foundation walls to anchor the support cables. Reason for the unusual construction: It will cost a third as much as conventional steel and concrete structures of equivalent size—one way to beat the skyrocketing building prices. Meanwhile, in Paris, France, the world's biggest inflated dome (center photo, far right) is undergoing tests as another means of cutting building costs.

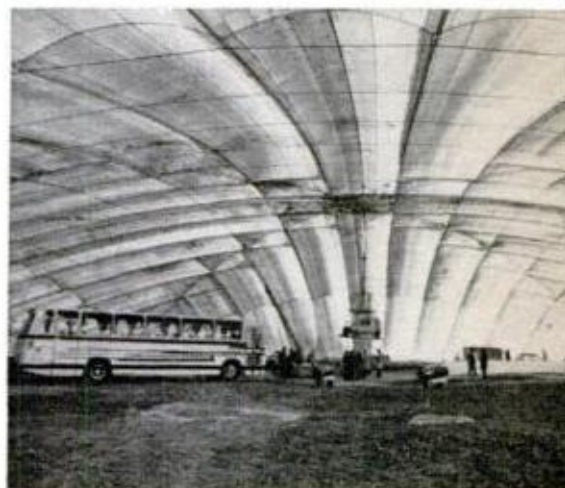



New way to go: Mini cars beat smog, traffic jams, fuel shortages

The growing problems of air pollution, traffic jams and dwindling fuel supplies are bringing with them new forms of mini transportation all over the world. The two "cars" at far left are about as small fully enclosed types as you're likely to find anywhere. Both are battery-powered electrics designed mainly for short-run shopping trips in congested areas. Both are silent, fume-free and take about a quarter the space of a conventional sedan. One at top, a two-seater, was developed by Dutch engineer Lund Schimmelpennik and runs 40 to 65 minutes per charge. Lower one is a French single-seater capable of speeds up to about 35 mph. At near left, a British housewife, Mrs. Anne Dorrington, rides a baby farm tractor from her rural home to a nearby highway where she hops a bus to Wokingham to save having to drive the family car into town. At bottom is another electric, this one a three-wheel shopping scooter built by David Fox of Sidcup, England, for his wife Pamela. Running on two car batteries, it costs only 30 cents a week to operate and rarely has trouble finding a place to park. Its only disadvantage: You get wet when it rains.



Roadside safety flasher

This roadside flasher starts blinking as car headlights approach to warn motorists of your presence on a dark street. No bigger than a pack of cigarettes, it contains a photoelectric cell that actuates the flasher automatically. Hooks to coat pocket or car fender. Acculux, Witte & Sutor GmbH, 7157 Murrhardt, West Germany.



Screw-in plug threads for small gas engines

Replace stripped sparkplug threads in small gas engines with self-tapping thread inserts. Tap-Lok Spark Plug Repair Kit includes six, plus a special driver for them. Inserts can be used in cast iron, aluminum, magnesium cylinder heads. List price is \$20.60; sold by motorcycle dealers and distributors, some auto-parts outlets. Groov-Pin Corp., 1125 Hendricks Causeway, Ridgefield, N.J. 07657.



Alarm buzzes 'tilt' to scare off intruders

This alarm requires no installation—just place it against a door or window or in your car. When it's tilted, it emits a piercing buzz. Uses standard flashlight batteries (not included); \$8.95 postpaid or two for \$16.95 from Pedi-Mold of New York, Inc., Dept. PM, 565 Fifth Ave., New York, N.Y. 10017.



Newsmen and police to get better, faster wire photos

Photos sent over telephone wires will travel four times faster and be clearer and sharper than present ones in a new transmission system developed jointly by the Associated Press and Massachusetts Institute of Technology. Called Laserphotos, they use a laser beam to expose dry silver paper. They take two minutes instead of the usual eight and arrive flat, dry and ready for use, requiring no chemical processing.

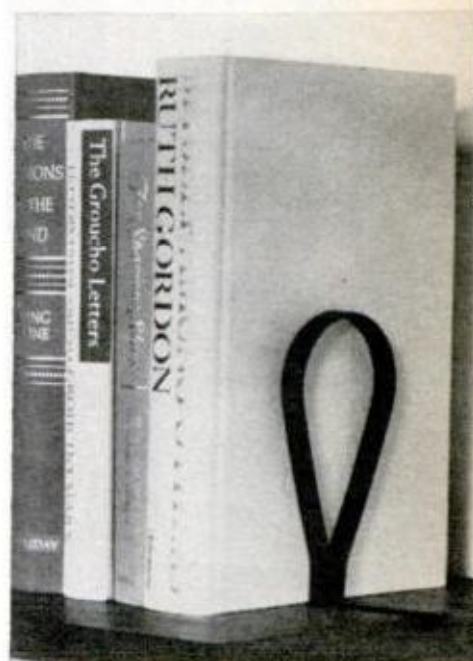

New book-keeper acts as desk rack or shelf system

Billed as the end for book-ends, Protect-A-Book prevents "bookslides" with its slip-proof, track-riding stops. Each set takes just an inch of shelf space. Maker suggests holding record albums, games, mail as well. Also available to add to standard bracket shelves. Sold in gold, silver, walnut and black, with choice of three sizes. Prices start at \$3.15. For information, write Merlin Mfg. Corp., Dept. PM3, 3545 North Clark St., Chicago, Ill. 60657.



Combination of high speed and short take-off and landing capabilities—unusual for a small homebuilt—makes the RV-3 an extremely versatile craft. It offers exciting sport flying, yet is safe, stable and easy to handle.

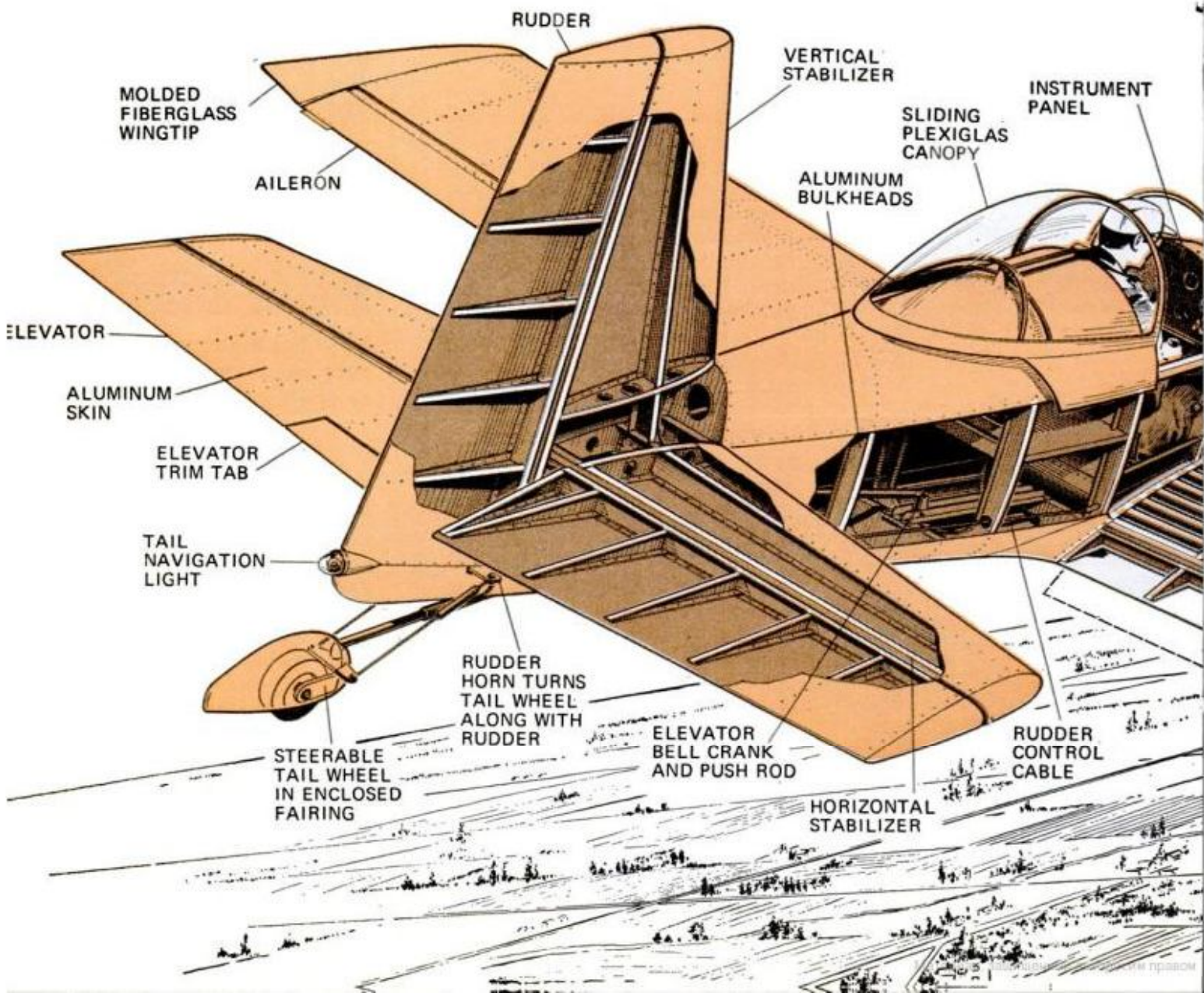

Fast, racy fun plane you can build yourself

It's smart-looking, easy to build, and you can even buy some of the parts ready-made to simplify construction.

by Sheldon M. Gallager and Howard Levy

A plane that offers fast, aerobatic performance and STOL characteristics all in one is like having your cake and eating it, too. But Richard Van Grunsven has managed to combine the two in his trim little RV-3 single-seater monoplane. Built for exciting sport flying along with safe, easy handling, it provides the best of two worlds. The versatile homebuilt—Dick's second—is the result of years of experience as an aircraft-parts maker and advanced pilot with a multiengine rating.

Powered by a 125-hp Lycoming engine, the RV-3 has a top speed of nearly 200 mph and cruises at 186 mph. At the same time, it has an exceptionally low stall speed of 45 mph and can land at 48 mph in as little as 300 feet. It can get off the ground in 250 feet. The secret of such short takeoff and landing (STOL) capabilities lies in the use of large control surfaces. Flaps and ailerons, paired together, span the entire length of the wings, providing tremendous control area. The flaps produce increased lift at low speeds, enabling the ship to land and take off in corn-patch-size fields. In addition, the ailerons incorporate a slight downward droop in their neutral position, thus serving, in effect, as extra flaps. This keeps the outer wing sections flying when at near-

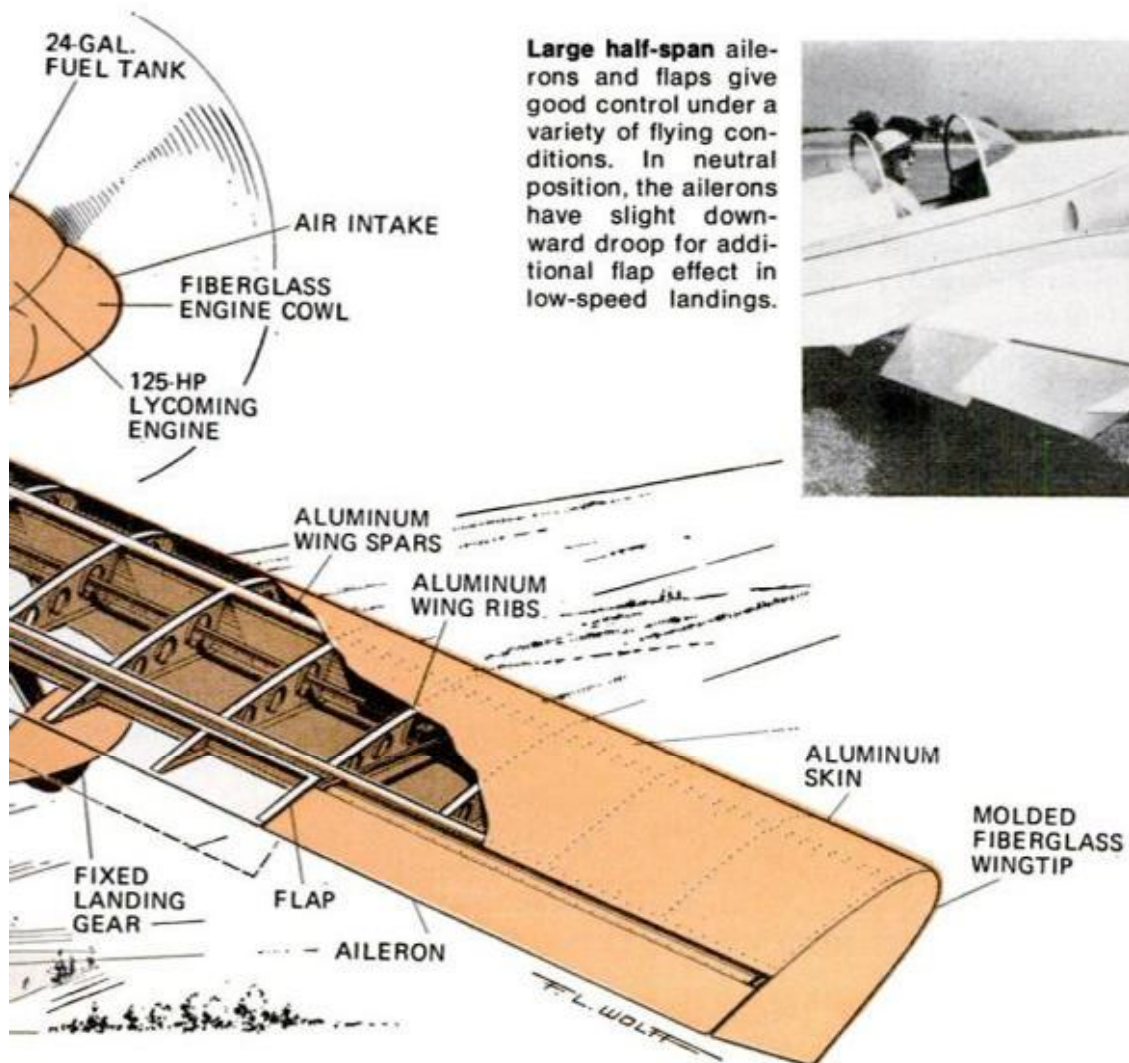

Large half-span ailerons and flaps give good control under a variety of flying conditions. In neutral position, the ailerons have slight downward droop for additional flap effect in low-speed landings.



PHOTOS BY HOWARD LEVY

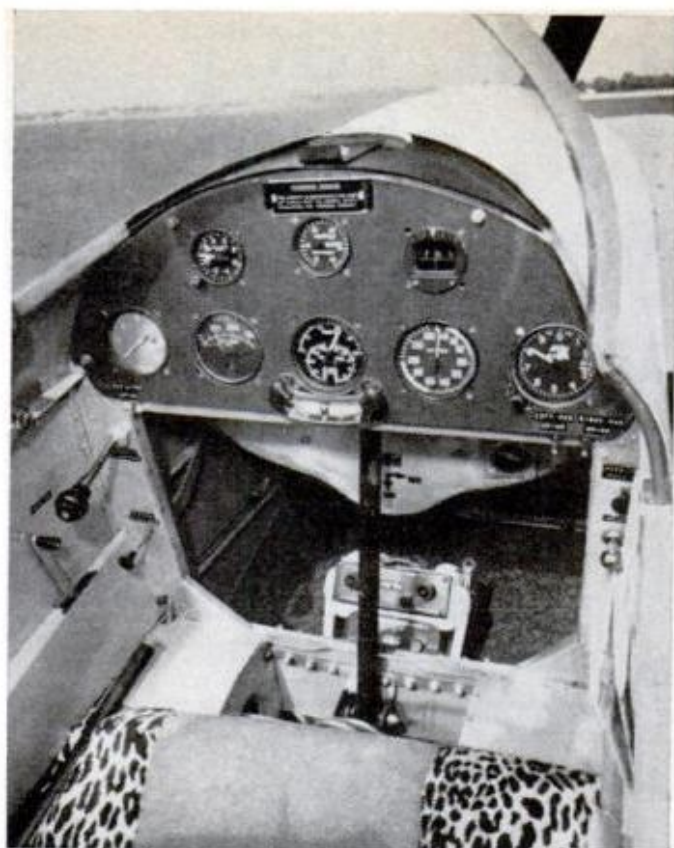

Cockpit is surprisingly roomy for small ship, has easily held many hefty six-foot-plus pilots. Instrument panel is simple and uncluttered, yet provides all essential flight gauges. Streamlined nose cowling, prop spinner and wheel pants (lower left) give ship a trim, sporty look, are expected to be available pre-molded of fiberglass for home builders wishing to buy the parts ready-made. Even tiny tail wheel (upper left) is enclosed in fairing—another slick touch to improve appearance as well as reduce drag. This and windshield, canopy, molded wingtips and other parts may also be offered as ready-to-install accessories.

stall speeds, prevents premature stalling and maintains good control and stability even below the normal stall point.

Those big ailerons are also what give the RV-3 its quick responsiveness in performing intricate and agile aerobatic maneuvers. They provide a fast roll rate of 170° a second—actually greater than that of the famous Pitts stunt plane. While the ship is not equipped with an inverted fuel system, it can execute all inside maneuvers—enough to put on a pretty spectacular one-man air show. Rate of climb is a breezy 1900 feet a minute, with a service ceiling of 21,000 feet. Accidental spins are virtually impossible. Even when forced into one, the ship quickly recovers—hands off the controls—within one rotation. According to Dick, "It's hard to get into trouble no matter how badly one messes up a maneuver."

Basic construction is of aluminum with

molded fiberglass fairings for the wingtips, engine cowling and wheel pants. Overall length is 19 feet, with a wingspan of $19\frac{3}{4}$ feet. The wings have a constant chord of 54 inches to simplify their shaping and covering. Empty weight is 695 pounds, gross 1050. Approximate cost with the 195-hp Lycoming engine runs around \$2500.

Complete plans for the RV-3 will be available this fall. While their exact price has not yet been established, they'll sell in the \$75 to \$90 range. Dick also plans to provide some of the parts ready-made to aid the beginner. These will include preformed wing ribs, wingtip fairings, nose cowling, prop spinner, wheel pants and possibly the landing gear, canopy and fuselage bulkheads. Further information on plans, parts and costs can be obtained from Richard Van Grunsven, Van's Aircraft, Rt. 2, Box 187, Forest Grove, Ore. 97116. ★★★

Overnight rod repair

by Karl Denny



PHOTOS BY ALBERT DENNY

Slam a car door or drop the trunk lid on your favorite fishing rod and suddenly you own a couple of useless stumps. Repair, however, can be quick, easy, inexpensive, and result in a rod that is stronger than new.

You'll need a small kit of clear epoxy cement, pocketknife, hacksaw, section of old glass rod and a rag. First trim the rough ends of the break with hacksaw and knife so the rod pieces butt together neatly. Next select a section from that old broken rod with a diameter that will slide easily inside the pieces you are re-joining. Cut a six-inch length.

Using about a teaspoonful of epoxy from tubes A and B, mix thoroughly with a slender stick. Tie a loop of cord in the middle of your six-inch insert plug to mark its center, and cover one-half completely with the epoxy mix. Insert this end into one rod section and push in to the center marking string. Now, with your mixing stick, coat the remaining three inches of the filler plug and insert into the other length of rod. Remove string when both ends butt tightly together.

After 20 minutes' drying, sight down the rod to check for straightness and bend slightly if any correction of joint is necessary. Re-check every 15 minutes until the joint sets. Coat with a final layer of epoxy. ★★★

OCTOBER 1973 151



Hollow fiberglass rod is easy to repair with knife, hacksaw, epoxy, 6-inch length of old rod.

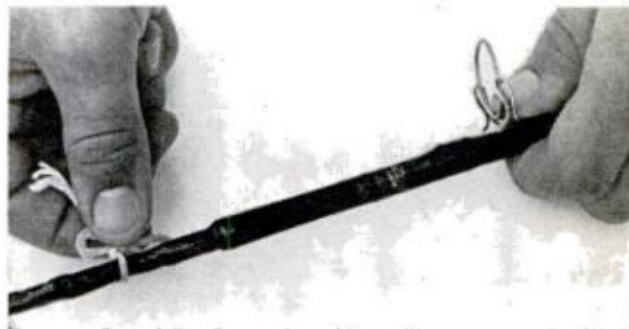

Plug insert, cut from old rod, is marked in center with string, epoxy coated, fitted into break.

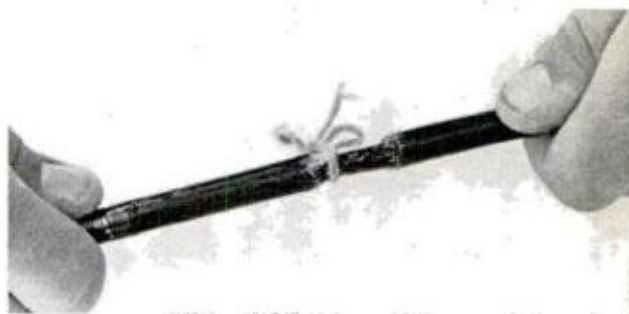

Second rod section, trimmed flush with knife and saw, is slid over other end of epoxied insert.



Final coat of epoxy, applied like paint to seal repair, makes joint stronger than original.

Sighting down rod while epoxy hardens allows slight bending corrections to insure straightness.



How you pay for boredom on the assembly line

The secret of making better cars with fewer bugs may be easier said than done: Let the men and women who build them work together and make decisions during production. Every do-it-yourselfer knows that.

by Robert Lund
DETROIT AUTO EDITOR

Could Detroit build better cars by eliminating the assembly line in favor of a team approach to automaking? Small groups of five or six putting the pieces together instead of one man standing at a station on the line and repeating the same monotonous routine for something like 1900 hours a year. If you reduce machine content and replace it with human content, do you get a better crafted car? With what effect on prices?

The auto companies have been trial-and-erroring answers to those questions for more than a year. They don't have all the answers yet, but they're beginning to draw distinctions between fact and theory.

The car firms feel the team assembly idea has merit and will work in some areas of automaking. But they say the concept can't be applied to the whole car and support a production run of 10,000,000 automobiles a year.

"The idea may work in Sweden," declares a Ford executive who has been involved in a team assembly project, "but how many cars do Volvo and Saab produce in a year? Something like 300,000? That's low volume by American standards. Ford alone—forget GM, Chrysler and American Motors—turns out as many cars in a month as Volvo and Saab produce in a year. You can go in for handcrafting on low volume. But you're asking for trouble if you try it on a high-volume operation."

But Detroit is interested in the team concept as a means of giving workers greater satisfaction with their jobs and as

a way of improving the quality of cars.

While Detroit's experience with the team approach is limited, automakers feel they've experimented with the idea to a point where they can begin to assess the trade-offs—what you lose, what you gain in substituting team assembly for line assembly. The good news/bad news as Detroit sees it:

□ *Good*: Durability, reliability and quality are equal to or better than output from a conventional assembly line. Minor sabotage—intentionally failing to tighten a screw or nipping a wire to cause a malfunction—is eliminated. In a team effort, the worker, in effect, stamps his name on the car. If something goes wrong, the fault can be traced back to the group and then to the individual. The buyer gets a better car, or at least that portion of it assembled by a team.

□ *Bad*: In team assembly, production declines. The auto companies are vague on this, saying they haven't had enough experience with the team system to work up figures to compare output against a regular line. One company that asked not to be identified said production dropped from an average of 900 units (subassemblies, not complete cars) per shift to 825-850 units per shift when it changed from a straight line to a team program.

More bad news: as production declines, prices increase.

On Detroit's scale, the disadvantages of team assembly outweigh the advantages. There are other ways of improving quality, automakers say, without paying the price penalty inherent in the team concept.

But that doesn't mean Detroit's dismissing the idea as a can't-win-for-losing failure. Group assembly has a lot going for it in specific situations.

The two areas where the team idea looks most promising are (1) on low-volume vehicles, (2) on subassemblies, putting complicated components together before the unit is installed on the car.

GM has tried the team approach on a



Assembly-line production techniques are being questioned by many American companies and by workers themselves. The concern is for better job satisfaction and products of better quality. A group assembly system was being evaluated by GM for production of its new motor home as shown here. A six-member team (below) handled the body; a three-member team the frame (below, left). Prototype is subjected to severe laboratory shake test (left).

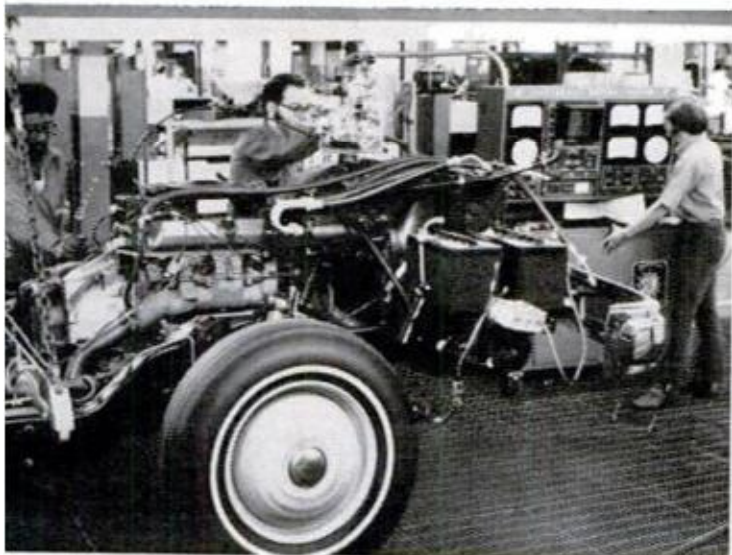

low-volume vehicle, the motor home produced by GMC Truck & Coach Div., with mixed results. The program was a success or failure, depending on how you interpret the results. Truck & Coach claims the experiment was "a qualified success." But the division had to back off on the project, indicating it didn't fare as well as GM hoped.

Originally, Truck & Coach had two different teams working on the vehicle. One, consisting of six members, was assigned to body trim and upfitting. There were seven such teams. Another, consisting of three members, assembled the chassis. There were 12 chassis teams.

The body trim and upfitting teams have been phased out. Their work is now done on an assembly line. The number of chassis teams has been cut from 12 to six.

What went wrong? *PM* talked with a GM official, an official of United Autoworkers Local 594 (representing workers at the Truck & Coach plant) and two members of the teams. Putting their stories together, this picture emerges:

Truck & Coach tried to tackle too many new elements at one time—a new product, new production equipment, new way of putting the pieces together, new training program for employees. Alex Mair, division general manager, said as much in a company press release: "Instituting the team building system simultaneously with production of a totally new vehicle in new facilities may have been too ambitious an undertaking."

What Mair didn't say is that Truck & Coach was disappointed with the low number of mobile homes being assembled by

'Participative management' means giving employees a say

the team method. Production never got above 15 to 20 units a day, against a production target of 30 to 35.

When GM pulled back on the program, last May, it said it would review the team idea, see if the bugs could be worked out and then give the plan another chance.

GM has had greater success with the team approach in another area of auto-making. The second project involves building car radios by the team method. There's another angle to the radio project. Workers are assigned to teams or work by themselves—one worker producing one radio.

How's it going? "The project offers potential," GM says with customary caution, "with respect to job satisfaction and improved performance." Improved performance can be translated to mean better, but not more expensive, radios.

Ford's also looking at the one-man, one-unit approach. At one of its parts plants, Ford has an experimental work force assembling instrument panels for its luxury cars. Workers sit at benches and put the panels together at their own pace. Again,

the results are a mixed bag of win some, lose some. The disadvantages are lower production and a higher investment in tools and plant space. On the plus side—not considering worker satisfaction, for whatever that's worth—quality is somewhat higher than from a line operation, but only if the bench worker is an experienced hand. If the worker is new on the job, there's no difference in quality.

Chrysler's looking at both the team method and the man-at-the-bench idea, although it hasn't actually applied either approach.

At a training center it operates for new employees, Chrysler has set up a mini production line with the stub frame of a car. As the frame moves down the line, the worker moves with it, so he becomes familiar with each operation. With this training, new workers have the necessary background to work into a team program, should Chrysler decide to go to group assembly. Chrysler also has a study underway aimed at giving workers a choice between a job on the line or at individual benches.

The auto companies are using the team idea in another way, possibly without even being aware of it. When a problem popped up, it used to be bucked to the department or individual in management in the direct line of fire. Maybe production, maybe purchasing, maybe quality control, maybe engineering, maybe whoever.

While there's still a lot of pinning the blame on the next guy at the lower ranks of management, more and more plants are using a team approach to solve problems and prevent faulty cars from falling into the hands of customers. When a problem arises, a team is sent in to solve it. Headed up by a professional troubleshooter, the team may consist of a design engineer, somebody from the service department, somebody from quality control, the production foreman and two or three workers who handle the part on the assembly line. Instead of trying to nail a victim for making a mistake, the emphasis is on fixing the problem. Chrysler's had good results

Automotive mirrors are assembled at Donnelly Mirrors by women working in groups. As part of a team, they work at their own speed; not to the speed of a line.



with this approach, improving the quality of cars and improving employee attitudes toward work.

The area of automaking where the team approach is given the best chance of taking over from the conventional assembly line is at the supplier level. Supplier plants aren't as complicated as auto plants. Where the auto plant has to juggle 15,000 pieces to produce 30 to 40 different models, no two exactly alike, the supplier handles a few hundred pieces and turns out two or three products.

The prime example of a team assembly operation in the supplier industry is Donnelly Mirrors. In fact, Donnelly may be the prize example of how the team system can be made to work in any industry in the United States.

The company, located in Holland, Mich., modestly describes itself as "a leading supplier of mirrors" to the Big Three, but it would be more accurate to say Donnelly is the leading manufacturer of original equipment mirrors.

The firm employs 600 workers and has practiced what it calls "participative management" for 20 years. About five years ago, Donnelly started to phase out the assembly line and put in a team system.

Everybody is pretty happy with the arrangement—Donnelly, its workers and especially the auto companies. Every week the company packs up one or two semi-trailers with mirrors and ships them off to Detroit. The quality of the product is almost unbelievable. Of the 50 to 100 semi-loads Donnelly delivers in the course of a year, the number of mirrors rejected by the car companies wouldn't fill the back seat of a station wagon. That's all rejects from GM, Ford and Chrysler combined.

If Donnelly has a complaint about the team system, it's that it works too well. The company has been so besieged by visitors—businessmen, labor leaders, management consultants, social scientists—who want to look at the layout and talk to workers, that the firm had to set up a schedule of factory tours. "It was hard to get the work out with so many visitors walking through the plant," a company spokesman explained. "So now we give organized tours twice a week." ★★ ★

How it works in Sweden

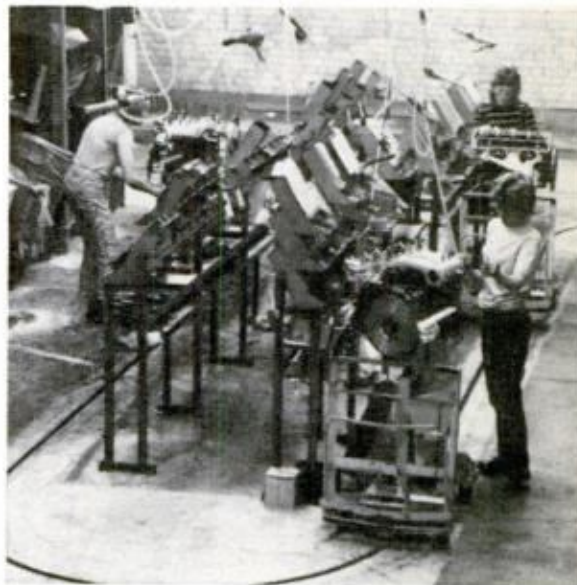

Group assembly of engines for Saab 99 models, as shown above, is a reality in Saab's plant in Södertälje, Sweden. And early next year Volvo will open an all-new facility in Kalmar built from the ground up for production based on the team concept of performing work.

One way to beat assembly-line boredom—even rebellion—is to eliminate the line. This is easier where annual production is a fraction of Detroit's. Still, limited group assembly at Saab and Volvo has not extended to assembly of entire automobiles—it's questionable whether it can be. Helping to find nontraditional approaches to relieving the monotony of making things are "production and development groups" within the shops.

The need for workers to be involved in production decisions is fully appreciated. In Saab's engine-assembly alcoves, four workers decide among themselves how a quota will be met: They can build one complete engine each, or team up and build one in a quarter of the time.

This seemingly basic participation in decision-making, is a new and welcome innovation for job enrichment, as Arne Gustavsson, Saab worker representative, told us. How far this power will extend is unresolved. Right up to having a say in production goals, say some. In *Job Power: Blue and White Collar Democracy*, author David Jenkins puts assembly-line boredom in a global perspective—because it's a problem of man vs. machine that is not only Detroit's . . . or Sweden's.—B.H.

How to buy the right antenna

by Leonard Feldman

What's the best TV or FM antenna? Check a few nearby rooftops, and you'll see that few people agree on the answer. And rightly. Each house may have a slightly different reception problem, and there's more than one solution to the problems you and your neighbors share. So the trick isn't finding the "best" antenna, but finding any one that's right for you.

First, let's deflate some myths that make

Familiar face: the yagi

The yagi is one of the most popular VHF-only types, especially for nearby suburban use, because it achieves moderately high gain with relatively few elements. The two looped elements are active ones; others include three "directors" in front, one rear reflector, all to increase directivity. Single-channel VHF antennas are usually yagis, though most yagis cover whole VHF band.

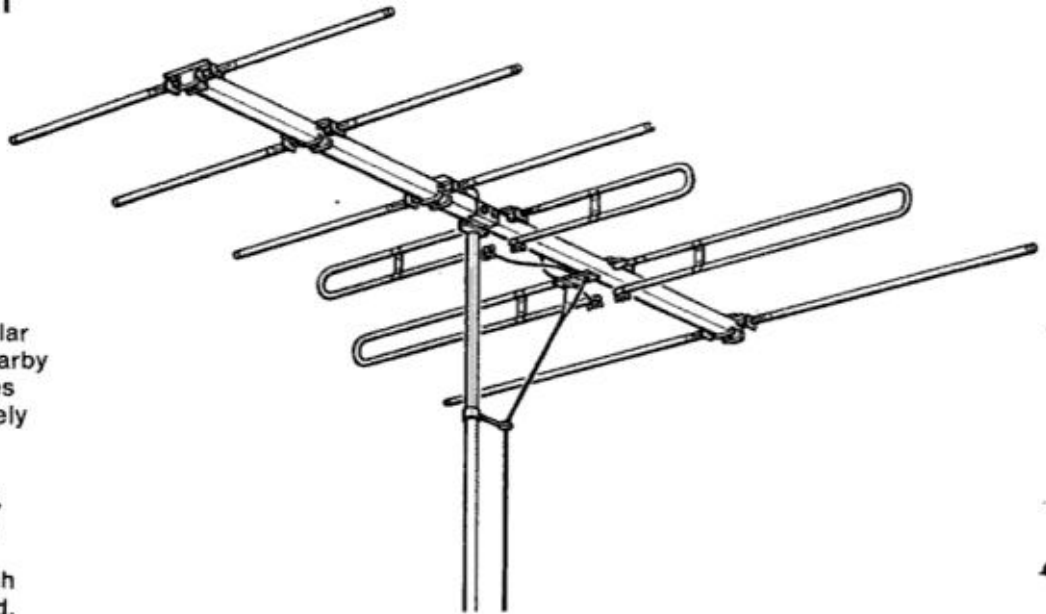

A yagi for UHF

Complex design (10 active elements, 12 directors and reflectors) shows that this model is for very weak fringe signal areas. Small size of elements shows it's solely for UHF. But its design is basically the same as that of the VHF yagi above.

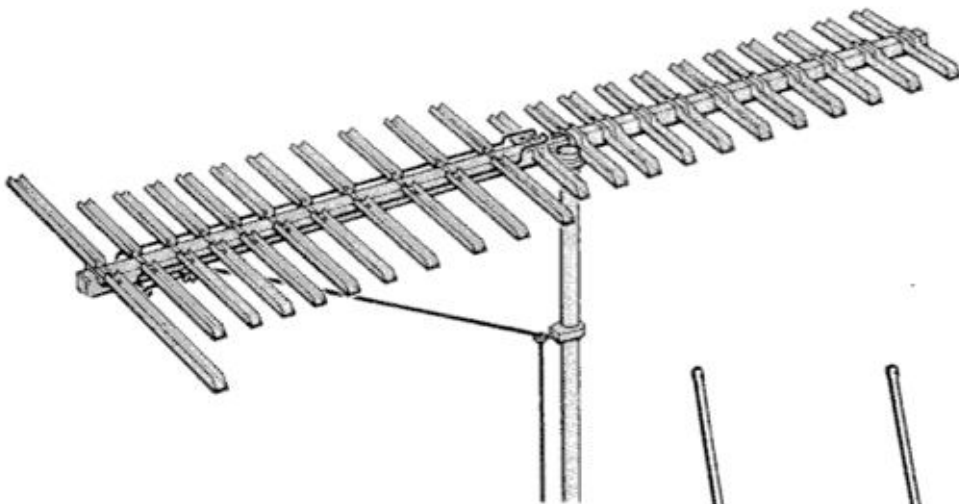

Swept yagi is all-active

Designed for VHF and FM use in strong signal areas, this variation on the yagi has all active elements, with no reflectors or directors. That gives it more gain than the one at the top of this page, but less directionality; what directionality it has comes from the V-sweep of its elements (open end faces the station).

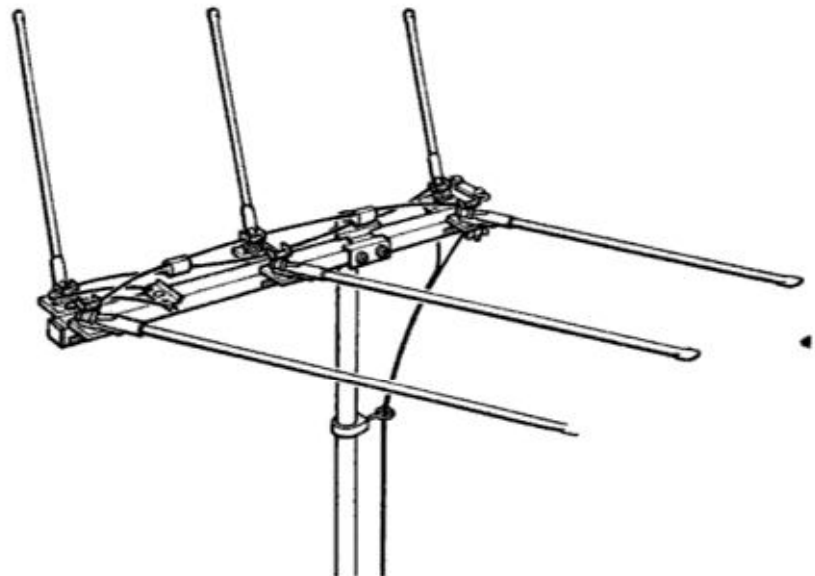

'Log-periodic' for all channels

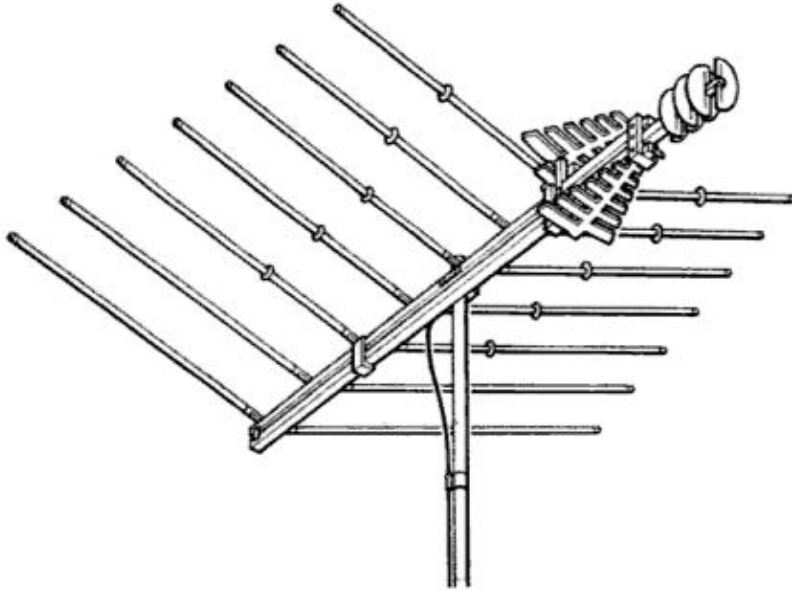

Called "log-periodic" because the spacing between its V-shaped active elements varies logarithmically, this model is actually two antennas in one: "Christmas-tree" cutouts at front form a second log-periodic section for UHF use; discs at front are UHF directors. A distant-cousin yagi, it uses many active elements, but no reflectors or directors. All-channel models usually require a "splitter" at the set (not shown) to direct signals to the set's VHF and UHF antenna terminals.

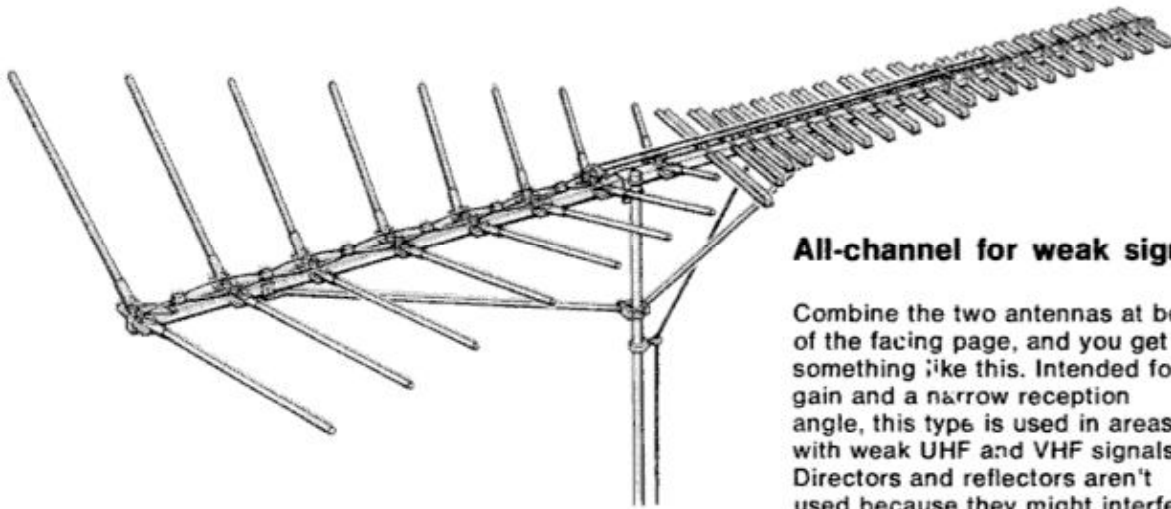

All-channel for weak signal areas

Combine the two antennas at bottom of the facing page, and you get something like this. Intended for high gain and a narrow reception angle, this type is used in areas with weak UHF and VHF signals. Directors and reflectors aren't used because they might interfere with UHF pickup.

Stacked array for further gain

In very weak signal areas, antennas can be stacked to increase gain. This setup came from the factory as a stacked array, but ordinary antennas can be stacked, too. Small UHF elements are mounted between the VHF sections.

antennas among the most misunderstood devices in consumer electronics. One insists that the more "elements" or rods it has, the better the antenna. Generally, more elements do indicate a higher-gain antenna which can pull in a stronger signal; but many antennas with few elements have greater gain than more complex models of other designs—and either type might offer more gain than you want or need. (Gain, by the way, is the ratio in db between an antenna's signal strength and that of the "standard"

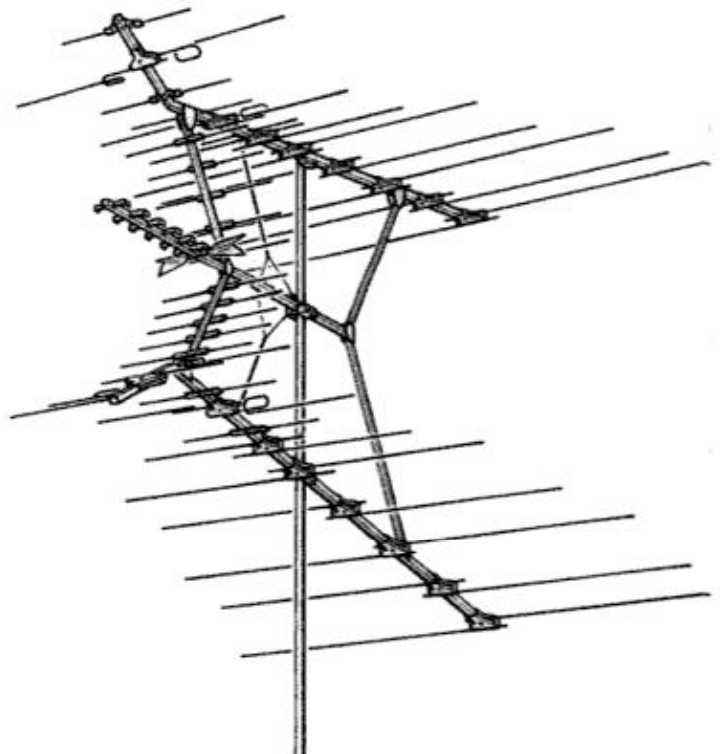

Reception problems determine your antenna choice

half-wave dipole shown on page 159.) Except in fringe and extreme fringe areas, gain is hardly ever the main concern in choosing an antenna. And the idea that the best antenna is always the one with the highest gain is still another myth.

Not all antenna elements are "active," but all are useful; while some actually pick up the signal, others serve as reflectors and directors that determine the antenna's directionality. But directionality, while more important than gain, isn't always the main consideration, either.

Still another myth is that special designs (or even specially-colored elements) are needed for proper reception in color. Actually, you don't need a special antenna for color TV—just a good one, since color makes reception defects easier to notice than they are in black-and-white. Coloring the elements, if it serves any good purpose at all,

just helps to delay the onset of corrosion.

Many myths get their start with ancient, obsolete realities—like the belief that all-in-one UHF/VHF/FM antennas aren't as effective as separate units. Once, such antennas were compromise designs. But today, just about every reputable antenna maker offers combination units that perform well without the clutter of two (or even three) antennas and their separate lead-ins.

What determines your antenna choice is your reception problems: how far away the stations are, and in what directions are the signals you want to get and the interference signals you want to keep out of your picture.

Contrary to popular opinion, reception problems out in "deep-fringe" areas about 60 miles or more from TV stations are among the easiest to solve, especially if all desired stations are in one distant city. Today's high-gain, multi-element antennas, while more costly than simpler varieties, are good enough to give most fringe viewers a snow-free picture.

If you live in nearby suburbia, it's even more likely you'll want to receive pictures from just one city. That problem is even easier to solve, with a less expensive, lower-gain antenna.

In the city, of course, gain is rarely a problem, since the transmitters are so close. But high city buildings can cause "ghosts"—reflected signals that arrive out-of-step because they've bounced along a longer path than the direct signals (on FM, these "mul-



Built-in booster amp on this Channel Master Chroma I makes it better than the ordinary indoor rabbit-ear.

Typical directional-antenna pickup pattern



'Ghosts' are just reflected signals

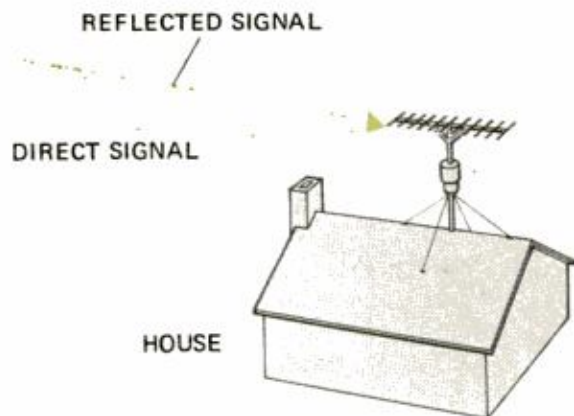
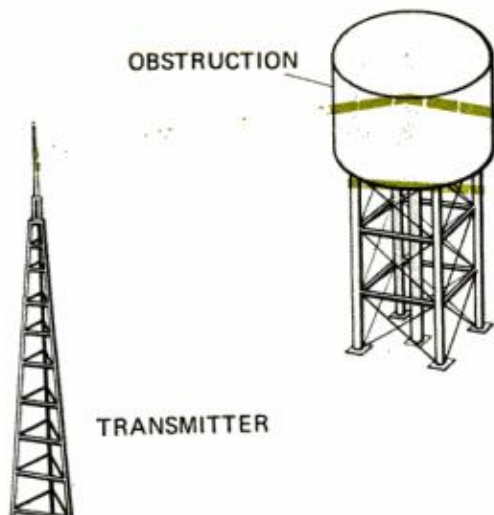

Reflected signals take a longer path, arrive at the antenna "out of step" to create ghosts.

tipath" signals can cause distortion, reduced or wandering stereo separation, noise, of fading). Man-made electrical interference, including harmonics from the city's profusion of TV and FM signals, can cause interference, too. What's more, all of these problems are far more severe than they were 10 or 20 years ago. Now there are more buildings and more interference sources—and color TV and stereo FM are more sensitive to their effects than black-and-white TV and mono FM are. (Quadraphonic FM will suffer even more from multipath.)

If you're lucky enough to get all your signals from just one direction, a highly directional antenna with moderate gain is your urban answer (high-gain antennas may cause reception problems in city sets by feeding in too strong a signal). Aimed at

the clearest signal (usually, but not always the direct one), it picks up off-axis reflections and interference only weakly. Many makers provide diagrams of their antennas directional patterns (one is illustrated on page 158). The most desirable characteristics, for most situations, are a narrow pattern and a high front-to-back ratio (the ratio between the antenna's gain for signals arriving on its frontal axis to its gain for signals arriving from the rear). For a given antenna design, the bigger the antenna, the more directional it is, the more gain it has—and the more it costs.

Directionality is fine, of course, but what if all your stations don't lie in one direction? Some omnidirectional antennas are equally sensitive to signals from all directions, but they're equally sensitive to noise and multipath from all directions, too. If you'll need to pick up VHF, UHF and FM stations from each of several directions, your best bet is an all-channel antenna mounted on a rotor so you can turn the roof antenna by remote control. Or, if you live in a fringe area between a large city with several VHF channels and a small city with UHF stations, you could use two antennas fixed in place on a single mast: a VHF antenna pointing toward the metropolis and a UHF model pointing the other way. (Spacing between such antennas, though, must be at least one-half the wavelength of the lowest channel to be

(Please turn to page 198)

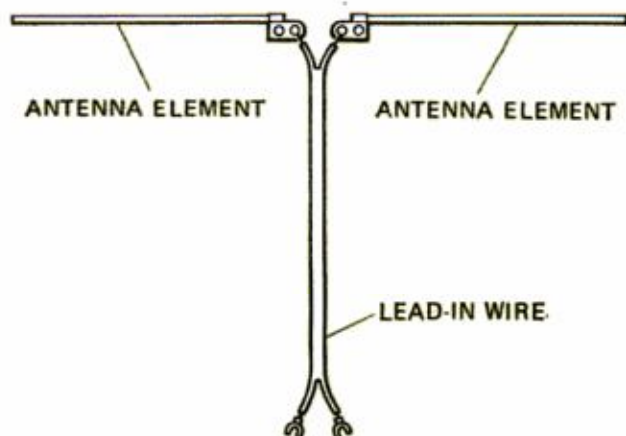

Standard half-wave dipole—the familiar "rabbit-ear"—has two elements, no reflectors. Its gain is defined as "zero," the standard against which higher gain antennas are always measured.

World's smallest full-size reflex camera

by Ivan Berger

ELECTRONICS EDITOR



PHOTOS BY PETER SCHNEIDER



Man-sized meter switch (above) can be checked with a touch or a glance to make sure it's off when you're not shooting. Lens-switching (right) is easy with bayonet mount, but your thumb can accidentally alter shutter-speed setting on ring around lens mount until you're used to it. Dial atop camera is meter's ASA setting.

Palm-sized Olympus OM-1 reflex takes full-frame 24x36-mm negatives on 35-mm film, has full-sized list of features, including through-the-lens meter, self-timer, shutter speeds to 1/1000 second and a wide range of compact lenses. Accessories include removable hot-contact flash shoe (on camera, below), motor drive (to come).

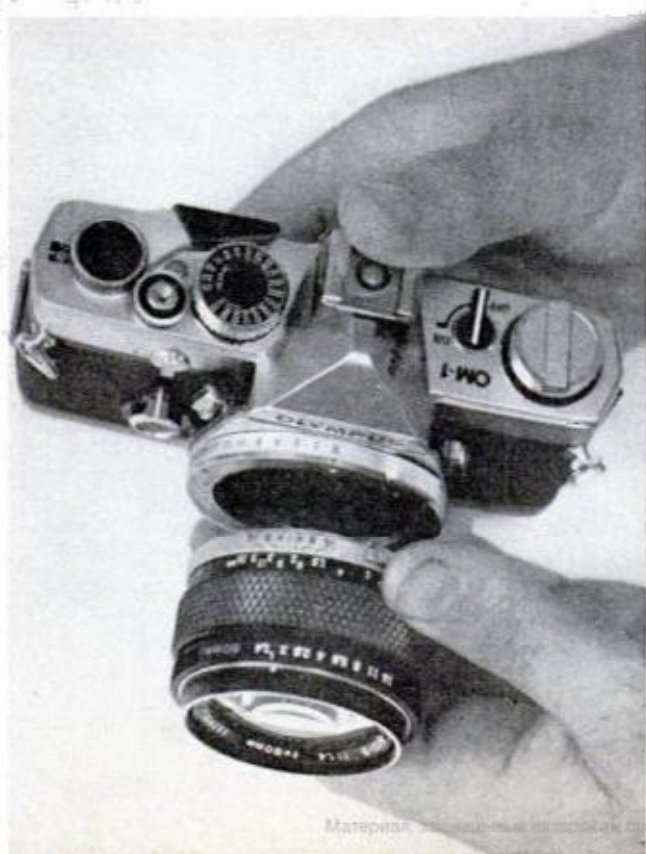



IVAN BERGER

Shooting into sun (left), multiple-coated OM-1 lens shows little flare except one diaphragm star. Center and bottom-weighted meter wasn't fooled by backlighting, gave perfect exposure of pretty model in this tricky situation.

Finger pointing to self-timer trigger (below) dwarfs camera. Separate trigger lets you shoot with or without self-timer delay, even after timer is cocked. Rewind release (above finger) is accessible when camera is on tripod.

Depth of field (bottom) is easy to gauge on OM-1's bright finder, even in dim light like this. Smooth shutter release and vibration-damped mechanism sharpen hand-held shots at slow shutter speeds (here, 1/15 sec., f/8).

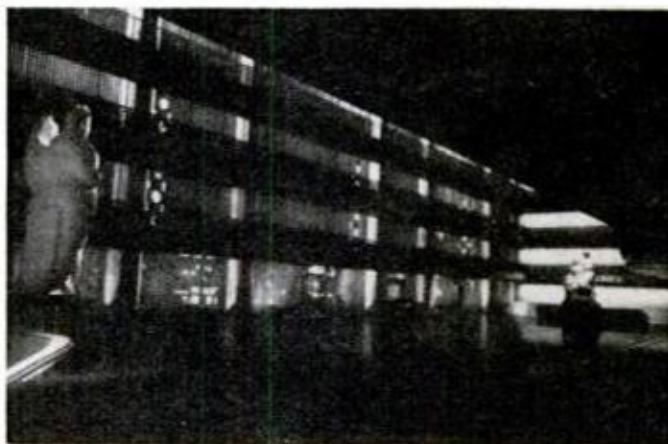

Carry the average 35-mm "miniature" reflex around your neck all day, hang a bag of its lenses on your shoulder, and you're guaranteed a royal charley horse by supertime. But Olympus's new OM-1 reflex can postpone the pain at least until midnight.

It's about 35 percent smaller and lighter than average. But it takes full-size 35-mm negatives and has all the major features you'd expect in its price class (now \$400-\$500, thanks to devaluation): through-the-lens, match-needle light meter, shutter speeds to 1/1000 second, self-timer, and a whole system of light, compact and interesting lenses and accessories.

The OM-1's viewfinder is one of the biggest and brightest I've used—30 percent bigger and 70 percent brighter than average. That makes its depth-of-field preview genuinely useful, instead of darkening the finder so much that you can't see. It's even easy to view with glasses on. But the eyepiece window is so close to the camera's surface that you'll often have to wipe off eyelash oils and perspiration steam. Focusing screens (12 are available) are interchangeable through the lens-mount hole.

The lens mount itself is the fast-change

bayonet type, and there are a lot of lenses to fit it—32 lenses in 20 focal lengths, including 8 and 16-mm fisheyes; wide-angles from 18 to 35 mm (with f/2 versions of the 24, 28 and 35-mm, and a 35-mm with perspective shift control); f/1.8, f/1.4 and f/1.2 normal lenses; telephotos from 85 to 1000 mm and a 75-150-mm zoom; and four macro lenses. (More are in the works.) Of these, 17 lenses in 13 focal lengths from 28 to 1000 mm are available now. I tried five—28, 35, 50, 100, 200—found all commendably sharp, contrasty and free from flare (though the 28 had some barrel distortion).

Physically, the lenses are as alike as

(Please turn to page 199)

A new low-cost portable drill press

Now, precision drilling wherever you work.

by Harry Wicks
WORKSHOP EDITOR

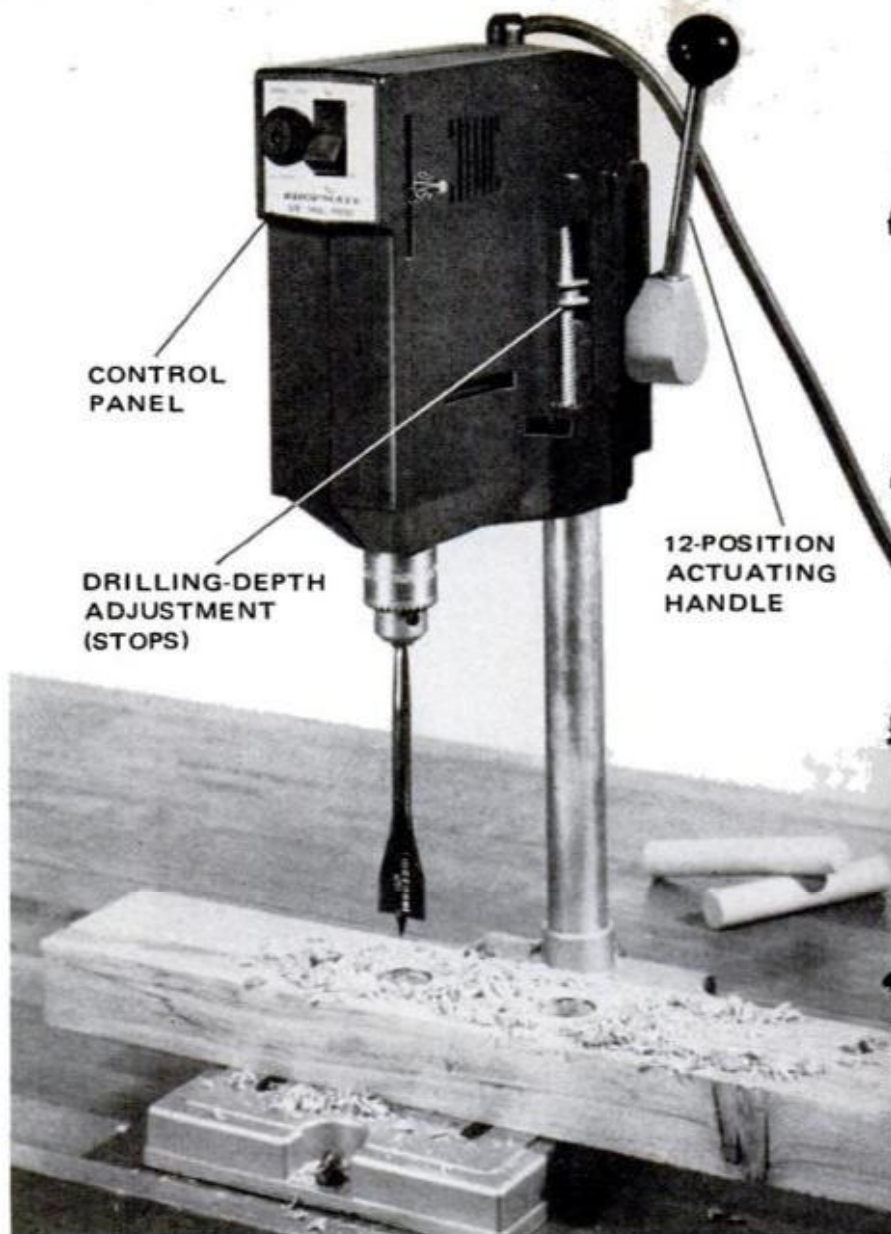

Wide range of drilling flexibility is possible with press; variable-speed range is 700 to 2000 rpm.

Power-control panel is in full view of operator for easy access. Turning dial clockwise increases speed.

When I first spotted the drill press shown on these pages I figured that if the tool was as good as the maker claims, *Popular Mechanics* readers should be told about it. Since you can't beat a drill press for drilling accuracy, the idea of owning one that you can lug to your project—indoors or out—will appeal to almost all do-it-yourselfers and journeymen. The surprise is that the Shopmate tool is in the same price range as a quality 3/8-in. portable drill: under \$70.

By now, most workshopers own, or are at least acquainted with, variable-speed tools. This tool has that advantage. You can turn it down as low as 700 rpm for heavy-duty drilling in metal or let it rip at 2000 rpm for boring in soft wood.

The exciting feature is the safety that's built in. The chuck key *must be inserted* in the slot as shown before the unit can be turned on. The press is easily adjusted, too.

To raise or lower the head, you simply ro-

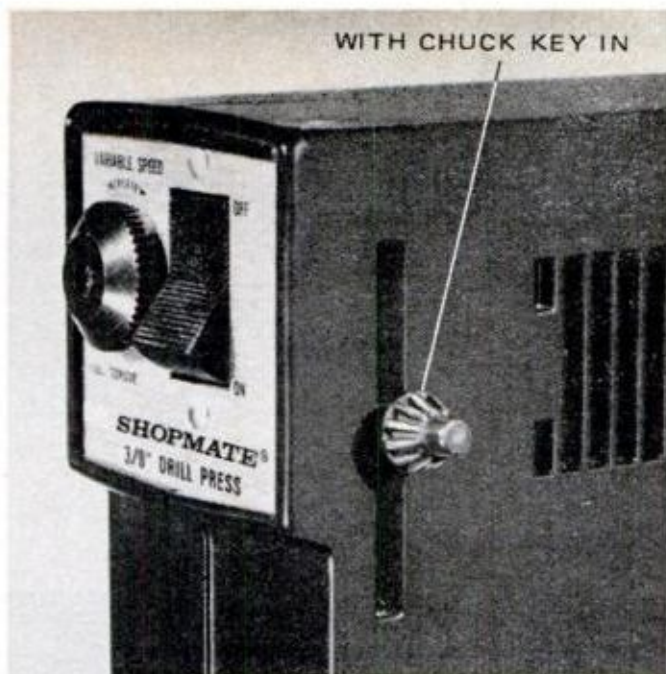

Chuck key is inserted in slot, twisted slightly until you hear click. Unit is then ready for drilling.

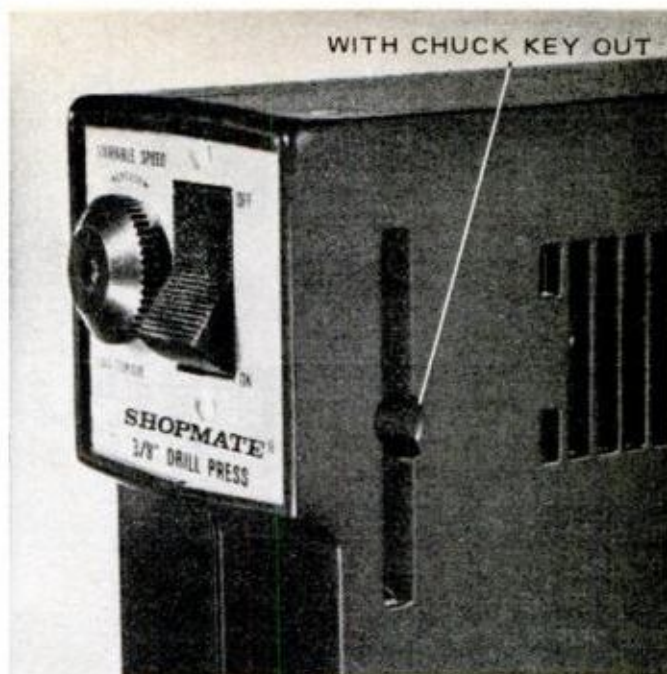

With chuck key removed from slot, accidental starts are impossible; on-off switch *cannot* be activated.

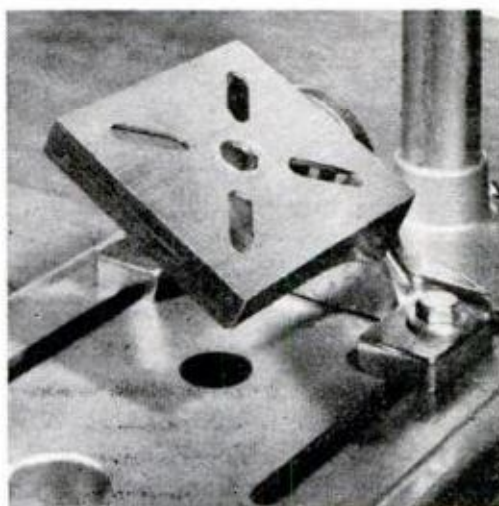
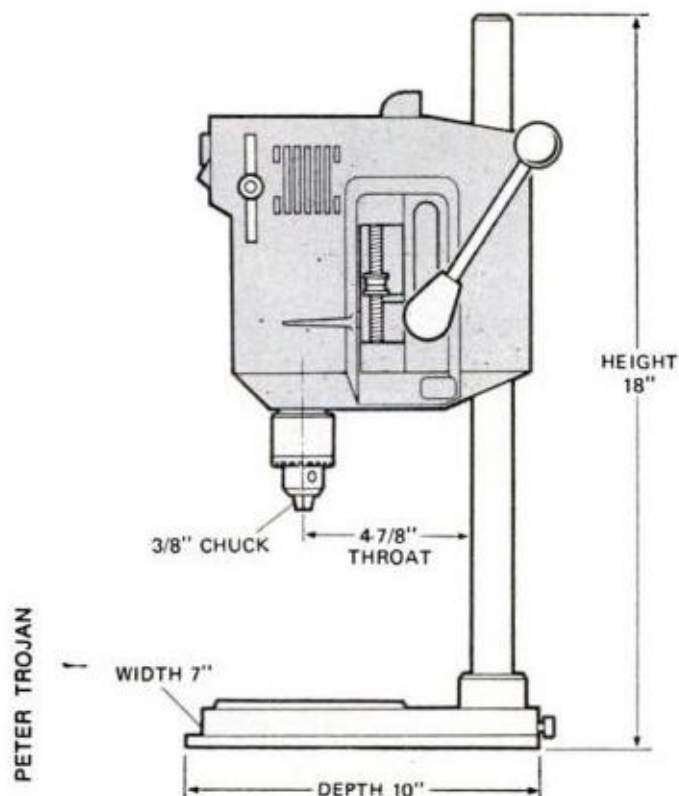

Tilt-table accessory permits drilling of accurate, angled holes in stock. The accessory is priced at about \$6.

tate the column lock counterclockwise and position the head where desired. The tilt-table accessory will add \$6 to your cash outlay, but is well worth the investment if your favorite projects call for much angled drilling. Another good feature: Full-Torque. This is essentially a sensing device in the switch mechanism that "senses" power requirements at various speeds and automatically increases power output of the motor as the drilling load increases. ★★★

MANUFACTURER'S SPECIFICATIONS

Shopmate Model 2450 Portable Drill Press

Capacity: steel, $\frac{3}{8}$ in.
wood, $\frac{3}{4}$ in.

Drilling depth adjustment: 0 to $2\frac{1}{8}$ in.

No-load speed: 700 to 2000 rpm
(variable)

Ampere rating at 115 v.: 2.7

Head adjustable: 360°

Weight: 12 pounds

Price: \$69.95

Chuck capacity: $\frac{3}{8}$ in.

Manufacturer: McGraw-Edison Co., Portable Electric Tools Div., 1200 East State St., Geneva, Ill. 60134.

What you should know about fluids for your car

If it weren't for fluids you wouldn't start, stop, turn . . . You name it!

by Mort Schultz

Without the right fluid your car's automatic transmission, brakes, engine, power steering and battery wouldn't function. Each of these systems uses a different fluid with specific properties. However, not all automatic transmission fluid is the same. Neither is all brake fluid, antifreeze coolant, motor oil or power-steering fluid. For that matter, the type of water you use in a battery can differ.

Whether you purchase fluids from an auto parts store, discount establishment, service station or elsewhere, you should understand what can happen if you use the wrong fluid. In some cases, using a fluid not suited for a particular system will cause damage. In other cases, safety or performance can be affected.

Consider automatic transmission fluid (ATF). General Motors, Chrysler and American Motors urge that you use an ATF called Dexron on their transmissions for long life and proper performance. Ford, however, requires that a fluid called Type F that meets Ford specification M2C33-F be used.

"If Type F fluid isn't used, improper performance can be expected," a Ford spokesman told me. "Furthermore, the car owner will void his warranty if it is still in effect."

Do Dexron and Type F differ that much? After all, both possess essentially the same additives, including inhibitors to prevent

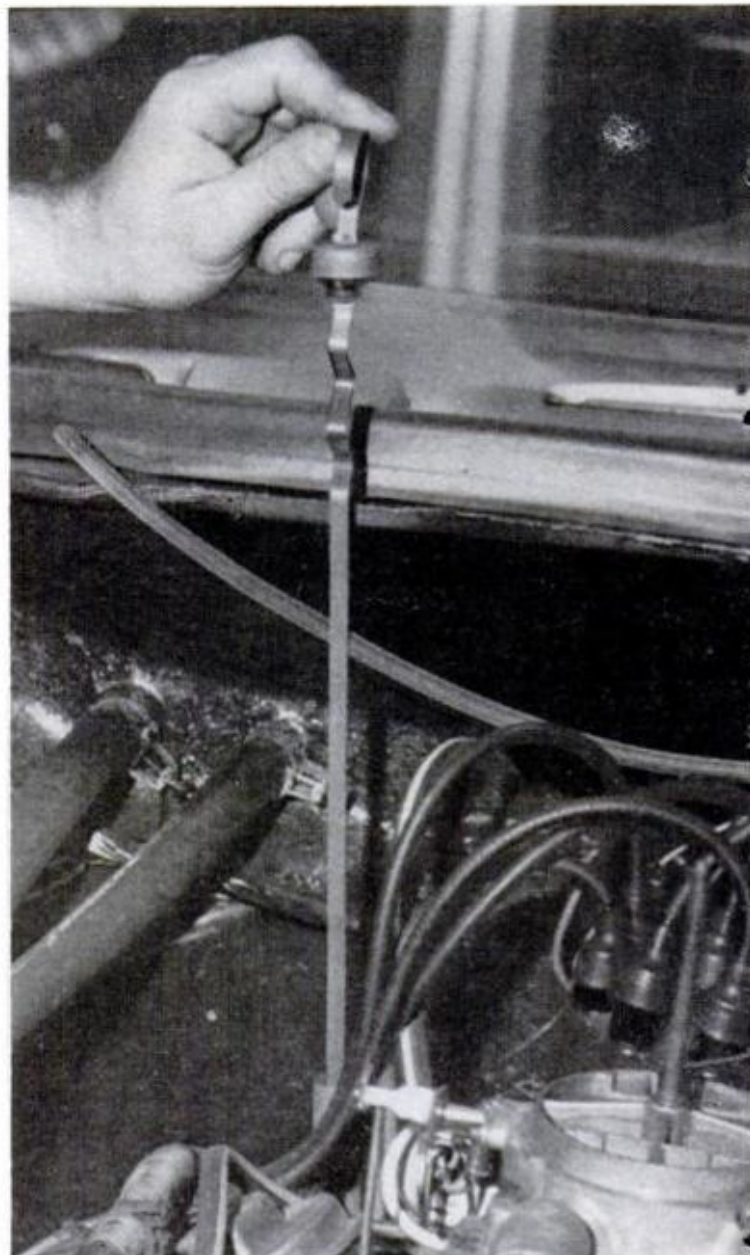

Automatic transmission dipstick is the long one! Check fluid level according to the manufacturer's directions and keep the dipstick clean. Make sure you don't pick up dirt on the end before reinserting it.

varnish, friction inhibitors to facilitate clutch operation, index improvers to maintain viscosity as temperature changes, and other chemicals to reduce wear and corrosion, prevent foaming and allow seals to swell slightly so that leaks are prevented.

However, Dexron and Type F must meet the specific requirements of the transmission in which they are used. These requirements differ. Hence, Dexron and Type F are different—not necessarily in additives they contain (both have much the same ingredients), but in the lesser or greater amount of one or more of these additives.

A major consideration by General Motors for its automatic transmissions has been to provide smooth shifting. Ford has been concerned about clutch slippage. Both objectives bear on the frictional properties of the ATF used, but for opposite reasons.

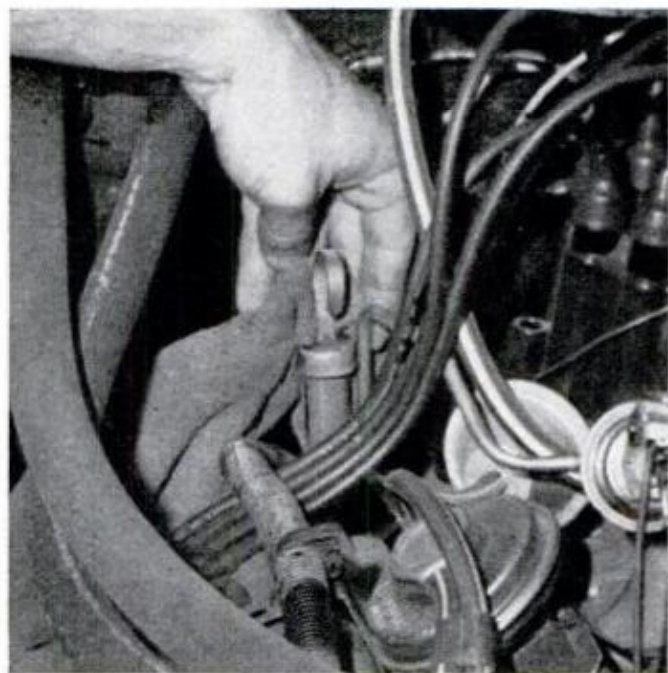

Dipsticks and covers over fluid reservoirs should be cleaned thoroughly *before* you remove them. Keep them clean and avoid contaminating the fluid.

The coefficient of friction of Type F fluid increases as the sliding speed of the clutch surfaces decreases. This gives clutches a "bite" that provides Ford transmissions with a firm, aggressive shift.

Dexron works in just the reverse way. This fluid's "grab" is reduced as the sliding speed of clutches slows down, which gives GM transmissions a softer shift.

Manufacturers continue to differ about changing ATF. Chrysler, Ford and AMC recommendations for 1973, for instance, advise that it isn't necessary to replace fluid

unless the vehicle is operated under extended severe conditions, which include towing a trailer and driving in city traffic more than 5 percent of the time.

All General Motors divisions excepting Cadillac recommend changing fluid in 1973 models every 24,000 miles under normal conditions and every 12,000 miles if a trailer is towed or the vehicle is used mostly in city traffic. Cadillac requires replacing of ATF at 100,000 miles.

If you abide by the "never-need-change" promise, it would be wise to keep a careful watch on the condition of fluid. When checking level, smell the dipstick and inspect fluid color. If fluid smells like varnish or if its color takes on a brownish-burned appearance, you should change it.

All manufacturers agree that fluid level should be checked often. Every 5000 miles

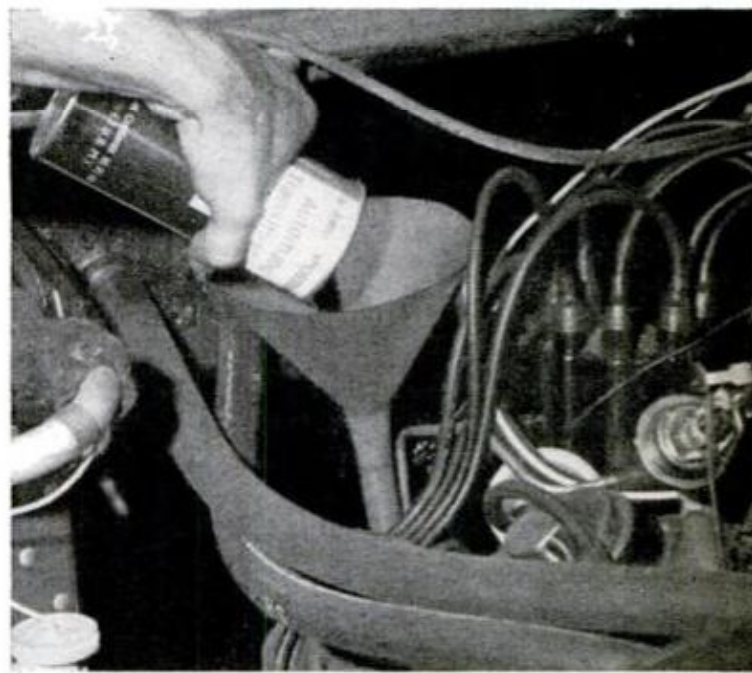

Adding fluids, such as a transmission fluid shown here, is often made easier with a funnel. Keep the funnel clean; wipe it before and after use.

is enough. The procedure is much the same from car to car, but see your owner's manual. Some makers want fluid level checked with the transmission lever in Neutral; others want the lever in Park.

Do not fill so that the level goes above the FULL line. Overfilling a transmission will result in foaming and loss of fluid through the vent, and possible slipping.

What about other automotive fluids? Is as much consideration needed when purchasing brake fluid as when buying ATF?

"The careful choice and use of hydraulic



Brake fluid should be of type specified by the manufacturer of your car. Fill reservoir to within one-quarter inch of top. Keep unused fluid sealed tightly.

brake fluid is absolutely necessary if dependable and safe braking performance is to be maintained in your passenger automobile." This answer is from the National Highway Traffic Safety Administration.

There may still be substandard fluids on the market (the government established standards in March 1972), so be careful. Each carmaker specifies in the owner's manual the type of hydraulic brake fluid safe to use. Follow the recommendations and verify them with data on container labels. Brake fluids differ, and two fluids may not be compatible. Furthermore, there are two kinds of brake fluid. One uses synthetic chemicals, while the other is made of natural substances, such as crude oil.

Check the brake-fluid level in your car every 5000 miles or so. Wipe off dirt from the master cylinder filler cap before removing it carefully. Fluid should be within $\frac{1}{4}$ inch of the top of the cylinder. If it isn't, add the fluid called for in your owner's manual.

After buying brake fluid, take care how you store any that is left over. If fluid becomes contaminated with water, a serious safety hazard will be created when that fluid is added to the system. Boiling point of good quality brake fluid is well above the high temperature created in the brake system. If fluid began to boil, brakes could cease to function because of vapor lock (air

pockets) developing in the system to interfere with hydraulic action.

Brake fluid left exposed to the atmosphere will soak up water so never store it in an open container. Even if a container is closed tightly, if it's partially filled and left in an area where there is a wide swing in temperature, you should discard the fluid. Condensation may have formed inside the can, contaminating the fluid.

When it comes to your car's cooling system, you have a choice of three types of cooling agents: water, methyl alcohol or ethylene glycol. Take it at face value . . . use ethylene glycol.

Water is cheap and will do a good job in keeping your engine cool. However, it will freeze when the temperature is too low, will boil when the temperature is too high, and will not inhibit rust and corrosion.

Methyl alcohol, sold in stores handling automotive supplies, is composed of more than 90 percent methyl alcohol and 10 percent water and dye. Most preparations also contain corrosion inhibitors. Methyl alcohol provides excellent freeze protection—a 50:50 solution of this coolant with water lowers the freeze point to 51 degrees below zero. However, it also lowers the boiling point of the coolant to 173 degrees, which is below the temperature at which a modern cooling system functions. Thus, methyl alcohol would rapidly boil away.

That leaves us with ethylene glycol, composed of about 93 percent ethylene glycol, 4 percent water, and 3 percent rust and corrosion inhibitors and dye. Some brands also contain an antileak compound.

A 50:50 solution of ethylene glycol and water provides a freezing point of minus 34° F., well below the lowest temperature in most of the United States. However, it is possible to get an even lower freeze point by using more ethylene glycol to water.

In addition to providing protection against rust and corrosion, and a low-enough freeze point, ethylene glycol meets the high-boiling-point requirement. As long as the radiator pressure cap is in good condition, the boiling point of a 50:50 ethylene glycol water mixture is 264°.

The way to tell if the ethylene glycol you find is a quality product is to read the label on the container, which will indicate the number of quarts of the antifreeze coolant that is needed in systems of different capacities to prevent freezing at different temperatures. If a 50:50 solution of ethylene

glycol and water does not provide protection against freezing to minus 34° F., the product is substandard.

Correct choice of the other fluid in your engine, motor oil, can be done by reading information on the oil container. Look for the oil's letter designation, a reference to carmaker requirements, and viscosity.

Oil cans now bear the letter designation SE, SD, SC, SB, or SA. These are classifications devised by the American Petroleum Institute (API) to indicate the type of service the oil will meet.

Auto manufacturers from 1971 onward require the use of engine oil meeting API classification SE. The letters "SE" must appear on the oil container singly or in conjunction with other designations.

SE oil best protects your engine from oil oxidation, high-temperature engine deposits, and rust and corrosion. It also assists in the control of emissions.

Oils designated SE contain an additive that neutralizes the corrosive acids which aren't completely removed by the emission system controls. This oil also possesses ingredients that keep the emission-control valve clean and operating.

If your car is a 1968, 1969 or 1970 model, you may use oil bearing the letter designation SD, and if your car was built prior to 1968, you can use an oil bearing the letter designation SC. These oils are sufficiently fortified to meet the needs of older engines. However, use of an oil designed for more severe service in these cars, such as SE, will not harm the engine.

No car manufacturer recommends use of an oil designated as SB or SA.

In addition to the API designation, the oil container should also have a statement that the oil meets or surpasses auto manufacturer requirements or standards.

As for the viscosity of the oil you should use, this depends on the anticipated temperature in your area. Consult your owner's manual since manufacturers vary in this recommendation.

Multiviscosity oil (oil that functions over a wide temperature range) or single viscosity oil are equally acceptable as long as the oil bears the letter designation called for above. However, your best choice is a multiviscosity oil, although it costs a few cents more. It covers a broader range of operating temperature and driving conditions.

About power-steering fluid, American Mo-

tors says to top off the power-steering reservoir with automatic transmission fluids labeled Dexron; GM and Ford say to use power-steering fluid if available—if not, use an ATF; Chrysler says never add automatic transmission fluid to the power-steering system—use only power-steering fluid.

Where ATF is acceptable, be aware that this applies only if you are adding fluid to raise the level. Where the power-steering system has been flushed, power-steering fluid should be used for refill.

The correct way to check the power-steering fluid level is to run the engine until the fluid has reached operating temperature. Then, turn the steering wheel all the way from left stop to right stop several times, shut off the engine, clean dirt from around the power-steering reservoir cap and remove the dipstick.

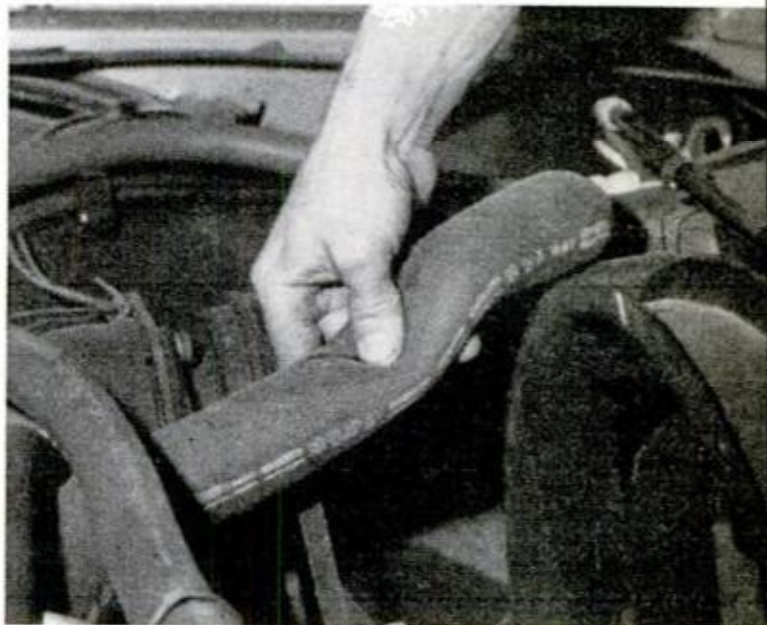

Coolant hoses should be checked thoroughly before you add a fresh charge of ethylene glycol to the system. Check radiator pressure cap at the same time.

As for the kind of water to use in the battery, all manufacturers agree that distilled water is best if maximum battery life is to be attained. However, tap water is better than no water at all although, like Buick, manufacturers qualify this by stating that "clean mineral-free tap water should be used."

In many parts of the United States, it's not possible to get clean mineral-free water from tap, but one way to get water pure enough for a battery is to filter tap water through a filtering device sold in hardware stores and used for filtering water that's poured into steam irons. ★★★

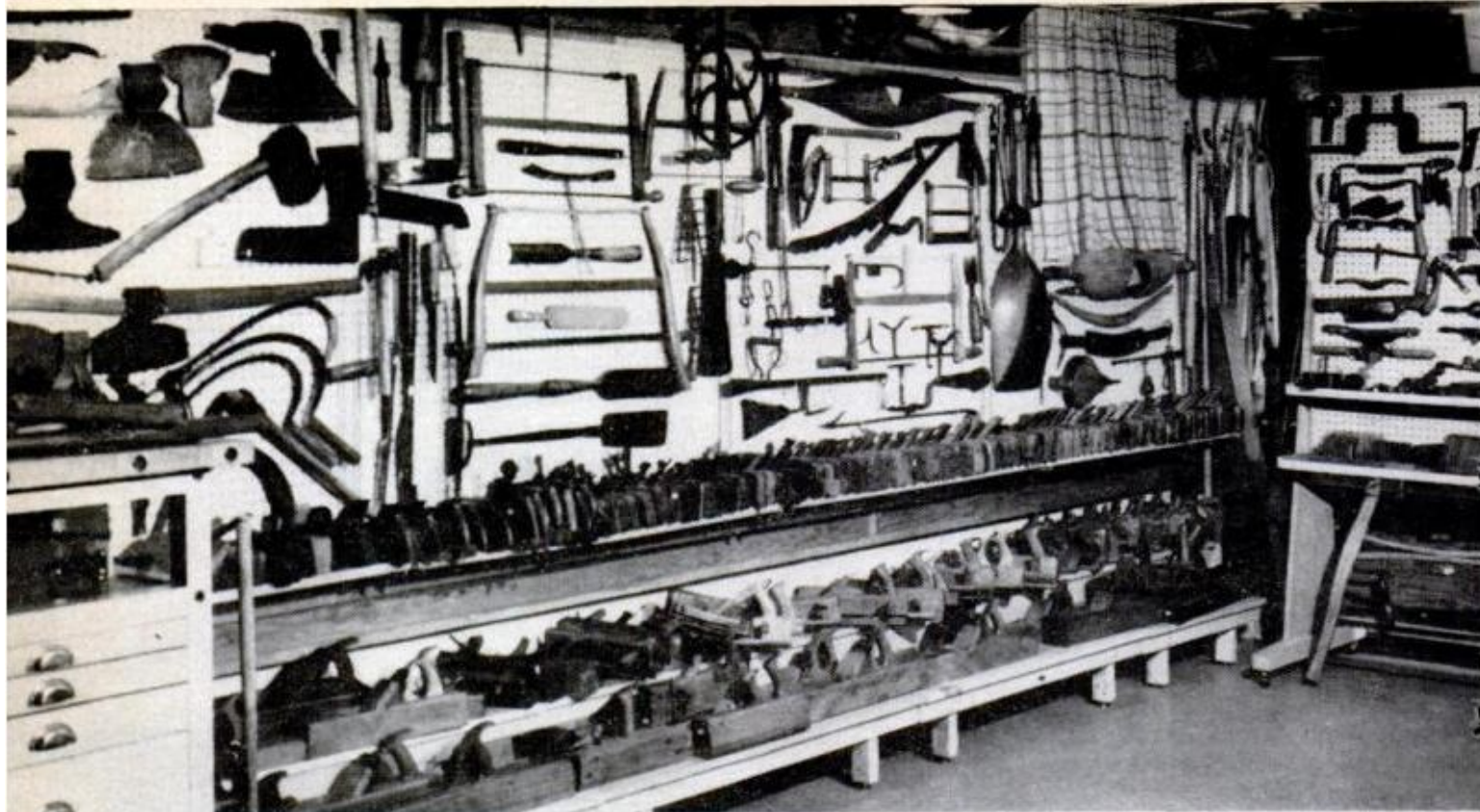

Photos: Robert D. Borst

One man's incredible antique tool collection

This shop boasts over 1500 tools the owner *doesn't* use—and a roomful that he does.

by Harry Wicks, WORKSHOP EDITOR

When Frank Sahlmann of Erie, Pa., descends the stairs to his basement workshop, he often isn't quite sure just what chore he will tackle when he gets there. Frank admits to "a split-personality of sorts when it comes to the shop." He enjoys the challenge of working on something new he has designed and worked out as

much as he does refurbishing and polishing up the latest antique tool he has acquired. Since he has been collecting antique tools for better than 10 years, "acquiring tools" bor-

ders on understatement. At last count early this year Frank had "acquired"—and has methodically catalogued—1587 antique tools of all types. The earliest dates back to about 1746. Sahlmann is especially drawn to primitive tools that illustrate how our ancestors "made do" with what they had at hand. As Frank points out, for example, the number of tools designed and turned out by early settlers just for the coring and peeling of apples "clearly illustrates just how important the apple was as a staple to the early farmers."

Some of Frank's antique tools are mounted on perforated hardboard along one wall. Others are neatly stacked in bookcase-like groupings, but those that are the pride of his collection are handsomely arranged on



Single-handed open scaper



Wooden bit stock

Tools from yesteryear

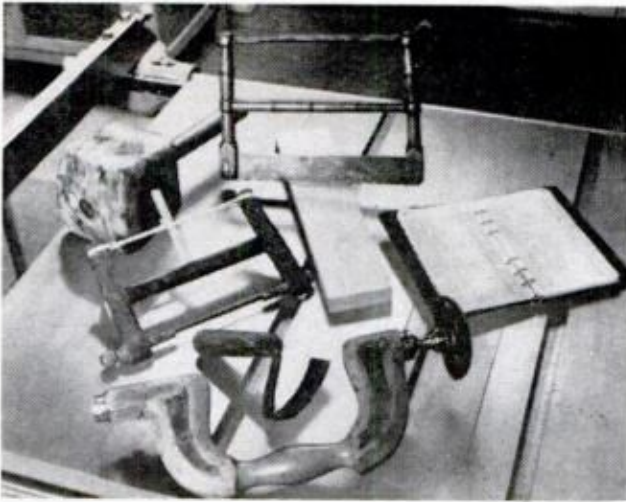

Cluster of antique tools picked at random from Sahlmann collection. Book catalogs the collection.

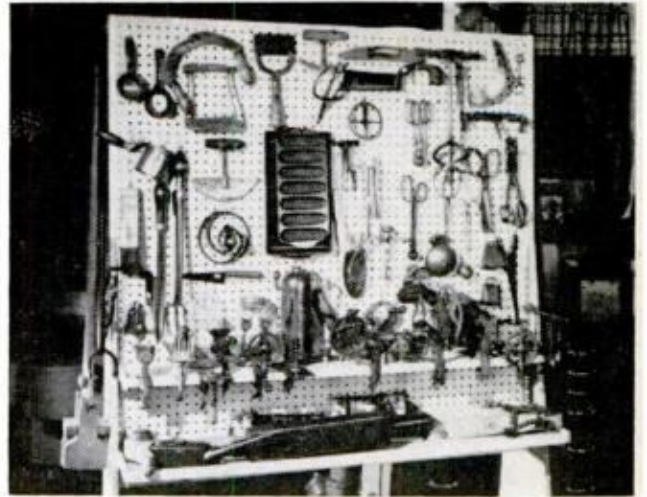

Kitchen tools, from apple corers to shears, give remarkable insight into early American farm life.

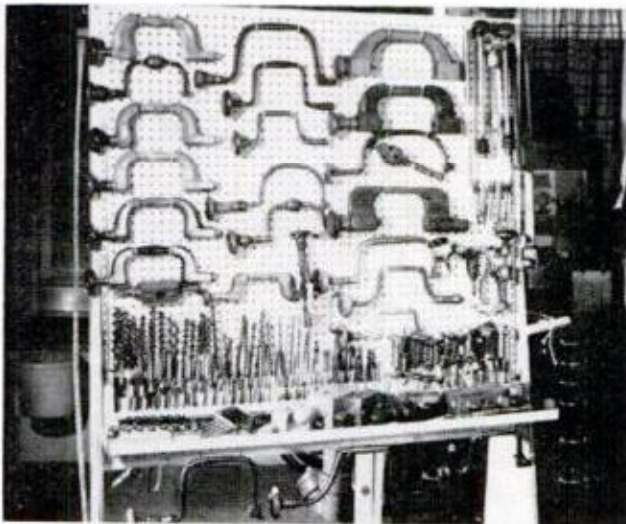

Brace and bit collection alone fills an entire display board. On page 171 are plans for toolboard.



Collection of all types of early tools is the most complete author has seen outside museum.



Woodworking tools—notice wood planes on shelf—comprise bulk of Frank Sahlmann's collection.

roll-about display boards he designed and custom-built. Though Frank uses his rolling toolboards to display his antiques, the concept is a good one for modern tools. Many workshoppers, we felt, would be interested in duplicating these for use in their own shops. Thus, we've drawn up plans you will find on page 171. One trick Frank uses, not shown in the photos, is to cover his display stands with muslin sheets. Since his active workshop is frequently filled with sawdust, this saves him considerable cleaning.

As are most experienced workshoppers, Sahlmann is thoroughly organized and systematic in his shop activities. A quick look at his floor plan verifies this; he

Good shop stunts you can use



Shop is always neat because tools are stored in drawers and small cabinets atop workbench.

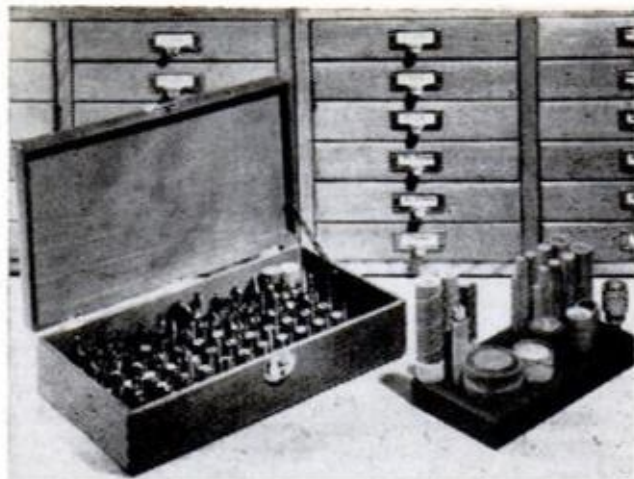

To keep bit shanks from rusting, Sahlmann stores them in holes drilled in nonporous, oiled Bakelite.

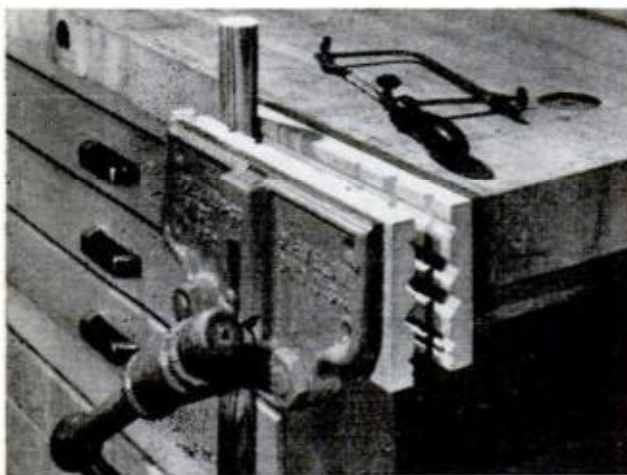

To protect fine woods, vise is equipped with easy-to-remove wood face blocks held by magnets.

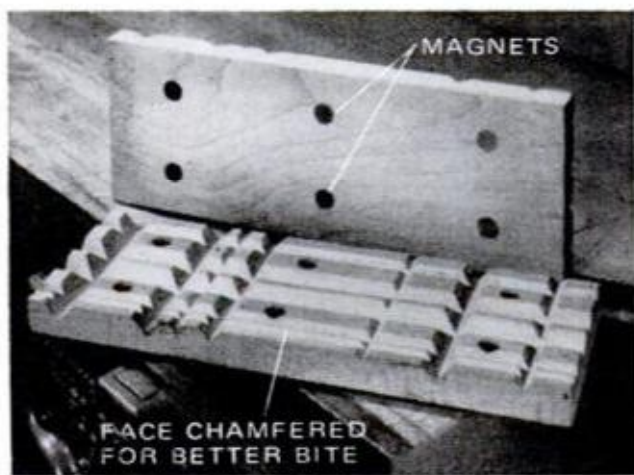

Six small magnets are used in each piece; faces are chamfered for better workholding grip.



Short lengths of lumber, too valuable to be tossed out, are stored on narrow shelves along wall.



Long boards and scraps of various-thickness plywood are stored upright in simple rack.

effectively utilizes just about every square inch of space in his basement for:

□ His numerous wood and metalworking projects.

□ Storage space galore, mostly in drawers and wall cabinets. As shown in the photos, he also keeps an ample supply of long and short lengths of lumber on hand.

□ Displaying his antique-tools collection, much of it carefully mounted on roll-about toolboards mentioned above.

The Sahlmanns live in an area rich in American history. Admittedly, Frank "can't resist the call" when he spots an ad in a local newspaper announcing an upcoming auction on a nearby Pennsylvania or southern New York farm. He is, of course, an expert on antique tools. As such, he is an

active member of the Early American Industries Assn., and makes a point of attending its semi-annual meetings.

(The EAIA is a nonprofit organization whose purpose is to encourage appreciation of early American industries of all types. Basically, members seek to discover, classify and, importantly, as Sahlmann observes, "to make collections available for exhibit so others can benefit from them.") Frank is happy that he has been helpful to individuals and organizations interested in learning more about early American life through his tool collection.

As far back as Frank can remember, he has been mechanically oriented. He spent most of his working years with General Electric in railway locomotive and equip-

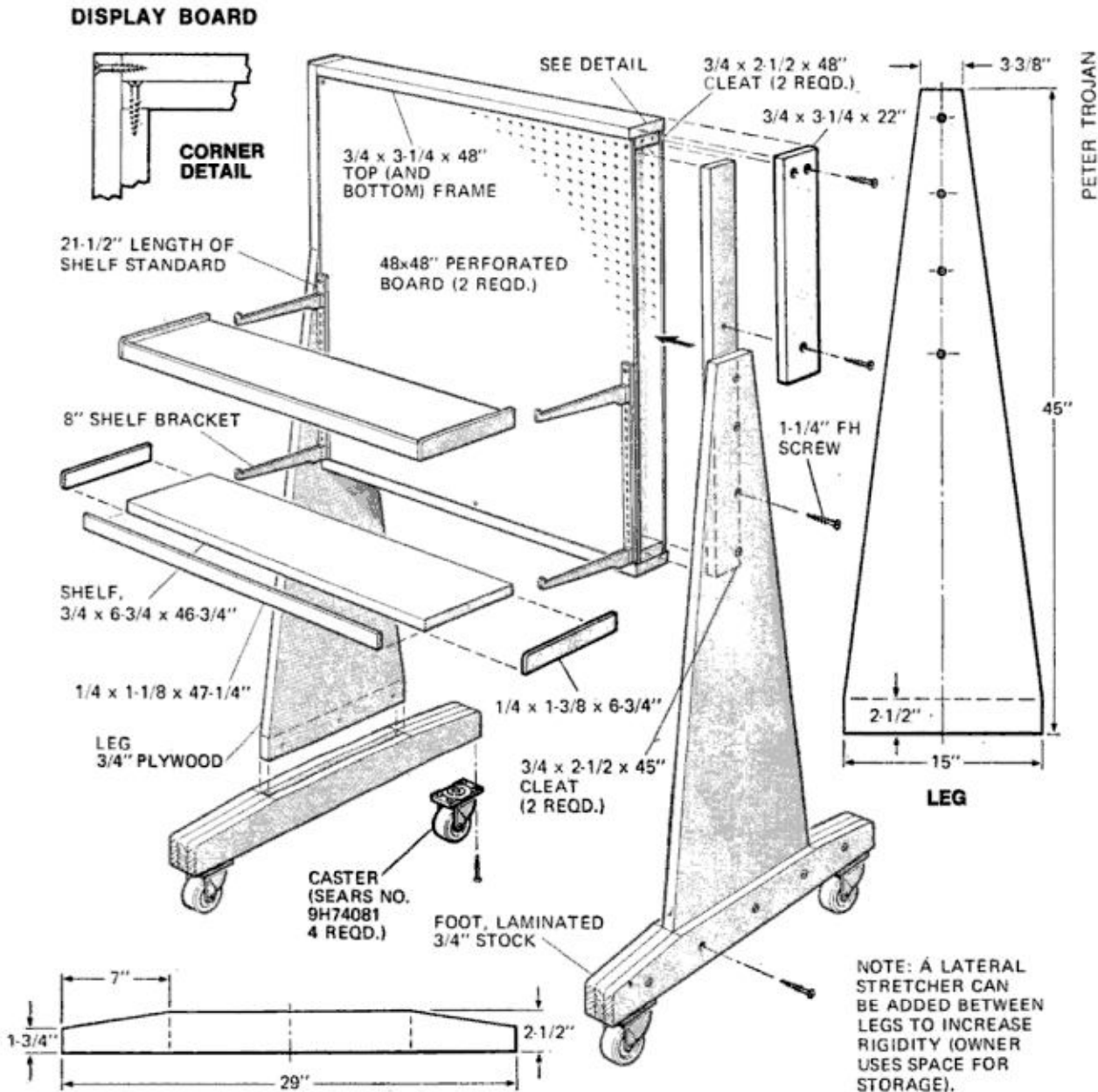

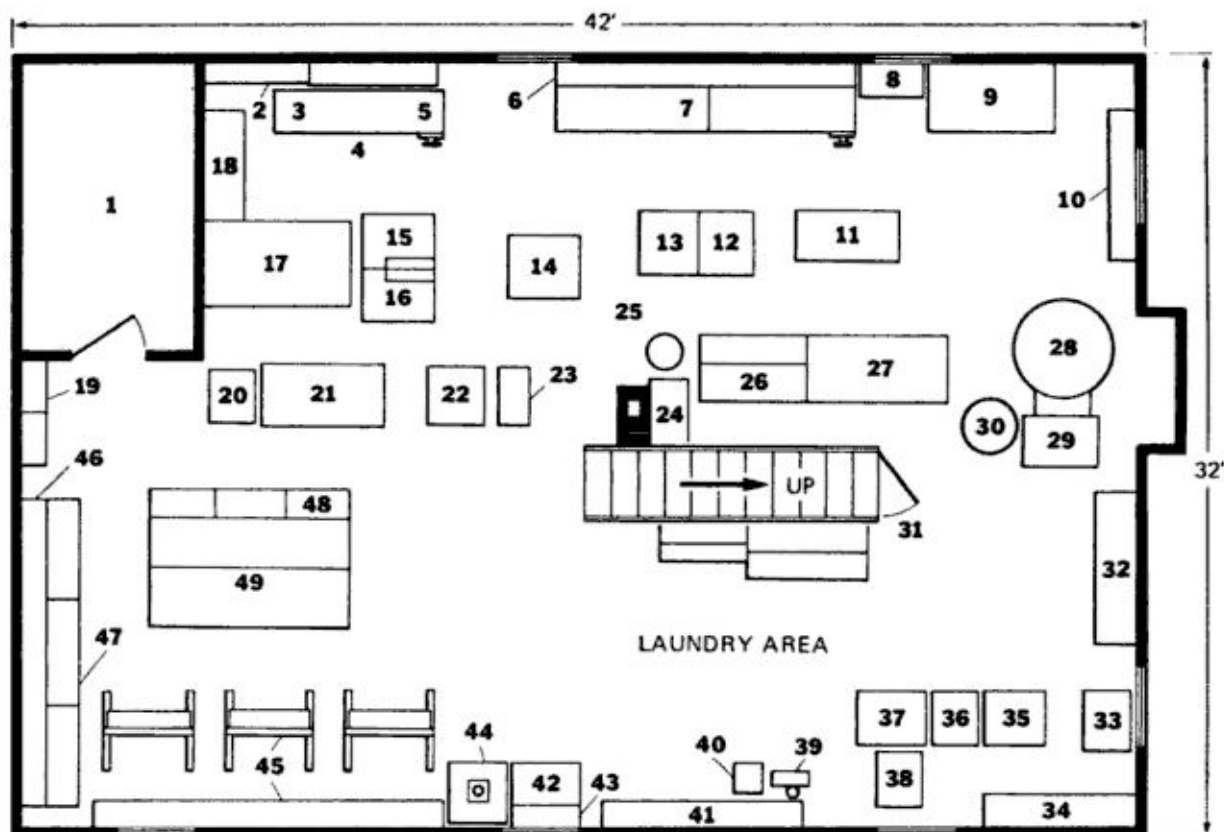

FLOOR PLAN

- | | | |
|--------------------------------|-------------------------------|---------------------------|
| 1. Storage for household items | 18. Open lumber storage | 35. Clothes dryer |
| 2. Wall shelves | 19. Cabinet storage | 36. Sink |
| 3. Bench grinder | 20. Delta shaper | 37. Clothes washer |
| 4. Workbench | 21. Wood lathe and grindstone | 38. Sink |
| 5. Buffer | 22. Thickness planer | 39. Folding ironing board |
| 6. Wall cabinets | 23. Delta jointer | 40. Dehumidifier |
| 7. Workbench | 24. Gas plate and chimney | 41. Wall cabinet |
| 8. Small-parts cabinet | 25. Water heater | 42. Cabinet |
| 9. Desk | 26. Cabinets | 43. Bookcase |
| 10. Bookcase | 27. File cabinet | 44. Router stand |
| 11. South Bend metal lathe | 28. Furnace | 45. Antique-tools display |
| 12. Delta bandsaw | 29. Filter and fan | 46. Wall cabinet |
| 13. Delta belt sander | 30. Gas-fired incinerator | 47. Bench with drawers |
| 14. Delta bench saw | 31. Storage under stairs | 48. Bookcase |
| 15. Delta drill press | 32. Cabinet storage | 49. Lumber storage |
| 16. Jigsaw | 33. Two-burner gas plate | |
| 17. Curtained lumber storage | 34. Wall storage cabinet | |

ment application and sales. "But," he says, "the mechanics of living never quite get turned off at 5:00 o'clock." His evenings, he adds, "just naturally seem to be an extension of my daytime interests."

Frank has been building or making something or another as far back as he can remember. His workshop skills and tool col-

lection increased until he reached the point where he makes practically all the repairs and improvements around his home "just for the fun of it." It's the challenge of "starting something new" that causes him to be in his workshop most evenings. "It sure beats watching TV and, thanks to *Popular Mechanics*, I find my shop skills challenged on a regular monthly basis."

His workshop setup is nearly perfect. He started out with a lot of room and made the most of it. As seen on the floor plan, he has also provided amply for his wife's "workshop corner"—washing machine, dryer and the like. And, more for the protection of his tools (from rust) than for his personal comfort, he has installed a dehumidifier. Since he oils his tools twice a year, his collection is literally rustproof. ★★

What about your shop?

Do you think it's a candidate for PM's Great Shop series? We're interested in all kinds—special purpose, automotive, family activity—as well as wood-working shops. Send snapshots and a brief description to Workshop Editor, *Popular Mechanics*, 224 West 57th St., New York, N.Y. 10019. If PM's editors agree, we will visit your shop to learn more about it. Snapshots cannot be returned unless a self-addressed, stamped envelope is enclosed.

HINTS

FROM READERS

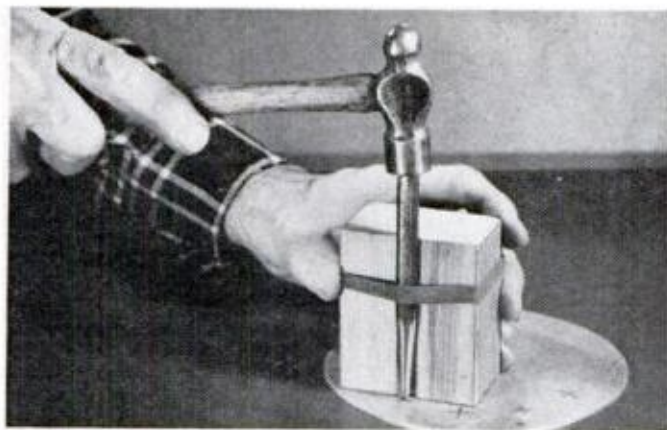

Center-punch jig

When drilling a number of holes in sheet metal, you can center-punch right on the button with this simple jig. Hardwood block has V-groove carefully cut to hold punch 90° to the work, with point exactly aligned so face of block will line up with center lines for holes. Rubber band keeps punch in place.—*E. Dussault, Oak Park, Ill.*

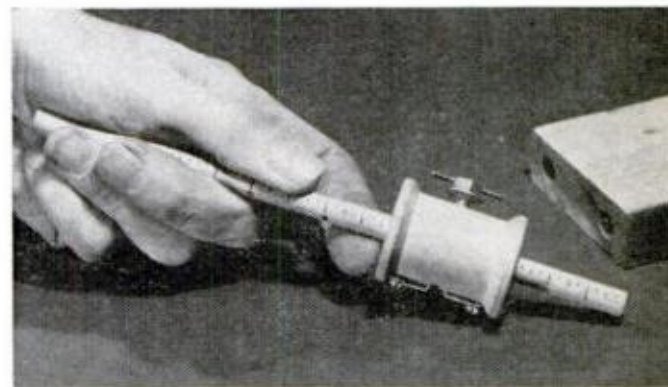
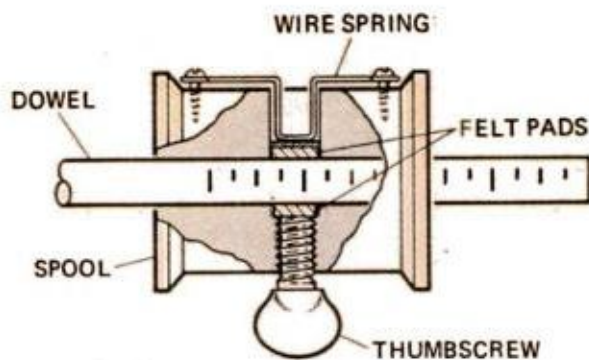

Spool, dowel make depth gauge

This depth gauge is made from a large spool and a snug fitting length of dowel—drill out spool if necessary. Positive sliding adjustment is given by felt pad and spring formed of 16-ga. music wire, with vinyl disc between them. For lockable gauge, drill and tap spool for 1/4-20 thumbscrew, add extra pad.—*Walter E. Burton, Akron, Ohio.*

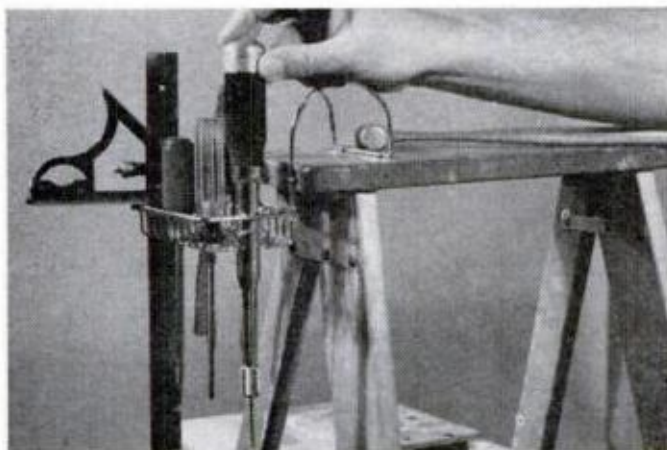

Stepladder tool rack

A wire soap dish fastened to the top of a stepladder will provide a serviceable rack for small hand tools while you are working from the ladder. It will also hold boxes of nails or screws. To attach the soap dish, use staples and drive them into the edge of the top platform.

—*Ken Patterson, Regina, Sask.*



Cutting 22½° angles

A professional cabinetmaker needed to cut 22½° angles, but his table saw's miter gauge did not give that adjustment. He cut a 45° angle on the end of a 12-in. scrap of 2x6 and screwed it to the gauge, set at 45°. Pointed brads were used in the 2x6 to help hold workpieces to be cut.

—*Leroy Brannon, Santa Fe, N.M.*



Sharpening tools is less of a chore with this unique self-oiling oilstone box. Apply steady pressure on the plunger and the pump is refilled in just a few seconds.

Make your oilstone

by Kenneth Wells

The oilstone holder shown above looks like an ordinary box used to house and protect an oilstone. Inside, it's another story. The box houses a simple pump in the base that ejects just the right amount of oil onto the stone automatically. The dimensions given in the drawing (facing page) suit the most popular-size stone—1x2x8 in.—but you can alter them to suit your favorite stone.

To make such a box, prepare a block of hardwood to the sizes given, then mark out the recesses in the base and lid to receive the stone and pump barrel. A drill press fitted with a router bit and equipped with a depth stop makes short work of removing the waste from the recesses although it can be done with a drill bit and chisel as shown at the right. Make the lid recess slightly larger than the base recess to provide an easy fit, and use a chisel to square up the corners of the recesses so that the stone will fit.

The base and lid of the box can be finished with two or three coats of polyurethane seal or shellac polish. To make the pump, follow the details in the drawing on the facing page. ★ ★ ★

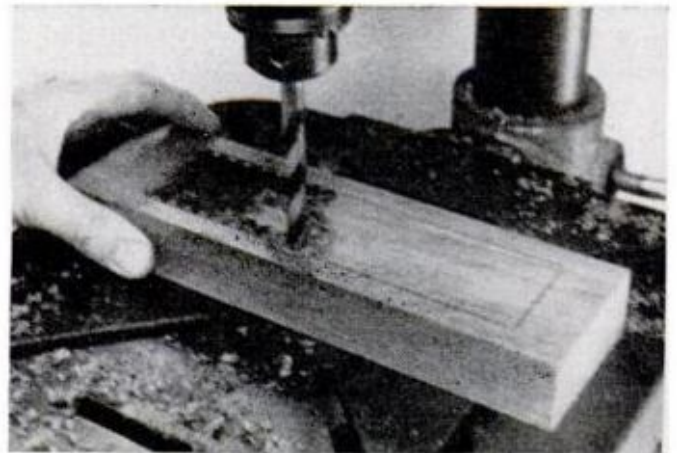

Quickest method of removing the stock from the waste portion of block is with a hefty bit in your drill press.

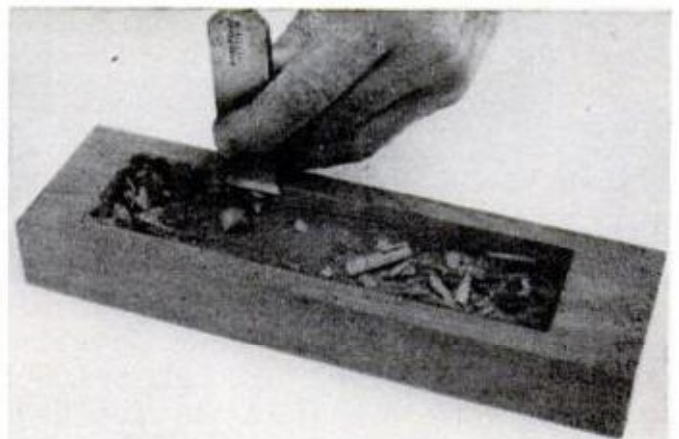

With most waste drilled out, a sharp chisel is used to cut a precise recess to suit your oilstone and pump.

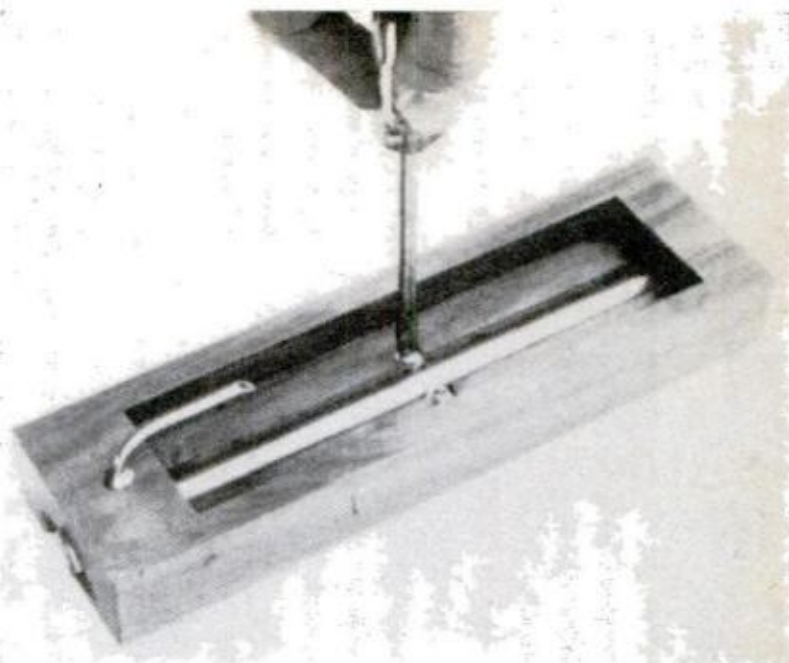
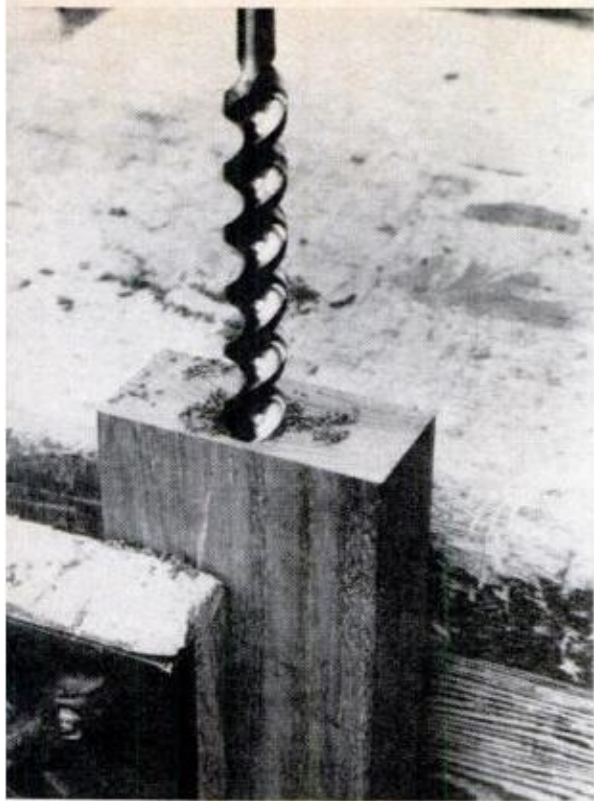

Box is rigidly clamped and hole for the pump barrel is bored using a hand brace and bit (left). Above: Pump barrel is being fixed in place. Besides keeping the oil at hand, the box protects your stone from collecting dust and dirt when it's in storage.

self-lubricating

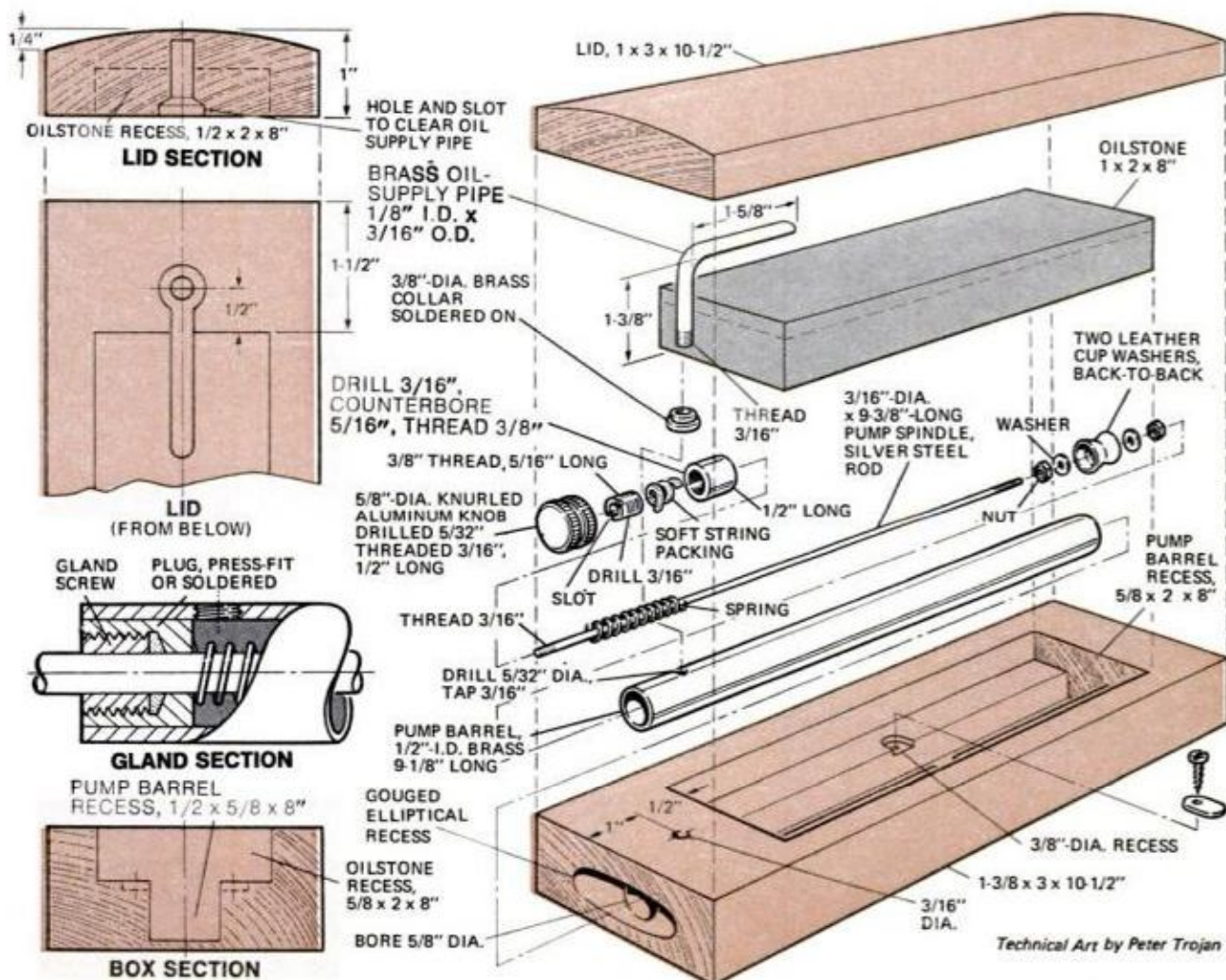

HINTS

FROM READERS

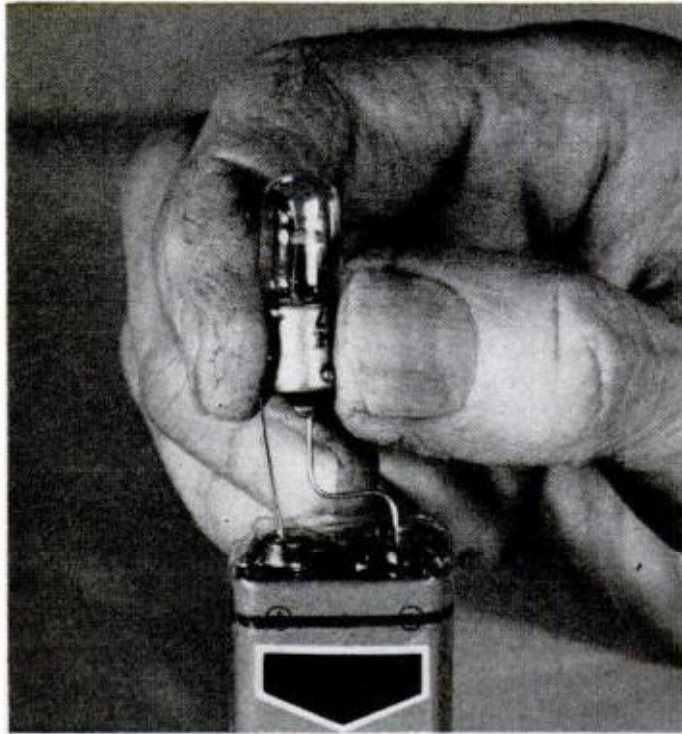

Tester for inexpensive batteries

Solder two straight pins (one bent) to a No. 40 or 47 bulb and you can test 9-v. transistor radio batteries from discount lots through the wrapping. Look for a bright, steady light.—*John Walker, Nanticoke, Pa.*

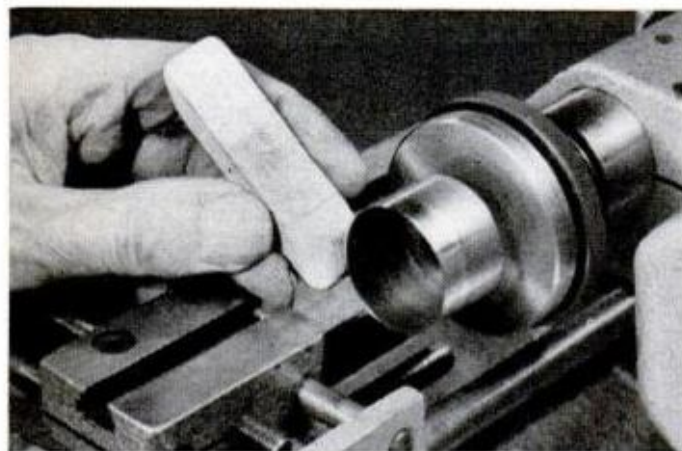

Eraser as lathe tool

A rubber eraser produces a pleasing polish on a revolving workpiece, can be used to apply rouge; resilience lets it follow contours. For greater abrasion, use an ink eraser.—*Walter E. Burton, Akron, Ohio.*

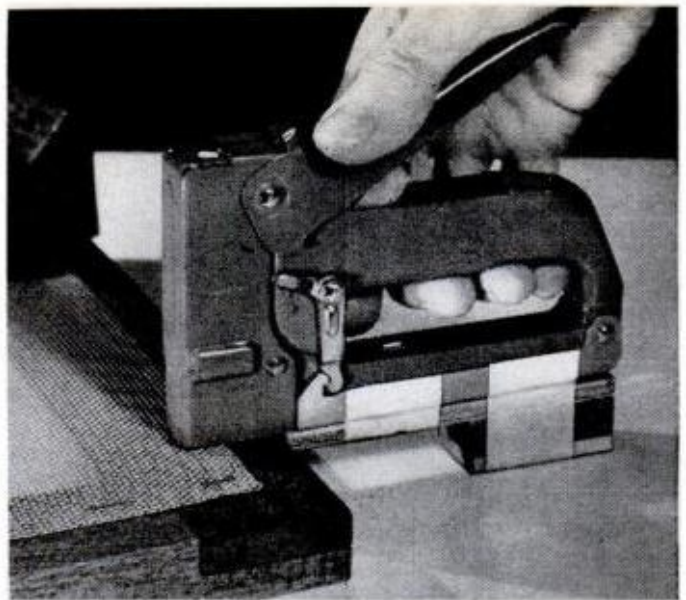

Guiding staple gun

Repeated stapling is easier with raiser and depth blocks taped under your staple gun. Width of blocks should be about $\frac{3}{4}$ in. for most models with height to suit work.

—*John W. Lower, Chambersburg, Pa.*

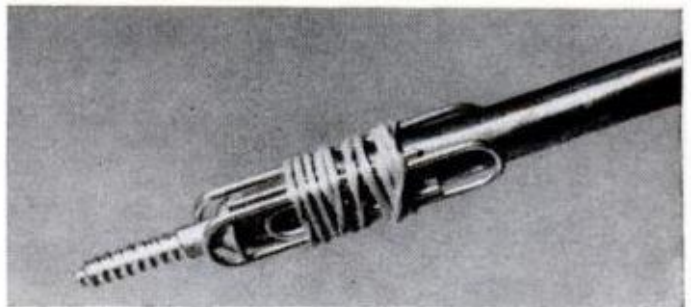

Instant screw-starter

To start a screw in a tight spot, hold its head between the ends of a pair of paper clips held to your screwdriver with a rubber band. Screwdriver will pull away easily afterward.—*William Swallow, Brooklyn.*

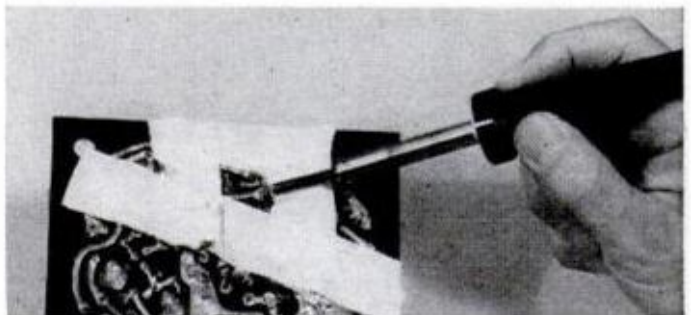

Tape is soldering guide

When I have located the fault in a printed circuit, I mark it off with masking tape to keep solder where it belongs—or to find the spot again later if the repair must be delayed.—*Ken Patterson, Regina, Sask.*

Come to where the flavor is.
Come to Marlboro Country.



mg. tar, 1.3 mg. nicotine
per cigarette, FTC Report Feb. 73

Warning: The Surgeon General Has Determined
that Cigarette Smoking Is Dangerous to Your Health.



FOUR-ROTOR SANDWICH FOR SUPERPOWER

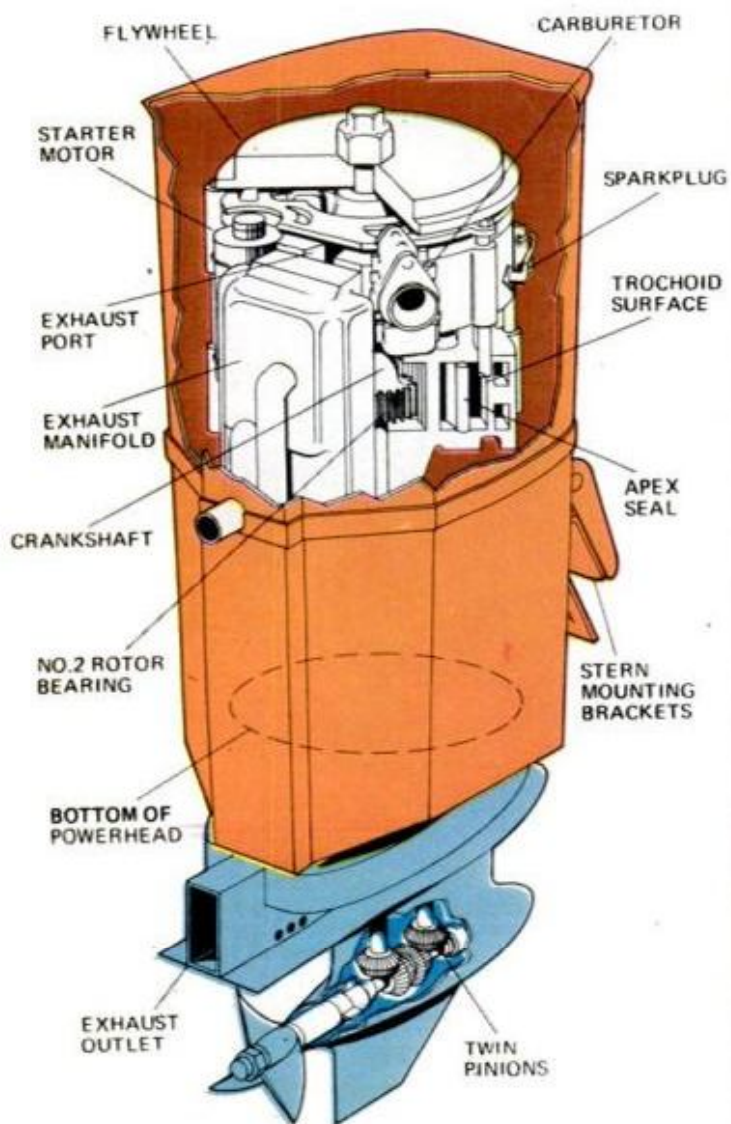



PM rotary outboard test tops 100 mph

by Bill McKeown
BOATING EDITOR

Ever see your outboard speedometer reach 100—and keep on going? Neither had I and it's some kick!

The power that can do it comes from Outboard Marine Corp.'s new Johnson rotary combustion outboard motor. (Evinrude will have one, too.) But right now this kicker is so new that no horsepower, no top speed, no weight, no price and no on-sale dates have been announced yet. After six years of secret development work, this seagoing Wankel-type Sea-Horse is first being sent out to prove itself on the race course. Charles Strang, OMC's marine products vice president and a former racing driver himself, believes that putting his products on the starting



PHOTOS BY DICK MATT

Skimming down the Miami stadium chute (above) at 106 mph, Popular Mechanics test driver proved new Johnson rotary has more push than any previous outboard. With four rotaries (far left) stacked right down to racing/surfacing cleaver prop, mill is still same size as motors with two-thirds less power. Climbing into cockpit for test runs, PM's McKeown has emergency kill-switch lanyard snapped to life jacket by champion factory driver Jimbo McConnell. If thrown free in flip, switch shuts off engine ignition. Gunning out (upper left) to accelerate "over the hump" and onto plane, boat bow rises high through porpoise period at about 60 and into high-speed range. With upper cowl removed (left) after tests, McKeown, McConnell and high-performance engineering chief Jack Leek recheck this potent new compact package of experimental outboard power.

line is the fastest way to perfect them. You may not win every race but you find out in a hurry any weakness and what's likely to go wrong. It's better that factory drivers rather than customers have trouble, he feels, and OMC's racing team has now been pulled off the big enduro two-cycle mills to spend full time proving the new rotaries.

The rig I was to drive was being set up in Florida at the Miami marine stadium for the upcoming Galveston, Tex., Speed Classic. The day before, two magazine boating writers had been allowed to wheel it around the stadium course at a "modest" 75 to 80 mph with the ignition detuned. But now the Sea-Horse and Scotti-craft tunnel-hull were set up for speeds that can run a rig to in-



Same size as conventional two-cycle mill but hiding four rotors stacked down to waterline, unit is compact.



Pretest briefing by McConnell and Leek must be detailed, since McKeown must solo the first time out.

stant splinters with one mistake. This was the first time a noncompany driver was being offered a chance to turn it wide open.

"How fast can it go flat out?" I wanted to know. Top speed of the new mill, I was told, is a function of the guts you've got.

"Actually, we don't know," explained Jack Leek, OMC high-performance operations chief. "We keep experimenting and getting more." With power available, new and bigger race boat designs to handle it are likely. "And we don't need to hang it on the hairy edge," ace factory driver Jimbo McConnell noted. Driving well above takeoff speeds for small aircraft, these hulls can suddenly go airborne, kite and crash in a fraction of a second. I remembered watching Jimbo and Rich McKinley trim the power tilt during test runs until only inches at the transom were still skimming the water. A thumb button on one side of the steering wheel swings the motor angle out to lift the bow and get up on plane. Then a button for your other thumb tucks the lower unit back under and you let-her-eat without catching too much tunnel air.

Squeezing one of their big conventional race-mills up to just 100 mph on a previous test a couple years ago, I recall going into the turn with the wheel cranked upside down while trying to remember which thumb to push for the vital retrim around the curve. But this new sandwich of four rotary motors on one crankshaft gives safer speed that can put you ahead of the pack without a scary bow-high attack for minimum wetted surface. "With this engine, you probably won't need to change the trim," I was told. "When you hit a porpoising period around 65 mph, accelerate on through and she'll level out." You hope.

Climbing up the trailer and easing into the tight little cockpit for this kind of run, you try to remember the feel of every hot boat you've ever tested or raced, and to memorize every expert tip you get. My instructors are the best. I remember 1966 mornings on the Arizona desert at Parker Dam when Jack Leek supervised runs for the world outboard speed record of 131.05 mph that stood until this August. Driving champions Jimbo and Rich check me out for engine fire-up. And for personal coach, Miami's Jim Wynne stands by. (Besides engineering the first successful stern drive, designing famous boats and winning two world offshore race championships, Wynne

(Please turn to page 182)

CHEVY

It never forgets it's a tough truck

CHEYENNE

Double-walled Fleetside tailgate.

Welded into a single solid unit that's two steel walls thick.

Double-wall Fleet-side cargo box.

Cargo box is double-walled, top to bottom, to help protect exterior wall from dents and nicks.

Double-wall insulated cab roof.

The two steel walls that form the cab roof are separated by a layer of insulation.

Power flow-through ventilation.

Electric fan starts changing cab air as soon as you turn the ignition key.

Full front wheel-housings.

All-steel one-piece inner front fenders help protect against rust and corrosion. Undercoated, too.



Tough all over . . . and under

Tough frame side and cross-member design.

Deep-section side rails joined by husky cross-members for a solid, rigid foundation.

Load Control rear leaf springs.

Two-stage multi-leaf design. As load weight increases, so does spring support. Result: a smooth ride without a load, strong support loaded.

Sixes and V8s to 454 cu. in.

All designed to operate efficiently on no-lead, low-lead or regular fuels.

Massive Girder Beam front suspension.

Front wheels are suspended independently. Tough coil springs at each wheel.

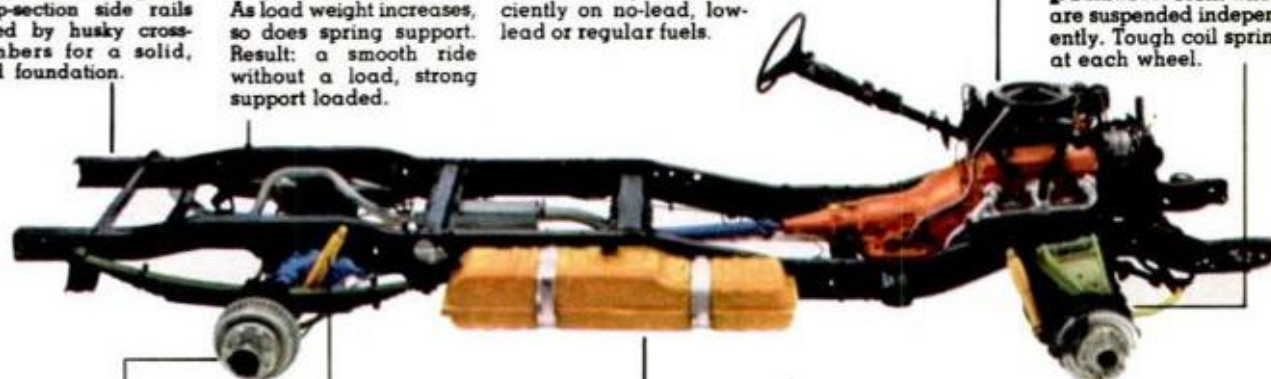

Finned rear drum brakes.

Cast iron-steel alloy and finned for efficient cooling. Drum design helps keep contaminants away from lining.

Staggered placement of rear shocks.

Positioned with one slanting forward, one aft to reduce brake and power hop.

Frame-mounted fuel tank.

Located outside the cab to eliminate fuel odor and slosh noise from cab interior.

Improved brake system.

Chevrolet announces an improvement in pickup brake systems. Complete brake systems are computer-matched to pickup size and capacity. Heavier duty trucks get heavier duty brakes automatically. Also new are front disc brake lining wear sensors which sound an audible signal when pads need replacement.

Building a better way

Chevrolet

to serve the U.S.A.

PM ROTARY OUTBOARD TEST

(Continued from page 180)

once powered across the Atlantic with two Johnson outboards, a feat never matched.)

Jimbo fastens the lanyard from the dash board "chicken switch" to my life jacket. It will cut the engine if I suddenly leave the boat in mid-air. No safety belts here. When something goes wrong you want out fast. Now the trailer is backed down into the water and Jack Leek wades in to give the bow a shove and head me toward the course. No neutral or reverse in rigs like this. Flip primer. Hit starter. The engine catches and rumbles at a throaty idle, yet remarkably smooth for slow speed.

A gusty breeze from offshore to the east is crossing Key Biscayne and chopping the straightaway past the stadium grandstand as I feel out the ride once around the oval, indicating about 60. Steering response is good, no skid or trip tendency during wide turns around the corner buoys. Heading into the wind gusts I ease it up to 75. Then,

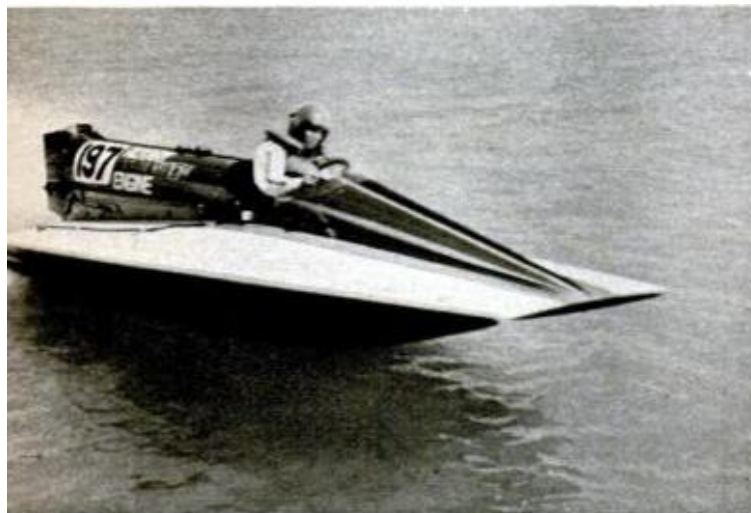

Airfoil hull planes with minimum wet-surface friction as engine, trimmed from wheel buttons, controls attack.



Trial start-up takes place on trailer before McConnell pushes McKeown off into deep water and on his own.

once rounded onto the more sheltered downwind leg I sight on the exit buoy, Miami's skyline beyond, and push the foot throttle down. A solid shove from behind holds me snug in the seat and with top-end torque acceleration I've never felt before, I'm up in the 90s and backing off for the turn. Another upwind run at "only" 75, but this time halfway around the curve I ease the throttle down and squirt past the entrance buoy into the stretch full bore. Halfway into the backstretch the speedometer is flickering at about 106 as I back off for the turn.

Succeeding laps test out the same with firm but manageable torque resistance in the steering and a smooth solid ride with the prop tucked slightly under.

Potential of the outboard rotaries is hard to estimate. Already in races they have lapped and run away from the souped-up high-performance conventional two-cycle engines with an estimated 200 hp, and even outdistanced big inboards. No horsepower has been revealed for these Wankel adaptations, only a cubic-inch displacement which OMC figures at 122. Director of engineering Si Metcalf and manager of RC projects George Miller, the combined brains behind the development, rate these pinwheel-pistoned gems two-thirds more powerful than any other outboard. That could peg the output somewhere between 244 and 340 hp. Factory drivers have already reported speeds of 120 mph.

Johnson and Evinrude snowmobiles are sporting 45-horse rotary combustion mills this winter, up 10 hp from last year, but even five of these stacked together would not total the punch of this RC Johnson. Sometime in 1974 or later, it may be sold in more modest horsepower ranges but should be a real winner in performance.

After buying development rights from Wankel and Curtiss-Wright in 1966 and spending millions on the project, what took OMC so long to create this engine while rotaries were already in production in Europe and Japan? This question from stockholders is said to have stimulated production, but an engine assured of long dependable life that can be turned out economically by American assembly-line methods was the goal. Once the engineers are satisfied they have a Sea-Horse that can match the reliable two-cycle kickers that Johnson has been producing for 50 years, we're likely to have a kind of low but speedy sound behind the powerboats on our waterways. ★★

Have one of mine.

Get hold of
honest taste.

Have an
Old Gold.



Warning: The Surgeon General Has Determined
That Cigarette Smoking Is Dangerous to Your Health.

20 mg. "tar," 1.3 mg. nicotine
av. per cigarette, FTC Report Feb. 73.

Материал, являющийся рекламой табака.

Next year's newest outboards

by Bill McKeown
BOATING EDITOR

Though monster rotary outboard motors may be tuning up just over the horizon somewhere for some future year, a boatman will have plenty of choice for standard clamp-on power, from 150 horses down, in 1974. The big kicker companies are earlier than ever in announcing their upcoming lines, and more surprises are sure by the time boat shows launch the new season afloat.

Mercury and Chrysler, Evinrude and Johnson have already previewed new power *(Please turn to page 188)*

Mercury leads power parade with a 150-hp mill pushing this Mako sportfishing model offshore where 9.8-hp Merc model 110 can be tilted down for trolling. The 110 has new hub cutter preventing mono-line damage.

Chrysler hooks up two new 90s to power new Chrysler Carvell III 20-foot outboard cruiser. Choice of 19 horsepower ratings is available, topped by the 135-hp production version of the 150-hp racing model.

Johnson motors speed along two MFG runabouts with new standard and Stinger loop-charged 70-hp Sea-Horse models, both same size as 65-horse models they will replace. Other Johnsons range from 2-hp to 135.

Evinrude offers special styling for '74 with new 135-hp Silver Deluxe Starflite skimming along this Check Mate speedster. Red, white and blue colors of other models include new Sizzler 50, Hustler 70 and Strangler 135.



FIND BURIED TREASURE

Powerful electronic detector finds buried gold, silver coins, etc. Write or call for free catalog. Dealer inquiries invited.



Financing Available **19.95**
Phone day - night (713) 682-2728 to
RELCO, Dept. D-3 **198.50**
BOX 10839, HOUSTON, TEX. 77018



TOOL CHESTS
of the
HIGHEST QUALITY
for your
PRECISION TOOLS..
GERSTNER TOOL CHESTS
Dept. **D-3**, 20 Cincinnati Street
Dayton, Ohio **45407**

Send 25¢ for Catalog

FREE Big New 1974 Catalog 1,600 Jokes, Tricks, Novelties



Send today for **FREE** World Famous catalog of hard-to-get novelties, gadgets, hobbies, sports, science, electronics, mod & psychedelic, jewelry, guns, fun-makers, timesavers, banks, school-office-artist items, photo-optical, motors/engines, auto/bike items, books, magic & occult, bargains, jokes & tricks, etc. No letter necessary. Send name & address to: **JOHNSON-SMITH, C100 Auto St., Mt. Clemens, Mich. 48043**

Model B-2
2 Ton



ALVA ALLEN Power Punch Presses 1 to 150 Ton Capacity

309.90 Complete line in hundreds of different style
FOB less and model combinations. Write for **FREE** literature on Presses and complete line of Punch Press accessories as - Feeds, Dies, etc.

Meets OSHA specifications

ALVA ALLEN INDUSTRIES Dept. PM, Clinton, Mo. 64735

TELLS HOW TO SELL YOUR INVENTION

If you have an invention that you believe has merit, write us at once for copy of copyrighted booklet "How to Go About Selling Your Invention." We work with manufacturers, and booklet reveals present markets, qualities of a saleable invention, current royalty rates being paid by manufacturers. Booklet is **FREE**, is offered to encourage new ideas we might submit to manufacturers. Just send name (no drawings, please) to **Kessler Sales Corp., Dept. D-510, Fremont, Ohio 43420**

AAMCO® And You Can Make It!

The world's largest transmission chain is still growing strong after nine years. Over 500 of our franchises located from coast to coast. New openings in some markets mean you too might qualify. For further information write:

AAMCO Transmissions, Dept. 011
408 E. Fourth St., Bridgeport, Pa. 19405

Build **POPULAR MECHANICS'** little **CARRIAGE HOUSE!** Simply great! A back-yard building that isn't an eyesore. Styling blends in with most homes. It will take your mower, lawn furniture and tools—or the kids' overnight guests. Use it as your shop or home office. Overall outside dimensions 10-ft. 4 in. x 12-ft. 4 in. For one complete set of plans send \$3.95 to **POPULAR MECHANICS Dept. FA, Box 1014 Radio City, N.Y. 10019**. For two sets of plans (you may need one for your local building department) send \$5.49.

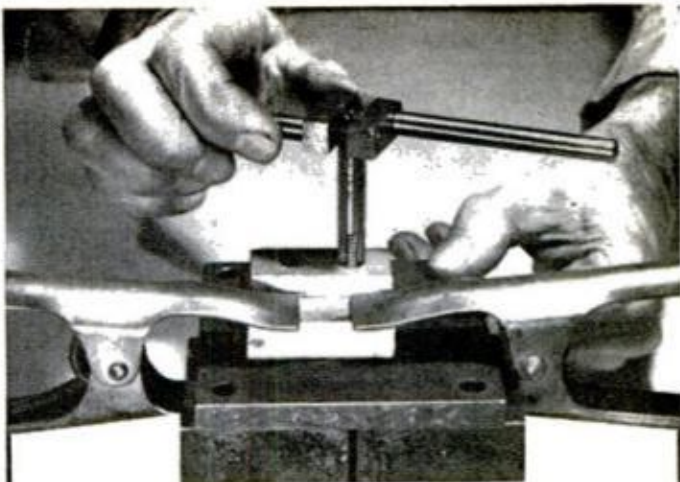

For the man who likes to do-it-himself.

With money-saving, "do-it-yourself" tips—more than in any other magazine—on how to maintain and repair your home, your car, your boat, your power mower, your TV and nearly everything that breaks down, wears out and needs fixing.

Plus feature articles on Automobiles and Driving, Shop and Crafts, Science and Inventions, Boating and Outdoor Recreation, Home and Yard, Electronics, Radio and TV, Photography... and much, much more!

ENTER YOUR SUBSCRIPTION NOW.

POPULAR MECHANICS

Simply fill in the form and mail it promptly.

POPULAR MECHANICS
250 West 55th Street
New York, New York 10019

Please enter my subscription for

1yr. \$5⁹⁷ or 2yrs. \$10⁹⁷

Name (please print)

Address

City State Zip

Payment of \$_____ is enclosed.

New Renewal

On new subscriptions, first copy will arrive in about 8 weeks.

(Above prices apply in U.S. & Possessions only. Canada add \$2 per year. All other countries add \$4 per year.)

WSF3J1

Outboards for '74 can turn out up to 150 hp

packages. More builders will be introducing gasoline and electric-powered pushers shortly. And rather than more muscle, outboards are adding refinements that provide more miles per gallon, no overboard fuel spillage and much longer motor, sparkplug and propeller life.

Highest horsepower for 1974 is a guessing game since more push is packed into the high-performance competition engines after every race, and leadership at the finish line keeps switching from Mercury to Evinrude to Johnson and back again. A dynamometer would probably show over 200 hp for the special-order racing mills. Next year's most potent production motor, however, comes in black from Mercury Motors.

The Merc 1500, biggest you can walk in and buy, will have 99.8-cu.-in. displacement that can produce 150 hp. Power trim will be offered as standard equipment on the long shaft 1500 ELPT and 115-horse 1150 ELPT models. Electric starting is standard for motors 40 hp and higher, with manual available for 40 and 50-hp models and an electric start kit optional on the 20 hp. Smallest Mercury is a 4-hp Merc 40. The 7.5 Merc

75 and 9.8-hp Merc 110 have new fishline cutters in the lower unit hub seal to prevent damage if a monofilament line is fouled and starts winding in. Both are also six pounds lighter than before and will have capacitor discharge ignition. All Mercs now use surface-gap sparkplugs. Starting with 4 hp, Merc models will be offered in 7.5, 9.8, 20, 40, 50, and "power ported" high-performance-piston 65, 85, 115 and 150 hp.

Chrysler reports seven new motors for its extensive 19-hp-range 62-model line for next year. Additions include 5, 10 and 15-hp motors, a mid-range 60, and 75, 90 and 135 high-performance powerplants. Called the most advanced in the line and "most powerful two-cylinder outboard anywhere," Chrysler's new 60 has Magnapower CD ignition system, a carburetor for each cylinder, light weight and improved silencing. The new 5-hp Swinger features an automatic reverse lock to prevent accidental tilt when backing, plus fixed-jet carburetor. New 10 and 15-horse models both have low profile hoods, shallow-water drives and "weedless" lower unit legs for fishing convenience. They provide for remote-control attachment, optional autoelectric starting, and the 10 can use 5 or 15-inch leg extensions and a wide choice of props for sailboat auxiliary power. The new 75 and 90 get their power from three cylinders and 72-cu.-in.-displacement. Up five hp over

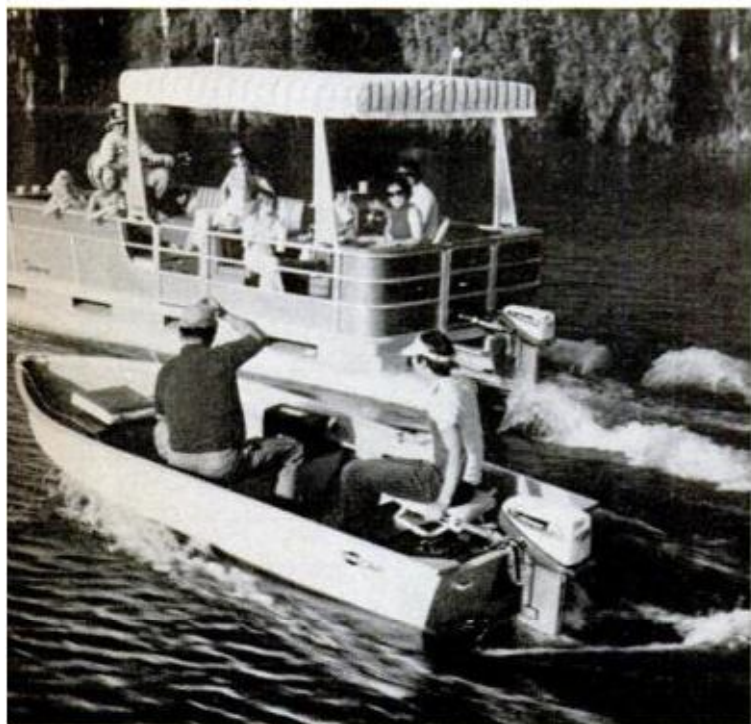

Little mills like these low-profile Johnsons provide plenty of push for inshore fishing and pontoon deckboats. The 9.9 and 15 are new additions for '74.



Largest and smallest Sea-Horses don't differ too much in compact size. Between come 4, 6, 9.9, 15, 25, 40, 50, 70, 85 and 115-hp selections in 32 models.

Highest horsepower three-cylinder outboard is Chrysler's claim for its new 90; latest Chrysler 60 is offered as power leader among two-cylinder production models.

Merc 1500 (below right) with 150 horses from 99.8 cu. in., rates as world's most powerful production outboard for '74. Long shafts have standard power trim.



Fishermen are using faster motors to reach the hot spots where the lunkers hide. Mercury's 85-hp Merc 850 uses pulse-tuned exhaust and "power ported" pistons for added output from new 66.6-cu.-in. kicker.

this year, the new 135 is a production model of Chrysler's high performance 150 hp racing engine.

Evinrude is adding special styling to



Three inches narrower and two inches shorter than this year's 9.5, new Evinrude 9.9-hp Sportwin and 15-hp Fastwin look-alikes have new power heads, hub exhaust. There are 16 other motors in the Evinrude line.

several models in its new 18-motor line, plus introducing the Scout, the first Evinrude electric. Hand-rubbed silver paint is a feature of the V-4 Silver Starflite, 135-hp line leader. A cupped stainless steel (SST) prop and 12-amp. alternator are also supplied. Completely new are compact 9.9 and 5-hp low-profile motors. The Triumph 70-hp in-line three-cylinder loop charged model is up five hp from this year's 65. A custom-styled Sport Line, the 50 Sizzler, 70 Hustler and 135 Strangler, have special color striped cowls. Power ranges of the complete new line are 2, 4, 6, 9.9, 15, 25, 40, 50, 70, 85, 115, and 135, plus the electric.

A Johnson V-4 Racing Stinger now holds the world outboard championship, and refinements developed from competition have been incorporated throughout the new Sea-Horse line. Johnson motors, and its new electric, will be available in the same horsepower as Evinrudes, and in 32 models. New big red-and-black graphics and styling color a Stinger 2 model of the new 70-horse Sea-Horse. For fishermen who need less power, more convenience has been added with electric start for compact low-profile new 9.9. and 15-hp motors. Outboarders of '74 have got a lot of choices to power their floating fun. ★ ★ ★

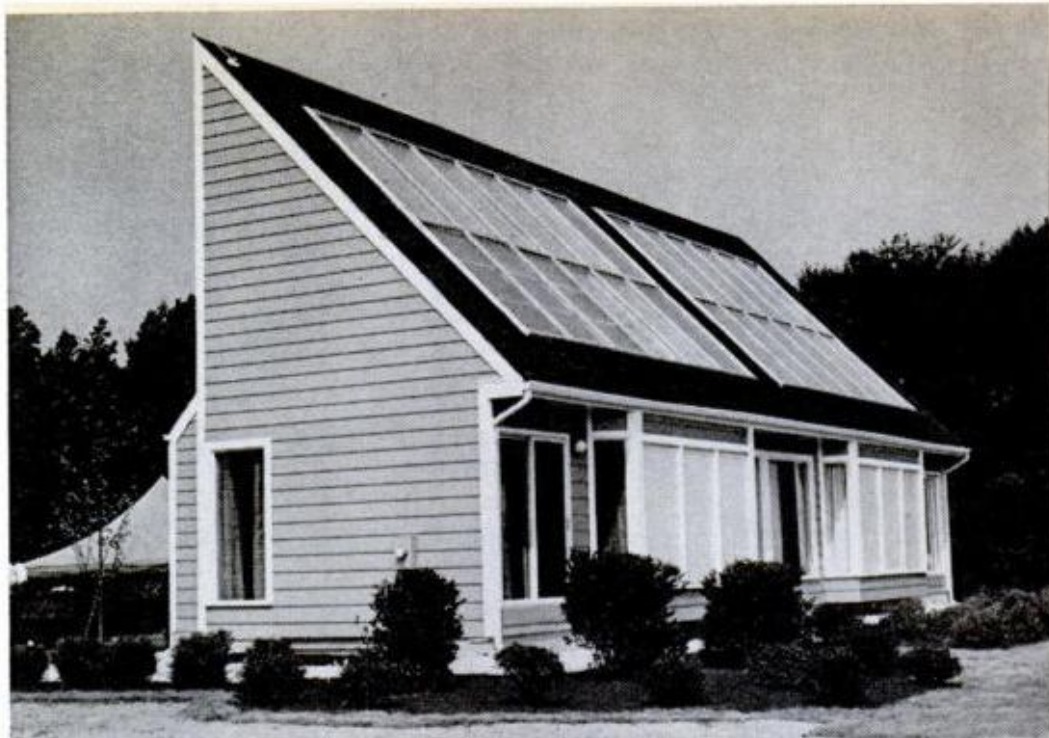

Switching on the sun

First solar home to produce both heat and electricity may be here sooner than you think.

by Sheldon M. Gallager



Viewed from south (top photo), structure has strange "half house" look, but garage and kitchen extending from north side (center) give more conventional appearance. Interior (bottom) looks about like any other—bright, cheerful, and surprisingly spacious. Tricks with full-height windows create light, airy effect even though south wall (left in photo) is almost entirely blocked off by solar panels.

They kid about its looking like half a house, but it's no joke. Scientists at the University of Delaware near Wilmington have come up with what may well be the first truly practical solar home able to operate almost entirely on free sunlight. The house is solar-powered, not just solar-heated—an important distinction. Unlike earlier designs, it's the first to provide both heat and electricity from the same source.

The trick lies in the use of cadmium sulfide roof panels similar to the solar cells that power our orbiting satellites and other space vehicles. The panels, facing southward to catch the sun, convert solar energy directly into electricity. This is fed to storage batteries that, in turn, supply power to

(Please turn to page 192)

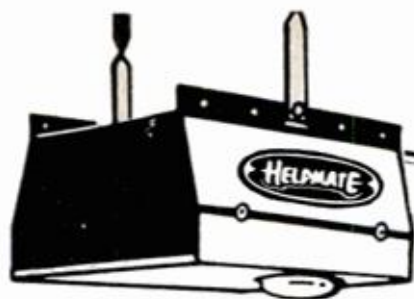

GARAGE DOOR OPERATOR
RADIO CONTROLLED



Buy Mail Order And Save

MODEL CD-5

ONLY ... \$134.95!

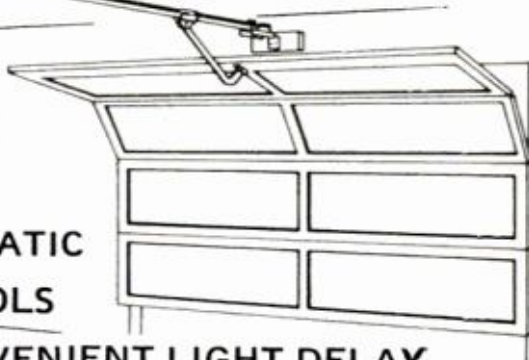

- 1/3 HP HEAVY DUTY • FULLY AUTOMATIC
- INTERFERENCE FREE RADIO CONTROLS
- INSTANT SAFETY REVERSE • CONVENIENT LIGHT DELAY

NOW you can buy the most POWERFUL DEPENDABLE garage door operator available anywhere DIRECT from the factory by mail and SAVE up to \$100! IMMEDIATE shipment NO WAITING Home delivery in 3 days via UPS. The HELPMATE opens and closes, illuminates and securely locks any garage with wood, metal or fiberglass doors up to 20' wide whether sectional or 1-piece. Requires but 1-3/4" clearance and 2 hours to install using our exclusive Homeowners Guide. Guaranteed 1 year. Choice of 4 models from \$99.95 budget unit to \$149.95 premium 1/3 HP screw drive system. Free brochure with limited time special offer sent promptly. HELPMATE Equipment Co. Box 217PM, Baroda, Michigan 49101, Telephone (616) 422-2311

STOP HUNTING! for small mechanical parts.

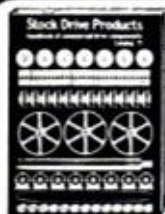

It's all here — in SDP's new 516 page combination reference and buying guide. Now you can easily locate the right mechanical parts for building or repairing any small machine — such as appliances, toys, engines, etc.

The handbook features detailed descriptions and prices for over 6,500 small drive components — all available from stock (not surplus). These include gears, chain and belt drives, motors, couplings, speed reducers, shafts, bearings, counters and vibration mounts. There's also an easy-to-read technical section to guide you in the use and proper selection of components.

Send for your copy today! Only \$1.49 PPD (deductible from your first order).

STOCK DRIVE PRODUCTS Division of Designatronics, Inc.
55 S. Denton Avenue, New Hyde Park, New York 11040, Dept. M.

EARN \$20.00 PER HOUR ASSEMBLING

TURF-RIDER

12 & 16 hp. tractor kits for yourself or resale. Full line of 20 attachments. Catalog, \$1; "Build-It-Yourself" Plans, \$5 (refunded on any purchase).

Struck Corp., Dept. PM103T, Cedarburg, Wis. 50312



IT'S ALMOST LIKE PRINTING YOUR OWN MONEY!

9¢ WORTH OF RAW MATERIAL becomes \$1.25 in less than 60 seconds—and ANYONE can LEARN to do it in a FEW SHORT HOURS!

Since 1922, Warner has enabled thousands of men and women to establish a business of their own—to reap the benefits of their own labor

and have the personal satisfaction, and independence, that comes with operating a business of their own. The new Warner Success Program, "Engraving as a Profitable Business," is now ready for you. Send for your FREE illustrated brochure. No salesman will call. Send your name and address on the coupon or a postcard. Be first in your area to cash in on this ground floor opportunity. SEND NO MONEY

and have the personal satisfaction, and independence, that comes with operating a business of their own.

Now, a revolutionary new machine makes it possible for an Independent Business Man with no "PULL" . . . **No Big Money to Invest . . . and, No Experience**—to start a business of his own, at home in his spare time. Here's what J. H. of Pennsylvania says:

\$7,280.00 for 1 to 1½ hours work an evening in my spare time—and without advertising. When I start to advertise I will have my own full-time business. Now the extra income gives my family the luxuries my present job does not afford.

Now you can get into this highly lucrative business, using your home as headquarters. No experience needed because we supply

WARNER ELECTRIC CO., DEPT. E-2-CL
1512 Jarvis Ave., Chicago, Ill. 60626

Engraving Division, Dept. E-2-CL
1512 Jarvis Ave., Chicago, Ill. 60626

Please rush your free illustrated brochure to:

Name _____

Address _____

City, State, Zip _____

SWITCHING ON THE SUN

(Continued from page 190)

lights, cooking facilities and other household appliances. Designated "Solar One," the Delaware system produces more than 20 kilowatt hours of electricity a day—easily enough to meet the average home's daily requirement of 18 kilowatt hours.

In the process of generating electricity, the solar roof collectors absorb tremendous heat, often reaching temperatures of several hundred degrees. Air blown along the underside of these collectors picks up the heat and carries it to a tank of salt that melts at 120°F. The molten salt acts as a heat-storage reservoir to keep the house warm throughout the dark night hours.

What happens when the sun doesn't shine? With its storage facilities, the house has sufficient heat and power reserves to last several sunless days. During long periods of bad weather, an auxiliary heat pump can be turned on to boost the temperature

of the molten salt reservoir. External power from a public utility can also be switched on.

In effect, each solar home is its own mini power-generating station. With thousands of such homes all making their own power, it's conceivable they could feed excess electricity to a central public utility during peak-demand daylight hours to offset power shortages, then get it back at night again when demands are low and power companies have electricity to spare—an intriguing possibility. By reversing the heating cycle, the salt can also be "frozen" and used like ice cubes to store cold for summer cooling—another fascinating feature. While Solar One is still experimental, it's estimated that the four-bedroom, 1½-bath home could be mass-produced in a few years to sell in the \$40,000 to \$45,000 range—not much more than what a conventional house of equivalent size would cost today. ★★★

Art: Peter Trojan



How solar panels provide both heat and electric power is shown at right. Electricity is stored in batteries for household use, while hot air is circulated through ducts to heat rooms. Photo above shows furnace blower similar to a conventional warm-air heating type.

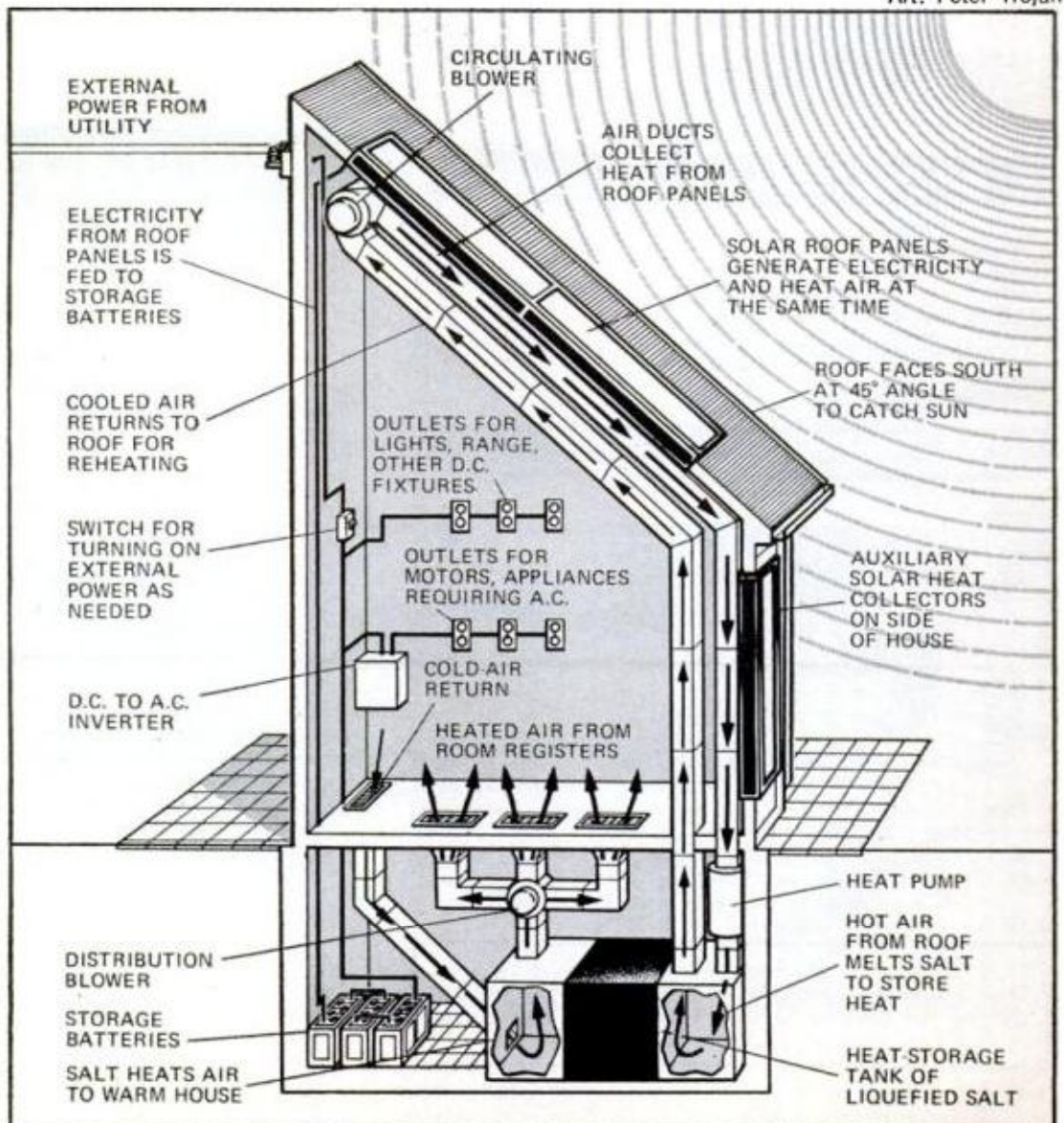

BUILD THESE BEAUTIFUL CLOCKS

BUY AT FACTORY PRICES AND SAVE \$200 OR MORE!

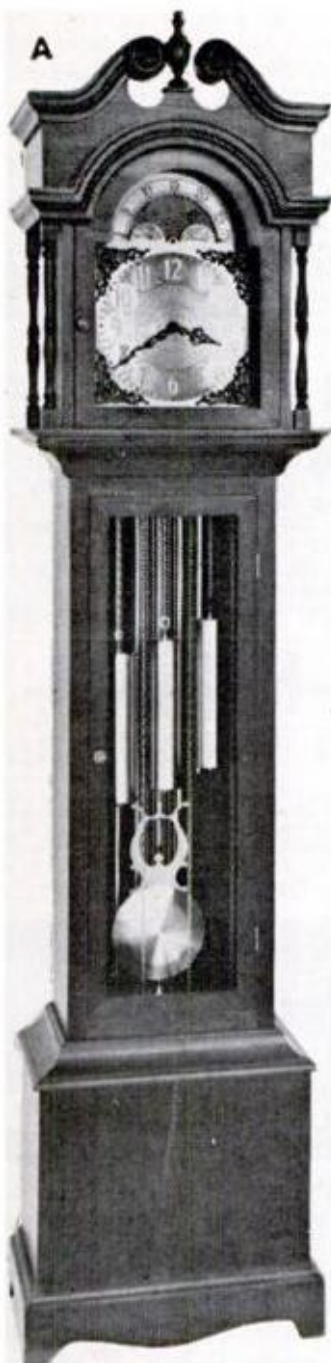

FIRST IN
QUALITY
STYLING &
SERVICE

Kits for you to cut and assemble in solid Cherry, Walnut and Honduras Mahogany. No plywood or plastic.

Handsome Moving Moon and "Tempus Fugit" Dials are gracefully styled in solid brass. German-made weight-powered movements play the beautiful Westminster, St. Michael and Whittington Chimes.

DO-IT-YOURSELF KITS

Send just \$1.00 for plans and instructions to build your choice of (A) Grandfather, (B) & (C) Grandmother, (D) Steeple, (E) Banjo — plus information-packed catalog of movements, dials, parts and kits to build these and 14 other fine clocks. All 5 plans — \$4.00.

CATALOG ALONE — 25¢

MONEY BACK GUARANTEE ON ALL ITEMS

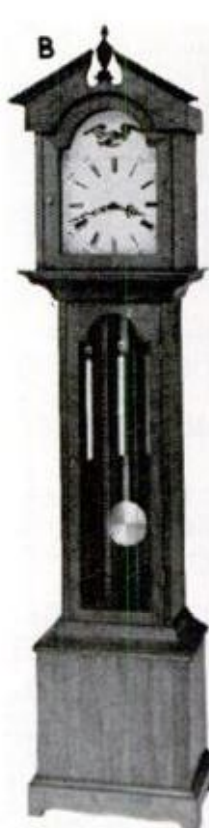

MASON & SULLIVAN COMPANY

ONE OF AMERICA'S LARGEST PRODUCERS OF
FINE ANTIQUE CLOCK REPRODUCTIONS SINCE 1947

OSTERVILLE, CAPE COD, MASS. 02655

IN CANADA: Colonial Times, Box 2 Stn S. Toronto, Ontario M5M466

MASON & SULLIVAN CO
Dept.PMP, Osterville, Mass. 02655
Please Rush the following plans:
CLOCK A B C D E @ \$1.00 each
Send all 5 plans @ \$4.00
Send catalog only @ 25¢

Name _____
Street _____
City _____ State _____ Zip _____

AMAZING NEW TUNGSTEN HYDRO-CATALYST

DO-IT-YOURSELF ANTI POLLUTION DEVICE—
SAVES GAS TOO.



- INCREASES GAS MILEAGE UP TO 22%
- INSURES PASSING COMPULSORY INSPECTIONS—
MAKES CARS LEGAL
- MEETS FEDERAL & LOCAL EMISSIONS
CODES-EPA TESTED
- RESTORES POWER DEPRIVED BY OTHER
ANTI POLLUTION EQUIPMENT
- GUARANTEED FOR LIFE OF CAR

ENDORSED BY FAMOUS RACE
CAR DRIVER MARIO ANDRETTI

The Tungsten Hydro Catalyst is a pre-combustion carburetor device that restores the power and gas economy robbed by other anti pollution equipment. And by changing the molecular structure of the gas/air mixture the Hydro Catalyst allows a clean burn, eliminating carbon monoxide up to 97%, hydrocarbons and nitrogen oxides up to 50%. Even your spark plugs will last up to 50% longer. Stalling, hesitation and diesling will cease. **And you will get premium performance on regular gasoline.** The Tungsten Hydro Catalyst makes cars legal and insures passing compulsory inspections. Famous race driver, Mario Andretti says "It really works to improve fuel economy and solve the pollution problem for a lot less money than even car manufacturers thought possible."

To get yours right away fill out this coupon and send check or money order for \$24.95 plus \$1.00 for postage and handling. Or charge to credit cards listed. New Jersey residents add 4% tax.

Order now and receive your FREE Clean Air Kit which includes a Pollution Control Valve (PCV Valve) and Air Filter Breather.

An exclusive product of Tungsten Contact Mfg. Co., Inc.

Tungsten Contact Mfg. Co., Inc. PM-1
c/o Mario Andretti P.O. Box 146, North Bergen, N.J. 07047

Gentlemen:
Please rush me _____ Tungsten Hydro Catalyst(s) and my FREE Clean Air Kit(s) at \$24.95 each. ADD \$1.00 for postage and handling.

Name _____

Address _____

City _____ State _____ Zip _____

Enclosed is: Check _____ Money Order _____

Charge to: American Express # _____

Diners Club # _____

Master Charge # _____

Bank Americard # _____

Carte Blanche # _____

Expiration date _____

Sign Here _____

NOTE: Please do not send cash!

GOVT. SURPLUS
and other bargains
SAVE to 90%



Send for this catalog

The world-famous Airborne Catalog. Fully illustrated. Contains 1000's of bargains in hydraulics, electrical, marine, automotive & hardware items . . . and more! A must for mechanics, machinists, hobbyists, sportsmen, inventors, etc. Send 35¢ to cover postage & handling. In a hurry? Send \$1 for airmail delivery. Must include zip.

AIRBORNE SALES CO. Dept. PM73
8501 Steller Dr., Box 2727, Culver City, Ca. 90230
Satisfying world-wide customers since 1945

**FREE OUTFIT STARTS YOU IN
BIG MONEY SHOE BUSINESS!**



Run your own profitable 'shoe store' business from home in spare or full time. We give you—FREE—complete Starting Outfit that makes you \$217.00 EXTRA each month for just 2 easy orders a day. You feature 350 fast-selling dress, sport, work shoe styles for men and women. Air-cushion shoes, many other special features! Sizes 4½ to 16—widths AA-EEEE. Draw on 300,000 pair stock. Earn prizes, bonuses, shoes for yourself—even a new car or color TV! Rush postcard for your FREE Starting Outfit today . . . Now!

MASON SHOE, Dept. F-781, CHIPPEWA FALLS, WIS. 54729

I-N-V-E-N-T-O-R-S WE NEED INVENTIONS

Sell your invention for cash—need money for Patent?—Are technical problems holding you back? Universal Inventions has helped inventors all over the world—just like yourself—why not you? Inventions provide the magic spring-board to sudden riches. REMEMBER, we either sell your invention or pay you a cash bonus. Write for details. **UNIVERSAL INVENTIONS, Dept. 13, Marion, Ohio 43302**

So easy to handle
you guide it with
Just ONE HAND!



Tiller users, for heaven's sake, please don't buy nor put up any longer with any other make of Tiller without giving yourself a chance to find out about our wonderfully different & better kind of Tillers — with POWER DRIVEN WHEELS and with tines in the REAR instead of the FRONT!

No Footprints!
No Wheelmarks!
No Struggle!

Please let us send you complete details, prices, OFF-SEASON SAVINGS, etc. Ask for FREE BOOK-LET. Clip this ad and write now to —

TROY-BILT® Roto Tillers, Dept. 30190
102nd St. & 9th Ave., Troy, N.Y. 12180

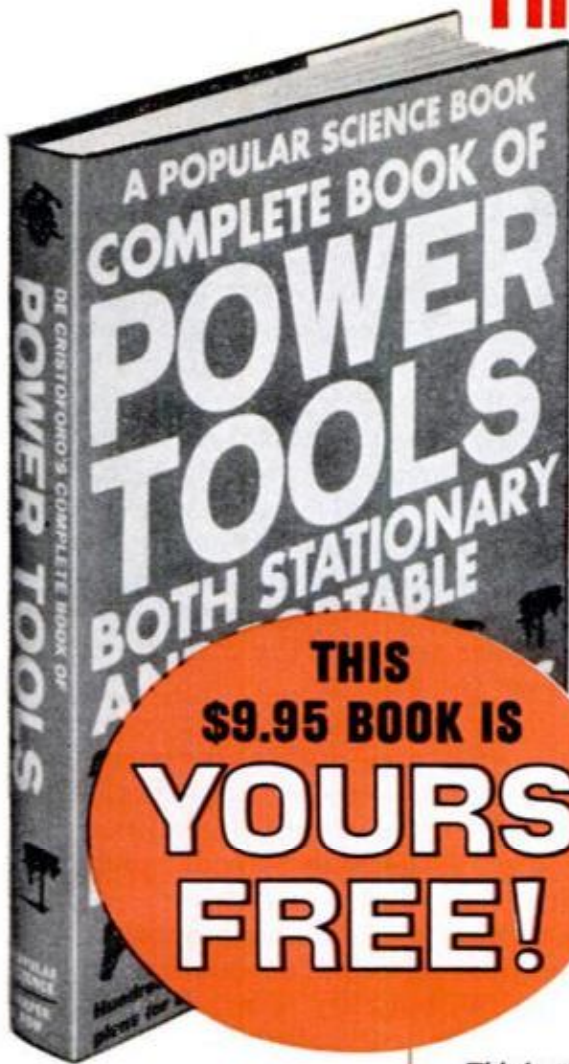

The ONE AND ONLY book that tells you everything you need to know about every power tool!

- How to adjust and align your power tools for perfect accuracy.
- Detailed construction plans for scores of jigs, mounts, pushsticks, holdowns you can build yourself.
- Big 8 1/4 x 10 1/4 size—448 pages.
- Over 1500 show-how photos and construction plans, plus detailed drawings of each tool and all its accessories, including: table saws, radial arm saws, jig saws, band saws, drill presses, lathes, jointers, shapers, bench grinders, belt sanders, disc sanders, portable circular saws, saber and bayonet saws, drills, routers, belt sanders, pad sanders, disc sanders, polishers, hand grinders, flex shafts.
- How to use your table saw to make saucer cuts, or to "turn" a taper on a table leg.
- How to do every imaginable routing technique.
- How to cut truly accurate mitre joints using a table saw.

THIS \$9.95 BOOK IS YOURS FREE!

Here's what happens when you join the Popular Science Book Club

- First, you get De Cristoforo's COMPLETE BOOK OF POWER TOOLS, a \$9.95 value, free...plus your first Club Selection, COMPLETE BOOK OF HOME WORKSHOPS, for only \$4.75. (Regular price of books is \$18.90!)
- Then, every four weeks, you'll receive an interesting, informative and colorful Club bulletin fully describing the coming selection and alternatives available, which you may accept or reject. If you want the selection, do nothing. It will be sent automatically. (If you do not want a book, simply return the card that is always provided by the date shown.) To retain full membership privileges, you need accept only one more book in the next year.
- As a PSBC member, you'll be offered the best books available on home improvements and repairs, how things work, appliance repairs, science, cars, math, mechanics, engineering, electronics—a broad range of practical and technical subjects.
- You save from 30% to 60% on every Club selection. Yet virtually all PSBC books are identical to publishers' editions.
- If, after examining the book, you are dissatisfied for any reason, you may return it for a full credit.

when you join the Popular Science Book Club and enjoy the COMPLETE BOOK OF HOME WORKSHOPS

as your first Club selection

for \$4.75 only (regularly \$8.95) —a 47% saving!



This book is as important as any tool you own or will ever buy. It tells you how to select the right tool and the right accessories for it...how to install it, align and adjust it...how to make it work harder for you, and last longer. Whether you've got a 1/4" drill or a radial arm saw, a small sabre saw or a large drill press, a buffer, a pad sander, or a router, you'll find new ways to use all your tools!

It's written by R. J. De Cristoforo—the most outstanding tool man in the world! It packs 30 years of experience into an encyclopedia of workshop techniques so detailed, so complete it can double—even triple—the effectiveness of the equipment you already have. And it can multiply your own skill and versatility many times over.

This amazing book, a gift to you, is valued at \$9.95—and the vast wealth of information it contains will be worth far more to you than that.

So mail the order card now! You'll get all this: the \$9.95 book FREE, the \$8.95 book for just \$4.75, plus guaranteed savings of 30% to 60% on every Club Selection you want. And, you need only buy one more book in the next year!

477-page guide will help you start a workshop from scratch or improve and up-date your present shop. Covers workshops of any kind—including hobby, plumbing, metalworking. Illustrated with nearly 500 photos, drawings, and detailed building plans for shop construction and expansion, workbenches, tool carriers, supply storage. Explains the differences and purposes of hundreds of tools. Provides important data on everything from nails and glue to furniture dimensions and masonry. Expert advice on stocking, maintenance shop safety, much more! Regular price, \$8.95. Special PSBC price only \$4.75.

Mail attached card today or write to
POPULAR SCIENCE BOOK CLUB
 44 Hillside Avenue
 Manhasset, N.Y. 11030

HOW TO BUY THE RIGHT ANTENNA

(Continued from page 159)

received—that's 104 inches for Channel 2.)

If all stations but one lie in the same direction, the exception could be picked up with a single-channel antenna added to the main mast. And since FM stations are more widely scattered than TV channels, you might find yourself aiming your TV antenna toward the nearest city, and mounting your FM antenna separately on a rotator.

What about antenna band-width? Most likely, you'll want an all-channel model; but if not, UHF-only and VHF-only models cost less, with the UHF-only models much smaller and a lot easier to install. Not all VHF antennas pick up FM programs, though the FM broadcast band lies between VHF Channels 6 and 7. Some antennas may have trap circuits deliberately blocking out the FM band so it can't interfere with Channel 5. Accessory traps may be used to block out adjacent local channels when you're trying to pick up a distant station.

Another useful aid for distant channels is a booster or preamplifier to strengthen the signal. But since a booster amplifies everything the antenna feeds it—signal, multipath and interference alike—its output signal may be stronger than its input, but no cleaner. So it pays to use one only when the best available antenna can't get a strong enough signal to override the "snow" caused by the set's internal noise. Even then, a booster may not help reception; unless its inherent "noise figure" (stated in db) is lower than that of your receiver (rarely stated for TV sets), it may generate as much snow as the set, or more.

Where a booster can work, it's best mounted at the antenna; the signal it picks up is undiminished by losses in the downlead to the set and unmixed with interference picked up by the downlead. Some mast-mounted preamps need separate wires to feed them their low-voltage power; others feed power up the downlead. Boosters mounted near the set are easier to install, but less effective.

If you've gone to the expense and effort of putting up a good antenna, you don't want to lose its benefits before the signal hits the set. If possible, use 75-ohm coaxial cable as your "lead-in" instead of the more

common 300-ohm flat-ribbon type. Coaxial cable picks up less interference and usually introduces less signal loss than 300-ohm twinlead. If your antenna isn't designed for 75-ohm use (most aren't), you'll need a matching transformer or "balun," often supplied with the antenna. Most sets need a balun at the other end of the line, too.

Antenna installations usually use a single downlead for VHF, UHF and FM signals, but most TV sets now have separate VHF and UHF antenna inputs. Splitters (often supplied with all-channel antennas) divide the signals for individual connection to their appropriate terminals, with little loss. To split a signal among several sets, however, you need a multiset coupler, which usually causes a loss in signal strength of 3 db or more. If this is no problem in your area, a coupler will save the cost and bother of antennas for each set.

If you can't put an antenna on your roof, you'll need an indoor antenna. In a wooden house, you might install an outdoor antenna in the attic, provided metalized insulation isn't used and there is room enough to aim the antenna properly. Most manufacturers offer indoor antennas for TV as well as FM, but they're not too satisfactory. To be practical and good-looking, they must be small and simple; so most indoor antennas are variations on the simple, low-gain dipole "rabbit ear," even though indoor antennas need more gain than antennas mounted high on the roof. Dipoles are usually bidirectional, with equal front and rear gain. While they do reduce interference and multipath pickup from their ends, their front-to-back ratios are virtually zero. And they're not as easy to aim as you might think, since by walking up to adjust the antenna, you may change the pattern of signal reflections in the room to one requiring a different antenna setting than the pattern that exists when you sit down again.

Nevertheless, if they're the only compromise you can have, try one of the better ones. Be careful, though, of models with base-mounted "tuning" switches; often, all the switch does is *decrease* the gain in most positions. One most effective unit I've found (there are others) is Channel Master's Chroma I (Chroma 82, for all-channel use), illustrated on page 158. It features tuning controls that really work, plus a built-in booster amplifier, helping to optimize the signal and reduce ghosts. ★★

SMALLEST FULL-SIZE REFLEX CAMERA

(Continued from page 161)

possible, with light, compact mounts, broad, rubberized focusing sleeves, and knurled diaphragm rings similarly placed on every lens from the 8-mm fisheye to the 400-mm telephoto. Most popular lenses from 21 to 200 mm share one filter size (49 mm), but you'll also need 55-mm filters for the fastest lenses, bigger ones for the long teles.

The shutter is the quietest of any reflex I can recall, thanks to 20 vibration dampers in the shutter and mirror mechanisms. These dampers, and the smooth shutter release, make it easier to shoot sharp, hand-held photos at slow shutter speeds.

Speeds are set by a ring around the lens mount. Once you get used to it, it's quicker than the usual knob on top, since it's so near the focus and f-stop control. But I wished that turning the shutter or f-stop controls in the same direction would affect exposure in the same, not opposite, ways.

Where you'd expect the shutter-speed knob is the exposure-meter's film-speed dial. It turns 360°, so you can go directly from ASA 25 to ASA 1600, but you can't reset it till you pull out the film advance lever and press a locking button.

The meter field is center and bottom-weighted, to concentrate on your subject and ignore skylight. It's hard to fool, even with backlighting, but if you want to correct for unusual effects, the needle in the finder tells whether you're one-half or one full stop off. The meter's range is staggering: I've measured at ASA 1600 from 1 second at f/1.4 to 1/1000 at f/32.

The self-timer, on the camera's front, has its own release, so you can still snap quickly if a shot comes up after you've cocked the timer. Olympus says it runs from 4 to 14 seconds; I timed it at 2 seconds (just right to delay slow, hand-held exposures till the trigger vibrations have died down) to 10 seconds. Above the timer are a mirror lockup and the rewind lever; the rewind's there to be accessible when the camera's on a tripod, or when the ultracompact motor drive (coming next year) is mounted.

The OM-1 isn't the least expensive reflex, it doesn't have interchangeable finders, and its lenses have no provision for electric-eye operation on future models. But unless you miss those features, have an investment in some other lens system, or find your hands too big to wrap around it comfortably, the Olympus OM-1 is a camera to consider. ★ ★ ★

BRADLEY GT



AMERICA'S BEST SELLING SPORTS CAR KIT



VW IN DISGUISE

- QUICK-EASY ASSEMBLY • WIDE CHOICE OF COLORS • EVERY PART INCLUDED EXCEPT VW • NO SPECIAL TOOLS REQUIRED

FOR FULL INFORMATION-FULL COLOR POSTER AND BROCHURE SEND \$2.00 TO:

BRADLEY AUTOMOTIVE

Dept. PM-10, 7669 Washington Ave. So., Edina, Mn. 55435

- Poster, Brochure and Complete Info. (\$2.00)
- Assembly Manual (\$7.00)

NAME _____

ADDRESS _____

CITY _____ STATE _____ ZIP _____

HOME PHONE (_____) _____

BUSINESS PHONE (_____) _____

OWN YOUR OWN SPARKPLUG CLEANER

TURBO BLAST CLEANER INCREASES PLUG LIFE UP TO 50,000 MILES

19.95
ppd

**CLEANS ALL TYPES OF PLUGS IN SECONDS
REQUIRES NO COMPRESSED AIR
POWERED BY RUGGED 12000 RPM 110 V MOTOR
LONG LIFE MAINTENANCE FREE DESIGN
SUPPLY OF ABRASIVE FOR CLEANING 250 PLUGS**

19.95
ppd



JAYCRAFT CORP., DPT. 10
760 North Marshall Ave.
El Cajon, CA. 92020

\$19.95 PPD.

Name _____
Address _____
City _____
State _____ ZIP _____

California Residents Add State Sales Tax

**SATISFACTION
GUARANTEED
OR YOUR MONEY
BACK WITHIN 30 DAYS**

**NEW Chairs, Sofas,
FURNITURE
FROM OLD**



• LEARN RE-UPHOLSTERY AT HOME... FOR FUN OR PROFIT!
Turn cast-offs into \$100's. No experience needed. We show you how... get you started fast!

Send for
FREE BOOK

Name _____ Age _____
Address _____
City _____ State _____ Zip _____

MODERN UPHOLSTERY INSTITUTE, Box 199-XPMORANGE, CA. 92669



OWN a Business

If employed, start part time. Alert dealers can gross \$12 hourly profit plus \$7 on EACH serviceman. Clean, revive, mothproof, flameproof rugs & upholstery. No shop needed. Nationally advertised on-location service. We train, guide and assist you. Easy to learn. Quickly established. Less than \$1200 down opens your dealership. Send today for FREE booklet. No obligation. No salesman will call.

DURACLEAN, 3-160 Duraclean Bldg., Deerfield, Illinois 60015

REAL ESTATE BE A BROKER

PAYS BIG! SEND FOR BIG FREE CATALOG NOW!
Graduates report making substantial incomes. Operate your own business quickly. Men, Women, all ages, learn easily. Course covers Sales, Appraising, Loans, Mortgages, & related subjects. **STUDY AT HOME** or in classrooms in leading cities. **Diploma Awarded. Write Today for FREE Book!**

FREE BOOK TELLS HOW

Accredited Member National Home Study Council. Approved Veteran Training.

WEAVER SCHOOL OF REAL ESTATE
3521-J7 Broadway (EST. 1936) Kansas City, Mo. 64111



LEARN MEAT CUTTING

Train quickly in 8 short weeks at Toledo for a bright future with security in the vital meat business. Big pay, full-time jobs—**HAVE A PROFITABLE MARKET OF YOUR OWN!** Time payment plan available. Diploma given. Job help. Thousands of successful graduates. **OUR 60th YEAR!** Send NOW for big new illustrated FREE catalog. No obligation. G.I. approved. No. 0197T

NATIONAL SCHOOL OF MEAT CUTTING
Dept. 50-B, Toledo, Ohio 43604

MAKE MONEY!

REPAIR HYDRAULIC JACKS



Earn while you learn at home. Millions of jacks in gas and auto service stations, trucking firms, body shops, riggers, factories and farms need servicing... most of which you can learn to repair. We show you HOW. Start spare time in your basement or garage. Big opportunity for mechanics. **ACT NOW!**

Write for Folder #1110 and Free Bonus Offer.

Hydraulic Jack Repair Manual Co., Inc.
P.O. BOX 3 • STATEN ISLAND, N.Y. 10314

MAKE \$200

or more this weekend!

B. ELLIS PUBLISHING COMPANY
810 31st St., Union City, N.J. 07808

Installing a burglar-fire alarm system in a home, store, factory or office. No experience needed. Electric, wireless, ultrasonic types—where to get—how to install—what to charge. Program includes manual—wiring diagrams—trap charts—proven tips for getting sales. Complete, professional, authentic instruction kit only \$9.95 PPD. Guaranteed. Order now and get free job pricing guide.

HERNIA BRIEF

New, from England... no metal parts... light, comfortable and hygienic. Has Miracle Adjust-A-Pad—allows instant pad adjustment. Wear this modern support and forget about your hernia. **10 DAY FREE TRIAL — NO CASH NECESSARY — YOU PAY ONLY ON SATISFACTION.** Send for full details.

SURGICAL INTERNATIONAL INC., Dept. 44
Box 24, 403 Kennedy Blvd., Somerdale, N.J. 08083

Repair any watch



... SWISS OR AMERICAN

Unique, modern Sweeney System starts you making repairs right away. Develops skill step by step at home in spare time. Diploma awarded. Free sample lesson. No obligation.

CHICAGO SCHOOL OF WATCHMAKING
Dept. 1103, Fox River Grove, Ill. 60021

"LISTEN IN" TO POLICE-FIRE RADIO CALLS IN YOUR CAR!

WORKS with ANY CAR—Portable or HOME RADIO! Just PLUGS in—No wiring—3 minute hookup! Switch instantly from regular to ALL POLICE-FIRE-EMERGENCY-COMMERCIAL-TAXICAB-STATE-CITY-GOV'T 2-way Radio calls in YOUR AREA. DUAL-HI-LOW BANDS TUNES 36-49 & 150-175 MHS. USE Everywhere—anytime—always works.
SEND ONLY \$2.00 (cash, Ck., M.O.) and pay postman \$9.99 plus COD post or send \$11.99 for ppd Del in USA. **COMPLETE**, ready to use with instructions. One Year service Warranty—**10 DAY MONEY BACK TRIAL** (if rtd). Sold Only—**DIRECT FROM FACTORY** at this Low Price!
WESTERN RADIO BPM-10 KEARNEY, NE 68847



BASEMENT TOILET

Flushes up to existing sewer or septic tank by powerful, self-contained pump operated by normal water pressure. No digging up floors. Clog resistant, easily installed. Make basement into game room, den, apartment with private bath. Financing available. Write for free literature.



DOSS, Dept. J-25, Box 10947, Houston, Tex. 77018

Hobby Horse Plans

17 1/2 x 23

Easy to follow plans with material list and step by step instructions.



Other plans available

- Hobby Horse (toy chest)
- Rubber Band Gun

Send \$2.00

Check - Cash - Money Order
plus 25¢ postage & handling.
Mich. residents add 4% MSST
All orders filled within 24 hours.

Greer Design Studios
P.O. Box 42, Dept. PM-10
Roseville, Mich. 48066

FLAMETHROWERS



STOP DRIVING BEYOND YOUR LIGHTS
150,000 candlepower sealed beams.
Over 2 1/2 times as bright as stock high beams.
No alterations, fit bright sockets on quad (4) light 12 volt systems. \$11.95/pair
Cash, check or M.O. no c.o.d. please
Warren Enterprises, Box 563 M
Skokie, Illinois 60076
EXTEND YOUR DRIVING LINE OF SIGHT

OWN YOUR OWN

**BRINGING LOWER PRICES TO CUSTOMERS
ALL OVER THE NATION.
BIG DEALER PROFITS
TOO!**



Customers are waiting for an American Speed Center in some areas. For complete information on how you can be an American Speed Center owner and make money . . . **THE AMERICAN WAY**, mail in coupon today.

AMERICAN SPEED CENTER . . . A CALIFORNIA CORPORATION

MAIL TODAY

TO: American Speed Center
125 Phoenix Avenue
Modesto, California 95351



PM-1

Please send me more information about an American Speed Center Franchise. I am a Vet

Name: _____ Age: _____

Street: _____ Phone A/C: _____

City: _____ State: _____ Zip: _____

TUNE-UP ANY GAS ENGINE TO PERFECTION



THE FAILURE OF JUST ONE PLUG WIRE REDUCES GAS MILEAGE AND POWER AS MUCH AS 25%! Amazing, easy to use NEOSCOPE tests plug wires, coil, coil polarity, coil wire, rotor gap, and much more assuring **MAXIMUM GAS MILEAGE** and **TOP PERFORMANCE**. NEOSCOPE is also a **TIMING LIGHT!** An easy to understand Manual is included. 100% Guaranteed. \$29.50 + \$1.50 handling. Californians add 5% tax.

NEOSCOPE, No. Hollywood, Calif. 91603



instant **teflon** surface

Apply A SURFACE OF TEFLON® INSTANTLY with Self Sticking Teflon Film. Slippery nonstick Teflon has scores of uses in home, shop, industry. Send \$0.25 for four page authoritative Popular Science reprint.

™ DuPont

CONNECTICUT HARD RUBBER CO.
407A East St., New Haven, Ct. 06509

BUILD, FLY YOUR OWN COPTER!

It's great sport to fly a Bensen Gyrocopter — lowest cost, too. Fly high or low, fast or slow. Adapts to floats. Pilot ages range from teens into 60's. Enjoy flying this easy way! Plans, parts and factory kits available. Get colorful info packet with photo, specs, 3-View Drawings. Send \$5 today!

BENSEN AIRCRAFT CORP., Dept. PM-103
RDU Airport, Raleigh, N. C. 27602



NAME _____

ADDRESS _____



5 DAY HOME TRIAL

DISCOUNT BREAKTHROUGH ON ACCORDIONS

SAVE 1/2 OFF retail prices of comparable accordions. Buy direct from world's largest dealer. Over 40 models for Student, Teacher, Professional. Electronic, Standard & Button Models—Amplifiers too! All Big Names. Try before you buy. Free accessories. E-Z Terms. Trades. Lifetime Performance Policy. **FREE** Color Catalogs/Discount price list. Rush coupon.

FREE Color Catalog

• Discount Prices

• 42 Models

Accordion Corp. of America—Dept. R-103
5535 W. Belmont Ave., Chicago, Ill. 60641

Send **FREE** accordion catalogs and discount prices. Include special information checked:

Accordion Amplifiers Button Accordions

Name _____

Address _____

City _____ State _____ Zip _____

ALL BIG NAMES

'BIG IRON' MOVES TO THE NORTH SEA

(Continued from page 133)

opened my hand, all I had to show was a few grains of sand. This kicked up an argument among the TVA people. One man said, 'Hell, he could have hidden that little bit of stuff in his suit before he went down.'"

But Hughes got the job, and a successful diving career was launched.

In 1964, he and a university buddy, John Johnson, (and three other men who later dropped out) formed World Wide Divers in Morgan City, La. Oceaneering International was formed when they merged with Lad Handleman's company, a California outfit specializing in deep-water work.

Today, Oceaneering has offices and facilities in such diverse places as Singapore, Australia, Canada, England, Iran, Nigeria and Indonesia.

The Oceaneer 1000 is one of the most sophisticated commercial diving systems to be found anywhere.

For deep diving, a mixed-gas atmosphere

Divers remain, in effect, at 500 feet as long as it takes to finish the job—days or even weeks.

—oxygen and helium—must be used. As a general rule, diving with compressed air is limited to about 200 feet. At greater depths, the diver is apt to suffer nitrogen narcosis, which affects his ability to work and may even endanger his life. Helium has no narcotic effect.

To be done efficiently, deep diving calls for a saturation system. This allows the diver ample bottom time to do the job and eliminates a long decompression after each dive. Decompression—a slow return to surface air pressure—may take days, but it's necessary to keep the diver from being hit by the "bends."

The term "saturation" refers to the diver's tissues, which become saturated with an inert gas such as helium after he has spent a certain period in a pressurized mixed-gas atmosphere. It takes about 24 hours to compress a diver for a 1000-foot dive.

The Oceaneer 1000 system is made up of two deck decompression chambers (DDCs), where the men live; a transfer-under-pressure chamber (TUPC) that mates to the diving bell; a control van that's the brain

center of the operation. The TUPC also functions as toilet and shower room.

If a job is at, say, 500 feet, the system would be pressurized close to that depth. (There are economic and practical reasons for not going the whole way; for our purposes, we'll stick with the 500-foot figure.) The divers will remain, in effect at a depth of 500 feet for as long as it takes to finish the job—days or even weeks. Whether the diver is eating or sleeping in the DDC, or working on the bottom, he's always pressurized to 500 feet.

When it's time to go to work, the divers—they usually work in pairs—move from the DDC to the transfer chamber and into the bell. The bell is then dropped and lowered to the job.

One diver exits through a bottom hatch, wearing helmet and hot-water-heated suit, and carrying whatever tools he needs. His lines are tended from the bell, where his buddy stands ready to give whatever help is needed.

In a drilling operation, the divers may have to inspect or make a repair on the blowout-preventer stack—a huge piece of machinery with valves and hydraulic rams. It's designed to prevent pockets of gas escaping from the well during drilling. Escaping gas can cause an explosion top-side.

Though the Oceaneer bell is equipped with lights, divers work mostly by feel in their murky environment. This is where experience pays off.

A deep dive may take about four hours. After the bell is up and mated with the TUPC again, the divers climb out of their suits, shower and grab a cup of coffee. In the Oceaneer DDCs, they can listen to piped-in hi-fi as they relax.

When the job is finally finished—and the divers are ready for shore leave—they go through decompression in their DDC. If they've been working at 1000 feet, it may take 8 to 10 days to decompress them.

The Oceaneer system calls for an eight-man crew: a diving supervisor, his assistant, four divers and two deckhands.

Though the system had been thoroughly tested, Oceaneering personnel on the 702 looked mighty happy after the first dive at the Shetland Islands location. The dive was to 478 feet—it went without a hitch.

At this writing, the Sedco 702 continues to drill, to probe the North Sea bottom for that dark ooze that makes all those engines turn and the wheels go 'round. ★★ ★

Now you can refinish your car's damaged surface areas professionally

You already have the skill to refinish your car's damaged surface. All you need is a few minutes practice on a tin can. Send a self-addressed stamped envelope, and we'll send you brief illustrated uncomplicated instructions free.

With Dupli-Color® touch-up paint, you can be sure of professional results. Used by millions, Dupli-Color duplicates your car's original color exactly. Dries in minutes to a hard high-gloss finish. Beautiful! Professional!

In all popular domestic and foreign car colors wherever auto supplies are sold. Brush-in-cap bottles, Auto-Spray® cans. Get color code number or letter from body plate.

DUPLI-COLOR. PRODUCTS

Dept. P, 1601 Nicholas Blvd., Elk Grove, Illinois 60007

Illustrated booklet shows tricks of the auto refinishing trade



Find body plate under hood or on front door jamb. Color code usually single letter or number. Get exact matching Dupli-Color.



Hold Dupli-Color spray can 8 to 10 inches from surface. Spray fast, smooth side-to-side strokes in one minute intervals.

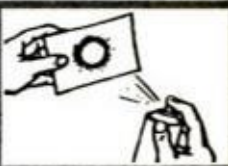

For touching up a small nick or scratch. Cut small hole similar in size and shape to nick and spray Dupli-Color through it.

MAGIC MAIL PLAN

that comes with this Little Machine CAN MAKE YOU \$1200 AN HOUR

The machine is turning out a job that will bring operator \$2.58, by mail. Material cost, only 11c



Write today for free facts about the newest and most fascinating of all new home operated businesses. For the first time, a simplified machine brings the fabulous profits of Plastic Sealing and Plastic Laminating within reach of the small operator. Anyone can learn to operate it with a few minutes practice. Then—with our MAGIC MAIL PLAN—can get mail orders pouring in daily with cash in every envelope.

No Canvassing or Selling

Fill orders at home in spare time to start. Then expand to full time business. We even supply circulars to bring back cash and orders. Rush name for all the facts you need to start. A postcard will do. No charge.

WARNER ELECTRIC CO., Dept. L-2-CL
1512 Jarvis, Chicago, Ill. 60626

PUMP DRAINS pools, cellars, laundry tubs IRRIGATES — CIRCULATES — SPRAYS



Heavy duty ball bearing pump. All metal, rust-proof Type XB. Stainless shaft. Use 1/4 HP or larger. 1 HP 1,200 GPH 60" high or 3,000 GPH 25" well. 5,200 GPH max. 1 1/4" in. 1" out. Belt or direct drive. \$14.95
Type P won't rust or clog. Bronze bearing. To 2,400 GPH. 1" in; 3/4" out. \$9.95
P'pd cash with order. Money back Guarantee.

LABAWCO, Box 40, Belle Mead, N.J. 08502

locksmithing and key making

PRACTICAL UP-TO-DATE COURSE — ONLY \$7.95



Teaches you how to pick locks, de-code, make master keys, repair, install, service, etc. New self-instruction lessons for every handyman, homeowner, carpenter, mechanic, service station operator, fix-it shop, hardware dealer, gunsmith. 53 easy illustrated lessons. Full price only \$7.95 postpaid. Satisfaction or refund guaranteed. Mail order today!

NELSON-HALL CO., Dept. 6KX-2
325 W. Jackson Blvd., Chicago 60606

HOME-WORKSHOP ELECTRIC ARC WELDER \$9.99!



WELDS—BRAZES—SOLDERS—CUTS—ALL METALS! Plugs into ANY 110 volt socket. MAKE—REPAIR most anything for CAR—HOME—BUSINESS. Lifetime BURNOUT GUARANTEE 10 day money back trial (if retnd). HEAVY DUTY Design. No experience needed—FREE WELDING LESSONS!

SEND \$2.00 (cash, ck, M.O.) and pay postman \$7.99 COD postage or send \$9.99 plus \$2.00 for postage—packing in U.S.A. COMPLETE READY TO USE. Includes BIG pack steel. Brazing, Solder, Carbon "touch" rods & ELECTROFLAME ARC TORCH! OFFER LIMITED—Order TODAY! MIDWAY WELDER, Dept. EPM-10, Kearney, Nebr. 68847

LEARN UPHOLSTERY AT HOME!



Men & Women All Ages! Send for free book on learning to reupholster chairs, divans, footstools, all furniture for BIG MONEY in spare or full time. No experience needed, no age or educational limits. We show you how and provide EVERYTHING needed to start: (1) Home training covering all phases, (2) all tools and 6 big furniture kits for practice, (3) free supplies, frames & materials to build \$300 worth of furniture, yours to keep or sell. Write TODAY for big free upholstery career book. No obligation, no salesman will call. VETERAN APPROVED.
Modern Upholstery Institute Box 64-XPM2, Orange, Calif. 92669.

SEND FOR FREE BOOKLET!

20 WOOD SAMPLES with woodworkers Catalog

ENJOY woodworking more! Let Constantine's big picture-packed Catalog-Manual help you build new furniture — refinish, restore beat-up cabinets, chairs, chests, tables, etc. Find instantly whatever you need. Buy at money-saving prices from world's largest catalog source for imported and domestic woods. Cabinet lumber, carving blocks, veneers, plywood, pipe briar, inlays and more!

Newest Catalog features new tools, materials, shop devices. Fabulous all-purpose clear finish. Glue that needs no clamps. Inlay picture kits, 99¢. Needed products found nowhere else. Plus wood-working instructions, plans, patterns!

Catalog & Wood Samples Only \$1

Dollar Fully Refunded on First Order

Accept this offer to own fascinating set of 20 2x4 specimens of world's glamorous veneers — Rosewood, Satinwood, Lacewood, Teak, etc! Compare! Then instantly identify finest woods wherever you go. Send only \$1 for Wood Samples and Woodworkers Catalog. Dollar refunded on first order.

CONSTANTINE

2051 Eastchester Rd., Bronx, N.Y. 10461

Enclosed \$1 for Wood Samples & Woodworkers Catalog. (\$1 refunded)



2,000

PRODUCTS FOR SHOP & HOME Woods — Veneers — Finishes Furn. Hardware — Lamp Parts Cane — Upholstery — Tools Picture Molding — Clock Kits

FREE WITH CATALOG "101 PROJECT IDEAS"

96 GIANT PAGES

Catalog only 50¢



Name _____

Address _____

Zip _____

OCTOBER 1973 203

(Continued from page 127)

on the verge of a renaissance. With the need for clean air, less traffic congestion and the reality of finite resources of raw materials and energy, I would be a more responsible citizen if I paid my \$55 a month to the commuter railroad. Instead, I drive halfway to work, park on the street, take the subway and save myself \$30 a month.

A car used regularly ages well, but, no doubt about it, mine gets a workout and potholes don't help. I've considered buying a small commuter car, new, of course: I wouldn't think of buying a used car—well, maybe, if it had a complete maintenance and service log. A second car would have its advantages, not the least of which would be extending the life of my 145. But the view for a new-car buyer today is foggy indeed.

Prices for '74 models, at this writing, haven't been announced, but all manufacturers promise a handsome increase. Some of it is for real hardware that's required—interlocks, 5/5 bumpers, fail-safe throttle and so on. Next year and in '76 prices will jump again for catalytic converters and passive restraints (read air bags) among other safety and emissions modifications (and possible other costs like a "disposal tax" which is the cost of junking the car paid at the time of purchase). There is the promise of slightly better fuel mileage and driveability with the improved emissions systems, but that promise has not kept 1973 from being Detroit's biggest sales year. Some attribute it to "pre-buying."

Another real concern for car owners is the outright, or economic, restrictions that will soon be put on car use. They include higher priced fuel or actual gas rationing, no-car zones in cities, rush-hour taxes (envisioned by Transportation Secretary Claude Brinegar as a way to curb rush-hour congestion), horsepower taxes . . . to continue is too mind-boggling.

Even more sweeping, as perceived by former Secretary of the Interior Stewart L. Udall, is the urgent need to change our petroleum-based transportation system completely—not just in the interest of clear air, but for the better husbandry of our remaining land, lower traffic death toll, lesser dependence on oil-rich nations.

I've just talked myself into riding it out in my present station wagon. Maybe when I need another car, the Atomic Energy Commission will be pumping the fuel. ★★

(Continued from page 127)

slot in a hotel parking lot and had to take a cab to the convention hall. Try explaining that on the expense account.

I'm tired of fighting with incompetent mechanics in dealer service departments trying to get warranty work done I'm entitled to under the new-car guarantee. For example, the Nova I just traded in on the Mustang had a defective buzzer/warning light hooked up with the seat belts. Nothing to make a federal case out of. I took the car back to the dealer seven times—by appointment, at times the dealer specified—to have the light fixed. The dealer always had an excuse for not fixing it. A friend in Chevrolet public relations got fed up hearing about my misadventures with the dealer and had the light repaired at the Chevy garage that takes care of company cars. But I don't think you should have to have pull at the factory to get a buzzer light fixed.

Who needs it? What can you do about it?

Not much, I'm afraid. I have to own an automobile, come dollar-a-gallon gas or dollar-an-hour parking.

But I'm looking for ways to cut down on the aggravation by cutting down on use of the car. I make more use of the phone. I bought an attachment for the tape recorder so I can do interviews over the phone. If it's not imperative to go into the office, I write on the dining-room table at home. If I have to go to the airport at certain times of day, I take the limousine.

I think I've solved the service problem. Except for big-money items covered by warranty, I have my service work done by a mechanic, Bob Swales, at the Shell gas station, a few blocks from my house. Bob knows what he's doing and I'd rather pay him a little extra for service work the dealer should do under warranty than waste time fiddling around in a dealer service department.

As I see it, the private automobile is in serious trouble with a lot of people. On prices, on upkeep, on service, on all counts. I'm not faulting cars as cars. But I'm unhappy with all the grief that goes with owning one. Until such a time as Detroit or the government or whoever solves some of the problems, I think the great American dream machine is going to spend more time parked in the garage.

Anybody want to buy a low-mileage Mustang next June or July? ★★

'74 CARS—MICHAEL LAMM

(Continued from page 127)

Autos Magazine for June-July 1972, I compared ownership costs for the Hornet with those of buying and driving a new Plymouth Satellite sedan. I then pitted driving costs (Hudson vs. Satellite) for two- and three-year periods at 15,000 miles a year.

Taking gasoline expenses, insurance, and maintenance as equal, the Satellite cost a hypothetical \$1521.75 more to operate for two years and \$2071.75 more for three years than the 22-year-old Hornet. That's simply because the Satellite cost more to begin with and could be expected to sell for relatively less at the ends of two and three years.

Before you rush out and buy an old car, keep these reservations in mind:

1) An older car like this has to be in abnormally good condition to begin with

1952 HUDSON HORNET

Costs of purchasing and reconditioning

Base purchasing price (June 1971)	\$ 350.00
1972 Calif. registration and license	14.00
California use tax	6.00
Four Lester wide-whitewall tires	254.00
Six new pistons and rings	80.97
Overhaul engine, parts and labor	127.24
Rebush and align front end	52.53
Four new shock absorbers	74.85
Overhaul and reline brakes	89.49
New rear-axle seals	19.95
Water pump (rebuilt)	10.00
Twin-H intake manifold (used), two carbs	25.00
New grille ornament	4.50
Chrome plating, misc. trim parts	60.00
Bodywork and partial repaint	110.00
Seat slipcovers	6.29

Total\$1284.82

Note: The above equipment was deemed necessary for safety and reliability before putting the Hudson on the road. Since that time, the transmission has been overhauled (\$211.68) and the valves reground (\$24.75 parts & tool rental). Prices include all taxes and shipping costs. Excluded are the costs of six Hudson parts cars.

before it becomes a practical proposition. If you have to *restore* it, it'll cost too much.

2) Unless you have weekends free to tinker and occasionally to go into the innards more deeply, stick with newer cars.

3) Figure on using this older vehicle as a second car, or even a third, but not as your sole transportation. (I have a 1967 Camaro in the garage just in case.)

4) Be prepared to spend some time scrounging for parts, and this includes buying and stripping parts cars.

If all this is your cup of tea, and it surely is mine, have at it. I've always considered Hudsons grossly overbuilt, so I expect this one to give me an easy 200,000 miles of service. Maybe I'm kidding myself, but if so, I haven't learned my lesson yet. ★★

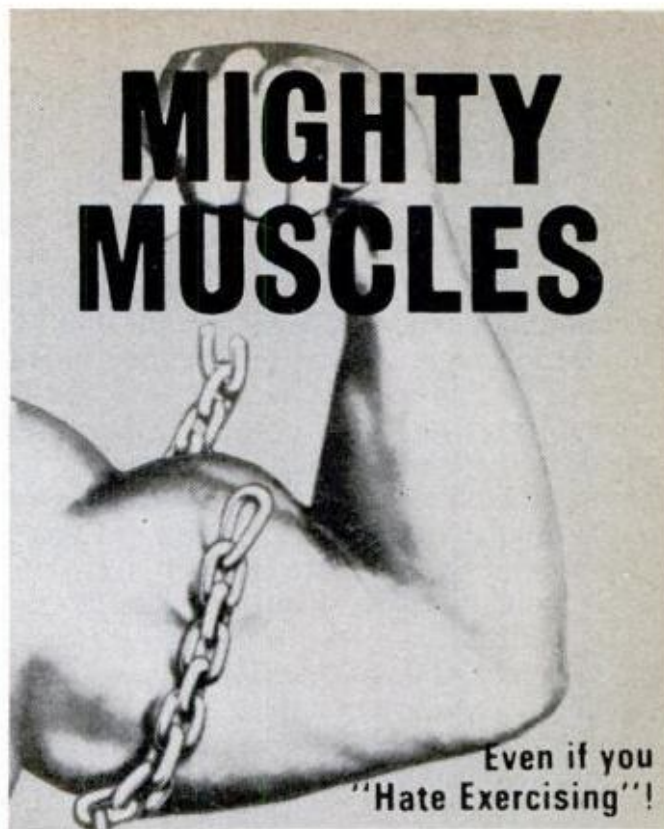

Now power-pack your body with inches of mighty muscle in just 5 minutes a day. Even if you've always "hated exercising," the proven-effective BULLWORKER System can help you build the body of your dreams F-A-S-T: amazing muscle-power increases of up to 4% per week or more: 50% increase in 3 months!

Compare these benefits with any other method. No weights. No barbells. No long and boring exercises. Bullworker is easy and quick to use, anywhere—at home, in the office. You don't even have to disrobe. In just 2 short weeks Bullworker guarantees to produce positive results you can actually see in a mirror, measure with a tape: otherwise YOU PAY NOTHING! Mail coupon today for free illustrated booklet and complete details. No obligation.

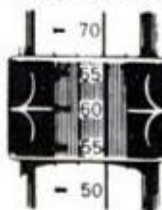

Built-in Powermeter

You can actually measure your musclepower g-r-o-w-i-n-g from the very first day.

FREE 24 page BOOKLET



Bullworker Service Dept. BW-883
201 Lincoln Blvd., Middlesex, N.J. 08846

Please send me my FREE full color booklet about BULLWORKER 2 without obligation. No salesman will call.

Name _____ Age _____
Street _____
City _____
State _____ Zip _____

Canada: Home delivery duty paid. Ask for FREE booklet.

'74 CARS—FORD

(Continued from page 118)

ing, sunroof, multiplex stereo and a raft of other options are available.

Turning to the other 1974 FoMoCo cars: In the luxury-personal field, Thunderbird and Mark IV get minor '74 styling revisions, mostly at the rear to accommodate now 5-mph bumpers. They share the 460 V8, standard airconditioning and the new quick-defrost ice-buster. This last, perhaps Ford's most interesting 1974 technical innovation, consists of a transparent, gold-plated mylar laminate sandwiched into the safety glass of the windshield and rear window. Copper bars around the laminate conduct electricity to the gold film at about 80 volts. Resistance within the film makes it heat very quickly, and it can defrost an iced windshield in two to five minutes.

The system has a high-voltage alternator in addition to the regular one, plus three circuits—one for the rear window and two for the windshield. It works by an on-off switch and has a reminder light. After it's been on for 10 minutes, a timer cuts juice to 70 percent. Ford got this better idea from the aerospace industry; if it catches on (it's optional only in '74 T-Birds and Mark IVs—no price given yet), it'll spread across the board. The gold, by the way, can't be seen up close.

As for full-sized Fords and Mercurys, we see few changes except for general upgrading of trim and larger engines as standard. The 460 V8 replaces the discontinued 429 in Marquis; the 400 replaces last year's 351 as standard in Ford's Country Squire and Mercury Montereys. These engines have new solid-state ignition systems, as do all FoMoCo V8s sold in California.

LTDs and Country Squires get steel-belted radial tires as standard and, of course, radials were already standard on Mercurys, Lincolns and Thunderbirds.

The 1974 Galaxie 500 has a plainer grille than the LTD, and the same difference distinguishes Montereys from Marquis. Full-sized Fords and Mercs can be ordered with equalizing trailer hitches in combination with certain towing packages.

Mercury's Cougar, extensively changed, includes body-on-frame construction for the first time. Basically, it shares the new Montego coupe's 114-inch wheelbase and all other dimensions. The '74 Cougar's sheet metal has been revised considerably, as has its interior. The car moves up to a more

luxurious plane this year, thanks to a long list of standard items: automatic trans, power steering, power front disc brakes, radial tires, vinyl roof, opera window, bucket seats, full instrumentation and much more. Base Cougar engine remains the two-barrel 351; 400 and 460 V8s are optional.

Not much new on 1974 Torinos and Montegos—different grilles and minor changes. All models get bigger gas tanks; electronic-ignition 400 and 460 V8s are optional, and steel-belted radials round out Ford's 1974 intermediates.

In compact and subcompact classes we see only detail revisions for the '74 Comet/Maverick and Pinto. Maverick and Comet got gloveboxes in mid-1973; they're still there. Pinto gets the wagon's bigger 2.0-liter engine as standard for 1974, with the 1.6 dropped. The 2.3-liter ohc Four becomes a Pinto option as well as the Mustang II's standard. The metric-dimensioned 2.3, by the way, is entirely different from the 2.0, with no parts interchangeable.

So except for the Mustang II, Ford is standing pretty pat for 1974, but with a range of cars that helped the company set records in '73. Expect much more radical changes for 1975. ★★★

'74 CARS—AMERICAN MOTORS

(Continued from page 114)

has full instrumentation, front sway bar and other good things. Stereo AM/FM is a first for Gremlin—also for Hornet.

Hornet has four models: the marvelous hatchback (my favorite car in the AMC line), two and four-door sedans and the Sportabout. A "D/L" package on Sportabout includes a new "Extra-Quiet" insulation treatment, reclining seats, wood-grain trim, roof rack, air deflector, wheel covers.

Javelin and AMX have minor trim changes in this their seventh edition. Optional packages include the Rallye-Pac and, for the AMX, a "Go" package of 360 or 401 V8, and other performance add-ons.

Ambassador has a new grille and front end to highlight its minor changes for '74. Overall length is up six to seven inches for bumper improvements and, as last year, standard equipment includes automatic transmission, airconditioning and more.

AMC models are covered by the Buyer Protection Plan, and that's the AMC story in brief. Meanwhile back in the studios and labs, those future-shock transportation modules take shape. Can you wait? ★★★

How to get rich

How can you get rich some day? Make a hit record . . . a killing on the stock market . . . or invent a gadget like the hula hoop?

For most of us, these are just dreams. But have you ever stopped to think that there is a way to get rich—possibly only one sure way? Most fortunes, as you know, are made by people who own their own business.

Perhaps you've thought of starting a small business of your own . . . a franchised drive-in, or maybe a service business. Trouble is, you need \$10,000 to \$15,000 to get started and even then it's a gamble—with slim chances of ever making really big money.

But there is *one* business which could make you rich—almost overnight! And the beauty of it is, you can start on a shoestring during your spare time, even while holding your regular job.

Cash by Mail

The business is Mail Order—and it's fabulous! Come up with a 'hot' new item . . . and WHAM!

It strikes like a bolt of lightning! Suddenly, you are deluged with cash orders from all over the country . . . MORE MONEY than you could ever make in a lifetime!

Like the Vermont dealer who ran one ad in Sports Afield Magazine. His ad pulled 22,000 orders—over A HALF MILLION DOLLARS IN CASH!

There is no other business where you can make a fortune so quickly!

● A beginner from Newark, N.J., ran his first small ad in House Beautiful—offering an auto clothes rack. Business Week reported that his ad brought in \$5,000 in orders. By the end of his first year in Mail Order, he had grossed over \$100,000!

● Another beginner—a lawyer from the midwest, sold an idea by mail to fishermen. Specialty Salesman Magazine reveals, "he made \$70,000 the first three months!"

Proof

It's a fascinating business! Running ads in newspapers and magazines . . . mailing gift catalogs . . . getting cash orders in your daily mail—steady as clockwork.

There is no other business where you can start on a shoestring and pyramid your profits—without investing in merchandise! One husband and wife mail order team took in \$40,000 selling one item. They obtained FREE ads in national magazines . . . didn't invest a cent in merchandise, and even got the supplier to ship all orders for them!

These exceptional cases are absolute proof that you can get rich in your own Mail Order business. Very rich. Even a U.S. Gov. Report stated: "A number of

one-man Mail Order enterprises make up to \$50,000!"

Pick up any magazine. Notice how the same mail order ads are repeated . . . month after month? That's concrete proof! You know those ads wouldn't be repeated over and over again—unless they were bringing in big cash profits to their owners.

The Secret

The secret of getting rich in Mail Order lies in *financial leverage*. It's a little-known, almost secret method—using other people's capital to make money for you!

You can get thousands of dollars worth of advertising in big national magazines—without investing your own money! And you don't have to write a single ad. Tested and proven ads are prepared for you by experts. Reinvest the profits from your first successful ad—to get more, larger ads, and the profits begin to snowball! It's like building a chain of stores . . . each new store puts more money in your pocket.

You mail out beautiful catalogs which offer hundreds of dollars worth of fine, quality gifts—yet you don't invest one

Repeat orders alone, just from mailing catalogs, could bring you a steady income for the rest of your life!

Yes, Mail Order is the fastest-growing, most profitable business in America! And now, with more people moving to the suburbs . . . the population explosion . . . and the expanding teenage market . . . we are on the verge of the BIGGEST BOOM in Mail Order history!

Now, with the help and backing of Mail Order Associates, Inc., of Montvale, N.J., you can follow the same proven steps to Mail Order success—using the 'secret' of financial leverage!

Start Now

We supply you with beautiful gift catalogs throughout the year. All products are dropshipped for you, with up to 100% mark-up! You get free samples of top-selling mail order items, plus monthly trade reports on 'hot' new products . . . tested, successful ads are sent to you monthly. You get advertising directories, postal laws, complete courses, expert guidance—EVERYTHING you need to practically guarantee YOUR SUCCESS. Why? Because *our* business depends upon your success. It's mutually profitable!

A recent feature article in Income Opportunities Magazine stated, "Mail Order Associates Inc., offers the most comprehensive Mail Order program ever offered to beginners." They go on to say, "This could be the opportunity you've been looking for. A chance to get in on the ground floor in a little-known business which we believe is on the verge of a new boom."

Free

We are now accepting a limited number of charter members in our new Mail Order Program. No previous experience is required but you must be over 21.

If you are sincerely interested in starting a profitable business of your own . . . if you can see the tremendous advantages which Mail Order offers . . . then ACT NOW!

Mail the coupon today, or simply send your name and address on a postcard. No salesman will call. We will send you a free book—gift catalog, reprints of feature articles, plus complete facts about our program. Write to:

Mail Order Associates, Inc., Dept. 506
Montvale, New Jersey 07645



The thrill of receiving money in your mail is one you'll never tire of!

cent of your own money in merchandise! Your catalogs are printed with your name and address, so all orders come to you. Everything is "drop-shipped" for you, and there's up to 100% mark-up! You pocket the cash profits immediately—even before the orders are shipped to your customers!

Rush Coupon for
FREE BOOK!

plus reprints of
Mail Order
articles

Mail Order Associates, Inc., Dept. 506
Montvale, New Jersey 07645

Please rush complete details on your Mail Order Program. I understand everything is free and there is absolutely no obligation. I am over 21.

Name.....

Address.....

City..... State..... Zip.....

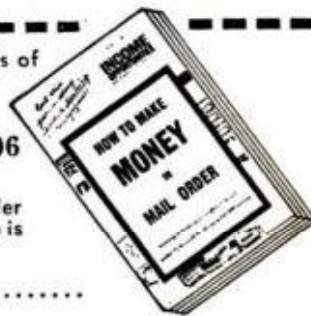

'74 CARS—CHRYSLER

(Continued from page 116)

ing air, cutting down on engine intake noise and increasing engine power.

Here's what's new name by name:

Dodge Monaco: Dodge has dropped the Polara name, and all the big cars now carry the Monaco imprint—Monaco, Monaco Custom and Monaco Brougham. There are 13 cars in all—three Monacos, five Customs and five Broughams. Three engines come in two or four-barrel versions.

The cars are shorter than last year. Wheelbase is the same, 122 inches, but overall length is down to 220.5 inches from 228.7. A new option, also available on other Chrysler makes, is a remote-control outside right mirror. The control lever for adjusting it is on the driver's right in the center of the dashboard. Radial tires are standard on Monaco Brougham, optional on others. The gas tank will hold a gallon more than in '73, 25 gallons on a fill-up.

Dodge Challenger: This one-model line—two-door hardtop—is pretty much the same as last year. There are two new options: a 360-c.i.d. V8 and steel-belted radial tires. The 360 engine replaces the 340-c.i.d. of last year. The 340 has been dropped.

Dodge Coronet and Charger: Charger comes in a coupe or hardtop, Coronet as a sedan or wagon. The 360 engine is a new option for Charger. If you want to pay extra, you can get an electrically-heated rear window and radial tires on both cars.

Dodge Dart: Six models, two-doors or four. New options include radials and the 360 engine. There's a new 2.94 axle ratio for cars with the 318 or 360-c.i.d. engines equipped with automatic transmissions.

Dodge Colt: Nothing new to report now because this car is on a calendar year—rather than a model year—and the new jobs won't be in from Japan until after Jan. 1.

Plymouth Fury: Twelve models, two or four-doors and five wagons. Wheelbase is longer than last year, 122 inches now vs. 120 then, but overall length is down from 223.4 inches to 219.9 inches. You can move the front seat back or forth an extra inch—total travel is 5½ inches—over last year. Fury is Plymouth's answer to the top-of-the-line Dodges and options that apply to Monaco also apply to Fury. Fury's rediscovered the manually operated vent window, but only for four-doors and you have to pay extra for it.

Plymouth Valiant: Three models, sedan, hardtop and coupe. The sedan's longer than last year, 197.6 inches, a gain of 3.8 inches. This makes for a little more legroom in the rear seat—Chrysler measures it at 1½ inches—and more trunk space. A sound insulation package, offered as an option on the sedan and hardtop last year, has been extended—also on an optional basis—to the Duster coupe for '74.

Plymouth Satellite: This is Chrysler's something-for-everybody car, with more models than any other series—15 of 'em, hardtops, sedans and wagons. Wagons have a new 9¼-inch axle assembly, excluding wagons equipped with the 381 engine and automatic gearshift. Chrysler claims the new axle is easier to service than the 8¾ incher it replaces and says the design reduces the chances of lubrication leaking out or water coming in.

Plymouth Barracuda: Two two-door hardtops. Both in specs and appearance the car is the same as last year. Radial tires are a new option.

Chrysler: Thirteen flavors, two-doors, four-doors and wagons. Standard on the New Yorker Brougham and available on the other cars is a dummy light that tells you if a door isn't closed securely and an indicator that signals how much fluid is left in the windshield washer container.

Imperial: A two-door and a four. Both wheelbase and overall length are down from last year. Wheelbase is 124 inches, against 127 a year ago. Length is 231 inches, against 235.3 in '73. A new four-wheel disc-braking system and radial tires are standard. All accessories optional on other cars are standard on Imperial except for a burglar alarm system and AM/FM stereo tape player.

Chrysler, along with other automakers, has made four changes or additions to its cars to comply with government regulations. Roof supports and rear bumpers have been beefed up; roofs to take 5,000 pounds of pressure without caving in more than five inches, rear bumpers to withstand a five-mph impact without damaging the car, same as front bumpers on '73s. All cars have the interlock ignition system, requiring you to buckle the belt and shoulder harness before the engine will turn over. No belt, no start. Finally, there's a fail-safe throttle. An extra throttle return spring has been added to insure return of the throttle to a closed position if one of the springs should fail. ★ ★ ★

"THE EASY WAY TO RICHES"

Recreation-Oriented Catalog Mail-Order Business

SPORTING GOODS, FIREARMS, FISHING TACKLE, WATER SPORTS EQUIPMENT AND MARINE PRODUCTS.

Less than \$300.00 for everything!

You read right! For less than \$300 you can have your own catalog mail-order business in this exciting, fascinating and profitable field. You could handle one of the largest, most diversified and most desirable lines of famous namebrand merchandise available from any mail-order firm.

And now we're going to make you a most unusual offer. You don't have to spend anywhere near \$300 to see what we're talking about. Send only \$10 for our "Easy Way to Riches" and learn everything. . . all the secrets on how to have your own business, and have it operating within 45 days.

We absolutely guarantee you that you can have such a business, including everything you need to run it, all for less than \$300 and in 45 days, or we'll immediately refund your \$10. We won't even deposit your \$10 payment until 30 days after we mail you your material.

That'll give you plenty of time to get it, look it over, and talk it over with your friends.

If you don't agree that it's worth at least a hundred times what you invested, send it back. Your uncashed check or money order will be returned.

The only reason we won't send it to you and bill you or send it C.O.D. is because both these methods involve more time and money. We're already going to give you the biggest bargain of your life.

We are going to show you how to do something that cost us tens-of-thousands of dollars to learn, and more tens-of-thousands of dollars to put into practice.

We are offering to show you how you can have an account established for the wholesale supply of the best known names in guns, ammo, fishing tackle, sporting goods, watersports equipment and marine products.

We'll show you how your supplier will package, label, insure and drop-ship your customers orders. . . orders that were pre-paid so you don't tie up your money.

You'll have your own custom printed catalogs.

All this, and complete, step-by-step instructions on how to accomplish the whole thing in 45 days.

It doesn't require education.

It doesn't require lots of capital.

It doesn't require luck.

It doesn't require talent or special qualifications.

It doesn't require experience.

Your age makes no difference.

What does it require? BELIEF! Enough to take a chance. Enough to absorb what we send you. Enough to put into action, a plan that could put you on the road to riches.

Have you ever thought what it would be like if you opened your mail each morning — in your own home — and money fell out! YOUR MONEY!

Imagine being able to afford the things you've always wanted. . . Being able to "take off" and go fishing, hunting or anything you desired whenever you wanted to. And, be secure in the knowledge that your business would keep running in your absence.

Just imagine what it would be like to be your own boss. Set your own hours. Work as little — or as much — as you please, realizing that the more you worked, the richer you'd become.

Sound like the impossible dream? It's not. . . We guarantee it!

PLEASE. . . Believe what we are telling you. To the best of our knowledge,

THERE HAS NEVER BEEN SUCH AN OFFER!
THERE HAS NEVER BEEN SUCH AN OPPORTUNITY!

Remember. . . you don't have to give up your present job. You don't need any special permits or licenses. And, you can work out of your home.

Now, the rest is up to you. Make us prove every statement we have made here. Send us the attached coupon now. We are not asking you to blindly believe us. JUST TRY IT. You have only an eight cent stamp to lose. But. . . what if we are right. Look what you could gain.

THIS COUPON WORTH \$10.00*

RECREATION ENTERPRISES, Dept. 57

657 West 19th Street, Suite I, Costa Mesa, California 92627

Okay fellows. . . it sounds impossible, but I've got nothing to lose. Send me your "EASY WAY TO RICHES" I've enclosed \$10 payment, but don't deposit my check until 30 days after you mail my material.

If I return all the material — for any reason — within that time, I understand you'll immediately return my un-cashed check.

Name _____

Address _____

City _____ State _____ Zip _____



*SPECIAL OFFER. If you mail this coupon within one week of the date at the top of this page — even if you decide to return all of the material for a refund, you'll receive a \$10.00 credit towards sporting goods of your choice. Complete details enclosed with your material.

'74 CARS—GENERAL MOTORS

(Continued from page 121)

and a heavier front stabilizer. The idea is that you can race the car on the weekend and then drive it to work on Monday without reworking it to eliminate the performance parts.

Pontiac: A couple models more: 35 cars against 33 in '73. New in terms of appearance changes are Bonneville, Catalina, GTO and the front end of the Firebird. Catalina and Bonneville coupes have fixed rear quarter windows.

More than any other carmaker, Pontiac, always comes up with a novelty. The only one-like-it Pontiac is pioneering this year is a hookup that allows you to adjust the foot pedals. The brake pedal and accelerator pedal can be moved up or down four inches. If you're a little taller or shorter than average, it's a welcome feature. To operate the device, you raise or lower a lever just under the dash left of the steering column. The option is available only on top-price cars—Grand Ville, Bonneville and Catalina.

Also in the what-will-they-think-of-next department, Pontiac has devised a high/low horn, a dealer-installed option that enables the car owner to lower the sound of the horn by flicking a switch.

GM's 350-c.i.d. four-barrel engine has been made standard on GTO and is available as an option on cars in the Ventura and LeMans series. GTO is actually a souped-up, shoot-the-works version of Ventura. The purists might argue that doesn't qualify GTO as a separate car. But by the time you get all the extra fixtures—something like 20 additional items—GTO doesn't look or handle like a regular-run Ventura.

Buick: Riviera is all new. There's a new LaSabre coupe. Regal, limited to a two-door last year, now comes in both a two and a four-door. The total count is 27 models, up one from 1973.

Buick has changed some of the names around. The LeSabre Custom name has been discontinued and LeSabres are now called LeSabre Luxus. Who says the convertible is dead? The Luxus series includes a softtop for 1974, also a special ride performance package.

In another name change, all Buick intermediates are now called Century 350. Same number of body styles as last year. The only difference is that where you could once choose between a "plain" (Century) or

"with frosting" (Century 350), in 1974 you must take the "with frosting" version.

Dual exhausts are available on everything Buick makes this year except Apollo. The company says the option provides an additional 15 hp on two-barrel engines and an extra 20 on four-barrel jobs.

Oldsmobile: There are 32 1974 cars, versus 27 last year. But that doesn't add up to five new cars. There's one new body style, a two-door Cutlass Salon. Four other cars that were custom-order offshoots of existing series last year have graduated to become in-their-own-right cars for 1974.

The Salon, a special order four-door in the Cutlass Supreme series last year, has been designated as a separate series for '74. Called the Cutlass Salon, it's a two-car line—coupe and sedan. Both body styles come with a special handling package—including radial tires—and center console as standard equipment. The Salons have the headlight dimmer switch located in the turn signal lever, rather than on the floor. This is probably a trend item on GM cars and all GM makes are expected to take the dimmer switch off the floor and mount it on the steering column over the next few years.

Olds has replaced the standard 98 coupe with an upgraded 98 Regency coupe. There's also a Regency sedan.

On the full-size cars, the warning lights are stacked in blocks, one item under the other, just left and right of the steering column. This is a good idea because the driver can see all the lights at a glance. The lights flash on for a few seconds when the car is started. If they then extinguish, it means all systems are go.

The 350-c.i.d. two-barrel engine in Delta models last year has been replaced by a 350 four-barrel. Olds says the extra barrels give slightly better mileage and reduce pollution.

There's a new sport-it-up package for Omega, Olds' compact. The extras include special suspension, steering wheel, mirrors, body paint, decals and super stock wheels.

The front-wheel-drive Toronado has identification changes. A new option is a landau padded vinyl roof and opera window.

Cadillac: Nine models, the same as last year. The cars are 2.2 inches longer than the '73s due to the beefed-up back bumpers. Grilles on all cars are mounted to the bumper and fold in on impact. Roll-down rear side windows in the Coupe de Ville and Calais have been dropped in favor of fixed glass. ★ ★ ★

For Sparetime or Full Time
Income, There's Good

MONEY IN SHARPENING

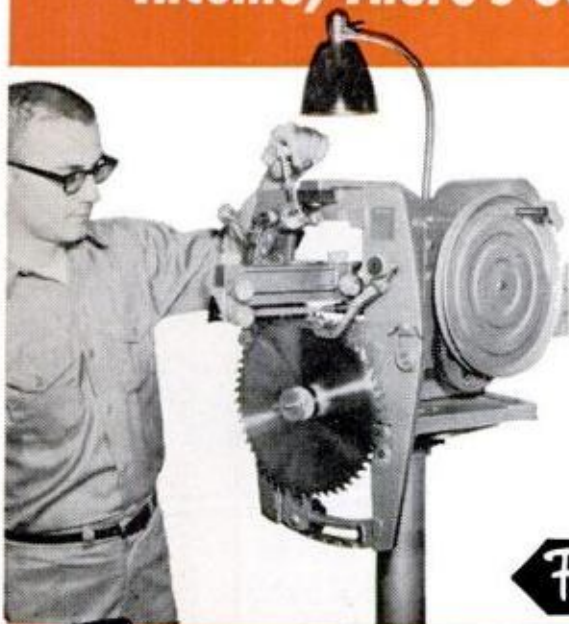

Here's a proven practical way to earn extra dollars in spare time—to develop a money-making repair business of your own. Investment is small. There's no overhead, no stock of goods to carry. No experience needed, no canvassing. You do it with the famous Foley Saw Filer that automatically sharpens all kinds of saws—and the Modern Lawn Mower Sharpener that precision sharpens all types of mowers.

EARN \$3 TO \$6 AN HOUR SPARETIME

Hundreds of people like yourself are making cash like this—\$20 to \$30 a week—right now in spare time. "My spare time saw filing business has made me \$952 these first ten months"—says R. T. Chapman. Many have built a complete sharpening service with such year-around profits. You can too, simply by following the sure, easy Foley Plan.



MANUFACTURING CO.
MINNEAPOLIS, MINN.



MONEY MAKING FACTS BOOKLET FREE!!!

This valuable book shows you how to start, how to get business from home owners, factories, carpenters, etc., and how to make profits fast. Mail coupon today. No salesman will call.

FOLEY MFG. CO. 1016-3 Foley Bldg., Minneapolis, Minn. 55418

Saw Filer information.

Lawn Mower Sharpener information.

Money Making Facts booklet.

NAME _____

ADDRESS _____

CITY _____

STATE _____

2 SETS, \$22



U.S. Surplus High Speed Rotary Files. Hardened Steel, use on any metal or wood for filing, drilling, milling, carving, routing — a thousand uses in every shop. Sets assorted in sizes from 1/8" to 1" cutting edge. All 1/2" shanks. All brand new, in air-tight, G.I. packs. Order now!
36 Tool Set, G.I. cost \$265.00, now \$15.00
16 Tool Set, G.I. cost \$109.00, now \$10.00
Save Even More, Both Sets, now \$22.00
100% Guaranteed. We Pay the Postage. Order Now!

U.S. SURPLUS CENTER DEPT. 503

715 Camden, San Antonio, Texas 78215

HOW TO BECOME A LOCKSMITH



COMPLETE BOOK OF INSTRUCTIONS

How To Fit Keys, Change Combinations, Master Key Locks, Keys By Number, Tools To Use, etc. Detailed illustrations. Satisfaction guaranteed. Get started! Order today. Only \$3 ppd.

A.A. Ancele, P. O. Box 69234, Los Angeles, Ca. 90069

HEADQUARTERS
FOR EVERY
TYPE & SIZE
AT REAL
DOWN-TO-
EARTH MONEY
SAVING PRICES!



ALL FAMOUS BRANDS!
TIRES!
AUTO TRUCK SPORT CAR
FARM TRAILER
TREMENDOUS SAVINGS!
LET US PROVE IT TO YOU!
... WRITE US TODAY ...

Send for your FREE catalog!

RELIABLE TIRE CO. 1111 Chestnut St. Camden, N.J. 08103

BASEMENT TOILET FLUSHES UP



TO OVERHEAD SEWER OR SEPTIC TANK. NO DIGGING UP FLOORS. INSTALLS EASY. Write McPHERSON, INC., BOX 15133, TAMPA, FLORIDA 33614

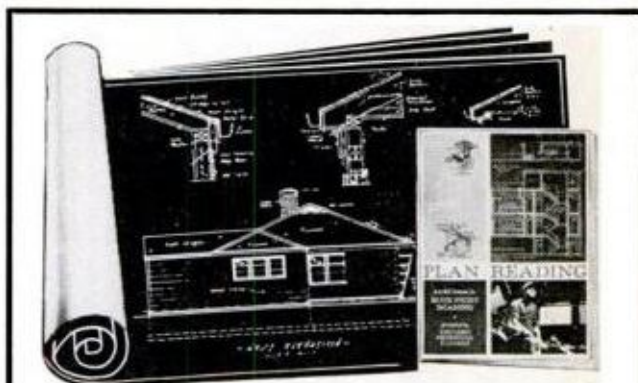

FREE BLUEPRINTS and TRIAL LESSON —for your greater success in Building

Beginners, craftsmen, even foremen and superintendents, have sent for these free blueprints and trial lesson in Plan Reading as a means of trying out Chicago Tech's home-study Builders training. Learn how you can master Plan Reading—Estimating—and the practical details of all types of construction in your spare time at home. Mail coupon below today—see how you, too, can prepare for a better job—higher income, or start your own contracting business.

CHICAGO TECHNICAL COLLEGE/School for Builders
2000 S. Michigan Avenue, Chicago, Ill. 60616

CHICAGO TECHNICAL COLLEGE
Dept. PM10-3, 2000 S. Michigan Ave.,
Chicago, Ill. 60616

Please mail me a Free Trial Lesson, Blueprints and Builders Catalog. I understand there is no obligation—no salesman will call.

NAME _____ AGE _____
ADDRESS _____
CITY _____ STATE _____ ZIP _____

Veterans
Check
Here

Announcing—1973 ED.

The Popular Mechanics Index and Shelf Wrapper

Here's a great idea that will multiply the value of your back issues of PM. Reserve your copy now!



Want to find an article on 17 ways to thiefproof your car? How to build a colonial footstool? The latest bicycle touring gear? How to remodel your bath, or how to take the high cost out of hi-fi?

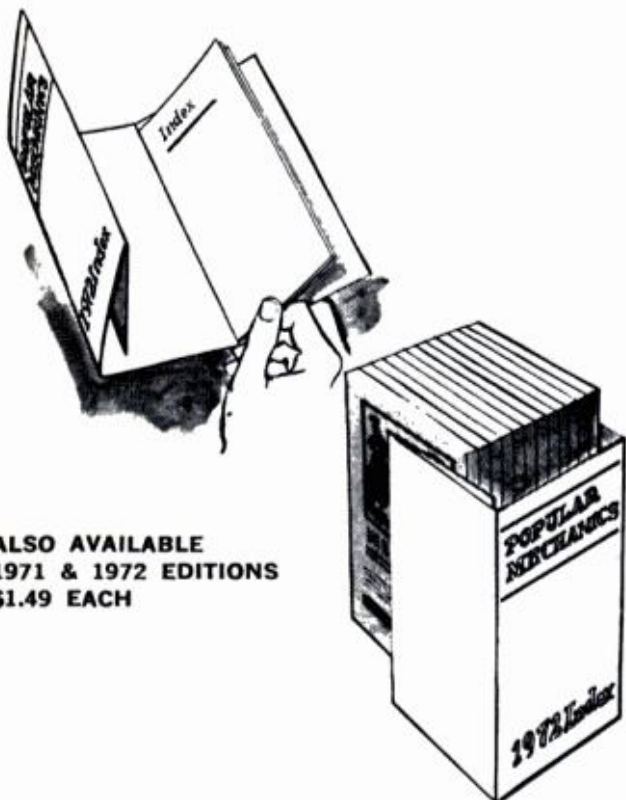

ALSO AVAILABLE
1971 & 1972 EDITIONS
\$1.49 EACH

Your copies of *PM* are chock-full of such information. *PM* publishes literally thousands of ideas and items each year. Sometimes, though, it can be frustrating to find an exact article that you recall appeared several months ago.

The new *PM Index and Shelf Wrapper* solves that problem. Each of those thousands of items which appears in *PM* throughout the year is not only referenced, but thoroughly cross-referenced as well. You can find *any* article you want in seconds! Or you can find *all* the articles on broad categories such as auto repair, electrical wiring, plumbing, photography and other subjects at a glance!

Best of all, the *Index* is bound into a handsome wrapper made of heavy board. The wrapper precisely encloses the 12 issues which are cross-referenced in the *Index*, and makes a beautiful and useful addition to your bookshelves.

Reserve *now* your copy of the *1973 Index and Shelf Wrapper* listing and cross-listing all *PM* articles published throughout 1973. We'll rush it to you just as soon as it becomes available in December.

The entire handsome package—*Index and Shelf Wrapper*—is yours for only \$1.49.

Write for your copy today!

Popular Mechanics, Dept. PMIX
Box 1014, Radio City,
New York, N.Y. 10019
Rush me, just as soon as it
becomes available, a copy of the
PM Index and Shelf Wrapper.
I enclose check or money order
for \$1.49.

CIRCLE YEARS WANTED 71-72-73

NAME _____
ADDRESS _____
CITY _____ STATE _____ ZIP _____

POPULAR MECHANICS

HOLIDAY SHOPPING GUIDE

SAVE! BUILD YOUR OWN POWER TOOLS

METAL PARTS KITS AT FACTORY DISCOUNT PRICES

- 10-in. TILT/ARBOR SAW
- 6-in. BELT SANDER
- SPINDLE SHAPER
- 9-in. TILT/TABLE SAW
- 18-in. BANDSAW
- 12-in. BANDSAW
- COMB. DRILL PRESS-LATHE

SAVE \$50 OR MORE with **PLANS, \$200** FULL-SIZE PATTERNS per Plan Deductible

Kits from \$19.99 to \$51.99
Featured in Popular Science, Mechanix Illustrated. Sold for 27 years. Thousands in use. Satisfaction guaranteed. Send \$2 each for Plans (state tools wanted), Catalog included. Or send 25¢ for Catalog!

GILLIOM MFG. CO.
Dept. PMT-10 St. Charles, Mo. 63301



Bartlett Flying Saucer ultra-light hovercraft powered by ordinary lawn mower engine—easy to build—fun to fly—complete plans, kit brochure, photos and supply sources \$3.00. All orders returned via airmail. Write:

HERB BARTLETT
Box 3339-M, Scottsdale, Arizona 85257

BUY YOUR OWN KART or MINI BIKE FRAME \$15!
for less than

SAVE UP TO \$50 IN COSTS...

NOW YOU CAN BUILD, BUY OR MODIFY your own recreational vehicle... Go Kart, Mini Bike or ATV... at **NEW LOW PRICES!** Giant new catalog includes hundreds of **FINEST QUALITY U.S.** made parts, kits and accessories. All welded Kart or Mini Bike Frames only \$14.95 (plus ship.). Catalog complete with plans, illustrations, pictures, diagrams & specifications only \$1.00 postpaid. Rush coupon today! (Calif res. add 5% sales tax)

Send check, cash or money order to → **KIT KAR, INC.** Dept. PMT 10
2521 W. Burbank Blvd. / Burbank, Calif. 91505

Send only \$1.00 for Catalog & Plans

MONEY BACK GUARANTEE

Print Name _____
Street _____
City _____ State _____ Zip _____

SAVE TIME... MAKE MONEY



SHARPEN SAWS... YOURS AND OTHERS

Professional workmanship comes easy with this portable precision tool which gums, joints, and then sharpens all types of circular saw blades, including cut-off, rip and combination styles as well as carbide tipped, dado heads and blades. Indexer eliminates guess work, sharpens any angle of bevel on circular saws from 4" to 24" diameter. Write for your free copy of "THE SAW FILING MAGIC of MICRO SHARP".

MARTIN ENGINEERING CO.
P.O. Box 337, Caledonia, Mich. 49316

DUNE-BUG

Complete plans & specs on how to build or buy - disc. prices on parts, kits, engines, & raw material.



Send \$1 for DUNE-BUG pkg. to: Box 987P10, Azusa, Ca. 91702, Ph (213) 334-0-334

MR. PERFECT PHYSIQUE™
Saul New York

Yes! Now you can gain weight, muscle-up all over. No gimmicks or gadgets. Just a brand new scientific body-building principle that packs on pounds of healthy body weight, slims flabby waistlines and gives you a brand new appearance. Add powerful muscles to your arms, chest, shoulders and legs. Send 25¢ coin to cover postage and handling costs, for **FREE** easy-to-follow plan.

now you can GAIN WEIGHT!

HERCULES II®, Dept. 15834
P.O. Box 78, Meadowvale, Ont. Canada

Name _____ (Please Print)
Address _____
City _____
State _____ Zip _____

FREE! Please send your free brochure under plain cover

SMALL ENGINES SERVICE MANUAL

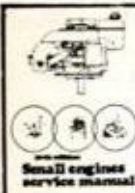

Small engine service manual

New 10th Edition
595

Send Check or Money order with order and we send Postpaid

Tells and Shows You How to Fix Small Gas Engines on LAWN MOWERS, Garden Tractors and Tillers and Power Equipment. Repair your own gas engines. *Make Money repairing for others.* New 10th edition gives complete information on repairing small gas engines under 15 cu. in. *Only universal repair book of its kind.* Information on all major manufacturers' engines. Over 300 pages with practical down-to-earth information for mechanics and *easy* for a beginner to follow.

HOW TO FIX YOUR BICYCLE



New 1st Edition
595

Send Check or Money Order with order and we send postpaid

Detailed instructions for adjusting and repairing the component parts used on all of the most popular bicycles. Covers over 120 models. *Fully illustrated. Easy to understand. Save time. Save Money.* A must for Every Bike Owner. Order Today. *Satisfaction Guaranteed*

SPECIAL Both for 10⁹⁵

Technical Publications Div
DEPT. PM-1073
1014 WYANDOTTE
KANSAS CITY, MO. 64105

SURVIVAL KIT

ALL OUTDOORSMEN—CYCLISTS
BOATERS—CAMPERS—SNOWMOBILERS

Includes energy foods, first aid items, 2-blade knife, mirror, compass, fishing tackle, waterproof container with matches, survival handbook, and more. In compact plastic resealable pouch. Weighs only 1 1/2 lbs. Satisfaction guaranteed. \$11.95 PPD—Cash, check, M.O.—Allow 3 weeks for delivery.

ED'S DISTRIBUTING CO.

P.O. Box 3212 Butte, Mont. 59701

PORTABLE STEAM CLEANER

Steam in 60 seconds



CLEAN: Engines—Air filters—lawn mowers—trucks—tractors

"Big enough to do the job, small enough to get there."

Fast, economical, ruggedly built. 3 year guarantee on coils & firebox. Propane fired. Weighs 120 lbs.

Auxiliary pump required on water pressures below 60 lbs. or on well systems.

WEDCO MFG. INC., Dept. M-4,

Box D, Jackson, Wyo. 83001

WATER
WATER
WATER
WATER
WATER

"HOW TO DRILL YOUR OWN WATER WELL"

\$1.00 ppd

SATISFACTION GUARANTEED

DEEPROCK CO.
OPELIKA, ALA. 36801

EXTRA MONEY

\$30 to \$50
A DAY



Operate a community sharpening service with an investment of \$150. Work from your basement or garage. Our manual guides you in professional methods of grinding, of business promotion and in pricing your work.

• Hand Saws • Circular Saws • Knives • Chain Saws
• Scissors • Pinking Shears • Clipper Blades
• Planer and Dado Blades • Mower Blades

John Rodock says: "Thanks for shipping Model 331. It has paid for itself many times since I purchased it. Please send latest price list on grinding wheels."

TREYCO P.O. Box 216-A
North Tonawanda, N.Y. 14120

START NOW...WRITE TODAY

100 SHOE STYLES FOR WIDE FEET and HIGH INSTEPS

EE to EEEEE Only
Sizes 5 to 13

Men only. Casual, dress, work shoes that really fit. Top quality. Money-back guarantee.

Write Today for FREE CATALOG



Not sold in stores

HITCHCOCK SHOES, INC.
Hingham 28-G, Mass. 02043



PORTABLE ELECTRIC POWER
BUILD-UR-OWN 110-volt plant from used parts and our PLANS. Also PLANS AVAILABLE for ALT-POWER, 110-volt power on your car, single TWIN-JET outboard motor for small boats and LIL BASS BOAT. Send \$2 for complete INFO PACKET on all plans, or write for FREE BROCHURE.

B-UR-O Co. 34161-B Coast Hwy.
Dept. PX, Dana Point, Calif. 92629

FIX LAWN MOWERS FOR FUN & PROFIT!

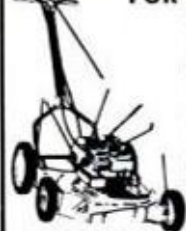

Fascinating new Handbook by F. Peterson gives you the knowledge skilled mechanics learn.

OVER 125 ILLUSTRATIONS show how to trouble shoot, repair carburetors, engines, balance and sharpen blades, etc. Exploded drawings are extensively used.

INSTRUCTIONS COVER reel, rotary and rider mowers, preventive and routine maintenance, how to identify brand names, where to obtain replacement parts. How to buy and use a lawn mower. Friends gladly pay \$10 to \$50 to fix their lawn mowers. Try the HANDBOOK OF LAWN MOWER REPAIR. Rush only \$6.95 plus 50¢ handling on 10-day money-back guarantee. EMERSON BOOKS, INC., Dept. 989X, Buchanan, New York 10511

PROTECT YOURSELF

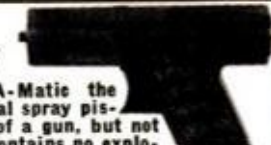

With Blast-A-Matic the potent chemical spray pistol. The feel of a gun, but not the danger. Contains no explosives or tear gas. Eight shots from a single cartridge. Stops muggers, rapists, gangs, in their tracks. Just aim at attackers face & squeeze the trigger. Use short bursts or long bursts. Temporarily blinds and disables for up to 15 minutes with no harmful after-effects. Always ready. Carry everywhere. Order today, for yourself—your loved ones. Only \$5.95 complete. Post paid. Replacement 8 shot cartridge ONLY \$1.95. For air delivery add \$1.00. No C.O.D. or minors. Illegal Calif., N.J., Canada.

TEAR GAS PRODUCTS CORP.

P.O. Box 291-M-10
Vincentown, N.J. 08088
Fastest mail order shippers in U.S.A.

WHEEL BALANCERS

Bubble & Suspension
\$14.95 to \$29.95

Trucks, all European & American cars. Send for free illustrations and price list.

JACOBSEN MANUFACTURING

P.O. Box 6143PM, 15025 Pacific Hwy. So.
Seattle, Washington 98188



Want to make some easy money?

Let us show you how to begin AT ONCE...full or spare time. Many report \$10 to \$50 PROFIT FIRST HOUR! Nothing to buy...no salesman will call. EVERYTHING NEEDED SENT FREE including BEAUTIFUL SAMPLE!

Write: Russell Products Co.
DEPT. K25 COLUMBIA, TENN. 38401



BUILD YOUR OWN

Cabover Campers • Covers
16' & 20' Travel Trailers
• PLANS •
PATTERNS • KITS
★ FREE CATALOG ★
GLEN L Recreational Vehicles



9152P Rosecrans, Bellflower, Calif. 90706

IMPORTED

LOCK BLADE KNIFE

ONLY \$275 each

9" Overall Length
5" When Closed
• Sharp and Tough
• Stainless Steel Blade



Locks into position to prevent accidental closing.

Razor sharp tough stainless steel blade for reliable use and hard long service. Money back in 5 days if not satisfied. Send \$2.75 plus 25¢ to cover postage and handling.

WESTBURY SALES CO.

P.O. Box 434, Westbury, N.Y. 11590
Dept. L-16-PM

KARATE

JUDO • SAVATE • JIU-JITSU

The Greatest Self-Defense System Known to Man! FREE Brochure reveals Self-Defense Techniques.

Send to: Universal, Dept. M
Box 39303, Detroit, Mich. 48239



FREE



SILVO
(BRAND NAME)
TOOL
CATALOG
Thousands
of exciting
tool values!

Stanley, Skill, Thor, Wen, Disston, Wiss, Wellsaw, Dremel, Plumb, Huot, Kennedy, Channellock, Rockwell, Helms, Vice-Grip, Crescent, Rigid, Pony Clamps, Unimat, Foredom and many other Nationally Advertised brands of Tools & Supplies. We ship Coast at price.

Send \$1.00 for our big 196 page tool catalog today.

Silvo Hardware Co., PM-73
107 Walnut St., Philadelphia, Pa. 19106

FACTORY CLOSEOUT!
AIR PISTOL \$6.95
(with Free can of pellets) **6** ppd.

Shoots both pellets and darts. This fine, well made .177 cal. German air pistol is just the ticket for target or Varmints.

Accurate. No CO2 cartridges to replace, either. Once in a lifetime bargain. Order several. Supply limited. Only \$6.95 ppd. (Secret leather holster, \$2.95 ppd.) 600 Deluxe Pellets, \$2.40 ppd. 20 Steel Darts, \$2.00 ppd. **AIR PISTOL, Dept. PM-10**
4535 Huntington Dr. South
Los Angeles, Calif. 90032



FREE!!! POWERFUL MUSCLES FAST!
Fantastic New Discoveries in the science of bodybuilding. Now, in the privacy of your bedroom, our method will add inches of powerful muscles to arms, chest, shoulders & legs. Learn secrets on trimming the waist with ultra-modern methods—fast! Results Guaranteed! Send for free brochure. Universal Bodybuilding, Box 485-M1, Dearborn, Mich. 48121.

Build **POPULAR MECHANICS'** little **CARRIAGE HOUSE!** Simply great! A backyard building that isn't an eyesore. Styling blends in with most homes. It will take your mower, lawn furniture and too's—or the kids' overnight guests. Use it as your shop or home office. Overall outside dimensions 10-ft. 4 in. x 12-ft. 4 in. For one complete set of plans send \$3.95 to **POPULAR MECHANICS Dept. FA, Box 1014 Radio City, N.Y. 10019.** For two sets of plans (you may need one for your local building department) send \$5.49.

ATTACK!

It can happen in your own home. A stealthy intruder—unheard—and then it's too late. Or... a tiny flame begins to grow into a roaring blaze. Now, at last, you can protect yourself, your family, your home against break-ins and fire damage with the dependable, proven Multi Monitor Home Security Alarm System. A sophisticated electronic system—at surprisingly low cost!

Dept M-1 Write for full details, including **FREE Home Security Planning Guide.**



MULTI MONITOR SYSTEMS INC.
Washington Federal Bldg.
633 N.E. 167th Street
Miami, Florida 33162

110 Volt A.C. GENERATORS

60 cycles. Fanbelt driven from car or gas engine. Operates T.V., refrigerators, radios, all power tools, projectors, P.A. systems and fluorescent lights. Over 12,000 in service. Guaranteed six months. 1500-watt \$65.00 postpaid. 3000-watt \$105.50 postpaid. Special X-1000 watt self-excited generator \$85.00 postpaid.

TOOL POWER™ patent pending

115 volts D.C. 5000-watts. 50 amps from your car's alternator. **Guaranteed 20 years.** Install in ten minutes. Operates all power tools, electric motors up to 2 h.p. Are welding, fast battery charging. Any like device by any name is an infringement of our patent pending. All copiers are notified. Be safe, buy from the inventor and developer. \$25.00 postpaid. Attractive dealer plan.

VIRDEN PERMA-BILT CO.,
P.O. Box 7160PM
2821 Mays, Amarillo, Texas 79109

DIGITAL: THEORY, DESIGN, CONSTRUCTION

LOGIC NEWSLETTER ©

SAMPLE COPY \$1.00
LOGIC NEWSLETTER
POB 252
WALDWICK, N.J. 07463

PLASTIC CUTTER

CUT SHEET PLASTIC, MICA, TILE, EASILY

AMAZING NEW TOOL

Save hundreds of dollars remodeling kitchen cabinets, ceilings, floors, etc. with this new cutter
ORDER NOW AND INSTRUCTIONS ON CUTTING WILL BE INCLUDED
Satis. Guar. No C.O.D.s
Add 50¢ Handl. & Post.
Dealership inq. inv'trd Only

\$4.98

TOLCO 930 N.W. 27th AVE.
MIAMI, FL.

DETROIT APPROVED PICKUP TANKS



Original equipment type poly, now available in auxiliary tanks for pickups. Increase gas capacity 40 gals. Far superior to metal, complete hidden, no body work necessary. Easy 1 hour installation—Truck discounts pay for tanks in a short time. Two tanks, brass valve, hose, complete. Meets Federal Regulations.

PICKUP EQUIPMENT CO. LTD.
Dept. PM-1073, P.O. Box 7635
WACO, TEXAS 76710
CALL TOLL FREE 800-433-2386

HEARING AIDS
UP TO **50% OFF** COMPARABLE AIDS ★

BUY DIRECT • 20 DAYS FREE TRIAL Body Aids \$49.95 up. Tiny All-in-the-Ear: Behind-the-Ear; Eye Glass Aids. No salesman will call. Write **LLOYDS**
★ Dept. PM, 905 9th St., Rockford, Ill. 61108 ★



Easy to Build PLANS AND INSTRUCTIONS for

- Go Kart\$2.00
- Mini Bike\$2.00
- Three Wheeler\$2.00
- Three Wheeler A.T.V. \$5.00
- Mini Car\$3.00
- Pedal Boat\$4.00
- 12' Sail Boat\$4.00
- Sail Board\$2.00
- Pontoon Boat\$1.00
- 8' Hydroplane\$2.00
- Two People Mini Jeep\$3.00
- Snowmobile Sleigh\$3.00



MINI VEHICLES PLANS
"DEPT. C"—P.O. Box 92
Chazy, N.Y. 12921

HEX NUT-SIZE RE-THREADER

DIES

Run on and off with regular wrench to renew bad threads! 7 Piece Die Set in Plastic Case works on sizes: 1/8", 5/16", 3/8", 7/16", 1/2", 9/16" and 5/8"



C7 = Coarse F7 = Fine Threads
\$3.25 Set, Get Both for \$6 Ppd.

Satisfaction Guaranteed
JAW MFG. Box 213 Reading, Pa. 19603



Build This All-Wooden Clock

Complete plans for building this unique clock. 100% wood. All moving parts visible. No special tools required. Separate

hour, minute, and second hands, weight driven, keeps perfect time. May be mounted in large grandfather case or displayed on pedestal or shelf. A simple project for the woodwork hobbyist or clock enthusiast. Plans only, \$4.00 plus 50¢ handling. R. D. Thomas, 1412 Drumcliffe Rd., Winston Salem, N. C. 27103

CLASSIFIED ADVERTISEMENTS

Rate: \$2.20 per word payable in advance each insertion. Capitalized words—75¢ per word additional. Minimum insertion ten words. To be inserted under the proper classification, copy must be in our office by the 10th of the second month preceding date of issue. The next available issue to place an advertisement in America's No. 1 Classified Section is December. The closing date is October 10th. Send remittance and order to H. E. Kappel, Popular Mechanics, 224 West 57th Street, New York, New York 10019. Please make remittance payable to Popular Mechanics.

POPULAR MECHANICS

WHEN ANSWERING ADVERTISEMENTS PLEASE USE THE ZIP CODE NUMBER

CHRISTMAS GIFT SHOPPING

CHRISTMAS Shop Early. Gift Catalog. Stamp 25¢. Deans, 1808 Neptune, Bossier City, La. 71010.

DISTINCTIVE Gift Ideas. Catalog 25¢. Gifts 'n Gadgets. (1A10), Box 312, Carrollton, Texas 75006.

ATTRACTIVE 10 "Stained Glass" Musical Angels. Perfect for Hanging on Christmas Tree. Send \$1.69 for Set. Zera & Co., 2227 South 15th St., Milwaukee, Wisconsin 53215.

FANTASTIC Gift! Actual Roses, Rosebuds, Preserved in 24KT. **GOLD**. Fashioned into Exquisite Brooches, Earrings, etc. Reasonably Priced! Free Literature! Laborhouse, Suite 1U, 148 West 67th, New York, New York 10023.

ANCIENT Roman Chess Sets & Beginners to Strategic Chess Books. Ideal for Gifts. Other Style Sets Available. Free info. Write: Hinsdale House, Dept. AM, 9117 Hasty Ave., Downey, California 90240.

USEFUL Gifts! Reasonable! Illustrated Catalogue 25¢. S&E Sales Co., Box 48PM, Brooklyn, N.Y. 11226.

JIGSAW Photopuzzle—From your Color or b/w photographs, 11x14 b/w puzzle. Photo Returned Unharmed. \$4.98: Our Times, 520-B Fifth Avenue, New York, New York 10036.

GENUINE Copper Link Bracelets. Lifetime Guarantee. Mens \$7.00, Ladies \$5.00. **JAMES**, Box 213, St. Joseph, Michigan 49085.

FREE CATALOG SAVES 40%. Quality Gifts. From Wholesaler. Wholesaling Books. Dealers Invited. We Dropship. Thomco. 171-08J Hillside, Jamaica, N.Y. 11432.

JUST CARRY IT. Made Exclusively Yours—Free . . . 28 Smart Styles . . . \$1.00. Meriam Bags, 9505 Lavergne, Skokie, Illinois 60076.

AUTOMOBILES

CAPACITIVE DISCHARGE IGNITIONS. DISCOUNTED. Rodgers, Son (PM), Box 3583, Anaheim, Calif. 92803.

AUTOMOBILE SIXTY SECOND TIRE FIX. No Tools—No Jack-Dealers Invited. Sample, And Details, ppd. \$3.98—Warne, 6922 Congress, Detroit 48207.

1974 AUTO Wholesale Prices, \$2.00. Petros Products, 5404-A South Mozart, Chicago, Ill. 60632.

"WARNING: Protected by Electronic Burglar Alarm" Decals 4/\$1.00. Protect Car, Boat, Cycle, Home, Office, Apt., Etc. Benci, 42 McKee, Floral Park, New York 11001.

PROTECT Your CAR Against THEFT. Write: Ameri-Way, 2475 Devon, Elk Grove Village, Illinois 60007.

"AUTOMOBILES", 1895—1930 REPRODUCTIONS. Wonderful, Rare Old Catalogues, Cartoons, Advertisement, Manuals, Humor Memorabilia: \$4.95, 38¢ Postage. White's, Route No. 1, 761AA Ludington, Michigan 49431.

MIDGET CARS

YOUR AD IN POPULAR MECHANICS WILL BE SEEN By More than 5,000,000 active buyers for your products and services. It costs only \$2.20 per word. And, if you wish to run all or part of your ad in bold capital letters—you can do so for as little as 75¢ per word additional. Act now! Send your Classified ad to: **POPULAR MECHANICS, CLASSIFIED DEPARTMENT, 224 WEST 57TH STREET, NEW YORK, N. Y. 10019.**

EASY TO BUILD PLANS AND INSTRUCTIONS FOR: GO KART . . . \$2.00—Mini Bike . . . \$2.00—Three Wheeler . . . \$2.00—Three Wheeler A.T.V. . . . \$5.00—Mini Car . . . \$3.00—Pedal Boat . . . \$4.00—12' Sail Boat . . . \$4.00—Sail Board . . . \$2.00—Pontoon Boat . . . \$1.00—8' Hydroplane . . . \$2.00—Two People Mini Jeep . . . \$3.00—Snowmobile Sleigh . . . \$3.00—**MINI VEHICLES PLANS, "DEPT. C2"**—P.O. BOX 92, CHAZY, N.Y. 12921.

AUTO SUPPLIES AND EQUIPMENT

ONLY This UNBELIEVABLE DIRECTORY Lists 950 Wholesalers who sell Direct! Everything wholesale! Auto Accessories, Watches, Televisions, Tvs, Tools—etc.—to Zippers! Guaranteed! Now \$3.95! (Regularly \$7.95) Wholesaler, 8616 Hull Drive, Philadelphia, Pa. 19118.

GREASE GUN Only \$2.95 plus \$4.00. Interprod, Box 216, Scarsdale, New York 10583.

SELL \$2.50 Can Guaranteed. Weldtite Transmission Conditioner, 120 North Fourth Street, North Wales, Penna. 19454.

110 VOLTS Portable Power Anywhere. Free Details. Grant & Masters, 837 Morton Street, New Castle, Penna. 16101.

TROUBLESHOOT Automatic Transmissions. Your Choice. Instructions \$5.00. Dapco, Box 729, Killeen, Texas 76541.

THIEVES CAN'T Drive your car when this easily installed system is used. Plans \$1.00—kit \$3.50. Farleys, Box 285, King of Prussia, Pa. 19406.

AIRMASTER Gas Saver Fits All Cars, \$14.95. Airmaster, Lenora, Kansas 67645.

ALTERNATOR/Generator Rebuilder's Course; includes Tooling & Test Equipment; Write: Hedelund Engineering, P.O. Box 2127, Sepulveda, California 91343.

PARTS: Army jeep and truck parts. Spare Parts & Equipment Co., P.O. Box 751, Lexington, Kentucky 40502.

RING-Valve Job while driving, \$6.50 postpaid. (Two-\$12.00). . . . Established 1951. . . . Results Guaranteed!! Motaloy, Grantham, Penna. 17027.

"FREE INFORMATION" Aire Puffed Plastic Seat Covers. For All Cars. Alpine Sales, 5213-A Alpine St., Fayetteville, N. Car. 28301.

SAVE \$\$\$\$ MOTALOY Ring-Valve Job \$5.95. **AIRMAILED!!** With **FREE GIFT!!** Guaranteed!! Free Information. Flewellings! Box 21-PM10, Tustin, California 92680.

GUARD YOUR CAR! Auto Guard Foils Car Thieves! Easy to install. Only \$7.95—Guaranteed! Order Now!! **HARCO**, Box 1296, Desk 1PM10, Jacksonville, North Carolina 28540.

TOWING Rig Complete \$295.00. Jeep Winches \$95.00. **BEJAY**, 4085 Lincoln, Venice, Calif. 90291.

UTILIZE AC Motors as AC generators—three phase motors on single phase—auto generator to DC motor—\$1.50 each. DanRan, Box D, Reno, Nevada 89506.

PREVENT Car Theft. Anti-Theft device installs in minutes. Send \$5.95 to: Jerson Enterprises, 16 Algiers Street, Plainview, New York 11803.

NOVEL Inexpensive Glowing Gage Continuously Checks Ignition Performance. **QARC**, Box 47876, Los Angeles, Calif. 90047.

BEAT THE METERMAID. Attractive, Useful Keychain Timer. Five Minutes to One Hour—sounds Buzzer. Send for further information or send \$5.98 now. **BARNEL**, 849 Granada Pkwy., Lindenhurst, New York 11757.

FREE—Plastic Gloves with "VACU-SHINE". Wash and Shine car 50—100 times with miracle cloth without soap or water in five minutes. Guaranteed! Only \$2.98. Moore Enterprises, 1115 Simpson, Dept. 102CA, Tupelo, Miss. 38801.

EXCLUSIVE FOREIGN Car Auto Dismantling. Import Auto Supply, 101 No. Manchester, Anaheim, California 92802. (714) 776-9900

AUTO DEFROSTER FOR THOSE COLD MORNINGS. Just plug into a cigarette lighter, super heated air melts thick ice and snow. Complete with snow scraper. Only \$8.50. Mr. Benny, 1353 Jefferson Ave., Brooklyn, N.Y. 11221.

GIVE YOUR CAR A Ring and Valve Replacing Job. Amazing Chemical Works While you Drive. **GUARANTEED!** One Treatment Needed! Only \$6.00. **UNITED PRODUCTS**, 767 Hamilton Drive, Pleasant Hill, California 94523.

SNOWMOBILES

KID'S SNOWMOBILE Under \$75.00: 3 1/2 H.P., Front Skis for Winter Wheels for Summer; Super Christmas Gift; Easy to follow Plans \$5.95. Albar-M10, RR Box 386, Yarmouth, Maine 04096.

MAKE YOUR OWN SNOWMOBILE. Propeller driven by a Continental aircraft engine. Drives over snow and ice. Becomes a "self contained" trailer in 15 min. when necessary to transport snowmobile over drv highways. Buy a photocopy of article as it appeared in P.M. for \$1.25. Send orders to: Popular Mechanics, Dept. HE, Box 1014, Radio City, N.Y. 10019.

AUTO TRAILERS

FIFTH Wheel Trailer, Pickup Camper, Cover, Trailers. Build Yourself. Save! Complete plans—Fifth Wheel \$9.95; Camper \$4.95; Trailer \$3.95; Cover \$2.95. Conversions—Econoline type Van \$3.95; Passenger bus or delivery Van \$3.95; Equipment Catalog \$1.00 (refundable). Details 25¢. Our 13th year. Viking Camper Supply, 99-F Glenwood, Minneapolis, Minn. 55403.

MOTORCYCLES, BICYCLES, MOTORSCOOTERS AND SUPPLIES

POWER COASTER-Elec. Bicycle Kit \$19.95 PP. Complete Instructions Included. Cooke Cycle Company, 9245 S. Meade, Oak Lawn, Illinois 60453.

MAKE Your Bicycle Electric, Plans \$2.95. Kielian, 130 Drake, South San Francisco, Calif. 94080.

HONDA, \$25. Other Bargains. Send \$1.00. (Refundable). Motorscooter, P443, Bend, Oregon 97701.

BOLT-ON TORQUE CONVERTER Makes out-dated, out-classed, mini-bikes competitive, mean machines. More Low end muscle—more high end hustle. Fits B&S, Tecumseh, most engines. 35 minute installations. \$34.95 ppd. No C.O.D. Information + decal 25¢. **MAX-TORQUE, Inc.,** 7300 Monticello, Skokie, Illinois 60076.

ILLUSTRATED catalog, 25¢. Parts And Accessories. Custom And Stock. For Most Makes and Models. Motorcycle Supply, Box 159M, Fairbury, Illinois 61739.

GO-KART—MINI-BIKE Plans. Easy to follow. **SAVE MONEY.** Build your own. Go-Kart plan \$2.00. Mini-Bike plan \$2.00. Both plans \$3.00. **GUARANTEED.** RWM Sales, P.O. Box 660A3, Belleville, Illinois 62222.

GO-KARTS Factory Direct Low As \$19.95. Send 35¢ for Catalog. Schmieder Motors, RD #1, Doylestown, Penna. 18901.

BICYCLES—Quality 3, 5, 10, 15 speeds Specialty Components, Tools, Clothes, Shoes, Etc. Send \$2.00. WARES Catalog, Department P.M., 2656 N. 76th, Milwaukee, Wisconsin 53213 (Since 1939)

BIKE AND MINI-BIKE GOGGLES. All Purpose, Well Padded, \$1.00 P.P. Phillips-Wilson, P.O. Box 3125 Augusta, Ga 30904.

BICYCLE PARTS CATALOG. Gold mine for hard to get foreign and domestic parts, tools and accessories. Send \$2.00 for this big 8 1/2 x 11 inch 160 page catalog. Refundable if not completely satisfied. Wheel Goods, Dept. J, 2737 Hennepin, Minneapolis, Minnesota 55408.

ATV'S! TRAIL-CYCLES! Trailers! Kits. Discount Catalog 25¢. Lorenzo, Danville, Illinois 61832.

BICYCLES—Replacement Parts, Tools, Accessories, Repair Books, over 1,000 Items. 1973 Catalog. \$1.00 Refundable with \$5.00 Purchase. Action Accessories, Box 15, Liverpool, New York 13088.

SPACE, ROCKETS AND ASTRONAUTS

50 DIFFERENT Space Program Post Cards \$3.25. Apollo Pictures, Box 487A, Melbourne, Florida 32901.

ANTIGRAVITY DEVICE. Brochure rushed free. AGD, Box 3062 PM, Bartlesville, Oklahoma 74003.

MILLION DOLLAR MODEL ROCKET SALE. Countdown for savings. Kits, Motors and Supplies. Everything 1/2 Price. Send 25¢ For Complete Catalog and Decal Packet. AVI, 10PM, Mineral Point, Wisc. 53565.



AVIATION

BUILD—One-Man jet helicopter. Easy Inexpensive. Detailed plans, drawings—\$5.00. Helicraft, Box 7153, Baltimore, Maryland 21218.

ALL About Ballooning. Handbook \$3.00. Aerostation, Box 141, Long-Sault, Ontario, Canada. KOC IPO

BE A Government licensed aviation mechanic. Practical training. Free Information. Aero Mechanics School, Dept. PM, Municipal Airport, Kansas City, Missouri 64116.

AIRBOAT Propellers, Engines, Hubs, Mounts, Supplies, Corvair, V-W Conversions. Removeable Airdrives. Catalog \$1.00. Banks-Maxwell, Box 3301E, Ft. Worth, Texas 76105.

AMAZING SCIENTIFIC BREAKTHROUGH IN HOT AIR BALLOONING! Use easily available materials and construct self-propelled models for less than 20¢ each which soar hundreds of feet. . . . Glow like UFO's at Night. Educational, and Great for Parties, Too. Guaranteed. Send \$1.00 for Complete Plans. Fly-By-Nite Kite Co., P.O. Box 8439, Richmond, Va. 23226.

HELICOPTER Kits. VW Powered, Inflight Photos and Information 50¢. Drawings \$5.00. Weilage Helicopters, Box 1267, Redwood City, California 94064.

HOVERCRAFT

HOVERCRAFT Plans. All sizes; Tested designs. Photos. Information: \$1.00. Universal Hovercraft, 2611 182nd Place, Redondo Beach, California 90278.

INSTALL Kart, Lawnmower, Snowmobile Power On This Hovercraft. Plans, Instructions, \$6.00. Airboat Plans Instructions, \$5.00. Design Book For Homebuilders, \$5.00. Palmer Aerosystems, P. O. Box 1891M10, Coral Gables, Florida 33134.

AERO-CAR. Amazing Hovercraft built easily with ordinary tools. Lawnmower engine power. Carries one man plus. Hovers, flies forward, backward, sideways over land/snow/water. Complete construction plans and brochure, \$5.95. Aero-Projects, Box 5118PM, Clinton, New Jersey 08809.

HOVERLOG '73—Most Complete Hovercraft Catalog Available. JLO Engines, Multi-Wing Fans, Plans, Kits, "Hoverbikes". Complete Catalog \$2.00. Venture, Dept. 503, Box 5273, Akron, Ohio 44313.

HOVERCRAFT Plans by **HOVERCRAFT ENGINEER.** Two Seats. Triple Engines, and Fast!!! \$1.00 Brochure, \$4.98 Complete Professional Size Drawings. Engineering Services Reg'd, P.O. Box 10, Fulton, New York 13069.



BOATS AND TRAILERS

NEW! FREE BROCHURE. Complete specifications 25 most popular race boats. Amazing, easy plans show how to build and save. Champion Boats, 5849 Hazelbrook, Lakewood, Calif. 90712.

LOUISIANA CAJUN PIROGUE PLANS. Easily Built in 8 Hours. 14' Long. Simple, Precise, Step Instructions. Send \$2.00. Parker Plans, 2843 Hyman Place, New Orleans, Louisiana 70114.

CANOE KITS—Wood Canvas, Molded Fiberglass—Free Catalog. Trailcraft, Inc. Box 60686, Concordia, Kansas 66901.

FIBERGLASS BUILDERS MATERIALS Lowest factory prices in cloth, matt, roving, resin, epoxy, foam, nails, fittings. Send \$1.00 for literature (refundable) or \$2.00 for literature plus booklet on Mold-making and "How to Fiberglass". Clark Craft, 16-P1 Aqua Lane, Tonawanda, N.Y. 14150.

FIBERGLASS Canoes, Kayaks, and Duckboats. Many exciting models. Easily assembled kits, \$44.95 up. Free Literature. Riverside Canoes, Box 5595P, Riverside, Calif. 92507.

FIBERGLASS Cloth, matt, polyester and epoxy resins. Wholesale catalog 25¢. Boat Molding book 30¢. Seifert's, Box 1206-M, Green Bay, Wis. 54305.

BOAT KITS-PLANS AND PATTERNS-FRAME KITS, World's largest catalog. Over 300 top designs from 7-77' in plywood, ferro cement and fiberglass. Sailboat include: Windmill, Snipe, Motor Sailers, Trimarans, Catamarans. Powerboats include: Cruisers, Houseboats, Deep V's, Fishin'ski, Runabouts, Hydroplanes. Canoes, Kayaks, inboards, outboards. Send \$1.00 for large catalog or \$2.00 for catalog plus "Boat Builders Guide". Clark Craft, 16-P Aqua Lane, Tonawanda, N. Y. 14150.

BOAT PLANS, FULL-SIZE PATTERNS, FRAME KITS With step by step written and pictorial instructions especially for amateurs. Easy to build. Send \$1.00 for **HUGE 100 PAGE** Illustrated Catalog. Over 125 modern designs from 8 to 49'. Includes Sail, Jets, Inboards, Outboards, Cruisers, Houseboats, Hot Boats, Catamarans, Hydros. Also available—"Boat Building With Plywood" Hard cover—219 pages \$7.50. GLEN L. 9152 MP Rosecrans, Bellflower, Calif. 90706.

FIBERGLASS Cloth and resin. World's finest cloth and non-rum resin, at direct mill prices Flotation foam. Complete line of plastics, silicon bronze and brass screws, save 60%. No sales tax. Boat Plans Catalog 25¢. Freight prepaid. Ship's Boat Supply, Box 11P, Linden Ave., Mantua Heights, N.J. 08051.

CANOE! Kayaks! Factory-direct quality kits. From \$25.00. Many different models. Canvas hulls. Strongest construction materials. Free literature. Sportscraft, Box 636-P, Allentown, New Jersey 08501.

FREE Catalogue—plans, patterns: Canoes, sailing canoes, kayaks, 14-17' trailable cruising sailboats. Quicksilver, 255A Shamrock Blvd., Venice, Florida 33595.

KAYAKS, Canoes, Plans, Kits, Finished Craft, Books. Free Catalog. Outdoor Sports, Box 1213P, Tuscaloosa, Ala. 35401.

BOAT Kits. Molded Fiberglass. Save money-assemble yourself. Factory model sections board into one-piece craft. 20 models-14' to 32' Cruisers, Runabouts, Sailboats, Accessories, Motors, Trailers. Easy terms. Free catalog. Luger, Dept. BC-73, 3800 West Highway 13, Burnsville, Minnesota, 55337.

NEW 1973 Outboards . . . Top Brands 6 H.P. \$288 . . . 18 \$418 . . . 40 \$565 . . . 50 \$728 . . . 65 Electric \$958 . . . 85 Electric \$1,098 . . . ALL SIZES . . . Scott-McCulloch Parts . . . Handling 50¢ . . . Electra Marine, 610 Merrick Rd., Lynbrook, New York 11563.

FIBERGLASSING? Complete Instructions! "Craftmans Fiberglass Manual." Only \$2.00 Postpaid! Edryn Corporation, Box 537-PF, Cocoa Beach, Florida 32931.

FIBERGLASS Cloth, mat, resin. Flotation foam. Complete supplies. Catalog 25¢. Kick-Shaw, Inc., 3511 Hixson Pike, Chattanooga, Tenn. 37415.

200 PLANS, Patterns, some Kits. Catalogs: Powerboat (2), \$1.25. Sailboat \$1.00. Boat, Pickup Camper, House Trailers, Cottage plan lists. Marinecraft, Box 161-M, Brighton, Mass. 02135.

(Continued on next page)

BOATS AND TRAILERS

(Continued from preceding page)

TWIN Engine Airboat. Portable Air-drives, Airboat Plans, \$5.00. Hovercraft Plans, \$5.00. Kits, Engines, Propellers, Supplies. Catalog \$2.00. Arrowcraft-PM, Pearland, Texas 77581.

CATAMARAN 45 foot fiberglass Hulls—Info-\$1.00—Int. Cats., POB 16185, Tampa, Florida 33617.

LIGHTS "THOUSAND-LIVES"™. Battery Powered, Cordless, RECHARGEABLE. Table-lites, Lanterns, Flashlights. Use Standard Dry Cells, or Nickel-Cadmium "LIFE-TIME" ("Never Buy Batteries Again"). Free Literature. Heydecker, 500-F West End Avenue, New York, New York 10024.

CAMPERS AND TRAILERS—KITS—PLANS—

VANS—Save Space, Avoid Built-ins. Rear-door portable camping kitchen, Crafts Workshop, Large Table, Plans \$1.00. Wilcox, Box 6204B, Albany, Calif. 94706.

CABOVER Campers & Pick-Up Covers for Compact & Standard Trucks, 16 & 20 Trailers. Build and Save. Large scale plans and full-size patterns with written & pictorial instructions. Complete accessory and aluminum covering kits. Free literature. Glen L. 9152PM Rosecrans, Bellflower, California 90706.

PERFECT Backcountry reception with your Radio, Campers, Trailers, Motor-homes, free details. Signal Booster, 18196 Camino Diablo, Yuma, Arizona 85364.

MARINE EQUIPMENT AND SERVICES

MARINE Engines, conversions, parts, equipment. Catalog Free! Stokes Marine Industries, Coldwater, Michigan 49036.

FREE Brochure Conversion Kits, Propellers, gears V-Drives 1/0 Drives Gas, Diesel, Starmarine, 1931 Embarcadero, Oakland, Calif. 94606.

MARINE Supplies, Ignition Parts. Free literature. Michael's, 991 Broadway, Bayonne, New Jersey 07002.

KITS for Engines. Beat 1975 emissions, gain performance on less fuel, even Kerosene. \$5.00 Kit for single cyl. and Diesels. For others, send stamped, self-addressed envelope. Power Genie, Box 872, Lancaster, Pa. 17604.

CONVERT Auto engines to marine. 68 Page Catalog, 50¢. Lehman Manufacturing Company, 800 Elizabeth Avenue, Linden 4, New Jersey 07036.

ATHLETIC AND BODY BUILDING COURSES

FREE SELF-DEFENSE Informative Literature. Men, Women, Teenagers. Illustrated Judo, Karate, Kungfu Books. Jorgensen, Box 70482-11073, Seattle, Washington 98117.

POWERFUL Muscles fast! Free brochure. Universal Bodybuilding, Box 4327-C, Dearborn, Michigan 48126.

KUNGFU, Illustrated instructions, \$2.00 complete. RSH, 5834 Manton, Chicago, Illinois 60646.

"GIANT Arms." Dr. Young. Revolutionary discovery. Inquire. Gaucho, Box 1769-A7, Chicago 60690.

"GIANT Arms". American Indian Hand Wrestling Kit!!!! Junior—\$7.98. Adult—\$12.98. Moneyback Guarantee. Modern Enterprises, Dept. PM10, Santa Anna, Texas 76878.

KUNG-FU, Karate, Judo Books. Fighting Weapons. Films. Giant Brochure-\$2.00. Green Dragon Fighting Society, Dept.-PM, 4350 N. Cicero, Chicago, Illinois 60641.

KUNGFU Manual on Poison-Hand, Death-Touch \$2.29. Manual on Fighting Like Cobra, Tiger, Dragon, Leopard, Snake—\$6.25. Green Dragon Kungfu Fighting Society, 4350 N. Cicero, Chicago, Illinois 60641.

MIGHTY BODY YOURS IN MINUTES A DAY. \$2.00 FULL COST. CHAMPAGNE'S, BOX 15322, BATON ROUGE, LOUISIANA 70815.

KUNG-FU Secrets. 350 Photos. Complete, Easy Instructions, \$1.95 + 30¢. Johnson-Smith, 10 Auto., Mt. Clemens, Mich. 48043.

ARMS 18-20 Inches in 90 Days or Refund!! Miraculous Revelation! \$3.00. Phenoministics, Box 281, Gresham, Oregon 97030.

SHORT STATURED? Growth, Height Increase Facts, Medical Details. Adults, Youngsters. 25¢ to: Physical Culture, Box 1548-PM10, Pompano Beach, Florida 33060.

MASCULINE Voice Builder, \$1.98 Training Album: Manmakers, Box 11567, Chicago, 60611

SPORTING GOODS AND EQUIPMENT

FREE Catalog low direct factory prices, fishing, Hunting, Archery, reloading Camping supplies. Send today. Herters Inc., Dept. CPM, Waseca, Minn. 56093.

FREE WHOLESALE CATALOG. Lure parts, Molds, Rod Blanks, Reels, Archery, Metal Detectors, Rare Hardwoods. Finnysports (ME), Toledo, Ohio 43614.

ARCHERY Lowest Discount Prices. All top brands. Orders shipped same day received. Money-back guarantee. World's Largest Supplier. Free catalog. Anderson Archery Corporation, Grand Ledge, Michigan 48837.

FREE CATALOG. Fishing Tackle, Archery Hunting and Camping Equipment. Lowest Prices. Cabela's, Inc., Dept. S-22, Sidney, Nebraska 69162.

MILITARY SURVIVAL KNIFE! Free Brochure: VRC Co., Box 4212-P, Columbus, Georgia 31904.

AQUARIUM SUPPLIES

AQUARIUMS. Filters, Fishfoods, Air-pumps. World-champion Guppies. 448-page Fishbook, \$3.95. Catalog 25¢. Fishmart, Ortonville, Mich. 48462.



FISHING, TACKLE, LURES

MOLDS—For casting your own fishing sinkers. Free illustrated booklet. Reading Instrument Co., Box P-78, Reading, Pa. 19603.

FISHERMAN'S DREAM BOOK—FREE, 170 page catalog just loaded with Hard-To-Find Fishing Tackle Specialties and Do-It-Yourself Goodies. Our 29th year. NETCRAFT Inc., Box 5510, Dept. PM-12, Toledo, Ohio 43613.

CAST Flexible Worms. Make your own lure, sinker molds. Easy, inexpensive, profitable. Free. Castolite, 73L/PMF, Woodstock, Illinois 60098.

CATCH All The Catfish You Want. Mv Secret. Send \$2.00 To: H.L.D., P.O. Box 1001, Destin, Fla. 32541.

EARTHWORMS, LIVE BAIT

HOW To Make Money Raising Fish-worms! Details Free. Gloworm, Department P0187, 3910 Efin, Louisville, Kentucky 40207.

EARN Money raising fishworms for us! Exciting details free! Oakhaven—56, Cedar Hill, Texas 75104.

FREE Literature. Profitable Business Raising Fishworms, Crickets. We Teach you how to Raise and Sell. Write today. Carter Fishworms, Plains, Georgia 31780.

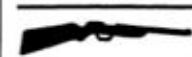

HUNTING, GUNS, DECOYS

PELLET GUNS For Fun or Serious Target Shooting Anywhere. Giant Selection. Finest Models. Satisfaction Guaranteed. New 100 page Catalog Free (\$1 value). Write: ARH, Dept. 15, Grantsville, West Virginia 26147.

DUCK And Goose Decoys. Buy direct and save. Send for free catalogue to: Decoys, Rt. 11, Box 229-B, Houston, Texas 77050.

GUN CABINET SHOWCASE PLAN. Holds up to six guns. Has storage for ammunition, scopes and cleaning gears. Sliding doors with lock. Photocopy of article \$1.00. Send orders to Popular Mechanics, Dept. HE, Box 1014, Radio City, New York 10019.

DOGS AND KENNELS

INSULATED DOG HOUSE PLAN. Floor slides out for easy cleaning. Roof is water proof. Photocopy of plan as it appeared in P.M. available for 50¢. Send order to Popular Mechanics, Dept. HE, Box 1014, Radio City, N.Y. 10019.



POULTRY & GAME BIRDS

QUAILS, Incubators, cages, supplies catalog. Marsh, 14216 Brookhurst, Garden Grove, Calif. 92643.

RABBITS—CHINCHILLAS—FUR BEARING ANIMALS

SECRETS Of Bunny Babying. Raise Rabbits for Fun and Profit. Good Eating too. Instruction Manual, \$3.00. Donlamb Box 1161, Provo, Utah 84601.

\$500-\$1000 MONTH Plan raising rabbits for us. Free details. White's Rabbitry-PM, Hudson, Ohio 44236.

RAISE Rabbits Successfully by knowing Facts. 48 Page Illustrated Book describing 25 Breeds. Housing, Breeding, Feeding, Markets, Marketing, etc. 25 cents. American Rabbit Association, 36 Arba Building, Bloomington, Illinois 61701.

EARN \$10,000 Yearly Raising Angora Wool and Breeding Stock. Details 25¢ coin. American Angora, Malta 12, Montana 59538.

TOPLESS INCOME RAISING Mutation chinchillas. 25¢ bulletin \$1.00. Chinchilla, 11PM10, Port Richey, Florida 33568.

RAISE Chinchillas. Guaranteed Income. Catalog \$1.00. DeShon Chinchilla, Route 2H, Roanoke, Indiana 46783. Missouri Agent, Rudolph Eggemann, 9615H Tocan Court, Affton, Missouri 63123.

PETS—BIRDS, CATS, HAMSTERS, ETC.

PETS, Reptiles, raccoons, skunks, squirrels. Catalogue 25¢. Trails End Zoo, St. Stephens, S.C. 29479.

HORSES, LIVESTOCK

"HOW TO TRAIN HORSES"—FREE Book tells how to break, train, make money with horses. Beery School, 1108, Pleasant Hill, Ohio 45359.

CAMPING EQUIPMENT AND TENTS

FREE 112-page Camping, Marine Color Catalog. Laacke & Joys, 1439 N. Water Milwaukee, Wisconsin 53202.

FREE Outdoorsman's Catalog. Features Outdoor clothing, boots, tents, packs, hunting, fishing, hiking equipment, government surplus etc. Satisfaction Guaranteed. Write for free copy today. P & S Sales, Dept. P-10, Box 45095, Tulsa, Okla. 74145.

NEW DISPOSABLE SLEEPING BAG of Waterproof Paper, lined with Styrene for Strength. Lightweight, Compact Warm to Minus 20° Ideal Year Round \$5.95 PPD. Satisfaction/Guaranteed. Mecca Enterprises, P.O. Box 416-PM, Toms River, New Jersey 08753.

ELECTRICAL SUPPLIES

TRANSMISSION Of Electrical Energy through the Atmosphere. Large amount of H.P. possible anywhere. Find out how. No Gimmick. Send \$2.—To: Tesla Research, 887 West, 20th Ave., Vancouver 9, B.C., Canada.

BATTERIES, GENERATORS

VX-6 RESTORES Battery Life, \$3.25. Bellco, 63 Address, Jacksonville, Florida 32208.

BATTERY Reconditioning Kit, includes molds, material, instructions. Apex Engineering, 3100 Romona, Atascadero, California 93422.

DON'T LET THIS HAPPEN TO YOU—over 31,000,000 batteries went dead in traffic last year. Amazing liquid formula can save your battery—Tested—Approved—Simple to use—**ONLY \$2.98 PLUS 50¢ HANDLING**. Guaranteed—order today. **SUNSHINE GIFT HOUSE, 2228 SAUL DRIVE, JACKSONVILLE, FLORIDA, 32216**

ENGINES, MOTORS

WINDING Data, 275 motors, \$1.25. Data Company, 512 Kensington, Kansas City, Mo. 64124.

STEAM Engine Kits, Catalog-Handbook \$1.00. Reliable Industries, New Baltimore, Mich. 48047.

MOTOR REWINDING SUPPLIES! Equipment plans! Modequip, Box 7266, Kansas City, Mo. 64113.

REWIND Car Generator for 110 VAC. Power Plant Plans \$2.00. Schmauss, 1228 East Cass, Tampa 33602.

ENERGY Amplifying Simple Transmission, Drawings \$5.00. Spaceman, Box 16046, Kansas City, Missouri 64112.

MACHINERY, TOOLS AND SUPPLIES

COMPLETE 4" Metal Cutting Lathe \$89.50. Machined Parts Kit Less Motor and Accessories \$29.50. Taig Mfg., Dept. T, 15048 Proctor, Industry, California 91746.

SMALL Foundry furnaces, Supplies. Free literature. Pyramid Products, 3736 South 7th Avenue, Phoenix, Arizona 85041.

MAXIMAT, Unimat Lathes, Metals, Micrometers. Catalogue 50¢. Industrial \$2.00. Campbell (PM), 1424 Barclay, Springfield, Ohio 45505.

1400 CATALOGS Listed and Described! Sources for **EVERYTHING** Imaginable! Rush \$2.00. **MASTERLOG**, Box 24413-(VI), Oakland, California 94623.

END Mills, Lathe Milling Attachments: Information. Potter, Box 73, Cedar Rapids, Iowa 52406.

SANDBLASTERS, \$32.50—\$749.50. Free Catalog—Truman, 1330 Market, Youngstown, Ohio 44507.

Router Bits 1/4" Shank, High Speed Used; Excellent Condition. \$2.50 Dozen. Postpaid, Lillian's, Box 4777, North Hollywood, California 91607.

"ATTACHALL" The threadless **MOTOR ARBOR** holds 33 different tools to fractional HP Motor (1/2" Shaft). Change tools in seconds. Its even for Professionals. Makes a Super-Mini-Home Workshop. Send \$2.50 postpaid. Price includes 25¢ Catalogue listing attachments and other inexpensive critical tools. ShopAlder Tool Co., 233M10 East 77 Street, NYC 10021.

TOOLS, Metal, Woodworking, Shop, Power, Hand, **LATHES** and Accessories. Catalog \$1.00. Refundable. Tools Unlimited, Inc., Box 7PM, Brentwood, New York 11717.

SINGLE Phase Runs Three Phase Motors. Secure Electronics, 32 Warren, Waban, Mass., 02168.

ASSORTMENTS. Nuts, Bolts, Screws. List 25¢ Coin. Nutty Co., Box 1576. SMS, Fairfield, Conn. 06430.

WELDING, SOLDERING, PLATING

LEARN COMPLETE PLATING BUSINESS. Metals, Plastics, Baby-Shoes, Make Your Own Equipment Fiberglass Tanks Over 30 Years Experience. \$5.00 Will Start You In Business. NU-Lite Platers Research, Inc., 72-32 Calamus Ave., Woodside, N.Y. 11377.

PLATING Equipment, Portable Platers, Supplies, and "Know-How". Build your own tanks for nickel, chrome, etc. Easy-to-install PVC liners. Rectifier components—all sizes. Schematics, parts, lists, formulas, operating instructions for all plating. \$10.00 post-paid. Guaranteed to save you 25%-75% or immediate refund. Some good used units for sale. Platers Service Company, 1511-A Esperanza, Los Angeles, California 90023.

SUPER-ROD. Metallurgical Breakthrough. Weld Aluminum, Brass, Copper, Pot Metal with Propane Torch. 12" rod \$2.00. K & B Supply, 4014 N. 7th Street, Suite 2A, Phoenix, Arizona 85014.

REFURNISH YOUR Workshop into Professional Electroplating Business. **GUARANTEED** kits, \$6.95! Complete illustrated manual \$3.00! Free details. **QREW**, Box 8-PJ, Bourbonnais, Illinois 60914.

GOVERNMENT SURPLUS

FREE! Nationwide Surplus List. Write today. Auctioneers, Box 872-P. Anoka, Minnesota 55303.

FREE Catalog Government Surplus and Sporting Goods. Enclose 8¢ Stamp. Bonanza Surplus, Box 725-PM, Grand Haven, Michigan 49417.

SURPLUS BARGAINS—War, government, industrial surplus at savings to 80%! Clothes, boots, coats, tents—bargains for farm, home, outdoors. **SEND FOR FREE CATALOG**—must give zip code. **SURPLUS STORE**, Sioux Falls, S.D. 57102.

JEEPS!!! PICKUPS!! 100,000 Items direct from government. Your area. Latest information & surplus categories: \$2.00 **MONEYBACK GUARANTEE**, Order manual #129, from "Dependable Products". Box 113, Vista, California, 92083.

NO CATCHES. Buy any surplus direct from U.S. gov't. All information \$2.00. Bridgeworth, P.O. Box 2292-C, Vancouver, Washington 98661.

1973 SURPLUS Army, Navy store, 52 Page illustrated catalog. Send 50¢. Ruvel, 3037 North Clark, Dept. 10-J, Chicago, Illinois 60614.

GOVERNMENT SURPLUS. How and Where to buy in your area. Send \$2.00. **SURPLUS INFORMATION**, 30177PM **HEADQUARTERS BUILDING**, Washington, D. C. 20014.

"U.S. GOVERNMENT SURPLUS Directory." How, Where to buy 100,000 items (including Jeeps) . . . low as 2¢ on dollar! Most complete information available . . . \$1.00. **SURPLUS DISPOSAL**, Box 6586-AJ, **WASHINGTON, D.C. 20009**.

JEEPS From—\$52.50; Typewriters from—\$4.15; Cars from—\$31.50. Walkie-talkies, motorcycles, airplanes, boats. Typical "As Is" bid bargains from Uncle Sam. Tremendous variety. Exciting free list. Write: Enterprises, Box 402-X93, Jamaica, New York 11430.

JEeps, TRUCKS, Cars From \$31.50 . . . Airplanes, Boats, Typewriters, Clothing, Camping, Sporting, Electronics, Photographic Equipment . . . 100,000 Surplus Bid Bargains Direct From Government Nationwide Typically Low as 2¢ on Dollar! Complete Sales Directory and Surplus Catalog \$1.00 (Deductible First \$10 Order From Included Catalog). U. S. Surplus Disposal, 2200 Fuller 601B-PPM, Ann Arbor, Michigan 48105

JEeps \$52.40, Airplanes \$75.01, Typewriters \$6.70, Boats \$7.50, Typical Bargains Available Nationwide. Sales Directory And Surplus Catalog \$1.00 (Refundable). Midwest Surplus, Box 401-PM, Dayton, Ohio 45401.

HOBBIES AND COLLECTIONS

HOBBY-CARVE—Home workshop wood carver—create beautiful wood reproductions of sculptures, plaques, figurines, sconces and bookends. Hundreds of work patterns available. Send 25¢ for "How To Make Quality Wood Carvings" booklet. Refunded with order. Write: Hobbi-Carve, 930 Duluth Street, Dept. PM, St. Paul, Minnesota 55106.

COLLECT Military Medals, list 25¢. Vernon, Box 387PM, Baldwin, N.Y. 11510.

NAZI Medals, Photos, and Jewelry. Also War Mementos from Other Countries. Catalog and War Poster, 25¢. Hutchinson House, Box 6411, Chicago, Illinois 60680.

LIONEL Trains Discount Prices Send \$1.00 For 1973 Catalog (Refundable). Railroad, Box 691, Dept PM, Endicott, New York 13760.

FREE \$1000 ANTIQUE CONFEDERATE BILL. Write, Zent Distributing, P.O. Box 589, Dickinson, North Dakota 58601.

MILITARY Relics: Large Catalog 10¢. Quincy, Box 7792-H, Tulsa, Oklahoma 74105.

NAZI War Souvenirs! Illustrated Catalog \$3.00 Cash (Refundable). Disco, Box 331, Cedarburg, Wisconsin 53012.

HAVE A Hobby—All Four Books for \$2.00. A Small Beautiful Garden. Artistic Touches in Garden and Home. How to Collect Stamps. How To Value Coins. Sent PP. M. M. Balch Co., Sheridan, Arkansas 72150.

#1:00 SURPRISE: SKYLAB Official Emblem—Foreign Medal—Catalog; Insignias, Box 71 M. Rockaway, New York 11694.

NAZI War Souvenirs Free Illustrated catalog. Delta, Box 361PS, Lafayette, Calif. 94549.

DECALS, EMBLEMS, PATCHES

CUSTOM Designed Embroidered Emblems, Decals, Inexpensive. Free Catalog, details. Southern Emblem, Box 8PMB, Toast, North Carolina 27049.

EMBLEMS Embroidered to your own design. Leading manufacturer offers custom emblems in any quantity. Send sketch for firm quote or write for free Design-Emblem Guide and literature. A-B Emblem, Box 5695, Weaverville, North Carolina 28787.

IMPEACH Nixon Buttons only \$1.00! Postpaid. Campbell, 2079 Woodbourne, Baltimore 21239.

SUPPORT OUR PRESIDENT! BIG 17" BUMPER STICKER: "I'M BACKING YOU, MR. PRESIDENT". SEND \$1.00. David Johnson, Box 394, Ansonia Station, New York, New York 10023.

FOIL BURGLARS, Get Security System Decals and Signs, Ward off Thieves. Feel Safe. Order 2 3x5 Decals, 2 Signs. Send \$1.98 + 25¢. Security, P.O. Box 22061, St. Louis, Missouri 63128.

EMBLEMATIC Fraternal Emblems. Free Brochure. Porter Specialty, P.O. Box 1568, Tampa, Florida 33601.



STAMP COLLECTING

"CONQUEST Of Mars". Yemen's Latest Collection. 10¢ With Space Approvals. Potomac Stamps, Washington, D.C. 20015.

(Continued on next page)

STAMP COLLECTING

(Continued from preceding page)

88 COUNTRIES—ONLY 10¢! Worth \$5.00 at catalog prices!! Incredible collection of genuine postage stamps from 88 different countries—from Afghanistan to Zambia, North to South Pole! British, French, Portuguese, Spanish Colonies. Old 19th Century, New Issues, Moon and Outer Space stamps, etc. All for only 10¢! Also, other exciting stamps to examine free. Buy any or none, return balance, cancel service anytime. Plus Wonderful Free Catalog! **H. E. HARRIS**, Dept. SS-63, Boston, Mass. 02117.

YOURS FREE! 40 RED CHINA Postage Stamps banned to American collectors for a generation by U.S. Gov't. Now at last you can legally own them; and these stamps are so worth having that experienced and beginning collectors alike want them—so act fast, because supplies are strictly limited! You also get 110 other stamps from Britain's Lost Empire plus illustrated Album to keep as a Bonus should you buy \$1 from our Approval Selection. Or return Album and 110 stamps with selection and buy nothing. Cancel service anytime. But Red China stamps are yours to keep! Send 10¢ for mailing while supplies last Kenmore, Milford RC-430, New Hampshire 03055.

STAMPS Free! New Issues—New Countries — Triangles — Rockets — Olympics — Scouts — Birds — Flowers — Animals — Also Old Canadian and U. S. Stamps. Plus complete illustrated Canadian Stamp Catalog. Send 10¢ for mailing. Gray Stamp Co., Dept. A, Toronto, Canada.

WOW! 110 All Different Germany 10¢. Commemoratives, Airmails, High Values, Big Catalog, bargain lists. Also, fine stamps from our approval service, which you may return without purchases and cancel service at any time. Jamestown Stamp, Dept. A103PM, Jamestown, New York 14701.

CANADA: 150 Different. \$2.00. No Approvals. The Stamp Box, Anchor Lane, Southold, New York 11971.

EXCHANGE, Send 200 Different with 25¢. Receive 250 Different. H. & R. Dubois, P. O. Box 271, Longueuil, P. Q. Canada.

FREE! Big Bargain Catalog—New Edition listing thousands of bargains including U.S. & B.N.A. stamps, packets, albums, accessories and supplies. Also, fine stamps from our approval service which you may return without purchases and cancel service at any time. Jamestown Stamp, Dept. E103PM, Jamestown, New York 14701.

U. S. PLATE Blocks 7 Different 3¢ Commemoratives \$1.00! Approvals. Gordon Davison, Hillsboro, New Hampshire 03244.

VANGOGH Gold-Framed Paintings. Multicolored Complete Postage Set Free! If Approvals Requested. Frija, R1, B157A, Red Hook, N.Y. 12571.

FREE Worldwide Packet. Pennv Approvals. Froehlich, Box 412A, Morton Grove, Illinois 60053.

DON'T Ever Miss This—Write for Details. Most Unusual Stamp Offer. Bileski, Station B, Winnipeg, Canada.

FREE BARGAIN LISTS! U.S. Mint Singles-Plate Blocks, Scotco, Box 855-PMN, Miami, Florida 33147.

AMAZING Value—Enormous Worldwide Collection! Hundreds of Colorful Stamps—Airmails, Commemoratives, Strange Countries, Nature's Wonders. Catalog over \$10.00, only 10¢. Approvals. Buy Any or None. Cancel Anytime. Daniel Healy, Box 1164PM10, Arlington Heights, Illinois 60006.

SENSATIONAL WORLD MIXTURE "ELITA": BIG THREE POUND PARCEL CONTAINS ABOUT 7000 STAMPS, THOUSANDS OF PICTORIALS, YOURS FOR JUST \$25.00 DELIVERED, DUTY FREE (HALF POUND SAMPLE \$5.00) LIST FREE WITH 200 STAMP OFFERS. **B. SCHULZE STAMPS LTD., 139A ESTELLINE, VICTORIA, B.C., CANADA.**

AIRMAILS 100 Different 60¢ w/inexpensive Approvals. Finch, Box 4103, Hacienda Heights, California 91745.

ISRAEL Pictorials, commems galore. 25 different, only 10¢ with low price U.S. and Foreign approvals. **KAYCO, P.O. Box 437, Flushing, N.Y. 11367 Dept. M.**

CANADA, 25 Different Commemoratives. 25¢ Approvals. Wilson, Box 116, Dollard des Ormeaux, Quebec, Canada.

FABULOUS Collection! 107 different stamps from all seven continents. Get Q.E.-II Silver Wedding (bound to be a classic), giant Mongol horseman, many other new, old issues from Asia, Africa, Europe, North, South America, Australia, Antarctica. Also stamp selections to examine. Buy any or none, return balance. Cancel service anytime. Send 10¢ now. **Williams Co., PM87, St. Stephen, N.B., Canada.**

200 WORLDWIDE 25¢ To Approval Applicants. Polze, Box 5215, Milwaukee, Wisconsin 53204.

KAZAM! 25¢, 50 Mid-Eastern, Approvals. **ALLADIN,** Box 602, Jefferson City, Tenn. 37760.

SINGLE STAMPS 2¢ and up. Mounted in books. **TRUST STAMP COMPANY, P. O. Box 100-P, Jamaica, New York 11435.**

LOOK! 100 Beautiful Romania Pict. 25¢ Approvals. Scenic Stamps, Box 1973-B, Vancouver, Wash. 98663.

22 TRIANGLE Stamps Only 10¢. Get This Timeless Treasure Of Gorgeous, Colorful, Triangle Shaped Postage Stamps. Approvals Included. Send Today! Stamps, Box 1444-B, Kitchener, Ontario, Canada.

100 DIFFERENT United States Stamps, 25¢ With U.S. Foreign Approvals. **ShelRön,** Box 547C, North Miami, Fla. 33161.

50 DIFFERENT Old U.S. Revenue stamps \$1.00. Winchester Stamps, Box 3592, Mansfield, Ohio 44907.

OLDER U.S. stamps, covers, on approval to adults only. Surprisingly good. **ENGLE,** Box 208P, Lowell, Michigan 49331.

TEN Different Nudes; 20¢. Approvals. Stamp Farm, 2M59, Oxford, Wis. 53952.

50 DIFF. U.S. COMMEMORATIVES 25¢. Fine U.S. Approvals Accompany. **Craig Stamps,** Box 425-N, Bellmore, N.Y. 11710.

FOREIGN Approvals! Gigantic values! 3¢ each. **ABC,** Dept. 3301-A, Box 6000, San Francisco 94101.

"AFRICA" 25 Beauties, 15¢. Approvals. **Gorliz,** Box 28765 PM, Memphis, Tennessee 38128.

U.S. MINT Specials! Flag set, complete \$1.00. 1¢, 2¢, 3¢ famous Americans (21 different) \$1.00. Free list. **Brooks,** 2601 Avenue "U," Brooklyn, N.Y. 11229.

PENNY! Approvals! Regardless catalogue! **Kloster,** 4164 52nd St., San Diego, Calif. 92105.

FREE Surprise collection sent with approvals. **Gould,** 1784 Union, San Francisco 94123.

ABSOLUTELY Free United States Mint Souvenir Sheet When Requesting United States Approvals. **K&B,** Box 70, Brooklyn, N.Y. 11223.

500 DIFFERENT Stamps, \$1.25. **Smith,** 508-A Brooks, College Station, Texas 77840.

100 DIFFERENT British Empire 10¢. Approvals. **Gibson,** Box 34, Lansdowne, Pa. 19050.

"INVERTED Error" Dag Hammarskjöld, 10¢ with approvals. **Belmont Stamps,** Washington, D. C. 20015.

100 OLD United States between 1861 and 1935. \$1.00. **Ed Roush,** 423 Shepard, Mansfield, Ohio 44907.

225 STAMPS For only 10¢! Airmails. Pictorials: stamps from strange countries cataloging up to 25¢ each! Plus unusual stamps to examine. Buy any or none return balance, cancel service anytime. **Mystic Stamp Co., Camden 80, New York 13316.**

20 HISTORICAL U.S. Commemoratives 10¢. Bargain U.S. Approvals. **PINTO,** Box 111, Park Ridge, Illinois 60068.

80 DIFFERENT U.S. Stamps. Includes 1943 flag stamp of occupied nations. Only 25¢. Approvals included. **Willett Co., Box 338-M, Yorktown Heights, N.Y. 10598.**

50 YEARS Old, fifteen different United States, over fifty years old—10¢ with approvals. **Jaxon,** Box 145-P, Brooklyn, New York 11230.

QUALITY AND LOW PRICE, EXCELLENT For advanced or beginner. Mounted approvals 2¢ up, all countries in **Scott's Order.** Preview Stamps, P.O. Box 20667, San Diego, California 92120.

U.S. BARGAIN, 50 Different 10¢, with beautiful worldwide, approvals. **Stamp Center,** Kennebunk, Maine 04043.

210 DIFFERENT U.S. Commemoratives \$1.00. Stamps, 7607 Larchview, Dallas, Texas 75240.

HITLER, 100 Germany 10¢! Approvals. **White Rock Stamps,** 13125 24th M Avenue, Surry, B. C., Canada.

RUSSIAN Space Collection 25¢, including Russian Approvals. **Snedco,** Waldwick, New Jersey 07463.

LIECHTENSTEIN #356-\$19.00; France #1100-\$4.00; UN 29-30-\$15.00; NH. CWO. Submit Lists Western Europe Only. **All N. Franklin,** Box 467L, Jamaica, 11434.

1500 FOREIGN \$2.00; 5000 \$4.00; 9000 \$6.00. 1000 pre-1939 USA, contains dues, revenues commemoratives, presidentials, high values, older issues, etc. \$3.00; 5000 \$12.00. 300 pre-1940 USA commemoratives \$2.00; 700 \$4.00. No approvals. **Meyers,** 5321 Fleming, Richmond, Calif 94804.

GET Scarce Kennedy memorial, Red China, Vietnam stamps plus new countries, topicals, commemoratives, many more! Valuable collection of 100 different stamps from the world over. Colorful new and old issues—wild animals, famous people, far places, others! Also stamp selections to examine. Buy any or none, return balance. Cancel service anytime. **Rush 10¢ today.** **Garcelon Co., 8PMA, Calais, Maine 04619**

LYNDON B. JOHNSON Memorial stamp on lovely First Day Cover addressed any name of your choice. 50¢ from: **K.M. WALSH,** Box 308-H, **TUCKAHOE, N.Y. 10707.**

50 DIFFERENT British Commonwealth Foreign Many Pictorials, Commemoratives, 10¢ Approvals Included. **City Stamp Co., Box 216, Station W., Toronto, Canada M6M-4Z2.**

BRITISH COMMONWEALTH Mint Pictorials. Ten Different 10¢ With Bargain Approvals. **Charles Locks,** 5607 La Mirada, Los Angeles, California 90038.

231 WORLDWIDE Stamps 10¢! Approvals. **Holland,** 1227A Sixth, Redlands, California 92373.

FREE Canadian, Approvals, Stamps Unlimited, Box 2338, Kalamazoo, Michigan 49003.

FREE! Illustrated Bargain List Plus Surprise Gift. **Eckert,** Box 205, Clifton, New Jersey 07015.

FREE, Mint Worldwide Packet. Approvals. **Hildebrand,** Box 5645, Redwood City, California 94063.

UNITED STATES COMMEMS 300 Different \$3.00; 400 Different \$6.00; 500 Different \$10.00; 600 Different \$30.00. **Norman Sparhawk,** 94 Pitman, Providence, Rhode Island 02906.

(Continued on next page)

STAMP COLLECTING

(Continued from preceding page)

PICK And Choose from Thousands of Stamps 3¢ Each. Continental, Box 9384M, No. Hollywood, Calif. 91609.

SPECIAL Offer! 100 Unusual Stamps 10¢ with Request for Approvals and Bargain List. Continental, Box 9384P, No. Hollywood, Calif. 91609.

THOUSANDS Of Stamps 3¢ each. Pan Pacific Stamp Co., P.O. Box 9413, No. Hollywood, Calif. 91609.

FREE Twelve New Africa, Rwanda etc., Approvals included. Alpaughco, Highbridge, NJ 08829.

VIETNAM 25 Different 10¢ approval. Sam Chazen, Box 95, Ozone Park, N.Y. 11417.

PACKET Of Canadian Mint 25¢ when requesting our General Approvals. Hoffman, R3, Lucan, Ontario NOM 2JO.

FREE 10 Japan War Stamps. Approvals. Schroeder, 1486 1/2 Sherburne, St. Paul, Minnesota 55104.

50 DIFFERENT Argentina—10¢. Approvals. Globestamps, Box 402, Biddeford, Maine 04005.

U.N. MINT Six Sets \$1.00. Phil'oot. 119 Chateau, Milwaukee, Wisconsin 53217.

20,000 WORLDWIDE Only 1-3¢ Each. Covey, Box 1137, Anna Maria, Florida 33501.

LARGE Pictorial Postage Stamps. Beautiful Flowers, Birds, Animals, Space, Sports, Many Others. 100 Different \$1.00. William Tucker, P.O. Box 8131, Greensboro, North Carolina 27410.

DOGS, Cats, 25 Different, 10¢. Approvals. Len Morris, Box 537M, Indian Hills, Colorado 80454.

COVERS U.S. 25 Different \$1.00. Free Gold List. Superior, Avon Lake, Ohio 44012.

40 DIFFERENT NUDES \$1.00. No Approvals. Kemp, 9952 Tamarack, Pacoima, California 91331.

BRITISH Commemoratives, 20 Different, 10¢. Approvals. Gant, Box 1385, Shreveport, Louisiana 71164.

MAGNIFICENT PAINTINGS! 25 Different Breathtaking Beauties for Only 25¢ With Approvals. Box 248-B, Station "T", TORONTO, M6B-4A1.

TREMENDOUS Savings on Complete Sets. Stan's, Box 546, Silverdale, Washington 98383.

BHUTAN: Fantastic 3-Dimensional Moon Landing Set. 25¢ with Approvals. Ftacek, Box 1023, Manteca, California 95336.

WORLD'S LARGEST STAMP 4 3/4" x 3 1/4". Unusual Sanda Island Painting—Plus Artistic Stamp Collection—30 Museum Masterpieces. Introductory Special. Discount Approvals. 25¢. Richley, Box 2288-M, Littleton, Colorado 80120.

APOLLO 11 Moonlanding. Set of Seven Multicolored giants from Guinea, Catalog value \$3.41. Only 10¢. Topical approvals. LeBlanc, Box 110-P1, Glen Cove, New York 11542.

BETTER GRADE U. S. Canadian stamps on approval. Borgen, Box 502, Alturas, Calif. 96101.

FACE VALUE!—All different U.S. Mint Commemoratives (some 1940s) only 50¢—plus free price lists. No Approvals. Maiken, Box 1434, Rockville, Maryland 20854.

100 U.S. OVER 25 Years Old. Airs, Commemoratives, Regulars. \$1.00. Bob Barrett, 5730 Muddycreek, Cincinnati, Ohio 45238.

107 EXCITING British Colonials. 25¢. Approvals. Castle, Box 15-PM13, Flushing, New York 11352.

FREE Stamps Send 10¢. Approvals UX Stamps, 320 Congress, Austin, Texas 78701.

25 US Commemoratives, Magnifier—10¢. Approvals. Mixdrak, 5630 Wilson, Chicago 60630.

SEND Only 5¢ for Worldwide Collection of over 50 different Singapore, Grenada, Chad, etc. Contains old and new issues, sports, animals, etc. You will also receive interesting lists and a certificate worth 50¢ toward purchases. Goliath Co., Dept. TP-1, Bethlehem, New Hampshire 03574.

SAVE Time! Money! Worry! Work! How? **NEW** First Day Cover Service! Special Offer. Cover And Details **FREE!** Whelpley, 7530-N Robin Rest, San Antonio, Texas 78209.

SEND Only 10¢ for nice collection of U.S. stamps including "\$5.00." issue and scarce mint Sipex Souvenir Sheet. You will also receive the most wonderful catalog of stamp offers in America. Littleton Stamps, Dept. SS1, Littleton, New Hampshire 03561.

FREE Duplicate Exchange, 2¢ Approvals. Beiden, Box 4175, Dearborn, Michigan 48126.

FREE British Colonies With Approvals. Chapmans, Box 487-B, Galesburg, Michigan 49503.

100 PICTORIALS \$1.00. Adult Approvals. Racon, 8221 Page, St. Louis, Missouri 63130.

2 NUDE Sets Plus 100 Others. Only 25¢. Approvals. Paschall, Box 331, Kosciusko, Miss. 39090.

HUNGARY'S Latest 1973 Bicolored Gigantic "Song Birds"—Free! Approvals plus 101 Bonus Sets. William Deems, 226X Race, Ravenswood, West Virginia 26164.

SUMMER Clearance \$50.00 Catalog Value USA Foreign Stamps just \$5.00. Hetricks, 39 East Main, Brookville, Pa. 15825.

7 COMPLETE SETS Poland—25¢ with Approvals. Duncan Stamps, RR #1, Duncan, B.C., Canada.

YEMEN C3-9 Mint. Cataloging \$13.25, \$1.00. Royal "Stamps," Tamaqua, Penna. —18252.

TRADE Your Duplicates! (Foreign) New "Free Bonus" Plan: NFK, Box 98-P, Newton Highlands, Mass. 02161.

\$10.00 CATALOG VALUE Wor'd Collection 50¢ with Approvals. Keim's, P.O. Box 3416, New Orleans, La. 70177.

FREE 25 Different Canada. Joseph Myers, 633 W. Michigan, Marshall, Michigan 49068.

FREE Collection—Colonials! Worldwide Approvals. Gains, Box 788-C, Mattoon, Ill. 61938.

FASCINATING Pick-And-Choose Packet Approvals. Worldwide. Bargain Hunter's Delight. Rivertown, Box 188P, Lowell, Michigan 49331.

LOCOMOTIVES—1973 Liberia Complete—25¢ with pictorial approvals. Robert Hedges, Route 3, Hagerstown, Md. 21740.

40 DIFFERENT U.S. COMMEMORATIVES 20¢ with U.S. and Canada Approvals. Mary C. Armstrong, Box 409, Kennett Square, Pennsylvania 19348.

STAMP Bargains Galore. Write: PUBEST, Zaragoza 297A, Ocotlan, Jal., Mexico.

307 DIFFERENT Triangles, Sports, Topical, Etc. Worth Near \$8.00. Only 25¢. Bargain Approvals. Free Catalog, \$1.00 Coupon. Jarto Stamps, East Syracuse, New York 13057.

CANADA Terrific Lot of 30 different, including Commemoratives, 15¢ to Approval Applicants. Lewis, 339 Beaconsfield Cres. Saint John W., New Brunswick, Canada.

3¢ PLATE Block 25¢ with comprehensive U.S. stamp and Supply catalog. Schultheis, Box 2151C, New Hyde Park, New York 11040.

FREE World Collection. Over 100 stamps. Approvals. Global, Box 792, Livermore, Cal. 94550.

60 DIFFERENT United States (30 Commemoratives 25¢. Seidenberg, Salem 169, Oregon 97308.

FREE! 10 African Beauties! 30 Others! Approvals. Cambridge, Box 2311, Heath, Ohio 43055.

COINS, TOKENS, CURRENCY

COINS At Discount Prices! Free Brochure. Gene Carlton, Chandler, Okla. 74834.

FREE: Lists of Thousands of Stamps and Coins. No Approvals. Bryson, 612M White, Toledo, Ohio 43605.

50 DIFFERENT Foreign Coins, \$3.00. Hoffman, Box 98-M, Clarence, New York 14031.

5 DIFFERENT Liberty Nickels, \$1.75. Free Catalog, Village Coin Shop, Dept. P, Plaistow, New Hampshire 03865.

LINCOLNS: 30 Different 1910-40 \$3.00. 35 Different Uncirculated \$3.00. Both \$5.00. Nayko, Box 233, Kennedy Airport, New York 11430.

MEXICO Revolutionary "Pancho Villa" 10 and 5 Centavos Copper Coins Dated 1915 Nice Condition only \$2.95 each. Delivered Postpaid. El Paso Coin Co., P.O. Box Q, El Paso, Texas 79952.

SILVER DOLLARS Uncirculated, 1880-81—1883-84-85 \$8.00 Ea. Catalogue 50¢. Shultz, Salt Lake City, Utah 84110.

BARGAIN Coin List, 10¢. Economy Sales, Box 92, Buzzard's Bay, Massachusetts, 02532.

MEXICO: Silver Dollars Dated 1957 To 1967 In Nice Condition. Ten For \$3.95 Delivered Postpaid. El Paso Coin Co. Inc., Suite 108. El Paso National Bank Bldg., El Paso, Texas 79952.

SEND Only 5¢ for valuable booklet "How To Collect Coins" which is loaded with expert advice. You will also receive 5 different foreign coins and your copy of the most unusual and interesting collectors catalog available anywhere. Littleton Coins, Dept. VB-1, Littleton, New Hampshire 03561.

22 "S" LINCOLNS Including 1955S, \$1.75. 24 1909-1939, \$1.75. 10 "S" Jeffersons, \$1.75. All different "I" \$1.75. \$5.00. HARRIS, 3350 P, El Camino, California 95051.

BEAUTIFUL Brilliant Uncirculated Silver Dollars—1878 to 1904. Our Date Selection \$8.48; Six Different \$48.48. Super-Bargain Lists 50¢. Bebee's Incorp., Omaha, Nebraska 68111.

1939-S NICKEL Nice Circulated. 75¢. Three for \$2.00. FREE Price List. Reitmeir, 916 Crawford, Bethlehem, Pennsylvania 18017.

COLLECT Coins! Catalogue 35¢. Raibl, 2355 Scenic Highway, Pensacola, Fla. 32503.

UNCIRCULATED 'S' Lincolns, three different, 10¢ Bargain lists included. Farley Coins, Metamora, Illinois 61548.

1939S JEFFERSON Nickel 60¢. Free Catalogue. Rongo, 1265 81 Street, Brooklyn, New York 11228.

USA SILVER Dollars Nice Condition 10 Different Dates Only \$39.95 post paid. El Paso Coin Co., P.O. Box Q, El Paso, Texas 79952.

LINCOLNS "50 Different" Before 1950 \$2.49. Frank Wood, Box One, No. Easton, Mass. 02356.

39 COIN Uncirculated Lincoln Set 1956-1973, \$2.00. Ed Frederick, Rte. 3, Mountain Home, Arkansas 72653.

COLLECT COINS For Profit! How to Start, Where to Sell. Lists of Valuable Coins. Check Your Change! Send \$1.00. Samuel Charles Company, 395 S. Havenside Ave., Newbury Park, California 91320.

(Continued on next page)

COINS, TOKENS, CURRENCY

(Continued from preceding page)

PAYING \$60.00 Each for U.S. \$20.00 Gold Coins. Prompt Payment Guaranteed. Ship registered for own protection. M. Tiitus, Box 1122, Menlo Park, California 94025.

COLLECT COINS For Profit! How to Start. Where to Sell. Lists of Valuable Coins. Check Your Change! Send \$1.00: M & W Sales, Dept. 1-10, Black Diamond, Washington 98010.

EXACT Replica Choice Colorado-California. HOF, 1418 Montague, Washington, D.C. 20011.

\$1000.00 BANKNOTE 25¢ with comprehensive U.S. coin and Supply catalog. Schultheis, Box 2151C, New Hyde Park, New York 11040.

COLLECT Coins For Profit! How To Start. Where to Sell.—Lists of Valuable Coins—Check Your Change!—Send \$1.00: Volpi's, 56-44 136 Street, Flushing, N.Y. 11355

ANTIQUES, RELICS, INDIAN GOODS & CURIOS

OFFICIAL Guide To Antiques. This 416 page volume will make you an authority on antiques. Over 1500 illustrations, 32 pages in color. Tells you what prices to Buy & Sell Thousands Of Antiques. \$4.98. Newland's, Fenelton, Pa. 16034.

FREE!! Lists Antiques, Indian Relics, 10 Arrowheads \$4.00. Hyde's, Box 2304, Santa Fe, New Mexico 87501.

INDIAN Relic list. Arrowheads \$4.00, doz. Folsom. \$5.00 each. C. Secrist, Deerfield, Missouri 64741.

APACHE ARROWHEAD COLLECTIONS—Perfect. 25—\$5.00, 100—\$15.00. **GERONIMO**, PMD1239, Apache Junction, Arizona 85220.

SELLING 10,000 Indian Relics. Arrowheads, Knives, Spearheads, Scrapers, Etc. List Free. Lear's, Glenwood, Ark. 71943.

AUTHENTIC WESTERN ARROWHEADS—Perfect, 25-\$5.00, 100-\$15.00, **BROKEN ARROW**, PMD1208, Scottsdale, Arizona 85252.

EVERYBODY LIKES DIXIE GUN WORKS.

TONS Of antique gun parts and supplies. All reproduction muzzle loading guns. Send \$2.00 for enlarged illustrated catalog No. 121. Dixie Gun Works, Union City 12, Tennessee.

RESTORE, Repair, Reproduce antiques any kind, size, with Castolite flexible molding and casting compounds. Easy, inexpensive, profitable. Free. Castolite, 73L/PMR, Woodstock, Illinois 60098.

ANTIQUA TELEPHONE PARTS. Cone Type Mouthpieces \$1.00 ea. \$8.00 dozen. Bell type Receivers with Cord—\$7.50 each. Rec shells \$4.00 each—\$36.00 dozen. Cranks \$1.50 each—\$15.00 dozen. Cloth Cords \$1.25 each—\$12.00. Telephone Company, Turtle Lake, Wisconsin 54889.

GLASS CUTTING—ALL YOU NEED TO KNOW! Every homeowner should know how to salvage pieces from precious scrap. Learn the pro techniques by purchasing a photocopy of article as it appeared in P.M. Price \$2.00. Send orders to Popular Mechanics, Dept. HE, Box 1014, Radio City, New York 10019.

ORIGINAL ANTIQUA Telephones. Illustrated Catalog—30¢. Telephone Company, Turtle Lake, Wisconsin 54889.

MODELS—CARS, SHIPS, TRAINS, PLANES ETC.

SHIP MODEL Kits, Plans, Fittings from our own Workshop. Big Illustrated Catalog: 50¢. Bluejacket Shipcrafters, 145-V Water Street, South Norwalk, Conn. 06854.

222 POPULAR MECHANICS

SHIP And Airplane Model Kits Catalog 25¢. Scientific, Inc., 340 Synder, Berkeley Heights, N.J. 07922.

SHIP Model Kits, fittings, plans, books, tools, engines, motors. Big illustrated catalog 50¢. Mass. residents add 3% tax. James Bliss & Co., Dept. SM, Route 128, Dedham, Mass. 02026.

MODEL Airplanes—Big 220 Page Catalog \$1.00. Sig Company, Montezuma, Iowa 50171.

SHIP And yacht model fittings: Pine construction hull kits; blueprints. Send 75¢ for illustrated catalog. A. J. Fisher, Inc., 1002 Etowah Avenue, Royal Oak, Michigan 48067.

LIVE Steam Engine Kits. Fascinating Hobby for Model Mechanics. Boilers, Fittings, Accessories. Pictured Catalog \$1.00. H.P.K. Models, Centuck 34, Yonkers, "S" New York 10710.

LIVE Steam powered backyard railroads! All sizes. Complete "bolt-together kits," and rough castings. Excellent drawings. 100 page catalog \$1.00. Little Engines, Lomita, California 90717.

GAMES, TOYS, PUZZLES, NOVELTIES

TWELVE DIFFERENT—\$1.00. Free catalogue. Gregory's, 6539 Emhouse, Dallas, Texas 75232.

KITES! Quality Action Styles! Brochure 10¢. Hutchinson, PM10, 83 Tremont, Barre, Vermont 05641.

MINIATURE CHARMS Make Fascinating Party Favors. Fantastic Assortment of 25 \$1.00. **TREASURE CHEST**. 9321 PM10 Cape View Avenue, Norfolk, Virginia 23503.

VOLUNTEER Puzzle Solvers Wanted for Computer Crossword Study. Send Stamped, Self-Addressed Envelope To P.O. Box 1176, Palo Alto, California 94302.

PLAY COMPUTER CHESS. Free Chess Catalog and Details. Computer Chess, 310 West Kemper Road, Cincinnati, Ohio 45246.

MAGIC TRICKS, JOKES, VENTRILOQUISM

HOUDINI'S Greatest Magic! You can do them all! Giant illustrated catalog 25¢. House Of 1000 Mysteries, P.O. Box 2026P, Pompano Beach, Florida 33061.

PROFESSIONAL Magical Effects. Ideal for the Beginner or Serious-Minded Magician! Catalog 50¢. Super Service! Midnight Magic Mfg. Co., 110 Proctor, Revere, Massachusetts 02151.

VENTRILOQUISM! Learn at home. Guaranteed. Information FREE! Dummy Catalog 25¢; Maher, Box 9037PM, Denver, Colorado 80209.

FREE! World's leading novelty catalog. 1600 Funmakers, Jokes, Tricks, Science, Sports, Hobbies, Jewelry, Psychedelia. Johnson-Smith, C-10, Mt. Clemens, Mich. 48043.

COMPLETELY illustrated catalog. 84 pages. 25¢. Manhattan Magic, Box 334-M, N.Y.C. 10011.

MAGIC MAGAZINE. Tricks, News, Dealers Offerings. Monthly Since 1936. 2 sample Copies \$1.00. Genii, P.O. Box 36068M, Los Angeles, California 90036.

WORLD'S Finest professional magic tricks. Joker's Novelties. Giant illustrated catalog 10¢. Top Hat, Evanston, Illinois.

FABULOUS MAGICS New 1973 catalogue 25¢. Our specialty orders shipped same day no substitutes. Fabulous Magic. 3319 East Charleston, Las Vegas, Nevada 89104.

BE A Magician! Two booklets explaining 156 tricks plus large professional catalog, \$1.00. Magic, Inc., 5082 Lincoln, Chicago, Illinois 60625.

MAGIC! Amaze, Mystify, Entertain! Hundreds Of Newest Tricks For Pocket, Parlor. Stage. Complete Catalog Only 25¢. Jeffries Magicland, Dept. 11, Dallas, Texas 75201.

TWO! Different Magic Catalogs. 25¢. Miami Magic, Box 1047, Miami 33133.

JOKES, Gags, Puzzles, Novelties, Magic Tricks. Latest Catalog. 25¢ Postage And Handling. Fun Shop, Box 5067, Mission Hills, California 91345.

FREE Trick and Magic Catalogue 35¢. Magic House, 531-A East-78th Street, Brooklyn, N.Y. 11236.

WOW! Largest Selection—newest, best tricks, jokes. Giant 150 page catalog 25¢. Abracadabra-MP, Colonia, New Jersey 07067.

LEARN VENTRILOQUISM! GUARANTEED. Information Free. Dummies, Courses, Puppets Catalog 25¢. Izzy's Ventriloquism School, 3746 West 63rd Street, Chicago, Illinois 60629.

LATEST Magic Catalog 25¢. Texarkana Magic, P.O. Box 2741, Texarkana, Ark. 75501.

VENTRILOQUISTS Dummy Catalogue 25¢. Storyteller Studios, Box 633PM, Bellflower, California 90706.

BOOKBINDING

REBIND YOUR DAMAGED BOOKS. With a few common tools and a homemade book press (plan included) you'll be able to handle anything from a torn hinge to a complete rebinding. Photocopy of article as it appeared in P.M. available for \$1.75. Send orders to Popular Mechanics, Dept. HE, Box 1014, Radio City, New York 10019.

BOOKS, CATALOGS, NEWSPAPERS

WORLD'S Most Outspoken Publication. Natural Health, Healing, Organic Gardening. Free Copy. Provoker Press, St. Catharines 102, Ontario.

AMAZING Offer! Hundreds Unusual Books! Details 25¢. (Refundable). Vanhook's, Etna Green, Indiana 46524.

FREE Distinctive Mail Order Catalog, 32 Pages Over 100 Products. Leonard Ray Dean, 1808 Neptune, Bossier City, La. 71010.

HIGHER INCOME, SECURITY And **POWER.** 256 page Book "THINKING BIG" Reveals Secrets that make Men Rich. Send \$2.00. Harvest House, 501-A La Rose Drive, Mobile, Alabama 36609.

FREE VENTRILOQUIST NEWSPAPER! Fascinating, Informative, Profitable! No obligation. Maher, Box 9037PB, Denver, Colorado 80209.

WIREAPPING EXPOSE—Your Privacy Invaded—Details \$1.00. Refundable. Don-Q, Box 548, Dept. PMO, Seattle, Wa. 98111.

FREE Book locating. Send wants. Bazaar Book Search, Box 496, Chico, California 95926.

LATEST Military Manuals/Books Catalog 25¢. Hillcrest Publications (K-18), McDonald, Ohio 44437.

FREE Book. Prophet Elijah Coming Before Christ. Megiddo Mission, Dept. 63, 481 Thurston Road, Rochester, N.Y. 14619.

NATIONAL Geographic Magazines, 1888-1971, any issue. Buxbaum, Box 465-PM, Wilmington, Delaware 19899.

FREE 32 Page Mail Order Catalogs. Distinctive Gifts. F. I. Grant, Box 1114, Black Mountain, North Carolina 28711.

FREE Exciting Gift Catalog From: The Birdhouse, 2283-A Pipestone Court, Orlando, Florida 32808.

HOW SUN'S ENERGY Can relieve our energy crisis. Sample newsletter \$1.00. Solar Energy Digest, Box 17776-B, San Diego 92117.

JESUS Books. Jesus Books, Metta-23, Box 932, Moorhead, Minnesota 56560.

(Continued on next page)

BOOKS, CATALOGS, NEWSPAPERS

(Continued from preceding page)

FREE Catalog. Blue Books, How-to-Books, Bargain Guides. Elston House, Centerville, Mass. 02632.

FREE Catalog 200 exciting self-improvement books \$1.00 and \$2.00. Frazier's Forum, P.O. Box 1511, Annex Sta., Providence, R.I. 02901.

FREE Catalog! "Self-Improvement Books." "Success!" "Happiness!" Wasdan's, Semmess, Alabama 36575.

HIGHER INCOME, Security and Power. 256 page Book "Thinking Big" reveals secrets that make men rich. Send \$2.00 Kinney (B-11)—1846 Baird, Madison, Wisconsin 53713.

SEND stamp & 25¢ for GRAY'S ALMANAC—P.O. BOX 457P—FRANKLINTON, LA. 70438

PLAYS, SONGS, MANUSCRIPTS

PUBLISHING Contract Guaranteed on selected songs and poems. Free evaluation. Hollywood Songwriters', 6253 Hollywood, 1117-PM, Hollywood, California 90028.

RECORDS Made. Publishing Contract Guaranteed On Accepted Songs, Poems. Send: Talent Searchers Of Hollywood, 6311-X Yucca, Hollywood, Calif. 90028.

SONGS, POEMS WANTED! For publishing, recording at our expense! TALENT, 17-PM, Longwood Road, Quincy, Mass. 02169.

SONGS, Poems Needed. New Songs Recorded. Publishing Guaranteed. Musically Yours, Box 606PM, Laurel, Florida 33545.

POEMS, LYRICS of religious, inspired nature needed for immediate publishing, recording consideration! We pay publishing, recording costs! CATHEDRAL RECORDING, P.O. Box 78-PM, North Weymouth, Mass. 02191.

COUNTRY-WESTERN SONGS Writing Workbook. Only \$3.49 From: Hammonds, 3 Baemar Place, Wheeling, West Virginia 26003.

POEMS, Songs wanted. Recording. Publishing guaranteed. Royalties. Radio-TV release. Broadway Music, Box 11647-PM, Sarasota, Fla. 33578.

SONGPOEMS, SONGS! Urgently Needed. Possible Recording/Publishing. 50-50 Agreement. Betty's Music Makers, 1417B Park Bldg., Pittsburgh, Pennsylvania 15222.

BUSINESS SERVICES

PROFITS FROM CLASSIFIED ADVERTISING! Booklet shows you how to start your own business with Classified Advertising. Only \$1.00 (Refundable with first order.) H. E. KAPPEL, POPULAR MECHANICS, DEPT. P, 224 WEST 57 STREET, NEW YORK, N.Y. 10019.

BUSINESS OPPORTUNITIES

SECRETS! Mail Order Success. Internationally famous expert reveals how to make home business fortunes. Beginners: Get free report "Make Money By Mail." Discloses free advertising profitable products. Mailco, Dept. GC70A, Woodland Hills, California 91364.

AUTO TRIM, CUSTOMIZING . . . Learn these high paying skills at home in spare time! Free Booklet, Auto Institute, Box 64-XPM, Orange, Calif. 92669.

SILVER RECOVERY Dealers WANTED!—Earn \$24,000.00 By Second Year!—No Investment! No Risk! Equipment Provided!—Our Manual "How to Start and Operate Your Own Silver Recovery Business" Gives Complete Details!—Manual Only \$9.95—Limited Offer!—Creative Products, 8415 Lofland, Dept. 103, Houston, Texas 77055.

FREE MILLIONAIRE BOOK "990 Successful, Little, One-Man Businesses". Work home! SBI-7, Kerrville, Texas 78028.

SUCCESS. Learn the **SECRET** fine points of making any business successful and receive **FREE COPY** of "How To Analyze Your Investment Opportunities" when you subscribe to the "Small Business Reference Letter". Three month trial subscription (New Subscribers) only \$2. One year \$18. Fascinating and Informative. Hamilton Publications, Dept. PMA, Box 156, Stratford, Conn. 06497.

INSTALL Burglar alarms without previous experience or costly equipment. Big profit. Free details. Nasco, Dept. G270A, Woodland Hills, California 91364.

EVERYBODY'S Guide: How to Profit from Ideas & Products. 64 Page Book \$2.00 pp. Clifton Park Gifts, Dept. 15, 2550 Upper Union Br., Schenectady, N.Y. 12309.

OWN Business! Collection, Vending, Bookkeeping, Restaurant, Swap Shop, 12 Others. Exciting Details Free! Specpro, P01G1, 3910 Elfin, Louisville, Kentucky 40207.

I MADE \$2,000.00 Monthly by Mail-order . . . Evenings Only! You Can Too—Free Proof! Asbury, Box 161-D, Madison, Ohio 44057.

IMPORT-Export Opportunity, profitable world-wide, mail order business from home, without capital or travel abroad. We ship plan for no risk examination. Experience unnecessary. Free Report. Meinger, Dept. G270A, Woodland Hills, California 91364.

FANTASTIC PROFIT POTENTIAL!!! Establish Your Own Successful Mailorder Book Business. Everything tested, proven, available. Free details, sample. Nationwide, Box 4367FE, Columbia, South Carolina 29240.

HOW TO FINANCE YOUR OWN BUSINESS. Get \$500 to \$2 million. Free offer. Capital-17, Kerrville, Texas 78028.

FREE Newsletter! "Selling Books By Mail". (Wholesale, Dropship, Imprints). Mailco, Box 1355, Sioux Falls, South Dakota 57101.

ESTABLISH Profitable Home-Operated Mailorder Business!! Minimum Investment. Everything Available to Insure immediate Success. Rush 25¢ Today for Complete Package. Learn how you can Cash in on this Great Moneymaking Opportunity. Carpenter, Box 6308B, Long Beach, California 90806.

WORLD'S EASIEST Mailorder Business. Free Details. Arteric-PM, 770 E. Griffith, Fresno, California 93704.

\$500.00 MONTHLY! Two Hours Per Day! Mail Order! Complete Instructions \$3.00! Hilmar, Box 347-DH, Valrico, Florida 33594.

RECEIVE \$250.00 Per Thousand—stuff Envelopes—Earn Immediately—Details 25¢. Saffar, Box 1956PM, Atlanta, Georgia 30301.

FREE Book! How to Sell Successfully by Mail Without Inventory. Write: AIDS, Route 5-A, Jefferson City, Missouri 65101.

LEARN Mailorder! Book Tells How! **FREE BROCHURE.** Edgar Brewer, Box 1268, New Haven, Connecticut 06505.

OPERATE Mail-Order Business From Home. Royce, 14603 Dorchester, GO-103, Dolton, Illinois 60419.

MECHANICAL Ability? \$100.00 Daily Possible. Your Business. Send \$2.00 to: J. Perry, Box H-1, Somerville, Mass. 02145.

STUFF Envelopes. \$26.00 Hundred for Beginners. Instruction Send \$1.00 Bill and Stamped Addressed Envelope. Keen, Box PM-9995, San Diego, California 92109.

INVENTORS! INNOVATORS! Cheap, Easy, Method Protects Inventions. Ideas, Plus Unique, New, Invention Service. \$3.00. Economy Enterprises, Dept. 23-P, Highland, Maryland 20777.

BIG Business in Vinyl Repair. Sensational process repairs, refinishes, recolors vinyl, leather, naugahyde furniture, car tops. One 20 minute job puts \$20 in your pocket. Make \$600 a month spare time. Homes, restaurants, offices, cars, unlimited customers. Easy to learn and do. Details Free. VIP, 2007 Montrose, Chicago, 60618.

NEW! Profitable Mail Order Business! Free Details! Xcito Businesses, 5715 N. Mozart, Chicago, Illinois 60659.

50-400% PROFIT!! Se'l Tested, Proven, Legitimate, Moneymaking Publications by mail. Complete Details 25¢. PAIT, 140T South B. Tustin, California 92680.

BIG Profits selling Nameplates. Custom Engraving—Free Details. R.P.H. Manufacturing, 249-F Winter, Stamford, Conn. 06905.

\$2000, MONTHLY Selling Information By Mail; Free Details: Clark, Box 80521-M, Atlanta, Georgia 30341.

CLAIM ABANDONED SILVER—\$20,000 Secret Revealed! Free Information: Silverman 4A-13, Box 548, Woodville, Texas 75799.

GUARANTEED. \$1.00 For Each Envelope You Stuff. Details \$2.00. Fuller, 228 Lemmon, Sumter, South Carolina 29150.

START Your Own Correspondence School. United Career Schools, 5820P Imperial Hyway, South Gate, Calif. 90280.

HERBALISM! The Home Gold Mine! **FREE LESSON, SEEDS!** Herba'ism Institute-B, Box 968, Glendora, California 91740.

BIG PROFITS!! SELL ENGRAVED, METAL, SOCIAL SECURITY PLATES, FREE SALES KIT! MYERS, 928-PM CRESCENTHILL, NASHVILLE, TENNESSEE 37206.

MAILORDER Dealers Wanted. Earn outstanding profits using tested promotions! Rutward-PD, Georgetown, Conn. 06829.

PIANO Tuning Learned Quickly at Home! Tremendous field! Musical knowledge unnecessary. GI Approved. Information Free. Empire School, Box 327, Miami, 33145.

WORLD'S Largest supply, Merchandise 25% to 40% under wholesale. Bankrupts. Closeouts 10¢ on dollar. Imports. Hong Kong clothes. Automobile discounts. Free details. International Buyers, Box 16386 MM, Portland, Oregon 97233.

SELL Books by mail. Complete dealer set-up—25¢. Midwest Mail Sales, Box 44R2-PM, Shawano, Wisconsin 54166.

MAKE A Years Income in 8 weeks Camping. No selling. Capital or Land necessary. Write: Edrus, Route 5, Box 5733, Gig Harbor, Washington 98335.

BECOME "Mortgage Broker." Lucrative! Capital Sources, Box 99-A, Uleta, Florida 33164.

MAKE Magnetic signs, Machineless method. Profits enormous. Write: R1B49APM, Bardstown, Ky. 40004.

ADVERTISING BUSINESS—YOU Own it. \$400 First Week or Money Back. Electric Neon Action Ad Clock, 229 W. Illinois, Chicago 60610.

HOLLYWOOD CEMENTCRAFT: Offers Highly Profitable Home Business. Experience Unnecessary. Unlimited Unique Pottery Designs Easily Made Without Moulds. Bird-baths, Fountains, Wishing-Well, Waterfalls, etc. Chemical Coloring Formulas. Marble-glazing. **FREE Illustrated Brochure. CONCRETE FACTS, 602 Athens Street, Altadena, California 91001.**

(Continued on next page)

BUSINESS OPPORTUNITIES

(Continued from preceding page)

COPUBLISH "Mail Sale Advertiser," leading mailorder paper. Copy and details 25¢: U.S.A. only. Vanroy Shirk, Lebanon, Pa. 17042.

VENDING Machine big catalog. Rake, 523 A Spring Garden, Philadelphia, Pa. 19123.

FREE Catalogs. Repair air conditioning refrigeration. Tools, supplies, full instructions. Doolin, 2016 Canton, Dallas, Texas 75201.

SELL Books by mail. 400% profit. Royal, Box 450-X, Cleveland, Ohio 44127.

\$70 TO \$200 WEEKLY—Home, Spare Time Simplified Mail Bookkeeping. Immediate Income. Easy. Auditax, Box 34741A, Los Angeles, Calif. 90034.

VENDING Machines. No selling. Routes earn amazing profits. Big catalogue Free. Parkway Corporation, 715PBM Ensor Street, Baltimore, Maryland 21202.

\$60.00 DAY. Manufacturing Concrete Posts. Blocks. Mold Equipment Catalog \$1.00 refundable. Carlayne, Route One, Box 95, Rapid City, South Dakota 57701.

MAILORDER Records help get increased business! Complete 32 page Record Book shows your inquiries, orders, advertising, expense, etc. Only \$1.00. **H. E. KAPPEL, POPULAR MECHANICS, DEPT. R, 224 WEST 57TH STREET, NEW YORK, NEW YORK 10019.**

REPAIR Hydraulic Jacks—Details Free. Write: Hydraulic Parts Supply, Box 295, Port Isabel, Texas 78578.

EARN \$60.00 Daily manufacturing Concrete Fence Posts. Practically no investment. Send stamped-addressed envelope. American, Excelsior Springs, Mo. 64024.

\$50.00 PLUS 50% COMMISSION Stuffing 200 already stamped, addressed envelopes, our circulars. Information 25¢ with stamped, self-addressed envelope. Brewster-PB, Clearwater, Florida 33517.

\$400.00 MONTHLY Raising giant fishworms. Soilless method. Charlie Morgan, Bushnell, Florida 33513.

EARN Money raising fishworms for us! Write: Oakhaven-38, Cedar Hill, Texas 75104.

WATCHMAKING Makes every day a payday. Learn this cash business at home. Free details, Chicago School of Watchmaking, YXA, Fox River Grove, Illinois 60021.

\$1.00 LISTS You year sent to 1000 Importers, Jobbers, Mailers, our mailing year. Dixie, King, North Carolina 27021.

\$200.00 SPARE Time earnings with your Tablesaw. Write: Workshop Five, 3800 Harney, Vancouver, Washington 98660.

STUFF Envelopes. \$25 Hundred. Immediate Earnings! Beginner's Kit, \$1.00 (refundable). Lewcard, P392M, Brea, Calif. 92621.

\$200 WEEKLY! Make, Sell Bricks! Free Information! Xcito Bricks, 5715 N. Mozart, Chicago, Ill. 60659.

\$2000.00 MONTHLY Selling Information By Mail. Ropchan, Box 5341P, Sherman Oaks, Calif. 91413

I MADE \$40,000.00 Year by Mailorder! Helped others make money! Start with \$15.00—Free Proof. Torrey, Box 318-Y, Ypsilanti, Michigan 48197.

SELL New Sensational Car Thief Signal. Lightning Seller. Samples for trial. Northwest Electric, Ave. 181, Mitchell, S. Dak. 57301.

BECOME Our Mail Order Distributor with \$150 Investment. Free Brochure. Audit Controls, 40 Brookside Ave., Fair Lawn, New Jersey 07410.

PORTABLE Sandblaster \$29.95. Distributor wanted. Free brochure. INKA, Box 66573—A, Houston, Texas 77006.

MAILORDER Millionaire helps beginners make \$500 weekly. Free report reveals secret plan! Executive (1A10), 333 North Michigan, Chicago 60601.

MAILERS Wanted!! Free Information. A. Allen, 2418 Lori, Santa Ana, California 92706.

FREE SECRET BOOK "2042 Unique, Proven Enterprises." Tiny businesses but huge profits! How Little Fellows beat inflation. Work home! Haylings-T23, Carlsbad, California 92008.

BOOKKEEPERS Operate Profitable Bookkeeping Service. Earn \$10.00-\$20.00 hour. Details free. Universal Bookkeeping, Box 664-M, Springfield, Missouri 65801.

SECRETS of getting rich with other people's money. \$5000+ possible in one day. Free details, JPA, Dept. 306, Box 101, Park Ridge, N. J. 07656.

\$200.00 DAILY In Your Mailbox! Opportunity To Follow Mailorder Experts. Free Details. Associates, Box 136-A, Holland, Mich. 49423.

RECEIVE Mail Galore! Your name on our national mailing lists, \$1.00. Sullins, Box 1313, Brunswick, Georgia 31520.

\$25.00 HUNDRED Addressing possible year 'round. Special information 25¢ with self-addressed stamped envelope. Cove-B, 627 Franklin, Clearwater, Florida 33517.

\$1000 MONTHLY from your own home. Write: Jordan, Box 884, Dept. PM10, Visalia, Calif. 93277.

DO SIMPLE ADDRESSING—Mailing. Receive \$12.95 orders. Keep \$8.00 profit. Details Free! Quality, Box 9-P, East Rockaway, N.Y. 11518.

MEN—Women! Fill out income tax forms at home in own business. We show you how. Simple, easy to learn. \$700 per month earnings possible. Details mailed free. No salesmen. Hurry. Federated Tax Home Training School, 2065 Montrose, Chicago 60618

MAKE \$7.50 to \$15.00 hourly building portable custom cases in your home. Huge demand. Get orders by mail. We supply materials, instructions—everything. Free details. Customcase, 6075 De Soto, Dept. C-P10, Woodland Hills, California 91364.

TAKE Catalog orders. We drop-ship 1001 best selling specialty products. Lowest below wholesale prices. Immediate Delivery. Spectacular home business opportunity. Free Book. Specialty Merchandise, Dept. S-P-10, Woodland Hills, California 91364.

HOW TO MAKE MONEY ADDRESSING, MAILING LETTERS. OFFER DETAILS 10¢. Lindbloom, 3636 West Peterson, Chicago 60659.

900% PROFIT Possible in magnetic signs. Get in on this fast growing, money making industry. We sell plans for building sign machines, supplies and custom signs. Dealers wanted. Magna, Box 1033M3, St. Charles, Mo. 63301.

MAIL Baby Catalogs Imprinted with your address to New Mothers for Big Profits! Details 25¢. Volz PM, Ypsilanti, Michigan 48197.

CALIFORNIA MANUFACTURER NEEDS Man to assemble our product and be local agent, experience unnecessary. May start while presently employed. Five-figure income for responsible applicant. S.K.R.M. Manufacturers, 2347 West 238 Street, Torrance, California 90501.

MAILORDER BEGINNERS LIBRARY, Learn Professional Secrets Inexpensively! Write: **HOW**, Box 4457PM10, Downey, California 90241.

INDEPENDENCE. FINANCIAL SUCCESS. Learn profitmaking secrets of home operated mail order business. Small amount of capital needed. No experience necessary. Our guidance can make you rich. Free report. Tipton, Dept. PM10, Box 19507, Oklahoma City, Oklahoma 73119.

\$92.00 FROM Square Foot Plywood (with Jigsaw or Bandsaw); 25¢ Rushes Revealing Details. Woderz, Bridgewater, Mass. 02324.

SMALL INVESTMENT LARGE PROFITS Start Plastic Sign Business, Auto Name Plates, Lawn Markers, Signs, Etc. A Good Money Raiser for Clubs. For Free Sample Write: Anchor Eng. Corp., 282 N.W. 2nd Street, Deerfield Beach, Florida 33441.

PLAN Ahead "1974's Greatest Mailorder Opportunities." Absolutely free. Neil H. Tasker, Shamokin, Pennsylvania 17872.

\$500 PER MONTH! Complete Home Business. Ready to go. No-Time-Limit Guarantee! Rush \$2.00. COLUMBIA, Box 24413-MJ, Oakland, California 94623.

UNLIMITED PROFITS FROM YOUR OWN ONE-MAN ELECTRONIC FACTORY. Capital unnecessary, sales handled by professionals. Revealing literature free. Barta-POMB, Box 248 Walnut Creek, California 94597.

\$150 WEEKLY Possible Addressing, Stuffing Envelopes. Information Send 25¢ Stamped, Addressed Envelope To: D & M Advertising, Box 4347—M, Colorado Springs, Colorado 80930.

EARN Thousands at home. How to sell books by mail. Free details. Wisdom House, Box 1106P, Largo, Florida 33540.

RAISE Rabbits, other Laboratory animals for us. We supply equipment, breeders and instructions. Details 25¢. Rabbits of Michigan, MP-11 Countyline Road, Pentwater, Michigan 49449.

300% PROFIT Possible—sell books by mail. Details. 25¢. Naggo, Box 11478PMB, Chicago, Illinois 60611.

HOW TO RAISE \$100.00 to \$1,000,000.00!! Write: Capital-PM, Dawsonville, Georgia 30534.

FANTASTIC PROFITS! Your Own Home Business. Fulker, 422 Northeast Knott, Portland, Oregon 97212.

FREE COLLECTION AGENCY Details!! \$1000.00 Monthly Possible. Master-PM, Dawsonville, Georgia 30534.

MONEY In Your Mailbox. Details Free! Russin, 8035 South Kostner, Chicago, 60652.

BECOME a Mail Order distributor with small investment. No inventory catalogs. Full Profit. Free detail's. Queens Enterprise, Box 1607-A, Grand Central, N.Y. 10017.

"**MAILORDER** Course! Home Study". 24 Easy Lessons. \$2.00. "Bill" Lambertson, 132 Tamiami Station, Dept. PM103, Miami, Florida 33144.

MAILORDER SUCCESS. All Information Needed to Start Business. Lindsey, Box 36023, Dallas, Texas 75235.

MAILORDER Imports, Report Reveals Foreign Drop Ship Sources. World Trader's Digest, Ideal Mailorder Items \$1.00. F. J. Grant, Box 1114, Black Mountain, North Carolina 28711.

FREE Literature: Profitable Mailorder Business. 24 Lessons Less Than 10¢ Each. Write Today. John Hooper, 4712 Harcourt Drive, El Paso, Texas 79924.

290.00 THOUSAND. Stuffing Envelopes. Immediate Income. Instruction Materials, \$1.00 (Refundable) and Addressed, Stamped Envelope. E. Enterprises, Box 242(MSPM), Provo, Utah 84601.

(Continued on next page)

BUSINESS OPPORTUNITIES

(Continued from preceding page)

SUBSTANTIAL PROFITS. Own your own business. Quickly learned. Operate from your home while continuing present job. Little over \$1,400.00 starts your own nationally and locally advertised business. Investigate immediately before your territory is taken. Free literature. Send today. Thixo-Tex, Inc., 5757 Lincoln Avenue, Dept. PM-3, Chicago, Illinois 60659.

NEW PLAN For Selling Books by Mail-order. Big Profit Sparetime Business. Details Free. Jemmar, Box 2202, Bremerton, Washington 98310.

IMPORT OPPORTUNITIES Free at our risk and expense for one full year. Earn \$15,000 or pay nothing. Northeast Imports, World Trade Division, Box 111M, Fremont, New Hampshire 03044.

\$2,000.00 MONTHLY. Amazing Mailorder Business. International, Box 217, Madison, Wisconsin 53701.

SEE How Mail Order Fortunes Are Made. Keystone, P.O. Box 106-PM, Rockaway, New Jersey 07866.

\$604.00 POSSIBLE. Money Back Program. Details 25¢. Wis. Box 188-PM Birnamwood, Wisconsin 54414.

YOU CAN Find Yourself and Your Big Opportunity. My Copyrighted Mind-Stimulator helps Thousands Forge Ahead. Amazing Message that helped 47 MILLION. Free! Frank Tibolt, 2819 Mt. Carmel, Glenside, Pa. 19038.

GINSENG Seeds, For Planting. Roots Bring over \$30.00 Per Pound. For Information. Write: Ginseng, McDonald, Tennessee 37353.

START Profitable Home Mailorder Business with Proven, Tested Baby Gift Catalog. Imprinted. Complete Profit Details, Sample Catalog 25¢. Langford, 600 National Drive, Grafton, Ohio 44044.

PROFIT FROM OUR EXPERIENCE. Experts Describe Beginning Business Problems and Economics. Easy-Read Series, First Pamphlet \$2.00 Refundable. Box 13213 Pittsburgh, Pennsylvania 15243.

HIGH Profit Potential from Plastic Engraving! Ideal Home Business. Trend Craftsmen, 4901P Perrine, Midland, Michigan 48640.

SELL Books Mailorder!! Highly Profitable. Free Details. Derbes, Box 2667, New Orleans 70176.

OPERATE PROFITABLE MAILORDER Business. Moneymaking spare time opportunity. Free Details. Wilfert Sales, 7580 Clough, Cincinnati, Ohio, 45244.

EXCITING Mailorder Business!!! Sell High Profit Moneymaking, Opportunity Manuscripts. Wide Selection. Rush 25¢ for Complete Instructions, Sample Catalog. Anthony, 3526PM Schoolcraft, Livonia, Michigan 48150.

DRAFTSMEN! Operate own **DRAFTING SERVICE!** Full, Part Time; Experience unnecessary; Details: Roberts Drafting, 1741 Circle Road, Baltimore, Maryland 21204.

YOUR Own Mailorder Catalog Business. No Merchandise Investment. Details 25¢ AM Sales, 31-14 94 St., East Elmhurst, New York 11369.

FABULOUS Spare-Time Earnings — Burglary Prevention. Details 25¢. Sample \$3.00. Marside, 115 Paloma, San Antonio, Texas 78212.

WHO'S MAKING A BUNDLE? Monthly Magazine tells How the Smart Guys are Making it. Exact Profits, Costs and How to get in. Free. Write: Insiders Report, 10M, Box 90954, Los Angeles 90009.

CAMPERS. Earn income while camping. No capital, Land or Selling required. Welba, Box 366, Anaheim, California 92805.

EARN \$2000 Monthly in Amazing Interesting Businesses. Free details H. Baker, 8496 Arnold, Anchorville, Mich. 48004.

RAISE Capital without collateral or credit. Unique plan assures success. Enterprises, Box 247-M, Columbus, Georgia 31902.

WE NEED GINSENG GROWERS! \$3,000-\$30,000 annually! We Buy Your Crop. Send \$2.00 for seed sample and information. Glass's Ginseng Exchange, Box 336, Rochdale Station, Jamaica, NY 11434.

NEW EXCITING BUSINESS. Free Details. T. Pearson, 787 Haight, San Francisco, Calif. 94117, Dept. 10.

66 2/3% OFF Retail! Lifetime home business! Free details. Olive, 1739 Lasenda, South Pasadena, California 91030.

\$10,000 MONTHLY Possible! Fantastic secret carpet cleaning formula revealed! Costs little—huge profits! Professional results guaranteed! Learn how to start your own cleaning business—easy! Every household your customer. Beat all competition. Sell formula/cleaning course by mail. Have your own name brand cleaning solutions. Complete, exciting details, \$1—refundable. Tower Carpets, Box 1066-H10P, La Habra, Calif. 90631.

THOUSANDS OF ITEMS—BELOW WHOLESALE. SEND \$2.00 FOR GIANT CATALOG (REFUNDABLE) TEXAS SPECIALTY HOUSE, 4701 ANDERSON RD. #19, HOUSTON, TEXAS 77045.

WHOLESALE AUTO SUPPLY DISTRIBUTORSHIPS. No inventory. No Franchise Fee. Automotive—114, Box 897, Aurora, Illinois 60507.

"INSTANT Cash" Social Security Plate Business! (Machine, Supplies—\$24.95!) Details:—Ideaco, Box 69828PX, Los Angeles 90069.

BEGINNER'S Mail Order Business Secrets. Details. Al's, PM, Atalissa, Iowa 52720.

FREE Details! Easy, Profitable Mailorder Business. Sabacy Products, Box 15206P, Lakewood, Colorado 80215.

"HOW To Start Your Own Business." Read Before Your Leap!—\$1.00. Associates, 113D28 Community, Shillington, Pennsylvania 19607.

HOW To Earn at Home Addressing Envelopes. Rush Addressed Stamped Envelope, (Your Name, Address), Gemgo, Box 332, Stoughton, Mass. 02072.

BIG PROFITS . . . As Research Expert!! Instructions \$3.00. AHCO, Box 3311, Dept. PM, Ft. Pierce, Florida 33450.

8 TRACK Tapes. \$24.00—Dozen. Rock, Soul, Country, Spanish. Free Catalog. Victor's, Box 10215, Cleveland, Ohio 44110.

\$25,000 + YEARLY—Sparetime. Guaranteed Mailorder System! Start with \$7.00 Rush 25¢ (refundable). Mears-PM, 5363 Essex, Alexandria, Virginia 22311.

HOW To Establish and Operate Profitable Mail Order Business. Free Details. Dunes Harbour, 310-A Southeast Parkway, Richmond, Indiana 47374.

SELL BURGLAR ALARMS. Set of Five Warning Stickers \$1.00. Lee Specialties, Box 32P, Dobbs-Ferry, New York 10522.

SPECTACULAR Profits! Establish Wholesale Business. Details 25¢ Woodlake House, Box 68-D, Woodland Hills, Calif. 91364.

\$13,250.00 in three months. Get Free Proof. Paco, Box 37157, San Antonio, Texas 78237.

SELL Books!! Complete Mailorder Plan. Vikari's, Box 1312PM2, Salt Lake City, Utah 84110.

\$2,000 MONTHLY In Fabulous New Business. Write: Nance, Box 25035E, Cincinnati, Ohio 45201.

SELL BURGLAR ALARMS. Set of Five Warning Stickers \$1.00. Lee Specialties, Box 32P, Dobbs Ferry, New York 10522.

THINKING Of Starting a Business? Read this Detailed Report, "How to Start and Form a Business." Only \$2.00 Postpaid. Business Research Services, 4047 Old York Road, Philadelphia, Penna. 19140.

EARN More than many professional men! \$1000. Month Mail Order Collection Agency. Continental, Box 2023-A, Des Moines, Iowa 50310.

PREPARE Tax Returns—Housewife Jo Ann Netzey made \$5,500 last season. Train at home. VA Approved. National Tax School, Monsey 2TD, New York 10952.

500 FRESH MAILING LISTS Perforated for \$1.00 bill REFUNDABLE. AIRMAIL ORDER to: R. RAJGOPAL, POST BOX 16629, BOMBAY 19, INDIA.

SUCCESSFUL FUTURE IN AUTO SALVAGE BUSINESS For Information Telling How You Can Succeed In Your Own Auto Salvage Business. Send \$3.95 To: Success, 3181 Woodside Drive, Jackson, Miss. 39212.

SELL Books By Mail. Dealership Information 25¢. House of Better Books, 33 Stonycliff Road, Centerville, Mass. 02632.

MONEYMAKING OPPORTUNITIES

BIG Profits in becoming a supplier to major industry through electroplating small parts and metalizing non-metals. Write for free particulars: Mason, Room MC-2-CP, 1512 Jarvis, Chicago, Illinois 60626.

MAKE Money with your Camera. Writing Fillers, Collecting Coins. Send \$3.00. American Enterprise, 1 Regina Street, Hicksville, New York 11801.

MONEYMAKING Opportunities from Consumer Education Association. Free Information. Associates, 7833 Coles, Chicago 60649.

EARN Money at Home by Mail. Free Details. Heuvel, 2030 Roblane, Muskegon, Michigan 49442.

THINK Big, Skyrocket Your Income. Gain Financial Security, Makes Men Rich. 256 Page Book, \$2.00. William Copley, 17016 Nubia, Covina, California 91722.

HOMEWORKERS. Earn 25¢ Each, Stuffing Envelopes. Rush 10¢. Gemco, B-21244A, Indianapolis 46221.

NEW! Official 224 Page Antique Handbook. Know the Value of what you Own. Buy. Illustrations. Wholesale and retail prices. \$1.98. McCullar Enterprises, Dept. L310, Box 12344, Dallas, Texas 75225.

THOUSANDS Of Moneymaking offers from America's Major Opportunity Companies. Rush \$1.00. Gallery, Box 48212/9B10, Atlanta 30340.

\$500.00 WEEKLY, Most PROFITABLE. Mail Order, Sell Information, Details. Smith, Box 176, Corona, California 91720.

SECRET Mailorder Technique. 500% Profit. \$1.00. Gallery, Box 48212-7B10, Atlanta 30340.

LEARN Sign Painting—\$1000 Monthly, Part-Time. Free Catalogue. Kaufmann Company, Centertown, Missouri 65023.

CLIP Newspaper items. \$1.00-\$5.00 each. Details free. Walter, Box 1360-PA, Erie, Pa. 16512.

\$100.00 EXTRA WEEKLY EASY! SPARE TIME! DETAILS, BEAUTIFUL SAMPLE FREE. RUSSELL PRODUCTS, DEPT. P41, COLUMBIA, TENNESSEE 38401.

CASH In on your Hobby. PHOTO report tells how, where. COLOR slide Markets. Send \$1.00 To: TOBEY'S, 419 University Blvd, East, Suite A2 648, Silver Spring, Md. 20901.

(Continued on next page)

MONEYMAKING OPPORTUNITIES

(Continued from preceding page)

MAKE Statuettes, novelties, imitation marble. Sell to stores or start gift shop. Free details, Marbleizing, 41 Waverton, St Louis, Mo. 63124.

HOW To Make Money Writing Short Paragraphs. Information Free on "Home Studies in Writing". Barrett, Dept. C-27-C1, 6216 N. Clark, Chicago 60660.

\$2.40 HOURLY Making simple wood novelties. Free details! Gene's, 55 Boxwood, Falmouth, Mass. 02540.

HOW TO GET RICH!! Free "Money-making Brochure"! Success International, Box 2447-C, Livonia, Mich. 48151.

VENDING Machines. No selling. Routes earn amazing profits. Big catalogue Free. Parkway Corporation, 715PMM Ensor Street, Baltimore, Maryland 21202.

PENNY STOCKS Have Profit Potential. Free Information. Analyst-P.M., Box 214, Redondo Beach, California 90277.

\$40 DAILY Possible tying fishing flies at home. Details 25¢. Flyco, Box 481PM, Albany, Oregon 97321.

EARN MONEY, learn mailorder, spare-time, at home, reading leading (since 1929) trade magazine, product sources, stories, tips. Sample 50¢, year \$5. Mail Trade, Box 1302, Springfield, Illinois 62705.

FREE—Easy Ways to make money selling exciting new products—Full—spare time. Send name, age, for 5 months free subscription. Salesman's Opportunity Magazine, 1460 Hancock Center, Dept. 17-KM, Chicago 60611.

ADDRESSERS—50 Companies want Addressers. Send self-addressed envelope. Cal Enterprises, Box 4516-X, Compton, Calif. 90224.

SWEPESTAKES Contests. How to win. Write for free information. General Contests, 1609-18 East 5th., Duluth, Minnesota 55812.

FREE SECRET BOOK "2042 Unique, Proven Enterprises." Largest successful collection! Fabulous "Little Knowns." Work home! Haylings-T22, Carlsbad, Calif. 92008.

\$200.00 FROM Sheet 1/4" plywood (scrap). Details 25¢. Novelties, 610 So. 24th, Elwood, Indiana 46036.

GET World's Biggest Wholesale Import Catalog. Write: World, Medina, Washington 98039.

START Small, HIGHLY PROFITABLE ELECTRONIC PRODUCTION IN YOUR BASEMENT. Investment, knowledge unnecessary. Postcard brings facts. Barta-PMN, Box 248, Walnut Creek, California 94597.

ADDRESSERS And Mailers Needed! Free Details! Splendid Opportunity! Delta, Box 24-P, Chalmette, Louisiana 70043.

SCIENTIFIC Messages: Big Earnings uncrowded profession. Learn spare time at home. Diploma awarded. Free catalog. Write: Anderson School, Dept. M-1C, Princeton, Illinois 61356.

SPARE Time Cash. Sell Famous Hanover Shoes. Actual Samples and sales kit Free. No experience needed. No age limit. Lowest prices for highest quality makes selling easy. Every man a prospect. Big daily commissions. For full details, write: Hanover Shoes, 1040 Carlisle, Hanover, Pa. 17331.

START Profitable Home Business Clipping Newspaper Items. Details Free. Benton House, Dept. 110, 1024 Benton, Fort Worth, Texas 76112.

MAILORDER, Home Business Ideas! Information Free! ABC Enterprises, Box 1824-P, Columbus, Georgia 31902.

\$250.00 PER Thousand stuffing envelopes! Unconditional Money-Back guarantee! Complete Starters Kit \$1.00. **HOMEWORKERS**, Box 24413-NJ, Oakland, Cal. 94623.

ADDRESSERS And Mailers Needed. Immediately Earning! Details 10¢. Lily, Box 4967-P10, NYC 10017.

OPEN The Door To Mailorder Knowledge. Write: Naggo, Box 11478PMM, Chicago, Illinois 60611.

HOMEWORKERS EARN \$150.00 WEEKLY ADDRESSING OUR SALESLETTER. IT'S SO EASY, SO PROFITABLE AND NO EXPERIENCE NECESSARY. DETAILS 25¢. **GLOBE ENTERPRISE**, BOX 2323-C, NEWARK, NEW JERSEY 07114.

GET RICH!! Sell Books Mailorder! Executive—21, Box 383, Jacksonville, Florida 32201.

SELL Your Photos. Report Tells How Where. Color Slide Markets. Send \$1.00. F. J. Grant, Box 1114, Black Mountain, North Carolina 28711.

\$75 DAILY showing car owners how to end Waxing-Polishing Forever. Samples details Free. International, 34 E. 12th Street, New York, N.Y. 10003, Dept. PMD-5.

SKETCH Photos (Homeworker's Goldmine!) Details. Gem, 365-D Longhill, Shelton, Conn. 06484.

EARN \$50-\$100 Weekly. Spare Time. Typing-Addressing Service. Details Free. Pat Richardson, Box 4097, Yuma, Arizona 85364.

NEED Cash? We Pay Cash for Newsclippings and Box Tops. Free Details. Troy Company, Dept. 511PM, Bayonne, N.J. 07002.

400% PROFIT From Square Foot 1/4" Plastic. Details Free. Jo-Mar-Ko, POB A34893, Detroit, Mich. 48234.

SELL Jewelry By Mail. **NO RISKS!** 100% Profit. Detailed "HOW-TO" KIT \$1.00. (Refundable). Fortune P. World, Box 4012, Foster City, California 94404.

100 BUSINESSES YOU CAN START FOR LESS THAN \$100. FREE REPORT. Educational, Box 3133D, Santa Rosa, California 95403.

LEARN The secrets of repairing junk batteries. "Fabulous Profits" at home. Apex Engineering, 3100, Romona, Atascadero, California 93422.

MAILORDER IMPORTS. Report Reveals Foreign Drop-Ship Sources. World Trader's Digest. Ideal Mailorder Items, \$1.00. **MERRICK ENTERPRISES**, 1006 Bancroft, Dept. DM 10, Coeur D'Alene, Idaho 83814. Booklet #MO-521.

DAYDREAMING! Stop! Opportunity Catalog Offers Books that can Make You Rich! 25¢. Hamlet House, 3A10, 6247 2nd N.W. Seattle 98107.

SELL YOUR PHOTOS. Report tells How. Where. Color Slide Markets. Only \$1.00. Free Catalog. GlenGarry Gifts, Dept. MR, 341 84th Street, Brooklyn, New York 11209.

SELL Your Photos. Report Tells How. Where. Color Slide Markets. Only \$1.00. Booklet #MO-521. Arlo's, Dept. 7-E, 3707 Third Street, Union Gap, Washington 98903.

HOW To make Money Writing Short Paragraphs. Inquire: Sunrise, 25P Lake Street, White Plains, New York 10633.

MONEY Available For Rewarding Pollution Reporters to Federal Government. Get Information Now. Send \$1.00. P.O. Box 10, Fulton, New York 13069.

PROVEN Successful Mailorder Imprint Catalog Program. Everything Tested, Available. Free Details, Sample Catalog. Allen, 554CS-7 Spruce, Garwood, New Jersey 07027.

FREE—Details About Amazing Book. "How To Make A Minimum of 60% on Your Savings. (Recorded Monthly—Mostly Tax Free)". Dr. LeSage, 111 East Everett, Dixon, Illinois 61021.

\$10.00 DAILY Writing Short Articles at Home. Begin Immediately! Copyrighted Report, Reveals How and Where. Send \$1.00. R. L. Enterprise, Dept. 1AM, POB 1172, Nashua, New Hampshire 03060.

MAKE MONEY Writing Fillers. Tells How, What to Write. Where to Sell. Booklet \$1.00. Distinctive Gift CATALOG FREE. Glenn Billings, 894 Almshouse Road, Ivyland, Pennsylvania 18974.

FREE Money Making Details. Importer, Box 11608, Santa Rosa, California 95406.

\$95.00 THOUSAND Addressing Mailing Circulars. Send stamped addressed envelope and 25¢: E. Matthews, 5009 Grindon Ave., Baltimore, Md. 21214.

PYRAMID Anything worth \$10.00 into \$100,000.00 without work—risk. Absolute Proof-Free. COSCO, Box 9007, Santa Rosa, CA 95405.

SELL YOUR PHOTOS Report Tells HOW, WHERE. Color Slide Markets. Booklet #MO 54P only \$1.00. **HALMAR HOUSE**, Dept. C44, 19537 South Redland Road, Oregon City, Oregon 97045.

FANTASTIC Seller 5 electrically lighted roses Red, Yellow or Pink, Sample \$3.00 Post Paid. Doz. Assorted—\$30.00. Sell for \$4.98. Collier, Box 306, Yucca Valley, Cal. 92284.

"MONEY CAN BE YOURS" WEALTHY Information. MONEY in My Mailbox Everyday. I have Learned Many ways since. "OPPORTUNITY KNOCKED MY DOOR DOWN". Send \$1.00 for Instruction to Follow. E. J. Sales, Dept. 12PM, Box 3084, Centerline, Michigan 48015.

WORLD'S Leading Contest Magazine, 50¢. Prizewinner, 1315 Central, St. Petersburg, Fla. 33705.

MAKE 300% Profit Without "Selling," just showing Color Catalog of Beautiful Low-Cost Jewelry, Money-Making Outfit Free. Minton, 309 Raritan Avenue, Dept. H24C, Highland Park, N.J. 08904.

"MILLION DOLLAR EXPORT BUSINESS" I'm making mine! Are you? Details \$2.00 (refundable) To: World Trade, P.O. Drawer 2347, Sepulveda, California 91343.

NEVER WON ANYTHING? Anyone Can Win Sweepstakes Contests! Free details. Services, Box 644-PCK, Des Moines, Iowa 50303.

DOES YOUR ORGANIZATION NEED BIG MONEY? I'll show you how to raise \$10,000, \$25,000 or even more. No selling! Details free. Powell—202F Village of Prestbury, Newark, Dela. 19711.

NO RISK OFFER!!! Establish Profitable Mailorder Catalog Business. Start with less than \$10.00. Complete details free. Nationwide, Box 75FF, Columbia, South Carolina 29202.

WIN In State Lotteries, Irish, Australian Sweepstakes! Don't buy tickets randomly. Give them a Chance. Information: Necaca, P.O. Box 851-P, Philadelphia, Pa. 19105

PROFITABLE OCCUPATIONS

MEN—Women! Start money-making Plastic Laminating business at home in spare time. Material costing 11¢ brings back \$2.58. No canvassing or selling but mail orders bring in \$20 a day. Write for full particulars free. Rush name on postcard to: Warner, Room LC-2-CP, 1512 Jarvis, Chicago, Illinois 60626.

FREE Literature—Start Your Own Mail Order Business at Home. The Tomlyn Co., Box 614 (J-3), Clifton, New Jersey 07012.

FT. SMITH Auction School, Ft. Smith, Ark. 72901. Resident & Home study. Veteran approved.

(Continued on next page)

PROFITABLE OCCUPATIONS

(Continued from preceding page)

BECOME A Mortgage Broker. Highly respected, interesting, lucrative prestige business. For complete information write: United, Box 6284-F, Marietta, Georgia 30060.

PLASTERCRAFT!!! Profitable home business. Molds available. Details: Lynnette, 6251C Mentor Park, Mentor, Ohio 44060.

SHARPEN—Scissors, Pinkers. Light, compact equipment. Supplies. Blackhawk's, Sheldahl, Iowa 50243.

HOW To Make Money Writing Short Paragraphs. Information Free on "Home Studies in Writing". Barrett, Dept. C-27-C2, 6216 N. Clark, Chicago 60660.

HOW TO Make Extra Money Writing Greeting Cards. "Fillers." Children's Stories and Articles. Not a Course. Free Details. Servat, 119-P East 26th, New York City 10010.

BAKE New greaseless doughnuts in kitchen. Sell Stores. Free Recipes. Michael Ray, Waseca, Minn. 56093.

SALESMEN-DISTRIBUTORS

\$100.00 EXTRA A week easy! Spare time! Double Air Cushion shoes. Men's, women's line. Dress, work, play. Highest commissions. Shoes for yourself. Outfit Free. Bronson, Dept. H-103, Minneapolis, Minnesota 55408.

COLLECTION System. Sample \$3.00. Dozen \$24.00. Sell \$15.00 Each. Creditors Service Company, Murphy, North Carolina 28906.

HERTEL Exclusive reference Bible! Make biggest profits with world's best seller! Startling 3-dimension cover! Demonstrator, supplies furnished. Top commissions plus extra bonus earnings! Write International Book, Dept. PM, Box 118, Wichita, Kansas 67201.

MAJOR 43 Year Old Greeting Card Publisher—now seeking full or part-time salesmen to contact retail stores. No experience necessary. Easy Sales. Huge Commission rate. Write today. Moderne Card Company, Dept. PM-10, 3855 North Lincoln Avenue, Chicago, Illinois 60613.

LONG Needed Invention. Want man contact service stations. Part time. Huge profits. Write: Cyclo, 3816 Dahlia, Dept. 191, Denver, Colo. 80201.

HOUSEHOLD PRODUCTS ROUTE. EARN \$25 or more daily. Also Party Plan opportunities for men, women full, part time. McNess, Freeport (26103) Illinois 61032.

PUBLICATIONS for local wholesale distribution, higher profits. Details, sample. \$1 refundable. Publisher, 404 West Jefferson, Springfield, Illinois 62702.

NEW, Compact fire extinguisher. Fantastic profits. Exclusive territories. Norwich Chemical, Norwich, Connecticut 06397.

AUTOMATIC Fishhooks. Free details. Samples, \$2.00. Aron, 61PM, Mastic Beach, New York 11951.

SELL Advertising Ball Pens, Calendars, Ad-Specialties—Build Own Repeat Business—Free Details—Fleming, Dept. A, 6535 Cottage Grove, Chicago 60637.

APARTMENT Occupants! Make \$90.00 Easily. Write: Gray, 3611P Bridge Manor, Kansas City, Mo. 64137.

EXTRA \$1200 Possible. Repeat. Exciting. Saylor, Box 622, Irving, Tex. 75060.

EARN Big money calling on business-professional men. Send us their delinquent accounts for collection. General Finance, Dept. PM-11, Columbia Bank Bldg., Kansas City, Missouri 64106.

EARN MONEY IMMEDIATELY. Sell nationally-Famous Knapp Shoes part-time or full time. High cash commissions immediately plus bonuses monthly, benefits. Your own hours, your own business. No investment. Free selling and training kit. Lowell Harris, Dept. PM-10, Knapp Centre, Brockton, Mass. 02401.

INCOME! Prospects! Unlimited! Good automotive products. Details, Jem. 6116-PM03 Orinoco, Indianapolis, Indiana 46227.

AGENTS WANTED

EVERY Man a prospect. Refundable sales kit offer showing line belt buckles, tie clasps, money clips, cuff links, lapels, identification badges, individualized with customer's name and emblems. Cap badges for trucking, bus, taxi, police, firemen, also postal, letter carriers and heavy construction emblems. Choice 5000 emblems. Hook-Fast, Box 1088-PM Providence, R.I. 02901.

WANT To Make Up To \$100 A Week spare time, and earn shoes for yourself for life, too? No investment. Rush card for free details. Mason Shoes, K-952, Chippewa Falls, Wisconsin 54729.

ESTABLISH Your own business. Low prices on used clothing, shoes, household goods. Unlimited profits. Free catalog. Northwestern Distributors, 2129-31 North Western Avenue, Chicago, Illinois 60647.

PRINTING, Advertising Salesmen—Excellent moneymaking sideline selling Decalcomania Name Plates, small quantities. Advertising Specialties, sign letters. Free Samples. Raico XL, Boston, Mass. 02119.

YOUR Own business. Used Suits \$1.50; Overcoats 65¢; Mackinaws 35¢; Shoes 12½¢; Ladies' Coats 30¢; Dresses 15¢. Enormous profits. Catalog Free. Nathan Portnoy Associates, 2109-4A Roosevelt Road, Chicago, Illinois 60608.

70 SOCIAL Security Plate Styles! Free Samples and Sales Kit. SYSTEMS, Dept. CN-18, Box 341, Northfield, Ill. 60093.

SELL Beautifully Jeweled Lucky Birthstone Zodiac social security plates. Big profits. Free sample. Wright, 1075-PZ Ringwood, Pompton Lakes, N.J. 07442.

MAKE MONEY IN SPARE TIME. As a subscription sales representative for leading national magazines, you can earn generous commissions while learning the art of selling. Instructions and supplies will be sent to you free. Send this ad with your name and address to: **POPULAR MECHANICS**, Room 1107L, 250 W. 55th St., New York, N.Y. 10019.

EMPLOYMENT INFORMATION

OVERSEAS JOBS—Now Hiring, 103 Countries. All Occupations, High Pay. Free Transportation, Tax Benefits. Latest Computerized Reports—\$2.00. **TRANSWORLD**, International Airport, Box 90802-E, Los Angeles, California 90009.

AUSTRALIA—NEW ZEALAND WANT YOU!!! 50,000 Jobs! Paid Transportation! Latest Information and Forms, \$1.00. Austco, Box 3623-E, Long Beach, California 90803.

AIRLINE Jobs! Money! Travel! How to apply \$1.00. Airtrek, Box 1052, Kendall, Florida 33156.

FLORIDA Employment Information Booklet. \$1.00! Sunshine, 4512N Jamaica, Tampa, Florida 33614.

HELP WANTED

MAKE EXTRA MONEY THIS FALL! IDEAL Opportunity for full, part time or retired persons. Show our Line of Specialty Advertising, Calendars and Executive Gifts to Business Firms in your area. No investments, collections, reports or district managers. Prompt friendly cooperation with a low pressure firm in our 64th year. Weekly commissions and liberal bonus. Can be developed into a full time business. Write to: John McNeer, Dept. PM-10, Newton Mfg. Co., Newton, Iowa 50208.

EARN At Home Addressing Mail. Details 25¢ and Stamped Envelope. Deeco-151, Box 9308, North Hollywood, Cal. 91609.

OVERSEAS Jobs—Europe, South America, Australia, Far East, etc. 2000 openings all trades. Construction. Office. Engineering Sales, etc. \$700 to \$3,000 month. Expenses paid. Free Information. Write: Overseas Jobs, International Airport, Box 536-M, Miami, Florida 33148.

OVERSEAS EMPLOYMENT . . . Australia, Europe, South America, Asia! All Occupations! \$700-\$3,000 monthly! Write: Employment International, Box 29217-AJ, Indianapolis, Indiana 46229.

REAL ESTATE AND FARMS

FREE CATALOG! Giant Fall-Holidays edition of country property! Over 5,200 New properties described, pictured—Land, Farms, Homes, Businesses—Recreation, Retirement. Selected Best throughout the U.S.! 73 Years' service—670 Offices. 41 states Coast to Coast. Mailed FREE from the World's Largest! **STROUT REALTY, Inc.**, 60MX E 42nd St., NY, NY 10017; 7-MX Dearborn, Chicago, Ill. 60603; 150-MX N. Santa Anita, Arcadia, Ca. 91006.

CANADIAN LAND FROM \$25.00 AN ACRE CHOICE. Properties available across Canada. Low monthly payments. Ideal for farming, cottages, hunting, fishing. Free Catalogue. Canadian Estate Land, Dept. PMC10, 286 Lawrence Ave. West, Toronto Ont., Canada. M5M 1B3.

CENTRAL Ontario—Choice 640 acre Sportsmen's paradises still available—\$20.00 plus \$6.50 taxes yearly. Maps, pictures. \$2.00 (Refundable). Information Bureau, Norval 4, Ontario, Canada.

FREE Catalog! **PHOTOS!** Coast to coast farms, business, retirement. All types, sizes & prices. **SAFE-BUY** Real Estate, Box 589-PM, Little Rock, Ark. 72203.

\$1 ACRE—Canadian border—hundreds campsites, islands, farmlands, directly from tax authorities. (Non-profit). Lists, photographs mailed. Register, Room 10, 110 Church Street, Toronto 1, Canada.

BOILING Spring Lakes—America's Greatest Real Estate Value, ¼ acre vacation or retirement homesites only \$995 cash price. Ten-year terms available. Money-back inspection guarantee. Carolina coast, multi-million dollar, 14,000 Acre development. 50 fresh water lakes, private ocean beach, golf course, motel, and country club. Free literature. Dept. 1-N, Boiling Spring Lakes, North Carolina 28461. (Registered under Federal Land Sales act but not offered to residents of states requiring separate registration.)

CANADIAN Vacation lands: Full price \$385.00. 40 acres. \$10 month. Suitable cottage sites, hunting, fishing, investment. Free information. Land Corporation, 3768-C Bathurst, Downsview, Ontario, Canada.

\$1.00 ACRE! USA and Canada. Lists, photographs mailed. Government Lands, 220 Delaware Ave., Buffalo, New York 14202.

GOVERNMENT LANDS FROM \$7.50 ACRE! Vacationing, Farming, Investment! Exclusive "**GOVERNMENT LAND BUYER'S GUIDE**" . . . plus "**LAND OPPORTUNITY REVIEW**" listing lands throughout U. S. Send \$1.00. Surplus Lands, Box 6588-AJ, Washington, D. C. 20009.

SURPLUS Forest, Mountain, Desert, Waterfront Land. Neglected Estates, Farms, Groves, Cabins. Throughout United States, Canada, Mexico. Low prices. Easy terms. Free list. Box 6272, Dept 46, Santa Ana, California 92706.

(Continued on next page)

REAL ESTATE AND FARMS

(Continued from preceding page)

FREE. . . . 264-page FALL catalog. Hundreds of top real estate values coast to coast! **UNITED FARM AGENCY.** 612-PM West 47th St., Kansas City, Mo. 64112.

CANADIAN Land. Full Price \$285.00. \$10.00 Down, \$10.00 Month. Ideal Vacation, Hunting, Fishing. Free Information, Vacation Acres. 7771A, Bernard, LaSalle 660, Canada.

IDEAL 5-ACRE RANCH. Lake Conchas, New Mexico. \$4,975. No Down. No Interest. \$30/mo. Vacation Paradise. Good Investment. Free Brochure, Ranchos: Box 2006GB, Alameda, California 94501.

FARM AND GARDEN EQUIPMENT

RIDING LAWNMOWER SALE 7 Horsepower Briggs and Stratton Powered \$189.00. Free Brochure. Tomco, Box 72, Oak Grove, Missouri 64075.



FLOWERS, PLANTS & NURSERY SUPPLIES

LEARN Landscaping and the growing of plants. Start a profitable business part or full time. Free information without obligation. Lifetime Career Schools, Dept. A-367, 255 Barry Avenue, Los Angeles, California 90064.

GINSENG BRINGING \$30 Pound. Have seeds, roots, Goldenseal. Full information. K. Collins, Viola, Iowa 52350.

LEARN Flower Arranging. Start business or Hobby. Free information on home study course. Lifetime Career Schools, Dept. B-772, 2251 Barry Avenue, Los Angeles, California 90064.

POPULAR MECHANICS COMPLETE GARDENING GUIDE. Information on how to make your lawn and garden beautiful. Tables and charts, and scores of show-how drawings. Planting dates and depths for all kinds of seeds and bulbs; when to prune and what, and how; information on the 56 most popular shrubs, and the 21 best hedges; how to lay flagstone, patio blocks, bricks—and much, much more. Printed on heavy plastic-coated cards, and spiral bound together. To order send \$3.95 to: Popular Mechanics, Box 1014, Dept. HE, Radio City, New York, N.Y. 10019 with your name and address.

CONSTRUCTION PLANS, BLUEPRINTS

HOUSE EXPANSION PLANS And detail instruction book provide anything from an extra room to 1000 s/f addition. Build what you need at big do-it-yourself saving. Book with 1 set working blueprints \$14.50! With 4 sets (required by contractors) \$20.00. Money-Saver Projects, Box 303-44B, Chappaqua, New York 10514. Information available.

PLANS For Mobile Homes \$7.50, R.V. \$5.00. Fast-Complete Pictorial Plans Do It Yourself and Save Half or More. Trailer Research, Box 554, Meridian, Idaho 83642.

LOG RACKS. Attractive addition to yard. Plans, two styles, \$2.00. VR2 Designs, 1349 Farragut, Kingsport, Tenn. 37664.

LOG CABINS

"A" FRAME Study Plan 50¢. Family House, Box 251, Westfield, New Jersey 07091.

BUILD Log Cabins, rustic furniture, fireplaces!!! Complete manual, \$3.00 . . . "A" Frame plans, \$2.00 . . . **Guaranteed.** . . . Beels, 956 Springdale, Atlanta, Georgia 30306.

"A" FRAME CABIN. \$500. Material. Purchase locally. Completely illustrated instruction manual & material list: \$2.00. Moneyback Guaranteed. Order plan #1924, from "Dependable Products", Box 113, Vista, California 92083.

"A" FRAME Cabin. 1184 square feet: \$1950. material. Purchase locally. Complete plans, illustrated instruction manual & material list: \$5.00. Moneyback guarantee. Specify plan #1601. "Reliable Products", Box 597, San Marcos, California 92069.

HOME CRAFTSMEN

SKIL-CRAFTS Current 200 plus page catalog with world's largest finest selection of Hobbycraft, leathercraft, artist supplies. Send \$1.00 for postage and handling; refunded on first \$5.00 minimum catalog order. Skil-Crafts, Box 105-P, Joplin, Mo. 64801.

WOOD—Domestic and Imported Hardwoods! 3500 items! Clock, musical instrument kits, Tools . . . discount prices! Hard-to-find hardware. 144 page catalog, 50¢. Craftsman, Dept. AX-103, 2729 Mary, Chicago, Illinois 60608.

WOODEN Tavern Lantern Plan—50¢. Bingham Plans, Box 74, Langhorne, Pa. 19047.

101 PATTERNS Of Smart Gifts, Novelties, Shelves, Action Windmills, p/us "Make Money Jig Sawing". \$2.00. Mastercraft 105M, 7041 Olcott, Chicago 60631.

WOODEN TOY PLANS, Description and Price list, 25¢. Box 443, Antioch, California 94509.

POPULAR MECHANICS MASTER SHOP GUIDE. Greatest product offered to a man with a workshop. All information printed on heavy boards, punched and ready to hang above his workbench. Covers wall fasteners, nails, screws, bolts, twist drills, abrasives, lumber, moulding patterns, plywood grades, hardboard, dry-wall plumbing supplies, electrical supplies. Plus information on score of other subjects. Send \$3.95 to: **POPULAR MECHANICS,** Dept. HE, 224 West 57th Street, New York, New York 10019.

CABINETMAKING MADE EASY And "How to Make Formica Counter Tops." Two excellent guides let you build kitchen cabinets and counter tops like professionals. Extraordinary guides bring master craftsmen's shortcut methods. Satisfaction guaranteed. Write: Japs, 126-P Seventh North, Hopkins, Minn. 55343.

CATALOG FULL SIZE FURNITURE PLANS —\$1.00 Refunded with first order. Traditional, Early American, over 150! Furniture Designs, 1425 Sherman, Dept. CP-103, Evanston, Illinois 60201.

ORNAMENTAL IRON WORK. Beautiful scrolls with inexpensive professional hender. Modular segments. Details Free. Fuschlin, Box 472, Woodland, California 95695.

WORKBENCH And tool panel anyone can build. Complete with material list. \$1.00. Way-Mar, 58 Underhill Road, Scarsdale, New York 10583.

PICTURE Framing—Profitable full or spare-time business. Easy to learn with handbook-course "Guide To Picture Framing Profits." \$1.50 Guaranteed. Free framing-supplies catalog included. Japs, 126-PM Seventh North, Hopkins, Minnesota 55343.

STAINED GLASS Professional photographic instructions by British craftsmen. Details 25¢. Old World Crafts, P.O. Box 7, Falmouth, Cornwall, England. TR11 2DY.

DO IT LIKE A PRO. Bind Your Car, Motorcycle, or Hi-Fi wiring with Tie-Dee Loops. Change that jumble of wires wrapped with electrical tape into a neat, professional installation. For sample package and price list 50¢, package 50 assorted loops, \$2.98. Mini-Mailer, Box 64583, Los Angeles, Calif. 90064.

IDENTIFICATION Name Plates, Gold stamped to Order. Free Sample. Doorposter, Box 30502, New Orleans, La. 70190.

UNIQUE Wood, Metal finishing, Refinishing and Antiquing products. New 1973-4 Catalog FREE. Birchwood Casey, Dept. 277, 7900 Fuller Road, Eden Prairie, Minn. 55343.

20 PLANS, Full Size Early American Novel Items for Fun or Profit. Send \$2.50. Carbone, Box 18099, Philadelphia, Penn. 19147.

BIRD HOUSES For Fun and Profits, 20 Projects And Plans, \$1.00. Infoco-P10, Box 34260, Washington, D.C. 20034.

MINIATURE Blast Furnace (Foundryette) 2400 F. 1½ to 50 lbs. capacity. Circular 25¢. Kansas City Specialties, Inc., Box 193, Middleton, Wisconsin 53562

HOME REMODELING

BUILD THIS ALL-IN-ONE DIVIDER. Hi-Fi, storage and seating all combined in this handsome home entertainment center. Photocopy of article as it appeared in P.M. shows you how. Price 85¢. Send orders to Popular Mechanics, Dept. HE, Box 1014, Radio City, New York 10019

DO-IT-YOURSELF

RANGES, GE, HotPoint Replacement. 3 Wire Surface Units. Send \$18.95 Small, \$21.95 Large. Write, Others, Make, Model, Size. Budass Co., Box 352, Levittown, New York 11756.

PROFESSIONAL Secrets Revealed. Concise Home Manuals. Furniture Refinishing—Furniture Repairs—Minor Upholstery. \$2.00 each. Lent Woodworking, Box 303, Sewickley, Pennsylvania 15143.

ROLL-TOP Trestle desk. Assemble yourself. Kit includes Hardware. \$49.95 PPD. Details! Andy's Woodshed, Dept. PM, 630 North Grant, Stockton, Cal. 95202.

STEAM Engines, Flash And Watertube Boilers, Burners, Steam Lawnmower, Pictures, Descriptions, Drawings 2 Dollars. We can supply Castings To Make The Old Popcornpopper Steam Engine. Travis Tool Co., Sidney, Iowa 51652.

BURGLAR-FIRE Alarm Supplies and Information. Free Catalog. Protecto Alarm Sales, Box 357A, Birch Run, Michigan 48415.

CONVERT MOWER Engines into air compressors. Write: Showalter, Box 409, Abilene, Kansas 67410.

REPAIR MINIBIKES, LAWNMOWERS, BICYCLES, Sewing Machines, Auto Engines, Mazda/Wankel, Motorcycles, Magic boats. Over 100 How-To-Books. Free Brochure. Mastercharge accepted. Sincere, Box 10422, Phoenix, Arizona, 85064.

BEAT INFLATION! Make Artificial Facebricks—Under 10¢ Sq. Foot. Any Color, Style. Details: Wagner, 1349 Ayrault Road, (A9B10), Fairport, N.Y. 14450.

ARTIFICIAL Fireplace Cabinet for T.V., Stereo, Bar Built of Wood Material. List Instructions Plans \$4.00. MMP Fireplaces, Box 1069, San Fernando, California 91341.

MAKE YOUR OWN INDIAN SOFTSOLE MOCCASINS. Professionally Graded Patterns and Instructions. Send \$1.00 with Shoe Size. Moccasins, 17 F RichMar Road, Owings Mills, Maryland 21117.

1400 CATALOGS Listed and Described Sources for EVERYTHING Imaginable! Rush \$2.00. MASTERLOG, Box 24413-Y1, Oakland, California 94623.

24" SHEET Metal Brake \$59.00 F.O.B. Omaha. Maple Village Shops, 9628 Sahler, Omaha, Nebr. 68134.

(Continued on next page)

DO-IT-YOURSELF

(Continued from preceding page)

MAKE The Engine you now have in your car working with Water. It will Cost you Less than \$30.00 to make it. Send \$10.00 for Information and Drawings Showing you How To Do It. Write: George Eliades, 271 Concord Avenue, Toronto 4, Canada.

NEW: One Drop Holds 2,000 Pounds. Industrially Developed Adhesive. Bonds Anything to Anything in Seconds. Dries clear, no Mixing. Each 130 Drop Tube \$1.98. Guaranteed. Mimic, Box 68, Albertson, New York 11507.

CENTRAL Air Conditioning Simplified. Humidifiers, Ductwork, Electronic Filters. Easy. Quick. Our Planning Guide Shows You Everything \$1.00. Air-Ways, 32 Washington Ave., Port Jefferson, New York 11776.

CONVERT TV to 6-ft. wide screen! B & W/Color. Do-It-Yourself—easy! Kit, instructions, lens, \$12.95 PPD. Free illustrated details. MACROCOM4, PM-10, Washington Crossing, Penna. 18977.

BUILD NEW FREE HEATING—Lighting Powerful—Perpetual unit. Wouldn't cost Penny to run. For Full instruction \$10.00 M.O. "Kosmon" Co., P.O. Box 68, Victoria, B.C., Canada.

MAKE Any Window, A Oneway Glass You Look Out, Nobody Looks In (11½x16) Plastic—\$3.00. Palmer, PO Box 1244PM, Phenix City, Alabama 36867.

STRONG Locks are Good Insurance! Protect Home, Auto, Bicycle. **FREE** Catalog. Home Products, Box 281, Plymouth, Michigan 48170.

ARTS AND CRAFTS

"GETTING Started in Stained Glass" 25¢. Whittemore, Box 2065Y, Hanover, Mass. 02339.

FREE LITERATURE For sculptors showing how to make molds, cast plastics. Adhesive Products Corporation, 1660 Boone Avenue, Bronx, N.Y. 10460.

FREE: New handicraft catalog. Supreme Handicrafts, Box 395-PM, Sioux Falls, South Dakota 57101.

LEARN Arts & Crafts at home. Excellent full or part time business opportunities, or hobby. Free booklets. Lifetime Career Schools, Dept. E-806, 2251 Barry Avenue, Los Angeles, California 90064.

MAKE Figurines, plaques, lawn ornaments. Molds, plastercraft kits, liquid rubber. Sample and catalogue 10¢. Wooley Company, Box 29-B, Peoria, Illinois 61601.

LEARN Flexible Mold Making and Casting in Plaster and Imitation Marble. Complete Instructions \$10.00. Rapid Marbleizing, 41 Waverton, St. Louis, Missouri 63124.

EMBED Flowers, seashells, photos, anything in clear Castolite for paperweights, desksets, unusual gifts. Reproduce any art objects in plastic, candlewax, metal, plaster. Profitable. Free. **CASTOLITE**, 73L/PMA, Woodstock, Illinois 60098.

BINOCULARS, TELESCOPES, MICROSCOPES, MAGNIFIERS

TELESCOPE (Reflectors) complete kits. Other accessories, request free literature. Criterion Manufacturing, Dept. PM 45, Hartford, Connecticut 06101.

FREE Binocular, Riflescope catalog. Discount sale. Save 50%. Free gift with order. Write: United Binoculars, BN-7208, 9043 So. Western, Chicago 60620.



CAMERAS AND EQUIPMENT

FREE CATALOG! Cameras, Lenses, Binoculars! Dickson Company, Box K-3979, Kowloon, Hong Kong. Airmail U.S. \$1.00!

FREE! FREE! BARGAIN BOOK Central Camera Co., Dept. 3101, 230 S. Wabash, Chicago, Ill. 60604.

USED Photographic Equip. Nationwide Monthly "Shopper" Free Sample. Shutterbug Ads, Box 730-P, Titusville, Fla. 32780.

PHOTOGRAPHY for pleasure or profit. Learn at home. Practical basic training. Long established school. Free booklet. American School of Photography, 555 E. Lange, Dept. 820-05, Mundelein, Illinois 60060. A home study school.

PHOTOS AND PHOTO SUPPLIES

CASH For **PHOTOS!** All Subjects! Latest Comprehensive Wand List & Manual \$2.25. Satisfaction Guaranteed! Research, Box 213, New York, New York 10016.

DARKROOM SINK WITH A BUILT-IN PRINT WASHER. Make it yourself, it's easy! For 75¢ you can buy a photocopy of the article as it appeared in PM. Send orders to **POPULAR MECHANICS**, Dept. HE, Box 1014, Radio City, N.Y. 10019.

SELL Your Photos. Report Tells How. Where. Only \$1.00. P-B Enterprises, 170 E. King St., Lancaster, Penna. 17602.

PHOTO FINISHING

CAMERA FANS! Expert photofinishing by one of Country's largest labs at lowest prices. Fast service and free "Foto-Fan" Stamps you quickly redeem for valuable Photo Supplies, 8MM Kodachrome \$1.29; 8 Exp. Kodachrome \$1.79; 35MM Kodachrome 20 Slides \$1.39; 8 Exp. Black White 69¢. Satisfaction guaranteed. Send exposed film or request free mailers, complete Price List and Gift Catalog. Direct Mail Photo, Box 8352-PM, Pittsburgh, Pa. 15218.

COLOR SLIDES

ADD Shape Zip to your slide shows! 57 cropping and novelty mask openings. Samples, details 25¢ coin. Heindl, 194 St. Paul St., Rochester, N.Y. 14604.

35MM COLOR Slides, 10,671 Individually sold. Described, Encyclopedia catalog 10¢. Wolfe Worldwide, Dept. 14-103, Los Angeles, Calif. 90025.

MOTION PICTURES AND SOUND EQUIPMENT

8MM, Super-8 sound Features, shorts. Discount priced. Hart, Box 452-A, Birmingham, Michigan 48012.

CLASSIC 8MM. MOVIES . . . 35MM. 2"x2" Color Slides. . . largest selection anywhere! Silent classics, comedy, history, sport, news, documentaries, features, others! 16MM films also Free catalog. Blackhawk Films, 690 Eastin-Phelan Bldg., Davenport, Iowa 52808.

UNUSUAL Movie supplies. Free circular. Esor, 47th Holly, Kansas City, Missouri 64112.

FREE! 64-Page catalog. 8-16MM film supplies, processing equipment. Superior, 448 N. Wells, Chicago 60610.

8MM—SUPER 8—16MM MOVIES! Biggest Selection! Lowest Prices! Free Catalog! Cinema Eight, Box PM, Chester Connecticut 06412.

FREE Catalog—8mm-16mm—Top Manufacturers—G & G Film Library, Box 321, Syosset, New York 11791.

16MM, 8MM Sound and Silent Classic Films. Free Catalog. Niles, 1019-PM So. Michigan, South Bend, Indiana 46618.

RADIO, TELEVISION AND HAM EQUIPMENT

AMAZING INDOOR TV ANTENNA: Cures Poor Reception. All Channels Clear. Plugs Into Wall Outlet. Guaranteed: \$1.98 Little Town Products, 40 Cottage, Morrisville, Vermont 05661.

SAVE Money on parts and Transmitting—receiving tubes. Foreign—domestic. Send 25¢ for giant catalog. Refunded first order. United Radio Company, 56-PM Ferry Street, Newark, N.J. 07105.

36¢ RADIO & TV Tubes. Free catalog. Cornell, 4213-17 University, San Diego, California 92105.

GOVERNMENT Surplus receivers, transmitters, sniperscopes, parts. Catalog 25¢. Meshna, Nahant, Mass. 01908.

GIANT Canadian Electronics Surplus Catalog. \$1.00. Etco PM, Box 741, Montreal.

RESISTOR Color Coder 50¢. Norvex Co., 3920 Larkin St., Norfolk, Va. 23513.

HIFI TAPES, RECORDS AND ELECTRONICS

YOUR FAVORITE RADIO Programs From 1940's on Records and Tapes. Great Christmas Gift Ideas. Catalog 50¢. Words and Pictures, PO Box 130, Fairfield, Connecticut 06430.

TAPE RECORDER PARTS, Belts, Heads, Etc. Catalog \$1.00 (deductible). Tapemech, Box 219, Fern Park, Florida 32730.

OLD Radio Programs. Stamp For Special Flyer. Stop, Box 3402M, Seminole, Fla. 33542.

FREE Catalogues, 2000 hard to find unusual records. Rose's Records, Box 7216, Louisville, Ky. 40207.

OLDIES 45 RPM Original Hits—Catalog 50¢. C&S Record Sales, Box 197, Wampsville, New York 13161.

FREE Catalog—Electronic Kits—Amplifiers—Preamplifiers—Psychedelic Strobes—SCA Adaptors—Color Organs—Digital Instruments—Guitar Amplifiers. **FREE** Subscriptions, SWTPC, Box PM32040, San Antonio, Texas 78284.

8-Track Tapes • Catalog free. C. Bolton, 1114 9th Ave., So. Sioux City, Nebraska. 68776.

OLD Radio Programs. All Your Favorites. Lowest Prices. Prompt Service. Catalogue 25¢. Nostalgic Radio, Box 29, Peoria, Ill. 61601.

FREE CATALOG—Tremendous Electronics Bargains. Pacific, Box 4192E, Mountain View, California 94040.

TAPES—8-Track—Low as \$1.10 Each. Free Catalog—800 Top Titles. Send Postcard. GemTone Industries, Box 57220, Dept. PM, Los Angeles, Calif. 90057.

SUSPENSE—Fibber—Benny; Others. Cassette \$4.00/Hour. Free Catalog. Radio-Heyday, 8162 West Balmoral, Chicago, Illinois 60656.

RECORDING Tape 7" Reels 2400' \$14.00. Dozen 1200' \$8.00 Dozen. Postpaid. Guaranteed. Mitchell, Box 132, Flushing, New York 11367



MUSIC AND MUSICAL INSTRUMENTS

ACCORDIONS And Amplifiers! New—Used. Cordovox. Excelsior—Top Makes! Save to 50%. Direct factory dealer. Terms. Trades accepted. 5 day home trial. Free Catalog—Discount prices. Write: Accordions Unlimited, Dept. R, 3147 North Luna, Chicago 60641.

SWISS Music Boxes, Movements. Finest. Tunes Made. Spielman, 55 West, 42nd. New York 10036.

GUITARKIT. Save \$\$\$\$\$. Record and Catalog \$1.00. Leisurekit, Box 2000, New Canaan, Connecticut 06840.

SWISS Musical Boxes, Movements, Musical Products. Bell Music, P.O. Box 1, Bay Station, Brooklyn, New York 11235.

(Continued on next page)

MUSIC AND MUSICAL INSTRUMENTS

(Continued from preceding page)

LEARN To read music in one evening. Free brochure. Jordan, 27495 Road 176, Dept. PM-10, Exeter, Calif. 93221.

EASY To Play And Make, Quality Dulcimers, Banjos, Thumb Pianos; Instruments And Kits. Can Be Profitable Hobby. **HERE**, Inc., #P. 410 Cedar Avenue, Minneapolis, Minn. 55404.

ELECTRIFY Player Pianos, Pump Organs Quickly, Inexpensively with Lee Silent Suction Units. Write: Lee Music, 525F Venezia Avenue, Venice, California 90291.

30% TO 50% DISCOUNT! Any Model: Guitar, Amp, Drum, Banjo, Dobro! Free Catalog! Warehouse P38, Box 16399, Fort Worth, Texas 76133.

PLAYER Piano Rebuilding—get details from: Vestal Press, Vestal 11, N.Y. 13850.

POEMS Wanted for songs. Nashville Music Productions, Box 40001-P, Nashville, Tennessee 37204.

VIOLIN And Guitar makers—send for latest Free Catalogue of woods & accessories. International Violin, PM1. 414 East Baltimore St., Baltimore, Md. 21202.

WHOLESALE! Professional Guitars, PA Systems, Altec Speakers, 240W RMS Amplifiers. Free Catalog. Carvin, Escondido, Calif. 92027.

RECONDITIONED Accordions for sale—Save \$\$\$, Top Brands. Write for free descriptive folder. A-1 Rebuildt Accordions, 31 E. 18th St., N.Y.C. 10003.

ACCORDION Top brands. Buy direct. Tremendous discounts. Trades accepted. Free brochure PM. Accordion-O-Rama, 874 Broadway, N.Y.C. 10003.

GUITAR, Banjo, Violin, Mandolin Making Materials, Accessories, Books. Catalog 25¢. Guitar Center, Box 15444, Tulsa, Oklahoma 74115.

NEW GUITAR MAKING BOOK & NEW TOOLS. Overholtzer, 618 Orient, Chico, Cal. 95926.

LEARN Banjo. 5-String Bluegrass. No music. Makes learning easy. Free details. Blaylock, Box 25-M, Marietta, Georgia 30060.

ACCORDION Manufacturing 6846-P North Avenue, Chicago, Illinois, 60635. Concertinas, Chromatics, Heligons, Hohners, Guitars, Drums, New, Used, Tuning, Repairing. Wholesale Catalogs Free.

30% DISCOUNT Name Brand Musical Instruments. Free Catalog. Freeport Music, 455F Route 110, Melville, N.Y. 11746.

BAND INSTRUMENTS, NAME BRANDS. Discount Prices. Free Catalog. Musical Instrument Wholesalers, Drawer 5370, Ft. Worth, Texas 76108.

KITS! Build Dulcimers, Guitars, Balalajas, Thumb Pianos, Haros. From \$2.95. Finished Dulcimers from \$19.95, 8665 West 13th Avenue-P, Denver, Colorado 80215.

PIANO TUNING Made Easy. Manual and all Necessary Tools, only \$22.50. Ten-Day Money-Back Guarantee. Details Free. Stamm industries, 813 West Lovell, Kalamazoo, Michigan 49007.

PLAY IMMEDIATELY! TRY FAMOUS GUITARIST'S GUARANTEED 10 lesson Course Including Record Album-Chord Manual-Guitarist's Dictionary. Big Package Worth \$12.95 Now \$4.95. Play Great Fast or Refund. Information Free. Imperial, 671-PM Second Avenue, New York, New York 10016.

BIG DISCOUNTS Wholesale. Musical Instruments. Accessories. Free Catalog. Nationals Music. POB 27206, Tucson, Arizona 85726.

WHOLESALE. Musical Instruments—Accessories. Allied, 573 Route 17, Paramus, New Jersey 07652.

GUITAR Taught on Tape. Free Details. Edward Pratt, 5720 S.W. 38th Court, Fort Lauderdale, Florida 33314.

EDUCATION AND INSTRUCTION

WELDING TRAINING Basic and advanced training for major welding processes—Arc, Gas, Pipe, TIG, MIG, plasma. Hobart, a non-profit school, is accredited by NATTS. Approved Ohio 70-12-0064 HT. Write for school bulletin and course schedule. **HOBART SCHOOL OF WELDING TECHNOLOGY**, Box 73, Troy, Ohio 45373.

SURVEYING PAYS BIG!!! United States Department of Labor reports Openings for 26,000 Surveyors in next ten years." Easy home-study plan guides you. Send for Free "Surveying Career Kit." North American School of Surveying, AZ, Newport Beach, California 92663.

HIGH SCHOOL Equivalency Diploma fast! Pass GED. New-type 5 week home preparation. Simplified, budget-priced. Information mailed free: Bright Futures, Box 514PMB, Jackson Heights, New York 11372.

"LEARN Fast as Geniuses!" \$3.95! (Refundable!). Castle's, 507-M Fifth, New York 10017.

DEGREE Program in Electronics Engineering. Our 27th Year! Free Literature. Cook's Institute, Dept. 10, Box 10634, Jackson, Miss. 39209.

FINGERPRINTING—Investigation. Exciting, secure career. Learn at home. Free book. State age. Institute of Applied Science, 1920 Sunnyside, Dept. 16A, Chicago, Illinois 60640.

IMPROVE Yourself. Free Literature Describes 88 Low Cost Books. Success, Confidence, Wealth, Personal Problems. Adair Enterprises, Dept. L2, 40 Longfellow, Mill Valley, Calif. 94941.

ADVERTISING Interest you? Professional Course. Write: Advertising Assistance-O, 655 Teresita, San Francisco 94127.

VENTRILOQUISM—Profitable Hobby or Career! **FREE** newspaper and Home Course Scholarship. Maher, Box 9037PI, Denver, Colorado 80209.

ACUPUNCTURE BOOKS And SUPPLIES **CATALOG!** Wong, Box 219W, Toronto, Canada M6M 4Z2.

LIVE, WORK, EARN OUTDOORS! Be a Park Ranger. Train in spare time at home. Important, rewarding, respected work. Good pay now. Great future. Trained men in demand. Details Free. National School, Dept. 4-30, 2019 20th St., NW, Washington, D.C. 20036.

VETERINARY ASSISTANT—Train at home for exciting animal care career. Send for **FREE** "Career Kit". North American Home-Study School of Animal Sciences, AZ, Newport Beach, California 92663.

MISSOURI Auction School. Veteran Approved. Free catalog. 1600-03 Genesee, Kansas City, Missouri 64102.

EXTENSION And Post-Graduate Awards in Philosophy, Art, Sciences, Botanic Medicine, Homeopathy, Radionics and others. 30 subjects. Curricular free (airmail \$1.00 refundable). Registrar, Sussex College of Technology, Highfield, DaneHill, Sussex, England.

LEARN Sewing Machine Repairing. Men, Women. Lucrative profits. Profession with bright future. Gresslin Correspondence School, Box 927, Spencer, Iowa 51301.

LEARN Auctioneering. Term soon. Free catalog. Reisch Auction College, Box 850, Mason City, Iowa 50401.

ORDINATIONS, Lifetime! Church chartered 1887! Write! 708 Bragg, Monroe, North Carolina 28110.

RELIGIOUS VOCATION? Write: Church of Holy Light Inc., P.O. Box 4478, Pittsburgh, Pa. 15205.

USED Courses! Books! Catalog 10¢. (Courses Bought). Lee Mountain, Pisgah, Alabama 35765.

AUTOSUGGESTION. Sleep-learning headquarters! Tapes, records, books, Gigantic catalog free. Research Association, Box 24PM, Olympia, Washington 9851.

OWN Collection agency. "Little Gold Mine!" Franklin Credit, Roanoke, Virginia 24004.

AUCTIONEERING. Resident or home Study Course. Free Catalog. Nashville Auction School, 1921 West End, Nashville Tennessee 37203.

PERFECT Husband-Wife Business. Learn Upholstery at home. Make \$10 in an hour. Buy—repair—sell for even bigger profits. Kits, tools, included. Free Booklet. Upholstery & Decorating School, (home-study), Dept. 5310-103, Little Falls, New Jersey 07424.

DETECTIVE Profession, Easy home study; free tie-tack or lapel pin, certificate, future. GI approved. Professional Investigators, Box 41345, Dept. CP, Los Angeles Calif. 90041.

DETECTIVE Course. Free Information. Universal Detectives, Box 8180-F, Universal City, California 91608.

LEARN To Fix Typewriters. Desperate shortage trained men. Hundreds needed. Make up to \$25 in one hour. Learn at home in spare time. Industry Approved course. Facts Free. Send name. Typewriter Repair School, (homestudy), Dept. 3310-103, Little Falls, New Jersey 07424.

PIANO Tuning quickly learned with home study course. Diploma granted. American Tuning School, 17050 Telfer Dr., Morgan Hill, California 95037.

SHORTCUTS To Success! Highly Effective, Profitable Short Courses, (75 Choices). Study At Home. Diploma Awarded. Our 27th Year. Free Literature. CIEE-25, Box 10634, Jackson, Miss. 39209.

WATCH REPAIRING. Learn at home in spare time. Diploma awarded. Free sample lesson. Chicago School of Watchmaking, Dept. YX, Fox River Grove, Illinois 60021.

UNLOCK Your Future. Become professional Locksmith by spare time home-study. Make up to \$6 per hour. All tools, equipment inc. Facts free. Send name. Locksmithing Inst. (Homestudy), Dept. 1310-103, Little Falls, New Jersey 07424.

SERVE God's Ministry. Free. Ordination. Bible Institute, Box 744, McKeesport, Pa. 15134.

LEARN Asleep or awake! Records, tapes, equipment! Free catalog! Drawer PM-400, Ruidoso, New Mexico 88345.

GET A British Degree. Divinity. Philosophy, Radionics. 35 Courses. Prospectus free. Brantridge, Forest School, Highfield, Dane Hill, Sussex, England.

NOW! Your Own Burglar/Fire Alarm Business. Train at home. Expanding field. Course includes professional tools Plus equipment, supplies for first job. Information by mail. Security Systems Management School (homestudy), Dept. 7310-103, Little Falls, N.J. 07424.

USED Courses! Books! List 10¢. Smith's, 124 Marlborough, Salem, Massachusetts 01970.

LEARN ACCOUNTING! U.S. Labor Department reports "33,000 NEW Accountants, 78,000 NEW Bookkeepers needed EACH YEAR for next ten years". Easy home-study plan prepares you. Approved for Veterans. Send for **FREE** "Accounting Career Kit". North American School of Accounting, AZ, Newport Beach, California 92663.

(Continued on next page)

EDUCATION AND INSTRUCTIONS

(Continued from preceding page)

JACK Hudson made \$20,000 working just 6 months in Accident Investigation. Train at home in spare time. No college. No selling. Free placement service for jobs that furnish car and expenses. Huge, growing field. Men needed urgently. Details Free. Universal Schools, Dept. 1-21, 1129 20th St. NW, Washington, D.C. 20036.

GRAPHOANALYSIS—Learn scientific handwriting analysis for profit, pleasure. Free sample lesson, catalog, reveals plan. Write: IGAS Inc., 325 Jackson, Dept. JX-2, Chicago 60606.

COMPLETE YOUR HIGH SCHOOL at home in Spare Time. Texts furnished. No Classes. Diploma. Our 76th year. Free Brochure. American School, Dept. X745, Drexel at 58th, Chicago 60637.

PIANO Technology—Electronic organ servicing, learned easily at home. G. I. Approved. Free booklet. Niles Bryant School, Dept. P, 3631 Stockton, Sacramento, California 95820.

HIGH School Diploma awarded to You by your State. Free details. VTC, 5027 Columbia, St. Louis, Missouri 63139.

PRACTICAL!—U.S. MEASUREMENT UNITS Versus **METRIC SYSTEM**. Precise Two-way Conversion Booklet. \$2.00 Postpaid. Satisfaction Guaranteed. Alex Kulchar, 1520 Spruce, Suite-200, Philadelphia, 19102.

ALTERNATOR Generator Rebuilder's Course including Equipment. See Auto Supplies and Equipment.

COLLEGE Degree at home. Your choice of subjects incl. Law. Easy tuition plan. Williams College, 915 Cerrillos Road, Santa Fe, New Mexico 87501.

KNOW ALL ABOUT METRIC. Home Study With Certificate. Free Information. **METRIC CONSULTING INTERNATIONAL**, P.O. Box A167, Ligonier, Penna. 15658.

I.Q., APTITUDE Tests, each \$2.00. Booklet "27 Ways To Improve Your I.Q." \$1.00. Gary Baumann, 4738 Arbor, Rolling Meadows, Illinois 60008.

LEGAL INVESTIGATION Pays big! Work with trial lawyers. Fascinating, big-pay career. Learn at home, spare time. No college. No experience. Details Free. Universal Schools, Dept. 3-21, 1129 20th St. NW, Washington, D.C. 20036.

FREE Book tells how you can learn camera repair and service. Home study or classroom. Write today! National Camera, Dept. EAD, Englewood, Colorado 80110.

BECOME Notary. Free particulars. Smids, 405 Richard Avenue, Evansville, Indiana 47711.

FOR INVENTORS

IDEAS, INVENTIONS AND PATENTS. An Easy to Read Book That Tells You in Plain Language How to Get a Patent. Complete Information, Including Sample Patent. Send \$4.95 Plus 60¢ Postage and Handling To: Pioneer Press, Dept. PM10, P.O. Box 78025, Atlanta, Georgia 30328.

INVENTIONS Wanted immediately for promoting on cash or royalty. Patented, Un-Patented. Free booklet outlines royalty rates, requirements. Write: Kessler Corporation, C-510FI, Fremont, Ohio 43420.

U.S. PATENT Office Searches, 234 Broadway, Room 3615, New York 10007. Free invention certificates.

PATENT Application Financing. Free patent search plan. Global Patent Division, 2420 77th, Oakland, Calif. 94605.

INVENTORS—United States Patent Office Searches, Patent Development Engineering, marketing of inventions—ideas by Licensed Professional Engineer—Patent Engineer and United States Patent Office Former Examiner. Inventions developed for patenting and marketing. We are contacted by many manufacturers seeking to purchase appropriate new products invented by our clients. Send for Free invention Certificate and Invention Information. Serving Inventors since 1948. George Spector, Licensed Professional Engineer—Patent Engineer—3615 Woolworth Bldg., New York, N.Y. 10007.

PATENT Searches including maximum speed, full airmail report and closest patent copies. Quality searches expertly administered with complete secrecy guaranteed. Free Invention Protection Form and "Patent Information." Write: Dept. 15, Washington Patent Office Search Bureau, Benjamin Franklin Substation, P.O. Box 7167, Washington, D.C. 20044.

PROSECUTE Your Own Patent Application. All Material Necessary—Write: Inventors Service, Box 3574, Washington, D.C. 20007.

FREE PAMPHLET: "Tips on Safeguarding Your Invention." Write: United States Inventors Service Company, 501-P Thirteenth Street N.W., Washington, D.C. 20004.

INVENTORS: Your ideas and inventions (patented; unpatented) expertly searched, developed for commercial appeal and cash/royalty sales to manufacturers by professional Invention Developer with excellent record of experience. B. S. Industrial Engineering; United States Patent Office former Patent Examiner. United States Government former Patent Advisor. Second decade reliable service! Member: United States Council International Chamber Commerce. Free "Invention Record" and "Recommended Protection Procedure." Airmailed! Write: Raymond Lee, Invention Developer, 230P-Park Ave., New York, New York 10017.

PATENT SEARCHES \$35 For simple search. Report mailed day after search is made. Lusk-Evans Limited, 1120 Connecticut Avenue, N. W. Suite 940, Washington, D.C. 20036.

PUBLICATIONS About Inventing, Patents, Marketing, Licensing. Write: Synthesis, Box 157, Manhattan, California 90266.

IDEAS, INVENTIONS AND PATENTS. An Easy to Read Book That Tells You How to Get a Patent in Plain Language. Complete Information, Including Sample Patent. Send \$4.95 and 60¢ Postage and Handling To: Pioneer Press, Dept. PM10, P.O. Box 76025, Atlanta, Georgia 30328.

NEEDING Assistance? **INVENTION DEVELOPMENT FOUNDATION**, 155 Kent Street, Ottawa, Canada K1P 5P3.

UNSOLD Widgets? Send Description: WTD Goutell, 175 Fifth Avenue, NYC 10010.

MR. INVENTOR: Ideas and Inventions Urgently Needed by Manufacturers. Product Development Assistance and Quality Patent Searches. Financial Assistance Plan if Required. Write: Charles S. Prince, Invention Consultant, 509-A 5th Avenue, New York City 10017.

PATENTS—Do It Yourself. Step by Step Detailed. Inventors Guide. 468 Goodspeed Road, Virginia Beach, Virginia 23451.

NEW, LOW COST Professional Marketing Service Offered for the First Time! We are the "Invention Connection" that Promotes the Sale of Patents and Ideas. Have Information About Your Invention Distributed to Hundreds of Manufacturers for a Modest, Reasonable Fee. For Complete Literature. Write: **IMSCORP**, Invention Division, 10600 Higgins, Rosemont, Illinois 60018.

FREE Inventors Procedure Check List. Rankin-File, Box 566M, Willoughby, Ohio 44094.

INVENTIONS WANTED

INVENTIONS Needed immediately for manufacturers. For additional information write: Kessler Corporation, C-5101W, Fremont, Ohio 43420.

CASH—ROYALTIES—PRESTIGE! **INVENTORS GET ACTION** Marketing Your Ideas . . . Inventions. Write Today For **FREE INFORMATION**. **THOMAS ENTERPRISES**, 310Q, 2412 West Seventh, Los Angeles, California 90057.

INVENTORS! Protect your ideas! Free "Recommended Procedures." Washington Inventors Service, 422F Washington Building, District of Columbia 20005.

FREE "Directory of 500 Corporations Seeking new Products." For information regarding developments, sale, licensing of your patented/unpatented inventions. Write: Raymond Lee Organization, 230-N Park Avenue, New York, New York 10017.

CASH—Royalties for patented, unpatented inventions. Global Marketing Service, 2420-G 77th, Oakland, California 94605.

WE EITHER sell your invention or pay cash bonus. Write for details. Universal Inventions, 28-E, Marion, Ohio.

INVENTORS! Don't sell or license your invention until you receive our offer. Eagle Development Company, Dept. H, 83 Wall Street, New York City 10005.

NEW PRODUCTS—INVENTIONS—IDEAS Researched/Developed/Marketed by Professional Organization for Cash/Royalty Sales. **FREE EXAMINATION** and **CONFIDENTIAL REPORT** of the Commercial Features of your Patented/Unpatented Invention. **FREE COPY** "How to Safeguard and Market Inventions to Industry." Write: **LAWRENCE PESKA ASSOCIATES**, 500-C Fifth Avenue, New York City 10036.

INVENTORS! Either we will sell your invention before you or anyone else does, or we will pay you a cash bonus. Get Free Invention Evaluation and information write: Gilbert Adams Organization, Invention Brokerage, Dept 15, 81 Wall St, New York, NY 10005.

INVENTORS—Our Large Factory Facilities in **HONG KONG** will Purchase Good Commercial Inventions and Product Ideas for **CASH** and **ROYALTIES** to Manufacture for our Worldwide Customer Accounts. Send for Free Booklet: "Handbook & Guide for Inventors." R S (North America) & Company, Box 149PMB, Tustin, California 92680.

MANUFACTURING

3RD DIMENSION Puzzle—Sample. Mfg. Plan \$2.00. Inventor, Box 861, Paradise, Calif. 95969.

BUY IT WHOLESALE

400,000 BARGAINS Below Wholesale! Many Free! Liquidations . . . Closeouts . . . Job Lots . . . Single Samples. Free Details. Bargainhunters Opportunities, Box 730-A, Holland, Michigan 49423

WORLD'S Largest wholesale sources. U.S., foreign factory suppliers will dropship for you. 200 free catalogs. Get free samples. Your business imprint catalog. Free details. International Rivers, Box 16386-M, Portland, Oregon 97233.

HEARING Aids, batteries, Wholesale. Catalog 25¢. Fiston, Box 1444, New Preston, Conn. 06777.

165 FREE Wholesale Catalogs! Mailorder Dropshippers. Your Business Imprint. Automobile Discounts. Free "Digest." Vault International, Box 7284W, Lexington, Kentucky 40502.

FASHIONABLE Silverplated Spoon Rings, \$12.00 Dozen. Snell's, 5581 Lancaster, Harrisburg, Pennsylvania 17111.

FREE Catalog. Gifts, Specialties, Toys, Below Wholesale. Crawford, 5275 DeLongpre, Hollywood, Calif. 90027.

BARGAIN ENCYCLOPEDIA 50,000 low cost items \$2.00. Winchester Enterprises, 2807PM Hargrave Street, Philadelphia, Penna. 19136.

(Continued on next page)

EXPORT-IMPORT

JAPAN: 1200 Products directory, illustrated Manufacturers' names, addresses. \$5.00. Send cash. Yamagata Office, 814 Togin Bldg., Marunouchi, Tokyo.

FOR THE HOME

KNEE PADS No more Sore Knees. Set of soft sponge rubber knee pads for in or out of doors. Fully adjustable straps to fit you. Just \$3.49. **NEWLAND'S**, Fenelton, Pa. 16034.

AT LAST A Battery Powered Home Smoke Detector. Free Details. H. Quenzer, 615 Central, Spring Lake Heights, New Jersey 07762.

WORLD'S Smallest Fire Alarm Plugs in Anywhere. Sounds Loud, Piercing Cry When Temperature Reaches 135°F., Allowing Ample Time for Action. Portable!! \$9.95—Guaranteed! Courtney Distributors, 296 Montrose, Winnipeg, Canada R3M 3M8.

BUYING A Home? Save Hundreds of \$\$\$! Free Information. KLB Enterprises, M133C, 8051 Meadow Lane, Indianapolis, Indiana 46227.

OF INTEREST TO WOMEN

PLASTERCRAFT!!! Profitable Home Business. Molds Available. Details: Lynnette, 6251CW Mentor Park, Mentor, Ohio 44060.

STUFF ENVELOPES! \$50.00 per hundred! Guaranteed earnings! Details 25¢. Smith's, Box 2469-PM, Newark, New Jersey 07114.

\$6.00 DOZEN Paid lacing baby boots! Cowboy, Warsaw 9, Indiana 46580.

\$500 MONTHLY Possible addressing—stuffing envelopes (longhand—typing) at home. \$500 monthly Clipping news items from your newspaper. Information: Send stamped self-addressed envelope. American, Excelsior Springs, Missouri 64024.

NEW magazine, foods, decorating, household tips, family living. Sample 25¢. Homemaker Magazine, 404 West Jefferson, Springfield, Illinois 62702.

WANT A new car, color TV, new clothes? Learn hundreds of ways to make money. 5 month subscription FREE. Write: Salesman's Opportunity Magazine, Dept. 17-KO, 1460 Hancock Center, Chicago 60611.

DO SIMPLE Addressing—Mailing. Receive \$12.95 Orders. Keep \$8.00 Profit. Details Free! Quality, Box 9—PW, East Rockaway, N. Y. 11518.

HOW TO MAKE MONEY ADDRESSING, MAILING LETTERS. OFFER DETAILS 10¢. Lindbloom, Dept PM, 3636 Peterson, Chicago 60659.

BINGO Winners Method. Only \$2.00. Bineo, Box 65, Lebanon, Pa. 17042.

EARN \$50-\$100 Weekly. Spare Time Typing-Addressing Service. Details Free. P. Richardson, Box 4097, Yuma, Arizona 85364.

MAKE MONEY Making Woodward's Lamps. Sparetime. Free Details. P.O. Box 10, Fulton, New York 13069.

EARN \$25.00 Hundred Stuffing Envelopes. Instructions \$1.00 (Refundable). Belmont, 4711-R Linden, Lincoln, Nebraska 68516.

GIFT SHOPPING

BELOW WHOLESALE. THOUSANDS OF ITEMS—SEND \$2.00 FOR GIANT CATALOG (REFUNDABLE) TEXAS SPECIALTY HOUSE, 4701 ANDERSON RD. #19, HOUSTON, TEXAS 77045.

FREE GIFT CATALOG. Filled with interesting and Unusual Items. Rainbow Products, Dept. PM, 1410 S. 31st Street, Philadelphia, Pennsylvania 19146.

FREE! Gift Catalog, Wide Appeal, Something for Everyone. Write To: Advance, 1101 East Six Court, Hialeah, Florida 33010.

FASCINATING Gift for boys and girls. **EXCITING** story of our earth in rocks and minerals. 50 Colorful Specimens, selected, mounted, classified. 67 Page study manual on mineralogy and geology. \$6.00 + 75¢ post. **FOUR WINDS ENTERPRISES, 87 ALPINE DRIVE, COHOCTON, NEW YORK 14826.**

"NEW GOLF TRAINER" Lets you Hit Ball as Often as Desired. Ball Returns After each Drive. Quick Return of Ball Analyzes Drives. Every Golfer Wants One, Makes Great GIFT. Guaranteed \$11.98 PP. Nick's Gifts, 9 First Street, Reynoldsville, Pennsylvania 15851.

FREE Gift Catalog or Two Different. Grybowski, Box 3575, Daly City, Calif. 94015.

NEW! Beautiful! Gift Catalog. Bonus Gift. Avoid Christmas Rush! Send \$1.00. (Refundable First Order). Gulf Coast Enterprises, Box 875 PM, Lynn Haven, Florida 32444.

FREE DISTINCTIVE GIFTS CATALOG. Kaitells Import, 2564 Nottingham, Cincinnati, Ohio 45225.

FINE Jewelry Rockbottom Priced! Bonus offer! Free List. Olive, 1739 Lasenda, South Pasadena, California 91030.

FREE Colorful Catalog with Bonus Gift. Alicia Company, Pelzer, South Carolina 29669.

DIRECT PHILIPPINES. Mail Order Woodware Handicraft, Factory Prices. Enclose US-\$2.00 For Price List Brochures. Write: Famous Anchorage, 511 Trade & Commerce Bldg., Juan Luna, Manila.

DISTINCTIVE GIFTS by Mail. Free Catalog. Kinney, (B-10)-1846 Baird, Madison, Wisconsin 53713.

WATCHES, OLD GOLD, JEWELRY

HIGHEST CASH For Gold, Jewelry, Gold Teeth, Rings, Diamonds, Watches, Silver, Platinum. Mail Articles Today: Free gift with Information. Chicago Gold & Precious Metals, 6 E. Monroe, Dept. 258, Chicago 60603.

WATCH And Clock repairing books. Free list. North American, Box 77-AK, Fox River Grove, Illinois 60021.

CASH Immediately for Old Gold, Jewelry, Gold Teeth, Watches, Diamonds, Spectacles, Silver, Platinum, Mercury. Free Information. Rose Industries, 29A East Madison, Chicago 60602.

CLOCK, Watch Repairing Tools, Supplies. Catalog, \$1.25. G/M. 1521-A West Magnolia, Burbank, California 91506.

WANTED . . . Gold, Silver, Platinum (any form). Coins. Information Free. Wilmot's, 1067 Bridge, Grand Rapids, Michigan 49504.

HEARING AIDS

HUGE SAVINGS. Eliminate dealer mark-ups. Free Trial. Batteries Wholesale. Terms arranged. Lloyds-PMC, Rockford, Ill. 61108.

HEARING Aids, Batteries, Discount Prices. Write: Rhodes, Box 518 PM, Paducah, Ky. 42001.

WHOLESALE Discounters! Famous Aids! Batteries! Repairs! AidMart, Drawer Z-2, St. Petersburg, Florida 33731.

HEARING Aids—Huge savings on tiny, all in the ear, eyeglass, behind the ear and body models. Free home trial. Low as \$10 monthly. Write for free catalog. Prestige, Dept. R-6, Box 10947, Houston, Texas 77018.

FREE—Hearing Aid Catalog. Save half! Write: **MONEYSAVERS**, 9530-PMO Langdon, Sepulveda, California 91343.



SCIENCE AND CHEMISTRY

PLATE Keys, coins etc. with bright nickel solution. Complete kit \$5.00. Platco, 3104 Trail Dr., Richmond, Va. 23228.

AMAZING! Scientific Catalog—Apparatus—Glassware—Chemicals. Catalog—50¢. Hagenow Laboratories, Manitowoc, Wisconsin 54220.

CHEMISTRY And Biology Catalog 35¢. Boulevard Laboratories, Suite 302, 3114 E. 83rd St., Chicago, Ill. 60617.

CATALOGUE Of those ver-ry hard-to-find chemical products, things that go boom, multi-stage rockets, 500 How-To books, 10,000 formulas of every conceivable mixture in science and industry. 50¢. Kenrus-C, Box 158M, Staten Island, New York 10309.

DISCOUNTED! Laboratory Chemicals, Glassware-Apparatus. Catalogue—50¢. Deluxe Scientific, Manitowoc, Wisconsin 54220.

FORMULAS, PLANS, ETC.

FIFTY FORMULAS For \$1.00. Q&A Distributors, R7, B68, Milton, Florida 32570.

ANY Formula \$5.00. Catalog—Manufacturing Treatise 25¢. Belfort, 192 N. Clark, Chicago 60601.

PLASTICS

CASTOLITE Pours like water, hardens like glass without heat. Crystal clear, colors. Embed flowers, seashells, mementos, anything. Make fine gifts. Form flexible molds over any pattern, size. Reproduce your own designs in plastics, candlewax, metal, plaster, cement. Profitable. Illustrated Manual and Catalog Only \$1.00. **CASTOLITE**, Dept. 73L/PM, Woodstock, Illinois 60098.

LARGEST Handicrafts and Candlecrafts Catalogue \$1.00. (Refundable). R.P.H. Manufacturing-24-M-10, Winter, Stamford, Connecticut 06905.

TREASURE FINDERS

FREE Catalog. Metal Locators. Detector, Room 1066-U, 102 W. Arrellaga, Santa Barbara, Ca. 93101.

SEARCH Treasure Finders. Locate gold, silver, coins, relics. Operate underwater. Money back guarantee. Free information. Search Electronics, Box 8396-A, St. Petersburg, Florida 33738.

TREASURE Finder locates buried gold, silver, coins, treasures. 6 powerful models. \$19.95 up. Instant financing available. Write or call for free catalog. Phone (713)-682-2728 day or night. Dealer inquiries invited. Relco, Dept. A-40, Box 10839, Houston, Texas 77018.

FREE 156 Page Detector Catalog. General Electronic Detection Co., Box 67, Bellflower, California 90706.

FIND Buried treasure with revolutionary patented, analytical metal detector. Features push button and automatic tuning, negligible ground pickup, greatest range. Free catalogue. Gardiner Electronics, Dept. 9, 4729 N. 7th Avenue, Phoenix, Arizona 85013.

POWERFUL Metrotech locator detect gold, silver, coins, relics. Moneyback guarantee, terms. Free information. Underground Explorations, Dept. A, Box 793, Menlo Park, California 94025.

GOLDAK Treasure locators—Pleasure and profit in a hobby you'll enjoy. Find coins, relics, gold, silver. Charge on Bank-American. **GOLDAK**, Dept. PM, 1101-A Air Way, Glendale, California 91201.

TREASURE Locators. Most complete line. Free information. **TESOROS**, Apartado 7-905, Mexico 7, Mexico.

TIRED OF DIGGING UP TRASH? The All New "Coinshooter" Rejects, Bottle Caps, Tin Foil, Nails and Shallow Trash, Detects Gold, Silver Coins and Jewelry. Free Literature. **D-TEX ELECTRONICS**, Box 451-U, Garland, Texas 75040.

(Continued on next page)

TREASURE FINDERS

(Continued from preceding page)

FREE FACT-FILLED CATALOG. World's largest line of metal detectors. Models as low as \$49.50 and up. Two year Guarantee. Three factory locations, U.S. and Canada, plus over 1,000 dealers and 35 Service Centers from coast to coast. No finer instruments made at any price. Budget terms. Write: **WHITE'S ELECTRONICS, INC., RM #381 1011 PLEASANT VALLEY ROAD, SWEET HOME, OREGON 97386.**

FISHER DETECTORS. You deserve the best. Free literature. FRL, Dept. PM-10, P.O. Box 490, Belmont, California 94002.

BUILD On Electronic Metal Detector for Under \$10.00! Complete Plans and Instructions \$3.00. Skevis Sales, 516 Fifth Avenue, New York, New York 10036.

FIND Gold, Buried Treasures. Any Depth, On And Off Location. With or Without Map. For Information Write: IOE, Box 31772, Aurora, Hoffman Heights Branch, Colo. 80010.

PRECIOUS STONES & MINERALS

GOLD Chimney Ore, Pound, Twenty Dollars. Prospector, 527 SE Morrison, Portland 97214.

500 POLISHED Gemstones \$5.00. Tumblecraft, 5401 James North, Minneapolis, Minn. 55430.

GET Free catalog no serious rockhound, gem cutter, jewelry maker, hobbyist or craftsman can be without. Full of bargains, exclusive items, low prices from largest suppliers and authorities in the field. Free new catalog just off the press, yours for the asking. Write: Grieger's, Dept. C-12, 900 South Arroyo Pkwy., Pasadena, California 91105.

ROCKHOUNDS!! Receive Interesting, Valuable Specimens Monthly. Free Information. Minerals, Box 4-87M4, Yucaipa, California 92399.

GOLDPANS Nugget trap inserts. Also use Dry. \$8.00 postpaid, or write for particulars. Supra Goldpans, P.O. Box 30, Clarkston, Wash. 99403.

PLACER Gold Samples \$5.00, refundable. Variety Bookshop, Box 140, Lewiston, Idaho 83501.

CARTOONING, COMMERCIAL ARTS, SHOWCARD & SIGN PAINTING

SIGN Painting—\$1000 per Month Part-Time. Free Catalogue. Kaufmann Supply, Centertown, Missouri 65023.

COMPACT 23 lesson Cartoon Course and Cartoonist's Magazine. \$2.00. Hartman, Box 30367, Lincoln, Nebraska 68510.

MODERN Cartooning taught by mail. Write for free brochure. Cartoonorama—Box 263-2M, Branford, Conn. 06405.

CARTOON For Money!! Big Free Book: Success, Box 885-C, Dearborn, Mich. 48121.

LEARN Sign painting at home. Free Talent test. Ben Kerns, Box 812-PM, Greenville, S.C. 29601.

FASCINATING Systems. Sign Painting-Cartooning. Straley, 1704 South Center, Springfield, Ohio 45506.

HOW TO MAKE MONEY WITH SIMPLE CARTOONS—Informative book sent FREE tells way to big income. Cartoonists Exchange, 910, Pleasant Hill, Ohio 45359.

LEARN Cartooning at Home. Approved for Veterans. Free Bulletin. Cartooning, Box 70690, Colorado Springs, Colorado 80933.

ADVERTISING AGENCIES, ADV. SERVICES, MAILING LISTS

ADVERTISE Timely Tips, Mailorder Magazine. Sample. 35. Lyke, 3042 Sherwood, Markham, Illinois 60426.

MAILING List, Most all Kinds, \$9.00
1000 Gummed, Circulars mailed \$5.00
1000. Dixmailers, King, North Carolina 27021.

ADVERTISING Weekly! 120,000 North-west Customers. Sample—\$1.25. Re-undable. Mareo's, Postbox 1253, Lynnwood Washington 98036.

MAILORDER ADVERTISERS!! CLASSIFIED ADVERTISING CAN BE MOST PROFITABLE AND REWARDING. PROBLEM IS TO KNOW WHAT TO DO, WHAT NOT TO DO. COLUMBIA CAN HELP YOU WITH YOUR MAILORDER PROGRAM. OVER 20 YEARS CLASSIFIED ADVERTISING EXPERIENCE. KNOWLEDGE OF BEST PULLING PUBLICATIONS. EXPERT COPY SERVICE IS ALL YOURS AT NO INCREASE OVER PUBLISHER'S STANDARD RATES. CHANCES ARE YOU WILL SAVE MONEY. WRITE TODAY FOR FREE DETAILS PLUS YOUR FREE COPY OF "MAILORDER ADVERTISER'S RATE GUIDE". COLUMBIA ADVERTISING AGENCY, BOX 257PM10, RICHMOND, INDIANA 47374.

ADVERTISING Ratebook leading newspapers, magazines, 25¢. Chicago Advertising Agency, 28-E Jackson, Chicago 60604.

TYPEWRITERS, DUPLICATORS, OFFICE EQUIP.

PROFITS FROM CLASSIFIED ADVERTISING! Booklet shows you how to start your own business with Classified Advertising. Only \$1.00 (Refundable with first order.) **H. E. KAPPEL, POPULAR MECHANICS, DEPT. P, 224 WEST 57TH STREET, NEW YORK, N. Y. 10019**

RUBBER STAMPS

ADDRESS Stamp, \$1.50 Free Literature. Allegheny, Box 14C, East McKeesport, Pa. 15035.

FREE Catalog, Pocket Stamp \$1.25, Self Inking Stamps, Seals, Rush Stamps, 132-P-Farmcrest, Rush, New York 14543.

FREE Catalog—Rubber Stamps, Business Cards, Labels, Printing, Youngers Stamp Shop, Princeton, Iowa 52768.

POCKET Stamp \$1.00. Dealer's Wanted. Day's, 97 Stark Avenue, Dover, New Hampshire 03820.

RUBBER Stamp made from your Original Sketch. Champlain, Box 3044, Seminole, Florida 33542.

FREE Stamp catalog, 45 type styles. Fast Service, low prices. Jackson's, Box 443A, Franklin Park, Illinois 60131.

POCKET Stamp \$1.00. Handle Stamp \$1.50. 1000 labels \$1.00. Martinhouse, 2052M East 24th, Brooklyn, 11229.

OFFICE SUPPLIES

MAILORDER RECORDS Help get increased business! Complete 32 Page Record Book shows your inquiries, orders, advertising, expense, etc. Only \$1.00. **H. E. KAPPEL, POPULAR MECHANICS, DEPT. R, 224 WEST 57TH STREET, NEW YORK, N. Y. 10019.**

STOP! ERASING FOREVER. Self Correcting Typewriter Ribbon. \$3.98 Guaranteed. State Name and Model of Typewriter. Williams, Dept. 2B10, 4401 Germantown Avenue, Philadelphia 19140.

PRINTING PRESSES, RUBBER STAMP OUTFITS

SIMPLE-X RUBBER STAMP PRESSES. Hydraulic operated, electrically heated. Sizes 5"X8", 8"X12", 10"X15". Starting outfits, Orders for presses, supplies shipped day received. Free catalog low supply prices. Send \$1.00 for postage and handling (refundable on first order). Custom Manufacturers, 406-P East Elm, Springfield, Missouri 65801.

PRINTING Presses, type, supplies, Lists, 10¢. Turnbaugh Service, Mechanicsburg, Pennsylvania 17055.

NEW Catalog No. 13, 120 Pages, hand printing presses, type fonts, supplies. Send \$1.00 deductible first order. Acme Type, 732 Federal, Chicago, Illinois 60605.

PRINTING MACHINES. Offset, Mimeograph, Typewriters, Composing, Machines. Dixgraph, King, North Carolina 27021.

SAME Day shipment on rubber stamp supplies. Revised wholesale price list No. 9 free. Star Stamp Supply, 732 Federal, Chicago, Ill. 60605.

MIMEOGRAPHS, Duplicators Prints. Several Colors Without Extra Drums, Rollers. Write: AM Sales, 31-14 94, E. Elmhurst, NY 11369.

MAKE Your own self-molding Rubber Stamps and Printing-Cuts. Plexirubber, Argyle A, Wisconsin.

RUBBER Stamp outfits, supplies. Kiewiet, 2025 Barney Road, Kalamazoo, Michigan 49007.

PRINT YOUR OWN—Printing Presses, type, supplies direct from factory. Send 25¢ for catalog and samples to: Kelsey Co., DM, Meriden, Conn. 06450.

LOW Priced Rubber Stamp Manufacturing Supplies, Starting Outfits. Martin, 1432 Major, Jefferson City, Missouri 65101.

RUBBER Stamp manufacturers supplies. Presses, starting outfits. Best prices, service. Catalog. Jackson Supply, Box 443A, Franklin Park, Ill. 60131.

PRINTING AND SUPPLIES

BUSINESS CARDS Raised Letters \$5.65 Thousand. Like Engraved. Free Samples. Kavanagh, Box 1222, Brooklyn, N.Y. 11202.

FREE Offset Catalog. Fast-Economical. Seaview, 212-26P 48th, Bayside, NY 11364.

FREE Literature: Business Cards, Rubber Stamps, Address Labels Printing Big Selection. Jordan's, 552 West O'Connor, Lima, Ohio 45801.

PRINTING Supermarket Short Run Specials. 1000-\$4.75, 5000-\$22; 1000 Envelopes \$8. Shipping 9 hours. Get Free Printing Specials Price List "Do You Make These 18 Mistakes When You Buy Printing." Speedy Offset Printers, 23889 Aurora, Bedford, Ohio 44146.

1000 EMBOSSED Business Cards \$5.25 Postpaid. Agents Wanted. Elco, 181-A, Sylvania, Ohio 43560.

QUICK Copy Offset Printing. Free Introductory Offer. Nationwide Printing, 73 E. University, Champaign, Ill. 61820.

DISTINCTIVE Embossed Letterheads, Envelopes, Cards Inexpensive. Postpaid. Universal, 226-K Myrtle, Scotch Plains, New Jersey 07076.

FREE Literature, Business Cards, Letterheads, Labels, Rubber Stamps. Geer's, 111 North Drive, Ottawa, Ohio 45875.

FREE Information About Personalized Business Printing. Longwood Press, Fort Johnson, N.Y. 12070.

PHOTOGRAPHIC .. Supplies—Business Cards—Send 10¢ for Catalog To: Lutz Co., P.O. Box 156, Dewitt, New York 13214.

QUALITY Printing. Novelty and Imported Items. Catalog 25¢. John G. Robeson, Box 2316, Hyattsville, Maryland 20784.

MULTIGRAPH, MIMEOGRAPH

PROFITS FROM CLASSIFIED ADVERTISING! Booklet shows you how to start your own business with Classified Advertising. Only \$1.00 (Refundable with first order.) **H. E. KAPPEL, POPULAR MECHANICS, DEPT. P, 224 WEST 57TH STREET, NEW YORK, N. Y. 10019.**

GUMMED LABELS

1000 GUMMED Address Labels \$1.00. Walt's, Box 960A, South Bend, Indiana 46624.

1,000 GUMMED ADDRESS LABELS \$1.00 FREE CATALOG. Acme, 1238 Voskamp, Pittsburgh, Pennsylvania 15212.

(Continued on next page)

GUMMED LABELS

(Continued from preceding page)

SURPRISE! 1,000 for 69¢ Guaranteed. **TALL#MART**, Box 3361PM, Tallahassee, Florida 32303.

SPECIAL! "1,000 Address Labels 75¢." Free Catalog. Wasden's, Semmes, Alabama 36575.

500 DISTINCTIVE Address Labels. To 4 lines. Plus Free Gift—\$2.00. Your choice: **SELFTICK** Glossy White or **GOLD** Gummed. Sunshine House. Box 318A, Scituate, Mass. 02066.

REMAILING SERVICE

CONFIDENTIAL: Receiving—Forwarding—Remailing. A. Naols, Box 3021, Noroton, Connecticut 06820.

DIRECTORY Qualified Remailers 50¢. International Remail-Forwarding Association, Box 1744-M, Miami, Florida 33134.

CONFIDENTIAL—RECEIVING— Forwarding. Remails 25¢. Hillegas, Box 169-P, Hainesport, New Jersey 08036.

SECRET. Receiving—forwarding. Discreet and confidential. Remail 25¢ single. Mail Forwarding Service, 8050 S. Main, Houston, Texas 77025.

MIAMI Remails 25¢—Monthly rates. Remails—view cards from 80 Foreign cities. Marle, Box 1266, Coral Gables, Florida 33134.

CONFIDENTIAL New York Mail Address \$3.00 Month. Telephone Service \$5.00. Re-mails 25¢. Details Free. Birnhan, 152 West 42, New York 10036.

REMAILS— Forwarding. 25¢—\$3.00 Monthly. Hill, P.O. Box 2408, Denver, Colorado 80201.

COLORADO Scenics, Remails 25¢, \$3.00. Mile-Hi, Box 1798-PM, Denver 80201.

CANADIAN Remails 35¢ Single. Perkins, Box 4415, Vancouver, Canada.

PONY-EXPRESS Your Mail, received-forwarded. Davis, 1391 Archer, Live Oak, Calif. 95953.

CANADA Remails—25¢—U.S.A. 35¢ (Postage Incuded) — \$5.00/mth. — 327 Kerrybrooke, Richmond Hill, Ontario 1A10, Canada L4C3R3.

REMAILS 25¢. Monthly \$3.00. Receiving. Forwarding. Box 412, Van Wert, Ohio 45891.

LINCOLN'S Hometown Remailing-Forwarding—\$3.00 Monthly. Business's Accepted. Box 2873, Springfield, Ill. 62708.

EUROPEAN Confidential Remails. Singles \$1.25. Forwarding \$4.00 Monthly. Sandy Taylor, 6520 Worms/Herrnsheim, Herrnsheimer Hauptstrasse 122A, Germany.

KEEP Your location secret: Use our address. Wright, BR-2112, Asheville, N. Car. 28802.

TEXARKANA, TEXAS Remails 25¢. Monthly \$3.00. Reamus, Box 6062, Texarkana, Texas 75501.

FREE-FIRST-MONTH-FREE. World Mail Bag, Drawer 568C, Anaheim, Cal. 92805.

YOUR Mail Received—Forwarded. Hedgpeth, 324-M South First, Alhambra, Calif. 91802.

REPAIRS AND SERVICING

PROFITS FROM CLASSIFIED ADVERTISING! Booklet shows you how to start your own business with Classified Advertising. Only \$1.00 (Refundable with first order.) **H. E. KAPPEL, POPULAR MECHANICS, DEPT. P, 224 WEST 57TH STREET, NEW YORK, N. Y. 10019.**

SPECIAL SERVICES

INFORMATION On Anything. Universal Information, Box 9131, Shreveport, La. 71109.

POPULAR MECHANICS INDEX AND SHELF WRAPPER 1971 and 1972 editions now available. You will be able to find any article that appeared in P. M. covering those years in seconds. These annual indexes will make your copies of P. M. even more valuable! Each \$1.49. Send checks to: Popular Mechanics, Dept. HE, Box 1014, Radio City, New York, New York 10019.

INFORMATION On anything. Ferguson Research Specialists, 72-25 Woodside, Woodside, New York 11377.

DELINQUENT ACCOUNTS? Free Guide of Solutions Aids Collecting. Hutt, P.O. Box 12146, Hartford, Conn. 06112.

TOBACCO

PIPE SMOKING PLEASURE, only as satisfying as the tobacco you put in it. Write for factory-fresh samples. Green River Tobacco, Box 991, Owensboro, Ky. 42301.

BRIAR PIPES. Discount Prices. Write: Maxima, Box 26-D2, Vails Gate, New York 12584.

BRIAR Blocks for Smoking Pipes. Pimao, Box 59211, Chicago, Illinois 60659.

FREE CATALOG, MEERSCHAUM PIPES. Save 60% on Hand Carved Beauties. Conner Imports, Box 9574-PM1, San Jose, Calif 95157

BETTER HEALTH

SLUGGISH? TIRED? Chinese Super-tonic \$9.95. Health, Box 65976, Vancouver, Canada.

SLEEP—Without pills! Simple exercises. 164 page book only \$1.00. Handy Sandy Enterprises, 439 Windsor Ave., Windsor, Conn. 06095.

PERSONAL

BORROW By Mail! Up to \$1500.00. Convenient terms. State Licensed. Postal Finance, Dept. 17-T, 6018 Military Ave., Omaha, Nebraska 68104.

DEBT PLAN WIPES OUT YOUR BILLS. Perfectly legal . . . Stops bankruptcy, lawsuits, garnishment. \$600 to \$25,000. Free details! Counselor-7, Kerrville, Texas 78028.

RELAX! Always tense and edgy? Nervous and irritable? Dr. Gutwirth's book, "You Can Learn to Relax", reveals how to avoid stress and attain complete relaxation in a short time! Send \$1.00. Alexander Mail Order Services, 4375 Knollton, Indianapolis, Indiana 46208.

GET STARTED In Highly Profitable Leisure Field. No selling. Unique! Immediate Details: Wayne Young, Carlton Rd., Harwinton, Connecticut 06790.

HANDWRITING Reveals hidden Character and Personality Traits! Medical studies now being made to detect cancer by handwriting! This 208 page course shows step-by-step method how "YOU Can Analyze Handwriting." A fascinating book for parties. Send \$2.00. Alexander Mail Order Services, 4375 Knollton, Indianapolis, Indiana 46208.

BIRTH CERTIFICATE, Baptism, Marriage, Divorce, High School, College Diplomas, Driver's License, Wills, General Agreement, Power Attorney, Lease, Building Contract, Karate Expert, Press Correspondent, Investigator. Any 3—\$1.00 . . . 7—\$2.00. (Catalog 25¢, applies next Order.) Legal Forms, Department 290, Box 554, Farmington, Michigan 48024

HOW To understand your dreams. Fascinating 110 page book analyzes apparently innocent dreams and reveals their inner meanings. You'll be amazed at your own dreams and their mysterious meanings. Send \$2.00. Alexander Mail Order Services, 4375 Knollton, Indianapolis, Indiana 46208.

INSTANT DEBT RELIEF Without borrowing. Without Bankruptcy. Have excellent credit in 45 days. Free!!! Wealth Building, Box B-10, 1996 Hoyt Street, Lakewood, Colorado 80215.

FREE Gospel Literature foretelling second coming of Christ. Scheall, Box 263-PM, Duluth, Minn. 55801.

NEED Money-Debts Too Big? Consolidate Bills. Free Emergency Loans. Write: Interstate, 28 E. Jackson, Suite 1204-X3, Chicago 60604.

LOSING HAIR? BALDING? DANDRUFF? Free copyrighted booklet. Dr. Shiffer Laboratories, Dept. 536, Box 398, Punta Gorda, Florida, 33950.

PSORIASIS Sufferers: Discouraged? Write for Free important Information that is helping thousands! Pixacol, Box 38-PM, Avon Lake, Ohio 44012.

BIBLE Questions answered. Stamped envelope. Bylon, 17167 Bentler, Detroit, Michigan 48219.

INVESTIGATORS. Latest electronic Aids. Free Literature. Clifton, 11500-P NW 7th Ave., Miami, Florida 33168.

RECORD Telephone Conversation automatically. Leaver Recorder Unattended. Robert's, Box 49-PM10, Parkridge, Illinois 60068.

RECEIVE Phony State Chartered University Degrees immediately. Box 11516. Tucson, Arizona 85706.

CASH LOANS by mail! Up to \$2,500 on signature alone. No collateral! Secret! Union Finance Company, 3608 No. 16th St., Dept. PM, Phoenix, Ariz. 85011.

SEE THRU WALLS! New Secret Two-Way Super Spy Device, instructions included. Guaranteed only \$2. World-10C20, 3047 University, San Diego, Cal. 92104.

TELL Fortunes accurately—Immediately! ESP Aids, Box 21-PM, Olympia, Washington, 98501.

TATTOO Removing—Chemical Do-it-Yourself Method—Free Details: Atlanta, 907P Beachpoint, Pickering, Ontario, L1W 2A4

"RULE Others With Thoughts." (Telepathy). Write: Clarion, Box 1769-A7, Chicago 60690.

STOP SMOKING NOW! Free details. Mark, Box 398X, Lewiston, Michigan 49756.

CREDIT Cards . . . loans . . . no credit investigation!!! Guaranteed Free report. Continental-23, Nicerville, Florida 32578.

SECRET LOANS BY MAIL. Borrow \$100 to \$3000 for any good reason in absolute privacy. No interviews, no endorsers, no co-signers. Fast service. Write: Dial Finance Co., Dept. 3517, 418 Seventh Street, Des Moines, Iowa 50309.

YOUR QUESTIONS FULLY ANSWERED . . . Regardless of your problem. Any Subject. Any Business. Reasonable Fees. Prompt. Reliable Details Guaranteed. Write Today. Bernal, Box 291PM, Mt. Vernon, New York 10551.

"MAKE Your Own Will" . . . **SIX** Forms, Information Booklet \$2.00. **GUARANTEED!!!** Plato, Box 207-P10, Saint-Davids, Pennsylvania, 19087.

SAFEGUARD YOUR FAMILY. Legal Will Forms and Instruction Booklet \$2.00. Jenmar, Box 2202, Bremerton, Washington 98310.

IDENTIFICATION CARDS and all types of certificates, send 8¢ stamps for samples. **DOWNES,** P.O. Box 10148, Cheyenne, Wyoming 82001.

LIVE SECURELY! Protect Your Family with a **LEGAL** Will. Complete Instructions, Samples, and Forms. Only \$1.95—Fully Guaranteed! Act Now! Basics, 903 Parkside, Elmhurst, Ill. 60126.

TICKLE Your Funnybone with Hilarious **HUGO'S HUMOR** Book, Laughs on Every Page. \$1.00 L. A. Specialties, 307A Northwest 8th Street, Little Falls, Minnesota 56345.

HAVE A CONFIDENTIAL CHICAGO ADDRESS: Business. Personal. Since 1944! MCOC-75, 216 Jackson, Chicago 60606.

(Continued on next page)

PERSONAL

(Continued from preceding page)

PROVEN! Develop Your Creative Powers Book Guarantees Success in any Endeavor! \$2.00. MyLin, 322 Franklin, Bel Air, Maryland 21014.

HOW INTELLIGENT Are You? Test reveals I.Q. in minutes! Send \$2.00 today—guaranteed!! Shoppers' Place, 106 Place Caron, Ste. Therese, Quebec, Canada.

SUCCESS AND POPULARITY—Six Ways to Develop Your Creative Powers. A Formula to Guarantee Success and Prestige in any Endeavor. Send \$2.00. Midwest Gift Center, 8444 Chamberlin, Dexter, Michigan 48130.

NONRESIDENT DEGREES! Nationwide Faculty. Catalog \$3.00. **UNITED STATES UNIVERSITY OF AMERICA**, Box 4552, Washington, D.C. 20017.

EASY WAY Stop Smoking. No Pills—Guaranteed. Send \$3.00: F&M Associates, Box 2136, Ordan, Utah 84401.

PSYCHIC Readings, Dream Interpretation. Free Information. Rev. Sanders, Box 31772, Aurora, Colorado 80010.

WANTED-MISCELLANEOUS

TOY TRAINS WANTED. Cash for Lionel, Ives, Flyer, DorFan Etc., any condition. 12135. Morrison, N. Hollywood, Calif. 91607.

MOLDS For Casting. Old lead Toys. Eccles, 1613 Dill, Burlington, Iowa 52601.

MERCURY. Gold, Silver, Platinum; Ores assayed. Wholesale Terminal, Norwood, Mass. 02062.

JAPANESE Swords Wanted. Don Beck, 1828 Ida, Ft. Wayne, Indiana 46808—219-437-1801.

WINEMAKING & OTHER RECIPES

CONCENTRATE Catalog. 60 Varieties. Vendramino Wine Co., Dept. A, 13273 Michigan Ave., Dearborn, Mich. 48126.

WINEMAKERS FREE Supply Catalog. Excellent Selection of Fruit & Grape Concentrates. Kraus, Box 451-L, Nevada, Missouri 64772.

WINEMAKERS. Free illustrated catalog of yeasts, equipment. Semplex, Box 12276R, Minneapolis, Minn. 55412.

WINEMAKER'S Supply Catalog—Free. Bacchanalia, 273 Riverside Ave., Westport, Conn. 06880.

HOMEWINE MAKING SEND For FREE Informative CATALOG of RECIPES, EQUIPMENT, and INGREDIENTS. Brewer's Yeast Dry Malt, Crystal Malt, Bottle Caps, Barrels, Chemicals, Concentrates, Over 250 Items. Winemaking Is A Fascinating Hobby. Write To: Danenberger's, Box 276-M, New Berlin, Ill. 62670.

WINEMAKER'S! Free Illustrated Catalogue of Quality Products. Brant's Wine Rack, Box 3256-M, Orange, California 92665.

WINE CELLAR—New low cost interlocking units in traditional design, unlimited capacity. Start with 7 bottle rack \$4.98, postpaid. Free picture brochure. Winemaker's Catalog. **ADDARACK**, Box 30230M, Cincinnati, Ohio 45230.

WINEMAKERS. Tremendous selection. Fast service. Free catalog. Winecraft; Columbia Mall; Columbia, Maryland 21043.

WINECRAFT—469 Items—Free Catalog. P.O. Box 11186, Phoenix, Arizona 85061.

LARGEST Stock supplies and equipment. We have the know-how. Write for catalog, advice, consultation . . . also wholesale. (231-6414) Jim Dandy Wine Supplies—now at 8454 Beechmont, Cincinnati, Ohio 45230.

FREE Information. Goldcoast Sourdough Starter. Stamp Muller, R.D. 2P, Chestertown, Maryland 21620.

BEAUTIFUL Diploma from American Amateur Wine Association with Yearly Membership Card, \$5.00. A.A.W.A., Suite 569, 1629 K Street, N.W., Washington, D.C. 20006.

WINEMAKERS . . . Free Illustrated Supply Catalog of Yeast, Equipment, Recipes. Continental, Box 18223-PM, Indianapolis, Ind. 46218.

TRY Muller's Rum Fruitcake Recipe \$1.00. Muller's, RD 2P, Chestertown, Maryland 21620.

WINEMAKERS: Free Catalog. Fast Service. Arbolyn, Box 663, West Columbia, South Carolina 29169.

MISCELLANEOUS

BLANK WILL FORMS!!!! \$2.00. Guaranteed!!!! Montalvo's Enterprises, 4834 Queen (2C), Corpus Christi, Texas 78415.

MAN'S First Moon Walk. Complete Newspaper (Atlanta). Best Offer. People's Drugs, Dallas, Ga. 30132.

PROTECT Your Family! Legal Will Form Protects Your Family!! Only \$1.50. Guaranteed! Modernworld, Box 25, Carle Place, New York 11514.

TV PICTURE TUBES manufactory direct, easy installation. Write: Ehnec Co., 405 E. Jefferson, Cheyenne, Wyo. 82001.

CUT Cigarette costs in half with our custom-blended tobacco and rollers: filter or plain. Free sample: Green River Tobacco, Box 954, Owensboro, Ky. 42301.

RECROOM LAMPS EXCITING. Gogo girls in motion many more barlites in color. For free brochure and pricelist send self address large stamp envelope to: Magic Motion Lamps, 2617 E. Birchwood Ave., Cudahy, Wisc. 53110.

BOOKS On antiques and their prices. Free circular!! P. Warman Publishers, Uniontown, Penna. 15401.

PRE-PACKAGED Toys complete with free self-selling display rack. Free Details. Toys, 1916 Fifth, Sacramento, California 95814.

SLEEPATRON. New device for inducing sleep. Gardiner Electronics, Dept. C, 4729 North 7th Avenue, Phoenix, Arizona 85013.

IDENTIFICATION CARDS. Send stamped self-addressed envelope for samples. **NIPCOM**, 727 North Main, Las Vegas, Nevada 89101.

EYEGASSES wholesale—Free Catalog. A-Z Optical Company, Box 175, Dept. R26, Bay Station, Brooklyn, N.Y. 11235.

1400 CATALOGS Listed and Described! Sources for EVERYTHING imaginable! Rush \$2.00. **MASTERLOG**, Box 24413-(UI), Oakland, California 94623.

CREDIT Cards . . . loans . . . no credit investigation!!! Guaranteed Free report. Continental-24, Nicerville, Florida 32578.

HEARING Aid batteries wholesale. Free list. Habs, Box 51, York, Penna. 17405.

ORNAMENTAL Iron designs. Book of 1600 beautiful, practical designs for railings, columns, etc. Free literature. Cunningham, 3881 South 3200 West, Box 19005, Salt Lake City, Utah 84119.

ASTROFOIL. For Sun, Shelter, Safety. Developed for NASA, Waterproof, Windproof, 84" X 66" 3 ounces. Tanning Aid, Emergency Blanket for Prevention of Injury Shock. 100's of uses for Motorists, Skiers, Snowmobilers, Campers. \$2.95 Plus .50 postage and Handling. **IMPEX** Associates, 1329 Griffin Ave., Mahtomedi, Minn. 55115.

MUSTACHE N BEARD Grooming Set Is for Any Man who wears a Mustache or Beard. Look Sharp—Set Includes Shears, Shaper, Brush, Comb, Mini Razor, Mustache Wax and Style Guide. Satisfaction Guaranteed. Send \$14.95. Merkle, Dept. 1PM10, Box 156, Defiance, Missouri 63341.

U.S. \$1000 Bills!! Obsolete Exact Replicas 5/\$4.00. National, Box 81652-XJ, San Diego, California 92138.

NEW Electronic Indoor TV Antenna. Plugs in wall outlet!! \$2.19—Guaranteed—Turman's, 2317 North Shannon, Sherman, Texas 75090.

MAKE Delicious Homemade Sausage and coldcuts. Free Illustrated Catalog—seasonings, casings, equipment, recipes. Stuff'n'Serve, Box 8009-65, Rochester, New York 14606.

DON'T PAY INCOME TAX. Legally. No matter what your income. Rich men's methods adapted for anyone's use. Free Details. Trauhhaus-47, Box 3004, Duluth, Minnesota, 55803.

REVOLUTIONARY New Pencils. Never Need Sharpening. 6 for \$1.00. Charles Leonard; Box 64, Itmann, West Virginia 24847.

HOBBY CRAFT SALES, YOU MAKE IT, WE SELL IT. Information 50c. P.O. 893, League City, TEXAS 77573.

PERMANENT MATCH-METAL MATCH. Pull out of Case, Strike it on Side 1 1/4" high. Use Ordinary Fluid. Send \$1.00 Post Paid. R. R. Sims, 51 Fair Place, Rochester, New York 14609.

SPIRITUAL ENLIGHTENMENT Do-it-Yourself Manual \$2.00. Universal Publishing Company, 8057 Central, Centerline, Mich. 48015.

HOW To Win Prize Contests. Details Free. Martins, Box 141-B, Fremont, Cal. 94537

GAMBLE WITHOUT LOSING. Playing computer blackjack. For complete program used on time-sharing computer, send \$1.00 to: D. McCoy, Dept. 7D6, 342 West 71 Street, New York, New York 10023.

DON'T DIE Without a Will! Self-explanatory blank will form \$2.00—Guaranteed. Clayton Sales (42810), 314 South Patterson Park, Baltimore, Maryland 21231.

HOW INTELLIGENT ARE YOU? Self-Scoring Test Reveals I.Q. in 45 Minutes! Send \$2 Today—Guaranteed!!!! Helton, Box 67184, PM-1-10, Century City, California 90067.

BURGLAR ALARMS & HOME PROTECTION

BURGLAR PROOF Your Home or Car. Less than \$5.00. Simple Effective Plans and Parts List Only \$2.00. Burglary Reduction Devices, Box 15768, Phoenix, Arizona 85060.

BURGLAR—PROOF YOUR HOUSE!! Treasury, Intelligence Expert's Modernized "Home Security Manual" demonstrates economical do-it-yourself savings!! Guaranteed. FREE information. Sullivan House, Department 27-0, 2402 South 222nd, Seattle 98188.

LOCKSMITHING Supplies—Buyers Guide \$1.00. Despubs, Box 22005H, Phoenix, Arizona 85028.

FREE Catalog on Burglar-fire Alarm Equipment. Protecto Alarm Sales, Box 357-D, Birch Run, Michigan 48415.

BURGLAR & FIRE ALARM SUPPLIES AND SYSTEMS. Send \$1.00 for catalog. J & J Alarm Systems, 51 Pythian Ave., Torrington, Conn. 06790.

BURGLAR—Fire Alarm Equipment. FREE 62 Page Catalog (limited time, regularly \$1.00). **K-TRONICS INDUSTRIES**, Box 391-M, Fairfield, Conn. 06430.

CUSTOM burglar alarm kits. Tasha Security Systems, P.O. Box 7944, Kansas City, Missouri 64129.

DOORMAT ALARM. Know instantly when anyone enters your premises. Free literature. Ayton, PM10, 5506 16th Avenue, Brooklyn, New York 11204.

PROTECT Valuables from Loss or Theft. Amazing Engraving Tool writes on Glass, Plastic, Ceramics, Metals. \$2.98. Maylor House, 5511 South 93rd Street, Omaha, Nebraska 68127.

Unadorned power tools.

4' Wood Lathe
at \$29.95

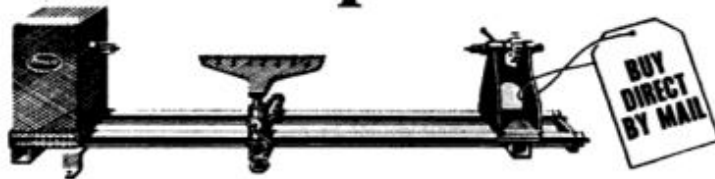

They do the same job as tools costing up to 5 times as much.

We skipped the chrome to save you money... but we did not skip anything on performance. Actually, we skipped more than just chrome, we cut out every costly frill that wasn't absolutely needed.

The lathe shown above isn't exactly flashy. We admit it. But in a recent article, Popular Science used it to demonstrate wood lathe technique and said: "You won't go wrong with this economical introduction to wood turning." It is typical of our tools which in spite of low prices, are full scale and offer full performance and precision.

HERE'S HOW WE DO IT . . . First, we don't claim our tools should sell for five times the price! Just that our tools do the same job . . . with the same accuracy, ease and speed . . . and will last at least as long. AMT tools cost less to make and are sold direct. They are bona fide quality power tools used by serious amateurs and professionals alike and if sold in retail stores would be much higher in price. We use no magic, let's be specific:

SIMPLICITY . . . AMT tools are soundly engineered to eliminate every frill and gimmick—to minimize material and production costs. Machined parts are used only where they're needed. Unadorned cast iron and aluminum save you a fortune.

DIRECT-FROM-FACTORY SAVINGS . . . You save a bundle, yet, we offer a double guarantee backed by a 38-year-old company with millions of satisfied customers . . . and hundreds of orders pour in daily.

LARGE VOLUME . . . Our own foundry and large mass production facilities plus large buying power all work to keep costs down.

STANDARD PARTS . . . Our designs use standard hardware items wherever possible. By avoiding custom-made parts we pass on tremendous savings to you.

If you are looking for power tools that perform like units costing many times our low prices, order today and you'll be one step closer to many hours of woodworking satisfaction.

Bill Morley



POWER SAW 8" tilt arbor saw

... crosscuts, rips, mitres, cuts compound angles, dados, coves, moldings. Completely assembled with ground cast iron table, safety guard, splitter, mitre gauge. Less blade, motor. Rip fence for easier work alignment, \$3.50 add'l. Ball bearing model, \$5.00 add'l. Takes 1/3 h.p. motor or larger, standard blades, attachments. Wt. 26 lbs., f.o.b. factory



\$19.95



FREE OFFER, cabinet base plans, . . . with one piece of 3/4" plywood, convert your \$19.95 saw into a floor model with a huge 27" x 24" top. Takes cabinet rip fence, \$4.50 add'l.

TWO GUARANTEES

10-DAY MONEY BACK GUARANTEE
Try any of these power tools and compare it with any similar machine at any price. If not satisfied, return it for prompt, no questions asked refund. We pay the return shipping charges.

10-YR. FULL SERVICE GUARANTEE
Any part or parts of these AMT power tools (except motor which carries a one year guarantee) which become inoperative for any reason within ten years after purchase date will be repaired or replaced by the factory with no cost to the purchaser other than postage.

AMERICAN MACHINE & TOOL CO.
4th & Spring St., Royersford, Pa. 19468



Brand new electric motor developing full 1 h.p. 17 lbs. (Purchased separately, \$24.85). With any AMT machine here. **\$19.90**

BUY DIRECT
... USE THIS HANDY
ORDER COUPON
NOW

AMERICAN MACHINE & TOOL CO., Dept. PM-03, Royersford, Pa. 19468

Please send me the units checked. Payment in full enclosed \$_____ or \$3 deposit each item enclosed, balance C.O.D. I must be fully satisfied or will return unit within 10 days for full refund. No questions asked.

- | | |
|--|--|
| <input type="checkbox"/> 8" Power Saw at \$19.95 | <input type="checkbox"/> Jointer Planer at \$29.95 |
| <input type="checkbox"/> Standard Rip Fence at \$3.50 | <input type="checkbox"/> Ball Bearing Spindle at \$10.00 |
| <input type="checkbox"/> Long Cabinet Rip Fence at \$4.50 | <input type="checkbox"/> Wood Shaper Kit at \$19.95 |
| <input type="checkbox"/> Ball Bearing Spindle at \$5.00 | <input type="checkbox"/> Opt. Hold Down Assembly at \$2.75 |
| <input type="checkbox"/> Belt Sander at \$19.95 | <input type="checkbox"/> 6" Swing 3' Lathe at \$14.95 |
| <input type="checkbox"/> Disc Sander Attachment at \$7.95 | <input type="checkbox"/> 12" Swing 4' Lathe at \$29.95 |
| <input type="checkbox"/> Mitre Gauge for Sander at \$1.95 | <input type="checkbox"/> Face Plate \$2.50 (either Lathe) |
| <input type="checkbox"/> Drill Press at \$39.95 | <input type="checkbox"/> Turning Chisels \$5.95 (either Lathe) |
| <input type="checkbox"/> G.E. Motor <input type="checkbox"/> \$19.90 (with other item) | <input type="checkbox"/> \$24.85 (purchased separately) |

NAME _____

ADDRESS _____

CITY _____

STATE _____

ZIP _____

3' WOOD LATHE . . . 6" swing.

Same precision and speed as \$40 units. Sturdy cast iron with tubular steel bed. Lever action tail stock, two-speed pulley, fits any motor. Set of 3 high speed turning chisels, \$5.95 add'l. 4" face plate, \$2.50 add'l. 15 lbs., f.o.b. factory

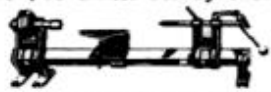

\$14.95

4' WOOD LATHE . . . 12" swing.

Industrial size, does the same job as \$75 units. Tubular steel bed rails, screw action tail stock, three-speed pulley. Use any motor. 3 high speed turning chisels, \$5.95 add'l. 4" face plate, \$2.50 add'l. 30 lbs., f.o.b. factory



\$29.95

JOINTER-PLANER 4 1/8" x 22".

Cast iron and steel, precision ground adjustable tables. For planing, joints, bevels, Rabbits to 3/8" depth. Fence adjustable 0° to 50°. Steel knives, dual guards. Use any motor. Precision ball bearing industrial model, \$10.00 add'l. Wt. 19 lbs., f.o.b. factory



\$29.95

BELT SANDER A precision unit.

It changes from horizontal to vertical in seconds. Heavy, sander includes 4" x 36" sanding belt. Uses 1/3 h.p. or larger motor. V-pulley drive and multi-purpose drive spindle.



Disc sander accessory, \$7.95 add'l. Mitre gauge, \$1.95 add'l. 15 lbs., f.o.b. factory

\$19.95

DRILL PRESS

Precision 32" radial unit has standard features and many extras. Depth of throat up to 16". Head tilts and table stays level. Drills to center of a 32" circle. All cast iron and steel. Takes standard motor. 32 lbs., f.o.b. factory.



\$39.95

WOOD SHAPER KIT Makes beads, coves, moldings, tongue-and-groove joints, etc. Accurate cuts at high speeds. Sealed greased-for-life ball bearings. Less wood. Takes 1/4 h.p. motor or larger, standard cutters. Optional hold down assembly, \$2.75 add'l. 15 lbs., f.o.b. factory



\$19.95

A man likes to come home to Black Velvet.

Every man wants to feel the smooth, imported whisky from Canada.
And every woman, too.



BLACK VELVET® BLENDED CANADIAN WHISKY. 80-86 PROOF. IMPORTED BY ©1973 HEUBLEIN, INC., HARTFORD, CONN.

Матеріал захищений авторським правом.



Spend a milder moment with Raleigh.

A special treatment softens the tobaccos
for a milder taste.



Trustworthy. You can always depend on this Mercury calendar watch by Timex. Sweep second hand. Chrome-plated case, stainless steel back. Yours for free B&W coupons, the valuable extra on every pack of Raleigh.

To see over 1000 gifts, write for your free Gift Catalog: Box 12, Louisville, Ky. 40201.

© BROWN & WILLIAMSON TOBACCO CORP.

Filter Kings, 16 mg. "tar," 1.2 mg. nicotine; Longs, 18 mg. "tar," 1.3 mg. nicotine, av. per cigarette, FTC Report February '73



Warning: The Surgeon General Has Determined
That Cigarette Smoking Is Dangerous to Your Health.