

# Popular Mechanics

## 3 CARTS FOR INDOOR/OUTDOOR LIVING

Mobile cooking center  
Bar-sink on wheels  
Roll-about stereo  
We show you how to build this PM-designed go-anywhere furniture Page 69



Clip-and-save know-how: Starts page 86

- How to build retaining walls
- How to fix aluminum screens
- How to pour concrete slabs
- How to repair a dishwasher

Combs on Main Street: Deadly rail and truck cargoes Page 132

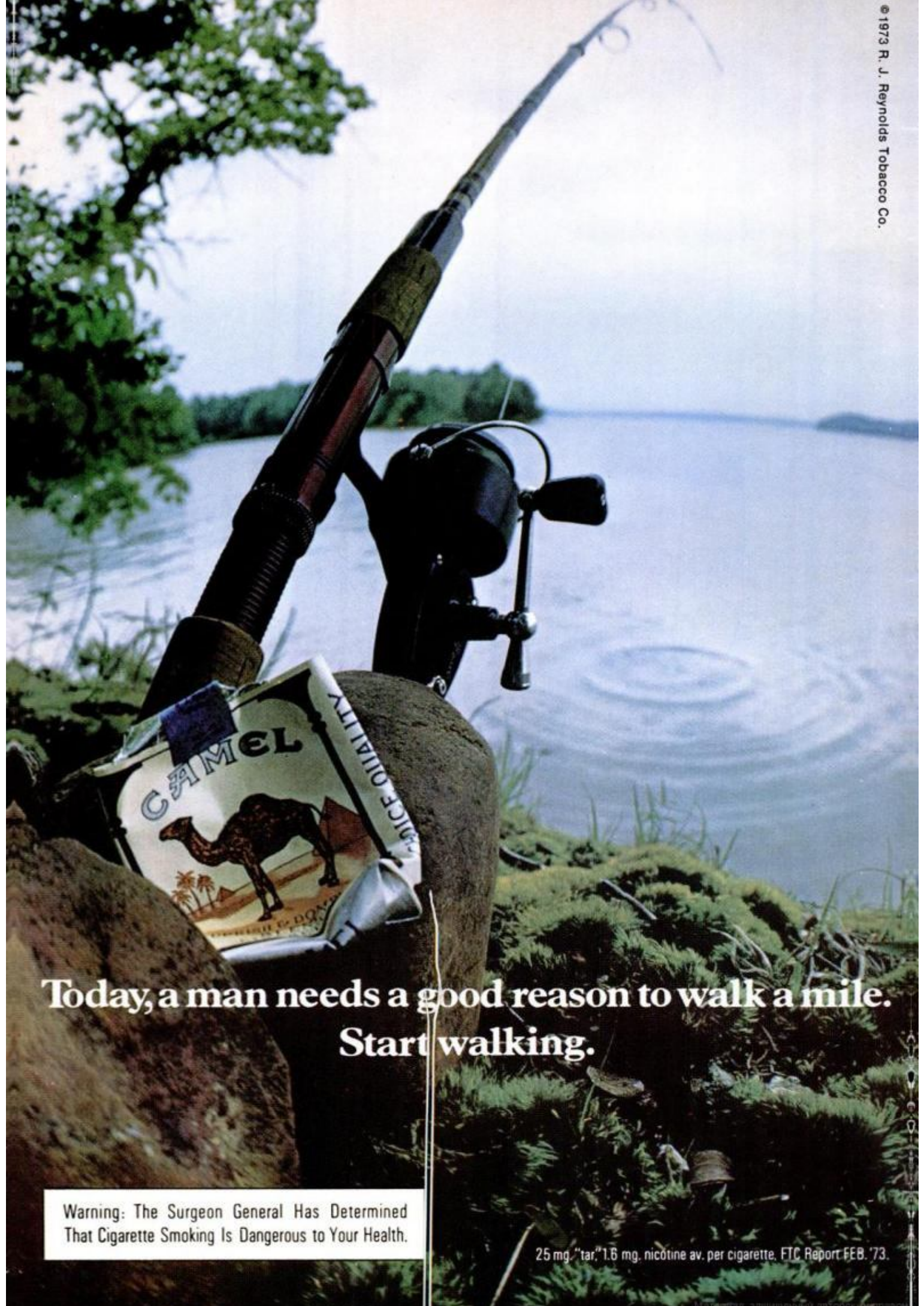

**Today, a man needs a good reason to walk a mile.  
Start walking.**

Warning: The Surgeon General Has Determined  
That Cigarette Smoking Is Dangerous to Your Health.

25 mg. "tar," 1.6 mg. nicotine av. per cigarette. FTC Report FEB. '73.



## When you're talking racing, records and performance, you're talking Monroe Shock Absorbers.

Monroe means increased performance. On the street, strip or on the track. For 19 out of 20 winners at Indianapolis. 18 consecutive USAC champions. Winners in all classes using shocks in major National Hot Rod Association events. 2 consecutive Baja winners. And, through a separate division, winners of all major NASCAR competitions.

So no matter what you want your car to do, there's a Monroe Shock Absorber to help you do it. There's the Monroe Super 500<sup>®</sup> Series. Monroe Load-Leveler<sup>®</sup>

stabilizing units. The Ride-Leveler<sup>™</sup> air adjustable shock absorber. And a complete line of high performance shocks called Max.

That's performance. That's Monroe. At Monroe, we know more about winning. And more about performance. And more about shock absorbers. Because our only business is making shock absorbers.

**MONROE** Monroe Auto E  
Monroe, Michigan 48161.

This One



UBW6-F9C-X41X

# Monroe The Shock and a Half.

# Clean air: good reason to use a great oil.

Today's anti-pollution systems are making the temperature of your motor oil higher than ever before. And if your system isn't working properly, that makes it even tougher on your oil and your engine. Today you should name your oil. By type. By SAE Grade. By brand.

Briefly, here's what's happening.

When the PCV valve is working properly, your car's engine is running cleaner than ever. Blowby

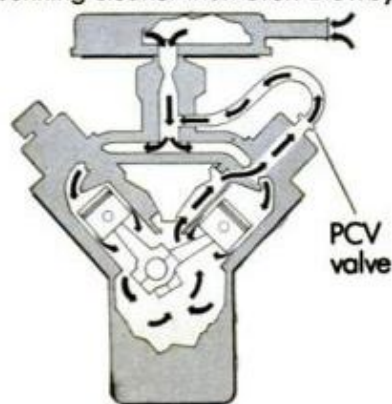

gasses that once seeped into the crankcase are recycled back to the combustion chamber. This not only keeps the air cleaner; it also keeps your oil cleaner.

**Keep your PCV Valve clean.** On the other hand, if the PCV valve gets clogged, combustion or blowby gasses are trapped in your crankcase and form damaging corrosive acids. What's more, today's engines must operate on a leaner fuel/air mixture than did engines in cars without anti-pollution devices. So today, your engine, and its motor oil, are operating under much higher temperatures.

**Other systems, more heat.** Today's improved combustion systems, supplemental air injection systems, lower compression ratios, air conditioning and power equipment are all "hot items." They put extra stresses on your engine that can send your motor oil's temperature over the 300° level.

**What heat can do to motor oil.** Heat is motor oil's number one enemy. Because, when heated, oil has a tendency to oxidize. Excessive oxidation causes oil to thicken—and not lubricate properly.



The newest service designation—see the chart—is "SE." It meets 1973 requirements and it's vitally important that you use it when recommended.

Then, especially these days, ask for the highest quality brand you can find. By name.

Old designation	New designation	Oil description
ML (Motor Light)	SA	Oil without additive, except that it may contain pour and/or foam depressant
MM (Motor Medium)	SB	Provides some antioxidant and anticuff capabilities
1964 MS (Motor Severe)	SC	Oil meeting the 1964-67 requirements of the automobile manufacturers. Provides low-temperature antisludge and antirust performance
1968 MS (Motor Severe)	SD	Oil meeting the 1968-71 requirements of the automobile manufacturers. Provides greater low-temperature antisludge and antirust performance
1971-73 (none)	SE	Oil meeting the 1972-73 requirements of the automobile manufacturers. Provides high-temperature antioxidation, plus greater low-temperature antisludge and antirust performance.

**Remedy #1. Change oil frequently.** Consider your car manufacturer's oil change recommendations as absolute minimums—under ideal conditions. Take careful note of the warnings against severe operations—such as heavy loads, sustained high-speed driving, constant heavy traffic, dusty roads, and extra cold weather. You might not be changing your oil often enough.

**Remedy #2. Know your motor oils.** First ask for the service designations and viscosity recommended in your owner's manual.

**Why Quaker State offers quality protection:** Quaker State is refined from 100% Pure Pennsylvania Grade Crude Oil, the world's choicest. Then it's put through an elaborate refining process.

Finally, it's fortified with a blend of additives, scientifically selected to retard oxidation, clean and disperse harmful deposits and to neutralize acids.

So ask for it, by name: Quaker State.



**Quaker State your car to keep it running young.**

# Is there a pump action shotgun that actually helps you stay on target? Shot after shot?

**Yes. The Remington Model 870 "Wingmaster" is designed to do just that. Here's how and why.**

Hunters don't always have a chance to get set for a shot. If a covey flushes without warning or the ducks suddenly veer from the decoys, the hunter has to go into action fast. That's when proper shooting techniques pay off.

A good hunter should practice shouldering his shotgun until getting it into position becomes a reflex. Always bring the stock to your cheek rather than your cheek to the stock. Keep it high enough on your shoulder so it isn't necessary to strain your neck muscles getting a good sight picture.

It's a good idea to wear your regular hunting clothes when you practice (especially if your jacket is thick or bulky). Then you'll be sure your shotgun "fits" properly when you're out in the field. And if it's a Model 870, you'll find it's balanced to swing smoothly and point fast.

**So much for the first shot.** But what happens if you have a chance for a double, or the bird you miss is still in range? That's when the 870's pump action comes to your aid.

**Here's a tip from Remington experts.** Recoil tends to force a barrel up and back. The 870's pump action actually lets you make use of this force to help bring the fore-end back to eject the hull. Then the forward motion of your hand, which chambers the next shell, helps you bring the gun back on target—ready to shoot—with no wasted time. Thus, your natural reactions to recoil help keep your

shotgun under constant control...to help you get set for that second shot as quickly as possible.

**What's more, the Model 870 has two separate action bars—one attached to each side of the fore-end—that let you pump it**

much more smoothly, shot after shot, without twisting or binding the action. That's double insurance it will feed and eject properly under all shooting conditions.

**Now there's an 870 that takes a load off your shoulders.** It's the 870 20 gauge "Wingmaster" Light-

weight—an easy-handling partner for easy all-day hunting.

It has a specially designed solid-steel receiver and a mahogany stock and fore-end. Yet it's so lightweight that with a 26" plain barrel it weighs only 5¾ pounds.

And although it's a lightweight, this Model 870 is engineered for heavyweight performance. It's available in standard or magnum models.

**If you have any doubts about the dependability or handling of the 870,** visit any trap field and you'll find it's a favorite with trapshooters everywhere. Remember, a trapshooter can fire four or five thousand shells a year or more—and he wants a gun that can take it. No wonder the Model 870 is the leader in the pump action field.

**Another advantage of the 870** is that it is made in five gauges and has interchangeable barrels (within gauge and chamber length) with different choke and barrel-length combinations to suit different types of hunting. You can change the barrels yourself in seconds. In 12 gauge alone, you can choose from 21 different barrel-length and choke combinations.

**If you hunt game that requires long shots,** take a look at the Model 870, 20 and 12 gauge magnum models. They can shoot interchangeably all 3" and 2¾" magnum shotgun shells, as well as high- and low-base shells, thus giving you a large selection of different loads.

And for trapshooters, we've recently brought out a special high-grade "All-American" Trap Gun.

We also have a regular left-hand model for southpaw shooters in 12 and 20 gauges. Right-hand Model 870 prices start at \$134.95\*. Use Remington ammunition, too. Our patented "Power Piston" one-piece wad helps put up to 10% more shot in the pattern compared to old-style wads.

**Remington Reports** are based on facts documented by the people who design and make our products. For a copy of our 1973 full-color catalog, send a postcard to: Remington Arms Company, Inc., Dept. 285, Bridgeport, Conn. 06602.

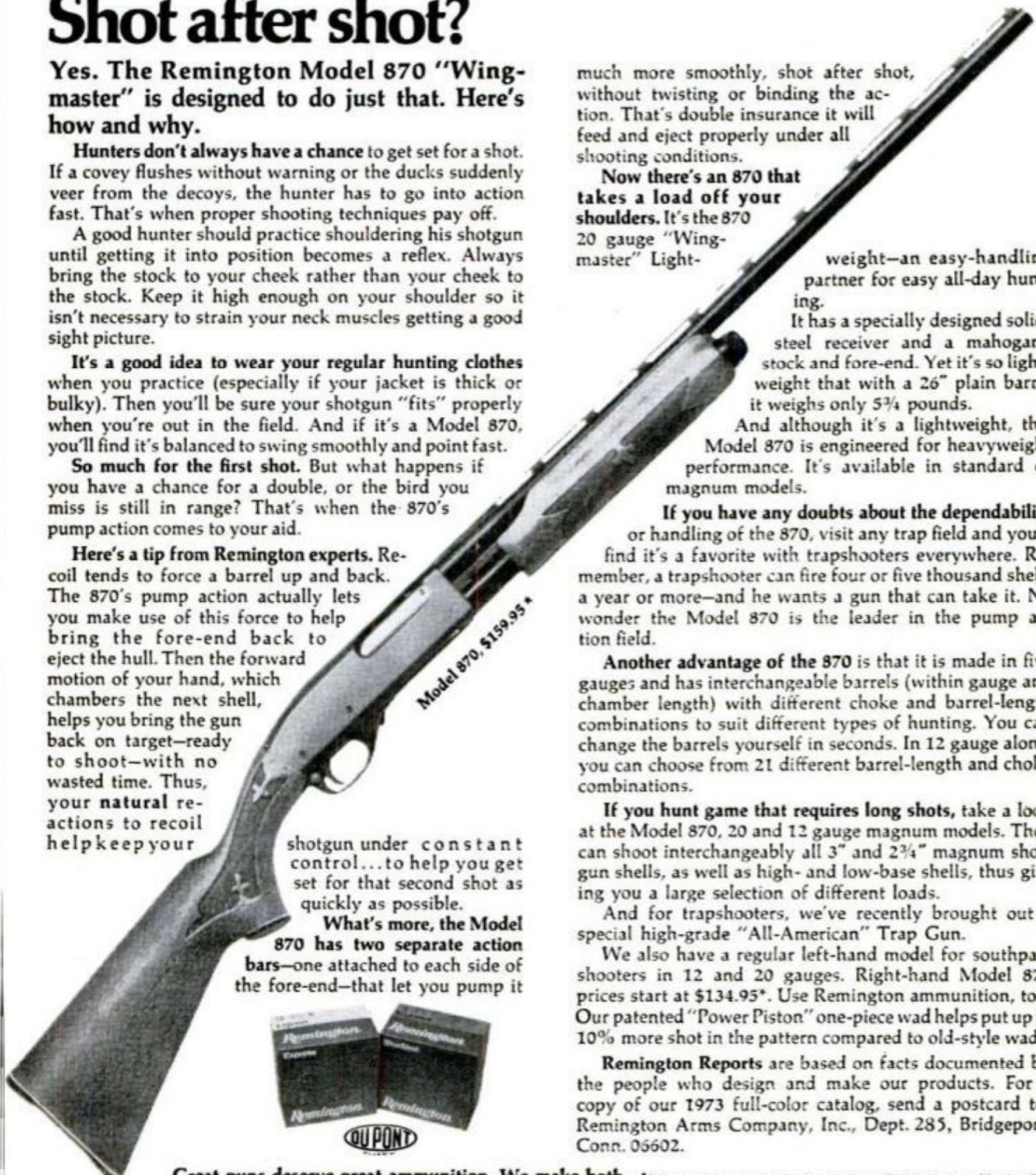

**Great guns deserve great ammunition. We make both.** \*Price shown is suggested minimum price, subject to change without notice. "Remington", "Wingmaster", and "Power Piston" are trademarks registered in the U. S. Pat. Off. "All-American" is a trademark of Remington Arms Company, Inc.

## AUTOMOBILES, DRIVING

- [32 Detroit Listening Post](#)
- [52 Imports and Motorsports](#)
- [120 PM Owners Report: Audi 100](#)
- [144 Will clean-air cops confiscate your car?](#)
- [172 Saturday Mechanic: For the life of your engine:  
Don't forget the filter](#)

## HOME AND YARD

- [69 Mobile entertaining indoors and out](#)
  - [72 1. Mobile cook-center](#)
  - [78 2. Roll-around wet bar with running water](#)
  - [82 3. Mobile hi-fi for music outdoors or in](#)
- [86 How to build retaining walls](#)
- [90 How to repair aluminum storms and screens](#)
- [92 How to lay out and pour concrete slabs](#)
- [96 How to fix your dishwasher](#)
- [142 Garden tractor you can build from a kit](#)

## ELECTRONICS, RADIO, TV

- [60 Five-tweeter speaker gives wide-angle sound](#)
- [137 Those color-TV tuning buttons: What they do—  
and don't do](#)
- [152 Low-cost, no-squint meter kit reads volts,  
ohms, amps.](#)
- [154 Heath's quietest cassette deck](#)

## SHOP AND CRAFTS

- [40 Hints from readers](#)
- [156 Steadyrest for lathe milling attachment](#)
- [158 With this miterbox you always saw in one direction](#)
- [160 Hints from readers](#)
- [162 Charming grandfather clock from a kit](#)
- [178 Hints from readers](#)
- [188 Hints from readers](#)
- [190 Hints from readers](#)
- [192 Hints from readers](#)

## BOATING, OUTDOORS

- [107 Custom rod to fly with](#)
- [148 New electric kicker for a new bass catcher](#)
- [151 Cartop boat booster for \\$10](#)

## PHOTOGRAPHY

- [14 Photo hints](#)
- [126 How to get great pictures in the great outdoors](#)

## SCIENCE, INVENTIONS

- [132 Bombs on Main Street: Dangerous cargoes that too  
often bring disaster to a community](#)

## AVIATION

- [102 Big-scale thrills at small-scale prices](#)
- [124 Homebuilt aircraft: Snappy little two-seater](#)

## EVERY MONTH

- [8 Letters](#)
- [22 Car Clinic](#)
- [42 Homeowners' Clinic](#)
- [48 Science Worldwide](#)
- [56 The Bicycle Shop](#)
- [62 All Outdoors](#)
- [62F Appliance Clinic](#)
- [108 It's New NOW: Latest products and developments  
\(A 12-page roundup\)](#)

INTERNATIONAL EDITIONS  
Australia, Caribbean, Denmark,  
Mexico, Southern Hemisphere,  
Sweden



[Bombs on Main Street . . . . . 132](#)

[Cook-center  
on wheels . . 69](#)



[How to get  
great pictures  
outdoors . . 126](#)



[\\$10 boat  
booster 151](#)



ON THE COVER: Three PM-designed carts for indoor/outdoor living: mobile cooking center, bar-sink on wheels, roll-about stereo. *Illustration by Van Kaufman*

AS A SERVICE TO READERS, *Popular Mechanics* publishes newsworthy products, techniques and scientific and technological developments. Due to possible variance in the quality and condition of materials and workmanship, *Popular Mechanics* cannot assume responsibility for proper application of techniques or proper and safe functioning of manufactured products or reader-built projects resulting from plans published in this magazine.



**Imagine positive rack and pinion steering like our Jaguar's.**



**The reliable, race-toughened engine of our MGB.**



**Rugged transmission and disc brakes like our Triumph's.**



**The same parentage as our Land Rover.**



**All in the Austin Marina.  
The tough economy car from British Leyland. \$2675.\***

Because it is comprised of proven components like those in the best of British Leyland, the Marina is one of the most experienced new economy cars on the market today.

The Marina has cat-like roadability, thanks to rack and pinion steering and torsion bar suspension, a sports car responsiveness with four-speed gearbox and front disc brakes, and the reliability of the MGB engine, already proven in over 2 billion miles of driving.

What's more, everything comes en-

closed in Marina's strong steel body whose lean, clean lines reflect the English appearance of uncluttered good looks.

Long-lasting good looks that are protected by an extensive anti-corrosive electroplating process and 64 square feet of undersealant for added protection.

Test drive the new Marina 2-door GT or 4-door sedan at your Austin MG dealer. For his name and for information about overseas delivery, call (800) 447-4700. In Illinois, call (800) 322-4400. The calls are toll free, of course.

**Austin Marina**  
The tough economy car  
from British Leyland

British Leyland Motors Inc.  
Leonia, New Jersey 07605



\*Manufacturer's suggested retail price P.O.E. Does not include inland transportation, local taxes and preparation charges. Whitewalls optional extra.

# OLDER SEAL LIQUID WRENCH



Liquid Wrench is the super-penetrating rust-solvent that loosens rusted nuts, bolts, screws and parts—in seconds! Safe on all metals, use it on a bulldozer or even your watch!



Lan-Lin gets down deep—removes paint, grease, grime, ink!

Trans-Medic stops transmission troubles! You'll feel the difference!

RADIATOR SPECIALTY CO., CHARLOTTE, N. C. 28201

Look for

## GUNK®

when you want to clean anything!

... like engines, power mowers, concrete driveways, parts.

There's a

GUNK

product for almost any degreasing job in factory, shop or home.



Engine Brite Engine Cleaner. Spray it on... hose it off! "Dirt and grease wash away."



B.O.P. Small Parts Cleaner with dip basket ...soaks parts clean.



GP cleans oil, grease, dirt from garage floors, driveways, power mowers, machinery.

GUNK LABORATORIES, 5829 W. 56, CHICAGO, ILL. 60638

Gunk Chicago Co.  
River Forest, Ill.

Radiator Specialty Co.  
Charlotte, N. C.

# Popular Mechanics

JIM LISTON, Editor

SHELDON M. GALLAGER, Executive Editor

JOHN A. LINKLETTER, Managing Editor

WAYNE C. LECKEY, Home and Shop Editor

ALVIN KIETZ, Art Director

BILL HARTFORD

Automotive

JOHN F. PEARSON

Science and Engineering

WM. T. McKEOWN

Boating and Outdoors

IVAN BERGER

Electronics and Photography

HARRY WICKS

Home Workshop

STEPHEN WALTON

Assistant, Home and Shop

MICHAEL LAMM

West Coast

ROBERT LUND

Detroit Automotive

GARRY WINTER

Copy Chief

RICHARD H. FUNK

Production

ALFREDO VEGA

Assistant, Production

DON EVANS

Technical Art Director

JOSEPH P. BEATON

Assistant Art Director

DAVID KOMITAU

Assistant Art Director

IRA HERRICK

Assistant Art Director

CLIFFORD B. HICKS

Special Projects

SOPHIE GRONOWICZ

Director, Bureau of Information

EVERETT JOHNSON

Cabinetmaker

DANIEL J. COLEMAN, Director of Advertising

ADVERTISING OFFICES: New York: 224 West 57th St., 765-8850; Chicago: 520 N. Michigan Ave., 527-2400; Detroit: General Motors Bldg., Trinity 5-8711; Cleveland: 20310 Chagrin Blvd., Shaker Heights, 283-7788; Los Angeles: 601 North Vermont Ave., 666-6263.

JOHN A. REGINA, Advertising Production Manager

Published by The Hearst Corporation

FRANK MASSI

President

JOHN R. MILLER

Executive Vice President

RICHARD E. DEEMS

President, Magazines Division

JOSEPH F. KERN

Publisher

ADDRESS ALL EDITORIAL COMMUNICATIONS TO: 224 West 57th St., New York, N.Y. 10019. For additional sources of information on the articles and products in this issue, write to Bureau of Information, Popular Mechanics, for free "Where-to-Find-It" list.

SUBSCRIPTION SERVICE: Mail all subscription orders, changes of address, correspondence concerning subscriptions, and Postmaster notices of undeliverable copies to Popular Mechanics, Box 646, New York, N.Y. 10019. Please enclose your latest address label for quickest service when writing about your subscription.

POPULAR MECHANICS IS PUBLISHED MONTHLY by The Hearst Corporation, 57th St. at 8th Ave., New York, N.Y. 10019, U.S.A., Frank Massi, President; John R. Miller, Executive Vice President; Harrison A. Mitnick, Treasurer; Harvey L. Lipton, Vice President and Secretary; Richard E. Deems, President of Magazines; Raymond J. Petersen, Executive Vice President of Magazines; William S. Campbell, Vice President and General Manager of Magazines; John F. D'Avolio, Vice President and Resident Controller of Magazines; Albert A. Rachoi, Vice President and Director of Circulation; Joseph F. Kern, Vice President for Popular Mechanics. Single copy in the United States and Canada, 60 cents. Subscription prices: United States and Possessions, \$3.97 for one year; \$10.97 for two years; \$14.97 for three years. Canada, add \$2.00 for each year. All other countries, add \$4.00 for each year. When changing address, give old address as well as the new, with postal-zone number, if any, and allow six weeks for change to become effective. Second-class postage paid at New York, N.Y., and at additional mailing offices. Authorized as second-class mail by the Post Office Department, Ottawa, and for payment of postage in cash. Registered as second-class matter at the Post Office at Mexico D.F., Mexico, June 20, 1950. © 1973 by The Hearst Corporation. All rights reserved. Printed in U.S.A.



# The "earn more" coupon.

## LA SALLE EXTENSION UNIVERSITY

A Correspondence Institution • 417 S. Dearborn Street, Dept. 92-116, Chicago, Illinois 60605

Please rush me, free and without obligation, the booklet and full information on the field I have checked below:

### ACCOUNTING

- Complete Accounting
- Income Tax
- CPA Training
- Bookkeeping

### BUSINESS MANAGEMENT

- Management Training

### REAL ESTATE

- Complete Real Estate
- Real Estate Brokerage

### STENOTYPE

- Machine Shorthand

### TRAFFIC & TRANSPORTATION

- Complete Training

### AIR CONDITIONING & REFRIGERATION

- Basic Training

### ELECTRONICS TECHNICIAN

- Basic Training

### DIESEL MECHANICS

- Basic Training

### DRAFTING

- Complete Training

### COMPUTER PROGRAMMING

- Basic Training

### LANGUAGE INSTRUCTION

- French  Spanish

### DENTAL OFFICE ASSISTANT

- Complete Training

### ART TRAINING

- Complete Training

### SECRETARIAL

- Complete Training

### AUTOMOTIVE MECHANICS

- Basic Training

### WRITING

- Non-Fiction  Fiction

### LAW COURSES

- Business Law
  - Claim Adjusting Law
  - Law for Police Officers
- No state accepts any law home study course, including LaSalle's, as sufficient education to qualify for admission to practice law.

### INTERIOR DECORATING

- Complete Training

### MOTEL/HOTEL MANAGEMENT

- Motel Management
- Hotel Management

### RESTAURANT MANAGEMENT

- Management Training

### MUSIC INSTRUCTION

- Piano  Guitar  Other

### HIGH SCHOOL

- Diploma Program

Mr. \_\_\_\_\_ Age.....  
Mrs. \_\_\_\_\_  
Miss \_\_\_\_\_ (Circle title and please print)

Address..... Apt. No.....

City..... State..... Zip.....

85-D

© 1973 LaSalle Extension University

# Thousands have mailed it. Why don't you?

It's only natural to want a bigger salary—plus the prestige and privileges that go with it. But perhaps your chances to move ahead and earn more are limited in your present job. Is it because you don't have the necessary training to command higher pay?

Our "earn more" coupon may help you—just as it has already helped many thousands who have mailed it. This coupon will bring you free information on a challenging career opportunity of your choice. And it will show you how to prepare for that opportunity without losing even a single day's pay from your present job. You'll discover how you can train for advancement in your present field—or for a fresh start in a new field—through LaSalle spare-time home study. You'll be a class of one,

choosing your own study hours in the comfort and privacy of your home.

### Take this first step.

If you're determined to earn more money and build a future, then let one of LaSalle's 21 career programs help you. For over 60 years, LaSalle has been a leader in home education, with more than 2 million ambitious men and women enrolled. Isn't it worth an 8¢ stamp to find out how LaSalle training could benefit you?

### Mail coupon for free booklet.

Right now, select the opportunity field that interests you most, then mail the coupon. LaSalle will rush you—without obligation—a free booklet that could change your whole future. LaSalle, 417 S. Dearborn Street, Chicago, Illinois 60605.

### Earning reports from some of LaSalle's more successful graduates:

"My salary has quadrupled since starting the course. I presently own three businesses and manage two others."  
—George R. Kelly  
W. Bridgewater, Mass.

"I am really grateful to LaSalle . . . in the past four years my income has increased over \$9,000."  
—Robert Kaitan  
Ridgewood, New York

"I have formed my own decorating company . . . also have an associate to work with me. We are doing offices, private homes, yachts and model homes complexes."  
—Mrs. Patricia Meine  
Palo Verdes Estates, Calif.

"Thanks to LaSalle's drafting course I have received two promotions. I now have a new and brighter future ahead of me."  
—William C. Warner  
Littleton, Pa.

"Thanks to my LaSalle training I have been promoted to Secretary Treasurer, and my salary has more than doubled."  
—Mrs. Mary Nyberg  
Los Angeles, Calif.

"In the last three years I have doubled my income. Without LaSalle training this would have been impossible. In the next three years I expect to double it again."  
—Paul Katter  
Pasadena, Calif.

"I was at a dead end when I enrolled with LaSalle, making only \$95 a week. Now my salary's up over \$2,800 a year."  
—Charles Dunin  
Indianapolis, Ind.

# Irwin workshop special



The workshop set you've been wanting. Get 6 precision-engineered Irwin Speedbor® "88" wood bits with 1/4" electric drill shank, sizes 3/8, 1/2, 5/8, 3/4, 7/8, 1". Plus an all metal storage rack. Specially priced for home, farm, factory, school workshop. Bits forged from finest tool steel. Heat tempered full length. Machine-sharpened for fast, clean, accurate cutting power. Irwin 13 bit set with rack also available, 1/4 to 1". Both sets gift boxed. Buy from your Irwin hand tools dealer.

**Irwin Screw Starter.** Marks hole, starts hole, threads hole for screw to easily enter wood and non-metal materials. Handiest tool in years for home and job. Get one soon.

® Registered U.S. Patent Office



**IRWIN**® every bit as good as the name

at Wilmington, Ohio 45177, since 1885

## How to buy a roof.

Whether you're buying a new home or re-roofing your present one, this free new booklet is *must reading*.

It shows the results of a unique demonstration Johns-Manville set up to reveal the virtues (and drawbacks) of the various types of roofing materials you have to choose from. Including asphalt shingles, shakes, slates, tiles and Rampart™ —J-M's new fiber glass shingles.

Please send me a copy of the booklet, "How to Buy a Roof."

Name \_\_\_\_\_

Address \_\_\_\_\_

City \_\_\_\_\_

State \_\_\_\_\_ Zip \_\_\_\_\_

**Johns-Manville** 

Johns-Manville, Box 5705-RP-181, Denver, Colorado 80217



## LETTERS

### TO THE EDITOR

#### Dutch Mini-Barn in Florida

Just completed the *Dutch Mini-Barn* (page 64, Aug. '72 *PM*). I left off some of the fancy trim as I spent roughly \$500 as far as I have gone.



I painted it bright barn red with white trim. It sure makes a great workshop for me—lots of headroom, too, as I am 6 feet 7. I look forward to every issue.

LAKE PARK, FLA.

G. J. BROCKLEBANK

*Complete construction plans for the Dutch Mini-Barn are still available for \$3.95 from Popular Mechanics, Dept. DM-L, Box 1014, Radio City, N.Y. 10019.*

#### More, not less

On page S28 of the *Car Care Guide* (May *PM*), you make the statement, "If you find the level is less than 1/4 inch below the top of the cylinder, add a high-quality brake fluid." It should say *more* than 1/4 inch.

HOWARD BEACH, N.Y.

GEORGE SCHMAHL

*Our mistake; you're right.*

#### Better bike price any day

*Eugene Sloane Picks the Best Bikes for Your Family* (page 98, June *PM*) fails to be of good service to readers.

We have five 10-speed, lightweight bicycles in our family (three different makes) with not one of them priced over \$69.95. One was priced at \$55. These bicycles have all the attributes of high-priced racing bi-

*(Please turn to page 10)*

# Smaller engines, front drive seen as fuel gets shorter

—Automotive News, April 23, 1973 (pg. 18)

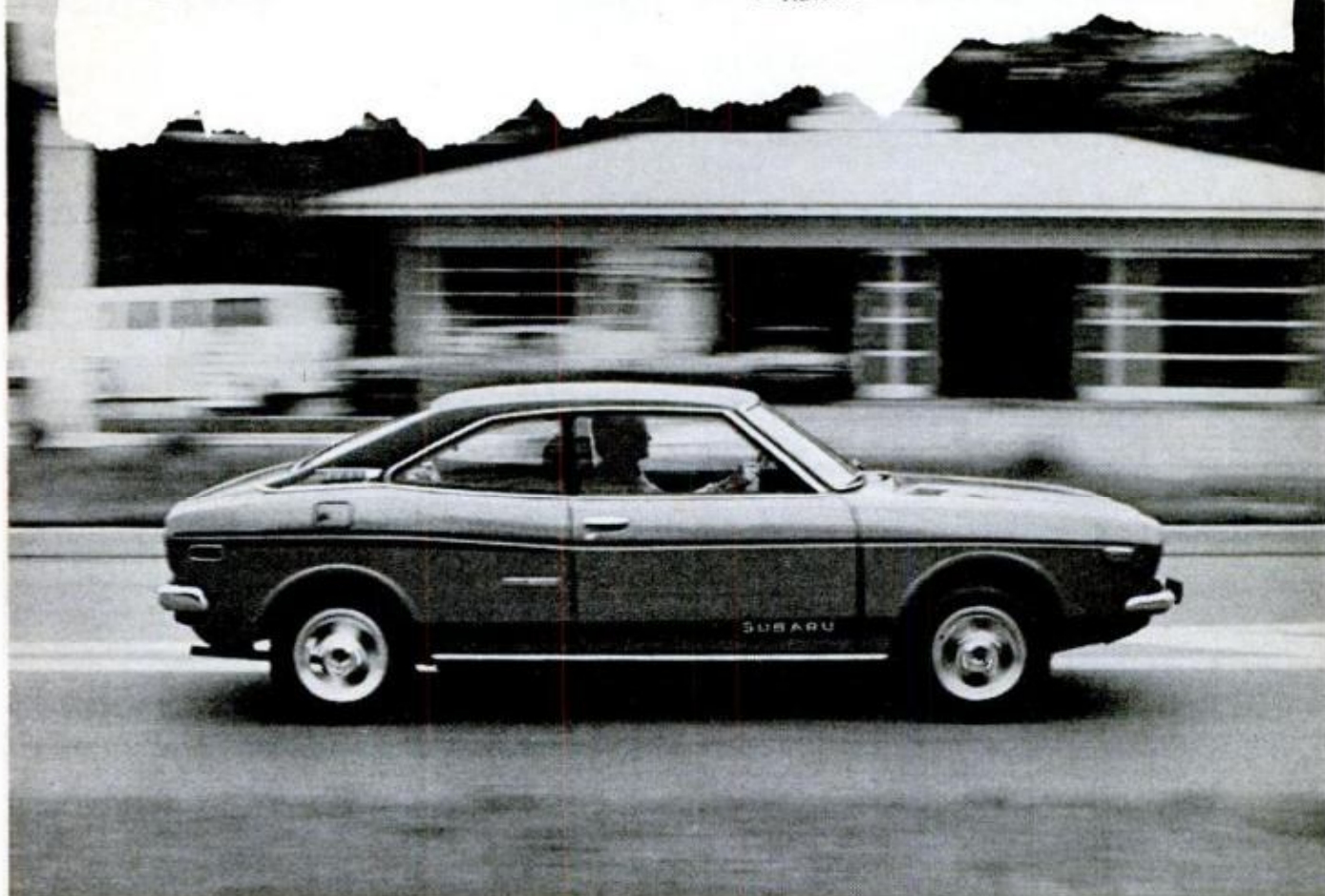

It's pretty obvious that the days of the big gas-gulpers are numbered. From now on, you're going to have to make every gallon count.

And that's where Subaru comes in.

Our unique, 4-cylinder Quadrozontal engine gets around 25 miles per gallon. On regular. And because of its horizontally-opposed design, vibration and wear are cut way down. Subaru is the only car to use this advanced, liquid cooled engine

design (but a number of airplanes do very well with it).

As for front wheel drive, we're right on target again. Automotive engineers agree that front drive is the best way to build superior handling and roadability into a car. And Subaru shows how right they are.

Subaru corners securely. It maintains straight-arrow control even in crosswinds. And with the weight of the engine directly over the driving wheels, it has more than enough traction to

climb snow-covered hills like a jackrabbit.

So for a good look at the shape of cars to come, call your nearest Subaru dealer. He'll be glad to arrange a test drive.

**Why wait for the others to catch up?  
Subaru's got it now.**



## The front wheel drive Subaru.

For your nearest dealer call 800-447-4700. In Illinois 800-322-4400.

Subaru automobiles priced from \$2397. Plus dealer prep., freight, state and local taxes if any. Subaru automobiles manufactured by Fuji Heavy Industries, Ltd., Tokyo, Japan. Imported by Subaru of America, Inc., Pennsauken, New Jersey.

## LETTERS

(Continued from page 8)

cycles: 27-inch wheels, circular chain guards, reflectors, wrapped handlebars, chrome rims. Two models have center-pull brakes, front and rear. Weights vary around 34 pounds.

We have been using these bicycles daily; they give us excellent performance. Yet, your author reports on only one 10-speed under \$100, and it is reported at \$99.50. We here can do very much better any day.  
FRESNO, CALIF.                      A. S. AVAKIAN

*If you've found low-priced bikes that are adequate for your needs—fine! However, after thousands of miles of touring and experiencing about every kind of breakdown known to bicyclists, Sloane is also well aware of what kind of components hold up under sustained hard use—and it was on the strength of his experience and actual tests of the bikes that he made his "best bike" selections. (He adds that "high-priced racing bicycles" do not have guards, reflectors or chrome rims—and weigh more like 22 pounds.)*

It was an interesting, enjoyable article—with the exceptions of some bikes you picked.

The Mercier 200 can easily match or better the Schwinn Deluxe Paramount. The Mercier 100 is a much finer and better running bike than the Raleigh Grand Prix. Your choice of the Crystal 220 was excellent for "adult bikes under \$100." The Ross 701 and 702, I think, are much better than the Schwinn Pixie; the Schwinns are much heavier.

CAMBRIDGE, MASS.

BENEDICT PALAIMA

### The last word on Morse

In your May *Letters*, R. T. McCleary criticizes the use of the term "Morse code" for what oceangoing ships employ as a communications medium. Surely he is being rather precious, as to find the original code as devised by Morse it would be necessary to visit a reference library.

What ships use is defined in signals publications as "The International Morse Code," based on the above and referred to in the trade simply as "Morse." If you men-

(Please turn to page 12)

## HOW MUCH COULD YOU BORROW?

**FIND OUT NOW!**

### HOW YOU SCORE YOURSELF

Just fill out the simple, self-scoring credit chart at right. Your score will tell you the amount of the personal loan (or line of credit) for which you may apply—up to \$3000.

### A CREDIT SERVICE OF ITT

Direct Credit Service, an ITT Financial Service Company, takes the doubt and uncertainty out of applying for a loan—and offers the modern conveniences and privacy of direct mail service.

Add up your score—then please write, or for extra fast action, telephone toll free:

**800-826-6959** (24 hrs. a day—7 days a week)

Miles E. Gibbons  
Suite 250  
100 Barstow Commons  
Eau Claire, Wis. 54701

If your score is:	17	18,19	20,21	Over 21
We invite you to apply for:	up to \$1,000	up to \$1,500	up to \$2,000	up to \$3,000

Enter the correct number in the point-score box at right, then add up your total score.

AGE	21-25	26-30	31-40	41-50	51-64	POINT SCORE
	1	2	3	3	3	<input type="text"/>
TOTAL INCOME (in thousands)	Under 8	8-10	10-12	12-15	Over 15	
	1	3	4	6	8	<input type="text"/>
YEARS WITH PRESENT EMPLOYER	Under 1	1-3	3-6	6-12	Over 12	
	1	2	3	4	5	<input type="text"/>
DEPENDENTS (including self)	1	2	3	4	Over 4	
	3	4	3	2	1	<input type="text"/>
YEARS AT PRESENT ADDRESS	Under 2	2-4	4-7	7-10	Over 10	
	1	2	3	4	4	<input type="text"/>
PERSONAL DEBT IN THOUSANDS (exclude mortgage)	Over 5	4-5	2½-4	1½-2½	Under 1½	
	0	1	2	4	6	<input type="text"/>

TOTAL

**direct credit**  
An ITT financial service company  
**DIRECT CREDIT SERVICE LTD.**

# IF YOU OWN A PICKUP TRUCK, CAN YOU PASS THIS TEST?

- 1.) Most people who buy pickup trucks end up carrying heavier loads than they think they will.
- 2.) Passenger car tires are designed to perform as well in truck service as they do on cars.
- 3.) All pickup truck tires cost more than comparable size passenger tires.

TRUE FALSE

<input type="checkbox"/>	<input type="checkbox"/>
--------------------------	--------------------------

<input type="checkbox"/>	<input type="checkbox"/>
--------------------------	--------------------------

<input type="checkbox"/>	<input type="checkbox"/>
--------------------------	--------------------------

(Answers below)

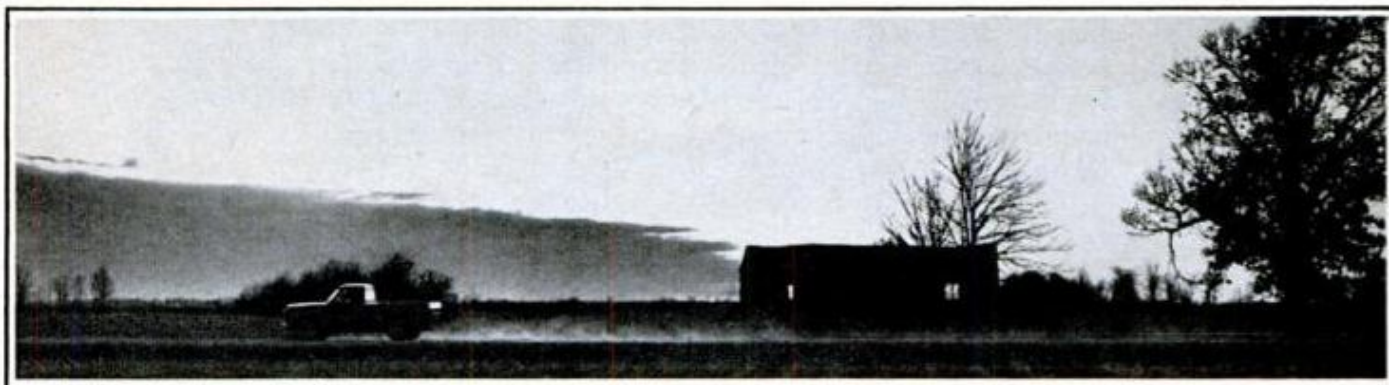

- 1.) **True.** Many people who buy a pickup plan on carrying only light loads. But because it has the capacity, and is so readily available to them and their friends, its load limits, particularly its tire load limits, are often exceeded.
- 2.) **False.** Passenger car tires are designed for car use. Truck tires, like the Firestone Transport, with a combination of shock-fortified nylon cord body plies, rugged tread design and rubber compound, reinforced beads and sidewalls, are designed for the tougher requirements of pickup trucks. In addition, the Transport has a 6-ply rating instead of a 4-ply rating of passenger car tires.
- 3.) **False.** Some sizes of Firestone Transport truck tires actually cost less than passenger tires. And you can even get them with whitewalls at your Firestone Dealer or Store.



Transport<sup>®</sup> Truck Tire

# Firestone

## LETTERS

(Continued from page 10)

tion the term "International Code" to a ship's officer, he will assume you mean a book containing groups of letters representing phrases, the latter being available in a choice of several languages. The letters, which are common, can be sent by flags—or in Morse.

S.S. RAJULA  
SINGAPORE

P. A. ARCHER  
RADIO OFFICER

### Student-built 'grandmother clock'



Here's a photo of the "grandmother clock" (*PM's Handsome Hall Clock*, page 124, Oct. '69 *PM*) built by Gordon Player, a 17-year-old graduate of this school. He made it of willow wood, stained it with walnut wiping stain and hand-rubbed it with Danish oil. Cost: \$190.

STRATFORD NORTH-ROSS KELTERBORN  
WESTERN SECONDARY SCHOOL  
STRATFORD, ONT.

### Worth a five-year subscription

Keep your good projects coming—I've been finding them highly useful. You had one quick run-through on repairs a few months ago—fireplaces et al (page 76, Jan. *PM*)—that quickly repaid me the price of a five-year subscription.

NEW YORK W. STEVENSON BACON

### Auto parts for his telescope

As a result of reading *The Sky's the Limit With This 200-Power Telescope* (page 166, Dec. '70 *PM*), I purchased the lens and instruction manual from Edmund Scientific Co. And today I am enjoying the use of my telescope.

I found it necessary to refer to the *PM* article for clarification and a simple explanation of various points. From the diagram printed with the article, I was able to transform some automotive transmission



parts into the equatorial movement. I hope you continue to publish the valuable and informative material.

HICKSVILLE, N.Y.

FELIX TIRANE

### Angle cutter for radial saw

We were pleased to see our Angle Cutting Table Surface for radial-arm saws on page 94 of *It's New Now* in April. Unfortunately, the price shown is incorrect. The price should be \$4.95 plus \$1 mailing, or \$5.95 postpaid. It can be ordered from Comparator Chart Engineering, Box 1250, Huntington Beach, Calif. 92647.

HUNTINGTON BEACH, CALIF. L. D. TAYLOR

### Saucy Shingle is well worth its cost

In building my *Saucy Shingle* (page 144, March '65 *PM*), I used a high-grade marine plywood and mahogany framing. I fiberglassed the seams and resined the rest. I used an epoxy paint which gave a gleam-



ing finish and a smooth surface. My boat weighs 100 pounds. The construction and rigging (less engine) cost about \$150, but it sure is worth it.

VALLEY CITY, N.D.

STEVE RIDEN

### Sap remover

Someone asked in your April issue how to

remove tree sap that drips on cars (*Automobile Clinic*, page 22).

The simplest way is to let your car stay outside for several hours on a rainy day. Then soft water from the rain will soften the sap. While it's still raining, put on a raincoat and hat and wash the car with a good soap and rough towel. I have had that trouble often, but this method never failed me yet. Hope this helps.

RIDLEY PARK, PA.

HAROLD A. MILLER

### Another use for stockings

Good idea—stocking on dryer vent for lint (*Hints From Readers*, page 125, April PM). I keep an old nylon stocking fastened over the end of my washer drain hose to catch lint, and I haven't had to have the floor drain cleaned since. A plumber told me it saves drain-cleaning bills. It does!

PONTIAC, MICH.

MRS. JAMES WILSON

### Credit to art industry

I would like to pay a personal compliment to your technical artist, Fred Wolff. His are truly excellent examples of technical illustration. He is quite a credit to the art industry.

WEST NEWTON, PA.

RICHARD STANCHIK

### Like the real thing

Yes, Dacor Brick-In-A-Can looks and feels like real brick (*Trowel-On 'Brick' Looks Like the Real Thing*, page 168, April PM). I, a woman, did it myself. The only difficulty I did have was in applying the mortar, which was just a little strenuous. But the top coat was simple.

WATERFORD, N.J.

GILDA PASSARRELLA

### Early start

*One (Young) Man's Shop* (page 98, Feb. PM) caught my interest for it was at his age that I started my cellar workshop. Later, in 1932, PM showed a small handmade woodturning lathe; I made it and its turning tools and won confidence. My workshop has expanded well since.

MALDEN, MASS.

PETER LEGON

# WE FINANCE YOU

WE'LL START YOU IN A

## Business of Your Own



Start in sparetime; build a money-making full-time business in your garage or basement. We'll start you in business with No Money Down. Your earnings easily cover the low monthly payments. Sharpening saws is an important service in any neighborhood or small town—You can earn \$3 to \$6 an hour sharpening hand, band or circular saws.

### No Experience! No Selling

The easy-to-operate Foley Saw Filer is automatic—it does the job for you. You can be doing business the day after you receive your machine. And with a saw filing business customers will come to you. No door to door selling! You are supplying a much needed service. If you'd like more information about this unique business opportunity, return coupon (no salesman will call) and we'll send you our fact-filled

### MONEY-MAKING BOOKLET FREE!



Foley Manufacturing Co.  
816-3 Foley Bldg., Minneapolis, Minn. 55418  
Send for FREE book on Money-Making facts about the sharpening business.

NAME \_\_\_\_\_  
ADDRESS \_\_\_\_\_  
CITY \_\_\_\_\_ STATE \_\_\_\_\_ ZIP CODE \_\_\_\_\_

## PAYS FOR ITSELF!



### Wheel Balancer only \$13.98

Float-O-Matic pays for itself the second time you use it. Quickly levels on any solid surface. Easy to use. Durable, light weight. Accurate bubble-centering concept means no guesswork . . . you're an expert in minutes. Extends tire life and allows greater control at freeway speeds. **MORE ACCURATE!** The lug holes on your wheel are machined within closer tolerances than the center hole. Float-O-Matic uses these closer tolerances to insure more accurate balancing than the older cone-type units. Fits all cars and light trucks except those with closed center wheel hubs. Can be used on VW, Saab, Peugeot and other imports with large center holes by adding adapter. **KIT:** Contains 50 assorted weights and balancing tool . . . \$8.99. **ADAPTER:** Allows balancing of all imported car wheels with large center holes . . . \$4.49. Send check or Money Order . . . Satisfaction Guaranteed.

**AUREUS INDUSTRIES** DEPT. 11

P.O. BOX 3 / MERCER ISLAND, WA 98040

Name \_\_\_\_\_

Address \_\_\_\_\_

City \_\_\_\_\_ State \_\_\_\_\_ Zip \_\_\_\_\_

Car(s)/yr \_\_\_\_\_

Balancer-\$13.98  Kit-\$8.99  Adapter-\$4.49

Add 50c for postage and handling.

AUGUST 1973

13

## How to aircondition a bathroom darkroom

If you're going to use your darkroom in summer, airconditioning is a must to keep your sweat off the enlarging easel. But the bathrooms many amateurs use as darkrooms have windows too narrow for most airconditioners. (Casement models will fit, but cost a lot and have too much cooling capacity for small rooms.) When a friend ran into this problem, I built him the frame and duct shown here—which also serve to darken the room for daytime processing.

Basically, it's just a box that butts against the window casing. T-shaped shelves, one resting on the window stool (ledge) and the other just below the airconditioner, keep it from slipping down (and duct the airconditioner's exhaust heat out); a steel strap bolted to the end of the upper T shelf rests against the outside wall to keep the frame from falling into the room (it's too big to fall out), and plywood doors shut out the light when necessary.

The airconditioner is a GE Porta-Cool, the smallest, lowest-capacity (4000 B.T.U.), lightest and about the least expensive (\$100) unit I could find. The frame was custom built to just fit around it. Weather-strip was installed after these photos were shot for a better air and light seal around the airconditioner and the doors.

Since the airconditioner just recirculates the air in the room, we mounted small fans (Lafayette No. 24P 39016, \$10.50) in each door, for ventilation. The light-trap boxes around each fan are boxes with tapered slits on three sides (all but the side facing the other fan); the edges of the slits overlap the fan's own ducts, blocking the light path, and the light-traps (shown unpainted here) were painted flat black inside to avoid reflections. Dimensions will vary according to the window the frame is mounted on; the only critical dimension is the airconditioner opening, 22½ in. wide by 14¼ in. high.—*Joyce Aysta, New York.*

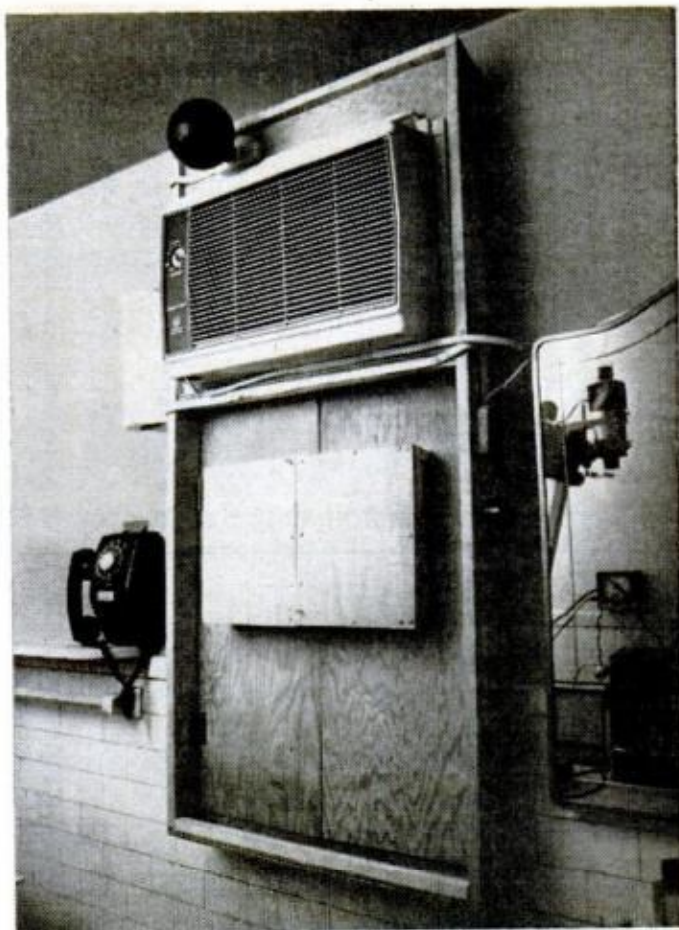

The problem was to fit that wide airconditioner (above) into that narrow bathroom window (below). But author added extra touches, including doors to cover the window during darkroom operation, exhaust fans with light-traps (boxes shown projecting from doors in photo above; one light-trap is shown uncovered below and on facing page), safelight socket, a.c. outlets (on side of frame away from camera) and darkroom phone (\$4.95 from Olson Radio). T-shaped shelf (below) ducts airconditioner heat out window; similar shelf holds frame bottom. Steel strap bolted to shelf rests on outside wall, prevents toppling.





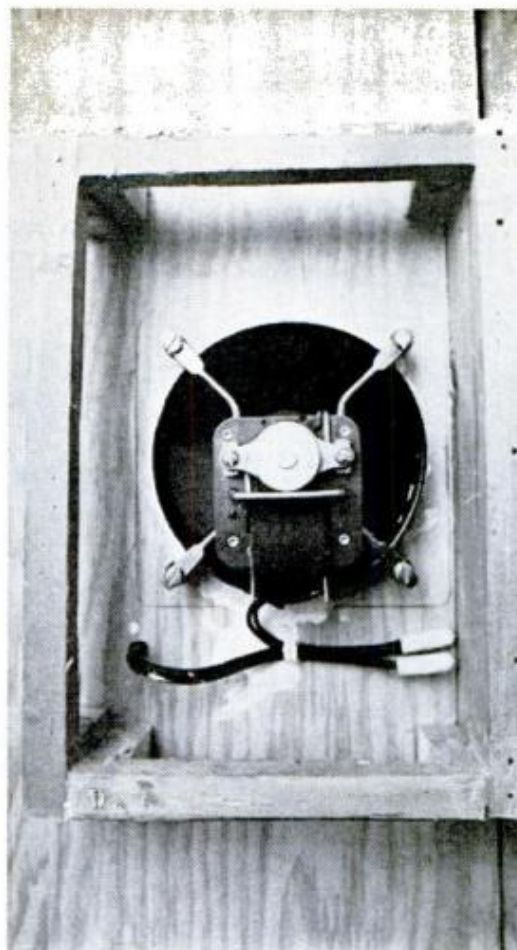
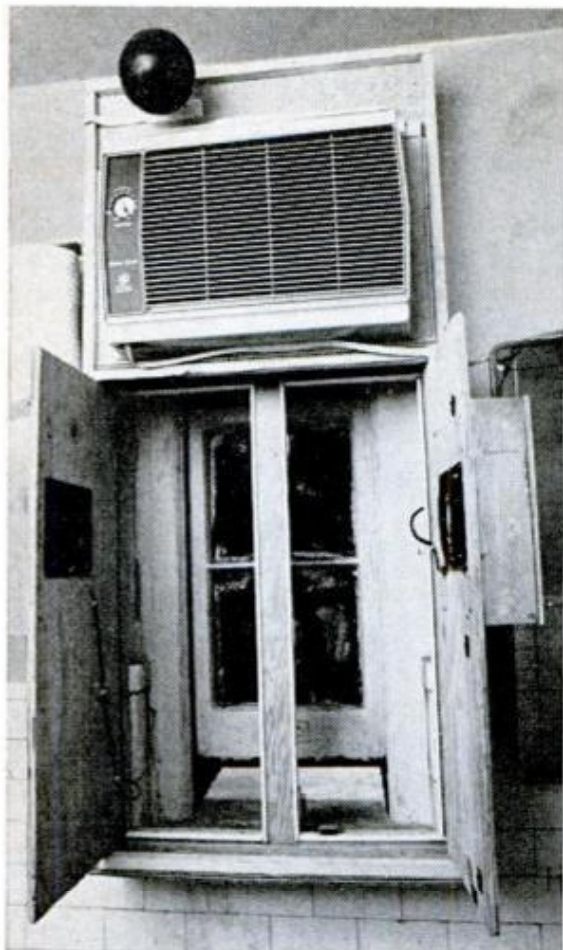

**Doors** (at far left) darken room, open to admit light. The weatherstrip shown is light seal. Fans are in doors to exhaust the darkroom fumes. Loop in the fan wire allows for easy flexing when doors are opened. Fans are housed in light-trap boxes, shown in profile.

**Light-trap** (left), shown here with lid removed and before interior was painted black, lets air out but no light in. Fan shroud extends far enough in room to overlap lip of frame, breaks light path. Frame slots have 45° bevel for smooth airflow. Fan opening, wire hole are caulked to gain light-tightness.

## Minolta helps you celebrate the morning.



You can find the wonder in a new day with a camera that doesn't hold you back, a camera fast enough to catch the fleeting moment.

From the moment you pick it up, you're comfortable with a Minolta SR-T. This is the 35mm reflex camera that lets you concentrate on mood and insight. The viewfinder gives you all the information needed for correct exposure and focusing. Because you never have to look away from the finder to adjust a Minolta SR-T, you're ready to catch the one photograph that could never be taken again.

Next time you're up with the dawn, be ready with a Minolta SR-T. For more information, see your photo dealer or write Minolta Corporation, 200 Park Avenue South, New York, N.Y. 10003. In Canada: Anglophoto Ltd., P.Q.

### Minolta SR-T 101/Minolta SR-T 102





# How to start making it early in life.

(A TRUE STORY)

Since he got out of the Navy, John Muirhead of Gales Ferry, Conn. has provided well for his family.

Two cars. A new house going up alongside a wooded lake. Even a handsome Great Dane named Sherman.

But John has bigger ambitions.

"I want my own air-conditioning business doing installations and repairs. For homes, office buildings, restaurants, small factories, motels.

"That's no dream. With the training I'm getting from ICS, I know I can do it.

"In fact, my ICS training helped me get the first job I ever applied for. I won out over two guys with college degrees, even though I had no experience. Because the boss could tell I had a practical, down-to-earth feel for heating and air-conditioning. And he respected the ICS name.

"Naturally, I was nervous at first. So I took my lesson diagrams with me on the job. And I could lick any problem.

"Pretty soon, they asked me to head up the air-conditioning department. I also picked up some repair and installation business of my own on the side. That's what's helping to pay for the new house."

## **The right combination for success**

John has the right combination for success. He's in a growing field. And he has good training for it. You could, too.

Especially if you're interested in one

of the fast-growing careers where ICS concentrates its training. Like accounting. Engineering. Auto repair. Electrician. Air conditioning, etc. (Check your choice on attached card.)

## **Ideal way to learn**

As an ICS student, you study at home, on your own schedule. You waste no time traveling to and from class. And you never have to miss a paycheck.

But you're never alone. Skilled instructors are always ready to help you.

If you ever have any doubts or problems or just want to talk to your instructor, you can even call ICS from anywhere, at any hour. Toll-free.

## **ICS training works**

ICS has trained 8,500,000 people in the past 80 years.

Some of the top American corporations (including Ford, U.S. Steel, Mobil, Alcoa, Pan Am, GE, Motorola and RCA) use ICS courses in their own training programs. Government agencies and unions have also approved ICS training.

## **Free demonstration lesson**

If you want your job to give you more, (more money, more day-to-day satisfaction, and more future) get our career guides and free demonstration lesson.

Remember, it's your life. You might as well make the most of it.

## **ICS**

*We'll show you a better way to earn a living.*

*Soon, a new home built on a wooded lake site will give John and Cheryl Muirhead lots of room for their growing family. (Photo: Frank Cowan)*

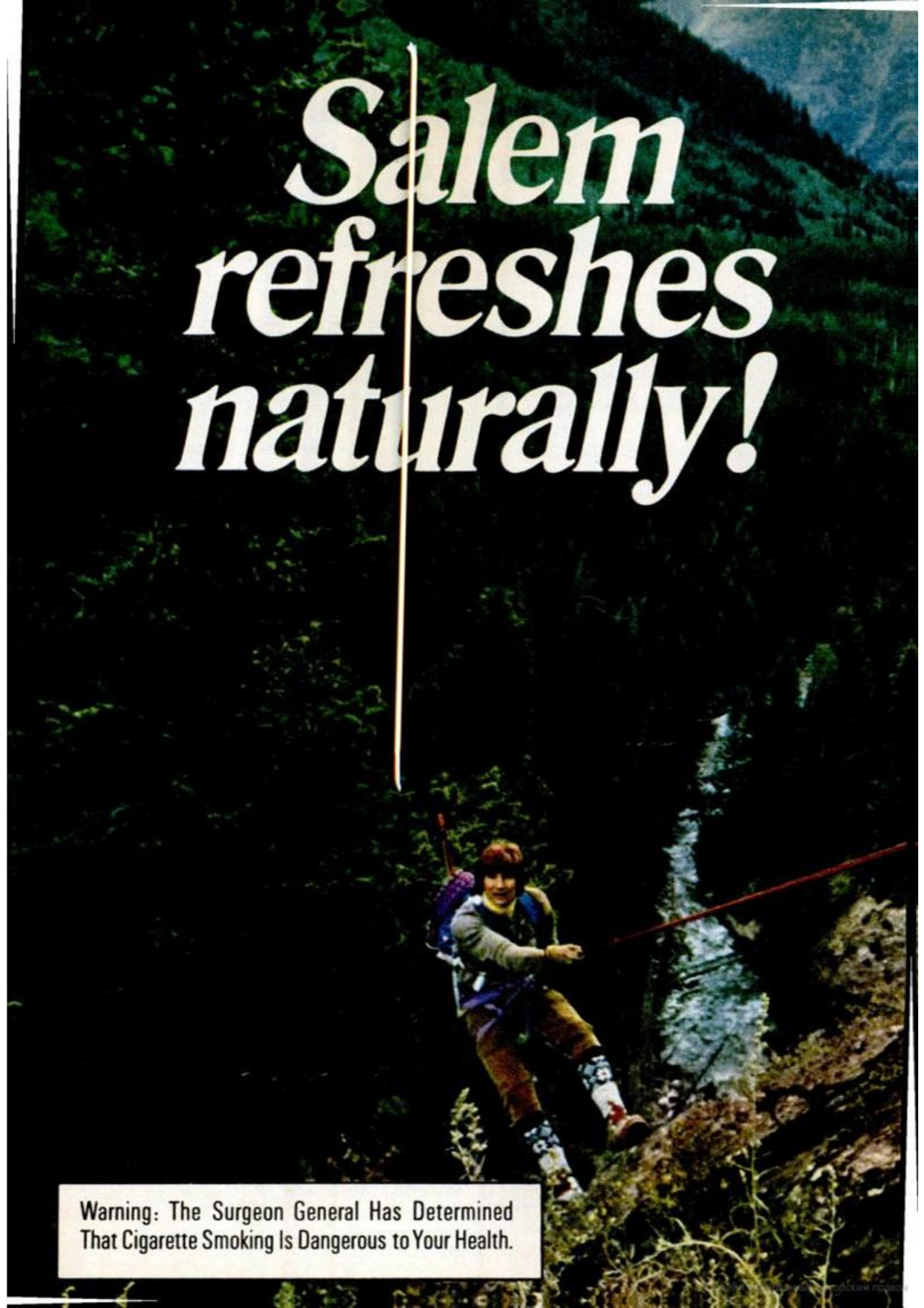
A person is rappelling down a rocky cliff face. They are wearing a blue jacket, brown pants, and a backpack. A red rope is attached to their harness. The background shows a lush green forest and a river flowing through a valley. The overall scene is outdoors and adventurous.

# *Salem refreshes naturally!*

Warning: The Surgeon General Has Determined  
That Cigarette Smoking Is Dangerous to Your Health.



# Natural Menthol Blend

(means naturally fresh taste)



Salem's unique blend features natural menthol, not the kind made in laboratories. Like our superb tobaccos, our menthol is naturally grown. You'll get a taste that's not harsh or hot... a taste as naturally cool and fresh as Springtime.



**King or Super King**

© 1973 R. J. REYNOLDS TOBACCO CO.

KING: 14 mg. "tar", 1.3 mg. nicotine av. per cigarette. SUPER KING: 21 mg. "tar", 1.5 mg. nicotine av. per cigarette. FTC Report FEB. 73

## CAR CLINIC

BY MORT SCHULTZ

### Service by the manual

*I recently bought a 1957 Buick Special and want to get a service manual. Can you tell me how?—G.S. Nemeth, Lethbridge, Alta.*

We've received many letters from readers asking about manufacturers' service manuals. Your dealer might have late-model manuals. Otherwise, write the manufacturer or organization that handles the manual you want. Some are listed here:

**Chevrolet:** Helm, Inc., 2550 East Grand Blvd., Detroit, Mich. 48211.

**Ford and Lincoln-Mercury:** Ford Service Publications, Box 07150, Detroit, Mich. 48207.

**Ford (prior to '49):** Polyprints, Box 31207, San Francisco, Calif. 94131.

**Corvette (prior to '63):** Chevrolet Div., General Motors, Owner Relations Dept., Room A-1077, GM Building, Detroit, Mich. 48202.

**Thunderbird ('56, '57):** Classic T Bird International Club, 2945 62nd Ave., Oakland, Calif. 94605.

**Buick:** Buick Motor Div., General Motors, Service Publications Dept., Flint, Mich. 48550.

**Cadillac:** Cadillac Motor Car Div., Publications Dept., 2860 Clark Ave., Detroit, Mich. 48232.

**Oldsmobile:** Oldsmobile Div., General Motors, Publication Dept., 920 Townsend St., Lansing, Mich. 48921.

**Pontiac:** Drake Printing Co., 2000 West Eight Mile Rd., Ferndale, Mich. 48220.

**Chrysler Corp. products:** Chrysler Corp., Building 410, Highland Park, Mich. 48203.

**American Motors products (including Jeep):** American Motors Corp., Consumer Relations Dept., 14250 Plymouth Rd., Detroit, Mich. 48232.

**GMC:** GMC Truck and Coach Div., General Motors, Publications Dept., 660 South Blvd. E., Pontiac, Mich. 48053.

**International Harvester:** International Harvester Corp., 401 North Michigan Ave., Chicago, Ill. 60611.

**Datsun:** Leo Adler, Parts Dept., 28001 Grand River at Eight Mile Rd., Farmington, Mich. 48024.

**Toyota:** Mid-Southern Toyota Distributors, Inc., Parts Dept., 10750 Grand Ave., Franklin Park, Ill. 60131.

**Volkswagen:** Autobooks, 2800 Magnolia Blvd., Burbank, Calif. 91505.

*and they tell me that new bushings are needed. Is this possible, and is Ford service correct in saying that grease fittings cannot be installed because there isn't enough room?—Harold A. Leach, North Webster, Ind.*

Grease fittings can be installed, but Ford believes them unnecessary, because lubrication at the upper end of the control arms at periodic intervals is not recommended. If an annoying squeak develops, lubricant can be applied with the special tool. According to Ford, a squeak develops so infrequently that installation of grease fittings would not be warranted.

Your problem, however, appears not to be a squeak, but a "clunk." This is another matter. The clunk may result from worn bushings as your dealer says, or from a worn shock absorber, weak spring or broken jounce bumper.

### Frozen airconditioner

*The airconditioner in my 1970 Pontiac Catalina freezes up on a highway after 20 to 30 minutes of fast driving. This cuts off airflow. What's wrong?—Roy M. Inouye, Galveston, Tex.*

Check the suction throttle valve, which controls evaporator air-outlet temperature. A faulty valve would cause the evaporator to freeze.

### Transmission 'burp'?

*I use my car—a 1971 Pontiac Catalina with 400-cu.-in. engine and automatic transmission—to pull a 1700-lb. camping trailer. Recently, while I was towing at about 55 mph, a cloud of smoke developed behind the car. Oil was found to be burning on the exhaust pipe. A repair shop operator said, "Nothing to worry about. The transmission*

*(Please turn to page 24)*

### Clunker

*A clunking noise has developed on the upper end of the A-frame member of my Ford Maverick. Ford service used a special tool to apply grease, but the noise is still there*

*NRI gives you the professional testing equipment and tools you need. Illustrated is the equipment you get with the NRI Master Automotive Technician's Course. Equally complete materials come with the Courses in Air Conditioning, Refrigeration and Heating.*



## Now you can learn these two well-paid skills at home... in your spare time

**1 NRI AUTOMOTIVE SERVICING**  
You get hands-on experience and the finest professional tools

Learning to service automobiles can be easy, exciting and profitable, the NRI way. You learn step-by-step proceeding at your own rate of speed and the courses are complete and professional in every way.



Richard Petty, America's winningest stock car racer and NRI Automotive Consultant, says, "NRI training gives you the kind of solid background you need to launch a career as a master mechanic, or to learn what you have to know to take good care of your own car. I especially like the "bite-size" lessons, and how NRI has covered practical service work... so a guy can learn with his hands."



### Your choice of two courses...

NRI gives you a choice of Master Automotive Technician training or a shorter Automotive Tune-up and Electrical Systems course for the man seeking greater understanding of basic car repair. With the Master Course, you get—at no extra cost—your own ignition analyzer scope (an NRI exclusive!), as well as a dwell-tachometer, timing light, complete set of tools, volt-amp tester, and assorted gauges.

**APPROVED UNDER GI BILL**—If you have served since January 31, 1955 or are in the service now, check GI line in the coupon.



### NRI TRAINING

3939 Wisconsin Avenue, NW,  
Washington, D.C. 20016



**2 NRI AIR CONDITIONING, REFRIGERATION & HEATING**  
Get in on the ground floor of a really growing industry

The NRI Air Conditioning, Refrigeration and Heating courses qualify you quickly to step into a high-paying career or part-time job. The programs were developed with technical assistance from the York Division of the Borg-Warner Corporation.

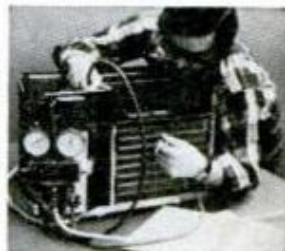

Enrollees in the Master Course may take an optional week of advanced laboratory work at the famous York Institute at no extra cost.

### Exclusive Training Units

NRI training units include a Circuit Demonstrator for circuit studies, and a Control Simulator for learning the fundamentals of electric controls.

### Window Air Conditioner

With the NRI Master Course, you receive a complete 5,000 BTU window air conditioner for system troubleshooting and your personal use.



NRI Training, 3939 Wisconsin Avenue, Washington, D.C. 20016

Please send me the free catalog I have checked below. I understand there is no obligation. No salesman will call.

I am interested in

- AUTOMOTIVE SERVICING 946-083  
 AIR CONDITIONING, REFRIGERATION, 513-083 AND HEATING

Name \_\_\_\_\_ Age \_\_\_\_\_  
(Please Print)

Address \_\_\_\_\_

City \_\_\_\_\_ State \_\_\_\_\_ Zip \_\_\_\_\_

Send me facts on GI Bill

Accredited Member National Home Study Council

RUSH CARD FOR ONE FREE NRI CATALOG

No Salesman Will Call

## CAR CLINIC

(Continued from page 22)

*burped." What is this and is it serious?*  
—M.A. Robinson, Oil City, La.

Some automatic transmission fluid may have been ejected from the transmission overflow because of the strain placed on the unit by the heat of trailering. The opening of the overflow is on line with the exhaust pipe. Be sure that the transmission isn't overfilled with fluid. Check the level as spelled out in your owner's manual, making sure that the transmission is well warmed up.

It would also be wise to consider installing an auxiliary transmission oil cooler. You will extend the life of the fluid and the transmission, and probably eliminate the "burp."

### Salted transmission

*A few months ago I drove my 1971 Volkswagen Beetle through high water. Since then I have had difficulty shifting into first gear and reverse, but only when it is rain-*

*ing. What do you think is wrong?—Israel Colon, Brooklyn.*

I think salt got into the transmission. The incident may have happened on one of Brooklyn's parkways, which are near bodies of saltwater. But even if you had driven through "fresh" water, road salt clinging to the underside of the car could have been washed into the transmission. Salt is probably restricting the clutch, but why in damp weather? Because in damp weather corrosive material expands. Salt could have also been washed into the bell-housing, where it is affecting the pressure plate and splines of the main shaft. It happens in first and reverse only, because in other gears synchros are in motion, making shifting easier. I think you should have the clutch fork, pressure plate, driven plate and transmission main shaft serviced.

### A cloudy prospect

*My problem is obtaining parts for a 1965 Sunbeam Alpine. Your help in locating a national supplier would be appreciated.—Jim Walery, Northridge, Calif.*

# You'd expect this kind of luxury in \$6,500 European cars.

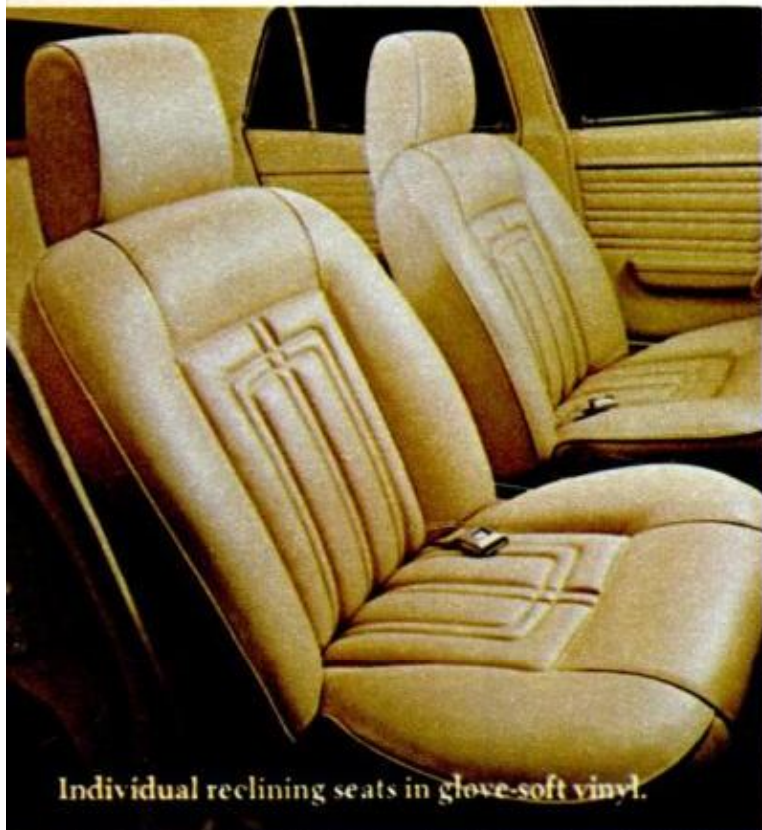

Individual reclining seats in glove-soft vinyl.



Wood-grain dash, cut-pile carpeting throughout.

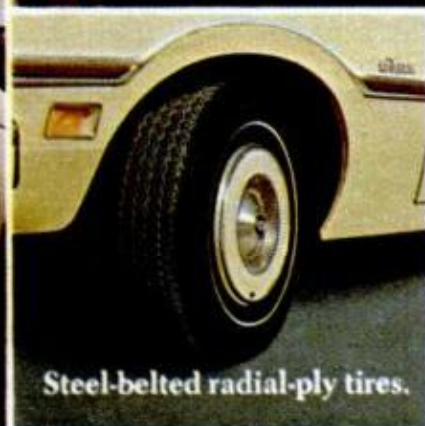

Steel-belted radial-ply tires.



Grained vinyl roof.



Sunbeam was made by Rootes Motor Corp. and handled in the United States by Chrysler dealers. I haven't been able to locate a national supplier, Jim, but suggest that you consult the parts department of Chrysler agencies. If the parts guy is helpful, he'll be able to get you what you need although you may have to wait a couple of months and you will also have to leave a deposit.

If the dealer says he can't help, suggest he contact his Chrysler regional office. Also try British Motor Car Distributors near you at 1200 Van Ness Ave., San Francisco, Calif. 94109.

### Spanking the bottom

*I own a '70 Ford Van Econoline (E-200) that bottoms out in the front on mild humps. The I-beam compresses the rubber stop block and is hitting the frame. Heavy-*

*duty shock absorbers haven't helped. Any suggestions?—Richmond Wadden Jr., Los Angeles.*

Try replacing the springs you now have with those used on current eight-cylinder models which have airconditioners.

### SERVICE TIPS

□ **A warning to Chrysler service departments** regarding the electronic ignition control unit in 1973 models can serve as a warning to Saturday mechanics, too. An electronic ignition control unit may not work if a heavy coating of grease is applied to wiring harness electrical terminals.

□ **1973 Oldsmobile owners:** Don't panic if the automatic transmission fluid turns a dark color or you get a strong smell from it that's usually associated with overheating. These conditions are normal, because a new fluid is being used. Oldsmobile recommends that the fluid be changed at 24,000 miles if the car is driven normally—at 12,000 miles if the car is put to a severe use, such as towing. ★★★

**GOT A PROBLEM WITH YOUR CAR?** Ask Mort about it. Send your question to Car Clinic, Popular Mechanics, 224 West 57th St., New York, N.Y. 10019. Letters cannot be answered individually, but problems of general interest will be published in the column.

## But not in an American compact at \$2,695.\*



Maverick with Luxury Decor Option. You get everything here, plus about 30 other luxuries. About those steel-belted radials: tests show that the average driver can expect 40,000 miles of tread life under normal driving conditions.

See your Ford Dealer. And while you're there, check on the other 1973 Mavericks. All have a refined suspension system, thicker seats and carpeting. The ride is quiet.

## FORD MAVERICK

FORD DIVISION 

\*Car shown: \$2,695 sticker price. Dealer preparation, destination charges, title fees and taxes extra.



# I'd like to give this to my fellow men... while I am still able to help!

I was young once, as you may be—today I am older. Not too old to enjoy the fruits of my work, but older in the sense of being wiser. And once I was poor, desperately poor. Today almost any man can stretch his income to make ends meet. Today, there are few who hunger for bread and shelter. But in my youth I knew the pinch of poverty; the emptiness of hunger; the cold stare of the creditor who would not take excuses for money. Today, all that is past. And behind my city house, my

summer home, my Cadillacs, my winter-long vacations and my sense of independence—behind all the wealth of cash and deep inner satisfaction that I enjoy—there is one simple secret. It is this secret that I would like to impart to you. If you are satisfied with a humdrum life of service to another master, turn this page now—read no more. If you are interested in a fuller life, free from bosses, free from worries, free from fears, read further. This message may be meant for you.

By Victor B. Mason

I am printing my message in a magazine. It may come to the attention of thousands of eyes. But of all those thousands, only a few will have the vision to understand. Many may read; but of a thousand only you may have the intuition, the sensitivity, to understand that what I am writing may be intended for you—may be the tide that shapes your destiny, which, taken at the crest, carries you to levels of independence beyond the dreams of avarice.

Don't misunderstand me. There is no mysticism in this. I am not speaking of occult things, of innumerable laws of nature that will sweep you to success without effort on your part. That sort of talk is *rubbish!* And anyone who tries to tell you that you can *think* your way to riches without effort is a false friend. I am too much of a realist for that. And I hope you are.

I hope you are the kind of man—if you have read this far—who knows that anything worthwhile has to be *earned!* I hope you have learned that there is no reward without effort. If you have learned this, then you may be ready to take the next step in the development of your karma—you may be ready to learn and use the secret I have to impart.

## I Have All The Money I Need

In my own life I have gone beyond the need of money. I have it. I have gone beyond the need of gain. I have two businesses that pay me an income well above any amount I have need for. And, in addition, I have the satisfaction—the deep satisfaction—of knowing that I have put more than three hundred other men in businesses of their own. Since I have no need for money, the greatest satisfaction I get from life is sharing my secret of personal independence with others—seeing them achieve the same heights of happiness that have come into my own life.

Please don't misunderstand this statement. I am not a philanthropist. I believe that charity is something that no proud man will accept. I have never seen a man who was worth his salt who would accept something for nothing. I have never met a highly successful man whom the world respected who did not sacrifice something to

gain his position. And, unless you are willing to make at least half the effort, I'm not interested in giving you a "leg up" to the achievement of your goal. Frankly, I'm going to charge you something for the secret I give you. Not a lot—but enough to make me believe that you are a little above the fellows who merely "wish" for success and are not willing to sacrifice something to get it.

## A Fascinating and Peculiar Business

I have a business that is peculiar—one of my businesses. The unusual thing about it is that it is needed in every little community throughout this country. But it is a business that will never be invaded by the "big fellows." It has to be handled on a local basis. No giant octopus can ever gobble up the whole thing. No big combine is ever going to destroy it. It is essentially a "one man" business that can be operated without outside help. It is a business that is good summer and winter. It is a business that is growing each year. And, it is a business that can be started on an investment so small that it is within the reach of anyone who has a television set. But it has nothing to do with television.

This business has another peculiarity. It can be started at home in spare time. No risk to present job. No risk to present income. And no need to let anyone else know you are "on your own." It can be run as a spare time business for extra money. Or, as it grows to the point where it is paying more than your present salary, it can be expanded into a full time business—overnight. It can give you a sense of personal independence that will free you forever from the fear of lay-off, loss of job, depressions, or economic reverses.

## Are You Mechanically Inclined?

While the operation of this business is partly automatic, it won't run itself. If you are to use it as a stepping stone to independence, you must be able to work with your hands, use such tools as hammer and screw driver, and enjoy getting into a pair of blue jeans and rolling up your sleeves. But two hours a day of manual work will keep your "factory" running 24 hours turning out a product that has a steady and

ready sale in every community. A half dollar spent for raw materials can bring you six dollars in cash—six times a day.

In this message I'm not going to try to tell you the entire story. There is not enough space on this page. And, I am not going to ask you to spend a penny now to learn the secret. I'll send you all the information, free. If you are interested in becoming independent, in becoming your own boss, in knowing the sweet fruits of success as I know them, send me your name. That's all. Just your name. I won't ask you for a penny. I'll send you all the information about one of the most fascinating businesses you can imagine. With these facts, you will make your own investigation. You will check up on conditions in your neighborhood. You will weigh and analyze the whole proposition. Then, and then only, if you decide to take the next step, I'll allow you to invest \$15.00. And even then, if you decide that your fifteen dollars has been badly invested I'll return it to you. Don't hesitate to send your name. I have no salesmen. I will merely write you a long letter and send you complete facts about the business I have found to be so successful. After that, you make the decisions.

## Does Happiness Hang on Your Decision?

Don't put this off. It may be a coincidence that you are reading these words right now. Or, it may be a matter that is more deeply connected with your destiny than either of us can say. There is only one thing certain: If you have read this far you are interested in the kind of independence I enjoy. And if that is true, then you must take the next step. No coupon on this advertisement. If you don't think enough of your future happiness and prosperity to write your name on a postcard and mail it to me, forget the whole thing. But if you think there is a destiny that shapes men's lives, send your name now. What I send you may convince you of the truth of this proverb. And what I send you will not cost a penny, now or at any other time.

**VICTOR B. MASON**  
1512 Jarvis Ave., Suite M-2-CJ  
CHICAGO, ILLINOIS 60626

# Are you with it?



In such relevant fields as ecology, medicine, communications, crime control, there are exciting new careers waiting for people with the right skills. **ELECTRONICS TRAINING** can help put you where the action is.

If you'd like to take an active part in solving some of the big problems facing the world—Cleveland Institute of Electronics training can be your key! Today's electronics specialists are working hand in hand with science and industry to perfect tools that will make a better life for all of us. And they're well paid for it, too!

If you are trained in Electronics, you can help develop new electronic equipment to save our lakes and rivers, to clean up the air we breathe. Help design the electronic devices that are revolutionizing medical science. Help build the electronic tools to fight crime. And in other growth fields such as aerospace, computers, communications, agri-business—just about everywhere—the trained electronics technician has a growing role in "what's happening!" With training, you can be one of these "with it" men. And getting the training you need to break into Electronics is easier than you might have

thought. You can learn Electronics at home, in your spare time, with CIE's step-by-step **AUTO-PROGRAMMED® Lessons**. You don't need college . . . or even a high school diploma. CIE removes the roadblocks, makes learning easier. You'll be amazed at your progress!

## Send for 2 FREE BOOKS

Whatever you're doing now, you owe it to yourself to look at the facts. Send for CIE's two **FREE BOOKS** that describe career opportunities in Electronics. Mail reply card or coupon today. For your convenience, we will try to have a representative call. If coupon is missing, write: Cleveland Institute of Electronics, Inc., 1776 E. 17th Street, Cleveland, Ohio 44114.

### Approved under G.I. Bill

All CIE career courses are approved for educational benefits under the G.I. Bill. If you are a Veteran or in service now, check box for G.I. Bill information.

## **CIE** Cleveland Institute of Electronics, Inc.

1776 East 17th Street, Cleveland, Ohio 44114  
Accredited Member National Home Study Council

### Please send me your 2 FREE BOOKS:

1. Your school catalog, "Succeed in Electronics."
2. Your book on "How to Get a Commercial FCC License."

I am especially interested in:

- |   |  |
|---|--|
| <input type="checkbox"/> Electronics Technology                 | <input type="checkbox"/> Industrial Electronics  |
| <input type="checkbox"/> Electronic Communications              | <input type="checkbox"/> First Class FCC License |
| <input type="checkbox"/> Broadcast Engineering                  | <input type="checkbox"/> Electronics Engineering |
| <input type="checkbox"/> Electronics Technology with Laboratory |  |

Name \_\_\_\_\_ Age \_\_\_\_\_  
(please print)

Address \_\_\_\_\_

City \_\_\_\_\_ State \_\_\_\_\_ Zip \_\_\_\_\_

**Veterans and Servicemen:**

Check here for G.I. Bill Information.

PM-82

# You look at more than 2 pickup campers.



# Shouldn't you look at more than 2 pickups to haul them?

It never fails to amaze us that people will spend weeks looking at one camper after another and yet when it comes to choosing a pickup to haul it they usually consider only two: Ford and Chevy.

We think they should at least consider a *third*.

Namely, INTERNATIONAL. The Other Pickup.

Now we realize that the fact that we make a pickup is one of America's best kept secrets.

But we just happen to make a great pickup. Especially for hauling your pickup camper.

  
**INTERNATIONAL HARVESTER**



Our ride is smooth. So is the handling. Our heavy duty suspension system is as rugged as they come. And you can choose automatic transmission, power steering and power brakes.

And we have important safety features like a collapsible steering column, a fuel tank located outside the cab and an optional anti-skid system available on two models.

Now, don't you think you should at least see what you've been missing?

The Other Pickup.  
At your International dealer.

 **International.**  
**The Other Pickup.**

## DETROIT LISTENING POST

### Sportiest Valiant ever

Plymouth's working up its sportiest Valiant as a four-door with everything on it. It will be the first car to carry the stamp of Chrysler's new styling chief. As it looks now, it won't be ready when Chrysler brings out its new cars the last week of September, but it should be in the showrooms shortly after the first of the year.

### Vega carbons coming

Vega will not be an exclusive Chevrolet product after 1974, although Chevy will retain exclusive use of the name. GM is ready now with three versions of the new Vega coming in '75, one to be sold by Chevrolet shops, another by Pontiac dealers and a third that Buick and Olds will have to fight over.

Olds is now favored to get the No. 3 version on the basis of the job it has done with its present all-from-the-same-mother car, Omega—a spin-off from Chevrolet's Nova, as are Pontiac's Ventura II and Buick's Apollo. But GM doesn't always reward its divisions with new cars on the basis of past performance. Who gets the new one may be decided on the basis of which division needs

a shot in the arm or the product lineup offered by competitive divisions of Ford and Chrysler. No. 2 and No. 3 versions of the car will have conventional engines, at least until the start of the 1976 model run, giving Vega sole use of GM's rotary through 1975 model production.

### Limited edition Vega

Coming in '74 will be the Cosworth Vega, a special-engine, special-driveline package with a sporty steering wheel and different exterior trim. Chevy says it will limit Cosworth production to one an hour—about 4000 units for the model year. Price hasn't been disclosed, but it will go for \$1700 to \$1900 over that of a regular Vega. Production will begin 30 to 60 days after the division launches its other '74 cars. GM expects to announce its '74s the third week of September, so the Cosworth will be along late in October or early November.

### GM refunding Wankel deposits

If you're not in the movies or an in-law of a member of GM's board of directors, don't-

*(Please turn to page 34)*

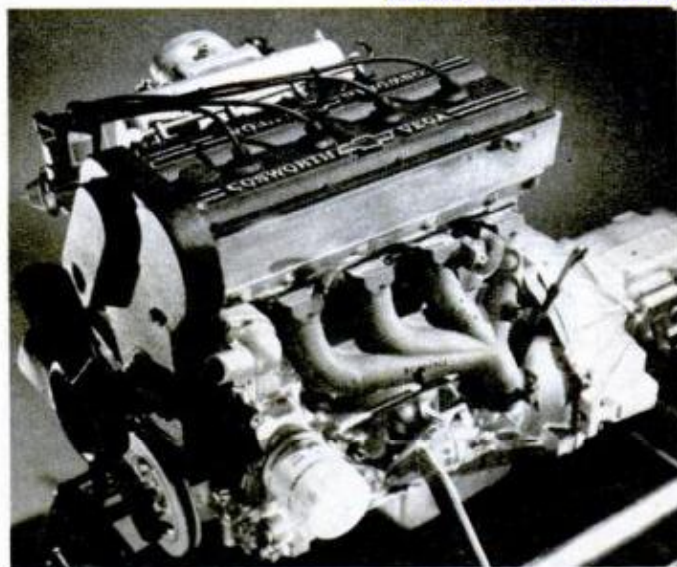
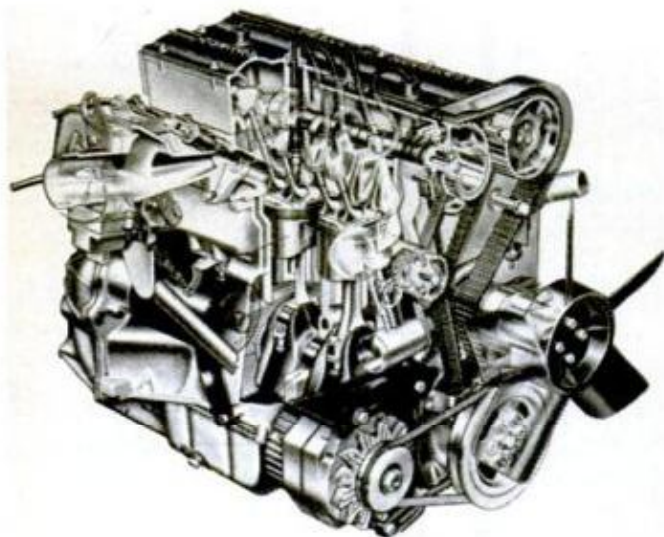

Red-hot engine for '74 Cosworth Vegas is twin ohc Four with fuel injection and solid-state ignition. Two-liter high-revver will go into 4000 hatchbacks in '74, more in '75. Details of car won't be released until fall.

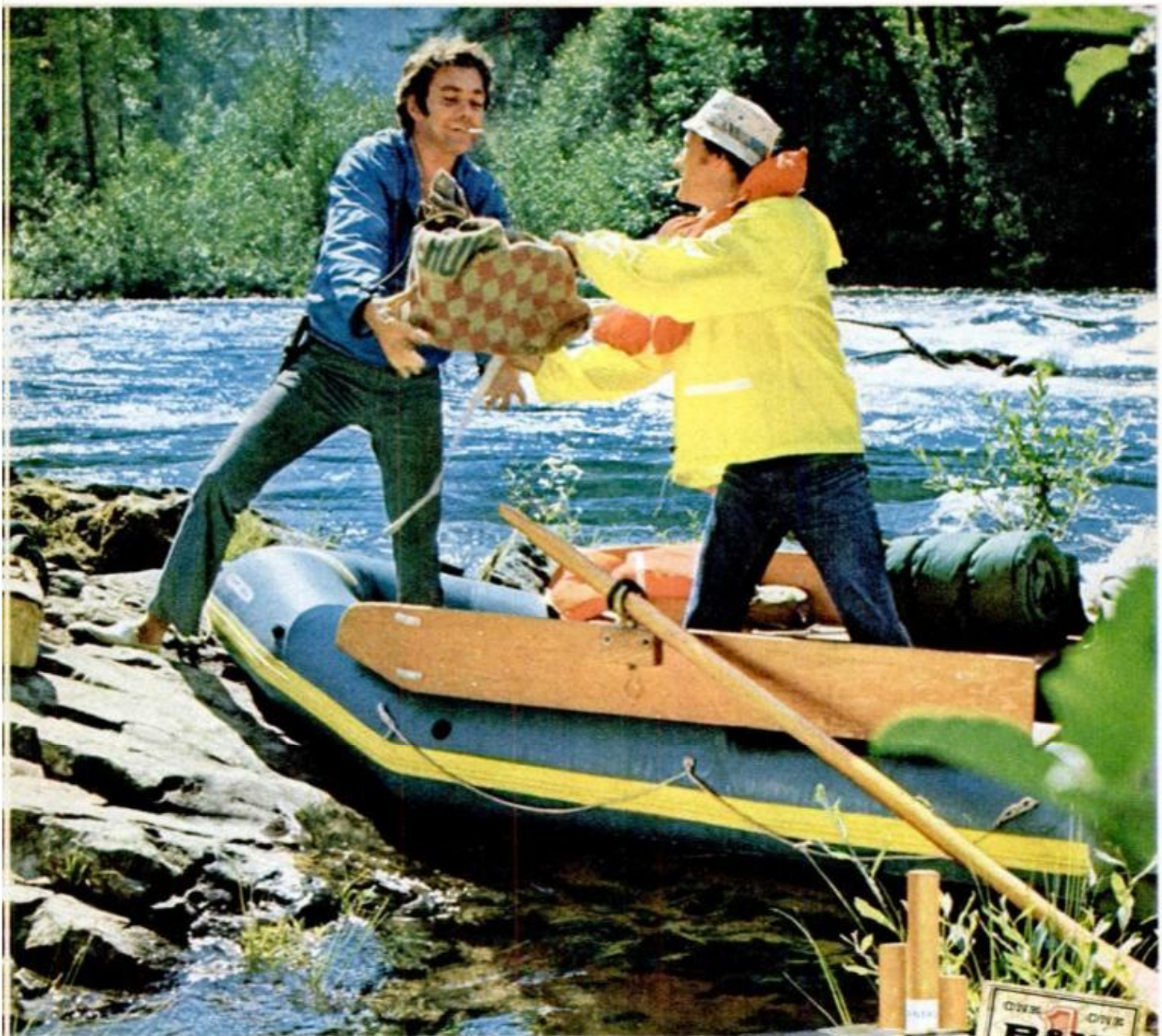

## Spend a milder moment with Raleigh.

A special treatment softens the tobaccos  
for a milder taste.

Rough it in comfort. Get a water-repellent Sportline Sleeping Bag just like the one shown for free B&W Raleigh coupons, the valuable extra on every pack of Raleigh.



To see over 1000 gifts,  
write for your free Gift Catalog:  
Box 12, Louisville, Ky. 40201.

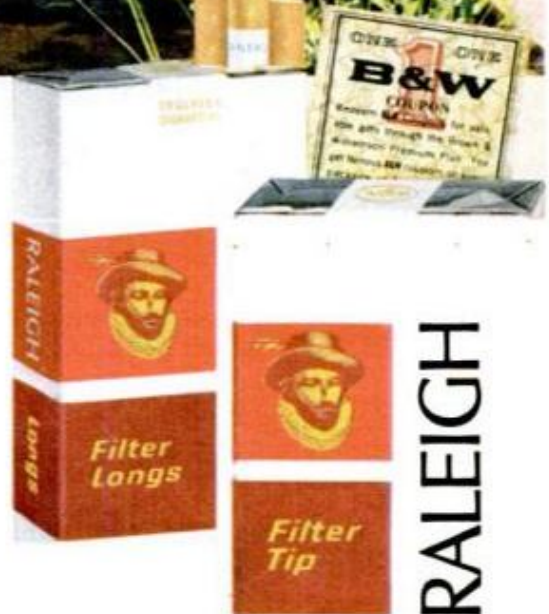

**RALEIGH**

© 1973 BROWN & WILLIAMSON TOBACCO CORP.

Filter Kings, 16 mg. "tar," 1.2 mg. nicotine; Longs, 18 mg. "tar,"  
1.3 mg. nicotine, av. per cigarette, FTC Report February 73

Warning: The Surgeon General Has Determined  
That Cigarette Smoking Is Dangerous to Your Health.

# Stripper Offer



## Strypeeze SEMI-PASTE paint remover

Clings and softens old finishes from every angle . . . for easy scrape-off or wash-off removal. Available where paint is sold.

**SAVOGRAN**   
Norwood, MA. 02062

### MODELMAKERS MACHINING CENTER IS 5-MACHINES-IN-1

Versatile Maximat combines lathe with vertical & horizontal mill, drill press, and grinder in one rugged, compact unit! Designed for labs, precision workshops and serious hobbyists. Three models available: 7" x 18"

7" x 24", 10" x 26". The Maximat is fun and easy to use. Anyone can machine like a "pro" with our fully illustrated Maximat instruction handbook, **Precision Machining Techniques** — only \$2. Dealers in all major cities.



**edelstaal**

American Edelstaal, Inc. Dept. BH-3  
Tenafly, N.J. 07670



## BUILD THESE BEAUTIFUL CLOCKS

NOW AT BIG SAVINGS!



Send just \$1 for plans & instructions to build choice of: (A) Grandfather, (B) Steeple, (C) Grandmother—plus information-packed catalog of movements, dials, parts & kits to build these & 16 other fine clocks. All 3 plans—\$2.50. Catalog alone—25¢.

**MASON & SULLIVAN COMPANY**  
Dept. PM, Osterville, Mass. 02655

### DETROIT LISTENING POST

(Continued from page 32)

bother sending GM your check to put you on the waiting list for a rotary-engine Vega when it comes out next year. You'll get your check back along a form letter saying you'll have to get in touch with your local dealer when the car goes on sale. There's a little legal nicety of being licensed to sell at retail in the individual states and GM doesn't sell direct to customers. Your best bet for early delivery of a Wankelized Vega would be to butter up the local Chevrolet dealer.

### Update on AMC's Wankel

Here's the straight stuff on American Motors' rotary engine program from the company executive nursemaiding the project: Gerald Meyers, v.p.-product. AMC's pushing development of the Wankel but hasn't reached a point of no return. The go or no-go decision will be made independent of GM's experience in installing a Wankel in Vega. There's no chance of AMC putting a Wankel in production in the next two years, but Meyers doesn't rule out a rotary installed in an American Motors car within that time. He says that the company could put a Wankel in a car short of the two years it would take to get the engine in production by buying one from a supplier.

### New four-wheelers

Ford and Chrysler are stepping up pre-production work on new four-wheel-drive vehicles. Ford's not satisfied with its Bronco sales and wants a larger, more versatile, more luxurious vehicle to sell against Chevy's Blazer and AMC's Jeep. Trend in four-wheelers, from Ford, Chrysler or elsewhere, will be to larger, more stylish cars. They'll still be utilitarian, but with more eye appeal.

### Price cut on antiskid

Ford has launched an aggressive program to cut the cost of its antiskid system to attract more buyers. The company is developing a less sophisticated skid-control system, expecting it can shave the \$200 price in the hope that it will be able to pull in more customers—for the '75 cars. ★★★



# a new look at the fabulous *Scorpion Too*

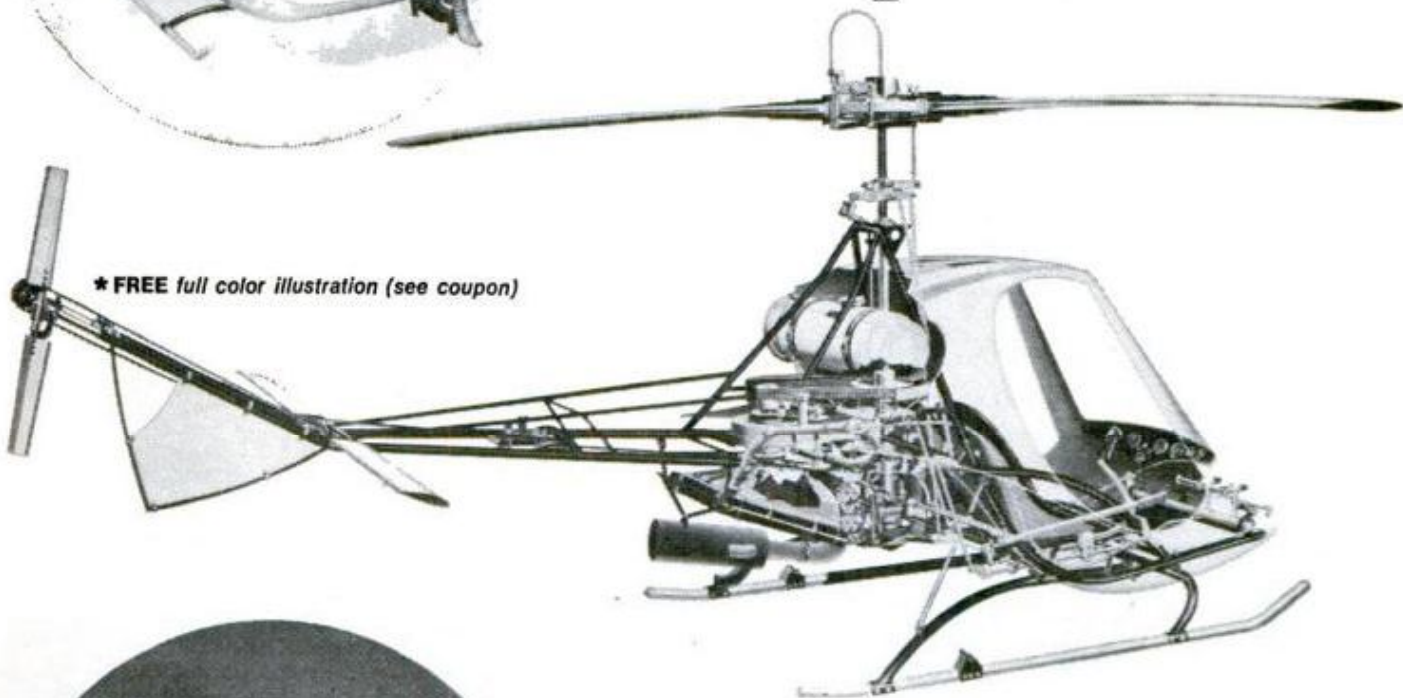

\*FREE full color illustration (see coupon)

## Have you heard about sport flying?

**Did you know that you can participate  
in your own personal helicopter.**

The Scorpion Too is RotorWay's answer to backyard flight.

Remember, the Scorpion is a true vertical take-off helicopter.

**It takes off straight up.**

Using a 140 h.p. engine, it cruises at 75 m.p.h. and can carry over 400 lbs. The most exciting news about the twin-seat Scorpion is its low cost, but then it's about time a helicopter became a recreational vehicle.



### Send \$5 now

for graphically illustrated  
color package containing:

- Fundamentals of rotorcraft flight
- Illustrated flight maneuvers
- How you learn to fly
- Scorpion development history
- Helicopter design theory
- Engineering definitions
- Power plant considerations
- Price information
- Performance specifications
- Unique features of the Scorpion Too
- Three-view dimensioned drawing
- Electrical and other options
- Exploded view of sub-assemblies
- Description of major component areas
- Information on how to proceed

**RotorWay**  
INCORPORATED

\* Enclose this coupon with your \$5 and you will receive free, along with your package, a 25"x38" full color reproduction of this beautiful scaled cut-away drawing (as shown above). Rotorway commissioned Dick Aleith, one of the West's leading illustrators, to create this work of art. It's truly a collector's item.

#### ROTORWAY, INC.

Dept. D3/14805 S. Interstate 10  
Tempe, Arizona 85281

Name \_\_\_\_\_  
Address \_\_\_\_\_  
City \_\_\_\_\_ State \_\_\_\_\_ Zip \_\_\_\_\_

# BE YOUR OWN BOSS. BUILD YOUR OWN BUSINESS.

Mail the card today for all the facts.

How many times in the last year have you thought about it . . . doodled it out on scratch paper . . . and left the daily treadmill knowing you could get a lot more done—and probably earn more money—in a business of your own?

Bell & Howell Schools can help you build the technical know-how that could become the foundation of a business of your own in electronics equipment servicing. Consumer electronics is growing like gangbusters. When you've mastered this complex equipment you could find a big demand for your skills. A business of your own in this field stands a pretty good chance of making it into the black when you've got skills that people are looking to buy.

Building a profitable business of your own needn't be just a "scratch paper dream." As a matter of fact, thirty years ago most of the electronics equipment you'll be servicing was a "scratch paper dream." Now look at it. Next year the world will buy about \$17 billion worth of consumer electronics equipment. Somebody's going to make a lot of money servicing that equipment. That's where you come in.

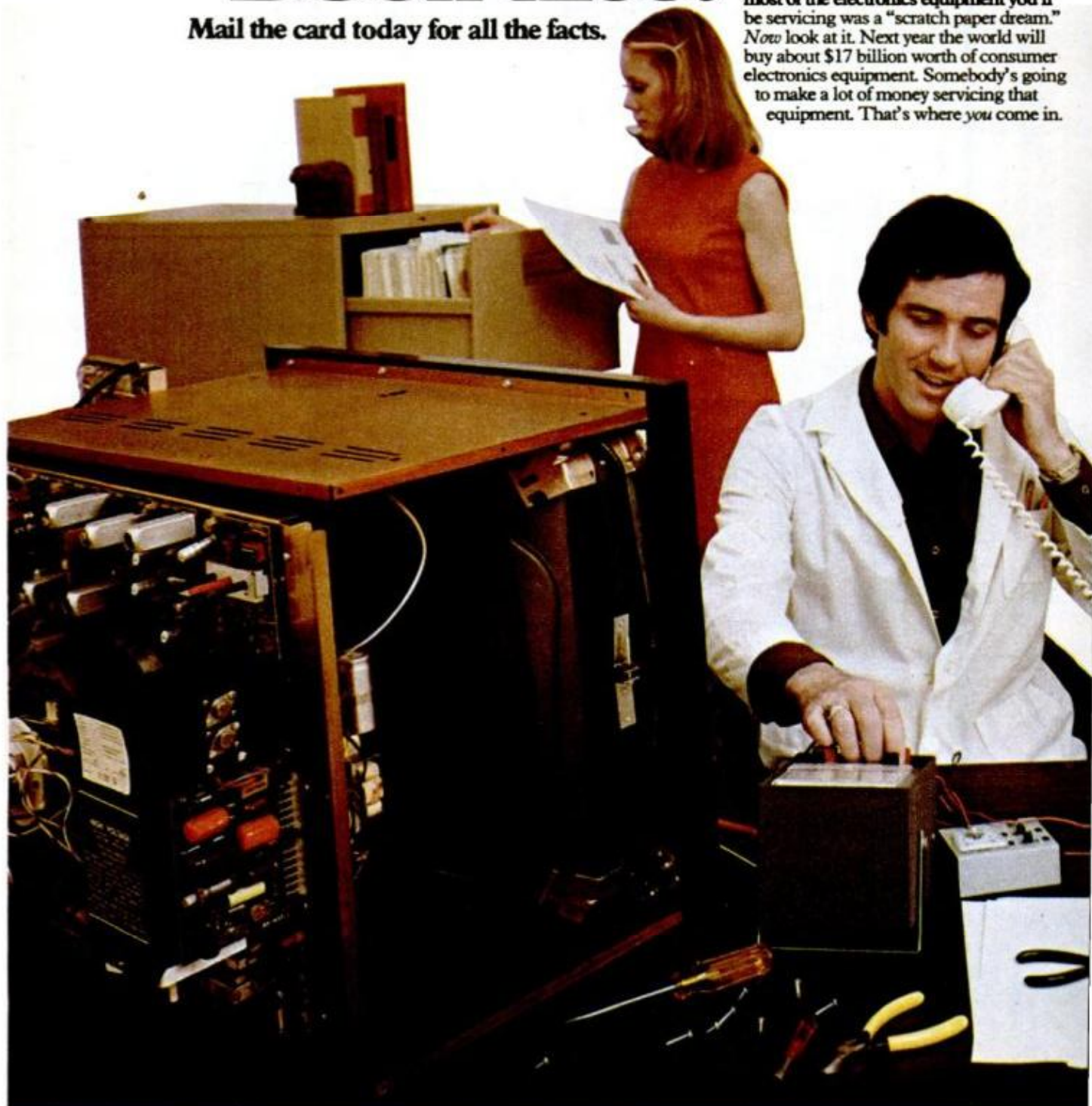

Just a few years ago, many of our graduates — guys just like you — saw the handwriting on the wall. They realized that a business of their own could really happen. Bell & Howell Schools helped them turn the growing field of electronics equipment servicing into a passport to independence and a successful business of their own.

**If you'd like to start your own business ...**

... the skills you learn in this unique Bell & Howell Schools learn-at-home program can give you the right kind of technical foundation — to help you set up your own electronics servicing business full time. You'll have the knowledge and practical skills you need to completely service and troubleshoot just about any kind of consumer electronics equipment a customer could send your way.

Or go it alone part time — in your spare time — for extra cash in addition to your regular income. It's a great way to get your feet wet in your new career ... get a good taste of the independence you'll enjoy ... and start earning extra money.

**Mail the postage-free card for all the facts about ...**

... growing opportunities in electronics for a guy who likes to work with his hands. Bell & Howell Schools offers a complete learn-at-home program that includes building yourself a 25-inch diagonal Bell & Howell solid state color TV!



**Beyond color TV, there's a whole new world ...**

... of home entertainment electronics equipment — from stereo systems to the new home videotape players. By 1985 the world will be spending about \$35 billion a year on consumer electronics equipment! Somebody will have to fix it when it goes haywire. How about you?

**One thing's certain, you're going to need ...**

... something to *sell* if you want to build yourself a successful career. That's what this Bell & Howell Schools program is designed to give you — up-to-date technical skills that electronics equipment owners are looking to buy.

**Getting ready for a business of your own means you have to start with ...**

... a hard look at what's happening in growth industries — like solid state electronics.

Today there's hardly an industry — or a leisure-time activity — that isn't touched by electronics technology. That spells "opportunity" for you — with the right training!

**The Bell & Howell solid state color TV you build is ...**

... an important part of your training because it gives you "firing line" experience with solid state equipment. Here are the technical details:  
 ■ Ultra-rectangular tube ■ 25-inch picture measured diagonally ■ full 315 sq. in. viewing area ■ solid state modular circuitry ■ 4 advanced IC's ■ 100 transistors ■ 72 diodes ■ individual plug-in circuit boards ■ special UHF/VHF tuning features ■ built-in self-service components

**If you'd like some personal advice on your program ...**

... talk over problems with a qualified instructor at one of our special "help sessions" — scheduled at Bell & Howell Schools and in many other cities. And you're only a toll-free call away whenever you'd like to discuss your program with an instructor!

**NEW ... with your first lesson, you get ...**

... the brand-new Laboratory Starter Kit! A volt-ohm-meter (VOM) with design panels, modular connectors, experimental parts, battery power source. Gives you immediate troubleshooting experience with your very first lesson.

**NEW ... you also build the new, improved ...**

... Bell & Howell Schools Electro Lab®! Gives you "hands on" experience with precision instruments you assemble and use in your new business:

**Design Console**

"Breadboard" circuits without soldering for both solid state and vacuum tube experiments. Patented modular connectors ... transistorized dual-range regulated DC power supply ... 12.6 volt center tapped AC power supply ... sine and square signal generator ... test speaker.

**Oscilloscope**

Professional technician's diagnostic instrument. 5-inch screen ... wide-band ... sharp screen images ... calibrated for peak-to-peak voltage and time measurements ... 3-way jacks for leads and plugs.

**Transistorized Voltmeter**

Measure current, voltage, resistance, on large dial ... combines vacuum-tube voltmeter with multimeter ... sensitive, 4-inch, jewel-bearing d'Arsonval movement.

510

**Get the facts.**

**Mail the postage-free card now.**

If card has been removed, write:

An Electronics Home Study School  
 DeVRY INSTITUTE OF TECHNOLOGY

ONE OF THE  
**BELL & HOWELL SCHOOLS**

4141 Belmont, Chicago, Illinois 60641

\*"Electro Lab" is a registered trademark of the Bell & Howell Company.

# HINTS

## FROM READERS

---

### Guitar-string shop tool

An old guitar string my daughter gave me has come in handy a number of times. Since the wire is stiff, though small in diameter, it is good for cleaning jets and small orifices. To make it easy to find and use I keep it coiled with a plastic bag twist tie, and I store it near my workbench.—*Harry Wheeler, Toledo, Ohio.*

---

### Dowel locks sliding doors

You have published other methods, but I have found that the best and simplest way to lock a sliding glass patio door is to cut a length of 1-in. dowel or broom handle and lay it in the door's track. To work best, the dowel should be a snug fit in length to jam the door closed.—*Vickie J. Walker, Spring Lake, N.C.*

---

### Chain length cleans bottles

When I had to clean a number of bottles, many with residue on the bottom, I found that the best way to do it is to drop in a 5-ft. length of brass chain and swish it around with some detergent. The chain scrapes the insides of the bottles and gets them spanking clean.—*Stephen N. Stresnic, Fort Lauderdale, Fla.*

---

### Tape keeps square from sliding

When using a carpenter's framing square to cut pieces of glass, you may find that the smooth steel tends to slip off the desired line. A length of masking tape applied to the underside of the square will keep it from shifting. The same thing can be done with any metal straightedge used as a guide for glass cutting.—*W. Szenker, Philadelphia.*

### Saving cement forms

To salvage the lumber used for a cement form without the bother of scraping it, I bought a roll of 4-mil plastic and covered the inside of the form with it. I made sure to tuck the bottom of the plastic under the form securely to keep cement from getting between the plastic and the wood.—*Carroll C. Stander Jr., Portage, Mich.*

---

### Cool cleanup trick

The cements used for installing plastic floor and wall tiles and decorator bricks are difficult to clean off tools, even when the recommended solvents are used. I tried leaving the tools in my freezer overnight and found that the cement chipped or peeled off most of them with ease.—*John J. O'Neil, Warwick, R.I.*

---

### Ring compressor for small cars

Plenty of auto-supply outlets sell ring compressors for larger cars, but sometimes it is hard to find one the right size for a small import. A good substitute is a large hose clamp, one that will open up to about 3 in. dia. You should be able to get one from any auto parts store.—*Charles Stubbe, Cherry Valley, Ill.*

---

### Nails lock bed slats

Although a way to lock bed slats into place was described in *PM* some time ago, the one I use is easier and costs next to nothing. With slats in position, drill a 1/8-in. hole through both slat and support strip. Drop a 6d common or box nail into the hole and it will keep the slat from shifting.—*John F. Bachmann, Fort Walton Beach, Fla.*

THE WORLD'S FASTEST, MOST SUCCESSFUL BODY SHAPER EVER!

# SLIM DOWN

**Our Guaranteed "5" Minute Body Shaper Does It ... Without Dieting!**

Joe Weider, fitness expert and trainer of champions since 1936 says:

**"Give me 5 minutes twice daily for only 7 days and you'll lose up to 3 inches from your waistline, up to 10 pounds of unwanted weight, and 'shape up' — or I will return every penny."**

### Let's face the facts why you're out of shape.

You eat the wrong combination of foods, you do not get enough exercise to thoroughly work your muscular, metabolic and respiratory systems daily. Because of this, fat accumulates around your waistline, heart and other body organs, slowing you down, aging your body and destroying your vitality, virility and youth. There is only one way to firm up and shape up: that is through proper exercise and proper nutrition. Effortless exercisers, reducing pills, sauna shorts, weighted belts, dangerous and painful diets and other gimmicks designed to appeal to your laziness will not work and have been exposed by the medical profession as frauds, ineffective and in some cases dangerous. They can only reduce your pocketbook. Face up to it... If you want to slim down, firm and shape up, you must work off the inches, and there is no safer, faster and more enjoyable way to do it than with our patented, truly miraculous "5" Minute Body Shaper Plan.

### How does this ingenious "5" Minute Plan slim, firm and shape you up?

Its miraculous slimming action is based on doing one simple "5" Minute Continuous Rhythm coordinated exercise! **That's all you do!** That's all your body needs to help make up for the lack of activity it doesn't get most of the day. The action is designed to supply your waistline and hips (where fat accumulates quickest, giving your body a flabby, weak and distorted look) with the activity it needs to slim you and keep you slim. It also burns off excess fat **FAST** by speeding up your metabolism and respiratory system, using up stored calories, carbohydrates and fats and releasing excess water, thereby shaping and firming up your total body!

Patent Pending. © Copyright Joe Weider, 1973

It's safer than strenuous gym workouts, beats the time consumption and dangers of gym workouts... or any other vigorous sport.

The unit weighs about 16 ounces and fits any wallet-size case. You can carry it with you and use it — anytime — wherever there's floor space for your body. Even while watching television.

### What the experts say:

*Medical Doctors, Chiropractors, Osteopaths, Athletic Coaches... agree it's the most successful Waistline-Weight Reducer and Shaping Up Plan ever invented!*

"Doctors have always known, exercise done while lying on the back virtually eliminates strains while slimming and reshaping the body. Yours is the finest Body Shaper Program on the market."

RICHARD TYLER, Chiropractor

"Beats jogging and working out in gyms — and much safer. I lost 4½ inches off my waist in 14 days."

JIM HANLEY, famous athletic coach

"Miraculous! Weighs less than a pound, is simple to use and beats working out in a gym with 30 different exercisers."

TOM MINOCHELLO, famous gym owner

"Based on sound physiological and medical knowledge, it burns fat and shapes the body without strain to the heart or other organs. I lost 32 lbs. of excess weight using it."

PIERRE GRAVEL, DC

## '5' MINUTE BODY SHAPER

**We'll slim your body... while you watch the girls!**

### What comes off in 14 days?

Individual results vary, but during an average 14-day period you can expect to lose up to 4 inches from your waistline and up to 10 pounds from your present weight. It strengthens your heart and lungs, increases stamina and endurance, improves your digestive function and general health. It also shapes you up — from head to toes. For a "5" Minute Exerciser — it sure does a lot.



**Weighs just 16 ounces. Small enough to fit into pouch shown.**

**FREE TRIAL OFFER: Get it off fast... and see measurable results in three days or every penny back!**

Proven results are already verified by the thousands. The guarantee is in writing. Now, can you think of a reason for not ordering your "5" Minute Total Body Shaper and start looking and feeling like a million... in just 3 days?

**DISCOVER A NEW JOY IN YOUR BODY GIVE IT SEX APPEAL! COMPLETE KIT ONLY \$9.95**

**JOE WEIDER, Dept. BR/H  
"5" Minute Body Shaper Plan  
21100 Erwin Street,  
Woodland Hills, Ca. 91364**

Dear Joe: Rush me your "5" Minute Body Shaper and Slimmers Course in plain wrapper, with your money back guarantee offer!

**I ENCLOSE \$9.95 FOR THE ABOVE.**

CASH  CHECK  MONEY ORDER

Send \$1.00 extra for Air-Mail. (No COD's Accepted)  
Calif. residents add 5% sales tax. (\$10.50)

Name .....

Address .....

City ..... State ..... Zip .....

IN CANADA: "5" Minute Body Shaper Plan, 2875 Bates Road, Montreal, Quebec

## HOMEOWNERS' CLINIC

BY W. CLYDE LAMMEY

### Shades stay up

*Several large window shades in my home won't stay down—they won't catch and hold in any position. The shades are not old, torn or discolored. What's wrong?—Mrs. R. M. Lamb, Chicago.*

It is likely that the ratchet ends of the rollers have been filled with lint, or that the springs installed in them have loosened. Take the shades down, brush lint out of the ratchets and use the tines of an old fork to retighten the springs. If no parts are bent or missing, the shades should then work properly.

### Veneer lifting

*I've stripped a chest of drawers which is veneered. With the remover washed off, some of the veneer has come loose and the edges have lifted. What happened, and what do I do next?—R. Dewey, Tulsa, Okla.*

It is quite possible that you dampened the glue under the veneer and, thus, softened it enough to make it let go in places. I'd try lifting the veneer with a sharp chisel, and forcing new glue underneath. Then clamp plywood on top, with wax paper in between, until the glue dries. If blisters result, slit each at its center, force glue through the slits underneath the veneer, and weight until dry.

### Sharpening lawn mower

*Can you tell me how to sharpen a reel-type lawn mower?—Vernon Sheff, Racine, Wis.*

Place the mower on a table or bench. Clamp or tie the handle securely. Remove the wheel, pinion and other parts, making sure that you keep them in order. Hold the reel shaft with lever-jaw pliers. Mix valve-grinding compound (obtainable from an auto-parts supplier) with oil to make a paste; brush this on the blades and bed knife. Adjust these parts for light contact

and turn the reel backward with the pliers. Keep the bed knife and reel blades in contact by repeated adjustment. When properly sharpened, they should contact smoothly along their whole length. Then readjust so that blades just clear the knife. Reassemble the parts in reverse order to that of their removal and lubricate.

### Gilding book edges

*I have several old volumes, bound in leather, which have the top and one edge of the pages gilded. I want to regild these if possible. How is this done?—Manley Post, Pittsburgh.*

By a professional bookbinder, if your books are heirlooms or otherwise valuable. But if the volumes are not so choice, you might try this method: Protect the edges of the book and binding with masking tape, clamp the book between two pieces of plywood and spray the exposed edges with gold paint, the type sold in aerosol cans.

### Determining soil needs

*My garden soil needs fertilizing, but how do I tell what and how much to apply?—Bill Leach, Alliance, Neb.*

By testing the soil. Kits for this purpose are available at most garden-supply stores and include full instructions. You can do the testing yourself or, in some cases, have it done at the store if you bring in some samples of your soil. Your state university extension service will also undertake this chore for you, either free or for a nominal charge. ★★

*Do you have a home maintenance or repair problem? Send it to Homeowners' Clinic, Popular Mechanics, 224 West 57th St., New York, N.Y. 10019. While letters cannot be answered individually, problems of wide interest will be discussed in this column.*

Your menthol cigarette lost its cool?  
Find the taste of extra coolness.  
Come up to KOOL,  
with pure menthol.



Kool Milds 14 mg. "tar," 1.0 mg. nicotine av. per cigarette, by FTC method. Kool Kings 17 mg. "tar," 1.4 mg. nicotine; Kool Longs 17 mg. "tar," 1.3 mg. nicotine av. per cigarette, FTC Report Feb. 73.

© BROWN & WILLIAMSON TOBACCO CORP.

Warning: The Surgeon General Has Determined  
That Cigarette Smoking Is Dangerous to Your Health.

14 mg. tar,  
1.0 mg. nicotine  
Now, lowered tar  
KOOL Milds





ONE-COAT

**spread**  
**Gel-Flo**

EXTERIOR ALKYD  
HOUSE PAINT



# Spred® Gel-Flo™

## The thick and easy house paint.

### Glides on in one coat even over black.

Just follow label directions.

There's no oil base house paint on the market anything like Spred Gel-Flo. Glidden made Gel-Flo so that even a "weekend painter" could do a fast professional paint job on his house.

Put it on thick, and Gel-Flo goes on thick with no sagging or running. It fills hairline cracks and gives two-coat protection where you want it — all in **one** easy coat. And that one coat works like two coats over any color —



even over black. Just follow label directions.

Or, put it on thin. You can get a lot of mileage out of Gel-Flo where siding and trim are still in good condition.

But easy, precision

painting isn't all you get from Spred Gel-Flo.

You also get top quality oil paint protection that resists blistering, peeling and any kind of rough weather and burning sun.

You can apply Gel-Flo any way you want! Spray it on, roll it on or brush it on. Any way, Gel-Flo glides on for the easiest paint job ever.

Spred Gel-Flo from Glidden. It's just waiting to turn you and your paint job — professional.

## Five Gel-Flo advantages to turn you into a painter's painter.

1. Gel-Flo "seals" tighter for better protection. Fills hairline cracks and surface imperfections with no running or dripping.
2. Gel-Flo is "settle free" because it's gelled. Stirring is almost unnecessary.
3. Gel-Flo paints on more easily because more of it loads on your brush, stays on the tip and glides on smoothly.
4. Gel-Flo adjusts to thick coats or thin as you paint — no waiting for a second coat.
5. Gel-Flo smooths itself on your house with that bright, clean professional finish that stays that way for 2 years or more.

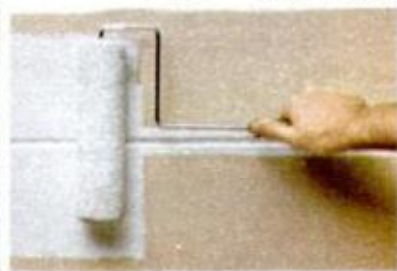

**SCM** GLIDDEN COATINGS & RESINS  
SCM CORPORATION, CLEVELAND, OHIO 44115

**Glidden**

# Jock itch (or chafing, rash, itching, sweating) shouldn't be treated lightly.

If your groin, thighs, or buttocks suffer from redness, rash, chafing, soreness, excessive perspiration, or Jock Itch (Tinea cruris), then you need medicated Cruex®.

Cruex soothes itchy, inflamed skin. Absorbs perspiration. Helps cushion against further irritation. And medicated Cruex helps prevent fungous infections that can develop.

Cruex spray-on powder reaches hard-to-get-at



places so you avoid the sting and burn of rubbing or smearing on ointments, creams or powders.

Get fast relief with soothing, cooling Cruex.

**Cruex. Guaranteed to work or your money back.**

© 1973 Pharmacrast Consumer Products

A PRODUCT OF **POWELL** CORPORATION

## "How I rewired my taillights with a plastic straw and Dow Corning Bathtub Caulk."

We knew our silicone rubber bathtub caulk was good for a lot more things than bathtubs, and when we heard how Larry Oswald of Sewickley, Pa., used it, our opinion was confirmed.

"When my taillights started getting dimmer and dimmer, I took them apart and found that the sockets, wires, everything, were all corroded.

"So I cleaned everything up, bought two new sockets, and decided this time that they weren't going to corrode.

"I had a tube of Dow Corning® Bathtub Caulk lying around the house, so I figured why not, and caulked up the sockets.

"Then I figured that if it'd work on the sockets, it'd work on the splices.

I cut two small pieces off a plastic drinking straw, slid one over each set of wires to keep them from getting stuck together, tied the wires together, and then pumped them full of caulk.

"It's been six months now, and my taillights are still brighter than ever."

Next time you're faced with a plumbing leak, broken gasket, or

almost any fix-it job around the house, get the Dow Corning Silicone Bathtub Caulk out of the bathroom and put it to work.

You'll find it in white and pastel decorator colors in the hardware or paint department of your favorite store. Look for Dow Corning Silicone Sealer in clear, black, or aluminum in tubes and cartridges, too.

Dow Corning Corporation, Dept. D-3102, Midland, Michigan 48640.

**DOW CORNING**



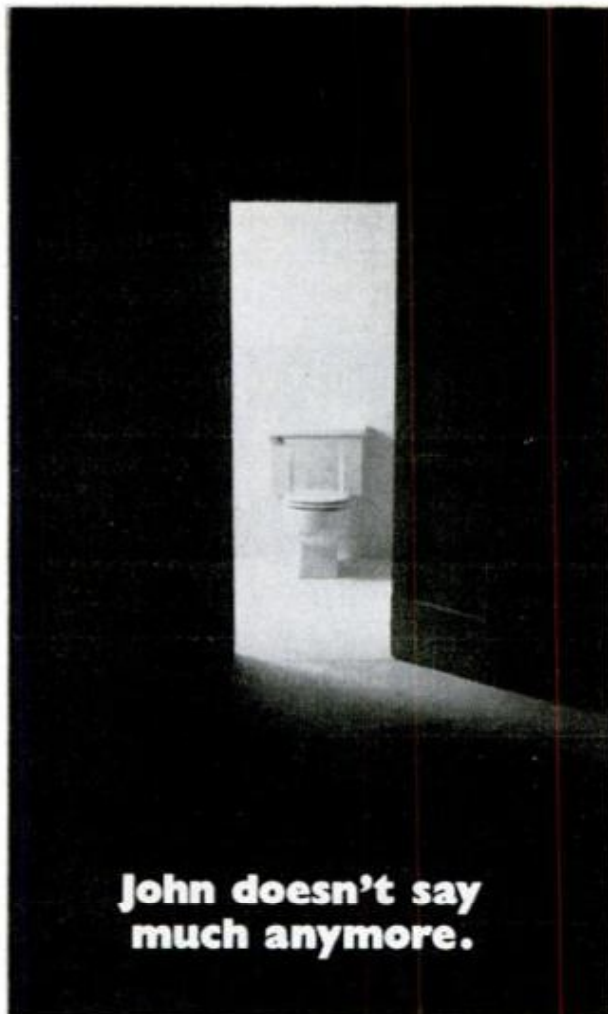

**John doesn't say  
much anymore.**

John used to be pretty obnoxious. He'd leak, squeak and sometimes even whistle.

He never knew when to shut up. Or shut off, for that matter. John had no self-control.

Finally, someone got smart and looked into his toilet tank. The problem was obvious. John's insides consisted of an ancient ball cock, rod arm and float ball. Complete with corrosion and leaks.

Once rid of those, John got what was coming to him: a Fluidmaster. The simple hydraulic device that eliminates old-fashioned rod arm, float ball, and other corrosive parts. To work with water pressure, instead of against it. For fast, positive shut-offs. And no leaks, squeaks, or whistles.

Write today for full details. And change your John into the strong, silent type.

Manufacturer of the Model 100, 200 and 400.



**FLUIDMASTER, INC.**  
1800 Via Burton  
Anaheim, Calif 92805

## AAMCO® And You Can Make It!

The world's largest transmission chain is still growing strong after nine years. Over 500 of our franchises located from coast to coast. New openings in some markets mean you too might qualify. For further information write:

**AAMCO Transmissions, Dept. 84**  
408 E. Fourth St., Bridgeport, Pa. 19405

HEADQUARTERS FOR EVERY TYPE & SIZE AT REAL DOWN-TO-EARTH MONEY SAVING PRICES!

**TIRES!**

ALL FAMOUS BRANDS!

AUTO TRUCK SPORT CAR FARM TRAILER

**TREMENDOUS SAVINGS!**

LET US PROVE IT TO YOU! ... WRITE US TODAY ...

Send for your FREE catalog!

RELIABLE TIRE CO. 1111 Chestnut St. Camden, N. J. 08103

## MOLDS

for making  
Ornamental Concrete  
Items...



Book about Aluminum Molds with prices and production trade secrets direct from world's largest mold manufacturer.

SEND \$3.00

CONCRETE MACHINERY COMPANY, INC.

P. O. BOX A99 - HICKORY, N. C. 28601

## ONE DROP WILL FIX IT

HOLDS UP TO

5,000 LBS.

**NOW... A NEW, Improved Formula** SUPER ALPHA CYANOACRYLATE®  
**SPACE AGE ADHESIVE**

It's used in hundreds of types of Professional and Industrial Applications... replaces nuts, bolts, welds, etc. Ideal for use on almost any material—metal, glass porcelain, plastics, rubber, ceramic, etc. NO Mixing—NO Clamping—NO Waiting, MOST BONDS SET IN A FEW SECONDS—Dries Clear. NOT AN IMPORT; MADE IN U.S.A. and packaged in an ultrasonically sealed tube with screw top. DISPENSES 132 DROPS... up to 150 APPLICATIONS. ONE DROP COVERS a Square Inch of Bonding Surface. Every home, every workshop should have it on hand.

**ONE DROP**

ORDER DIRECT with 30 Day Money-Back Guarantee

- 132 Drop Dispenser (2 grams) \$3.00 postpaid  
 SAVE... Order two for only \$5.00  
— Send check or money order — No C. O. D.'s.

**Oneida**

**ONEIDA ELECTRONIC MFG. INC. Meadville, Pa. 16335**

## SCIENCE WORLDWIDE

### This is a big year for tornadoes

Tornadoes have struck the United States in record numbers this year, according to the National Weather Service. Some 700 tornadoes occurred from Jan. 1 to May 29, compared with the previous high of 504 for the first five months of 1957. The Weather Service ascribes the increased activity to a stronger than normal jet stream flowing into the United States from the southwest. Fatalities reached 59 by May 29, more than double the total for all of 1972.



### The Inflatobird flies again

Intended as a rescue vehicle for stranded airmen, the Inflatobird failed to interest the military when it was introduced in '55. Now the maker, Goodyear Aerospace Corp., has hopes it might catch on as drone, remotely piloted vehicle or as a minimum aircraft for reconnaissance. The plane stores in a pod that can be dropped by parachute. It can be inflated by compressor or with bottled gas, has a 60-hp engine and a wooden prop. The only controls are a stick and rudder. Inflated, the plane is 19 feet long, has a 28-foot wingspan and carries enough fuel for five hours of flight. Engine compression keeps the plane inflated—even if it has taken a few bullet punctures.

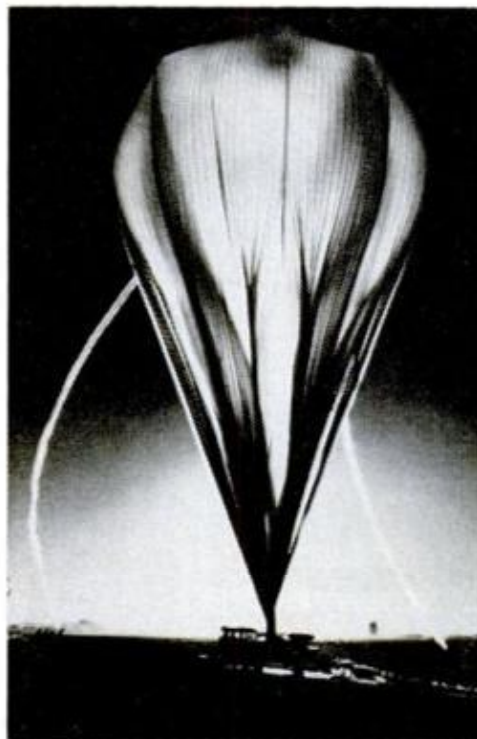

### Balloon-borne astronomy lab

The old-fashioned balloon, created to immense proportions, is an important tool of astronomers. Earlier this year, a team of Australian and MIT scientists sent a huge helium-filled balloon aloft in the interior of Australia. It carried 1800 pounds of instruments to measure X-ray radiation from space. The vehicle reached altitudes well above 100,000 feet, remained airborne for 26 hours and produced scientific results that were "extremely rewarding." The payload was recovered about 500 miles from the launch site. An American design, the giant free-flying balloon was constructed of polyethylene film.

### Cleaning can lead to coughs

The vacuum cleaner can be a serious source of pollution in the home, according to Kansas State University researchers. When the vacuum's exhaust hits an unclean part of a rug it can double the amount of airborne

*(Please turn to page 50)*

# LIVE IN THE WORLD OF TOMORROW...TODAY!

## A BETTER LIFE STARTS HERE

(And our FREE CATALOG is packed with exciting and unusual ecological & physical science items—plus 4,000 finds for fun, study or profit . . . for every member of the family.)



### KNOW YOUR ALPHA FROM THETA!

For greater relaxation, concentration, listen to your Alpha-Theta brainwaves. Ultra-sensitive electrode headband slips on/off in seconds—eliminates need for messy creams, etc. Atch'd to amplifier, filters brainwaves, signals beep for ea. Alpha or Theta wave passed. Monitoring button simulates Alpha sound; audio & visual (L.E.D.) feedback. Reliable, easy-to-use unit—comparable to costlier models. Completely safe. Comprehensive instruction booklet. No. 1635H..(8x3x4"; 24 oz.)...\$124.50 Ppd.

### "FISH" WITH A GIANT MAGNET

#### Go Treasure Hunting On The Bottom!

Fascinating fun, and sometimes very profitable! Tie a line to our 5-pound Magnet—drop it overboard in bay, river, lake or ocean. Troll it along the bottom. Your "treasured" haul can be outboard motors, anchors, other metal valuables. Five-pound Magnet is war surplus—Alnico V Type that cost the Government \$50. It lifts over 150 pounds on land—much greater weights under water!

Stock No. 70,571H .....\$14.00 Ppd.  
Stock No. 70,570H.. 3½ lbs... \$8.75 Ppd.  
Stock No. 60,215H.. 1½ lbs... \$5.75 Ppd.



### 130 EXPERIMENTS IN OPTICS ...



and photography! Optix® Experiments Kit is a complete optical & photography lab for 130 exciting experiments. Lets you recreate the periscope, telescope, microscope, kaleidoscope! . . . Build a 35mm reflex camera with interchangeable lens system! Make, develop photographic film! Enjoy the fun and fascination of having your own optics lab. Fully illustrated 112-pg. manual, 8½"x11", clearly explains usage of this stimulating kit's 114 precision engineered components.  
Stock No. 71,646H ..... \$21.00 Ppd.

### NEW! FIND TREASURE ANYWHERE

Best beep-frequency oscillator-type metal detector around... designed for us by leading aerospace engineers to include top features of other models. Big, sensitive 4" meter & amplifying circuit, 4x9" waterproof search head, integ. circuits, trans., built-in speaker or headphone (not incl.), vernier dial & vol. control, 30" telescoping alum. shaft, Req. 2-9v batt. (not incl.)

No. 80,190H..(4 LBS.) \$171.00 Ppd.  
No. 80,191H (STD. MODEL) \$91.50 Ppd.



### GIANT WEATHER BALLOONS—8' OR 16' DIAMETER

"Balls of fun" for kids, traffic stoppers for stores, terrific for amateur meteorologists. Create a neighborhood sensation. Great backyard fun. An exciting beach attraction. Amateur meteorologists can use these balloons to measure cloud heights, wind speed and temperature. Made of heavy-duty neoprene. Inflate with vacuum cleaner or auto air hose; or locally available helium for high rise.

(8' Diameter)  
Stock No. 60,568H ..\$2.50 Ppd.  
(16' DIAMETER)  
Stock No. 60,632H ..\$8.75 Ppd.



### TERRIFIC BUY!

### AMERICAN MADE! OPAQUE PROJECTOR



Projects illustrations up to 3" x 3½" enlarges them to 35" x 30" if screen is 6½ feet from projector. You get even larger pictures if screen is farther away. No film or negatives needed. Primarily intended for children, this unit projects charts, diagrams in color or black & white. 115v AC. 6 foot cord and plug are included. Size is 12" x 8" x 3½" wide. Weighs just 1 lb. 2 ozs. Comes with a sturdy plastic case.

Stock No. 70,199H ... \$8.75 Ppd.

### MAIL COUPON FOR GIANT FREE CATALOG!

164 PAGES • MORE THAN 4500 UNUSUAL BARGAINS!

Completely new Catalog Packed with huge selection of telescopes, microscopes, binoculars, magnets, magnifiers, prisms, photo components, ecology and Unique Lighting items, parts, kits, accessories -- many hard to get surplus bargains. 100's of charts, illustrations. For hobbyists, experimenters, schools, industry.

**EDMUND SCIENTIFIC CO.**  
300 Edscorp Building, Barrington, N. J. 08007  
Please rush Free Giant Catalog "H"

Name \_\_\_\_\_  
Address \_\_\_\_\_  
City \_\_\_\_\_ State \_\_\_\_\_ Zip \_\_\_\_\_



### ORDER TODAY! COMPLETE AND MAIL

**EDMUND SCIENTIFIC CO.**

300 Edscorp Building, Barrington, N.J. 08007

How Many	Stock No.	Description	Price Each	Total

PLEASE SEND  GIANT FREE CATALOG "H" **MERCHANDISE TOTAL \$**  
**HANDLING CHARGE \$1.00\***

I enclose  check **TOTAL \$**  
 money order for \$ \_\_\_\_\_

NAME \_\_\_\_\_

ADDRESS \_\_\_\_\_

CITY \_\_\_\_\_ STATE \_\_\_\_\_ ZIP \_\_\_\_\_

\*50¢ ON ORDERS OVER \$5.00



# RIDGID

## Bench Yoke Vises

Full width, alloy-steel jaws with specially cut hardened teeth positively anchor pipe for threading, reaming, and cutting. Malleable iron base and yoke can't break or warp. Integral bender and rear pipe rest. When work is done, vise releases instantly. Eight models, 1/8" — 6" capacity.

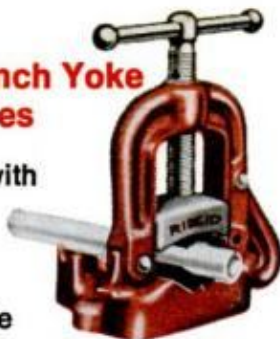

## RIDGID Drop Head Ratchet Threaders

Three exposed ratchet models, 1/8" — 2". Two enclosed ratchet models, 1/8" — 1 1/4". Interchangeable die heads lock in, yet are easily removed. Dies can be reversed for close-to-wall

threading. Factory testing and ratchet action assure perfect threads on pipe and conduit with minimum effort.

## RIDGID Pipe Cutters

Patented shock absorbing nylon bearing on the feed screw means easy, smooth tracking. Straight burrless cut every time. Perfectly balanced. Big comfort-grip handle. Extra-long shank to protect feed screw threads. Converts to 3-wheel cutter for close quarters by replacing rollers with cutter wheels. 1/8" — 2" capacity.



## RIDGID Thread Cutting Oils

Two types available: Nu-Clear and Dark. Exactly formulated blends specifically designed for more efficient threading, longer die life. Germicidal too.



Free Catalog: Covers the complete line of famous RIDGID Pre-tested Work Saver Tools. Write Dept. PM-383, The Ridge Tool Company, Elyria, Ohio 44035, U.S.A.

# RIDGID®

Ridge Tool Subsidiary  
Emerson Electric Co.  
EMERSON

## SCIENCE WORLDWIDE

(Continued from page 48)

dust for a two-hour period. By shielding the exhaust, the researchers reduced contamination by nearly two-thirds. The KSU scientists advise persons with a respiratory problem to clean less frequently.

## Old campfire provides clue

The oldest accurately dated evidence of man in the state of Virginia has been set at 10,000 years ago, according to a U.S. Geological Survey radiocarbon-dating expert and scientists from Catholic University and the University of Maryland. They determined the date from bits of charcoal from campfires used by early Indians at a site near Front Royal, Va. Carbon-14, absorbed by animals and plants, decreases at a known rate after the organism's death.

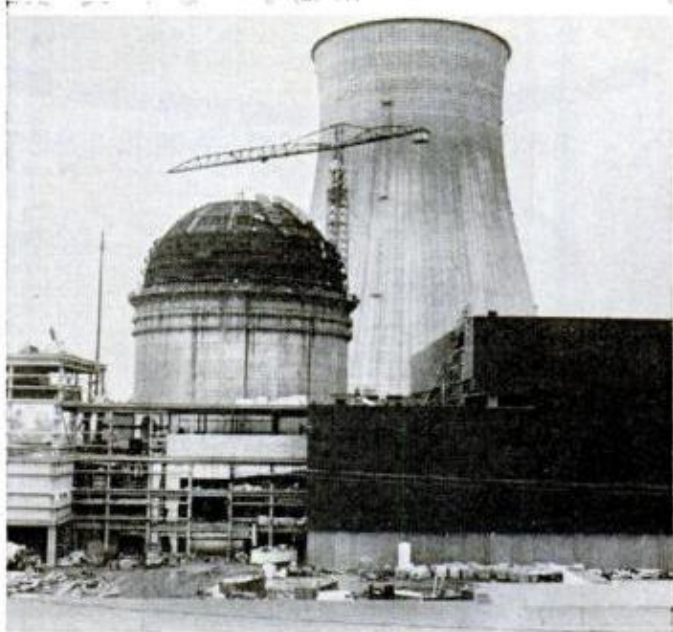

## Nuclear powerplant for Northwest

Once thought to have an abundance of hydroelectric power, the Northwest now needs other sources of electric energy. One source will be a 1.13-million-kilowatt nuclear plant now under construction about 42 miles from Portland, Ore. To avoid thermal pollution in the nearby Columbia River, water from the plant's condenser will be air-cooled in a 500-foot tower. The \$298-million installation is scheduled for completion in 1975. ★★★

**Front end shimmy  
can start right here.**



**Right here is where  
Shimmy Stop stops it.**

**Introducing Shimmy Stop...a totally unique do-it-yourself way to  
restore worn ball joints without spending a lot of money!**

Worn ball joints can cost you a bundle . . . because they affect the way tires wear, the way your car tracks, the way your car handles, and the way the front end keeps its alignment. That adds up to loss of front end precision. But until now, the only way to solve the problem was to replace the ball joints. That can cost up to one hundred dollars.

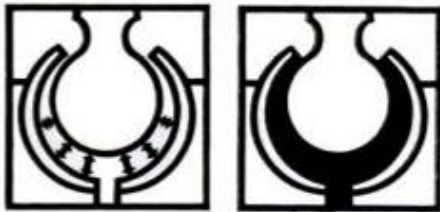

Shimmy Stop restores front end precision . . . SHIMMY STOP actually restores worn ball joints that are still within recommended tolerances. Once SHIMMY STOP compound is mixed (in its own cartridge) and injected directly into the ball joint, it cures to a rugged self-lubricating solid that fills the worn area between ball and socket. It actually reduces the tolerance to zero!

Once Shimmy Stop cures to a self lubricating solid . . . it lasts for thousands and thousands of miles. The 3M Company



Look for this display in your favorite auto supply store . . . it gives you the complete SHIMMY STOP story. And ask for your FREE ball joint wear gauge. The gauge makes it easy to determine your need for SHIMMY STOP. What could be fairer?

developed, tested and proved SHIMMY STOP in all kinds of cars under all kinds of conditions. (in fact 3M spent 7 years developing SHIMMY STOP and tested it for more than a million miles.)

Because Shimmy Stop is simple to use . . . you can beat the high cost of replacement parts. Installation is easy. In fact, once you've read the illustrated instructions, the job should take you just about 30 minutes.

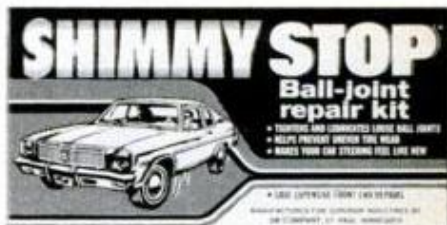

**SHIMMY  
STOP™**



**SUPERIOR INDUSTRIES  
INTERNATIONAL, INC.**

DEPT. PB • 14721 KESWICK STREET • VAN NUYS  
CALIFORNIA 91405 • PHONE (213) 873-5181

## IMPORTS AND MOTORSPORTS



### New British beat

The Austin-Morris group of British Leyland Motors is planning to rock the market in Europe with its new Allegro. The all-new car isn't destined for the U.S. market, at least not in the foreseeable future. The Allegro is in the tradition of the legendary Mini with front, transverse engine and front-wheel drive. Among new features are



wax-injected body sections and hydragas suspension—cylinders of compressed nitrogen at each wheel.

### Never misses a beat

There's no beat to miss in a rotary-engined dragster. Among the growing number of Wankel-powered competition cars on the circuits is "Project Rotary," a rail being run by the Dana Corp. Rotary powerplants are capable of spinning out a lot of power for their weight, providing that engine seals and gaskets are doing their job. That's Dana's interest: The company's Perfect Circle Div. and Victor Div. are using Project Rotary as a test bed for engine seals and parts that will be used in production passenger cars. Win or lose, developing race-proven parts is the name of the game.

### Up against the wall

Our 142 gains speed and "climbs" the test track at Volvo's all-new proving grounds at Hallerad, Sweden. We drove all of Volvo's cars around the impressive facility when it was officially opened early this summer. All the company's vehicles are tested there and we drove the trucks, too. Volvo Penta is well known here, but less known are the big-rig buses and trucks; forestry and construction equipment; aircraft engines; and specialty vehicles, all of which were at the proving grounds for the inauguration day.



### Unbeatable book

Herald Books has done it again: *World Cars 1973* is the definitive volume on cars in production in the world today. In addition to being a catalog of production cars country by country (some 800 cars in 27 countries), the book includes 80 introductory pages with essays on current trends, motor racing and special car bodies. The indices include a history of carmakers and coachbuilders, names and prices of all models, even top

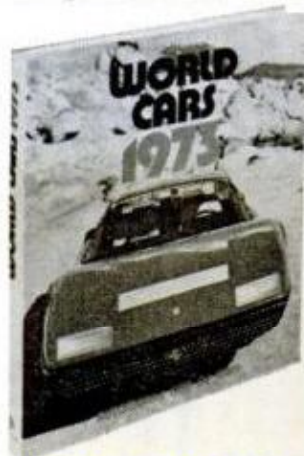

(Please turn to page 54)



# Why play the oil filter numbers game... when the name of the game is filtering efficiency

When it comes to oil filters, AC is not in the numbers game...we're in the business of filtering oil.

At AC, we work on the premise that the worth of an oil filter is judged on its filtering efficiency...not the number of filters involved. We pride ourselves on our filtering efficiency...and we do it with a single filter! We find it's not the number of filters that counts...it's how well the filter does the job.

We run tests to make sure that AC Oil Filters provide effective filtration. We use engine wear test data to determine how well our filters are doing. After all, our job is to keep harmful contaminants away from vital engine parts...that's what counts in the filter business.

We can build a filter so fine that nothing could get through...not even the oil...and we can build a dozen screens that will let sand, shavings and marbles through. The secret of filtration is getting a filter that will trap harmful contaminants yet pass clean oil to the engine right up to the time of a filter change. That's the ideal filter balance.

In line with our goal of providing the best in filtration, we may never reach perfection...but you can bet we'll never play the numbers game. We contend one filter gets the job done, especially if it's built the way AC builds filters.

If we wanted to play the numbers game, we are capable of building a three-stage filter, but numbers alone wouldn't make it more efficient. AC is in the business of providing you with efficient oil filtration for your car...nothing more, nothing less. Ask for an AC Oil Filter at your next oil change.



AC SPARK PLUG DIVISION

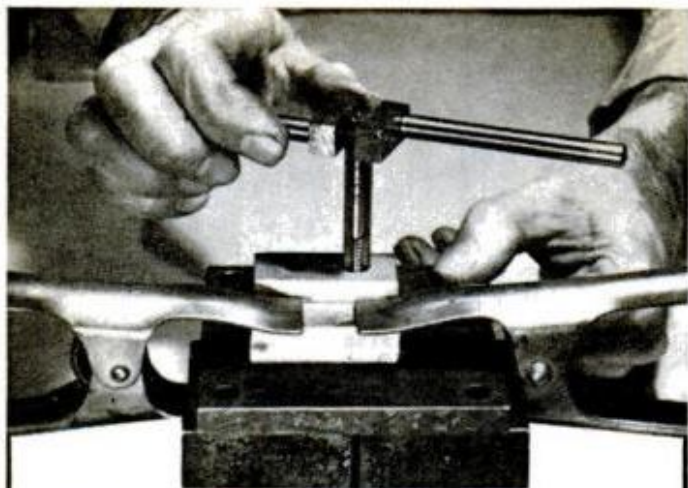

## For the man who likes to do-it-himself.

With money-saving, "do-it-yourself" tips—more than in any other magazine—on how to maintain and repair your home, your car, your boat, your power mower, your TV and nearly everything that breaks down, wears out and needs fixing.

Plus feature articles on Automobiles and Driving, Shop and Crafts, Science and Inventions, Boating and Outdoor Recreation, Home and Yard, Electronics, Radio and TV, Photography... and much, much more!  
**ENTER YOUR SUBSCRIPTION NOW.**

# POPULAR MECHANICS

Simply fill in the form and mail it promptly.

**POPULAR MECHANICS**  
250 West 55th Street  
New York, New York 10019

Please enter my subscription for

1yr. \$5<sup>97</sup> or  2yrs. \$10<sup>97</sup>

Name (please print)

Address

City State Zip

Payment of \$\_\_\_\_\_ is enclosed.

New  Renewal

On new subscriptions, first copy will arrive in about 8 weeks.

(Above prices apply in U.S. & Possessions only. Canada add \$2 per year. All other countries add \$4 per year.)

WSF3H1

## IMPORTS AND MOTORSPORTS

(Continued from page 52)

speed of all cars listed. \$19.50 at bookstores. Herald Books, Box 17, Pelham, N.Y. 10803.

### Movin' machines

Race-car repairs are simple—with the right tools like a milling machine, lathe, drill press, metal-cutting bandsaw, grinder, finisher, welding equipment, portable tools and nondestructive test gear. It's all in Rockwell's big bus at the races on USAC's Championship Trail. If you wonder how teams put race cars back together over-



night, fabricating hardware, polishing cranks and routinely working miracles with metal, the answer is partly in this mobile shop used free by competitors. After the season Rockwell makes the shop available to vocational schools for instruction in metalworking and automotive technology.

### Sparking safety

Safety fuel cells are now more available to enthusiasts. If you're running a high-performance street, sports or drag car, off-road vehicle or high-speed pursuit car, chances are you can get a unit from Aero Tec Laboratories. Their cell replaces the conventional gas tank to minimize fuel-tank cracking or rupture and eliminate fuel spillage in an accident or rollover. The container has aluminum valves and fittings and a flexible bladder filled with safety foam. It is approved by FIA, SCCA, NASCAR, USAC and IMSA, used by racing teams and in government limos. For more information write ATL at 1100 Blanch Ave. Norwood, N.J. 07648. ★★★



from the leading **HOW-TO** publisher . . .

a new edition of



**Popular  
Mechanics**

**25¢**

**Plans  
Publications  
Projects**

Listed inside are the famous *PM* publications: the *Master Shop Guide*, containing all the basic shop information you've ever wanted to know; the *Gardening Guide*, jammed with how-to for green-thumbers; a series of great auto tune-up booklets; plans for everything from a beautiful tool-storage structure to a 20-foot travel trailer! Also, we offer a special service—photocopies of a thousand and more great *PM* articles of the past.

FOR ORDERING INSTRUCTIONS  
see pages 31 and 32.

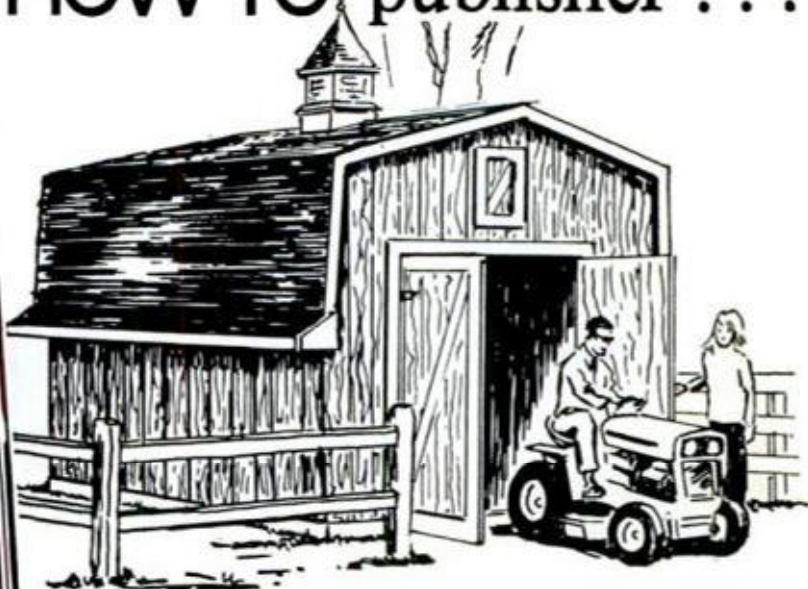

Want to impress your relatives, astound your friends—and have a ball doing it? Send for this great *new* edition of the famous *Popular Mechanics Catalog*. You may find yourself building your own airplane, or a beautiful little “Mini-Barn” for storage in your back yard, or any of a thousand other fascinating projects. No matter what your interests, you'll find plans listed in this fully illustrated catalog that will set your mind spinning, from garages to ground-effect machines, from elaborate models to complete houseboats, from house plans to fine little one-evening projects. The *Catalog* also lists the greatest how-to books and shop guides ever published. *Order your copy of this brand new edition today!* Send only 25¢ to cover postage and handling.

**Popular Mechanics, Box 1014, Dept. CO-8,  
Radio City, N.Y. 10019.**

I am enclosing 25¢ in coin (no stamps please) for  
my copy of the *Popular Mechanics Catalog*.

Name \_\_\_\_\_

Address \_\_\_\_\_

City \_\_\_\_\_ State \_\_\_\_\_ Zip \_\_\_\_\_

## THE BICYCLE SHOP

BY EUGENE A. SLOANE

### Ten-speed side-play

*The sprocket on my 10-speed moves back and forth, and I'm wondering if that's normal.—Rob Archer, Enaville, Idaho.*

Yes, its normal for a 10-speed rear gear cluster (sprocket) to have a lot of side-play. All of them do.

### No gears 6 through 9?

*I recently bought a 10-speed, and the dealer told me not to use the No. 6, 7, 8 or 9 gears because the derailleur was not made to stretch this far. Is this correct?—Jim Ramsdell, Canastota, N.Y.*

You should be able to use every gear on a 10-speed. The dealer told you wrong. If you have trouble, then the derailleurs are not adjusted correctly. Of course, if you have changed to a wider gear freewheel, you would have to change to a derailleur with capacity to handle the wider gear range. Generally, you should not have to use the smallest rear gear with the smallest front gear or the largest rear gear with the largest (diameter) front gear, but you should be able to use them if you wish to.

### Double a five-speed

*Can I change the front chainwheel on a five-speed to make it into a 10-speed?—John Austin, Greenwich, Conn.*

Yes, you can remove your single-speed chainwheel and put on a double chainwheel. You will need a longer axle to accommodate the extra chainwheel, and of course you will need a front gearshifter (derailleur) and a gearshift lever. I estimate cost for parts to be about \$15 and labor about \$10 or \$12.

### Cable snapper

*I've had a 10-speed bicycle for two years*



**Surfboards, camping gear, skis, groceries**—in fact, almost anything you want to tote somewhere can be carried behind your bicycle on the Bike Packer, a new single-wheel trailer. The low-slung Packer is made of tubular steel and has a baked-enamel finish. It weighs under 12 pounds and disassembles for storage or shipment. Price of the unit, including duffel bag and bike hitch, is \$34.95 postpaid (without the duffel bag, \$29). Coalson Tackle Co., 1241 East Chestnut, Building K, Santa Ana, Calif. 92701.

*and have been doing my own repairs. Now I have a problem. In one month I have snapped four rear derailleur cables. Can you help me?—Matthew Manes, Fayetteville, N.Y.*

Four broken cables in 30 days is indeed unusual. I assume you mean the cable came apart as if cut by a knife. I've seen the leaded ends of cables come off, though this is rare. It would appear that somewhere

*(Please turn to page 58)*

For easier starting, lower emissions, smoother idling, no stalling, faster take-offs and better mileage.



# THE CARBURETOR CLEANER.



**Inside.** Just pour a pint of GUMOUT into your gas tank. It cleans out all the jets and passages, removes the gum and varnish while you drive.



**And out.** It takes less than a minute to clean the outside of your carburetor with Jet Spray GUMOUT. Throat, automatic choke, linkage, throttle plate—all clean like new.

**GUMOUT** Division, Pennsylvania Refining Company, Cleveland, Ohio 44104

## THE BICYCLE SHOP

(Continued from page 56)

along the cable travel there is a sharp edge or burr against which the cable rubs. Check cable tube ends, cable tunnels and where the cable enters the derailleur for sharp edges.

### Tires for a Belgian bike

*I bought a bicycle in Belgium, and when I got back to the States I couldn't find new tires to fit it. Where can I buy 28 x 1<sup>5</sup>/<sub>8</sub>-in. tires?—Bob Brickweg, Melrose, Minn.*

Those tires are, of course, nonstandard. However, Raleigh does supply a bicycle with that size tires; your Raleigh dealer should be able to get them from his supplier.

### Don't tamper with a Manta-Ray

*I would like to convert my five-speed Schwinn Manta-Ray into a 10-speed by adding a dual chainwheel. But I'm afraid the 24-inch wheels and short wheelbase would make it hard to shift in certain gears or cause undue wear. Is this change advisable?—Jeff Miller, Clarks Summit, Pa.*

Generally, I do not recommend going to the time, work and expense of this type of conversion on what is essentially a heavy, cumbersome toy. The Manta-Ray, which is no longer made, weighs upward of 40 pounds. I suggest you sell it and buy a better, more efficient 10-speed that fits you—such as the new Schwinn Varsity Sport with 24-inch wheels, 10 speeds and turned-down bars.

### New paint for a 10-speed

*I wish to spray paint my 10-speed. Should the frame be sanded first? Do I need an undercoat or base? What's the best paint to use?—Jim Schools, Riverside, Calif.*

You'll have to strip all the parts off the bicycle or mask them with masking tape. After removing all oil, grease and road dirt, sand the frame lightly; this will give the new paint "bite" for good adherence. You won't need an undercoat because the frame already has one. Spray two or three coats on, sanding lightly between coats with very fine sandpaper and allowing 24 hours for

each coat to dry. Both Raleigh and Schwinn have small cans of spray paint for bicycles in a wide variety of colors.

### Three-speed instructions

*Recently I bought a bicycle with a Sturmey-Archer three-speed coaster brake. Instructions received with the bike were minimal. I can handle everything but the coaster brake. Do you have an address for Sturmey-Archer?—Irvin Reigner, Port Republic, N.J.*

You can reach Sturmey-Archer through Raleigh Industries, 1168 Commonwealth Ave., Boston, Mass. 02134.

### Can't shift into first

*I have a five-speed bike that won't shift into first gear. The shift lever goes all the way down, but the chain goes only to the second-speed gear and then starts rattling. I tried adjusting the derailleur setscrew, but that doesn't help. What would?—Bill Jones, Stamford, Conn.*

I assume you mean the chain won't shift from the next to the smallest diameter gear to the smallest diameter gear. Most likely you have the cable drawn up too tightly into the derailleur. Push the gear lever all the way forward. Loosen the cable locknut on the derailleur and let the cable go through (or pull it through) until you have just a slight bit of slack in the cable where it parallels the down tube. Then gently pull out this slack by tugging on the loose end of the cable at the derailleur and tighten the cable locknut at the derailleur. It's also possible you have so much grit and gunk in your derailleur that it's stuck in place; try cleaning it in kerosene. It's also possible you're adjusting the wrong derailleur stop bolt (for the big gear instead of the little gear).

### Ambitious 12-year-old

*I like bikes and would like to open my own repair shop. But I'm only 12. What should I do?—Ed Hill, Alliance, Ohio.*

Get a job with a local shop. If necessary, work free just to gain experience. When your employer finds how valuable you are, I'm sure he'll pay what you're worth. ★★ ★



# Five-tweeter speaker gives wide-angle sound

by Ivan Berger  
ELECTRONICS EDITOR

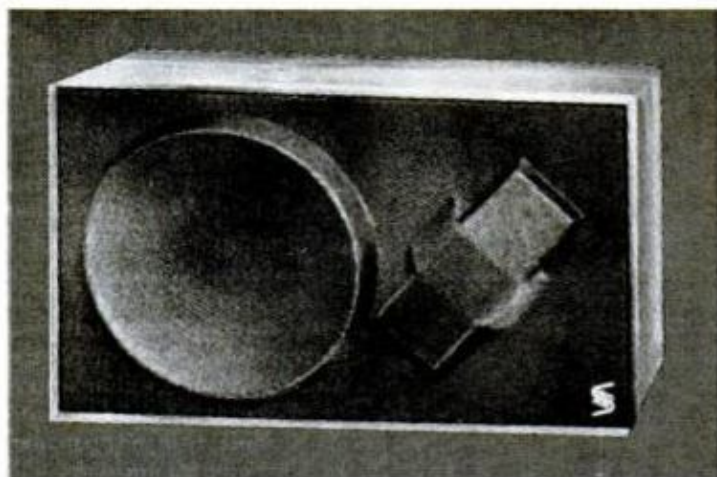

**Cross-shaped tweeter assembly, shown with grille removed (top), spreads highs evenly through room. Optional grille (above) lets speaker positions show through; standard grille (right) doesn't.**

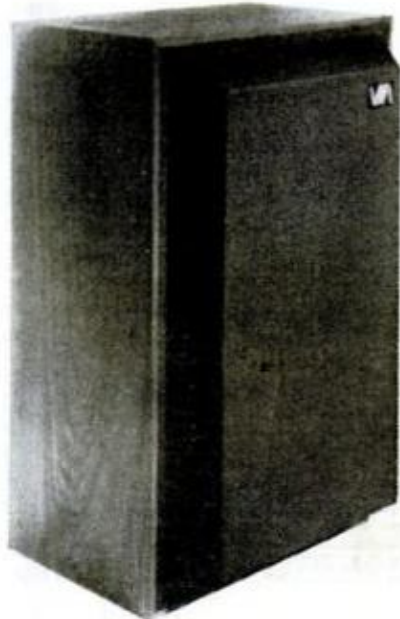

**H**igh frequencies sometimes sound fine directly in front of a speaker, but fade away as the listener moves to one side. Micro/Acoustic's solution to the problem is a bookshelf speaker system with five tweeters, angled so that one will face you no matter where you sit.

The tweeters are in a cross-shaped array, one facing dead ahead and the other four angled outward. The array is then set at an angle, so dispersion will be the same whether the cabinet rests on one side or on its end. There are tweeter-level controls for the front-facing tweeter and for the four angled ones.

The system gives a more open, spacious sound, both because there is no treble falloff at the sides of the sound fields, and because the listener is surrounded by additional highs—reflections of those coming from the other tweeters. Since these reflections come from all angles, the effect is a bit like that of omnidirectional speakers.

Overall, the sound is clean, well-balanced, with a crisp and solid bass. The speakers are \$149.50 each, with a choice of grille styles. For more information, write Micro/Acoustics, 8 Westchester Plaza, Elmsford, N.Y. 10523. ★★★



## OF POPULAR MECHANICS



### Those dangerous grade crossings

Each year 1500 are killed, 7000 injured at 223,000 grade crossings in this country. Electronic warning devices are our best hope for a solution.

### Compost machines

Shredder, grinder, chipper—what's the difference? Which best suits your needs for recycling garden trash and making rich compost? PM describes what each machine does and presents the latest models and prices.



### Desks to suit any need

This desk is a wonderful home office; closed, it's a handsome wood-grained credenza. One of three you-build-it desks designed by PM editors.



### Cutting board

A good cutting board is a valuable tool for any shop or darkroom. This multipurpose board is a dandy to work with, even if you're a left-hander. It can be scaled to meet your needs and built for less than \$10.

### Bike carrier

This cartop carrier mounts five bikes without disassembly. You can build it in a weekend for \$30 from our plans.

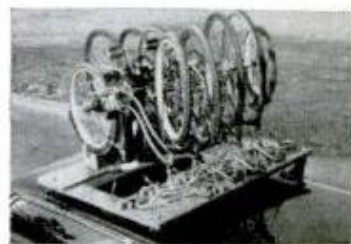

## PLUS

How to fell a tree • How outdoor gear can serve in power failures • Why clean-air '74 cars will cost \$300 more • How to troubleshoot a water heater • How to install stereo speakers in your car • Fiat's new XI/9. • Fitting out for bass • How to add a fairing to your motorcycle • How to build a practice tennis court.

**Buy it on your newsstand. Better yet, make sure you'll keep getting this kind of exciting fare. Send this coupon with your check to:**

**POPULAR MECHANICS**  
250 West 55th Street  
New York, New York 10019

Please enter my subscription for  1 yr. \$5.97 or  2 yrs. \$10.97

Name \_\_\_\_\_ (Please print)

Address \_\_\_\_\_

City \_\_\_\_\_ State \_\_\_\_\_ Zip \_\_\_\_\_

Payment of \$\_\_\_\_\_ is enclosed.  New  Renewal

On new subscriptions, first copy will arrive in about 8 weeks.

(Above prices apply in U.S. and Possessions only. Canada, add \$2 per year. All other countries, add \$4 per year.)

WPM3H1

## ALL OUTDOORS

### Chris-Craft ends an era

When Chris-Craft announced recently it had just built its last wooden boat and has now converted the famous line entirely to modern metals and plastics, it seemed to mark the end of a boatbuilding era stretching back to the Ark. Boats from many builders will still be formed from wood, of course, and pleasure-craft owners still find it an easy material to work with and maintain.

But today's boat owner also needs to work with aluminum, steel and bronze, fiberglass-reinforced plastics and various new resins, sealants and lubricants, paints and cleaners. Many have exceptional strength and life but are tricky to use. The best book we have seen that updates all these topics for the do-it-yourself skipper has just been published. Called *Modern Marine Maintenance*, it is by John L. Duffett, a prominent yachtsman, marine surveyor and practicing expert in this field. For \$6.95 from book and marine stores or *Motor Boating & Sailing*, 224 West 57th St., New York, N.Y. 10019, it ought to be able to save a boating reader its purchase price quickly.

### Sail—and save gas

Sailboating is a particularly easy answer to the gasoline shortage, and a bargain source of information is available from the American Sailing Council of the National Assn. of Engine & Boat Manufacturers, 537 Steamboat Rd., Greenwich, Conn. 06830. Its 162-page illustrated directory lists 1000 day-sailers, one-design racers, multihulls, offshore racers, cruisers and motorsailers with addresses of manufacturers and class associations; 50 cents while the supply lasts.

### Inspect your rigs before you move on

Camped at a "Hazardous Mobile Home Park or Recreational Site" recently? The northeastern states have a number of them, according to a list from the U.S. Department of Agriculture. Gypsy moth caterpillars and eggs, it seems, are hitching rides to uninfected parts of the country aboard mobile homes and recreational vehicles. The USDA's Animal and Plant Health Inspec-

(Please turn to page 62B)



MIAMI-METRO PHOTO

**Twin hulls and a pickle-fork nose**, plus a horizontal tail stabilizer, may make a new look for unlimiteds. Pay 'N Pak, David Heerensperger's Seattle hydro, was

driven by Mickey Remund to set new qualifying (119 mph), lap, heat and race records while winning the Miami Champion Spark Plug Regatta.



CARPET DETERGER



UPHOLSTERY DETERGER



WALL DETERGER

# PART TIME or FULL TIME

*have your own  
money-making  
business*

**You offer a service everybody needs . . . work part time or full time . . . own your equipment . . . keep all you earn . . . start with just a small investment . . . and we help you every step of the way!**

Have your own money-making business and make the kind of income you probably thought impossible. You can when you clean carpeting or upholstery or walls with Von Schrader professional cleaning equipment. Every home, every building, are potential customers. And every customer represents repeat business.

Moreover, we help you every step of the way . . . just as we have helped thousands of other Von Schrader Associates build money-making businesses for almost 40 years. Here are some comments. Carpet: "You people sure helped me and I'll never forget it. I'm averaging about \$18,000 a year."—*H. Kendall*. "During first 2 months made \$2500 net."—*R. Pilong*. Upholstery: "One day I did a \$135 job. Best week was \$500."—*C. Lambert*. "We passed over the

\$450 mark in five days."—*T. E. Baylor*. Wall: "I work just 2 or 3 days a week. Best month was \$1200."—*J. R. Johnson*.

There are three easy-to-operate Von Schrader Detergers. You need no special skills. Each offers a proven way to a growing income. (1) Von Schrader Carpet Deterger gives deep-level cleaning to carpeting. (2) Von Schrader Upholstery Deterger cleans fabrics and synthetics beautifully. (3) Von Schrader Wall Deterger cleans walls (and ceilings) five times faster than by hand.

You can start with just one Deterger. Then, as your business keeps growing, you may want to add the other two and thus offer a complete cleaning service.

There are no fees, royalties, or contracts. There's no franchise involved to shackle you with giving up part of your income. Instead, you own your equipment, keep all you earn. Cost of the equipment is so small you may find it hard to believe. What's more, we help you get started and continue to help afterwards. For complete information—without any obligation—send for the interesting free booklet.

**"Let me send you our free booklet that gives all the facts"**

—Francis von Schrader, President



Read about the big demand for on-location cleaning, see why Von Schrader Detergers are the finest of their kind, how easy they are to operate. Learn how other men have become financially independent, how Von Schrader helps you every step of the way. Fill in the coupon and send for free booklet. **Extra! Special Recorded Message included with booklet.** Listen as Francis von Schrader talks to you personally about your growing future with Von Schrader Detergers.



Three proven ways to your own profitable business with Von Schrader Detergers.

39 years of helping people earn good money

**VON SCHRADER company**

1084 Place, Racine, Wisconsin 53403

Please send complete information on Von Schrader Detergers.

Name \_\_\_\_\_

Address \_\_\_\_\_

City \_\_\_\_\_

State \_\_\_\_\_ Zip \_\_\_\_\_



For rough going when it's wet as well, L.L. Bean, Inc., Freeport, Me., has added Vigram lug soles to its famous Maine Hunting Shoes. They are \$28.50 postpaid.



This revolver rotates barrels to fire two .45-cal. shots in two seconds. For black powder shooters, new Hopkins & Allen/High Standard Muzzle Loader is \$140.



Wigly Crawler from Lazy Ike can make like a snake with spoon molded in head. Action and depth control according to rate of retrieve are claimed for new lure.

## ALL OUTDOORS

(Continued from page 62)

tion Service wants units moving from sites on the "hazardous" list to be inspected before they move on. But with the spread of this threat to foliage, it wouldn't hurt for all campers to take a good look at their tents and rigs before packing to move on.

If you don't want to camp out but would rather build an A-frame summer cottage (or a pole-frame hunting cabin, farm cottage, Adirondack shelter, horse barn or trailer, greenhouse or boating landing), the Government Printing Office also has *Recreational Buildings & Facilities*, a 70-cent booklet that tells how.

### Traveler finder

A new along-the-highway aid for travelers uses a television screen at 350 Stuckey's roadside stores across the country. By pushing the buttons for his phone number at any stop, a motorist sees on the TV screen if anyone has tried to contact him by calling Stuckey's headquarters computer in Eastman, Ga. Numbers the driver should call for messages appear on the screen, and the computer stores these numbers for five days. The system should help to contact a traveler in an emergency. And it's free.

### RV assist from carmakers

RV shoppers and owners alike have new aids going for them via local car dealers. Dodge offers *Guidelines to Safe and Care-free Campering*, with information about proper loads for passenger-car towing as well as selecting and outfitting a recreational vehicle. The booklet is also available free from Box 970P, Detroit, Mich. 48231.

Two new offerings from Ford are *Let Ford Take You Camping*, a survey of vehicles available plus coupons for free campground passes, and *Ford Outdoors*, published by the editors of *Ford Times*.

Chevrolet's *Recreational Vehicle Buyer's Guide* provides 82 pages of solid information and suggestions for choosing and using trailers and pickup campers, conversions and motor homes. It can be ordered for 50 cents from Box 7271PM, Detroit, Mich. 48202, or through Chevy dealers. Also available are a *1973 National Parks & Monuments Road Guide*, 140 pages covering 280

(Please turn to page 62D)

# Announcing

## Popular Mechanics Picture-Tools— the handiest shop-organizers ever designed

POPULAR MECHANICS PICTURE-TOOLS are a great new idea to take the confusion out of *what goes where* on workshop tool panels.

The complete PM PICTURE-TOOL KIT consists of seven big sheets (9¾ x 11¾ in.) of a special heavyweight paper with a pressure-sensitive adhesive on the back. On each sheet are beautiful drawings of hand tools and portable power tools—all (74 in total) you're likely to have in your shop. Most are full size; the others, only slightly reduced.

Also enclosed in the kit is a blank sheet of the same special paper, printed in an overall color to match the tools. This sheet enables you to design your own drawings or silhouettes of any special tools you have.

Each of the PM PICTURE-TOOLS is carefully die-cut. You simply peel it off the backing paper and apply it to the proper spot on your panel. You can apply PICTURE-TOOLS to any painted or unpainted wood, plywood, hardboard and even perforated-hardboard surface.

Later if you want to move a few tools or rearrange the entire panel, you can peel off

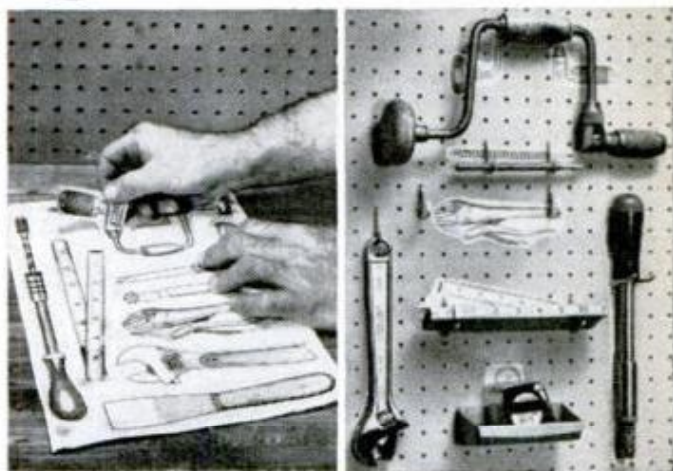

the PM PICTURE-TOOLS and move them to new locations. They are reusable!

Once your PICTURE-TOOLS are in place, you'll know at a glance exactly where each tool in your shop belongs. You'll also know—again at a glance—what tools are missing.

Best of all, you'll be surprised how PM PICTURE-TOOLS will instantly and dramatically enhance the appearance of your shop!

**Order your PM PICTURE-TOOL KIT today!**  
Only

# \$3.95

Popular Mechanics, Box 1014 (Dept. PT), Radio City, N.Y., N.Y. 10019

Enclosed is my check or money order for \$3.95.

Send my PM PICTURE-TOOL KIT to:

Name \_\_\_\_\_

Address \_\_\_\_\_

City \_\_\_\_\_

State \_\_\_\_\_

Zip \_\_\_\_\_

## ALL OUTDOORS

(Continued from page 62B)

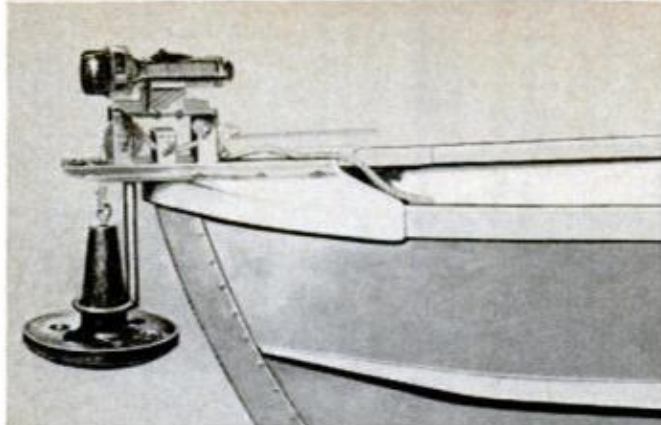

Anchor handling without falling overboard is among advantages of Anchor Caddy. Bracket holds anchor snug but clear of bow to lower or haul in. \$19.95.

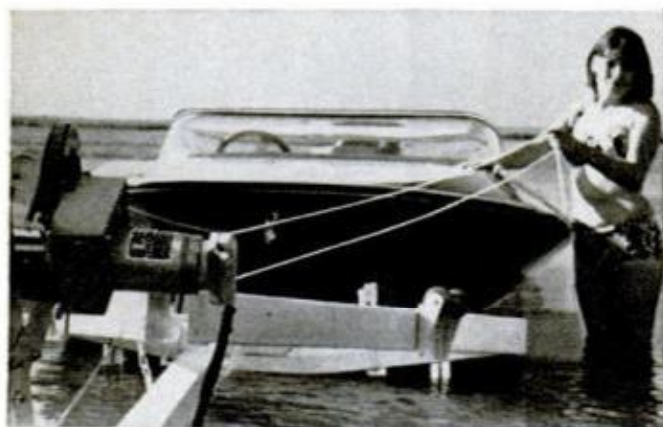

Heavier inboard and stern-drive craft can be hauled out with Dutton-Lainson DLE 7000 using 12-v. power and 25-ft. lanyard control or hand crank. \$165.95.



Designed to keep a trailer's hitch locked whether or not it is hooked up to the tow vehicle, the All-Safe Hitch Lock from Waukegan Outdoor Products is \$10.

parcs, monuments, recreational areas and historical sites of the National Park Service, and the *Chevrolet Trailering Guide for Passenger Cars and Trucks*. Groups and organizations can also borrow three half-hour movies: *The High Roads*, *The Water Roads* and *The Historic Roads of America*.

And from the Recreational Vehicle Institute, the RV industry's trade association, comes a consumer guide called *The Way to Go*, a good introduction to the sport. It's available through many RV outlets or directly, for 50 cents, from the RVI, 2720 Des Plaines Ave., Des Plaines, Ill. 60018.

### New tackle boxes resist plastic worms

Most fishermen now know how effective the new plastic worms are in catching lunkers and damaging tackle boxes. Now a number of manufacturers claim new plastics they use resist the corrosion and paint-softening caused by tray storage of plastic worms. Several makes we have given a preliminary test seem to be holding up well. When tackle-box shopping, check for this quality.

### European air travelers get RV package

Air travelers who want to camp the Grand Tour of Europe have a new bargain RV package available. Swissair will have a Mercedes or VW camper caravan waiting for you at the Zurich airport—fully equipped (even maps and china, linens and champagne). Two weeks of unlimited mileage is less than \$940 for two, including round-trip air fare.

### Coming outdoor events

Aug. 7-10, Heavy Bench Rest Nationals, National Bench Rest Shooters Assn., Springfield, Mo.; Aug. 17-25, Grand American Trapshooting Tournament, Amateur Trapshooting Assn., Vandalia, Ohio; Aug. 18, Hennessy California Offshore Powerboat Race, Marina Del Rey, Calif.; Aug. 18-26, National Fall Championship Shoot, National Muzzle Loading Rifle Assn., Friendship, Ind.; Aug. 31-Sept. 3, Metallic Silhouette Championships, National Rifle Assn., Tucson, Ariz.; Sept. 22, National Hunting & Fishing Day. ★★

**SUKII**  
MADE IN U.S.A.  
蒸気洗源  
誰にも使える

# EVERYBODY'S STEAMCLEANER

## HOT DOUBLE OFFER!

... and almost everyone is a prospect

- Air Conditioning
- Animal Farms
- Boats, Marinas
- Building Cleaning
- Business Machines
- Cafes, Hotels
- Cycle Shops
- Dairies
- Farms, Ranches
- Fish Markets
- Fur Farms
- Garages
- Ice Plants
- Industrial Plants
- Lawn Mower
- Meat Markets
- Print Shops
- Refrigeration
- Saw Mills
- Service Stations
- Super Markets
- Truckers
- Veterinarians

TAKE THE FOOLISHNESS  
OUT OF STEAMCLEANING

**SUKII**  
MADE IN U.S.A.  
蒸気洗源  
誰にも使える

PRODUCES  
HOT  
STEAM

**FAST!**

DEALER'S \$**189**<sup>50</sup>  
PRICE

## BIG MONEY 2 WAYS!

1. DEVELOP YOUR OWN SUKII DEALERSHIP—  
Big Money Filling Demand All Over Your Territory

Earn a giant \$135.00 profit per sale. Dozens of different kinds of businesses . . . service stations, garages, factories, farmers, etc. . . . earn extra profits by saving time and work cleaning their property and equipment. Keeps customers happy, too.

2. BE A SUKII FRANCHISE DISTRIBUTOR—  
Earn Biggest Profits, Realize Your Dreams

Openings available right now for top-flight men and organizations qualified to step into the booming SUKII picture. Unique moneymaking program with protected territory.

MAKE YOUR SUKII PROFIT CHOICE  
AND MAIL COUPON TODAY!

**SUKII**  
INTERNATIONAL

P.O. BOX 973  
JACKSON, WYOMING  
83001



SUKII . . .

lightweight,  
quickfiring,  
long-lived, easy  
to operate, the  
choice of steam  
cleaners. L.P.  
gas fired and  
at a price users  
can live with.

DESIGNED FOR SIMPLICITY.  
LOW MAINTENANCE COSTS—  
NO OILS OR GREASE.

### CLEAN UP RIGHT HERE

Get All The Facts!

SUKII

Dept. PM-8

P.O. Box 973, Jackson, Wyo. 83001

Tel me how to clean up with new, re-designed SUKII instant steam cleaning machine!

- Here's check or m.o. for \$189.50—rush one demonstrator machine (\$325.00 retail value) and moneymaking details.
- Tell me how to get started as SUKII dealer.
- How do I qualify for that EXCLUSIVE FRANCHISE and PROTECTED TERRITORY as a SUKII distributor?

PHONE \_\_\_\_\_

NAME \_\_\_\_\_  
SHIPPING ADDRESS \_\_\_\_\_

(Please do NOT use P.O. Box No.)

CITY \_\_\_\_\_ STATE \_\_\_\_\_ ZIP \_\_\_\_\_

## APPLIANCE CLINIC

BY PAUL MANN

### Capacitor capers

*Your explanation of how a reader may have ruined his new ohmmeter was quite good. However, you stated that an appliance capacitor may be discharged by shorting across its leads to ground. This is true in many cases, but not all. Some capacitors have internal fuses. If they are shorted to ground, the fuse will blow and render the capacitor useless. To be perfectly safe, a man can do as you suggested—disconnect the capacitor leads and bypass the capacitor with a jumper. Or he can safely discharge a capacitor by using a 20,000-ohm, 2-w. resistor, or by setting a voltmeter to a high voltage setting, such as 1000 v.—O. James Rickley, Greeley, Colo.*

Thanks, O.J. You emphasize a point that needed it.

### Nutty knob

*My Westinghouse Filter-Clean portable dishwasher (model SFK5A) is out of synchronization. For example, when I press the double-wash button and then turn the timer knob, the knob moves past the wash cycle to rinse before the dishwasher starts operating. On the rinse-hold cycle, if I press the rinse-hold button and turn the timer knob to rinse-hold, nothing happens, but if I move the timer knob to the off position and then to wash, the appliance comes on. A repairman installed a new timer, but no success. How do I solve this complicated problem?—Alphonse Moore, Philadelphia.*

With a simple solution. Replace the timer knob. It is probably cracked or worn and has slipped so it isn't lining up properly with the timer shaft, and therefore isn't lining up properly with cycle selections.

### Putting it to use

*I received a Facit typewriter, model 1620, as a birthday present, but I never did get an owner's manual. The local dealer has been of*

*no help. Can you suggest something?—Robert Taylor, Lynn Center, Ill.*

Yes. Use your Facit typewriter to write the company and ask for the owner's literature: Facit-Odhner, Inc., 501 Winsor Dr., Secaucus, N.J. 07094.

### Doing a no-burn

*Here's an odd one for you. The left front burner of our 20-year-old, four-burner Frigidaire electric range will not heat up unless the other burners are also switched on. Why?—Joe Holmes, New Castle, Pa.*

The burner has probably developed a bad switch, which would account for its not working by itself. It's possible that the switch for this burner has shorted itself across the switch of one of the other burners, so that when that burner is turned on, the left front burner also gets electricity and heats up. There's one more point that should be mentioned. Some electric ranges have one burner connected in series with another to act as a griddle warmer. If your range is one of these, the left front burner may be connected in series with the left rear burner. For the griddle burner to operate, both burners have to be switched on.

### Odds-on

*I have a Whirlpool automatic washer that's about 10 years old. It has three water-temperature settings: hot, warm, cold. When we switch to hot and turn the machine on, the water barely trickles into the tub. Yet, on the cold-water setting, it flows forcefully. Do I need a new valve or something?—Frank Murray, Greensboro, N.C.*

Your washer needs something, but odds are 99 to 1 in your favor it's not a new part. Close the hot water valve on the line to the washer, unscrew the hose connection from the faucet and clean out that small intake filter screen you'll find in the hose inlet. I

(Please turn to page 62H)



TOM McCAHILL says:

**"If you'd rather  
earn \$25 or \$30  
an evening than  
watch TV..."**

**Grab this  
Free Book!"**

I'm not against the tube, but I'd hate to pass up \$5 to \$7 an hour just to catch those old movie reruns. You can make that kind of money in your spare time by being the man in demand: an Appliance repairman. Guys who can keep appliances going are wanted in more states than the FBI's top ten. And NRI can teach you everything you have to know ... at home ... in your spare time.

So you've never wired a plug ... NRI can show you how.

Even Edison had to do some studying. And there's no easier way to learn than the low-cost, home study course put together by the Appliance Division of NRI Home Training. All the lessons are fully-illustrated and easy to understand. Thousands of guys like yourself have learned basic electricity and how to use test instruments. The course covers the electrical and mechanical operation of every type of appliance from toasters and coffee makers to dishwashers; from vacuum cleaners and automatic laundry equipment to air conditioning and refrigerators. They even show you how to fix farm and commercial appliances and small, one-lung engines. Their staff of experts works with you every step of the way. NRI includes a professional Appliance tester in the low tuition. Almost a million men have studied with this great school,

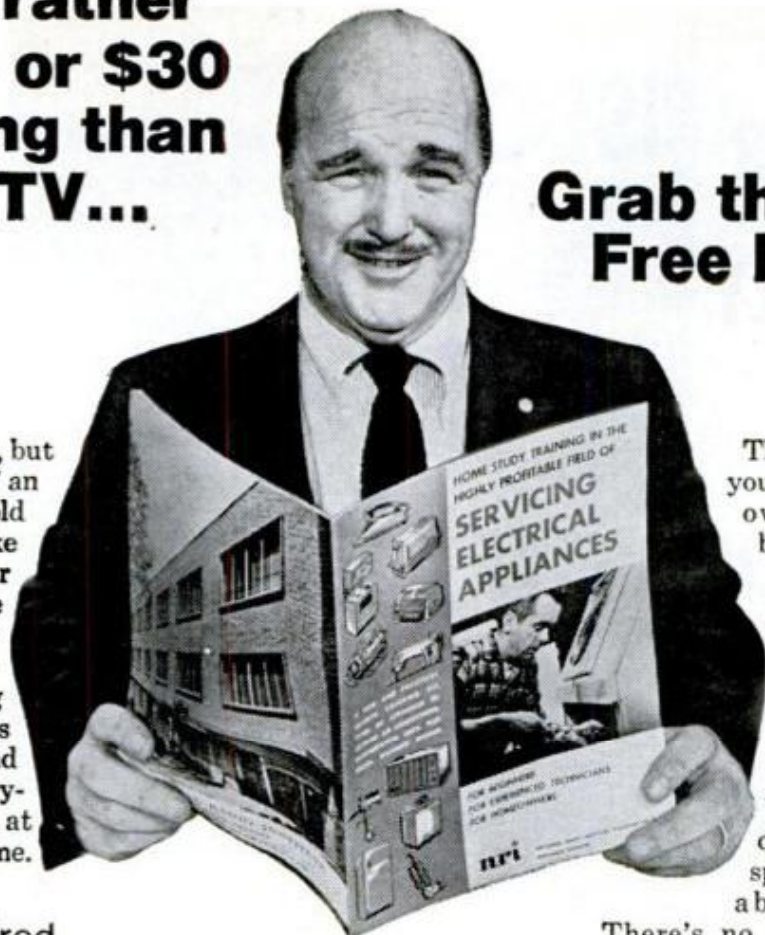

Think of the money you'll save when your own appliances go bloolie!

The important thing is to make up your mind that you really want to get ahead. Do yourself a favor and send in the coupon below. You'll get back a colorful catalog that spells out everything about the course.

There's no obligation and no salesman will call ... NRI doesn't need any with this course. All you invest is an 8¢ stamp, and you've got nothing to lose, except that empty feeling in your wallet.

so you know they've got this home study business down pat.

Hang onto the job you've got; learn in your spare time.

There's no need to give up your present job in order to learn a skill. With NRI, you study in your spare time, at your own rate. Many of their students have more than paid for the tuition fee within their first couple months servicing electric Appliances.

*Tom McCahill*

**AVAILABLE UNDER NEW GI BILL**

If you served since January 31, 1955 or are in service, check GI line in coupon.

Grab this FREE book today and see what NRI can do for you.

**NRI TRAINING**

600-083

3939 Wisconsin Avenue, Washington, D.C. 20016

Send me the free book on Professional Appliance Servicing.  
NO SALESMAN WILL CALL.

Name \_\_\_\_\_ Age \_\_\_\_\_

Address \_\_\_\_\_

City \_\_\_\_\_ State \_\_\_\_\_ Zip \_\_\_\_\_

Accredited Member National Home Study Council  Check for facts on GI Bill

**IT MAKES  
CARS  
RUN  
BETTER**

**PROBABLY  
YOURS,  
TOO**



**TEST DRIVE IT  
YOU'LL LIKE IT!**

**SPECIAL OFFER**

Rislone National Championship Racing Jacket only \$7.95 prepaid. Durable nylon-cotton Rislone yellow with red, black racing stripes. S, M, L, XL. Send check or money order to: Rislone National Champion Jacket, P.O. Box 457, Bonner Springs, Kansas 66012.



**THE SHALER CO.**

Waupun, Wisconsin 53963  
In Canada: The Canadian Shaler Products Co. Ltd. Ontario

**MAGIC MAIL PLAN**  
*that comes with this Little Machine*  
**CAN MAKE YOU \$1200 AN HOUR**

The machine is turning out a job that will bring operator \$2.58, by mail. Material cost, only 11c



Write today for free facts about the newest and most fascinating of all new home operated businesses. For the first time, a simplified machine brings the fabulous profits of Plastic Sealing and Plastic Laminating within reach of the small operator. Anyone can learn to operate it with a few minutes practice. Then—with our MAGIC MAIL PLAN—can get mail orders pouring in daily with cash in every envelope.

**No Convassing or Selling**

Fill orders at home in spare time to start. Then expand to full time business. We even supply circulars to bring back cash and orders. Rush name for all the facts you need to start. A postcard will do. No charge.

**WARNER ELECTRIC CO., Dept. L-2-C**  
1512 Jarvis, Chicago, Ill. 60626

**APPLIANCE CLINIC**

(Continued from page 62F)

bet it's clogged by water deposits built up over the years.

**Out of its element**

*A break has developed in the flat-ribbon wire of my toaster's heating element. What can I use to repair it?—Paul F. McRae, Des Moines, Iowa.*

Resistance-wire cements are sold by appliance dealers and at hardware stores. However, such repairs are temporary. The permanent solution for your problem is to buy a replacement element.

**At long range**

*Our home is equipped with a Republic ThermoGlas water heater. We get hot water okay, but not very much. Can you make a long-range diagnosis of what the problem may be?—Ronnie Maron, Duarte, Calif.*

You don't give me much to go on—but let's set down a few thoughts. First, if the hot water lasts a very short time (about a minute) and then turns cold, the dip tube may be leaking. This tube directs incoming cold water from the top to bottom of the tank. Hot water comes out from the top. If the dip tube has broken off or is leaking at the top, cold water will be delivered.

If water is turning cold at one faucet only, such as the shower or bathtub, the mixing valve there may be bad, diverting cold water to the hot-water side. If so, nothing may be wrong with the water heater.

Possibly your burner flame or thermostat is set too low. Ask your local gas company to have a serviceman check gas-operating functions of the appliance; there is usually no charge for this.

Finally, when you say you don't get "very much" hot water, you're not being too specific about the problem. *How to Troubleshoot a Water Heater*, in next month's *PM*, should be good reading for you. ★★★

*If you have a question about any appliance, send it to Appliance Clinic, Popular Mechanics, 224 West 57th St., New York, N.Y. 10019. Sorry, but letters cannot be answered individually. Problems of wide interest will be answered in this column.*

# Jobs open up for Technicians with down-to-earth training!

Opportunities are everywhere and the pay is excellent in the technical service industries. But it takes the right training to get a man started: NTS Project-Method Home Training!

You learn by building the latest equipment and test instruments (which are included in your tuition). You're guided every step of the way by easy-to-read NTS Lessons.

When you graduate, you know service and repair from the bottom up, inside-out!

You have answers on the tip of your tongue. Know-how at your fingertips. You have the down-to-earth training experience employers are willing to pay good money for!

Find out. Send card today. No obligation. No salesman will call.



Solid-State Color TV  
315 Sq. In. picture

## ELECTRONICS DIVISION

NTS offers a wide-range of training with solid-state equipment (almost all of it commercially available). Build a solid-state 315 sq. in. Color TV; solid-state B&W TV; solid-state FM multiplex Receiver and Speakers; solid-state Oscilloscope; solid-state Compu-Trainer. Plus, Amateur Phone Transceiver, FET Volt-Ohmmeter, Electronic Tube Tester, Signal Generator, and more! Get valuable experience in the latest electronics technology. Read details in catalog.



## AIR CONDITIONING/ REFRIGERATION & HEATING DIVISION

NTS provides you with the important tools of the trade! Courses include specially-designed Hermetic Unit Analyzer — a tester with multiple applications; Leak Detector-Soldering Kit — with hundreds of uses; Charging-Testing-Purging Manifold Set with dispensing and piercing valves. Plus, Socket, Wrench, Open-End Wrench, Tube Bender Sets, and more!



## MECHANICS DIVISION

NTS includes professional tools and test equipment. Earn as you learn. Make money even before you graduate! Big 109 piece Socket Wrench and Tool Set — all American made! And a Performance Kit — Timing Light, Smog Valve Tester, Compression Tester, Remote Starter Switch, Dwell Tach, Alternator-Generator-Regulator Tester. Also, "Speed Shop" lessons and diesel training.



## HOME APPLIANCE DIVISION

Multiply your experience with appliance circuitry through the exclusive NTS Circuit Trainer. Eliminates the need to buy dozens of appliances for training purposes. The 4-in-1 Appliance Tester performs many troubleshooting tasks. It includes an Ohmmeter, Voltmeter, Ammeter, and Wattmeter; measures both AC and DC currents; it will be valuable to you during training and on the job!

## APPROVED FOR VETERAN TRAINING

Accredited Member: National Association of Trade & Technical Schools; National Home Study Council.

## CLASSROOM TRAINING AT LOS ANGELES

Train in sunny Southern California. NTS occupies a city block with over a million dollars in training facilities. Check box.

## NATIONAL TECHNICAL SCHOOLS

WORLD-WIDE TRAINING SINCE 1905

Resident & Home Study Schools  
4000 So. Figueroa St., Los Angeles, CA. 90037

## NATIONAL TECHNICAL SCHOOLS

WORLD-WIDE TRAINING SINCE 1905

Resident & Home Study Schools  
4000 So. Figueroa St., Los Angeles, CA. 90037

Send for color Catalog and Sample Lesson — both FREE!  
Check below. No salesman will call. No obligation.

- Electronics Division       Mechanics Division  
 Air-Conditioning, Refrigeration, Heating Division       Home Appliance Division

NAME \_\_\_\_\_ AGE \_\_\_\_\_

ADDRESS \_\_\_\_\_

CITY \_\_\_\_\_ STATE \_\_\_\_\_ ZIP \_\_\_\_\_

- Check for Veteran Training under G.I. Bill  
 Check if interested in information on Classroom Training in Los Angeles

Dept. 201-083

# Dodge takes the mystery out of buying your first

## (or your second or your third...)

As an adventurer that's considering a recreational vehicle, you've probably found it's difficult to decide which unit is best for you. Take price. You can spend as little as \$150 for a pickup cap cover. Or go first class and spend as much for your home on wheels as you would for a house. To get you started, we've listed here most of the major types of recreational vehicles. After you have a general idea of what you want, stop in and see your Dodge Dealer. He may have what you're looking for right on display. And he'll do his best to answer any questions you may have.



### First, Slide-on Campers.

This is a popular way to start for several reasons. First, if you already own a pickup, you're halfway there. But before you buy a camper, check the carrying capacity of your pickup and make sure the center of gravity of the camper matches up with the recommended load location of the pickup. Second, you can move into more deluxe campers easily. Just keep the pickup and trade in the top. Finally, for those who like to get far off the beaten path, the four-wheel-drive pickup is probably the most surefooted RV you can have. Obviously great for hunters, fishermen, and the like.



Only Dodge offers you the new Club Cab pickup. It has room inside for the things you don't want to leave outside.

Dodge has developed one of the most interesting pickup innovations in recent years. The Club Cab. It has 34 cubic feet of extra storage space behind the seat. Room for the camping equipment you don't want inside the camper. Optional jump seats are available if you prefer. Like the other Dodge pickups, the Club Cab can be equipped with a special camper package. It provides the basic equipment you need to carry today's larger slide-on campers.



# recreational vehicle.

## Second, Motor Homes.

Motor homes are much more than vacation units. They're ideal for traveling with large families or taking friends to outdoor events such as football games. Or serving as a year-round hospitality suite. Motor homes are built by various manufacturers in a variety of sizes and interior luxury levels. But no matter which one you choose, you'll find Dodge builds the chassis for 80 percent of all motor homes.

### Van Conversions and Mini Motor Homes.

Van conversions are basically compact vans which offer added conveniences such as a stove or fold-down beds. Mini motor homes, on the other hand, offer expanded bodies and many of the conveniences of larger motor homes. Such as a shower, generator, and air conditioner. Again in this area, Dodge supplies more chassis for mini motor homes than any other manufacturer.

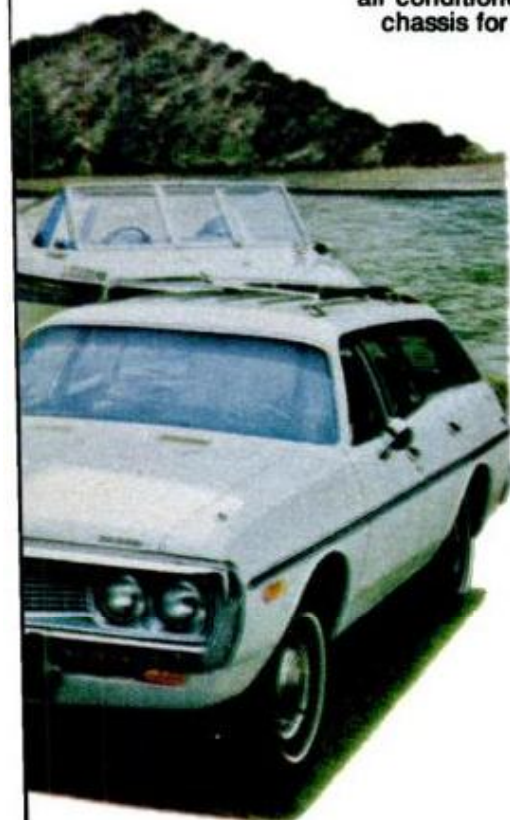

## Third, Trailer Towing.

This is the easiest way to start because you already own half the equipment. Your car. However, here again to handle the extra load, all cars require some special equipment. To make it easy for trailer towers, Dodge offers Chrysler-engineered, factory-installed towing packages. Depending on the car you select, you can get the basic equipment you need to handle a trailer weighing up to 7,000 pounds.



**Turn to Dodge for  
leadership in  
Recreational Vehicles.**

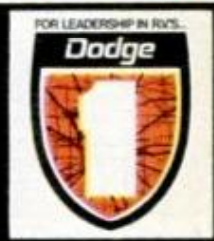

# Marlboro



Marlboro Red  
or Longhorn 100's—  
you get a lot to like.



8 mg. tar, 1.3 mg. nicotine  
av. per cigarette, FTC Report Feb. '73

Warning: The Surgeon General Has Determined  
That Cigarette Smoking Is Dangerous to Your Health.

# Mobile entertaining indoors and out

Three novel roll-abouts—  
a cooking center, wet bar  
and hi-fi on wheels—give  
you a mobile rec room for  
year-round use anywhere.

**R**oll these three mobile carts out on a deck or patio and you have, in effect, an "instant" outdoor playroom all set up and ready to go for family fun and party entertaining. A brand-new concept in flexible, go-anywhere furniture developed by PM editors, the carts include a complete cooking unit with electric barbecue and built-in refrigerator (see below), a wet bar with sink and running water, and a self-contained stereo music center on wheels.

What's best about these versatile roll-abouts is that they're not limited just to outdoor use, either. There's no having to store them away between seasons while



**Mobile cook center** is designed for use with electric barbecue from Char-B-Que and a Sears mini refrigerator. Compartment on right side is for storing supplies.

PHOTOS BY  
ROBERT D. BORST



waiting for another summer to come around. Companion-styled with the smart good looks of fine furniture, they're as handsome and functional indoors as out. The cooking center, in addition to its barbecue and mini fridge, features swing-up extension wings that make it ideal for doubling as a buffet server inside. The rolling





wet bar and music center shown on these pages are match mates with hinged tops that swing down to conceal their contents when not in use. Closed, they look like sleek, modern credenzas ready for service in a living or dining area. On the next 14 pages, PM shows you how to build these unusual pieces you can't buy anywhere.



# 1. Mobile cook-center

by Harry Wicks

DESIGNED BY THE AUTHOR



**At indoor buffet (above) cart becomes the center of attraction. For buffet use, a three-well food warmer replaces the barbecue setup shown on page 69.**

**Compact refrigerator from Sears holds food and drink for typical get-together. Storage area is a bonus: Cooking and serving equipment is always at hand.**



This cook-center has a lot going for it if you enjoy year-round entertaining. During the warm months it's sure to draw raves from your neighbors when they spot it on your patio. At season's end, you simply roll it indoors for use in the family room. And, when not in service (photo above) it's a handsome piece of furniture that will suit any room decor.

The concept started with the electric barbecue cooker manufactured by the Char-B-Que Co., New Shrewsbury, N.J. The cooker can be used outside (indoors in a fireplace) for barbecues and, with its lid closed, for delicate, Chinese smoke cooking. Of die-cast aluminum the Char-B-Que is offered in four colors—orange, yellow, avocado and black. It sells for about \$60.

The other piece of equipment that played a major part in the cart's design is the coppertone Mini-Fridge which we selected from Sears, Roebuck's fall/winter 1972 catalog.

And the plastic-laminated countertop is an exciting new product too. The latest pattern from Formica Corp., it's called Butcherblock Maple. It looks like the real thing; in all probability, only experienced workshoppers will be able to spot the difference. The drop leaves, on which you cut and prepare vegetables, are the real thing, of course, made up of laminated strips of maple.

At the end of this article, you'll find a list of manufacturers of all major components used—including hardware.

To build your cart, it's a must to have your mini-refrigerator on hand. It will determine the final size of the cart (except for height). The top on the cart shown is at a comfortable, and recommended, cooking

BOTTOM VIEW OF SLIDE SUPPORTS

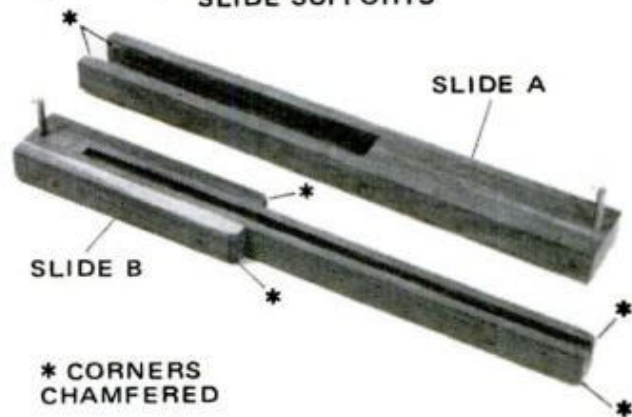

Drop-leaf supports are of walnut, slide B inserts into slide A when the slides are fully retracted.

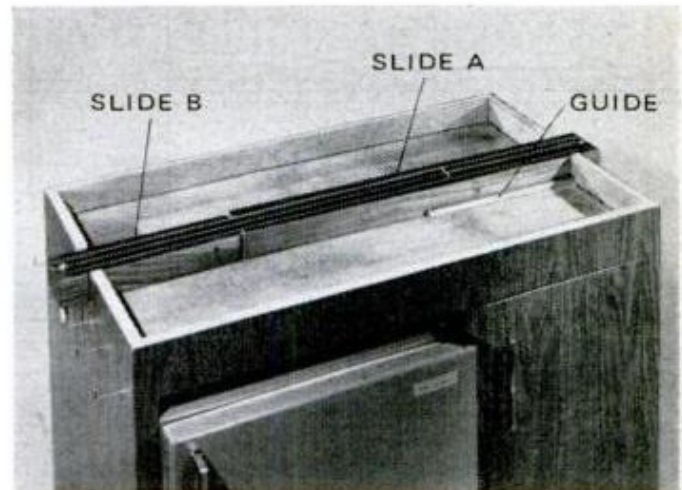

Slide B travels on a single 25-in.-long guide. Slide A is sandwiched between pair of 12-in. guides.

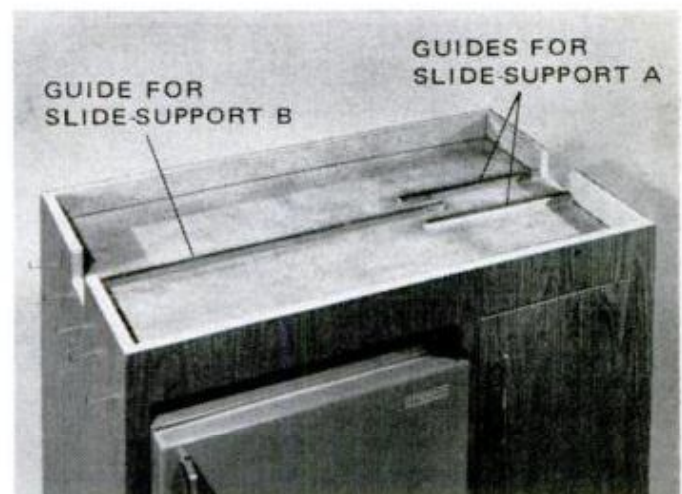

Guides should also be of hardwood. When satisfied with location, secure them with glue and 1-in. screws.

# 'Butcherblock' top looks like the real thing

height when used with the electric barbecue. If possible, do not alter this dimension.

Start building by laying out the cart parts on two sheets of plywood. Before cutting, take time to double check those critical dimensions concerning the refrigerator. Assemble the cabinet using waterproof glue and screws and then apply the Gunstock Walnut laminate using contact cement. (See *How to Work With Plastic Laminates*, page 154, Mar. '70 PM, for laminating know-how.) You can flop the box about

so you can trim laminate overhang using your router and a carbide cutter, but you will have to do some hand-filing to square the four corners in each of the two openings at front.

Next, make the cabinet top. After cutting the two pieces, use waterproof glue and 1 1/4-in. No. 8 screws to join the pieces. The top can now be covered with plastic laminate. Do the edges first and finish by applying the top.

Glue-up the maple chopping blocks (or

## Plywood cutting schedule

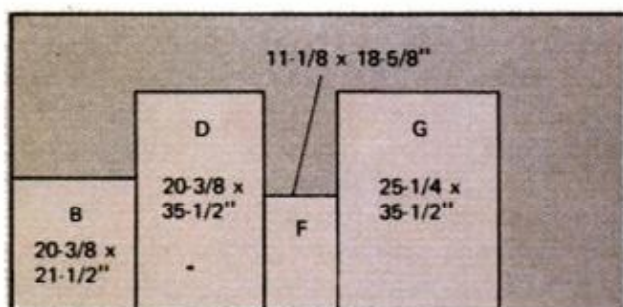
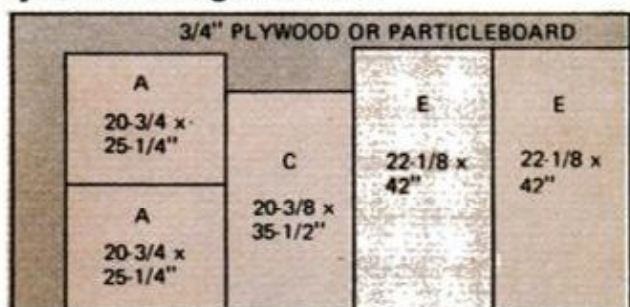

## How to make the slide supports

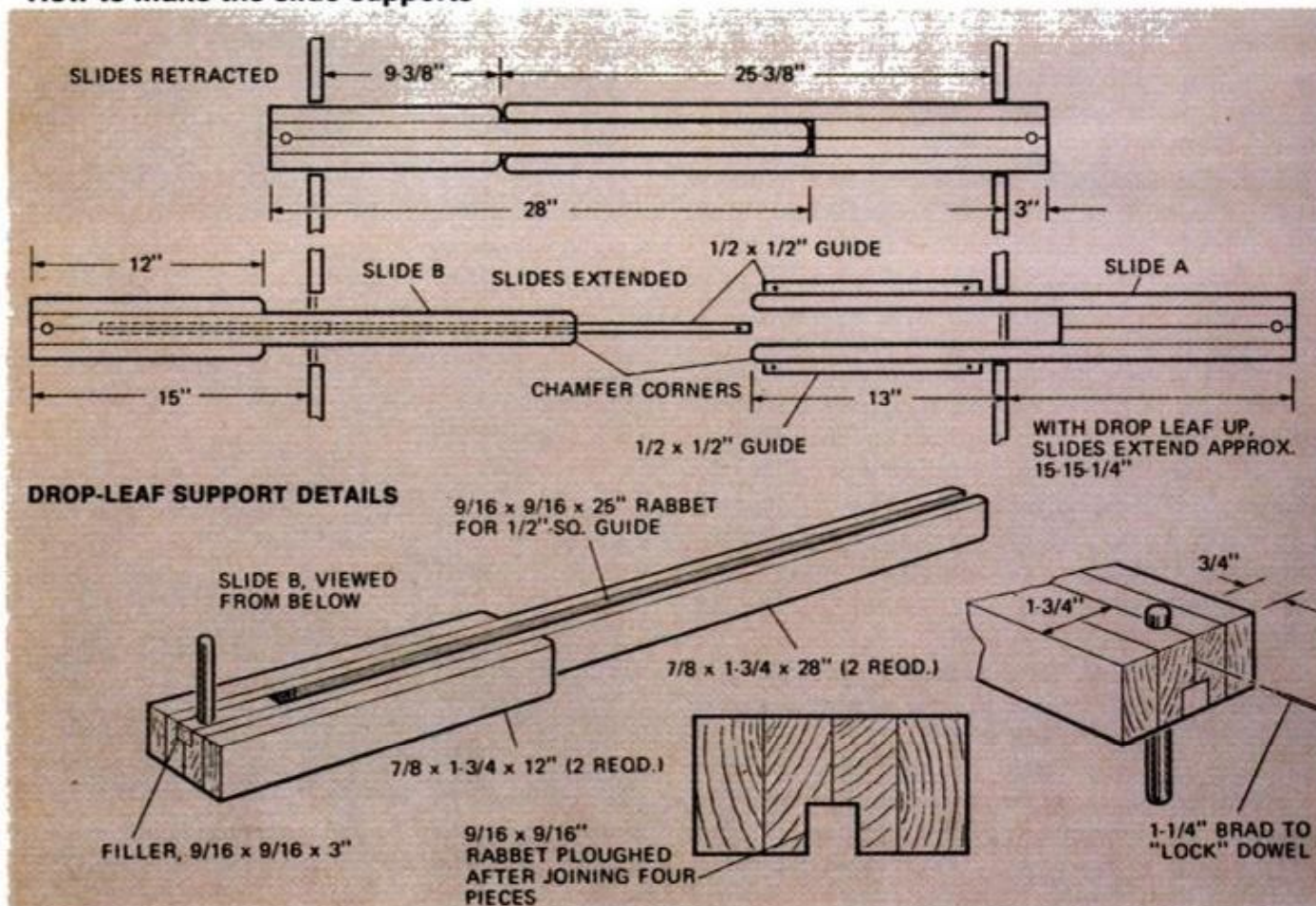

consider having this step done at your local lumberyard mill) and fasten these to the countertop using 2-in. brass-plated continuous hinge. Make absolutely certain that you drill adequate-size pilot holes in the maple chopping blocks for the hinge screws or you are almost sure to pop the heads off a number of screws.

Although the weight of the top itself holds it in place, you are well advised to anchor it using one lagscrew as shown in the drawing below. The four corner blocks

prevent lateral movement of the top but at any social gathering there is a chance that a guest will lean on one of the upraised drop leaves. With the cooker going full blast, that could cause a tragedy. The single anchor, we found, absolutely prevents any chance of tilting the top.

When you're satisfied with the installation, remove lagscrew and top so that you will have less weight to handle while you work on the remaining details. For example, the cart can now be rested on its back

### Exploded view of the mobile cook-center

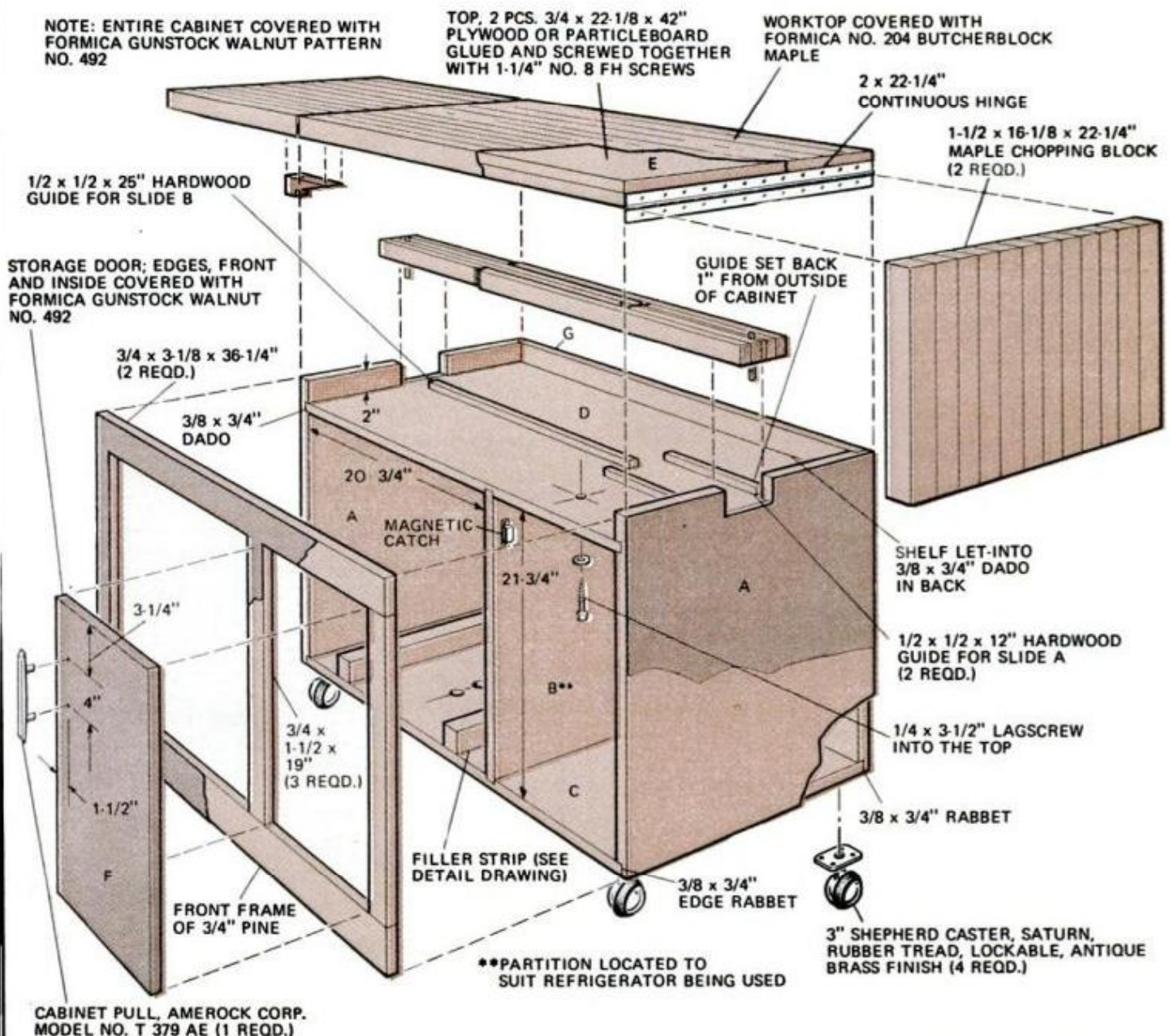

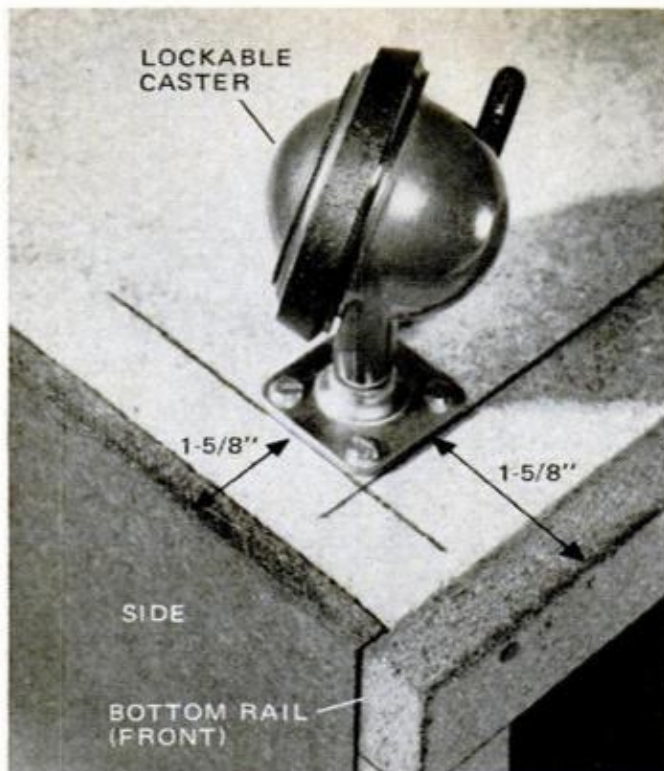

**Lockable casters**, by Shepherd Casters, permit cart to roll easily on patio surface despite unit's weight. The casters used are mobility-rated at 100 lbs. each.

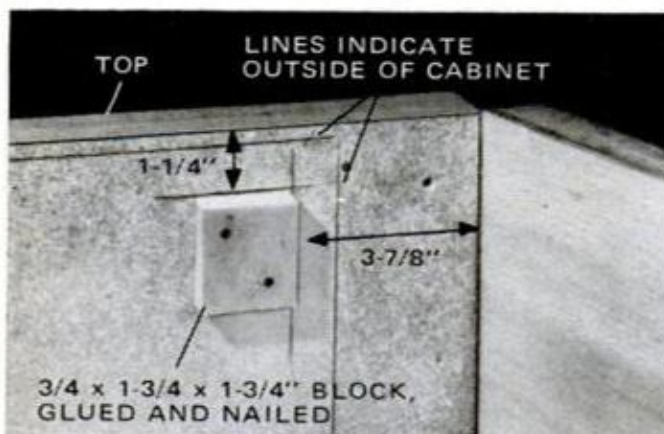

To locate top on its base, place the top on unit and measure overhang on all four sides. Then, using a pencil, draw the cabinet outline on the top. Flop the top and locate one block at each corner as shown.

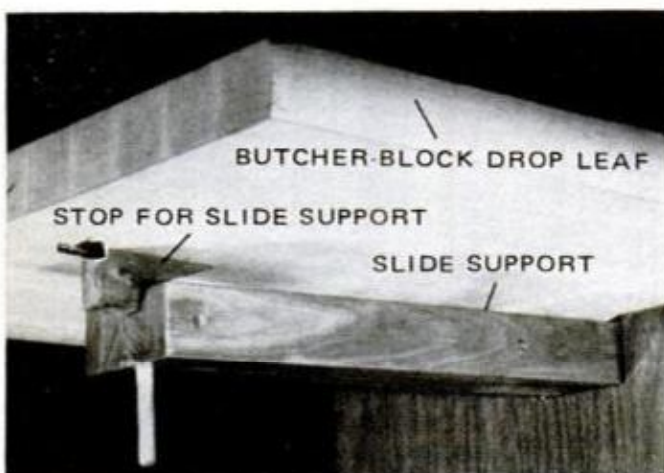

Position hardwood stop so slide-support assures drop leaf being level with cabinet top when extended.

and the casters attached. This makes it easier to move the cart around as you advance to the finishing stages. Right the cabinet and you can go to work installing the flush-mounted storage door (after first fitting and laminating it). To keep this cart's look compatible with its match-mates, Soss hinges were used to mount the door. You could, if desired, pick a pair of flush-mount hinges that will match the door pull, but keep in mind that no such hardware was used on the other two carts (if you plan to build them).

The barbecue tools hang from 2-in. brass L-hooks. Simply lay out your set of tools as you prefer and turn the hooks into pre-drilled pilot holes. If your cooking-tool collection is substantial, add hooks at the right end of the cabinet.

The slide supports for holding up the drop leaves look trickier to build than they actually are. Take the time to study the details in the drawings and photos. Notice that slide B inserts into slide A when both are pushed into the cabinet. You'll need four lengths of hardwood 28 in. long and

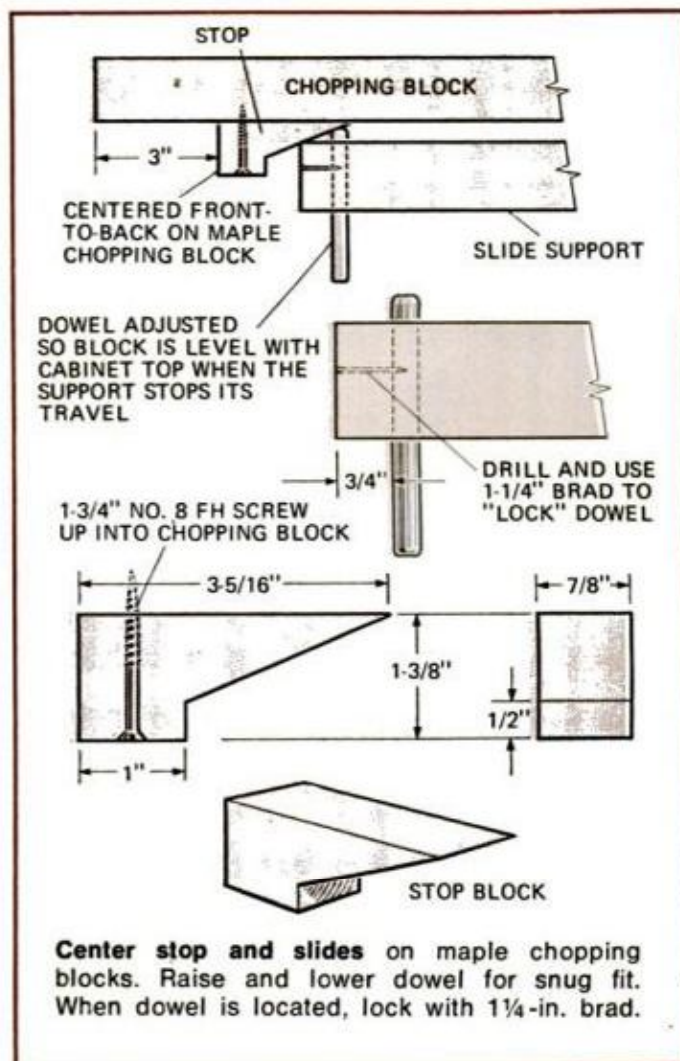

Center stop and slides on maple chopping blocks. Raise and lower dowel for snug fit. When dowel is located, lock with 1/4-in. brad.

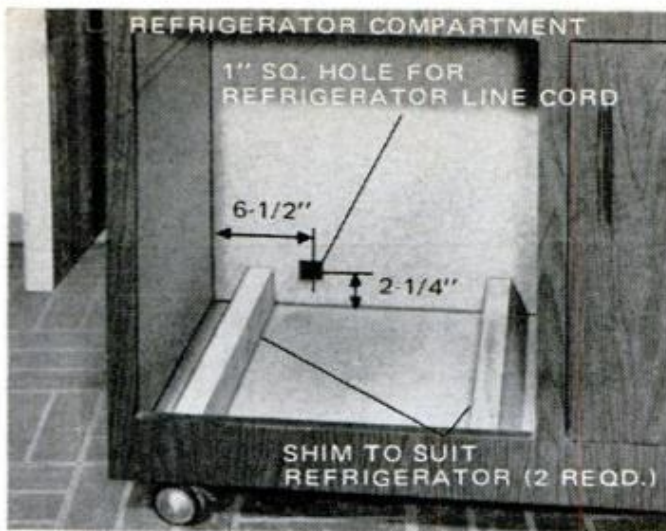

Refrigerator compartment must be sized to suit model. Shims should be sized so refrigerator slides in and out easily—with space at top for air circulation.

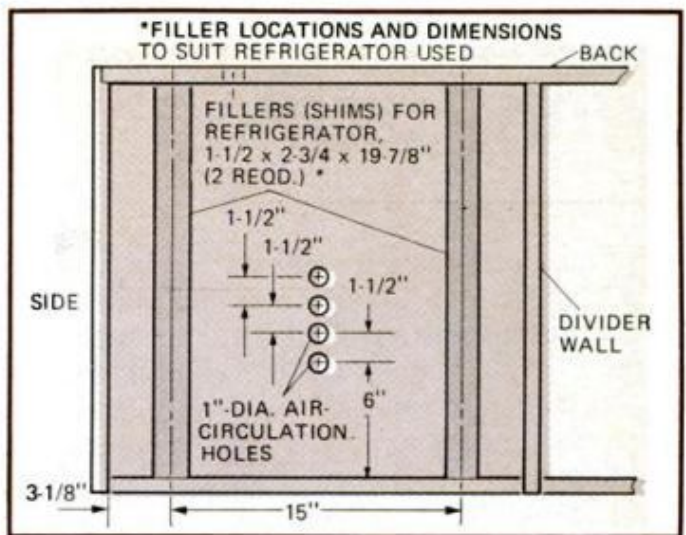

Adequate venting is a must. Drill minimum of four holes—more if you select larger-size refrigerator. Shims beneath are then glued and tacked in place.

four lengths 12 in. long to make the pair. After gluing up the supports, plough the rabbet along the length of slide B which will travel on the 1/2-in. square guide. You can cut a blind rabbet, but it is easier to run the full length of the slide and then add a small filler strip at the outboard end.

After making your slides, position them in the cabinet to mark the guide location. At this time also check the stop position when slides are retracted—they should stop with 3 in. projecting from the cabinet.

To locate the small triangle-shaped slide support stops, lift the first drop leaf and extend the support exactly 15 in. Note: The slide should butt the stop snugly so that the leaf is level with the top. When you have achieved this position, mark and drill for fastening the stop. Repeat the procedure on the second drop-leaf.

The final step is to install the shims (fillers) on which the refrigerator rests. They should be level with, or slightly higher than, the bottom rail so the refrigerator can be easily removed. ★★★

### Manufacturers of materials

**Plastic laminate,** Butcherblock maple No. 204 and Gunstock Walnut No. 492, Formica Corp., 120 East 4th St., Cincinnati, Ohio 45202.

**Electric barbecue;** Electric Char-B-Que, New Shrewsbury, N.J. 07753.

**Ground fault interrupter,** Model GFP-115, Harvey Hubbell, Bridgeport, Conn.

**Casters;** Saturn (SN) 3-in. lockable casters, Shepherd Casters, Inc., St. Joseph, Mich. 49085.

**Refrigerator;** Model 644.73872, Sears, Roebuck catalog.

**Door pull;** Model T 379 (AE), Amerock Corp., Rockford, Ill.

NOTE: LOCATION OF HOOKS FOR BARBECUE TOOLS TO SUIT OWNER'S COLLECTION

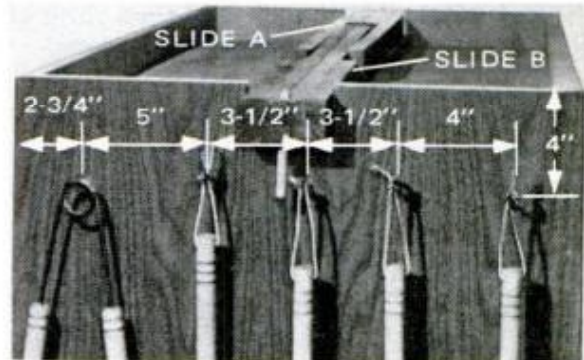

Barbecue tools are always at the ready on this cart. Hooks are spaced to suit owner's barbecue tools.



For safety, use ground fault interrupter on outdoor outlet. (model shown is by Harvey Hubbell). Use No. 12-ga. extension cord to power refrigerator, cooker.

## 2. Roll-around wet bar with running water

You don't usually expect to turn on a faucet in a small home bar and really get running water—but you do with this one. Not only does the novel unit feature a built-in sink and water supply, but, like the mobile cooking center shown on the preceding pages, it's also designed for versatile, go-anywhere use—out on a deck or patio for summer entertaining or indoors in a play or family room for year-round enjoyment any time. Like the cooking center, it rolls on heavy-duty, ball-type Shepherd casters and is finished in the same exterior materials to have a similar appearance. The sink board is covered with Butcherblock Maple laminate—a new Formica countertopping that so closely duplicates the look of a real wood chopping board you have to touch it to tell the difference. The top, sides and doors are faced with Gunstock Walnut—another new Formica pattern with deep, rich, wood-grained walnut tones.

The rolling bar is designed around

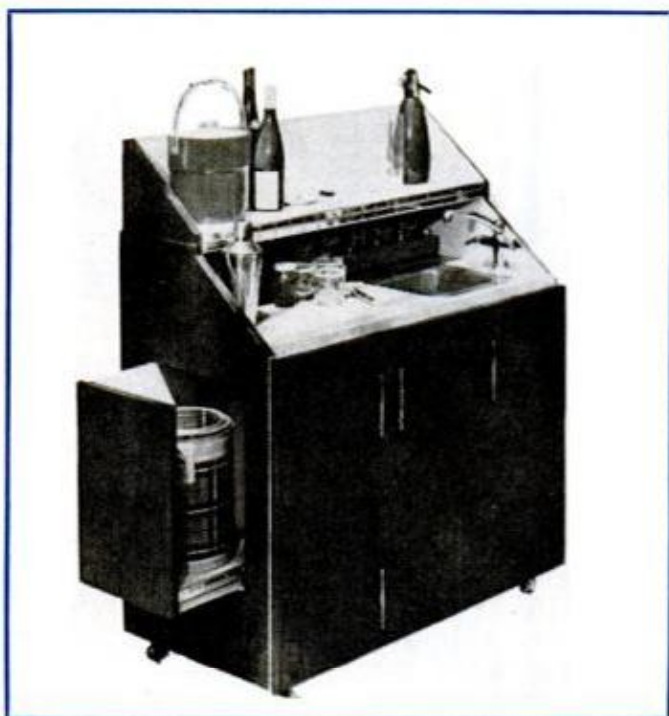

With top open, mobile bar provides a two-level work and serving counter for mixing drinks, with sink at right end on lower level. Slide-out drawer stores an ice cooler, matches similar wings on the hi-fi cart.

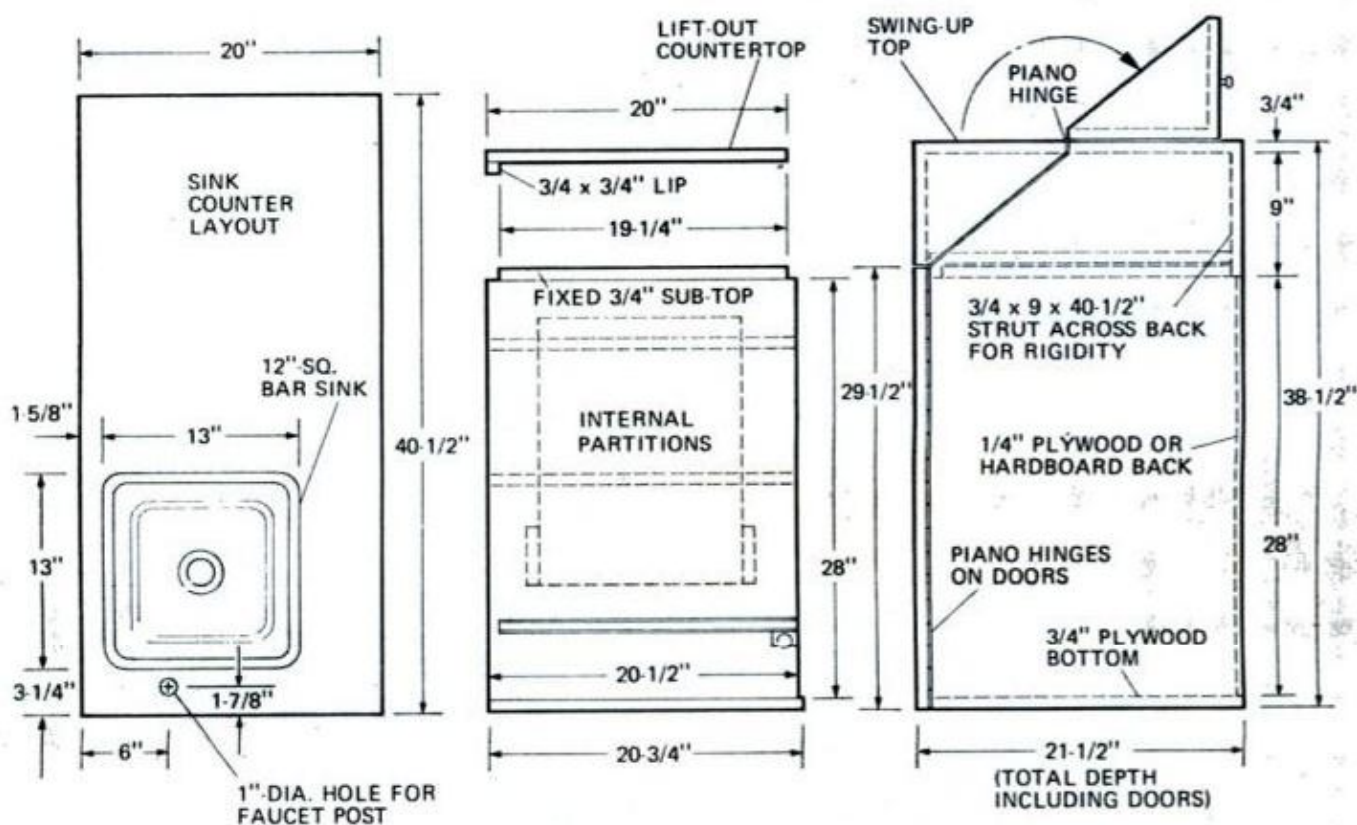



# By Sheldon Gallager

EXECUTIVE EDITOR  
DESIGNED BY THE AUTHOR

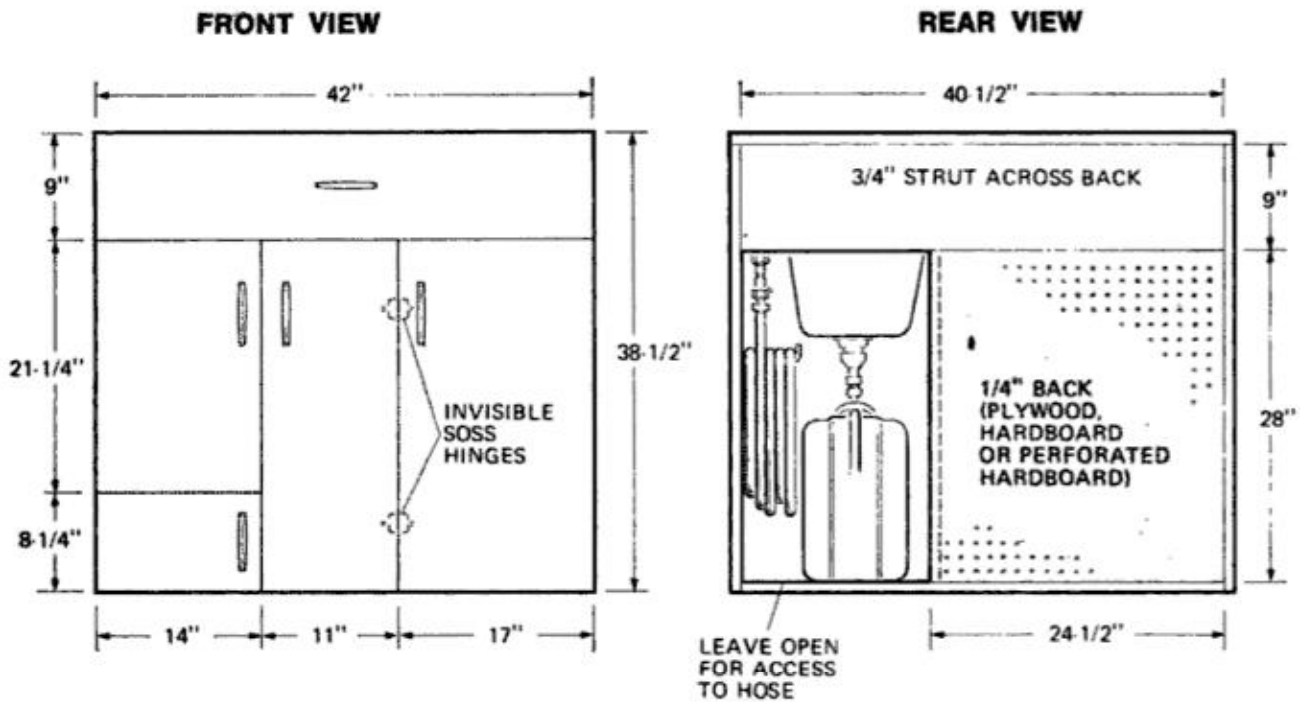

## MOBILE PATIO BAR

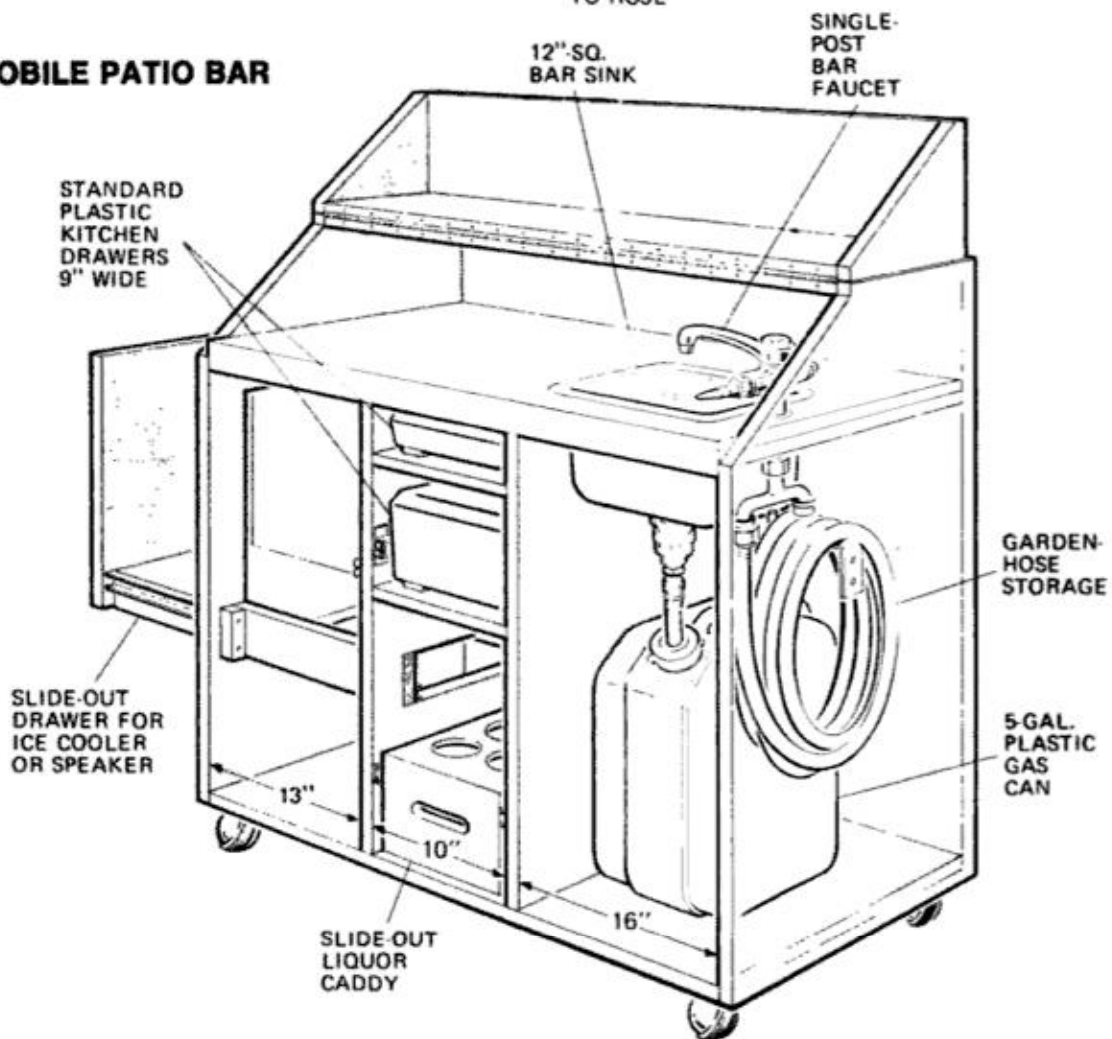



### PORTABLE GLASS CARRIER

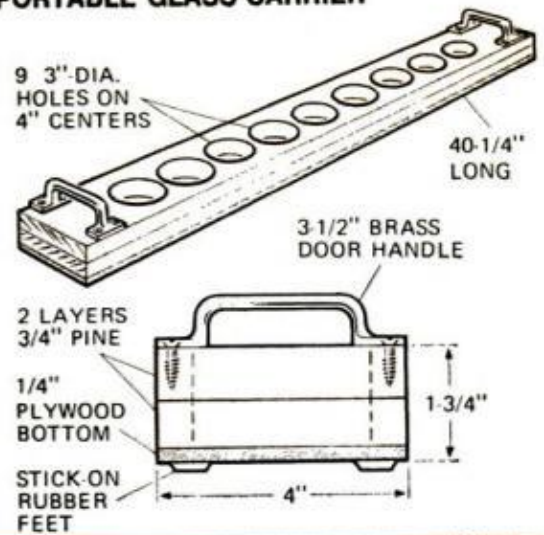

Portable glass carrier stores at rear of counter on lower level, but can be lifted out and placed on upper shelf for easier access when bar is in use. It holds nine short Old-Fashioned-type glasses in holes in rack.

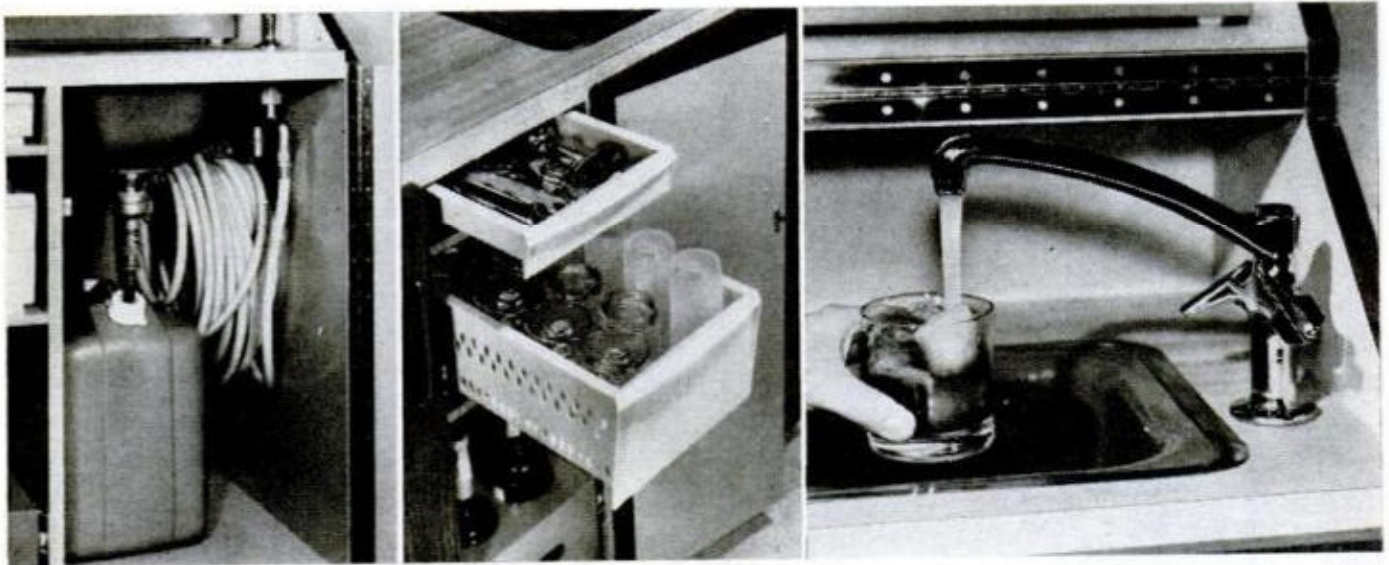

Sink drains into 5-gal. gas can (left, above) used as temporary "holding tank." Water is fed from garden hose stored on hanger alongside tank. The single-post

pantry faucet (right) is smart-looking, has high-mount spigot, making it easy to slip a glass under it. Plastic drawers (center) hold glasses, bar supplies.

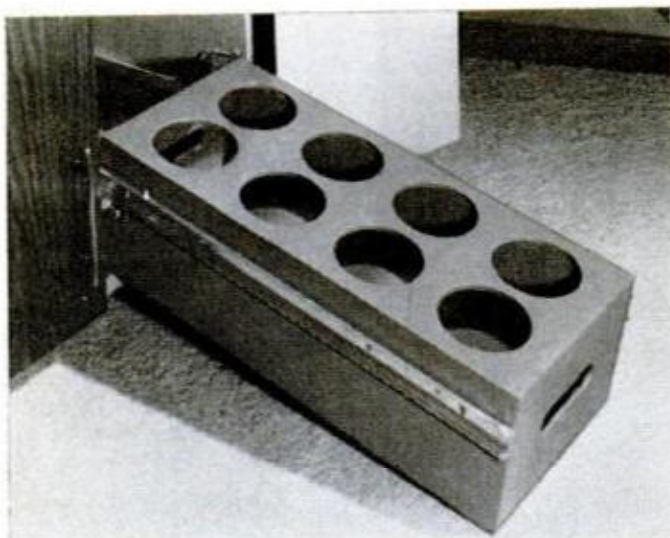

### SLIDE-OUT LIQUOR CADDY

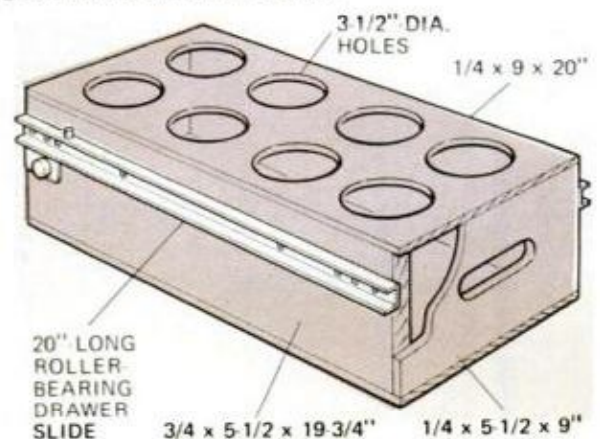

Slide-out liquor caddy is located at bottom of the center section in cart, rolls on standard 20-in.-long metal drawer guides. It is a simple box of 3/4-in.

plywood with 3/4-in. sides. Eight 3 1/2-in.-diameter holes in the top hold most types of liquor bottles and keep them from tipping over when cart is rolled about.

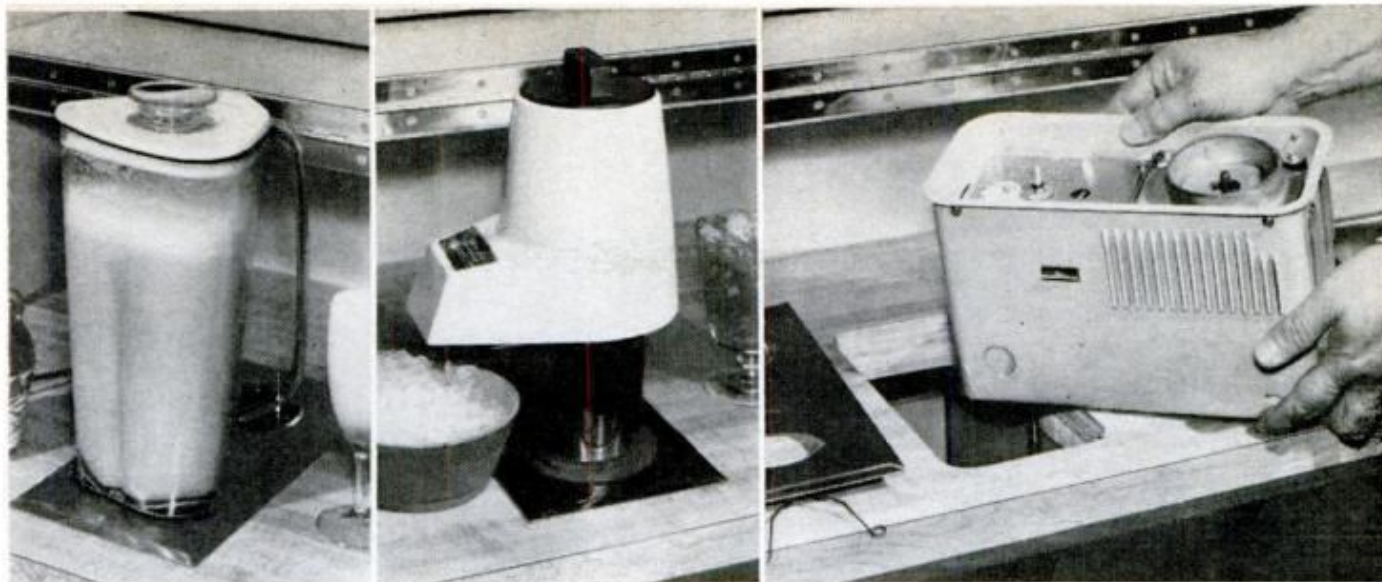

Optional accessory that adds usefulness to bar is NuTone's built-in countertop kitchen-appliance center. Motor unit recesses into counter (right, above), takes snap-in drink blender (left) and ice crusher (center).

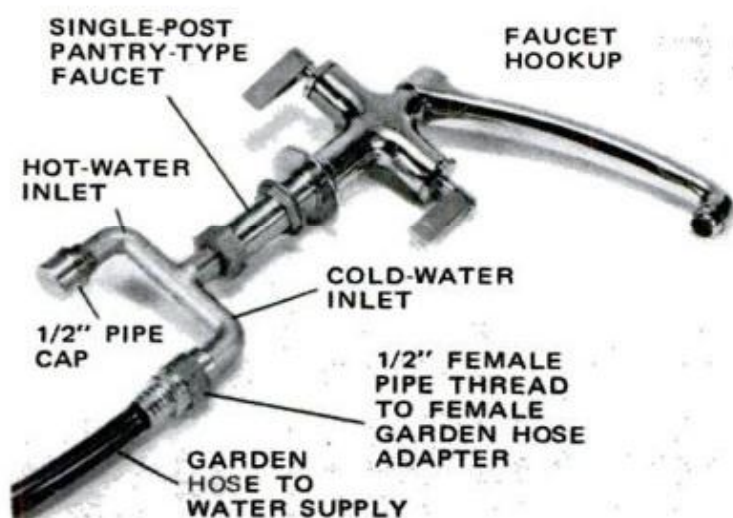

Simple faucet hookup to garden hose is shown above, using pipe-to-hose adapter. Hot-water inlet, unused, is capped off.

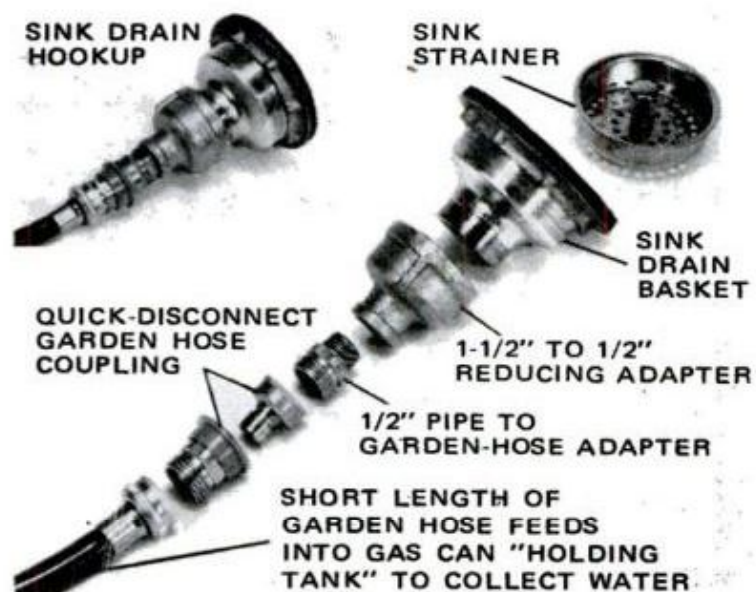

Sink drain requires 1½-to-½-in. pipe reducing adapter, plus garden hose coupling, to feed sink waste into holding tank.

a trim little 12-in.-square Kohler sink with a handsome chrome single-post, pantry-type Kohler faucet. The sink comes in several striking colors—bright red, deep blue, brown and orange. We chose the red, which adds a gay, colorful, festive touch to the maple bartop and walnut exterior. The pantry-type faucet is ideal for bar use because its high-mount spigot is easy to reach under for filling drinks and rinsing glasses. The water hookup is simple—merely a garden hose connected to the faucet's cold-water inlet by means of a hose adapter fitting, as shown in the photo at left. To be sure the hose stays clean, buy a new one and keep it for bar use only—never use one that's been lying around the yard collecting dirt.

Indoors, the hose can be connected to a laundry tub, washing-machine filler pipe or similar water source, or you can make a semipermanent hookup with plastic pipe or copper tubing. Since hot water is rarely needed in a bar, the faucet's hot-water inlet is capped off and not used.

The sink drains into a five-gallon plastic gas can that serves as a "holding tank" like those used in motor homes and campers. The can easily holds the small amount of water used in the course of an evening's party and eliminates the need for complicated waste plumbing. Since nothing really dirty goes into the tank, sanitation isn't a problem. Just remember to empty its contents after each use

### 3. Mobile hi-fi for music outdoors or in



With speaker wings extended (left), you have a complete hi-fi center with good stereo separation. Shown here are



Garrard Zero-100 turntable and Panasonic receiver. Closed (right), unit becomes stylish credenza.

and rinse it out to keep it clean. The can stores in a compartment under the counter and is quickly detached from the sink drain for emptying. Using a slip-type, quick-disconnect hose coupling speeds the job.

Besides the built-in sink, the mobile bar cart offers several other novel features. A hinged top swings up to form an extra serving shelf above the sink counter and closes to conceal the bar when it's not in use. There's a portable glass rack, a slide-out bin to hold an ice cooler at one end and a handy liquor caddy that stores whiskey bottles in neat, partitioned compartments to keep them from spilling when the cart is moved about.

As a companion to the bar, the identically styled mobile music center shown on these pages makes an attractive and useful match mate. Like the bar, it rolls on 3-in. Shepherd casters for use indoors or out, has a similar hinged top to hide its contents when not in use and is finished with the same Butcher-block Maple laminate for the counter and Gunstock Walnut for the exterior. In addition, the inside of the top on both the bar and hi-fi carts is finished with Formica's Harvest Gold laminate or can be painted if you prefer. To tell how these handsome look-alike carts appear in color, see pages 70 and 71. Here they're shown in an outdoor setting on Ozite's colorful, striped Sunnyside Up outdoor car-

#### OUTSIDE END PIECES

(SAME FOR BOTH CARTS)

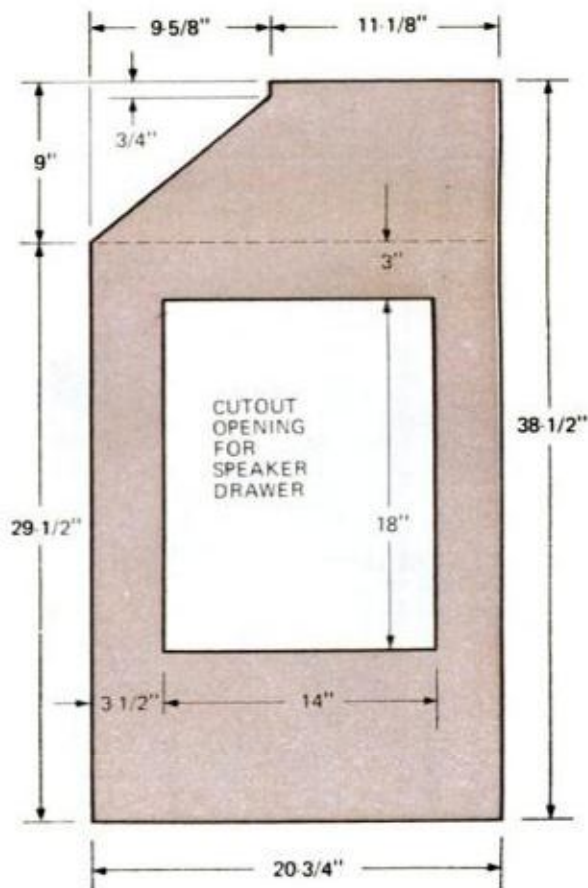

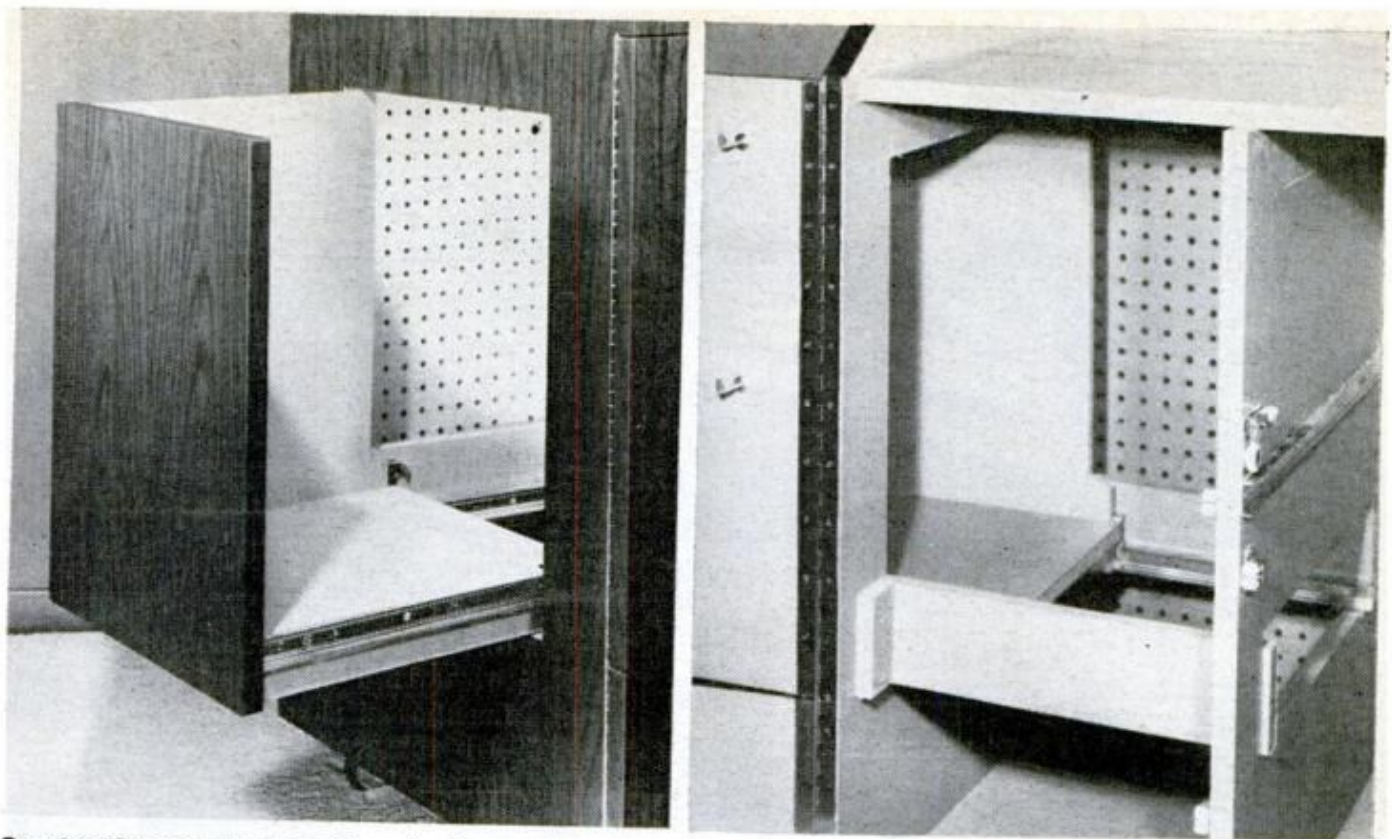

Construction of speaker wings is shown above. Interior view (right) shows how wings slide on standard

14-in. drawer guides held by wood side rails. Rail ends extend through partition for adequate clearance.

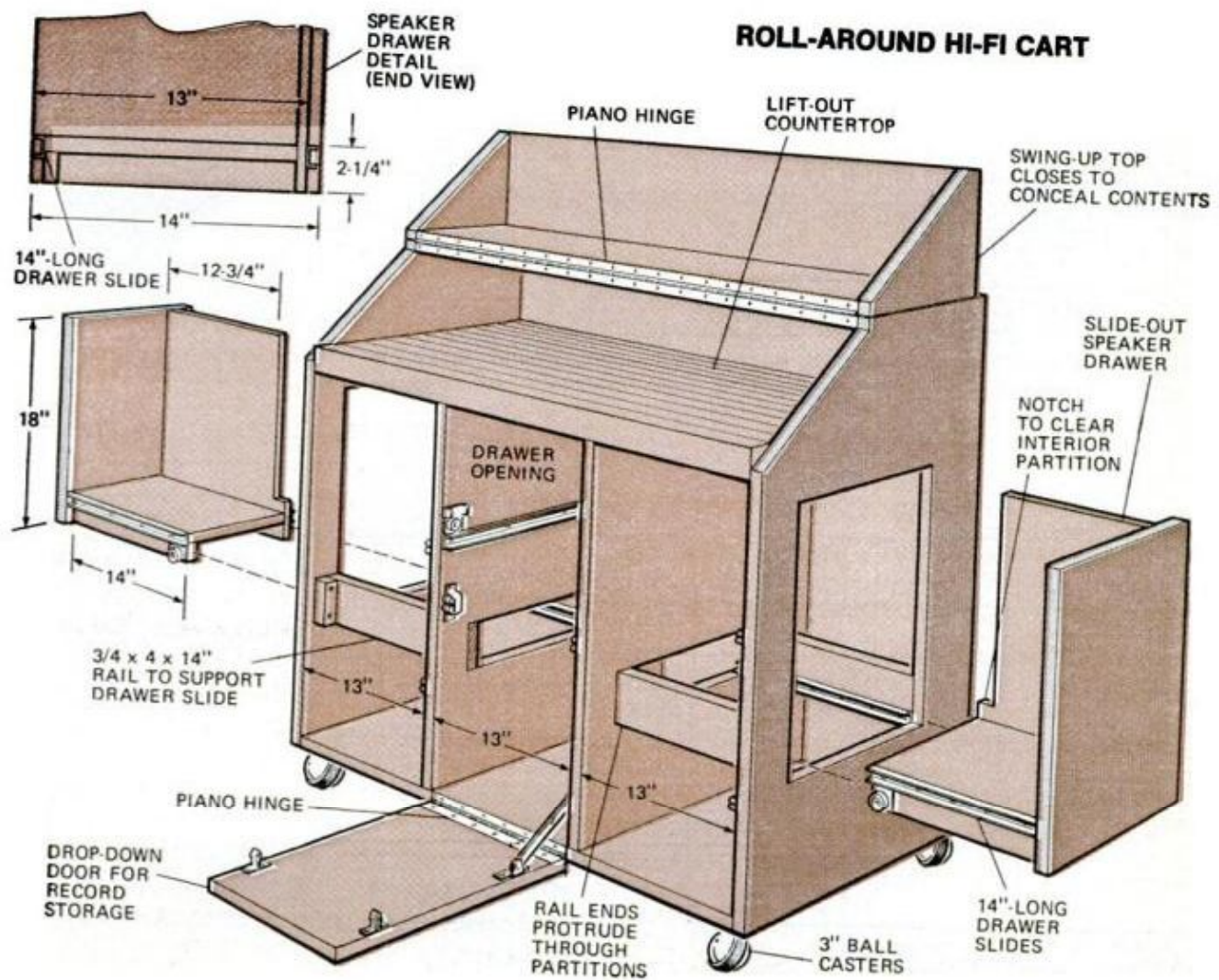

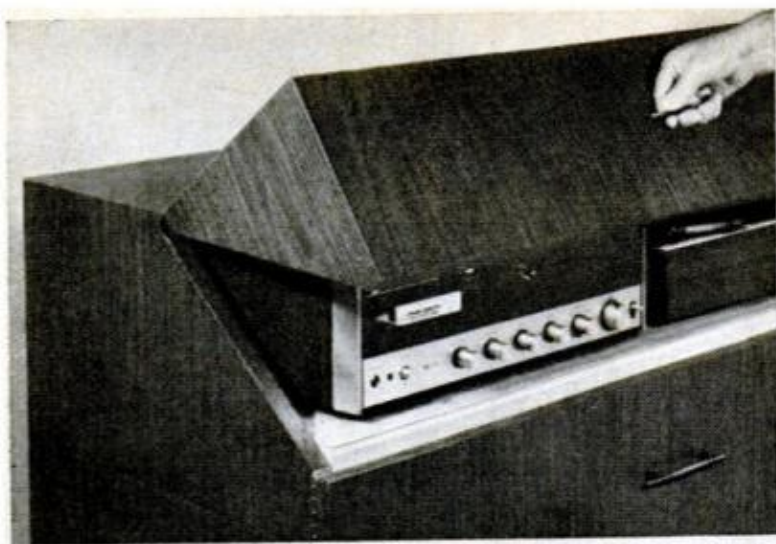

### SWING-UP TOP DETAIL

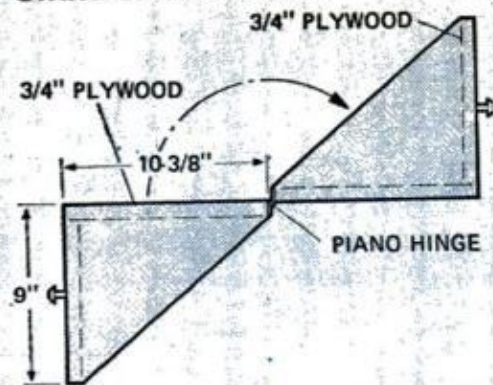

(SAME FOR BOTH BAR AND HI-FI CARTS)

Hinged top swings down to conceal contents when bar or hi-fi cart is not in use. Hinged section is deliberately made  $\frac{3}{4}$  in. shallower than rear half so that handle won't hit wall when top is swung back in open position.

### SLIDE-OUT HI-FI DRAWER

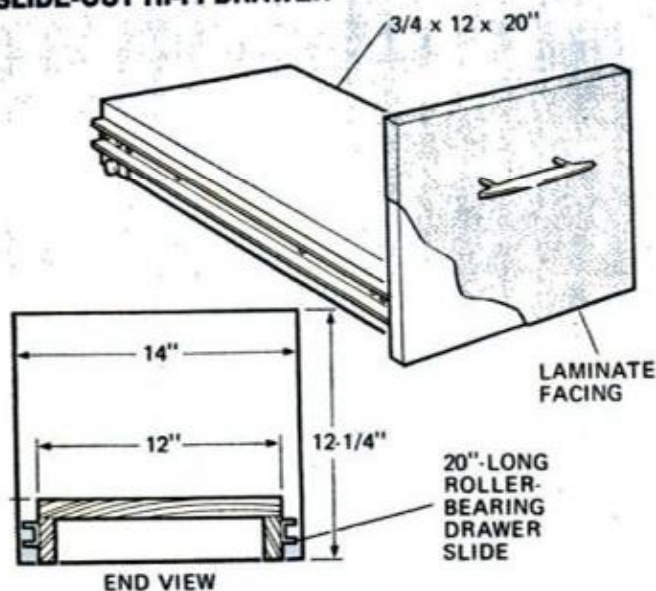

Slide-out drawer in music cart holds additional hi-fi equipment that won't fit on upper counter—here, a Panasonic cassette deck. It rolls on standard metal drawer guides, can also house slide projector set to go.

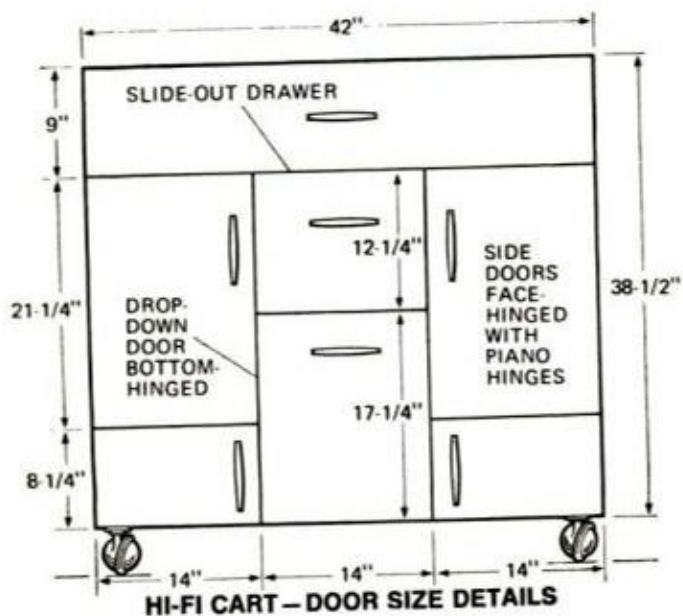

HI-FI CART - DOOR SIZE DETAILS

peting—an ideal covering for a deck or patio.

The music cart stows everything you need for a complete hi-fi system on wheels. There's room on the counter for both a receiver and record player or similar equipment, and a drawer pulls out from underneath to hold additional gear such as a cassette deck, tape recorder or slide projector. Twin speaker wings pull out from the ends for good stereo separation, then slide back in out of the way when they're not in use. There's also plenty of space for storing records, tapes and other supplies in drawers and compartments at the base of the cart.

To simplify construction, ready-made

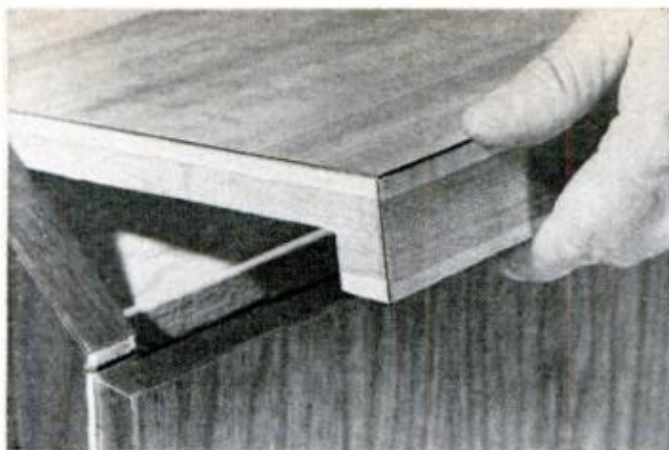

**Lift-out countertop** is removable for easy cleaning. Note self-edged front lip for thick, rich appearance.



**Drawers under speakers** store tapes, other hi-fi supplies. Door backs are handy for hanging headphones.

plastic drawers are used in several places in both the bar and music carts. These are the type made by Rubbermaid for kitchen use and are readily available in hardware and variety stores. They come in stock 9 and 12-in. widths for several dollars apiece. The carts' dimensions have been carefully worked out to accommodate these standard sizes. There's provision for two 12-in. drawers at the bottom of the hi-fi unit and one in the bar cart under the ice cooler. The bar also takes two 9-in. sizes in its center compartment for bar utensils, cocktail glasses and other supplies.

The bar and hi-fi carts are identical in construction except for the arrangement of their internal compartments. Each is 42 in.



**Record-storage compartment** has drop-down door that doubles as convenient shelf for sorting selections.

long, 21½ in. deep and 42 in. high. The basic parts are all of ¾-in. plywood with lighter ¼-in. material for the backs, either plywood or hardboard. Note that the countertop in each is actually double-thick. There's a fixed sub-top to give the cart rigidity. On top of this is a separate lift-out counter board that can be removed for easy cleaning or for replacing should the board become marred or you wish to change to a new color scheme. This lift-out top has a ¾-in.-square strip tacked across its front edge to form a 1½-in. deep lip. The lip is self-edged in the same Butcherblock Maple laminate as the top surface, giving the counter the thick, rich appearance of a real chopping block. For tips on applying the laminate, see the section on building the mobile cooking center.

The dimensions shown here are for the wood parts alone and do not take in account the extra thickness of the plastic laminate. This is done for the convenience of those who may prefer to give the carts a natural-wood or painted finish, omitting the laminate. If you decide to apply the laminate facings, slight adjustments must be made in a few of the dimensions to allow for their ¼-in. thickness. With one exception, the doors and swing-up tops are all face-attached with full-length piano hinges, elimi-

*(Please turn to page 182)*

# How to build retaining walls

Though a sloped piece of ground is often attractive, just as frequently it is a homeowner's headache. Water and wind erosion can raise havoc with the land and, though seeding may solve the problem, it creates another: The resulting growth is hard to maintain. In most cases, a retaining wall—if properly built—is the answer.

One important point to keep in mind: Water trapped behind a retaining wall will cause damage by freezing. Thus, you will need good drainage, such as that provided

by laying perforated drain tiles alongside the base of the inside wall as shown. Though drain tiles are desirable behind a dry (stone or tie) wall, they are a *must* behind masonry walls. Tiles should be pitched about  $\frac{1}{4}$  in. per lineal foot and lead to a dry well (or should be elbowed out through the earth at the end of the wall). You should also cover the tiles with at least 1 ft. of coarse gravel. Any moisture will then flow along the asphalted wall and be picked up by the tiles.

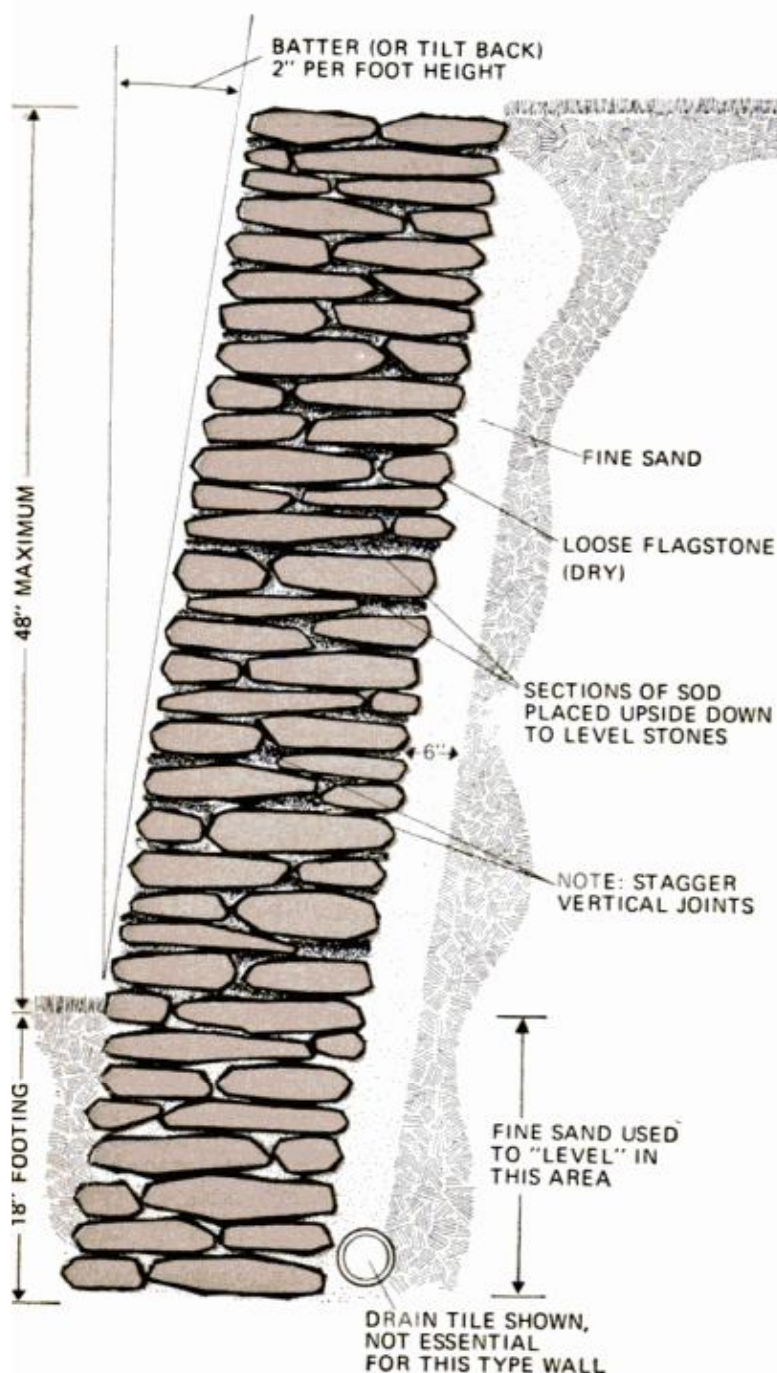

## Dry stone walls

A loose or "dry" wall of stone or flagstone is easiest to build, but this type must not be used when a height of more than 4 ft. is required. Its porosity will give such a wall some protection from the heaving and settling that's caused by weather changes, but it still should have a dry footing (sand) at least 18 in. deep.

Once the location has been determined, dig a trench 18 in. deep by 18 in. wide. Start laying the stone in place, taking care to see that adjacent stones are nearly the same thickness. Where there is an uneven thickness of stones in the footing, this may be leveled with an inch or two of fine sand. When you start the next course above, be sure to place the stones so that joints are staggered—solid stone above each joint in the course below—to "lock" the wall together.

After laying the footing, backfill and tamp behind each course as it is laid above the base grade; backfilling later could make the wall buckle. To level stones above grade, place sections of sod on them, upside down. Roots of the sod will hold the earth in place until settling is complete, also facilitate planting of vines or creepers in the finished wall. The wall should tilt back to get a finished face batter (rake) of about 2 in. for each foot of wall height—about 8 in. for a 4-ft. wall. A dry wall may taper to a minimum thickness of 12 in. at the top, but since an 18-in.-thick wall is stronger, it's recommended.



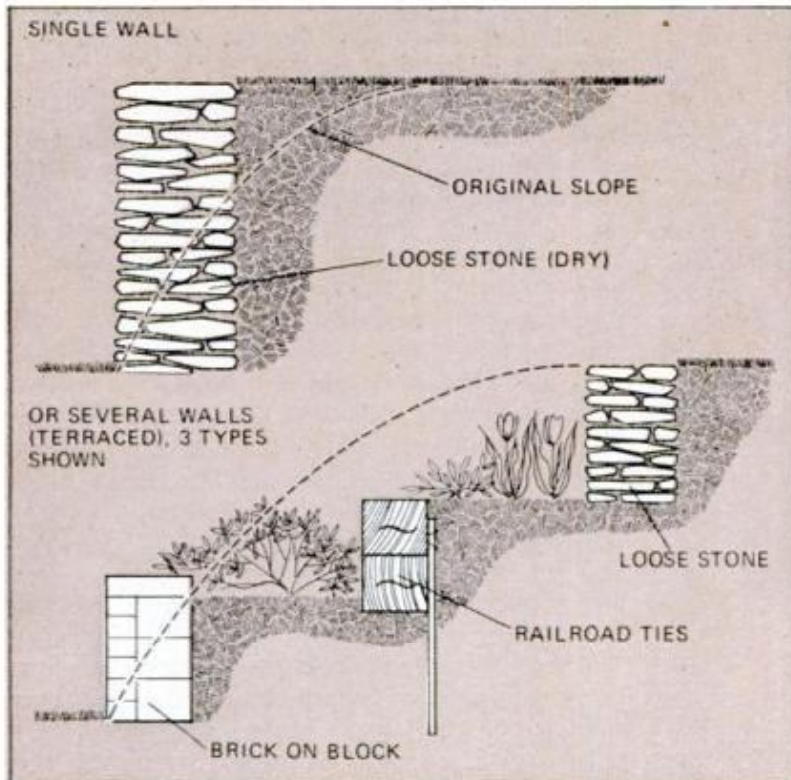

### Terracing alternative

The higher the wall, the more complicated and more difficult it will be to construct it. Especially for a greater drop, you may want to consider the alternative of "stepping" or terracing the slope with two or more smaller walls. These may be of different types, as shown in the drawing at left, or all the same.

To avoid the nuisance of having to mow grass on the steps, ornamental planting is suggested. Height of the walls and depth of the terraces will, of course, depend on the original slope of the land, and you must have enough horizontal space to step a given height or you will have to build a higher wall. As a rule of thumb, the depth of each terrace must be at least equal to the height of the wall below it; otherwise, the condition will be the same as that of a single wall that has been built too high and not strong enough.

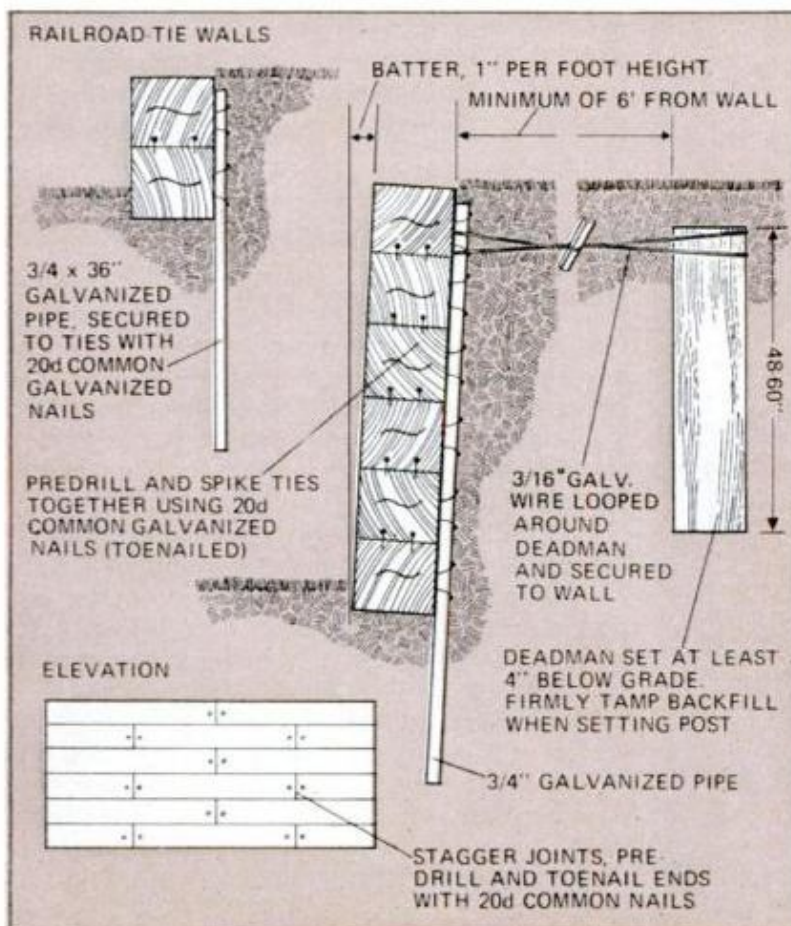

### Railroad-tie walls

A retaining wall made of used railroad ties is nearly as easy to erect as a dry stone wall. While the footing required is not as deep, hauling and placing ties—weighing about 210 lbs. each—will require help. Ties up to three tiers high can be stacked, if joints are staggered, with only a leveled trench 6 in. deep for a footing. A section of  $\frac{3}{4}$ -in. galvanized pipe, driven at least 18 in. into the earth and clinched to the ties with 20d galvanized common nails, will hold them.

Walls higher than three tiers should employ "deadmen" in addition to pipe support. A deadman is a device driven into the ground away from the wall (usually about 6 ft. back) and tied to it to help it resist outward earth pressure. A section of tie in a post hole is ideal as its width will keep it from cutting into the soil. You can also use galvanized pipe of at least  $1\frac{1}{2}$ -in. diameter driven into the earth. Either type deadman is fastened to the tie-pipe on the wall with several turns of  $\frac{3}{16}$ -in. galvanized tie-wire, tightened like a tourniquet.

For construction of retaining walls greater than 4 ft. high, see page 89.

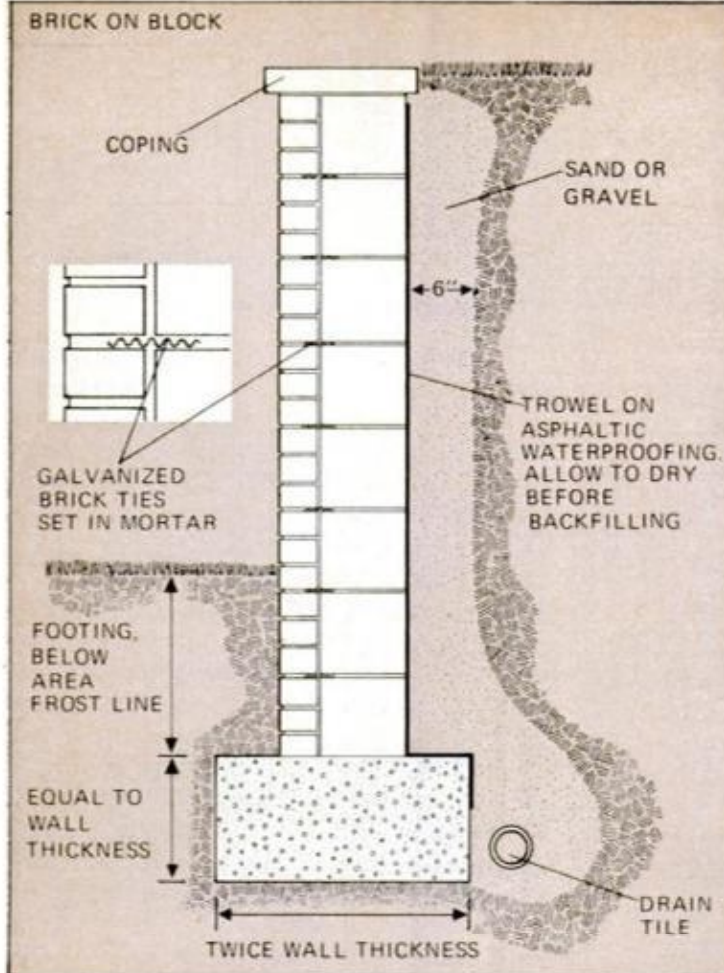

## Brick-on-masonry wall

A wall of concrete block with a brick facing is easier to build than one of poured concrete but, like the walls on the preceding pages, it should be no higher than 4 ft. It can be built in three stages—footing, block and brick. Determine its location and dig the footing of a width equal to twice the wall thickness at its base and a depth equal to the wall thickness. The bottom of the footing must be below the frost line in your area.

Pour the footing (see *How to Lay Out and Pour Concrete Slabs*, page 92); a rented mixer or ready-mix concrete is a must for this operation. Level top of footing with shovel or board; do not trowel. The next day, start laying the blocks. Mortar mix is 1 part cement, about 1 part lime and 4 to 6 parts fine mason's sand. Commercial mixes are available, but cost more than making your own. After mixing mortar with just enough water to make it workable, butter footing for a distance of about three blocks. Butter the ends of the blocks and set them in place. Level by tapping with a board and hammer; trowel excess mortar off joints. Continue for the length and height of the wall. For maximum strength, insert galvanized brick ties spaced 3 ft. apart into mortar to hold the brick facing (veneer).

When the block backup is complete, lay brick similarly, inserting brick ties in corresponding joints. Dress joints with  $\frac{3}{8}$ -in. dowel before they set. For best appearance, you may want to have a professional lay the brick. Coping or a cap is necessary to keep water out and prevent freezing damage. This may be of stone or flagstone, or brick laid in a soldier course, ends facing outward. Block should be coated on the earth side with a thick layer of asphaltic mix, and drain tile set before backfilling.

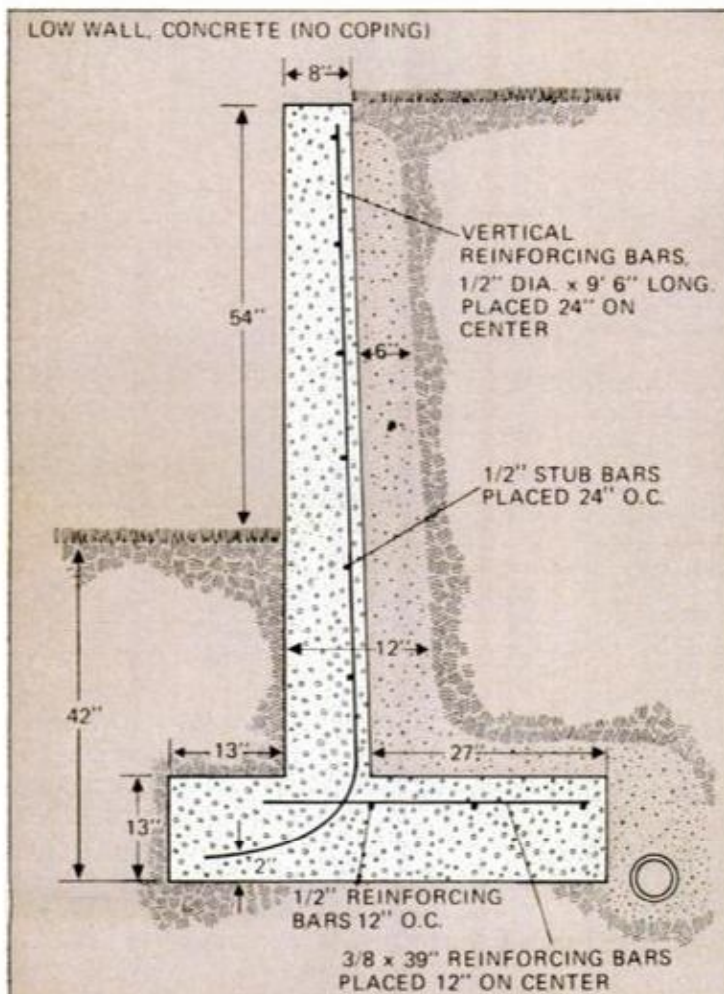

## Reinforced concrete wall

Few homeowners will want to take on the engineering and other work required for this type of wall. But if you should be contemplating having a reinforced concrete wall built, an understanding of the design principles is an important consideration.

The footing used here is an integral part of the wall and is tied to it by steel reinforcing bars. The "head" (weight) of earth behind the wall on the footing determines its size. If a contractor should tell you that a wall of this type is "no problem," watch out.

If a reinforced concrete wall is a must for you, it will be worth the \$75 to \$100 fee you would pay to have an engineer check your contractor's drawings. The engineer's fee will generally turn out to be only a very small portion of the total cost of a reinforced concrete retaining wall.

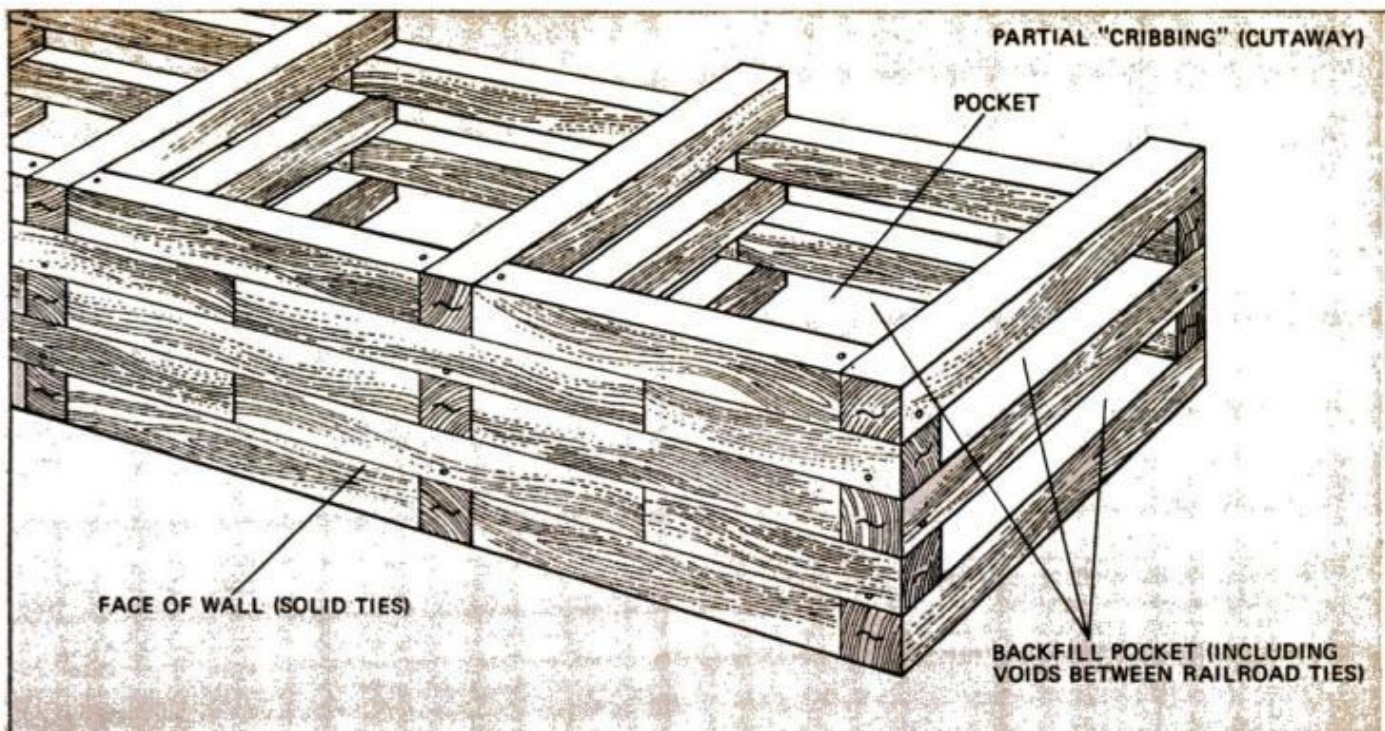

### Cribbing with railroad ties

If you need a retaining wall higher than 4 ft. and want to build it yourself, the method to use is called "cribbing" railroad ties. The job will be a lot of work, and you should allow plenty of time for it, but the result will be a self-draining wall of great thickness and strength. Essentially the construction of a series of boxes, cribbing requires cutting, predrilling and spiking of ties, as well as the moving of a large amount of earth. *Caution:* Railroad ties are "pressure-treated"—

creosoted clear through the wood—so be sure to wear goggles while cutting them (using a two-man saw or portable circular saw with coarse-set or rip blade). Face of the wall is solid, with joints staggered. Holes are predrilled and ties spiked together by toenailing with 20d galvanized common nails. Then the pocket is backfilled. Earth in the pocket acts structurally as part of wall; voids between ties allow for drainage through sides, reducing pressure on face of the wall.

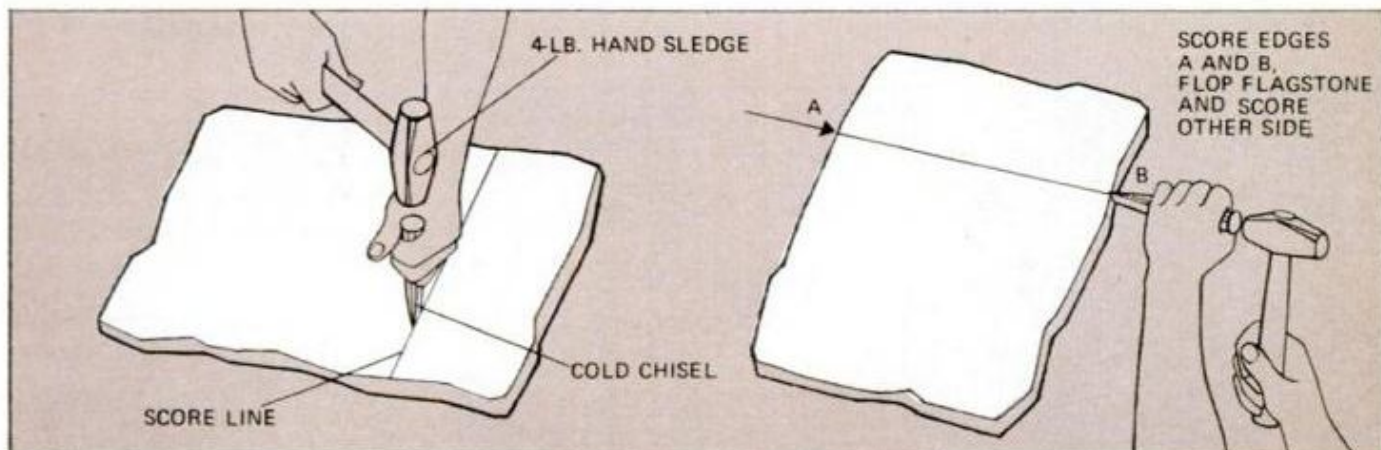

### Cutting stones

When you have to cut a piece of flagstone or fieldstone to get a straight edge to lay, use a cold chisel and hammer or mallet (hand sledge). First score a guideline on both flat sides of the stone, then nick the edges about  $\frac{1}{8}$  in. deep to join the score marks on the flat surfaces. Then lay the stone on the ground to nick the scoring on the flat sides, also to a depth of  $\frac{1}{8}$  in. When the scoring has been deepened on all four sides, continue

tapping, but now with harder blows. Go all the way around, working from the middle of each side outward toward the edges, until the stone breaks along the score.

Done correctly, this entire operation should take about five minutes. Object of the scoring is to make the break occur where you want it; otherwise, efforts with hammer and chisel are almost bound to result in a fractured, useless stone. ★★

# How to repair aluminum storms and screens

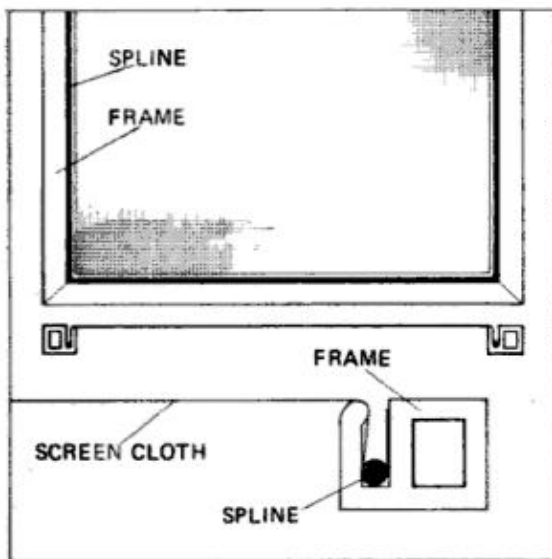

## 1. Typical aluminum screen

The screen cloth is secured by a plastic spline in frame groove. Replacing a torn window screen is simple if proper technique and tools are used. Begin by locating the ends of the spline in groove, lift them with an awl or screwdriver blade and pull the spline out of groove on all four sides of the frame. If the spline breaks, it must be replaced. In that event, save a sample of the old spline in order to purchase the correct size for replacement (it's sold in most hardware stores).

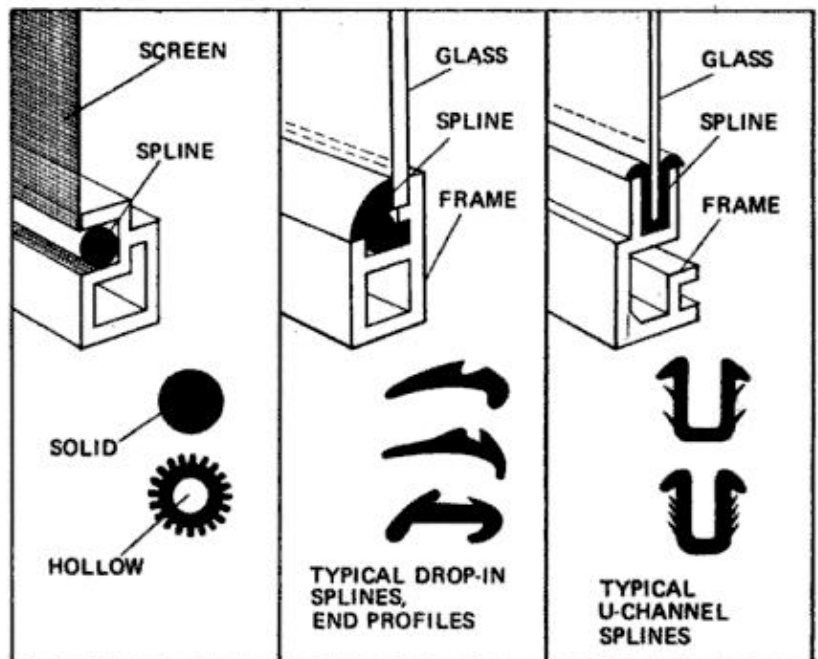

## 2. Splines for aluminum storms and screens

Splines are made in a variety of shapes. At left above are round splines, solid or hollow, used to secure screens to frames. There are two kinds of storm-sash frame, each with its own type of spline. Drop-in type, center, is easier to handle as it does not require disassembly of frame for re-glazing. Take-apart type, right, using U-channel splines, must be disassembled. Frame and spline designs vary considerably, depending upon the maker, but correct spline shape and size is usually available by the package or roll.

## 3. Reinstalling screen wire

Push old screen out from back of frame. Measure outside length and width of frame and cut new screen at least 2 in. oversize in all directions. Holding screen down on frame, use installation tool's convex roller to force screen into groove with five or six passes—don't try it with one pass or screen will rip. Place spline on groove, force it in place with concave roller. Turn frame, repeat on opposite side, pulling screen tight and working convex roller down and to outside of frame. If frame bows, start over with new screen. If not, place spline with concave roller. Screen should now feel tight. Using scissors, make V-cuts in screen at corners to relieve tension; then finish last two sides in same way.

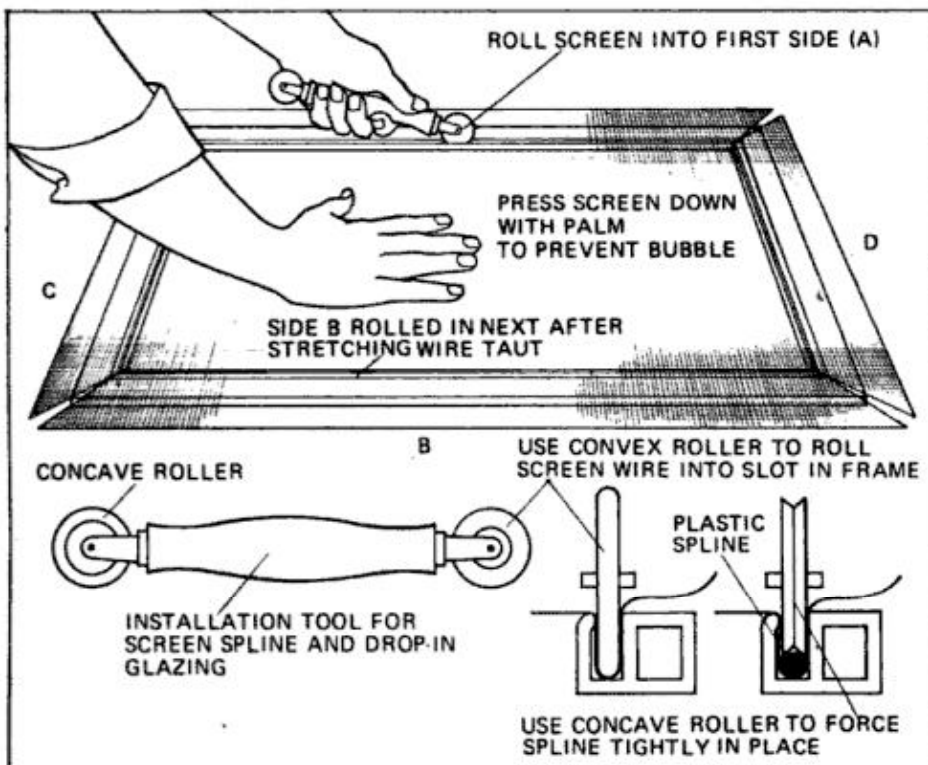

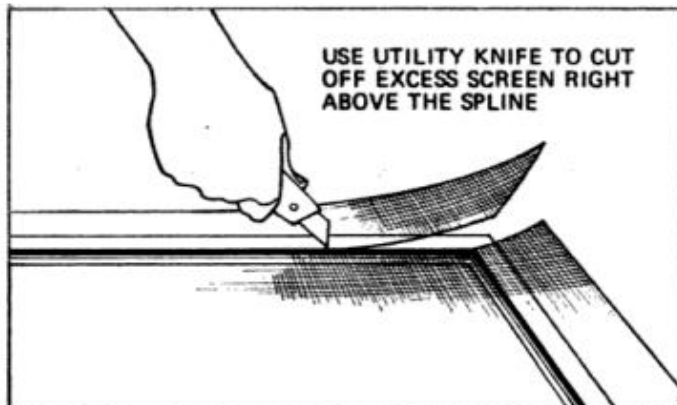

#### 4. Trimming the wire

After screen has been grooved and locked in with spline on all four sides, insert tip of utility knife just above spline in groove's outer side. Hold frame and run knife along inside edge. Excess screen can now be pulled away and discarded. Take care when cutting to avoid splines.

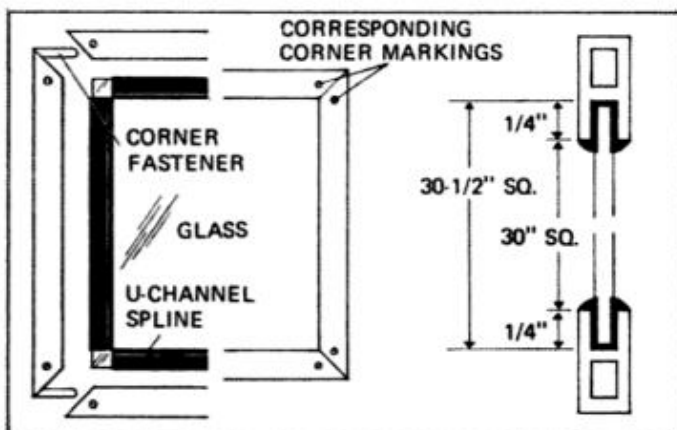

#### 6. Assuring accurate reassembly

6. Take-apart frame, above, should be match-marked at three corners to assure accurate reassembly. For width and height of frame for glass, take distances between opposite U-channel bottoms. Be sure to allow (subtract) for the spline. Fit U-channel spline over all four edges of the pane. Then, using a wood or plastic mallet, gently tap a section of the frame—one without corner fasteners—into place over the spline on the glass edge. Repeat on opposite edge, then line up frame sections to which corner fasteners are attached with corresponding holes on first two sides. After gently tapping frame together, replace corner assembly screws or clips (sketch right).

#### 7. For smooth operation

Keep window tracks clean and spray with silicone lubricant. Mild cleaner and water will remove discoloration; avoid abrasives.

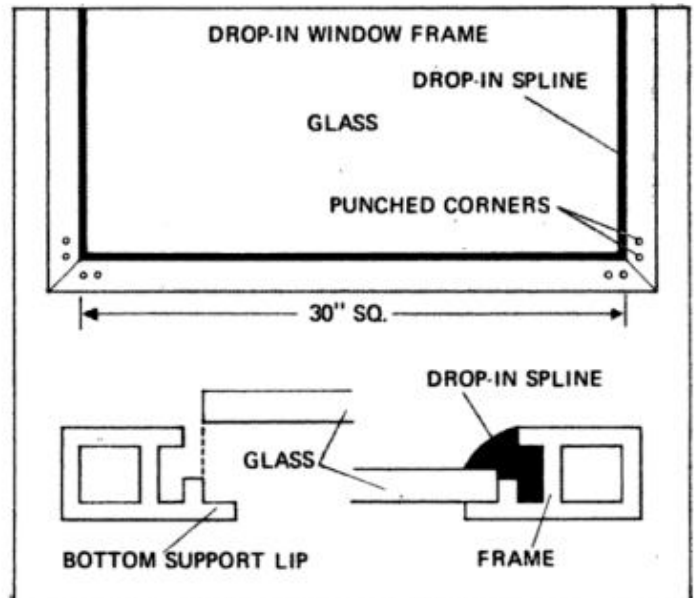

#### 5. Reglazing aluminum storm sash

Replacement of glass in aluminum storm sash requires precaution of wearing gloves and safety goggles. To remove glued-in glass, brush the pieces with paint remover; save a scrap piece to assure you buy the right thickness for your replacement pane. Frame above, a drop-in type, does not come apart. Measure inside dimensions including support lips. Cut window glass to size and carefully lay it inside the frame so that it rests on the lips. Insert drop-in spline by laying it on the window beveled side up and pushing it into the frame with your fingers. Repeat the procedure for the other three sides and the window is finished. Here, too, if old spline breaks, replace it.

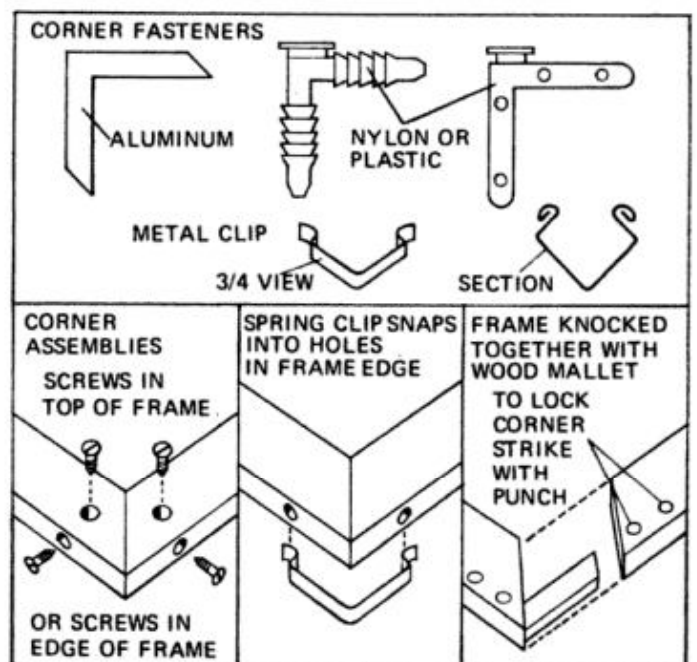

# How to lay out and pour concrete slabs

Make no mistake about it, plenty of hard work is involved in pouring concrete yourself. But there is an immediate reward; one you can see in your wallet. For example, recent rates in the New York area for a 4-in. slab, with footings, were about \$5.50 per sq. ft. when done by a professional. Do the job yourself and your cost will be closer to \$1.50 per sq. ft. But if you don't do the job right, you may have to live with a

cracked or heaving slab or drainage problems—that could require breaking up the slab into rubble and starting over. Use the professional know-how on these and the following two pages and your savings will be permanent.

For small jobs you'll find it most economical to buy the sand, aggregate (gravel) and cement and mix them yourself—by hand or with a rented cement mixer. Or you

INDEPENDENT CONCRETE FLOOR SLAB AND BLOCK FOUNDATION WALL

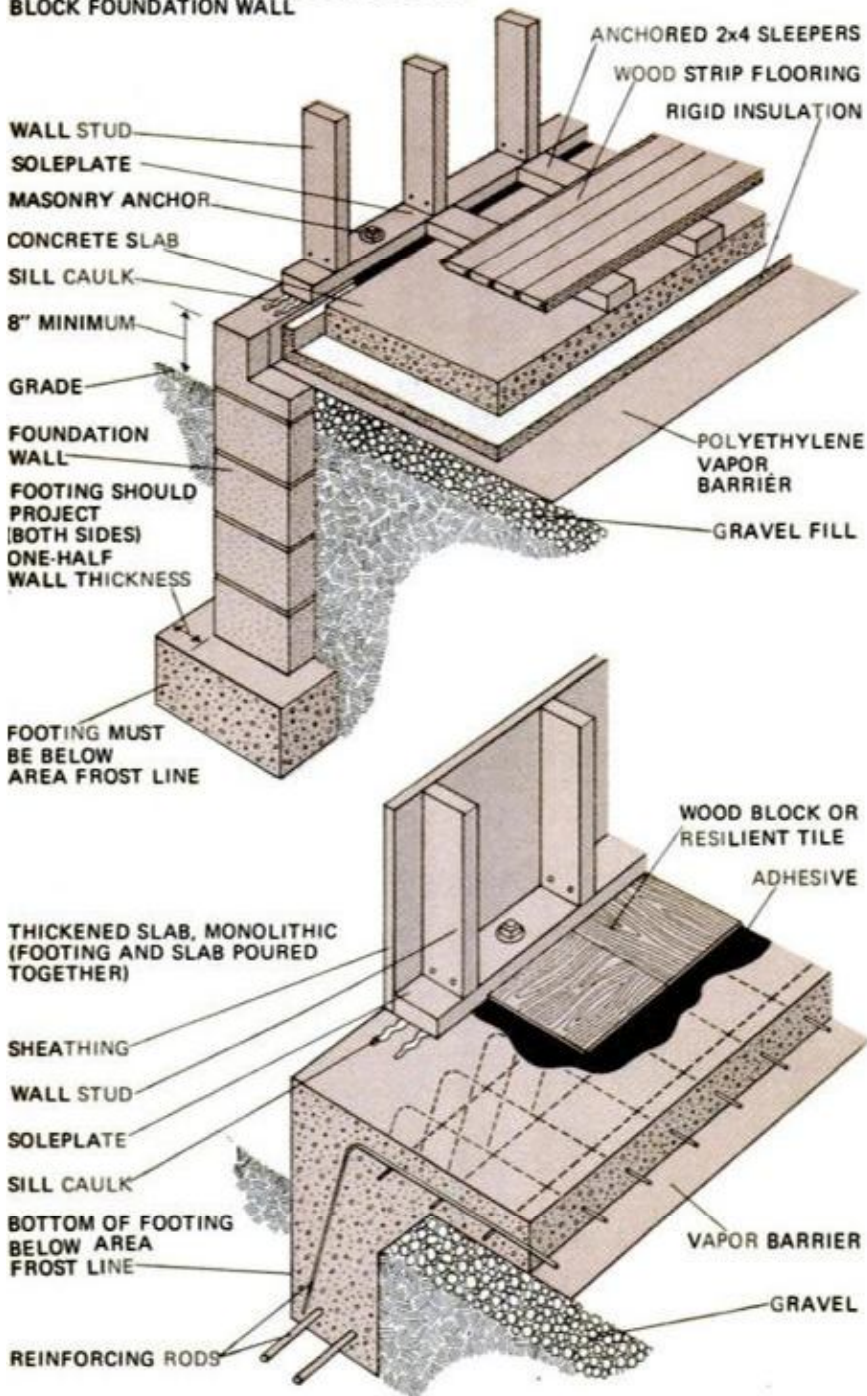

## Typical slab construction

Thickened-edge, monolithic slab-and-footing combinations are recommended for patios, with or without a roof structure or bearing wall above. Independent footings, foundation walls and slabs are the better way when an enclosed structure will be built over the slab; this allows for placing of perimeter insulation and vapor barrier in stages between pours. The bottom of the footing always must be below the area frost line.

Several basic construction rules should be adhered to throughout any job: First, never refill the excavation or trench with dirt if you've dug too deep—pour extra concrete instead. Second, most footings should be a minimum of 12 in. deep, and twice the width of the foundation-wall thickness. For example, for a wall built of 8-in. block, footings should be 16 in. wide, projecting 4 in. to either side of the wall. Third, if the soil is of a low load-bearing capacity, you may find it will be necessary to construct wider and reinforced footings.

"Load bearing capacity" refers to all the weight that will be imposed on each lineal foot of perimeter area (footing area) by the structure above, the live weight it will carry and the snow load on the roof. As all soil has a maximum bearing capacity in tons per sq. ft., it is an important factor in footing design. Imagine standing on a 1-ft.-square piece of plywood on dry beach sand, and then trying the same thing in a marsh—the plywood has to be a lot bigger or you'll sink. Your local building department can provide general information on soil load-bearing capacity in your area. If any question remains about your property in particular, you can have a qualified engineer (P.E.) check it for you.

DATA BY JOHN GAYNOR

can use a commercially prepared mix sold by the bag. But for the big jobs—a driveway, for example—your best bet is to buy ready-mixed concrete.

The best time to pour is when the temperature is between 40° and 85° F. Cold-weather pouring adds so many complications the homeowner should avoid it. In hot, dry weather, subgrade and forms should be dampened. If it rains on the day you've

planned to place concrete, reschedule the job. If you want to color your concrete, use mineral-oxide pigment; it's sold in several colors at most paint and hardware stores. Mix it with sand before combining ingredients. Pigment used should never be more than 10 percent, by weight, of the cement used; otherwise it will weaken the slab. Colored ready-mix concrete is available, but usually only in large quantities.

ILLUSTRATIONS BY ADOLPH BROTMAN

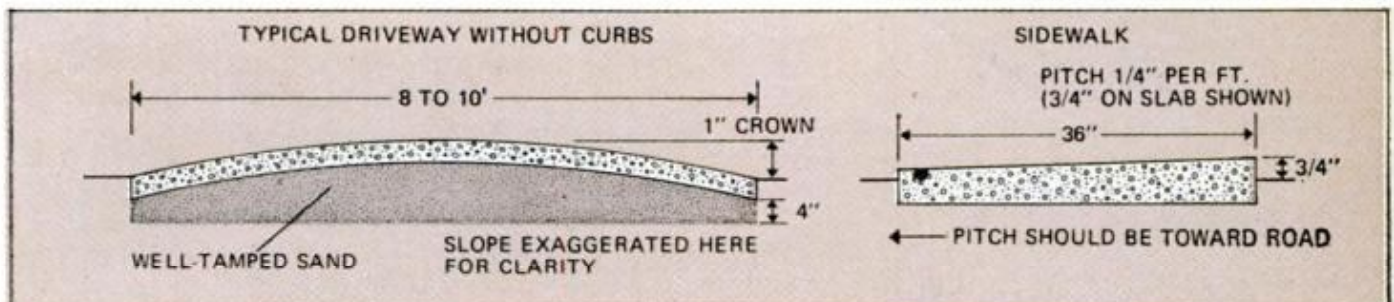

### Typical slabs for driveway and sidewalk

Each slab shown above is pitched for positive water runoff. A typical driveway (left), 8 to 10 ft. wide, has a 1-in. crown at the center and a pitch of 1/4 in. per foot along its length to divert rainwater. A sidewalk from edge to edge is also

pitched 1/4 in. per foot (right)—its low side toward the street, not your property. Driveway slab thickness should be 5 in. minimum; for heavy duty, pour 6-in. slab and use steel-mesh reinforcing. Typical sidewalk slab is 4 in. thick.

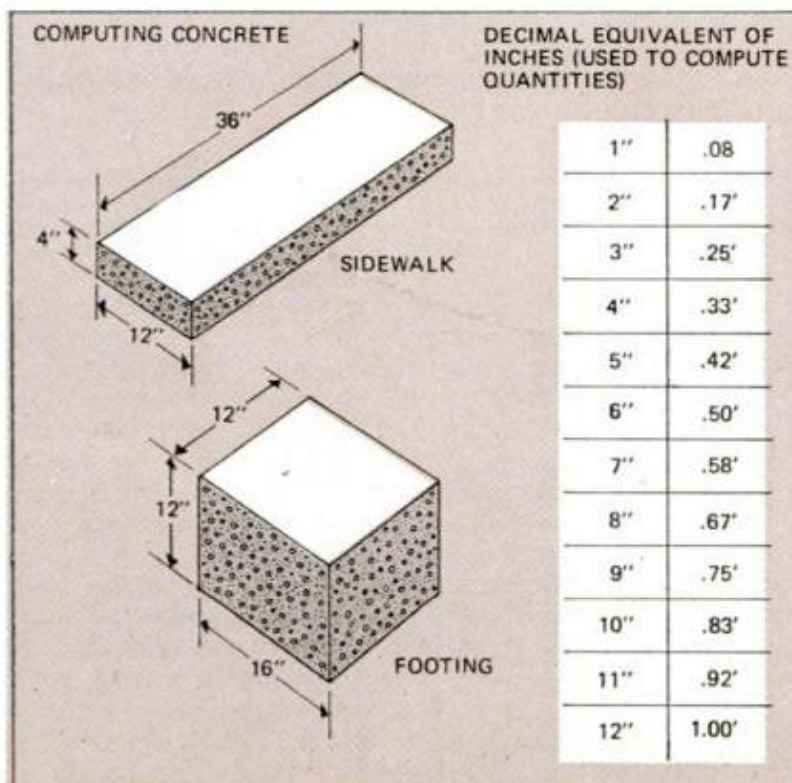

### Computing quantities

Ready-mix concrete is sold by the cubic yard; 1 cu. yd. is usually the minimum order. To compute the amount you will need, you must find the cubic footage of the slab to be poured, then convert this figure to cubic yards. Multiply length by width by thickness in feet, then divide by 27. Decimal equivalents of inches make the calculation easier.

Sidewalk slab, 4 x 12 x 36 in.:

$$\frac{0.33 \times 1 \times 3}{27} = 0.037 \text{ cu. yd.}$$

Section of footing, 12 x 12 x 16 in.

$$\frac{1 \times 1 \times 1.33}{27} = 0.049 \text{ cu. yd.}$$

Thus, if your run (lineal footage) of this footing were 20 ft., you would need about 1 cu. yd. of concrete.

It is good practice to add about 5 percent for waste to your estimate—roughly, 1 cu. yd. for each 20.

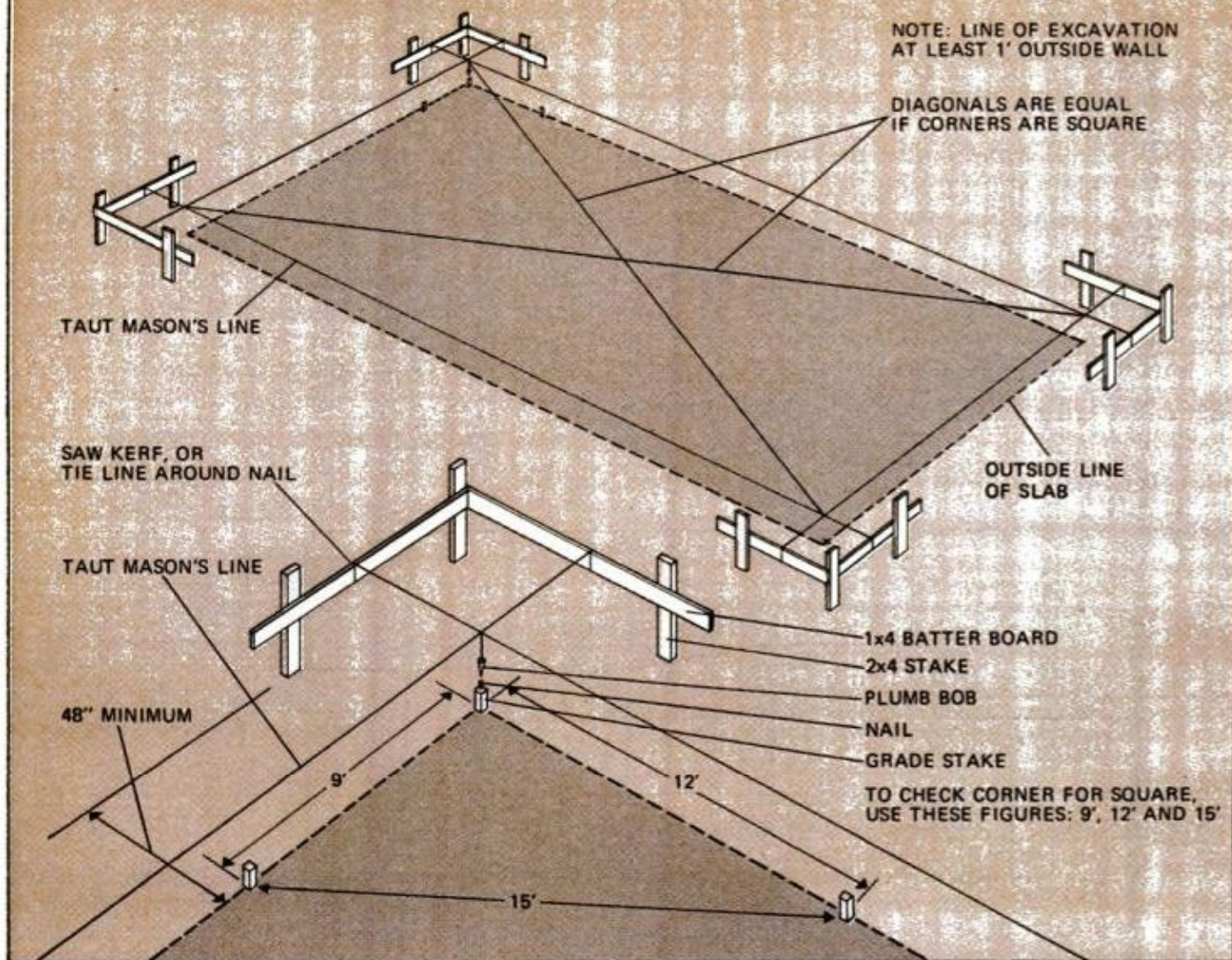

### How to lay out a slab with square corners

To lay a slab, you must locate a grade stake accurately at each corner. Each way shown above will give precise, square corners. Batter boards (on firmly anchored stakes) should be leveled one to the next. Use plumb bob, or 20d nail or larger, to

set grade nails at corners. Fix mason's line to saw kerfs in batter boards or use common nails so line can be repositioned if disturbed. Allow for form width when excavating; tamp ground—below footing—before pouring.

### Water use important when mixing and pouring concrete

Water content of concrete is extremely important. For a strong mix, water should not exceed 6 gal. per full sack (94 lb.) of cement. Use clean water only—as a rule of thumb, if you can drink it, you can use it for concrete. Add just enough to make the mix workable. Although too much water makes pouring easy it also keeps cement from adhering to the aggregate. The result of such a pour will be a weak slab.

For most homeowner jobs, a mix ratio of cement to fine aggregate (sand) to coarse aggregate (gravel) of 1, 2 and 3 is best. Ready-mix concrete may not offer you a choice of ratios, and the mix may have to be varied with the size of gravel—measured by the maximum diameter of the pieces of stone—locally available. Coarse aggregate with a maximum size of 2 in. is not recommended for

slabs; 1 to 1½ in. is normal.

Mixing your own concrete, when practical, gives you greater control. For a 1:2:3 ratio, a good guideline is that the volume of sand used should be about 2/3 of the volume of coarse aggregate. For a 100-sq.-ft. slab 4 in. thick, you would need 0.64 cu. yd. of sand, 0.95 cu. yd. of gravel and 8.4 sacks of cement. You can figure on using about seven sacks of cement for each cubic yard of concrete at a 1:2:3 ratio.

Whenever possible, concrete should be poured continuously and kept practically level throughout the area being placed. Where the sides of a slab will be visible, smack the forms smartly with a hammer. This will prevent what is called a "honeycomb" appearance, caused by air bubbles, and give neat, good-looking edges.



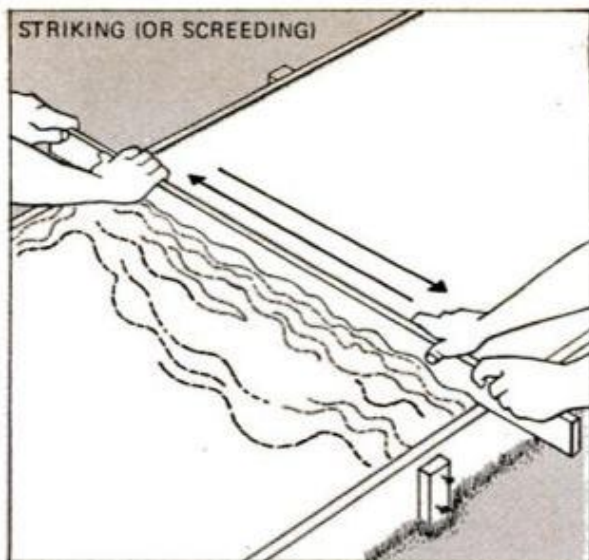

### Surface finishing

After concrete is poured, it must be struck (trade terms are striking and screeding) immediately by drawing a board back and forth across the surface. Use a side-to-side sawing motion as you advance; press projecting stones (aggregate) below the surface. When concrete built up ahead of the screed makes it difficult to move, shovel the excess away. To crown a driveway, the underside of the strikeboard is cut concave.

An hour after striking off, the surface can be "floated," bringing water to the top and texturing the concrete. Work a wood float in a swirling motion, taking care not to "saucer" any spot—or it will collect puddles. For a smooth surface, follow the floating with a steel trowel, used in wide, sweeping arcs. Do not trowel until the water sheen has left the surface. Keep in mind that neither floating nor troweling should be overdone—too much water brought up will make the slab weaker. Excess troweling also brings up "fines," small particles that make the surface produce dust.

After floating and troweling (if desired) and removing separators, round off slab edges with an edger and finish cross joints with groover.

### Curing time extends for weeks

Curing of concrete is a chemical process that continues for weeks after pouring. New concrete must be kept damp or the evaporation of water will make hydration (the combination of water with cement and aggregate) incomplete and your slab weak. Cover the surface with burlap, felt or layers of newspaper and keep this covering moist for five to seven days—at least a week in hot, dry weather. Depending on temperature and humidity levels, moisten once or twice a day.

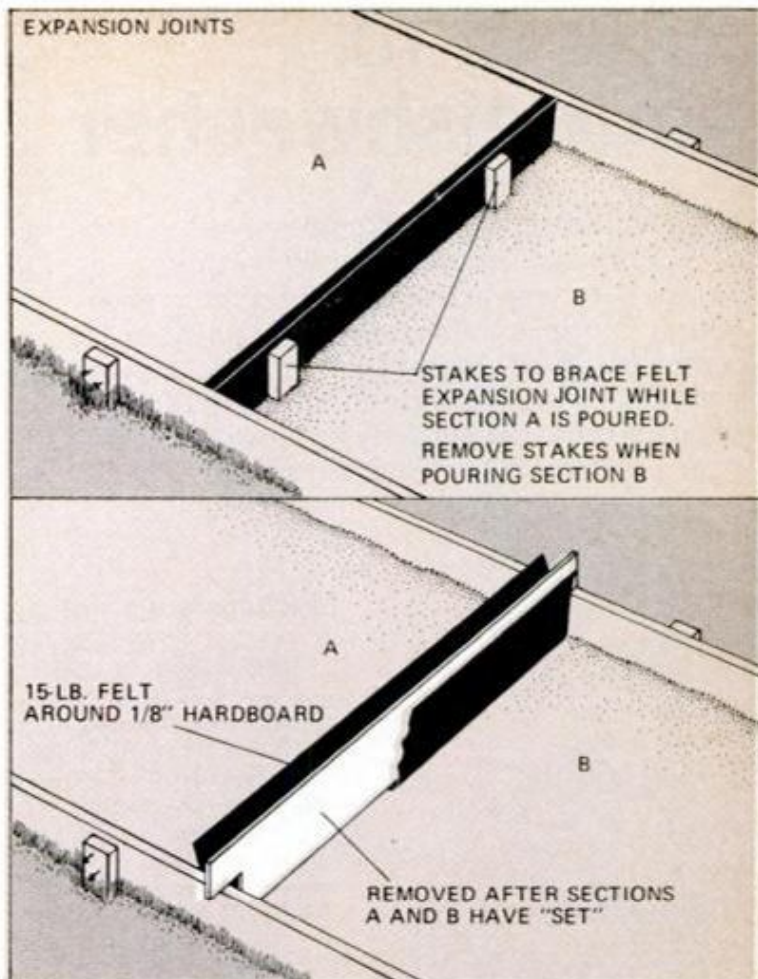

### Expansion joints

Driveways should be divided into 20-ft.-long sections using felt expansion joints (top drawing). Brace the joint as shown while pouring the first section. Remove stakes when enough concrete has been poured in the second section to make the felt immovable. If sidewalks are to have separated slabs, separators should be placed at intervals of 6 ft. You can make separators of  $\frac{1}{8}$ -in. tempered hardboard inserted in folded tarpaper. Place them at right angles to the slab forms, and pour concrete on both sides of each one to keep them straight. When you finish the surface, remove the hardboard but leave the tarpaper in place in the joint. Excess can be trimmed away after concrete has set. False expansion joints—for appearance—can be made with a groover after surface finishing has been done. ★★★

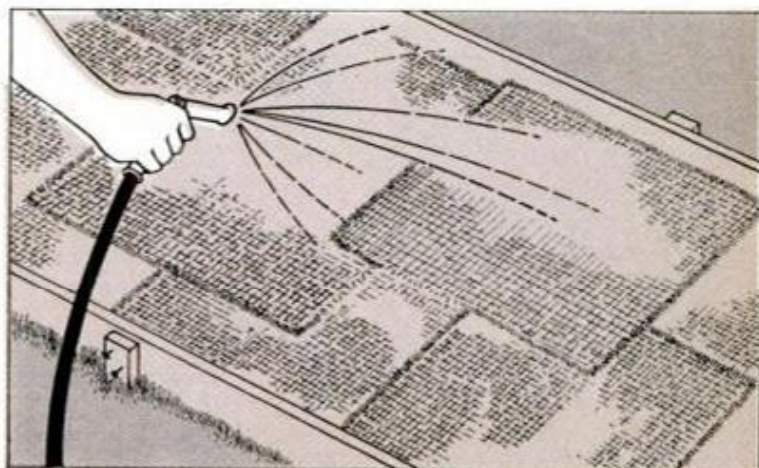

# How to fix your dishwasher

When dishwasher troubles occur, they are most often caused by washing conditions—water problems, detergent problems, improper stacking of dishes or a combination of these factors. The accompanying troubleshooting charts will help you correct these conditions, as well as common problems of mechanical origin. The il-

lustration on the facing page shows the typical locations of dishwasher components. The other illustrations show specific parts and assemblies from dishwashers made by several different manufacturers.

When making electrical checks and tests on a dishwasher or any other appliance, it is important to understand the manufac-

## PROPER STACKING OF DISHES

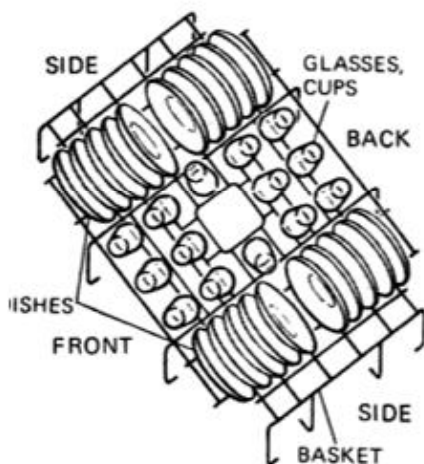

## DOOR-LATCH ASSEMBLY

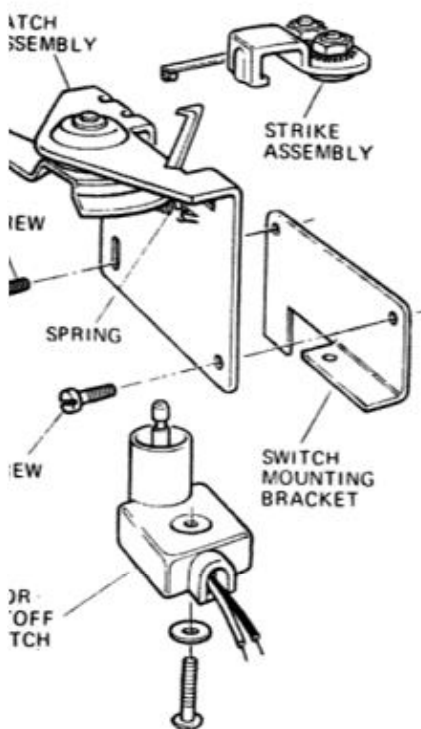

## Machine does not operate

POSSIBLE CAUSES	ACTION TO TAKE
1. Door not latched.	Latch door. Make sure handle locks all the way to the right.
2. Door microswitch defective.	Press button on microswitch manually. You should hear a definite clicking noise. If not, replace switch.
3. Latch lever or spring not pressing against microswitch.	Attach door latch to fully depress button or bend or replace spring on microswitch.
4. Timer defective.	Turn on the timer very slowly. It should advance and turn the machine on. If not, replace the timer.
5. Line wires loose or apart.	Check line junction box under machine. All wires should be tight and capped or taped.
6. Blown fuse or tripped circuit breaker.	Check fuse or circuit breaker.
7. Selector buttons not depressed fully.	Press desired cycle button all the way in.

## Door will not close

POSSIBLE CAUSES	ACTION TO TAKE
1. Door seal loose or binding inside tank.	Check entire door gasket. All gasket clips or points should be inserted in their proper slots.
2. Door striker.	Shim door striker until door latch catches it and closes very easily.
3. Improper installation.	Remove screw fasteners and let machine spring back, releasing it of any tension. Close door. If no binding, resecure screw fasteners in new position. Also, check level of machine.
4. Door hinges out of adjustment.	Check both hinges. If broken, replace. If out of adjustment, loosen hinge screws. Adjust door until it closes easily, then tighten screws.
5. Bottom service panel.	Check clearance of upper door with bottom service panel. If rubbing or binding, lower the panel or raise upper door by hinges.

turer's wiring diagram (for diagram symbols, see *How to Fix Your Automatic Washer*, page 66, Jan. '73 PM). This diagram is shown in the instruction manual for portable dishwashers. For built-in models, the diagram can be found either behind the front-door panel or behind the control panel at the top of the door. It may be glued to

the machine or rolled up. Since built-in dishwashers are wired directly to the main junction box, and because the combination of water and electricity can be lethal, it is important to use *extreme* caution when making any tests. Know what fuse or circuit breaker controls your dishwasher, and keep it *off* when working under the machine.

DATA BY ED FRANZESE

### Common dishwasher components

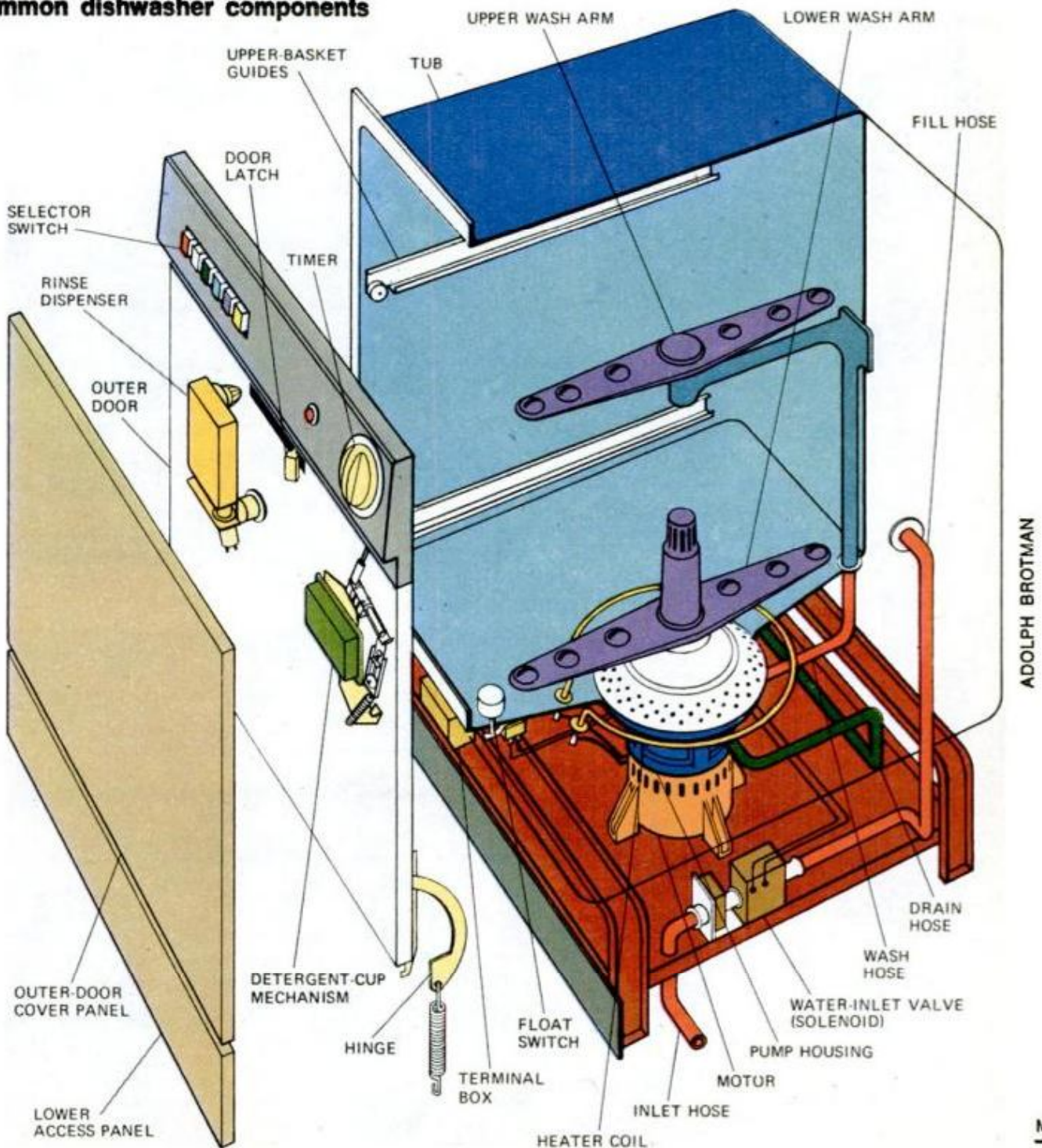

MORE  
→

## WASH MECHANISM

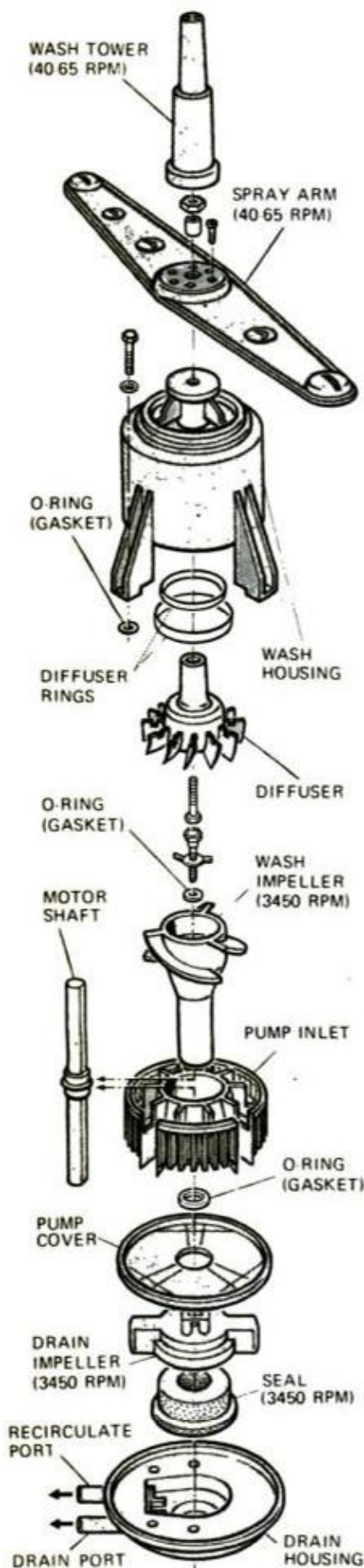

## Failure to fill

POSSIBLE CAUSES	ACTION TO TAKE
1. Water valve solenoid.	Turn timer to fill position. Check voltage with 115-v. test light at terminals. If voltage exists but valve won't open, replace solenoid.
2. Water inlet line.	Be sure water valve is in full open position.
3. Float switch (some machines).	Check float-stem position on float switch. It should sit squarely in seat. To test, pick up float inside of tub and let it drop. Definite clicking noise should be heard. Check also for loose or fallen wire from float switch.
4. Pressure switch.	Press rubber diaphragm disc of switch with finger. Definite clicking noise should be heard. If not, replace pressure switch.
5. Water valve assembly.	Filter screen can be clogged. Disassemble and flush line and screen. Check calcium buildup near diaphragm and pin. Replace bad parts if possible. If not, replace whole valve.
6. Low water pressure.	Check flow pressure with screw-on gauge at sink. It must be between 15 and 120 p.s.i.

## Water won't shut off

POSSIBLE CAUSES	ACTION TO TAKE
1. Water valve stuck open.	Disassemble and clean. Check valve. If it still hangs up, replace.
2. Water-valve bleed hole clogged.	Disassemble valve and clean bleed hole in solenoid valve with pin.
3. Timer stuck on fill cycle.	Check timer. Fill cycle should last about 60 seconds. If timer doesn't advance, replace.
4. Float switch defective.	Check float switch for internal short. Place 115-v. test lamp across terminals. Depress switch spring; lamp should light. Release switch button; lamp should go out. If not, replace switch. Also, listen for definite clicking sound. If none, replace switch.

## Dishwasher does not clean

POSSIBLE CAUSES	ACTION TO TAKE
1. Not enough water.	See section on "Failure to fill" above.
2. Water not hot enough.	Check water temperature. It should be about 150° F. Run hot-water tap in sink before turning on machine or change temperature setting on house hot-water heater.
3. Wash or spray arm clogged.	Check holes in wash or spray arms for blockage by food particles or, possibly, small pieces of broken glass.
4. Not enough detergent or wrong kind.	Adjust detergent to correct water hardness. If water is hard, add more detergent. If detergent is caked in detergent dispenser cup, switch to a more granular brand.
5. Wash arm not turning.	Make sure that no utensil or dish is stopping wash-arm rotation.
6. Dishes improperly stacked.	Restack with space around each piece; avoid any clutter or pile-up. Face soiled sides of cups in top rack toward center of rack.

## Water will not drain

POSSIBLE CAUSES	ACTION TO TAKE
1. Pump impeller jammed or broken.	Check impeller blades for pieces of food jammed into them. Clear items and test. If impeller has broken vanes, replace.
2. Pump motor winding defective.	Advance timer to a drain cycle. If motor hums, check for obstacles in impeller. If impeller turns freely and motor still hums, then pump-motor winding is defective. Replace motor.
3. Drain hose kinked.	Check for any sharp bends in the drain hose. Straighten hose and place helical spring (tube bender), a little larger than the o.d. of hose, over kinked area to prevent a recurrence.
4. Drain hose clogged.	Disconnect drain hose from motor housing. Blow through the hose until line clears and reconnect it.
5. Timer stuck in wash cycle.	Check timer. If timer doesn't advance by itself, replace it.

## Detergent cup fails to open

POSSIBLE CAUSES	ACTION TO TAKE
1. Detergent left in cup too long, or put in a wet cup causing it to harden.	Use only amount of detergent specified by the manufacturer. Make sure cup is dry. If the detergent still cakes, switch to a more granular brand.
2. Improperly racked dishes or utensils.	Reposition around detergent cup all dishes or utensils that could possibly prevent the cup from opening.
3. White calcium deposits around cup lid or shaft mechanism (due to hard water).	Clean all calcium deposits around mechanical operating mechanisms of the detergent cup. Use vinegar.
4. Detergent-cup solenoid valve.	Place 115-v. test lamp across both solenoid terminals. Advance timer in fill cycle until test light glows. If solenoid doesn't work, replace.
5. Timer.	Advance timer to positions in the fill cycle that activate detergent-cup mechanism. Place 115-v. test lamp across solenoid terminals. If no voltage is indicated, timer contacts are defective. Replace timer.

## Motor will not run

POSSIBLE CAUSES	ACTION TO TAKE
1. Motor hums.	Check for a food particle or piece of broken glass that's jammed in pump impeller. Clear and test.
2. Motor kicked out on overload.	Check line voltage, $\pm 10$ percent of 115 v., or binding of the motor shaft. Turn by hand to free shaft.
3. Timer defective.	Advance timer to all wash and drain cycles. Check motor operation on each one. If motor fails to run, replace timer.
4. Motor defective.	Direct-test motor with test jumper. If motor still fails to run, replace it.

## DRAIN PUMP

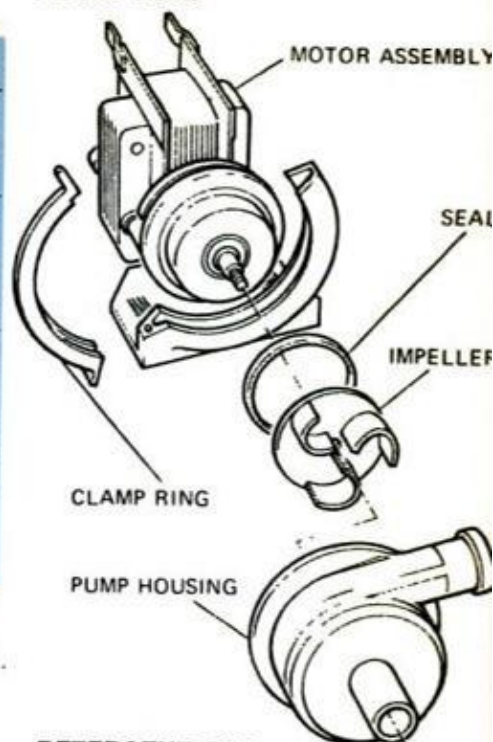

## DETERGENT-CUP ASSEMBLY

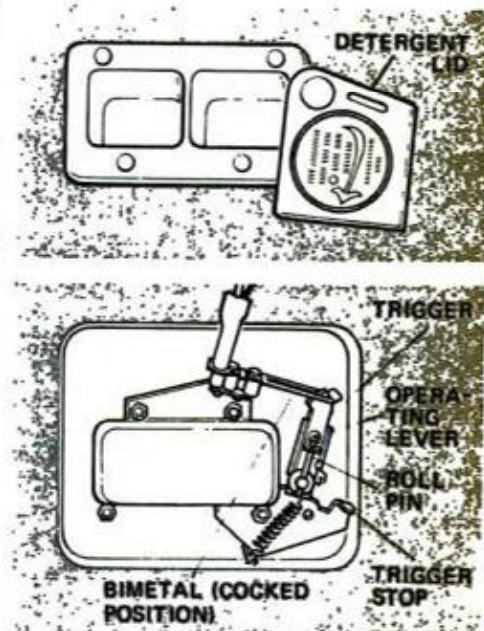

## FLOAT SWITCH

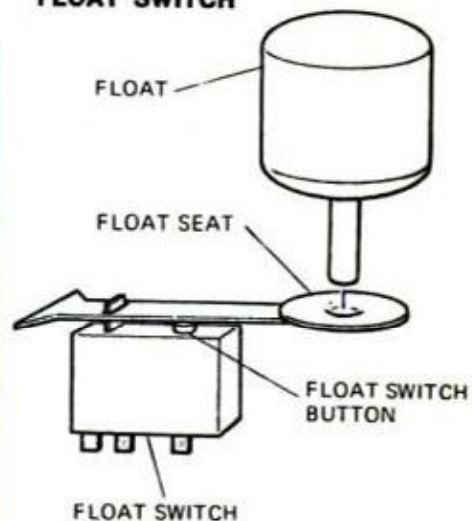

## JUNCTION-BOX ASSEMBLY

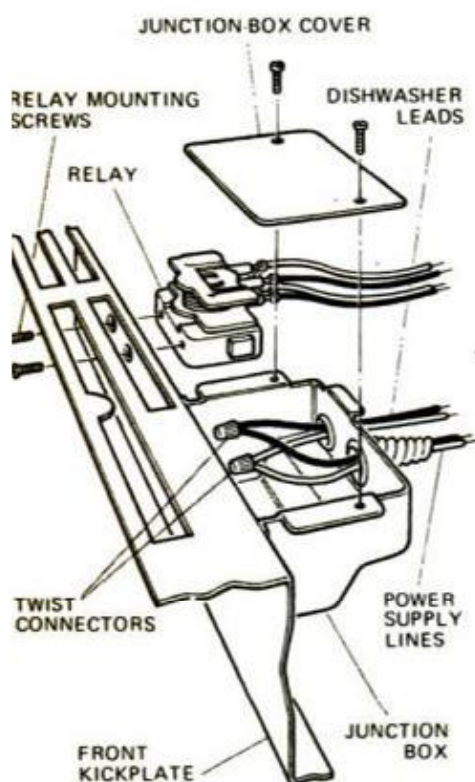

## Dishwasher operates when door is open

POSSIBLE CAUSE	ACTION TO TAKE
1. Door switch is shorted.	Replace door switch.

## Dishes do not dry

POSSIBLE CAUSES	ACTION TO TAKE
1. Heater element burned out.	Replace heater element.
2. Calcium buildup on heater element.	Clean heater element of all calcium deposits.
3. Wire off heater element.	Replace wire and tighten connections.
4. Water not hot enough.	Check water temperature. It should be approximately 150° F.
5. Water still in dishwasher.	Refer to section "Water will not drain," page 99.
6. Improper stacking of dishes.	Rack the dishes so that there is air space provided around each and see that they are neither jammed together nor piled on top of each other.
7. Fan motor inoperative (some machines).	Direct-test the fan motor with a test jumper wire. If the motor still fails to operate, replace it.

## MAIN-DOOR ASSEMBLY

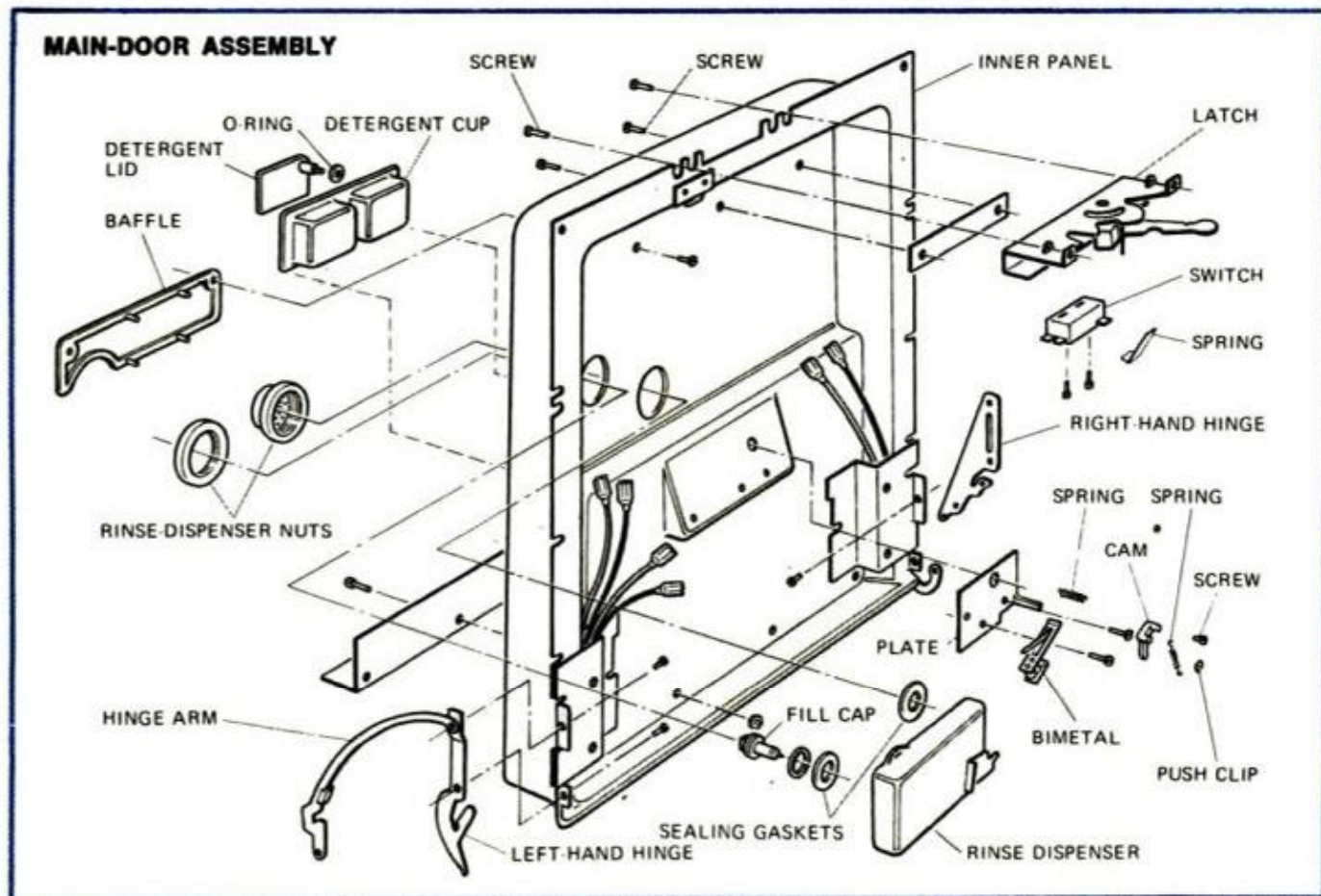

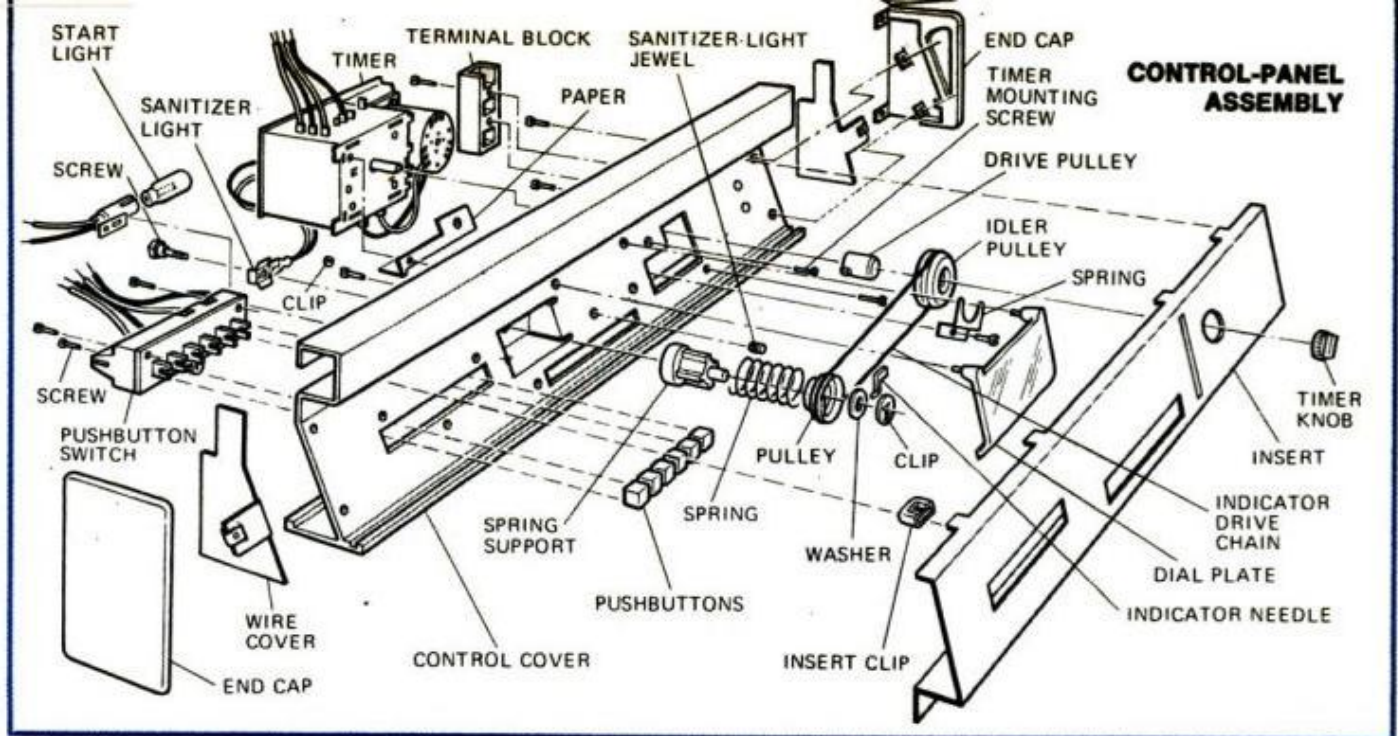

## Dishwasher is leaking

POSSIBLE CAUSES	ACTION TO TAKE
1. Door gasket loose or worn.	Check door gasket. It should be clipped in its proper slots. If gasket is torn or flat with no compression left, replace.
2. Door hinges broken or out of adjustment.	Replace broken hinges. Loosen hinges so door sits tight against gasket and retighten.
3. Inlet line fitting.	Check inlet line near water solenoid valve. Tighten compression nut.
4. Motor seal.	Check for water stains or leaks around motor shaft. Replace motor seal.
5. Door alignment.	Check door fit on gasket; it should not bind. See section "Door will not close," page 96.
6. Loose hose clamps.	Check all hoses and connections under machine for slippage or water stains.
7. Heating element seals.	Check seals at heating-element holes. If leaking, tighten. If leak remains, replace seals.
8. Nuts, bolts and screws.	Check attachments to tub. Noticeable dripping can be corrected by tightening or caulking the fasteners with putty.

## Abnormal water noise

POSSIBLE CAUSES	ACTION TO TAKE
1. Water hammer "thud noise."	Install water-hammer eliminator or pressure reducer (from maker) on inlet line to lower water pressure. Set water heater to 150° F.
2. Water chatter "low-frequency pulsing."	See that inlet piping is at least 3/8 in. i.d. Secure piping to avoid vibration. Set water heater to 150° F.
3. Water flutter "rumble."	Set water heater to 150° F. Install small hand valve in inlet line to cause partial restriction. If valve is already in line, close or open more to adjust pressure.
4. Water whistle "hiss" to shrill whistle.	See answer to No. 3 above and apply the same action.

## WATER-INLET VALVE

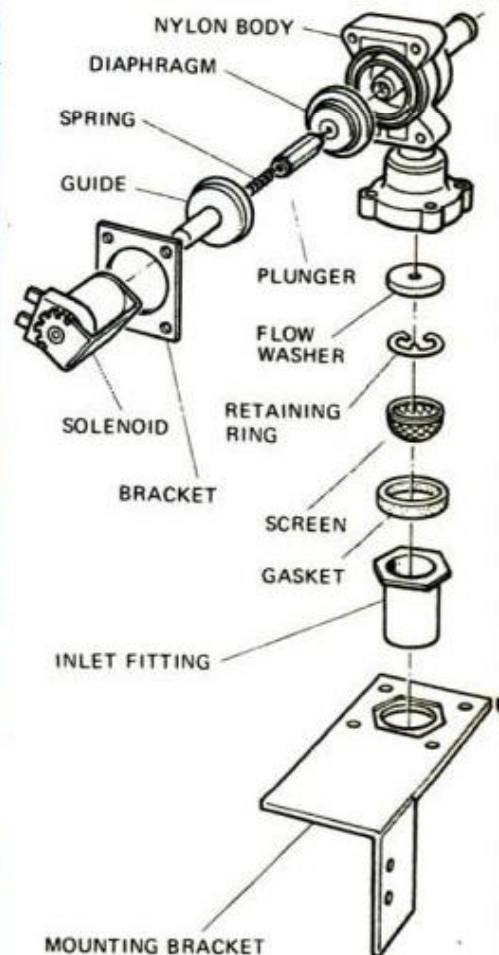

## UPPER-RACK SLIDE ASSEMBLY

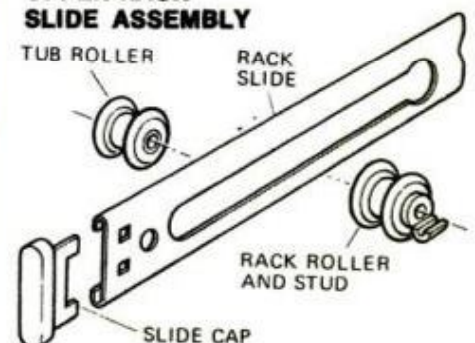



# Big-scale thrills at small-scale prices

Today's growing interest in outdoor hobbies is bringing with it a brand-new generation of colorful, low-cost flying models for fun and excitement your whole family can share.

by Sheldon M. Gallager

A bright blue and red Fokker struggles frantically to evade a Sopwith Camel closing in on its tail. A tiny red and white Pitts Special loops, rolls and does wing-overs almost as realistically as the world-famous aerobatic stunt plane it's patterned after. A strange-looking space missile carrying two smaller rocket planes blasts off its launching pad and soars to a height of several hundred feet as the two piggyback ships automatically detach themselves and glide gracefully back to earth—the latest in model rocketry depicting how a future space shuttle might operate.

All over the country, the air is filling with the high-pitched whir of miniature props and the nostalgic scent of burning engine fuel. The fun of flying model planes and rockets is being rediscovered in a new era—with new thrills, new equipment and a new interest in outdoor hobby activities the whole family can enjoy. The models have come a long way from the balsawood and tissue-paper days when you spent weeks on

**Classic Fokker DVII** World War I German fighter is typical inexpensive gas-powered plastic Cox model. It costs about \$10, has readily replaceable parts.







**Newest, most spectacular** rocket to join growing model fleet is this ingenious three-part space shuttle replica by Cox. On takeoff, main booster stage carries with it two smaller rocket planes attached to the sides. At top of the flight, the nose cone separates, the two rocket planes detach and glide back to earth in slow, gentle spirals, and booster floats down on a gaily colored parachute.



**One of hottest racers** ever to cross a finish line is P-51D "Miss America," authentically reproduced in colorful model at left.

**Unusual prop-powered speedster** at left, below, is patterned after Bonneville Shrike racer. All models shown here are by Cox.

**Two aerobatic biplanes** play tag in simulated flight shot below. One at right is copy of world-famous Pitts Special stunt plane.



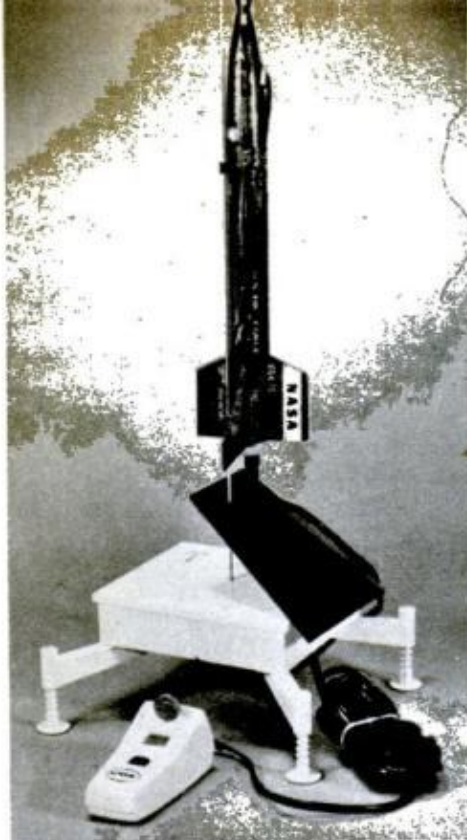
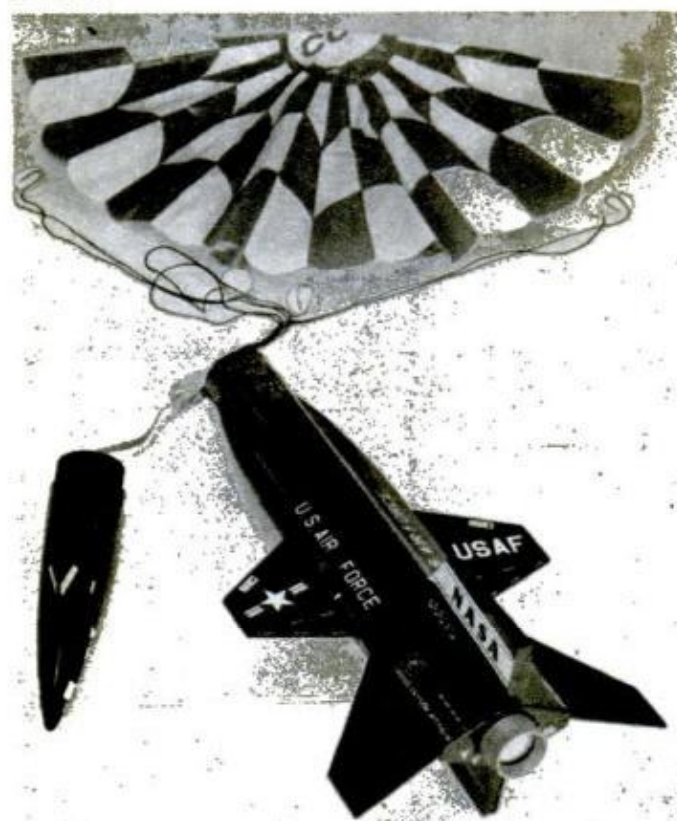

**Poised for takeoff** on a realistic-looking launching pad is authentic reproduction of NASA's sleek X-15 rocket plane, first ship to explore the fringes of outer space. Original reached altitudes of 350,000 feet and hit speeds of more than 4500 mph. This Cox scale model automatically deploys a parachute at top of flight and floats gently to the ground.



**Camouflaged P-40E Warhawk**, an historic World War II fighter, comes ready to fly in kit containing fuel and all other necessary supplies. Made by Testor, it sells for \$9.95, is molded of tough, unbreakable plastic.

**Rivets racer**, modeled after Bill Falck's all-time Formula I air race champion, comes in for smooth landing at right. Cox replica has 23-inch wingspan, is powered by .049 engine.



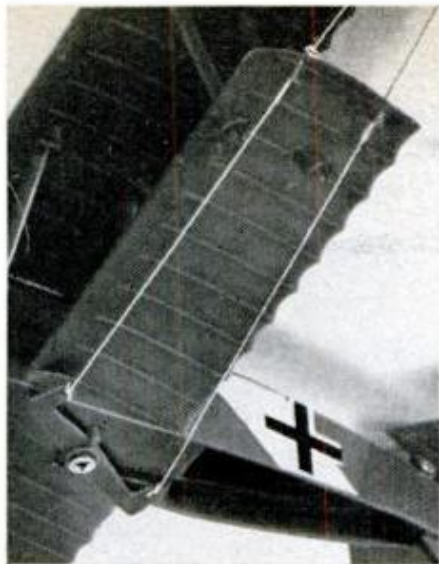
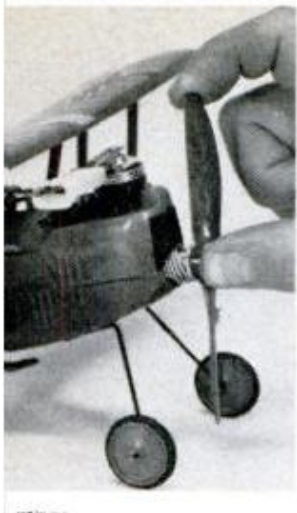

**Starting is easier nowadays.** Coil spring (far left) spins prop for you—you just wind it up and let go. Improved battery clip (below), unlike old alligator type, slips firmly onto cylinder. Center photo shows simple bell crank for moving elevator up and down.

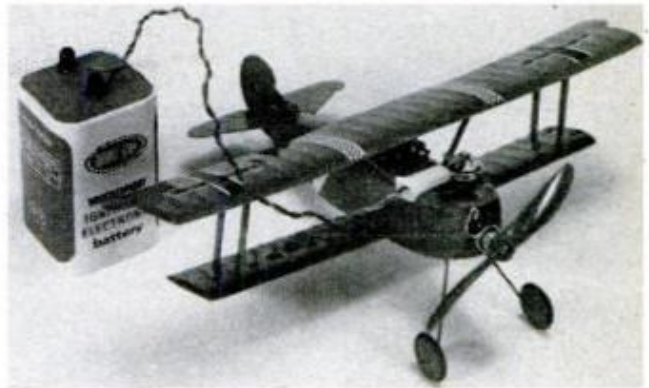

elaborate construction only to have your prized creation end up in a heartbreaking heap of scrap after its first brief flight. Today's gas-powered models, for the most part, come preassembled and ready to fly. They're made in eye-catching colors of tough, virtually indestructible plastic. If you should break a part, it's easily replaced. Cox, one of the biggest makers of gas-powered, control-line planes, supplies a full list of replacement parts with each one you buy. Prices for ready-to-run models range from under \$10 to less than \$20, complete with engine and control line—about as inexpensive a hobby as you can find.

Improved engines, fuels, batteries and other parts also make model flying easier and more fun than ever. Gone are the finger-blistering days when you spun the prop over and over by hand, praying the engine would catch, only to have it fizzle out a few seconds later after it did. Today, many models incorporate spring-wind starters that make engine starting almost automatic. You merely hook the prop in the spring, wind it backward and let go. Off she roars—usually on the first try. Most models can be flown in as little as a 30-foot circle. With practice, you can do dives, climbs, loops and other exciting maneuvers using a simple

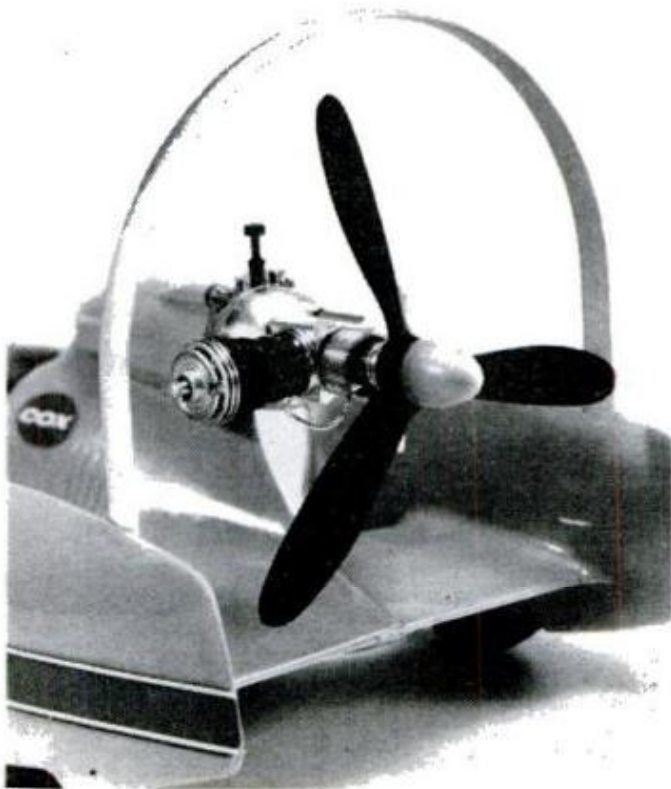

**Unusual prop-powered racing car** is model of actual Shrike speedster tested on Bonneville salt flats in Utah. The Cox replica, 12 inches long, is driven by same .049 engine used in many gas-powered model planes. It can be run free on a straight course or tethered to a stake for operation in a small, circular pattern where space is restricted.

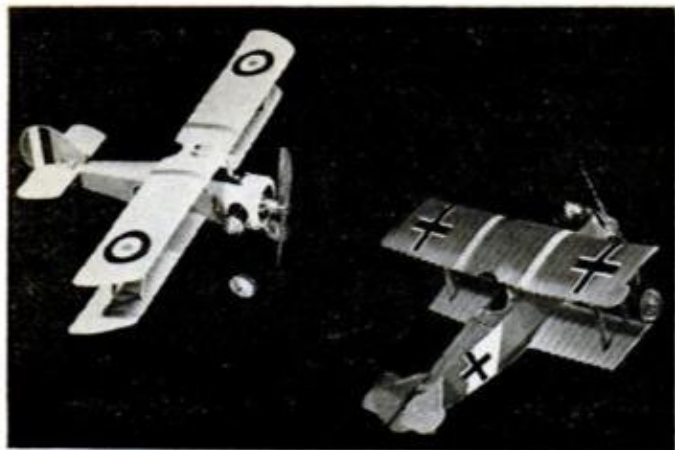

World War I fighters go at each other in simulated dogfight above. Sopwith Camel at left and Fokker D.VII at right have 13-inch wingspan, are powered by .049 engines, sell around \$10. Photo at far right shows how Cox models are easily disassembled to replace parts. Cox kit (near right) has fuel, battery, wrenches, supplies.

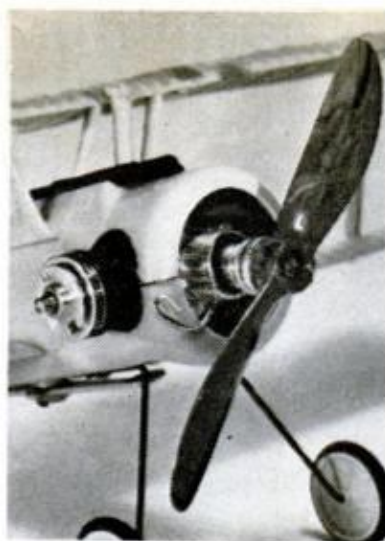

Kit-built Bomarc missile consists of preformed plastic and balsawood parts, goes together to produce dramatic 23-inch-long replica of Air Force's surface-to-air interceptor. Made by Estes, kit is \$6.50. The launching stand and remote-control, electric-firing system are available separately for \$11.95.



control linkage that moves the model's elevator up or down.

Cox offers a wide range of preassembled models from vintage fighters to modern racers. They're all there—Camels and Fokkers from World War I, Mustangs, Corsairs and P-40 Warhawks from World War II, and sleek stunt and racing planes like the famous Miss America and Pitts Special. Also available from Cox is a selection of gas-powered racing cars and propellant-powered rockets. Another maker of inexpensive ready-to-fly models is Testor's. For those who like to build their own, Estes offers a line of propellant-powered rockets and missiles in kit form. These sell for as little as \$2.25 to \$6.50. Some Cox rockets are also available as kits for do-it-yourself assembly. Catalogs, prices and additional information can be obtained from the following companies: L. M. Cox Mfg. Co., Inc., 1505 East Warner Ave., Santa Ana, Calif. 92705; Estes Industries, Inc., Box 227, Penrose, Colo. 81240; Testor Corp., 11500 Tennessee Ave., Los Angeles, Calif. 90064. ★★★



# Custom rod to fly with



PHOTOS BY L. LAREDO



**F**ly-fishing is considered the ultimate art for the angler, but also one of the most expensive when you're first fitting out. Experts have paid \$200 and up for their perfect rod, but now Phillipson—one of the top brands and a new division of 3M—offers a kit for \$25 that provides the added pleasures of making your own.

Highest quality epoxy-bonded Scotchply fiberglass blanks and stainless guides, plus a carboloy stripping guide, are provided. After reel seat and cork grips are installed, guides are positioned and secured in place with wrappings of nylon thread supplied. Figure an evening's work to do this, following the detailed instructions. Wrappings are finished with five or six coats of varnish. Write your name on the butt section and varnish it as well. Dealer sources are available from 3M/Phillipson, 3M Center, St. Paul, Minn. 55101.—*Bill McKeown*

**Sensitive flex** is only one of the pleasures you get with the new custom 3M/Phillipson fly rod. Kits are being offered for glass or bamboo fly and spin rods.



**Cork grips and reel seat** are firmly secured in place with a rod cement that comes with the kit. The cork is predrilled, providing a perfect fit to glass blank.



**Guides for fly line** are positioned along the rod sections, as with this 8-footer, at spacings shown in kit instructions and are merely Scotch-taped in place.



**Nylon thread** that's tensioned by running it through stacked books replaces tape to wrap and fasten the guide feet. Varnishing the wrap completes the rod.

# IT'S NEW NOW



## Modern British liner to sail all the way from Mexico to Alaska

Anyone who thinks ocean liners are dead will have to take another look—specifically at this modern new British giant, the "Spirit of London." The 17,000-ton vessel is virtually a floating city with luxury accommodations, huge shopping center, a variety of restaurants, swimming pools, ballrooms, gymnasiums and other deluxe facilities. The ship will cruise the West Coast from Mexico to Alaska.

## Flameless heater is safe even near explosive fumes

You can safely use this portable flameless heater around cars, spray paints and in other situations where flammable liquids or fumes would be hazardous near conventional space heaters. Unit works on a chemical catalytic principle; models give 5000 to 32,000 B.T.U.s of heat. Prices start at \$32. For further information, write Impala Industries, 1106 East 37th St. North, Wichita, Kans. 67204.

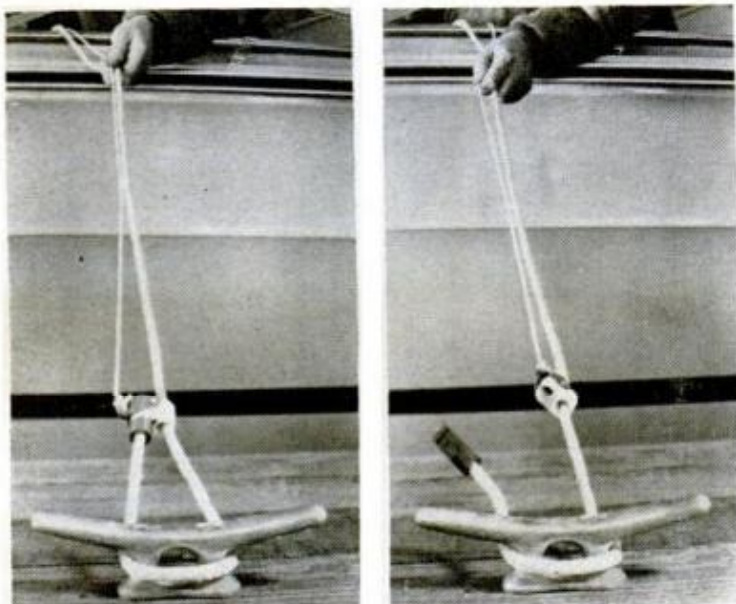

## You don't have to jump in and out of your boat to release this mooring line—just give it a yank and it slips free by itself

How do you cast off a mooring line without getting out of the boat to untie it? With this self-releasing line, you can do just that. The line is looped around a dock cleat and its end inserted in an eye fitting to hold the loop closed. Pulling a release cord retracts the eye, allowing the loop to open and slip free from the cleat. The 12-foot nylon Mooring Mate is \$5.95 from Pacific Diversified Products, 732 S.E. Powell Blvd., Portland, Ore. 97202.

## Dispenser rack keeps cans of refreshment at your fingertips

This dispenser rack neatly stores 10 12-ounce cans of your favorite beverage in your refrigerator, uses space efficiently and ends battles with stubborn plastic-ring can holders. Load it from top, and the coldest can will always be up front, ready for use. Dispenser sells for \$1.99 plus 50 cents postage and handling from Paval, Dept. PM, 1709 North Chestnut St., Arlington Heights, Ill. 60004.

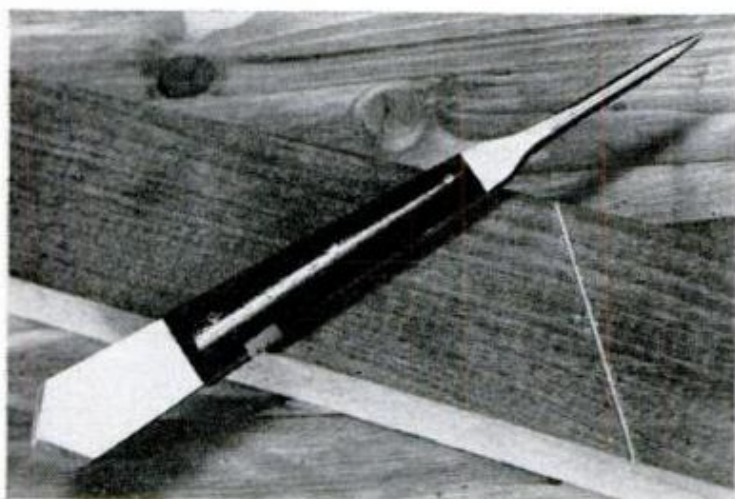
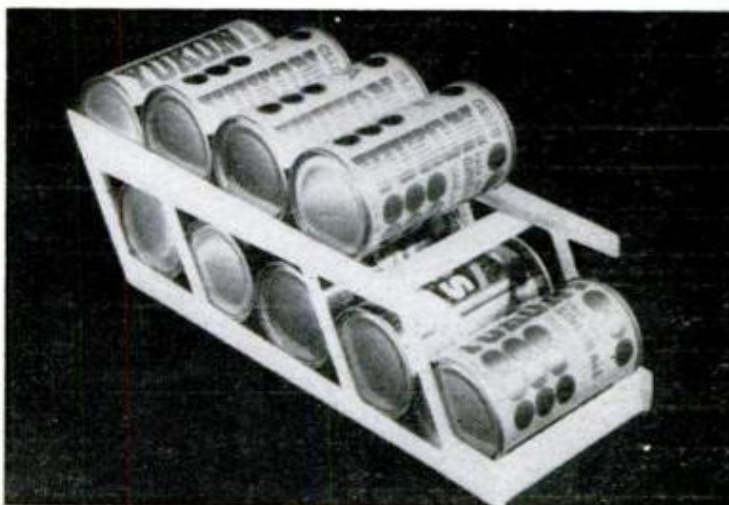

## Mark wood indelibly with cabinetmaker's scriber

A line scribed with a knife or an awl can be easier to follow than a smudgeable pencil line when working with wood. This cabinetmaker's "striking" knife has both—two cutting edges at one end and an awl at the other—and rosewood grips besides. Made from one piece of hand-forged Sheffield tool steel, it's \$1.95 plus handling and shipping costs from Brookstone Co., Peterborough, N.H. 03458.

## Fiberglass kit for fixing practically anything includes everything packed in its own mixing tray

With this \$4.95 kit, you can use fiberglass to repair almost anything—such as an auto body or a boat hull—or to make useful articles. It includes three square feet of a specially treated glass-fiber cloth, eight-ounce can of resin, tube of liquid hardener and spatula—all nested in a plastic mixing tray with step-by-step instructions. The handy kit is marketed by Woodhill Chemical Sales Corp., Box 7183, Cleveland, Ohio 44128.





## Two neat, invisible ways you can conceal those pesky speaker and TV wires

Here are two ways you can neatly hide wires for hi-fi speakers, home intercoms, burglar alarms, TV antennas and other low-voltage applications without drilling holes in walls and fishing cables between studs. In the system shown at far left, hollow plastic molding strips are fastened in the corners along walls and ceilings and are capable of carrying several pairs of wires. The strips come in 6 and 8-foot lengths and can be painted to match existing decor. For prices, write New York Testing Labs, 81 Urban Ave., Westbury, N.Y. 11590. At near left is a self-adhering tape with two thin, flat conductors that can be pasted on any wall or ceiling surface and painted or papered over for a virtually invisible installation. The Conduct-O-Tape is also made in a three-wire version and in one designed especially for 300-ohm TV twinlead. A starter kit containing 50 feet of two-wire tape and connector fittings is \$8 from Sun Spot Products, 417 North State St., Chicago, Ill. 60610. Additional 50-foot lengths are \$3 each. Longer lengths and the special three-wire and TV twinlead types are available in rolls of up to 500 feet from the manufacturer, Hobby Hill, Inc., 415 North State St., Chicago, Ill. 60610.

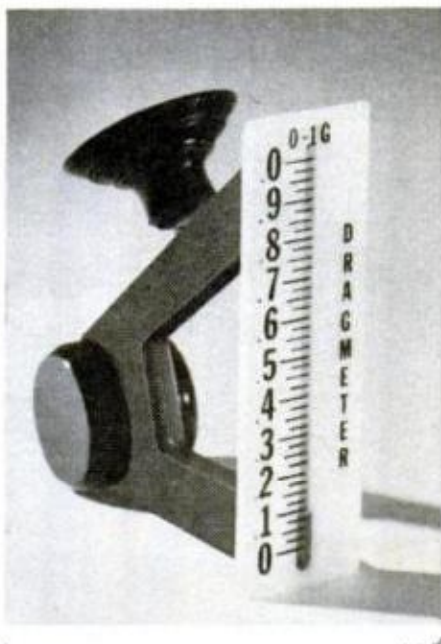

## Instant acceleration checker for your car

You can check your car's acceleration merely by watching the graduated vial in this inexpensive accelerometer. As you tromp on the gas, a red liquid rises to indicate maximum acceleration in tenths of a G. Because the instrument reacts instantly, readings can be taken within 20 feet at low speeds, ending the need for making timed 0-60-mph runs—often difficult or illegal on public roads. For comparison, standard G performance ratings for all popular car makes are included. Dragmeter attaches to windshield with suction cup, is \$7.95 from General Axial Engine Co., 38 Franklin Ave., Lockport, N.Y. 14094.





**Miter table guide for portable circular saws**

Precision cutting with a portable saw is offered by Motor Miter. According to the manufacturer, it lets you use any small-base portable circular saw for accurate angled ripping, crosscutting and dadoing, and permits compound miter cuts as well. Angular adjustment is regulated by means of a graduated dial and setscrew. Workpiece can be fed through the saw or the saw can be passed over it. Unit mounts on a workbench or, for outdoor use, clamps onto a sawhorse. It weighs 28 pounds, disassembles rapidly for portability. The tool sells for \$69.95, plus shipping, or \$103.50, plus shipping, with Skil Model 574 saw. Motor Miter Co., Highway 35, Prairie du Chien, Wis. 53821.

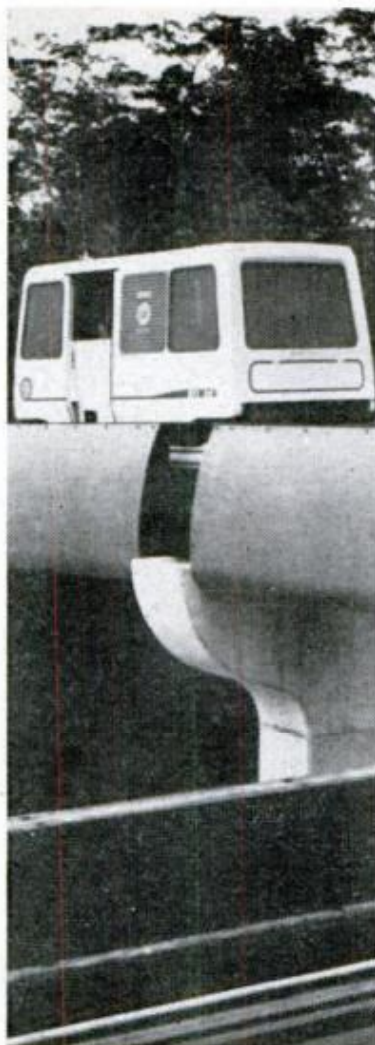

**Private 'el' for college students**

Not many college students have their own rapid-transit system like those at West Virginia University at Morgantown, W. Va. Small electric-power cars scoot back and forth across university grounds on elevated trestles, whisking the lucky students to and from classes without their having to poke their noses outside. The cars are actually part of an experimental, high-speed automated transportation system being developed at the university for future public use. Stopping, starting, switching, routing of cars to various destinations are fully computer-controlled.



**Two easy-to-build, low-cost weekenders**

Here are two inexpensive ways to get a weekend home. At top is a canvas dome on geodesic frame of slip-together aluminum tubing. Its diameter is 14½ feet; floor space, 160 sq. ft. Framing can go up in hour, disassembles to fit in car trunk; \$549 from New Earth, Box 6820, San Francisco, Calif. 94101. Kit-built wood-frame cabin below is sold as shell you erect and finish yourself. It's 24 by 32 feet, with 768-sq.-ft. space, three rooms, bath, L-shaped sun-deck. Basic shell less foundation and fixtures is \$4495. Adventure Homes, Inc., Box 243, Fairlawn, N.J. 07410.

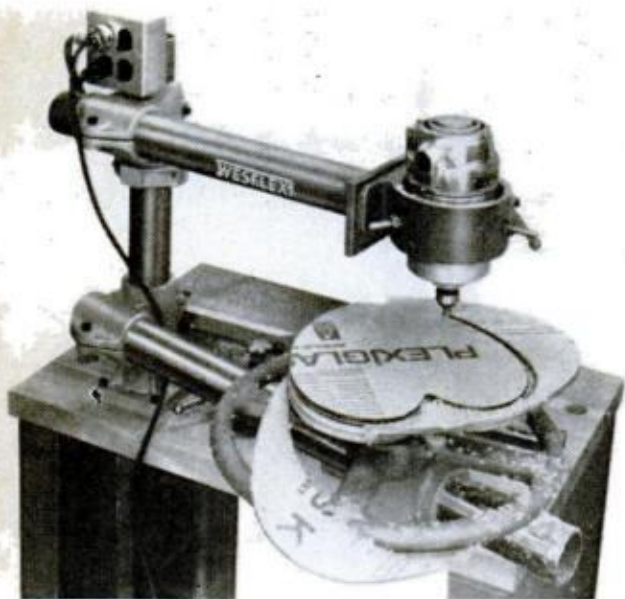

## Radial arm for router has vacuum workpiece hold-down

If you're planning a supershop, you'll want one of these versatile tools. It's the Wesflex Radial Arm Router/Shaper. Put an electric or pneumatic router into its universal bracket, and it will cut any shape from sheet material—any size from 48 inches down to two inches diameter. Dustproof vacuum pump holds template and workpiece in place. Optional accessories include shaper fence assembly and under-table bracket, pneumatic downfeed assembly for internal cuts and grooving of sheet surfaces. Basic unit, less router and stand, is \$740 from Wesflex Machine Co. Inc., 287 Riverside Ave., Westport, Conn. 06880.

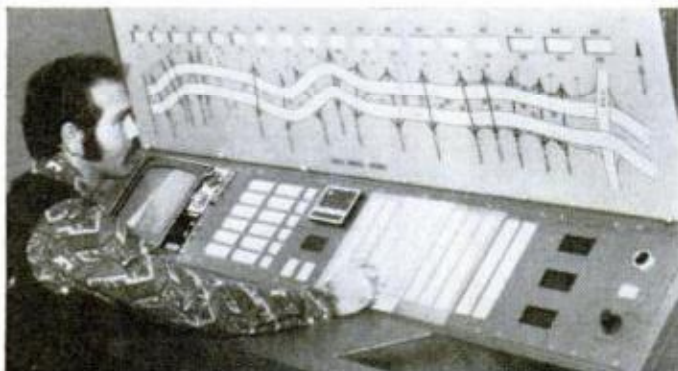

## Now computers operate highway traffic, even park cars by remote control

Automotive traffic is becoming more automated every day. Men pressing buttons at huge consoles are controlling cars on highways, bridges and in parking garages just like railroad dispatchers are routing trains. In photos at top, a console operator keeps traffic moving over busy Santa Monica Freeway near Los Angeles. Road sensors transmit traffic density, lane blockages and other data to a maplike indicator board. From this the

operator can flash messages to motorists on roadside signs about conditions such as "Accident Ahead." GTE Sylvania developed the computerized system. At lower left, a police "towerman" controls traffic on the Verrazano-Narrows Bridge in New York City, watching TV monitor screens in a Cutler-Hammer system. At lower right, cars are parked by remote control in an electronically automated garage in Munich, Germany.

**Mini-battleship looks like the real thing, even has water-firing turret guns**

Look at the lower photo at right and you can't be sure whether you're seeing a real battleship or not. The giveaway is the upper view, showing an inside close-up of what is actually a superdetailed, operating replica of the now-retired USS Massachusetts battleship used in World War II. The 18-foot-long model, built on a scale of 1 to 38, is powered by a 6-hp outboard engine, carries a crew of two and, for simulated realism, fires streams of water from swiveling turret guns. Her fiberglass superstructure swings up for access to the cockpit, and the engine is concealed under her after turret gun. A small exhaust fan carries away engine fumes to keep them out of the crew's quarters. The mini-battleship's captain and builder is Cecil Gates, a California high-school shop instructor who plans to sell the model in kit form for about \$825. It weighs 800 pounds, has a beam of four feet and makes about eight knots. Two 12-volt car batteries power horns, searchlights, a PA system and pumps for the water cannons. Information about the model and kit is available for 50 cents from Cecil Gates, 22942 Dolorosa St., Woodland Hills, Calif. 91364.

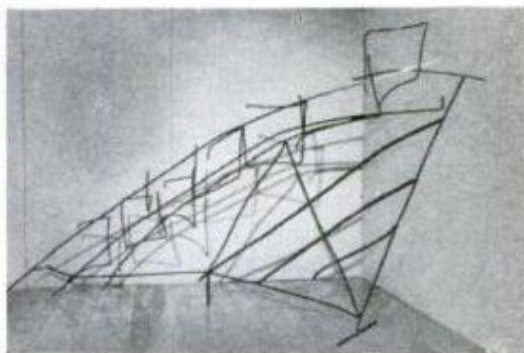

**From famous doodles to artistic sculpture**

Casual doodles don't usually end up as works of art—but those of the late President John F. Kennedy have done just that. Sculptor Ralph Mitchell Tate, fascinated by the imaginative scribblings, produced 21 pieces of wire sculpture from them, including the sailboat at left and stairlike structure at right. At center is a sheet of the doodles from which he worked.

# NOW

## Yesterday's news is today's furniture

Here's a new way to make furniture and avoid the cost of lumber at the same time. You build smart, modern bookshelves, desks, tables and chairs with rigid tubing made from recycled paper. A California company has a special process for treating the paper waste so that 75 pounds of it, for example, becomes a coffee table. Lengths of tubing are sold in a variety of colors. They are assembled with plastic connectors, so that they can be taken apart and rearranged quickly; shelving and tabletops are added. Prices range from \$17 for a small rack to \$33 for a large bookshelf. Maker claims tubing is as strong as conventional materials. For information, write Environmental Concepts Products Co., 9100 Wilshire Blvd., Beverly Hills, Calif. 90212.

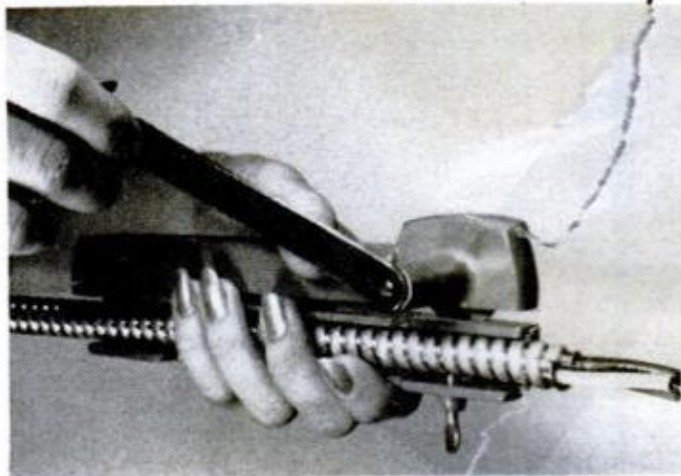

## Quick cutter for armored cable

Roto-Split is claimed to cut thinwall conduit and BX cable from  $\frac{3}{8}$ -inch to  $\frac{5}{8}$ -inch diameter quickly and conveniently with a few turns of its handle. It has an automatic stop to prevent damage to insulated wires inside. Open-channel construction of the nine-ounce tool permits cutting in middle of a roll. Price is \$8.95 plus \$1 postage from Seatek Co., Dept. PM, Box 74, Norwalk, Conn. 06856.

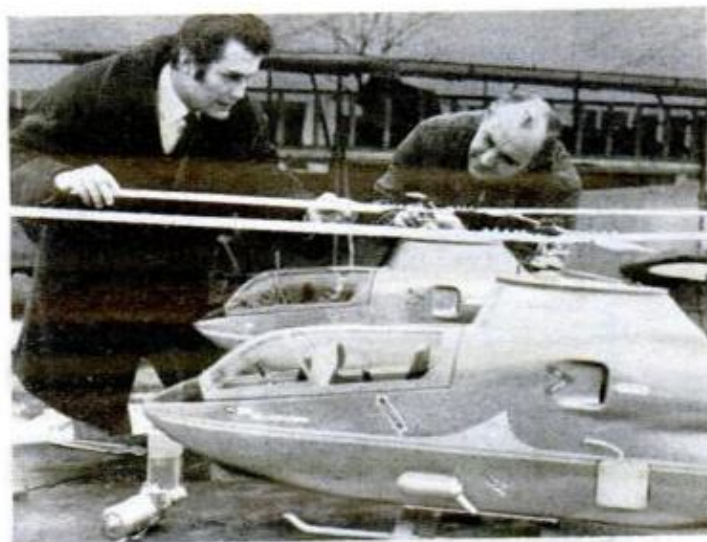

## Pretty models cost a pretty penny

Almost big enough to fly in yourself, these giant 6-foot-long radio-controlled model helicopters are powered by 1-hp gasoline engines; hit speeds up to 60 mph and can stay aloft 20 minutes. Patterned after the Bell Huey Cobra, they're made by Hegi Co., Nuernberg, Germany. No toys, the elaborate replicas sell for 2200 marks—nearly \$800 in U.S. money.

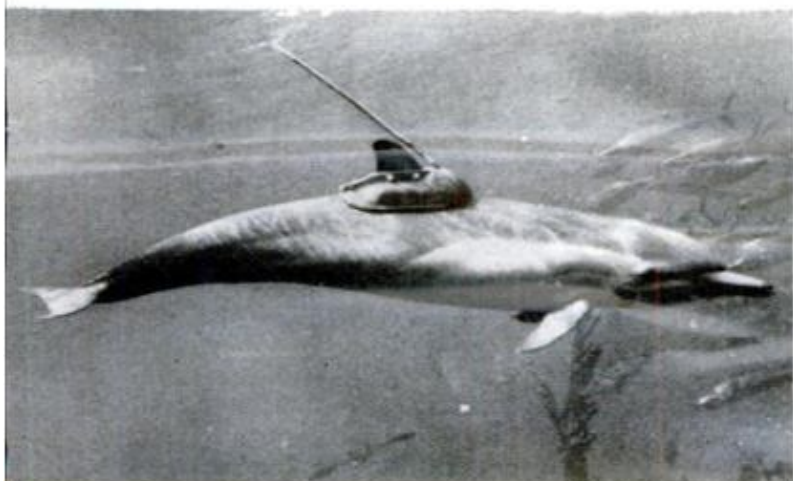

### 'Wired' porpoise tracks tuna for fishermen

Sprouting a radio antenna from its dorsal fin, this obliging porpoise transmits its position to waiting tuna fishermen. Why are tuna fishermen interested in porpoises? Well, porpoises and tuna are natural aquatic companions so wherever the porpoise goes there's likely to be a school of tuna swimming with it—and that's what the fishermen want to find. The tracking test is taking place off San Diego.



### Craft sets for youngsters offer professional features

These kits will let rockhounds and ceramists aged 10 and up make brilliant gemstones and symmetrical pottery. Rock tumbler (top) has an all-rubber barrel for quieter, leakproof operation. Set includes stones, grit, polish and blanks for making jewelry. Under \$20. Pottery wheel has variable-speed motor—high speed for centering, low speed for finishing. Outfit requires no heat, includes self-hardening clay, air-dry glaze. Under \$45. Sold in department and toy stores. Skil-Craft Corp., 325 West Huron St., Chicago, Ill. 60610.



### Kit for welding aluminum

Repairing aluminum articles in the home or shop is easy with a butane or oxyacetylene torch and this Aluma-Weld Kit, the maker says, with welds at least as strong as the original metal. Kit consists of 18 inches of highly deoxidized welding rod, flux and instructions. \$5.95 postpaid from Multi-Product Co., Box 5517, San Antonio, Tex. 78201.

# NOW



## Book plus kit helps you build wide range of electronic projects

Two for the price of one is the object of this novel book-kit combination. You get a book of plans for building dozens of simple electronic projects plus a kit of parts for making one particular device. The sets are available in a choice of 10 kits, including an audio mixer, power amplifier, wireless mike, diode tester and the garage light control shown at left. \$4.95 to \$9.95 from Tab Books, Blue Ridge Summit, Pa. 17214.

## Lively camper-cruiser puts you out where the breezes blow

Up-front lounging is provided for in this new Glastron Vagabond camper-cruiser—a welcome feature for those who like to climb out on the bow. The 21-footer packs a lot of living in a small hull—sleeping accommodations for four, full galley, head, dinette table and cockpit lounges. The cabin has a hardtop sun roof and can be completely enclosed with canvas for camping. Standard power is 302-cu.-in. V8 engine. Glastron Boat Co., Box 9447, Austin, Tex. 78766.



## Just flip a lever to change tanks on this quick-release scuba pack



Changing scuba tanks on this quick-release backpack is a simple matter of flipping a handle at the side. The handle, shown at far left, operates a cam-action clamp arrangement that opens the tank-retaining band just far enough to let you easily slip out one tank and insert another without having to fuss with screws—especially handy if you don't have a screwdriver with you. The pack also features molded-in handgrips for carrying and dual-release buckles on waistband and shoulder strap. \$28 in black or orange. Healthways, 5340 West 102nd St., Los Angeles, Calif. 90045.

## Navy men get a new type of 'life preserver'—for smoke, not water

The sailor at right isn't warding off bees or mosquitoes—he's demonstrating a new emergency escape breathing device designed by the Navy to reduce the hazard of smoke inhalation in shipboard fires. The simple, lightweight aid, destined to become standard equipment for all Navy personnel, consists of a collapsible plastic face mask connected to a small canister of compressed air. The air lasts eight minutes—enough for the wearer to reach safety, even in dense smoke on a large ship.

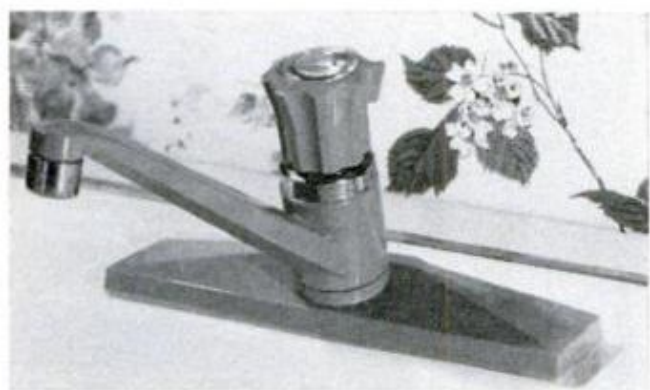
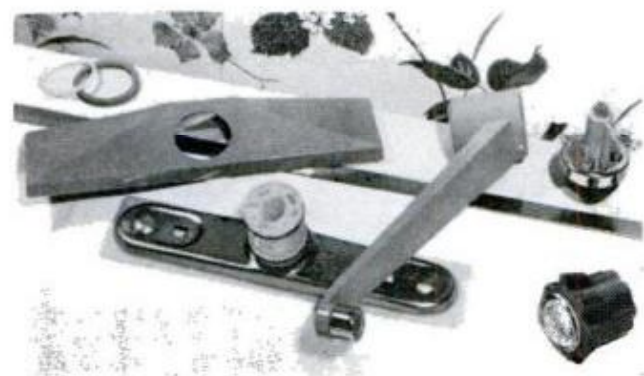

## Chameleon faucet can change its color to match your decor

This single-handle lavatory faucet can change colors in minutes when you redecorate, and the manufacturer says its mechanism, with just one moving part, should last almost indefinitely. Handle, shell and underbody can be replaced in any of five colors in 10 minutes with a Phillips screwdriver, according to maker, Bradley Corp., Menomonee Falls, Wis. 53051.



## Electric 'wheelchair' helps the handicapped get around easier, faster

Gliding smoothly along on small, concealed wheels under its base, this new pedestal-type, electric-powered wheelchair can move in any direction, pivot on its own axis for quick turns and raise and lower its seat height to any desired level—all at the touch of pushbuttons. The Queensway Chair was developed by engineers at Queen Mary College in London.



## 'Instant' trenches for combat troops—or 'My, what big teeth you have, Grandma!'

Weary British foot soldiers won't have to dig their own trenches and foxholes with this big mechanical jaw to do it for them. Developed by the Royal Engineers, the machine has a series of claws on an endless belt that scoop out earth and carry it up to a second conveyor running crosswise at the top. The upper conveyor dumps the soil off to the side, forming an additional raised barrier along the edge of the trench. It can throw the earth to either side—depending on which way the enemy is coming.



## Compact heaters warm up chilly places

Electric heat you can put where you need it is offered by Singer's line of unit heaters. They have high-capacity elements in cast-aluminum heating grids, and can be hung from brackets or placed temporarily where needed. They're available in several models, delivering as much as 42,000 B.T.U. per hour, with or without thermostatic control. For information, prices, write The Singer Co., Climate Control Div., 62 Columbus St., Auburn, N.Y. 13021.



## A sportsman's scope you wear like a wristwatch

Worn like a wristwatch, this tiny six-power monocular scope gives you a quick view of distant objects without having to carry a heavy pair of binoculars around your neck. Designed for nature lovers, hunters, boaters and other outdoorsmen, Wristscope weighs only 3½ ounces, is smaller than a pack of cigarets. It focuses from 10 feet to infinity and has a wide field of view (210 feet at 500 yards). \$17.50 from Ranging, Inc., Rochester, N.Y. 14625.



## People-sized checkerboard makes an outdoor playground for giant-sized fun

Housing developer J. Edward Thornberg of Clear Lake, Iowa, has come up with a novel idea in community playgrounds. It's a huge concrete checkerboard with large squares painted alternately red and black. The playing pieces are 16-inch-diameter wood circles light enough for youngsters to move easily from space to space. To accommodate a number of neighborhood kids, the game is played with teams of four to a side, each child making every eighth move. Otherwise, standard rules are followed.



## Tray for shop or kitchen is sold ready to roll

A convenience for kitchen or workshop, this preassembled roll-out tray is quickly installed with four screws at the base of any cabinet or on top of open shelves. It has ball-bearing slides and is finished in white wood-grained vinyl. Three inches high and 20 inches deep, it's available in widths from 10 to 22 inches, priced from \$12.50 to \$17.50 through building supply dealers or from Hardware Designers, Inc., 120 Kisco Ave., Mount Kisco, N.Y. 10549.



## Fuji offers free 'Do Not X-Ray' labels to traveling photographers

Travelers worried about having film ruined by X-ray inspection at airports and other checkpoints can avoid the problem by pasting colorful warning labels on their camera bags, luggage and shipping cartons. The labels alert inspectors who, as an alternative to X-raying, will examine the contents visually. A set of six is available free by sending a request and self-addressed, stamped envelope to Fuji Photo Film, 350 Fifth Ave., New York, N.Y. 10001.

# Strong workmanship but weak torque on the low end

A nationwide survey based on 2 million owner-driven miles.

by **Michael Lamm**  
WEST COAST EDITOR

There are two dash bins, in addition to regular glove compartment. Grab handles are a thoughtful touch, but rear windows should open out.



Front-wheel drive, plus radial tires, gives surefooted traction. Drivers learn not to back off in real hard cornering, which causes rear to slide as with all fwd cars

The German Audi 100, produced by the same people who make Volkswagen and Porsche, is claimed to have the virtues of "the world's seven greatest cars"—at a price below all but one of them. Outwardly the Audi looks like a smaller Mercedes, and not by accident. Its designers tried hard to capture some M-B flavor.

But is the Audi as great as its admen make it out to be? In the area of workmanship, definitely yes. Nearly 88 percent of the owners we surveyed rated Audi workmanship "good to excellent." That's the highest percentage we've gotten this year, the 1973 average being 65.5 percent so far.

Also high on drivers' lists of praises is the Audi's handling. With front-wheel drive, standard radial tires, rack-and-pinion steering and power disc brakes, owners feel they're in a sports car, not a family sedan. Owners likewise nod appreciatively at such thoughtful touches as *comfortable* and *easy-*



to-use inertia-reel shoulder harnesses, admirable gas economy (18-22 mpg), adequate rear legroom and a full-sized trunk.

On the minus side, the most serious complaint seems to be a lack of low-speed torque. The four-cylinder, water-cooled engine displaces 114.2 cu. in. (1871-cc) and puts out 91 bhp at a very high 5100 rpm. Torque rates 111 lb.-ft. at 3500 rpm. This last figure means relatively weak muscle at low rpm, which in turn means it takes a lot of revving and clutch slippage to get the car rolling from standstill (with standard transmission). Owners of automatic-equipped Audis also feel the lack of low-speed torque and complained additionally of rougher shifts than they'd been used to with American cars. (This "slowness" certainly hasn't been inherited by the smaller, just introduced, Audi Fox. See *Cars the Red Baron Would Love*, page 138, July PM.).

Another, more surprising gripe focused

**Mini-Mercedes styling** satisfies owners' ego and is their main reason for buying Audi. Relatively narrow pillars give good vision, and while the car looks small outside, it's not at all cramped in rear seat or front buckets.



## 'I bought my Audi because . . . I wanted something different.'

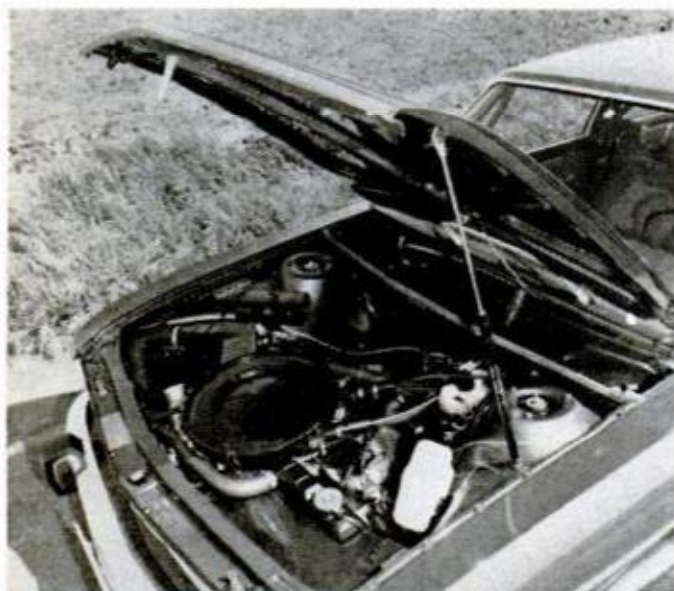
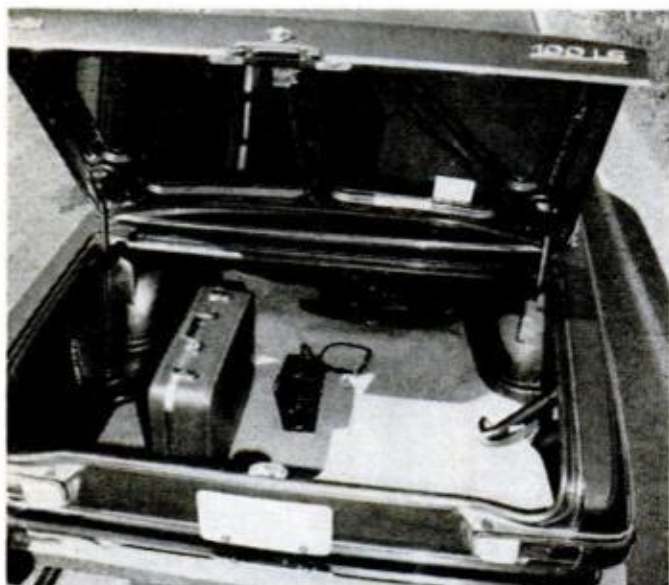

There's lots of room in the trunk and two handy storage compartments at sides. Four-cylinder engine stands ahead of transaxle, with radiator offset to left and cooled by electric fan. Everything's accessible.

Inboard front disc brakes are standard, but several owners would have liked power steering (not offered). Audi's 185.2-inch overall length makes parking easy. Car's unitized body-chassis isn't free from rattles.



on body rattles. Why should a car with a unitized body/chassis rattle, especially one that rates so high on workmanship? No one seems to know the answer, but there it is—that consistent mention of annoying rattles.

Nor were Audi owners too crazy about dealer service. Sixty percent rated it "average to poor" despite (or perhaps because of) the Audi's 12-month, 20,000-mile warranty.

But let's hear it from the owners.

"I find the car very comfortable, and so do my passengers. They have all expressed amazement at the Audi's room and ride," purrs an Illinois landscape contractor. A New York crane oiler: "I bought my Audi because I was tired of all those standard-looking American cars. I wanted something different." (Styling ranks first as the owners' principal reason for buying the Audi.)

"The Audi is very deceptive when you first see it from the outside," notes a Massachusetts secretary. "because when you get inside it has as much room as a big U.S. car."

A high-mileage Ohio traveling salesman: "I'll buy another Audi if this one holds up well to 120,000 miles without major repairs. The only thing wrong now (at 17,000 miles) has been that the carburetor needed reworking. Complaint: The windshield wiper on the driver's side doesn't wipe far enough to the left. This leaves a large unwiped area."

A Wisconsin nontraveling salesman: "This is my fourth new car and by far the most superior in engineering and dollar value. It's good-looking, has no blind spots, the front drive gives complete control in slippery situations, shifting is smooth, it gets good gas mileage, and it has the best seat belts I've ever used. My only suggestion would be to replace the idiot lights with real gauges. Otherwise I'm a very pleased Audi owner and recommend it highly."

An Indiana research chemist: "It could possibly use power steering and a little more horsepower, but not at the expense of fuel economy. Front-wheel drive is great in heavy snow. It's the right-size car for me, with the right amount of room inside and in the trunk."

A Virginia retired federal employee: "My chief objection to buying an Audi was my preference for a U.S. car for patriotic reasons. But better vision, headroom and



**Receptacle ends** for beautifully designed, three-point inertia-reel belts are always at hand. Twin dials on

dash are easy to read; owners prefer gauges to idiot lights used. Bigger overrides would protect the grille.

legroom made me decide in its favor. I am 5-8. Among U.S. cars, I checked out the Dart, Hornet, Nova, Omega and Valiant. Only the Valiant had satisfactory vision and room, but the Audi seemed better engineered, and surface workmanship was obviously better."

A dissatisfied New York dairyman complains: "I leave the car for a full day for service. When I pick it up, I am told it has been fixed, but it never is. I bought the car only because of Audi's advertising. Workmanship is poorer than expected. The car simply isn't worth the price. Passengers find the rear uncomfortable because the rear windows won't open. I have no praises for this car, but it does look nice from the

outside. The windshield still leaks, and the oil light comes on constantly, even though there's plenty of oil in the engine, and the warranty seems highly overrated. I am very disappointed with this car."

A Wisconsin teacher counters and sums up: "I think the Audi is every bit the car it's advertised to be. I'm not a car lover by any means—in fact, to me cars have more negative than positive virtues. But the Audi is a more sane approach to individual transportation than the monsters Detroit produces. I'm all for smaller-sized, quality cars, and the Audi is a good example. I paid more for the Audi than I've ever paid for a car before (\$4250), but at this point I'm not sorry." ★★★

## Summary of 1973 Audi Owners Reports\*

<b>Total miles driven</b> .....	1,942,253	<b>Ride</b> .....	21.6	<b>Dealer repairs satisfactory?</b>	
<b>Series:</b>		<b>Workmanship</b> .....	14.6	Yes .....	61.9%
Audi 100 .....	2.6%	<b>Specific dislikes:</b>		No .....	38.1
Audi 100-LS .....	92.4	<b>Rattles</b> .....	15.3%	<b>Dealer service opinion:</b>	
Audi 100-GL .....	4.9	<b>Poor gas mileage</b> .....	11.5	Good to excellent .....	40.1%
<b>Body style:</b>		<b>Poor dealer service</b> .....	10.9	Average to poor .....	60.0
Two-door sedan .....	27.5%	<b>Transmission</b> .....	10.9	<b>Workmanship opinion:</b>	
Four-door sedan .....	72.5	<b>Brakes</b> .....	8.5	Good to excellent .....	87.9%
<b>Transmission:</b>		<b>What changes would you like?</b>		Average to poor .....	12.1
Automatic .....	58.8%	<b>Add power steering</b> .....	11.9%	<b>Is the Audi your only car?</b>	
Manual .....	41.2	<b>Fewer rattles</b> .....	8.7	No .....	59.7%
<b>Average miles per gallon:</b>		<b>Bigger engine</b> .....	8.4	Yes .....	40.3
Local driving .....	18.0	<b>Better battery location</b> .....	8.4	<b>Other makes of cars owned:</b>	
Long distance .....	22.0	<b>(it's under the rear seat)</b>		Volkswagen .....	23.8%
<b>Why the Audi?</b>		<b>Less engine surge</b> .....	6.5	Chevrolet .....	16.0
<b>Styling</b> .....	27.9%	<b>More power</b> .....	5.8	Ford .....	10.2
<b>Economy</b> .....	25.9	<b>Had any mechanical trouble?</b>		Buick .....	5.3
<b>Size</b> .....	22.9	Yes .....	68.2%	Pontiac .....	5.3
<b>Quality</b> .....	15.6	No .....	31.8	<b>Age distribution of owners:</b>	
<b>Reputation</b> .....	14.1	<b>What type of trouble?</b>		15-29 years .....	33.0%
<b>Handling</b> .....	12.9	<b>Carburetor</b> .....	30.3%	30-49 years .....	47.0
<b>Specific likes:</b>		<b>Electrical</b> .....	15.4	50-plus .....	20.0
<b>Handling</b> .....	63.2%	<b>Transmission</b> .....	11.1	<b>Would you buy another Audi?</b>	
<b>Comfort</b> .....	50.6	<b>Brakes</b> .....	7.3	Yes .....	87.5%
<b>Styling</b> .....	38.6	<b>Oil leaks</b> .....	6.4	No .....	12.5
<b>Economy</b> .....	36.3	<b>Did you repair it yourself?</b>			
		No .....	98.3%		
		Yes .....	1.7		

\* Percentages might not equal 100% due to rounding or insufficient data.

# Snappy little two-seater you can build yourself

by Sheldon M. Gallager  
and Howard Levy

When the Davis DA-2A was first unveiled a few years ago, it drew such humorous quips as "Is that an airplane or the crate it came in?" Admittedly, the boxy little two-place monoplane is not likely to win any beauty contests, but for the beginning home builder it represents the ultimate in design simplicity and ease of construction. The all-metal craft is as flat-skinned, slab-sided and square-cornered as you can get—all deliberately calculated to make assembly a breeze. What it lacks in sex appeal, it makes up for in surprisingly snappy performance. Pilots who have flown it claim it has the oomph of a Cherokee on half the power and handles as smartly as an aerobatic Pitts Special.

Despite its packing-crate resemblance, the DA-2A manages a trim, sporty look nonetheless. Its most distinctive feature is a jaunty V-tail, chosen both for its rakish appearance and also because it's actually simpler to construct than a conventional tail—you build only two control surfaces instead of three. The twin "ruddervators" are cleverly coordinated through a gimbal arrangement that permits them to function simultaneously as both rudders and elevators. The stubby wings have no flaps, and the tricycle landing gear is nonretractable—again for the utmost in simplicity.

The DA-2A's designer is Leon Davis, a top mechanic for Aero Commander. Proof that he must be doing something right is the fact that he's sold more than 140 sets of plans for the DA-2A to other home builders. The plane has also won two awards from the Experimental Aircraft Assn. for "Most Outstanding Design" and "Most Popular Aircraft." Dual-control, side-by-side seating makes the ship ideal as a trainer for beginning pilots or for two fliers who enjoy tak-



**V-shaped tail** has only two movable control surfaces that double as both rudders and elevators. While the arrangement looks tricky, it's actually easier to build than a conventional tail, gives ship a rakish, sporty appearance.

ing turns at the controls. Either control stick is quickly removable so as not to interfere with nonpiloting passengers just along for the ride. In back is luggage space that can be converted to extra seating for two youngsters—handy for family outings.

Another feature of the DA-2A is its relatively low cost—about \$1600, including engine. The prototype is fitted with a 65-hp Continental, but can take engines of up to 100 hp for those wanting something a bit hotter. Even on its modest 65 horses, the DA-2A is no slouch. It can hit 120 mph, cruises at 110, climbs 600 feet a minute and has a range of 450 miles on a 20-gallon fuel tank. Empty weight is 610 pounds, 1125 gross. Overall length is 17½ feet, and the wings span 19 feet. Complete plans for the DA-2A are \$110 from Leon Davis, 3501 Baumann Ave., Midland, Tex. 79701. An information kit is also available for \$2 for the convenience of those desiring more details before purchasing plans. ★ ★ ★



PHOTOS BY HOWARD LEVY

Despite its boxy design, ship is snappy, outperforms many homebuilts of equivalent size and power.



Wide, roomy cockpit with dual-control, side-by-side seating (right) offers unusual comfort and spaciousness for craft of DA-2A's size. Instrument panel, shown partially completed, includes full instrumentation and radio in finished form. One control stick is removed here.



Simple tricycle-type landing gear (near left) is nonretractable, has two main fixed wheels on spring-steel tubular struts, plus nose wheel. The nose wheel is steerable, has series of rubber doughnuts to cushion shocks, saving cost and weight of hydraulic absorber. Photo at far left shows plane's nose with prop and engine cowling removed. Prototype has a 65-hp Continental engine, but is stressed to take heftier powerplants of up to 100 hp.



The long shadows of sunrise and sunset bring out details that would fall flat if photographed in the high noon of day as in these desert badlands.

## How to get great pictures in the great outdoors

A professional wildlife photographer's secrets

by E.P. Haddon

For the sportsman, outdoor photography is a hobby within a hobby. And it's a hobby you can master with nothing more than a small camera that fits in your shirt pocket, plus some knowledge of and attention to simple techniques.

The basic requirement is a good camera that's easy to tote—but even the least expensive Instamatic can give good results if it's used properly. And even heavy telephoto outfits (good for camera-stalking game) are totable on long hikes: Just transfer the camera's weight to your pack frame with two belt hooks and some nylon tape (see top photo, facing page).

Good pictures start with good framing and composition. If you studied all the volumes on good composition and then squeezed out the nonessentials, it would boil down to this: An effective picture has good balance, it is pleasing to the eye



and it contains no unnecessary distractions.

Low camera positions are a helpful compositional trick many photographers ignore. Shooting upward from a low angle, you can dramatize subjects by making them look taller and by emphasizing the texture of the foreground. And aiming upward to shoot your subject against the sky eliminates much background clutter.

To make the sky more interesting, clouds can be emphasized with filters: For black and white, you can use yellow, orange or red filters for increasingly dramatic (and decreasingly natural) effects; with color, you can use only a polarizing filter, which darkens that portion of the sky at a right angle to the sun, and which also can be used with black and white film. When shooting distant scenics, or whenever shooting color at altitudes above 5000 feet, you should use skylight or haze filters to eliminate excess blue. Shooting bighorn in the Sangre de Cristo mountains, two miles above sea level, I find my shots look sick without such filters. (If you're shopping for an interchangeable-lens camera it pays to look for one whose lenses all take the same filter size.)

Focusing also affects your background. If it's cluttered and unattractive, use a wide-open lens to throw it out of focus. But for general scenics or action whose exact distance you can't foresee, use the smallest lens opening that permits an adequate shutter speed, to keep the greatest possible range of distances in focus; and use your lens's depth-of-field scale (most non-



A spotlight held this frog fascinated while we shot close-up from 3 feet away with a 90-mm tele. Flash on camera was augmented by slave flash held by a friend.

PHOTOS BY THE AUTHOR



Transfer your camera's weight from your neck to your packframe when backpacking, and you can hike for days. Author did it with nylon tape and belt hooks (circle).



Backlighting is most effective in open meadows, snow-covered landscapes and on the beach—especially when there is some wildlife around to cast extra shadows.

**Bird photography takes patience.** It is best to hide where birds nest, feed or gather. Blinds are necessary for close-ups of waterfowl and other nervous birds. This prairie falcon was snapped from hiding, with a long, 180-mm telephoto lens.

**Author hid, flash at the ready, by log where crocodile was likely to climb.** Flash off camera on 5-foot cord dramatized eye and teeth with sidelighting.



**Deadly cottonmouth moccasin**, shot from 20 inches with 90-mm lens and close-up attachment, couldn't strike—he was not coiled. Electronic flash stopped tongue.



automatic cameras have one) to place that depth where it will be most useful.

The subject's angle to the camera is also important. Animals and people are best shot facing the camera, and action is best shot moving into or across the picture, not out of it—basically a matter of aiming the camera a bit ahead of the action, so there will be more space in front of the action than behind it.

Action that's moving toward the camera is also easier to stop than action moving across the camera's field of view. A deer coming head-on at full-speed might be stopped with a shutter setting of 1/500 second (see photo on facing page); but running broadside across the camera's field close by, he might need 1/1000.

Where you expect to be shooting action in subdued light (or where you'll need fast shutter speeds to reduce the effects of tele lens shake) use a fast film such as High Speed Ektachrome for slides, or Tri-X for black-and-white prints. But slower films, such as Plus-X black and white, Ektachrome and Kodachrome for color slides, and Kodacolor for color prints will give you finer detail, so use them where high film speed isn't needed.

A faster film also helps you shoot on overcast or rainy days, when colors are soft and greens especially vivid. When the sun is out, try to shoot in the early morning and afternoon when the light is most dra-



**Barbary sheep**, among the wariest of big game, are hard to stalk. These were shot from a hiding place across the canyon, with a 500-mm telephoto lens on a  $2\frac{1}{4} \times 2\frac{1}{4}$  single-lens reflex camera. Telephotos are among most useful lenses for wildlife.

**Using trees for concealment**, author shot this elk herd storming past the camera. For such head-on action,  $1/500$  second is a fast-enough shutter speed. But broadside close-ups taken just as the elk moved past the camera required a faster shutter speed,  $1/1000$  second.



matic and long shadows accentuate landscapes and the animals that move across them. Early light is especially good for features of distant mountains that fall flat at high noon. If you find sunset or sunrise light too red, you can cool it down a bit with an 92A filter; if you want to accentuate the redness, try a Sky 1A or Haze.

Noon, oddly enough, is a good time for flash. Use it to fill in the shadows under noses and hat brims. When the sun is lower, flash fill-in lets you face subjects away from the sun, for more relaxed, squint-free expressions; properly done, such back-lighting is more dramatic, too. Fill-in is also good with sidelighting. The technique of fill-in flash is basically a matter of juggling flash and sunlight exposure so the subject gets its main exposure from the sun and a bit less exposure from the flash—the object is to lighten the shadows, not to wash them out altogether.

Flash is about your only choice when shooting game at night. The flash is too quick to scare the game, and it stops action beautifully. Nighttime flash shots do have an artificial look, with dark backgrounds, washed-out foregrounds and red eyes. But you can eliminate the red eyes and get more natural lighting by using a long flashcord and holding your flash off the camera. You can attach the flash to an overhanging tree limb with a camera clamp.

Electronic flash beats bulb flash on the

**Snow and beaches** can fool exposure meters—take a reading from your gloved hand, or follow exposure recommendations on your film's instruction sheet.



**90-mm medium tele** knit together this shot of falconer and dog by bringing the distant peaks into greater prominence.



**Camp scenes are a must** for thorough coverage of a pack trip. Here, the low morning light brought out considerable detail in light-colored sand, tent and kayak.

trail. A pocket-sized flash can give you as many as 150 shots or more on two sets of alkaline AA batteries (more batteries are easy to bring along), and there are no used bulbs to be carted back or to litter up the trail. Rechargeable flashes are okay, but only if you'll be back regularly to an a.c. power line for recharging.

Both electronic flash and cameras can be damaged by moisture. So take plenty of plastic bags to protect them from rain. You can even shoot single-lens reflex cameras while they're in a bag: Just cut holes for the lens and eyepiece, and clamp the edge of the bag to the lens with a lens hood.

If you're going to expose your camera regularly to heavy rains, snow, salt spray or canoe upsets, the Nikonos is tops. Sealed for underwater use, it also makes a great all-weather camera. It's my favorite for use on boats, but I've also used it when stalking mountain sheep above the timberline during summer rain and hail storms.

Whatever game you're stalking with a camera, you need the same tricks hunters use. Cling to the shadows, keep upwind from easily spooked game, walk slowly with



**With self-timer and pocket-sized camera clamp, you can become part of the picture. Wide-angle lens caught depth of field.**

a light tread, and anticipate what lies ahead. Preset your shutter speed and lens opening for existing conditions (automatic, electric-eye cameras do this for you) so you'll have nothing to do when an animal appears but aim, focus and shoot. If you're lying in wait at a water hole, salt lick or wherever the animal's location is predictable, you can save even more time by pre-focusing where you expect to see him.

The right equipment does make a difference in wildlife photography. A camera clamp is among the most useful pieces of gear, holding the camera so you can set a self-timer and get in the picture yourself, steadying it for time exposures, or holding a flashgun away from the camera. Add a long rubber-bulb or cable release and a camouflage poncho, and you're equipped to shoot birds in their nests. For close-ups of plants, insects and trout flies, use a single-lens reflex camera with auxiliary close-up lenses or extension tubes. With a polarizing filter, to cut through water-top reflections, you can even shoot a close-up portrait of a feeding fish. And reflex cameras are great

*(Please turn to page 187)*



**Tripod straps easily to the "Expedition" pack. When an ice ax is carried, the tripod can be strapped to the top of the pack frame. This Vivitar weighs under five pounds.**

# Bombs on Main Street

Dangerous cargoes roll across America by truck and rail. Too often they bring disaster to a community.

by Frank A. Tinker



A holocaust was touched off on a busy street in Indianapolis when a gasoline truck flipped and burst into flame. The driver, seen at bottom of photo, crawls from wreckage, his clothing on fire.



Last May the 18,000 residents of Roseville, Calif., learned what it was like to be under siege. Bombs blasted, shrapnel whistled, fires raged and mushroom clouds billowed in a violent nightmare that lasted 36 hours. The bombardment destroyed 10 homes, damaged about 400 others, and sent more than 30 persons to the hospital.

The source of the destructive power was a munitions train in Roseville's big rail yard. The train had contained some 7000 bombs bound ultimately for Southeast Asia. A fire apparently had touched off the first blast, but investigators were unable to explain how it got started. At this writing, that remains a mystery.

The Roseville disaster is by no means an



**Indianapolis inferno** claimed the lives of four when three cars plowed into wrecked truck. The tragedy occurred in 1966.

isolated event. Explosives constitute just one of 1000 different kinds of hazardous materials—simply called HM in the transportation field—that are shipped daily by rail and truck in all sections of the country. It's estimated that the railroads alone experienced 80 "serious" HM accidents in 1972. Six involved explosions, one of which caused injury to more than 230 persons.

Shipping hazardous materials is, of course, legal and very necessary for a nation as highly industrialized as ours. Among the most common hazardous materials are gasoline, propane and hydrogen, all carried in trucks marked **FLAMMABLE**.

If the warning label says **POISON**, the cargo might be a pesticide like parathion,

closely related in composition and effect to the nerve gas of World War II. **POISON GAS**, on the other hand, may indicate a cargo of phosgene, which is not only a war weapon but a common ingredient in plastics manufacture and in typewriter-ribbon dyes.

Federal regulations call for trucks carrying HM to follow sparsely settled routes, but these restrictions are hard to enforce. Though most hazardous cargo is moved without mishap, the list of near catastrophes makes frightening reading. Poison cargoes have as much potential for tragedy as do the more explosive substances. An agent of the Office of Hazardous Materials, an arm of the U.S. Department of Transportation, admits that authorities keep their

fingers crossed against the possibility of a poison spill in a populated area.

A few years ago a trailer loaded with parathion overturned in the desert near Blythe, Calif. Some of the truck's containers ruptured and a small part of the cargo spilled onto Highway 80. The shipment was poorly labeled and before the danger was recognized several persons had walked through the spillage. Eventually the highway was closed and a radio alert broadcast. Some 60 persons were given medical inspections and released; the driver and two investigators required hospital treatment.

"Why it didn't kill off half of the people passing through that area I'll never know,"

a state highway agent observed. Only some 85 gallons of the concentrate was actually spilled, however, and this in an outlying desert area. If the truck's entire cargo of about 20,000 pounds had been released a few miles east in Blythe itself, the story would have been tragically different.

With such cargo aboard their vehicles, drivers would be expected to exercise particular caution. The majority do. Some, amazingly, appear to be indifferent. Investigators in this field give as an example the disaster that occurred at Roseburg, Ore., in 1959. Thirteen persons died, 125 were injured, and an eight-block area was wiped out when a dynamite truck exploded.

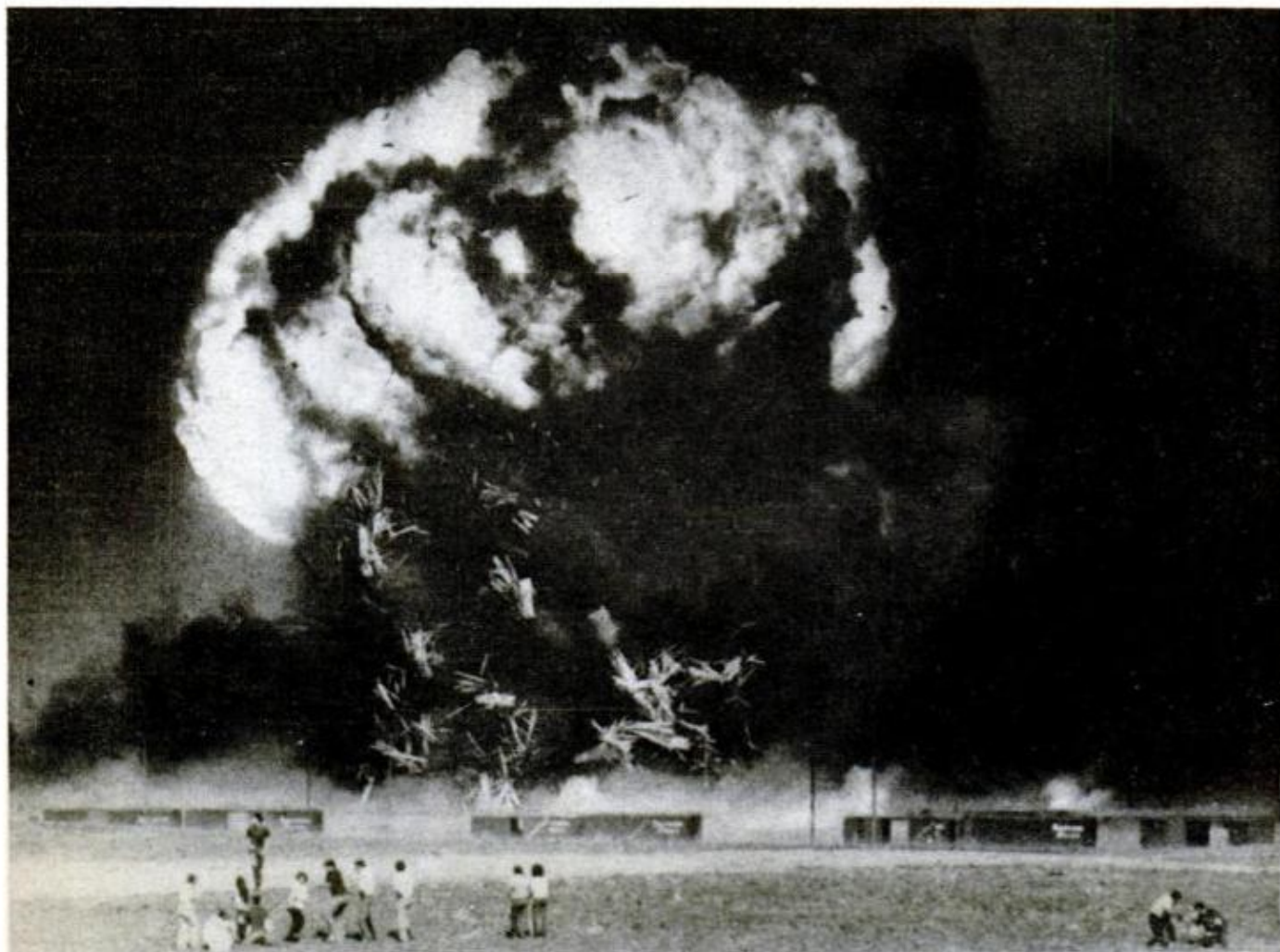

**Booming explosions, flame, flying debris, mushroom clouds** filled the air when a munitions train blew up in the Roseville, Calif., rail yard last May.

**Damage** was estimated at more than \$5 million. Some 120 railroad cars were destroyed and 150 damaged. Many homes in the area were also hit.



Rule 397.5, Department of Transportation's regulations states—and stated then—that such a cargo “. . . must be attended at all times by its driver or a qualified representative . . .” Nevertheless, the driver parked the truck near a lumberyard and went to bed. During the night the yard caught fire and touched off the holocaust, destroying an industrial section of the city.

A 1970 analysis of accidents involving HM compiled by the Bureau of Motor Carrier Safety lists many disquieting mishaps. A trucker with ammunition aboard dozed, drifted across the center line, and died with two other drivers when he collided head-on with their tractor-trailer. In Oregon, a truck driver who apparently fell asleep at the wheel was killed when his flatbed trailer carrying anhydrous ammonia overturned. (Fumes from this common chemical have killed people who happened to be near such a spill.)

In Ohio, fire engulfed a loading area when a driver pulled out without uncoupling the hose leading to a gas storage tank; six persons died and \$250,000 damage was done. The '70 study shows that gasoline, simply because it is the most frequently transported HM, heads the list in causing property damage and deaths.

In the case of railroads, poor maintenance and faulty equipment are the most common causes of HM accidents. This industry's shaky financial situation has caused extensive deterioration of roadbeds and rolling stock, reflected in a rising derailment rate. It is estimated that one-fourth of the freight cars and half the locomotives now in use are overage, while trackage on some lines is literally falling apart.

The railroads claim an accident rate less than that of trucks, but they would have a hard time selling that claim to many people in Ohio, Texas and other states.

Some months ago, 40 cars were derailed in Ohio—tankers loaded with chemicals that caught fire and menaced a nearby community. When the same thing happened in Houston, Tex., in 1971, firemen were caught by an exploding tank of chemicals as they fought the fire. The blast leveled the switching yard.

Town after town has been hit by such accidents. In 1969 a train buckled when brakes were slammed to avoid a pedestrian near Glendora, Miss. Tank cars carrying vinyl chloride began exploding, wrecking the area and causing toxic gas to accumu-



**National guardsmen** watch smoke rise from wreck at Glendora, Miss. (top photo). Thousands were evacuated from their homes when lethal gas leaked from cars.

**Exploding gas** following a 1970 derailment at Crescent City, Ill., resulted in injury to 66 persons and property damage estimated at \$1.7 million.

late in low-lying sections. Eventually 17,000 people had to be evacuated.

Another derailment in '69, in Nebraska, caused a tank car to fracture, releasing 29,000 gallons of anhydrous ammonia. Six people were killed and 53 injured from breathing the caustic fumes. The National Transportation Safety Board found that the accident was due to "track deficiencies."

What can be done to lessen the dangers inherent in transporting hazardous materials? Part of the answer is money—lots of it—to modernize railroad equipment.

According to the Federal Railway Administration, which oversees railroad operations, causes of mishaps are divided almost equally between human error and defective equipment. This agency is drawing up regulations designed to overcome deficiencies in safety inspections, hasten retirement of old rolling stock, and place speed limits on freight trains. The rail industry is said to be working on a study of tank-car safety.

How to minimize the HM danger on highways is another problem. Complicating it is the very number of hazardous materials that are shipped. About 1000 HM categories and more than 200,000 specific substances are now listed by the government. Many require special methods of packaging and handling.

"What we need is education—for shippers, carriers and the public!" says Judd Shelton of the Bureau of Motor Carrier Safety. "We can go into any warehouse and find violations of hazardous-materials regulations."

He cites the example of a gunpowder shipment marked as weighing only 1 pound when it actually weighed 100 pounds. The shipper had deliberately avoided more expensive packaging and labeling by listing the lower weight.

Tragedies have occurred, he emphasizes, simply because labels or placards have been in error or disregarded. The railroad fire at Houston claimed its victims because of inadequate marking on the overturned cars and the unavailability of the shipping documents, which left firemen facing an unknown combustible.

This type situation helps account for the fact that 65 percent of people killed due to HM emergencies are firemen and police.

"These loads are not placarded just because someone thinks it's a good idea," says Shelton, "but because people have been

*(Please turn to page 183)*



**Because so much of it is shipped,** gasoline heads list of causes of hazardous-materials accidents. A wrecked truck (top photo) can do great damage.

**Arizona state agents** check truck stops and shipping terminals for violators of safety regulations. Trail of liquid on road led to this truck (middle photo).

**Vehicle inspection** is carried out by highway patrolman and state agents. Safety experts found several items of faulty equipment on this rig.

# Those color-TV tuning buttons: What they do—and don't do

by Jim Lockett

Those automatic tuning systems color TV makers have added to their products in recent years make it a lot easier to get and keep a good color picture on your set—but a lot harder to figure out which set best suits your needs and offers the greatest value. And just to make things a little harder for you, manufacturers have planted a thicket of made-up terms and advertising claims between you and any understanding of what they really have to offer.

Despite the impressive-sounding Madison Avenue names—InstaMatic Permalock, Color Master, AccuMatic, ABC—most systems are simply a combination of fairly standard circuits. But this doesn't mean all are alike. Each manufacturer employs his own particular combination of automatic tuning circuits and some have come up with much more convenient total packages than others.

Basically, there are two classes of automatic tuning systems: preset and active. Preset systems generally have one or more pushbuttons that switch picture controls to levels preset at the factory, overriding the viewer's manual controls. Active systems, such as automatic fine tuning or automatic color control, employ circuitry that continuously compensates for changes in the incoming signal or in other conditions. Most sets nowadays

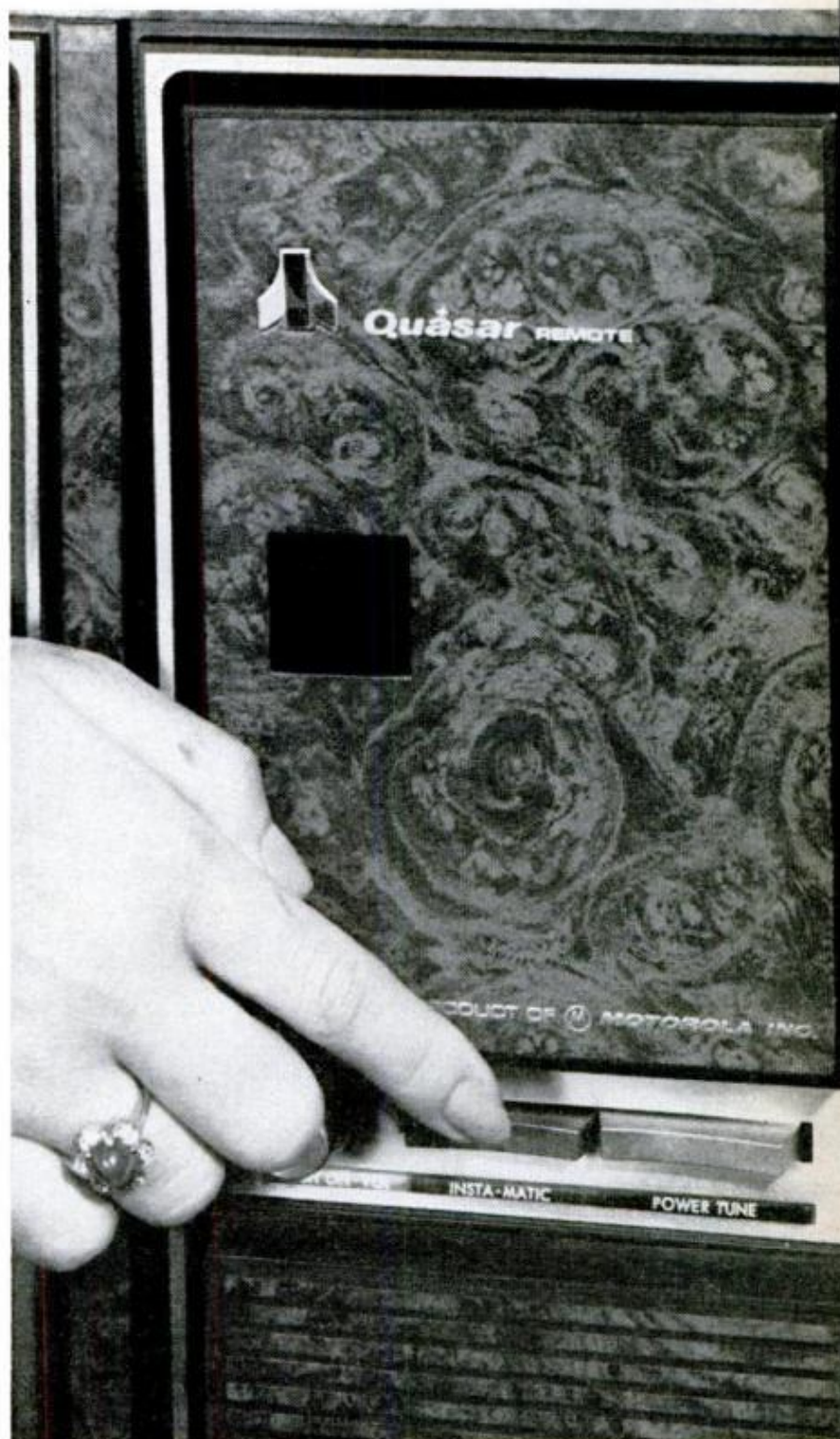



Electronic sensors (on screen) help factory technicians adjust preset controls for "pushbutton" color.

employ both, in one form or another. In many cases, both preset and active circuits are activated by a single pushbutton on the front of the set and are promoted by the manufacturer under a single, all-encompassing name of his own invention.

Let's look at the preset systems first. The simplest type uses a single pushbutton to completely disconnect manual picture controls, setting and locking tint, color intensity, contrast and brightness at predetermined levels. In some cases, one or two picture adjustments may not be tied into the preset pushbutton, or the various adjustments might be divided between two buttons instead of grouped on one, but the principle is the same.

Pushing the preset button will usually give you an acceptable picture, but not as

COMPANY	NAME OF TUNING SYSTEM	AFT	MAIN TUNING CONTROL OPERATES:				
			ATC	PRESET COLOR LEVEL	PRESET TINT	PRESET BRIGHTNESS	PRESET CONTRAST
ADMIRAL	Color Master	Yes	Yes	Yes	Yes	No	No
AE	One Touch Color	Yes	Yes	Yes	Yes	No	No
AIKACHI	APS Plus	No	Yes	Yes	Yes	Yes	Yes
ALCANTARA	Color Lock	Yes	No	Yes	Yes	No	No
ALCANTARA	Videomatic	Yes	No	Yes	Yes	Yes	Yes
AMONTGOMERY WARD	Auto Color	Yes	No	Yes	Yes	Yes	Yes
AMPHIPHON	Insta-Matic	Yes	Yes	Yes	Yes	Yes	Yes
ANASONIC	Q-Lock	No	Yes	Yes	Yes	Yes	Yes
APC. PENNEY	Chroma-Lock	No	Yes	Yes	Yes	Yes	Yes
ARLCO	Philcomatic II & III	Yes	Yes	Yes	Yes	Yes	Yes
ARLCO	AccuMatic IV	No	Yes	Yes	Yes	Yes	Yes
ARLCO	Trimatic	No	Yes	Yes	Yes	Separate button	"Bricon"
ARLCO	One-Button Color	Yes	Yes	Yes	Yes	Yes	Yes
ARLCO	ACS	Yes	No	Yes	Yes	Yes	Yes
ARLCO		Yes	No	Yes	Yes	No	No
ARLCO	Perma-Lock	No	No	Yes	Yes	Yes	No
ARLCO	Tele-Magic	Yes	Yes	Yes	Yes	Yes	Yes
ARLCO	ABC (Automatic Balanced Color)	Yes	Yes	Yes	Yes	Yes	Yes
ARLCO	Chromatic	No	Yes	Yes	Yes	Yes	Yes

good as you can tune yourself if you're any good at knob twiddling. Of course, you can always change the preset levels—they can usually be adjusted from the back of the set using a screwdriver—but when you change channels, you'll be right back where you started. The problem is, broadcast signals vary too much. Even without changing channels, readjustment of color and tint is often necessary from time to time. Then, too, at different room light levels you'll want different amounts of brightness and contrast; and different members of your family may prefer different color and tint settings.

Still, the preset pushbutton has advantages. If there are people in your family who can't get the hang of adjusting a color set, the pushbutton will give them a watch-

able picture and reduce the likelihood that they'll scramble all the manual controls in a hopeless effort to get a good one. And any time you're feeling lazy, or not very particular about the picture you're watching, the button may prove convenient. On the other hand, there's nothing a preset pushbutton can do that a mark on each of the manual controls wouldn't do just as well. If you already own a color set without a preset pushbutton, or you want to save a few bucks by buying a set without one, why not tune up the set very carefully and then put a dot of nail polish on each control and a dot on the control panel next to it? It won't have as much gimmick appeal, but it will accomplish the same purpose.

Zenith used to put a mark on each picture adjustment knob, on the theory that the

SEPARATE AFT CONTROL OR DEFEAT?	EFFECT OF MANUAL CONTROLS IN AUTO MODE	OTHER REMARKS
No	None	
No	Slight	Separate, 3-way flesh-tone (ATC) adjustment.
Yes	None	
Yes	None	ATC always on.
Yes	Slight	In auto mode, "Videomatic Eye" compensates for room-light-level changes. ATC always on.
Yes	None	ATC always on.
Yes	None	ATC always on.
Yes	Slight, on color and tint only.	
Yes	Slight, on color and tint only.	
AFT shuts off when fine-tuning knob is touched.	Slight	Light indicates when fine tuning is within range where AFT can operate.
Yes	Slight	
Yes	None	Separate buttons for: AFT; ATC, tint and color; brightness and contrast.
No	Slight	
No	None	Separate ATC control. Some remote-control models show channel numbers on screen.
Yes	Slight	Pushing fine-tuning knob defeats AFC. No ATC.
Yes	None	ATC always on.
Yes	None	
No	Slight	Green-correction circuit operates in auto mode, for less blue flesh tones.
Yes	Slight, on tint and color only.	"Power Sentry" keeps picture quality constant despite power surges or reduced line voltages.

## Some automatic systems let you make minor adjustments

user could find the best setting, pull the knob off and then put it back on with the mark at 12:00 o'clock. It was a good idea, but they apparently found they couldn't compete with the "magic" of pushbuttons. Most people are impressed when a salesman, with the press of a button, snaps in a good picture on a completely misadjusted set.

A variation on the basic preset pushbutton that is becoming increasingly common allows the viewer to make minor adjustments, using the manual controls, even when the pushbutton is engaged. With the pushbutton disengaged, manual controls have full effect; but when you push the button in, the effect of the manual controls is reduced to a narrow range that still allows for differences in viewer preference and signal transmission. The amount of adjustment that is possible with the pushbutton engaged varies from manufacturer to manufacturer. Some allow so much range that you could still get a pretty awful picture if you wanted to. Some others allow so little range that you almost couldn't tell you were affecting the picture at all if the maker didn't tell you so.

Systems that allow you to make minor adjustments even when the pushbutton is engaged offer greater flexibility—and more opportunity for error. But they do nothing that marking the dials wouldn't do if you marked off a range on the dial instead of just indicating a single setting.

But active color-tuning systems do accomplish more than could be done with marks on dials. In theory at least, they reduce the number of times you have to get up and readjust your set, because they compensate automatically for variations in the broadcast picture.

Automatic color control (ACC) and automatic tint control (ATC) are the most common types of active color-tuning systems. ACC is nearly universal, though some sets have more effective versions of it than others. Its purpose is to eliminate variations in color intensity that might result from changes in reception conditions.

ATC is designed to produce pleasing flesh tones in the picture, eliminating reddish or greenish faces. It works by emphasizing the range of colors that is normally found in human skin—but unfortunately, elec-

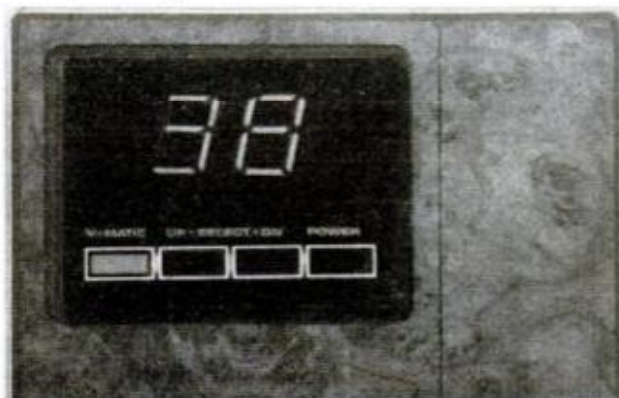

**New Magnavox tuning system** has digital channel read-out, no knob (one button sweeps to the higher channels, another tunes set to the lower ones). Its "V-matic" button controls automatic color-setting system.

tronic circuitry can't tell if it's masking out the green shadows on a person's face or muddying a football field that's actually supposed to be bright green. All shades of color in the picture that are close to flesh tone, especially greens and yellows, are "pushed" toward flesh color by ATC. Even so, a subtle amount of flesh tone emphasis is probably desirable, despite the accompanying loss of color fidelity. Given the imperfect state of color broadcasting and receiving equipment in the country today, ATC is probably the only way to get consistently acceptable facial coloration without hovering over the tint control yourself. But when buying a color set, be sure to avoid those with an overzealous ATC that gives the whole picture an orange cast.

Unfortunately, ATC is usually activated



**Experimental Panasonic** shown last year had 11 plates, each of which tuned in a preselected channel when touched lightly. Panasonic also exhibited a prototype having a digital channel indication.



**Making remote-control tuning easier**, too, this new Sharp displays a big, bright channel number on its screen for a few seconds each time you tune in a new channel: then the number merely fades away.

by the same pushbutton that switches picture adjustments to preset levels. That means you can't have one without the other. Still worse are the few sets that provide no way of turning off ATC at all. With these, you can never have true color reproduction, even under ideal conditions. Those few sets that have separate switches for ATC are best.

There are two types of devices for making fine tuning easier: memory fine tuning, which is really a preset system, and automatic fine tuning (AFT). Memory fine tuning "remembers" the last setting of the fine-tuning control that was used on each channel. After you go around the dial once and tune in each station, you shouldn't have to touch the fine tuning again for at least a couple of months. AFT electronically

locks in on the strongest signal near the frequency that the set is tuned to, so you may never have to adjust fine tuning yourself. Almost all sets have memory fine tuning; all but the cheapest also have AFT.

There are times when you will want to defeat AFT, as when a strong interference signal is present on nearly the same frequency as the station you are watching. If AFT wasn't deactivated in such a case, it might lock onto the interference instead of the desired signal. On some sets, AFT is activated by the same button as preset picture controls, so if you turn off AFT, you have to manually adjust picture controls as well. What's worse, if you want to activate AFT on these sets, you have to settle for the preset picture adjustments, too. Some sets have an AFT defeat switch which eliminates the first problem but not the second. Fortunately, many sets, including those made by RCA, Zenith and several Japanese manufacturers, have a completely independent AFT control.

Only Magnovox offers an active "tuning" system that compensates for changes in room light levels. On some of its sets, a light-dependent resistor, called a "Videomatic Eye," senses the amount of light in the room and either increased or decreases brightness, color intensity and contrast to coincide with changes in room light. Most people don't vary the amount of light in the room very much when watching TV, but Videomatic is an interesting gimmick

*(Please turn to page 182)*

## How to evaluate AFT

First, determine how great a range the AFT has. Turn the AFT off, slightly misadjust the manual fine tuning, then turn the AFT back on. If the picture snaps back perfectly (or at least as good as you can get by careful manual adjustment), AFT is doing its job. Repeat this procedure, detuning the manual fine-tuning control more and more each time, until you go beyond the range of the set's AFT. This tells you exactly how far off fine tuning can be without being beyond AFT's reach.

Next, check to see how accurate the AFT is: With the AFT off, carefully adjust the manual fine-tuning control for the best possible picture. Then, turn the AFT back on. There probably won't be any change for the better, but there certainly should be none for the worse. (In some sets, AFT actually locks in offcenter, which is a lot worse than having no AFT at all.)

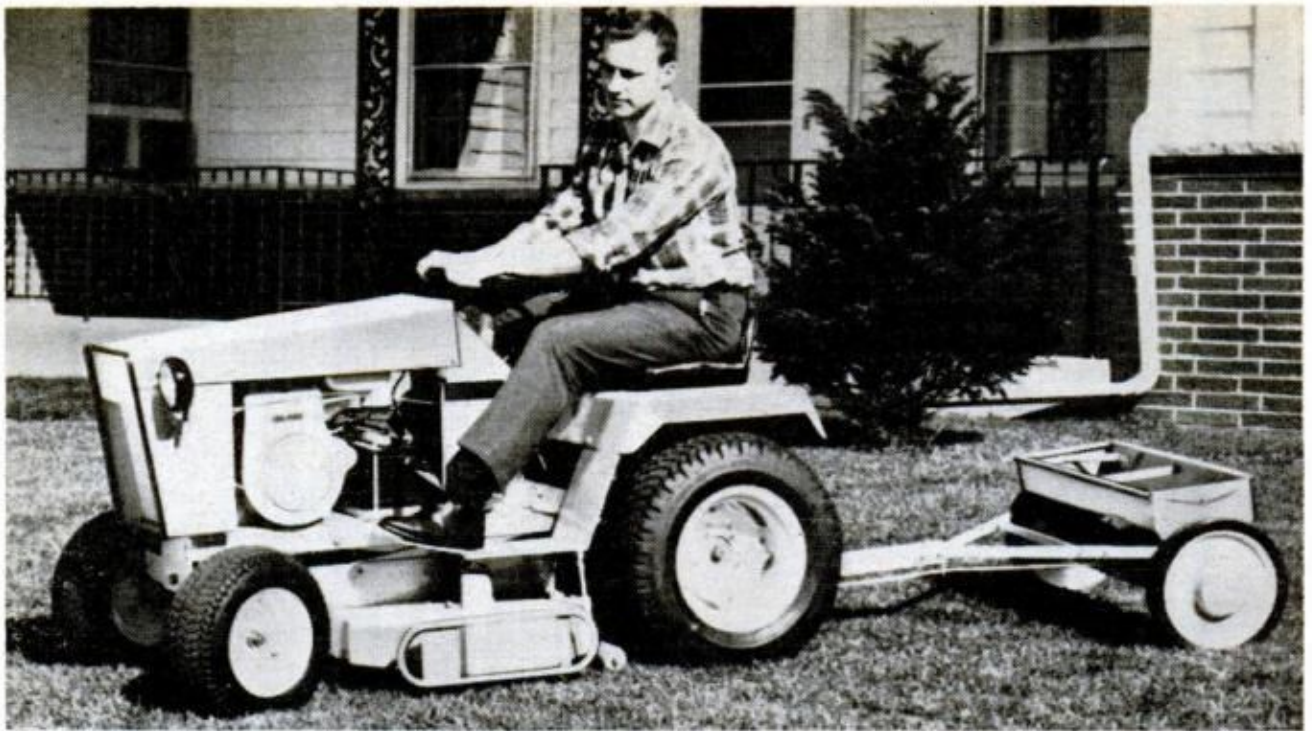

Powerful 12-horse kit-built tractor purrs along pulling a spreader above, has headlights for night use.

## Garden tractor you can build from a kit

by Gerald Kratsch

You can build a lot of things from kits these days, but one of the latest and most unusual is this assemble-it-yourself garden tractor that arrives in a carton of parts. Made by Struck, the kit tractor is available with two power options—a 12 or 16-hp Tecumseh engine—and with either manual or electric start. Base price for the 12-hp version is about \$600—several hundred dollars less than ready-made models of comparable size and power. The 16-hp kit is about \$850 and includes electric start, again offering substantial savings over equivalent store-bought machines.

Though lacking some of the decorative frills of ready-builts, the Struck Turf-Rider is designed for simple assembly, easy maintenance and rugged use. Its 48-inch wheelbase, 23 by 8.50-12 oversize rear tires and hefty weight of 650 pounds all combine to give it good traction and muscle for handling a variety of tough yard jobs. Attachments include a 55-inch rotary mower, snowthrowers up to 48 inches in clearing width, a bulldozer blade, spreader cart, lawn roller and several plowing and tilling accessories. For added traction on snow, soft ground or



**Kit of parts** looks like this when it arrives. Note engine and transmission already mounted on prewelded chassis to speed assembly. Doing your own work saves money, also makes replacement of parts easier later.



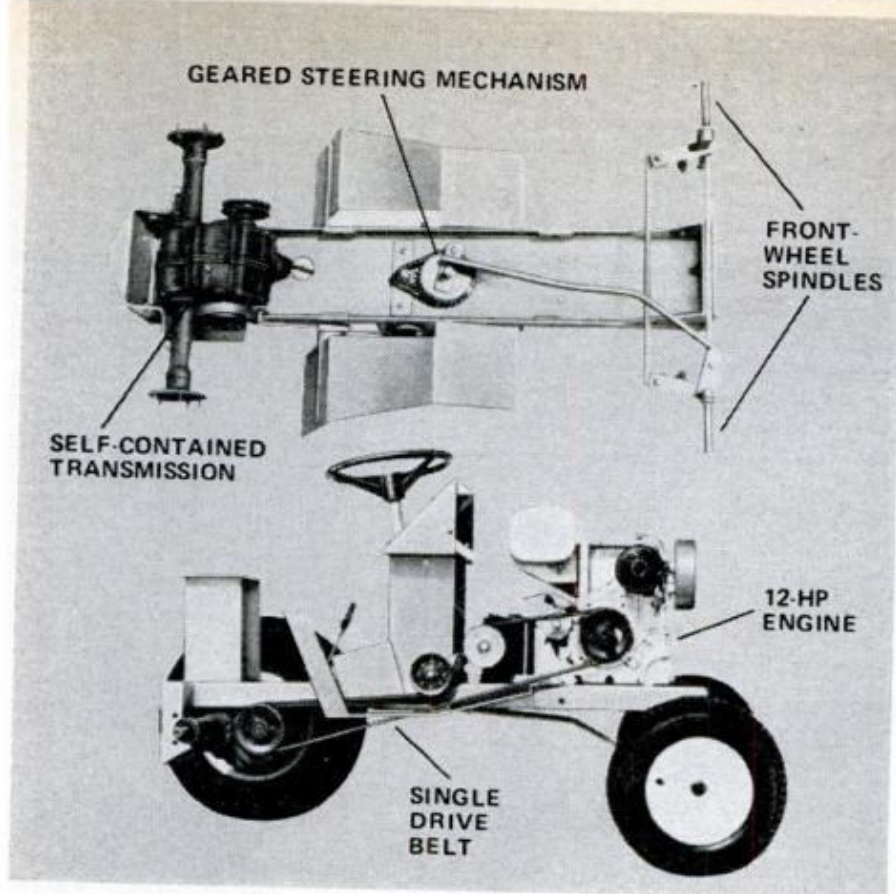

**Simple construction** is shown in stripped-down chassis views of 12-hp model at left. Near-vertical steering-wheel shaft turns small sprocket underneath that, in turn, drives larger sprocket with crank arm attached to move front-wheel spindle linkage. This, in effect, provides geared steering arrangement through a reduction ratio for easy turning of the tractor's front wheels with a minimum of effort.

rough terrain, the 16-horse model can be fitted with a half-track conversion drive priced at about \$250. A 400-pound-capacity front-end loader is also available in kit form for about \$250.

Building your own tractor is not as much of an undertaking as it may seem. The kit comes partially preassembled to speed construction. The engine and a self-contained Peerless transmission are already mounted on the chassis frame. From there on, it's mainly a bolt-together operation. All holes are predrilled, and no welding is required. A few wrenches are virtually the only tools needed. Assembly time averages five to seven hours depending on how fast you work—an easy weekend job.

The drive is basically simple, consisting of a single V-belt from engine to transmission, with a foot pedal that combines the functions of brake and clutch in one control. A sprocket arrangement provides the equivalent of geared steering for easy turning of the tractor's front wheels. Powered accessories are quickly attached and removed in minutes. For further information on the Turf-Rider kits, write C. F. Struck Corp., Cedarburg, Wis. 53012. ★ ★ ★



**Heftier 16-hp model** comes with half-track crawler-tread drive for added traction on snow or difficult terrain. It can also be fitted with a front-end loader, shown above, having 400-pound capacity.

# Will clean-air cops confiscate your car?



The deadline on our freedom to drive “any old car” anywhere we want is closing in—because that freedom affects our health and the health of others. To meet federally prescribed standards for healthful air, state governments may soon change your driving habits and hit your pocketbook with some or all of the following measures—unless the air in your locale can be kept clean without them: Inspection of all vehicles for emissions; retrofitting of older vehicles with emissions-control devices, and banning of cars from downtown areas.

In California, the retrofitting of older cars with antipollution devices to decrease emissions of oxides of nitrogen ( $\text{NO}_x$ ) is law. Here is what motorists in that state need to know about driving a legal car.

## by Michael Lamm

WEST COAST EDITOR

California owners of 1966-70 model cars are now required by law to install new antipollution devices on their cars. Month by month, almost all of the state's 4.5-million cars of this vintage must be retrofitted according to a prescribed schedule. What is the cost for such a device, and its installation? It can't exceed \$35, as prescribed by law. But there are many more questions in the minds of motorists; here are some of them, and the answers.

### *What are these various devices for?*

They are designed to cut exhaust emissions of oxides of nitrogen ( $\text{NO}_x$ ). The reason is that hydrocarbons (HC), in combination with  $\text{NO}_x$ , react in sunlight to form photochemical smog, which particularly plagues Southern California.

### *Who needs them?*

By state law, passed in 1971, they are required on all 1966-70 cars registered in the state of California.

### *Why only on 1966-70 cars?*

To achieve reductions in HC and carbon monoxide (CO), the auto manufacturers during those years used higher combustion temperatures. This resulted in reductions of HC and CO, but *increased*  $\text{NO}_x$ . The retrofit (add-on) devices are designed to decrease  $\text{NO}_x$  on these model-year cars.

### *Don't earlier and later model cars have to have them, too?*

Some 1970 and all 1971-and-later cars were redesigned so as to reduce  $\text{NO}_x$  as well as HC and CO. Pre-1966 cars were not considered to have as acute an  $\text{NO}_x$  problem. They must, however, now have devices of their own that reduce both HC and  $\text{NO}_x$ .

### *What are they?*

One of two devices, both basically vacuum

spark-advance disconnect, designed to reduce the two emissions that cause photochemical smog. The approved devices are made by Air Quality Products and General Motors. Along with the disconnect, the AQP device has some additional spark retard at low speeds, restores normal spark advance at higher speeds and also functions as an electronic ignition system. The GM device is simpler, with an override to restore spark advance at high coolant temperatures. By law, the installed cost of each must not exceed \$85. The AQP device costs \$65-85, depending on the mechanic's labor rate in your area. The GM device is about \$25.

### *Does that mean I have to put one on my 1949 Chevy?*

No. They're required only on 1955-65 models, and only upon resale or when first registered in the state.

### *Who's responsible for its installation?*

The seller, since the vehicle cannot be transferred unless proof of installation is shown by a Certificate of Compliance and a window sticker issued by state-licensed installation and inspection stations.

### *Who are these stations?*

Some 9000 shops throughout the state, approved by the state's Consumer Affairs Bureau of Automotive Repair. Each is iden-

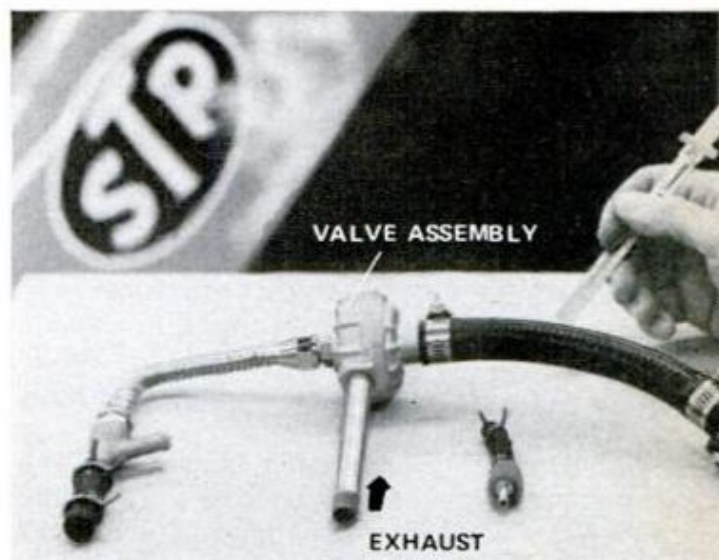

**Exhaust emissions** are measured with equipment as shown on the facing page. Proposed state emissions checks would use this type of equipment at inspection stations. Police in California are using portable equipment in roadside checks. A type of pollution-control device required in California, shown above, connects between exhaust and intake manifolds metering gas back to the combustion chamber to inhibit the formation of undesirable  $\text{NO}_x$ .

tified by a blue-and-yellow shield to indicate that it is an "Official Pollution Control Device Station." They can be auto shops, car dealers and service stations.

*Who makes the devices for the 1966-70 cars?*

Six different approved devices, or systems, for cars with engines over 140-c.i.d. are made by Echlin, Dana, STP, Carter, Contignitron and Carco. The latter two, however, are only "conditionally approved" until these two smaller companies can establish proof of "financial responsibility and marketing ability." One device by STP has been approved for cars under 140-c.i.d. and down to 50-c.i.d.

*Who decided these devices were the best ones?*

The California Air Resources Board, a four-man, one-woman board appointed by the lieutenant-governor of the state.

*Who tested them, and to what standards?*

Compliance with the initial standards, based on a reduction of  $\text{NO}_x$  by at least 30 percent on engines over 140-c.i.d., was judged on the basis of data submitted by each manufacturer on from 16 to 24 vehicles he had tested. In most cases, the ARB engineers conducted confirmatory tests on state vehicles.

After the first device for the larger engines was accredited (Echlin's) with a  $\text{NO}_x$  reduction of 42 percent, that became the new standard the others had to achieve for engines of that size. The STP device for the smaller engines (under 140-c.i.d.) was working against a 20 percent  $\text{NO}_x$  reduction standard. They achieved a 42 percent decrease also, which has become the new standard for any other manufacturer seeking approval for his device in this class.

*What are the differences among the various devices?*

The major difference is in whether they use vacuum spark-advance disconnect (VSAD) and/or exhaust-gas recycling (EGR). Echlin, Carter and Contignitron all use VSAD in conjunction with other controls or systems. Carco uses full VSAD. The Dana and STP devices are basically exhaust-gas recirculation with VSAD under some conditions.

*Why do some of the devices use VSAD*

## A large market for small cars? Automakers are ready

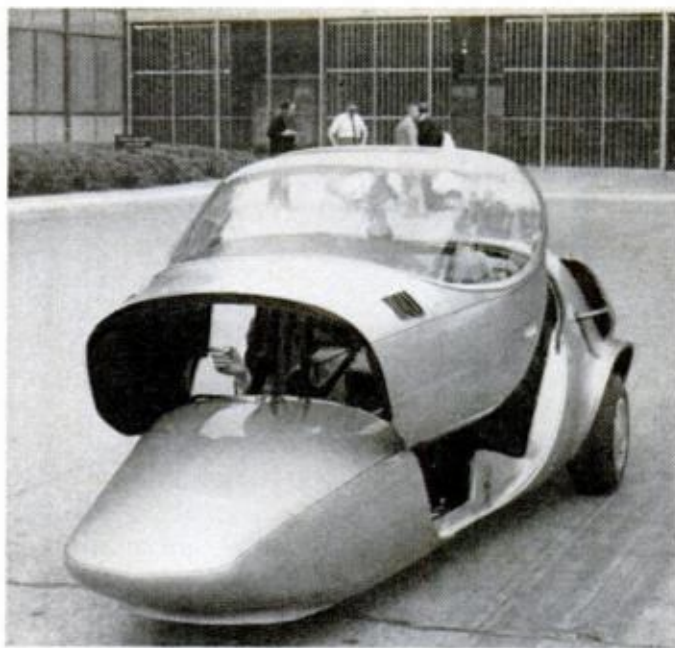

**Small urban vehicles**, such as these experimental electric and gasoline-powered cars shown by General Motors Engineering, are sensible transportation packages for downtown areas—as long as they are not sharing roads with full-size cars and taxis, which would be suicide. If the demand for clean air (and less congestion) banishes private cars from the centers of American cities, there will be a big market for these and other concepts of ecological people movers.

and others EGR? What's the difference?

VSAD is simple to achieve, costs little and reduces NO<sub>x</sub>. But, most experts agree that it can also result in engine overheating, exhaust-valve damage and higher fuel consumption. When coupled with spark retard, exhaust-gas temperatures tend to go even higher, and fuel economy drops even further, ARB engineers say. Manufacturers using VSAD disagree on claims of exhaust-valve damage, however.

As for EGR, this is a system also used on 1971 and later Detroit production cars to control NO<sub>x</sub>. Some concern about the possibility of accelerated engine wear due to iron oxide in the recycled gas has been expressed, but no data seems to support it.

*What are the other differences among the various devices? How does each work?*

Carter's is basically a VSAD system with some overrides. When installed timing is retarded, idle is adjusted to "lean best," and the carburetor vacuum source is plugged. To restore vacuum spark advance over 65 mph, or when engine coolant temperature exceeds 225° F., an electrically operated vacuum solenoid valve and electronic speed sensor team up to do the job.

Dana's Retronox system uses engine speed to selectively control exhaust-gas recirculation and the spark advance. At lower engine speeds, the system operates as a vacuum spark-advance disconnect. As speed picks up, an engine-speed switch is actuated, supplying vacuum to the distributor and EGR valve servo motor. This reconnects vacuum spark advance and recycles some exhaust from the exhaust manifold back to the intake manifold.

The Echlin device consists of a "sonic generator" said to create ultrasonic waves which travel through a flexible tube to a plate under the carburetor. These waves are said to impinge on the air/fuel mixture, breaking up the fuel droplets into even finer particles. In addition, vacuum spark advance is disconnected, ignition timing is retarded, and the idle is reset.

STP's device is basically an EGR system. It has an EGR valve that meters either exhaust gas only, or a combination of gas and fresh air—depending on throttle position—through a velocity nozzle to a point below the carburetor. A vacuum (air) bleed fitting in the distributor vacuum-advance line lowers the vacuum in the line, modifying the vacuum advance.

Contignitron has a "solid-state device" using transistorized and electronic switches to control current switching and spark time duration. Vacuum spark advance is disconnected.

Carco's "device" is a simple plugging off of the vacuum source to the distributor with rubber caps, along with additional timing retard.

*Will any of these devices make my car run better?*

Not according to the ARB. Some of the manufacturers claim their devices do improve performance.

*If they don't make it run better, what good are they?*

The main purpose is to reduce NO<sub>x</sub>. They all do that, anywhere from 40 to 50 percent.

*Will they make my car run worse?*

That seems to depend on the type of de-

---

#### **NEXT MONTH:**

#### **What Detroit is doing to meet the clean-air standards for 1975-76.**

---

vice—and whom you listen to. The EGR devices (STP and Dana) get the highest marks from the ARB. Both have less exhaust-gas temperature increases, and less effect on coolant temperature than the VSAD-type devices (Echlin, Carter, Contignitron and Carco), according to a report by the Air Resources Board.

*What about fuel economy?*

The ARB says the Dana and STP devices will give an average fuel penalty of from 3 to 7 percent in city driving. The others, they say, will penalize a car from 6 to 10 percent. It also depends on how you drive and at what speeds.

*Can any of these devices cause damage to my engine?*

Any of those using VSAD under most conditions, plus additional spark retard, ARB engineers say, can cause overheating of the engine coolant, higher exhaust-valve temperatures, with possible damage to the exhaust valves themselves.

*What do the various devices cost?*

By state law, no installer can legally

*(Please turn to page 184)*

# New electric kicker for a new bass catcher

A little pedal-steered mill joins a plushly appointed rig for landing lunkers in luxury.

by Bill McKeown

Lately our finny friends underwater have been looking up at an amazing assortment of new hulls, powerplants to push them and an appetizing array of different lures.

But two of pleasure boating's biggest producers, Johnson outboards and Starcraft boats, apparently decided there is still room for improvement. Both have just come up with specialized products for the booming sport of angling.

Johnson Motor Co., offered PM an exclusive preview of a trolling outboard that should be available any day now. This is the first electric with the Johnson name. Evinrude is reported to be introducing a similar mill shortly (though it had a not-for-sale electric back in 1933 for floating sight-seers through the Chicago World's Fair, before the days of quieter kickers).

Our test boat is the latest from the company that may be volume leader in fiberglass and aluminum boat production. Called the Starcraft 16 Bill Dance Pro, it is a model that aims to include all the features bass-chasers could want. Fabled fisherman Bill Dance, the Memphis ace who has won first slot in 12 out of 25 national tournaments and placed in eight others, helped design the layout and fittings.

Electric motors aren't new, but recently sales have been booming as inshore anglers learn the advantages of cutting off their



Lunker bass sitting on cypress knees can't hide from new bass boat and Johnson outboard combo. Bow motor lifts easily for following fish into shallows.



Starcraft 16 Bill Dance Pro model tops line of special models for fishing. It's rated for 70-hp motor on transom, 5.6 passengers or 1300 pounds of gear aboard.



3 4



2



5

**1. Standard equipment** included in the \$1995 boat are running lights and interior lights, a locking fuel and battery compartment, a live well hooked up to an aerator and a recirculating pump, two anchormates, a bilge pump and a locked cabinet for rod storage.

**2. Two fishing chairs** that swivel, are well upholstered, have adjustable arms and will rock back are among the comfort features that were specified by Bill Dance as standard equipment in the new Starcraft. Upright safety flotation is also included.

**3. Johnson** electric motor's mounting bracket allows an easy lanyard pull for the tip-up when the water gets too shallow or a switch is made to standard power. Dangerous lean overboard is not needed for change-over. Vertical adjustment is 15 inches.

**4. Switch panel** below the Lowrance Locator/Sounder, an optional accessory, has controls for lighter, bilge pump, live-well aerator and recirculating pump and drain, as well as running lights and interior lights. Mechanical steering is standard.

**5. Testing fish** as well as the new boat and electric mill (and taking a sneak preview of Johnson 70-hp motor for 1974), PM's McKeown and Outboard Marine electric engineer Wayne Beem (seated) approved the open layout and forward platform for casting.



PHOTOS BY JERRY IMBER  
at Cypress Gardens, Fla.

AUGUST 1973 149



1

**1. Locking down new electric** on bow deck before a fast run over chop is aided by rubber tab fitting rudder fin slot. Foot-pedal control stows under gunwale.

**2. Powerhead direction pointer** proved convenient when steering, driving boat by battery and when lifting out motor. Dial lights for night fishing.

**3. Final test of any fishing rig** is the catch. A fast, smooth ride at speed and quiet controllable battery performance indicate boat can get to the lunkers.

big stern powerplants to switch on silent little electric spinners that can sneak up on lakeside lunkers. Guesses place electric outboard sales between 150,000 and 300,000 last year with 15 companies already in the field. Johnson is joining a busy league, but has some interesting extras for its entry.

Speeding across a choppy chain of lakes near Florida's Cypress Gardens at Winter Haven, we were first impressed with the way this midget mill could ride a bouncing bow. A lock latch for the mounting bracket plus an additional rubber tab that snugs between motor housing and rudder fin combine to hold the rig tight to the foredeck. We have seen other makes bounce, lash and threaten to tear free at less speed than the 30-plus we were winding from a peppy prototype of Johnson's 1974 70-hp Seahorse.

A handle and lanyard make unlatching and locking down the electric for drive position easy while seated—with no need to



2

3



lean far outboard and chance falling in. Clips to clamp to a battery are supplied. Our Starcraft, however, had a built-in socket for plugging in the motor or a battery charger. About 3½ hours of full speed operation is estimated from a 70-amp/hour battery. The foot-pedal steering control proved quite easy to use, and the variable-speed dial with clear numbers plus on-off switch on the pedal are large enough to use with lug bottom boots. Particularly useful is a propeller position pointer (lighted for night use) in the top of the power unit that shows direction of its ¼-hp thrust.

Though the Bill Dance Pro has the same dimensions, 5.6-passenger and 70-hp capacity, as Starcraft Bassmaster and Deluxe models, all the locking cabinets, wells, lights, anchors and recirculating aerator pumps that are standard equipment for under \$2000 make it one of the best bass bargains around. ★★★



# Boat booster for \$10

by Mark Sosin



**Cartopping a boat** takes a lot less brawn when twin slide rod pipes are fastened to the roof brackets.



**Slant of pipes** clears side of the car, allowing the gunwales to ride at an easy angle up onto carrier.



**Roof rack is drilled** on right side of the car to take bolt securing the pipe. Rack is rounded off at top edge.

A cartop boat booster for under 10 bucks is a bargain even if you don't have a bad back like fisherman Les Hodax. To handle his hull without help, he designed the simple system shown.

Most boats are slightly wider than standard rooftop carriers. You can mount 2x4s to extend your carriers a few inches more than the distance between the gunwales of your boat. Mount the 2x4s to your carriers with through-bolts, but countersink the bolt heads so they will not catch the gunwales as the boat slides into position.

In addition, you will need two lengths of light-walled pipe about one inch in diameter and two bolts from six to eight inches long. Length of the pipes will depend on the height of your vehicle. They should slant to the ground without touching the side of your car. One end of each 2x4 is notched out to receive the pipe in the center, and that end is rounded off to make sliding the boat on and off easier. A 1/4-inch hole is drilled through this end of each 2x4 and also through one end of each pipe. Now all you have to do is lay the pipe in the notch, slide the bolt through the matching holes, and your pipe rails are ready for the boat.

To prevent the boat from sliding too far, and to help secure it while traveling, Hodax loads from the right side and has mounted angle irons on the left side of his 2x4s to hold the boat in place. ★★★



**Angle irons on left side** of the roof rack prevent the boat from sliding too far; help hold it for travel.

# Low-cost, no-squint meter kit reads volts, ohms, amps.

by Karen McKenzie

Wouldn't it be great to have a multi-meter you could read clearly across the width of your workbench—or from across the room? Especially one that didn't cost an arm and a leg? Now you can, with Heathkit's new IM-1202 digital multimeter.

For only \$79.95, it gives you direct readings, in illuminated numbers  $\frac{1}{16}$  inch high, of a.c. and d.c. currents from .01 milliamperes to 1990 ma. (1.99 amps.); d.c. volts from .01 to 1000; a.c. volts (rms) from .01 to 700, and resistance from .01 to 1990 ohms. Though there are three cold-cathode readout tubes, the IM-1202 is called a "2½-digit" meter, because its first digit reads only "1" or blank; a full, three-digit meter would read from 00 to 999, rather than the Heath's 00-199 range. The decimal point moves automatically as you switch measurement ranges and doubles as a "comma" after the first digit in the 0-2000 range.

Digital metering has many advantages: You can't "pin" the nonexistent needle; instead, over-range inputs are indicated by a rather dim signal light, and reversed-polar-

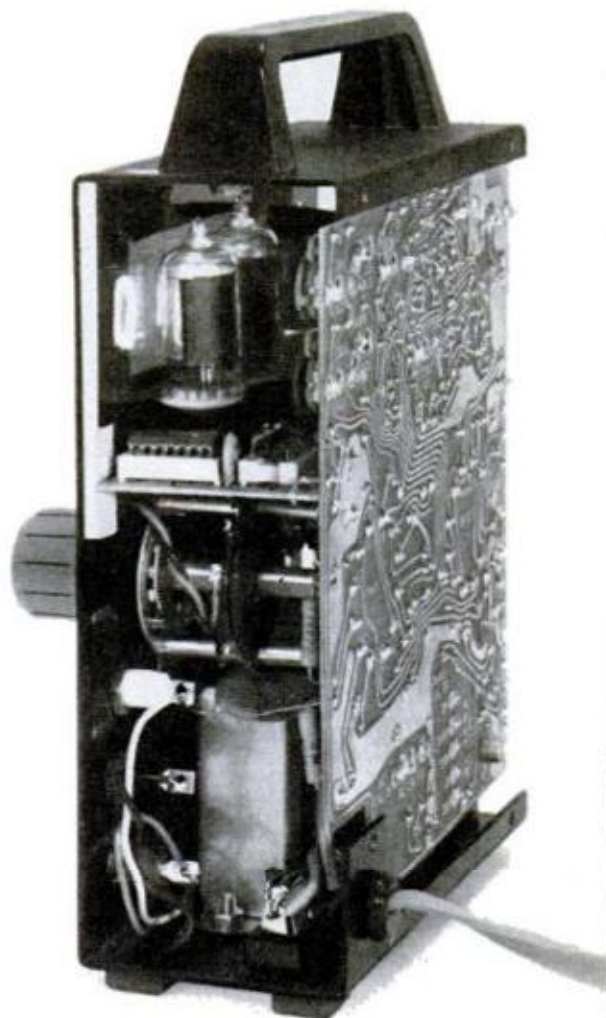

ity d.c. signals just read "00" until you flip the handy polarity-reversal switch. Additional indicators also remind you which way that switch is set. With a digital meter, you can't read the wrong meter scale (or read the meter wrong because you're seeing the needle from an angle), and resistance readings—usually jammed up in one part of the ohms scale and widely spaced in another—are linear throughout the measuring range. Also, the IM-1202 doesn't use a battery for resistance measurements, so you never have to worry about a dead battery or corroded terminals, and you don't have to set "zero" or "ohm" adjustment pots before use. The only drawbacks are the lack of decibel (db) and center-channel scales.

The kit builds quickly (eight hours) because construction, though tight, is all on plug-in boards. The IM-1202 offers lots of convenience for a modest amount of your time and money. ★★★

**Cold-cathode tube** (right) gives bright, clear display (opposite page, left). Few parts (below) mean an easy, eight-hour assembly, despite the tight construction.

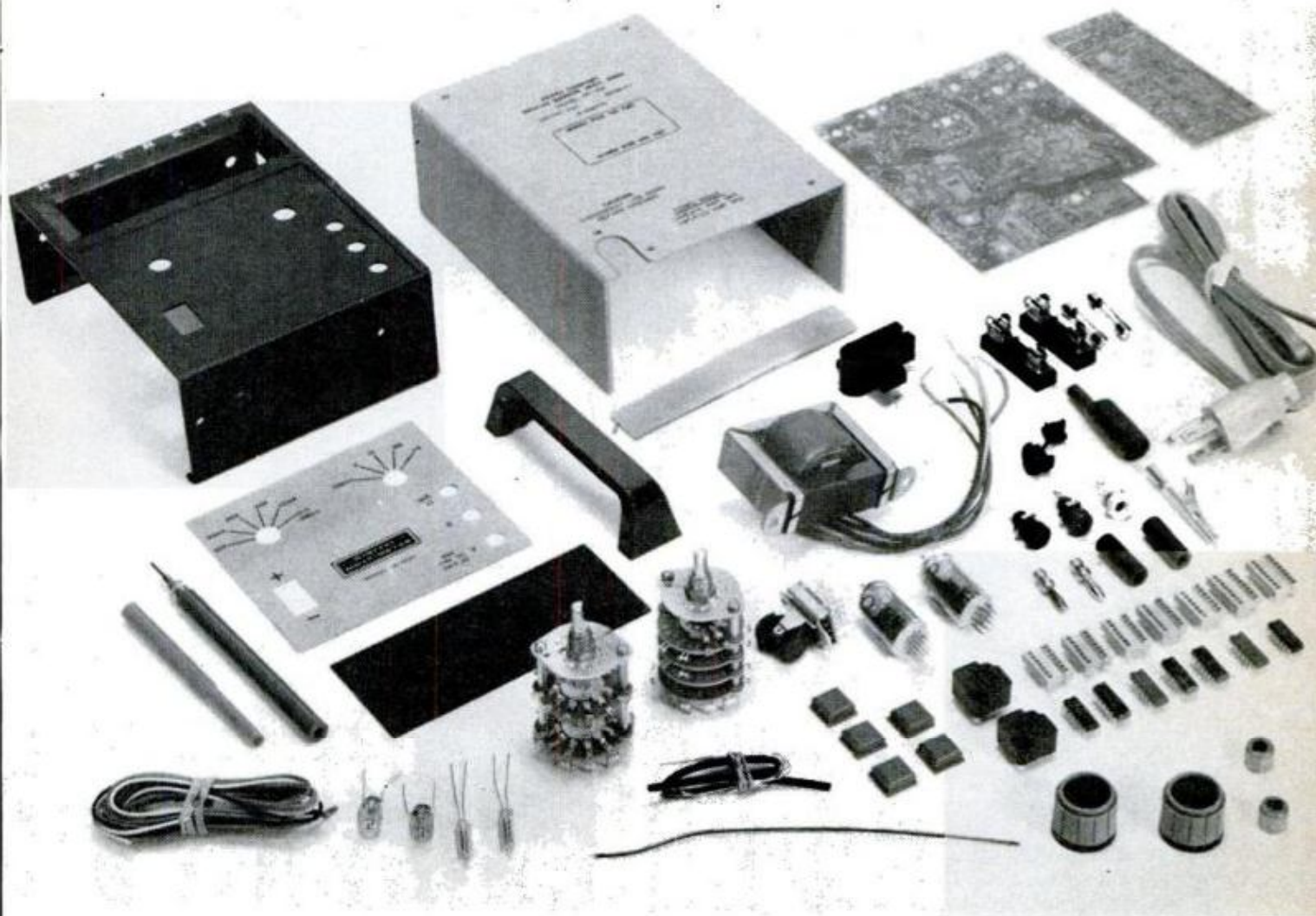
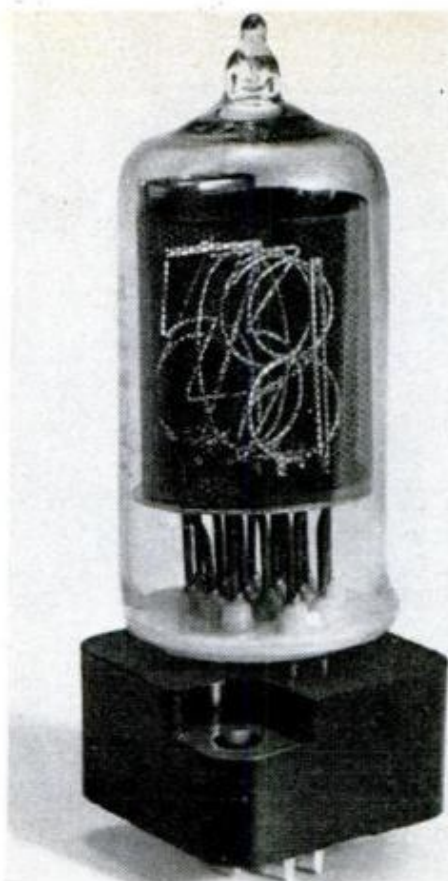

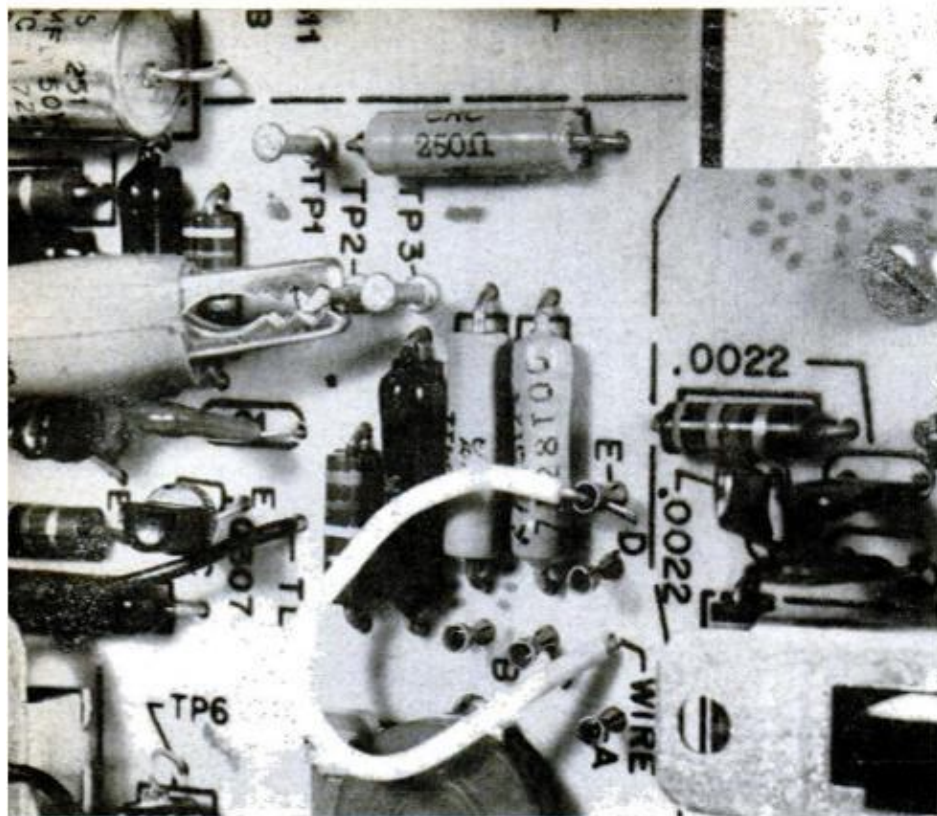

# Heath's quietest cassette deck

by Ivan Berger  
ELECTRONICS EDITOR

PHOTOS BY ROBERT D. BORST

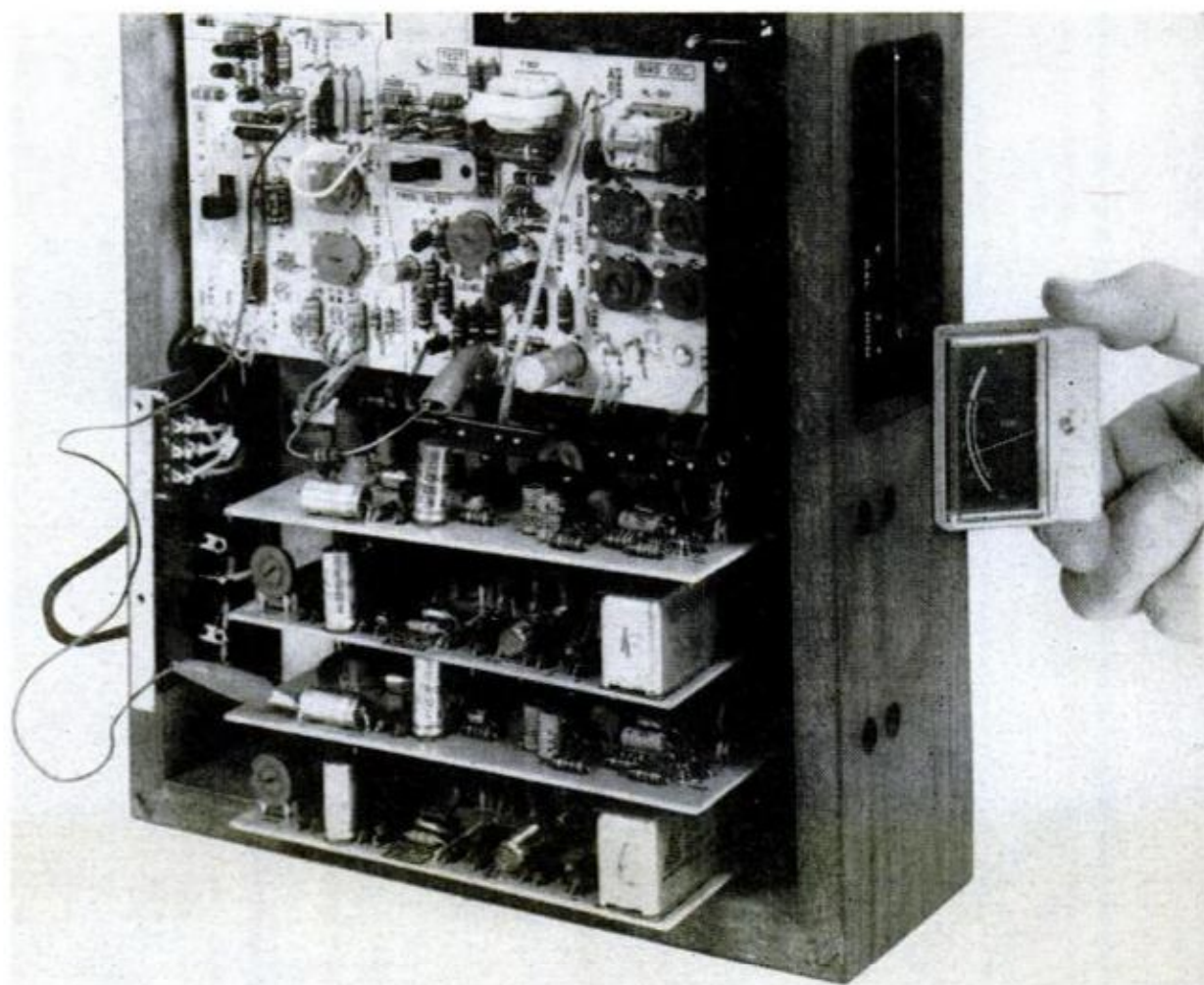

**Circuit checks are easy**, as in most of today's Heathkits, using a built-in mirror—here, the right-channel VU meter. Close-up (top) shows test-point studs and holes (A, B, C, D, E) for test-programming wire, but not all test points were as easy to find.

Noise (tape hiss, to be exact) and fluttery tape-speed variations are the biggest enemies of high-quality cassette recording. The Dolby noise-reduction system has just about conquered the first problem, and 3M-Wollensak has a cassette transport mechanism that pretty well takes care of the second. Now, Heath has put them both together in a \$250 cassette deck kit.

As a result, the new Heathkit AD-1530 sounds as good as many open-reel tape decks: Its frequency response goes from 40 Hz to 14 kHz ( $\pm 3$  db) on the new chromium dioxide tapes, 40-12 kHz on regular iron oxide ones. (A switch sets the recording bias, input levels and playback equalization for regular or CrO<sub>2</sub> tape formulations.) With the Dolby switch in, the signal-to-noise ratio above 4000 Hz (where the hiss is) becomes a highly respectable -58 db (better than studio machines were just a few years ago). With Dolby switched out (as it would have to be when you played recordings not made with the Dolby system), the signal-to-noise ratio is 48 db; that's respectable for a cassette deck, but no match for open-reel machines.

The Wollensak transport comes preassembled, ready to wire in. Instead of the common keyboard controls, it uses pushbuttons for stop and start (interlocked with the on-off switch, so turning off the power puts the transport in stop mode, while pushing the play switch turns the power on), a smaller button for record, two small, flip levers for pause and eject, and a larger, side-to-side lever for fast-forward and rewind. This sounds confusing, but in practice you learn to operate it by touch.

When the tape comes to an end, the controls shift automatically to "Stop" mode, saving wear and tear on both tape and transport. The rewind-forward lever doesn't lock, so you have to hold it until you've reached your desired stopping point on the tape. But since the AD-1530 takes only 45 seconds to rewind an entire C-60 cassette, that's less of a bother than it could have been. And wow and flutter are a reasonably low 0.25 percent or less.

Electrical controls—the input level controls, stereo/mono, CrO<sub>2</sub>/regular, and Dolby switches—and the big, bright VU meters are all grouped on the left side of the machine. Mike inputs and the mike/line selector switch are on the front panel; line inputs and outputs and the Dolby calibration tone switch are on the rear.

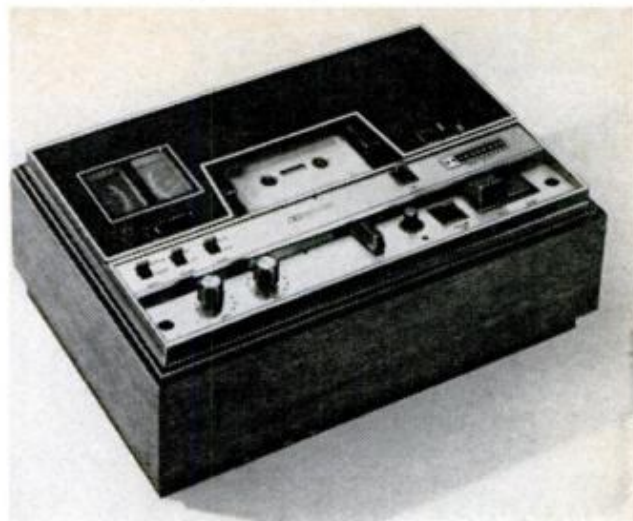

If Heath's new AD-1530 looks like a Wollensak, that's because it uses the same transport mechanism.

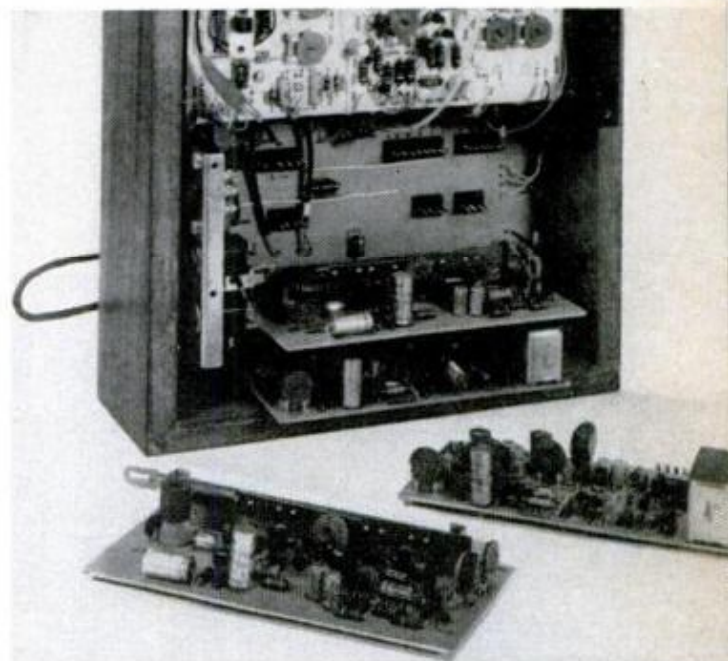

Amplifier (left) and Dolby (right) circuits are on plug-in boards. Interchangeable left and right-channel circuit boards simplify troubleshooting.

Voltages and circuit operation can be checked and aligned without external test instruments: Just clip the built-in test lead to the appropriate test points (they're dotted all over the plug-in Dolby and amplifier boards and the fully accessible oscillator/power supply), slip another test lead into one of the holes provided, and the deck's own VU meters tell you whether all is well or not. This was easy, once the page with the map of test points was located, but longer wires on the right-channel VU meter would have made it easier.

Construction and checking took about 20 hours with no particular problems. The built-in test procedure did help us track down a few of our goofs, though. ★★★

# Steadyrest for lathe milling attachment

by Walter E. Burton

When a lathe milling attachment cannot be mounted without considerable overhang, annoying vibration and chatter can develop. To prevent this, lathe operators often wedge pieces of wood or metal between the lower end of the milling-attachment vise and the carriage.

Because such makeshift wedging is unstable and unpredictable, I made this milling steadyrest to fit my 9-in. lathe. The rest is simply an adjustable rectangle formed by two steel bars and two carriage bolts. To permit bar A to be positioned closer to bar B, I cut the nuts directly under it to about half thickness. Even greater travel is possible by machining a rabbet the length of bar B so angle A can move as far as the half nuts and washers permit.

The washers are leather and are placed between the nuts and the top surface of bar B to provide "give," which is needed if the top bar is not quite level with respect to the plane of vise movement. A thin leather

Steadyrest placed across saddle provides support to overhanging vise of lathe milling attachment.

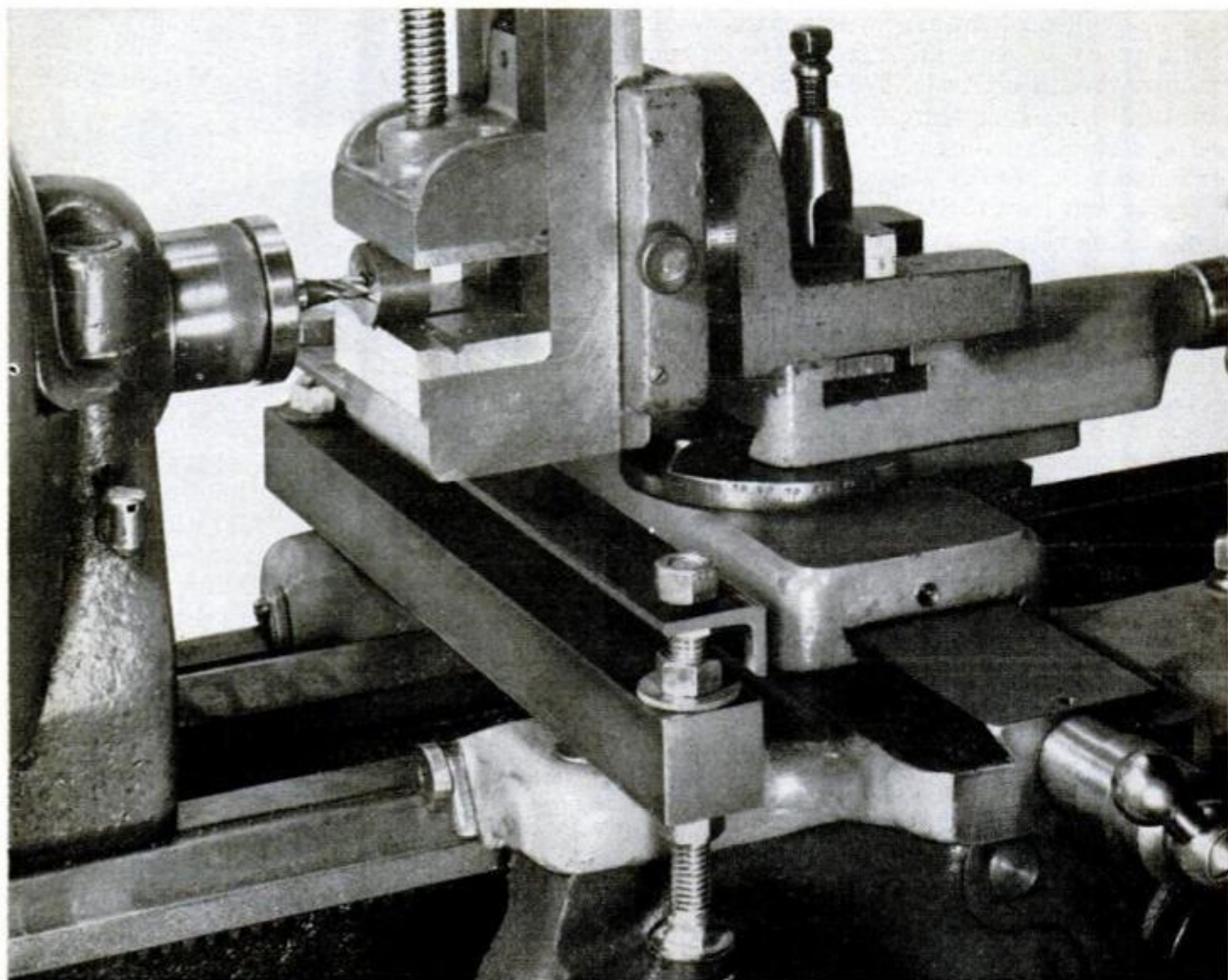

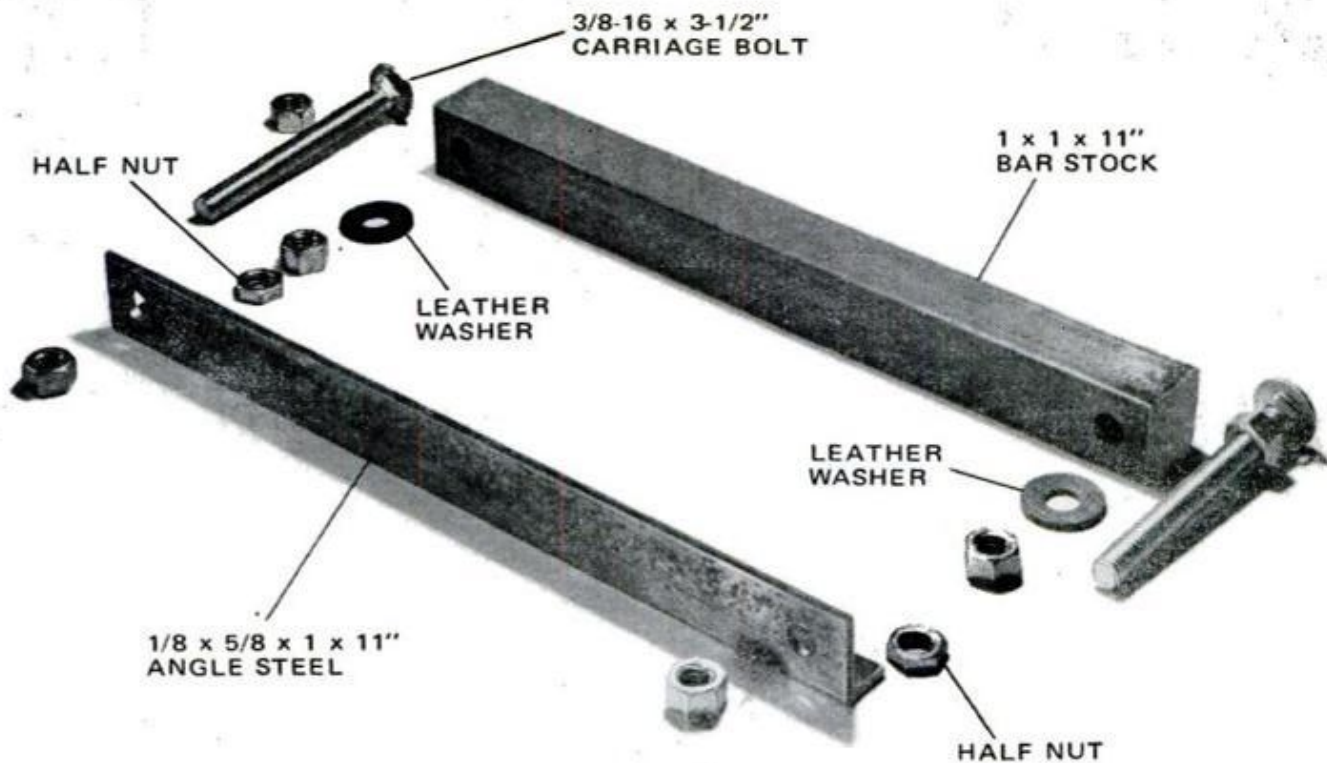

layer can be cemented to the bottom of bar B to prevent marring the saddle's finish.

In use, the steadyrest can be wedged with various degrees of tightness between the milling vise and saddle. Ideally, pressure should be firm, but not enough to prevent smooth movement of the vise over the top bar. When the feed is accomplished by moving the entire carriage (with slides not operating), the steadyrest can be a tighter fit between vise and saddle.

The steadyrest is installed as follows: Loosen the two lower nuts on each bolt and position bar B on the saddle. Raise the upper bar by hand and hold it against the vise while the loosened nuts are tightened by hand. Then adjust the nuts at each end of bar B with a wrench so that bar A presses uniformly against the lower surface of the vise and pressure is adequate without interfering with horizontal movement of the workpiece. Too much divergence from parallelism between bar A and the plane of vise movement can lead to "jamming," thus affecting the accuracy of the cut by forcing the vise assembly upward.

Each complete turn of a 16-thread nut shifts position 0.0625 in. A little oil on top of bar A can help reduce drag as the vise moves over it.

The steadyrest is intended primarily for use in operations that involve horizontal

(Please turn to page 165)

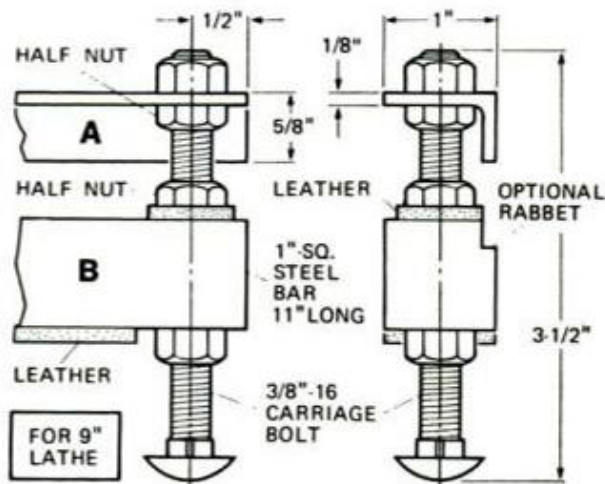

**Wedging action of steadyrest** is achieved by moving the nuts at each end which bear against the lower bar. Final adjustment is made with rest in position.

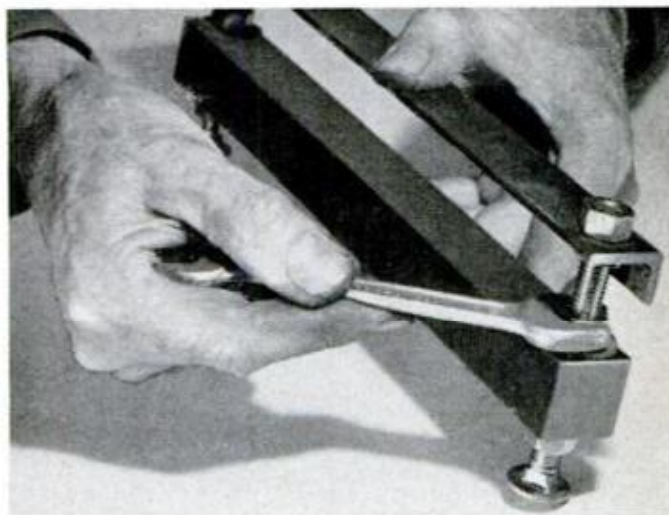

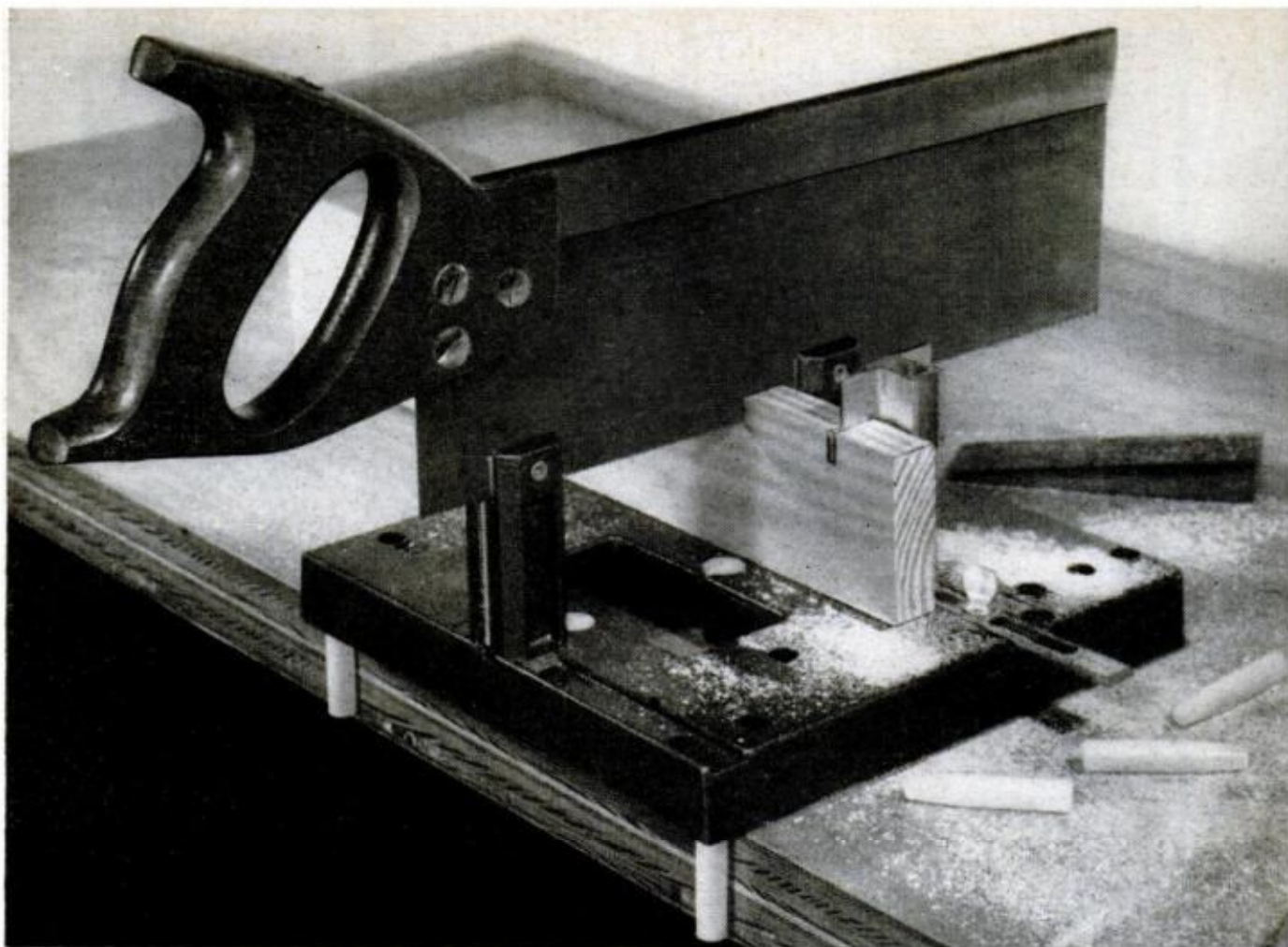

PHOTOS BY ROBERT D. BORST

Two tapered pegs inserted in holes in underside of base hook box over edge of bench. Here selector head, engaging initial saw kerf, automatically sets second cut for perfect fitting joint.

## With this miterbox you always saw in one direction

Ever try to cut a lapped dovetail tenon in a miterbox? Probably not because it can't be done—not with any conventional box. But you can do it, and several other neat tricks with a unique new miterbox called Jointmaster. Differing from ordinary miterboxes in which the saw has to be lifted from one slot to the other, or swung from right to left to saw a miter, the saw in this English import stays put in its two guide pillars and you shift the work. This means you always saw in one direction, a feature lefties will appreciate.

Another handy innovation not found on other miterboxes is a selector head which fits an adjustable and interchangeable cutoff stop. In use, the head allows for the thickness of the saw blade and thus automatically spaces the width of the recess (dado) when cutting an end lap or middle-lap joint. With a Jointmaster you can cut all joints, and more, shown on the facing page.

Interchangeable pegs made to fit a series of holes in the base are used to position the work for either miter or butt joints, also to hook the miterbox over the edge of a bench or table.

Made of die-cast aluminum and measuring only  $8\frac{3}{8}$  in. square, it sells for \$20.95 postpaid (less saw) from Jointmaster, Dept. PM, 4767 Clark Howell Hwy., Atlanta, Ga. 30348. ★★★



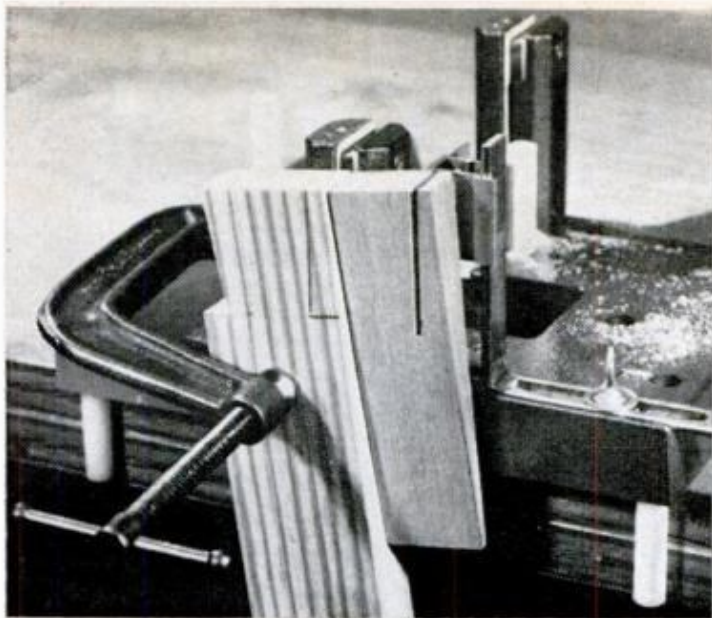

Tapered wedge is used to mark dovetail, then wedge and selector head team up to position work at proper angle.

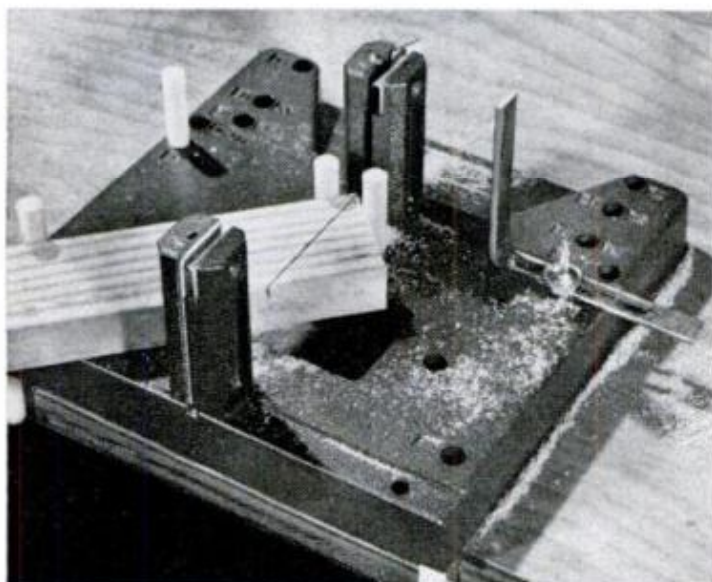

Pegs placed in front of rear guide pillar position work for mitering end 45°. Saw remains in set position. Miterbox has six work-positioning pegs and wooden marking wedge. Adjustable depth stop rides saw-blade stiffener.

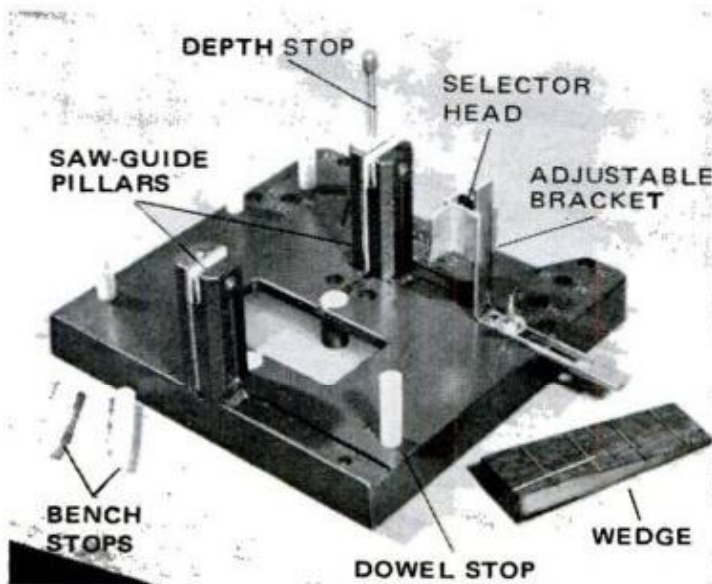

Typical joints you can make  
(with saw and chisel)

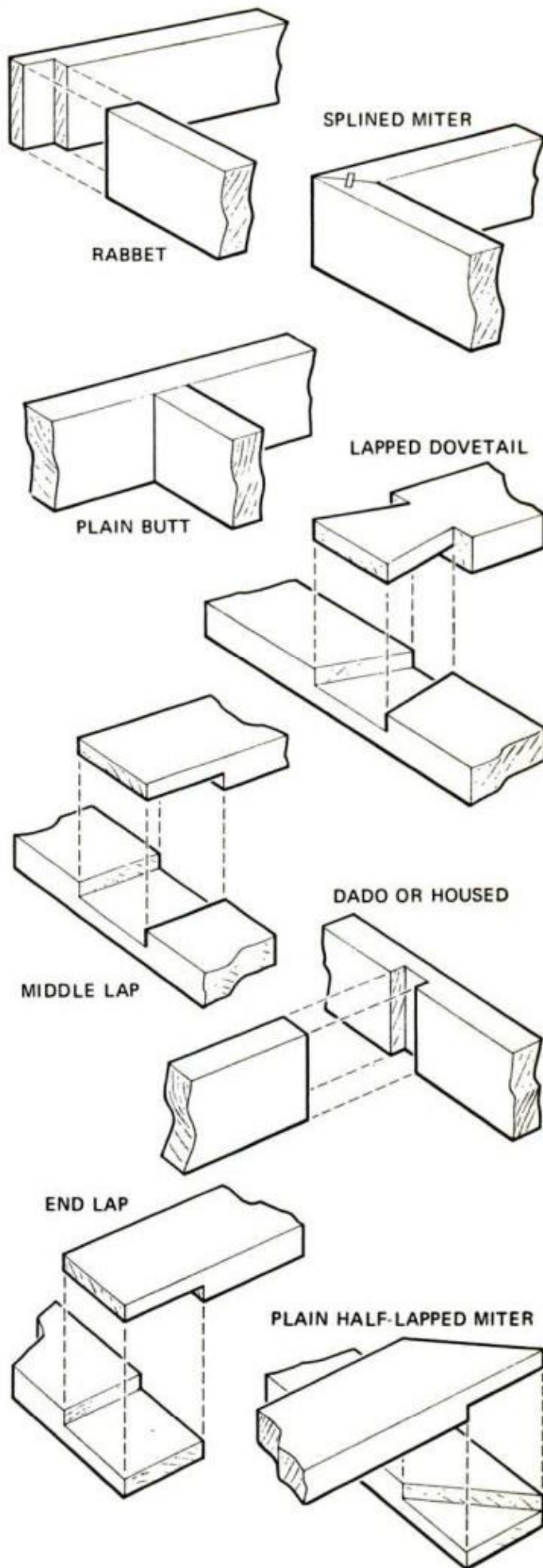

# HINTS

## FROM READERS

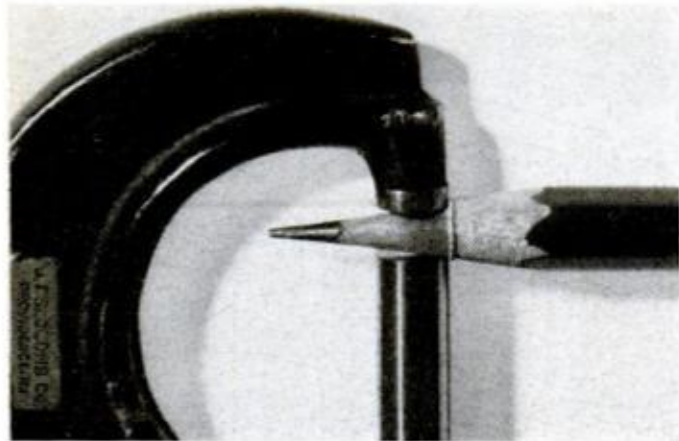

### Pencil 'remembers' hole size

When you are without a hole gauge and need to measure the inside diameter of a hole, force a wood pencil point into it. Later, use your micrometer on the ring formed and get a measurement accurate enough to tell you what size drill made the hole.

—Parry C. Yob, Fair Oaks, Calif.

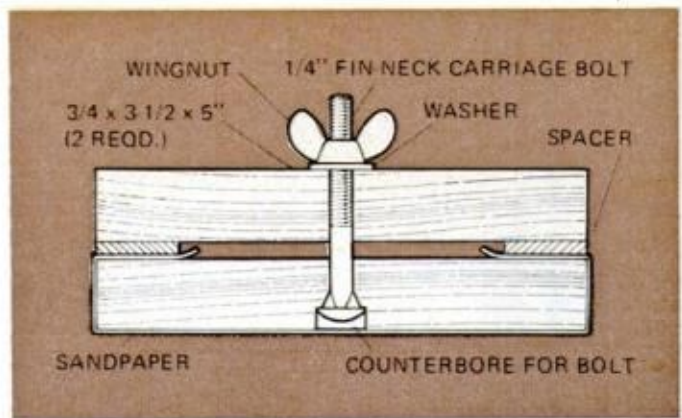

### Jiffy sanding block

This sanding block takes less than five minutes to make. The size suggested above allows convenient use of one-third of a standard sandpaper sheet, but you can easily increase the size to take a half sheet. Spacers are  $\frac{1}{8}$ -in. wood or cardboard.

—Robert Brightman, Great Neck, N.Y.

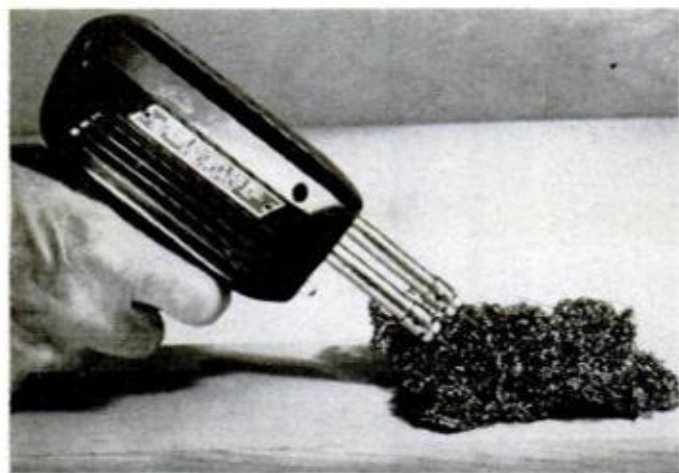

### Pot cleaner is soldering aid

For peak efficiency, a solder gun must be free of scale (oxidized solder). A good improvised "sponge" for removing this build-up is a metal pot cleaner (loose mesh type, not fine steel wool) stapled to scrap board to keep it from shifting as gun tip is wiped across it.—Burt Web, Skokie, Ill.



### Old phone book is handy shop pad

One way to recycle an old telephone directory or an out-of-date catalog is to use it as a workbench pad. It's helpful when handling greasy parts, painting, gluing or doing any work that requires a clean surface. Tear off a page or two whenever necessary.—Walter E. Burton, Akron, Ohio.

# Have one of mine.

**You'll like  
the taste of  
Old Gold.**



Warning: The Surgeon General Has Determined  
That Cigarette Smoking Is Dangerous to Your Health.

20 mg. "tar," 1.3 mg. nicotine  
av. per cigarette, FTC Report Feb. 73.

© 1973 Lorillard



---

## Charming grandfather clock from a kit

---

by Rosario Capotosto

**B**uilding a fine grandfather clock from scratch is not the easiest project you can tackle. Not only does it require a shopful of tools, it takes a cabinetmaker's touch (which not everyone has). But even with tools and know-how, there's another problem: where to find the wood to build it. Because of a scarcity of black walnut and other fine cabinet woods, it has become increasingly difficult to find suitable lumber.

For this reason, it's beginning to pay amateur and craftsman alike to build furniture from kits, and it's particularly true when building a grandfather clock. The wood problem is solved. The parts come pre-cut so you don't need many tools and you can almost be a beginner when it comes to putting the pieces together.

To find out how easy it is to put a clock kit together I picked a black-walnut one from the Emperor Clock Co., Fairhope, Ala. 36532, and an eight-day weight-driven movement which strikes the famous Westminster chimes; 4 notes on the quarter hour, 8 on the half hour, 12 on the three-quarter hour and 16 notes on the hour. These notes are struck on four mechanically tuned rods, while the hour chime strikes on four more rods.

The kit contains 55 pre-cut parts; some

**One of four kits available, the Emperor model 120 (left) stands 74 in. high, sells for \$129.50 less movement. Westminster chimes movement, model 100M, is an additional \$79.50.**



**Many parts are look-alikes** so first step when unpacking carton is to mark each piece as per master list.

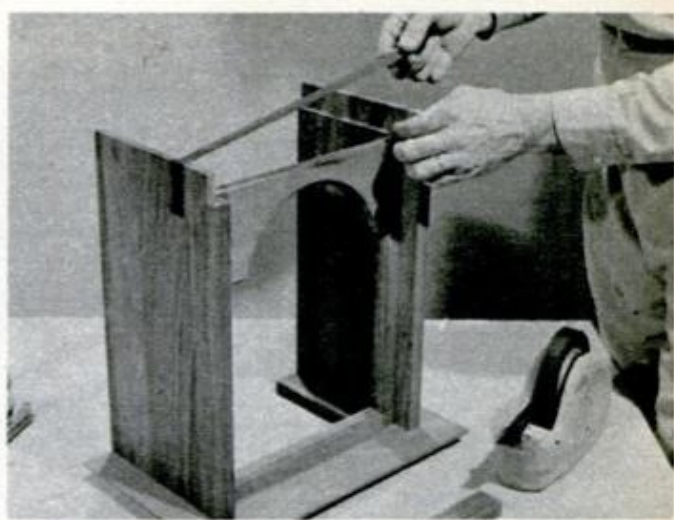

**To check parts for fit,** make dry-run assembly using masking tape to hold them before final gluing, nailing.

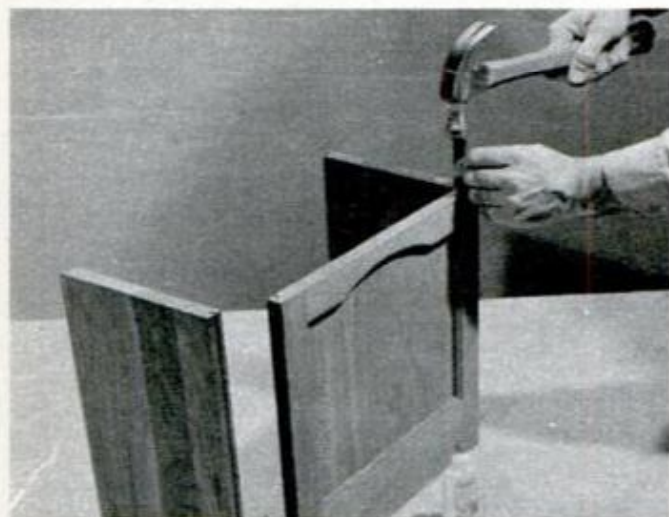

**Front corner joints of base section** are pulled together securely with clamp nails after applying white glue.

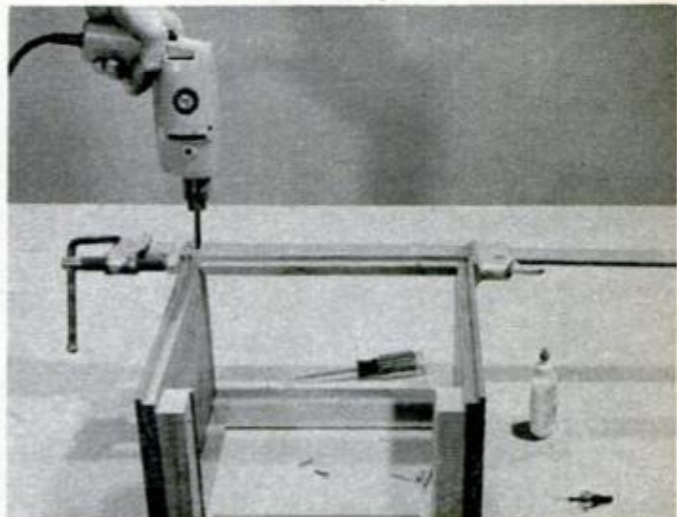

**Screw holes must be drilled** by the builder. Here bar clamp is used to hold rear brace in place for drilling.

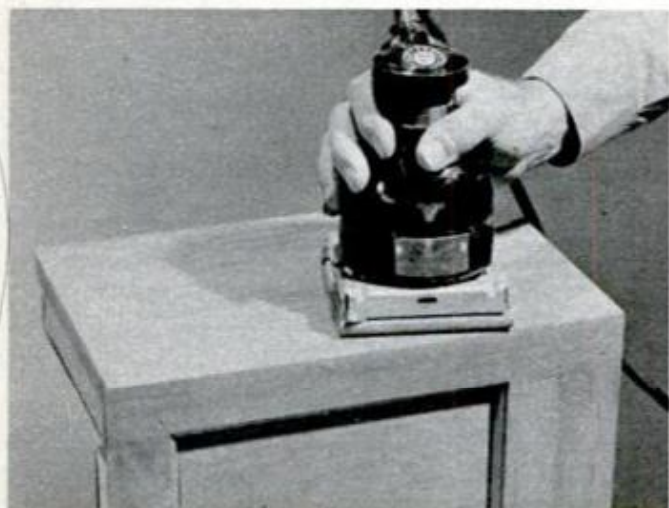

**Finish-sand all you can** before adding trim and making final assemblies. The fewer obstructions, the better.

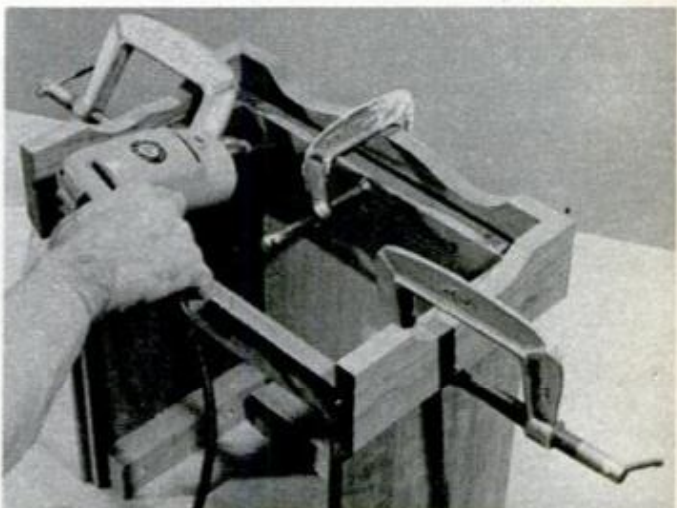

**Adding mitered "feet"** to base section is a lot easier when done before base is attached to the waist section.

**KIT CONTAINS THESE PRECUT PARTS**

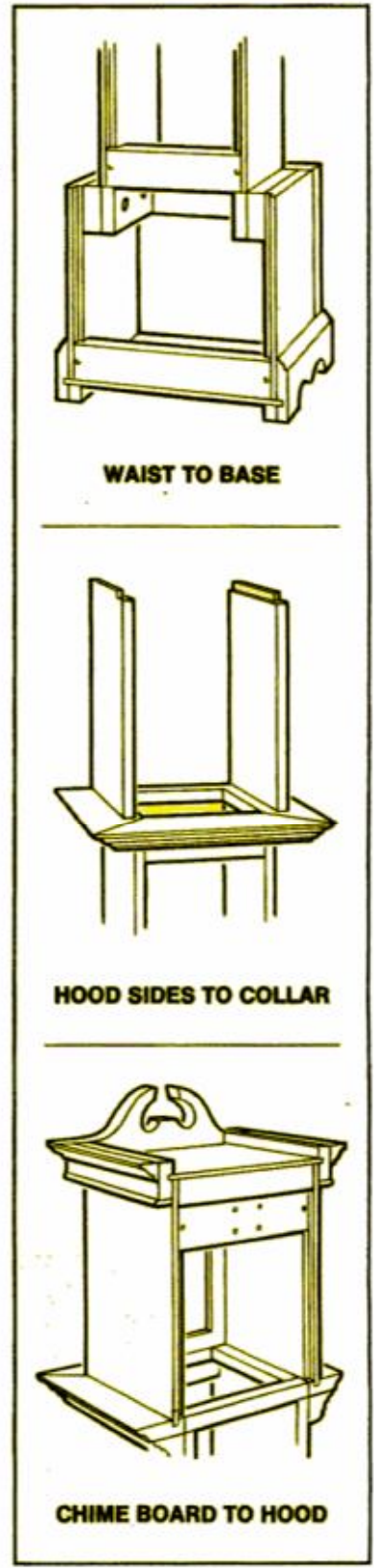
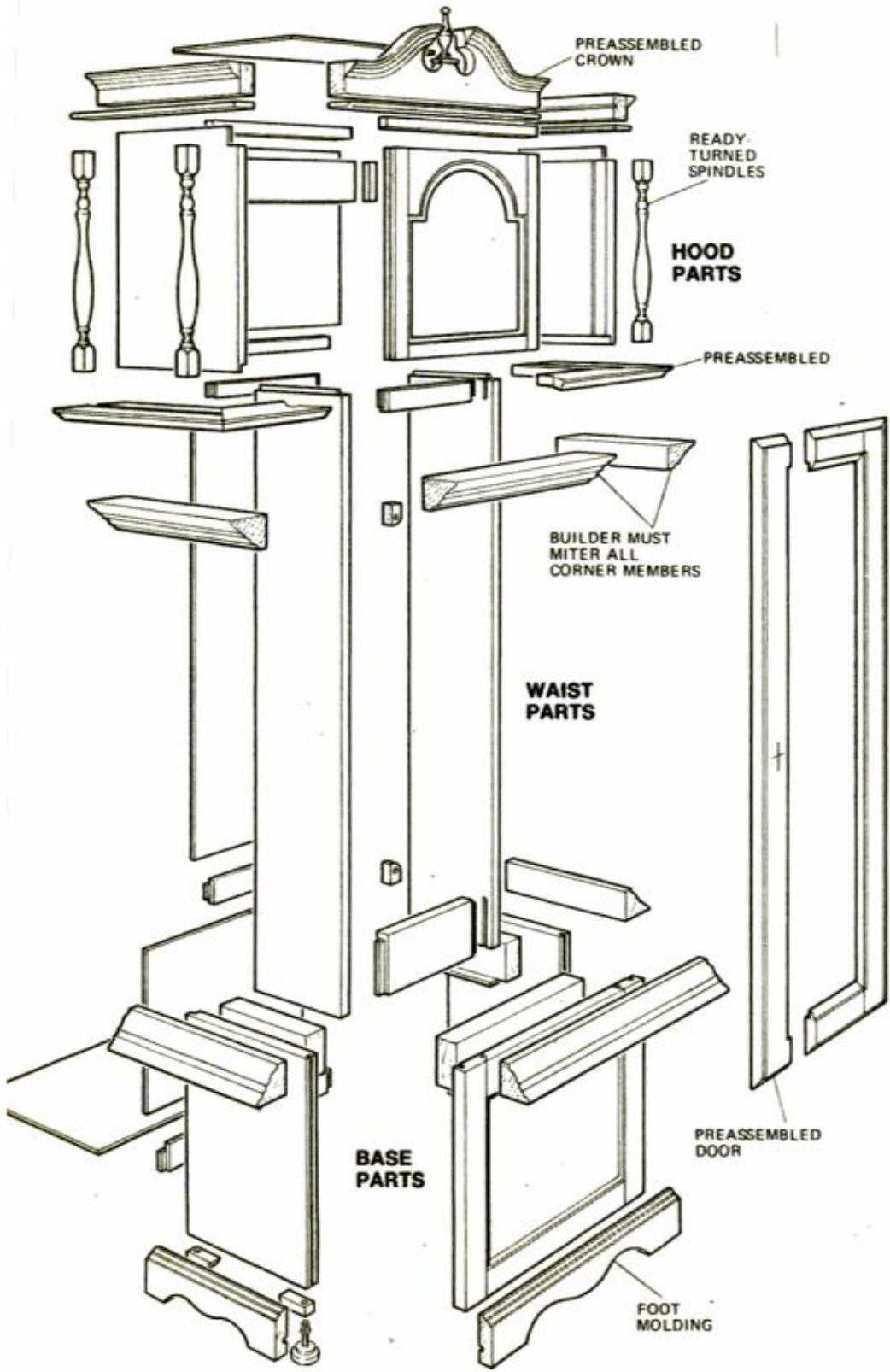

are even preassembled. These include the breakfront swan neck, waist and dial doors, dial frame and the sculptured front base. Furnished hardware includes plastic inserts and levelers, door hinges, bullet and magnetic catches for hood and waist doors, T-nuts for the sound board, door pulls and clamp nails. Things you must buy extra are

the glass for the doors, brads, sandpaper and the finishing materials.

While the parts of some clock kits come completely cut, in this kit the trim molding, the returns for the hood and the crown front come uncut and require mitering by the builder. These parts are purposely left

*(Please turn to page 166)*

# SUBSCRIBER'S

## Change of Address Form

Please use this form to notify us at least six weeks before you move to your new address.

**1. Present address:** Attach address label from a recent issue, or print your name and address exactly as shown on the label.

NAME \_\_\_\_\_  
 ADDRESS \_\_\_\_\_  
 CITY \_\_\_\_\_ STATE \_\_\_\_\_ ZIP \_\_\_\_\_

**2. Fill in new address:**

NAME \_\_\_\_\_  
 NEW ADDRESS \_\_\_\_\_  
 CITY \_\_\_\_\_ STATE \_\_\_\_\_ ZIP \_\_\_\_\_

**3. Mail this form to:**

**POPULAR MECHANICS**  
 Subscription Service Dept.  
 Box No. 646  
 New York, N.Y. 10019

## WANTED

If you're a mover looking for that once-in-a-lifetime profit opportunity in an exploding growth industry, write for free INFORMATION KIT about one of the major breakthroughs in security systems since the beginning of crime. Flashguard answers an urgent, unfilled need and presents perhaps the most exciting business opportunity in any industry today. No experience. Start part-time. FLASHGUARD, INC. Dept. 3, 927 Penn Ave., Pittsburgh, Pa. 15222.

USE ZIP CODES  
 WHEN ANSWERING ADS

# NEW RUBBER STAMP BUSINESS PAYS BEGINNERS UP TO \$16.50 AN HR. START AT HOME IN SPARE TIME

The multi-million dollar Rubber Stamp business—once controlled by a few big companies—is now being taken over by small operators—one in each community throughout the United States. Men and Women who have this inexpensive machine can turn out huge quantities of Rubber Stamps with special wording that buyers once were forced to buy from big cities. Material costing only 27c makes a stamp that sells for \$2.75. The machine that does the work is simple and easy to operate and it turns out as many as six Rubber Stamps at a time, each with different wording such as names, addresses, notices, stock numbers, prices and other "copy" needed by offices, factories and individuals. Working full capacity, it can earn as much as \$33.00 an hour for the operator! Now you can get into the big-pay business yourself, with your own home as headquarters. You don't need experience. We supply everything, including complete instructions and eight ways to get business coming in fast. We even help finance your start. Start making up to \$16.50 an hour from the very beginning. Cash in on the profitable Rubber Stamp business in your community, right away. We'll mail full particulars FREE and no salesman will call. Be first in your locality. Rush coupon or send your name on postcard now to:

**RUBBER STAMP DIV., Dept. R-2-CJ**  
 1512 Jarvis Ave. • Chicago, Illinois 60626

## HOME FRUIT DRYER

With our plans and instructions, you can make your own fruit dryer using salvage parts and inexpensive materials. Only ordinary tools are required. Dried peaches, pears, and apples surpass any candy made for being purely delicious. This unit has a large capacity and will cost just a few dollars to build. Complete plans and instructions are just \$3.00.

## THRIFTWAY

P.O. Box 914, Provo, Utah 84601



### BUILD YOUR OWN GRANDFATHER CLOCK

Save over 50% by building your own grandfather clock. Stately, straight-sided "AMERICAN CLASSIC" with beveled plate glass sides. Narrow waist designs: "SPIRIT OF '76" with finely sculptured crown and brass-tipped pillars; or easy to build, always popular "SPIRIT OF THE CENTURY." Our kits are Red-i-Kut, semi-assembled, hand-crafted of solid 3/4" kiln-dried mahogany, cherry or walnut. Tubular bell or Westminster rod chimes. Moving moon dials painted by our own artists, and our own original Goddess Diana or Lady Florentine pendulums. Gorgeous solid bronze dials with raised numerals and corners. Send \$2.50 for all three plans, plus description of kits and movements, as folks have for more than fifty years.

**KUEMPEL CHIME CLOCK WORKS & STUDIO**  
 Route 3, Box 240A, Excelsior, Minnesota 55331

## LEARN UPHOLSTERY AT HOME!



Men & Women All Ages! Send for free book on learning to reupholster chairs, divans, footstools, all furniture for BIG MONEY in spare or full time. No experience needed, no age or educational limits. We show you how and provide EVERYTHING needed to start: (1) Home training covering all phases, (2) all tools and 6 big furniture kits for practice, (3) free supplies, frames & materials to build \$300 worth of furniture, yours to keep or sell. Write TODAY for big free upholstery career book. No obligation, no salesman will call. **VETERAN APPROVED.**

Modern Upholstery Institute Box 899-UPM, Orange, Calif. 92669.

**SEND FOR FREE BOOKLET!**

**THIS LITTLE TABLE TOP MACHINE  
 MAKES EVERYTHING SIMPLE & EASY**

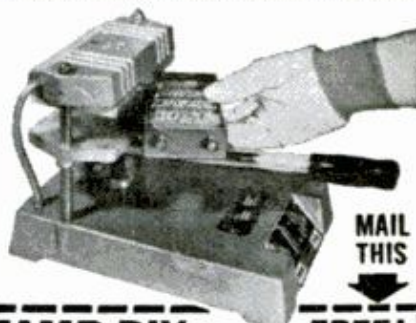

MAIL THIS

**RUBBER STAMP DIV. FREE!**  
 1512 Jarvis Avenue Dept. R-2-CJ, Chicago, Ill. 60626

Please rush full particulars about your financing plan and the little machine that can get me started in the profitable Rubber Stamp business at home in spare time. Everything you send me is FREE and no salesman will call.

Name \_\_\_\_\_  
 Address \_\_\_\_\_  
 City \_\_\_\_\_  
 State \_\_\_\_\_ Zip \_\_\_\_\_

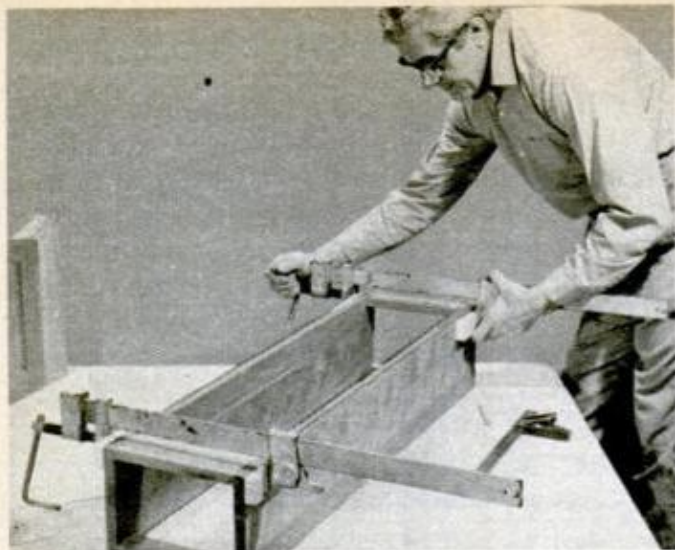

**Bar clamps** hold the waist section true while you drill screw holes in each end of the rear cross member.

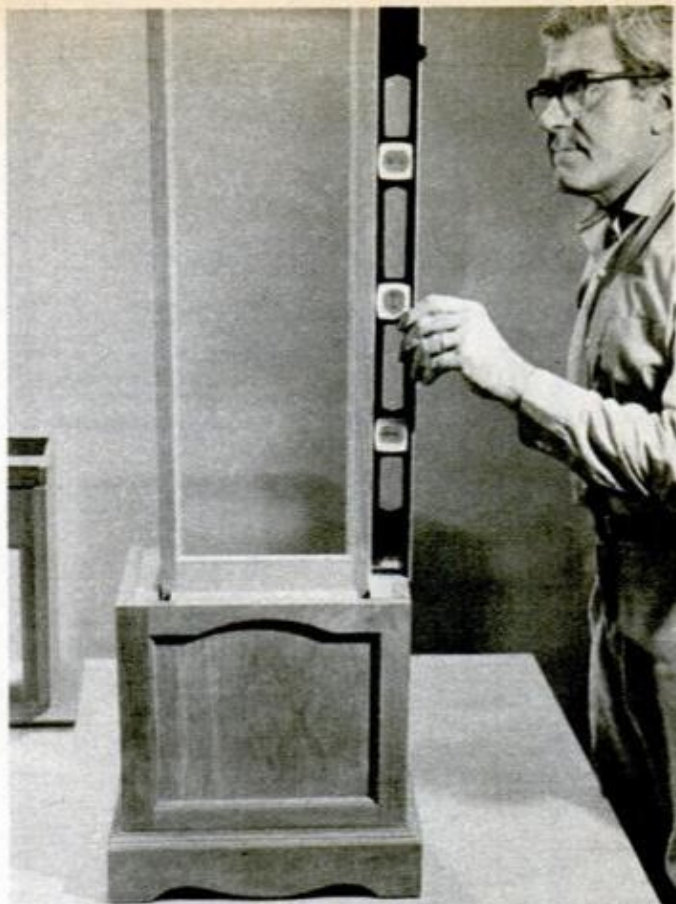

**When setting up waist**, do it on a level surface and plumb it with level to avoid a leaning-tower assembly.

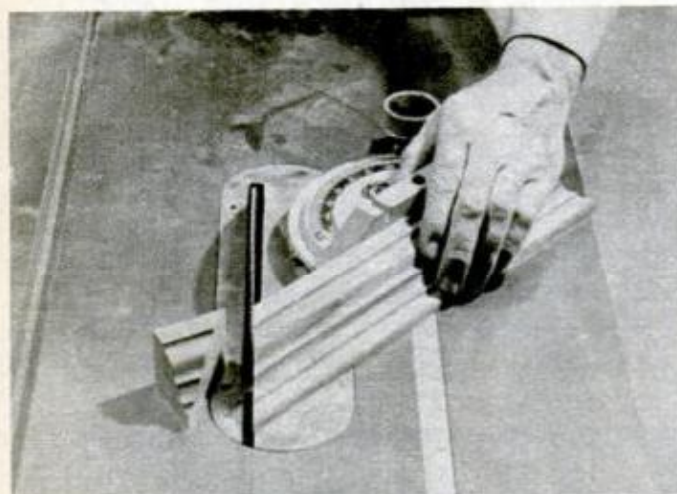

**All trim comes extra long** with square ends and requires mitering. Use care in cutting right on button.

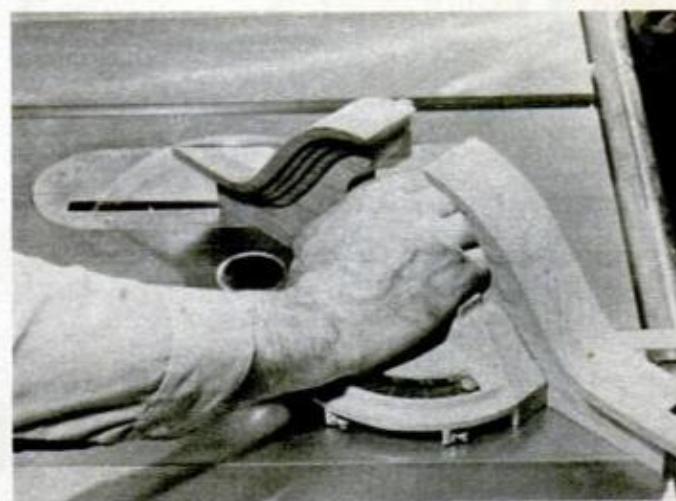

**Crown assembly must be mitered too.** Go easy in cutting it. A smooth-cutting blade is best for all miter cuts.



**When adding crown molding**, use paper spacers at tops of columns to provide clearance for gluing-on later.

## GRANDFATHER CLOCK FROM A KIT

*(Continued from page 164)*

uncut because moisture can and does affect pre-cut parts, particularly mitered joints, causing the unsealed wood to shrink and create poor-fitting joints.

Assembly sequence as shown in the photos begins with the base of the case, followed by the waist, hood and finally the trim molding and doors. The foot, already preshaped, must be mitered at the two front

*(Please turn to page 168)*



# Now you can refinish your car's damaged surface areas professionally

You already have the skill to refinish your car's damaged surface. All you need is a few minutes practice on a tin can. Send a self-addressed stamped envelope, and we'll send you brief illustrated uncomplicated instructions free.

With Dupli-Color® touch-up paint, you can be sure of professional results. Used by millions, Dupli-Color duplicates your car's original color exactly. Dries in minutes to a hard high-gloss finish. Beautiful! Professional!

In all popular domestic and foreign car colors wherever auto supplies are sold. Brush-in-cap bottles, Auto-Spray® cans. Get color code number or letter from body plate.

## DUPLI-COLOR. PRODUCTS

Dept. P, 1601 Nicholas Blvd., Elk Grove, Illinois 60007

Illustrated booklet shows tricks of the auto refinishing trade



Find body plate under hood or on front door jamb. Color code usually single letter or number. Get exact matching Dupli-Color.



Hold Dupli-Color spray can 8 to 10 inches from surface. Spray fast, smooth side-to-side strokes in one minute intervals.



For touching up a small nick or scratch. Cut small hole similar in size and shape to nick and spray Dupli-Color through it.

### PRESCRIPTION EYEGLASSES BY MAIL

direct from  
manufacturer

Your own doctor's prescription will be filled, or your present lenses duplicated. The latest fashions. All types of lenses available. Accuracy and perfect fit absolutely guaranteed.

**SEND FOR FREE FAMILY CATALOG. TODAY!**  
Est. in a hurry to receive a catalog?  
1959 . . . add 25¢ for 1st class mail.

**PRISM OPTICAL INC.**  
Dept. M-20 135 West 41st St., N.Y., N.Y. 10036

### GARAGE DOOR OPERATORS

EASY HOME INSTALLATION  
RADIO CONTROLLED

## \$99<sup>95</sup>

Chain & Screw Drive Models  
**FOUR MODELS FROM THOUSANDS IN USE - FREE BROCHURE**  
HELPMATE EQUIPMENT COMPANY  
Dept. P.M.-2, First & Lake St., Baroda, Mich. 49101 Shipped PP or UPS

### HEAVY DUTY WELDER

with special \$7.00 gift offer to  
Popular Mechanics Readers  
**10-DAY FREE TRIAL**  
Lifetime Guarantee

## 18<sup>95</sup>

POST PAID

Buy Factory Direct and Save  
Fits ordinary 110V outlet  
**Not one - but 6 welding heats**

Weld, braze, solder or cut most anything made of metal. No experience necessary. Follow simple instructions to make repairs on cars, trailers, farm and lawn equipment, bicycles, appliances, etc. Make campers, boats, furniture, hundreds of valuable items. **NOTHING ELSE TO BUY!** Comes complete with full face shield, pack of welding and brazing rods, heavy duty power cables, special electric torch attachment, ground clamp, flux, easy-to-follow illustrated instructions, rod holder, etc. Uses standard 1/8" rods to weld iron, steel, brass, bronze, aluminum, other metals. New improved HEAVY DUTY circuit gives more welding power. Gives 4 times the heat needed to melt toughest iron. Plus into ordinary 110V outlet. 6 WELDING HEATS for professional quality welding of "tough" to "light-weight" metals. 10 day MONEY BACK GUARANTEE. Lifetime parts and service guarantee. An excellent gift for any occasion. **FREE!** Mention you saw this ad in Popular Mechanics and receive a \$7.00 gift pack of welding rods free. For same-day C.O.D. shipment just call (713) 682-5681 or send only \$2.00 and pay postman \$16.95 plus small C.O.D. when delivered or charge to your BankAmericard or Master Charge card or for postpaid shipment send \$18.95 check or M.O. to WEL-DEX, Dept. W-203, Box 10776, Houston, Tex. 77018.

## Print For Profit

Cards, Stationery, Envelopes, Advertising, labels, tickets, announcements, Q.S.I.L. cards, greeting, sympathy, prayer cards, tags, etc. Save money. Pays for itself in a short time.

**Own a Printing Business**

We supply everything direct from factory only. Easily followed rules. Also raised printing like engraving. Have home shop. Add to income. Send 25¢ for catalogue. **KELSEY PRESSES 73-W, Meriden, Conn. 06450**



KELSEY PRESSES

**NO JOKE: The trouble with shooting**

### BENJAMIN'S NEW SUPER SINGLE SHOT AIR RIFLE

is that owners could talk a donkey's hind leg off in telling about its power and accuracy—far and away the most potent in its class—and how it gives you the upper hand on target and small game hunting trips, time and again!

Despite Benjamin's enviable reputation, would you believe some folks are under the impression that it can't be all that wonderful? To set things straight, once and for all, we present the impartial views of those that saw it from the business end:

Soupy Can: "Plinking tin cans is duck soup for Benjamin."  
J. Rabbit: "Thanks to Benjamin, I'm in it up to my ears."

Paper Target: "Benjamin helps you improve your aim at home in off-season."

What more can we add other than to say see your sporting goods dealer now. There are many expertly crafted features in a Benjamin that set it apart for all uses—indoors or out. Choice of BB or 177 or 22. Reasonably priced.

**BENJAMIN AIR RIFLE COMPANY**  
896 Marion St., St. Louis, Mo. 63104  
You Can **DEPEND** on BENJAMIN **FREE CATALOG**

Walnut Monte Carlo Stock and New Design Pump Handle. Thumb Safety Behind Breech.

### WHITE'S METAL DETECTORS

WHITE'S ELECTRONICS, INC. manufacture the World's Largest and Finest Line of Mineral and Metal Detectors. Ghosttowing, beachcombing, bottle hunting, coin hunting—all types of TREASURE HUNTING or PROSPECTING, amateur or professional. Detect conductive metals—Gold, Silver, Copper Nuggets—Coins—Rings—Jewelry, etc. Underwater or on the land. "There are no finer at any price" 25 production models to choose from—T.R. or B.F.D.

Priced from ~~\$250~~ up  
—Always specify the Blue & Gold  
ASK FOR WHITE'S BY NAME  
—Free Literature—  
WHITE'S ELECTRONICS  
Rm. No. 512  
1011 Pleasant Valley Rd.  
Sweet Home, Oregon  
33784 Hazel Street  
Albion, N.Y. U.S.A.  
Elk Air Industrial Park  
Dexter Drive, East  
Erhart, Indiana 46514



Four husky wood screws, driven into the top edge of waist section, hold the hood section securely in place.

## GRANDFATHER CLOCK FROM A KIT

*(Continued from page 166)*

corners along with the trim molding. The waist is assembled and joined to the base. Then attach the factory-assembled waist collar, the hood and dial-frame assembly. Hanging the doors completes the case.

While excellent easy-to-follow instructions are furnished with the kit, I found a few points worth passing on to builders. To simplify finishing the hood I did not

*(Please turn to page 185)*

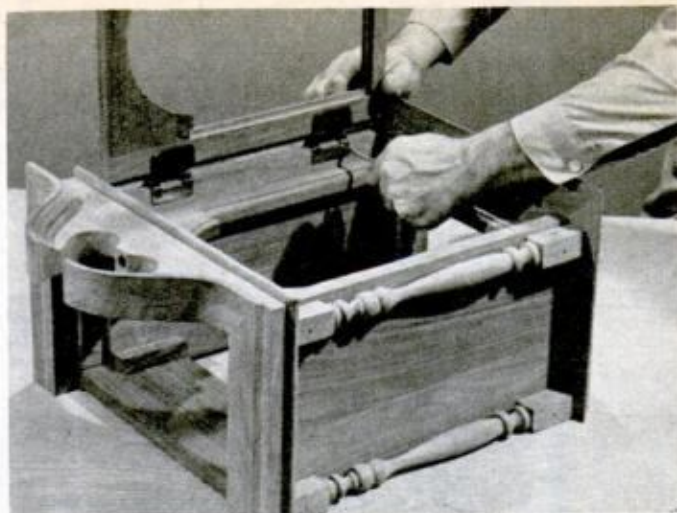

Doors, columns and hardware are removed before applying finish. Glass is installed in the two doors last.

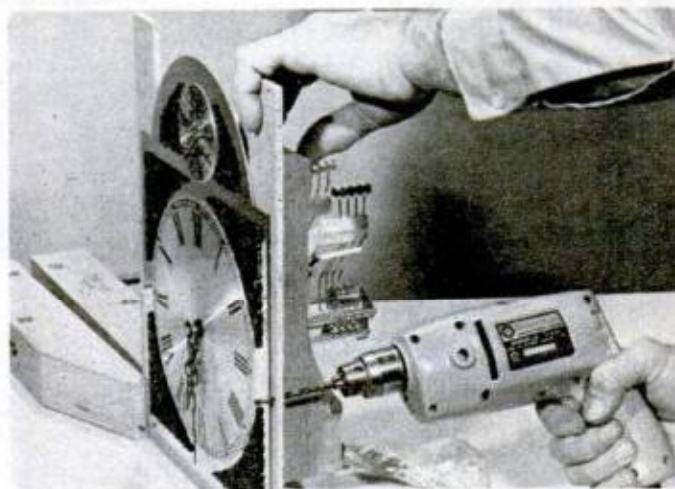

Wood handscrew (clamp) provides handy support for holding dial and works upright as you work on them.



Movement is mounted on board that in turn is screwed to dial frame from inside. Chimes attach to soundboard.

# You get more for your money from NRI

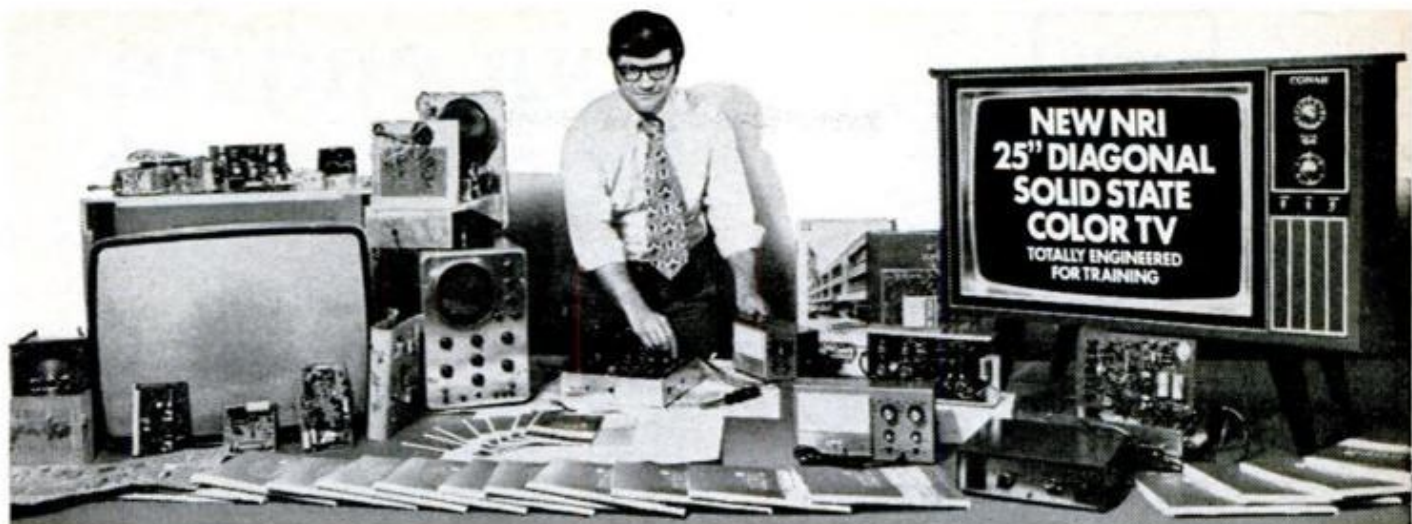

**SOLID STATE TRAINING**—Learn-by-doing with NRI equipment. TV-Radio Servicing course includes 25" diagonal color TV, with handsome woodgrained cabinet at no extra cost; wideband service type oscilloscope, color bar crosshatch generator, transistorized volt-Ohm meter, and solid-state radio kit. Other courses equally complete.

## NRI Programmed Equipment Gives You Priceless Confidence, Makes Learning TV-Radio, Electronics Fast and Fascinating

NRI pioneered the idea of supplying home-study students with custom designed training kits to give practical on-the-job experience as you learn. Today, NRI's "3-Dimensional" training can't be equalled. You get more value—from the exclusive Achievement Kit sent the day you enroll, to "bite-size" texts and custom training equipment. Learning TV-Radio, Electronics or Communications at home is easy, exciting, the NRI simplified, dramatized way.

### BE A SKILLED TECHNICIAN IN AMERICA'S FASTEST GROWING INDUSTRY

Regardless of your educational background, you can learn the Electronics field of your choice the practical NRI way. The NRI color catalog, sent to you free and without obligation, tells you how you can qualify quickly to be a part of the fast growing Electronic Age; about engineering jobs in business, industry, broadcasting, government, now offered to men without college degrees. It will open your eyes to the great number of success opportunities available right now in the high-pay world of TV-Radio Servicing, Broadcasting-Communications and Industrial-Military Electronics. With NRI technical training, you can take your choice of a wide variety of career

openings or have a business of your own. And if you choose one of five NRI courses that include FCC License preparation, you must earn your FCC License or NRI refunds your tuition!

### MAKE \$5 TO \$7 AN HOUR EXTRA IN SPARE TIME STARTING SOON

Tens of thousands of NRI graduates are proof it is practical to train at home in your spare time. Keep your present job while preparing for a better one, and earn \$5 to \$7 an hour extra in spare time while you train, fixing sets for friends and neighbors. NRI shows you how. Equipment you build and keep becomes useful in your work.

### STEP UP TO BETTER PAY, A BRIGHTER FUTURE

NRI can help you, but the decision to act must come from you. Decide now to move ahead . . . mail the postage-free card today for your FREE NRI color catalog. No obligation. No salesman will call. NATIONAL RADIO INSTITUTE, Electronics Division, Washington, D.C. 20016.

#### APPROVED UNDER GI BILL

If you served since January 31, 1955, or are in service, check GI line on postage-free card or in coupon.

### CASH IN ON THE BOOM IN COLOR TELEVISION



The NRI TV-Radio Servicing course includes your choice of black and white or color TV training equipment. Color TV needs thousands of trained men to keep pace with millions of sets being sold every year. NRI prepares you quickly. Cash in on the boom.

Mail insert card for  
**your FREE NRI  
color CATALOG**

No salesman will call



# For the life of your engine: Don't forget the filter

Lubricating oil gets to the right places in your engine through a complex circulatory system, and the oil filter makes sure it gets there clean.

by Paul Weissler

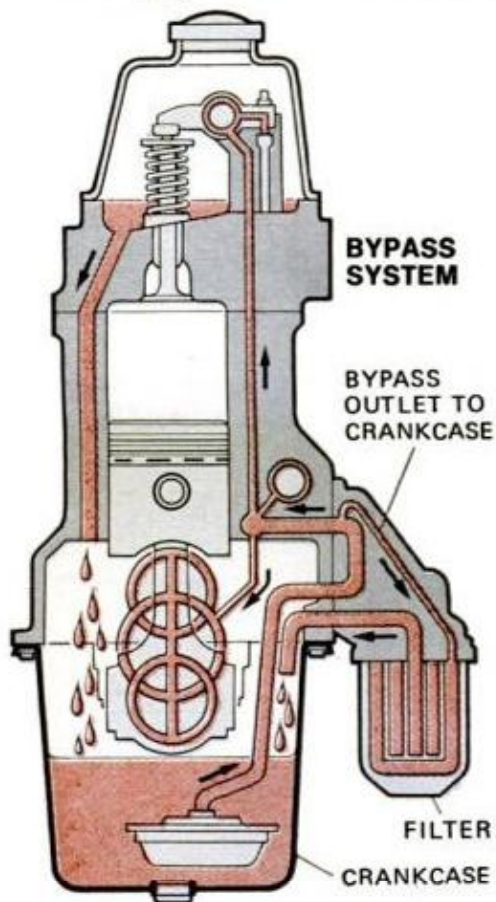
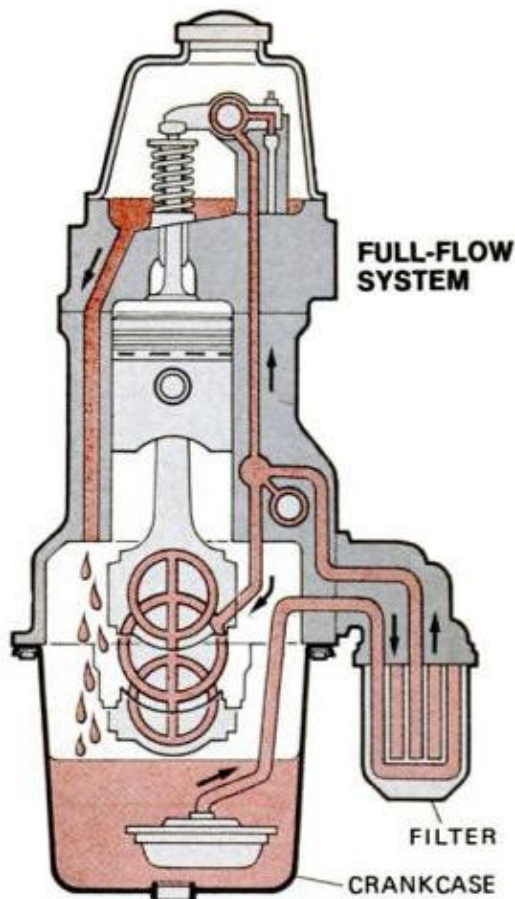

**Normal full-flow system** where all engine oil passes through an oil filter is shown at top. Some applications use a bypass system where main supply goes right to engine and small amount to filter.

An engine oil filter is almost a blind purchase. You can't test it before you install it, or even after it's used. You can't even tell if it's properly assembled without cutting it apart.

Oil filters aren't all the same, and the amount of money you spend is no indicator of quality. There are many gimmick filters that promise miracles and cost plenty, but don't deliver.

There are a handful of big names you can rely on, like AC, Deluxe, Fram, Lee, Motorcraft, NAPA, Purolator, STP, Wix, plus private brands they manufacture. An explanation of how your filter works will reveal why the most widely available design, and the one considered the best, is the single-element, pleated-paper type.

An oil filter is supposed to remove abrasive particles in a certain size range from the oil, before they can get to the bearings. It also should trap a reasonable amount of sludge, although most of the sludge is kept in suspension by oil additives and comes out when the oil is drained.

The filter should have a relief valve (unless one is built into the engine), and this valve should open only when the filter element cannot pass an adequate amount of

oil for the bearings. The relief valve normally opens only when the filter element is clogged or the oil is very cold and, therefore, too thick to flow readily through the element.

There are two important things an oil filter should not do:

1. It should not remove detergent and other additives from the oil.

2. It should not pose such a high restriction that oil can only trickle through the filter at operating temperatures, forcing the relief valve to remain open and allowing most of the oil to bypass the element on its way to the bearings.

Carmakers give filter engineers lots of specifications. The canister must be of a certain size, oil flow must be at a certain rate, the filter element must trap virtually all of the particles in a certain size range and the relief valve must open at a certain pressure.

A filter could be made so fine that it would trap much smaller particles than the carmakers specify, but to get adequate oil flow it might have to be larger than allowed. Even then, it might clog so quickly that it would not last the carmaker's specified drain intervals.

There is no industry agreement as to what size particles cause what percentage of engine wear, but over the years it has been found that filters removing particles down to 10 microns (.0004-inch) with high

efficiency provide excellent engine protection. The carmakers' actual specifications are usually not quite this stringent, but quality filters provide this degree of particle removal.

There are two basic types of filtration: full-flow and partial (also called bypass). In the full-flow design, *all* the oil goes through the filter before reaching the bearings. In a partial flow, 15 to 20 percent of the oil is diverted to the filter. Eventually, all the oil goes through the partial-flow, but potentially-damaging particles get many chances to reach the bearings before being trapped. All Detroit passenger cars today have full-flow filters. Many trucks have both full-flow and partial-flow filters.

A filter can trap a particle either of two ways: by stopping it as it hits the surface of the element, called "surface impingement," or in a deep maze, called "depth entrapment."

Pleated paper (actually a resin-impregnated, heat-cured cellulose) is the most widely used filter medium today. It is basically a surface impingement filter, although some particles are trapped in the layers of the paper. The oil flows through the pores of the paper.

Cotton fibers, wood shavings and wound cotton are media used in depth filtration, with packed cotton fibers being the most common.

A quality paper (pleated to provide a

## OIL FILTER CONSTRUCTION

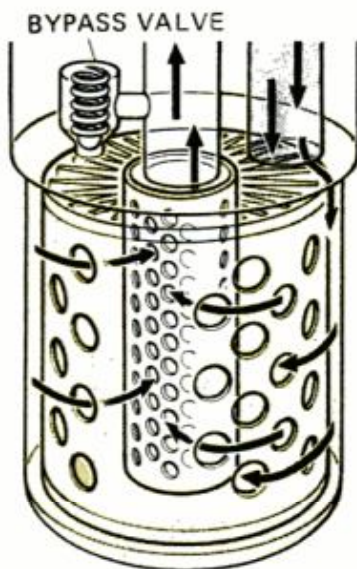

**Oil filter construction** shows oil entering the canister around outside, passing through element to outlet.

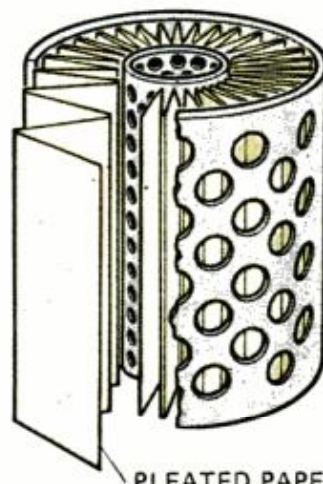

**Pleated paper element** in the oil filter is a special heat-resistant, resin-impregnated cellulose.

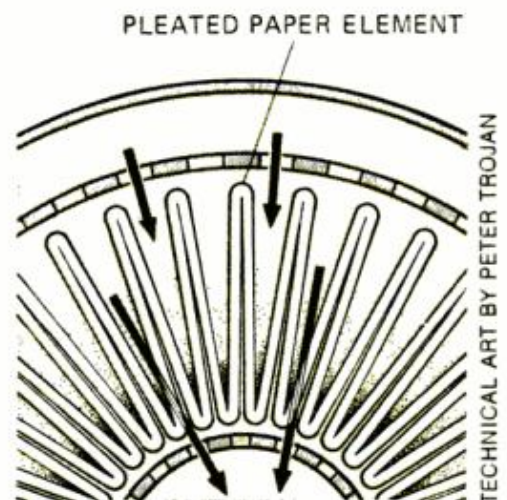

**Particle entrapment** in the pleated paper filter is extremely effective. Oil passes through pores of paper.

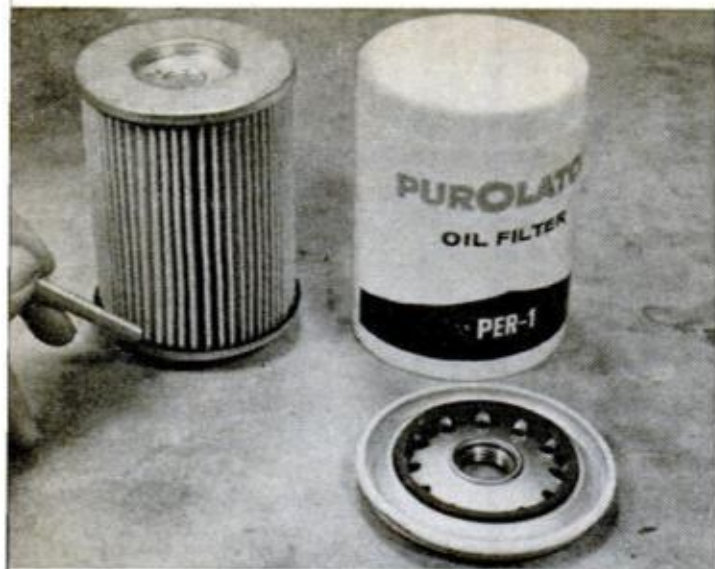

**End seal of pleated paper element in filter canister must be strong. If it breaks, oil will bypass element.**

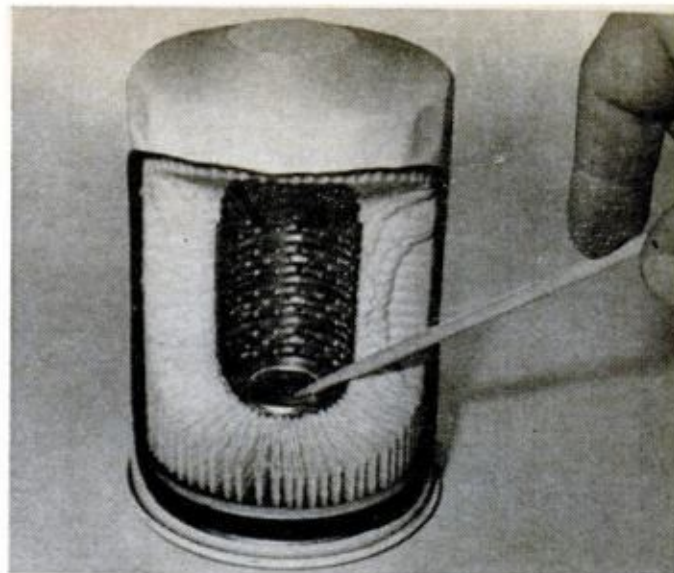

**Bypass valve on engine end of filter has a pressure specification that lets it open if element is clogged.**

maximum amount of filtering surface in a small container) has a number of advantages over depth filters:

1. With good quality control, it provides very predictable filtration of particles of any chosen size. That is, you can make paper to filter out particles of just about any size range with 98 to 99 percent accuracy on a single pass of the oil through the filter element.

2. It is not subject to channeling. Oil under pressure can drill channels through loosely packed sections of a cotton-fiber or wood-shavings filter. Oil flowing through these channels is not being effectively filtered.

3. It is not subject to breakaway of particles. In the depth filter, pieces of cotton or wood can break away from the filter.

4. It does not remove additives from the oil. Although most depth filters do not have a real problem in this area, some can remove additives (particularly oil-viscosity-index improvers) from the oil.

With the advantages of paper filters you might wonder why anyone makes depth filters. In fact, the big three filter companies, AC, Fram and Purolator, make only paper filters for automobile full-flow replacements.

The properly packed depth filter, however, does have the advantage of somewhat better sludge removal, and in trucks, which have to go up to 250,000 miles between engine overhauls, it is often installed as a bypass filter, to supplement the paper full-flow.

Ford is the only carmaker using a depth

filter for original equipment, although it approves the paper filters for replacement use. The Ford filter is actually a two-element design: a coarse fiber doughnut that removes approximately 100-micron particles, and a cotton-fiber depth filter that takes out 10-micron-plus particles.

This works as a combination full-flow filter. Most of the oil goes through the coarse doughnut, and some goes through the depth filter (oil, like electricity, takes the path of least resistance, which in this case is the coarse route).

Ford thought it needed the extra margin of protection against sludge when it went to the six-month, 6000-mile oil-and-filter change some years ago. Ford engineers were afraid of what would happen if motorists stretched the oil-change interval too far past their limits. Their fears probably were unjustified, for engine oils have been improved and the majority of people don't go even as far as 6000 miles between changes.

Two-element filters also have been promoted to handle the low-temperature situation, when the oil is too thick to run through the 10-micron filter and the relief valve is forced open.

With a coarse filter, the theory goes, the oil will get some filtration when cold. The problems with the theory are these: 1) To get a significant cold oil flow through the filter, you've got to make it so coarse that you might as well rely on the oil pump screen to keep out anything big; 2) You can't get rid of the coarse filter once the oil warms

*(Please turn to page 176)*

# Does More Than Help Shrink Swelling Of Hemorrhoidal Tissues Due To Infection

Also gives Prompt, Temporary Relief in Many Cases from Pain, Itching in Such Tissues.

Doctors have found a remarkably successful medication that actually helps shrink swelling of hemorrhoidal tissues when infected and inflamed. And it *does more*. In many cases it gives relief for hours from pain and itching in

these tissues. Tests by doctors proved this true in many cases.

The medication used in these tests was Preparation H. And no prescription is needed for Preparation H®. Ointment or suppositories.

**Learn ACCOUNTING at home** 

1000s high pay "Big Income" jobs open to men, women in Accounting. Bookkeeping Tax Return. Send for FREE "ACCOUNTING CAREER KIT." Approved for Veterans.

**INCLUDED WITH COURSE**

NAME \_\_\_\_\_ AGE \_\_\_\_\_  
 ADDRESS \_\_\_\_\_  
 CITY \_\_\_\_\_ STATE \_\_\_\_\_ ZIP \_\_\_\_\_

**FREE ACCOUNTING BOOK!**

**NORTH AMERICAN SCHOOL OF ACCOUNTING, Dept. 24178**  
 Accredited Member, National Home Study Council • 4500 Campus Dr., Newport Beach, CA. 92663

## NEW 8 HP SUPER BRONC

THE BIG BIKE FOR ALL SEASONS

Model VT-8 Kit  
 Price — \$279.95



**HEALD'S NEW "SUPER BRONC"**

Model VT-8 has a new 8 HP 306 cc Tecumseh engine. Torque Converter drive, big air cushion tires, front and rear shocks, large padded seat, chrome fenders, #40 chain and chain tightener. Optional features include 21" x 12" wide, knob tires both front and rear, electric start, lights, aux. 5 qt. gas tank, front ski and quiet spark arrester muffler. Super Bronc comes in money saving easy-to-build semi-kit form. Kit price Model VT-8 — \$279.95. Ideal for farm or recreational use.

FOR MORE INFORMATION WRITE:  
 HEALD INC., Dept. PM-8, P.O. Box 1148,  
 Benton Harbor, Michigan 49022

**FREE CATALOG**

**USE WHAT THE PROS USE!**



- LUBRICATES
- PENETRATES
- PREVENTS RUST

Available wherever automotive products are sold.

**CRC CHEMICALS**  
 Div. C. J. Webb Inc.  
 Dresher, Pa.

## "LISTEN IN" TO POLICE-FIRE RADIO CALLS IN YOUR CAR!

WORKS with ANY CAR—Portable or HOME RADIO! Just PLUGS in—No wiring—3 minute hookup! Switch instantly from regular to ALL POLICE-FIRE-EMERGENCY-COMMERCIAL-TAXICAB-STATE-CITY-GOV'T 2 way Radio calls in YOUR AREA. DUAL-HI-LOW BANDS TUNES 36-49 & 150-175 MHS. USE Everywhere—anytime—always works.



**SEND ONLY \$2.00** (cash, Ck., M.O.) and pay postman \$9.99 plus COD post or send \$11.99 for ppd Del in USA. COMPLETE, ready to use with instructions. One Year service Warranty—10 DAY MONEY BACK TRIAL (if rtd). Sold Only—DIRECT FROM FACTORY at this Low Price!

WESTERN RADIO BPM-8 KEARNEY, NEBR. 68847

**2 SETS, \$22**

U.S. Surplus High Speed Rotary Files. Hardened Steel, use on any metal or wood for filing, drilling, milling, carving, routing — a thousand uses in every shop.

Sets assorted in sizes from 1/4" to 1" cutting edge. All 1/4" shanks. All brand new, in air-tight, G.I. packs. Order now!

36 Tool Set, G.I. cost \$265.00, new ..... \$15.00  
 16 Tool Set, G.I. cost \$109.00, new ..... \$10.00  
 Save Even More, Both Sets, new ..... \$22.00

100% Guaranteed. We Pay the Postage. Order Now!

U.S. SURPLUS CENTER DEPT. 503

715 Camden, San Antonio, Texas 78215

**RONSON**

**Multi-Fill**  
 fuels most butane lighters



From 49¢

The clean quality butane that won't clog.

## BUILD, FLY YOUR OWN COPTER!

It's great sport to fly a Bensen Gyrocopter — lowest cost, too. Fly high or low, fast or slow. Adapts to floats. Pilot ages range from teens into 60's. Enjoy flying this easy way! Plans, parts and factory kits available. Get colorful info packet with photo, specs, 3-View Drawings. Send \$5 today!

**BENSEN AIRCRAFT CORP., Dept. PM-83**  
 RDU Airport, Raleigh, N. C. 27602

NAME \_\_\_\_\_

ADDRESS \_\_\_\_\_



Build **POPULAR MECHANICS'** little **CARRIAGE HOUSE!** Simply great! A back-yard building that isn't an eyesore. Styling blends in with most homes. It will take your mower, lawn furniture and tools—or the kids' overnight guests. Use it as your shop or home office. Overall outside dimensions 10-ft. 4 in. x 12-ft. 4 in. For one complete set of plans send \$3.95 to **POPULAR MECHANICS Dept. FA, Box 1014 Radio City, N.Y. 10019.** For two sets of plans (you may need one for your local building department) send \$5.49.

## FOR THE LIFE OF YOUR ENGINE, DON'T FORGET THE FILTER

(Continued from page 174)

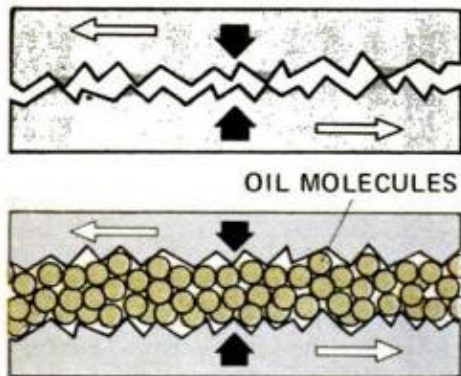

**Metal surfaces** under microscope are jagged; oil keeps them apart.

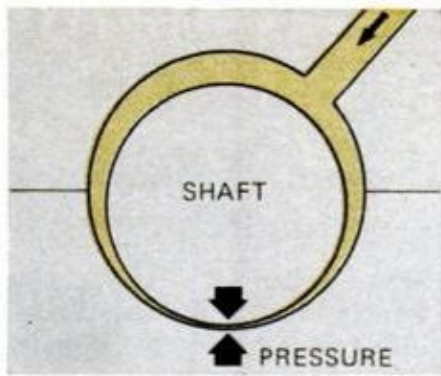

**Wedging action of oil:** Slowly rotating crankshaft at left is close to bearing surface. As speed increases shaft is lifted away from surface.

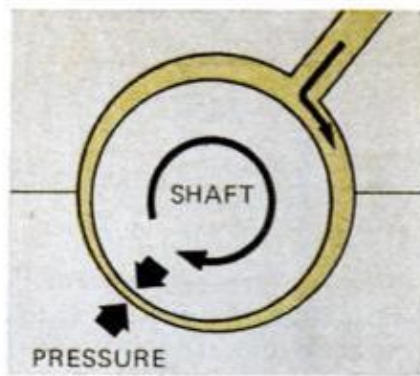

up. Some filter engineers have tried to separate the two elements with a check valve, but once the finer filter gets some dirt in it, the check valve pops open and stays open.

All single-element paper filters are not the same. Filter paper is only as good as the quality control of the maker. Some cheap paper filters have paper of wildly inconsistent porosity. The pores in some sections will be so small that oil can barely get through, and other sections will be so big that oil and abrasives pour through. Other cheap filters have good paper, but less of it (wide-angle pleats), so there's less filtering area and shorter element life. Still others use a paper with larger pores, which allows unacceptable abrasives to pass through.

A feature of some new pleated-paper filters is the addition of spacers to ensure a uniform spacing of the pleats.

Accurate relief valves are a key component of quality filters. A weak relief valve may stay open under all operating conditions, and virtually all the oil will bypass the filter element. Another type of valve used in oil filters that are mounted so that the oil runs back into the engine when it is not running is the antidrain-back valve. It closes to keep oil in the filter so it gets to bearings faster than it would from the crankcase when the engine is started again.

Good end sealing is another important factor. If oil pressure can blow a filter element's end seal, oil will take the path of least resistance and flow past the blown seal, bypassing the filter. A strong canister is also necessary to withstand any possible pressure surge.

Look out for filters for which very exag-

gerated claims are made. One is a filter that claims to trap acids with a rod the size of a large nail. Tests have shown that before this alloy rod absorbed anything, the oil would have to be so acid that the crankcase would probably have been partly eaten away.

A high-priced two-element filter, it is claimed, removes twice as many harmful particles. With quality paper filters taking out 98-99 percent on the first try, there's just no way the arithmetic works.

Another filter is said to be cleanable in solvent and reusable. This type is normally made of sintered bronze (bronze pellets fused together). It's a very coarse filter (100-micron) and it can't even be cleaned properly in a laboratory.

Also available is an adapter that permits you to use, of all things, toilet paper rolls as filter elements. Unfortunately, this adapter converts the full-flow system into a partial-flow, possibly voiding the car maker's warranty, and certainly reducing the filtration. Additionally, toilet paper is made to fall apart easily (so it flows down the drain), which is not the characteristic you want in a filter element. Quality filter paper, by contrast, is immune to engine heat, acids and even traps the small amount of free water droplets in the oil. The price of a toilet-paper adapter, incidentally, could pay for 50,000 miles or more of quality filtration.

When shopping for a filter, try to get a top name filter and try to get it at a discount price. Most auto-parts jobbers stock top brands, and if they're looking for retail trade, you should get a third off list price. Ask. You may find one of these brands even cheaper in a discount house. ★★★



## PUMP DRAINS pools, cellars, laundry tubs IRRIGATES — CIRCULATES — SPRAYS

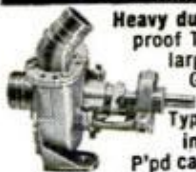

Heavy duty ball bearing pump. All metal, rust-proof Type XB. Stainless shaft. Use 1/4 HP or larger. 1 HP 1,200 GPH 60" high or 3,000 GPH 25" well. 5,200 GPH max. 1 1/4" in; 1" out. Belt or direct drive. \$14.95 Type P won't rust or clog. Bronze bearing. To 2,400 GPH. 1" in; 3/4" out. \$9.95 P'pd cash with order. Money back Guarantee.

LABAWCO, Box 40, Belle Mead, N.J. 08502

## KEEP YOUR JOB WHILE YOU BUILD YOUR OWN BUSINESS

Own and manage a nationally advertised business in your area. Each full-time serviceman adds several thousand dollars to your job salary. We equip them for 7 on-location services in homes, motels, offices, stores. We train, guide, help finance, back you. Just \$1195 cash puts you in prestige, lifetime business. Get full facts by mail. Write TODAY before your area is taken.

DURACLEAN INTERNATIONAL, 3-168 Deerfield, Ill. 60015

## HOME-WORKSHOP ELECTRIC ARC WELDER \$9.99!



WELDS—BRAZES—SOLDERS—CUTS—ALL METALS! Plugs into ANY 110 volt socket. MAKE REPAIR most anything for CAR—HOME—BUSINESS. Lifetime BURNOUT GUARANTEE 10 day money back trial (if retrnd). HEAVY DUTY Design. No experience needed—FREE WELDING LESSONS!

(cash, ck, M.O.) and pay postman \$7.99 COD postage or send \$9.99 plus \$2.00 for postage—ONLY packing in U.S.A. COMPLETE READY TO USE—Includes BIG pack steel, Brazing, Solder, Carbon "touch" rods & ELECTROFLAME ARC TORCH! OFFER LIMITED—Order TODAY! MIDWAY WELDER, Dept. EPM-8, Kearney, Nebr. 66847

## BASEMENT TOILET FLUSHES UP



TO OVERHEAD SEWER OR SEPTIC TANK. NO DIGGING UP FLOORS. INSTALLS EASY. Write McPHERSON, INC., BOX 15133, TAMPA, FLORIDA 33614

## START A BUSINESS

in your neighborhood



Sharpen Hand or Power Saws with the

## FOLEY SAW FILER

Start your business in sparetime and make CASH PROFITS right away. No stock to carry, no selling involved, no experience needed—the Foley Saw Filer does every sharpening job **automatically!** Earn \$3 to \$6 an hour sparetime in your own garage or basement. Profit 90c on every dollar.

Best of all, every saw you sharpen, will be resharpened again and again—watch your repeat business grow! Add cash to your income now, while you build retirement security with the Foley Saw Filer.



## MOWER SHARPENER

Precision-grind all hand and power lawn mowers—a perfect job every time.



**FREE BOOK** shows how you can make money as thousands of others have. Send coupon today. There's no obligation, and no salesman will call—so write today!

Foley Manufacturing Co.  
843-3 Foley Bldg., Minneapolis, Minn. 55418  
Send for FREE book on Money-Making facts about the sharpening business.

NAME \_\_\_\_\_  
ADDRESS \_\_\_\_\_  
CITY \_\_\_\_\_ STATE \_\_\_\_\_ ZIP CODE \_\_\_\_\_

# A Brand New Edition of the Famous PM CATALOG of Plans and Publications

Here it is—the great *NEW* edition of the *PM Catalog!* Want to build a garage, sidewalk car for the kids, run-about, sailboat, even an airplane or house? You'll find all these great plans listed here, along with a thousand and one other fascinating projects; also the finest of how-to books and shop guides. You know they're great if they're from *Popular Mechanics*. Send 25¢ for your *PM Catalog* today!

Popular Mechanics, Box 1014, CO-8  
Radio City, N.Y. 10019.

I am enclosing 25¢ in coin (no stamps please) for my copy of the *Popular Mechanics Catalog*.

Name \_\_\_\_\_  
Address \_\_\_\_\_  
City \_\_\_\_\_ State \_\_\_\_\_ Zip \_\_\_\_\_



MAIL THIS COUPON

# HINTS

## FROM READERS

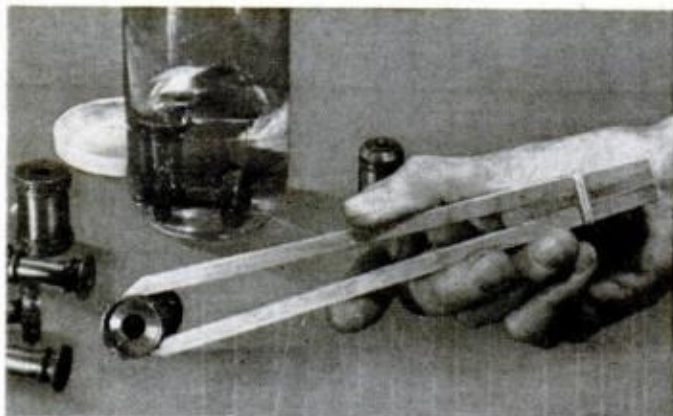

### Tongs sprung with silicone

Heavy-duty wooden tongs, useful for handling metal parts in cleaning solutions, can be made from strips of wood with a section of dowel for a pivot and silicone sealing compound to give them their elasticity. Let the silicone harden for at least a day before using the tongs.

—Walter E. Burton, Akron, Ohio.

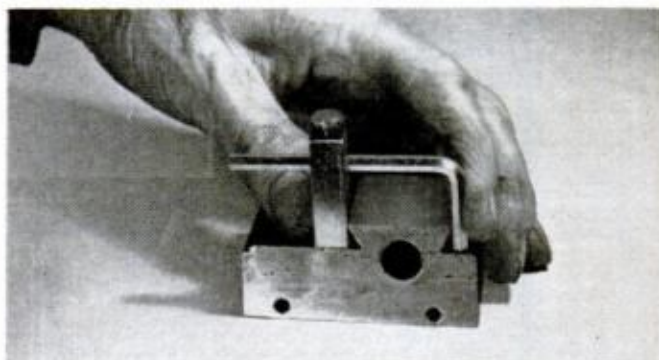
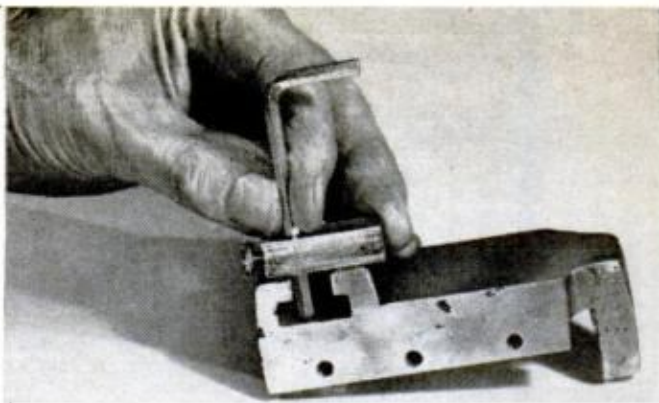

### Two-way emergency tool

After misplacing my calipers, I made this device from an Allen wrench and a steel block, and later found that it served as a depth gauge as well. Drill the block so that the wrench's short leg will be even with the bottom of the block, then drill and tap into this hole for a clamping screw.

—Peter Legon, Malden, Mass.



### Miniature socket wrenches

Allen-head capscrews can be used as small socket wrenches for hard-to-reach places. Lock a wingnut with a standard nut onto the threaded part of the capscrew to form a handle. "Wrenches" in a variety of sizes can be made this way, down to 1/8-32 for very small parts.

—Joseph Giambalvo, Brooklyn

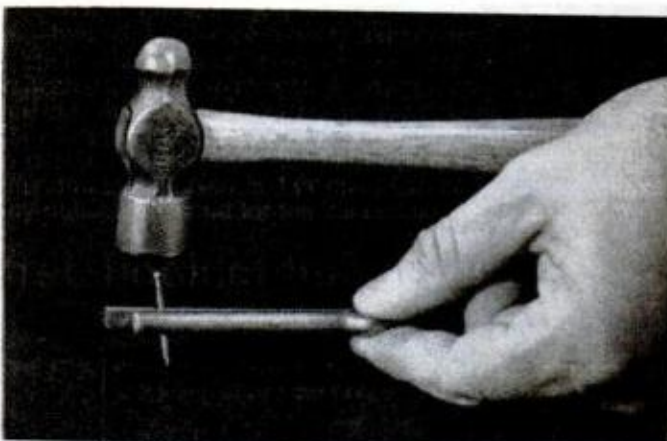

### Starter for small nails

Tiny nails, tacks and brads are often very difficult to start. Try using a large cotter key to grip the nail. After the nail has been firmly started, the cotter key is easily withdrawn. This trick can be extremely useful when you're nailing or tacking in places that are hard to reach.

—Ken Patterson, Regina, Sask.

# Here it is!

# Popular Mechanics

# COMPLETE GARDENING GUIDE

All the basic information on home gardening at your fingertips!



**Partial list  
of contents:**

- Landscaping**
- Garden surfaces**
- Gardening in your  
climate**
- How to improve  
your soil**
- Starting seeds**
- Trees**
- All kinds of  
transplanting**
- Shrubs**
- All about pruning**
- Flowers**
- Lawn care**
- Vegetables**
- Garden pools**
- Fruits, nuts  
and herbs**
- Container gardening**
- Outdoor play areas**
- Storage structures**

FIRST WE assembled every bit of information you need to know to make your lawn and garden the most beautiful in your neighborhood. We condensed *these* basics to *their* essentials. Then we added more than 20 fact-packed tables and charts, and scores of show-how drawings. Finally, we printed this vital material on heavy plastic-coated cards, and spiral-bound them together.

*You'll be amazed at the vast amount of information packed into your COMPLETE GARDENING GUIDE!* Planting dates and depths for all kinds of seeds and bulbs; when to prune what, and how; information on the 56 most popular shrubs, and the 21 best hedges; all about ground covers; the shapes and heights of the 52 most popular tree species; how to select evergreens; how to lay flagstone, patio blocks, bricks; how to build decks; all about air-layering, whip-grafting and other ways of starting plants; how and when to transplant almost anything; all about lawn renovation; and much, much more. *You can have all this basic gardening know-how at your fingertips!*

*No gardener can be a complete gardener without the COMPLETE GARDENING GUIDE! Order your copy today!*

**POPULAR MECHANICS, Box 1014 (Dept. GG) Radio City, New York 10019**

Enclosed is my check for \$3.95.

Send my PM GARDENING GUIDE to:

Name \_\_\_\_\_

Address \_\_\_\_\_

City \_\_\_\_\_ State \_\_\_\_\_ Zip \_\_\_\_\_

AUGUST 1973

181

## ROLL-AROUND WET BAR

*(Continued from page 85)*

nating fussy fitting and mortising. The exception is on the center door in the bar where there's no way of hinging it directly to the cart without its interfering with the door to the holding tank under the sink. To simplify matters, this door is hinged to the edge of the sink door next to it, using invisible Soss hinges. Thus, the middle door can be opened separately or both doors can be opened together for access to the tank.

There are only two tricky steps in construction—fitting the slope-sided swing-up tops and installing the slide-out speaker and ice-cooler drawers. Start by laying out the end pieces first since these determine the carts' overall shape—the rest of the parts will fall into place naturally from there. If you're building both carts, cut all four end pieces at one time—they're identical. The slide-out drawers for the speakers and ice cooler are also identical and offer a special advantage: If you want to place the two matching carts end-to-end to form one long credenza, you can use the ice-cooler drawer in the bar cart to hold the speaker normally stored in the left-hand end of the hi-fi cart. This will allow both speakers to be extended even when the carts are butted together. It will also improve stereo separation by putting the speakers farther apart. Handles on the drawers are intentionally omitted so the carts will fit flush together without any hardware to get in the way. The drawers are easily opened by reaching in and pushing them out from inside.

Standard K-V roller-bearing drawer guides are used on all slide-out parts. The speaker and ice-cooler drawers take stock 14-in. lengths, while the liquor caddy and tape-recorder drawer need longer 20-in. sizes. These metal tracks require a 1/2-in. clearance on each side so make the drawers an inch narrower than the openings into which they fit. The ready-made Rubbermaid drawers come with their own plastic slides and are easily mounted with four screws in each.

The 12-in. sink used in the bar cart is Kohler's Addison Model K-6550, which sells for about \$36 with trim rim and strainer basket. The pantry-type faucet is the Simplex Model K-7890, priced at around \$21. These are available at plumbing-supply dealers. If you have difficulty locating one in your area, write the Kohler Co., Kohler, Wis. 53044, for information on local sources.

If you should select a faucet other than the one shown here, be sure it stands no higher than 7 in. above the top of the counter. This is maximum height to allow adequate clearance for the top to swing down over the faucet without hitting it. Note that the faucet is mounted off-center to the sink, close to the front edge of the counter. This makes it more readily accessible and gets it out from under the overhanging shelf above. All handles on both carts are straight modern pulls in antique brass finish and match the one on the mobile cook-center. They're Amerock Model No. T-379. ★★★

## THOSE COLOR-TV TUNING BUTTONS

*(Continued from page 141)*

that might prove a convenience for some.

When shopping for a color set, one of the biggest problems you'll encounter is determining exactly what automatic tuning systems each set has—it's a cinch the salesman won't know. The listing on page 138 should help you in this department, but if you are considering a set that's not on the list, or if you forget to bring it with you, you can discover a lot about any set by performing a few simple tests.

To find out which controls are affected by the preset button, just push it in and try using the manual controls, one at a time. Obviously, if a control has no effect at all, it's tied into the preset pushbutton. If one or more of the picture controls have some effect with the pushbutton engaged, compare the amount of effect possible with the button in to the amount with it out to see if pushing the button limits the range of the control. Next, misadjust the fine tuning slightly and then push the preset pushbutton to find out if AFT is activated by it. If there is a separate AFT switch, experiment to see if it is a completely independent control or if it is just a defeat switch that can turn AFT off when the pushbutton is engaged, but can't turn it on when the pushbutton is disengaged.

Once you know exactly what each set you are considering has in the way of automatic tuning systems, you still have to decide what you want. Just as with automobile transmissions, you have to weigh the convenience of an automatic against the flexibility and control offered by a "stick." The only difference is, with a color TV you have several degrees of automation to choose from. ★★★

## BOMBS ON MAIN STREET

(Continued from page 136)

killed or maimed by similar loads when they blew."

Recognition of a particular danger undoubtedly saved lives in Arizona when an investigator was called to examine a truck with a cargo that had suddenly started "to smoke." The fact that the truck had just passed through a rain shower made the investigator suspicious—and a whiff of the vapor confirmed his suspicions.

He called off local firemen who stood ready to douse the cargo with water. The shipment was a chloride compound that would give off chlorine when wet. Dousing could have released a cloud of gas fatal to anyone venturing near or driving past.

Lacking regulations of their own, about half of our states have adopted the Transportation Department code on hazardous cargoes. Still, it is agreed that many laws, particularly those involving packaging and marking, are outdated and too complicated. A revised system of labeling and placarding is under study.

One thing that an alerted public can demand is the establishment of safe and clearly designated routes through settled areas for truckers and even railway carriers of HM loads. In addition, "safe havens" should be established for overnight parking of such cargo. Such areas should be fenced and under constant surveillance. A few states already have these havens.

Manufacturers of hazardous materials, aware of their products' potential for disaster, have set up a round-the-clock advisory service, available to anyone who may be faced with an emergency involving these materials. This service, called CHEM-TREC, is located in Washington, D.C., and is available free by calling 800-4240-9300.

The National Agricultural Chemicals Assn. also has a Pesticide Safety Team Network, located in Cincinnati, which can furnish personnel, equipment and expertise for decontamination of pesticide spills. The 24-hour number to call is 513-961-4300. The American Assn. of Railroads has a Bureau of Explosives in Washington (call 202-293-4000) that offers similar assistance in railway incidents. The U.S. Office of Hazardous Materials is reached at 202-426-1830.

The above numbers should be kept handy by anyone involved in handling or shipping hazardous cargo. It's one way to help safeguard the Main Streets of America. ★ ★ ★

## GOVT. SURPLUS

and other bargains  
**SAVE to 90%**



Send for this catalog

The world-famous Airborne Catalog. Fully illustrated. Contains 1000's of bargains in hydraulics, electrical, marine, automotive & hardware items ... and more! A must for mechanics, machinists, hobbyists, sportsmen, inventors, etc. Send 35¢ to cover postage & handling. In a hurry? Send \$1 for airmail delivery. Must include zip.

**AIRBORNE SALES CO.** Dept. PM73  
8501 Steller Dr., Box 2727, Culver City, Ca. 90230  
Satisfying world-wide customers since 1945

## \$12.95 BLACK DIAL TELEPHONES



Complete add \$2.00 for color  
Factory rebuilt Western Electric in white, beige, ivory, pink, green or blue. If 4 prong plug is required add \$2.00. Fully guaranteed.

Designs may vary.

Write for free list. All shipments F.O.B.

**SURPLUS SAVING CENTER**

DEPT. PM-83, WAYMART, PENNA. 18472

## HOW TO GET RICH -- AT HOME!



There is no other business like mail order. Start on a shoestring in your spare time and make a fortune fast. It strikes like a bolt of lightning! Millions read your ad and suddenly you are swamped with cash orders from all over the country. **MORE MONEY** in 60 days than you could earn in a lifetime! Write for free book and complete details. **Mail Order Associates, Inc. Dept. 411, Montvale, N.J. 07645**

**Build this good looking storage building in your own back yard!**



Here's a great way to take the strain off your garage. This handsome back-yard building has plenty of room for tractors, lawnmowers, bikes, tools or whatever. You can use it for a workshop, an escape room, a bunkhouse for the kids, or even a pool house.

It measures 8 feet by 12 feet; has a second floor; and can be built by most any handyman.

Plans give detailed building instructions. You probably will want to order two sets of plans as you likely will have to submit one set to your local building department.

Mail to: **Popular Mechanics**  
Box 1014 Dept. CH  
Radio City  
New York, New York 10019

Please send me plans for **Popular Mechanics'** back-yard storage building as indicated below. Enclosed is my payment in full.

One Set \$3.95     Two Sets \$5.49

NAME \_\_\_\_\_

ADDRESS \_\_\_\_\_

CITY \_\_\_\_\_ STATE \_\_\_\_\_ ZIP \_\_\_\_\_

## CLEAN-AIR COPS

*(Continued from page 147)*

charge more than \$35 for parts and labor to install a device, plus sales tax on the parts. Carter, Dana, Echlin and STP sell for that amount. Contignitron says its unit can be installed for about \$30, while Carco estimates a charge of around \$8. The Bureau of Automotive Repair points out, however, that mechanics can *legally* charge the full \$35 to install any of these devices.

### *When must I have a device installed?*

Except for those who sold their cars during the February-to-July period of this year, and therefore had to put a device on then, everyone else who owns a 1966-67 car will have to make the installation dependent on the last arabic number on his license plate. If your number ends in "1" you are among the first, starting in July. Then "2" follows in August, "3" in September, and so on. The last cars to have devices installed during April, 1974—will have a last number of "0" or letters only. Any new cars brought in the state also have to be fitted. *Note:* At press time, California's state legislature was considering delaying the start of this timetable as much as seven months.

### *Who can install it for me?*

Any mechanic, though if the work is not done at an approved pollution station, you must have your car inspected at such a station to get a Certificate of Compliance.

### *What's that?*

A certificate issued through the Bureau of Automotive Repair stating that you have an approved device on your car. That, and a windshield sticker, costs \$5. At a pollution station it's part of the installation cost.

### *Can I put the device on myself?*

You can, if you can find someone willing to sell one to you. You would still have to have it certified—and possibly have it re-installed if you did not do it properly.

### *What if I remove the device later? Who's going to know?*

You could get caught in the periodic roadside safety/pollution checks by the California Highway Patrol. The fine could be from \$50 on up. In addition, when it is time to renew your registration in 1975, the application will be turned down if you

fail to show your Certificate of Compliance.

### *Does everyone have to put a NO<sub>x</sub> device on his car?*

The majority of owners of 1966-70 cars under 6001 pounds will have to. The exceptions are: those with engines under 50-c.i.d.; those which operate on LP-gas (propane) or natural gas, including dual-fuel systems (which run alternately on gasoline and gaseous fuel); those originally designed and approved with a special manifold and multiple carburetors, cold-air induction, turbocharging, or fuel injection; those with centrifugal advance distributors; most 1970 GM cars; those equipped with an Air Quality Products 1966-70 "Pure Power" system; and certain others that cannot be fitted with approved devices.

For example, Dana devices cannot go on engines under 140-c.i.d., or be used with capacitor-discharge ignition systems, or on air-cooled engines (1966-69 Corvairs). Echlin devices cannot go on engines under 200-c.i.d., be used with vacuum-advance distributors, on any Internationals or on air-cooled engines. Carter devices cannot be fitted to engines under 140-c.i.d. or on those with vacuum-advance distributors.

There are no restrictions for STP. When and if Contignitron and Carco devices are manufactured, the former will not be fitted to engines under 200-c.i.d. and the latter to engines under 140-c.i.d.

### *What about engine modifications? Some of these actually reduce emissions, I'm told. Would that make it exempt?*

Not those modifications made *after* the car is first sold. And, regardless of what you do to an engine, you cannot alter, disconnect, or otherwise defeat the effectiveness of your engine's emission-control system. This includes the NO<sub>x</sub> retrofit devices.

### *Will I have to perform any maintenance on any of these devices?*

Most of them are warranted for 50,000 miles. Maintenance, limited by law to not more than \$15 for every 12,000 miles, is usually minor—such as removing and cleaning a filter once a year. Of course, there is always the chance of failure of a valve, an electrical component, so on. The ARB has tried to anticipate what the maintenance will be, but only owner use will really tell. ★★★

## GRANDFATHER CLOCK FROM A KIT

(Continued from page 168)

glue the four turned columns in place beforehand as per instructions but left them off until last. This permitted me to apply the stain and finish freely with no obstructions. I used paper spacers when installing the crown molding so there would be sufficient clearance for the columns when ready to glue and nail in place.

Also, instead of gluing each section (base, waist and hood) together I found it helpful to join them with screws. The waist, for example, is held to the base with four  $\frac{1}{4}$  x  $1\frac{1}{2}$ -in. lagscrews from the inside. Likewise, four husky wood screws, driven vertically into the top edge of the waist, are used to hold the hood securely in place.

I applied two coats of McCloskey Magic Sealer to finish the case, rubbed between coats with fine steel wool and followed with wax. The resultant rich walnut tone produced a truly handsome clock. ★★

## STEADYREST

(Continued from page 157)

movement of the workpiece, such as end-milling a slot in a block or bar, or cutting a chamfer or groove along an edge. Direction of cutter rotation with respect to the workpiece movement can be a factor. You may notice immediately that the steadyrest is particularly effective when the cutter tends to force the workpiece down against it.

As already indicated, there are two principal ways in which the part being milled can be moved past the cutter: 1) The carriage is locked in place and all movement of the workpiece is controlled by operating the cross-feed and compound-slide screws. In this case, pressure between steadyrest and vise should not be great enough to interfere with horizontal vise movement, and the top bar A should be parallel with the plane of such movement; 2) the cross and compound slides remain stationary while the workpiece is fed against the cutter by moving the entire carriage. This might be done in end-milling a notch in the edge of a piece of  $\frac{1}{8}$ -in.-thick steel. The steadyrest can be wedged between vise and saddle.

When milling in a lathe, you should remember two things: Always make certain that the workpiece is clamped securely, and that the milling attachment and compound slide (if the attachment is mounted over the toolpost slot) are firmly fastened to discourage horizontal shifting. ★★



# DRAFTING PAYS BIG!

Your FUTURE in DRAFTING

APPTITUDE TEST SAMPLE LESSON ALL 3 FREE

U.S. Labor Dept. says "42% more Draftsmen needed in next 10 years." Easy home-study plan guides you. Send for FREE "Drafting Career Kit."

• APPROVED FOR VETERANS.

NAME \_\_\_\_\_ AGE \_\_\_\_\_

ADDRESS \_\_\_\_\_

CITY \_\_\_\_\_ STATE \_\_\_\_\_ ZIP \_\_\_\_\_

**NORTH AMERICAN SCHOOL OF DRAFTING, Dept. 34178**  
Accredited National Home Study Council 4500 Campus Dr., Newport Beach, Calif. 92663

### FIND BURIED TREASURE

Powerful electronic detector finds buried gold, silver coins, etc. Write or call for free catalog. Dealer inquiries invited.



Financing Available **19.95** to **198.50**

Phone day - night (713) 682-2728

**RELCO, Dept. D-3**  
BOX 10839, HOUSTON, TEX 77018

### DEVCON "5 Minute" Epoxy

BRAND

#### SUPER-FAST BONDING & REPAIRS

Bonds all metals, wood, glass, ceramic, etc. in 4-7 minutes. Ideal for hobbyists.

Send for TWIN-TUBE PACKAGE **\$1.25** (INCLUDES POSTAGE)

ONLY



**BEAVER PRODUCTS**  
BOX 541, Beverly Farms, Mass. 01915

## This easy-to-build model flies on CO<sub>2</sub>



Whether you are a typical model builder or an ace at the local model-plane meets, here is an unusual little plane to add to your squadron. It's sophisticated but fairly easy to build and is powered by a simple, smokeless, almost silent CO<sub>2</sub> engine.

The PM-BEE can be built as a free-flight or radio-controlled flier. Full-scale patterns are available. Just fill out the coupon below.

To: Popular Mechanics  
Box 1014 Dept. BEE  
Radio City  
New York, New York 10019

Please send me complete plans and patterns for building the PM Bee. Enclosed is payment of \$3.49.

NAME \_\_\_\_\_

ADDRESS \_\_\_\_\_

CITY \_\_\_\_\_ STATE \_\_\_\_\_ ZIP \_\_\_\_\_

# HOW TO FIX YOUR DISHWASHER

(Continued from page 101)

## Dishwashing hints

### RINSE DISPENSER



PROBLEM	ACTION TO TAKE
1. Water spots.	Too much detergent. Determine amount by experimentation. Use a rinse conditioner in the final rinse to eliminate water spots.
2. Stains and films.	Caused by water or household plumbing. Use oxalic acid, vinegar or Clorox to remove. Eliminate all silverware and metal to prevent their corrosion from this treatment.
3. Iron film (brown stain).	Wash dishes with full cup of detergent. Omit dry cycle. Use two teaspoons oxalic acid crystals. Wash dishes a second time. Eliminate dry cycle. Wash again with a full cup of detergent. Use dry cycle. Repeat procedure as necessary until stains are gone.
4. Lime film.	Too much detergent with very hard water. Use pint vinegar; run machine through cycle.
5. Coffee, tea and food stains.	Fill detergent cup. Pour 1 teaspoon liquid chlorine bleach over detergent. Operate the dishwasher through a normal cycle.
6. Metallic stains on dishes.	Aluminum abraded into a dish as a result of improper stacking. Remove with household alkali (Drano, lye, washing soda, Clorox).
7. Aluminumware discolored.	Rebrighten with cream of tartar. Fill detergent cup with cream of tartar and let dishwasher go through wash cycle only. Polish aluminumware with soap-filled steel wool pads.
8. Glasses and glassware filming and etching.	Water hardness causes glass to film. Eliminate it by using rinse agents, vinegar or citric acid. Etching cannot be eliminated.
9. Glass breakage.	Due to improper loading. Never wash glasses and cups in the lower rack; the force of water is enough to knock them together or blow them upward out of the rack completely.

### DOOR-HINGE ASSEMBLY

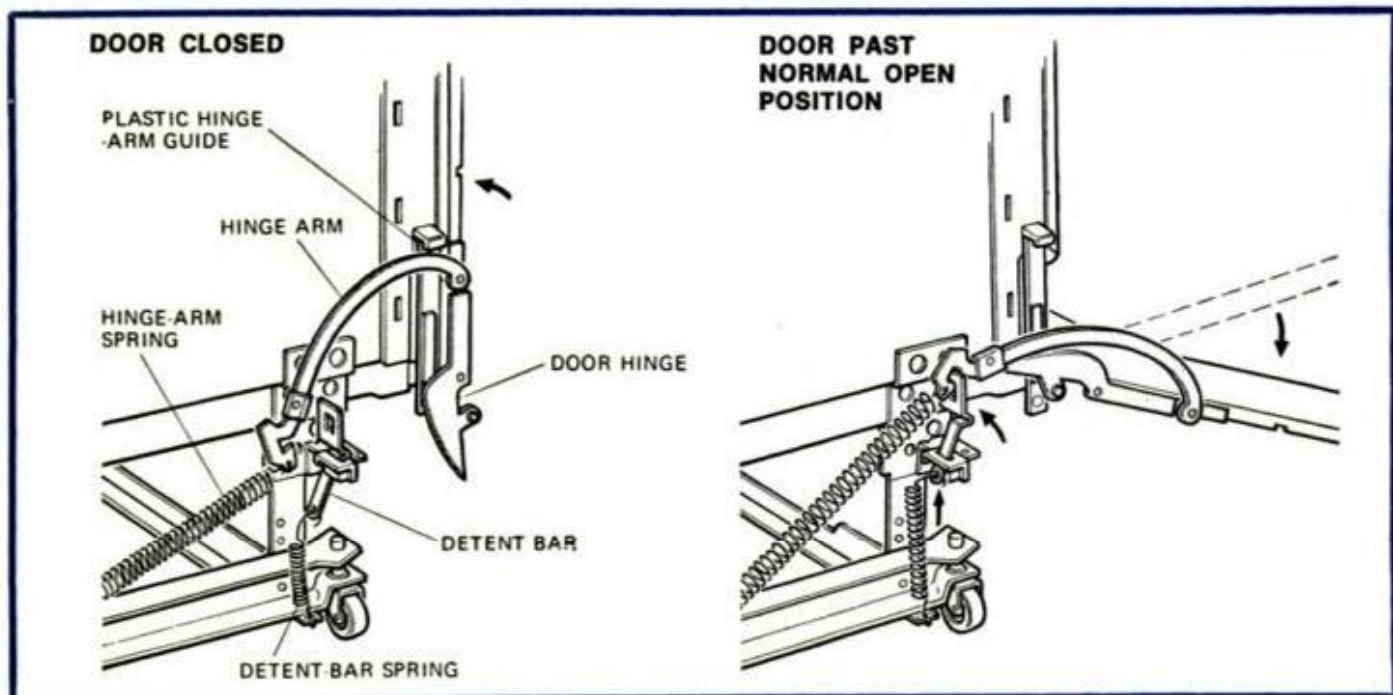



## PICTURES IN THE GREAT OUTDOORS

(Continued from page 131)

with long telephoto lenses, bridging the barriers of distance so you can photograph wary wildlife without lengthy stalking.

Since telephotos magnify camera shake, it pays to learn some rifleman's tricks, too: Squeeze off your shots as slowly with a camera as you would with a rifle. Steady your camera by bracing your arms against trees, rocks or fences, or drop into a rifleman's crouch. "Gunstock" mounts, many of which can be folded up compactly, also help. The experienced backpacker can even bring along a light, but sturdy, tripod.

On the other hand, you can travel light and still get good pictures. I often take along the 15-ounce Rollei 35, a full-frame 35-mm camera that features a brilliant viewfinder, a built-in exposure meter, shutter speeds from 1/2 to 1/500 second, and a 40-mm Tessar f/3.5 lens that folds in for compact carrying. My whole Rollei outfit, complete with lens hood, filters, Rollei electronic flash and film, can be carried in a jacket pocket or a small Camp Trails belt pouch. Similar, but less expensive (and a bit less compact), cameras are available

## Try the rainspout fixer

from

**DAP**



DERUSTO® GALV-A-GRIP™ paint sticks tight to slick metal surfaces—galvanized, aluminum, tin—to prevent paint peeling problems. Primes and finishes gutters, downspouts, flashings.

### America's First Name in Home Fix-up



DAP Inc., Dayton, Ohio 45401  
Subsidiary of *Plough, Inc.*

## Try the tub fixer

from

**DAP**



DAP KWIK-SEAL®. A bright white tub and tile caulk that seals joints and cracks watertight around tubs, sinks, showers, tiled areas. Beautifies bath and kitchen. Stays flexible. Resists mildew.

### America's First Name in Home Fix-up



DAP Inc., Dayton, Ohio 45401  
Subsidiary of *Plough, Inc.*

from Fujica, Konica, Minolta, Olympus, Petri and Yashica, many with coupled rangefinders and most with automatic exposure control. Many outdoor photographers swear by the rugged, compact old Leicas which, unlike other compacts, take interchangeable telephoto and wide-angle lenses.

Simple cameras, which are usually even lighter and easier to carry, can also yield good shots, of course (I've seen some nice results from Pocket Instamatics). But remember that Instamatic film is bulkier to pack than 35-mm, and fewer film types are available in that size.

At the other extreme, 2 1/4 x 2 1/4 cameras, such as the Hasselblad single-lens reflex, the Mamiya interchangeable-lens twin-lens reflex (especially the current models, which are lighter than the old ones) and the light, rugged Rolleiflex, are also used on the trail for the greater detail and tonal range their larger negatives provide. Some really dedicated nature photographers even pack 4x5 view cameras.

But whatever your camera, it's not the equipment but the thought and care you put into your shooting that make your picture trophies true records of the drama and beauty of your trips. ★★

# HINTS

## FROM READERS



### Sinkproof keys

When boating, fishing or working around water, it's a good idea to take this simple precaution against losing your keys—string a large cork on the chain. Or you can keep chain and cork in your boat and attach them to your regular key ring before going out on the water.

—William Swallow, Brooklyn

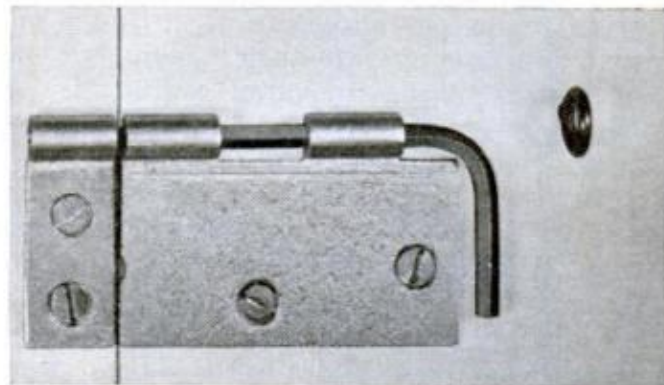
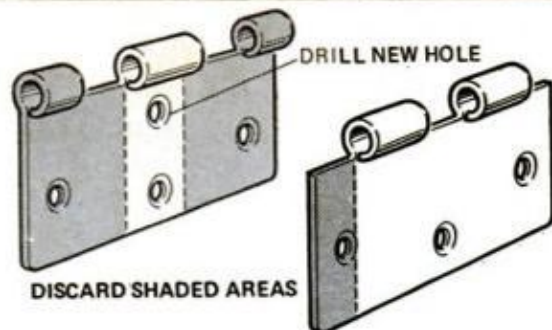

### Improved door bolt

A door or cabinet can be secured with a bolt latch made from a removable-pin butt hinge, an L-shaped Allen wrench and a screw eye. The screw eye acts as a stop to keep the wrench from being pulled out too far, yet can be turned to release the wrench when it is needed for its original purpose.

—Walter E. Burton, Akron, Ohio

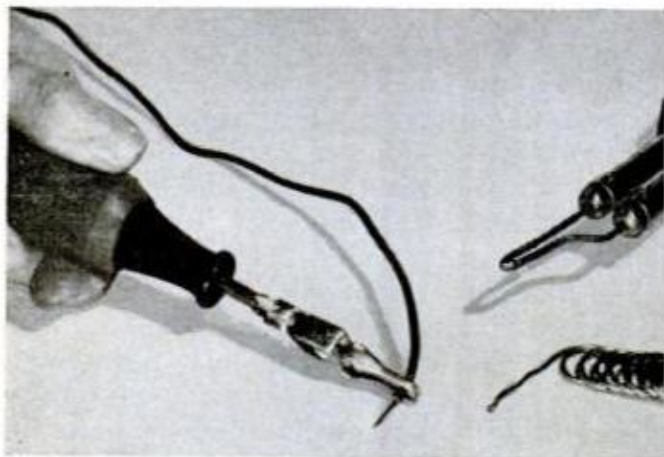

### Alligator with handle

An alligator clip soldered to the end of an old, small screwdriver is a versatile tool. I use it to hold wires for soldering, especially in hard-to-reach places. My wife puts a match into it to light candles in deep vases, and it is also good for lighting gas burners.

—George Hagstrom, Stevens Point, Wis.

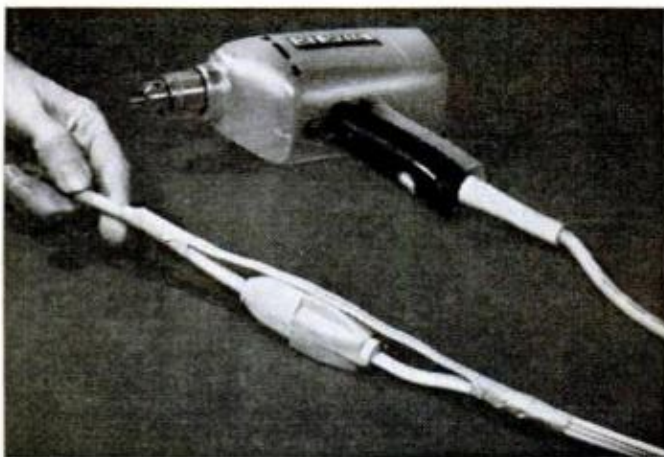

### Power-cord reinforcement

If you can't find a regular "cord connector" for reinforcing extension-cord connections against pull, you can make one from a length of lamp cord or small rope and masking tape. When no longer needed, the reinforcement is quickly removed by peeling off the tape.

—W. B. May, Oak Park, Ill.

# Announcing— The Popular Mechanics Index and Shelf Wrapper

Here's a great idea that will multiply the value of your back issues of PM. Reserve your copy now!



Want to find an article on 17 ways to thiefproof your car? How to build a colonial footstool? The latest bicycle touring gear? How to remodel your bath, or how to take the high cost out of hi-fi?

Your copies of *PM* are chock-full of such information. *PM* publishes literally thousands of ideas and items each year. Sometimes, though, it can be frustrating to find an exact article that you recall appeared several months ago.

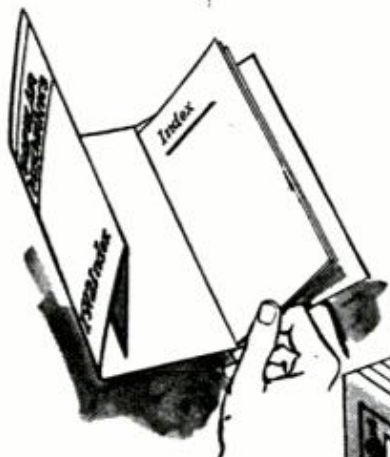

The new *PM Index and Shelf Wrapper* solves that problem. Each of those thousands of items which appears in *PM* throughout the year is not only referenced, but thoroughly cross-referenced as well. You can find *any* article you want in seconds! Or you can find *all* the articles on broad categories such as auto repair, electrical wiring, plumbing, photography and other subjects at a glance!

Best of all, the *Index* is bound into a handsome wrapper made of heavy board. The wrapper precisely encloses the 12 issues which are cross-referenced in the *Index*, and makes a beautiful and useful addition to your bookshelves.

Reserve *now* your copy of the 1972 *Index and Shelf Wrapper* listing and cross-listing all *PM* articles published throughout 1972.

ALSO AVAILABLE  
1971 EDITION  
\$1.49



The entire handsome package—*Index and Shelf Wrapper*—is yours for only \$1.49. Write for your copy *today!*

Popular Mechanics, Dept. PM-71-72 Box 1014, Radio City, New York, N.Y. 10019 Rush me, just as soon as it becomes available, a copy of the <i>PM Index and Shelf Wrapper</i> . I enclose check or money order for \$1.49.	NAME _____
	ADDRESS _____
	CITY _____ STATE _____ ZIP _____

# HINTS

## FROM READERS

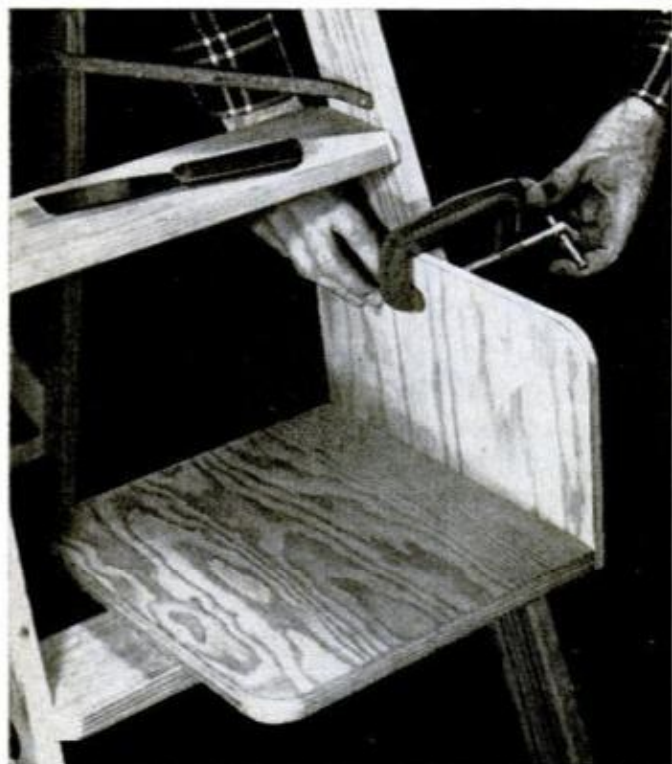

### Platform for stepladder footroom

Work more comfortably on a stepladder with a platform of  $\frac{3}{4}$ -in. plywood ( $\frac{3}{8}$ -in. on the side), clamped firmly to the side of the ladder.—*Andrew Vena, Philadelphia.*

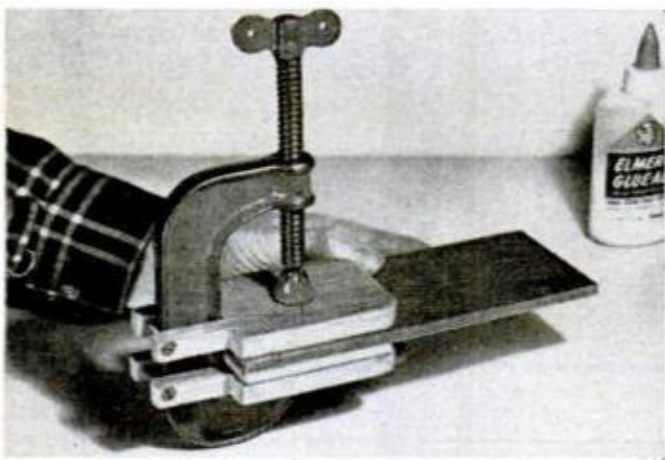

### C-clamp 'enlarger'

Big jaws for a C-clamp permit gluing of wide work. To keep them handy, slot them to fit over clamp's back, then fasten with nut and bolt.—*Peter Legon, Malden, Mass.*



### Quick nail caddy

Keep nails in paper bags and they'll wind up all over the place. I keep mine in cans bolted together with a plywood handle—it also makes them a lot more portable. Make your own handle or use the kind sold in craft shops for ladies' homemade tote bags.

—*M. David Rubbo, Johnstown, Pa.*



### Parts holder for ladder

Besides boring toolholding holes into your stepladder shelf, you can also screw on one or two soft plastic cups—the kind cheese spread comes in—to hold nails and screws. Use the lids to keep the parts from spilling when the ladder is folded.

—*Walter E. Burton, Akron, Ohio.*

# I-N-V-E-N-T-O-R-S

## WE NEED INVENTIONS

Sell your invention for cash—need money for Patent?—Are technical problems holding you back? Universal Inventions has helped inventors all over the world—just like yourself—why not you? Inventions provide the magic spring-board to sudden riches. REMEMBER, we either sell your invention or pay you a cash bonus. Write for details. UNIVERSAL INVENTIONS, Dept. 13, Marion, Ohio 43302

### BEA MOTOR cycle MECHANIC!



Cycles are "BIG BUSINESS" ... and so is Fixing Them!

Write Today for FREE "Career Kit." State age. SPARTAN SCHOOL OF MOTORCYCLE REPAIR, Dept. 34178 4500 Campus Dr., Newport Beach, Ca. 92663

Make big money. Train at home. No need to quit school or job. Special cycle tools and test instruments included.

## BASEMENT TOILET

Flushes up to existing sewer or septic tank by powerful, self-contained pump operated by normal water pressure. No digging up floors. Clog resistant, easily installed. Make basement into game room, den, apartment with private bath. Financing available. Write for free literature. DOSS, Dept. J-25, Box 10947, Houston, Tex. 77018

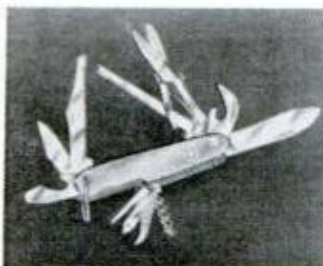

### SWISS ARMY TYPE KNIFE

Precision quality, all stainless steel 3 1/4" knife is 12 tools in one! Features scissors, cap lifter, hole punch, can opener, nail file, cork screw, fish scaler, screwdriver, fish hook disgorging, saw blade, large cutting blade and a small cutting blade. Perfect for the fisherman, the camper and the handyman. No. 005 Swiss Army Type Knife \$4.49 Messer Inds Mail Order DP 3331 N. 8th Fresno, Calif. 93726

## EARN MONEY FAST!

### REPAIR HYDRAULIC JACKS

Earn while you learn at home. Millions of jacks in gas and auto service stations, trucking firms, body shops, riggers, factories and farms need servicing ... most of which you can learn to repair. We show you HOW. Start spare time in your basement or garage. Big opportunity for mechanics. ACT NOW!

Write for folder PM8, and free bonus offer



HYDRAULIC JACK REPAIR MANUAL CO., INC. G.P.O. BOX 3 • STATEN ISLAND, N. Y. 10314



## Repair any watch

### ... SWISS OR AMERICAN

Unique, modern Sweazey System starts you making repairs right away. Develops skill step by step at home in spare time. Diploma awarded. Free sample lesson. No obligation.

CHICAGO SCHOOL OF WATCHMAKING Dept. 183, Fox River Grove, Ill. 60021



## LEARN MEAT CUTTING

Train quickly in 8 short weeks at Toledo for a bright future with security in the vital meat business. Big pay, full-time jobs—HAVE A PROFITABLE MARKET OF YOUR OWN! Time payment plan available. Diploma given. Job help. Thousands of successful graduates. OUR 50th YEAR! Send Selection Guide, Discount Prices. Write NOW for big new illustrated FREE catalog. No obligation, G.I. approved. No. 0197T

NATIONAL SCHOOL OF MEAT CUTTING Dept. 50-2, Toledo, Ohio 43604

## ACCORDIONS • Big Discounts

Buy Direct Importer-to-You

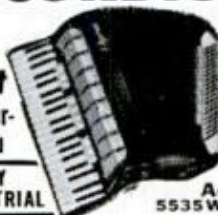

### NEW ELECTRONIC MODELS

SAVE 1/2 42 "New Sound" Electronic and Standard models, Amplifiers too! All Famous Makes. Try before you buy—5-Day Trial. Easy Terms, Trade-Ins. Free Accessories. Money Back Guarantee. Free Color Catalogs, Handy Selection Guide, Discount Prices. Write

5-DAY HOME TRIAL

Accordion Corporation of America 5535 W. Belmont, Dept. R-83, Chicago, Ill. 60641

## locksmithing and key making

### PRACTICAL UP-TO-DATE COURSE — ONLY \$7.95

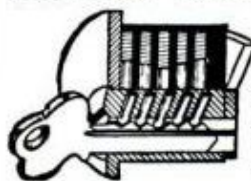

Teaches you how to pick locks, de-code, make master keys, repair, install, service, etc. New self-instruction lessons for every handyman, homeowner, carpenter, mechanic, service station operator, fix-it shop, hardware dealer, gunsmith. 53 easy illustrated lessons. Full price only \$7.95 post-paid. Satisfaction or refund guaranteed. Mail order today!

NELSON-HALL CO., Dept. 6HX-2 325 W. Jackson Blvd., Chicago 60606

## Be a VETERINARY ASSISTANT

... Lab Aide, Zookeeper, Pet Shop/Kennel Owner  
MEN - WOMEN! Train at Home in Spare Time ...  
Send for Career Kit — ALL FREE!

Name \_\_\_\_\_ Age \_\_\_\_\_  
Address \_\_\_\_\_  
City \_\_\_\_\_ State \_\_\_\_\_ Zip \_\_\_\_\_  
North American School of Animal Sciences, Dept. 34178  
Careers by Home Study  
4500 Campus Dr., Newport Beach, CA 92663



## SuperBonder™ Adhesive makes 10 second repairs.



Miracle SuperBonder adhesive, by Loctite, repairs almost anything and everything ... in seconds ... without clamps. Bond vinyl to metal car trim, repair vinyl upholstery, valuable ceramics, china, glassware, toys. Build models. Send check or money order for \$2.00 plus 50c for postage and handling for SuperBonder, from Loctite, the makers of Lock n' Seal. MONEY BACK GUARANTEE

SuperBonder Offer P3  
Box 1014  
Hartford, Connecticut 06101



Please send \_\_\_\_\_ tube(s) SuperBonder. \$2.00 per tube plus 50c per order enclosed for handling and postage. (Conn. residents add 7% State tax.) Allow minimum 14 days for delivery.

NAME \_\_\_\_\_ AGE \_\_\_\_\_

ADDRESS \_\_\_\_\_

CITY \_\_\_\_\_ STATE \_\_\_\_\_ ZIP \_\_\_\_\_

TM Loctite Corp.

# HINTS

## FROM READERS

---

### Protection for door frames

A summer's worth of bicycle, lawnmower and yard-cart traffic can leave a lot of nicks and gouges in the outer edges of a garage or basement door frame. You can protect these vulnerable edges from this damage by screwing lengths of do-it-yourself aluminum angle to them.

—*John F. Dinges, Homewood, Ill.*

---

### Emergency bottoming tap

Lacking a bottoming tap, I ground a flat about  $\frac{1}{8}$  in. long (and a little past the minor diameter) on the side of a machine screw. After going as deep as I could with a plug tap, I used my improvised tool to get to the bottom of the blind hole—while taking care not to jam the tap.

—*Robert K. Harvey, Lawrence, Me.*

---

### Numbers for printer's copy

A small print shop converting from letterpress to offset printing found that old calendars were a good source of considerable quantities of large numerals in odd sizes and shapes. They used them for making pasteups when printing large, one-of-a-kind ads and sale circulars.

—*Lane Olinghouse, Missoula, Mont.*

---

### 'Gliders' for patio furniture

My heavy, redwood outdoor furniture is hard to move around on indoor/outdoor carpet. So I made "gliders" for the 2x4 legs of the furniture by tacking  $1\frac{1}{2}$  x  $2\frac{1}{2}$ -in. scraps of vinyl floor tile to the bottoms of them with escutcheon pins, then spraying the tile with silicone lubricant. Pins were countersunk with sharp hammer blows.

—*Herman E. Seemann, Rochester, N.Y.*

---

### Tape helps saw toe line

When cutting a piece of dark-stained wood or molding to an exact size, it can be virtually impossible to see a pencil line marked for the cut. But if you draw it on masking tape, you won't have any trouble seeing and following it. Tape the workpiece's underside, too, to prevent splintering.

—*Robert Brightman, Great Neck, N.Y.*

---

### Prank-stopping grease

Kids like to play tricks on each other, and letting air out of bicycle tires is one of them. I suggested to my son that he smear a little grease on his bike's valve caps. Kids will usually think twice about getting into anything too icky, and my son hasn't had a flat tire since.—*Dennis H. Richardson Sr., Perkinsville, Vt.*

---

### Crack-stopping trick

When you pour a concrete floor from which a steel post will protrude, wrap a piece of heavy tarpaper around the post to a point slightly above the floor line. This will act as a cushion (an expansion joint) for the concrete to expand against as it sets and will help to prevent cracks.

—*Luther H. Mead, Chatham, N.J.*

---

### Modelmaking tool

Instructions for plastic model kits tell you to "mushroom" the ends of axles and propeller shafts by pressing them with a heated paring knife. For a neater job, I prefer to use the head of a 3d box nail. I've made a permanent tool of one by inserting the nail in a drilled length of dowel, with chamfered edges and painted for appearance.—*Floyd S. Adams, Geneva, N.Y.*

---

# Find the answers to 1001 workshop questions

## quickly, easily with the POPULAR MECHANICS MASTER SHOP GUIDE

24 hangup boards, coated with wipe-clean plastic keep vital how-to-do-it information always at your finger tips.



Here in an easy to use, last-forever format are the answers to everything you'll ever need to know about: nails, screws, bolts, wall-fasteners, drills, abrasives, lumber, hardwoods, moldings, plywood, hardboard, gypsum, adhesives, plumbing, electrical work, floor and wall tile, glass. Facts on remodeling measurements, gutters, concrete, garden chemicals. Plus—all on one board—a ruler, protractor, 45-degree triangle, and compass for accurate circles! You'll reach for the MASTER SHOP GUIDE for every job you tackle!

What nail should you use? How many pounds will a 1/4-inch toggle bolt hold? How can you save money ordering lumber? What size quarter-rounds are available? How do you bleach close-grained hardwoods? What glue is best?

Repairs, too! Illustrations on plumbing, electrical, floor or wall tile, plastic laminates, glass, remodeling. All the basic dimensions you'll need!

By the editors of *Popular Mechanics*—order yours now—you'll use it the rest of your life!

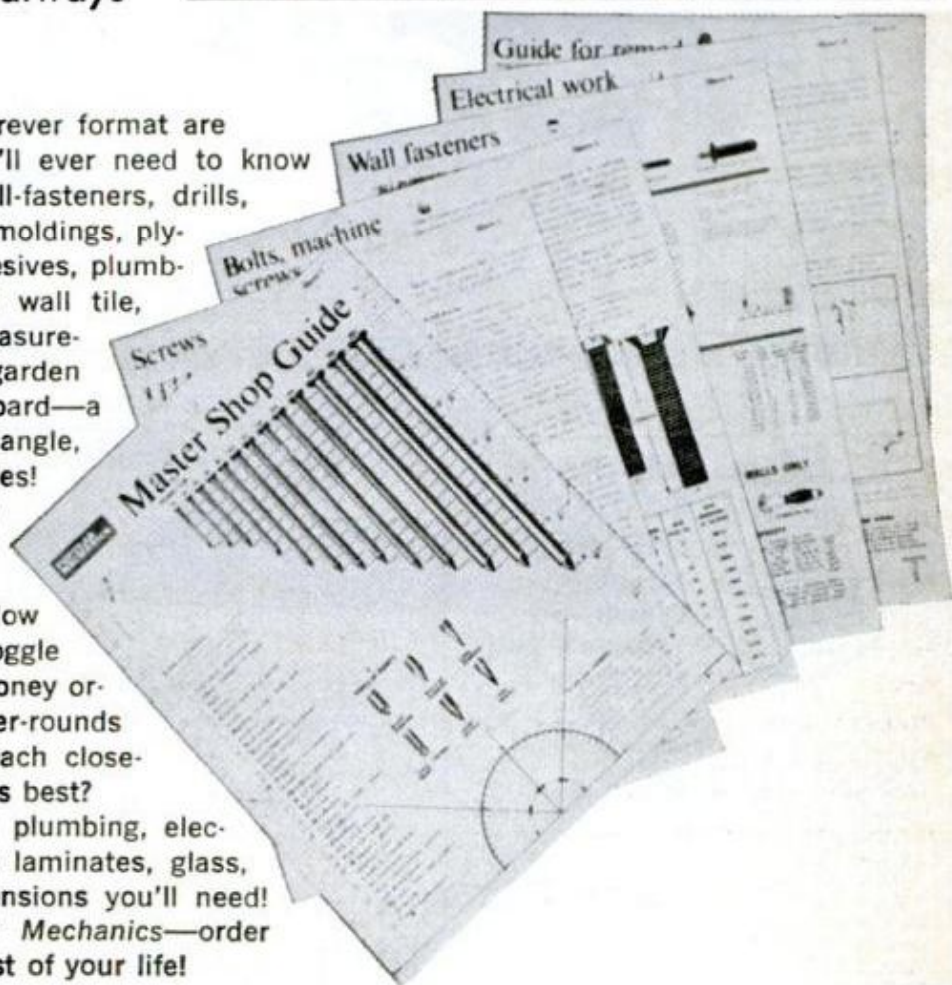

Popular Mechanics, Dept. SG-8  
Box 1014, Radio City,  
New York, N.Y. 10019

Rush me \_\_\_\_\_ sets of the  
MASTER SHOP GUIDE.

I enclose check or money order  
for \$3.95 for each set ordered.

NAME \_\_\_\_\_

ADDRESS \_\_\_\_\_

CITY \_\_\_\_\_ STATE \_\_\_\_\_ ZIP \_\_\_\_\_

# The Bargain Hunter

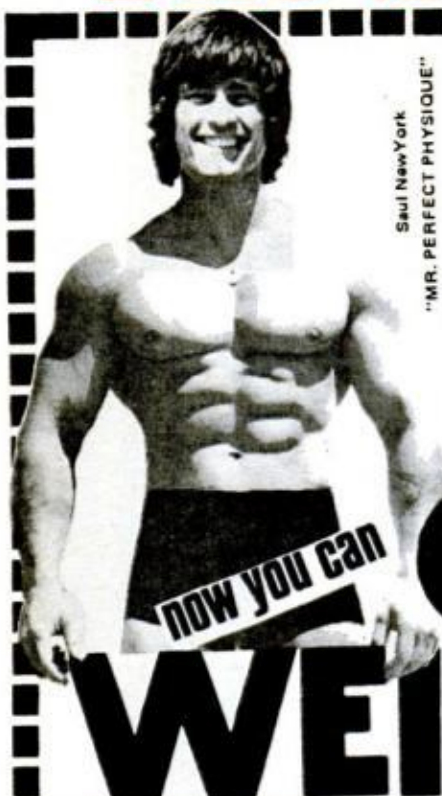

Saul New York  
"MR. PERFECT PHYSIQUE"

Yes! Now you can gain weight, muscle-up all over. No gimmicks or gadgets. Just a brand new scientific body-building principle that packs on pounds of healthy body weight, slims flabby waistlines and gives you a brand new appearance. Add powerful muscles to your arms, chest, shoulders and legs. Send 25¢ coin to cover postage and handling costs, for FREE easy-to-follow plan.

# now you can GAIN WEIGHT!

HERCULES II<sup>®</sup>, Dept. 15832  
P.O. Box 78, Meadowvale, Ont. Canada

**FREE!**

Please send your free brochure under plain cover

Name \_\_\_\_\_ (Please Print)  
Address \_\_\_\_\_  
City \_\_\_\_\_  
State \_\_\_\_\_ Zip \_\_\_\_\_

## PORTABLE STEAM CLEANER

Steam in 60 seconds



**CLEAN:** Engines—Air filters—lawn mowers—trucks—tractors

"Big enough to do the job, small enough to get there."

Fast, economical, ruggedly built. 3 year guarantee on coils & firebox. Propane fired. Weighs 120 lbs.

Auxiliary pump required on water pressures below 60 lbs. or on well systems.

WEDCO MFG. INC., Dept. M-4,  
Box D, Jackson, Wyo. 83001

## EARN TO \$50,000.00 YEAR

NEW EXPLODING MEDICAL CLAIM SERVICE FIELD. NO EXPERIENCE NECESSARY. FOR INFORMATION SEND \$2.00 TO CLAIMS, 3908 LEE DRIVE SUITE 108, ANNISTON, ALABAMA 36201.



## BUILD-UR-OWN BASS BOAT AND JET OUTBOARD MOTOR

BOTH are designed for SAFE FUN or FISHING at minimum cost. Easy to build from our PLANS & INSTRUCTIONS. Also PLANS available for PORTABLE ELECTRIC POWER PLANT using an auto alternator & Alt-Power, 110-volt power in your car. Send \$2 for complete INFO PACKET on all PLANS, or write for FREE BROCHURE.

B-UR-O Co., Dept. PV  
34161-B Coast Hwy.  
Dana Point, Calif. 92629



## ALARM STICKER DECALS Scare Away Would-be Thieves and Molesters.

Protect your Home, Car, Office, Boat, Cycle or any personal possession you don't want stolen or tampered with.

These 3 color **inside/outside** professional decals will supply you with the added protection needed to make would-be thieves go elsewhere!

**Futronic Security System decals are exactly the same as those sold with expensive alarm systems** (and until now most people had to buy the complete alarm system to get the decals). Now you can enjoy this added protection for pennies!

For your decals write Dept. C.P.O. Box 333, Main Station, Yonkers, N.Y. 10702  
Send for 1 decal 39¢; 3 decals \$1.00; 7 decals \$2.00; 10 or more, 26¢ ea. (Include your zip.)

**Futronic Security Systems**  
a division of M.J.F. Futronic Systems, Inc.

## 110 Volt A.C. GENERATORS

60 cycles. Fanbelt driven from car or gas engine. Operates T.V., refrigerators, radios, all power tools, projectors, P.A. systems and fluorescent lights. Over 12,000 in service. Guaranteed six months. 1500-watt \$65.00 postpaid. 3000-watt \$105.50 postpaid. Special X-1000 watt self-excited generator \$85.00 postpaid.

**TOOL POWER<sup>™</sup> patent pending**

115 volts D.C. 5000-watts, 50 amps from your car's alternator. **Guaranteed 20 years.** Install in ten minutes. Operates all power tools, electric motors up to 2 h.p. Arc welding, fast battery charging. Any like device by any name is an infringement of our patent pending. All copiers are notified. Be safe, buy from the inventor and developer. \$25.00 postpaid. Attractive dealer plan.

VIRDEN PERMA-BILT CO.,  
P.O. Box 7160PM  
2821 Mays, Amarillo, Texas 79109

## MECHANICAL FINGERS

Four strong, needle-sharp spring-steel feelers on curvable shaft. Positive control—no springs. Durable. Many uses. Recover articles from hard-to-reach places. Remove plumbing stoppages. 24 in. \$2.50; 16 in. \$2.25; Pair \$3.50. Postage prepaid. 5129 No. 6th St. Phoenix Az. 85012. (Agents: inquire about deal.)

## DETROIT APPROVED PICKUP TANKS



Original equipment type poly, now available in auxiliary tanks for pickups. Increase gas capacity 40 gals. Far superior to metal, complete hidden, no body work necessary. Easy 1 hour installation—Truck discounts pay for tanks in a short time. Two tanks, brass valve, hose, complete. Meets Federal Regulations.

**PICKUP EQUIPMENT CO. LTD.**  
Dept. PM-873, P.O. Box 7635  
WACO, TEXAS 76710  
CALL TOLL FREE 800-433-2386

USE ZIP CODES  
WHEN ANSWERING ADS

Build Your Own Kit  
**CANOE or KAYAK.**  
Quality Wood/  
Canvas Designs.  
From \$25.00  
Free Literature!  
**SPORTSCRAFT**  
Box 636-PM Allentown, N.J. 08501



**IMPORTED  
LOCK BLADE  
KNIFE**

ONLY \$275 each

9" Overall Length  
5" When Closed

- Sharp and Tough
- Stainless Steel Blade



Locks into position to prevent accidental closing. Razor sharp tough stainless steel blade for reliable use and hard, long service. Money back in 5 days if not satisfied. Send \$2.75 plus 25¢ to cover postage and handling.

**WESTBURY SALES CO.**  
P.O. Box 434, Westbury, N.Y. 11590 Dept. L-264-PM

**WATER WATER WATER WATER WATER**

"HOW TO DRILL YOUR OWN WATER WELL"

**\$1.00ppd**

SATISFACTION GUARANTEED

**DEEPROCK CO.**  
OPELIKA, ALA. 36801

**FACTORY CLOSEOUT!  
AIR PISTOL \$6.95**  
(with Free can of pellets) 6ppd.

Shoots both pellets and darts. This fine, well made .177 cal. German air pistol is just the ticket for target or Varmints.

Accurate. No CO2 cartridges to replace, either. Once in a lifetime bargain. Order several. Supply limited. Only \$6.95 ppd.



(Secret leather holster. \$2.95 ppd.)  
600 Deluxe Pellets, \$2.40 ppd.  
20 Steel Darts, \$2.00 ppd.  
**AIR PISTOL, Dept. PM-8**  
4535 Huntington Dr. South  
Los Angeles, Calif. 90032

**DUNE-BUG**

Complete plans & specs on how to build or buy - disc. prices on parts, kits, engines, & raw material.



Send \$1 for DUNE-BUG pkg. to: Box 987PB, Azusa, Ca. 91702, Ph (213) 334-0334

**BUILD YOUR OWN**

Cabover Campers • Covers  
16' & 20' Travel Trailers  
• PLANS •  
PATTERNS • KITS  
★ FREE CATALOG ★  
Recreational Vehicles  
**GLEN L**



9152P Rosecrans, Bellflower, Calif. 90706

**KARATE**

JUDO • SAVATE • JIU-JITSU

The Greatest Self-Defense System Known to Man! FREE Brochure reveals Self-Defense Techniques.

Send to: Universal, Dept. M  
Box 39303, Detroit, Mich. 48239 **FREE**



**FREE!!! POWERFUL MUSCLES FAST!**

Fantastic New Discoveries in the science of bodybuilding. Now, in the privacy of your bedroom, our method will add inches of powerful muscles to arms, chest, shoulders & legs. Learn secrets on trimming the waist with ultra-modern methods—fast! Results Guaranteed! Send for free brochure. Universal Bodybuilding, Box 485-MI, Dearborn, Mich. 48121.

DIGITAL: THEORY, DESIGN, CONSTRUCTION

**LOGIC NEWSLETTER** ©

SAMPLE COPY \$1.00  
LOGIC NEWSLETTER  
POB 252  
WALDWICK, N.J. 07463

**FLASHLIGHT BATTERY POWERED CLOCK UNIT**



Fastens thru one 3/8" hole

**\$9.50**  
POSTPAID

Driftwood, picture frames, mirrors, baskets, dinner plates, etc. can make exciting original wall and desk clocks to enhance and beautify your home for years to come. These unique clocks can be much appreciated gifts to amaze and delight the receivers and can easily be assembled in quantity for profitable resale. This fine fully warranted American made unit requires only a 3/8 inch hole for assembly and is flashlight battery powered. Shipped complete with hands and a booklet offering specifications, numerous design ideas, many assembly hints and instructions. \$9.50 Postpaid. 2-5 units, \$8.00 each and 6-20 units, \$7.25 each. 10 day money back guarantee. Order today or send 50¢ (refundable) for the design and assembly booklet. **LINDHE'S, 505 Morro Bay Blvd., Morro Bay, Calif. 93442.**



Bartlett Flying Saucer ultra-light hovercraft powered by ordinary lawn mower engine—easy to build—fun to fly—complete plans, kit brochure, photos and supply sources \$3.00. All orders returned via airmail. Write:  
**HERB BARTLETT**  
Box 3339-M, Scottsdale, Arizona 85257

**Want to make some easy money?**

Let us show you how to begin AT ONCE...full or spare time. Many report \$10 to \$50 PROFIT FIRST HOUR! Nothing to buy...no salesman will call. EVERYTHING NEEDED SENT FREE including BEAUTIFUL SAMPLE!

Write: **Russell Products Co.**  
DEPT. K25, COLUMBIA, TENN. 38401

**FREE**

**YOUR OWN RADIATOR BUSINESS**

**"\$70,000**

**LAST YEAR"**

says D. Carter, Lemoyne, Pa.



Complete turn-key package: training school in radiator repair technology and business management plus special power-equipped auto radiator shop. Don Carter writes: "Averaging \$30 an hour, expect to hit \$80,000 next year." Mail this coupon for complete story.

NAME \_\_\_\_\_  
ADDRESS \_\_\_\_\_  
CITY \_\_\_\_\_ STATE \_\_\_\_\_  
ZIP \_\_\_\_\_ PHONE \_\_\_\_\_

**INLAND MFG. CO. Dept. PM-8**  
1108 Jackson Street • Omaha, Nebr. 68102

**BEAT THE DICE TABLES**

All Legalized Casinos

**Double-Your-Money-Back GUARANTEE!**

Place only 5 bets. All numbers are in your favor including 7.. 2, 3, 4, 5, 6, 7, 8, 9, 10, 11, 12.

You win every roll!

Send \$1 For Details  
**M.C. CORBIN CO. Dept. MGPM8**  
Box 869 Radio City Sta. N.Y. 10019

**SILVO**  
(BRAND NAME)  
TOOL CATALOG  
Thousands of exciting tool values!

Stanley, Skil, Thor, Wen, Disston, Wiss, Wellsaw, Dremel, Plumb, Huot, Kennedy, Channellock, Rockwell, Heliol, Vise-Grip, Crescent, Rigid, Pony Clamps, Unimat, Foredom and many other Nationally Advertised brands of Tools & Supplies. We ship Coast to Coast at prices Hard to Beat. Send \$1.00 for our big 152 page tool catalog today.

**Silvo Hardware Co., PM-73**  
107 Walnut St., Philadelphia, Pa. 19106

**PLASTIC CUTTER**

CUT SHEET PLASTIC, MICA, TILE, EASILY

**AMAZING NEW TOOL**

Save hundreds of dollars remodeling kitchen cabinets, ceilings, floors, etc. with this new cutter

ORDER NOW AND INSTRUCTIONS ON CUTTING WILL BE INCLUDED

Satis. Guar. No C.O.D.s  
Add 50¢ Handl. & Post.  
Dealership inq. invited Only

**\$4.98**

**TOLCO** 930 N.W. 27th AVE. MIAMI, FL.

Easy to Build PLANS AND INSTRUCTIONS for

- Go Kart .....\$2.00
- Mini Bike .....\$2.00
- Mini Car .....\$3.00
- Pedal Boat .....\$4.00
- Sail Boat .....\$2.00
- Snowmobile Sleigh \$3.00

Mini Vehicles Plans Dept.-C P.O. Box 92 Chazy, N.Y. 12921

# CLASSIFIED ADVERTISEMENTS

Rate: \$2.20 per word payable in advance each insertion. Capitalized words—75¢ per word additional. Minimum insertion ten words. To be inserted under the proper classification, copy must be in our office by the 10th of the second month preceding date of issue. The next available issue to place an advertisement in America's No. 1 Classified Section is October. The closing date is August 10th. Send remittance and order to H. E. Kappel, Popular Mechanics, 224 West 57th Street, New York, New York 10019. Please make remittance payable to Popular Mechanics.

POPULAR MECHANICS

WHEN ANSWERING ADVERTISEMENTS PLEASE USE THE ZIP CODE NUMBER

## AUTOMOBILES

**DON'T PAY** For Unnecessary Auto Repairs. Ex-Auto Mechanic Tells All \$1.00. Doherty PM83A, 3321 Winlock, Torrance, California 90505.

**SUPERSKATES**, Racing. Gasoline Powered, Plans, Booklet, \$5.50. Free Picture. Nicholas, Box 10095, St. Petersburg, Florida 33733.

**CAPACITIVE DISCHARGE IGNITIONS. DISCOUNTED.** Rodgers, Son (PM), Box 3583, Anaheim, Calif. 92803.

**TUNE UP.** Do Your Own. Save Money. Do It Right. Fully Explained \$3.95. GM, Box 1237, Garland, Texas 75040.

**AUTOMOBILE SIXTY SECOND TIRE FIX.** No Tools—No Jack-Dealers Invited. Sample. And Details, ppd. \$3.98—Warne, 6922 Congress, Detroit 48207.

**TUNE-UPS.** Do Yourself. Instructions 50¢. Autotune, Box 18488, Cleveland, Ohio 44118.

**SCR/CD IGNITION.** Increased Performance. Mileage. Fits most cars. Negative ground. State make, displacement, model year. \$44.95. Texas residents add 5% sales tax. Magna Dwell, Box 2171, Abilene, Texas 79604.

## MIDGET CARS

**KARTS and MINI-BIKE** Parts Catalog Only \$1.00. ARE, P.O. Box 159, Lindenhurst, N.Y. 11757.

## AUTO SUPPLIES AND EQUIPMENT

**NEW . . . AUTO/TRUCK SAFETY MONITORS.** Small dash mounted units, unique, decorative, useful. Reads out in colored lights while driving. Plans: Road Condition Monitor \$4.00, Road temperature Monitor \$3.00, Tire and Wheel Monitor \$4.00, Road Icing Alarm \$3.00, Driver Fatigue Alarm \$3.00. To: W. Lawson, R & D, R1, Box 299E, Milton, Delaware 19968.

**REVOLVING LANTERN.** Dual Action Emergency Red Warning. White Beam For Repairs. \$5.98. Meg. D. D. House, Box 1183, P.a.m.d.a.e. California 93550

**STOP Auto Truck Theft.** Obtain Most Effective Electronic Protection Available. Auto Guard. Guarantee \$7.95 (Postpaid). Mc's, Box 19061-A8, New Orleans 70179.

**VW TOOLS** For the Do-It-Yourself Mechanic. Illustrated Catalogue, 50 cents. Volks Tool Supply, P.O. Box 660, Houston, Texas 77001

**AIRMASTER** Gas Saver Fits All Cars. \$14.95. Airmaster, Lenora, Kansas 67645.

**ALTERNATOR/Generator** Rebuilder's Course; includes Tooling & Test Equipment; Write: Hedelund Engineering, P.O. Box 2127, Sepulveda, California 91343.

196 POPULAR MECHANICS

**PARTS:** Army jeep and truck parts. Spare Parts & Equipment Co., P.O. Box 751, Lexington, Kentucky 40502.

**RING-Valve** Job while driving. \$6.50 postpaid. (Two-\$12.00). . . . Established 1951. . . . Results Guaranteed!! Motaloy, Grantham, Penna. 17027.

**IS CAR** Maintenance Killing Your Bankroll? Send \$1.00 today for tune-up Specifications on Foreign & Domestic Cars from '58 to '73. Bristol Auto Parts, Inc., 21 North St., Bristol, Conn. 06010.

**NOVEL** Inexpensive Glowing Gage Continuously Checks Ignition Performance. QARC, Box 47876, Los Angeles, Calif. 90047.

**VIOLATION?** Dirty car. Penalty? Five minutes. Fine? Vacu-Shine. Jem, 6116 Orinoco, Indianapolis, Indiana 46227.

**AIR PURIFIER FOR YOUR CAR OZO AUTO.** Destroy Pollution, Destroy Odors, Smoke, Exhaust Fumes in your Car. Transistorized One Year Warranty. Send Check or Money Order for Only \$37.50 Each PPD. Pure Air Products—P. O. Box #218, Basking Ridge, New Jersey 07920. Dealer Inquiries Invited.

**POWER** Electric Appliances from Alternator equipped cars. Information Free. D. Godard, Box 229A, RR1, Washington, North Carolina 27889.

**FREE FLASHLIGHT** With MOTALOY Ring-Valve job \$5.95. Guaranteed. Free Information. Flewellings', Box 21-PM8, Tustin, California 92680.

**MIRACLE CLOTH** Washes, Polishes Automobile In Minutes Without Soap Or Water. **FREE SAMPLE.** Thomas Co., Automobile Dept. 171-08 Hillside, Jamaica, N.Y. 11432.

**RING-VALVE JOB WHILE DRIVING!! 1973-MOTALOY'S 20TH ANNIVERSARY!!** (It Works And Works!) Results Guaranteed. \$5.95 Airmail PPD. (Two-\$11.00!) Motaloy Division CH, RR8, Box 604, Fayetteville, North Carolina, 28304.

**SAVE Money!** Permanent Automobile Air Filter. Guaranteed. \$4.50 Postpaid. State make, cylinders. Camus, Box 97, Burlington, Ontario, Canada L7R3X8.

**STOP THIEVES** With new patented hood lock. 2000 lb. test strength, plus pick proof 5-pin tumbler lock. Kit \$4.95 plus 75¢ postage **FREE** specifications on request. R.M. Home Products, P.O. Box 281, Plymouth, Mich. 48170

## MOTORCYCLES, BICYCLES MOTORSCOOTERS AND SUPPLIES

**1912 INDIAN CATALOG** Authentic. Quality Reproduction. 24 Pages, 31 Pix. Spanning 6 Models. \$3 PPD. BARNALL, Box 507-E, Lake Arrowhead, Calif. 92352. Send 25¢ For Brochure On Motorcycle Books & Posters.

**SUPER RACING KARTS.** 7 and 8 Horsepower Briggs And Stratton Aluminum Block Engines. A-Bone Racing Frame With Drum Brake. Supercharger And/Or Torque Converter Optional. Completely Assembled. Ready To Race! Complete Information—25¢. Write To—**CHAPMAN RACING MOTORS**, 112 Bleckley Street, Anderson, South Carolina 29621.

**MINI-BIKE.** Go-Kart. Engines. Clutches. Wholesale. Information 25¢. Lorenzo, Danville, Illinois 61832.

**MAKE** Your Bicycle Electric. Plans \$2.95. Kielian, 130 Drake, South San Francisco, Calif. 94080.

**HONDA,** \$25. Other Bargains. Send \$1.00. (Refundable). Motorscooter, P443, Bend, Oregon 97701.

**BOLT-ON TORQUE CONVERTER** Makes out-dated, out-classed, mini-bikes competitive, mean machines. More Low end muscle—more high end hustle. Fits B&S, Tecumseh, most engines. 35 minute installations. \$34.95 ppd. No C.O.D. Information + decal 25¢. **MAX-TORQUE, Inc.**, 7300 Monticello, Skokie, Illinois 60076.

**CYCLE DISCOUNT CATALOG**—Thousands of custom and competition motorcycle accessories at savings up to 40%. Why pay more? Rush \$2.00 today. Refunded. C.O.D. Box 116 PM, Rohrerstown, Pa. 17571.

**GO-KART—MINI-BIKE** Plans. Easy to follow. **SAVE MONEY.** Build your own. Go-Kart plan \$2.00. Mini-Bike plan \$2.00. Both plans \$3.00. **GUARANTEED.** RWM Sales, P.O. Box 600A3, Belleville, Illinois 62222.

**FANTASTIC ZEEMO ELECTRIC BICYCLE** Plans-Complete, Illustrated. \$3.95. **ZEEMO**, 2239 N. Lincoln, Chicago, Illinois 60614.

**ILLUSTRATED** Catalog, 25¢. Parts And Accessories. Custom And Stock. For Most Makes And Models. Motorcycle Supply, Box 159M, Fairbury, Ill. 61739.

**GO-KARTS** Factory Direct Low As \$19.95. Send 35¢ for Catalog. Schmieder Motors, RD #1, Doylestown, Penna. 18901.

## SPACE, ROCKETS AND ASTRONAUTS

**ANTIGRAVITY** Spacetravel Plans! Scientific Experiments Reveal New Force. \$3.00. Carter, Box 831, Avalon, Calif. 90704.

**SKYLAB-APOLLO** Patches. Astronaut Designed. Collectors Authentic Replicas. Related Items. Galaxie A-8, 1628 Vassar, Houston, Texas 77006.

**MILLION DOLLAR MODEL ROCKET SALE.** Countdown for savings. Kits, Motors and Supplies. Everything 1/2 Price. Send 25¢ For Complete Catalog and Decal Packet. AVI, 7PM, Mineral Point, Wisc. 53565

(Continued on next page)



## AVIATION

**AIRBOAT** Engines, Propellers, Hubs, Mounts, Supplies, Corvair, VW Conversions, Removable airdrives, Propellers, Hubs for Snowmobile Engines. Catalog \$1.00. Banks-Maxwell, Box 3301E, Fort Worth, Texas 76105.

**BUILD**—One-Man jet helicopter. Easy Inexpensive. Detailed plans, drawings—\$5.00. Helicraft, Box 7153, Baltimore, Maryland 21218.

**ALL** About Ballooning. Handbook \$3.00. Aerostation, Box 141, Long-Sault, Ontario, Canada. KOC 1PO

**BE A** Government licensed aviation mechanic. Practical training. Free Information. Aero Mechanics School, Dept. PM, Municipal Airport, Kansas City, Missouri 64116.

**HANG GLIDING**, Self-Soar, Skysurf: Free Information Kit. Service To Students, Instructors, Business. All Top Plans Available: Books Too. Sample **LOW & SLOW** Magazine, \$1.00. Send To: **SELF-SOAR** Association, Box 1860, Santa Monica, California 90406.

**HANG GLIDERS**. Proven Rogallo Design. Plans—\$5.00. Kits, Accessories, Complete Kites. Compare Quality And Price Before You Buy. Free-Flight Systems, 10730 Whiteoak, Granada Hills, California 91344.

## HOVERCRAFT

**INSTALL** Kart, Lawnmower, Snowmobile Power On This Hovercraft. Plans, Instructions, \$6.00. Airboat Plans Instructions, \$5.00. Design Book For Homebuilders, \$5.00. Palmer Aerosystems, P. O. Box 1891M8, Coral Gables, Florida 33134

**AERO-CAR**. Amazing Hovercraft built easily with ordinary tools. Lawnmower engine power. Carries one man plus. Hovers, flies forward, backward, sideways over land/snow/water. Complete construction plans and brochure. \$5.95. Aero-Projects, Box 5118PM, Clinton, New Jersey 08809.

## INFLATABLE BOATS

**QUALITY** inflatables. Pyrawa canoes from \$34.95. Kaik dinghies from \$19.95. Lightweight. Compact. Portable. Packs in own carrying bag. Ideal for fishermen, backpackers, river runners, outdoorsmen. Rugged, safe for whitewater rivers, ocean surf, rocky streams, lakes. Built to last! Free color brochure. Leisure Imports, Dept. PM8, St. James, N.Y. 11780.



## BOATS AND TRAILERS

**FREE** Canoe-Kit Literature. Fiberglass raw materials Catalogue 25¢. Custom Fiberglass, Box 101-PM3, Mount Juliet, Tennessee 37122.

**BOAT** Kits. Molded Fiberglass. Save money—assemble yourself. Factory molded sections bond into one-piece craft. 20 models—14' to 32' Cruisers, Runabouts, Sailboats, Accessories, motors, trailers. Easy terms. Free catalog. Luger, Dept. BC73, 3800 West Highway 13, Burnsville, Minnesota 55337.

**FIBERGLASS BUILDERS MATERIALS** Lowest factory prices in cloth, matt, roving, resin, epoxy, foam, nails, fittings. Send \$1.00 for literature (refundable) or \$2.00 for literature plus booklet on Mold-making and "How to Fiberglass". Clark Craft, 16-P1 Aqua Lane, Tonawanda, N.Y. 14150.

**FIBERGLASS** Canoes, Kayaks, and Duckboats. Many exciting models. Easily assembled kits. \$44.95 up. Free Literature. Riverside Canoes, Box 5595P, Riverside, Calif. 92507.

**FIBERGLASS** Cloth, matt, polyester and epoxy resins. Wholesale catalog 25¢. Boat Molding book 30¢. Seifert's, Box 1206-M, Green Bay, Wis. 54305.

**BOAT KITS-PLANS AND PATTERNS-FRAME KITS**, World's largest catalog. Over 300 top designs from 7-77' in plywood, ferro cement and fiberglass. Sailboats include: Windmill, Snipe, Motor Sailers, Trimarans, Catamarans. Powerboats include: Cruisers, Houseboats, Deep V's, Fishin'ski, Runabouts, Hydroplanes, Canoes, Kayaks, inboards, outboards. Send \$1.00 for large catalog or \$2.00 for catalog plus "Boat Builders Guide". Clark Craft, 16-P Aqua Lane, Tonawanda, N. Y. 14150.

**BOAT PLANS, FULL-SIZE PATTERNS, FRAME KITS** With step by step written and pictorial instructions especially for amateurs. Easy to build. Send \$1.00 for **HUGE 100 PAGE** Illustrated Catalog. Over 125 modern designs from 8 to 49'. Includes Sail, Jets, Inboards, Outboards, Cruisers, Houseboats, Hot Boats, Catamarans, Hydros. Also available—"Boat Building With Plywood" Hard cover—219 pages \$7.50. **GLEN L**, 9152 MP Rosecrans, Bellflower, Calif. 90706.

**FIBERGLASS** Cloth and resin. World's finest cloth and non-run resin, at direct mill prices Flotation foam. Complete line of plastics, silicon bronze and brass screws, save 60%. No sales tax. Boat Plans. Catalog 25¢. Freight prepaid. Stiles Boat Supply, Box 11P, Linden Ave., Mantua Heights, N.J. 08051.

**CANOE!** Kayaks! Factory-direct quality kits, from \$25.00. Many different models. Canvas hulls. Strongest construction materials. Free literature. Sportscraft, Box 636-P, Allentown, New Jersey 08501.

**FREE** Catalogue—plans, patterns: Canoes, sailing canoes, kayaks, 14-17' trailable cruising sailboats. Quicksilver, 255A Shamrock Blvd., Venice, Florida 33595.

**KAYAKS**, Canoes, Plans, Kits, Finished Craft, Books. Free Catalog. Outdoor Sports, Box 1213P, Tuscaloosa, Ala. 35401.

**NEW 1972** Outboards—Top Brands—6 H.P. \$288—18 \$416—40 \$565—50 \$718—65 Selectric \$958—All Sizes—Scott-McCulloch Parts—Handling 50¢—Electra Marine—610 Merrick Road, Lynbrook New York 11563.

**SAILS**, 75 Square Foot Nylon Lateens, For Canoes, Sailboards, Prams. Striped. New. \$36.00 Each Postpaid. Bacon & Associates, 528-PM Second Street, Annapolis, Maryland, 21403.

**RACE BOAT PLANS**. All classes inboard, outboard hydros, runabouts. Huge savings using easy to follow blueprints, instructions. 27th year! Brochure 50¢ refundable. Champion Boats, 5849 Hazelbrook, Lakewood, Calif. 90712.

**CANOE** Kits—Wood Canvas, Molded Fiberglass—Free Catalog. Trailcraft, Inc. Box 60686, Concordia, Kansas 66901.

**LIGHTS** "THOUSAND-LIVES"<sup>™</sup> Battery Powered, Cordless, RECHARGEABLE. Table-lites, Lanterns, Flashlights. Use Standard Dry Cells, or Nickel-Cadmium "LIFETIME" ("Never Buy Batteries Again"). Free Literature. Heydecker, 500-E West End Avenue, New York, New York 10024.

**MINI-HYDROPLANE** High Performance From Small Outboard. Build Over Weekend For \$30. Plans \$4.00. Aquacraft, Box 447, White Rock, South Carolina 29177.

## CAMPERS AND TRAILERS—KITS—PLANS—

**CAVOVER** Campers & Pick-Up Covers for Compact & Standard Trucks, 16 & 20 Trailers. Build and Save. Large scale plans and full-size patterns with written & pictorial instructions. Complete accessory and aluminum covering kits. Free literature. **Glen L**, 9152MP Rosecrans, Bellflower, California 90706.

**SPORTSVAN CAMPER CONVERSION PLANS**. Dodge, Ford, Chevrolet! Thirty-two Jumbo Size Pictures show you how to build Kitchens; Storage Units; Adult, Youth, Child Beds; Drapery; Screens; Four large, easy to read Instruction Sheets! Plans by retired Camper Manufacturer. (\$3.50). Shepard Campsters, Route 1—Box 81, Oklawaha, Florida 32679.

**PERFECT** Backcountry reception with your Radio, Campers, Trailers, Motorhomes, free details. Signal Booster, 18196 Camino Diablo, Yuma, Arizona 85364.

## MARINE EQUIPMENT AND SERVICES

**MARINE** Engines, conversions, parts, equipment. Catalog Free! Stokes Marina Industries, Coldwater, Michigan 49036.

**CONVERT** Auto engines to marine. 68 Page Catalog, 50¢. Lehman Manufacturing Company, 800 Elizabeth Avenue, Linden 4, New Jersey 07036.

**FREE** Brochure Conversion Kits, Propellers, gears V-Drives 1/0 Drives Gas, Diesel, Starmarine, 1931 Embarcadero, Oakland, Calif. 94606.

**MARINE** Supplies, Ignition Parts. Free literature. Michael's, 991 Broadway, Bayonne, New Jersey 07002.

## ATHLETIC AND BODY BUILDING COURSES

**KARATE SUPER**, 200 Illustrations 191 pages instructions, complete \$1.25. Jorgensen, Box 70482-1873, Seattle, Washington 98117.

**POWERFUL** Muscles fast! Free brochure. Universal Bodybuilding, Box 4327-C, Dearborn, Michigan 48126.

**BE** Taller! 2" to 4". Secret illusionary methods, devices, Height Increasers, lifts. For Treatise, send \$1.00 to: Physical Culture, Box 1548-PM10, Pompano Beach, Fla. 33060.

**KUNGFU**, Illustrated instructions. \$2.00 complete. RSH, 5834 Manton, Chicago, Illinois 60646.

**KUNG-FU** Secret # Manual—\$2.00—Green Dragon Fighting Society, 4350 N. Cicero, Chicago, Illinois 60641.

**MASCULINE** Voice Builder 98¢. Man Makers, Box 11567, Chicago, Illinois 60611.

"**GIANT** Arms." Dr. Young. Revolutionary discovery. Inquire. Gaucho, Box 1769-A7, Chicago 60690.

**STRENGTH BUILDING FAST ISOMETRICS!** Illustrated Instructions. No Apparatus Needed. Complete \$2.00. Mitchco, P.O. Box 2604, Mobile, Ala 36601

**KUNG-FU**, Karate, Judo Books, Fighting Weapons, Films, Giant Brochure—\$2.00. Green Dragon Fighting Society, Dept-PM, 4350 N. Cicero, Chicago, Illinois 60641.

## SPORTING GOODS AND EQUIPMENT

**NEW!** Swiss Type Army Knife! It's a Portable Tool Kit in one. 2 Knives, Can Opener, Scissors, Screwdriver, Bottle Opener, File, Cork Screw and Awl. Strong Durable Stainless Steel Blades. With Case. Money Back Guarantee. Send \$7.95. La Tain Enterprises, P.O. Box 87, Wallingford, Pa. 19085

**FREE** Catalog low direct factory prices, fishing, Hunting, Archery, reloading Camping supplies. Send today. Herters Inc., Dept. CPM, Waseca, Minn. 56093.

**FREE WHOLESALE CATALOG**. Lure parts, Molds, Rod Blanks, Reels, Archery, Metal Detectors, Rare Hardwoods. Finnysports (ME), Toledo, Ohio 43614.

**ARCHERY** Lowest Discount Prices. All top brands. Orders shipped same day received. Money-back guarantee. World's Largest Supplier. Free catalog. Anderson Archery Corporation, Grand Ledge, Michigan 48837.

**FREE CATALOG**. Fishing Tackle, Archery Hunting and Camping Equipment. Lowest Prices. Cabela's, Inc., Dept. S-20, Sidney, Nebraska 69162.

(Continued on next page)



## FISHING, TACKLE, LURES

**MOLDS**—For casting your own fishing sinkers. Free illustrated booklet. Reading Instrument Co., Box P-78, Reading, Pa. 19603.

**FISHERMAN'S DREAM BOOK**—FREE, 170 page catalog just loaded with Hard-To-Find Fishing Tackle Specialties and Do-It-Yourself Goodies. Our 29th year. **NETCRAFT Inc.**, Box 5510, Dept. PM-12, Toledo, Ohio 43613.

**BASS FISHERMEN.** Kit molds, 450 worms, 6 colors. Details with other fishing items. 25¢. Woodard Mailorder Hutt, P.O. Box 146, Hartford, Conn 06112.

## EARTHWORMS, LIVE BAIT

**EARN** Money raising fishworms for us! Exciting details free! Oakhaven—56, Cedar Hill, Texas 75104.

**FREE** Literature. Profitable Business Raising Fishworms, Crickets. We Teach you how to Raise and Sell. Write today. Carter Fishworms, Plains, Georgia 31780.

**BIG** Profits Raising Worms Soilless Method, Three Oaks, Dresden, Tennessee 38225.



## DOGS AND KENNELS

**SPANIELS** (American Water) Hunter's—Retrievers. Snapshots. Bovey's, Plainfield, Wisconsin 54966 (715-335-6984).

**DUCK** And Goose Decoys. Buy Direct And Save. Send For Free Catalogue To: Decoys, Rt. 11, Box 229B, Houston, Texas, 77050.

## POULTRY AND GAME BIRDS

**QUAILS.** Incubators, cages, supplies catalog. Marsh, 14216 Brookhurst, Garden Grove, Calif. 92643.

**GAMEBIRDS:** Started and Adult. Pheasant, Quail, Chukar, Mallards, Turkeys: Game and Ornamental. Catalogue, 35¢. Northwest Farms, Inc., Box 3003-PM, Portland, Oregon 97208.

## RABBITS—CHINCHILLAS—FUR BEARING ANIMALS

**\$500-\$1000 MONTH** Plan raising rabbits for us. Free details. White's Rabbitry-PM, Hudson, Ohio 44236.

**RAISE** Rabbits Successfully by knowing Facts. 48 Page Illustrated Book describing 25 Breeds. Housing, Breeding, Feeding, Markets, Marketing, etc. 25 cents. American Rabbit Association, 36 Arba Building, Bloomington, Ill. 61701.

**EARN** \$10,000 Yearly Raising Angora Wool and Breeding Stock. Details 25¢ coin. American Angora, Malta 12, Montana 59538.

**TOPLESS INCOME RAISING** Mutation chinchillas. 25¢: bulletin \$1.00. Chinchilla, 11PM8, Port Richey, Florida 33568.

**RAISE** Chinchillas. Guaranteed income. Catalog \$1.00. DeShon Chinchilla, Route 2H, Roanoke, Indiana 46783.

## PETS—BIRDS, CATS, HAMSTERS, ETC.

**PETS,** Reptiles, raccoons, skunks, squirrels. Catalogue 25¢. Trails End Zoo, St. Stephens, S.C. 29479.

## HORSES, LIVESTOCK

**"HOW TO TRAIN HORSES"**—FREE Book tells how to break, train, make money with horses. Beery School, 1108, Pleasant Hill, Ohio 45359.

198 POPULAR MECHANICS

## CAMPING EQUIPMENT AND TENTS

**FREE** 112-page Camping, Marine Color Catalog, Laacke & Joys, 1439 N. Water, Milwaukee, Wisconsin 53202.

**JUNGLE MACHETE:** Woodsman survival tool. 24" Razor Sharp tempered steel. Guaranteed, \$6.50 ppd. Airmail Money Order to: Semerca, Box 27-C, Guatemala, Central America.

## ELECTRICAL SUPPLIES

**LIGHT DIMMER CONTROL KIT**—600 Watt, Easy To Assemble, install \$3.95. Pacesetter, Dept. 83M, 7808 N. 13th Avenue, Phoenix, Arizona 85021

**CONVERT 220 SINGLE PHASE** To three phase simply and economically. Run several three phase motors simultaneously. Illustrated wiring instructions \$2.00. C. Montgomery, 1826 Shepherd Road, Anderson, Indiana 46011.

**LAMP** Parts. Catalog, prices, wiring instructions. 50¢. Refunded first order. Gyro, 5218P N.W. 35 Ave., Miami 42, Florida 33142.

## BATTERIES, GENERATORS

**BATTERY** Reconditioning Kit, includes molds, material, instructions. Battery Shop, Box 820, La Quinta, California 92253.

## ENGINES, MOTORS, MAGNETS

**WINDING** Data, 275 motors, \$1.25. Data Company, 512 Kensington, Kansas City, Mo. 64124.

**STEAM** Engine Kits, Catalog-Handbook \$1.00. Reliable Industries, New Baltimore, Mich. 48047.

**REWIND** Car Generator for 110 VAC. Power Plant Plans \$2.00. R. Schmauss, 1228 East Cass Street, Tampa, Florida 33602.

**MOTOR REWINDING SUPPLIES!** Equipment plans! Modequip, Box 7266, Kansas City, Mo. 64113.

## MACHINERY, TOOLS AND SUPPLIES

**SMALL** Foundry furnaces. Supplies. Free literature. Pyramid Products, 3736 South 7th Avenue, Phoenix, Arizona 85041.

**MAXIMAT,** Unimat Lathes. Metals. Micrometers. Catalogue 50¢. Industrial \$2.00. Campbell (PM), 1424 Barclay, Springfield, Ohio 45505.

**4" METAL** Cutting Lathe Kit \$29.50. Completely assembled machining unit \$89.50. Taig Mfg. Dept. T, 15048 Proctor, Industry, Calif. 91746.

**1400 CATALOGS** Listed and Described! Sources for EVERYTHING Imaginable! Rush \$2.00. MASTERLOG, Box 24413-(VH), Oakland, California 94623.

**END** Mills. Lathe Milling Attachments: Information. Potter, Box 73, Cedar Rapids, Iowa 52406.

**METAL** Cutting Band Saws. Use Vertically or Horizontally. As Low as \$119.95. 3 1/2 x 6" Cutting Capacity. Write To: Saws, P.O. Box 295, Dept. A, Marcellus, Michigan 49067.

**HEAVY DUTY MULTI-SNIP** Cuts Through Almost Anything. Steel Wire, Sheet Metal, Plastic, Leather, Etc. Comes with Vinyl Coated Handle. Guaranteed. Send \$3.75 To: Hopewell Enterprises, 3101 Harding Ave., Aliquippa, Pennsylvania 15001.

**NUTS,** Bolts, Screws, Washers, Threaded Rod, Assortments, Catalog 25¢. Nutty Co., Box 1576 SMS, Fairfield, Conn. 06430.

## WELDING, SOLDERING, PLATING

**SUPER-ROD.** Metallurgical Breakthrough. Weld Aluminum, Brass, Copper, Pot Metal with Propane Torch. 12" rod \$2.00. K & B Supply, 4014 N. 7th Street, Suite 2A, Phoenix, Arizona 85014.

**PLATING** Equipment, Portable Platers, Supplies, and "Know-How". Build your own tanks for nickel, chrome, etc. Easy-to-install PVC liners. Rectifier components—all sizes. Schematics, parts, lists, formulas, operating instructions for all plating. \$10.00 post-paid. Guaranteed to save you 25%-75% or immediate refund. Some good used units for sale. Platers Service Company, 1511-A Esperanza, Los Angeles, California 90023.

**WELDERS.** Convert To Heliarc. High Frequency Unit 0-225AMP. Plans \$4.00. Convert To DC Plans \$3.00. Information Supply Co., Box 166, College Park, MD, 20740.

## GOVERNMENT SURPLUS

**GOVERNMENT** Surplus. **NATIONWIDE** Complete Brochure \$1.00. Hilco **AUCTIONEERS,** Anoka, Minnesota 55303.

**JEeps!!! PICKUPS!!** 100,000 Items direct from government. Your area. Latest information & surplus categories: \$2.00 **MONEYBACK GUARANTEE.** Order manual #127, from "Dependable Products", Box 113, Vista, California, 92083.

**NO** CATCHES. Buy any surplus direct from U.S. gov't. All information \$2.00. Bridgeworth, P.O. Box 2292-C, Vancouver, Washington 98661.

**1973 SURPLUS** Army, Navy store. 52 Page illustrated catalog. Send 50¢. Ruvel, 3037 North Clark, Dept. 8-J, Chicago, Illinois 60614.

**JEeps** \$52.40. Airplanes \$75.01. Typewriters \$6.70. Boats \$7.50. Direct from Government, Directory and Surplus Catalog \$1.00 (Refundable). Midwest Surplus, Box 401-PM, Dayton, Ohio 45401.

**GOVERNMENT SURPLUS,** How and Where to buy in your area. Send \$2.00. **SURPLUS INFORMATION,** 30177PM **HEADQUARTERS BUILDING,** Washington, D. C. 20014.

**"U.S. GOVERNMENT SURPLUS Directory."** How, Where to buy 100,000 items (including Jeeps) . . . low as 2¢ on dollar! Most complete information available . . . \$1.00. **SURPLUS DISPOSAL,** Box 6586-AH, WASHINGTON, D.C. 20009.

**UNUSUAL BARGAINS!!** Official Guide Tells How, Where. Guaranteed! \$2.00. Surplus, 1804 Savannah, Dept. A-3, Charleston, S.C. 29407.

**JEeps** From—\$52.50; Typewriters from —\$4.15; Cars from—\$31.50. Walkie-talkies, motorcycles, airplanes, boats. Typical "As Is" bid bargains from Uncle Sam. Tremendous variety. Exciting free list. Write: Enterprises, Box 402-X91, Jamaica, New York 11430.

**YOU, TOO,** Can Be A Successful Bidder For Gov't. Surplus Goodies. \$2.00 Will Bring How And Where Details. S&S Surplus Sales, (Since 1946), Box 476, Gainesville, Texas 76240.

## HOBBIES AND COLLECTIONS

**COLLECT** Military Medals, list 25¢. Vernon, Box 387PM, Baldwin, N.Y. 11510.

**NAZI** War Souvenirs Free Illustrated catalog. Delta, Box 361PS, Lafayette, Calif. 94549.

**NAZI** Medals, Photos, and Jewelry. Also War Mementos from Other Countries. Catalog and War Poster, 25¢. Hutchinson House, Box 6411, Chicago, Illinois 60680.

**BOTTLE COLLECTING!!** Cleveland's "Bottle Pricing Guide" lists/prices 3,600 new/old bottles. 1250 pictured. 18 categories. \$5.95 postpaid. Cleveland, 320AHM Main, San Angelo, Texas 76901.

**50 GORGEOUS** Jungle Butterflies \$2.90. 20 Exotic Seashells \$1.25. Collectors Wonderland, Box 1170, New York 10008.

**BABY** Shoe Bronzing Hobby That Pays. Details. NBC-PM, Gower, Missouri 64454.

(Continued on next page)

## DECALS, EMBLEMS, PATCHES

**CUSTOM** Designed Embroidered Emblems, Decals, Inexpensive. Free Catalog, details. Southern Emblem, Box 8PMB, Toast, North Carolina 27049.

**EMBLEMS** Embroidered to your own design. Leading manufacturer offers custom emblems in any quantity. Send sketch for firm quote or write for free Design-An-Emblem Guide and literature. A-B Emblem, Box 5695, Weaverville, North Carolina 28787.



## STAMP COLLECTING

**75 DIFF. CHINA**—Only 10¢! Scarce, genuine postage stamps (Catalog Price Guaranteed Over \$6.00!) from all 3 Chinas: pre-1950, Nationalist China (Taiwan); plus Communist China. Ancient mysteries, modern marvels, Mao, Chiang, Great Wall, etc.—this valuable collection only 10¢! Also, other exciting stamps to examine free. Buy any or none, return balance, cancel service anytime. Plus Wonderful Illustrated Catalog! H. E. Harris, Dept. A-86, Boston, Mass. 02117.

**YOURS FREE! 40 RED CHINA** Postage Stamps banned to American collectors for a generation by U.S. Gov't. Now at last you can legally own them; and these stamps are so worth having that experienced and beginning collectors alike want them—so act fast, because supplies are strictly limited! You also get 110 other stamps from Britain's Lost Empire plus illustrated Album to keep as a Bonus should you buy \$1 from our Approval Selection. Or return Album and 110 stamps with selection and buy nothing. Cancel service anytime. But Red China stamps are yours to keep! Send 10¢ for mailing while supplies last. Kenmore, Milford RC-430, New Hampshire 03055.

**FABULOUS** Collection! 107 different stamps from all seven continents. Get Q.E.-II Silver Wedding (bound to be a classic), giant Mongol horseman, many other new, old issues from Asia, Africa, Europe, North, South America, Australia, Antarctica. Also stamp selections to examine. Buy any or none, return balance. Cancel service anytime. Send 10¢ now. Williams Co., PM87, St. Stephen, N.B., Canada.

**25 LARGE** Poland Stamps. 20¢. No Approvals. Field, 2109AA North Argonaut, Stockton, California 95204.

**DREAMS COME TRUE.** 1001 British Empire Mixed off Paper Including Pictorials \$1.00 Plus 10¢ postage. Exchange Offers List Enclosed. Trading Post, P.O.B. 52, Alexandria, Virginia 22313.

**FREE BARGAIN LISTS!** U.S. Mint Singles-Plate Blocks, Scotco, Box 855-PML, Miami, Fla. 33147.

**200 WORLDWIDE** 25¢ To Approval Applicants. Polze, Box 5215, Milwaukee, Wisconsin 53204.

**KAZAM! 25¢, 50 Mid-Eastern, Approvals. ALLADIN,** Box 602, Jefferson City, Tenn. 37760.

**SINGLE STAMPS** 2¢ and up. Mounted in books. **TRUST STAMP COMPANY,** P. O. Box 100-P, Jamaica, New York 11435.

**LOOK! 100 Beautiful Romania Pict.** 25¢ Approvals. Scenic Stamps, Box 1973-B, Vancouver, Wash. 98663.

**FREE Mixture,** Contains Many Commemoratives, Pictorials, British Colonies, Foreign, Approvals. City Stamp Co., Box 216, Station "W", Toronto 15, Ont., Canada. M6M-422

**22 TRIANGLE** Stamps Only 10¢. Get This Timeless Treasure Of Gorgeous, Colorful, Triangle Shaped Postage Stamps. Approvals Included. Send Today! Stamps, Box 1444-B, Kitchener, Ontario, Canada.

**100 DIFFERENT** United States Stamps, 25¢ With U.S., Foreign Approvals. ShelRon, Box 547C, North Miami, Fla. 33161.

**50 DIFFERENT** Old U.S. Revenue stamps \$1.00. Winchester Stamps, Box 3592, Mansfield, Ohio 44907.

**OLDER U.S.** stamps, covers, on approval to adults only. Surprisingly good. **ENGLE,** Box 208P, Lowell, Michigan 49331.

**TEN Different Nudes:** 20¢. Approvals. Stamp Farm, 2M57, Oxford, Wis. 53952.

**50 DIFF. U.S. COMMEMORATIVES** 25¢. Fine U.S. Approvals Accompany. Craig Stamps, Box 425-N, Bellmore, N.Y. 11710.

**FOREIGN Approvals!** Gigantic values! 3¢ each. ABC, Dept. 3301-A, Box 6000, San Francisco 94101.

**"AFRICA"** 25 Beauties, 15¢. Approvals, Gorliz, Box 28765 PM, Memphis, Tennessee 38128.

**U.S. MINT** Specials! Flag set, complete \$1.00. 1¢, 2¢, 3¢ famous Americans (21 different) \$1.00. Free list. Brooks, 2601 Avenue "U," Brooklyn, N.Y. 11229.

**PENNY!** Approvals! Regardless catalogue! Kloster, 4164 52nd St., San Diego, Calif. 92105.

**FREE Surprise** collection sent with approvals. Gould, 1784 Union, San Francisco 94123.

**ABSOLUTELY** Free United States Mint Souvenir Sheet When Requesting United States Approvals. K&B, Box 70, Brooklyn, N.Y. 11223.

**500 DIFFERENT** Stamps, \$1.25. Smith, 508-A Brooks, College Station, Texas 77840.

**100 DIFFERENT** British Empire 10¢. Approvals. Gibson, Box 34, Lansdowne, Pa. 19050.

**"INVERTED Error"** Dag Hammarskjold, 10¢ with approvals. Belmont Stamps, Washington, D. C. 20015.

**100 OLD** United States between 1861 and 1935. \$1.00. Ed Roush, 423 Shepard, Mansfield, Ohio 44907.

**225 STAMPS** For only 10¢! Airmails. Pictorials: stamps from strange countries cataloging up to 25¢ each! Plus unusual stamps to examine. Buy any or none return balance, cancel service anytime. Mystic Stamp Co., Camden 80, New York 13316.

**FREE! 10 African Beauties! 30 Others!** Approvals. Cambridge, Box 2311, Heath, Ohio 43055.

**20 HISTORICAL** U.S. Commemoratives 10¢. Bargain U.S. Approvals. **PINTO,** Box 111, Park Ridge, Illinois 60068.

**80 DIFFERENT** U.S. Stamps. Includes 1943 flag stamp of occupied nations. Only 25¢. Approvals included. Willett Co., Box 338-M, Yorktown Heights, N.Y. 10598.

**50 YEARS** Old, fifteen different United States, over fifty years old—10¢ with approvals. Jaxon, Box 145-P, Brooklyn, New York 11230.

**QUALITY AND LOW PRICE. EXCELLENT** For advanced or beginner. Mounted approvals 2¢ up, all countries in Scott's Order. Preview Stamps, P.O. Box 2066/, San Diego, California 92120.

**U.S. BARGAIN,** 50 Different 10¢, with beautiful worldwide, approvals. Stamp Center, Kennebunk, Maine 04043.

**210 DIFFERENT** U.S. Commemoratives \$1.00. Stamps, 7607 Larchview, Dallas, Texas 75240.

**HITLER,** 100 Germany 10¢! Approvals. White Rock Stamps, 13125 24th M Avenue, Surry, B. C., Canada.

**RUSSIAN** Space Collection 25¢, including Russian Approvals. Snedco, Waldwick, New Jersey 07463.

**FREE WORLDWIDE** Commemoratives, Pictorials Beautiful Stamps, Approvals. Closson, P.O. Box 663, Madison, North Carolina 27025.

**LIECHTENSTEIN #356-\$19.00; France** #1100-\$4.00; UN 29-30-\$15.00; NH. CWO. Submit Lists Western Europe Only. All NH. Franklin, Box 467L, Jamaica, 11434.

**FREE \$1.50** Better Grade Worldwide. Approvals. Stamps Unlimited, Box 2338, Kalamazoo, Mich. 49001.

**FREE "Space",** with packet approvals. Sunset Stamps, Box 69473, Los Angeles, California 90069.

**PAINTINGS—25** Different 25¢. Northern, Box 565, Hull, Quebec, Canada.

**60 DIFFERENT** United States (30 Commemoratives) 25¢. Seidenberg, Salem 169, Oregon 97308.

**IRELAND** 50 Used \$2.00. George Ginovsky, Box 2370, Hyattsville, Maryland 20784.

**FREE,** Mint British Colonies Packet. Approvals. Hildebrand, Box 5645, Redwood City, California 94063.

**\$10 CATALOG** Value for \$1.00. Sam's, Box 710, Spencer, Iowa 51301.

**231 STAMPS** 10¢! Approvals. Holland, 1227A Sixth Street, Redlands, California 92373.

**1500 FOREIGN** \$2.00; 5000 \$4.00; 9000 \$6.00. 1000 pre-1939 USA, contains dues, revenues commemoratives, presidentials, high values, older issues, etc. \$3.00; 5000 \$12.00. 300 pre-1940 USA commemoratives \$2.00; 700 \$4.00. No approvals. Meyers, 5321 Fleming, Richmond, Calif 94804.

**500 DIFFERENT** World Wide 50¢! Approvals. Gordon Davison, Hillsboro, New Hampshire 03244.

**\$10.00 CATALOG** VALUE World Collection 50¢ with Approvals. Keim's, P.O. Box 3416, New Orleans, La. 70177.

**FASCINATING** Pick-and-Choose Packet approvals. Bargain hunter's Delight, as much is taken from old collections. Rivertown, Box 188P, Lowell, Michigan 49331.

**SEND** Only 10¢ for nice collection of U.S. stamps including "\$5.00." Issue and scarce mint Sipex Souvenir Sheet. You will also receive the most wonderful catalog of stamp offers in America. Littleton Stamps, Dept. SS1, Littleton, New Hampshire 03561.

**SEND** Only 5¢ for Worldwide Collection of over 50 different Singapore, Grenada, Chad, etc. Contains old and new issues, sports, animals, etc. You will also receive interesting lists and a certificate worth 50¢ toward purchases. Goliath Co., Dept. TP-1, Bethlehem, New Hampshire 03574.

**107 BRITISH** Colonies. Terrific Bargain. 25¢. Approvals. Castle, Box 15-PM83, Flushing, New York 11352.

**100 MINT** Large Pictorials, \$2.00. Lists Included. Penniston, Box 7253, Arlington, Va., 22207.

**STOCK** Reduction Sale. Send \$1 for \$2 Value; \$2 for \$5 Value. Gallery, Box 35291, Los Angeles 90035.

**FREE!** Big Bargain Catalog—New Edition listing thousands of bargains including U.S. & B.N.A. stamps, packets, albums, accessories and supplies. Also, fine stamps form our approval service which you may return without purchases and cancel service at any time. Jamestown Stamp, Dept. E83PM, Jamestown, New York 14701.

**WOW!** 110 All Different Germany 10¢. Commemoratives, Airmails, High Values, Big Catalog, bargain lists. Also, fine stamps from our approval service, which you may return without purchases and cancel service at any time. Jamestown Stamp, Dept. A83PM, Jamestown, New York 14701.

**400 MIXED** U.S. 25¢. Approvals. Wright, Box 753-M, Hagerstown, Maryland 21740.

**72 DIFFERENT** U.S. 10¢ with Approvals. Album Service, Soledad 6, Calif. 93960.

**"HUNTING ANIMALS"**—Wolves, Elk, Deers—Poland's Latest 1973 Commemoratives—Free! Approvals Plus 101 Bonus Sets. William Deems, 226 Race, Ravenswood, West Virginia 26164.

(Continued on next page)

## STAMP COLLECTING STAMP COLLECTING

(Continued from preceding page)

**GET** Scarce Kennedy memorial, Red China, Vietnam stamps plus new countries, topicals, commemoratives, many more! Valuable collection of 100 different stamps from the world over. Colorful new and old issues—wild animals, famous people, far places, others! Also stamp selections to examine. Buy any or none, return balance. Cancel service anytime. Rush 10¢ today. Garcelon Co., 8PMA, Calais, Maine 04619

**WORLDWIDE** 500 Different \$1.10. 1000 Different \$2.20. Hefen, Sugar Grove, Ohio 43155.

**LYNDON B. JOHNSON** Memorial stamp on lovely First Day Cover addressed any name of your choice. 50¢ from: **K.M. WALSH**, Box 308H, TUCKAHOE, N.Y. 10707.

**FREE** Pictorials with Approvals. Chapman Stamps, Box 487-P, Galesburg, Michigan 49053.

**RUSSIA:** 50 Commemoratives 40¢. Approvals. Austin, 1509 Eighteenth, Woodward, Oklahoma 73801

**FREE!** 55 Different, Including Triangles, Space, Others! Nice, Low Cost Approvals. L. Baird, PM-35, Box 8128, Portland, Oregon 97207.

**255 DIFFERENT** Worldwide: 15¢. Approvals. Tibbets, 8675 Meadow, Downey, California 90242.

**FREE** New used Congo animal set. Approvals included. Alpaughco, Highbridge, N.J. 08829.

## COINS, TOKENS, CURRENCY

**TWENTY** Obsolete Currency Replicas \$1.25. Harley Hood, General Delivery, Phoenix 85026.

**1909 VDB's!** Rare Lincoln Cents, \$3.95. 3 for \$10.00. Coins West, 21 Central, Campbell 1, Calif.

**COLLECT COINS FOR PROFIT.** How To Start, Where To Sell, Lists Of Valuable Coins. Check Your Change. Send \$1.00. Parker Place, 229 Uteg, Crystal Lake, Ill. 60014.

**SILVER DOLLARS** Uncirculated, 1880-81—1883-84-85 \$8.00 Ea. Catalogue 50¢. Shultz, Salt Lake City, Utah 84110.

**100 INDIAN** And Lincoln Cents 1920's and older \$5.00. 100 early "S" Cents \$5.00. 100 Mixed Steel Cents \$5.00. 40 Buffalo Nickels \$5.00. Free Catalog. Wesley Rood, Box 9, West Union, Iowa 52175.

**BARGAIN** Coin List, 10¢. Economy Sales, Box 92, Buzzard's Bay, Massachusetts, 02532.

**USA SILVER** Dollars Nice Condition 10 Different Dates Only \$39.95 post paid. El Paso Coin Co., P.O. Box Q, El Paso, Texas 79952.

**COINS** At Discount Prices! Free Brochure. Gene Carlton, Chandler, Okla. 74834.

**MEXICO:** Silver Dollars Dated 1957 To 1967 In Nice Condition. Ten For \$3.95 Delivered Postpaid. El Paso Coin Co. Inc., Suite 108, El Paso National Bank Bldg., El Paso, Texas 79952.

**MEXICO** Revolutionary "Pancho Villa" 10 and 5 Centavos Copper Coins Dated 1915 Nice Condition only \$2.95 each. Delivered Postpaid. El Paso Coin Co., P.O. Box Q, El Paso, Texas 79952.

**FREE:** Lists of Thousands of Stamps and Coins. No Approvals. Bryson, 612M White, Toledo, Ohio 43605.

**5 DIFFERENT** Indianhead Pennies \$2.90. Free Catalog. Village Coin Shop, Dept. P, Plaistow, N.H. 03865

**22 "S" LINCOLNS** Including 1955S, \$1.75. 24 1909-1939, \$1.75. 10 "S" Jeffersons, \$1.75. All different. All three \$5.00. **HARRIS**, Box 2308P, Santa Cruz, California 95060.

**GOLD (1865) Mexican Maximiliano** Peso, Bu \$2.95. Northwoods, Bigfork, Minn. 56628.

**CALIFORNIA** Gold Gem Uncirculated, 1860 \$10 1.50 5/6.95. 1855 \$20 1.75 5/7.95 50¢ 1853-1857 5/1.95 25/6.95. Catalog 25¢. Information on Getting Your own Business \$2.95. Allen, 5674-D Beacon, Pittsburgh, Pa 15217

**UNCIRCULATED 'S'** Lincolns, three different, 10¢ Bargain lists included. Farley Coins, Metamora, Illinois 61548.

**COIN** Catalogue 50¢. Raibl Enterprises, 2355 Scenic Highway, Pensacola, Florida 32503.

**COLLECT COINS** For Profit! How To Start, Where To Sell. Lists Of Valuable Coins. Check Your Change! Send \$1.00. Dahler Enterprise, 3233 M'haha, Minneapolis, Minnesota 55406.

## ANTIQUES, RELICS, INDIAN GOODS & CURIOS

**FREE!!** Lists Antiques, Indian Relics, 10 Arrowheads \$4.00, Hyde's, Box 2304, Santa Fe, New Mexico 87501.

**INDIAN** Relic list, Arrowheads \$4.00, doz. Folsom. \$5.00 each. C. Secrist, Deerfield, Missouri 64741.

**APACHE ARROWHEAD COLLECTIONS**—Perfect, 25—\$5.00, 100—\$15.00. **GERONIMO**, PMD1239, Apache Junction, Arizona 85220.

**SELLING** 10,000 Indian Relics. Arrowheads, Knives, Spearheads, Scrapers, Etc. List Free. Lear's, Glenwood, Ark. 71943.

**AUTHENTIC WESTERN ARROWHEADS**—Perfect, 25—\$5.00, 100—\$15.00. **BROKEN ARROW**, PMD1208, Scottsdale, Arizona 85252.

## EVERYBODY LIKES DIXIE GUN WORKS.

**TONS** Of antique gun parts and supplies. All reproduction muzzle loading guns. Send \$2.00 for enlarged illustrated catalog No. 121. Dixie Gun Works, Union City 12, Tennessee.

**JAPANESE** Swords Wanted; Don Beck, 1828 Ida, Ft. Wayne, Indiana 46808—219-437-1801.

## MODELS—CARS, SHIPS, TRAINS, PLANES ETC.

**REAL ROCKETS—YOU BUILD 'EM AND YOU FLY 'EM!** Single and multi-stage, scale and original designs, even ready-to-fly. Launch birds to 2,500 feet again and again—with gentle parachute recovery. Safe, inexpensive solid-propellant engines, transmitters, featherweight cameras. Start your own model rocket collection with a big, new, color catalog of over 80 rockets from 49¢ up. Send 25¢ for catalog to: **ESTES INDUSTRIES**, Dept. 7M, Penrose, Colo. 81240.

**AUTHENTIC** Scale Model Cars—Not toys! **COMPLETELY ASSEMBLED!** Antique, Classic, Contemporary. Catalog 25¢ (Refundable). Richard's Auto Models, Box 8-W, Parsippany, New Jersey 07054.

**SHIP MODEL** Kits, Plans, Fittings from our own Workshop. Big Illustrated Catalog: 50¢. Bluejacket Shipcrafters, 145-V Water Street, South Norwalk, Conn. 06854.

**SHIP** And Airplane Model Kits Catalog 25¢. Scientific, Inc., 340 Synder, Berkeley Heights, N.J. 07922.

**SHIP** Model Kits, fittings, plans, books, tools, engines, motors. Big illustrated catalog 50¢. Mass. residents add 3% tax. James Bliss & Co., Dept. SM, Route 128, Dedham, Mass. 02026.

**MODEL** Airplanes—Big 220 Page Catalog \$1.00. Sig Company, Montezuma, Iowa 50171.

**SHIP** And yacht model fittings: Pine construction hull kits; blueprints. Send 75¢ for illustrated catalog. A. J. Fisher, Inc., 1002 Etowah Avenue, Royal Oak, Michigan 48067.

**LIVE** Steam powered backyard railroads! All sizes. Complete "bolt-together kits," and rough castings. Excellent drawings. 100 page catalog \$1.00. Little Engines, Lomita, California 90717.

## GAMES, TOYS, PUZZLES, NOVELTIES

**PUZZLENTS—GAMES** and **PUZZLES** Magazine \$9.00/yr. Sample Issue \$1.00. Box 1176F, Palo Alto, Cal. 94302.

**KITES!** Quality Action Styles! Brochure 10¢. Hutchinson, PM8, 83 Tremont, Barre, Vermont 05641.

## MAGIC TRICKS, JOKES, VENTRILOQUISM

**HOUDINI'S** Greatest Magic! You can do them all!! Giant illustrated catalog 25¢ House Of 1000 Mysteries, P.O. Box 2026P, Pompano Beach, Florida 33061.

**WOW!** Largest selection—newest, best tricks jokes. Giant 120 page catalog 25¢. Abracadabra, Highway 27MP, Lake Colonia, New Jersey 07067.

**FREE!** World's leading novelty catalog. 1600 Funmakers, Jokes, Tricks, Science, Sports, Hobbies, Jewelry, Psychedelia. Johnson-Smith, C-10, Mt. Clemens, Mich. 48043.

**COMPLETELY** illustrated catalog. 84 pages. 25¢. Manhattan Magic, Box 334-M, N.Y.C. 10011.

**MAGIC MAGAZINE.** Tricks, News, Dealers Offerings. Monthly Since 1936. 2 sample Copies \$1.00. Genii, P.O. Box 36068M, Los Angeles, California 90036.

**WORLD'S** Finest professional magic tricks. Joker's Novelties. Giant illustrated catalog 10¢. Top Hat, Evanston, Illinois.

**FABULOUS** MAGIC'S New 1973 catalogue 25¢. Our specialty orders shipped same day no substitutes. Fabulous Magic, 3319 East Charleston, Las Vegas, Nevada 89104.

**BE A Magician!** Two booklets explaining 156 tricks plus large professional catalog. \$1.00. Magic, Inc., 5082 Lincoln, Chicago, Illinois 60625.

**MAGIC!** Amaze, Mystify, Entertain! Hundreds Of Newest Tricks For Pocket, Parlor, Stage. Complete Catalog Only 25¢. Jeffries Magicland, Dept. 11, Dallas, Texas 75201.

**TWO!** Different Magic Catalogs. 25¢. Miami Magic, Box 1047, Miami 33133.

**CATALOG** 10¢. Magic, Tricks, Novelties. Plus Free Trick. Sun Magic, Oakhill, Williston, Vermont. 05495.

**CLASSIC MAGIC.** Everyone An Expert! Amaze Friends. Free Illustrated Catalog. Interenter, Box 7728, Dept. PM1, Riverside, California 92503.

**CATALOG** 10¢. 1,500,399 tricks, jokes, novelties. Elbee, 7408P, San Antonio, Texas 78207.

## BOOKBINDING

**LEARN ANCIENT ART OF BINDING BOOKS BY HAND,** at home, fascinating, money-making craft. Illustrated with photographs and drawings. Complete course \$9.95 postpaid. Particulars free. **PBC BOOK-BINDING**, 601 West Fifth Street, Bonham, Texas 75418.

## BOOKS, CATALOGS, NEWSPAPERS

**WORLD'S** Most Outspoken Publication, Natural Health, Healing, Organic Gardening. Free Copy. Provoker Press, St. Catharines 102, Ontario.

**THIS** is your Life—Jesus. Metta, Box 932, Moorhead, Minnesota 56560.

**LIKE** Free catalogs? Diane P. Anderson, 260 Crittenden Blvd., Rochester, N.Y. 14642.

**FREE** Bargain Book Catalog Success, Wealth, Business, Sports. Subjects Galore. Stagecoach Sales, 250P Circle Drive, Ruidoso Downs, New Mexico 88346.

**1908 SEARS** ROEBUCK Catalog (736 Pages) \$3.62 Plus .38¢ Postage. Dempsey Graham, Rt. 1, Box 117-PM, Cuba, Alabama 36907.

(Continued on next page)

## BOOKS, CATALOGS, NEWSPAPERS

(Continued from preceding page)

**BOOK SALE!** Free List of low cost popular books. Gnu Gifts, Box 22547P1, Ft. Lauderdale, Florida 33315.

**WIRETAPPING EXPOSE**—Your Privacy Invaded—Details \$1.00, Refundable. Don-Q, Box 548, Dept. PMO, Seattle, Wa. 98111.

**THE VINEYARD**—Tough Talking Orthodox Christian Journal, \$3.00, 1745 No. Cicero, Chicago, Ill. 60639.

**BOOK SALE!** For the entire family 20¢ to 50¢. Free brochure, Winchester Enterprises, 2807PM Hargrave Street, Philadelphia, Penna. 19136.

**BIBLE SECRETS** Opposing Church Tithing \$1.25. Books, Linn, Missouri 65051.

**FREE! OUTSTANDING BOOK BROCHURE #308.** Describes Mind Stimulating Success Oriented Books. The Family Workshop, 513 Lewis Avenue, San Leandro, California 94577.

**BOXING FANS**—Read "American Boxing News"—Inside Facts, National Fight Results, Stories, Photos. Send \$1.00—Special 4 Month's Subscription. Dept. 50, Box 554, Farmington, Michigan 48024.

**FREE** Book locating. Send wants. Bazaar Book Search, Box 496, Chico, California 95926.

**LATEST** Military Manuals/Books Catalog 25¢. Hillcrest Publications (K-18), McDonald, Ohio 44437.

**FREE** Book, Prophet Elijah Coming Before Christ, Megiddo Mission, Dept. 63, 481 Thurston Road, Rochester, N.Y. 14619.

**NATIONAL** Geographic Magazines, 1888-1971, any issue. Buxbaum, Box 465-PM, Wilmington, Delaware 19899.

**LOGIC NEWSLETTER.** Learn Theorv. Design, Symbolic Logic, **BOOLEAN ALGEBRA**, Sample Copy \$1.00. **LOGIC NEWSLETTER**, P.O.B. 252, Waldwick, New Jersey 07463.

**FREE!** 276 Magazines monthly—Cars, Sports, Gardening, Health, Patents, Books, Business Opportunities, Music, Land, Science, Export-Import, Photography, Hobbies, Tools, Travel . . . 67 subjects! Complete directory \$1.00—Satisfaction Guaranteed. Aleph-B, Box 5877-PM1, Stanford, California 94305

**CATALOGS!** Receive Many! Catalog Directory \$1.00. Box 305, Plymouth Meeting, Pa. 19462.

**UNUSUAL** Books! Greatest Buy—40 For \$3.00. International, Box 7798PMAG, Atlanta, Georgia 30309.

**HOW** To Get Success, Wealth, Popularity. Have Confidence. Send for **FREE** List Of Low Cost Books. Lee's Gifts, 10790 Coogan, Dallas, Texas 75229.

**UNIQUE** Unusual Books for Your Personal Improvement. Send for **FREE** Illustrated Catalogue. House Of Bel-Aire, 4208A Fitch Avenue, Baltimore, Maryland 21236.

**INTERESTING** Magazine! Something for Everyone! Sample Copy: 25¢. Micci, Box 938-PM, Las Vegas, Nev. 89101.

**QUALITY BOOKS** Moneymaking, Self-Improvement, Others—Free Details—Ralpco—Box 8184W, St. Paul, Minnesota 55113.

**AUTO** Repair Book Shows You How To Save Hundreds Of Dollars On Expensive Automobile Repairs. Send \$2.45. S&S Enterprises, 56 Roy Drive, Dept. PM8, Nesconset, N.Y. 11767

## PLAYS, SONGS, MANUSCRIPTS

**SEARCHING** For HITS. Song Poems wanted. **FREE** Evaluation. American Music Co., Box 9829-P, Jackson, Mississippi 39206.

**SONGPOEMS, SONGS!** Urgently Needed. Possible Recording/Publishing. 50-50 Agreement. Betty's Music Makers, 222B 150th Avenue, Madeira Beach, Florida 33708.

**PUBLISHING** Contract Guaranteed on selected songs and poems. Free evaluation. Hollywood Songwriters', 6253 Hollywood, 1117-PM, Hollywood, California 90028.

**RECORDS** Made. Publishing Contract Guaranteed On Accepted Songs, Poems. Send: Talent Searchers Of Hollywood, 6311-X Yucca, Hollywood, Calif. 90028.

**SONGS, POEMS WANTED!** For publishing, recording at our expense! **TALENT**, 17-PM, Longwood Road, Quincy, Mass. 02169.

**OPPORTUNITY!** Poems Needed. Free information. Successful Songs. RFD 3, Brookfield, Conn. 06804.

**SONGS, Poems, Tapes** Wanted At Once For Immediate Recording/Publishing Contract. Free Evaluations. Three Rivers Music Center, 3269 West Liberty Avenue, Dept. B, Pittsburgh, Penna. 15216.

**SONGWRITERS!** Spirited, religious poems, songs wanted for **FREE** publishing, recording consideration by Chapel Orchestra-Choir. **CHAPEL RECORDING**, P.O. Box 162-PM, Wollaston, Mass. 02170.

## BUSINESS SERVICES

**PROFITS FROM CLASSIFIED ADVERTISING!** Booklet shows you how to start your own business with Classified Advertising. Only \$1.00 (Refundable with first order.) **H. E. KAPPEL, POPULAR MECHANICS, DEPT. P, 224 WEST 57 STREET, NEW YORK, N.Y. 10019.**

## BUSINESS OPPORTUNITIES

**A FORTUNE IN JUNK!** Learn Upholstery at home . . . turn cast-offs into chairs, sofas worth \$100's. No experience needed. We show you how . . . even supply all tools and practical furniture kits! Veteran Approved. Booklet mailed **FREE**. Modern Upholstery Institute, Box 899 UPM2, Orange, Calif. 92669

**INCREASED PROFITS GUARANTEED.** Professional Monthly Reports Help You Boost Sales **OR MONEY BACK.** Sample Edition Includes Bonus Profit-Finder Table. Only \$1.00. Baughan, Postbox 1426-FP, Plainfield, New Jersey 07061.

**START BUSINESS RIGHT.** Learn Methods, Hidden Problems. Simple, Blunt Pamphlet by old pro \$2.00. Box 13213, Pittsburgh, Penna. 15243.

**EXTRAORDINARY** Opportunities. Your Name On Computerized Nationwide Mailing Lists. \$1.00. J-R Associates, Box 55, Nanticoke, Pennsylvania 18634.

**HOW** To Make Big Money In Mail Order. Details Free! Looksee, Box 3483, San Antonio, Texas 78211.

**300% PROFIT** Possible—Sell Books By Mail. Details, 25¢. Naggo, Box 11478PMB, Chicago, Illinois 60611.

**BIG** Profits selling Nameplates, Custom Engraving—Free Details. R.P.H. Manufacturing, 249-C Winter, Stamford, Conn. 06905.

**IMPORT-Export** Opportunity, profitable world-wide, mail order business from home, without capital or travel abroad. We ship plan for no risk examination. Experience unnecessary. Free Report. Mellinger, Dept. G2708, Woodland Hills, California 91364.

**PROFIT** Selling Books By Mail. Proven Plan. Details and sample catalog \$1.00. Sabacy Products, Box 15206F, Lakewood, Colorado 80215.

**START** A Profitable Business At Home. My Booklet Explains, Tells How. Only \$1.00. Ellis Keller, 820-M Calvert St., York, Pa. 17403.

**12,000 NET** Yearly Possible In Your Own Mailorder Business. Proven Method! Free Details. Write: Miller, Box 629A, Fulks Run, VA 22830.

**SECRETS!** Mail Order Success. Internationally famous expert reveals how to make home business fortunes. Beginners: Get free report "Make Money By Mail." Discloses free advertising profitable products. Mailco, Dept. GC708, Woodland Hills, California 91364.

**DISTRIBUTE** Specialty Merchandise. Buy Below Wholesale. Details Free. Ecu Wholesale, Box 215-A, Ecu, Mississippi 38841.

**STAINLESS** Pollution Control Products—Your Business Opportunity To Make Money—No Financial Investment Needed. Free Information. Health, 11550 Larch, Minneapolis 55433.

**FREE**—"618 Successful Home Operated Business Opportunities" Brochure. Also, Free Offer "589 Things You Can Get Free . . . Plus "Directory, Answers ALL The Moneymaking, Moneysaving Offers You Need. Free Details. Casa Alexi, 2709 Crystal, Chicago, Illinois 60622

**MAILORDER BEGINNERS:** Several Proven Starter Programs. Free Details! Hautala, Box 125, Williston Park, New York 11596.

**20,000-YEAR** And More Possible, Advertising Business Or Mailorder. Details 35¢ Handling, Self-Addressed, Stamped Envelope to: McCater, (P2), 317 West Grand, National Park, New Jersey 08063.

**SANDBLASTERS** \$32.50-\$749.50. Free Catalog. Truman's, 1330 Market, Youngstown, Ohio 44507.

**\$2000, MONTHLY** Selling Information By Mail; Free Details: Clark, Box 80521-M, Atlanta, Georgia 30341.

**WORLD'S EASIEST** Mailorder Business. Free Details. Arteric, Box 5025, Fresno, California 93755.

**ESTABLISH** Profitable Home-Operated Mailorder Business!! Minimum Investment. Everything Available To Insure Immediate Success. Rush 25¢ Today For Complete Package. Learn How You Can Cash In On This Great Moneymaking Opportunity. Carpenter, Box 6308A, Long Beach, California 90806.

**CLAIM ABANDONED SILVER**—\$20,000 Secret Revealed! Free Information: Silverman 4A-13, Box 548, Woodville, Texas 75799.

**HELP US** Introduce Revolutionary New Patented Item To Pipe-Smokers And Stores. **BIG EARNINGS**, Full And Part-Time. **FREE DETAILS.** KenMar's, Box 41, Zeigler, Illinois 62999.

**HIGHER INCOME** Security and Power, 256 Page Book **THINKING BIG** Reveals Secrets That Make Men Rich, Book #WB123 Only 2.00. Hankinson's Sales, Inc., 2113 E. Ellicott St., Tampa, Fla. 33610 Fla. Residents Ad 4% Sales Tax.

**HATE** Working for Others? Be Your Own Boss "**BIG MONEY**" Can Be Yours With Your Own Mail Order Business. Details, 25¢. J&L Sales, Box 33246, San Diego, California 92103.

**\$2,000 MONTHLY** In Astonishing Spare Time Business. Robert Ober, 660 Groff Ave., Elizabethtown, Pa. 17022.

**\$300 WEEKLY** At Outdoor Flea markets. No Selling. Instructions \$1.00. Refundable. Abel, 1115 West Farnum, Royal Oak, Michigan 48067.

**MONTHLY \$1500**—From your home, easily!! Write: E. Enterprises (P8), 1019 Hillside, Valdosta, Ga. 31601.

**SACRIFICE!** \$1000.00 Plastic Laminating Business—\$199. Write: Cumberland, Monticello, Ky. 42633.

**SELL** Gifts By Mail. Wholesale. Retail. Free Details. Send-Away-EK, Georgetown, Connecticut 06829.

**CASH** For Newspaper Clippings. Royce, 14603 Dorchester, GC-83, Dolton, Illinois 60419.

**AMAZINGLY INFORMATIVE NEWSLETTER** Reveals Best Business and Investment Opportunities. Free Details. Quality Products, 32 Maine Avenue, Carteret, New Jersey 07008.

**GUARANTEED.** \$1.00 For Each Envelope You Stuff. Details \$2.00. Fuller, 228 Lemmon, Sumter, South Carolina 29150.

(Continued on next page)

## BUSINESS OPPORTUNITIES

(Continued from preceding page)

**FREE Details—Home MAILORDER Business—National Mailorder, 249 Main Street, Dept. 4B8, Farmingdale, N.Y. 11735.**

**FORTUNE In Apartments. Details \$2.00. Rainbow, Box 267C, Elkin, N.C. 28621.**

**HOW TO Earn at Home Addressing Envelopes. Rush Self-Addressed, Stamped Envelope. Vera-Lynn, 1630A Noriega, San Francisco, California 94122.**

**PROFITABLE Mailorder Opportunities Year \$1.00. Nationwide Mailers, Box 4367-DB, Columbia, South Carolina 29240.**

**MAILORDER FAILURES Outnumber Successes! Why? Your Future DEMANDS Reply to: PATHFINDERS—Suite 205-A-25 Van-Keipen Avenue, Jersey City, New Jersey 07306. Information Rushed FREE.**

**MAILORDER Dealers wanted—Outstanding opportunity! Details 25¢. Mears-PM, 5363 Essex, Alexandria, Va. 22311.**

**START Your Own Correspondence School. United Career Schools, 5820P Imperial Hwy, South Gate, Calif. 90280.**

**I MADE \$2,000.00 Monthly by Mailorder . . . Evenings Only! You Can Too! -Free Proof! Asbury, Box 161-D, Madison, Ohio 44057.**

**HERBALISM! The Home Gold Mine! FREE LESSON, SEEDS! Herbalism Institute-B, 1339 Remuda, Glendora, California 91740.**

**BIG PROFITS!! SELL ENGRAVED, METAL, SOCIAL SECURITY PLATES. FREE SALES KIT! MYERS, 928-PM CRESCENTHILL, NASHVILLE, TENNESSEE 37206.**

**MAILORDER Dealers Wanted. Earn outstanding profits using tested promotions! Ruward-PD, Georgetown, Conn. 06829.**

**PIANO Tuning Learned Quickly at Home! Tremendous field! Musical knowledge unnecessary. GI Approved. Information Free. Empire School, Box 327, Miami, 33145.**

**WORLD'S Largest supply, Merchandise 25% to 40% under wholesale. Bankrupt. Closeouts 10¢ on dollar. Imports. Hong Kong clothes. Automobile discounts. Free details. International Buyers, Box 16386 MM, Portland, Oregon 97233.**

**SELL Books by mail. Complete dealer set-up—25¢. Midwest Mail Sales, Box 44R2-PM, Shawano, Wisconsin 54166.**

**MAKE A Years Income in 8 weeks Camping. No selling. Capital or Land necessary. Write: Edux's, Route 5, Box 5733, Gig Harbor, Washington 98335.**

**BECOME "Mortgage Broker." Lucrative! Capital Sources, Box 99-A, Uleta, Florida 33164.**

**MAKE Magnetic signs, Machineless method. Profits enormous. Write: R1B49APM, Bardstown, Ky. 40004.**

**ADVERTISING BUSINESS—YOU Own it. \$400 First Week or Money Back. Electric Neon Action Ad Clock, 229 W. Illinois, Chicago 60610.**

**HOLLYWOOD CEMENTCRAFT: Offers Highly Profitable Home Business. Experience Unnecessary. Unlimited Unique Pottery Designs Easily Made Without Moulds. Bird-baths, Fountains, Wishing-Well, Waterfalls, etc. Chemical Coloring Formulas. Marble-glazing. FREE Illustrated Brochure. CONCRETE FACTS, 602 Athens Street, Altadena, California 91001.**

**COPUBLISH "Mail Sale Advertiser," leading mailorder paper. Copy and details 25¢. U.S.A. only. Vanroy Shirk, Lebanon, Pa. 17042.**

**VENDING Machine big catalog. Rake, 523 A Spring Garden, Philadelphia, Pa. 19123.**

**FREE Catalogs. Repair air conditioning refrigeration. Tools, supplies, full instructions. Doolin, 2016 Canton, Dallas, Texas 75201.**

**SELL Books by mail. 400% profit. Royal, Box 450-X, Cleveland, Ohio 44127.**

**\$70 TO \$200 WEEKLY—Home, Spare Time Simplified Mail Bookkeeping. Immediate Income. Easy. Auditax, Box 34741A, Los Angeles, Calif. 90034.**

**VENDING Machines. No selling. Routes earn amazing profits. Big catalogue Free. Parkway Corporation, 715PBM Ensor Street, Baltimore, Maryland 21202.**

**\$60.00 DAY. Manufacturing Concrete Posts. Blocks. Mold Equipment Catalog \$1.00 refundable. Carlayne, Route One, Box 95, Rapid City, South Dakota 57701.**

**MAILORDER Records help get increased business! Complete 32 page Record Book shows your inquiries, orders, advertising, expense, etc. Only \$1.00. H. E. KAPPEL, POPULAR MECHANICS, DEPT. R, 224 WEST 57TH STREET, NEW YORK, NEW YORK 10019.**

**REPAIR Hydraulic Jacks—Details Free. Write: Hydraulic Parts Supply, Box 295, Port Isabel, Texas 78578.**

**EARN \$60.00 Daily manufacturing Concrete Fence Posts. Practically no investment. Send stamped-addressed envelope. American, Excelsior Springs, Mo. 64024.**

**\$50.00 PLUS 50% COMMISSION Stuffing 200 already stamped, addressed envelopes, our circulars. Information 25¢ with stamped, self-addressed envelope. Brewster-PB, Clearwater, Florida 33517.**

**\$400.00 MONTHLY Raising giant fishworms. Soilless method. Charlie Morgan, Bushnell, Florida 33513.**

**EARN Money raising fishworms for us! Write: Oakhaven-38, Cedar Hill, Texas 75104.**

**FREE 1973 100-Page Catalog waiting to bring you Big spare-time cash commissions. Sell Advertising Book Matches. Every business a prospect . . . complete selling instructions furnished Steady, repeat business. Dept. MX-873, Superior Match Company, 7530 South Greenwood Avenue, Chicago, Illinois 60619.**

**WATCHMAKING Makes every day a payday. Learn this cash business at home. Free details. Chicago School of Watchmaking, YVA, Fox River Grove, Illinois 60021.**

**\$1.00 LISTS You year sent to 1000 Importers, Jobbers, Mailers, our mailing year. Dixiem, King, North Carolina 27021.**

**\$200.00 SPARE Time earnings with your Tablesaw. Write: Workshop Five, 3800 Harney, Vancouver, Washington 98660.**

**STUFF Envelopes. \$25 Hundred. Immediate Earnings! Beginner's Kit, \$1.00 (refundable). Lewcard, P392M, Brea, Calif. 92621.**

**\$200 WEEKLY! Make, Sell Bricks! Free Information! Xcilo Bricks, 5715 N. Mozart, Chicago, Ill. 60659.**

**MAIL Baby Catalogs Imprinted with your address to New Mothers for Big Profits! Details 25¢. Volz PM, Ypsilanti, Michigan 48197.**

**I MADE \$40,000.00 Year by Mailorder! Helped others make money! Start with \$15.00—Free Proof. Torrey, Box 318-Y, Ypsilanti, Michigan 48197.**

**SELL New Sensational Car Thief Signal. Lightning Seller. Samples for trial. Northwest Electric, Ave. 179, Mitchell, S. Dak. 57301.**

**BECOME Our Mail Order Distributor with \$150 Investment. Free Brochure. Audit Controls, 40 Brookside Ave., Fair Lawn, New Jersey 07410.**

**MAKE \$40 daily! Manufacture, Sell Patio Tiles! Free Details! Hilmar, Rt. 1, Box 347D H, Valrico, Fla. 33594.**

**PORTABLE Sandblaster \$29.95. Distributor wanted. Free brochure. INKA, Box 66573—A, Houston, Texas 77006.**

**MAILORDER Laws. Know The Facts \$2.00. Guaranteed. Ideal Enterprises, Box 515-H, Woodbridge, New Jersey 07095.**

**SELL Books Mailorder!! Highly Profitable! Details. Derbes, Box 2667, New Orleans 70176.**

**MAILORDER Millionaire helps beginners make \$500 weekly. Free report reveals secret plan! Executive (1A8), 333 North Michigan, Chicago 60601.**

**\$19 HOURLY Profit—Own Business with one service man. Quickly learned. Easy to do. Operate from home. Little over \$1000 starts your own nationally advertised business while continuing present job. Investigate immediately before your territory is taken. Free booklet explains everything. Send today. Then decide. Duraclean, C3-166 Duraclean Bldg., Deerfield, Ill. 60015.**

**MAILORDER Catalogs. Your Name Imprinted. Merchandise Drop-Shipped. Details 25¢. AM Sales, 31-14-94, East Elmhurst, N.Y. 11369.**

**FREE SECRET BOOK "2042 Unique, Proven Enterprises." Tiny businesses but huge profits! How Little Fellows beat inflation. Work home! Haylings-T19, Carlsbad, California 92008.**

**BOOKKEEPERS Operate Profitable Bookkeeping Service. Earn \$10.00-\$20.00 hour. Details free. Universal Bookkeeping, Box 664-M, Springfield, Missouri 65801.**

**SECRETS of getting rich with other people's money. \$5000+ possible in one day. Free details. JPA, Dept. 304, Box 101, Park Ridge, N. J. 07656.**

**GROUND Floor opportunity in an Engraving business of your own—spare time or full time. One piece of raw material costing \$4.50 will produce products worth \$180.00! Free particulars! Write: Warner, Room EC-2-CK, 1512 Jarvis, Chicago, IL 60626.**

**INFORMATION Dealers. Needed Proven Method Reaches HUNGRY, GROWING MARKET. Free Details. NRG-A8, Vanburger Rd., Owego, New York 13827.**

**\$1000 PER MONTH Possible, From Your Own Home. Write: Charles A Enterprises, R-1, Box 1022, Bend, Oregon 97701.**

**SUCCESSFUL FUTURE IN AUTO SALVAGE BUSINESS For Information Telling How You Can Succeed in Your Own Auto Salvage Business. Send \$3.95 To: Success, 3181 Woodside Drive, Jackson, Miss. 39212.**

**\$200.00 DAILY In Your Mailbox! Opportunity To Follow Mailorder Experts. Free Details. Associates, Box 136-A, Holland, Mich. 49423.**

**RECEIVE Mail Galore! Your name on our national mailing lists, \$1.00. Sullins, Box 1313, Brunswick, Georgia 31520.**

**STUFF Envelopes. \$28.00 Hundred. Immediate Earnings. Beginners Kit, \$1.00 (Refundable). John Keen, P.O. Box 9995, San Diego, Calif. 92109.**

**GENEROUS Profits Mailing Information. Sierra Products, 5540 Winding Way, Carmichael, California 95608.**

**1000% PROFIT Bronzing Baby Shoes At Home. Free Literature. NBC-PM, Gower, Missouri 64454.**

**DON'T Die without a will! Blank will form protects your family. Only \$2.00. Instructions included. 100% guaranteed. Order today!! Barons, Box 1033-Y4, St. Charles, Missouri 63301.**

**50 BUSINESSES You Can Start With Little or No Capital. Details \$1.25. DAWVEST, Box 4249, Long Beach, Calif. 90804.**

**\$25.00 HUNDRED Addressing possible year round. Special information 25¢ with self-addressed stamped envelope. Cove-B, 627 Franklin, Clearwater, Florida 33517.**

**\$1000 MONTHLY from your own home, Write: Jordan, Box 884, Dept. PM8, Visalia, Calif. 93277.**

**DO SIMPLE ADDRESSING—Mailing. Receive \$12.95 orders. Keep \$8.00 profit. Details Free! Quality, Box 9-P, East Rockaway, N.Y. 11518.**

**INSTALL Burglar alarms without previous experience or costly equipment. Big profit. Free details. Nasco, Dept. G2708, Woodland Hills, California 91364.**

(Continued on next page)



## BUSINESS OPPORTUNITIES

(Continued from preceding page)

**328 FAST**, easy ways to make money! Free! Rush name, address, zip. Perry, 13263-E Ventura Blvd., Studio City, Calif. 91604.

**MEN—Women!** Fill out income tax forms at home in own business. We show you how. Simple, easy to learn. \$700 per month earnings possible. Details mailed free. No salesmen. Hurry, Federated Tax Home Training School, 2065 Montrose, Chicago 60618

**HOW to Make Money in Real Estate.** Write: Howard, Box 577-B, Bozeman, Montana 59715.

**MAKE** durable building plastic easily. Waterproof, fireproof, economical. Bays Laboratory, Cedaredge, Colo. 81413.

**BECOME** Tax Consultant. Our students earn \$1,000-\$3,000 every tax season preparing returns evenings, State approved. National Tax School, Monsey 2QD, New York 10952.

**AMAZING!** Mail Order business "KNOW-HOW" 2-hour Course \$2.00 FREE details. Fortune World, Box 4012, Foster City, California 94404.

**MAKE** \$46 From square foot plywood: jigsaw or bandsaw necessary. Free details. Woodar, Bridgewater, Mass. 02324.

**"MAILORDER** Course! Home Study." 24 Easy Lessons. \$2.00. "Bill" Lambertson, 132 Tamiami Station, Dept. PM83, Miami, Florida. 33144.

**\$2000 MONTHLY** In Astonishing Spare Time business Details. David Maney, 6477 Atlantic Ave., #302, Long Beach, Calif. 90805.

**FREE—166** Wholesale Catalogs! Complete Mailorder Information. Get Started Correctly.—Jay's Mail Order Sales, 2208 Hermitage Avenue, Wheaton, Maryland 20902.

**RAISE CAPITAL WITHOUT COLLATERAL** Or Credit. Unique plan assures success. Enterprises, Box 247-M, Columbia, Georgia 31902.

**CAMPERS**, Earn income while camping. No capital, Land or Selling required. Welba, Box 366, Anaheim, California 92805.

**MAILERS** Wanted!! Free Information. A. Allen, 2418 Lori, Santa Ana, California 92706.

**HOW To Sell Books By Mail.** Send \$3. Gelinis Enterprises, PMA, P.O. Box 601, Station N, Montreal 129, Canada

**MAKE** \$7.50 to \$15.00 hourly building portable custom cases in your home. Huge demand. Get orders by mail. We supply materials, instructions—everything. Free details. Customcase, 6075 De Soto, Dept. C-P8, Woodland Hills, California 91364.

**MAILORDER** Home Business. Success for beginners. Write: Evans, Box 8277 PM8, Tampa, Florida 33604.

**QUALIFIED?** Extra money in major industry. Free test. Saylor, Box 622, Irving, Texas 75060.

**TAKE** Catalog orders. We drop-ship 1001 best selling specialty products. Lowest below wholesale prices. Immediate Delivery. Spectacular home business opportunity. Free Book. Specialty Merchandise, Dept. S-P-8, Woodland Hills, California 91364.

**IMPORT EXPORT** Operate World Wide Mail Order Business From Home. Over 24,000 Items Available Direct From Overseas Suppliers. Drasher Enterprises, Box 4637D, Philadelphia, Penna. 19127.

**RACK JOBBERS—Buy** Below Wholesale, Catalog \$1.00 Refundable With First Order. Star-Delta Sales, Box 12332, Knoxville, Tenn. 37912.

**SOCIAL Security Business—\$24.95!** (Machine included). Details: Ideaco, Box 69828PV, Los Angeles 90069.

**\$13,250.00** IN three months. Get Free Proof. Paco, Box 37157, San Antonio, Texas 78237.

**DISTRIBUTORS** Wanted. Greatly Needed Product. Very Profitable Setup. Superior, PM3, 2421 South Fulton Place, Tulsa, Okla. 74114.

**HOW TO MAKE MONEY ADDRESSING, MAILING LETTERS. OFFER DETAILS 10¢.** Lindbloom, 3636 West Peterson, Chicago 60659.

**HOW TO RAISE \$100.00 to \$1,000,000.00!! CAPITAL-A. . .** Dawsonville-4, Georgia 30534

**FREE "Collection Agency Details!!"** \$1000.00 Monthly possible. Write Today: Master-B, Dawsonville-4, Georgia 30534.

**FREE Money Plan.** Get Secrets for \$500 to \$2 million. Business capital, loans, cash. Free details. Capital-17, Kerrville, Texas 78028.

**HOW To Earn At Home Addressing Envelopes.** Rush Self-Addressed, Stamped Envelope. F and J, Box 8546-A, San Jose, California 95123

**FREE MONEY—I'll Pay You To Answer My Advertisement On Business Opportunities With Real Money.** Box 460F, Lomita, California, 90717.

**LET Others** make money for you. Start home business. I show you how. Free Report, Morgan, Dept. G2708, 6100 Variel, Woodland Hills, California 91364

**FREE Millionaire Book "990 Successful, Little One-Man Businesses."** Work home! SBI-7, Kerrville, Texas 78028.

**900% PROFIT** Possible in magnetic signs. Get in on this fast growing, money making industry. We sell plans for building sign machines, supplies and custom signs. Dealers wanted. Magna, Box 1033M1, St. Charles, Mo. 63301.

**\$2000.00 MONTHLY** Selling Information By Mail. Ropchan, Box 5341P, Sherman Oaks, Calif. 91413

**CALIFORNIA MANUFACTURER NEEDS** Man to assemble our product and be local agent, experience unnecessary. May start while presently employed. Five-figure income for responsible applicant. S.K.R.M. Manufacturers, 2347 West 238 Street, Torrance, California 90501.

**MAILORDER OPERATORS** Register yourself on our computer data base. Inquire: Colonial Mailorder Services, 13 East Spring Street, Alexandria, Virginia 22301

**WE NEED GINSENG GROWERS!** \$3,000-\$30,000 Annually! We Buy Your Crop. Send \$2 For Seed Sample And Information. Glass's Ginseng Exchange, Box 336, Rochdale Station, Jamaica, NY 11434.

**MAILORDER BEGINNERS LIBRARY,** Learn Professional Secrets Inexpensively! Write: HOW, Box 4457PM8, Downey, California 90241.

**ROBOTS:** Real, Talking, Sales Promotional money-makers. Free Details, Orben PR-8, 33 Parkview Ave., White Plains, N.Y. 10604.

**\$2000.00 MONTHLY** Selling Information by Mail. Lee, Fox Plaza, Box 2904, San Francisco, California, 94102.

**GREAT NEW GOLDEN OPPORTUNITIES:** Goals getting success kit. Free Details. Orben PK-8, 33 Parkview Ave., White Plains, N.Y. 10604.

**VACUUM** Signmaker. Element, Instructions, \$10.00. Homecraft, 2350 W47N, Denver, Colorado 80211.

**YOUR OWN MAIL ORDER BUSINESS! 4 MILLION NEW PROSPECTS ANNUALLY!! 25¢ BRINGS VALUABLE DETAILS. EVANS ENTERPRISES DEPT. 23PM, 77 MAY STREET, IRVINGTON, NEW JERSEY 07111.**

**YOUR GREATEST OPPORTUNITY:** Work less, earn much more money, enjoy easy life, achieve your goals. Free details. Orben PY8, 33 Parkview Ave., White Plains, N.Y. 10604.

**BE YOUR Own Boss.** Every Advertiser in this Section is in Mailorder. Why not You? Report gives details. \$1.00. Hama House, Dept. PMH, 110 Hama, Barrington, Ill. 60010.

**FOR SALE AUTO PARTS STORES.** For locations and information write: G. A. Millinger, 2754 Quincannon Lane, Houston, Texas. 77043

**EARN** More than many professional men! \$1000. Month Mail Order Collection Agency. Continental, Box 2023-A, Des Moines, Iowa 50310.

**PROFITABLE BUSINESS—Molding Rubber, Hobby Supplies.** Details 10¢. Chaney's, 5415 L San Jose Blvd., Jacksonville, Fla. 32207.

## MONEYMAKING OPPORTUNITIES

**OVER \$16.50** an hour. Spare time at home! Rubber Stamp industry needs small manufacturers. We furnish all equipment and know-how! Particulars free! Write: Roberts, Room RC-2-CK, 1512 Jarvis, Chicago, Ill. 60626.

**CLIP** Newspaper items. \$1.00-\$5.00 each. Details free. Walter, Box 1360-PA, Erie, Pa. 16512.

**RETIRE ANYTIME** In Luxury! Easy, Legitimate! Details. Premier Enterprises, Box 10597-AH, Pittsburgh 15235.

**MONEY MAKING** Clock Kits. 100% Profit. Movements, Dials. Catalog 25¢. Newport, Box 6848A, Burbank, Calif. 91505.

**OPEN** The Door To Mailorder Knowledge. Write, Naggo, Box 11478PMM, Chicago, Illinois 60611.

**\$100.00 EXTRA WEEKLY EASY! SPARE TIME! DETAILS, BEAUTIFUL SAMPLE FREE.** RUSSELL PRODUCTS, DEPT. P41, COLUMBIA, TENNESSEE 38401.

**ADDRESS** Envelopes. \$1.60 each one mailed. Enclose 25¢ and stamped envelope for details. Modern, Box 222PM, Upland, Calif. 91786.

**\$40 HUNDRED** stuffing Envelopes For U.S. Begin Immediately, Everything Supplied. Send \$1.00. Casper-E, Felt, Idaho 83424.

**MONEY** Available To Help You Operate In Mailorder. For Information, Samples Of Type Plans Acceptable, 100 Buyers Names And \$1 Trade Certificate, Send \$1.00 Postage And Handling. Cooper, 1605 Stetson Ave., Modesto, Calif. 95350.

**EXTRA** Income Mailing Circulars!! Rush Self-Addressed-Stamped Envelope, Variety, 7CPM, Wilste, Hillsdale, N.J. 07642.

**CASH** In on your Hobby. PHOTO report tells how, where. COLOR slide Markets. Send \$1.00 To: TOBEY'S, 419 University Blvd. East, Suite A2 648, Silver Spring, Md. 20901.

**HOW** To make money clipping newspaper items. \$2.00—\$10.00 each. . . Details free. Clippings, Box 5877—PM1A, Stanford, California 94305.

**SELL** Your Photos. Report Tells How, Where. Color Slide Markets. Only \$1.00. Humes Enterprises, Dept.-A2, 511½ W. 89th St., Los Angeles, California 90044.

**GET RICH FAST!!!** Easy, Proven Way—Spare Time! Secret "How" Report (B-5)—\$1.00. Centaur, 82 Aldine, Rochester, New York 14619.

**WATERBEDS** Discover the High Profits in Selling Waterbeds in Your Home or Office. Make \$1000.00 and More a Month in Your Spare Time. Send \$1.75 for Your Opportunity Brochure To: Profit Products, P.O. Box 22561, Sacramento, Calif.

**GROW GINSENG** For Profit. Write for Free Growing Information. Pulvermacher's Produce, Dept. C, Richland Center, Wis. 53581.

**MAKE** Statuettes, novelties, imitation marble. Sell to stores or start gift shop. Free details. Marbleizing, 41 Waverton, St. Louis, Mo. 63124.

**HOW** To Make Money Writing Short Paragraphs. Information Free on "Home Studies in Writing". Barrett, Dept. C-27-A, 6216 N. Clark, Chicago 60660.

(Continued on next page)

## MONEYMAKING OPPORTUNITIES

(Continued from preceding page)

**\$2.40 HOURLY** Making simple wood novelties. Free details! Gene's, 55 Boxwood, Falmouth, Mass. 02540.

**WORLD'S** Leading contest magazine, 25¢. Year, \$4.00. Prizewinner, 1315 Central, St. Petersburg, Fla. 33705.

**HOW TO GET RICH!!** Free "Money-making Brochure"! Success International, Box 2447-C, Livonia, Mich. 48151.

**VENDING** Machines. No selling. Routes earn amazing profits. Big catalogue Free. Parkway Corporation, 715PMM Ensor Street, Baltimore, Maryland 21202.

**FREE**—Easy Ways to make money selling exciting new products—Full—spare time. Send name, age, for 5 months free subscription. Salesman's Opportunity Magazine, 1460 Hancock Center, Dept. 17-HM, Chicago 60611.

**PENNY STOCKS** Have Profit Potential. Free Information. Analyst-P.M., Box 214, Redondo Beach, California 90277.

**200% PROFIT** Selling Rings. Triple Money in 30 Days or Money Back. Free Details, Anka, P.O. Box 8036-PM, Cranston, Rhode Island 02920.

**\$40 DAILY** Possible tying fishing flies at home. Details 25¢. Flyco, Box 481PM, Albany, Oregon 97321.

**EARN MONEY**, learn mailorder, spare-time, at home, reading leading (since 1929) trade magazine, product sources, stories, tips. Sample 50¢, year \$5. Mail Trade, Box 1302, Springfield, Illinois 62705.

**ADDRESSERS**—50 Companies want Addressers. Send self-addressed envelope. Cal Enterprises, Box 4516-X, Compton, Calif. 90224.

**SWEEPSTAKES** Contests. How to win. Write for free information. General Contests, 1609-18 East 5th., Duluth, Minnesota 55812.

**FREE SECRET BOOK** "2042 Unique, Proven Enterprises." Largest successful collection! fabulous "Little Knowns." Work home! Haylings-T18, Carlsbad, Calif. 92008.

**\$200.00 FROM** Sheet 1/4" plywood (scrap). Details 25¢. Novelties, 610 So. 24th, Elwood, Indiana 46036.

**LEARN** The secrets of repairing junk batteries. "Fabulous Profits" at home. Battery Shop, Box 820, La Quinta, California 92253.

**GET** World's Biggest Wholesale Import Catalog. Write: World, Medina, Washington 98039.

**START Small, HIGHLY PROFITABLE ELECTRONIC PRODUCTION IN YOUR BASEMENT.** Investment, knowledge unnecessary. Postcard brings facts. Barta-PML, Box 248, Walnut Creek, California 94597.

**MAILORDER** One man operation can earn \$5,000-\$10,000 yearly—No merchandise investment, company dropships, does all work. Free details. Sunnyside, 39-02-PM 47th Street, Long Island City, New York 11104.

**HOMEWORKERS EARN \$150.00 WEEKLY ADDRESSING OUR SALES LETTERS. DETAILS 25¢. CUR-JON MAILERS, BOX 523-PM, MAPLEWOOD, N.J. 07040.**

**BIG Money** In "Hot Dogs". Build A Street Vendor's Pushcart. Easy Plans \$3.00. Thomas, 100 Bellvue, Chicago 60611.

**FREE INFORMATION** \$50.00 \$100.00 per week selling gifts from Sales Kit. Sample item \$1.00. NEE-LON, Box 6497PM, Philadelphia, Pa. 19145.

**HOMEWORKERS.** Earn \$1.60 Each. Mailing Envelopes. Rush 10¢. Gemco, B-21244A, Indianapolis 46221.

**SELL Your Photos, Report Tells How, Where.** Color Slides, Markets Only \$1.00. Greenleaf Sales, Dept. A, 1102 30th St. North West, Winter Haven, Florida 33880.

**ADDRESSERS** And Mailers Needed! Free Details! Splendid Opportunity! Delta, Box 24-P, Chalmette, Louisiana 70043.

**PRACTICAL** Rabbit Raising 48 page book \$1.00. Vidikapa, Box 1543-PM, Tampa, Fla. 33601.

**SCIENTIFIC** Messages: Big Earnings uncrowded profession. Learn spare time at home. Diploma awarded. Free catalog. Write: Anderson School, Dept. C-1C, Princeton, Illinois 61356.

**MAKE MONEY** With your CAMERA Millions of Photos and Color Slides bought each year by Newspapers and Magazines. BOOKLET tells you what kind of photos they want—how to submit them—how much they pay. Laws and Regulations and where to Sell. Only \$1.00. Pacific Enterprise, 4694 Berwick Dr., PM52, San Diego, Cal. 92117.

**EARN** \$50-\$100 Weekly Home Typing. Details Free. Pat Richardson, Box 4097, Yuma, Arizona 85364.

**\$15 HOURLY!** Learn Methods and Shortcuts of Repairing Fiberglass on Cars and Boats. Only \$3—Guaranteed! Order today! Penwal Products, 1865C Lilac Lane, Dept. 1P8, Aurora, Ill. 60506.

**SKETCH** Photos (Homeworker's Goldmine!) Steady Market Details. Gem, 365-D Longhill, Shelton, Conn. 06484.

**\$250.00 PER** Thousand stuffing envelopes! Unconditional Money-Back guarantee! Complete Starters Kit \$1.00. HOMEWORKERS, Box 24413-MH, Oakland, Cal. 94623.

**NEWSLETTER** \$10,000 Guarantee, Or Pay Nothing. Robinson Enterprises, Box 38, Augusta, Georgia 30901.

**AMAZING** "Streamlined Home-Study Mail Order Course". \$2.50. Cazin, 526 Maple, Redwood City, California 94063.

**\$125.00 WEEKLY** Home Addressing Clipping News Items From Your Newspaper. Information Send \$1.00, Stamped Self-Addressed Envelope. Southwest Sales, Box 1257, Las Vegas, Nevada 89101.

**NEVER WON ANYTHING?** Anyone Can Win Sweepstakes Contests! Free Details. Services, Box 644-PCH, Des Moines, Iowa 50303.

**CAMERA** Owners, Make Your Hobby Pay. Sell Your Pictures! Booklet Tells You How And Where. \$1.00. Cardinal Sales, 2108 South Glen, South Bend, Ind. 46613.

**DEMONSTRATORS** Needed. Car Electricity Adapter Provides 110V, 2500W Electricity From Car Alternator. Sells Itself. RLH Enterprises, Box 8908, Shreveport, Louisiana 71108.

**SPARE** Time Cash. Sell Famous Hanover Shoes. Actual Samples and sales kit Free. No experience needed. No age limit. Lowest prices for highest quality makes selling easy. Every man a prospect. Big daily commissions. For full details, write: Hanover Shoes, 1040 Carlisle, Hanover, Pa. 17331.

**WANT** To get rich buying penny mining stocks? Send \$2.95 for copy "Secrets of Stock Promoters." A.N.A. Distributors, 301-2515 Burrard, Vancouver 9, B.C., Canada

**\$10,000 ANNUALLY** Growing Plants in Your own Backyard. Establish a Second or Full Time Income. Details, Nagaho, Box 493H, Miller Place, N.Y. 11764

**MAILORDER IMPORTS,** Report Reveals Foreign Drop-Ship Sources. World Trader's Digest. Ideal Mailorder Items. \$1.00 MERRICK ENTERPRISES, 1006 Bancroft, Dept. DM8, Coeur D'Alene, Idaho 83814. Booklet #MO-521.

**\$100.00 WEEKLY** possible home addressing! \$125.00 Weekly possible clipping items From Your Newspaper. Information: Send \$1.00 and Stamped Self Addressed Envelope. Box 412, Vails Gate, New York 12584.

**DO SIMPLE** Addressing And Mailing. \$8.00 Profit! Details 25¢ with stamped, self-addressed envelope. Johnson Home Workers, JA-1, POB 141, Seale, Alabama 36875.

**MAILORDER,** Home Business Ideas. Details Free! ABC Enterprises, Box 1824, Columbus, Georgia 31902.

**HOW-TO-DO-IT BOOKS** FOR EVERY PURPOSE. FULLY ILLUSTRATED. EDITED BY EXPERTS IN THIS FIELD OVER 30 YRS. AUTHENTIC GUIDES TO PROFITABLE CAREERS. FREE DETAILS. ELM MARKETING SERVICE, BOX N, CENTRALIA, ILL. 62801.

**YOU WILL INVENT** A Money-Making Product Within 4 Weeks—Or You Don't Pay A Cent! KMP, Box 3727-P, Anaheim, California 92803.

**CREATE YOUR OWN PROFITABLE BUSINESS FROM SCRATCH:** Free details. Orben PB-8, 33 Parkview Avenue, White Plains, N.Y. 10604.

"SHELLCRAFT For Fun and Profit" \$1.00. "Typewriter Profits" \$2.00. LORENE'S, Dept. PM, 632—75th, Everett, Washington 98203.

## PROFITABLE OCCUPATIONS

**FT. SMITH** Auction School, Ft. Smith, Ark. 72901. Resident & Home study. Veteran approved.

**BECOME** A Mortgage Broker. Highly respected, interesting, lucrative prestige business. For complete information write: United, Box 6284-F, Marietta, Georgia 30060.

**LEARN GUN REPAIR GUNSMITHING** In spare time. Book, details 10¢. Modern Gun Repair School, Dept. 2208, 4225 N. Brown, Scottsdale, Arizona 85251.

**PLASTERCRAFT!!!** Profitable home business. Molds available. Details: Lynnette, 6251C Mentor Park, Mentor, Ohio 44060.

**MAKE MONEY IN SPARE TIME.** Earn generous commissions as a subscription sales representative for leading magazines. For full details and instructions, send this ad with your name and address to: POPULAR MECHANICS, Room 1107M, 250 W. 55th St., New York, N.Y. 10019

**SHARPEN**—Scissors, Pinkers, Light, compact equipment. Supplies. Blackhawk's, Sheldahl, Iowa 50243.

## SALESMEN-DISTRIBUTORS

**SELL** Blue Ribbon Hertel Bible . . . startling cover with Nativity in full color 3-dimension. Top commission, liberal bonus. Sells itself! Every order pays top profit. Liberal easy credit plan. No investment. Demonstrator furnished. Write for everything! International Book, Dept. PM, Box 118, Wichita, Kansas 67201.

**HOUSEHOLD PRODUCTS ROUTE. EARN \$25** or more daily. Also Party Plan opportunities for men, women full, part time. McNess, Freeport (2683) Illinois 61032.

**\$100.00 EXTRA** A week easy! Spare time! Double Air Cushion shoes. Men's, women's line. Dress, work, play. Highest commissions. Shoes for yourself. Outfit Free. Bronson, Dept. H-83, Minneapolis, Minnesota 55408.

**PUBLICATIONS** for local wholesale distribution, higher profits. Details, sample, \$1 refundable. Publisher, 404 West Jefferson, Springfield, Illinois 62702.

**NEW,** Compact fire extinguisher. Fantastic profits. Exclusive territories. Norwich Chemical, Norwich, Connecticut 06397.

(Continued on next page)

## SALESMEN-DEVELOPERS

(Continued from preceding page)

**AUTOMATIC** Fishhooks. Free details. Samples, \$2.00. Aron, 61PM, Mastic Beach, New York 11951.

**EARN** Big money calling on business-professional men. Send us their delinquent accounts for collection. General Finance, Dept. PM-11, Columbia Bank Bldg., Kansas City, Missouri 64106.

**PORTRAIT** Dealership. Details/Samples \$1.00. Goodrich, Box 654, Poughkeepsie, N.Y. 12602

**SELL** Advertising Ball Pens, Calendars, Ad-Specialties—Build Own Repeat Business—Free Details—Fleming, Dept. A, 6535 Cottage Grove, Chicago 60637.

### AGENTS WANTED

**WANT** To Make Up To \$100 A Week spare time, and earn shoes for yourself for life, too? No investment. Rush card for free details. Mason Shoes, K-952, Chippewa Falls, Wisconsin 54729.

**MAKE** Big Money. Contact Dealers. Thousand Different Imports Dropshipped From Our Warehouse. Write: Kupcek Specialty, Box 56, Lemont, Illinois 60439.

**ESTABLISH** Your own business. Low prices on used clothing, shoes, household goods. Unlimited profits. Free catalog. Northwestern Distributors, 2129-31 North Western Avenue, Chicago, Illinois 60647.

**PRINTING**, Advertising Salesmen—Excellent moneymaking sideline selling Decalcomania Name Plates, small quantities. Advertising Specialties, sign letters. Free Samples. Raico XL, Boston, Mass. 02119.

**EVERY** Man a prospect. Refundable sales kit offer showing line belt buckles, tie clasps, money clips, cuff links, lapels, identification badges, individualized with customer's name and emblems. Cap badges for trucking, bus, taxi, police, firemen, also postal letter carriers and heavy construction emblems. Choice 4000 emblems. Hook-Fast, Box 1088-PM, Providence, R.I., 02901.

**YOUR** Own business. Used Suits \$1.50; Overcoats 65¢; Mackinaws 35¢; Shoes 12½¢; Ladies' Coats 30¢; Dresses 15¢. Enormous profits. Catalog Free. Nathan Portnoy Associates, 2109-AA Roosevelt Road, Chicago, Illinois 60608.

**\$75** DAILY showing car owners how to end Waxing-Polishing Forever. Samples details Free. International, 34 E. 12th Street, New York, N.Y. 10003, Dept. PMD-3.

**SELL** Home Study Career Courses Wholesale. Bakers, 313 Harrison, Sullivan, Illinois 61951.

**CHRISTMAS** Cards, Families, individuals and business firms. Customer's name imprinted. Beat inflation—earn unusually high commissions from this medium—and high-priced line. No investment. No inventory. Free Sample Album. Process Corp. (our 52nd year). Dept. Y-331, 3450 S. 54th Ave., Chicago, Illinois 60650

### EMPLOYMENT INFORMATION

**POTENTIAL EMPLOYER LIST** For list containing names and addresses of potential employers. Send \$2.00 to: Box 58913, Dept. E, Houston, Texas 77058.

**AUSTRALIA** Most Comprehensive Information, From Americans Now Living In Australia, \$2.00 For Brochure, Ausco Inquiry, Box 29, Burra 5417, South, Australia.

**AUSTRALIA!! AUSTRALIA!! FREE DETAILS!!** Paid Transportation. Latest Information on Jobs. Send age, occupation. Write: Associated, Box 17-B-141, Lafayette, California, 94549.

**OVERSEAS** And U.S. Jobs. \$1.00 Brings Listing of 145 Firms with Worldwide Employment. Gibbons, 164 Auriga, Lompoc, California 93436.

**ATLANTA** Georgia Job Opportunities. \$2.00. Galaxy, Box 1062, Marietta, Georgia 30061.

**OVERSEAS JOBS**—Now Hiring, 103 Countries, All Occupations, High Pay, Free Transportation, Tax Benefits. Latest Computerized Reports—\$2.00. **TRANSWORLD**, International Airport, Box 90802-E, Los Angeles, California 90009.

**AUSTRALIA—NEW ZEALAND WANT YOU!!!** 50,000 Jobs! Paid Transportation! Latest Information and Forms, \$1.00. Austco, Box 3623-E, Long Beach, California 90803.

### HELP WANTED

**OVERSEAS** Jobs—Europe, South America, Australia, Far East, etc. 2000 openings all trades. Construction, Office, Engineering Sales, etc. \$700 to \$3,000 month. Expenses paid. Free Information. Write: Overseas Jobs, International Airport, Box 536-M, Miami, Florida 33148.

**OVERSEAS EMPLOYMENT** . . . Australia, Europe, South America, Asia! All Occupations! \$700-\$3,000 monthly! Write: Employment International, Box 29217-AH, Indianapolis, Indiana 46229.

**FREE DETAILS! . . . AUSTRALIA . . .** Paid Transportation!! Jobs Galore!! Send age, occupation Write: Associated, Box 17-BA-141, Lafayette, California 94549.

**WORLD-WIDE . . . U.S.A. JOBS GALORE!!!** All occupations. Enjoy: Asia, Europe, Africa, South America, Florida, California, \$700.00 to \$3,500.00 monthly. Paid Overtime. Travel Allowance. Free Details! Send age, occupation. Write: Global Employment, Box 706-B-141, 2 Orinda, California 94563.

### REAL ESTATE AND FARMS

**NEW! FREE CATALOG!** Giant Fall-Holidays edition of country property! Over 5,200 New properties described, pictured—Land, Farms, Homes, Businesses—Recreation, Retirement. Selected Best thruout the U.S.! 73 Years' service—670 Offices, 41 states Coast to Coast. Mailed FREE from the World's Largest! **STROUT REALTY, Inc.**, 60-MX E. 42nd St, NY, NY 10017; 7-MX Dearborn, Chicago, Ill. 60603; 150-MX N. Santa Anita, Arcadia, Ca. 91006.

**CANADIAN LAND FROM \$19.00 AN ACRE CHOICE.** Properties available across Canada. Low monthly payments. Ideal for farming, cottages, hunting, fishing. Free Catalogue. Canadian Estate Land. Dept. PMC 8, 286 Lawrence Ave. West, Toronto 20, Ont., Canada.

**CENTRAL** Ontario—Choice 640 acre Sportsmen's paradises still available—\$20.00 plus \$6.50 taxes yearly. Maps, pictures. \$2.00 (Refundable). Information Bureau, Norval 4, Ontario, Canada.

**FREE** Catalog! **PHOTOS!** Coast to coast farms, business, retirement. All types, sizes & prices. **SAFE-BUY** Real Estate, Box 589-PM, Little Rock, Ark. 72203.

**IDEAL 5-ACRE RANCH.** Lake Conchas, New Mexico. \$3,475. No Down. No Interest. \$29/mo. Vacation Paradise. Money Maker. Free Brochure. Ranchos, Box 2003PS, Alameda, California 94501.

**\$1 ACRE**—Canadian border—hundreds campsites, islands, farmlands, directly from tax authorities. (Non-profit). Lists, photographs mailed. Register, Room 10, 110 Church Street, Toronto 1, Canada.

**BOILING** Spring Lakes—America's Greatest Real Estate Value. 1/3 acre vacation or retirement homesites only \$900 cash price. Ten-year terms available. Money-back inspection guarantee. Carolina coast, multi-million dollar, 14,000 Acre development. 50 fresh water lakes, private ocean beach, golf course, motel, and country club. Free literature, Dept. 1-L, Boiling Spring Lakes, North Carolina 28461. (Registered under Federal Land Sales act but not offered to residents of states requiring separate registration.)

**\$1.00 ACRE!** USA and Canada. Lists, photographs mailed. Government Lands, 220 Delaware Ave., Buffalo, New York 14202.

**CANADIAN** Vacation lands: Full price \$385.00. 40 acres. \$10 month. Suitable cottage sites, hunting, fishing, investment. Free information. Land Corporation, 3768-C Bathurst, Downsview, Ontario, Canada.

**MICHIGAN 10 TO 160 ACRE TRACTS** Lake Superior-Marquette Area from \$99.00 Acre Cabins, Trailers, camping welcome. (Acreage anywhere in Michigan). **FREE PICTURES.** Any terms **A-OK** with **BLOCH BROTHERS.** Write: 3650 Dixie, Drayton Plains 16, Michigan 48020.

**AVOID** Costliest Mistake of lifetime. Expert reveals "How to Avoid the Ten Biggest Home-Buying Traps," now paperback. Money-back Guarantee. Send \$2.95 plus 35¢ handling. All About Houses, PM, Piermont, N.Y. 10968.

**GOVERNMENT LANDS FROM \$7.50 ACRE!** Vacationing, Farming, Investment! Exclusive "GOVERNMENT LAND BUYER'S GUIDE" . . . plus "LAND OPPORTUNITY REVIEW" listing lands throughout U. S. Send \$1.00. Surplus Lands, Box 6588-AH, Washington, D C. 20009

**SURPLUS** Forest, Mountain, Desert, Waterfront Land. Neglected Estates, Farms, Groves, Cabins. Throughout United States, Canada, Mexico. Low prices. Easy terms. Free list. Box 6272, Dept 46, Santa Ana, California 92706.

**FREE . . . Big 256-page Catalog.** Hundreds of top real estate values coast to coast! **UNITED FARM AGENCY**, 612-PM West 47th St., Kansas City, Mo. 64112.

**CANADIAN** Land. Full Price \$285.00. \$10.00 Down, \$10.00 Month Ideal Vacation, Hunting, Fishing. Free Information. Vacation Acres, 7771-A, Bernard, LaSalle 660, Canada.

 **FLOWERS, PLANTS & NURSERY SUPPLIES**

**LEARN** Landscaping and the growing of plants. Start a profitable business part or full time. Free information without obligation. Lifetime Career Schools, Dept. A-365, 2251 Barry Avenue, Los Angeles, California 90064.

**THE** Most beautiful tropical palm. Fast growing, easy care for, grown inside or out. Send for your seeds today. \$1.00. Palm City, Box 787, San Juan, Texas 78589.

**LEARN** Flower Arranging Start business or Hobby. Free information on home study course. Lifetime Career Schools, Dept. B770, 2251 Barry Avenue, Los Angeles, California 90064.

### BUILDING AID BOOKS

**HANDYMEN**, Builders. Measure levels and grade differences on 150' building site, garden, patio, septic system in minutes with 1/16" accuracy. Build this simple, accurate level in one evening for under \$4.00. Replaces expensive optic level on average job, yet only one person required. Detailed plans, instructions sent airmail, duty-free for only \$1.00. Rodlen Builders, Haliburton, Ontario, Canada.

### CONSTRUCTION PLANS, BLUEPRINTS

**SICK** Of Conventional, Dull Houses? Build "Mod", Individualistic Home. Really Different. Details \$2.00. Box 500, Space 16, Coeur d'Alene, Idaho 83814.

(Continued on next page)

## CONSTRUCTION PLANS, BLUEPRINTS

(Continued from preceding page)

**HOUSE EXPANSION PLANS** And detail instruction book provide anything from an extra room to 1000 s/f addition. Build what you need at big do-it-yourself saving. Book with 1 set working blueprints \$14.50! With 4 sets (required by contractors) \$20.00. Money-Saver Projects, Box 303-44B, Chappaqua, New York 10514. Information available.

**SAVE THOUSANDS OF DOLLARS!** If you plan to buy or build within the next 5 years, you need the 40 years' experience of **BOB REX HUNT** who has three times in the last four years designed and built the best low cost home in the United States. Send \$1.00 and long self-addressed, stamped envelope for information brochure of plans and moneysaving procedures. Includes Popular Mechanics' \$7500 house (1969) issue; Mom & Dad's \$7000 house (saves \$800 a month in nursing home fees); beauty, space and luxury home for 40% of market value; 4 unit apartment will add \$500 a month to your income after 10 years; a home for wheelchair patients; vacation house, etc. Bob Rex Hunt, R. R. 1, Cicero, Indiana 46034.

**LOG RACKS**—Build attractive unit. End yard mess. Plans, two styles. Simple wood construction. \$2.00. VR2 Designs, 1349 Farragut, Kingsport, Tenn. 37664.

## LQ CABINS & HOMES

**BUILD** Log Cabins, rustic furniture, fireplaces!!! Complete manual, \$3.00. "A" Frame plans, \$2.00 . . . **Guaranteed.** . . . Beels, 956 Springdale, Atlanta, Georgia 30306.

**"A" FRAME CABIN.** \$500. Material. Purchase locally. Completely illustrated instruction manual & material list: \$2.00. Moneyback Guarantee. Order plan #1922, from: "Dependable Products", Box 113, Vista, California 92083.

## HOME CRAFTSMEN

**SKIL-CRAFTS** Current 200 plus page catalog with world's largest finest selection of Hobbycraft, leathercraft, artist supplies. Send \$1.00 for postage and handling; refunded on first \$5.00 minimum catalog order. Skil-Crafts, Box 105-P, Joplin, Mo. 64801.

**101 PATTERNS** Of smart Gifts, Novelties, Shelves, Action Windmills, plus "Make Money Jig Sawing." \$2.00. Mastercraft, 85M, 7041 Olcott, Chicago 60631.

**CABINETMAKING MADE EASY** And "How to Make Formica Counter Tops." Two excellent guides let you build kitchen cabinets and counter tops like professionals. Extraordinary guides bring master craftsmen's shortcut methods. Satisfaction guaranteed. Write: Japs, 126-P Seventh North, Hopkins, Minn. 55343.

**1400 CATALOGS** Listed and Described! Sources for EVERYTHING Imaginable! Rush \$2.00. **MASTERLOG**, Box 24413-(WH), Oakland, California 94623.

**POPULAR MECHANICS MASTER SHOP GUIDE.** Greatest product offered to a man with a workshop. All information printed on heavy boards, punched and ready to hang above his workbench. Covers wall fasteners, nails, screws, bolts, twist drills, abrasives, lumber, moulding patterns, plywood grades, hardboard, dry-wall plumbing supplies, electrical supplies. Plus information on score of other subjects. Send \$3.95 to: **POPULAR MECHANICS**, Dept. HE, 224 West 57th Street, New York, New York 10019.

**CATALOG FULL SIZE FURNITURE PLANS** —\$1.00 Refunded with first order. Traditional, Early American, over 150! Furniture Designs, 1425 Sherman, Dept. CP-83, Evanston, Illinois 60201.

206 POPULAR MECHANICS

**ORNAMENTAL IRON WORK.** Beautiful scrolls with inexpensive professional bender. Modular segments. Details Free. Fuschin, Box 472, Woodland, California 95695.

**WORKBENCH** And tool panel anyone can build. Complete with material list. \$1.00. Way-Mar, 58 Underhill Road, Scarsdale, New York 10583.

**WOODWORKING** Catalog and Manual 50¢. Plus free "101 Project Ideas." World's most beautiful veneers, lumber, plywood! Wood finishing, upholstery supplies, Cane, Lamp Parts, Furniture hardware, Animal whittling blocks, 2,000 workshop products. Constantine, 2051-C Eastchester Road, Bronx 10461.

**BANDSAWS,** Bench saws, sander, lathe-drillpress, shaper, from **BUILD IT YOURSELF KITS.** Plans \$2.00 each or catalog 25¢. Gilliom Mfg., St. Charles, Missouri, 63301.

**BOOKLETS** Making Items from Coat-hangers; 50¢; Profitable Lamp Making 35¢; Handcraft Ideas 35¢; All 3 Above \$1.00. Tomkos, 26½ E. Broad, W. Hazleton, Pa. 18201.

**PICTURE Framing**—Profitable full or spare-time business. Easy to learn with handbook-course "Guide To Picture Framing Profits." \$1.50 Guaranteed. Free framing-supplies catalog included. Japs, 126-PM Seventh North, Hopkins, Minnesota 55343.

**BIRD HOUSES** For Fun and Profits. 20 Projects And Plans. \$1.00. Infocore-P8, Box 34260, Washington, D.C. 20034

**20 PLANS**—Full size—Early American Novel Items for Fun or Profit. Send \$2.50. Cerbone — Box 18099 — Philadelphia, Penna. 19147.

## DO-IT-YOURSELF

**ROLL-TOP** Trestle desk. Assemble yourself. Kit includes Hardware. \$49.95 PPD. Details! Andy's Woodshed, Dept. PM, 630 North Grant, Stockton, Cal. 95202.

**FREE!** List of Low Cost Popular Books. Money Making Opportunities, Personality, Success, Astrology, Tell Fortunes, Dreams, Confidence. Send For Free List! Amistad Harvest Of Gifts, 214 A Santa Maria, Del Rio, Texas 78840.

**100 YEARS** Of Natural Aging Created With Application Of Wood Age. Not A Stain But Clear Liquid. Gives Depth, Color And Beauty Of Wood Grown Old From Years Of Aging. Use On All Woods. Only \$2.98. Mountain Valley Products-IPM8, 19510 Zetak Lane, Crosby, Texas 77532.

**STEAM** Engines, Flash And Watertube Boilers, Burners, Steam Lawnmower, Pictures, Descriptions, Drawings 2 Dollars. We can supply Castings To Make The Old Popcornpopper Steam Engine. Travis Tool Co., Sidney, Iowa 51652.

**BOOK Thumb Indexing Tool**—Fast, Professional, Guaranteed!! \$19.95. Golden West, Box 7864, Long Beach, Cal. 90807.

**AIR CONDITIONING.** Increase Cooling Of Your System By 20% At No Cost. No Special Tools Needed. Fully Explained. \$2.00. AC, Box 1237, Garland, Texas, 75040.

**BURGLAR-FIRE** Alarm Supplies and Information. Free Catalog. Protecto Alarm Sales, Box 357A, Birch Run, Michigan 48415.

**CONVERT MOWER** Engines into air compressors. Write: Showalter, Box 409, Abilene, Kansas 67410.

**REPAIR MINIBIKES, LAWNMOWERS, BICYCLES,** Sewing Machines, Auto Engines, Mazda/Wankel, Motorcycles, Magic boats. Over 100 How-To-Books. Free Brochure. Mastercharge accepted. Sincere, Box 10422, Phoenix, Arizona, 85064.

**CAPTURE** Small Animals Alive. Free Details. Blakeco, 3955 Raymond, Ogden-84403

**UTILITY BARN** 8'x12'! Detailed plans with material list. \$2.50—Guaranteed! JaBar, Dept. 3CB, 1448 West Strasburg, West Chester, Penna. 19380.

**FORCED** Air Furnace Vibrating Your Home? Detailed Ductwork Vibration Suppressor Instructions and Supply List. \$2.00. BBC Products, Box 284, Lemont, Ill. 60439

**SAVE** Money. Make Your Own Soldering Gun Inexpensively. \$3.00. Washburn, Box 347, Holley, New York, 14470.

**CONVERT** TV to 6-ft. wide screen! B & W/Color. Do-It-Yourself—easy! Kit, instructions, lens, \$12.95 ppd. Free illustrated details. Macrocoma PM-8, Washington Crossing, Penna. 18977.

**BUILD** Unique Fish Smokehouse From Simple Household Appliances. Plans \$1.00. Monarch, 98 Wilkes, Brantford, Ontario, Canada. N3T 4W1.

**BEAT INFLATION!** Make Artificial Facebricks—Under 10¢ Sq. Foot. Any Color, Style. Details: Wagner, 1349 Ayrault Road, (A9B), Fairport, N.Y. 14450.

**USED** Book Bargains, radio, TV, watch-making, autos, etc. Free list. Truth Seeker, Box 2832, San Diego, Cal. 92112.

**BUILD YOUR OWN BASEBALL PITCHING MACHINE.** Little League through High School. Approximate cost to build is \$10. (Less with your scrap lumber and hardware materials). To receive plans to build, mail \$2. your name and address, To: Baseball Pitching Machine A., P.O. Box 591, Mansfield, Ohio 44901.

## ARTS AND CRAFTS

**"GETTING** Started in Stained Glass" 25¢. Whittemore, Box 2065Y, Hanover, Mass. 02339.

**FREE LITERATURE** For sculptors showing how to make molds, cast plastics. Adhesive Products Corporation, 1660 Boone Avenue, Bronx, N.Y. 10460.

**FREE:** New handicraft catalog. Supreme Handicrafts, Box 395-PM, Sioux Falls, South Dakota 57101.

**LEARN** Arts & Crafts at home. Excellent full or part time business opportunities, or hobby. Free booklets. Lifetime Career Schools, Dept. E-804, 2251 Barry Avenue, Los Angeles, California 90064.

**MAKE** Figurines, plaques, lawn ornaments. Molds, plastercraft kits, liquid rubber. Sample and catalogue 10¢. Wooley Company, Box 29-B, Peoria, Illinois 61601.

**A TRULY REWARDING HOBBY** For Fun, Gifts. **PROFITS!** Mold useful, decorative items with Casting Plastic, Candlewax, Plaster or Dough. Choose from the largest selection of molds and related supplies available anywhere. Send \$1.00 (refundable) today for your 120—page catalog. Specialty Products, Dept. B-2, 731 Brooks Road, Muskegon, Michigan 49442.

## BINOCULARS, TELESCOPES, MICROSCOPES, MAGNIFIERS

**FREE** Binocular, Rifle scope catalog. Discount sale. Save 50%. Free gift with order. Write, United Binoculars, BN-7008, 9043 So. Western, Chicago 60620.

**TELESCOPE** (Reflectors) Complete Kits. Other accessories, request free literature. Criterion Manufacturing, Dept PM 43, Hartford, Connecticut 06101.

**300 POWER ACHROMATIC TELESCOPE** Build From \$38 Optics Kit. Free Brochure. Astrocraft, Box 447, White Rock, South Carolina 29177.

(Continued on next page)



## CAMERAS AND EQUIPMENT

**FREE! FREE! BARGAIN BOOK** Central Camera Co., Dept. 381, 230 S. Wabash, Chicago, Ill. 60604.

**USED** Photographic Equip. Nationwide Monthly "Shopper" Free Sample. Shutterbug Ads, Box 730-P, Titusville, Fla. 32780.

**POPULAR** Cameras—Accessories! Best Prices! Mandarin, 214 Shaws Building, Hong Kong.

**PHOTOGRAPHY** for pleasure or profit. Learn at home. Practical basic training. Long established school. Free booklet. American School of Photography, 555 E. Lange, Dept. 820-03, Mundelein, Illinois 60060. A home study school.

**OIL** Coloring Photographs—A fascinating hobby or profitable sideline for those with artistic talent. Learn at home. Easy simplified method. Free booklet. National Photo Coloring School, 555 E. Lange, Dept. 820-00, Mundelein, Illinois 60060. A home study school.

## PHOTO FINISHING

**CAMERA FANS!** Expert photofinishing by one of Country's largest labs at lowest prices. Fast service and free "Foto-Fan" Stamps you quickly redeem for valuable Photo Supplies. 8MM Kodachrome \$1.29; 8 Exp. Kodacolor \$1.79; 35MM Kodachrome 20 Slides \$1.39; 8 Exp. Black White 69¢. Satisfaction guaranteed. Send exposed film or request free mailers, complete Price List and Gift Catalog. Direct Mail Photo, Box 8352-PM, Pittsburgh, Pa. 15218.

## COLOR SLIDES

**35MM COLOR** Slides. 10,671 Individually sold. Described. Encyclopedia catalog 10¢. Wolfe Worldwide, Dept. 14-83, Los Angeles, Calif. 90025.

## MOTION PICTURES AND SOUND EQUIPMENT

**16MM** Famous Classics. Illustrated catalog 25¢. Manbeck Pictures, 3621-PM Wakonda Drive, Des Moines, Iowa 50321.

**CLASSIC 8MM. MOVIES . . . 35MM.** 2"x2" Color Slides. . . largest selection anywhere! Silent classics, comedy, history, sport, news, documentaries, features, others! 16MM films also Free catalog. Blackhawk Films, 690 Eastin-Phelan Bldg., Davenport, Iowa 52808.

**UNUSUAL** Movie supplies. Free circular. Esor, 47th Holly, Kansas City, Missouri 64112.

**FREE!** 64-Page catalog. 8-16MM film supplies, processing equipment. Superior, 448 N. Wells, Chicago 60610.

**8MM—SUPER 8—16MM MOVIES!** Biggest Selection! Lowest Prices! Free Catalog! Cinema Eight, Box PM, Chester Connecticut 06412.

**FREE** Catalog—8mm-16mm—Top Manufacturers—G & G Film Library, Box 321, Syosset, New York 11791.

**16MM, 8MM** Sound and Silent Classic Films. Free Catalog. Niles, 1019-PM So. Michigan, South Bend, Indiana 46618.

## RADIO, TELEVISION AND HAM EQUIPMENT

**FREE** Bargain List, Electronic Parts. SAC, Box 276, South Glastonbury, Conn. 06073.

**SAVE** Money on parts and Transmitting—receiving tubes, Foreign—domestic. Send 25¢ for giant catalog. Refunded first order. United Radio Company, 56-PM Ferry Street, Newark, N.J. 07105.

**36¢ RADIO & TV** Tubes. Free catalog. Cornell, 4213-17 University, San Diego, California 92105.

**GOVERNMENT** Surplus receivers, transmitters, snooperscopes, parts. Catalog. 25¢. Meshna, Nahant, Mass. 01908.

**GIANT** Canadian Electronics Surplus Catalog. \$1.00. Etco PM, Box 741, Montreal.

**RADIO & TELEVISION TRAINING.** Fix Radios & TV's first week—New Dynamic method. Write: Radio Television Training, Box 279, P-83, Syracuse, New York 13206.

## HIFI TAPES, RECORDS AND ELECTRONICS

**TAPES, 8-Track, Low As \$1.10 Each.** Free Catalog-800 Top Titles. Send Postcard. GemTone Industries, Box 57220, Dept. PM, Los Angeles, Calif. 90057.

**FREE** Catalogues, 2000 hard to find unusual records. Rose's Records, Box 7216, Louisville, Ky. 40207.

**OLDIES** 45 RPM Original Hits—Catalog 50¢. C&S Record Sales, Box 197, Wampsville, New York 13161.

**SUSPENSE—Fiber—Benny; Others.** Cassette \$4.00/Hour. Free Catalog. R—Garofalo, 8162 W. Balmoral, Chicago, Illinois 60656.

**FREE** Catalog—Electronic Kits—Amplifiers—Preamplifiers—Psychedelic Strobes—SCA Adaptors—Color Organs—Digital Instruments—Guitar Amplifiers. **FREE** Subscriptions, SWTPC, Box PM32040, San Antonio, Texas 78284.

**8-Track Tapes • Catalog free.** C. Bolton, 1114 9th Ave., So. Sioux City, Nebraska. 68776.

**SCOTCH** Recording Tapes. Biggest Discounts! Catalog 10¢. Tower, Lafayette Hill, Pa. 19444.

**FREE CATALOG—Tremendous** Electronics Bargains. Compukits, Box 4188E, Mountain View, California, 94040.

**OLD** Radio Programs. All Your Favorites. Lowest Prices, Prompt Service. Catalogue 25¢. Nostalgic Radio, Box 29, Peoria, Ill. 61601.



## MUSIC AND MUSICAL INSTRUMENTS

**MONEY** In Music. Free information. Crawford's, Box 958-BMH, San Rafael, Calif. 94902.

**FREE CATALOG—30% DISCOUNT.** Best Names In Musical Instruments. Dial For Music, 7 Crescent Drive, Spring Valley, N.Y. 10977.

**LEARN** To read music in one evening. Free brochure, Jordan, 27495 Road 176, Dept. PM-8, Exeter, Calif. 93221.

**EASY** To Play And Make. Quality Dulcimers, Banjos, Thumb Pianos; Instruments And Kits. Can Be Profitable Hobby. **HERE, Inc., #P. 410 Cedar Avenue, Minneapolis, Minn. 55404.**

**ELECTRIFY** Player Pianos, Pump Organs Quickly, Inexpensively with Lee Silent Suction Units. Write: Lee Music, 525F Venezia Avenue, Venice, California 90291.

**30% TO 50% DISCOUNT!** Any Model: Guitar, Amp, Drum, Banjo, Dobro! Free Catalog! Warehouse P36, Box 16399, Fort Worth, Texas 76133.

**PLAYER** Piano Rebuilding—get details from: Vestal Press, Vestal 11, N.Y. 13850.

**POEMS** Wanted for songs. Nashville Music Productions, Box 40001-P, Nashville, Tennessee 37204.

**VIOLIN** And Guitar makers—send for latest Free Catalogue of woods & accessories. International Violin, PM1, 414 East Baltimore St., Baltimore, Md. 21202.

**WHOLESALE!** Professional Guitars, PA Systems, Aitec Speakers, 240W RMS Amplifiers. Free Catalog. Carvin, Escondido, Calif. 92027.

**WHOLESALE.** Musical Instruments—Accessories. Allied, 573 Route 17, Paramus, New Jersey 07652.

**RECONDITIONED** Accordions for sale—Save \$\$\$, Top Brands. Write for free descriptive folder. A-1 Rebuildt Accordions, 31 E. 18th St., N.Y.C. 10003.

**ACCORDION** Top brands. Buy direct. Tremendous discounts. Trades accepted. Free brochure PM. Accordion-O-Rama, 874 Broadway, N.Y.C. 10003.

**GUITAR, Banjo, Violin, Mandolin Making** Materials, Accessories, Books. Catalog 25¢. Guitar Center, Box 15444, Tulsa, Oklahoma 74115.

**NEW GUITAR MAKING BOOK & NEW TOOLS.** Overholtzer, 618 Orient, Chico, Cal. 95926.

**LEARN** Banjo. 5-String Bluegrass. No music. Makes learning easy. Free details. Blaylock, Box 25-M, Marietta, Georgia 30060.

**ACCORDION** Manufacturing 6846-P North Avenue, Chicago, Illinois, 60635. Concertinas, Chromatics, Heligons, Hohners, Guitars, Drums. New. Used. Tuning, Repairing. Wholesale Catalogs Free.

**ACCORDIONS** And Amplifiers! New—Used. Cordovox, Excelsior—Top Makes! Save to 50%. Direct factory dealer. Terms. Trades accepted. 5 day home trial. Free catalog—Discount prices. Write: Accordions Unlimited, Dept. R, 3147 North Luna, Chicago 60641.

**POEMS,** Songs wanted. Recording. Publishing guaranteed. Royalties. Radio-TV release. Broadway Music, Box 11647-PM, Sarasota, Fla. 33578.

**PLAY** Chord Piano in 10 days. Convincing details! **FANFARE,** Box 17C, RR1, Covington, Indiana 47932.

**BIG DISCOUNTS** Wholesale. Musical Instruments. Accessories. Free Catalog. Nationals Music. POB 27206, Tucson, Arizona 85726

**KITS!** Build dulcimers, guitars, balalaikas, thumb pianos, harps. From \$2.95. Finished dulcimers from \$19.95. 8665 West 13th Avenue, Denver, Colorado 80215.

**30% DISCOUNT** Name Brand Musical Instruments. Free Catalog. Freeport Music, 455F Route 110, Melville, N.Y. 11746.

## EDUCATION AND INSTRUCTION

**WELDING TRAINING** Basic and advanced training for major welding processes—Arc, Gas, Pipe, TIG, MIG, Plasma. Hobart, a non-profit school, is accredited by NATTS. Approved Ohio 70-12-0064 HT. Write for school bulletin and course schedule. **HOBART SCHOOL OF WELDING TECHNOLOGY,** Box 73, Troy, Ohio 45373.

**NOW! Be A CREDIT-COLLECTION SPECIALIST—Jobs** Waiting For Novice—Advancement For Experienced Collectors—J. Scalò—1250 Camino Real—#306, Millbrae, California 94030.

**MOTORCYCLE MECHANIC.** Train at home in Spare Time. Make good Money in motorcycle shop or Start Own Business. Motorcycle Tools, test instruments included. **FREE "Career Kit!"** Dept. AZ, Spartan School/Motorcycle Repair, 4500 Campus Drive, Newport Beach, CA 92663.

**LEARN** Computer Programming. For More Information Write: Reb, 205 State Highway, Avoca, Pennsylvania 18641.

(Continued on next page)

## EDUCATION AND INSTRUCTIONS

(Continued from preceding page)

**WANT CIVIL SERVICE JOB?** Secure Future. Good Pay. High Test Score Helps Get The Job Desired. It's Easy: Find Out How. Write: WinFar Enterprises, 1 Robinson Drive, Baldwinsville, New York 13027.

**HOW INTELLIGENT** Are You? Self-scoring test reveals I.Q. in 45 minutes. Guaranteed! Only \$2.00. Moore Enterprises, 1115 Simpson, Dept. 102, Tupelo, Miss 38801

**SURVEYING PAYS BIG!!!** United States Department of Labor reports "openings for 26,000 Surveyors in next ten years." Easy home-study plan guides you. Send for Free "Surveying Career Kit." North American School of Surveying, AZ, Newport Beach, California 92663.

**VETERINARY ASSISTANT**—Train at home for exciting animal care career. Send for FREE "Career Kit". North American Home-Study School of Animal Sciences, AZ, Newport Beach, California 92663.

**NONRESIDENT DEGREES! HONORARY DEGREES!** Nationwide Faculty. Catalog: \$3. United States University Of America, Box 4552-PM, Washington, D.C. 20017.

**MISSOURI** Auction School. Veteran Approved. Free catalog. 1600-03 Genesee, Kansas City, Missouri 64102.

**EXTENSION** And Post-Graduate Awards in Philosophy, Art, Sciences, Botanic Medicine, Homeopathy, Radionics and others. 30 subjects. Curricular free (airmail \$1.00 refundable). Registrar, Sussex College of Technology, Highfield, Dane Hill, Sussex, England.

**PIANO** Technology—Electronic organ servicing, learned easily at home. G. I. Approved. Free booklet. Niles Bryant School, Dept. P, 3631 Stockton, Sacramento, California 95820.

**LEARN** Sewing Machine Repairing. Men, Women. Lucrative profits. Profession with bright future. Gresslin Correspondence School, Box 927, Spencer, Iowa 51301.

**LEARN** Auctioneering. Term soon. Free catalog. Reisch Auction College, Box 850, Mason City, Iowa 50401.

**ORDINATIONS**, Lifetime! Church chartered 1887! Write! 708 Bragg, Monroe, North Carolina 28110.

**RELIGIOUS VOCATION?** Write: Church Of Holy Light Inc., P.O. Box 4478, Pittsburgh, Pa. 15205.

**USED** Courses! Books Catalog 10¢. (Courses Bought). Lee Mountain, Pisgah, Alabama 35765.

**AUTOSUGGESTION**. Sleep-learning headquarters! Tapes, records, books, Gigantic catalog free. Research Association, Box 24PM, Olympia, Washington 9851.

**OWN** Collection agency. "Little Gold Mine!" Franklin Credit, Roanoke, Virginia 24004.

**AUCTIONEERING**. Resident or home Study Course. Free Catalog. Nashville Auction School, 1921 West End, Nashville Tennessee 37203.

**PERFECT** Husband-Wife Business. Learn Upholstery at home. Make \$10 in an hour. Buy-repair-sell for even bigger profits. Kits, tools, included. Free Booklet. Upholstery & Decorating School, (home-study), Dept. 5310-083, Little Falls, New Jersey 07424.

**DETECTIVE** Profession, Easy home study; free tie-tack or lapel pin, certificate, future. GI approved. Professional Investigators, Box 41345, Dept. CP, Los Angeles Calif. 90041.

**DETECTIVE** Course. Free Information. Universal Detectives, Box 8180-F, Universal City, California 91608.

**LEARN** To Fix Typewriters. Desperate shortage trained men. Hundreds needed. Make up to \$25 in one hour. Learn at home in spare time. Industry Approved course. Facts Free. Send name. Typewriter Repair School, (homestudy), Dept. 3310-083, Little Falls, New Jersey 07424.

**PIANO** Tuning quickly learned with home study course. Diploma granted. American Tuning School, 17050 Telfer Dr., Morgan Hill, California 95037.

**DETECTIVE** And Fingerprinting Courses. Write. Detectives, Box 185-P, Fairfield, Alabama 35064.

**SHORTCUTS** To Success! Highly Effective, Profitable Short Courses. (75 Choices). Study At Home. Diploma Awarded. Our 27th Year. Free Literature. CIEE-25, Box 10634, Jackson, Miss. 39209.

**WATCH REPAIRING**. Learn at home in spare time. Diploma awarded. Free sample lesson. Chicago School of Watchmaking, Dept. YV, Fox River Grove, Illinois 60021.

**UNLOCK** Your Future. Become professional Locksmith by spare time home-study. Make up to \$6 per hour. All tools, equipment inc. Facts free. Send name. Locksmithing Inst, homestudy, Dept. 1310-083, Little Falls, New Jersey 07424.

**SERVE** God's Ministry. Free. Ordination. Bible Institute, Box 744, McKeesport, Pa. 15134.

**LEARN** Asleep or awake! Records, tapes, equipment! Free catalog! Drawer PM-400, Ruidoso, New Mexico 88345.

**COLLEGE** Degree At Home. Your Choice of Subjects incl. Law. Easy Tuition Plan. Williams College, 1310 State Street, Boise, Idaho 83702.

**GET A** British Degree. Divinity, Philosophy, Radionics. 35 Courses. Prospectus free. Brantridge, Forest School, Highfield, Dane Hill, Sussex, England.

**FREE** Accredited High School Diploma Information! (NO Examination). Washington High Academy, Drawer 247E, Mango, Florida 33550.

**COLLEGE** Degree Programs Through Home Study. Catalogue \$1.00. B647, Morgantown, Kentucky 42261.

**NOW!** Your Own Burglar/Fire Alarm Business. Train at home. Expanding field. Course includes professional tools Plus equipment, supplies for first job. Information by mail. Security Systems Management School (homestudy), Dept. 7310-083, Little Falls, N. J. 07424.

**USED** Courses! Books! List 10¢. Smith's, 124 Marlborough, Salem, Massachusetts 01970.

**BRICKLAYING** Information, send 8-cents. The Pretio Services, P.O. Box 114, Durham, N.C. 27702.

**COMPLETE YOUR HIGH SCHOOL** at home in spare time. Texts furnished. No classes. Diploma. Our 76th year. Free Brochure. American School, Dept. XC45, Drexel at 58th, Chicago 60637.

**PHOTOGRAPHIC TRAINING**—Ohio Institute of Photography, 4435 Patterson Road, Dayton, Ohio 45430, VA Approved, Ohio #72-11-0344T.

**EARN HIGH SCHOOL** Equivalency diploma from your state. Business, college accepted. 5 week home study program, guarantees you pass GED. Simplified, fun, budget-priced. Brochure mailed free. Bright Futures Corporation, Box 514PMA, Jackson Heights, New York 11372.

**FREE** Book tells how you can learn camera repair and service. Home study or classroom. Write today! National Camera, Dept. EAD, Englewood, Colorado 80110.

**SCIENTIFIC** Massage: Big Earnings uncrowded profession. Learn spare time at home. Diploma awarded. Free Catalog. Write: Anderson School, Dept. J-1CA, Princeton, Illinois 61356.

**LEARN ACCOUNTING!** U.S. Labor Department reports "33,000 NEW Accountants, 78,000 NEW Bookkeepers needed EACH YEAR for next ten years". Easy home-study plan prepares you. Approved for Veterans. Send for FREE "Accounting Career Kit". North American School of Accounting, AZ, Newport Beach, California 92663.

**SUCCESS** And Popularity—Six Ways to Develop Your Creative Powers. A Formula to Guarantee Success and Prestige in Any Endeavor. Only \$2.00. College-Town, Dept. 14PM8, 152 West 42, Suite-536, New York, N.Y. 10036

**PLAY** Piano regardless of age. Chord formula with Cassette Music Teacher. Refundable. \$6.95. Music, Box 128, Milford, Ohio 45150.

**LIFETIME** Ordinations. Free Home Training. Word-Science-Faith Church, 6 Buswell, #7, Boston, Mass. 02215.

**LET** Copyright Laws Make You Rich With Very Small Investment. Amazing Course \$3.00. Resnick, P.O. Box 1151, North Miami Beach, Florida 33160.

## FOR INVENTORS

**U.S. PATENT** Office Searches, 234 Broadway, Room 3615, New York 10007. Free invention certificates.

**INVENTORS**—United States Patent Office Searches, Patent Development Engineering, marketing of inventions—ideas by Licensed Professional Engineer—Patent Engineer and United States Patent Office Former Examiner. Inventions developed for patenting and marketing. We are contacted by many manufacturers seeking to purchase appropriate new products invented by our clients. Send for Free Invention Certificate and Invention Information. Serving Inventors since 1948. George Spector, Licensed Professional Engineer—Patent Engineer—3615 Woolworth Bldg., New York, N.Y. 10007.

**PATENT** Application Financing. Free patent search plan. Global Patent Division, 2420 77th, Oakland, Calif. 94605.

**PATENT** Searches including maximum speed, full airmail report and closest patent copies. Quality searches expertly administered with complete secrecy guaranteed. Free Invention Protection Form and "Patent Information." Write: Dept. 15, Washington Patent Office Search Bureau, Benjamin Franklin Substation, P.O. Box 7167, Washington, D.C. 20044.

**PROSECUTE** Your Own Patent Application. All Material Necessary—Write: Inventors Service, Box 3574, Washington, D.C. 20007.

**FREE PAMPHLET:** "Tips on Safeguarding Your Invention." Write: United States Inventors Service Company, 501-P Thirteenth Street N.W., Washington, D.C. 20004.

**INVENTORS:** Your ideas and inventions (patented: unpatented) expertly searched, developed for commercial appeal and cash/royalty sales to manufacturers by professional Invention Developer with excellent record of experience. B. S. Industrial Engineering; United States Patent Office former Patent Examiner. United States Government former Patent Advisor. Second decade reliable service! Member: United States Council International Chamber Commerce. Free "Invention Record" and "Recommended Protection Procedure." Airmailed! Write: Raymond Lee, Invention Developer, 230P-Park Ave., New York, New York 10017.

**INVENTORS! EITHER I WILL SELL YOUR INVENTION BEFORE YOU** or anyone else does, or I will pay you a cash bonus. Get Free Invention Evaluation and information: write Gilbert Adams, Invention Broker, Dept. 15, 81 Wall St., New York, NY 10005.

**FREE** Details "How to Safeguard, Develop and Market Your Invention." Write: World Wide Inventor's Service Co., 501A Fifth Ave., New York 10017.

(Continued on next page)

**FOR INVENTORS***(Continued from preceding page)*

**INVENTORS**—If you have an invention for sale, patented or unpatented, write for free brochure outlining manufacturers requirements, royalty rates. Kessler Corporation, C-58FI, Fremont, Ohio 43420.

**FREE Inventors Procedure Check List.** Rankin-File, Box 566M, Willoughby, Ohio 44094.

**PATENT SEARCHES \$35** For simple search. Report mailed day after search is made. Lusk-Evans Limited, 1120 Connecticut Avenue, N. W. Suite 940, Washington, D.C. 20036.

**INVENTIONS WANTED**

**CASH—ROYALTIES—PRESTIGE! INVENTORS GET ACTION** Marketing Your Ideas . . . inventions. Write Today For **FREE INFORMATION.** THOMAS ENTERPRISES, 310M, 2412 West Seventh, Los Angeles, California 90057.

**INVENTORS!** Protect your ideas! Free "Recommended Procedures." Washington Inventors Service, 422F Washington Building, District of Columbia 20005.

**FREE "Directory of 500 Corporations Seeking new Products."** For information regarding developments, sale, licensing of your patented/unpatented inventions. Write: Raymond Lee Organization, 230-N Park Avenue, New York, New York 10017.

**CASH—Royalties** for patented, unpatented inventions. Global Marketing Service, 2420-G 77th, Oakland, California 94605.

**WE** Either sell your invention or pay cash bonus. Write for details. Universal Inventions, 28-E, Marion, Ohio.

**INVENTORS!** Don't sell or license your invention until you receive our offer. Eagle Development Company, Dept. H, 83 Wall Street, New York City 10005.

**INVENTIONS** wanted immediately for promoting on cash or royalty. Patented, Un-Patented. Free booklet, outlines royalty rates, requirements. Write: Kessler Corporation, C-58IW, Fremont, Ohio 43420.

**NEW PRODUCTS—INVENTIONS—IDEAS** Researched/Developed/Marketed by Professional Organization for Cash/Royalty Sales. **FREE EXAMINATION and CONFIDENTIAL REPORT** of the Commercial Features of your Patented/Unpatented Invention. **FREE COPY** "How to Safeguard and Market Inventions to Industry." Write: LAWRENCE PESKA ASSOCIATES, 500-C Fifth Avenue, New York City 10036.

**BUY IT WHOLESALE**

**WORLD'S** Largest wholesale sources. U.S., foreign factory suppliers will dropship for you. 200 free catalogs. Get free samples. Your business imprint catalog. Free details. International Buyers, Box 16386-M, Portland, Ore. 97233.

**MEXICO IMPORTS**—Handbags, Wallets, Dealers Cost. Free brochure. Lumbley, Dept. P. Post Office Box 5535, San Diego, California 92105.

**HEARING Aids, batteries, Wholesale.** Catalog 25¢. Fiston, Box 1444, New Preston, Conn. 06777.

**165 FREE Wholesale Catalogs!** Mailorder Dropshippers. Your Business Imprint, Automobile Discounts. Free "Digest." Vault International, Box 7284W, Lexington, Kentucky 40502.

**GIANT** Below Wholesale Catalog. Thousands Toys, Gifts, Novelties. Only \$2.00. Refundable. Copus, 72 Mitchell, Barberton, Ohio 44203.

**FREE Catalog.** Gifts, Specialties, Toys, Below Wholesale. Gregory. 5275 DeLongpre, Hollywood, Calif. 90027.

**FREE Money Making Details.** Importer, Box 11608, Santa Rosa, California 95406.

**EXPORT-IMPORT**

**JAPAN:** 1200 Products directory. Illustrated Manufacturers' names, addresses. \$5.00. Send cash. Yamagata Office, 814 Togin Bldg., Marunouchi, Tokyo.

**BIG MONEY** Importing direct from the Manufacturers, Mailorders and Dropshipped Products Directory, Action Profit Tool. Send \$3.00. Siboney Trading Corp. P.O. Box 1681, Rochester, NY 14603.

**FOR THE HOME**

**WARNING** Stickers! Deters burglars!—Warns your property protected by alarm system. Place on doors-windows! 5-\$1, 12-\$2! Guaranteed! Hillside House, Dept. W8, 1019 Hillside, Valdosta, Ga. 31601.

**SURE KILL** Kills roaches & waterbugs or money back. Guards against reinfestation. Send \$2.98 to: Sure Kill Dist., P. O. Box 329, Godfrey, Ill. 62035.

**FIRE—PROTECTION' MINIATURE** Fire Alarm Plugs Into Any Outlet. Portable. Really Sounds Off! Order Today—Guaranteed! \$10.95. J&J Enterprises, 4902 Wall Avenue, Richmond, California 94804.

**SAVE HUNDREDS FURNISHING HOME** Specific Instructions. Guaranteed. Harmony House Report. \$3.98. Box 143, Newport, Penna. 17074.

**OF INTEREST TO WOMEN**

**\$12.00 STARTS** Your Profitable Perfume Manufacturing Business. Free Details. JTD Sales, Box 56069, Chicago 60656.

**\$500 MONTHLY** Possible clipping newspaper items—at home, spare time. Details free. Clippings, Box 5877—PM1C, Stanford, California 94305.

**WANT** A new car, color TV, new clothes? Learn hundreds of ways to make money. 5 month subscription **FREE.** Write: Salesman's Opportunity Magazine, Dept. 17-HO, 1460 Hancock Center, Chicago 60611.

**\$6.00 DOZEN** Paid lacing baby boots! Cowboy, Warsaw 9, Indiana 46580.

**\$500 MONTHLY** Possible addressing—stuffing envelopes (longhand—typing) at home. \$500 monthly Clipping news items from your newspaper. Information: Send stamped self-addressed envelope. American, Excelsior Springs, Missouri 64024.

**NEW** magazine, foods, decorating, household tips, family living. Sample 25¢. Homemaker Magazine, 404 West Jefferson, Springfield, Illinois 62702.

**EARN UP TO \$150.00 WEEKLY . . .** Home addressing for us. Details 25¢. Smith's, Box 2469-PM, Newark, New Jersey 07114.

**EARN** Extra \$50-\$100 Weekly Addressing. Details Free. P. Richardson, Box 4097, Yuma Ariz. 85364.

**DO SIMPLE** Addressing—Mailing. Receive \$12.95 Orders. Keep \$8.00 Profit. Details Free! Quality, Box 9—PW, East Rockaway, N. Y. 11518.

**HOW TO MAKE MONEY** Writing Short Articles At Home. Secret Is Knowing What To Write And Where To Sell. Send \$1.00 to: Princess Gifts & Novelties, Dept. A-5, 1305 Ritchie Rd., Forestville, Md. 20027.

**HOW TO MAKE MONEY ADDRESSING, MAILING LETTERS. OFFER DETAILS 10¢.** Lindbloom, Dept PM, 3636 Peterson, Chicago 60659.

**GIFT SHOPPING**

**FREE CATALOG.** Gifts For All Occasions. Mundus International, P.O. Box 69-B, Selden, New York 11784.

**NEW** Digital Watch! Quality Swiss Craftsmanship, Mainspring Guaranteed! A Great Gift! \$24.95. Stanton, Box 484, Indianapolis, Indiana 46206.

**FED UP With MOSQUITO BITES?** Write: Tuto, 405 Roncesvailes, Toronto-3, Canada.

**CRAFTSMAN'S LIST** of 150 New England gift shops: \$2.00. Uncanoonuc Co., Box 715, Hooksett, New Hampshire 03106.

**GENTLEMAN'S KNIFE** Sturdy Wafer-Thin, 3 oz., leather covered, forged steel. Includes Scissors, Screw Driver, Bottle Opener, Nail File. \$5.00 P.P. Satisfaction Guaranteed. MYERS ENTERPRISES Co., Rd. 300S, Liberty, Indiana 47353.

**PERSONALIZED** Debonnaire Plastic Playing cards—your initials 2 or 3 in Gold Script-Assorted colors—2 full decks. Attractive, reusable case. Only \$4.50 post-paid. Quality Guaranteed. Colo Enterprises, Gravesend Station, Drawer H, Brooklyn, New York 11223.

**FREE Catalog.** Cottrell's Sales Company, 6253 South Michigan Avenue, Chicago, Illinois 60637.

**WATCHES, OLD GOLD, JEWELRY**

**WATCH** And Clock repairing books. Free list. North American, Box 77-AH, Fox River Grove, Illinois 60021.

**CASH** Immediately for Old Gold, Jewelry, Gold Teeth, Watches, Diamonds, Spectacles, Silver, Platinum, Mercury. Free Information. Rose Industries, 29-A East Madison, Chicago 60602.

**DIGITAL** Watches! New Look in Time! Swiss Movement. Accurate! Large Numerals! Brushed Gold Finished Case! Only \$22.95—Guaranteed! Order Today! Kona, 530 Concord Place, (1B8), Anaheim, California 92805.

**HIGHEST CASH** For Gold, Jewelry, Gold Teeth, Rings, Diamonds, Watches, Silver, Platinum. Mail Articles Today. Free gift with information. Chicago Gold & Precious Metals, 6 E. Monroe, Dept. 1258, Chicago, 60603.

**UNDERWATER WATCH MORTIMA** 17 Jewels—Calendar—100% waterproof—only \$19.95 Postpaid. Satisfaction guaranteed. Jerome Jones, Bulls Gap Road, Hollins, Alabama 35082.

**JEWELRY:** Genuine and imitation diamonds. Other magnificent stones. Low prices. Free catalog. Ball, 115 Elvis Court, Metairie, Louisiana 70001.

**WEARING APPAREL**

**PERSONALIZED** Iron-On Clothing Labels. Details **FREE.** Edgar Brewer, Box 1268A, New Haven, Connecticut 06510.

**HEARING AIDS**

**HUGE SAVINGS.** Eliminate dealer mark-ups. Free Trial. Batteries Wholesale. Terms arranged. Lloyds-PMC, Rockford, Ill. 61108.

**HEARING Aids, Batteries, Discount Prices.** Write: Rhodes, Box 518 PM, Paducah, Ky. 42001.

**WHOLESALE** Discounters! Famous Aids! Batteries! Repairs! AidMart, Drawer Z-2, St. Petersburg, Florida 33731.

**FREE—Hearing Aid Catalog:** Write: "MailSales", 9530 PMG Langdon, Sepulveda, California 91343.

**SCIENCE AND CHEMISTRY**

**PHYSICS** Supplies. List 35¢. Swinth, 3235 39th S.W., Seattle, Washington 98116.

**HAWAIIAN LAVA** Sample And Scientific Description—\$1.00. Menehune Treasures, 6201-106PM, Milolii Place, Honolulu, Hawaii 96825.

*(Continued on next page)*

## SCIENCE AND CHEMISTRY

(Continued from preceding page)

**AMAZING!** Scientific Catalog—Apparatus—Glassware—Chemicals. Catalog—50¢. Hagenow Laboratories, Manitowoc, Wisconsin 54220.

**CHEMISTRY** And Biology Catalog 35¢. Boulevard Laboratories, Suite 302, 3114 E. 83rd St., Chicago, Ill. 60617.

**CATALOGUE** Of those ver-ry hard-to-find chemical products, things that go boom, multi-stage rockets, 500 How-To books, 10,000 formulas of every conceivable mixture in science and industry. 50¢. Kenrus-C, Box 158M, Staten Island, New York 10309.

**DISCOUNTED!** Laboratory Chemicals, Glassware-Apparatus. Catalogue—50¢. Deluxe Scientific, Manitowoc, Wisconsin 54220.

**CALCULATOR** Owners: use your + - × ÷ calculator to compute **SQUARE ROOTS**, trigonometric functions, logarithms, exponentials, and more; quickly, accurately, easily! Manual \$2.00. Mallmann Optics and Electronics, Computer Division, 836 South 113, West Allis, Wisconsin 53214.

### FORMULAS, PLANS, ETC.

**ANY** Formula \$5.00. Catalog—Manufacturing Treatise 25¢. Belfort, 192 N. Clark, Chicago 60601.

**MAKE WATERPROOF MASONRY PAINT** \$1.00 GALLON. Formula and instructions \$2.00. Pritchard Products, 1925-45th St., Lubbock, Texas 79412

**FORMULAS—** Moneymaking— Useful—Asstd. Send \$1.00. Box 5928, New York, New York 10017.

### PLASTICS

**LARGEST** Handicrafts Supply Catalogue \$1.00 (Refundable). R.P.H. Manufacturing, 24-M-5, Winter, Stamford, Connecticut 06905.

**CASTOLITE** Pours like water, hardens like glass without heat. Crystal clear, colors. Embed natural flowers, seashells, mementos, anything. Make fine gifts. Form flexible molds over any pattern, size. Reproduce your own designs in plastics, candlewax, metal, plaster, cement. Profitable. Illustrated Manual and Catalog Only \$1.00. **CASTOLITE**, Dept. 731/PM, Woodstock, Ill. 60098.

### TREASURE FINDERS

**SEARCH** Treasure Finders. Locate gold, silver, coins, relics. Operate underwater. Money back guarantee. Free information. Search Electronics, Box 8396-A, St. Petersburg, Florida 33738.

**TREASURE** Finder locates buried gold, silver, coins, treasures. 6 powerful models. \$19.95 up. Instant financing available. Write or call for free catalog. Phone (713)-682-2728 day or night. Dealer inquiries invited. Relco, Dept. A-40, Box 10839, Houston, Texas 77018.

**FREE** 156 Page Detector Catalog. General Electronic Detection Co., Box 67, Bellflower, California 90706.

**FIND** Buried treasure with revolutionary patented, analytical metal detector. Features push button and automatic tuning, negligible ground pickup, greatest range. Free catalogue. Gardiner Electronics, Dept. 9, 4729 N. 7th Avenue, Phoenix, Arizona 85013.

**POWERFUL** Metrotech locator detect gold, silver, coins, relics. Moneyback guarantee, terms. Free information. Underground Explorations, Dept. A, Box 793, Menlo Park, California 94025.

**GOLDAK** Treasure locators—Pleasure and profit in a hobby you'll enjoy. Find coins, relics, gold, silver. Charge on Bank-Americard. **GOLDAK**, Dept. PM, 1101-A Air Way, Glendale, California 91201.

**TREASURE** Locators—Most complete line. Free information. **TESOROS**, Apartado 7-905, Mexico 7, Mexico.

**TIRED OF DIGGING UP TRASH?** The All New "Coinshooter" Rejects, Bottle Caps, Tin Foil, Nails and Shallow Trash. Detects Gold, Silver Coins and Jewelry. Free Literature. **D-TEX ELECTRONICS**, Box 451-U, Garland, Texas 75040.

**FREE FACT-FILLED CATALOG.** World's largest line of metal detectors. Models as low as \$49.50 and up. Two year Guarantee. Three factory locations, U.S. and Canada, plus over 1,000 dealers and 35 Service Centers from coast to coast. No finer instruments made at any price. Budget terms. Write: **WHITE'S ELECTRONICS, INC.**, RM #381 1011 PLEASANT VALLEY ROAD, SWEET HOME, OREGON 97386.

**FISHER DETECTORS.** You deserve the best! Free literature. FRL, Dept. PM-8, P.O. Box 490, Belmont, California 94002.

### PRECIOUS STONES & MINERALS

**500 POLISHED** Gemstones \$5.00. Tumblecraft, 5401 James North, Minneapolis, Minn. 55430.

**GET** Free catalog no serious rockhound, gem cutter, jewelry maker, hobbyist or craftsman can be without. Full of bargains, exclusive items, low prices from largest suppliers and authorities in the field. Free new catalog just off the press, yours for the asking. Write: Grieger's, Dept. C-12, 900 South Arroyo Pkwy., Pasadena, California 91105.

**ROCKHOUNDS!** Receive Interesting, Valuable Specimens Monthly. Free Information. Minerals, Box 487M2, Yucaipa, California 92399.

**GOLDPANS** Nugget trap inserts. Also use Dry. \$8.00 postpaid, or write for particulars. Supra Goldpans, P.O. Box 30, Clarkston, Wash. 99403.

**PLACER** Gold Samples \$5.00, refundable. Variety Bookshop, Box 140, Lewiston, Idaho 83501.

### CARTOONING, COMMERCIAL ARTS, SHOWCARD & SIGN PAINTING

**SIGN** Painting—\$1000 per Month Part-Time. Free Catalogue. Kaufmann Supply, Centertown, Missouri 65023.

**COMPACT** 23 lesson Cartoon Course and Cartoonist's Magazine. \$2.00. Hartman, Box 30367, Lincoln, Nebraska 68510.

**MODERN** Cartooning taught by mail. Write for free brochure. Cartoonorama—Box 263-9L, Branford, Conn. 06405.

**CARTOON** For Money!! Big Free Book: Success, Box 885-C, Dearborn, Mich. 48121.

**LEARN** Sign painting at home. Free Talent test. Ben Kerns, Box 812-PM, Greenville, S.C. 29601.

**FASCINATING** Systems. Sign Painting-Cartooning. Straley, 1704 South Center, Springfield, Ohio 45506.

**HOW TO MAKE MONEY WITH SIMPLE CARTOONS**—Informative book sent FREE tells way to big income. Cartoonists Exchange, 98, Pleasant Hill, Ohio 45359.

**LEARN** Cartooning at Home. Approved for Veterans. Free Bulletin. Cartooning, Box 70690, Colorado Springs, Colorado 80933.

### ADVERTISING AGENCIES, ADV. SERVICES, MAILING LISTS

**FRESH** Lists. Cash Buyers. Free Details. Box 392PM, Brea, California 92621.

**ADVERTISING** Ratebook leading newspapers, magazines, 25¢. Chicago Advertising Agency, 28-E Jackson, Chicago 60604.

**MAILING** List, Most all Kinds, \$9.00 1000 Gummed, Circulars mailed \$5.00 1000. Dixmailers, King, North Carolina 27021.

**MAILING** Lists. Gift Buyers. 1000 Gummed \$9.00. Raymond St. 210, 817-25 St. Paul St. 210, Baltimore, Md. 21202

### RUBBER STAMPS

**FREE** Rubber Stamp Brochure. Excellent Service And Prices. Dorsay Products, Box 247, Brighton, Mass. 02135.

**RUBBER** Stamps. 3 lines, \$2.50. Free Estimates. Tabco, Tomkins Cove, New York 10986.

**FREE** Catalog. Pocket Stamp \$1.25. Self Inking Stamps, Seals. Rush Stamps, 132-P-Farmcrest, Rush, New York 14543.

**FREE** Catalog—Rubber Stamps, Business Cards, Labels, Printing. Youngers Stamp Shop, Princeton, Iowa 52768.

**POCKET** Stamp \$1.00. Dealer's Wanted! Day's, 97 Stark Avenue, Dover, New Hampshire 03820.

**FREE** Stamp catalog. 45 type styles. Fast Service, low prices. Jackson's. Box 443A, Franklin Park, Ill. 60131.

### OFFICE SUPPLIES

**MAILORDER RECORDS** Help get increased business! Complete 32 Page Record Book shows your inquiries, orders, advertising, expense, etc. Only \$1.00. **H. E. KAPPEL, POPULAR MECHANICS, DEPT. R, 224 WEST 57TH STREET, NEW YORK, N. Y. 10019.**

### PRINTING PRESSES, RUBBER STAMP OUTFITS

**SIMPLE-X RUBBER STAMP PRESSES.** Hydraulic operated, electrically heated. Sizes 5"x8", 8"x12", 10"x15". Starting outfits. Orders for presses, supplies shipped day received. Free catalog low supply prices. Send \$1.00 for postage and handling (refundable on first order). Custom Manufacturers, 406-P East Elm, Springfield, Missouri 65801.

**RUBBER** Stamp manufacturers supplies. Presses, starting outfits. Best prices, service. Catalog. Jackson Supply, Box 443A, Franklin Park, Ill. 60131.

**PRINTING** Presses, type, supplies, Lists, 10¢. Turnbaugh Service, Mechanicsburg, Pennsylvania 17055.

**NEW** Catalog No. 13, 120 Pages, hand printing presses, type fonts, supplies. Send \$1.00 deductible first order. Acme Type, 732 Federal, Chicago, Illinois 60605.

**PRINTING MACHINES.** Offset, Mimeograph, Typewriters, Composing, Machines. Dixgraph, King, North Carolina 27021.

**SAME** Day shipment on rubber stamp supplies. Revised wholesale price list No. 9 free. Star Stamp Supply, 732 Federal, Chicago, Ill. 60605.

**MIMEOGRAPHS.** Duplicators Prints. Several Colors Without Extra Drums, Rollers. Write: AM Sales, 31-14 94, E. Elmhurst, NY 11369.

**MAKE** Your own self-molding Rubber Stamps and Printing-Cuts. Plexirubber, Argyle A, Wisconsin.

**RUBBER** Stamp outfits, supplies. Kiewiet, 2025 Barney Road, Kalamazoo, Michigan 49007.

### PRINTING AND SUPPLIES

**PROFESSIONAL BUSINESS FORMS.** Low Prices. 32-Page Catalog 25¢. Lancing Company, Box 1515, Burlington, N.Car. 27215.

**BUSINESS**—Personal Printing, Labels, Cards, Economical. Samples. Burnfin, Weaubleau, Mo. 65774.

**BUSINESS CARDS** Raised Letters \$5.65 Thousand. Like Engraved. Free Samples. Kavanagh, Box 1222, Brooklyn, N.Y. 11202.

**FREE** Literature, Business Cards, Letterheads, Rubber Stamps, Business Labels, Name and Address Labels. Lifetime Social Security Plates, Medical Plates, Identification Tags. Geer's, 111 North Drive, Ottawa, Ohio 45875.

(Continued on next page)



## PRINTING AND ADDRESS LABELS

(Continued from preceding page)

**FREE** Offset Catalog. Fast-Economical. Seaview, 212-26P 48th, Bayside, NY 11364.

**FREE** Literature: Business Cards, Rubber Stamps, Address Labels Printing Big Selection. Jordan's, 552 West O'Connor, Lima, Ohio 45801.

**QUALITY** Printing. Novelty and Imported Items. Catalog 25¢. John G. Robeson, Box 2316, Hyattsville, Maryland 20784.

**SMALL** businessman's special: 500 letterheads, #10 envelopes, business cards and invoices. \$14.95. Other printing bargains. Allstate Press, 5302-PM North Milwaukee, Chicago 60630.

**PRINTING** Supermarket Short Run Specials. 1000-\$4.75, 5000-\$22; 1000 Envelopes \$8. Shipping 9 hours. Get Free Printing Specials Price List "Do You Make These 18 Mistakes When You Buy Printing." Speedy Offset Printers, 23868 Aurora, Bedford, Ohio 44146.

**1000 EMBOSSED** Business Cards \$5.25 Postpaid. Agents Wanted. Elco, 181-A, Sylvania, Ohio 43560.

**QUICK** Copy Offset Printing. Free Introductory Offer. Nationwide Printing, 73 E. University, Champaign, Ill. 61820.

**\$4.99 FOR 1000** Embossed **BUSINESS CARDS**. Free Samples. Budco, 911, Los Altos, California 94022.

**DISTINCTIVE** Embossed Letterheads, Envelopes, Cards Inexpensive. Postpaid. Universal, 226-B Myrtle, Scotch Plains, New Jersey 07076.

**BUSINESS** Cards and Stationery—State your Occupation—we'll send appropriate samples. A.E. Lutz Co., P.O. Box 156, Dewitt, New York 13214.

## MULTIGRAPH, MIMEOGRAPH

**PROFITS FROM CLASSIFIED ADVERTISING!** Booklet shows you how to start your own business with Classified Advertising. Only \$1.00 (Refundable with first order.) **H. E. KAPPEL, POPULAR MECHANICS, DEPT. P, 224 WEST 57TH STREET, NEW YORK, N. Y. 10019.**

## GUMMED LABELS

**SPECIAL!** "1,000 Address Labels 75¢." Free Catalog. Wasdin's, Semmes, Alabama 36575.

**500 PRESSURIZED** Address Labels \$2.00. Wait's, Box 960A, South Bend, Indiana 46624.

**1,000 GUMMED ADDRESS LABELS \$1.00 FREE CATALOG**, Acme, 1238 Voskamp, Pittsburgh, Pennsylvania 15212.

**1,000 GUMMED ADDRESS LABELS, BOXED \$1.00. FREE CATALOG. BELMONT**, 4711C Linden, Lincoln, Nebr. 68516.

**500 DISTINCTIVE** Address Labels, To 4 lines. Plus Free Gift—\$2.00. Your choice: **SELFTICK** Glossy White or **GOLD** Gummed. Sunshine House, Box 318A, Scituate, Mass. 02066.

## REMAILING SERVICE

**PHILIPPINE** Reairmails \$1.00. Alejandro, 288 Morato Avenue, Quezon City, Philippines.

**YOUR** Mail Received-Forwarded. Hillegas, Box 169-P, Hainesport, New Jersey 08036.

**CONFIDENTIAL**, Fast, Personal, not just words, but a Service. Byrd's Remail, Box 1568, Asheville, N.C. 28802. Rates on Request.

**YOUR** Mail Received Here, Forwarded To You. Wright, MA-2112, Asheville, NC 28802.

**KING CRAB CAPITAL OF THE WORLD** 35¢. Remails. Receiving, Forwarding, Re-addressing. Postcards and Souvenirs. Monthly Rates. Oceanside, Box 1455, Kodiak, Alaska 99615.

**NEW YORK CONFIDENTIAL** Remails 25¢; \$2.75 Monthly. Details Free. Ross, Box 706-M, North Bellmore, N.Y. 11710.

**FREE** NASA Postcard. Space City Remails, Box 9296PM, Houston, Texas 77011.

**DEPENDABLE** Mail Service. Forwarding Remailing. \$3.00 Monthly. Remails 25¢ Each. Keats, Box 10162, Louisville, Ky. 40210.

**SECRET**. Receiving—forwarding. Discreet and confidential. Remail 25¢ single. Mail Forwarding Service, 8050 S. Main, Houston, Texas 77025.

**RECEIVING** — Forwarding — Remailing, Monthly Rates. Nortex, Drawer 5370, Ft. Worth, Texas, 76108.

**MIAMI** Remails 25¢—Monthly rates. Remails—view cards from 80 Foreign cities. Marle, Box 1266, Coral Gables, Florida 33134.

**YOUR** Mail Received—Forwarded. Hedgpeth, 324-M South First, Alhambra, Calif. 91802.

**CONFIDENTIAL** New York Mail Address \$3.00 Month. Telephone Service \$5.00. Re-mails 25¢. Details Free. Birnhan, 152 West 42, New York 10036.

**CONFIDENTIAL**. Receiving Forwarding. Monthly Rates. Davis, Box 5012A, Reno, Nevada 89503.

**HOLLYWOOD** Remails—Forwarding. 25¢; \$3.00 Monthly. Confidential. Box 1302, Hollywood Sta., Calif. 90028.

**CANADA**. Confidential Remails 25¢. Monthly Forwarding. Others. Rowland, Box 4, Station "H", Toronto, Ontario. MAC 5H7.

**REMAILS** 25¢ ea., \$3 monthly. Heirloom Enterprises, P.O. Box 249, Tenino, Wash. 98589.

**MILE-HI** Remails 25¢. Monthly rates Box 1798-P, Denver, Colo. 80201.

## REPAIRS AND SERVICING

**PROFITS FROM CLASSIFIED ADVERTISING!** Booklet shows you how to start your own business with Classified Advertising. Only \$1.00 (Refundable with first order.) **H. E. KAPPEL, POPULAR MECHANICS, DEPT. P, 224 WEST 57TH STREET, NEW YORK, N. Y. 10019.**

**"INSTANT HOME REPAIR BOOK"** shows and tells how to fix anything around the house from a dripping faucet to a faulty furnace. Complete, easy-to-find, easy-to-follow advise from a professional repairman tells what to do 'til the repairman comes, how to AVOID repairs with proper maintenance. Profusely illustrated. 320 pages, 4" x 6", durable hard cover. Fits in your tool box. Pays for itself in the first service call you avoid! Only \$2.25 from Career Institute, Dept. 82000, Mundelein, Illinois 60060.

## SPECIAL SERVICES

**AUTHORITATIVE** Information On Anything! \$2.00 (Deductible). Metzler Research, Box 2206PV, Astoria, New York 11102.

**INFORMATION** On Anything. Universal Information, Box 9131, Shreveport, La. 71109.

**INFORMATION** On anything. Ferguson Research Specialists. 72-25 Woodside, Woodside, New York 11377.

**KEEP** Your copies of PM—and watch for the inexpensive Annual Index, available in January 1972. It will enable you to locate any article which appeared in 1971 or find information on any particular subject in just a few seconds. The Annual Index will make your copies of PM even more valuable! Price \$1.49. Send checks to: Popular Mechanics, Dept. HE, 224 W. 57th St., New York, N. Y. 10019.

## TOBACCO

**PIPE SMOKING PLEASURE**, only as satisfying as the tobacco you put in it. Write for factory-fresh samples. Green River Tobacco, Box 991, Owensboro, Ky. 42301.

**BRIAR PIPE** Make or repair your own. Photocopy of article shows you all the details. Price \$1.00. Send order to **POPULAR MECHANICS**, Dept. HE, 224 West 57 St., New York, N. Y. 10019.

**BRIAR PIPES**. Discount Prices. Write: Maxima, Box 26-D, Vails Gate, New York 12584.

**ELECTRIC** Cigarette machine makes them better—easier. Free details. Mahair, 415 Morris Bridge Road, Zephyrhills, Fla. 33599.

## BETTER HEALTH

**SLUGGISH? TIRED?** Chinese Super-tonic \$9.95. Health, Box 65976, Vancouver, Canada.

**STOP SMOKING!** NEW 96 Page Book Presents Medical and Psychological Method That May Save Your Life. Money Back Guarantee. Send \$1.00 Plus .25¢. Bill Hall Sales Co., 342 Taylor's Ferry Rd., Bessemer, Ala. 35020.

**LIFE SAKE NATURAL VITAMINS**—Herbs. E 100 I.U., caps. \$1.50. Free catalog. 809 River Ave., Eugene, Oregon 97402

**BACKACHE?** Painful Joints? **RECEIVE** amazing relief overnight by using a simple method. **SEND \$2.00 today—MONEY** back guarantee. D. Biles, 4503 East Ocean Blvd, Long Beach, Calif. 90803

**STOP Smoking!** New book reveals how. Only \$2.00. Includes **FREE** gift catalog. Gold Coast Gifts. 718 Walnut. Pacific Grove, Calif. 93950.

**PSORIASIS SUFFERERS:** Special Offer On 2 Oz. Psorex Cream Plus 6 Oz. Psorex Shampoo. Regular \$7.25 Both For \$3.99. Tom's Pharmacy, 196 South Citrus, West Covina, California 91791

## PERSONAL

**INSTANT DEBT RELIEF** Without borrowing. Without Bankruptcy. Have excellent credit in 45 days. Free!!! Wealth Building, Box B-8, 1996 Hoyt Street, Lakewood, Colorado 80215.

**HIGHER INCOME**, Security And Power. 256 Page Book "Thinking Big" Reveals Secrets That Make Men Rich! Send \$2.00. **HAN** Trading Co., North Shore, Derry, N.H. 03038.

**IDENTIFICATION CARDS SEND** stamped self-addressed envelope for samples. **DOWNES**, P.O. Box 10148, Cheyenne, Wyoming 82001.

**MEN-WOMEN!** No more gray hair or dandruff. Youthair colorless, greaseless, preparation darkens your hair safely, gradually. Send check, money order \$2.98. Lanzi Enterprise of America, M-658 New Dorp Lane, Staten Island, New York 10306

**BECOME** Ordained Minister, Free Information. Church, Box 324, Daytona Beach, Florida 32015.

**NEED** Money-Debts Too Big? Consolidate Bills. Free Emergency Loans. Write Interstate, 28 E. Jackson, Suite 1204-X3, Chicago 60604.

**LOSING HAIR? BALDING? DANDRUFF?** Free copyrighted booklet. Dr. Shiffer Laboratories. Dept. 536, Box 398, Punta Gorda, Florida, 33950.

**PSORIASIS** Sufferers: Discouraged? Write for Free important Information that is helping thousands! Pixacol, Box 38-PM, Avon Lake, Ohio 44012.

**BIBLE** Questions answered. Stamped envelope. Bylon, 17167 Bentier, Detroit, Michigan 48219.

**INVESTIGATORS**. Latest electronic Aids. Free Literature. Clifton, 11500-P NW 7th Ave., Miami, Florida 33168.

**RECORD** Telephone Conversation automatically. Leaver Recorder Unattended. Robert's, Box 49PM8, Parkridge, Illinois, 60068.

**RECEIVE** Phony State Chartered University Degrees immediately. Box 11516, Tucson, Arizona 85706.

(Continued on next page)

**PERSONAL**

(Continued from preceding page)

**CASH LOANS** by mail! Up to \$2,500 on signature alone. No collateral! Secret! Union Finance Company, 3608 No. 16th St., Dept. PM, Phoenix, Ariz. 85011.

**UNBREAKABLE COMBS**, Family Variety (12) Packet. Only \$1.00. "Airway", P.O. Box 1080, Cedar City, Utah 84720.

**SEE THRU WALLS!** New Secret Two-Way Super Spy Device, instructions included. Guaranteed only \$2. World-8C20, 3047 University, San Diego, Cal. 92104.

**TELL** Fortunes accurately—Immediately! ESP Aids, Box 21-PM, Olympia, Washington, 98507.

**TATTOO** Removing—Chemical Do-it-Yourself Method—Free Details: Atlanta, 907P Beachpoint, Pickering, Ontario, L1W 2A4

**"RULE** Others With Thoughts." (Telepathy). Write: Clarion, Box 1769-A7, Chicago 60690.

**STOP SMOKING NOW!** Free details. Mark, Box 398Z, Lewiston, Michigan 49756.

**BORROW** By Mail! Up to \$1500.00. Convenient terms. State Licensed, Postal Finance, Dept. 17-N, 6018 Military Ave., Omaha, Nebraska 68104.

**FIND** What **CREDIT REPORTS** say about you. \$2.00. Galaxy, Box 1062, Marietta, Ga. 30061.

**CREDIT** Cards . . . loans . . . no credit investigation!!! Guaranteed Free report. Continental-23, Nicerville, Florida 32578.

**LOSE WEIGHT** Eat 6 Times Daily. Proven Method Only \$1.00 Postpaid. Colo Enterprises, Gravesend Station, Drawer H, Brooklyn, New York 11223.

**I HELPED** Thousands Wipe Out Debts. Clear credit. Immediate relief to \$25,000. Free details. Counselor-7, Kerrville, Texas 78028

**TO FIND SUCCESS, FIND YOURSELF!** Free Lecture helps thousands. Frank Tibolt, 2819S Mt. Carmel Ave., North Hills, Pennsylvania 19038.

**SECRET LOANS BY MAIL.** Borrow \$100 to \$3000 for any good reason in absolute privacy. No interviews, no endorsers, no co-signers. Fast service. Write Dial Finance Co., Dept. 3515, 418 Seventh Street, Des Moines, Iowa 50309

**GINSENG.** Legendary body, mind rejuvenating. Sample and Catalog \$1.00. Herbal Holding, 5854, Cal. 91413.

**WANTED-MISCELLANEOUS**

**MERCURY**, Gold, Silver, Platinum; Ores assayed. Wholesale Terminal, Norwood, Mass. 02062.

**WINEMAKING & OTHER RECIPES**

**FREE** Winemakers Comprehensive Supply Catalog. Winemakers, Box 24, Abington, Pa. 19001.

**WINEMAKERS**—Imported 5 gallon Barley Wine Kits complete with reusable equipment—\$6.95 + \$.50 post; Renaissance Vintners, Box 3476, Santa Monica, Cal. 90403.

**CONCENTRATE** Catalog. 60 Varieties. Vendramino Wine Co., Dept. A, 13273 Michigan Ave., Dearborn, Mich. 48126.

**WINEMAKERS FREE** Supply Catalog. Excellent Selection of Fruit & Grape Concentrates. Kraus, Box 451-L, Nevada, Missouri 64772.

**WINEMAKERS.** Free illustrated catalog of yeasts, equipment, Sempex, Box 12276R, Minneapolis, Minn. 55412.

**WINEMAKERS** . . . Free Illustrated Supply Catalog of Yeast, Equipment, Recipes. Continental, Box 18223-PM, Indianapolis, Ind. 46218.

**WINEMAKER'S** Supply Catalog—Free. Bacchanalia, 273 Riverside Ave., Westport, Conn. 06880.

**WINEMAKING Kit**—\$4.98 Free Catalog and Recipes. JIMDANDY, Box 30230M, Cincinnati, Ohio 45230.

**HOMEWINE MAKING SEND** For FREE Informative CATALOG OF RECIPES, EQUIPMENT, and INGREDIENTS. Brewer's Yeast Dry Malt, Crystal Malt, Bottle Caps, Barrels, Chemicals, Concentrates, Over 250 Items. Winemaking Is A Fascinating Hobby. Write To: Danenberger's, Box 276-M, New Berlin, Ill. 62670.

**WINEMAKER'S!** Free Illustrated Catalogue of Quality Products. Brant's Wine Rack, Box 3256-M, Orange, California 92665.

**WINE CELLAR**—New low cost Interlocking units in traditional design, unlimited capacity. Start with 7 bottle rack \$4.98, postpaid. Free picture brochure. Wine-maker's Catalog. ADDARACK, Box 30230M, Cincinnati, Ohio 45230.

**AMERICAN** Amateur Wine Association Card and a Beautiful Diploma for \$5.00. Show Your Friends you have Wine Making Talent. Suite 659, 1624 K Street NW, Washington, D.C. 20006.

**WINEMAKERS.** Tremendous selection. Fast service. Free catalog. Winecraft; Columbia Mall; Columbia, Maryland 21043.

**WINEMAKERS:** Free Catalog. Fast Service. Arbolyn, Box 663, West Columbia, South Carolina 29169.

**MISCELLANEOUS**

**DEGREES CERTIFICATES DIPLOMAS** Send \$3.00 for samples. DOWNES, P.O. Box 10148, Cheyenne, Wyoming 82001.

**BEVERAGE** Caddy holds drinks in any moving vehicle without spilling! \$2.29 Guaranteed! Thomas Sales, 453 Cummings, Virginia Beach, Virginia 23452.

**LIKE JOGGING, SPORTS?** Light digital pedometer registers miles, in (tenths), walked or run. Slips on belt, waistband. Accurate. Satisfaction Guaranteed! \$12.95. Rainbow Enterprises, R.D. 2, West Mountain Road, Glens Falls, New York 12801.

**CUT** Cigarette costs in half with our custom-blended tobacco and rollers: filter or plain. Free sample: Green River Tobacco, Box 954, Owensboro, Ky. 42301.

**DON'T** Die Without a will! Self-explanatory blank will forms \$2.00 guaranteed. Clayton Sales, Dept. (4288), 314 South Patterson Park Avenue, Baltimore, Maryland 21231.

**RECREATION LAMPS EXCITING.** Gogo girls in motion many more barlites in color. For free brochure and pricelist send self address large stamp envelope to: Magic Motion Lamps, 2617 E. Birchwood Ave., Cudahy, Wisc. 53110.

**BEEF JERKY—HOMEBREW.** Beat Inflation! Genuine, authentic recipes. \$2.00. Broadmoor Sales, 993 West Longview Ave., Littleton, Colorado 80120.

**BOOKS** On antiques and their prices. Free circular!! P. Warman Publishers, Uniontown, Penna. 15401.

**SUFFERING** From Arthritis? Try Ginseng; Information Free. Write: Ginseng, Asheville 53, North Carolina.

**ORNAMENTAL** Iron designs. Book of 1600 beautiful, practical designs for railings, columns, etc. Free literature. Cunningham, 3881 South 3200 West, Salt Lake City, Utah 84119.

**PRE-PACKAGED** Toys complete with free self-selling display rack. Free Details. Toys, 1916 Fifth, Sacramento, California 95814.

**HOW INTELLIGENT ARE YOU?** Self-Scoring Test Reveals I.Q. In 45 Minutes! Send \$2 Today—Guaranteed!!! Helton, Box 67184 PM-1-8, Century City, California 90067.

**SLEEPATRON.** New device for inducing sleep. Gardiner Electronics, Dept. C, 4729 North 7th Avenue, Phoenix, Arizona 85013.

**HOME** Water Distillers. Portable Appliances. Purest Water, Pennies Per Gallon. Remove All Impurities, Bad Tastes. Free Details. United Vito—Way, Box 2216-PM, Everett, Washington 98203.

**IDENTIFICATION CARDS.** Send stamped self-addressed envelope for samples. NIPCOM, 727 North Main, Las Vegas, Nevada 89101.

**EYEGASSES** wholesale—Free Catalog. A-Z Optical Company, Box 175, Dept. R26, Bay Station, Brooklyn, N.Y. 11235.

**HOW INTELLIGENT** Are You? Self-scoring test reveals I.Q. in 45 minutes! Send \$2 today—guaranteed!! Mann, 3545 Lincolnshire Woods, Dept. 8A1, Toledo 43606.

**TEST** Your I. Q.! Discover hidden traits, abilities. \$2.00. Louise Tennell PM8, 107A East Laurel, Compton, Cal. 90220.

**DON'T** Die without a Will! Two Blank forms only \$2. Guaranteed! Gibson Enterprises, 2826 Kulshan St., Bellingham, Wash. 98225.

**1400 CATALOGS** Listed and Described! Sources for EVERYTHING imaginable! Rush \$2.00. MASTERLOG, Box 24413-UH, Oakland, California 94623.

**PLEASE** Protect Yours. Order Blank Will Form Today. \$2.—Guaranteed. "Indosoc" Rt. 1, Jupiter Ave., Dept. 1H8, Inverness, Florida 32650

**CREDIT** Cards . . . loans . . . no credit investigation!!! Guaranteed Free report. Continental-24, Nicerville, Florida 32578.

**NIXON** Watergate Buttons 3 Different \$2.00. Dowling, 1950 Clove Road, Staten Island, N.Y. 10304

**THIRTY** Re-usable Unwoven Cotton and rayon Towels. \$1.50—Guaranteed!! Barcum House, Department 388, 1919 Briarcliffe Boulevard, Wheaton, Ill. 60187.

**BLANK WILL FORM.** \$2.00. Guaranteed! Order Today! J. G. Enterprises, Box 314, Moncure, N. Car 27559

**EASY** To understand manual for writing business letters. Be sure, be correct! Only \$2.98. Order Today! Lomar Exclusives, Box 5, Dept. P., Arroyo Grande, Cal. 93420

**IMPROVE** Your Personality. Fascinating 110 Page Book "Dynamic Thinking" Shows How. Only \$1.00. Adair Enterprises, Dept. K2, 40 Longfellow, Mill Valley, Calif. 94941.

**HEARING** Aid batteries wholesale. Free list. Habs, Box 51, York, Penna. 17405.

**TV PICTURE TUBES** manufactory direct, easy installation. Write: Ehnes Co., 405 E. Jefferson, Cheyenne, Wyo. 82001.

**BURGLAR ALARMS & HOME PROTECTION**

**LOCKSMITHING** Supplies—Buyers Guide \$1.00. Despubs, Box 22005H, Phoenix, Arizona 85028.

**FREE** Catalog on Burglar-fire Alarm Equipment. Protecto Alarm Sales, Box 357-D, Birch Run, Michigan 48415.

**BURGLAR & Fire Alarm Equipment.** Low Prices. Hundreds Of Items. 1973 Catalog. Over 60 Pages. Just \$1.00 (Refundable on first order). K-TRONICS INDUSTRIES, Box 391, Dept. PM, Fairfield, Conn. 06430.

**BURGLAR** Protection System, including Diamond Marking Pencil, Magnifying Lens, Warning Stickers, Registration Book. \$8.95. Guaranteed. Hourglass, 233 Towercliffe, Suite 2H, Ballwin, Missouri 63011.

**PROTECT YOUR CAR AGAINST THEFT.** Mail Self-Addressed and Stamped Envelope to: Ameri-Way, 2475 Devon Ave., Elk Grove Village, Illinois 60007

**BURGLAR & FIRE ALARM SUPPLIES AND SYSTEMS.** Send \$1.00 for catalog. J & J Alarm Systems, 51 Pythian Ave., Torrington, Conn. 06790.

# NOW ... PERMATEX GIVES YOUR CAR AN EVEN BRAKE!

The whole idea about brakes is that you shouldn't have to think about them. You step on the pedal . . . the car stops. And modern brakes are pretty good about taking care of themselves. They need minimum care. But they do need care. Here's a pair of products from Permatex to help keep your brakes in tip-top shape.

**DISC BRAKE QUIET:** How can you not think about your brakes if they keep squealing at you? Disc Brake Quiet takes care of all that. It positively stops disc brake squeal, simply and economically. Just spray Permatex Brake Quiet on the back of your disc brake pads. Then reassemble. That's all there is to it. Brake Quiet has been proven in Europe, where disc brakes have been around for a long, long time. Now it's available here for the first time. Only from Permatex.

**BRAKE CLEAN:** Brake Clean gets rid of dirt, oil, grease, brake fluid, and anything else you don't want on your linings, pads, drums, springs, and the like. Just spray it on, and flush the dirt away. Best of all, it's non-flammable, so you can use it anywhere.

Both products are proven by Permatex on the track and on the road. You'll find them, like all Permatex products, in NASCAR garages, service stations, and wherever automotive products are sold.

Pick up the pair, and go back to forgetting about your brakes.



**Permatex**  
our name is our bond

Yes, longer yet milder

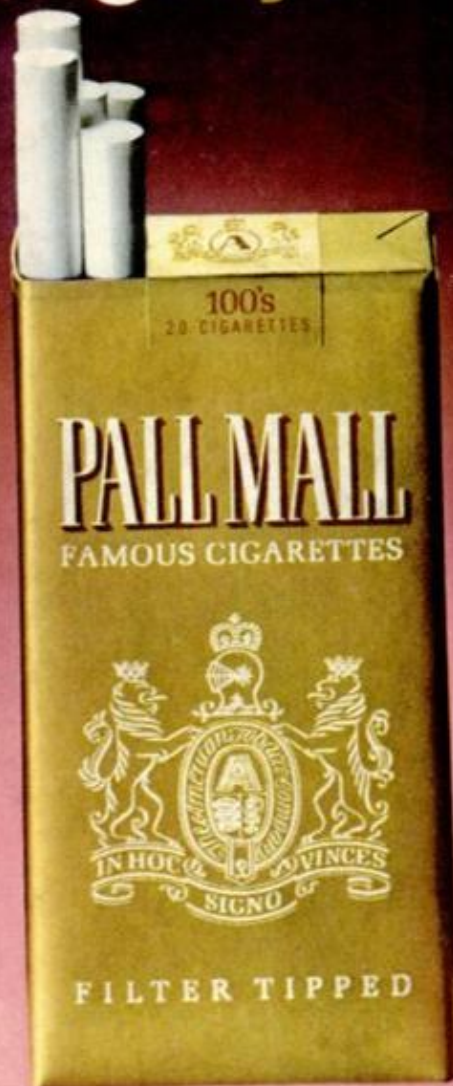

**PALL MALL**  
**GOLD 100's**

Longer length, milder taste

Warning: The Surgeon General Has Determined  
That Cigarette Smoking Is Dangerous to Your Health.

20 mg. "tar" 1.4 mg. nicotine av. per cigarette, FTC Report FEB:73.