

Popular Mechanics

THE LITTLE STORAGE BUILDING YOU NEED

It frees your garage of clutter, doubles as a playhouse for the kids Page 162

150-mph karting: Your chance to be a race driver Page 69

How to get more outdoor living space Page 100

CLIP-AND-SAVE KNOW-HOW:

- How to replace disc-brake pads
- How to troubleshoot an air conditioner
- How to build a brick-and-sand patio
- How to install wrought-iron railings

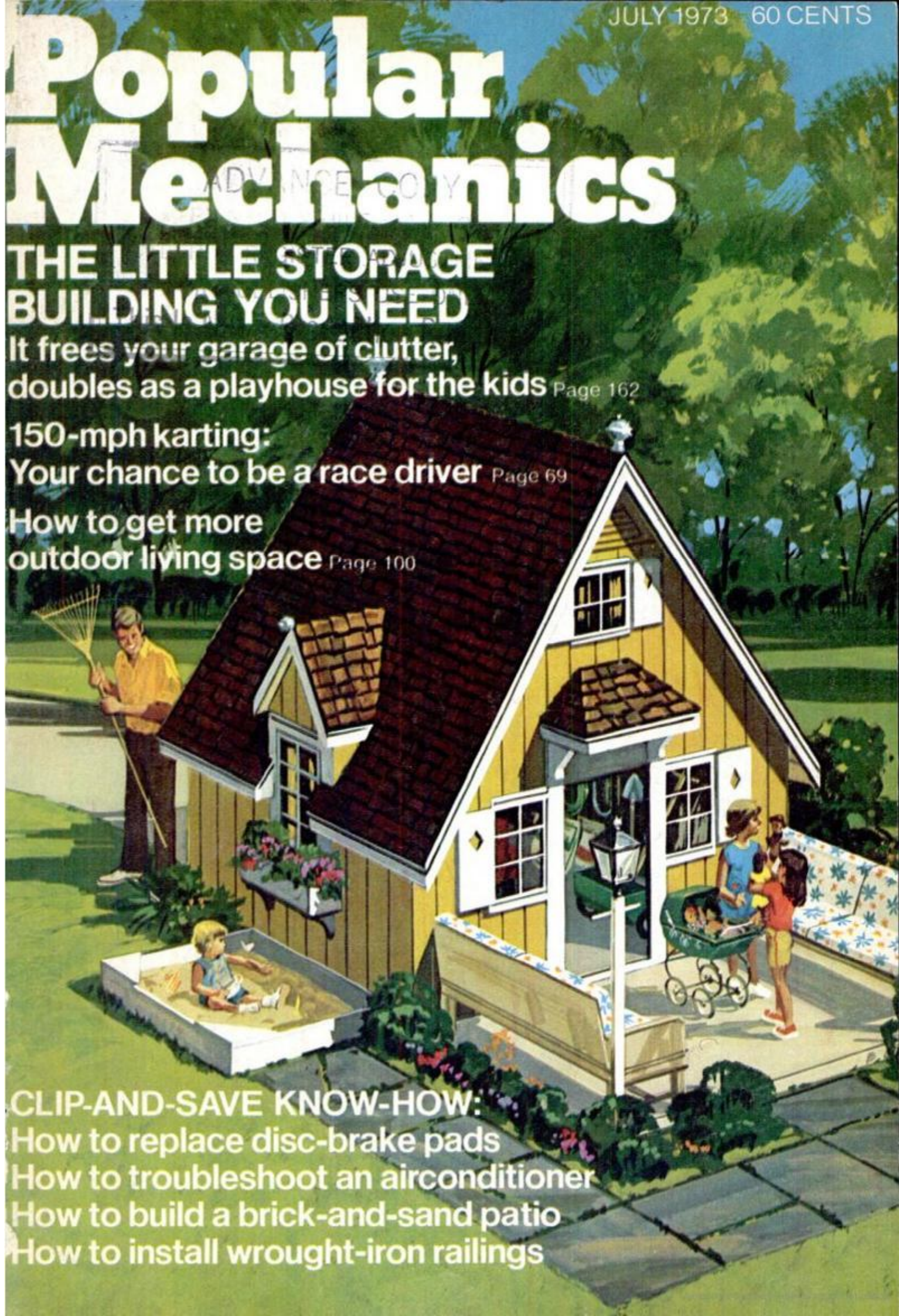

Tried and true. A nice quality these days.



THE "ASK-FOR" MOTOR OIL. A SYMBOL OF EXCELLENCE FOR OVER 85 YEARS. REFINED FROM 100% PURE PENNSYLVANIA GRADE CRUDE OIL.

Jeep Introduces Automatic 4-Wheel Drive.

QUADRA-TRAC™—Someday all 4-wheel drive vehicles may have a system like it... Jeep Wagoneer has it now.



Here's how it works and what it does for you:

Quadra-Trac eliminates shift lever and front locking hubs.

Quadra-Trac is full-time automatic 4-wheel drive. There's no need to get out and lock in the front wheel hubs or even shift a lever... Quadra-Trac eliminates both. 4-wheel drive is automatically there when you need it—on or off the highway.



Quadra-Trac offers superior traction.

Under test conditions, two Jeep Wagoneers, one Quadra-Trac, one without, were asked to make an accelerating turn on a water-soaked road. The Wagoneer with Quadra-Trac remained in control, while the other vehicle had a tendency to fishtail.

Quadra-Trac works in a new way.

A third differential allows torque to be directed automatically to the wheels that have the best traction. If the wheels on one axle start to slip, as on ice or rough terrain, the wheels on the other axle automatically take over.

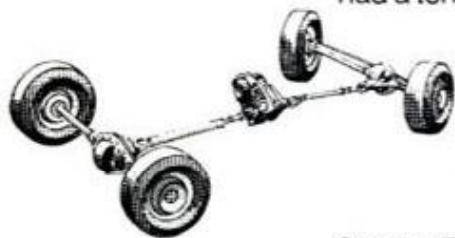

Quadra-Trac is one of the most advanced 4-wheel drive systems ever developed and it's available now on Jeep Wagoneer and Jeep Truck. If you want to know more about it, see your Jeep dealer. He's the 4-wheel drive expert.

Jeep
Toughest 4-letter word on wheels.

CHANNELLOCK

Gives You More In Hand Tools Including

FULL POLISH FINISH

(quality you can SEE)

The honest gleam of drop forged steel, fine polished end to end. No plating, no black handles, no "good enough" compromise anywhere. Craftsmanship in every detail. Quality you see, not just hope for. CHANNELLOCK'S bonus to you at no extra cost.

HERE'S MORE. Our catalog gives you an arm-chair review of our complete line. It's yours for the asking.



TOOLS BY
CHAN NEL LOCK[®]

MEADVILLE, PA. 16335

There is steel in the heart of Toyo Steel Cabled Radial highway passenger car tires to support a 40,000 mile tread life guarantee*. Tough, flexible 2 ply radial sidewalls. 2 steel cabled belts. Plus 2 cord belts for added puncture resistance and strength. 6 plies strong under the tread. Cool running. Easy rolling. Tenacious grip traction. Popular 70 and 78 series. **Check the Yellow Pages for your Toyo Dealer.**



Steel Cabled Radials

Toyo Tire (U.S.A.)
Corporation
3136 E. Victoria St.
Compton,
CA 90221

Heart of Steel

This One



EKXP-3EC-H39H

*Every Toyo Steel Cabled Radial highway passenger car tire is guaranteed to have an original tread life of 40,000 miles with normal passenger car use. Should the tread wear out before 40,000 miles, the owner should submit his guarantee certificate and worn out tire to any Toyo dealer in the continental United States. The Toyo dealer will give credit toward a new tire, or cash refund, at his option, for an amount determined by multiplying the adjusting dealer's actual current retail price at the time of adjustment, by the percentage of mileage not run. (This is a correction of a guarantee previously advertised.)

AUTOMOBILES, DRIVING

- [42 Imports and Motorsports](#)
- [56 Detroit Listening Post](#)
- [69 Karting: Everybody's chance to be a race driver!](#)
- [84 How to replace disc-brake pads](#)
- [88 PM Owners Report: Ford Ranchero](#)
- [89 PM Owners Report: Chevrolet El Camino](#)
- [138 Cars the Red Baron would love!](#)
- [142 Four electronic kits for your car](#)
- [152 Saturday Mechanic:](#)
How to track down a handling problem

HOME AND YARD

- [72 How to troubleshoot your airconditioner](#)
- [78 How to build a brick-in-sand patio](#)
- [82 How to install wrought-iron railings](#)
- [100 Creative deck and patio ideas you can borrow](#)
- [162 Little beauties for tools and kids: Three storage buildings that double as playhouses](#)

BOATING, OUTDOORS

- [103 Lead this trailer to water](#)
- [126 A leg-powered machine for easy swimming](#)
- [128 Guns too slick to shoot](#)
- [132 A 'black box' that tests boats](#)
- [134 New line on boat ropes](#)
- [137 Bow for far-out archers](#)

SHOP AND CRAFTS

- [96 An Early American hutch-table you can build](#)
- [156 Drill-press overarm makes your router twice as handy](#)
- [160 Hints from readers](#)
- [168 Hints from readers](#)
- [172 Fly-cutter holder you can make for your lathe](#)
- [176 Penney's new portable power saw](#)

AVIATION

- [85 Homebuilt aircraft: Tandem 'two-holer' you can fly from either seat](#)
- [122 New autopilot got started with Ben Franklin's kite](#)

ELECTRONICS, RADIO, TV

- [142 Four electronic kits for your car](#)
- [146 Those under-\\$200 receivers: Yes, they're really hi-fi](#)

PHOTOGRAPHY

- [14 Photo hints](#)
- [105 New fun with underwater photos](#)

SCIENCE, INVENTIONS

- [132 A 'black box' that tests boats.](#)

EVERY MONTH

- [8 Letters](#)
- [22 The Bicycle Shop](#)
- [30 Car Clinic](#)
- [38 Science Worldwide](#)
- [46 All Outdoors](#)
- [60 Appliance Clinic](#)
- [66 Homeowners' Clinic](#)
- [110 It's New NOW: Latest products and developments \(A 12-page roundup\)](#)

Popular Mechanics

JULY 1973 • VOL. 140 No. 1

INTERNATIONAL EDITIONS

Australia, Caribbean, Denmark, Mexico, Southern Hemisphere, Sweden



Storage building-playhouse . . . 162

Car handling problems . 152



Fun with underwater photos . . . 105

Know the right ropes for your boat. 134



ON THE COVER: The little storage building you need that doubles as a playhouse for kids. *Illustration by Carl Kinschert*

AS A SERVICE TO READERS, *Popular Mechanics* publishes newsworthy products, techniques and scientific and technological developments. Due to possible variance in the quality and condition of materials and workmanship, *Popular Mechanics* cannot assume responsibility for proper application of techniques or proper and safe functioning of manufactured products or reader-built projects resulting from plans published in this magazine.

Stanley has 2 new ways to shave, file, trim.



Introducing the Surform® Shaver and the Surform Mini-File. Just what's needed in every workshop. They do great smoothing jobs—especially in tight areas—that ordinary tools can't.

Like all Stanley Surform tools, replaceable blades feature super sharp, pre-set, edge-cutting teeth. Won't clog; are fast, safe. Take on wood, plastic, plaster, soft metals.

STANLEY

One-handed Surform Shaver trims, shaves, scrapes with an easy pulling action. Great helps you do things right for curves, corners, tight angles. Won't "chatter" or chip edges. About \$1.79 with an extra blade.

Blade on Surform Mini-File is only 1/2" wide. Just-right to file grooves, smooth joints, cut notches, square corners. You'll wonder how you ever did without one. About \$2.69.



"Until now installing a bathtub was a real problem."

But now there's Versa-Bath. Borg-Warner's new 4-piece bath/shower cove, a remodeler's delight.

Versa-Bath is packaged in one easy-to-carry carton, will fit through any standard doorway, and assembles quicker than a blinkin' of an eye. Its rigid walls fasten right to the studs. No sub-walls. No tiling. No grouting.

Versa-Bath is easy to clean with just the wiping of a damp cloth, and will maintain its brilliant lustre over the years.

You'll find Versa-Bath at leading building supply stores nationally. To find your Borg-Warner dealer, dial 800-243-6000, free, any time, any day. (In Connecticut, 1-800-882-6500.) Or write: Borg-Warner, Plumbing Products Division, Mansfield, Ohio 44902.

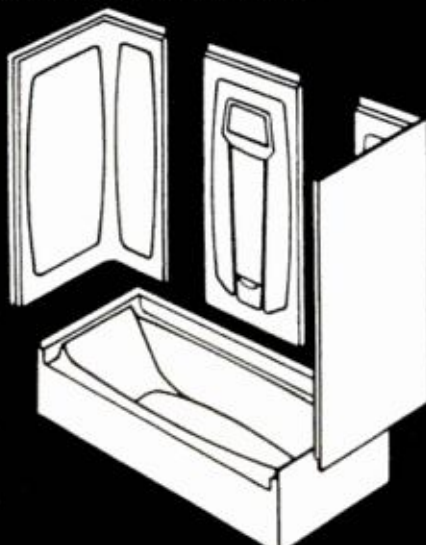

Borg-Warner Corporation
Plumbing Products Division



Popular Mechanics

JIM LISTON, Editor

SHELDON M. GALLAGER, Executive Editor

JOHN A. LINKLETTER, Managing Editor

WAYNE C. LECKEY, Home and Shop Editor

ALVIN KIETZ, Art Director

BILL HARTFORD	Automotive
JOHN F. PEARSON	Science and Engineering
WM. T. McKEOWN	Boating and Outdoors
IVAN BERGER	Electronics and Photography
HARRY WICKS	Home Workshop
STEPHEN WALTON	Assistant, Home and Shop
MICHAEL LAMM	West Coast
ROBERT LUND	Detroit Automotive
GARRY WINTER	Copy Chief
RICHARD H. FUNK	Production
ALFREDO VEGA	Assistant, Production
DON EVANS	Technical Art Director
JOSEPH P. BEATON	Assistant Art Director
DAVID KOMITAU	Assistant Art Director
IRA HERRICK	Assistant Art Director
CLIFFORD B. HICKS	Special Projects
SOPHIE GRONOWICZ	Director, Bureau of Information
EVERETT JOHNSON	Cabinetmaker

DANIEL J. COLEMAN, Director of Advertising

ADVERTISING OFFICES: New York: 224 West 57th St., 765-6850; Chicago: 520 N. Michigan Ave., 527-2400; Detroit: General Motors Bldg., TRinity 5-8711; Cleveland: 20310 Chagrin Blvd., Shaker Heights, 283-7788; Los Angeles: 601 North Vermont Ave., 666-6261.

JOHN A. REGINA, Advertising Production Manager

Published by The Hearst Corporation

FRANK MASSI
President

JOHN R. MILLER
Executive Vice President

RICHARD E. DEEMS
President, Magazines Division

JOSEPH F. KERN
Publisher

ADDRESS ALL EDITORIAL COMMUNICATIONS TO: 224 West 57th St., New York, N.Y. 10019. For additional sources of information on the articles and products in this issue, write to Bureau of Information, Popular Mechanics, for free "Where-to-Find-It" list.

SUBSCRIPTION SERVICE: Mail all subscription orders, changes of address, correspondence concerning subscriptions, and Postmaster notices of undeliverable copies to Popular Mechanics, Box 646, New York, N.Y. 10019. Please enclose your latest address label for quickest service when writing about your subscription.

POPULAR MECHANICS IS PUBLISHED MONTHLY by The Hearst Corporation, 57th St. at 8th Ave., New York, N.Y. 10019, U.S.A., Frank Massi, President; John R. Miller, Executive Vice President; Harrison A. Mitnick, Treasurer; Harvey L. Lipton, Vice President and Secretary; Richard E. Deems, President of Magazines; Raymond J. Petersen, Executive Vice President of Magazines; William S. Campbell, Vice President and General Manager of Magazines; John F. D'Avolio, Vice President and Resident Controller of Magazines; Albert A. Rachol, Vice President and Director of Circulation; Joseph F. Kern, Vice President for Popular Mechanics. Single copy in the United States and Canada, 60 cents. Subscription prices: United States and Possessions, \$5.97 for one year; \$10.97 for two years; \$14.97 for three years. Canada, add \$2.00 for each year. All other countries, add \$4.00 for each year. When changing address, give old address as well as the new, with postal-zone number, if any, and allow six weeks for change to become effective. Second-class postage paid at New York, N.Y., and at additional mailing offices. Authorized as second-class mail by the Post Office Department, Ottawa, and for payment of postage in cash. Registered as second-class matter at the Post Office at Mexico D.F., Mexico, June 20, 1950. © 1973 by The Hearst Corporation. All rights reserved. Printed in U.S.A.

Have you seen this coupon before?

© 1972 LaSalle Extension University - A Correspondence Institution

It has helped to start many men and women on the road to higher pay.

Just looking at it won't get you anything.. but putting it in the mail may change your whole future!

The LaSalle coupon is one of the most often-seen coupons in America. To many who have mailed it, it has proved a first step to opportunity and good fortune.

Cut Along Dotted Line - Seal (Tape, Paste or Staple) and Mail Today.

MAIL THIS HANDY POSTAGE-PAID COUPON-ENVELOPE

Cut coupon along dotted lines, fill in your name and address . . . fold, seal (tape, paste or staple) and mail. No stamp or envelope is necessary.

Please rush me, without obligation, FREE booklet on the field I have checked:

ACCOUNTING

- Complete Accounting
- Income Tax
- CPA Training
- Bookkeeping

BUSINESS MANAGEMENT

- Management Training

REAL ESTATE

- Complete Real Estate
- Real Estate Brokerage

TRAFFIC & TRANSPORTATION

- Complete Training

AUTOMOTIVE MECHANICS

- Basic Training

DIESEL MECHANICS

- Basic Training

COMPUTER PROGRAMMING

- Basic Training

LANGUAGE INSTRUCTION

- French Spanish

MUSIC INSTRUCTION

- Piano Guitar
- Other

DRAFTING

- Complete Training

HIGH SCHOOL

- Diploma Program

INTERIOR DECORATING

- Complete Training

DENTAL OFFICE ASSISTANT

- Complete Training

ART TRAINING

- Complete Training

SECRETARIAL

- Complete Training

ELECTRONICS TECHNICIAN

- Basic Training

LAW COURSES

- Bachelor of Laws Degree
 - Business Law
 - Claim Adjusting Law
 - Law for Police Officers
- No state accepts any law home study course, including LaSalle's, as sufficient education to qualify for admission to practice law.

STENOTYPE

- Machine Shorthand

MOTEL/HOTEL MANAGEMENT

- Motel Management
- Hotel Management

RESTAURANT MANAGEMENT

- Management Training

WRITING

- Fiction
- Non-Fiction

AIR CONDITIONING & REFRIGERATION

- Basic Training

46D FOLD HERE ↓ (DO NOT CUT) SEAL AND MAIL TODAY - NO STAMP NEEDED. 8

FIRST CLASS
PERMIT NO. 27
CHICAGO, ILL.

BUSINESS REPLY MAIL

No postage stamp required if mailed in the United States

Postage will be paid by

LA SALLE EXTENSION UNIVERSITY

A Correspondence Institution

417 S. DEARBORN STREET
CHICAGO, ILLINOIS 60605

If your goals are bigger pay and more frequent promotion, you owe it to yourself to find out without delay, what LaSalle home study can do for you.

LaSalle gives you modern, comprehensive instruction in many well-paid, fast-growing fields where there is a continuing demand for trained personnel. You learn at home; lessons come to you by mail. You are a class of one.

For more than sixty years, LaSalle has been a leader in home study. It has a large staff of experi-

enced instructors. The cost of training is low. A LaSalle diploma is a respected credential.

You should act now. LaSalle training may make a big difference in your future. One student reports: "I received a \$2,000 yearly increase since enrollment with LaSalle. My regret is that I didn't enroll before." Many letters like this come to LaSalle. Get full information now on the field that interests you. Mail postpaid coupon above to LaSalle, 417 S. Dearborn St., Chicago, Illinois 60605.

SOLDER SEAL LIQUID WRENCH



Liquid Wrench is the super-penetrating rust-solvent that loosens rusted nuts, bolts, screws and parts—in seconds! Safe on all metals, use it on a bulldozer or even your watch!



Lan-Lin gets down deep—removes paint, grease, grime, ink!

Trans-Medic stops transmission troubles! You'll feel the difference!

RADIATOR SPECIALTY CO., CHARLOTTE, N. C. 28201

Look for

GUNK®

when you want to clean anything!

... like engines, power mowers, concrete driveways, parts.

There's a

GUNK

product for almost any degreasing job in factory, shop or home.



Engine Brite Engine Cleaner. Spray it on... hose it off! "Dirt and grease wash away."



B.O.P. Small Parts Cleaner with dip basket... soaks parts clean.

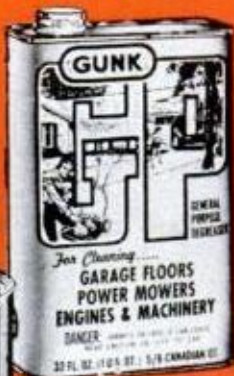

GP cleans oil, grease, dirt from garage floors, driveways, power mowers, machinery.

GUNK LABORATORIES, 5829 W. 66, CHICAGO, ILL. 60638
Gunk Chicago Co. River Forest, Ill. Radiator Specialty Co. Charlotte, N. C.

LETTERS

TO THE EDITOR

Car Care Guide

Thank you for the May edition. The *Car Care Guide* is worth the price of all the issues. It has helped me in many ways.

ANDERSON, IND.

RALPH E. TOOLEY

Your *Car Care Guide* seems to be one of the most complete that I have seen. It may serve as the main part of a car-care course that I've been trying to organize to help people, including my customers, properly care for their cars.

ALBUQUERQUE, N.M.

ROBERT R. MILLER

This type of information could well be instrumental in saving some lives on the highways this summer.

MILWAUKEE, WIS.

RICHARD G. JOHNSON

The enormous amount of information in the guide boggled my mind. If nothing else, all that information proved conclusively that a person could spend his whole lifetime just performing routine maintenance and repairs on his car.

CHICAGO

KEN GREENBERG

But what we're telling you, Ken, is how to make it a spare-time, not lifetime, job.

Your corporation is to be commended for the fine job in publishing the *Car Care Guide*. It is informative and has much factual material.

BAY CITY DRIVING SCHOOL

RICHARD STARRY

GREEN BAY, WIS.

CLASSROOM COORDINATOR

More weight for giants of the road

I wish you could produce a few more articles like *Giants of the Road: Why They Cost So Much* (page 136, May *PM*) as I am sure many truckers as well as everyday people would find them extremely interesting.

GREEN BAY, WIS.

GLEN TAGGE

Depending on a number of things, normal diesel fuel weighs approximately 7.5 pounds

(Please turn to page 10)

A plug for people who change their own

We figure you power buffs have lots of interests and lots of equipment to go with them. So NGK builds a plug for practically every internal combustion engine made.

Also, being mechanically hip, you appreciate quality and efficiency. So we build the most efficient, toughest plug we can. The kind you'd want to put in your own car, bike, outboard, buggy...whatever.

But all our plugs — and it takes the company computer to keep track of them — have one thing in common: a never-say-die "Heart of Copper".

Used in place of ordinary iron cores, this highly conductive copper core delivers maximum performance under all conditions.

It dissipates heat fast, cuts down plug damaging hot spots and piston-popping pre-ignition. A long-nosed insulator holds just the right amount of heat to reduce tip fouling. In hot engines or cold, under easy or hard use, NGK's fire on time, every time.

If you're a motorcycle owner, you probably know all about NGK performance. You sports car types do, too. But NGK's work just as great in utility and recreational vehicles. And they'll fire-up your hairy V-8 as quick as your one-lunger saw.

Take our tip. Screw in a set of "Heart of Copper" NGK's. They're a change for the better.

NGK, the long life, hi-performance plug.

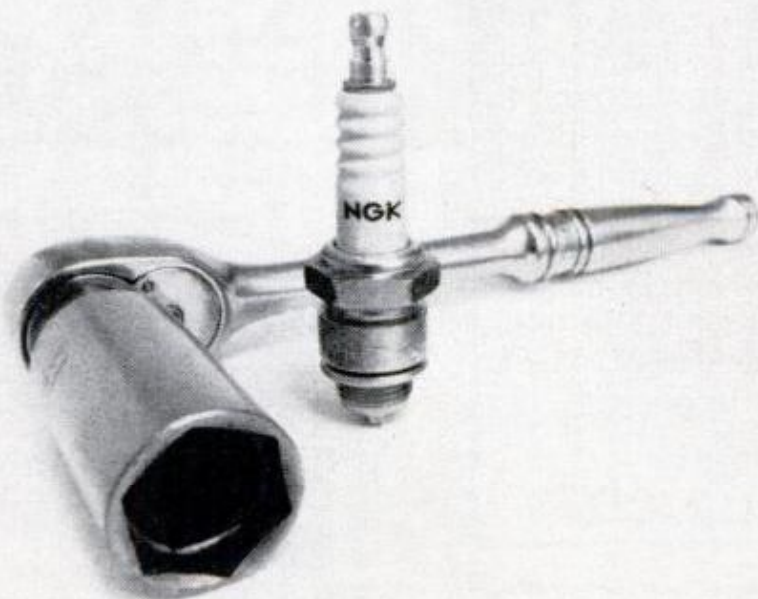

All the chain saw you need costs just

\$99.95*



It's the 6.9 lb.** Mini Mac 1. Only McCulloch makes a saw this light, for this little.

The right tool for the right job — you know that's what counts. So if all you use a chain saw for is limbing, trimming and cutting firewood around your own



yard — this is *all* the saw and *all* the power you need! It's lighter than any saw in the world for the price. Its 10" bar will cut a 6" log in just 5 seconds and even zip through 20" logs. And it comes with something you just can't acquire anywhere else — McCulloch's 26 years of professional chain saw engineering know-how. So, now you can get the best saw specially designed for your yard — the Mini Mac 1 — for only \$99.95.* Why pay more?

McCulloch

McCulloch Corporation, 6101 West Century Blvd., Los Angeles, Calif. 90045

*Manufacturer's suggested list price, including bar and chain.

Prices slightly higher in Canada and Alaska.

**Weight less cutting attachments.

See your McCulloch dealer — He's listed in the Yellow Pages under "saws."

LETTERS

(Continued from page 8)

per gallon. Thus, the fuel in each 140-gallon tank will weigh 1050 pounds, and both tanks will carry a total of 2100 pounds — vs. the 1400 pounds cited in the article (at five pounds per gallon).

INDIAN HARBOUR BEACH, FLA. W. E. ANDRUSS

How to cool a bulb

I cannot believe that a firm as reputable as Kodak does not recommend using the FAN-ONLY position of the switch for cooling slide-projector bulbs (*Letters*, April PM). We use six Kodak Model 800 Carousel units daily and have ruined more bulbs than we would like to remember due to insufficient cooling.

TEXAS A&M UNIVERSITY EDWARD HOLLAND JR.
COLLEGE STATION, TEX.

Kodak stopped recommending the FAN-ONLY switch for cooling bulbs several years ago. The reason: Thermal shock involved in fast cooling can damage not only the bulb but the projector's heat-absorbing glass as well. Have you ever tried a long-term test of disabling the FAN-ONLY switch on three projectors to see which three get the longest bulb life?

Exceeding help

Eugene Sloane's writing of recent months concerning building, lacing and truing a wheel (*The Bicycle Shop*, page 21, March PM, and page 40, April PM) has been of exceeding help and service. As an avid cyclist myself, my opinion speaks for many other enthusiasts. Although special feature authors always get the praise, I'd like to extend my personal thanks to a deserving author of informative books and a useful column.

CEDAR RAPIDS, IOWA

JIM WICKS JR.

Two-way mat cutter

I've been using the Dexter Mat Cutter (photo, page 179) recommended in *Good Art at a Price You Can Afford* (page 73, Feb. PM) for several years—but with the blade facing forward, not backward. The cutter is easier to steer when pushed, and a close look at the housing suggests that it was so designed. (With a plywood jig, one

can also cut circular or oval mat openings which are especially effective for portraits.)
REGENSBURG, W. GERMANY RICHARD RUNDELL

Harry Wicks, who wrote the article, says he won't knock a technique that works—but the instructions do say to use it the way he photographed it.

Wrong on two counts

The excellent exposure of our "Sure-Drive" product (NOW, page 116, May PM) was spoiled because in two instances the product was called a wrong name. Even more important, the name of the manufacturer is Stanley Hardware, New Britain, Conn.



Your error in stating it came from "Stanley Tools" is particularly unfortunate because it is the only such product the Hardware Div. has produced.

THE STANLEY WORKS E. C. BENFIELD, MGR.
NEW BRITAIN, CONN. PUBLIC INFORMATION

Do security checks ruin film?

The lab that develops my film recently told me that one roll was double-exposed. Could the new airport X-ray security devices possibly have caused this?
SCITUATE, MASS. M. McCALLUM

According to Kodak, the X-ray equipment used by most major airlines uses high-speed, high-voltage X-ray pulses that won't affect film, even if you change planes and go through airport security checks several times. But some of the smaller airlines use less expensive equipment that will affect it.

Overexposure and X-rays have different

(Please turn to page 12)

Power to go



McCulloch Portable Generators

Here's electric power where you need it, when you need it — on camping trips, outdoor building projects, for standby power during storms, blackouts and other power emergencies. McCulloch's super lightweight generators are small enough to fit in the back of your car. And the unique design, with only one moving part, means they're the most reliable you can buy. Three sizes, all with our Double Warranty.



H-1500. 1,500 watt capacity. 68 lbs.
115 volts. 60 cycles. **\$199.95***
Only

H-2000. 2,000 watt capacity. 83 lbs.
115 volts. 60 cycles. **\$289.95***

H-3000. 3,000 watt capacity. 129 lbs.
115 or 230 volts. 60 cycles. **\$399.95***

*Manufacturer's suggested list price. Slightly higher in Alaska and Canada.

McCulloch

McCulloch Corporation
6101 West Century Boulevard
Los Angeles, California 90045

See your McCulloch dealer — He's listed in the Yellow Pages under "saws."

LETTERS

(Continued from page 11)

effects on the film. Overexposed negatives look blacker than normal ones, but their edges are as clear as the edges of normally exposed film. X-ray fog darkens the entire film, including the edges.

Back issues are a help

As a nonmechanic who has started working on my own car, I have found the back issues of PM better than any manuals.

SMYRNA, GA.

W. F. PITTMAN

Westinghouse kit will help you

I have just read the procedure for replacing the heater element or heater coil in Westinghouse electric dryers in *Appliance Clinic* (page 44, Jan. PM).

The problem is familiar to servicemen; however, the average do-it-yourselfer may overlook procedures and techniques, resulting in short life for the repairs.

Genuine Westinghouse renewal part heat-

ing coils include a set of instructions along with mounting nuts, washers and terminal studs. The new parts supplied in our coil kits are intended to replace all the old ones. Our present field replacement coil kit will repair all Westinghouse dryers manufactured since 1962.

WESTINGHOUSE ELECTRIC CORP. D. E. KREIS
MANSFIELD, OHIO LAUNDRY EQUIPMENT
SERVICE ENGINEER

Pickup in the classroom

There's some additional information I need beyond that in *Recorders by the Pocketful* (page 80, April PM). My grandson feels the need for a recorder during lectures in a college classroom when the instructor is sometimes 50 feet away. Which mini would have a built-in microphone with the greatest receiving ability?

HAMLET, IND.

ELMER A. ASZMAN

Almost any microphone, whether separate or built into a recorder, will pick up more noise than anything else when it's 50 feet from a classroom instructor. ★★★

NEW CORONET BUILT-IN DISHWASHER

WASHES AND DRIES DISHES in 5 minutes

Now, for the first time after eight successful years of sales exclusively to the Builder/Developer, the Coronet Built-In Dishwasher is being offered directly to you, the "Do-It-Yourselfer"! A totally unique concept, the CORONET operates on water line pressure only. Using automatic dishwashing detergent, it requires only a two minute wash. The drying is accomplished in three minutes by heat retained in the dishes from the hot water wash. There are no electric motors, pumps, or electrical connections required. Only two plumbing

connections are necessary, one to the valve and one to the drain. Complete detailed installation instructions are provided with each unit along with a countertop cut-out template. A real savings "plus", the CORONET is designed to provide maintenance free operation over extended use, as there are only two moving parts. Lids in decorator colors of Pastel Yellow, Pastel Avocado, and Harvest Gold are optional at \$1.50 each. Standard Lid color is appliance white. Also available at \$1.50 each is a wood-grained vinyl lid insert.

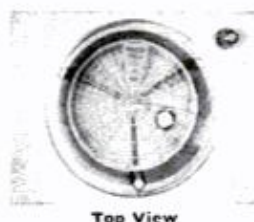

Top View



Minimum Lost Storage



Ideal in Corner



Order now at the Special Price of \$93.00, freight paid in Continental U. S. A. (Residents of Missouri add 4% Sales Tax.)

Send check or money order to:

Coronet Imperial Corporation
6755 Southwest Avenue
St. Louis, Missouri 63143*

*Write for descriptive brochure

**WHATEVER YOUR PLANS,
THEY PROBABLY DON'T INCLUDE
TIRE TROUBLE.**



Steel Radial 500—we think you'll say "They're the best tires I've ever owned". • A 40,000 mile radial (that's 3 or 4 years of average driving). • Two belts of brass plated, high tensile steel cord under the tread. • Better handling and steering than any conventional tire we have on the road today. • A computer designed quiet running tread. • And six ways to charge it at most Firestone Dealers and Stores.



**Let Firestone put the 40,000 mile Steel Radial 500
between you and tire trouble.**

Firestone
The people tire people

PHOTO HINTS

FROM READERS

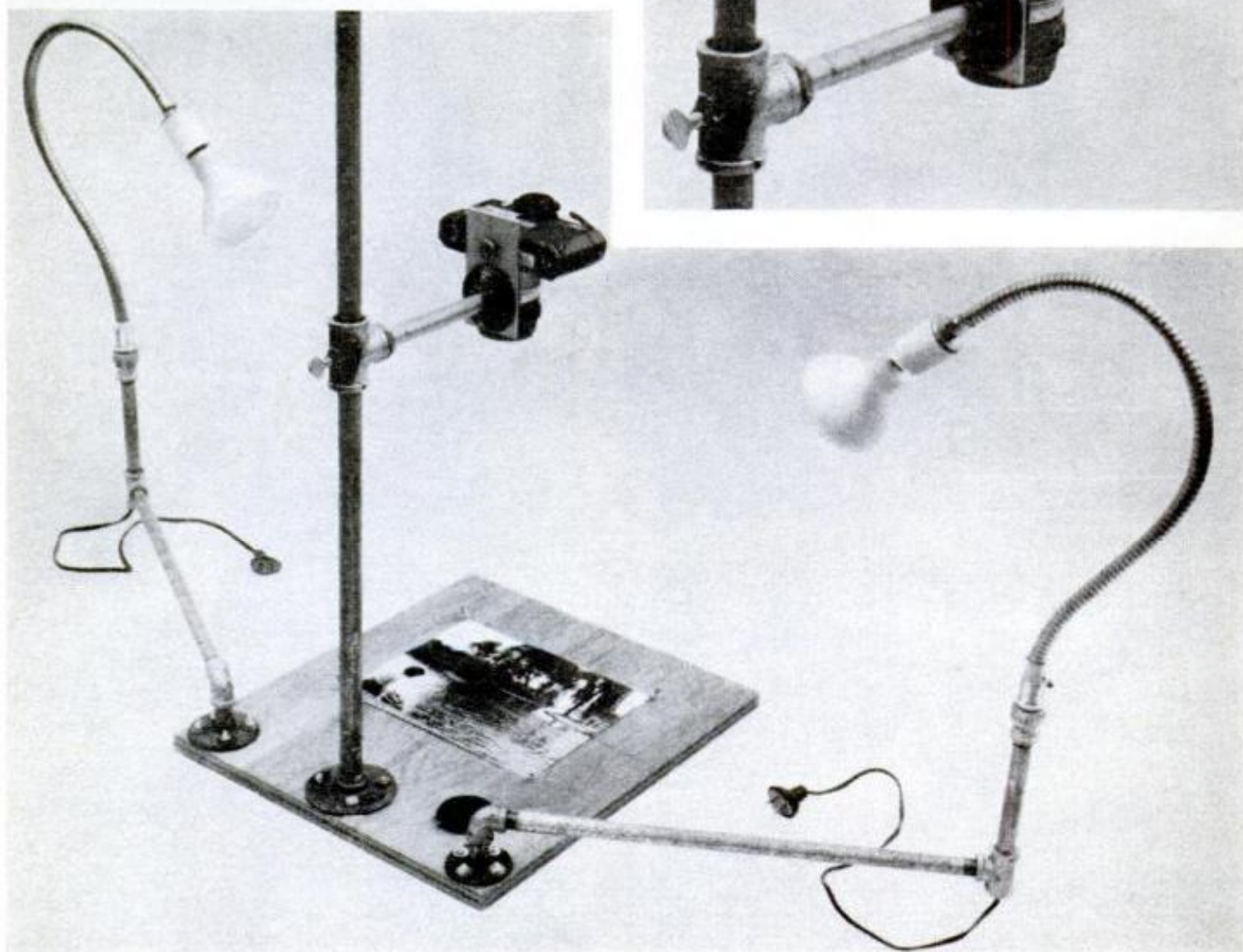

Simple copy stand

Unable to find a satisfactory copy stand at a reasonable price, I built my own. Besides copy work, it also handles movie titling and many small, tabletop photo jobs. It can be used in either vertical or horizontal position, and will support cameras up to 4x5.

Construction is fairly obvious, requiring only standard hardware, plumbing and electrical items, and no unusual tools.

The baseboard is $\frac{3}{4}$ -in. plywood, countersunk, counterbored or raised on feet to provide clearance for the bolt heads that hold the pipe flanges.

The camera arm is $\frac{3}{8}$ -in. pipe mounted with an adapter to a $\frac{3}{4}$ -in. pipe tee that slides up and down a $\frac{1}{2}$ -in. upright. Drill and tap the tee to take a thumbscrew, as

seen above, to lock the camera in position.

At the other end of the arm, the camera is mounted by a $\frac{1}{4}$ -20 thumbscrew or knurled screw to a platform of $\frac{1}{8}$ or $\frac{3}{16}$ -in. aluminum, fastened to a $\frac{3}{8}$ -in. pipe flange by two countersunk $\frac{3}{16}$ -in. machine screws. (Make sure the $\frac{1}{4}$ -20 screw protrudes enough to grip the camera's tripod socket firmly, but not enough to push out the top of the socket.)

Lamp arms use $\frac{3}{8}$ -in. pipe and fittings, with goosenecks (from an electrical supply house) attached with a $\frac{1}{2}$ -to- $\frac{3}{8}$ -in. pipe reducer, and the lamps mounted in ceramic sockets.

Used pipe and fittings can be utilized, at a considerable savings.

Assembly takes about an hour, and the stand is easily dismantled for storage.

—Warner G. Tilsher, Rosemead, Calif.

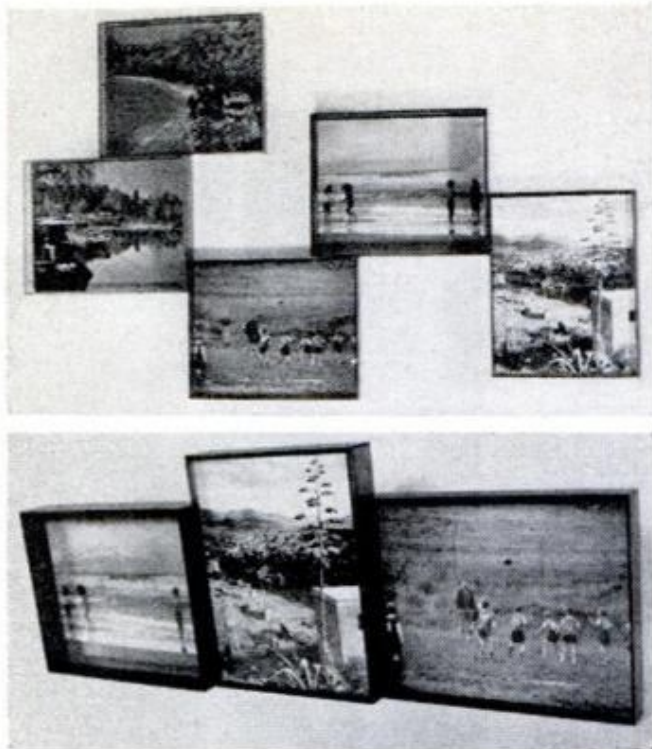

Decorate your wall with photos

Want to display your prize photos dramatically? Decorate your wall with a group of them in these colorful frames. They're easy to make and easy to vary in appear-

ance to obtain a lively, eye-catching effect.

The basis for each frame is a piece of clear, 1/8-in. Plexiglas, cut exactly to match the size of each picture. The frame sides are made from 1/8-in. colored Plexiglas strips, each 1/4 in. longer than the side of the picture it will mount against. Miter the edges of each strip 45°, and temporarily assemble the complete frame—clear cover and all four edge strips—with masking tape. Then carefully cement with a syringe filled with solvent cement. When the cement has dried, insert the picture and a cardboard backing sheet. To hold the photo in place, cement small Plexiglas retaining tabs behind the cardboard. Cement the tabs lightly, so you can knock them out to change the picture.

When you've finished building all the frames you need, lay them on the floor and cement them together in any desired pattern. Lively staggered patterns, like the one at upper left, are easy to make and attractive, and you can add a great deal of variety by varying the color and depth of the frame edges, and mounting the photos at different depths within the frames.

—Dwayne L. Hardin, Federal Way, Wash.



Minolta helps you understand courage.

Smile at the challenges of everyday life. All it takes is a sense of humor and a responsive camera to see the pictures that are everywhere.

If you have the insight, a Minolta SR-T could be the camera. This is a 35mm reflex you'll be comfortable with from the moment you pick it up. It lets you concentrate on the picture, because the viewfinder shows all the information needed for correct exposure and focusing. You never have to look away from the finder to adjust a Minolta SR-T, so you're ready to catch the one photograph that could never be taken again.

Next time you see the funny side of life, be ready with a Minolta SR-T. For more information, visit your photo dealer or write Minolta Corp., 200 Park Ave. So., N.Y., N.Y. 10003. In Canada: Anglophoto Ltd., P.Q.

Minolta SR-T 101/Minolta SR-T 102





You can go pretty far. With no college. And no connections.

(A TRUE STORY)

If you want the good things in life, you don't have to hassle your way through four years of college.

Gary Burnash didn't. (College just wasn't his bag.) Yet, Gary is a real success in every sense of the word.

Wonderful family. Nice home in the suburbs of Detroit with a swimming pool the kids just love. A hunting lodge about 200 miles deep into the Michigan woods. With his own snowmobile to take him to some of the best hunting spots a man can get to.

Gary's income has more than tripled in the last six years. And anytime he wants a raise, he just takes it. Because, now he's half owner of the Sheler Corporation, a machine tool company that makes prototype parts for the automobile industry.

Gary got to the top of that company in just six years (at age 34). But he didn't do it by flashing a college diploma. Or being related to the owner.

As soon as he got his job at Sheler, he also signed up for the ICS course in Mechanical Engineering. He studied at home, in spare time. And when the boss heard about it, he gave Gary some design work to do at home. The rest is history.

The right combination for success

Gary Burnash has the right combination for success. He's in a growing field. And he has good training for it. You could, too.

Especially if you're interested in one of the fast-growing careers where ICS concen-

trates its training. Like Electrician. Engineering. Automotive Mechanic. TV Repair & Servicing. Drafting. Air Conditioning. (Check your choice on attached card.)

Ideal way to learn

As an ICS student, you study at home, on your own schedule. You waste no time traveling to and from class. And you never have to miss a paycheck.

But you're never alone. Skilled instructors are always ready to help you.

If you ever have any doubts or problems or just want to talk to your instructor, you can even call ICS from anywhere, at any hour. Toll-free.

ICS training works

More than 8,500,000 men and women have turned to ICS for career training in the past 80 years.

Government agencies, unions and some of America's top corporations (including Ford, U.S. Steel, Mobil, Alcoa, Pan Am, GE, Motorola and RCA) use ICS courses in their own training programs.

Free demonstration lesson

If you want your job to give you more (more money, more day-to-day satisfaction, more future) send for our career guide booklets and free demonstration lesson.

Remember, it's your life. You might as well make the most of it.

ICS

We'll show you a better way to earn a living.

Gray Burnash and his "crew." Shopping for a new boat to enjoy on nearby Lake Huron. (Photograph by Frank Cowan)

“King of the Surf”

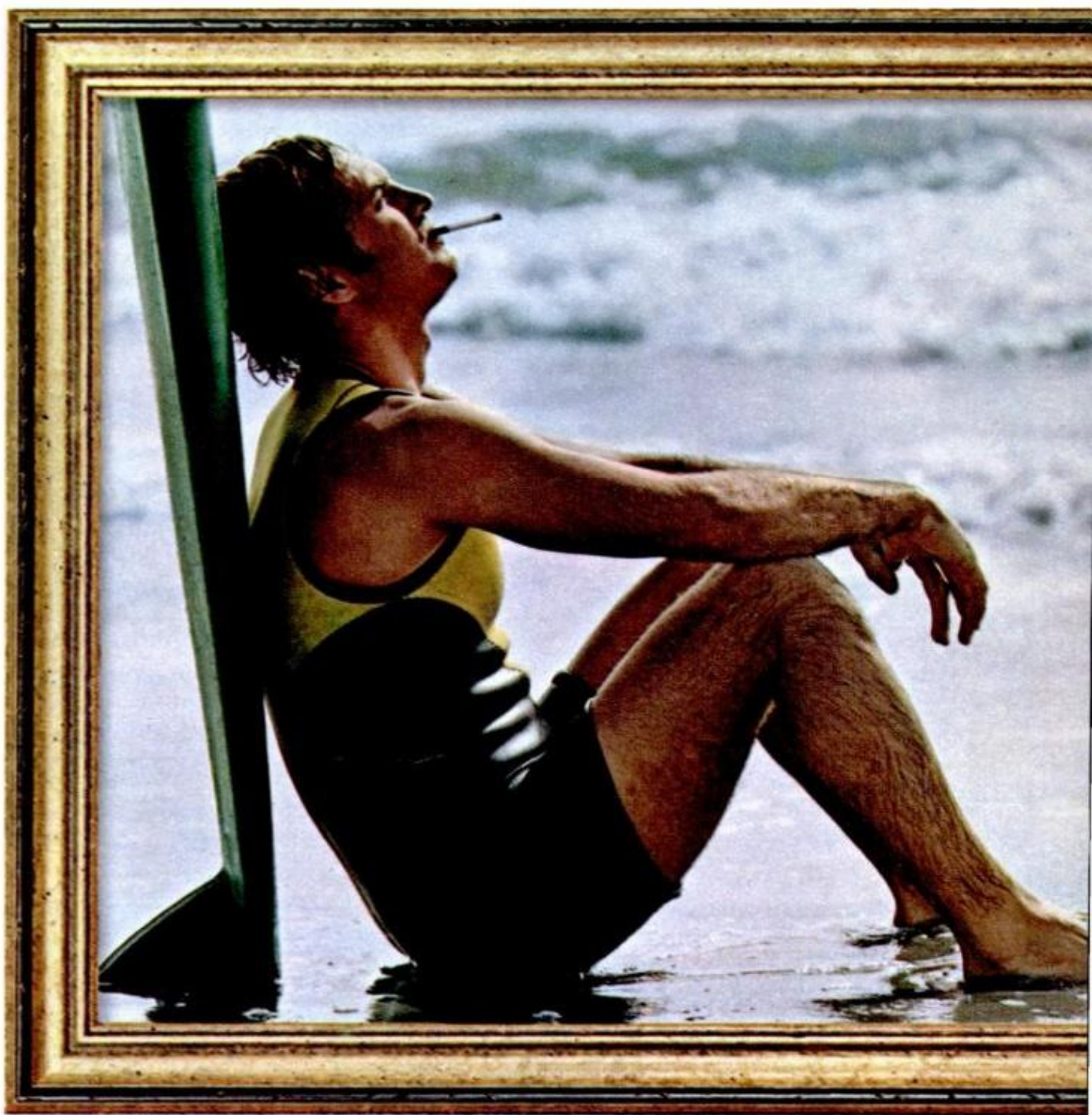

**Warning: The Surgeon General Has Determined
That Cigarette Smoking Is Dangerous to Your Health.**

How good it is

Winston tastes good,
when a cigarette should.



© 1973 R. J. Reynolds Tobacco Co.
BOX: 20 mg. "tar", 1.3 mg. nicotine, PACK: 20 mg. "tar", 1.4 mg. nicotine, av. per cigarette, FTC Report FEB. '73.

THE BICYCLE SHOP

BY EUGENE A. SLOANE

There's a boom on in bike sales in the United States, and with the boom has come a great increase in the number of bicycles imported into this country. The poor quality of some of the bicycles is masked by the cosmetic treatment of fancy paint jobs, so when it comes to buying a bike it pays to know how to tell a clunker from a well-made machine. Here is how to select a bicycle that will give you good value for the money.

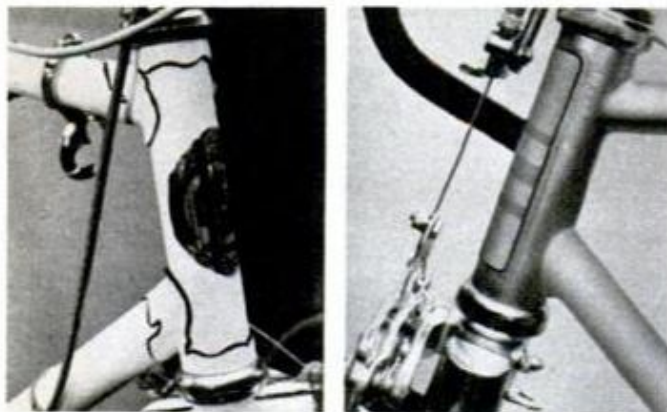

1. Check frame joints. Look for a lugged frame rather than a frame in which tubes are simply stuck into each other and welded. Photo at left shows a fine, lugged frame. Photo at right shows a weaker, unlugged frame. Exceptions: Schwinn and DBS Oglaend unlugged-frame bikes have frame members that are reinforced with an extra bead at the weld in the joints.

2. Heft the bike. The lighter the bike, the more it costs. A \$250-and-up bicycle should weigh no more than 24 pounds. A \$100 10-speed will weigh up to 40 pounds. Look for a 10-speed weighing from 24 to 30 pounds at the most. Any heavier and you'll be carrying around extra iron that will weigh you down. The bike above, left, weighs 24 pounds, costs \$350.

3. The brakes. Side-pull brakes are not as good as center-pull (top of next column). Exceptions: Shimano and Campagnolo side-pulls, which are cam-actuated and expensive. Better bikes will have center-pulls, and the very best, either Shimano or Campagnolo side-pulls. Good center-pull brand names are Mafac,

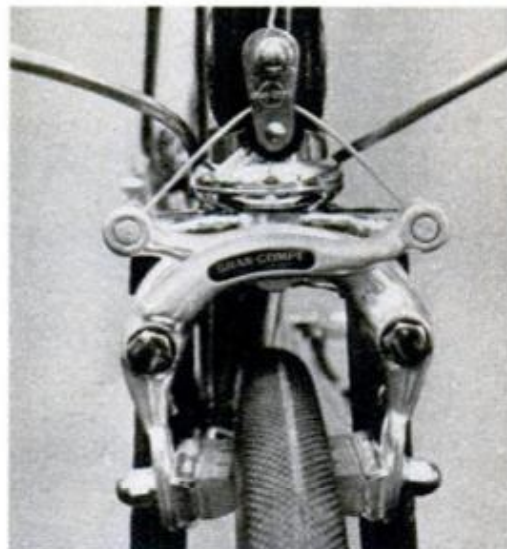

Dia-Compe. Universal, Balilla and Weinmann. Squeeze the brake levers. The brakes should meet the rim flats firmly when levers are depressed no more than one inch, so that both the wheels are locked.

4. Check the parts. A better bike will have aluminum rims, hubs and cranks. A cheaper bike will have steel components. The very best machines are equipped with aluminum-alloy cotterless cranks and chainwheels, like those in the top photo, right. The cheaper bikes have steel cotted cranks or one-piece steel cranks, like that in the lower photo.

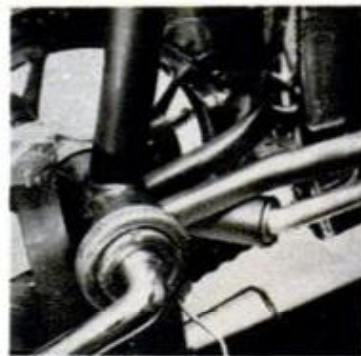

5. Wheel trueness. Spin wheels, and with a finger on the brake block, check wheels for lateral (side to side) and concentric (roundness) trueness. Wheels

(Please turn to page 24)

Schick Super II

against I.

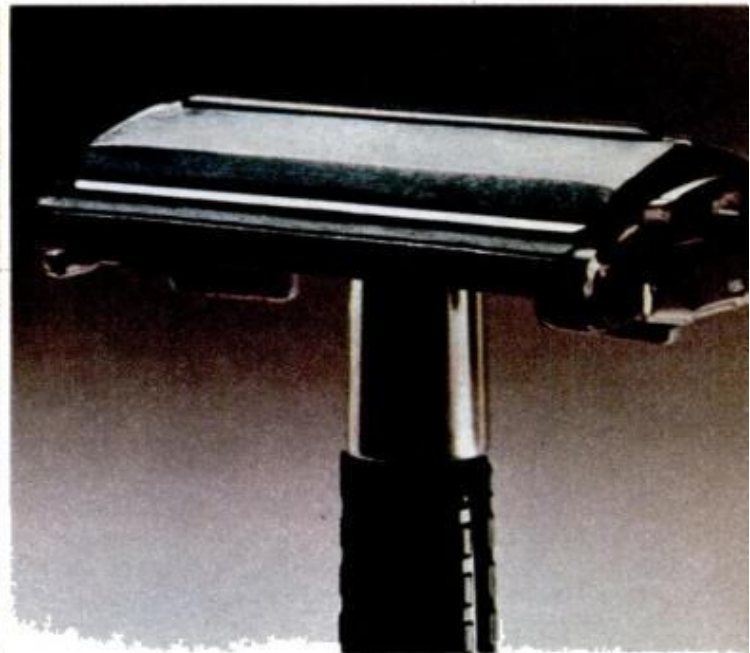
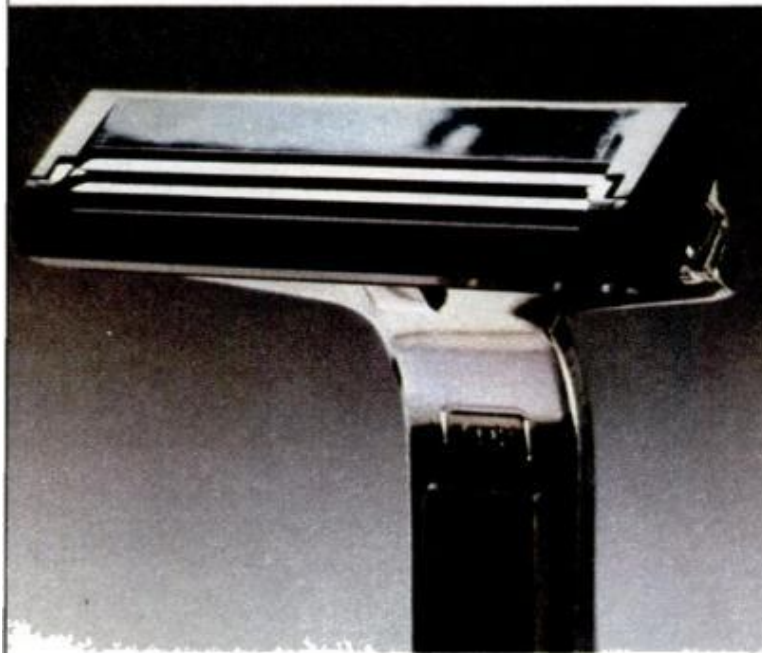

How double is a double edge razor, really?
There's never more than one edge working for you. While the other one's out there goofing off.

Now compare with the Schick Super II:
Both edges are on your side. Always working together.

The first edge shaves you close like your double edge now. The second edge shaves you closer.

There's really no comparison.
It's two against one.
Unfair maybe. But that's life.

Schick^{Super II}
Two Bladed Razor



The Schick Super II. Put both edges on your side.

©Schick Safety Razor Co., Div. Warner-Lambert Co.

Материал, защищенный авторским правом

THE BICYCLE SHOP

(Continued from page 22)

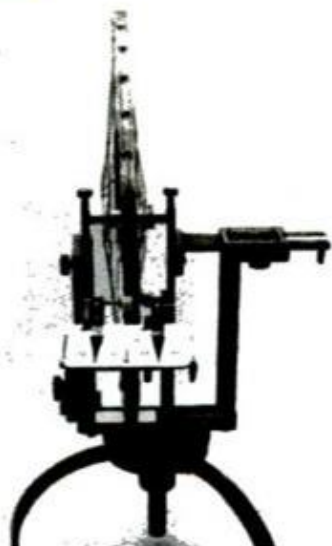

should show little or no untrueness; don't accept a bike with wheels more than $\frac{1}{32}$ -in. out of true in either dimension. Photo shows a wheel-truing machine with rim true laterally and concentrically.



wheel following in the track of the front wheel. With a ruler, make sure the wheels are centered between the fork blades and the rear seat stays. Ride the bike "hands off" the handlebars—or have an experienced cyclist do so. The bike should ride true and not pull to one side.

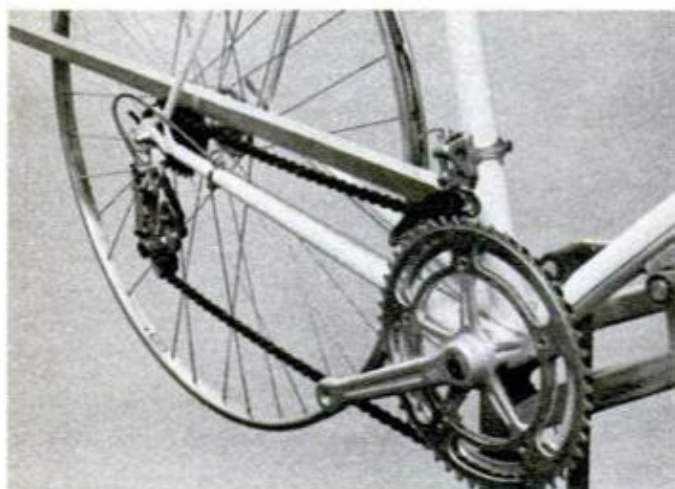

6. Chainwheel. Slip the chain off the chainwheel (the big front gear). Spin the chainwheel and sight down it to check for trueness (a straightedge may help, as shown in the photo). There should be no wavy spots. Spin the chainwheel again. It should turn freely, without evidence of binding. Grasp the pedals in either hand and push the pedals and cranks from side to side to check for sideplay; there should be none.

7. Hubs. Remove both wheels. Spin the axle between thumb and forefinger. The axle should turn freely without a feeling of tightness or roughness. Holding both axles, twist them up and down to check for sideplay; there should be none.

8. Frame alignment. If possible, ride the bike on a wet street, holding the front wheel straight and coasting. Both wheels should track true, with the rear

9. Inspect tires. Inflate 27 x $1\frac{1}{4}$ -in. and 27 x $1\frac{1}{8}$ -in. tires to 90 pounds (90 p.s.i.) Inspect the tires carefully for bubbles and other defects in the tread and, particularly on tubulars, the sidewalls. Make sure tubular tires are glued firmly onto rims by trying to peel the tire off. On clinchers, check sidewall where it meets the rim, at the valve particularly, to make sure the tire bead is seated into the wheel "well" and is not bulging outward.

10. Make sure the bicycle fits you. Straddle the top tube with both feet on the ground. There should be $\frac{1}{2}$ to 1-in. clearance between you and the top tube. More than 1-in. clearance means the bike is too small, and you would have to have the seat awkwardly high. Less than $\frac{1}{2}$ -in. clearance means the bike is too big and you could be hurt if on a quick stop you had to dismount and came into hard contact with top tube.

11. Where to buy. This should, perhaps, have been first. I really do recommend that you buy a bicycle only in a bicycle store, preferably one that sells and services only bicycles. An exception would be bike shops that cater to ski trade in the off-season. The reason: A bicycle comes to a retailer requiring adjustment of brakes, wheel alignment, hub and bottom bracket cones (usually), saddle height and a dozen other little things. If adjustment is not done, the bicycle can be hard to pedal or downright unsafe.

A look at the ads run by big department stores and discount chain stores tells you how little these outlets know about bicycles, the type of bicycle they are likely to have available (flimsy, cheap construction, for the most part) and how poorly an untrained clerk may assemble your bike for you. Some ads read "calibrated center-pull brakes." There's no such thing; they are caliper brakes. One ad I saw stated that a bicycle had a "racing-type kickstand." A racing cyclist would never have any kind of kickstand; even the better bicycles do not have kickstands. Kickstands are heavy and permit a strong wind or passerby to knock the bicycle down. I think they're useless.

It's much safer to buy from a man who makes his living repairing and adjusting bikes.

If you follow these steps, you'll have a reasonable chance of buying a bike that will fit you and a machine that's properly adjusted before it leaves the store. ★★★



Impala at Crater Mountains, Arizona.

There's so much to see, make sure you're around to see it. Buckle up.

Every time we try to give you one reason why Impala is a great value, we end up with a dozen.

1 Improved front bumper system retracts and returns on minor impact to help cushion shock.

2 Impala's traditionally high resale value is something you'll appreciate at trade-in.

3 Improved power ventilation keeps outside air coming in even when you're stopped.

4 Sturdy, protective side-guard beams in every door.

5 Variable-ratio power steering that gives good road feel, turns easily and quickly for parking.

6 Power brake system. Up front, fade-resistant discs. On rear wheels, finned drums.

7 Three-range Turbo Hydramatic. One of the world's finest automatic transmissions.

8 Full foam seats give you the kind of comfort usually associated with cars priced higher than Impala.

9 Double-panel steel roof serves two purposes: adds strength and helps reduce noise.

10 Full Coil suspension, springs computer-selected to suit weight of car and equipment selected.

11 Standard V8 engine that provides big-car performance with advanced emission controls.

12 3-point seat and shoulder belt system features single buckle, reminder light and buzzer.

Impala. Truly, the great American value. When you buy it. And when you sell it.

Chevrolet. Building a better way to see the U.S.A. 

USE IT ALL AS YOU GET READY FOR A NEW CAREER...

\$1,500.00 worth of two-way radio electronic communications equipment!

Bell & Howell Schools announces a new learn-at-home program that gives you "hands on" experience with commercial-grade equipment—as you prepare for a business of your own in two-way radio electronic communications servicing.

You need "hands on" experience with a real, commercial-band FM transceiver and actual commercial-grade test equipment—to take full advantage of growing opportunities in electronic communications.

Two-way radio communications is a healthy growth area in electronics. And it's lucrative. Almost two million commercial two-way radio systems now serve as vital communications links for trucks, planes, boats and taxis. And the FCC requires each system to have its equipment serviced regularly by a licensed technician. That's where you come in. But you need career-oriented training—plus your FCC license.

Knowing how to put an amateur radio kit together won't help when you're "on the job"—servicing two-way radio systems for aircraft or advising trucking companies about their land-mobile communications system. For that, you need "hands on" experience with the real thing. This unique new Bell & Howell Schools learn-at-home program gives you just that. You can work with the equipment by attending one of our special "help sessions" or by dropping by one of the Bell & Howell resident schools. If neither of these plans



is convenient, you can have the equipment shipped to your home in return for a \$100 deposit, which is refundable when you return the equipment.

Find out more about this exciting new Bell & Howell Schools program. There's no obligation.

For free facts, mail attached card today!

Let Bell & Howell Schools help you get ready for an exciting career or business of your own in two-way radio electronic communications!

Bell & Howell Schools has helped thousands of people prepare for careers—and businesses of their own—in electronics. You can have absolute confidence in the thorough training you get.

Expert instructors at Bell & Howell Schools plan each program to answer a single question: "What qualifications will you need to take advantage of *actual career opportunities* in electronics?" They then build each program to give you those exact qualifications.

To get ready for a business of your own in two-way radio, you need: 1) career-oriented training; 2) FCC License; 3) "hands on" experience with commercial-grade equipment. Bell & Howell Schools now offers this new at-home training program that gives you all three. (See FCC License Warranty on attached card.)

JUST LOOK AT ALL THE EQUIPMENT YOU'LL WORK WITH DURING YOUR TRAINING PROGRAM WITH BELL & HOWELL SCHOOLS!

Commercial-Band FM Transceiver . . . exactly the kind of two-way radio you'll service throughout your career.

Deviation Meter

. . . model favored by many working technicians to check modulation of transmitted signal.

Frequency Meter . . .

highly sensitive instrument used to check signal frequency within precise tolerances established by government standards.

Power Output Meter . . . meter

used almost universally by trained and licensed technicians to check power output—or wattage—of signal.

Alignment Generator

. . . a custom-designed unit you use to generate test signals for transceiver alignment.



FCC REGULATIONS GIVE YOU THE OPPORTUNITY TO START YOUR OWN BUSINESS!

The Federal Communications Commission requires that all commercial two-way communications systems be checked and serviced by a licensed technician at regular intervals.

As a Bell & Howell Schools graduate, you'll have the technical know-how you need. With your FCC license, you can go out and eventually build your own business—signing contracts with companies that use two-way radio. FCC regulations could mean security and regular income for you!

BELL & HOWELL SCHOOLS OFFERS YOU THESE SPECIAL ADVANTAGES:

Help Sessions Scheduled regularly every few Saturdays at the Bell & Howell Schools and in many other cities throughout the U.S. and Canada. Top instructors give you personal help and guidance.

Transfer Privileges After completion, you can transfer to any of the resident schools for more advanced study, if you wish.

Lifetime National Placement Assistance Helps you locate a job after you complete your program — and throughout your career.

Veterans' Benefits We are approved by the state approval agency for Veterans' Benefits.

Student Financial Aid We are an eligible institution under the Federally Insured Student Loan Program.

EXCLUSIVE ELECTRO-LAB®—YOURS TO KEEP!

To make sure you get practical experience with instruments used daily by professionals, we've integrated into your program three precision instruments you assemble yourself and keep:

Design Console Use this to rapidly "breadboard" circuits without soldering.

Oscilloscope Offers bright, sharp screen images, 3-way jacks for leads, plugs.

Transistorized Meter Registers current, voltage and resistance.

DETACH AND MAIL POSTAGE-FREE CARD TODAY! OR WRITE:

An Electronics Home Study School

DeVRY INSTITUTE OF TECHNOLOGY



ONE OF THE **BELL & HOWELL SCHOOLS**

4141 Belmont, Chicago, Illinois 60641

4 07 R 3

CAR CLINIC

BY MORT SCHULTZ

Locked out

I own a 1970 Plymouth Duster. The left-inside door lock button has come loose and no longer actuates the lock when pressed down. Can this be repaired without removing the inside door trim and panel?—Vernon W. Jones, Harrisonville, Mo.

No. The panel and trim have to come off. This problem, which others have experienced, occurs when a small plastic clip on the end of the linkage rod wears away or comes loose. This clip has to be replaced and the only way to get to it is you know how!

Schnozzola troubleshooting

I had a Ford air conditioner installed in my 1971 Ford pickup. Every now and then I hear something that sounds like water hitting a hot skillet, and then fumes that make me ill permeate the vehicle and I have to turn the air conditioner off. Mechanics look at me as if I'm nuts—"freon is odorless," they tell me. Maybe so, but something is making me and others who ride in the truck sick. I'm scared to death to use the air conditioner. Please help. It's hot here.—Ms. L. E. Hall, Tecopa, Calif.

The mechanics are correct. Freon is odorless. What I think is happening, though, is that condensation from the evaporator drain hose is hitting the hot exhaust pipe, producing fumes. I suggest you have the drain hose rerouted. And, just to be sure, have an air conditioner specialist check your system for leaks.

Heavy problem

My 1972 Buick has had a vibration from the day I bought it that can be felt in the seat, armrests, floor, accelerator pedal and steering wheel. It is discernible below 20 mph, quite heavy at about 30 mph and most pronounced at 60 mph and above. Tires have been dynamically balanced. The driveshaft

is clean. This is hard to take from a car that retails for \$7100. Do you know if this is a repetitive complaint, and can you help with some timely ideas?—Milton C. Dubay, Mount Clemens, Mich.

I have seen similar cases in which the tires were the center of trouble. They had heavy spots no amount of balancing could eliminate. The problem isn't confined to a particular brand. I suggest you tell the dealer you want five different tires. If the complaint has been on record since you bought the car, Buick should resolve this at no cost to you. Buick has told me to tell you that if you have no luck with your dealer, you should contact your Buick zone customer service department. Check your owner's manual for its location.

Tough shifting

The four-speed transmission of my 1972 Vega GT is very difficult to shift into first or second gear when the transmission is cool and the engine is running. It is easier first to shift into third or fourth gear, and then into first or second. The shift into first becomes easier when the transmission warms up, but still isn't as it should be. I've taken the car to two different Chevrolet dealers, and both say: "You've got the same problem as a million other Vega owners. We have no cure." Any suggestions?—John W. McCarter, Gardner, Kans.

Check the clutch-release bearing adjustment. With engine running at normal idle speed, depress clutch for three to five seconds until it stops spinning. Shift into Reverse. If the gears clash, the clutch isn't releasing completely and should be adjusted as explained in the 1971-72 Vega shop manual, page 7-2. It may also prove beneficial to drain the lubricant from the transmission and put in SAE 80 GL-5 lube. Do not use SAE 80-90 or 90 GL-5.

Chevrolet contends that manual transmissions are generally more difficult to shift

(Please turn to page 32)



Spend a milder moment with Raleigh.

A special treatment softens the tobaccos
for a milder taste.

Good fishing ahead when
you cruise along with this
Phantom M-3 electric fishing
motor by Pflueger. Lightweight,
quiet, 2-speed control. Yours for
free B&W coupons, the valuable
extra on every pack of Raleigh.

To see over 1000 gifts, write for your
free Gift Catalog: Box 12, Louisville,
Ky. 40201.



© BROWN & WILLIAMSON TOBACCO CORP.

Filter Kings, 16 mg. "tar," 1.2 mg. nicotine; Longs, 16 mg. "tar,"
1.3 mg. nicotine, av. per cigarette, FTC Report February '73

**Warning: The Surgeon General Has Determined
That Cigarette Smoking Is Dangerous to Your Health.**

CAR CLINIC

(Continued from page 30)

when cold and adds, "The Vega transmissions are no exception."

Nesting birds

I like my 1972 Oldsmobile 88 okay, but it's driving me to the nuthouse because of a constant chirp coming from the parking brake. I've tried oil, silicone and bracing the pedal back with a block of wood. Only driving with my foot on the pedal seems to help. What can I do?—Larry Nuckols, Ecorse, Mich.

If this is like other Oldsmobiles, the noise is being caused by the parking brake cables rubbing against the underbody between guide and frame. By putting your foot on the pedal, you apply tension to the cables, moving them away from the underbody. Coat the cable with water-resistant grease. If this doesn't silence your canary, slit a length of windshield-washer hose and tape it around cable at the point of contact.

Another possibility is that the guide is rubbing on the crossbar. File top and bottom of the slot in the crossbar with a rattail file to get rid of the contact points.

Recall modification fails

I own a 1971 Plymouth Cricket in which the steering mechanism was replaced recently as a result of the manufacturer's recall program. Since this modification, I have experienced occasional momentary losses of steering on left turns and also while driving on a straight road. My dealer is willing to make any necessary corrections, but can't locate the trouble. Can you help?—John Bergeron, Dayton, Ohio.

To my knowledge, the modification has been successful. Yours is the first indication I've had to the contrary. I can only imagine that you got a bad rack and pinion, but ask the dealer to check the job. It may need a rack adjustment. If the work must be done again, the latest engineered rack and pinion is part No. 71266734.

Ping Pong, Swedish style

I would like your advice about the pinging problem with a 1970 Volvo station wagon that mechanics have failed to solve. One says it's caused by using low octane fuel, but I use only premium, so he recommended that I switch brands. I did—the problem remains. Another said it was my carburetor, so he cleaned and adjusted it and checked sparkplugs and fuel pump. The problem prevails. Why?—Vincente B. Untalan, Dover, Del.

Let's start from the beginning. You must use premium fuel in this engine. Ignition timing, carburetor adjustment and valve adjustment must be right on the money. Ignition timing is 10° BTDC. When adjusting it, the vacuum line must be disconnected and plugged. Now, if pinging remains and you have airconditioning in the vehicle, check to see if the pulleys are in correct position. If yours is one of the Volvos with airconditioning that has had drive pulleys improperly installed or mismarked, ignition timing will be way off. Check to see that the top-dead-center mark is lined up with the marker when No. 1 piston is at top dead center. Finally, realize that a buildup of carbon in the engine will cause higher compression and pinging. Until the situation is corrected, use a light foot on the accelerator: you can usually feel the point at which pinging starts.

SERVICE TIPS

□ **Dodge tells us** that tread noise from radial-ply tires in some 1973 models is caused by "mold flash" across the tread that's trapping air in the grooves. Fix it by inspecting tires and breaking the flash wherever it's found with scissors or a screwdriver. The flash need not be removed—only broken so that air can pass freely.

□ **Oldsmobile is on record** as opposing the use of commercially available carburetor air cleaner devices that open the air cleaner to additional air. Manufacturers of these devices claim that benefits include better gas mileage and quicker starts. Oldsmobile says, "The carburetor is designed for maximum efficiency of the fuel and emissions systems, and no add-ons should be used." ★★

GOT A PROBLEM WITH YOUR CAR? Ask Mort about it. Send your question to Car Clinic, Popular Mechanics, 224 West 57th St., New York, N.Y. 10019. Letters cannot be answered individually, but problems of general interest will be published in the column.

Ride the heavy-duty shock that doesn't have a heavy price.

Ride the Red Ryder™. The big, strapping heavy-duty shock that's priced with the most popular standard 1" shock absorbers.

Red Ryder is a heavy-duty shock that's bred for performance, with a full 1 3/16" piston. Compared to a standard 1" shock, Red Ryder has a 40% larger piston area for outstanding handling and control.

But most important, Red Ryders are really durable. So durable, in fact, that we guarantee them for as long as you own your car.

Ride the Red Ryder.

Gabriel®
the shocking difference



Guaranteed for as long as you own your car.

Maremont guarantees Gabriel Red Ryders against defects and wear-out for as long as you own your car. Present proof of purchase to dealer for replacement. Cost of removal and installation not included.

Dodge introduces the longest van chassis in the business so you can ride in the roomiest mini motor homes on wheels.

Extra room for storage and camping comfort can be yours with the new chassis from Dodge. Innovative Dodge engineering gives you these new features that can be underneath your mini motor home. The 145-inch wheelbase. No one else has it. And it comes with dual rear wheels, 360

V8, 10,000-pound GVW, power steering, automatic transmission, and Electronic Ignition System. What happens when imagination takes over? The same old thing. Progress.



10,000-POUND GVW

OPTIONAL AIR CONDITIONING



Turn to Dodge for leadership in Recreational Vehicles

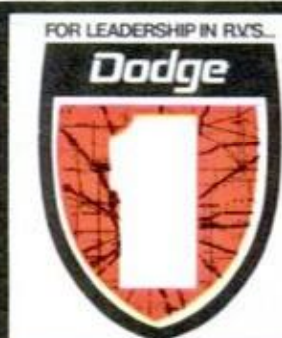

**Look for a Dodge
foundation under mini
motor homes from
these fine builders.**

Action Industries, Inc.
Americana Leisure Industries
Aspen Coach Corp.
Automotive Conversion Corp.
Banner Homes Corp.
Bendix Homes System
Bivouac Industries, Inc.
Boyd Manufacturing Co.
Brougham Industries
California Camper Mfg.
Caribau Mfg., Inc.
Chalivier Industries, Inc.
Champion Homes, Inc.
Chinook Mobilodge Co.
Coachmen Industries, Inc.
Cobra Industries, Odyssey, Inc.
Compact Equipment
Contempo Campers, Inc.
Cooks Mfg., Inc.
Corder Mfg. Co.
Cruisair Mtr. Corp.
Cudgen Industries, Inc.
CST Industries, Inc.
Dan Coach Co., Inc.
Dereball Industries, Inc.
Four Winds Camper Mfg. Co.
Frank Industries, Inc.
Franklin Coach Co., Inc.
Golic Homes, Inc.,
Div. Midas-International
Gutura Industries, Inc.
Hadding Del Ray
Industries, Inc.
Hobstar Industries, Inc.
Hypsy Campers
Holiday Wheels, Inc.
Honorbuilt Trailers, Inc.
Huntsman, Inc.
International Mobile Homes,
Incorporated
International Recreation Corp.
of California
Imboree Ind., Inc.,
Fleetwood Enterprises
Insen Marine, Inc.
Jayot Motor Home Div.
Ken-Craft Products, Inc.,
Div. Midas-International

King Mfg. Co.
Kit Manufacturing Co.
Lazy Daze, Inc.
Mel-Mar Industries, Inc.
McNamee Coach Corp.
Mobile Scout Mfg. Corp.
Mobile Traveler, Inc.
Norris Homes, Inc.,
Div. Midas-International
Open Road Industries, Inc.
Pioneer Industries, Inc.
Pontaf Motor Homes
Pride-N-Joy Industries, Inc.
Recreational Enterprises Corp.
Recreational Vans, Inc.
Red Dale Coach Co., Inc.
Redman Western Corp.
Robinhood Motor Homes, Inc.
Security Industries, Inc.
Shasta Trailers Co.
Superior Motor Homes
Shelton Industries, Inc.
Skyline Corp., Nomad Div.
Sportscoach Corp.
Starcraft Co. Recreation
Veh. Div.
Sundial Campers
Tejas Mfg. Co.
Tioga Industries, Inc.
Trail Boss Trailers
Travco Corp.
Travel Equipment Corp.
Travel-On Equipment Corp.
Travel Queen Coaches
Travel Recreation, Inc.
Traveleze Trailer Co.
Turtle Top
Vega Corp.
Western Commander, Inc.
Williams Craft Mfg. of Ohio
Winnebago Industries
Wolverine Camper Co.

**All build on chassis
from Dodge... depend
on it.**



PUBLICATIONS **WORTH WRITING FOR**

PM'S PICTURE-TOOLS are a great new idea to take the confusion out of *what goes where* on workshop and tool panels.

The complete PM **PICTURE-TOOL KIT** consists of seven big sheets (9 $\frac{3}{4}$ x 11 $\frac{3}{4}$ in.) of a special heavy-weight paper with a pressure-sensitive adhesive on the back. On each sheet are beautiful drawings of hand tools and portable power tools—all you're likely to have in your shop (74 in total). Most are full size; the others nearly so.

Also enclosed in the kit is a blank sheet of the same special paper, printed in an overall color to match the tools. This sheet enables you to design your own drawings of special tools.

Each of the PM **PICTURE-TOOLS** is carefully die-cut. You simply peel off the backing paper and apply it to the proper spot: on painted or unpainted wood, plywood, hardboard and even perforated-hardboard surface.

Later, if you want to move a few tools or rearrange the entire panel, you can peel off the PM **PICTURE-TOOLS** and reuse them in new locations!

Once your **PICTURE-TOOLS** are in place, you'll know at a glance exactly where each tool belongs.

Order your PM **PICTURE-TOOL KIT** today. Simply send a check or money order for \$3.95 to Popular Mechanics, Dept. PT, Box 1014, Radio City, New York, N.Y. 10019. Be sure to enclose your name and address. ★★

HOW MUCH COULD YOU BORROW?

FIND OUT NOW!

HOW YOU SCORE YOURSELF

Just fill out the simple, self-scoring credit chart at right. Your score will tell you the amount of the personal loan (or line of credit) for which you may apply—up to \$3000.

A CREDIT SERVICE OF ITT

Direct Credit Service, an ITT Financial Service Company, takes the doubt and uncertainty out of applying for a loan—and offers the modern conveniences and privacy of direct mail service.

Add up your score—then please write, or for extra fast action, telephone toll free:

800-826-6959 (24 hrs. a day—7 days a week)

Miles E. Gibbons
Suite 250
100 Barstow Commons
Eau Claire, Wis. 54701

If your score is:	17	18,19	20,21	Over 21
We invite you to apply for:	up to \$1,000	up to \$1,500	up to \$2,000	up to \$3,000

Enter the correct number in the point-score box at right, then add up your total score.

AGE					POINT SCORE
21-25	26-30	31-40	41-50	51-64	
1	2	3	3	3	
TOTAL INCOME (in thousands)					
Under 8	8-10	10-12	12-15	Over 15	
1	3	4	6	8	
YEARS WITH PRESENT EMPLOYER					
Under 1	1-3	3-6	6-12	Over 12	
1	2	3	4	5	
DEPENDENTS (including self)					
1	2	3	4	Over 4	
3	4	3	2	1	
YEARS AT PRESENT ADDRESS					
Under 2	2-4	4-7	7-10	Over 10	
1	2	3	4	4	
PERSONAL DEBT IN THOUSANDS (exclude mortgage)					
Over 5	4-5	2½-4	1½-2½	Under 1½	
0	1	2	4	6	
TOTAL					

An ITT financial service company
direct credit
DIRECT CREDIT SERVICE LTD.

Jock itch (or chafing, rash, itching, sweating) shouldn't be treated lightly.

If your groin, thighs, or buttocks suffer from redness, rash, chafing, soreness, excessive perspiration, or Jock Itch (Tinea cruris), then you need medicated Cruex®.

Cruex soothes itchy, inflamed skin. Absorbs perspiration. Helps cushion against further irritation. And medicated Cruex helps prevent fungous infections that can develop.

Cruex spray-on powder reaches hard-to-get-at



places so you avoid the sting and burn of rubbing or smearing on ointments, creams or powders.

Get fast relief with soothing, cooling Cruex.

Cruex. Guaranteed to work or your money back.

"How I rewired my taillights with a plastic straw and Dow Corning Bathtub Caulk."



We knew our silicone rubber bathtub caulk was good for a lot more things than bathtubs, and when we heard how Larry Oswald of Sewickley, Pa., used it, our opinion was confirmed.

"When my taillights started getting dimmer and dimmer, I took them apart and found that the sockets, wires, everything, were all corroded.

"So I cleaned everything up, bought two new sockets, and decided this time that they weren't going to corrode.

"I had a tube of Dow Corning® Bathtub Caulk lying around the house, so I figured why not, and caulked up the sockets.

"Then I figured that if it'd work on the sockets, it'd work on the splices.

I cut two small pieces off a plastic drinking straw, slid one over each set of wires to keep them from getting stuck together, tied the wires together, and then pumped them full of caulk.

"It's been six months now, and my taillights are still brighter than ever."

Next time you're faced with a plumbing leak, broken gasket, or

almost any fix-it job around the house, get the Dow Corning Silicone Bathtub Caulk out of the bathroom and put it to work.

You'll find it in white and pastel decorator colors in the hardware or paint department of your favorite store. Look for Dow Corning Silicone Sealer in clear, black, or aluminum in tubes and cartridges, too.

Dow Corning Corporation, Dept. D-3102, Midland, Michigan 48640.

DOW CORNING



GARAGE DOOR OPERATOR... \$99⁹⁵!

- RADIO CONTROLLED from car transmitter or wall switch
- SAFETY night and day year 'round
- SECURITY door locks tight when closed
- CONVENIENCE in car control any weather
- LIGHTING garage lights automatically
- VERSATILE fits all lifting type wood, metal or fiberglass doors sectional and 1-piece
- EASY HOME INSTALLATION in just 2-3 hours
- SAVE up to 50% direct factory purchase and PP or UPS home delivery
- GUARANTEED one year
- FREE brochure

HELPMATE Equipment Co., Box 51PM, Baroda, MI 49101

WHITE'S METAL DETECTORS

WHITE'S ELECTRONICS, INC. manufacture the World's Largest and Finest Line of Mineral and Metal Detectors. Ghostfishing, beachcombing, bottle hunting, coin hunting all types of TREASURE HUNTING or PROSPECTING, amateur or professional. Detect conductive metals—Gold, Silver, Copper, Traps—Coins—Ring—Jewelry, etc. Underwater or on the land. "There are no fees at any price." 75 production models to choose from—T.R. or B.F.D.

Priced from \$75.00 up

—Always specify the Blue & Gold Ask FOR WHITE'S BY NAME

—Free Literature—**WHITE'S ELECTRONICS** Rm. No. 512

1011 Pleasant Valley Rd. Sweet Home, Oregon 97138
23784 Hazel Street Atsford, B.C. Canada
Elk Air Industrial Park Dexter Drive, East Elkhart, Indiana 46514

START A MONEY-MAKING BUSINESS FOR LESS THAN \$50!

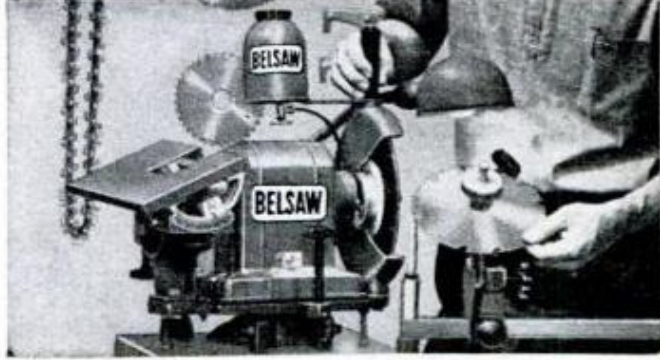

You can have your own lifetime business right at home . . . work in spare time . . . and make up to \$200 a month CASH! My FREE PLAN gives you all the facts: How to start, how to grow. You don't need previous experience. You don't have to sell. I'll even finance you. People bring you the work and pay cash. Over 90¢ of every dollar you collect is clear cash profit. And you work when you want to. Let me prove you can't find a more certain, lower cost, higher paying business of your own.

Just Mail Coupon—No Salesman Will Call

BELSAW SHARP-ALL CO., Stan Field, Pres. 714K Field Bldg., Kansas City, Mo. 64111

Name _____

Address _____

City _____ State _____ Zip _____

FREE BOOK

SCIENCE WORLDWIDE

Radar detects space hazard

Saturn's famous rings appear to be composed of solid chunks—a yard or more in diameter—rather than of ice crystals, dust or gas. That's the finding of Jet Propulsion Laboratory astronomers after history's first successful radar probe of the big planet. They used NASA's 210-foot dish in the Mojave Desert to beam signals on a round-trip of 1.5 billion miles, which took 2 hours and 15 minutes to complete. The bounce-back signals indicated solid material with rough, jagged surfaces. The rings, say the scientists, "must be considered an extreme hazard to spacecraft."



Microwave ovens become hot subject

Are microwave ovens completely safe to use? A leading consumer-testing organization thinks not, stating in a report that animal experimentation proves that microwaves can cause cataracts and other bodily damage. The organization tested 15 different ovens and found that all "allowed at least some microwave radiation . . . to escape . . ." Quick to refute the charges was Amana Refrigeration, Inc., maker of the most popular line of the fast-cooking ovens. Amana spokesmen said that the standard of permissible leakage—1 milliwatt per square centimeter—had been set by the federal government and pointed out that their ovens register below that level in routine factory checks (see photo). At a press briefing, Dr. James A. Van Allen, the well-known physicist, said he owned an Amana and would sit on it "for a solid year while it is in full operation, with no apprehension as to my safety."



Perfect patient for student dentists

New aid in training dentists and dental assistants is a rubber and plastic head that does everything but bleed and groan. Plastic skin texture is like the real thing, the jaws are fitted with replaceable teeth that can be pulled or drilled, and jaw action is realistic. The ersatz patient was developed by the National Institute of Dental Health, Bethesda, Md. The manikin permits students to get used to working within the confined area of the mouth without hurting a real patient.

Laser used for baggage sorting

A new baggage sorting-routing system for airline terminals will be unveiled this fall at Miami's International Airport. It uses a gas laser to "read" encoded labels on bags moving along a conveyor. Decoded information is relayed to a digital controller that signals a sorting device, then routes each bag. Made by Bendix Recognition Systems of Southfield, Mich., the system will cost \$2.5 million and sort 70 bags per minute.

New program to help inventors

Inventors with projects that qualify can get technical help under a new government

(Please turn to page 40)

If all your job pays is money you should read this.

The Air Force offers you a good salary plus many other important benefits. Like a 30-day paid vacation in your very first year. Try finding that in civilian life.

You also get expert medical and dental care. There are money-saving buys at our commissaries and exchanges. And if you want to continue your education while in the Air Force, we make it possible. And speaking of good deals, you can travel free on Air Force planes when available, and get low-cost flights on commercial lines. Sound good? Well, try these benefits on for size, too... the Air Force gives you clothing, food and housing. And the wide selection of jobs available is a benefit that can be helpful for your entire life.

You select the job you want and if it's available, we guarantee you'll have it before you sign up.

What type of work will you be happy doing? Mechanical work? Medical? Something to do with Electronics? We have that and much more. We'll give you the best training available. And pay you as you learn. You'll wind up with a rewarding skill...and with plenty of experience in it. Civilian employers like that!



Want more reasons to join? You can get them all, plus answers to any questions you might have by contacting your local Air Force Recruiter. Or call 800-447-4700, toll free (in Illinois call 800-322-4400) for the location of your nearest Air Force Recruiting Office. Or just send in the coupon.

A job with the Air Force...it pays in more ways than one.

Air Force Opportunities
Box A
Randolph AFB, Texas 78148

1-PM-73

Please send me more information. I understand there is no obligation.

Name _____ Sex (M) (F)

(Please Print)

Address _____

City _____ State _____

Zip _____ Phone _____

Soc. Sec. # _____ Date of Birth _____

Find yourself in the Air Force.

LIVE IN THE WORLD OF TOMORROW . . . TODAY!

UNUSUAL BARGAINS

NEW PRODUCTS • NEW MATERIALS • NEW IDEAS

AMAZING NEW WANKEL ENGINE KIT!



Thrill to the fun of building your own see-through motorized model of revolutionary pistonless type engine . . . only engine experts think economically modifiable to meet new pollution standards. Replaces piston, cylinder, crank assemblies with rotating discs (sections removed for firing chambers). Smaller than conventional; fewer parts, greater reliability, same speed w/less horsepower. Features: flashing plugs, rubber fan belt, stick-shift on-off switch. Req. 2-1.5V batt. (not incl.).

No. 71,424H \$6.75 Ppd.
549-Page Wankel Engine Book
Stock No. 9,439H \$15.25 Ppd.

"FISH" WITH A MAGNET



Go treasure hunting on the bottom! Fascinating fun & sometimes profitable! Tie a line to our 5 1/2-lb. Magnet—drop it overboard in bay, river, lake or ocean. Trawl it along bottom—your "treasure" haul can be outboard motors, anchors, other metal valuables. 5 1/2-lb. Magnet is war surplus—Alnico V Type—Gov't cost \$50. Lifts over 150 lbs. on land.
Stock No. 70,571H \$14.00 Ppd.
Stock No. 60,215H 1 1/2 lbs. \$5.75 Ppd.
Stock No. 70,570H
3 1/2 lbs. (lifts 40 lbs.) . . . \$8.75 Ppd.

ACTUAL WORKING SOLAR HOME PLANS

SEE FEATURE ARTICLE JUNE ISSUE!



Learn all about the most fascinating possible home of the future. It can be your "now" answer to today's energy crisis in housing. Expert Dr. Harry E. Thomason tells advantages, problems, savings, and more in this important 20-pg fact-filled booklet. Also includes 8-page over-size insert of basic, actual solar home plans, a valuable guideline to you and your architect in fitting space requirements, design ideas, and local area building codes.

No. 9440H (Solar House Plans)
\$10.00 Ppd.

GIANT WEATHER BALLOONS



"Balls of fun" for kids, traffic stoppers for stores, terrific for amateur meteorologists. Create a neighborhood sensation. Great backyard fun. Exciting beach attraction. Amateur meteorologists use to measure cloud heights, wind speed and temp. Made of heavy-duty neoprene. Inflate with vacuum cleaner or auto air hose; or locally available helium for high rise.

Stock No. 60,568H (8' size) \$2.50 Ppd.
Stock No. 60,632H (16' size) \$8.75 Ppd.

AMERICAN MADE OPAQUE PROJECTOR



Projects illustrations up to 3" x 3 1/2" —enlarges them to 35" x 30" if screen is 6 1/2 ft. from projector, larger pictures if screen is farther away. No film or negatives needed. Primarily intended for children. Projects charts, diagrams, color or black-and-white in darkened room. 115 v. A.C. . . . 6 ft. cord and plug included. Size 12" x 8" x 4 1/2" wide. Weight 1 lb. 2 ozs. Plastic case.

Stock No. 70,199H \$8.75 Ppd.

'Bright Ideas' in Unique Lighting Big, new 100-page handbook packed with facts, loaded with illustrations. All latest developments, applications, equipment. 8 1/2" x 11" looseleaf paper to fit 3 rings. Stock No. 9100 H \$3.00 Ppd.



MAIL COUPON FOR GIANT FREE CATALOG!

164 PAGES • MORE THAN 4,000 UNUSUAL BARGAINS!

Completely new 1973 Catalog. Packed with huge selection of telescopes, microscopes, binoculars, magnets, magnifiers, prisms, photo components. Ecology and unique lighting items, parts, kits, accessories—many hard-to-get surplus bargains. 100's of charts, illustrations. For hobbyists, experimenters, schools, industry.

EDMUND SCIENTIFIC CO. 300 Edscorp Building, Barrington, N. J. 08007
Please rush Free Giant Catalog "H"

Name _____
Address _____
City _____ State _____ Zip _____

EDMUND SCIENTIFIC CO. MONEY BACK GUARANTEE
300 EDSCORP BLDG. BARRINGTON, NEW JERSEY 08007

ORDER BY STOCK NUMBER • ADD \$1 HANDLING CHARGE • SEND CHECK OR MONEY ORDER

SCIENCE WORLDWIDE

(Continued from page 38)

program—the Experimental R&D Incentives Program—according to the National Science Foundation. Prototypes of inventions judged promising will be put through "performance validation" tests by one of a number of federal labs. The purpose is to find ways of cutting the time required to make new processes, services and products available to the public. For information, write: NSF Program Manager, National Science Foundation, Room 549, 1800 G St., N.W., Washington, D.C. 20550.



Plastic trap for curious seagull

One among many environmental problems is plastic debris. It's found almost everywhere—far out at sea and in such remote places as Arctic beaches. That it can be harmful to wildlife was demonstrated anew recently when a Pacific gull was found on a California beach, its neck caught in a plastic container used in packaging six-packs of beer. It's thought the bird saw the plastic floating, poked its head through a hole to look below and died of strangulation.

Satellite system monitors volcanoes

New assignment for NASA's experimental Earth Resources Technology Satellite (ERTS-1) is as a volcano watchdog, according to the U.S. Geological Survey. ERTS-1 is keeping an eye on 15 volcanoes in the United States, Iceland, Guatemala, El Salvador and Nicaragua. Data from sensors on the volcanoes is automatically beamed to the satellite, then to Earth again. Recently, the system successfully detected signs of activity in a Guatemalan volcano six days before it erupted. ★ ★ ★

Front end shimmy can start right here.



Right here is where Shimmy Stop stops it.

Introducing Shimmy Stop...a totally unique do-it-yourself way to restore worn ball joints without spending a lot of money!

Worn ball joints can cost you a bundle . . . because they affect the way tires wear, the way your car tracks, the way your car handles, and the way the front end keeps its alignment. All of that can add up to a dangerous loss of front end precision. But until now, the only way to solve the problem was to replace the ball joints. That can cost up to one hundred dollars.

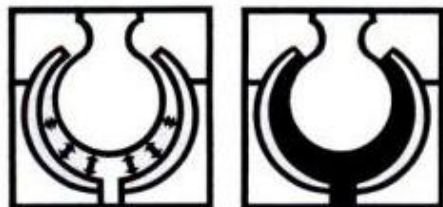

Shimmy Stop restores front end precision . . . SHIMMY STOP actually restores worn ball joints that are still within recommended tolerances. Once SHIMMY STOP compound is mixed (in its own cartridge) and injected directly into the ball joint, it cures to a rugged self-lubricating solid that fills the worn area between ball and socket. It actually reduces the tolerance to zero!

Once Shimmy Stop cures to a self lubricating solid . . . it lasts for thousands and thousands of miles. The 3M Company



Look for this display in your favorite auto supply store . . . it gives you the complete SHIMMY STOP story. And ask for your **FREE** ball joint wear gauge. The gauge makes it easy to determine your need for SHIMMY STOP. What could be fairer?

developed, tested and proved SHIMMY STOP in all kinds of cars under all kinds of conditions. (in fact 3M spent 7 years developing SHIMMY STOP and tested it for more than a million miles.)

Because Shimmy Stop is simple to use . . . you can beat the high cost of replacement parts. Installation is easy. In fact, once you've read the illustrated instructions, the job should take you just about 30 minutes.

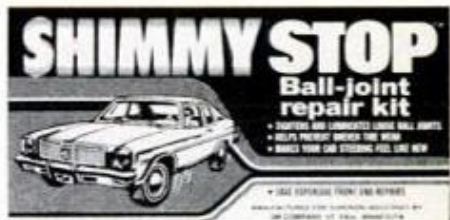

SHIMMY STOP™



SUPERIOR INDUSTRIES INTERNATIONAL, INC.

DEPT. P7 • 14721 KESWICK STREET • VAN NUYS, CALIFORNIA 91405 • PHONE (213) 873-5181

IMPORTS AND MOTORSPORTS

Red-hot thirst-quencher

The 1000-hp, turbocharged Porsche 917-10K is out to blitz the '73 Can-Am series—again. Driver George Follmer is looking to take the crown two years running. The "Royal Crown," we should say, since the



cola company is sponsoring the Porsches this year, and the team preparing the cars is Bobby Rinzler Motoracing. The \$1-million season has just kicked off and all the SCCA Canadian-American Challenge Cup events are being televised nationally. Here's the schedule:

July 8	Gainesville, Ga.
July 22	Watkins Glen, N.Y.
Aug. 12	Lexington, Ohio
Aug. 26	Elkhart Lake, Wis.
Sept. 16	Irish Hills, Mich.
Sept. 30	Edmonton, Alta.
Oct. 14	Monterey, Calif.
Oct. 28	Riverside, Calif.

A monocoque motorcycle?

Not since the Vincent Black Shadow—which had the front and rear suspension connected to the engine and was therefore nicknamed the "frameless wonder," has such a radical idea been proposed—but this one's even been built. Builder of this prototype is Dan Hanebrink of Monotrack Engineering, in Costa Mesa, Calif. They manufacture disc brakes, mag wheels and air-oil suspensions for motorcycles.

Hanebrink's dream bike is a rolling idea lab. It's got an 18-inch magnesium wheel—stronger than a wire wheel and lighter, to reduce unsprung weight. It's got a single

disc brake but, on a production version, dual discs will be optional.

The suspension up front is damped by an air-oil system similar to that used on Austin American cars—there is a remote reservoir and each oscillation displaces a piston damping against a body of oil. Instead of having a hand brake for the front wheel and a foot brake for the back, Hanebrink plans to have one lever for front and rear. The engine is a Kohler three-cylinder two-stroke rated at roughly 80 hp. The snowmobile engine uses a torque converter: There's no chain. Instead, the primary drive comes off the side of the engine using a one-inch-wide timing belt. The belt goes around a huge sprocket almost as big as the rear wheel.

The chassis of the prototype is welded

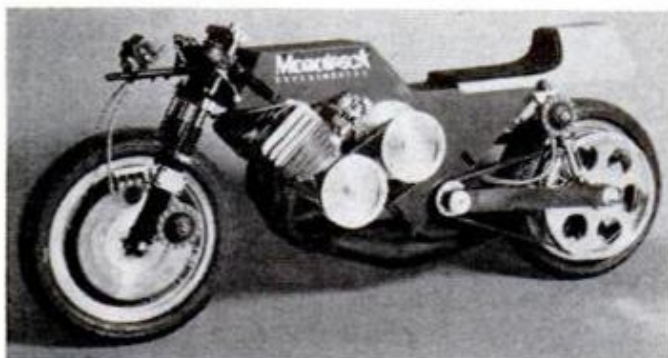

magnesium weighing a scant 13 pounds! There's a fiberglass fairing over the frame and luxuries like electric starting to match the automatic transmission.

When will it be in production? Probably when a major manufacturer approaches Hanebrink with a sweet deal or when his Monotrack company sells enough accessories to support such a venture.

The Volkswagen 'Thing'?

It started out as VW's "jeep" back in the army days of the 1940s; then, as the Type 181, it was made in Mexico for sale there;

(Please turn to page 44)

No Miracles Today!

Just a few ideas from AC that may help improve your gasoline mileage.

We don't claim to be miracle workers, but we have a few ideas that may help you improve your gasoline mileage.

First, check your driving habits. Don't practice jack-rabbit starts when the light turns green. Take off smoothly and drive at a steady pace. Avoid needless acceleration . . . weaving in and out of traffic. Slow down before stopping; that'll help your brakes, too. And for sure don't drive at excessive speeds.

Second, make sure your engine is properly tuned. Remember, you can lose up to 12 percent gasoline efficiency when one spark plug in an eight-cylinder engine fails to fire. Intermittent missing and fouling also take their toll.

And third, whether you have your car tuned at your local service retailer or you tune it yourself, we would like to recommend AC Fire-Ring Spark Plugs. There's a set of ACs engineered to meet your car needs and driving conditions. Available most everywhere quality automotive parts are sold. We believe ACs will do a good job for you. We make them.



AC SPARK PLUG DIVISION

LEARN TO BE A SKILLED LOCKSMITH



Change combination of pin tumbler cylinder—**EARN \$1.50** in 15 MIN.

Owner loses key; pick car trunk—**EARN \$5.50** in 10 or 20 MIN.

TYPICAL JOBS EARN YOU \$271 PART TIME (in only 53 hours!)



Install new knob door lock—**EARN \$15.00** in 30 MIN.

After-hour emergency opening—**EARN \$2.50** to \$5.50 in 20 MIN.

Hundreds have succeeded like these Belsaw Graduates:

R. W. Davis, St. Louis, Mo.: "I am doing a wonderful business thanks to your course in locksmithing. Last Saturday I took in \$110.00."

Pierson Crook, Los Angeles, Calif.: "I am making \$200 a month extra income with the Belsaw Locksmith Course. I would recommend your course to anyone."

Big demand for skilled Locksmiths! Earn big money spare time in your own home. Be your own boss. No layoffs. Steady year 'round income. Age and schooling are no handicap.

BELSAW INSTITUTE training... approved by master locksmiths...helps you start faster with easy picture lessons guided by your own mail instructor.

Get thorough job training on all types of locks. We supply tools, equipment and business help: how to start, how to charge, how to get jobs, how to earn while you learn and build a lifetime cash-profit business. Accredited Member National Home Study Council. Approved by State Board of Education. Approved for Veterans.



This key machine is yours to keep!

MAIL COUPON—NO SALESMAN WILL CALL

BELSAW INSTITUTE, 104K Field Bldg. Kansas City, Mo. 64111

Send **FREE** book, "Keys To Your Future!"



Name _____

Address _____

City _____ State _____ Zip _____

IMPORTS AND MOTORSPORTS

(Continued from page 42)

now, VW of America is importing it from the VW de Mexico plant in Puebla as, you guessed it, a recreational vehicle. Someone at VW is rumored to have asked, "What'll we call the thing?" And, zap, the question was answered.



The Thing has four doors that are removable, a windshield that folds down and detachable top and side curtains. The Thing is powered by the Super Beetle engine and, at \$2750, costs slightly more.

PM authors write on!

Two writers who have prepared stories for *Popular Mechanics* over the years are Karl Ludvigsen and Doug Richmond. Karl is a prolific motoring journalist who has published two books on the Corvette, one on Group 7 racing and an impressive volume on the Mercedes-Benz racing cars. His latest work is a pocket guide to rotary engines, *Wankel Engines A to Z*. It has the history, the people, the technical details and a unique visualization of how the Wankel works that you receive by flipping pages to see it go through two revolutions. It's \$5.95 plus

50 cents for postage from Karl, 68 Weston Rd., Weston, Conn. 06880. Doug's latest book, which follows his *All About Mini-bikes*, is *How to Select, Ride and Maintain Your Trail Bike*. \$5 each from H.P. Books, Box 50640, Tucson, Ariz. 85703. ★★

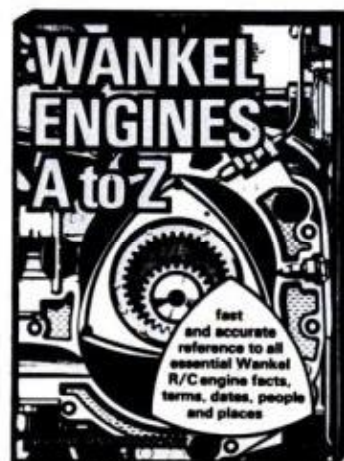

HEAVEN ONLY KNOWS HOW OFTEN YOU SHOULD CHANGE YOUR OIL.

First it was every thousand miles. Then somebody said every fifteen hundred. Then somebody else told you six thousand. It depends on who you ask. And it's enough to confuse anybody.

There's no absolute rule to how often you should change your crankcase oil. The time of year and climate have a lot to do with it. But don't leave it to heaven. There's a lot at stake, and a lot to know.

Your driving habits can be a factor. Oil should be changed more often under conditions of extensive idling, trailer pulling, driving in dusty conditions, and short trip operation at low temperatures.

So even though we've been in the gasoline and oil business for so many years, even we can't give you a simple answer.

We do recommend an oil change at least every 3000 miles or 3 months; but you should never exceed the automobile manufacturer's recommendation.

You should also read your owner's manual very carefully. Especially the fine print, which might reveal some exceptions according to your climate and driving practices.

If you still can't determine how often to change your oil, bring the manual and the car to your dealer. He changes a lot of oil in your area for people who probably have the same driving habits and type of automobile as yours.

Of course, we hope the dealer you bring your car to is a Gulf dealer. He'd be glad to help you learn about that, and anything else you'll like to know about your automobile.

You can also send your questions direct to Gulf Consumer Information, Box 1519-H, Houston, Texas 77001.

You see, we'd like you to learn all you want to know about your car. And our products. That way we can keep you on the road. And us, too.

GET TO KNOW GULF AND YOU'LL GET TO KNOW YOUR CAR.



GULF OIL CORPORATION

ALL OUTDOORS

Fishing, that lowly art, joined the big money sports this spring when the Bass Anglers Sportsman Society and Miller High Life Beer teamed up to sponsor the final B.A.S.S. tournament this coming October. The 24 top fishermen from six qualifying contests this year will vie for first prize of over \$10,000 and title of world's bass fishing champion.

As in previous years, finalists will be put on a chartered airliner and not told the mystery site for the fish-off until they are in the air. As in preliminary tests, only artificial lures can be used and all fish will be released alive after the weigh-in scoring.

Bass Anglers Sportsman Society, Box 3044, Montgomery, Ala. 36109, is open to all fishermen and now has over 100,000 members, according to B.A.S.S. president Ray Scott, and the newly added sponsorship will also make possible increased environmental programs and coast-to-coast conservation seminars. And on Oct. 24 to 26, during the Miller High Life Bass Masters Classic world championship, any of us 60-million fishermen who didn't make the finals can relax at the end of a cane pole and then

figure out just how we'll win it next year.

Camping in the National Park System, a new pocket-sized guide listing more than 29,000 campsites in 92 areas, is available for 50 cents from the Government Printing Office, Washington, D.C. 20402. Campground use fees are \$1 to \$4 per night for improved facilities, but back-country areas usually require only a permit. Computerized reservations are being tested for Acadia, Everglades, Grand Canyon, Yosemite, Yellowstone and Grand Teton.

Competition calendar: July 4-6, Speer Matches, Knoxville, Tenn.; 6-8, International BB Gun Championships, Arizona State University, Phoenix, Ariz.; 10-22, U.S. International Skeet, Cleveland Winchester Gun Club, Chardon, Ohio; July 23-Aug. 20, NRA National, Camp Perry, Ohio; July 26-Aug. 3, National Skeet Assn. World Championships, Forest City Gun Club, Savannah, Ga.; July 31-Aug. 3, Varmint & Sporter Nationals, Kelbly's Rifle Range, Marshallville, Ohio. National Hunting & Fishing Day is Sept. 22.

(Please turn to page 48)

Hutch is Chevrolet's name for new canvas cover making RV out of Vega and Nova hatchbacks and Vega Kammback for under \$60. For the LUV pickup, a \$138 hutch and cargo cover convert to cabin plus porch "Kabana."



a new look

at the fabulous Scorpion Too



* FREE full color illustration (see coupon)

Have you heard about sport flying?
Did you know that you can
participate in your own
personal helicopter

The Scorpion Too is RotorWay's
answer to backyard flight.

Remember, the Scorpion is a
true vertical take-off helicopter,
it takes off straight up.

Send \$5 now
for graphically illustrated
color package containing:

- Fundamentals of rotorcraft flight
- Illustrated flight maneuvers
- How you learn to fly
- Scorpion development history
- Helicopter design theory
- Engineering definitions
- Power plant considerations
- Price information
- Performance specifications
- Unique features of the Scorpion Too
- Three-view dimensioned drawing
- Electrical and other options
- Exploded view of sub-assemblies
- Description of major component areas
- Information on how to proceed

Using a 140 h.p. engine, it cruises at 75 m.p.h. and can
carry over 400 lbs. The most exciting news about the
twin-seat Scorpion is its low cost, but then it's about
time a helicopter became a recreational vehicle.



RotorWay

* Enclose this coupon with your \$5 and you will
receive free, along with your package, a 25"x38"
full color reproduction of this beautiful scaled
cut-away drawing (as shown above). RotorWay
commissioned Dick Aleith, one of the West's
leading illustrators, to create this work of art.
It's truly a collector's item.

ROTORWAY, INC.
Dept. Z/14805 S. Interstate 10
Tempe, Arizona 85281

Name _____
Address _____
City _____ State _____ Zip _____



BUILD THESE BEAUTIFUL CLOCKS

NOW AT BIG SAVINGS!

Send just \$1 for plans & instructions to build choice
of: (A) Grandfather, (B) Steeple, (C) Grandmother—
plus information-packed catalog of movements, dials,
parts & kits to build these & 16 other fine clocks. All
3 plans—\$2.50. Catalog alone—25¢.

MASON & SULLIVAN COMPANY
Dept. PM, Osterville, Mass. 02655



WHAT'S HE DOING?

Making a Concrete
Flower Pot! . . . and
SO CAN YOU!

Make and sell your own
Ornamental Concrete items.
Rush \$3.00 for Book
about Aluminum Molds
with prices and production trade secrets
direct from world's largest mold manufacturer.
Over 350 designs to select from.

Send **\$3.00** **CONCRETE MACHINERY COMPANY**
Today To ➔ P. O. BOX A99 - HICKORY, N. C. 28601



EXTRAORDINARY OFFER!

To Help You Start **YOUR OWN
BUSINESS**

No Money Down

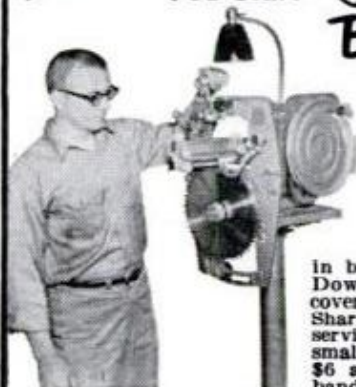

Start in sparetime; build
a money-making full-time
business in your garage or
basement. We'll start you
in business with No Money
Down. Your earnings easily
cover the low monthly payments.
Sharpening saws is an important
service in any neighborhood or
small town—You can earn \$3 to
\$6 an hour sharpening hand,
band or circular saws.

No Experience! No Selling

The easy-to-operate Foley Saw Filer is automatic—it does
the job for you. You can be doing business the day after you
receive your machine. And with a saw filing business
customers will come to you. No door to door selling! You are
supplying a service they need. If you'd like more information
about this unique business opportunity, return coupon (no
salesman will call) and we'll send you our fact-filled

MONEY-MAKING BOOKLET FREE!

Foley Manufacturing Co.
743-3 Foley Bldg., Minneapolis, Minn. 55418
Send for FREE book on Money-Making
facts about the sharpening business.

NAME _____
ADDRESS _____
CITY _____ STATE _____ ZIP CODE _____



ALL OUTDOORS

(Continued from page 46)



Fifth-wheel trailers can raise roof too with a push-up addition from Pop-Top of Mentor, Ohio. Headroom was raised from 54 to 81 inches on Jayco Li'l Rascal.



Keeping outdoors out is purpose of Nomad vinyl camp mat by 3M. Dirt caught outside RV or tent filters through or washes out. \$5.98 at camp, RV outlets.

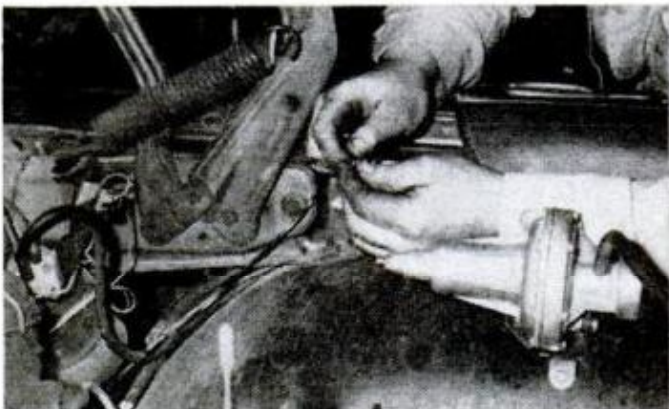

Load-Tamer from Scovill, Waterbury, Conn., is a \$60 dash-control vacuum-power, compressor to adjust rear air shock absorbers and level vehicle towing trailer.

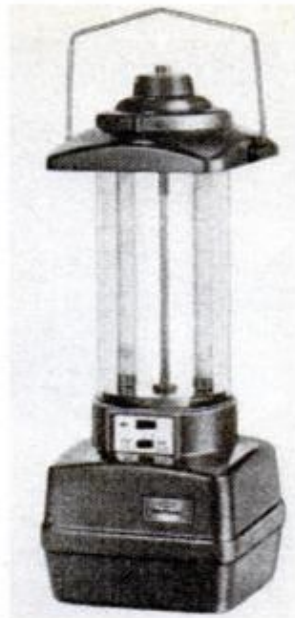

Sportsman 360 Fluorescent Lantern, from Ray-O-Vac has dual tubes for circle of shadowless light, bulb, hi-lo switches, waterproof seals; \$38 with batteries.

Canteen said to keep contents hot or cold is "fully insulated" Alpine from Polaron Products, New Rochelle, N.Y. Has safety-orange high impact plastic case, foam insulation, washable plastic liner, carrying strap and attached cap. Holds quart, \$2.89.



AFC indoor-outdoor cordless lamp by Ashflash, South Norwalk, Conn., is attractive enough for nights in an RV, rugged for outside use. \$9.95 with batteries.



Join the **bass-boat boom** and pay up to \$10,000 for a fully fitted-out boat—or build this 15-footer with \$19 plans or a \$99 frame kit obtained from Glen-L, 9152 Rosecrans, Bellflower, Calif. 90706.

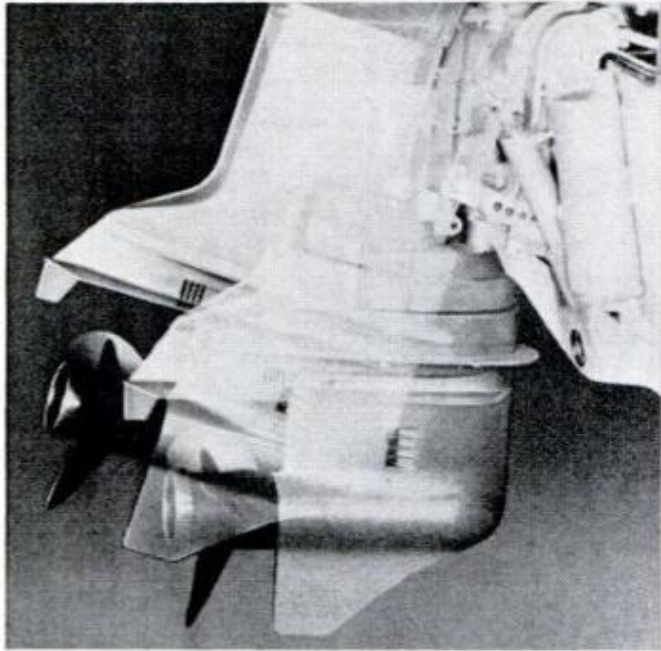

Trim and Tilt Kit made available by OMC Accessories provides flick-of-the-switch power adjustments for 65 to 135-hp Evinrude and Johnson outboards while they are running, and offers full tilt for beaching.

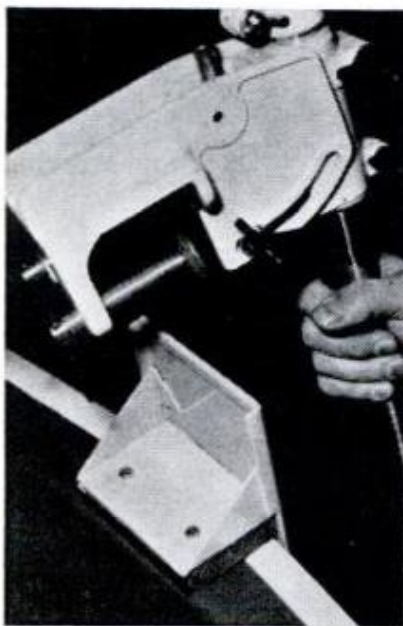

Now every boat can mount one of the popular electric trolling motors on its bow, transom or along the gunwale with this new \$6.95 bracket manufactured by Tempo Products, Solon, Ohio 44139.



WonderTroll 624 fishing motor by Shakespeare, Kalamazoo, Mich., takes 24 volts from two 12-volt batteries for extra power and range, or can run on 12 volts.

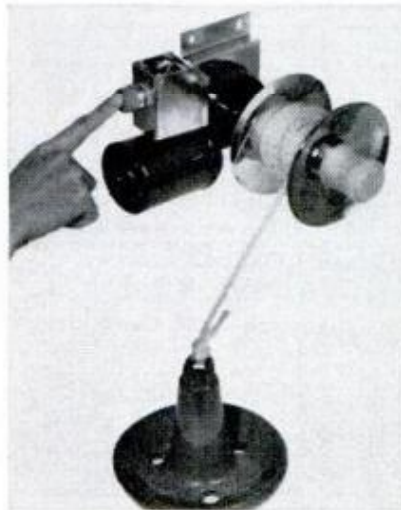

Bass-boat fishermen should like convenience, safety of 12-volt Auto-Anchor Winch, \$95. Waukegan Outdoor Products, Gurnee, Ill. For 18-lb. anchor, 50-ft. line.

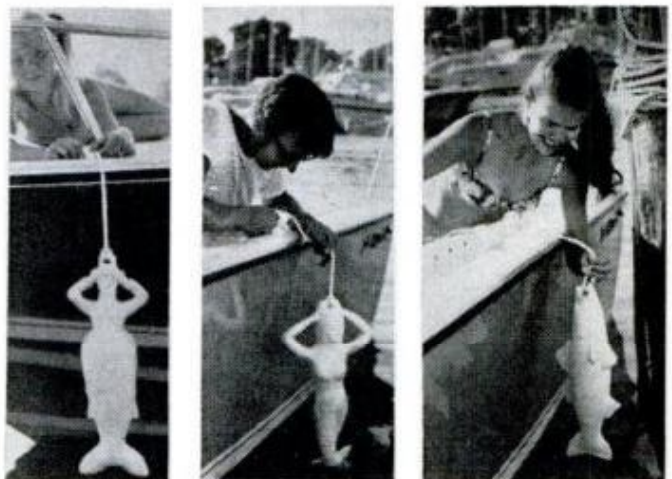

Fancy fender figurines in rugged white vinyl represent Jonah, mermaid and a fish; 20-inch Fender Characters by N.A. Taylor, Gloversville, N.Y., are \$7.95 each.

If you're big on Circus side shows, you'll just love this book.

The original ANOMALIES AND CURIOSITIES OF MEDICINE, an encyclopedia of rare and extraordinary cases of abnormalities of medicine and surgery was first published in 1896.

Today it's being published again in its entirety—295 illustrations, 968 pages of text. Most of the photographs in this book were too frightening to show; and we sincerely did not want to offend anyone. But without a doubt, this is one of the most interesting and fascinating books we've ever come across.

Never has one book on the subject of human curiosities contained so much! Such famous cases of human abnormalities like the grotesque "Elephant-Man," the green "Alligator-Boy," the "Elastic Skin-Man," the famous "Siamese Twins," Eng and Chang, plus hundreds of others.

As entertaining as this book may be, it was seriously written by two doctors, giving in-depth medical explanations of each abnormality covered.



WARNING: THIS BOOK IS NOT FOR THE SQUEAMISH!

To be honest with you, when we first saw this book, everyone at the office (Broadway Bookfinders) said, "Ugh." But once we got over the shock, we couldn't put the book down. For those who enjoy this kind of reading and have a strong stomach, you'll find this book fascinating, unusual and very freaky!

Only \$5.95. Moneyback Guarantee
 ----- please print -----
BROADWAY BOOKFINDERS, DEPT. A-47
1966 BROADWAY, NEW YORK, N.Y. 10023

Please rush me _____ Anomalies and Curiosities of Medicine at \$6.55 ea. (\$5.95 plus 60 cents post. and hand.) Enclosed is my payment of \$_____. If not satisfied, I'll return the book within 10 days for a full refund.

name _____
 address _____
 zip _____
 Make check/M.O. payable to Broadway Bookfinders



HEAVY DUTY WELDER

with special \$7.00 gift offer to Popular Mechanics Readers
10-DAY FREE TRIAL
Lifetime Guarantee

Buy Factory Direct and Save **18⁹⁵** POST PAID

Fits ordinary 110V outlet
 Not one • but 6 welding heats



Weld, braze, solder or cut most anything made of metal. No experience necessary. Follow simple instructions to make repairs on cars, trailers, farm and lawn equipment, bicycles, appliances, etc. Make campers, boats, furniture, hundreds of valuable items. **NOTHING ELSE TO BUY!** Comes complete with full face shield, pack of welding and brazing rods, heavy duty power cables, special electric torch attachment, ground clamp, flux, easy-to-follow illustrated instructions, rod holder, etc. Uses standard 1/8" rods to weld iron, steel, brass, bronze, aluminum, other metals. New improved HEAVY DUTY circuit gives more welding power. Gives 4 times the heat needed to melt toughest iron. Plus into ordinary 110V outlet. 6 WELDING HEATS for professional quality welding of "tough" to "light-weight" metals. 10 day MONEY BACK GUARANTEE. Lifetime parts and service guarantee. An excellent gift for any occasion. **FREE!** Mention you saw this ad in Popular Mechanics and receive a \$7.00 gift pack of welding rods free. For same-day C.O.D. shipment just call (713) 682-5681 or send only \$2.00 and pay postman \$16.95 plus small C.O.D. when delivered or charge to your BankAmericard or Master Charge card or for postpaid shipment send \$18.95 check or M.O. to WEL-DEX, Dept. W-203, Box 10776, Houston, Tex. 77018.

locksmithing and key making

PRACTICAL UP-TO-DATE COURSE — ONLY \$7.95

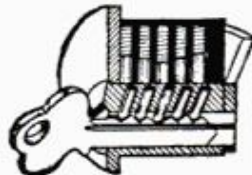

Teaches you how to pick locks, de-code, make master keys, repair, install, service, etc. New self-instruction lessons for every handyman, homeowner, carpenter, mechanic, service station operator, fix-it shop, hardware dealer, gunsmith. 53 easy illustrated lessons. Full price only \$7.95 postpaid. Satisfaction or refund guaranteed. Mail order today!

NELSON-HALL CO., Dept. 6GX-2
 325 W. Jackson Blvd., Chicago 60606



UPHOLSTERING AND DECORATING FOR PROFIT! Men & Women All Ages!

At home, we show you how, incl. tools, kits to make and sell. Accredited NHSC. Approved Veteran Training. No salesmen. Upholstery & Decorating School, Div. Technical Home Study Schools, Dpt. 5110-073, Little Falls, N. J. 07424

ACCORDIONS • Big Discounts

Buy Direct Importer-to-You

5-DAY HOME TRIAL

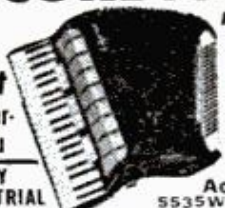

NEW ELECTRONIC MODELS

SAVE 1/2 42 "New Sound" Electronic and Standard models. Amplifiers too! All Famous Makes. Try before you buy—5-Day Trial. Easy Terms, Trade-Ins. Free Accessories. Money Back Guarantee. Free Color Catalogs, Handy Selection Guide, Discount Prices. Write

Accordion Corporation of America
 5535 W. Belmont, Dept. R-73, Chicago, Ill. 60641

LEARN UPHOLSTERY AT HOME!



Men & Women All Ages! Send for free book on learning to reupholster chairs, divans, footstools, all furniture for BIG MONEY in spare or full time. No experience needed, no age or educational limits. We show you how and provide EVERYTHING needed to start: (1) Home training covering all phases, (2) all tools and 6 big furniture kits for practice, (3) free supplies, frames & materials to build \$300 worth of furniture, yours to keep or sell. Write TODAY for big free upholstery career book. No obligation, no salesman will call. Veteran Approved. Modern Upholstery Institute, Box 899-TPM, Orange, Calif. 92669.

HOME-WORKSHOP ELECTRIC ARC WELDER \$9.99!



WELDS—BRAZES—SOLDERS—CUTS—ALL METALS! Plugs into ANY 110 volt socket. MAKE-REPAIR most anything for CAR—HOME—BUSINESS. Lifetime BURNOUT GUARANTEE 10 day money back trial (if retrnd), HEAVY DUTY Resistant. No experience needed—FREE WELDING LESSONS!

SEND \$2.00 (cash, ck, M.O.) and pay postman \$7.99 COD postage or send \$9.99 plus \$2.00 for postage. Includes E.G. pack steel, Brazing, Solder, Carbon "touch" rods & ELECTROFLAME ARC TORCH! OFFER LIMITED—Order TODAY! MIDWAY WELDER, Dept. EPM-7, Kearney, Nebr. 66847



Repair any watch

... SWISS OR AMERICAN

Unique, modern Sweazey System starts you making repairs right away. Develops skill step by step at home in spare time. Diploma awarded. Free sample lesson. No obligation.

CHICAGO SCHOOL OF WATCHMAKING
 Dept. 173, Fox River Grove, Ill. 60021



HOW TO BECOME A LOCKSMITH

COMPLETE BOOK OF INSTRUCTIONS

How To Fit Keys, Change Combinations, Master Key Locks, Keys By Number, Tools To Use, etc. Detailed illustrations. Satisfaction guaranteed. Get started! Order today. **Only \$3 ppd.**

A.X. Ancele, P. O. Box 69234, Los Angeles, Ca. 90069

POPULAR MECHANICS PM-BEE! Plan for a radio-controlled model that flies on CO₂. Fuel is nonflammable and odorless. Sophisticated and simple to build! To obtain full-scale pattern from which you can trace off the parts direct, send \$3.49 to POPULAR MECHANICS Dept. FA, Box 1014 Radio City, New York, N.Y. 10019.

DRAFTING PAYS BIG!



YOUR FUTURE IN DRAFTING
APPTITUDE TEST
SAMPLE LESSON
ALL 3 FREE

U.S. Labor Dept. says "42% more Draftsmen needed in next 10 years." Easy home-study plan guides you. Send for FREE "Drafting Career Kit."
• APPROVED FOR VETERANS.

NAME _____ AGE _____
ADDRESS _____
CITY _____ STATE _____ ZIP _____
NORTH AMERICAN SCHOOL OF DRAFTING, Dept. 34177
Accredited National Home Study Council 4500 Campus Dr., Newport Beach, Calif. 92663

PAYS FOR ITSELF!

Wheel Balancer only \$13.98



Float-O-Matic pays for itself the second time you use it. Quickly levels on any solid surface. Easy to use. Durable, light weight. Accurate bubble-centering concept means no guesswork... you're an expert in minutes. Extends tire life and allows greater control at freeway speeds. **MORE ACCURATE!** The lug holes on your wheel are machined within closer tolerances than the center hole. Float-O-Matic uses these closer tolerances to insure more accurate balancing than the older cone-type units. Fits all cars and light trucks except those with closed center wheel hubs. Can be used on VW, Saab, Peugeot and other imports with large center holes by adding adapter. **KIT:** Contains 50 assorted weights and balancing tool... \$8.99. **ADAPTER:** Allows balancing of all imported car wheels with large center holes... \$4.49. Send check or Money Order... Satisfaction Guaranteed.

A FUN-FRAME PLAYHOUSE TO BUILD



A real fun playground for children with a swing set, sandbox, play table and a seesaw. An attractive addition to your backyard. Complete construction plans, detailed diagrams, and material lists. One set of plans \$3.95, two sets \$5.50 (you may need to file one set with your local building dept.). To order plans: Send your check or money order to: **IDEA ENTERPRISES, Dept. PM, P.O. Box 1720, Grand Central Station, New York, N.Y. 10017.**

All plans sent postpaid first class mail

AUREUS INDUSTRIES DEPT. 11
P.O. BOX 3 / MERCER ISLAND, WA 98040

Name _____
Address _____
City _____ State _____ Zip _____
Car(s)/yr _____

Balancer-\$13.98 Kit-\$8.99 Adapter-\$4.49
Add 50c for postage and handling.

SuperBonder™ Adhesive fixes almost anything.



Miracle SuperBonder adhesive, by Loctite, repairs almost anything and everything... in seconds... without clamps. Bond vinyl to metal car trim, repair vinyl upholstery, valuable ceramics, china, glassware, toys. Build models. Send check or money order for \$2.00 plus 50c for postage and handling for SuperBonder, from Loctite, the makers of Lock n'Seal.

MONEY BACK GUARANTEE

SuperBonder Offer
Box 1014 P1
Hartford, Connecticut 06101

Please send _____ tubes SuperBonder. \$2.00 per tube plus 50c per order enclosed for handling and postage. (Conn. residents add 7% State tax.) Allow minimum 14 days for delivery.

NAME _____ Age _____
ADDRESS _____
City _____ STATE _____ ZIP _____

KARATE



**JUDO-SAVATE
JIU-JITSU**
The Greatest Self-Defense System Known To Man! Learn-At-Home-Course reveals hundreds of deadly self-defense secrets, which will enable you to protect yourself from any attacker! Easy to learn! **FREE COLORFUL BROCHURE REVEALS SELF-DEFENSE TECHNIQUES.**

Send to: **UNIVERSAL, Dept. M**
BOX 39303 DETROIT, MICHIGAN 48239

FREE

BELSAW PLANER • MOLDER • SAW



30-DAY FREE Trial!



Now you can use this **ONE power-feed shop** to turn rough lumber into moldings, trim, flooring, furniture... **ALL popular patterns. RIP... PLANE... MOLD—separately or all at once with a single motor. Free 30-Day Trial. Low Cost—only \$35 down.**

Send Postcard Today—No Salesman Will Call
BELSAW POWER TOOLS 904K Field Bldg., Kansas City, Mo. 64111

AUGUST PREVIEW

OF POPULAR MECHANICS

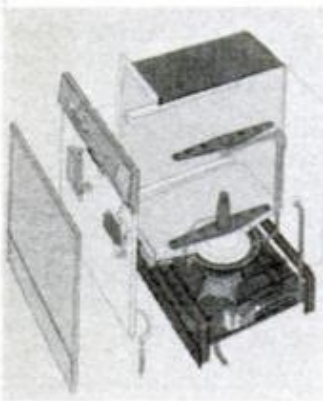

How to repair a dishwasher

This article can save you a \$15 "walk-in" charge to have an appliance repairman diagnose what's wrong with your dishwasher. And with our troubleshooting charts you can probably make the repair or replacement yourself.



Big-scale thrills at a small-scale price

If you'd rather fly model planes than build them, you can now get gasoline-powered plastic warbirds and racers for as little as \$10.

Grandfather clock kit

Time was when only a highly skilled craftsman would attempt to build a clock like this. Now you can start with a kit of precut hardwoods and preassembled parts and know you'll end up with a handsome clock that will be an heirloom.



New patio carts

PM plans three carts for indoor/outdoor use: mobile cooking center, bar-with-sink on wheels, roll-about stereo unit. Great for a rec room. You can't buy one; we show how to build them.

Hazardous cargoes

Dynamite, poison gases, artillery shells—all kinds of deadly cargoes are rolling by truck and rail through our cities and down the streets of unsuspecting towns. Here's what can be done to lessen the danger.



PLUS

How to repair aluminum screens and storms • A snappy little two-place plane you can build • What those TV tuning buttons do and don't do • What cars need to meet California's clean-air standards. • How to repair a dishwasher. • Garden tractor you build from a kit • How to build retaining walls • How to take great pictures in the great outdoors.

Buy it on your newsstand. Better yet, make sure you'll keep getting this kind of exciting fare. Send this coupon with your check to:

POPULAR MECHANICS
250 West 55th Street
New York, New York 10019

Please enter my subscription for 1 yr. \$5.97 or 2 yrs. \$10.97

Name _____ (Please print)

Address _____

City _____ State _____ Zip _____

Payment of \$_____ is enclosed. New Renewal

On new subscriptions, first copy will arrive in about 8 weeks.

(Above prices apply in U.S. and Possessions only. Canada, add \$2 per year. All other countries, add \$4 per year.)

WPM3G1

The day Bill told off his boss



ARE YOU WORKING FOR PEANUTS IN A DEAD END JOB? GET SMART. SEND FOR 2 FREE BOOKS LIKE BILL DID!

Be sure to send for your 2 FREE books today. For your convenience, we will try to have a representative call. If coupon has been removed, write to Cleveland Institute of Electronics, Inc., 1776 East 17th Street, Cleveland, Ohio 44114.

CIE Cleveland Institute of Electronics, Inc.

1776 East 17th Street, Cleveland, Ohio 44114
Accredited Member National Home Study Council

Please send me your 2 FREE BOOKS describing the opportunities in Electronics and how to prepare for them.

Name _____
(Please print)

Address _____

City _____

State _____ Zip _____ Age _____

APPROVED FOR TRAINING UNDER G. I. BILL

Veterans and Servicemen:
 Check here for G.I. Bill information.



DETROIT LISTENING POST

New but not unique

The new Mustang coming in a couple months may be hard-pressed to live up to its advance billing—on two counts. One, contrary to the press agency that Ford's putting out about the car being as much of a pacesetter as the original 1965 Mustang, the new version doesn't look that new. It will be an everything-new car that's readily distinguishable from the current Mustang. But it won't be a nothing-else-like-it car in the way that the '65 was a unique concept.

And where you could buy a '65 for \$2400, son-of for '74 is expected to cost close to \$3000 delivered because of the luxury touches it'll carry. Ford isn't worried about the price angle, because there are a certain number of people who will always want to have an all-new car the first year out, price no object. But once the first-year stampede has subsided, Ford may have to delete some of the deluxe gear in an effort to get the price down to a level where it will attract more buyers.

Fewer options

Ford's about had it with the something-for-everybody approach to automaking. No company in the business has tried harder than Ford to let the customer build his own car by picking the pieces out of the catalog, designating exactly what he wants put on or left off.

They used to say in Dearborn that if it'd beat GM out of a sale, Ford would put the wheels on the roof. No more. The company feels many of its problems in recent years—recalls, getting engines certified by the government, relationships with dealers and suppliers—can be attributed to too much diversity of product.

The please-'em-all policy is going to be cut back. One of the first cuts will be in choice of engines. Ford sells half as many cars as GM and has three times as many engines. Two, the 429 and 460-c.i.d., will be weeded

out in the next 18 months. And that's just for openers.

Other options will be made standard or you'll have to buy the next highest priced car for the privilege of playing take it or leave it.

Moving to metrics

Ford will be the next automaker to switch to metrics, following GM's lead. Ford is actually a centimeter ahead of GM at this point, because the Pinto engine and most Pinto transmission parts are already in metrics. Also, the 2.3-liter ohc engine for the '74 Mustang being built in Lima, Ohio, will be all metric. GM won't get into metric measurements until its Wankel engine goes into production.

Both Ford and GM are estimating that the complete changeover will take at least 10 years.

Rear lights to leave the bumper

All '74 Ford cars made in the United States will have rear lights built into the body, rather than into the bumper. All automakers are moving in this direction and it is just a matter of time—depending on when a car is due for a major model change—until the body-mounted headlights and taillights become an industry-wide standard. The idea is to put the lights in protected areas where they are least likely to be damaged in an accident.

Lower lines call for squeeze under hood

With lower belt lines and hoods—especially hoods—to be the trend on future cars, General Motors is seeking to squash, flatten and compact everything installed under the hood

(Please turn to page 58)

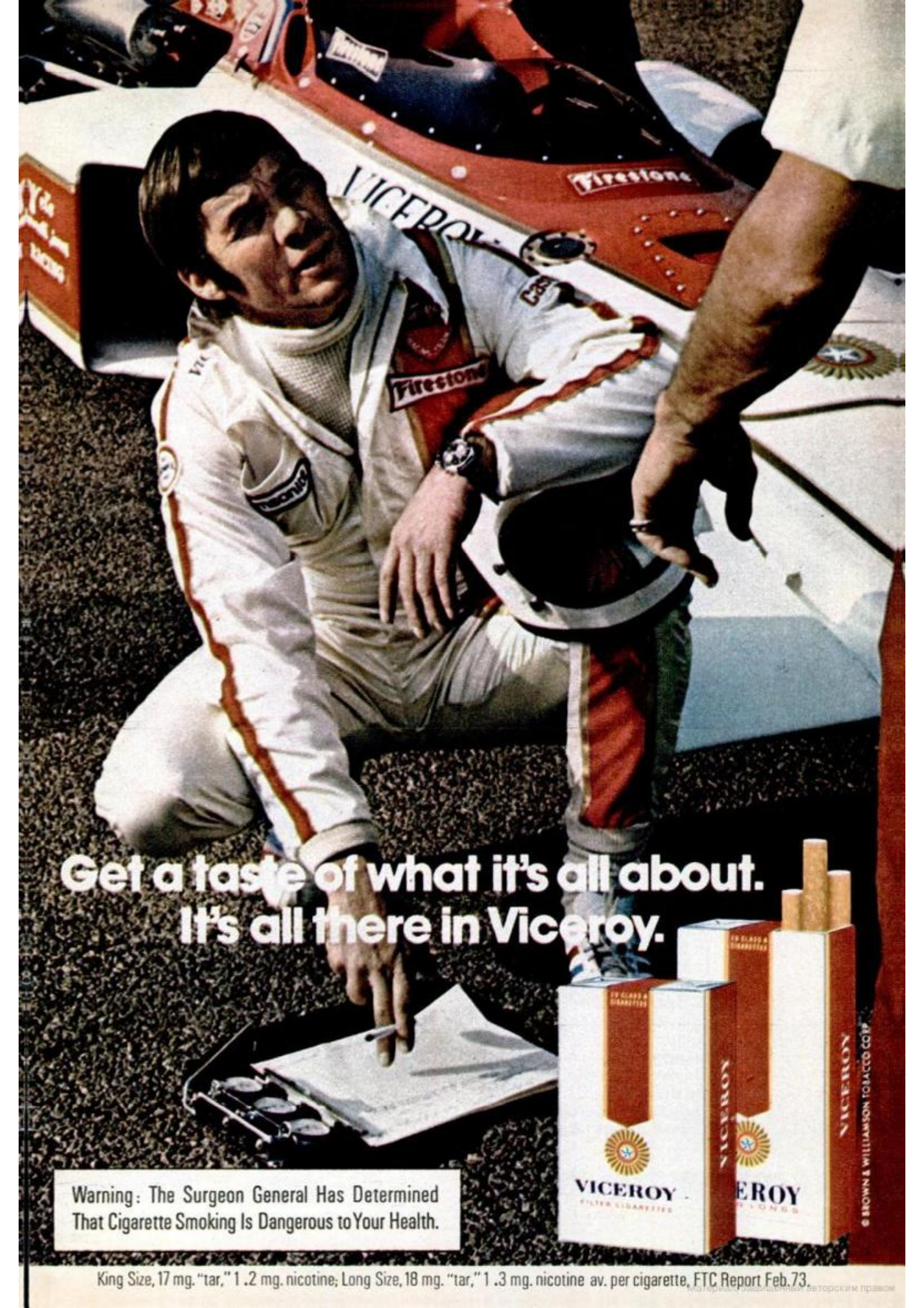

**Get a taste of what it's all about.
It's all there in Viceroy.**

Warning: The Surgeon General Has Determined
That Cigarette Smoking Is Dangerous to Your Health.

King Size, 17 mg. "tar," 1.2 mg. nicotine; Long Size, 18 mg. "tar," 1.3 mg. nicotine av. per cigarette, FTC Report Feb. 73.

© BROWN & WILLIAMSON TOBACCO CO.®

Power Steering and Tilt-Wheel Steering. Make your camper drive more like your car.



Camping can be a whole lot more pleasant with Power Steering and Tilt-Wheel Steering in your GMC or Chevrolet camper. It's a comfort-and-convenience package that helps make driving easier.

Power Steering does for your camper what it does for your GM car. Reduces steering effort. Makes parking easier. Improves handling, even on rough back roads.

Tilt-Wheel Steering adds another dimension of convenience. By moving up, out of the way, for easy entry and exit. By adjusting up or down to your most comfortable driving position. And you can change the steering wheel position as often as you like *while you drive*... to help fight fatigue.

Ask your GMC or Chevrolet dealer for a demonstration of Power Steering and Tilt-Wheel Steering. Full-time help with the driving.

Saginaw Steering Gear Division,
General Motors Corporation

SAGINAW POWER STEERING
TILT-WHEEL STEERING



DETROIT LISTENING POST

(Continued from page 56)

that can be miniaturized or squeezed into a smaller space.

This will be a tough job. With the engine compartments already bulging over, it will take some extremely clever packaging by engineers and designers to drop their hoods two or three inches.

Three-pony parley for AMC

American Motors is convinced it has a winner in the new ponycar that it plans to bring out a year from this fall. What had started out to be a single car is being stretched into a three-car line, including the basic two-door, a fastback sports version and a hatchback. It's not a sure thing yet, but the fastback sports version is a good candidate for a Wankel engine.

Pull-out instrument panels

Easy-to-service instrument panels—remove a few screws and the panel drops down or pulls out for quick access to wiring and parts stashed behind the dash—will be extended to all of GM's standard-size cars and its top-priced intermediates within two years. Some Pontiacs and Buicks have the feature now and GM says that experience reports from both owners and mechanics have been nothing but good. Easy-service panels will also be used on some '74 Chrysler cars.

Numerical gas gauge

Chrysler Imperial—probably the '75 car but if not, the '76—will have a digital gas gauge. But it hasn't been decided yet whether the readout numbers will be in gallons left in the tank or miles of travel the car can go before the fuel supply is exhausted. The company is working on both versions. The problem with giving the figures in miles of travel is that it will emphasize poor mileage and Chrysler obviously doesn't want to make a point of that. You can run your own mileage check, of course, but that's not the same as having the figures flashing in front of you as a constant reminder that the engine is a guzzling glutton. ★★★

It pays to go by the book.

Chilton's Auto Repair Manual, 1973.

(American cars 1966-1973)

This is easily the best book of its kind
ever assembled.

Comprehensive. No other manual comes close. Either in our detailed coverage of just about every repair job, or in our special sections on trouble-shooting, tune-ups, engine rebuilding, emission controls, windshield wipers and the Wankel engine. In scope, detail and clarity they're unequalled.

Understandable. You don't have to be a professional. We use simple, everyday vocabulary, and go through each job methodically, step by step. (There's even a special section that tells you how to use the book.)

Loaded. There are tables, charts, drawings, diagrams and exploded views galore. Over 4,000. There are almost 1500 pages. And we cover every popular American car from 1966 through 1973. (Including Jeep and the new Olds Omega.)

Chilton's Auto Repair Manual, 1973. Get it now at your local bookstore or automotive department. Or return the coupon below.

CHILTON BOOK COMPANY

Radnor, Pa. 19089

Chilton Book Company
Dept. PM 1173
Chilton Way, Radnor, Pa. 19089

Please send me CHILTON'S AUTO REPAIR MANUAL, 1973, for which I enclose check/money order for \$10.95, plus any applicable tax. If not satisfied with this book, I may return it postpaid, in clean saleable condition, within 10 days for full refund.



Name _____

Address _____

City _____

State _____ Zip _____

APPLIANCE CLINIC

BY PAUL MANN

Clue search

I have a Westinghouse automatic washer. The soak and spin cycles work okay, but I can't activate the wash cycle. What's wrong?—A. Culteone, South Euclid, Ohio.

You don't give me too much information but the part of your letter that says "I can't activate the wash cycle" provides a clue. Does your washer fill with water automatically, agitate for one minute and then stop, allowing clothes to soak—the kind that stays in the soak phase until you move the control two notches by hand, throwing the washer into rinse and final spin? If moving the control doesn't start the rinse cycle, the trouble probably lies with a faulty timer.

If you have an all-automatic machine that doesn't kick into the agitate cycle, the problem is likely to be a defective transmission or motor.

Not so automatic

I have an automatic water softener that's been a pain since I bought it in 1968. The only thing "factory-trained" servicemen have done is to replace one sensor with another. The unit simply doesn't regenerate automatically as advertised. One serviceman had the nerve to tell me to operate the unit manually. I paid for an automatic conditioner—why can't I have an automatic conditioner?—Gordon A. Berg, Menasha, Wis.

I hate to be the voice of gloom, but the guy who told you to use the machine manually was doing you a favor. In theory, "automatic" water softeners that employ sensors should work automatically; in practice, they often do not because of certain variables that can't be controlled. Servicemen found out quickly—now the public is learning.

In units with sensors, automatic operation should begin when two solid-state sensors detect that the bed of resin has been exhausted and needs regeneration. To do

this, the sensors measure resistance between a layer of resin that's charged and the layer needing regeneration. Fine—except that this action is often disrupted by an outside source, such as iron or other impurity in the water, or a fluctuation in water temperature. There's no economical way to control these variables, so it's best to forget about the automatic feature and try to get your money's worth with manual operation.

You shouldn't condemn all automatic devices because of this one's actions. Another way to achieve automatic regulation is by programming—that is, using a timer set to kick off automatic regeneration at programmed intervals. This automatic feature, in use many years, is reliable.

Perpetual motion

I have a problem with a General Electric Versatronic clothes dryer. When used on automatic cycle, the machine does not shut off. I have to disconnect it manually. The timer motor has been changed. What else do you think is wrong?—Stuart Jacobson, Farmingville, N.Y.

The motor may be grounded or there may be a short in the wiring. In any event, it's not a do-it-yourself repair. Call in a qualified General Electric serviceman.

Flip flop

I have a Sunbeam Steam Ironmaster, model S-6. Can you tell me how to get at the steam-on, steam-off control knob located in front of the handle so it can be repaired? The knob won't stay in the up position.—Alfred Baldassari, Bronx, N.Y.

Look for a small plastic pin on the handle at front. Pry it up with a knife blade until it can be removed with pliers. This will re-

(Please turn to page 62)

Seven & Seven.

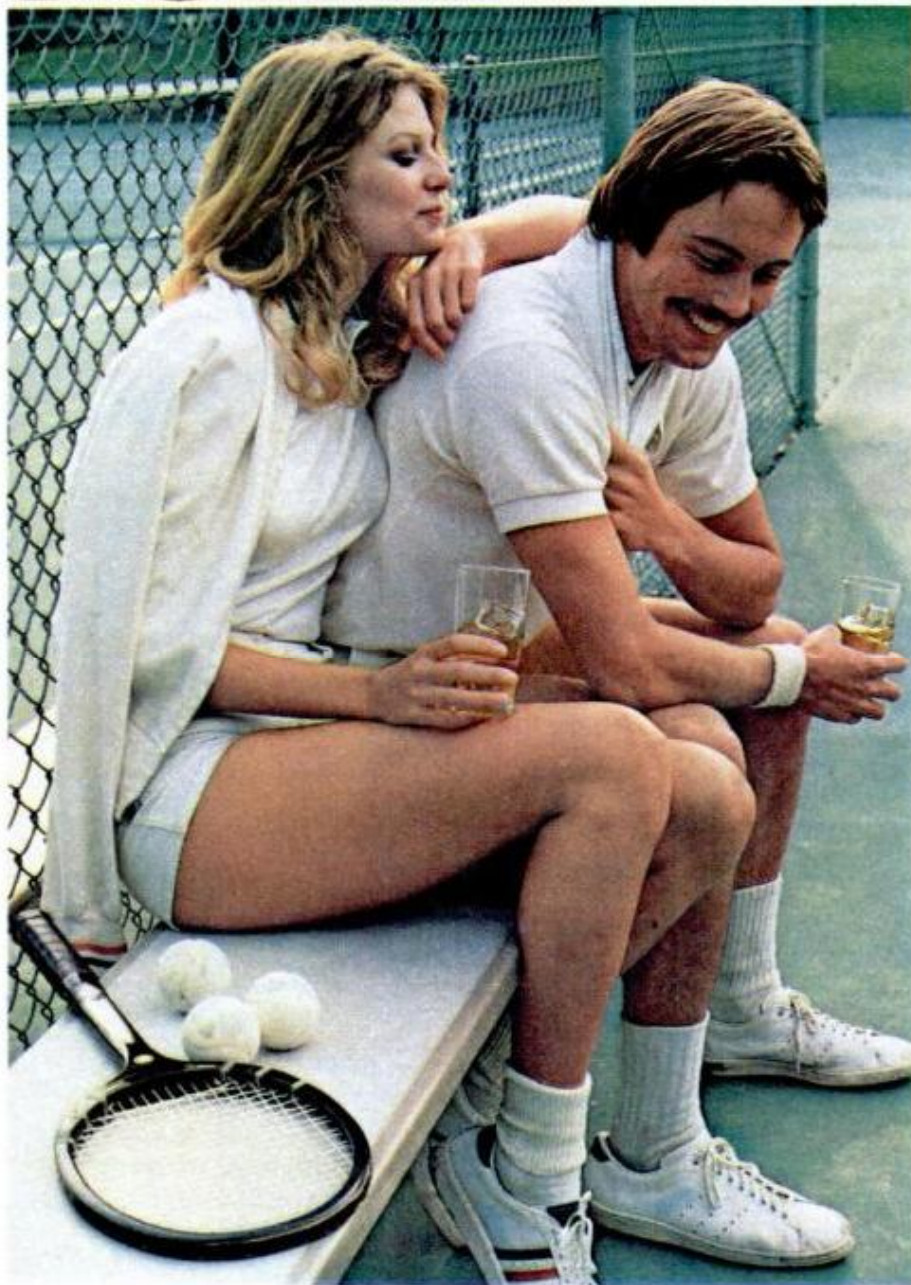

When you know you've gotten the most out of yourself, that's when you feel your best. Right?

And that's when you deserve the one drink that's always at its best.

Seagram's 7 Crown and 7 Up.

Get it nice and tall over plenty of ice. Then settle into it.

Seven & Seven.

It belongs to moments like this.



Seagram Distillers Co., N.Y.C. American Whiskey - A Blend. 86 Proof.

"Seven-Up" and "7 Up" are registered trademarks identifying the product of the Seven-Up Company.

THE SCOTT ENGRAVER

Your spare time money-maker

Scott's SM100 turns 10¢ worth of plastic laminate into a product you can sell for 75¢ to \$1.00. Every business is a prospect. Make name plates, signs, plaques and more . . . in just minutes, using just one hand. A complete, ready-to-operate engraving shop to help you make big money in your spare time!

To find out more, send for free catalog, today.
Dept. 5107

SCOTT MACHINE DEVELOPMENT CORP.

P. O. Box 217
Walton, New York 13856

Scott fills every engraving need—
from stock to fonts.



FREE *Kirsten* CATALOG OFFER

Send me your fully illustrated color catalog of the complete line of Kirsten pipes and accessories.

NAME _____

ADDRESS _____

CITY _____

STATE _____ ZIP _____



\$9

postpaid

Kirsten
PIPE CO., INC.

P.O. Box 70526-PM-7
Seattle, WA 98107

APPLIANCE CLINIC

(Continued from page 60)

lease the handle, exposing the base of the knob, held by a U-shaped clip. If it has fallen out of place, reset it.

Coffee brake

We have an automatic coffeemaker that makes about 30 cups—when it's working. A rubber part attached to the plunger in the spigot either comes loose or loses its elasticity. When it fouls, the spigot becomes inoperative, and there lie 30 cups of coffee that have to be ladled from the pot. Is there a place where we can buy this part, or is it necessary to buy a new spigot, which is almost as expensive as a new coffeemaker?—Ralph W. Kinsey, Lamesa, Tex.

The rubber part can be bought separately for about 75 cents. If you can't get it in Lamesa, one parts supplier who will send it to you is Boulevard Brunswick Appliance Service, Milltown Rd. and State Hwy. 18, East Brunswick, N.J. 08816. If you order, be sure to specify the appliance by manufacturer and model number.

New life

I have a tip for your readers, concerning a Hoover upright vacuum cleaner we bought a few years ago. At first, it did a good job, but it gradually went sour and wouldn't pick up ravelings. It also blew dust around the room. I took off the bag and started the unit, placing my hand over the large opening over which the bag fits. Absolutely no air. I disconnected the unit and started probing around inside with a piece of wire. Guess what I discovered? The sponge rubber lining had somehow folded over and cut off suction. I straightened out the lining, and now the vacuum works as good as new.—R. A. Prehm, Marysville, Wash.

It just goes to prove that curiosity and ingenuity can breathe new life into seemingly dead appliances. ★★★

If you have a question about any appliance, send it to Appliance Clinic, Popular Mechanics, 224 West 57th St., New York, N.Y. 10019. Sorry, but letters cannot be answered individually. Problems of wide interest will be answered in this column.

Jobs open up for Technicians with down-to-earth training!

Opportunities are everywhere and the pay is excellent in the technical service industries. But it takes the right training to get a man started: NTS Project-Method Home Training!

You learn by building the latest equipment and test instruments (which are included in your tuition). You're guided every step of the way by easy-to-read NTS Lessons.

When you graduate, you know service and repair from the bottom up, inside-out!

You have answers on the tip of your tongue. Know-how at your fingertips. You have the down-to-earth training experience employers are willing to pay good money for!

Find out. Send card today. No obligation. No salesman will call.



Solid-State Color TV
315 Sq. In. picture

ELECTRONICS DIVISION

NTS offers a wide-range of training with solid-state equipment (almost all of it commercially available). Build a solid-state 315 sq. in. Color TV; solid-state B&W TV; solid-state FM multiplex Receiver and Speakers; solid-state Oscilloscope; solid-state Compu-Trainer. Plus, Amateur Phone Transceiver, FET Volt-Ohmmeter, Electronic Tube Tester, Signal Generator, and more! Get valuable experience in the latest electronics technology. Read details in catalog.



AIR CONDITIONING/ REFRIGERATION & HEATING DIVISION

NTS provides you with the important tools of the trade! Courses include specially-designed Hermetic Unit Analyzer — a tester with multiple applications; Leak Detector-Soldering Kit — with hundreds of uses; Charging-Testing-Purging Manifold Set with dispensing and piercing valves. Plus, Socket, Wrench, Open-End Wrench, Tube Bender Sets, and more!



MECHANICS DIVISION

NTS includes professional tools and test equipment. Earn as you learn. Make money even before you graduate! Big 109 piece Socket Wrench and Tool Set — all American made! And a Performance Kit — Timing Light, Smog Valve Tester, Compression Tester, Remote Starter Switch, Dwell Tach, Alternator-Generator-Regulator Tester. Also, "Speed Shop" lessons and diesel training.



HOME APPLIANCE DIVISION

Multiply your experience with appliance circuitry through the exclusive NTS Circuit Trainer. Eliminates the need to buy dozens of appliances for training purposes. The 4-in-1 Appliance Tester performs many troubleshooting tasks. It includes an Ohmmeter, Voltmeter, Ammeter, and Wattmeter; measures both AC and DC currents; it will be valuable to you during training and on the job!

APPROVED FOR VETERAN TRAINING

Accredited Member: National Association of Trade & Technical Schools; National Home Study Council.

CLASSROOM TRAINING AT LOS ANGELES

Train in sunny Southern California. NTS occupies a city block with over a million dollars in training facilities. Check box.

NATIONAL TECHNICAL SCHOOLS

WORLD-WIDE TRAINING SINCE 1905

Resident & Home Study Schools

4000 So. Figueroa St., Los Angeles, CA. 90037



NATIONAL TECHNICAL SCHOOLS

WORLD-WIDE TRAINING SINCE 1905

Resident & Home Study Schools

4000 So. Figueroa St., Los Angeles, CA. 90037

Send for color Catalog and Sample Lesson — both FREE! Check below. No salesman will call. No obligation.

- Electronics Division Mechanics Division
 Air-Conditioning, Refrigeration, Heating Division Home Appliance Division

NAME _____ AGE _____

ADDRESS _____

CITY _____ STATE _____ ZIP _____

Dept. 201-073

- Check for Veteran Training under G.I. Bill
 Check if interested in information on Classroom Training in Los Angeles

HOMEOWNERS' CLINIC

BY W. CLYDE LAMMEY

Leak in a flat roof

My garage has a flat roof and there's a leak near its center. Examination turns up what looks like a small blister. What can I do about fixing this?—M. Daly, Nashville, Tenn.

Assuming the blister is in the mineral roll-roofing, you could, of course, slit and flatten the blister and apply an entirely new roof with "hot-mop" tar. But, to just seal the blister, slit it and force roof mastic in the slit under the felt. Nail down both sides of the slit with flathead roofing nails. Then cover the entire patched area with a healthy-sized piece of asphalt roof felt (mineral roll-roofing) laid over roofing compound. Nail down the rim of the patch and seal all edges with mastic.

Sapwood shows through finish

I have a small desk, a reproduction, and on the drop lid a strip, or streak, of lighter wood is beginning to show quite noticeably. Is there any way to conceal this without removing all the finish from the lid?—Emmet Polk, Dallas.

If I can judge correctly from your brief description, this is a piece of sapwood, which often shows up after prolonged exposure to light, even where the wood was originally stained. I doubt that you will be able to obtain a satisfactory job of spot-finishing without removing the original finish down to the wood. After you take off this finish, you can conceal the lighter wood by rubbing in a stain made from artist's colors. Allow this to dry thoroughly—at least 48 hours—and then refinish it in the original color.

Noisy electric clock

I have an older-type electric clock that's making noises—a scratchy humming sound

that keeps me awake. If I tip the clock slightly, the noise changes pitch, but continues. Can anything be done to quiet the racket?—Bill Johnson, Minneapolis.

In the older electric clocks, you can generally attribute this trouble to the tiny gear train that runs dry and becomes noisy because of lack of lubricant. Disconnect the cord from the outlet, take off the back of the case, and you'll see the gear train just back of the dial. Clean the gears with alcohol or lacquer thinner and apply a drop or two of oil—never more—to the gearing. Clock oil, in a container with a tiny spout, is best; it is sold by clock parts dealers and some jewelers and antique shops. But a light machine oil or household oil can be used.

While you are at it, lubricate the motor as well, remembering that just a drop or two does it.

Decorating narrow windows

How does one decorate those tall, narrow windows in an old home like mine? Two are in pairs, but two others are single. The tops are semicircular.—Mrs. Reginald Kemper, Cincinnati.

I would think first of either cafe curtains or deep valances with drapery, with the latter being made wider than the windows and attached to the wall (see *How to Hang Drapery Traverse Rods*, page 144, March '73 PM). This treatment will have the effect of lowering the height of the windows and at the same time promoting the feeling of width. Of course, there are several other treatments, but it seems to me that the valances would be most effective, especially in a large room. ★★

Do you have a home maintenance or repair problem? Send it to Homeowners' Clinic, Popular Mechanics, 224 West 57th St., New York, N.Y. 10019. While letters cannot be answered individually, problems of wide interest will be discussed in this column.



We'll pay you \$61.08 a weekend, or more, now. And pay you for life when you retire.

The money's important—but it's only one reason for prior-service men and women to join the Air Force Reserve. You've already invested a certain number of years. Put in time against your 20-year retirement benefits. Benefits civilian employment will hardly match. It's your insurance policy against the years coming. Why give it up?

For two days a month, plus two weeks a year, you can keep the investment you made, add to it, and reap the benefits.

And all the while, there's added income. Plus a chance to learn a new skill or improve your present one. Plus travel. Plus limited exchange privileges. Plus that feeling you've become so familiar with when you know you're doing a great job for your country.

All the reasons benefit you. Call 800-525-9984, toll free. (In Colorado call 800-332-9952.) Or send in the coupon. We'll give you the location of your nearest Air Force Reserve Unit.

**Air Force Reserve.
Your Local Air Force.**

Air Force Reserve 3-PM-73
Box A

Randolph AFB, Texas 78148

Please send me more information. I understand there is no obligation.

Name _____ Sex ____ (M) ____ (F)
(Please Print)

Address _____

City _____

State _____ Zip _____ Phone _____

Soc. Sec. # _____ Date of Birth _____

Former Grade _____ Former Specialty _____

JULY 1973 67

Материал, защищенный авторским правом

Can you spot the Camel Filters smoker?



© 1973 R. J. Reynolds Tobacco Co.

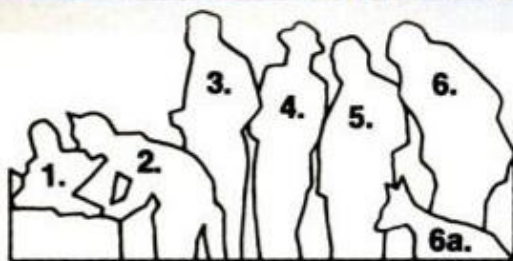

At class reunions almost everybody has a gimmick. Try picking the one who doesn't go along. **1.** Nope. He's Don Wand. Won school essay contest with "The Art of Pre-Marital Dancing." Gimmick: 200 mm holder to balance his 100 mm cigarette. **2.** No. It's Rah-Rah Mendelson, ex-cheerleader. Gimmick: He's wearing it. Smokes whatever he finds in his pouch. **3.** No. He's Moe Mentum, alias "Stone Hands" for dropping passes. Just dropped statue of school mascot. **4.** T. Deious, school bore. Gimmick: His voice, off-key contralto. Smokes oval cigarettes (he sat on his soft-pack and liked it). **5.** Curley Gilroy. His hair was voted "Most Likely to Recede." Gimmick: Staples toupee on. Also staples his roll-your-owns. **6.** Right. He's still his own man. Likes his cigarette honest, no-nonsense, too. Camel Filters. Easy and good tasting. **6a.** Kicky VIII, mascot. Has eyes only for Mendelson (see 2 above).

Camel Filters.
They're not for everybody
(but they could be for you).



Warning: The Surgeon General Has Determined
That Cigarette Smoking Is Dangerous to Your Health.

20 mg. "tar", 1.3 mg. nicotine av. per cigarette, FTC Report FEB. '73.

Материал, защищенный авторским правом

Checking her engine on easy warm-up laps before competition is karting's Grand National Champion, Kathey Hartman. Her husband, John, builds some of the hottest karts in the sport and she races them—in both sprint and enduro competition. Moreover, she is "top wrench," building and tuning the engines.

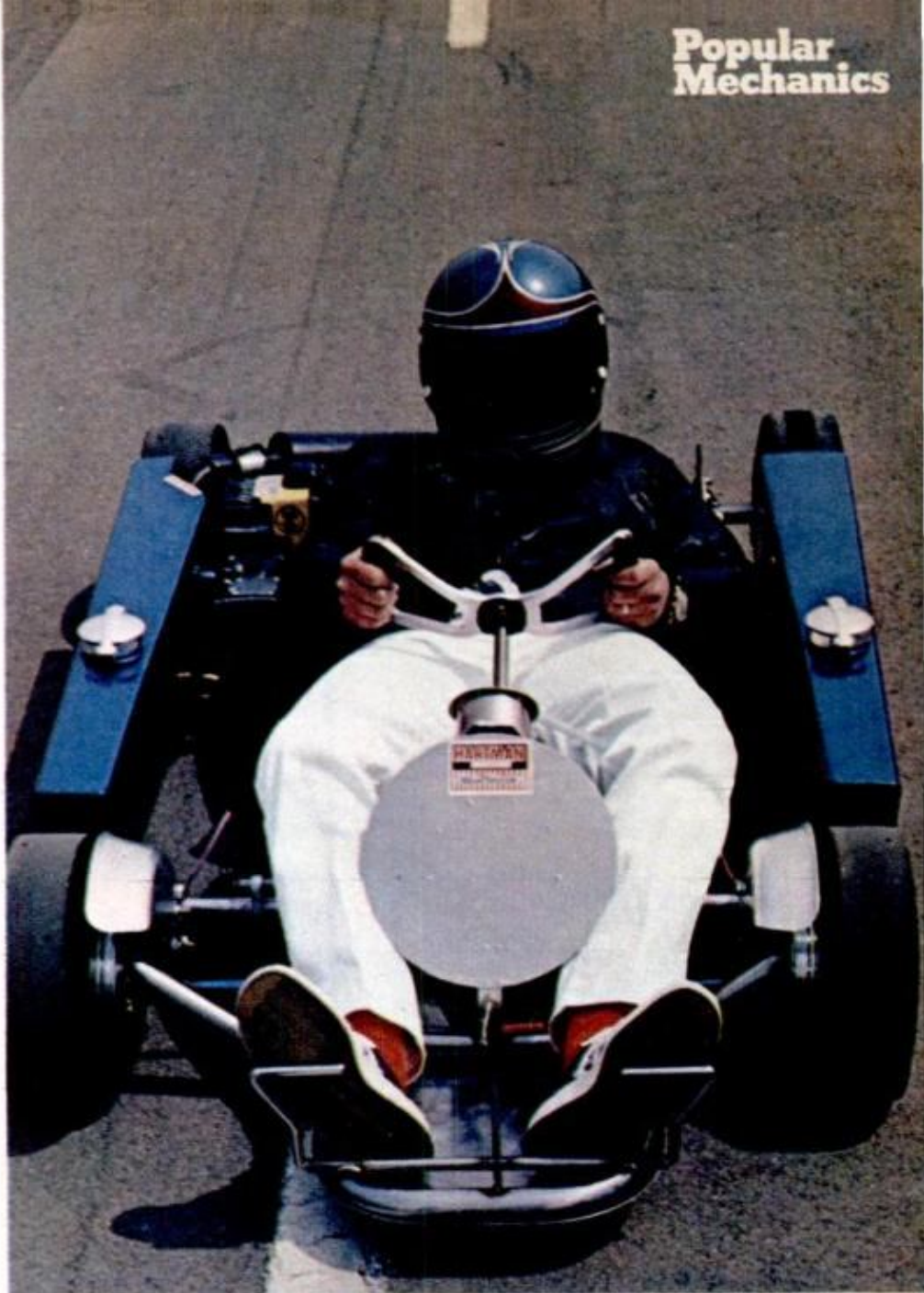

Karting: Everybody's chance to be a race driver!

Once they were lawnmower engines on frames; now they look—and go—like Formula 1 racers!

by Michael Lamm
WEST COAST EDITOR

If you thought karting was dead, you couldn't be more wrong! Karting is very much alive and running machines you wouldn't believe. But they're for real.

The wildest karts now look like miniaturized Can-Am cars, and that's about what they are. They run in a class called FKE (Formula Kart Experimental). The fiberglass bodies are so low that the driver has to lie almost flat on his back to drive one. Top speed of this class? About 130 mph, and since that's with superfast steering ($\frac{1}{3}$ turn lock to lock), FKE spells flying.

Another class, the big C-Open karts, can out-dig AA/Fuel dragsters up to about 50 mph. Wings and spoilers aren't in the rule books yet, but drivers are putting them on anyway to keep from taking off.

These karts aren't anything like the ones



FKE classes allow bodies on karts (above) and inspire all kinds of wild designs. Most are one-offs built by owner/drivers. Long distance enduros are one-hour road races with modified LeMans standing starts (right).



The three karts in foreground are "Moles" or limited-production models. These bodied bombs run in two classes: 6.1 and 8.25-cu.-in. engines. The fancy paint jobs and the pinstripping are de rigueur!

you remember. Four-wheel disc brakes with dual master cylinders are now commonplace. Some karts use adjustable tuned expansion pipes that the driver shifts like a transmission. He can lengthen or shorten his exhaust system to maximize performance throughout the rpm band.

Simplicity, though, remains the byword. After trying and discarding all sorts of suspension systems over the years, karters have settled for letting their frames be their springs. Today's kart chassis are usually 4130 chrome moly. This makes the chassis extremely flexible. Up to a point, the more flexible the frame, the better the kart handles. On some, you can pick up one front wheel and raise it three inches before the other tire leaves the ground.

That's just a bare sampling of some of the amazing innovations going on in this newly revitalized sport.

I talked to Tom Bates, editor of *Karter News*, and asked him whether drivers can actually see when they're flat on their backs in some of these enduro karts. "Not so well as in a sprint kart, where you sit more upright," he said. "But the enduros aren't going through such sharp turns as the sprints. On most of the big enduro tracks—and enduro karts usually run on regular sports-car tracks like Ontario Motor Speedway, Mosport, Riverside, Watkins Glen, La-

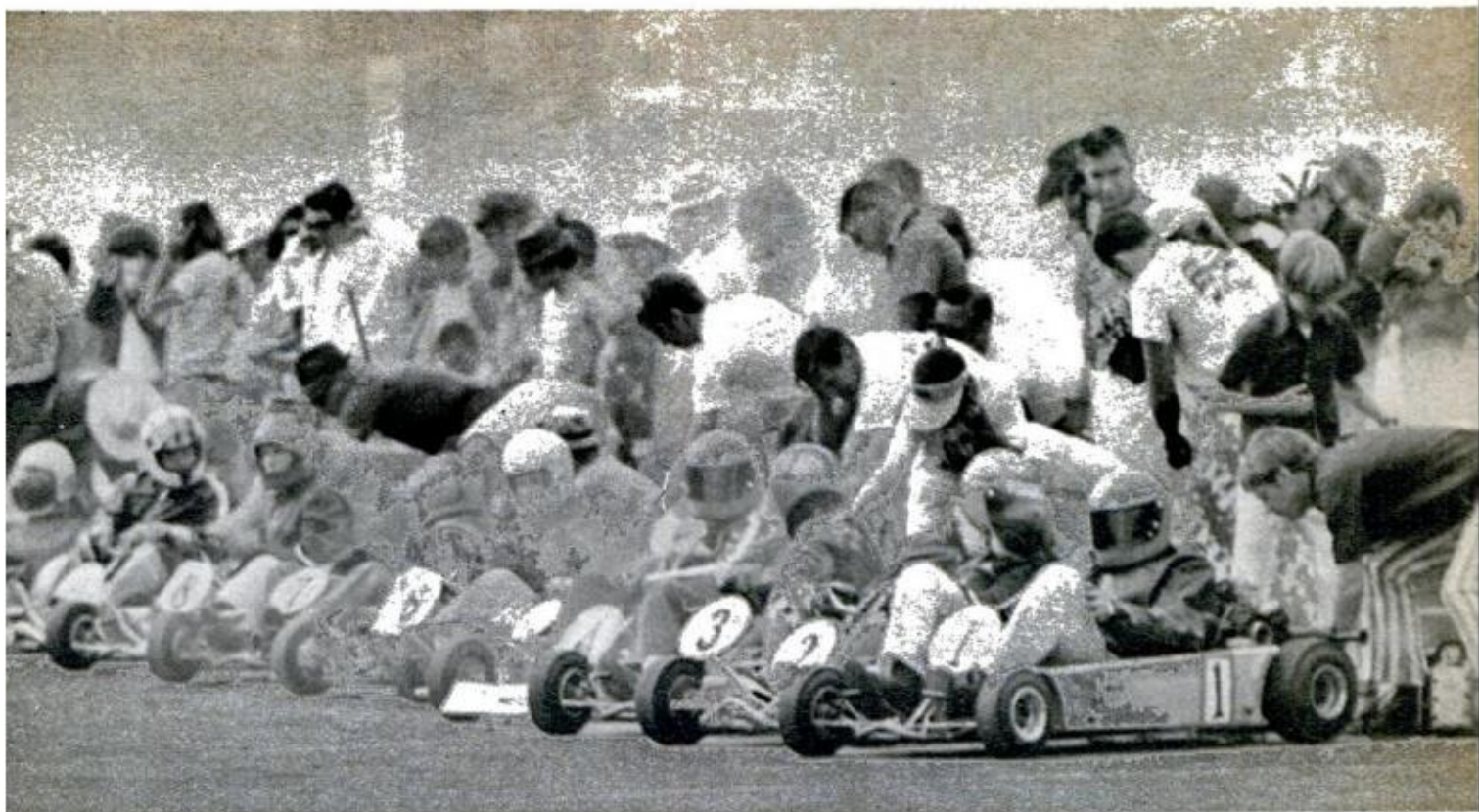

PHOTOS BY TOM BATES AND JOHN DUKE, *Karter News*

guna Seca and so forth—on these, you can just about go flat out all the way around.

“At Riverside, for example, the only place you slow down . . . you lift momentarily at Turn 6 and maybe a little at Turn 7. Riverside’s dreaded esses are nothing but a straightaway for the laydown karts.”

What speeds do these racing karts average in actual competition? Tops in C-Open

goes to 160 mph, but most karters rarely hit that because of traffic and the need to stay on the course! But to give you an example of average speeds, compare karts with the big boys. A couple of years ago, Jackie Stewart won the Questor GP at Ontario in a Matra Formula I, averaging 98 mph. Karts now circle that same course at 94 mph. At Michigan International Speedway, a kart re-

(Please turn to page 182)

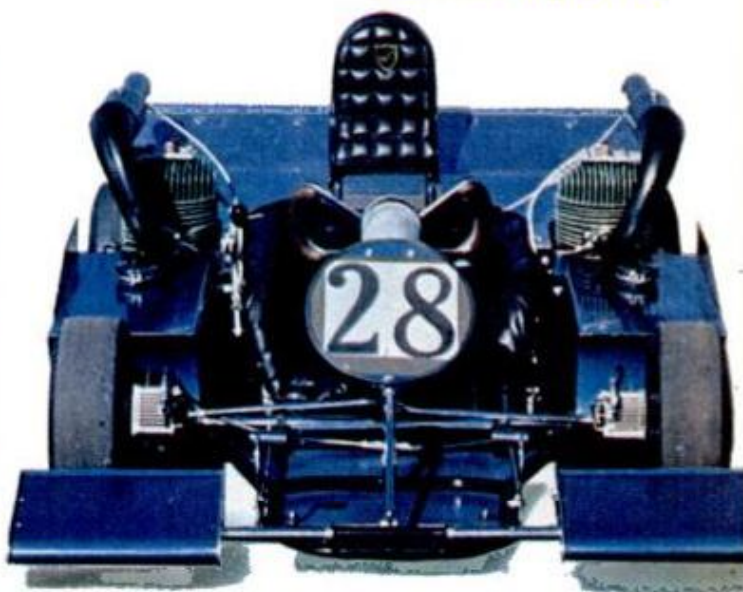

Karts like No. 28 have wings and spoilers to keep them on ground at 150 mph! Side fuel tanks feed thirsty twin-engines. Enduro races (left) are run on big road courses like Watkins Glen and Riverside, turn laps close to fastest sports cars.

How to troubleshoot your airconditioner

If you find after a winter's "hibernation" that your room airconditioner doesn't work as well as it did last summer, don't call a serviceman right away. There are a number of checks you can make to determine what's wrong and pinpoint the part or parts that need replacing. You'll be surprised at what you can save by being your own appliance repairman.

It may be that the air filter is simply dirty. A dirty filter restricts airflow over

the cooling coil and cuts efficiency. Some models have a permanent-type germicidal filter made of spongy material that can be washed in soap and water, rinsed, squeezed dry and reinstalled. Others have fiberglass filters that should be replaced when laden with dust and lint.

The unit's inner compartment should also be cleaned. Although there are two types of chassis—one that slides out like a drawer and one that has to be totally removed from

DATA BY ED FRANZESE

Typical window airconditioner

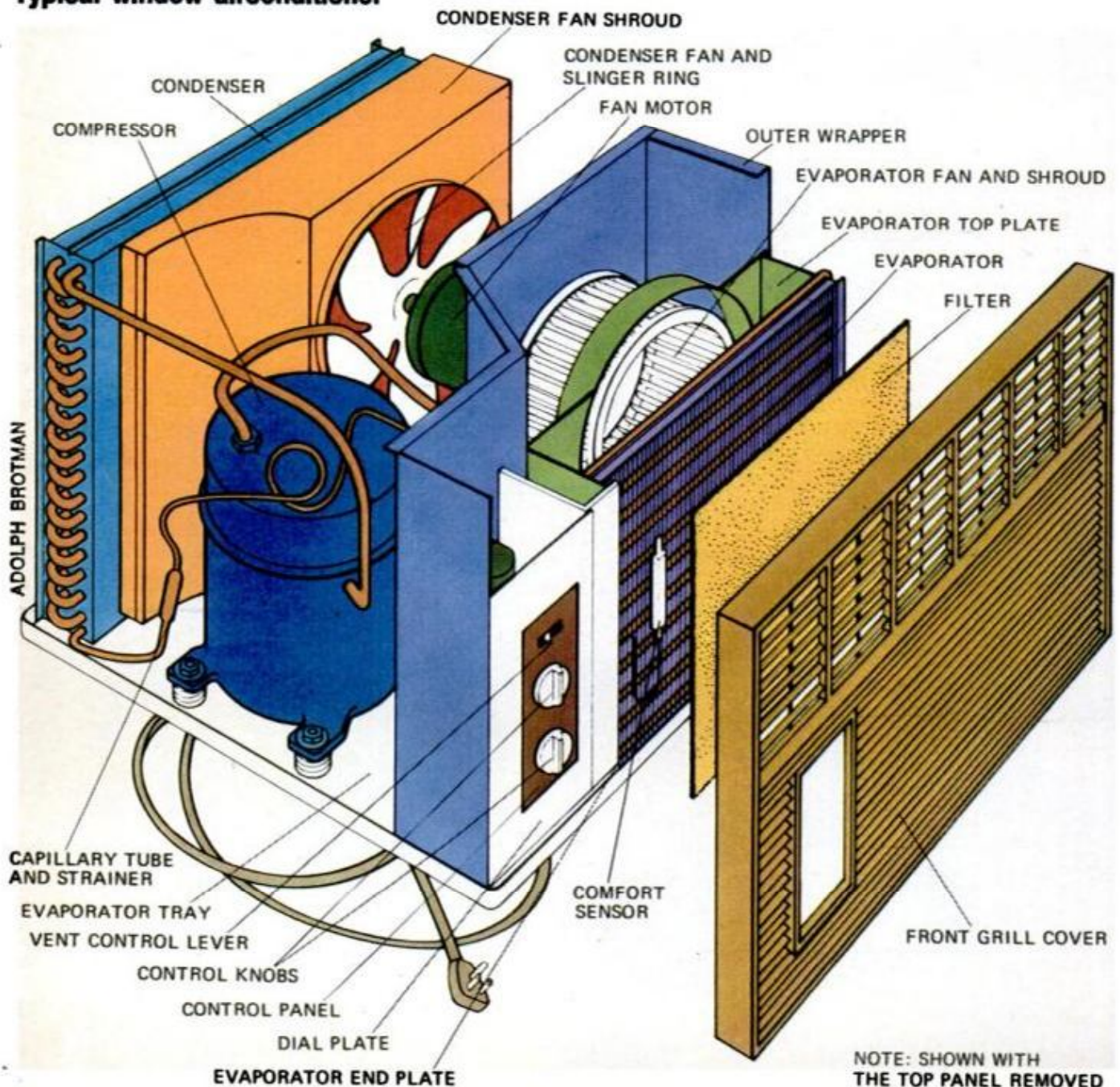

the window—both are cleaned the same way: Use a vacuum cleaner to blow dirt and lint off the condenser and evaporator. Then clean the compressor, fan motor and blades and tubing with a quickly evaporating solvent such as trichloroethylene, sold in hardware and paint stores.

When reinstalling a window unit, especially the chassis-type that does not slide out, be sure it is properly tilted for condensate flow and drain of water (usually $\frac{1}{8}$ to $\frac{1}{4}$

in. low on the outside. Finally, make sure the unit is plugged in.

During the hottest days of summer, it's good practice to operate the air conditioner on MAXIMUM or HIGH COOL. At this setting, air is cooled, filtered, dehumidified and circulated at the highest rate. On average summer days and at night, switch the unit to LOW COOL to reduce current draw and prevent possible icing up of the evaporator on cool nights. ★★★

Unit will not run

POSSIBLE CAUSES

- 1 Blown fuse or open circuit breaker.

ACTION TO TAKE

Check voltage at wall receptacle with test lamp. If lamp doesn't light, replace fuse or reset circuit breaker. Make certain air conditioner is off.

- 2 Broken or loose wiring connection.

Check service cord at wall outlet and cord connections on control switch.

- 3 Defective thermostat.

Unplug unit. Turn thermostat to Cool position. Check for continuity (uninterrupted connection) across thermostat's terminals with a continuity tester, available at hardware stores. If no continuity exists, replace the thermostat.

- 4 Defective start capacitor.

Unplug unit. Remove start capacitor (the smaller of two capacitors located behind control panel). Replace with new capacitor of the same rating.

Fan runs, compressor does not

POSSIBLE CAUSES

- 1 Defective thermostat.

ACTION TO TAKE

Turn thermostat to High Cool, place jumper wire across thermostat terminals. If compressor comes on, replace thermostat.

- 2 Defective run capacitor.

Unplug unit. Remove run capacitor (the larger of two capacitors behind control panel) and replace it with new one of the same rating.

- 3 Overload switch open or defective.

Remove overload switch (may be attached to outside of compressor). Place continuity tester across overload terminals. There should be a reading if overload is at room temperature (70° F.). If no reading, replace overload.

- 4 Loose or broken wiring connections.

Check all wiring and terminals. Clean all rust and replace defective wiring and terminals.

- 5 Mechanical "stall" or defective compressor.

Temporarily hook up compressor directly to power line to see if it will run (try this only on 117-volt models, not on 220-volt types). Do this for just a few seconds. If compressor fails to start, a new compressor may be needed.

MORE
→

REFRIGERANT CYCLE IN AIRCONDITIONER

Refrigerant cycle at the right is in all window airconditioners. All have same components and pattern of flow. The amount of refrigerant used in system is only difference.

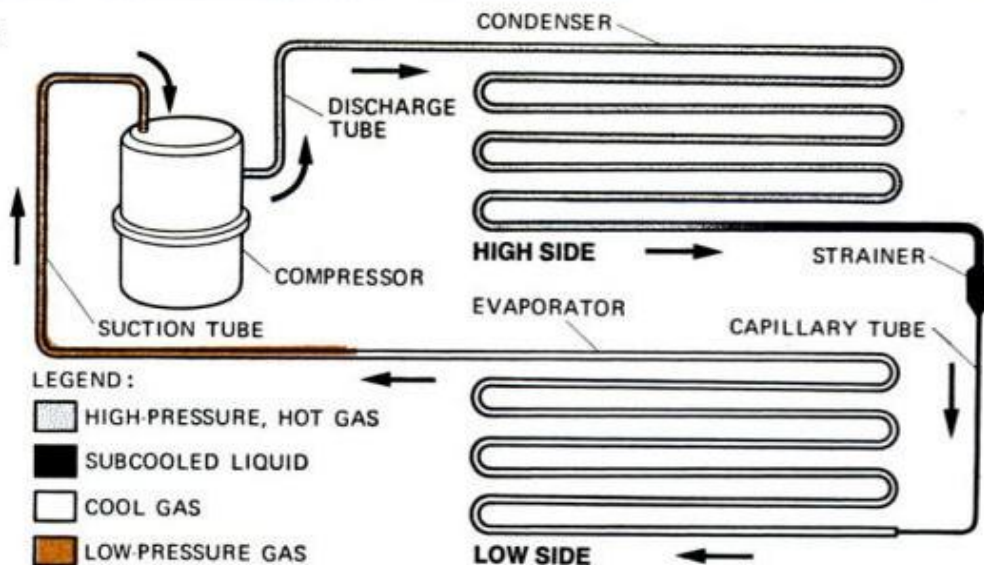

Compressor runs, but fan does not

POSSIBLE CAUSES

1 Defective fan switch.

ACTION TO TAKE

Unplug unit. Place continuity test lamp across High, Medium and Low terminals on switch (refer to the manufacturer's schematic). If no reading is indicated at any or all terminals, replace switch.

2 Defective fan capacitor.

Unplug unit. Replace fan capacitor (usually common with run capacitor) with one of exactly same rating.

3 Defective fan motor winding.

Unplug unit. Check each winding (High, Medium and Low) of fan motor with continuity test lamp. Refer to wiring diagram for proper connections or bridge tester across switch terminals and ground on motor housing. If no reading is indicated in any winding, replace fan motor.

4 Blower wheel binding.

Try to spin blower wheel. Failure of wheel to spin freely is a result of improper clearance. Adjust blower wheel on motor shaft or blower shroud surrounding the fan assembly.

Unit blows fuse or trips circuit breaker

POSSIBLE CAUSES

1 Unit restarted too soon after running.

ACTION TO TAKE

Allow three to five minutes for the system to balance (pressures to equalize) before turning the unit on again.

2 Circuit overloaded.

Place the airconditioner on a line by itself and check for proper fusing.

3 Stuck or defective compressor.

See the section "Fan runs, compressor does not," page 73.

4 Defective run capacitor.

Unplug the unit. Then replace the defective part with a new run capacitor which has exactly the same capacity rating.

5 Wiring shorted or grounded to frame.

Check all electrical connections to the compressor and behind the control panel. Connections should be tight and should not touch any metal parts of the airconditioner.

Unit short cycling

POSSIBLE CAUSES	ACTION TO TAKE
1 Thermostat short cycling.	Evaporator is either blocked or dirty and must be cleaned. Make sure that only the thermostat sensing bulb is touching the evaporator and is clamped tightly to it.
2 Defective condenser.	Check the fan operation. If the fan should become hot and stop, replace the motor. Check the blades for clearance.
3 Condenser dirty.	Blow out the condenser (using the blower of your vacuum cleaner) until light can be seen through the fins.
4 Defective overload.	If the compressor isn't overheated, and the overload is at room temperature, and no continuity is read across the overload terminals, replace the overload switch.
5 Unit restarted too soon after running.	Allow from three to five minutes for the system to restore its pressure balance; then try restarting the unit again.

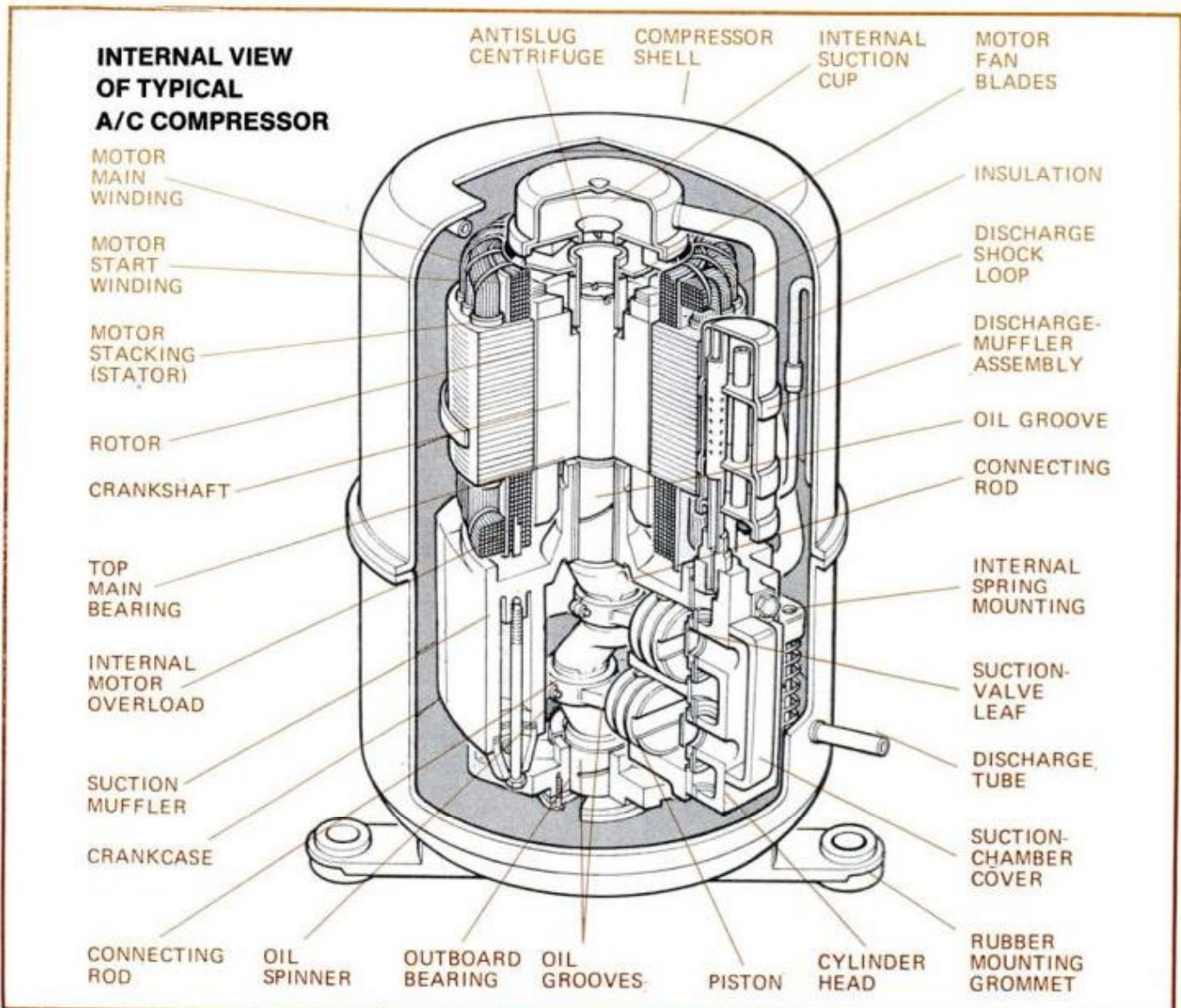

PETER TROJAN

MORE →

Unit not cooling

Heat survey: Multiply volume of room in cu. ft. by 10 if another room or an insulated attic is above, by 18 if not. Multiply result by factor for exposure of the longest wall (north 16, east 17, south 18, west 19) and divide by 60 to get B.T.U. rating.

POSSIBLE CAUSES	ACTION TO TAKE
1 Thermostat set warm.	Turn thermostat to a higher setting.
2 Filter dirty.	Check filter for dirt accumulation. Light should be able to pass through it. Replace or wash filters according to brand.
3 Condenser dirty or restricting airflow.	Blow out condenser with vacuum cleaner and clean fins of all dirt buildup.
4 Compressor won't run.	See section "Fan runs, compressor does not," page 73.
5 Leaking seals.	Check all seals around window. Make sure windows are shut and that curtains or furniture don't block unit.
6 Undersized unit.	Make heat survey of room for correct B.T.U. size of unit. Check according to accompanying directions.
7 Refrigerant leak.	Check amperage (current draw) of unit while it runs (you can do this if you have an ammeter handy). Compare current reading to manufacturer's nameplate amperage rating to see if motor is drawing current properly. If current draw is below rated amperage and everything else checks okay, this may indicate a refrigerant leak. Test for leaks by rubbing soapy solution over outside of tubing and around joints. Watch for bubbles that show up leaks. If leaks are found, call serviceman to repair and recharge unit.

PROPER EXTENSION-CORD WIRE SIZES AND LENGTHS (For use with 117-volt airconditioning units)

LENGTH OF CORD (in feet)	AMPERES REQUIRED (see nameplate on units)							
	6	8	10	12	14	16	18	20
				AWG Wire Size				
to 25	18	18	16	14	14	12	12	12
26-50	16	16	14	14	12	12	12	10
51-75	14	14	12	12	10	10	10	8
76-100	14	12	12	12	10	10	8	8

Evaporator frosts over

POSSIBLE CAUSES	ACTION TO TAKE
1 Restricted airflow over evaporator.	Check for dirty filter, blocked air passages, lint buildup on the blower wheel or blocked fins on the evaporator. Clean all items.
2 Outside temperature too low.	If temperature outside drops below 70° F., either turn unit off or set thermostat at Low Cool and fan at Low Speed.
3 Thermostat too high or defective.	Lower setting of thermostat. If problem still exists, turn thermostat off and check for continuity between the terminals. If a reading exists, thermostat is defective and must be replaced.
4 Refrigerant leak or undercharge.	See section "Unit not cooling" (above).
5 Low fan speed.	Check fan for higher speed, binding at housing, loose blade on shaft or defective motor. Correct or replace motor.

TYPICAL OUTLET RECEPTACLES

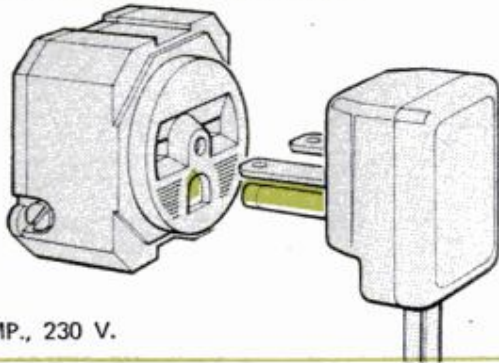

15 AMP., 230 V.

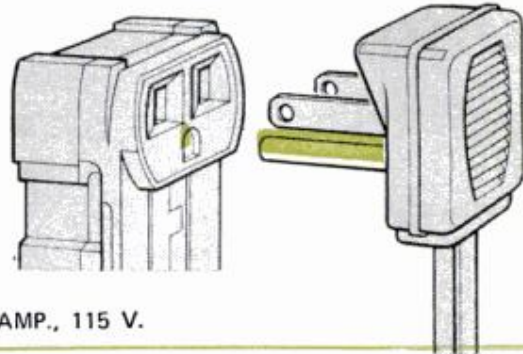

15 AMP., 115 V.

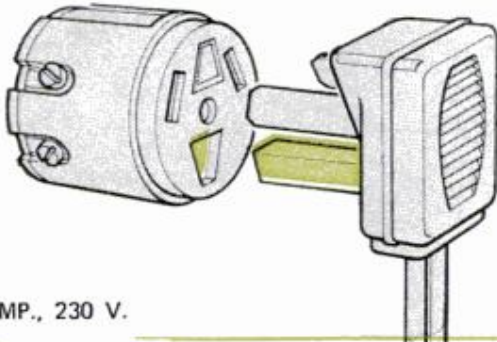

20 AMP., 230 V.

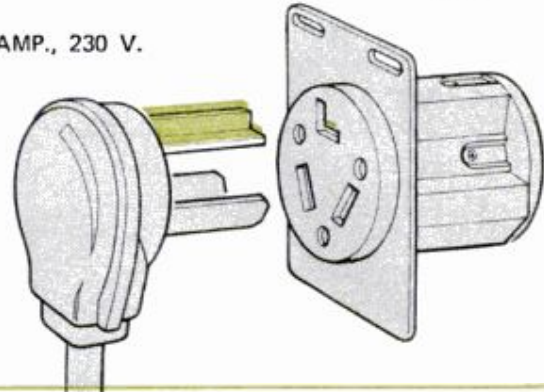

30 AMP., 230 V.

Noisy operation

POSSIBLE CAUSES

ACTION TO TAKE

- 1 Tubing vibration.

Reshape or bend tubing so there is no rubbing of tubing against metal.

- 2 Fan blade loose on shaft or bent.

Check to make sure that blade does not spin freely on motor shaft. Bend or straighten fan blades until the noise is minimal.

- 3 Fan motor loose on mounts.

Tighten fan motor mounts. Check motor alignment.

- 4 Loose parts.

Check installation for tightness, cover for tightness, and look over the entire unit for loose screws or washers.

Unit drips water

POSSIBLE CAUSES

ACTION TO TAKE

- 1 Cabinet not properly leveled.

Adjust unit so that it has a slight downward pitch toward outside end (Maximum pitch $\frac{1}{4}$ in.)

- 2 Condensate drain holes plugged.

Check and clean holes of any blockage.

- 3 Slinger-ring fan on condenser out of adjustment.

Check slinger-ring clearance from base pan. It should be $\frac{1}{16}$ in. Too much clearance reduces water pickup.

- 4 Extreme humidity.

Sweating formations are normal under these conditions. Try to improve all seals and minimize window or door openings.

How to build a brick-in-sand patio

The dictionary says that a patio is a "walled-in courtyard open to the sky." But today, perhaps, that description doesn't exactly fit the typical American patio. Walled-in? Yes in some cases, with shrubbery or privacy screens. Open to the sky? Sure, but many homeowners add a roof to gain use during rainy weather. A better, and contemporary, description is that a patio is an outdoor living room.

Of the many types of patios you can choose from, a brick-in-sand patio—no matter which border you prefer—remains attractive throughout the years. Unlike concrete, it won't crack or settle, and because water will drain through rather than run off, it can be perfectly level. That's a plus when it comes to arranging your patio furniture. Still another advantage is that damaged bricks are easily replaced in short order.

The bricks you choose can be either new or used. But for attractiveness, the latter hold an edge because of color variation and mortar stains. New common brick costs about the same as used brick.

Your first step is to select the patio site. Because it is considered as an outdoor family room, the patio should be placed near a door. This will prove to be convenient when you are entertaining or dining outside.

Borders are a personal choice; with railroad ties holding a slight edge among homeowners. You can buy ties from most large nurseries; also check your local classified directory under "Ties, Railroad." Though you can use new ties, used ones are more pleasing to the eye when placed stone-pocked side up. *Caution:* Be sure to protect your eyes and skin when working with creosoted railroad ties. ★★★

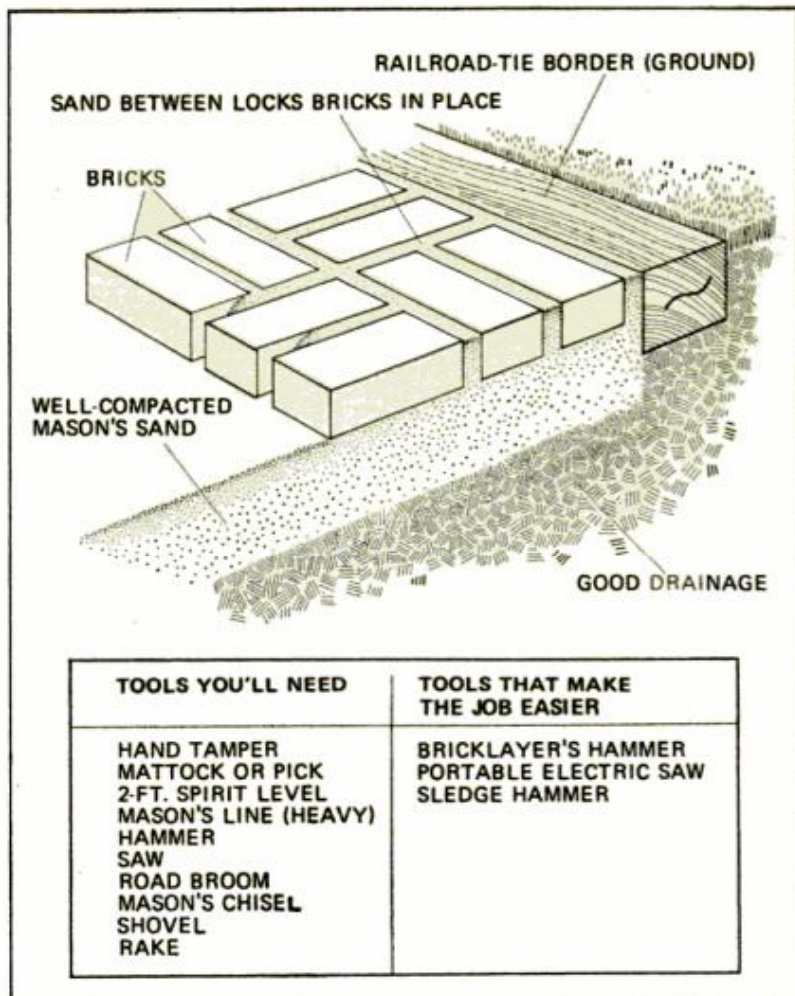

Types of borders (grounds)

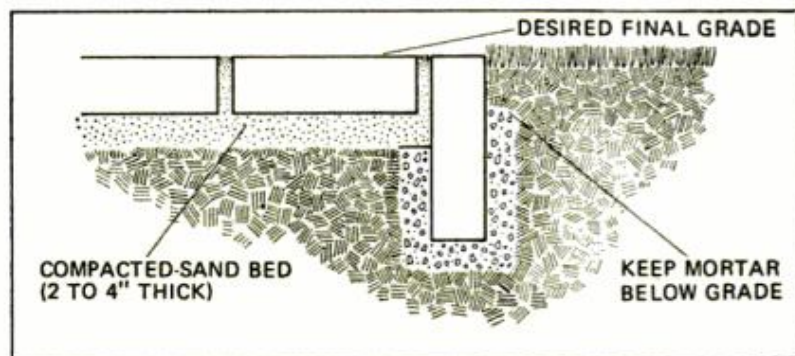

Brick on end in mortar

For a brick-on-end border, bricks are set in a mortar footing placed in a trench that's at least 6 in. wide and 10 in. deep. Pour the mortar in bottom of the trench and set the bricks in place. Tap the bricks gently to seat them in the mortar and check the row occasionally with a spirit level. Then place mortar on both sides of the bricks and tamp it firmly with a short length of 1x2 lumber.

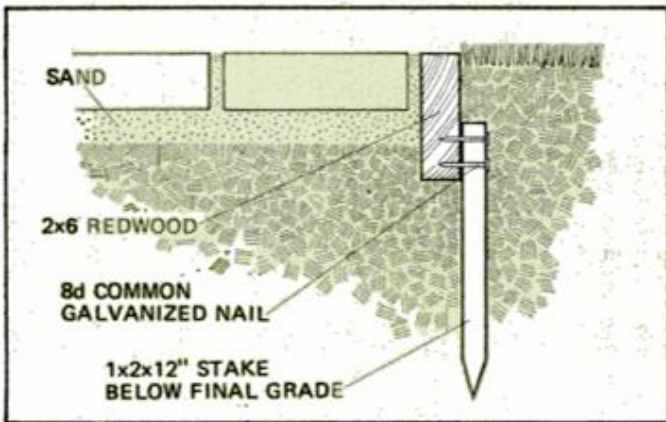

2x6 redwood border

This type of border needs less digging once grade has been determined. Set stake, establish grade at that point and nail 2x6 to stake. Level 2x6 and nail to second stake at other end. If the 2x6 hangs in air at either point, prop it with brick to desired level and backfill outside of border with soil. Gentle sloping of soil may also be required, or a second border (terrace) can be added.

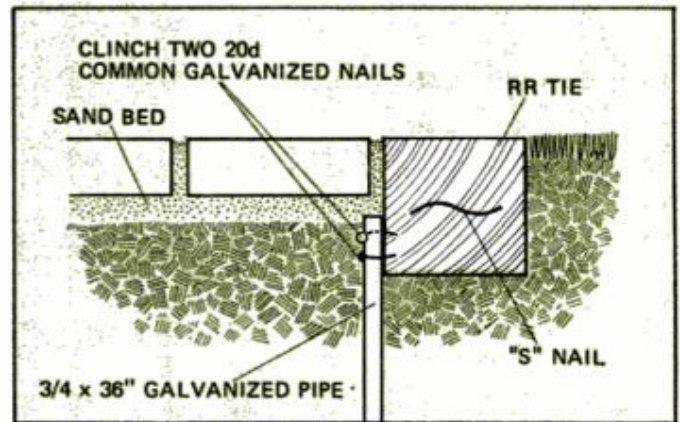

Railroad ties flush with ground

Ties may be set in excavated trench to be flush with grade and inside area excavated for the sand bed. To prevent ties from "rocking," drive in galvanized pipes as shown and clinch a pair of 20d galvanized nails around pipe. Ties come in 6x8 and 7x9-in. sizes, each 8 ft. long. They're heavy—approximately 210 pounds each—so make certain you have help on the day you set them.

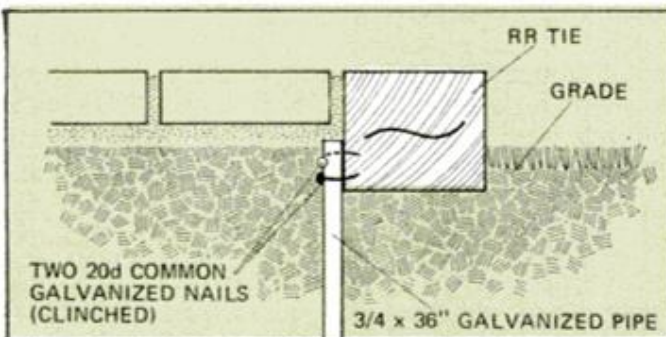

Railroad ties above grade

For step effect, a single course of ties can be set in a very shallow trench. If ground slopes away sharply, ties may be stacked at low point two ties high. Again, a minimum of interior excavation is required, but you should dig down to assure good drainage before placing sand bed. Pipe "stabilizers" are a must here—every 4 ft.

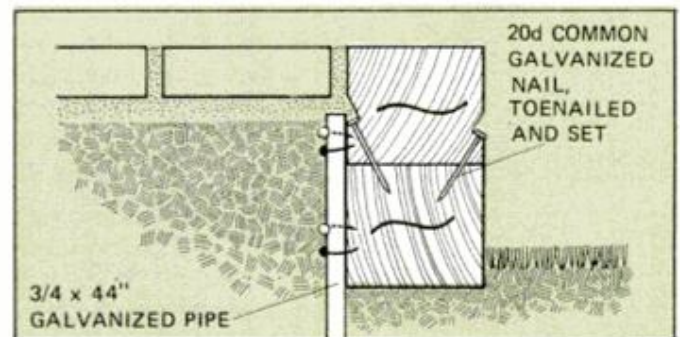

Double course of ties

Notice that pipe stabilizer on this type border spans both ties with nails driven into each of them. Ties should also be toenailed at the sides using same-size nails. Since this wood is very dense, drilled pilot holes may be needed. Nailheads can be set flush with heavy nailset, but with a rustic effect, this is of minor concern.

Choosing a pattern

Four of the most popular brick patterns are shown at right. No matter which you choose, you'll have a bit of "make-up" (adjustment) to keep consistency of pattern.

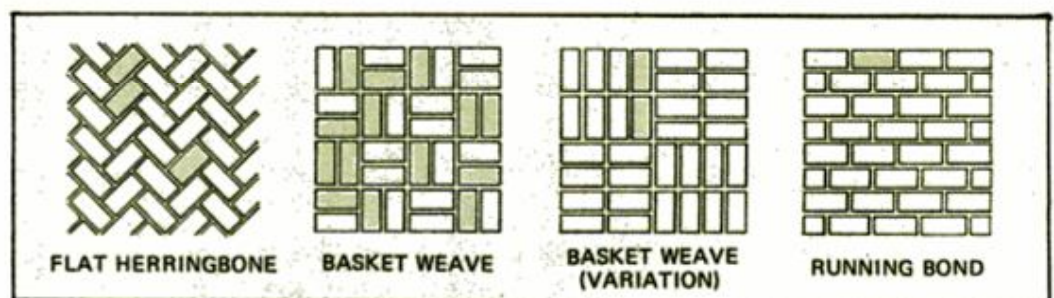

Working with brick

In addition to border materials, you'll need bricks, mason's sand, sharpened 1x2 stakes about a foot long and 8d common nails. Use chart at right to compute your needs for brick and sand. Quantities may vary slightly, but the chart is a guide for 100 sq. ft. of finished patio area. Bricks may be $\frac{3}{8}$ to $\frac{1}{2}$ in. apart or butted. To cut one with minimum waste, use bricklayer's hammer or a 20-oz. hammer and mason's wide chisel. Bricks should rest on a flat, solid surface. Until you get the "feel" of the tool, a score line around all sides will help. For safety, wear goggles and be sure there is no audience in the path of flying chips.

COMMON BRICK SIZE

MATERIALS FOR 100 SQ. FT.	CLOSED JOINT (BRICKS BUTTED)	$\frac{3}{8}$ "- $\frac{1}{2}$ " JOINT
BRICKS	500	450
SAND PER 1" DEPTH	$\frac{1}{3}$ CU. YD.	$\frac{1}{2}$ CU. YD.

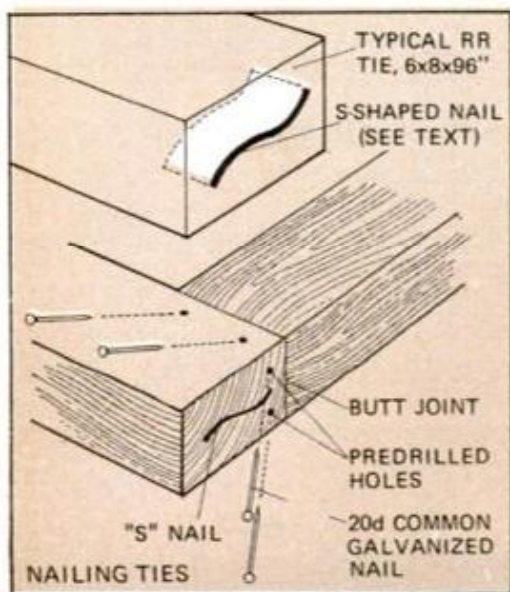

Working with railroad ties

Railroad ties (left) can be cut with a two-man saw or a portable circular saw equipped with a coarse-set or rip blade. Since this saw blade will not cut fully through the tie, mark cutting lines on all four sides; then make the four cuts, flopping the tie after each pass of the saw. When you're cutting near one end of a tie, make certain that you remove the "S" nail driven into the end grain. In most cases, you can pry it out with an awl and pliers. *Caution:* Railroad ties are creosoted clear through, so wear goggles while you are cutting them. Butt the corner joints as shown; no need to miter them. To keep corner closed tightly, toenail joint with hefty nails.

Laying out your patio

After choosing your patio site, lay out the area by driving stakes at all points where the direction changes. Fasten a mason's line from stake to stake; then study the proposed patio before you put a spade into the earth. When you're satisfied with the shape and size, start excavating for the border. Level the trench as you go

from stake to stake using a straight 2x4 (no more than 12 ft. long) and a spirit level to transfer marks from one stake to another. Where stakes are over 12 ft. apart, drive in an intermediate stake for grade purposes. Tip: As you dig, try to throw soil well away to avoid having to move it a second time.

Railroad-tie installation

Once you have leveled the trench where the railroad ties will rest, stretch a mason's line to align ties as you place them. Use a pry bar with bricks for a fulcrum for easy lifting where you want to add soil to raise a tie. After leveling each tie, anchor it with 3-ft. lengths of galvanized pipe driven at 2-ft. intervals and attached as shown. Excavate area within border of ties and fill with mason's (mortar) sand. Thorough tamping is a must.

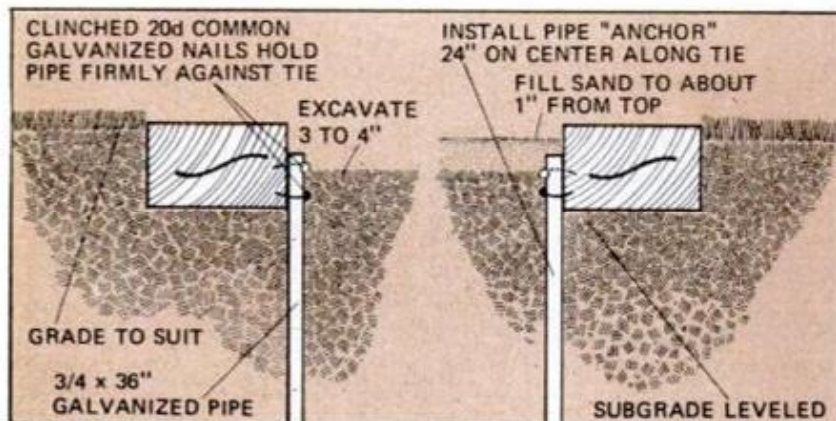

Leveling the sand bed

When all borders are in place, the interior can be excavated. You should remove all topsoil to provide good drainage (see bottom drawing). Next, fill in this interior area with mason's (stone-free) sand to the top of the borders. After hand-tamping the backfill, screed the sand fairly level using either a 2x4 with shim or a notched 2x6 as shown below. On narrow walks, borders can be used for screeding. For wider spans, you must install a temporary, intermediate ground for screeding. To screed, strike the board side to side to drag sand ahead as you go. Fill low spots from the pile you're dragging ahead of the screed. Finally, compact sand with an over-night soaking from a lawn sprinkler.

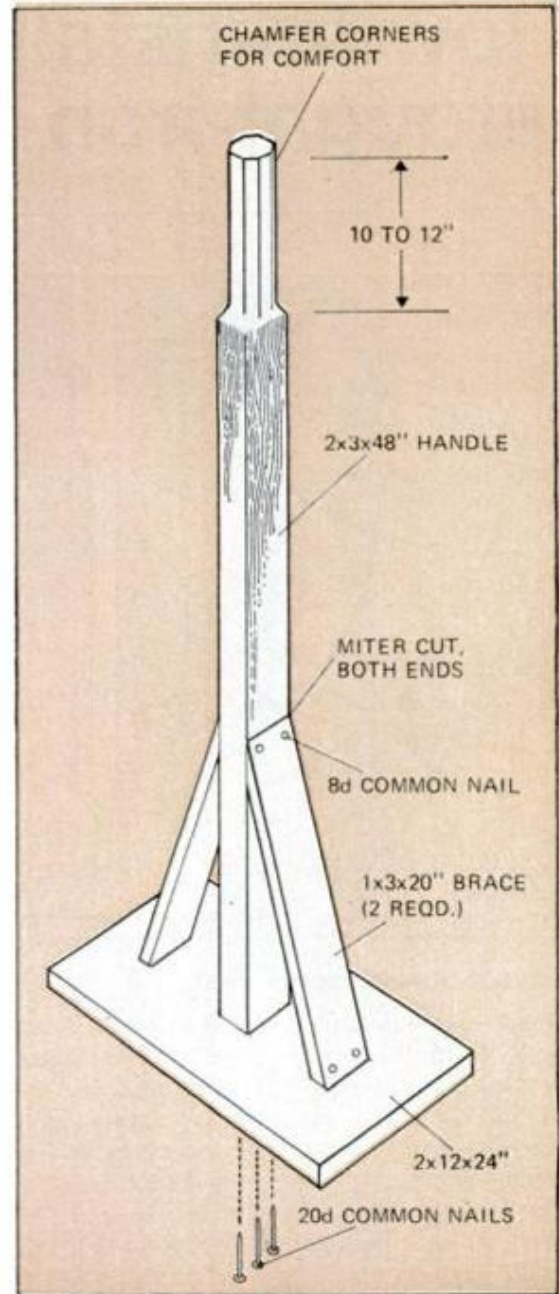
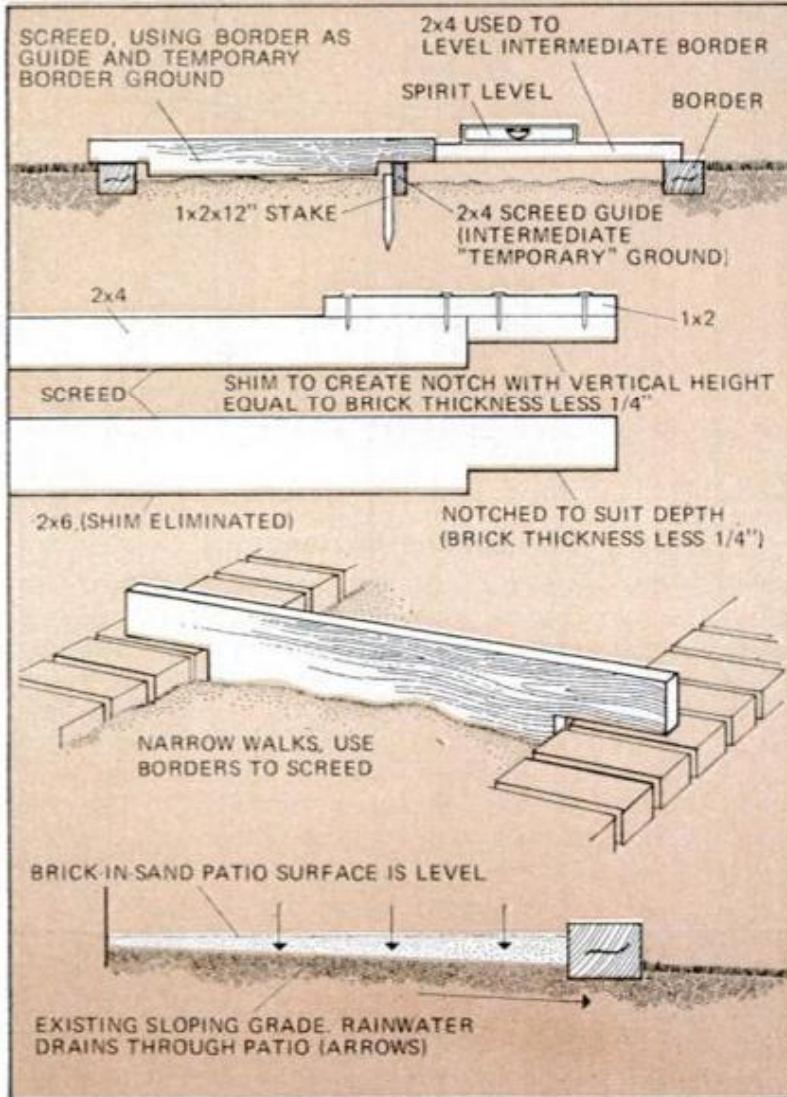

Shop-built tamper

Compacting the sand bed is essential, so you must have a tamper. While you may rent one from most tool-rental shops, you should consider making yours for permanent ownership. A tamper is handy in landscape work.

Laying and sand-locking bricks

Start laying bricks in pattern of your choice. As you set each brick, tap it firmly with your hammer handle to "set" it level. After you have covered about 10 sq. ft., shovel on some mason's sand and brush it in place with a firm street broom to lock in the bricks. Repeat this step until all bricks are laid; then give the entire patio a thorough second sanding and brooming. Soak your patio for several hours with your lawn sprinkler. When it's fully dry, sand and broom it again to fill in voids, and

repeat until no voids develop in joints when patio is soaked. When patio is completely dry, clean it and, for aesthetic reasons, creosote the wood border. When using creosote, follow instructions on can and wear long-sleeved shirt, gloves and goggles. Save some sand and bricks until your patio is fully weathered. Further sanding may be required and, quite likely, some split bricks will need replacing. You'll have these answers within two months of the day you completed your patio.

How to install wrought-iron railings

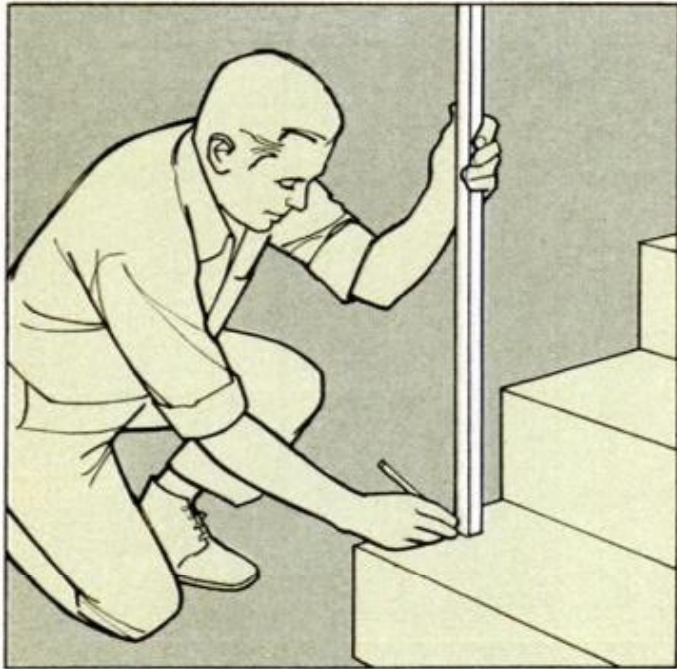

Locate newel posts first

Newel posts are used for end posts, corner posts and intermediate posts. The number required is determined by overall size of stoop. A stoop that is the same width as steps generally requires four posts. A stoop wider than the steps can require as many as six or more posts. Posts are anchored to masonry stoop and steps by flanges that are attached with expansion bolts inserted in predrilled holes. Concrete bit is used to drill holes.

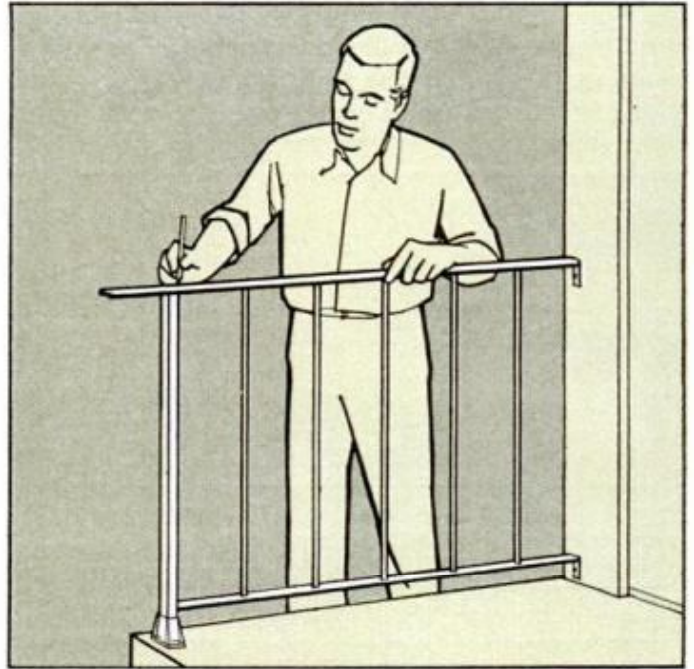

Mark rail sections for length

After newel posts are in place, preassembled, adjustable rail sections are marked for length. Here in order to maintain uniform spacing of spindles, excess length is cut from each end of upper and lower rails. To cut the rails, you'll need a hacksaw. A vise will simplify holding. Any burred edges should be smoothed with a file so connectors insert easily. Railings are usually installed 31 in. high and even with tops of newel posts.

To figure railings

Make a rough sketch of your stoop with measurements as shown at the right. To find number of 4 or 6-ft. rail sections you'll need, measure from house to edge of platform. To determine whether a 4 or 6-ft. rail section is needed for the steps, measure length of stairs, top to bottom as shown. To find number of newel posts required, figure one for each corner of platform, one each for top and bottom of stairs. If railings consist of more than one section, add one post for each added section.

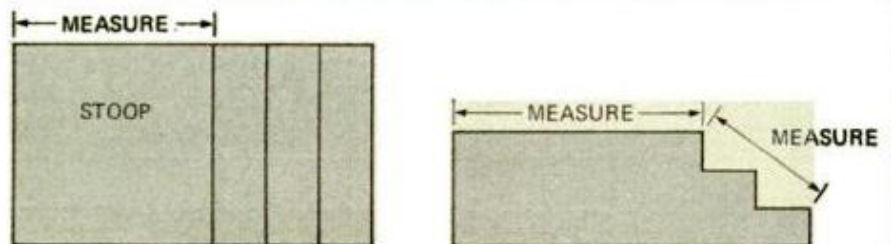

If platform is:

- 3 ft. or less
- 3 ft. on both sides
- 4 ft. or less
- 6 ft. or less
- 8 ft. or less
- 10 ft. or less

Order:

- One 4-ft. section (cut down)
- One 6-ft. section (cut in half)
- One 4-ft. section
- One 6-ft. section
- Two 4-ft. sections
- Two 6-ft. sections (cut down)



Install upper rail sections first

Rail sections are attached to newel posts with adjustable connectors that require no drilling. Each connector slides inside upper and lower rails and is tightened by a setscrew. Rail sections come in 4 and 6-ft. lengths and require support posts between sections. Same connectors attach sections to house. Before drilling holes, be sure to level railing. If it's to be attached to wood, use regular screws; if to masonry, bolts in expansion anchors.

Rail sections bent to suit steps

Preassembled rail sections adjust to any stair slope. To bend, put foot on lower rail and push forward on top rail to suit stair pitch. Spindles are generally electrically fused to top and bottom rails to make railing stronger than welded ironwork. Connectors are bent to same angle as rail section to join the section to top and bottom newel posts. Extra wrought-iron scrolls, called lamb's tongue and finial, are available for newel posts at bottom step.

Four basic parts

Only four basic parts are required to add a wrought-iron railing to any porch or stoop.—rail section, support post, adjustable connector and flange. Support (newel) posts are 1¼ in. square, 35 and 48 in. high. Posts fit into flanges, which are attached with setscrews; flanges are anchored to wood or masonry with screws or expansion bolts. Adjustable connectors join rail sections to posts like an Erector set. Complete railings are made up of 4 and 6-ft. sections, joined end to end with a post between.

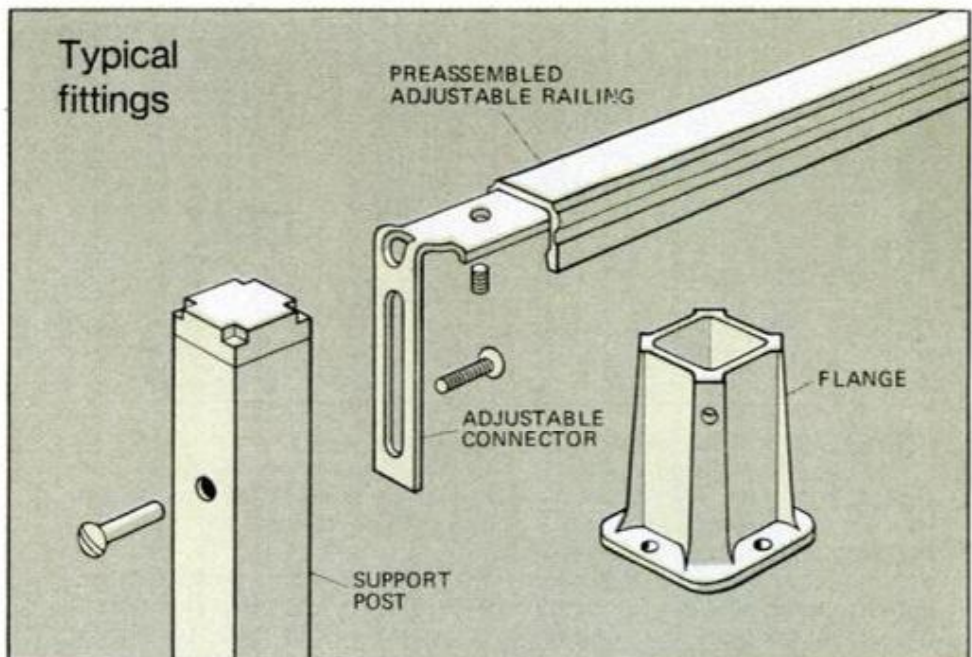

How to replace disc-brake pads

Replacing disc-brake pads is like putting two pieces of bread in a toaster. You pop out the two worn pads and pop in two new ones. Of course, like any job on your car you tackle yourself, the first time is the hardest—you don't know if you have all the right tools, and, if unfamiliar with replacement parts that you've bought, whether you've been sold the right ones!

But don't hesitate; this job really is easy. Remove each wheel with a disc brake so you can check the remaining thickness of friction material on the pad. Replacement thickness is $1/16$ to $1/8$ inch. If you do need new pads, follow these simple steps to put them in.

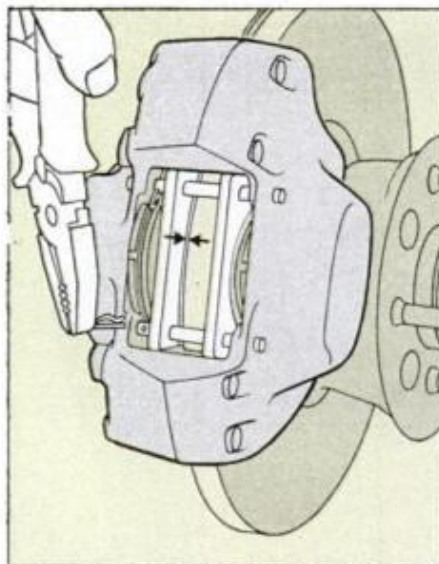

1 The stationary housing that surrounds the rotating brake disc is called the brake caliper. In this are pistons that push against the brake pads when you step on the brake. These pads squeeze the disc to prevent it from turning. The thickness of the inboard pad here is down to $1/16$ th inch.

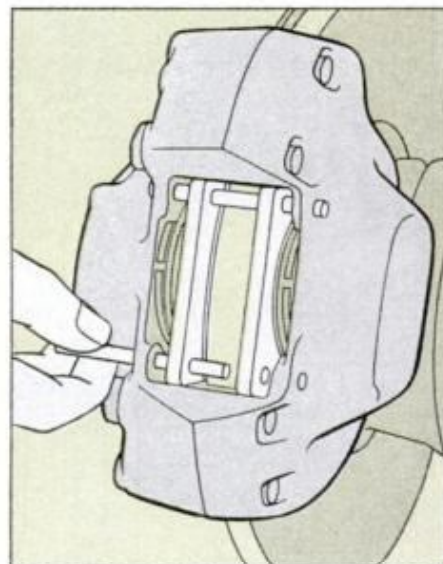

2 Friction surface of pad is integral with a backing plate held in place by two guide pins. After removing hairpin-shaped locking clips (as in step 1) pull guide pins out. (Also remove the damper springs if your brakes use them.) This leaves inboard and outboard disc-brake pads free for removal.

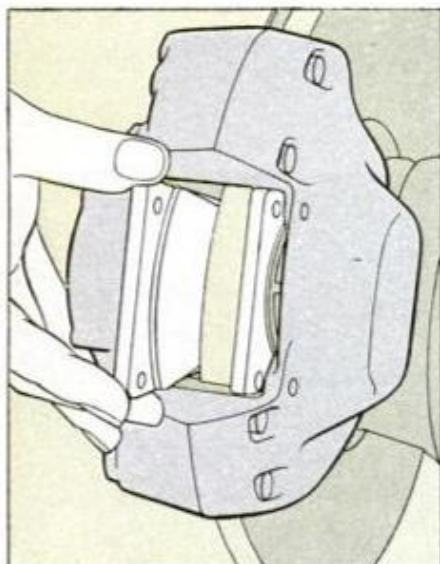

3 Remove both pads by sliding them straight out. If you can't get a good grip, get it with a pair of locking pliers and pull them out that way. With both pads out, the pistons and their surrounding rubber boots will be exposed. Check that the boots are in good condition. They keep fluid in.

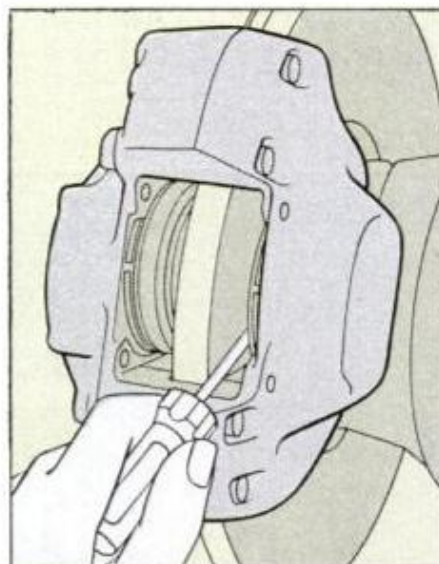

4 Pistons have to be pushed back into the calipers to make room for the new, thicker pads. You can use a screwdriver shank as a lever, but be sure to wrap the tip so you don't scratch the disc. Pushing back the piston forces hydraulic fluid into the master cylinder. Catch any overflow.

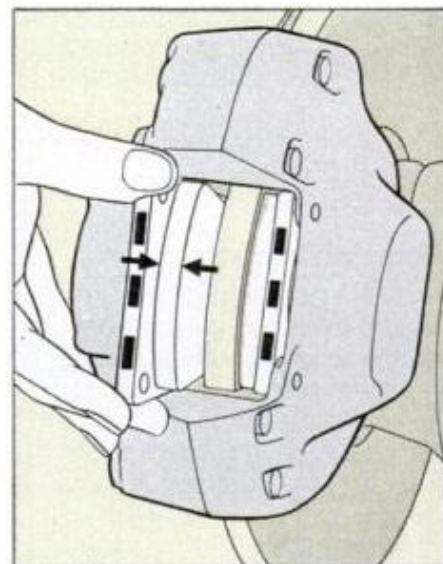

5 After pistons are pushed back, which usually can be done without opening bleeder nipples on calipers, there is room to slide the new pads into place. Here the new outboard pad is in place and the inboard pad is being installed. That's it! Use brake gently for a while to seat pads.

ROY GRINNELL

Tandem 'two-holer' you can fly from either seat



Rear-folding wings make ship easily trailerable on its own wheels. The tail wheel is fitted with a tow bar to fit standard ball-type bumper hitch on car for road-towing.

Patterned after military-style flight trainers, this trim little two-seater features dual controls, folding wings, simple construction and low cost.

by Sheldon M. Gallager
and Howard Levy

Tony Spezio spells it slightly differently, but his homebuilt DAL-1 "Tuholer" is a true two-holer just the same—two cockpits in tandem, each equipped with complete flight controls. The dual-control feature makes the craft ideal for the beginning builder who wants to try his new wings under the guidance of an experienced pilot or for two buddy pilots who enjoy flying together. In fact, PM has received many requests for just such a small, light, easy-to-build two-place training plane, and the DAL-1 fills the bill nicely. It's fully approved by the FAA in the experimental class and has won a good-design award from the Experimental Aircraft Assn. At

PHOTOS BY HOWARD LEVY



Cockpit close-up at right shows joy-stick control, rudder pedals and flight gauges on instrument panel. Both front and rear cockpits are identically instrumented for convenience in flying from either seat. Instruments include compass, altimeter and air-speed, rate-of-climb and bank-and-turn indicators.

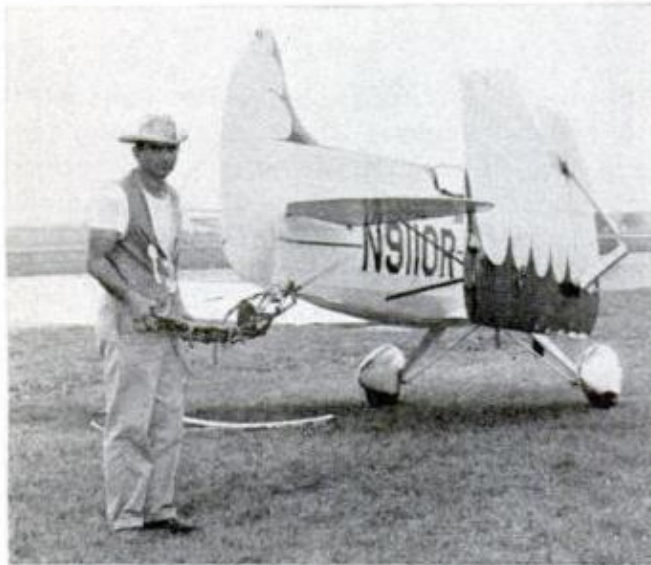
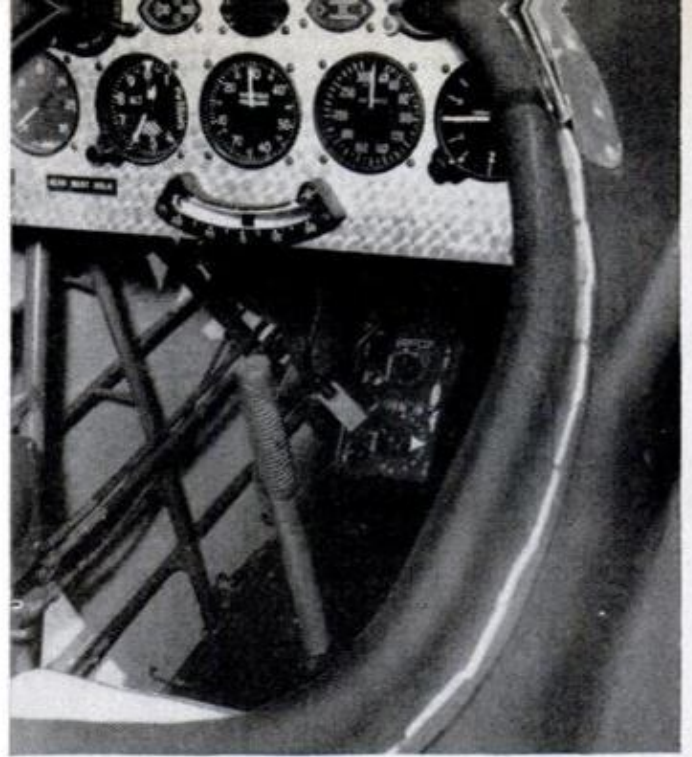

Ship is so light the tail can be easily lifted by one person (left) for attaching tow bar to car hitch for trailering. How wings fold is shown in photos below. After main latch bolt is released, wing is turned vertically on two-way pivot, then swung back against side of fuselage. Slot exposing wing-fold linkage is covered with removable, snap-in fairing strips. Entire job takes less than 10 minutes.

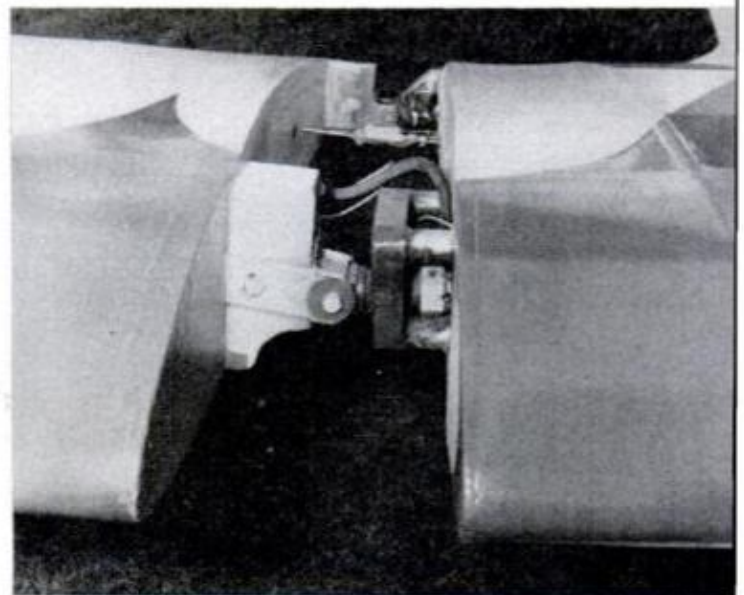

last count, 21 copies have already been successfully built and flown from Spezio's plans, and others are under construction.

The DAL-1 combines the best of two worlds: While functionally patterned after the simplicity and easy handling of a military flight trainer, it also offers the esthetic appeal of a sleek, racy sport plane. Those who recall the classy little midget Gee Bee racer of the 30s will note certain similarities—the resemblance isn't accidental. Spezio, an engineering technician for the FAA, had a loving feeling for the tiny Gee Bee and incorporated some of its trim appearance into his own creation. Best of all, perhaps, are the ship's low construction cost—about \$800—and its trailerability to and from nearby airports. Rear-folding wings make the DAL-1 easily towable on its own wheels, thus saving hangar and tie-down fees and enabling Spezio to garage his plane at home for spare-time tinkering on it right in his own back yard.

The DAL-1 is powered by a 125-hp Lycoming O-290G-4, a ground engine converted to aircraft use. This gives the ship a maximum speed of 152 mph, a cruising speed of 128 mph and a range of 400 miles. Rate of climb is a zippy 2000 feet per minute, with a service ceiling of 12,000 feet. The craft lands at as little as 40 mph and in a run of only 170 feet. Takeoff run is 160 feet. The landing gear is fixed to simplify construction, but is streamlined with faired struts and wheel pants to minimize drag.

The fuselage and tail assembly are of tubular steel, while the wings are built up from spruce spars and ribs—much like the balsawood construction on model planes. The entire ship is covered with a skin of cotton fabric. Overall length is 18 feet, 3 inches, with a wingspan of 24 feet, 9 inches, a wing chord of 5 feet and a height of 54 inches. Empty weight is 810 pounds; gross, 1400. One unusual touch for a low-wing monoplane is the use of wing struts running diagonally from the fuselage to points outboard of the wing-fold pivots. The struts add extra bracing and lessen strain on the pivot linkages. The ends are detachable to permit the wings to fold for towing or storing the craft.

Plans for the Tuholer are \$40 and include 33 sheets of construction details, full-size wing-rib patterns and 22 assembly photos. These are available from Tony's wife, Dorothy Spezio, 211 Dennis Drive, Absecon Heights, N. J. 08201. ★★★

Some of the many Tuholers built from Spezio's plans are shown below. Note that plane can be flown from front seat (top photo) or rear one (second from top) depending on pilot's preference and handling characteristics. Also note slight differences in fuselage configuration. Some builders keep line from rear headrest to tail straight, as in prototype, while others prefer sweeping dip, as in bottom photo.

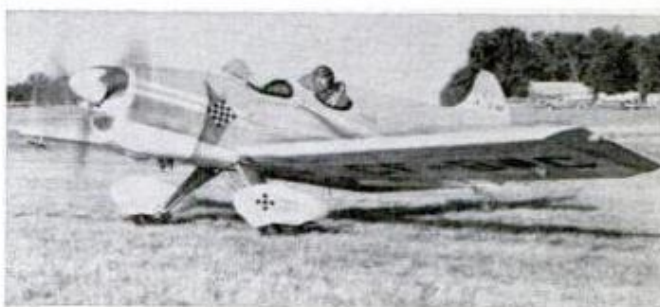

Do these stylish haulers

by Michael Lamm

PHOTOS BY THE AUTHOR

A nationwide survey based on 1,300,000 owner-driven miles.

There's a boom in pickups right now—large ones, small ones, and in between. While the Japanese imports battle it out in the mini range, and while there's no end of rugged full-sized standard pickups to choose from, only two automakers offer contenders in what we might call the "coupe pickup" class: Ford and Chevrolet.

It's easy to see why people buy these vehicles. Ford's Ranchero combines the riding qualities and appearance of a coupe with the workhorse stamina and versatility of a true pickup. So, too, does the El Camino.

The Ford/Chevrolet feud has raged for decades, so the choice of a Ranchero over an El Camino (or vice-

[Please turn to page 90](#)



Versatility and good looks rank highest as reasons for buying both the Ranchero and El Camino. Ranchero offers six-cylinder engine, but most people go for 400-c.i.d. V8.

PM OWNERS REPORT: CHEVROLET EL CAMINO

really lead double lives?

A nationwide survey based on 1,400,000 owner-driven miles.

An Ohio service station mechanic explained that he bought his El Camino "because it looks so good, and it's much safer for carrying loads than a station wagon."

El Camino owners find their pickups handy, versatile vehicles, and they use them for the same duties as Ranchero owners: work, recreation and simply as cars. "It does the job of two units," avers an Ohio builder, "because it rides and handles as well as a sedan and yet will haul good-sized loads."

A Michigan plumber noted: "I use it for work but also find it excellent for recreation—snowmobiling and motorcycling. My only complaint is that the neighbors

(Please turn to page 91)



Sharp styling and coupe-like appearance draw high praise from El Camino owners. Magish wheel covers are made of rubber. There's no Six; owners opt for 350 V8 over the 307.

FORD RANCHERO

(Continued from page 88)

'Does most everything a real pickup will do, but rides and handles like a luxury car and looks great.'

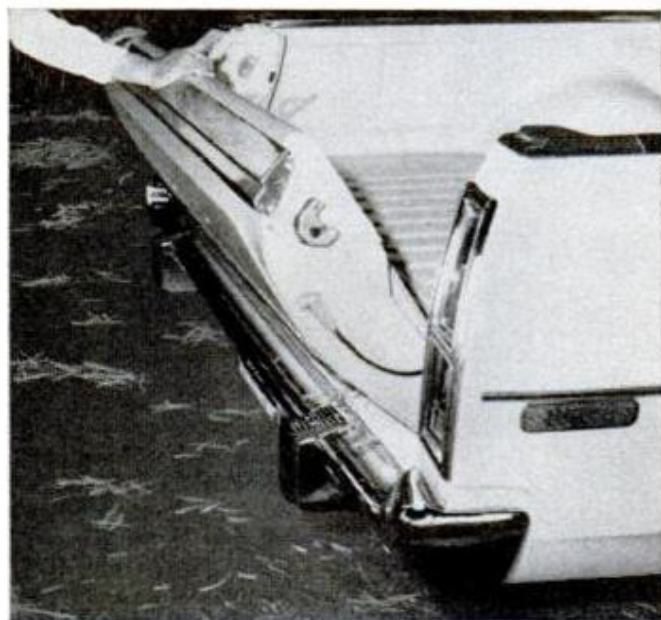

Nearly vertical tailgate makes it easier to carry big boxes and camper shells. Some owners grumbled about poor vision to rear sides but liked hold-downs inside bed. A few suggested incorporating two-way tailgate.

versa) becomes largely a matter of emotion. Dimensions, load capacity, and prices fall within fractions of each other. The Ranchero offers a Six and El Camino doesn't, but hardly anyone buys one of these vehicles with a six-cylinder engine anyway, so it's almost academic. The Ranchero's heritage is strictly Torino; the El Camino's pure Chevelle.

Here are some typical answers to our why-did-you-buy-a-Ranchero question: A Florida steelworker said, "I'd already used up six Rancheros since the first one came out in 1957, so why not another?" An Illinois construction superintendent: "I bought mine for work and camping, and I think it looks better than an El Camino." An Ohio oiler: "Needed something the wife would drive and could use as a second car." "I need it to do light hauling, and it rides and drives like an auto," wrote a Tennessee industrial foreman. Many of our respondents mentioned that they particularly liked the Ranchero's appearance. "It's just a good-looking car," affirmed an Indiana factory worker.

Here are some specific praises owners had for their Rancheros: "Does most everything a real pickup will do, but rides and handles like a luxury car and looks great." "Am especially happy with the riding qualities." "Appearance seems to catch the eye of others as well as myself." "My wife would rather drive the Ranchero than our LTD." "Holds the road better than most medium-sized cars." "It's the best-handling American car I've driven—feels more like a sports car than a pickup."

How about complaints? As with most newer U.S. cars, poor gas mileage headed the list of grumbles. A Missouri computer technician sums it up for many owners by saying, "I have an opinion about the anti-pollution equipment on *all* 1973 cars. I previously owned a 1969 Ranchero with the identical engine and options and got 15-17 mpg (as against 10-12 for this one). It seems to me that I'm now burning 67 percent more gas, defeating the intended purpose of the smog equipment by burning up the earth's energy supply more quickly, plus costing me more money."

What changes would Ranchero owners

(Please turn to page 92)

CHEVROLET EL CAMINO

(Continued from page 89)

'Passengers say it rides better than a car—wife likes to drive it better than our Pontiac. So do I.'

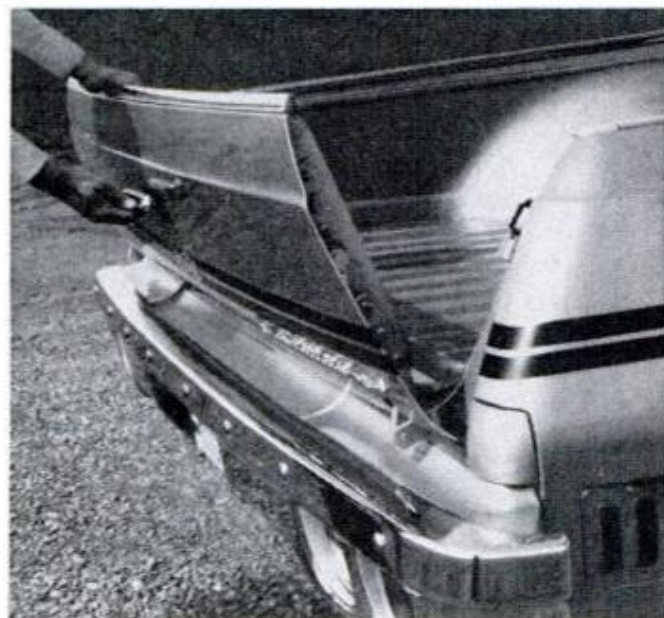

El Camino's canted tailgate, sweeping bed walls make it hard to find camper shells and tool boxes that fit. The 46-inch width between wheelhouses won't let 4-foot plywood lie flat. Pillars again block rear visibility.

are always borrowing it for odd jobs." A Washington fruit grower commented: "I like the air shocks for carrying heavy loads. I grow and pack my own fruit and use the El Camino in all my work. It rides as well as the average car but will haul quite a load."

Here's a sampling of specific praises for the El Camino: "Ride and handling qualities are excellent with the heavy-duty suspension." "Passengers say it rides better than a car—wife likes to drive it better than our Pontiac. P.S.—So do I!" "Smart styling." "I had two El Caminos before—a 1965 and 1969—and liked them very much, same as this one." "Good resale value." "Easy to load and unload." "Good brakes, performance, ride and looks." "Just enough truck but not too much." "Ideal for going to and from work, for carrying my bird dogs, and good as a second car."

What faults did owners find with the El Camino? A sizable portion felt that workmanship wasn't up to acceptable standards. Fully 67.6 percent rated workmanship average to poor. A Michigan lineman noted, "It could be a beautiful car if they would work all the bugs out of it." Complaints centered on thin and rough paint, sloppy carpeting, misaligned panels, leaks and whistles around windows and similar items. They're not serious things, but are noticeable enough to annoy owners.

The complaint heard next-most-often centered on poor gas mileage, but no need to dwell on that *again*. All 1973 cars seem to suffer, and owners lay the blame squarely on 1973 antipollution equipment.

In the why-don't-they department, we got these suggestions from owners: "I do construction work and find the 46 inches between wheelhouses is just 2½ inches too narrow to lay a 4-foot plywood board flat in the bed. Why can't the factory add just 2½ more inches to the width back there?" "Can't they hide those tailgate hinges somehow—they look goofy." "The windows need frames around them for extra strength. The way they are now the windows whistle and it rains in when I crack them for ventilation." "Reposition the window crank handles." "Raise the roof 2-3 inches." "Front and rear bumpers should

(Please turn to page 93)

'I have to let smoke out by opening the side window, and that's noisy and lets the rain in.'

FORD RANCHERO

(Continued from page 90)

suggest? "Move the spare to give more luggage space." "Spare makes seat too upright." "If they'd make the rear pillars thinner, it would be easier to see out the back window." "Improve the ventilation or add a vent wing, because as it is now, I have to let smoke out by opening the side window, and that's noisy and lets the rain in." "Needs built-in hooks behind seat to accommodate clothes rod." "Bigger glove compartment." "The front bumper sticks out too far."

How do owners rate comfort? "Very comfortable, and I especially like the air-conditioning." "No complaints from passengers, but I think the seatback leans too far back, and there's no adjustment." "Fresh air should feed through the heater without having to turn on the blower." "After owning a rough-riding Mach I Mustang, the Ranchero is very comfortable." "I'm glad I picked the Ranchero over standard pickups—much less noise, and it rides like a car." "Very comfortable, but the windows don't seal properly, and to prevent them from rattling, you have to roll them all the way down before you roll them up again."

Not surprisingly, both Ranchero and El Camino owners put their pickups to nearly the same uses: work, recreation and simply driving them as another car. On the average, most owners use their Rancheros more for recreation and simple driving than for work. Certain types of professionals can

(Please turn to page 94)

Ranchero's spare and jack bolt behind passenger's seat, leaving not enough lockable storage space, say some. Seatback angle also didn't please everyone, but there was no agreement whether it's too steep or too recumbent. Ranchero offers choice of five engine displacements. Poor gas mileage loomed as a major complaint, as with all 1973 cars, and a high percentage of owners blamed antismog equipment for sluggish performance plus gas guzzling.

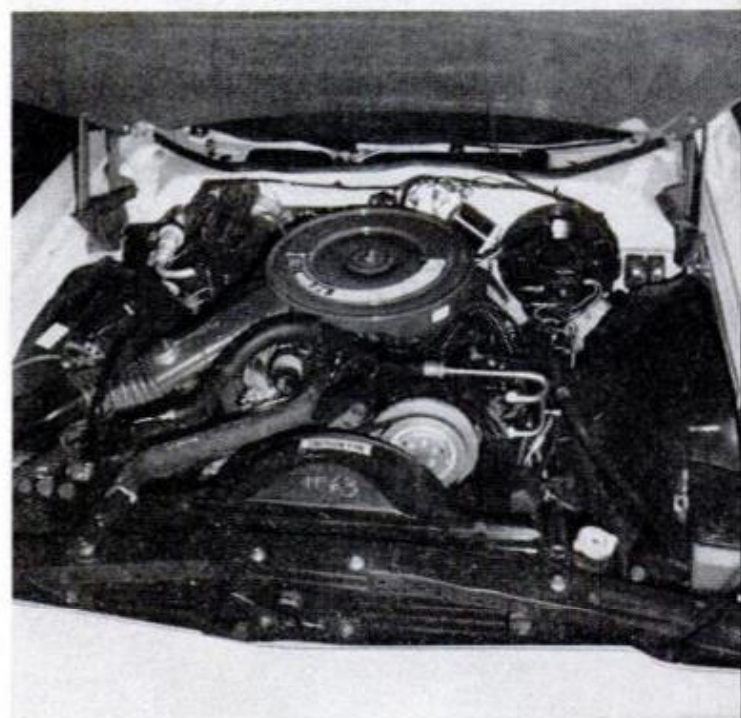

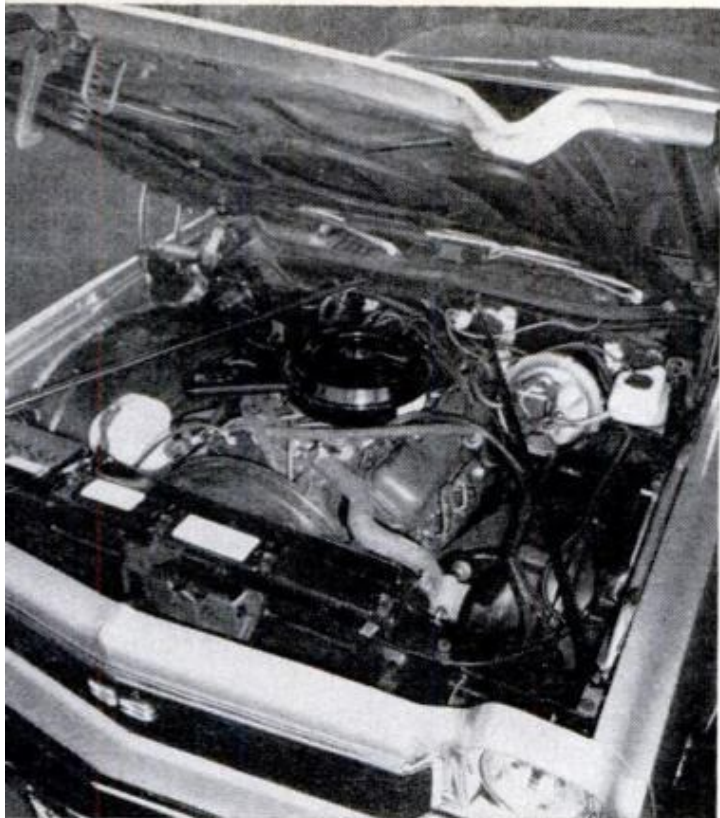

A number of owners suggested less body tuck so the sides get less mud spatter and fewer nicks from stones.

CHEVROLET EL CAMINO

(Continued from page 91)



Optional swivel front seats in El Camino are handy idea borrowed from Monte Carlo. Here again, spare and tools fit behind seats, but El Camino has deep storage bin behind driver's seat. This can accept smaller valuables like cameras. Rimless windows tend to whistle and leak in both pickups, a condition owners feel might easily be cured with vent wings and frames. The 350 engine comes with two or four-barrel carb; all El Camino V8s operate on regular fuel.

be designed so they conform to the looks of the car."

A number of owners also suggested less body tuck along the rockers so the sides get less mud spatter and fewer nicks from flying stones. Cargo-bed drainage seems to be a minor problem (as in all pickups). And some of the owners found that the El Camino's doors were both too long and too heavy.

The swivel seats (optional) make entry and exit easier, especially with the relatively low roof, but they also leave this strictly a two-passenger vehicle. El Camino and Ranchero owners grumbled about spare-tire and jack locations, wishing that these items could be hidden somewhere else (but where?) so the space behind the seats might be used for personal cargo.

Everyone commented favorably on the El Camino's general comfort and good riding qualities. Quite a few mentioned the pneumatic rear-suspension levelers, saying they really helped with heavy loads. Unloaded, though, both the El Camino and Ranchero tended to lose traction on ice and snow.

The El Camino uses coil springs all around, while the Ranchero has conventional leaf springs in the back. Both pickups offer optional heavy-duty and performance suspension packages plus equipment for trailer towing.

As in the Ranchero, owners complained of reduced rear vision due to the overly

(Please turn to page 95)

FORD RANCHERO

(Continued from page 92)

'I am a horseshoer; find the Ranchero most convenient.'

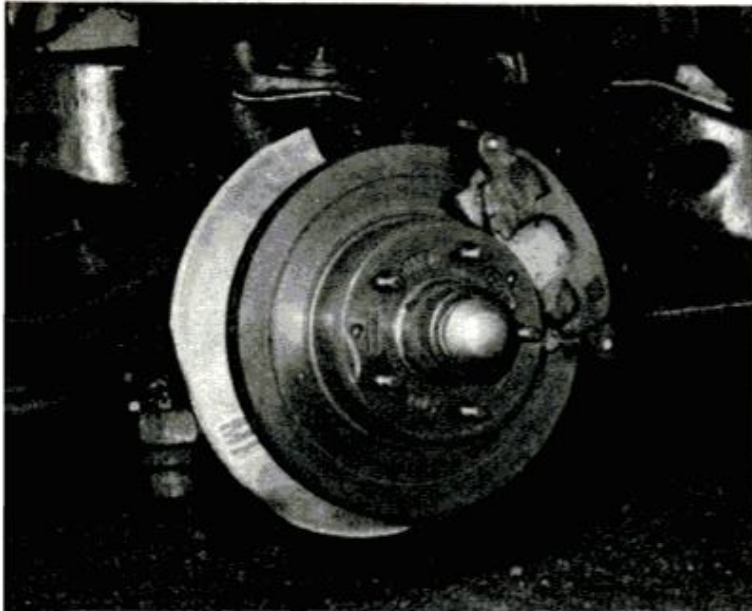

Ranchero and El Camino both make front disc brakes standard, backed by finned rear drums for greater fade resistance. Discs are much less affected by water; thus make sense for soggy service on ranches and farms.

use pickups of this type exclusively for business: contractors, welders, salesmen of various sorts, and so on. More normally, the owner tends to have a bit of acreage somewhere or a business that lends itself to occasional light hauling—filling-station owners, repairmen, painters, and at least one horseshoer in New Jersey.

Quite a number of owners mentioned hauling recreational equipment—not so much campers but skis, snowmobiles, motorcycles, bikes, hunting and fishing gear, boats, small trailers and surfboards. One Air Force captain says he uses his Ranchero to carry his flying and parachuting paraphernalia.

Owners rated the Ranchero's quality of workmanship quite high, and several of them praised such small touches as tie-downs in the bed and the nearly vertical tailgate.

Asked whether they'd buy another, 83.5 percent said yes, and a West Virginia coal miner notes, "If everyone owned a Ranchero they would never want any other kind of pickup truck." ★ ★ ★

Summary of 1973 Ford Ranchero Owners Reports*

Total miles driven1,292,081

Engines:

250-cu.-in. Six	0.4%
302-cu.-in. V8	35.2
351-cu.-in. V8	3.3
400-cu.-in. V8	57.8
429-cu.-in. V8	3.3

Transmissions:

Automatic	98.5%
Three-speed manual	0.7
Four-speed manual	0.7

Series:

Ranchero 500	51.2%
Ranchero GT	36.5
Ranchero Squire	12.3

Average miles per gallon:

250-cu.-in. Six, not enough replies	
302-cu.-in. V8: local driving	11.0
long trips	13.3
351-cu.-in. V8, not enough replies	
400-cu.-in. V8: local driving	10.4
long trips	12.5
429-cu.-in. V8, not enough replies	

Why the Ranchero?

Pickup feature	48.1%
Styling	32.8
Owned one before	11.6
Comfort	7.1

Specific likes:

Handling	46.5%
Styling	43.3
Comfort	32.2

Ride	31.8
Power	13.5
Hauling ability	10.2

Specific dislikes:

Poor gas mileage	26.0%
Emission control devices	9.9
Poor rear vision	6.5
Poor workmanship	5.0

Types of work used for:

Hauling	26.9%
Construction	14.4
Farming	9.3
Commuting	7.4
On-the-road selling	6.0

Types of recreation used for:

Fishing	32.3%
Traveling	26.0
Hunting	24.0
Camping	22.9
Boating	10.4

Number of vehicles owned:

Ranchero only	19.4%
Two vehicles	58.1
Three vehicles	15.8
Four or more vehicles	6.9

Other makes of vehicles owned:

Ford	23.7%
Chevrolet	10.3
Buick	10.3
Oldsmobile	9.4
Mercury	8.9
Ford truck	7.1

Comfort opinion:

Good to excellent	92.4%
Average to poor	7.6

Workmanship opinion:

Good to excellent	70.6%
Average to poor	29.4

Had any mechanical trouble?

No	58.5%
Yes	41.5

What type of trouble?

Carburetor	17.5%
Transmission	12.3
Hard starting	7.0

Did you repair it yourself?

No	91.2%
Yes	8.8

Dealer repairs satisfactory?

Yes	59.4%
No	40.6%

What changes would you like?

Better rear vision	15.5%
Better gas mileage	8.8
Different styling	7.1
Seatback angle	6.7
Remove smog equipment	5.0

Age distribution of owners:

15-29 years	19.9%
30-49 years	42.6
50-plus	37.4

Would you buy another Ranchero?

Yes	83.5%
No	16.5

*Percentages might not equal 100% due to rounding or insufficient data.

CHEVROLET EL CAMINO

(Continued from page 93)

'It's sporty and has class and style.'



Four-wheel coil-spring suspension of El Camino has pneumatic load levelers in the rear as standard equipment. Inflation can be adjusted by way of a valve stem that's conveniently located beneath the license plate.

large and wing-like pillars. Another nagging complaint centered on the El Camino's tail-light wiring plugs. Snow and ice tossed up from the rear tires builds up here, unplugs the jacks, and renders El Caminos unlighted from behind. "It takes about an hour to chisel the ice out of this area and replug the lights," says a Colorado construction engineer.

"Most people can't tell it has an open bed until they get up close," remarks a California court clerk. "It's sporty and has class and style," echoes an Arizona truck broker. "Little maintenance in 12,000 miles except for washes and sparkplugs," notes a Texas rancher. And a Texas lawyer sums up his feelings this way: "I am really high on this vehicle. It does the light hauling I require, and for heavy purposes it can handle up to two tons in a trailer. It is very easy to drive, and the El Camino's ride is equal to that of any automobile. As for handling—it's way above the standard pickup."

To our question, "Would you buy another El Camino," 77.2 percent said yes. ★★

Summary of 1973 Chevrolet El Camino Owners Reports*

Total miles driven1,392,211

Engines:

307-cu.-in. V8	5.5%
350-cu.-in. V8	87.3
454-cu.-in. V8	7.3

Transmissions:

Automatic	85.4%
Four-speed manual	9.3
Three-speed manual	5.2

Series:

El Camino	50.6%
El Camino Custom	49.4

Average miles per gallon:

307-cu.-in. V8: local driving	11.4
long trips	13.5
350-cu.-in. V8: local driving	11.3
long trips	13.7
454-cu.-in. V8: local driving	10.1
long trips	13.4

Why the El Camino?

Pickup feature	45.1%
Styling	22.4
Owned one before	14.6
Versatility	13.4
Comfort	8.2

Specific likes:

Handling	51.8%
Styling	39.5
Comfort	30.8
Ride	27.3
Pickup features	15.4

Specific dislikes:

Poor workmanship	20.9%
Poor gas mileage	18.7
Water entry in rain	10.1
Lack of power	7.8
Styling	5.6

Types of work used for:

Hauling	40.4%
Commuting	16.1
Construction	15.2
Farming	10.9

Types of recreation used for:

Traveling	27.6%
Camping	27.6
Fishing	26.6
Hunting	24.0
Boating	15.6

Number of vehicles owned:

El Camino only	21.1%
Two vehicles	60.0
Three vehicles	10.0
Four or more vehicles	8.9

Other makes of vehicles owned:

Chevrolet	36.7%
Oldsmobile	13.6
Pontiac	10.9
Buick	10.0
Chevrolet truck	9.0
Ford	6.8

Comfort opinion:

Good to excellent	90.0%
Average to poor	10.0

Workmanship opinion:

Good to excellent	32.4%
Average to poor	67.6%

Had any mechanical trouble?

Yes	52.9%
No	47.1

What type of trouble?

Electrical	19.3%
Transmission	11.0
Carburetor	10.3
Gas gauge	8.3
Speedometer cable	6.2

Did you repair it yourself?

No	91.7%
Yes	8.3

Dealer repairs satisfactory?

Yes	59.0%
No	41.0

What changes would you like?

Different styling	9.3%
More headroom	7.2
More legroom	7.2
Better workmanship	6.8
Add vent windows	5.9

Age distribution of owners:

15-29 years	31.6%
30-49 years	37.1
50-plus	31.2

Would you buy another El Camino?

Yes	77.2%
No	22.8

*Percentages might not equal 100% due to rounding or insufficient data.

An Early American hutch-table you can build

When not in use as a dining table, it serves as a handsome wall table or chair and quickly converts to give extra tabletop space when you need it.

by Harry Wicks

WORKSHOP EDITOR

When a chair-table like that seen on the facing page has storage area below the top, it is usually—for obvious reasons—called a hutch-table. Technically it's a trestle table, say antiques experts.

The hutch-table shown appeared in *Simulated Beams and Paneling Make a World of Difference* (page 112, April '72 *PM*). Ever since readers spotted it in this living-room setting, we have been receiving scores of letters asking for plans to duplicate it. Thus we returned to the workshop for a second go-around on the project and here's the result. (The original was built about 16 years ago.)

Besides its charm, a hutch-table is particularly practical. When it's not needed as a table, you can position it against a wall to serve as a decorator piece fitted with a lamp or seat cushion.

Our experience has proven this table to be one of the most practical—and treasured—pieces in our home. Since it is so easy to flip down the "back" to create a table, it is frequently used for buffet parties or whenever the kids have a gang in on a rainy afternoon. Because it is constructed in the "primitive" Early American style—distressed and antiqued—the table looks as good as, if not better than, it did new. Aging has just added to the patina of the wood and nicks and scratches have simply been filled with a quality stain-concealer.

Selecting materials. For best results, use either Idaho, eastern or sugar pine to make the table. However, if you have the desire, and confidence in your cabinetry skills, there's no reason not to make it of cherry, walnut or any other fine hardwood. For economy, you may prefer to use lower-cost knotty pine. (In my opinion this is a mistake over the long pull because the material is more frustrating to work with, and stands a better-than-average chance of checking and splitting over a period of time in a heated home.) But, if you do select such material, lay out the various parts carefully. Do not have knots fall along a line where cutting and shaping will occur. When you're rounding those corners, there's a strong possibility of knots falling out entirely.

Edge-gluing. Because of the width of the bench sides, top and shelves (E), these parts are cut from glued-up stock. Use stock no wider than 4 in. to avoid any chance of warpage or cupping—if that were to happen to the cabinet, it could stop the drawers from sliding. Professionals alternate the annular rings of the boards being edge-glued as shown in the sketch on page 190.

Edges to be joined must be perfectly square. If desired, you can have the boards pushed through a planer at your lumberyard mill for a slight charge. Use glue and



PHOTOS BY ROBERT D. BORST

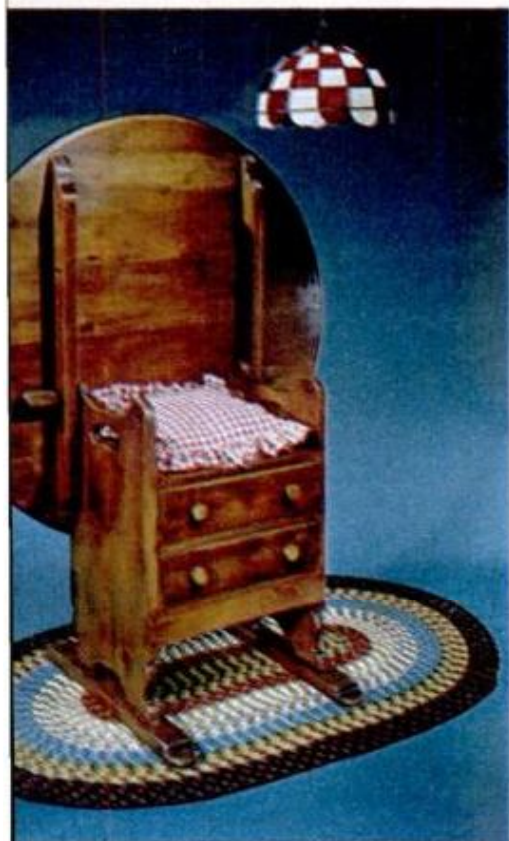

Charm and function are the distinctive features of this hutch-table. When table is not in use (left), hutch is provided with cushion for extra seat. Other photos show unit in service for functional table needs.

Drawers slide on hardwood

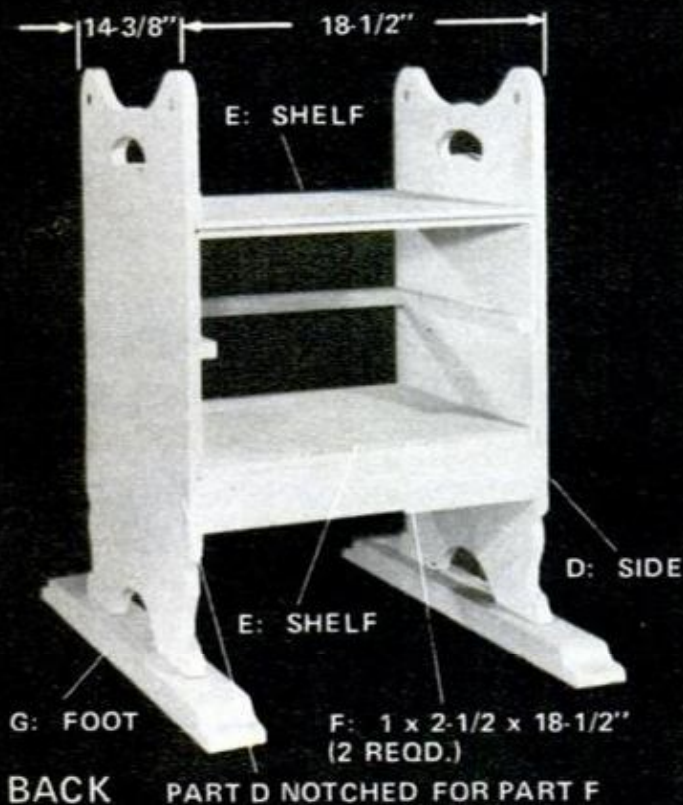
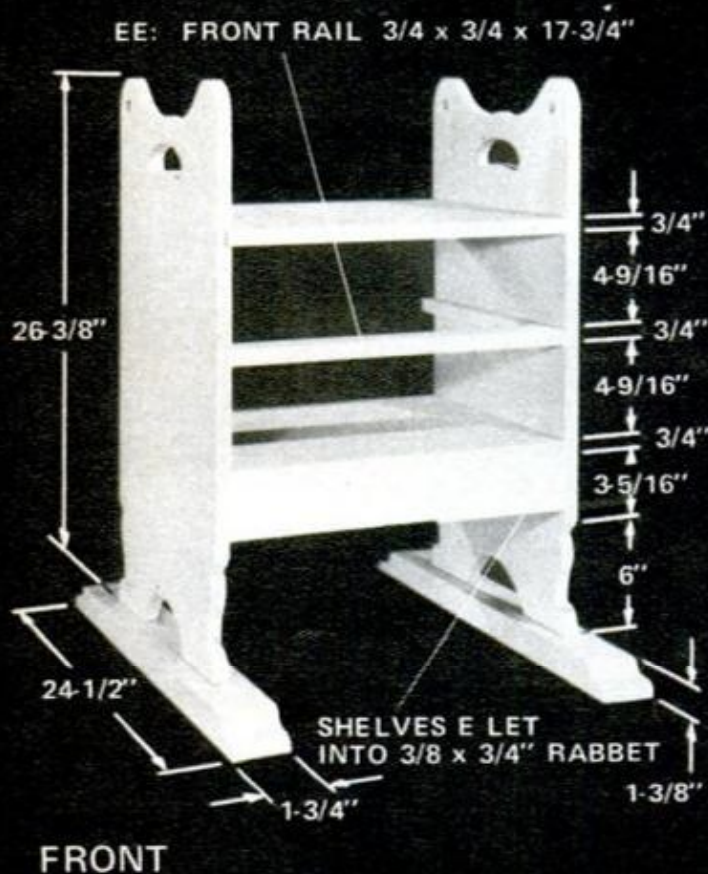

dowels to make up the boards to desired width; then clamp the boards, but don't overtighten them. Simply run the clamps to close all joints neatly. Then sight along the edge to make certain you haven't "clamped in" a warp. When satisfied with the setup, wipe off all excess glue and set the section aside to dry for at least 24 hours. Follow the same procedure for all edge-glued members.

While these parts are drying, use the patterns shown on 2-in. squares (page 99) to lay out the curved members: feet and top braces. These are best cut by a band-saw and next-best cut by a sabre saw with a long blade. You can of course, do the shaping with a coping saw (as the old craftsmen did); it will just take longer. After cutting, sand the shaped portions.

The next day, you can lay out the sides and top and cut to shape. Important: Temporarily tack the sides together and cut both at the same time. Then, lay out the locations for the dadoes for the top and bottom shelves (E) and push the pieces through the dado-head cutters. To prevent any chance of the piece drifting as you plough the dadoes, use your miter-gauge clamping device. There's no need to dado the sides for the drawer slides. These are simply surface-mounted $\frac{3}{4}$ -in. square strips of hardwood.

With all parts cut and sanded, temporarily assemble the piece and mark the back (side and shelves) for rabbeting for the plywood back panel. Disassemble the piece and, using your router and a $\frac{1}{4}$ -in. rabbet cutter, make the edge rabbet. Then chuck a $\frac{1}{4}$ -in. rounding over ($\frac{1}{4}$ round) bit in the router and round all edges including top and bottom edges of the top. You will not be able to use the router to round over the shaped edges of the ends of the feet. Here, I found the Surform file and round file did the job best. Finally, sand all pieces, working up to a fine-grit paper.

Locating the top. Lay the top good-side down on your workbench. Turn the bench upside down and center it on the top. *Note:* For strength, braces should be perpendicular to direction of boards in the top. When you're satisfied with the fit, position the braces along the outside of the cabinet,

Simplicity of table assembly is visible in front and back views showing the table in partially constructed stage. All information you need to duplicate the piece is given in the photos here and on page 181, in the drawings at far right and in the text.

leaving some tolerance (about 1/16 in. on each side). Next, mark the brace locations and remove the bench. Making certain that the braces stay aligned with your pencil marks, tack the braces in place using 4d finishing nails through the ends of the braces. Flop the top and use a long straight-edge to draw a line directly over the center of the braces. Drill and counterbore three holes for each brace as indicated in the drawing. Turn in the screws and, after applying glue, push in short lengths of dowel plugs. (Good doweling technique calls for leaving dowel plugs slightly above the surrounding surface. When glue has dried, the protruding dowels can be sanded flush with the top.)

Hinge pins are simple affairs. All four are made alike, each from two parts, a 3-in. block of pine and a 4 1/4-in. length of 1/2-in. dowel. It's easier to make these production style, cutting all blocks at the same time. Ditto the dowel cutting, chamfering, drilling and sanding steps. Dowels are simply glued in the blocks.

To locate the holes in bench sides and braces (part B), set the bench right-side up on your workbench. Position the tabletop on the bench. Note there is a difference in spacing of holes—you need greater distance at the back where the top will pivot. When the top is lined up, use two C-clamps on the ends of one brace to lock the top securely to the bench side. You'll need a 1/16-in. shim to maintain that clearance mentioned earlier. If you're right on, a scrap of Formica is just the thing for a perfect shim.

With a 1/2-in. spade bit, bore the holes through the first brace using a backup board on the side to prevent splintering when the bit breaks through. Then, leaving the clamps in place, swing around to the other side and bore the pair of holes required there. Remove the clamps and test-fit the hinge pins. They should fit snugly and not slide freely. If they are too tight, enlarge the holes slightly with a round file. Later, when the table is completed, you can always spray on silicone so that the pins will slip in and out of place without fracturing.

Drawers are of standard construction. The fronts are of 3/4-in. stock; sides and back of 1/2-in. stock and the bottom of 1/4-in. plywood. The front and sides are dadoed (1/2 in. up from the bottom edge) to

(Please turn to page 190)

Best methods for locating braces on the top is to position top correctly on bench and make match-marks. Then tack braces to the top, flop it and bore holes for screws.

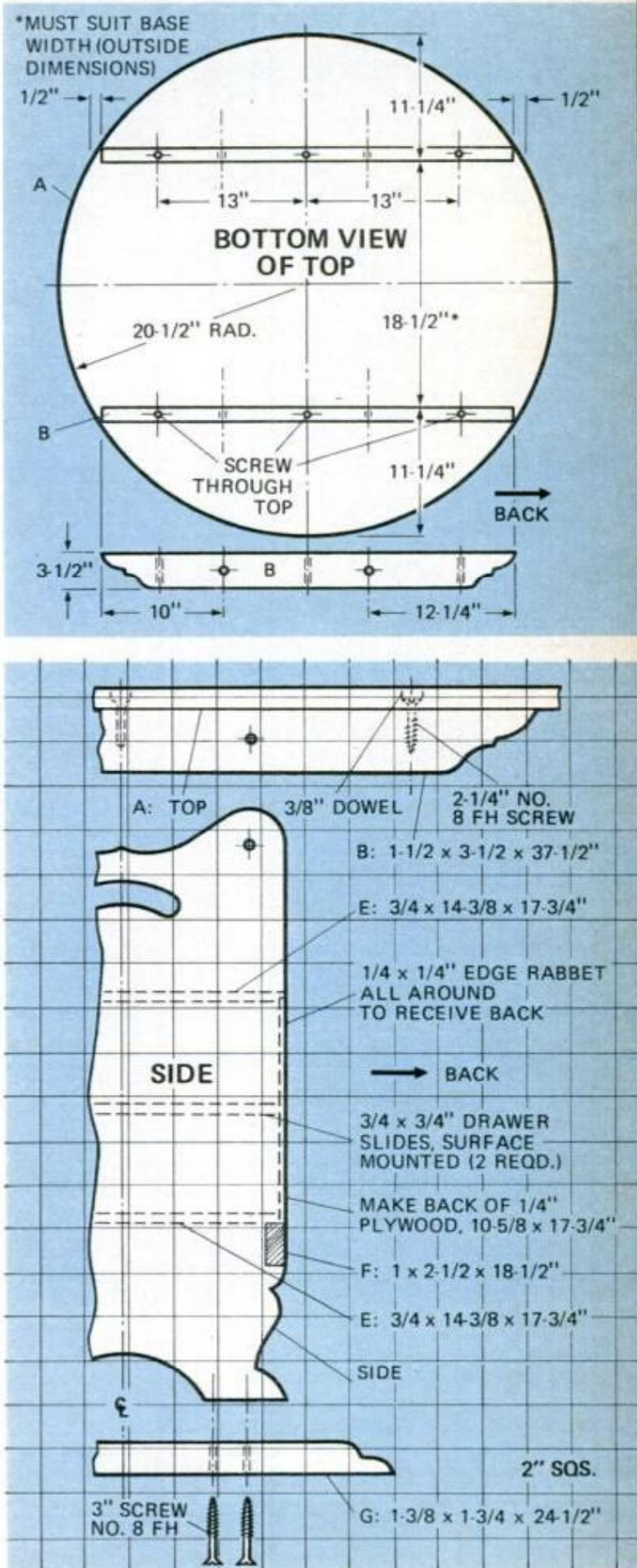

Creative deck and patio

DATA BY BARBARA GORDER

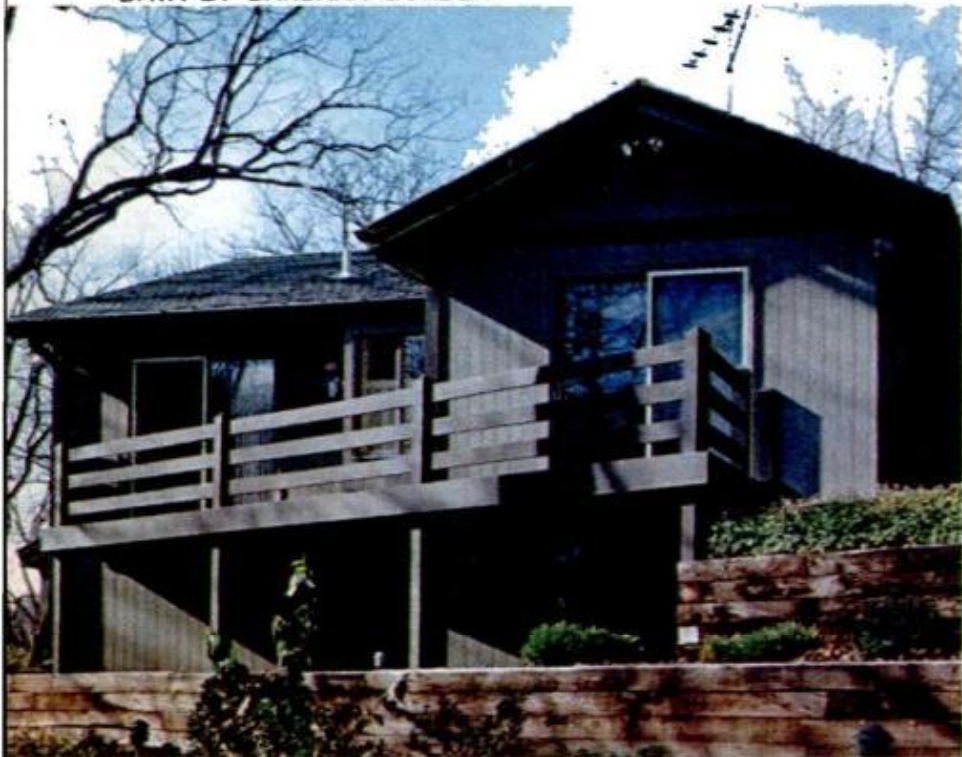

Outdoor living has become a way of life for the typical American family. Moderate seasons and temperate climates have especially stimulated homeowners' desire for an outdoor "family room." The cost to build a deck is substantially lower than that of a same-size addition and, considering the use that the entire family will get from the new space, it's money well spent.

We've rounded up three particularly handsome decks—including the double-tiered variety for hilly sites (facing page) designed by Saint Paul, Minn., landscape architect Marion Fry. In addition, you'll find all the basics you need to know for good deck construction shown in



Decks often offer the only means for outdoor living on steep building plots (top photo) and are popular for homes on level ground as well. The older home shown in the snapshot at left was re-designed by architect Russell Zenk of Minneapolis. The house-coordinated deck plays an important role; it provides an adult entertainment center at night and a children's play area by day.

ideas you can borrow

PHOTOS BY LES TURNAU

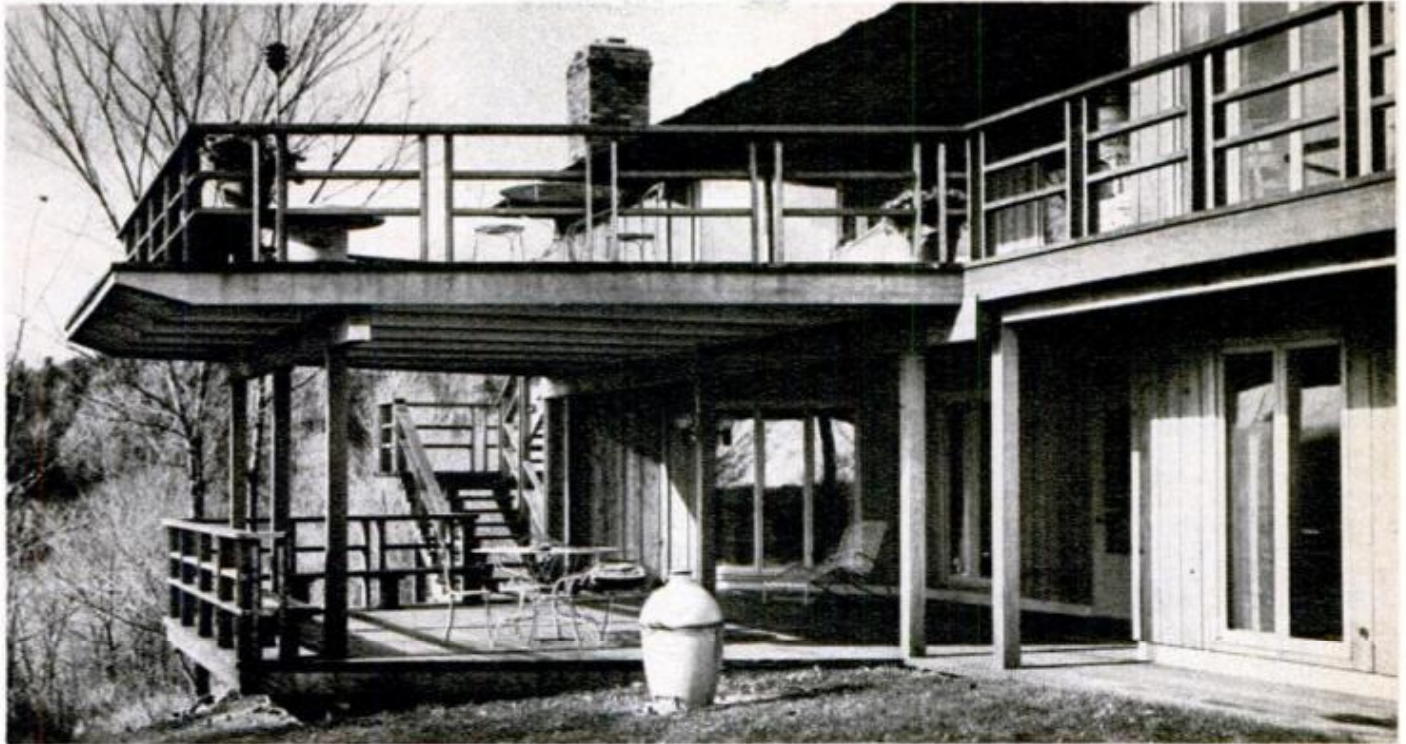

This huge double-tiered deck extends along entire length of the house at rear. Bonus: It overlooks a lake.

TYPICAL PATIO CONSTRUCTION

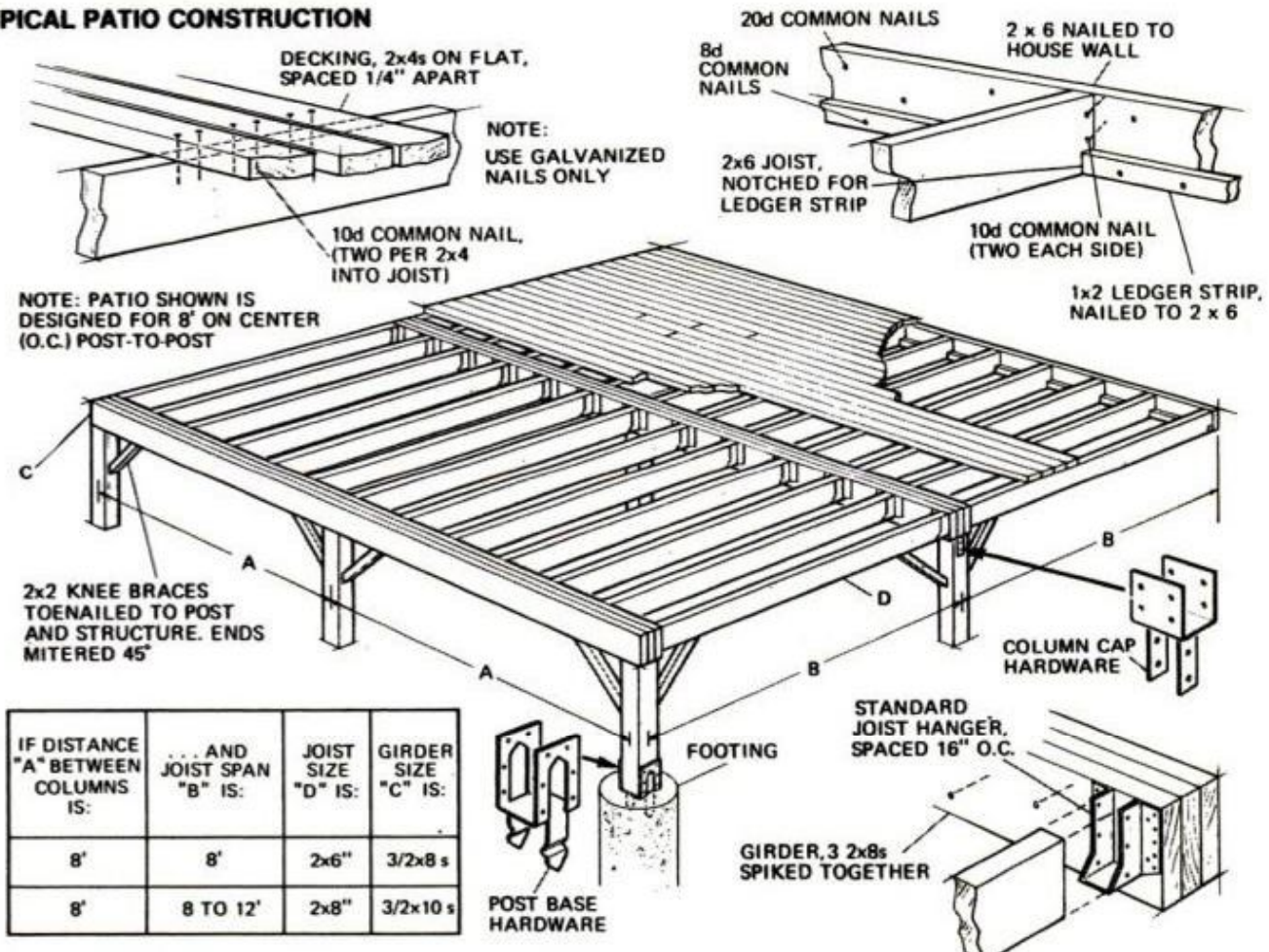

FRED L. WOLFF

HOW TO LAY OUT STAIRS

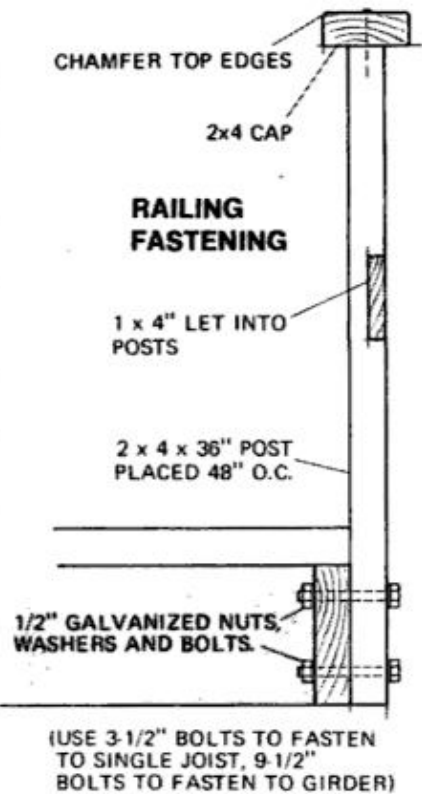
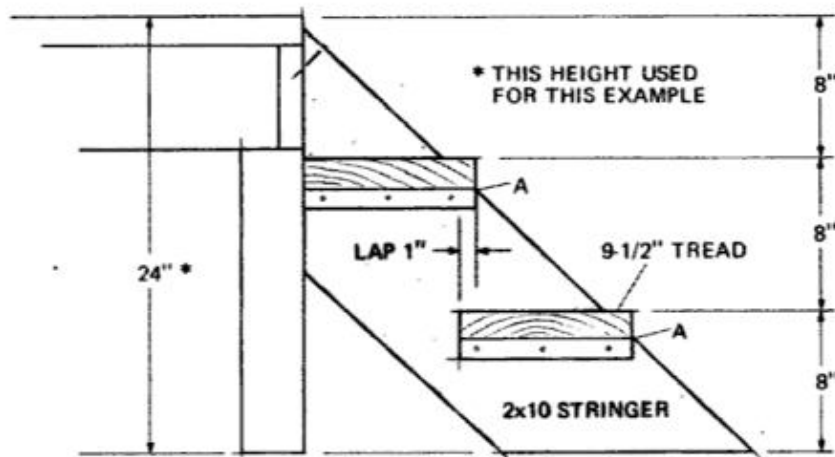

Stair design is tricky, but can be accomplished by a do-it-yourselfer. Important point is that riser height should never exceed $8\frac{1}{2}$ in.—ideally, riser times tread (width) should equal 72. Thus, with an 8-in. rise, tread should be 9 in. For best results, lay out stairs actual-size on plywood or clean garage floor. Measure height from deck to ground and try riser height of 8 in. Deck height of 24 in. divided by 8 equals three "spaces." Since ground and deck are not counted, that means two treads will be required to make the 24-in. rise above.

1/2" GALVANIZED NUTS, WASHERS AND BOLTS.

(USE 3-1/2" BOLTS TO FASTEN TO SINGLE JOIST, 9-1/2" BOLTS TO FASTEN TO GIRDER)

SECTION DRAWING OF METHOD FOR FASTENING TO HOUSE

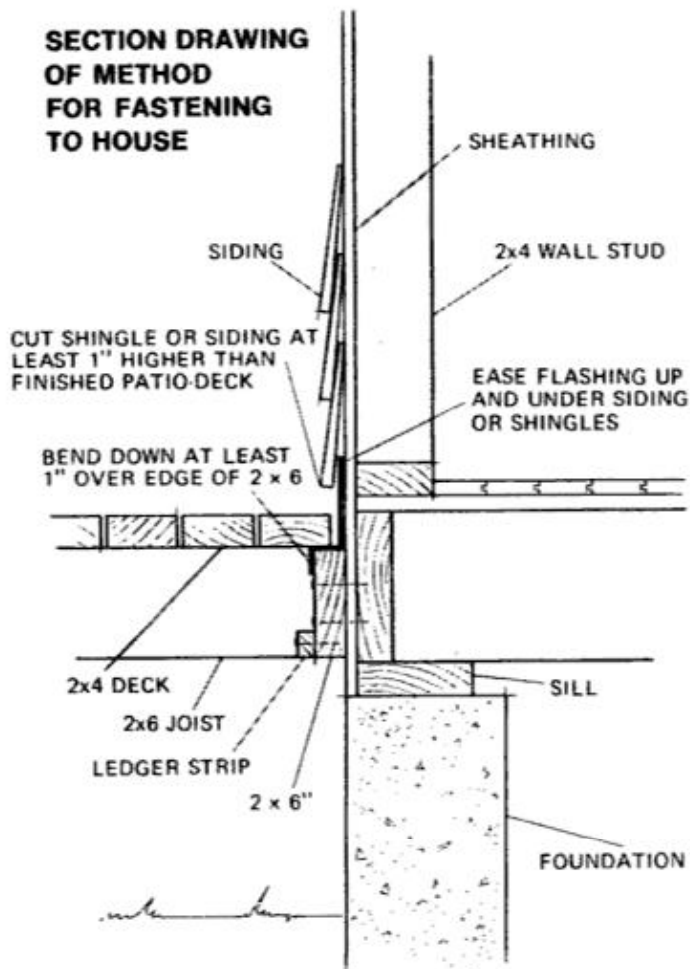

* NOTE: FINISHED PATIO-DECK SHOULD BE LOWER THAN INTERIOR FLOOR

the drawings on these pages. Even if you decide to have a contractor build your deck, the information given in the drawings will let you determine whether the job is being done properly.

The type of materials to use is important. Usual decking requirements are wood that offers a high decay resistance, nonsplintering, good stiffness (for strength), wear resistance and minimal chance of warping. Woods with heartwood that combine these characteristics—from a good to a high degree—include: southern pine, cedar, redwood and cypress.

Open decking, as shown in the sketches, is usually nominal 2x4s spaced $\frac{1}{4}$ in. apart over joists. Here, because rainwater will run through the deck, good drainage below—away from the house—is a must. For a solid deck, which will be covered by outdoor carpet, use only exterior-grade plywood over the joists. Keep in mind that a solid deck must be pitched to provide positive water runoff. Flashing, installed as shown, is imperative.

Preservative treatment of wood decking is also important. So, if possible, use wood that has been pressure-treated and, for longevity, treat your decks annually with preservative. Finally, before building your deck, be sure to check your plans with your local building department to assure that they conform with local codes. ★★★



Kayot's Executive Cruiser can speed at up to 30 mph with up to 85 hp clamped behind or slow down for fishing, sunning and sleeping aboard at anchor or at dockside. The new deckboat weighs 1880 pounds, can carry up to 2730 aboard, will sleep five and offers extensive accessories.

Lead this trailer to water



Call this a pontoon boat, deckboat, houseboat, amphibian trailer, tent camper or an Executive Cruiser as the builders do—it adds up to a versatile recreational vehicle ashore and afloat. Made by the marine division of Kayot, Inc., Box 789M, Mankato, Minn. 56001, this new 25-footer converts easily from cruiser to camper with canvas curtains that can completely enclose the 22x8-foot deck and provide seven feet of headroom inside. Rated for up to 85 hp, it is reported to top water-ski speeds of more than 30 mph.

V-bottom aluminum pontoons help to smooth the ride, and at anchor or ashore on a trailer, the cruiser will sleep five and can carry complete galley and camping accessories. Its price is \$3950.



Fully canvased (center, left), Cruiser becomes over-nighter for comfortable RV trailering to campground, offers three-burner stove, LP tank, sink, icebox.

Half-and-half enclosure (left), fine for sunny weather, allows converting trailer boat to hunting lodge or shoreside cabin. Family car can haul, launch rig.

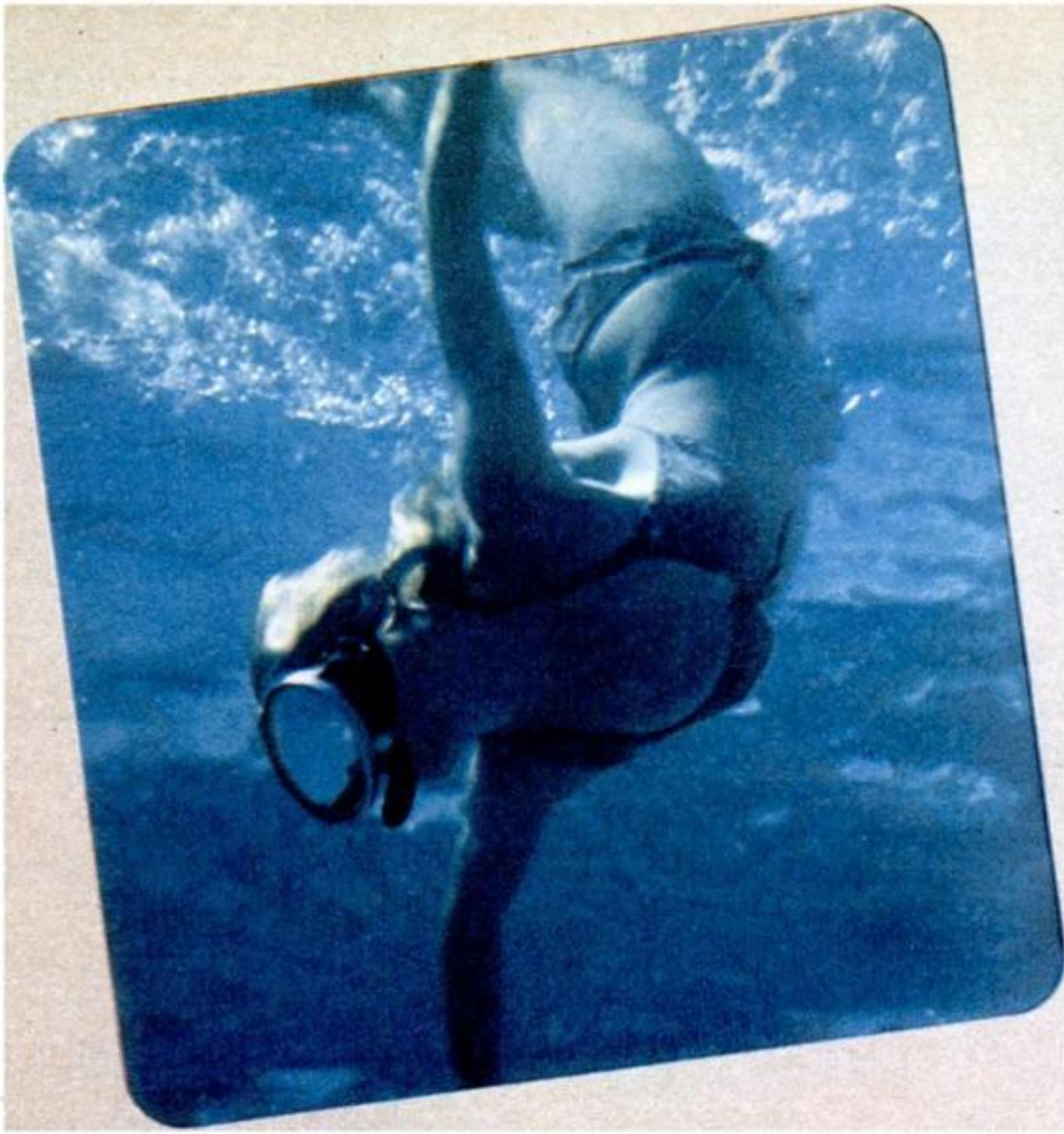

Underwater action shots are easy to get even with inexpensive equipment. Photos shown here were all made with Kodak Instamatic X-45 in \$39.95 Ikelite housing. Bottom view at right shows six-foot-wide sting ray. Middle two shots above show Ikelite's twin-grip housing for Kodak's new binocular-shaped XL movie cameras.



New fun with underwater photos

A fast-growing sport almost as popular as skin diving itself, marine photography is easier than ever with waterproof housings for as little as \$30. There's even one for Kodak's new Pocket Instamatic.

by Scott Gallager

When I showed up for a recent oceanographic expedition in the Bahamas with a little plastic box and an Instamatic camera, there were some snickers from friends. Shoot underwater photos with a snapshot camera? I was a bit doubtful myself, but I was determined to try. As a marine research diver and scuba instructor, I've seen the \$1000 rigs the pros use, and there's a tendency to think underwater photography is a rich man's sport only. This, I discovered, is a lot of nonsense.

The fact is, if you own an Instamatic or 35-mm single-lens reflex, you can take good underwater photos at relatively little expense. Edmund Scientific, for example, sells an underwater housing for Instamatics that

*(Turn page for more photos;
text continues on page 108)*

Latest camera to join growing underwater fleet is minisized Kodak Pocket Instamatic, shown in Ikelite housing (top photos, right). Housing has controls for shutter release, film advance and focus, can be fitted with flashcube and clip-on sportsfinder. Price is \$29.95. Rig at lower right is one used to make color shots on facing page. Also by Ikelite, housing takes Instamatics, is \$39.95.

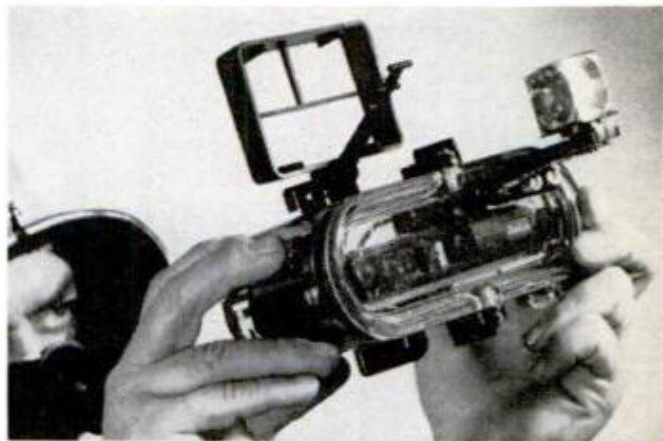

A fascinating array of fittings and hardware

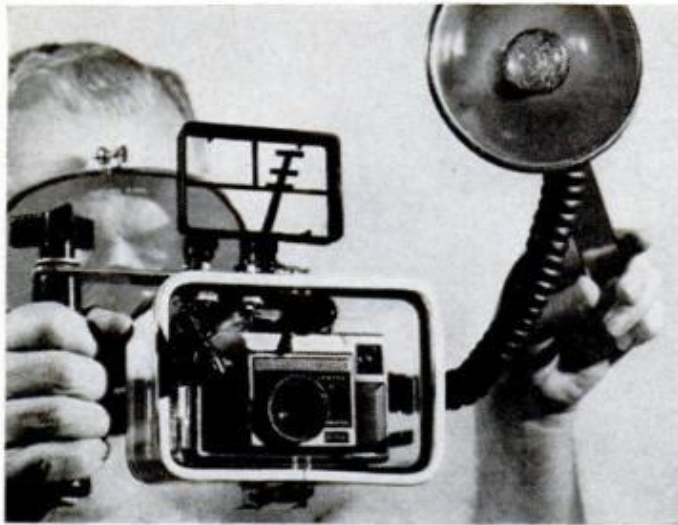

Several flash hookups are possible with versatile Ikelite housings. Reflector flash with coil cord (upper left) can be removed for off-camera side lighting. Flashcube bracket above comes with either noncoil cord (shown here) for fixed mounting or coil cord for removal. Photo at lower left shows how adapter snaps into flashcube socket on camera to fire external flash. Batteries to power flash slip into clips in housing.

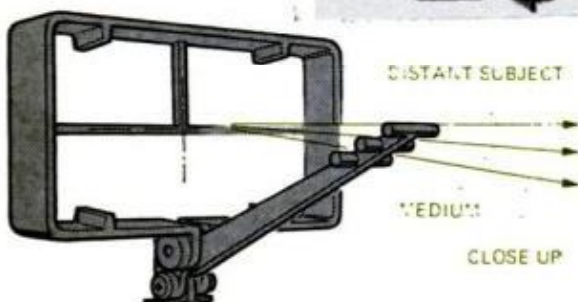
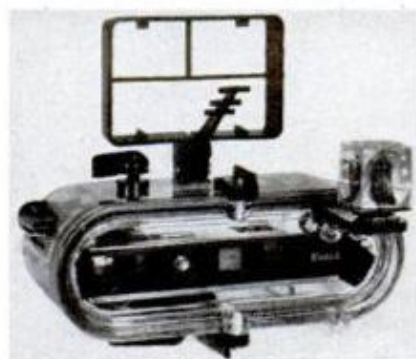

Housing for Pocket Instamatic can be supplied with small, compact flashcube bracket (left, above) or with longer extension arm (right) to put flash farther ahead of camera. Drawing at lower left shows how sportsfinder works. By aligning crossbar with various "rungs" on ladder sight, you can aim camera for long, medium or close-up shots.



Three least expensive housings are shown above. One at left, made by Oceanic Products, is sold by Edmund Scientific for \$21. It takes Instamatic models 100, 104, 124 and 134, features molded recess for flashcube, permitting flash to be used right on camera. At center is Ikelite's \$29.95 housing for Instamatic models 314, 414 and most X-series types; \$39.95 version at right is for earlier Instamatic models 104, 124, 134 and 304. These two require external flash.

Nicely molded handgrip, removable flash arm and interchangeable filters are features of Seacor housing at right. Made for Konica C35 cameras, it's priced at \$74.95 for basic housing, with grip, flash and other accessories extra. Entire rig, including camera, grip and flash, can be purchased for \$224.80.



For SLR shooters, highly sophisticated housings are available from Ikelite for most common 35-mm makes. Two shown at right above are for Honeywell Pentax and Minolta SRT-100 and SRT-101 models. Basic price for housing alone is

\$149.95. Extras include removable coil-cord reflector-flash arm (center; about \$20), clip-on sportsfinder (about \$6) and strobe-flash attachments (not shown). Interchangeable lens ports (lower right) allow use of tele lenses.

Shooting movies underwater can be fun, too

costs just \$21, including provision for flash. Ikelite, one of the biggest makers of underwater equipment, carries a full line of housings for virtually all Instamatics made, most common 35-mm SLRs and many movie cameras. Prices start as low as \$29.95. Outfits like Upsi, Seacor and Oceanic Products also offer housings for a variety of cameras.

As evidence of the growing popularity of underwater photography, housings are even being made for Kodak's new minisized Pocket Instamatic. Ikelite's sells for \$29.95 and for an added \$4.95 can be equipped to

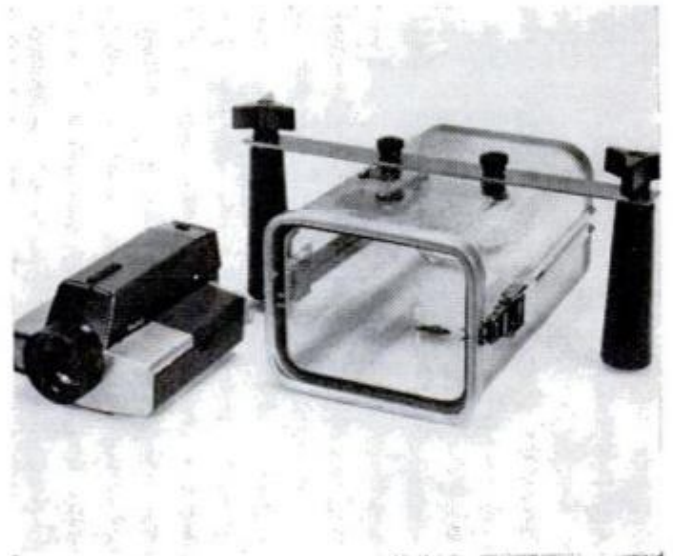

Underwater movies are becoming more practical today, especially with Kodak's new high-speed Super-8 color film that needs no artificial light in most cases. Ikelite housing has twin handles for good grip, is designed particularly for Kodak's binocular-shaped XL-33 and XL-55 Super-8 models. It's \$59.95 for XL-33, \$69.95 for XL-55, the latter incorporating zoom and filter controls. At far right is housing for Mini Eumig and Bolex Super-8 cameras, about \$60 from Eumig or Ikelite.



fire standard flashcubes. Also new are housings for Kodak's latest binocular-shaped XL-series Super-8 movie cameras. Made by both Ikelite and Upsi, they range from about \$60 to \$100. With Kodak's new high-speed color film, it's possible to shoot colorful underwater movies in natural sunlight. Most housings are made of clear, unbreakable plastic with watertight seals tested to withstand pressures up to 200 to 300 feet. You just slip in your camera, clamp on the faceplate, and you're ready to shoot. The simpler models provide shutter-release and

film-advance controls; more advanced types handle focus, zoom, diaphragm settings and other functions, depending on the camera.

I don't say the results you get with a \$30 housing will equal those of a \$1000 rig—they can't be expected to—but they'll be surprisingly colorful and dramatic, and they'll provide the fun and thrill of knowing you shot them yourself. It's hard to beat the sense of satisfaction and excitement you get watching a shot you made underwater blown up later on a four-foot-wide projection screen—the effects are fascinating even

(Please turn to page 180)

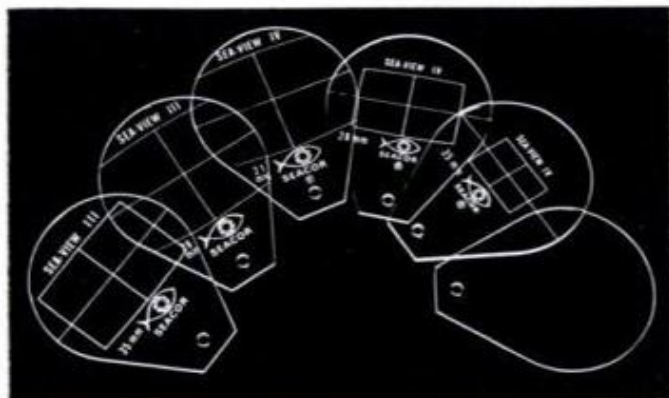
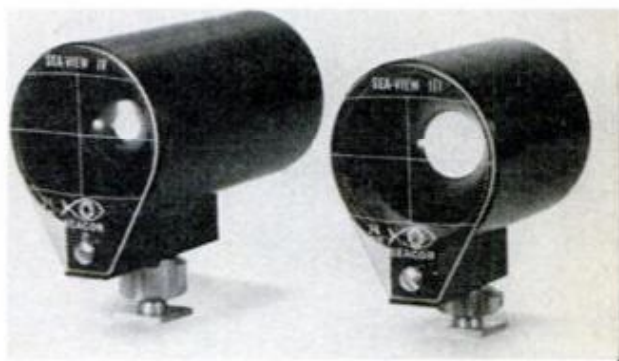

Optical viewfinders eliminate one of biggest underwater problems—aiming camera correctly. With these Seacor finders you can see exactly where camera is pointing and what picture area is taken in. Interchangeable front grids (left) let you tailor finder to your specific focal-length lens. Finders have standard shoe mounts, fit most housings, are \$40 to \$50.



Typical underwater shots that are easy to make without elaborate gear show girl diver (left), view from inside marine cave looking out (center) and

large brain coral (right). All were made with Instamatic X-45 under natural sunlight without flash at shallow depths of 10 to 15 feet.

IT'S NEW

NOW

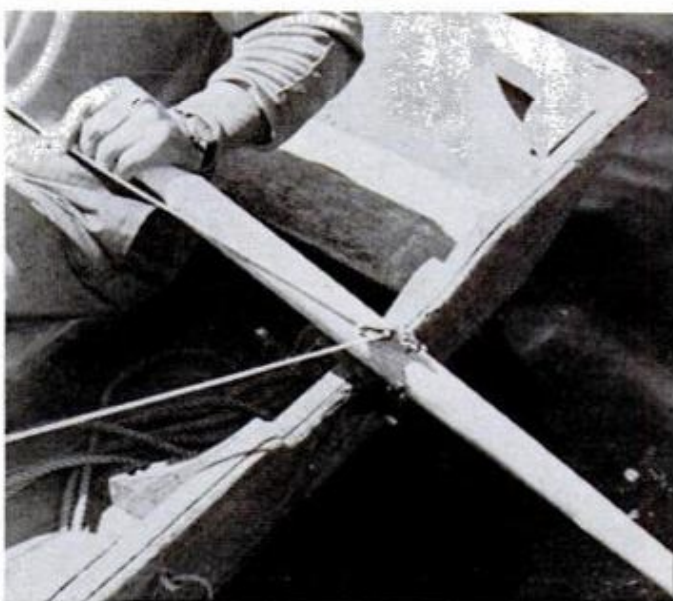
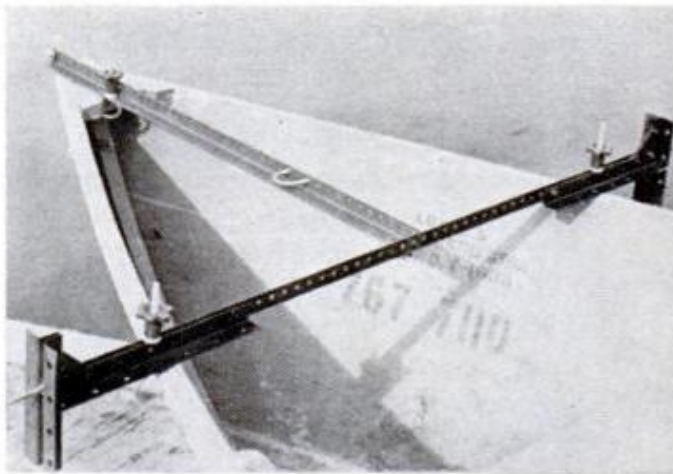

Improved diving mask and snorkel

Easier underwater swimming is the object of these new skin-diving aids. Unusually shaped mask (far left) sweeps outward at the sides for fuller, wider vision and incorporates a purge valve for expelling trapped water. Molded-in finger wells (near left) permit squeezing nose to equalize ear pressure without lifting mask. Snorkel has purge valve in the flex hose, also for easy expulsion of trapped water. Scubaview mask is \$13; Seaflex snorkel, \$3.50. Healthways, 5340 W. 102nd St., Los Angeles, Calif. 90045.

From rowboat to sailboat in minutes with this easy-to-attach mast, rudder and leeboard rig

Any rowboat or other small open craft can be equipped for sailing in minutes with the simple clamp-on rig shown on the facing page. An aluminum mast is held in place by a T-shaped arrangement of slotted braces that hook over the bow and gunwales and adjust easily to any size hull (upper photo, near left). Leeboards bolt on the ends of the crossbrace to provide the function of a keel. The rudder is merely an oar-like arm that fits over the transom and pivots for steering (lower photo). The ROWfish rig comes in three sail sizes: one with 45 sq. ft. for lightweight boats 12 to 14 feet long for \$121; one with 60 sq. ft. for heavy boats or those more than 14 feet in length for \$137; and a 75-square-footer for larger, heavier craft for \$168. The last is a sloop rig with Bermuda mainsail and Genoa jib. Freight charges excluded. A F Marine Co., Box 3, West Hempstead, N.Y. 11552, sells conversion kits.



Now it's automatic changers for cartridge tapes

You can play 8-track cartridge tapes like a stack of records with these automatic changers. RCA model at top holds five tapes, has AM/FM/FM stereo radio, two speakers for \$329.95. Deck alone, \$169.95. Toyo (lower left) plays six 2 or 4-channel tapes, is not yet priced. MGA Mitsubishi (lower right) takes three tapes, is \$99.95.

Would you believe—a race for tractors?

They didn't break any speed records, but they had a lot of fun in this oddball race for farm tractors recently staged at Kent, England. First to streak—that is, chug—across the finish line was famed Brazilian racing driver Emerson Fittipaldi, shown in his big-tired Ford "special." His speed? Well, no one is exactly saying.



NOW

For shooting pictures, not bullets

Fancy gunstock camera mount is about as close as you can get to the look and feel of a real gun. Made to steady long telephoto lenses, it's shaped like an actual rifle stock, has a walnut finish and features front grip with built-in shutter-release trigger. With adjustable mounting platform and shoulder strap, \$39.95 plus \$2.50 for shipping from Bass Camera, 179 West Madison St., Chicago, Ill.



Steam bike beats pedaling, pollution

When David Sarlin gets tired of pedaling, he simply switches to steam power and rides merrily along. The single-cylinder, double-acting engine, a work of art in itself made of brass, develops 100 p.s.i. and speeds to 16 mph. It uses a little gasoline to heat water for steam, but is virtually smog-free and noiseless. It drives the bike's front wheel through a rubber roller and is easily removable. Plans are \$9.50 from Sarlin, 2321 Russell St., Berkeley, Calif. 94805.





Spear fishing with a real bang

You fire these underwater spear guns just like a real one—with an explosive charge. Cartridge-loading guns pack more punch than rubber-band-powered models and save having to hand-stretch the rubber into place for each shot. Single-barrel type (left) is \$75; double-barrel version (right), \$100. Tapmatic Corp., 1851 Kettering St., Irvine, Calif. 92705.



Now they're making umbrellas for pipes yet!

As every pipe smoker knows, it's hard to keep tobacco dry in a pouring rain. Now there's an answer—a miniature umbrella that clips to the side of the bowl to keep water out of your pipe, if not off you. The solid gold novelty is priced at—brace yourself—\$835! Dunhill's Ltd., 650 Fifth Ave., New York, N.Y., sells it.



Frank Lloyd Wright magic for mobile homes

That aluminum shoe-box look for the house that arrives on wheels may be replaced by something better. The Frank Lloyd Wright Foundation, Taliesin West, Scottsdale, Ariz., has designed the smartly styled 12x71-footer (left) plus plans for fitting out up to 50 variations of three basic single and double-width models into a "harmonious community development." National Homes, Lafayette, Ind., is building the mobile homes. The first, on display at Arizona Mobile Home Industries in Phoenix, is priced under \$10,000, has floor-to-ceiling picture windows with wood-type trim, interior decor and furniture and outdoor landscaping.



A 'wet' suit you wear dry to keep warm under water

No, this isn't a new kind of water sport—just a demonstration of the latest in thermal wear for scuba divers. Unlike the usual skin-tight "wet" suit, Unisuit is partly inflated with air, forming a layer of insulation around the diver's body that's said to keep the wearer warm even in icy waters. To prove suit's buoyancy, a pretty assistant playfully stands on a floating test diver at far left. Poseidon Systems, Perth Amboy, N.J., is the maker.

Scooter has its ups and downs

This unusual cross between a scooter and bicycle is propelled merely by pumping up and down on the footboard. The board is attached to an offcenter hub on the rear wheel that forces the wheel to rotate as board moves up and down. Price is \$59.50 from Wheel Thing, Inc., 361 West El Manino Real, Mountain View, Calif. 94040.

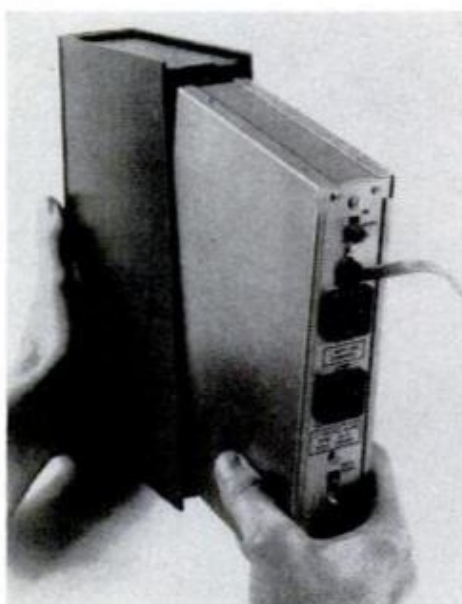
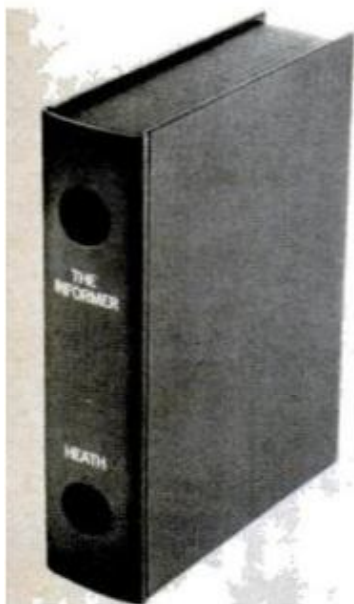

You can't tell a book by its cover—this one's really a burglar alarm

Hiding unobtrusively in a bookshelf, this kit-built ultrasonic sensor detects motion in a room or entryway and sets off a loud alarm if an intruder attempts to break in. The sensor, powered by 117-volt a.c., slips into a booklike cover (near left) and has outlets in back for plugging in an audible alarm, warning light or both. A built-in 30-second delay gives you time to deactivate the alarm before triggering it. GD-39 kit is \$49.95 from Heath Co., Benton Harbor, Mich. 49022.

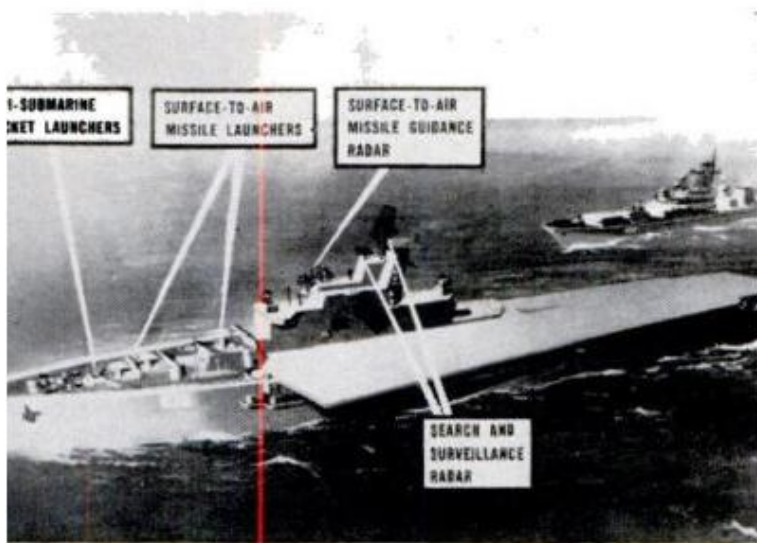

The Russians are coming: Sneak peak at a deadly new Red Navy carrier

Russia's first true aircraft carrier is shown at left in artist's concept made from secret satellite photos taken by NATO observers. Unlike earlier types that can launch helicopters only, the new giant has a 600-foot-long angled flight deck to handle fixed-wing fighters and bombers. Estimated overall length is 900 feet—equal to three football fields. Foredeck is laid out like a cruiser's with guns and missile launchers, making a deadly all-purpose attack vessel.

Rain or shine, nothing affects this outdoor speaker

Encased in weatherproof plastic, the mod-styled hi-fi speaker at right can be left outdoors all summer for patio use, then brought indoors in winter. The smart white pedestal-type enclosure houses a 12-inch down-firing woofer, mid-range and tweeter; handles 75 watts, has response of 30 to 20,000 cycles and measures about 25 inches high by 17 inches in diameter. \$139.95 from Empire Scientific Corp., 1055 Stewart Ave., Garden City, N.Y. 11530.

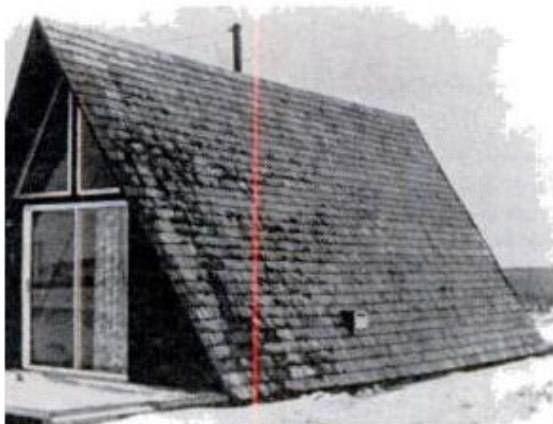

A weekender that really goes up in a weekend

This weekend vacation lodge can actually be put up in a weekend, ready for use. A lock-together system enables the 16 by 32-foot A-frame to be assembled in two days by do-it-yourselfers. Roof and floor panels prefinished inside and out are insulated for year-round use. Included are 4 by 16-foot front deck, full kitchen and bath facilities, gas furnace and prewired electrical fixtures for 12 or 117-volt power. About \$6000. R-J Industries, Inc., Box 237, Readlyn, Iowa 50668.



NOW

Better watch your parking or you may get plucked right off the road

Illegally parked cars get a quick lift off to the pound with the hydraulic rig shown below. Currently under test by London police, the truck-mounted crane makes it possible to pick up a car from the side without having to jockey a tow truck into position in front, often difficult on crowded streets. Two slings slip under the ends of the car and raise it onto the truck's flat bed for hauling away. The Z-Wagon is made by Telehoist, Ltd., Manor Rd., Cheltenham, England.



A fisherman for the man, a family cruiser for the woman

If you want a sport fisherman and your wife prefers a family cruiser, you can each have your way with this combination fisherman/cruiser. Deep-V F-24 Trojan 24-footer, fully equipped for fishing, has a galley, head and sleeping quarters for family outings. Handles engines up to 225 hp., is stout enough for off-shore use, small enough to trailer. For prices, write Trojan Yacht, Box 1571, Lancaster, Pa. 17604.

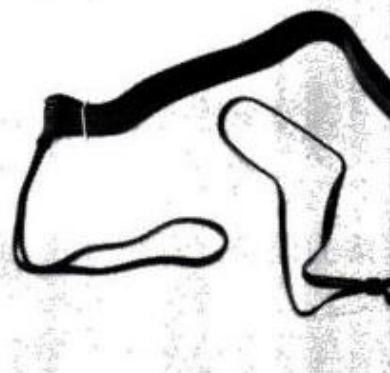

All-purpose shoulder sling for gun or tripod

Toting a tripod, gun or similar gear on long hikes is easy with this slip-on shoulder sling. Loops on ends are simply hooked over object to be carried and pulled tight by slip rings to hold them in place. Adjustable sling, made by Kalimar, is about \$3. Available at camera shops and discount centers.



How to stop a runaway truck going downhill: Just turn it back uphill

Going down steep mountain roads in the Alps can be hazardous for heavily laden trucks if their brakes fail. Now Austrian authorities have solved the problem by installing a series of "bremswegs"—brake roads—along long downgrades. Short pull-off strips curve sharply upward, bringing a runaway truck to a safe stop.

Gauge helps keep you on the level

Campers who travel rugged back-country roads can tell at a glance if their vehicle is tipping over too far for safety by watching the little ball in this Tilt-O-Meter. Fastened to dashboard, the device indicates degrees of tilt; shows danger points in red. \$7 postpaid, J. C. Whitney, 1917 Archer Ave., Chicago, Ill.

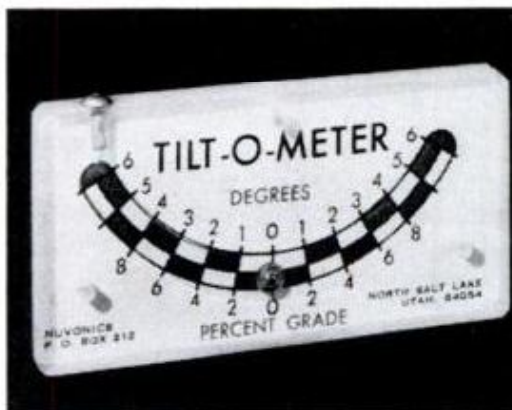

Coming: 4-channel receivers that play everything—matrix, discrete, discs and tape

Until now, 4-channel amplifiers and receivers usually contained only decoders for 4-channel records and FM-stereo broadcasts using matrix encoding systems like Columbia's SQ or Sansui's QS. If you wanted to play discrete 4-channel Quadradisc records, you needed a special external demodulator. This fall we'll see the start of a new breed of all-in-one receivers with matrix decoders and Quadradisc demodulators built in. First models to be publicly announced are the Akai AS-980 (upper left) and the JVC 4VR-5446 (bottom). Both will have optional "joystick" remote balance controls like that sitting atop the Akai. Latter will deliver 120 watts output, cost about \$700; JVC's will put out about 170 watts and is expected to sell around \$550.



NOW

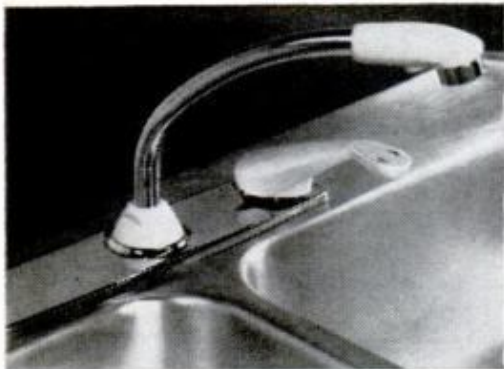

Low-priced 'joy-stick' faucet

This contemporary single-handle faucet is in the same price range as conventional two-handle types, according to the maker. Priced at \$16.40, the washerless faucet, named Aquamix, has a ceramic disc cartridge that's said to withstand better the silt, sand and minerals in water that erode washers. Designed for quick, one-man installation, the top-mounted unit is meant for standard three-hole sinks. Available at plumbing suppliers. American-Standard, New Brunswick, N.J. 08903, makes it.



Plywood liner makes instant cedar closets

Clothing and linens will take on that luxurious cedar-chest scent when stored in a closet paneled with aromatic cedar plywood closet liner. The ¼-in. panels are sold in standard 4x8-ft. sheet size and have a smooth-surfaced knotty red cedar face veneer that requires no staining or finishing and little maintenance. The manufacturer claims the liner's cost is comparable to wallboard prices, says application is easy, and suggests paneling pantries and utility areas as well as closets with it. For information, prices and the name of nearest source, write Boise Cascade, Communications Dept., Box 4463, Portland, Ore. 97208.



Vinyl siding is 'house paint' you press in place

Self-adhesive vinyl "siding" takes the place of paint, goes on over existing siding, eaves, fascias and trim. Sold in 27-inch by 50-foot rolls. MAClar costs less than a professional paint job, the maker claims. Sample kit is available for \$1 from Bryce-Branton, 690 Southern Ave., Muskegon, Mich. 49441. Flexible plastic strips can be easily cut to any width or length to fit over existing surfaces. The material is applied merely by pressing it in place; it requires no surface preparation provided old paint is in reasonably sound condition. For quantity prices, write maker.



This 'still' is for water

Distilled, purified water—two gallons a day—is provided for home use by Aquaspring. Tap water is heated to boiling inside, then condensed on aluminum cooling fins and collected in a plastic container. Operating on household current, the unit removes all dirt, salt, chlorine, pesticides and mercury from water, according to maker, New Medical Techniques, Inc., 1700 Summer St., Stamford, Conn. 06905. Suggested retail price for Aquaspring is \$89.95.



Chain 'handcuffs' doorknob

New kind of door chain boasts quick, easy installation with a single screw eye in the doorframe. Other end of chain is attached to a ring—easy to slip on and off doorknob from inside, impossible from outside. Chain is protected by steel sleeve to help prevent cutting or sawing. Lektro-Guard chain guard is \$3.95 plus 25 cents for handling from Jespersen House, 712 East 9th St., Spokane, Wash. 99202.

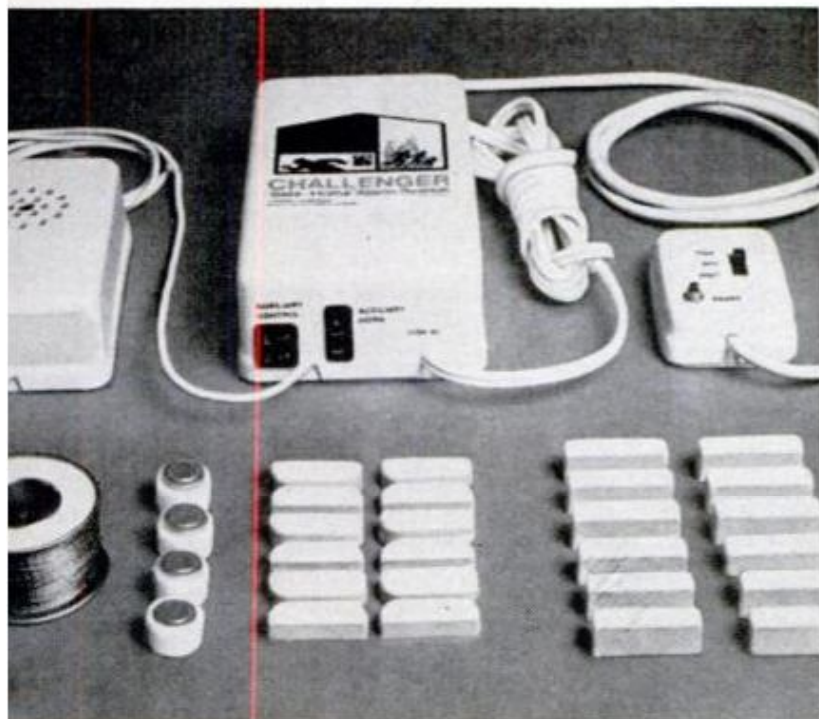

Burglary and fire-alarm combination has stick-on parts

Burglary and fire protection with easy installation is claimed for Challenger Safe-Home Alarm System. For \$95, the basic kit includes intrusion sensors for six doors or windows and fire sensors for four locations, plus a solid-state master panel, a control unit with time-delay circuits, loud horn and 250 ft. of connecting wire. All components have self-sticking backs, and solderless connectors are used. According to the maker, a pair of scissors is the only tool required for installation. Other sensors, howlers, gongs are also offered. Crismar Corp., 7 Johnson Ave., Plainville, Conn. 06062, is the manufacturer.

NOW



All-in-one road emergency kit

This handy kit-for-all-occasions is designed to handle virtually any highway emergency situation you're likely to meet on vacation travels or camping trips. The case includes 8-ft. jumper cables, aerosol tire inflator, aerosol fire extinguisher, emergency blinker, high-intensity spotlight, gasoline siphon pump, first-aid kit and complete instruction book. \$19.95 plus \$2 postage and handling from Penthouse Products, 909 Third Ave., New York, N.Y. 10022.

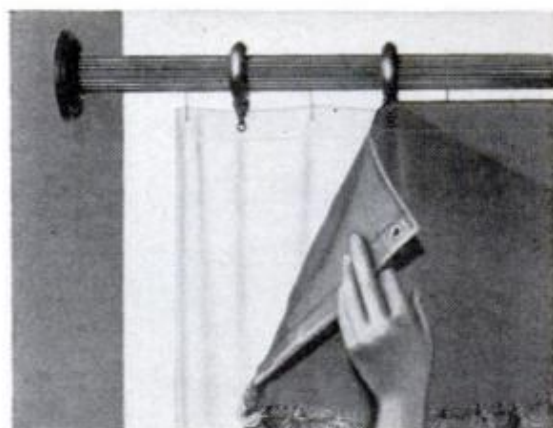

Two tracks separate shower curtain from liner

A new shower-curtain rod, Chateau by Kirsch, has two tracks. One in back holds grommeted liners, while decorative rings, which slide without marring rod's finely fluted finish, hold either grommeted or pinch-pleated shower curtains. In antique white or antique brass, rod is made to coordinate with a complete line of other bath accessories. Sells for \$16.79 at department stores.



To mulch or not to mulch— you can take your choice with these two new mowers

You can leave grass cuttings on your lawn for mulch or sweep them up clean. Bolens' Mulching Mower (far left) has a fully enclosed housing said to create suction that picks up and recuts grass clippings and leaves until deposited as a finely shredded mulch. Latest Lawn-Boy (near left) vacuums clippings and leaves, bags them for easy removal. For information, write Bolens Div., FMC Corp., Port Washington, Wis., and Lawn-Boy, Outboard Marine Corp., Lincoln, Nebr.

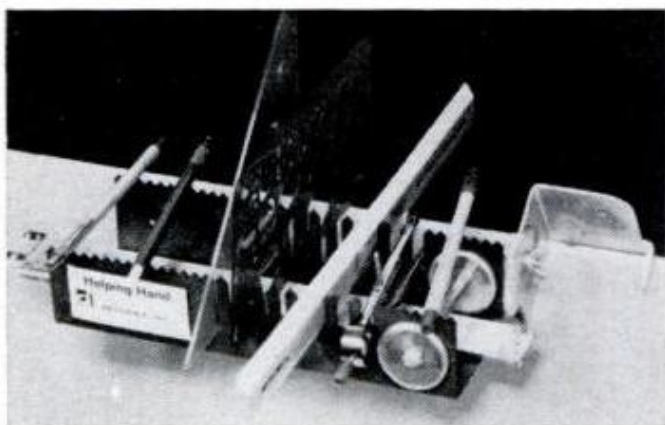

Holder keeps instruments handy whatever drawing board's angle

Set your drawing board at any angle and Helping Hand will keep your instruments nearby without danger they'll slide off. Holder clamps to side or top edge of board, won't interfere with drafting machine or T-square. Helping Hand is \$9.95 with clamp, \$4.50 without, from Devonics, Inc., 1515 Chatsworth Blvd., San Diego, Calif. 92107.

Ladder aid does double duty

Working for long periods on a ladder with narrow rungs can be tiring on the feet. Put yourself on a firmer footing with any round-runged ladder with Tote-Step. The device hooks over a rung to give you a secure, comfortable perch. It also doubles as a tool carrier when not on the ladder. \$9.90 postpaid from Tote-Step Corp., 6801 Industrial Loop, Greendale, Wis. 53129.

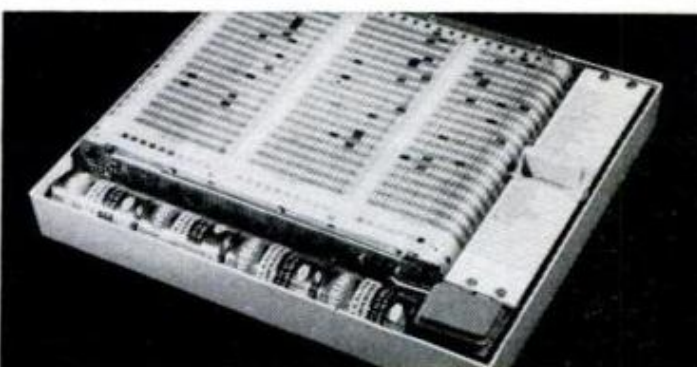

Forget those phone numbers and dial by name instead

Dialing finger tired? Have a robot dial your local and long-distance calls—all you do is move a slide to the name you want, pick up the receiver and push one button. The device, placed under the telephone, runs on D batteries or optional a.c. adapter. It's programmed to the desired numbers with a special pencil and won't interfere with normally dialed calls. The Name Caller is available for both single-line home phones and multiline business phones. The basic unit is \$49.50. Mascom Products Corp., 2835 Columbia St., Torrance, Calif. 90503, makes it.

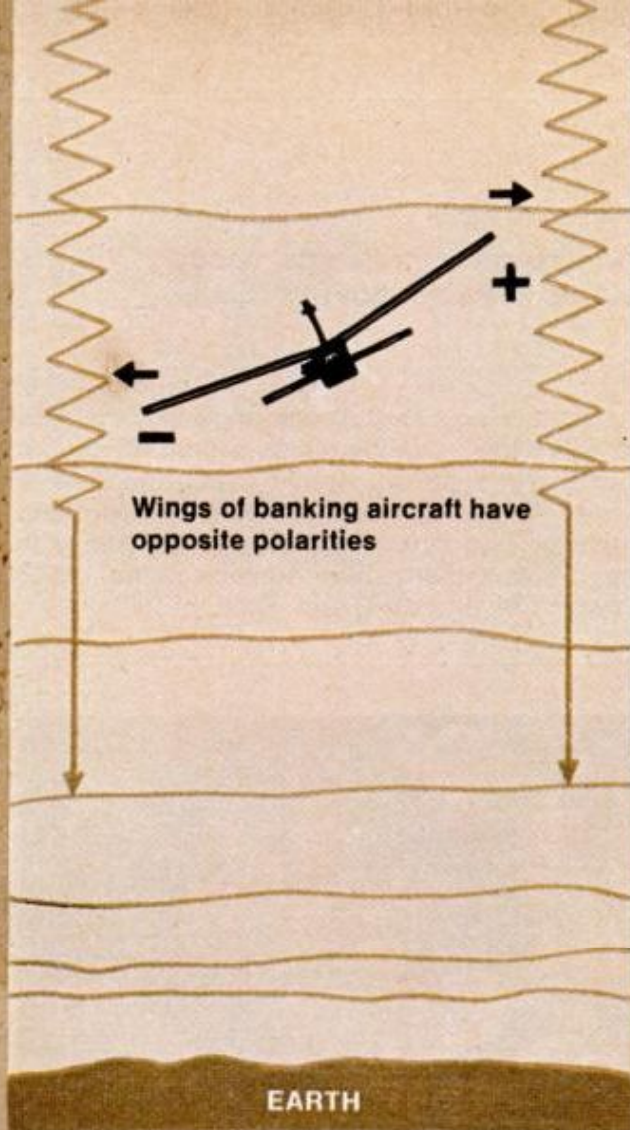

Wings of banking aircraft have opposite polarities

EARTH

Autopilot reacts to electrical charges in atmosphere. In drawing (above), it will cause wing with plus charge to dip until level flight is attained.

With autopilot on, plane's tendency is to maintain level flight. If put into spin (autopilot off), plane will pull out moments after autopilot is switched on again.

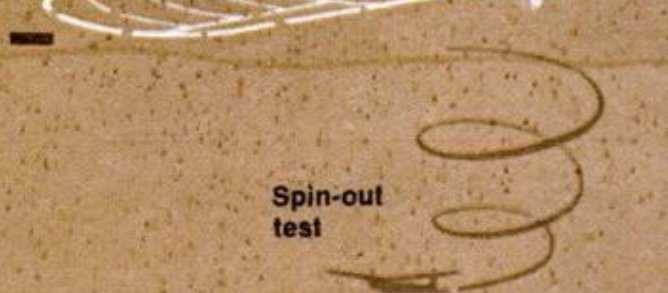

Spin-out test



Nose and fin sensors control pitch

R. Brant

New autopilot got started

Researchers were investigating clear air turbulence when they made a discovery that led to a revolutionary type of autopilot—a device that reacts to electricity in the atmosphere. But will it work in full-sized aircraft?

by D. J. Holford

Maynard Hill and John Rowland were trying to track CAT. Hill and Rowland work at the Johns Hopkins Applied Physics Laboratory in Maryland, and the CAT they were after is Clear Air Turbulence—a type of turbulence that strikes without warning and is most common at jetliner cruising altitudes.

Since CAT is frequently associated with rising air, the researchers were looking for a detector that would warn a pilot when he was entering rising air. One approach

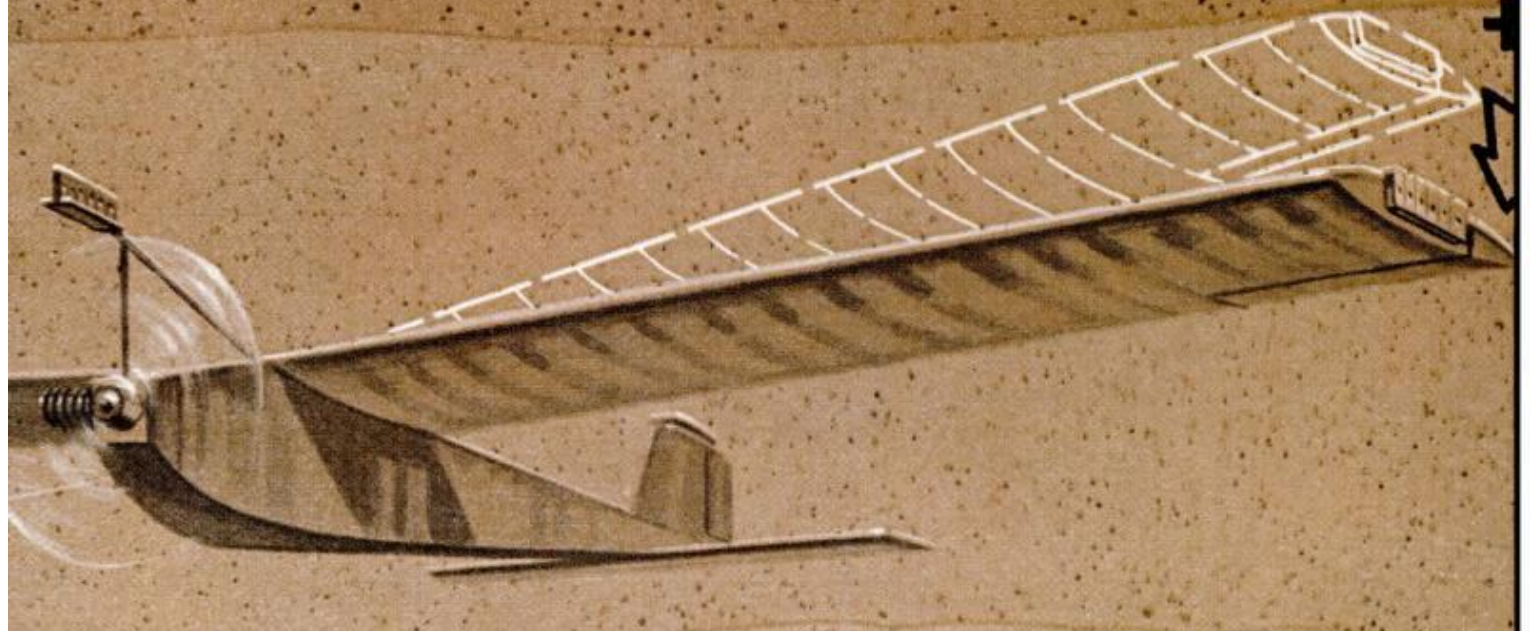

The atmosphere is a huge capacitor—electric storage field—with the Earth negative and the air above it positively charged. As shown in drawing, the top of the atmospheric layer has charge of 350,000 volts; Earth's surface, zero volts. Voltage layers encircle the Earth like the layers of an onion. A man standing in the open at ground level would get a reading of zero volts at his feet and about 300 volts several inches above his head.

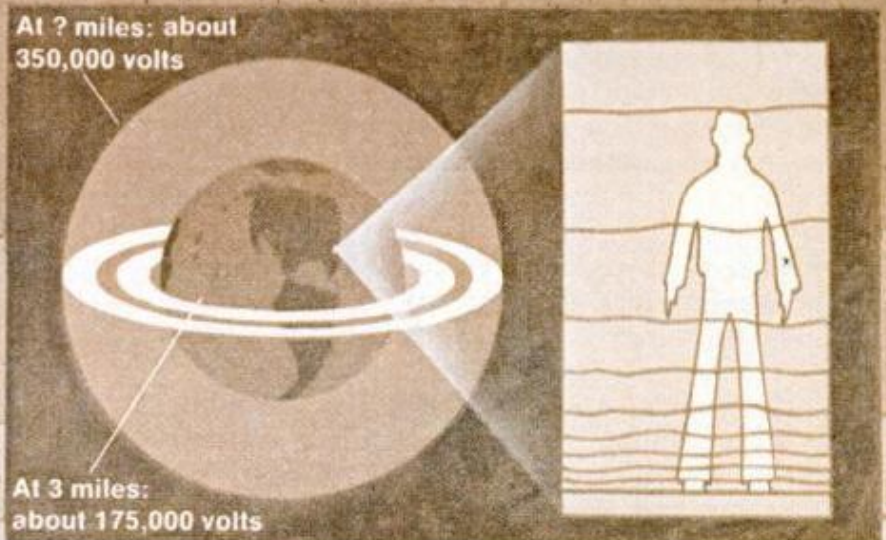

with Ben Franklin's kite

that seemed promising was to measure the voltage of air passing the wingtips, the theory being that rising air would pick up dust particles, some of which might be electrically charged.

They installed sensitive voltage detectors in a radio-controlled model aircraft. (Hill, a skilled R/C model builder, holds several world performance records for models.) The equipment was set up to transmit signals to the ground. Rising air near the left wingtip might cause a high-pitched tone

to be transmitted; a lower note would indicate rising air near the right wingtip.

The theory sounded good, but in practice it was disappointing. The tone differences were too small to serve as a useful CAT-warning device. But Hill was not ready to scrap the system. It seemed to him that the changes in tone they did hear were somehow related to the maneuvers of the aircraft.

With help from a fellow aeromodeler, Ben Givens, the equipment was modified to

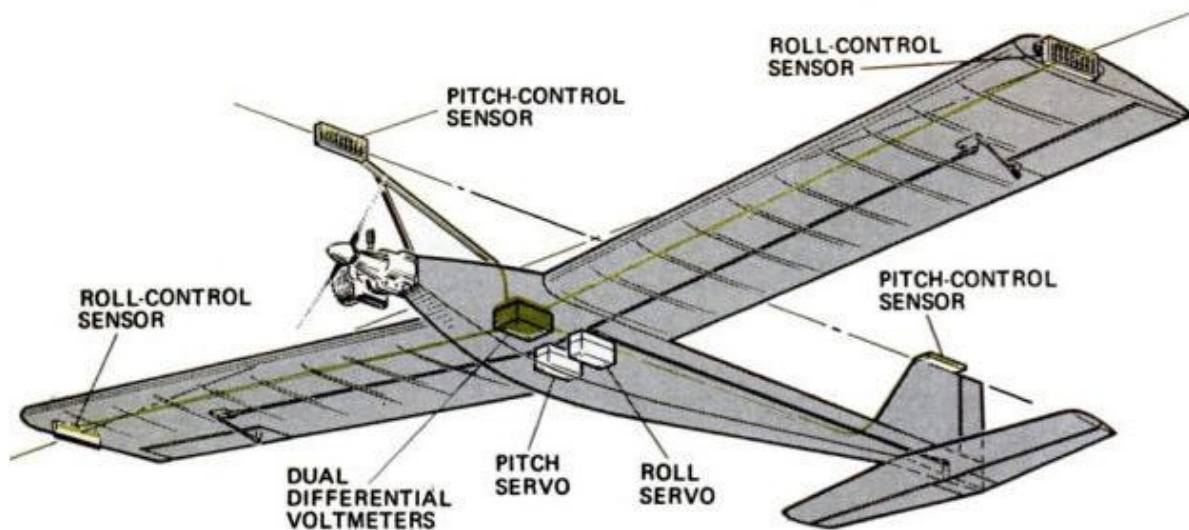

Autopilot in model aircraft used by researchers has few components. Forward sensor is mounted on a boom to protect it from engine's oily exhaust.

make it more sensitive. Gear was added so that the signals could be taped along with Hill's comments as he controlled the model. The results were just what could be expected if the control signals of an autopilot were converted to musical tones. Something was causing the signals to vary whenever the model changed attitude.

The next step was obvious: Install an autopilot. Instead of using complex and expensive gyroscopes to control the plane, the researchers decided to use the variations in wingtip voltage. After the autopilot was installed, Hill put the model into a steep dive, then switched control over to the autopilot. The results were startling. The model immediately leveled off and flew smoothly and sedately. Hill tried to roll it by radio control, but all the autopilot would permit was a gentle turn.

Having proved that they were indeed onto something useful, Hill and his colleagues added other detectors in the nose and tail to provide pitch control. Then they placed a heavy wrench in the tail to unbalance the plane. When the aircraft was flown without the autopilot it went into a violent series of stalls, dives and steep climbs; but with the autopilot on, it snapped back into level flight within seconds. If inverted when the autopilot was turned on, the plane would roll or loop back into level flight.

The autopilot worked like a dream, and was simple to build. Hill sent details to a team at Wright-Patterson AFB who were also using R/C models for research. In six days the Wright-Patterson team had their own system and it worked as well as Hill's.

Radio-controlled model, piloted by Maynard Hill, comes in for easy landing. Flights such as this proved that autopilot functioned well in gusts and turbulence.

Since then several aeromodelers have built duplicates of the autopilot—a simple device that weighs only three ounces, has no moving parts and costs under \$100.

But what makes it work?

The answer starts with Ben Franklin and his kite. When he flew a kite in a thunderstorm, he gave the first practical demonstration of atmospheric electricity. Since then many men have studied and measured electrical charges in the air, but no one seems to have devised any useful

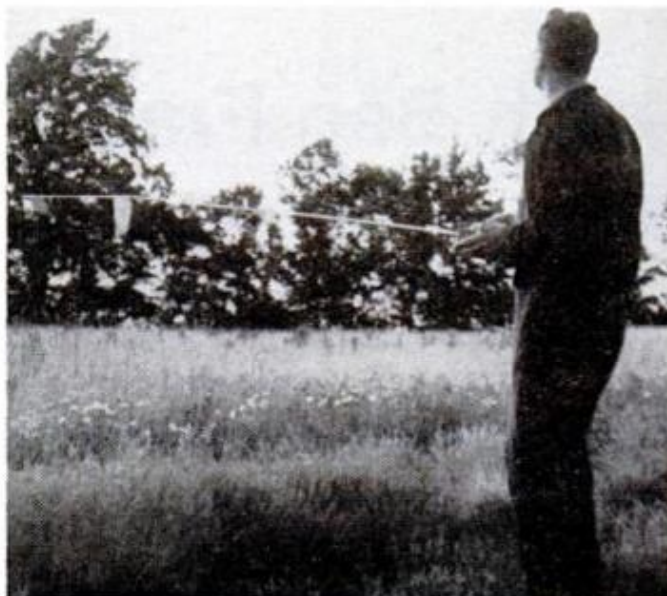

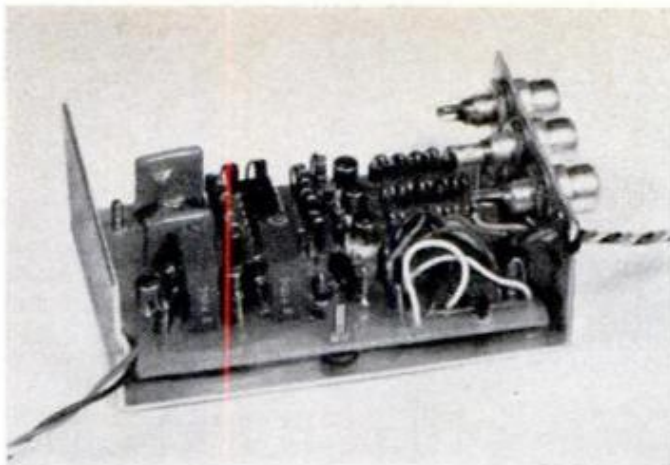

Electrostatic autopilot (left) weighs about three ounces with batteries. It's examined below by Hill (right) and two of his colleagues, Ray Cole (center) and Ben Givens. Hill has flown a radio-controlled model plane to a record altitude of 27,000 feet.

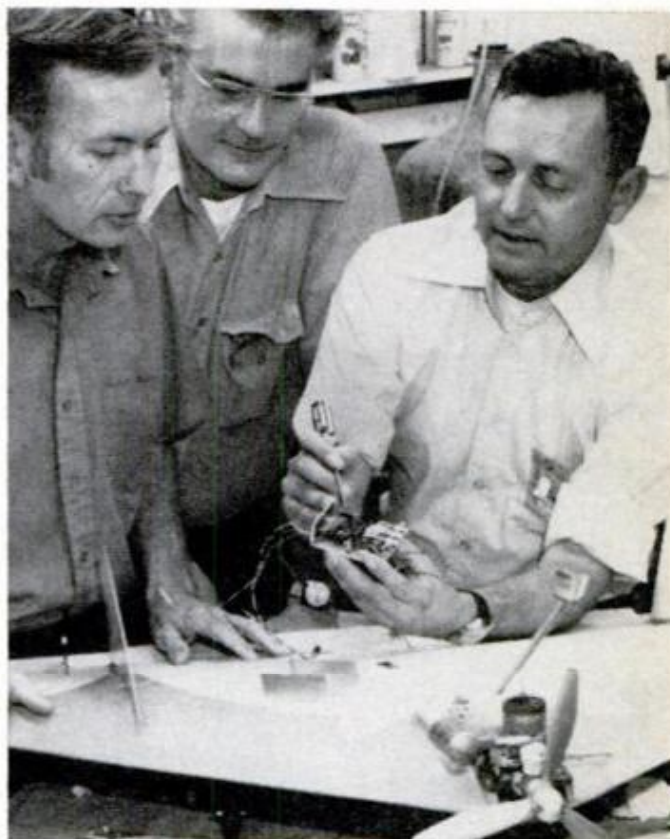

applications. Even Hill and his colleagues made their discovery by accident.

The difference in voltage between the upper atmosphere and the Earth's surface is around 350,000 volts, which is spread throughout the entire thickness of the atmosphere. At ground level, if you stand in the open, the voltage differential between your feet and a point several inches above your head will be about 300 volts. The space between layers separated by one volt is about one-fifth of an inch at sea level, changing gradually to about four inches at 20,000 feet. You don't feel this voltage because the current is too small to sense. Also, the field becomes distorted by your presence and tends to flow around and over you.

These voltage layers encircle the earth like layers of an onion. They are almost perfectly horizontal except for the bottom ones, distorted by buildings, hills and trees. What Hill's autopilot does is sense which layer the wingtips are in and try to keep them both in the same layer.

An obvious question: "What happens in a thunderstorm?" No one knows for sure. Models with the autopilot have been flown within a two-mile radius of visible lightning, and the flights remained stabilized. But full-size aircraft are frequently hit by lightning. So before scientists can think about installing electrostatic autopilots in manned aircraft they will have to learn a great deal more about the effects of thunderstorms and other weather conditions on the electric field.

It is not even known how well, if at all, the system will work in an all-metal aircraft. All the tests to date have been with models with nonmetallic skins. Perhaps the presence of a large metal object—a big plane—will short out the field. If the system is to be used on metal aircraft, the

detectors may have to be mounted on long insulated probes.

But it does work well in models, in good weather conditions. One other application that it appears ideal for is training RPV pilots. RPVs—Remote Piloted Vehicles—are promising to take over many of the more hazardous military missions. In effect, they are highly sophisticated R/C models and an electrostatic autopilot could be a boon to the student RPV pilot; it would keep the aircraft stable for him while he mastered "flying" techniques.

Another possible application is in light aircraft for training students. With an electrostatic autopilot, the instructor could relax, for even the most ham-fisted novice could not stall or spin the aircraft.

But all this, except for the model aircraft application, is pure speculation. As Hill points out, what is needed now is a thorough investigation of the autopilot and its possible applications. The discovery is at the same stage transistors were in 1950. We know that it works and we know roughly how. But we don't know enough details to use the discovery for anything more than a sophisticated and intriguing gadget. ★ ★ ★

A leg-powered machine for easy swimming

by John F. Pearson
SCIENCE EDITOR

On first try, Colleen failed to extend her arms forward and did not generate much thrust. She also should have worn a mask and snorkel. An instructor in the PepsiCo, Inc., employee health program, Colleen volunteered for PM test swim.

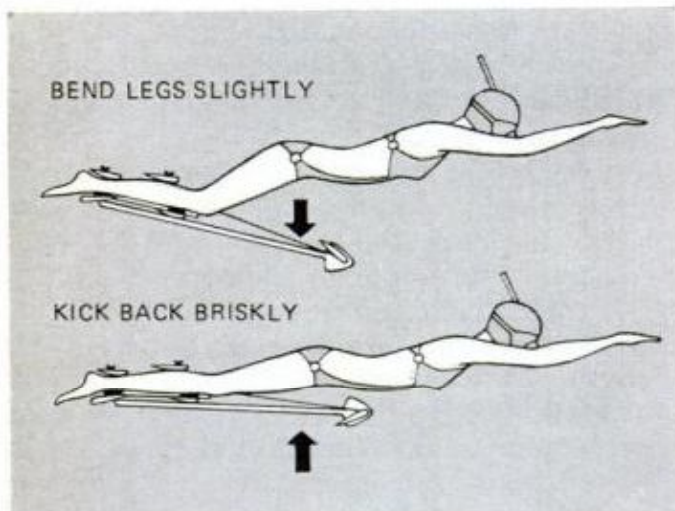
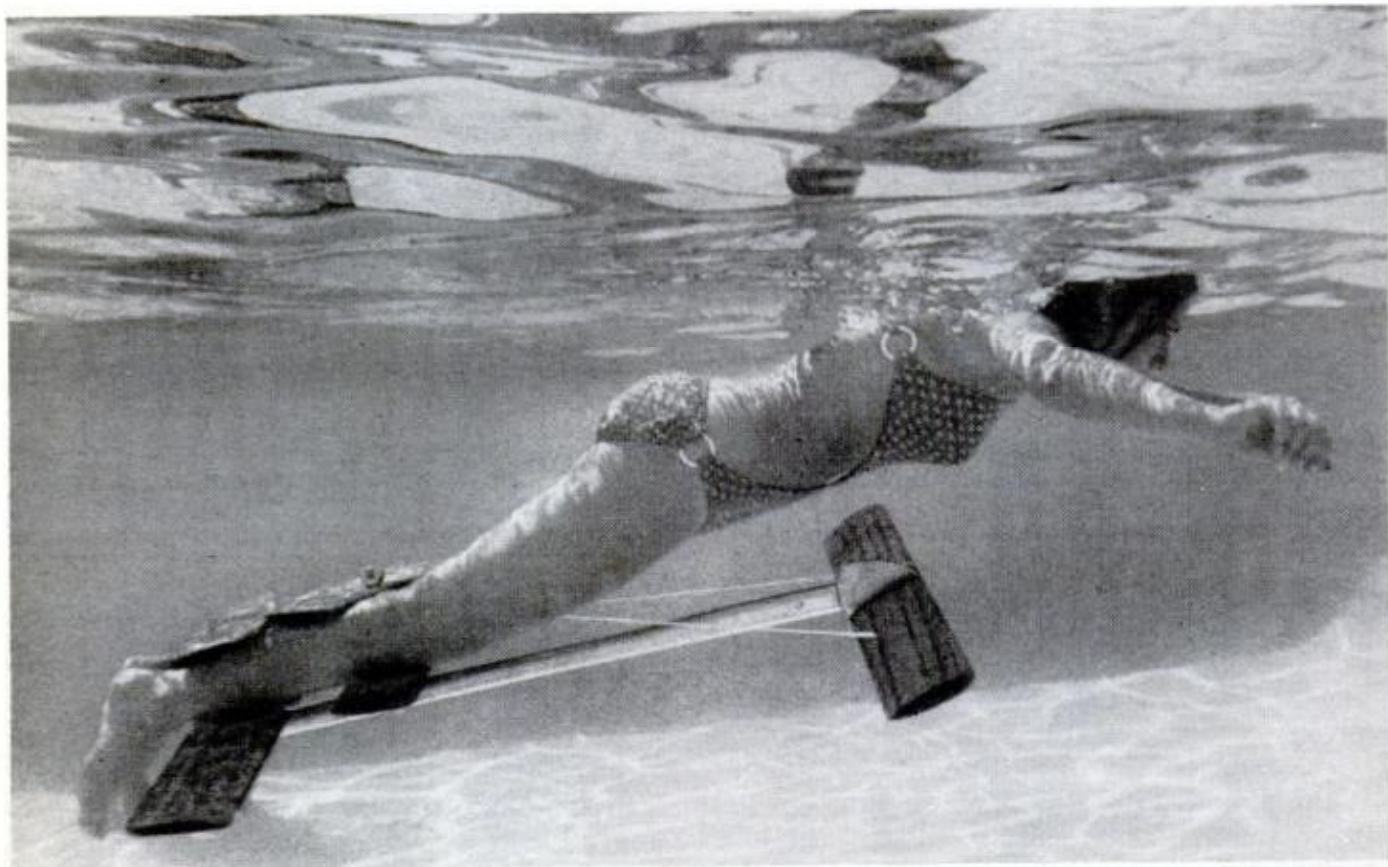

Body should be held straight with head in the water for minimum drag. Note that on return swing the front wings feather, slicing the water as they sweep up toward body.

With his strange-looking Aqueon swimming machine, Cal Gongwer sweeps through the water—banking and turning in large figure-eights—with the ease and grace of a seal. It's a tough act to follow.

When my turn came, I was pleased to find that straight-ahead swimming was not difficult and that I could develop considerable thrust. Another swimmer, Colleen Dunlevy, did all right, too, once she got the hang of it.

The Aqueon is no toy—it's a practical device that allows the scuba diver or surface swimmer to achieve greater distance or speed. It leaves the hands and arms free to carry a camera, spear gun or tools.

The apparatus consists of an aluminum tube and wooden crosspieces. A fixed blade

at the rear acts as a stabilizer and two movable blades or wings in front provide propulsion. Nylon cords connect the wings to a spring. You power the Aqueon by doing a dolphin kick. The front wings move up and down in a sculling action to create thrust.

For best results, you should wear a mask and snorkel. They enable you to keep your face down, eliminating the need to raise your head to breathe. Your body should be fully stretched out, arms extended in front. Your arms are used only for steering; any swimming movements slow you down. The Aqueon requires much less exertion than fins. A few years ago, Gongwer swam the 25-mile Catalina Channel, off California, in under 12 hours. The most impressive part of the feat was that he towed a surfboard carrying a 160-pound man.

You can move fast, too. Aqueon-equipped swimmers can do 25 yards in 8.4 seconds—without a starting dive. Top freestyle swimmers, starting with a racing dive, need 9.8 seconds to cover the distance.

An engineer and expert in hydrodynamics, the 58-year-old Gongwer is in better condition than most men half his age. He swims daily. Out of the water he is a successful inventor and holds a number of patents, many for underwater devices. He says he spent about 20 years perfecting the Aqueon.

The device is available as a kit (\$97.50) or finished unit (\$124.50). It's sold by the Pan Western Research Corp., 1506 Dorothy Lane, Newport Beach, Calif. 92660. ★★

You "mount" the Aqueon by slipping lower legs between rubber-cushioned boards (top photo). For the beginner it's best to accomplish this in shallow water. Once the boards are adjusted to fit your legs, it's no trick to mount or dismount in any depth of water. Though the Aqueon (middle photo) looks simple enough, it's a scientifically designed apparatus. It knocks down into a compact bundle for travel and weighs only 13 pounds. Colleen encountered no difficulty when carrying it into the pool.

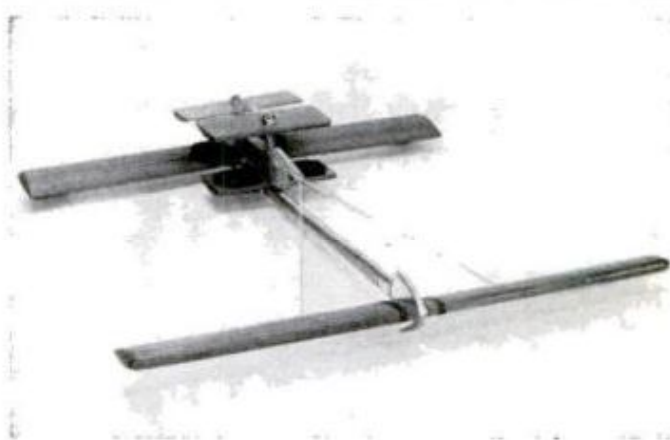
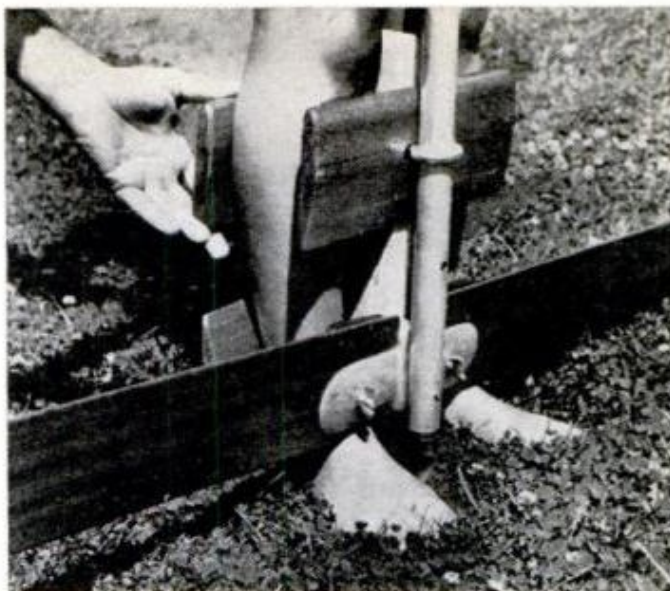

Guns too slick to shoot

These handsome replicas are called commemoratives, and they may be making money for you while just hanging there on the wall.

by Joe Kelleher

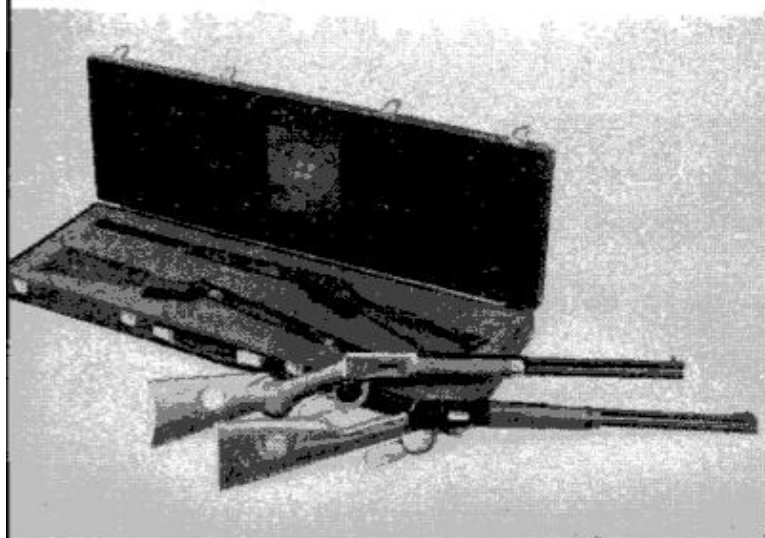

Brace of Marlins in fitted case are .22 and .30-.30. Winchesters are Lone Star and Illinois Centennial.

Guns have always fascinated Americans, and now commemorative models are attracting people who never owned a gun before. True collectors' items, these guns usually have ornate engraving on the receiver or descriptive medallions inset into the stock. Many feature brass trim or old-fashioned octagon barrels. Priced well over market value for similar guns, these reminders of historical events are seldom bought to be fired. Most owners keep their guns in their special boxes or display cases, and some consider them primarily an investment.

Unlike stocks and bonds, commemorative guns rarely decrease in value. Many gun shops discount list prices to some degree but not commemoratives; they usually go for full list. Often limited editions are sold on a special order or reservation basis before production even starts. Current value of any commemorative depends to a large extent on the number of guns issued. Back in 1961, Colt produced a short-barrel .45 single-action sheriff's model, the first of the Lawman Series. Production was 478 pistols in blue at \$130 and 20 nickel-plated guns at \$140. If you can find one today, the blued guns will bring at least \$400. But market value of the rare nickel models is estimated to be a whopping \$800 to \$1000.

Even commemoratives issued in large numbers have increased in value. The Winchester Centennial '66 carbine and rifle are good examples. More than 100,000 were produced, yet they are now worth about 60 to 70 percent more than list. Colt issued more than 24,000 Civil War Centennial pistols for \$32.50 in 1961. Asking price today for these single-action .22s is around \$75.

If you get this collecting bug, specializing can also protect your investment and help it grow. You can select pistols associated with historic personalities, or lever-action rifles of one caliber. Some advanced collectors try to find different commemoratives with the same serial number.

Save the box the gun came in and any booklets with it. Many purchasers of Winchester's '66 Centennial threw the carton away. Those special boxes are worth more than \$25 today. The best guide to what a gun is worth is the \$1 *Price List* published by Cherry's Sporting Goods, Geneseo, Ill. 61254. It's considered a collectors' standby.

Virtually every U.S. gun manufacturer and several well-known sporting goods houses have issued some form of commem-



Colt .45 auto, boxed at top center, is WWI model honoring second Marne battle. Top left: Colt's New Jersey .22; below, .36 R.E. Lee cap and ball. Center, boxed, are Navy Arms Colt .36, Remington .44 replicas. Upper right: boxed Colt .22 Golden Spike Model with commemorative spike. Below right: model of the U.S. Grant Colt .36.

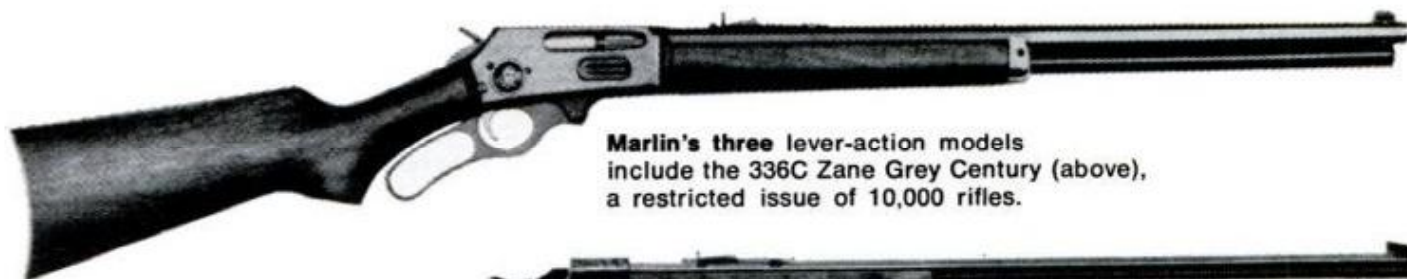

Marlin's three lever-action models include the 336C Zane Grey Century (above), a restricted issue of 10,000 rifles.

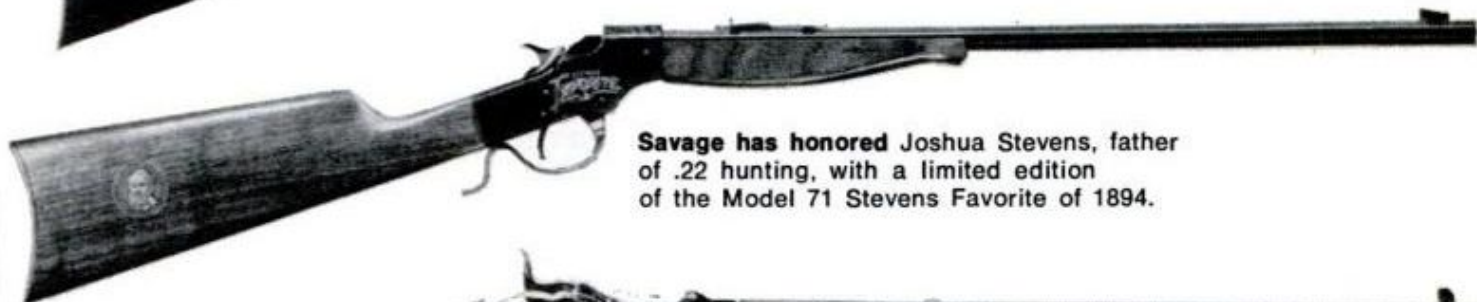

Savage has honored Joshua Stevens, father of .22 hunting, with a limited edition of the Model 71 Stevens Favorite of 1894.

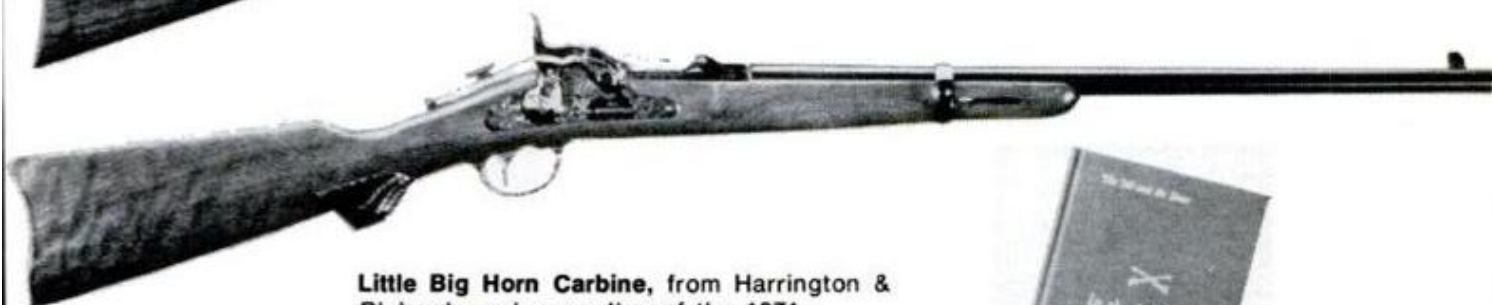

Little Big Horn Carbine, from Harrington & Richardson, is a replica of the 1871 Springfield 45-70, comes with book.

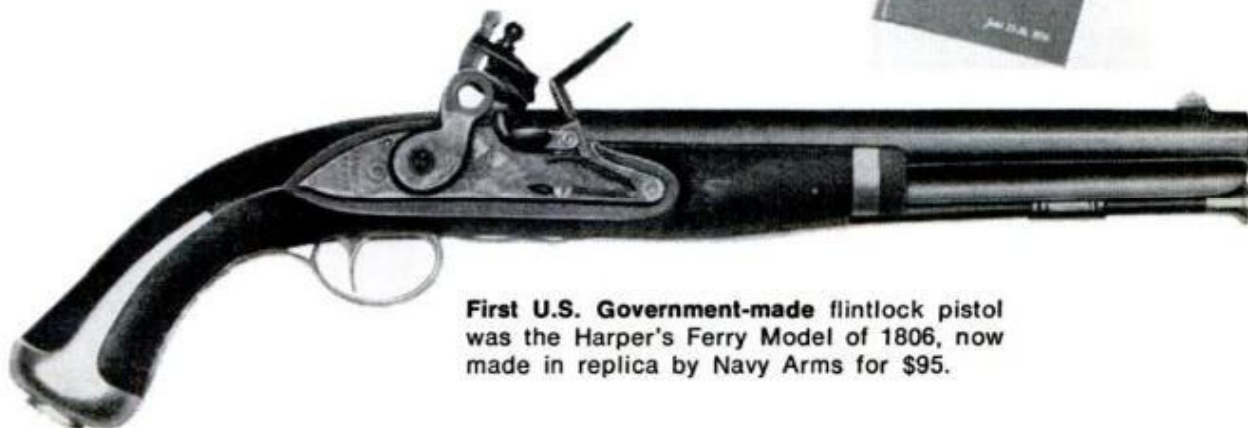

First U.S. Government-made flintlock pistol was the Harper's Ferry Model of 1806, now made in replica by Navy Arms for \$95.

In 10 years, many have doubled in value

orative. The big year was 1971 when NRA commemoratives came out. Even Daisy issued an NRA Centennial carbine. Some makers like Colt and Winchester issued their commemoratives with fanfare, while Remington, the country's oldest gunmaker, celebrated its 150th anniversary quietly. In 1966 Remington issued seven different shotguns and rifles to celebrate. They had "Remington Arms Company, Inc. 1816-1966," and a flintlock rifle design surrounded by scrollwork engraved and gold filled on the left side of the receiver. Most of these guns are being used by happy hunters, but the entire series in mint condition would make a fine collection.

Colt is the big daddy of commemoratives and started the ball rolling with the 125th Anniversary Model of the single-action .45 in 1961. Since then, Colt has issued more than 100 commemorative pistols, mostly single-action models chambered for .22 or .45 cal. In 1967 Colt started its World War I series with a \$200 specially decorated and inscribed .45 Auto commemorating the Battle of Chateau Thierry. Since then, three more WWI models at \$220 and two WWII guns at \$250 have been issued. Deluxe and Special Deluxe versions list for \$500 and \$1000 now.

One recent Colt issue is the matched set of Robert E. Lee and Ulysses S. Grant Commemorative Navy Model .36 cap and ball pistols. The handsomely cased pair with powder flask, bullet mold, nipple wrench and tin of percussion caps was offered for \$500. The fitted, velvet-lined black-walnut case makes an attractive display for any den or study. Only 250 matched sets were produced; resale value should rise rapidly.

Savage Arms Anniversary Edition of the 1895 rifle was issued in 1970; some may still be at gun shops. This collector's model features a crescent-shaped brass butt plate, inlaid brass medallion on the stock, gold-filled engraving on the blued receiver, brass-finished lever and cartridge carrier and a Schnabel fore-end. The 24-inch tapered octagon barrel is chambered for the .308 Winchester (7.62-mm) cartridge and tipped with a brass blade front sight. Production stopped at serial No. 9999 and the price was \$195. While a true commemorative, the gun is based on the famous Savage

Model 99; many purchasers will find it hard not to try the 1895 for hunting.

For collectors sticking to .22 cal., Savage offered the Model 71—a limited edition of the famous Stevens Favorite—for \$75. A medallion on the stock is inscribed "Joshua Stevens, father of 22 Hunting," and the case-hardened receiver has "Stevens Favorite" inscribed in gold on both sides. Model 71 has a 22-inch octagon barrel, Schnabel foregrip and gold-plated lever and hammer. The Favorite, issued in 1894, was the first rifle chambered for the .22 long-rifle cartridge developed by Joshua Stevens.

Iver Johnson started producing single-shot percussion pistols in 1871, and 100 years later the firm that still bears his name issued a set of Centennial Commemoratives to honor the founder. Available only in .22 cal., four revolvers were offered as singles or a boxed four-gun set with the same serial number. Limited to 450 sets, the four guns are the M-67, M-50, M-55A and the M-57A. The blue/black revolvers have six-inch barrels, polished hammers and triggers, gold front sights and the gold lettering "1871 IJ 1971" in a square on the frame. The four-gun set retailed for \$298.50; single-cased guns, from \$69.50 to \$85.

Winchesters won the West and are leading the field in total commemorative rifles. Their first was a modified Model 94, The Wyoming Diamond Jubilee Carbine, produced in 1964. Real interest in commemorative Winchesters started in 1966 with the Centennial '66 rifle and carbine. Called Old Yellow Boy because of its brass-colored receiver and butt plate, the Model 1866 sold like hot cakes from a chuck wagon. Winchester added significance to many models by issuing them in conjunction with historical organizations. For example, the Buffalo Bill rifle and carbine had the endorsement of the Buffalo Bill Memorial Assn. More than \$500,000 in royalties were paid by Winchester, enabling the association to enlarge its museum in Cody, Wyo.

Commemorative rifles have also been issued in conjunction with the Theodore Roosevelt Assn., Golden Spike Centennial Commission, Game Conservation International, National Cowboy Hall of Fame and National Rifle Assn. Purchasers of these

(Please turn to page 185)



1



3



2

1. Iver Johnson sets of four Centennial .22-cal. revolvers were limited to 450 having the same serial number, \$299.

2. High Standard Olympic Commemorative Model .22 Supermatic Military Trophy was timed for '72 Olympics, priced \$550.

3. First Smith & Wesson commemorative honors 150th Texas Ranger anniversary with a Model .357 Magnum, Bowie knife.

4. For a do-it-yourself replica, a \$100 kit from Numrich Arms provides building parts for muzzle-loader Minuteman rifle.

4

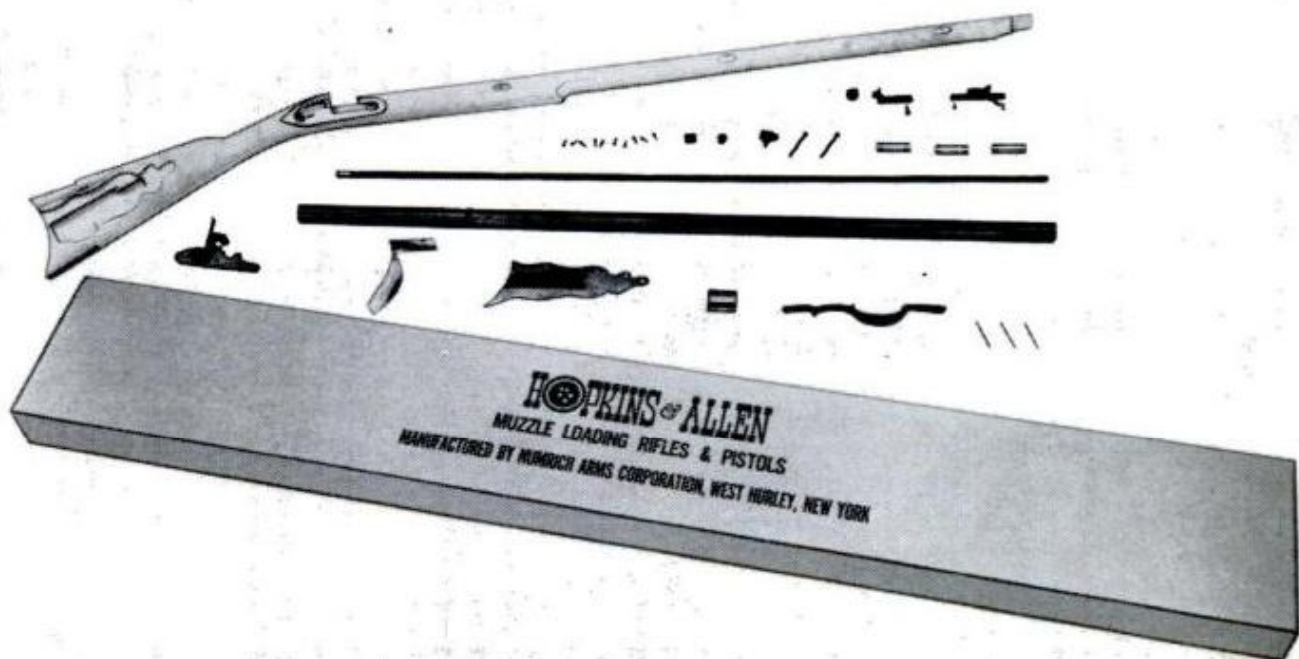

A 'black box' that tests boats



Maneuvering at speed is one good test of boat stability and safety. Black-box readouts and observations of this tri-hull showed it could handle its rated power safely, might use a higher-horsepower motor.



Swinging wide around marker buoy on test program's slalom course, the driver is dodging an imaginary swimmer or log ahead while reading the boat's stability rating on the meter of the black box.

PHOTOS BY AL LIMBURG

A meter dial may soon be pointing out good boats—and bad ones

by Red Marston

How much horsepower you can clamp on the back of your outboard boat used to be determined by the size of motor you could afford. Too often it seemed to be the bigger, the better.

Now bigger engines and new boating laws make using excessive horsepower impractical, illegal and dangerous. Overpowering has been found to be one cause of boating accidents. Presently, the Coast Guard requires all outboard craft to have a capacity plate stating the weight load of passengers and the amount of horsepower a boat can safely carry. A formula that computes boat length times transom width in feet is applied to a table of coefficients, and the result is the highest horsepower allowed.

This is considered a generally reliable method, but recent tests made in an on-the-

water evaluation at Naples, Fla., proved again that performance is also considerably influenced by hull design. Two boats with almost exactly the same dimensions, according to the formula, may perform differently with the same amount of power. Could a set of instruments be assembled to determine if a hull and motor combination was safe and efficient? Boating engineers from across the country came to find out.

It was decided tests should explore the tricky relationships between boat shapes and horsepower limits under conditions where sudden maneuvering has to be done. A slalom-like course, similar to that used by water skiers, was laid out. A total of 43 boats made 292 test runs over it. Each had an instrument package installed to record signs of instability and grade good matching of hull and power.

Tests were conducted by the Boating Industry Assn. (BIA), and the Outboard Marine Corp. test center at Naples was headquarters for the massive job of rigging over three dozen new boats with various horsepower combinations—some deliberate-



1 Experts on shore noted performance of boats running through course traps to be certain black-box readings correlated with real characteristics of hull at speed.



2 Spinning out in a spray shower, hull hidden here behind a water wall showed it could not handle rated power, became unstable in a tight emergency turn wide open.



3 Black-box engineers set up rig so meter at helm position would give constant stability reading as cockpit instruments recorded.

4 Outboard hulls of all varieties, 43 in all, were rigged for speed stability black-box tests. Many proved under or over-power-rated.



HORSEPOWER CAPACITY TEST COURSE

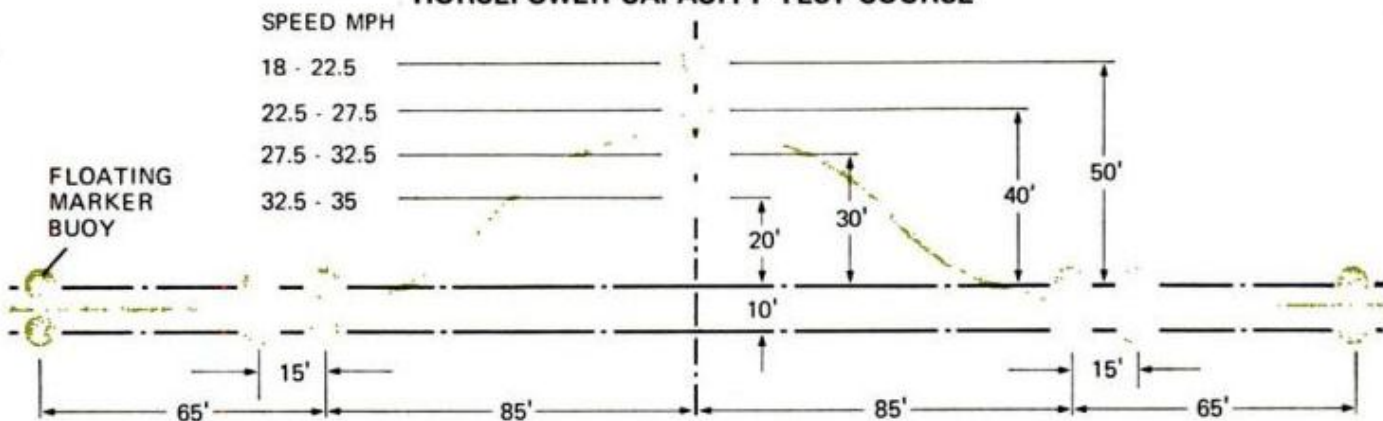

Craft with top speed of 27.5 to 32.5 mph drives course shown to swerve around obstacle buoy, test handling.

ly over the formula limits—to test reactions on the water. Driving over the courses was handled by experienced boat testers. A “jury” of expert observers watched carefully to insure that the instruments recorded all signs of instability.

The boats, from 13 to 24 feet long, were first clocked over a measured distance to determine top speed in miles per hour. Craft topping 35 mph ran a longer course with 120 feet between the maneuvering markers and only a 10-foot deviation for speeds above 42. One of the theoretical considerations of the course was a boat operator having to make a violent turn to avoid a swimmer or floating log. The instrument package, referred to as “the black box” by the test participants, was programmed to

record stability on a 1-to-10 scale. The more unstable, the higher the readings.

A week of testing showed Donald Reed, director of engineering for BIA, that Coast Guard regulations now based solely on the industry-developed formula should be amended to allow boats to be rated by a test-course method. Test results showed some boats tended to spin out during maneuvering with recommended power, while others could handle additional push. Tests with the black box might also point out a bad hull design before it went into production, and it is hoped the box will be available to boat builders within a year. Meanwhile, boat owners, even without the “black box,” can experiment with their own test courses—carefully.

★★★

New line on boat ropes

The latest slippery synthetics are hard to knot but more than twice as strong

by Bob Whittier

Go to your marine dealer to buy some rope and you are likely to find yourself staring at a bewildering assortment. Today there are so many colors, sizes and types of material that you may be tempted to pick one kind and try to use it for every purpose afloat or, worse still, go back to using an old length of clothesline.

Effective and safe handling of even the smallest boat requires the use of rope, so a working knowledge of modern cordage is indispensable. Some of the new synthetic ropes are so superior that they can save you a lot of money and possibly your boat as well. Often craft that have gone adrift from dock or mooring are seen with broken lines of the wrong type and size.

In ropemakers' language, anything one inch in diameter or less is called "cordage." As the size decreases, the words to use are rope, cordage, twine and string, in that order. For boatmen, the word "rope" refers to the product only while it is still in the store. Once aboard, it becomes "line" such as dock line, anchor line, towline. Light ropes (actually cordage) used to hoist sails and flags are called halyards. The rope used to position the boom of a sailboat is called a sheet.

Old boatmen had to be familiar with natural fiber ropes such as manila, hemp, sisal, henequen, coir, linen and cotton. Manila is the only one of these still in much use afloat. Cotton used to be favored for lines aboard sailboats because it had a good "hand," which meant it was comfortable to grasp. Now it is being replaced by more durable synthetics. Never use an old cotton clothesline as a dock or anchor line; it's likely to break and you'll lose your boat.

Sisal rope today is mostly a rough grade offered in 50 and 100-foot lengths in bargain

stores. It has about 80 percent of the strength of manila and suffers from rotting. Though cheap and useful for binding bundles ashore, it should not be confused with stronger manila.

Manila rope is still universally available and is often the only kind at hardware stores far from yachting centers. It appears low in price, diameter for diameter, when compared with synthetics, but the latter are usually 150 to 290 percent stronger. A thinner synthetic can be selected to do a given job safely, and the first cost then is not so much greater. It lasts so much longer than manila that the final cost is even lower.

Manila has its good and bad points. It will take any common knot or splice easily and dependably. It is easily grasped and held, and is still popular for anchor lines on small boats where sunlight soon dries it out. But if stowed while wet in a rope locker,



Above and below the water, nylon has the stretch to absorb wave shocks, plus life to fight off borers, rot.

it will quickly lose its strength from rot. It is also hurt by acids, oils and other chemicals.

Used as a mooring line in the water, it can be attacked by pollutants, slime and marine borers. Constant immersion accelerates deterioration of its vegetable fibers and it can lose 50 percent of its strength in one summer. It can, however, be bought treated to resist rot and marine growths, and a boatman can treat his own manila with rope preservative.

Popular synthetic ropes include nylon, polyester (sold under trade names like DuPont's "Dacron"), polypropylene and polyethylene. There are others, and some special-purpose synthetic ropes made of blends. A boatman may encounter many trade names; study manufacturers' literature to sort these out. Most pleasure boatmen can get along with the four basics mentioned above.

Nylon rope is up to 290 percent stronger than manila and considerably more durable. It does not rot and is not attacked by marine borers. It can last five times longer than manila, but can suffer from prolonged exposure to sunlight and sometimes stiffens after long immersion in colder water. It is slightly heavier than water and sinks. Nylon's outstanding characteristic is its elasticity. It stretches under load and has excellent shock resistance. It makes a good anchor, mooring or towline but is poor for

lines used to adjust the set of sails and is sometimes tricky when used on a winch. Because it stretches under load, some knots tend to jam tighter in it.

Dacron rope is called both Dacron and polyester, depending on the maker. It has slightly less sheen than nylon, and is about 220 percent stronger than manila. Like nylon, it is resistant to water and chemicals, will not rot, can safely be stowed while wet, and will sink. Its outstanding characteristic is that it stretches very little. This makes it favored for lines on sailboats that are used to hold sails in place in the proper shape. Dacron makes a poor anchor or mooring line because it does not stretch to absorb jerks.

Polyethylene and polypropylene rope are much alike. Polyethylene has about 160 percent more strength than manila and polypropylene about 175. Both gain about five percent strength when soaked in water, where nylon tends to lose five to 10 percent. Both are rot and mildewproof and are highly resistant to common chemicals. They are less elastic than nylon, more so than manila, and make good general-purpose toelines. A water-ski line, for example, should not be too rubbery. The outstanding feature of polyethylene and polypropylene ropes is that they float on water indefinitely. As toelines they will not sink and foul the towboat's propeller. In some forms, they tend to be stiff and hard and often do not hold knots very well. Clips and splicing are

Rope used for winches
(from left): steel, nylon, solid braid and diamond polyethylene.



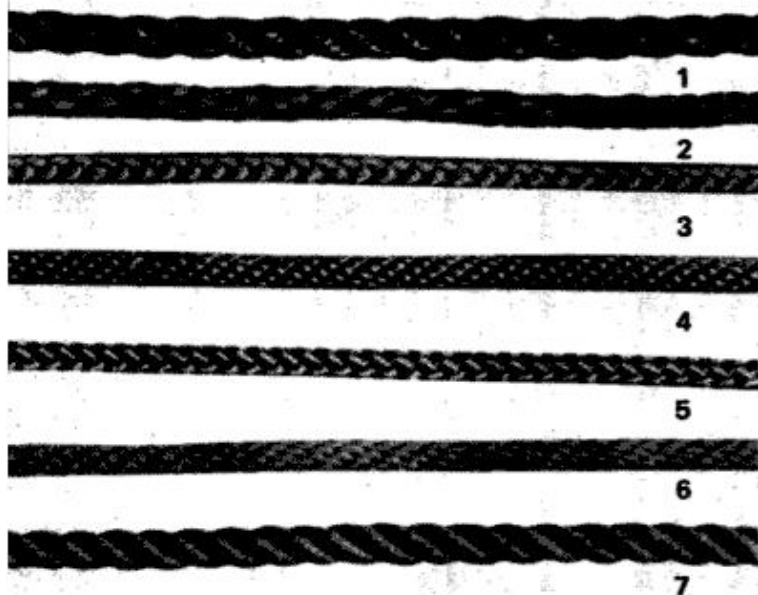

Old and new ropes include twisted manila (1), diamond braid polyethylene (2), pimm sheet for comfortable handling (3), solid braid nylon (4), V-braid nylon (5), solid braid polypropylene (6) and twisted cotton (7). Choice depends on strength, price, "hand," long life.

used to make secure connections. The use of these ropes is growing rapidly.

Any suitable material can be made into rope, either by twisting or by braiding. Common manila is an example of twisted construction, common sash cord of braided. The machinery used makes twisting faster and usually a cheaper method—a useful point to know when comparing ropes.

Modern synthetic fibers are made by extrusion. The material in liquid state is squeezed out of a tiny nozzle like toothpaste from a tube, after which it hardens into long filaments that are wound on spools or bobbins. Rope made from continuous strands like this is called monofilament rope in contrast to spun rope made from short strands. Some synthetic ropes can be slippery, so for certain uses where a good hand grip is necessary, such as in commercial fishing lines, sailboat sheets, and industrial uses, the monofilament can be chopped, spun into yarn and made into spun synthetic rope. Since the strength of any spun rope depends on the friction between the many filaments for resistance to slippage between the strands, spun synthetic ropes tend to be less strong than monofilament ones of identical synthetic material, although generally above the strength of manila.

When a twisted rope is bent sharply, strands on the outside of the bend are stretched and may break. Strands in braided rope lie more diagonally to the rope's length

and are strained less in a bend. Braided rope is favored for sailboat lines for this reason when it must go through pulleys. Often sailboat lines pass through jam cleats and deck winches and need uniform diameter and compression to work well. Solid or "double braided" rope, rather than "hollow," is best for this. Hollow braided ropes are used for ski tow lines, small anchor lines and jobs having few or no pulleys.

While synthetics will usually accept and hold knots, there are pointers to know. Knots that depend on friction can be less reliable when used in a slippery rope. Nylon can slip excessively when used to make a common cleat hitch or square knot. A stiff braided rope can tend to "back off" some knots and hitches. Rope makers publish pamphlets with good advice on selecting knots to match your rope; your marine dealer may have some. The average boat owner is safe with the general rule that a rope's working strength should be only about one-fifth its rated breaking strength. For a small boat, a thin synthetic may be strong enough but hard to handle so it is worthwhile to buy a larger diameter that is easier to use.

Synthetic ropes are now available in a variety of colors, with a light coffee color recently popular for yachting use. Olive drab synthetic is frequently military surplus that may be overaged. Colored strands woven into a rope may be a maker's trademark or indicate special-purpose rope. Check the maker's literature. Polypropylene and polyethylene use colors to make them more visible while floating on the water.

While water and rot are the enemies of natural fibers, sunlight tends to damage synthetics. Store them in a cool shady place if possible to take full advantage of their long and useful life. ★★★

Which rope to choose—where to use it

- Sisal:** For economical bagging, wrapping ashore.
- Manila:** General-purpose economy use. Don't store damp. Treat with preservative for underwater use.
- Dacron:** Use as sailboat lines for high strength and low stretch.
- Nylon:** Dock, anchor, mooring lines where stretch acts as shock absorber. More expensive, stronger, longer life. Won't rot, but hardens in sun.
- Polyethylene and polypropylene:** Use for floating line for ski towing. Slippery, holds knots poorly.
- Strength ratings:** Manila, 100 percent; polyethylene and polypropylene, 160 to 175 percent stronger than manila; nylon and Dacron, 220 to 290 percent stronger than manila. For boat use, choose diameters that are easy to handle.

Bow for far-out archers

by Penny Nicolai

PHOTOS BY MARIO ROMO



Cable system increases bow strength while front rod balances it.

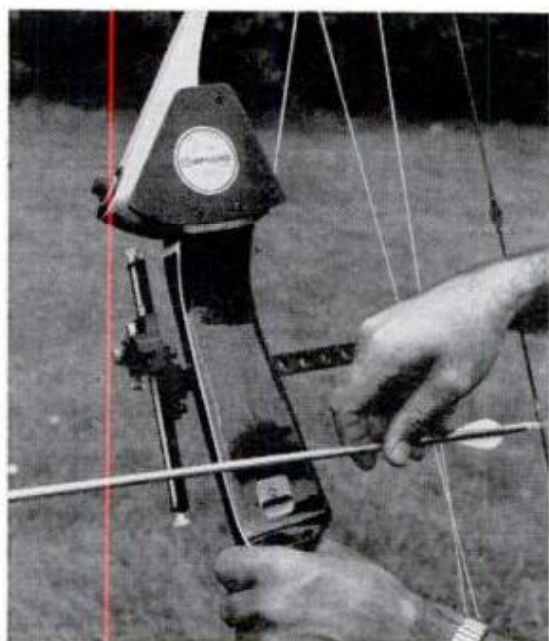

Sight can be set for range and windage.

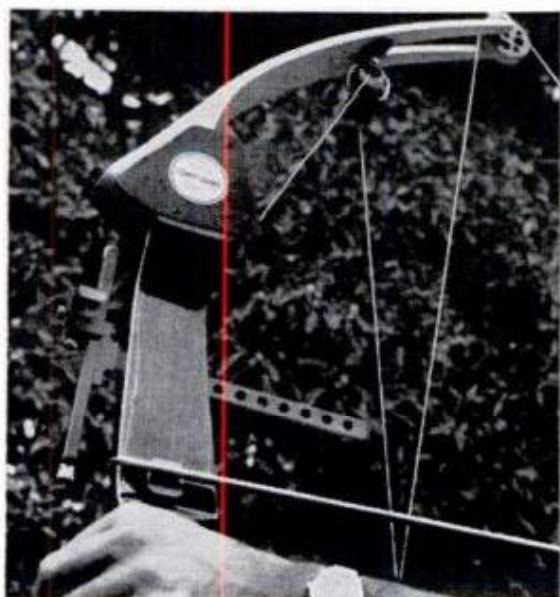

Eccentric sheave tops limb for added push.

The English longbow was good enough for Robin Hood and several centuries of other archers, but now science has stepped in. Today's bows are laminated, recurved and equipped with sights, and now there is a trussed-up model that could have caused nightmares in Sherwood Forest. It's called the Jennings Compound Bow, has 75 parts, and looks like a rigger's puzzle with its jumble of sheaves, cables and eccentrics.

The block-and-tackle system of crossing cables, however, is designed to make it impossible to bend one limb more or less than the other, adding to stability. With less limb movement needed and less inertia to overcome, the increase in force is said to improve arrow speed by 20 to 50 percent.

At the end of each limb is a small wheel with its axis off center. These eccentrics act as levers. In effect, they increase the length of the bow, decrease the pull weight at full draw, and make holding much easier while aiming. The eccentrics also create an acceleration of the string on arrow release that is claimed to be smoother than with recurve bows and allows use of lighter arrows because of less distortion.

The compound bow can be disassembled for storage or left strung without damage. Individual limb flexibility as well as bow weight is adjustable. The model shown is fitted with a Williamson Miletron scope and a stabilizer jutting out in front. A tournament bow costs about \$250 from Jennings Compound Bow Inc., 10945 Burbank Blvd., North Hollywood, Calif.

And is this bow more accurate? All bows are inherently accurate if properly used. Putting an arrow in the center of the target is still up to the archer. ★★★

Cars the Red Baron would love!

The dogfighters you meet on the road are in for a tough scrap against the superb performance and handling of these two new German imports—passenger cars, at that!

by Bill Hartford
AUTO EDITOR

Cars made in Germany are special in a lot of ways. Even GM brags about "German precision imported by General Motors" when they talk about the Opel. What German craftsmanship means to the average driver who's simply looking for a "good car" is that the doors close gently with a *click* and a *clunk* instead of a "slam!"

It means something else entirely for drivers who know that cars made in Germany are designed to spend a good part of their lives running flat out on autobahns because there are no speed limits! The enthusiastic driver probably also knows something about the history of the racing cars, and the production cars, made by Audi, BMW, Opel, Mercedes-Benz and Porsche. And he certainly is concerned with the vehicle dynamics of any car he's driving because they affect the decisions he makes behind the wheel.

The average driver who takes a close look at the new Audi Fox or the Mercedes and sees how they are put together will appreciate that they are "good cars," but it will take a turn behind the wheel and an above average interest in cars to realize *how good*. In the case of the Mercedes-Benz 450SE, or longer-wheelbased 450SEL, it is simply the best-engineered, safest, produc-

Flying high, the new Mercedes-Benz 450SE pulls Gs against the test-track wall while a pair of Audi Foxes dice through the pylons in a display of maneuverability.





tion passenger sedan you can buy in the United States. When that is what you want (and there's only one place to get it!), the SE's price of \$13,500 is not unreasonable—not when domestic “luxury” sedans, comparably equipped, are pushing \$10,000. It is not even really a fair comparison: Most often, the purchaser of a Mercedes is concurring with an engineering philosophy that he wants and gets in a Mercedes-Benz automobile; too often, the buyer of a domestic, luxury car is seeking something else, not necessarily having anything to do with cars or their real worth.

In the case of the Audi Fox, it is, at \$3399, the best car in its price range that is at once an economical family sedan and a lightweight acrobat that will do everything you want it to—except Immelmann turns! The Fox weighs a scant 1840 pounds (over 100 pounds lighter than the VW Super Beetle) which is the prime reason it moves out so smartly with a liter-and-a-half displacement.

The engine is a 1471-cc, water-cooled, overhead-cam, in-line Four that nets 75 hp at 5800 rpm. That results in a favorable power-to-weight ratio and you can expect 0 to 60 times in the 10-second range. Top

speed should be close to 100 mph at the 6500-rpm redline. We ran the car at Palm Beach International Raceway but didn't top 90-mph before having to brake at the end of the straight (front discs and rear drums are in a dual-diagonal circuit and are vacuum-assisted).

It is under heavy braking especially with unequal traction between left and right wheels that the car's “self-stabilizing” steering geometry does its job. A skilled driver could prevent a locked-wheel skid from developing into a spin, but with negative kingpin offset (see technical drawing), there's no need to work at controlling the car; the locked-up wheel is prevented from wrenching the car's steering. It works so well that the Fox can be hauled down to a stop with hands off the steering wheel, while one side of the car is running on a slippery, soaped-up surface as we witnessed at the Raceway.

It is this stability, and the fact that the Fox does not compromise a smooth and steady ride for light weight and nimble handling, that should make the car attractive even to drivers used to the dubious comfort and security of a “big-car ride.” That's not to mention a 91-octane fuel con-

sumption that we estimate to be around 30 mpg and never under 25 mpg, not even in hard, high-speed driving.

The Fox is also convincing that a car can be small outside and big inside. (It's 164.4 in. long, 63 in. wide and 53.9 in. high on a wheelbase of 98.2 in.) The interior is roomy, comfortable and neatly laid out. There's plenty of headroom, which is only slightly reduced when the optional sunroof is fitted, and seats are fully reclining.

Everywhere there is a sense of order and neatness that is perhaps greatest under the hood. What catches your eye first is the transparent cover on the fuse and relay box. Through it you see all the fuses lined up in a row. And, like VWs, the car is equipped with plug and wiring for computer diagnosis. Service intervals are every 10,000 miles.

The Fox is fascinating enough by itself, but it is even more intriguing since VW will soon have a version of the car that will differ only slightly.

A Fox running 90 to 100 mph on the autobahn still has to move over for a Mer-



MERCEDES-BENZ 450SE/SEL FRONT SUSPENSION

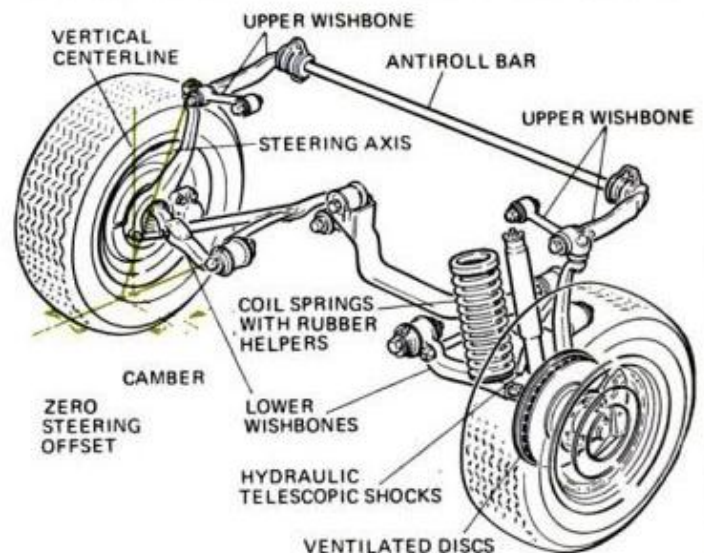

Mercedes 450s are four-door, luxury sedans with near-race-car handling. Front suspension, in fact, was developed for the C-111 experimental sports car (See "The World's Most Advanced Car" page 88, Jan. '70 PM). Car uses no front-axle carrier or "subframe." Pivoting axes of upper and lower wishbones are nonparallel, designed to cross each other for antidive control under braking, which is only one benefit of front geometry (see text). Front seat's three-point shoulder/lap belts retract into body pillars, and antidazzle wing mirror, adjustable from inside, breaks away under impact.

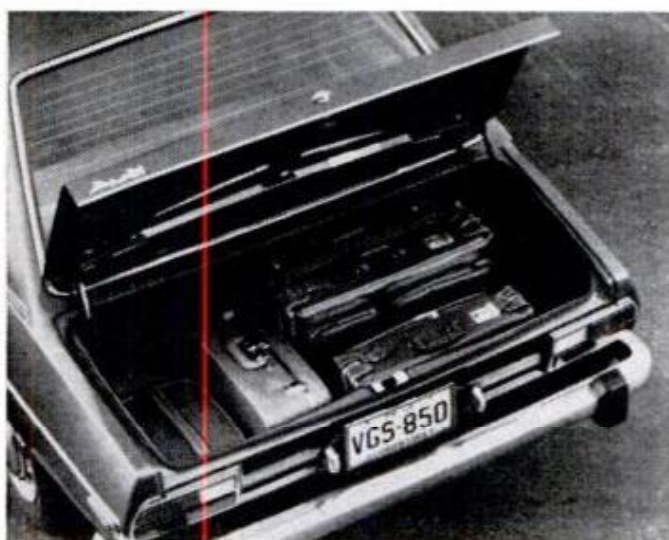

**AUDI FOX
FRONT SUSPENSION**

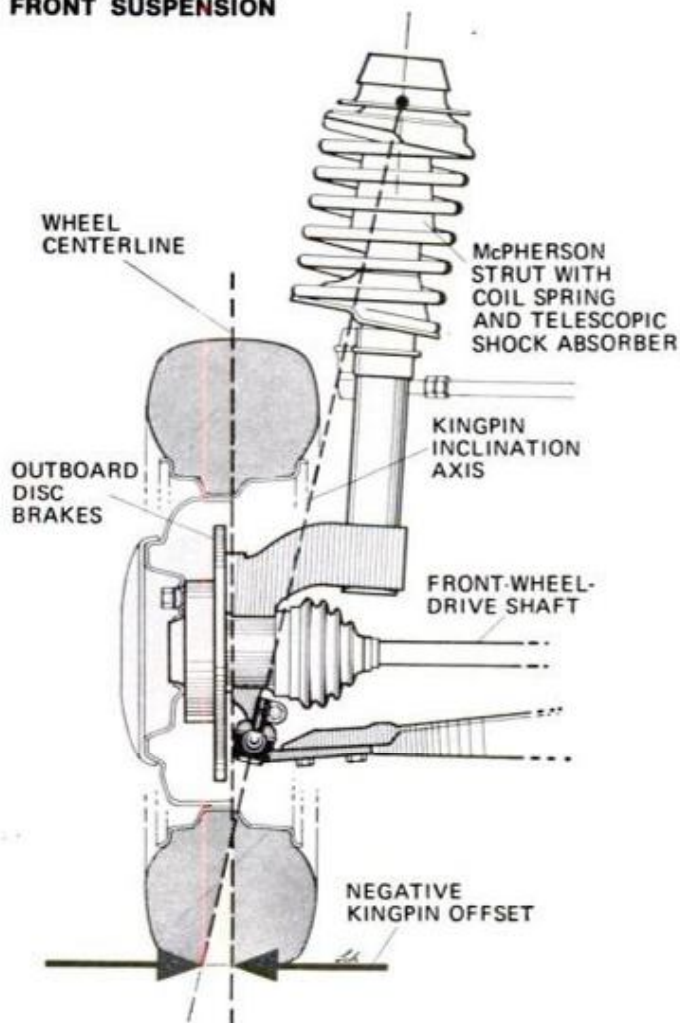

cedes-Benz. A 450SE or SEL is capable of closing at speeds greater than 130 mph. We drove the SE at an indicated 130 mph earlier this year and realized that what is so extraordinary about the car is not that it is a luxury passenger car capable of getting up to that speed, but that it has been designed and engineered to be at home at such a speed, that it puts minimal demands on the driver and that it stops quickly and controllably from that speed.

That's why driving it at 60 to 70 mph around the New York area recently was such an interesting experience: you knew that no matter what the road surface, how sudden the maneuver or panic stop, the SE was trifling. And I think that most drivers will be able to feel this even if they have not driven it at speed. Even a simple test drive is a consummate driving experience.

A feeling more quickly experienced when you first drive the car is not its amazing stability in sudden, violent inputs to the steering, but its easy maneuverability:

(Please turn to page 179)

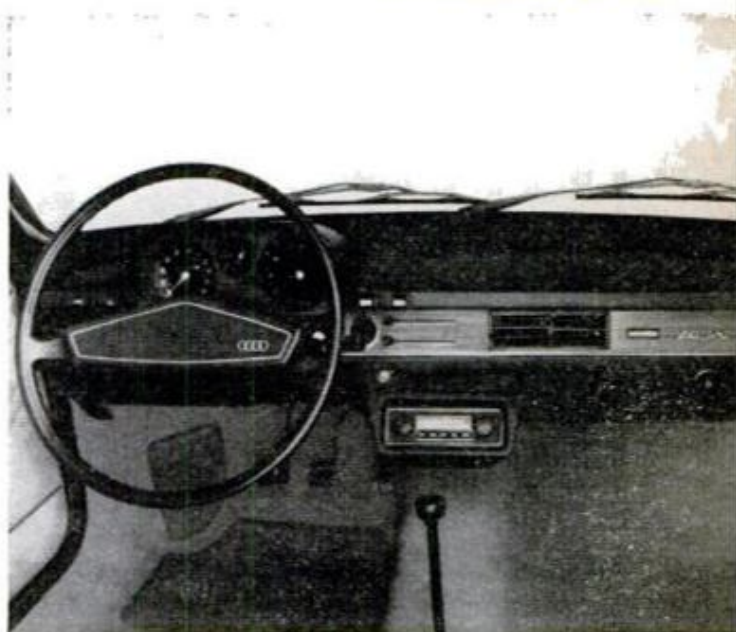

Audi Fox is a front-wheel drive sedan available in two and four-door models. Introduced last year in Europe as the Audi 80, it has clinched an enviable list of "Car of the Year" awards. Workmanship is impeccable, acceleration surprising and handling safe and predictable. The "self-stabilizing" steering system works on principle of negative kingpin offset (positive on most cars) to provide a restoring torque under braking. Interior layout is roomy and neat. Four-speed synchro is standard; three-speed automatic transmission is optional. The trunk is especially large for the size of the car.

Four electronic kits for your car

by Ivan Berger
ELECTRONICS EDITOR



PHOTOS BY ROBERT D. BORST



Flanked by two tachometers (left, ArcherKit tach from Radio Shack; right, SWTP digital) are Radio Shack's Archerkit windshield wiper delay (center left) and Eico's Model 1080 inverter/battery charger.



Today's cars are full of electronic circuits, from radios and tape players to tachometers, windshield-wiper controls and various types of alarms. But if your car lacks any of these gadgets, you can add them with do-it-yourself kits.

We checked out four such kits from three manufacturers: an Eico kit that doubles as both an inverter for running a.c.-powered tools and gadgets from your car battery and as a battery recharger; a Radio Shack ArcherKit that operates your windshield wipers in bursts to clear off light rain, and two tachometers—a dial-type ArcherKit and a digital tach from Southwest Technical Products.

The Eico 1080 inverter is just one of three such kits. The lower-priced 1070 and 1075 are lower-wattage units (110 and 160 watts respectively) than the 220-watt 1080, and only the 1080 doubles as a battery charger. That's logical, since the more power drawn from your battery (unless the engine's running, of course), the more likely it is to go dead.

As an inverter, the 1080 can run many 117-volt power tools, vacuum cleaners or other devices you may want to use in your car—even several at once, as long as they draw less than 220 watts total. Draw more and you can damage the unit, so no toasters or coffeemakers for roadside snacks. (We even blew the output transistors trying the unit with a too-hefty electric drill.) Like most inverters, the 1080 doesn't necessarily deliver an exact 60 Hz., so you can't usually drive clocks, tape recorders and phonographs with it. And since the output is an unfiltered square wave (not the smooth a.c. sine wave you get from the power company), radios or receivers powered from

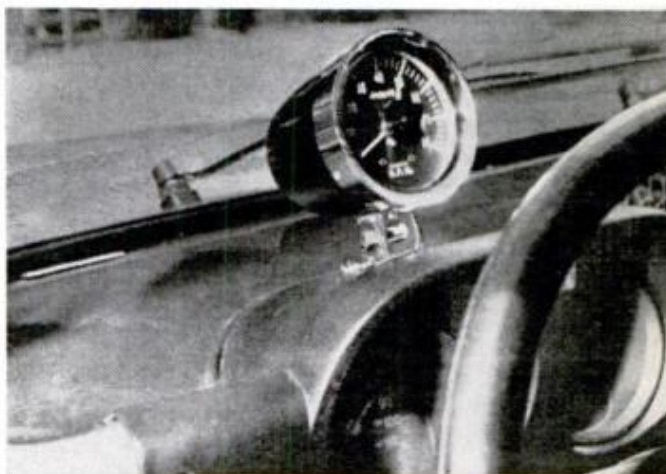

ArcherKit tachometer mounts on your dashboard (top) or under it—just swivel the tach within its case. The kit is an easy one to assemble, and takes but five hours, plus another hour or two for installation.

Eico inverter converts 12-volt power of your car's battery to 117-volt a.c. so you can run small tools and appliances. Small number of parts (center left) and the wide-open construction (near left) make it easy to build this kit in four hours.

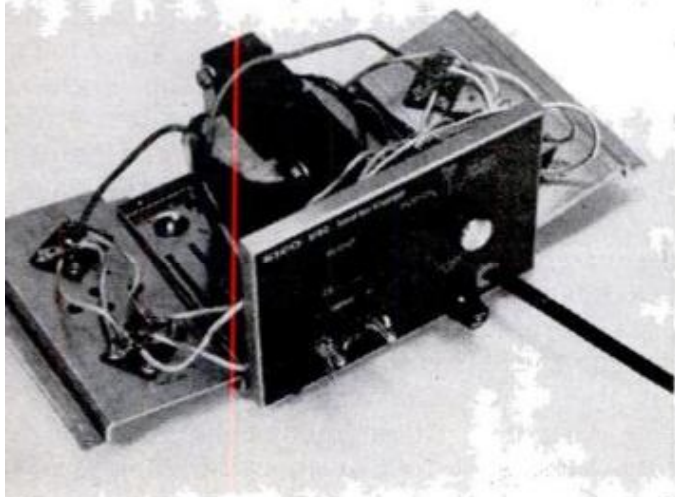

The two tachometers took radically different approaches

the 1080 may pick up a lot of noise, unless they have excellent built-in power-line filtering.

As a battery charger, the 1080 automatically regulates the charge to the battery, reducing it as the battery approaches full charge. Even so, Eico doesn't recommend it for use as a trickle charger.)

As you'd expect from its wide-open construction (and from the small difference between its \$44.95 kit and \$59.95 wired prices), the 1080 was a cinch to build, taking just about four hours. We found only one design goof: though Eico recommends you use regular jumper cables for the battery connections, the 1080's 12-volt terminals are so close together that it's hard to avoid shorting your battery clips together. However, there's plenty of room to move the negative terminal to one side, if you don't mind drilling an extra hole before assembling the kit.

The \$12.95 ArcherKit windshield wiper delay was another useful and easily built addition to the car. Switch it in, and your windshield wipers operate in bursts (adjustable from one second long to continuous operation), spaced up to one minute apart. That makes it perfect for those drizzly days when you'd otherwise be constantly switching your wipers on to clean the windshield, then off again to keep the blades from squeaking.

It's easy to install (just two wires to your fuse block and two to the wiper switch), and looks like it shouldn't take much longer than an hour to build. I took 2½ hours, but only because I disregarded the printed circuit board and wired the parts together directly, so I could fit them into a mini-box about half the size of the space-consuming case that Radio Shack provides.

The two tachometers we tested took radically different approaches to their jobs. Radio Shack's ArcherKit is a thoroughly conventional type, reading from 0 to 8000 rpm in a 240° sweep around a ¾-inch illuminated dial. It can be used on any four, six, or eight-cylinder, four-stroke engine with a 12-volt electrical system. Like most electronic tachs, it connects to your car's battery and coil with three leads. The tach can be rotated to any desired angle within the case, so you can mount it above or below

the dash (or sideways, if that's more convenient) and still have the dial right-side up. The adjustable redline indicator can be set wherever you like—but unfortunately, neither Radio Shack nor any other manufacturer I know tells you how to figure out the proper setting. Assembling the tach took only five hours; installation time, which varies from car to car, would be additional.

But today's trend in instruments is away from dials like the Archer tach's to direct digital readouts. Hence, the Southwest Technical Products digital meter. A glance at its display shows your engine's speed precisely to the nearest 10 rpm—no need to interpolate your rpm from a needle moving between calibrations spaced 200 to 500 rpm apart.

It seems a great idea, until you think about it. Because only rarely—when tuning your engine, for example—do you need to know your exact rpm. When driving, you're more interested in how far up into your engine's rev range you've gone, and how close you are to its best shift points or to its maximum recommended (redline) speed. A dial tach tells you all this at a glance, as its needle climbs up or drops back around the dial. But a digital meter, though it tells you precisely where you are at any moment, doesn't tell you where that spot is within the range under consideration. You have to memorize the significant numbers (admittedly, no difficult task) to interpret the tach's readings correctly.

More seriously, the SWTP tach lacks any redline indication to warn you as you over-rev. That's probably not inadvertent, since a redline indicator (especially one adjustable for any car) would raise the tach's already high price (\$79.95) even higher. And adding a redline indicator yourself is almost out of the question; for one thing, there's no leftover space within the case.

The digital-tach printed circuit boards were well thought out (though two holes on one board hadn't been drilled); parts layouts were neat and uncluttered and component positions were clearly marked. The division of the circuitry among seven modules (three of them identical) made both construction and error-checking easier, and the modules fit together easily and accur-

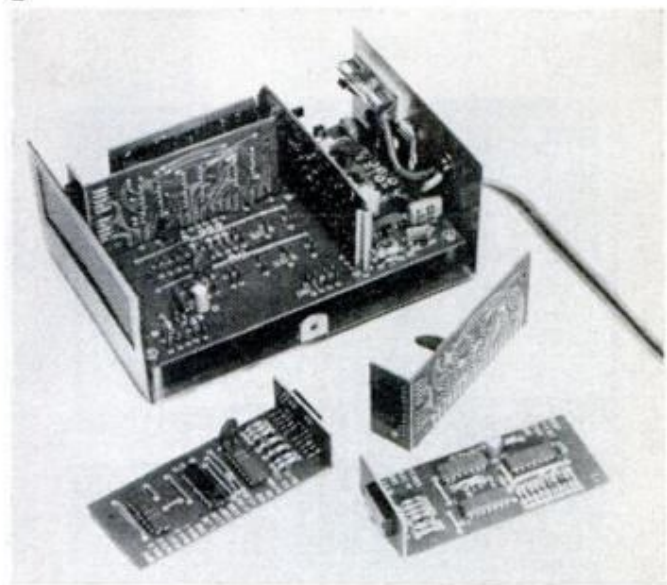
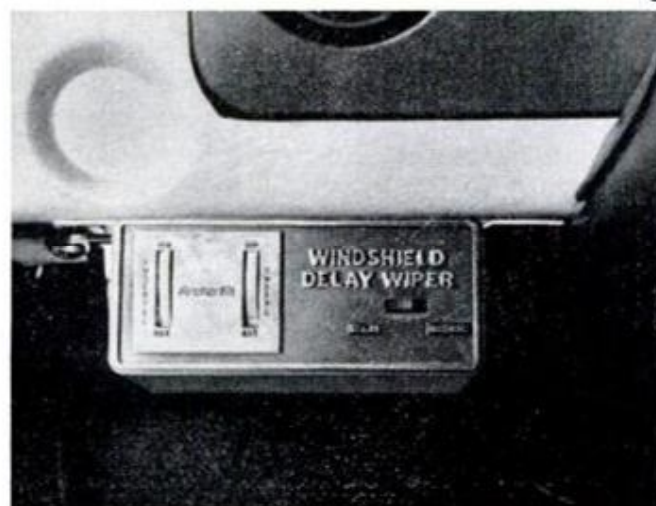
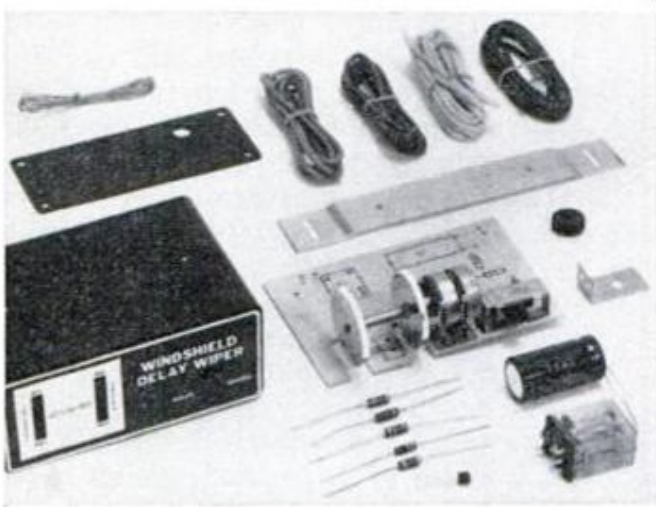
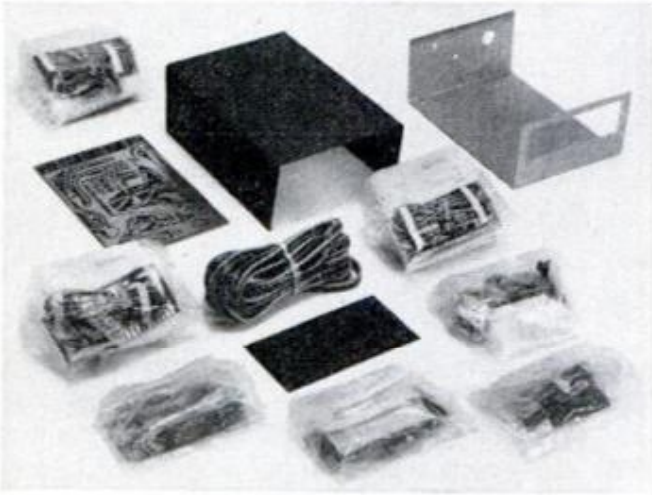
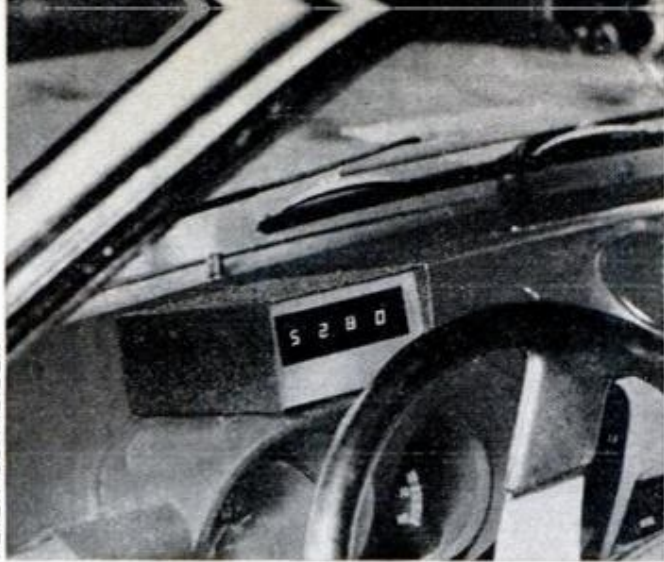

Digital tach (1) is shown just sitting on dash; SWTP makes no real provision for mounting it. Tach's modular design (2) simplifies construction (3) and service, but modules aren't too secure (see text). Wiper delay (4) is probably the simplest and most useful of the kits, but takes a lot of under-dash space (5).

ately. Even the unique connecting wire showed intelligence: A flat cable of three color-coded wires laid edge to edge, it made the right connections very easy to identify. And the instruction book, though not as well bound as, say, a Heathkit manual, was clearly written and illustrated.

Nonetheless, construction took nine hours, not counting the complications caused by missing components (less than 10 of them, but still more than average), a pair of diodes that could not be told apart, and some misprinted circuitry on one board. And because the bent-wire contacts that connect the circuit modules to each other don't make secure enough physical or electrical contact, the reading could be changed by squeezing the tachometer case, and might change with normal vibration when the car was on the road.

We say "might" because we haven't road-tested the tach yet. On top of everything else, Southwest Technical made no provision for mounting it.

For further information, write: Eico, 283 Malta St., Brooklyn, N.Y. 11207; Radio Shack, 2617 West Seventh St., Fort Worth, Tex. 76107; and Southwest Technical Products, 217 West Rhapsody, San Antonio, Tex. 78216. ★★★

Those under-\$200 receivers: Yes, they're really hi-fi

by Andy Santoni



Even inexpensive components look fancy today. From bottom to top: Pioneer SX-424, Sylvania CR2742, Fisher 170 and Heathkit AR-1214 receivers, followed by Pioneer TX-6200 tuner, Heathkit AA-1214 amplifier, Kenwood KA-2002 amplifier, and Heathkit AJ-1214 tuner.

These days, you can expect quite a lot from stereo receivers in the \$200 price range. Major hi-fi manufacturers offer surprisingly good low-cost stereo components (though the price is rapidly changing: thanks to the dollar's fluctuations, the under-\$200 receivers I tried out for this article will probably cost a bit over \$200 by the time you read this).

And a stereo receiver usually is your best choice for a low-cost component system. Audio buffs and dealers dwell on the advantages of separate tuners, preamplifiers and amplifiers, or high amplifier power, but if you're going to listen to your system in a small room or at low volume levels, they'd be a waste of space and money. And 4-channel receivers in this price range are so absurdly low-powered (under 10 watts RMS per channel) that you're best off deferring your move to quadraphonic sound until you can afford to do it right—and you can, without wasting your investment in stereo components, by plugging in adapters.

Of course, separate tuners and amplifiers offer greater flexibility and choice than receivers of comparable quality: You can choose a more powerful amplifier and less sensitive tuner (or vice versa), instead of a receiver's generally balanced capabilities; and separate components let you upgrade

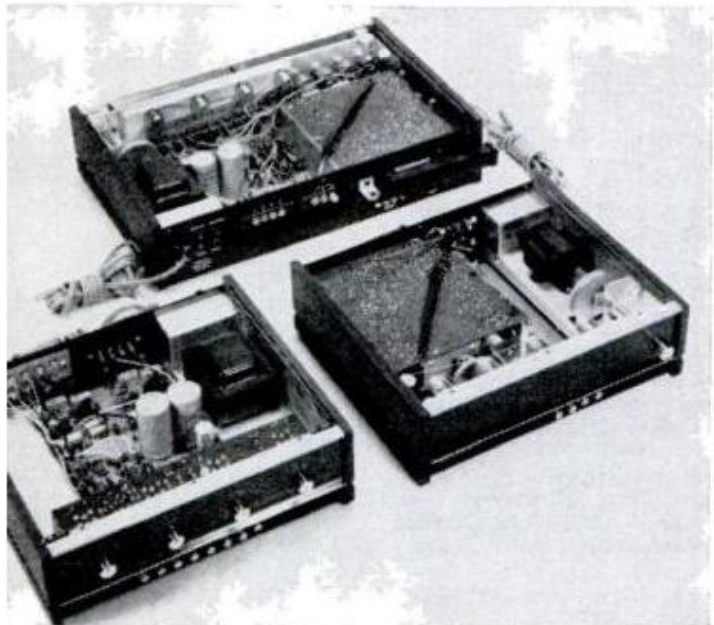

Pioneer TX-6200 tuner (top) isn't much smaller than the Pioneer SX-424 receiver it's sitting on, though the receiver has both tuner and amplifier. Most tuner dials, today, black out when power's off—we show them lit across the page.

Heathkit AA-1214 amplifier, AJ-1214 tuner show a strong family resemblance to AR-1214 receiver, using same circuits on the same circuit boards. Heathkits have fewer features than other units shown, but this makes them easier to build.

your system in smaller, less expensive steps.

But whether you choose a \$200-range receiver or its equivalent tuner and amplifier, you'll get performance and features you would have had to pay a lot more than \$200 for a few years back. Take the Fisher 170, for example—about as typical a receiver as you'll find in this class. Its continuous power output is 14 watts per channel at 8 ohms—pretty close to average and enough to drive even fairly inefficient speakers to high volume levels without noticeable distortion. (Though this is the most rigorous standard for measuring amplifier power, most components in this price range cite the IHF dynamic power at 4 ohms more prominently, often skipping continuous power altogether. By this less demanding standard, the Fisher would rate at 48 watts total.)

The Fisher's FM tuner specs ($2.5\mu\text{V}$ IHF usable sensitivity, 40-db selectivity and 64-db ultimate tuner signal-to-noise ratio), also about average, are good enough to pick up most FM stations cleanly, and clearly separate the stations that crowd together in a big metropolitan area like New York. Like its competitors, it also picks up AM.

Control facilities include all the basics you'd expect in a good component receiver: a large, easy-to-use tuning knob, an FM station dial with linear spacing (no bunching up of stations in one part of the band), separate controls for volume, stereo balance, bass and treble (not a single combined tone control, as on cheaper systems), a stereo mono switch, switched loudness compensation, a speaker selector switch and tape monitoring facilities.

The stereo-mono switch is useful when you listen to old mono records or weak stereo-FM signals. Switching in the loudness compensation boosts the bass at low volume levels to compensate for the ear's low-level bass losses. And the speaker-selector switch lets you shut off the speakers when listening through headphones, or switch on a pair of extension speakers for listening in another room (but though most of these switches allow both sets of speakers to be connected at once, few of these receivers have enough power to drive four speakers adequately).

Tape monitor facilities are a lot more useful than they look. They're designed for use with three-head recorders that let you check the quality of the recording by play-

Preamp-out and amp-in jacks on this Kenwood amp simplify use of accessory equalizers or 4-channel adapters, while leaving tape monitor jacks free. A bolt-on plate locks the preamp-amp separation switch in whichever position you prefer.



Makers of \$200-and-under receivers

Akai America, Ltd., 2139 East Del Amo Blvd., Compton, Calif. 90220.

BSR (USA) Ltd., Route 303, Blauvelt, N.Y. 10913.

Concord Div., Benjamin Electronics, 40 Smith St., Farmingdale, N.Y. 11735.

Eico Electronic Instrument Co., Inc., 283 Malta St., Brooklyn, N.Y. 11207

Fisher Radio, 11-40 45th Rd., Long Island City, N.Y. 11101.

Harman-Kardon, Inc., 55 Ames Court, Plainview, N.Y. 11803.

Heath Co. (Heathkit), Benton Harbor, Mich. 49022,

Hitachi Sales Corp., 48-50 34th St., Long Island City, N.Y. 11101.

JVC America, Inc., 50-35 56th Rd., Maspeth, N.Y. 11378.

Kenwood Electronics, 15777 South Broadway, Gardena, Calif. 90248.

KLH Research & Development Corp., 30 Cross St., Cambridge, Mass. 02139.

Lafayette Radio Electronics, 111 Jericho Turnpike, Syosset, N.Y. 11791.

Magnavox, 345 Park Ave., New York, N.Y. 10022.

Miida Electronics, 2 Hammerskjold Plaza, New York, N.Y. 10017.

Mikado Electronics, 1072 Bryant St., San Francisco, Calif. 94103.

Nikko Electric Corp. of America, 5001 Lankershim Blvd., North Hollywood, Calif. 91601.

Olson Electronics, 260 South Forge St., Akron, Ohio 44327.

Onkyo, 25-19 43rd Avenue, Long Island City, N.Y. 11101.

Panasonic, 200 Park Ave., New York, N.Y. 10017.

U.S. Pioneer Electronics, 178 Commerce Rd., Carstadt, N.J. 07072.

Realistic, Radio Shack, 2617 West Seventh St., Fort Worth, Tex. 76107.

Rotel of America, Inc., 2642 Central Ave., Yonkers, N.Y. 10710.

Sansui Electronics, 32-17 61st St., Woodside, N.Y. 11377.

Sanyo Electric, Inc., 1200 West Walnut St., Compton, Calif. 90220.

Sherwood Electronic Laboratories, Inc., 4300 North California Ave., Chicago, Ill. 60618.

H.H. Scott, Inc., 111 Powder Mill Rd., Maynard, Mass. 01754.

Sony Corp. of America, 47-47 Van Dam St., Long Island City, N.Y. 11101.

Spectrosonic, 1301 65th St., Emeryville, Calif. 94608.

Superscope, Inc., 8150 Vineland Ave., Sun Valley, Calif. 91352.

Sylvania Electric Products Co., 700 Ellicott St., Batavia, N.Y. 14020.

Toshiba America, Inc., 280 Park Ave., New York, N.Y. 10017.

ing it back as you're taping. But a number of other accessories can also be plugged into the monitor jacks, including equalizer-type frequency balance controls, and four-channel decoders. A few receivers and amplifiers—such as the Kenwood KA-2002 amplifier shown—have separate preamp-out and power-amp-in jacks that can also be used for these accessories.

Two receivers I tried even had some 4-channel facilities built in. One, the Sher-

wood S-7100A, had a rear-panel FM 4-channel jack to feed an accessory decoder for four-channel multiplex broadcasts should they—and the decoder—become available.

The other was Sylvania's CR2742, which had a built-in "passive" 4-channel decoder (the type that divides the output from two amplifiers among four speakers). It adds some spacious quadraphonic "feel" to regular stereo material and quadraphonic discs, though it won't usually distribute the four



Tape monitor jacks can also be used with 4-channel adapters, so Pioneer marks its rear panel for both functions. Large multipin tape connector is for single DIN plug.

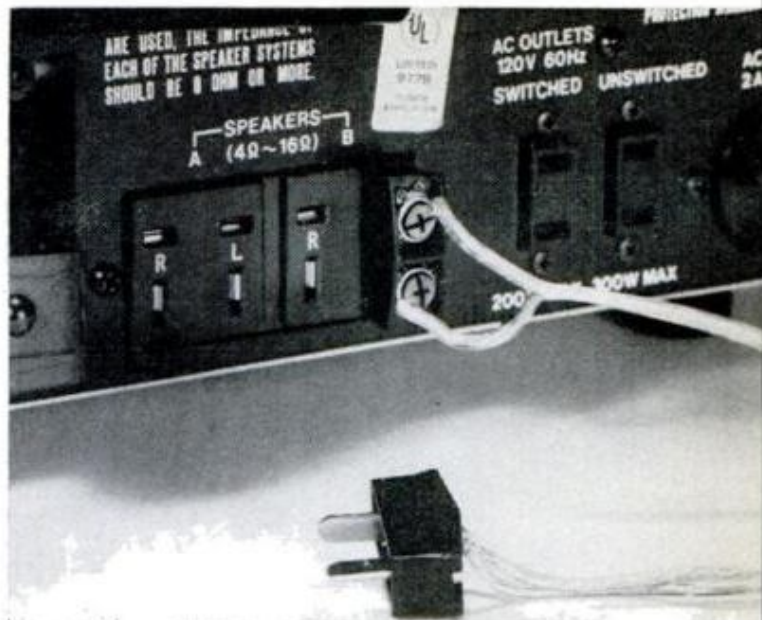

Speakers plug into Pioneer receivers, amplifiers, making it easier to wire in speakers, switch connections, or remove the receiver, no matter how tightly it's crammed in place.



Pioneer tuner has two pairs of output jacks; one with constant level, one with adjustable output level. Clamp below 75-ohm antenna screw holds round, shielded 75-ohm cable.

inputs mystifies me (if you can afford two turntables, why not buy a more expensive receiver?). On the other hand, I see a lot of sense in Sylvania's making those inputs switch-selectable for either magnetic or ceramic cartridges, so you can use it temporarily with a cheap ceramic while you're upgrading an inexpensive system.

If the Sylvania's list of controls is impressive, so are the controls themselves—unusually solid-feeling pushbuttons and toggles and an edgewise tuning knob that takes some getting used to (as did the odd placement of the stereo-mono switch, between the AM and Phono selector buttons). At 22 watts per channel (continuous power from 20 to 20,000 Hz into 8 ohms), it's also one of the most powerful receivers in its class. Impressive, especially from a company you think of for TV consoles, not stereo components.

But Sylvania has no monopoly on ingenious features. Even testing just nine components, I found several items worth remarking about. In control features, for example, the Pioneer receiver has click-stops at the center positions of its treble, bass and balance controls, helping you find their neutral settings. Kenwood's amplifier has tone controls with click-stops every two db around their scales, that let you reset your controls precisely. Still another tone-control feature is found on one of the units I didn't check out, the Toshiba SA-410. Its "MFR" bass and treble controls can be set to start working at 1000 Hz, like most tone controls,

channels precisely the way the quadraphonic record producers intended.

The Sylvania receiver has a number of useful features that aren't quite as common in its price class as the Fisher's. Its front-panel controls include high and low-frequency filters (handy for cleaning up noisy and hum-plagued signals or scratchy records) and a muting switch that cuts out both FM interstation noise and stations too weak to be heard clearly (if you want to hear a weak and distant station, you switch the muting off). Its extra set of phono

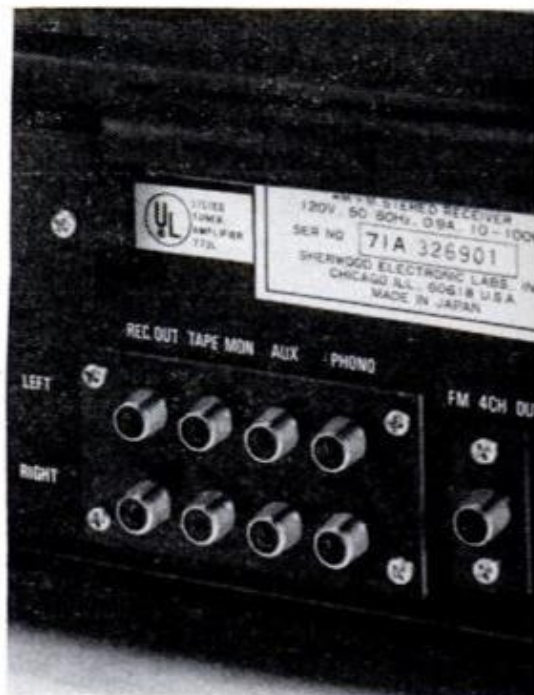

Unique tape-dubbing jack on the front panel of the Sherwood S-7100A receiver serves as tape in or tape out, according to setting of tape monitor switch. Extruded lip surrounding tuning dial and main (tuning and volume) controls is a distinctive styling accent. Four-channel jack on rear panel awaits whatever quadraphonic FM broadcasts systems may arise.

or to come in at 400 and 4000 Hz respectively if you prefer to leave your mid-range frequencies unaffected.

I would have liked to see a high-blend switch on some of these components, to clean up noisy stereo FM broadcasts without reducing them altogether to mono. But I don't know of any receivers in this price range with that feature.

Just about all receivers and amplifiers today have front-panel headphone jacks, but two of these receivers have other front-panel jacks as well. Pioneer's contribution is a monophonic microphone input for use in recording (or just amplifying) your voice or other sounds; but, since using it shuts off the other inputs, you can't sing along with your records or radio broadcasts. Sherwood's front-panel extra is a jack for dubbing to or from an external tape recorder, depending on the tape monitor switch setting. Another convenient tape connection is a rear-panel DIN socket on the Pioneer and Kenwood that lets you make all four connections to a stereo recorder with just one cable.

Pioneer also has unique connections for speakers—flat-bladed plugs that make it easier to plug, unplug and switch speakers (especially if the receiver's mounted in

cramped quarters) and to wire in the speakers without shorting the leads together (which can damage some receivers). In addition, the Pioneer—and several other units—have fuses protecting the speakers and output sections.

Heath's AR-1214 receiver and AA-1214 amplifier have one internal feature I didn't notice on the other units: phono level controls. Adjust them to match your phono cartridge's output, and you can switch from phono to FM or any other source without having to simultaneously readjust the volume control. Other than that, though, the Heaths are spartan-simple. The AR-1214 is the only receiver I tried that lacked a tuning meter and a speaker-selector switch. And though it is the least expensive receiver in this group, it's also the only one you have to put together yourself (Heath calls it a "5-evening kit," but it took me 15 hours). I'd recommend it if you enjoy kit-building (as I do), or if you're interested in good performance at minimum cost and don't mind doing without a few frills. I could say the same about the AA-1214 amplifier and AJ-1214 AM/FM tuner—both good basic separate components in kit form.

All of the components in this group are modest performers, compared to today's

medium and high-priced equipment, but the difference is seldom as easy to hear as it is to spot on a spec sheet. Unless you live in Radio City Music Hall or the Grand Canyon, you probably don't need more than a few watts per channel for normal listening levels. With moderately efficient speakers (though they're getting harder and harder to find these days), a receiver that can deliver 10 continuous watts of power or more per channel will still have some power in reserve to prevent overloads on peaks like cymbal clashes or plucked guitar transients.

That's where "dynamic power" comes in, as a partial index of transient overload ability: Of two receivers with the same continuous power capability, the one with the greater dynamic (or "music") power will handle peaks a little better.

Certainly, a budget receiver won't handle deep bass as powerfully or as cleanly as an expensive one, but you'll probably use it with inexpensive speakers that couldn't deliver all that bass no matter what receiver they were used with. I've heard speakers for not much more than \$50 each that were good—well-balanced and clean-sounding—but they still didn't have the bass capacity of higher-priced ones. When you listen through headphones, of course, the difference in power becomes academic (though the difference in signal-to-noise ratio between these and more expensive receivers may sometimes be noticeable).

The same holds true for FM specifications. The IHF sensitivity of even these low-priced receivers is rapidly approaching the theoretical limit, and is very close to that of even the most expensive tuners (Heath's AR-1214 has $2.0 \mu\text{V}$ sensitivity; its \$380 AR-1500 has $1.8 \mu\text{V}$). Ultimate signal-to-noise ratios—even more important specifications than IHF sensitivity—are pretty similar in both low-priced and high-priced components.

Where the high-priced components do pay off is in low distortion (especially on loud peaks), better amplifier signal-to-noise ratio, and their tuner sections' greatly increased resistance to interference (such as that caused by man-made noise, other stations, and multi-path signal reflections), and in the provision for additional features, of course.

So there are many situations where a comparatively low-priced receiver can be well worth buying. If you want a stereo system in a vacation home, a second system in another room (the playroom, for example), or to take off to a college dorm, it is ideal. And, of course, it could be your main equipment if you're starting to build a component system on a modest budget. All in all, today's \$200 receivers sound (and often look) so good that you may never notice that they didn't cost a great deal more—until you check your bankbook. ★★★



Chrome-plated knobs and levers stud the Sylvania CR27-42A's control panel; they feel just as solid as they look. Black bar at the lower right is an edgewise tuning knob, which takes some getting used to.

How to track down a handling problem

by Mort Schultz

Front-end alignment is the adjustment of camber, caster and toe-in. When adjusted to spec, most handling problems are eliminated. There are other things to check before paying for a front-end alignment, however.

Do you find out that you need a front-end alignment by waiting for your tires to wear? Or should you spend \$15 regularly to align your front end when it may not need alignment? Neither is advisable. What you should do is develop a sensitive feel for your car from behind the wheel. When a car's front wheels are out of alignment, its handling characteristics and steering are affected. Before suspecting faulty front-end alignment, though, check steering and suspension components. Start by examining shock absorbers.

If you see an obvious oil leak from a shock, seals have probably failed and the component should be replaced. A light film of oil is normal, so don't discard a good shock. If your car has new shock absorbers (less than a year old), keep in mind that recent developments in seals have lessened the likelihood of failure and leaking. But

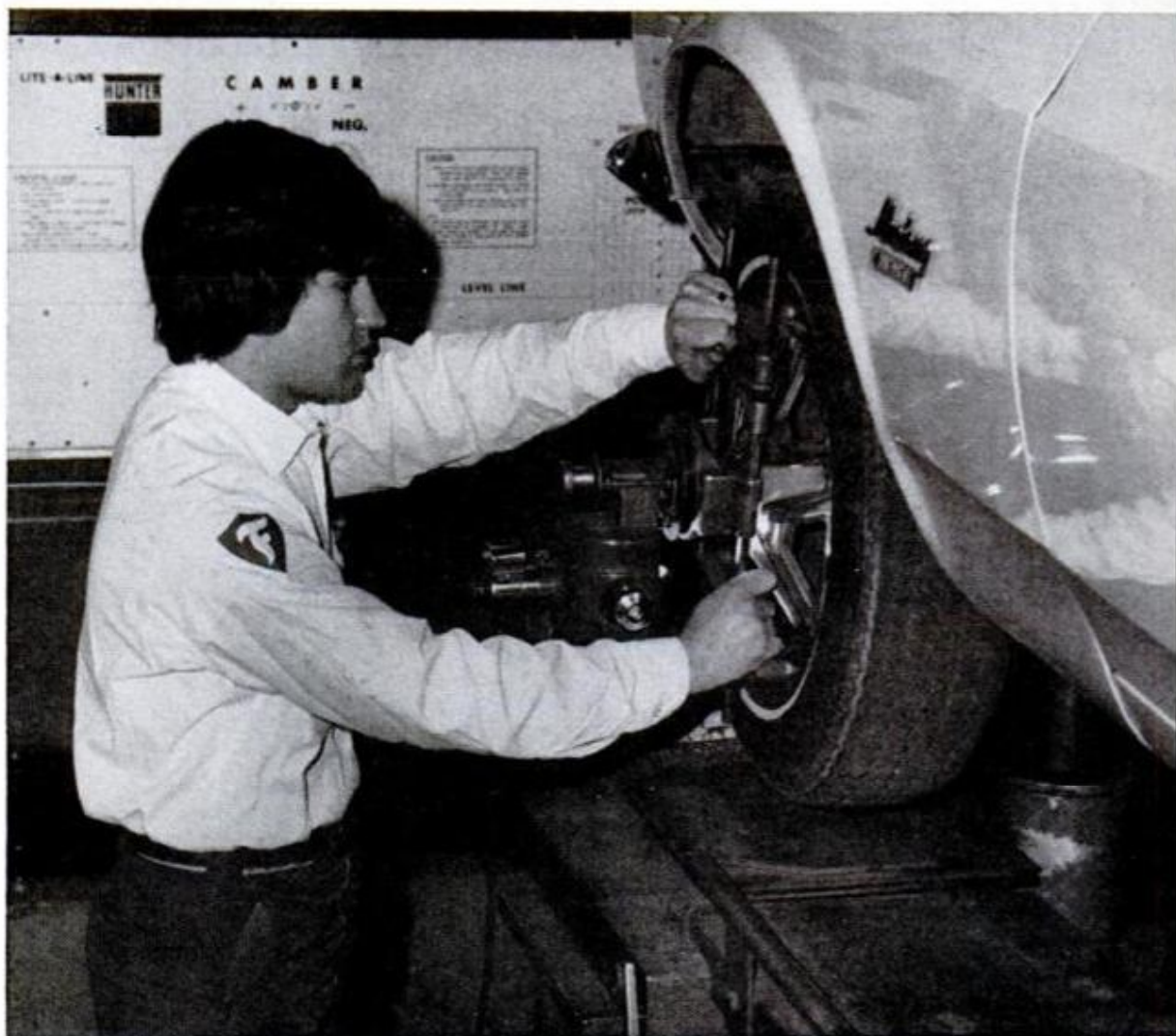

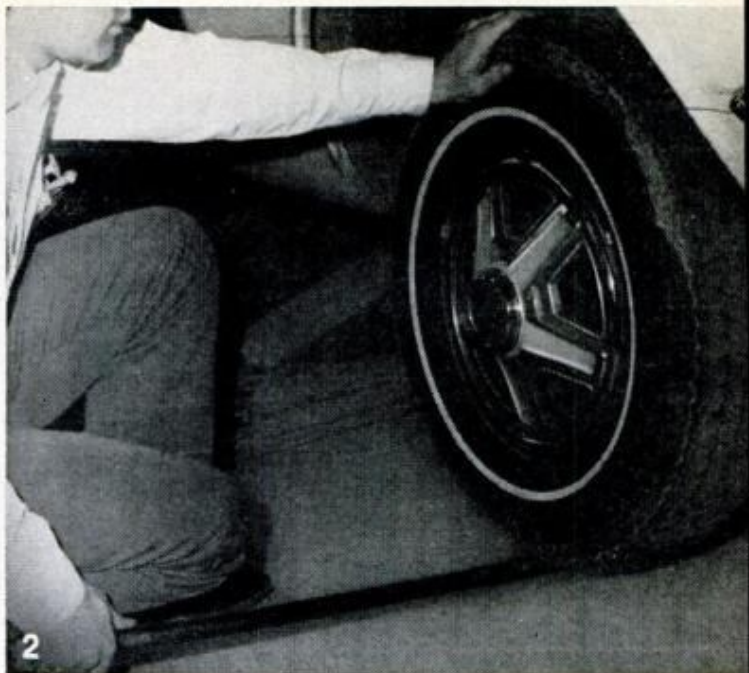

this doesn't eliminate the fact that shock absorbers wear out internally, so even if they don't show signs of leaking, check for wear. Give the car a jounce at each corner. Push down and up on the bumper several times, increasing the length of the stroke each time. Release the bumper at the bottom of a down stroke.

If up-and-down movement stops quickly, the shock is probably okay. But if the car bounces two or more cycles, the shock should be removed for further testing before a decision is made to replace it.

Worn or damaged ball joints adversely affect handling. Ball joints of some 1973 models have visual wear indicators. If the seat of the nipple is flush with or inside

1 To check that shocks are doing their job of damping up and down movement, jounce car at each corner and observe that movement stops quickly.

2 Excessive play in ball joints: For a quick way to test, try to move wheel up and down vertically. A "clunk" indicates looseness probably in excess of manufacturer's tolerances. For an accurate check, use gauge (see text).

3 Too much side-to-side play indicates a need for wheel-bearing adjustment.

4 To seat wheel bearings after lubrication or replacement, spin the wheel as you snug up on the spindle nut.

the joint, the ball joint is worn. In other models and those prior to '73, ball-joint condition is checked by taking the load off the load-carrying member with a jack. In some cars, this will be the lower ball joint—in others it is the upper ball joint.

With the load relieved and wheel and tire off the ground, place a pry bar beneath the tire and apply an upward force. This tests the joint's axial (up-down) motion. Place your hand on top of the tire as you measure axial movement. If there is motion and a "clunk" as the pry bar is pushed up and released, suspect ball-joint wear.

Manufacturers provide their own specifications for how much axial movement is permissible. Find out what the specification is for your car. A simple cardboard gauge to measure ball-joint wear comes in a new ball-joint repair kit called "Shimmy Stop". If you're not sure just how worn are your ball joints, you can pick up the gauge free where "Shimmy Stop" is sold.

Check front-wheel bearings next. Raise the front wheels so they hang free. Grasp a tire at the top and bottom, and push in and pull out. If more than very slight movement is felt, bearings may need adjustment.

Manufacturers recommend different ways of adjusting front-wheel bearings, and you should follow their instructions. Generally, however, you remove the hub cap, pull out and discard the cotter pin and pull off the spindle nut cap. Then spin the wheel and simultaneously run up the spindle nut until it is snug. This seats bearings.

If the wheel has a brake drum, back off one castellation slot. Turn back to the nearest cotter-pin hole and install a new pin—wrap its legs securely around the nut. Turn the wheel to check for binding.

If the wheel has a brake disc, bearings are seated as explained above. Then back off the spindle nut until it begins to loosen. Then run it up hand-snug. Loosen the nut until a hole in the spindle lines up with a slot in the nut. Insert a new cotter pin and test for binding.

With the car raised, look carefully at the steering linkage. Any bent parts? Grasp and shake tie rods, pitman arm, idler arm and relay rod. Looseness indicates a worn member that should be replaced.

Check tires for sidewall bulges that indicate damage to sidewall plies. Radial tires, of course, show a normal sidewall bulge. Adding air in excess of recommended pressure to eliminate the bulge will overinflate the tire and lead to excessive tread wear.

Incorrect tire inflation can be a chief cause of almost every type of troublesome symptom affecting handling, including wander, pulling, sway, shimmy, hard steering and tire squeal on turns. Make sure tires are inflated (when cold) to recommended pressure before road-testing your car.

Here is a basic road-test procedure listing symptoms and some most likely causes:

1. *Start by gripping your steering wheel tightly and driving at 15-20 mph.* If steering seems jerky—that is, if you feel the shock of one wheel and then the other as



they roll over slight bumps in the pavement, check for the following:

- Steering-gear damage, damaged steering linkage component, damaged suspension part (ball joint, spindle).
- Tire-wheel assembly imbalance.
- Out-of-round or cupped tires.

2. Drive across railroad tracks on a slight angle at 15 to 20 mph, feeling for shimmy.

Shimmy is an oscillating motion of the front wheels at low speed that is felt as an almost uncontrollable movement of the steering wheel. Causes of shimmy include:

- Incorrect tire pressure.
- Loose or worn ball joints, steering linkage components or steering gear.
- Broken suspension coil spring or spring part.

3. Drive about 60 mph with your hands placed lightly on the steering wheel. The road should be as straight and as level as possible. You are testing for wander and wheel tramp.

Wander is the tendency of a car to drift slightly to one side and then to the other as you are attempting to steer a straight course. Wheel tramp is an oscillating motion in the front wheels at high speed that is felt as movement in the steering wheel, and in the seat of the pants.

The likely causes of wander are:

- Incorrect tire pressure.
- Loose or damaged ball joints, steering gear, steering linkage, spring parts or spindle.
- Front-end misalignment.

Conditions that usually cause tramp are:

- Incorrect tire pressure.
- Tire-wheel imbalance.
- Out-of-round or cupped tires.
- Loose or worn shock absorbers.
- Possibly front end misalignment.

4. At a speed of 30 to 40 mph, drive on a flat road with your hands off but near the steering wheel. If your car runs straight for two tenths of a mile or more, you need not be concerned that the following conditions are causing pulling to one side:

- Incorrect tire pressure.
- Front-end misalignment.
- Unequal brake adjustment.
- Front tires of unequal diameter because of wear or differences in design.
- Wheel-bearing misadjustment.
- Steering-gear misalignment.

5. Drive at about 30 mph on a safe, desolate stretch of road and weave rapidly from one side of the road to the other. Determine if there is any difficulty in turning or recovery. Then make a few turns at different speeds in an empty parking lot. Notice if steering is hard. As the car comes out of a turn, release the steering wheel and see if the vehicle straightens. If a hard steering condition exists, or if steering return is poor, look for—

- Incorrect tire pressure.
- Lack of lubrication on steering linkage, in steering gear or in ball joints.
- Front-end misalignment.
- Bad steering-gear adjustment, damaged steering or suspension component. ★★ ★

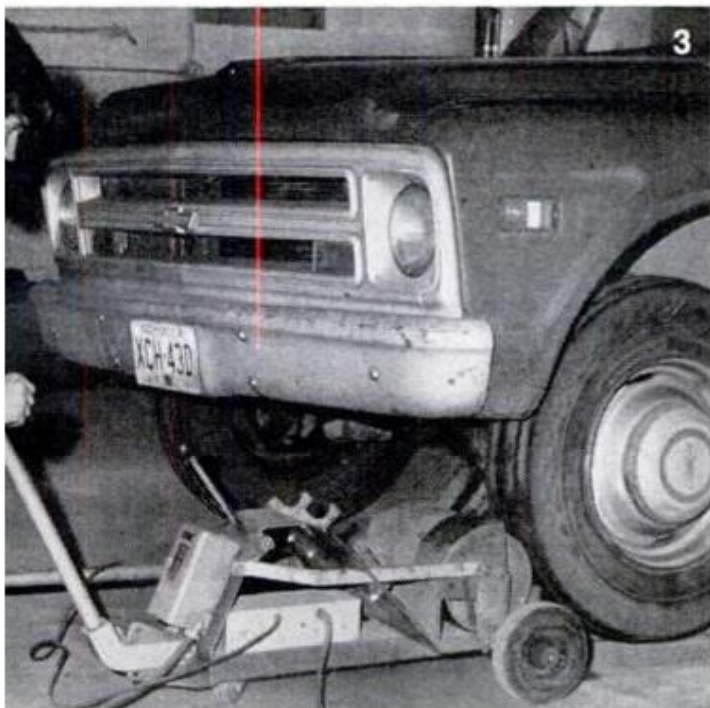

1 **Steering linkages** should be checked from the steering gear box all the way to front wheel spindles. Looseness or damage will cause handling problems.

2 **Correct tire inflation** is most important and affects handling profoundly. Sidewall bulge of radial tires with correct pressure is normal as shown here.

3 **Spinning wheels** on car allows for accurate dynamic balancing of tire/wheel assembly. Improper balance can cause shimmy, tramp, jerky steering and, of course, uneven tire wear.

Drill-press overarm makes your router twice as handy

A portable router becomes a jig-guided carving machine when suspended by a bracket

by Wayne C. Leckey
HOME AND SHOP EDITOR



Among the examples of work that's made easy with a router overarm are this trinket chest and cheese cutting board. Recessed areas in the top of each are made with a core-box bit guided by pin and template. Other projects include oval picture frames and fretwork.

Making use of the rigid steel column of a drill press and its tilting cast-iron table, this clamp-on overarm makes your portable router twice as useful and handy. Held in a fixed position above the work, the router becomes a highly efficient carving tool which knows no limits when it comes to surface routing. Normally limited by the size of the router's base as to the size of recess it can bridge, here the router can span any size recess within the 15½-in. capacity of the overarm.

In addition, I found through the use of templates and jigs that you can mass-produce identical work with factory precision and speed. You can both rabbet and shape irregular work, such as oval picture frames, and you can do angular routing and mortising merely by tilting the drill-press table.

The rugged overarm is designed to clamp to a standard 2¾-in.-diameter drill-press column. However, if your column is smaller, or if you don't own a drill press, you can purchase a

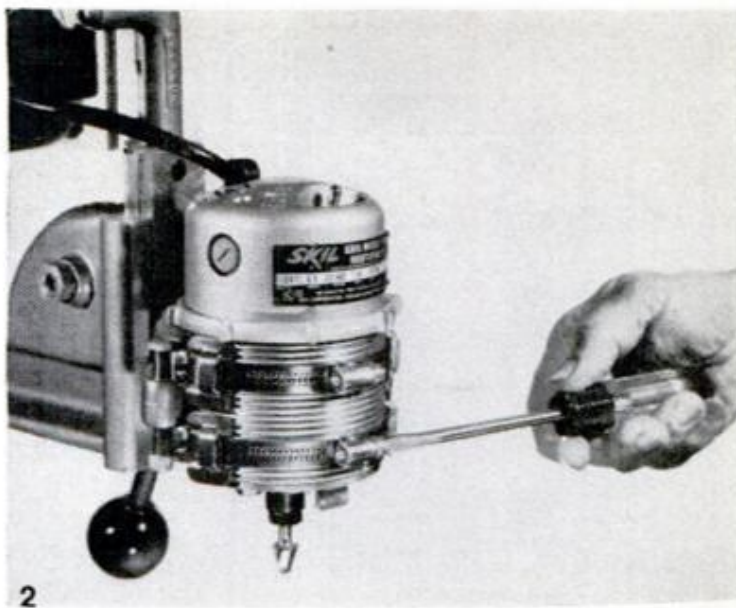
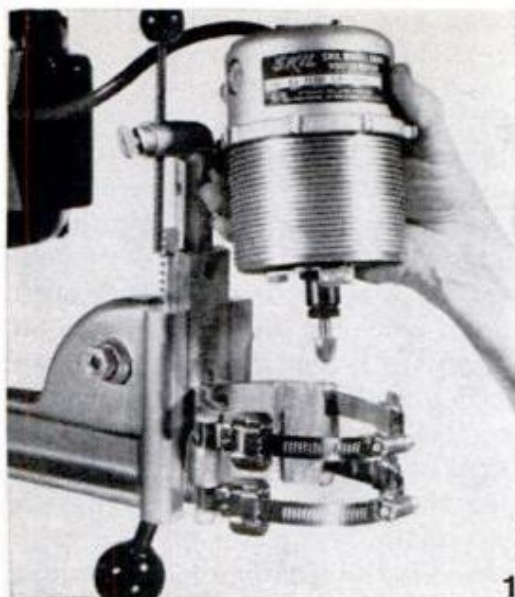

1 The overarm will accept any make of portable router that has a 3 to 4¼-in.-diameter body. The router's base is removed, of course, whenever the router is to be used in the overarm.

2 Router is held securely in end of the overarm with hose clamps. Geared bands are tightened around router with a screwdriver. Router can be removed quickly for regular portable use.

3 Overarm clamps around 2¾-in.-diameter drill-press column with two bolts. It adjusts up and down on the column, swings away when not in use by loosening one bolt, holds router rigidly.

4 Overarm has an adjustable stop to assure identical depth when you carve duplicate items. Raising and lowering lever locks with twist of knob. Overarm extends 15½ in. from column.

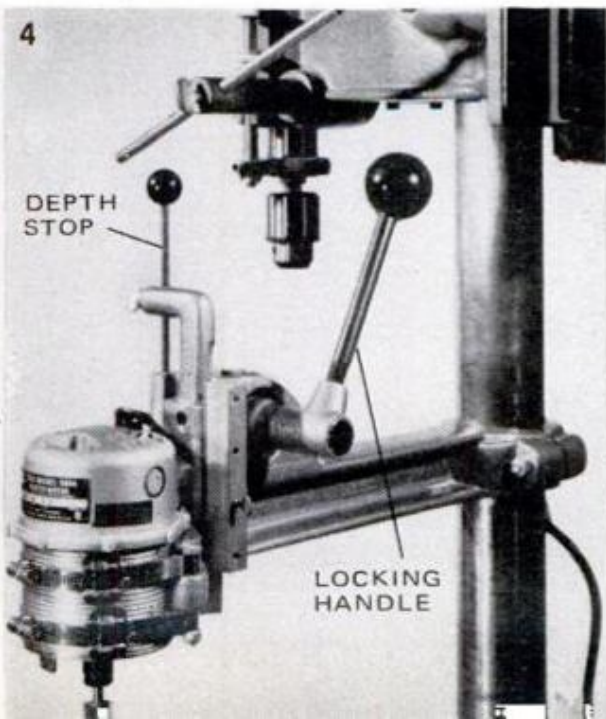
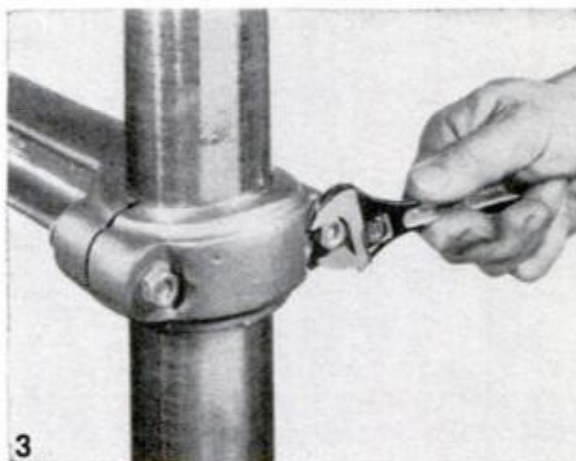

special 28-in. column and base for bench mounting. The overarm will accept any standard portable router having a 3 to 4¼-in.-diameter body. It has an adjustable depth stop for repetitive work, a rack-and-gear lever for raising and lowering the router and geared band clamps that make it easy to remove the router when you wish to use it with its regular base as a portable router.

Routing and carving are done with the work resting on an auxiliary wooden table consisting of a subtable bolted to the drill-press table and a free-sliding top table. The latter is movable in and out over the subtable, and has grooves for inserting a wood fence. Interchangeable starting and guide pins are held in an aluminum block which is flush-mounted with the table surface. In use, the drill-press table is swung and positioned at a 90° angle to the drill-press head, and the overarm is centered over the worktable.

While you can purchase the wooden work-

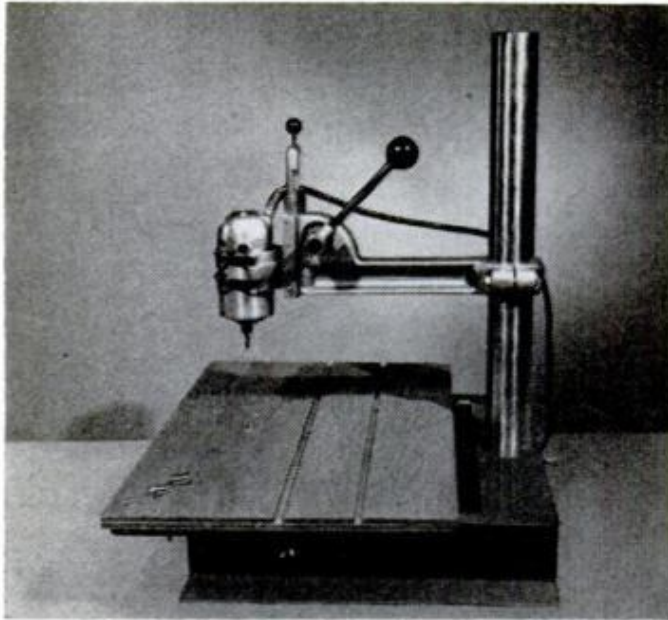

Bench model is available complete with a welded steel base, 28-in.-high steel column, wooden table and an overarm when a separate unit is desired.

table along with the overarm, the details below show how you can make your own. Wingnuts and clamping strips along each side lock the sliding table to the subtable. If you don't have tools to make guide pins and pin block, you can buy them as a kit. □ *Pin routing.* With a guide pin in the table and centered directly under the router bit, you can produce quantities of identical items by a method called pin routing. Here you either guide the work by holding the edge against the stationary guide pin or follow the pin around the inside of a template tacked to the bottom of the work. In each case, the finished work is identical with the pattern, and since the router bit and work are actually guided by the pin, you can't make a mistake.

□ *Angle mortising.* Precision mortising at an angle is made easy by simply tilting the drill-press table. In this case, the work is positioned under the router bit in a special jig, the router bit is lowered into the work to the desired depth and the work

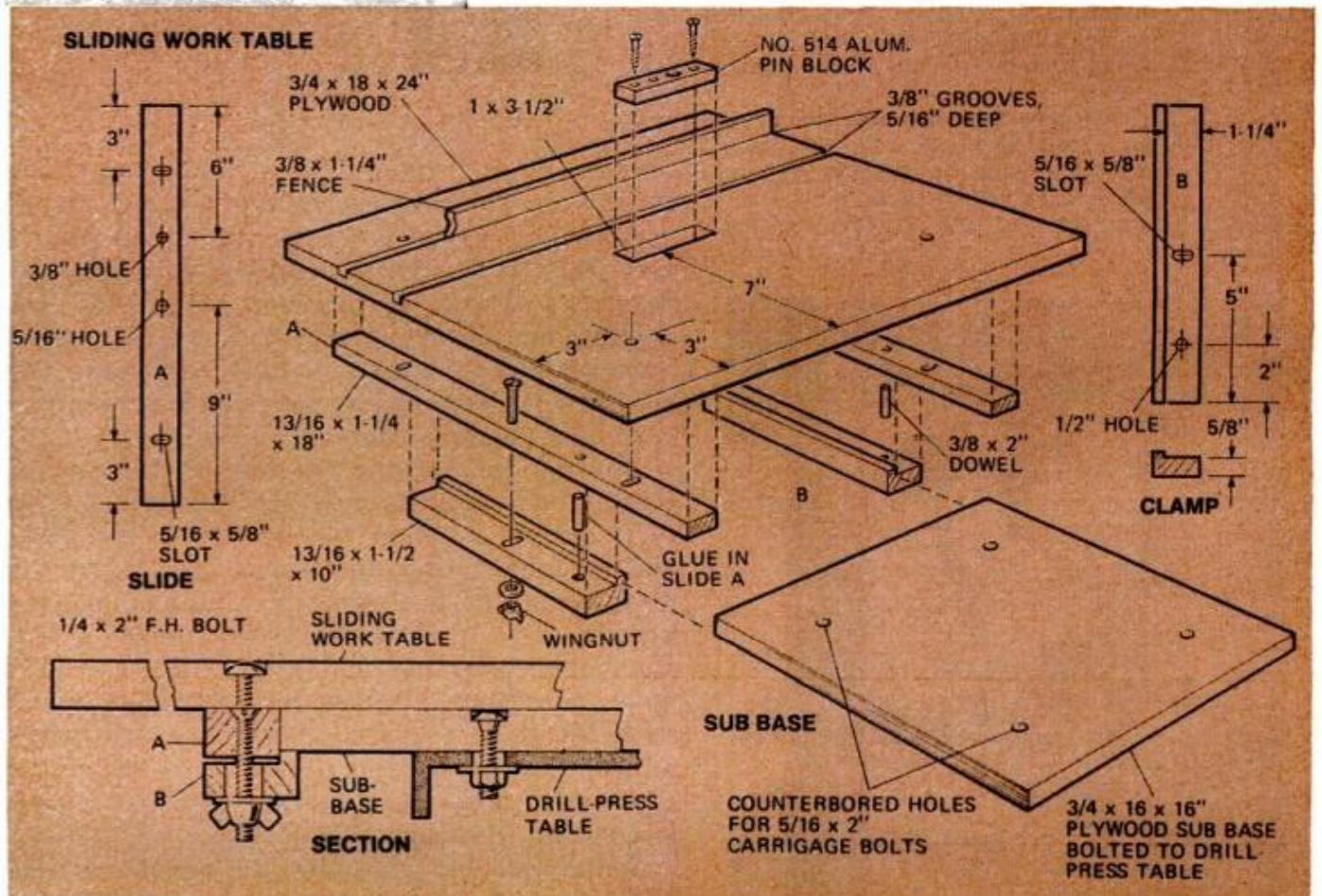
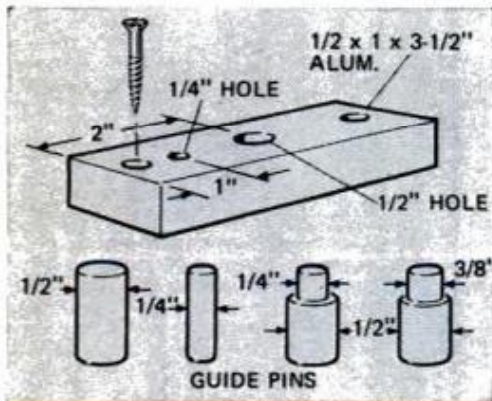

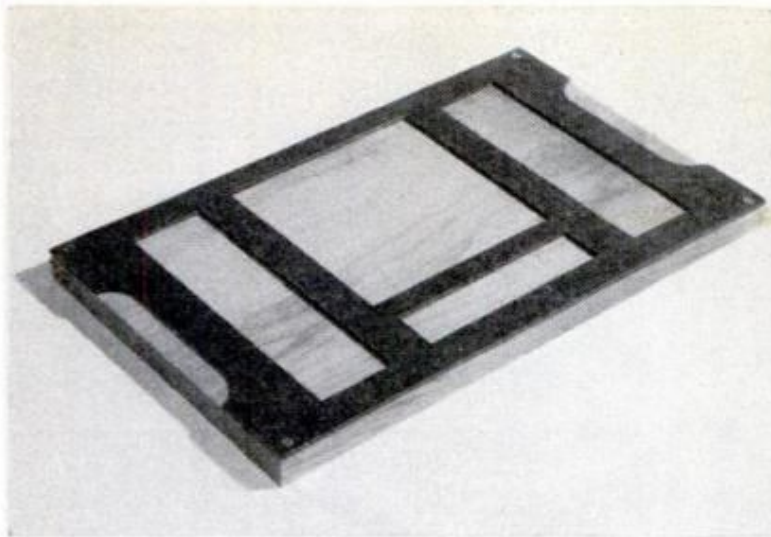

Pin in the worktable follows template tacked to underside of workpiece (left) to guide router bit when same outline is repeated in top surface of workpiece

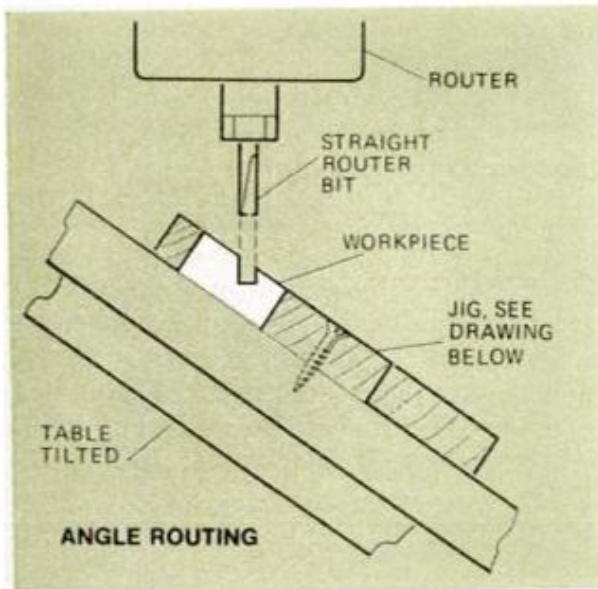
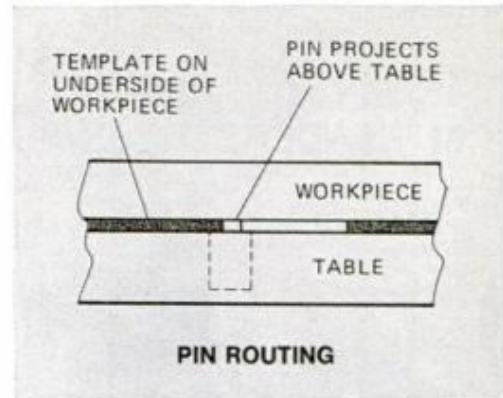

The starting pin is used only when you are running against a pin and not in a groove. It is placed on the feed side of the worktable and to the left of the guide pin. To start the cut, the work should be placed against the starting pin, then swung clear of it when jig makes contact with guide pin.

When overarm is used on floor-model drill press with a tilting table (below and left) you can rout mortises at angle by tilting worktable and using jig.

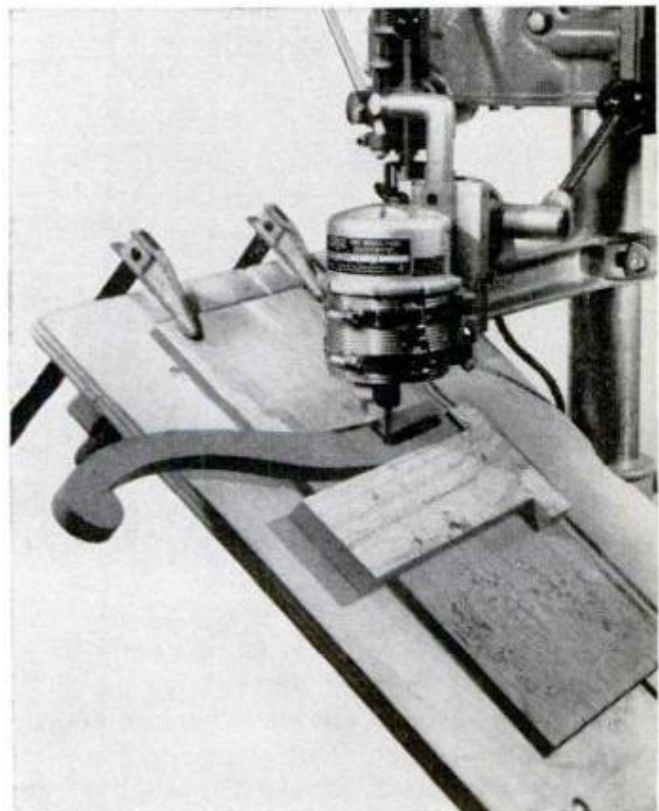

is moved forward in the jig to cut the mortise.

□ *Fence routing.* For straight routing, the guide pins are removed from the table and a wood fence is placed in one of the table grooves. Then the table clamps are loosened and the table is pushed in or out to position the router bit with the work. With this setup, glass rabbets for one-piece picture frames are quickly and neatly made by passing the work along the fence. Stops attached to each end of the fence will automatically limit the length of the rabbets on a mass-production basis. Outer edges of the frames can be shaped later with a pilot-tip bit.

The overarm (less router) sells for \$124, the worktable is \$35 and the guide-pin kit \$9. They can be ordered from Bryden Router Overarm, 2407 Arden Drive, Champaign, Ill. 61820. ★★

HINTS

FROM READERS



Chuck adapter holds wood disc

A piece of steel shafting, 1 in. in diameter and 1½ in. long, drilled lengthwise for a screw and two nails and attached from the back, provides a simple adapter for mounting a wood disc in the chuck of a metal-turning lathe. The screw centers and holds the disc; the outboard nails keep it from turning.—*Walter E. Burton, Akron, Ohio.*

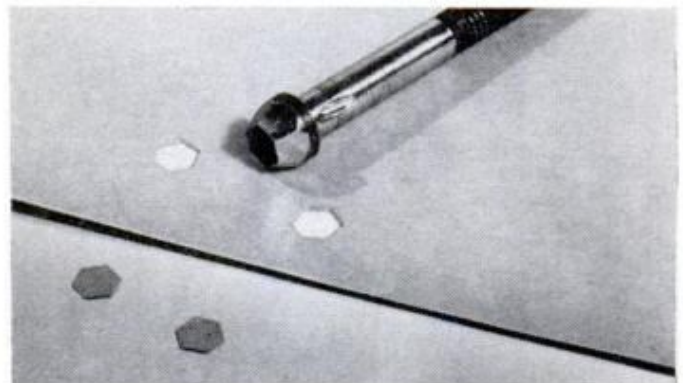
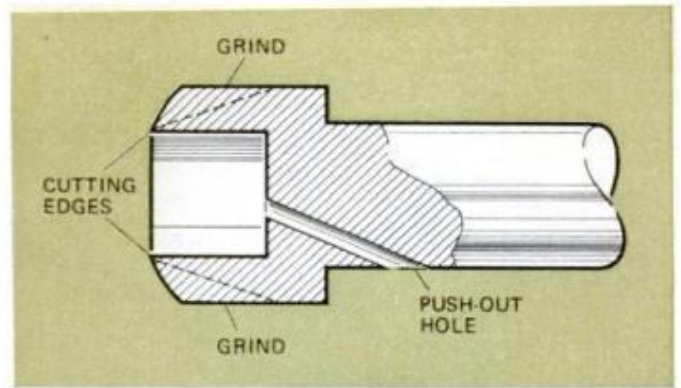

Capscrew makes punch

You can convert a hexagonal-socket cap-screw into a hollow hexagon punch for thin materials by grinding six new surfaces for cutting edges. A diagonal hole is drilled as shown, through which cut pieces can be pushed out. An assortment of punches can be made this way from different-size cap-screws.—*Burt Web, Skokie, Ill.*



Sleeves for cable

The sleeves used to form looped ends in ¼-in. cable are put in place with powerful presses—seldom available when emergency repairs are needed. But you can use short sections of copper tubing for such sleeves if you clamp them tightly with lever-jaw pliers, then seal tubing ends with solder.

—*Parry C. Yob, Fair Oaks, Calif.*

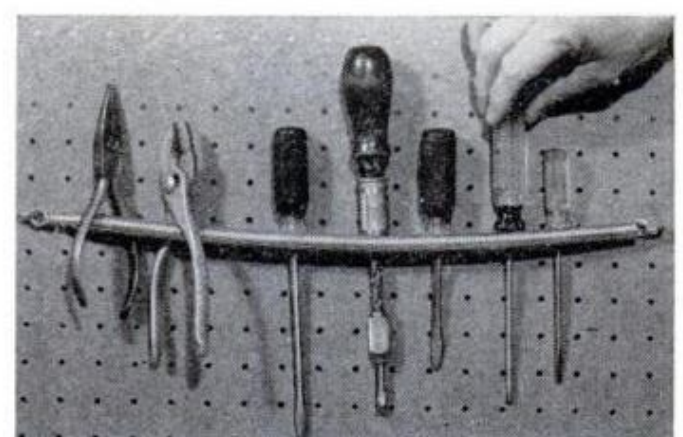

Door spring holds tools

A screen-door spring on the workshop wall provides hanger space for a number of tools and is easy to mount on perforated hardboard. Stretch the spring slightly when putting it up. Most hand tools can be held under the spring, but some, such as pliers, can straddle it.

—*Ken Patterson, Regina, Sask.*

Ken Waller writes to tell us that...

CASE #136
(In a continuing series)

"I lost 3 inches off my waistline, 6 pounds...and shaped up-in 5 days!"

"I did it with one 5-minute exercise, twice daily, lying on my back—WITHOUT DIETING!"



PHOTOS
UNRETOUCHED

BEFORE

RESULTS
NOTARIZED

AFTER
5
DAYS

The first body shaper so effective—
results have been notarized!

Before I started on the "5-Minute Body Shaper" Plan I weighed-in at 220 on November 1st. On that date my waist measured 36 inches. On November 5th, just five days later, I weighed 214 and my waist measured 33 inches. I'd

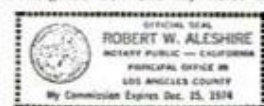

lost 6 pounds and 3 inches from my waist in just five days with no special dieting or exercise. Just the "5-Minute Body Shaper" Plan. KEN WALLER

Nov. 1st.
Weight 220
Waist 36"

"I'm usually in good shape, being a physical fitness buff, but when I moved from St. Louis to Los Angeles, I neglected my eating and fitness habits. I gained weight and softened up. I had no time to go to the gym, so I tried the '5-Minute Body Shaper' Plan. I was amazed at how fast I firmed, trimmed, tightened up my waist and got rid of extra body fat. It sure beats jogging and gym workouts for people who have little time to shape up! Thanks for your well thought out plan! Good luck with it!"

Nov. 5th
Weight 214 (lost 6 lbs.)
Waist 33" (lost 3 inches)

HERE'S WHAT THE EXPERTS SAY:

"Doctors have always known, exercise done while lying on the back, virtually eliminates strain while slimming and reshaping the body. Yours is the finest Body Shaper Program on the market." RICHARD TYLER, Chiropractor

"Beats jogging and working out in gyms—and much safer. I lost 4½ inches off my waist in 14 days."

JIM HANLEY, famous athletic coach

"Based on sound physiological and medical knowledge, it burns fat and shapes the body without strain to the heart or other organs. I lost 32 lbs. of excess weight using it."

PIERRE GRAVEL, President,
Canadian Council of Chiropractic Research

WHAT IS THIS INGENIOUS PLAN?

The Weider "5-Minute Body Shaper" plan is based on doing ONE CONTINUOUS RHYTHMIC CO-ORDINATED EXERCISE. That's all you do! This one 5-minute exercise is designed to attack the Waistline and Hipline (where fat accumulates quickest, giving your body a flabby, weak and distorted look)—as well as burn off excess body fat fast by speeding up your metabolism, burning stored calories and releasing excess water—while re-shaping your bustline, hipline, firming up your legs and arms—YOUR TOTAL FIGURE!

It's safer than strenuous gym workouts, beats the time consumption and dangers of gym workouts.... or any other vigorous sport.

The unit weighs about 8 ounces and fits any wallet-size case. You can carry it and use it wherever there's floor space—anytime. Even while watching television.

WHAT COMES OFF IN 14 DAYS?

Individual results vary, but during an average 14-day period, you can expect to lose up to 4 inches from your waistline and up to 10 pounds from your present weight. It strengthens your heart and lungs, increases stamina and endurance, improves your digestive function and general health. It also shapes you up—from head to toes. For a "5-Minute Exerciser"—it sure does a lot."

Patent Pending. © Copyright Joe Weider, 1973

EXPOSING EFFORTLESS EXERCISERS

Reader's Digest (September, 1971), New York Times and Good Housekeeping, among others, exposed sauna wraps, inflated belts, weighted belts and effortless exercisers as frauds. Scientific researchers, medical and fitness experts all agree... there is only one way to firm, shape and trim up your body... you must work the inches off!

NO GIMMICKS, NO CATCHES MONEY BACK GUARANTEE OFFER

Because this isn't a "gimmick" plan—and you have been fooled in the past by "effortless exercisers"—I make you this

UNCONDITIONAL GUARANTEE.

"GET IT OFF FAST"—and see measurable and firming results in 3 days or return the exerciser for a full 100% refund!

Proven results are already verified. The guarantee is in writing. Now you can think of a reason not ordering your "5-Minute Total Body Shaper"?

'5' Minute BODY SHAPER

The Body Shaper that Works

FREE TRIAL OFFER!

Weight just 16 ounces!



See your exciting new body begin to take shape in 3 days or return lightweight Body Shaper (small enough to fit into pouch shown) for a full 100% refund!

DISCOVER A NEW JOY
IN YOUR BODY —
GIVE IT SEX APPEAL
COMPLETE KIT ONLY
\$995

JOE WEIDER, DEPT. PM-7

21100 Erwin Street, Woodland Hills, California 91364

Dear Joe: Rush me your 5 Minute Total Body Shaper and Slimmer Course in plain wrapper, with your money back guarantee offer!

I Enclose \$9.95 For The Above. Cash Check Money Order
\$1.00 extra for Air Mail. (No COD's Accepted). Calif. residents add 5% sales tax (10.50)

Name _____
Address _____
City _____ State _____ Zip _____

IN CANADA: "5" Minute Body Shaper Plan, 2875 Bates Road, Montreal, Quebec





Little beauties for tools and kids

Stick up a shed and neighbors may hate you. But build one of these cute storage buildings and they'll love you. So will your kids, since all three structures double as playhouses.

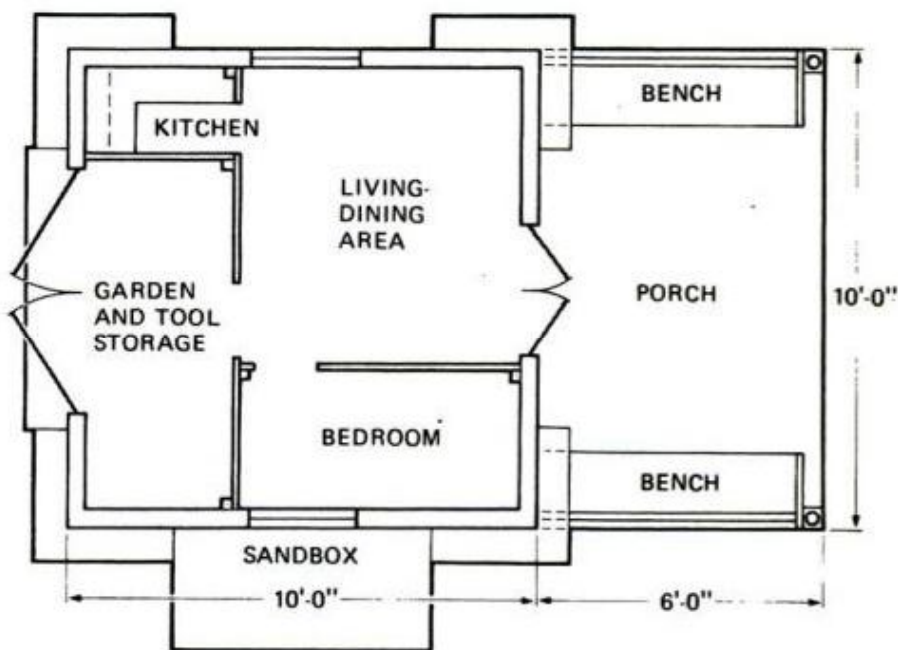

The Storybook: Plan No. 1300

What most homeowners need today more than anything else is more storage space—the garage just isn't big enough any more to store the countless items required to keep a home and yard shipshape and today's family on the go. Such bulky items as a riding mower, snowblower, patio furniture and bicycles leave little room for the family car.

To lick the clutter problem, many have purchased back-yard storage buildings which are little more than sheet-metal sheds—eyesores to neighbors and frowned on by others in areas where local ordinances rule them out.

Looking more like a storybook cottage than a toolhouse, the compact structure shown at the left

will add to the looks of any back yard and bring shrieks of delight from youngsters eager to move in and begin house-keeping. As the floor plan shows, wide barn-type doors and ramp at the rear make it easy to park a riding mower or garden tractor inside, and a walled-off section paneled with perforated hardboard will let you hang a lot of garden tools and other garage clutter.

If the playhouse feature is not needed in your case, and you are lucky enough not to have a storage problem, any one of the three little houses could make a worthwhile

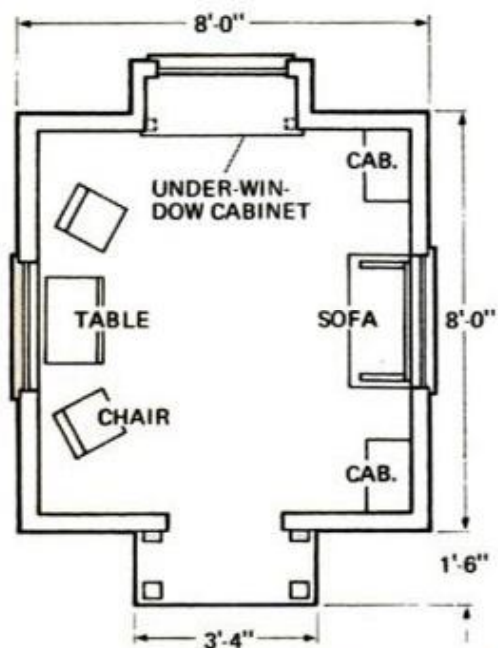

The Southern: Plan No. 1301

Features pillared porch with Dutch door and picture window (above) at rear. Shake roof is topped off with "birdhouse" cupola. Plans include slide that can be added to roof.

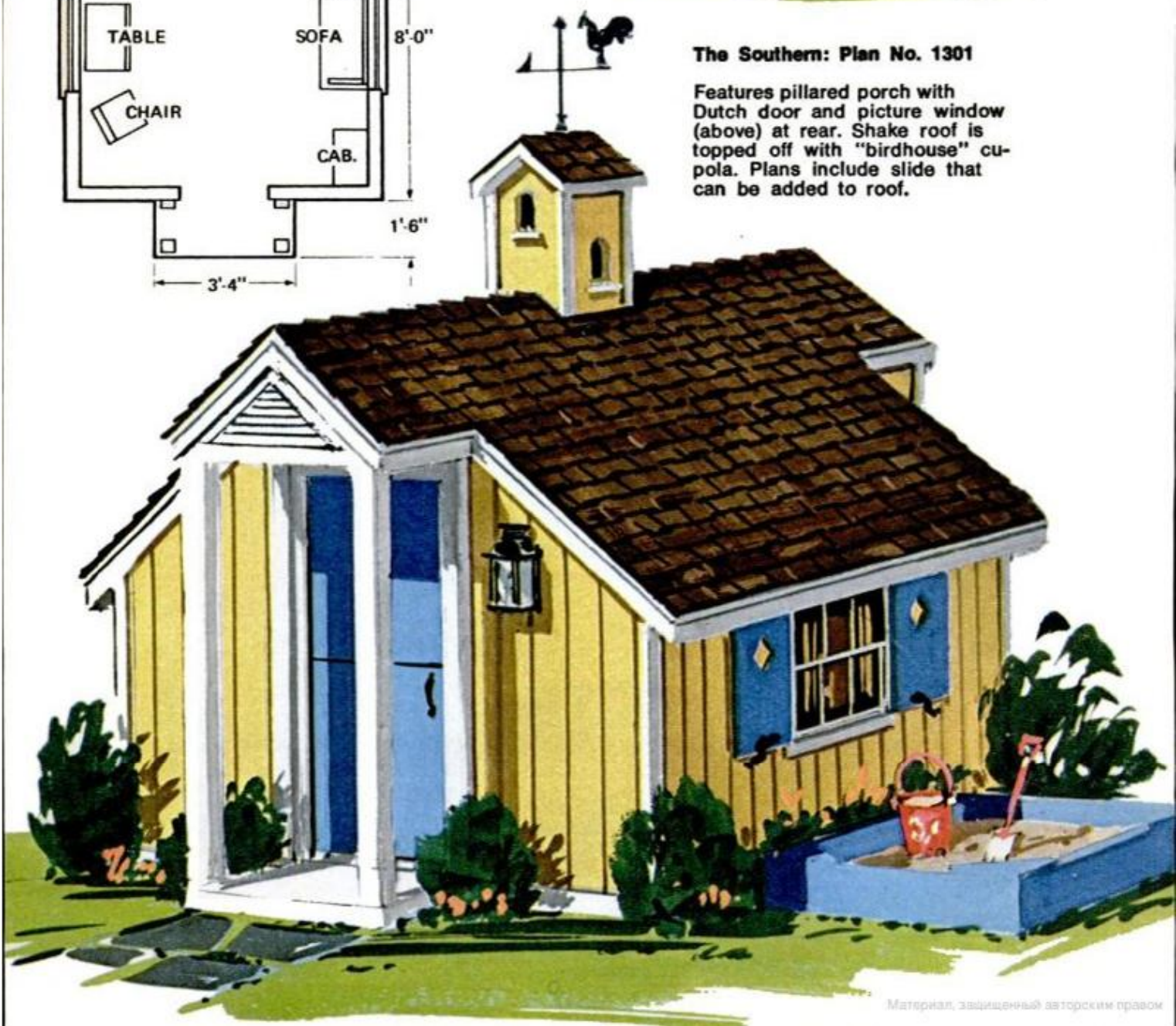



IT'S ALMOST LIKE PRINTING YOUR OWN MONEY!

9¢ WORTH OF RAW MATERIAL becomes **\$1.25** in less than 60 seconds—and ANYONE can LEARN to do it in a FEW SHORT HOURS!

Since 1922, Warner has enabled thousands of men and women to establish a business of their own—to reap the benefits of their own labor and have the personal satisfaction, and independence, that comes with operating a business of their own.

Now, a revolutionary new machine makes it possible for an Independent Business Man with no "PULL" . . . No Big Money to Invest . . . and, No Experience — to start a business of his own, at home in his spare time. Here's what J. H. of Pennsylvania says:

\$7,280.00 for 1 to 1½ hours work an evening in my spare time—and without advertising. When I start to advertise I will have my own full-time business. Right now I am using the extra income to give my family the luxuries my present job does not afford.

Now you can get into this highly lucrative business, and use your own home as headquarters. No experience needed because we supply everything. The new Warner Success Program, "Engraving as a Profitable Business," is now ready for you. We will send you a FREE illustrated brochure and no salesman will call. Send no money — just your name and address on the coupon or on a postcard. Be the first in your locality to cash in on this ground floor opportunity.

Warner Electric Co., Dept. E-2-CH
1512 Jarvis Ave., Chicago, Ill. 60626

Engraving Division, Dept. E-2-CH SEND NO MONEY
 1512 Jarvis Ave., Chicago, Ill. 60626

Please rush your free illustrated brochure to:

Name _____

Address _____

City, State, Zip _____

SUBSCRIBER'S

Change of Address Form

Please use this form to notify us at least six weeks before you move to your new address.

1. Present address: Attach address label from a recent issue, or print your name and address exactly as shown on the label.

NAME _____

ADDRESS _____

CITY _____ STATE _____ ZIP _____

2. Fill in new address:

NAME _____

NEW ADDRESS _____

CITY _____ STATE _____ ZIP _____

3. Mail this form to:

POPULAR MECHANICS
 Subscription Service Dept.
 Box No. 646
 New York, N.Y. 10019

MODELMAKERS MACHINING CENTER IS 5-MACHINES-IN-1

Versatile Maximat combines lathe with vertical & horizontal mill, drill press, and grinder in one rugged, compact unit! Designed for labs, precision workshops and serious hobbyists. Three models available: 7" x 18"

7" x 24", 10" x 26". The Maximat is fun and easy to use. Anyone can machine like a "pro" with our fully illustrated Maximat instruction handbook, **Precision Machining Techniques** — only \$2. Dealers in all major cities.



edelstaal American Edelstaal, Inc. Dept. BG-3
 Tenafly, N.J. 07670

HOME FRUIT DRYER

With our plans and instructions, you can make your own fruit dryer using salvage parts and inexpensive materials. Only ordinary tools are required. Dried peaches, pears, and apples surpass any candy made for being purely delicious. This unit has a large capacity and will cost just a few dollars to build. Complete plans and instructions are just \$3.00.

THRIFTWAY

P.O. Box 914, Provo, Utah 84601

back-yard hideaway for a number of hobbies. Isolated from the din of TV and other family activities, such a house would make an ideal mini-office to escape to. As a place to tinker, it provides an isolated area where you can make all the noise and sawdust (and smells) you want without a complaint. A little house like this would be a great place for a sewing center, and in a pinch it could serve as an overnight guest house. It wouldn't take much to heat it with a plug-in electric heater, and a small in-the-wall airconditioner would make the building comfortable in hot weather.

As you see listed at the right, complete building plans are available for all three houses. You will need at least two sets, one to work from and a second for your local building department—most local ordinances require a building permit for outbuildings. When you get the permit, you'll be advised about the distance the structure must be built from property lines. ★★★

How to order plans

You can purchase complete plans for any one of the three storage buildings featured in this article for \$3.95 for one set, \$5.49 for two sets. Each set measures 17 x 22 in. and includes complete instructions, building tips and materials list. Send orders to Storage Buildings, Popular Mechanics, Box 1014, Radio City, N.Y. 10019. Specify plan number and number of sets you want. Allow three weeks for mailing.

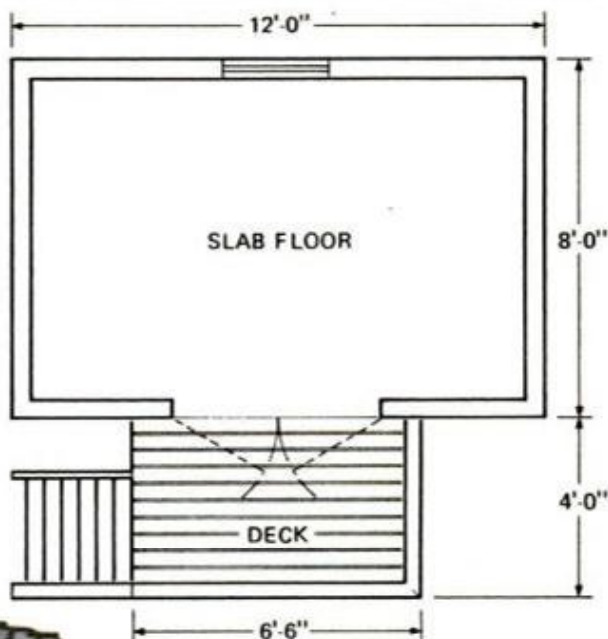

The A-Frame: Plan No. 1302

Stairs leading to balcony provide access to crawl-in loft. Double, swinging front doors make it easy to wheel in tractor or snowblower.

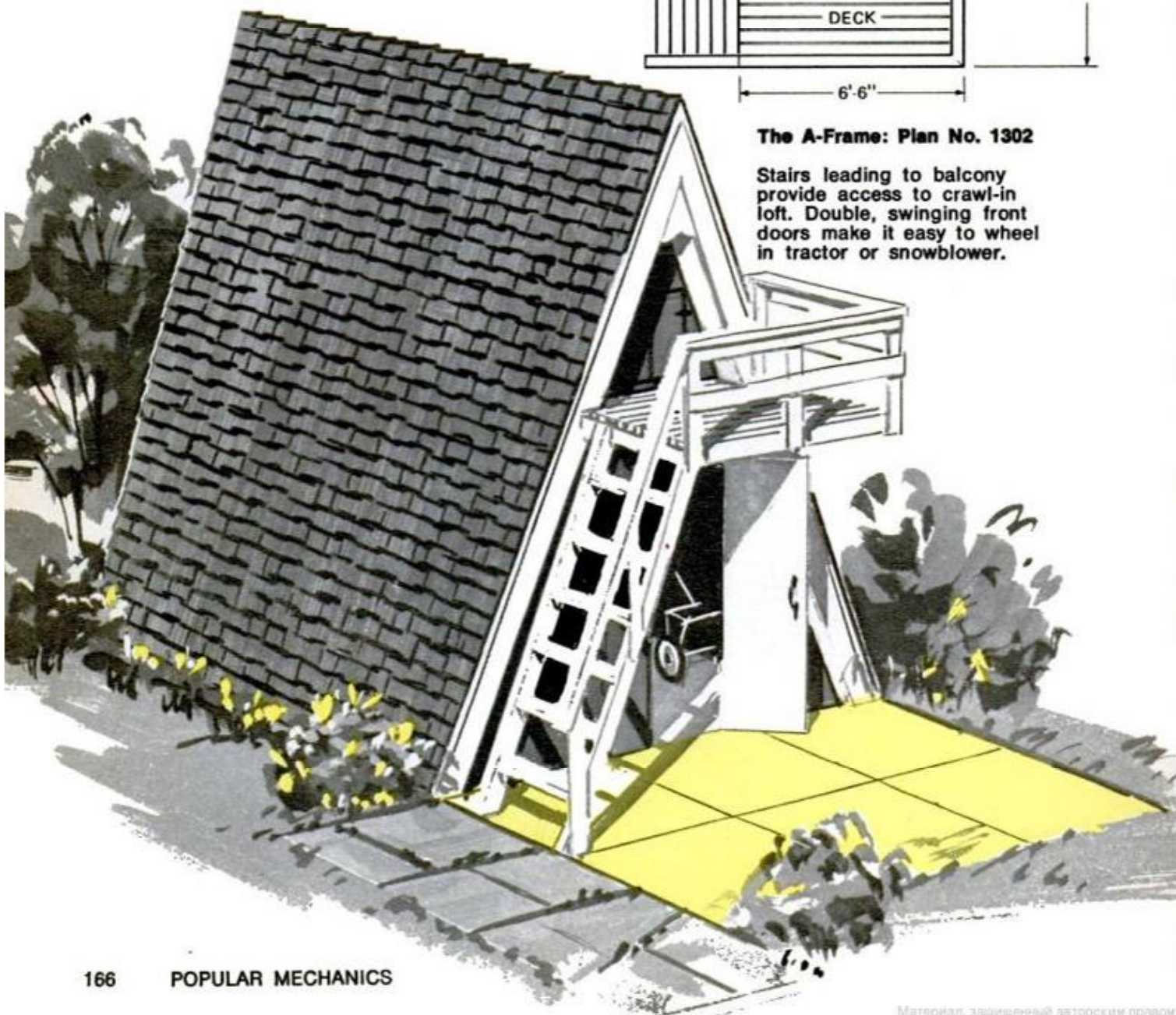

Bring the great outdoors to town on National Hunting & Fishing Day September 22, 1973

The first National Hunting & Fishing Day, September 23, 1972 saw some 4 million people visiting Open Houses hosted by over 3,000 sportsmen's clubs throughout the country.

With your help, NHF Day this year can be far bigger, can introduce millions more of the public to the conservation achievements of America's 55 million hunters and fishermen.

One great way to improve on last year's achievement is to take NHF Day into town. That's what many clubs did last year, especially those without their own club grounds, and the results were outstanding. People who might have overlooked a program at a rod and gun club in the country flocked by the thousands to programs staged at shopping centers, town squares and athletic fields.

So don't be held back if your club has no facilities of its own for holding a



gala NHF Day event. Start planning now to hold one in town.

Send for the new, revised National Hunting and Fishing Day Action Manual. Bulging with knowledge gained from last year's 3,000 celebrations, this new manual gives you complete "how, where and what" information on organizing, promoting and conducting a successful NHF Day celebration. It answers every question.

You can also order a special NHF Day Aids Kit containing everything you'll need to advertise and dress up your event in red, white and blue: streamers, signs, banners, posters, bumper stickers, plus publicity announcements that your local newspaper, radio or TV station will want to use.

Please order today. Making NHF Day happen in your town is up to you.



TO: NHF DAY
1075 Post Road, Riverside, Connecticut 06878

Please send _____ copies of the NHF Day Action Manual
@ \$2.00 per copy.

Please also send _____ NHF Day Aids Kits @ \$3.00 per
kit.

I enclose \$ _____ to cover the cost of my order.

Name _____

Organization _____

Address _____

City _____ State _____ Zip _____

HINTS

FROM READERS



Steel-wool holder

An empty shotgun shell makes an ideal holder for steel wool for use in a shop or kitchen. Stuff the steel wool into the shell with a pencil or dowel to keep from getting metal splinters in your fingers. Cut away the sides of the shell to expose fresh steel wool as needed.

—Bob Brightman, Great Neck, N.Y.



Inexpensive tape holder

A shop tape dispenser that will hold as many as eight rolls of different kinds of tape—masking, friction and cellophane, for example—is simply an inexpensive holder for toilet-paper rolls. A pair of scissors on a piece of string tied to the holder will always be handy for cutting tape.

—Ken Patterson, Regina, Sask.



Safe toaster tongs

Sticking a metal fork into a toaster is dangerous. Tongs for safe toast retrieval can be quickly made from scraps of fancy woods. Use epoxy glue so tongs can be washed, and make blades diverge slightly by clamping with a hand screw at slight angle or by tapering two sides of the spacer block.—David Warren, Crystal Lake, Ill.



Making special bolts

When a bolt is needed in a hurry, especially one with threads all the way to the head, it can be made from a piece of threaded rod, a nut and a section of nail used as a pin or rivet (or the nut could be soldered, brazed or welded on). For an emergency machine screw, saw a slot across the head.

—Walter E. Burton, Akron, Ohio.

Now! Do any car repair this quick, easy way

You can "breeze through" engine jobs, tune-ups, front end jobs, brake repairs, steering adjustments, carburetor adjustments, alternator servicing — almost ANY car service or repair job ON THE VERY FIRST TRY!



1 FIND THE TROUBLE!
MOTOR's AUTO REPAIR MANUAL features Trouble-Shooter Section and detailed trouble-shooting info thruout, to help you spot 4,200 car troubles and find the repair needed. No guesswork!



2 FIX THE TROUBLE!
Step-by-step instructions, photos, diagrams show you where to start, what tools to use. Factory experts practically guide your hands through every move. You can't go wrong!

OVER 1,000-PAGE ILLUSTRATED GUIDE SHOWS YOU

How to Fix Almost Any Part of Almost Any Car

YES! MOTOR's giant new AUTO REPAIR MANUAL is the answer to practically all your car repair problems. Almost every car repair on popular-make cars built since 1967 is explained and illustrated in fool-proof detail. You will develop new speed and confidence on any repair job you tackle.

Try it FREE for 10 Days

Words can't possibly describe the vast contents . . . the thousands of photos and diagrams . . . the easy-as-pie instructions . . . the wonderful feeling when you know you've got that car running like new again!

You've got to see it, use it for yourself! That's why we offer to send it to you, at our risk, for FREE ten-day trial. Try it. See how it makes even the toughest jobs seem like child's play. If you're not 100% satisfied, just send it back and you won't owe a penny!

are guided by the men who actually build the cars, for this book "boils down" the time-cutting and work-saving methods from 300 official factory shop manuals.

This NEW, REVISED EDITION gives you just about everything you need to know to service or repair engines, transmissions, brakes, ignition systems, automatic level controls, exhaust emission controls, speed controls, carburetors, fuel pumps, universals, steering, alternators, etc., etc. — practically every part of the car makes listed below.

Over 1,000 double-size pages include more than 3,000 pictures, 300 Quick-Check charts, 55,000 essential specifications—more than 225,000 service and repair facts! It includes all the new 1973 models.

No wonder you'll see copies of MOTOR's Manual on almost every garage workbench in the country. No wonder it's used by schools, factories, the U.S. Army & Navy. Over 6,000,000 copies sold.

SEND NO MONEY

Just mail the coupon. Use the Manual for 10 whole days FREE. If it doesn't pay for itself in time and money saved within 10 days, return it and owe nothing. But act now! **MOTOR BOOK DEPT., P.O. Box 2316, F.D.R. Station, New York, N. Y. 10022.** (Schools Bookstores: Write for Discounts.)

MOTOR'S AUTO REPAIR MANUAL

Nearly 1 FOOT HIGH
Over 3,000 Illustrations
Over 1,000 Pages

OVER 6,000,000 COPIES SOLD

PRaised BY BEGINNER AND EXPERT MECHANICS ALIKE . . .



"I am a racing 'bug' and expect the most out of my cars. Your Manual has been of excellent help to me." — Duane Davis, Indiana (Racing Advisor)



"I always rely on my Motor Books. They're well illustrated — and complete and simple." — Mr. Erv Jones, Minnesota (Garage Owner)



"Motor's Auto Repair Manual is invaluable to me. I depend on it for all makes and models." — Mr. W. W. Forlines, Virginia (Mechanic)

MOTOR BOOK DEPT.

P.O. Box 2316, F.D.R. Station, N.Y., N.Y. 10022

Please send me the Manuals checked below for ten days free examination:

- 11122 MOTOR's Auto Repair Manual, \$10.95
 12526 MOTOR's Auto Engines & Electrical Systems, \$10.95

If I am not fully satisfied, I will return the shipment promptly and owe nothing. Or I will keep it and pay the total price in three monthly installments, plus a small shipping charge.

I WANT TO SAVE SHIPPING CHARGES

I am enclosing payment of \$..... in full and you will pay shipping charges. (Same return privileges, refund guaranteed.) **F117**

Print Name.....

Address.....

City & State..... Zip Code.....

Signature Please..... Age.....

Offer available only in the Continental United States and Canada. Prices slightly higher in Canada. Delivery will normally be 3-4 weeks in Eastern United States and slightly longer west of the Mississippi.

(M. M. Books)

Same Offer on MOTOR'S AUTO ENGINES & ELECTRICAL SYSTEMS

1,300 pics, how-to text on principles; design, upkeep of engine & electrical systems. Check box in coupon.

Almost Everything You Need to Know to Fix Cars Like a Crack Mechanic. The instructions and pictures are so complete, so clear, you just can't go wrong. Your hands

FIX ALL THESE CARS

Volkswagen
Mustang
Barracuda
Chevy II
Pontiac
Thunderbird
Buick
Imperial
Cadillac
Continental

Mark III
Mercury
Ford
Chevelle
Chevrolet
Vega
Chrysler
Plymouth
Oldsmobile
Hambler
Dodge

Cougar
Taronado
Valiant
Dart
Javelin
Montego
AMX
Pinto
Hornet
Maverick
... and more!

FREE 10-DAY TRIAL

Return and Pay Nothing If Not Satisfied

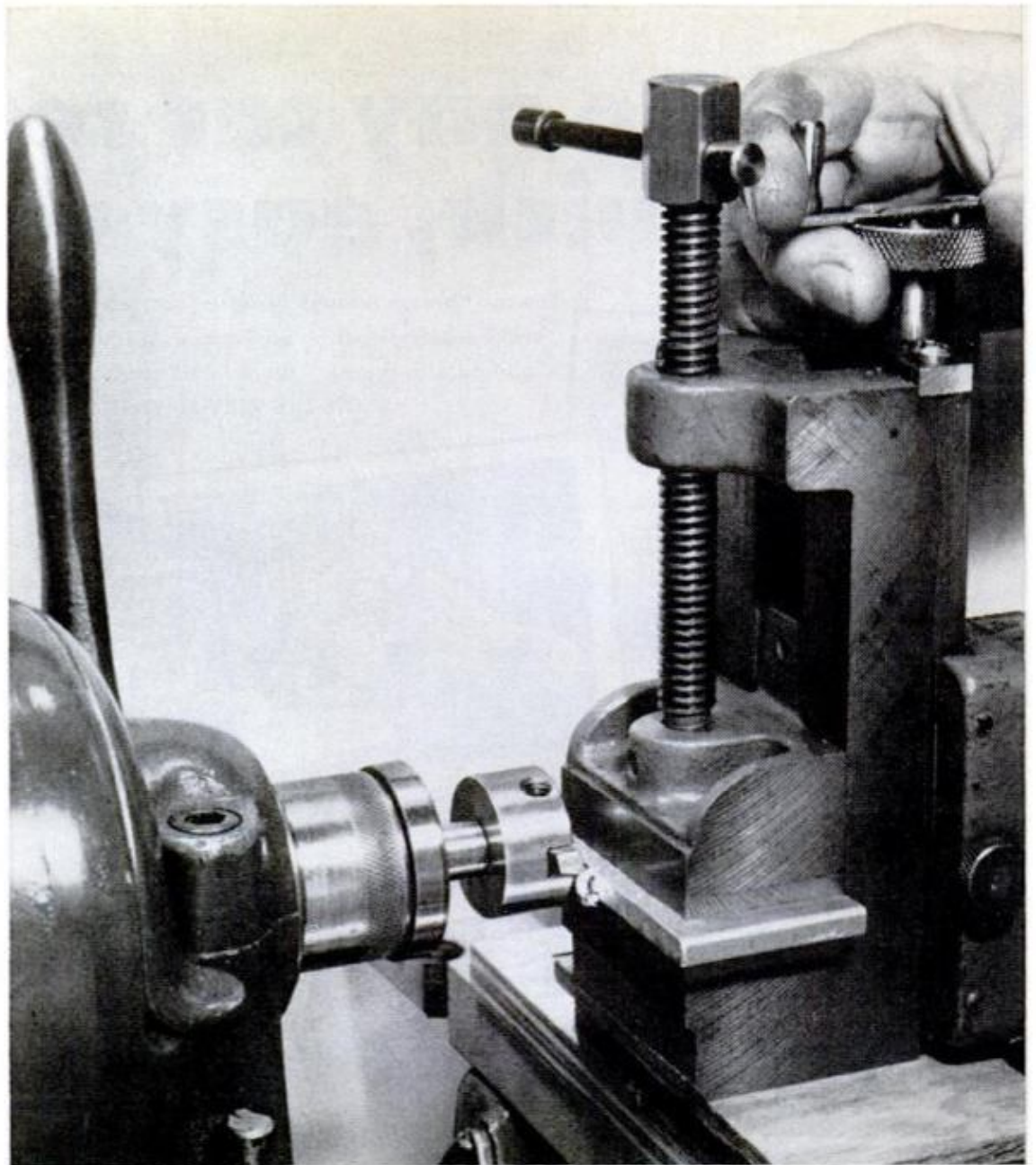

Fly-cutter in 9-in. lathe is smoothing edge of 1/4-in. aluminum plate held in a milling vise.

Fly-cutter holder you can

by Walter E. Burton
PHOTOS BY THE AUTHOR

After the shank is turned (right), head of the holder is machined and faced in a three-jaw chuck.

Head is tilted to mill a sloping slot by placing two twist drills between shank (right center).

Cutter bit is locked in the holder by hollow-head setscrews turned with an Allen wrench (far right).

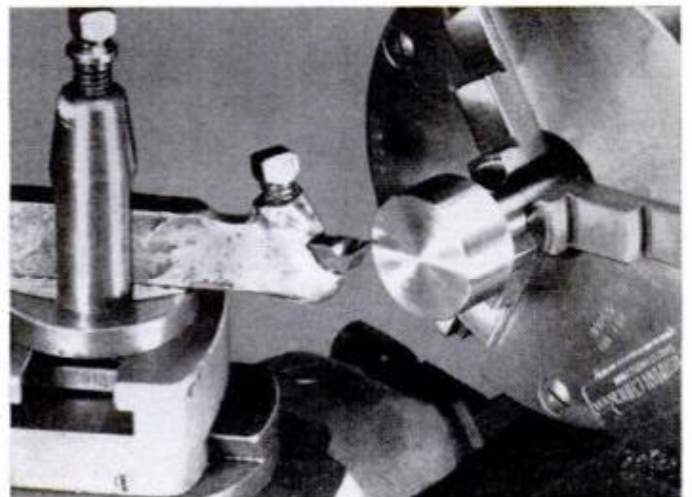

This simple shop-made fly cutter will do the work of an expensive multitoothed milling cutter. It's particularly useful for facing operations on workpieces that are held in a milling-attachment vise, and for certain boring jobs.

The tool consists of a standard $\frac{1}{4}$ x $\frac{1}{4}$ -in. high-speed-steel lathe bit clamped in a sloping slot in a rotatable holder. The sloping slot positions the bit so its cutting tip is beyond the face of the holder. The tip is ground much like that of a conventional lathe bit.

In a typical setup, the tool and holder are mounted in the headstock chuck and the workpiece is clamped in the vise of a carriage-mounted milling attachment. Because the work should be held as rigidly as possible, the overhanging vise is steadied by placing wooden blocks under it. Here the vise is run down against the top block, but not so tightly that the cross feed can't be used to move the workpiece past the cutter. Generally it is desirable to take rather shallow cuts and feed the work gradually and evenly, with the lathe at a slow or medium speed. Often the resulting surface is so smooth no further finishing is required.

The tool is made by turning down a length of $1\frac{1}{4}$ -in. steel rod to form a $\frac{1}{2}$ x $2\frac{3}{4}$ -in. shank with a $\frac{5}{8}$ -in.-thick head, then cutting a $\frac{1}{4}$ -in.-wide slot ($\frac{3}{16}$ in. deeper at one end than the other) across the face of the head. Two holes are drilled and tapped for setscrews that lock the cutting bit in its slot.

Since fly cutters can throw chips, it's wise to wear safety goggles or a face mask and to keep your shirt collar buttoned. ★ ★ ★

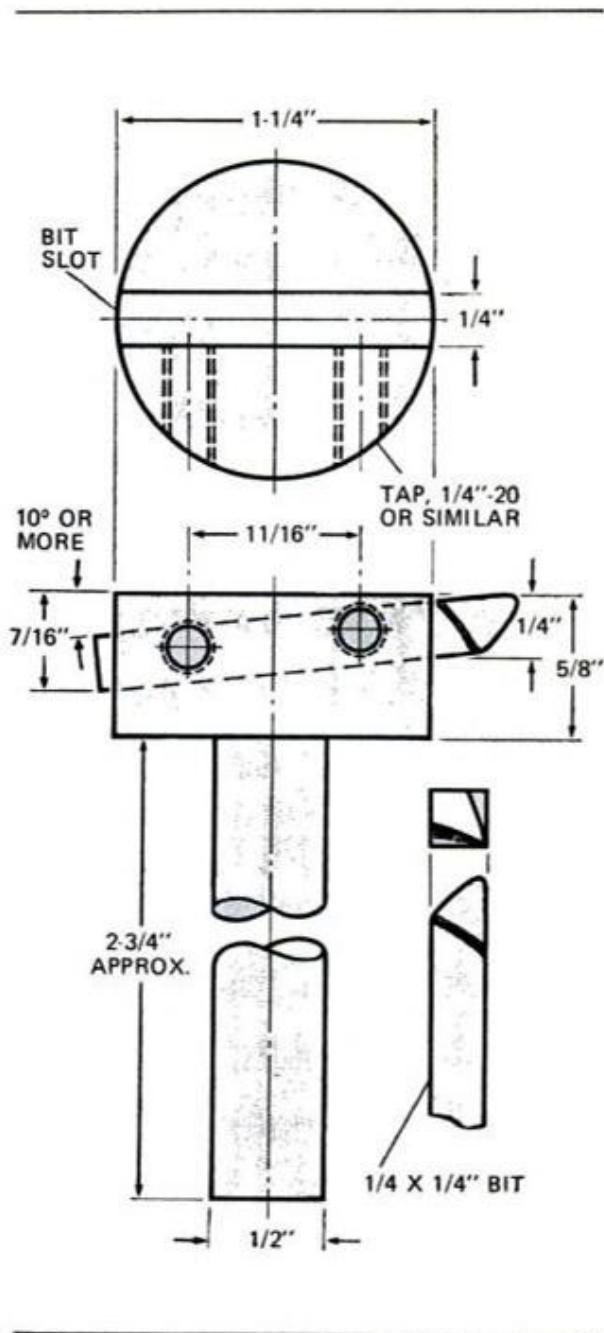

make for your lathe

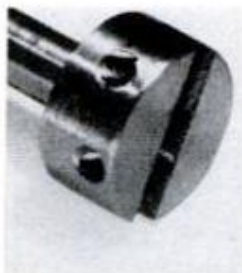
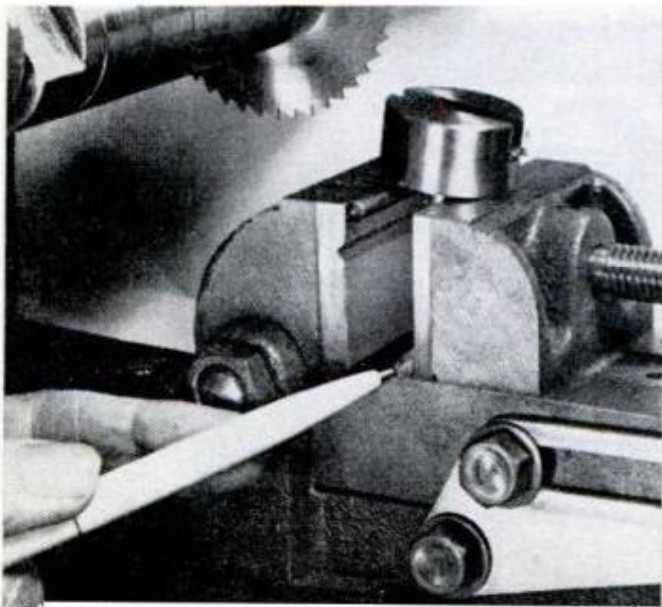

Now you can refinish your car's damaged surface areas professionally

You already have the skill to refinish your car's damaged surface. All you need is a few minutes practice on a tin can. Send a self-addressed stamped envelope, and we'll send you brief illustrated uncomplicated instructions free.

With Dupli-Color® touch-up paint, you can be sure of professional results. Used by millions, Dupli-Color duplicates your car's original color exactly. Dries in minutes to a hard high-gloss finish. Beautiful! Professional!

In all popular domestic and foreign car colors wherever auto supplies are sold. Brush-in-cap bottles, Auto-Spray® cans. Get color code number or letter from body plate.

DUPLI-COLOR® PRODUCTS

Dept. P, 1601 Nicholas Blvd., Elk Grove, Illinois 60007

Illustrated booklet shows tricks of the auto refinishing trade



Find body plate under hood or on front door jamb. Color code usually single letter or number. Get exact matching Dupli-Color.



Hold Dupli-Color spray can 8 to 10 inches from surface. Spray fast, smooth side-to-side strokes in one minute intervals.



For touching up a small nick or scratch. Cut small hole similar in size and shape to nick and spray Dupli-Color through it.

COLLECTOR CLASSICS

Authentic! Full Size Machined Metal Models
Disassembles Like Originals — Over 30 Parts

Museum quality precision machined metal classics look, feel, weigh like real guns. Will fool experts. Perfectly legal—**CANNOT BE FIRED**. Blued and disassembles like originals. Decorate your den, office rec-room. Send for **free** color brochure of 35 famous historical to classic military firearms. Each model made of over 30 blued, hand-finished parts—delivered fully assembled.

METAL MODELS FOR DISCRIMINATING COLLECTORS
(Money back guarantee.)



Model 1776 Flintlock Pistol

Carried by Continental soldiers in Revolutionary War—A classic reproduction of old world craftsmanship—#830 ONLY \$39.95.

U.S. Model 1851 Navy Colt

Used by Union & Confederate troops in U.S. Civil War—#400 ONLY \$26.95.



U.S. Model 1873 Western Peacemaker

Legendary firearm of old west. Choice of frontier sheriffs & Texas Rangers—#101 ONLY \$24.95.



U.S. cal. 45 Service Automatic

Trusted sidearm of U.S. troops in W.W. I, W.W. II & Korea—Rated best military pistol in the world. #300 ONLY \$24.95.

German P-08

By Geo. LUGER—German officer pistol—Prized souvenir in W.W. I & W.W. II #200 ONLY \$26.95.



MADE OF OVER 30 PARTS AND CAN BE DISASSEMBLED. ALL MODELS ARE SAME SIZE & WEIGHT AS ORIGINALS

COLLECTOR CLASSICS, LTD.®

Dept. PM-7 610 Franklin St., Alexandria, Virginia 22314

Send #101 #200 #300 #400 #830

Enclosed \$..... Add \$1.25 postage per model

Charge to my: BankAmericard Mastercharge

Am. Ex. #

Name

Address

City/State/Zip

SEND FREE CATALOG OF OVER 35 MODELS.

Finally—Hacksaw Blades That Last!!



Better than any other on the market. They cut well and last longer! Used by the professionals, now available to the public. Made of the finest Sheffield steel.

Specify 18, 24, 32 teeth per inch. Also specify 10" or 12" in length. \$9.00 per pack of 10. \$78.00 per one hundred—price includes handling and postage. No C.O.D.'s. Send \$2.00 for fantastic catalogue of other products the pros use. Cash, check or money order.

SWANSON MOTOR RACING
713 W. 16th Street, Costa Mesa, California 92627

I-N-V-E-N-T-O-R-S WE NEED INVENTIONS

Sell your invention for cash—need money for Patent?—Are technical problems holding you back? Universal Inventions has helped inventors all over the world—just like yourself—why not you? Inventions provide the magic spring-board to sudden riches. **REMEMBER**, we either sell your invention or pay you a cash bonus. Write for details. **UNIVERSAL INVENTIONS, Dept. 13, Marion, Ohio 43302**

BUILD, FLY YOUR OWN COPTER!

It's great sport to fly a Bensen Gyrocopter — lowest cost, too. Fly high or low, fast or slow. Adapts to floats. Pilot ages range from teens into 60's. Enjoy flying this easy way! Plans, parts and factory kits available. Get colorful info packet with photo, specs, 3-View Drawings. Send \$5 today!

BENSEN AIRCRAFT CORP., Dept. PM-73
RDU Airport, Raleigh, N. C. 27602

NAME _____

ADDRESS _____



HOW TO GET RICH -- AT HOME!



There is no other business like mail order. Start on a shoestring in your spare time and make a fortune fast. It strikes like a bolt of lightning! Millions read your ad and suddenly you are swamped with cash orders from all over the country. **MORE MONEY** in 60 days than you could earn in a lifetime! Write for free book and complete details. Mail Order Associates, Inc. Dept. 407, Montvale, N.J. 07645

BASEMENT TOILET FLUSHES UP



TO OVERHEAD SEWER OR SEPTIC TANK.
NO DIGGING UP FLOORS. INSTALLS EASY. Write

McPHERSON, INC., BOX 15133, TAMPA, FLORIDA 33614

The bargain hunter

WORLD'S SMALLEST FIRE ALARM

The World's Smallest Fire Alarm plugs in anywhere—attic, furnace, room, garage, bedroom. Great for homes, offices, warehouses, stores, factories, farm buildings, hotels, schools, anywhere low cost high efficiency protection against fire is needed. This tiny alarm with a big voice really sounds off when temperature reaches 135°. Allows plenty of time for effective action. Can be moved from room to room, even packed for use in motel and hotel rooms. Operates on 110 to 120V current. Plugs directly into outlet, no batteries to run down. A necessity for low cost protection against fire. Weight 6 ounces. Only \$10.95 PPD Satisfaction guaranteed.

Triple P Enterprises
Bingham Road Dept. IM
Solon, Maine 04979

110 Volt A.C. GENERATORS

60 cycles. Fanbelt driven from car or gas engine. Operates T.V., refrigerators, radios, all power tools, projectors, P.A. systems and fluorescent lights. Over 12,000 in service. Guaranteed six months. 1500-watt \$65.00 postpaid. 3000-watt \$105.50 postpaid. Special X-1000 watt self-excited generator \$85.00 postpaid.

TOOL POWER™ patent pending

115 volts D.C. 5000-watts. 50 amps from your car's alternator. Guaranteed 20 years. Install in ten minutes. Operates all power tools, electric motors up to 2 h.p. Arc welding, fast battery charging. Any like device by any name is an infringement of our patent pending. All copiers are notified. Be safe, buy from the inventor and developer. \$25.00 postpaid. Attractive dealer plan.

VIRDEN PERMA-BILT CO.,
P.O. Box 7160PM

2821 Mays, Amarillo, Texas 79109

FREE CATALOG

UP TO 50% OFF COMPARABLE KITS*

• BUY DIRECT • SAVE \$\$\$

FREE Catalog—Electronic Kits—Amplifiers—Preamps—Psychedelic Strobes—Burglar Alarms—Digital Tachometer—More: Free Catalog, SWTPC, Box P32040, San Antonio, Texas 78284.



ALARM STICKER DECALS Scare Away Would-be Thieves and Molesters.

Protect your Home, Car, Office, Boat, Cycle or any personal possession you don't want stolen or tampered with.

These 3 color inside/outside professional decals will supply you with the added protection needed to make would-be thieves go elsewhere!

Futronic Security System decals are the same kind as those sold with expensive alarm systems (and until now most people had to buy the complete alarm system to get the decals). Now you can enjoy this added protection for pennies!

Futronic Security Systems division of M.J.F. Futronic Systems, Inc., P.O. Box 333, Main Station, Yonkers, New York 10702.

Send for 1 decal 39¢; 3 decals \$1.00; 7 decals \$2.00; 10 or more, 26¢ ea. Include your zip.



Bartlett Flying Saucer ultra-light hovercraft powered by ordinary lawn mower engine—easy to build—fun to fly—complete plans, kit brochure, photos and supply sources \$3.00. All orders returned via airmail. Write:

HERB BARTLETT

Box 3339-M, Scottsdale, Arizona 85257



DUNE-BUG BIKES OR KARTS

\$1 PLANS PARTS OR COMP. UNITS
One dollar brings you complete info, on how and what to build or buy. Discount prices (automatic clutch, \$9.95). Parts, kits, engines, and raw materials, comp. drawings, pictures & specifications.



\$1 for DUNE-BUG bike or kart info, or \$3 for all to: Box 987-P7 Azusa, California 91702

YOUR OWN RADIATOR BUSINESS

"\$70,000 LAST YEAR"

says D. Carter, Lemoyne, Pa.



Complete turn-key package: training school in radiator repair technology and business management plus special power-equipped auto radiator shop.

Don Carter writes: "Averaging \$30 an hour, expect to hit \$80,000 next year." Mail this coupon for complete story.

NAME _____
ADDRESS _____
CITY _____ STATE _____
ZIP _____ PHONE _____

INLAND MFG. CO. Dept. PM-7
1108 Jackson Street • Omaha, Nebr. 68102

THE U.S.A. IS GOING METRIC!

Dial Conversions like you dial a telephone! You can't afford to be without the...

DIAL-A-CON ANGLO-MET-CONVERTOR



EASY TO USE . . . EASY TO READ . . . convert English measures to metric on one side . . . metric measures to English on the other . . . in dry and liquid measures, miles/kilometers, inch/mm., feet/meters, yards/meters, fahrenheit/centigrade. 6" dia. Made of heavy, durable plastic. U.S. Pat. 3,544,768. Only \$5.98 ea. plus 50¢ shipping. Send check or m.o. (No c.o.d.'s) to:

HOWARD ALAN INDUSTRIES, METRIC DIVISION
Dept. PM-7, P.O. Box-311, Northfield, Illinois 60093

AquaBug

Breaking The Pound Barrier

AquaBug makes the lightest outboard motors in the world. But did you know that, pound for pound, our motors develop almost **twice** the horsepower, and better than 70% more **thrust** than the small motors sold by Evinrude, Johnson, Seagull, Ward's and Sears? Or that their smallest motors weigh at least 240% more than ours?

And did you know that we're the **only** outboard manufacturer to publish certified thrust figures, and our Guarantee **in full**, in national ads? Which means you'll know, **before** you buy, what the motor and the manufacturer will do **after** you buy.

AQUABUG GUARANTEE

We will repair or replace any motor found to be defective in design or manufacture, without charge for labor, parts, or service, for a full year. FOR THREE YEARS, we will do the same for the entire drive chain, from drive shaft to gears to prop. We assume you will use the motor in a normal way, and exercise reasonable maintenance from time to time. Your **only** obligation is to get the motor to and from our world-wide network of Service Centers, or our factory.

Every motor we make is compatible with our famous AquaBug/System, which lets you switch to an electric motor, or a generator, as the need arises. (See product reports in Boating, April '73; Popular Mechanics, February '73.) It's all in our brochure, free for the asking.

SeaBorne Systems, Inc./Dept. PM-7
100 Merrick Road, Rockville Centre, N. Y. 11570
(516) 536-8100

Name _____

Address _____

City _____

State _____ Zip _____

- Master Charge # _____
 Bank Americard # _____
 AquaBug II Outboard Motor, \$135 postpaid.
 Send me your Illustrated Brochure, free of charge.

For immediate shipment, send certified check, teller's check, money order — or your Master Charge or Bank Americard number. (N.Y. residents add sales tax.) 25% on C.O.D.'s



AquaBug II
1.9 C.I.D.
35 lbs. Thrust
\$135

Penney's newest portable power saw

PM's shop editor put the saw through its paces on a recent project. Here are his findings.

by Harry Wicks
WORKSHOP EDITOR

I've used Penney's newest portable circular saw during a number of shop sessions and can report that it has features that you'd find on saws selling for a lot more. All points considered—construction, power and comfort—it meets competition in the same price range head-on. The saw sells for \$50.

Labeled Model 4939 by J.C. Penney, the tool is double-insulated and is said to have a motor that will "withstand frequent overloads caused by continuous cutting." To check that claim, I put in a rip blade and did repetitive, nonstop cutting in 2-in. stock for 10 minutes. There was no overheating or slackening of the saw's cutting zip.

As far as I am concerned, there's some good news and some bad news about that on-off safety button (see E, photos below). First, the good news: The on-off button must be depressed before the trigger can be squeezed to start up the saw. That's good protection against accidental starts, such as when you happen to pick up the tool with your finger on the trigger. And when the trigger is released, it automatically disengages the switch—the trigger won't operate again until the button is depressed first.

Now, the bad news. The button is poorly located. As a right-hander, on continuous runs I found my thumb uncomfortable. Then the thought occurred to me that, for a

(Please turn to page 178)

PHOTOS BY ROBERT D. BORST

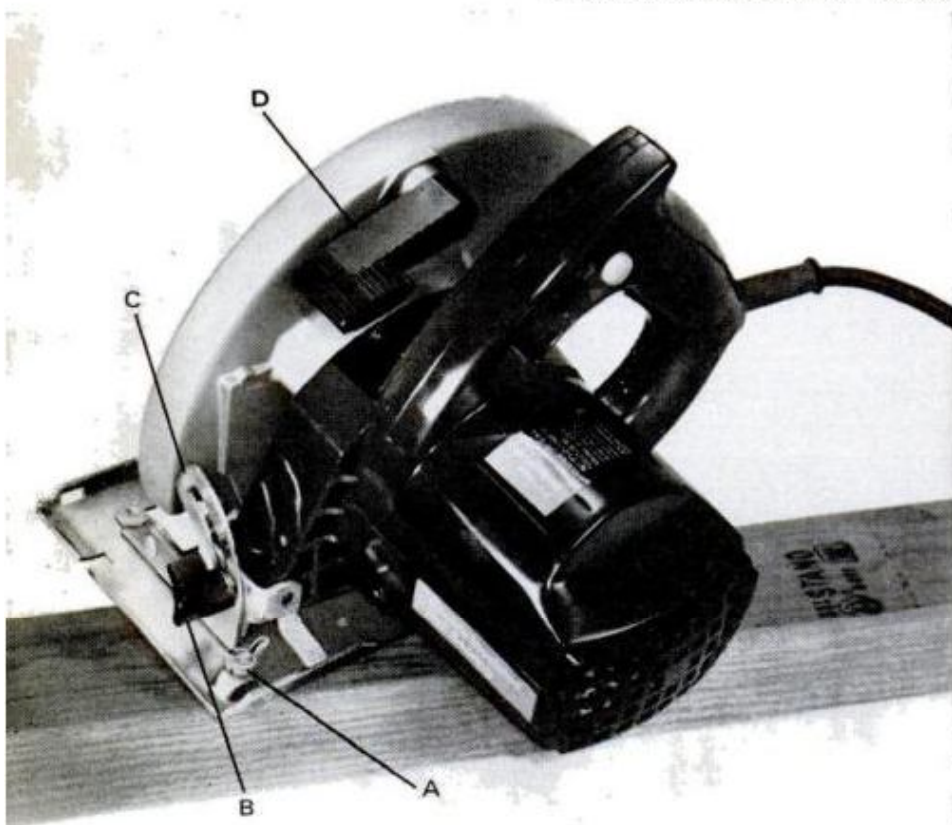

Innovation on the saw is the on-off switch (E) which must be pressed before trigger (F) can be squeezed. Other features shown in photos are: (A) wing screw for holding rip guide; (B) bevel locking knob; (C) bevel quadrant; (D) lift lever for blade guard (see text); (G) elevation locking knob.

LOGIC NEWSLETTER

SAMPLE COPY \$1.00
LOGIC NEWSLETTER
POB 252
WALDWICK, N.J. 07463

**BEAT
THE
DICE
TABLES**
All
Legalized
Casinos

**Double-Your-Money-
Back GUARANTEE!**

Place only 5 bets. All numbers
are in your favor including 7,
2, 3, 4, 5, 6, 7, 8, 9, 10, 11, 12.

You win every roll!

Send \$1 For Details
M.C. CORBIN CO. Dept. MGPM7
Box 869 Radio City Sta. N.Y. 10019

IMPORTED LOCK BLADE KNIFE

ONLY \$2.75 each

9" Overall Length
5" When Closed

- Sharp and Tough
- Stainless Steel Blade



Locks into position to prevent accidental closing. Razor sharp tough stainless steel blade for reliable use and hard, long service. Money back in 5 days if not satisfied. Send \$2.75 plus 25¢ to cover postage and handling.

WESTBURY SALES CO.
P.O. Box 434, Westbury, N.Y. 11590
Dept. L-258-PM

WATER WATER WATER WATER WATER WATER

"HOW TO DRILL YOUR OWN WATER WELL"

\$1.00 ppd

SATISFACTION GUARANTEED

DEPROCK CO.
OPELIKA, ALA. 36801

BECOME AN ARTIST OVERNIGHT!

Fantastic new manual shows you how to produce life-size oil images of anyone in minutes or double your money back! ALL you need is oil or acrylic paint, brush, canvas. No expensive equipment needed. Amaze your friends. Make extra money part time. Uses no photos, gadgets, or painting by numbers. Even a child can do it. Complete method. \$3.98



JIFFY PORTRAIT, DEPT. P.M.7
1315 Ronan Ave., Wilmington, Calif. 90744

SOLID VINYL MATS

to cushion your feet. Ideal for workshop or hobby center, 4 ft. wide. Available in 4, 6, 8, 12 ft. Lengths 20¢ per sq. foot plus \$1 handling.

CUSHIONMAT

P.O. Box 16902
Memphis, Tn. 38116

ANNOUNCING POPULAR MECHANICS INDEX AND SHELF WRAPPERS—1971 & 1972 EDS.

A great idea that will multiply the value of your back issues of PM. The indexes are bound in handsome wrappers made of heavy board and enclose the 12 issues which are cross-referenced in the Index. Makes beautiful and useful additions to your bookshelves. Price \$1.49 ea. Send orders to Popular Mechanics (Dept. IW) Box 1014 Radio City, New York, N.Y. 10019.

GRANDFATHER CLOCKS

SAVE 50%
BUILD YOUR OWN
FROM OUR
SEMI-ASSEMBLED
CASE KITS



We are the ONLY producer of COMPLETELY HAND-CRAFTED semi-assembled clock kits! Major assemblies carefully fitted and joined by experienced cabinet-makers. (No power tools required.)

- Highest quality imported German movements
- Tubular or rod chimes
- Moving moon dials
- Kits for wall & mantel clocks available
- Templates & case plans

All movements & dials in stock for
IMMEDIATE DELIVERY
Send 50¢ for complete catalog

H. DeCOVNICK & SON,
P.O. Box 68, Dept. M73
Alamo, Calif. 94507



FREE!!! POWERFUL MUSCLES FAST!

Fantastic New Discoveries in the science of bodybuilding. Now, in the privacy of your bedroom, our method will add inches of powerful muscles to arms, chest, shoulders & legs. Learn secrets on trimming the waist with ultra-modern methods—fast! Results Guaranteed! Send for free brochure. Universal Bodybuilding, Box 485-MI, Dearborn, Mich. 48121.

LICKITY SPLITTER

ENDS WOOD SPLITTING DRUDGERY

New low cost COMPACT MODEL... for farmers, camps, cottagers. 10 ton ram, 2 cycles per min., splits logs 25" x 18". Carried in car trunk, placed upright or hung for storage. For details write:

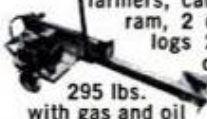

PIQUA ENGINEERING, INC., Dept. P, Box 605 Piqua, O. 45356

Build Your Own Kit CANOE or KAYAK.

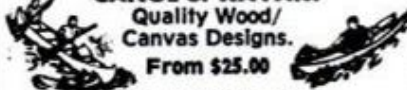

Quality Wood/
Canvas Designs.

From \$25.00

Free Literature!

SPORTSCRAFT
Box 636-PM Allentown, N.J. 08501

FLASHLIGHT BATTERY POWERED CLOCK UNIT

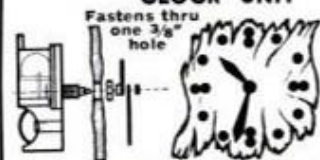

\$9.50
POSTPAID

Driftwood, picture frames, mirrors, baskets, dinner plates, etc. can make exciting original wall and desk clocks to enhance and beautify your home for years to come. These unique clocks can be much appreciated gifts to amaze and delight the receivers and can easily be assembled in quantity for profitable resale. This fine fully warranted American made unit requires only a 3/4 inch hole for assembly and is flashlight battery powered. Shipped complete with hands and a booklet offering specifications, numerous design ideas, many assembly hints and instructions. \$9.50 Postpaid, 2-5 units, \$8.00 each and 6-20 units, \$7.25 each. 10 day money back guarantee. Order today or send 50¢ (refundable) for the design and assembly booklet. **LINDHE'S, 505 Morro Bay Blvd., Morro Bay, Calif. 93442.**

DETROIT APPROVED PICKUP TANKS



Original equipment type poly, now available in auxiliary tanks for pickups. Increase gas capacity 40 gals. Far superior to metal, complete hidden, no body work necessary. Easy 1 hour installation—Truck discounts pay for tanks in a short time. Two tanks, brass valve, hose, complete. Meets Federal Regulations.

PICKUP EQUIPMENT CO. LTD.

Dept. PM-773, P.O. Box 7635
WACO, TEXAS 76710
CALL TOLL FREE 800-433-2386

SILVO

(BRAND NAME)
TOOL

CATALOG

Thousands
of exciting
tool values!



Stanley, Skil, Thor, Wen, Disston, Wiss, Wellsaw, Dremel, Plumb, Huot, Kennedy, Channellock, Rockwell, Helois, Vise-Grid, Crescent, Rigid, Pony Clamps, Unimat, Foreman and many other Nationally Advertised brands of Tools & Supplies. We ship Coast to Coast at prices Hard to Beat. Send \$1.00 for our big 152 page tool catalog today.

Silvo Hardware Co., PM-73
107 Walnut St., Philadelphia, Pa. 19106

1600 Novelties

FREE! New World Famous Catalog

Hard-to-get Novelties, Jokes, Tricks, Hobbies, Sports, Science, Electronics, Funmakers, Psychedelia, Emblems, Posters, Magic, Games, Gifts, Models, Money Makers, Jewelry, Bargains, Gadgets, Books, Photo & Optical, Tools, Watches, etc. No letter necessary. Send name, address.

Johnson Smith Dept. C107, Mt. Clemens, MI 48043

1973 BICYCLE PARTS CATALOG

Over 1000 Items For 1-3-5-10 Speed 20" to 27" Bicycles Amateur or Professional



- Accessories
- Replacement Parts
- Conversion Kits
- Repair Books
- Gear Ratio Charts

\$1 Refundable with \$5 order.

ACTION ACCESSORIES

Box 15, Liverpool, N.Y. 13088

Easy to Build PLANS

AND INSTRUCTIONS for



- Go Kart\$2.00
- Mini Bike\$2.00
- Three Wheeler\$2.00
- Three Wheeler A.T.V. \$5.00
- Mini Car\$3.00
- Pedal Boat\$4.00
- 12' Sail Boat\$4.00
- Sail Board\$2.00
- Pontoon Boat\$1.00
- 8' Hydroplane\$2.00
- Two People Mini Jeep\$3.00
- Snowmobile Sleigh\$3.00



MINI VEHICLES PLANS

"DEPT. C"—P.O. Box 92
Chazy, N.Y. 12921



PENNEY'S PORTABLE POWER SAW

(Continued from page 176)

left-handed person, the button would be downright unwieldy. To activate the trigger, a lefty has to work his hand into such a position that the palm side of his index finger (near the joint) would have to do the pressing of the on-off switch.

The safety switch is a good idea, especially for beginners, but I'd prefer to see it relocated on top of, and centered on, the handle.

Points I particularly liked: The blade guard lift (see D in photo on page 176) that's located between the handle and the upper blade guard. When making plunge cuts, it eliminates reaching across the saw to lift the blade guard out of the way so you can lower the spinning blade into the work. Because I'm accustomed to the lever location on my old saw, the new position took some getting used to. However, a first-saw buyer should feel comfortable with it immediately because he won't have the acquired habit (as I do) of reaching across. Even so, after a couple of cabinet-making sessions, I was completely accustomed to the different lever location.

I also liked the blade guard stop (see arrow, top photo, left). It's an added safety factor that prevents overlifting the blade guard and exposing an excessive amount of blade.

The sawdust ejector system is effective, too. It does a good job of spewing sawdust away from the cutting line—and the operator.

My conclusion: Given proper care, Penney's Model 4939 saw is a rugged tool that should give you years of home and shop use. ★★★

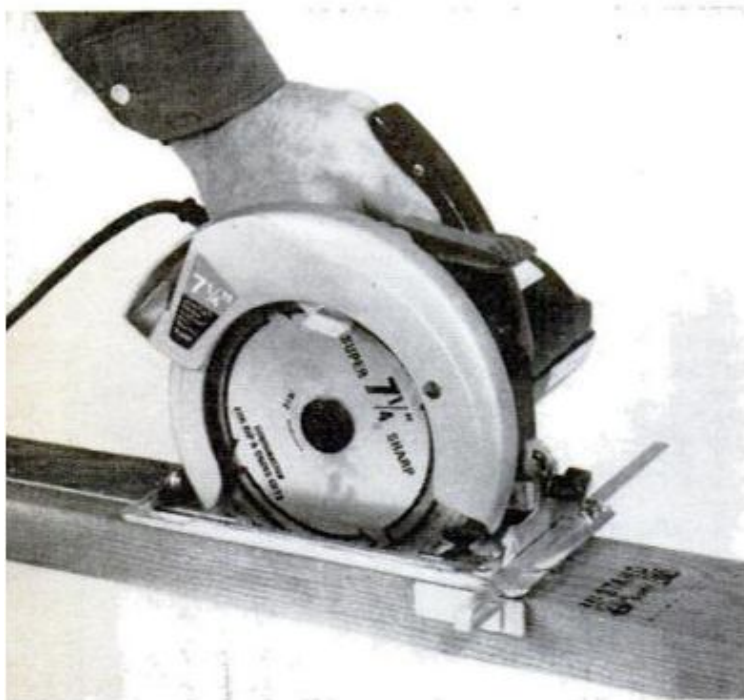
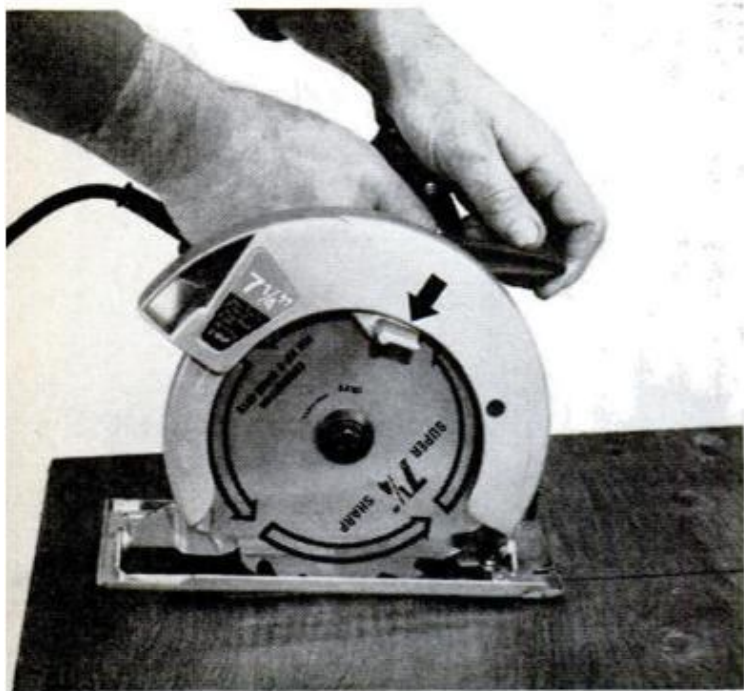

Lift lever (top photo) is good safety feature, allows user to raise blade guard when making plunge cut without reaching over the handle. Arrow indicates the blade-guard stop which limits blade cover travel so minimum amount of spinning blade is exposed. Lower photo shows rip guide in use. It provides straight cutting despite being held by the single wing screw.

SPECIFICATIONS Model 4939 portable circular saw

Maximum blade diameter	7¼ in.
Housing Motor	Double-insulated Universal, a.c. only, 25-60 Hz.
Amp. rating at 115 v.	10
No-load speed	5200 rpm
Price	About \$50

Distributed by J.C. Penney, 1301 Avenue of the Americas, New York, N.Y. 10019. At Penney Stores or by mail order through catalog.

CARS THE RED BARON WOULD LOVE!

(Continued from page 141)

turning circle is only 37.5 feet and that's for a car with a wheelbase of 112.8 feet. (Overall length is 195.3 in.; width, 73.6 in. and height, 56.1 in.). This advantage of increased steering angle (4°) and smaller turning circle is just one virtue of the new front suspension (see technical drawing, page 140). The lower A-arm is conventional, but the upper arm links with an antiroll bar for variable upper-arm angle. Brake as hard as you want, the result is (sorry, Red Baron) no nosediving.

The front geometry also includes zero steering offset. The Fox goes negative in the steering or kingpin offset, but in a heavier car like the Mercedes (4000 pounds) even moving the offset to zero from the usual positive results in heavier steering. But since power steering is standard, little effort is needed. It may feel a bit heavy, but only if you're used to domestic power-steering units which make steering easy to the point of losing road feel—which should not be engineered out of any car.

Rear suspension is independent, of course, using semitrailing arms. An anti-roll bar is also used across the diagonal swing arms. Solid discs are used in rear, vented up front. The 25-gallon fuel tank is over the rear axle to minimize chance of rupture in a collision.

Fuel-tank location typifies the safety engineering in the new series. The roof takes a static loading of 10 tons and the passenger compartment is rigid compared to the easily deformable front and rear sections. Door-lock design incorporates a counterweight arrangement that acts to keep doors closed in a collision; rear doors have childproof locks; wiper design keeps them flat on windshield at any speed and rain troughs channel water away from windows.

Caught in a downpour, we found that the rain troughs along the windshield pillars work extremely well, but later while washing the car, we were surprised to find the metal edge at the bottom disappointingly sharp (the only thing we could find to fault). So if you chance to own a 450SE (and wash it yourself) watch it!

Watching me wash the 450SE, a neighbor asked, "What'll she do?" He meant mpg! We found the 4.5-liter, o.h.c., fuel-injected V8 good for 15 mpg on a steady high-speed trip. That's pretty economical flying. ★★★

GOVT. SURPLUS

and other bargains
SAVE to 90%

Send for this catalog



The world-famous Airborne Catalog. Fully illustrated. Contains 1000's of bargains in hydraulics, electrical, marine, automotive & hardware items . . . and more! A must for mechanics, machinists, hobbyists, sportsmen, inventors, etc. Send 35¢ to cover postage & handling. In a hurry? Send \$1 for airmail delivery. Must include zip.

AIRBORNE SALES CO. Dept. PM73
8501 Steller Dr., Box 2727, Culver City, Ca. 90230
Satisfying world-wide customers since 1945

WANTED

If you're a mover looking for that once-in-a-lifetime profit opportunity in an exploding growth industry, write for free INFORMATION KIT about one of the major breakthroughs in security systems since the beginning of crime. Flashguard answers an urgent, unfilled need and presents perhaps the most exciting business opportunity in any industry today. No experience. Start part-time. **FLASHGUARD, INC.** Dept. 3, 927 Penn. Ave., Pittsburgh, Pa. 15222.

PUMP DRAINS pools, cellars, laundry tubs IRRIGATES — CIRCULATES — SPRAYS



Heavy duty ball bearing pump. All metal, rust-proof Type XB. Stainless shaft. Use 1/4 HP or larger. 1 HP 1,200 GPH 60" high or 3,000 GPH 25" well. 5,200 GPH max. 1 1/4" in. 1" out. Belt or direct drive. \$14.95
Type P won't rust or clog. Bronze bearing. To 2,400 GPH. 1" in; 3/4" out. \$9.95
P'pd cash with order. Money back Guarantee.

LABAWCO, Box 40, Belle Mead, N.J. 08502

HYDRAULIC JACK REPAIRS

Earn While You Learn at Home

Earn while you learn at home. Millions of jacks in gas and auto service stations, trucking firms, body shops, riggers, factories and farms need servicing . . . most of which you can learn to repair. We show you HOW. Start spare time in your basement or garage. Big opportunity for mechanics. ACT NOW!

Write for folder No. PM-7 and free bonus offer.



HYDRAULIC JACK REPAIR MANUAL CO., INC.

G. P. O. BOX 3 • STATEN ISLAND, N. Y. 10314

Print For Profit



Cards, Stationery, Envelopes, Advertising, labels, tickets, announcements, Q.S.L. cards, greeting, sympathy, prayer cards, tags, etc. Save money. Pays for itself in a short time.

Own a Printing Business

We supply everything direct from factory only. Easily followed rules. Also raised printing like engraving. Have home shop. Add to income. Send \$5 for catalogue. **KELSEY PRESSES 73-T, Meriden, Conn. 06450**

FIND BURIED TREASURE

Powerful electronic detector finds buried gold, silver coins, etc. Write or call for free catalog. Dealer inquiries invited.



Financing Available 19.95
Phone day - night (713) 682-2728 to
RELCO, Dept. D-3 198.50
BOX 10839, HOUSTON, TEX. 77018

LEARN

MEAT CUTTING



Train quickly in 8 short weeks at Toledo for a bright future with security in the vital meat business. Big pay, full-time jobs—**HAVE A PROFITABLE MARKET OF YOUR OWN!** Time payment plan available. Diploma given. Job help. Thousands of successful graduates. **OUR 50th YEAR!** Send illustrated FREE catalog. No obligation. No. 0197T

NOW for big new illustrated FREE catalog. No obligation. G.I. approved. **NATIONAL SCHOOL OF MEAT CUTTING**
Dept. 50-Y, Toledo, Ohio 43604

NEW FUN WITH UNDERWATER PHOTOS

(Continued from page 109)

if the pictures aren't perfect by strict photographic standards.

In one respect, inexpensive cameras and housings are an advantage underwater because they present you with a minimum of controls to fuss with and things to remember to do. Swimming underwater requires enough concentration itself without having to bother with complicated settings and adjustments. Simple point-and-shoot cameras make underwater photography as easy as taking snapshots on dry land. Also, water is a great equalizer. Because it necessarily adds a murky, hazy quality to even the best marine photos, it can make an inexpensive lens look almost as good as a high-priced one.

While scuba gear is helpful, it is by no means a necessity. Most of my underwater shots were made on free dives within 5 to 30 feet of the surface—about as deep as the average sport diver is likely to go anyway. In fact, the shallower the water, the better off you'll be because you'll have more natural sunlight to work with. Underwater, light falls off rapidly the deeper you go, distant objects fade into oblivion and colors lose their brilliance. The best shots are made at depths of 5 to 15 feet and, where possible, against a light, sandy bottom. While clear, bright tropical waters are ideal, you can still have plenty of fun shooting in small lakes, ponds, even swimming pools. If there aren't any interesting natural objects to photograph underwater, try shooting action shots of other divers. Pretty girls in colorful bikini suits are—for obvious reasons—good subjects and are my own personal choice. A dive mask is a must for seeing clearly underwater, and a snorkel is useful for shooting downward while floating lazily on the surface.

Most housings can be fitted with inexpensive underwater flashguns. They're easy to use and a big help on most shots. As a general rule, use flash on dull days, in dark waters and at any time you're shooting below about five feet. Even in bright sunlight, flash is useful for adding front fill on backlit subjects and for bringing out more sparkle and brilliance in colors. On cameras designed to take flashcubes, a clever little adapter plugs into the flashcube socket to fire the flash externally. Be sure to pick the right housing for your particular camera—

there's an important difference. X-type Instamatics that are triggered mechanically rather than electrically require a separate power supply built into the housing; models that contain their own flash batteries do not.

If your camera has automatic electric-eye exposure control, there's another point to remember. Plugging in a flashcube, or in this case the adapter, overrides the electric-eye system on such cameras. If you plan to shoot without flash, be sure *not* to connect the adapter when inserting the camera in the housing. Otherwise, you'll be set for flash, the electric eye will be inoperative and you'll get badly underexposed pictures.

For maximum clarity and detail, shoot as close as possible, being careful, though, not to exceed the usual two-foot minimum focusing distance. The best shots are made at 4 to 6 feet, with 8 to 10 feet about maximum. Beyond that, everything blurs into nothingness. If your camera has a close-up setting, as most Instamatics do, be sure to reset this after each shot as it usually returns automatically to the long-distance infinity setting if you don't. Since it's difficult to use the camera's regular viewfinder underwater, some form of external viewfinder is helpful. Clip-on sportsfinders are available for most housings, but can fool you because they usually show more area than the camera actually takes in. Before going underwater, check the camera's viewfinder against the sportsfinder's frame so you can judge how much picture area you're really getting. Another aid is the newer optical type of viewfinder sold by Seacor. Though more expensive, it's much more accurate than the open-type sportsfinder and can be fitted with interchangeable front grids to match the finder's viewing area to the camera's picture-taking area.

For catalogs, prices and additional information on underwater housings and accessories, write the following manufacturers: Ikelite Underwater Systems, 3303 North Illinois St., Indianapolis, Ind. 46208; Edmund Scientific Co., 150 Edscorp Building, Barrington, N.J. 08007; Seacor, Inc., Box 22126, San Diego, Calif. 92122; Upsi Underwater Photographic Scientific Inventions, Inc., Box 26, Marathon, Fla. 33050; Oceanic Products, 814 Castro St., San Leandro, Calif. 94577; Eumig, Inc., Lake Success Business Park, 225 Community Dr., Great Neck, N.Y. 11020. ★★★

EARLY AMERICAN HUTCH-TABLE

(Continued from page 99)

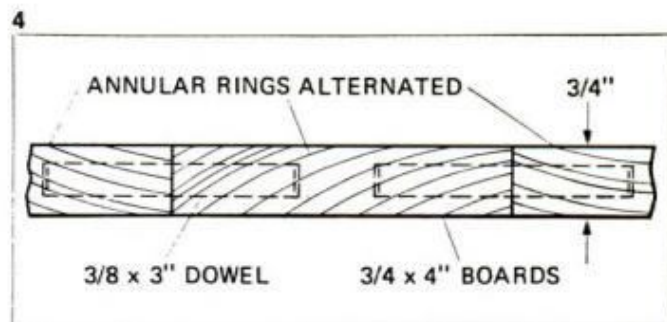
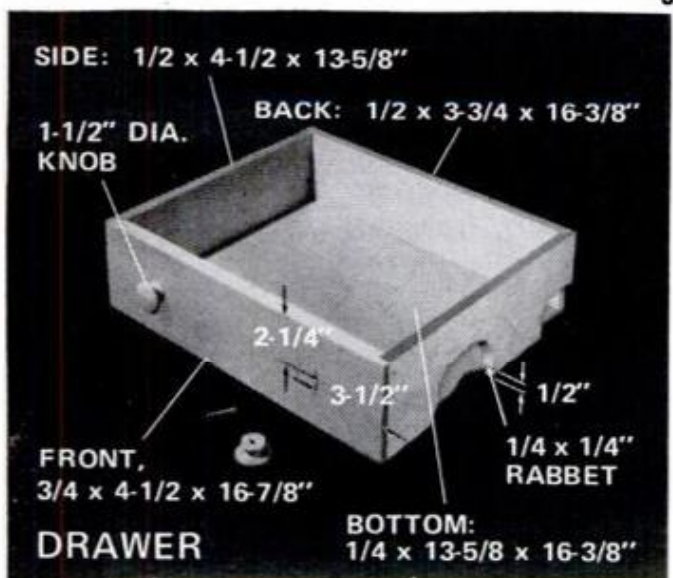
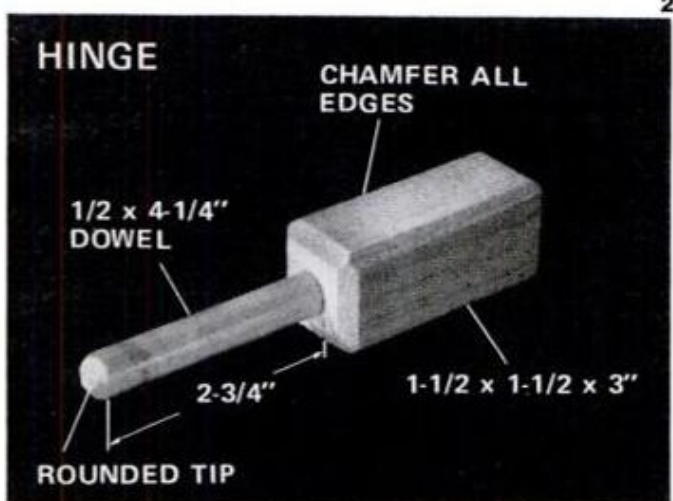
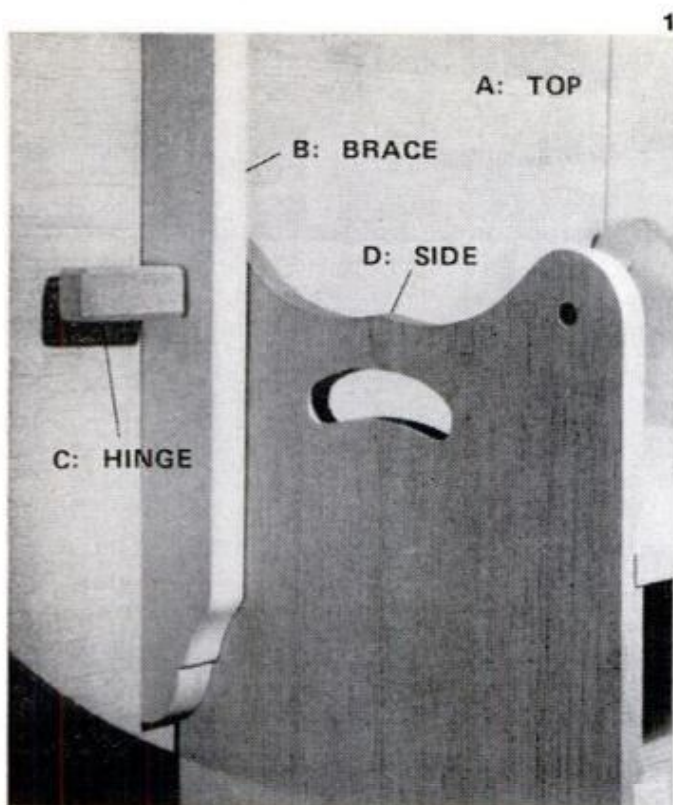

receive the drawer bottom. And the sides are let into an edge-rabbet on the drawer front. Notice that the drawer back is cut narrower than the sides. This method simplifies construction; the back simply fits into edge-rabbets on the sides, and the bottom is attached by driving brads up through the bottom into the back. Lay out for the drawer knobs and drill these holes to suit the knob screws.

Finishing the piece. When satisfied that the piece is sanded smooth, give it a thorough dusting. Next, apply a honey-tone pine stain and after 10 to 15 minutes, depending upon desired shade-depth, wipe off the excess stain and allow the piece to dry overnight. Apply a wash-coat of shellac to seal the wood and allow to dry.

My preferred finish is McCloskey's egg-shell, or satin, Heirloom finish. It's a varnish but it sets rather quickly, thus diminishing the amount of dust that settles on the surface. Apply at least two coats at least 24 hours apart and buff lightly with 00-grade steel wool between coats. Let the piece "cure" for four to six weeks; after that, if desired, it can be rubbed with paste wax. ★★★

1. Tabletop pivots on pair of "hinges." When top is down, second pair is used at front to securely lock the top in place.

2. The required four hinge-pins are constructed alike. All pins (dowels) should fit snugly in holes in braces and sides.

3. Drawer construction is basic; bottom is let-into sides and front. To affix back, use 4d finishing nails up through bottom.

4. Narrow boards are edge-glued and doweled to make up pieces for sides, shelves (E) and top. To lessen chance of warpage, annular rings should be alternated as shown.

KARTING

(Continued from page 71)

cently came within seven seconds of Mark Donohue's NASCAR AMC lap time, and the kart had the added handicaps of no transmission and a chicane to get through. The chicane was a temporary zigzag deliberately set up with pylons in a fast part of the circuit to slow the karts.

To help explain this recent upswing in karting popularity, let's go back a moment to the good old days. Karters usually credit Art Ingels with developing the first true racing go-kart in 1955, although back-yard putt-putts had been around since the dawn of autodom. Art Ingels worked at that time for Frank Kurtis in Glendale, Calif., constructing Indy cars and midgets.

When McCulloch dumped thousands of 7.5-c.i.d., two-stroke lawnmower engines on the market in 1955, you could pick one up for \$14. Art Ingels did just that, and he stuck it on the back of a rectangular pipe-work frame. After attaching four industrial wheels, a seatback, some rudimentary brakes, and a steering wheel, he used to amuse the Kurtis Kraft crew by scooting around the parking lot like a dog with his tail on fire. People watching thought it looked like fun, so they built karts, too, or had Art do it for them. Within a few months, the go-kart rage had spread across the country to the East Coast and beyond. *Life Magazine* ran pictures of Gen. Curtis LeMay piloting a go-kart, and suddenly every kid and his dad (or vice-versa) had to have one.

Kart manufacturing companies sprang up overnight and turned out all types on Detroit-style production lines. Karters formed local clubs, and from these grew the International Kart Federation (IKF) which today remains the hobby's backbone.

Then around 1965, interest in karting evaporated almost as quickly as it had come. A few diehards hung on, though, and the IKF survived. Today the IKF claims over 6000 members and a roster that's growing at a healthy rate. Membership is truly international, with all 50 states plus England, Germany, Scandinavia, Japan, Thailand, the Philippines and other nations represented.

The IKF sanctions races, obtains insurance, and acts as the sport's rule-making body. Broadly speaking, go-kart racing is of two types—sprint and enduro. Sprint

races are run on short, tight, twisty tracks. These tracks average about half a mile around, and races are run by heats or laps—three 8 to 10-lap heats for each class, with a motocross points system. Because of the tightness of these tracks, sprint karts are geared for acceleration and hit 60 to 80 mph tops.

Enduros, on the other hand, are run by the hour—usually one-hour events, sometimes two. As Tom Bates says, enduros usually borrow sports-car race courses. Here, karts are of the laydown type. They don't accelerate nearly so quickly as the sprints, but their top speed is about twice as high. In enduros, the main effort is to make the engines stay together at those fantastic rpms (up to 13,000) for the specified times.

Almost all modern karts use two-stroke engines. Today's most popular kart engines are being imported from Italy, and Italian two-strokes are conceded to be better than anything available elsewhere.

The Komet K-88 and B-Bomb, made in Milan, dominate serious karting competition. These are 6.1-cu.-in. (100-cc) and 8.25-cu.-in. (135.22-cc) units respectively, and most IKF classes specify these displacements or their doubles (for twin-engine classes) as maximums.

Before the Komets came along, McCulloch two-strokes dominated. These McCullochs used (and still use) reed valves. The Komets, on the other hand, use rotary valves—discs with triangular holes. The rotary-valve engines proved so superior in output and flexibility that the IKF had to make special classes for them. Today competition is divided into reed-valve and rotary-valve classes. Trouble is, they're not called simply reed and rotary classes. They're called "reed" and "stock-appearing" and "open." "Stock-appearing" means the Italian engines have to look on the outside just as they did when they emerged from their shipping boxes. There are also "box-stock" classes for reeds. Adding to this confusion, the IKF lists 14 competition classes in sprint racing and 14 more for enduros.

Two-stroke technology is so far advanced in karts that even the Japanese motorcycle industry is taking kart engines apart to see how the karters do it. When the Japanese bike makers were just discovering 5-port engines, karters were already into 10-ports;

(Please turn to page 184)

MAN'S WORK!

YOUR OWN CRAWLER TRACTOR BUILT FOR \$498.95 (7 HP.)

Fun to build kit of top quality parts. Exciting to run — turns 360° within own length. Tremendous traction. Bulldozer, snowblower, lawn & garden attachments — and more! 12 hp. kit, \$748.95. Plans only — only \$5. Catalog of 30 kits, \$1. Write: Struck Corp., Dept. PM73, Cedarburg, Wis. 53012.

At Last a New Amazingly Simple

GAS TURBINE JET ENGINE

Build from easy to follow plans. Length 15", Dia. 8½", Wt. 15 lbs. Fuel: Gasoline or Kero.

"Screamin' Demon" develops 20 H.P. Ideal project for serious-minded hobbyists, students; scientific and industrial arts classes. Make on 9" metal cutting lathe with milling attachment. For use on small racing boats, midget cars, etc. Full size assembly drawings with critical dimensions, bill of materials and photos. Price \$5.00. No C.O.D. SAVOY SCIENTIFIC, BOX 1398, SANTA MONICA, CALIF. 90408



Make Rubber Stamps for BIG PAY

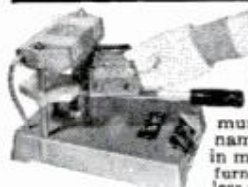

Need more money? Earn \$60-\$75 a week, spare time, at home making rubber stamps for offices, factories, individuals. Hundreds of uses. Hundreds of prospects—everywhere. Right in your own community. Turn out special stamps for names, addresses, notices, prices, etc., in minutes with table-top machine. We furnish everything and help finance you, at less than bank rates. Write for free facts. No salesman will call.

Rubber Stamp Div., 1512 Jarvis, Dept. R-2-CH, Chicago 60626

\$12.95 BLACK DIAL TELEPHONES

Complete



add \$2.00 for color
Factory rebuilt Western Electric in white, beige, ivory, pink, green or blue. If 4 prong plug is required add \$2.00. Fully guaranteed.

Designs may vary.

Write for free list. All shipments F.O.B.

SURPLUS SAVING CENTER

DEPT. PM-73, WAYMART, PENNA. 18472

"LISTEN IN" TO POLICE-FIRE RADIO CALLS IN YOUR CAR!

WORKS with ANY CAR—Portable or HOME RADIO! Just PLUGS in—No wiring—3 min. site hookup! Switch instantly from regular to ALL POLICE-FIRE-EMERGENCY-COMMERCIAL-TAXICAB-STATE-CITY-GOV'T 2 way Radio calls in YOUR AREA. DUAL-HI-LOW BANDS TUNES 36-49 & 150-175 MHS. USE Everywhere—anytime—always works.

SEND ONLY \$2.00 (cash, Ck., M.O.) and pay post. man \$9.99 plus COD post. or send \$11.99 for ppd Del in USA. COMPLETE, ready to use with instructions. One Year service Warranty—10 DAY MONEY BACK TRIAL (if rtnd). Sold Only—DIRECT FROM FACTORY at this Low Price. WESTERN RADIO BPM-7 KEARNEY, NEBR. 68847



U. S. Surplus High Speed Rotary Files. Hardened Steel, use on any metal or wood for filing, drilling, milling, carving, routing—a thousand uses in every shop. Sets assorted in sizes from ¼" shanks. All brand new in airtight, G.I. packs. Order now!

36-pc. Tool Set, G. I. cost \$265.00, now \$15.00
16-pc. Tool Set, G. I. cost \$109.00, now \$9.00
Save Even More, Both Sets, now \$22.00

U. S. SURPLUS CENTER

C-1790 Nason Avenue
COLUMBUS, OHIO 43207

WRIST ROCKET

AMERICA'S HARDEST HITTING SLING

Range 225 yd. — 232 fps. Matched replacement rubbers and LEATHER pouch assembly \$1.00 At dealers or order direct.

WRIST ROCKET Mfg.
P.O. BOX 21-B
Columbus, Nebraska 68601



\$3.00 Post. Pd. in USA No C.O.D.'s
Orders outside USA add \$1.50 for postage and handling

JULY 1973 183

FREE PLAN

Be Your Own Boss New Business Opportunity FILING SAWS



Start a steady repeat CASH business in your basement or garage. Earn \$3 to \$6 an hour in your spare-time! Excellent profits in saw sharpening business! Automatic Foley Saw Filer, easy to operate, files combination saws, hand, band, and circular saws. No experience needed. H. C. Delbert wrote us: "Since I got my Foley Filer 5 years ago, I have averaged 4½ saws each day since I started."

Every saw you sharpen brings you more customers. "I rented a two-car garage and have all the work I can do," writes Charles H. Smith.

FREE BOOK Shows How to Start

Fact filled booklet tells you how to start a sparetime business immediately; how to get new business, how to advertise. Rush coupon now; get "Money Making Facts" and details on Easy Payment Plan. No Salesman will call.

Send Coupon for FREE BOOK Money Making Facts

FOLEY MANUFACTURING CO.
716-3 Foley Bldg. Minneapolis, Minn. 55418

Send FREE BOOK—"Money Making Facts", and Time Payment Plan.

Name _____

Address _____



PEN RADIO



AMAZING TINY RADIO hidden in a pen. Listen in secret to your favorite sport, news or music show! Use almost anywhere—in or out-of-doors. Tiny earphone included for private listening. Amazing circuit is self-powered. Plays

GUARANTEED TWO YEARS

forever at no cost. No batteries. Ready to use. Use 30 days, money back if not pleased. IF BROKEN WITHIN 2 YEARS WE WILL REPLACE AT NO CHARGE. Order today: Only \$2.25 add 35c postage, handling. Grandpa's Shop, Dept. RA-1, 9043 S. Western Ave., Chicago, Ill. Mail Orders only.

Muzzle Loading KITS

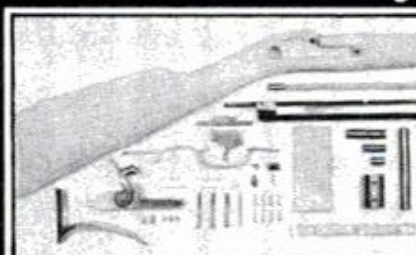

Complete with all parts needed to make a handsome, fully shootable Kentucky Rifle. .44 cal. precision rifled octagonal barrel, front and rear sights. Stock is fully rifled and Semi-inletted. All holes drilled and

tapped. Illustrated instructions. Available in Percussion and Flintlock Models. Model KA705, Percussion (pictured) \$57.45 + \$2 Shipping.

Complete Kentucky Pistol Kits available from \$19.95 (Percussion) plus postage.

CONNECTICUT VALLEY ARMS, INC.

Dept. PM
Higganum, Conn. 06441

Enclosed is a self-addressed, stamped envelope. Please send FREE Brochure on CVA Muzzle Loading Kits.

Name _____

Address _____

City _____

State _____

Zip _____



CONNECTICUT VALLEY ARMS, INC.

KARTING

(Continued from page 182)

now they're up to 12. Two-strokes, of course, have no poppet valves; in fact there are only seven moving parts in the typical one-lung kart engine. Output in some of the Komets is right at 3 to 4 horses per cube.

Classes exist for stock, stock-appearing, and modified engines. The IKF also sets the ages of drivers in various classes so kids aren't competing with adults. It also specifies weight limits and stages a series of Grand National events as in hot rodding, stock-car racing, and so forth. For 1971 and 1972, the Grand National Champion was Kathey Hartman.

What kind of people go into karting? Does it always start with an interest by the kids, which then turns into adult fever? Tom Bates of the IKF's *Karter News* sees it this way:

"It is a family sport, and we have a tremendous cross section participating—doctors, lawyers, Indian chiefs, blue-collar, white-collar, male and female, all ages from 8 on up. And it's a participant sport; not so much a spectator sport. So the people you see watching are usually friends or family. It's not uncommon to see the kids race in one event, then Mom takes the kart for another race, and finally Dad drives it in a third."

We asked Tom what sort of investment a family would have to make to be competitive.

"All-new equipment, maybe \$1000 for a single-engined job or \$1600 for one with twin engines. If you're in it for pure fun, you can get by for half that. But if you're really into it, \$2000 for a Hartman Blue Streak, say, with one of Kathey Hartman's engines. That's sort of the Ferrari of karting. Then if your ability matches the kart's capability, you're going to win races. You get more kicks for less money in karting, though, than in practically any other type of auto racing around. A lot of frustrated Walter Mitty sports-car drivers go into karting, especially into FKE. They wear the Nomex flameproof suits and Bell Star helmets and driving gloves—that sort of things. I guess I'm one of them myself!"

What does the future hold for karting? Will it go commercial the way hot rodding and sports-car racing have? Or will

it stick with the grass roots and family fun?

"It probably won't go commercial in a big way, because it doesn't lend itself to becoming a big-time spectator sport. But it's not strictly amateur either. Even today a few kart manufacturers and several dealers field racing teams. These teams dominate competition, especially in enduro racing, mostly because they can spend more time in preparing their vehicles than can families or private individuals.

"As for big prizes and fat purses, there aren't any. Karters race mostly for fun and glory. Only trophies are given even at Grand National events. Manufacturers and dealers do put up merchandise, true, and sometimes participants get together a pot to make things a little more interesting. One group that races together regularly in B-Limited drops \$5 each into the pot. The kart that's leading at the end of the first lap picks it up. It gets pretty hairy on that first lap.

Readers interested in more information on karting should write the International Kart Federation, 733 Edna Pl., Covina, Calif. 01732. This year's IKF Enduro Grand Nationals, by the way, are to be held at Ontario Motor Speedway in Southern California over the July 4 weekend, so if you want to see the best in karting action, be there!

★★★

KEEP YOUR COPIES OF PM . . .

**. . . and watch for
the inexpensive Annual
Index that will be avail-
able in December.**

The Index will enable you to locate any article which appeared in 1973 or find information on any particular subject in just a few seconds.

**The Annual Index makes
your copies of Popular Me-
chanics more valuable!**

GUNS TOO SLICK TO SHOOT

(Continued from page 130)

special endorsed models have the double pleasure of contributing to a worthwhile cause as well as gaining a handsome gun.

One most-sought-after Winchester is the special presentation model of the Buffalo Bill rifle. The first 300, given to the association by Winchester, went to individuals who donated \$1000 to the museum. The 309 series has a gold-plated hammer, trigger, loading gate, borearm tip and butt plate.

Marlin has issued three lever-action commemoratives—the 39 Century Ltd., 39 Article II and the 336C Zane Grey Century. Issued to honor the 100th anniversary of the birth of the famous western author in 1972, the 336C was restricted to 10,000 units and should be one of the better investments for collectors.

Harrington & Richardson's Little Big Horn Carbine commemorates the famous battle between the 7th Cavalry and the Sioux. The replica of the 1871 U.S. Springfield Officer's Model is a faithful copy of the trap door, single-shot .45-70 black powder carbine issued to cavalry troopers from 1871 to 1890. Each Little Big Horn model

Try the wood panel fixer

from **DAP**



PANEL-NU™. You spray it on and wipe it off to clean, beautify and restore paneling and other finished wood surfaces. Hides scuffs and scratches on paneling, cabinets, wood trim and moldings.

America's First Name in Home Fix-up



DAP Inc., Dayton, Ohio 45401
Subsidiary of *Plough, Inc.*

Try the glue fixer

from **DAP**



DURATITE® White Glue dries clear and sticks tight to handle dozens of household bonding and mending jobs. An excellent adhesive for wood, cloth, paper, porous materials.

America's First Name in Home Fix-up



DAP Inc., Dayton, Ohio 45401
Subsidiary of *Plough, Inc.*

comes with a 128-page hard-covered book describing the part the carbines played in the famous battle. Reproduction was limited to 5000 units, and the price is \$200.

These are just an introduction to commemoratives being issued regularly. Every month or so in the pages of this magazine you will note announcements of new models that renew and honor highlights of our history. And once you start collecting, you are hooked for more than life, for these guns quickly become family heirlooms. As new issues are offered, most dealers will cooperate with you if you want to order specific serial numbers, matched pairs in different calibers or any other sequences.

Collectors can also consider the black-powder pleasures of muzzle-loading replicas such as those from the Navy Arms Co., or percussion revolvers like Sturm, Ruger's notable Old Army model. Remarkably detailed nonfiring Replica Models now on the market make collecting possible in spite of restrictive local laws, and even old reprint catalogs are offered by the Personal Firearms Record Book Co.

As your gun collection grows, its value as an attractive display will increase—and so will the money you have invested. ★★

CLASSIFIED ADVERTISEMENTS

Rate: \$2.20 per word payable in advance each insertion. Capitalized words—75¢ per word additional. Minimum insertion ten words. To be inserted under the proper classification, copy must be in our office by the 10th of the second month preceding date of issue. The next available issue to place an advertisement in America's No. 1 Classified Section is September. The closing date is July 10th. Send remittance and order to H. E. Kappel, Popular Mechanics, 224 West 57th Street, New York, New York 10019. Please make remittance payable to Popular Mechanics.

WHEN ANSWERING ADVERTISEMENTS PLEASE USE THE ZIP CODE NUMBER

AUTOMOBILES

CAPACITIVE DISCHARGE IGNITIONS. DISCOUNTED. Rodgers, Son (PM), Box 3583, Anaheim, Calif. 92803.

SUPERSCATES. Racing, Gasoline Powered, Plans, Booklet, \$5.50, Free Picture, Nicholas, Box 10095, St. Petersburg, Florida 33733.

SCR/CD IGNITION Increase Performance, Mileage. Fits Most Cars, Negative Ground, State Make, Displacement, Model Year, \$44.95. Texas Residents Add 5% Sales Tax. Magna Dwell, Box 2171, Abilene, Texas 79604.

TUNE UP. Do Your Own. Save Money. Do It Right. Fully Explained \$3.95. GM, Box 1237, Garland, Texas 75040.

AUTOMOBILE SIXTY SECOND TIRE FIX. No Tools—No Jack-Dealers Invited. Sample, And Details, ppd. \$3.98—Warne, 6922 Congress, Detroit 48207.

CLASSIC 55-7 Thunderbirds headquarters. 1973 illustrated catalog "Everything for the Birds" and "T-Bird Story" Airmailed anywhere. Send \$10.00, package postpaid with credit memo applicable on orders included. New 2nd hand parts, accessories, sheet metal, tops, etc. **SHELL'S** Box 767-PM, Santa Monica, Calif. 90401 (213) 393-9840.

MIDGET CARS

GO-KARTS Factory Direct Low As \$19.95. Send 35¢ for Catalog. Schmieder Motors, RD #1, Doylestown, Penna. 18901.

GO-KARTS Mini-Bikes Parts. Catalog \$1.00. A.R.E., P.O. Box 159, Lindenhurst, New York 11757

FUN Kart Plans Send \$3.00 To: A.R.E., P.O. Box 159, Lindenhurst, New York 11757.

AUTO SUPPLIES AND EQUIPMENT

AIRMASTER Gas Saver Fits All Cars, \$14.95. Airmaster, Lenora, Kansas 67645.

MOTALOY, Ring-Valve, Job-Driving, Guaranteed, Literature. Miley Enterprises, Box 1533, Decatur, Ga. 30031.

SAVE Dollars Buying Tires, Batteries, Etc. Illustrated Booklet. Send \$2.00. Workshop, Box 393, Bethpage, New York 11714.

PARTS: Army jeep and truck parts. Spare Parts & Equipment Co., P.O. Box 751, Lexington, Kentucky 40502.

ALTERNATOR/Generator Rebuilder's Course; includes Tooling & Test Equipment; Write: Hedelund Engineering, P.O. Box 2127, Sepulveda, California 91343.

FREE Flashlite With **MOTALOY** Ring Valve Job \$6.00. Guaranteed, Flewellings', Box 21, PM7, Tustin, Calif. 92680.

RING-Valve Job while driving, \$6.50 postpaid, (Two-\$12.00). . . . Established 1951. . . . Results Guaranteed!! Motaloy, Grantham, Penna. 17027.

"PATENTED" Revolving Exterior Automobile Mirror. Novel, Safe, Stays Clear All Weather. \$16.00, Two \$30.00. Revmirror, Box 3335, Cape Town, R.S.A

CALCULATOR, Trip Expenses, Arrival Times, Gas Mileage, Tax, Expense Accounts Recorded \$2.25 P.W. Photography, Box 562, Oak Ridge Station, Royal Oak, Michigan 48073.

RING—VALVE JOB WHILE DRIVING! 1973—**MOTALOY'S 20TH ANNIVERSARY!** (It works and works!) Results guaranteed! \$5.95 Airmail ppd. Motaloy Division, CH, RR8, Box 604, Fayetteville, North Carolina 28304.

HYDRAULIC Jack repair kits parts and supplies. Catalog 50¢ (in coin). Hydraulic Jack Packing & Tool Co. Inc., General P.O. Box 3, Staten Island, N.Y. 10314.

AUTO-GUARD Prevents Auto Theft. Protects Cars, Trucks. Engine won't start. Hot wiring, master keys, useless. Guaranteed! Send \$6.95 Postpaid. Calypso Enterprises, Box 44483S, Los Angeles Calif. 90044.

AMAZING! ROLLS ROYCE Appd. liquid Car Cleaner/Wax. Standard equipment on new RR's. Remarkable results guaranteed. Free literature or \$4.98 plus 50¢ postage: Noel Enterprises, 236-PM7, East 48, Brooklyn, N.Y. 11203.

IS Car Maintenance Killing Your Bankroll? Send \$1.00 today for tune-up Specifications on Foreign & Domestic Cars from '58 to '73. Bristol Auto Parts, Inc., 21 North St., Bristol, Conn. 06010.

AUTON Ignition, with **DOOMSDAY SPARK**, Information, Autonics, Box 1581K, National City, California 92050.

NEW* AUTO/TRUCK SAFETY MONITORS** Small dash mounted units, unique, decorative, useful. Reads out in colored lights while driving. Plans: Road Condition Monitor \$4.00, Road Temperature Monitor \$3.00, Tire and Wheel Monitor \$4.00, Road Icing Alarm \$3.00, Driver Fatigue Alarm \$3.00. To: W. Lawson, R&D, R1, Box 299E, Milton, Delaware 19968.

NOVEL Inexpensive Glowing Gage Continuously Checks Ignition Performance. **QARC**, Box 47876, Los Angeles, Calif. 90047.

VIOLATION? Dirty car. Penalty? Five minutes. Fine? Vacu-Shine. Jem. 6116 Orinoco, Indianapolis, Indiana 46227.

AIR PURIFIER FOR YOUR CAR OZO AUTO. Destroy Pollution, Destroy Odors, Smoke, Exhaust Fumes in your Car. Transistorized One Year Warranty. Send Check or Money Order for Only \$37.50 Each PPD. Pure Air Products—P. O. Box #218, Basking Ridge, New Jersey 07920, Dealer Inquiries Invited.

INSTANT PRESSURE CHECKS! Anytime, Anywhere With These Permanent Valve Extending Tire Pressure Gauges. Easy To Install. 4 For \$2.98 PPD. **MOSCO**, 722 South Racine, Chicago, Illinois 60607.

AUTO TRAILERS

FIFTH Wheel Trailer, Pickup Camper, Cover, Trailers. Build Yourself. Save! Complete plans—Fifth Wheel \$9.95; Camper \$4.95; Trailer \$3.95; Cover \$2.95. Conversions—Econoline type Van \$3.95; Passenger bus or delivery Van \$3.95; Equipment Catalog \$1.00 (refundable). Details 25¢. Our 13th year. Viking Camper Supply, 99-F Glenwood, Minneapolis, Minn. 55403.

MOTORCYCLES, BICYCLES MOTORSCOOTERS AND SUPPLIES

SUPER RACING KARTS. 7 And 8 Horsepower. Briggs And Stratton Aluminum Block Engines. A-Bone Racing Frame With Drum Brake; Supercharger And/Or Torque Converter Optional. Completely Assembled. Ready To Race! Complete Information-25¢. Write To—**CHAPMAN RACING MOTORS**, 112 Bleckley Street, Anderson, South Carolina, 29621.

MINI-CYCLES. Go-Carts, Engines, Tires. Discount Catalog 25¢. Lorenco, Danville, Illinois 61832.

HONDA, \$25. Other Bargains. Send \$1.00. (Refundable). Motorscooter, P443, Bend, Oregon 97701.

BOLT-ON TORQUE CONVERTER Makes out-dated, out-classed, mini-bikes competitive, mean machines. More Low end muscle—more high end hustle. Fits B&S, Tecumseh, most engines. 35 minute installations. \$34.95 ppd. No C.O.D. Information + decal 25¢. **MAX-TORQUE, Inc.**, 7300 Monticello, Skokie, Illinois 60076.

BICYCLES—Replacement Parts, Tools, Accessories, Repair Books, over 1,000 Items. 1973 Catalog. \$1.00 Refundable with \$5.00 Purchase. Action Accessories, Box 15, Liverpool, New York 13088.

RECHARGEABLE 12-V Bicycle Power Unit. Plans \$5.00. Sound & Signal, Truth or Consequences, New Mexico 87901.

ILLUSTRATED Catalog 25¢. Parts and Accessories Custom and Stock For Most Makes and Models. Motorcycle Supply, Box 159M, Fairbury, Ill. 61739.

BUILD A 10 Speed Bicycle out of a 3 Speed with the right Selection of Inexpensive High Quality Parts from any bike shop for almost as little as 1/3 the cost of a new one. Find Out How. Plans \$2.00. Cycle Engineering, Box 2285, Walnut Creek, California 94595.

(Continued on next page)

SPACE, ROCKETS AND ASTRONAUTS

ANTIGRAVITY Spacedrive Plans! Scientific Experiments Reveal New Force. \$3.00. Carter, Box 831, Avalon, Calif. 90704.

MILLION DOLLAR MODEL ROCKET SALE. Countdown for Savings. Kits, Motors and Supplies. Everything 1/2 Price. Send 25¢ for Complete Catalog and Decal Packet. AVI, 7PM, Mineral Point, WI. 53565.



AVIATION

GROUND School—Not Just a Book, a Guaranteed Home Study Course. All Ratings. Free Literature. Pilot, Box 444, Chanhassen, Minnesota 55317.

HANG Gliders. Three different designs. Plans, kits ready-to-fly. Large catalogue, 25¢. Eipper-Formance, Inc., P.O. Box 246-M, Lomita, Calif. 90717.

AIRBOAT Engines, Propellers, Hubs, Mounts, Supplies, Corvair, VW Conversions. Removable airdrives, Propellers, Hubs for Snowmobile Engines. Catalog \$1.00. Banks-Maxwell, Box 3301E, Fort Worth, Texas 76105.

BUILD—One-Man jet helicopter. Easy inexpensive. Detailed plans, drawings—\$5.00. Helicraft, Box 7153, Baltimore, Maryland 21218.

HUNDREDS Aircraft Photos. Past, present. Illustrated catalogue 25¢. Astro Photographers, Box 243, Kennedy Airport, New York 11430.

ALL About Ballooning. Handbook \$3.00. Aerostation, Box 141, Long-Sault, Ontario, Canada. KOC IPO

BE A Government licensed aviation mechanic. Practical training. Free Information. Aero Mechanics School, Dept. PM, Municipal Airport, Kansas City, Missouri 64116.

HANG GLIDERS. Proven Rogallo Design. Plans—\$5.00. Kits, Accessories, Complete Kits. Compare Quality and Price Before You Buy. Free-Flight Systems, 10730 Whiteoak, Granada Hills, California 91344.

HOVERCRAFT

AERO-CAR. Amazing Hovercraft built easily with ordinary tools. Lawnmower engine power. Carries one man plus. Hovers, flies forward, backward, sideways over land/snow/water. Complete construction plans and brochure. \$5.95. Aero-Projects, Box 5118PM, Clinton, New Jersey 08809.

INFLATABLE BOATS

QUALITY inflatables. Pyrawa canoes from \$34.95. Kaik dinghies from \$19.95. Lightweight. Compact. Portable. Packs in own carrying bag ideal for fishermen, backpackers, river runners, outdoorsmen. Rugged, safe for whitewater rivers, ocean surf, rocky streams, lakes. Built to last! Free color brochure. Leisure Imports, Dept. PM7, St. James, N.Y. 11780.



BOATS AND TRAILERS

FREE 112-page Camping, Marine Color Catalog. Laacke & Joys, 1439 N. Water, Milwaukee, Wisconsin 53202.

FIBERGLASS BUILDERS MATERIALS Lowest factory prices in cloth, matt, roving, resin, epoxy, foam, nails, fittings. Send \$1.00 for literature (refundable or \$2.00 for literature plus booklet on Mold-making and "How to Fiberglass". Clark Craft, 16-P1 Aqua Lane, Tonawanda, N.Y. 14150.

FIBERGLASS Canoes, Kayaks, and Duckboats. Many exciting models. Easily assembled kits. \$44.95 up. Free Literature. Riverside Canoes, Box 5595P, Riverside, Calif. 92507.

BOAT KITS-PLANS AND PATTERNS-FRAME KITS, World's largest catalog. Over 300 top designs from 7-77' in plywood, ferro cement and fiberglass. Sailboats include: Windmill, Snipe, Motor Sailer, Trimarans, Catamarans. Powerboats include: Cruisers, Houseboats, Deep V's, Fishin'ski, Runabouts, Hydroplanes. Canoes, Kayaks, inboards, outboards. Send \$1.00 for large catalog or \$2.00 for catalog plus "Boat Builders Guide". Clark Craft, 16-P Aqua Lane, Tonawanda, N. Y. 14150.

BOAT PLANS, FULL-SIZE PATTERNS, FRAME KITS With step by step written and pictorial instructions especially for amateurs. Easy to build. Send \$1.00 for **HUGE 100 PAGE** Illustrated Catalog. Over 125 modern designs from 8 to 49'. Includes Sail, Jets, Inboards, Outboards, Cruisers, Houseboats, Hot Boats, Catamarans, Hydros. Also available—"Boat Building With Plywood" Hard cover—219 pages \$7.50. **GLEN L,** 9152 MP Rosecrans, Bellflower, Calif. 90706.

FIBERGLASS Cloth and resin. World's finest cloth and non-run resin, at direct mill prices flotation foam. Complete line of plastics, silicon bronze and brass screws, save 60%. No sales tax. Boat Plans. Catalog 25¢. Freight prepaid. Stiles Boat Supply, Box 11P, Linden Ave., Mantua Heights, N.J. 08051.

CANOE! Kayaks! Factory-direct quality kits, from \$25.00. Many different models. Canvas hulls. Strongest construction materials. Free literature. Sportscraft, Box 636-P, Allentown, New Jersey 08501.

FREE Catalogue—plans, patterns: Canoes, sailing canoes, kayaks, 14-17' trailable cruising sailboats. Quicksilver, 255A Shamrock Blvd., Venice, Florida 33595.

FIBERGLASS Cloth, matt, polyester and epoxy resins. Wholesale catalog 25¢. Boat Molding book 30¢. Seifert's, Box 1206-M, Green Bay, Wis. 54305.

KAYAKS, Canoes, Plans, Kits, Finished Craft, Books. Free Catalog. Outdoor Sports, Box 1213P, Tuscaloosa, Ala. 35401.

FIBERGLASS Cloth, mat, resin. Flotation foam. Complete supplies. Catalog 25¢. Kick-Shaw, Inc., 3511 Hixson Pike, Chattanooga, Tenn. 37415.

CANOE Kits—Wood Canvas Molded Fiberglass—Free Catalog. Trailcraft, Inc. Box 60686, Concordia, Kansas 66901.

COMPLETE Kayak Kits. Liquid Marine-Tex finish. Strong But Light. Low as \$59.50. Free Literature. Rogue Kayaks, Box 1281, Medford, Oregon 97501.

NEW 1972 Outboards—Top Brands—6 H.P. \$288—18 \$416—40 \$565—50 \$718—65 Electric \$958—All Sizes—Scott-McCulloch Parts—Handling 50¢—Electra Marine—610 Merrick Road, Lynbrook New York 11563.

BOAT Kits. Molded Fiberglass. Save money-assemble yourself. Factory molded sections bond into one-piece craft. 20 models-14' to 32' Cruisers, Runabouts, Sailboats, Accessories, Motors, Trailers. Easy terms. Free catalog. Luger, Dept. BC-73, 3800 West Highway 13, Burnsville, Minnesota, 55337.

FIBERGLASSING? Complete Instructions! "Craftmans Fiberglass Manual." Only \$2.00. Postpaid! Edryn Corporation, Box 537-PC, Cocoa Beach, Florida 32931.

200 DESIGNS. Patterns, Many Kits. Prams, Rowboats, Dories, Canoes, Duckboats, Utilities, Runabouts, Hydros, Cruisers, Catboats, Catamarans, Trimarans, Sloops, Ketches, Cutters, Schooner. Catalogs: Powerboat \$1.00, Sailboat 50¢. Marinecraft, Box 161-M, Brighton, Mass. 02135.

INFLATABLE BOATS! Many Exciting Models Can be Fitted with 7.5—115 H.P. motors. Free Catalog. United Marine Co., 6358 So. Keeler, Chicago, Illinois 60629.

SAILS, 75 Square Foot Nylon Lateens, For Canoes, Sailboards, Prams, Striped. New, \$36.00 Each Postpaid. Bacon & Associates, 528-PM Second Street, Annapolis, Maryland, 21403.

BUILD A HOUSE BOAT FOR LESS THAN \$1000. It's a 25 footer with a graceful vee bow. Best of all, with its 8ft. beam it's trailerable. Plans \$24.50. Send to: **POPULAR MECHANICS,** Dept. HE, 224 W. 57th St., New York, New York 10019.

CAMPERS AND TRAILERS—KITS—PLANS—

BUILD YOUR OWN VAN CAMPER—Dodge, Ford, Chevrolet! Thirty-two large pictures show you how to build Kitchens; Storage Units; Adult, Youth, Childs Beds; Drapery; Screens! Easy to read directions! Plans by retired Camper Manufacturer for General Motors! (\$5.00). Shepard Campsters, Route 1, Box 81, Oklawaha, Florida 32679.

CABOVER Campers & Pick-Up Covers for Compact & Standard Trucks, 16 & 20 Trailers. Build and Save. Large scale plans and full-size patterns with written & pictorial instructions. Complete accessory and aluminum covering kits. Free literature. Glen L, 9152PM Rosecrans, Bellflower, California 90706.

CAMPER EQUIPMENT: Discounted prices, complete selection parts, equipment, accessories. \$1.00, refundable, 200+ page catalog. **ALLWEATHER SUPPLIERS,** Dept. PM, 832 Seward, Evanston, Illinois 60202.

MARINE EQUIPMENT AND SERVICES

MARINE Engines, conversions, parts, equipment. Catalog Free! Stokes Marine Industries, Coldwater, Michigan 49036.

CONVERT Auto engines to marine. 68 Page Catalog, 50¢. Lehman Manufacturing Company, 800 Elizabeth Avenue, Linden 4, New Jersey 07036.

FREE Brochure Conversion Kits, Propellers, gears V-Drives 1/0 Drives Gas, Diesel. Starmarine, 1931 Embarcadero, Oakland, Calif. 94606.

MARINE Supplies, Ignition Parts. Free literature. Michael's, 991 Broadway, Bayonne, New Jersey 07002.

COMPETITION MARINE EQUIPMENT. Over 300 items for complete auto conversions and installations in high performance SK and ski boats. Mail \$1.00 for new '73 catalog complete with photos, specifications and prices. Glenwood Marine, Dept. PM, 1627 W. El Segundo Blvd., Gardena, California 90249.

RECLINER Boat Seat Kit. Easily Made. Neptune Mfg., 11615 Southeast Lexington, Portland, Oregon 97266.

ATHLETIC AND BODY BUILDING COURSES

POWERFUL Muscles fast! Free brochure! Universal Bodybuilding, Box 4327-C, Dearborn, Michigan 48126.

BE Taller! 2" to 4". Secret illusionary methods, devices, Height increasers, lifts. For Treatise, send \$1.00 to: Physical Culture, Box 1548-PM9, Pompano Beach, Fla. 33060.

KUNGFU, Illustrated instructions. \$2.00 complete. RSH, 5834 Manton, Chicago, Illinois 60646.

MASCULINE Voice Builder 98¢. Man Makers, Box 11567, Chicago, Illinois 60611.

"GIANT Arms." Dr. Young. Revolutionary discovery. Inquire. Gaucho, Box 1769-A7, Chicago 60690.

JIU-JITSU ILLUSTRATED Instruction Complete 130 Pages, \$1.00. Jorgensen, Box 70482-1773, Seattle, Washington 98117.

BARBELL Course \$1.00. Booklet 10¢. Good Barbell, B-542, Seneca, Missouri 64865.

ENDURANCE! Powerful, loose muscles for Karate Gymnastics \$3.00. Route One, Box 500, Space 16 Coeur d'Alene, Idaho 83814.

(Continued on next page)

BODY BUILDING COURSES ATHLETIC AND (Continued from preceding page)

KUNG-FU, Karate, Judo Books, Fighting Weapons, Films, Giant Brochure-\$2.00. Green Dragon Fighting Society, Dept-PM, 4350 N. Cicero, Chicago, Illinois 60641.

KUNG-FU-Secret # Manual-\$2.00-Green Dragon Fighting Society, 4350 N. Cicero, Chicago, Illinois 60641.

ARMS, 18-20 Inch in 90 Days or Complete Refund!! Miraculous Revelation! \$3.00. Phenoministics, Box 281, Gresham, Oregon 97030.

SPORTING GOODS AND EQUIPMENT

PLAY BETTER GOLF! Three New Ideas. Free Information. Liberty House, Dept. PM7, 55 Orient Ave., Brooklyn, N.Y. 11211.

FREE Catalog low direct factory prices, fishing, Hunting, Archery, reloading Camping supplies. Send today. Herters Inc., Dept. CPM, Waseca, Minn. 56093.

FREE WHOLESALE CATALOG. Lure parts, Molds, Rod Blanks, Reels, Archery, Metal Detectors, Rare Hardwoods, FinnySports (ME), Toledo, Ohio 43614.

FREE 1973 Catalog! Guaranteed lowest prices! Rods, Reels, Lures, Accessories—Thousands of items. Cabela's, Inc., Dept. S-19, Sidney, Nebraska 69162.

SAFETY PLUS COMFORT—Worlds Finest Body Contoured **LIFE BELTS** First Time Offered Direct—Send \$5.95 Plus Weight and Waist Measurements To—Easy Float, Box 339—Avinger, Texas 75630.

NOW AVAILABLE! Three New Products To Improve Your Golf Game. Literature Free. Norm's Golf Accessories, 33 Voorhees Street, Teaneck, New Jersey 07666.

ARCHERY Lowest Discount Prices. All top brands. Orders shipped same day received. Money-back guarantee. World's Largest Supplier. Free catalog. Anderson Archery Corporation, Grand Ledge, Michigan 48837.



FISHING, TACKLE, LURES

MOLDS—For casting your own fishing sinkers. Free illustrated booklet. Reading Instrument Co., Box P-78, Reading, Pa. 19603.

FISHERMAN'S DREAM BOOK—FREE, 170 page catalog just loaded with Hard-To-Find Fishing Tackle Specialties and Do-It-Yourself Goodies. Our 29th year. **NETCRAFT** Inc., Box 5510, Dept. PM-12, Toledo, Ohio 43613.

FANTASTIC SECRET CATCHES MORE FISH. New. Patented. Guaranteed. \$3.00 Complete or \$1.00 for Information. Vogels, 17416T Pioneer, Artesia, Calif. 90701.

EARTHWORMS, LIVE BAIT

EARN Money raising fishworms for us! Exciting details free! Oakhaven—56, Cedar Hill, Texas 75104.

FREE Literature. Profitable Business Raising Fishworms, Crickets. We Teach you how to Raise and Sell. Write today. Carter Fishworms, Plains, Georgia 31780.

BIG Profits Raising Worms Soilless Method. Three Oaks, Dresden, Tennessee 38225.



DOGS AND KENNELS

SPANIELS (American Water) Hunter's—Retrievers. Snapshots. Bovey's, Plainfield, Wisconsin 54966 (715-335-6984).

POULTRY AND GAME BIRDS

QUAILS, Incubators, cages, supplies catalog. March, 14216 Brookhurst, Garden Grove, Calif. 92643.

RABBITS—CHINCHILLAS—FUR BEARING ANIMALS

RAISE Rabbits Successfully by knowing Facts. 48 Page Illustrated Book describing 25 Breeds. Housing, Breeding, Feeding, Markets, Marketing, etc. 25 cents. American Rabbit Association, 36 Arba Building, Bloomington, Ill. 61701.

EARN \$10,000 Yearly Raising Angora Wool and Breeding Stock. Details 25¢ coin. American Angora, Malta 12, Montana 59538.

TOPLESS INCOME RAISING Mutation chinchillas. 25¢: bulletin \$1.00. Chinchilla, 11PM7, Port Richey, Florida 33568.

RAISE Chinchillas. Guaranteed income. Catalog \$1.00. DeShon Chinchilla, Route 2H, Roanoke, Indiana 46783.

PETS—BIRDS, CATS, HAMSTERS, ETC.

PETS, Reptiles, raccoons, skunks, squirrels. Catalogue 25¢. Trails End Zoo, St. Stephens, S.C. 29479.

HORSES, LIVESTOCK

"HOW TO TRAIN HORSES"—FREE Book tells how to break, train, make money with horses. Beery School, 1107, Pleasant Hill, Ohio 45359.

VETERINARY Guide to Farmers. The only book of its kind. Send \$6.95 to **POPULAR MECHANICS**, Dept. VG, 224 West 57 Street, New York, N.Y. 10019.

CAMPING EQUIPMENT AND TENTS

FREE Jumbo 124-large camping catalog. Largest selection in the U.S.—I. Goldberg, Dept. PM, 902 Chestnut Street, Philadelphia, Pa. 19107.

TRAVEL AND RESORTS

KNOW What to See Before Leaving on Vacation. Regional Addresses, Northeast, Southeast, Northwest, Southwest. \$1.50 Ea. (4) \$5.00. Vacation Info., Box 263, Rochelle Park, N.J. 07662.

ELECTRICAL SUPPLIES

LAMP Parts. Catalog, prices, wiring instructions. 50¢. Refunded first order. Gyro, 5218P N.W. 35 Ave., Miami 42, Florida 33142.

LIGHT DIMMER CONTROL KIT—600 Watt, Easy to Assemble, Install. \$3.95. Pacesetter, Dept. 73M, 7808 N. 13th Avenue, Phoenix, Arizona. 85021.

BATTERIES, GENERATORS

BATTERY Reconditioning Kit, includes molds, material, instructions. Battery Shop, Box 820, La Quinta, California 92253.

CORROSION KILLS batteries. Spray on **KOROSION KILLER**, wipe off Corrosion. \$2.98 Guaranteed. Royalty PM27, 81 East State, Columbus, Ohio 43215.

TOOLS FOR SALE

215 PC. TOOL SET \$44.95 PLUS POST-AGE. Write: Opportunity House, 1335 N. Orange Drive, Hollywood, California 90028.

ENGINES, MOTORS, MAGNETS

WINDING Data, 275 motors. \$1.25. Data Company, 512 Kensington, Kansas City, Mo. 64124.

STEAM Engine Kits, Catalog-Handbook \$1.00. Reliable Industries, New Baltimore, Mich. 48047.

MOTOR REWINDING SUPPLIES! Equipment plans! Modequip, Box 7266, Kansas City, Mo. 64113.

REWIND Car Generator for 110 VAC. Power Plant Plans \$2.00. R. Schmauss, 1228 East Cass Street, Tampa, Florida 33602.

MACHINERY, TOOLS AND SUPPLIES

FOLDING Scissors \$2.00. Wire Cutter \$4.00. Raymond Opio, 817-25 St. Paul St. 210, Baltimore, Maryland. 21202.

ENGRAVING TOOL New Device for Home and Shop. Write on Glass, Plastic, Ceramics, Metal. Sharp Perma-Tip Engraving Tool is Made of Tungsten Carbide. Writes Clearly on any Surface; Never Needs Sharpening. This Valuable, but Simple to use Instrument will Protect your Personal items from loss and theft. Send \$2.98 (Connecticut Residents Add 7% Sales Tax) To: The Gift Horse, 340 Bennetts Road, Ridgefield, Connecticut 06877.

SMALL Foundry furnaces. Supplies. Free literature. Pyramid Products, 3736 South 7th Avenue, Phoenix, Arizona 85041.

MAXIMAT, Unimat Lathes. Metals. Micrometers. Catalogue 50¢. Industrial \$2.00. Campbell (PM), 1424 Barclay, Springfield, Ohio 45505.

4" METAL Cutting Lathe Kit \$29.50. Completely assembled machining unit \$89.50. Taig Mfg., Dept. T, 15048 Proctor, Industry, Calif. 91746.

SHOPSMITH IS BACK! Send 25¢ for Catalog, Includes Accessories, Prices, Parts. Factory Authorized Sales and Service. Hobbymodels, 418 Fulton St., Peoria, Illinois 61602.

1400 CATALOGS Listed and Described! Sources for EVERYTHING Imaginable! Rush \$2.00. **MASTERLOG**, Box 24413-(VG), Oakland, California 94623.

SEND For Complete Catalog of Maintenance Free Stainless Steel Nuts, Bolts, Washers, Etc. \$1.25. Summit Fasteners, Box 183, Lansdale, Pa. 19446.

NUTS, Bolts, Screws, Washers, Threaded Rod, Assortments, Catalog 25¢. Nutty Co., Box 1576 SMS, Fairfield, Conn. 06430.

SINGLE Phase Runs Three Phase Motors. Secure Electronics, 32 Warren, Waban, Mass., 02168.

END Mills. Lathe Milling Attachments: Information. Potter, Box 73, Cedar Rapids, Iowa 52406.

PUBLIC SALE! PROFESSIONAL Socket Wrench and Tool Set, 106 Top Grade Pieces. Small Overhead allows you 50% **DISCOUNT.** \$35.95 Value, Now Unbelievable, **BELOW WHOLESALE \$17.95 BARGAIN.** **SEND NO MONEY.** Satisfaction Guaranteed. Dealer Inquiries Invited. We Dropship. For **FREE** Pictured Brochures Write Today. Thomas Co., Tools Division, 171-08 Hillside, Jamaica, New York 11432.

METAL Cutting Band Saws. Use Vertically or Horizontally. As Low as \$119.95. 3½ x 6" Cutting Capacity. Write To: Saws, P.O. Box 295, Dept. A, Marcellus, Michigan 49067.

50% DISCOUNT! All Tools. Buy Direct. \$1.00 (Refundable) Brings **BIG** Tool Listing for 1,001 Uses, Together With Valuable Samples. Cash Industries, Box 4804-PM7, Pittsburgh, Pennsylvania 15206.

(Continued on next page)

Материал, защищенный авторским правом

WELDING, SOLDERING, PLATING

PLATING Equipment, Portable Platers, Supplies, and "Know-How". Build your own tanks for nickel, chrome, etc. Easy-to-install PVC liners. Rectifier components—all sizes. Schematics, parts, lists, formulas, operating instructions for all plating. \$10.00 post-paid. Guaranteed to save you 25%-75% or immediate refund. Some good used units for sale. Platers Service Company, 1511-A Esperanza, Los Angeles, California 90023.

WELDERS. Convert To Heliarc. High Frequency Unit 0-225AMP. Plans \$4.00. Convert To DC Plans \$3.00. Information Supply Co., Box 166, College Park, MD. 20740.

SUPER-ROD Metallurgical Break-through. Weld Aluminum Brass Copper Pot Metal With Propane Torch. \$2.00/Rod. K & B Supply, 4014 N. 7th Street, Suite 2A, Phoenix, Arizona 85014.

GOVERNMENT SURPLUS

MAKE MONEY On **GOVERNMENT SURPLUS.** How and Where to Buy. Send \$1.00. Grove of California, Dept. PM-117, 1018 W. Celeste, Fresno, Calif. 93705.

GOVERNMENT Surplus. **NATIONWIDE** Complete Brochure \$1.00. Hilco **AUCTIONEERS,** Anoka, Minnesota 55303.

JEES!!! PICKUPS!!! 100,000 Items direct from government. Your area. Latest information & surplus categories: \$2.00 **MONEYBACK GUARANTEE.** Order manual #126, from "Dependable Products", Box 113, Vista, California, 92083.

NO CATCHES. Buy any surplus direct from U.S. gov't. All information \$2.00. Bridgeworth, P.O. Box 2292-C, Vancouver, Washington 98661.

1973 SURPLUS Army, Navy store, 52 Page illustrated catalog. Send 50¢. Ruvel, 3037 North Clark, Dept. 7-J, Chicago, Illinois 60614.

JEES \$52.40. Airplanes \$75.01. Typewriters \$6.70. Boats \$7.50. Direct from Government. Directory and Surplus Catalog \$1.00 (Refundable). Midwest Surplus, Box 401-PM, Dayton, Ohio 45401.

GOVERNMENT SURPLUS. How and Where to buy in your area. Send \$2.00. **SURPLUS INFORMATION,** 30177PM **HEADQUARTERS BUILDING,** Washington, D. C. 20014.

"U.S. GOVERNMENT SURPLUS Directory." How, Where to buy 100,000 items (including Jeeps) . . . low as 2¢ on dollar! Most complete information available . . . \$1.00. **SURPLUS DISPOSAL,** Box 6586-AG, WASHINGTON, D.C. 20009.

42,000,000 ACRES Valuable Government Land still available. Some for \$2.00 per Acre. Buy, lease, or homestead Free. For 1973 Report send \$1.00. Government Land, Box 789PM York Penna. 17405.

JEES!!! TRUCKS!!! CAMPERS!!! LAND!!! Buy surplus direct from Government, your area. Complete Information \$2.00 **GUARANTEED.** Garden, Box 1631A4, Minot, North Dakota 58701.

MAKE MONEY ON GOVERNMENT SURPLUS. How and Where to Buy. Directory of Surplus Offices. Sale Terms. Mail Order Items Send \$1.00. **PACIFIC ENTERPRISE-PM1273, 4694 BERWICK DRIVE, SAN DIEGO, CALIFORNIA 92117.**

HOBBIES AND COLLECTIONS

COLLECT Military Medals, list 25¢. Verncn. Box 387PM, Baldwin, N.Y. 11510.

NAZI War Souvenirs Free Illustrated catalog. Delta, Box 361PS, Lafayette, Calif. 94549.

NAZI Medals, Photos, and Jewelry. Also War Mementos from Other Countries. Catalog and War Poster, 25¢. Hutchinson House, Box 6411, Chicago, Illinois 60680.

BOTTLE COLLECTING!! Cleveland's "Bottle Pricing Guide" lists/prices 3,600 new/old bottles. 1250 pictured. 18 categories. \$5.95 postpaid. Cleveland, 320AHM Main, San Angelo, Texas 76901.

50 GORGEOUS Jungle Butterflies \$2.90. 20 Exotic Seashells \$1.25. Collectors Wonderland, Box 1170, New York 10008.

FIGHTING SHIPS PHOTO REGISTRY Booklet listing world's largest collection of Navy and Coast Guard Pictures with hull numbers Only \$1.00. Our Navy, Brooklyn, N.Y. 11217.

BABY Shoe Bronzing Hobby That Pays. Details. NBC-PM, Gower, Missouri 64454.

DECALS, EMBLEMS, PATCHES

CUSTOM Designed Embroidered Emblems, Decals, Inexpensive. Free Catalog, details. Southern Emblem, Box 8PMB, Toast, North Carolina 27049.



STAMP COLLECTING

FREE! \$10.00 Giant Stamp Collection of 300 all different colorful, valuable postage stamps from Africa—Europe—Asia—British Empire—Worth \$10.00—\$12.00 at catalogue prices. Also money-saving Booklet. All yours as a Get-Acquainted Gift. Adults only. Other fine stamps enclosed for your inspection. Frasek Co. Inc., PM7, White Plains, New York 10601.

50 BIG Beauties 10¢ with approvals. Irvines, 1726 East Earl Drive, Phoenix, Ariz. 85016.

FREE! Big Bargain Catalog—New Edition listing thousands of bargains including U.S. & B.N.A. stamps, packets, albums, accessories and supplies. Also, fine stamps from our approval service which you may return without purchases and cancel service at any time. Jamestown Stamp, Dept. E73PM, Jamestown, New York 14701.

WOW! 110 All Different Germany 10¢ Commemoratives, Airmails, High Values, Big Catalog, bargain lists. Also, fine stamps from our approval service, which you may return without purchases and cancel service at any time. Jamestown Stamp, Dept. A73PM, Jamestown, New York 14701.

KAZAM! 25¢, 50 Mid-Eastern, Approvals. **ALLADIN,** Box 602, Jefferson City, Tenn. 37760.

SINGLE STAMPS 2¢ and up. Mounted in books. **TRUST STAMP COMPANY,** P. O. Box 100-P, Jamaica, New York 11435.

SCANDINAVIAN 70 different .34¢ Payment USA Mint Stamps. Kimber, 14301 Varby, Sweden.

EXCEPTIONAL! Outstanding Mint Complete Sets On Approval At Fair Prices. Dave Bergman, Box 231, Weymouth, Mass. 02188.

LOOK! 100 Beautiful Romania Pict. 25¢ Approvals. Scenic Stamps, Box 1973-B, Vancouver, Wash. 98663.

FREE Mixture. Contains Many Commemoratives, Pictorials, British Colonies, Foreign, Approvals. City Stamp Co., Box 216, Station "W", Toronto 15, Ont., Canada. M6M-422

22 TRIANGLE Stamps Only 10¢. Get This Timeless Treasure Of Gorgeous, Colorful, Triangle Shaped Postage Stamps. Approvals Included. Send Today! Stamps, Box 1444-B, Kitchener, Ontario, Canada.

200 WORLDWIDE 50¢ To Approval Applicants. Polze, Box 5215, Milwaukee, Wisconsin 53204.

50 DIFFERENT Old U.S. Revenue stamps \$1.00. Winchester Stamps, Box 3592, Mansfield, Ohio 44907.

OLDER U.S. stamps, covers, on approval to adults only. Surprisingly good. **ENGLE,** Box 208P, Lowell, Michigan 49331.

FREE New used Congo animal set, Approvals included. Alpaughco, Highbridge, N.J. 08829.

TEN Different Nudes: 20¢. Approvals. Stamp Farm, 2M56, Oxford, Wis. 53952.

50 DIFF. U.S. COMMEMORATIVES 25¢. Fine U.S. Approvals Accompany. Craig Stamps, Box 425-N, Bellmore, N.Y. 11710.

FOREIGN Approvals! Gigantic values! 3¢ each. ABC, Dept. 3301-A, Box 6000, San Francisco 94101.

3¢ PLATE Block 25¢ with comprehensive U.S. stamp and Supply catalog. Schultheis, Box 2151C, New Hyde Park, New York 11040.

"AFRICA" 25 Beauties, 15¢. Approvals. Gorliz, Box 28765 PM, Memphis, Tennessee 38128.

100 DIFFERENT United States Stamps, 25¢ With U.S., Foreign Approvals. ShelRon, Box 547C, North Miami, Fla. 33161.

U.S. MINT Specials! Flag set, complete \$1.00. 1¢, 2¢, 3¢ famous Americans (21 different) \$1.00. Free list. Brooks, 2601 Avenue "U," Brooklyn, N.Y. 11229.

PENNY! Approvals! Regardless catalogue! Kloster, 4164 52nd St., San Diego, Calif. 92105.

FREE Surprise collection sent with approvals. Gould, 1784 Union, San Francisco 94123.

ABSOLUTELY Free United States Mint Souvenir Sheet When Requesting United States Approvals. **K&B,** Box 70, Brooklyn, N.Y. 11223.

500 DIFFERENT Stamps, \$1.25. Smith, 508-A Brooks, College Station, Texas 77840.

100 DIFFERENT British Empire 15¢. Approvals. Gibson, Box 34, Lansdowne, Pa. 19050.

"INVERTED Error" Dag Hammarskjold, 10¢ with approvals. Belmont Stamps, Washington, D. C. 20015.

100 OLD United States between 1861 and 1935. \$1.00. Ed Roush, 423 Shepard, Mansfield, Ohio 44907.

225 STAMPS For only 10¢! Airmails. Pictorials: stamps from strange countries cataloging up to 25¢ each! Plus unusual stamps to examine. Buy any or none return balance, cancel service anytime. Mystic Stamp Co., Camden 80, New York 13316.

FREE! 10 African Beauties! 30 Others! Approvals. Cambridge, Box 2311, Heath, Ohio 43055.

VALUABLE Collection! Get scarce Red China, Pope John, Apollo 14, Antigua military costume, Iwo Jima memorial stamps, many more. 100 Different new and old issues from the world over—savage warriors, wild beasts, famous people, exotic scenes. Also stamp selections to examine. Buy any or none, return balance. Cancel service anytime. Rush 10¢ handling. Garcelon Stamp Co., OPMX, Calais, Maine 04619.

20 HISTORICAL U.S. Commemoratives 10¢. Bargain U.S. Approvals. **PINTO,** Box 111, Park Ridge, Illinois 60068.

80 DIFFERENT U.S. Stamps. Includes 1943 flag stamp of occupied nations. Only 25¢. Approvals included. Willett Co., Box 338-M, Yorktown Heights, N.Y. 10598.

50 YEARS Old, fifteen different United States, over fifty years old—10¢ with approvals. Jaxon, Box 145-P, Brooklyn, New York 11230.

QUALITY AND LOW PRICE. EXCELLENT For advanced or beginner. Mounted approvals 2¢ up, all countries in Scott's Order. Preview Stamps, P.O. Box 20667, San Diego, California 92120.

(Continued on next page)

BUSINESS OPPORTUNITIES

(Continued from preceding page)

MAKE huge profits selling your own name brand single ingredient odorless deodorant which kills all odors. For use in Hospitals, Homes, Farms, etc. Sample and Formula \$3.95 postpaid. Frantom, 59PM Sapphire, Dvale, Trinidad WI.

MAILORDER Millionaire helps beginners make \$500 weekly. Free report reveals secret plan! Executive (1A7), 333 North Michigan, Chicago 60601.

PORTABLE Sandblaster \$29.95. Distributor wanted. Free brochure. INKA, Box 66573-A, Houston, Texas 77006.

PROFITABLE Mailorder Business! Proven Step By Step Program—Free Details—National Mailorder Exchange, 249 Main Street, Dept. 4B7, Farmingdale, N.Y. 11735.

BUILD Custom Cases at home for profit. Get orders by mail. We supply materials, instruction—everything. Free home business details. Custom Case Supply Co., 6075 CPG, De Soto Avenue, Woodland Hills, California 91364.

MAILORDER Laws. Know The Facts \$2.00. Guaranteed. Ideal Enterprises, Box 515-G, Woodbridge, New Jersey 07095.

HIGH Profit Potential from Home Engraving Business! Steady Earnings. Write: Trend Craftsmen, 4901N Perrine, Midland, Michigan 48640.

BE YOUR Own Boss. Every Advertiser in this Section is in Mailorder. Why not You? Report gives details. \$1.00. Haman House, Dept. PMG, 110 Haman, Barrington, Ill. 60010.

MAKE OVER \$92.00 FROM Square Foot Plywood (with Jigsaw or Bandsaw); Amazing (proof); Explicit, revealing details 25¢. Wodertz, Bridgewater, Mass. 02324.

RAISE CAPITAL WITHOUT COLLATERAL or credit. Unique plan assures success. Enterprises, Box 247-M, Columbus, Georgia 31902.

\$19 HOURLY Profit—Own Business with one service man. Quickly learned. Easy to do. Operate from home. Little over \$1000 starts your own nationally advertised business while continuing present job. Investigate immediately before your territory is taken. Free booklet explains everything. Send today. Then decide. Duraclean, C3-166 Duraclean Bldg., Deerfield, Ill. 60015.

\$2,000 MONTHLY POSSIBLE Home Based Business, it's a Winner. Free Information. E-B Enterprises, Suite 811, 2105 Benecia, Los Angeles, Calif. 90025.

MAILORDER Catalogs. Your Name Imprinted. Merchandise Drop-Shipped. Details 25¢. AM Sales, 31-14-94, East Elmhurst, N.Y. 11369.

SELL Books Mailorder!! Highly Profitable! Details. Derbes, Box 2667, New Orleans 70176.

FREE SECRET BOOK "2042 Unique. Proven Enterprises." Tiny businesses but huge profits! How Little Fellows beat inflation. Work home! Haylings-T17, Carlsbad, California 92008.

SECRETS of Mailorder Pros revealed! \$4.95 postpaid. Trader Mike, Box 1305-P, Newark, New Jersey 07101.

BOOKKEEPERS Operate Profitable Bookkeeping Service. Earn \$10.00-\$20.00 hour. Details free. Universal Bookkeeping, Box 664-M, Springfield, Missouri 65801.

SECRETS of getting rich with other people's money. \$5000+ possible in one day. Free details. JPA, Dept. 303, Box 101, Park Ridge, N. J. 07656.

HOW TO EARN MONEY AT HOME. Information 25¢ plus stamped self-addressed envelope. Clemmons House, Clemmons, N. Car. 27012.

PREPARE Tax Returns—Housewife Jo Ann Netzey made \$5,500 last season. Train at home. VA Approved. National Tax School, Monsey 2HB, New York 10952.

START A "PROFITABLE" Mailorder Business—Sell "NEEDED" Information! Free details. Hautala, Box 125, Williston Park, New York 11596.

CREATIVE? Make Money Selling Information. Free Mailorder Mini Course. MOAA, Box 21091-C, Philadelphia, Penna. 19154.

24 MAILORDER LESSONS Only \$2.00 or Free Details. Mundus, P.O. Box 69-A, Selden, N.Y. 11784.

FANTASTIC Profits! Dropshipping Works! Try it: EVB, Box 262PM, Parkchester, New York 10462.

GROUND Floor opportunity in an Engraving business of your own—spare time or full time. One piece of raw material costing \$4.50 will produce products worth \$180.00! Free particulars! Write: Warner, Room EC-2-CK, 1512 Jarvis, Chicago, IL 60626.

INSTALL Burglar alarms without previous experience or costly equipment. Big profit. Free details. Nasco, Dept. G2707, Woodland Hills, California 91364.

SECRETS! Mail Order Success. Internationally famous expert reveals how to make home business fortunes. Beginners: Get free report "Make Money By Mail." Discloses free advertising profitable products. Mailco, Dept. GC707, Woodland Hills, California 91364.

HOW And Where To Get Capital. Get \$500 to \$2 million. Free information. Counselor-17, Kerrville, Texas 78028.

328 FAST, easy ways to make money! Free! Rush name, address, zip. Perry, 13263-E Ventura Blvd. Studio City, Calif. 91604.

FREE Millionaire Book . . . "Get A Fortune in successful, little business. Work home! SBI-7, Kerrville, Texas 78028.

IMPORT-Export Opportunity, profitable world-wide, mail order business from home, without capital or travel abroad. We ship plan for no risk examination. Experience unnecessary. Free Report. Mellinger, Dept. G2707, Woodland Hills, California 91364.

INFORMATION Dealers Needed. Proven Method Reaches **HUNGRY, GROWING MARKET.** Free Details. NRG-A7, Vanburger Rd., Owego, New York 13827.

FREE, \$3.00 Copy "Advanced News Letter". Rare money-making opportunity bargains. Our 58th year. Vernon, Box 3434PM, Clearwater Beach, Florida. 33515.

\$500.00 WEEKLY EASY, Selling Business Information by Mail, Free Details: Clark, Box 80521-M, Atlanta, Georgia. 30341.

"MAILORDER Course! Home Study", 24 Easy Lessons, \$2.00. "Bill" Lambertson, 132 Tamiami Station, Dept. PM73, Miami, Florida. 33144.

\$1000 PER MONTH Possible. From Your Own Home. Write: Charles A Enterprises, R-1, Box 1022, Bend, Oregon 97701.

SUCCESSFUL FUTURE IN AUTO SALVAGE BUSINESS For Information Telling How You Can Succeed in Your Own Auto Salvage Business. Send \$3.95 To: Success, 3181 Woodside Drive, Jackson, Miss. 39212.

DROP-SHIP BOOK BARGAINS CATALOG. 50% profit. Catalogs 3¢. Start now 25¢. Selbooks, 712 South Missouri Ave. Clearwater, Fla. 33516.

STATE SALES TAX GUIDE FOR MAIL ORDER DEALERS—all 50 states \$2.00. Willemens House, Dept. P1, 73 Woodridge St., Woodridge, New Jersey 07075.

BLACK HISTORY! Dealers Wanted. Retail \$44.20—Wholesale \$11.25. (502) 968-2607—Anytime.

"A BUSINESS OF YOUR OWN." THIS NEW BOOKLET SHOWS YOU—STEP BY STEP—HOW TO: DRAW UP A BUSINESS PLAN WHICH WILL SELL YOUR BANKER: START-UP; AND SUCCESSFULLY MANAGE ANY TYPE OF BUSINESS. NO WILD PROMISES—WE SELL KNOW-HOW. \$3.00 . . . Business Topics, Box 3218, Damariscotta, Maine 04543.

\$200.00 DAILY In Your Mailbox! Opportunity To Follow Mailorder Experts. Free Details. Associates, Box 136-A, Holland, Mich. 49423.

NEED To \$1200 extra? Free assay. Saylor, Box 622, Irving, Texas 75060.

RECEIVE Mail Galore! Your name on our national mailing lists, \$1.00. Sullins, Box 1313. Brunswick, Georgia 31520.

MAKE MONEY at Flea Markets. Instructions \$1.00. Abel Products Company, Dept. PM202, 1115 West Farnum, Royal Oak, Michigan 48067.

\$2000.00 MONTHLY Selling Information by Mail. Lee, Fox Plaza, Box 2904, San Francisco, California. 94102.

CUSTOM UPHOLSTERY MAKES \$\$\$! Re-do chairs, sofas, seats, even boats, cars, campers, for high pay. No Experience needed. We show you modern ways, furnish illustrated home instruction, tools, supplies, beautiful material choices. Send for big **FREE** Book, **FREE** Project lesson. Modern Upholstery Institute, Box 899-TPM2, Orange, Calif. 92669.

BIG Profits selling Nameplates. Custom Engraving—Free Details. R.P.H. Manufacturing, 249-C Winter, Stamford, Conn. 06905.

FREE Details!! Proven Home Money-makers. Choose from 14 different plans. Write: Moimex, 11256 Gonsalves, Cerritos, California 90701.

\$250.00 PER Thousand stuffing envelopes! Unconditional Money-Back guarantee! Complete Starters Kit \$1.00. **HOMEWORKERS,** Box 24413-MG, Oakland, Cal. 94623.

"HOW To Build Fortune In Real Estate". Guaranteed!!!! Send \$2.98. Kibbie, Box 2742, Dept. 7H1, Jacksonville 32203.

WE NEED GINSENG GROWERS! \$3,000-\$30,000 Annually! We Buy Your Crop. Send \$2 for Seed Sample and Information. Glass's Ginseng Exchange, Box 336, Rochdale Station, Jamaica, NY 11434.

SPECIAL OFFER Genuine White Oak Used Whiskey Barrels, 50 Gallon \$15.00 Each. F.O.B. For Furniture Or Wine Making. James Dulaney, 10801 Main Street, Fairfax, Va. 22030 (Dealers Wanted)

BE INDEPENDENT—Your Own Business—50 Profitable Ventures you can Start on a Shoestring. Complete Details \$1.25. Maiser, Box 8906, Corpus Christi, Texas 78412.

START Your Mailorder Business. Free Details. Pelfree, 3904 Longview Drive, Atlanta 30341.

STUFF Envelopes. \$28.00 Hundred. Immediate Earnings. Beginners Kit, \$1.00 (Refundable). John Keen, P.O. Box 9995, San Diego, Calif. 92109.

GENEROUS Profits Mailing Information. Sierra Products, 5540 Winding Way, Carmichael, California 95608.

GET Business Advice!! Send Your Questions, \$1.00. Schleicher, 7 Dove, Albany, New York 12210.

1000% PROFIT Bronzing Baby Shoes At Home. Free Literature. NBC-PM, Gower, Missouri 64454.

MAKE durable building plastic easily. Waterproof, fireproof, economical. Bays Laboratory, Cedaredge, Colo. 81413.

\$1,000 MONTHLY Possible. New Advertising-Mailorder Business. Superior PM-2, 2421 So. Fulton Place, Tulsa, Okla. 74114.

DON'T Die without a will! Blank will form protects your family. Only \$2.00. Instructions included. 100% guaranteed. Order today!! Barons, Box 1033Y3, St. Charles, Missouri 63301.

(Continued on next page)

BUSINESS OPPORTUNITIES
(Continued from preceding page)

50 BUSINESSES You Can Start With Little or No Capital. Details \$1.25. **DAWVEST**, Box 4249, Long Beach, Calif. 90804.

\$25.00 HUNDRED Addressing possible year round. Special information 25¢ with self-addressed stamped envelope. Cove-B, 627 Franklin, Clearwater, Florida 33517.

REUPHOLSTERY. Profitable Home Business. Illustrated Manual \$2.00. Guaranteed. Russell, P-73, 1566 So. Burkhardt, Evansville, Indiana 47715

\$1000 MONTHLY from your own home. Write: Jordan, Box 884, Dept. PM7, Visalia, Calif. 93277.

FREE! Sample Letterheads, Envelopes And Printing Prices. Lakeview Printing, Box 108A, Muskego, Wis. 53150.

DO SIMPLE ADDRESSING—Mailing. Receive \$12.95 orders. Keep \$8.00 profit. Details Free! Quality, Box 9-P, East Rockaway, N.Y. 11518.

WORLD'S GREATEST BARGAINS. U.S., Foreign Wholesalers. Buy Direct... Start Your Own Sparetime Business. Free Details. Yorkshire, Box 401-B, Molalla, Oregon 97038.

FULL Or part time dealers wanted for revolutionary two-seat Sport Family Land/Seaplane kits. VW powered, now in production at Larkin Aircraft Corp., Dept. PM, Freedom, California. Initial investment under \$500.

PROFIT Selling books by mail. Proven Plan. Details and sample catalog, \$1.00. Sabacy Products, Box 15206C, Lakewood, Colo. 80215.

I'LL PAY YOU To Answer My Advertisement on Business Opportunities, with Real Money. Free Money, Box 460A, Lomita, California. 90717

MONEYMAKING OPPORTUNITIES

OVER \$16.50 an hour. Spare time at home! Rubber Stamp industry needs small manufacturers. We furnish all equipment and know-how! Particulars free! Write: Roberts, Room RC-2-CK, 1512 Jarvis, Chicago, Ill. 60626.

SELL Your Photos, Report Tells How. Where. Color Slides Markets Only \$1.00. Greenleaf Sales, Dept. A, 1102 30th St. North West, Winter Haven, Florida 33880.

BIG PROFITS! "How to make money writing". Full details \$1.00. Decamps Specialties, 356B Princeton, San Francisco, Cal. 94134.

FREE Details. Build Spare Time Mail Order Business Using Baby World Catalogs. Everything Supplied. Henlor Products, Dept. BW2, 2338 East 1st Street, Brooklyn, N.Y. 11223.

MONEY Can be made with small ads. Ad cost advanced and ads placed. You repay later. Goldcraft, 115 Garner Road, Lilburn, Ga. 30247.

DROP SHIP To Mailorder Fortune. Free Details. Young, Marion, North Carolina 28752.

\$2.40 HOURLY Making simple wood novelties. Free details! Gene's, 55 Boxwood, Falmouth, Mass. 02540.

HOW To Make Money Writing Short Paragraphs. Information Free on "Home Studies in Writing". Barrett, Dept. C-27-A, 6216 N. Clark, Chicago 60660.

MAKE \$1.00 PER SALE Selling engraved metal Social Security plates. **FREE SALES KIT**. Engravaplates, Box 10460-199, Jacksonville, Florida 32207.

MAKE Statuettes, novelties, imitation marble. Sell to stores or start gift shop. Free details. Marbleizing, 41 Waverton, St. Louis, Mo. 63124.

WORLD'S Leading contest magazine, 25¢. Year, \$4.00. Prizewinner, 1315 Central, St. Petersburg, Fla. 33705.

HOW TO GET RICH!! Free "Money-making Brochure"! Success International, Box 2447-C, Livonia, Mich. 48151.

VENDING Machines. No selling. Routes earn amazing profits. Big catalogue Free. Parkway Corporation, 715PMM Ensor Street, Baltimore, Maryland 21202.

FREE—Easy Ways to make money selling exciting new products—Full—spare time. Send name, age, for 5 months free subscription. Salesman's Opportunity Magazine, 1460 Hancock Center, Dept. 17-GM, Chicago 60611.

PENNY STOCKS Have Profit Potential. Free Information. Analyst-P.M., Box 214, Redondo Beach, California 90277.

200% PROFIT Selling Rings. Triple Money in 30 Days or Money Back. Free Details. Anka, P.O. Box 8036-PM, Cranston, Rhode Island 02920.

\$40 DAILY Possible tying fishing flies at home. Details 25¢. Flyco, Box 481PM, Albany, Oregon 97321.

EARN MONEY, learn mailorder, spare-time, at home, reading leading (since 1929) trade magazine, product sources, stories, tips. Sample 50¢, year \$5. Mail Trade, Box 1302, Springfield, Illinois 62705.

ADDRESSERS—50 Companies want Addressers. Send self-addressed envelope. Cal Enterprises, Box 4516-X, Compton, Calif. 90224.

SWEEPSTAKES Contests. How to win. Write for free information. General Contests, 1609-18 East 5th., Duluth, Minnesota 55812.

FREE SECRET BOOK "2042 Unique, Proven Enterprises." Largest successful collection! fabulous "Little Knowns." Work home! Haiyings-T16, Carlsbad, Calif. 92008.

\$200.00 FROM Sheet 1/4" plywood (scrap). Details 25¢. Novelties, 610 So. 24th, Elwood, Indiana 46036.

LEARN The secrets of repairing junk batteries. "Fabulous Profits" at home. Battery Shop, Box 820, La Quinta, California 92253.

GET World's Biggest Wholesale Import Catalog. Write: World, Medina, Washington 98039.

NEWSCLIPPINGS Needed! We Pay Cash for certain Newsclippings. Tory Company, MP, Bayonne, New Jersey 07002.

START Small, HIGHLY PROFITABLE ELECTRONIC PRODUCTION IN YOUR BASEMENT. Investment, knowledge unnecessary. Post-card brings facts, Barta-PMK, Box 248, Walnut Creek, California 94597.

MAILORDER One man operation can earn \$5,000-\$10,000 yearly—No merchandise investment, company dropships, does all work. Free details. Sunnyside, 39-02-PM 47th Street, Long Island City, New York 11104.

SELL Your Photos. Big Demand. Booklet Tells How. Where. Laws, Etc. \$1.00. Princess Gifts & Novelties, Dept. A-3, 1305 Ritchie Road, Forestville, Maryland 20027.

EXECUTIVE MAILORDER FRANCHISES **FREE!** 400% Profit selling advanced moneymaking books. Sell self-selling baby necessities. Free Details. Trinity, 1712F Lee, Detroit, Michigan 48206.

\$100.00 WEEKLY Possible Home Addressing! \$125.00 Weekly Possible Clipping Items From Your Newspaper. Information: Send \$1.00 And Stamped Self-Addressed Envelope. Winder's, 328 Jackson Avenue, Elyria, Ohio 44035.

HOMEWORKERS EARN \$150.00 WEEKLY ADDRESSING OUR SALES LETTERS. DETAILS 25¢. CUR-JON MAILERS, BOX 523-PM, MAPLEWOOD, N.J. 07040.

ADDRESSERS Mailers Needed. Details 10¢. Borchardt, Dept. GP, Postbox 1022, Mineral Wells, Texas 76067.

BIG Money In "Hot Dogs". Build A Street Vendor's Pushcart. Easy Plans \$3.00. Thomas, 100 Bellvue, Chicago 60611.

FREE INFORMATION \$50.00 \$100.00 per week selling gifts from Sales Kit. Sample item \$1.00. NEE-LON, Box 6497PM, Philadelphia, Pa. 19145.

ADDRESS Envelopes. \$1.60 Each One Mailed. Enclose 25¢ And Stamped Envelope For Details. Modern, Box 222PM Upland, Calif. 91786.

GET RICH FAST!!! Easy, Proven Way—Spare Time! Secret "How" Report—\$1.00. Centaur, 82 Adine, Rochester, New York 14619.

DO Simple Addressing And Mailing. \$8.00 profit! Details 25¢ with stamped, self-addressed envelope. Johnson Home Workers, JA-1, POB 141, Seale, Alabama 36875.

SKETCH Photos (Homeworker's Goldmine!) Steady Market. Details. Gem, 365-D Longhill, Shelton, Conn. 06484.

HOMEWORKERS. Earn \$1.60 Each, Mailing Envelopes. Rush 10¢. Gemco, B-21244A, Indianapolis 46221.

ADDRESSERS And Mailers Needed! Free Details! Splendid Opportunity! Delta, Box 24-P, Chalmette, Louisiana 70043.

RETIRE ANYTIME In Luxury! Easy, Legitimate! Details. Premier Enterprises, Box 10597-AG, Pittsburgh 15235.

\$200.00 WEEKLY POSSIBLE. Complete Sales Kit \$5.00. Details 25¢. G. S. Products, 2712 N. Mc Vickers, Chicago, Illinois 60639.

AMAZING Book: "Profits In Mail Order". \$2.75. Cazin, 526 Maple, Redwood City, California 94063.

HOW To Win Prize Contests. Details free. Martins, Box 141-B, Fremont, California 94537.

NEWSLETTER \$10,000 Guaranteed or Pay Nothing. Robinson Enterprises, Box 38, Augusta, Ga. 30901.

\$250.00 PER Thousand, stuffing envelopes! Unconditional Money-Back guarantee! Complete Starters Kit \$1.00. **HOMEWORKERS**, Box 24413-NG, Oakland, Cal. 94623.

\$10 DAILY Writing Short Articles at Home. Begin Immediately! Copyrighted Report Reveals How and Where. Send \$1.00. Andy's Gift Shop, 113 Flintrock, Del Rio, Texas 78840.

400% PROFIT From Square Foot 1/4" Plastic. Details 35¢—Plus Stamp. Jo-Mar-Ko, P.O. Box 34893, Detroit, Mich. 48234.

"PROFITABLE PLASTER CASTING"—Exciting New Book!!—Details! Exclusive, 827 Yout, Racine, Wisconsin 53402.

EARN MONEY AT HOME! Details 25¢. Setco Business Service, 2000 Douglas Ave., Dept. A. Clearwater, Florida 33515.

MONEY Available to help you operate in mailorder. For information, samples of type plans acceptable, 100 buyers names and \$1 trade certificate, send \$1.00 postage and handling. Lampart Enterprises, 13132 Mackenzie, Detroit, Mich. 48228.

MAKING YOUR MONEY GROW! Priceless Discovery Can Make You \$200 a Day and More! New Book Shows How To Reap a Fortune From Stock Market and Without Paying Commissions! Why Reveal? More People in Better It Works. Includes Free Coupons Worth \$48.75! Only \$19.95—Guaranteed! Order Today!! Frekl, 51 Magnolia Drive, Dept. 1A7, St. Louis 63124.

\$\$\$ FINANCIAL INDEPENDENCE!! Be Independent Businessman—No Tricks; Selling. 8¢ Stamp, C-M, 11922 Santa Monica Blvd., West Los Angeles, Calif. 90025.

(Continued on next page)

Материал, защищенный авторским правом

MONEYMAKING OPPORTUNITIES

(Continued from preceding page)

START Making Money At Home Today! Guaranteed results, revealed. Write: Opportunity Research, Dept. MJ3-2544 East 16th Street, Brooklyn, N.Y. 11235.

EARN \$100.00 Day. My Book Shows How. Simpkins, Indian Valley, Virginia. 24105.

YOUR Ambitions obtained AUTOMATICALLY! Proven! Details. Premier Enterprises, Box 10597-BG, Pittsburgh 15235.

PROFITABLE OCCUPATIONS

MOLDS For Ornamental Concrete, Catalog Containing Over 700 Molds \$2.00. Plycrete Mold Company, Elk Rapids, Mich. 49629.

FT. SMITH Auction School, Ft. Smith, Ark. 72901. Resident & Home study. Veteran approved.

BECOME A Mortgage Broker. Highly respected, interesting, lucrative prestige business. For complete information write: United, Box 6284-F, Marietta, Georgia 30060.

SHARPEN—Scissors, Pinkers. Light, compact equipment. Supplies. Blackhawk's Sheldahl, Iowa 50243.

LEARN GUN REPAIR GUNSMITHING in spare time. Book, details 10¢. Modern Gun Repair School, Dept. 2207, 4225 N. Brown, Scottsdale, Arizona 85251.

PLASTERCRAFT!!! Profitable home business. Molds available. Details: Lynette, 6251C Mentor Park, Mentor, Ohio 44060.

SALESMEN-DISTRIBUTORS

PUBLICATIONS for local wholesale distribution, higher profits. Details, sample, \$1 refundable. Publisher, 404 West Jefferson, Springfield, Illinois 62702.

SELL Advertising Ball Pens, Calendars, Ad-Specialties—Build Own Repeat Business—Free Details—Fleming, Dept. A, 6535 Cottage Grove, Chicago 60637.

UNIQUE New Product. Samples 50¢. Goodrich, Box 654, Poughkeepsie, New York 12602.

NEW, Compact fire extinguisher. Fantastic profits. Exclusive territories. Norwich Chemical, Norwich, Connecticut 06397.

AUTOMATIC Fishhooks. Free details. Samples, \$2.00. Aron, 61PM, Mastic Beach, New York 11951.

EARN Big Commission Full or Part Time. Show America's largest line Low Priced Business Printing and Advertising Specialties Plus Calendars in season. No experience. No investment. No collections or Deliveries. On-the-spot commissions. Big Free Sales Kit Samples hundreds items used daily by businessmen. Merchandise bonuses for you. Build profitable repeat business. Start now. National Press, Dept. 73-B, North Chicago, Ill. 60064.

\$100.00 EXTRA A week easy! Spare time! Double Air Cushion shoes. Men's, women's line. Dress, work, play. Highest commissions. Shoes for yourself. Outfit Free. Bronson, Dept. H-73, Minneapolis, Minnesota 55408.

HERTEL exclusive reference Bible! Make biggest profits with world's best seller! Startling 3-dimension cover! Demonstrator, supplies furnished. Top commissions plus extra bonus earnings! Write International Book, Dept. PM, Box 118, Wichita, Kansas 67201.

EARN MONEY IMMEDIATELY. Sell nationally-Famous Knapp Shoes part-time or full time. High cash commissions immediately plus bonuses monthly, benefits. Your own hours, your own business. No investment. Free selling and training kit. Lowell Harris, Dept. PM-12 Knapp Centre, Brockton, Mass. 02401.

WANTED—Man contact service stations. Long needed invention. Huge Profits. Write Cyclo, 3816 Dahlia, Dept. 177, Denver, Colo. 80207.

AGENTS WANTED

ESTABLISH Your own business. Low prices on used clothing, shoes, household goods. Unlimited profits. Free catalog. Northwestern Distributors, 2129 No. Western Avenue, Chicago, Illinois 60647.

PRINTING, Advertising Salesmen—Excellent moneymaking sideline selling De-calomania Name Plates, small quantities. Advertising Specialties, sign letters. Free Samples. Raico XL, Boston, Mass. 02119.

EVERY Man a prospect. Refundable sales kit offer showing line belt buckles, tie clasps, money clips, cuff links, lapels, identification badges, individualized with customer's name and emblems. Cap badges for trucking, bus, taxi, police, firemen, also postal letter carriers and heavy construction emblems. Choice 4000 emblems. Hook-Fast, Box 1088-PM, Providence, R.I., 02901.

YOUR Own business. Used Suits \$1.50; Overcoats 65¢; Mackinaws 35¢; Shoes 12½¢; Ladies' Coats 30¢; Dresses 15¢. Enormous profits. Catalog Free. Nathan Portnoy Associates, 2109-AA Roosevelt Road, Chicago, Illinois 60608.

\$75 DAILY showing car owners how to end Waxing-Polishing Forever. Samples details Free. International, 34 E. 12th Street, New York, N.Y. 10003, Dept. PMD-2.

MAKE MONEY IN SPARE TIME. As a subscription sales representative for leading national magazines, you can earn generous commissions while learning the art of selling. Instructions and supplies will be sent to you free. Send this ad with your name and address to: **POPULAR MECHANICS**, Room 1107L, 250 W. 55th St., New York, N.Y. 10019.

EMPLOYMENT INFORMATION

POTENTIAL EMPLOYER LIST For list containing names and addresses of potential employers send \$2.00 to: Box 58913, Dept. E, Houston, Texas 77058.

AUSTRALIA Most Comprehensive Information, From Americans Now Living In Australia, \$2.00 For Brochure, Ausco Inquiry, Box 29, Burra 5417, South, Australia.

AUSTRALIA!! AUSTRALIA!! FREE DETAILS!! Paid Transportation. Latest Information on Jobs. Send age, occupation. Write: Associated, Box 17-B-140, Lafayette, California, 94549.

OVERSEAS JOBS—Now Hiring, 103 Countries. All Occupations, High Pay, Free Transportation, Tax Benefits, Latest Computerized Reports—\$2.00. **TRANSWORLD**, International Airport, Box 90802-E, Los Angeles, California 90009.

AUSTRALIA—NEW ZEALAND WANT YOU !!! 50,000 Jobs! Paid Transportation! Latest Information and Forms, \$1.00. Ausco, Box 3623-E, Long Beach, California 90803.

HELP WANTED

OVERSEAS JOBS—Europe, South America, Australia, Far East, etc. 2000 openings all trades. Construction, Office, Engineering Sales, etc. \$700 to \$3,000 month. Expenses paid. Free Information. Write: Overseas Jobs, International Airport, Box 536-M, Miami, Florida 33148.

OVERSEAS EMPLOYMENT . . . Australia, Europe, South America, Asia! All Occupations! \$700-\$3,000 monthly! Write: Employment International, Box 29217-AG, Indianapolis, Indiana 46229.

FREE DETAILS! . . . AUSTRALIA . . . Paid Transportation!! Jobs Galore!! Send age, occupation. Write: Associated, Box 17-BA-140, Lafayette, California 94549.

WORLD-WIDE . . . U.S.A. JOBS GALORE!!! All occupations. Enjoy: Asia, Europe, Africa, South America, Florida, California, \$700.00 to \$3,500.00 monthly. Paid Overtime. Travel Allowance. Free Details! Send age, occupation. Write: Global Employment, Box 706-B-140, 2 Orinda, California 94563.

EARN At Home Addressing Mail. Details 25¢ and Stamped Envelope. Deeco-151, Box 9308, North Hollywood, Cal. 91609.

REAL ESTATE AND FARMS

FREE CATALOG! Giant SUMMER edition! Over 5,200 properties described, pictured—Land, Farms, Homes, Businesses—Recreation, Retirement. Selected Best thru-out the U.S.! 73 Years' service, over 660 Offices. 41 states Coast to Coast. Mailed FREE from the World's Largest! **STROUT REALTY, Inc.** 60-MX E. 42nd St NY, NY 10017; 7-MX S. Dearborn, Chicago, Ill. 60603; 521-MX E. Green, Pasadena, Calif. 91101.

CANADIAN LAND FROM \$19.00 AN ACRE CHOICE Properties available across Canada. Low monthly payments. Ideal for farming, cottages, hunting, fishing. Free Catalogue. Canadian Estate Land, Dept. PMC 7, 286 Lawrence Ave. West, Toronto 20, Ont., Canada.

\$1.00 ACRE! USA and Canada. Lists, photographs mailed. Government Lands, 220 Delaware Ave., Buffalo, New York 14202.

CENTRAL Ontario—Choice 640 acre Sportsmen's paradises still available—\$20.00 plus \$6.50 taxes yearly. Maps, pictures. \$2.00 (Refundable). Information Bureau, Norval 4, Ontario, Canada.

FREE Catalog! PHOTOS! Coast to coast farms, business, retirement. All types, sizes & prices. **SAFE-BUY** Real Estate, Box 589-PM, Little Rock, Ark. 72203.

IDEAL 5-ACRE RANCH. Lake Conchas, New Mexico. \$3,475. No Down. No Interest. \$29/mo. Vacation Paradise. Money Maker. Free Brochure. Ranchos, Box 2003PS, Alameda, California 94501.

\$1 ACRE—Canadian border—hundreds campsites, islands, farmlands, directly from tax authorities. (Non-profit). Lists, photographs mailed. Register, Room 10, 110 Church Street, Toronto 1, Canada.

BOILING Spring Lakes—America's Greatest Real Estate Value. 1/3 acre vacation or retirement homesites only \$900 cash price. Ten-year terms available. Money-back inspection guarantee. Carolina coast, multi-million dollar, 14,000 Acre development. 50 fresh water lakes, private ocean beach, golf course, motel, and country club. Free literature, Dept. 1-K, Boiling Spring Lakes, North Carolina 28461. (Registered under Federal Land Sales act but not offered to residents of states requiring separate registration.)

CANADIAN Vacation lands: Full price \$385.00. 40 acres. \$10 month. Suitable cottage sites, hunting, fishing, investment. Free information. Land Corporation, 3768-C Bathurst, Downsview, Ontario, Canada.

GOVERNMENT LANDS FROM \$3.50 ACRE! Vacationing, Homesteading, Investment! Exclusive "U.S. GOVERNMENT LAND BUYER'S GUIDE" . . . plus "LAND OPPORTUNITY REVIEW" listing lands throughout U.S. Send \$1.00. Surplus Lands, Box 6588-AG, Washington, D.C. 20009.

FREE. . . . BIG 256-page catalog. Hundreds of top real estate values coast to coast! **UNITED FARM AGENCY**, 612-PM West 47th St., Kansas City, Mo. 64112.

MICHIGAN 10 TO 160 ACRE TRACTS Lake Superior-Marquette Area from \$99.00 Acre Cabins, Trailers, camping welcome. (Acreage anywhere in Michigan). **FREE PICTURES.** Any terms A-OK with **BLOCH BROTHERS.** Write: 3650 Dixie, Drayton Plains 16, Michigan 48020.

(Continued on next page)

FARM AND GARDEN EQUIPMENT

RIDING LAWNMOWERS Shipped from factory—New 7 Horsepower, \$189.00. Freight paid. Free brochure: Tomco, Box 72, Oak Grove, Mo. 64075.

SAVE \$45.00 when you build one of these famous Vermont large wheeled carts from the new Low Cost Kit. Free Catalog: Garden Way Research, Dept. 4438-T, Charlotte Vermont 05445.

DRINKING WATER—PURIFIER

WATER ANALYSIS: \$2.00 for Sample Bottle, Mailer, and Price List. PMC, Box 6182, Chicago, 60680.



FLOWERS, PLANTS & NURSERY SUPPLIES

LEARN Landscaping and the growing of plants. Start a profitable business part or full time. Free information without obligation. Lifetime Career Schools, Dept. A-364, 2251 Barry Avenue, Los Angeles, California 90064.

GREENHOUSE—10'x12' Fiberglass, Fast, easy construction! Plans \$3.00. Guaranteed! Southwest-A2, Box 275, Garland, Texas 75040.

SLEEPING BEAUTY Plant Sleeps When Touched. \$1.00 For Five Seeds. Bill Ayle, APDO-Aereo 52136, Medellin Columbia, South America.

CACTUS Catalogue .20c. Over 1,000 Varieties. Henrietta's Nursery. 1345 N. Brawley, Fresno, Cal. 93705.

CONSTRUCTION PLANS, BLUEPRINTS

HOUSE EXPANSION PLANS And detail instruction book provide anything from an extra room to 1000 s/f addition. Build what you need at big do-it-yourself saving. Book with 1 set working blueprints \$14.50! With 4 sets (required by contractors) \$20.00. Money-Saver Projects, Box 303-44B, Chappaqua, New York 10514. Information available.

PADDLEWHEEL Houseboat. Amusing twenty footer. Plans \$5.00. Route One, Box 500, Space 16, Coeur, d'Alene, Idaho 83814.

BUILD A ROUND PICNIC TABLE. Send For Plans, \$1. Reg. Table \$2. Round Table: Culver Construction, 208 W. Crawford, Upper Sandusky, Ohio 43351.

POPULAR MECHANICS CATALOG Of plans, publications and projects. Covers shop and home projects. Want to build a plane, a hovercraft, boats, swimming pools, patios and garden furniture. Fireplaces, kitchen cabinets. 32 pages crammed full of fascinating and useful projects. Send for this illustrated catalog to: **POPULAR MECHANICS**, Dept HE, 224 W. 57th St., New York, N. Y. 10019. Price 25¢

LOG CABINS & HOMES

BUILD Log Cabins, rustic furniture, fireplaces!!! Complete manual, \$3.00 . . . "A" Frame plans, \$2.00 . . . **Guaranteed.** . . . Beels, 956 Springdale, Atlanta, Georgia 30306.

"A" FRAME CABIN. \$500. Material. Purchase locally. Completely illustrated instruction manual & material list: \$2.00. Moneyback Guarantee. Order plan #1921, from: "Dependable Products", Box 113, Vista, California 92083.

SAVE THOUSANDS Build Your Own Home. Complete Instructions \$2.00. To: Highway 32 Gift Shop, Rt. 2, Stockton, Mo. 65785.

"A" FRAME CABIN For Less Than \$500. Blueprint & Material List \$2.00. Global Plans, Box 747, Delaware, Ohio 43003.

HOME CRAFTSMEN

SKIL-CRAFTS Current 200 plus page catalog with world's largest, finest selection of Hobbycraft, leathercraft, artist supplies. Send \$1.00 for postage and handling; refunded on first \$5.00 minimum catalog order. Skil-Crafts, Box 105-P, Joplin, Mo. 64801.

101 PATTERNS of smart Gifts. Novelties, Shelves Action Windmills, Plus "Make Money Jig Sawing". \$2.00. Mastercraft, 75M 7041 Olcott, Chicago 60631.

CABINETMAKING MADE EASY And "How to Make Formica Counter Tops." Two excellent guides let you build kitchen cabinets and counter tops like professionals. Extraordinary guides bring master craftsmen's shortcut methods. Satisfaction guaranteed. Write: Japs, 126-P Seventh North, Hopkins, Minn. 55343.

1400 CATALOGS Listed and Described! Sources for **EVERYTHING** Imaginable! Rush \$2.00. **MASTERLOG**, Box 24413-(WG), Oakland, California 94623.

POPULAR MECHANICS MASTER SHOP GUIDE. Greatest product offered to a man with a workshop. All information printed on heavy boards, punched and ready to hang above his workbench. Covers wall fasteners, nails, screws, bolts, twist drills, abrasives, lumber, moulding patterns, plywood grades, hardboard, dry-wall plumbing supplies, electrical supplies. Plus information on score of other subjects. Send \$3.95 to: **POPULAR MECHANICS**, Dept. HE, 224 West 57th Street, New York, New York 10019.

CATALOG FULL SIZE FURNITURE PLANS—\$1.00 Refunded with first order. Traditional, Early American, over 150! Furniture Designs, 1425 Sherman, Dept. CP-73, Evanston, Illinois 60201.

ORNAMENTAL IRON WORK. Beautiful scrolls with inexpensive professional bender. Modular segments. Details Free. Fuschlin, Box 472, Woodland, California 95695.

WORKBENCH And tool panel anyone can build. Complete with material list. \$1.00. Way-Mar, 58 Underhill Road, Scarsdale, New York 10583.

WOODWORKING Catalog and Manual 50¢. Plus free "101 Project Ideas." World's most beautiful veneers, lumber, plywood! Wood finishing, upholstery supplies, Cane, Lamp Parts. Furniture hardware, Animal whittling blocks, 2,000 workshop products. Constantine, 2051-C Eastchester Road, Bronx 10461.

PORTABLE Bar; 4' x 4' x 16". Finished Top 4' x 3" x 20". Complete Instructions \$1.75. Workmans, Day Rd., Mansfield, Ohio 44903.

YOUR NAME Plate on your Products. Six plates, Gold Stamped, Black or Walnut, \$7.95. Free Sample. Doorposter, Box 30502, New Orleans, La. 70190.

BANDSAWS, Bench saws, sander, lathe-drillpress, shaper, from **BUILD IT YOURSELF KITS.** Plans \$2.00 each or catalog 25¢. Gilliom Mfg., St. Charles, Missouri, 63301.

BE A Modern Craftsman with Plexiglas®. Full-color booklet pictures 42 exciting projects and tells you how to make them. Send 25¢ to Rohm and Haas Company, P.O. Box 4480PM, Philadelphia, Pa. 19140.

PLANS Wooden Toys, Clocks, Furniture, Wall Plaques and More For Fun Or Profit. Free Plans List—Pridmore, 218 Gemini, Madison, Alabama 35758.

BOOKLETS Making Items from Coat-hangers; 50¢; Profitable Lamp Making 35¢; Handcraft Ideas 35¢; All 3 Above \$1.00. Tomkos, 26½ E. Broad, W. Hazleton, Pa. 18201.

PICTURE Framing—Profitable full or spare-time business. Easy to learn with handbook-course "Guide To Picture Framing Profits." \$1.50 Guaranteed. Free framing-supplies catalog included. Japs, 126-P Seventh North, Hopkins, Minnesota 55343.

BIRD HOUSES For Fun and Profits. 20 Projects And Plans, \$1.00. Infoco-P7, Box 34260, Washington, D. C. 20034.

DO-IT-YOURSELF

SINK Troubles Eliminated Permanently. Steiner, 408 43rd Street, Union-City, N.J. 07087.

BURGLAR-FIRE Alarm Supplies and Information. Free Catalog. Protecto Alarm Sales, Box 357A, Birch Run, Michigan 48415.

WALL-SIZED TV . . . Build a 72-INCH TV PROJECTOR for under \$15.00. Free details: Macrocoma, Dept. PM-7, Washington Crossing, Pennsylvania 18977.

CONVERT MOWER Engines into air compressors. Write: Showalter, Box 409, Abilene, Kansas 67410.

1400 CATALOGS Listed and Described! Sources for **EVERYTHING** Imaginable! Rush \$2.00. **MASTERLOG**, Box 24413-(YG), Oakland, California 94623.

REPAIR MINIBIKES, LAWNMOWERS, BICYCLES, Sewing Machines, Auto Engines, Mazda/Wankel, Motorcycles, Magic, boats. Over 100 How-To-Books. Free Brochure. Mastercharge accepted. Sincere, Box 10422, Phoenix, Arizona, 85064.

UTILITY BARN 8'x12'! Detailed plans with material list. \$2.50—Guaranteed! JaBar, Dept. 3C7, 1448 West Strasburg, West Chester, Penna. 19380.

IF YOU CAN FIX A DRIPPING FAUCET you can install central air conditioning in your forced air furnace and save up to \$200. Only ordinary hand tools needed. Complete kits cost as little as \$500*. Write for free "how to" brochure. McGraw-Edison Co. 729E N. Clark St., Albion, Michigan 49224. *Cost varies according to size and construction of home.

BEAT INFLATION! Make Artificial Face-bricks, Under 10¢ Sq. Foot. Any Color. Style. Details, Wagner, 1349-A9 Ayrault Rd., Fairport, N.Y. 14450.

BOTTLE-CUTTER Plans, Build For \$2.50. Enclose \$1.25. Budget Plans, 3147 Tuell, Grand Rapids, Michigan 49504.

FREE Swimming Pool Heat. Build your own economical Solar Heater. Complete sketches and instructions \$2.00. Rowland Enterprises, Box 224, Lansing, Michigan 48902.

COLDS! One After The Other Until Two years Ago. No Head Colds Since! Information \$1.00. R. Box 3691, Santa Barbara, Calif. 93105.

DON'T DIE Without A Will! Blank **WILL** Form Protects Your Family. Only \$2.00 Guaranteed! Order today!! **VIKINGS**, 571 Anchor Lane, Dept. 101, Ft. Pierce, Fla. 33450.

ARTS AND CRAFTS

"**GETTING Started in Stained Glass**" 25¢. Whittemore, Box 2065Y, Hanover, Mass. 02339.

FREE LITERATURE For sculptors showing how to make molds, cast plastics. Adhesive Products Corporation, 1660 Boone Avenue, Bronx, N.Y. 10460.

FREE: New handicraft catalog. Supreme Handicrafts, Box 395-PM, Sioux Falls, South Dakota 57101.

MINIATURES, Sea Shells, Beads, Jewelry, unusual Novelties. Discount catalog 35¢. Artcrafts, Box 1386-PM, Santa Barbara, Calif. 93102.

LEARN Arts & Crafts at home. Excellent full or part time business opportunities, or hobby. Free booklets. Lifetime Career Schools, Dept. E-803, 2251 Barry Avenue, Los Angeles, California 90064.

MAKE Figurines, plaques, lawn ornaments. Molds, plastercraft kits, liquid rubber. Sample and catalogue 10¢. Wooley Company, Box 29-B, Peoria, Illinois 61601.

(Continued on next page)

Материал, защищенный авторским правом

ARTS AND CRAFTS

(Continued from preceding page)

GLASS Tubing and rod. Pope Scientific, Box 495, Menomonee Falls, Wisc. 53051.

BINOCULARS, TELESCOPES, MICROSCOPES, MAGNIFIERS

FREE Binocular, Riflescope catalog. Discount sale. Save 50%. Free gift with order. Write, United Binoculars, BN-6908, 9043 So. Western, Chicago 60620.

TELESCOPES (Reflectors) complete kits. Other accessories, request free literature. Criterion Manufacturing, Dept. PM 42, Hartford, Connecticut 06101.

MANON MEANS FINE BINOCULARS! Write: Manon, PM, 17171 Beach Blvd., Huntington Beach, Calif. 92647.



CAMERAS AND EQUIPMENT

FREE! FREE! BARGAIN BOOK Central Camera Co., Dept. 371, 230 S. Wabash, Chicago, Ill. 60604.

USED Photographic Equip. Nationwide Monthly "Shopper" Free Sample. Shutterbug Ads, Box 730-P, Titusville, Fla. 32780.

POPULAR Cameras—Accessories! Best Prices! Mandarin, 214 Shaws Building, Hong Kong.

PHOTOS AND PHOTO SUPPLIES

CASH From your photo hobby, trip photos. Send for Postpaid Copyrighted Report "How to Make Money with Your Camera." Send Cash or Check \$1.00 To: Don Stuart Research, Nehalem and Columbia Streets, Birkenfeld, Oregon 97016.

PHOTO FINISHING

CAMERA FANS! Expert photofinishing by one of Country's largest labs at lowest prices. Fast service and free "Foto-Fan" Stamps you quickly redeem for valuable Photo Supplies. 8MM Kodachrome \$1.29; 8 Exp. Kodachrome \$1.79; 35MM Kodachrome 20 Slides \$1.39; 8 Exp. Black White 69¢. Satisfaction guaranteed. Send exposed film or request free mailers, complete Price List and Gift Catalog. Direct Mail Photo, Box 8352-PM, Pittsburgh, Pa. 15218.

COLOR SLIDES

35MM COLOR Slides, 10,671 individually sold. Described, Encyclopedia catalog 10¢. Wolfe Worldwide, Dept. 14-73, Los Angeles, Calif. 90025.

MOTION PICTURES AND SOUND EQUIPMENT

CLASSIC 8MM. MOVIES . . . 35MM. 2"x2" Color Slides . . . largest selection anywhere! Silent classics, comedy, history, sport, news, documentaries, features, others! 16MM films also Free catalog. Blackhawk Films, 690 Eastin-Phelan Bldg., Davenport, Iowa 52808.

UNUSUAL Movie supplies. Free circular. Esor, 47th Holly, Kansas City, Missouri 64112.

FREE! 64-Page catalog. 8-16MM film supplies, processing equipment. Superior, 448 N. Wells, Chicago 60610.

8MM—SUPER 8—16MM MOVIES! Biggest Selection! Lowest Prices! Free Catalog! Cinema Eight, Box PM, Chester Connecticut 06412.

FREE Catalog—8mm-16mm—Top Manufacturers—G & G Film Library, Box 321, Syosset, New York 11791.

16MM, 8MM Sound and Silent Classic Films. Free Catalog. Niles, 1019-PM So. Michigan, South Bend, Indiana 46618.

RADIO, TELEVISION AND HAM EQUIPMENT

36¢ RADIO & TV Tubes. Free catalog. Cornell, 4213-17 University, San Diego, California 92105.

SAVE Money on parts and Transmitting—receiving tubes, Foreign—domestic. Send 25¢ for giant catalog. Refunded first order. United Radio Company, 56-PM Ferry Street, Newark, N.J. 07105.

GOVERNMENT Surplus receivers, transmitters, snooperscopes, parts. Catalog. 25¢. Meshna, Nahant, Mass. 01908.

GIANT Canadian Electronics Surplus Catalog. \$1.00. Etco PM, Box 741, Montreal.

AMAZING INDOOR TV ANTENNA: Cures Poor Reception. All Channels Clear. Plugs Into Wall Outlet. Guaranteed: \$1.98. Little Town Products, 37 Cottage, Morrisville, Vermont 05661.

HIFI TAPES, RECORDS AND ELECTRONICS

FREE Catalogues, 2000 hard to find unusual records. Rose's Records, Box 7216, Louisville, Ky. 40207.

OLDIES 45 RPM Original Hits—Catalog 50¢. C&S Record Sales, Box 197, Wampsville, New York 13161.

TAPE RECORDING COURSE: Taught by Studio Engineers. Free information. NNA, Box 7216, Rye, N.Y. 10580.

OLD Radio On Tape. Catalog \$1.00. (Refundable). Radio Vault, Box 9032-PM, Wyoming, Michigan 49509.

WHOLESALE—Stereo 8 track tapes. Tremendous savings. Send for free catalog. Specialty Products, Box 397, Butte, Montana 59701.

TAPES, 8-track, low as \$1.10 each. Free catalog—800 top titles. Send postcard: GemTone Industries, Box 57220, Dept. PM, Los Angeles, Calif. 90057.

SUSPENSE—Fibber—Benny; Others. Cassette \$4.00/Hour. Free Catalog. R—Garofalo, 8162 W. Balmoral, Chicago, Illinois 60656.

FREE CATALOG—Tremendous Electronics Bargains. Pacific, Box 4188M, Mountain View, California 94040.

FREE Catalog—Electronic Kits—Amplifiers—Preamplifiers—Psychedelic Strobes—SCA Adaptors—Color Organs—Digital Instruments—Guitar Amplifiers. **FREE** Subscriptions. SWTPC, Box PM32040, San Antonio, Texas 78284.

8-Track Tapes • Catalog free. C. Bolton, 1114 9th Ave., So. Sioux City, Nebraska. 68776.

MYLAR Recording tape 7" 1200' \$1.00, 7" 1800' \$1.79. C-60 Cassettes 3 \$2.39. Meacham, 609 Springer Terrace, Dept. PM2, Los Altos, California 94022.



MUSIC AND MUSICAL INSTRUMENTS

SWISS Musical Boxes, Movements, Musical Products. Bell Music, P.O. Box 1, Bay Station, Brooklyn, New York 11235.

LATEST In Musical Sound Instrument. 8 Page booklet gives full details, 25¢ stamps U.S.A. A. Barty, Box 29938, Los Angeles, Calif. 90029.

BUILD Your Own GUITAR. Full size, rich sounding. Kit contains everything needed. Only \$19.95. Guaranteed. Free Information. M. L. Korpak, P.O. Box 6061, Arlington, Virginia 22206.

LEARN To read music in one evening. Free brochure, Jordan, 27495 Road 176, Dept. PM-7, Exeter, Calif. 93221.

FREE CATALOG—30% DISCOUNT. Best Names In Musical Instruments. Dial For Music, 90 North Main Street, Spring Valley, N.Y. 10977.

EASY To Play And Make, Quality Dulcimers, Banjos, Thumb Pianos; Instruments And Kits. Can Be Profitable Hobby. **HERE**, Inc., #P, 410 Cedar Avenue, Minneapolis, Minn. 55404.

ELECTRIFY Player Pianos, Pump Organs Quickly, Inexpensively with Lee Silent Suction Units. Write: Lee Music, 525F Venezia Avenue, Venice, California 90291.

30% TO 50% DISCOUNT! Any Model: Guitar, Amp, Drum, Banjo, Dobro! Free Catalog! Warehouse P35, Box 16399, Fort Worth, Texas 76133.

PLAYER Piano Rebuilding—get details from: Vestal Press, Vestal 11, N.Y. 13850.

POEMS Wanted for songs. Nashville Music Productions, Box 40001-P, Nashville, Tennessee 37204.

VIOLIN And Guitar makers—send for latest Free Catalogue of woods & accessories. International Violin, PM1, 414 East Baltimore St., Baltimore, Md. 21202.

WHOLESALE! Professional Guitars, PA Systems, Altec Speakers, 240W RMS Amplifiers. Free Catalog. Carvin, Escondido, Calif. 92027.

WHOLESALE. Musical Instruments—Accessories. Allied, 573 Route 17, Paramus, New Jersey 07652.

RECONDITIONED Accordions for sale—Save \$\$\$, Top Brands. Write for free descriptive folder. A-1 Rebuildt Accordions, 31 E. 18th St., N.Y.C. 10003.

ACCORDION Top brands. Buy direct. Tremendous discounts. Trades accepted. Free brochure PM. Accordion-O-Rama, 874 Broadway, N.Y.C. 10003.

GUITAR, Banjo, Violin, Mandolin Making Materials, Accessories, Books. Catalog 25¢. Guitar Center, Box 15444, Tulsa, Oklahoma 74115.

NEW GUITAR MAKING BOOK & NEW TOOLS. Overholtzer, 618 Orient, Chico, Cal. 95926.

POEMS, Songs wanted for hit recording, guaranteed Publishing, radio release. America's most popular new talent studio. Broadway Music Productions, 11647PM Bee Ridge, Sarasota, Florida 33578.

30% DISCOUNT Name Brand Musical Instruments. Free Catalog. Freeport Music, 455F Route 110, Melville, N.Y. 11746.

30% + DISCOUNT. Name Brand Musical Instruments. Free Catalog. Continental Music, P. O. Box 3001, Dept. D, Garden City, New York 11530.

LEARN Banjo. 5-String Bluegrass. No music. Makes learning easy. Free details. Blaylock, Box 25-M, Marietta, Georgia 30060.

ACCORDION Manufacturing 6846-P North Avenue, Chicago, Illinois, 60635. Concertinas, Chromatics, Heligons, Hohners, Guitars, Drums. New, Used. Tuning. Repairing. Wholesale Catalogs Free.

ACCORDIONS And Amplifiers! New—Used. Cordovox, Excelsior—Top Makes! Save to 50%. Direct factory dealer. Terms. Trades accepted. 5 day home trial. Free catalog—Discount prices. Write: Accordions Unlimited, Dept. R, 3147 North Luna, Chicago 60641.

CONCERTINAS, New & Used—Music—Complete Repairs On Accordion & Concertina. Free Catalogs. World's Largest Concertina Co., Brown Distributing Co., New Ulm, Minnesota 56073.

UKULELE Fans, Subscribe "Ukuleleist" Newsletter. \$2. Five Issues. 2015-3 Mokuhan Road, Wai'uku, Maui, Hawaii 96793.

(Continued on next page)

MUSIC AND MUSICAL INSTRUMENTS

(Continued from preceding page)

KITS! Build dulcimers, guitars, balalajas, thumb pianos, harps. From \$2.95. Finished dulcimers from \$19.95. 8665. West 13th Avenue, Denver, Colorado 80215.

CONSERVATION TRAINING

GAME WARDEN, Government Hunter, Forestry, Park & Wildlife Service announce job openings regularly. Prepare at home for outdoor work, good pay, security. Approved for Veterans! **FREE!** "CONSERVATION CAREER KIT." North American School of Conservation, MPS, Newport, California 92663.

EDUCATION AND INSTRUCTION

SURVEYING PAYS BIG!!! United States Department of Labor reports "openings for 26,000 Surveyors in next ten years." Easy home-study plan guides you. Send for Free "Surveying Career Kit." North American School of Surveying, AZS, Newport Beach, California 92663.

NONRESIDENT DEGREES! HONORARY DEGREES! Nationwide Faculty. Catalog: \$3. United States University of America, Box 4552-PM, Washington, D.C. 20017.

NOW! Be A CREDIT—COLLECTION SPECIALIST—Jobs Waiting For Novice—Advancement For Experienced Collectors—J. Scalo—1250 Camino Real—#306, Millbrae, California 94030.

MISSOURI Auction School. Veteran Approved. Free catalog. 1600-03 Genesee, Kansas City, Missouri 64102.

EXTENSION And Post-Graduate Awards in Philosophy, Art, Sciences, Botanic Medicine, Homeopathy, Radionics and others. 30 subjects. Curricular free (airmail \$1.00 refundable). Registrar, Sussex College of Technology, Highfield, Dane Hill, Sussex, England.

PIANO Technology—Electronic organ servicing, learned easily at home. G. I. Approved. Free booklet. Niles Bryant School, Dept. P, 3631 Stockton, Sacramento, California 95820.

LEARN Sewing Machine Repairing. Men, Women. Lucrative profits. Profession with bright future. Gresslin Correspondence School, Box 927, Spencer, Iowa 51301.

LEARN Auctioneering. Term soon. Free catalog. Reisch Auction College, Box 850, Mason City, Iowa 50401.

ORDINATIONS. Lifetime! Church chartered 1887! Write! 708 Bragg, Monroe, North Carolina 28110.

RELIGIOUS VOCATION? Write: Church Of Holy Light Inc., P.O. Box 4478, Pittsburgh, Pa. 15205.

USED Courses! Books Catalog 10¢. (Courses Bought). Lee Mountain, Pisgan, Alabama 35765.

AUTOSUGGESTION. Sleep-learning headquarters! Tapes, records, books, Gigantic catalog free. Research Association, Box 24PM, Olympia, Washington 9851.

OWN Collection agency. "Little Gold Mine!" Franklin Credit, Roanoke, Virginia 24004.

AUCTIONEERING. Resident or home Study Course. Free Catalog. Nashville Auction School, 1921 West End, Nashville Tennessee 37203.

PERFECT Husband-Wife Business. Learn Upholstery at home. Make \$10 in an hour. Buy-repair-sell for even bigger profits. Kits, tools, included. Free Booklet. Upholstery & Decorating School, (home-study), Dept. 5310-073, Little Falls, New Jersey 07424.

DETECTIVE Profession, Easy home study; free tie-tack or lapel pin, certificate, future. GI approved. Professional Investigators, Box 41345, Dept. CP, Los Angeles Calif. 90041.

DETECTIVE Course. Free Information. Universal Detectives, Box 8180-F, Universal City, California 91608.

LEARN To Fix Typewriters. Desperate shortage trained men. Hundreds needed. Make up to \$25 in one hour. Learn at home in spare time. Industry Approved course. Facts Free. Send name. Typewriter Repair School, (homestudy), Dept. 3310-073, Little Falls, New Jersey 07424.

PIANO Tuning quickly learned with home study course. Diploma granted. American Tuning School, 17050 Telfer Dr., Morgan Hill, California 95037.

DETECTIVE And Fingerprinting Courses. Write. Detectives, Box 185-P, Fairfield, Alabama 35064.

SHORTCUTS To Success! Highly Effective. Profitable Short Courses. (75 Choices). Study At Home. Diploma Awarded. Our 27th Year. Free Literature. CIEE-25, Box 10634, Jackson, Miss. 39209.

WATCH REPAIRING. Learn at home in spare time. Diploma awarded. Free sample lesson. Chicago School of Watchmaking, Dept. YT, Fox River Grove, Illinois 60021.

UNLOCK Your Future. Become professional Locksmith with spare time home-study. Make up to \$6 per hour. All tools, equipment inc. Facts free. Send name. Locksmithing Inst., (homestudy), Dept. 1310-073, Little Falls, New Jersey 07424.

SERVE God's Ministry. Free. Ordination. Bible Institute, Box 744, McKeesport, Pa. 15134.

VETERINARY ASSISTANT—Train at home for exciting animal care career. Send for **FREE** "Career Kit". North American Home-Study School of Animal Sciences, AZS, Newport Beach, California 92663.

LEARN Asleep or awake! Records, tapes, equipment! Free catalog! Drawer PM-400, Ruidoso, New Mexico 88345.

COLLEGE Degree At Home. Your Choice of Subjects incl. Law. Easy Tuition Plan. Williams College, 1310 State Street, Boise, Idaho 83702.

GET A British Degree. Divinity. Philosophy. Radionics. 35 Courses. Prospectus free. Brantridge, Forest School, Highfield, Dane Hill, Sussex, England.

LET Copyright Laws Make You Rich With Very Small Investment. Amazing Course \$3.00. Resnick, P.O. Box 1151, North Miami Beach, Florida 33160.

UNIVERSITY Degree, University of Louisiana, P.O. Box-50 Franklin, La. 70538. Send \$1.00 for Research On Education and Curricular.

FREE Accredited High School Diploma Information! (NO Examination). Washington High Academy, Drawer 247E, Mango, Florida 33550.

COLLEGE Degree Programs Through Home Study. Catalogue \$1.00. B647, Morgantown, Kentucky 42261.

USED Courses! Books! List 10¢. Smith's, 124 Marlborough, Salem, Massachusetts 01970.

NOW! Your Own Burglar/Fire Alarm Business. Train at home. Expanding field. Course includes professional tools Plus equipment, supplies for first job. Information by mail. Security Systems Management School (homestudy), Dept. 7310-073, Little Falls, N. J. 07424.

BRICKLAYING Information, send 8-cents. The Pretio Services, P.O. Box 114, Durham, N.C. 27702.

COMPLETE YOUR HIGH SCHOOL at home in spare time. Texts furnished. No classes. Diploma. Our 76th year. Free Brochure. American School, Dept. X845, Drexel at 58th, Chicago 60637.

SAVE HUNDREDS FURNISHING HOME Specific Instructions. Guaranteed. Harmony House Report. \$3.98. Box 143, Newport, Penna. 17074.

WELDING TRAINING Basic and advanced training for major welding processes—Arc, Gas, Pipe, TIG, MIG, Plasma. Hobart, a non-profit school, is accredited by **NATTS**. Approved Ohio 70-12-0064 HT. Write for school bulletin and course schedule. **HOBART SCHOOL OF WELDING TECHNOLOGY**, Box 73, Troy, Ohio 45373.

COLLEGE DEGREES AT HOME! Complete Directory Accredited Universities Offering Correspondence Courses. \$2.00. Research, Box 48533PM, Los Angeles, Calif. 90048.

PHOTOGRAPHIC TRAINING—Ohio Institute of Photography, 4435 Patterson Road, Dayton, Ohio 45430, VA Approved, Ohio #72-11-0344T.

EARN HIGH SCHOOL Equivalency diploma from your state. Business, college accepted. 5 week home study program. guarantees you pass GED. Simplified, fun, budget-priced. Brochure mailed free. Bright Futures Corporation, Box 514PMA, Jackson Heights, New York 11372.

FREE Book tells how you can learn camera repair and service. Home study or classroom. Write today! National Camera, Dept. EAD, Englewood, Colorado 80110.

FOR INVENTORS

IDEA—Invention—Then What! Rankin-File, Box 566M, Willoughby, Ohio 44094.

WORTHWHILE Inventions Marketed. Patented or Unpatented. Harvey Engineers, Cambridge, Maryland 21613.

U.S. PATENT Office Searches, 234 Broadway, Room 3615, New York 10007. Free invention certificates.

INVENTORS—United States Patent Office Searches, Patent Development Engineering, marketing of inventions—Ideas by Licensed Professional Engineer—Patent Engineer and United States Patent Office Former Examiner. Inventions developed for patenting and marketing. We are contacted by many manufacturers seeking to purchase appropriate new products invented by our clients. Send for Free invention Certificate and Invention Information. Serving Inventors since 1948. George Spector, Licensed Professional Engineer—Patent Engineer—3615 Woolworth Bldg., New York, N.Y. 10007.

PATENT Application Financing. Free patent search plan. Global Patent Division, 2420 77th, Oakland, Calif. 94605.

PATENT Searches including maximum speed, full airmail report and closest patent copies. Quality searches expertly administered with complete secrecy guaranteed. Free Invention Protection Form and "Patent Information." Write: Dept. 15, Washington Patent Office Search Bureau, Benjamin Franklin Substation, P.O. Box 7167, Washington, D.C. 20044.

PROSECUTE Your Own Patent Application. All Material Necessary—Write: Inventors Service, Box 3574, Washington, D.C. 20007.

FREE PAMPHLET: "Tips on Safeguarding Your Invention." Write: United States Inventors Service Company, 501-P Thirteenth Street N.W., Washington, D.C. 20004.

INVENTORS: Your ideas and inventions (patented: unpatented) expertly searched, developed for commercial appeal and cash/royalty sales to manufacturers by professional Invention Developer with excellent record of experience. B. S. Industrial Engineering; United States Patent Office former Patent Examiner. United States Government former Patent Advisor. Second decade reliable service! Member: United States Council International Chamber Commerce. Free "Invention Record" and "Recommended Protection Procedure." Airmailed! Write: Raymond Lee, Invention Developer, 230P-Park Ave., New York, New York 10017.

(Continued on next page)

Материал, защищенный авторским правом

FOR INVENTORS

(Continued from preceding page)

INVENTORS! EITHER I WILL SELL YOUR INVENTION BEFORE YOU or anyone else does, or I will pay you a cash bonus. Get Free Invention Evaluation and information: write Gilbert Adams, Invention Broker, Dept. 15, 81 Wall St., New York, NY 10005.

FREE Details "How to Safeguard, Develop and Market Your Invention." Write: World Wide Inventor's Service Co., 501A Fifth Ave., New York 10017.

EUROPE/ASIA MARKET for inventions booming, but metric descriptions required. New calculator converts U.S. lengths, distances, area, weights, liquids with slide-rule accuracy. \$3.00 postpaid. Guaranteed. Fischer/Robinson, Dept. PM45N-307, Box 711, Worthington, Ohio 43085.

INVENTIONS Wanted immediately for promoting on cash or royalty. Patented, Un-Patented. Free booklet outlines royalty rates, requirements. Write Kessler Corporation, C-57FI, Fremont, Ohio 43420.

IMMEDIATE Cash, for patent applications. Free patent searches. Write for details. Universal Patents, 184-D, Marion, Ohio.

INVENTORS Service. Specifications. Amendments. Drawings. Pen-Ink, 50 East 42, NYC., 10017.

INVENTIONS WANTED

\$20,000 CASH Advance plus monthly Royalty offered for acceptable Steam Engine Design. Specifications and Contract Airmailed. Send \$10. Money Order To: Tech Industries, Portland, Conn., 06480.

INVENTORS! Protect your ideas! Free "Recommended Procedures." Washington Inventors Service, 422F Washington Building, District of Columbia 20005.

FREE "Directory of 500 Corporations Seeking new Products." For information regarding developments, sale, licensing of your patented/unpatented inventions. Write: Raymond Lee Organization, 230-N Park Avenue, New York, New York 10017.

CASH-Royalties for patented, unpatented inventions. Global Marketing Service, 2420-G 77th, Oakland, California 94605.

WE Either sell your invention or pay cash bonus. Write for details. Universal Inventions, 28-E, Marion, Ohio.

INVENTORS! Don't sell or license your invention until you receive our offer. Eagle Development Company, Dept. H, 83 Wall Street, New York City 10005.

NEW PRODUCTS—INVENTIONS—IDEAS Developed/Marketed by Professional Organization. **FREE INFORMATION** "How To Market Inventions To Industry". **LAWRENCE PESKA ASSOCIATES**, 500-C Fifth Avenue, New York City 10036.

INVENTIONS Needed immediately for manufacturers. For additional information write Kessler Corporation, C-57IW, Fremont, Ohio 43420.

OUR Manufacturing Contacts Seek Marketable Inventions. Harvey Engineers, Cambridge, Maryland 21613.

MR. INVENTOR: The Inventor Of The World Famous Torso-Twister Reducer Exerciser And Over One Hundred More Will Conduct Patent Searches, Develop And Market Your Ideas. For Details Write, Charles S. Prince, Invention Consultant, Dept. Marie, 509-5th Avenue, New York City 10017.

BUY IT WHOLESALE

HEARING Aids, batteries, Wholesale. Catalog 25c. Fiston, Box 1444, New Preston, Conn. 06777.

165 FREE Wholesale Catalogs! Mailorder Dropshippers. Your Business Imprint, Automobile Discounts. Free "Digest." Vault International, Box 7284W, Lexington, Kentucky 40502.

WORLD'S Largest wholesale dropship sources. U.S., foreign. Factory suppliers dropship direct to you or customers. Now!, have your own catalog for pennies. Free details. International Buyers, Box 16386-M, Portland, Oregon 97233.

FREE!! Discount Shopper's Guide. Write: Brandser, Box 3, Bayport, Minn. 55003.

FREE Catalog. Gifts, Specialties, Toys, Below Wholesale. Howard, 5275 DeLongpre, Hollywood, Calif. 90027.

HAWAIIAN LAVA Sample And Scientific Description—\$1.00. Menehune Treasures, 6201-106PM, Milolii Place, Honolulu, Hawaii 96825.

EXPORT-IMPORT

JAPAN: 1200 Products directory. Illustrated Manufacturers' names, addresses. \$5.00. Send cash. Yamagata Office, 814 Togin Bldg., Marunouchi, Tokyo.

ORIGINAL Oil Paintings \$96.00 Dozen. McDaniel, 3632 Topax, Claymont, Delaware 19703.

DIRECT From Scandinavia: Grandfather's clocks, wrist watches, Pencils, Telephones, Playing cards, colour films, colour magazines, color slides. Catalog \$2.00. Write to: Ado-Mail, Gothersgade 97, DK 1123, Copenhagen. Denmark.

FOR THE HOME

RID Your home of roaches. Effectively, easily. 2 packages, roach tabs, with directions \$1.00 postpaid. Theodore Gordon, Box 1223, New Haven, Conn. 06505.

INTRODUCTORY, Stamp Moistener 35c. Feola, 9 Pearl Street, Somerville, Massachusetts 02145.

SOGGY Toast With Poached Eggs? Not With **EGGLIFTER**. Instantly Drain Anything Cooked In Liquid! Eggs! Meatballs! Name It! **FREE** Gourmet Recipe! Stainless. Guaranteed, \$3.50. Box 666A7, South Orange, New Jersey 07079.

GLASS MAGNETS! Magical New Discovery. Eliminates Tape. 101 Uses. **FUN**, \$1.25. Magnets, 2429 South Lyndale, Minneapolis, Minn. 55405.

WORLD'S Smallest Fire Alarm, No Batteries, Plugs In Anywhere, Protect Home. \$10.95. Delight, Box 2463, Universal City, Texas 78148.

OF INTEREST TO WOMEN

\$25.00 DAILY Possible addressing-stuffing envelopes. Typewriter-longhand, also Clipping News items at home. Information; Send stamped addressed envelope. Ame-38, Box 310, Le Mars, Iowa 51031.

WANT A new car, color TV, new clothes? Learn hundreds of ways to make money. 5 month subscription **FREE**. Write: Salesman's Opportunity Magazine, Dept. 17-GO, 1460 Hancock Center, Chicago 60611.

\$6.00 DOZEN Paid lacing baby boots! Cowboy, Warsaw 9, Indiana 46580.

\$500 MONTHLY Possible addressing-stuffing envelopes (longhand—typing) at home. \$500 monthly Clipping news items from your newspaper. Information: Send stamped self-addressed envelope. American, Excelsior Springs, Missouri 64024.

NEW magazine, foods, decorating, household tips, family living. Sample 25c. Homemaker Magazine, 404 West Jefferson, Springfield, Illinois 62702.

EARN UP TO \$150.00 WEEKLY . . . Home addressing for us. Details 25c. Smith's, Box 2469-PM, Newark, New Jersey 07114.

ADDRESSERS And Mailers Needed. Details 10c. Lindbloom, Dept. POM, 3636 Peterson, Chicago 60659.

BINGO Early! How to select cards with lucky numbers. Guidebook \$2.00. Gift House, Box 5007-P, Ft. Lauderdale, Florida 33310.

EARN Extra \$50-\$100 Weekly Addressing. Details Free. P. Richardson, Box 4097, Yuma Ariz. 85364.

\$700 MONTHLY. Immediate income. Stuff envelopes at home. Information, send self-addressed stamped envelope. Cottage, Box 25053-CBG, Los Angeles, Calif. 90025.

DO SIMPLE Addressing—Mailing. Receive \$12.95 Orders. Keep \$8.00 Profit. Details Free! Quality, Box 9—PW, East Rockaway, N. Y. 11518.

SAVE MONEY! 120 Ways to Use Leftovers. Send \$2. L. Battle, Box 9869, Philadelphia, PA. 19140.

\$12.00 STARTS Your Profitable Perfume Manufacturing Business. Free Details. JTD Sales, Box 56069, Chicago, 60656.

GIFT SHOPPING

FREE Distinctive Gift Catalog. Hanson House, 163 Meadowbrook Farm, N.Y. 14514.

FREE Catalog. Cottrell's Sales Company, 6253 South Michigan Avenue, Chicago, Illinois 60637.

UNUSUAL Gifts By Mail. Free Catalog. Rotay, 9504 Buck Lodge Court, Adelphi, Maryland 20783.

100 EXCITING PHOTO-STAMPS From your Favorite Picture now only \$2.00. Send Photo or Negative to: Ames Gifts, 1357 Noble Ave. Bronx, New York 10472.

FREE! Catalog of Distinctive Gifts. Arts & Craft Company, Dept. 10107, 123 Oxford Lane, Glendale Heights, Illinois 60137.

"NEW INVENTION!" Barbecue Cutting Fork. Free Details. Colo Enterprises, Gravesend Station., Drawer H, Brooklyn, N.Y. 11223.

WATCHES, OLD GOLD, JEWELRY

WATCH And Clock repairing books. Free list. North American, Box 77-AG, Fox River Grove, Illinois 60021.

CASH Immediately for Old Gold, Jewelry, Gold Teeth, Watches, Diamonds, Spectacles, Silver, Platinum. Mercury Free Information. Rose Industries, 29-A East Madison, Chicago 60602.

DIGITAL Watches! New Look in Time! Swiss Movement. Accurate! Large Numerals! Brushed Gold Finished Case! Only \$22.95—Guaranteed! Order Today! Kona, 530 Concord Place, (1B7), Anaheim, California 92805.

HIGHEST CASH For Gold, Jewelry, Gold Teeth, Rings, Diamonds, Watches, Silver, Platinum. Mail Articles Today. Free gift with Information. Chicago Gold & Precious Metals, 6 E. Monroe, Dept. 1158, Chicago, 60603.

HEARING AIDS

HUGE SAVINGS. Eliminate dealer mark-ups. Free Trial. Batteries Wholesale. Terms arranged. Lloyds-PMC. Rockford, Ill. 61108.

HEARING Aids, Batteries, Discount Prices. Write: Rhodes, Box 518 PM, Paducah, Ky. 42001.

WHOLESALE Discounters! Famous Aids! Batteries! Repairs! AidMart, Drawer Z-2, St. Petersburg, Florida 33731.

FREE—Hearing Aid Catalog. Money-Savers, 9530—PMC Langdon, Sepulveda, California 91343.

(Continued on next page)



SCIENCE AND CHEMISTRY

AMAZING! Scientific Catalog—Apparatus—Glassware—Chemicals. Catalog—50¢. Hagenow Laboratories, Manitowoc, Wisconsin 54220.

CHEMISTRY And Biology Catalog 35¢. Boulevard Laboratories, Suite 302, 3114 E. 83rd St., Chicago, Ill. 60617.

CATALOGUE Of those ver-ry hard-to-find chemical products, things that go boom, multi-stage rockets, 50J How-To books, 10,000 formulas of every conceivable mixture in science and industry. 50¢. Kenrus-C, Box 158M, Staten Island, New York 10309.

DISCOUNTED! Laboratory Chemicals, Glassware-Apparatus. Catalogue—50¢. Deluxe Scientific, Manitowoc, Wisconsin 54220.

FORMULAS, PLANS, ETC.

LIQUID LATEX Paratol 706-G compound for making rubber molds. Toughest, finest quality. Instructions. Money-back guarantee. Postpaid \$3.75 quart, \$10 gallon. TESTWORTH, 139 Commercial, Addison, Ill. 60101.

FORMULAS — Valuable — Moneymaking. Useful—Assorted. \$1.00. Box 5928, Grand Central Sta., N.Y. 10017.

PLASTICS

LARGEST Handicrafts Supply Catalogue \$1.00 (Refundable). R.P.H. Manufacturing, 24-M-7, Winter, Stamford, Connecticut 06905.

CASTOLITE pours like water, hardens like glass without heat. Crystal clear, colors. Embed natural flowers, seashells, mementos, anything. Make fine gifts. Form flexible molds over any pattern, size. Reproduce your own designs in plastics, candlewax, metal, plaster cement. Profitable. Illustrated Manual and Catalog Only \$1.00. CASTOLITE, Dept. 73H/PM, Woodstock, Ill. 60098.

PLEXIGLASS—HOW TO WORK WITH! Gasslike, tough and beautiful, it's fascinating stuff to build with. It saws, drills just as easily as wood and can be bent when it's heated. Photocopy of PM article. Price \$1.00. Send order to: Popular Mechanics, HE, 224 W. 57th St., New York, N.Y. 10019.

TREASURE FINDERS

SEARCH Treasure Finders. Locate gold, silver, coins, relics. Operate underwater. Money back guarantee. Free information. Search Electronics, Box 8396-A, St. Petersburg, Florida 33738.

TREASURE Finder locates buried gold, silver, coins, treasures, 6 powerful models. \$19.95 up. Instant financing available. Write or call for free catalog. Phone (713)-682-2728 day or night. Dealer inquiries invited. Relco, Dept. A-40, Box 10839, Houston, Texas 77018.

FREE 156 Page Detector Catalog. General Electronic Detector Co., Box 67, Bellflower, California 90706.

FIND Buried treasure with revolutionary patented, analytical metal detector. Features push button and automatic tuning, negligible ground pickup, greatest range. Free catalogue. Gardiner Electronics, Dept. 9, 4729 N. 7th Avenue, Phoenix, Arizona 85013.

POWERFUL Metrotech locator detect gold, silver, coins, relics. Moneyback guarantee, terms. Free information. Underground Explorations, Dept. A, Box 793, Menlo Park, California 94025.

TREASURE SEEKERS: Authentic Colorful 17 X 22 inch frameable treasure site maps. California Pacific or Gulf Caribbean Atlantic area. Send \$7.00 for both, \$4.00 each. Kwin-Lin Co., N-93 Fairview Ave., Paramus, New Jersey. 07652

GOLDAK Treasure locators—Pleasure and profit in a hobby you'll enjoy. Find coins, relics, gold, silver. Charge on Bank-Americard. **GOLDAK**, Dept. PM, 1101-A Air Way, Glendale, California 91201.

TREASURE Locators. Most complete line. Free information. **TESOROS**, Apartado 7-905, Mexico 7, Mexico.

TIRED OF DIGGING UP TRASH? The All New "Coinshooter" Rejects, Bottle Caps, Tin Foil, Nails and Shallow Trash. Detects Gold, Silver Coins and Jewelry. Free Literature. **D-TEX ELECTRONICS**, Box 451-U, Garland, Texas.

FREE FACT-FILLED CATALOG. World's largest line of metal detectors. Models as low as \$49.50 and up. Two year Guarantee. Three factory locations, U.S. and Canada, plus over 1,000 dealers and 35 Service Centers from coast to coast. No finer instruments made at any price. Budget terms. Write: **WHITE'S ELECTRONICS, INC.**, RM #381 1011 PLEASANT VALLEY ROAD, SWEET HOME, OREGON 97386.

FISHER DETECTORS. You deserve the best! Free literature. FRL, Dept. PM-7, P.O. Box 490, Belmont, California 94002.

PRECIOUS STONES & MINERALS

500 POLISHED Gemstones \$5.00. Tumblecraft, 5401 James North, Minneapolis, Minn. 55430.

GET Free catalog no serious rockhound, gem cutter, jewelry maker, hobbyist or craftsman can be without. Full of bargains, exclusive items, low prices from largest suppliers and authorities in the field. Free new catalog just off the press, yours for the asking. Write: Grieger's, Dept. C-12, 900 South Arroyo Pkwy., Pasadena, California 91105.

ROCKHOUNDS!! Receive interesting, valuable specimens monthly. Free information. Minerals, Box 487M1, Yucaipa, California 92399.

HOBBYIST, FREE California **FOOLS GOLD** Ore Sample. Handmined From Mother Load Country. Send \$1.00 To Cover Postage, Handling. Price For Quantity On Request. Messer Ind., 3331 North 8th, Fresno, California 93726.

CARTOONING, COMMERCIAL ARTS, SHOWCARD & SIGN PAINTING

COMPACT 23 lesson Cartoon Course and Cartoonist's Magazine. \$2.00. Hartman, Box 30367, Lincoln, Nebraska 68510.

MODERN Cartooning taught by mail. Write for free brochure. Cartoonorama—Box 263-8L, Branford, Conn. 06405.

CARTOON For Money!! Big Free Book: Success, Box 885-C, Dearborn, Mich. 48121.

LEARN Sign painting at home. Free Talent test. Ben Kerns, Box 812-PM, Greenville, S.C. 29601.

FASCINATING Systems. Sign Painting-Cartooning. Straley, 1704 South Center, Springfield, Ohio 45506.

HOW TO MAKE MONEY WITH SIMPLE CARTOONS—Informative book sent FREE tells way to big income. Cartoonists Exchange, 96, Pleasant Hill, Ohio 45359.

LEARN Cartooning at Home. Approved for Veterans. Free Bulletin, Cartooning, Box 70690, Colorado Springs, Colorado 80933.

ADVERTISING AGENCIES, ADV. SERVICES, MAILING LISTS

MAILING LISTS. Fresh, quality Listings. Buyers. Gummed. \$7.50/1000. Circulars Mailed. Free Details. Moneymaker, Box 175-P, North Branford, Conn. 06473.

FRESH Lists. Cash Buyers. Free Details. Box 392PM, Brea, California 92621.

ADVERTISING Ratebook leading newspapers, magazines, 25¢. Chicago Advertising Agency, 28-E Jackson, Chicago 60604.

MAILING List, Most all Kinds, \$9.00 1000 Gummed, Circulars mailed \$5.00 1000. Dixmailers, King, North Carolina 27021.

RUBBER STAMPS

DELUXE Address Stamp \$2.00. Metal Pocket Stamp \$3.00. **FAST, DEPENDABLE SERVICE.** Gagne, Box 46612A, Bedford, Ohio 44146.

CUSTOM Made Rubber Stamps. Immediate Shipment. Willis, Box 291, Aberdeen, Maryland 21001.

FREE Catalog, Pocket Stamp \$1.25, Self Inking Stamps, Seals. Rush Stamps, 132-P-Farmcrest, Rush, New York 14543.

FREE Catalog—Rubber Stamps, Business Cards, Labels, Printing. Youngers Stamp Shop, Princeton, Iowa 52768.

RICH Cherry Finish Handle Address Stamp \$1.95. A-Z Stamps, 216 Edenfield, Azusa, Calif. 91702.

FREE stamp catalog. 45 type styles. Fast Service, low prices. Jackson's, Box 443A, Franklin Park, Ill. 60131.

POCKET Stamp \$1.00. Dealer's Wanted! Day's. 97 Stark Avenue, Dover, New Hampshire 03820.

OFFICE SUPPLIES

MAILORDER RECORDS Help get increased business! Complete 32 Page Record Book shows your inquiries, orders, advertising, expense, etc. Only \$1.00. **H. E. KAPPEL, POPULAR MECHANICS, DEPT. R, 224 WEST 57TH STREET, NEW YORK, N. Y. 10019.**

PRINTING PRESSES, RUBBER STAMP OUTFITS

SIMPLE-X RUBBER STAMP PRESSES. Hydraulic operated, electrically heated. Sizes 5"x8", 8"x12", 10"x15". Starting outfits. Orders for presses, supplies shipped day received. Free catalog low supply prices. Send \$1.00 for postage and handling (refundable on first order). Custom Manufacturers, 406-P East Elm, Springfield, Missouri 65801.

PRINTING Presses, type, supplies, Lists, 10¢. Turnbaugh Service, Mechanicsburg, Pennsylvania 17055.

NEW Catalog No. 13. 120 Pages, hand printing presses, type fonts, supplies. Send \$1.00 deductible first order. Acme Type, 732 Federal, Chicago, Illinois 60605.

PRINTING MACHINES. Offset. Mimeograph. Typewriters. Composing. Machines. Dixgraph, King, North Carolina 27021.

SAME Day shipment on rubber stamp supplies. Revised wholesale price list No. 9 free. Star Stamp Supply, 732 Federal, Chicago, Ill. 60605.

LOW Priced Rubber Stamp Manufacturing Supplies, Starting Outfits. Martin, 1432 Major, Jefferson City, Missouri 65101.

TYPE, Presses, Supplies. Barco Type Mfg., 237 S. Evergreen, Bensenville, Ill. 60106.

RUBBER Stamp Manufacturers! Increase Your Profits! Write—B. Zwier, Box 788, Mokena, Ill. 60448.

MIMEOGRAPHS, Duplicators Prints. Several Colors Without Extra Drums, Rollers. Write: AM Sales, 31-14 94, E. Elmhurst, NY 11369.

RUBBER Stamp manufacturers supplies. Presses, starting outfits. Best prices, service. Catalog. Jackson Supply, Box 443A, Franklin Park, Ill. 60131.

(Continued on next page)

Материал, защищенный авторским правом

PRINTING PRESSES. RUBBER STAMP OUTFITS

(Continued from preceding page)

MAKE Your own self-molding Rubber and Printing-Cuts. Plexirubber, Wisconsin.

RUBBER Stamp outfits, supplies. Kiewiet, 2025 Barney Road, Kalamazoo, Michigan 49007.

PRINTING AND SUPPLIES

BUSINESS—Personal Printing. Labels, Cards. Economical. Samples. Burnfin, Weaubleau, Mo. 65774.

FREE Literature, Business Cards, Letterheads, Rubber Stamps, Business Labels, Name and Address Labels, Lifetime Social Security Plates, Medical Plates, Identification Tags. Geer's, 111 North Drive, Ottawa, Ohio 45875.

BUSINESS CARDS Raised Letters \$5.65 Thousand. Like Engraved. Free Samples. Kavanagh, Box 1222, Brooklyn, N.Y. 11202.

FREE Offset Catalog. Fast-Economical. Seaview, 212-26P 48th, Bayside, NY 11364.

FREE Literature: Business Cards, Rubber Stamps, Address Labels Printing Big Selection. Jordan's, 552 West O'Connor, Lima, Ohio 45801.

BUSINESS Cards and Stationery—State your Occupation—we'll send appropriate samples. A.E. Lutz Co., P.O. Box 156, Dewitt, New York 13214.

QUALITY Printing. Novelty and Imported Items. Catalog 25¢. John G. Robeson, Box 2316, Hyattsville, Maryland 20784.

SMALL businessman's special: 500 letterheads, #10 envelopes, business cards and invoices. \$14.95. Other printing bargains. Allstate Press, 5302 North Milwaukee, Chicago 60630.

PRINTING Supermarket Short Run Specials. 1000-\$4.75, 5000-\$22; 1000 Envelopes \$8. Shipping 9 hours. Get Free Printing Specials Price List "Do You Make These 18 Mistakes When You Buy Printing?" Speedy Offset Printers, 23862 Aurora, Bedford, Ohio 44146.

1000 EMBOSSED Business Cards \$5.25 Postpaid. Agents Wanted. Elco, 181-A, Sylvania, Ohio 43560.

BUSINESS CARDS Raised Letters Ideal for Home and Business. \$5.25 Per Thousand. Send Layout to: Eastern Graphics, Box 211, Rowayton, Conn. 06853.

BUSINESS CARDS, 1,000—\$4.95. Engraved. Samples. Budco, 911, Los Altos, California 94022.

QUICK Copy Offset Printing. Free Introductory Offer. Nationwide Printing, 73 E. University, Champaign, Ill. 61820.

MULTIGRAPH. MIMOGRAPH

PROFITS FROM CLASSIFIED ADVERTISING! Booklet shows you how to start your own business with Classified Advertising. Only \$1.00 (Refundable with first order.) H. E. KAPPEL, POPULAR MECHANICS, DEPT. P, 224 WEST 57TH STREET, NEW YORK, N. Y. 10019.

GUMMED LABELS

1000 GOLD STRIPE LABELS \$1.25 up to four lines. Three C's, Dept. B, Box 11, Blaine, Washington. 98230.

500 PRESSURIZED Address Labels \$2.00. Wait's, Box 960A, South Bend, Indiana 46624.

1,000 GUMMED ADDRESS LABELS \$1.00 FREE CATALOG. Acme, 1238 Voskamp, Pittsburgh, Pennsylvania 15212.

1,000 GUMMED ADDRESS LABELS, BOXED \$1.00. FREE CATALOG. BELMONT, 4711C Linden, Lincoln, Nebr. 68516.

UNIQUE! 1000 INITIAL Address Labels \$1.—. Olive, 1739 Lasenda, South Pasadena, California 91030.

1000 DELUXE, Gold Stripe, Padded Labels. Send Name, Address and Zip Code. \$1.00. Free Plastic Box With Order. D'Lynn's Shop, 2011 West Bond St., Denison, Texas 75020.

500 DISTINCTIVE Address Labels. To 4 lines. Plus Free Gift—\$2.00. Your choice: SELFSTICK Glossy White or GOLD Gummed. Sunshine House, Box 318A, Scituate, Mass. 02066.

REMAILING SERVICE

EUROPEAN Confidential Remails. Orders acknowledged. 1/\$1.25. 2/\$2.15. Mary Taylor, 6520 Worms/Herrnsheim, Herrnsheimer Hauptstrasse 122, Germany.

UTAH \$3.00 Month, 25¢ Each. D&C, Box 1303, Provo, Utah 84601.

NEW YORK CONFIDENTIAL Remails 25¢; \$2.75 Monthly. Details Free. Ross, Box 706-M, North Bellmore, N.Y. 11710.

KING CRAB CAPITAL OF THE WORLD 35¢. Remails. Receiving, Forwarding, Re-addressing. Postcards and Souvenirs. Monthly Rates. Oceanside, Box 1455, Kodiak, Alaska 99615.

CALIFORNIA Remails 25¢. Specify Date 50¢. O'Gara, Box 39-B, Lomita, Calif. 90717.

FREE NASA Postcard. Space City Remails, Box 9296PM, Houston, Texas 77011.

WE ARE Receivers and Reforwarders of Business and Personal Mail. Try Us for Results. Dunn Mail System, 1758 First Avenue, New York, New York 10028.

DEPENDABLE Mail Service. Forwarding. Remailing. \$3.00 Monthly. Remails 25¢ Each. Keats, Box 10162, Louisville, Ky. 40210.

SECRET. Receiving—forwarding. Discreet and confidential. Remail 25¢ single. Mail Forwarding Service, 8050 S. Main, Houston, Texas 77025.

RECEIVING — Forwarding — Remailing. Monthly Rates. Nortex, Drawer 5370, Ft. Worth, Texas. 76108.

MIAMI Remails 25¢—Monthly rates. Remails—view cards from 80 Foreign cities. Marle, Box 1266, Coral Gables, Florida 33134.

YOUR Mail Received—Forwarded. Hedgpeth, 324-M South First, Alhambra, Calif. 91802.

CONFIDENTIAL New York Mail Address \$3.00 Month. Telephone Service \$5.00. Re-mails 25¢. Details Free. Birnhan, 152 West 42, New York 10036.

CONFIDENTIAL. Receiving Forwarding. Monthly Rates. Davis, Box 5012A, Reno, Nevada 89503.

REMAILS 25¢. Schneider Enterprises, POB 9369, Midtown Plaza, Rochester, N.Y. 14604.

NIAGARA FALLS Remails 25¢. Post Cards 6/\$1.00. New Market, Box 2015, Niagara Falls, N.Y. 14301.

INDY Personal-Prompt-Reliable. 25¢ ea., \$2.50 Per Month. Crossroads, P.O. Box 40043P, Indianapolis, Ind. 46260.

HOLLYWOOD Remails—Forwarding. 25¢; \$3.00 Monthly. Confidential. Box 1302, Hollywood Sta. Calif. 90028.

KEEP Your Location Secret. Use our Address. Wright-2112, Asheville, N.Car. 28802.

REPAIRS AND SERVICING

PROFITS FROM CLASSIFIED ADVERTISING! Booklet shows you how to start your own business with Classified Advertising. Only \$1.00 (Refundable with first order.) H. E. KAPPEL, POPULAR MECHANICS, DEPT. P, 224 WEST 57TH STREET, NEW YORK, N. Y. 10019.

SPECIAL SERVICES

SWAP ANYTHING—25 Word Ad \$1.00— Sample 25¢. Kelly Swap Sheet, Box 3174, North Hollywood, Calif. 91609.

INFORMATION On anything. Ferguson Research Specialists, 72-25 Woodside, Woodside, New York 11377.

KEEP Your copies of PM—and watch for the inexpensive Annual Index, available in January 1972. It will enable you to locate any article which appeared in 1971 or find information on any particular subject in just a few seconds. The Annual Index will make your copies of PM even more valuable! Price \$1.49. Send checks to: Popular Mechanics, Dept. HE, 224 W. 57th St., New York, N. Y. 10019.

TOBACCO

PIPE SMOKING PLEASURE, on'y as satisfying as the tobacco you put in it. Write for factory-fresh samples. Green River Tobacco, Box 991, Owensboro, Ky. 42301.

BRIAR PIPE Make or repair your own. Photocopy of article shows you all the details. Price \$1.00. Send order to POPULAR MECHANICS, Dept. HE, 224 West 57 St., New York, N. Y. 10019.

BETTER HEALTH

GRAPEFRUIT DIET Send \$1.00. Vidikapa, Box 1543-PM7, Tampa, Florida 33601.

STOP SMOKING! NEW 96 Page Book Presents Medical and Psychological Method That May Save Your Life. Money Back Guarantee. Send \$1.00 Plus 25¢. Bill Hall Sales Co., 342 Taylor's Ferry Rd., Bessemer, Ala. 35020.

PERSONAL

NO WILL? Live reassured. Blank will form protects your family! Only \$2.00. Guaranteed. Order today! Cumberland 247, Box 400, Saint Marys, Georgia 31558.

LOSING HAIR? BALDING? DANDRUFF? Free copyrighted booklet. Dr. Shiffer Laboratories, Dept. 536, Box 398, Punta Gorda, Florida, 33950.

PSORIASIS Sufferers: Discouraged? Write for Free important information that is helping thousands! Pixacol, Box 38-PM, Avon Lake, Ohio 44012.

BIBLE Questions answered. Stamped envelope. Bylon, 17167 Bentler, Detroit, Michigan 48219.

INVESTIGATORS. Latest electronic Aids. Free Literature. Clifton, 11500-P NW 7th Ave., Miami, Florida 33168.

NEED Money—Debts Too Big? Quick Cash. Secret Emergency Loans. Free Consolidation Plan Application. Interstate, 28 E. Jackson, Suite 1204-X3, Chicago 60604.

RECORD Telephone Conversation automatically. Leaver Recorder Unattended. Robert's, Box 49PM7, Parkridge, Illinois, 60068.

RECEIVE Phony State Chartered University Degrees immediately. Box 11516, Tucson, Arizona 85706.

SECRET LOANS BY MAIL Borrow \$100 to \$3000 for any good reason in absolute privacy. No interviews, no endorsers, no co-signers. Fast service. Write: Dial Finance Co., Dept. 3167, 405 S. 16th Street, Omaha, Nebraska 68102.

CASH LOANS by mail! Up to \$2,500 on signature alone. No collateral! Secret! Union Finance Company, 3608 N. 16th St., Dept. PM, Phoenix, Ariz. 85011.

GINSENG. Legendary body, mind rejuvenator. Sample and Catalog \$1.00. Herbal Holding, 5854, Cal. 91413.

UNBREAKABLE COMBS, Family Variety (12) Packet. Only \$1.00. "Airway", P.O. Box 1080, Cedar City, Utah 84720.

BEAUTIFUL ORDINATION CERTIFICATE. Details Free. Write. Ministry Of Service Church, Box 526, Seymour, Texas 76380.

(Continued on next page)

PERSONAL

(Continued from preceding page)

BIRTH CERTIFICATE, Baptism, Marriage, Divorce, High School, College Diplomas, Wills, Driver's License, General Agreement, Power Attorney, Bill Sale, Real Estate Lease Any 3 blank forms \$1.00, 7—\$2.00. (Free Catalog.). Legal Forms, Dept. 290, Box 554, Farmington, Michigan 48024.

BORROW By Mail! Up to \$1500.00. Convenient terms. State Licensed. Postal Finance, Dept. 17-N, 6018 Military Ave., Omaha, Nebraska 68104.

SECRET Plan Wipes Out All Debts. \$500 to \$25,000 in as little as 90 minutes. Clear credit. Free details. Counselor-7, Kerrville, Texas 78028.

BLANK Forms, Will, Birth, High School. Each \$2.00; set \$4.00. Guaranteed. Dee, 4013D Guadalupe, Austin, Texas 78751.

DON'T Die without a will! Blank will form protects your family!! Send \$2—guaranteed. Enelco, 18 Woodmere, Dept. PM1, Jackson Tenn. 38301.

IDENTIFICATION CARDS, Photo Laminated Certificates, Diplomas, Send Stamped Self-Addressed Envelope. For Samples. **DOWNES**, P.O. Box 10148, Cheyenne, Wyoming 82001.

SEE THRU WALLS! New Secret Two-Way Super Spy Device, instructions included. Guaranteed only \$2. World-7C20 3047 University, San Diego, Cal. 92104.

ARTHRITIS? MUSCULAR ACHE? TENSION? Enjoy Soothing Whirlpool Bath Massage. Discount Prices. Engineering Sales, 40 Manner Ave., Garfield, N.J. 07026.

OREGON Inventors Council, non-profit. Invention Development and Marketing Assistance, Box 19, University of Oregon, Eugene, Oregon 97401.

TELL Fortunes accurately—Immediately! ESP Aids, Box 21-PM, Olympia, Washington, 98507.

TATTOO Removing—Chemical Do-it-Yourself Method—Free Details: Atlanta, 907P Beachpoint, Pickering, Ontario, L1W 2A4

"RULE Others With Thoughts." (Teletype). Write: Clarion, Box 1769-A7, Chicago 60690.

WANTED-MISCELLANEOUS

MERCURY, Gold, Silver, Platinum; Ores assayed. Wholesale Terminal, Norwood, Mass. 02062.

WINEMAKING & OTHER RECIPES

OKEFENOKEE WINE RECIPE: Old Pioneer formula. Years of success. Local grocery ingredients—household kitchen utensils produce distinctive wine. Guaranteed. Rush \$3.00. Cumberland 1A7, Box 400, Saint Marys, Georgia 31558.

WINEMAKERS FREE Supply Catalog. Excellent Selection of Fruit & Grape Concentrates. Kraus, Box 451-L, Nevada, Missouri 64772.

WINEMAKERS. Free illustrated catalog of yeasts, equipment, Semplex, Box 12276R, Minneapolis, Minn. 55412.

WINEMAKERS . . . Free Illustrated Supply Catalog of Yeast, Equipment, Recipes, Continental, Box 18223-PM, Indianapolis, Ind. 46218.

WINEMAKER'S Supply Catalog—Free. Bacchanalia, 273 Riverside Ave., Westport, Conn. 06880.

WINEMAKING Kit—\$4.98 Free Catalog and Recipes. **JIMDANDY**, Box 30230M, Cincinnati, Ohio 45230.

HOMEWINE MAKING SEND For FREE Informative CATALOG of RECIPES, EQUIPMENT, and INGREDIENTS. Brewer's Yeast Dry Malt, Crystal Malt, Bottle Caps, Barrels, Chemicals, Concentrates, Over 250 Items. Winemaking Is A Fascinating Hobby. Write To: Danenberger's, Box 276-M, New Berlin, Ill. 62670.

WINEMAKER'S! Free Illustrated Catalog of Quality Products. Brant's Wine Rack, Box 3256-M, Orange, California 92665.

WINE CELLAR—New low cost interlocking units in traditional design, unlimited capacity. Start with 7 bottle rack \$4.98, postpaid. Free picture brochure, Winemaker's Catalog. **ADDARACK**, Box 30230M, Cincinnati, Ohio 45230.

WINEMAKERS. Make Delicious Wines—Champagne. Illustrated Instructions \$2.00. Enielas, Box 15894, Salt Lake City, Utah 84115.

WINEMAKERS: Free Catalog. Fast Service. Arbolyn, Box 663, West Columbia, South Carolina 29169.

HOME Winemaking is rewarding—Free catalog. The Wine Shop, 426 Penn Ave., West Reading, Pa. 19602.

MISCELLANEOUS

BEEF JERKY—HOMEBREW. Beat Inflation! Genuine, authentic recipes. \$2.00. Broadmoor Sales, 993 West Longview Ave., Littleton, Colorado 80120.

WINECRAFT—469 Items—Free Catalog. P.O. Box 11186, Phoenix, Arizona 85061.

DON'T DIE Without A Will! Blank Will form protects your family Only \$2.00. Guaranteed! Order Today. R. L. Richardson, 11600 Constitution-NE, Albuquerque, New Mexico 87112.

BOOKS On antiques and their prices. Free circular!! P. Warman Publishers, Uniontown, Penna. 15401.

SUFFERING From Arthritis? Try Ginseng: Information Free. Write: Ginseng, Asheville 53, North Carolina.

ORNAMENTAL Iron designs. Book of 1600 beautiful, practical designs for railings, columns, etc. Free literature. Cunningham, 3881 South 3200 West, Salt Lake City, Utah 84119.

PRE-PACKAGED Toys complete with free self-selling display rack. Free Details. Toys, 1916 Fifth, Sacramento, California 95814.

SLEEPATRON. New device for inducing sleep. Gardiner Electronics, Dept. C. 4729 North 7th Avenue, Phoenix, Arizona 85013.

HEARING Aid batteries wholesale. Free list. Habs, Box 51, York, Penna. 17405.

HOME Water Distillers. Portable Appliances. Purest Water, Pennies Per Gallon. Remove All Impurities, Bad Tastes. Free Details. United Vito—Way, Box 2216-PM, Everett, Washington 98203.

WIN AT POKER, Know What Wins. Learn The Odds To Winning Hands. Rush \$1.00. Mail Shopper, Box 158PMB, Valley Stream, New York 11582.

TV PICTURE TUBES manufactory direct, easy installation. Write: Ehes Co., 405 E. Jefferson, Cheyenne, Wyo. 82001.

ROLL yer own. With our new cigarette rollers. Plain filtertip, king. Less than a penny each. Free sample. Green River Tobacco, Box 954, Owensboro, Ky. 42301.

IDENTIFICATION Cards, Electronic Surveillance Equipment, Catalog 25¢. Como, Box 758, Palatine, 60067.

DREAMS Learn Their Mysterious Inner Meanings! 110 Page Book "How To Understand Your Dreams" Send \$2.00 To: Decade Distributors, P.O. Box 152, New Britain, Conn. 06050.

DOG COAT-OF-ARMS. Proclaims Your Dogs Ancestry, Breeds, History! 8½X11 Framed. Mention Dogs Breed When Ordering!! Only \$6.95—Guaranteed!! Northwest, 22404 42ND., Mountlake Terrace, Wash. 98043.

MAGNETS All types. Specials—20 disc magnets, or 2 stick magnets, or 10 small bar magnets, or 8 assorted magnets. \$1.00. Maryland Magnet Com. Box 192-A, Randallstown, Maryland

BIRTH Certificates, Diplomas! 2-\$3.50. Guaranteed! McCater House, Dept. B1002, 317 West Grand, National Park, New Jersey 08063.

IDENTIFICATION CARDS, Send stamped self-addressed envelope for samples. **NIPCOM**, 727 North Main, Las Vegas, Nevada 89101.

KILL All your Roaches and Waterbugs with **SURE KILL**. 5 Year Guarantee. Safe for Family and Pets. Only \$3.98 plus 60¢ postage and handling. McCater's, Dept. B1002, 317 West Grand, National Park, New Jersey 08063.

DON'T Die Without a Will! Blank Will Form Protects Your Family. Excellent Quality. Durable Paper. Instructions—Only \$2.00. Guaranteed! Order Today!! DeMuir, 38 Franklin, Dept. 1A7, Lockport, N.Y. 14094.

NEVER Won Anything? Anyone can win Sweepstakes Contests. Details \$1.00. Zent Distributing, 546B 4th Avenue West, Dickinson, N.Dak. 58601.

BLACKLIGHT Bulb Illuminating Blacklight Posters. Fits Ordinary Light Sockets. \$2.50. Pattersons, Box 202, South Lake Tahoe, California 95705.

DON'T Die Without a Will! Blank Will Form Protects Your Family. Only \$2—Guaranteed! Order Today!! McCourt, 4113 West Highland Parkway, Dept. IP7, Blasdell, New York 14219.

RARE McGovern, Eagleton Campaign Buttons. Guaranteed Originals \$1.00 Each, 6 for \$5.00. Dowling, 1950 Clove Rd., Staten Island, N.Y. 10304.

EYEGLASSES wholesale—Free Catalog. A-Z Optical Company, Box 175, Dept. R26, Bay Station, Brooklyn, N.Y. 11235.

CONVERT Rotary Lawn Mower To Snow-Blower In Minutes! Kit \$8.88. Plus 75¢ Postage. Dundee Engineering, Box 234, Dept. M—Petersburg, Mich. 49270.

BABIES Shoes Bronzed \$9.00 pair. Norton Inc. 8639 Walton Blvd., Plymouth, Mich. 48170.

HOW INTELLIGENT Are You? Self-scoring test reveals I.Q. in 45 minutes! Send \$2 today—guaranteed!! Mann, 3545 Lincolnshire Woods, Dept. 7A1, Toledo 43606.

HOW INTELLIGENT ARE YOU? Self-Scoring Test Reveals I.Q. In 45 Minutes! Send \$2 Today—Guaranteed!!! Helton, Box 67184 PM-1-7, Century City, California 90067.

BIRTH Certificates, Marriage Certificates, Diplomas! 2 blank forms \$1.00. Sample 10¢. Standard Forms, Box 482-M, Washington, D.C. 20044.

BURGLAR ALARMS & HOME PROTECTION

LOCKSMITHING Supplies—Buyers Guide \$1.00. Despuhs, Box 22005H, Phoenix, Arizona 85028.

FREE Catalog on Burglar-fire Alarm Equipment, Protecto Alarm Sales, Box 357-D, Birch Run, Michigan 48415.

BURGLAR & FIRE ALARM SUPPLIES AND SYSTEMS. Send \$1.00 for catalog. J & J Alarm Systems, 51 Pythian Ave., Torrington, Conn. 06790.

BURGLAR & Fire Alarm Equipment. Low Prices. Hundreds Of Items. 1973 Catalog, Over 60 Pages. Just \$1.00 (Refundable on first order). **K-TRONICS INDUSTRIES**, Box 391, Dept. PM, Fairfield, Conn. 06430.

FIRE! Fire! World's Smallest Alarm. Plugs in anywhere. Tiny unit with Big Voice assures Family Protection! Only \$10.95—guaranteed. Enelco, 18 Woodmere, Dept. 1PM, Jackson, Tenn. 38301.

DETECT TORNADOES Within 18 Miles With Revolutionary Device. Free Details. Agents Needed. Bourdeau, 2205 Kingston, Waukegan, Ill. 60085.

'73 Ford pickups
start the better
ideas coming
all over again!

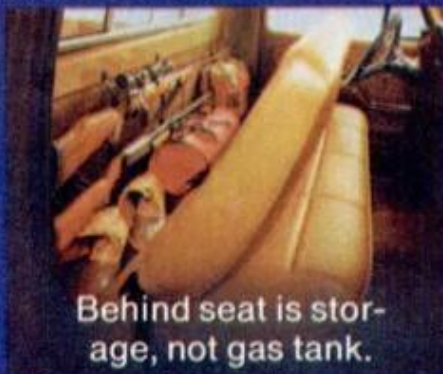

Behind seat is stor-
age, not gas tank.



Ford box cover fits
right, looks right.



Full-foam seat 5 in.
deep is standard.



Optional "air" is all
neatly built in.



Box sides are full
depth double-wall.



Front disc brakes
standard exc. 4x4.



Roomiest Ford ever
—quiet, comfortable.

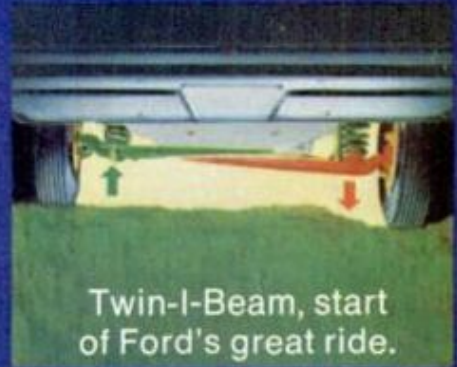

Twin-I-Beam, start
of Ford's great ride.



A better idea for safety:
Buckle up.

FORD PICKUPS

FORD DIVISION



Works like a truck / rides like a car.

Does your cigarette taste hot?
Only KOOL, with pure menthol,
has the refreshing taste
of extra coolness.



Come up to KOOL

Kool Milds 14 mg. "tar," 1.0 mg. nicotine av. per cigarette, by FTC method. Kool Kings 17 mg. "tar," 1.4 mg. nicotine; Kool Longs 17 mg. "tar," 1.3 mg. nicotine av. per cigarette, FTC Report Feb. 73.

© 1973, BROWN & WILLIAMSON TOBACCO CORP.

Warning: The Surgeon General Has Determined
That Cigarette Smoking Is Dangerous to Your Health.



14 mg. tar,
1.0 mg. nicotine

Now, lowered tar KOOL Milds