

Popular Mechanics

26 pages
New models
New conveniences
New ways to go
MOTOR CAMPING

MARCH 1973
50 CENTS

For \$607 you can build this camper

It fits Toyota, Datsun, LUV and Courier mini pickups Page 178

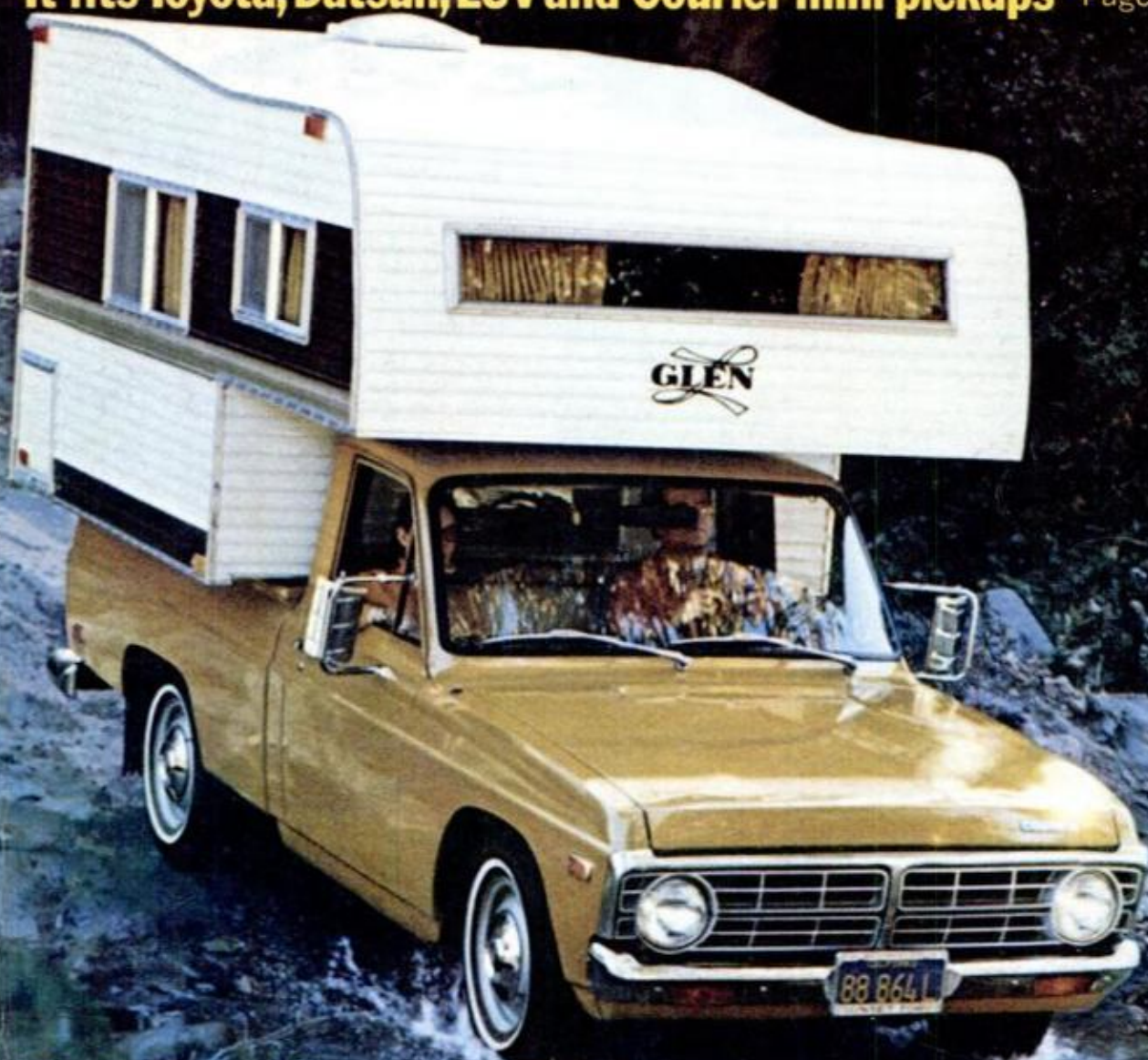

Sewing centers: the kind women want but can't buy

We offer plans for four — from a wall-hung space-saver to a deluxe freestanding unit.

Build any one of them and you'll be a hero. Page 77

How to: Adjust a Pinto carburetor

Cut, splice and connect wires ■ Build a basement partition

Hang drapery traverse rods ■ Patch a hole in sheet flooring

Meet the new Omega. If you think you can't afford an Olds, think again.

A smaller Olds at a lower price.

Omega is a whole new kind of Olds—a compact. But one with Olds big-car thinking built into three interesting variations: 2-door coupe, 3-door hatchback and 4-door sedan. All of them a lot of Olds for the money.

Omega is not your basic little car.

It's nearly 500 pounds more car than some smaller compacts. The wheelbase is longer—111 inches. And you can feel this extra size and heft working for you on the road. It's solid and steady. Roomy. Comfortable. Agile and maneuverable.

You get what you bargained for.

Omega gives you nice things you may have to pay extra for in other compacts. A deluxe interior with new "wet-look" vinyl trim. Full carpeting. Chrome trim around the windows and wheel openings. And 250 cubic inches of engine. There are

also things some compacts don't offer at any price! A glove compartment with a door and a lock. Rear windows that roll down. And generous trunk space.

Add some neat ideas of your own.

You can order a vinyl roof for looks. Our famous Rocket 350 V8 for go. Sporty high-back bucket seats and a console for the coupe and hatchback. Even a special tent that converts the hatchback into a camper.

It feels like a bigger car. Get into an Omega and notice the comfort. The way you sit up, how right the steering wheel position seems, how easily the car responds. Sure, you can get a lesser compact for less money—but then, it wouldn't be an Olds Omega. Oldsmobile. Always a step ahead.

'73 Oldsmobile Omega.



Hatchback Coupe

Coupe

Town Sedan



CHANNELLOCK

Gives You More In Hand Tools Including

TOUGHNESS

That Stands Up
To Tough Jobs
Year After Year

You'll take pride—as do we—in the beautiful finish and fine craftsmanship of your CHANNELLOCK tools. But even more, you'll like their durability, their toughness in hard service year after year. The skilled forging of beautiful, tough, hard working hand tools has been our only business at CHANNELLOCK since 1886. Best of all, you pay no premium price for CHANNELLOCK quality. LIKE TO SEE THE ENTIRE LINE? Send for our catalog . . . yours for the asking.



This One



NBGO-HDE-3T1Y

TOOLS BY
CHAN NEL LOCK

MEADVILLE, PA. 16335

Jeep Introduces Automatic 4-Wheel Drive.

QUADRA-TRAC™—Someday all 4-wheel drive vehicles may have a system like it... Jeep Wagoneer has it now.



Here's how it works and what it does for you:

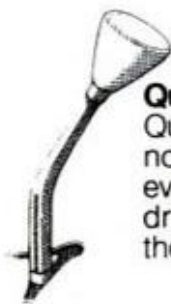

Quadra-Trac eliminates shift lever and front locking hubs.

Quadra-Trac is full-time automatic 4-wheel drive. There's no need to get out and lock in the front wheel hubs or even shift a lever... Quadra-Trac eliminates both. 4-wheel drive is automatically there when you need it—on or off the highway.



Quadra-Trac offers superior traction.

Under test conditions, two Jeep Wagoneers, one Quadra-Trac, one without, were asked to make an accelerating turn on a water-soaked road. The Wagoneer with Quadra-Trac remained in control, while the other vehicle had a tendency to fishtail.

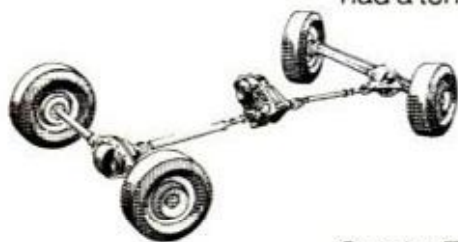

Quadra-Trac works in a new way.

A third differential allows torque to be directed automatically to the wheels that have the best traction. If the wheels on one axle start to slip, as on ice or rough terrain, the wheels on the other axle automatically take over.

Quadra-Trac is one of the most advanced 4-wheel drive systems ever developed and it's available now on Jeep Wagoneer and Jeep Truck. If you want to know more about it, see your Jeep dealer. He's the 4-wheel drive expert.

Jeep
Toughest 4-letter word on wheels.

Winchester 22 Magnum Rim Fire cartridges were pioneered by Winchester-Western to give hunters and shooters the power of a center fire at a price that lets them get plenty of practice.

Check the new low cost of Super-X Magnum Rim Fires in both Winchester and Western brands:

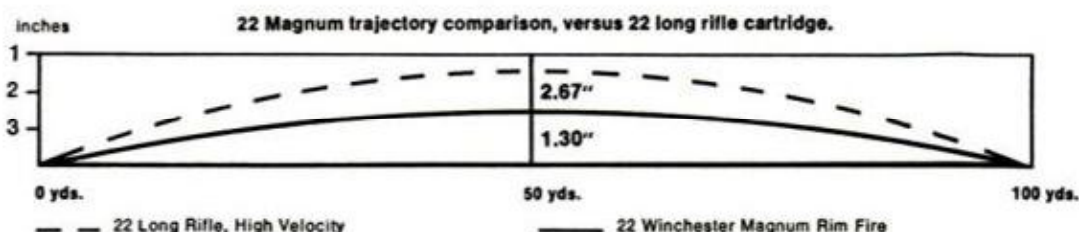

A proven performer that was first in the field. Ten years ago a new era of rim fire power and varmint shooting performance started with the introduction of 22 Winchester Magnum Rim Fires, economical loads that fit between regular 22s and costly center fires. Because of the logical simplicity of the new Magnum load, plus its wind-bucking accuracy, and extra power for shooting varmints, game, and pests, so many manufacturers brought out rifles and pistols for it that the Winchester Magnum quickly became the standard of the industry.



Choice of two bullets. Two bullets let you suit your load to your game. Perfect for the toughest varmint, the 40 grain jacketed hollow point hits with conclusive wallop . . . accuracy . . . out where the regular 22 rim fires really slow down. The 40 grain full metal case bullet delivers the same velocity, with long range performance ideal for small targets.



Not a sub small-bore. After exhaustive tests, Winchester-Western technical experts concluded that a magnum rim fire should be a full 22 caliber for maximum accuracy and top wind-bucking ability. After testing both undersized and oversized calibers, they settled on 22 as providing the best balanced load when all of the factors affecting performance are considered. When you add up all that, plus two bullet choices, powered by clean, progressive-burning Olin Ball Powder, and consistent, non-corrosive priming in a precision-drawn case, you've got a load you can shoot with confidence . . . Now at a new low price that lets you shoot it as much as you like.



New Winchester Model 9422M Magnum chambered for 22 Winchester Magnum Rim Fire loads. This new lever action 22 magnum rifle, patterned after the famed Model 94 Winchester was built specifically to handle the Winchester Magnum load, and to bring out the best in Super-X, the original brand of extra power that's never been topped. You get accuracy, reliability, and performance every time. The new Model 9422M is carved from solid steel and rich walnut with no shortcuts or substitutions. Magnum rim fire 22s available in either Winchester or Western brands. **WINCHESTER-Western** 275 Winchester Avenue, New Haven, Conn. 06504.



winchester
the way you
want it

HOW TO . . .

Make a space-saver sewing center . . . 77



Adjust your Pinto carburetor . . . 134

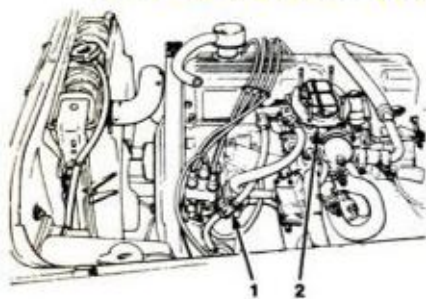

Patch a hole in sheet flooring . . . 142

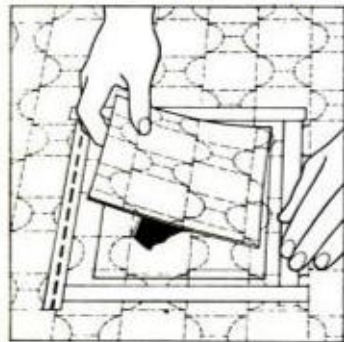

Know what it takes to tow . . . 174



AUTOMOBILES, DRIVING

- [34 Imports and Motorsports](#)
- [50 PM Owners Report: Pontiac Grand Am](#)
- [70 Detroit Listening Post](#)
- [129 When tire pressure drops, radio sounds the alarm](#)
- [130 How Detroit is 'tuning' its new cars for radial tires](#)
- [134 Saturday Mechanic: Simple way to adjust your Pinto carburetor](#)

HOME AND YARD

- [108 A pool for all seasons](#)
- [116 Yardpower roundup for '73](#)
- [138 How to cut, splice and connect wires](#)
- [140 How to frame a basement partition](#)
- [142 How to patch a hole in sheet flooring](#)
- [144 How to hang drapery traverse rods](#)
- [146 A 'dust-free' home electronically](#)

SHOP AND CRAFTS

- [77 Sewing centers—the kind women want but can't buy](#)
- [80 The island unit](#)
- [83 The high-rise unit](#)
- [86 The dual unit](#)
- [88 The dual-role unit](#)
- [149 Hints from readers](#)
- [150 Double-duty drill-press fence](#)
- [152 Hints from readers](#)

SPACE, AVIATION, MILITARY

- [89 Homebuilt 'model' plane you can really fly](#)
- [124 Those wild new wings: Will they really fly?](#)

ON THE COVER: For \$607 you can build this camper to fit mini pickups.
Photo by Mario Romo

AS A SERVICE TO READERS, Popular Mechanics publishes newsworthy products, techniques and scientific and technological developments. Because of possible variance in the quality and condition of materials and workmanship, Popular Mechanics cannot assume responsibility for proper application of techniques or proper and safe functioning of manufactured products or reader-built projects that result from plans published in this magazine.

'73 RV CAMPING SPECIAL

- [154 New rigs for roll-along recreation](#)
- [160 Chopped vans](#)
- [160 Fifth-wheel trailers](#)
- [162 Motor homes](#)
- [163 Mini rigs](#)
- [164 Drivers' Report: Travco Minihome](#)
- [166 Drivers' Report: Winnebago D-20T](#)
- [168 Drivers' Report: Grumman Motorhome](#)
- [170 How to buy or rent a used RV](#)
- [172 Gear to go](#)
- [174 Know what it takes to tow](#)
- [178 Cabover camper you can build for a compact pickup](#)

BOATING, OUTDOORS

- [122 For fishing offshore and on](#)

PHOTOGRAPHY

- [42 Photo hints](#)
- [104 Polaroid's new SX-70 color camera](#)

ELECTRONICS, RADIO, TV

- [111 New irons for better soldering](#)

EVERY MONTH

- [8 Letters](#)
- [21 The Bicycle Shop](#)
- [30 Science Worldwide](#)
- [38 Appliance Clinic](#)
- [57 Automobile Clinic](#)
- [67 All Outdoors](#)
- [74 Homeowners' Clinic](#)
- [92 It's New NOW: The latest products and developments \(A 12-page roundup\)](#)

Stanley has 2 new ways to shave, file, trim.



Introducing the Surform® Shaver and the Surform Mini-File. Just what's needed in every workshop. They do great smoothing jobs—especially in tight areas—that ordinary tools can't.

Like all Stanley Surform tools, replaceable blades feature super sharp, pre-set, edge-cutting teeth. Won't clog; are fast, safe. Take on wood, plastic, plaster, soft metals.

STANLEY

One-handed Surform Shaver trims, shaves, scrapes with an easy pulling action. Great for curves, corners, tight angles. Won't "chatter" or chip edges. About \$1.79 with an extra blade.

helps you do things right

Blade on Surform Mini-File is only 1/2" wide. Just-right to file grooves, smooth joints, cut notches, square corners. You'll wonder how you ever did without one. About \$2.69.





The real beauty of Lindal Cedar Homes. . .

**Walls
that were
made for
each other.**



Our double walls of thick, pre-cut cedar planks *lock* together for fast, weather-tight assembly—with precious little nailing! Extra-thick floor and roof decking also dovetails for both savings *and* strength. For details, prices, and 82 house plans, send \$1 for your Lindal Planbook.

LINDAL CEDAR HOMES

10411 Empire Way S.
Seattle, Wa. 98178
Phone (206) 725-0900

Enclosed is \$1. for my Lindal Cedar Homes Planbook.



PM 33

Name _____
Address _____
City _____
State _____ Zip _____
Area Code _____ Phone _____

Lindal homes are sold throughout the world.

JIM LISTON

Editor

SHELDON M. GALLAGER JOHN A. LINKLETTER

Executive Editor Managing Editor

WAYNE C. LECKEY ALVIN KIETZ

Home and Shop Editor Art Director

Published by The Hearst Corporation

RICHARD E. BERLIN, PRESIDENT

RICHARD E. DEEMS

President, Magazines Division

JOSEPH F. KERN

Publisher

BILL HARTFORD _____ Automotive
JOHN F. PEARSON _____ Science and Engineering
WM. T. McKEOWN _____ Boating and Outdoors
IVAN BERGER _____ Electronics and Photography
HARRY WICKS _____ Home Workshop
MICHAEL LAMM _____ West Coast
ROBERT LUND _____ Detroit Automotive
GARRY WINTER _____ Copy Chief
RICHARD H. FUNK _____ Production
ALFREDO VEGA _____ Assistant Production
DON EVANS _____ Technical Art Director
FRED A. LEERS _____ Assistant Art Director
JOSEPH P. BEATON _____ Assistant Art Director
DAVID KOMITAU _____ Assistant Art Director
CLIFFORD B. HICKS _____ Special Projects
SOPHIE GRONOWICZ _____ Director, Bureau of Information
EVERETT JOHNSON _____ Cabinetmaker

ADDRESS ALL EDITORIAL COMMUNICATIONS TO: 224 West 57th St., New York, N.Y. 10019. For additional sources of information on the articles and products in this issue, write to Bureau of Information, Popular Mechanics, for free "Where-to-Find-It" list.

DANIEL J. COLEMAN

Director of Advertising

ADVERTISING OFFICES: New York: 224 West 57th St., 765-6850; Chicago: 520 N. Michigan Ave., 527-2400; Detroit: General Motors Bldg., TRinity 5-8711; Cleveland: 20310 Chagrin Blvd., Shaker Heights, 283-7788; Los Angeles: 601 North Vermont Ave., 666-6263.

JOHN A. REGINA _____ Advertising Production Manager

SUBSCRIPTION SERVICE: Mail all subscription orders, changes of address, correspondence concerning subscriptions, and Postmaster notices of undeliverable copies to Popular Mechanics, Box 646, New York, N.Y. 10019. Please enclose your latest address label for quickest service when writing about your subscription.

POPULAR MECHANICS IS PUBLISHED MONTHLY by The Hearst Corporation, 57th St. at 8th Ave., New York, N.Y. 10019, U.S.A. Richard E. Berlin, President; Richard E. Deems, President of Magazines; John B. Miller, Executive V-Pres. of Magazines; Raymond J. Petersen, Senior V-Pres. of Magazines; William S. Campbell, V-Pres. of Magazines; Albert A. Rachol, V-Pres. and Director of Circulation; Joseph F. Kern, V-Pres. for Popular Mechanics; Frank Massi, Executive V-Pres. and Treasurer; Harvey L. Lipton, Secy. Single copy in the United States and Canada, 50 cents. Subscription prices: United States and Possessions \$5.00 for one year; \$9.00 for two years; \$12.00 for three years. Canada, add \$2.00 for each year. All other countries, add \$4.00 for each year. When changing address, give old address as well as the new, with postal-zone number, if any, and allow six weeks for change to become effective. Second-class postage paid at New York, N.Y., and at additional mailing offices. Authorized as second-class mail by the Post Office Department, Ottawa, and for payment of postage in cash. Registered as second-class matter at the Post Office at Mexico D.F., Mexico, June 20, 1950. © 1973 by The Hearst Corporation. All rights reserved. Printed in U.S.A.

POPULAR MECHANICS

Материал защищен авторским правом

Have you seen this coupon before?

© 1972 LaSalle Extension University. A Correspondence Institution

It has helped to start many men and women on the road to higher pay.

Just looking at it won't get you anything... but putting it in the mail may change your whole future!

The LaSalle coupon is one of the most often-seen coupons in America. To many who have mailed it, it has proved a first step to opportunity and good fortune.

MAIL THIS HANDY POSTAGE-PAID COUPON-ENVELOPE

Cut coupon along dotted lines, fill in your name and address . . . fold, seal (tape, paste or staple) and mail. No stamp or envelope is necessary.

Please rush me, without obligation, FREE booklet on the field I have checked:

- | | | | | |
|---|--|---|---|---|
| ACCOUNTING
<input type="checkbox"/> Complete Accounting
<input type="checkbox"/> Income Tax
<input type="checkbox"/> CPA Training
<input type="checkbox"/> Bookkeeping | COMPUTER PROGRAMMING
<input type="checkbox"/> Basic Training
DRAFTING
<input type="checkbox"/> Complete Training
DIESEL MECHANICS
<input type="checkbox"/> Basic Training
LANGUAGE INSTRUCTION
<input type="checkbox"/> French <input type="checkbox"/> Spanish
MUSIC INSTRUCTION
<input type="checkbox"/> Piano <input type="checkbox"/> Guitar
<input type="checkbox"/> Other | AIR CONDITIONING & REFRIGERATION
<input type="checkbox"/> Basic Training
INTERIOR DECORATING
<input type="checkbox"/> Complete Training
DENTAL OFFICE ASSISTANT
<input type="checkbox"/> Complete Training
ART TRAINING
<input type="checkbox"/> Complete Training
STENOTYPE
<input type="checkbox"/> Machine Shorthand
SECRETARIAL
<input type="checkbox"/> Complete Training | LAW COURSES
<input type="checkbox"/> Bachelor of Laws Degree
<input type="checkbox"/> Business Law
<input type="checkbox"/> Claim Adjusting Law
<input type="checkbox"/> Law for Police Officers
No state accepts any law home study course, including LaSalle's, as sufficient education to qualify for admission to practice law. | MOTEL/HOTEL MANAGEMENT
<input type="checkbox"/> Motel Management
<input type="checkbox"/> Hotel Management
RESTAURANT MANAGEMENT
<input type="checkbox"/> Management Training
WRITING
<input type="checkbox"/> Fiction
<input type="checkbox"/> Non-Fiction
HIGH SCHOOL
<input type="checkbox"/> High School Diploma |
|---|--|---|---|---|

TRAFFIC & TRANSPORTATION
 Complete Training

AUTOMOTIVE MECHANICS
 Basic Training

Dept. 87-066

Print Name..... Age.....

Address..... Apt. No.....

City & State..... Zip.....

46D FOLD HERE ↓ (DO NOT CUT) SEAL AND MAIL TODAY - NO STAMP NEEDED. 7

FIRST CLASS
 PERMIT NO. 27
 CHICAGO, ILL.

BUSINESS REPLY MAIL
 No postage stamp required if mailed in the United States

Postage will be paid by
LA SALLE EXTENSION UNIVERSITY
A Correspondence Institution
417 S. DEARBORN STREET
CHICAGO, ILLINOIS 60605



If your goals are bigger pay and more frequent promotion, you owe it to yourself to find out without delay, what LaSalle home study can do for you.

LaSalle gives you modern, comprehensive instruction in many well-paid, fast-growing fields where there is a continuing demand for trained personnel. You learn at home; lessons come to you by mail. You are a class of one.

For more than sixty years, LaSalle has been a leader in home study. It has a large staff of experi-

enced instructors. The cost of training is low. A LaSalle diploma is a respected credential.

You should act now. LaSalle training may make a big difference in your future. One student reports: "I received a \$2,000 yearly increase since enrollment with LaSalle. My regret is that I didn't enroll before." Many letters like this come to LaSalle. Get full information now on the field that interests you. Mail postpaid coupon above to LaSalle, 417 S. Dearborn St., Chicago, Illinois 60605.

You're Never Out of a Job With a Sparetime

BUSINESS OF YOUR OWN



Turn your spare hours into extra dollars this proven, practical way—start your own money-making sharpening business! No selling or canvassing, no experience needed . . . you do it all automatically with the Foley Saw Filer or Mower Sharpener.

Earn \$6⁰⁰ to \$8⁰⁰ an hour In Sparetime

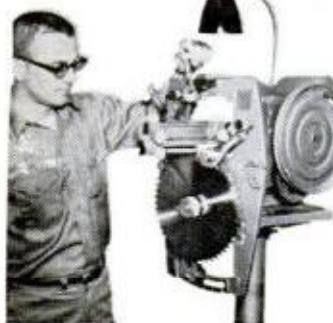

Hundreds of people like yourself are making cash like this—\$20 to \$30 a week—right now in spare time. "My spare time saw filing business has made me \$952 these first ten months"—says R. T. Chapman. Many have built a complete sharpening service with year-around profits. You can, too, simply by following, the sure, easy Foley plan.

No Experience or Training Needed

You can sharpen combination (rip and crosscut) circular saws, hand saws, band saws, crosscut circular saws—and do a perfect job every time without experience or special training. The precision Foley Filer does it for you automatically! A complete repair shop in one machine! Set up in basement or garage, work your own hours in your own way and earn big sparetime profits.



Husband and Wife Have Going Business

Here's the story from Dick and Jo Ann Koester after being in business 10 months: "We have acquired another Foley Saw Filer and for the past two months we have been in full-time operation. As we live in a small town of 150 population in farm area we use our truck to pick up saws in five nearby towns. With a family to support and plans for building to our house we had to pick up business fast and already sharpen an average of 15-20 saws a day. Business for the future looks even better as good machine filing is our best advertising."

Minimum Cash Needed

No franchise fees! Foley will help finance you and will also help you establish your own profitable business in your garage or basement. Your profits easily handle the low monthly payments. Send coupon for complete information. No salesman will call on you.

WE
FINANCE
YOU

FOLEY MFG. CO. 316-3 Foley Bldg.
Minneapolis, Minn. 55418

Send more information.

Name _____

Address _____

City _____ State _____ Zip Code _____

LETTERS TO THE EDITOR

A moral tale

Very fine article on *How to Fix Your Automatic Washer* (page 66, Jan. PM). But you forgot something.

Four months ago our neighbors had trouble with their washer. It would not agitate properly or empty all the way. A new clutch didn't do any good. The parts man said, "It's gotta be the transmission." Well, Mr. Smith's machine had 18 years under its belt, and he wasn't going to waste that money on a new part and still have an old machine.

Mr. Smith, who's a saver of parts, proceeded to tear the machine apart, top first. He cut all the wires off—maybe he could use the switch on something, and the neon light, and the motor. Then we received a phone call: When he pulled out the agitator, there was an article of clothing wrapped around underneath it.

Moral: Don't cut your wires till you remove the agitator from the machine.
CORNWELLS HEIGHTS, PA. FLO HUNKAPILLER

A matter of degree

In the January issue I noticed two small errors. On page 140 (*Router Know-How, Part 2*) the angle as shown should be 68° from horizontal instead of 22° (which is from vertical). On page 176 (*\$300 Pool Table for \$107*) the same type of error occurs. The table-leg angle as shown should be 14° from vertical instead of 76° (which is from horizontal).

When things like this happen, it makes me feel good—I don't want to be the only one who makes mistakes.

ALLENTOWN, PA. BOB SCHAFFER

Battery repair

In *How to Stretch the Life of Your Battery* (page 125, Dec. '72 PM), the author describes battery-post repair procedure whereby a torch is used to melt lead into a mold on the battery to reconstruct a new terminal post.

Using an open flame that close to a battery can be dangerous.

Hydrogen gas is a normal by-product of the chemical action within a battery dur-

(Please turn to page 10)

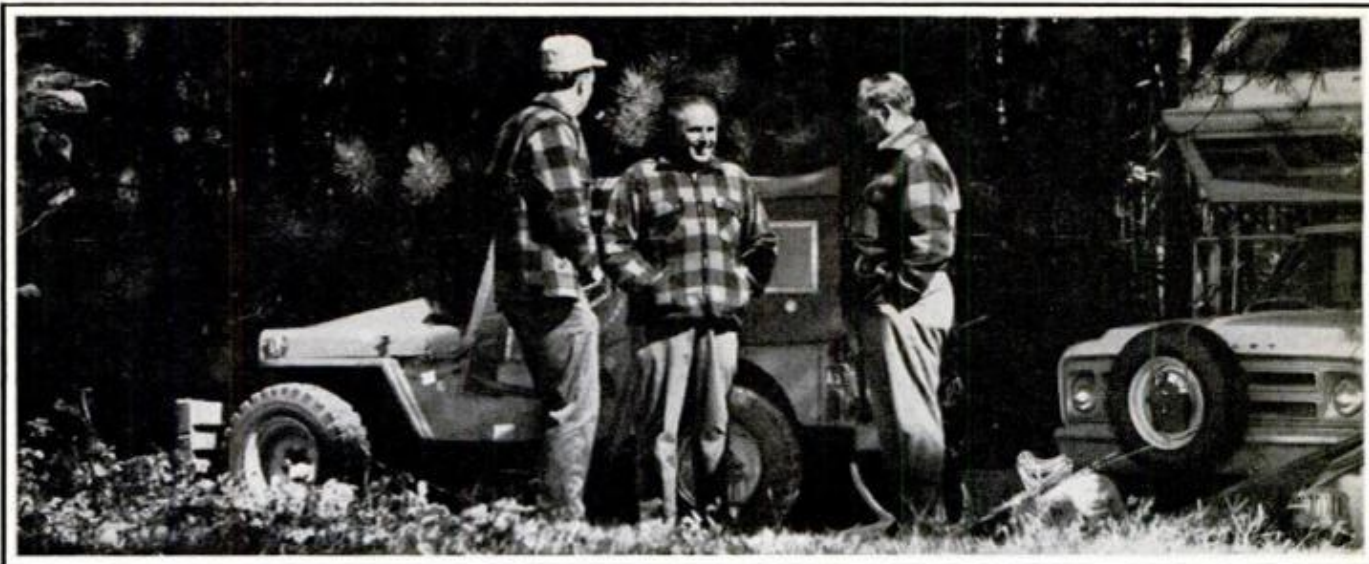

**STEVE PETRASEK IS HEARING
FROM A LOT OF CAMPER OWNERS WITH PROBLEMS...
THAT FIRESTONE'S WIDE OVAL TIRE SYSTEM
CAN SOLVE.**

Tire engineer Steve Petrasek heard from a lot of people after we ran the story about his annual 31 hour run to the wilds of Montana using the Firestone Wide Oval System. One even started out: "Help", and many talked about problems ranging from poor mileage with present tires to a need for more traction, better road control, and load capacity information.

The Wide Oval System may not be the answer to every camper problem, but it solves a lot of them, which is why these tires are Steve's choice for the tough driving he and his buddies do each year with a jeep in tow. Remember, as a Firestone engineer with a racing, farm and truck tire background, Steve can take his choice of tires. And he sticks with The System.

See your Firestone Dealer or Store and find out why.

On the front you put Firestone's Transport 500 Wide Oval® truck tires. They're the steering part of The System, with a wide, wide tread designed



to build stability under that camper and deliver more miles than the Transport Wide Oval tires they replaced in our line.

On the rear go Firestone's Traction All Season™ Wide Oval truck tires, the *drive* part of The System. Their treads are computer-designed to behave nicely at turnpike speeds, and to move your camper through snow, sand and mud when you turn off the mainline.

**The Wide Oval System
for Campers.**

Firestone

LETTERS

(Continued from page 8)

ing the charging process. Hydrogen gas, even in small concentrations, is explosive and when confined within a battery and ignited by spark or flame can violently burst the battery. Sulfuric acid could be splattered into the face and eyes of anyone working on the battery.

I personally know of three battery explosions. One was caused by a person examining electrolyte level with a match. Another happened when a mechanic accidentally short-circuited a battery terminal to ground with a wrench. The third one was caused when a mechanic used a pair of pliers to short from the positive to negative terminal to see if it was "hot."

Undoubtedly, battery posts can be repaired in the manner described in the article, but I would first empty the battery of all electrolyte, flush it with water, then fill it completely with water before attempting repair with a torch.

BROOKINGS, ORE.

ALLEN J. FRANK

You recommend a very dangerous pro-

cedure. The article suggests pouring "pure" sulfuric acid into the battery, 1/2 ounce at a time. Perhaps you did not know that adding such quantities of sulfuric acid which is more than 50-percent "pure" will cause a violent reaction causing a spray of acid to the reader's hands and face. One should use 20 to 25-percent sulfuric acid (which even at that strength is called "fuming") and *one should always wear glasses or goggles.*

We work with 90-percent sulfuric acid every day, and we have learned that even a small amount can burn the skin or even ignite some substances when spilled.

BARBOUR RESEARCH ROBERT G. BARBOUR
LABORATORY DIRECTOR
WEST LOS ANGELES

We received many letters from readers rightly concerned about hydrogen gas in storage battery cells. The gas is generated only during the charging process.

We reported on the technique employed by Sytronic Battery Co. of Plainview, N.Y., operated by Seymour Seligman. He has never had a battery explosion. He re-

(Please turn to page 14)

Get perfectly exposed flash pictures like this. Automatically.



With a Honeywell Auto/Strobonar all you do is trip the shutter; the flash does the rest. It sends light out to your subject, then *automatically* shuts itself off when the subject receives the exact amount of light necessary for a perfect exposure. And it works with any fine camera.

Find out why Honeywell Strobonars are easier and more economical than flashbulbs. Write us for our **FREE** 20-page booklet that tells you everything you ever wanted to know about electronic flash, all in simple everyday language. Just write Honeywell Photographic, Dept. 116-121, P.O. Box 22083, Denver, Colorado 80222.

Honeywell



YOU GET ALL THIS with new NRI Master Automotive Technician home training. Included is the NRI Achievement Kit we send you the day you enroll . . . ten outstanding kits of automotive testing and repair equipment, plus educator-acclaimed NRI "bite-sized" texts — all yours to keep and use for years to come.



NRI announces a dramatic new way to learn Automotive Repair at home

Top auto experts praise NRI's new training plans

NRI's two new home training programs in Automotive Servicing and Repair have been acclaimed by three of America's foremost automotive experts. Richard Petty, America's winningest stock car racer says, "I especially like the way NRI has programmed essential training equipment they give you into step-by-step instruction." Tom McCahill, car tester and writer, commented, "The Master Automotive Technician



course gives ambitious guys a great start on a top dollar career. And that Tune-Up and Electrical Systems program can save do-it-yourselfers a bundle." William H. G. France, president of NASCAR reported, "The new NRI courses for mechanics are amazingly complete and seem to cover all major aspects of today's sophisticated cars. If you're at all interested in automotive training, I suggest you investigate NRI."



Professional equipment included at no extra cost

NRI gives you the choice of Master Automotive Technician training or a shorter Automotive Tune-Up and Electrical Systems course for the man seeking greater understanding of basic car repair. The Master course covers every major aspect of auto repair, from changing spark plugs to operating your own garage or car-care center. You not only learn the how and why with NRI's proved-in-use "bite-sized" texts, but you also get professional training equipment you need to actually do the work on your own or other cars as you move along in your home training. Equipment you get—at no extra cost—includes your own ignition-analyzer scope, as well as a dwell-tachometer, timing light, complete set of tools, volt-amp tester and assort-

ed gauges. You get ten kits in the Master Automotive Technician course, eight with the shorter Automotive Tune-Up and Electrical Systems Training program. The professional tools and equipment you get from NRI are yours to keep and use in the years to come, as you build a top-pay career as a Master Mechanic, or earn \$5 to \$7 an hour in spare time, or simply save money by repairing your own cars at home.

Train with the leader

The same pioneering home training methods and innovations which have made NRI the leader in other career training fields are now offered to ambitious men who want to turn their interest in cars into a solid, well-paying career. Take a tip from Richard Petty, Tom McCahill and Bill France, and train at home with the leader. Rush coupon now for free NRI Automotive Catalog. NRI, 3939 Wisconsin, Washington, D.C. 20016. **NO SALESMAN WILL CALL.**

APPROVED UNDER GI BILL—If you have served since January 31, 1955, or are in service now, check GI line in the coupon.

946-033

**Rush coupon
for FREE catalog**



NRI Training
3939 Wisconsin Avenue, N.W.,
Washington, D.C. 20016



Please send me your new Automotive Catalog. I understand there is no obligation. **NO SALESMAN WILL CALL.**

I am interested in Master Course Tune-Up Course.

Check here for facts on G.I. Bill

Name _____ Age _____
(Please print)

Address _____

City _____ State _____ Zip _____

ACCREDITED MEMBER NATIONAL HOME STUDY COUNCIL

**This car has no gaskets.
This car has no lock washers.
How does it run?**

164.835 mph

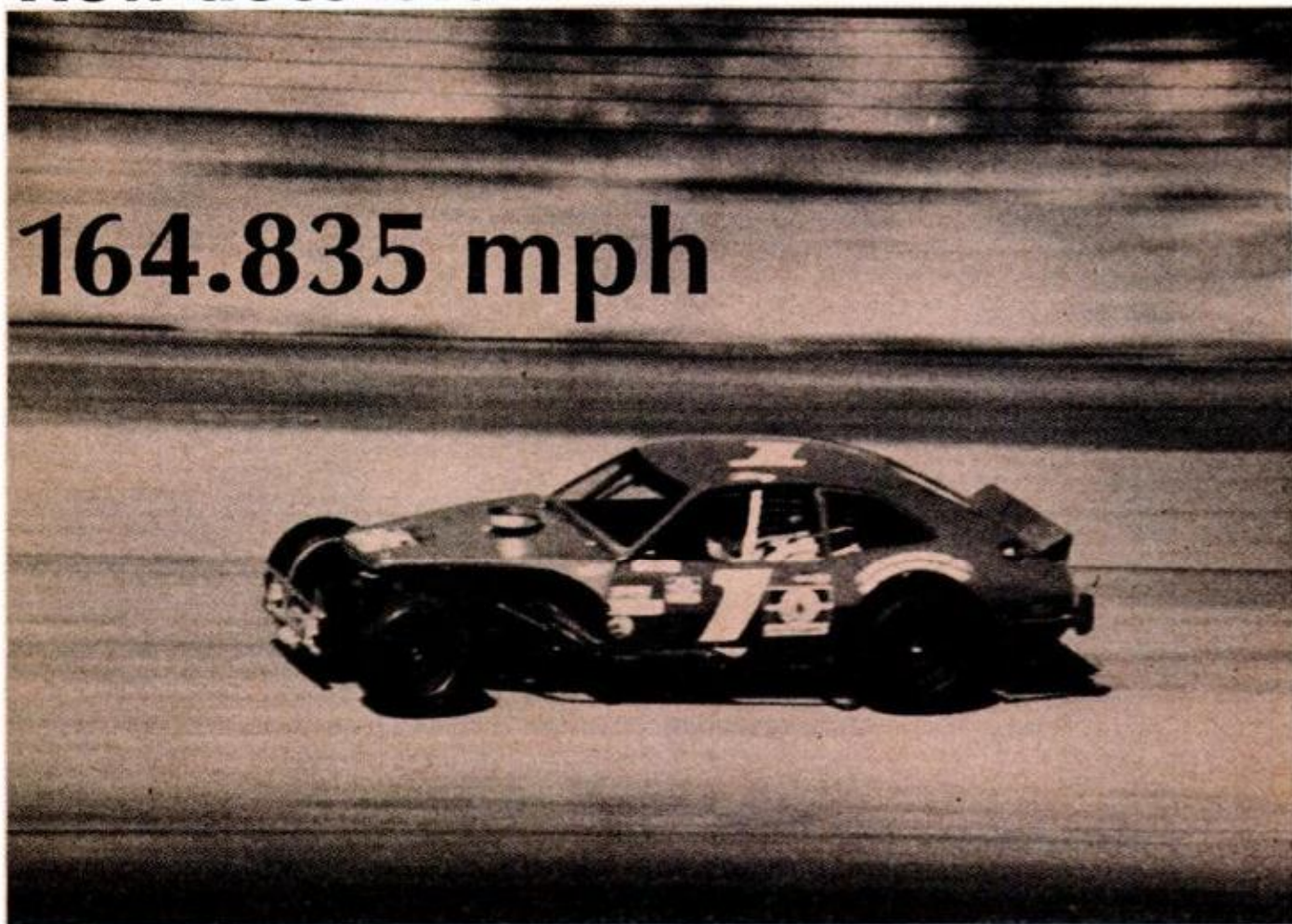

That blur you see whizzing by on the banking at Daytona is the new Permatex Modified. We put it together without one gasket or lock washer or locking device of any kind. Then we ran it under NASCAR's eagle eye for 250 miles at racing speeds.

It ran very well indeed. We lapped the oval in 55.6 seconds. On the road course we knocked off lap times of 2:04, which is a second off the record. All in all it was a pretty successful first run.

The products used included our Silicone Form-A-Gasket, that actually makes any size or shape gasket, and our amazing Lock Nut which makes any threaded fastening absolutely vibration proof.

Why did we do it? Just to remind you that Permatex products perform. That's why you find them at NASCAR garages, service stations, and wherever automotive products are sold.

You'll be hearing more about this car because we expect to be doing a lot more with it.

Want a free Permatex decal? It's yours for the asking. Send us a self-addressed stamped envelope and we'll do the rest.



PERMATEX COMPANY, INC.
P. O. Box 1350, West Palm Beach,
Florida 33402 305/686-0880

our name is our bond *Permatex*



Only
DREMEL[®]
puts it all
together!

the complete MOTO-SHOP:..

... for EVERYONE ... young, old, in-between, he or she — fun for avid hobbyists, pride for the skilled craftsman and creative buff, and fixing it power for the do-it-yourselfer ... EVERYWHERE. ... in your camper; at your office; in the kitchen, basement, rec. room, or attic; in school — the Dremel shop sets up anywhere there's an electrical outlet. (stores away in a 2 sq. ft. space) ... for EVERYTHING ... sawing, sanding, drilling, grinding, polishing, routing, sharpening, buffing, carving, engraving, deburring, trimming, you name the power tool job.

Dremel, putting together better ideas in compact packages for over 40 years!

DREMEL[®]
creative power tools

Dremel Manufacturing Co.
Dept. 903C, Racine, WI 53406



• MOTO-SHOPS • MOTO-TOOLS • ENGRAVERS • SHOE POLISHERS

Power Gun 1000 fastens everything...

The Power Gun 1000 is every homeowner's friend. It's the first extra heavy duty staple gun that does it all. You'll find hundreds of uses, indoors and out. It's a cinch to put up ceiling tile, fencing, paneling, insulation, etc.

There's a Power Lever for heavy duty drive, Power Dot for Super Drive, Swing-open bottom loading, At-a-Glance window



to check load and a built-in Staple Extractor. No jam problem—easy to clear. Sold separately...or in a kit



with three attachments—one for wiring, one for screens, one for shades. Both come in handsome carrying case.

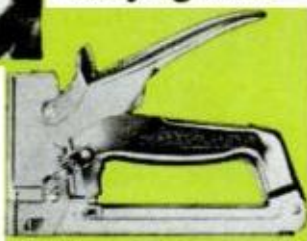

Swingline
32-00 Skillman Avenue, Long Island City, N.Y. 11101

LETTERS

(Continued from page 10)

moves the caps and allows the battery to air out before the posts are repaired.

Seligman further explains that as long as sulfation of the plates has not gone so far as to short the plates, acid is added to bring up specific gravity of the electrolyte. It should have a specific gravity of 1.265. (Our term, "pure," is regrettably somewhat ambiguous; it means that there are no impurities such as metal in the acid used for etching.) The acid is added to the cells a little at a time.

For complete safety, you will want to wear goggles, a rubber apron and safety gloves.

Celica's better than we said

I don't know who you contacted for opinions on the Toyota Celica ST (*PM Owners Report*, page 86, Jan. *PM*), but I wasn't one of them. So you may have my belated opinion to go with those you published.

The Celica is unquestionably the finest car I have ever owned. It is the first car I ever took delivery on that had zero factory defects. It is the first car I ever bought where the dealer sat down in the car with me for 15 minutes and went over all the dials, knobs and features before sending me off. It is the first car that ever offered me a special key to use in parking lots, that would not open the trunk or glove compartment. It is the first car that gave me a trouble light and toolkit. I could go on and on.

You panned the dealers and servicemen, but the two dealers I have dealt with could not have been better.

PHILADELPHIA

DR. R. ALEXANDER

Mod-24 framing

This Mod-24 building construction method "developed by the American Plywood Assn. and Western Wood Products Assn." (*What the New 24-Inch Framing System Means to You*, page 62, Dec. *PM*) is nothing new to me. My father has been using this type of framing for some 35 or 40 years. It has proven to be very sound construction.

LAFAYETTE, LA.

LYNN J. CURRY

I built my own home and used 24-inch frame spacing in some portions, instead of

the traditional 16 inches. I encountered several problems.

First, my materials costs were higher! The local building code specified 1/2-inch plywood subfloor for 16-inch joist spacing and 3/4-inch for 24-inch spacing. The higher cost of thicker plywood was partially offset by using fewer joists; however, the code required a bigger joist (2x12 instead of 2x10) in order to maintain the required load-carrying capacity of the floor. The net result was an increased cost of about \$150 for subfloor and joists.

There was a saving of \$40 or \$50 for the stud framing lumber.

The roof costs were about \$70 higher with 24-inch rafter spacing. Again, it was a matter of being required by the code to use thicker plywood and heavier rafters to compensate for increased spacing.

Second, the insulation in the walls does not maintain its proper shape. The 24-inch span gives enough play for the fiberglass to expand and eliminate the air space, which decreases the effectiveness of the insulation.

Finally, most 4x8 sheets of paneling have grooves that coincide with 16-inch framing. This hides nail heads. With 24-inch spacing, nailheads ended up in the middle of a simulated plank where they are more visible.

MILLERS, MD.

DAVID W. R. BROWN

Sears service manuals

We were surprised that the local Sears, Roebuck appliance-repair parts department contacted by your writer said it could not supply manuals for washers or dryers more than one year old (*Appliance Clinic*, page 58, Nov. '72 PM).

Kenmore service manuals are available through any of Sears Parts Departments. When ordering, ask for Kenmore Automatic Washer Service Manual (part No. 821462-A) and Kenmore Automatic Dryer Service Manual (part No. 828693).

The washer manual, for example, is designed to provide basic knowledge of the operation of the automatic washer. It does not cover a specific model, but covers in detail the repair of most components used on any model.

SEARS, ROEBUCK AND CO.
CHICAGO

SERVICE DEPT.

MARCH 1973

except what Rivet-It fastens

Riveting Plier fastens almost anything to anything strong, tight, neat, easy. Rivet-It is a do-it-yourself tool anyone can use to make a clean, professional-looking fastening job!

It's easier than nuts, bolts, screws, welding and soldering. You can do a hundred and one jobs—strong, tight, neat—just the way the factory does.

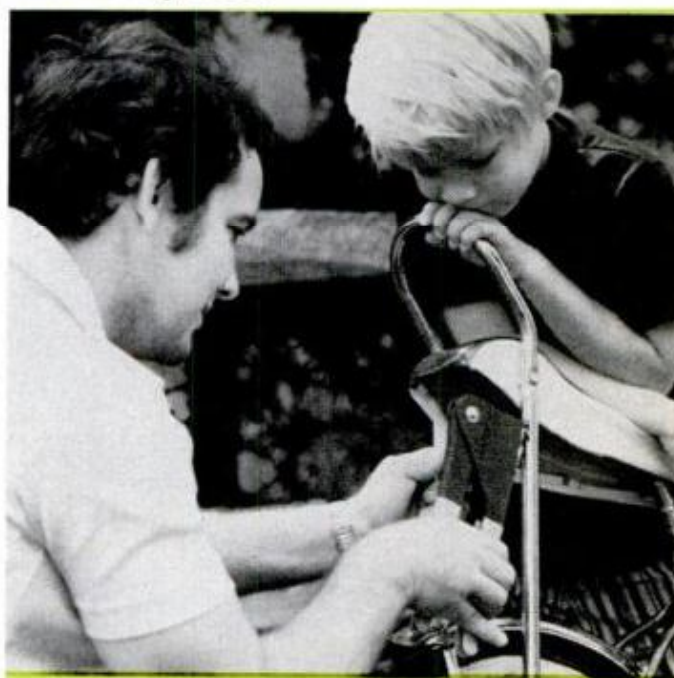

Rivet-It places, sets and cuts a rivet with one hand from either side. No reaching behind.

Ideal for autos, appliances, boats, camp-



ing equipment, motorcycles, snowmobiles, sleds, bicycles, toys, gutters and downspouts, pots and pans, metal furniture, mobile homes, trailers.



Swingline[®]
32-00 Skillman Avenue Long Island City, N.Y. 11101

25 technical careers you can learn in 2 years or less.



How far can you go without four years of college? Here's what the U.S. Government says about it in a booklet published by the U.S. Office of Education:

"A lot of people think that careers are meant for college graduates—jobs are for everybody else.

"Ten years ago, they may have had a point.

"But something's happened recently to change all that. A revolution in science and technology...

"You no longer need four years of college to start out on a scientific or technical career.

"You can break into any field—from medicine to computers to engineering

to the space program—with only a year or two of education. Just become a technician."

Free Guidance Materials

To help you select the technical career field that's right for you, we've listed opportunities in the special coupon, at right. And you can find out what you should know about the field you like best by simply checking off your choice and mailing the coupon today.

Free Guidance Booklet

By return mail, you will receive a free ICS Career Guidance Booklet that describes the opportunities, income and job security you might expect in your newly chosen field. It will also explain how ICS can help you get the

training you need to break into this new career field...right in your home...during your spare time...without losing a single day's pay from your present job ...and without ever setting foot in a classroom.

Free "Demonstration Lesson"

In addition, you'll receive a free "Demonstration Lesson" that lets you see for yourself why picking up the job skills you need—the ICS way—may be easier than you think.

More than 8,500,000 men and women have turned to ICS for career training since 1890. Some 2,000 American firms and government agencies are using ICS training programs to upgrade their employees. (Among these firms are such names as Ford, U.S. Steel, Chrysler, Mobil, 3M Company,

Take advantage of this U.S. Government booklet and get started in a big-income career.

"...you no longer need four years of college to start out on a scientific or technical career.

"You can break into any field — from medicine to computers to engineering to the space program — with only a year or two of education. Just become a technician." *U.S. Office of Education*

Alcoa, Pan Am, GE, Motorola and RCA.)

ICS career training is approved for veterans training, and is Accredited by the Accrediting Commission of the National Home Study Council. Just mail the coupon for your free guidance materials to: ICS, Scranton, Pa. 18515.



ICS International Correspondence Schools
Scranton, Pennsylvania 18515

RA505P

Please send me free ICS Career Guidance Booklet and a free "Demonstration Lesson" for the field I have checked below. I understand I am under no obligation.

- | | | | |
|--|--|---|--|
| <input type="checkbox"/> Architecture | <input type="checkbox"/> Communications, Broadcasting Technician | <input type="checkbox"/> Surveying & Mapping | <input type="checkbox"/> Engineering Technician |
| <input type="checkbox"/> Air Conditioning, Refrigeration & Heating | <input type="checkbox"/> Computer Servicing | <input type="checkbox"/> Drafting (Mechanical) | <input type="checkbox"/> FCC Licensing (Electronics) |
| <input type="checkbox"/> Automotive Mechanics | <input type="checkbox"/> Diesel, Gas Mechanic | <input type="checkbox"/> Electrician | <input type="checkbox"/> TV Servicing & Repair |
| <input type="checkbox"/> Auto Body Rebuilding Specialist | | <input type="checkbox"/> Electronics Technician | <input type="checkbox"/> CATV Tech. |
| <input type="checkbox"/> Engineering (Civil, Electrical, Mechanical, Chemical) | <input type="checkbox"/> Check here for special information, if age 16 or under. | | |

MR., MRS., MISS

AGE

ADDRESS

APT.

CITY

STATE

ZIP

“Old Friends”

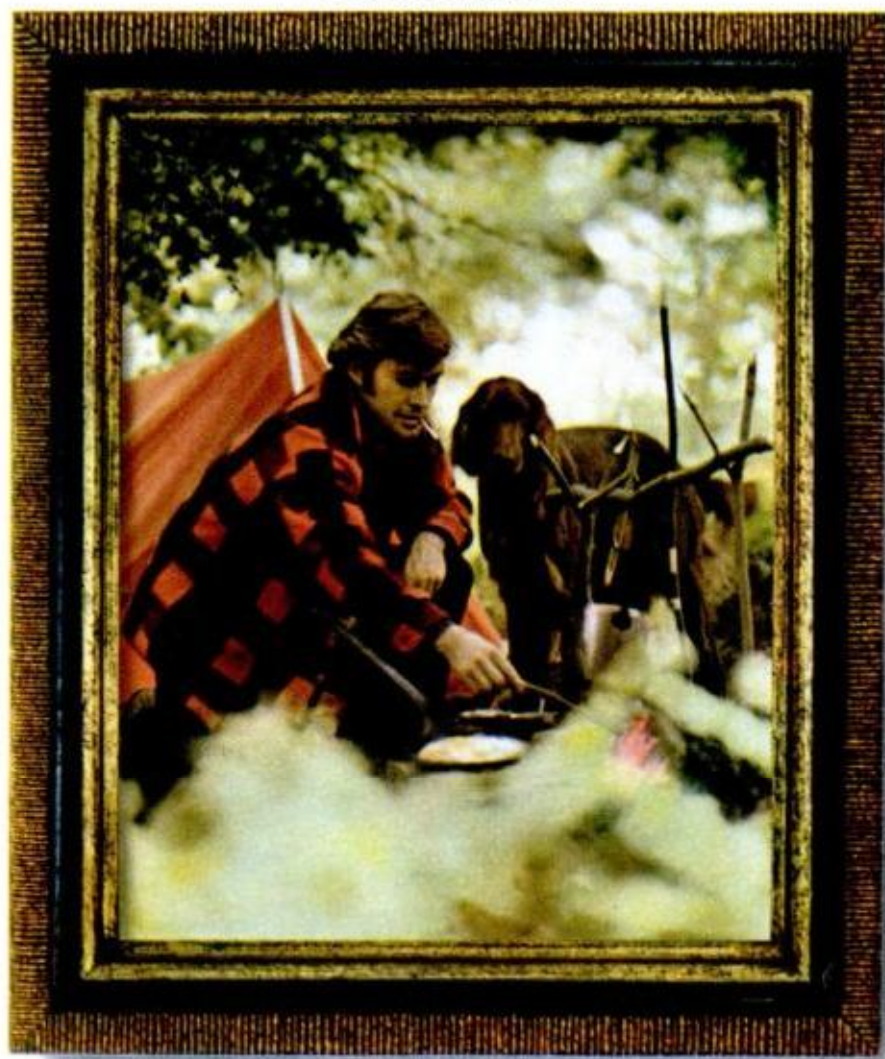

How good it is

Winston tastes good,
when a cigarette should.



Warning: The Surgeon General Has Determined
That Cigarette Smoking Is Dangerous to Your Health.

© 1972 R. J. REYNOLDS TOBACCO CO.

20 mg. "tar", 1.3 mg. nicotine av. per cigarette, FTC Report AUG. '72.

THE BICYCLE SHOP



By EUGENE A. SLOANE

How to build and lace a bicycle wheel

YOU WILL EVENTUALLY hit a hole in the road hard enough to flatten your rim. Then you'll begin to hear a rhythmic thump, thump, thump coming from the afflicted wheel which seems unrelated to any random rough spots you're riding over. You will very likely then have a flat spot bad enough that no amount of truing and aligning of the rim will remove it. Now you will need a new rim.

Or, you may simply decide to upgrade your bike with better hubs and rims, or switch from clinchers to tubulars but use your old hubs. For these or other reasons, you may want to lace a new rim onto an existing hub, or vice versa.

For some reason, probably because of the maze and complex angles of spokes, lacing and building a wheel has for years been a virtual mystery to even skilled home bike mechanics. I once saw a West Coast math professor busily figuring out spoke angles with compass and protractor, with the idea of computing spoke angles so he could follow an existing wheel as he laced a new one. Wheel building simply isn't that difficult, although even with these simplified steps it might take you an hour to finish lacing your first wheel. You should soon be able to poke all the spokes in rim and hub in 30 minutes, and with practice in 10 minutes. That's not bad, considering a bike shop charges upward of \$6 to \$8 to build a wheel, exclusive of parts.

In this issue I will discuss wheel building only. Truing and aligning the wheel will be the subject of next month's *Bicycle Shop*.

In building a wheel, I assume you will be using a 36-hole rim and hub and 27-inch tubular or clincher tires, since most of the better 10-speeds sold today are so equipped. However, those instructions also

apply to other wheels with "crossed over four" spokes.

First, a few tips:

- *Make sure you have the right-size spoke.* Use an old spoke, or, if you have a wide flange hub and are lacing a 27-inch rim, use 12 or 12 $\frac{1}{16}$ -inch spokes. I prefer Robergel spokes for strength, but Union will do.

- *Remove freewheel gear cluster on rear wheel so you can poke spokes in hub in freewheel side.*

- *If you're lacing a small flange hub (1-inch diameter), you can still use 12-inch spokes if you cross three instead of four (see below).*

- *If spokes do not fit easily into hub holes, or spokes won't bend so spoke head seats easily into hub hole, ream hub holes out with a $\frac{3}{32}$ -inch drill; if still too tight, with a $\frac{7}{64}$ -inch drill.*

- *Definitions: Rim is the part the tire goes on. Hub contains bearing and axle. Spoke head is the part with the curved section and flat head. Spoke nipple is the short tubular threaded piece that holds the spoke on the rim.*

- *A 1-inch hole drilled in your workbench holds the hub upright for easier lacing.*

(Please turn to page 22)

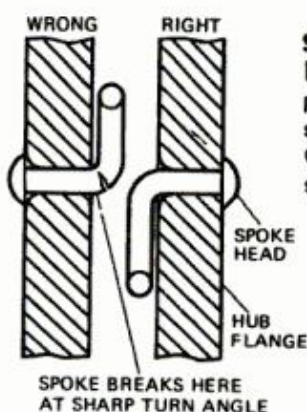

SOME HUBS have every other hole countersunk. Always put spoke head in uncountersunk hole (drawing, left). Countersinking will relieve stress where spoke curves

HUB HOLES in one flange are offset from holes in the other flange. Poke a spoke down through the top flange; it lands between holes in the facing hub flange, as shown in photo

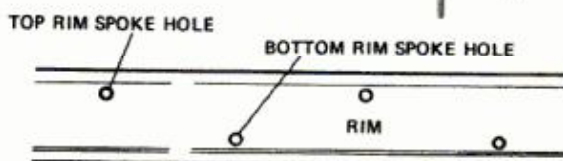

RIM HOLES are also offset. Every other hole is closer to the edge of the rim, as shown. Ignore the rim valve hole throughout these instructions; do not count it as a spoke hole as you lace the wheel

THE BICYCLE SHOP

(Continued from page 21)

Step 1: Hold hub upright in one hand, nine spokes in the other hand, spoke heads up. Poke a spoke down into every other hole in hub top flange (drawing, below). If every other hole is countersunk, poke spokes in noncountersunk holes. Now, using a spoke from top flange as guide, with hub still held as before in one hand, poke spokes down into every other hole in bottom flange, starting with first hole in bottom flange to left of where guide spoke hits flange. Do not put spoke into countersunk hole!

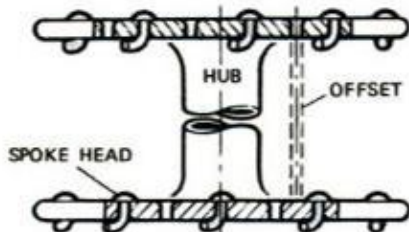

Step 2: With hub in same position as in Step 1, fan out spokes and, holding spokes so they won't fall out, turn hub over. Poke spokes in remaining holes in top and bottom flanges, with spoke heads up (drawing, below). (Relative position of spoke heads depends on which flange faces up.)

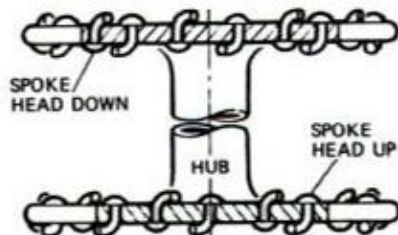

Step 3: Spread all spokes out and lay fully spoked hub on bench. Put rim down so hub is more or less centered. (We will from here on refer to spokes in hub as head-up or head-down. Head-up means spoke head faces upward from top of flange; head-down means spoke head faces downward, so spoke comes through flange hole from underneath. See drawing above.)

Step 4: Put any head-up spoke from top hub flange in any top rim spoke hole. Thread nipple on about six turns. (From here on thread nipple on each spoke as you insert it in rim.) Count off four rim holes to right of first spoke inserted in rim and put next right head-up spoke from top hub flange into that hole, which is a top rim hole. Continue until all top hub flange spokes are in all top rim holes and nipples threaded on. (Ignore the mess of spokes around you; concentrate on spoke involved.) Photo shows first four spokes installed. Note rim is moved

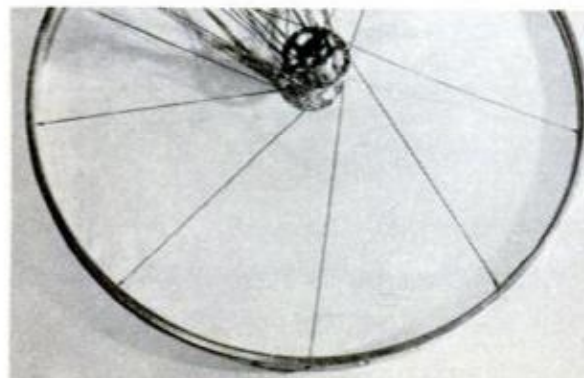

to left so spokes are twisted to clear just out-board of the next left head-down spoke in top hub flange, which is vital to wheel lacing. Note also the three empty rim holes between each spoke, two bottom holes and one top hole. Top holes are for remaining spokes in top hub flange.

Step 5: Take any of the remaining nine head-down spokes from top hub flange and cross over three spokes to right and under the fourth spoke and put in top hole in rim (drawing, below). Note that spoke E, which is the one we are lacing in Step 4, passes over spokes A, B, and C and under spoke D.

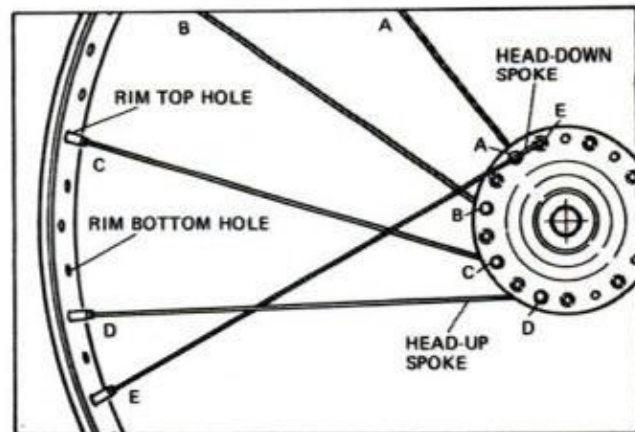

Step 6: Lace the remaining eight head-down spokes in hub top flange as per Step 5, crossing over the three spokes to the right and under the fourth spoke. Thread nipples on as you go. You should now have laced groups of two spokes in the rim, with one empty hole between the two, as shown between spokes D and E in the drawing above.

Step 7: Turn the wheel and hub over. Take any head-up spoke in the top flange. Refer to hub photo, page 21, which shows that spoke holes in top and bottom flanges are offset instead of being drilled vertically in line top to bottom. In the photo accompanying this step, letters designate key spokes.

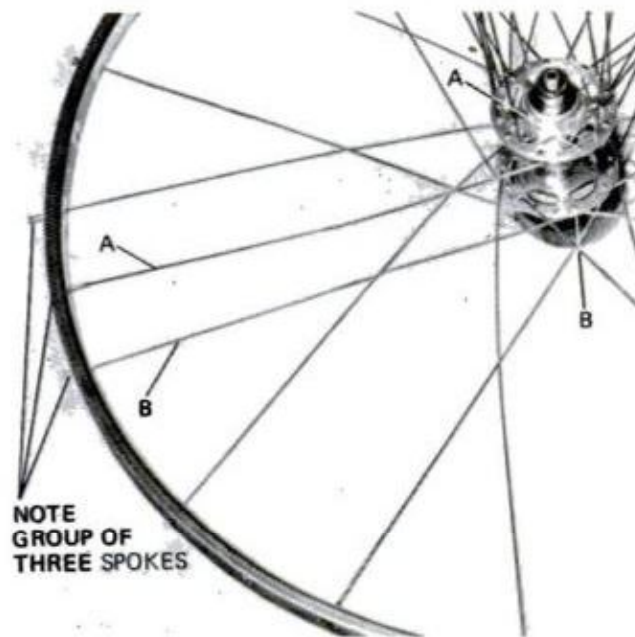

NOTE
GROUP OF
THREE SPOKES

Sight down any head-up spoke (A) in top flange (the flange that's now on top) or use a spoke as a guide, and find the head-up spoke (B) in bottom flange

(Please turn to page 24)



A truck for all seasons.

The Datsun Li'l Hustler Pickup. Besides being a die-hard workhorse, it's a spunky little fun packer for all seasons.

Fact is, you can stow up to 1440 pounds of friends and fun in Li'l Hustler's new roomier cab and all-steel 6-foot bed. Whenever the spirit moves you.

And move you will. With a 1600 cc overhead cam engine that can stretch a gallon of gas up to 25 miles. A silky-smooth 4-speed gearbox, or

new optional 3-speed automatic. And, something else you won't get with any other small truck: Li'l Hustler sales and service.

You're not limited to certain "truck" dealers, or geographical areas. Datsun backs you nationwide at every one of our nearly 1,000 dealers from sea to shining sea.

Of course, you'd expect that from America's original small truck. Maybe that's why we're still No. 1. Drive a Datsun... then decide.

Own a Datsun Original.

From Nissan with Pride

NEW FREE BOOK DISCUSSES HOW TO SELL YOUR INVENTION

If you have an invention (whether patented or unpatented) that you believe has commercial value, our Free Booklet entitled "How to Go About Selling Your Invention" may help you save time and money.

We are specialists in representing inventors and submitting their inventions to manufacturers. We work with scores of manufacturers who are seeking new products or new product ideas, and we therefore know which firms may be interested in your particular invention. Our service is designed to do all those things the average inventor lacks the knowledge or facilities for doing, or does not have time to do. We prepare your sales letters, folios, duplicate drawings, handle correspondence, select the firms.

We charge the standard commission (on sales) and a modest fee for the submitting service. This fee is refunded if a manufacturer buys your invention through our efforts. We are a nationally known concern with an impeccable reputation for ethics and integrity.

The Free Booklet we have prepared especially for inventors contains such information as current royalty rates being paid by manufacturers, discusses many types of inventions, the possible market for them, tells the effective methods of presenting your invention for sale, whether you employ us or do it yourself, and outlines how we may be able to help you.

You can obtain this booklet "How to Go About Selling Your Invention" by mailing the coupon below. And if you wish to write us for comments on your invention, please do so. We make no charge for consultation. But please do NOT send drawings or models. Just describe the purpose and nature of your invention. Mail the coupon to K. O. Kessler, Pres., Kessler Sales Corporation, Dept. D-53, Fremont, Ohio 43420.

You are welcome to ask your lawyer, local Bank, Chamber of Commerce to carefully check on our reputation for honesty and fair-dealing.

---MAIL THIS COUPON---

Mr. K. O. Kessler, President, Dept. D-53
Kessler Sales Corp., Fremont, Ohio 43420

Please mail me a copy of your Free Booklet "How to Go About Selling Your Invention." It is understood that this does not obligate me in any way to use your Service.

My Name

Street Address

City State..... Zip.....

THE BICYCLE SHOP

(Continued from page 22)

just to left of head-up spoke in top flange above. Line head-up spoke in top flange roughly parallel with the head-up bottom flange spoke you have just found (spoke to left below). Insert the head-up spoke from top flange into top rim hole to right of the head-up bottom flange spoke you were using as a guide. (This is the next hole to right of the bottom flange head-up spoke.) Note the relationship of top flange head-up spoke (Spoke A) to its counterpart (spoke B) in bottom flange.

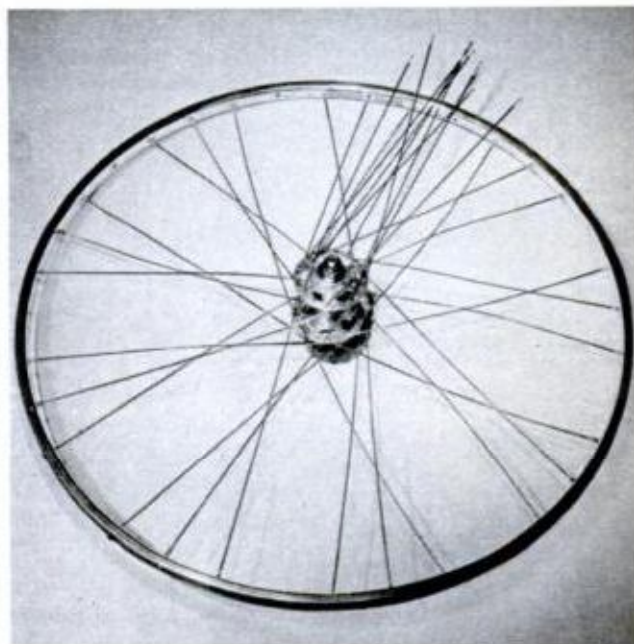

Step 8: Continue lacing head-up holes in top flange into rim as per Step 7. When finished, spokes will be in groups of three, as shown above. Lace spokes to left, as in Step 4.

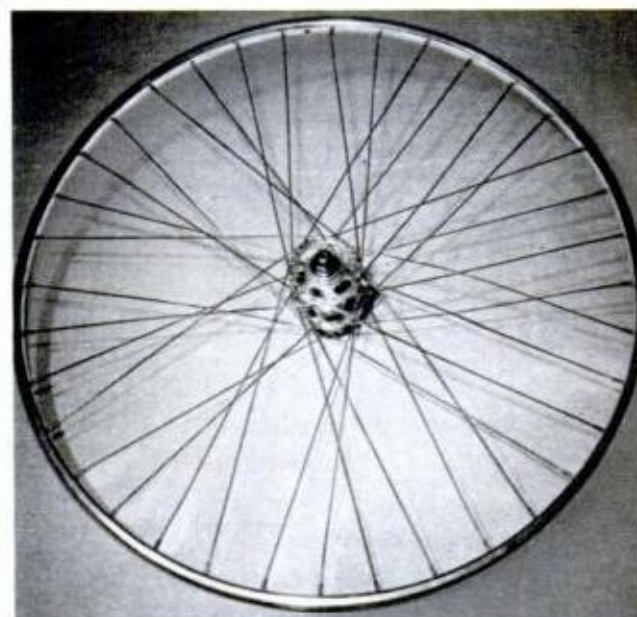

Step 9: Lace remaining nine head-down spokes in top flange to right, crossing over the first three and under the fourth spoke just as you did in Steps 5 and 6. Take up all nipples (with ratchet screwdriver for speed) so only one or two spoke threads show. You are now ready to align and "true up" the wheel, which will be discussed next month. ★★

Seven & Seven.



That's Seagram's 7 Crown and 7 Up.

It's very easy.

All you need is a lazy afternoon, a place where no one can find you, and each other. Take your shoes off, build a crackling fire, and fill two large mugs with 7 Up and 7 Crown, America's light tasting whiskey.

Then settle back, smile and make your first toast together.

Seven & Seven. Easy to say. Easy to mix. And easy to enjoy.



Seagram Distillers Co., N.Y.C. American Whiskey—A Blend. 86 Proof.

"Seven-Up" and "7 Up" are registered trademarks identifying the product of the Seven-Up Company.

Here's the Easy,
Step-by-Step
Way to

FIX ALMOST ANY PART OF ALMOST ANY CAR

Engines, Brakes, Transmissions, Rear Ends, Alternators—Yes, All These Parts

BRAND-NEW
EDITION!
Includes 1973
Models

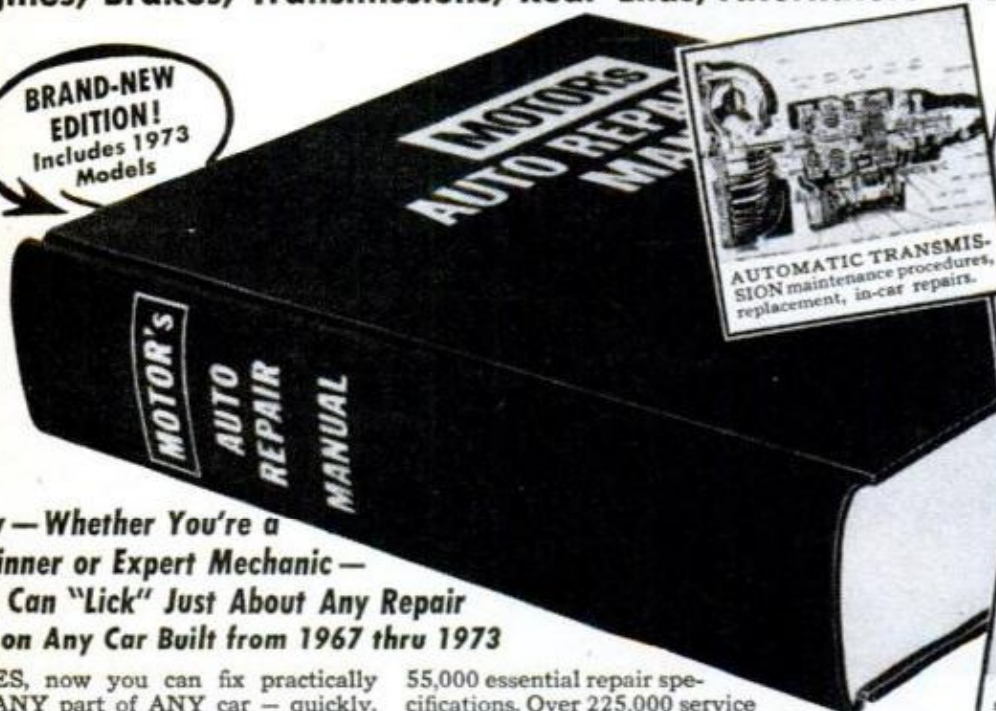

AUTOMATIC TRANSMISSION maintenance procedures, replacement, in-car repairs.

Over THREE THOUSAND pictures make every operation easy as A-B-C.

Diagrams, tables and text take the "mystery" out of ignition systems.

You get illustrated step-by-step adjustment procedures for all types of carburetors.

Now—Whether You're a Beginner or Expert Mechanic—You Can "Lick" Just About Any Repair Job on Any Car Built from 1967 thru 1973

YES, now you can fix practically ANY part of ANY car—quickly, easily, and right! From carburetor adjustment to a complete overhaul, it's easy when you have MOTOR's famous illustrated Auto Repair Manual. It's like having a staff of factory experts and MOTOR's field-trained engineers beside you, guiding you every step of the way. No wonder so many thousands of beginners and experts alike use this step-by-step, illustrated Manual.

55,000 essential repair specifications. Over 225,000 service and repair facts. Instructions and pictures so clear you can't go wrong! Experts and beginners alike are amazed by the time and labor saving methods.

SIX
MILLION
COPIES
SOLD!

The "Meat" of 300 Official Shop Manuals

The editors have put together the "know-how" from 300 Official Shop Manuals and "boiled it down" into one fully-illustrated, easy-to-understand guide.

Here's ILLUSTRATED step-by-step guidance on Automatic Transmissions, Alternators, Distributors, Carburetors, Three and Four-Speed Transmissions, Power Brakes, Power Steering, Starters, Brakes, PLUS MUCH MORE.

SEND NO MONEY
Try Book for 10 Days FREE

Just mail coupon, We'll rush your copy for free 10-day trial. See for yourself what this amazing book does for you. Guaranteed to pay for itself in 10 days, or you owe nothing. MOTOR Book Dept., P.O. Box 2316, F.D.R. Station, New York, N.Y. 10022.

SEND NO MONEY
Try Book for 10 Days FREE

Clears Up 'Mysteries'

"I always rely on Motor when I do a repair I am not familiar with. Well illustrated, complete, simple." —E. Jones, Minnesota (Shop Owner)

Great Help For Student

"Motor pulled me out of some rough spots in high school and even now. At present, I'm in the Armed Forces, attached to the motor pool." —W. Bekemerer, Missouri (Apprentice)

MOTOR's Manual "starts from scratch"—leads you through the entire job with easy step-by-step directions, clear "how-to" pictures. Tells you WHERE to start, which TOOLS to use, WHAT to do!

3,000 Pictures So Complete,
So Simple, You CAN'T Go Wrong!

NEW REVISED edition covers all you need to know to repair all the makes 1967-1973 listed below, including all the new models! Over 1,000 pages. Over 3,000 "This-is-How" pictures lead you every step of the way. Hundreds of "Quick-Check" charts—

Same Offer on MOTOR's AUTO ENGINES & ELECTRICAL SYSTEMS

700 pages, 1,300 big pictures. Clear text explains how parts work; principles involved; design; construction; maintenance. Covers all parts of engines & entire electrical system. For FREE trial, check box in coupon.

Brand-New — Covers All These Makes

Volkswagen	Ford	Corvair
Mustang	Chevelle	American
Barracuda	AMX	Olds FBS
Buick Special	Chevrolet	Falcon
Chevy II	Gremlin	Javelin
Pontiac	Chrysler	Nova
Thunderbird	Plymouth	Tempest
Buick	Cougar	Corvette
Imperial	Rambler	Valiant
Cadillac	Dodge	Front Drive
Lincoln	Oldsmobile	Cadillac
Dart	Maverick	Torino
Continental	Toronado	Pinto
Mark III	Montego	Challenger
Mercury	Comet	Hornet
Vega	Fairlane	... More!

MOTOR BOOK DEPT.

P.O. Box 2316, F.D.R. Sta., New York, N.Y. 10022

Please send me the Manuals checked below for ten days free examination:

11122 MOTOR's Auto Repair Manual, \$10.95

12526 MOTOR's Auto Engines & Electrical Systems, \$10.95

If I am not fully satisfied, I will return the shipment promptly and owe nothing. Or I will keep it and pay the total price in three monthly installments, plus a small shipping charge.

I WANT TO SAVE SHIPPING CHARGES. I am enclosing payment of \$..... in full and you will pay shipping charges. (Same return privileges, refund guaranteed.) F113

Print Name.....

Address.....

City & State..... Zip Code.....

Signature Please..... Age.....

Offer available only in the Continental United States and Canada. Prices slightly higher in Canada. Delivery will normally be 3-4 weeks in Eastern United States and slightly longer west of the Mississippi. (H.W. Books)

Jobs open up for Technicians with down-to-earth training!

Opportunities are everywhere and the pay is excellent in the technical service industries. But it takes the right training to get a man started: NTS Project-Method Home Training!

You learn by building the latest equipment and test instruments (which are included in your tuition). You're guided every step of the way by easy-to-read NTS Lessons.

When you graduate, you know service and repair from the bottom up, inside-out!

You have answers on the tip of your tongue. Know-how at your fingertips. You have the down-to-earth training experience employers are willing to pay good money for!

Find out. Send card today. No obligation. No salesman will call.



Solid-State Color TV 315 Sq. In. picture

ELECTRONICS DIVISION

NTS offers a wide-range of training with solid-state equipment (almost all of it commercially available). Build a solid-state 315 sq. in. Color TV; solid-state B&W TV; solid-state FM multiplex Receiver and Speakers; solid-state Oscilloscope; solid-state Compu-Trainer. Plus, Amateur Phone Transceiver, FET Volt-Ohmmeter, Electronic Tube Tester, Signal Generator, and more! Get valuable experience in the latest electronics technology. Read details in catalog.



AIR CONDITIONING/ REFRIGERATION & HEATING DIVISION

NTS provides you with the important tools of the trade! Courses include specially-designed Hermetic Unit Analyzer — a tester with multiple applications; Leak Detector-Soldering Kit — with hundreds of uses; Charging-Testing-Purging Manifold Set with dispensing and piercing valves. Plus, Socket, Wrench, Open-End Wrench, Tube Bender Sets, and more!



MECHANICS DIVISION

NTS includes professional tools and test equipment. Earn as you learn. Make money even before you graduate! Big 109 piece Socket Wrench and Tool Set — all American made! And a Performance Kit — Timing Light, Smog Valve Tester, Compression Tester, Remote Starter Switch, Dwell Tach, Alternator-Generator-Regulator Tester. Also, "Speed Shop" lessons and diesel training.



HOME APPLIANCE DIVISION

Multiply your experience with appliance circuitry through the exclusive NTS Circuit Trainer. Eliminates the need to buy dozens of appliances for training purposes. The 4-in-1 Appliance Tester performs many troubleshooting tasks. It includes an Ohmmeter, Voltmeter, Ammeter, and Wattmeter; measures both AC and DC currents; it will be valuable to you during training and on the job!

APPROVED FOR VETERANS

Accredited Member: National Association of Trade & Technical Schools; National Home Study Council.

CLASSROOM TRAINING AT LOS ANGELES

Train in sunny Southern California. NTS occupies a city block with over a million dollars in training facilities. Check box.

NATIONAL TECHNICAL SCHOOLS

WORLD-WIDE TRAINING SINCE 1905
Resident & Home Study Schools
4000 So. Figueroa St., Los Angeles, CA. 90037

NATIONAL TECHNICAL SCHOOLS

WORLD-WIDE TRAINING SINCE 1905

Resident & Home Study Schools
4000 So. Figueroa St., Los Angeles, CA. 90037

Send for color Catalog and Sample Lesson — both FREE! Check below. No salesman will call. No obligation.

- Electronics Division Mechanics Division
 Air-Conditioning, Refrigeration, Heating Division Home Appliance Division

NAME _____ AGE _____

ADDRESS _____

CITY _____ STATE _____ ZIP _____

- Check for Veteran Training under G.I. Bill
 Check if interested in information on Classroom Training in Los Angeles

Dept. 201-033

science worldwide

By JOHN PEARSON



Dr. Feinbloom checks out specs

VISION OF PARTIALLY SIGHTED PERSONS can be improved from 600 to 1000 percent through the use of new "zoom" spectacles, according to the inventor, Dr. William Feinbloom, a New York City optometrist. Each eyepiece has two lenses that are separated by about an inch of airspace. The system is said to greatly increase the amount of light that hits the eye. Dr. Feinbloom claims his invention can help people with less than 10 percent of normal vision, enabling them to read magazines, watch television and, in some cases, drive a car. Dr. Feinbloom makes his spectacles available to all who need them, declaring: "My invention belongs to the world." Still, the glasses are expensive, costing from \$600 to \$800 a pair.



Weigh-in for two-day-old pig

THE SOURCE OF MUCH-NEEDED PROTEIN in developing countries could be the rabbit, long noted for its ability to proliferate. That's the theory of researchers at the Battelle Laboratories, Columbus, Ohio. They say that rabbits offer high nutritional value at low investment cost as well as returns from the sale of pelts and other by-products. Studies indicate that a female can produce five litters a year—about 150 pounds of marketable rabbit.

THE SMALLEST PIGS in the world—averaging about 80 pounds as adults—are bred at the University of Gottingen, West Germany. They stem from a line of miniature American pigs and are used for research. Porkers are good test subjects because they suffer many of man's ailments, have similar circulatory systems and will eat whatever man eats, an aid in carrying out research in human digestive problems. But standard-sized pigs—some top 1000 pounds—are too big and heavy for most lab facilities. They also eat too much.



Plastic pyramids trap the sun

THOUGH APOLLO 17—the last moon mission—is over, scientists on Earth will continue to receive live reports from the moon for at least two years. An extensive network set up by Apollo crews since 1969 and powered by atomic energy allows for direct relay of data from experiments on the moon. Instruments in the network measure such things as tremors beneath the lunar surface, heat radiating from within the moon, gravitational and magnetic forces, and particles in the lunar atmosphere.

A HEATING PROBLEM was solved in the sprawling entertainment center on Britain's Isle of Man by constructing its walls and roof of transparent plastic. When

(Please turn to page 32)

If you like to work with your hands, consider all these different ways you can



HAVE FUN and MAKE MONEY in AIR CONDITIONING



FASCINATING HOBBY... PART TIME MONEYMAKER...



... "SECOND SKILL" TO FALL BACK ON ...



OR A BUSINESS OF YOUR OWN!

If you like working with your hands, the coupon at the bottom of this ad could be your ticket to many enjoyable hours . . . and some very pleasant money, too.

That's because this coupon brings you free details of the unique Liberty School course in AIR CONDITIONING, Refrigeration and Heating. What's so special about Liberty's Air Conditioning Course? First—it's designed with fun in mind. Repairing air conditioners, heating units, refrigerators is fascinating, relaxing, satisfying work for men who like to do things with their hands. There's a feeling of real accomplishment in "making things run again." And knowing how to fix these essential items can SAVE you a fortune on repair bills! Thanks to Liberty, you can learn at home.

Second—Liberty School's Air Conditioning Course shows you the way to a part time income repairing air conditioners, heating units and refrigerators (more and more homes now have all three)

around your neighborhood.

Third—Liberty's highly professional, yet-easy-to-learn-at-home system gives you a "second skill" to fall back on in case you're laid off of your regular job...especially important in these uncertain times. 40,000 more trained men are needed in Air Conditioning every year—at a time when men of other skills and trades are wishing for work!

Fourth—as a skilled Air Conditioning technician you can look forward to a retirement income or retirement business for yourself. No previous experience needed! We teach you everything, at home, in your spare time . . . you can go on working at your regular job while you're preparing for a better future.

So whether you're looking for an interesting hobby . . . part time money . . . a "second skill" to fall back on . . . or a profitable retirement business of your own . . . mail the coupon and get the facts. Who knows? It might even lead to an exciting new career!

YOU'LL LIKE THE LIBERTY SCHOOL

It's different. Directed by Roy Anderson, whose experience in training men at home goes back to 1935, The Liberty School employs no salesman . . . sells no costly, unnecessary equipment. That's why The Liberty School can teach you valuable skills and turn out topnotch graduates at so much less cost than many other schools.

LIBERTY SCHOOL Dept. J-3
1111 W. Park, Libertyville, Ill. 60648

THE LIBERTY SCHOOL, Dept. J-3
1111 W. Park
Libertyville, Ill. 60648

**NO SALESMEN
WILL CALL!**

MAIL free details telling how I can learn at home to have fun and make money in AIR CONDITIONING, Heating & Refrigeration.

Name _____ Age _____
Address _____
City _____ State _____ Zip _____

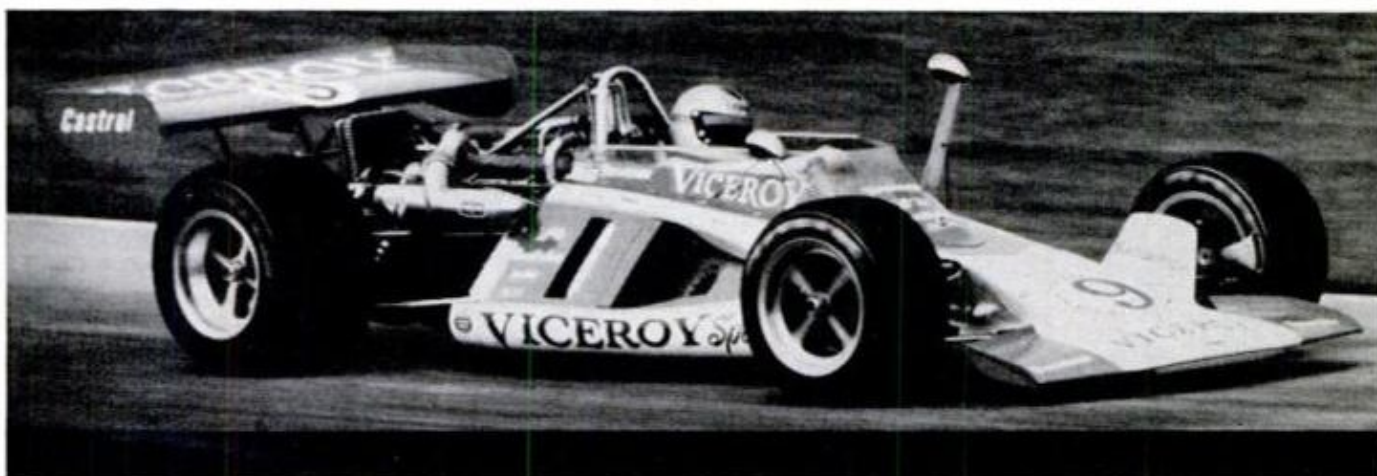

The Inside Story

Castrol GTX Motor Oil—superfine lubrication for a high speed racing car—taking 200 MPH torture, proving its stamina. To win your trust. Because the demands on your car engine are tough as any race. 365 fast morning starts every year. Stop and go traffic. Air conditioners. And towing trailers. Every year, experienced race drivers like Al Unser, Joe Leonard and Mario Andretti prove Castrol GTX engine lubrication and protection is the best. But everyday, your engine demands prove you need Castrol GTX Motor Oil the most. Yes, Castrol GTX Motor Oil costs more. Quality usually does. But in the long run, Castrol Quality is still cheaper than new engine parts. Castrol Oils, Inc., New York, N.Y.



LIVE IN THE WORLD OF TOMORROW... TODAY!

UNUSUAL BARGAINS

NEW PRODUCTS • NEW MATERIALS • NEW IDEAS

AMAZING NEW WANKEL ENGINE KIT!



Thrill in the fun of building your own see-through motorized model of revolutionary pistonless type engine... only engine experts think economically modifiable to meet new pollution standards. Replaces piston, cylinder, crank assemblies with rotating discs (sections removed for firing chambers). Smaller than conventional, greater reliability, same speed w/ less horsepower. Feat: flashing plugs, rubber fan belt, stick-shift on-off switch. Req. 2-1.5V batt. (not incl.)

No. 71.424H (4 1/2" X 5" X 9") \$6.75 Ppd.
 510-Page Wankel Engine Book
 Stock No. 9.439H \$15.25 Ppd.

"FISH" WITH A MAGNET



Go treasure hunting on the bottom! Fascinating fun & sometimes profitable! Tie a line to our 5 1/2-lb. Magnet—drop it overboard in bay, river, lake or ocean. Troll it along bottom—your "treasure" haul can be outboard motors, anchors, other metal valuables. 5 1/2-lb. Magnet is war surplus—Alnico V Type—Gov't cost \$50. Lifts over 150 lbs. on land.

Stock No. 70.571H \$14.00 Ppd.

Stock No. 60.215H 1 1/2 lbs. \$ 5.75 Ppd.
 Stock No. 70.570H 3 1/2 lbs. (lifts 40 lbs.) \$ 8.75 Ppd.
 Stock No. 85.152H 15 3/4 lbs. (lifts 350 lbs.) \$33.60 FOB

GIANT WEATHER BALLOONS



"Balls of fun" for kids, traffic stoppers for stores, terrific for amateur meteorologists. Create a neighborhood sensation. Great backyard fun. Exciting beach attraction. Amateur meteorologists use to measure cloud heights, wind speed and temp. Made of heavy-duty neoprene. Inflate with vacuum cleaner or auto air hose; or locally available helium for high rise.

Stock No. 60.568H (8' size) \$2.50 Ppd.
 Stock No. 60.632H (16' size) \$7.00 Ppd.

HONDA 750 "FOUR" ENGINE KIT



Build big 1/3 scale see-thru motorized wkg model of the 4-cyl engine that makes 750 Four most advanced motorcycle on the mkt. 68 hp. engine that won Daytona revs up to 8000rpm, top speed over 125 mph. Feat: overhead cam 4-stroke engine design; 4 synch carbs, 4 upswept mufflers, & hemi heads with offset valves. Shows valve opening & closing, piston cycle, flashing plugs, etc. 187 metal & plastic pre-colored parts, display stand, instrs. Req. 2 "AA" Batt (not incl.)

Stock No. 71.750H \$12.95 Ppd.

AMERICAN MADE OPAQUE PROJECTOR



Projects illustrations up to 3" x 3 1/2" —enlarges them to 35" x 30" if screen is 6 1/2 ft. from projector, larger pictures if screen is farther away. No film or negatives needed. Primarily intended for children. Projects charts, diagrams, color or black-and-white in darkened room. 115 v. A.C. . . . 6 ft. cord and plug included. Size 12" x 8" x 4 1/2" wide. Weight 1 lb. 2 ozs. Plastic case.

Stock No. 70.199H \$8.75 Ppd.

'Bright Ideas' in Unique Lighting Big, new 100-page handbook packed with facts, loaded with illustrations. All latest developments, applications, equipment. 8 1/2" x 11" looseleaf paper to fit 3 rings. Stock No. 9100 H \$3.00 Ppd.



MAIL COUPON FOR GIANT FREE CATALOG!

164 PAGES • MORE THAN 4,000 UNUSUAL BARGAINS!

Completely new 1973 Catalog. Packed with huge selection of telescopes, microscopes, binoculars, magnets, magnifiers, prisms, photo components. Ecology and unique lighting items, parts, kits, accessories—many hard-to-get surplus bargains. 100's of charts, illustrations. For hobbyists, experimenters, schools, industry.

EDMUND SCIENTIFIC CO. 300 Edscorp Building, Barrington, N. J. 08007
 Please rush Free Giant Catalog "H"

Name _____
 Address _____
 City _____ State _____ Zip _____

EDMUND SCIENTIFIC CO. 300 EDSCORP BLDG. BARRINGTON, NEW JERSEY 08007
 ORDER BY STOCK NUMBER • SEND CHECK OR MONEY ORDER • MONEY-BACK GUARANTEE

SCIENCE WORLDWIDE

(Continued from page 30)

the sun shines, the building heats up to 80° F. When it's cloudy, auxiliary boilers take over. The plastic is shaped into thousands of tiny pyramids, which, engineers say, act as "sun traps." The walls are strong enough to withstand the 120-mph gusts that are generated by storms over the Irish Sea.

The environment

AIR POLLUTION seems to be everywhere, including high in the Swiss Alps. The Rhone glacier, once an almost transparent river



of ice, is covered with a layer of gray dirt that has been formed over the years by waste particles from industrial sources, autos and jetliners.

EFFECTS OF AIR POLLUTION on plant life are illustrated in a series of 35-mm color slides prepared by the Department of Agriculture. They're designed to help identify pollutants that harm vegetables and fruits, field crops, and ornamental plants and trees. A set of 105 frames, for \$18.50, can be ordered from the Photography Div., Office of Information, U.S. Department of Agriculture, Washington, D.C.

A TECHNIQUE for "marking" seagoing oil shipments with invisible magnetic tags has been developed by General Electric scientists. Every time a tanker takes on petroleum, its cargo could be tagged with a batch of magnetic dust. Each batch would have slightly different magnetic properties from all others used, and the properties would be registered as a code. In the event of an oil spill, the tag could quickly be analyzed and the culprit identified. ★ ★ ★



only you can save hunting...

Today hunting is safer than ever. The National Safety Council reports a 7.4% decrease in hunting accidents in the past decade. The Metropolitan Life Insurance Company points out hunting is safer than swimming or fishing.

BUT... Some people aren't interested in facts. They want hunting stopped forever. Here's what they're repeating often enough so the public is starting to believe them. (Write NRA for list of sources.)

"The yearly death and accident rate among hunters and innocent civilians indicates that hunting should be outlawed."

"The only herd that needs trimming is the herd of hunters."

"Hunters are generally a destructive, dangerous lot who have made a mess of our wildlife resources."

HOW can you, as a sportsman, fight this kind of talk? Best way is by joining NRA now. Become an NRA member and give us more muscle in our continuing efforts to tell and sell the truth about hunting and firearms. It's time you stood up for the hunting and shooting heritage you, as an American, believe in. Fill in and mail your application for NRA membership today. Tomorrow will be too late.



Yours Free!

Join NRA now and receive a gift copy of the valuable, all-new, 1973 NRA HUNTING ANNUAL. Here's everything you need for better hunting... where to go...

where to stay... full list of 600 guides and outfitters who subscribe to NRA's Code of Ethics. Make this your best year ever afield. Join NRA today.

ENROLLMENT APPLICATION



EXTRA BONUS! Get this attractive NRA lapel emblem and NRA decal for your car—FREE

YES... please start my subscription to The AMERICAN RIFLEMAN right away, and send me a confirming enrollment application to entitle me to all NRA benefits. Also, rush me my FREE 1973 Hunting Annual.

- | | |
|---|--|
| <input type="checkbox"/> 1 year, \$7.50 | <input type="checkbox"/> 5 years, \$32.50 (Save \$5.00!) |
| <input type="checkbox"/> 3 years, \$20 (Save \$2.50!) | <input type="checkbox"/> Please send bill |
| <input type="checkbox"/> Payment enclosed | 1903D-1 |

Enclose payment now and save your Association dollars in billing costs

Name _____ Age _____

Address _____

City _____ State _____ Zip _____

NATIONAL RIFLE ASSOCIATION 1600 Rhode Island Ave., N.W. • Washington, D.C. 20036

IMPORTS AND MOTORSPORTS

BY BILL HARTFORD



OFF-ROAD RACING is a bouncy sport. The front end of your vehicle is airborne half the time, and your rear end the other! There are lots of dropouts—and rollovers as teams battle the ruts and rocks along the way. During the last Baja 1000 from Mexicali to La Paz the International Scout II, pictured above, winner of category II, rolled twice before blasting into La Paz two hours before the nearest competition. The Baja 1000 is sanctioned by the National Off Road Racing Assn. (NORRA) and divided into 10 classes for 10 types of vehicles. The Scout II took honors in the factory-production, two-wheel-drive class. The only modifications made by driver Jimmy Jones and navigator Cass Cassinelli were the allowable ones of chaining the engine to the frame and changes in exhaust system, manifold and carburetor. You can get more information about off-road racing by writing to NORRA at 1616 Victory Blvd., Suite 200, Glendale, Calif. 91201.

BACK ON THE ROAD and paved ovals this month is the smooth and fast kind of auto racing in which cars have a ground clearance of one pebble and the tracks are vacuumed before the machines line up on the grid. Championship (Indy-car) racing starts March 17 at Phoenix. Trenton's next on April 15 and then Indy on May 28. The rest of the season stacks up: July 1, Pocono; July 15, Cambridge Junction, Mich.; Aug. 12, Milwaukee; Sept. 2, Ontario; Sept. 23, Trenton again and Nov. 3, back at Phoenix for the traditional finale. The fastest cars on the track last year were Dan Gurney's Eagles, but they

might not have top speed in the bag this year: The new Mark II Parnelli car (owners, Vel Miletich and Parnelli Jones; designer, Maurice Philione; drivers, Al Unser and Mario Andretti) turned 197.8 mph in testing at Ontario Motor Speedway—and that was in the very first days of testing.

MINIBIKES! WHAT'S A PARENT TO DO? It seems that minibikes are often more of a problem than a pastime. Certainly for responsible parents who participate in the purchase of the machine and set up rules for their use. There's some good advice in a new pamphlet published by the National Highway Traffic Safety Administration of the U.S. Department of Transportation. You can get a single copy free by writing the Consumer Product Information Center, General Services Administration, Seventh and D Sts., S.W., Washington, D.C. 20407.

NEW TO THE TOYOTA LINE for 1973 is a four-door Corona station wagon. It has a top-hinged tailgate and shares with the sedan and hardtop all their features as well as running gear, differing only in dimensions and weight: wheelbase, 96.9 in.; overall length, 171.3 in.; height, 55.9 in.; and curb weight, 2490 pounds. Also new is a three-speed automatic transmission for the Celica ST (See Owners Report: Toyota Celica, page



86, Jan. '73 PM), and a performance boost for the Mark II's ohc Six: The 156.4-cu.-in. engine puts out 122 net hp, up 12 percent over '72 versions.

BEST FIRST SPORTS CAR for my money and for people who really love to drive is the Triumph Spitfire—and it's better for '73. Overall styling is the same as it has been but the engineering changes are many. It's now called the Spitfire 1500 because engine displacement is up to 1493

(Please turn to page 36)

TOUGH!

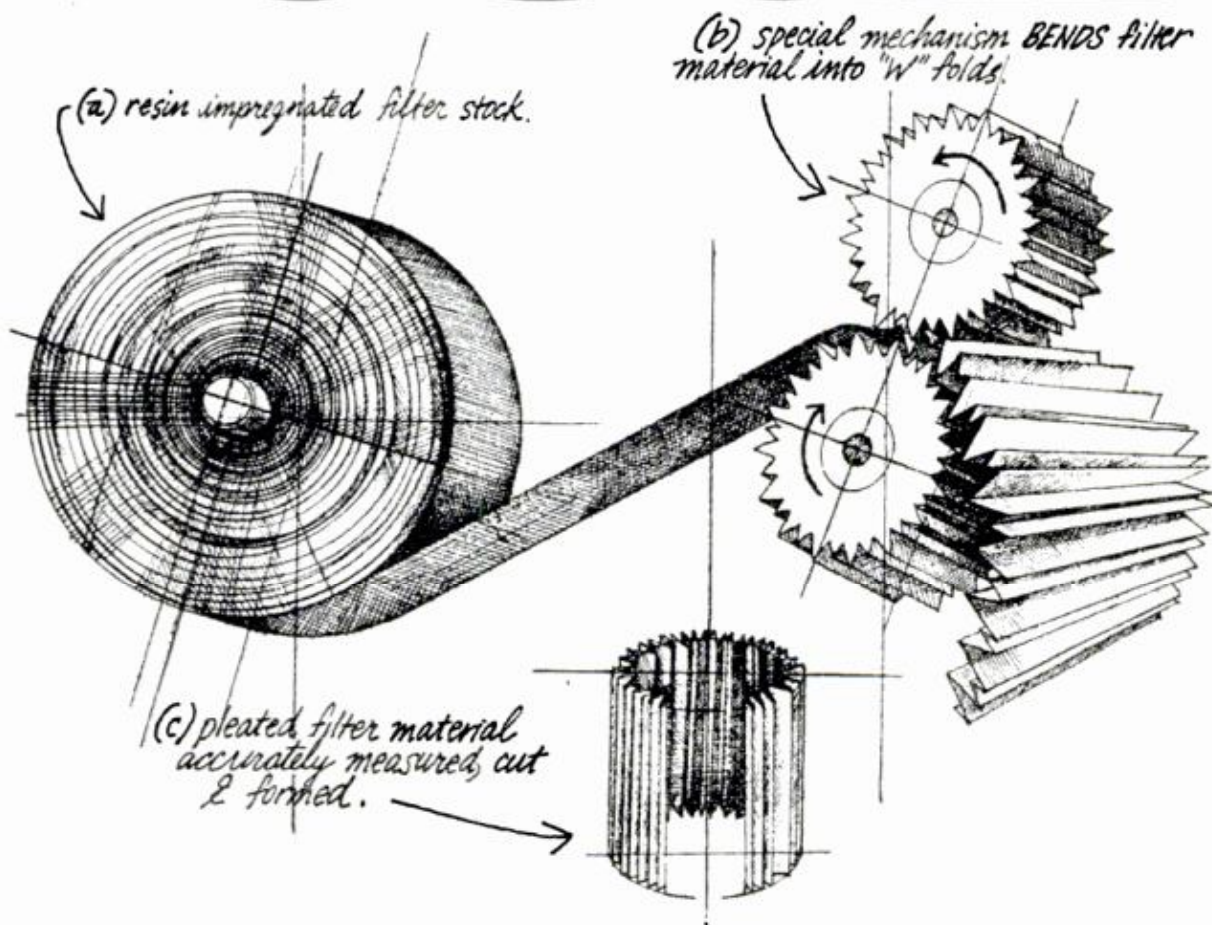

AC Oil Filters are built tough... to help keep your engine running clean

To help assure that AC Oil Filters are tough, AC bends filter material into shape instead of "scoring." Scoring can break the fibers, creating weak spots that could rupture under constant oil pump pressure pulsations.

"Bending in the pleats," as illustrated above, helps assure uniform strength throughout the filter material.

This is just one of the manufacturing methods used by AC to help make sure every oil filter will perform

long and efficiently under all operating conditions. It's one of the ways AC helps assure you of filtering quality and protection.

There is a difference in oil filters. AC's fold is just one of them. One more reason it'll pay you to go with a tough one for your car . . . an AC Oil Filter.

Next oil change, whether you do it yourself or have it done, insist on an AC Oil Filter.



AC keeps you going when the going's tough



AC SPARK PLUG DIVISION

NEW PEP for your COMPACT or MINI CAR

Special
Formula
Ideal
Viscosity
Right
Quantity
Easy Pour
Container



RISLONE for Compacts and Minis gently cleans up oil screens, oil passages, PCV valves and valve guides increasing power and RPM. Feel the difference in minutes. Performance lasts because it is a direct result of better oil circulation and lubrication to all critical parts of your engine. Add to any motor oil for cooler running, better performance, longer engine life.

Look for Rislone in the new red, white and blue can at auto stores and mass merchandisers. The only engine treatment on the market designed SPECIFICALLY for small engines. ASK FOR IT.

THE SHALER COMPANY
Waupun, Wisconsin 53963

PRESCRIPTION EYEGLASSES direct from manufacturer



**Your own doctor's prescription
will be filled, or your present
lenses duplicated.**

The latest fashions. All types of lenses available. Accuracy and perfect fit absolutely guaranteed.

SEND FOR FREE FAMILY
CATALOG, TODAY!



Est. 1959

PRISM OPTICAL INC.

Dept. M-102 135 West 41st St., N. Y., N. Y. 10036

IMPORTS AND MOTORSPORTS

(Continued from page 34)



cc (from 1296) with attendant increases in horsepower and torque. A larger clutch has been fitted for the additional torque, and rear-axle ratio is taller (3.89:1) for less noise and better fuel mileage at speed. Interior changes include new seats, dash, steering wheel and excellent, inertia reel, lap/shoulder belts of the three-point type for quick, convenient one-hand connection to the center anchor. What else is new? Base price. It's up to \$2895.

P.S. If you're really into Triumphs (even if you don't own one) you can join the Triumph Sports Owners Assn., 600 Willow Tree Rd., Leonia, N.J. 07605. It's \$5 a year which puts you on the list for the very informative TSOA Newsletter.

CATALOGOMANIA. Homeowners have their Sears and Wards. Outdoorsmen have their L.L. Bean and Eddie Bauer. Electronics experimenters have their Lafayette and Heath. And auto parts and add-on nuts have their J.C. Whitney. The full-fledged catalog for motor-sports fans is the latest Auto World whopper. Officially called the 1973 Model Cars & Motorsports catalog, the 150-pager is full of all kinds of model cars and racing cars as well as real racing equipment for full-size

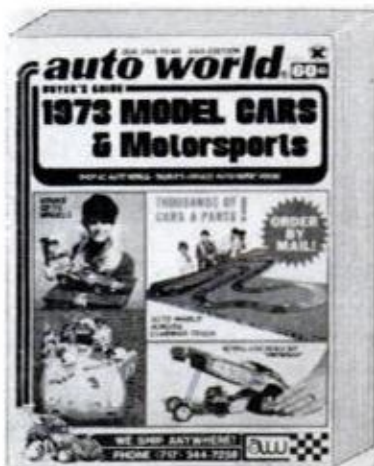

cars. The guy who gets it together is Oscar Koveleski—a name you know if you follow auto racing. If you can't find the catalog on newsstands for 60 cents, you can send 50 cents to Auto World, 701 North Keyser Ave., Scranton, Pa. 18508.

DO-IT-YOURSELF GUIDE: The U.S. Bureau of Customs has all the rules for importing a car. Send a dime to the U.S. Government Printing Office, Washington, D.C. 20402. The publication is Stock No. 4802-0027. ★ ★ ★



CARPET DETERGER



UPHOLSTERY DETERGER



WALL DETERGER

3 proven ways to your own money-making business

You offer a service everybody needs . . . work full time or part time . . . own your equipment . . . keep all you earn . . . start with just a small investment . . . and we help you every step of the way!

Have your own money-making business and make the kind of income you probably thought impossible. You can when you clean carpeting or upholstery or walls with Von Schrader professional cleaning equipment. Every home, every building, are potential customers. And every customer represents repeat business.

Moreover, we help you every step of the way . . . just as we have helped thousands of other Von Schrader Associates build money-making businesses for almost 40 years.

There are three easy-to-operate Von Schrader Detergers. Each offers a proven way to a growing income. (1) *Von Schrader Carpet Deterger* gives deep-level cleaning to carpeting. (2) *Von Schrader Upholstery Deterger* cleans fabrics and synthetics beautifully (3) *Von Schrader Wall Deterger* cleans walls (and ceilings) five times faster than by hand.

You can start with just one Deterger. Then, as your business keeps growing, you may want to add the other two and thus offer a complete cleaning service.

There are no fees, royalties, or contracts. You own your equipment, the finest of its kind. And your investment is so small you may find it hard to believe. For complete information—without any obligation—send for the free booklet described below.



“Let me send you our free booklet that gives all the facts”

—Francis von Schrader, President

Read about the big demand for on-location cleaning, see why Von Schrader Detergers are the finest of their kind, how easy they are to operate. Learn how other men have become financially independent, how Von Schrader helps you every step of the way. Fill in the coupon and send for free booklet.

Extra! Special Recorded Message included with booklet. Listen as Francis von Schrader talks to you personally about your growing future with Von Schrader Detergers.



VON SCHRADER company

1033 Place, Racine, Wisconsin 53403

Please send complete information on Von Schrader Detergers.

Name _____

Address _____

City _____

State _____ Zip _____

APPLIANCE CLINIC

By PAUL MANN

When hard is too hard

We recently moved into this area where well water prevails. This water leaves whitish deposits on pots and pans after water has been boiled in them, and the only way to remove them is with steel wool. Is this indicative of excessive iron in the water? What can be done about it?—Mary Cruden, Omer, Mich.

It sounds as if you have a typical hard-water condition; that is, water contains calcium (lime) and magnesium rather than iron. Iron in the water would be indicated by brown to black stains on fabrics and porcelain.

If a hardness condition is at a critical stage, it will not only leave deposits, but can plug water pipes, and leave scale in water heaters and steam irons. The solution is to install a water softener, but you probably won't want to purchase this rather expensive unit unless it turns out that your situation is critical. How can you find out?

Water hardness is measured in grains per gallon. Water in a home usually falls between 3 and 30 grains per gallon. When hardness exceeds a 10-grain concentrate, the installation of a water softener is recommended.

Take a clean plastic vial of water to a well driller in your area. Most of them have equipment to test the hardness of water.

Powerless power cord

Our General Electric portable dishwasher has a retractable power cord. Our problem is that retraction now is so sluggish that the entire power cord isn't retracted. Can I do something about this?—Walter Lawrence, Orlando, Fla.

Of course. The probable cause of your trouble is a need for lubrication. There are two points that require lubricant. Take the reel apart, clean it thoroughly and lubricate these points with Vaseline or a silicone.

Another cause for sluggish retraction is a weak spring. If the condition continues, remove the spring and get a replacement at a GE dealer or hardware store.

Washer 'tears' clothes

We are having a problem with clothes tearing in our washing machine. What causes this and what can be done to prevent it?—Mitchell Berry, Winston-Salem, N.C.

When a washing machine "tears" clothes, the trouble is usually chemically or mechanically induced.

Chemical damage is most often caused by improper use of bleach. Pouring bleach on clothes without proper dilution or measuring can cause small round holes in fabrics or will weaken the strength of the fabric so it tears easily. Chemical damage can also result from using soaps having a high lye content.

To determine if tears are being caused by bleach, have a druggist mix a two-part Fehling solution as follows:

Solution A: Dissolve 70 grams of sodium hydroxide and 175 grams of potassium sodium tartrate in 400 cc of distilled water. Dilute to make 500 cc.

Solution B: Dissolve 30.64 grams of copper sulfate in distilled water. Dilute to make 500 cc.

Don't mix the solutions until you are ready to use them. Then mix equal parts in a heatproof glass container and completely immerse a damaged item of clothing. Slowly bring the solution to a boil and continue to boil it for three minutes. Then remove the item of clothing for examination.

If tears are being caused by improper use of bleach, the damaged area will look pink and its tensile strength will be very weak. Conversely, areas that haven't been affected by bleach will be light blue in color and strong.

Mechanical damage can be caused by a problem with the machine itself or by a sharp foreign object introduced into the machine. Since the agitator is the one part that comes in contact with clothing most often, start your search here.

Is the agitator cap tight so that clothing isn't getting snagged? Is the agitator surface smooth? Is its bottom edge no more than $\frac{7}{16}$ inch off the bottom of the tub?

If there are any rough projections on

(Please turn to page 40)



NRI Appliance Training Division
 3939 Wisconsin Avenue
 Washington, D.C. 20016

600-033

Send me your illustrated **FREE CATALOG** that tells about opportunities in Servicing Electrical Appliances, and gives details of NRI's low-cost training plan. I understand there is no obligation. No salesman will call.

Name _____ Age _____

Address _____

City _____ State _____ Zip _____

CHECK HERE FOR FACTS ON GI BILL

If you have served since January 31, 1955, or are in service now, check box above.

MAIL COUPON ABOVE FOR THIS

FREE NRI CATALOG

Learn professional methods of appliance repair

Refrigeration and Air Conditioning included. Save on your own repairs, learn a skill in demand, earn extra income or start your own business.

Short, easy course trains you at home to make \$5 to \$7 an hour starting soon.

Mail the coupon above for your **FREE NRI Catalog**. Find out how you can prepare quickly at home to do professional appliance servicing.

After only a few lessons, you can be ready to start servicing your own appliances or start earning \$5 to \$7 an hour fixing appliances for friends and neighbors. The entire training can be finished in a few months.

NRI Appliance training is the fastest way to a new job or skill or extra income in a spare time or full time business of your own. Wherever you live or want to live, you'll find a demand for top-notch appliance servicemen.

With a billion appliances in use, there are probably thousands needing repair right in your own neighborhood. They mean



NRI APPLIANCE TRAINING DIVISION • Washington, D.C. 20016
 Accredited Member National Home Study Council

cash profits for you starting soon. Put your spare time to good use. Appliance servicing can give you the extra cash you may be seeking to do and buy the things you've always wanted.

- Low-cost NRI training covers —
- Small and large home appliances
 - Air conditioning
 - Refrigeration
 - Portable electric tools
 - Small gasoline engines
 - Farm and commercial equipment

Professional appliance testing equipment is included in your NRI course at no extra cost — to help you speed troubleshooting and repair jobs. Mail coupon now for your **FREE NRI Catalog**. No salesman will call. National Radio Institute, Appliance Training Division, Washington, D.C. 20016.

TRY... TRI-ROD...FOR FUN

FAR AND AWAY AMERICA'S BEST BUY IN A THREE-WHEELED VEHICLE. FULL LINE OF ACCESSORIES FOR YEAR-ROUND PROFIT.

THINK YOU'D LIKE TO BE A TRI-ROD DEALER? WE HAVE A COMPLETE LINE OF DEPENDABLE MODELS FOR YOU TO SELL.

FULL FIBERGLASS MULTI-COLOR METALFLAKE BODIES. PRICE RANGE \$425.00 UP.

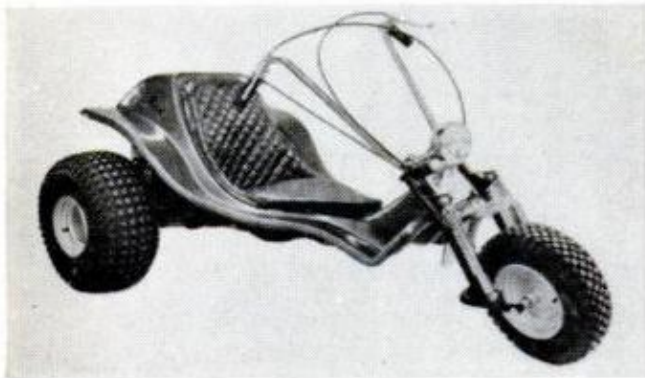

WITH OR WITHOUT FRONT AND REAR SUSPENSION

BGW

BOX 3683
MANSFIELD, OHIO 44907
Phone: (419) 522-0665

Please rush full details on how to make money as a BGW Dealer or Distributor.

Name _____



Address _____

City _____ State _____

WANTED...

BURGLAR & FIRE PROTECTION

by







Electro-Sentry
BURGLAR ALARM
Professional Type
Do-It-Yourself
protection for your
home and business.



Magna-Sentry
BURGLAR & FIRE ALARM
Low cost protection for your
and your family.



Ultrasonic-Sentry BURGLAR ALARM
Protects you with harmless invisible ultrasonic waves.



GC ELECTRONICS
Division of Hydrometals, Inc.
Rockford, Illinois 61101 U.S.A.

Take this ad to your electronic supplier for your copy of "Security & You" for only 50¢.

APPLIANCE CLINIC

(Continued from page 38)

the agitator, try to smooth them down with sandpaper or a file. If the agitator is broken, have it replaced.

Check the basket by rubbing an old nylon stocking over its entire surface. If the stocking gets caught, you have encountered a projection that should be smoothed down.

If the agitator and basket aren't damaged, then clothing is probably being torn by foreign matter which is being introduced into the wash water. For example, watch out for particles of gravel that get hung up in pockets and cuffs.

Finally, keep in mind that clothing wears and certain spots will become weaker than others. This makes them more susceptible to tearing. These weak spots can be detected easily by holding the clothing up to a light.

Waste water worries

I recently installed a waste disposer and am experiencing leaks between the sink and sink flange. I've removed and reinstalled the unit a couple of times, each time using a generous amount of plumber's putty under the sink flange. What can be done to stop these annoying leaks?—Robert Buchanan, Woodland, Calif.

You may have gotten something fouled up in locating the position of the sink flange and allied parts.

In tightening the mounting studs, apply firm even pressure. Make sure that the snap ring is in the groove on the sink flange. If gaskets and seals are not properly set and tight, the leakage will continue regardless of how much putty you have used.

Supplier of service manuals

Parts Distributors Corp. of 932 Old York Rd., Abington, Pa. 19001, informs us it has available service manuals of many major appliance manufacturers. You can obtain a free listing of these manuals by mailing the company a stamped self-addressed envelope. ★★★

If you have a question about any appliance, send it to Appliance Clinic, Popular Mechanics, 224 West 57th St., New York, N.Y. 10019. Sorry, but letters cannot be answered individually. However, problems of widest interest will be answered in this column.

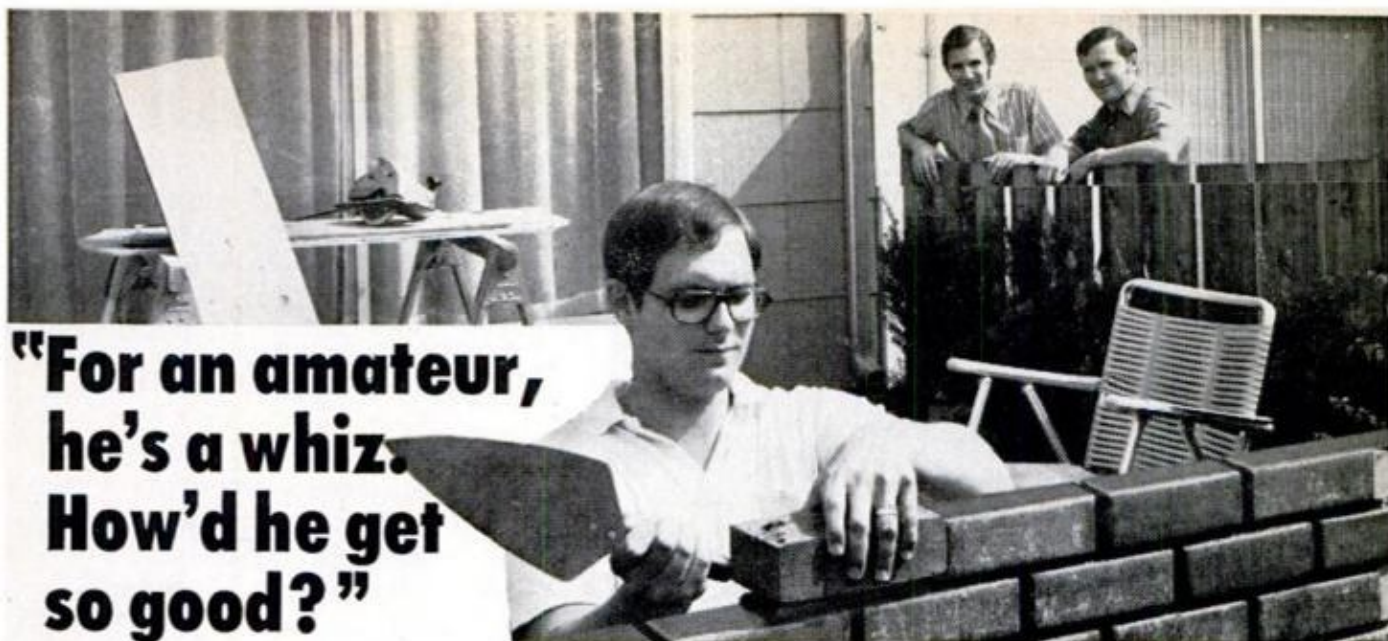

**"For an amateur,
he's a whiz.
How'd he get
so good?"**

Whatever practical skills you've been wanting to develop, Audel has comprehensive, step-by-step Guides to help you. They show you all the professional tricks of the trades in

clearly diagrammed and illustrated "how-to" steps. They can save for you, over and over. Here are nine of Audel's many fields . . .



CARPENTERS AND BUILDERS LIBRARY

1612 pages of the latest information on modern construction in four volumes. They cover every phase of carpentry from foundations to finishing with easy-to-grasp, step-by-step instructions . . . all illustrated with thousands of diagrams, charts and photos.
No. 23169 4 Volumes \$18.50



MASONS AND BUILDERS LIBRARY

Two illustrated volumes on the science of masonry and bricklaying. Packed with how-to information and directions, rules, processes, definitions, formulas, diagrams, tables, estimating. A complete and authentic trade reference library. 752 pages.
No. 23185 2 Volumes \$11.25



PLUMBERS AND PIPEFITTERS LIBRARY

A valuable 3-volume guide to the principles, methods and shortcuts of modern plumbing. Tools, fittings, fixtures, installation, drainage, welding and much more are all covered in these fully illustrated, easy to understand volumes.
No. 23155 3 Volumes \$12.50



MACHINISTS LIBRARY

Three books covering the entire field — 1216 profusely illustrated pages on practical fundamentals of basic machine shop operations, setup and operation of spot machines, down-to-earth data on toolmaking procedures, layouts, jigs and fixtures, etc. . . . equally valuable for beginners and experienced men alike.
No. 23174 3 Volumes \$16.95

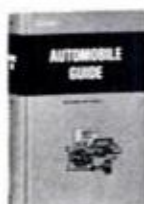

AUTOMOBILE GUIDE (3rd Edition)

A practical reference and guide for servicemen and owners. Hundreds of working diagrams covering construction, service and repairs of modern cars.
No. 23192 \$8.95

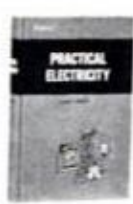

PRACTICAL ELECTRICITY (2nd Edition)

Presents the fundamentals of electricity in clear, concise terms. Easily grasped explanations and over 1300 illustrations and diagrams, for electrical workers and apprentices.
No. 23160 \$5.95



HOME APPLIANCE SERVICING

Handy and practical "how-to" instructions for servicing, repairing, assembling, wiring and testing practically all home appliances.
No. 23016 \$6.95



HOME REFRIGERATION AND AIR CONDITIONING

Practical information on operation, servicing and repairing of modern household refrigerators and air conditioners. Covers auto air conditioners, too.
No. 23133 \$6.95

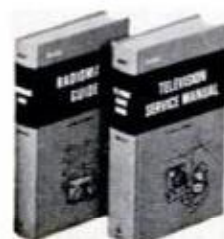

RADIO AND TV LIBRARY

Two volumes covering all you need to know about radio and TV. The Books — Radioman's Guide (3rd Edition) and Television Service Manual (3rd Edition) — provide basic step-by-step guidance for the operation, trouble-shooting and repair of radio, black and white and color TV.
No. 23161 The 2-book Library \$11.50
No. 23162 TV Service Manual \$5.95
No. 23163 Radioman's Guide \$5.95

PO33

**Theodore Audel & Co., Division of
HOWARD W. SAMS & CO., INC.,
4300 West 62nd Street, Indianapolis, Indiana 46268**

Please mail me for 10 days' FREE EXAMINATION the books I have checked at right. I agree to mail \$3 in 10 days for each book or set ordered and to further mail 1/2 of the purchase price 30 days later, with balance plus shipping costs to be mailed within another 30 days. I may return the books for refund if not completely satisfied.
Save shipping costs. Check here if you enclose full payment (plus sales tax, if any). We will pay postage charges. You have same return privilege. Canadian prices slightly higher.

Name _____
Address _____
City _____ State _____ Zip _____

23169
 23185
 23155
 23174
 23192
 23160
 23016
 23133
 23161
 23162
 23163

Photo Hints

Darkroom table sink

YOUR DARKROOM SINK—if you have one—is probably too deep to hold your trays at a convenient working height and too narrow to hold all of them at once. And normal spills and splashes mess up the floor if you just set your trays on a table.

I decided to build a tabletop just big enough to hold my trays, put a high lip around it, and made it into a darkroom sink.

The bottom is $\frac{3}{8}$ -inch exterior plywood (2x6 feet, in my case), boxed in with 1x6 stock and supported on a lip of a 1x2 lumber. For sealing (and to make round corners easy to wipe clean), I put stock 1-inch cove molding around the inside edges of the bottom, caulked the molding, then covered it with a coat of fiberglass boat resin and molded 6-in. fiberglass tape over that. I installed drain rails (stock, $\frac{1}{2}$ -in. half-round molding) to allow spills and wash water to drain under the trays and print washer and I put a sink drain and strainer at one end. Finally, I gave the entire sink a coat of the resin. You can use epoxy or polyester resin—but if you choose epoxy, do the job in a well-ventilated space and beware of fumes.

You can mount the finished sink on homemade legs or ready-made ones, build it into a counter top, or even lay it on top of two tables, cabinets or saw-horses of convenient (and matching) height. If you have to put your sink away between darkroom sessions, you may want to put the drain in a corner of the sink for easier emptying when you're through.—*Victor W. Kondra, Goleta, Calif.*

POPULAR MECHANICS

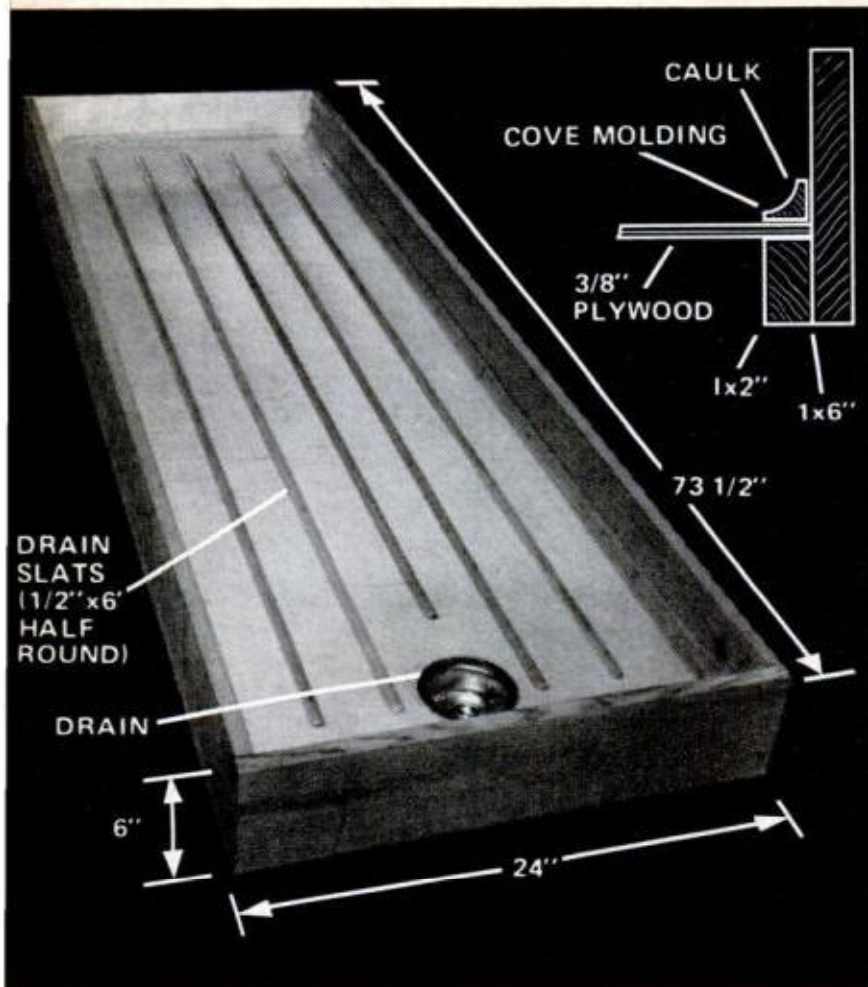

SINK DIMENSIONS were chosen to match my trays and fit the space I had available—you can vary length and width to match your space and trays. Six-inch height keeps sink shallow enough for easy print agitation, allows use of standard 1x6 lumber (actually smaller than nominal size, but exact dimensions aren't critical). Drain rails, (stock half-inch, half-round molding) raise trays above sink floor, allowing liquids to drain easily. For temporary setups, place bucket under drain

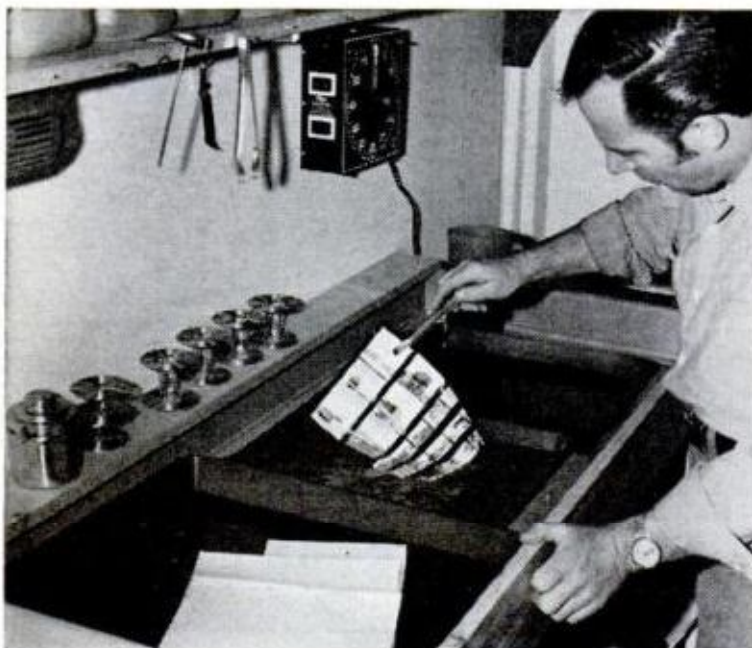

FINISHED SINK holds three large print trays. Shallow design is ideal for temporary darkrooms, since it's easy to store

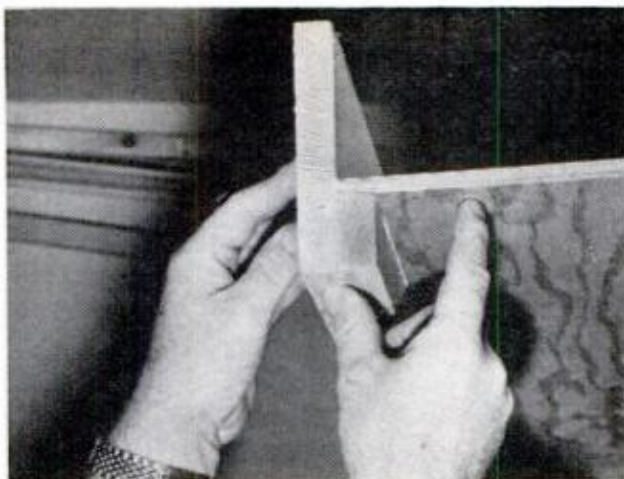

END VIEW (above) shows side rail, sealing lip and plywood bottom. Glue and nail sealing lip to the side, then glue and nail the bottom to the inside edge of the sealing lip. End sections are butt-nailed into position before cove moldings are installed

COVE MOLDINGS (top right) form added seal, make smoothly curved base for fiberglass tape overlay; curves make spills easier to wipe up, too. Coat both flat sides of the cove moldings thoroughly with a caulking compound before nailing them in place

FIBERGLASS CLOTH TAPE, applied over cove molding, provides an extra seal against leakage, smoother corners. After installing tape, drain and drainage rails, seal the entire sink with fiberglass boat resin (polyester or epoxy—but beware of epoxy fumes)



You can feel the difference.

Just holding this sturdy, lightweight little camera gives you the feeling that now, at last, you can take great pictures. Anywhere. Any time. The Minolta Hi-matic F has a balance, a construction, a "feel" that inspires confidence. Since the "F" is an amazing electronic instrument that does everything for you except focus, the results invariably prove worthy of the confidence it inspires.

For literature, write Minolta Corp., 200 Park Ave. So., N. Y., N. Y. 10003. In Canada: Anglophoto Ltd., P.Q.

The Electronic
Minolta Hi-matic F



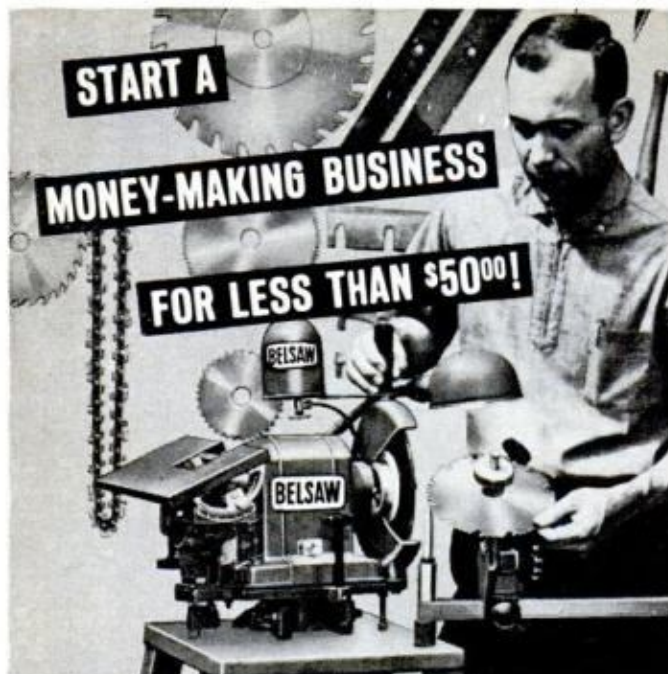

No Selling, No Inventory... All Cash Profits and YOU Set The Hours!

You can have your own lifetime business right at home... work in spare time... and make up to \$200 a month CASH! My FREE PLAN gives you all the facts: How to start, how to grow. You don't need previous experience. You don't have to sell. I'll even finance you. People bring you the work and pay cash. Over 90¢ of every dollar you collect is clear cash profit. And you work when you want to. Let me prove you can't find a more certain, lower cost, higher paying business of your own.

Does The Belsaw Pay? YOU BET!

"My Sharp-All shop is now averaging me \$300.00 a month."

*Roy Jennings
Sandwich, Illinois*

"Think the world of my Sharp-All. Am grossing \$4,000 a year on a part-time basis."

*Lawrence Stevenson
E. Syracuse, New York*



SEND FOR FREE FACTS!

Just Mail Coupon — No Salesman Will Call

BELSAW SHARP-ALL CO.

713M Field Bldg. Kansas City, Mo. 64111

Send details of FREE TRIAL OFFER and Free Book "Lifetime Security!" No obligation.

Name _____

Address _____

City _____

State _____ Zip _____



SuperBonder™

Those two dragsters are held together with SuperBonder — 3000 h.p. couldn't pull them apart. Yet Loctite SuperBonder is easy to use. No mixing. Sets in seconds without clamps. SuperBonder permanently bonds metals, alloys, glazed ceramics, glass, plastic, vinyl and rubber... repairs just about anything that breaks... replace metal or vinyl trim on your car. Mount towel bars on tile. Mend plastics, rubber boots and heirloom glassware. Ask for SuperBonder at your hardware store or auto parts dealer.



Newington, Connecticut

The better way to hold parts together.

**Protect home and property!
VOLTAGE MONITOR**

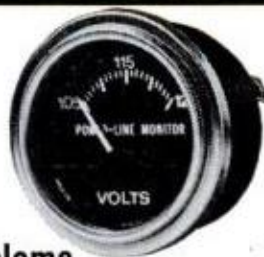

spots power problems like low voltage, inadequate wiring

New Power-Line Monitor can identify low voltage or inadequate wiring as source of trouble. Just plug the amazing P-L Monitor into any electrical outlet like a nightlight. Instantly shows AC line voltage. Accurate within 1 volt. Identifies areas of low voltage or inadequate wiring which can cause shrinking TV picture, sluggish power tools or appliances, excessive blown fuses, etc. Order P-L Monitors for home, business or as gifts. Detailed instructions included. **\$12.95 ppd.** We guarantee satisfaction or money back.

PROCON, Dept. 2603

36 South Street, Burlington, Vermont 05401

5-in-1 MINIATURE MACHINE SHOP

UNIMAT

VERSATILE UNIMAT converts from precision lathe to vertical mill, drill press, grinder or polisher. Easy to use. Make all small precision parts—for models, guns, cameras, inventions. \$149.50, ready-to-use. Send for free details (Available in Canada.)

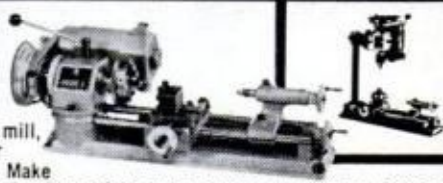

AMERICAN EDELSTAAL, INC DEPTBC-3, 1 ATWOOD AVE, TENAFLY, N J 07670

IF YOU'VE NEVER OWNED A CHAIN SAW, YOU NEED ALL THE HELP YOU CAN GET.

Now that you're considering buying your first chain saw, you could be in for a lot of hard work.

There are literally hundreds of chain saws to choose from.

At all kinds of prices. In all kinds of sizes. With all kinds of features.

And if you've never owned a chain saw, how in the world are you supposed to know which one will end up being right for you?

That's exactly what we at Homelite had to ask ourselves when we set out to design your first chain saw.

SHOULD YOUR FIRST CHAIN SAW HANDLE LITTLE JOBS? OR BIG JOBS?

Chances are you're going to use your chain saw for two basic kinds of jobs.

Little jobs. Like pruning trees and clearing brush.

And big jobs. Like cutting trees

and firewood.

So to make both jobs less like jobs, we designed your first chain saw with a separate trigger for each of them.

For the little jobs, the XL 2 has a trigger up front.

This lets you hold the saw at the balance point, over the center of gravity. Which simply means that you can get right up on top of your work, when you

need really tight control.

And we put a second trigger in the rear for the big jobs.

Which gives you greater leverage and a fantastic sense of power.

HOW LIGHT SHOULD YOUR FIRST CHAIN SAW BE?

There would be no point in designing your first chain saw, if it were so heavy you didn't want to pick it up.

So we weighed the Homelite XL 2 in at 7¼ pounds (less bar and chain).

Light enough to make it easy to handle. Heavy enough so it doesn't feel like a toy.

HOW CHEAP SHOULD YOUR FIRST CHAIN SAW BE?

In designing your first chain saw, we at Homelite had to make a crucial decision.

Whether to give you an extremely low price and very little chain saw.

Or a lot of chain saw and sell it at a price we could both live with.

This will give you an idea of what we decided:

Your first chain saw has an all-weather ignition so that it starts when you want it to start.

Your first chain saw has a chain oiler that automatically lubricates the guide bar and chain so you don't have to remember to press a button.

Your first chain saw has a 12" guide bar with a gas-welded tip that even Paul Bunyan would have trouble wearing out.

Your first chain saw has a rugged carbon steel saw chain and die cast magnesium housing.

And it has all these things at a price we think is rather irresistible.

\$119.95.

After all, what would be the point of designing your first chain saw if we first couldn't lure you into buying it.

HOMELITE® XL2

WITH TWO TRIGGERS.
A FRONT TRIGGER FOR LITTLE JOBS.
A BACK TRIGGER FOR BIG JOBS.



For the Homelite dealer nearest you, check the Yellow Pages under Saws.

HOMELITE, A **Textron** DIVISION, P.O. BOX 100, S.W. CITY, MO. 64409. MANUFACTURED IN U.S.A. ©1973

Magazine within a magazine



Give your home a new lease on life. PM's *Home Ideas Guide* can do just that with great ideas like: How to facelift the exterior, add a bath, get a new entry, create an unusual basement room, improve lighting . . . 40 pages.



How to install plastic 'beams'

Rough-hewn beams may be what you want for the ceiling of your den or family room. Urethane foam "beams" are the answer.



How to fly a model copter

Flying radio-controlled model helicopters is a challenging new sport. PM tells what it takes to build one and fly one.



Kit-built fifth-wheel trailer

Handy? You can build this 18-foot trailer that puts the hitch load in the bed of a standard or imported pickup truck.



Mini recorders compared

New miniature cassette recorders are small enough to slip in a pocket. PM tests 18 brands and lists the results.

PLUS

Owners tell what they think of the Ford LTD, Custom 500, Galaxie and the Olds Omega • Tow rig for snorkeling • Sofa you can build in a weekend • Flying boat you can build yourself • Movie cameras: What you get for under \$100 • How to build a soil-conditioning tumbler • How to get a professional brake job • Make your oilstone self-lubricating • Handy stand for a sander • Clock that lets you see it work

Buy it on your newsstand. Better yet, make sure you'll keep getting this kind of exciting fare. Send this coupon with your check to:

POPULAR MECHANICS
250 West 55th Street
New York, New York 10019

Please enter my subscription for 1 yr. \$5 or 2 yrs. \$9

Name _____ (Please print)

Address _____

City _____ State _____ Zip _____

Payment of \$_____ is enclosed. New Renewal

On new subscriptions, first copy will arrive in about 8 weeks.

(Above prices apply in U.S. and Possessions only. Canada, add \$2 per year. All other countries, add \$4 per year.)

WPM3C1

POPULAR MECHANICS

MAKE EXTRA \$\$\$ EVERY DAY!

Get into the big, year-round

EXTRA MONEY BUSINESS

That's EASY to learn—EASY to do
—and EASY ON YOU!

Be a LOCKSMITH!

Make Up to \$10 an Hour—even while learning! Train FAST at Home!

Before there have been money-making opportunities been so big for qualified Locksmiths. Now lucrative regular lock and key business has multiplied a thousandfold as millions seek better protection against zooming inflation. Yet there's only one Locksmith for every 17,000 people!

EARN THE QUICK AND EASY BELSAW WAY

Take advantage of this tremendous opportunity for year-round EXTRA INCOME in sparetime—or in a full time, high-profit business of your own... now and for THE REST OF YOUR LIFE! All tools plus professional Key Machine given you with no charge. These plus practice equipment, plus easy illustrated lessons, plus personalized help from expert instructors, plus business-getting guide—enable you to make \$5 to \$10 an hour almost from the start! Hundreds we've trained have done it. So YOU!

JOIN THESE BELSAW MONEYMAKERS

"Earned \$500 while learning. My best month was \$125. Business gets better and better." V. Tizio, Brooklyn, N.Y.

"Learned \$110 last Saturday! I'm doing wonderfully. Locksmithing is a great business." R. W. Davis, St. Louis, Mo.

**FIND OUT ALL ABOUT IT
No Obligation—
No Salesman Will Call**

Discover what's in Locksmithing for you with Belsaw training... how you can depend on this urgently needed business for MORE INCOME, EASIER, MORE ENJOYABLE LIVING now and for retirement. Just fill in and send this coupon to receive full information by return mail.

Do it TODAY!

Belsaw Institute
103M Field Bldg.
Kansas City, Mo. 64111

Approved for Veteran Benefits

Accredited Member
National Home
Study Council



Also available in Canada

Clears \$75 a Week Sparetime!

"I'm proud to be a Belsaw graduate and a success in this great profession. I'm making over \$300.00 a month in my sparetime with your training—the best there is."

Henry Rivas—Los Angeles, Cal.



**THIS PRO KEY MACHINE—
YOURS TO KEEP**

can add \$25 to \$40 a week to your income... and doesn't cost you a penny extra!



SEND FOR EXCITING FACTS

Tells how to Make Money in Locksmithing—Spare Time or Full Time—Almost from the Start.

CUT ALONG DOTTED LINES... FOLD IN HALF... SEAL AND MAIL

Mail This Card Today—No Stamp Needed!



LOCKSMITHS ENJOY ALL THESE ADVANTAGES:

- You're part of a firmly established, vitally necessary professional trade.
- Shortage of qualified locksmiths everywhere.
- Clean, respected work that's easy to do—and easy on you.
- You collect cash for work—no credit losses, no collection expenses, no employment problems.
- Business-getting methods are simple. No salesmanship required.
- You're a trusted member of your community.

Please send me free of cost or obligation your publication "Keys to Your Future" on how Belsaw can train me to quickly make money in Locksmithing and how all tools and Key Machine are given me to keep. I understand no salesman will call.

Name _____

Address _____

City _____ State _____ Zip _____

FOLD IN HALF HERE

FIRST CLASS
PERMIT NO. 1014
KANSAS CITY, MO.

BUSINESS REPLY MAIL

No Postage Stamp Necessary if Mailed in the U.S.

Postage will be paid by—
BELSAW INSTITUTE
103M Field Building
Kansas City, Missouri 64111



CUT ALONG DOTTED LINES

There's a Good Job for You in the Glamorous Hotel-Motel Business!

No matter what you're doing now — no matter what your previous experience is — we can train you for a high-paying, exciting job in the booming hotel-motel business!

HOW DO YOU GET THE TRAINING YOU NEED?

First, you learn the basics of the business at home. You don't have to leave your present job. You don't lose your income. You study in your *spare* time with individual help from our instructors. You learn at your own pace and the learning is really fun because the hotel-motel business is really fun!

ON-SITE TRAINING

Once you've satisfactorily completed the at-home study program, you're ready for the optional, no additional cost, on-the-spot observation at Florida's fabulous 600 room Dutch Inn in Lake Buena Vista, Florida, host community to Walt Disney World. You'll get to observe how the Disney people do things at the only hotel-motel on the Disney World site. You'll get hands-on experience under the guidance of top pro's in the industry who work everyday in the job they're training you to do.



ARE THERE JOBS AVAILABLE?

There are more than 83 different kinds of jobs in the hotel-motel field. Look at some of these opportunities: if you like to work with your hands, you can be a Maintenance Engineer. If you like to work with people, you can work at the Front Desk. If you like parties, you can be in the Convention-Sales Department. If you like sports, you can be at the Pool and Cabana. If you like to work with numbers, you can be in Accounting. And many more!

WHERE CAN YOU WORK?

Anywhere! In the mountains, at the seashore, in the city, in the country. There are new hotels going up everywhere and every one of them needs qualified people now!



Banquet and
Restaurant



Maintenance
Engineering

Attention Vets! This program is approved for the training of Veterans and the government pays 90% of the costs for you! Actually, because the program is approved for Veterans Training, there is absolutely no out-of-pocket expense to you now.

SOUND RIGHT FOR YOU? HERE'S WHAT YOU DO NOW!

Call us *collect*. Ask for Jack McAllister. He'll tell you all about the course and about the fun that's in store for you. Remember, we pay for the call. Call collect, today. 609-424-1717.

NO SALESMAN WILL COME TO YOUR HOUSE!

American Training Services is accredited by the National Home Study Council; approved for the training of Veterans; Eligible Institution — Federal Insured Student Loan Program.



AMERICAN TRAINING SERVICES

Headquarters in Cherry Hill, N.J. and Nashville, Tennessee.
An American Stock Exchange Company.

609-424-1717

Your new way to big pay in the "HOT" career — Air Conditioning



For your money, for your future, Air Conditioning is one of the "hottest" technical service careers in America today! Growing almost twice faster than the nation's economy. The need for trained men almost twice as great as in many other technical fields. Value of installations is running ahead of even color TV!

But trained men are so scarce that some dealers keep names of their best men secret to prevent having them hired away. The nation-wide manpower crunch so critical that it's "write-your-own-ticket-time" in this \$2.2 billion industry.

As a skilled AC trouble-shooter, you can command top pay. Big overtime. Work and live where you like. Start your own full or part-time business. Enjoy a clean service career of growing income; even bigger demand is coming.

News that makes the difference

Now, for the first time, you can train at home with this **official**, industry-association approved course. It's the **only** home-study course written and endorsed by the North American Heating & Air Conditioning Wholesalers Association. So you know it's right.

NEWS Need for thousands of new technicians in booming field brings action! Now, for the first time, you can train at home with this **OFFICIAL** industry association course. It's "insider" training. The **ONLY** course Approved and Endorsed by



It's the course you couldn't get before because it has always been reserved for "insiders" — association members and their dealers.

But, now, thousands of new Air Conditioning technicians must be trained and put to work — fast. So this official course has been opened up to you, through special arrangement with Universal Schools, Washington, D.C.

Your "Insider" opportunity

This is "insider" training, because it's the course industry employers want you to take. And, it's "insider" opportunity. Because, while this is not a job guarantee, you get this exclusive advantage: When you are trained, the Association will send your name to some 1,200 member outlets around the country — outlets in touch with nearly 25,000 dealers!

Send for FREE information

Here's your best chance to prepare for a more-money future in one of the "hottest" tech careers today. Mail coupon now for Free Information. **No obligation. No salesman will call.**

Learn how you can take industry-association approved training in your own home, in your spare time. How you can be an "insider" in this booming, big pay field.



Universal Schools, Dept. 52593
527 - 7th St., Des Moines, Iowa 50308

Send Free Information on industry-association approved training for opportunities in Air Conditioning. I have no obligation. No salesman will call on me.

Name _____

Address _____

City _____

State _____ Zip Code _____

An Accredited Home-Study Institution

Training includes special tools and instruments of the profession — yours to keep and use on the job.



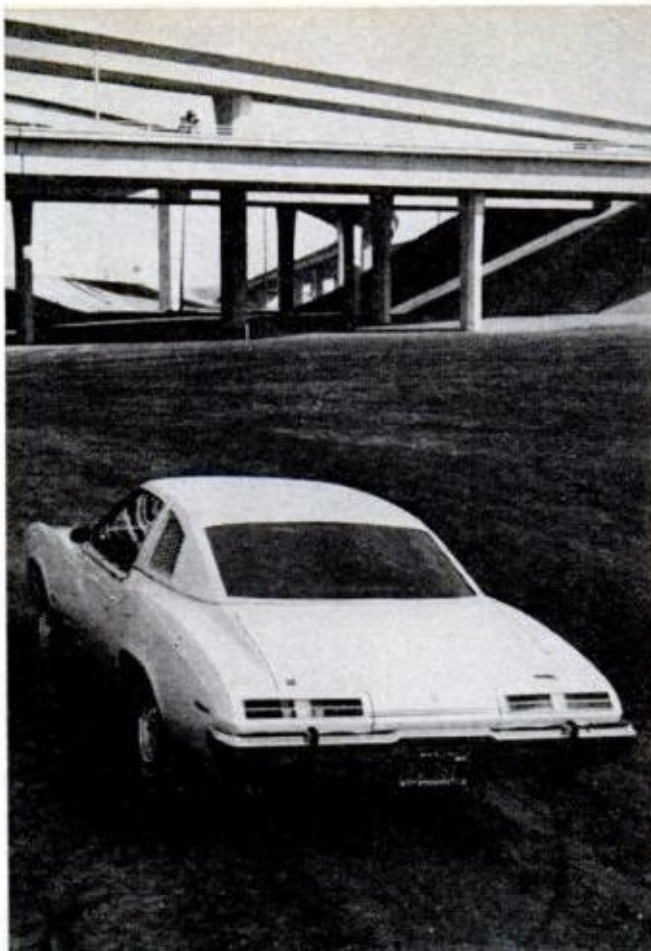
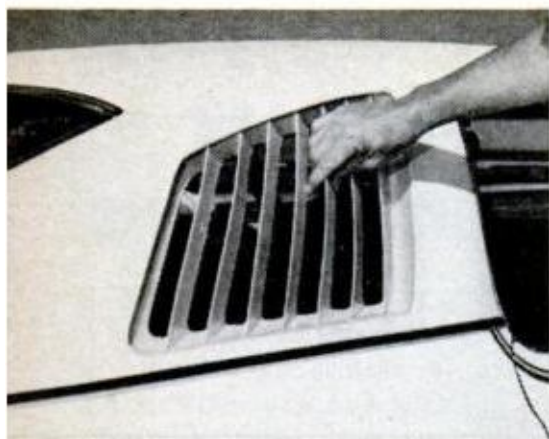

BOPPABLE NOSE pops back, but vinyl racing stripe cracks if wrinkled too often. Louvered side windows don't go down, are hard to clean. Driver can see out of them but rear riders can't

PM OWNERS REPORT: PONTIAC GRAND AM

To Pontiac, it's a 'European

By **MICHAEL LAMM**, West Coast Editor

Photos by the author

DOESN'T LOOK like the average car —looks more foreign," says a Massachusetts welder. What he apparently doesn't realize is that Pontiac went to an awful lot of trouble to give that impression.

Neither this owner nor (judging from responses to our survey) most other Grand Am owners realize that Pontiac has spent considerable time and money to make this a genuine American grand touring car in the European tradition (see *What makes this American gran turismo car European?* page 52). Pontiac's effort has apparently been lost on all but a handful of Grand Am owners.

Too few buyers understand that General Motors "went European" this year

with four of its A-bodied intermediates: the Grand Am, Chevy's Monte Carlo, Buick's Regal and the Olds Cutlass Salon. All four try to capture the Continental *gran turismo* flavor. They offer the nearest thing to sports-car handling ever put into American cars of this size. Handling in each case comes via finely tuned suspensions and chassis set up for steel-belted radial tires (standard equipment), good disc braking, quick steering, plus stabilizer bars front and rear.

The car magazines have all called the Grand Am "Detroit's Mercedes." Despite stiffer-than-normal suspension, Pontiac engineers have given the Grand Am a comfortable long-distance ride. Its stylists reached for European verve inside and out, with luxury touches and tidbits not normally found in U.S. cars—adjustable lumbar supports inside the front seat—



HANDLING AND MANEUVERABILITY are two qualities Pontiac engineers very successfully put into Grand Am. Many owners bought the car for other reasons, but they soon discovered its European *gran turismo* virtues

A nationwide survey based on 700,000 owner-driven miles **GT,' but do owners agree?**

backs, for instance, or the dimmer switch in the turn signal stalk, plus a very British-looking instrument panel with instruments set in real mahogany.

Has Pontiac succeeded? Or is all this *gran turismo* sophistication lost on buyers who don't appreciate it?

One of the first questions we asked was, "Why did you buy your Grand Am—what tipped the scale in its favor?" Here are typical answers: "Many features available at thousands of dollars less than other luxury cars." "Styling." "Because I didn't know what make it was the first time I saw it; I thought it was a foreign car." "Wanted a smaller car and was impressed with the Grand Am's appearance."

The majority of reasons ran in that general vein. Most owners couldn't have cared less about touring in the grand European manner. They weren't swayed by han-

dling, responsiveness, braking, maneuverability, or any of the rest of it.

But then, about every 15 questionnaires we'd get another type of response. This was from people who understood what the Grand Am was all about. To wit: "I bought my Grand Am because it's a radical departure from GM's norm—suspension and handling foremost."—Ohio rubber worker. "Because of its European-like handling and comfort plus Detroit's luxuries."—New Jersey bank examiner. "Where else for the price can you get a car that has been engineered so soundly?"—Ohio shipping clerk. "The chassis tuned to the radial tires, lumbar-adjustable bucket seats in a four-door, and gauges on the instrument panel—wow!"—Indiana technical writer.

So while most people fell for the Grand Am's looks, which did play an important

role in all buying decisions, about one out of 15 buyers had deeper reasons.

Once purchased, owners began to discover what they'd gotten. "Very comfortable, especially on trips." "Cruises effortlessly, rides surprisingly well on *silent* radial tires." "I like the standard features such as disc brakes, steel-belted radial tires, reclining bucket seats, the smooth handling and quick response." "I drive an average of 60,000 miles a year, and this is the best road car I've ever had." "Corners best of any car I've ever driven."

An Albuquerque jeweler compared his Grand Am to the 1968 Mercedes 280SE sedan he'd traded in on it. "I'll never un-

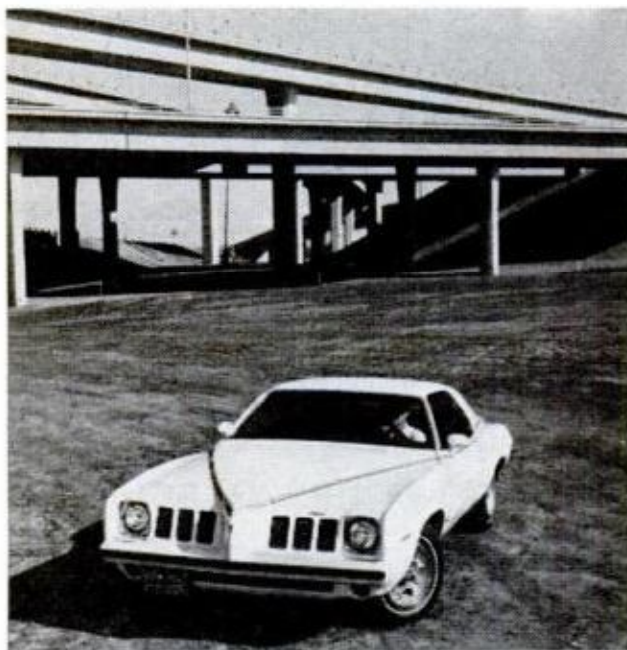

DISTINCTIVE FRONT sets Gran Am apart from other Pontiac intermediates, but rear looks like Le Mans

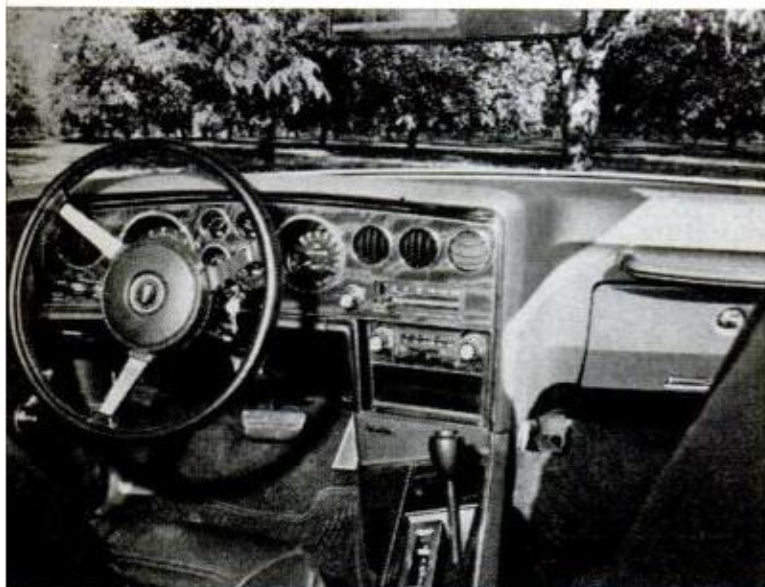

DRIVER-ORIENTED COCKPIT sets full gauges in real mahogany dash. Turbo Hydra-Matic trans is standard

derstand the Mercedes' shortcomings. It's superbly designed and the engineering is faultless. But it was always noisy (engine and wind) and too expensive to maintain. When we traded it at 42,000 miles, it needed an engine overhaul, used a quart of oil every 300 miles, and chugged at idle (cure:

(Please turn to page 52B)

What makes this American gran turismo car European?

THE AUTOMAKERS' DREAM is sports-car handling in a family sedan. The Europeans got there first: Jaguar, Mercedes, Citroen, BMW and so on.

Not to be outdone, GM decided that if the Europeans can do it, so can we. GM set out to build—and did build—four cars that embody true gran turismo handling, maneuverability, braking and performance, combined with a good long-distance ride, roominess, general comfort and luxury.

For 1973, all four of GM's A-bodied intermediates—Pontiac Grand Am, Chevy Monte Carlo, Olds Cutlass Salon and Buick Regal—offer true GT models. These cars really handle. Let's see what makes Grand Am that way.

The Grand Am's chassis was set up specifically for steel-belted radial tires. (See *How Detroit is "tuning" its new cars for radials*, which begins on page 130.) Suspension uses heavy-duty everything, including harder rubber bushings, a thicker front stabilizer (1.12 in. o.d.), a standard rear stabilizer and a bit more suspension travel than found in normal Pontiac intermediates.

Shock absorbers, called Pliacell, have internal plastic membranes that separate the hydraulic fluid from the gas. At high speeds on rough roads, most shocks tend to aerate (gas and fluid mix, causing bubbles). This kills a shock's effectiveness. But Pliacell shocks can't aerate.

Despite a much stiffer-than-normal suspension, the Grand Am's ride is very smooth and silent—surprisingly so. At 80 mph, the car feels like most others doing 60.

Two V8s in four horsepower ratings lend impressive performance. Hottest is the LS2 Super Duty 455-cu.-in. V8 at 310 hp net. This engine has fittings at the back of the block for quick conversion to dry-sump lubrication (for racing). Transmission choices include the Muncie M21 wide-ratio four-speed or GM's Turbo Hydra-Matic (standard).

Conclusion: If you want a car that handles—and one that handles the family as well—the Grand Am and its three A-bodied cousins will give you more grand touring for your money than anything from Europe.—M.L.

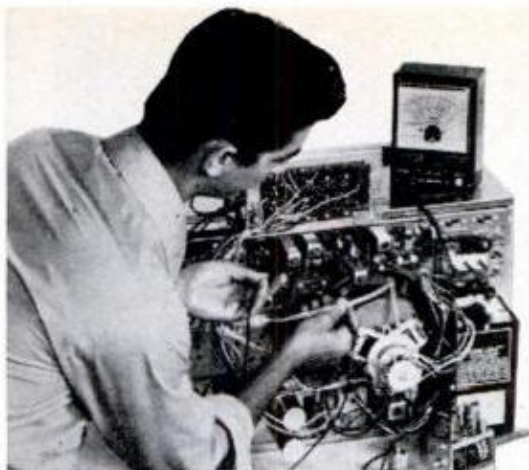

RCA Institutes Home Training may be your best investment for a rewarding career in electronics :

1 A broad range of courses to help you get the technical training for good-paying jobs in such rewarding fields as communications, color TV servicing, FCC license preparation and industrial instrumentation.

2 RCA's exclusive AUTOTEXT method — an easy, fast, simplified way to learn electronics at home.

3 You get "Hands-On" Training — as many as 21 kits in RCA Institutes' Master TV/Radio Servicing Program.

4 Easy payment plans.

5 Approved by N.Y. State Education Dept. for the training of Veterans. Licensed by the New York State Education Dept. Accredited Member National Home Study Council.

6 CASSETTE SYSTEM — an optional extra — It's almost like having an instructor in your home.

This entire fold-over coupon makes a no-postage-required business-reply envelope. Fill in your name and address ...then cut out along dotted lines...fold, seal and mail.

RCA INSTITUTES, Inc., Home Study School
320 West 31st St., New York, N. Y. 10001

699-303-0

Send me free illustrated career catalog. No salesman will call.

Name _____ Age _____

(please print)

Address _____

City _____ State _____ Zip _____

- Check here if interested in Classroom Training. (N.Y. or Phila.)
 Veterans check here

NO STAMP NEEDED

You must seal (Staple, tape or glue) before mailing.

FOLD HERE

DO NOT CUT HERE

FIRST CLASS
Permit No. 10662
New York, N.Y.

BUSINESS REPLY MAIL

No Postage Necessary if Mailed in United States

Postage will be paid by

RCA INSTITUTES

Home Study School
320 West 31st St.
New York, N. Y. 10001

699-303-0

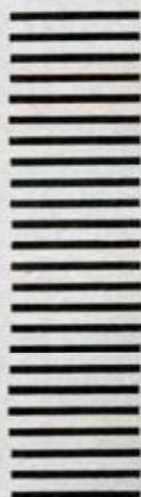



BUCKET SEATS in two- and four-door Gran Ams use harder perimeter bolsters for good lateral support



SEATBACKS ADJUST not only for rake, but also have back supports inside that can be dialed firm, soft

PONTIAC GRAND AM

(Continued from page 52)

a \$400 injector pump). That's why we began to look for a car with Mercedes virtues but for less money and upkeep. The Grand Am has common domestic faults, but the ride is true and precise, it doesn't float at highway speeds, it turns in a reasonable circle, it doesn't stick out yards beyond the axles, it fits into my garage, it carries five people at 70 mph, and you can carry on a normal conversation at that speed."

What are some of those "domestic faults"? Owners rated workmanship good/excellent by a two-thirds majority—terrific for a Detroit car. When asked for specific complaints, 23.3 percent had none—a remarkable showing. But there are gripes.

"Alloy wheels are too soft—a brick will total one, and did!" "It's extremely difficult to find steel-belted radial snow tires to fit this car." "No rear legroom in the coupe, no light in the heater control or trunk." [*They're optional.*] "The tuck-under of the body makes it impossible to keep clean." "Louvered rear side windows look nice, but the glass is hard to clean, and nobody sitting in the back seat can see out." "Gas mileage is less than I expected with the two-barrel carburetor." [*Lots of owners complained of poor gas mileage.*] "Not enough headroom, legroom, nor trunk space." "Lousy workmanship."

We asked owners, "If you were willing to spend \$1000-\$2000 more for a car, would you have bought a different one?" An amazing three out of every four said no. Of those who said yes, 31.3 percent wanted a Pontiac—probably the Grand Prix or Grand Ville with more luxury and comfort options than they ordered with the Grand Am. Next came Mercedes-Benz, then Toronado and finally Cadillac. We also got a smattering of BMW, Pantera, Triumph Stag, Corvette, etc.

Several owners mentioned that passers-by would punch the Grand Am's pliable nose just to see it spring back. This caused the pinstriping decal to crack and peel. But the ultimate testimonial in favor of the plastic schnozzola came from an Indiana postmaster. He says, "I am adding this little note to tell you just how effective the new bumper really is. My wife was struck across the front of our Grand Am while waiting at an intersection. The car that swiped her was doing more than 40 mph, according to the police report, when he brushed his side against the Pontiac's nose. The other car's doors and fenders were torn, and damage was estimated at \$700. Damage to our Grand Am: \$30. The investigating officer said that if he hadn't seen it with his own eyes, he'd never have believed it."

What are some suggestions owners have for improving the Grand Am?

"Swivel bucket seats and the door straps moved back so they're not such a long

(Please turn to page 52D)

Every home a super receiver

ELECTRONIC MIRACLE TURNS YOUR HOUSE WIRING INTO A JUMBO TV ANTENNA

- uses no current
- plugs in to any outlet
- no special tools or additional material required
- no more rabbit ears . . . ugly outside antennas

Utilizes all the wiring in your home
... every room a reception area

Do you know that you have one of the greatest TV antennas ever constructed? It's better than any set of rabbit ears, more efficient than complicated external antennas. It's your house. Yes, the wiring in your home constitutes a giant antenna that acts as a super receiver for TV, FM, all kinds of difficult reception.

And the secret to using all this reception potential is an amazing little plug in attachment that utilizes the receptivity of your house wiring without using a single bit of electrical power. Yes, you simply attach the adapter easily & quickly to your set . . . plug it in to any wall outlet and immediately your entire electrical system is working for you. No ugly looking rabbit ears, no difficult, dangerous to maintain external antennas, and reception so sharp and clear it will amaze you even in the more difficult areas. Order one for every set in your house, no interference from simultaneously operating sets. Only \$1.99. Full instructions included.

JAY NORRIS CORP.

25 W. Merrick Rd., Dept. ME-43, Freeport, N.Y. 11520



**BUY WITH CONFIDENCE —
MONEY BACK GUARANTEED**

**Jay Norris Corp., 25 W. Merrick Rd. Dept. ME-43
Freeport, N.Y. 11520**

Please rush _____ Indoor TV Antenna(s)
@ only \$1.99 plus 50¢ shipping and handling,
under your money back guarantee.

SAVE! Order TWO Antennas for only \$3.50 plus
50¢ shipping and handling.

Check or money order enclosed for total \$ _____
_____ (N.Y. residents add sales tax).

Name (print) _____

Address _____

City _____

State _____ Zip _____

©1972, Jay Norris Corp.

Summary of 1973 Pontiac Grand Am Owners Reports*

Total miles driven	715,402
Body styles:	
2-door coupe	77.4%
4-door sedan	22.6
Engines:	
400-cu.-in. V8, 2-bbl.	65.4%
400-cu.-in. V8, 4-bbl.	26.8
455-cu.-in. V8, 4-bbl.	7.7
455-cu.-in. V8, 4-bbl. SD ..	0.0
Average mpg by engines:	
400-cu.-in. V8, 2-bbl.	
local driving	11.1
long trips	13.7
400-cu.-in. V8, 4-bbl.	
local driving	10.9
long trips	13.3
455-cu.-in. V8, 4-bbl.	
local driving	10.4
long trips	12.5
Transmissions:	
Automatic	98.4%
4-speed manual	1.6
Why did you buy a Grand Am?	
Styling	78.5%
Handling	31.0
Size	10.3
Would you have bought a different car if you'd had \$1000 to \$2000 more to spend?	
No	74.1%
Yes	25.9
If "yes," what car?	
Pontiac (with more options) ..	31.3%

Mercedes-Benz	25.0
Olds (mostly Toronado)	12.5
Cadillac	7.8
Specific likes:	
Handling	79.1%
Design—appearance	68.3
Comfort	36.1
Riding qualities	32.1
Performance	13.3
Roadability	12.4
Specific dislikes:	
Poor gas mileage	22.1%
Poor workmanship	16.7
Trunk too small/unusable	6.3
Thin or cracking paint	6.3
No rear legroom	5.4
Lack of power	5.4
What changes would you like?	
More front, rear legroom	14.7%
Different styling	10.9
Better workmanship	7.6
Better materials	6.2
More headroom	6.2
Had any mechanical trouble?	
No	55.6%
Yes	44.4
What type of trouble?	
Carburetor	15.3%
Electrical	9.0
Windshield wipers skip	9.0
Speedometer cable	8.1

Steering	7.2
Engine diesels	7.2
Did you repair it yourself?	
No	97.2%
Yes	2.8
Dealer repairs satisfactory?	
Yes	70.5%
No	29.5
Is the Grand Am your only car?	
No	61.2%
Yes	38.8
Other cars owned:	
Pontiac	34.6%
Chevrolet	16.3
Ford	10.5
Volkswagen	7.2
Oldsmobile	5.9
Cadillac	5.9
Workmanship opinion:	
Good to excellent	67.8%
Average to poor	32.2
Dealer service opinion:	
Good to excellent	65.1%
Average to poor	34.9
Age distribution of owners:	
15-29 years	41.6%
30-49 years	39.7
50-plus	18.7
Would you buy another Grand Am	
Yes	87.2%
No	12.8

*Percentages might not equal 100% due to rounding or insufficient data.

PONTIAC GRAND AM

(Continued from page 52B)

reach." "Rear windows should roll down and also be easier to clean." "Better seals on doors and windows so they don't leak air and water." "Individual rear-end styling—now it's the same as on the regular Le Mans." "Seatback releases are in a terrible location. These should all be standardized." "Heavier front shocks with the 455 V8—my car bottoms."

The last word comes from a New Mex-

ico property administrator who writes, "It is the best overall car I have ever purchased, due to its outstanding handling, roadability, comfort, safety, and roominess. I have been a GTO buyer for 10 years, but I am convinced that Pontiac has come up with a car that is a GTO-plus with all its features greatly improved at the same time. And it is one of the most looked-at cars I have ever owned, including the first 1964 GTO and a 1955 Buick Century (doozies in their day). The mildest reaction I get is 'TERRIFIC!'" ★ ★ ★



SLOTTED GLOVEBOX DOOR lets conditioned air pass through, yet doesn't limit the size of compartment

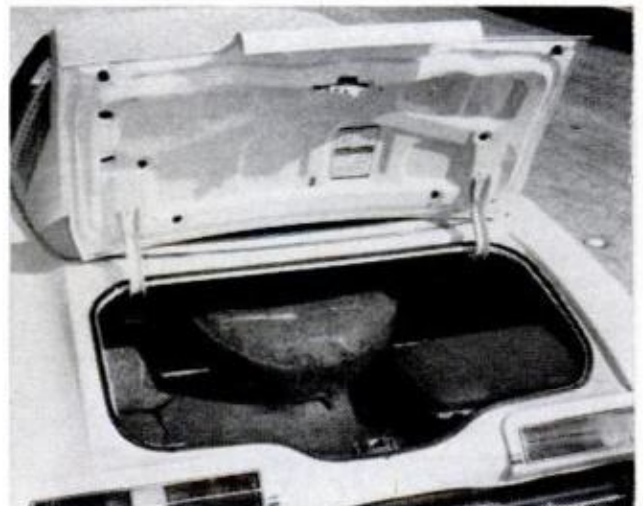

TOO SMALL, say many owners, and quite a bit of valuable space is taken up by trunk-gobbling spare



PLANER • MOLDER • SAW

30-DAY FREE Trial!

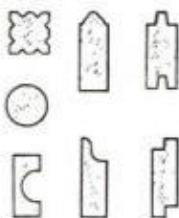
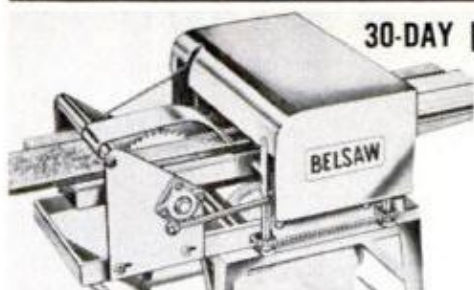

Now you can use this ONE power-feed shop to turn rough lumber into moldings, trim, flooring, furniture... ALL popular patterns. RIP... PLANE... MOLD—separately or all at once with a single motor. Free 30-Day Trial. Low Cost—only \$35 down.

Send Postcard Today—No Salesman Will Call.

BELSAW POWER TOOLS, 903M Field Bldg., Kansas City, Mo. 64111

New Gas Engine Sale

Briggs & Stratton, Lauson, Wisconsin, Kohler, etc. as low as \$29.50. New surplus. Send 25¢ for 100 page catalog listing 100's of items.

MASTER MECHANIC MFG. CO., Dept. A-33 Burlington, Wis.

COUNTERFEIT GUNS

Authentic machined metal replicas of famous firearms disassemble like originals.

Precision machined metal models look, feel, weigh, disassemble like real guns — Over 30 hand finished parts Perfectly legal — CANNOT be fired. Great for decorating den, office, rec. room. Send for free color brochure of 28 models of famous historical to modern military firearms.



#300
U.S. .45
\$21.95

REPLICA MODELS Inc.

Dept. PM-3, 610 Franklin St., Alexandria, Virginia 22314

Send #300. Add \$1.25 postage per model.

Enclosed \$ _____

NAME _____

ADDRESS _____

CITY _____ STATE _____ ZIP _____

PLEASE SEND FREE FULL COLOR CATALOG.

Build **POPULAR MECHANICS'** little **CARRIAGE HOUSE!** Simply great! A back-yard building that isn't an eyesore. Styling blends in with most homes. It will take your mower, lawn furniture and tools—or the kids' overnight guests. Use it as your shop or home office. Overall outside dimensions 10-ft. 4 in. x 12-ft. 4 in. For one complete set of plans send \$3.95 to **POPULAR MECHANICS** Dept. FA, Box 1014 Radio City, N.Y. 10019. For two sets of plans (you may need one for your local building department) send \$5.49.

MARCH 1973



These 3 BIG DRAFTING KITS GIVEN TO YOU!

... when you train at home with NASD for a

HIGH PAY JOB IN DRAFTING!



Take your pick of 1000s big salary jobs open to Draftsmen. U.S. Labor Dept. reports "42% more Draftsmen needed in next 10 years—not enough applicants to fill jobs available now." Easy home-study plan has helped 100s beginners toward \$\$\$\$\$, security, prestige as Draftsmen—many with only grade school training. Others report good earnings drafting part time while still learning. Why not you?

RUSH COUPON FOR FREE KIT!

Mail coupon for FREE "DRAFTING CAREER KIT," Sample Lesson, Drafting Aptitude Test including new 5-Way Drafting Instrument & 20-Page Book, "Your Future in Drafting"—ALL FREE.

G.I. approved. Write today.



NORTH AMERICAN SCHOOL OF DRAFTING, Dept. 34173
4500 Campus Drive, Newport, California 92660
Rush "Drafting Career Kit," including Book, Sample Lesson, Aptitude Test & Drafting Instrument—All Free!

NAME _____ AGE _____
ADDRESS _____
CITY _____ STATE _____ ZIP _____

What makes everything run better?

handycan.

THE AEROSOL TROUBLESHOOTER

can...



- **LUBRICATE** far better than oil.
- **LOOSEN** rusted bolts.
- **PROTECT** against rust and corrosion.
- **DRY OUT** wet ignitions and metal.

Handycan can unstick doors, locks, hinges. Lubricate hand and garden tools, appliances, autos. Prevent rust and corrosion on sports equipment. Dry out wet ignitions in auto and boat engines. De-ice frozen locks. If it needs fixin'... Handycan can!

If your dealer is sold out, send \$2 for can postpaid.



Magic American Chemical Corporation
Cleveland, Ohio 44122

How to get rich

How can you get rich some day? Make a hit record . . . a killing on the stock market . . . or invent a gadget like the hula hoop?

For most of us, these are just dreams. But have you ever stopped to think that there is a way to get rich—possibly only one sure way? Most fortunes, as you know, are made by people who own their own business.

Perhaps you've thought of starting a small business of your own . . . a franchised drive-in, or maybe a service business. Trouble is, you need \$10,000 to \$15,000 to get started and even then it's a gamble—with slim chances of ever making really big money.

But there is *one* business which could make you rich—almost overnight! And the beauty of it is, you can start on a shoestring during your spare time, even while holding your regular job.

Cash by Mail

The business is Mail Order—and it's fabulous! Come up with a 'hot' new item . . . and WHAM!

It strikes like a bolt of lightning! Suddenly, you are deluged with cash orders from all over the country . . . MORE MONEY than you could ever make in a lifetime!

Like the Vermont dealer who ran one ad in Sports Afield Magazine. His ad pulled 22,000 orders—over A HALF MILLION DOLLARS IN CASH!

There is no other business where you can make a fortune so quickly!

● A beginner from Newark, N.J. ran his first small ad in House Beautiful—offering an auto clothes rack. Business Week reported that his ad brought in \$5,000 in orders. By the end of his first year in Mail Order, he had grossed over \$100,000!

● Another beginner—a lawyer from the midwest, sold an idea by mail to fishermen. Specialty Salesman Magazine reveals, "he made \$70,000 the first three months!"

Proof

It's a fascinating business! Running ads in newspapers and magazines . . . mailing gift catalogs . . . getting cash orders in your daily mail—steady as clockwork.

There is no other business where you can start on a shoestring and pyramid your profits—without investing in merchandise! One husband and wife mail order team took in \$40,000 selling one item. They obtained FREE ads in national magazines . . . didn't invest a cent in merchandise, and even got the supplier to ship all orders for them!

These exceptional cases are absolute proof that you can get rich in your own Mail Order business. Very rich. Even a U.S. Gov. Report stated: "A number of

one-man Mail Order enterprises make up to \$50,000!"

Pick up any magazine. Notice how the same mail order ads are repeated . . . month after month? That's concrete proof! You know those ads wouldn't be repeated over and over again—unless they were bringing in big cash profits to their owners.

The Secret

The secret of getting rich in Mail Order lies in *financial leverage*. It's a little-known, almost secret method—using other people's capital to make money for you!

You can get thousands of dollars worth of advertising in big national magazines—without investing your own money! And you don't have to write a single ad. Tested and proven ads are prepared for you by experts. Reinvest the profits from your first successful ad—to get more, larger ads, and the profits begin to snowball! It's like building a chain of stores . . . each new store puts more money in your pocket.

You mail out beautiful catalogs which offer hundreds of dollars worth of fine, quality gifts—yet you don't invest one



The thrill of receiving money in your mail is one you'll never tire of!

cent of your own money in merchandise! Your catalogs are printed with your name and address, so all orders come to you. Everything is "drop-shipped" for you, and there's up to 100% mark-up! You pocket the cash profits immediately—even before the orders are shipped to your customers!

Repeat orders alone, just from mailing catalogs, could bring you a steady income for the rest of your life!

Yes, Mail Order is the fastest-growing, most profitable business in America! And now, with more people moving to the suburbs . . . the population explosion . . . and the expanding teenage market . . . we are on the verge of the BIGGEST BOOM in Mail Order history!

Now, with the help and backing of Mail Order Associates, Inc., of Montvale, N.J., you can follow the same proven steps to Mail Order success—using the 'secret' of financial leverage!

Start Now

We supply you with beautiful gift catalogs throughout the year. All products are dropshipped for you, with up to 100% mark-up! You get free samples of top-selling mail order items, plus monthly trade reports on 'hot' new products . . . tested, successful ads are sent to you monthly. You get advertising directories, postal laws, complete courses, expert guidance—EVERYTHING you need to practically guarantee YOUR SUCCESS. Why? Because *our* business depends upon your success. It's mutually profitable!

A recent feature article in Income Opportunities Magazine stated, "Mail Order Associates Inc., offers the most comprehensive Mail Order program ever offered to beginners." They go on to say, "This could be the opportunity you've been looking for. A chance to get in on the ground floor in a little-known business which we believe is on the verge of a new boom."

Free

We are now accepting a limited number of charter members in our new Mail Order Program. No previous experience is required but you must be over 21.

If you are sincerely interested in starting a profitable business of your own . . . if you can see the tremendous advantages which Mail Order offers . . . then ACT NOW!

Mail the coupon today, or simply send your name and address on a postcard. No salesman will call. We will send you a free book—gift catalog, reprints of feature articles, plus complete facts about our program. Write to:

Mail Order Associates, Inc., Dept. 322
Montvale, New Jersey 07645

Rush Coupon for
FREE BOOK!

plus reprints of
Mail Order
articles

Mail Order Associates, Inc., Dept. 322
Montvale, New Jersey 07645

Please rush complete details on your Mail Order Program. I understand everything is free and there is absolutely no obligation. I am over 21.

Name.....

Address.....

City..... State..... Zip.....

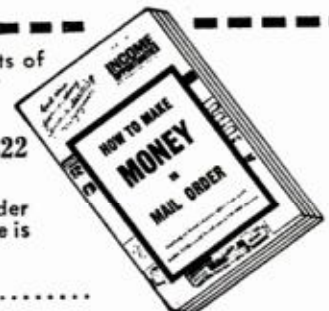



"Average

Land Prices

Up 10%.

Recreational

Land Increasing

At Much

Higher

Rate"

*President's Message to Congress
Jan. 30, 1967

OUR GUARANTEE — If at any time during the period of one year from date of your purchase agreement, you personally inspect your land and are not totally satisfied with your Wild Horse Mesa property, you will be entitled to a total refund of all money you have paid. You need only present your written request for refund to a representative of Seller at the time of inspection.

You can still own Colorado land for only \$24.50 per month.

• No Down Payment • No Interest • No Salesmen • Just \$24.50 per month • Total Price \$2,450 • Buyer Protection Plan • 2½ Acres (Equal to 10 City Lots) of Growing Colorado.

THERE IS ONLY ONE COLORADO

Large land buyers discovered this growing state long ago. Most areas in Denver, Aspen, Vail and Colorado Springs are rapidly expanding causing property in these areas to become more desirable. Now a new area, the San Luis Valley in Southern Colorado, is open to the individual buyer. For years so much of this area has been tightly held by a few large land owners. But now a part of this beautiful valley, Wild Horse Mesa, is available to you for vacation, retirement or long term investment.

WILD HORSE MESA, YOUR SPECIAL PLACE

Fresh, clean air to breathe. You will see neighboring mountain peaks which reach for the clear blue sky. Roam the Pinon and Ponderosa woodlands, ride the wild horse trails and see the wild horse herds which still roam the mesa top. The Mesa overlooks one of the San Luis Valley's largest lakes . . . Lake Sanchez, where your family can swim, sail, water ski and fish for flashing Northerns and Rainbow Trout.

LAND BUYERS ENJOY MANY EXTRAS

Three national forests, within 50 miles, offer unexcelled hunting, camping, exploring and hiking. Snow skiers find Taos and Red River, New Mexico, both within 65 miles. Modern conveniences are here too. School, shopping, churches and friendly people in San Luis and Questa within 22 miles.

ALL THIS FOR ONLY \$24.50 PER MONTH.

These are but a few reasons why property at this price and these terms is going fast. It will never be any easier to buy your own 2½ acre retreat in Wild Horse Mesa. Just \$24.50 total monthly payment. No down payment, no sales commissions. Every dollar is applied to the purchase of your land.

TAKE ACTION NOW

Buy while these low current prices are still in effect. We are proud of our reputation for doing business fairly and honestly. We want you to know about us. Write any Costilla County Official, County Court House, San Luis, Colorado. Be first this time. Fill out coupon below.

WILD HORSE MESA

VALLEY PLAZA CENTER - ALAMOSA, COLO. 81101

Please reserve a 2½ acre tract in my name. I understand that there is no obligation and that I may purchase my property for \$2,450.00, with no money down, no interest and monthly payments of only \$24.50. Please rush my color brochure, purchase agreement and land map showing the exact location of my property. No salesman will call.



Name _____

Address _____

City _____

State _____

Zip _____

PM 1

(I am interested in the purchase of _____ 2½ acre sites)

This offer is subject to all local, state and federal regulations.

45 different plans. 25¢ each.

Furniture

- Patio Furniture
- Utility Table
- Wall Desk
- Room Divider/Storage
- Built-In Bar
- Corner Study Area
- Planter Table
- Foldaway Table
- American Beauty Bar

Outdoor

- Outdoor Storage Wall
- Outdoor Storage Port
- Garden Storage Cabinet
- Tool Cabinet Workbench
- Lawn Tool Storage
- Modular Plant Boxes
- Knockdown Sawhorses
- Storage Pergola
- Portable Dog Kennel



- Outdoor Storage Unit
- Vertical Venetian Blind Fence
- Garden House
- Patio Chair
- Patio Chaise Lounge
- Umbrella Table
- Patio Serving Cart
- Carport & Patio Shelter

Storage

- Overhead Cabinet

- Garage Wall Storage
- Unit Storage Wall
- Odds & Ends Cabinet
- Under Eave Storage
- Child's Storage Wall
- Trash Can Bin
- Hobby, Laundry & Sewing Center
- Storage Divider Plan
- Tampa Tool Box
- Movable Laundry Center
- 3-Way Sports Cabinet

Toys

- Portable Sand Box
- Child's Table & Stools
- Bunk Beds
- Portable Toy Storage
- Tower Fort
- Rocking Horse
- Club House

Send me catalogs (25c) with the complete list of 81 plans and a picture of each project.

American Plywood Association, Department PM-033, Tacoma, Washington 98401

Name _____

Address _____

City _____ State _____ Zip _____

Please print clearly. This will be your mailing label.



Plywood quality-tested by the Division for Product Approval.



MFG

Challenger 12

Pressure molded fiber glass tri-hull

BIA CERTIFIED

\$199.00



Challenger 14

\$229.00

* F.O.B. FACTORY

- ROD HOLDERS
- INSULATED BAIT WELL
- TRANSOM DRAIN
- FOAM FLOTATION

White or Hunter Green

SEE YOUR MFG DEALER

MFG BOAT CO., UNION CITY, PA.

World's largest producer of fiber glass boats

ORIGINAL SELF-STICKING

magic-mounts®

FOR ALL YOUR HANG-UPS

- | | | |
|----------------|-------------------|---------------|
| 29¢ | 39¢ | 49¢ |
| STRIP HANGERS | CLIP-HANGERS | UTILITY HOOKS |
| KEY RACKS | WALL HANGERS | WALL HOOKS |
| PROTECTOR PADS | MINI-HOOKS | CUP HOOKS |
| | ALL-PURPOSE HOOKS | |

MILLER STUDIO, INC., NEW PHILADELPHIA, OHIO 44663

WHAT'S HE DOING?

Making a Concrete Flower Pot! ... and **SO CAN YOU!**

Make and sell your own Ornamental Concrete items. Rush \$3.00 for Book about Aluminum Molds with prices and production trade secrets direct from world's largest mold manufacturer. Over 350 designs to select from.



Send **\$3.00** CONCRETE MACHINERY COMPANY

Today To ➔ P. O. BOX A99 - HICKORY, N. C. 28601

You get more for your money from NRI



SOLID STATE TRAINING—Learn-by-doing with NRI equipment. TV-Radio Servicing course includes 25" color TV, with handsome woodgrained cabinet at no extra cost; wide-band service type oscilloscope, color bar crosshatch generator, transistorized volt-Ohm meter, and solid-state radio kit. Other courses equally complete.

NRI Programmed Equipment Gives You Priceless Confidence, Makes Learning TV-Radio, Electronics Fast and Fascinating

NRI pioneered the idea of supplying home-study students with custom designed training kits to give practical on-the-job experience as you learn. Today, NRI's "3-Dimensional" training can't be equalled. You get more value—from the exclusive Achievement Kit sent the day you enroll, to "bite-size" texts and custom training equipment. Learning TV-Radio, Electronics or Communications at home is easy, exciting, the NRI simplified, dramatized way.

BE A SKILLED TECHNICIAN IN AMERICA'S FASTEST GROWING INDUSTRY

Regardless of your educational background, you can learn the Electronics field of your choice the practical NRI way. The NRI color catalog, sent to you free and without obligation, tells you how you can qualify quickly to be a part of the fast growing Electronic Age; about engineering jobs in business, industry, broadcasting, government, now offered to men without college degrees. It will open your eyes to the great number of success opportunities available right now in the high-pay world of TV-Radio Servicing, Broadcasting-Communications and Industrial-Military Electronics. With NRI technical training, you can take your choice of a wide variety of career

openings or have a business of your own. And if you choose one of five NRI courses that include FCC License preparation, *you must earn your FCC License or NRI refunds your tuition!*

MAKE \$5 TO \$7 AN HOUR EXTRA IN SPARE TIME STARTING SOON

Tens of thousands of NRI graduates are proof it is practical to train at home in your spare time. Keep your present job while preparing for a better one, and earn \$5 to \$7 an hour extra in spare time while you train, fixing sets for friends and neighbors. NRI shows you how. Equipment you build and keep becomes useful in your work.

STEP UP TO BETTER PAY, A BRIGHTER FUTURE

NRI can help you, but the decision to act must come from you. Decide now to move ahead . . . mail the postage-free card today for your FREE NRI color catalog. No obligation. No salesman will call. NATIONAL RADIO INSTITUTE, Electronics Division, Washington, D.C. 20016.

APPROVED UNDER GI BILL

If you served since January 31, 1955, or are in service, check GI line on postage-free card or in coupon.

CASH IN ON THE BOOM IN COLOR TELEVISION



The NRI TV-Radio Servicing course includes your choice of black and white or color TV training equipment. Color TV needs thousands of trained men to keep pace with millions of sets being sold every year. NRI prepares you quickly. Cash in on the boom.

Mail insert card for your FREE NRI color CATALOG

No salesman will call



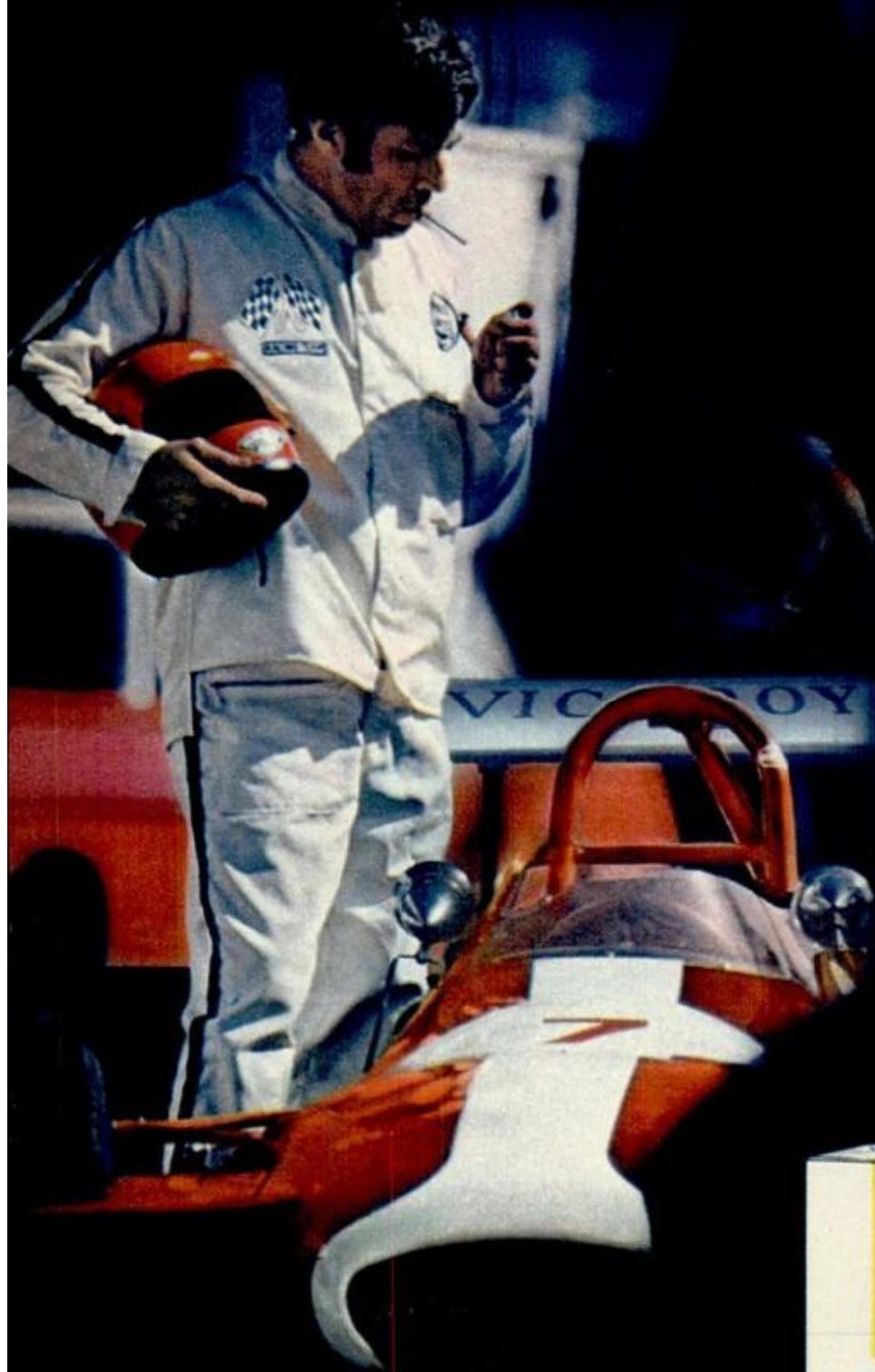

**Get a taste of
what it's all about.
Get the full taste of Viceroy.**



© 1971, BROWN & WILLIAMSON TOBACCO CORP.

Warning: The Surgeon General Has Determined
That Cigarette Smoking Is Dangerous to Your Health.

King Size, 18 mg. "tar," 1.3 mg. nicotine; Long Size, 19 mg. "tar,"
1.5 mg. nicotine av. per cigarette, FTC Report Aug. 72.

SOLUTIONS FOR MECHANICAL HEADACHES

AUTOMOBILE CLINIC

BY MORT SCHULTZ

Gasketless

Should there be gaskets under the sparkplugs of a 1970 Dodge Dart slant Six engine? My car never had any, and opinions are divided as to whether they are required.—N.K. Flynn, San Juan, P.R.

Gaskets are not required if sparkplugs have tapered seats, which make a gas-tight seal when firmly tightened. The seat is the part of the plug immediately above the thread that sets itself against the sides of the cylinder hole. All plugs with square seats require gaskets.

Keeping a Chevy going

Several owners of 1972 Chevrolets, myself included, are having trouble keeping a cold engine running. It starts quickly, but stalls if you take your foot off the gas pedal. Once warm, the engine runs great. What can be done to get rid of this problem?—Donald Tymn, Sterling Heights, Mich.

The problem may occur because vacuum is pulling the choke butterfly plate open too soon. This can be corrected by adjusting the choke vacuum break as spelled out in the 1972 Chevrolet service manual. Another reason may be a poorly adjusted idle-stop solenoid, which should be adjusted according to instructions in the manual.

Finally, some modifications have been made by Chevrolet to the choke closing assist spring and thermostatic choke coil, both of which have a bearing on your problem. Ask your dealer to apply the instructions given in technical service bulletins 72-T-1 and 72-T-3.

Toyota's brake problem

I own a 1971 Toyota Corona which at 4500 miles wore out its front-disc rotors and pads. The same thing happened at 9200 miles. The dealer has made repairs, but doesn't seem to have a lasting solution to the problem. Can you help?—F. Neal Sever, Pittsburgh.

According to Toyota, the procedure outlined in service bulletin Y-7 (10-27-71)

"will accomplish outstanding results" if brakes are squealing or short life is encountered. Toyota contends the trouble is caused by disc-brake calipers which aren't returning to full release position and suggests you remove all four caliper guides, clean all contact surfaces and lubricate these surfaces with Loc-tite or a comparable antiseize lubricant.

More on towing

In the Sept. 1972 Auto Clinic you described for Owen T. Reeves how to tow an automatic-transmission car for a long distance with another car having an automatic transmission. You failed to mention that unless the drive wheels are raised off the ground the driveshaft should be disconnected. When a car with automatic transmission is towed, the front pump in the transmission is inoperative and serious transmission damage can result from insufficient lubrication.—Ewing Kelly Hill, Huntsville, Ala.

Right you are, Mr. Hill. Thank you for clarifying this omission.

Filter follies

Can you tell me if Chrysler Corp. has issued instructions regarding a 1972 Plymouth Valiant with 318-cu.-in. engine? The oil filter which the dealer sells doesn't fit, because it is too long and hits against the torsion bar. Is this common?—Angelo Lorenzo, Stony Point, N.Y.

All 318-cu.-in. engines manufactured after March 1, 1972, for Valiants and Dodge Darts no longer have a right-angle adapter that allows the long oil filter to clear the torsion bar. The "shorty" oil filter (Chrysler part No. 3549957) should be used in these models. If your dealer wants proof, refer him to Chrysler-Plymouth service bulletin 10-04-72C (2-23-72).

Hope for Opel

I can't get my 1972 Opel 1.9-liter engine to idle although I adjust the carburetor

(Please turn to page 58)

You'd expect this kind of luxury in \$6,500 European cars.

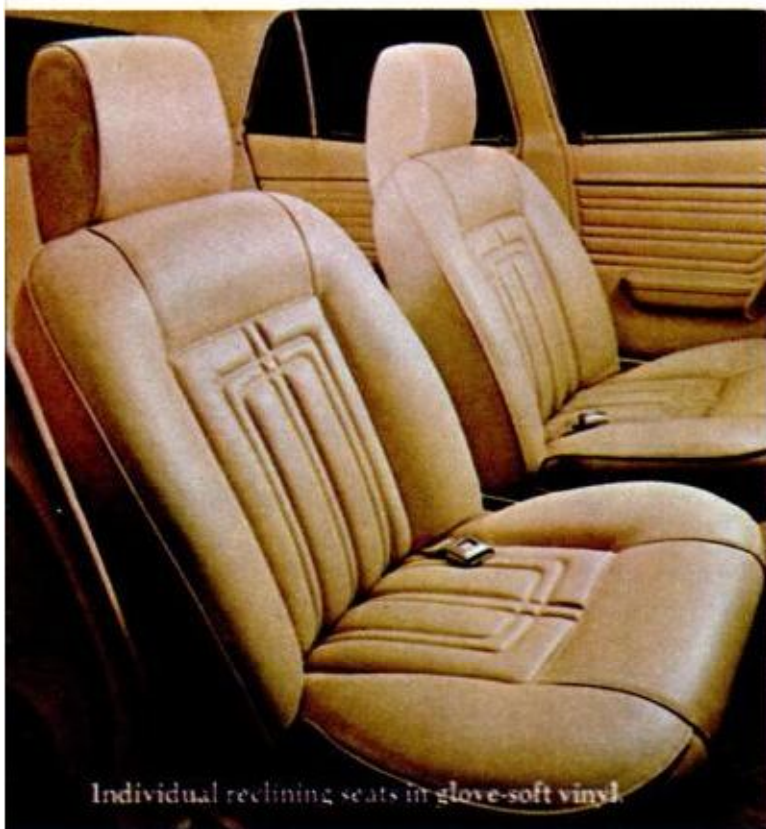

Individual reclining seats in glove-soft vinyl.



Wood-grain dash, cut-pile carpeting throughout.

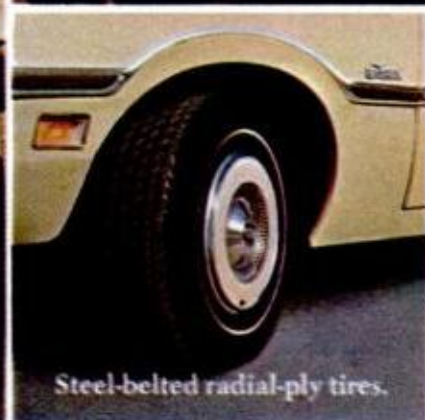

Steel-belted radial-ply tires.



Grained vinyl roof.

AUTOMOBILE CLINIC

(Continued from page 57)

just as the book says. What now?—Charles Walsh, Duluth, Minn.

Check the idle jet for contamination. The idle jet is above the mixture screw and the idle-bleed screw near the top of the carburetor. It has a very small orifice in its end. Any contamination at this point will cut off all fuel to the idle circuit. Blow it out with compressed air. Also check the four carburetor hold-down studs and the six bolts that hold the intake manifold to the cylinder head. An air leak between the carburetor and intake manifold or between the intake manifold and cylinder head will upset the idle.

Stumbling Pinto

I am the owner of a 1972 Ford Pinto Runabout which occasionally experiences engine cut-out on right turns only. The dealer replaced the carburetor, but to no avail. Any ideas?—Mrs. F. Sykes, Key West, Fla.

Replacing the carburetor and not setting the float level to specification is a fre-

quent oversight. Your engine may be starving for gas on right turns, because the float has been set too low. Have the dealer adjust the level to spec. If the problem persists, then the cause is probably a short in the ignition's primary circuit.

Frozen transmission

Because of our severely cold winters—as cold as minus 50° F.—the standard transmission of my 1963 Chevrolet pickup truck becomes unbearably hard to shift. Last winter I broke two gearshift levers from the steering column. The grease gets too hard. Any solution?—Tim Jollymore, Duluth, Minn.

When winter approaches, drain the transmission and put in gear lubricant SAE 75 (GL-5), which is equivalent to an SAE 10 engine oil. When warm weather returns, drain the transmission once again and switch back to multipurpose gear lubricant SAE 90.

Taking the rap

Lately, on first starting my 1968 Chrysler Newport with 383-cu.-in. engine in the

But not in an American compact at \$2,809.*



Maverick with Luxury Decor Option. You get everything here, plus about 30 other luxuries. About those steel-belted radials: tests show that the average driver can expect 40,000 miles of tread life under normal driving conditions.

See your Ford Dealer. And while you're there, check on the other 1973 Mavericks. All have a refined suspension system, thicker seats and carpeting. The ride is quieter.

FORD MAVERICK

FORD DIVISION



*Car shown: \$2,809 sticker price, including 302 V-8 engine. Dealer preparation, destination charges, title fees and taxes extra.

morning I hear a distinct rap in the engine that lasts until the oil-pressure light goes out. This takes almost 10 seconds. Is this a warning of some major headache?—Peter Pianta, Bayside, N.Y.

The fact that the rap disappears indicates oil-starved bearings during the period of time that the oil-pressure light is on. It could be a forewarning of major trouble. Lack of oil pressure can be caused by a low oil level, diluted oil, a stuck oil-pump relief valve, a damaged oil-pump suction tube, or a weak oil pump. Have the problem fixed before serious damage is done.

Service tips

● **Car owners** have been doing a double-take at the windows of their cars for some time, not certain whether the eerie patterns they've been seeing mean that the glass is defective or their eyes are going bad. Under certain climatic conditions—on a clear fall day, for

example—polarized color patterns appear. This will also happen when you're wearing polarized sunglasses. It's normal and can't be removed by washing, polishing, replacing the glass or closing your eyes.

● **Cricket owners**—chirp, chirp—take it from Plymouth: The heat range sparkplug the company says you should use (page 51 of your owner's manual) is not the one you should be using. The right one for all Cricket engines is the N7Y.

● **Three cheers for 3M.** It has a simple, inexpensive way of repairing instrument-panel chrome plastic strips that have had the chrome rubbed off. Get a roll of Pressure Sensitive Tape No. 426 (3M's, of course) from an auto-supply dealer and cut a length of the desired size. Press the tape on firmly and carefully to remove wrinkles—who wants a plastic strip that looks like a prune?—and trim it with a sharp razor blade or X-Acto knife. You won't be able to tell it from the original. ★★★

GOT A PROBLEM WITH YOUR CAR? Ask Mort about it. Send your question to Auto Clinic, *Popular Mechanics*, 224 West 57th St., New York, N.Y. 10019. Letters cannot be answered individually, but problems of general interest will be published in the column.

TUNE IT RIGHT! TUNE IT YOURSELF! IT'S EASY AND YOU SAVE WITH AUTO "TUNE-UP" AIDS FROM RADIO SHACK!



These Micronta test instruments put YOU in control of your car's performance! Do the checks and adjustments usually done only by "high-priced" mechanics. Save on repair bills, get the pride and satisfaction of driving a car you've kept in "top tune" yourself! Exclusive at our 1600 stores in all 50 states!

Auto Tune-Up Analyzer. Does every electrically based tune-up and testing function—has color-coded scales for amps, volts, rpm, cam dwell, even a points tester! Includes tune-up chart and easy-to-follow instructions. \$39.95



Automatic Dwell/Tachometer. Gives instant, simultaneous readings of engine rpm and dwell angle—lets you adjust points exactly for peak performance and gas mileage! Features an exclusive automatic ignition starter switch that turns engine on or off from outside car. \$31.95

NOTE: All testers designed for 4, 6, 8-cylinder engines, 6 or 12-volt systems, pos. or neg. gnd.



DC Power Timing Light. Operates from your 6 or 12-volt car battery to help you get maximum mileage, economy. Checks ignition timing, spark advance, distributor cam wear. \$21.95

Hand-Held Dwell-Tach-Points Tester. Goes along anywhere for instant checks of engine performance. Great for "in-the-field" use! Color-coded leads, insulated clips. \$17.95

FREE '73 CATALOG! AT YOUR 148
NEARBY STORE OR SEND IN THIS COUPON
180 pages! Stereo Hi-Fi, CB, Ham, Kits, Radios,
Recorders, Tools, More!

Name _____ Apt. # _____
Street _____
City _____ State _____ Zip _____

Radio Shack
and ALLIED RADIO STORES
A TANDY CORPORATION COMPANY
P. O. Box 1052, Fort Worth, Texas 76107

PUBLICATIONS **WORTH WRITING FOR**

PM'S PICTURE-TOOLS are a great new idea to take the confusion out of *what goes where* on workshop and tool panels.

The complete PM **PICTURE-TOOL KIT** consists of seven big sheets (9¾ x 11¾ in.) of a special heavy-weight paper with a pressure-sensitive adhesive on the back. On each sheet are beautiful drawings of hand tools and portable power tools—all you're likely to have in your shop (74 in total). Most are full size; the others nearly so.

Also enclosed in the kit is a blank sheet of the same special paper, printed in an overall color to match the tools. This sheet enables you to design your own drawings of special tools.

Each of the PM **PICTURE-TOOLS** is carefully die-cut. You simply peel off the backing paper and apply it to the proper spot: on painted or unpainted wood, plywood, hardboard and even perforated-hardboard surface.

Later, if you want to move a few tools or rearrange the entire panel, you can peel off the PM **PICTURE-TOOLS** and reuse them in new locations!

Once your **PICTURE-TOOLS** are in place, you'll know at a glance exactly where each tool belongs.

Order your PM **PICTURE-TOOL KIT** today. Simply send a check or money order for \$3.95 to Popular Mechanics, Dept. PT, Radio City, New York, N.Y. 10019. Be sure to enclose your name and complete address. ★★

MARCH 1973

Winners

have a style all their own.

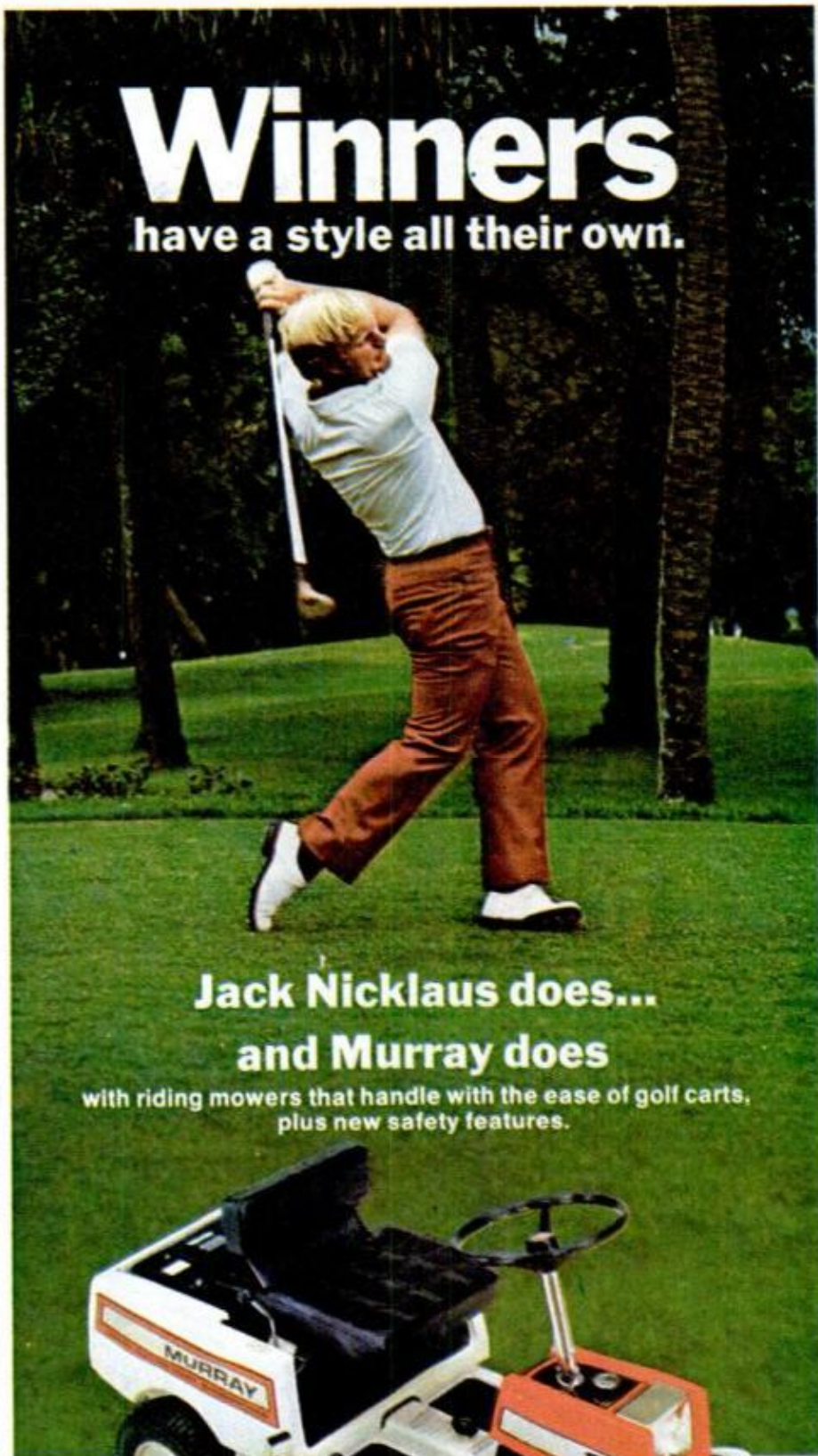

**Jack Nicklaus does...
and Murray does**

with riding mowers that handle with the ease of golf carts,
plus new safety features.



See the full line of Murray Mowers at the Jack Nicklaus sign, or write for name of nearest dealer.

THE MURRAY OHIO MFG. CO., BRENTWOOD, TENN. 37027

ITT Credit Reserve can give you the security of knowing \$3,000 is available to you within 24 hours.

ITT Credit Reserve is a personal financial service funded and established by America's eighth largest company, International Telephone & Telegraph Corporation.

On acceptance, you establish for yourself and your family a \$3,000 line of credit, all or any part of which may be drawn upon in less than 24 hours.

A payment schedule and full information on interest rates are available upon inquiry.

Your inquiry about ITT Credit Reserve will be treated in complete confidence.

ITT CREDIT RESERVE

a service of International Telephone and Telegraph Corporation



Please send information on ITT Credit Reserve. No obligation, of course.

NAME _____ AGE _____
 ADDRESS _____
 CITY _____ STATE _____ ZIP _____

Mail to: K. B. Leverly, Service Director, 2081 First Security Building, Salt Lake City, Utah 84111 or phone toll-free 800-453-9100 (24 Hours A Day—7 Days A Week).

FREE *Kirsten* CATALOG OFFER

Send me your fully illustrated color catalog of the complete line of Kirsten pipes and accessories.

NAME _____
 ADDRESS _____
 CITY _____
 STATE _____ ZIP _____



\$9

postpaid

Kirsten
PIPE CO., INC.

P.O. Box 70526-PM-3
 Seattle, WA 98107

SUBSCRIBER'S

Change of Address Form

Please use this form to notify us at least six weeks before you move to your new address.

1. Present address: Attach address label from a recent issue, or print your name and address exactly as shown on the label.

NAME _____
 ADDRESS _____
 CITY _____ STATE _____ ZIP _____

2. Fill in new address:

NAME _____
 NEW ADDRESS _____
 CITY _____ STATE _____ ZIP _____

3. Mail this form to:

POPULAR MECHANICS
 Subscription Service Dept.
 Box No. 646
 New York, N.Y. 10019

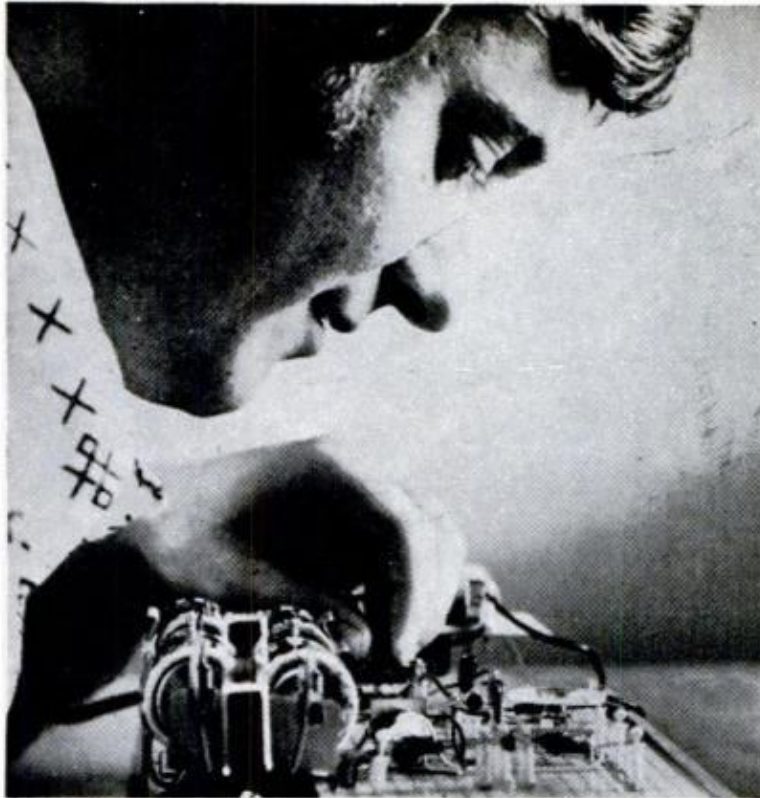

You Learn to Make Money ...with CIE's Electronics Laboratory!

Now you can learn Electronics by performing more than 200 practical, skill-producing experiments...with authentic industrial components...at home...in your spare time.

You learn by doing! This 161-piece Laboratory includes the up-to-date equipment you'll need — such things as an IC (integrated circuit), printed circuit board, FET (field effect transistor), photovoltaic cell, DC motor, microphone, multimeter, soldering iron and power supply.

You put theory into *practice* right in your own *home*... in your spare time...while you go right on pulling down your present pay. It's CIE's exciting space-age "Electronics Technology with Laboratory" program... a unique combination of CIE's special AUTO-PROGRAMMED® Lessons and laboratory equipment. It is the *practical* way to learn Electronics!

Prepare for a High-paying Career

You see, when you "learn by doing," you're *ready to do*...you're *armed* with the know-how to meet the challenges of a high-paying career in Electronics... prepared to go after an exciting, relevant job in a growing field such as medical technology, pollution control, radio and TV broadcasting, computers...just to name a few. Once you have some experience, you can make \$12,000 a year or more.

But that's not all! When you successfully complete your Electronics Laboratory course, you'll get a CIE Diploma. And, you'll be able to pass the Government FCC examination or be entitled to a full refund of all tuition paid! CIE's Money-Back Warranty is valid during the completion time allowed for your course.

Send today for CIE's 2 FREE BOOKS about opportunities in Electronics. For your convenience, we will try to have a representative call. Mail reply card or coupon to CIE...or write: Cleveland Institute of Electronics, Inc., 1776 E. 17th St., Cleveland, Ohio 44114.

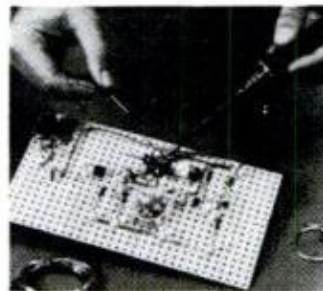

You learn how to construct circuits and connect them with a soldering iron, which is part of your CIE laboratory equipment. This "hands on" experience is extremely valuable.

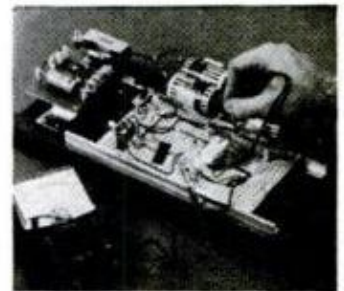

Testing and troubleshooting are an important part of your learning experience. Your laboratory has a precision multimeter to diagnose electronic troubles quickly and accurately.

APPROVED UNDER G.I. BILL

All CIE career courses are approved for educational benefits under the G.I. Bill. If you are a Veteran or in service now, check box for G.I. Bill information.

CIE Cleveland Institute of Electronics, Inc.

1776 East 17th Street, Cleveland, Ohio 44114
Accredited Member National Home Study Council

Please send me your 2 FREE BOOKS — The CIE school catalog, "Succeed in Electronics" and "How To Get a Commercial FCC License."



Name _____ (Please Print)

Address _____

City _____

State _____ Zip _____ Age _____

Veterans and Servicemen:

Check here for G.I. Bill information.

PM-77

Can you spot the Camel Filters smoker?

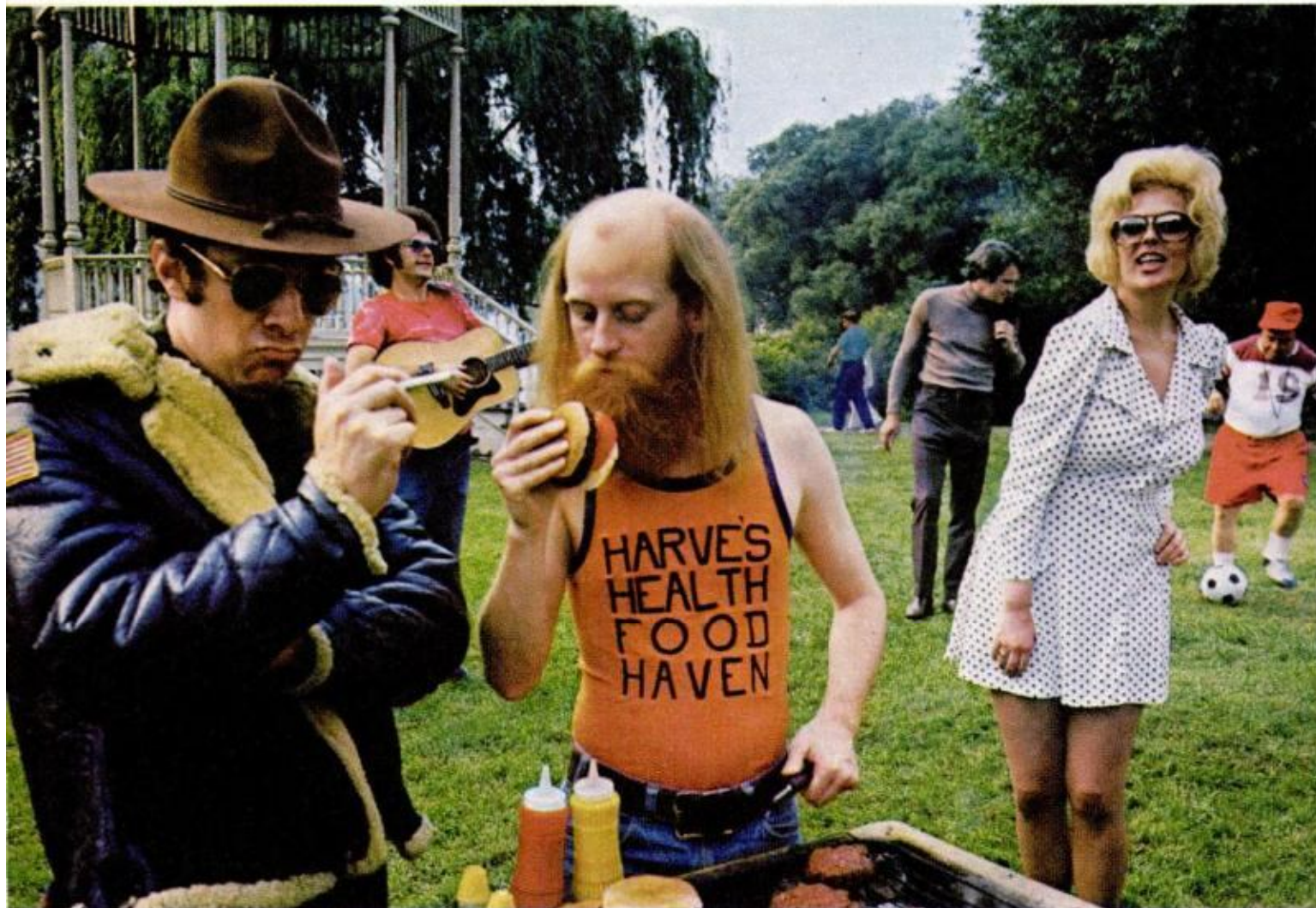

©1972 R. J. Reynolds Tobacco Company, Winston-Salem, N. C.

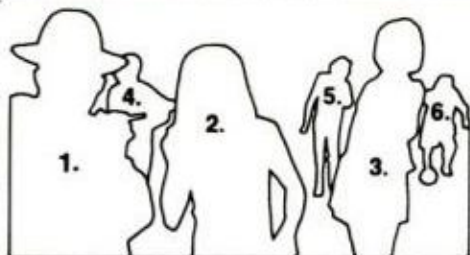

In this picture everybody has a gimmick... almost everybody. Try picking the one who doesn't go along. **1.** Nope. He's Lance Boyle. Gimmick: brags about wars he was never in. Yells "bombs away" as

he flicks his French cigarette. **2.** Sorry. He's Harvey Dibble. His restaurant specializes in dried prunes. Gimmick: smokes wheat germ cigarettes. **3.** Eunice Trace, Starlet. Gimmick: restoring wholesomeness to movies. (Last film review: "At last, a movie the entire family can walk out on.") **4.** Smokey Stanhope, accountant. Gimmick: a guitar. Unfortunately makes the mistake of playing it. **5.** Right. He's just himself. And he sees through all the gimmicks. That's why he wants an honest, no-nonsense cigarette. Camel Filters. Easy and good tasting. Made from fine tobacco. **6.** Calls himself "Killer." Gimmick: thinks soccer uniform enhances his image. When he puffs out his chest, his pants fall down.

Camel Filters.
They're not for everybody
 (but they could be for you).



Warning: The Surgeon General Has Determined That Cigarette Smoking Is Dangerous to Your Health.

20 mg. "tar"; 1.4 mg. nicotine av. per cigarette, FTC Report AUG.'72.

ALL By BILL McKEOWN OUTDOORS

THE OUTDOORSMAN'S special recognition event this year will be the second annual National Hunting and Fishing Day.—Sept. 22.

BACKPACKING has inspired improvements recently for several items of expensive outdoor gear. Some small tents now are lighter and better, and warm down sleeping bags are more compact and comfortable.

An interesting switch on the outer fly over a tent is the Filmgap insulating liner for inside Warmlite tents. Suspended inside the tent, its 10 layers of aluminized plastic film are claimed to provide enough warmth so that sleeping bags often are not needed. Warmlite down bags, available in single and triple-layer models, come with built-in foam bottom pads for soft sleeping while keeping out cold from beneath. Both items, developed by Stephenson's, 23206 Hatteras St., Woodland Hills, Calif. 91364, are described in an informative and cheerful catalog.

Alpine Designs is also introducing improved sleeping bags. Its High Loft down models have new over-the-shoulder and high-arc foot design to insure adequate bag warmth top and bottom as well as in between.

CANOE CAMPERS have several new sources for tips concerning waterways to explore. Florida Canoe Trail Guide describes 16 river trips that now make up the state's canoe trail system. Campsites, boat ramps and wayside parks are indicated as well as information about fish to be caught and nature sights to see. The 40-page booklet is available from the Florida Dept. of Natural Resources, Div. of Recreation and Parks, Larson Building, Tallahassee, Fla. 32304. It's free.

In magazine form and for \$3 from Box 673, Humble, Tex. 77338, is Texas Rivers and Rapids. Eight notable rivers in this big state are covered in detail with photographs, drawings and recommendations about suitable seasons and water levels, as well as topographical maps needed. Even checklists of clothing, first aid equipment, personal gear and hints for canoe camp cooking are provided.

Helpful tips for planning a group canoe trip have been collected by a troop of Girl Scout Mariners into a booklet available from Ed Nelson, Grumman Boats, Marathon, N.Y. Nelson also can provide a free Rent-A-Canoe directory

giving sources of canoes for hire in 34 states plus canoe-trip information in Illinois, Ohio, New Jersey, Maine's Allagash River, Indiana, Tennessee, Delaware, New York's Adirondacks, Wisconsin, Crow Wing region in Minnesota, Michigan, and the upper Connecticut River in New Hampshire.

A RAY OF LIGHT may be replacing mechanical weed harvesters, Argentine flea beetles and chemicals potentially dangerous to the environment. All had been previously used in attempts to control water hyacinths and other plants and weeds that have been practically choking some southern rivers and streams. Dr. Ralph Scott, a former Army Corps of Engineers scientist, has patented a laser beam application which directs the beam by mirrors to irradiate aquatic plant life, and the device is now undergoing testing by the Corps of Engineers. It may also have a weed-control application along highway and railroad rights-of-way, while avoiding any air or ground contamination.

THAT READY-TO-LIVE-IN summer-camp cottage, the mobile home, is being improved. All units built by Mobile Home Manufacturers Assn. members since the first of this year have had to have provisions for tie-downs as standard equipment. The organization has also recommended tie-down requirements as a part of the safety standards for all mobile home construction. Occasional wind-storm damage indicates that summer home camps of any type should be properly secured.

RECREATIONAL VEHICLE owners can travel inexpensively if they want to, but often they don't, according to a recent study by the Recreational Vehicle Institute. The average family spends an average of \$62 a day, according to industry spokesman Paul DuPre. What he calls RVcationers apparently like to eat in restaurants and stop in hotels and motels on occasion. This change of pace may help keep the pastime popular.

THE HUNTER'S RED JACKET may not make him a target, but it is also not as visible as he likes to think, according to recent studies. As the sun sets and light level goes down, so does the attention value of red, it seems. Bright fluorescent orange is likely to replace it. The new shade never appears naturally in nature, is easily spotted by people with defective color vision, but does not appear to be noticed by color-blind big game. Tests by the Massachusetts Division of Fisheries

(Please turn to page 68)

**MAKE BIG MONEY
IN EITHER OF THESE TWO FIELDS**



**TRACTOR-TRAILER
DRIVER**

We can train you to operate the big diesel rigs. Study at home followed by practical training at school-owned facilities in Miami, Fla. Accredited Member NHSC. Home Office—Miami, Fla.

APPROVED FOR VETERANS AND INSERVICE PERSONNEL

**HEAVY EQUIPMENT
OPERATOR**

Learn to operate cranes, draglines, scrapers, clamshells, bulldozers, backhoes, trenchers. Study at home followed by practical training at school-owned facilities in Miami, Fla. Accredited Member NHSC. Home Office—Miami, Fla.



UNIVERSAL TRAINING SERVICE, Dept. PM
1901 N.W. 7 St., Miami, Fla. 33125 • Phone: (305) 642-0800

- TRACTOR-TRAILER DRIVER
- HEAVY EQUIPMENT OPERATOR

PLEASE PRINT

Name _____
 Address _____
 City _____ State _____
 Zip _____ Phone _____ Age _____

NOW!
**Install Central Air
 Conditioning In Your
 Home Yourself**



Thousands of comfort-minded "do-it-yourselfers" have already used our complete kits to add central air conditioning to their forced air furnaces—at a cost of as little as \$500.* If you can fix a dripping faucet you can install the system yourself with a few simple hand tools, and save up to \$200 (even more in some areas) on installation costs. We help you select the right size unit, and provide easy-to-follow installation instructions. Mail coupon today for free illustrated brochure.



*Cost varies according to size and construction of home.

McGraw-Edison Co., Air Comfort Division
 729A N. Clark Street, Albion, Mich. 49224
 It sounds great! Please rush me your brochure on
 Do-It-Yourself Central Air Conditioning Kits.

NAME _____
 ADDRESS _____
 CITY & STATE _____ ZIP _____

ALL OUTDOORS

(Continued from page 67)

and Game indicate that fluorescent hunter orange stands out best under the widest range of light conditions and terrain. A drop in hunter mishaps in Maine is credited to use of the brilliant color, and six states have now made wearing hunter orange mandatory. It sounds like a good investment for any outdoorsman shopping for new clothes.

DRIVERS' LICENSES FOR BOATMEN is an unpopular subject, and the alternative seems to be proper education. The industry's Let's Go Boating Committee has recently compiled sources for a number of free courses around the country, with addresses for more information about them. For U.S. Power Squadron class locations and dates, write USPS, 50 Craig Road, Montvale, N.J. 07645. It has more than 490 branches. Main offices of the Coast Guard Auxiliary are located in Boston, St. Louis, New York, Norfolk (Va.), Miami, Cleveland, Long Beach (Calif.), San Francisco, Seattle and Honolulu. Boating class information is also available from the American Sailing Council of the National Assn. of Engine & Boat Manufacturers, Box 583, Greenwich, Conn. 06830; the Boating Industry Assn., 401 North Michigan Ave., Chicago, Ill. 60611, and the American Water Ski Assn., Seventh St. and Ave. G, S.W., Winter Haven, Fla. 33881. Many gasoline companies also have booklets covering boating areas for cruising, camping and shoreside facilities.

FOR STICK-IN-THE-MUDS, we came across a fine off-the-road item in a 1912 PM that could come back in style for snow, sand and rutted trail driving today. Take a metal plate with bent-down, saw-toothed sides or a heavy square plank with long spikes driven through to stick out of the bottom. Pound it into the ground with a rock or mallet and hook to it a heavy-duty ratchet hoist, the kind recommended for anchoring to the tree that's never there when you want to winch your 4-W-D out of a ditch. We tried our simple block-and-tackle accessory with a two-ton ratchet hoist. You stand on your block to keep it in place while the tackle does the work. It turns out to be as good a back-country accessory gadget as it was along the rutted roads of 60 years ago.

A 90-MPH BOAT is claimed for Broadbill XXIV, a 24-foot offshore fisherman from Broadbill Marine, Fort Lauderdale, Fla. We don't believe it, but we're willing to be shown. She's ruggedly built in a deep-V design of Hetron fire-retardant resin and fiberglass. But 90 mph? ★★ ★

The new Dodge Club Cab gives you more room up front so you can have more room out back.

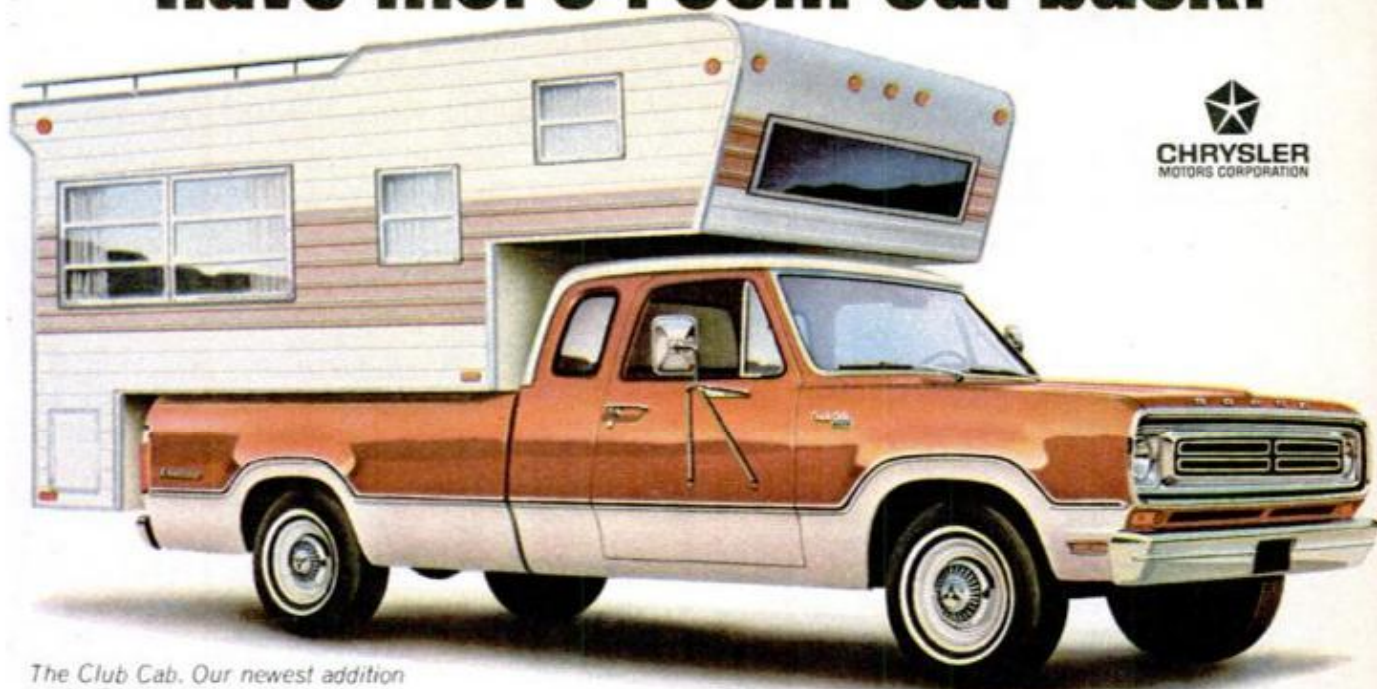

The Club Cab. Our newest addition to the Dodge pickup line.

Campers. Only Dodge gives you 34 cubic feet of extra storage space up front for things you don't want to jam in the back!



Handy's the word for it—the easy-to-reach storage space Dodge gives you right behind the seats of every Club Cab. Think about things you could use that space for. Lounge chairs. Grilles. Lots more. Got the list? Okay, the Dodge Club Cab has the extra storage room you need, and there's even room for auxiliary jump seats, if you like. Dodge gives you all this room and convenience in a pickup that will fit in any standard 20-foot garage.

When you buy a Club Cab, you're not just buying room. You're buying one of the most advanced pickups on the road today. You're getting an Electronic Ignition System for surer starts in any weather. And this system is virtually maintenance-free. The Club Cab comes in the famous Dodge Camper Special versions with all the heavy-duty equipment you need for taking a camper across the country. All Sweptline pickups feature front disc brakes, double-wall construction all around, and independent front suspension for a smooth Dodge ride. It's this kind of extra care in engineering that makes a difference in Dodge... depend on it.



AGAIN THIS YEAR,

WHAT'S NEW IN PICKUPS COMES FROM DODGE...DEPEND ON IT.

DETROIT LISTENING POST

BY ROBERT LUND

GOLD FEVER AT FORD. If you go for the gee-whiz stuff, Ford's got a trick windshield coming on two of its '74 cars—Mark IV and T-bird—that should interest you. Especially if you live in a part of the country hit by a fair amount of snow and ice.

The glass is called Sierrcin, after the company that developed it. The windshield is of conventional construction, a sandwich consisting of two thin layers of glass separated by a sheet of plastic. The plastic Ford will use is impregnated with gold. Yep, real gold. The gold carries current through the window, warming it up to melt ice and snow. The window will work off an alternator—90 volts, 10 amps—and cars equipped with the glass will come with a second alternator as standard equipment. Ford has worked out all the safety angles so if you're standing in a puddle or water has accumulated on the floor of the car, you can't electrocute yourself.

Window warmers and ice melters aren't new, but don't confuse this with anything you've heard of before. The best ice melter you can buy now takes a minimum of 20 minutes to clear one thickness of ice. Sierrcin glass will clear two thicknesses of ice in less than five minutes. It also tints the glass to keep the sun out of your eyes.

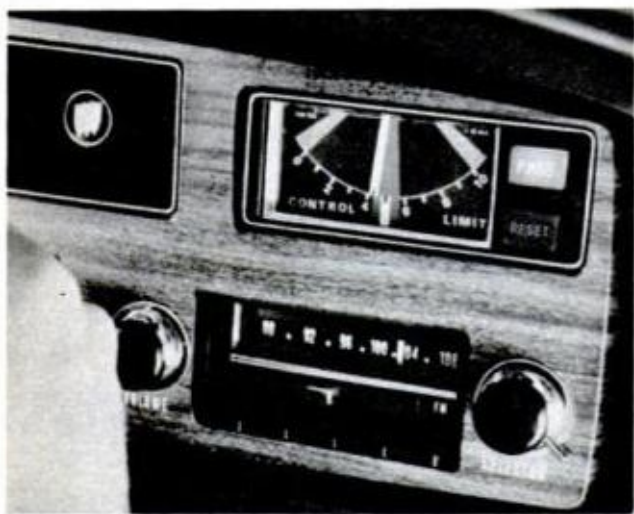

GM LEADS IN RESEARCH to keep drunk drivers off the road. Its latest driver-reaction measuring device installed in an experimental car uses a dashboard meter. When a key is inserted in the ignition, the needle starts to fluctuate, and the driver must steer well enough to keep needle in the narrow center sector. The car won't start unless he passes the test

Ford will install the item in both the windshield and backlight, but not in the sideglass. It'll be an option and the price will be fairly steep. Around \$175.

ALUMINUM BUMPERS. GM and Ford are expected to experiment with all-aluminum bumpers on a limited number of '74 cars. Odd angle is that the light metal will apparently be used on low-price, low-weight cars. Aluminum's advantage is, of course, its light weight. But it's on the big and mid-size cars, not the small jobs, where weight's becoming a problem. So what's the point of putting aluminum bumpers on small cars? Could be that carmakers want to acquire some back-up experience with aluminum—both from a production standpoint and how aluminum bumpers hold up in the hands of customers—before going to aluminum on heavier, higher price cars.

SOFT CARS VS. HARD CARS. The National Highway Traffic Safety Administration is working on an idea that could cause most engineers in Detroit to take early retirement. The government agency thinks automakers should build two types of cars—soft and hard. Soft cars would be the big jobs, hard cars the small ones. Thus occupants of small cars would have more of a chance of surviving when involved in an accident with a big car. And you think you've got problems.

SPORTIVA'S NO MUSTANG. A Ford source denies that the dolled-up Pinto (Sportiva) making the rounds of auto shows is a disguised version of the new Mustang coming this fall. Sportiva has the same general dimensions as the new-generation Mustang, but the real thing will be a sharper, more rakish-looking car than the show Pinto.

ENGINEERS ARE DOWNCAST over mileage reports coming in on the '73 cars—standard-size cars in particular. Cars that realized a fair 12 to 15 miles to the gallon in proving-ground tests before the '73s went on sale are averaging a skinny 8 to 11 mpg in the hands of owners. This doesn't apply to all makes, but all companies have their share of gas hogs.

What about next year? Engineers say they

(Please turn to page 72)

Schick Super II

against I.

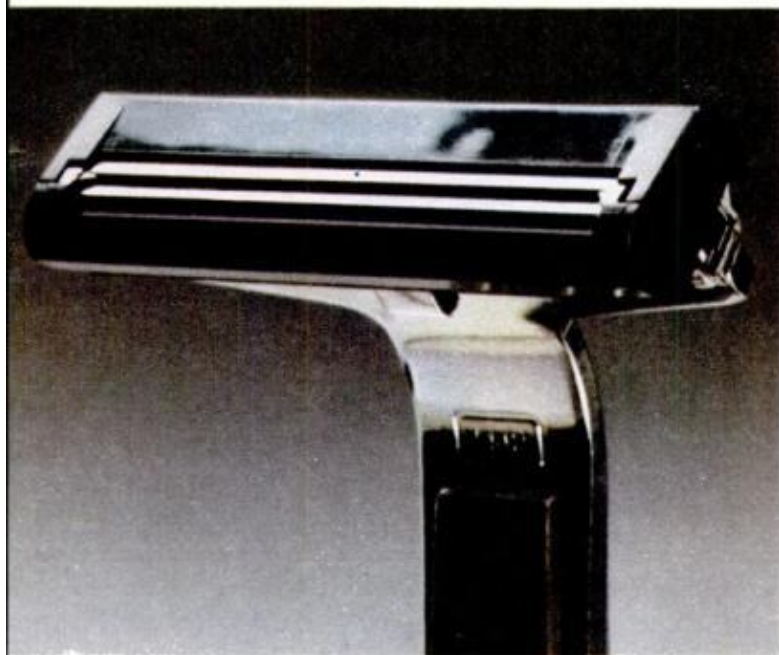

How double is a double edge razor, really?
There's never more than one edge working for you. While the other one's out there goofing off.

Now compare with the Schick Super II:
Both edges are on your side. Always working together.

The first edge shaves you close like your double edge now. The second edge shaves you closer.

There's really no comparison.
It's two against one.
Unfair maybe. But that's life.

Schick-II
Two Bladed Razor



The Schick Super II. Put both edges on your side.

©Schick Safety Razor Co., Div. Warner-Lambert Co.

Материал, защищенный авторским правом

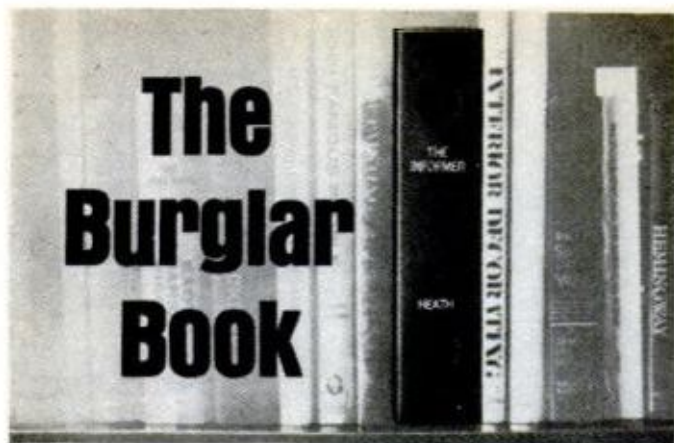

"The Informer", by Heath, disguises the new GD-39 Ultra-sonic Intrusion Kit Sensor and it can stop a burglar cold. To install, you simply plug it into a 120 VAC wall outlet, then plug an external alarm, light, or both into the receptacles provided. Place it on a bookcase or table to survey an entire room or an entranceway. Features include adjustable sensitivity, automatic or manual reset, built-in 30-second delay on alarm. You can build this money-saving kit in about two evenings, even if you're a beginner. Order your Heathkit Burglar Book now.

Kit GD-39, 5 lbs.49.95*

		HEATH Schlumberger	
HEATH COMPANY, Dept. 17-3 Benton Harbor, Michigan 49022			
<input type="checkbox"/> Please send FREE Heathkit Catalog.			
<input type="checkbox"/> Enclosed is \$ _____, plus shipping			
Please send model(s) _____			
Name _____			
Address _____			
City _____		State _____	Zip _____
Prices & specifications subject to change without notice. *Mail order prices; F.O.B. factory. GX-273			

Handloaders! Get Pacific's New Catalog

A complete and easy-to-understand catalog of reloading equipment. 38 pages display the nation's most complete line of reloading tools.

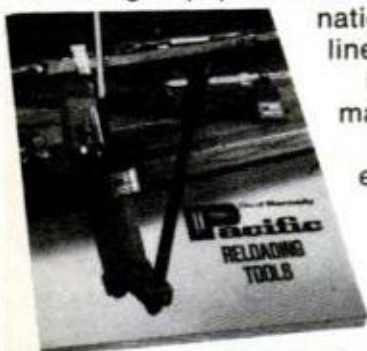

It contains all information to intelligently select reloading equipment. Includes cartridge charts, exploded views, parts lists, recommended loads, and much more.

Send 25¢ for handling and postage

Div of Hornady
Pacific TOOL COMPANY

Dept. PM-3, P.O. Box 2048, Grand Island, NE. 68801

Please send me the 38-page Pacific Catalog.
Here is my 25¢.

NAME _____

ADDRESS _____

CITY _____ STATE _____ ZIP _____

DETROIT LISTENING POST

(Continued from page 70)

can't promise improvement, but they think mileage has bottomed out.

SERVICE CHECK BY COMPUTER. Want to put your car through a computer to find out what service it will need for the next 40,000 to 50,000 miles? You can do it for two bucks. The idea was conceived by a parts company, Fram. Here's how it works:

You have to fill out a questionnaire supplying a detailed rundown on your car and how to use it. You can get the form at dealers handling Fram products or write Fram Plan, Fram Automotive Div., East Providence, R.I. 02916. (Don't send the \$2 until after you've filled it out.) Fram will run the information through a computer and send back a personalized reading on service work you should have done as the car ages. Some duplication of information appears in the owner's manual, but Fram factors in a lot of things that aren't there—personal driving habits, geographic location and type of roads you drive on, for example. For your \$2, you also get a book of service tips on what to look for if your car conks out.

This isn't a pitch to sell parts, because the computer printout doesn't mention products or dealers by name. And the company promises not to turn your name and address over to a sharpie who's going to hustle you to buy something. It's a pretty good deal for the money, especially if you're buying a used car and want to know what service bills you might be getting into. The \$2 fee entitles you to only one crack at the computer. If you want another reading later on, you have to pay again.

PREWRINKLED CARS NEXT? Carmakers are looking at a process that permits designs to be worked into the sheet metal when the part is stamped out. This isn't exactly a new idea, but there's a new wrinkle—the design can be changed, giving the appearance of a new model, without reworking the entire panel. The precrinkling is said to increase the strength of the metal, just as corrugated tin is stronger than a flat sheet. The idea is credited to the steel industry. Companies supplying Detroit with raw materials are coming up with all kinds of offbeat ideas in an effort to get automakers to use more of one material, less of another. Steel, copper, aluminum, powdered metals, plastics, glass, rubber, you name it—it's a real battle royal. It's a good shake for car buyers because it gets everybody innovating and improving. ★ ★ ★



IN YOUR  LOCAL

AIR



FORCE
RESERVE

For just one weekend a month and 15 active duty days a year, the Air Force Reserve can offer you the skill of a lifetime in your own backyard.

Start by mailing in the coupon. Or, call 800-525-9984 toll free. In Colorado call 800-332-9952.

Air Force Reserve, Box A, Randolph AFB, Texas 78148

Please send me more information on the Air Force Reserve Program.

1-PM-31

Name _____ Address _____
(Please Print)
 City _____ State _____ Zip _____
 Phone _____ School _____ Soc. Sec. # _____ Age _____ Sex _____

HOMEOWNERS' CLINIC

BY W. CLYDE LAMMEY

Extra insulation in attic

I need more insulation in my attic to keep out both heat and cold. At present there are 3-in. batts between 2x6 joists. Should I add more batts or use a pour-type insulation?—Ross Ihler, Cincinnati.

It might be permissible to use batts over batts but I think I would prefer the pour-type, especially if you are now experiencing no problems with moisture in the attic.

The pour-type insulation is somewhat easier to handle in cramped quarters, is quite as effective, and may be a bit cheaper in the end. The fill should be at least flush with tops of joists, or perhaps a little over.

Stubborn leak in ceiling

I live in an old home with a big bay window in the living room. During a driving rain a leak develops near this window, wetting the ceiling plaster. I've patched the roof of the bay, but the leak persists. There's no sign of a leak upstairs. Can you figure this out for me?—Stanley Charter, Utica, N.Y.

I suspect that the flashing over the bay is faulty. Rainwater runs down the siding and enters a small opening you've failed to stop with the patch. From here it courses along a joist, then creeps over the plaster and eventually shows as a wet spot in the ceiling.

I'd try again; you may have to remove some shingles to locate the point where the water gains entry. Either reflash or close the opening with roofing cement. I'm assuming, of course, that the rainwater is not coming from above and coursing down a stud from the plate.

Regluing oval picture frame

I have an antique oval picture frame measuring 20x25 in. Apparently it's made of four curved pieces joined with a peculiar dovetail-like joint. One piece is loose and needs regluing. How do I clamp the frame until the glue dries?—Mrs. R. Peabody, Bangor, Me.

Such frames are usually joined before machine-shaping with a modified "box" dovetail or box joint. Clean the open joint of all old hardened glue, taking care not to alter its shape.

Clamping of the frame probably will be a little tricky but can be done with a band clamp, or "web" clamp available from Albert Constantine & Son, 2050 Eastchester Rd., Bronx, N.Y. 10461. Or a rubber gluing clamp (a heavy rubber band) can be obtained from Brookstone Co., Dept. C-12, Brookstone Building, Peterborough, N.H. 03458.

Loose marble top

I've bought a nightstand with a marble top about 15 in. square. It is not attached. What adhesive or glue should I use to fasten it in place?—Roy Wilkins, Rochester, N.Y.

Although it may have been done, I've never seen a marble top of any size attached with adhesive. Usually it is held in place with some form of cleating that's made a part of the original construction and finished to match the wood. One marble top I've seen had shallow holes drilled near the four corners on the bottom face. Short locating dowels were fitted loosely in these holes to hold the top in place. I saw a small top recently that had a single cleat, or stop, cemented to the underside, but I suspect that this may not have been done originally.

As for your particular case, you might well find that a tape having adhesive on both sides will do an adequate job in holding the top in place.

Flooded asphalt-tile floor

The tiled floor (asphalt tile) in part of my basement was flooded recently. Water remained on the floor about three days and drained away slowly. Will the tile loosen?—Ruben Asp, Racine, Wis.

I don't know. But if tiles have not loosened at joints or corners by now, they are not likely to do so in the future, especially if they were properly installed originally. I wouldn't lose any sleep over this situation. ★★

Do you have a home maintenance or repair problem? Send it to Homeowners' Clinic, Popular Mechanics, 224 West 57th St., New York, N.Y. 10019. While letters cannot be answered individually, problems of wide interest will be discussed in this column.

Spend a milder moment with Raleigh.

A special treatment softens the tobaccos for a milder taste.



A down-to-earth idea. "Forrester" Hunting Boots by Wolverine. Get a pair for free B&W Raleigh coupons, the valuable extra on every pack of Raleigh.

To see over 1000 gifts, write for your free Gift Catalog: Box 12, Louisville, Ky. 40201.



Warning: The Surgeon General Has Determined That Cigarette Smoking Is Dangerous to Your Health.

© 1973 BROWN & WILLIAMSON TOBACCO CORP.

Filter Kings, 17 mg. "tar," 1.3 mg. nicotine; Longs, 19 mg. "tar," 1.5 mg. nicotine, av. per cigarette, FTC Report August '72

Explorer Special Sale!

Limited time only! Special Ford Pickups with special discounts on a choice of popular options...including Cruise-O-Matic, power steering, air conditioning.

The '73 Ford Pickup starts out a great buy. Its better ideas include behind-seat storage, full-foam seating, front disc brakes, the roomiest Ford pickup cab ever.

And now you can get an even better buy: A specially equipped Explorer Special. It comes in F-100 or F-250 models... 6¾' or 8' bodies... 2- or 4-wheel drive. And offers three special packages at big savings.

Special Package A: Choice of special exterior paints: Bright Lime, Grabber Blue, Burnt Orange • Special interior trim in Blue,

Avocado or Orange • Color-keyed floor mats • Bright front bumper guards with rubber strips • Bright windshield and drip mouldings • Explorer name plate • Mag-style wheel covers (F-100 4 x 2) • Bright wheel covers (F-250 4 x 2) • Unique lower body side tape stripe • Bright, low-mount Swing-Lok mirrors (long-arm western mirrors on Camper Specials) • Bright rope tie-down hooks on 6¾' models • Bright box side rails on 8' models.

Special Package B: Package A plus... Power steering • Cruise-O-Matic.

Special Package C: Package B plus... Air conditioning • Tinted glass.

Special money-saving discounts now at your Ford Dealer's. Limited time only!



A better idea for safety: Buckle up.

F-100 Explorer Special, shown with optional whitewall tires, tool storage box and rear bumper.

FORD PICKUPS

FORD DIVISION





THIS COMPACT SEWING CENTER becomes a decorative wall plaque when swung up out of way. Open, it extends to a king-size, 20x65-in. work counter



Sewing centers — the kind women want but can't buy

By **WAYNE C. LECKEY**
Home and Shop Editor

*Color photos by
Robert D. Borst*

*Technical art by
Fred L. Wolff*

LIKE ANY HOBBY, sewing becomes more enjoyable and creates a lot less clutter when you have a work center where there's a place for everything and everything is in one convenient place.

We kept this thought in mind in designing these four highly functional sewing centers. Incorporated in each design you'll find a work counter for pattern cutting, shelves and roomy drawers for keeping fabrics, yarns and patterns handy and trays for pins, needles and threads. Two of the centers are designed to attach to a wall; all fold up in a minimum of space.

Most sewing-machine stands we've seen are just that—stands for sewing machines. They provide a

place to store the machine when it's not in use and that's about all. Few, if any, offer a good-size worktable to spread out a pattern. There's little space to keep dress patterns handy. There's no space to stow your sewing and often a lack of tray space to hold countless little items. We've tried to give you these features that most stands lack.

Any portable-type sewing machine is adaptable to any of the four centers shown here. The machine shown in the photos is Singer's *Golden Touch & Sew*, and the counter cutouts were made to fit its particular base. While a cutout allows the machine to sit flush, this can be optional: the machine can simply sit on top of the counter. Plans and instructions for building all four of PM's sewing centers begin on page 80.

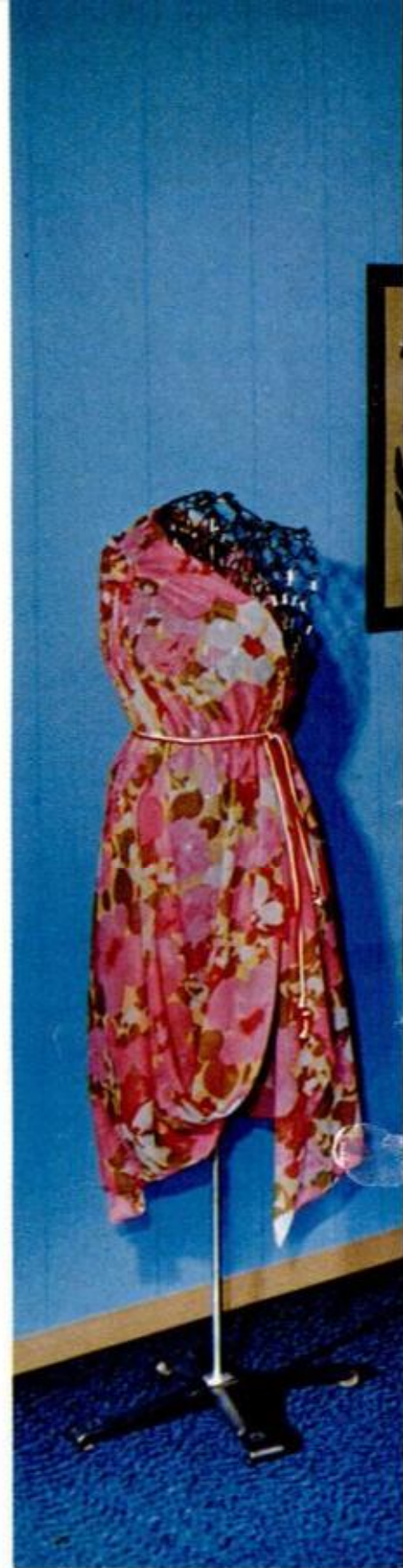

DROP LEAVES on sewing center at left swing up to provide a whopping work surface nearly 84 in. long. Five center drawers offer storage space galore. Sewing machine fits in cutout, stores in compartment under hinged lid. Closed, unit takes but 24-in. floor space

POPULAR MECHANICS



THE ULTIMATE in sewing centers, this one opens up to offer maximum convenience. Standing 7 ft. tall, it features a closet for storing an iron and ironing board, a swing-down 28x64½-in. cutting board, a leg-free, pull-down sewing machine, a mirror door and more storage space than you'll ever need. Three common interior doors are used for the front; the rest is chiefly plywood. When tipped on side, cabinet will easily pass through any standard-height doorway

1. The island unit

KING-SIZE WORK CENTER accessible from all sides is provided by this cabinet when it's opened and brought out from the wall. We built it entirely of plywood and limited the lamination to certain surfaces to save cost. With surfaces covered as shown below, all exposed parts (leaves, top, drawer fronts) that show when the cabinet is closed have a beautiful ready-made finish.

Decorative plastic laminate offers a durable, slick counter surface ideal for cutting fabrics. However, you can stain or paint the cabinet if you prefer.

In checking the construction details and sections A-A (page 82), you'll see that you can make the sides with $\frac{1}{4}$ or $\frac{3}{4}$ -in. plywood. The $\frac{1}{4}$ -in. thickness cuts down on cost and weight but requires a bit more work; $\frac{1}{4}$ -in. dados (grooves) are required in the back, top and front members.

Begin by cutting the $\frac{3}{4}$ -in. back panel.

It will be $22\frac{3}{4}$ in. or $23\frac{1}{4}$ in. wide, depending on the plywood thickness used for the sides. Where $\frac{1}{4}$ -in. plywood is used, run $\frac{3}{8}$ -in.-deep grooves along the two outer edges of the back $\frac{7}{8}$ in. in from the edge. Next cut the two top rails and front pilasters— $1\frac{3}{8}$ or $1\frac{5}{8}$ in., as the case may be—and run similar grooves in them $\frac{7}{8}$ in. in from the edge. Study section A-A and its alternate.

A $\frac{3}{4}$ -in.-thick bottom nails to the back panel even with the bottom edge, and a second panel ($\frac{1}{2}$ in. thick) is installed $8\frac{1}{4}$ in. down from the top. The latter is $\frac{3}{4}$ in. shorter, front to back, than the bottom one. If the sides are $\frac{1}{4}$ in. thick, the bottom member has to be notched at the front corners to fit around the pilasters and be even with them. You'll notice the two top rails project $\frac{1}{2}$ in. beyond the faces of the pilasters so the hinged cover has a lip across the front.

Start assembling the parts you have cut,

COMPARTMENT UNDER LID provides storage space for portable machine. Bin at rear is handy for filing patterns. Cut-out in counter is optional; the machine can rest on top if you desire. Use friction-type lid support; it helps to hold up the lid when storing sewing machine

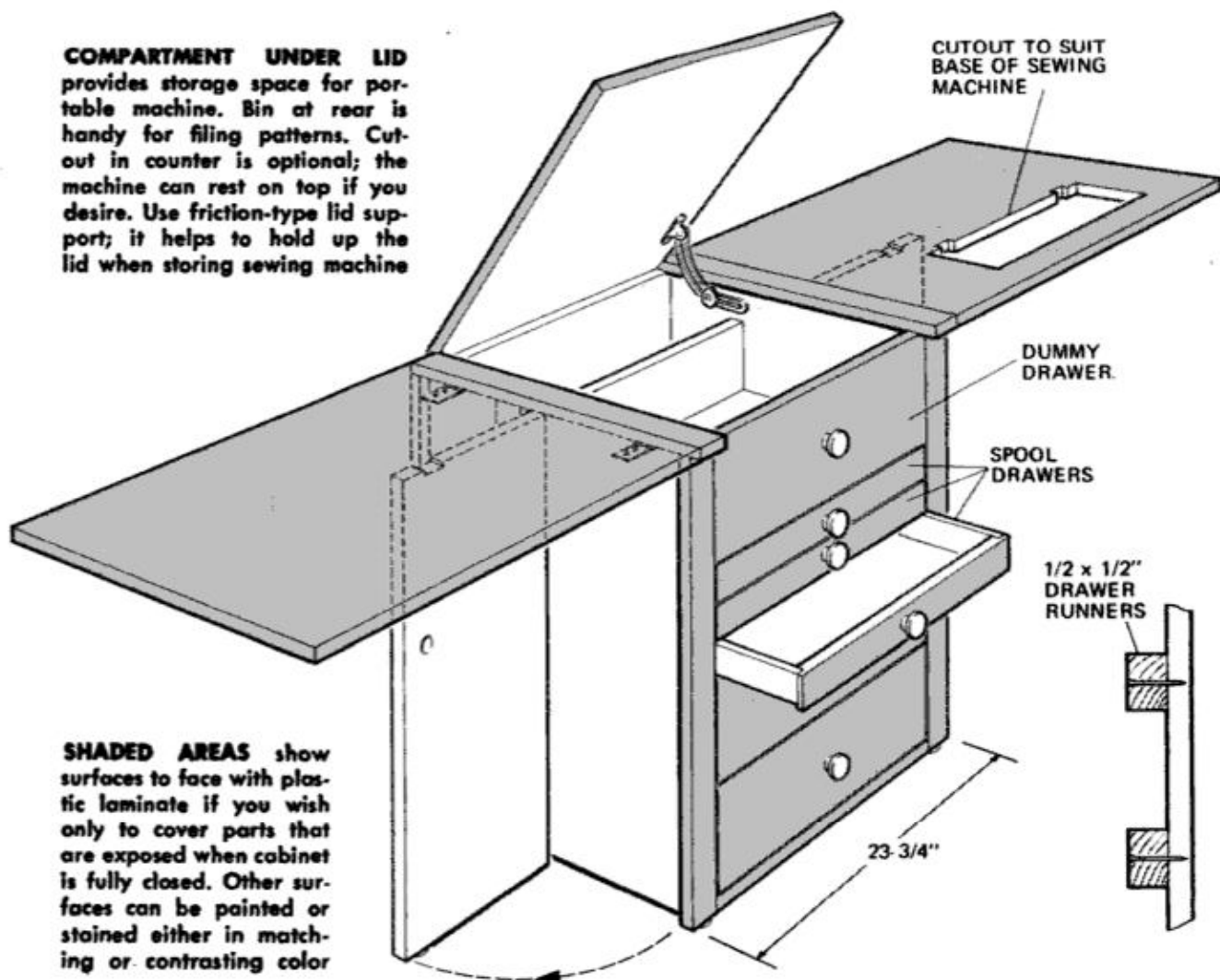

nailing the bottom to the back first, then the 1/2-in. bottom, followed in order by the sides, top rails and pilasters. If you plan to cover the parts with plastic laminate, you won't have to worry about nailheads showing. If not, you'll have to set and putty the nails that show in the top rails and pilasters.

The 8 3/4-in. dummy drawer front is cut and fitted next. Notice that it is held in place with glue blocks on the inside, and that it fits even with the bottom member. We found it easier to apply the plastic laminate to the face of it before gluing it in place. Notice how the laminate (see section B-B) is cut back 1/16 in. at each end to simulate normal drawer clearance. A 6-in.-wide partition, either 20 or 20 1/2 in. long, as the case may be, is installed in the machine compartment 15 in. from the front and nailed in through the sides.

Supporting wings for drop leaves are hinged to 3/4 x 3-

in. vertical members, added to recessed sides of the cabinet 11 in. back from the front. Finger holes are made an inch or so in from the front edges of the wings, and a notch is made in the top of each one so that it will clear the front hinges. Allow a 1/8-in. space for clearance at the cabinet front so that the wings will swing out easily.

Follow typical drawer construction in making the five drawers. With the exception of the bottom drawer, the sides and backs are cut 1/2 in. narrower than the fronts to allow for 1/2 in. runners on which the drawers slide.

Cut the hinged top 19 7/8 in. wide and use a piano hinge to attach it securely across the back. Complete it with a friction-lid support. Hinge the two drop leaves, then place the cabinet on its back and drive rubber-cushion furniture glides into the four corners and outer ends of the wings. ★★★

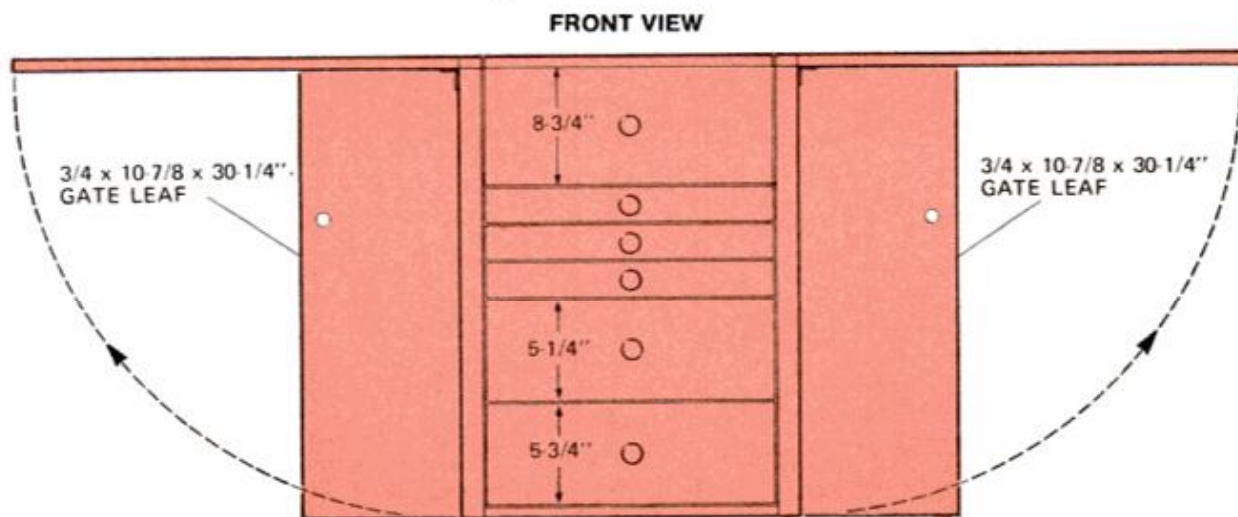
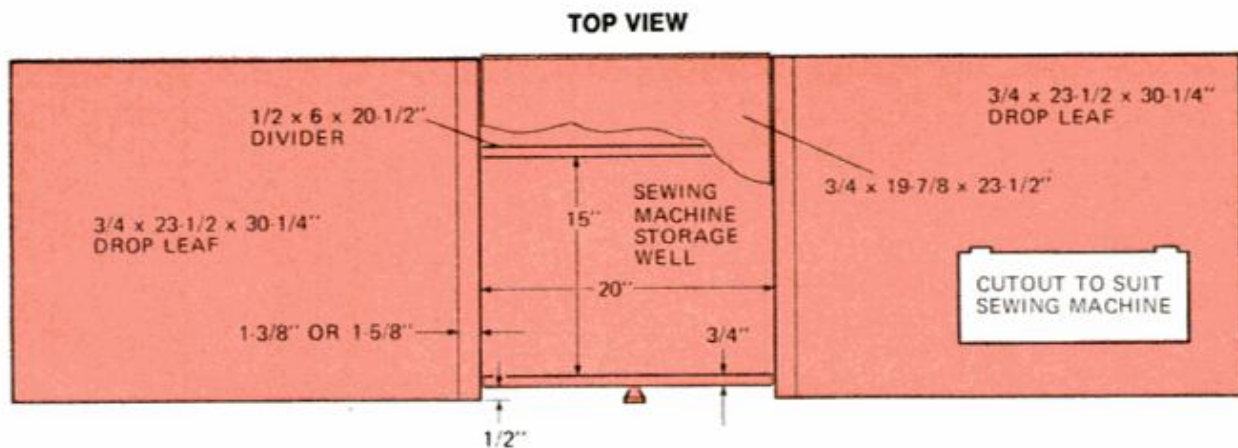
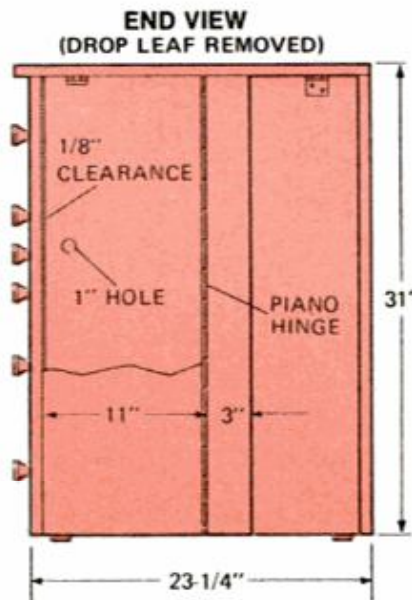

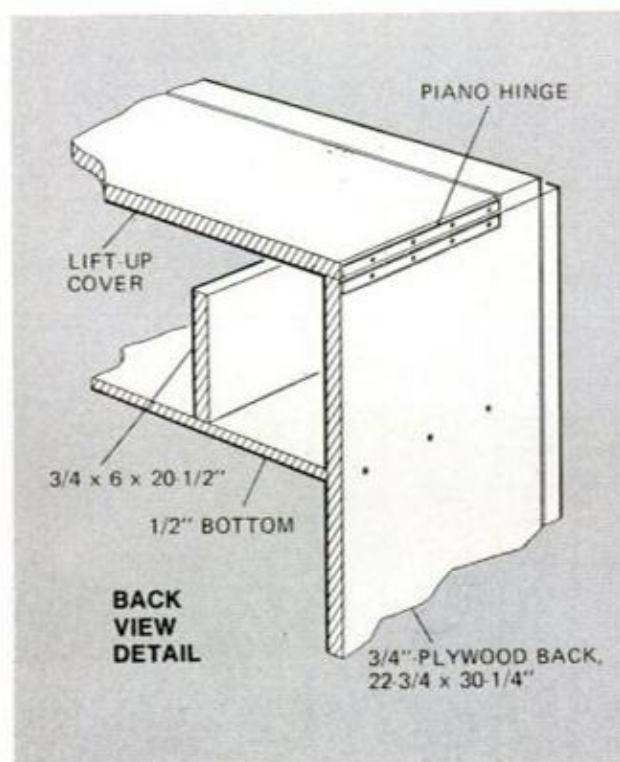
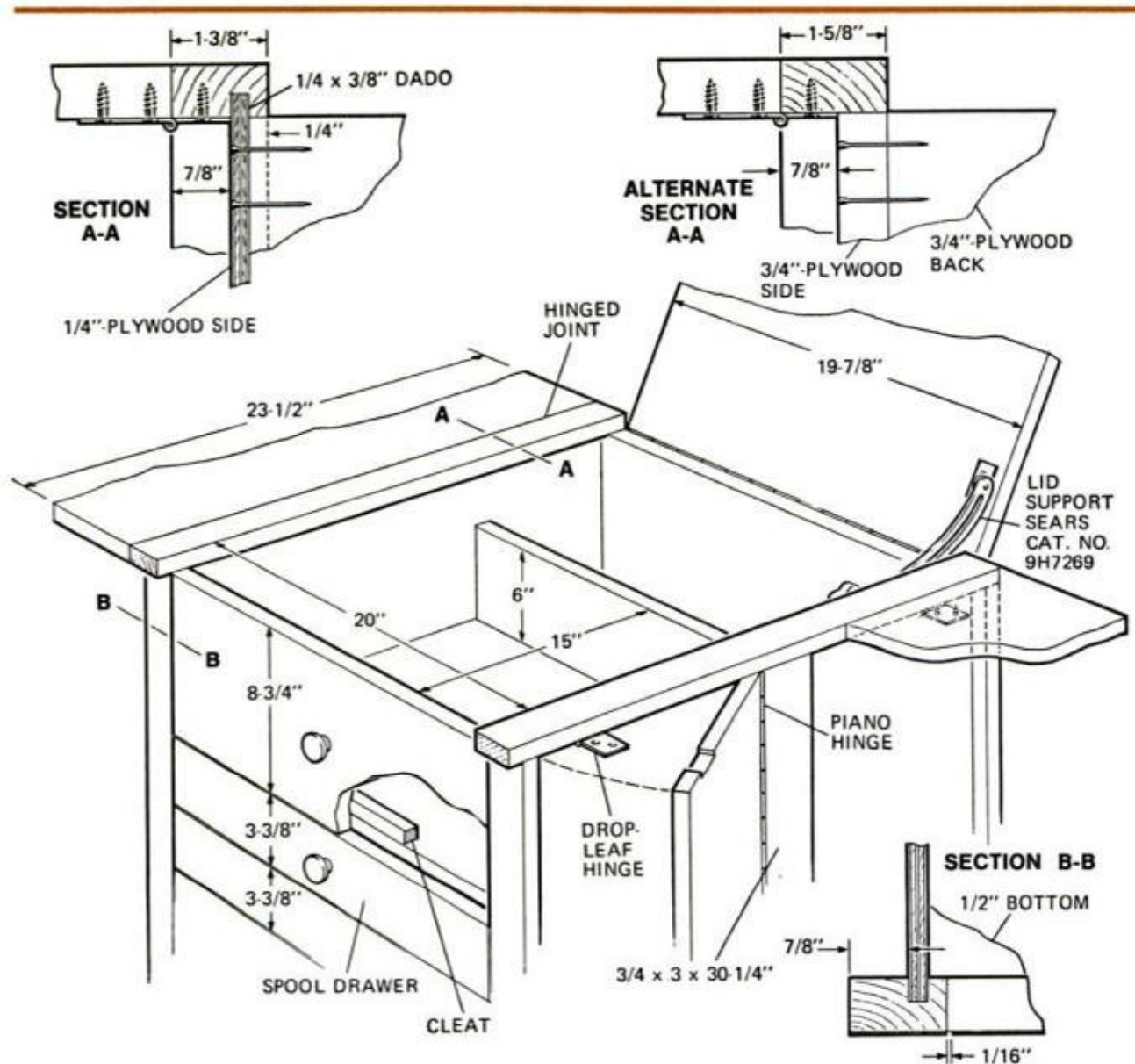

Cementing plastic laminate

1. Cut your laminate $\frac{1}{8}$ in. oversize all around.
 2. Surfaces to be bonded must be dry and clean.
 3. Apply even coat of contact cement to both laminate and wood, using brush or spreader.
 4. Let both surfaces dry before bonding (10-20 minutes normally). Surfaces will bond when adhesive will adhere but not transfer to brown wrapping paper if touched lightly. If cement becomes too dry (over 3 hours), apply another coat.
 5. Bring surfaces in contact exactly where desired (cement bonds instantly on contact, so you can't shift the work later). Two overlapping pieces of kraft paper placed over cement will let you position the laminate without sticking. When laminate is where you want it, pull out one paper, press down the plastic, then pull out second paper.
 6. Using rubber mallet or hammer and wood block, apply pressure all over surface for positive contact.
 7. Trim laminate flush with work; use block plane and flat file or router and special laminate cutter.
 8. Clean tools, brushes with contact-cement solvent.
- For more detailed information, refer to *How to Work With Plastic Laminates*, page 154, March '70 PM.

2. The high-rise unit

EMPHASIZING CONVENIENCE, this sewing center is built around three $1\frac{3}{8}$ -in. flush doors, one left intact and the others cut into sections. The boxlike case to which they are hinged and pivoted is divided into three compartments by two vertical partitions.

To make the case, cut two side members $13\frac{1}{4} \times 84\frac{3}{4}$ in., then cut a $\frac{3}{8} \times \frac{3}{4}$ -in. rabbet in the top edges and $\frac{3}{8} \times \frac{3}{4}$ -in. dadoes $2\frac{1}{4}$ in. up from the bottom. The rabbets are for a 13×76 -in. top mem-

ber; the dadoes for a 13×76 -in. bottom member. A $\frac{1}{4}$ -in. plywood back laps the edges of top and bottom members, but fits in rabbets cut in the edges of the two side members. The two partitions, 13×81 in., are nailed in place through top and bottom members. The left partition is positioned $25\frac{1}{4}$ in. from the outside; the right one, $23\frac{1}{4}$ in.

Front edges of the case are faced with $1\frac{1}{8} \times 1\frac{1}{2}$ -in. trim pieces of pine, with a 3-in.-wide piece across the bottom. De-

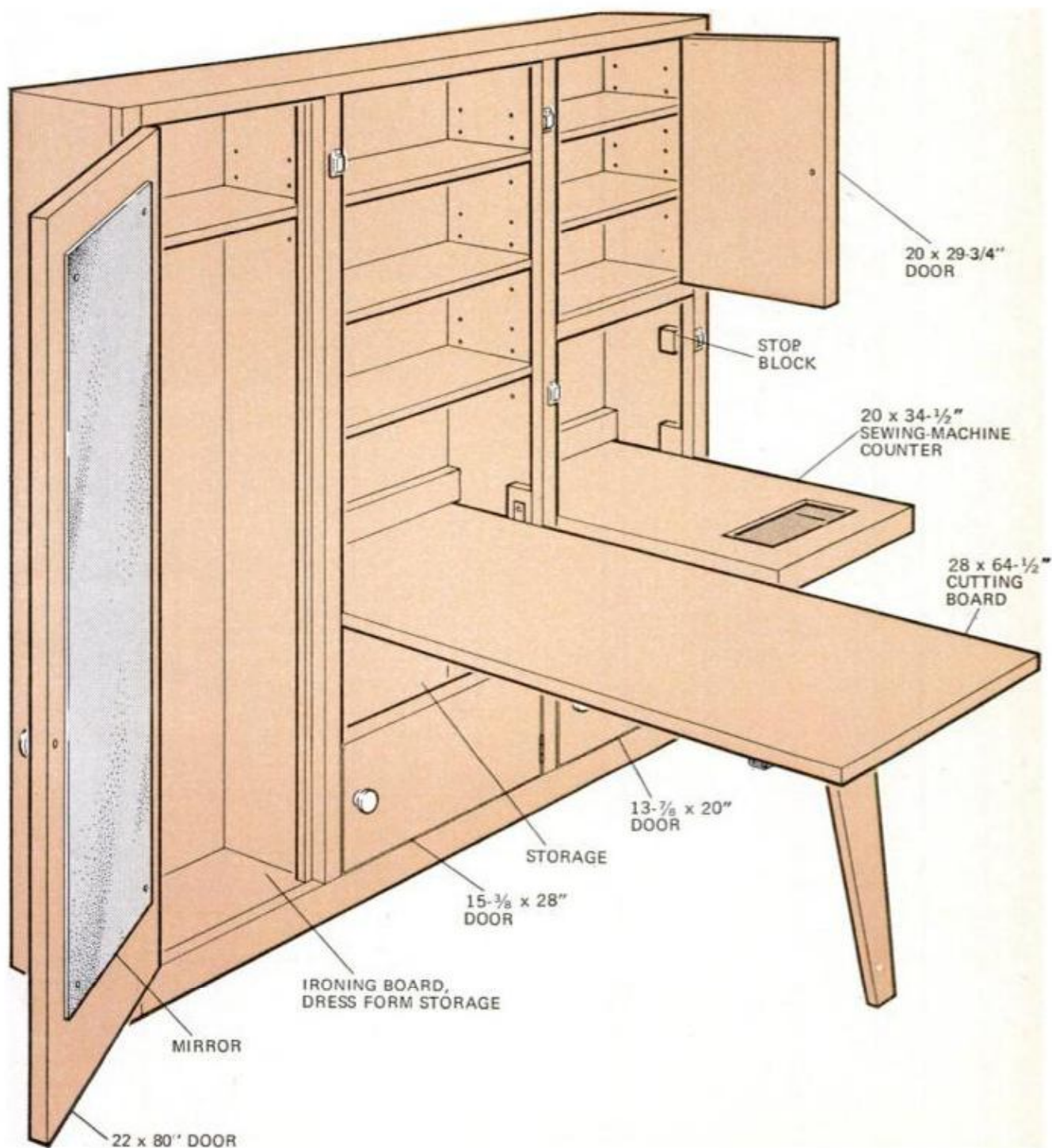

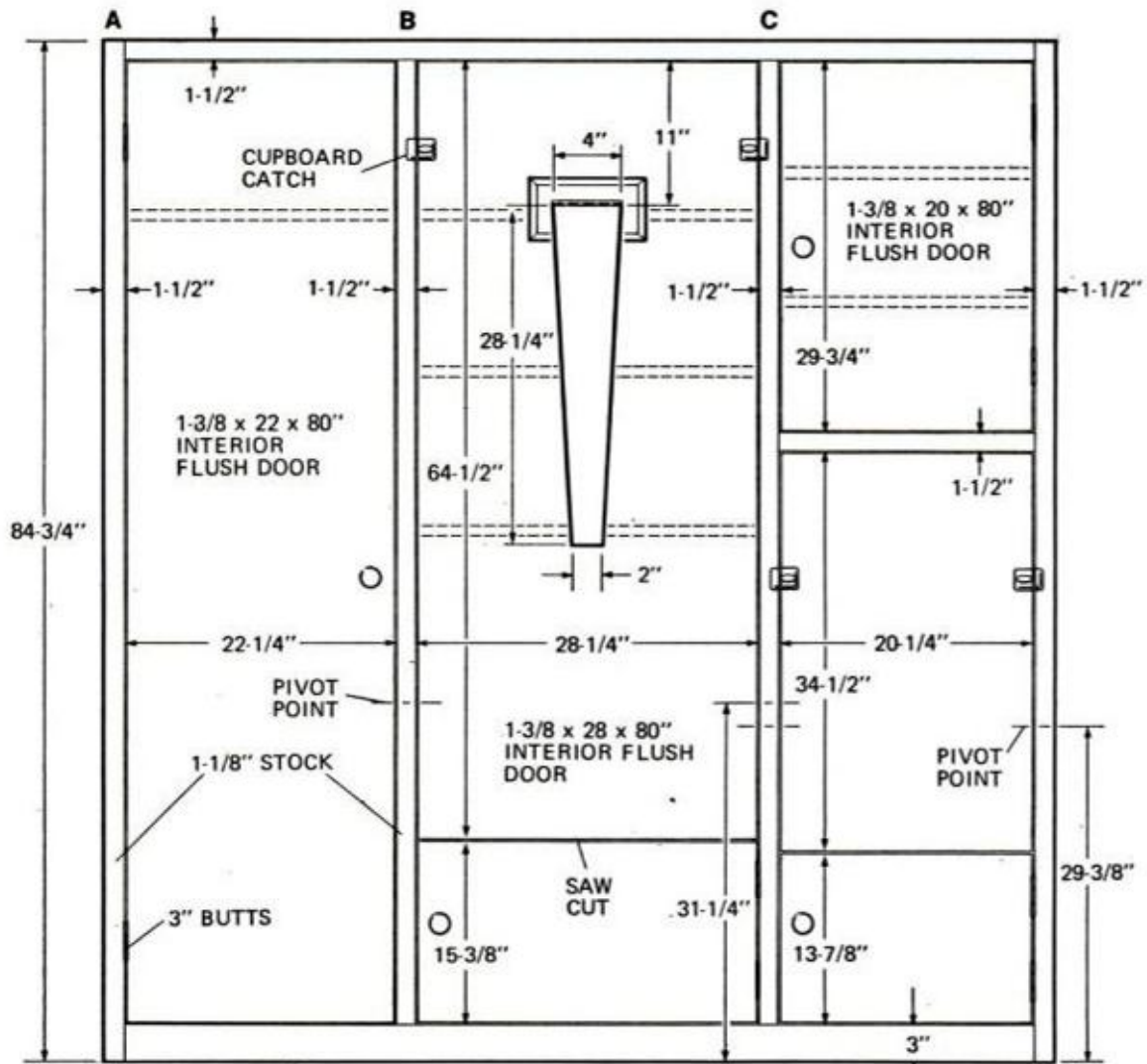
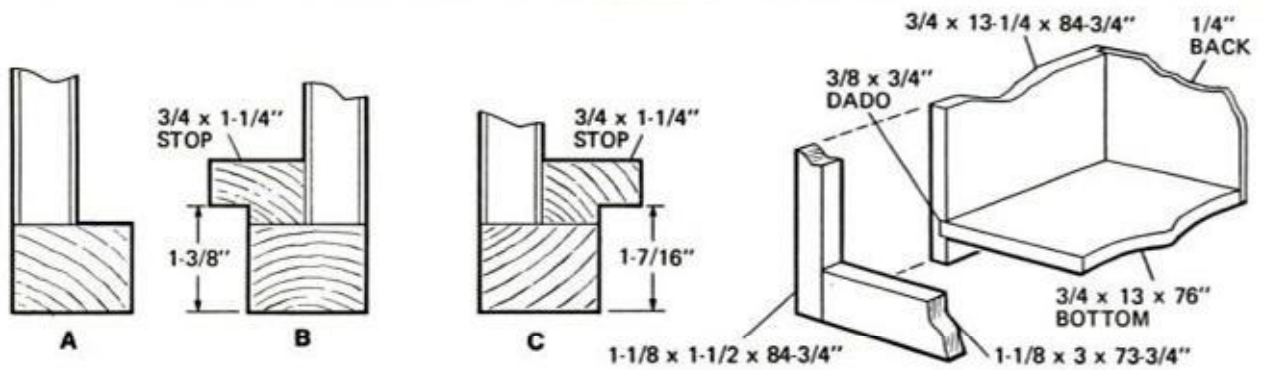
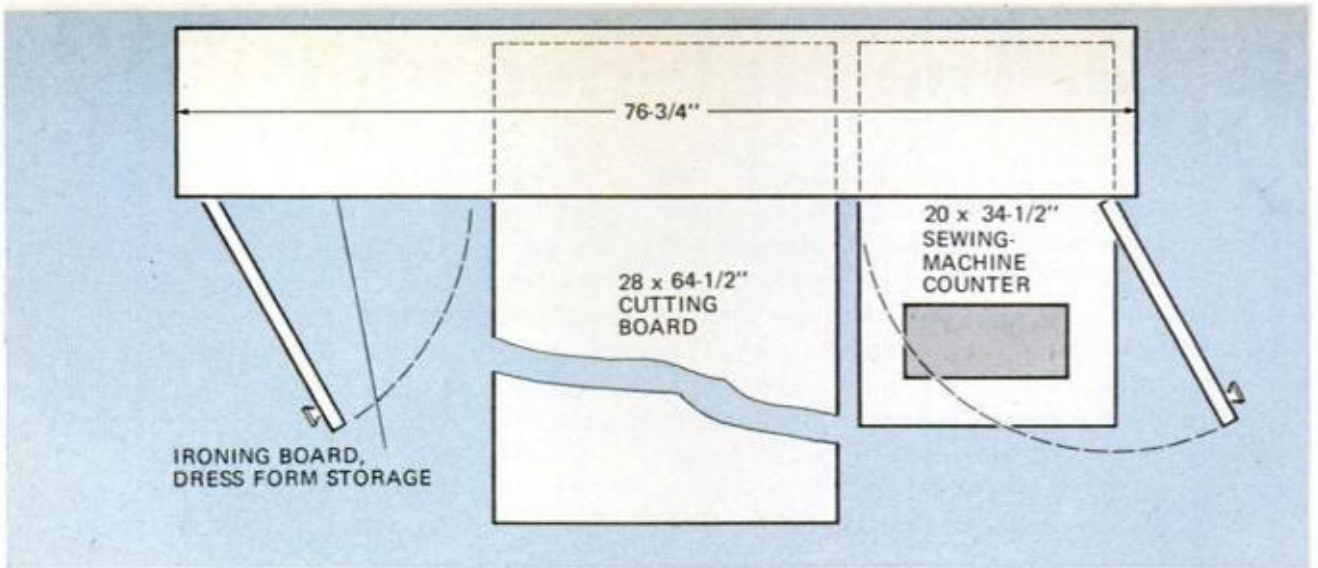

tails B and C, page 84, show how the trim is kept flush with inner faces of the two partitions. Casing nails are used to attach the trim, and the heads are set and puttied.

The left-hand compartment is fitted with a stock 22x80-in. flush door hinged with regular 3-in. door butts. The opening as dimensioned provides $\frac{1}{8}$ -in. door clearance all around. A rabbeted stop is on the full length of the door (see detail B); similar stops are on both right-hand doors; the upper stop being $29\frac{3}{4}$ in. long, the lower one $13\frac{7}{8}$ in. The upper right compartment has a $\frac{3}{4}$ -in. bottom $31\frac{1}{2}$ in.

down from the top, and a $1\frac{1}{2}$ -in. trim piece covers the edge.

The 28-in. center door is cut in two sections at a point $64\frac{1}{2}$ in. from one end. Since interior doors are hollow, filler strips of solid wood must be inserted and glued in the cut ends. The $64\frac{1}{2}$ -in. section is the cutting board and is covered on the back with plastic laminate before being pivoted to the cabinet.

The 20-in. right-hand door is cut in three sections: $29\frac{3}{4}$, $34\frac{1}{2}$ and $13\frac{7}{8}$ in. The $34\frac{1}{2}$ -in. section is a swing-up sewing-machine counter. To provide a well for

(Please turn to page 201)

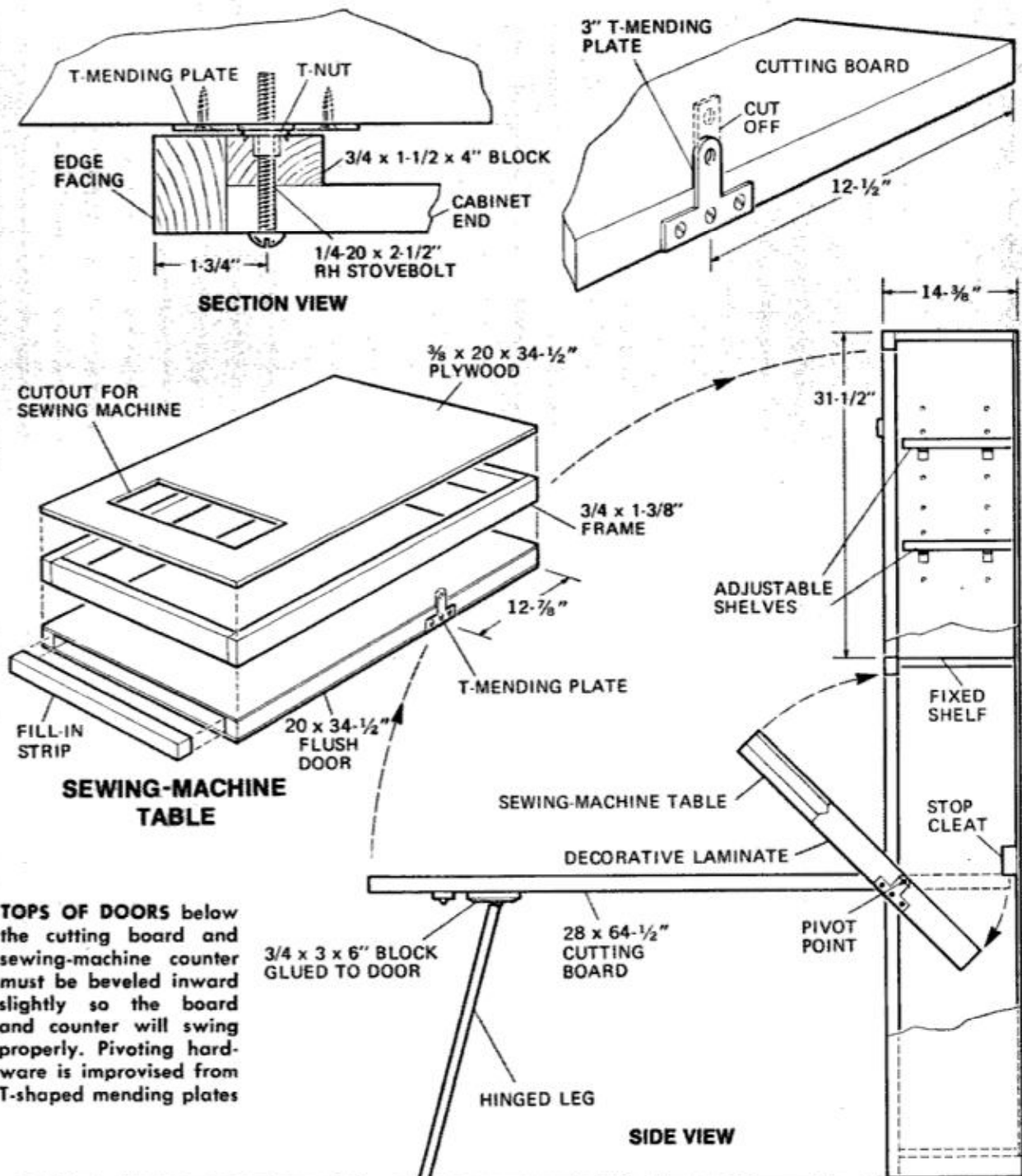

TOPS OF DOORS below the cutting board and sewing-machine counter must be beveled inward slightly so the board and counter will swing properly. Pivoting hardware is improvised from T-shaped mending plates

3. The dual unit

SIMPLEST TO MAKE of the four sewing centers created in the *PM* shop is a dual-unit sewing center that appeals to the builder who wants to spend a minimum of time and money. Of its two individual units, one is attached to the wall to accommodate a portable sewing machine and the other is placed alongside. Together they offer the sewer convenience and storage galore.

Little more than a box fitted with a back and shelves, the drop-counter wall unit is practically a hammer and saw project. The ends and the top and bottom members are cut in pairs as are the four shelves. The top and bottom boards lap the end members, and the two long shelves butt between. To gain "headroom" for nailing the short divider in place, you should install the lower long shelf first, then the two short shelves and finally the upper one. Chains support the drop front; hooks and eyes hold it shut. Two 3-in.

angle brackets across the top and bottom anchor the unit solidly to wall studs.

Although the base unit is twice as deep as the wall unit, construction is much the same. The top and bottom members lap the end members, and a divider forms compartments. One difference you'll notice in basic construction is the 1½-in. apron that's let in across the front at the top. This requires ¾ x 1½-in. notches cut before assembly.

The sit-down ironing board pivots on a single carriage bolt that passes through a hole in the second shelf and swings clear of the end when not in use. Two drawers with handholds are made to slide easily in the 12 and 22½-in. openings. Stock cabinet louvers are used for doors and trimmed to fit. They're hinged to fold, and held shut by magnetic catches.

The wall unit should be hung so that the drop front will level at about table height (30 in.) when open. ★★★

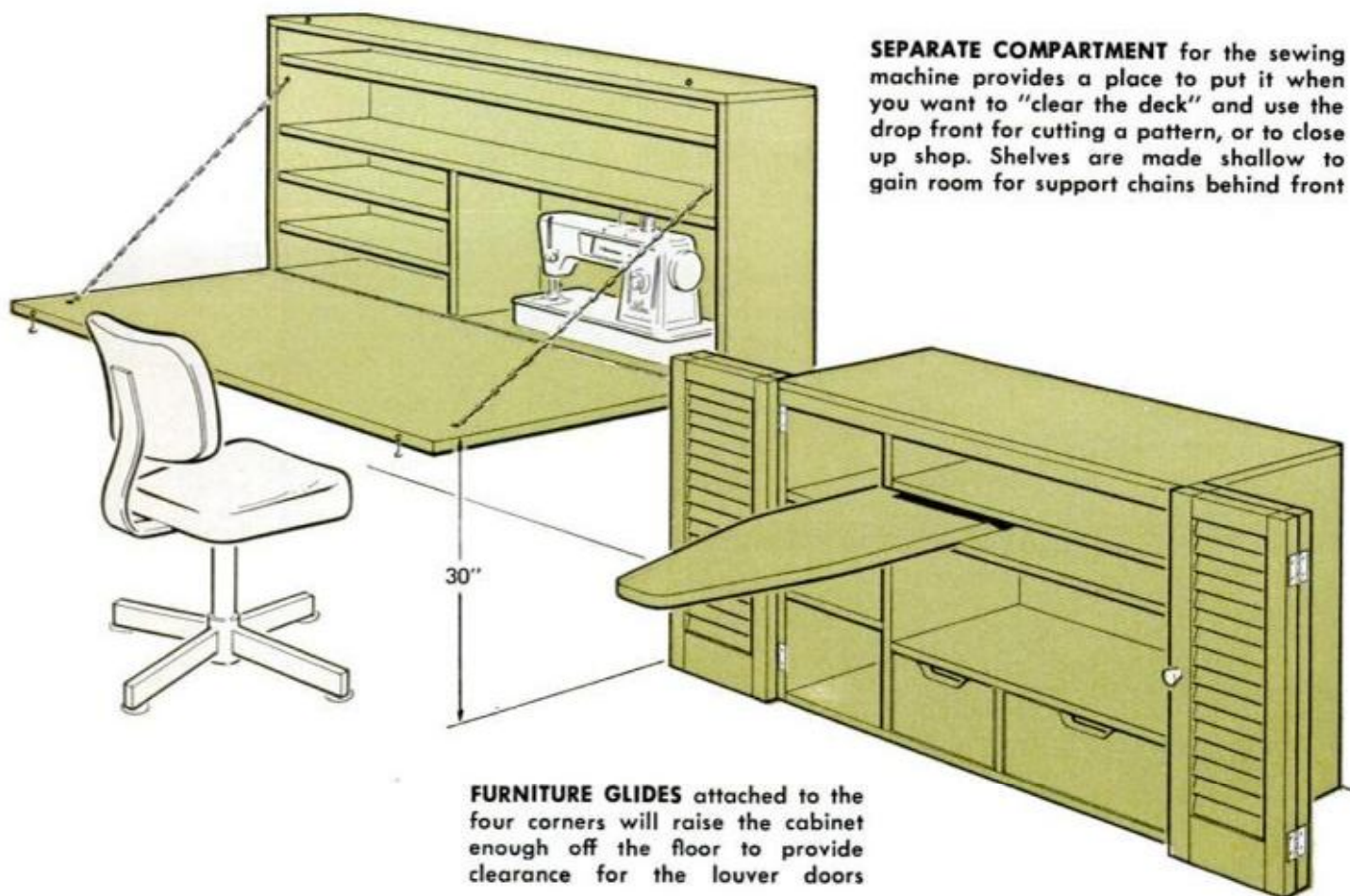

SEPARATE COMPARTMENT for the sewing machine provides a place to put it when you want to "clear the deck" and use the drop front for cutting a pattern, or to close up shop. Shelves are made shallow to gain room for support chains behind front

FURNITURE GLIDES attached to the four corners will raise the cabinet enough off the floor to provide clearance for the louver doors

WALL UNIT

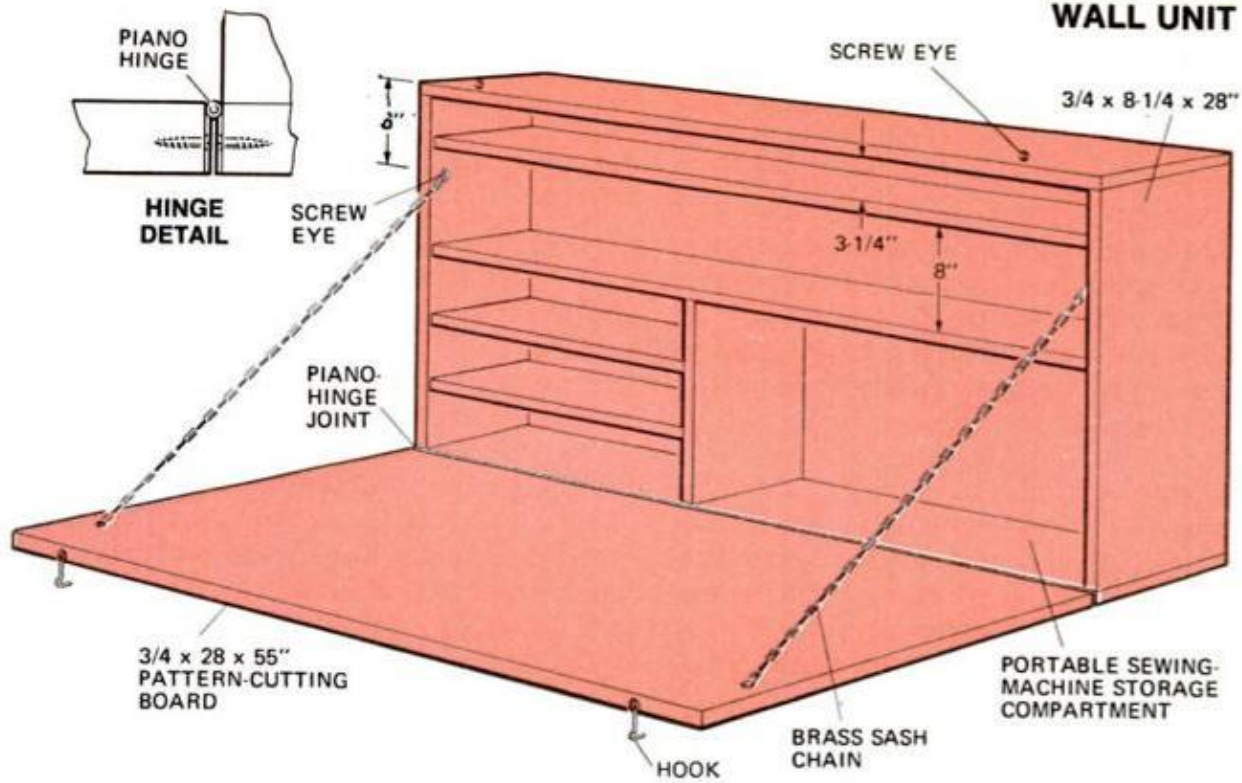

FLOOR UNIT

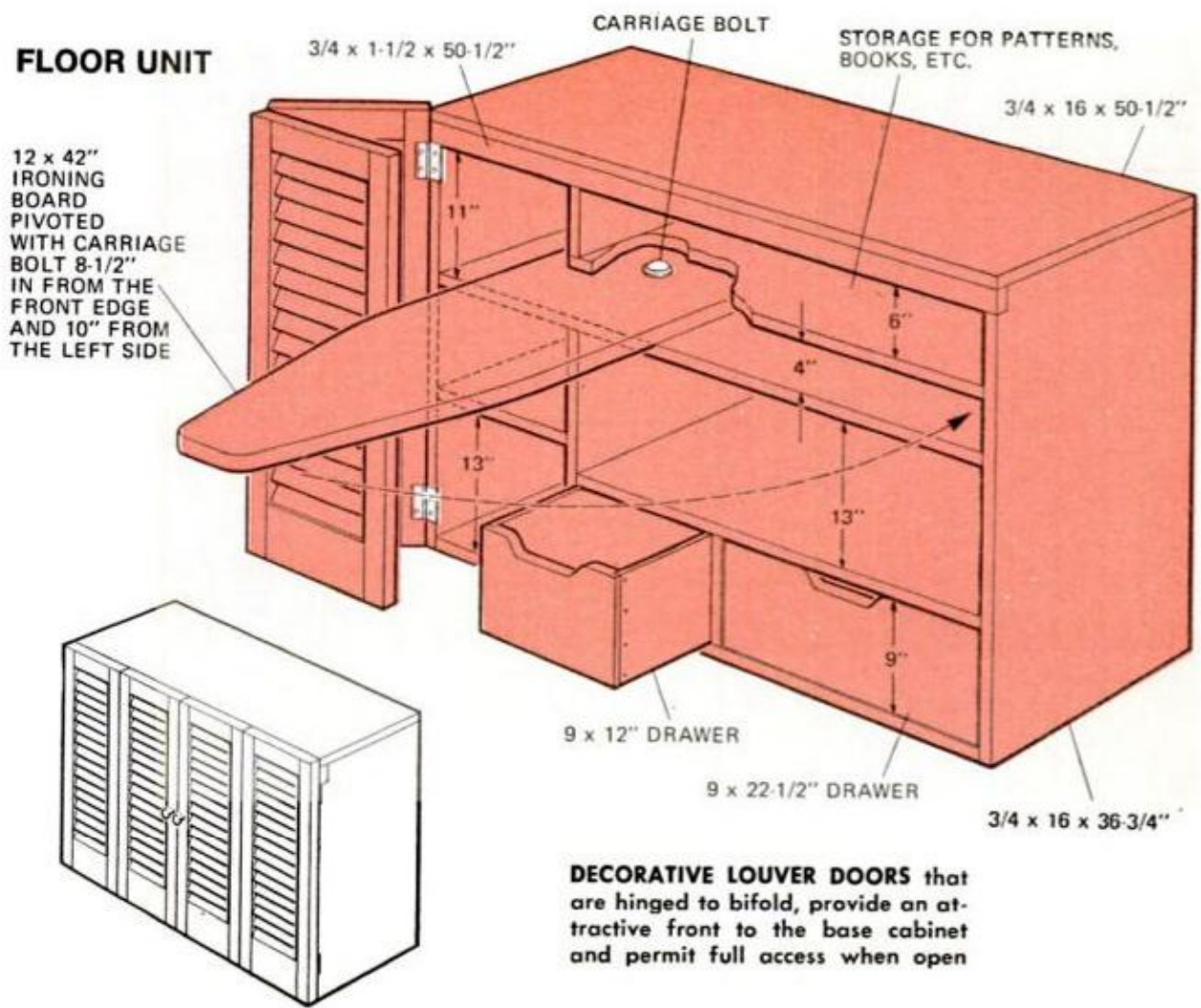

4. The dual-role unit

WHERE SPACE IS LIMITED and there just isn't room to have a sewing center in the way all the time, this one retracts against the wall to serve as a decorative plaque. When stored, it projects only 14 in. from the wall, leaving free floor space under it.

There are three parts: a cabinet bolted securely to a wall, a counter and cutting board hinged to the cabinet, and a swing-down cabinet-leg hinged to the outboard end of the cutting board for support. The leg has a picture-frame door that swings open to support a flip-over extension. When fully open, the cutting board measures some 65 in. long and 24 in. wide. The wall cabinet provides storage for the machine, and shelves above for sewing, patterns and what not. The cabinet-leg has shelves for odds and ends, and the back of the door has four handy trays for thread, buttons, thimbles and the like. The door front is made to look like a framed picture. Hooks and eyes keep the whole

thing stored against the wall. When in use, the sewing machine is flush in a cutout in the cutting board.

Except for the two mounting cleats, the back of the wall cabinet is open. Each side is 9 x 32½ in. and is rabbeted top and bottom for 8 and 9-in.-wide members 19¼ in. long. Two 8-in.-wide shelves fit between in dadoes, the bottom one being placed 17 in. down from the top and even with the notched cutback.

The cabinet-leg, 20 in. wide and 30¼ in. high, is made from 1x4 pine. Edges are rabbeted for a ¼-in. plywood back, side members are dadoed for ½-in. shelves, and 19¼-in. top and bottom members

(Please turn to page 198)

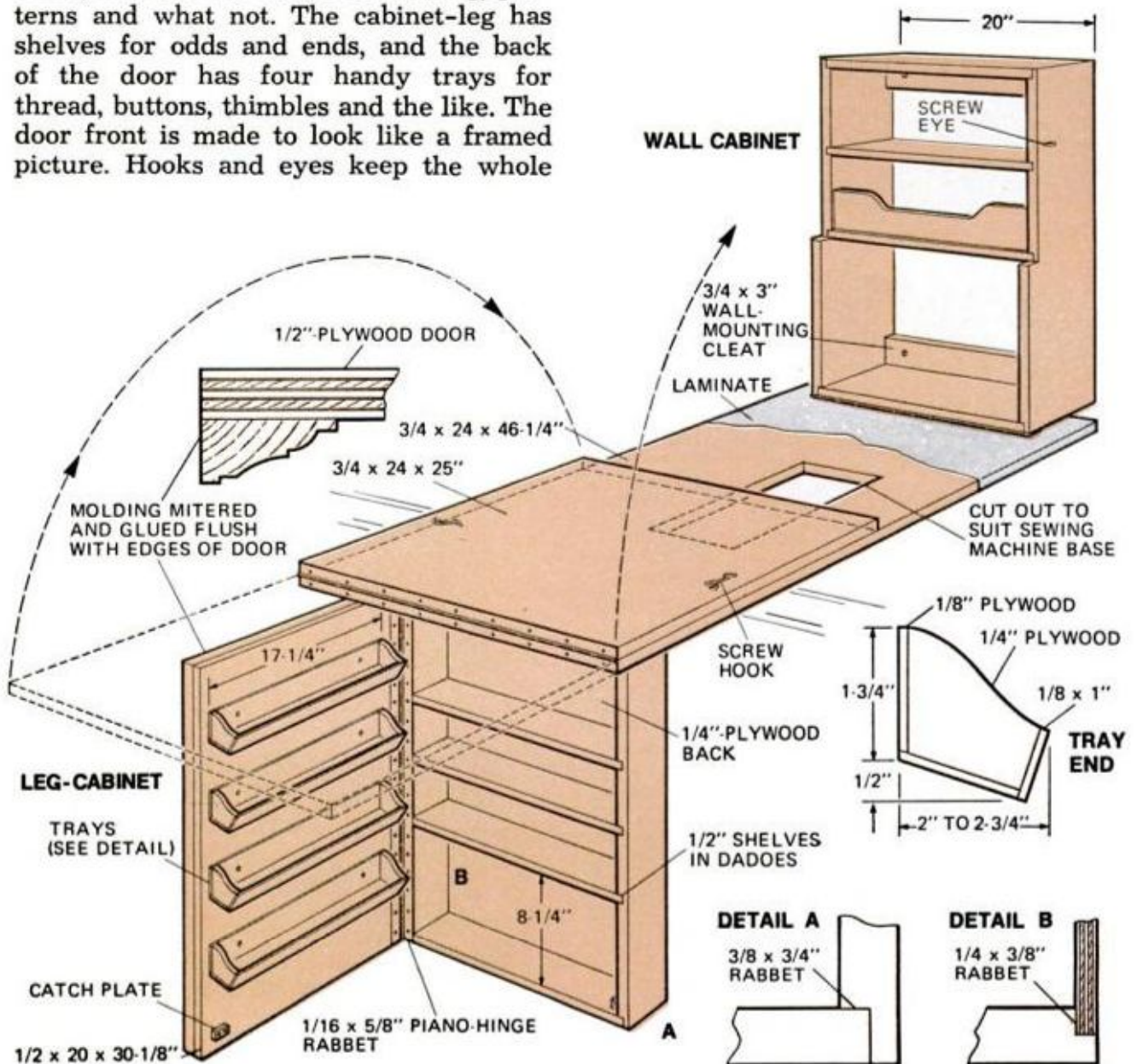



SHIP IS SMALL but amazingly light, strong and maneuverable, with a healthy top speed of 170 mph. Removable wing sections weigh only 22 pounds each, are easily handled by one man (top photo below). Attaching wing requires only four main bolts, plus one for aileron control; can be done in 15 minutes

Homebuilt 'model' plane you can really fly

Patterned after modelmaking techniques, this all-wood-and-plastic single-seater is light, low in cost and really fun to build

By **SHELDON M. GALLAGER** and
HOWARD LEVY / Photos by Howard Levy

IF THIS TRIM little low-wing single-seater looks something like an overgrown model, the resemblance isn't just a coincidence. Its designer, Ken Rand, has been building model planes as a hobby for years in between his professional duties as a flight test engineer for Douglas Aircraft in California. When he decided to build his own plane—one he could actually fly in instead of control from the ground—it was only natural that his vast modelmaking experience should play a part in the craft's construction. Except for engine and fittings, the ship is fabricated almost entirely from wood and plastics. Called the KR-1 after Rand's initials, it's fully approved for flight in the amateur-built category and

MARCH 1973

89

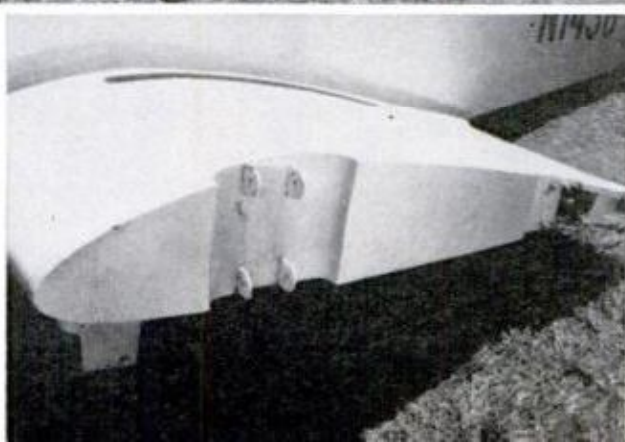

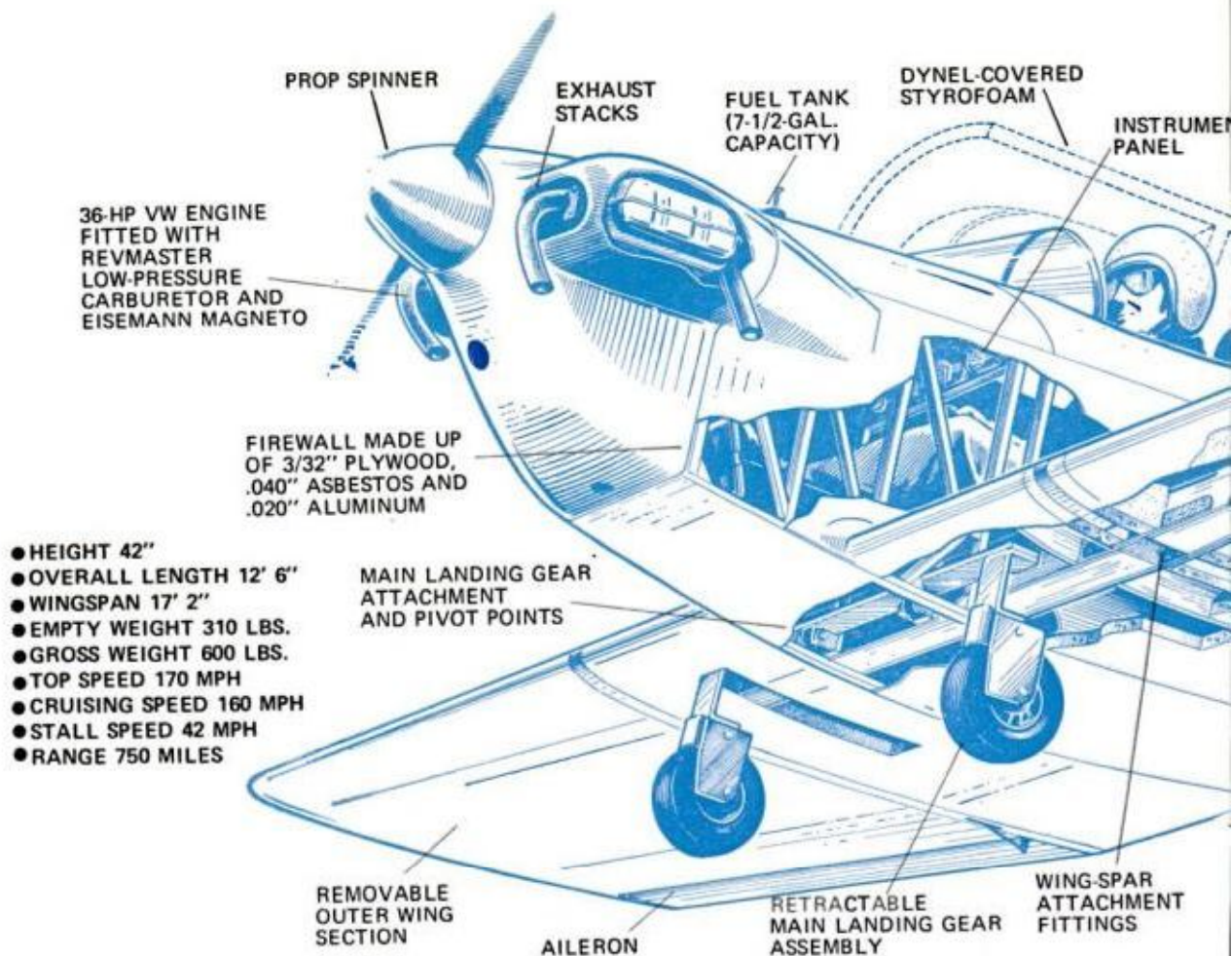

- HEIGHT 42"
- OVERALL LENGTH 12' 6"
- WINGSPAN 17' 2"
- EMPTY WEIGHT 310 LBS.
- GROSS WEIGHT 600 LBS.
- TOP SPEED 170 MPH
- CRUISING SPEED 160 MPH
- STALL SPEED 42 MPH
- RANGE 750 MILES

has been copied by other homebuilders from Ken's plans.

In addition to basic modelmaking techniques, Ken has added some novel features of his own. Most wing ribs are shaped from Styrofoam plastic with the spaces in between filled with Styrofoam slabs. This assembly is covered with a smooth, taut reinforcing skin of Dynel epoxy, producing a strong, light wing weighing a mere 22 pounds per section. In a similar way, contoured areas such as engine fairings, nose cowling, tail surfaces and the curved top portion of the fuselage are all carved from Styrofoam—like shaping balsa-wood in a model. The main air-frame is merely a boxlike structure sheathed with plywood to simplify construction.

The landing gear is seemingly primitive, yet ingeniously simple, too. The wheel struts are attached to a hinged crossbar. Pulling up on a handle swings the wheels back and upward into wing pockets to re-

UNUSUAL "CANOPY" swings up sideways on piano hinge for easy access to small cockpit. Even when closed, cockpit is still open type with windshield but can be fitted with a plastic bubble for full enclosure if desired. Behind cockpit is cargo space

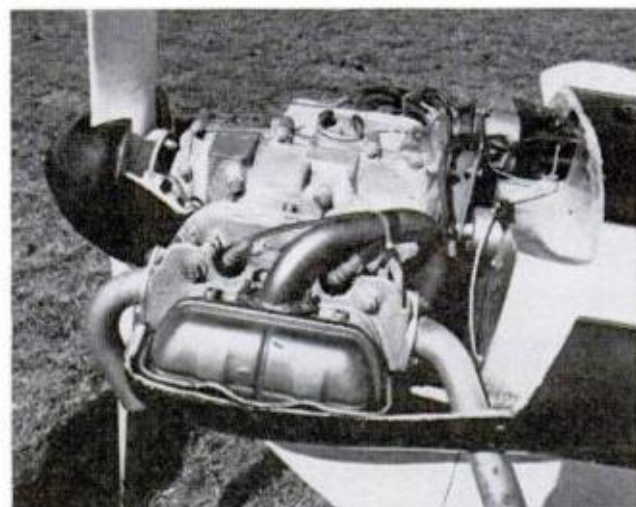

MINI POWERPLANT is 36-hp VW engine fitted with Eisemann magneto and Revmaster low-pressure injector carburetor. Exhaust stacks are curved downward



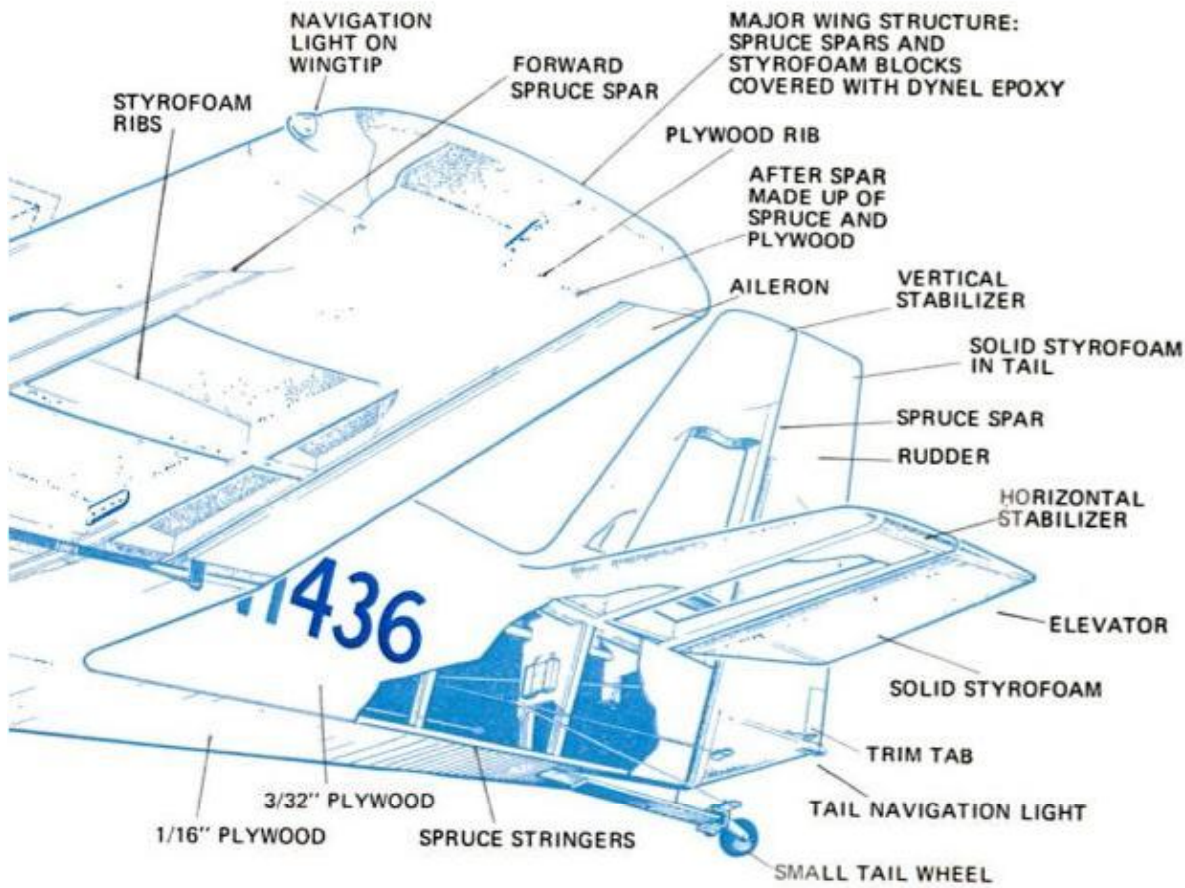

RUDDER AND ELEVATOR control surfaces are shaped from solid Styrofoam blocks (top photo at left). Simply made landing-gear struts (bottom) fold upward into wing pockets to retract wheels in flight

tract them for flight. The crossbar is spring-loaded to cushion shocks.

What's so surprising is the ship's impressive performance on modest power. Out of a junked 36-hp VW engine of 1957 vintage, the KR-1 squeezes a top speed of 170 mph and cruises at a brisk 160. Rate of climb is 600 feet per minute, with a service ceiling of 12,000 feet and a range of 750 miles on a 7½-gallon fuel supply. The plane can land at a leisurely 50 mph and gets off the ground in 500 feet.

Much of the KR-1's performance can be attributed to its light weight—only 310 pounds empty and 600 pounds gross. Overall length is a scant 12½ feet—less than many cars—with a wingspan of 17 feet, 2 inches. To make the plane readily stowable in a garage, its wings are removable. Another feature is a side-hinged partial canopy that swings up for easy access to the tiny cockpit. KR-1 plans are \$20 from Ken Rand, 6171 Cornell Drive, Huntington Beach, Calif. 92647. ★★★

IT'S NEW **NOW**

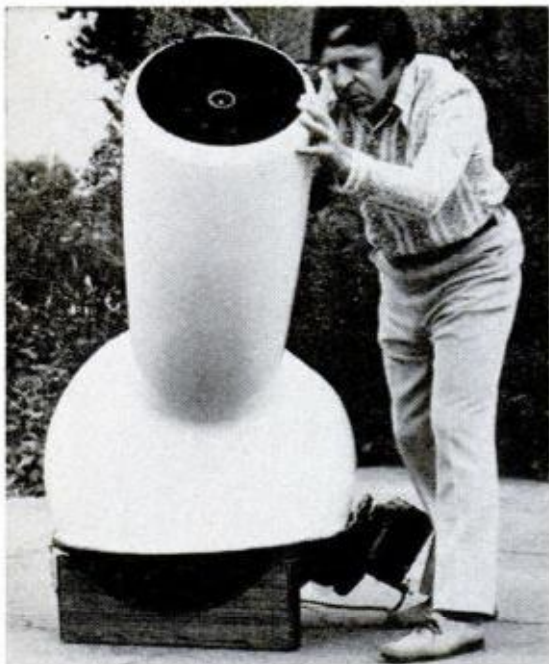

Big scope floats in small 'pond'

When amateur astronomer Norm James designs a telescope to be stable, it's really stable. For the one above he built a floating mount—a ball-ended base that rests in a water-filled basin. The scope is turned by a suction-cup drive (upper right), enabling it to track smoothly and accurately without vibrations from passing cars or other shocks. Photos at right are of 1968 solar eclipse taken through the homemade scope. Plans are 50 cents from Norman F. James, 10513 Vall Dr., Sunland, Calif.

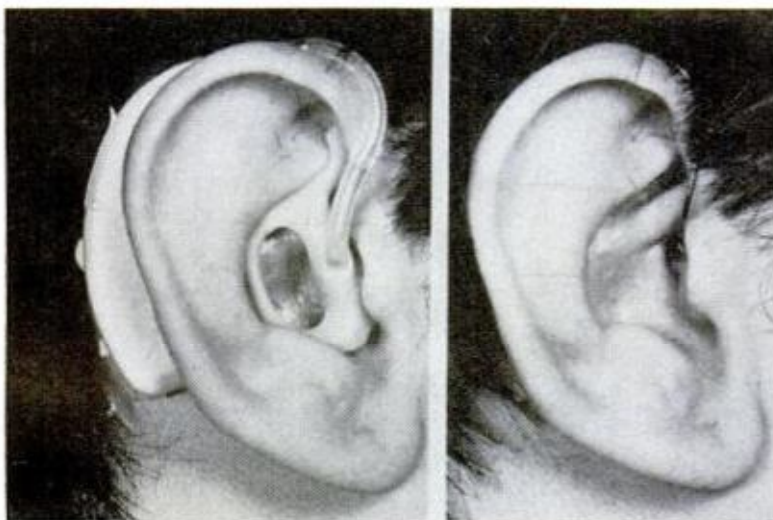
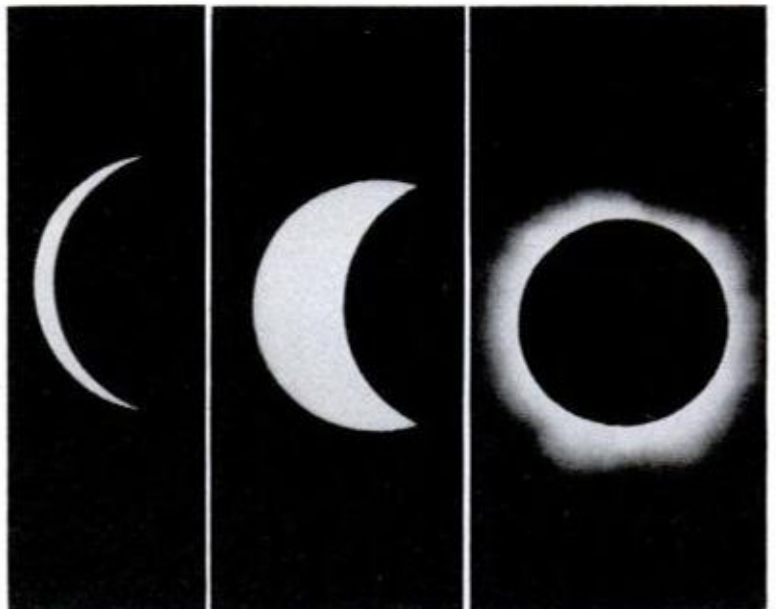
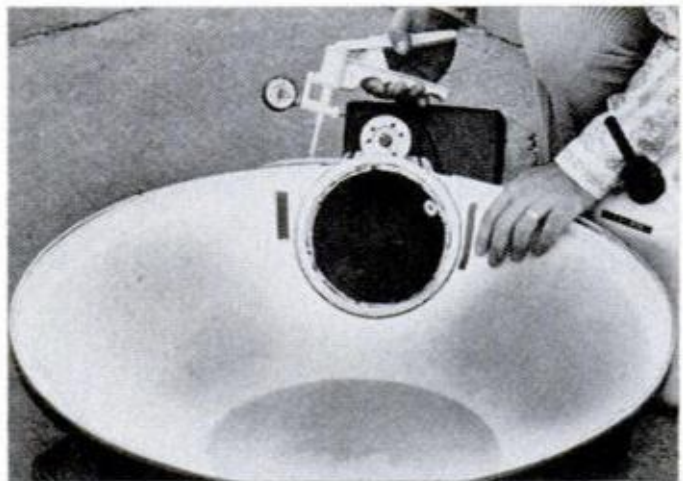

Invisible hearing aid wears a tiny 'wig' so you can't tell it from your own hair

A virtually invisible hearing aid is made possible by inserting a tiny speaker directly into the ear canal and running a fine wire to a small amplifier behind the ear. The amplifier is covered with synthetic hair to match the wearer's own (near left compared to conventional hearing aid at far left). Medacoustics, Inc., 609 Fifth Ave., New York, N.Y., sells the device, said to compare in price with standard models.

THE LATEST PRODUCTS AND DEVELOPMENTS



Concrete 'highways' to help speed fast trains of the future

Concrete railroad ties, long thought to be too brittle and unresilient for practical use, are now being tested in England. The trick, engineers found, is to cast the ties as part of a continuous concrete roadbed, much like a concrete highway. The system, if successful, could provide safe, maintenance-free track, especially important for Britain's planned high-speed trains.



Latest in kits: Now you can build your own tough, three-wheeler ATV

This kit-built ATV not only gives you a lot of wild, bouncy fun riding it, but also provides the money-saving satisfaction of putting it together yourself. The rugged three-wheeler, powered by an 8-hp Tecumseh engine, has hefty foot-wide, 21-inch tires for good traction on soft ground or sand. Super Tryke kit is \$369.95. Heald, Inc., Box 1148, Benton Harbor, Mich.

MARCH 1973

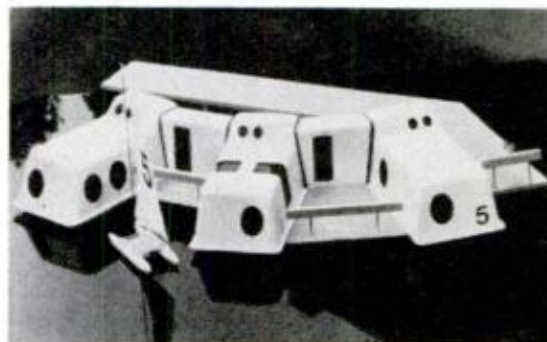

Home may be in a houseboat city

A floating "city" of houseboats may be one answer to finding housing space in highly populated areas. It consists of modular-shaped houseboats that couple together with interconnecting passageways, docks and shopping facilities. If you want to take a trip, you just detach your floating home and sail away. Conceived by Danny Chan of Hong Kong, idea was one of winning designs in a contest sponsored by Alcoa.



Unsticker for stuck wheel nuts

Unsticking stubborn wheel nuts is easy with this clever torque-multiplying lug wrench. One end fits over the nut to be removed; the other end is anchored on another nut. A ratchet handle turns a crank wheel to increase leverage, quickly loosening the nut. Made by Firma Fritz Wegner, Stormsweg 12 Hamburg, Germany.

93



Hello, Mom, we just sank!

Hawaiian beaches not only abound in bikini-clad bathing beauties, but now boast a network of shore-side emergency telephones similar to those along U.S. highways to aid motorists in distress. The phones, located at spaced intervals around the tourist-popular island of Oahu, are designed to speed help to injured surfers, victims of boating accidents, even stranded sunbathers who leave keys locked in their cars.



Double-ender fire engine comes and goes either way

Said to be the biggest firefighting vehicle in Europe, this mammoth German pumper hurls streams of water or foam from twin turret-mounted "cannons" on top. Giant tanks inside hold 5000 gallons of water and more than 300 gallons of foam. Used in Frankfurt, the 50-ton truck has two 500-hp engines and control cab at each end to steer in either direction for quick maneuvering in close quarters.

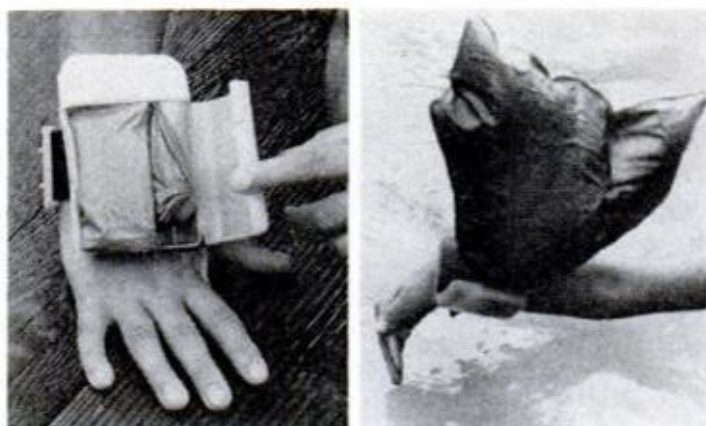

'Wristwatch' life preserver

Worn like a wristwatch, this tiny cigaret-pack-sized inflatable life preserver is designed to save the bulk of conventional life jackets and also be with you at all times when you're not wearing a jacket. Pressing a button instantly inflates a plastic flotation bag from a built-in CO₂ cartridge. The Aqua-Aid is \$4.45 from New Era Products Corp., 2670 Meadow Rd., Lumberton, N.C.



'Flying saucer' sofa doesn't really fly—but oh what fun you can have on the ground

If you cross a flying saucer with a sofa, you get this circular party seat—sort of a raised version of the popular "conversation pit." It won't get off the ground, but it does save cutting a hole in your floor. The novel whatever-it-is is sold in England by Oscar Woollens, 423 Finchley Rd., London, for—guess—about \$1200.



Pedal-powered car saves on gas, cuts pollution, but you provide the go

If you pedal fast enough, you can keep up with traffic in this foot-powered mini-car designed for low-cost, short-run shopping and commuting trips. The Pedicar has five forward speeds, reverse and 8 cu. ft. of cargo space; even headlight, windshield wiper and rear-view mirror. Most states permit its use on local roads but not highways, says its maker, Environmental Trans-Sport Corp., Box 566, Windsor, Conn. 06095.



Space date: U.S. and Russian astronauts to meet in orbit

How the U.S. Apollo and Soviet Soyuz spacecraft will link up in orbit is demonstrated above by NASA-built models. The rendezvous, scheduled for 1975, will be the first between two nations and will also test out the feasibility of using one space vehicle to rescue another in distress. The Apollo is shown in the foreground with its docking and crew-transfer module connecting it with the Soyuz ship in the background.

MARCH 1973



This giant hydraulic 'can opener' frees trapped crash victims in seconds

Getting trapped accident victims out of badly smashed cars or other wreckage is quick work with these powerful hydraulic "jaws." The spreading jaws exert five tons of force and can strip off a jammed door or raise a crushed roof in 20 seconds. The portable rescue rig is powered by a 5-hp engine and, for special jobs, can be fitted with grab hooks, cutting blades or chains. It was developed by Hurst Performance, Inc., Warminster, Pa.

NOW

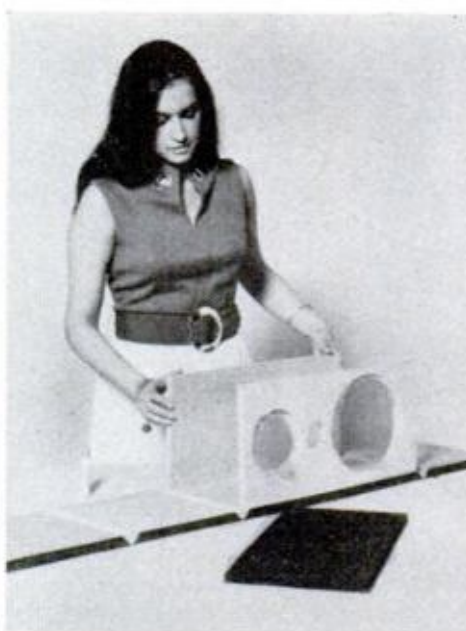
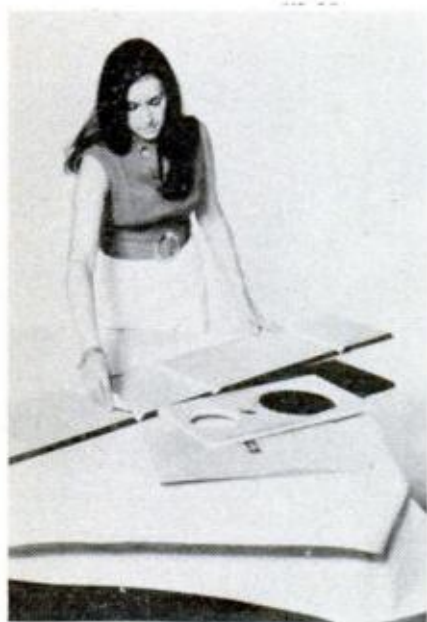

Speakerless speaker kit saves you money by letting you use your own speakers in an easy-to-assemble prefinished enclosure



This kit-built speaker enclosure has a novel feature—it not only saves some of the cost of ready-made models, but lets you use speakers you may already have or wish to buy separately. Parts come knocked down (top photo, far left), but fold together quickly to produce a handsome walnut-finished enclosure of high-quality, acoustic-suspension design (bottom photo, near left). Kit includes a speaker baffle with pre-cut openings for standard speaker diameters of 2½, 5 and 8 inches. Two models—a two-way for tweeter and woofer, and a three-way for tweeter, mid-range and woofer—are available. Speakers are not included, but can be supplied. For prices and additional information, write to National Tel Tronics, 98 Cutter Mill Rd., Great Neck, N.Y. 11021.

Pocket-sized Minolta mini camera now comes with strobe flash adapter packaged in handy all-in-one kit

Electronic flash is now available for Minolta's popular 16-Qt sub-miniature pocket camera, eliminating the need for flashbulbs. Camera and strobe come in a boxed kit (right) that includes carrying case, strobe adapter and film for \$110. Camera takes 16-mm film in easy-load, drop-in cartridges for color slides and color or black-and-white prints.





Add-on video player attaches to any TV

You can play video tape cartridges through your own TV set with this add-on unit, said to be the first for use with any existing TV. The Cartrivision player, previously available only in TV consoles, will be sold separately for about \$700 at department and appliance stores.



Two famous SLR cameras go completely automatic

Automatic exposure is now available on two well-known 35-mm SLR cameras—the Canon EX Auto (top, above) and Nikonmat EL (bottom). You just set desired shutter speed—diaphragm openings are automatically adjusted. Cameras have center-weighted through-the-lens light meters, can be switched to manual operation. Canon EX Auto, with 1/500-second speed and 50-mm f/1.8 lens, is \$229.50, Bell & Howell, 7235 North Linder Ave., Skokie, Ill. Nikonmat EL, with 1/1000-second speed and 50-mm f/2 lens, is \$450, Ehrenreich Photo-Optical Ind., 623 Stewart Ave., Garden City, N.Y.



First pollution-free all-electric bus

Proving that pollution-free electric buses may be practical for the future is this compact battery-powered Electrobus already available for short-run urban uses. It seats 20 passengers, hits up to 35 mph, runs three to five hours on a single battery charge and can also be converted to a cargo van. Priced at \$28,000, it's made by Tork-Link, 12457 Ventura Blvd., Studio City, Calif.



Two-way cooking top

This one-piece, glass ceramic top developed for kitchen ranges by PPG Industries, One Safeway Center, Pittsburgh, Pa. 15222, combines a cooking surface with counter space. Usable with ordinary cookware, surface becomes hot only directly over heat source, leaving remaining space for storage. The top, now used for electric ranges, is being considered for gas models. Write PPG for nearest dealer.

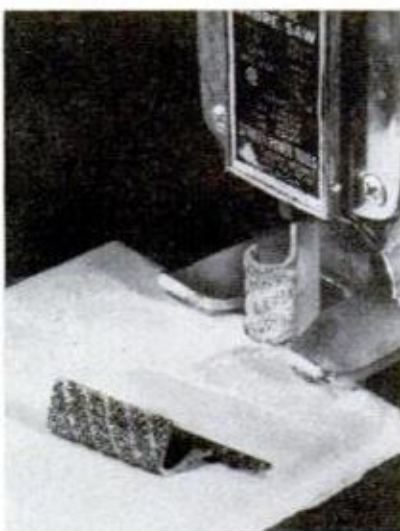

Converts sabre saw into a power file

A new saw attachment called Saber-File converts your sabre saw to a power file. The file has tiny particles of tough tungsten carbide fused to the working faces, which are claimed to file with ease ceramic tile, fiberglass, asbestos and plastic laminates, as well as wood. The packed set of two, consisting of one flat file and one half-round file, sells for \$3.25 postpaid (plus tax where applicable). The manufacturer is New Concepts Co., Inc., Box 182, 1945 Cary Rd., Algonquin, Ill. 60102.



It's the age of aquariums

Newest look in aquariums is this freestanding contemporary bubble tank. The 21-inch-diameter globe of clear plastic provides good viewing, and a concealed filtration system operates through a center service channel to supply fish needs. Standing 36 inches high overall, the aquarium rests on a molded rigid-urethane pedestal. \$139 from Vaungarde, Inc., Dept. PM, 1210 West Oliver St., Owosso, Mich. 48867.

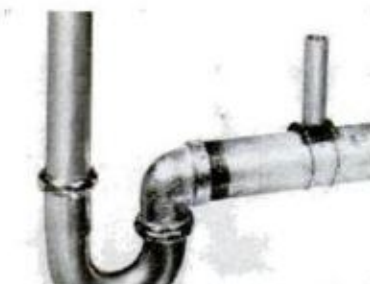

Here's a way to stop drain 'gargle'

Gargling noises in a drain can be stopped by an Automatic Vacuum Breaker. Said to let water rush faster for scouring action, it's mounted in a hole near the trap and secured with wires. \$8; Al Steiner Co., 408 43 St., Union City, N.J.



Socket-wrench kit in a carrying case

Socket wrench kit has nine 1/4-inch drive sockets, nine 3/8-inchers, plus sparkplug socket, two extensions, 3/8 to 1/4-inch adaptor, spinner handle, reversible ratchet, carrying case. \$23.65, Crescent Div., The Cooper Group, Box 728, Apex, N.C.



Easy cleaning with a huff and a puff

Though in use for years in technical laboratories, professional dusting instrument called Dust-Off is now available to the consumer for reaching those hard-to-dust areas and for photography buffs. The tool uses Freon gas, which can be controlled from a delicate puff to a powerful blast. The larger shop version, comes with 15-oz. canister complete with reusable chrome trigger valve and nozzle, sells for \$9.95 (refills are \$1.95.) The disposable-when-empty Dust-Off Jr. is priced at \$2.75, comes with flexible extension rod for precision dusting. Available at local photography and hi-fi outlets. Falcon Safety Products, Inc., Mountainside, N.J. 07092.

MARCH 1973



Intermittent blending—automatically

Latest pushbutton blender from Waring features a switch labeled Dynablend that automatically gives the unit on/off intermittent blending. The handy control permits user to do any necessary dry blending such as nuts, dry cheeses or to make bread crumbs. Available in white, avocado and gold at appliance and department stores, it's priced under \$30.



Stops rug raveling

Put a bead of Mr. Quick Liquid Carpet-Binding along the edges of your rugs and carpets, and annoying rug raveling will stop. Vinyl-base liquid forms an invisible coating when dry, is claimed to give long-lasting effectiveness. Four-ounce applicator bottle \$1.50 ppd. from Carpet Products Co., Box S, Central Square, N.Y. 13036.

99

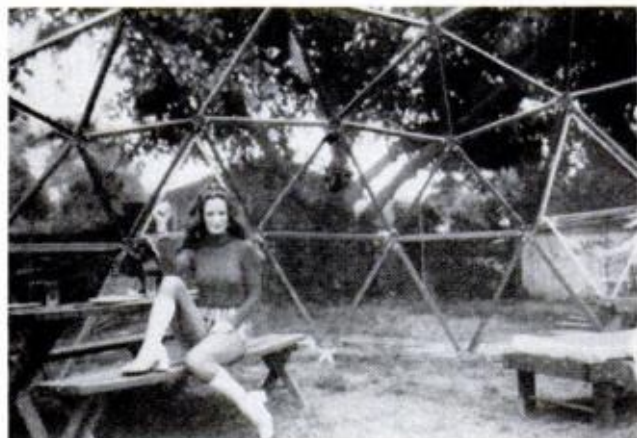

Do-it-yourself dome: Portable fun house for all-weather, anywhere use

It's a back-yard party and picnic shelter, an all-weather pool or patio cover, a portable beach, vacation or hunting cabin—you name it—it's anything you want to make it. The kit-built dome is 18 feet in diameter and goes together like an Erector set in about three hours with two working. Knocked down (upper left), the parts fit easily in a car trunk and consist of redwood struts and pre-drilled aluminum hubs that bolt together for quick assembly. Geodesic design provides a sturdy, self-supporting structure with 255 square feet of unobstructed floor space and more than 11 feet of headroom at the top. Basic frame price is \$750, with clear or opaque skin coverings extra. Portasphere Industries, 16616A Ventura Blvd., Encino, Calif. 91316.



In any language, it's 'out of gas'

Motorists in distress can let passing drivers know their needs with this emergency handbook by the German firm of Bleicher Verlags in Stuttgart. It contains pictures that can be understood in any language like the gas can above (out of fuel) and the wrench across the page (need tools).



Now handicapped persons can drive a car right from their own wheelchair

Wheelchair-bound handicapped persons can drive as easily as anyone else with this German designed hydraulic lift that swings the chair up and into the car. Special controls enable the occupant to drive the car from the chair. In this country, similar lifts and control conversions can be obtained for Chevy vans; may eventually be available for other vehicles. Estimated cost is \$1500. For information, consult Helper Van-Lift, 832 N.W. 1st St., Fort Lauderdale, Fla.

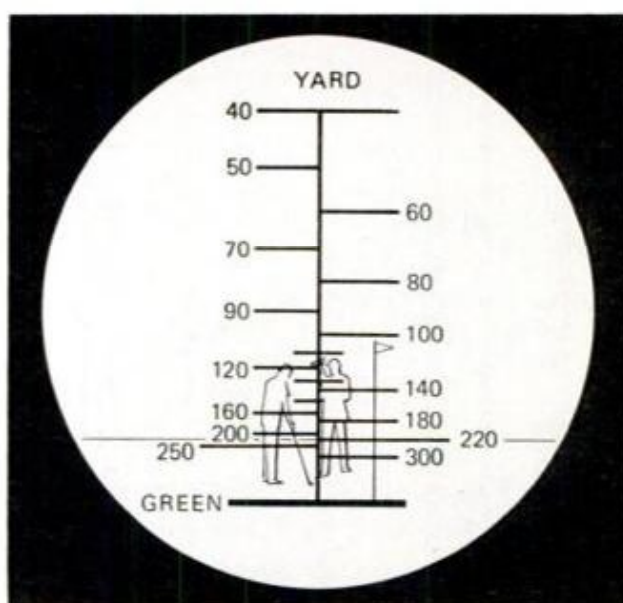

Scope sights golf shots for you

You can improve your golf shots with this handy pocket rangefinder that eliminates the need for judging distances by eye. The principle is based on the fact that the standard 8-foot-high green flag appears taller or shorter, depending on how far you are from it. You aim the scope at the flag, and a scale indicates the yardage needed to reach the green according to the pole's height, as in diagram above. Golf-Scope is \$19.95. Tasco, 1075 N.W. 71st St., Miami, Fla. 33138.



MARCH 1973

101

NOW

Two new cooking aids for your kitchen

Claimed to cook "the world's finest bacon," Mr. Bacon Pan is an oven broiler designed for those who want to avoid saturated fats and greases. Meat is sandwiched between crown and lid, for cooking from both sides simultaneously. \$5.95 at department stores. Nation Wide Products Co., Box 14334, Fort Worth, Tex. 76117. Lectro-Frank (far right) cooks juicier, tastier hot dogs in less time than it takes to boil water because dogs are cooked by current passing through them. UL-approved, cooker is machine-washable. \$7.95 post-paid. Star Mart, Box 28133, San Diego, Calif. 92128.

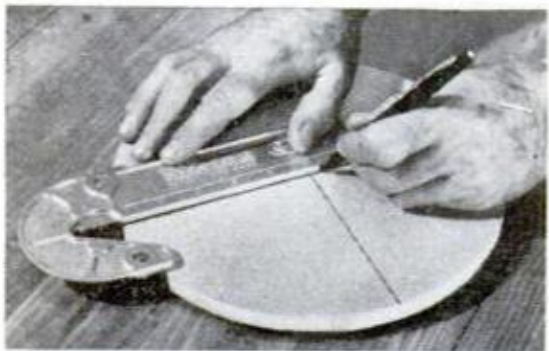
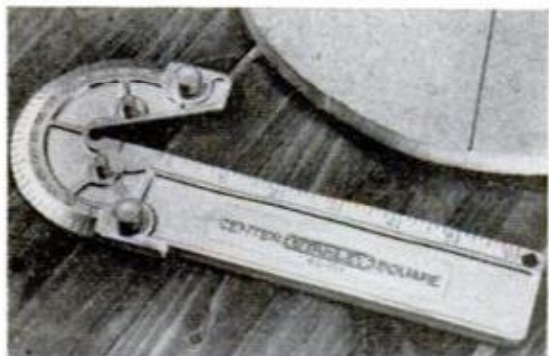
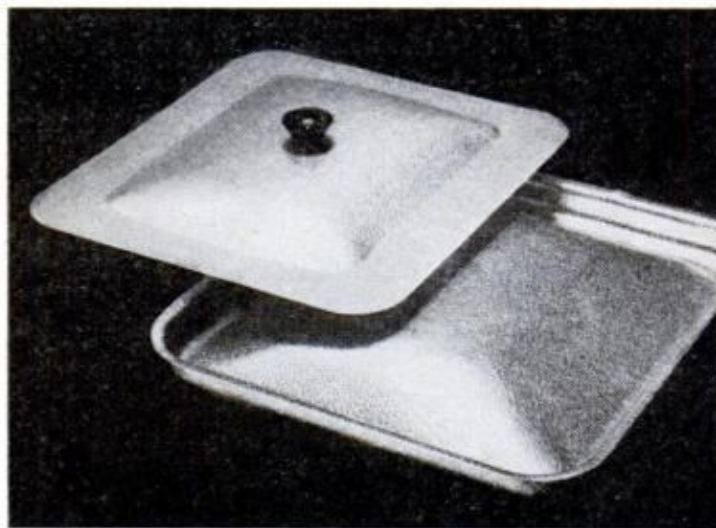

Versatile square locates circle centers, too

Latest tool from Stanley Tools, Div. of The Stanley Works, Dept. PID, New Britain, Conn. 06050, can handle a number of common, yet tricky, tasks encountered by professional and do-it-yourself woodworkers alike. It can be used as a square, a protractor to mark off any desired angle at any point on a workpiece, or for finding centers of circles from as large as a tabletop to as small as a chair leg or dowel. Center Square No. 46-101 is about \$2 at hardware suppliers.

102



Put an end to fumble-finger frustration

The Screwstart, firmly holding a screw against its tip, is used to locate and start a screw to a point where a standard screwdriver takes over. And for dropped screws, the tool has a magnet mounted on the back for easy retrieval. No. 65-155 above, \$2.69; Stanley Tools, Div. of The Stanley Works, New Britain, Conn. 06050.

POPULAR MECHANICS



**Snoopy electric brush
for your 'Peanuts'
operates on a
couple of batteries**

Novel aid to a youngster's oral health is the Snoopy Power Toothbrush by Kenner. The action brushes teeth clean (just like grown-ups' electric toothbrushes), but because it is powered by two D-batteries in the doghouse, there's no cord to plug in. Two toothbrushes are included, and the doghouse has neat compartments for storing them. With wall-mounting bracket, about \$7.

MARCH 1973



**Rechargeable home
burglar alarm
can be heard
for a quarter mile**

Powered by nickel cadmium batteries, this easy-to-attach Garland Burglar Alarm can be recharged hundreds of times in any 110-volt wall outlet. It hangs on a doorknob, and if the door is opened, sounds an alarm for over an hour that can be heard up to a quarter mile away, says the maker. Compact 7½-ounce alarm is \$14.95 ppd.; Dynatron, Inc., Dept. PM, 26 Fahey St., Stamford, Conn.

103

DR. EDWIN LAND, head of Polaroid, shows cutaway diagram of new SX-70 camera in folded position. See other cutaways below

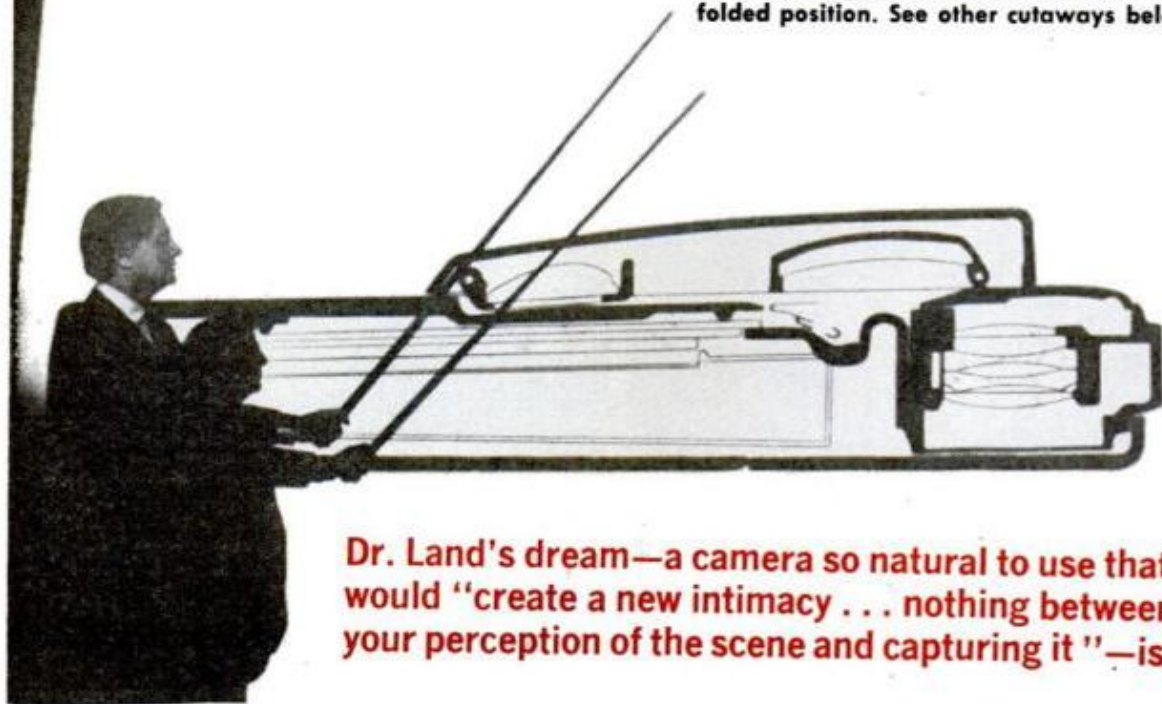

Dr. Land's dream—a camera so natural to use that it would “create a new intimacy . . . nothing between your perception of the scene and capturing it”—is here.

POLAROID'S NEW SX-70 COLOR CAMERA:

‘Our dream was to change photography’

By IVAN BERGER, Photography Editor

TO DR. EDWIN LAND, inventor of the Polaroid Land camera, the revolutionary new Polaroid Land SX70 and its equally revolutionary new film are more than new inventions. To him, they represent a personal dream fulfilled—or at least progressing rapidly toward fulfillment from the original instant-picture Polaroid of 1947.

Dr. Land began the SX-70 as a dream, “. . . a dream that some day we would be able to take a wallet from a pocket . . . open it and close it . . .

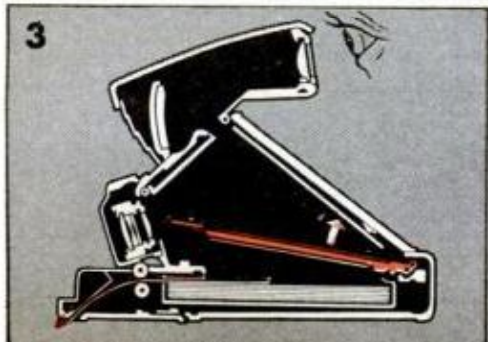
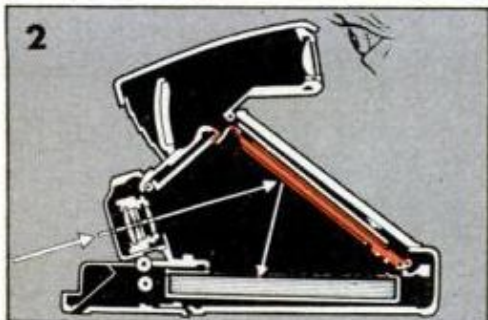
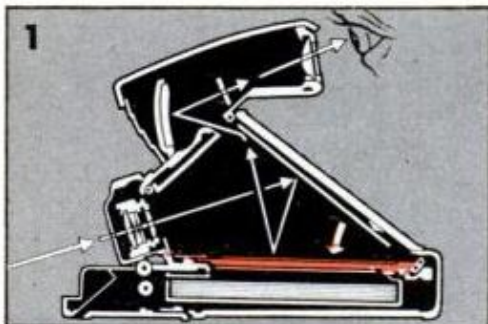

REFLEX DESIGN uses double-sided, hinged mirror (color). In the viewing position (1), light rays bounce from fixed mirror to hinged mirror's upper surface, thence to another portion of fixed mirror and through small pupil into viewfinder section. Curved mirror projects aerial image (dashed line) which is viewed through eyepiece. In the taking position (2), hinged mirror rises, and light rays bounce from its underside directly to the film. In the processing stage (3) motor (not shown) pushes film out between rollers; roller pressure ruptures chemical pod, spreading chemicals inside the film unit

and that would be all you'd have to do to get a picture." After 10 years and \$250 million spent in its development, "The camera grew from a wallet to a cigaret case to a cigar case—22 ounces—and will go into a side pocket or an overcoat pocket.

"That meant an entirely new concept in the chemistry of the film, in the structure of the film . . . utterly new concepts in electronics, in shutters and viewers. It meant having the courage to start all of those things at once, to build factories. . . . All taking the chance that if the dream was worthwhile, nothing could stop the convergence and coincidence of all those efforts to achieve the fulfillment of the dream."

Dr. Land saw it not just as a camera, but as a philosophy—the same that had spurred the development of the first Polaroid Land process: ". . . to generate a new intimacy between the human being and the world around him, a domain in which you would see something—a person, a flower, an arrangement of buildings against the sky—



PICTURE COMES OUT less than two seconds after you push red shutter button and develops in front of your eyes. Knurled wheel above shutter button focuses lens from 10 inches to infinity. Black and white knurled wheel at other side of camera is lighten/darken control, just above electric-eye cell



SIZE COMPARISON between the old and new Polaroids shows how compact SX-70 is, whether folded (above) or unfolded (below). Camera is lighter, too—just 22 ounces vs. 2½ lbs for the older version. New print, 3½ x 3¼ inches in picture area, is a little smaller (13 percent) than 2¾ x 3¼-inch print from old camera

GE FLASHBAR makes ten flashes—after the first five have been fired, you turn it around to use the second five. Flash won't fire if you're out of film (but film will be exposed if you should forget to flip Flashbar). The flash exposures are automatically correct from 10 inches to 20 feet

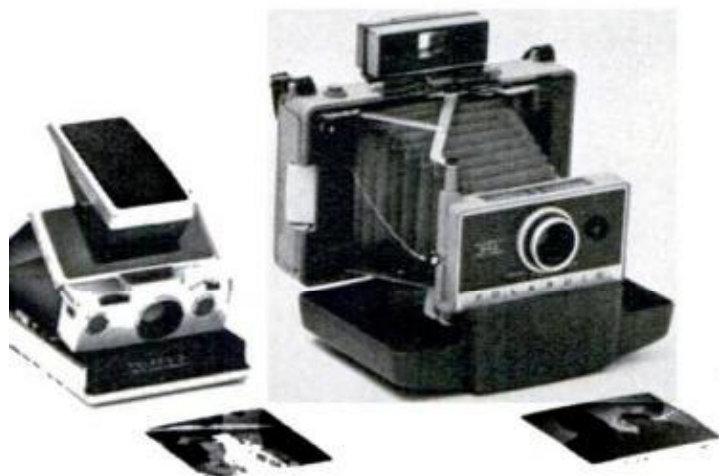

**CUTAWAY VIEW
POLAROID LAND SX-70**

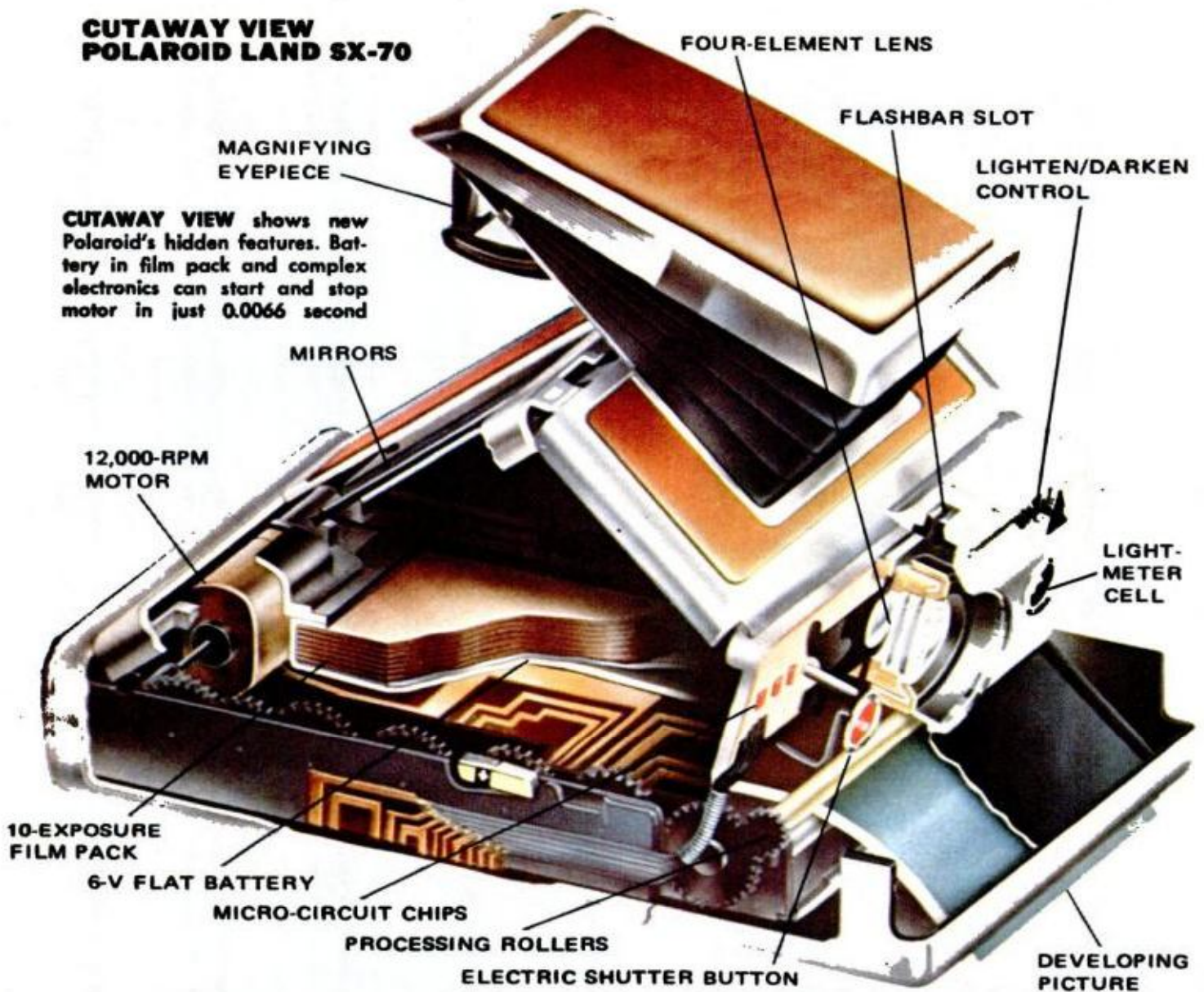

and then, looking through the camera, go quickly from focusing to touching the button . . . and capture the feeling that you had."

But the result of the dream is more than a philosophy—it's the most innovative new

camera design since the original Polaroid, and probably the first Polaroid camera that will influence conventional camera design.

For one thing, it's the first single-lens reflex that folds. That alone involved sur-



POPULAR MECHANICS

prising developments in lenses, focusing systems, even in mirrors. And its new film system required new developments in motor and motor control technology, as well as in the film itself.

And it's a beauty to use. Tug on the viewfinder, and the camera snaps open. Lift it to your eye and roll the knurled wheel beneath your right index finger, and the image snaps into focus as fast as on most 35-mm single-lens reflexes—only this sharp-focusing image is coming through an f/8 lens, instead of the faster ones required for good focusing in conventional reflex designs.

The shutter button goes off with a gentle touch that causes no camera shake (it's an electrical switch, not the usual mechanical actuator). The motor blips so quickly it's more like a hiccup than a

(Please turn to page 202)



NEW FILM'S COLORS ARE VIVID, even on cloudy days (above). A picture begins to emerge from the green-gray chemical protective coat in less than a minute (upper right) and continues to improve until it's fairly good in 3 or 4 minutes or fully developed, with rich, saturated colors in about 10. Close-ups (left) are easy to take; the newly designed lens focuses easily down to 10 inches, yielding images about one-half life size. (An accessory close-up lens is coming that will let you focus down to 5 inches for life-size images). With flash, the lens closes down as you focus closer to compensate for greater brightness as the flash gets nearer to the subject. At 10 inches, the aperture has decreased from its full f/8 to a tiny f/90, yielding tremendous depth of field—from 7½ to 12½ inches. The black and white studio shot at far left illustrates the camera's unique close-up capability and gives cross section of props used for color shot at near left; focus extends from far flowers almost to nearest grapes

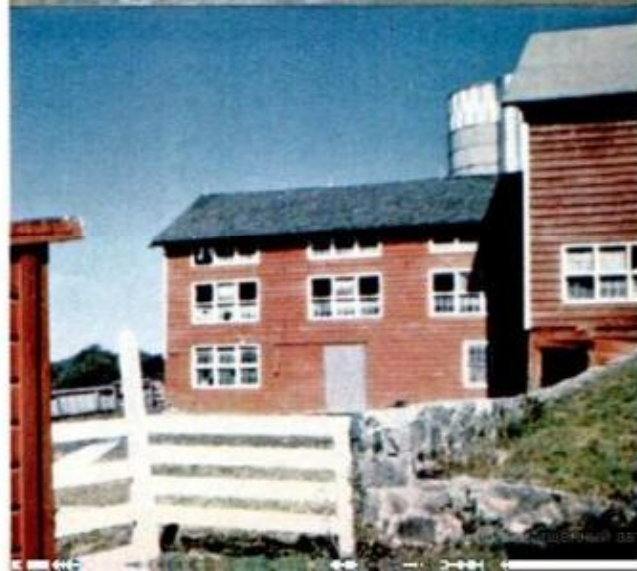



Photos by
Les Turnau

Data by
Annette Sukov

A pool for all seasons

IN NEED OF MORE SPACE, especially for family recreation, the owners of this home decided to create an addition that would give them year-round access to their favorite activity, swimming. They live in Minnesota, where winters are prolonged and frigid, so an outdoor pool really would not have been the answer.

The job was neither simple nor inexpensive. In order to convert an existing bedroom into the new concept, an extra 640 square feet had to be added. To do it, a 20-foot portion of the existing foundation wall was torn out and a supporting

beam-and-post system—that would adequately handle the newly imposed load—was designed and installed.

The face of the pool is brick. This brick extends upward about 18 inches above floor level (as can be seen in the photos). A spokesman for the designing architectural firm, Arthur Dickey Associates, Inc., AIA, noted that ceramic tile and slate were also used in constructing the pool. He added, though, that the ceramic tile was rather difficult to apply in the free-form shape.

Since removal of the tremendous amount



THE ADDITION of a new room, complete with a heated swimming pool, has provided more recreational dining, entertainment and storage facilities for the home pictured on these pages. The luxurious 880-sq.-ft. room is finished with cedar boards on the inside walls, while indoor-outdoor carpeting is on the floor. The free-form pool measures 24 ft. diagonally. Since the greatest depth is only 68 in., there is no diving board

MARCH 1973

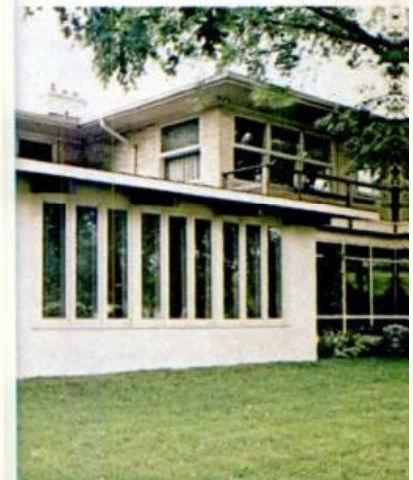

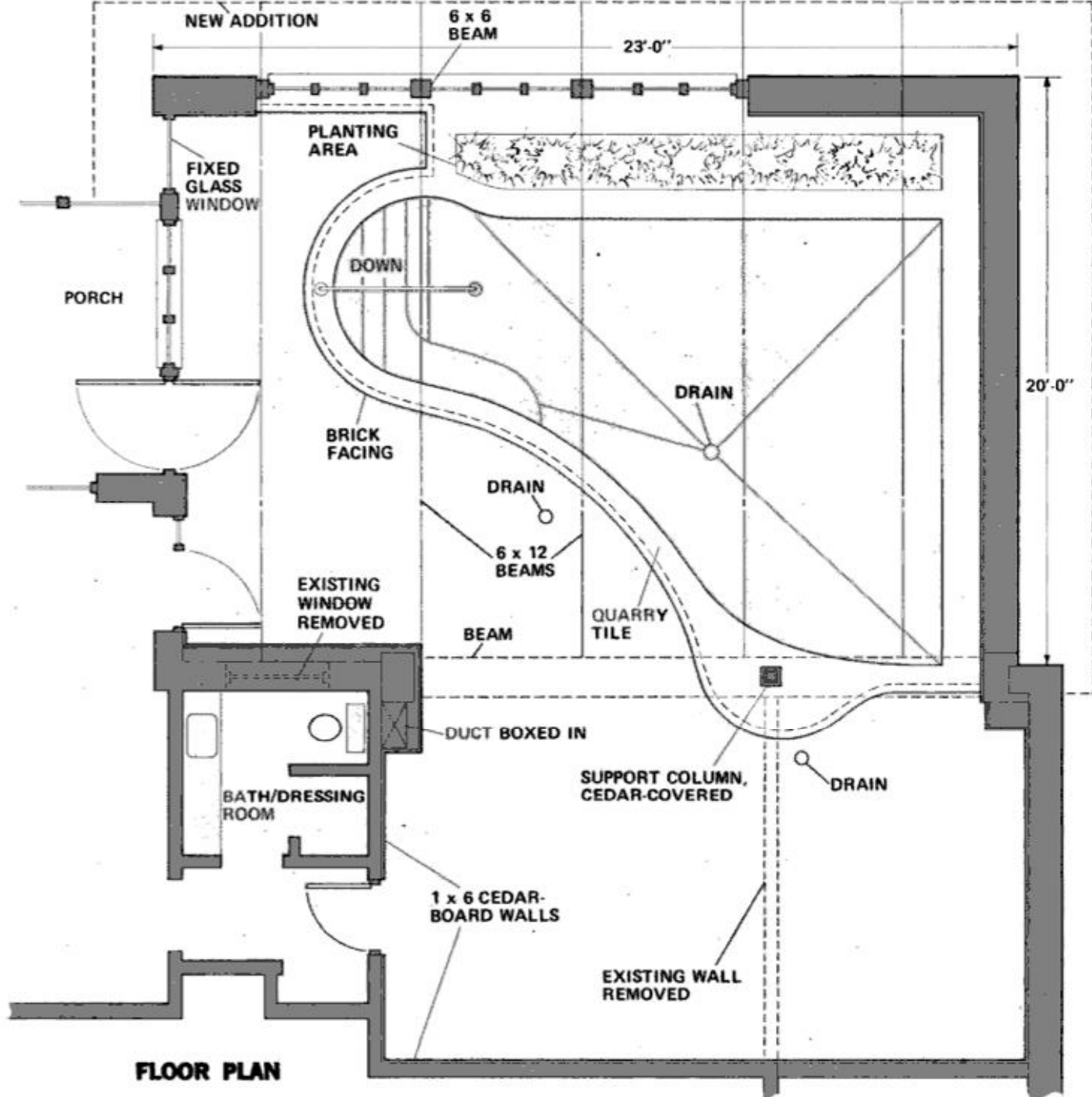

FLOOR PLAN

of humidity (present in a room such as this) is of paramount concern, a humidistat is located in the game room. And, because the existing heating plant could not take on the task of warming the new structure, a new forced-air system was installed. Exhausting—to handle that moisture mentioned above—is an integral role of the new system.

Pool lighting is located between the beams overhead; all lights are incandescent for a warm look. Top-quality Pella casement windows reveal the view to the rear grounds. As can be seen in the floor plan, two wood doors were also installed, leading to an existing porch and the recreation area. Cost of all this elegance came high: Remodeling ran \$27,000, the pool another \$7000. ★★★

A NEW FORCED-AIR heating system was installed in the room (but not airconditioning). The critical point to be kept in mind when installing an indoor, heated pool is the proper venting necessary for removal of excessive moisture created. Improper, or underdesigned, vent system could result in condensation pouring off those clerestory windows in rainstorm proportions. Since this isn't a job to economize in, make certain your system is designed and installed by a qualified mechanical engineer

New irons for better soldering



By JOHN BURROUGHS

A SOLDERING SAMPLER: (A) Heathkit, \$15.95; tips, \$5.75. (B) 200-watt American Beauty, \$23.80. (C) Ungar Solder-Off, \$1.50. (D) Solder-Wick, \$1.49. (E) Soldavac, \$3.95. (F) Weller Tempmatic, \$14.75; powerhead, \$10.25. (G) Ungar dual-heat gun, \$10.95. (H) Ungar Imperial iron, three tips, \$10.50; heat cartridge, \$5.35; tips, \$1.40. (I) Weller Marksman, \$3.50; two tips, 85 cents. (J) Ungar Princess, three tips, \$10.75. (K) Ungar pencil, three tips, \$6.25; heat elements, about \$2; tips, 50 cents. (L) Wahl Iso-tip cordless with recharger stand, \$19.95; tip, \$2.25

NOT LONG AGO, you had three choices when you went to buy a soldering iron: big, bologna-sized irons built for heavy soldering on pipes and sheet metal; hefty, high-powered, induction-loop guns, and stubby little pencil irons with one or two low-powered tips for electronic work.

These irons are still around, but now they have a lot of company: single-post guns, thermostatically-controlled guns and irons, irons powered by rechargeable batteries and low-voltage irons with variable-transformer power supplies. The old, original pencil irons now have more tips and elements than ever before. And there are even many new

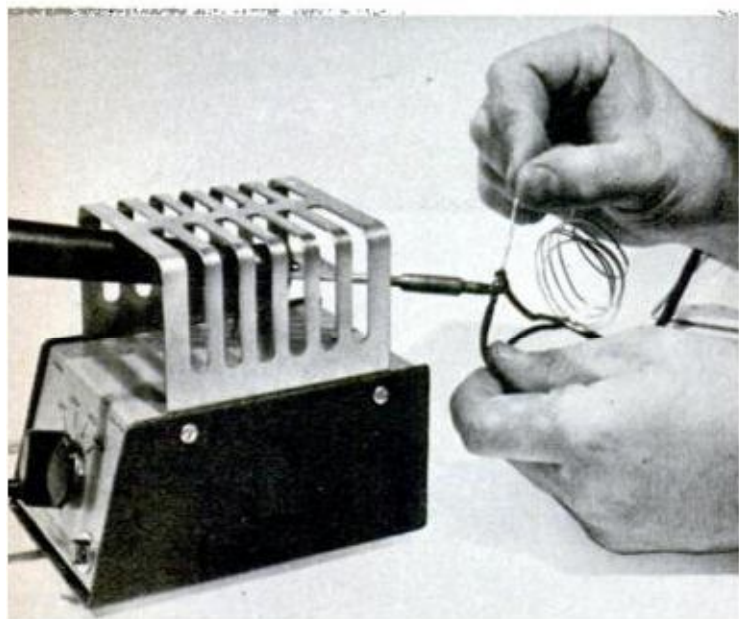

HEATHKIT IRON goes together in an hour or so. Transformer in base gives three switch-selected heat ranges and electrically isolates soldering tip. Cage stand shields iron tip in rest position, preventing accidental burns—but it can also work as a "third hand," holding iron extended as shown here

tools for desoldering—a necessity in today's printed-circuit era.

Pencil irons have long been the most popular tools for kit-building, electronic construction and other jobs involving repeated use, since they stay warm as long as they're plugged in. They're also the least expensive irons, with many models costing less than \$5.

The first small pencil irons were simple handles, with interchangeable, ceramic-encased heating elements that screwed in like Christmas-tree bulbs. Some of these elements had built-in tips; others (usually those with fine tips which could be quickly eaten away by chemical interaction with the solder) had screw-in or screw-on tip-lets (see photo, page 114) which cost less

to replace than entire heating elements. Today, many tip-lets are also available with solder-resistant plating, which about doubles their cost but lengthens their lives up to 10 times. Other tips have different household uses, including plastic cutting and sealing and decorative wood burning.

Newer pencil irons have cooler, slimmer, better-balanced handles, which make them easier to hold, and come with more fine tip-lets and fewer heavy ones in keeping with today's emphasis on delicate, heat-sensitive electronic components. Some, such as the Ungar Princess, have elements delivering as little as 10 watts. Other irons, such as the Oryx (not shown here) have thermostatic controls that keep the tip within $\pm 4^\circ$ F. of any preset tem-

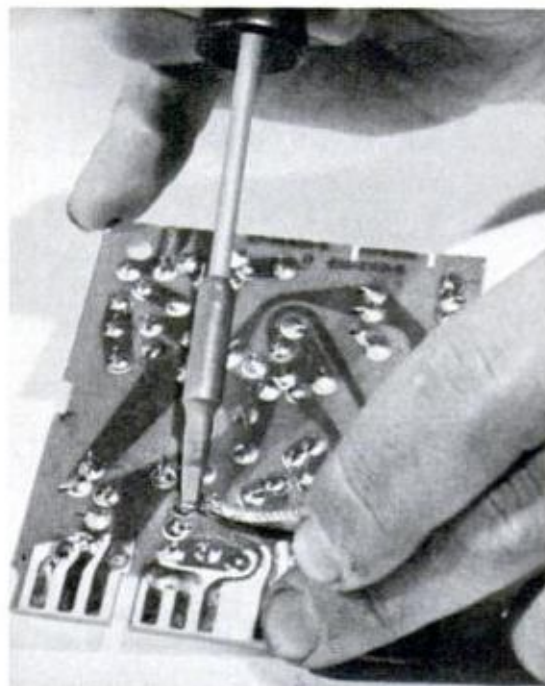
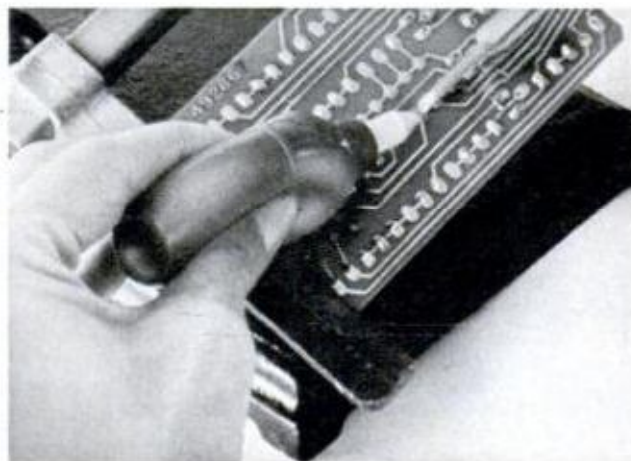

DESOLDERING is eased by a variety of tools: Ungar Solder-Off (upper left) sucks away molten solder; its Teflon tip resists melting. Solder-wick (lower left) blots up solder by capillary action, comes in four widths, costs \$1.49 per five-foot roll. Solda-vac (upper right, shown with Wahl cordless iron) is

perature from 400° to 750° F. Still others, such as the Heathkit, operate on low voltages from transformer power supplies (usually built into soldering iron stands), with switch-controlled tip temperatures.

The transformer-powered irons also prevent damage to integrated circuits and field-effect transistors caused by current leakage or induction during soldering: some regular pencil irons have three-wire grounded cords for the same reason.

Another new kink is the instant-heat soldering pencil from Wall. It's a slim three-ounce design with dual elements. Pushing a switch on the handle turns on the high-wattage element, which brings the tip up to operating temperature in seconds. Then a thermal relay cuts out that

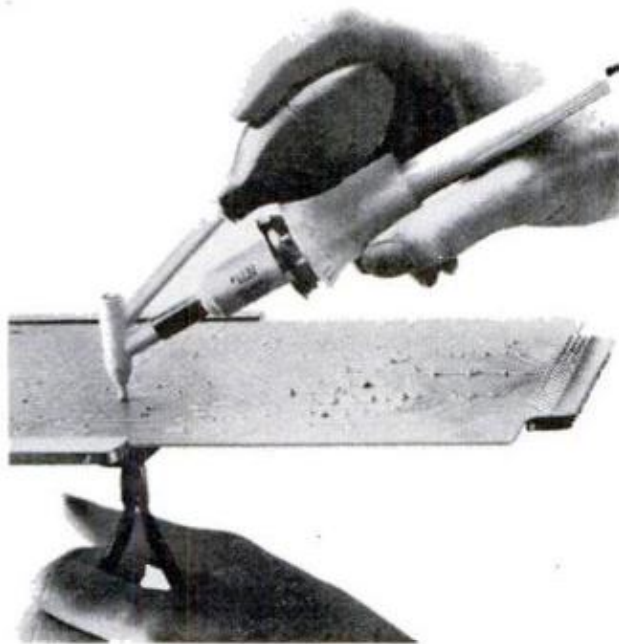
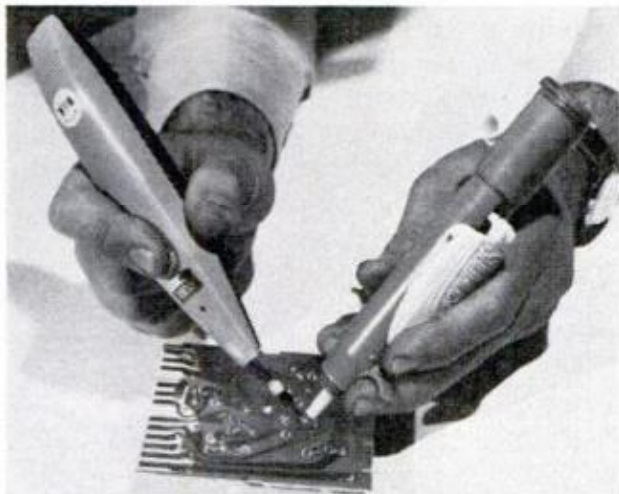

fast, powerful, trigger-operated vacuum, not recommended for ultrafine printed circuits. Ungar Hot-Vac costs \$14.25, combines a soldering pencil and Solder-Off in one handful. Ungar tools are at most electronic parts stores; others shown are from Jensen Tools, 4117 North 44th St., Phoenix, Ariz. 85018

MARCH 1973

element and cuts in a low-wattage element to maintain proper heat with no chance of overheating. When a higher heat is required, the relay cuts in again for as long as necessary.

Because pencil irons are continuously hot, they should be cradled in a safety stand whenever you're not actually using them, so they won't accidentally burn you, your bench or their own power cords. Stands are available to match most pencil irons, including an ingenious, \$4.70 American Beauty model that closes like a clamshell over an iron as soon as the iron is laid in place. Continuously-heated irons tend to "dry out," losing their "tinning"—the thin coat of solder that promotes good heat transfer between iron and joint. American Beauty has two answers to that, too: a \$4.70 stand that keeps the iron tip in a pool of molten solder, and temperature-regulating stands (about \$20-\$25) that reduce the current to the iron when it's in its cradle.

Tip temperatures on pencil irons vary with both tip size and wattage. Among regular pencil irons, 25-watt models with tip temperatures from about 600°-800° (600°-650° with fine tips) are best for general electronic soldering; 35-watt irons (650°-850°) are best for general-purpose household electrical and shop work, and still more powerful tips are best for moderately heavy work, such as soldering jewelry. For fine electronic work on transistorized equipment, 10-25 watt irons should be used: a 10-watt iron, with a tip temperature from 575°-650°, is especially recommended. More powerful irons are okay if they're thermostatically controlled.

Soldering guns are widely used for heavy soldering (except for very heavy pumbing or sheet-metal work, for which big pencil irons are preferred) and for intermittent soldering, where their quick heating times allow switching on for each connection to be soldered, then switching off again to conserve electricity and prevent tip drying or charring. The first such guns were loop-induction types pioneered by Weller around World War II. In these guns, a very-low-voltage, very-high-ampere current from a step-down transformer flows through a copper-loop tip, heating it to soldering temperature in a few seconds. Heat is controlled by "feathering" the trigger switch, turning it rapidly on and off as the tip cools or warms. But in-

duction guns have disadvantages: They're heavy. Their loop tips are hard to get into tight corners. Feathering the trigger correctly takes some skill. And the heavy tip current can induce destructive currents in some electronic circuits and components.

Newer guns, such as the Wen 450, 222 and 75, and the Weller Tempmatic, eliminate these disadvantages. They're lighter. Their tips are simple posts that can fit almost anywhere. Their tip temperatures are automatically controlled, with no feathering required. And their potential

for induction-current damage is lower. They have one disadvantage, though: single-post guns take about 10 seconds to warm up, four times as long as loop models; that's no problem in most home uses, but it makes them less suitable for production-line work.

Weller's Tempmatic gun (\$14.75) has a ferromagnetic thermostat in its "Powerhead" tip assembly, that switches a fast-heating element on and off to maintain tip temperature, clicking audibly as the gun is used. Powerheads are interchangeable, and two are available, both rated at 150 watts: the 3/16-inch chisel-point head delivers 700° for general soldering, and the 1/8-inch cone-tipped model delivers 600° for electronic work. Extra Powerheads cost \$10.25 each.

Wen's guns use a different regulating system: a transformer in the gun handle supplies low-voltage current to a new kind of heating element in each tip. The element's resistance is higher when hot than when cold; so as heat is drawn from the gun's tip, cooling the element, its lowered

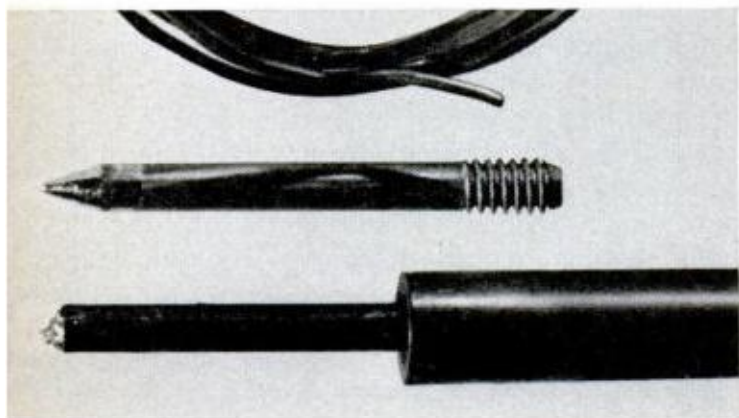

REPLACEABLE TIPS are a necessity (top) since solder erodes copper tips (especially thin ones) quickly, eventually erodes even plated ones. But tip interchangeability also increases an iron's versatility; accessories for Ungar pencil (above) include heating elements from 27 to 50 watts, tips from 0.056 to 0.395-inch diameters, Anti-Seize to keep tips from "freezing" in sockets. Not shown: desoldering tips to contact all pins of an integrated circuit at once. Shiny white tips are plated to give longer life



PENCIL IRONS come in a variety of sizes, from 20 to 600 watts, for jobs from fine wiring to heavy soldering of pipes and sheet-metal joints. Since they stay hot all the time, the pencils are best where joints are made frequently, but should be kept in protective stands (above) between joints. Other stands available include temperature-regulating models that reduce tip heat when the iron is cradled to increase tip life, units that hold tip in molten solder, and those having sponges for tip cleaning

resistance draws more current until the lost heat is restored. Again, changing the tip changes the wattage (Wen doesn't rate its tips by temperature). Wen's \$13.95 Model 450 iron takes 25-100, 100-200 and 200-250-watt tips; its \$7.95 Model 222 Hotrod takes the same 25-100 and 100-200-watt tips, and the \$5.95 Soldering Pistol (shaped like a toy revolver) has a non-interchangeable tip delivering 30-100 watts. Extra tips are \$1.40 for the 222 and 450, \$1.10 for the pistol.

The cordless iron is another new type, operating from built-in, rechargeable batteries. Most widely available is the Wahl Iso-Tip, with 50 watts of output and a tip temperature of over 700° F. It's handy for use wherever cords would get in the way (inside electronic consoles, for example) or where power is unavailable (fixing car electronics, model planes, and the like). Fine and general-purpose tips are available, as are a protective carrier and a recharger that plugs into a car's cigarette lighter socket. A Wen cordless is coming, too, that will be similar in appearance ex-

cept for its longer, right-angled tip.

Irons have come a long way from the first heavy, electric ones that were always too hot or too cool—and even farther from the very first, fire-heated ones.

Most of the equipment shown and mentioned here (especially Ungar, Weller and Wen) is available from most electronic parts stores. If you can't find what you want, Jensen Tools & Alloys, at 4117 North 44th St., Phoenix, Ariz. 85018, sells most of this equipment (American Beauty, Oryx, Soldavac, Solder-Wick, Ungar, Wahl Iso-Tip and Weller) by mail. The Heathkit iron is available only from Heath, Benton Harbor, Mich. 49022.

Other manufacturers' addresses include: American Beauty, American Electrical Heater Co., 6110 Cass Ave., Chicago, Ill. 60631; Ungar, 238 East Manville St., Compton, Calif. 90220; Wahl Clipper Co., 2902 North Locust, Sterling, Ill. 61031; Wall Manufacturing Co., Kingston, N.C. 28501; Weller, Box 345, Easton, Pa., and Wen Products, Inc., 5810 Northwest Highway, Chicago, Ill. 60631. ★ ★ ★



CHANGING POWERHEADS on Weller Tempmatic gun changes tip size and temperature, but not wattage. 150-watt tip shown has screwdriver point, automatically regulated 700° tip temperature; 150-watt conical head has 600° temperature. Head costs \$10.25

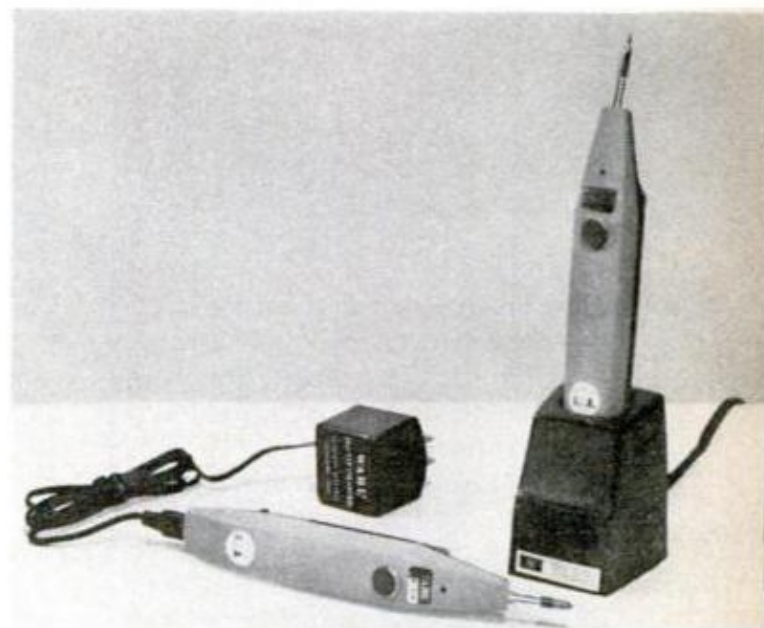

CORDLESS WAHL Iso-Tip irons store enough power for up to 160 solder joints in built-in, rechargeable nickel-cadmium battery, have "headlights" to illuminate work. Model 7600 (left) costs \$22.95, plugs into recharger (but can't be used while recharging); Model 7550 (\$24.95) drops right into its recharger stand, lifts out instantly and easily for soldering

SINGLE-POST GUNS get in tight spots better than older, inductive-loop types, have regulated tip temperatures. Black gun is Wen: its \$13.95 model takes light, medium and heavy heat-range tips (25-450 watts); \$7.95 model, light and medium tips (25-200 watts). Other gun is a Weller Tempmatic (\$14.75)

Yardpower roundup for '73

If it's time to get a new mower and you're thinking about a rider or tractor, here's a cross section of major makers' offerings, including specs and prices

SHOPPING for a riding mower or lawn tractor can be as much fun—or as frustrating—as shopping for a new car. The options are almost as numerous. How much horsepower do you need? Should you go for hydrostatic drive? Is electric starting worth the extra money? And then there are all those attachments—dumpcart, spreader, sweeper—to consider.

Your final choice should be based on the size and topography of your lawn, and the amount of heavy work (hauling, grading) you plan to do. A big, hilly lawn calls for more muscle.

You'll get a good idea of what's available—and for how much—through a few minutes' study of the spec charts on pages 118 and 119. They provide a cross section of the market. Bear in mind that not all makers are included, nor all models of a particular line. The chart had to be condensed because of space limitations.

For the most part, prices are rounded out to the nearest dollar, and are f.o.b. at the factory. Prices for tractors do not necessarily include the rotary mower attachment. Horsepower ratings of electric units are approximate equivalents. ★★★

116

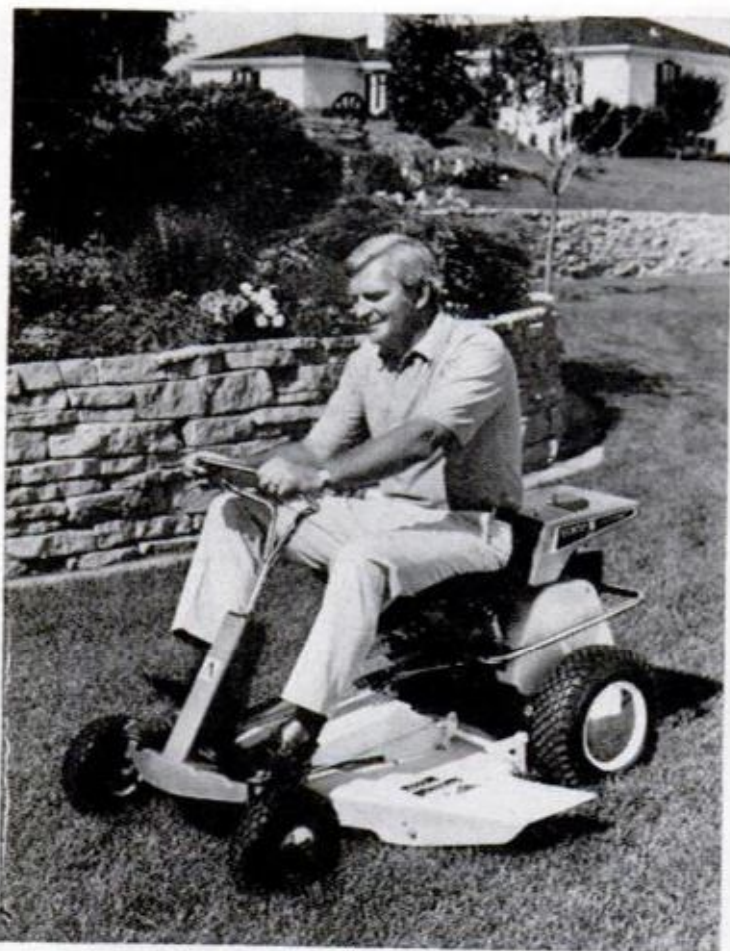

THE 5-HP SCAMP is made by Allis-Chalmers and it sells for \$419. It features electric starting, a foot-controlled clutch and a 26-inch rotary mower



THREE 12-VOLT BATTERIES supply power for John Deere's Electric 90. It has 34-inch mower, can cut about an acre of lawn on a charge, and costs \$885

POPULAR MECHANICS



YOU CUT A 28-INCH SWATH with the Bolens 728, a ride powered by 7-hp Tecumseh engine. It has three forward speeds, reverse, shifts "on the go"

POWERED by 8-hp Briggs & Stratton, Murray's model 3-3233 has three forward speeds, cuts 32-inch swath. The slick rider is priced at \$550

By GERALD KRATSCH



INTERNATIONAL'S CADET 75 (right) offers 7-hp engine, optional electric starting and takes 32-inch cut. A variety of attachments is available



DUMPCARTS, TRAILER-SWEEPERS and other attachments are offered for Toro's Whirlwind riding mowers. Shown at left is the 7-hp model that sells for \$500

MARCH 1973

117



Yardpower '73

SNAPPER RIDING MOWER series for '73 includes six models with 5 or 8-hp engines. The grass-catcher attachment holds up to six bushels of clippings

Make/Model	Engine/HP	1	2	3	4
AMF 1281 1293	B&S 8	Yes	3	36	NA
	B&S 8	Yes	4	36	NA
Allis-Chalmers Scamp Scamp	B&S 8	Yes	2	30	\$645
	B&S 5	Opt.	2	26	419
Ariens Emperor Emperor Emperor Fairway Fairway Fairway Fairway	B&S 8	Yes	6	38	700
	Tecumseh 8	Yes	6	30	630
	Tecumseh 8	No	6	30	500
	Tecumseh 7	Yes	4	26	570
	Tecumseh 7	No	4	26	450
	Tecumseh 5	Yes	4	26	500
Bolens 728	Tecumseh 5	No	4	26	380
	Tecumseh 7	Opt.	3	28	489
John Deere 90 57	Electric	Yes	3	34	885
	Tecumseh 7	Opt.	3	34	535
Gilson 52040 52039 52038	B&S 8	Yes	3	30	630
	B&S 8	No	3	30	555
	B&S 5	No	3	25	420
Homelite RE-8E RE-5	B&S 8	Yes	2	30	655
	B&S 5	No	2	24	414
Huffman H1543 H1533 H1513	B&S 8	Yes	3	32	585
	B&S 8	Yes	3	26	525
	B&S 5	No	1	26	385
International Harvester Cadet 75 Cadet 55	B&S 7	Opt.	3	32	585
	B&S 5	No	3	28	NA
Jacobsen Mark III Mark III Mark II Mark II 42635	B&S 8	Yes	Inf.	30	640
	B&S 8	No	Inf.	30	560
	B&S 7	Yes	Inf.	30	NA
	B&S 6	No	Inf.	30	NA
	B&S 5	No	Var.	25	NA
Lawn-Boy 9369ES 9329ES 9369 9266	B&S 8	Yes	3	36	700
	B&S 8	Yes	3	32	670
	B&S 8	No	3	36	580
	B&S 5	No	3	26	400
Massey-Ferguson MF 7 MF 6 MF 5	Tecumseh 7	Opt.	3	34	650
	Tecumseh 6	Opt.	3	32	470
	Tecumseh 5	Opt.	2	26	379
McDonough Snapper 3080S 2680S 2680 2650S	B&S 8	Yes	5	30	610
	B&S 8	Yes	5	26	570
	B&S 8	No	5	26	460
	B&S 5	Yes	5	26	510
Murray 3-3633 3-3233 3-3063 3-3013 3-2513 3-2503	B&S 8	Yes	3	36	570
	B&S 8	Yes	3	32	550
	B&S 8	Yes	3	30	500
	B&S 8	No	3	30	390
	B&S 7	No	3	25	370
	B&S 5	No	3	25	330
New Holland R-8 R-8 R-5	B&S 8	Yes		30	646
	B&S 8	No		30	547
	B&S 5	No		26	436
Roper K83233R K83133R K52233R K52133R K51133R	B&S 8	Yes	3	32	580
	B&S 8	No	3	32	500
	B&S 5	Yes	3	26	460
	B&S 5	No	3	26	380
	B&S 5	No	1	26	300
Simplicity Wonder Boy 963 Wonder Boy 900	B&S 8	Yes	2	30	645
	B&S 5	Opt.	2	26	430
Toro Whirlwind Standard 525XE 725XE Sportsman	Tecumseh 12	No	1	25	330
	Tecumseh 17	Yes	4	25	450
	Tecumseh 17	Yes	4	25	500
	B&S 8	Yes	3	32	600
Yard-Man Mustang 3770	B&S 8	Yes	4	36	NA

1973
riding
mowers

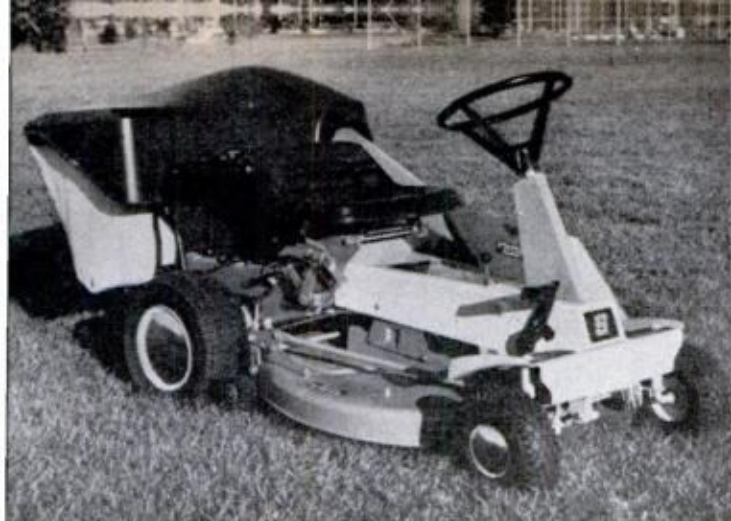

THIS 8-HP WONDER BOY cuts a 30-inch swath and provides a five-bushel collection hopper in back. Made by Simplicity Corp., the unit lists for \$645

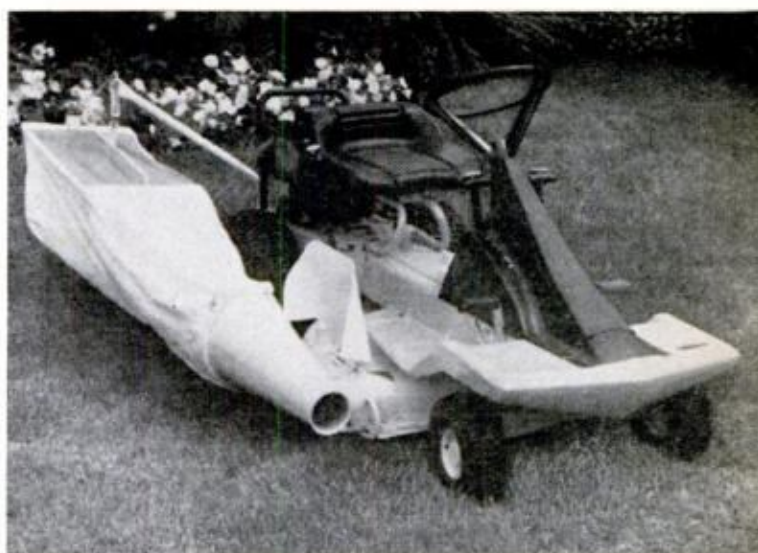

FOUR MODELS in the Ariens Fairway line are available for '73. They're powered by 5 or 7-hp Tecumseh engines and offer big grass catchers as accessories

MAKE/MODEL	Engine/HP	1	2	3	4
Allis-Chalmers 416H 416S 410S 410 Homesteader	Kohler 16	Yes	Var.	42-48	\$1695
	Kohler 16	Yes	4	42-48	1570
	Kohler 10	Yes	4	42-48	1295
	Kohler 10	Yes	3	42-48	1230
	B&S 8	Yes	3	36	780
Ariens Manorway	B&S 8	Yes	6	38	900
Bolens HT-18 QT-16 H-16 G-14 G-10 G-8	Kohler 18	Yes	Var.	54	2730
	Onan 16	Yes	Var.	48	2195
	Tecumseh 16	Yes	Var.	42	1825
	Tecumseh 14	Yes	6	42	1525
	Tecumseh 10	Yes	3	38	1235
	B&S 8	Yes	3	32	895
John Deere 140H1	Kohler 14	Yes	Var.	47	1765
Ford 145	Kohler 14	Yes	Var.	42-50	1656
GE Elec-Trak E20 E15 E12 E10M E8M	16	Yes	32	42	1750
	14	Yes	28	42	1585
	12	Yes	12	42	1420
	10	Yes	9	36	1090
	8	Yes	3	36	795
Gilson Heavyweight 53015 Heavyweight 53013 Low Profile	B&S 16	Yes	Var.	42	1715
	B&S 10	Yes	4	42	1274
	B&S 8	Yes	Var.	36	NA
Gravelly 814 408	14	Yes	8	50	1634
	Kohler 8	Yes	4	34	923
Homelite T-16H T-10 T-8 T-7	B&S 16	Yes	Var.	42-48	1665
	B&S 10	Yes	6	42-48	1250
	B&S 8	Yes	3	32-36	760
	B&S 7	Yes	3	32-36	675
J.I. Case 446 108	Onan 16	Yes	Inf.	44-48	1717
	B&S 8	Yes	3	34	746
Huffman H-1113 H-1093 H-1078 H-1015	Tecumseh 10	Yes	3	32	699
	B&S 8	Yes	3	32	599
	B&S 8	Yes	3	26	455
	B&S 5	No	1	24	199
International Harvester Cub Cadet 149 Cadet 76	14	Yes	Inf.	38-42-48	1629
	7	Yes	3	36	799
Jacobsen GT-14 GT-12 GT-10 LT-885 LT-750	Kohler 14	Yes	Var.	42	1885
	Kohler 12	Yes	Var.	42	1685
	Kohler 10	Yes	5	42	1390
	B&S 8	Yes	Var.	34	1095
	B&S 7	Yes	3	34	875
Massey-Ferguson MF 14 MF 12G MF 8H	Kohler 14	Yes	Inf.	48	1822
	Tecumseh 12	Yes	4	42	1266
	Tecumseh 8	Opt.	Inf.	34	972
New Holland S-16 S-8G	Kohler 16	Yes	Inf.	48	2055
	B&S 8	Yes	3	36	1008
Roper T63231R T32231R T02231R T82231R	Onan 16	Yes	6	NA	1435
	R&S 13	Yes	6	NA	1135
	Tecumseh 10	Yes	6	NA	935
	B&S 8	Yes	6	NA	835
Simplicity Sovereign 3416H Landlord 3410S Broadmoor 738 Yeoman 648	B&S 16	Yes	Inf.	42-48	1595
	B&S 10	Yes	4	42	1275
	B&S 8	Yes	3	36	935
	B&S 8	Yes	3	32	825
Wheel House 18 Automatic 16 Automatic 14 Automatic 10 Automatic 12 8-Speed 8 4-Speed Ranger 700	Kohler 18	Yes	Inf.	48-60	2167
	Kohler 16	Yes	Inf.	48	1706
	Kohler 14	Yes	Inf.	48	1609
	Kohler 10	Yes	Inf.	36-42	1405
	Kohler 12	Yes	6	36-42-48	1320
	Kohler 8	Yes	3	36	908
	Tecumseh 7	No	3	32	624

1973 garden tractors

KEY

- 1—Electric start
- 2—Forward speeds
- 3—Cutting width (inches)
- 4—Price
- NA—Not available
- Inf.—Infinite
- Var.—Variable
- B&S—Briggs & Stratton



GILSON 8-HP TRACTOR has low profile and 36-inch, twin-bladed mower. Traction-drive system is said to deliver smooth power in all speeds

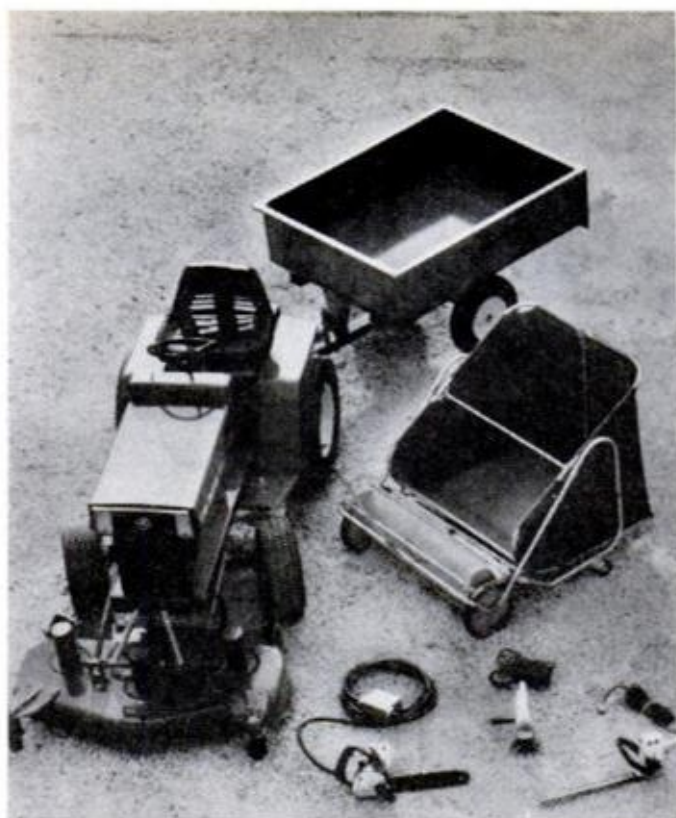

ACCESSORIES such as electric chain saw and hedge trimmer run off power unit of GE's Elec-Trak tractors. Standard attachments are also available

Yardpower '73

Garden Tractors



AN 8-HP TECUMSEH powers the smallest tractor in the Massey-Ferguson line. It carries a mower that cuts a 34-inch swath, has a hydrostatic transmission offering a variety of speeds. Its price: \$972



GRAVELY 408 LAWN TRACTOR carries a 34-inch rotary mower under its frame. The sleek machine also boasts cast-iron axles and an 8-hp cast-iron engine

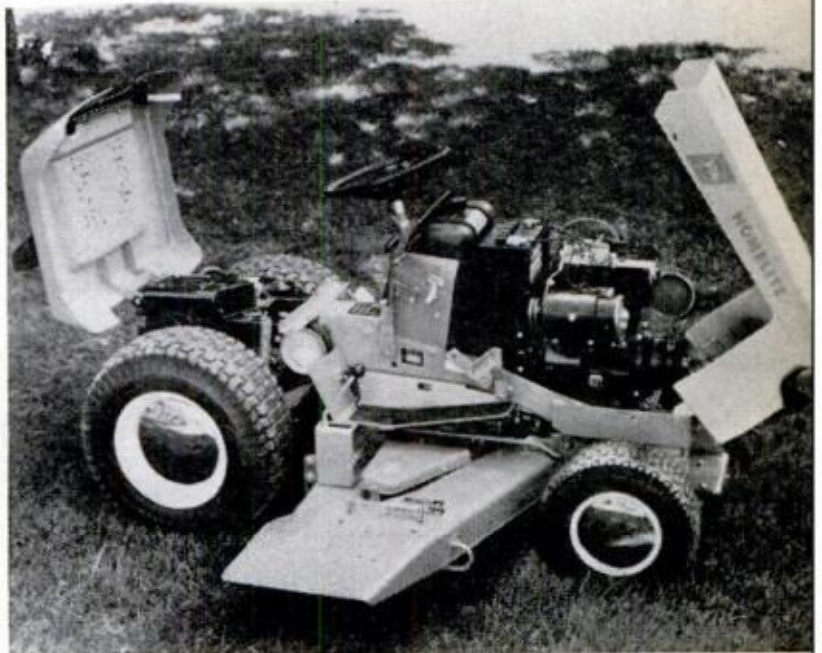

FIVE TRACTORS from 7 to 16 hp, make up the Homelite line for 1973. Shown at right is model T-16, a powerful performer. Price: \$1495

WHEEL HORSE couples a 48-inch mower to 16-hp engine in its big Automatic garden tractor (right). Attachments include hefty sweepers, snowblowers



SPERRY NEW HOLLAND has upped lawn tractor line to four units. The S8 is a compact 8-hp machine that offers optional hydrostatic transmission

For fishing offshore and on

ANY BOAT used to be good enough to boat a fish. Not any more. Now special new craft are being created to aid the angler. Small hulls head out into open seas to stalk big gamefish. Bass boats, loaded with new options that increase passenger comfort, speed across more sheltered waters to secret fishing holes, then switch to slow troll by electric motor. The big open utilities can equal the catches of the expensive sports-fishing machines on the Great Lakes or along ocean shorelines if the weather is favorable. The selected models shown here should be seeing a lot of action this summer. ★★★



STARCRAFT will offer 14, 16 and 18-foot bass boats, including deluxe models designed by bass champion Bill Dance with locked storage, live wells, trihull



OPEN WATERCRAFT now feature seakindly deep-V hull variations and higher topsides to keep out waves and spray. Boston Whaler's 21-foot Outrage (top) was first tested on rough New England waters. The 19-foot Cobia Fisherman (center) also uses the open cockpit and midships control console. Wellcraft 17 and 20-foot Fisherman outboards have hulls by deep-V pioneer Ray Hunt, can carry 100 and 150 hp. Unobstructed gunnels, casting platforms are standard

BASS RAIDER, new from Cobia, is a 15-footer with tri-V hull, foredeck for electric motor mount, 70-hp rating, seating capacity for five, underseat icebox

POPULAR MECHANICS

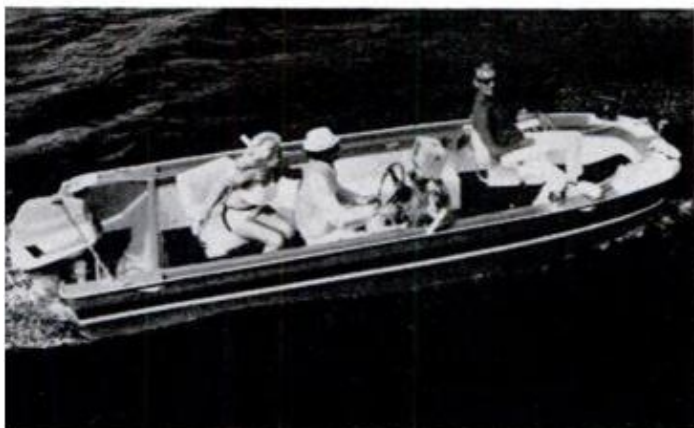

OUACHITA's extensive bass-boat line includes new Convincer UT 16-footer with upright flotation, 95-hp rating, running and interior lights, ballast tank

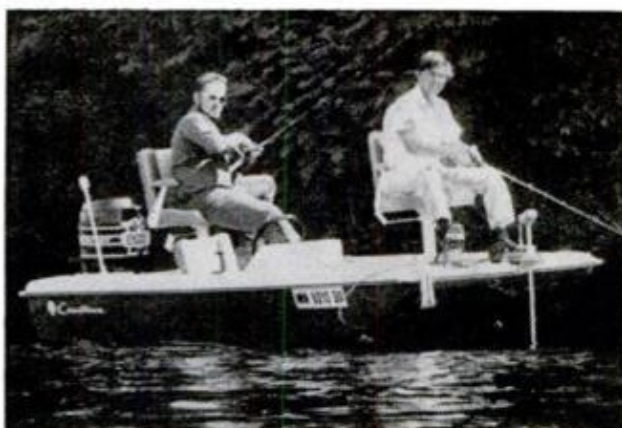

CRESTLINER calls 15-foot hull of its first bass boat a "Muskie stabilized vee-wing." The fiberglass out-board includes two pedestal swivel fishing chairs

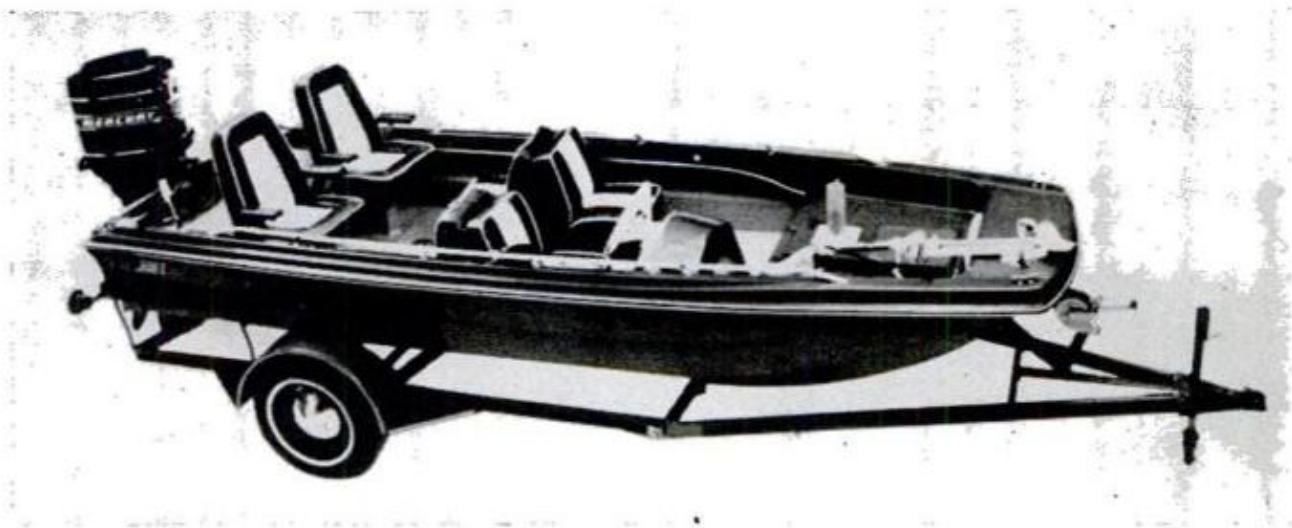

TIDE CRAFT's Miss Pro switches from bass boat to family ski boat in less than five minutes by moving fore and aft platform chairs from pedestals to stern lounge positions shown; 16-footer takes 80-hp motor

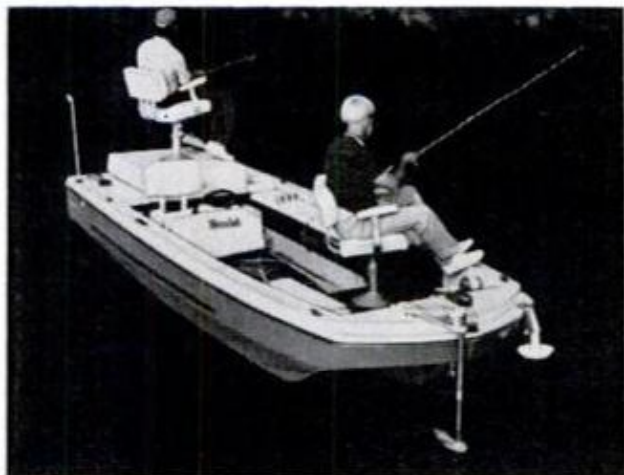

SUPER PRO LTD. from MonArk provides 140-hp stern drive or water jet for power, 10-speed trolling motor, depth finder, matching trailer for this 16-footer
MARCH 1973



TERRY BASS BOSS, built by Delhi (and driven here by Cypress Gardens fisherman Pat Callan), comes in color to match special Johnson Stinger 65-hp motor

Those wild new wings: will they really fly?

Aircraft designers are having a field day trying shapes that look kooky, but may just be crazy enough to revive America's problem-plagued supersonic jet transport

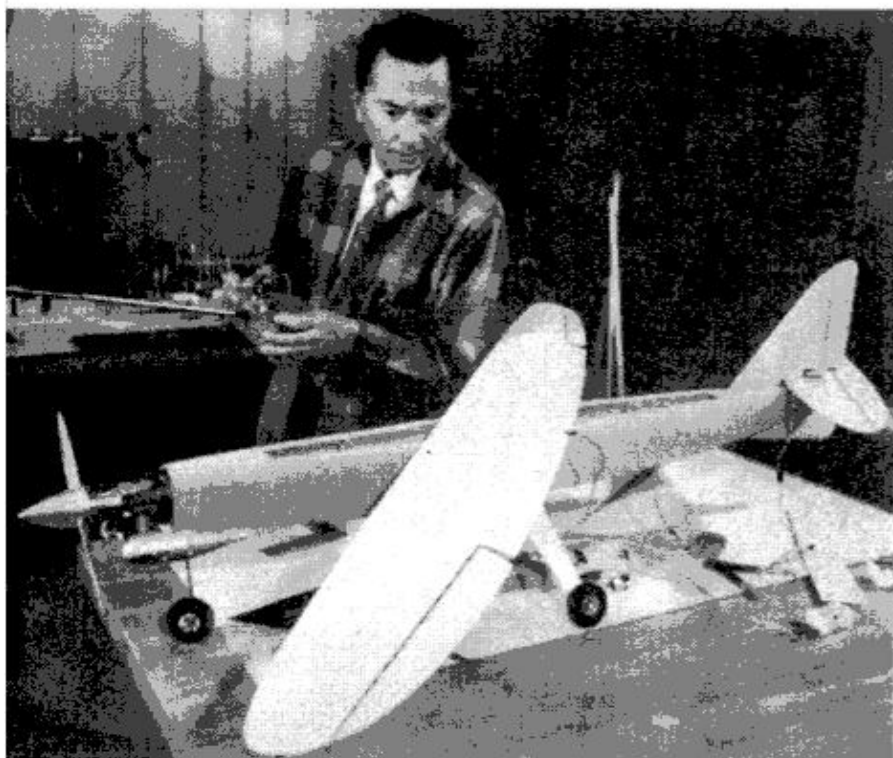

ANTISYMMETRICAL WING pivots sideways in flight, giving the strange-looking craft the appearance of a pair of "flying scissors." Above is five-foot radio-controlled model built by NASA inventor Dr. Robert T. Jones to help test out wing's principle. How idea works is shown on facing page. Because opposing wing and tail surfaces are offset, they don't "fight" each other with their turbulence. This reduces drag, lowers power needs and permits supersonic speeds without producing a dangerous "sonic boom." For low-speed landings and takeoffs, the wing and tail swing back to conventional straight positions

By WALTER B. HENDRICKSON JR.

IT LOOKS LIKE a flying mistake. At high speeds, its centrally pivoted wing and tail surfaces turn sideways at a 45° angle to the fuselage, giving the craft the freakish appearance of a pair of flying scissors. At low speeds, the wing and tail swing back to a straight-across position like those on a conventional airliner.

But the "antisymmetrical" design, as it is called, is no freak. As strange as it may look in flight, this radical new aircraft has proven so successful in tests that it may be just what is needed to revive America's foundering supersonic transport program, officially killed by Congress in 1969 because of strong objections to then-current SST proposals.

Developed by Dr. Robert T. Jones, senior staff scientist at NASA's Ames Research Center in Mountain View, Calif., the weird antisymmetrical concept is designed to provide the high speed of supersonic jet travel, while still maintaining the advantages of low-speed subsonic flight. The problem, says Doctor Jones, is that we've always assumed wings had to be symmetrical because man's flying machine was originally patterned after nature's—the bird. "But there are no supersonic birds," he points out.

Supersonic flight requires a whole new approach because odd things happen at supersonic speeds that don't at lower speeds. At subsonic speeds, advancing shock waves "warn" the air ahead that a plane is approaching, and the air starts to part to let it through. These shock waves travel at exactly the speed of sound. At sonic speeds, the air ahead gets no advance warning since the plane is traveling at the same speed as its own shock waves. The craft thus slams into the unprepared air like a solid wall, generating much more violent shock effects. These shocks cause heavy drag-producing turbulence that saps engine power and triggers

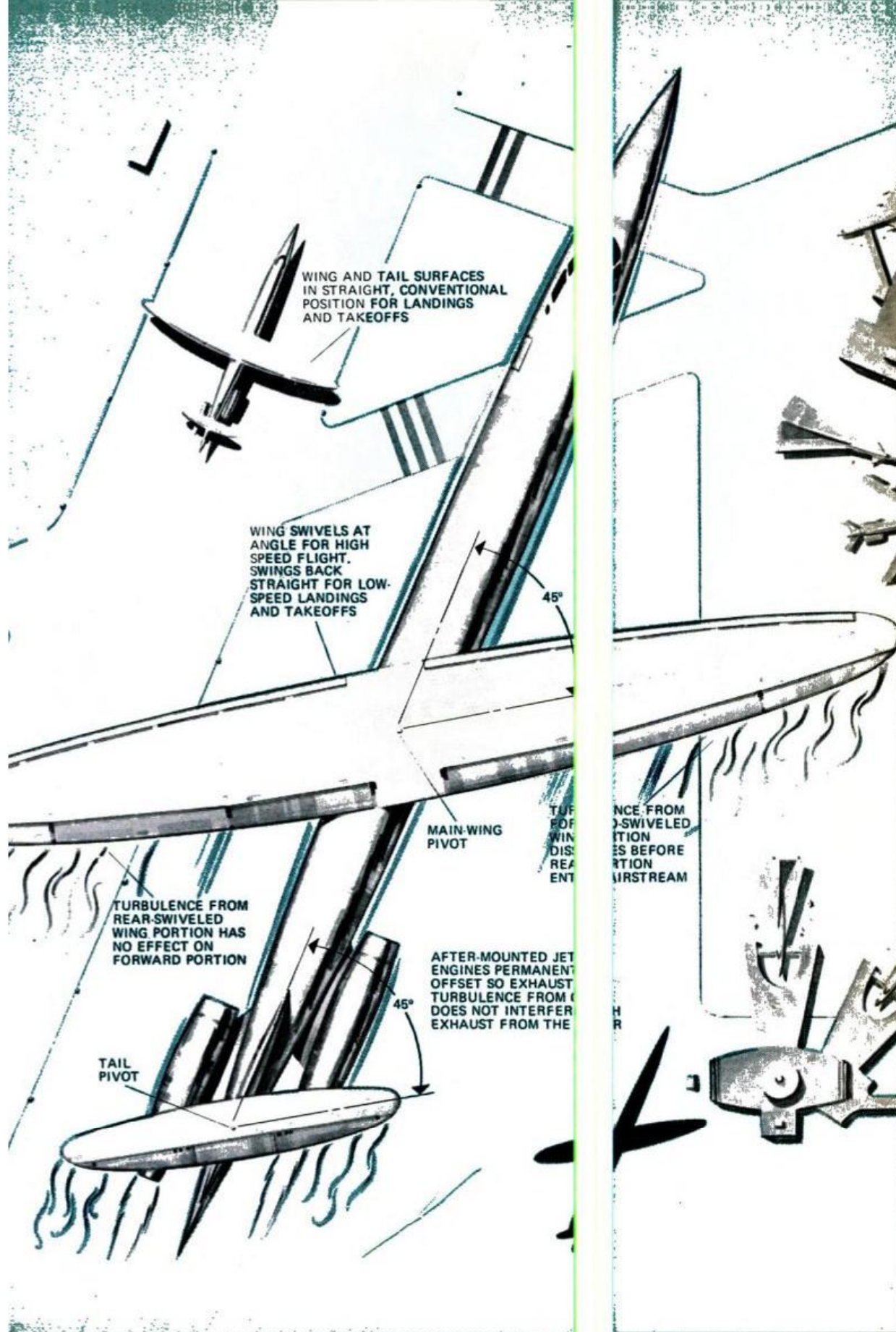

WING AND TAIL SURFACES
IN STRAIGHT, CONVENTIONAL
POSITION FOR LANDINGS
AND TAKEOFFS

WING SWIVELS AT
ANGLE FOR HIGH
SPEED FLIGHT.
SWINGS BACK
STRAIGHT FOR LOW-
SPEED LANDINGS
AND TAKEOFFS

MAIN-WING
PIVOT

TURBULENCE FROM
REAR-SWIVELED
WING PORTION HAS
NO EFFECT ON
FORWARD PORTION

TAIL
PIVOT

AFTER-MOUNTED JET
ENGINES PERMANENT
LY OFFSET SO EXHAUST
TURBULENCE FROM ONE
DOES NOT INTERFERE
WITH EXHAUST FROM THE
OTHER

TURBULENCE FROM
REAR-SWIVELED
WING PORTION
DOES NOT INTERFERE
WITH EXHAUST FROM
THE FORWARD
PORTION

H
R

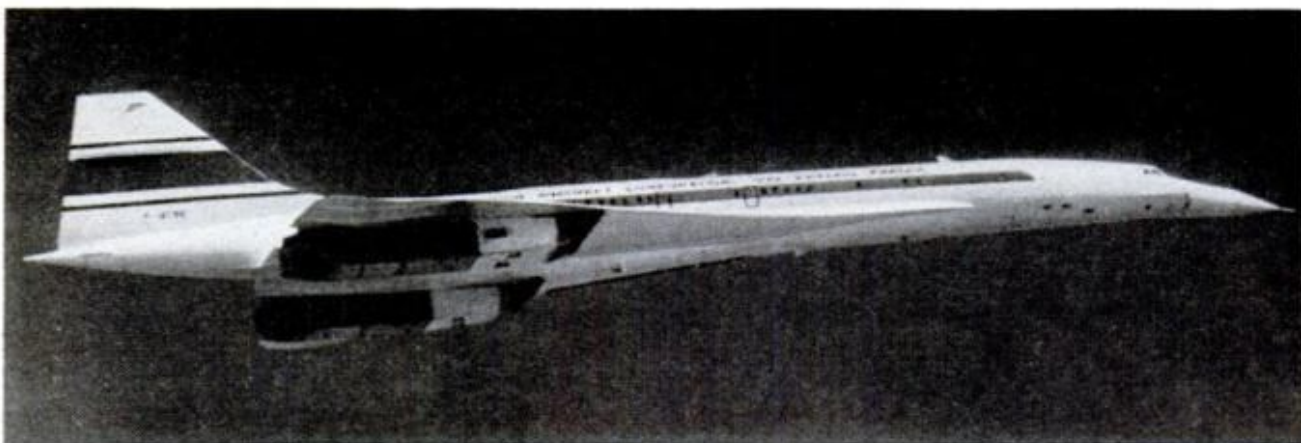

DELTA-WING CONCORDE, joint British-French venture, is designed to cruise at 1400 mph. The SST prototype has been successfully test-flown, but is still several years away from commercial passenger service

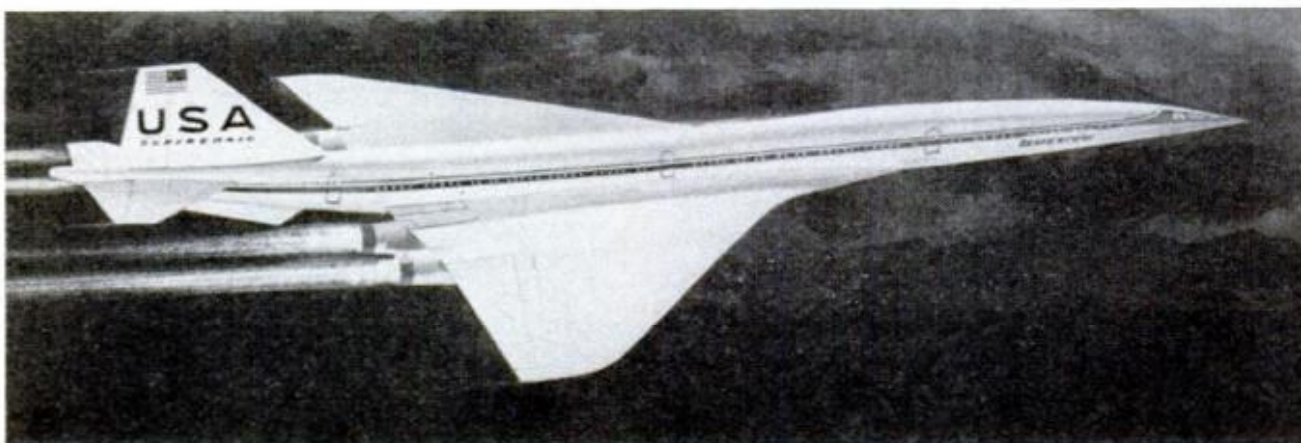

AMERICA'S ENTRY in the supersonic race, Boeing's SST, never got off the drawing board, let alone the ground. High costs, objectionable noise and fears of pollution caused Congress to kill the project in 1969

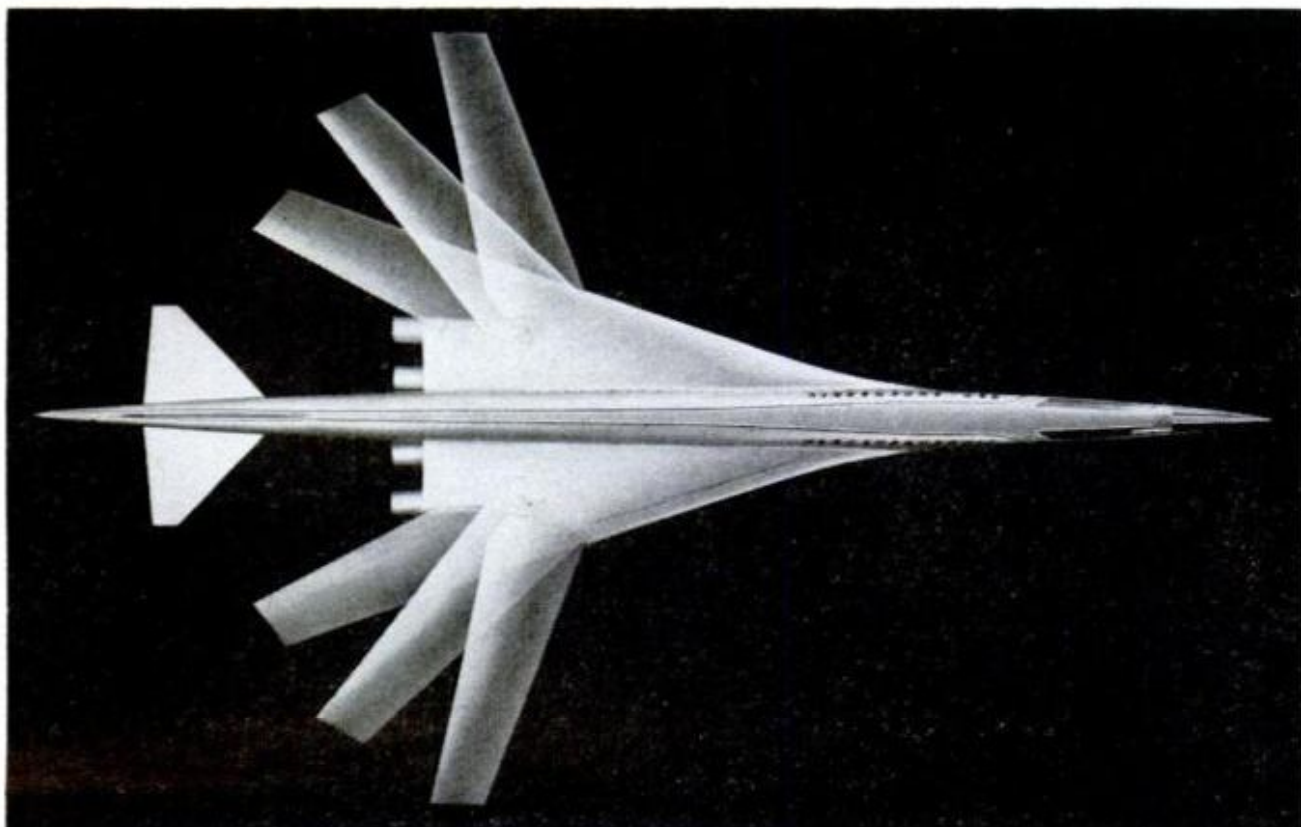

NEW SWING VERSION represents Boeing's hope for reviving interest in the SST program. Wings extend outward for low-speed landing and takeoff, then fold back for high-speed cruising at up to 1800 mph

the earth-shattering "sonic boom" that can smash windows and do other serious damage on the ground.

Sweeping back the wings helps to reduce these shock effects, but creates other problems. The narrow, stubby swept wings, while efficient at high speeds, provide little lift at low speeds. For this reason, both swept and delta-winged jetliners must land and take off at high speeds, requiring extra-long runways. The British-French supersonic Concorde, still undergoing tests, needs 9700 feet to take off and up to 7700 feet to land, preventing it from using many of today's world airports restricted to 5000-foot landing and takeoff capacities. In addition, delta-winged craft like the Concorde and the Russian Tupolev-144 SST must land so nose-high for adequate lift that their pilots would be unable to see the ground if it weren't for the addition of the so-called "droop snoot"—a complicated pivoted nose that tilts the cockpit downward for better visibility during landings.

The proposed antisymmetrical configuration would eliminate all these problems. With the pivoted wing and tail turned at an angle to the fuselage, the shock and turbulence created by the forward-swung portions dissipate before the rearward-swung portions enter the same wall of air. Thus the two, being offset, do not have a chance to react against each other and build up increased shock and turbulence. This reduces drag, permits greater speed on less power and significantly lessens the danger of sonic boom damage. Wind-tunnel tests on models of the antisymmetrical design indicate the craft could safely reach speeds up to Mach 1.4—nearly 1½ times the speed of sound or about 945 mph at 35,000 feet (sound travels at approximately 660 mph at jet altitudes). Sonic boom would not be a problem at speeds up to Mach 1.2. Over unpopulated open country or ocean waters, where ground shocks pose no hazards, the antisymmetrical SST could reach Mach 1.5.

MARCH 1973

HOW THE SUPERCRITICAL WING WORKS

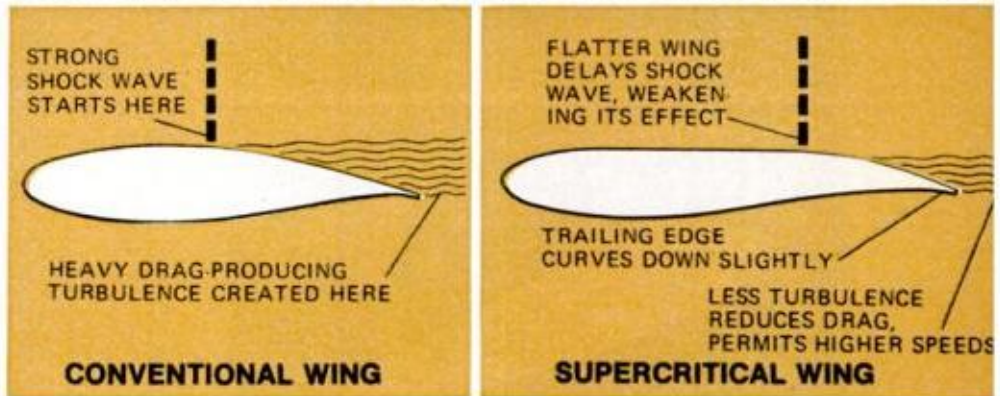

SUPERCRITICAL WING, another NASA development like the antisymmetrical concept, is designed to improve performance at or near sonic speeds. Flatter on top than conventional wing, it delays onset of sonic shock waves, weakening drag-producing turbulence. This increases speed and maneuverability. Wing is seen in Navy F-8 fighter test above

What's more, the antisymmetrical design would not require the high landing and takeoff speeds characteristic of present swept-wing craft. For landings and takeoffs, the pivoted wing and tail surfaces would simply swing horizontally at right angles to the fuselage like those on subsonic jetliners. This would provide increased lift for low-speed, short-run landings and takeoffs, enabling the plane to use existing jetports, even those handling relatively small jetliners like the DC-9.

The added lift gained at low speeds and decreased drag at high speeds would also allow it to use the less powerful but considerably quieter turbofan-type jets employed by subsonic airliners. By contrast, a delta-winged SST like the Concorde requires four times as much power as the antisymmetrical SST.

While the antisymmetrical SST's top speed of around 1000 mph is not as impressive as the Concorde's 1400 mph or the original Boeing's projected 1800 mph, it's still fast enough to get you from New York to San Francisco in 3½ hours—and that's really going some. More than speed alone, the antisymmetrical SST's economical power requirements, reduced noise and pollution effects, short-run land-

MEANWHILE, THE DEBATE CONTINUES: HOW DO WINGS REALLY FLY ANYWAY?

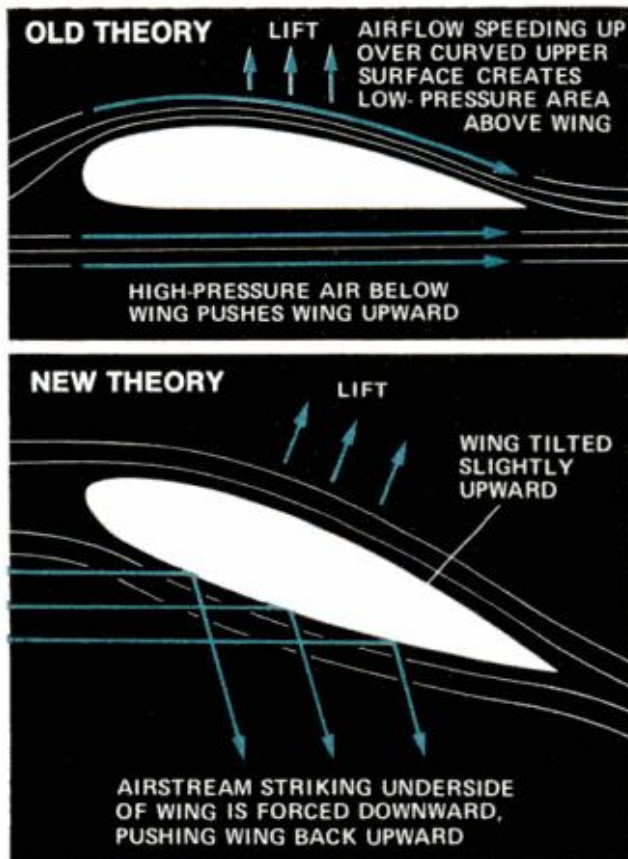

EVERY SCHOOLBOY KNOWS an airplane flies because air flowing over the curved upper surface of wings speeds up, creating a low-pressure "suction" that gives the plane its lift (top diagram). Now this long-accepted theory is being challenged by the belief that it's actually the ram effect of air striking the slightly upturned undersurface of the wings that produces the lift (lower diagram). The wings try to force the air downward, and the air reacts by pushing back upward. Ironically enough, neither theory explains how an airplane flies upside down

ing and takeoff capabilities and lack of sonic boom dangers all add up to big pluses in its favor. It was objectionable noise, fears of pollution and the sonic shock threat that figured prominently in the government's decision to shelve the earlier SST project.

In addition, Dr. Jones points out that the single central pivot arrangement on the antisymmetrical wing is much simpler and safer structurally than the more complicated variable-sweep, swing-wing mechanisms currently used in F-111 and F-14 fighters. Failures in these wing mechanisms, though now supposedly corrected, caused several F-111s to crash. The worst that could happen to the antisymmetrical wing, claims Dr. Jones, is

128

that it might jam in the straight or angled position. Either way, the ship could still fly—an important fail-safe feature. So promising is the concept, in fact, that NASA has granted Boeing a research contract to do further studies on the novel design.

The antisymmetrical wing, while perhaps the most spectacular, is only one of several striking new developments that may help to give the ailing SST program a much-needed shot in the arm. Boeing, on its own, has come up with a revised version of its earlier SST, this one incorporating the variable-sweep, swing-wing principle. Despite the poor showing of the F-111, Boeing is convinced the swing-wing system can be practical if properly designed. The wings are pivoted so they swing back for high-speed supersonic flight, but can be extended straight out for low-speed landings and takeoffs. This, if successful, would solve the runway problem, but other questions of noise, pollution and power requirements still remain.

Interestingly enough, the first Boeing SST was aimed at carrying 300 passengers, while the later version has been revised downward to seat 200. The Concorde holds fewer still—136. Just how many the antisymmetrical SST will tote is not yet known, but there may be a trend in the making toward smaller, more manageable SSTs rather than the

(Please turn to page 206)

AND NOW A TILT-WING DELTA DOES ITS THING

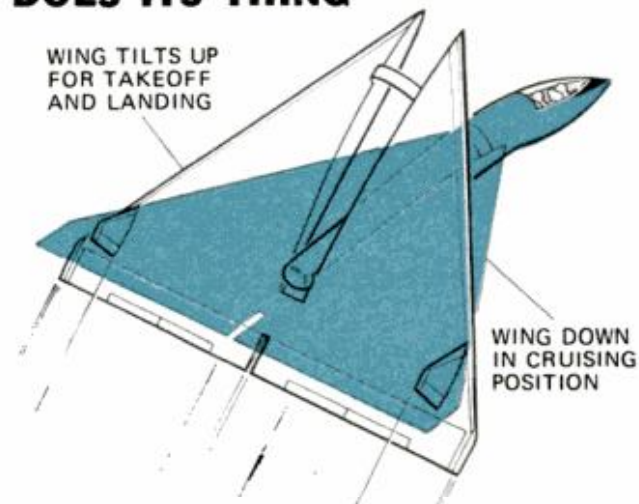

PIVOTED DELTA WING is designed to tilt up at low speeds to sharpen angle of attack and provide increased lift, making possible short-run landings and takeoffs. At high speeds, the wing would retract to a horizontal position as less lift is required

POPULAR MECHANICS

When tire pressure drops . . . radio sounds the alarm

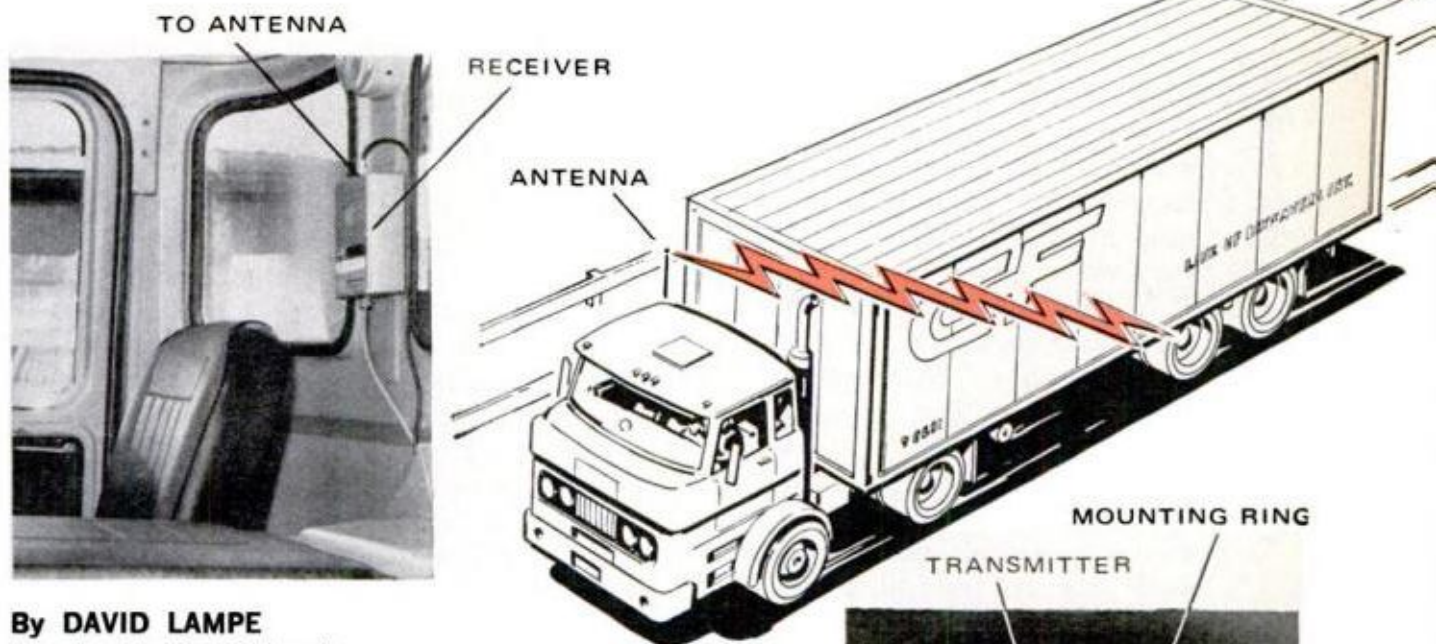

By **DAVID LAMPE**
Drawing by Roy Grinnell

IN A CAR you feel a sudden drop in tire pressure right away. That's not always true if you're driving a bus or truck. Sudden loss of pressure in a heavy-vehicle tire means weakening and probably losing an expensive tire, and wasting gasoline because of the extra drag of the flat. At worst, it can result in loss of control: the bigger the vehicle, the greater the risk.

Tire-pressure monitoring is now possible with a new electronic system developed in England by one of the world's leading manufacturers of automotive testing devices. The system is simple, inexpensive and can be mounted on any heavy vehicle in minutes.

All you do is bolt a steel ring to the outside of the truck's wheels (only one ring for a pair of wheels on a single axle), install a special radio receiver in the cab, and connect tire valves to the pneumatic monitor on the ring.

The system is activated by a centrifugal switch when the vehicle reaches a speed of eight mph. After that, if the pressure of any tire drops more than 10 pounds per square inch, the monitor on its hub will trigger the tiny radio transmitter powered by long-life batteries also on the ring. A continuous shrill note is emitted from the receiver until you reduce speed to eight mph.

The tire-pressure monitoring system has been road and laboratory tested under all possible atmospheric conditions. Even steam cleaning doesn't disturb it.

The monitoring system should be available in the United States soon. The manufacturer is Heenan Aspa, Ltd., Shrub Hill Road, Worcester WR4 9EQ, England. ★★★

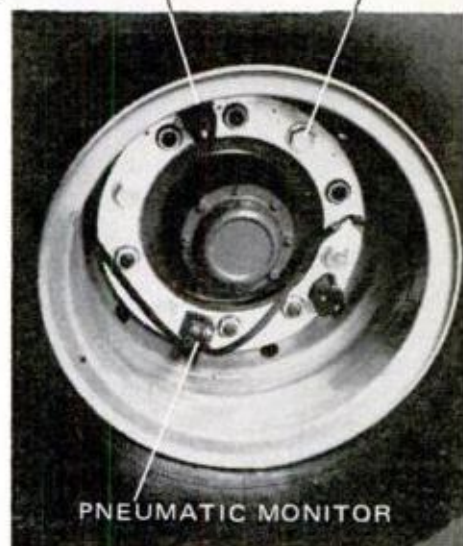

LOSS OF TIRE PRESSURE is detected by pneumatic monitor which turns on a transmitter. These components and the transmitter batteries are located on tire mounting ring. Signal is broadcast to cab receiver which emits a shrill tone. The volume of the receiver is adjustable but it is designed so that it can't be turned off completely. Driver then won't forget to make the first stop to get air. He locates tire losing air by holding a small magnet near the pneumatic monitors to override the centrifugal switch, and he listens for the tone from the receiver in the cab

How Detroit is 'tuning' its new

Four small, important footprints are your car's only contact with the road—so important that more and more cars are being designed from the ground up to run on radials.

By ROBERT LUND

A BETTER TIRE is forcing Detroit to build better cars. Better in a lot of ways: in ride, handling, steering response and fuel economy. Cars that are safer, quieter and more durable.

All that from a tire? The tail wagging the dog? Not exactly, because the automakers still call the shots, and the tire companies have to go along with whatever Detroit decrees. But after years of obedience to Detroit's bidding, tire companies are beginning to have a subtle influence on the way cars are put together.

Tiremakers owe their new-found clout to the development of the radial tire.

The radial was put into production without blessing from Detroit. This was a gutsy play on the part of the tire industry. The auto companies not only withheld their blessing, they kissed off the tire without giving it a chance.

The president of General Motors spoke for most of the industry when he said American cars couldn't be tuned to radials. The other companies echoed GM's veto. "American car buyers want a soft, plush ride," auto engineers pontificated in chorus, "and U.S. cars don't have suspension systems to accommodate radials." The only outlets the tiremakers could find for radials in the early days were foreign cars and the replacement market.

Ford was the first U.S. automaker to about-face. In 1970, Ford offered radials on Thunderbird and Mark IV. The company installed the tires on a timid six-tenths of one percent of its 1970 model production. Starting with the '73 model run, Ford offered steel-belted radials on everything it makes—standard equipment on Continental Mark IV, Lincoln Continental, Thunderbird and two Mercs—Marquis and Monterey, optional on other Ford products. That speck-in-the-eye 0.6 percent installation rate recorded in 1970 had jumped up to 31 percent as of late last year. Even that figure may be shattered before the model year is out. On Maverick and Comet—cars on which radials cost extra—Ford thinks the installation rate this year could run as high as 45 percent.

Although Ford is taking all the radials it can get from Firestone, General, Goodrich, Goodyear, Michelin (of France) and Uniroyal, it hasn't been able to get enough of the tires to satisfy demand.

At GM, radials are standard on Pontiac Grand Am and Grand Prix SJ, Buick Riviera GS, Oldsmobile Cutlass Supreme Salon, Chevrolet Monte Carlo S coupe and Landau and Corvette. (In the case of Pontiac Grand Prix SJ and Olds Cutlass Salon, the cars themselves are optional models of other cars. But if you order the

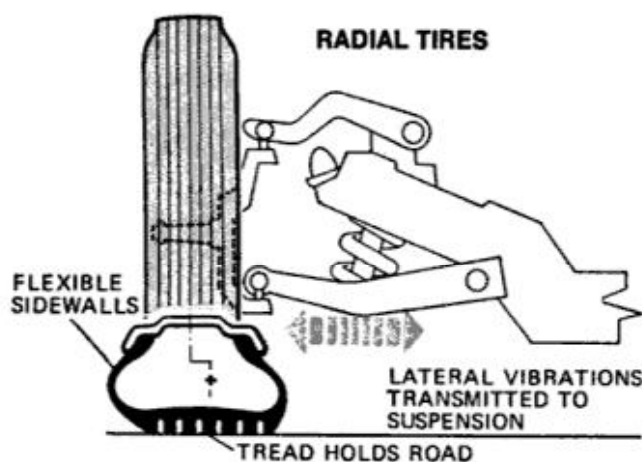
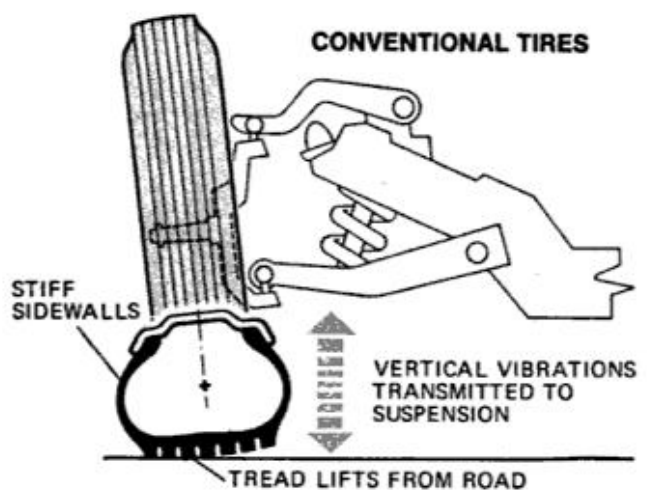

IN A HARD TURN and in normal driving, the radial tire transmits more lateral vibrations to your car's suspension than the conventional, bias-ply tire. Result is a different pattern of ball-joint wear, for example, but the new radial tires can still be fitted to your present car

optional car, you get radial tires with it.)

The other car divisions and companies are making radials available, either as standard gear or optional, as fast as they can rig their cars to accommodate the tire and line up a source of supply. The supply situation is improving in a hurry. Firestone has applied for a patent on a process that will permit production of bias-ply, bias-belted and radial tires on the same line using existing equipment. And Good-year has significantly expanded its radial-tire line for domestic cars.

What caused Detroit to change its mind about radials—to go from a thumbs-down attitude to gung-ho enthusiasm?

Automakers didn't like the idea of making changes in the car to match it with the tire. They'd always worked the other way around. The car came first and the tires were hung on later. With the radial, it's a two-way proposition. Car and tire have to be matched to each other.

"I admit we were bullheaded," a chassis engineer for a Big Three division recalls. "Michelin tried to interest us in radial tires in the early '60s. We couldn't see it. The ride was too hard. Then Pirelli came along with refinements. Pirelli made changes in the tire, relating it to specific suspension systems. This was an improvement over the Michelin original, but the Pirelli version still required changes in the suspen-

sion system of the vehicle. This was a whole new pitch for us. We were used to calling the tune and having Akron dance to it."

Now Detroit is beginning to see the light. Auto producers have made or are working on structural changes in cars to permit use of radial tires.

Ford is ahead of everybody else in this business—at least in the United States—and the steps it takes to prepare its cars (some of them, but not the entire Ford fleet) for radials indicates the extent of the engineering job that has to be done to bring vehicle and tires in tune with each other. Here's what Ford does to "radialize" its cars:

Radial tires have an inherent harshness that is transferred to the vehicle at low speeds. The car rides rough and noisy. Any imperfections or impacts in the road are transferred to the vehicle. Ford isolates vibrations by the way it tunes the car—

FOR BEST RIDE and handling, a car's suspension, body-to-frame and engine mounts are designed with a choice of tires in mind. In short, the tires should be part of design of any new car. Increased fore and aft and lateral stiffness is required when radials are to be used (see text)

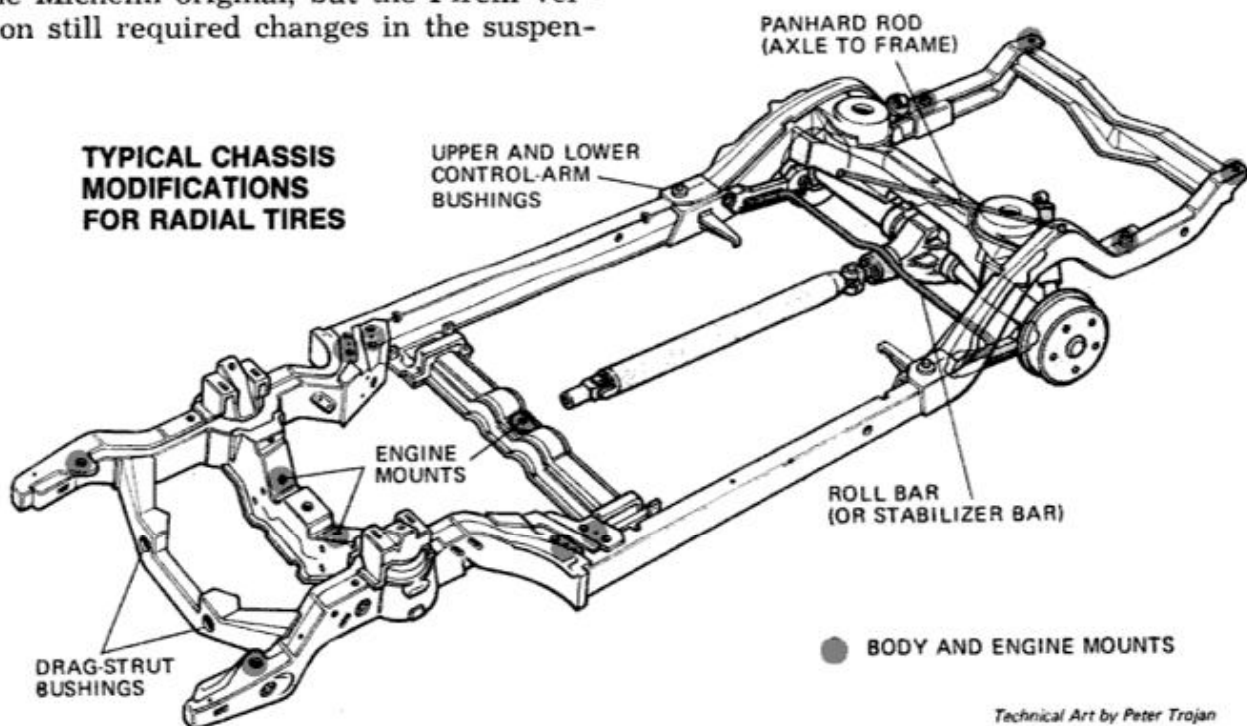

the way the body is floated on the frame through body mounts.

Engine, engine mounts and front suspension are tuned for fore and aft stiffness. Ford does this by using a special drag strut attachment—what body engineers call a puck. This is a rubber bushing that allows the suspension to compensate for impact harshness.

In the rear suspension, Ford uses a panhard rod. This controls lateral stiffness of the suspension. In a car that hasn't been tuned for radials, rear suspension consists of three fore and aft links. There's no lateral control. Thus the car can shift sideways. The panhard rod, which is attached from the suspension—the axle itself—up to the frame, prevents sideway shifting.

Ford found that existing lateral control in its cars was such that it had to install a bayonet-end attachment to get better control of lateral kick caused by disturbances from the rear suspension. This was done to correct a condition called hot-weather burble—a lateral disturbance characteristic of most radial-ply tires under hot-weather, hot-running conditions.

Those are the steps taken to tune a car for radials when the car is built on a body/frame. But not all cars are built on body/frames. All automakers produce some unitized body cars—body and frame are one piece. This rules out changing the way the body floats on the frame.

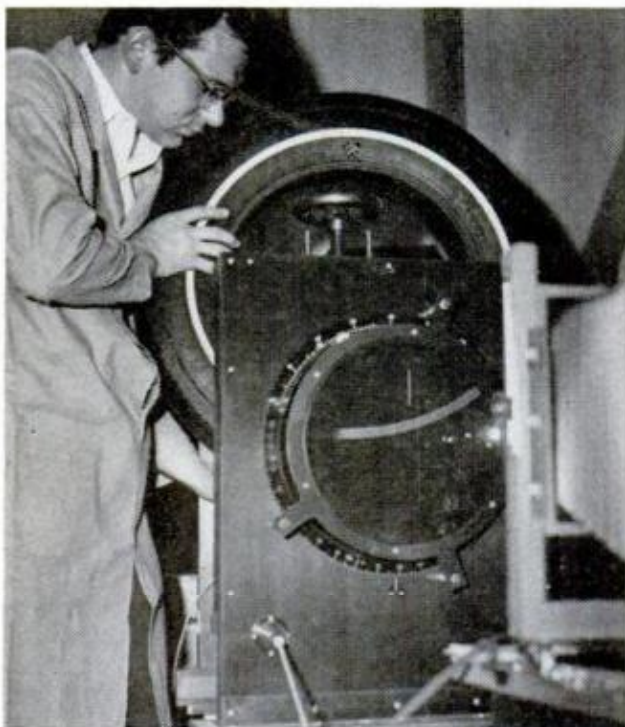

STRESSES ARE PHOTOGRAPHED by polariscope in check of new Mini-Sport radial tire in Firestone lab

Here are 11 leading questions you

Can I put radials on my old car without suspension set for radials?

Yes. You won't have any trouble handling the car, steering it and maneuvering from lane to lane. You may notice a rougher ride at speeds from the mid-20s to 30-32 miles an hour. The rough ride will be less noticeable after you get above 35 mph. Once you hit 60 to 70, the hard ride will disappear entirely, and you'll get the same smoothness of ride and benefits of wear you'd get with a car tuned for radials.

Can I put conventional tires on my car with suspension set for radials?

Yes. The ride won't be as smooth as you'd get with radials. But there's no danger in switching from radials to nonradials on cars tuned for radials.

If I've got bias-ply or bias-belted tires and have to replace a tire, can I replace it with a radial?

You can't mix one radial with three non-radials. And vice versa—you can't use three radials with one nonradial. Mixing is dangerous because radials and nonradials have different handling characteristics. Under certain conditions, mixed tires will fight each other and you can lose control of the car.

Some tire men say you can get away with putting two radials on the rear of the car—but only on the rear and on both wheels—with conventional tires on front wheels. But you do this at your own risk. The auto and tire companies don't recommend it.

There's no danger in mixing radial tires made by different tire manufacturers.

Unitized body cars have to undergo structural changes to tune them to radials. Each company has a slightly different approach and body engineers are now working on the problem. This doesn't mean you can't buy a unitized body car with radials and get just as good a ride and benefits as with radials on a body/frame car. But tuning is more complicated.

What are the benefits of radials and how are they better than conventional tires for your present car?

● All radials are guaranteed for a minimum of 40,000 miles. The radial is a tougher tire. It can take impacts better than belted-bias and bias-ply tires and is less susceptible to puncturing. But there's a

might ask about radial tires—and straight answers

What do radials cost? How much more than nonradial tires?

Radials will run you anywhere from \$40 to \$90 per tire, against a \$25 to \$40 price range for conventional tires. But you might make a deal for less than that, if your tire dealer's having a sale—tire dealers are always having sales—or if your trade-in tire has a lot of tread left on it. Check the newspaper ads and shop around.

Do the special elements that go into tuning a car for radials require periodic servicing or replacement?

No special service or maintenance. Nothing you wouldn't do to a car without suspension set for radials.

How about the tires themselves? Do they require special attention?

Proper inflation is important, but no more so than with nonradial tires. A radial can handle underinflation better than a bias-ply or bias-belted tire. With overinflation, radials give a harsh ride. "Like a hay wagon, bumpy-bang along," as one engineer described it.

Is tire balancing more or less important with radials than with other tires?

Equally important, but not more or less. If you want a good high-speed ride, the only way to get it is by balancing the wheels on-car.

Do radials have to be rotated?

Rotation will extend the life of the tires and American tiremakers recommend regu-

lar back-to-front, crisscrossing. One foreign company, Pirelli, guarantees its radials for 40,000 miles without rotation. But Goodyear advises that you rotate to realize the full potential of tire life. Keep them on the same side of the car: Left front to left rear; left rear to left front; right front to right rear; right rear to right front. If you use the spare: Left front to left rear; left rear to left front; right front to spare; spare to right rear; right rear to right front.

Can radials be retreaded?

Yes. But if you buy a retread, make sure the job's been done right. Look at the sidewall from *inside* the tire. If there's been severe damage to the sidewall, if it has a big patch on it or series of small patches, demand a guarantee in writing. Or pass it up.

Can I use tire studs in radials?

Sure. The Swiss and Swedes do. Many radial snow tires are made with the holes to accept studs.

Why do radials bulge out at the bottom, so it looks as if you have a flat?

Among the advantages of the radial is that it puts more rubber on the road. It sits on the ground and develops high lateral thrust forces. When you go around a corner, the tire wants to stay on the road, hug the ground, rather than slide or tip up from the road, as with conventional tires. Don't try to take the bulge out by adding air beyond the pressure recommended by the manufacturer. The bulge is natural "fat." Leave it alone.—R.L.

trade-off here. The radial is not as strong in the sidewall as conventional tires. The sidewall is thinner on radials and you have to guard against rupturing the side rubber. Watch out for car washes where the car moves in a groove. If there are jagged edges on the track, don't risk it.

● Because it has a soft sidewall, a radial is cool-running. It doesn't generate heat—there's less chance of a blowout.

Radials purge water better than non-radials. Water is less likely to build up in grooves, reducing risk of hydroplaning.

● There's less rolling resistance with radials, increasing fuel mileage. According to a study by Firestone, the savings in fuel amounts to about six percent.

● The radial is a quieter-running tire. George Brush, manager of tire development for Firestone, says a regular belted-bias tire emits natural frequencies in the range of 160 to 165 cycles per second. The natural frequencies on radials range between 55 to 65 cycles per second. The frequencies flatten out at higher speeds, so that with a radial virtually no vibration is transferred to the vehicle at speeds above 40 to 50 mph.

● When the car has been tuned for radials, it's easier to steer, you use less effort, and steering is more responsive.

● Finally, the radial gives better resistance to side slip in crosswinds and on winding roads. ★ ★ ★

The simple way to ...

Adjust your Pinto carburetor

THIS PROCEDURE is condensed from a booklet in a new series offered by *Popular Mechanics*. The booklet shows how to do the major maintenance jobs on 1971 and 1972 Ford Pintos with the 2000-cc (two-liter) engine.

To order the booklet, send \$1.99 to Popular Mechanics, Dept. XYZ, Box 1014,

Radio City, N.Y. 10019; include your address and zip code.

Other available books are: VW Beetles 1966 through 1971 (\$1.99 each); a large booklet for all VW Beetles 1965 through 1971 (\$2.95); 1970-71 Toyota Corona (8R-C engine) booklet (\$1.99) and 1971-72 Chevy Vegas (\$1.99).

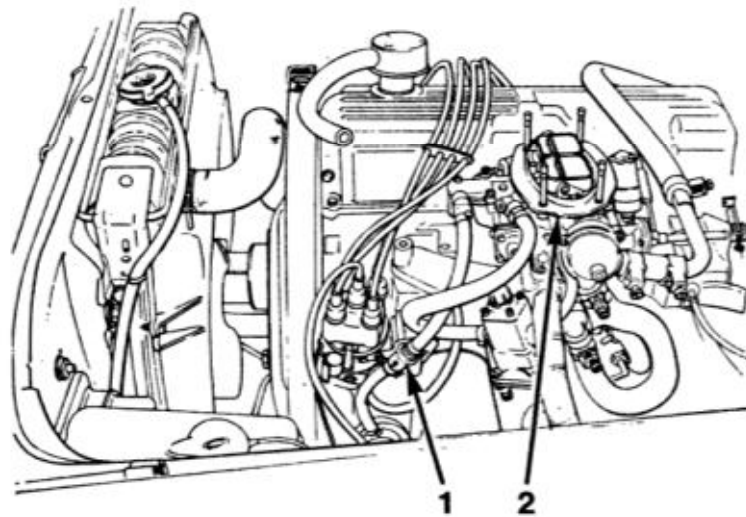

Instructions in this section show how to replace the fuel filter (1) and adjust the carburetor (2). The fuel filter should not be cleaned, but should be replaced every 12,000 miles.

The carburetor should be adjusted every 6000 miles or whenever a tune-up is performed to obtain maximum engine performance and gas mileage.

Before adjusting the carburetor it is essential that the engine be properly timed and the emission control system be serviced.

WARNING: Be sure to keep area well ventilated when working with fuel. Do not smoke or work with fuel near garage water heaters or electric heaters.

Be sure area is well ventilated before starting engine.

Be sure to keep hands and equipment clear of fan and drive belts when engine is running.

Emergency brake must be on. Transmission must be in park or neutral.



TOOLS, PARTS AND SUPPLIES:

Common screwdriver (1)
3/8-inch open-end wrench (2)
Dwell-tachometer (3)

Diagonal cutting pliers (4), if required
Fuel filter (5)
Clean cloth

Replace Fuel Filter

WARNING: Be sure to keep area well ventilated when working with fuel. If crimp-type clamps (1) are installed, clamps must be removed by cutting.

1. Loosen two clamps (6) or cut two clamps (1).
2. Disconnect fuel lines (2,5) from fuel filter (4). Discard fuel filter.

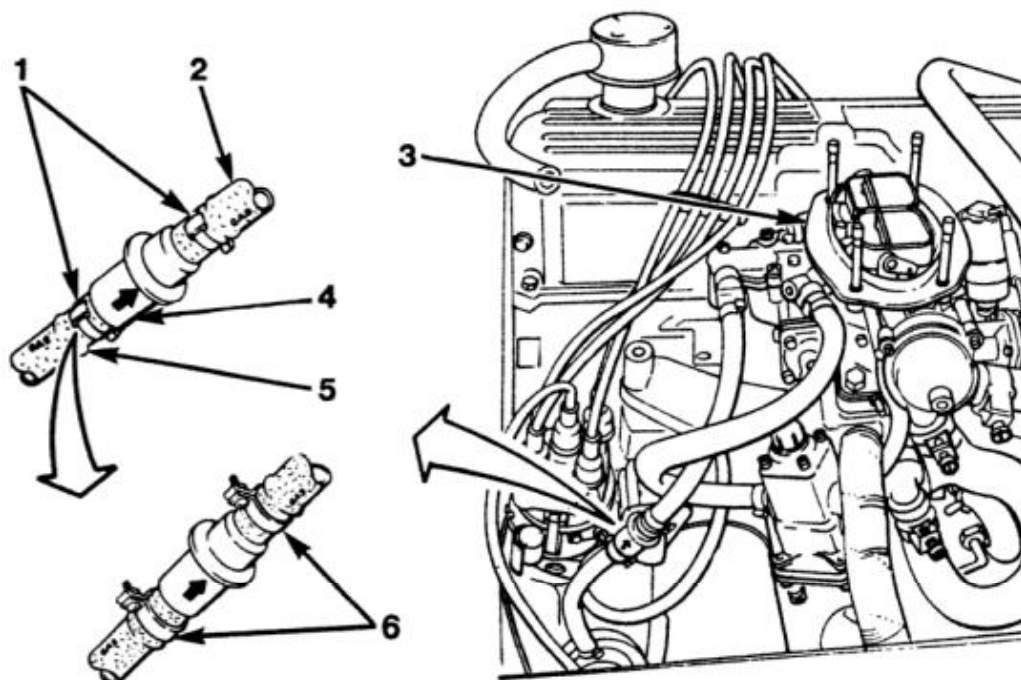

CAUTION: Be sure fuel filter (4) is installed with arrow on filter pointing toward carburetor (3).

1. Place one clamp (1) on each fuel line (2,5).
2. Connect fuel lines (2,5) to fuel filter (4). Using diagonal cutting pliers, squeeze two clamps (1) until tight. Go to Step 4.
3. Connect fuel lines (2,5) to fuel filter (4). Tighten two clamps (6).

WARNING

Be sure area is well ventilated before starting engine.

Be sure to keep hands and equipment clear of fan and drive belts when engine is running.

4. Start engine.

PART 2

Adjust Carburetor

See operator's manual supplied with dwell-tachometer for instructions on use of meter.

1. Connect meter to engine.
2. Remove four wingnuts (2). Loosen clamp screw (1), if installed.

All engine-speed adjustments can be made with air cleaner (3) raised, but not removed, for access to adjusting screws.

After adjustment is made, air cleaner (3) must be lowered to make accurate readings on dwell-tachometer.

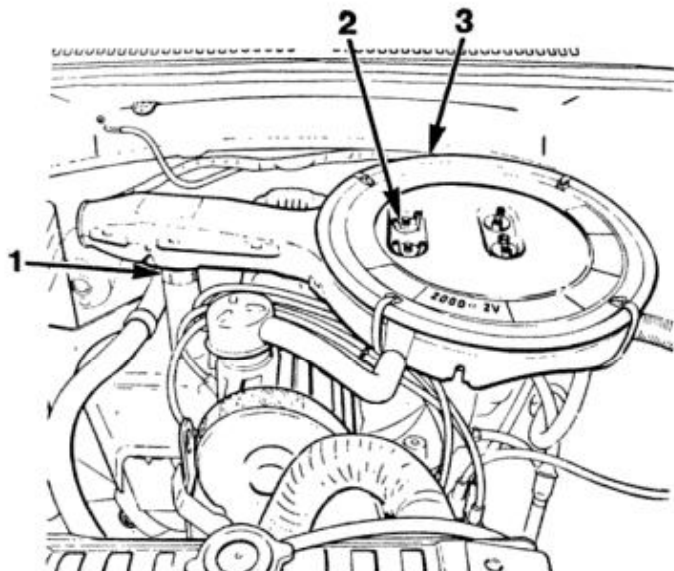

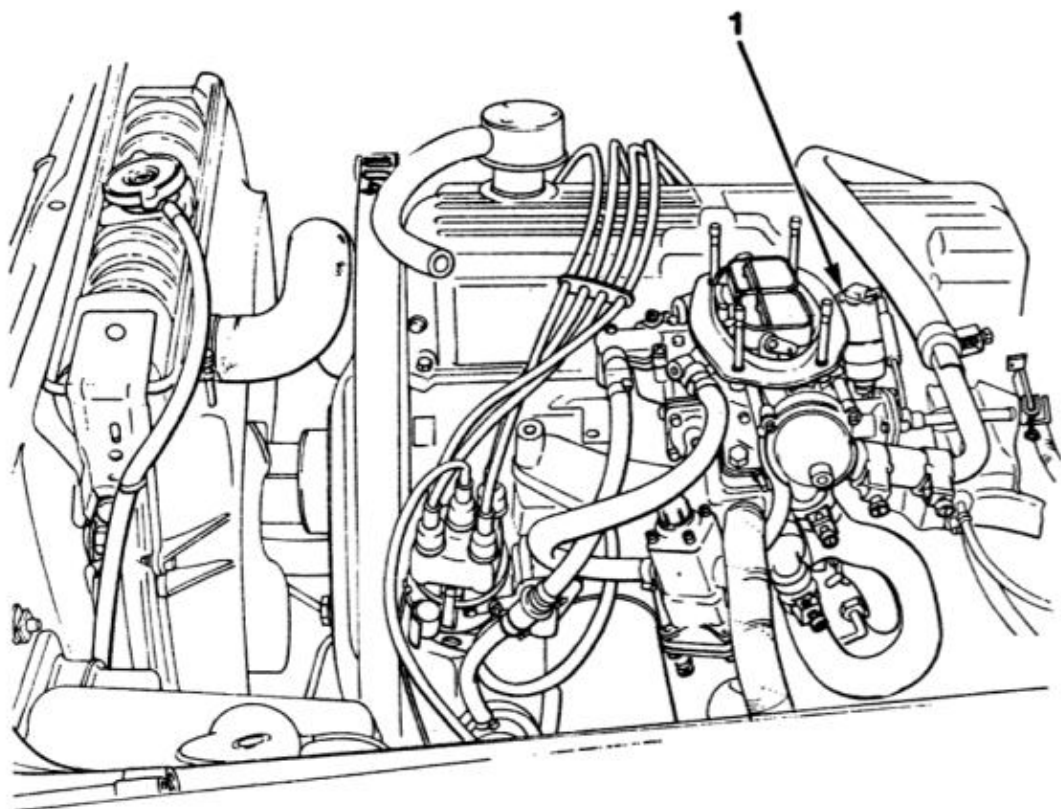

WARNING: Be sure area is well ventilated before starting engine. Be sure to keep hands and equipment clear of fan and drive belts when engine is running. Be sure emergency brake is on.

1. Start engine. Allow engine to warm up for at least 15 minutes.
2. Place following accessories, if installed, at positions indicated: air conditioner, ON; automatic transmission, DRIVE.

If your car has an automatic transmission, idle speed is adjusted to 650 rpm.

If your car has a standard transmission, idle speed is adjusted to 725 rpm.

If throttle solenoid (1) is not installed, go to Part 4, Step 5.

If throttle solenoid (1) is installed, go to Part 4, Step 1.

PART 4

1. Adjust solenoid nut (2) until reading on meter is at correct rpm.
2. Disconnect solenoid quick disconnect (3) by pulling apart.
3. Adjust curb idle screw (1) until reading on meter is 500 rpm.
4. Connect solenoid quick disconnect (3). Go to Step 6.
5. Adjust curb idle screw (1) until reading on meter is at correct rpm.
6. Place following accessories, if installed, at positions indicated:
Air conditioner—OFF
Automatic transmission—PARK.

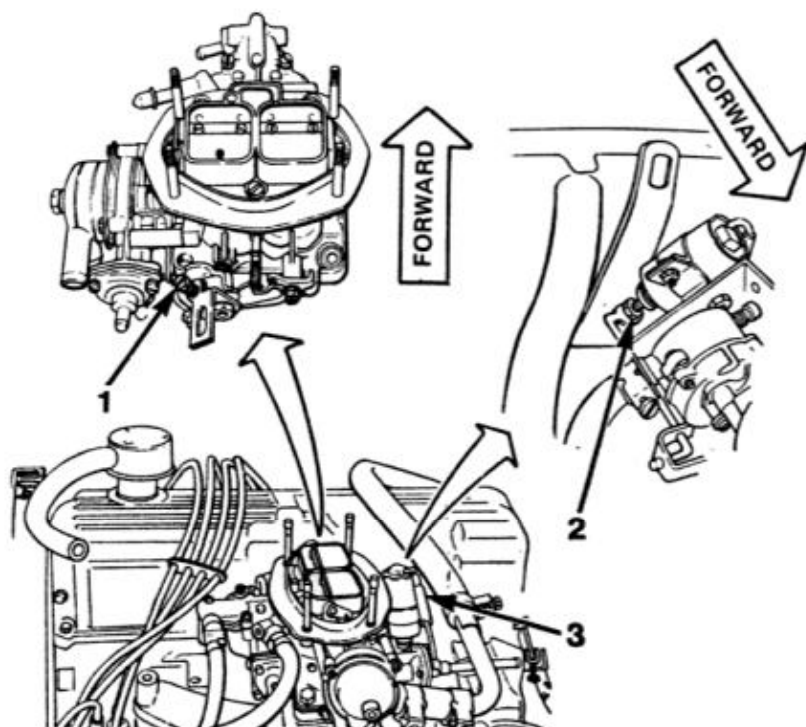

PART 5

Read Steps 1 and 2 before continuing.

1. Increase engine speed by lifting up on throttle lever (1) until reading on the meter is 3000 rpm.
2. Release throttle lever (1) suddenly. Check that engine speed decreases below 800 rpm within 1.5 to 5.0 seconds.

If engine speed decreases below 800 rpm within 1.5 to 5.0 seconds, go to Part 6, Step 1.

If decel valve type (4) is installed, an authorized mechanic must make decel valve adjustment. Go to Part 6, Step 1.

If decel valve type (3) is installed, continue on.

Turn adjuster (2) on decel valve (3) $\frac{1}{2}$ turn clockwise to decrease time, or $\frac{1}{2}$ turn counterclockwise to increase time.

3. Turn adjuster (2) $\frac{1}{2}$ turn. Go to Step 1 to recheck decel valve (3).

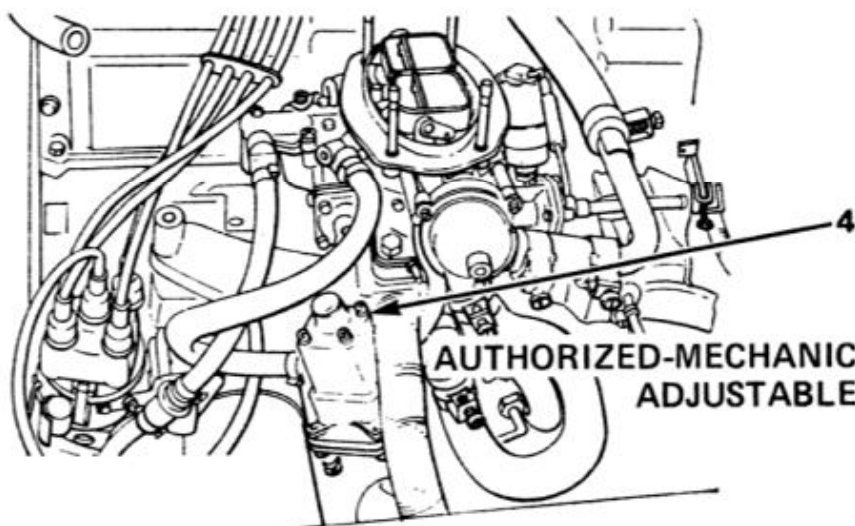
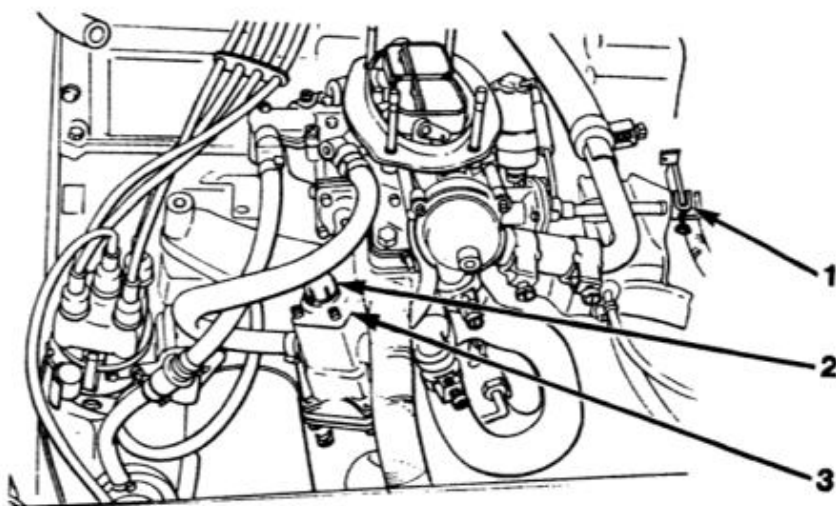

PART 6

1. Stop engine
2. Disconnect dwell-tachometer.
3. Tighten clamp screw (1), if installed.
4. Install four wingnuts (2).

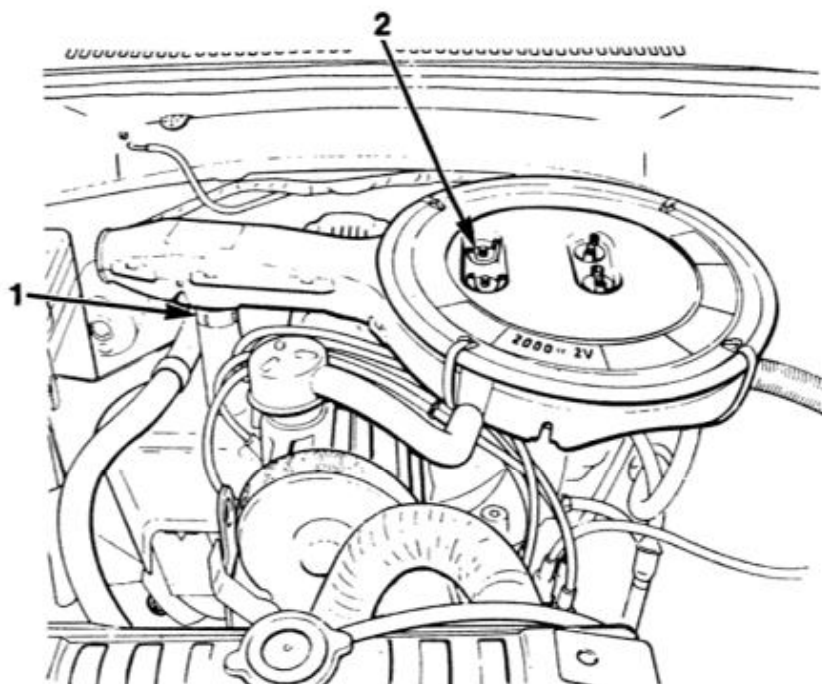

How to cut, splice and connect wires

THE WIRING SYSTEMS that may be used in residences usually consist of either flexible-armor type (BX) or non-metallic sheathed cable with ground wire. Local codes may ban the latter system, but, in any event, the systems should not be intermixed. If your home is wired with BX cable and you are adding an outlet, stick with BX armored cable. Regardless of the wiring type you use, the basic techniques for joining (splicing) these wires are the same. That's what this is all about—good techniques for making safe and proper electrical joints.

Basic points you should know: Wiring, stated simply, serves as the conductor carrying electrical current from house service panel to its ultimate use as heat, light or power source (outlet). It is important to use the right size wire; one that complies with local and national codes. (Size will depend on line load.) In any event, wiring must be installed properly. ★★★

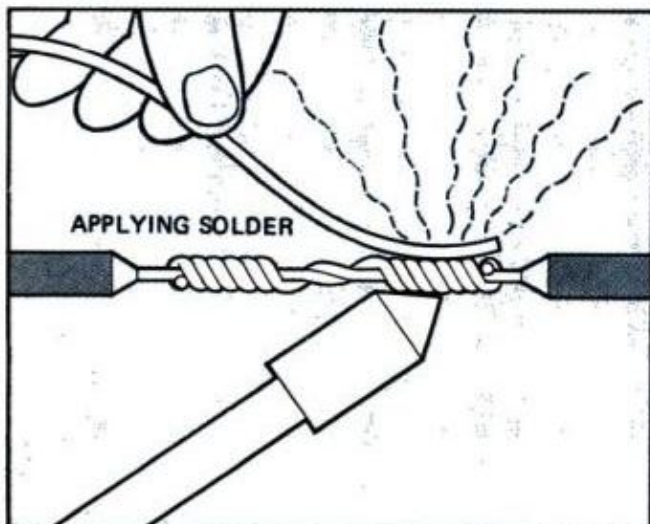

4. Soldering the splice

To assure that solder flows easily, first coat the wires with electric soldering paste. Apply the soldering-iron tip to the wires and heat the wires until solder melts and flows into every crevice (spaces between turnings). Rigidity in an electrical connection cannot be overemphasized; solder should completely cover the exposed joint—and be applied so that it will neither crack nor chip-off when the wires are eventually pushed into the switch or outlet box.

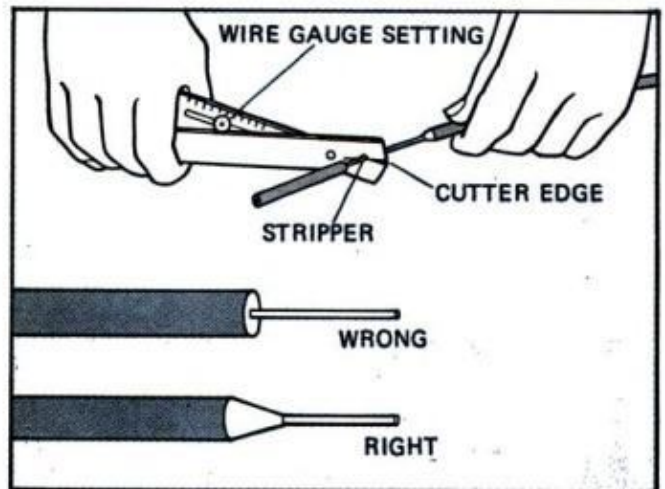

1. Stripping and cutting wire

A combination wire cutter and stripper is a handy pocket tool that cuts and strips clean the most common sizes of stranded and solid wire. A button on the handle lets you set the jaws to desired gauge when stripping so you can remove insulation without breaking the wire. Expose ½ in. of conductor by removing insulation as shown, with insulation shaped like a sharpened pencil rather than a blunt cut. Tool's nose can be used to form the loop on wires for installation under the terminal screws.

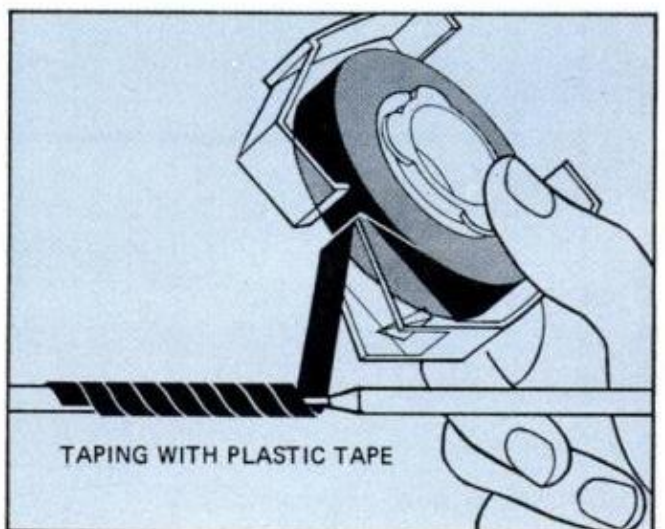

5. Doing a neat taping job

Most professional electricians today prefer to use plastic tape—rather than rubber or friction tape. It lets you do a faster, neater and cleaner job because its dispenser will cut the tape exactly where you want. Since this tape is relatively inexpensive, don't skimp on it. Start at least ½ to 1 in. on the insulation, loop tape around the connection and continue winding tape neatly around until the splice is completely covered. Plastic tape is also known as electrical tape.

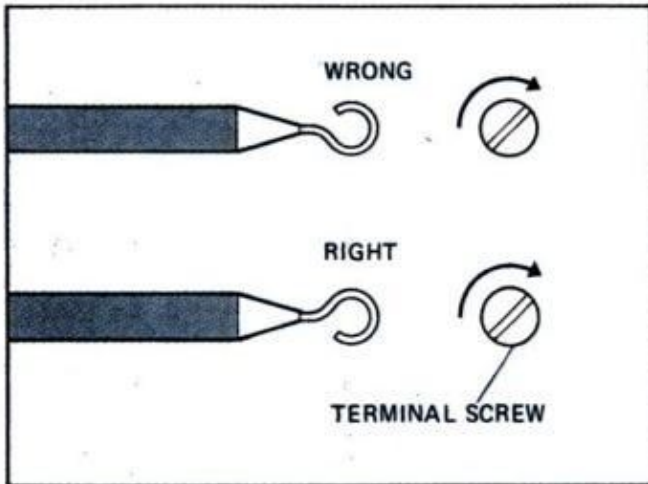

2. Making good connection at screw

The bared wire should be bent to form a loop that will fit tightly under the screwhead. It is important to attach the loop in the direction in which the screw turns as it is tightened. Installed backward, the wire is likely to back out as the screw is turned, resulting in a poor connection with shock-hazard potential. *Good installation hint:* After connecting wires to screw terminals, wrap two turns of electrical tape around the outlet to cover screw-heads completely for added safety.

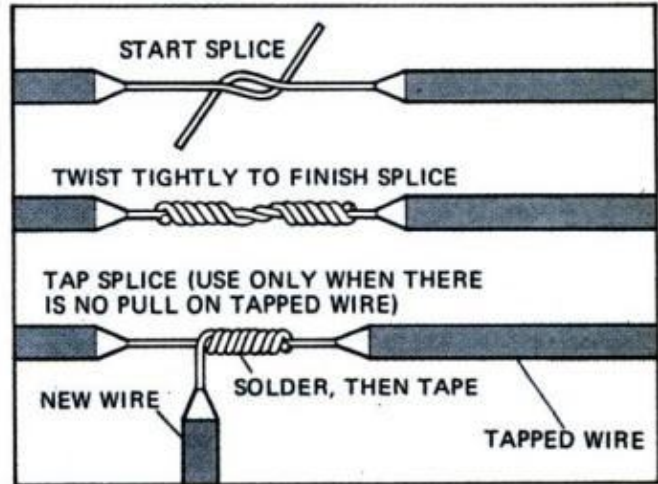

3. Splicing (joining) wire

A permanent connection of two or more wires is called a splice. To make one, remove about 3 in. of insulation from both wires and cross them about 1 in. from the insulation. Then, using your fingers and pliers, make about six to eight turnings to create a neat, tight joint. Joining a wire at right angles to a continuous wire is called a tap splice; use such a connection only if there is no pull on the tapped wire. A splice, done correctly, should be as strong as a continuous wire.

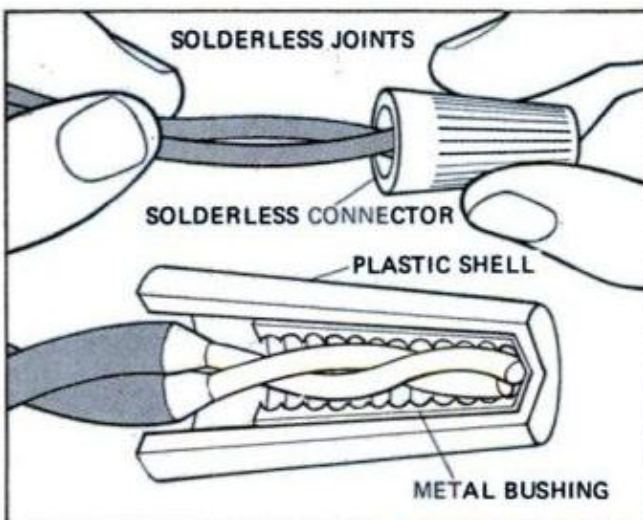

6. Using solderless connectors

Most do-it-yourselfers today prefer using solderless connectors. These plastic caps—with threaded metal insert—let you do just that. You simply turn the caps onto the wires as shown. For extra safety, when you're sure that a connector is full-on, give a slight tug to make sure it won't slip off when wires are pushed into the box. *Smart tip:* Wrap plastic electrical tape around connector and the wires to prevent any chance that the connector will slip out.

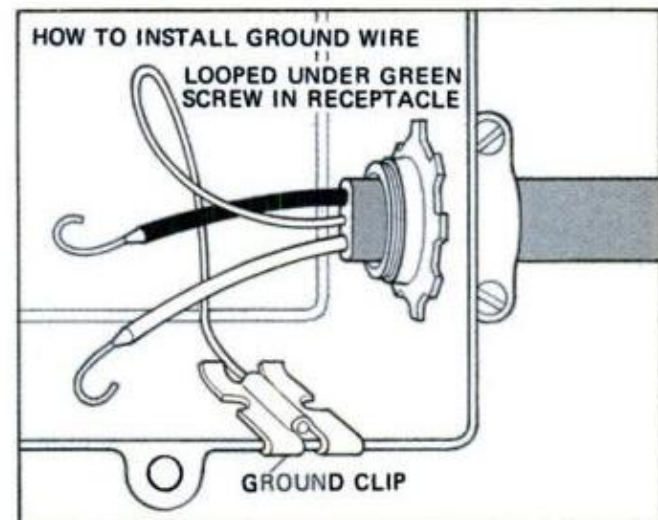

7. Connecting the ground wire

If you are using nonmetallic cable, grounding is required. And, under the NEMA Code effective last January, receptacles must be grounded from green screw to a ground clip mounted on the box. To do it, the ground (bared) wire is looped under the green screw (on receptacle), then pushed through ground clip as shown. Illustration shows a simple installation of ground wire to outlet box to assure a continuous grounded system—reducing shock danger from exposed metal (accidentally livened).

How to frame a basement partition

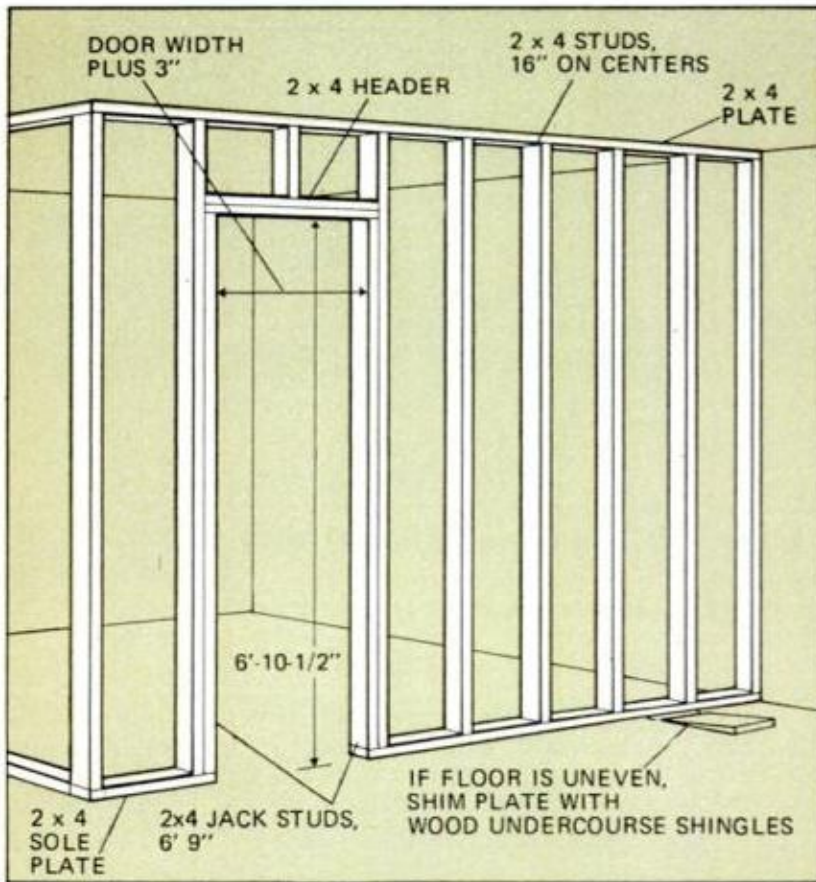

WHETHER you decide to use your basement as a family fun-room or leave the foundation walls bare and lay out the space to provide areas for specific family interests—workshop, sewing center or the like—it's a pretty safe bet that you'll get more efficient use from that room by installing walls.

The basics of such carpentry are shown on these pages. The important point to keep in mind—if this is your first crack at doing it yourself—is to be sure to spend the time that you should in planning and laying out the walls. A typical partition wall (left) is of 2x4 construction, but since these walls are nonload-bearing, you can save a few bucks by using 2x3s. Door opening is standard; you may need a shorter door if ceiling is low. ★★

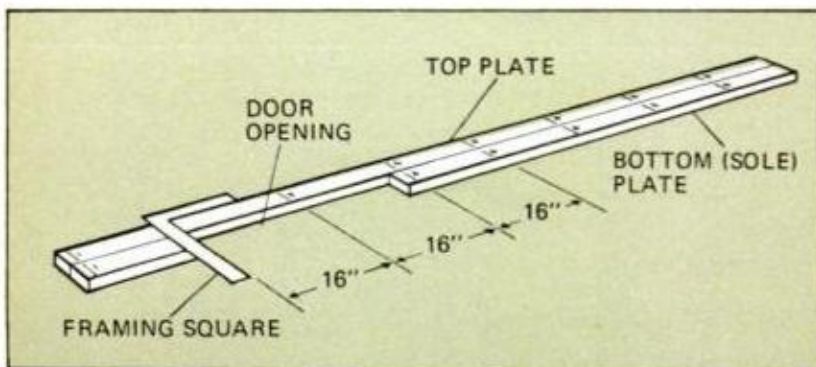

Laying out studs

Partition walls can be erected by using single plates at bottom and top. Use long stock (at least 10-footers) for this chore, making certain that it's free of twist and bow. After cutting the plates to the required length, lay them side by side and mark off the stud locations (16 in. on center). Cut away portions for the door openings on the bottom plates only.

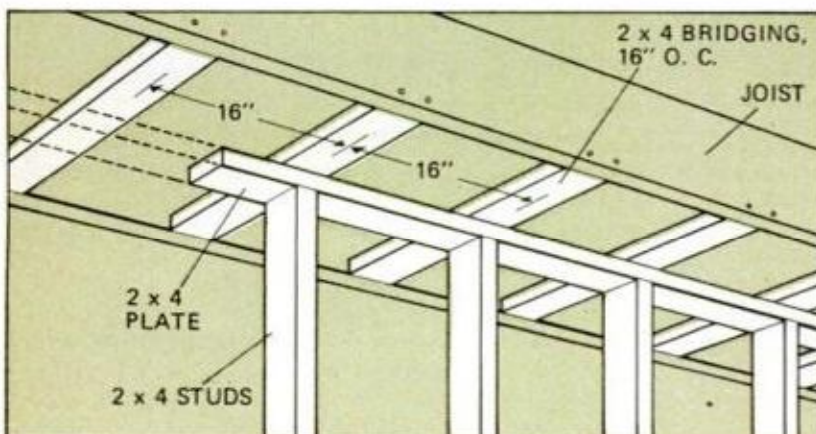

Providing solid nailing

If your partition wall will be parallel with and between joists, you'll have to install nailers (often called cats) between—and flush with bottom of—the joists. The minimum number of nailers should be three in a 10-ft. plate-run—put one near each end and a third at center. (You'll obtain greater wall rigidity if you space nailers 16 in. o.c.) Cut the nailers for a force-fit between joists and install each of them with two 10-penny (10d) common nails spiked through the joists into the ends.

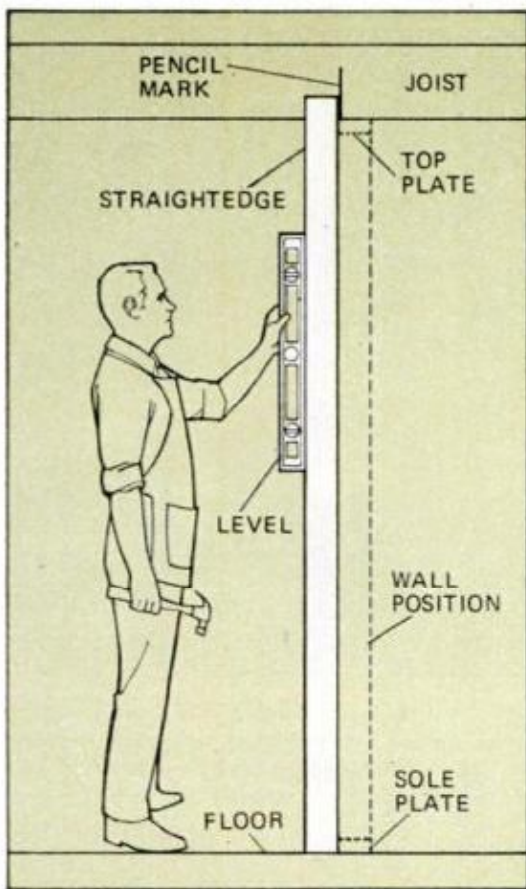

Locating top plate

To set the wall, snap a chalkline on the floor to mark the partition location. Then fasten the bottom plate in position, using either fluted masonry nails (wear safety goggles), lead anchors or masonry pins. To locate the top plate directly over the sole plate, use a straightedge (length of 2x3) and level as shown above. Plumb the straightedge and make several marks on the joists for the top plate at several points along the plate run.

Nailing a stud

To toenail a stud, place the stud on the line on the bottom plate and about an inch or so above the plate, then drive two 8d nails at about a 60° angle. Even though you buck the board (brace it with your shoe) it will move slightly off the line; bring it back to the line by driving a third 8d nail on the opposite side. Finally, to fix the stud, drive in a fourth nail on the face, or narrow, side. Repeat the toenailing at the top if installing the studs individually as mentioned under the heading *Building the wall* in the column at the right.

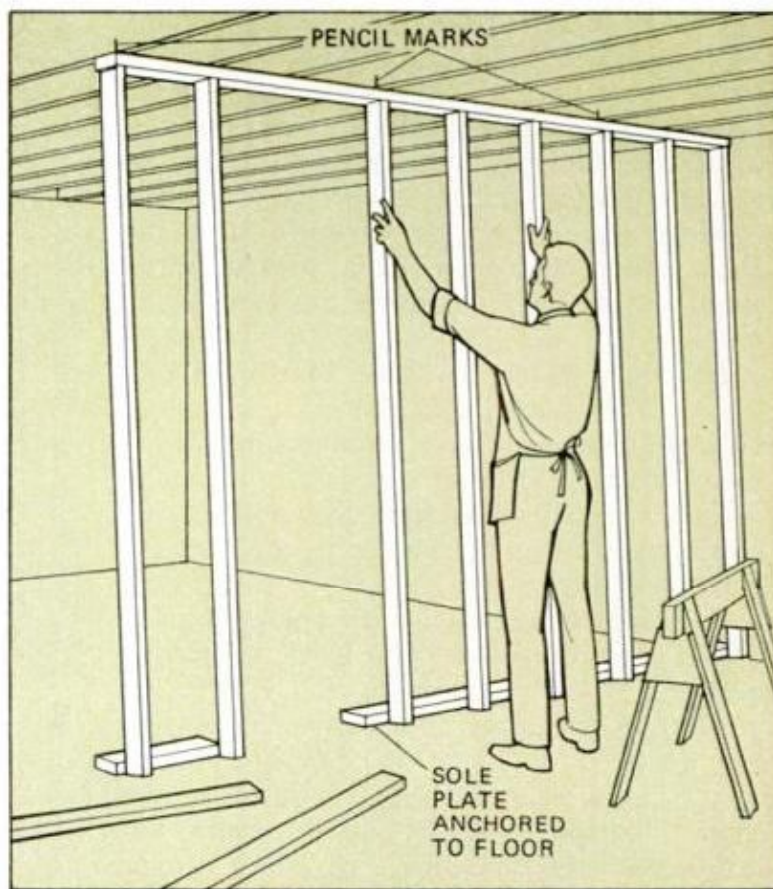

Building the wall

If your concrete floor is in good shape—that is, relatively level—you can assemble the studs to the top plate on the floor, then tilt the wall up into position as a unit. Check studs with your level (both vertical planes must be plumb) and fasten the top plate to joists with 10d nails spaced 16 in. o.c. But if your floor is not level, fasten the top plate only to those points marked on the joists and cut and install the studs one at a time. Stand on the sole plate to mark a stud for length, then cut the stud full (i.e., leave the line). Such a force-fit bears against the plates for rigidity; when you remove your weight, plate springs up.

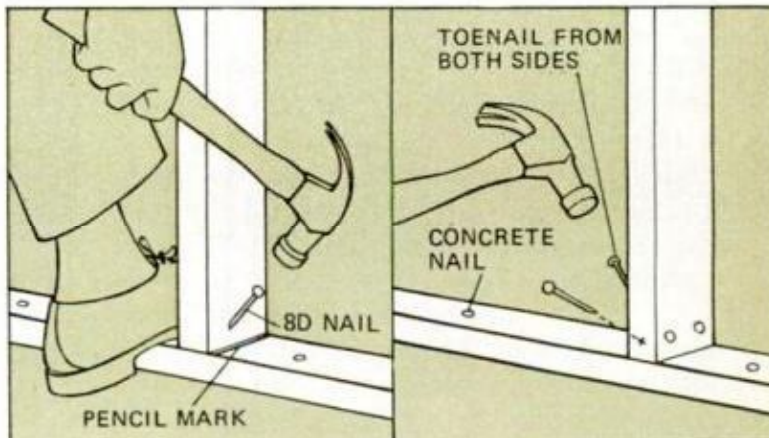

How to patch a hole in sheet flooring

THERE'S AN ADVANTAGE to having a tile floor. When a tile is damaged and must be replaced, there's no need to try making the "patch" invisible—you want it to be seen since it contributes to the overall grid pattern of the floor. Replacing it requires little more than carefully breaking out the bad tile, chiseling away the hardened cement and cementing the new tile in place.

Making a patch in sheet flooring is different. This patch must be as invisible as possible to keep it from standing out like a sore thumb. While it's possible to make such a patch hard to spot, this depends on how carefully and accurately you cut the patch and the recess.

The six steps shown here are similar to those used in marquetry work in which outlines of both the patch and the recess are cut at the same time. Here's how you can do it.

Assuming you can obtain a piece of the same flooring, cut a square somewhat larger than the damaged area. Place it over the worn spot and align the pattern of the patch and the floor precisely. Before it shifts, hold the oversize patch on the floor with masking tape around all four edges. Then, cut through both thicknesses of linoleum. Use a thin-blade knife that's razor sharp and a metal straightedge. Extend the outline of the patch well beyond the damaged section.

Now peel off the tape and discard the scrap, keeping the square patch. If you find you didn't cut completely through the flooring, retrace the cut with the knife, being careful to stay on the line. Remove the old linoleum within the scored lines, scrape the recess clean of old adhesive, and dust clean. Check that patch fits and that it's flush with the surface. Coat the back of the patch sparingly with linoleum cement. If too much is applied, it will ooze out around the edges. Press patch in place and lay a wax-paper sheet over it. Place a flat board over the paper. Rest a heavy weight on this overnight; then wipe up any cement smears with a damp cloth. ★★★

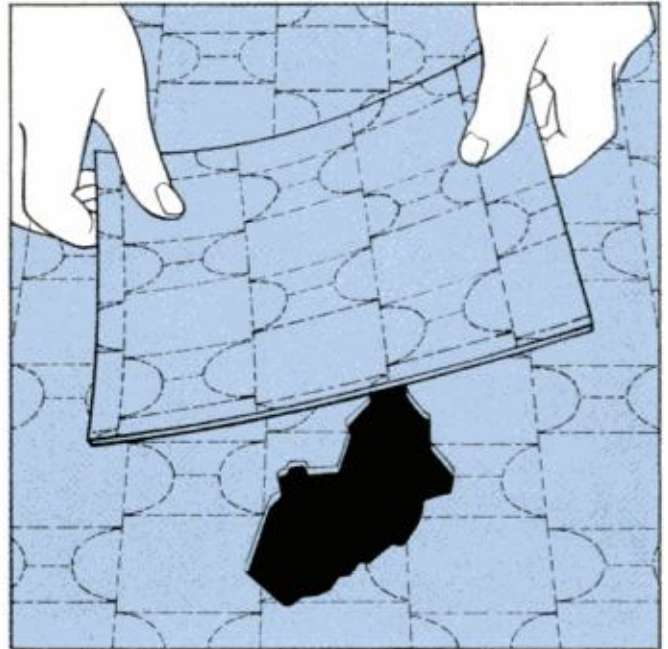

1 OBTAIN A PIECE of identical linoleum and from it cut a square somewhat larger than the damaged area. Then place square over the spot and carefully align the two patterns exactly in both directions

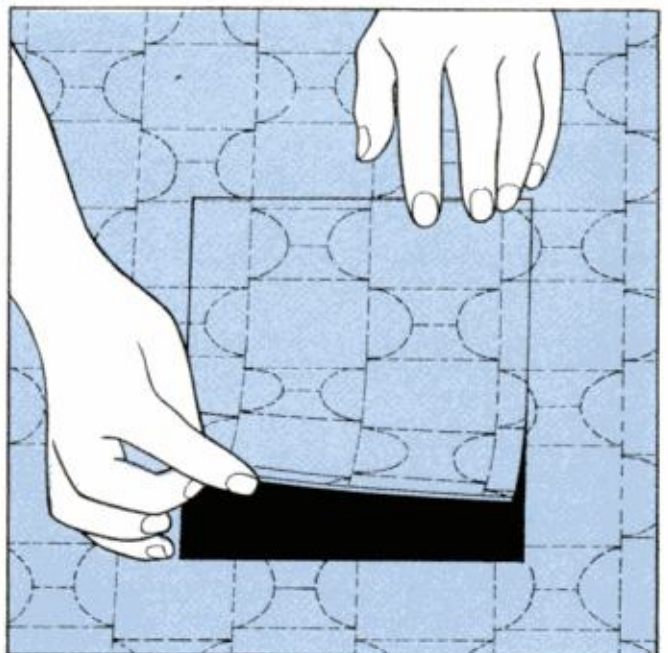

4 IF YOU SCORED LINES CAREFULLY, the patch should fit perfectly. To assure that patch will be level with the surrounding surface, chisel and scrape out any old hardened cement, then brush it clean

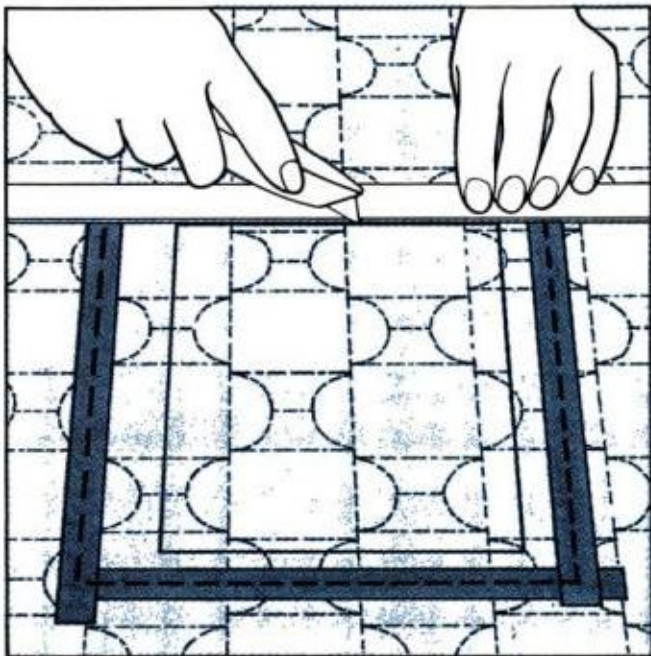

2 WHEN IN POSITION, tape the scrap to floor with strips of masking tape around four edges. Mark a square outline and, with a sharp knife and a straightedge, cut through both thicknesses of linoleum

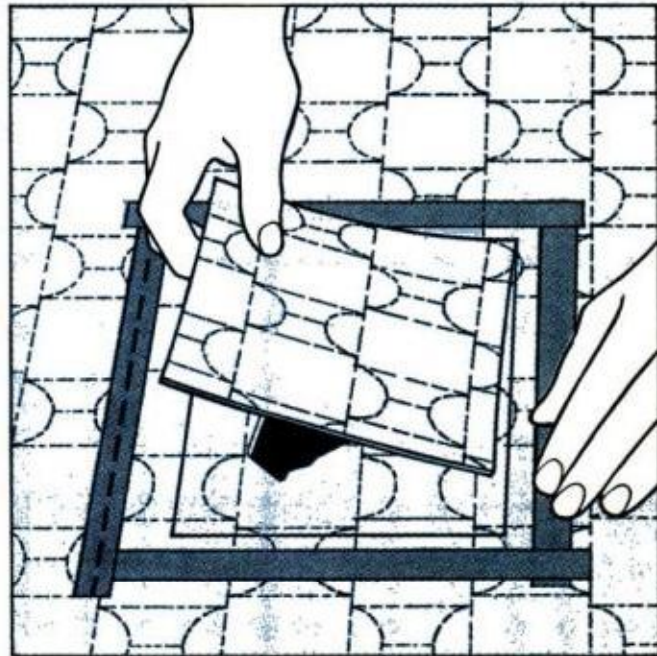

3 LIFT OUT THE PATCH and peel off the tape. Throw away the leftover scrap. If you find that you didn't cut completely through the second layer, retrace the scored lines with a knife, keeping on the lines

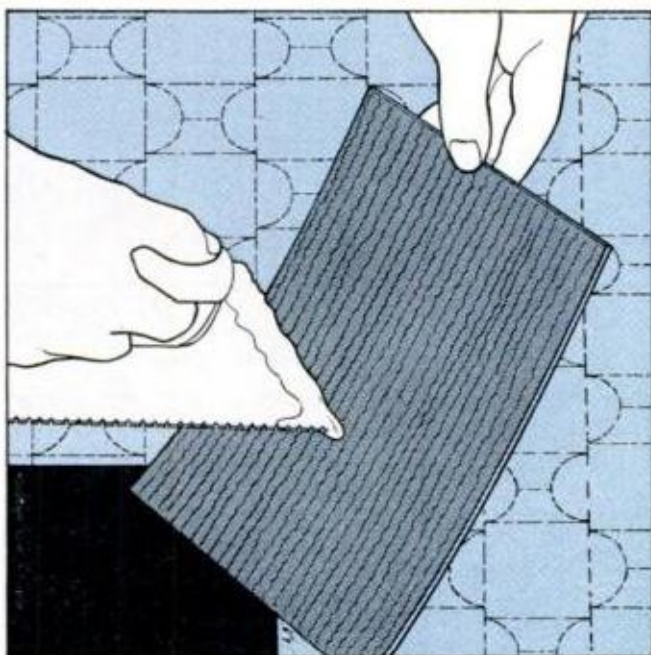

5 APPLY CEMENT SPARINGLY to the back of patch; too much will take longer to dry and continue to ooze out at the joints when you step on patch. Use linoleum cement and apply with a notched trowel

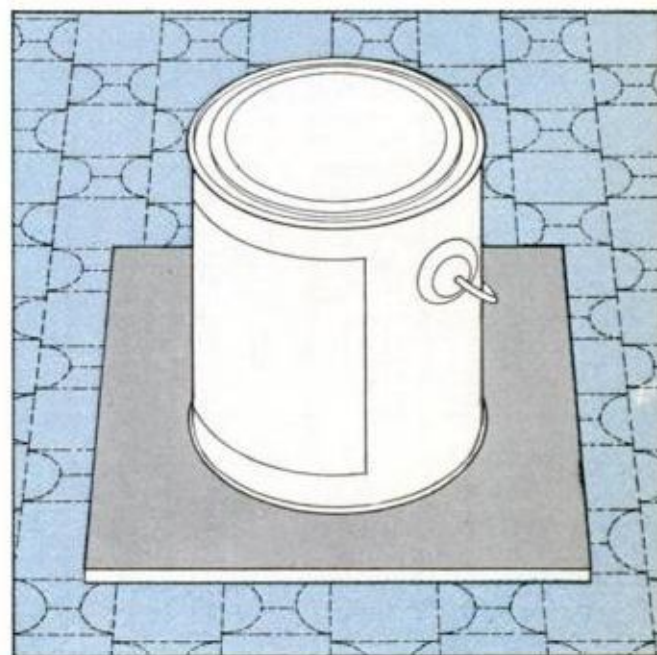

6 PRESS PATCH IN PLACE and keep it flat by weighting it with something heavy. Use board under it to distribute weight evenly. Place wax paper over the patch so board won't stick to the flooring

How to hang drapery traverse rods

PUTTING UP new drapery rods so they stay is a job all homeowners face at times, whether they're moving into a new home or switching over to today's bold, new drapery hardware. Since the popular trend is to stack the draperies back off the glass, you won't always find a stud where you want it. If you do, you're lucky, but chances are you'll be faced with attaching the brackets to a hollow part of the wall. You can't drive plain screws into the plaster; they won't hold. The answer is a Molly fastener which is designed to hold anything securely to a wall when you are unable to drive a screw into a stud.

Plan to place brackets for the rods above the casing, or at least 4 in. above the glass and an equal distance from the ceiling. ★★★

GLASS WIDTH	STACKBACK SPACE	ROD WIDTH
20"	20"	40"
26"	22"	48"
32"	24"	56"
38"	26"	64"
44"	28"	72"
50"	30"	80"
56"	32"	88"
62"	34"	96"
68"	36"	104"
75"	37"	112"
81"	39"	120"
87"	41"	128"
94"	42"	136"
100"	44"	144"
106"	46"	152"
112"	48"	160"
119"	49"	168"

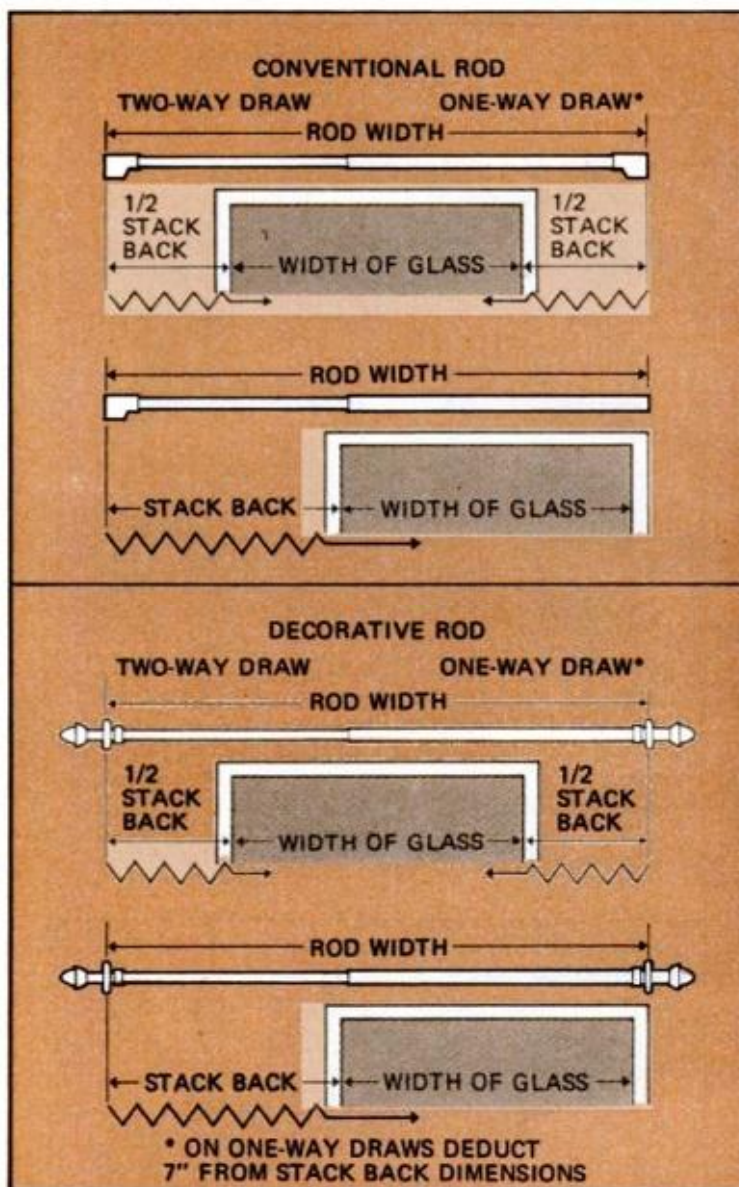

DATA FROM KIRSCH CO.

How to find the right rod length

With a draw treatment, it's best to have the draperies stack back over the window frame and wall, uncovering all the glass. To do this, you must know the amount of wall space needed for the open panels before buying and installing the traverse rods. Use the chart at the left to find the correct rod length. Begin by measuring the glass width of your window. Say it's 38 inches wide. The chart shows you'll need 26 in. of wall for stack-back. So you add 38 and 26 in. and you'll see that you need a rod 64 in. long. The drawings above illustrate where the stack-back will be located. Stack-back is the amount of space occupied by open draw draperies. Space will vary depending on panel width, pleat spacing and fabric bulk. Since windows have two sides, you divide the stack-back distance in half (in this case 13 in.) to see how far the rod should extend on wall, beyond the glass. If using one-way draw draperies, add the full 26 in. to one side.

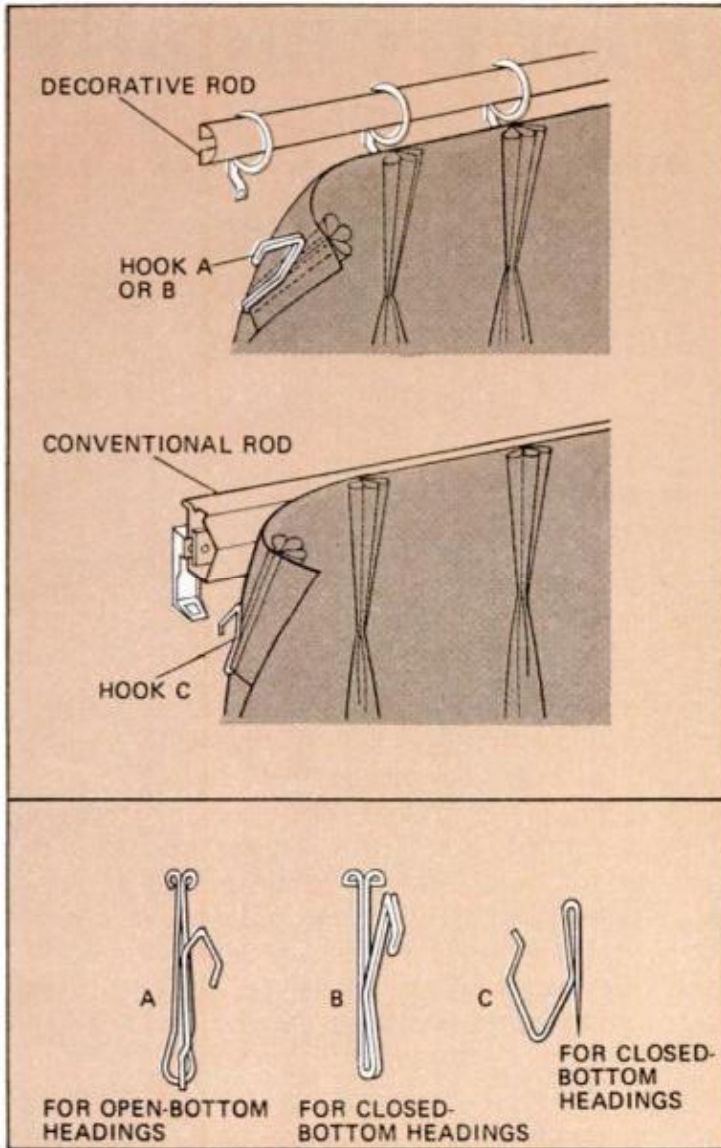

Selecting proper drapery hooks

The right drapery hooks can mean the difference between tip-tilt headings and those that stand properly erect. Always important, your choice of hooks is vital to the proper appearance of draperies hung on decorative traverse rods. At each window you will need one hook for each drapery pleat, plus four for returns and overlaps.

On a decorative rod, the heading covers the pendants and falls just below the bottom of the rings. On a conventional rod, the heading extends to cover the rod. Thus hooks for conventional rods must be longer from the top of the hook to the top of the shank than hooks used for decorative rods.

Ways to anchor brackets securely

Correct fastening devices are a "must" for proper installation of drapery hardware. Wood screws 1 1/4 in. long threaded the full length of the shanks are suitable for attaching brackets to studs. If wood studs can't be located or bracket location falls between studs, Mollies (hollow-wall anchors) should be used as shown below. They are inserted in holes drilled through plaster or dry wall, tapped flush with the surface to embed the points and finally pulled up tight on the back by turning the screw that comes with the anchor.

When mounting lightweight drapery rods on the wall, you can use plastic screw anchors. These tapered sleeve-type plugs are tapped in place in undersize holes drilled through the plaster. When a full-thread wood screw is turned into the plug, it spreads the split plastic sleeve and anchors it securely in place.

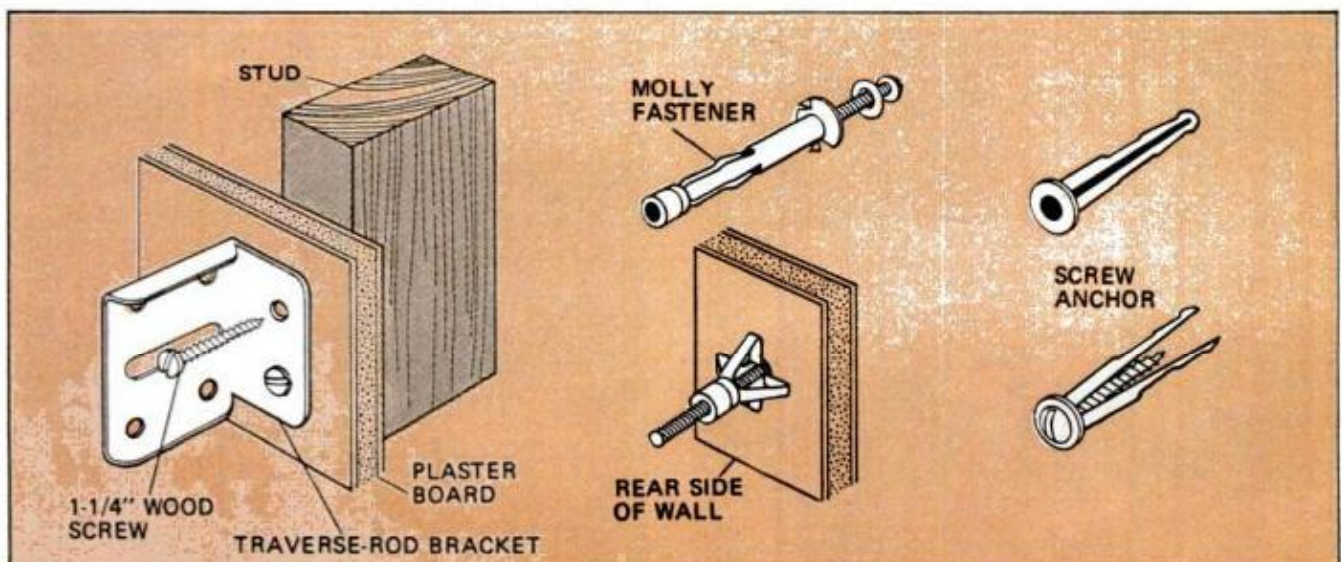



A 'dust-free' home electronically

Attached to your furnace, an electronic air cleaner will collect 200 times more dust than a fiberglass filter.

By **WAYNE C. LECKEY**,
Home and Shop Editor

Photos by Robert D. Borst

IF YOU THOUGHT you had trapped a lot of dust and dirt the last time you cleaned your fiberglass furnace filter, you'd be surprised at the number of minute particles which passed right through.

But you shouldn't blame the filter; it's simply impossible for a mechanical-type filter in a forced-air furnace to trap more dust than it does. Only when airborne dust has to pass through the ionizing section of an electronic cell can you hope to

trap and collect the millions of microscopic particles which normally escape back into your house—and lungs.

Truly an indoor pollution fighter, an electronic air cleaner takes on the job of removing tiny airborne pollution particles such as dirt, soot, pollen and smoke from the air in your home every time the furnace blower turns on. With these microscopic particles caught, your home and everything in it is bound to stay

CELLS ARE ACCESSIBLE through door at front. Opening of door automatically shorts-out the high voltage

ELECTRONIC CELLS pull out like drawers for periodic washing. Straps provide flat "suitcase" handles

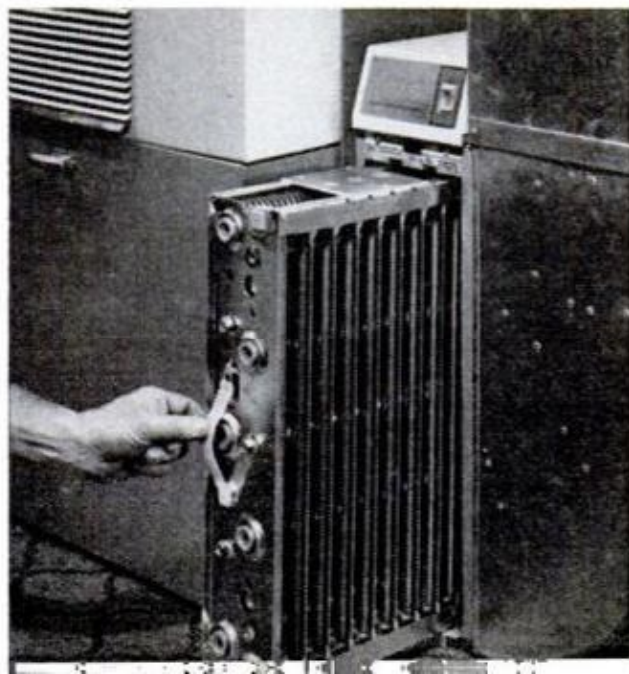

ORDER OF ASSEMBLY

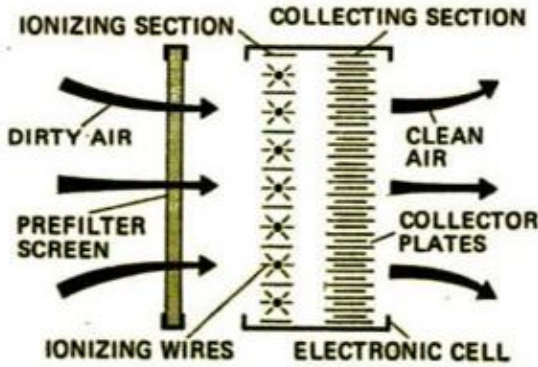
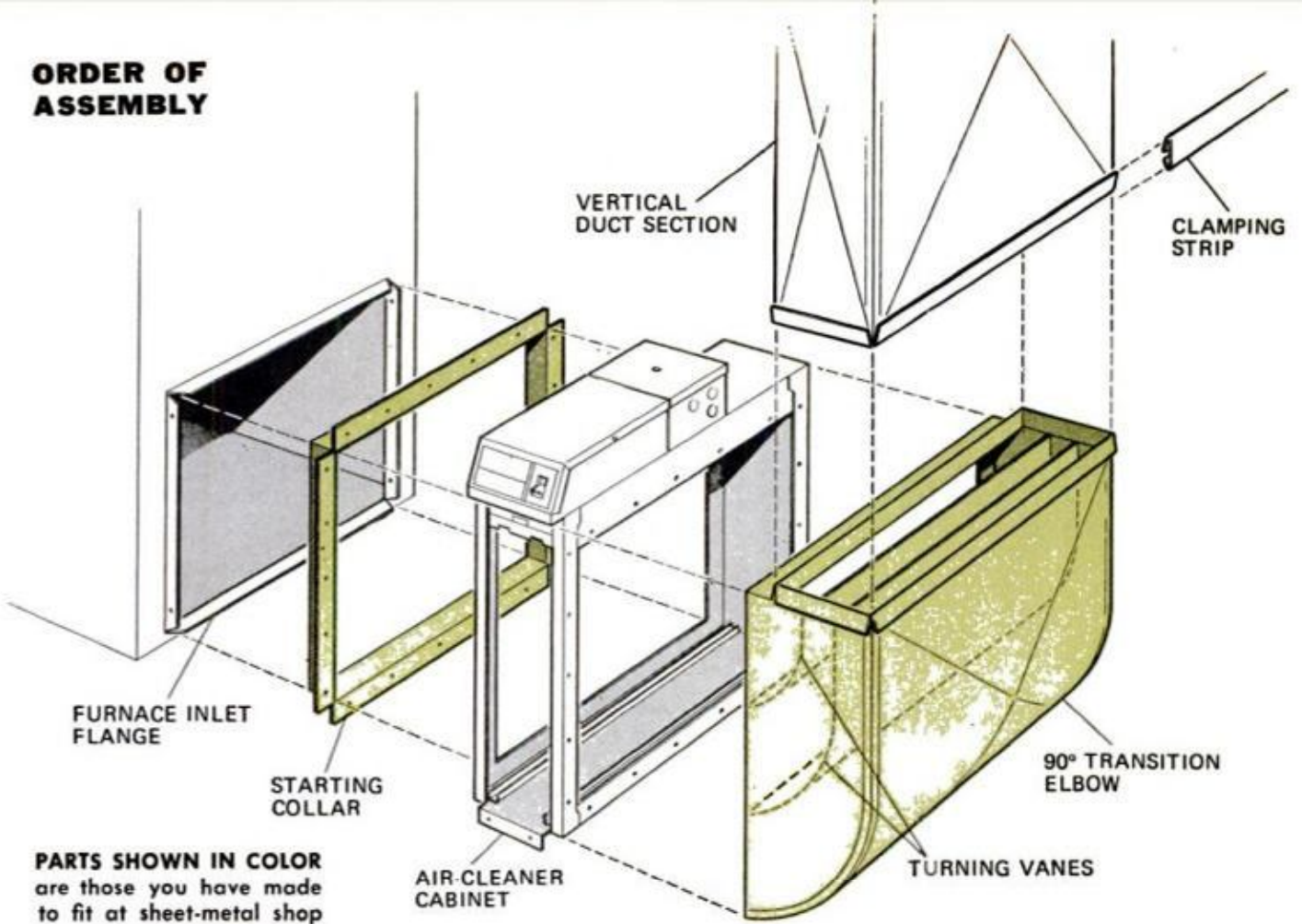

cleaner longer, and you'll be breathing clean, pollen-free air. According to the manufacturer, Honeywell's electronic air cleaner will remove up to 95 percent of airborne dirt and 99 percent of the pollen from the air that is circulated through it, making the cleaner about 20 times more efficient than a mechanical filter.

Here's how it works: The principle is called "electrostatic precipitation." Airborne dust that is carried to the electronic

POP RIVETS ARE USED to attach collar to one side of cleaner cabinet, transition elbow to other side

CLEANER REQUIRES 7-IN. SPACE between furnace and vertical duct. If less, an offset section is used

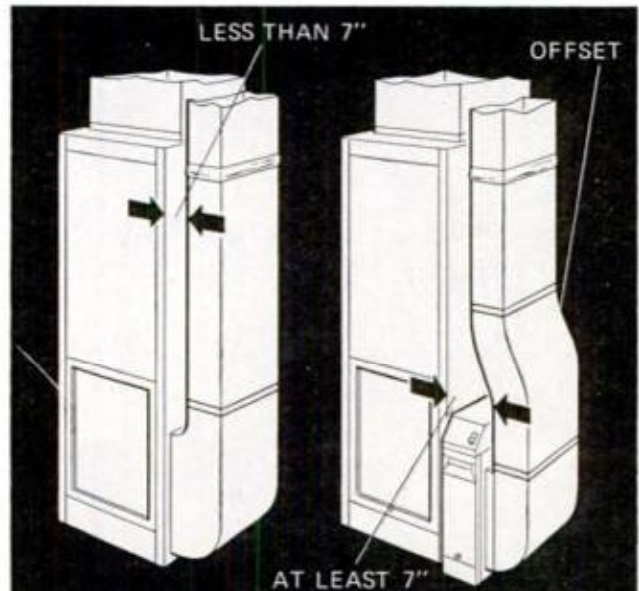
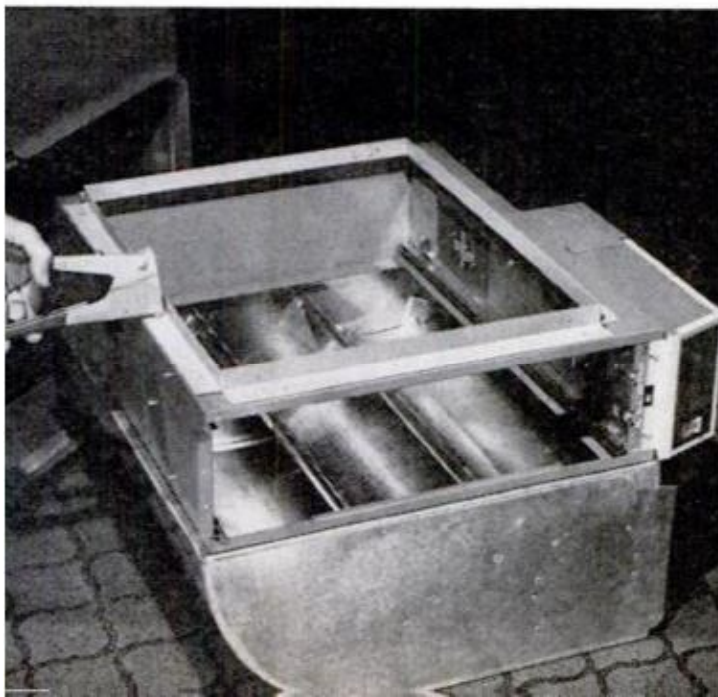

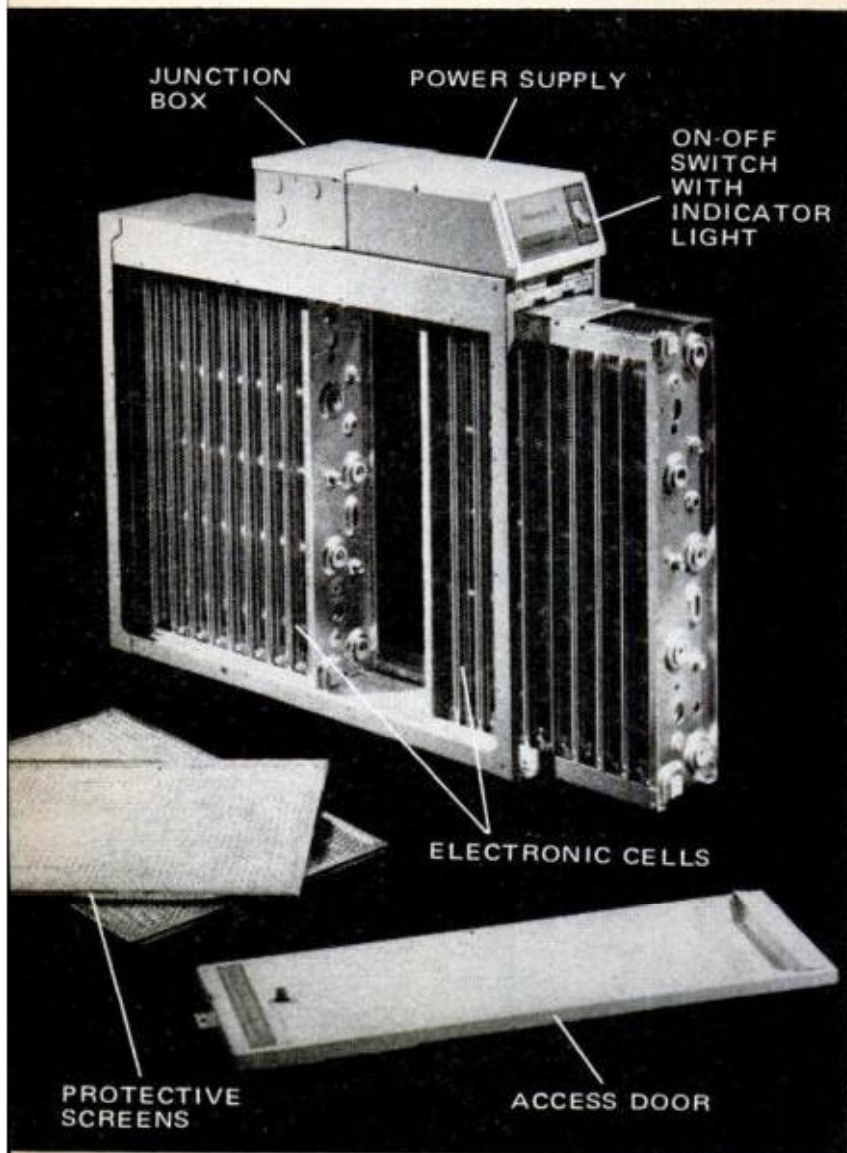

AIR CLEANER includes two electronic cells, high-voltage power supply, junction box, two screens, access door

COLLAR-CLEANER-ELBOW assembly is attached to side of blower compartment with screws through its inlet flange

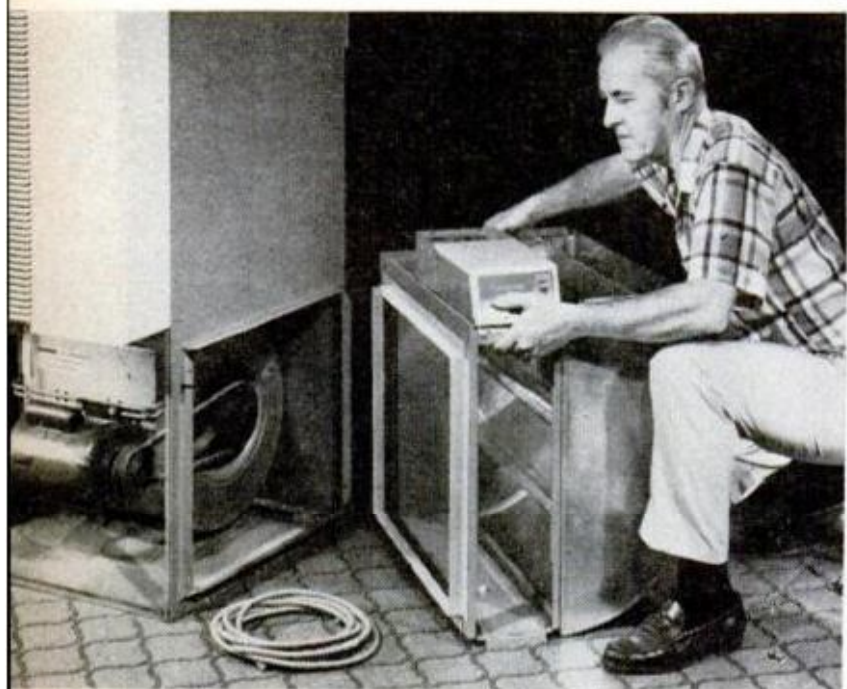

cleaner and furnace through the return air registers and ducts of your heating and cooling system, first passes through a prefiltering screen which traps the larger particles such as lint, feathers and animal hair. Particles such as smoke and pollen, too small to be stopped by the porous screen, pass on to an ionizing section where they receive an intensive positive electrical charge. The charge makes them cling to a series of oppositely charged electrical plates in much the same way iron filings are attracted by a magnet. Here they collect and remain until the two drawer-like cells are removed and the dirt is washed off in an automatic dishwasher or laundry tub. The cleaned and filtered air, of course, passes on to the blower compartment of your furnace before being recirculated through the house.

Since the air cleaner "runs" when the blower runs, it costs no more to operate than a 50-w. light bulb. An indicator light tells you when the cleaner is operating properly, and as an additional check of the cleaner's performance, a test button is provided at the bottom of the access door. Pushing the button discharges the collecting section of the cell momentarily and produces snapping or arcing sounds. The sounds indicate that the cleaner is working as it should.

You have a choice of a manual-wash unit or a more sophisticated (and expensive) automatic-wash model, in 16x25 in. and 20x25-in. sizes. The smaller units are suitable for forced-air systems with capabilities up to 1400 cubic feet per minute (c.f.m.), representing 3½ tons of cooling; the larger ones are applicable to systems up to 2000 c.f.m.

The air cleaner is adaptable to all forced-air furnace and cooling systems, and adding it to an existing installation is a fairly simple job. Its best location is in the return-air duct right where it enters the blower compartment. To provide an even distribution of airflow across the electronic cells, the existing right-angle elbow in the duct must be re-

(Please turn to page 207)

HINTS FROM READERS

Better break for your sander

If the abrasive paper on your orbital sander has a tendency to break at the ends long before the grit is worn out, try this stunt. Before installing the sandpaper, place two strips of masking tape across the paper at the ends as shown. The tape will strengthen the paper at the points where it normally tears.

—Karl R. Timm, Jacksonville, Fla.

Loose-leaf ring revisited

I've seen several good uses for loose-leaf rings in *Hints from Readers* but not the use that I have for them. I use such a ring to keep my box-end wrenches together and in sequence, as well as keeping metrics from mixing with U.S. sizes. If possible, keep metrics on one ring, U.S. wrenches on a second.

—Gil Longwell, Hagerstown, Md.

Washers save tearing of webbing

When renewing the plastic webbing on folding lawn and patio chairs, you can increase the holding power of the cup screws if you place washers over the holes in the folded ends and insert the screws through them. The washers help prevent raveling and tearing of the webbing at the holes when undue strain is applied.

—J. Carpenter, Williamstown, N.J.

New use for old baby bottles

Old nursing bottles make ideal glue or paint-applicator bottles. Simply insert the handle of a small modelmaker's brush through the hole in the nipple until the brush hangs 2 in. below the rim. The nipple provides an airtight seal around the brush, yet allows the brush to be pushed deeper into the bottle as glue level descends.—William Butler, Liverpool, N.Y.

A job for file tangs

A file tang can be used to enlarge holes in sheet metal if it's hardened first. Break off the flat file, heat the tang to cherry red, plunge it into cold water, then clamp it in a wooden slot, as shown. (A round file can be shortened and used in a regular file handle.) For best results, grind the tang's edges sharp.

—Peter Legon, Malden, Mass.

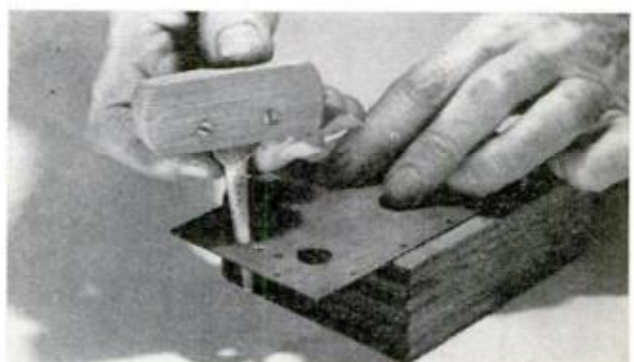
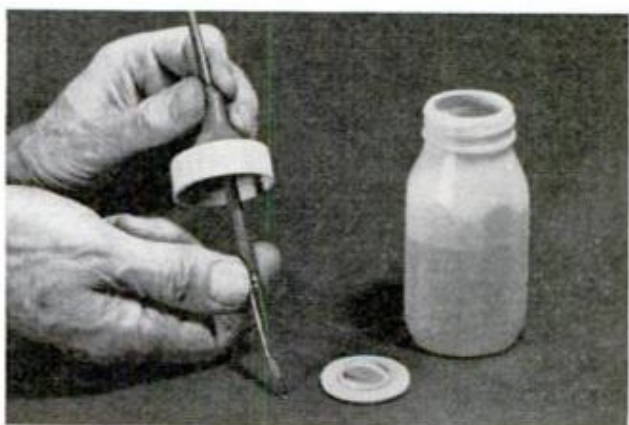
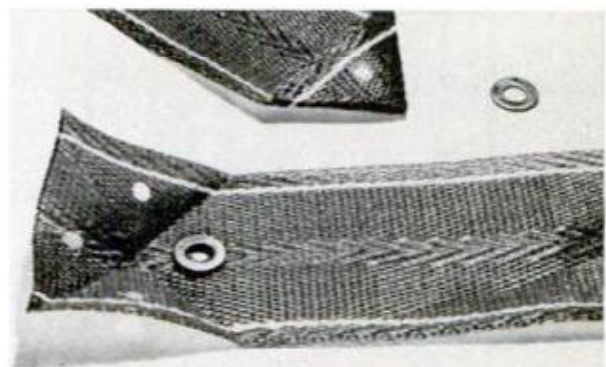

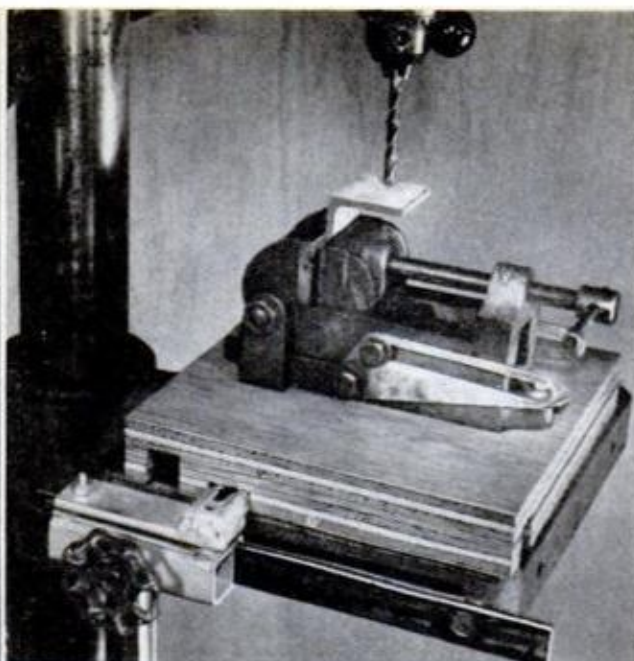
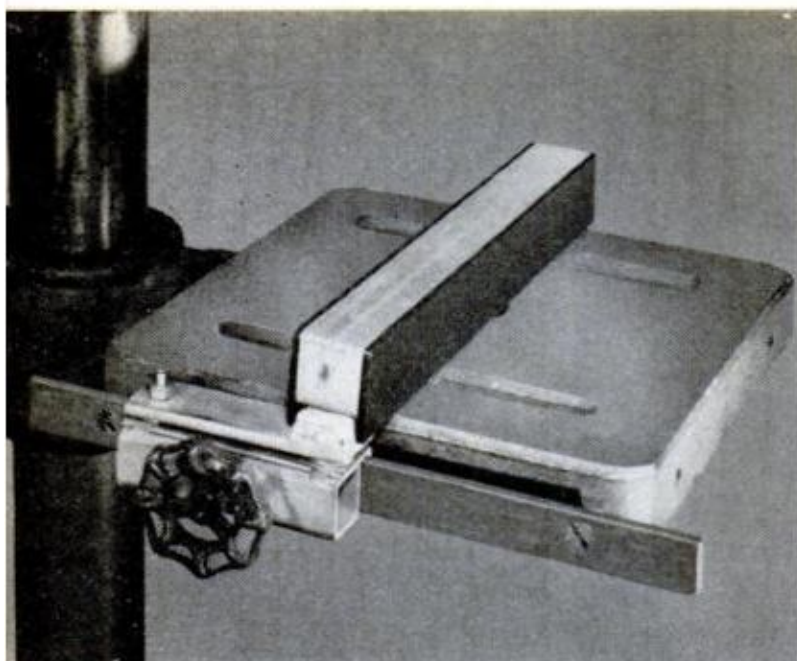

TO USE VISE HOLDER ON DRILL PRESS, the high fence is removed and holder is hooked over the low fence

Double-duty drill-press fence

By WILLIAM G. WAGGONER

HIGHLY VERSATILE is this drill-press fence that can be quickly removed and replaced with a handy vise holder you can use on your drill press and radial saw. As a drill-press fixture, it provides a high and low fence that is movable across the full depth of the table. When an extra guide bar is added to your bandsaw table, the same fence can be used for ripping and resawing.

The vise holder consists of two squares of $\frac{3}{4}$ -in. plywood, glued together and dadoed on the underside with deep and shallow grooves. The deep grooves permit the holder to straddle and slide along the fence of a radial saw when metalwork is to be cut off or slotted with an abrasive wheel. The shallow groove lets the holder hook over the low drill-press fence and stay put without clamping. The high fence will be handy for drilling straight rows of holes, routing and precision tapping.

The guide bar on which the fence travels is a $\frac{1}{4}$ x 1-in. length of flat steel and is attached to the left edge of the drill-press table with two $\frac{1}{4}$ -20 fh bolts turned into tapped holes. Sections of $\frac{1}{8}$ -in. pipe hold the bar $\frac{1}{2}$ in. out from the table. It's best to wait and spot the tapped holes after the fence is made so it will lie flat on the drill-press table. The oversize

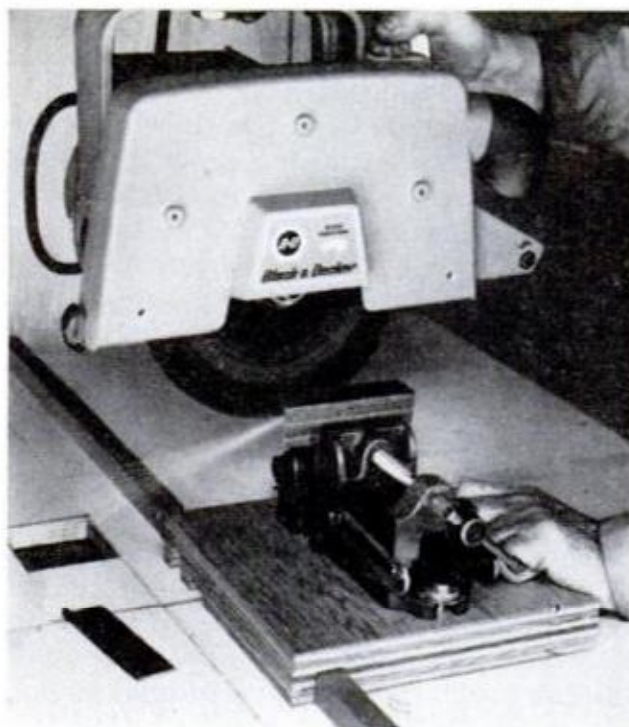
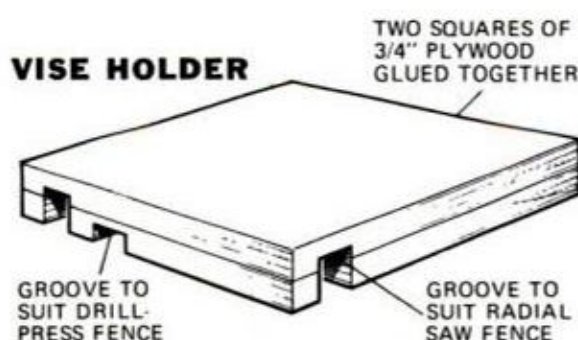

RIGHT-ANGLE GROOVES in vise holder let you hook it over a radial-saw fence two ways for cutoff work

POPULAR MECHANICS

FENCE DETAILS

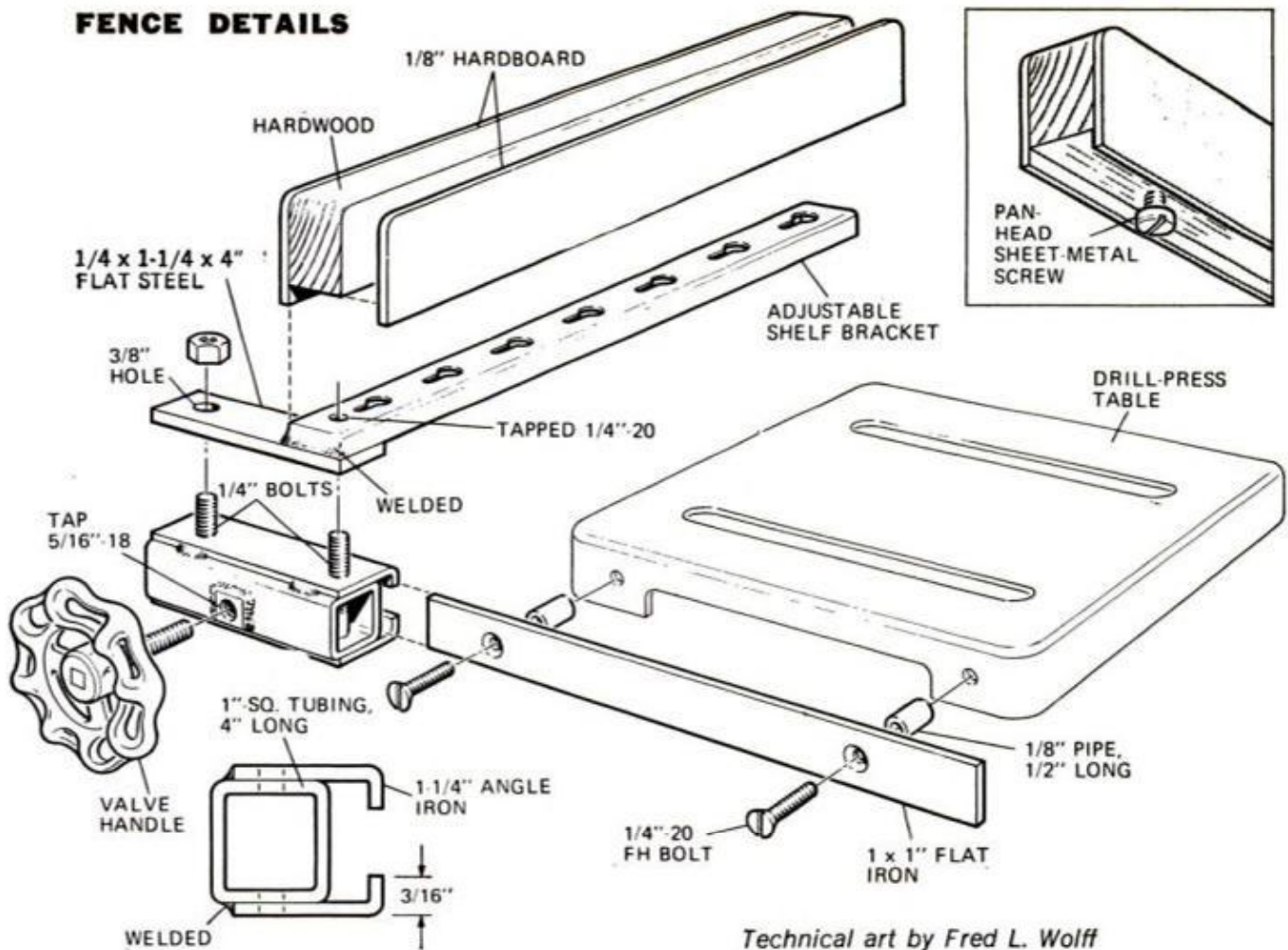

(3/8-in.) hole permits the fence to be squared up with the table.

The low fence is a length of shelf standard welded to a 1/4 x 1 1/4 x 4-in. piece of flat steel. It is drilled for two 1/4-in. bolts, one hole being tapped. The high fence is made by sandwiching a pine or hardwood member between two pieces of 1/8-in. hardboard. The hardboard facings extend below the hardwood core to create a groove along the bottom so the high fence will fit over the low fence. Pan-head, sheet-metal screws in the bottom edge of the high fence lock it firmly to the keyhole slots in the low fence and permit it to be removed quickly.

The clamping fixture is made from a 4-in. section of 1-in.-sq. tubing and has two sections of 1 1/4-in. angle iron welded to it. One leg of each angle is cut back to 3/16 in. to provide a lip, top and bottom, to hook over and ride along the guide bar.

Welding of the angle iron to the square tubing is done by drilling holes through angle iron, touching the torch through the holes and grinding the welds flush. If you use a C-clamp to hold the angle-iron

pieces in place, and insert the guide bar before welding, you'll have an accurately fitting fixture. When a handle from a valve is used for a tightening knob, hack-saw the head from a bolt, file the end to fit the square hole in the valve handle and spot-weld it. ★★★

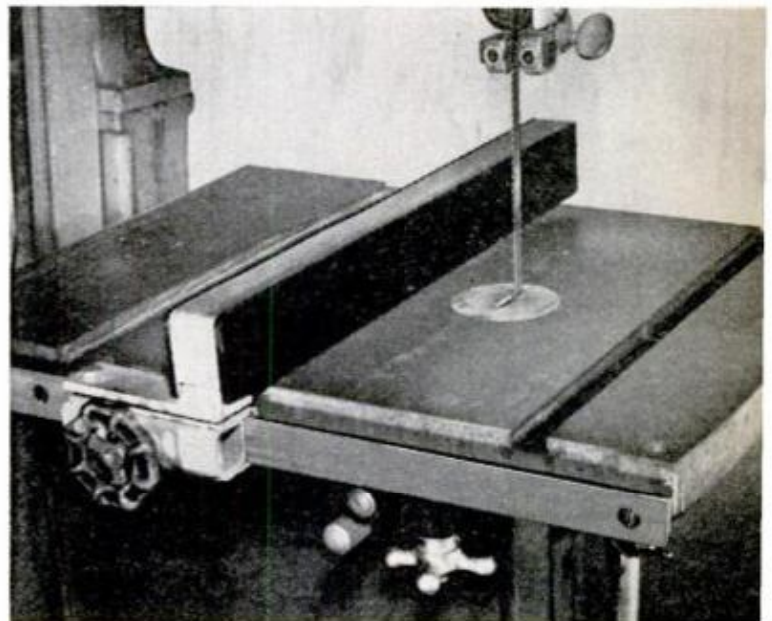

WITH EXTRA GUIDE BAR ADDED to bandsaw table, the drill-press fence is interchangeable for ripping

HINTS

FROM READERS



No-cost lamp shade

A practical shade/reflector for a bare bulb can be assembled by slipping a foil pie plate over the socket on your drop cord. To be safe, first wrap several turns of electrical tape around the socket.—*Ken Patterson, Regina, Sask.*



No-tangle cord storage

Long extension cords, such as those used for yard tools, can be conveniently stored by wrapping around a length of $\frac{3}{4}$ -in. board. Cut slots at ends for male and female plugs, and for hanging.—*John F. Dinges, Homewood, Ill.*



For driftless drilling

Next time you have to drill a hole on a vertical surface, and want to do it without having to make a punch mark to prevent bit-drift, just notch a rubber plate-scraper to serve as a holder.—*William Swallow, Brooklyn.*

A better way to plant fenceposts rigidly

When you're setting fenceposts, simply tamping the backfilled earth is often insufficient to keep posts plumb. I've found that by dampening and mixing the backfill with about one part Portland cement to five parts soil, posts are kept almost as

rigid as in concrete. Mix on the ground with a shovel. Add enough water to make the mix form a tight ball when squeezed, but without leaving water on your fingers. After placing, tamp backfill with a 2x4. —*Richard Day, Palomar Mountain, Calif.*

NEXT MONTH IN SHOP AND CRAFTS

HOME IDEAS GUIDE. Forty pages of attractive, sensible home-improvement and modernization ideas from the people who have the know-how. You'll see many exciting new products that are available now for upgrading your home, plus basement family rooms with ideas galore, exterior remodeling work that will let you do away with that "tract house look," the latest concept in home heating, how to make light fixtures for the kitchen, and much more. It's an exciting issue you can't afford to miss.

HOW TO BUILD A SOIL CONDITIONER. Gardening buffs are sure to want one of these easy-to-build soil tumblers. Constructed of two-by stock and $\frac{3}{4}$ -in. plywood, it can be made on Saturday, used on Sunday.

MAKE THIS HANDY STAND FOR YOUR ORBITAL SANDER. Ordinarily, small parts are just about impossible to sand because you can't get a good finger grip on the workpiece. Build this little bench stand and you're sure to get more from your sander.

PLUS: A sofa from a solid-core door, a self-lubricating oilstone, an easy-to-assemble clock kit, and more.

If this is what you remember best after spending the weekend in the country, your camper was probably built with Starcraftsmanship.

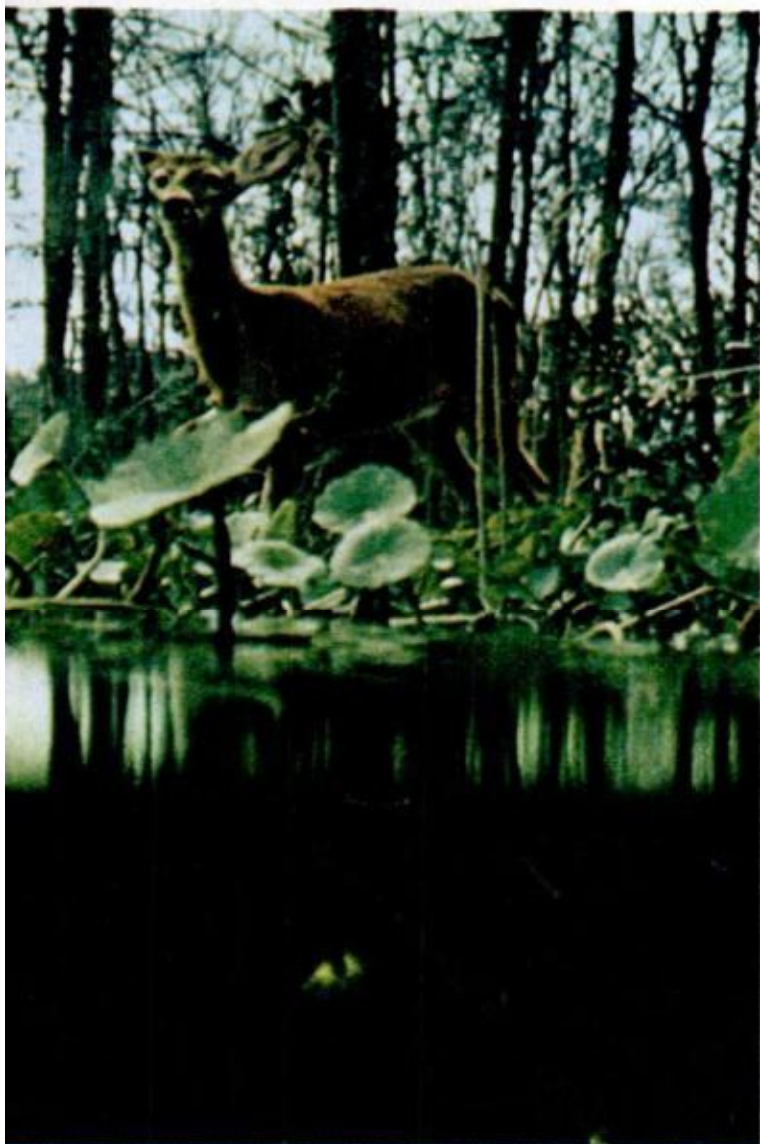

Before you buy a camper, think what you're buying it for.

To see the sunset on the ground instead of on your neighbor's garage.

To show your kids that all wild animals don't live in zoos.

Whatever reason you come up with, one thing is clear. You don't buy a camper for the camper. You buy it for the trip.

At Starcraft we never forget that fact.

That's why we build campers that call more attention to your trip than they do to themselves.

It takes Starcraftsmanship.

Starcraftsmanship is our standard of excellence.

Coming up to that standard has meant

developing the leading research and design center in the industry.

We've designed the telescopic lifter system. So you can spend five minutes setting up camp and a day enjoying it. Not the other way around.

We designed the 35" high kitchen sink so when the sun sets you can watch it without an aching back that you got bending over the supper dishes.

We've designed a lot of features.

But more than our features and the quality materials we build them out of, we put value in craftsmanship.

When we measure a camper for a cabinet, we measure it accurately.

We treat the floors before we lay the linoleum so it won't buckle or deteriorate. We make $\frac{3}{16}$ " holes for $\frac{3}{16}$ " screws. And then we don't forget to screw in the screw after we made the hole.

In short, we build campers that don't end up rattling and jerking like a mass-produced accumulation of nuts, bolts, and metal.

Maybe that's why more people buy Starcraft campers than any other kind.

Think of it this way. If the moment that deer stepped out of the woods you reached for the camper door and the door handle came off in your hand. Which would you remember? The door handle? Or the deer?

Write to us for information about the Galaxy 6 and 8, or any of our 10 camper models and the name of your nearest dealer. Dept. G36-3 Starcraft Company, Goshen, Indiana 46526



The more you live with it, the more you appreciate it.



STARCRAFT

The more you live with it, the more you appreciate it.

By **BILL McKEOWN**, RV Editor

OUTDOORS this year, motor campers will head for highway horizons in a bigger selection of vacation homes that drive and tow. More height, length and even width are being added to larger models. Small ones feature less set-up time and fewer self-containment complications. Trailer trends favor big fifth wheelers, while smaller models of the booming motor homes chop the back off vans and add on all the comforts of a very compact apartment. This year, expect typical inside features to include running water



PICKUP CAMPER BODIES, like Swinger's new 11-foot Sky Lounge with front and rear cab-over windows, are improving livability

Standard travel trailers still sell most, but chopped vans, fifth wheels, motor homes and assorted mini models are growing fastest in popularity now.

New rigs



QUICK SETUP TIME figures less than 60 seconds for the Coleman Minuteman, a tent-camper-type model that hinges from low-tow profile to seven-foot headroom. Under \$700

FIFTH-WHEEL TRAILERS, with the cargo-bed hitch accounting for that fifth, have jumped from three builders three years ago to nearly 100. As in El Dorado below, size is feature



for roll-along recreation



MOTOR HOMES are looking less like moving vans. Seven-sleeper Xplorer, above, has streamlined look



COMPACT II, 13-footer from Hunter Structures, Dallas, pops top for camping, lowers to garage

SLEEPING FOR FOUR is claim of 13½-foot Love Bug with light hitch load for easy small-car towing





OBSERVER is new penthouse motor home from Harvest RVs, South El Monte, Calif. Unit is recommended for spectator sports or for use as a rally control center



system and a galley, wiring to add outside current, options at least for a toilet, and any number of heating, cooling, refrigerating, cooking and lighting appliances as rig size increases. Outside, the new RV may offer more color choice, better streamlining and construction to meet stricter industry standards.

RIDING HIGH, the driver of Shasta's new Motorhome looks out over traffic. Features include aluminum skin and frame, steel roll bars and rubber body mounts

As in other fields, standards are becoming important in this growing industry; a shopper looking at new RVs should first be sure the units have the oval Recreational Vehicle Institute seal certifying that the manufacturer has complied with electrical, plumbing and heating codes.



Electric outlets, for example, must be conveniently and safely located, with wiring leading to properly grounded UL-approved panelboards. Size of water supply piping is specified, drain fixtures must be individually trapped, fresh-water tanks need to be of tested and approved types, and holding tank drain outlets are required to be accessible and have enough clearance to allow a simple drain-hose connection. Stoves and heaters must be of approved types, installed and vented so they aren't near flammable materials and curtains. LP-gas piping and joints cannot

TOYOTA AND CHINOOK Mobilodge team up to provide this camper with push-up top built on a 110-inch half-ton truck chassis, and sleeping a family of four

be enclosed in walls and floors where a leak might cause gas to be trapped. Instead, all tubing must be run in the open, usually under the vehicle, where it is accessible for inspection and repair.

FOLDING TRAVEL TRAILER that hinges down its four Retractable-Walls to camper-trailer height, Rolite 1700 Self-Contained has power-lift top, toilet, shower

RVI standards inspectors visit member firms regularly to insure compliance. During 1972 five members were expelled for failure to correct deviations from the safety standards, and undoubtedly the RVI

(Please turn to page 158)



The Honda Trail 90 not only gets you away.

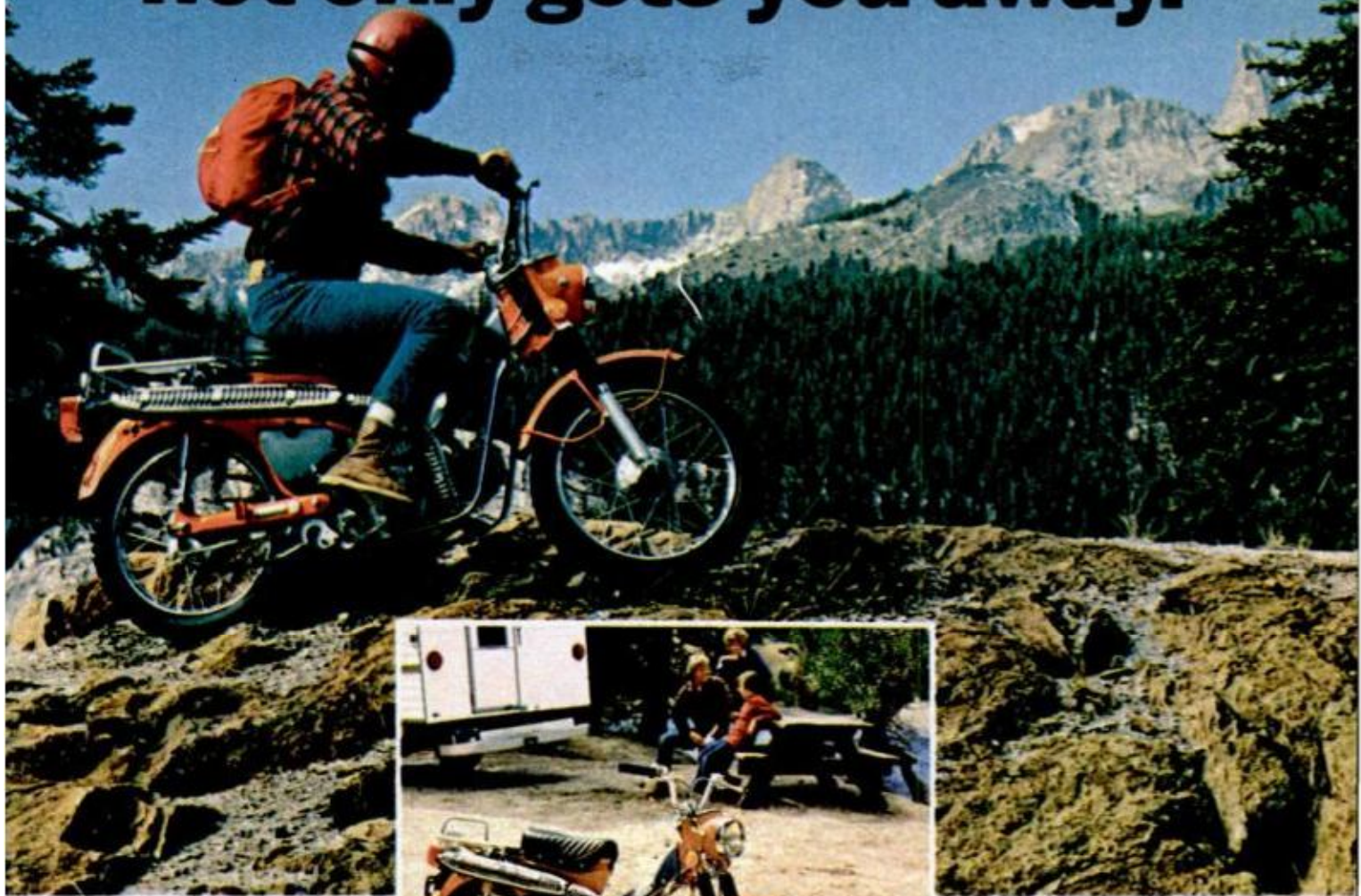

It gets you back.



A Honda CT-90 is dependable. And when you're riding rugged mountain trails, miles from the nearest road, that's the most important thing of all.

It's a bike designed specifically for the most intrepid outdoorsman. Dependability built-in throughout. Sure-grip knobby tires. Telescopic suspension. Adjustable carburetor. An eight-speed "Posi-Torque" dual-range transmission — high for taking it easy, low for rough riding and climbing.

The Trail 90 has the convenience features to go with its dependability. The handlebars can swivel for easy transport. A handy reserve fuel tank lets you explore further out than ever before. And a tripmeter built into the speedometer lets you know how far you've gone.

The USDA-approved spark arrester/muffler on the CT-90 helps protect the environment. While the wrap-around heat shield on the exhaust pipe helps protect you. And, of course,

for more protection there's the strong Honda warranty. You should become familiar with its provisions.

It all adds up to the trail bike more Americans depend on than any other—the Honda Trail 90. See it along with the many other models at your nearest Honda dealership. Honda has a model there for every different type of riding—trail, dirt, road, on/off road or minibike. And they're all Honda dependable.

HONDA

From Mighty to Mini, Honda has it all.

For safety, we recommend that you always wear a helmet and eye protection, keep your lights on and check the local laws before you ride. For a free color brochure, write: American Honda Motor Co., Inc., Dept. QB, Box 50, Gardena, Calif. 90247. ©1973 American Honda Motor Co., Inc.

Материал, эскизы и авторские права



TRI-LEVEL FIFTH-WHEELER from Ardon Mobile, Santa Ana, Calif., adds a double bed over tow-truck cab. Space in the 34-foot unit is said to equal a 42-footer

NEW RV RIGS

(Continued from page 156)

inspection system has improved vehicles available and kept the government from moving in to write RV building directives.

As of the first of this month, however, the National Highway Traffic Safety Administration, Department of Transportation, has issued a consumer information regulation requiring "manufacturers of trucks capable of accommodating slide-in campers to provide information on the cargo weight rating and the longitudinal limits within which the center of gravity for the cargo weight rating should be located." Pictures of where the camper should be placed on the truck and instructions telling how gear should be loaded will also be required.

Camper builders must also put center-of-gravity position labels on their rigs and weight of unit and equipment, with more data in an owner's manual, as of next September. Hopefully the new standard will "reduce overloading and improper load placement in truck-camper combinations, and unsafe truck-camper matching, in order to prevent accidents resulting from the adverse effects of these conditions on vehicle steering and braking."

Present estimates put about 4 million RVs on the road, ranging from \$300 tent trailers to \$50,000 motor coaches. Travel trailers sold last year totaled around 250,000; camping trailers, 108,000; motor homes, 102,000; truck campers, 110,000, and pickup covers, 150,000. Trailers are obviously the most popular RVs, aided by the new boom in fifth-wheel units, and motor homes are growing fast now that less expensive van conversions and chopped vans are swelling the market. Trailer sales increased 30 percent during

158



FORD AMERICAN ROAD is name of new luxury pickup camper you haven't seen before. Built by Starcraft for marketing through Ford dealerships, this slick 11½-footer made of 1-piece fiberglass claims full self-containment, two holding tanks plus design innovations



DOUBLE-DUTY TRAILERS, like All Sports Vehicle from Ace Traveler, Alfred, Me., has four swing-up bunks to allow rear loading of snowmobile or motorcycles



BUNKS FOR SIX, compact car towing, are among the claims for 13½-footer by Playpac Industries, Staten Island, N.Y. Rig even includes enclosed toilet room

the year but motor homes were up nearly 80 percent. Shoppers seem to like the idea of an RV with the motor aboard. The big car companies may sometime build assorted RVs as well. GM is producing a large motor home and Ford is working with Starcraft on a camper for Ford pickups.

Also on the market are tiny trailers for motorcycles and ATVs, rigs that collapse for garaging or open for travel with snowmobiles or trailbikes inside, and rigs to roll-along almost any size family. Americans seem to be rediscovering the out-of-doors. ★★★

POPULAR MECHANICS

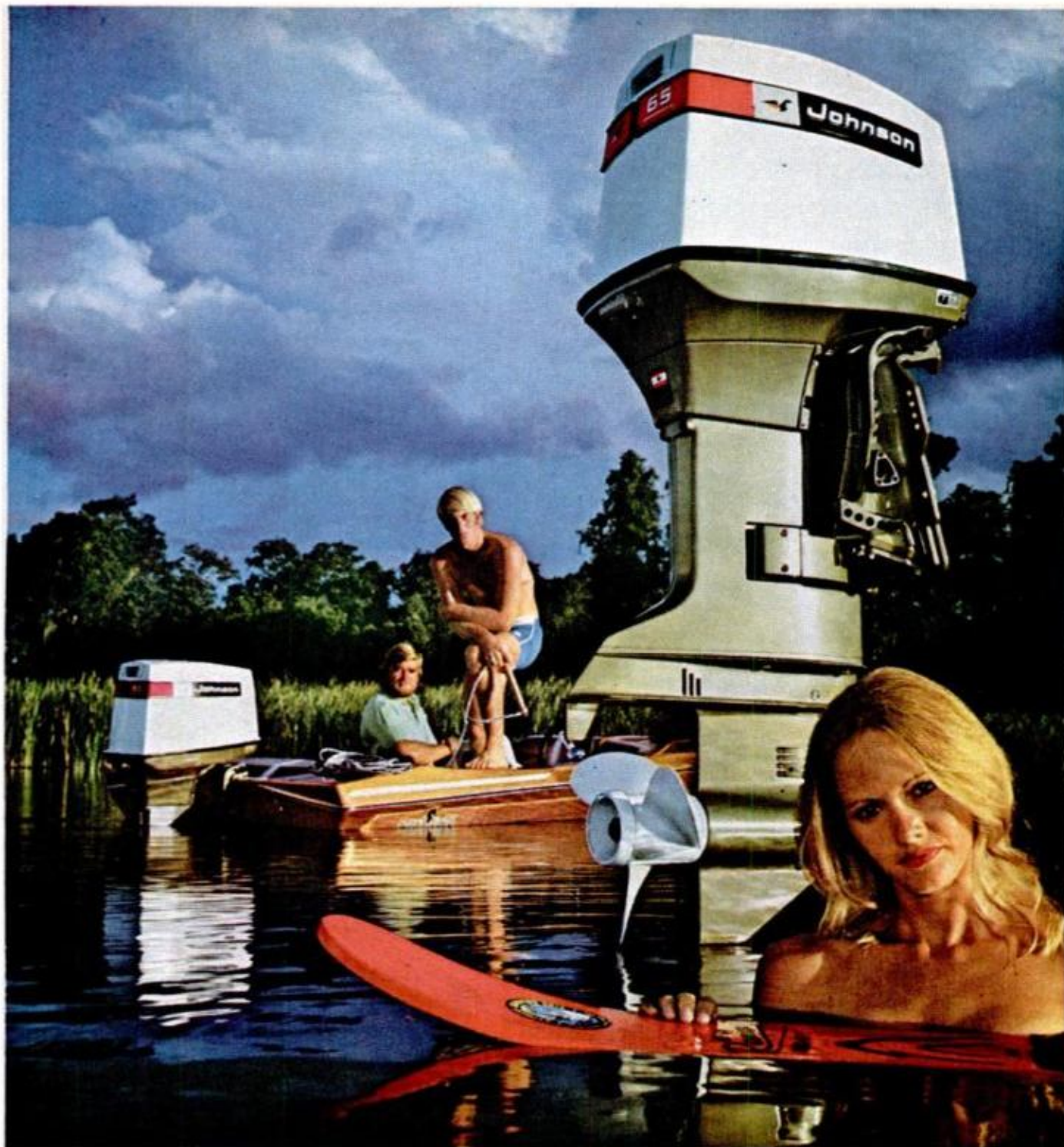

Free! Up to five extra miles of water skiing.

Johnson's 65 gives you more skiing, more cruising than comparable competitive outboards.

You get this extra mileage from every six-gallon tank of gas at mid-range speeds because the 65 is exhaust tuned and Loop-Charged.

Exhaust tuning means we use exhaust sound waves to pack more of the new fuel charge into the cylinders. For more power. On less gas.

Loop-Charging brings fuel in and pushes the exhaust out in one continuous power loop. Again, you get more performance without using more gas.

But we didn't stop there. Our MagFlash™ capacitor

discharge ignition system sends up to 37,000 volts of spark to the plugs in less than five millionths of a second. For quicker starts. Smoother running. Long plug life.

So visit your Johnson dealer's and consider a Sea-Horse 65. Or its Loop-Charged brother, the 50 hp.

Not only do you get a lot more skiing. You get a lot more engine. Write for free catalog.

First in dependability.
Johnson
 outboards

Division Outboard Marine Corporation Johnson Outboards, Sea-Horse Drive, Waukegan, Illinois 60085 Dept. PM-373



Chopped vans

Mini motor homes, coach vans—no matter what you call them, they're coming on in popularity



SUPERIOR has widened its van motor home by 14 inches without changing basic Dodge or Chevy chassis



MINNIE WINNIE is Winnebago's new van conversion with optional layouts with a bathtub or six-sleeper



STARCRAFT's Mini has front or rear-door layouts for use on Ford, Chevy, Dodge or Dodge Dual chassis

Fifth-wheel trailers

On the go with two wheels or four

NEWEST of travel trailers and a type unheard of five years ago, these versatile split-level models offer hitch security that makes it possible for passengers to ride aboard in some areas. Fifth-wheelers are

towed by pickups or ranch wagons, with trailer attached to the cargo bed. In sizes now from 18 to 30 feet and more, they are growing rapidly in popularity.

Usually the trailer's upper level over the cargo bed is fitted out with twin bunks or a double bed. Ardon Mobile, in Santa Ana, Calif., has even added an extension over the truck cab for a Tri-Level fifth wheel unit.



QUINSTAR 24-foot model is new addition to line of Coachmen 26 and 28 models. All three fifth-wheelers are mounted on wide-track tandem axles with four-wheel electric brakes. A three-way gas/electric refrigerator, 33-gal. holding tank and 12-volt converter system are standard



MOTOVATOR Mini-Motorhome from Cayo has aircraft look, dual holding tanks, full self-containment

BUILT ONTO THE BACK of vans and panel trucks, this turtle-type invention keeps the front cab and controls but offers walk-through space into a camper body that has standing headroom, bunks for four or more, plus fully self-contained kitchen and bathroom with even a bathtub in new plusher models. Prices rise rapidly from the cost of a luxury car to an average of under \$10,000. Bigger than the big station-wagon vans but smaller than truck-chassis motor homes, the chopped van is a less expensive way for a couple or small family to try touring in an RV that still feels much like a passenger car.



MIDAS MINI 220, new version of the smaller 190, claims special insulation and sleeps six to eight



FRANKLIN Travel Home comes with Dodge, Chevy or Ford chassis, options of eight-cylinder engines, dual rear wheels, full-sized bathtub and forced-air heat



EL DORADO has this new 18-footer for towing by imported mini-pickups and other small light trucks

MIDAS Model 290 Fifth Wheel is newest in an extensive line. Full bath, sleeping for six provided

CONTINENTAL's new Trans-Continental 30-footer has aerodynamic exterior and "stateroom" interior

MARCH 1973

161





BIGGER MODELS, like this 28-foot StarCruiser, now can offer optional interior layouts, including one with bathtub. Starcraft also makes 22 and 28-footers, plus a 35-foot Executive model suitable for business meetings



Motor homes

More style, convenience, dollars

ONE OF THE FIRST popular motor homes was the still-popular Volkswagen van camper, but now this booming section of the sport offers everything from minis to motor coaches built from converted interstate buses. Sales were up 88 percent in 1971, the last year for which figures are in, and although they're only 10 percent of RVs on the road, they took 35 percent of dollars spent. Van conversions, chopped vans and conventional motorized models on truck chassis all fit in the category of motor homes.

Domestic rig prices start around \$5000 and go skyward past \$20,000 when you leave stock rolling homes and head into customized vehicles. Self-powered and self-contained, they are big rigs to take from campsite to shopping center, but they offer luxury living anywhere a highway may lead a family of touring campers. ★★★

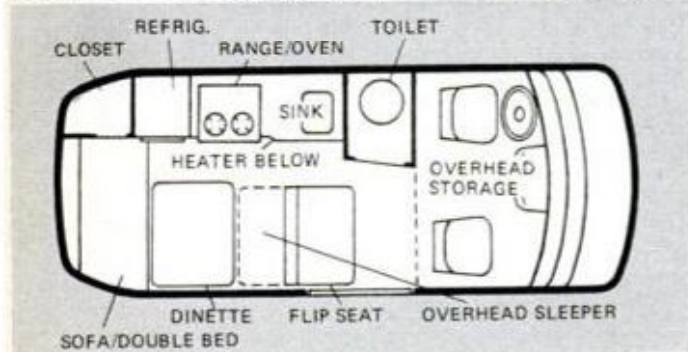

MINI MOTOR HOMES are increasingly favored by first-time buyers, renters. CamperRent, with 14 branches, offers this Open Road model, sleeping family of five



ADVANTAGES of compactly designed yacht cabin are in Kayot from builder of boats, fifth-wheel trailers

FIRST DIESEL motor home is claim of Monarch from Matoroam, a 25-footer on a Mercedes-Benz chassis





CANVAS or solid-state plastic sides are now options from Apache. Eagle 6 and 8 are six or eight-sleepers

Mini rigs

Compact camping is still thriving

MORE FUN in less space gets a new boost each year from the makers of small trailers. All are particularly suitable for towing with small foreign and domestic cars, and make handy camp cabins for sportsmen who don't mind a little crowding. Besides those shown, there's Playpac, Tri-Fab's Love Bug 13, Combi Camp 500, Trail King with a lifetime guarantee for its tent camper erection system, and Mini Kamper that can be towed by a motorcycle. ★★



MINUTEMAN is Coleman's name for its new flip-top camper. Setup time is said to be just 60 seconds

WILD WORLD from Apeco RVs can come in colors to match small car; has built-in bar, patio, sleeps five

MARCH 1973



SWING-OUT KITCHEN for serving inside or out with top up or down is feature of Starcraft Swinger 6



QUEEN-SIZED BED, claimed to be first in a camper trailer, is provided in Coleman's largest Yorktown



RV Drivers' CAMPING '73 **Report:** **Minihome**

Take a Ford Econoline, raise the roof, slick the interior, and sleep two in comfort—add more only if you must

By **BILL McKEOWN**
Photos by *Lorraine Laredo*

WHAT IS LARGE ENOUGH to be livable, small enough to be maneuverable and cheap enough to be practical? Every RV builder comes up with a different compromise for this cross between a house and a car, but one of the happiest I've driven is Travco's Minihome.

Originally it may have been ahead of its time. VW, Pop Top, Travco Div. of PRF Industries and other companies and individuals had been making camper conversions of station wagon vans and panel trucks for a number of years. But when Motor Homes div. of Travco in 1968 mated a fixed fiberglass top over the cut-out roof of a Ford Econoline, the result was a particularly sleek conversion. Its name, "Minihome," has now become almost the general name for miniature motor homes made this way.

Owners we've talked with immediately point out obvious advantages—and disadvantages. The rig is practically passenger-car size and easy to drive around town or on the highway without feeling you're steering a moving van. Drive it home, however, and the 8-foot height is



COVERED WAGONS used to take weeks, but today's van conversion wagon campers need only hours to cruise through Arizona ponderosas at Flagstaff and along the cliffs of Oak Creek Canyon. Minihome's high roof adds headroom, weight, cost and subtracts miles per gallon. Self-containment and accessories make inside living convenient, but compact. Airconditioning proves its value keeping out dust along back-country trails



too tall for the garage, a car wash or a drive-in movie. It wheels along at turn-pike speeds but may average 12 mpg or less if heavily loaded or bucking strong winds. Aerodynamically, it's remarkably clean, however, and strong gusts cause little more buffeting than in a passenger car, and nothing like the drifting a light imported van can experience.

Now the rigs are called Travco Family Wagons, are available on Ford, Dodge or Chevy vans and, along the way, have lost some of the early complaints. Given a rough road, the Minihome could bottom out with teeth-jarring slams. Owners of first models have switched, or should switch, to heavy-duty shocks. Brake fade was another scary trait of the Econoline that is now reported under control.

But old and new complaints, we find, are minor, and often the result of beginner RV-camper experience. An owner in Vermont reported he froze the kitchen plumbing of his rig shortly after buying it for the family for Christmas. He was unhappy, but admits he now drains his water

(Please turn to page 208)



PASTURE PARKING for camping, as above at RKO, Chugwater, Wyo., is easy with layouts such as those shown below. Front seats swivel aft for meals or drop-leaf table folds and rear seat opens into double bed. The rear doors open for a picnic access to stove

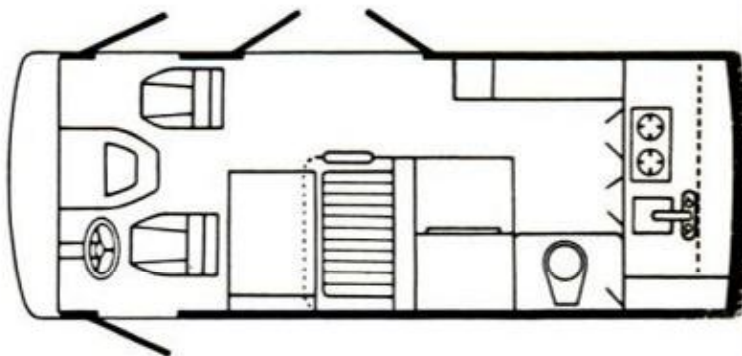

HARDLY BEEPING ITS HORN, Winnebago added a 20-foot motor home to its Brave series last summer, but first-time buyers and experienced rec vehicle owners soon discovered this to be one of the best buys on the market.

The 18-foot Brave is the bottom-dollar model at \$6700, but the D-20T offers far more than its additional 2 feet 8 inches for \$705 more. What appeals most to buyers is the straight aisle plan with twin gauchos in a rear lounge area. A table that folds into the rear wall can be extended with leaves to seat six to make a "family size" dinette. The gauchos, with back cushions removed, can be used as twin beds or can be converted to a king-size 7x7-foot bed. Large glass areas give the lounge a wide view.

The D-20T is built on the Dodge 125-

inch wheelbase; the D-18 on the 104. At 20 feet 11 inches overall, this "Winnie" is only slightly longer than a full-size station wagon, yet its 6-foot 4-inch interior height provides more full headroom than mini motor homes of the same length. The front bunk folds up; driver and copilot don't have to crouch to get into their seats.

The galley has double stainless-steel sinks, 4-cu.-ft. gas/electric refrigerator, three-burner range and range hood with exhaust fan. The bath has marine toilet, shower, lavatory and medicine cabinet. The unit has a 46-gallon pressurized water system, 6-gallon water heater, 30-gallon holding tank, and a thermostatically controlled forced air furnace. Plenty of cabinet space helps to keep the vehicle shipshape.

After a six-month test of this model we rate it "Excellent" for livability. It can



Motor home test:

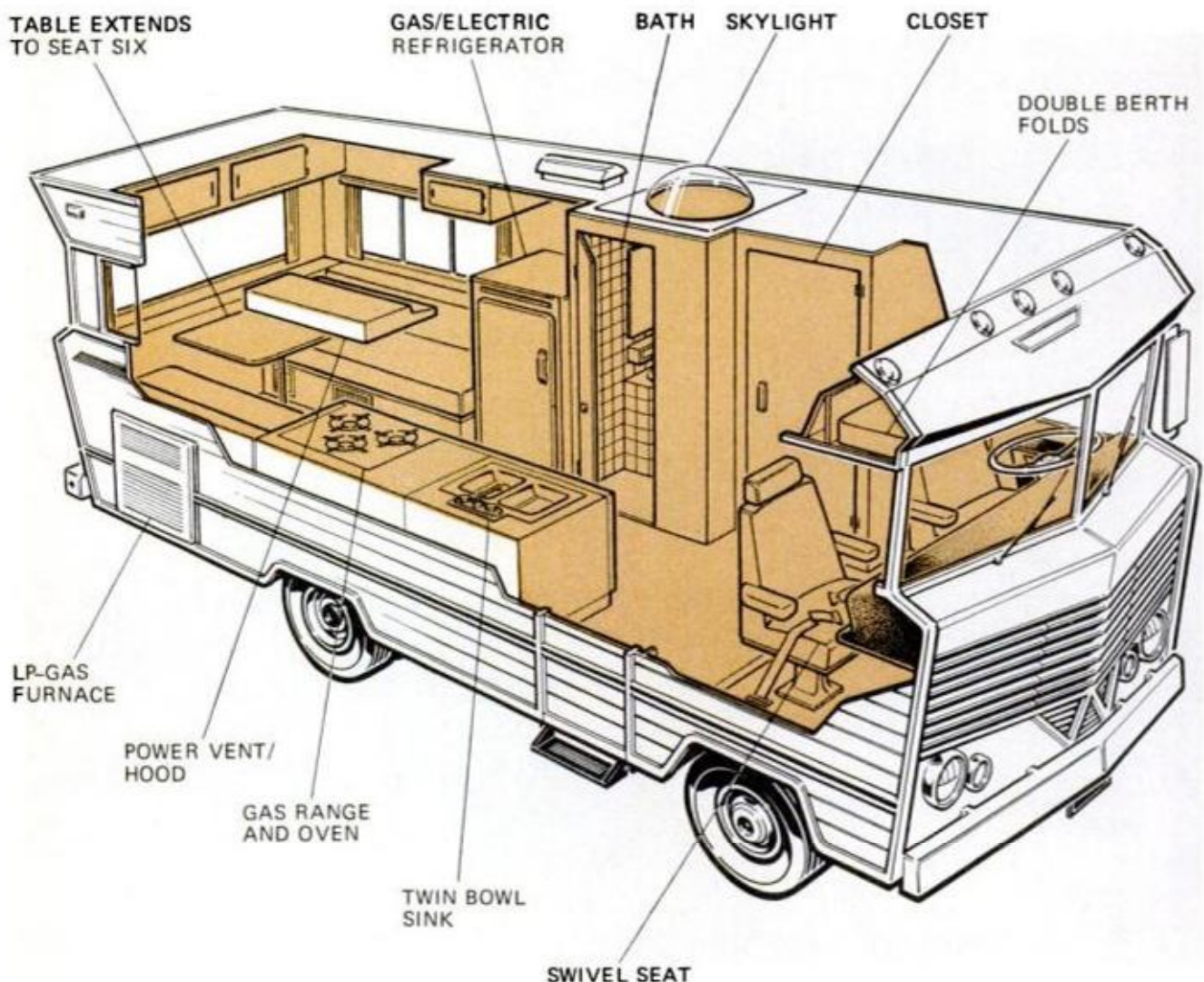

accommodate four adults with ease, or two adults and three or four small children—if the youngsters use the 7x7-foot bed.

We can give only a "Fair" performance rating to this unit which comes with the Dodge 318-cu.-in. engine. The 318 is a troublefree powerplant, but with a GVW of 11000 pounds, the D-20's cruising speed, drops to a maximum of 40 on most long turnpike grades. If downshifting manually to second to maintain rpm doesn't bother you, you'll get your kicks from knowing that you have a durable powerplant. The 413-cu.-in. engine (optional at extra cost) is the answer if you want more power. Gas mileage, as any motor home owner knows, depends on what way the wind is blowing and how hard you want to push. Fully loaded and cruising at 50, the D-20 will get 7 mpg.

The ride—for passengers in the lounge area—is rough. The driver and copilot come off easier but they know they're on a truck chassis. But the stiff suspension has advantages: stability in turns and less buffeting from crosswinds and passing trucks.

D-20T owners we interviewed are generally well pleased with their '73 models.

"Much more stable in crosswinds than my previous motor home (another make)," says a highway engineer. "Well satisfied with the body construction and cabinetry," says a Pennsylvania carpenter, "but the 318 seems to be lugging on hills unless I downshift." "Enough room in the galley so we aren't squeezing past each other." "I'm 5-foot-7," says a retired postal worker,

Please turn to page 208

Winnebago D-20T

By JIM LISTON, Editor



LARGE GLASS AREA gives rear lounge a three-way view. Our test vehicle had 4000-watt powerplant and 10,000 B.T.U. roof air conditioner (both optional). Cooler runs off powerplant on road, does excellent job without need for car air. Forced-air furnace keeps vehicle warm in coldest weather. Luggage rack and ladder proved to be useful options. Tire mount swings left to give access to compartment

WINDSHIELD and all windows are tinted for more efficient airconditioning. Two 70-amp. batteries are accessible on slide-out tray behind left front wheel. Twin 30-lb. LP-gas bottles are carried in left rear compartment. Floor plan (opposite) shows wide middle aisle that gives this model spaciousness found only in larger motor homes. Not shown are additional cabinets over sink and range



Driver's Report: Grumman

PM TEST VEHICLE, here at KOA campground near Montreal, was a 25-foot, rear-bath model on International chassis with 392-cu.-in. International engine. Pilot and copilot (below) sit in comfortable, adjustable pedestal seats. Motorhome sleeps six in two couch/beds (diagram, facing page), two bunks and the dinette's double bed



PM driver agrees with owners who like its solid construction

THE GRUMMAN NAME, which appeared on rugged World War II carrier-based aircraft and on the spectacular Apollo moon lander, connotes durability to those who buy Grumman Motorhomes. In interviews with owners, we found near unanimous praise of the vehicle's "solid construction." Even the strongest critic agreed on that point.

The ".102-inch lifetime aluminum plate body," Grumman literature explains, is so tough that "a .38-calibre bullet fired at close range wouldn't penetrate." We didn't try any wild experiments like that with our test vehicle, but preferred to take the claim on faith.

Neither did we do any slow rolls to prove that its "riveted and welded body plate" is sufficiently supported by "Z-bar and channel-bar aluminum extrusions" and the aluminum flooring by its "I-beam section carlings spaced eight inches on centers." But tooling along the highway, you really do have the comfortable feeling of being surrounded by a solid, pro-

(Please turn to page 210)

Motorhome

By JOHN A. LINKLETTER

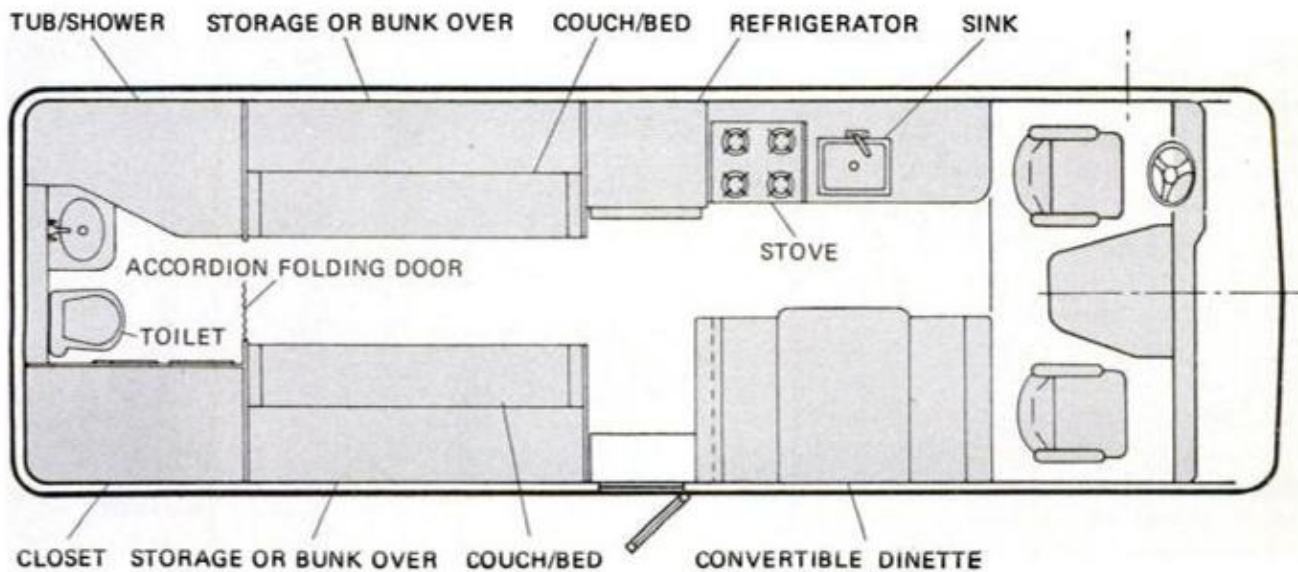

How to buy or rent

By **WAYNE HARRIS**

Illustrations by Roy Grinnell

WITH OVER 4 MILLION used recreational vehicles around today, there are plenty to choose from for the camper who wants his fun on the go. Good older models are cheaper now, and if you still can't afford your choice—form a club (as boatmen and pilots do) and buy your dream machine as a joint venture.

Having several people check over your selection is a good idea anyway. Second-hand RVs can have all the problems of a car *and* a home. RV performance and ap-



TEST motorized RV for heat buildup by stopping and accelerating on hills

pliances differ from autos and houses, however. It is well for a newcomer to rent first (see checklist at right) to learn which type of vehicle is best for him, and how all the gadgets work and are maintained.

First, look over the outside of the rig. Any dents, punctures, rust spots on the sides? Loose plumbing underneath? Gouges in the roof? Many owners have driven through the woods where low branches could rip the top, but have never used a ladder to climb up and check the roof condition. Dents won't matter much, but a hole that has let in rain could have caused inner-wall damage that may not show. Small side repairs can often be made inexpensively with epoxy putty. But a smashed corner where roof and two sides meet, or the bottom panel of a rounded metal-riveted coach, where other panels may have to be removed, might take up to a \$500 professional repair. Get estimates and a deduction from your purchase cost.

170

Rips in the canvas of a tent camper can be repaired by an awning shop, or possibly replaced by the manufacturer if you are buying a model from one of the long established companies like Apache, Starcraft, Nimrod. Flat fiberglass punc-



LEAN to side, tongue-heaviness or back droop can indicate bad springs, loading

tures are easy to fix, but slashes or broken curved contours may require a quote from an RV or boat-repair shop. An auto-body shop can give an estimate on steel frame and sheet-metal work. And look at the tires. Replacement could cost under \$20 a pair for a small trailer to several hundred for a set of steel-belted radial wide ovals on a big motor home.

Inside the rig, jump on the floor and push on the walls. If construction seems flimsy, pass it up. Stains around windows and vents may indicate minor leaks that can be inexpensive to seal and fix, or a hatch left open by mistake during a rain squall. But water seepage into inner walls may have started wood rot and structural problems. Fill all water tanks and look, as well, for leakage from plumbing. Accessible joint leaks can be cured, but tearing out walls to find a break could be too expensive.

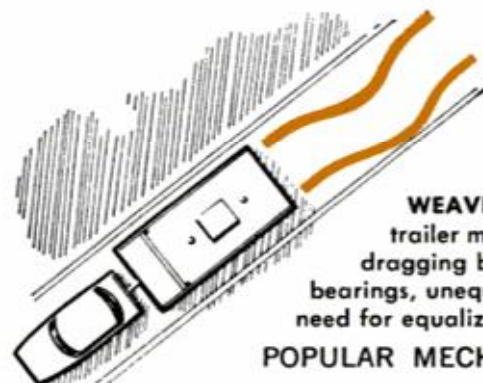

WEAVING of a trailer may show dragging brakes or bearings, unequal load, need for equalizing hitch
POPULAR MECHANICS

a used RV

All LP-gas and electric appliances—stove, lights, refrigerator, furnace, air-conditioner, water heater, pumps, intercom, plug-in outlets—should be operated long enough to be thoroughly tested. Using a well-tuned TV set, does the picture roll because the generator is off-cycle? At least you know before you buy.

Musty interior? It may be evidence of soggy inner walls. Proceed with caution. Lots of dust around? The rig may have a sprung door or windows that don't quite close. Tap water discolored? Toilet holding tank clogged? Find out why before you buy. An RV dealer can give you replacement costs of a new stove, toilet, furnace or refrigerator. You may arrange to have the expense deducted from the purchase cost.

A road test is essential for a motorized RV and helpful with trailers as well. Does the trailer or mounted pickup



LEAK MARKS around the windows? Sealant should fix this, but check for wall damage

camper lean to one side? Check for broken springs. A rig that sways and fish-tails may require an equalizing hitch. Test brakes and check wheel bearings as well.

A pickup camper body must be removed to check the condition of the cargo bed, camper floor and jacks. Underway, watch for excessive sway, rear sag, fender rub. Try to test a motor home for several hours, stopping and starting on a steep hill to check overheating, transmission slip, ping, brake fade and wheel-bearing squeal.

Bargain orphan RVs are around from companies no longer in business. But you may never locate replacement parts. ★★

MARCH 1973

RV rental checklist

Is this the RV for you? First be sure the rig is big enough for your family, hunting and fishing buddies, or in-laws—whatever the size of the gang that's going along. A cute little "six-sleeper" may be comfortable at night for only four adults.

Enough room and privacy? If you're trying to sell your wife on the sport, be sure to pick a model she feels comfortable in, and won't catch cabin fever if a long, rainy weekend cages you all inside with the dog, cat and kids. Rent one with an enclosed bathroom and more space for longer trips.

Big motor home? Little van conversion? Pickup camper? Travel trailer? Tent-type camper trailer? Look over accommodations and accessories of each. Take a short trial trip near home first.

How does it work? Part of your rental fee should include a complete demonstration of all features and appliances before you leave. Ask lots of questions, even if you think you know the answers. The water pump, toilet, galley or furnace may work differently than others you've seen in use. If the rental dealer can't give you printed instructions, take notes. If he doesn't have time to let you open the tent trailer, start the generator or light the oven while he watches, shop elsewhere.

Can your car tow the rig? Makeshift trailer hitches are unsafe with any trailer. For rigs over 1500 pounds, consider a load-equalizer hitch. Is your car in shape to pull a load behind, stop it, lug it up hills in hot weather? Ask a mechanic who knows. Add extension side mirrors if rear vision is impaired.

Does the refrigerator work? Many new RV renters don't know they may need a bubble level to be sure their LP-gas refrigerator base is absolutely horizontal.

Does galley faucet produce water? Have dealer fill your tank and show how hand, electric or air-pressure water system works. Note if tank makes water smelly or unpalatable.

Electric lights turn on, appliances work? See if heavy-duty extension cord for campground outlet is supplied, if auxiliary battery for lights supplements engine-starter battery.

Generator supplied? Learn how to start and service it. Locate 110-volt outlets.

Toilet aboard? Find how it works, when and how it is emptied.

Water heater? Learn how to light it.



Gear to go

Add-ons and accessories aid convenience, comfort



TOP THAT GOES UP for headroom and down for garaging is offered by Pop Top Co., Mentor, Ohio, for all van models, including VWs, from 1962 on. Original top can be cut out by sabre saw for home installation, or done by a dealer.



FOR CHOCKING the wheels of a boat, travel or tent trailer parked on a slope or ramp, or for use with any car or RV while you change a tire, the folding Wheel Block from Valley Tow-Rite, Lodi, Calif., is available. It's \$5.26 at marine and RV accessory dealers.



CUSTOM CAB, a four-door seating five, is built on Ford, Dodge and Chevrolet $\frac{3}{4}$ and one-ton chassis by Tri-Van Inc. for fifth-wheeling. Storage box, mid-opening gate are added.



LEVELING a camper can be the trick to make a refrigerator operate, pots stay on the stove and a bed stop sloping. For \$21.95, the Level-It, Box 4097, Fresno, Calif., is an answer.

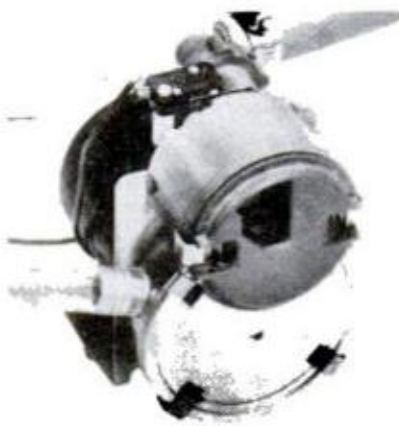

NO FREEZE-UP in winter, no cycling water spurts, no damage from city pressure are claims for Electra-Flo pump, \$45 from Humphrey Products, Kalamazoo, Mich.

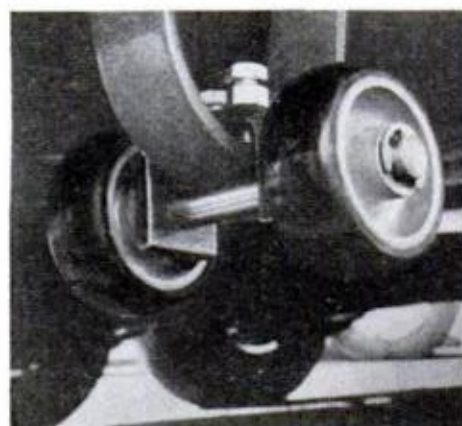

BOTTOMING of trailer tail on rough terrain, driveway curbs is said to be prevented by bolting new Skid-Roll on rear skid bars. Advance Products, Pinole, Calif.

POPULAR MECHANICS



UTILITY BOX BODY is the name for this new option from International trucks. Camper special or vocational pickups with it can offer lockable storage space that also helps keep weight low for good balance with camper insert.

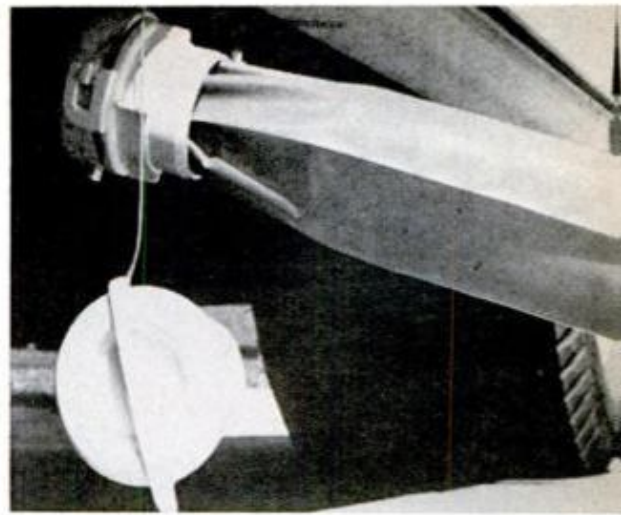

UNPLEASANT CHORE of holding tank dumping is made easier with Dispos-A-Hose, Promotional Engineering, International Falls, Minn.



EVEN A MOTOR HOME, camper or trailer with high roof can carry 300-pound 16-foot hull using Load-A-Boat system of American Recreational Products, Lynnwood, Wash.

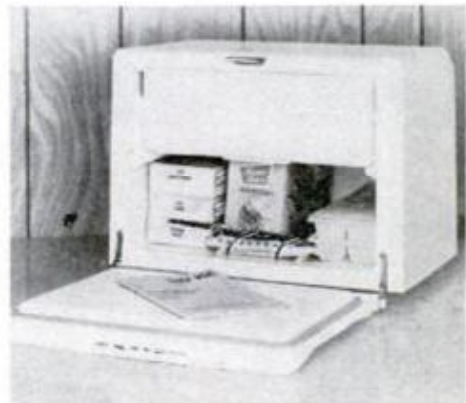

QUICK SHIFT from icebox to freezer is possible with BMC Kardel Freezer Insert, by Blackstone Mfg., 4630 West Harrison, Chicago. Ice cubes in 45 minutes.

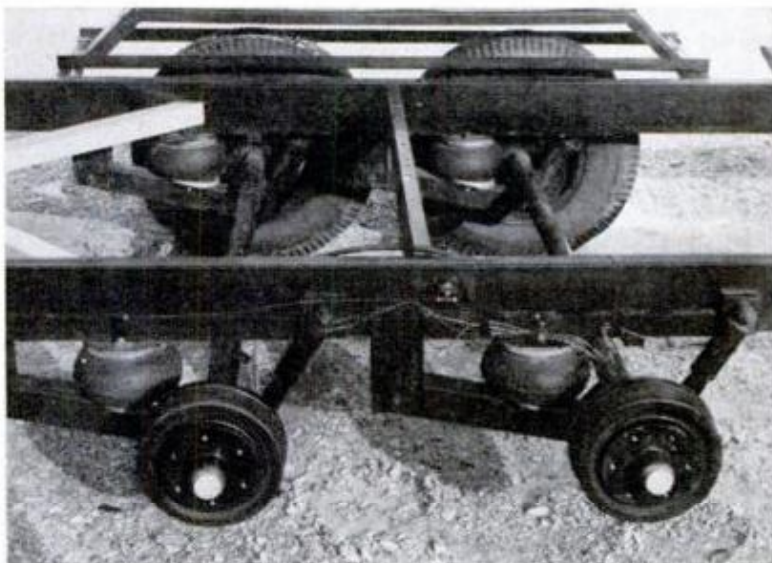

RIDING ON AIR is reported to ease out the bumps for travel trailers. Hammer Blow Co., Wausau, Wis., provides Air Ride suspension systems for tandem-axle motor homes as well, can offer dashboard-controlled campsite leveling.



VOLTAGE VARIATIONS, a campsite threat to airconditioners and TVs, are checked with \$13 meter of J. F. Ivan, Governor Ave., Cleveland.



Know what it takes to tow

By MORT SCHULTZ

ARE YOU going to buy a 1973 car that will be used to tow a trailer weighing over 1000 pounds?

Even if you aren't sure, it would pay to order the car from the factory with trailer-towing equipment. Having to outfit the car later after you've taken delivery

- NOTES:**
- (1) No changes required for 1000-2000-lb. trailers
 - (2) Except Eldorado
 - (3) Standard on Caprice, Impala, Bel Air sedan, wagons
 - (4) Standard on Laguna, Malibu, Deluxe wagons
 - (5) Standard on Caprice, Impala, Bel Air, Monte Carlo Sedans and all wagons
 - (6) Standard on Caprice, Impala, Bel Air sedans and wagons and on Monte Carlo
 - (7) Can tow up to 7000 lbs. with more powerful engine
 - (8) No changes required for up to 1500-lb. trailer
 - (9) Standard on Coronet and Satellite wagons
 - (10) Can tow up to 4000-lb. trailer with standard V8 engine; up to 6000 lbs. with more powerful engine
 - (11) No changes required for up to 2000-lb. trailer
 - (12) Can tow up to 5000-lb. trailer with standard V8 engine; up to 7000 lbs. with more powerful engine
 - (13) Standard on wagons
 - (14) No changes required for 1000-3500-lb. trailer
 - (15) For high-temperature, heavy-traffic or hilly terrain operation, or if trailer is wider than front of car
 - (16) Optional V8 engine required on Catalina only
 - (17) For cars without airconditioning

Trailer towing equipment for passenger cars

Car Manufacturer and Model	Trailer Weight (lbs.)
American Motors—All Models	1000-2000
American Motors—Ambassador, Matador	2000-5000
American Motors—Jeep Wagoneer (1)	2000-6000
Buick—All Models (1)	2000-3500
Buick—Centurion, Electra, Estate Wagon, LeSabre, Riviera	3500-6000
Cadillac—All Models	1000-2000 2000-6000
Chevrolet—All Models	1000-2000 2000-4000
Chevrolet—All Station Wagons	4000-6000
Chevrolet—Bel Air, Caprice, Impala Sedans	4000-7000
Chrysler—All Models (1)	2000-5000
Dodge—Dart	1000-2500
Dodge—Charger, Coronet (8)	1500-4000
Dodge—Monaco, Polara (11)	2000-5000
Ford—Pinto	1000-2000
Ford—Custom, Galaxie, LTD Brougham, LTD	1000-2000 2000-3500 3500-6000
Ford—Torino	1000-2000 2000-3500 3500-6000
Ford—Thunderbird (1)	2000-6000
International—Travelall (1)	2000-6000
Lincoln (14)	3500-6000
Mercury—Full Size	1000-2000 2000-3500 3500-6000
Mercury—Montego	1000-2000 2000-3500 3500-6000
Oldsmobile—Omega	1000-2000
Oldsmobile—Cutlass	1000-2000 2000-3500
Oldsmobile—Custom Cruiser, Vista Cruiser, Toronado	1000-2000
Oldsmobile—Custom Cruiser	2000-3500 3500-7000
Oldsmobile—Vista Cruiser	2000-3500 3500-6000
Oldsmobile—Toronado	2000-3500 3500-6000
Oldsmobile—Delta, 98	1000-2000
Oldsmobile—Delta	2000-3500 3500-7000
Oldsmobile—98	2000-3500 3500-7000
Plymouth—Valiant	1000-2500
Plymouth Satellite (8)	1500-4000
Plymouth—Fury (11)	2000-5000
Pontiac—Bonneville, Catalina, Grand Safari, Grand Ville, Safari	1000-2000 2000-3500 3500-6000

Know what it takes to tow

from the dealer may vary from costly to almost impossible.

The average price for having trailer-towing equipment installed in a new car at the factory is between \$100 and \$200. Adding this same equipment after the car has been built might boost this cost to nearly \$500.

What you will need will differ from car to car and from trailer weight class to trailer weight class, but generally will include heavy-duty suspension, heavy-duty cooling, heavy-duty charging system, wiring harness and a high gear ratio rear end.

Most cars and RV drivers also benefit from a more powerful engine, automatic transmission, power brakes and power steering.

"Can't I leave the selection of this equipment to the new-car salesman?" people ask.

It isn't wise. Some salesmen don't know

The average price for having towing equipment installed in a new car at the factory is between \$100 and \$200.

beans about trailer-towing equipment, while others will try their best to sell you everything but the automobile agency itself.

It is best to make your own selection. The chart with this article, summing up the necessary changes that should and can be made to 1973 cars that may tow trailers, will help. Use it in conjunction with the manufacturer's list of "tow packages" and trailering equipment, which you can get at a dealer's. Then pick out the exact items you will need.

But be conscious of two terms you will encounter on many manufacturers' lists—"required" and "recommended."

"Required" refers to equipment your car

must positively have to pull a trailer safely.

"Recommended" equipment refers to equipment that is nice to have, but not really necessary. It includes such things as airconditioning, automatic speed control, steel-belted tires and a dual exhaust system.

Give careful consideration to the kind of driving you will be doing. RV trips are not much like the local runs to work, shops or a neighbor's house. Owning a rig that can travel cross-country will mean you'll probably want to go. Towing your first trailer on your first camping trip, in fact, you are likely to plan for higher speed and longer distances than are wise. Fast driving is possible, but it takes more concentration and is more fatiguing. An airconditioner, for example, may more than pay off on long hot runs across a desert or in the muggy traffic of a tropical resort. Even the reduction in road noise which closed windows and an airconditioner can provide will be helpful in delaying that tired feeling and can aid driver safety.

Mountains are often a question mark for the flatlands driver. Every year travelers do trail across mountains without special equipment or problems, in well-tuned cars and with special care and careful driving to prevent overheating of engine and brakes. But hill country is attractive and pleasant to visit, and a trailer owner should move the options of more power and cooling from "recommended" to "required" if much mountain travel is planned.

Off-road running on gravel and woodland trails is also a good argument for larger tires.

Some manufacturers offer trailer-towing equipment as a "package." Ask about this, but note that all necessary items may not be included.

Most carmakers do not offer a hitch. Consult your trailer dealer for proper choice of this essential item. ★★★

The Great Pickup Mystery.



When most people think about buying a pickup they usually think about just two makes—Ford and Chevy.

Which is precisely why we call INTERNATIONAL "The Other Pickup."

But just because we're not exactly a household word doesn't mean we don't make a great pickup truck. We do.

And if we could just get people to look at us they'd make some surprising discoveries.

First, we have a really smooth ride. And we handle beautifully. And you can select an economical six or any one of three powerful V-8's. Or choose between torsion bar or leaf spring suspension. Or have automatic transmission, power steering and power brakes.

And there's important safety features like a collapsible steering column, a fuel tank located outside the cab and an anti-skid system, available on two models.

So before you buy a pickup, try ours.

The Other Pickup. At your International dealer.

Some people come away saying it's not The Other Pickup.

It's the only pickup.



International. The Other Pickup.

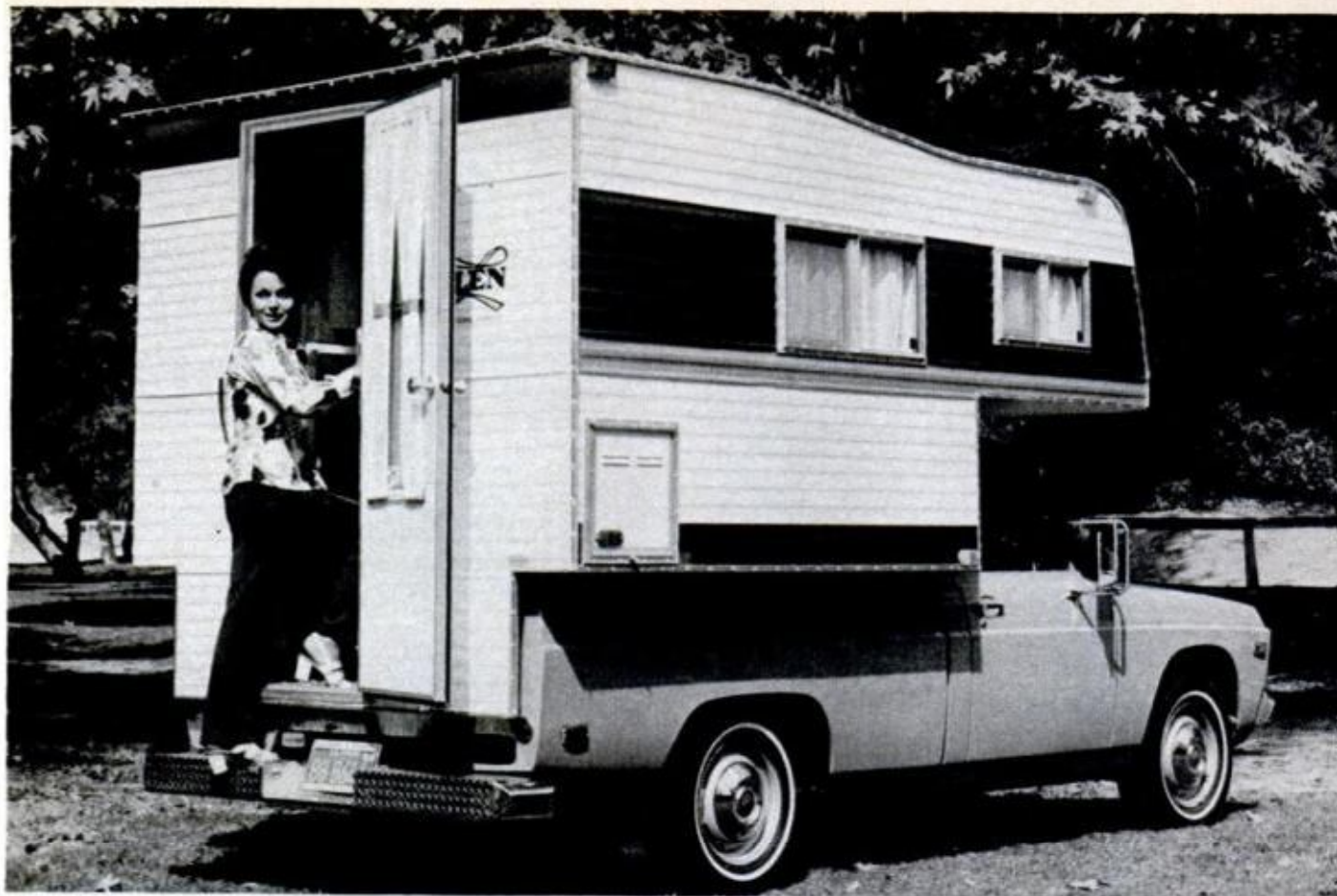

Cabover camper you can

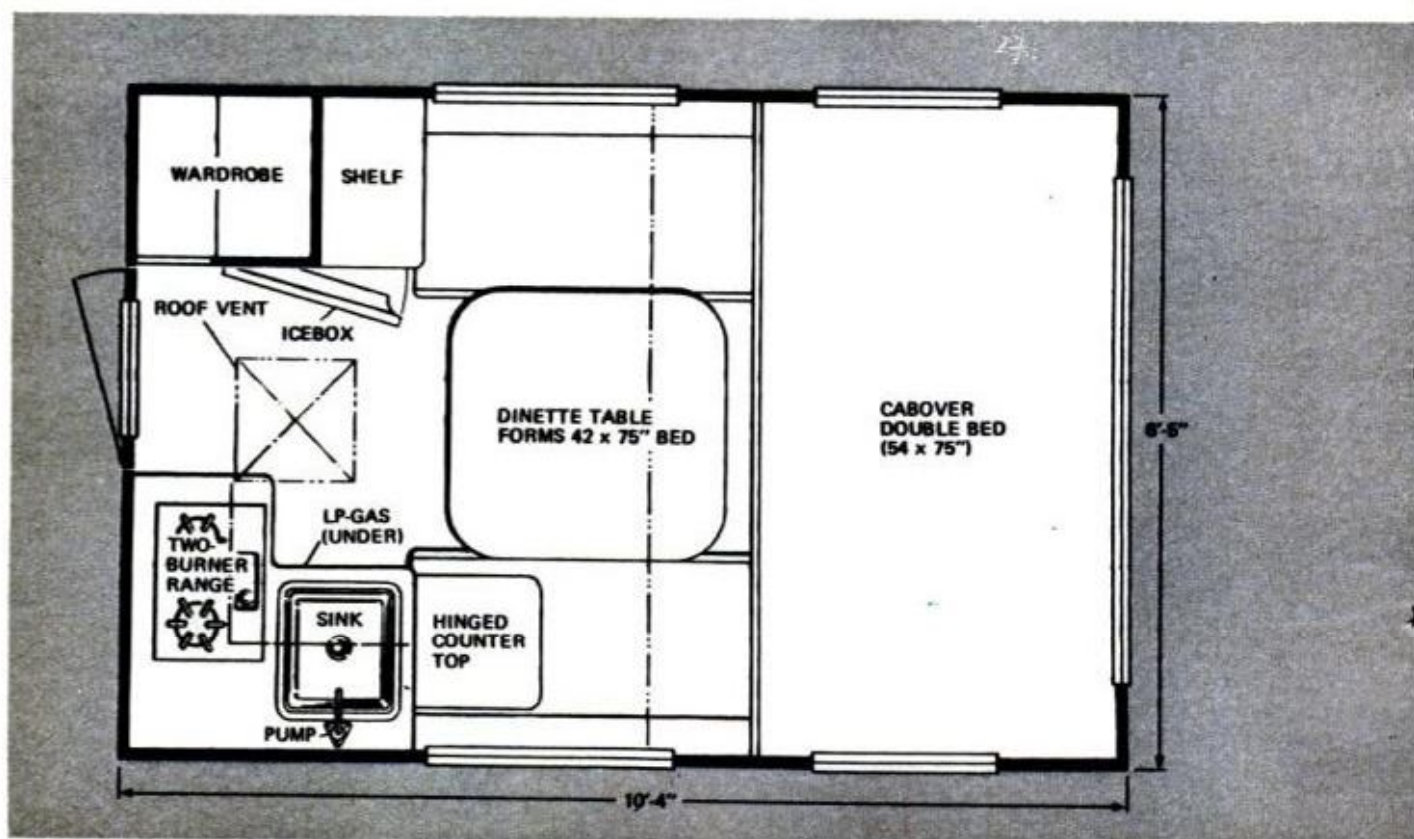



TINY KITCHEN AREA contains two-burner range, sink and self-contained water supply. An icebox is installed on the opposite side of the camper

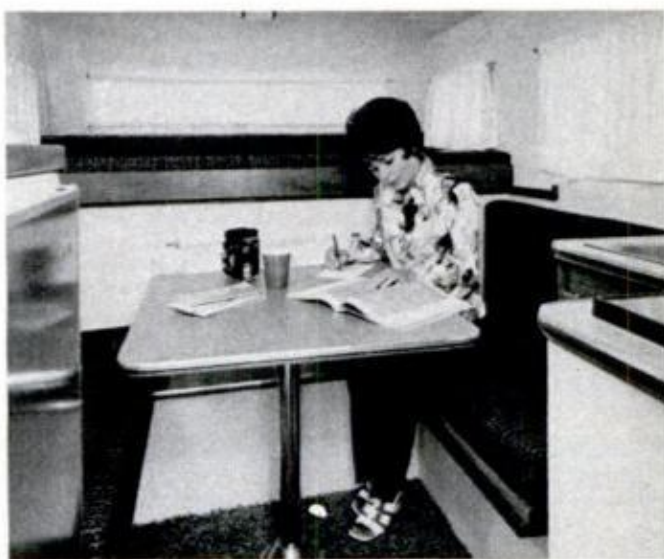

DINETTE TABLE provides the main work surface. It is made of plywood covered with plastic laminate. Leg is removable to permit lowering of tabletop to form bed

build for a compact pickup

For less than \$2800, you can have a good-looking, practical camper that sleeps four adults. You build the camper unit for \$607 and anchor it to a new—or used—lightweight truck.

THE "IMPORTER" doesn't provide all home comforts, but for \$607 in materials and equipment—plus your time and know-how—it can convert a typical light pickup into a cozy camper for four adults.

The designer—Glen L Recreational Vehicles of Bellflower, Calif.—says the camper will fit shortbed pickups such as the Datsun, Toyota, Mazda, Chevrolet-LUV or Ford-Courier. Glen L used a Courier—bought in California for \$2150, including taxes—for purposes of this article. Construction photos begin on page 180.

The finished camper reportedly has a "dry" weight of about 850 pounds, a safe load for the small truck. Glen L's Courier-Importer combo averages 17.7 mpg in city and freeway driving. ★★ ★



CAMPER SLEEPS FOUR—two on cabover bed and two on bed made by bridging space between benches with tabletop. Cushions double as mattress

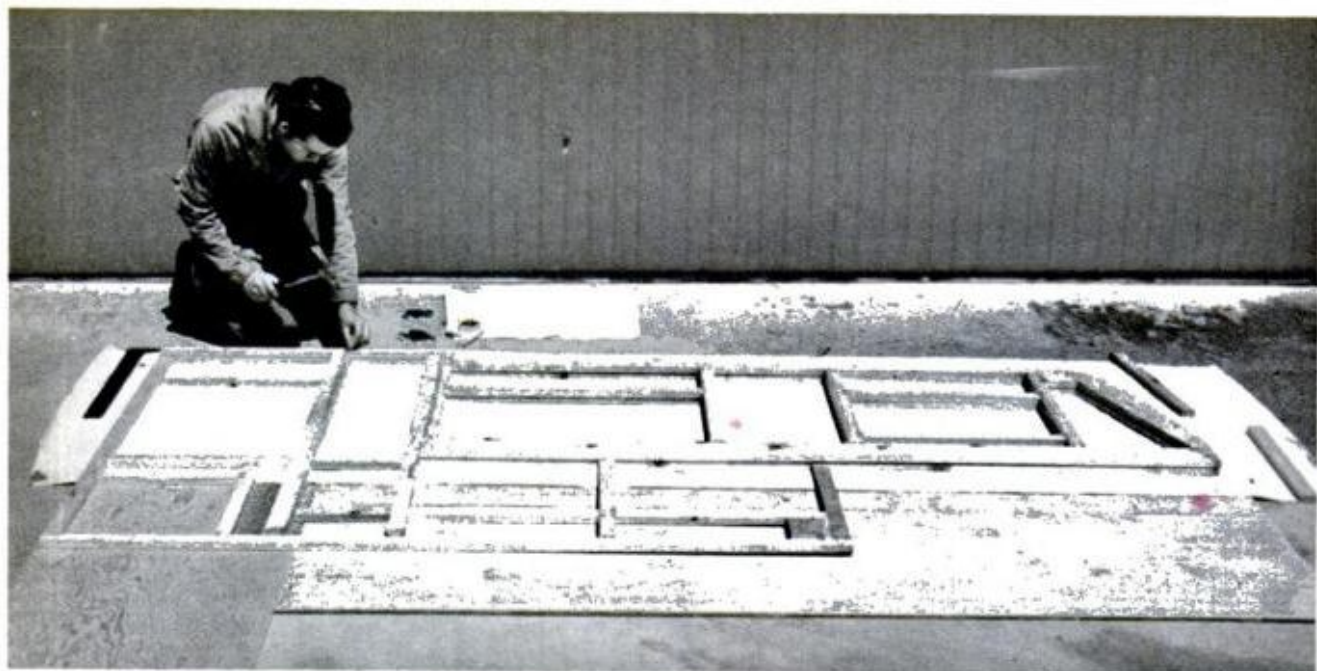

SIDEWALL is fabricated over plywood base covered by full-sized pattern. To assure accuracy, the second sidewall should be assembled directly over the first

FLOOR AND "SIDE WINGS" are glued and screw-fastened. Construction throughout is of $\frac{3}{8}$ -inch plywood. Thicker plywood would add unwanted weight

(For more construction photos, see page 182)

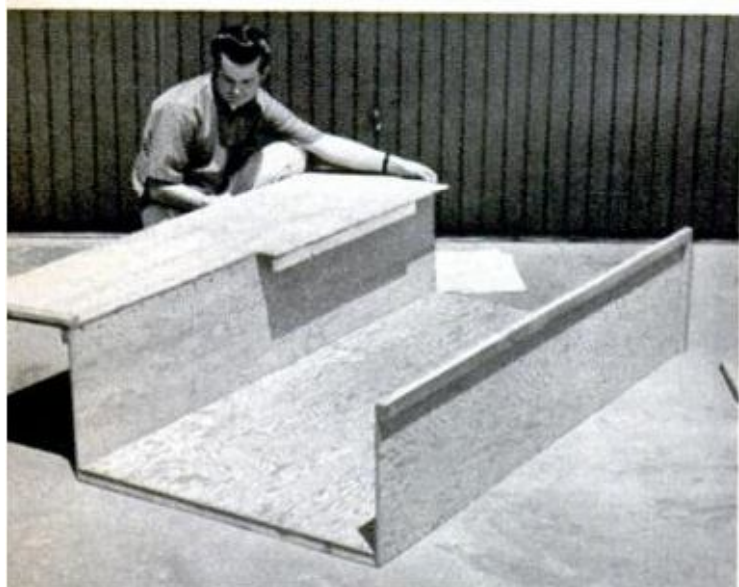

SCREWS AND MASTIC are used in joining sidewall to the front wall. Mastic is used where gluing is not practical and where an airtight joint is required

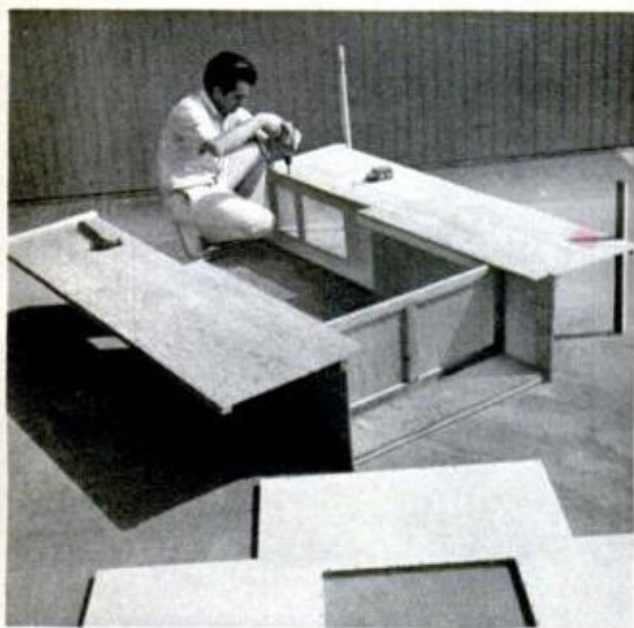

UPRIGHT "LEGS" are used to support the side-wings during assembly. The finished front wall can be seen lying in foreground. Note window cutout

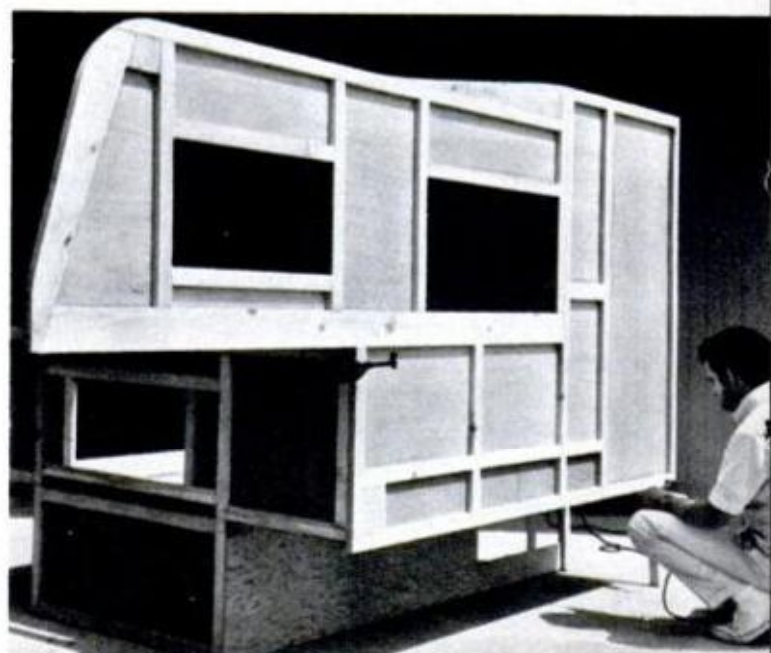

Get away from the crowd.
Get the flavor you want in
Old Gold Filters.



20 mg. "tar," 1.1 mg. nicotine
av. per cigarette. FTC Report Aug. '72

Warning: The Surgeon General Has Determined
That Cigarette Smoking Is Dangerous to Your Health.

CABOVER CAMPER

(Continued from page 180)

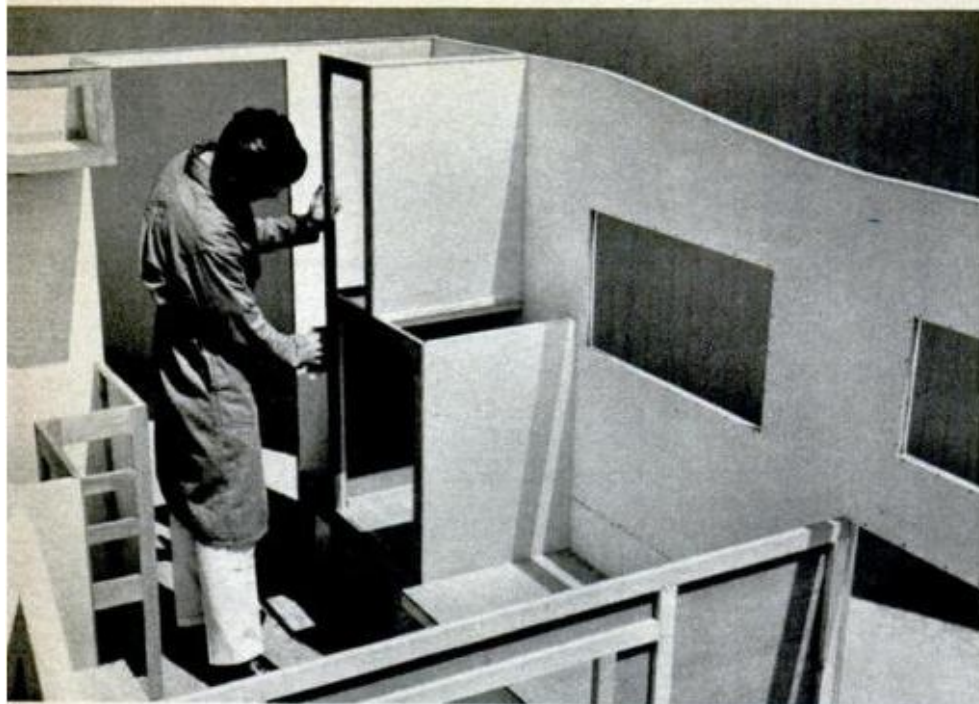

AFTER WALLS are joined, much of the interior can be completed. It's best to put in the cabinets before installation of the roof. The fronts of cabinets can be built of solid wood and doweled at corner joints. Doors should be of the panel type, rather than of the solid variety, to keep the camper's weight down

THE ROOF is preassembled in sections. Starting at the front, the first roof panel is progressively bent into place and screw-fastened to the tops of the sidewalls. Successive roof sections are butt-joined at the time they are laid over the roof beams

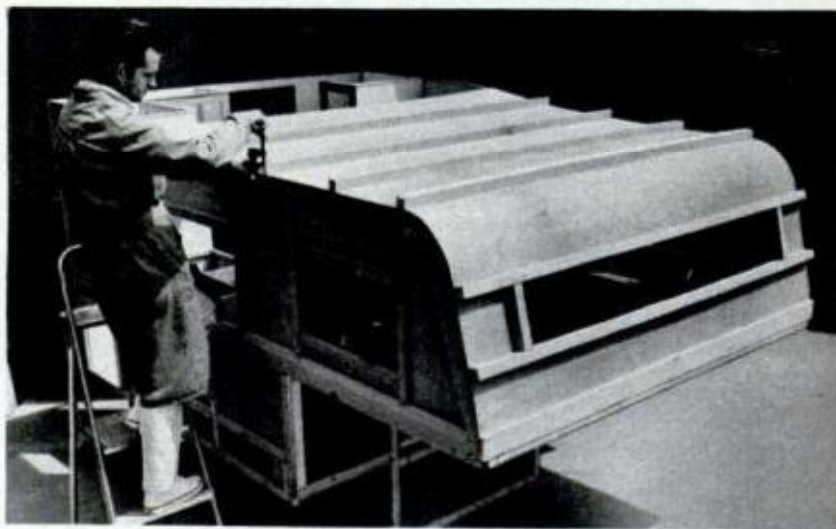

ALUMINUM SKIN is started at the top. However, before any aluminum is put on, the camper's entire surface is checked for protruding nails or staples

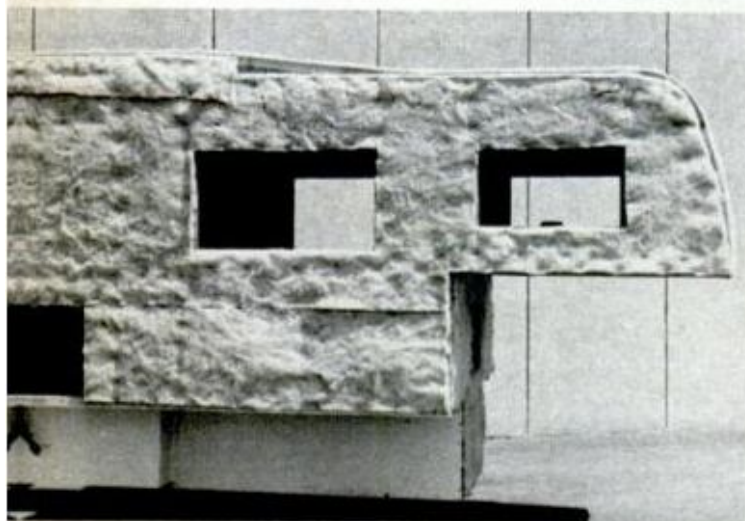

AFTER ELECTRICAL WIRING has been installed, a blanket-type fiberglass insulation of half-inch thickness is stapled or tacked to the walls and the roof

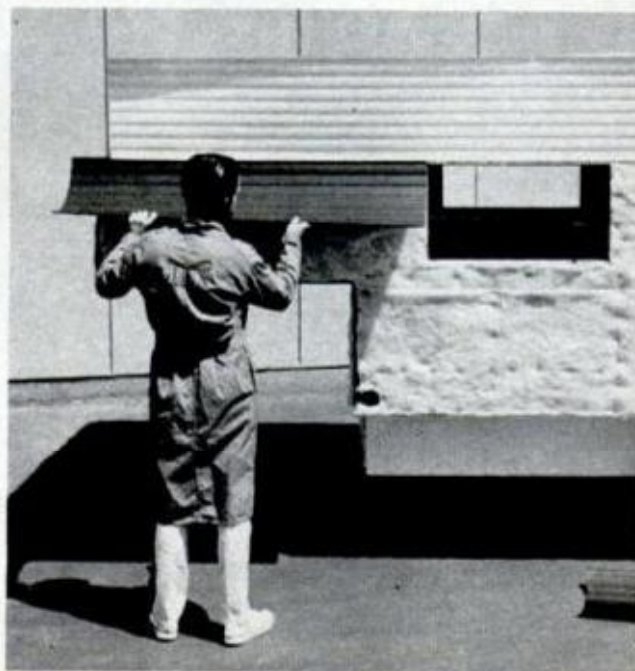

(For more construction photos, see page 184)
182

Plymouth Gold Duster.

**You get a lot for your money.
And a vinyl roof for no money.**



It only happens once a year. A car gets made like this one here. Plymouth Gold Duster. You get all the Duster specialties: room for five, cavernous trunk, electronic ignition. And more.

You get a nice deep carpet to tickle your feet.

It runs door-to-door and wall-to-wall. And it complements one of the plumpest, poshest vinyl-seat interiors you ever saw



on a compact like our Gold Duster. (As if there were a compact like our Gold Duster.)

You get whitewalls, wheel covers, and special trim.

Why not? These are probably the kind of things you'd order on a car, whether or not you were getting a special deal.

Except that with Gold Duster, you're getting a special deal.



You get a canopy vinyl roof that's right in style.

It looks like it came off a gold reptile. You can get it at no extra charge when you buy the car as described. Since the factory doesn't charge the dealer, he doesn't have to charge you.

Gold Duster. It's a Gold Sticker value.



Plymouth Gold Duster. Chrysler Plymouth

Extra care in engineering... it makes a difference.

CABOVER CAMPER

(Continued from page 182)

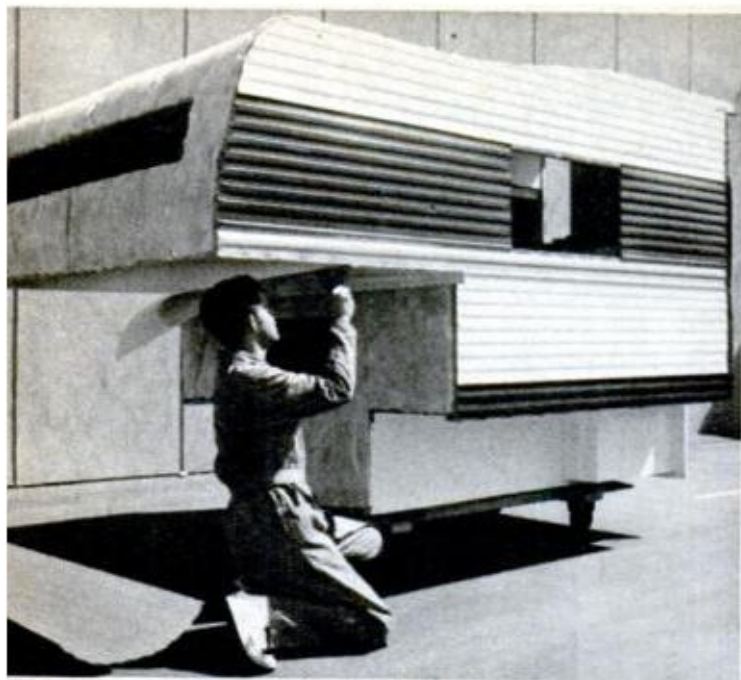

ALUMINUM IS INSTALLED under cabover in a prescribed sequence to insure getting a tight seam. An angle strip is used to conceal the front wall joint

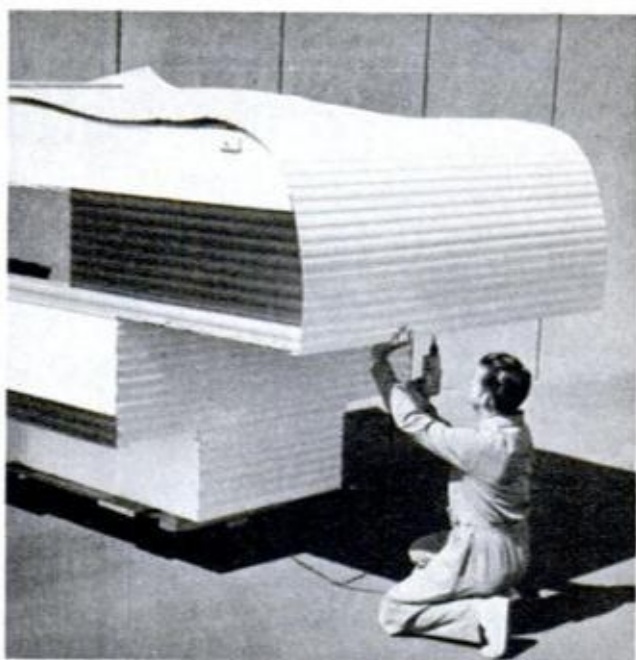

ROOF METAL comes in a continuous sheet that is fastened under cabover with hex-head screws. Running lights are installed before the roof is put on

WINDOWS are fitted into wall openings and mastic is used around flanges to prevent leaks. Wiping with a solvent will remove excess mastic from aluminum



HOW TO ORDER PLANS

Plans, pictorial instruction booklet, material listings and full-length patterns of the upper portion of camper sidewalls are available. Price of package is \$10 postpaid. Order from Glen L Recreational Vehicles, Dept. PM, 9152 East Rosecrans, Bellflower, Calif. 90706.

FINAL RESULT is a neat combination of Importer and Ford-Courier. To minimize load on the truck, weight is shaved wherever possible. For instance, plans call for an icebox instead of a heavier refrigerator. In addition to d.c. current from truck's battery, camper can be equipped with a.c. system that is hooked to outside source when the compact camper is parked



The Popular Science Book Club,
America's leading "how-and-why" Club,
invites you to . . .

TAKE BOTH these complete, essential "how-to" volumes absolutely **FREE**

...with your first selection
yours **\$4.95** 358 pages
for only **\$8.95** Sells for

You need accept only one more
Club Selection or Alternate in
the coming year!



Here are two of the most complete, authoritative books ever written for the man who's handy around the house — and both are yours FREE as a new member of the Popular Science Book Club!

And what a pair they make! *The Complete Book of Home Improvement* will give you all the practical, step-by-step guidance you need to turn your home into a castle — with the best in modern living. Once you learn the right techniques, you'll be amazed at how little it costs (and how easy it is) to improve your floors and walls . . . add a skylight . . . modernize your kitchen and bathroom . . . add a fireplace . . . add living space . . . and lots more!

Having the right tools in a well-organized workshop is often half the battle . . . and *The Complete Book of Home Workshops* will familiarize you with virtually everything that's been invented to make your job easier! Almost every type of tool is covered for you, drills to lathes, from vises to stud drivers. It's a storehouse of information you'll turn to before every job you tackle!

Think of it — you get these two fantastic volumes FREE! And with them comes your first Selection — *The Complete Book of Home Repairs and Maintenance* — for only \$4.95! (It regularly sells for \$8.95.) This unprecedented "homeowner's bible" will show you how to get your whole house humming at maximum efficiency. It covers your electrical system . . . doors and locks . . . floors and stairs . . . basement and foundation — even roof repairs! You won't be afraid of breakdowns once you have this book in your library — not to mention the money you'll save!

Together, these three volumes come to over 1400 pages of specific information . . . covering just about everything the home handyman could want to know or do. They regularly sell for a total of \$29.85 — and they're all yours for less than a \$5.00 bill!

How can you go wrong on an offer like this? Mail the postpaid card now!

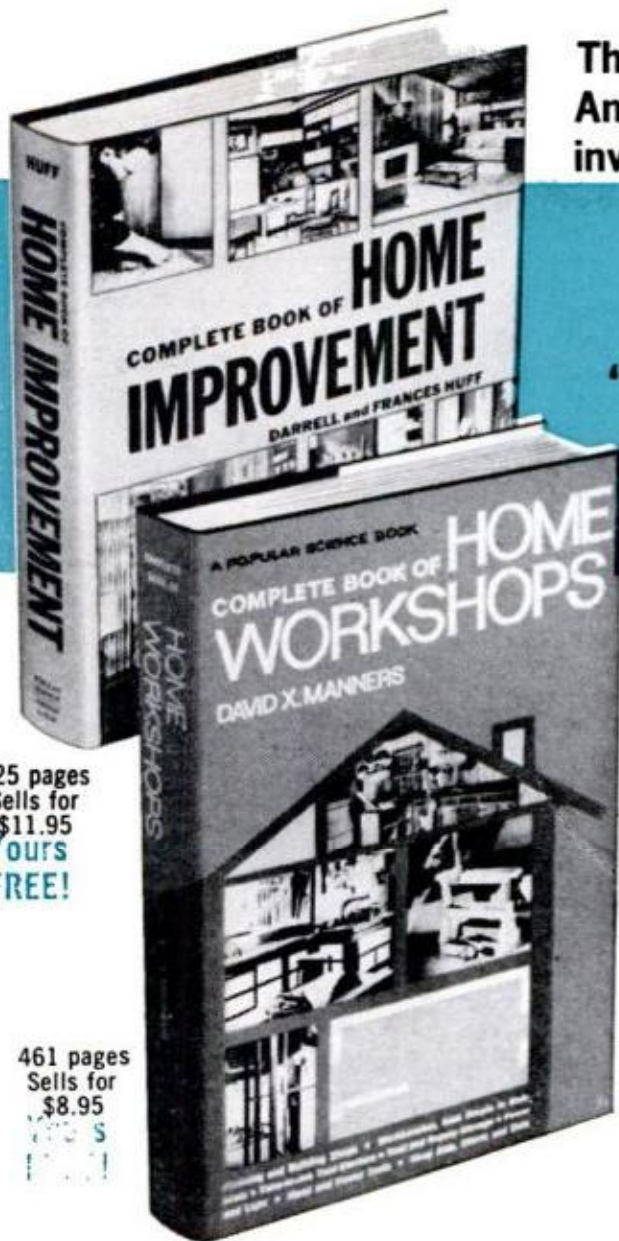

625 pages
Sells for
\$11.95
Yours
FREE!

461 pages
Sells for
\$8.95
Yours
FREE!

SOME OF THE BENEFITS YOU'LL GET AS A MEMBER OF THE POPULAR SCIENCE BOOK CLUB

- Sensational introductory offer — including two big FREE books!
- Huge discounts — 30% to 60% off regular list price on all books!
- No shortcuts on quality — virtually every book is identical to the original publisher's edition. No reductions in size or type, no cheaper bindings!
- Many books "custom-written" for members — Popular Science Book Club regularly commissions books by top experts in their fields — books specifically written for members' interests.
- Your only obligation — to buy one book from us during the coming year. (After that, if you wish, you may maintain all membership privileges by buying just one book a year. You may, of course, cancel any time after fulfilling your commitment.)

Every four weeks, you'll receive a Club bulletin fully describing the coming Selection and many Alternates. If you want the Selection, do nothing and it will be sent automatically. If you want an Alternate — or no book at all — just indicate your preference on the special form we provide and return it by the date specified. That's all!

Camping '73 Shopping Guide

Estwing

Campers Grills

No. EG-20—\$4.90

postpaid
Heavy Duty Folding Grill
Individually Packaged
in Heavy Vinyl Bag for
Easy Packing & Storing
Chrome Plated—12"x18"—
Wt. 3½#

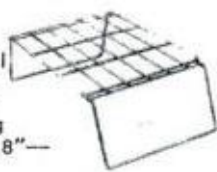

Swingaway Outdoor Grill

Just Drive Grill Post
in Ground for Easy Set-Up
12"x18"—Chrome Plated
Individually Boxed for
Easy Packing & Storing
Wt. 3½#—No. EG-18—
\$4.60 postpaid

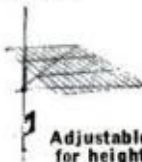

Adjustable
for height

Estwing World Famous Sportsman's Axe

Forged One-Piece Solid Steel
Expertly Tempered Hand
Finished Keen, Sharp
Cutting Edge. No. E24A—
\$8.70 postpaid. Genuine
Leather Grip



Length 13½"
Sheath Free

Estwing MFG. CO. Dept. PM-3
2647 8th Street Rockford, Illinois 61101



LEARN LOGIC

Unique Newsletter
Sample copy \$1.00

LOGIC NEWSLETTER

POB 252
Waldwick, NJ 07463

FIBERGLASS PANELS UP TO 50% DISCOUNT



FACTORY B-GRADE

Brand Name reinforced translucent panels.
Never needs painting, never rusts, never dents.
Good for greenhouses, fences, patio, trailer—
100! uses. For free price list write:

Price Brothers, OUTLET PANEL CO.
H'way 57, Grand Junction, Tenn. 38039



AMAZING CAR WASH THAT USES NO WATER.
A fantastic new dry cleaner silicone, treated
car mop cleans and polishes. Looks newer and
will stay that way longer. \$3.48 each, 2 for
\$5.96. Satisfaction guaranteed. BOBS GIFTS,
PMC-3, 5069 Meadow, Dallas, Texas—75215

THE RICHARDSONS
BATTLE CREEK, MI

TRAILER-CAMPER NAMEPLATE

Your name permanently engraved on attractive
matte finish, tough, weatherproof plastic.
The size is 3" x 10" and available in black,
green and red with white letters or white
with black letters. Maximum 20 letters per
line. Adhesive backed for easy installation.
2-line plate, \$3.95 or 3-line plate, \$4.95 p.pd.

TREND CRAFTSMEN

4901 Perrine Midland, MI 48640

PUMA MINI BIKES

Buy direct & SAVE!
Deluxe kits with or
without engines at low,
low prices. Send self-
addressed & stamped
envelope or 10¢ for
FREE brochures.

**EASTERN
ENTERPRISES**
509 W Wash-
ington St.,
Dept. PM-3,
Los Angeles,
CA 90015



HEX NUT-SIZE RE-THREADER

DIES

Run on and off with regular
wrench to renew bad threads!
7 Piece Die Set in Plastic Case
works on sizes: ¼", 5/16",
3/8", 7/16", 1/2", 9/16" and 5/8"

C7 = Coarse F7 = Fine Threads
\$3.25 Set, Get Both for \$6 Ppd.

Satisfaction Guaranteed

JAW MFG. Box 213 Reading, Pa. 19603



CORDLESS TABLE LAMP

A smartly styled lamp that you
never plug in. Powered by a
long lasting standard battery
(not included) inside the base.
Ideal for camping, boats, picnics
or patio. Essential for use in
power failures. No more dangerous
kerosene lamps or candles.
It could save a life or prevent a
serious fire. Only \$8.49.

Ridgewood Gifts, Dept. 62
1247 Springhill Road, Albany, Oregon 97321



ERECT A VACATION HOME IN A WEEKEND?

Yes, with a Dome-in-a-Kit. Assemble a
hurricane-proof, space-age dome for under
half the cost of any
other building.



ALSO you might
qualify to become a
dome distributor.
Make big profits by
selling prefabricated
domes for cabins, cottages, mote's, stores,
offices, greenhouses, etc. Protected small
investment. Unlimited potential.
See dome models in Or., Wa., Mt., Co.,
Ga., and N.J.

DETAILS FREE

DOMI INDUSTRIES
28 Hwy 9, Farmingdale, N.J. 07727

WHEEL BALANCERS

Bubble Type

\$14.95 to \$24.95

For wheels with center holes
up to 6" in dia. Also Saab,
all V.W.'s, Renault, Peugeot,
Citroen & small trucks.
Send for detailed information
and illustrations. 206/243-9330.

JACOBSEN MANUFACTURING

P. O. Box 6143, 15025 Pacific Hwy. So.
Seattle, Washington 98188



COINS • COINS • COINS

We have just purchased another large mixture
of U.S. coins and we don't have time to
sort them. These coins date from the late
1800's to 1958. 1000 coins per lot—only
\$39.95 postpaid.

M.G.M. COMPANY

Box 151, Reading, Mass. 01867



PIGSKIN COIN PURSE

The smart and simple way
to carry change. Compact
3" x 3" size and has two
compartments. Rim holds
change in easy view and
prevents coins from falling
when open. Personalized
with two or three initials.
An ideal gift for the hard
Pigskin Coin Purse \$2.25 Postpaid, no CODs
MSM Enterprises, Dept. 34, 1515 West 2nd St.
Lawrence, Kansas 66044.

IMPORTING MADE EASY!

Our Dropship and Import Guide explains import
inner workings in easy to follow language,
reveals how to import in small lots.
Furnishes valuable sources plus tips on where
to buy, what to sell for sky-high profits.
Profit margin can run up to 1000%!

Send \$3.00 now to:

E. LOKER

50 Berkley Rd., Galt, Ontario N1S 3G6

HOLD CAMERA OR BINOCULARS SAFELY

Secured to chest ready for instant use. No
neck strain with patented Kuban Hitch. One
size fits all. Quality made elastic straps,
spring steel adapters, heavy-duty snaps. Ideal
gift for fishermen, photographers, boaters,
skiers, snowmobilers, hikers. \$7.50 postpaid.
Satisfaction guaranteed. Free literature.

Write: **KUBAN HITCH**, Dept. PM, 5280 N.E.
Main Street, Mpls., Minn. 55421.

MOUNTAINEER SURVIVAL KNIFE

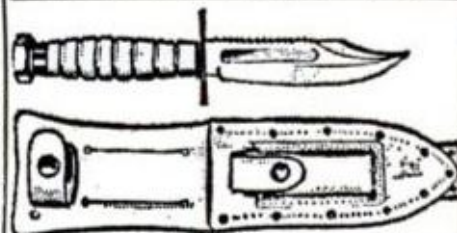

Hand crafted, double-edged super honed 5"
razor sharp blade. Overall length—10". Com-
plete with deluxe leather sheath and honing
stone. Combination knife is fish scaler, ham-
mer, saw & hatchet. Ideal for hunting—
limited quantity.

ONLY \$995 Regular \$25 Value
Plus \$1.00 Postage

Send Check In Full, No C.O.D.'s Please
MERIT • Dept. PL-1 •
51 Stanton • Newark, N.J. 07114

Camping '73 Shopping Guide



PROFESSIONAL FISH FLIES

A collection which any fisherman would be proud to own. A Professional dry fly assortment featuring 20 of the world's most famous flies. Displayed in a leather-like, snap case which charts each of the selections on the inside cover. Hook size #12. Case 7 1/4" x 6 1/4" x 1 1/4". #630 Fish Flies \$5.98 Postpaid. NO COD's. Order now from:

HSM Enterprises, 1515 West 2nd St., Lawrence, Kansas 66044 Dept. 34

EMERGENCY SUBMERSIBLE PUMP

12 V. Battery operated, pumps water from streams, pools, basins, sump pits, manholes, boats, etc.

Flooding worries ended when home or away, due to sump pump or power failure. Heart, work and money saver.

Write **TRUSTY WARNS, Super Pump,**
Wood Dale, Illinois 60191

PEST ARREST

Releases Insect Chasing—Lemon Scented Vapors

Perfect for Camping
Carefully Formulated
Resealable Metal Canister
Postpaid Sample Only \$2.00

CRESCENDO CENTRE

120 Meadow Run Hamburg, N. Y. 14075



BACKACHE WHILE DRIVING?

RELAX WITH A CAR MASSAGE PILLOW

Plugs into standard cigarette lighter receptacle or into the adaptor
Car Massage—\$19.95
Adaptor—\$7.95

Hoffman, Dept. 26, Gratz, Pa. 17030

OUTDOORSMANS KIT

This Handy Kit contains an Electric Air Pump, Auto Spotlight, Siphon pump, Hand warmer, POWERFUL 5-cell flashlight, miniature tool kit perfect for repairs to fishing reels, guns, etc., PLUS a heavy gauge vinyl Raincoat with carrying bag and sturdy Plastic Water Jug with 6 Cups. A must for every camper, hunter, fisherman. Satisfaction Guaranteed or Money Refunded. Only \$14.95 POSTPAID.

FUTURITY COMPANY
Box 1193, Raton, New Mexico 87740



CAMPERS CHECK LIST

119 Essential items listed
Pad of 50 sheets \$1.00 ppd.

TREND CRAFTSMEN

4901 Perrine
Midland, MI 48640

BUSHNELL EXPO.

Powerful, shockproof, waterproof, it floats. Four coated prisms, ten coated lenses, coated in fiberglass. Weighs 12 ounces. 4" high. Unique instant "Thumb focus." Full 8 power, wide sports field of view. 394' at 1000 yards. Binocular Bikini. Full year warranty. \$29.95 plus \$1.00 postage. **OLDE TAPPAN HOUSE**, 19 Thomas Circle, Tappan, N. Y. 10983.

BUILD YOUR OWN

Cabover Campers • Covers
16' & 20' Travel Trailers
• PLANS •

PATTERNS • KITS

★ FREE CATALOG ★
GLEN L Recreational Vehicles

9152P Rosecrans, Bellflower, Calif. 90706



UNIQUE SHAVER SHARPENER—Get smoother, faster shaves . . . guaranteed! Scientifically designed rotary sharpener for floating head and regular Norelco electric shavers. Just 1 minute a month gives your razor the sharpest cutting edge possible. A real value which provides peak efficiency and better-than-ever closeness. Send \$2.98 for No. 625 **NORELCO SHARPENER**
Logan Gift House, R-3, PM-3, Logansport, Indiana 46947

A \$20 Value **Now Only \$9.95**
Postage Paid

24" COPPER CROWN CUPOLA

For ventilation and/or decoration.

Has all-weather construction and anodized aluminum roof for long life. Cupola is easily assembled and can be used as a starter kit for Purple Martin bird house. Price effective until December 1973. Send \$9.95 and we pay shipping. Immediate delivery

L & M CABINET SHOP Box 2513M Dearborn, MI 48123



FURNITURE STRIPPING

Excellent Income Opportunity

Part Time . . . Full Time . . . Men . . . Women. Remove paint and varnish from wood or metal chemically, safely. Eliminate messy hand work. Complete franchise cost: \$3,585 delivered. For details:

AMITY INC.

Chemical Div., Dept. P
P.O. Box 3298, 3127 E. Washington Avenue
Madison, Wisconsin 53704 (608) 249-6677

BUILD YOUR OWN CAMPER

SAVE UP TO 50%



VIKING CAMPER SUPPLY, INC.
99-8P Glenwood Ave.,
Minneapolis, Minn. 55403

Please send _____ for which I enclose \$_____
NAME _____
ADDRESS _____
CITY _____
STATE _____ ZIP _____

Complete, easy to follow plans, instructions, materials list.

Camper Plans\$3.95
Travel Trailer\$3.95
Pickup Cover\$2.00
CONVERSION PLANS:
Econoline Type Van..\$2.95
Passenger Bus or
Delivery Van.....\$2.95
Satisfaction Guaranteed

EQUIPMENT CATALOG \$1.00

Rotundable on First Order.
Send Dime for Details.
Save 50% on Camper Kit.
All items from catalog to build \$1,795. Camper, 8', 10', 10'6" or Chassis Unit.



ELECTRIC ARC WELDER \$11.99

\$18.95 VALUE!—NOW ON SALE!
WELDS—BRAZES—SOLDERS—CUTS—MOST METALS! Plugs into ANY 110 volt socket. MAKE—REPAIR MOST ANYTHING FOR CAR—HOME—BUSINESS. Lifetime BURNOUT GUARANTEE 10 day money back trial (if retrnd). **HEAVY DUTY MADE!** No experience needed—FREE WELDING INSTRUCTIONS!

SEND ONLY \$2.00

(cash, ck. M.O.) and pay postman \$9.99 COD postage or send \$11.99 plus \$1.00 postage for paid del. in U.S.A.! **COMPLETE READY TO USE**—Includes BIG pack Steel, Brazing, Solder, Carbon "touch" rods and **ELECTROFLAME ARC TORCH!** BEST EVER MADE! OFFER LIMITED—Order TODAY!
MIDWAY WELDER Dept. FPM-3 Kearney, Nebr. 68847



NEW SUPER TRYKE

KIT PRICE \$369.95



YEAR ROUND FUN

HEALD'S NEW "SUPER TRYKE" Has full suspension front and rear, large 21" dia. x 12" wide ATV tires and 8 H.P. 306 cc, Tecumseh Engine. Torque Converter drives differential rear axle through #40 chain. Options include electric start, front ski, lights, roll bar, spark arrester muffler. Tryke comes in easy-to-build semi-kit form. Base kit price \$369.95. Ideal for farm or recreational use on snow, sand or trails.

FOR MORE INFORMATION WRITE
HEALD INC., Dept. PM-3, P.O. Box 1148,
Benton Harbor, Michigan 49022

FREE CATALOG



Utah: National Park State

Capture Southern Utah in a 200-mile circle. Inside are 5 national parks, 3 national monuments, 14 state parks, 1,800 miles of Lake Powell shoreline, 3 national forests, more than 5,000 motel rooms, 132 developed campgrounds and 12 major highways including I-15 and I-70. It's the most impressive concentration of natural wonders in the world... in just one third of Utah. No wonder Utah is the Park State. Right? Write!

ARCHES NATIONAL PARK: 89 natural-stone arches... largest concentration in the world.

ZION NATIONAL PARK: Mile-high monoliths, sandstone temples, and the eerie path of the Virgin River.

BRYCE CANYON NATIONAL PARK: An 8,000-foot plateau with red, orange and scarlet towers and canyons.

CANYONLANDS NATIONAL PARK: 2,000-foot canyons, 9,000-foot mountains and 1,500-year-old Indian ruins.

CAPITOL REEF NATIONAL PARK: Mountains carved into domes, 1,000-foot canyon walls capture the rainbow's colors.

Please send me a Utah travel kit!

Utah!

Utah Travel Dept. PM-13
Council Hall
Salt Lake City, Utah 84114

Name _____
Address _____
City _____
State _____ Zip _____

RESTORE JUNK FURNITURE

This was a beat up sofa I bought for \$5.00— and sold for \$30000

MAKE UP TO \$1000 AN HR. OR MORE!

FURNITURE UPHOLSTERY AND REFINISHING ARE PROFIT-PACKED SKILLS YOU CAN NOW EASILY LEARN AT HOME!

... and make a week's pay IN A SINGLE DAY!

If you can tie a knot and hammer a tack, you can learn how to reupholster and re-finish furniture. And you can learn quickly — the practical MUI Home Study way. Join thousands who have mastered this fascinating craft in their spare time — while keeping their regular jobs.

Once you are skilled in Upholstery you'll never be in want of "something to do" — whether for pleasure or profit. You'll find fun and excitement searching for discarded furniture — and restoring it to like-new condition. Upholstery is much more than just a highly profitable occupation... it can be a satisfying, creative hobby for both men and women.

GET STARTED NOW... WRITE TODAY for our FREE 32-page book, "BIG PROFITS IN UPHOLSTERY." Free sample lessons and complete details. There's no obligation — and no-one will call. Approved for Veterans and Non-Veterans.

MODERN UPHOLSTERY INSTITUTE, BOX 899 - JCA, ORANGE, CA 92669

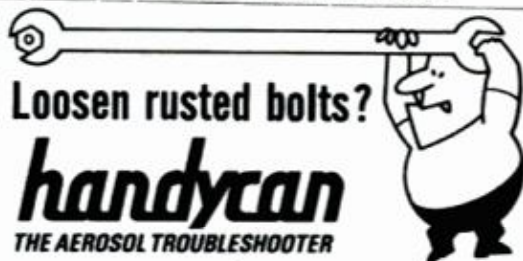

Loosen rusted bolts?

handycan

THE AEROSOL TROUBLESHOOTER

can!

Lubricates, drives out moisture, stops rust, too!

HYDRAULIC JACK REPAIRS

Earn While You Learn at Home

Earn while you learn at home. Millions of jacks in gas and auto service stations, trucking firms, body shops, riggers, factories and farms need servicing... most of which you can learn to repair. We show you HOW. Start spare time in your basement or garage. Big opportunity for mechanics. ACT NOW!

Write for folder No. PM-3 and free bonus offer.

HYDRAULIC JACK REPAIR MANUAL CO., INC.

G. P. O. BOX 3 • STATEN ISLAND, N. Y. 10314



IF YOU CAN SING, WHISTLE, OR HUM A TUNE...

you can play the Musical Saw. No notes to read, no musical knowledge required. Since 1921 we have furnished the entire world this unusual, sweet-toned instrument. If you are 10 or 70, you play or no pay. Musical Saw, soft hammer, bow, resin and lessons mailed on 5 days' trial. Write today for details and free copy of "Sawing News of the World," picturing successful saw musicians. MUSSEHL & WESTPHAL, 107 Fort St., Fort Atkinson, Wisconsin. 53538.



U. S. Surplus High Speed Rotary Files. Hardened Steel, use on any metal or wood for filing, drilling, milling, carving, routing—a thousand uses in every shop. Sets assorted in sizes from 1/8" shanks. All brand new in airtight, G.I. packs. Order now!

36-pc. Tool Set, G. I. cost \$265.00, now \$15.00
16-pc. Tool Set, G. I. cost \$109.00, now \$9.00
Save Even More, Both Sets, now \$22.00

U. S. SURPLUS CENTER

C-1790 Mason Avenue
COLUMBUS, OHIO 43207

MAKE UP TO \$12 AN HOUR AT HOME

Let Me Prove It To You FREE!

I'll show you how Plastic Laminating at home, spare time, can give you as much as \$12 each hour you operate. Table-top machine sets up anywhere. Easy. Fun. No experience needed. We furnish everything. We'll even help finance you. No house-to-house selling. Orders come by mail. Write for facts FREE. No salesman will call.



WARNER ELECTRIC, Dept. L-2-CC, 1512 Jarvis, Chicago, IL 60626

Материал защищен авторским правом



with Recreational Vehicles

Be your own travel agent...120 days a year! Saturdays, Sundays, long weekends and your vacation add up to 120 days of family fun and freedom with your own recreational vehicle.

Think about it...two-day trips or two-month tours to exciting places, anywhere! Vacations unlimited are really possible and you can afford them.

"The Way to Go" is a full color booklet explaining the types of recreational vehicles, where to take them, how to buy them and lots more.

Send 50¢ with this coupon
for your copy of "The Way to Go"

Name _____
Address _____
City _____ State _____ Zip _____



**RECREATIONAL
VEHICLE INSTITUTE**
Dept. 33, O'Hare Office Center North
2720 Des Plaines Ave.,
Des Plaines, Ill. 60018

MORE BOAT. MORE ENGINE. LESS MONEY.

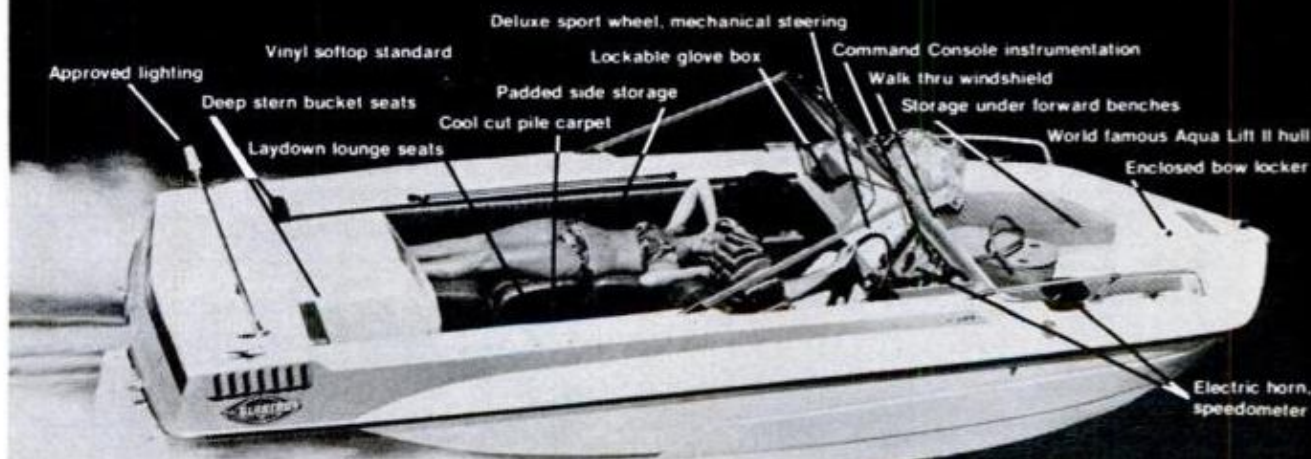

World's largest manufacturer of fiberglass boats.

V-179 stern drive comes with
Glastron 302 cu. in. 130 hp standard.
V-178 outboard takes power to 125.

Design and engineering excellence made Glastron boats worldwide favorites — 28 models: family boats, fishboats, cruisers. Dollar for dollar, there are no better boats than the '73 Glastrons. And Glastron's "Total Package" is your best stern drive value. We make both the boat and engine, covered under one basic warranty, with one-stop service at 1200 Glastron dealers all over the world.



GLASTRON BOAT COMPANY
Dept. PM-33, P.O. Box 9447, Austin, Texas 78766

Please send full information on all '73 Glastrons, and name of my nearest Glastron dealer.

Name _____
Address _____
City _____ State _____ Zip _____

THE HEAVIEST HUMAN ON RECORD WEIGHED 1,069 LBS. AND WAS BURIED IN A PIANO CASE!

The Highest Divorce Settlement Ever Made Was \$9,500,000. A War That Lasted 38 Min. A Woman Who Bore 69 Children. The Largest Insect... a "Goliath Beetle." The World's Most Expensive Wine At \$300 Per Glass.



The biggest! The smallest! The richest! The highest! The oldest! The longest! The fastest! The greatest!

The Guinness Book Of World Records contains over 3,000 records of science, nature, the achievements of man, the world of sports, the arts, entertainment and little known fantastic phenomena. Packed with unbelievable facts and over 350 photos.

♦♦♦♦♦ **NEW ENLARGED EDITION:** ♦♦♦♦♦
It contains all major Olympic Records recently broken at Munich, Germany.

Settle any argument! Amaze your friends! You will not be able to put it down. This 600 page hard covered volume is a must for any library. Nearly 10,000,000 copies sold worldwide. **Only \$5.95** (plus postage and handling). moneyback guarantee.

----- please print -----
BOOK OF WORLD RECORDS, DEPT-G-84
1966 BROADWAY, NEW YORK, N. Y. 10023

Please rush me **Guinness Book Of World Records** at \$5.95 each (plus 60¢ postage and handling). Enclosed is my check or money order for _____. If I am not completely satisfied, I will return the book within 15 days for a full refund.

name _____
address _____
zip _____

Make check/money order payable to
Book Of World Records

Quality inflatables from \$19.95



•Pyrawa Canoes •Kaik Dinghies

Whitewater rivers, ocean surf, remote streams and lakes—our fine inflatable canoes and dinghies are ideal for fishermen, backpackers, outdoorsmen, river-runners and family fun! Canoes from \$34.95, dinghies from \$19.95!

Send for free color brochure!

Leisure Imports, Inc., Dept. PM 3-73
St. James, New York 11780



Attex. The go anywhere, do anything vehicle.

For anybody.

An Attex all-terrain vehicle will conquer land or water, snow or sand with equal ease, making it perfect for everything from hunting and fishing to just plain old family fun. We have four models for you to choose from, one just right for your budget. Send for more information and our free brochure, **How To Choose An ATV.**

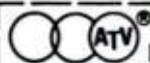

Manufacturing Company

PM-3

1215 William Flynn Highway
Route 8, Glenshaw, Pa. 15116

Name _____

Address _____

City _____ State _____ Zip _____



BUILD THIS POPULAR 19 ft. MOTORHOME AND SAVE \$\$\$

Designed especially as a do-it-yourself project. (See cover story Jan 1971 PM) Twenty pages 18 x 24 blueprints, step by step **INSTRUCTION BOOK** with many in-process photos. Includes **CUTTING LISTS** for wood and steel parts and **KIT CATALOG**. \$35.00. Plans also available for 23 and 25 ft models. All materials available at big discount.

LariDel Enterprises, Rt. 2, Box 123,
Gaston, Oregon 97119. Ph 503-985-7273.

Learn Profitable Profession in few months at Home



MEN AND WOMEN, 18 TO 60

Earn big pay as a skilled operator in Scientific Massage. Many employment opportunities. Easy to learn and do. Diploma awarded. Open your own office or earn good income from Doctors, Hospitals, Clubs and other health or recreational centers. Wonderful part-time profession. Low monthly payments. Write today for free Anatomy Charts and catalog. No obligation.

ANDERSON SCHOOL OF SCIENTIFIC MASSAGE
Dept. C-1, Princeton, Illinois 61356

OWN a Business



If employed, start part time. Alert dealers can gross \$12 hourly profit plus \$7 on EACH serviceman. Clean, revive, mothproof, flameproof rugs & upholstery. No shop needed. Nationally advertised on-location service. We train, guide and assist you. Easy to learn. Quickly established. Less than \$1200 down opens your dealership. Send today for FREE booklet. No obligation. No salesman will call.

DURACLEAN, 3-163 Duraclean Bldg., Deerfield, Illinois 60015

Red Wing cut this boot apart



**...so your feet
know what they're getting into.**

Red Wing work shoes and boots have long been considered tops in the trade by the hard-working men who wear them. And for good reason: fit, comfort and long lasting service. Now you can see some of these reasons—full-grain leathers, solid steel shanks, "Sweat-Proof" flexible split leather insoles—and more. Come try on the pair fit for your job... at your nearby Red Wing work shoe headquarters. Your feet will appreciate the difference.

Sure
cure for
5 o'clock
feet

RED WING

RED WING
SHOES

RED WING SHOE COMPANY • Dept. PM, Red Wing, Minnesota 55066

IF YOU CAN USE ANY OF THESE TOOLS...



...you could build a whole new future...

and build
yourself
a Bell & Howell
solid state
color TV while
you're at it!



If you're already handy with a set of tools, here's a way to pick up a pretty thorough knowledge of electronics: build yourself a solid state color TV as part of a complete learn-at-home program from Bell & Howell Schools.

This important project gives you valuable "hands on" experience with solid state circuitry—the kind of *practical* experience you'll need to build a successful career. It's a vital part of your total electronics education.

Once you've completed your program, you could be ready to build a new career—or start a business of your own—in home entertainment electronics.

Fix stereo systems . . . FM-AM radios . . . phonographs . . . tape recorders

With your new skills, you can build and service stereo-hi-fi systems—including FM-AM radios . . . phonographs . . . open reel tape recorders and cassette or cartridge player/recorders. You could even build yourself a complete "home entertainment communications center"—complete with the new gadgetry of cartridge television when it comes out. The skills you build up by following this brand-new program are more than enough to service almost *any* type of home entertainment electronic device.

A complete at-home learning program in home entertainment electronics

Don't confuse this program with an ordinary hobby kit. It's much more than that. It's a complete at-home learning program prepared by skilled instructors at Bell & Howell Schools.

It doesn't matter if you've never had any training in electronics before. Nobody's going to start throwing "diodes" and "capacitors" at you right off. You start with the basics. You take it one step at a time. You walk before you run. And you'll be amazed at how quickly you start to feel comfortable with things that seemed complicated at the beginning.

Attend special "help sessions" if you like

In case you should run into a sticky problem or two—one that you can't handle on your own—come in and see us. We've scheduled help sessions every few Saturdays at the Bell & Howell Schools and in many other cities throughout the U.S. and Canada. Drop by. Meet an expert instructor in person. Talk over any rough spots with him—and with other students. You'll enjoy the chance to "talk shop."

Master the most up-to-date solid state circuitry

Solid state is here to stay. Not just color TV but almost every type of electronic device will eventually move farther and farther in the direction of *total* solid state circuitry. Get to know the most advanced "trouble-shooting" techniques for these sophisticated circuits. You'll find an almost irresistible demand for your skills.

Why you should know electronics

No matter where you look, the amazing

technology of electronics is becoming a bigger and bigger part of the picture. More and more automotive parts and diagnostic instruments are electronic. Many large manufacturing plants use sophisticated electronic systems—controlled by a few skilled electronics technicians. The increasing use of two-way radio . . . the huge promise of cable television . . . the astonishing growth of electronic data processing all open doors to exciting new career opportunities for the man with thorough training in electronics. In fact, the day may come when the man who does *not* have electronic skills will be severely handicapped in many industries.

Why you should get your training from Bell & Howell Schools

Skilled instructors at Bell & Howell Schools—carefully selected for their knowledge, experience and teaching ability—plan each program with the utmost care and attention. Each year, they spend about \$200,000.00 improving programs and materials and keeping them in step with new developments in electronics. Thousands of people have used their Bell & Howell Schools training as the foundation for new careers and businesses of their own in electronics.

You build and keep the exclusive Bell & Howell Schools Electro-Lab®—a complete laboratory-in-the-home

To make sure you get practical experience with instruments used daily by professionals, you build and keep a Design Console, an Oscilloscope and a Transistorized Meter (see details at right). These are the three instruments you'll work with constantly—both during your program and thereafter.

CONSIDER THESE ADVANTAGES:

Help Sessions We've scheduled "help sessions" every few Saturdays at the Bell & Howell Schools and in many other cities throughout the U.S. and Canada. Top instructors give you expert guidance and you meet other students, too.

Resident Study After you complete your program, you can transfer to any of the resident schools for more advanced study, if you wish.

Lifetime National Placement Assistance When you complete your course, we help you locate a position in the field of Electronics that fits your background and interests. This unique service is available at any time after you graduate.

Veterans' Benefits We are approved by the state approval agency for Veterans' Benefits. Check the box for details.

Student Financial Aid We are an eligible institution under the Federally Insured Student Loan Program. Check the box for details.

Detach postage-paid reply card and mail today for free information



25-inch picture (measured diagonally)

■ **Bell & Howell Solid State Color TV.** Ultra-rectangular tube . . . 25-inch picture measured diagonally . . . full 315 sq. inch viewing area. Solid state modular circuitry . . . 4 advanced IC's . . . 100 transistors . . . 72 diodes . . . individual plug-in circuit boards. Special UHF/VHF tuning features . . . built-in self-service components.

■ **Design Console** Use this to rapidly "breadboard" circuits without soldering. Equipped with built-in power supply . . . test light . . . speaker . . . patented plug-in modular connectors.

■ **Oscilloscope** Portable 5-inch wide-band oscilloscope offers bright, sharp screen images . . . calibrated for peak-to-peak voltage and time measurements . . . 3-way jacks for leads, plugs, wires.

■ **Transistorized Meter** Combines most desired features of vacuum-tube voltmeter and quality multimeter. Registers current, voltage and resistance measurements on a large, easily-read dial. Features sensitive, 4-inch, jewel-bearing d'Arsonval meter movement.

For Free Information, Mail Card Today!

If card has been removed, write:

An Electronics Home Study School

DEVRY INSTITUTE OF TECHNOLOGY

ONE OF THE

BELL & HOWELL SCHOOLS

4141 Belmont, Chicago, Illinois 60641

347R2

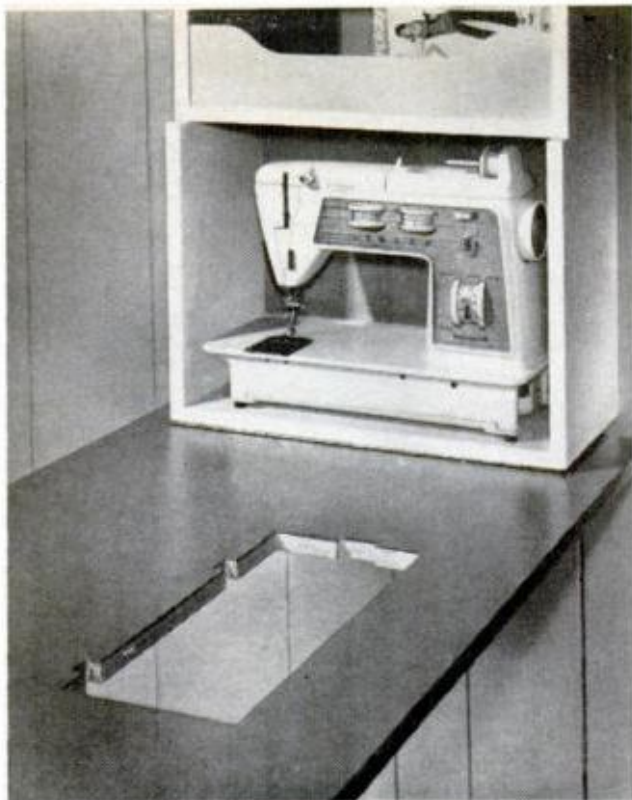

SEWING MACHINE STOWS in base of open wall-hung cabinet when sewer calls it a day and closes up shop

DUAL-ROLE SEWING CENTER

(Continued from page 88)

are housed in $\frac{3}{8}$ -in.-deep rabbets. The $\frac{1}{2}$ -in. plywood-panel door has a mitered frame of lumberyard molding glued to the front. Mat and picture are framed by simply gluing them to the plywood with rubber cement. The picture you see in the prototype is a reproduction of a painting by Johannes Vermeer (1632-1675) called *The Lace Maker*. If you'd like a print, send \$7 to Ostreicher's Prints, Inc., 43 West 46th St., New York, N.Y. 10036.

The framed door is attached with a piano hinge set in $\frac{1}{16}$ -in.-deep rabbets in both door and cabinet so there is no gap between the two when closed. The four spool trays vary in depth from 2 to $2\frac{3}{4}$ in., with bottom tray being the deep-

(Please turn to page 200)

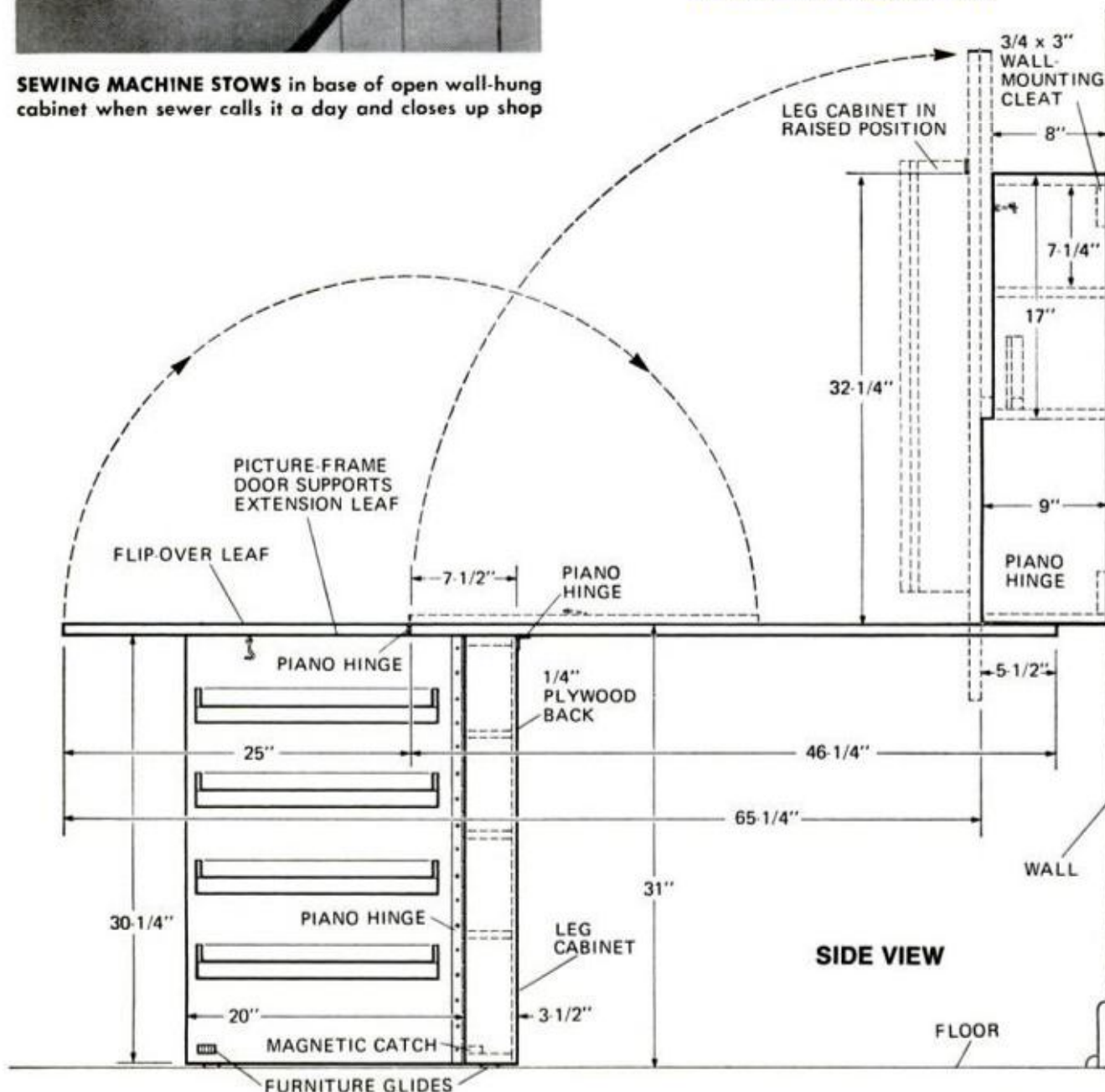

If only you knew how to...

- start a stalled car
- refinish furniture
- build a room in your attic
- make a burglar alarm
- stop a leak in the basement
- soundproof a ceiling
- build a backyard barbecue
- repair broken appliances
- tile your bathroom
- do your own plumbing
- build your own sauna
- install your own switches
- letter your own signs
- build a patio or a porch

...you'd probably save a fortune!

TAKE THIS **FREE** VOLUME

with no obligation to buy . . . and let
**POPULAR MECHANICS DO-IT-YOURSELF
ENCYCLOPEDIA** show you how!

With this big FREE book you can make home repairs and improvements you never dreamed you could do so easily. You'll be guided step-by-step with illustrations that make each project crystal clear — even for beginners!

Start saving right away! Avoid high labor charges.

Learn how to cure 8 common car ailments with simple tools; decorate a child's room; burglar-proof your home; soundproof a room . . . save \$1,000 or more!

Vol. 1 of the Popular Mechanics Do-It-Yourself Encyclopedia, worth \$3.49, is yours **FREE**—to show you the fun and savings of "do-it-yourself."

Turn to this reference when your TV or toaster fails . . . build a Hi Fi center . . . plant a "lazy man's lawn" . . . or "antique" your favorite chair.

You'll learn basic techniques for building, painting, soldering, and power tools. You'll find detailed diagrams for cabinets, bunk beds, closets, kitchens, wiring and lighting. Expert advice on design and decor. Valuable tips on how to buy materials, select an appliance that will last, even what to look for when you buy a house. But that's not all!

Enjoy sports, hobbies, crafts, and save even more!

Your Popular Mechanics Do-It-Yourself Encyclopedia shows how to build midget cars, model planes, and how to soundtrack your own movies. You can even learn the ABC's of skiing, boating, fishing, and camping out.

Beautify your home for the holidays. Make your own gifts. Cane a chair. Bind a book. Keep the kids busy with special projects. It's all yours in the complete set . . . 16 volumes . . . 3,136 pages . . . over 10,000 illustrations . . . bound in handsome, washable, crimson bindings.

Mail this NO RISK coupon today!

We'll rush you Volume 1 absolutely FREE. You may then receive additional volumes for free examination and keep as many as you wish for only \$3.49 plus postage and handling. You may cancel the program at any time, or return any volume for full credit, and no more will be sent. In any case, Volume 1 is yours to keep.

Don't delay—fill out and return the coupon at the right to be sure of getting your FREE volume.



Exclusive Bonus With
Free Volume

PROJECT-A-PLAN

Included in your FREE volume. Lets you blow up small scale plans to full scale working plans right in your own living room or workshop.

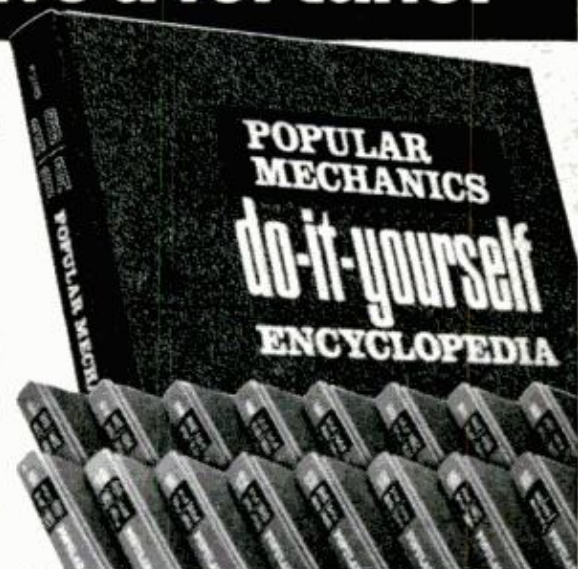

MAIL THIS COUPON NOW

**Popular Mechanics Books
Box 2315, F.D.R. Station, N.Y., N.Y. 10022**

This certificate entitles you to a free gift — Vol. 1 of the 16-vol. Popular Mechanics Do-It-Yourself Encyclopedia, with no obligation to buy anything ever.

As a subscriber in good standing, you'll enjoy free examination of the additional volumes as you receive them. In about 6 weeks we'll send you Vol. 2, and 4 weeks later Vol. 3. After that, at approximately monthly intervals, we'll send you shipments of Vols. 4-6, 7-9, and 10-16. Also, you'll receive annual supplementary volumes as they are published on free 14-day approval with no purchase obligation. This way you'll be able to complete the set in 6 months, and keep it up-to-date. You may cancel at any time or return any volume within 14 days for full credit and no more will be sent. Take as many volumes as you like — or none at all. For each volume you keep, you'll be billed just \$3.49 plus postage and handling. But you need never pay for more than 1 volume per month no matter how many you have received. There is no charge for this extended payment service.

F013

Name _____

(Please Print)

Address _____

City _____

State _____ Zip _____

Signature _____

HM Books



HINGED PICTURE FRAME provides access to thread and other items, even when sewing center is stored

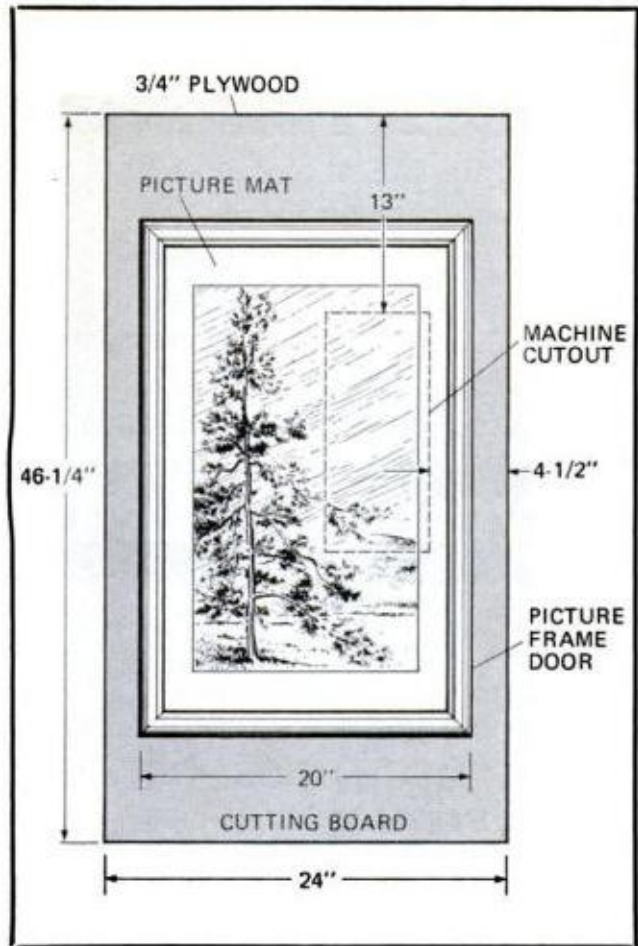

DUAL-ROLE SEWING CENTER

(Continued from page 198)

est. Ends are cut from $\frac{1}{4}$ -in. wood, the rest from $\frac{1}{8}$ in. Each tray is fastened to the door, after painting, with small oval-head wood screws.

We banded the edges of the cutting board first with plastic laminate, then covered the top surface, before hinging

the extension to the end with a 20-in. piano hinge. To assure that the extension aligns properly with the cutting board when it lies back on top of it, hold them with two C-clamps while you hinge them together. As shown in side-view drawing, page 198, the hinge point for the cabinet-leg at the outboard end of the cutting board is $7\frac{1}{2}$ in. It's hinged to the wall cabinet $5\frac{1}{2}$ in. from the end. ★★★

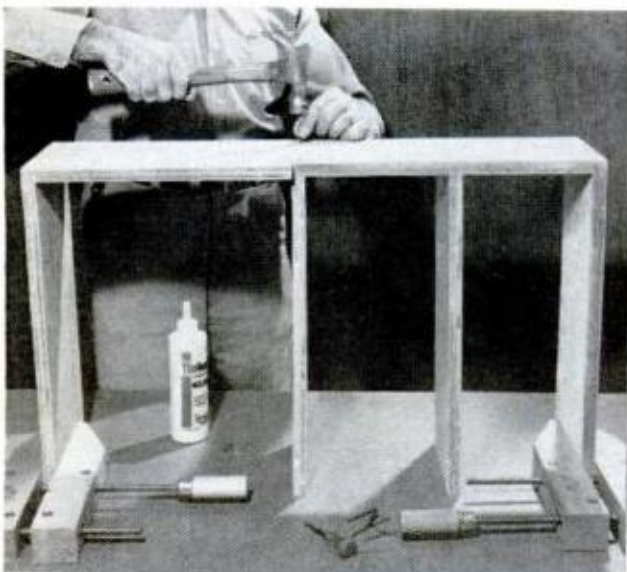

PAIR OF WOOD CLAMPS is of great help for holding part of wall cabinet during first phase of assembly

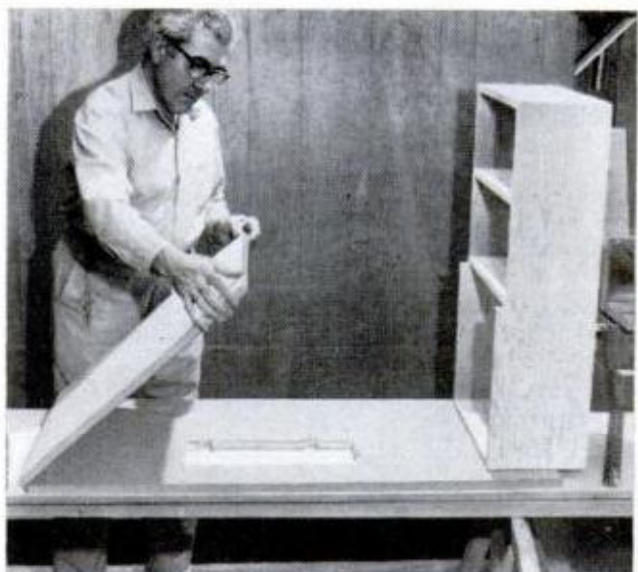

FLIP-OVER EXTENSION should align with edges of cutting board when it lies back on top for storage

HIGH-RISE SEWING CENTER

(Continued from page 85)

the base of the machine, the counter must be double-thick as shown in the detail on page 85, after which the top surface and the three exposed edges of the sandwich are covered with plastic laminate.

Modified mending plates and $\frac{1}{4}$ -20 T-nuts are used to pivot the cutting board and machine counter. As shown, the plates are attached to the edges, $12\frac{1}{2}$ in. from the far end in the case of the cutting board, $12\frac{7}{8}$ in. for the counter. T-nuts are installed in $\frac{3}{16}$ -in. holes in the cabinet at points $29\frac{3}{8}$ in. up from the bottom for the counter and $31\frac{1}{4}$ for the cutting table. Both sets of holes are drilled $1\frac{3}{4}$ in. in from the edge. Roundhead stovebolts are turned through the T-nuts from the outside, through the pivot holes in the mending plates and on into holes in the edges of the counter and cutting board. Bolts $2\frac{1}{2}$ in. long are required for the machine counter, 1 in. long for the cutting board. Study the detail on page 85 to understand more clearly how the T-nuts are used.

A stop block across the back supports

Try the rust fixer

from **DAP**



DERUSTO® Enamelized Spray Paint. Prevents rust, stops rust. Has rust preventive primer built into every color. Beautifies, protects new and rusted metal surfaces with push-button ease. In 23 colors plus clear.

America's First Name in Home Fix-up



DAP Inc., Dayton, Ohio 45401
Subsidiary of *Plough, Inc.*

Try the rainspout fixer from **DAP**



DERUSTO® GALV-A-GRIP™ paint sticks tight to slick metal surfaces—galvanized, aluminum, tin—to prevent paint peeling problems. Primes and finishes gutters, downspouts, flashings.

America's First Name in Home Fix-up



DAP Inc., Dayton, Ohio 45401
Subsidiary of *Plough, Inc.*

the counter in a level position when it's down, and regular cupboard catches are used to hold the cutting board and sewing-machine counter when up. Friction catches hold the four doors shut. A swing-down leg hinged to a block glued to the front of the cutting board supports it. All shelves are adjustable; more can be added.

The method used to hold the machine securely in the counter cutout so it can be swung up depends on your particular machine and its base. One way to fasten it would be to drill four small holes through the metal base, countersink them and drive nickel-plated oval-head wood screws into the plywood top. ★★★

Next month in PM

Special 40-page Home Ideas Guide

Full of the know-how you need to: Face-lift your home. Come up with a really different family room. Make your own light fixtures. Install a prefab bath. Get a new entry. Discover new products.

Radio-controlled whirlybirding

A whole new idea in R/C model flying with helicopters you can build from kits.

POLAROID'S NEW SX-70

(Continued from page 107)

whir (to raise the two-sided hinged mirror from viewing to taking position, the 12,000-rpm motor turns just seven revolutions in 0.0066 of a second!). The screen darkens and stays dark for the duration of the exposure (anywhere from 1/200 to 20 full seconds, automatically timed) plus the 1½ seconds it takes for the motor to spit the film out of a concealed slot at the front of the camera. Then the image is back, and you're ready to shoot another picture—or even shoot off every film in the pack in sequence, only 1½ seconds apart.

The motor drive is important, since it prevents the biggest single cause of poor Polaroid pictures to date: uneven tugging of the film packet from the camera. And the film packet is important, too: for this film has no paper wrapper and gooey, chemical-laden negatives to peel off and throw away. Instead, the film emerges from the camera with an opaque, grayish-

You no longer have to count seconds . . . the new film times its own development.

turquoise chemical layer protecting its developing image from the light, and with all chemicals sealed inside the plastic film packet.

Gradually, right before your eyes, the image pushes through the opaque layer, showing a recognizable outline in about one minute recognizable colors within four. After five minutes, the colors look good, and they continue to improve subtly until they reach their brilliant, vivid, deeply colored final stage—in about 10 minutes. Then development stops, automatically.

The new SX-70 film has clearer, richer colors than Polaroid Colorpack 108 film, with pinker skin tones, and none of 108's graininess (even under an 8X magnifier, SX-70 looks grainless). But its latitude is still too narrow to capture full details in both light and dark picture areas, and it's still a bit insensitive to green.

SX-70 film also has less grain and richer colors than conventional Kodacolor-X, but Kodacolor still has the edge in latitude and color accuracy.

On the other hand, Polaroid still has the edge in time, the immediacy that was the keystone of Dr. Land's original vision. And though the new film takes far longer than the old one's 60 seconds to develop, you no longer have to stand around counting seconds, since the new film times its own development. You can just slip the exposed films into your pocket and walk on. Or, you can sit and watch since, as Dr. Land points out, the new process gives you "the joy any child knows in the darkroom of seeing the picture come out under the red light. Only this is the first darkroom in which you can see color developing . . . a darkroom which is a light room."

At the other end of the time scale, the new Polaroid film's pictures should outlast those of the old film (and, possibly, those of conventional color films as well). That's quite a trick, considering that the negative and chemicals, sealed within the print packet, can't be stripped away as the old film's could. So making the prints permanent took not only new, fade-resistant metalized dyes (the fruit of 15 years of Polaroid research), but also new film and developer chemistry that would lock those dyes into their proper places, and lock up the other chemicals in harmless form as soon as the development stage was complete.

Even the film packet makes a contribution: Of Mylar plastic, it forms a scratch-resistant, waterproof window over the image. (And since the top and bottom Mylar layers are of equal thickness, the new prints won't curl.)

There are 10 such plastic packets in each SX-70 film pack, plus a unique, flat battery for the motor, photocell and flash. But even with a fresh battery in every pack (which should end battery troubles), the new pack is the most compact in Polaroid's history, and costs two cents less per shot than regular Polacolor 108.

The camera's compactness stems largely from the film's, but the unique, folding reflex design (see illustrations, pages 104-106) accounts for it still more—not only because the camera folds, but because the mirrors lengthen the light path without lengthening the camera. Even the f/8 lens is uniquely compact: though its focal length is 4.6 inches its thickness is only 0.4 inch, a fraction of the thickness of conventional designs, and the front element

(Please turn to page 204)

LEARN — \$AVE — FIGHT — WIN!

SPECIAL—ALL 4 for \$19.95.



502 — PRACTICAL PICTORIAL GUIDE TO MECHANISMS AND MACHINES. Every kind of mechanical motion or holding device is illustrated and explained. With its vast classified collection of 4000 illustrations and photos, this book is an invaluable aid to the engineer, inventor, mechanic or hobbyist. **only \$7.95.**

503 — ELECTRICAL ENGINEERS HANDBOOK ILLUSTRATED. A comprehensive guide and reference for practicing engineers, students and serious craftsmen. This book contains hundreds of designs, drawings, charts and tables covering modern engineering principles, wiring techniques, AC & DC motors, technical symbols, much more! **only \$7.95.**



512 — KEY TO ADVANCED ELECTRONICS. Features advanced concepts and theories with emphasis on Component and Circuit behavior. Tuned Circuits, Modulation and Demodulation, Test Equipment, Computers, etc., all these and more are presented and explained clearly and simply. Completely illustrated. **only \$4.**

513 — ENGINEERS HANDBOOK ILLUSTRATED. Has 320 pages of text and schematic drawings supplying information on engines, power sources, electrical systems, motors, batteries, generators, controls, brakes, gears, bearings, joints, plumbing, lighting, air conditioning and refrigeration. **only \$5.95.**

SPECIAL—ALL 4 for \$8.95.



511 — KEY TO BASIC ELECTRONICS—Discusses aspects of TV, radio, transistors, amplifiers, and other electronic circuitry. By emphasizing circuit operations, this easy to read guide, trains the man who wants to repair, rather than design electronic circuits. **only \$4.**

1512 — BE YOUR OWN CARPENTER—Covers every aspect of woodworking and the tools necessary to do any job—big or small. Easy to read step by step explanations and illustrations will make your work resemble the quality of a master craftsman in every way. **only \$2.95.**

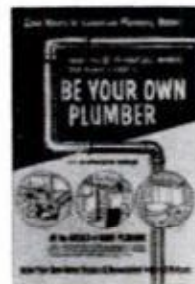

3164 — HOME REPAIRS MADE EASY—This complete guide makes all repairs simple. Clearly detailed explanations and illustrations save you time and money. Add value to your home in your spare time. **only \$2.**

1514 — BE YOUR OWN PLUMBER—Avoid those sky-high bills for leaky faucets and clogged drains! Learn how to make simple repairs and renovations . . . even install your own fixtures! Money saving information on your house and plumbing system. Fully illustrated. **only \$2.95.**

SPECIAL—ALL 4 for \$4.

3133 — KEY TO JUDO—Easy to follow illustrations and how to do it directions show you every move. Covers everything from the basic principles, nerve centers, Finger Jab, the Bludgeon, etc. **only \$2.**

3169 — KETSUGO—Dedicated to complete self defense. The combined fighting arts of AIKIDO, YAWARA, ATEWARE, SAVATE, etc. Clearly and simply explained with illustrations and charts. **only \$1.**

3170 — SUPER KARATE—Ward off any attacker. Your fingers, hands, feet and elbows become super weapons—the deadliest art of self defense known. Over 200 illustrations. **only \$1.**

3176 — KASHI-NO-BO—The secrets of the fastest and most effective fighting technique ever developed by the Oriental Masters—The unbeatable method of stick fighting for defense and counter attack. **only \$1.**



SPECIAL—ALL 4 for \$5.95.

3101 — HOW TO PLAY POKER AND WIN! Card expert Sidney Radner tells you how to play your cards. With the helpful hints and instructions you'll be sure to win more often by playing wisely and well. **only \$2.**

3102 — HOW TO PLAY DICE AND WIN! Now learn the actual odds and probabilities of each and every roll. You'll find pointers on how to bet when you are shooting or fading—the right and wrong bets for you. Prepare for that weekly or big money game! **only \$2.**

3103 — PLAY THE HORSES AND WIN! Learn the three basics necessary to win at the track: How to Pick the Best Horses; How to Get Better Odds; and How to Get Insurance Against Losses. No more doubts about your ability to Win, Lose or Draw! **only \$2.**

3109 — PLAY THE TROTTERS AND WIN! The entire gamut of harness racing from A to Z is covered in this book that explains the "hows" and "whys" in simple language. You'll learn the techniques of picking the horses that will make you a winner. **only \$2.**



MAX PADELL INC., 830 BROADWAY, NEW YORK, N.Y., DEPT. PM-33

Gentlemen: I enclose \$_____ . Please send me the following books:

NAME _____

ADDRESS _____

CITY _____ STATE _____ ZIP _____

502	511	3133	3101
503	1512	3169	3102
512	3164	3170	3103
513	1514	3176	3109

MONEY BACK GUARANTEE—NO COD's

POLAROID'S NEW SX-70

(Continued from page 202)

moves less than $\frac{1}{4}$ inch to focus from infinity down to 10 inches.

Dr. Land needed such a compact lens to make the camera foldable. But its close-focusing ability (the SX-70 takes half life-size images at 10 inches, life-size ones at 5 inches with an accessory) was important to him, too: "In our dream . . . we didn't want the kind of camera that stops at three feet or even at two. . . . There's endless excitement within your hand's reach—that's your three-dimensional world."

Making the camera easy to focus (and it is) took still more revolutionary thinking. With only an f/8 lens, a conventional ground-glass image would be far too dark to focus on. And Dr. Land didn't want to use split field or microprism, since he felt "the whole beauty of the picture, with nothing to break it up, no little rings or prisms in the middle, was the important part."

So the SX-70's focusing system is as

SX-70's focusing system is as much like a telescope's as a camera's

much like a telescope's as a camera's. The image is formed and viewed in mid-air rather than on a ground glass. The main function of a ground glass—blurring the out-of-focus light rays so you can tell them from the focused ones—is accomplished by a microscopic pattern on the upper (viewing) surface of the moving mirror (see page 104). This pattern is superimposed on a Fresnel pattern that brightens the image as a Fresnel lens under a ground glass does. But this patterned mirror, unlike ordinary ones, reflects asymmetrically—where an ordinary mirror in the film plane would reflect the image right back to the sloping mirror above it, and back out the lens, the SX-70's viewing mirror casts its image at an angle, to pass it on to the viewfinder. All to let you "live in the viewfinder . . . seeing an image in space without seeing the focusing screen, so that you come out with the feeling that there's nothing between you and the image itself."

Exposure is controlled by a two-blade, two-hole shutter assembly that doubles

as the lens diaphragm. Press the electric shutter button (the "cable release" is also an electric switch), and the shutter closes down to darken the film chamber while the mirror rises from viewing to taking position (see page 104), opens to the correct f-stop, then closes again until the mirror falls back into the viewing position.

The shutter's second hole covers the light-meter cell (a photodiode that's far more accurate than conventional light cells), so the light read by the meter during exposure is proportional to that reaching the film.

Plug in one of the new, 10-shot GE Flash-Bars, though, and the exposure system changes. The shutter automatically sets itself to $\frac{1}{30}$ second, while the lens aperture varies with the distances, closing down as you focus closer to compensate for the flash's brighter illumination of nearby objects. From f/8 at 20 feet, the lens closes down to a pinhole f/90 at 10 inches, giving tremendous depth of field for closeups (see page 106). Unlike Polaroid's earlier flash exposure system, which cut off the shutter when enough light had bounced back from the subject, the SX-70's focus-linked system can't be fooled by light or dark backgrounds—but it can't compensate for light or dark subjects, either.

There are five bulbs on each of the Flash-Bar's two sides, each one half the size and twice the light output of those in flashcubes. GE-developed circuitry in the camera automatically skips all used bulbs to fire the next live one. When you're out of film, the Flash-Bars won't fire (but you can waste a film if you've used up your Flash-Bar). One problem, though: red-eye reflections caused by the flash's proximity to the lens, and most troublesome with the middle bulb of the five-flash array; Polaroid is bound to bring out a flash extender, just as Kodak did to solve the same problem on its Pocket Instamatics.

Listen to Dr. Land talk about his dream-child, and the word "remarkable" pops up in every other paragraph. Considering how many revolutionary developments went into its design—new lens, film, chemistry, viewfinder, camera design, flash and motor control circuitry—that's even more remarkable as an understatement. ★★★

IT PAYS TO OWN YOUR PHONE!

DESIGNERS' UPRIGHT PHONE



\$49⁹⁵

With dial, plug, Buzzer & cable

Beautiful memories of the '20s. Stands one foot high with dial in base. Black.

Brass finish available at \$5 add'l.

DESK DIAL PHONE

ASSORTED STYLES



\$8⁹⁵

With ringer, plug, dial and cable

An extra phone at a budget price without any extra charges! Full utility. Black.



PRINCESS-style PHONE

\$19⁹⁵ With dial, plug and cable

Sleek and low design. Colors: white, beige, blue, pink. Buzzer, if needed, at \$10 add'l.



FRENCH-style PHONE

\$19⁹⁵ With dial, plug and cable

A vintage beauty! Easy dialing base. Black.



MODERN COLOR PHONE

With ringer, plug, dial and cable **\$19⁹⁵**

Luxury looking and fine-functioning. Colors: white, beige, blue, green, ivory, pink, red, yellow, black.

"TRENDLINE" PHONE

\$59⁹⁵



With ringer, dial, plug & cable

The trimmest design and the newest trend in phone glamor! Colors: white, ivory, green, blue, beige, pink, red.



\$49⁹⁵

With dial, plug, Buzzer & cable

Ericofon

SCULPTURED PHONE

Decorators' delight! Swedish beauty prize winner. Dial and stop button at bottom. Colors: white, ivory, green, beige, blue, red, pink.



BATHROOM EXTENSION PHONE

\$19⁹⁵

With plug and cable

Be the person to have everything! Here is comfort-plus! Colors: white, black, beige, red, ivory, green.

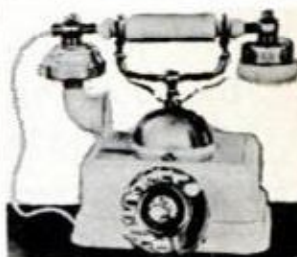

FRENCH CRADLE PHONE

With ringer, dial, plug & cable **\$49⁹⁵**

Genuine look of elegance! Authentic in every detail. Colors: ivory with gold, black with gold.

TELEPHONE AMPLIFIER



Complete **\$19⁹⁵**

For the busy person whose hands needn't be occupied when phoning. Carry on with your work while using the phone. Transistorized with volume control. Battery operated; for instant use. No installation necessary. Add \$1.00 pstg/hdlg

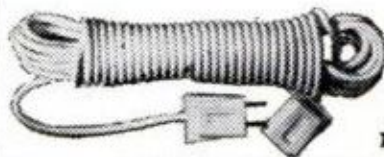

\$2⁹⁹

Add 60c pstg/hdlg

25 FOOT PHONE EXTENSION CORD

Have the convenience of your phone reaching every part of room. With welded 4-prong plug and jack. Off-white color.

MODERN WALL PHONE

\$9⁹⁵

With ringer, plug, dial and cable

Delightful style. Hang it in convenient place. Black. Worth double this price.



METROPOLITAN TELETRONICS CORP
Dept. P3, 35 WEST 35th ST. New York, N.Y. 10001

Please send me.....phones as follows:

.....
.....

Mail \$1 for our-illustrated Catalog. Full refund with 1st order.

Name _____

Address _____

City _____ State _____ Zip _____

N.Y. Residents add sales tax. Send check or money order.

All phones are ready for instant use. Just plug in. No additional charges on phone bill.,

Add \$1.50 pstg/hdlg charge for each phone. (\$2 pstg/hdlg west of Mississippi)

Include applicable sales tax.

TOTAL COST \$
Shipping Chg
Tax, if any

AMOUNT ENCLOSED \$

THOSE WILD NEW WINGS

(Continued from page 128)

giant behemoths envisioned a decade ago.

While Boeing is busy experimenting with its swing wing, the delta wing has not been forgotten, either. In an effort to overcome its basic shortcoming of rapid loss of lift at low landing speeds, two designers are proposing a really wild scheme. It's also a swing wing—but up and down instead of sideways. The delta is hinged at the tail and slotted in the middle to straddle the fuselage. Developed by Mason and Granbyrne Trupp of Tampa, Fla., it can be tilted up or down at will to vary its angle of attack and thus its lift. As the pilot makes his landing approach, he gradually raises the wing. This has the same effect as coming in nose-high, except that the fuselage remains level for good ground visibility without the need for an elaborate droop snoot. Very short landing runs are possible

... the raised wing acts like a giant air brake once the plane touches down.

since the raised wing acts like a giant air brake once the plane touches down.

Short takeoffs are another advantage claimed for the system. Since the engines are attached to the wing and point downward in the raised position, they thrust the ship upward at a steep angle, getting it off the ground quickly. In flight, the wing retracts for high-speed cruising.

Another unconventional design coming along is the so-called "supercritical" wing. Like the antisymmetrical wing, it is also a NASA development, this one the work of Dr. Richard T. Whitcomb at the Langley Research Center in Hampton, Va. Unlike the antisymmetrical wing, however, it is designed primarily for improving performance at near-sonic speeds rather than at high supersonic speeds. Flatter on top than the conventional airfoil, its object is to "delay" or push back the impact of sonic shock waves to a point farther back along the wing. This reduces drag produced by sonic turbulence and results in greater speed and maneuverability. To compensate for some loss of lift caused by the flatter wing, the trailing edge curves down slightly, giving added

upward thrust something like the increased lift an airliner gets with its wing flaps angled downward on landings and takeoffs.

The new wing has already been successfully tested on a modified F-8 Navy fighter and is expected to be especially beneficial to military aircraft where increased speed and maneuverability are vital in aerial combat. The term supercritical, incidentally, is used to indicate a "delayed effect," just as supercooling of liquids delays or lowers the freezing point below normal freezing temperatures.

Meanwhile, back at the drawing board, a heated debate is beginning to develop over just how airplanes fly in the first place. The long-accepted "Bernoulli theory" is now getting its lumps from retired NASA expert Norman F. Smith of Alvin, Tex., who's had 30 years of experience in aerodynamic design. The established schoolbook explanation is based on the assumption that air flowing over the curved upper surface of a wing is forced to speed up to cover the longer distance in the same time as slower-moving air passing along the flatter underside. According to Bernoulli's law that a fluid decreases in pressure as it increases in speed, the faster-moving air above the wing creates a low-pressure "suction" effect that gives a plane its lift.

Not so, claims Smith. Anyone who has ever stuck his hand out the window of a moving car knows that if you turn your palm upward, your hand "flies" upward. If you turn it downward, it's forced downward. This, says Smith, is actually what makes an airplane fly. Air striking the slightly upturned underside of the wing is forced downward and reacts by pushing the wing—and plane—back upward. Thus the credit should go to Newton (for every action, there is an equal and opposite reaction) rather than to Bernoulli, argues Smith. He doesn't deny that the Bernoulli effect may take place; he simply doesn't believe it's the primary source of lift. His theory is at least partially borne out by the fact that most modern high-speed wings are virtually symmetrical in cross section anyway.

But whether it's Newton or Bernoulli, antisymmetrical or supercritical, swing-wing or tilt-wing, a lot of exciting things are happening in aviation today that just may bring about a dramatic new breakthrough in jet-age air travel. ★★★

'DUST-FREE' HOME

(Continued from page 148)

placed with one fitted with turning vanes.

You can have this part made to fit the cleaner at a sheet-metal shop, along with a starting collar sized to slip over the furnace inlet flange. As shown in the drawing on page 147, the collar is attached to one side of the cleaner and the transition elbow to the other. Holes are already in the frame of the cleaner, and I found that Pop rivets were perfect for fastening the three parts together. To attach the assembled unit to the furnace, you simply slip the starting collar over the inlet flange and drive pan-head, sheet-metal screws in from the sides to hold it. Avoid using Pop rivets here since they would make it difficult to detach the cleaner assembly from the blower compartment should you wish to do so at a later date.

The old furnace filter is discarded, of course, and the blower compartment cleaned thoroughly before you start.

If the vertical drop of the return-air duct is less than 7 in. from the side of the furnace, an offset section of duct will have to be used to assure proper alignment. All joints in the return-air system between the air cleaner and furnace should be caulked and sealed to prevent dust from entering the clean airstream.

The electronic cells slide in place with their contacts up and airflow arrows matching the airflow. The ionizer sections and the protective screens must be on the *upstream* side of the cells.

The air cleaner is wired to operate only when the furnace blower is running. Access to the junction box is gained from the top of the unit, and wiring diagrams are provided to suit your particular blower motor.

From time to time, you may hear a snapping noise coming from the air cleaner. Called arcing, this may occur when the cleaner collects an unusually large particle, when the cells are still wet after washing or when they are very dirty.

Caution: The access door of the cleaner is connected to a shorting mechanism that discharges the high-voltage power supply when the door is opened. *Always turn off the blower switch before touching any internal parts of the cleaner.*

For additional information and prices write Honeywell, 2701 Fourth Ave. South, Minneapolis, Minn. 55403. ★ ★ ★

GOVT. SURPLUS

and other bargains
SAVE to 90%



Send for this catalog

The world-famous Airborne Catalog. Fully illustrated. Contains 1000's of bargains in hydraulics, electrical, marine, automotive & hardware items ... and more! A must for mechanics, machinists, hobbyists, sportsmen, inventors, etc. Send 35¢ to cover postage & handling. In a hurry? Send \$1 for airmail delivery. Must include zip.

AIRBORNE SALES CO. Dept. PM73
8501 Steller Dr., Box 2727, Culver City, Ca. 90230
Satisfying world-wide customers since 1945

New! 3-D Sight Magnifiers ENLARGES CLOSE WORK ^{ONLY} \$1.98 SMALL PRINT!

WORTH MUCH MORE!

See clearer, work faster, more accurately with less eye strain, less fatigue and tension with **HEAD BAND MAGNIFIER**. Wear like glasses, they'll magnify about 3x and leave hands free to work.

Produces a 3-dimensional effect, where each detail appears to stand out. **FOR CLOSE WORK, REPAIRS, SEWING, HOBBIES, etc.** Sturdy, lightweight, adjusts to all sizes. With or without glasses. Powerful prismatic polished lenses. Only \$1.98 + 50¢ for Post. and Hdg. PPD. (2 for \$3.50, 3 for \$5.00) **WORTH MUCH MORE! MONEY BACK GUARANTEE.**

Nu Find Prod., Dept. HB979 Box 205, Church, N.Y.C. 10008



GARAGE DOOR OPERATOR... \$89⁹⁵!

- RADIO CONTROLLED from car transmitter or wall switch
- SAFETY night and day year 'round
- SECURITY door locks tight when closed
- CONVENIENCE in car control any weather
- LIGHTING garage lights automatically
- VERSATILE fits all lifting type wood, metal or fiberglass doors sectional and 1-piece
- EASY HOME INSTALLATION in just 2-3 hours
- SAVE up to 50% direct factory purchase and PP or UPS home delivery
- GUARANTEED one year
- FREE brochure

HELPMATE Equipment Co., Box 51PM Baroda, MI 49101



Print For Profit

Cards, Stationery, Envelopes, Advertising, labels, tickets, announcements, Q.S.L. cards, greeting, sympathy, prayer cards, tags, etc. Good Profits, Pays for itself in a short time.

Own a Printing Business

We supply everything direct from factory only. Easily followed rules. Also raised printing like engraving. Have home shop. Add to income. Send 25¢ for catalogue. **KELSEY PRESSES Meriden, Conn. 06450**

MAIL THIS COUPON TODAY!

KELSEY PRESSES, DEPT. 73-F, Meriden, Conn. 06450

I enclose 25¢ send big catalog and samples.

Name _____

Address _____

City _____ State _____ Zip _____

TRAVCO'S MINIHOME

(Continued from page 165)

tank in the fall, puts antifreeze in his Porta Potti chemical toilet, uses no running water through the faucets aboard until spring and has no more trouble.

Handling heat was a problem for a New Orleans man. He bought his Minihome without the optional Mark IV built-in air conditioner. Shopping around later, he found no company would guarantee effective cooling of the rig unless a bulky rooftop unit was installed up there. Since the good looks of the Ford conversion is one of the pluses mentioned by a number of owners, it would appear wise to order the Travco Family Wagon with built-in air conditioner, no matter what make of chassis, or shop for a used Minihome with the cooling system already installed.

We never experienced insufficient cooling with our model, or excessive engine heat in traffic or mountain driving in tests of over 20,000 miles. A cool feature we especially favored was a 12/110-volt refrigerator that kept cold drinks ready.

Going back to get them could be a skull-snapper, however, if the top pipe berths were left in place. A cross-brace to hold the aft end of the bunks was a bore to duck constantly. Most owners we surveyed dismantle the top bunks every day after one or two scalplings. The agreement, in fact, is that this Family Wagon is comfortably laid out for two with any of the optional interior arrangements, but that camping gets more crowded with even small children along. Perhaps especially with children, although our crew of three is eager for a Minihome trip at any time. With the rear seat folded down into a roomy double bed, they have plenty of space for games or naps.

Rear dinette and gaucho floor plans are offered for the new Royale I and II models. A Busyvan is also available which a camper can fit out himself. Many companies like the walk-around headroom and buy it for their own commercial applications. The latest Travco Family Wagon Lift-top Royale I starts at \$4995 and goes up as more deluxe accessories are substituted or added. Royale II and Maxi Custom have hard tops.

Owners like to describe the many ways they use their rigs. I remember showing TV star Johnny Carson through mine. He was thinking of it as a base of operations

while skiing. Really self-contained? I got into mine in Maine and didn't step out until I reached the Mexican border in Arizona seven days later. Driving alone was lonely, but the Minihome ran like a well-wound watch. Take someone along and, as any owner can tell you, compact camping can be easy—and fun. ★★★

WINNEBAGO'S D-20T

(Continued from page 167)

"and I can't reach the headlight dimmer switch. That will have to be changed. But the windows in the rear bedroom are wonderful. My wife and I lie in bed in the morning in the campground and watch the birds."

For the birds is the front muffler clamp, according to a South Carolina rental agent. All three of his units (and our test vehicle) had loose mufflers. Dodge dealers offer an "improved" clamp, but the permanent cure is welding.

The gauchos—sofa beds—in most motor homes today seem to have been designed for Wilt the Stilt. Those in the D-20T make up into a king-size bed, but they leave a lot to be desired in seating comfort. The sofa seat height is 21 inches; the depth to the bolster cushion 26 inches. (Average chair height is 18 inches, depth 21 inches.) Most adults find their feet dangle above the floor if they want back-cushion support—the gauchos' dimensions were determined by the water tank under one and the furnace under the other.

We couldn't do anything about seat height, but in the test vehicle we cut seat depth to 18 inches by building top-opening wedge-shaped cabinets behind the bolster cushions. These are sloped at a comfortable angle, provide firm support and additional storage space.

Despite minor gripes, the D-20 model seems to be the ideal size for those who want the spaciousness of a full-size motor home in a length most mini motormakers must stretch to reach. It is currently Winnebago's best seller. ★★★

GRUMMAN'S MOTORHOME

(Continued from page 169)

tective cage that doesn't rattle or squeak.

Seated before an adjustable steering wheel in a comfortable airplane-type seat, which moves up, down, backward and forward, the driver has excellent visibility

(Please turn to page 210)

The Greatest Advance In Soldering—The Wahl "Cordless Soldering Iron"!

The Perfect Soldering Tool For The Electronic Enthusiast, The Model Builder, The Home Handyman, and Campers.

- Completely Portable
- 8" Long—Weights Only 6 Ounces
- Push Button Operation
- Built-In Work Light
- Recharges Automatically
- Heats In 5 Seconds



only
\$19⁹⁵
plus postage

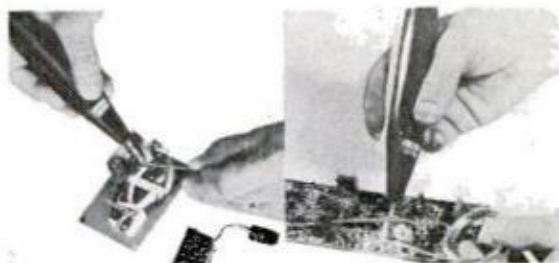

Complete working freedom for those tough soldering jobs. No cord to get in the way—truly a portable soldering instrument. The Wahl "Iso-Tip" Cordless Soldering Iron is powered by long-life nickel cadmium batteries. Fully charged, unit gives up to 100 solderings at a tip performance of 50 watts. This amazing tool is specially designed for good feel and balance—8" long and only 6 ounces in weight. Just press the button and full soldering heat of 700° F is reached in just 5 seconds. You will gain a new dimension of versatility and precision. **WARRANTY**... Your Wahl Cordless Soldering Iron is of such high quality that the manufacturer will repair or replace this instrument for 1-year from date of purchase if it fails to operate satisfactory.

Please ship me _____ Cordless Soldering Irons at \$19.95 each plus 75¢ postage and insurance each. (Illinois residents add 5% Sales Tax.)

Check or money order enclosed.

NAME _____

ADDRESS _____

CITY _____ STATE _____ ZIP _____

Place in envelope and mail to: **300PM**
CONTEMPORARY MARKETING, INC.
607A Country Club Drive
Bensenville, Illinois 60106

NEW RUBBER STAMP BUSINESS PAYS BEGINNERS UP TO \$16.50 AN HR.

**START AT HOME
IN SPARE TIME**
with Table Top Machine!

We Help Finance You
... at less than bank rates!

The multi-million dollar Rubber Stamp business—once controlled by a few big companies—is now being taken over by small operators—one in each community throughout the United States. Men and Women who have this inexpensive machine can turn out huge quantities of Rubber Stamps with special wording that buyers once were forced to buy from big cities. Material costing only 27¢ makes a stamp that sells for \$2.75. The machine that does the work is simple and easy to operate and it turns out as many as six Rubber Stamps at a time, each with different wording such as names, addresses, notices, stock numbers, prices and other "copy" needed by offices, factories and individuals. Working full capacity, it can earn as much as \$33.00 an hour for the operator! Now you can get into the big-pay business yourself, with your own home as headquarters. You don't need experience. We supply everything, including complete instructions and eight ways to get business coming in fast. **We even help finance your start.** Start making up to \$16.50 an hour from the very beginning. Cash in on the profitable Rubber Stamp business in your community, right away. We'll mail full particulars FREE and no salesman will call. Be first in your locality. Rush coupon today or send your name on postcard to:

RUBBER STAMP DIV., R-2-CC
1512 JARVIS AVENUE • CHICAGO, ILL. 60626

MARCH 1973



RUBBER STAMP DIV.
1512 Jarvis Ave., R-2-CC
Chicago, Illinois 60626

FREE!

Please rush full particulars about your financing plan and the little machine that can get me started in the profitable Rubber Stamp business at home in spare time. Everything you send me is FREE and no salesman will call.

NAME _____

ADDRESS _____

CITY _____ STATE _____ Zip Code _____

GRUMMAN'S MOTORHOME

(Continued from page 208)

ahead and to the sides. Double mirrors on each side give him rear visibility. With power brakes, power steering and automatic transmission, the Motorhome seems designed to pamper the driver. The front-access door to the oil filler and radiator does pamper the driver who's accustomed to lifting the engine cover alongside his seat to check oil.

The 392-cu.-in. International engine in the test vehicle pulled the big Motorhome along easily at 60 or 70 mph (getting 8.29 mph overall, we found) and had enough extra push for passing on a hill.

The ride is like any other motor home built on a stiff-suspension chassis—pretty good for the driver and copilot in their pedestal seats, but somewhat rough as you move back over the rear wheels. The suspension has its pluses, though: You don't fight to keep going straight in crosswinds, and there's good control and stability in turns (as we proved in a frantic lane-shift at 60 mph to avoid a car backing up on a throughway).

In a campground, with three kids and a dog along, we experienced a certain amount of stepping on one another's feet, but that seems to be part of motor-home living—with a family, anyway. Otherwise, life is comfortable in a Grumman, with its deep-pile carpeting, four-burner range with oven and fan exhaust, seven-cubic-foot gas/electric refrigerator, hot and cold water, marine toilet and ample storage space. The rear-bath model we tested even has a bathtub. (The side-bath 25-footer trades off the tub for a spacious bedroom in the rear.)

We liked the nicely finished interior and the fact that there's plenty of space between upper and lower bunks so the bottom sleeper doesn't get claustrophobic.

Grumman has been building motor homes nearly four years (with 25 previous years' experience building Olson vans and trucks). A 23-footer, once in the lineup, has been dropped, so present choices are:

- 21-foot Motorhome with side bath (new for 1973). Basic price: \$10,750. It's a four-sleeper, with bunk options for four more. Chassis/engine choices are Dodge, Chevrolet and International, all with 137-inch wheelbase.

- 25-foot Motorhome with side bath. Basic

price: \$14,670. It's a four-sleeper, with bunk options for three more. Chassis/engine choices are Dodge, Chevrolet and International on a 159-inch wheelbase.

- 25-foot Motorhome with rear bath. Basic price: \$14,880. We tested this one. It has sleeping for six, with an optional bunk over the driver's seat for a seventh. Chassis choices are the same as above.

- 28-foot Motorhome with side bath (new for 1973). Basic price: \$17,990. Built for the "adventuresome couple, the retired couple," this model has twin beds in a rear bedroom plus a couch toward the front that converts to a double bed to sleep a total of four. It has Dodge or International chassis with a 178-inch wheelbase.

Owners, who had individually driven 9000 to 22,000 miles, reported getting 7 to 8 mpg with the 25-footer and 7 to 10 mpg with the 23-footer.

The side bath vs. rear bath option of the 25-foot machine had proponents on both sides. "I like the bathtub back there; it makes a kind of utility area that's great for drying ski clothes," said a New Jersey college professor. But lack of a tub in the side bath is no loss, reported a teacher who prefers the big bedroom at the rear.

"There's no comparison with the stability of the Grumman," the teacher continued. "It gives you a feeling of security and quality." A New York electrical engineer likes "its construction and how it looks," and another engineer says simply: "Built solid." Most other owners agreed.

Complaints ranged from "none" to "minor" to a list of 20 grievances from a New York physician who "will never again buy a motor home from a dealer who is unprepared and/or unwilling to give full service." He had "windshields popping out, cracks in the fiberglass roof, fuel line burning through where it lay on the exhaust manifold, transmission selector that slips out of position, air leak around the door" to list some. But, he concedes, "Overall body work is excellent," and it "will be a fine coach" when all is right.

An Indiana real-estate man who's a reserve jet pilot, tried 11 motor homes before he bought a Grumman—and he puts it to a most unusual use: "I take customers and their children to see houses. The kids stay in the Motorhome and watch TV and drink Cokes. Then when we conclude business we may have a martini out of the refrigerator." ★★★



BUILD THESE BEAUTIFUL CLOCKS

NOW AT BIG SAVINGS!

Send just \$1 for plans & instructions to build choice of: (A) Grandfather, (B) Steeple, (C) Grandmother—plus information-packed catalog of movements, dials, parts & kits to build these & 16 other fine clocks. All 3 plans—\$2.50. Catalog alone—25¢.

MASON & SULLIVAN COMPANY
Dept. PM, Osterville, Mass. 02655



HEARING AIDS

Huge savings on tiny, all-in-the-ear, behind the ear, eye-glass and body models. New space age models are so tiny and well concealed your closest friends may never even notice. **FREE HOME TRIAL.** Low as \$10 monthly. Money back guarantee. Order direct and save. Write today for free catalog and confidential booklet. **PRESTIGE, Dept. T-29, Box 10947, Houston, Tex. 77018.**



MORE POWER FOR BIG JOBS

man-size **ECONOMY TRACTOR**

Mow 2-3 acres/hour, plow acreage fast. Big 14 hp engine, all-gear drive for more work-power. No belt or fluid-drive loss. Over 20 implements, 48" dozer, 32" tiller, 48" snow-blower. Write: **ECONOMY TRACTOR 1005 K-3 Anoka Avenue Waukesha, Wis. 53186**



WHITE'S METAL DETECTORS

WHITE'S ELECTRONICS, INC. manufacture the World's Largest and Finest Line of Mineral and Metal Detectors. Ghosttowning, beachcombing, bottle hunting, coin hunting—all types of **TREASURE HUNTING** or **PROSPECTING**, amateur or professional. Detect conductive metals Gold, Silver, Copper, Nuggets, Coins, Rings, Jewelry, etc. Underwater or on the land. "There are no fees at any price." 25 production models to choose from. T.R. or B.F.O.

Priced from **\$75.00 up**
—Always specify the Blue & Gold ARK-FUN WHITE'S BY NAME

—Free Literature—**WHITE'S ELECTRONICS**

H. P. 512
1011 Pleasant Valley Rd.
Sweet Home, Oregon
33784 Hazel Street
Atsford, B.C., Canada
Eis An Industrial Park
Drexel Drive, East
Elmlet, Indiana 46514



1¢ SALE

GUARANTEED 10 YEARS



The knife for hunting, fishing and all around use. Mirror polished. Imported stainless steel blade honed to a razor's edge. Rugged. Opens quickly, easily. Locks into position. Blade will not close when in use. Press button in handle to close. Safety finger guard. Sure-grip handle. Balanced for target throwing. **IF BROKEN WITHIN 10 YEARS WE WILL REPLACE AT NO CHARGE!** Use 30 days. Money back if not pleased. Special to sale. **REG. PRICE \$1.98. Send \$1.99 & receive 2 knives. Add 49¢ postage, handling. Remit TOTAL \$2.48 for 2 knives. ORDER NOW! Midwest Knife Co., 9043 S. Western Ave., Dept. DD-6208, Chicago, Ill. 60620. Est. 1938.**

MARCH 1973

211

EARN \$20.00/HOUR



by assembling unique 7 or 12 hp **MINI-DOZER®** bulldozer kit for yourself or resale. 20 attachments—Loader, Mower, Snowblower, Plow, etc. "Build-it-yourself" plans—\$5.00. Catalog of Dozer and 30 other assembly kits—\$1.00 (Refunded on any purchase). **STRUCK CORP., Dept. P3DB3, Cedarburg, Wis. 53012**

EARN \$20.00/HOUR

by assembling unique 12 or 16 hp **TUFF-RIDER®** tractor kit for yourself or resale. 20 attachments—57" Mower, Snowblower, Plow, Loader, etc. "Build-it-yourself" plans—\$5.00. Catalog of Tuff-Rider and 30 other assembly kits—\$1.00 (Refunded on any purchase). **STRUCK CORP., Dept. P3TM3, Cedarburg, Wis. 53012**

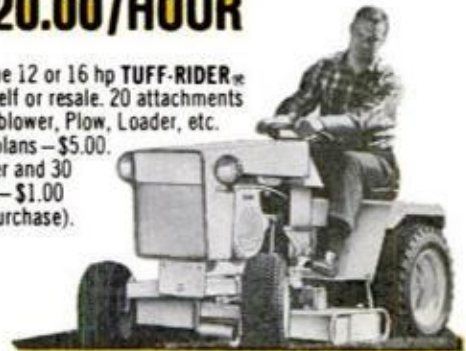

EARN \$20.00/HOUR

by assembling unique 12 or 16 hp **HALF-TRAC®** tractor kit for yourself or resale. 20 attachments—Loader, Plow, Cultivator, Snowblower, etc. "Build-it-yourself" plans—\$5.00. Catalog of Half-Trac and 30 other assembly kits—\$1.00 (Refunded on any purchase). **STRUCK CORP., Dept. P3HL3, Cedarburg, Wis. 53012**



HELPS DRAW OUT BOILS

Here's quick, proven relief when unsightly and painful boils make you feel miserable. Soothing **BOIL-EASE** with 7 medicated ingredients helps reduce swelling and pain. Protects against infection, so you look and feel better fast.

BOIL-EASE®



ARROW

All-Purpose **STAPLE GUN** T-50

SHOOTS A STAPLE

Uses 6 Staple Sizes 1/4" to 9/16" including Ceiltile.

WHEREVER YOU'D DRIVE A NAIL!

At Hardware, Lumber & Building Supply, Stationery, Variety and other retail outlets.

ARROW FASTENER COMPANY, INC.
271 Mayhill Street, Saddle Brook, N. J. 07663

APPLIANCE REPAIR BOOKS

Written in easy-to-understand language by experts in the service field with illustrations and diagrams! Acclaimed by instructors and professionals alike! How to diagnose and repair refrigerators, air conditioners, washers, dryers, ranges, dishwashers, vacuum cleaners, motors, water heaters, coffeemakers, hair dryers, food mixers, can openers, electric irons, floor polishers and many others. Also, fundamentals of solid state, setting up a shop, using test equipment and a lot more. Only \$2.65 to \$4.90 each!

SEND FOR FREE DESCRIPTIVE PRICE LIST

CHAROUS & NIEBERGALL INC., 5841 MONTROSE, CHICAGO 60634

WESTERN HAIG

.12 CALIBER
SPECIAL FACTORY
OFFER!



\$300
post-paid

USES POWDER CHARGE

This small bore gun shoots .12 cal. steel bullets fired by small 4.4 mg. powder charge. Not a CO₂ gun. You'll like the handsome lines, grip, and balance. Western in style, but patented ball and cap action allows this low price. 9 1/4" steel barrel cased in knurled styrene stock, overall 13 1/2". Develop pistol form, accuracy at a fraction of cost of large cal. pistols. Comes with 50 steel bullets. Satisfaction guaranteed. Send \$3.00 to:

HAIG MFG. CO., P.O. Box 26-JA, Hamba, Calif. 91802

TERRIFIC "BUY" IN 75 POWER TELESCOPE—\$4.98

3 telescopes in one —25 power for ultrabright images, 45X and 75X for extra long range. Guaranteed to bring people, sports, ships, moon, etc. 75 times closer. (Also use as strong microscope.)



for the money, NOT A KIT—ready to use, 4 ground, polished lenses; 5 sections, brass bound, 3 feet long, closes to 1 foot. Directions for use. Money back guarantee. Postpaid. Order now!

Busse Sales, Dept. PM69, 331 Church St., Hartford, Conn. 06101

Bean's Outdoor Sporting Specialties

Free Spring Catalog



Just Off The Press

Fully illustrated featuring fishing, camping and summer sports equipment. Outdoors apparel and footwear for men and women. Many items of our own manufacture. Our 61st year of providing dependable, high grade sporting specialties. All fully guaranteed.

Send Free Catalog

Name _____

Address _____

Zip _____

L. L. Bean, Inc.
626 Main St., Freeport, Maine 04032

BE A LANDSCAPE CONTRACTOR

LEARN MODERN LANDSCAPING for exciting hobby or profit. Thousands of spare or full time money making opportunities. Start a profitable business—we show you how. Study and earn your certificate at home. Write today for Free Book. **LIFETIME CAREER SCHOOLS** Dept. A-408 2251 Barry Ave. Los Angeles, Calif. 90064

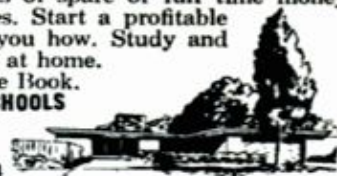

locksmithing and key making

PRACTICAL UP-TO-DATE COURSE—ONLY \$7.95



Teaches you how to pick locks, de-code, make master keys, repair, install, service, etc. New self-instruction lessons for every handyman, homeowner, carpenter, mechanic, service station operator, fix-it shop, hardware dealer, gunsmith. 53 easy illustrated lessons. Full price only \$7.95 post-paid. Satisfaction or refund guaranteed. Mail order today!

NELSON-HALL CO., Dept. 6CX-2
325 W. Jackson Blvd., Chicago 60606

At Last a New Amazingly Simple

GAS TURBINE JET ENGINE

Build from easy to follow plans. Length 15", Dia. 8 1/2", Wt. 15 lbs. Fuel: Gasoline or Kero.

"Scream Demon" develops 20 H.P. Ideal project for serious-minded hobbyists, students; scientific and industrial arts classes. Make on 9" metal cutting lathe with milling attachment. For use on small racing boats, midget cars, etc. Full size assembly drawings with critical dimensions, bill of materials and photos. Price \$5.00. No C.O.D.

SAVOY SCIENTIFIC, BOX 1398, SANTA MONICA, CALIF. 90408



BLAST FURNACE—FOUNDRYETTE 2400 F



Since 1935
Hobbyists • Schools • Inventors, etc. Make your own castings of any metal from cast iron, down to lead and zinc. Available in 6 sizes, 1/2 to 50 lbs. Complete units from \$50.40 to \$162. Send 25¢ for circular—refundable.

KANSAS CITY SPECIALTIES CO. Dept. P-3
P.O. Box 193
Middleton, Wisc. 53562



UPHOLSTERING AND DECORATING FOR PROFIT! Men & Women All Ages!

At home, we show you how, Incl. tools, kits to make and sell. Accredited NHSC. Approved Veteran Training. No salesmen. Creative Upholstery & Decorating School Div. Technical Home Study Schools, Dpt. 5110-033, Little Falls, N. J. 07424

FIND BURIED TREASURE

Powerful electronic detector finds buried gold, silver, coins, etc. Financing available.



Write for free catalog 1995 to 19850
RELCO, Dept. D-3
BOX 10839, HOUSTON, TEX. 77018

WRIST ROCKET

AMERICA'S HARDEST HITTING SLING
Range 225 yd.—232 fps.
Matched replacement rubbers and LEATHER pouch assembly \$1.00
At dealers or order direct.



WRIST ROCKET Mfg. P.O. BOX 21-B
Columbus, Nebraska 68601

\$300 Post. Pk. in USA by C.O.D.
Orders outside USA add \$1.00 for postage and handling



Repair any watch

... SWISS OR AMERICAN

Unique, modern Sweazey System starts you making repairs right away. Develops skill step by step at home in spare time. Diploma awarded. Free sample lesson. No obligation.

CHICAGO SCHOOL OF WATCHMAKING
Dept. 133, Fox River Grove, Ill. 60021

POWER HACKSAW KIT ONLY \$24.95



Also 51 other money-saving projects to be built in the home workshop. Lathes, drill presses, vises, etc. Send 50¢ for 28 pg. Catalog.

C.F. STRUCK CORP., Dept. P3P3, Cedarburg, Wis. 53012

**USE
WHAT THE
PROS USE!**



- LUBRICATES
- PENETRATES
- PREVENTS RUST

Available wherever automotive products are sold.

CRC CHEMICALS
Div. C. J. Webb Inc.
Dresher, Pa.



LEARN MEAT CUTTING

Train quickly in 8 short weeks at Toledo for a bright future with security in the vital meat business. Big pay, full-time jobs—HAVE A PROFITABLE MARKET OF YOUR OWN! Time payment plan available. Diploma given. Job help. Thousands of successful graduates. **OUR 50th YEAR!** Send NOW for big new illustrated FREE catalog. No obligation, G.I. approved.

NATIONAL SCHOOL OF MEAT CUTTING
Dept. 50-U, Toledo, Ohio 43604



HEARING AIDS

**SALE—
SAVE
UP TO 1/2!**

SUPER SAVINGS! Newest. Finest. All types. Buy **DIRECT** & save up to **HALF!** No salesmen. Sold by **AIR MAIL on HOME TRIAL. FREE Catalog.** Write: **MONEYSAVERS,** Dept. PM-3D, 9530 Langdon Ave., Sepulveda, Cal. 91343

FREE CATALOG — WRITE!

Wood Craftsmen/Hobbyists



NEW 144 PAGE CATALOG HARDWOODS

Domestic and Imported

Short Dimensions or Long Lengths
Wood Panels—Fine Hardwood Plywoods

Inlays, Turning Blocks, Pre-cut Veneer Picture Kits, Mouldings

Pre-cut Wood Kits—Picture frame stock, Banding, Ornaments

Everything in fine kiln dried woods for the serious craftsman

Power tools—name brands at big discounts

Wood finishing products—Hundreds of woodworking hand tools

Hard-to-find Cabinet Hardware ...pulls, casters, slides, locks hinges, glides — and more!

Full line—Lamp Parts—Upholstery Supplies

Clock and music box movements

Special picture section — 32 fine woods in color

NEW COMPLETE KITS! 3 STRING DULCIMER GUITAR

Big choice Wood Inlay
Marquetry Pictures
and Table Tops



Corner shelf



Birdhouse



Spice rack



Table planter



Bird feeder



Table planter

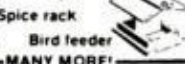

Bird feeder

MANY MORE!

Over 2000 Items! Mail Coupon for Catalog

Craftsman Wood Service Co., Dept. A-33
2729 South Mary Street, Chicago, Illinois 60608

Rush new 144 page color catalog. I enclose 50¢ for handling.

Name _____

Address _____

City _____ State _____ Zip _____

a new look

★ **FREE** full color illustration (see coupon)

at the fabulous Scorpion Too

**Have you heard about sport flying?
Did you know that you can
participate in your own
personal helicopter**

The Scorpion Too is RotorWay's
answer to backyard flight.

**Remember, the Scorpion is a
true vertical take-off helicopter,
it takes off straight up.**

Using a 140 h.p. engine, it cruises at 75 m.p.h. and can carry over 400 lbs. The most exciting news about the twin-seat Scorpion is its low cost, but then it's about time a helicopter became a recreational vehicle.

Send \$5 now
for graphically illustrated
color package containing:

- Fundamentals of rotorcraft flight
- Illustrated flight maneuvers
- How you learn to fly
- Scorpion development history
- Helicopter design theory
- Engineering definitions
- Power plant considerations
- Price information
- Performance specifications
- Unique features of the Scorpion Too
- Three-view dimensioned drawing
- Electrical and other options
- Exploded view of sub-assemblies
- Description of major component areas
- Information on how to proceed

★ Enclose this coupon with your \$5 and you will receive free, along with your package, a 25"x38" full color reproduction of this beautiful scaled cut-away drawing (as shown above). Rotorway commissioned Dick Aleith, one of the West's leading illustrators, to create this work of art. It's truly a collector's item.

ROTORWAY, INC.
Dept. BB/14805 S. Interstate 10
Tempe, Arizona 85281

Name _____

Address _____

City _____ State _____ Zip _____



RotorWay

Are you missing half the joy of your guitar?

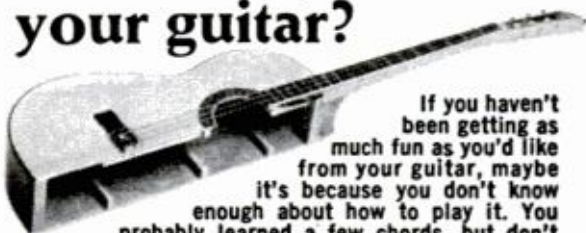

If you haven't been getting as much fun as you'd like from your guitar, maybe it's because you don't know enough about how to play it. You probably learned a few chords, but don't know how to go further. If so, let us help you. We'll teach you to read music and play pick style with both notes and chords—the way a teacher would. The difference is we teach with lessons by mail, and it costs a lot less. Courses in other instruments too—piano, spinet organ, accordion, violin, saxophone. If 17 or over, write for free booklet with more details. Send your name, address, zip code and list instrument you want to learn. Write U.S. School of Music, Studio A303, Port Washington, N.Y. 11050.

ACCREDITED MEMBER NATIONAL HOME STUDY COUNCIL

© 1973 U.S. SCHOOL OF MUSIC

398



handycan

THE AEROSOL TROUBLESHOOTER

makes everything run better

- Lubricates far better than oil.
- Loosens rusted parts.
- Protects against rust.
- Dries out wet ignitions and metal.



USE ZIP CODES WHEN ANSWERING ADS

HEAVY DUTY WELDER

with special \$7.00 gift offer to

Popular Mechanics readers

10-DAY FREE TRIAL

Lifetime Guarantee

Brand New **1895**

Model **1895**

Fits ordinary 110V outlet

Not one - but 6 welding heats



Weld, braze, solder or cut most anything made of metal. No experience necessary. Follow simple instructions to make repairs on cars, trailers, farm and lawn equipment, bicycles, appliances, etc. Make campers, boats, furniture, hundreds of valuable items. **NOTHING ELSE TO BUY!** Comes complete with full face shield, pack of welding and brazing rods, heavy duty power cables, special electric torch attachment, ground clamp, flux, easy-to-follow illustrated instructions, rod holder, etc. Uses standard 1/8" rods to weld iron, steel, brass, bronze, aluminum, other metals. New improved HEAVY DUTY circuit gives more welding power. Gives 4 times the heat needed to melt toughest iron. Plugs into ordinary 110V outlet. 6 WELDING HEATS plus continuously variable carbon-arc heat regulation control lets you weld anything from "tough" jobs to light-weight metals with ease. This important feature saves you money and time. Makes it possible for even beginners to start welding professionally the very first day. Pays for itself quickly. An excellent gift for any occasion. **IT'S AUTOMATIC:** Current is turned ON when arc is struck, OFF when rod is lifted from work. Eliminates need for troublesome foot switch. Speeds up work.

FREE! Mention that you saw this ad in Popular Mechanics and receive a \$7.00 gift pack assortment of "touch weld" welding rods. Automatic arc striker. Weld with "push button" ease. Lifetime guarantee. 10 day **MONEY BACK GUARANTEE.** You must be satisfied or return for refund. Send only \$2.00 and pay postman \$16.95 plus postage when delivered or send \$18.95 cash, check or money order for immediate postpaid shipment.

WEL-DEX MFG. CO., Dept. W-203, Box 10776, Houston, Texas 77018

PUMP DRAINS pools, cellars, laundry tubs IRRIGATES — CIRCULATES — SPRAYS



Heavy duty ball bearing pump. All metal, rust-proof Type XB. Stainless shaft. Use 1/4 HP or larger. 1 HP 1,200 GPH 60" high or 3,000 GPH 25" well. 5,200 GPH max. 1 1/4" in; 1" out. Belt or direct drive. \$14.95 Type P won't rust or clog. Bronze bearing. To 2,400 GPH. 1" in; 3/4" out. \$9.95 P'd cash with order. Money back Guarantee.

LABAWCO, Box 40, Belle Mead, N.J. 08502



5 DAY HOME TRIAL

DISCOUNT BREAKTHROUGH ON ACCORDIONS

SAVE 1/2 OFF retail prices of comparable accordions. Buy direct from world's largest dealer. Over 40 models for Student, Teacher, Professional. Electronic, Standard & Button Models—Amplifiers too! All Big Names. Try before you buy. Free accessories. E-Z Terms. Trades. Lifetime Performance Policy. **FREE** Color Catalogs/Discount price list. Rush coupon.

FREE Color Catalog

Discount Prices
42 Models

Accordion Corp. of America—Dept. R-33
5535 W. Belmont Ave., Chicago, Ill. 60641

Send **FREE** accordion catalogs and discount prices. Include special information checked:

Accordion Amplifiers Button Accordions

Name _____

Address _____

City _____ State _____ Zip _____

100% legal SURVIVAL HUNTING BLOW-GUN UNAVAILABLE ELSEWHERE USA made lifetime weapon **IMMED. DEL.**

1/2 OFF **100 FREE STEEL DARTS** **BONUS OFFER** .38 caliber Reusable Tempered **GUARANTEED 10 YEARS** **NOW ONLY \$6.88** ~~\$12.95 list~~

SILENT, POWERFUL, ACCURATE, HITS LIKE A RIFLE BULLET. Improved version of most effective native weapon—Malaysia's hunting blowgun. Thrilling sport! Kills varmints, pests. Tranquillizes. Survival. Defense. Ideal gift. Compressed breath gives amazing power. 200 ft. range. Astound friends! Rugged .38 cal. precision aluminum. Pierces 1/2" plywood. Speed 300 ft./sec. Not a toy! Has 100—5" & 8" steel darts (kit), targets, instructions. Compact 4 1/2 Ft. model \$6.88! Popular 5 1/2 Ft. \$7.88! Magnum 6 1/2 Ft. \$8.88! Extra darts: \$2.50 per 100! \$10 per 500. **BUY 2 GUNS GET 500 "BONUS" DARTS FREE (\$10 value)! BUY 3 GUNS GET 1000 DARTS (\$20 value)! BUY 4 GET 1600! (\$32 value) Add .65c postage EACH gun. IF BROKEN WITHIN 10 YEARS WE WILL REPLACE AT NO CHARGE! Use 30 days. Money back if not delighted.**

HOUSE OF WEAPONS, Box 7285-V2, Univ. Sta., Provo, Utah 84601. Send cash, check or money order.



PEN RADIO

AMAZING TINY RADIO hidden in a pen. Listen in secret to your favorite sport, news or music show! Use almost anywhere—in or out-of-doors. Tiny earphone included for private listening. Amazing circuit is self-powered.

GUARANTEED TWO YEARS

forever at no cost. No batteries. Ready to use. Use 30 days, money back if not pleased. **IF BROKEN WITHIN 2 YEARS WE WILL REPLACE AT NO CHARGE.** Order today! Only \$2.25 add 35c postage, handling. Grandpa's Shop, Dept. RA-7508, 9043 S. Western Ave., Chicago, Ill. Mail Orders only.

1600 Novelties

FREE! New World Famous Catalog

Hard-to-get Novelties, Jokes, Tricks, Hobbies, Sports, Science, Electronics, Funmakers, Psychodelia, Emblems, Posters, Magic, Games, Gifts, Models, Money Makers, Jewelry, Bargains, Gadgets, Books, Photo & Optical, Tools, Watches, etc. No letter necessary. Send name, address, Johnson Smith Co., Dept. 103 Mt. Clemens, Michigan 48043

The bargain hunter

110 Volt A.C. GENERATORS

60 cycles. Fanbelt driven from car or gas engine. Operates T.V., refrigerators, radios, all power tools, projectors, P.A. systems and fluorescent lights. Over 12,000 in service. Guaranteed six months. 1500-watt \$65.00 postpaid. 3000-watt \$105.50 postpaid. Special X-1000 watt self-excited generator \$85.00 postpaid.

TOOL POWER™ patent pending

115 volts D.C. 5000-watts, 50 amps from your car's alternator. **Guaranteed 20 years.** Install in ten minutes. Operates all power tools, electric motors up to 2 h.p. Arc welding, fast battery charging. Any like device by any name is an infringement of our patent pending. All copiers are notified. Be safe, buy from the inventor and developer. \$25.00 postpaid. Attractive dealer plan.

VIRDEN PERMA-BILT CO.,

P.O. Box 71607M

2821 Mays, Amarillo, Texas 79109



1852 "50¢ CALIFORNIA GOLD PIECES" 1882

75¢ Each 25 Assorted .. \$12.00
7 Different .. \$ 4.00

DLH Sales

422-PM3 Washington Building
Washington, D.C. 20005

PIANO TUNING MADE EASY

Excellent manual and all necessary tools, only \$22.50. Ten-day money-back guarantee. Free particulars. Stamm Industries, 297 Young, Oregon, Ill. 61061.

WHO READS THOSE "LITTLE ADS"?

Just about Everybody reads the "Little Ads" . . . MEN, WOMEN (AND YOUNGSTERS!) . . . PROSPECTS-BY-THE-MILLIONS—who regularly respond to "Want-Ads" . . . scheduled by most of the nation's Direct-Response Ad-Agencies, and Direct Advertisers . . . in the CLASSIFIED Market Place Sections that appear in 92 leading National Magazines with more than 45-million monthly circulation . . . a BIG potential market for your "Offers."

HERE'S HOW YOU GET M-A-I-L

To get full information about those big-pulling "Little Ads" write today: S. Omessi, Adv. Mgr., CLASSIFIED, INC., 100 E. Ohio St., Dept. 72, Chicago, Illinois 60611.

PERMANENT MATCH

AMAZING
INVENTION
SELLS
LIKE MAD!



Lights up to 15,000 times. Pull this ingenious metal wonder out of its case, strike on side, and presto!—it's lit. Amazes everyone who sees it. **MAKE BIG PROFITS.** Show to friends, fellow-workers, in stores, offices, taverns, factories, sells on sight for \$1.00. Order at low wholesale prices ONLY \$4.90 per doz.; \$14.25 for 3 doz.; \$39.20 for 12 doz. (2 samples \$1.00). Catalog of 100 other fast sellers included free! Lakeside Company, Dept. PP-33, 6800 N. Campbell Ave., Chicago, Ill. 60645.

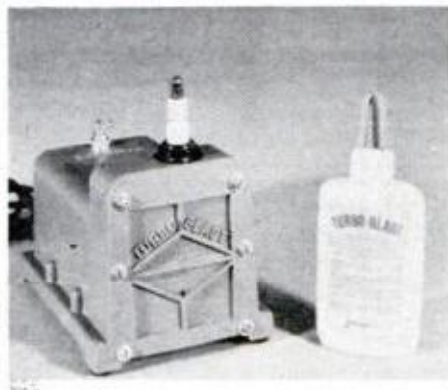

TURBO-BLAST SPARK PLUG CLEANER

GET UP TO 50,000 MILES ON YOUR SPARK PLUGS

Use the new TURBO-BLAST machine to clean all types of spark plugs—including platinum-tipped plugs. Operates on (110 v) household current. Rugged 12,000 RPM motor drives a fan which blasts a stream of tiny glass beads to scour a plug clean in seconds. Kit also includes illustrated instruction booklet, special thread-cleaning brush and a supply of glass beads for over 250 plugs. Additional beads are readily available. If not completely satisfied, unit may be returned within 10 days and your money will be refunded. Complete kit is only \$19.95 including handling and postage.

Mail this coupon for your TURBO-BLAST cleaner to:

JAYCRAFT CORPORATION **\$19.95**
760 North Marshall Ave. ppd
El Cajon, CA 92020

Name _____
Address _____
City _____
State _____ Zip _____

California Residents add \$1.00 Tax. 2

GRANDFATHER CLOCKS

SAVE 50%
BUILD YOUR OWN
GRANDFATHER AND
GRANDMOTHER

WEIGHT DRIVEN CLOCKS

- Highest Quality Imported Movements from Germany
- Tubular or Rod Chimes
- Moving Moon Dials
- Pre-cut Semi-assembled Handcrafted Case Kits (No power tools required)
- Dials, Barometers, Hygrometers, Templates and Case Plans.

All movements and dials in stock.

Send 50c for complete catalog

H. DeCOVNICK & SON,
P.O. Box 68, Dept. M33
Alamo, Calif. 94507
EST. 1947



GLASS BLOWER KIT \$23.⁹⁵ ppd.

Make Glass Miniature
SHIPS-BIRDS-BOTTLES

ILLUSTRATED

Instruction Book \$3.00

Willis Glass Supply Co.

P.O. Box 3460, Studio A,

Anaheim, Calif. 92803



HANDY DANDY Storage JARS



Handy Dandy plastic caps hook onto 1/8" peg-board to hold popular, quarter-twist food jars (such as baby food) with 1-15/16" neck. Unbreakable, clear plastic jars are also available.

QTY	CAPS	JARS	CAPS & JARS
10	\$1.00	\$ 2.00	\$ 2.75
24	-	4.50	-
36	3.50	6.25	8.75
72	6.00	11.50	16.00
144	11.50	22.00	30.00

PPD USA. No C.O.D.'s
WICKLIFFE INDUSTRIES
P.O. Box 286, PM-3
Wickliffe, Ohio 44092

IMPORTED

LOCK BLADE KNIFE

ONLY \$275 each

9" Overall Length
5" When Closed

- Sharp and Tough
- Stainless Steel Blade

Locks into position to prevent accidental closing.

Razor sharp tough stainless steel blade for reliable use and hard, long service. Money back in 5 days if not satisfied. Send \$2.75 plus 25¢ to cover postage and handling.

WESTBURY SALES CO.

P.O. Box 434, Westbury, N.Y. 11590 Dept. L-241-PM



THE AUTO ELECTRIC



with 150 V.D.C. meter Postage \$1.25

\$14⁹⁵

110V D.C. electricity from a vehicle alternator

- Light Bulbs
- Power Tools
- Battery Charging

Auto Air Equipment, Inc.
P.O. Box 2886—Amarillo, Tex. 79105

WATER WATER "HOW TO DRILL YOUR OWN WATER WELL" WATER WATER \$1.00ppd SATISFACTION GUARANTEED WATER WATER DEEPROCK CO. OPELIKA, ALA. 36801

SINGLE TWIN-JET OUTBOARD

Dual jet outlets with separate controls give exceptional slow-speed maneuverability to small boats. BUILD-UP OWN plans allow using locally available auto & hardware store parts. Also PLANS available for PORTABLE ELECTRIC POWER PLANT using auto alternator & ALT POWER, 110-volt power in your car.

FREE illustrated literature

BUREAU CO., Dept. PP

34161-B Coast Hwy., Dana Point, Calif. 92629

SAVE! BUILD YOUR OWN POWER TOOLS



METAL PARTS KITS AT FACTORY DISCOUNT PRICES

- 10-in. TILT/ARBOR SAW
- 6-in. BELT SANDER
- SPINDLE SHAPER
- 18-in. BANDSAW
- 12-in. BANDSAW
- COMB. DRILL PRESS-LATHE

SAVE \$50 OR MORE PLANS, with FULL-SIZE PATTERNS \$200 per Plan Deductible

Kits from \$19.99 to \$49.99. Featured in Popular Science, Mechanix Illustrated. Sold for 26 years. Thousands in use. Satisfaction guaranteed. Send \$2 each for Plans (state tools wanted), Catalog included. Or, send 25¢ for Catalog!

GILLIOM MFG. CO.
Dept. PMT-3 St. Charles, Mo. 63301

HEARING AIDS UP TO 50% OFF COMPARABLE AIDS

BUY DIRECT • 20 DAYS FREE TRIAL Body Aids \$39.95 up. Tiny All-in-the-Ear: Behind-the-Ear; Eye Glass Aids. No salesman will call. Write LLOYDS * Dept. PM, 905 9th St., Rockford, Ill. 61108 *



Thousands of exciting tool values!

SILVO (BRAND NAME) TOOL CATALOG
Thousands of Exciting Tool Values! Stanley, Millers Falls, Skil, Thor, Wen, Diaston, Wiss, Wellsaw, Dremel, Speedy Sprayers, Plumb, Huot, Kennedy, Channellock, Porter-Cable, Rockwell, Melios, Vise-Grip, Crescent, Ridgid Pony Clamps, Unimat, Foredom and many other Nationally Advertised brands of Tools & Supplies. We ship Coast to Coast at prices Hard to Beat. Send \$1.00 for our big 152 page tool catalog today. Silvo Hardware Co., PM-3, 107 Walnut St., Philadelphia, Pa. 19106.

BUILD YOUR OWN CANOE

WOOD & CANVAS OR FACTORY MOLDED FIBERGLASS
MANY MODELS TO CHOOSE FROM \$1950 FREE CATALOG
BASIC WOOD KIT! TRAILCRAFT, INC.
Box 60679, Concordia, Kansas 66901

"LISTEN IN" TO POLICE-FIRE RADIO CALLS IN YOUR CAR!

WORKS with ANY CAR—Portable or HOME RADIO! Just PLUGS in—No wiring—3 minute hookup! Switch instantly from regular to ALL POLICE-FIRE-EMERGENCY-COMMERCIAL-TAXICAB-STATE-CITY-GOV'T 2 way Radio calls in YOUR AREA. DUAL-HI-LOW BANDS TUNES 36-49 & 150-175 MHS. Use Everywhere—anytime—always works.
SEND ONLY \$2.00 (cash, Ck., M.O.) and pay postman \$9.99 plus COD pstg or send \$11.99 for ppd Del in USA. COMPLETE, ready to use with instructions. One Year service Warranty—10 DAY MONEY BACK TRIAL (if rtd). Sold Only—DIRECT FROM FACTORY at this Low Price!
WESTERN RADIO BPM-3 KEARNEY, NEBR. 68847

Compressed air from car lighter!

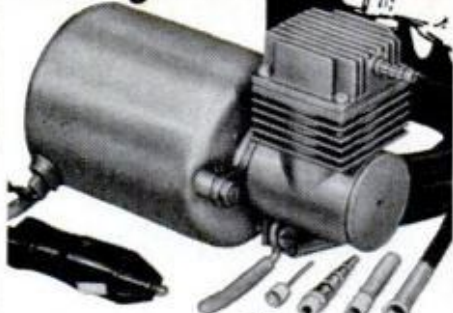

auto-flator

● Now have air wherever you go! Even remote areas. Emergency air for tires, air jacks, space-saver spare. Inflate mattresses, boats, rafts, pools. Plugs into 12-volt system in auto, trailer, truck, boat. Space-age size . . . only 6 1/2 inches long. Amazing pressure up to 60 lbs. Only \$29.95 (plus \$1.00 shipping) with air hose and inflator attachments. Send check or money order on 10-day, money-back, guarantee.

W. R. BROWN CORPORATION
2773 N. Normandy Ave., Chicago, Ill. 60636

Easy to Build PLANS AND INSTRUCTIONS for

Go Kart	\$2.00
Mini Bike	\$2.00
Mini Car	\$3.00
Pedal Boat	\$4.00
Sail Boat	\$2.00
Snowmobile Sleigh	\$3.00

Mini Vehicles Plans Dept.-C P.O. Box 92 Chazy, N.Y. 12921

The Metric System is Coming Use the New DIAL-A-CON® ANGLO-MET CONVERTER (Reversible)

In heavy duty plastic-6" Post Paid \$5.95 Each
Check or money order NO C.O.D.
Order from manufacturer FELSENTHAL INSTRS. CO. 7450 W. WILSON AVE. CHICAGO ILL. 60656

U.S. PAT. 3,544,768
Metric to English on back side

NAME _____
ADDRESS _____
ZIP _____

YOUR OWN RADIATOR BUSINESS

"\$70,000 LAST YEAR" says D. Carter, Lemoyne, Pa.

Complete turn-key package: training school in radiator repair technology and business management plus special power-equipped auto radiator shop. Don Carter writes: "Averaging \$30 an hour, expect to hit \$80,000 next year." Mail this coupon for complete story.

NAME _____
ADDRESS _____
CITY _____ STATE _____
ZIP _____ PHONE _____
INLAND MFG. CO. Dept. PM-3
1108 Jackson Street • Omaha, Nebr. 68102

POPULAR MECHANICS PM-BEE!

Plans for a radio-controlled model that flies on CO2. Fuel is non-flammable and odorless. Sophisticated and simple to build! To obtain full scale pattern from which you can trace off the parts directly, send \$3.49 to POPULAR MECHANICS Dept. FA, Box 1014, Radio City, New York, N. Y. 10019

WEB GUARANTEES IMMEDIATE, LASTING RUPTURE RELIEF

OR YOUR MONEY BACK IN FULL!

Enjoy a stronger, happier life. Wear a Web for strong support and lasting relief of reducible inguinal rupture. If not completely satisfied, return within 30 days for full refund of purchase price.

Write for FREE book on rupture care. WEB TRUSS Dept. PM-4 Hagerstown, Md.

WINDWATCH™ ANEMOMETER-WIND VANE \$19.95



Neon lights in indoor indicator show wind speed and direction. Decorative indicator with gold dial in dark mahogany case. Designed for desk use or wall mount. Outdoor instruments of durable aluminum with electrical parts enclosed in rigid vinyl housings. Easy to assemble and install. Attach directly to roof or pole. Comes with wire and materials for installation up to 60 feet. Uses regular 120V AC. Unique low amp circuit assures absolute safety. A fascinating addition to any home. Five year guarantee. 15 day trial. Your satisfaction or money back. Only \$19.95 postpaid.

WINDWATCH DEPT. F12, 104 HEIMANN SAN ANTONIO, TEXAS 78205

\$12.95 BLACK DIAL TELEPHONES

Complete add \$2.00 for color
Factory rebuilt Western Electric in white, beige, ivory, pink, green or blue. If 4 prong plug is required add \$2.00. Fully guaranteed.

Designs may vary. Write for free list. All shipments F.O.B.
SURPLUS SAVING CENTER
DEPT. PM-33, WAYMART, PENNA. 18472

I-N-V-E-N-T-O-R-S WE NEED INVENTIONS

Sell your invention for cash—need money for Patent?—Are technical problems holding you back? Universal Inventions has helped inventors all over the world—just like yourself—why not you? Inventions provide the magic spring-board to sudden riches. REMEMBER, we either sell your invention or pay you a cash bonus. Write for details. UNIVERSAL INVENTIONS, Dept. 13, Marion, Ohio 43302

BASEMENT TOILET FLUSHES UP



TO OVERHEAD SEWER OR SEPTIC TANK. NO DIGGING UP FLOORS. INSTALLS EASY. Write McPHERSON, INC., BOX 15133, TAMPA, FLORIDA 33614

CLASSIFIED ADVERTISEMENTS

Rate: \$2.20 per word payable in advance each insertion. Capitalized words—75¢ per word additional. Minimum insertion ten words. To be inserted under the proper classification, copy must be in our office by the 10th of the second month preceding date of issue. The next available issue to place an advertisement in America's No. 1. Classified Section is May. The closing date is March 10th. Send remittance and order to H. E. Kappel, Popular Mechanics, 224 West 57th Street, New York, New York 10019. Please make remittance payable to Popular Mechanics.

POPULAR MECHANICS

WHEN ANSWERING ADVERTISEMENTS PLEASE USE THE ZIP CODE NUMBER

AUTOMOBILES

AUTOMOBILE SIXTY SECOND TIRE FIX. NO TOOLS—NO JACK-DEALERS INVITED. SAMPLE, DETAILS, PPD. \$3.98—WARNE, 6922 CONGRESS, DETROIT, MICHIGAN—48207.

1971-1972 DODGES, Fords, Chevrolets, Checkers from \$599. to \$1099. Free catalog. Send 25¢ handling. Pan Am, 31 Hanse Ave., Freeport, N.Y. 11520, Dept. 151.

CAPACITIVE DISCHARGE IGNITIONS. DISCOUNTED. Rodgers, Son (PM), Box 3583, Anaheim, Calif. 92803.

MAGIC, Inexpensive formula for cleaning motors. Wash away tar and grease from anything. Send \$2.00 to: Like-Nu, 3087 JFK Rd., Dubuque, Iowa 52001.

STOP CAR THEFT! KROOKLOK* Just Hook It, Steering Wheel To Brake Pedal, Lock It! Leave It 7 Day Trial Offer. \$16.95. Angle's, Box 56MO, Shrewsbury, Mass. 01545.

1958 THRU 1960 T-Bird Owners—For Information, Write: Vintage T-Bird Club Of America, 26056 Deerfield, Dearborn Heights, Michigan 48127.

MIDGET CARS

YOUR AD IN POPULAR MECHANICS WILL BE SEEN By More than 5,000,000 active buyers for your products and services. It costs only \$2.20 per word. And, if you wish to run all or part of your ad in bold capital letters—you can do so for as little as 75¢ per word additional. Act now! Send your Classified ad to: **POPULAR MECHANICS, CLASSIFIED DEPARTMENT, 224 WEST 57TH STREET, NEW YORK, N. Y. 10019.**

AUTO SUPPLIES AND EQUIPMENT

HYDRAULIC Jack repair kits, parts and supplies. Catalog 50¢ (in coin). Hydraulic Jack Packing & Tool Co. Inc., General P.O. Box 3, Staten Island, N.Y. 10314.

SAVE Money, End Expensive Auto Repairs. You do the job yourself. Nationally—Known Auto Expert Shows you How Easy it can be. Send \$2.25 To: **DUTCHWAY ENTERPRISES, 1155 East 35th Street, Suite A-20, Dept.—AC, Brooklyn, New York 11210.**

ALTERNATOR/Generator Rebuilder's Course; Includes Tooling & Test Equipment. Write: Hedelund Engineering, P.O. Box 2127, Sepulveda, California 91343.

PARTS: Army jeep and truck parts. Spare Parts & Equipment Co., P.O. Box 751, Lexington, Kentucky 40502.

\$1.00 BALANCES 4 Car wheels perfectly. Instructions \$2.98. Fletcher—906M Lindale—Richardson, Texas 75080.

AUTO Parts and Tools, Dealers Cost. Catalogs, 50¢. Auto Parts, Box 66, Hollis, New York 11423.

RING-Valve Job while driving, \$6.50 postpaid, (Two-\$12.00). . . . Established 1951. . . . Results Guaranteed!! Motaloy, Grantham, Penna. 17027.

NOVEL Inexpensive Glowing Gage Continuously Checks Ignition Performance. **QARC, Box 47876, Los Angeles, Calif. 90047.**

RING-VALVE JOB While You Drive!!! Fully Guaranteed \$6.00 . . . Two \$11.00 . . . Motaloy-MF, Box 1149, Midland, Texas 79701.

REMARKABLE New, Heavy-Duty Auto Cloth gives 50 to 100 car cleanings—without water. Guaranteed, \$2.98 Ar-Nor, 20 Bulwer Place 1R, Brooklyn, N.Y. 11207.

MOTALOY, Ring-Valve Job While Driving—\$6.00. Literature. E&G Sales, Box 18384-P, Memphis, Tennessee 38118.

ELECTRICAL Circuit Testers, high & low voltage, combination hi-lo with detachable ground wire to avoid shock, two spare tubes contained in handle, continuity tester, well designed, Free Brochure, Mead Tool Co., 444 Espanola Way, Miami Beach, Fla. 33139.

RADIATOR PROBLEMS? Heating? Leaking? Rusting? Experienced Journeyman Thoroughly Explains Cooling System. Send \$2.00 to: Radiator Care, Box 547, Whittier, Calif. 90602.

MOTALOY—Ring-Valve Job While Driving. \$6.00. Guaranteed. Free Information. James Bryant—2133 Arcadia Place—Jacksonville, Florida 32207.

12 VOLT DROP LIGHT, 25 FT CORD. Connects to Car Battery, \$9.95. Extra bulbs \$1.25 each. Crosby's Auto, Box 276, Alto, Texas 75925.

AMAZING New Product. Keeps Car Windshield, Mirrors, Windows Free Of Fog. Use In Car—Home. Lasts For Years. Only \$1.19. James P. Oliver, 22 Waveland Ave, Winchester, Ky. 40391. Free Information On Request. Money Back Guarantee.

AMAZING New Vacu-Shine Miracle Cloth Will Dry Wash Your Car 50 To 100 Times! **GUARANTEED!** Send \$2.98 Now. Layneco, Box 71014-PM3, Arco Plaza, Los Angeles 90071.

AUTO ACCESSORY: "Thieves won't get away with cars protected with the GAS LOK". This ingenious device cuts off the flow of fuel when the switch is on "off". The car will go only as far as the fuel in the carb will take it—and a wire crossing won't change that situation. Marketing agents wanted, Profitable. Write: Statewide Security Depositors—GAS LOK Sales Division—726 38th Street, Sacramento, California 95816.

AUTO TRAILERS

PICKUP Camper, Trailer or Pickup—Cover . . . Build yourself. Save! Complete plans \$3.95 each Cover plans \$2.00 Conversion Plans—econoline type van \$2.95; passenger bus or delivery van \$2.95. Satisfaction guaranteed. Equipment catalog \$1.00 (refundable). Details 10¢. Viking Camper Supply, 99-F Glenwood, Minneapolis, Minnesota 55403.

MOTORCYCLES, BICYCLES MOTORSCOOTERS & SUPPLIES

BUILD "Popular Mechanics" MINIBIKE Featured June 1967. Detail plans, photographs, illustrated parts catalog \$2.00 refundable or catalog 25¢. Gilliom Minibike, St. Charles, Missouri 63301.

HONDA! \$25 Other Bargains. Send 50¢. Motorscooter, P443, Bend, Oregon 97701.

BOLT-ON TORQUE CONVERTER Makes out-dated, out-classed, mini-bikes competitive, mean machines. More Low end muscle—more high end hustle. Fits B&S, Tecumseh, most engines. 35 minute installations. \$34.95 ppd. No C.O.D. Information + decal 25¢. **MAX-TORQUE, Inc., 7300 Monticello, Skokie, Illinois 60076.**

ILLUSTRATED Catalog 25¢. Parts And Accessories, Custom And Stock, For Most Makes And Models. Motorcycle Supply, Box 159M, Fairbury, Ill. 61739.

MINIBIKE. Build Your Own. Bolted construction, no welding. Plans \$2.95. Kits available. Stapleton Manufacturing, Lumber City, Georgia 31549.

BICYCLE PARTS CATALOG. Gold mine for hard to get foreign and domestic parts, tools and accessories. Send \$2.00 for this big 8½ x 11 inch 160 page catalog. Refundable if not completely satisfied. Wheel Goods, Dept. J, 2737 Hennepin, Minneapolis, Minnesota 55408.

MINI-BIKE, Go-Carts. Wheels. Engines. Wholesale catalog 25¢. Lorenzo, Danville, Illinois 61832.

DISCOUNT Motors, Torque Converters \$26.00, American Made Clutches, \$9.75. Bicycles, Government Surplus Info—Send \$1.00 (Refundable) to: MCS, PM, 8 Lacy Street, Warren, Penna. 16365.

ELECTRIC Bicycle Plans, \$2.95, Kielian, 130 Drake, South San Francisco, Calif. 94080.

SPACE, ROCKETS AND ASTRONAUTS

ANTIGRAVITY DEVICE. Brochure rushed free. AGD, Box 3062 PM, Bartlesville, Oklahoma 74003.

(Continued on next page)

SPACE, ROCKETS AND ASTRONAUTS

(Continued from preceding page)

FREE. Flying **MODEL ROCKET** Kit. Act Now. Offer Limited. Send 25¢ for Packet of Iron-ons, Decals, Literature and "Free Rocket" Details. Aerospace Vehicles, Inc., Mineral Point, Wisconsin 53565.



AVIATION

AVIATION Surplus Big Bargain Catalogue 60¢. Box 52PM4, Thomasville, Penna. 17364.

AIRBOAT Engines, Propellers, Hubs, Mounts, Supplies, Corvair, VW Conversions, Removable airdrives, Propellers, Hubs for Snowmobile Engines. Catalog \$1.00. Banks-Maxwell, Box 3301E, Fort Worth, Texas 76105.

BUILD—One-Man jet helicopter. Easy inexpensive. Detailed plans, drawings—\$5.00. Helicopter, Box 7153, Baltimore, Maryland 21218.

JET Strap-On Helicopter Plans \$2.00. Information 20¢. Compco, Inc., Box 1267, Redwood City, California 94064.

ALL About Ballooning. Handbook \$3.00. Aerostation, Box 141, Long-Sault, Ontario, Canada. KOC 1PO

HELICOPTER PARTS, Brand new government surplus Helicopter parts, factory new, in original package, currently used in Viet Nam, very unique looking, ideal conversation piece, etc. average government cost over \$60. limited quantity \$2.50 Ea plus 5¢ postage. D.C. **HELICOPTERS**, 157 Norton Village Lane, Rochester, New York 14609.

HANG GLIDERS Proven Rogallo Design. Plans—\$5.00. Kits, Accessories, Completed Kites. Free-Flight Systems, 10730 Whiteoak, Granada Hills, Cal. 91344.

SURPLUS, Instruments, Radio's, Engines, Parts. POB 1137, Venice, California 90291.

WINDSHIELDS, BUBBLE CANOPIES, HEMISPHERES. Sizes, Shapes. Pamphlet. Bouwens Aerospace, Thwing, LeRoy, New York 14482.

AIRBOATS, 8 To 45 Horsepower. Portable Airdrives. Airboat Plans, \$5.00. Twin Engine Hovercraft Plans, \$10.00. Small Hovercraft Plans, \$5.00. Propellers, Engines, Supplies, Catalog \$2.00. Arrowcraft-MM, Pearland, Texas 77581.

HOVERCRAFT

AERO-CAR. Amazing Hovercraft built easily with ordinary tools. Lawnmower engine power. Carries one man plus. Hovers. flies forward, backward. Sideways over land/snow/water. Complete construction plans and brochure. \$5.95. Aero-Projects, Box 5118PM, Clinton, New Jersey 08809.

"**PRACTICAL** Design Guide" \$5.00. Plans, Instructions, Hovercraft, \$6.00. Airboat \$5.00. (Information, \$1.00 Refundable). Palmer Aerosystems. P.O. Box 1891M, Coral Gables, Florida 33134.



BOATS AND TRAILERS

BOAT Kits. Molded Fiberglass. Save money—assemble yourself. Factory molded sections bond into one-piece craft. 20 models—14' to 32' Cruisers, Runabouts, Sailboats, Accessories, motors, trailers. Easy terms. Free catalog. Luger, Dept. BC-73 3800 West Highway 13, Burnsville, Minnesota 55337.

FIBERGLASS BUILDERS MATERIALS Lowest factory prices in cloth, matt, rovine, resin, epoxy, foam, nails, fittings. Send \$1.00 for literature (refundable) or \$2.00 for literature plus booklet on Mold-making and "How to Fiberglass". Clark Craft 16-P1 Aqua Lane, Tonawanda, N. Y. 14150.

BOAT KITS-PLANS AND PATTERNS-FRAME KITS, World's largest catalog. Over 300 top designs from 7-77' in plywood, ferro cement and fiberglass. Sailboats include: Windmill, Snipe, Motor Sallers, Trimarans, Catamarans. Powerboats include: Cruisers, Houseboats, Deep V's, Fishin'ski, Runabouts, Hydroplanes, Canoes, Kayaks, inboards, outboards. Send \$1.00 for large catalog or \$2.00 for catalog plus "Boat Builders Guide". Clark Craft, 16-P Aqua Lane, Tonawanda, N. Y. 14150.

BOAT PLANS, FULL-SIZE PATTERNS, FRAME KITS With step by step written and pictorial instructions especially for amateurs. Easy to build. Send \$1.00 for **HUGE 100 PAGE** Illustrated Catalog. Over 125 modern designs from 8 to 49': Includes Sail, Jets, Inboards, Outboards, Cruisers, houseboats, Hot Boats, Catamarans, Hydros. Also available—"Boat Building With Plywood" Hard cover—219 pages \$7.50. **GLEN L.** 9152 MP Rosecrans, Bellflower, Calif. 90706.

FIBERGLASS Canoes, Kayaks, and Duckboats. Many exciting models. Easily assembled kits. \$39.95 up. Free Literature. Riverside Canoes, Box 5595P, Riverside, Calif. 92507.

FIBERGLASS Cloth and resin. World's finest cloth and non-run resin, at direct mill prices Flotation foam. Complete line of plastics, silicon bronze and brass screws, save 60%. No sales tax. Boat Plans. Catalog 25¢. Freight prepaid. Stiles Boat Supply, Box 11P, Linden Ave., Mantua Heights, N.J. 08051.

CANOES! Kayaks! Factory-direct quality kits. from \$25.00. Many different models. Canvas hulls. Strongest construction materials. Free literature. Sportsraft, Box 636-P, Allentown, New Jersey 08501.

SAILBOAT KITS New all glass 16 ft. Catamaran, Penguin, OK, Blue Jay, Windmill, Snipe, Lightning, and El Toro. Free catalog. Taft Marine Corporation, Dept. PM-3, 6512 Shingle Creek Parkway, Minneapolis, Minn. 55430.

LIGHTS Of all kinds, electrical accessories, portable power, cook and tableware. Free catalog. Bass, Box 901PM, Marblehead, Mass. 01945.

FREE Catalogue—plans, patterns: Canoes, sailing canoes, kayaks, 14-17' trailable cruising sailboats. Quicksilver, 255A Shamrock Blvd., Venice, Florida 33595.

PLANS. Full-Size Patterns, frame kits with step-by-step instructions specially for amateurs. Send \$1.00 for new catalog just off press—nearly 100 pages, over 125 designs 8' to 49': Sail, Jets, Inboards, outboards, Cruisers, Houseboats, Hot Boats, Catamarans, Hydros. Glen L. 9152 PM Rosecrans, Bellflower, Calif. 90706.

NEW 1973 Outboards... Top brands... 6 H.P. \$278.00... 18 \$404.00... 40 \$548.00... 50 \$698.00... 65 Electric \$928.00... All sizes... Scott-McCulloch Parts... Literature .50¢... Electra Marine... 675 Merrick Rd. Lynbrook, N.Y. 11563.

FIBERGLASS Cloth, matt, polyester and epoxy resins. Wholesale catalog 25¢. Boat Molding book 30¢. Seifert's, Box 1206-M, Green Bay, Wis. 54305.

FREE 112-page Camping, Marine Color Catalog. Laacke & Joys, 1439 N. Water, Milwaukee, Wisconsin 53202.

CANOE KITS—Wood Canvas, Molded Fiberglass—Free Catalog. Trailcraft, Inc., Box 60686, Concordia, Kansas 66901.

FIBERGLASS Cloth, mat, resin. Flotation foam. Complete supplies. Catalog 25¢. Kick-Shaw, Inc., 3511 Hixson Pike, Chattanooga, Tenn. 37415.

SILENT DYNAMITE!! SUPERFAST LAN: SAILER!! Build Easily, Inexpensively! Detailed Plans, Photographs—\$5.00. Kits Available: Information, Pricelist—\$1.00. Refundable. Shelby Industries, Box 6034-A, Albany, California 94706.

KAYAKS, Canoes, Plans, Kits, Finished Craft, Books. Free Catalog. Outdoor Sports, Box 1213P, Tuscaloosa, Ala. 35401.

DIRECTORY: 174 Boat Plans, \$2.00. Moore, Box 852, Ashland, Oregon 97520.

PLANS, Patterns, Kits, Catalogs: Powerboat \$1.00, Sailboat 50¢. Pram Kits \$49.95. Marinecraft, Box 161-M, Brighton, Mass. 02135.

CAMPERS AND TRAILERS—KITS—PLANS—

PLANS & Kits—Motor Homes, Chassis Mounts, Pickup Campers, Covers, Trailers, Bus & Van Conversions, Modifications & Bultins. Complete Easy To Follow Large Scale Plans, Patterns And Detailed Instructions. Supplies, Parts & Accessories, All Your Needs At Low Discount Prices. Details Free. Lucky, Box 8657 A3 White Bear Lake, Minnesota 55110.

MARINE EQUIPMENT AND SERVICES

MARINE Engines, conversions, parts, equipment. Catalog Free! Stokes Marine Industries, Coldwater, Michigan 49036.

CONVERT Auto engines to marine. 68 Page Catalog, 50¢. Lehman Manufacturing Company, 800 Elizabeth Avenue, Linden 4, New Jersey 07036.

FREE Brochure Conversion Kits, Propellers, gears V-Drives 1/0 Drives Gas, Diesel. Starmarine, 1931 Embarcadero, Oakland, Calif. 94606.

MARINE Supplies, Ignition Parts. Free literature. Michael's, 991 Broadway, Bayonne, New Jersey 07002.

ATHLETIC AND BODY BUILDING COURSES

SIT And Sway The Paunch Away . . . Booklet. Complete With Illustrations, Shows You How—\$1.00. William H. Sarver, Box 447, Braddock, Pa. 15104.

"**GIANT** Arms." Dr. Young's. D.C. revolutionary discovery. \$3.00. Satisfaction or refund. Gaucho, 1769-A-7, Chicago 60690.

DESTRUCTIVE Power Punch Professional Secrets by Registered Black Belt plus Membership Card \$3.00. Karate Academy, Highway 35, Wannamassa, New Jersey 07712.

POWERFUL Muscles fast! Free brochure! Universal Bodybuilding, Box 4327-C, Dearborn, Michigan 48126.

AMAZING Abdominal Development. Unique Mini Exerciser Free Brochure. Cimo Box 741, Corona, N.Y. 11373.

TERRIFIC Muscles And Perfect Body Proportion Without Special Apparatus Or Exercisers. Free Proof. Hercules II, P.O. Box 78-PM1, Meadowvale, Ont., Canada.

EXERCISE Like Birds Fly! Nature's oscillating power improves shape! Inexpensive! Unusual details free! Circo, 2515 Euclid, Santa Monica, Calif. 90405.

SECRET Brick breaking plus one punch knockout techniques \$1.00, Joe Francer, 522 West James, Lancaster, Pennsylvania 17603.

SCIENTIFIC HORIZONTAL EXERCISER brings muscular, cardiovascular, neurological fitness to all ages, even handicapped. **ONLY 10-15 MINUTES PER DAY OF MODERATE RHYTHMIC MOTION REQUIRED.** Stores easily. Backed by university research. Free color brochure. **CISCO**, Dept. H-2, Box 403, Lincoln, Ill. 62656.

SHORT STATURED? Growth Height Increase Facts, Medical Details. Adults, Youngsters, 25¢ to: Physical Culture, Box 1548-PM5, Pompano Beach, Fla. 33060.

SPORTING GOODS AND EQUIPMENT

FREE Catalog low direct factory prices, fishing, Hunting, Archery, reloading Camping supplies. Send today. Herters Inc., Dept. CPM. Waseca, Minn. 56093.

AIR GUNS! Most name brands. At discount prices. Free Price list. **TOBY'S**, Box 3100-PMF, Miami, Fla. 33169.

SPORTING GOODS AND EQUIPMENT

(Continued from preceding page)

FREE WHOLESALE CATALOG. Lure parts, Molds, Rod Blanks, Reels, Archery, Metal Detectors, Rare Hardwoods, Finnyports (ME), Toledo, Ohio 43614.

FREE 1973 Catalog! Guaranteed lowest prices! Rods, Reels, Lures, Accessories—Thousands of items. Cabela's, Inc., Dept. S-15, Sidney, Nebraska 69162.

OUTDOORSMEN: Free Brochure. LEV-O-GAGE for recreational Vehicles, Aircraft, Boats. TEMP-O-GAGE for Inside-Outside Temperature. Thornton's, 1212 Aspen Street PM, Longmont, Colorado 80501.



FISHING, TACKLE, LURES

MOLDS For fisherman's sinkers, jigs, squids, casting and spinning lures. Free catalog. Sweet Molds, Tonawanda 1, New York 14150.

MOLDS—For casting your own fishing sinkers. Free illustrated booklet. Reading Instrument Co., Box P-78, Reading, Pa. 19603.

FISHERMAN'S DREAM BOOK—FREE, 170 page catalog just loaded with Hard-To-Find Fishing Tackle Specialties and Do-It-Yourself Goodies. Cur 29th year. NETCRAFT Inc., Box 5510, Dept. PM-12, Toledo, Ohio 43613.

HANDSOME Fishing Rod Rack—\$2.98. Professional Dry Fly Assortment 20—\$5.98. Satisfaction Guaranteed. Diane P. Anderson, 260 Crittenden Blvd, Rochester, NY 14642.

DOUGH Bait Recipes \$1.00. Marfam, P.O. Box 78333, San Antonio, Texas 78228.

FISH WITH THE WINNER—Mepps Original French Spinners took 57 awards in latest Field & Stream and Sports Afield contests—more than next 4 lures combined. Discover why in 1973 Mepps Fisherman's Guide. Send 25¢ with name, address to: Sheldon's, Inc., Box 708, Antigo, Wisconsin 54409.

EARTHWORMS, LIVE BAIT

HYBRID Redworms 5000—\$12.00; 20,000—\$24.00. Postpaid with raising instructions. Brazos Bait Farms, Route 4, Waco, Texas 76705.

ANNOUNCING! Nature's Newest Cash Crop... Fishworms! Amazing Newsletter Free! Gloworm, P01B4, 3910 Elfin, Louisville, Kentucky 40207.

EARN Money raising fishworms for us! Exciting details free! Oakhaven—56, Cedar Hill, Texas 75104.

FREE Literature. Profitable Business Raising Fishworms, Crickets. We Teach you how to Raise and Sell. Write today. Carter Fishworms, Plains, Georgia 31780.

BIG Profits Raising Worms. Soilless Method. Three Oaks, Dresden, Tennessee 38225.



DOGS AND KENNELS

LOOKING For a Special Puppy—Send \$2.00 for catalog with prices and information on more than 100 breeds. Hoppe's Kennels—Rt. 2A—Hill City, Kansas 67642.

POULTRY AND GAME BIRDS

GAMEBIRDS: Eggs, Chicks, Started, Adult. Pheasant, Quail, Chukar, Waterfowl, Turkey; Game And Ornamental. Poultry. Catalogue, 35¢. Northwest Farms, Inc., Box 3003-PM, Portland, Oregon 97208.

COLOR Poultry Book \$2.50—"Everything You Name It"! Official Bantam Book \$3.00; Pheasant Breeding \$5.95; Ducks, Geese, Swans of North America \$7.95. Stromberg's Pets Unlimited, Fort Dodge 25, Iowa 50501.

QUAILS, Incubators, cages, supplies catalog. Marsh, 14216 Brookhurst, Garden Grove, Calif. 92643.

RABBITS—CHINCHILLAS—FUR BEARING ANIMALS

RAISE Rabbits Successfully by knowing Facts. 48 Page Illustrated Book describing 25 Breeds, Housing, Breeding, Feeding, Markets, Marketing, etc. 25 cents. American Rabbit Association, 36 Arba Building, Bloomington, Ill. 61701.

RAISE Chinchillas. Guaranteed income. Catalog \$1.00. DeShon Chinchilla, Route 2H, Roanoke, Indiana 46783.

\$500-\$1000 MONTH Plan Raising Rabbits for Us. Free Details. White's Rabbitry, Mt. Vernon, Ohio 43050.

MAKE Big Money Raising Chinchillas, Cavies, Rabbits for us. Catalog 25¢. Keeney Brothers, New Freedom, Pa. 17349.

TOPLESS INCOME RAISING Mutation Chinchillas. 25¢; Bulletin \$1.00 (Refundable). Chinchilla, 11PMT, Port Richey, Florida 33568.

EARN \$10,000 Yearly Raising Angora Wool and Breeding Stock. Details 25¢ coin. American Angoras, Malta 12, Montana 59538.

BABY Raccoons, Red Fox, Skunks, Guaranteed 3 days. Your Possession Shipped Air Express C.O.D. \$25.00 each. 50% Required before we ship. Shipping May Till August. Higginbottom, Box 291, Cross Plains, Texas 76443.

PETS—BIRDS, CATS, HAMSTERS, ETC.

LIVE Seahorses, marine specimens, aquarium supplies. Illustrated catalog 35¢. Marine, Box 23158-G, Ft. Lauderdale, Florida 33307.

950 PICTURE Pet Hobby Supply Catalog 50¢. "Everything—You Name It"! Cage Making Equipment. Stromberg's Pets Unlimited, Fort Dodge 25, Iowa 50501.

HORSES, LIVESTOCK

"HOW TO TRAIN HORSES"—FREE Book tells how to break, train, make money with horses. Beery School, 1103, Pleasant Hill, Ohio 45359.

VETERINARY Guide to Farmers. The only book of its kind. Send \$6.95 to POPULAR MECHANICS, Dept. VG, 224 West 57 Street, New York, N.Y. 10019.

CAMPING EQUIPMENT AND TENTS

FREE Outdoorsman's Catalog. Features outdoor clothing, boots, tents, packs, hunting, fishing, hiking equipment, government surplus etc. Satisfaction Guaranteed. Write for free copy today. P & S Sales, Dept. P-3, Box 45095, Tulsa, Okla. 74145.

TRAVEL AND RESORTS

FREE Information FLORIDA VACATION. Motel Discounts. Vacation Enterprises, 2500 Channing, Cleveland, Ohio 44118.

ELECTRICAL SUPPLIES

LAMP Parts. Catalog, prices, wiring instructions. 50¢. Refunded first order. Gyro, 5218P N.W. 35 Ave., Miami 42, Florida 33142.

DIMMER CONTROL KIT—600 watt, easy to assemble, install. \$4.95. Pacesetter, Dept. 33M, 7808 N. 13th Avenue, Phoenix, Arizona 85021.

MOTORS!! 1/500HP-50HP. AC. DC. 515 Page Catalog. \$2.00. Refundable first order. Werth's, Box 1902MB, Cedar Rapids, Iowa 52406.

BATTERIES, GENERATORS

BATTERY Reconditioning Kit, includes molds, material, instructions. Battery Shop, Box 820, La Quinta, California 92253.

BATTERY Terminal Protectors Stop Battery Corrosion. Free Literature. Pracna's, 3301 Buchanan Road, #83, Antioch, California 94509.

NIKE Missile Nickel Cadmium Battery Cells \$1.49 Each. Send Stamped, Self-Addressed Envelope For Listing Of Other Cells And Batteries For All Uses. Esse Surplus Co., 368 S. Meridian St., Indianapolis, Ind. 46225.

ENGINES, MOTORS, MAGNETS

WINDING Data, 275 motors, \$1.25. Data Company, 512 Kensington, Kansas City, Mo. 64124.

STEAM Engine Kits, Catalog-Handbook \$1.00. Reliable Industries, New Baltimore, Mich. 48047.

MOTOR Rewinding Supplies! Equipment plans! Modequip, Box 7266, Kansas City, Mo. 64113.

MACHINERY, TOOLS AND SUPPLIES

SURPLUS 4" Metal Cutting Lathe, Ball Bearing Spindle—\$39.50. Taig Mfg., 15048 Proctor, Industry, Calif. 91746.

SMALL Foundry furnaces. Supplies. Free literature. Pyramid Products, 3736 South 7th Avenue, Phoenix, Arizona 85041.

END Mills. Lathe Milling Attachments: Information. Potter, Box 73, Cedar Rapids, Iowa 52406.

MAXIMAT, Unimat Sale. Unbeatable low prices. Deco-M, 562 Howard Avenue, Staten Island, N.Y. 10301.

SANDBLASTING Outfit \$29.95 (Air-compressor required). Free brochure. Inka, Box 66573-X, Houston, Texas 77006.

NUTS, Bolts, Screws, Washers, Catalog 25¢. Also Assortments. Nutty Co., Box 1576SMS, Fairfield, Conn. 06430.

TOOLS, EQUIPMENT & SUPPLIES! We List Over FOURTEEN-HUNDRED Different CATALOGS of Materials and Accessories for Arts, Crafts, Automotive, Electronics, Industry. Send \$2.00. MASTERLOG, Box 24413VC, Oakland, California 94623.

MAXIMAT, Unimat Lathes, Metals, Micrometers. Catalogue 50¢. Industrial \$2.00. Campbell (PM) 1424 Barclay, Springfield, Ohio 45505.

CHAIN Saw Service Manual—step-by-step care, repair of 360 models. 240 pages, profusely illustrated. \$5.95 postpaid. Chain saw parts catalog free. Zip-Penn, Box 179-S2, Erie, Pennsylvania 16512.

UNIMAT, MAXIMAT, DREMEL, Micro-flame, Etc.—Catalog 25¢. Pioneer Electric, Box 7X, Brentwood, New York 11717.

SOLVE Tapping, Drilling, Cutting, Sawing, Reaming, Problems. Revolutionary cutting oil for all metals. Trial bottle \$1.00. Kane, 2906 Oak, League City, Texas 77573.

FINEST Woodcarving Tools Catalog 50¢. Woodcarvers Supply, 3112 West 28th, Minneapolis, Minn. 55416.

METAL Cutting Band Saws. Use Vertically Or Horizontally. Less Than \$100.00. Send Addressed Stamped Envelope For Full Details To: Saws, P.O. Box 295, Marcellus, Mich. 49067.

50% DISCOUNT All tools. Buy Direct. \$1.00 (Refundable) brings BIG Listing and valuable samples. Cash Industries, Box 4804-PM2, Pittsburgh, Pennsylvania 15206.

WELDING, SOLDERING, PLATING

WELDERS. Convert To Heliarc. High Frequency Unit 0-225AMP. Plans \$4.00. Convert To DC Plans \$3.00. Information Supply Co., Box 166, College Park, MD. 20740.

(Continued on next page)

WELDING, SOLDERING, PLATING

(Continued from preceding page)

PLATING Equipment. Portable Platers, Supplies, and "Know-How". Build your own tanks for nickel, chrome, etc. Easy-to-install PVC liners. Rectifier components—all sizes. Schematics, parts lists, formulas, operating instructions for all plating. \$10.00 post-paid. Guaranteed to save you 25%-75% or immediate refund. Some good used units for sale. Platers Service Company, 1511-A Esperanza, Los Angeles, California 90023.

TURN Your Workshop into Plating Shop for \$5.95! **GUARANTEED** Kits, Manuals, Supplies. **FREE** Details! Qrew, Box 8-Ph, Bourbonnais, Illinois 60914.

GOVERNMENT SURPLUS

JEEP And Gov't. Surplus Buying Manual (Jeeps Pictured) 75¢. Surplus Bargain Catalogue 60¢. Both \$1.00. Surplus Bargains, Box 789PM3, York, Penna. 17405.

JEES!!! PICKUPS!!! 100,000 Items direct from government. Your area. Latest information & surplus categories: \$2.00 **MONEYBACK GUARANTEE**. Order manual #122, from "Dependable Products", Box 113, Vista, California, 92083.

NO CATCHES. Buy any surplus direct from U.S. gov't. All information \$2.00. Bridgeworth, P.O. Box 2292-C, Vancouver, Washington 98661.

JEES Typically From \$53.90 . . . Trucks From \$78.40 . . . Airplanes, Typewriters, Boats, Clothing, Camping, Sporting, Photographic, Electronics Equipment. Wide Variety, Condition. 100,000 Bid Bargains Direct From Government Nationwide. Complete Sales Directory and Surplus Categories Catalog \$1.00 (Deductible First \$10.00 Order From Our Separate included Catalog). Surplus Service, Box 820-A, Holland, Michigan 49423.

MILITARY Surplus-Direct From Our Warehouse. Illustrated Catalog \$1.00; Lea Surplus, Dept-50, Box 679, Fairlawn, New Jersey 07410.

"U.S. GOVERNMENT SURPLUS Directory." How, Where to buy 100,000 items (including Jeeps) . . . low as 2¢ on dollar! Most complete information available . . . \$1.00. **SURPLUS DISPOSAL**, Box 19107-AC, WASHINGTON, D.C. 20036.

1973 SURPLUS Army, Navy store, 52 Page illustrated catalog. Send 50¢. Ruvel, 3037 North Clark, Dept. 3-J, Chicago, Illinois 60614.

JEES From—\$52.50; Typewriters from \$4.15; Cars from—\$31.50. Walkie-talkies, motorcycles, airplanes, boats. Typical "As Is" bid bargains from Uncle Sam. Tremendous variety. Exciting free list. Write: Enterprises, Box 402-X86, Jamaica, New York 11430.

JEES!!! TRUCKS!!! LAND! 100,000 Amazing Bargains direct from Uncle Sam nationwide. How, where your area. Complete Sales Directory \$2.00. **MONEYBACK GUARANTEE**. Diversified Surplus, Box 27177-F, San Antonio, Texas 78227.

SURPLUS BARGAINS—War, government, industrial surplus at savings to 80%! Clothes, boots, cots, tents—bargains for farm, home, outdoors. **SEND FOR FREE CATALOG**—must give zip code. **SURPLUS STORE**, Sioux Falls, S.D. 57102.

JEES \$52.40. Airplanes \$75.01. Typewriters \$6.70. Boats \$7.50. Direct from Government, Directory and Surplus Catalog \$1.00 (Refundable). Midwest Surplus, Box 401-PM, Dayton, Ohio 45401.

JEES, Typically from \$53.97 . . . Trucks from \$77.47 . . . Airplanes, Typewriters, Boats, Clothing, Camping, Sporting, Photographic, Electronics equipment, Wide Variety, condition. 100,001 Bid Bargains from Government nationwide. Complete Sales Directory and Surplus Catalogue \$1.00. (Deductible first \$10.00 order from our Surplus Bargains Catalogue). Surplus, Box 1P, Spring Grove, Penna. 17362.

GOVERNMENT SURPLUS. How and Where to buy in your area, send \$1.00. **SURPLUS INFORMATION**, 615-PM **HEADQUARTERS BUILDING**, Washington, D.C. 20036.

JEES . . . Boats . . . Camping 100,000 Bargains direct from Government. Guaranteed latest howto, your area \$2.00. Ross, Box 476313, Caseyville, Illinois 62232.

GOVERNMENT Surplus. New manual. How to buy nearest to your location. \$1.00. Info, 256 W. Main, Canfield, Ohio 44406.

100 MILITARY Insignias \$10.00. M&M, 144 E. Houston, San Antonio, Texas 78205.

SURPLUS Tremendous. Savings. Buying Directly From The Government. Instructions \$1.00. Surplus, Box 1126, San Luis Obispo, California 93401.

GOVERNMENT LANDS . . . Low as \$3.50 acre! Vacationing . . . Homesteading . . . Investment! Exclusive "Government Land Buyer's Guide" . . . plus "Land Opportunity Review" listing lands throughout U.S. Send \$1.00 Surplus Lands, Box 19107-AO, Washington, D.C. 20036.

HOBBIES AND COLLECTIONS

HOBBY-CARVE—Home workshop wood carver—create beautiful wood reproductions of sculptures, plaques, figurines, sconces and bookends. Hundreds of work patterns available. Send 25¢ for "How To Make Quality Wood Carvings" booklet. Refunded with order. Write: Hobbi-Carve, 930 Duluth Street, Dept. PM, St. Paul, Minnesota 55106.

COLLECT Military Medals, list 25¢. Vernon, Box 387PM, Baldwin, N.Y. 11510.

NAZI War Souvenirs Free illustrated catalog. Delta, Box 361PS, Lafayette, Calif. 94549.

NAZI Medals, Photos, and Jewelry. Also War Mementos from Other Countries. Catalog and War Poster, 25¢. Hutchinson House, Box 6411, Chicago, Illinois 60680.

50 GORGEOUS Jungle Butterflies \$2.90. Collectors Wonderland, Box 1170, New York 10008.

FIVE Friends with large collection of WW I, WW II, Man in Space Photos and Memorabilia. Want to exchange. What do you need? N. Penna, 210 5th Avenue, N.Y.C., N.Y. 10010.

DECALS, EMBLEMS, PATCHES

CUSTOM Designed Embroidered Emblems, Decals. Inexpensive. Free Catalog, details. Southern Emblem, Box 8PMB, Toast, North Carolina 27049.



STAMP COLLECTING

88 COUNTRIES—ONLY 10¢! Worth \$5.00 at catalog prices! Incredible collection of genuine postage stamps from 88 different countries—from Afghanistan to Zambia, North to South Pole! British, French, Portuguese, Spanish Colonies. Old 19th Century, New Issues. Moon and Outer Space stamps, etc. All for only 10¢! Also, other exciting stamps to examine free. Buy any or none, return balance, cancel service anytime. Plus Wonderful Free Catalog! H. E. Harris, Dept. SS-46, Boston, Mass. 02117.

YOURS FREE! 20 Almost Rare Stamps from 12 Lost Nations—Most a Half-Century Old! Nations overrun by invaders and never freed again. Stamps so appealing that experienced and beginning collectors alike will want them. You get 110 other stamps from Britain's Lost Empire plus illustrated Album to keep as a Bonus should you buy \$1 from our Approval Selection. Or return Album and 110 stamps with selection and buy nothing. Cancel Service anytime. But Lost Nations stamps are yours to keep! Send 10¢ for mailing while supplies last. Kenmore, Milford LN-293, New Hampshire 03055.

FREE! \$10.00 Giant Stamp Collection of 300 all different colorful, valuable postage stamps from Africa—Europe—Asia—British Empire—Worth \$10.00—\$12.00 at catalogue prices. Also money-saving Booklet. All yours as a Get-Acquainted Gift. Adults only. Other fine stamps enclosed for your inspection. Frasek Co. Inc., PM3, White Plains, New York 10601.

RARE Stamp Free! Also new packet Aden to Urundi, with Kennedy, Triangles, Space, Sports, Ships, Dogs, Cats, Reptiles, plus others. All free. Send 10¢ for mailing. Empire Stamp Co., Dept. 1, Toronto, Canada.

SURPRISE Collection! Exotic mint British Colonials absolutely free with approvals. Viking, Great Neck, N.Y. 11021.

PRE-1945 FOREIGN, 400 Different \$1.00. Raney, 1003 Elm, New Albany, Indiana 47150.

U.S. 50 Different Commemoratives 10¢! Approvals. Gordon Davison, Hillsboro, New Hampshire 03244.

200 WORLDWIDE 50¢ To Approval Applicants. Polze, Box 5215, Milwaukee, Wisconsin 53204.

FREE Worldwide Packet. Penny Approvals. Froehlich, Box 7, Waukegan, Illinois 60085.

JAPAN, CHINA, AUSTRALIA, KOREA—100 Different Only 25¢ With Fascinating World Approvals. Ephemera, Box 25934-P, Los Angeles 90025.

50 DIFFERENT Old U.S. Revenue stamps \$1.00. Winchester Stamps, Box 3594, Mansfield, Ohio 44907.

AUSTRALIA—50 Different—10¢ With Approvals, Value Company, 10209A Tenbrook, Silver Spring, Maryland 20901.

OLDER U.S. stamps, covers, on approval to adults only. Surprisingly good. ENGLE, Box 208P, Lowell, Michigan 49331.

WOW! 1000 Different Worldwide Stamps (\$35.00 Cat. Value) \$2.00 with profit sharing approvals. Universal, Box 6MA, Kenosha, Wisconsin 53141.

FREE, Mint Worldwide Packet. Approvals. Hildebrand, Box 5645, Redwood City, California 94063.

FREE New used Congo animal set, Approvals included. Alpaughco, Highbridge, N.J. 08829.

TEN Different Nudes: 20¢. Approvals. Stamp Farm, 2-M52, Oxford, Wis. 53952.

50 DIFF. U.S. COMMEMORATIVES 25¢. Fine U.S. Approvals Accompany. Craig Stamps, Box 425-N, Bellmore, N.Y. 11710.

FOREIGN Approvals! Gigantic values! 3¢ each. ABC, Dept. 3301-A, Box 6000, San Francisco 94101.

3¢ PLATE Block 25¢ with comprehensive U.S. stamp and Supply catalog. Schultheis, Box 2151C, New Hyde Park, N.Y. 11040.

ONE CENT STAMPS. Write for jumbo books of stamps at 1¢ each, mounted in Scott order. **BULLOT APPROVALS**, 6815 Bay Pkwy, Brooklyn, N.Y. 11204.

"AFRICA" 25 Beauties, 10¢. Approvals. Gorliz, Box 28765 PM, Memphis, Tennessee 38128.

100 DIFFERENT United States Stamps, 25¢ With U.S. Foreign Approvals. ShelRon, Box 547C, North Miami, Fla. 33161.

U.S. MINT Specials! Flag set, complete \$1.00. 1¢, 2¢, 3¢ famous Americans (21 different) \$1.00. Free list. Brooks, 2601 Avenue "U", Brooklyn, N.Y. 11229.

PENNY! Approvals! Regardless catalogue! Kloster, 4164 52nd St., San Diego 5, Calif. 92105.

FREE Surprise collection sent with approvals. Gould, 1784 Union, San Francisco 94123.

PENNY Stamps! 1000 Mounted in book at 1¢ each! Trust Stamp Company, P.O. Box 100-P, Jamaica, New York 11435.

(Continued on next page)

STAMP COLLECTING*(Continued from preceding page)*

ABSOLUTELY Free United States Mint Souvenir Sheet When Requesting United States Approvals. **K&B**, Box 70, Brooklyn, N.Y. 11223.

500 DIFFERENT Stamps, \$1.00. Smith, 508-A Brooks, College Station, Texas 77840.

100 DIFFERENT British Empire 15¢. Approvals. Gibson, Box 34, Lansdowne, Pa. 19050.

60 DIFFERENT United States (30 Commemoratives) 25¢. Seidenberg, Salem 169, Oregon 97308.

"INVERTED Error" Dag Hammarskjold, 10¢ with approvals. Belmont Stamps, Washington, D. C. 20015.

100 OLD United States between 1861 and 1935. \$1.00. Ed Roush, 423 Shepard, Mansfield, Ohio 44907.

225 STAMPS For only 10¢! Airmails, Pictorials: stamps from strange countries cataloging up to 25¢ each! Plus unusual stamps to examine. Buy any or none return balance, cancel service anytime. Mystic Stamp Co., Camden 80, New York 13316.

NEW Issues—Free Weekly Illustrated list. Brooks, 2601N Avenue "U," Brooklyn, N.Y. 11229.

12,000 DIFFERENT! AMAZING New Plan Builds Your Collection Systematically, Country By Country. Only 50¢ Weekly. Ware, Monroe, Conn. 06468.

FREE! 10 African Beauties! 30 Others! Approvals. Cambridge, Box 2311, Heath, Ohio 43055.

LIECHTENSTEIN 356-\$19.00; France #1100-\$4.00; UN 29-30-\$15.00; NH, CWO. Submit Lists Western Europe Only. All NH. Franklin, Box 467F, Jamaica, 11434.

VALUABLE Collection! Get scarce Red China, Pope John, Apollo 14, Antigua military costume, Iwo Jima memorial stamps, many more. 100 Different new and old issues from the world over—savage warriors, wild beasts, famous people, exotic scenes. Also stamp selections to examine. Buy any or none, return balance. Cancel service anytime. Rush 10¢ handling. Garcelon Stamp Co., OPMX, Calais, Maine 04619.

CANADA Sports Complete 10¢, Canadian Approvals. Harley Boardman, Little Valley, New York 14755.

1000 PRE-1939 USA, contains dues, revenues, commemoratives, presidentials, high values, older issues, etc. \$3.00; 5000 \$12.00. 300 pre-1940 USA commemoratives \$2.00; 700 \$4.00. 5000 foreign \$3.00; 9000 \$5.00. No approvals. Meyers, 5321 Fleming, Richmond, California 94804.

20 HISTORICAL U.S. Commemoratives 10¢. Bargain U.S. Approvals. **PINTO**, Box 111, Park Ridge, Illinois 60068.

BETTER GRADE U. S., Canadian Stamps. Borgen, Box 502, Alturas, California 91601.

FREE Beautifully Designed Space Selection, Approvals, House of Hoke, Sebring, Florida 33870.

WORLDWIDE COLLECTION. 2,000 Different \$7.00. Larbig, Box 2617, Lakewood, Ohio 44107.

RICHARD NIXON Inauguration Day Souvenir Cover. Addressed any name your choice. Special Postal markings. 50¢ each. **K.M. WALSH**, Box 308A, TUCKAHOE, New York 10707.

VIETNAM 25 Different 10¢ approval. Sam Chazen, Box 95, Ozone Park, N.Y. 11417.

FREE—Worldwide \$1.00 Value. Approvals. Stamps Unlimited, 101 W. Inkster, Kalamazoo, Mich. 49001.

7 COMPLETE SETS Poland—25¢ With Approvals, Duncan Stamps, RR #1, Duncan, B.C., Canada.

"CONQUEST Of Mars", Yemen's Latest Collection. 10¢ With Space Approvals. Potomac Stamps, Washington, D.C. 20015.

MINT STAMPS—25 All different, Worldwide, Large and Beautiful only 10¢, approvals. Cornett, P.O. Box 711, Miami Springs, Florida, 33166.

80 DIFFERENT U.S. Stamps. Includes 1943 flag stamp of occupied nations. Only 25¢. Approvals included. Willett Co., Box 338-M, Yorktown Heights, N.Y. 10598.

FREE!! 25 US Commemoratives, 2" Diameter Magnifier—10¢. Approvals. Mixdrak, 5630 Wilson, Chicago 60630.

GIANT Stamp Collection including: Astronauts, Satellites, Moonrocks, Boy Scout issue. Complete U.N. Set, recent Olympic and Sport issues from many countries, etc. Plus Big Stamp Dictionary and approvals. Everything 10¢! Stampex, Box 47-RM, White Plains, N.Y.

50 YEARS Old, fifteen different United States, over fifty years old—10¢ with approvals. Jaxon, Box 145-P, Brooklyn, New York 11230.

255 DIFFERENT Worldwide: 15¢. Approvals. Tibbets, 8675 Meadow, Downey, California 90242.

FREE Mammoth Collection, Scott's International or Master Global Albums, when you buy our approvals. Bargain Service, Box 5345, Santa Ana, Calif. 92704.

KAZAM! 25¢, 50 Mid-eastern, Approvals. **ALLADIN**, Box 602, Jefferson City, Tenn. 37760.

TIMELESS TREASURE. 22 Tempting Triangles 10¢. Approval Stamps, Box 1444-B, Kitchener, Ontario, Canada.

EXCHANGE, Send 100-200 different foreign with 35¢. Receive different. Patterson, Lancaster, New York 14086.

FREE! 50 DIFFERENT WORLDWIDE. Also receive the most Dynamic Catalog of Foreign Stamp Offers in Existence. Free Bonus Plan. No Approvals. B&S Stamps, Box D-11, Morton Grove, Ill. 60053.

FREE 50 Worldwide, Approvals. University Stamps, P.O. Box 1471, Lake Worth, Florida 33460.

NINE American Space Issues Value: 65¢. 40¢. Approvals. Middle Earth Stamps, Box 1173-P, Evansville, Indiana 47713.

FREE Old U.S. Stamps. Approvals. Chapmans, Box 487-S, Galesburg, Michigan 49053.

RUSSIAN Space collection 25¢. Russian Approvals. Snedco, Box 68-P, Waldwick, N.J. 07463.

QUALITY AND LOW PRICE. EXCELLENT For advanced or beginner. Mounted approvals 2¢ up, all countries in Scott's Order. Preview Stamps, P.O. Box 20667, San Diego, California 92120.

U.S. BARGAIN, 50 Different 10¢, with beautiful worldwide, approvals. Stamp Center, Kennebunk, Maine 04043.

FREE World Collection. Over 100 stamps. Approvals. Global, Box 427, Livermore, Cal. 94550.

FREE! Big Bargain Catalog—New Edition listing thousands of bargains including U.S. & B.N.A. stamps, packets, albums, accessories and supplies. Also, fine stamps from our approval service which you may return without purchases and cancel service at any time. Jamestown Stamp, Dept. E33PM, Jamestown, N.Y. 14701.

FREE 50 Stamps Including Grenada, British Honduras, St. Kitts, Approvals. Moulmbou, 1834P Bassett, Anaheim, Calif. 92805.

SHARIAH PAINTINGS Complete mint set 10¢. Plus topical collection: Space, Sports, etc. Worth much more, plus approvals and bonus Purchase plan. Daniel Healy, PM/1, 821 North Haddow, Arlington Heights, Illinois 60004.

BREATHTAKINGLY BEAUTIFUL 50 Different Mint Monaco Multicoloured Pictorials—Commemoratives \$1.00 With Mint Complete Set Approvals. Pagoda, Box 132E, Sidney, Ohio 45365.

3-D SPACE Stamp. 20¢. No Approvals. Field, 2109H North Argonaut, Stockton, Calif. 95204.

FREE Mixture, Contains Many Commemoratives, Pictorials, British Colonies, Foreign. Approvals. City Stamp Co., Box 216, Station "W", Toronto 15, Ont., Canada.

210 DIFFERENT U.S. Commemoratives \$1.00. Stamps, 7607 Larchview, Dallas, Texas 75240.

WOW! 110 All Different Germany 10¢. Commemoratives, Airmails, High Values, Big Catalog, bargain lists. Also, fine stamps from our approval service, which you may return without purchases and cancel service at any time. Jamestown S amp, Dept. A33PM, Jamestown, N.Y. 14701.

10 CANAL ZONE 25¢. Approvals. Merkel, 30 Grandview, South Hadley Falls, Mass. 01075.

10N.A.'S Unique Map Shaped Stamp. Apollo Moon Landing, Old Master Painting, Malaysia Butterfly, Granada Olympic Sailing Ship, Cayman Islands Charles Dickens, Bhutan Boy Scout, Virgin Islands Pirate plus 100 others! Only 10¢ when requesting approvals. Select only those desired, return balance. Cancel Service any time. **DOUGLAS COOK**, Dept. PM-10, Las Vegas, Nevada 89112.

\$2.00 EXCEPTIONAL Value. Only 10¢ To New Approval Applicants. Jenco, Box 242, Wayne, N.J. 07470.

"WHOLESALE" U.S.—Foreign Pricelist and catalog Free! Everything Guaranteed. Schneider, Box 1240, Grand Rapids, Michigan 49501.

300 STAMPS 25¢ With Approvals. Marquardt, Box 4503, Milwaukee, Wisconsin 53207.

1200 MISSION Mixture \$1.00. 7000 \$5.00. Stamps, Box 9, West Union, Iowa 52175.

FREE 10 Japan War Stamps. Approvals. Schroeder, 1486 1/2 Sherburne, St. Paul, Minnesota 55104.

TWENTY Australia Pictorials 25¢. Penniston, Box 7253, Arlington, Va., 22207.

SENSATIONAL Clearance. Forty Different Packets Only \$1.00. Norge, Wyckoff, N.J. 07481.

50 BIG Beauties 10¢ with approvals. Irvines, 1726 East Earl Drive, Phoenix, Ariz. 85016.

300 WORLDWIDE 30¢ with country packet approvals. P. R. Scharping, Dept. PM1, Box 1796, Lancaster, Calif. 93534.

FREE BARGAIN LISTS! U.S. mint singles—plate blocks. Scotco, Box 855-PMF, Miami, Fla. 33147.

PICK And Choose, 2¢ each. Pickrell, Box 10, Bohannon, Va. 23021.

LIQUIDATING Tremendous Accumulation. Collections, Lots, Miscellaneous. Lists free. Alatalo, Maynard, Massachusetts 01754.

HORSE Cavalry Soldiers, Poland's latest Gigantic Bicolored Commemoratives—Free! Approvals plus 101 Bonus Sets. William Deems, 226 Race, Ravenswood, West Virginia 26164.

40 DIFFERENT Nudes \$1.00. No Approvals. Kemp, 9952 Tamarack, Pacoima, Ca. 91331.

FREE 25 Different Canada. Joseph Myers, 633 W. Michigan, Marshall, Michigan 49068.

SPAIN—50 Different 10¢. Approvals. Hijop, Box 505, Norristown, Pennsylvania 19404.

BLUE CHIP Mint European Approvals. LaFleur, Box 1987, Rapid City, South Dakota 57701.

BRITISH BONANZA! 107 Exciting Colonials, magnificent Commemoratives. 25¢. Approvals. Castle, Box 15-PM3, Flushing, New York 11352.

(Continued on next page)

STAMP COLLECTING

(Continued from preceding page)

15 DIFFERENT, Catalog value over \$1.00. Only 10¢ with approvals. David Knower, Ferryville, Wisconsin 54628.

35 DIFFERENT U.S. 3¢ Commemoratives, 25¢, accompanying approvals. C&L Stamps, Box 336, Maugansville, Maryland 21767.

EXCITING Mexican Munich Olympic Set Only 50¢ With Pictorial Approvals. Robert Hedges, Route 3, Hagerstown, Md. 21740.

US SPECIAL Commemoratives 225 Different \$1.00, 300 \$2.50, 400 \$4.50, 500 \$9.50, No Approvals. Regency Stamps, Box 8854, Pittsburgh, PA 15221

FREE 100!! Approvals, Buza, 5206 Fuller, Schofield, Wisconsin 54467 (Comicbooks Pricelist, 50¢).

START Your Own Stamp Business!! Write: International, 6767LL South Atlanta, Tulsa 74136.

OVERPRICED APPROVALS? Our low prices prove it! Send for list. Dunn, 46 Niles Hill, New London, Connecticut 06320.

SEND Only 10¢ for the most wonderful catalog of stamp offers in America. You will also receive a special bonus collection of 150 different stamps from St. Vincent, Rwanda, Russia, etc. Littleton Stamps, Dept. MN-1, Littleton, N.H. 03561.

COINS, TOKENS, CURRENCY

1943 COPPER LINCOLN CENT (Reprocessed) \$3.00 Each, \$100.00 Per Roll. Satisfaction Guaranteed, Music City Sales, Box 8267-PM-2, Nashville, Tenn. 37207.

MEXICO: Silver Dollars Dated 1957 To 1967 In Nice Condition. Ten For \$3.95 Delivered Postpaid. El Paso Coin Co. Inc. Suite 108, El Paso National Bank Bldg., El Paso, Texas 79952.

\$1000.00 BANKNOTE 25¢ with comprehensive U.S. coin and Supply catalog. Schulthels, Box 2151C, New Hyde Park, N.Y. 11040.

SILVER DOLLARS Uncirculated, 1880-81—1883-84-85 \$5.00 Ea. Catalogue 50¢. Shultz, Salt Lake City, Utah 84110.

LINCOLNS 1909-1958 Every year including 1909VDB, 1922D. 50 different (Regularly \$12.60.) **SPECIAL \$6.95.** HARRIS, Box 2037P, Santa Cruz, California 95060.

COINS At Discount Prices! Free Brochure. Gene Carlton, Chandler, Okla. 74834.

BARGAIN Coin List, 10¢. Economy Sales, Box 92, Buzzard's Bay, Massachusetts, 02532.

GOLD—(1865) Mexican Maximilliano Peso, Bu \$1.95. Northwoods, Bigfork, Minn. 56628.

100 INDIAN And Lincoln Cents 1920's And Older \$5.00. Free Catalog. Wesley Road, Box 9, West Union, Iowa, 52175.

COIN Catalogue free! Raibl Enterprises, 2355 Scenic Highway, (PC), Pensacola, Florida 32503.

FIVE Indianheads \$1.95: Terrific Listing 25¢. Nelson, Box 306-J, Chappaqua, New York 10514.

FOREIGN COIN COLLECTIONS—21 Different \$1.00. 49 Different \$2.50. Paper Money 8 Different \$1.00. Wentz, Box 2439P, Newark, New Jersey 07114.

UNCIRCULATED 'S' Lincolns, three different, 10¢. Bargain lists included. Farley Coins, Metamora, Illinois 61548.

SPANISH Treasure catalogue. Bargains on Coins, Gold, Treasure. Special Bit of eight \$1.00 with catalogue. Colonial House, 909 Travis, Houston, Texas 77002.

1909-VDB LINCOLN, Fine, \$1.25. Free Catalog. Village Coin Shop, Dept. P, Plaistow, N.H. 03865.

FREE: Lists of Thousands of Stamps and Coins. No Approvals. Bryson, 612M White, Toledo, Ohio 43605.

PENNIES 30 Different "S" Mints 1919S, 1922S Includes 1955S Plus Reprocessed 1943PDS \$2.00. Free List. Krilietich, Box 34273, San Francisco, Calif. 94134.

MAKE MONEY On ALL Lincoln Wheat Back Cents. For detailed information, send 50¢ and self-addressed, stamped envelope. Carter, Box 3057, Falls Church, Va. 22043.

LINCOLNS: 50 Mixed 1909-40 \$2.00. 35 Different uncirculated, \$2.00. Nayko, 172-15 D Effington, Flushing, New York 11358.

FREE COIN COLLECTION—Build your collection without spending 1¢ for coins. Find them electronically. Set includes assembled transistorized detector with speaker, earphone, batteries, instructions, coin folder, 3 coin tubes, 5 coin holders, magnifier, **FREE** coin magazine subscription, and U.S. Price Guide guaranteeing sale of coins at listed prices. 30-day money-back guarantee. Send \$29.95 postpaid to: Treasure House, Dept. PA3A, Tennent, N. J. 07763.

BEAUTIFUL Uncirculated Silver Dollars—1878 to 1904. Our Date Selection \$5.48: Three different \$14.88; Nine different \$41.48. Lists Other Bargains 18¢. Bebee's, Incorp. Omaha, Nebraska 68111.

ANTIQUES, RELICS, INDIAN GOODS & CURIOS

10 BEAUTIFUL Arrowheads \$2.00. Guajardo's, 8713 Shaver, El Paso, Texas 79925.

FREE!! Lists Antiques, Indian Relics, 10 Arrowheads \$4.00. Hyde's, Box 2304, Santa Fe, New Mexico 87501.

EVERYBODY LIKES DIXIE GUN WORKS.

TONS Of antique gun parts and supplies. All reproduction muzzle loading guns. Send \$2.00 for enlarged illustrated catalog No. 121. Dixie Gun Works, Union City 12, Tennessee.

PERFECT Flint Knife, 4 Perfect Arrowheads, Hide Tanner, \$4.00. List Free. Lear's, Glenwood, Ark. 71943.

INDIAN Relic list, Arrowheads \$4.00. doz. Folsom. \$5.00 each. C. Secrist, Deerfield, Missouri 64741.

APACHE ARROWHEAD COLLECTIONS—Perfect. 25—\$5.00, 100—\$15.00. **GERONIMO,** PMD1239, Apache Junction, Arizona 85220.

ANTIQUE, Bottle, Avon Collectors!!! Free Catalog Listing 256 books. Cleveland Book Supply, 320BBH Main, San Angelo, Texas 76901.

SEND \$1.00 For the Antique Trader, (America's Largest Antique Newspaper) and The Price Guide to Antiques, Regular \$1.50, both only \$1.00 postpaid. Box 1050, Dubuque, Iowa 52001.

ANTIQUA CLOCK Parts-Material List 40¢. Box 388, Atwater, Ohio 44201.

MODELS—CARS, SHIPS, TRAINS, PLANES ETC.

SHIP Models Kits, fittings, plans, books, tools, engines, motors. Big illustrated catalog 50¢. Mass. residents add 3% tax. James Bliss & Co., Dept. SM, Route 128, Dedham, Mass. 02026.

LIVE Steam powered backyard railroads! All sizes. Complete "bolt-together kits." and rough castings. Excellent drawings. 100 page catalog \$1.00. Little Engines, Lomita, California 90717.

SHIP And yacht model fittings: Pine construction hull kits; blueprints. Send 75¢ for illustrated catalog. A. J. Fisher, Inc., 1002 Etowah Avenue, Royal Oak, Michigan 48067.

LIVE Steamers. A Man's Hobby. Big Engines Scaled To Model Sizes. Stationary, Marine, Boilers, Gauges, Pumps, Fittings. Catalog \$1.00. H.P.K., "Q", Centuck 34, Yonkers, New York 10710.

SHIP MODEL Kits, Plans, Fittings from our own Workshop. Big illustrated Catalog: 50¢. Bluejacket Shipcrafters, 145-V Water Street, So. Norwalk, Conn. 06854.

MODEL Airplanes—Big 220 Page Catalog \$1.00. Sig Company, Montezuma, Iowa 50171.

SHIP Models Catalog 25¢. Scientific, Inc., 340 Snyder, Berkeley Heights, N. J. 07922.

NEWEST, GREATEST FLYING HOBBY—ROCKETS! Zoom from realistic electric launch systems to 2,500 feet on safe, thrifty, solid-propellant power. Gentle parachute recovery for over-and-over-again flights. Tracking, experiments, real miniaturized still and movie cameras. Build your own exciting, low-cost space-age adventure—starting with a big, new full-color catalog of over 80 models, (including ready-to-fly). Send 25¢ to: **ESTES INDUSTRIES,** Dept. 7G, Penrose, Colorado 81240.

FREE. Flying MODEL ROCKET Kit. Act Now. Offer Limited. Send 25¢ for Packet of Iron-Ons, Decals, Literature and "Free Rocket" Details. Aerospace Vehicles, Inc., Mineral Point, Wisconsin 53565.

GAMES, TOYS, PUZZLES, NOVELTIES

NEW PUZZLE For Amateurs and Pros, Send \$1.50. Beltoy, 5 Morley, Greenfield Park, Quebec, Canada.

MAGIC TRICKS, JOKES, VENTRILOQUISM

HOUDINI'S Greatest Magic! You can do them all!! Giant illustrated catalog 25¢. House Of 1000 Mysteries, P.O. Box 2026P, Pompano Beach, Florida 33061.

CATALOG 10¢. 1,500.399 Tricks, jokes, Novelties. Elbee, 7408-P San Antonio, Texas 78207.

500 TRICKS—Large 1973 Catalog. Newest Magic For Pocket, Parlor, Stage. Send 25¢. Fastest Mail Service. Jeffries Magicland, Dept. 11, Dallas, Texas 75221.

LEARN VENTRILOQUISM! Courses. Dummies, Marionettes. Catalog 25¢. **MAGIC, NOVELTY Catalog 20¢.** Rizzy's Ventriloquism Magic School, 3746 West 63rd Street, Chicago, Illinois 60629.

FREE! World's leading novelty catalog. 1600 Funmakers, Jokes, Tricks, Science, Sports, Hobbies, Jewelry, Psychedelia. Johnson-Smith, C-10, Mt. Clemens, Mich. 48043.

COMPLETELY Illustrated catalog. 84 pages. 25¢. Manhattan Magic, Box 334-M, N.Y.C. 10011.

WORLD'S Finest professional magic tricks. Joker's Novelties. Giant illustrated catalog 10¢. Top Hat. Evanston, Illinois.

FABULOUS MAGIC'S New 1973 catalogue 25¢. Our specialty orders shipped same day no substitutes. Fabulous Magic, 3319 East Charleston, Las Vegas, Nevada 89104.

BE A Magician! Two booklets explaining 156 tricks plus large professional catalog, \$1.00. Magic, Inc., 5082 Lincoln, Chicago, Illinois 60625.

TELEVISION TRICK CARDS \$1.75 Catalog 25¢. Wayne's Trick Shop, Warren, Pa. 16365.

TWO Different Magic Catalogs 25¢. Miami Magic, Box 1047, Miami 33133.

MAGIC! Great hobby. Start with Genii monthly magazine. Dealers, tricks, news. 4 month trial \$2.00. Genii, Box 36068M, Los Angeles, Cal. 90036.

VENTRILOQUISTS Dummy Catalogue 25¢. Storyteller Studios, Box 633PM, Bellflower, California 90706.

TWO Novelty Tricks plus Big Illustrated Catalog 25¢. Magicians Discount Prices. Sun Magic, Oakhill, Williston, Vermont 05495.

SELF-TEACHING Magic Set, with Casette, Books, 60 tricks \$10.95. . . . Huge Professional Catalog. Free Tricks, \$1.00; Imperial, Box 623-P2, Worcester, Massachusetts 01601.

(Continued on next page)

MAGIC TRICKS, JOKES, VENTRILOQUISM

(Continued from preceding page)

SILLY, Giberish, Doubletalk, Meaningless-Saying Stickers. Stick anywhere. 4x4". \$1, \$2, \$3 Sets. JR Norris, Postbox 44377-A, Indianapolis, 46244.

HOUDINI'S Original Magic Shop. Established 1856. Send 25 cents for illustrated Catalog containing 5000 Tricks. Mindreading, Puzzles, and Jokes. Flossio-Hornmann, 304 West 34th St., New York 10001.

BOOKS, CATALOGS, NEWSPAPERS

PUBLISH Your Book! Join our successful authors: All subjects invited. Send for free appraisal and detailed booklet. Carlton Press, Dept. PMO, 84 Fifth Avenue, New York 10011.

LATEST Military Manuals/Books Catalog 25c. Hillcrest Publications (K-18), McDonald, Ohio 44437.

FREE BOOK, Prophet Elijah Coming Before Christ. Megiddo Mission, Dept. 63, 481 Thurston Road, Rochester, N.Y. 14619.

NATIONAL Geographic Magazines, 1888-1971, any issue. Buxbaum, Box 465-PM, Wilmington, Delaware 19899.

FREE Catalog. How-To-Books, Bargain Guides, Blue Books. Elston House, Centerville, Mass. 02632.

FREE 306 Magazines Monthly. Write: Diamond, Box 15473J, San Diego, California 92115.

WIRETAPPING and the Laws—Your Privacy Invaded—Free Brochure—Don-Q, Box 548, Dept. PMO, Seattle, Washington 98111.

FIFTY YEARS TO ERASE. The dramatic memoir of the Author's successful struggle to have his court-martial erased. \$3.00 plus 30c for postage. Fifty Years To Erase, 31 Oak Drive, Dept. A, Sicklerville, N.J. 08081.

SUCCESS And Popularity. Six Ways To Develop Your Creative Powers. Send \$2.00. Free Catalog. Vivian Archer, 306 Marian Street, Graham, N.C. 27253.

TODAY—Now! Live life better thru Self-Improvement, Inspirational ACTION Books. **FREE** exciting folder. **TODAY**—Now! Write: **DYNAMICO**, 2105-AAA Wallace, Bronx, N.Y. 10462.

BUYING Magazines, Postcards, Books, Music. Elles, 2311 West Ninth, Los Angeles 90006.

FREE Book List. Write subject of interest. Bookfinders, Box 341, Dept. AA2, Northbrook, Illinois 60062.

FORTUNE In Home. Old Comic Books, Medals, Buttons, Toys. Book of prices. Where to Sell, \$2.25, postage included. Imperial Sales, 16C Emerson St., Old Bridge, N.J. 08857.

ESCAPE Crowded Cities—Enjoy Country Sunshine. "Your Dream Acres" Has The Answers. \$2.00 Guaranteed. Slater, Route 2, PM3, South Whitley, Indiana 46787.

THE Greatest Success Book Ever Written **HOW TO GET WHAT YOU WANT**. A True Guide For Success. \$2.95 Postage Paid. Brainard Distributing, 4705 1st St. N.E., Unit 327, St. Petersburg, Florida 33703. Money Back Guarantee.

BOOK SALE! Low Cost Books . . . Personality, Self Analysis, Personal Problems, Wealth, Business, Confidence, Golf, Bowling, Handwriting, Dreams, And 87 Others. Send For Free List. **FIFI'S**, Dept. PM, 107 Ellis Lane, Lafayette, Louisiana 70501.

PLAYS, SONGS, MANUSCRIPTS

SONGS, SONGPOEMS Wanted For Radio Show. Hollywood Music Productions, 6425-PM, Hollywood Boulevard, Hollywood, California 90028.

PUBLISHING Contract Guaranteed on selected songs and poems. Free evaluation. Hollywood Songwriters', 6253 Hollywood, 1117-PM, Hollywood, California 90028.

SONGPOEMS, SONGS! Urgently Needed. Possible Recording/Publishing. 50-50 Agreement. Betty's Music Makers, 1417B, Park Building, Pittsburgh, Pennsylvania 15222.

RECORDS Made. Publishing Contract Guaranteed On Accepted Songs, Poems. Send: Talent Searchers Of Hollywood, 6311-X Yucca, Hollywood, Calif. 90028.

POEMS Set to music. Songs recorded. Send poems, songs. Crown Music, 49-C West 32, New York 10001.

BUSINESS SERVICES

PROFITS FROM CLASSIFIED ADVERTISING! Booklet shows you how to start your own business with Classified Advertising. Only \$1.00 (Refundable with first order.) **C. A. MARTIN, POPULAR MECHANICS, DEPT. P, 224 WEST 57 STREET, NEW YORK, N.Y. 10019.**

SAVE Cash! Advertising copy, Layout, Production, Sales-Clinching Letters, Coupons, Catalogs. Data \$2.00. Baughan Creative Services, Box 1426-Z, Plainfield, New Jersey 07061.

BUSINESS OPPORTUNITIES

EASY-To-Start rubber stamp business at home in spare time. Make up to \$16.50 an hour without experience. Facts free! Write to: Roberts, Room RC-2-CC, 1512 Jarvis, Chicago, Illinois 60626.

FREE Money Secrets. Get Plan For \$500 to \$2 million. Business capital, loans, cash. Free details. Capital-17, Kerrville, Texas 78028.

INSTALL Burglar alarms without previous experience or costly equipment. Big profit. Free details. Nasco, Dept. G270J, Woodland Hills, California 91364.

PREPARE Tax Returns—Policeman Albert Myers made \$2000 his very first season. Train at home. VA Approved. National Tax School, Monsey, 2KD, N.Y. 10952.

EARN \$50.00 To \$100.00 Weekly possible, home typing. Complete instructions, \$2.00. Jordan, 27495 Road 176, Dept. PM-34, Exeter, Calif. 93221.

IMPORT-Export Opportunity, profitable world-wide, mail order business from home, without capital or travel abroad. We ship plan for no risk examination. Experience unnecessary. Free Report. Mellinger, Dept. G2703, Woodland Hills, California 91364.

HOME Portraiture. Big Money. Send Stamped Return Envelope. **PHOTOGRAPH**, 5334-P Sunset, Hollywood 90027.

ARE You Bald? Sell Mens Hairpieces Sparetime! Fantastic Profits! Mac, Box 21091, Philadelphia, Penna. 19154.

311 FAST, Easy ways to make money! Free! Rush name, address, zip. Perry, 13263-D Ventura Blvd. Studio City, Calif. 91604.

\$39.00 STARTS Profitable mailorder business selling books. Complete explanation free. Neil H. Tasker, Shamokin, Pennsylvania 17872.

MERCHANDISE At Wholesale, use yourself or resell. \$1.00 for catalog. EDC, Box 49, Buffalo, New York 14224.

PIANO Tuning Learned Quickly At Home! Tremendous field! Musical knowledge unnecessary. GI approved. Information free. Empire School, Box 327, Miami 33145.

FREE Millionaire Book. Get hundreds of successful, little one-man businesses. Work home! SBI-7, Kerrville, Texas 78028.

BUILD Custom Cases at home for profit. Get orders by mail. We supply material's, instruction—everything. Free home business details. Custom Case Supply Co., 6075 CPC, De Soto Avenue, Woodland Hills, California 91364.

SECRETS! Mail Order Success. Internationally famous expert reveals how to make home business fortunes. Beginners: Get free report "Make Money By Mail." Discloses free advertising profitable products. Mailco, Dept. GC703, Woodland Hills, California 91364.

OPERATE A Charm and Modeling business by mail. Everything furnished. Royce, GM-33, 14603 Dorchester, Dolton, Illinois 60419.

\$\$\$ MACHINE! New, Easily Built, Cheap! **REPRODUCES, CARVES, ENGRAVES!** Economy Enterprises, Box 23P, Highland, Maryland 20777.

I MADE \$3,000.00 Monthly in Mailorder Evenings only. You can too! Free Proof—Bryant, 8601 Bowling Green, Austin, Texas 78758.

HOW And Where to get capital. \$5000 + possible in one day. Free details. JPA, Box 101-BC, Park Ridge, N.J. 07656.

OWN YOUR OWN Light manufacturing business. Operate full or part time from home. Free information. Box 11214, Charlotte, N.C. 28209.

HERBALISM! The home gold mine! Free lesson. Herbalism Institute-B, 1339 Remuda, Glendora, Calif. 91740.

OPPORTUNITY Knocks Only Once—Inv'ts It!!! Free Information For Stamp. TBOR, Box 1692-D, F.D.R. Station, New York 10022.

WORLD'S Largest supply, Merchandise 25% to 40% under wholesale. Bankruptcy Closeouts 10c on dollar. Imports. Hong Kong clothes. Automobile discounts. Free details. International Buyers, Box 16386 MM, Portland, Oregon 97233.

SELL Books by mail. Complete dealer set-up—25c. Midwest Mail Sales, Box 44R2-PM, Shawano, Wisconsin 54166.

1000% PROFIT Bronzing Baby Shoes. Free Literature. NBC, Box C-4-PM, Coral Springs, Florida 33065.

MAKE A Years Income in 8 weeks Camping. No selling. Capital or Land necessary. Write: Edru's, Route 5, Box 5733, Gig Harbor, Washington 98335.

BECOME "Mortgage Broker." Lucrative! Capital Sources, Box 99-A, Uleta, Florida 33164.

MAKE Magnetic signs, Machineless method. Profits enormous. Write: R1B49APM, Bardstown, Ky. 40004.

ADVERTISING BUSINESS—YOU Own it. \$350 First Week or Money Back. Electric Neon Action Ad Clock, 229 W. Illinois, Chicago 60610.

HOLLYWOOD CEMENTCRAFT: Offers Highly Profitable Home Business. Experience Unnecessary. Unlimited Unique Pottery Designs Easily Made Without Moulds. Bird-baths, Fountains, Wishing-Wells, Waterfalls, etc. Chemical Coloring Formulas. Marble-glazing. **FREE** Illustrated Brochure. **CONCRETE FACTS**, 602 Athens Street, Altadena, California 91001.

COPUBLISH "Mail Sale Advertiser." leading mailorder paper. Copy and details 25c. U.S.A. only. Vanroy Shirk, Lebanon, Pa. 17042.

VENDING Machine big catalog. Rake, 523 A Spring Garden, Philadelphia, Pa. 19123.

DRAFTSMEN! Operate own **DRAFTING SERVICE!** Full, Part Time; Experience unnecessary; Details: Roberts Drafting, 1741 Circle Road, Baltimore, Maryland 21204.

FREE Catalogs. Repair air conditioning refrigeration. Tools, supplies, full instructions. Doolin, 2016 Canton, Dallas, Texas 75201.

MAKE \$46 From square foot plywood; jigsaw or bandsaw necessary. Free details Woodar, Bridgewater, Mass. 02324.

ADDRESSERS And Mailers Needed. Details 10c. Lindbloom, 3636 West Peterson, Chicago 60659.

(Continued on next page)

BUSINESS OPPORTUNITIES

(Continued from preceding page)

BIG PROFITS!! SELL ENGRAVED, METAL, SOCIAL SECURITY PLATES. FREE SALES KIT! MYERS, 928-PM CRESCENTHILL, NASHVILLE, TENNESSEE 37206.

I MADE \$40,000.00 Year by Mailorder! Helped others make money! Start with \$10.00—Free Proof. Torrey, Box 318-Y, Ypsilanti, Michigan 48197.

MAIL Baby Catalogs Imprinted with your address to New Mothers for Big Profits! Details 25c. Volz PM, Ypsilanti, Michigan 48197.

\$25.00 HUNDRED Addressing. Possible Year 'round. Complete instructions 25c for registration, postage. Cove, Box 1348-B, Clearwater, Florida 33517.

\$70 TO \$200 WEEKLY—Home, Spare Time Simplified Mail Bookkeeping. Immediate Income. Easy. Auditax, Box 34741A, Los Angeles, Calif. 90034.

VENDING Machines. No selling. Routes earn amazing profits. Big catalogue Free. Parkway Corporation, 715PBM Ensor Street, Baltimore, Maryland 21202.

\$60.00 DAY. Manufacturing Concrete Posts. Blocks. Mold Equipment Catalog \$1.00 refundable. Carlayne, Route One, Box 95, Rapid City, South Dakota 57701.

MAIL Order Collection Agency can make you \$1000.00 monthly. Free Details. Continental, Box 2023-A, Des Moines, Iowa 50310.

SELL Books by mail. 400% profit. Royal, Box 450-X, Cleveland, Ohio 44127.

CLIP Short newspaper items. To \$10.00 each. Details free. Foster, 272-M-3, Brooklyn 11235.

MAILORDER Records help get increased business! Complete 32 page Record Book shows your inquiries, orders, advertising, expense, etc. Only \$1.00. C. A. MARTIN, POPULAR MECHANICS, DEPT. R, 224 WEST 57TH STREET, NEW YORK, NEW YORK 10019.

HOMEWORKERS. \$100.00 Weekly Addressing for firms. Begin immediately. Details—send stamped, addressed envelope. Hamilton, 272-TMA3, Brooklyn 11235.

\$200.00 DAILY In your mailbox! Your opportunity to do what mailorder experts do. Free details. Associates, Box 136-A, Holland, Michigan 49423.

TAKE Catalog orders. We drop-ship 1001 best selling specialty products. Guaranteed lowest below wholesale prices. Fantastic spare-full time home business. Free book show you how. SMC, 6061 SPC, De Soto Avenue, Woodland Hills, California 91364.

REPAIR Hydraulic Jacks—Details Free. Write: Hydraulic Parts Supply, Box 295, Port Isabel, Texas 78578.

EARN \$60.00 Daily manufacturing Concrete Fence Posts. Practically no investment. Send stamped-addressed envelope. American, Excelsior Springs, Mo. 64024.

RECEIVE MAIL Galore! Your name on our national mailing lists, 50c. Sullins, Box 1313, Brunswick, Georgia 31520.

\$50.00 PLUS 50% COMMISSION Stuffing 200 already stamped, addressed envelopes, our circulars. Information 25c with stamped, self-addressed envelope. Brewster-PB, Clearwater, Florida 33517.

JOIN The professionals. Profitable Gift Catalog Distributorship. Giftfair, 1430-40 Wells, Milwaukee, Wisconsin 53233.

PROFITABLE BUSINESS—Molding Rubber, Hobby Supplies. Details 10c. Chaney's, 5415 L San Jose Blvd., Jacksonville, Fla. 32207.

HOMEWORKERS Wanted. Details 16c Stamps. Brodin Company, 28P Rainbow Village, Columbia, Mo. 65201.

TRANSPARENCIES Wanted. Learn FREE-LANCING. American Color, Box 2193, Sepulveda, California 91343.

MAILORDER Catalogs. Your Name Imprinted. Merchandise Drop-Shipped. Details 25c. AM Sales, 32-28 100th, East Elmhurst, N.Y. 11369.

400,000 BARGAINS Below wholesale! Many free. Liquidations... closeouts... job lots... single samples. Free details. Bargainhunters Opportunities, Box 730A, Holland, Michigan 49423.

\$400.00 MONTHLY Raising giant fishworms. Soilless method. Charlie Morgan, Bushnell, Florida 33513.

EARN Money raising fishworms for us! Write: Oakhaven-38, Cedar Hill, Texas 75104.

MEN-Women Make Big Profits At Home! In Plastics, part or full time! Home process teaches you with equipment we give you free to make hundreds of 3-D plastic products, candy and candle molds, plaques, signs. Skin and Bubble package. Also resin casting. Write today for free details. Nationwide Plastics, Dept. AVX, 4140 Eagle Rock Blvd., Los Angeles, Ca if. 90065.

NEW Manual. How To Manufacture Concrete Floor Tiles For Fun, Profit. Very Small Investment, Easy Method. Complete Instructions, \$6.00, Guaranteed. Hilmar, Route One, Box 347-D, Valrico, Florida 33594.

SELL LIFETIME METAL SOCIAL SECURITY PLATES. BIG PROFITS! SAMPLE AND SALES KIT FREE. RUSSELL PRODUCTS, MAURY COUNTY SHOPPING CENTER, DEPARTMENT P41, COLUMBIA, TENNESSEE 38401.

FREE 1973 100-Page Catalog waiting to bring you Big spare-time cash commissions. Sell Advertising Book Matches. Every business a prospect... complete selling instructions furnished. Steady, repeat business. Dept. MX-373, Superior Match Company, 7530 South Greenwood Avenue, Chicago, Illinois 60619.

FREE Collection Agency Details. \$1000.00 Monthly Possible. Master, Drawer 77009-PM, Atlanta, Georgia 30309.

900% PROFIT In Magnetic Signs, Candle Molds, Packaging plus 1000s of plastic items. Free details. NPC, Dept. 292, 4200 Panamint, Los Angeles, California 90065.

EARN \$2,000.00 Monthly in Astonishing Spare Time Business. Details Write: James Carmack, 233 1/2 N. Main Street, Manteno, Illinois 60950.

WATCHMAKING Makes every day a payday. Learn this cash business at home. Free details. Chicago School of Watchmaking, YPA, Fox River Grove, Illinois 60021.

MEN—Women! Fill out income tax forms at home in own business. We show you how. Simple, easy to learn. \$700 per month earnings possible. Details mailed free. No salesmen. Hurry. Federated Tax Home Training School, 2065 Montrose, Chicago 60618.

MAILORDER!! Enjoy Wonderful Income. Financial Security! Everything furnished. Start making money now. Write: Allen, 554CS-6 Spruce, Garwood, New Jersey 07027.

MAILORDER Dealers Wanted. Earn outstanding profits using tested promotions! Executive type business. Details Free. Rutward, Box 735-PD, Norwalk, Conn. 06852.

FREE Sample. Sell Lifetime Social Security Plates, Big Profits! Utis, 10716 Francis, 1PM, Los Angeles, California 90034.

BUMPER Sticker Printer Kit puts you into bumper sticker and T-shirt printing business fast! Great at swap meets, churches, organizations and for anyone who wants to say their own thing. No stencils to cut, easy to operate. Enough materials to earn \$200! Write: Bumper Sticker Printer, Dept. 55, Box 234, Torrance, California 90501.

DON'T DELAY. Write today. Start your own mail-order business. Send inquiries to: Remos, Box Bl-3, Garden Grove, Cal. 92640.

MONEY In Mail Order. Free Details. Island, Box 157-F, Bayside, N.Y. 11361.

INTERNATIONALLY KNOWN MANUFACTURER 1972 SALES 357 MILLION DOLLARS OFFERS YOU A Chance To Be In Your Own Business High Profits—New mobile auto parts distribution—152 Now Operating Nationwide. Valley Forge Products, Div. Annet Inc., Dept. S, Box 96, Inwood, N.Y. 11696.

HOMEWORKERS—MAKE UP TO \$10 IN AN HOUR ALL PROFIT, doing Invisible Re-weaving/Reknitting on holes, cuts, tears in any fabric, even knits. Oldest, largest home study reweaving school shows you how, helps you get customers fast. Details mailed free. FABRICON, 2008 Montrose, Chicago 60618.

MAIL ORDER DISTRIBUTORSHIPS available for \$150 investment Free brochure. Dept. M104, Audit Controls, 28 Brookside Ave., Fair-Lawn, New Jersey 07410.

CALIFORNIA MANUFACTURER NEEDS Man to assemble our product and be local agent, experience unnecessary. May start while presently employed. Five-figure income for responsible applicant. S.K.R.M. Manufacturers, 2347 West 238 Street, Torrance, California 90501.

SPARETIME Profits. Literature free. Raibl Enterprises, 2355 Scenic Highway, (PB), Pensacola, Florida 32503.

FREE Details—Your Own Mailorder Business—No investment. Passco, Box 926, Fresno, California 93714.

\$1.00 LISTS You year sent to 1000 Importers, Jobbers, Mailers, our mailing year. Dixieme, King, North Carolina 27021.

MAKE \$2,000 Monthly! Copy The Mail-order Experts!! Only \$3.00!!! Potomac, PM-3, Box 3083, Alexandria, Virginia 22302.

EXECUTIVE Mailorder Franchises Free!! Full-Line, Uncopied Baby Necessities Immediately Self-Sell. 4,000,000 Yearly Prospects. Astonishing Profits. Trinity, 1712A Lee, Detroit, Michigan 48206.

LAWS—REGULATIONS: For Mailorder. Details—Free. TCR, Box 787PM, New York 11757.

\$500.00 WEEKLY Can Be Yours! Safe, Steady results with proven mailorder method!! Free Details! Delta, Box 24-P, Chalmette, Louisiana 70043.

EARN Thousands at home. How to sell books by mail. Free details. Wisdom House, Box 1106P, Largo, Florida 33540.

HOW To Raise \$100.00 To \$1,000,000.00!! Drawer 77009-A, Atlanta, Georgia 30309.

MAILERS Wanted!! Free Information. A. Allen, 2418 Lori, Santa Ana, California 92706.

\$200.00 SPARE Time earnings with your Tablesaw. Write: Workshop Five, 3800 Harne, Vancouver, Washington 98660.

COPYWRITING, Ghostwriting for Mail-order Dealers. Goutell, 175 Fifth Avenue, N.Y.C. 10010.

YOUR OWN MAIL ORDER BUSINESS! 4 MILLION NEW PROSPECTS ANNUALLY!! 25c BRINGS VALUABLE DETAILS. EVANS ENTERPRISES DEPT. PM, 77 MAY STREET, IRVINGTON, NEW JERSEY 07111.

1000 HOME Businesses Described Stamp, Bakers, 313 Harrison, Sullivan, Ill. 61951.

MAILORDER SUCCESS Can Be yours. Get the facts. Start the right way. Free details. Mister Unique Mail, Box 555, Dept. PM3, Los Alamitos, California 90720.

EXCITING! Wholesale, Mail Order, Direct Sales. Starting Kit \$2.00. Refundable. Olympic Products, 152 W. 42 St. Dept. 536, New York, N.Y. 10036.

STEADY Profits from home engraving. Supply business, industry. Trend Craftsmen, 4901H Perrine, Midland, Michigan 48640.

CLOCK Fixing Simplified, Instructions, Tools. Free details. Thiese, Genoa, Illinois 60135.

(Continued on next page)

BUSINESS OPPORTUNITIES

(Continued from preceding page)

LEARN MAILORDER! Earn thousands sparetime! Stop just wishing for higher income. Free details. Avalon, Dept. 313-1, 1185 Washington Street, Newton, Massachusetts 02165.

MAILORDER INSTRUCTION PUBLICATIONS!! Professional. Reliable. Profitable. Write: **HOW**, Box 4457PM3, Downey, California 90241.

GAIN Financial Independence!!! Proven Mailorder Technique Insures Success. Free details explain. Diamond, Box 223A, Pottsboro, Texas 75076.

FREE SECRET BOOK "2042 Unique, Proven Enterprises." Tiny businesses but huge profits! How Little Fellows beat inflation with fabulous "Little Knowns." Work home! Haylings-T7, Carlsbad, California 92008.

SELL Books!! Complete Mailorder Plan. Vikari's, Box 1312PM2, Salt Lake City, Utah 84110.

MAKE Durable building plastic easily. Waterproof, fireproof, economical. Bays Laboratory, Cedaredge, Colo. 81413.

MAKE MONEY ON MAILORDER IMPORTS. Report Reveals Foreign Drop-Ship Sources. Ideal Mailorder Items. Send \$1.00. Mason, Dept. 311-B, 50 Agate, East Brunswick, New Jersey 08816

UNIQUE Opportunity earn \$1500 monthly. Free Details. Wemco, Box 294, Pawtucket, R.I. 02862.

BELOW WHOLESALE Catalog Hundreds of best selling products. \$1.00, refundable on first order. Astro Products, Box 715-PC, College Park, Maryland 20740.

OPPORTUNITY!! Establish Your Own Mail-Order Business. Big Profits! Visionfax, Box 62-CB, Midland Park, New Jersey 07432.

DO SIMPLE ADDRESSING—Mailing. Receive \$12.95 orders. Keep \$8.00 profit. Details Free! Quality, Box 9-P, East Rockaway, N.Y. 11518.

BIG Profits building PICNIC-TABLES! Complete construction-merchandising course available... Particulars \$1.00 (applicable) Plus stamped envelope. DD Enterprises, RFD-1-246, Morrisonville, New York 12962.

WINNING SUCCESS IN MAILORDER BUSINESS \$4.95. Send order or write for Free Literature on other Money-making books. **BROOKLANNE**, Box 1071, Bloomington, Ind. 47401.

MAILORDER, We Drop-Ship, Giant Catalog \$2.00 (Refunded). Sherwood Dist., Box 6044, Sherwood, Arkansas 72116.

WE NEED GINSENG GROWERS! \$3,000—\$30,000 Annually! We Buy Your Crop. Send \$2 For Seed Sample And Information. Glass's Ginseng Exchange, Box 336, Rochdale Station, Jamaica, NY 11434.

GUATEMALAN Typical Items. Free Catalog. Mapilon, Box 268, Guatemala, Central America.

\$2000.00 MONTHLY Selling Information By Mail. Ropchan, Box 5341P, Sherman Oaks, Calif. 91413.

100 SOURCES (Manufacturers, Distributors) PLUS Business Starting Information. \$1.00. Schleicher, 7 Dove, Albany, New York 12210.

MAIL LETTERS!!! Make \$8.00 Profit Every Order. Free Details. Stayer Enterprises, 3704 Warwick, Peoria, Illinois 61614.

OUTSTANDING Opportunity—Sell Information By Mail. Details 25¢. Walter Mangerson Co., Rhinelander, Wisconsin 54501.

MAKE Money in Wholesale. Everything you need for full or part time business. Details Free. Raven House, Box 4277M, Burlington, N.C. 27215.

STUFF Envelopes. \$25 Hundred. Immediate Earnings! Beginner's Kit, \$1.00 (refundable). Lewcard, P392M, Brea, Calif. 92621.

\$500 WEEKLY. Mail Order Plans. Free. Rane, 18 Oneida, Centereach, New York 11720.

FREE Report, "How to Write an Ad That Will Sell Anything!" (Your own Advertising Agency?) Simon, 1280-AA Sawmill, Yonkers, N.Y. 10710.

MONEY MAKING OPPORTUNITIES GALORE! Read Mail Order's **TIMELY TIPS** Magazine. 48th year! Sample copy 25¢. Major, 1310 Bloomfield, Hoboken, New Jersey 07030.

MAILORDER: How to prepare your own catalog for pennies! Free Catalog! Obie-B3, Brooklyn, New York 11219.

FREE BOOK "999 Successful, Little-Known Businesses." Work Home! Plymouth-B3, Brooklyn, New York 11204.

BOOKKEEPING Service. Operate your own. We train you. Universal Bookkeeping, Box 664-M, Springfield, Missouri 65801.

OPERATION: Make Money, \$1000.00 per month possible. **FREE** Details. Maxwell, Box 10126, Houston, Texas 77010.

MAILORDER Expert Helps You Make \$2000 Monthly. Spare time only. Free details. Mark Scott, 2330A Beacon Lane, Naples, Florida 33940.

BOXES, All Sizes, Free Catalog, Lakeside, Dept. 10, Silver Lake, Minn. 55381.

MAILORDER LAWS REVEALED! Booklet Only \$2.00! Rehberg Associates, Box 812, Evanston, Illinois 60204.

MANY New Plans, Signs, Concrete. Homecraft, 2350 W47N, Denver, Colorado 80211.

"MAILORDER Laws And Regulations." Know The Facts. \$2.00. "Bill" Lambertson, 132 Tamiami Station, Dept. 33, Miami, Florida 33144.

\$100 WEEKLY Telephoning locally. Details 35¢. Ace Distributors, Box 933, Greensburg, Pa. 15601.

MONEYMAKING OPPORTUNITIES

HOW Much Does being your own boss or making \$25,000.00 per year interest you? The Warner breakthrough in the Engraving field could be your future. Write: Warner, Room EC-2-CC, 15112 Jarvis, Chicago, Illinois 60626.

FREE SOCIAL SECURITY PLATE. Send us your name and number. Kern Products, 246A Richmond Avenue, N. Massapequa, N.Y. 11758.

NEED MONEY??? Our Unique Catalog (Only One Of It's Kind In The World) Just Published Shows 56 Ways To Get It! Rush 50¢ For Your Copy Today And Expect Something Different! None Free "Potter's". 2002 South State, Salt Lake City, Utah 84115.

\$2000 MONTHLY In Amazing Interesting Businesses. Moon Enterprises, 7501 Springbok Road, Chesterfield, Virginia 23832.

UNLIMITED GROWTH POTENTIAL. Make extra spending money or an excellent yearly income selling a totally unique line of fine cookware and cutlery products. China and flatware too. Distributed and guaranteed by Wear-Ever Aluminum, Inc., a subsidiary of Alcoa. Exceptional opportunities to develop into career and management positions. Write today: R. W. Dispennett, V. P. Marketing, Wear-Ever Aluminum, Inc., Dept A58, 1089 Eastern Avenue, Chillicothe, Ohio 45601. An equal opportunity company.

YOUR Own Advertising Agency! Offer professional copy, artwork! Details plus merchandising report. 25¢. Idea Treasury, 1280-M Sawmill, Yonkers, N.Y. 10710.

MAKE MONEY IN SPARE TIME. Earn generous commissions as a subscription representative for leading magazines. For free details, send this ad with your name and address to: **POPULAR MECHANICS** Room 1107S 250 W. 55th St., New York, N.Y. 10019.

DOUBLE Your Money Back If You Can't Win Continuously At The Races. Simple, Speedy, Accurate. Free Report And Proof. Send Self-Addressed Stamped Envelope. Morgan, Box 25053-CDC, Los Angeles, California 90025.

MONEYMAKING Manuals—Work at Home! Mears-PM, 5363 Essex, Alexandria, Virginia 22311.

START Small, HIGHLY PROFITABLE ELECTRONIC PRODUCTION IN YOUR BASEMENT. Investment, knowledge unnecessary. Postcard brings facts. Barta-PMG, Box 248, Walnut Creek, California 94597.

MAKE MORE MONEY—Start your own Home Business. Our publications show you how. Books—by—Mail, 333 N. Michigan, Chicago, Illinois 60601.

INEXPENSIVE Burglar, Fire, Smoke, Auto Alarms. Extinguishers, Supplies. Watchdog Alarms, Williamsburgh, Ohio 45176.

WE BUY NEWSPAPER CLIPPINGS of Wedding Announcements for 50¢ each. Details \$1.00. Clippings, Box 3146DC, Odessa, Texas 79760.

SPARE Time Cash. Sell Famous Hanover Shoes. Actual Samples and sales kit Free. No experience needed. No age limit. Lowest prices for highest quality makes selling easy. Every man a prospect. Big daily commissions. For full details, write: Hanover Shoe, 972 Carlisle, Hanover, Pa. 17331.

\$2.40 HOURLY Making simple wood novelties. Free details! Gene's, 55 Boxwood, Falmouth, Mass. 02540.

LEARN The secrets of repairing junk batteries "Fabulous Profits" at home. Battery Shop, Box 820, La Quinta, Cal. 92253.

MAKE \$1.00 PER SALE Selling engraved metal Social Security plates. **FREE SALES KIT.** Engravaplates, Box 10460-199, Jacksonville, Florida 32207.

WORLD'S Leading contest magazine, 25¢. Year, \$4.00. Prizewinner, 1315 Central, St. Petersburg, Fla. 33705.

MAKE Statuettes, novelties, imitation marble. Sell to stores or start gift shop. Free details. Marbleizing, 41 Waverton, St. Louis, Mo. 63124.

HOW TO GET RICH!! Free "Money-making Brochure"! Success International, Box 2447-C, Livonia, Mich. 48151.

VENDING Machines. No selling. Routes earn amazing profits. Big catalogue Free. Parkway Corporation, 715PMM Ensor Street, Baltimore, Maryland 21202.

FREE—Easy Ways to make money selling exciting new products—Full—spare time. Send name, age, for 5 months free subscription. Salesman's Opportunity Magazine, 1460 Hancock Center, Dept. 17-CM, Chicago 60611.

GET World's Biggest Wholesale Import Catalog. Write: World, Medina, Washington 98039.

CLIP Newspaper items. \$1.00-\$5.00 each. Details free. Walter, Box 1360PA, Erie, Pa. 16512.

HOW To Make Money Writing Short Paragraphs. Information Free. Barrett, Dept. C-27-S1, 6216 N. Clark, Chicago 60660.

PENNY STOCKS Have Profit Potential. Free Information. Analyst-P.M., Box 214, Redondo Beach, California 90277.

200% PROFIT Selling Rings. Triple Money in 30 Days or Money Back. Free Details, Anka, P.O. Box 8036-PM, Cranston, Rhode Island 02920.

BECOME Notary Public! Have dignified sideline. Free details. Stationers Exchange, Box 617, Kilgore, Texas 75662.

\$40 DAILY Possible tying fishing flies at home. Details 25¢. Flyco, Box 481PM, Albany, Oregon 97321.

(Continued on next page)

MONEYMAKING OPPORTUNITIES

(Continued from preceding page)

EARN MONEY, learn mailorder, spare-time, at home, reading leading (since 1929) trade magazine, product sources, stories, tips. Sample 50¢, year \$5. Mail Trade, Box 1302, Springfield, Illinois 62705.

HAVE FUN Making Extra Money in your Spare Time. Potential unlimited. We provide your start. Send \$5 To: J&G Enterprise, P.O. Box 667, Sierra Vista, Arizona 85635.

NEED MONEY?? Easy, Smart-Money Methods to Skyrocket Your Income! Write: Stayer Enterprises, 3704A Warwick, Peoria, Illinois 61614.

\$100.00 POSSIBLE Using \$2.00 glue. Regluing Chairs etc. for self, extra income, my methods \$6.00. Hettinger, 3823 N. Southport, Chicago 60613.

MAILORDER, Sell Engraved Social Security Plates. Complete Dealer Set-up. AM Sales, 32-28 100th, East Elmhurst, N.Y. 11369.

ADDRESSERS—50 Companies want Addressers. Send self-addressed envelope. Cal Enterprises, Box 4516-X, Compton, Calif. 90224.

\$200 DAILY In Your Mailbox. Proven Mailorder Business—Never Fails. Beginners. Free Details. Pen's, Box 86609-PM, North Vancouver, B.C.

SCIENTIFIC Massages: Big Earnings uncrowded profession. Learn spare time at home. Diploma awarded. Free catalog. Write: Anderson School, Dept. C-1C, Princeton, Illinois 61356.

400% PROFITS Selling Books!! Advanced Publications Reveal Unexpected Mailorder Opportunities. Franchises Free. Trinity, 1712B Lee, Detroit, Michigan 48206.

MAKE Money at home! 49 Ways. Write—Coach Publishers, Box 834H—Bangor, Maine 04401.

FREE Catalog—Start Own Business Part Time. The James Company, 59 James Street—A-373, Toms River, New Jersey 08753.

NEED \$80,000, \$50,000, \$30,000? Your Lifetime Opportunity to Fabulous riches. Write airmail today for free information on our plan. MEYER, APARTADO 664, Guatemala, Central America.

EARN 10% PER MONTH ON YOUR MONEY. "How to Organize a Factoring Company." Our 5000 word report gives complete details, including sample forms and records. Requires only modest capital. Write: CAPITAL FACTORING CORP., PO BOX 914, Dept. L, Provo, Utah 84601.

TELEPHONE REPORTERS Needed immediately. Set own fees. Enjoy prestige. Information \$1.00. Dollarsavers, 10 Paddock, Hudson, N.Y. 12534.

\$100.00 WEEKLY At Home. Free Materials. Patterns and Instructions Guaranteed. \$2.50. Fircrest Resort, Rt. 1, Blaine, Washington 98230.

\$125.00 WEEKLY Correcting Pupils' Lessons! Samples. \$1.00! Castle's, 507-PL Fifth, New York City 10017.

INVITATION To the PROFITABLE WORLD of MAILORDER. Details 25¢. Devine, Box 56069, Chicago 60656.

EARN CASH AT HOME! Sell Paragraphs, Photos, Coins, Imports By Mail. Free Information. Sherman, 73 Notre Dame, Hudson Falls, New York 12839.

ANTIQUES, BUY! SELL! TRADE! Comprehensive 264 Page Handbook Contains Wholesale, Retail Prices, Over 800 Illustrations. \$1.98. Global Creations, 1029 Carrin Drive, Tallahassee, Florida 32301.

INCREASE YOUR INCOME, Security And Power. 256 Page Book Reveals Secrets That Make Men Rich. Only \$2.00. Fueston Enterprise, 11588 Southwood Drive, Saratoga, California 95070.

BIG MONEY GUARANTEED! Mail Order—Wholesale Book Sources—Printing & Office Supplies—Camera—Typewriter—Sewing Machine Profits—\$3.98 each. Cee More Products, F73, 6308 Eberhart, Chicago, 60637.

FREE! Catalogue listing low cost books, money making opportunities. Park Avenue Products, 3615 South Park Avenue, Springfield, Illinois 62704.

\$3,000 IN 60 Days Legally. Details \$1.00 Guaranteed. Brodin Company, 28 Rainbow Village, Columbia, Missouri 65201.

PUBLICATION Outlines Home Businesses Money-making Opportunities. Profitable Hobbies 25¢. Pearson Enterprises, 11428 Church, Chicago 60643.

HOMEWORKERS EARN \$150.00 Weekly addressing our Sales Letters. Details 25¢. Cur-Jon Mailers, Box 523-PM, Maplewood, N.J. 07040.

HOW To Earn At Home Addressing Envelopes. Send Self Addressed Stamped Envelope To: R.H.M. Productions, 11 Willard Ave., Mt. Vernon, New York 10553.

SWEEPSTAKES Contests. How to win. Write for free information. General Contests, 1609-18 East 5th., Duluth 12, Minnesota 55812.

BURGLAR'S Touch opens doors without force. Stopped by your protection. Installations sold fast. Convincing demonstration. Complete instructions with samples. \$2.98. Torrey, 210RR, Brightwater, Clearwater, Florida 33515.

START TODAY! Make money writing short fillers for magazines. Complete 10 lesson professional guidance course. Send \$6.45 Postpaid, Trade Center, Dept. 711, 1102 Malone Drive, Orlando, Florida 32810.

"HUNDRED Uses for old newspapers." Recover cost! Amazing! 25¢ plus stamped envelope. DD Enterprises, RFD-1-246, Morrisonville, NY 12962.

HOMEWORKERS. Earn 50¢ each, collecting names. Rush 10¢. Gemco, B-21244A, Indianapolis 46221.

DROP Ship Your Way To A Mail Order Fortune with "Drop Ship Buyer's Guide." \$3.25. Cazin, 526 Maple, Redwood City, Calif. 94063.

EARN EXTRA CASH Easy—Assemble And Sell Easy Moving Product. Send \$1.00 To: Bobco, Box 2486, Sanford, N.C. 27330.

FREE SECRET BOOK "2042 Unique. Proven Enterprises." Largest successful collection! fabulous "Little Knowns." Work home! Haylings-T8, Carlsbad, Calif. 92008.

MAKE \$10.00 DAILY WRITING SHORT ARTICLES. Copyrighted Report Reveals How and Where. Send \$1.00. Mason, Dept. 311-A, 50 Agate, East Brunswick, New Jersey 08816.

BEGINNERS Make \$15.00 an hour with New Mail Order Business. Free details. KOST, 15-P SAYLES, LOWELL, MASS. 01851.

\$200.00 FROM Sheet 1/4" plywood (scrap). Details 25¢. Novelities, 610 So. 24th, Elwood, Indiana 46036.

EARN Money On Money You Spent. New book reveals easy to follow details. Only \$4.95. International, Box 29023, Memphis, Tenn. 38111.

WE LIST & Describe HUNDREDS OF COMPANIES that will pay you or help you make money working for yourself. Send \$2.00. **HOMEWORKERS INDEX**, Box 24413-RC, Oakland, Calif. 94623.

\$2,000 MONTHLY Is Possible! New! Mail Order Profit Plan Details 25¢—Wilf's, Box 4172, London, Canada.

MONEY Making Booklets. Free List. W. Naggo, Box 11478, Chicago, Illinois 60611.

I WON the Big Contests! Will help you win! Wiemels, 325-D Elmwood, Bay Village, Ohio 44140.

FREE Signature analysis! Discover moneymaking and romantic potentials. Certified handwriting agency. Profigraph, Box 503YM, Brigham City, Utah 84302.

500% PROFIT From Scrap Lumber. Details 35¢. What-Not Shop, P.O. Box 149, Waterloo, New York 13165.

DEALERS Run our \$2 pulling ad: Keep \$1.75 per order, we fill orders for 25¢. Rush \$2.00 for complete instructions. Satisfaction Guaranteed. Ortis, Box 152, Brooklyn, N.Y. 11217.

ENORMOUS Mailorder Profits! Money Back Guarantee. Tested, Proven, No Experience Necessary. Rush \$1.00. Thompson Enterprises, 1120 Cherrylawn, Pontiac, Michigan 48055.

HOW To Be Healthy, Wealthy, Wise. Free List of Books, Reports. Hutton's, Rt 3, Box 171-A, Chesterton, Indiana 46304.

CAMERA Owners! Earn \$100.00 to \$700.00 From Your Photos. \$1.00 Booklet tells you how. Jackson Mail Order Sales, 411 E. Coleman Street, Crothersville, Ind. 47229 Dept. 11.

EARN AT HOME Addressing Envelopes. Rush Stamped, Self-Addressed Envelope. Zip Mailers, Route 2, Box 704, Henderson, N.C. 27536.

HOW To Make Money in Mailorder, Information Free. London House, 2566 Colden Avenue, Bronx, New York 10469.

MAKE MONEY! Own your own remailing business. Complete instructions. Send \$2.00. The Mailbasket, 27350 Bradford, Southfield, Mich. 48076.

\$650.00 WEEK MAILING CATALOGS. Details \$1.00. (refundable). HAROLD, P.O. Box 22313, Cleveland, Ohio 44122 Dept M.

PROFITABLE OCCUPATIONS

SECRET Loans—Get \$500 . . . \$35,000 . . . Up to \$2 million easily. Free details. Capital-25, Kerrville, Texas 78028.

BAKE New greaseless doughnuts in kitchen. Sell stores. Free recipes. Michael Ray, Waseca, Minn. 56093.

FT. SMITH Auction School, Ft. Smith, Ark. 72901. Resident & Home study. Veteran approved.

BECOME A Mortgage Broker. Highly respected, interesting, lucrative prestige business. For complete information write: United, Box 6284-F, Marietta, Georgia 30060.

HOW To Make Money Writing Short Paragraphs. Information Free. Barrett, Dept. C-27-S2, 6216 N. Clark, Chicago 60660.

LEARN GUN REPAIR GUNSMITHING In spare time. Book, details 10¢. Modern Gun Repair School, Dept. 2208, 4225 N. Brown, Scottsdale, Arizona 85251.

SHARPEN Scissors, Pinkers. Inexpensive equipment, tools, supplies. Blackhawk's, Sheldahl, Iowa 50243.

FIX, SELL, TYPEWRITERS. Book \$2.95. United Typewriters, 12429 Southeast Stephens, Portland, Oregon 97233.

JOIN THE HANDYMAN CAN For fun or Profit. First project, **WISHING WELL BARBEQUE**. Send Stamped, Self-Addressed Envelope. **THE HANDYMAN CAN**, P.O. Box 391, Hales Corners, Wisc. 53130.

RETIRE ANYTIME . . . IN LUXURY! Be Independent! Easy, Legitimate. Free details. Premier Enterprises, Box 10597-AC, Pittsburgh, Penna 15235.

PLASTERCRAFT!!! Profitable home business. Molds available. Details: Lynnette, 6251C Mentor Park, Mentor, Ohio 44060.

SALESMEN-DISTRIBUTORS

EARN Big Commission Full or Part Time. Show America's largest line Low Priced Business Printing and Advertising Specialties Plus Calendars in season. No experience. No investment. No collections or Deliveries. On-the-spot commissions. Big Free Sales Kit Samples hundreds items used daily by businessmen. Merchandise bonuses for you. Build profitable repeat business. Start now. National Press, Dept. 73-B, North Chicago, Ill. 60064.

(Continued on next page)

SALESMEN-DISTRIBUTORS

(Continued from preceding page)

PUBLICATIONS for local wholesale distribution, higher profits. Details, sample, \$1 refundable. Publisher, 404 West Jefferson, Springfield, Illinois 62702.

HOUSEHOLD PRODUCTS ROUTE. EARN \$25 or more daily. Also Party Plan opportunities for men, women full, part time. McNess, Freeport (2633) Illinois 61032.

NEW, Compact fire extinguisher, Fantastic profits. Exclusive territories. Norwich Chemical, Norwich, Connecticut 06397.

LONG NEEDED INVENTION. Want man contact service stations. Full or Part Time. Huge Profits. Write: Cyclo Mfg., 3816 Dahlia, Dept. 140, Denver, Colo. 80207.

CRIME Personal Protection Devices. Mass Demands, Tremendous Profits. Sheriff, Box 113, Twinsburg, Ohio 44087.

MAKE MORE MONEY IN 1973. Use your spare time to show our New Line of Specialty Advertising, Calendars and Executive Gifts to Business Firms in your area. Prompt, friendly cooperation with a low pressure, progressive firm, in our 64th year, rated AAA-1. No investment or collections. Weekly commissions and Liberal Bonus. Samples furnished. Can be developed into a full time business. Write to: John McNeer, Dept. PM-3, Newton Mfg. Co., Newton, Iowa 50208.

HERTEL Exclusive reference Bible! Make biggest profits with world's best seller! Startling 3-dimension cover! Demonstrator, supplies furnished. Top commissions plus extra bonus earnings! Write: International Book, Dept. PM, Box 118, Wichita, Kansas 67201.

SELL Advertising Ball Pens, Calendars, Ad-Specialties—Build Own Repeat Business—Free Details—Fleming, Dept. A, 6535 Cottage Grove, Chicago 60637.

\$100.00 EXTRA A week easy! Spare time! Double Air Cushion shoes. Men's, women's line. Dress, work, play. Highest commissions. Shoes for yourself. Outfit Free. Bronson, Dept. H-33, Minneapolis, Minnesota 55408.

POLLUTION FIGHTING ORGANIC DIGESTERS. Distributorships Open. For septic systems, drains, treatment plants. Also, Organic Control products for farm, sewerage lagoons, etc. Complete line proven products for home, industry. Only investment is merchandise. Start with \$25.00 order or less. Unused supplies returnable for refund. Excellent opportunity, growing field. Free test materials, literature. Write: Ryter Organics, Dept. 172, Madelia, Minn. 56062.

\$50-\$100 EVERYDAY. Commission paid daily. Changeable Electrical signs for businessmen. Associated, 137-K North Western, Los Angeles, 90004.

BECOME A Successful Manufacturers' Representative. Manufacturers' Agents Newsletter tells you which firms are looking for representatives, the firms products line and territories available. For information write: Manufacturers' Agents' Newsletter, Dept. 152A, 23573 Prospect Ave., Farmington, Michigan 48024.

AGENTS WANTED

TEAR Out This Ad And Mail With Name. Address for big box of home needs and cosmetics for Free Trial, to test in your home. Tell your friends, make money. Rush name. Blair, Dept. 31AD, Lynchburg, Va. 24505.

WILL You test new items in your home? Surprisingly big pay. Latest conveniences for home, car. Send no money, just your name. Kristee, 141, Akron, Ohio 44308.

YOUR Own business. Used Suits \$1.50; Overcoats 65¢; Mackinaws 35¢; Shoes 12½¢; Ladies' Coats 30¢; Dresses 15¢. Enormous profits. Catalog Free. Superior Jobbing Company, 2111-AA West Roosevelt, Chicago, Illinois 60608.

ESTABLISH Your own business. Low prices on used clothing, shoes, household goods. Unlimited profits. Free catalog. Northwestern Distributors, 2129 No. Western Avenue, Chicago, Illinois 60647.

SELL VITAMINS. Nationally Advertised vitamin program—including Vitamins "E" and "C" uniquely packaged in handsome "VitaBox" dispenser cartons. Build own repeat business—Excellent profit. Superior quality vitamins. Invest as little as \$100.00 to start your own business. Details—Vitamin Club of America, 9601 Wilshire Blvd., Beverly Hills, Calif. 90210.

FREE Selling Outfit—Office Supplies, Machines, Furniture and Equipment. Oseco, 3505-PM Elston, Chicago 60618.

PRINTING, Advertising Salesmen—Excellent moneymaking sideline selling Decalcomania Name Plates, small quantities. Advertising Specialties, sign letters. Free Samples. Ralco XL, Boston, Mass. 02119.

WANT TO MAKE UP TO \$100 A WEEK Spare time, and get free shoes for life, too? No investment. Rush Card for free details. Mason Shoes, K-930, Chippewa Falls, Wisconsin 54729.

EVERY Man a prospect. Refundable sales kit offer showing line belt buckles, tie clasps, money clips, cuff links, lapels, identification badges, individualized with customer's name and emblems. Cap badges for trucking, bus, taxi, police, firemen, also postal letter carriers and heavy construction emblems. Choice 4000 emblems. Hook-Fast, Box 1088-PM, Providence, R.I., 02901.

REPRESENT Largest manufacturer of magnetic signs spare or full time. TRIMETRIC, 337 Elroblar, Ojai, California 93023.

EMPLOYMENT INFORMATION

OVERSEAS JOBS—NOW HIRING, 103 Countries, All Occupations, High Pay, Free Transportation, Tax Benefits, Latest Computerized Reports—\$2.00. TRANSWORLD, International Airport, Box 90802-E, Los Angeles, California 90009.

AUSTRALIA—NEW ZEALAND! FREE DETAILS! 50,000 Jobs! Paid Transportation! 1973 Information and Forms. Send Age, Occupation. Austco, Box 3623-EX, Long Beach, California 90803.

FLORIDA WANTS YOU? Concise, Complete Unbiased **GENERAL FACTS YOU DON'T** Know. \$2.00 Refundable. Idlease, P.O. Box 171-P2, Cape Coral, Fla. 33904.

FLORIDA Employment Opportunities! Disneyworld! Newspaper Classifieds! Booklet \$1.00. Sunshine, 4512N Jamaica, Tampa, Florida 33614.

AUSTRALIAN Facts, 634 Pages, 357 Photographs—\$2.25. Australasian Newspapers, Magazines: 10 Pounds—\$7.00; 30 Pounds—Including Relevant Australian Books—\$15.00; 35 Pound Deluxe Combination—\$35.00. 100% legitimate imports. A! Different. Postpaid. Australasian News, Box 6428, Torrance, California 90504.

MERCHANT Marine Employment Information. Ocean-Tug-River-Men, Women. \$4.00. Box 25, Peru, Indiana 46970.

FREE Government Benefits Galore! Details. Premier Enterprises, Box 10597-CC, Pittsburgh, Penna. 15235.

FIND GENUINE JOB OPENINGS! All States! Hawaii! Alaska! Canada! Employment Guides Show How. \$1.00 each state wanted. Nationwide, Box 165-P, Homewood, Illinois 60430.

AUSTRALIA!! AUSTRALIA!! FREE DETAILS!! Paid Transportation. Latest Information on Jobs. Send age, occupation. Write: Associated, Box 17-B136, Lafayette, California, 94549.

AUSTRALIA WANTS YOU NOW—Thousands of jobs. Government paid transportation. Latest booklet with employers list, housing, prices, taxes, transportation, social life, etc. \$1.00. Vonst, Box 237P, Santa Ana, California 92702.

LEARN MOTEL Business, Great Career Opportunities Worldwide. For Placement Details Send \$2.00. Crest Motel, Box 65, Bayard, Fla. 32224.

HELP WANTED

OVERSEAS Jobs—Australia, Europe, South America, Far East. Openings in all trades and professions. Free information Write: Foreign Jobs Co., Box 2235 AMF, Miami, Florida 33159.

OVERSEAS EMPLOYMENT . . . Australia, Europe, South America, Asia! All Occupations! \$700-\$3,000 monthly! Write: Employment International, Box 29217-AC, Indianapolis, Indiana 46229.

OVERSEAS Jobs—Europe, South America, Australia, Far East, etc. 2000 openings all trades. Construction, Office, Engineering Sales, etc. \$700 to \$3,000 month. Expenses paid. Free Information. Write: Overseas Jobs, International Airport, Box 536-M, Miami, Florida 33148.

EARN At Home Addressing Mail. Details 25c and Stamped Envelope. Deeco-151, Box 9308, North Hollywood, Cal. 91609.

HOMEWORKERS—Mailing—Addressing for advertisers. Pay's \$94.00 weekly. Everything Furnished, Instructions \$1.00. Order Now! \$6.00 Gift Free! Refundable if not as represented. Morrison's, PM2441, Patton, Philadelphia 19132.

WORLD-WIDE . . . U.S.A. JOBS GALORE!!! All occupations. Enjoy: Asia, Europe, Africa, South America, Florida, California. \$700.00 to \$3,500.00 monthly. Paid Overtime. Travel Allowance. Free Details! Send age, occupation. Write: Global Employment, Box 706-B136, Orinda, California 94563.

FREE DETAILS! . . . AUSTRALIA . . . Paid Transportation!! Jobs Galore!! Send age, occupation. Write: Associated, Box 17-BA136, Lafayette, California 94549.

REAL ESTATE AND FARMS

NEW! FREE CATALOG! Big SPRING Edition! Over 5,200 Properties described, pictured—Land, Farms, Homes, Businesses—Recreation, Retirement. Selected Best throughout U.S.! 73 Years' service, 648 Offices, 40 states Coast to Coast. Mailed FREE from the World's Largest! STROUT REALTY, 60-MX E. 42nd St. NY, NY 10017. 7-MX S. Dearborn, Chicago, Ill. 60603. 521-MX E. Green, Pasadena, Cal. 91101.

CANADIAN LAND FROM \$19.00 AN ACRE CHOICE Properties available across Canada. Low monthly payments. Ideal for farming, cottages, hunting, fishing. Free Catalogue. Canadian Estate Land, Dept. PMC-3, 286 Lawrence Ave. West, Toronto 20, Ont., Canada.

ARIZONA—1¼ Acres, Hearts of Hunting And Farming Centers. \$1,100—Low Terms. Mrs. Anna Young, Glenarm Land Co., 2233 North 7th St., Phoenix, 85006.

THIRTEEN Percent Return From Rented Mobile Homes Lots. Buy Now. Information: \$5.00. Box 1436-PM, Crystal River, Florida 32629.

CENTRAL Ontario—Choice 640 acre Sportsmen's paradises still available—\$20.00 plus \$6.50 taxes yearly. Maps, pictures. \$2.00 (Refundable). Information Bureau, Norval 4, Ontario, Canada.

GOVERNMENT LANDS FROM \$3.50 ACRE! Vacationing, Homesteading, Investment! Exclusive "U.S. GOVERNMENT LAND BUYER'S GUIDE" plus "LAND OPPORTUNITY REVIEW" listing lands throughout U.S. Send \$1.00. Surplus Lands, Box 19107-AC, Washington, D.C. 20036.

FREE. . . . BIG 264-Page Catalog. Hundreds of top real estate values coast to coast! **UNITED FARM AGENCY,** 612-PM West 47th St., Kansas City, Mo. 64112.

(Continued on next page)

REAL ESTATE AND FARMS

(Continued from preceding page)

\$1.00 ACRE! USA and Canada. Lists, photographs mailed. Government Lands, 220 Delaware Ave., Buffalo, New York 14202.

IDEAL 5-ACRE RANCH. Lake Conchas, New Mexico. \$3,475. No Down. No Interest. \$29/mo. Vacation Paradise. Money Maker. Free Brochure. Ranchos: Box 2003PS, Alameda, California 94501.

HOW I MADE OVER \$30,000 IN ONE YEAR. From my home, as a Real Estate Agent, starting with less than \$100.00. Also, hints, to selling, listings, advertisements, Salesman, etc. Send \$1.00 to: Real Estate No. 11, Box 157, Standish, Mich. 48658.

ARIZONA—Beautiful 2½ acres, \$995, easy terms. For investment, retirement or vacation. Lake Havasu-Kingman area. Ev King, Broker, 202-M East McDowell Road, Phoenix 85004.

MICHIGAN 10 TO 160 ACRE TRACTS Lake Superior-Marquette Area from \$99.00 Acre. Cabins, Trailers, camping welcome. (Acreage anywhere in Michigan). **FREE PICTURES.** Any terms A-OK with **BLOCH BROTHERS.** Write: 3650 Dixie, Drayton Plains 16, Michigan 48020.

\$1 ACRE—Canadian border—hundreds campsites, islands, farmlands, directly from tax authorities. (Non-profit). Lists, photographs mailed. Register, Room 10, 110 Church Street, Toronto 1, Canada.

CANADIAN Vacation lands: Full price \$385.00. 40 acres. \$10 month. Suitable cottage sites, hunting, fishing, investment. Free information. Land Corporation, 3768-C Bathurst, Downsview, Ontario, Canada.

FREE Catalog! PHOTOS! Coast to coast farms, business, retirement. All types, sizes & prices. **SAFE-BUY** Real Estate, Box 589-PM, Little Rock, Ark. 72203.

COLORADO LAND KIT! SHOWS You the most spectacular land you've ever seen... in the heart of Colorado's famed high country! Contains brochure with 17 full color photos, map, information on fishing, hunting, riding, camping. Explains how you may own 5 acres with no down payment, no interest, just \$20.00 a month! This could be your investment and recreation dream come true. Send for free land kit to: Aspen Lakes Ranch, Dept. PM6, Box 1207, Colorado Springs, Colorado 80901.

ARKANSAS Farms, Ranches, Acreage. Clean Air, Pure Water, Excellent Hunting, Fishing, Low Taxes. Free Bargain List: American Farm Agency, Drawer "C", Mena, Arkansas 71953.

FARM AND GARDEN EQUIPMENT

RIDING LAWNMOWERS Shipped from factory—New 7 Horsepower, \$189.00. Freight paid. Free brochure: Tomco, Box 72, Oak Grove, Mo. 64075.



FLOWERS, PLANTS & NURSERY SUPPLIES

LEARN Flower Arranging and Floristry. Start full or part time business or hobby. Free information on home study course. Lifetime Career Schools, Dept. B-699, 2251 Barry Avenue, Los Angeles, California 90064.

GREENHOUSES, 12' Fiberglass and UltraViolet Shielded from \$109.95. Free catalog. Greenhouseman, Box 2666-M-3, Santa Cruz, California 95060.

SPRINKLER Spike watering system installs in minutes in your own hose. Free illustrated brochure. Eric Johnson Co., 67 Bonanza Rd., Palm Springs, Calif. 92262.

LEARN Landscaping and the growing of plants. Start a profitable business part or full time. Free information without obligation. Lifetime Career Schools, Dept. A-360, 2251 Barry Avenue, Los Angeles, California 90064.

GINSENG Bringing \$20.00 pound. Have seeds roots. Goldenseal. Full Information. K. Collins, Viola, Iowa 52350.

BUILDING AID BOOKS

POPULAR MECHANICS CATALOG Of Plans, publications and projects. Covers shop and home projects. Want to build a plane, a hovercraft, boats, swimming pools, patios and garden furniture. Fireplaces, kitchen cabinets. 32 pages crammed full of fascinating and useful projects. Send for this illustrated catalog to: **POPULAR MECHANICS,** Dept HE, 224 W. 57th St., New York, N. Y. 10019. Price 25¢

CONSTRUCTION PLANS, BLUEPRINTS

HOUSE EXPANSION PLANS And detail instruction book provide anything from an extra room to 1000 s/f addition. Build what you need at big do-it-yourself saving. Book with 1 set working blueprints \$14.50! With 4 sets (required by contractors) \$20.00. Money-Saver Projects, Box 303-44B, Chappaqua, New York 10514. Information available.

LOG CABINS & HOMES

BUILD Log Cabins, rustic furniture, fireplaces!!! Complete manual, \$3.00... "A" Frame plans, \$2.00... **Guaranteed.** . . . Beels, 956 Springdale, Atlanta, Georgia 30306.

"A" FRAME CABIN. \$500. Material. Purchase locally. Completely illustrated instruction manual & material list: \$2.00 Moneyback Guarantee. Order plan #1917 from: "Dependable Products", Box 113, Vista, California 92083.

HOME CRAFTSMEN

WOOD—Domestic and Imported Hardwoods, 3500 items! Clock, musical instrument kits. Tools . . . discount prices. Hard-to-find hardware. 144 page catalog, 50¢ Craftsman, Dept AX-33, 2729 Mary, Chicago, Illinois 60608.

PICTURE Framing—Profitable full or spare-time business. Easy to learn with handbook-course "Guide To Picture Framing Profits." \$1.50 Guaranteed. Free framing-supplies catalog included. Japs, 126-PM Seventh North, Hopkins, Minnesota 55343.

WOODWORKING Catalog and Manual 50¢. Plus free "101 Project Ideas." World's most beautiful veneers, lumber, plywood! Wood finishing, upholstery supplies, Cane, Lamp Parts, Furniture hardware, Animal whittling blocks. 2,000 workshop products. Constantine, 2051-C Eastchester Road, Bronx 10461.

CABINETMAKING MADE EASY And "How to Make Formica Counter Tops." Two excellent guides let you build kitchen cabinets and counter tops like professionals. Extraordinary guides bring master craftsmen's shortcut methods. Satisfaction guaranteed. Write: Japs, 126-P Seventh North, Hopkins, Minn. 55343.

SKIL-CRAFTS Current 200 plus page catalog with world's largest, finest selection of Hobbycraft, leathercraft, artist supplies. Send \$1 for postage and handling: refunded on first \$15 minimum catalog order. Skil-Crafts, Box 105-P, Joplin, Mo. 64801.

20 PLANS—Full Size—Early American Novel Items for Fun or Profit. Send \$2.50. Cerbone—Box 18099—Philadelphia, Penna. 19147.

BIRD HOUSES For Fun And Profits. 20 Projects And Plans. \$1.00. Infoco, Box 34260, Washington, D. C. 20034.

C.D.I. LAMP BUTLER—Complete Plans —Control both Bedside Lamps from Either Side of the Bed. Especially nice for King and Queen Size Bedroom Suites. Special Achievement Certificate included Worth 50¢. Complete Plans \$2.00. Craftsman's Dreamprints, Inc., P.O. Box 16232, Charlotte, N.C. 28216.

CATALOG FULL SIZE FURNITURE PLANS —\$1.00 Refund with first order. Traditional, Early American, over 135! Furniture Designs, 1425 Sherman, Dept. CP-33, Evanston, Illinois 60201.

SUPER EAVESDROPPER Hear Intimate Conversations Hundreds of Feet Away. Complete How To Build Instructions. Send One Dollar To: Zelnor Associates Today. 1488 Vallombrosa Avenue, Chico, Calif. 95926.

HAND Paint Your Own Beautiful Wall Murals. For Colorful Brochure With Complete Directions, Send 1.00 To: Modern Murals—205 No. 1st, Brainerd, Minnesota 56401.

TOOLS, EQUIPMENT & SUPPLIES! We List Over **FOURTEEN-HUNDRED** Different **CATALOGS** of Materials and Accessories for Arts, Crafts, Automotive, Electronics, Industry. Send \$2.00. **MASTERLOG,** Box 24413-WC, Oakland, California 94623.

POPULAR MECHANICS MASTER SHOP GUIDE. Greatest product offered to a man with a workshop. All information printed on heavy boards, punched and ready to hang above his workbench. Covers wall fasteners, nails, screws, bolts, twist drills, abrasives, lumber, moulding patterns, plywood grades, hardboard, dry-wall plumbing supplies, electrical supplies. Plus information on score of other subjects. Send \$3.95 to: **POPULAR MECHANICS,** Dept. HE, 224 West 57th Street, New York, New York 10019.

BEST WORKBENCH PLAN Ever. Plus Free Lumber Conversion Chart. \$1.00. **WAY-MAR,** Dept. 45, 58 Underhill Road, Scarsdale, New York 10583.

101 PATTERNS Of Smart Gifts, Novelties, Shelves, Action Windmills, plus "Make Money Jig Sawing". \$2.00. Mastercraft, 35M, 7041 Olcott, Chicago 60631.

BRIAR Blocks. Pretuned smoking pipes. Materials. Pimop, Box 59211, Chicago, Illinois 60659.

LATHE Enthusiasts, five unique project drawings. \$1.00. Greene, 205 Northwest 63rd, Gladstone, Missouri 64118.

DOGHOUSE Plan—simple, sturdy, no waste. \$1.00—Homecraft, Box 91145, Louisville, Ky. 40291.

BUILD PLYWOOD AQUARIUMS—15 to 110 gallons and **SAVE \$\$\$.** Proven practical, economical. Send \$2.25 for complete instructions and working drawings to: **DUR-E-SHEL,** 6902 Prairie Dr., Middleton, Wisc. 53562.

WOOD CHAIN—MOVABLE LINKS!! Easily Made from one piece **SOLID** wood! Amaze Friends, Decorative. \$1.00. Guaranteed. Brings Detailed Manual, Drawings, **PHOTOGRAPH.** Atco, Box 33-B, Floral Park, New York 11002.

TOASTERS Rarely Wear Out! Elements break. Fix **PERMANENTLY,** Easily. Full instructions, bonding agent for 50 toasters. Send \$1.00. Guaranteed. Airey Specialty A3, 54 Nelson, Winchester, Mass. 01890.

KEEP Your copies of PM—and watch for the inexpensive Annual Index, available in January 1973. It will enable you to locate any article which appeared in 1972 or find information on any particular subject in just a few seconds. The Annual Index will make your copies of PM even more valuable! Price \$1.49. Send checks to: Popular Mechanics, Dept. HE, 224 W. 57th St., New York, N. Y. 10019.

(Continued on next page)

HOME CRAFTSMEN

(Continued from preceding page)

WOOD WORKS WALL CLOCK/Twelve Inch Dial/Hand Tools Only/Most Worthwhile—Plans & Instructions (27 Pages) \$7.50—Dual Design, Box 3828, Granada Hills, Calif. 91344.

DO-IT-YOURSELF

BURGLAR-FIRE Alarm Supplies and Information. Free Catalog. Protecto Alarm Sales, Box 357A, Birch Run, Michigan 48415.

REPAIR MINIBIKES, LAWNMOWERS, BICYCLES, Sewing Machines, Auto Engines. Build concrete, Plywood, boats, trailers. Over 100 How-To-Do books. Free brochure. Sincere, Box 10422, Phoenix, Arizona 85016.

CONVERT MOWER Engines into air compressors. Write: Showalter, Box 409, Abilene, Kansas 67410.

SAVE MONEY! "How-To" books. Free details. Vernco, Box 121, Whittier, Calif. 90608.

PROJECTION TV . . . Convert Your Portable to **SEVENTY INCH TV** Projector for Under \$10.00. Free Details: Macrocoma, Dept. PM3, Washington Crossing, Pennsylvania 18977.

SAVE Auto Labor Charges. Repair book shows how. \$1.95. Viola West Enterprises, 183A Viola Road, Monsey, N.Y. 10952.

END EXPENSIVE Auto Repairs! Book by auto expert explains how. Order now. Save! \$1.95. Ben-Mar Gifts, 8 Woodrow Avenue, Staunton, Virginia 24401.

FREE BROCHURE! Make Exotic Perfumes. Essences \$5.00, results guaranteed. Albert Bley, Importer, Box 602, Wilmington, Calif. 90744.

REDECORATE YOUR HOUSE NOW—Before moving or buying anything. New! Home Decorator's Easy Color ROOMPLAN Shows How. Every room picture detailed for successful results! Send \$1.00: Bookmark, Box 5275-PM-3, Kansas City, Missouri 64112.

RED BARN Utility Building 8' x 12' only \$75.00. Complete Plans \$3.00 or write for information on easily assembled kits. H&H Woodworking, 1683 Ohio Pike, Amelia, Ohio 45102.

INSTALL Your Own Central Air Conditioning, Humidifiers, Ductwork. Easy, Quick. Our Planning Guide Shows You Everything. Air-Ways, 32 Washington Ave., Port Jeff. Sta., N.Y. 11776.

INSTALL Your Own Underground Sprinkler System. Send \$3.00 for illustrated instructions. Sprinklers, Box 121, Dunedin, Fla. 33528.

WATERBED Build your own Waterbed. Send 25¢ for Plans and Info. Cornucopia, P.O. Box 713, Porterville, Calif. 93257.

MAKE Low Cost Sheet Metal Brake, For Work Bench. Instructions \$3.00. Cole, 9628 Sahler, Omaha, Nebraska 68134.

DRIP! Cushions stop downspout noise. Set of 4; \$1.00. Aquasite, P.O. Box 327, Cupertino, Calif. 95014.

"HOW TO DO IT" Books, Every Conceivable Subject. Free Listings. Write: **YANKEE INGENUITY INC.**, 303 Lamartine St., Boston 02130.

CHAIN SAW POWER TAKE OFF, Operate Pumps, Compressors, Generators, Drills. \$12.95 Up. Free Brochure. **PORTA POWER**, 8004 Talbot Rd., Edmonds, Wash. 98020.

ARTS AND CRAFTS

"GETTING Started in Stained Glass" 25¢. Whittemore, Box 2065Y, Hanover, Mass. 02339.

MAKE Figurines, plaques, lawn ornaments, Molds, plastercraft kits, liquid rubber. Sample and catalogue 10¢. Wooley Company, Box 29-B, Peoria, Illinois 61601.

FREE LITERATURE For sculptors showing how to make molds, cast plastics. Adhesive Products Corporation, 1660 Boone Avenue, Bronx, N.Y. 10460.

LEARN Arts & Crafts at home. Excellent full or part time business opportunities, or hobby. Free booklets. Lifetime Career Schools, Dept. E-799, 2251 Barry Avenue, Los Angeles, California 90064.

FREE: New handicraft catalog. Supreme Handicrafts, Box 395-PM, Sioux Falls, South Dakota 57101.

MOLD MAKING KIT—Make Your Own Molds, Duplicate Medallions, Buttons, Figurines, Candles. Send \$7.95. Candle Capers, Box 130, Freeland, Michigan 48623.

BINOCULARS, TELESCOPES, MICROSCOPES, MAGNIFIERS

TELESCOPES (Reflectors) Complete Kits. Other accessories, request free literature. Criterion Manufacturing, Dept. PM 39, Hartford, Connecticut 06101.

HOLD Camera or Binoculars safely secured to chest ready for instant use. No neck strain with patented Kuban Hitch. One size fits all. Quality made elastic straps, spring steel adapters, heavy-duty snaps. Ideal gift for fishermen, photographers, boaters, skiers, snowmobilers, hikers. \$7.50 postpaid. Satisfaction guaranteed. Free literature. Write: Kuban Hitch, Dept. PM. 5280 N.E. Main Street, Minneapolis, Minn. 55421.

FREE Binocular, Rifle scope catalog. Discount sale. Save 50%. Free gift with order. Write, United Binoculars, BN-6508, 9043 So. Western, Chicago 60620.

POCKET MAGNIFIER, 5X mounted automatic, \$1.00 each. SM, 5720 Virginian Rd., Philadelphia, Pa. 19141.

MANON MEANS FINE BINOCULARS! SALE! Write: "Manon PM", 17171 Beach Blvd., Huntington Beach, Calif. 92647.

LENSES 30 for \$1.98. 5mm dia. to 52mm dia. Terrific War Surplus Values. Cost Many Many Dollars. Many uses. Leather case included. DuMaurier Co., Elmira, NY 14901.



CAMERAS AND EQUIPMENT

FREE Sample Photographic Traders Monthly magazine. Shutterbug Ads, Box 730, Titusville, Florida 32780.

PHOTOGRAPHY FOR pleasure or profit. Learn at home. Practical basic training. Long established school. Free booklet. American School of Photography, 555 E. Lange St., Dept. 820-02, Mundelein, Illinois 60060.

FREE! FREE! BARGAIN BOOK Central Camera Co., Dept. 331, 230 S. Wabash, Chicago, Ill. 60604.

PHOTO FINISHING

CAMERA FANS! Expert photofinishing by one of Country's largest labs at lowest prices. Fast service and free "Foto-Fan" Stamps you quickly redeem for valuable Photo Supplies. 8MM Kodachrome \$1.29; 8 Exp. Kodacolor \$1.79; 35MM Kodachrome 20 Slides \$1.39; 8 Exp. Black White 69¢. Satisfaction guaranteed. Send exposed film or request free mailers, complete Price List and Gift Catalog. Direct Mail Photo, Box 8352-PM, Pittsburgh, Pa. 15218.

COLOR SLIDES

35MM COLOR Slides, 10,671 Individually sold. Described. Encyclopedia catalog 10¢. Wolfe Worldwide, Dept. 14-33, Los Angeles, Ca if. 90025.

MOVIE-Slide Effects From 49¢. Film-fex, Box 223PM, New Hyde Park, New York 11040.

MOTION PICTURES AND SOUND EQUIPMENT

UNUSUAL Movie supplies. Free circular. Esor, 47th Holly, Kansas City, Missouri 64112.

FREE! 64-Page catalog. 8-16MM film supplies, processing equipment. Superior, 448 N. Wells, Chicago 60610.

CLASSIC 8MM. MOVIES . . . 35MM. 2"x2" Color Slides. . . largest selection anywhere! Silent classics, comedy, history, sport, news, documentaries, features, others! 16MM films also. Free catalog. Blackhawk Films, 569 Eastin-Phelan Bldg., Davenport, Iowa 52808.

8MM-SUPER 8-16MM MOVIES! Biggest Selection! Lowest Prices! Free Catalog! Cinema Eight, Box 245-PM, N.Y.C. 10028.

16MM, 8MM Sound and Silent Classic Films. Free Catalog. Niles, 1019-PM So. Michigan, South Bend, Indiana 46618.

FREE Catalog—8mm-16mm—Top Manufacturers—G & G Film Library, Box 321, Syosset, New York 11791.

RADIO, TELEVISION AND HAM EQUIPMENT

36¢ RADIO & TV Tubes. Free catalog. Cornell, 4213-17 University, San Diego, California 92105.

GIANT Canadian Electronics Surplus Catalog. \$1.00. Etc—PM, Box 741, Montreal

SAVE Money on parts and Transmitting—receiving tubes, Foreign—domestic. Send 25¢ for giant catalog. Refunded first order. United Radio Company, 56-PM Ferry Street, Newark, N.J. 07105.

RESISTOR Color Coder 50¢. Norvex Co., 3920 Larkin St., Norfolk, Va. 23513.

WIRELESS FM Transmitter Kit, \$5.95. Llectronix, Box 42, Madison Heights, Michigan 48071.

GOVERNMENT Surplus receivers, transmitters, snooper scopes, parts. Catalog. 25¢. Meshna, Nahant, Mass. 01908.

TUBE TESTER Model TV-7 \$59.95—Multimeter Model ME-6 \$32.50. Government Surplus—Appear Excellent. Show Some Use—Satisfaction Guaranteed. Write: Dept. DH For Details. Artko Corp., 6401 S. Tucson Blvd., Tucson, Arizona 85706.

HIFI TAPES, RECORDS AND ELECTRONICS

FREE Catalogues, 2000 hard to find unusual records. Rose's Records, Box 7216, Louisville, Ky. 40207.

FREE Catalog—Electronic Kits—Amplifiers—Preamplifiers—Psychedelic Strobes—SCA Adaptors—Color Organs—Digital Instruments—Guitar Amplifiers. FREE Subscriptions. SWTPC, Box PM32040, San Antonio, Texas 78284.

8-TRACK Cartridges, Cassettes. Tremendous Discounts. Write for Free Catalogue. Exhibo West, Box 5174-PM, Mission Hills, Calif. 91340.

OLDIES! 45 RPM Original Hits Catalog 50¢. C. & S. Record Sales, Box 197, Wampsville, New York 13163.

8 TRACK Tapes Latest Hits, Auto, Home Players. Lowest Prices, Free List. APPOLLO Distr., 19150 Niver, OAKLEY, Mich. 48649.

STEREO Tapes At Rock Bottom Discounts. Free Lists. R & R House, Dept. M3, Route 3, #1024, Bessemer, Ala. 35020.

(Continued on next page)

HIFI, TAPES, RECORDS AND ELECTRONICS

(Continued from preceding page)

HEAR All the music you pay for with our new four-channel Quadraphonic Adapter. Complete with Front-Rear Volume Controls, Smart wooden cabinet, Decoder instructions, and rear speaker enclosure plans. \$21.95. Finarts, Box 9037, Salt Lake City, Utah 84109.



MUSIC AND MUSICAL INSTRUMENTS

ACCORDIONS And Amplifiers! New-Used. Cordovox, Excelsior—Top Makes! Save to 50%. Direct factory dealer. Terms. Trades accepted. 5 day home trial. Free catalog—Discount prices. Write: Accordions Unlimited, Dept. R, 3147 North Luna, Chicago 60641.

LEARN To read music in one evening. Free brochure, Jordan, 27495 Road 176, Dept. PM-3 Exeter, Calif. 93221.

SONGWRITERS! London Company In USA Needs Poems, Lyrics For New Songs. Stamp For Details, Musical, 1305/P North Highland, Hollywood, Calif. 90028.

FREE CATALOG—30% DISCOUNT. Best Names In Musical Instruments. Dial For Music, 90 North Main Street, Spring Valley N.Y. 10977.

EASY To Play And Make, Quality Dulcimers, Banjos, Thumb Pianos; Instruments And Kits. Can Be Profitable Hobby. **HERE, Inc.,** #P, 410 Cedar Avenue, Minneapolis, Minn. 55404.

ELECTRIFY Player Pianos, Pump Organs Quickly, Inexpensively with Lee Silent Suction Units. Write: Lee Music, 525F Venezia Avenue, Venice, California 90291.

30% TO 50% DISCOUNT! Any Model: Guitar, Amp, Drum, Banjo, Dobro! Free Catalog! Warehouse P31, Box 16399, Fort Worth, Texas 76133.

PLAYER Piano Rebuilding—get details from: Vestal Press, Vestal 11, N.Y. 13850.

POEMS Wanted for songs. Nashville Music Productions, Box 40001-P, Nashville, Tennessee 37204.

VIOLIN And Guitar makers—send for latest Free Catalogue of woods & accessories. International Violin, PM1, 414 East Baltimore St., Baltimore, Md. 21202.

WHOLESALE! Professional Guitars, PA Systems, Altec Speakers, 240W RMS Amplifiers. Free Catalog. Carvin, Escondido, Calif. 92027.

ACCORDION Manufacturing, 6846-P North Avenue, Chicago, Illinois 60635. Concertinas, Hohners, Chromatics, Guitars, Drums. New, Used. Tuning, Repairing. Wholesale Catalogs Free.

NEW FREE CATALOG! Musical Instruments, Accessories, Instruction Books. Marina Music, Box 718-C, Marina Del Rey, California 90291.

FREE Song Selling Information. Peerless Publications, Box 193-A, Bloomfield, Conn. 06002.

WHOLESALE. Musical Instruments—Accessories. Allied, 573 Route 17, Paramus, New Jersey 07652.

30% DISCOUNT Name Brand Musical Instruments. Free Catalog. Freeport Music, 455F Route 110, Melville, N.Y. 11746.

RECONDITIONED Accordions for sale—Save \$\$\$, Top Brands. Write for free descriptive folder. A-1 Rebuildt Accordions, 31 E. 18th St. N.Y.C. 10003.

ACCORDION Top brands. Buy direct. Tremendous discounts. Trades accepted. Free brochure PM. Accordion-O-Rama, 874 Broadway, N.Y.C. 10003.

SWISS Music Boxes, Movements. Highest Quality. Spielman, 55 West 42nd, New York 10036.

PLAY DEEPTONE MUSICAL SPOONS Instrument Easy Instructions \$3.00 P.P. United World Products, Warwick, N.Y. 10990.

GUITAR, Banjo, Violin, Mandolin Making Materials, Accessories, Books. Catalog 25¢. Guitar Center, Box 15444, Tulsa, Oklahoma 74115.

MUSIC—Sheets—Books—Methods for all Instruments. Write: Music For You, 217 N. Main, Blacksburg, Va. 24060.

PLAY Chord Piano In Ten Days Or Money Back. Free Details. Belle, Dept. PM1, 341 Dabney Drive, Henderson, N.C. 27536.

MUSIC Learning Breakthrough. Learn Notes, Piano, Guitar, Accordion Overnight. Details—George Sales, 12721 Willowbrook, Compton, Calif. 90222.

NEW GUITAR MAKING BOOK & NEW TOOLS. Overholtzer, 618 Orient, Chico, Cal 95926.

CONSERVATION TRAINING

GAME WARDEN, Government Hunter, Forestry, Park & Wildlife Service announce job openings regularly. Prepare at home for outdoor work, good pay, security. Approved for Veterans! Free! "Conservation Career Kit." North American School of Conservation, MPW, Newport, California 92663.

MOTEL HOTEL MANAGEMENT TRAINING

MOTEL MANAGERS Wanted by leading chains, resorts, motels-hotels everywhere. Men, women, couples enjoy free rent, plenty of free time. Easy home-study plan. Approved for Veterans. Free! "Motel Career Kit". North American School of Motel-Hotel Management, AZW, Newport, California 92663.

EDUCATION AND INSTRUCTION

FINGERPRINTING—Investigation. Exciting, secure career. Learn at home. Free book. State age. Institute of Applied Science, 1920 Sunnyside, Dept. 163, Chicago, Illinois 60640.

"LEARN Fast As Geniuses!" \$1.00! Burke's, Brook Road, Charlton, Massachusetts 01507. Albrecht's, 2653-S Hoover, Los Angeles 90007. Jackson's, 2408 High, Denver 80205. Williams', R2, #504, Harrah, Oklahoma 73045. Graddy's, General Delivery, Hoxie, Arkansas 72433. Altic's, 49 Partridge Hill's, Hyde Park, New York 12538. Cady's, 7194E Pine, Truth or Consequences, New Mexico 87901. Attaway's, #475, Grapeland, Texas 71844.

LEARN Sewing Machine Repairing. Men, Women. Lucrative profits. Profession with bright future. Gresslin Correspondence School, Box 927, Spencer, Iowa 51301.

MISSOURI Auction School. Veteran Approved. Free catalog. 1600-03 Genesee, Kansas City, Missouri 64102.

LEARN ADVERTISING. Course Like University Extension. AAI-P, 655 Teresita Blvd., San Francisco 94127.

BE A Real Estate Broker, Big Earnings. Prepare quickly, easily. Approved for Veteran Training. Free Catalog. Weaver School, 3519-PA Broadway, Kansas City, Missouri 64111.

DEGREES Without residence requirements! Honorary degrees. Catalog: \$3.00. United States University Of America, Box 4552-PM, Washington, D.C. 20017.

LEARN How To Have Power Over People. Make them say "YES." Amazing book reveals ways. Act Now! Send \$2.00. Pennington Gifts, Box 472, New City, New York 10956.

COMPUTER CODE punched in your checks and bills easily decoded. Instruction manual \$3.00 postpaid. Spectrum-AC, P.O. Box J, Euless, Texas 76039.

BREAKTHROUGH Using motivational cassettes guarantees Self Improvement, Personal Achievement, Executive Development. Free brochure. Achievement, Box 1282-PM, Brooklyn, N.Y. 11202.

FREE Introductory Course. God's Great Salvation. Home Bible Studies, Box 370PM, Elkhart, Ind. 46514.

GET A British Degree. Divinity. Philosophy, Radionics. 35 Courses. Prospectus free. Brainridge Forest School, Highfield, Dane Hill, Sussex, England.

EXTENSION And Post-Graduate Awards in Philosophy, Art, Sciences, Botanic Medicine, Homeopathy, Radionics and others. 30 subjects. Curricular free (airmail \$1.00 refundable). Registrar, Sussex College of Technology, Highfield, Dane Hill, Sussex, England.

LEARN Auctioneering. Term soon. Free catalog. Reich Auction College, Box 850, Mason City, Iowa 50401.

LEARN Massage. Home Study Course. Free Details. Massage, Box 190-PM, Quincy, Mass. 02169.

LEARN TO SKI Within thirty Minutes!!!! Famed instructor gives lessons about Equipment, Positions, Principles on Photograph Record. Guaranteed—\$5.95 Sheldon's, Dept. 1, Box 1003, Lancaster, Penna. 17604.

SLEEP LEARN Deep Relaxation, Weight Reduction, Success Attitude. Free Brochure. Select Recording Studios, Box 55011-PM, Seattle, Washington 98155.

SELF IMPROVEMENT BOOKS. HUNDREDS! FREE INFORMATION. S&S ENTERPRISES, Joplin, Mo. 64801.

BREAK INTO ANNOUNCING, NEWSCASTING, SPORTSCASTING! I will show you how! Send \$4.95 today—complete! Bob Doner Productions, Box 654, Elk Rapids, Michigan 49629.

YOUR ABILITIES REVEALED! 45 Minute Selfscoring I.Q. Test. Reusable with Friends, Children! \$2.00. Guaranteed! Avalon, Dept. 313-6, 1185 Washington Street, Newton, Massachusetts 02165.

ORDINATIONS. Lifetime! Church chartered 1887! Write! 708 Bragg, Monroe, North Carolina 28110.

RELIGIOUS VOCATION? Write: Church Of Holy Light Inc., P.O. Box 4478, Pittsburgh, Pa. 15205.

USED Courses! Books Catalog 10¢. (Courses Bought). Lee Mountain, Pisgah, Alabama 35765.

AUTOSUGGESTION. Sleep-learning headquarters! Tapes, records, books, Gigantic catalog free. Research Association, Box 24PM, Olympia, Washington 9851.

OWN Collection agency. "Little Gold Mine!" Franklin Credit, Roanoke, Virginia 24004.

AUCTIONEERING. Resident or home Study Course. Free Catalog. Nashville Auction School, 1921 West End, Nashville Tennessee 37203.

USED Courses! Books! List 10¢. Smith's, 124 Marlborough, Salem, Massachusetts 01970.

COLLEGE DEGREES AT HOME! Complete Directory Accredited Universities offering Correspondence Courses \$2.00. RESEARCH, Box 48533PM, Los Angeles, Calif. 90048.

WELDING CAREER TRAINING—Arc, Pipe, Gas, TIG, MIG, Plasma. Write for free bulletin. Accredited NATTS. Approved Ohio No. 70-12-0064 HT. HOBART SCHOOL OF WELDING TECHNOLOGY, BOX 73, TROY, OHIO 45373.

(Continued on next page)

EDUCATION AND INSTRUCTIONS

(Continued from preceding page)

AVIATION JOBS—Train at nation's largest aeronautics school for pilot license, helicopter pilot, aviation technician, maintenance, powerplant, airframe technician, radio telephone operator, aircraft accident insurance adjuster, aviation electronics or instrument technician. Indicate if eligible for G.I. Benefits. Write for free "Career Kit": Spartan Airschool, International Airport, Dept. AZWM, Tulsa, Oklahoma 74151.

FREE Book tells how you can learn camera repair and service. Home study or classroom. Write today! National Camera, Dept. EAD Englewood, Colorado 80110.

VETERINARY ASSISTANT—Train at home for exciting animal care career. Send for **FREE** "Career Kit". North American Home-Study School of Animal Sciences, AZW, Newport Beach, California 92663.

HIGHLY Effective college-level home study programs in Electronics Engineering and Engineering Mathematics. (Our 27th Year). Free Literature. Cook's Institute, Dept. 10, Box 10634, Jackson, Miss. 39209.

PERFECT Husband-Wife Business. Learn Upholstery at home. Make \$10 in an hour. Buy-repair-sell for even bigger profits. Kits, tools, included. Free Booklet. Upholstery & Decorating School, (home-study), Dept. 5310-033, Little Falls, New Jersey 07424.

DETECTIVE Profession. Easy home study; free tie-tack or lapel pin, certificate, future. GI approved. Professional Investigators, Box 41345, Dept. CP, Los Angeles Calif. 90041.

DETECTIVE Course. Free Information. Universal Detectives, Box 8180-F, Universal City, California 91608.

LEARN To Fix Typewriters. Desperate shortage trained men. Hundreds needed. Make up to \$25 in one hour. Learn at home in spare time. Industry Approved course. Facts Free. Send name. Typewriter Repair School, (homestudy), Dept. 3310-033, Little Falls, New Jersey 07424.

PIANO Tuning quickly learned with home study course. Diploma granted. American Tuning School, 17050 Telfer Dr., Morgan Hill, California 95037.

DETECTIVE And Fingerprinting Courses. Write. Detectives, Box 185-P, Fairfield, Alabama 35064.

SHORTCUTS To Success! Highly Effective, Profitable Short Courses. (75 Choices). Study At Home. Diploma Awarded. Our 27th Year. Free Literature. CIEE-25, Box 10634, Jackson, Miss. 39209.

WATCH REPAIRING. Learn at home in spare time. Diploma awarded. Free sample lesson. Chicago School of Watchmaking, Dept. YP, Fox River Grove, Illinois 60021.

UNLOCK Your Future. Become professional Locksmith by spare time home-study. Make up to \$6 per hour. All tools, equipment inc. Facts free. Send name. Locksmithing Inst., (homestudy), Dept. 1310-033, Little Falls, New Jersey 07424.

HIGH SCHOOL DIPLOMA For Adults. Earn State Diploma. Accepted by Civil Service, business, colleges. Low cost. No tedious study. Money-back guarantee. Details: H-S Program, Suite 2505, 1221 Avenue of Americas, New York, N. Y. 10020.

GRAPHOANALYSIS—Learn scientific handwriting analysis for profit, pleasure. Free sample lesson, catalog, reveals plan. Write: IGAS Inc., 325 Jackson, Dept. CX-2, Chicago 60606.

GAME WARDEN. Government Hunter, Forestry, Park & Wildlife Service announce job openings regularly. Prepare at home for outdoor work, good pay, security. Approved for Veterans! Free! "Conservation Career Kit." North American School of Conservation, AZW, Newport, California 92663.

COLLEGE Degree at home. Your choice of subjects incl. Law. Easy tuition plan. Williams College, Parker, Arizona 85344.

SERVE God's Ministry. Free. Ordination. Bible Institute, Box 744, McKeesport, Pa. 15134.

LEARN Asleep or awake! Records, tapes, equipment! Free catalog! Drawer PM-400, Ruidoso, New Mexico 88345.

SICK? How to keep well. Get booklet \$2.00. J C Cooper, 1605 Stetson, Modesto, Calif. 95350.

COMPLETE YOUR HIGH SCHOOL At Home in spare time. Texts furnished. No classes. Diploma. Our 76th year. Free Brochure. American School, Dept. X345, Drexel at 58th, Chicago 60637.

FOR INVENTORS

INVENTIONS Needed immediately for manufacturers. For additional information Write Kessler Corporation, C-53F1, Fremont, Ohio 43420.

U.S. PATENT Office Searches, 234 Broadway, Room 3615, New York 10007. Free invention certificates.

IMMEDIATE Cash, for patent applications. Free patent searches. Write for details. Universal Patents, 184-D, Marion, Ohio.

INVENTORS! Don't sell or license your invention until you receive our offer. Eagle Development Company, Dept. H, 83 Wall Street, New York City 10005.

SYNTHESIS MAGAZINE—About Invention. Write: Box 157, Manhattan Beach, California 90266.

INVENTORS—United States Patent Office Searches, Patent Development Engineering, marketing of inventions—Ideas by Licensed Professional Engineer—Patent Engineer and United States Patent Office Former Examiner. Inventions developed for patenting and marketing. We are contacted by many manufacturers seeking to purchase appropriate new products invented by our clients. Send for Free invention Certificate and Invention Information. Serving Inventors since 1948. George Spector, Licensed Professional Engineer—Patent Engineer—3615 Woolworth Bldg., New York, N.Y. 10007.

PATENT Application Financing. Free patent search plan. Global Patent Division, 2420 77th, Oakland, Calif. 94605.

PATENT Searches including maximum speed, full airmail report and closest patent copies. Quality searches expertly administered with complete secrecy guaranteed. Free Invention Protection Form and "Patent Information." Write: Dept. 15, Washington Patent Office Search Bureau, Benjamin Franklin Substation, P.O. Box 7167, Washington, D.C. 20044.

PROSECUTE Your Own Patent Application. All Material Necessary—Write: Inventors Service, Box 3574, Washington, D.C. 20007.

HOW TO Apply, Obtain And Promote Patents And Inventions. Complete Do-It-Yourself Professional Guide. \$1.00. Infoco, Box 34260, Washington, D. C. 20034.

SPECIFICATIONS, Drawings, Search \$8.00. Pen-Ink, 50 East 42, New York City 10017.

YOUR Invention, Product, Idea. Selling It. Guaranteed; Details \$2.00. Refundable. Allied Associates, 4720 So. Vermont, Los Angeles, Calif. 90037.

INVENTORS! Either I will sell your invention before you do, (either through your own efforts or those of another firm) or I will pay you a cash bonus. For Free Invention Evaluation and information, write: Gilbert Adams, Invention Broker, Dept. 15, 81 Wall St., New York, N.Y. 10005.

INVENTORS: Your ideas and inventions (patented: unpatented) expertly searched, developed for commercial appeal and cash/royalty sales to manufacturers by professional Invention Developer with excellent record of experience. B. S. Industrial Engineering; United States Patent Office former Patent Examiner. United States Government former Patent Advisor. Second decade reliable service! Member: United States Council International Chamber Commerce. Free "Invention Record" and "Recommended Protection Procedure." Airmailed! Write: Raymond Lee, Invention Developer, 230P-Park Ave., New York, New York 10017.

INVENTORS SAVE Hundreds Of Dollars. Comprehensive Development, Evaluation Guide. Send \$9.98. Product Evaluation Assoc., 8004 Talbot Rd., Edmonds, Wash. 98020.

FREE PAMPHLET: "Tips on Safeguarding Your Invention." Write: United States Inventors Service Company, 501-P Thirteenth Street N.W., Washington, D.C. 20004.

INVENTIONS WANTED

MR. INVENTOR: Inventions Urgently Needed by Manufacturers. Ideas Developed. Patent Searches \$25.00. Patent Application Financing if Desired. Charles S. Prince, Invention Consultant, Dept. 24, 353, West 57th St., New York, New York 10019.

INVENTORS—If you have an invention for sale, patented or unpatented, write for free brochure outlining manufacturers requirements, royalty rates. Kessler Corporation, C-53IW, Fremont, Ohio 43420.

INVENTIONS Wanted. Patented: unpatented. Tremendous manufacturers lists. Global Marketing Service, 2420G 77th, Oakland, California 94605.

WE Either sell your invention or pay cash bonus. Write for details. Universal Inventions, 28-E, Marion, Ohio.

NEW PRODUCTS—INVENTIONS—IDEAS Developed/Marketed by Professional Organization. **FREE INFORMATION** "How To Market Inventions To Industry". Lawrence Peska Associates, 51-C East 42nd Street, New York City 10017.

FREE "Directory of 500 Corporations Seeking new Products." For information regarding developments, sale, licensing of your patented/unpatented inventions. Write: Raymond Lee Organization, 230-N Park Avenue, New York, New York 10017.

INVENTORS! Protect your ideas! Free "Recommended Procedures." Washington Inventors Service, 422F Washington Building, District of Columbia 20005.

BUYING AND SELLING

FREE Catalog, Buy Or Sell Best Gift Products Available. Strausbaugh Products Co., Seven Valleys, Pa. 17360.

SACRIFICE SALE—DOCTOR'S Orders. Ornamental Concrete business in resort area. No competition. Molds to pour \$1200.00 per day wholesale. 406-962-3432 Lawn Ornaments, Joliet, Montana 59041.

BUY IT WHOLESALE

HEARING Aids, batteries, Wholesale. Catalog 25¢. Fiston, Box 1444, New Preston, Conn. 06777.

165 FREE Wholesale Catalogs! Mailorder Dropshippers. Your Business Imprint. Automobile Discounts. Free "Digest." Vault International, Box 7284W, Lexington, Kentucky 40502.

(Continued on next page)

BUY IT WHOLESALE

(Continued from preceding page)

WORLD'S Largest wholesale dropship sources. U.S., foreign. Factory suppliers dropship direct to you or customers. Now!, have your own catalog for pennies. Free details. International Buyers, Box 16386-M, Portland, Oregon 97233.

8 TRACK Tapes Latest Hits, Auto, Home Players. Lowest Prices. Free List. **APOLLO** DISTR. 19150 Niver, **OAKLEY**, Mich. 48649.

PROFITS GALORE, Panty Hose. A&H Wholesale, P.O. Box 639, East St. Louis, Ill. 62202.

TYPE, Presses, Supplies. Barco Type Mfg., 237 S. Evergreen, Bensenville, Ill. 60106.

NEW 1973 WHOLESALE SUPPLY DIRECTORY. Sale Price \$2.00. Winchester Enterprises, 2807 PM Hargrave Street, Philadelphia, Penna. 19136.

FREE CATALOG. Gifts, Specialties, Money-making Manuals, Buy Below Wholesale. Chapman, 5275 DeLongpre, Hollywood, Calif. 90027.

FREE Catalog. Gifts, Toys, Novelties. Below Wholesale. Zipco, Box 1264-PM3, Ontario, Calif. 91762.

HEARING Aid Batteries wholesale. Top Quality. List Free. Raven House, Box 4277PM, Burlington, N.C. 27215.

EXPORT-IMPORT

JAPAN: 1200 Products directory. Illustrated Manufacturers' names, addresses. \$4.00. Send cash. Yamagata Office, 814 Togin Bldg., Marunouchi, Tokyo.

DIRECT From Scandinavia: Grandfather's clocks, wrist watches, Pencils, Telephones, Playing cards, colour films, colour magazines, color slides. Catalog \$2.00. Write to: Ado-Mail, Gothersgade 97, DK 1123, Copenhagen, Denmark.

FOR THE HOME

YOUR OWN PERSONAL ZODIAC PLAQUE Next to a photograph the finest personal treasure available. Beautify the wall of your living room, bedroom, or den with this distinctively exciting 7" round art-form uniquely cast in burnished bronze bas relief. One—\$4.95; Three—\$12.95; Family service—4 or more, \$4.12 each. Check or Money Order. Checks must clear before delivery. Send Birth Date(s) to: JR. & SR., 7405 Colchester Drive, Clinton, Maryland 20735.

OF INTEREST TO WOMEN

HOMEWORKERS Directory! National firms seeking help. Information 30¢ with stamped, self-addressed envelope. Economy-AD, 627 Franklin, Clearwater, Florida 33517.

1000% PROFIT Bronzing Baby Shoes. Free literature. NBC, Box C-4PM-10, Coral Springs, Florida 33065.

WANT A new car, color TV, new clothes? Learn hundreds of ways to make money. 5 month subscription FREE. Write: Salesman's Opportunity Magazine, Dept. 17-CO, 1460 Hancock Center, Chicago 60611.

\$6.00 DOZEN Paid lacing baby boots! Cowboy, Warsaw 9, Indiana 46580.

HOW To Make Money Writing Short Paragraphs. Information Free. Barrett, Dept. C-27-S3, 6216 N. Clark, Chicago 60660.

HOMEWORKERS! \$100.00 Weekly addressing for firms. Begin immediately. Details—send stamped, addressed envelope. Hamilton, 272-TM-3, Brooklyn 11235.

HOME Newspaper clippers needed. \$500 monthly possible. Details free. Foster, 272-MA-3, Brooklyn 11235.

\$500 MONTHLY Possible addressing—stuffing envelopes (longhand—typing) at home. \$500 monthly Clipping news items from your newspaper. Information: Send stamped self-addressed envelope, American, Excelsior Springs, Missouri 64024.

NEW magazine, foods, decorating, household tips, family living. Sample 25¢. Homemaker Magazine, 404 West Jefferson, Springfield, Illinois 62702.

EARN UP TO \$150.00 WEEKLY . . . Home addressing for us. Details 25¢. Smith's, Box 2469-PM, Newark, New Jersey 07114.

BIG Profits from Dolls! Start your own hobby-business dressing, making, repairing and selling dolls. Free information. Lifetime Career Schools, Dept. D-244, 2251 Barry Avenue, Los Angeles, California 90064.

LEARN Expert Cake Decorating, Candy Making. Free details to housewives. Candy & Cake Institute, Dept. BPC, 1600 Cabrillo Avenue, Torrance, California 90501.

ADDRESSERS And Mailers Needed. Details 10¢. Lindbloom, Dept. POM, 3636 Peterson, Chicago 60659.

\$100 WEEKLY Possible . . . Homework, Addressing. Sparetime! Details Send Self-addressed, Stamped Envelope. National, 14-2LC, Brooklyn 11214.

BINGO Early! How to select cards with lucky numbers. Guidebook \$2.00. Gift House, Box 8095P, Ft. Lauderdale, Florida 33310.

GRAPEFRUIT DIET. Lose A Pound A Day. Look better, feel better. Diet Plan \$3.00 postpaid. Spectrum-AC, P.O. Box J, Euless, Texas 76039.

MAKE Ukrainian Easter Eggs Book—\$2.00. Box 295, Saline, Mich. 48176.

EARN THOUSANDS! Sparetime Enterprises For Women. \$1.00. Moneyback if not worth hundreds times cost! Avalon, Dept. 313-3, 1185 Washington Street, Newton, Massachusetts 02165.

ASTHMA AGONY ENDED EASILY. Drugless home treatment. Free facts airmailed. J. Mortimer, Box 1353, Winnipeg, Canada R3C 2Z1.

GIFT SHOPPING

FREE Gift Catalog. Marlo's Imports, Dept. M, 2397 Clinton Road, Jackson, Michigan 49202.

FREE Gift Catalogue. MAILOR Sales, Dept. PM3-73, 14 North Grand, Eugene, Oregon 97402.

FREE CATALOG On Gift Ideas. Send today. F & J Merchandise, 42-95 Main Street, Flushing, New York 11355.

25 PERSONALIZED PENCILS. Name imprinted in gold. Rackliffe, Pondmeadow, Westbrook, Connecticut 06498.

GIFT Shopping made easy! Send for Illustrated color catalogue. S&E Sales Co., Box 48-PM, Brooklyn, N.Y. 11226.

FREE FANTASTIC GIFT CATALOGUE. FREE SILVER DOLLAR BONUS GIFT. TREASURE CHEST, 9321PM3, CAPE VIEW AVENUE, NORFOLK, VIRGINIA 23503.

WATCHES, OLD GOLD, JEWELRY

HIGHEST CASH For Gold, Jewelry, Gold Teeth, Rings, Diamonds, Watches, Silver, Platinum. Mail Articles Today. Free gift with information. Chicago Gold & Precious Metals, 6 E. Monroe, Dept. 758, Chicago 60603.

FREE Catalogue—Ancient Replica Clocks. Masters, 82 Doudeauville, Paris 18, France, (Airmail \$1.00).

WATCH And Clock repairing books. Free list. North American, Box 77-AC, Fox River Grove, Illinois 60021.

WANTED . . . Gold, Silver, Platinum (any form). Coins. Information Free. Wilmot's, 1067-A Bridge, Grand Rapids, Mich. 49504.

HEARING AIDS

HUGE SAVINGS. Eliminate dealer mark-ups. Free Trial. Batteries Wholesale. Terms Arranged. Lloyds-PMC, Rockford, Ill. 61108.

HEARING Aid Catalog—Free! New "hidden" miniature aids. Save to 1/2! (No Salesmen.) Write: MONEYSAVERS, Dept. 3PMC, 9530 Langdon, Sepulveda, California 91343.



SCIENCE AND CHEMISTRY

CHEMISTRY And Biology Catalog 35¢. Boulevard Laboratories, Suite 302, 3114 E. 83rd St., Chicago, Ill. 60617.

LASER Parts Catalog 60¢. Moynihan, 107 North Brighton, Atlantic City, New Jersey 08401.

DISCOUNTED! Laboratory Chemicals, Glassware-Apparatus. Catalogue—50¢. Deluxe Scientific, Manitowoc, Wisconsin 54220.

COMPLETE Laboratory Catalog 35¢. Laboratory Sales, Box 161-A, Brighton, Mass. 02135.

AMAZING! Scientific Catalog—Apparatus—Glassware—Chemicals. Catalog—50¢. Hagenow Laboratories, Manitowoc, Wisconsin 54220.

CATALOGUE Of those ver-ry hard-to-find chemical products, things that go boom, multi-stage rockets, 500 How-To books, 10,000 formulas of every conceivable mixture in science and industry. 50¢. Kenrus-C, Box 158M, Staten Island, New York 10309.

FREE. Flying MODEL ROCKET Kit. Act Now. Offer Limited. Send 25¢ for Packet of Iron-ons, Decals, Literature and "Free Rocket" Details. Aerospace Vehicles, Inc., Mineral Point, Wisconsin 53565.

LASER Bargains. Catalog—\$1.00 (Refundable), Plasma Systems, "373PM", Box 3261, San Jose, Calif., 95116.

FORMULAS, PLANS, ETC.

GUARANTEED! Any Method-FORMULA-Information—\$5.00! Tech Research, 2505 35th, Lubbock, Texas 79413.

PLASTICS

CASTOLITE Pours like water, hardens like glass without heat. Crystal clear or colors. Embed natural flowers, other objects. Make fine gifts. Reproduce your own designs in plastics, wax, metal, plaster, cement, etc. Make flexible molds over any pattern, any size. Profitable. Manual: 25¢. CASTOLITE, 73C/PM, Woodstock, Illinois 60098.

LARGEST Handicrafts Supply Catalogue \$1.00 (Refundable). R.P.H. Manufacturing, 24-M-3, Winter, Stamford, Connecticut 06905.

TREASURE FINDERS

FIND Buried Coins, Artifacts. Treasure, with a White, Fisher, Metrotech or Bounty Hunter metal detector. Free literature. Gettysburg Electronics, 27 Chambersburg St., Gettysburg, Penna. 17325.

FREE 156 Page Detector Catalog. General Electronic Detector Co., Box 67, Bellflower, California 90706.

FISHER DETECTORS. You deserve the best! Free literature. FRL, Dept. PM-3, P.O. Box 490, Belmont, California 94002.

(Continued on next page)

TREASURE FINDERS

(Continued from preceding page)

SEARCH Treasure Finders. Locate gold, silver, coins, relics. Operate underwater. Money back guarantee. Free information. Search Electronics, Box 8396-A, St. Petersburg, Florida 33738.

FIND Buried treasure with revolutionary patented, analytical metal detector. Features push button and automatic tuning, negligible ground pickup, greatest range. Free catalogue. Gardiner Electronics, Dept. 9, 4729 N. 7th Avenue, Phoenix, Arizona 85013.

TREASURE Locators. Most complete line. Free information. Book "All you need to know about Treasure" \$4.95. Twelfth Edition. Tesoros, Apartado 7-905. Mexico 7. Mexico.

DISCOVER AMERICA'S FASTEST GROWING HOBBY. White's Electronics, Inc., would like to send you—absolutely FREE, their 42 page, fact-filled catalog on Mineral and Metal Locating Equipment. Amateurs or Professionals select from the world's largest line of metal detectors priced as low as \$79.50, up. Detect Gold, Silver, Copper—Nuggets, Coins, Jewelry, etc. Budget terms available. For your convenience we have three major factory locations in the U.S. and Canada, as well as over 1,000 authorized dealers to serve you. See your local Yellow Pages under "Metal Locating Equipment", or write: White's Electronics, Inc. Room No. 381, 1011 Pleasant Valley Road, Sweet Home, Oregon 97386—Elk-Air Industrial Park, Dexter Drive, East, Elkhart, Indiana 46514—or White's Electronics Ltd., 33784 Hazel Street, Abbotsford, British Columbia, Canada.

GOLDAK Treasure locators—Pleasure and profit in a hobby you'll enjoy. Find coins, relics, gold, silver. Charge on BankAmericard. GOLDAK, Dept. PM 1101-A Air Way, Glendale, California 91201.

FIND Buried Gold, Silver, Jewelry, Coins, Relics, Magnetic Mineral Deposits With Ray Jefferson's Low Cost. Transistorized Metal/Mineral Detectors. 3 Exciting Models. All With Fatigue Free Arm Rest. Fun And Profitable. Write For Free Color Catalog. Ray Jefferson, Dept. MDPM, Main And Cotton Streets, Philadelphia, Penna. 19127.

TREASURE Finder locates buried gold, silver, coins, treasures. 5 powerful models. \$19.95 up. Instant financing available. Free catalog. Relco-A-40, Box 10839, Houston, Texas 77018.

POWERFUL Metrotech locator detect gold, silver, coins, relics. Moneyback guarantee, terms. Free information. Underground Explorations, Dept. A, Box 793, Menlo Park, California 94025.

PRECIOUS STONES & MINERALS

GET Free catalog no serious rockhound, gem cutter, jewelry maker, hobbyist or craftsman can be without. Full of bargains, exclusive items, low prices from largest suppliers and authorities in the field. Free new catalog just off the press, yours for the asking. Write: Grieger's, Dept. C-12, 900 South Arroyo Pkwy., Pasadena, California 91105.

ROCKHOUNDS!! Receive Interesting, Valuable Specimens Monthly. Free Information. Minerals, Box 487YH, Yucaipa, California 92399.

500 POLISHED Gemstones \$5.00. Tumblcraft, 5401 James North, Minneapolis, Minn. 55430.

CARTOONING, COMMERCIAL ARTS, SHOWCARD & SIGN PAINTING

"HOW TO MAKE MONEY WITH SIMPLE CARTOONS"—Informative book sent FREE tells you to big income. Cartoonists' Exchange 93, Pleasant Hill, Ohio 45359.

FASCINATING Systems. Sign Painting. Cartooning. Straley, 1704 South Center, Springfield, Ohio 45506.

COMPACT 23 lesson Cartoon Course and Cartoonist's Magazine. \$2.00. Hartman, Box 30367, Lincoln, Nebraska 68510.

MODERN Cartooning taught by mail. Write for free brochure. Cartoonama—Box 263-4L, Branford, Conn. 06405.

CARTOON For Money!! Big Free Book: Success, Box 885-C, Dearborn, Mich. 48121.

SIGNS! Make-your-own! **SIGN-RITE** Self-Adhering Letters and numbers! 4 Types! 5 large Sizes! 8 material Styles! Choice of Colors! Inexpensive! Prompt service! **FREE BROCHURE!** Americraft Mfg. Co., Box 25034 Northgate, Seattle, Wash. 98125.

Sign Painting—\$1000 per Month Part-Time. Free Catalogue. Kaufmann Supply, Centertown, Missouri 65023.

LEARN Sign painting at home. Free Talent test. Ben Kerns, Box 812-PM, Greenville, S.C. 29601.

ADVERTISING AGENCIES, ADV. SERVICES, MAILING LISTS

FRESH Mailing Lists. \$9.00 1000. Gummed Labels. Miller, Box 5631-M, Charlottesville, Virginia 22903.

ADVERTISING Ratebook leading newspapers, magazines, 25¢. Chicago Advertising Agency, 28-E Jackson, Chicago 60604.

MAILING List, Most all Kinds. \$9.00 1000 Gummed, Circulars mailed \$5.00 1000. Dixmailers, King, North Carolina 27021.

RUBBER STAMPS

POCKET Stamp, Three Lines \$1.00. Catalog, Rush Stamps, 132-P, Rush, New York 14543.

FREE 48 Page Catalog. Rubber stamps, printing, office supplies. Youngers Stamp Shop, Princeton, Iowa 52768.

ADDRESS Stamp \$1.43. Signature Stamp \$2.95. Catalog. Carol's, McCloud, Oklahoma 74851.

FREE Stamp catalog. 45 type styles. Fast Service, low prices. Jackson's, Box 443A, Franklin Park, Ill. 60131.

OFFICE SUPPLIES

MAILORDER RECORDS Help get increased business! Complete 32 Page Record Book shows your inquiries, orders, advertising, expense, etc. Only \$1.00. **H. E. KAPPEL, POPULAR MECHANICS, DEPT. R, 224 WEST 57TH STREET, NEW YORK, N. Y. 10019.**

PRINTING PRESSES, RUBBER STAMP OUTFITS

SIMPLE-X RUBBER STAMP PRESSES, Hydraulic operated, electrically heated. Sizes 5"x8", 8"x12", 10"x15". Starting outfits Orders for presses, supplies shipped day received. Free catalog low supply prices. Send \$1.00 for postage and handling (refundable on first order). Custom Manufacturers, 406-P East Elm, Springfield, Missouri 65801.

PRESS 'N' PRINT Mimeograph Machines. Brand New, Complete With Supplies. Only \$34.95. Details 25¢. Devine, Box 56069, Chicago 60656.

SAME Day shipment on rubber stamp supplies. Revised wholesale price list No. 9 free. Star Stamp Supply, 732 Federal, Chicago, Ill. 60605.

NEW Catalog No. 13, 120 Pages, hand printing presses, type fonts, supplies. Send \$1.00 deductible first order. Acme Type, 732 Federal, Chicago, Illinois 60605.

RUBBER Stamp outfits, supplies. Kiewiet, 2025 Barney Road, Kalamazoo, Michigan 49007.

TYPE, Presses, Supplies. Barco Type Mfg., 237 S. Evergreen, Bensenville, Ill. 60106.

PRINTING Presses, type, supplies, lists, 10¢. Turnbaugh Service, Mechanicsburg, Pennsylvania 17055.

PRINTING MACHINES. Offset, Mimeograph, Typewriters, Composing, Machines. Dixgraph, King, North Carolina 27021.

RUBBER Stamp manufacturers supplies. Presses, starting outfits. Best prices, service. Catalog. Jackson Supply, Box 443A, Franklin Park, Ill. 60131.

MAKE Your own self-molding rubber-stamps and Printing Cuts. Plexirubber, Argyle A, Wisconsin.

PRINTING AND SUPPLIES

BUSINESS CARDS Raised Letters \$5.65 Thousand. Like Engraved. Free Samples. Kavanagh, Box 1222, Brooklyn, N.Y. 11202.

BUSINESS Cards, Rubber Stamps, Printing. Free Literature. Jordan's, 552 West O'Connor, Lima, Ohio 45801.

FREE Offset Catalog. Fast-Economical. Seaview, 212-26P 48th, Bayside NY 11364.

1000 EMBOSSED Cards \$5.50. Fast. Graphics, 106D High, Westerly, R.I. 02891.

QUICK Copy Offset Printing, Free Introductory Offer. Nationwide Printing, 73 E. University, Champaign, Ill. 61820.

INEXPENSIVE Envelopes, Letterheads, Tickets, Forms, Small Quantities. Lexprint, Box 1735, Lexington, Ky. 40501.

"101 WAYS To Save Money on All Your Printing." 136-page illustrated book \$4.95 (Calif. \$5.20.) ppd. Halls of Ivy Press, 13050 Raymer Street, North Hollywood, Cal. 91605.

DISTINCTIVE Embossed Letterheads, Envelopes, Cards. Inexpensive. Postpaid. Universal, 226-D Myrtle, Scotch Plains, New Jersey 07076.

100 PERSONALIZED Postcards \$1.35. Business printing. Longwood Press, Fort Johnson, N.Y. 12070.

PRINTING Supermarket Short Run Specials. 1000-\$4.75, 5000-\$22; 1000 Envelopes \$8. Shipping 9 hours. Get Free Printing Specials Price List "Do You Make These 18 Mistakes When You Buy Printing." Speedy Offset Printers, 23831 Aurora, Bedford, Ohio 44146.

MULTIGRAPH, MIMEOGRAPH

PROFITS FROM CLASSIFIED ADVERTISING! Booklet shows you how to start your own business with Classified Advertising. Only \$1.00 (Refundable with first order.) **H. E. KAPPEL, POPULAR MECHANICS, DEPT. P, 224 WEST 57TH STREET, NEW YORK, N. Y. 10019.**

GUMMED LABELS

1,000 GUMMED ADDRESS LABELS \$1.00 FREE CATALOG, Acme, 1238 Voskan, Pittsburgh, Pennsylvania 15212.

500 PRESSURIZED Address Labels \$2.00. Wait's, Box 966A, South Bend, Indiana 46624.

1000 LABELS \$1.00. Eldee Printing, 152 W. 42 St., N.Y.C. 10036.

1000 GUMMED Address Labels \$1.00. FA Enterprises, 662 Main, Woburn, Mass. 01801.

1,000 GUMMED ADDRESS LABELS—79¢! Excellent quality!! Rackliffe, Pondmeadow, Westbrook, Connecticut 06498.

1000 ADDRESS Labels 50¢, 3000—\$1.25. Booklet 1001 Things Free 60¢. Specialties, Ora, Indiana 46968.

1000 GUMMED ADDRESS LABELS \$1.00; Morgan, Box 484-PM3, Anna, Ill. 62906.

(Continued on next page)

REMAILING SERVICE

EXOTIC HAWAII, Remails 25¢ each. \$3.00 Monthly. Dorcliff, Inc., 736 South Street, Honolulu, Hawaii 96813.

SECRET. Receiving—forwarding. Discreet and confidential. Remail 25¢ single. Mail Forwarding Service, 8050 S. Main, Houston, Texas 77025.

RECEIVING — Forwarding — Remailing, Monthly Rates. Nortex, Drawer 5370, Ft. Worth, Texas, 76108.

MIAMI Remails 25¢—Monthly rates. Remails—view cards from 80 Foreign cities. Marle, Box 1266, Coral Gables, Florida 33134.

CONFIDENTIAL. Receiving Forwarding. Monthly Rates. Davis, Box 5012A, Reno, Nevada 89503.

YOUR Mail Received—Forwarded. Hedgpath, 324-M South First, Alhambra, Calif. 91802.

PARIS Post Cards 5/ \$1.00. Reairmail Singles \$2.00—Rates. Masters, 82 Doudeauville, Paris 18 France.

CONFIDENTIAL Receiving—Forwarding \$3.00 Monthly. Remails 25¢. Doug, Box 165, Schenectady, N.Y. 12301.

CHARLESTON, S.C. Remailing, et cetera. Details. SPECTRUM, P.O. Box 3574, 29407.

CONFIDENTIAL New York Mail Address \$3.00 Month. Telephone Service \$5.00. Re-mails 25¢. Details Free. Birnhan, 152 West 42, New York 10036.

CONNECTICUT CONFIDENTIAL. 25¢ Single. Monthly and Double Remail, Details Free. Ivy Forwarding, Box 2159, Darien, Conn. 06820.

NEW YORK CITY Or New Jersey Remails 20¢—Monthly \$2.50. Details: Wentz, Box 2439P, Newark, New Jersey 07114.

REMAILS \$3.00 monthly. 25¢ Each. Marge, Box 6972, Burbank, Calif. 91504.

MILWAUKEE Remails Singles .25¢, Monthly \$5.00. Aaron, 2634 North 40 Street, Milwaukee 53210.

AFRICA Re-Airmailings \$1.00. Souvenirs. Lauri, Box 3007, Durban, South Africa.

MAIL Receiving-Forwarding, Confidential Address. Wright, Box 2112-M, Asheville, N. C. 28802.

REPAIRS AND SERVICING

PROFITS FROM CLASSIFIED ADVERTISING! Booklet shows you how to start your own business with Classified Advertising. Only \$1.00 (Refundable with first order.) **H. E. KAPPEL, POPULAR MECHANICS, DEPT. P, 224 WEST 57TH STREET, NEW YORK, N. Y. 10019.**

SPECIAL SERVICES

INFORMATION On anything. Ferguson Research Specialists, 72-25 Woodside, Woodside, New York 11377.

ARE you filing your copies of PM? If you are, you'll want an inexpensive Annual Index, available in January, that will make your file copies much, much more useful. Refer to any article in seconds! And if you aren't filing your copies of PM—start now! Price \$1.49. Send checks to: Popular Mechanics, Dept. HE, 224 W. 57th St., New York, N.Y. 10019.

TOBACCO

ROLL yer own. With our new cigarette rollers. Plain, filtertip, king. Less than a penny each. Free sample. Green River Tobacco, Box 954, Owensboro, Ky. 42301.

1 PINT Sweet Flakes Chewing-Smoking. 50¢ Each PostPaid. Jolley Farms, Dresden, Tennessee 38225.

IT'S CUSTOM Blended pipe tobacco. Finest tobacco. Expertly blended. Factory fresh. Write for free sample. Green River Tobacco Company, since 1914, Box 991, Owensboro, Ky. 42301.

BRIAR PIPE Make or repair your own. Photocopy of article shows you all the details. Price \$1.00. Send order to **POPULAR MECHANICS, Dept. HE, 224 West 57 St., New York, N. Y. 10019.**

PERSONAL

NEW False Dental Plate, low as \$31.95. 24 Hour Service. No impression. Lightweight DuPont Beauty Pink Plastic. Satisfaction or money back. Free details, shipping box. West, Dept. G-203, 3816 W. Lawrence, Chicago, Illinois 60625. (Not available to Illinois residents).

SECRET LOANS BY MAIL. Borrow \$100 to \$3000 for any good reason in absolute privacy. No interviews, no endorsers, no co-signers. Fast service. Write: Dial Finance Co., Dept. 3378, 405 S. 16th Street, Omaha, Nebraska 68102.

SECRET Plan Wipes Out All Debts. Get \$600 to \$25,000 relief. Clear credit. Free details. Counselor-7, Kerrville, Texas 78028.

HOW Intelligent Are You??? Self-Scoring I.Q. Test, Instructions. Only \$2.00. Order Today!!! Paramount House, Box 9664-C2A, Little Rock 72209.

BORROW By Mail! Up to \$1500.00. Convenient terms. State Licensed. Postal Finance, Dept. 17-A, 6018 Military Ave., Omaha, Nebraska 68104.

PSORIASIS Sufferers: Discouraged? Write for Free important information that is helping thousands! Pixacol, Box 38-PM, Avon Lake, Ohio 44012.

INSTANT DEBT RELIEF Without borrowing. Without Bankruptcy. Have excellent credit in 45 days. Free!!! Wealth Building, Box B-3, 8840, Hoyt Drive, Thornton, Colorado 80229.

BIBLE Questions answered. Stamped envelope. Bylon. 17167 Bentler, Detroit, Michigan 48219.

CASH LOANS by mail! Up to \$2,500 on signature a one. No collateral! Secret! Union Finance Company, 3608 No. 16th St., Dept. PM, Phoenix, Ariz. 85011.

WHO Else Wants Credit Cards? Learn how to get credit cards fast, easy! Get new credit without investigation, Box J-27, Hallandale, Florida 33009.

INVESTIGATORS. Latest electronic Aids. Free Literature. Clifton, 11500-P NW 7th Ave., Miami, Florida 33168.

RUPTURED. Relief and comfort. No understraps, elastic or steel. Write: Hand-Lock Products, Preston 4, Ont., Canada.

FREE Gospel Literature foretelling second coming of Christ. Scheall, Box 263-PM, Duluth, Minn. 55801.

NEED Money-Debts Too Big? Quick Cash. Secret Emergency Loans. Free Consolidation Plan. Interstate. 28 E. Jackson, Suite 1204-X3, Chicago 60604.

TELL Fortunes accurately—Immediately! ESP Aids, Box 21-PM, Olympia, Washington, 98507.

WOW! Free Illustrated Occult Catalogue! Stanray, Dept-A2, GPO Box 3317, NYC 10001.

"RULE Others With Thoughts." (Telepathy) Write: Clarion, Box 1769-A7, Chicago 60690.

TATTOO Removing—Chemical Do-it-Yourself Method—Free Details: Atlanta, 907P Beachpoint, Pickering, Ontario.

MEN Of DIVORCE, Getting Ripped Off? Learn Rights: Choices. Send \$3.00 For Gamemanship. ADAM, 343 S. Dearborn, Chicago, Ill. 60604.

RECORD Telephone Conversation Automatically. Leaver Recorder Unattended. Robert's, Box 49PM2, Parkridge, Illinois 60068.

HIGHER INCOME, Security and Power. 256 page book "Thinking Big" reveals secrets that make men rich! Only \$2.00. Satisfaction Guaranteed. MAILOR Sales, Dept. PM3-73, 14 North Grand, Eugene, Oregon 97402.

SOCIAL Security Plates. Free Offer. Gibson, 810 Broer, Toledo, Ohio 43607.

DON'T Die without a will, blank will form protects your family. Only \$2. Guaranteed. Order today. Walker Sales, 1921 Surf Avenue, Brooklyn, New York 11224.

AMAZING Telagripe Complaint Kit. \$1.60. Roberson, Box 6404, Anaheim, California 92806.

HIGHER INCOME Security and Power. 256 page book "Thinking Big" reveals secrets that make men rich. Send \$2.00. Vera H. Miller, 7447 South Rhodes, Chicago, Illinois 60619.

INSURANCE—Boats, Mobile Homes, Snowmobiles, trailers—Elbee-8007 Broadway, Elmhurst, NY 11373 212-899-2900.

WIN Friends—Start Living—Stop Worrying. These Excellent Books Are Your Opportunity For Prosperity and Happiness. \$5.00. Weiner, 21-73 28 Street, Astoria 11105.

"HOW To Attract Good Luck", Free Illustrated Folder. ENJAY, Dept. MEC, 160 Fifth Ave, N.Y.C. 10010.

ACUPUNCTURE. Atlas, Western edition. 23" x 35" color, \$5.00. Books available. Herbal Holding, Box 5854PM, Sherman Oaks, California 91413.

BIRTH CERTIFICATE, Baptism, Marriage; High School, College Diplomas; Driver's License, Wills, Bill Sale, General Agreement, Real Estate Lease. Any 3 Forms, \$1.00. (Many Others, List Included.) Legal Forms Company, Dept. 252, 22502 Orchard Lake Road, Farmington, Michigan 48024.

RECEIVE Phony State Chartered University Degrees immediately. Box 11516, Tucson, Arizona 85706.

MAKE YOUR OWN WILL! 4 Will Forms and Attorney's Instructions protect your Family. Only \$2.00—guaranteed! Order today!! Masterman, Department 1B15, 1544 Red Cedar, St. Paul, Minnesota 55121.

SMOKERS!! I did, now don't, you shouldn't. Need Help? \$2.00. PETE FABLE, Box 651, Brighton, Ill. 62012.

LIKE BASEBALL? Free Literature on hobbies, playing, schools, Junior Leagues, and gifts. No obligation. Baseball Associates, Box 10626 M, St. Petersburg, Florida 33733.

WANTED-MISCELLANEOUS

MERCURY, Gold, Silver, Platinum: Ores assayed. Wholesale Terminal, Norwood, Mass. 02062.

BASEBALL Cards Wanted! Dollar each for old cards. Hobbyist, Box 3731M, Detroit, Mich. 48215.

WINEMAKING & OTHER RECIPES

WINEMAKERS. Free illustrated catalog of yeasts, equipment, Sempex, Box 12276R, Minneapolis, Minn. 55412.

WINEMAKERS . . . Free Illustrated Supply Catalog of Yeast, Equipment, Recipes. Continental, Box 18223-PM, Indianapolis, Ind. 46218.

(Continued on next page)

WINEMAKING & OTHER RECIPES

(Continued from preceding page)

WINEMAKERS Yeast, Recipes & Catalog 25¢; Kraus, Box 451-L, Nevada, Missouri 64772.

WINEMAKERS . . . Personalized Wine Labels, Free Samples, Grancom, Box 2929, Milwaukee, Wisconsin, 53218.

WINEMAKER'S Supply Catalog—Free, Bacchanalia, 273 Riverside Ave., Westport, Conn. 06880.

WINEMAKERS: Free informative catalog, recipes, Arbolyn, Box 663, West Columbia, S.C. 29169.

WINEMAKING WHOLESALE AND Retail Equipment, Supplies, Ingredients. Send for FREE color catalog and ordering forms: Little Monk Sales, Box 362P, Winnetka, Ill. 60093.

WINEMAKING Kit—\$4.98 Free Catalog and Recipes, JIMDANDY, Box 3U230M, Cincinnati, Ohio 45230.

MAKE WINE! New Handbook Contains Amazing Recipes, Use Standard Kitchen Items, Guaranteed Delicious. Send \$2.00. Randall, 4501 Telephone #8A, Houston, Texas 77017.

WINEMAKER'S! Free Illustrated Catalogue of Quality Products, Brant's Wine Rack, Box 3256-M, Orange, California 92665.

MAKE Fine Wines, Champagne, Easy, Using Kitchen Utensils, 7 Great Recipes!! Only \$2.00 Guaranteed. WILLIAMSON, 146 Merrick Road, Lynbrook, N. Y. 11563.

MAKE WINE!!! New Winemasters' Manual Contains Amazing Recipes Using Kitchen Utensils, Guaranteed Delicious or Money Back. Send \$3.00 to: McGuire Sanders, Box 2485-P3, Orcutt, Cal. 93454.

HYDROMETER USERS: Take The Pain Out Of Measuring Gravities With The Radically New VINTECH Hydrometers. NO POURING! Precision Plus Temperature Compensation. \$7.50 Postpaid. Information On Request. Vintech, 28 N. Halsted St., Suite 1200, Chicago, Illinois 60606.

HOMEWINE MAKING SEND For FREE informative CATALOG OF RECIPES, EQUIPMENT, and INGREDIENTS, Brewer's Yeast Dry Malt, Crystal Malt, Bottle Caps, Barrels, Chemicals, Concentrates, Over 250 Items. Winemaking Is A Fascinating Hobby. Write To: Danenberger's, Box 276-M, New Berlin, Ill. 62670.

CHEESEMAKING KIT. Newest homecraft sensation! Easy Instructions, Recipes, Complete Equipment, \$9.95 Plus 95¢ handling. The Mailbasket, 27350 Bradford, Southfield, Mich. 48076.

MISCELLANEOUS

TAMPERPROOF Check protection—Pocket checkwriter makes altering checks almost impossible—guaranteed—Only \$5.95—Aneva's—1C3, 4221 S. 6th—A39, Milwaukee 53221.

BOOKS On antiques and their prices. Free circular!! P. Warman Publishers, Uniontown, Penna. 15401.

SUFFERING From Arthritis? Try Ginseng: Information Free. Write: Ginseng, Asheville 53, North Carolina.

ORNAMENTAL Iron designs. Book of 1600 beautiful, practical designs for railings, columns, etc. Free literature. Cunningham, 3881 South 3200 West, Salt Lake City, Utah 84119.

PRE-PACKAGED Toys complete with free self-selling display rack. Free Details. Toys, 1916 Fifth, Sacramento, California 95814.

BIRTH Certificates, Marriage Certificates, Diplomas! 2 blank forms \$1.00. Sample 10¢. Standard Forms, Box 482-M, Washington, D.C. 20044.

SLEEPATRON. New device for inducing sleep. Gardiner Electronics, Dept. C, 4729 North 7th Avenue, Phoenix, Arizona 85013.

TREMENDOUS Profits, Selling Books By Mail, Lakeside, Dept. B1, Silver Lake, Minn. 55381.

U.S. \$1000 Bills!! Obsolete Exact Replica's 5/\$4, National, Box 1391-X, Clearwater, Florida 33517.

PROTECT Your Hard-Earned Money!!! Check Protector Prevents Alterations, Prints To \$9,999.99. Compact, Neat, Professional. Just \$5.98 With Ink Pad, Supply, Order Today!!! Paramount House, Box 9664-C3A, Little Rock, 72209.

HEARING Aid batteries wholesale. Free list. Habs, Box 51, York, Penna. 17405.

MAKE Your own will!!! Forms—Instruction Manual. Only \$2.00—Guaranteed. JayMar, Box 646PB, Maysville, Ky 41056.

FASCINATED By Astrology, ESP, UFOS, Occult? Six Issues—\$2.95. Spaceview Magazine, 103-S Goodhue Building, Beaumont, Texas 77701.

CHESS Problems (With Answers) For Beginners \$1.00. Foster's, Box 235, Vandalia, Ohio 43577.

52 CERTIFICATES!!! Birth, Marriage, Driver License, Divorce, Karate, Electrician, Mechanic, High School, College. Rushed Airmail! Two—\$1.00, five—\$2.00. Deluxe "Goldsealed" Versions One—\$1.00, five—\$4.00. New catalogue 25¢. Filforms, Box 1808-BM, Albany, New York 12201.

REMARKABLE Mimeograph Machine! Simplified operation—complete with supplies! Guaranteed. Only \$34.95. Details Free! Gifts 'n Gadgets (IA3), Box 312, Carrollton, Texas 75006.

WOOD BARRELS . . . Pine Buckets, Crates, Planters, "Authentic" Barrel Banks, Spigots. Send 35¢ for 1973 catalogue. Cordell Enterprises, 1622 Morse, Chicago, Illinois. Jobbers Inquiries Invited.

INSTANT High School Diploma. Replace lost diploma with this blank form. Space for name, school, graduation date. Only \$2.00. Birth certificate included free. Rojod Sales Co, Box 636, Santee, Calif. 92071. Dept C B3A.

BLANK High School Diploma and Birth Certificate. Only \$2.00. Kenlee, Dept. 2A3, 466 River Road, Bogota, New Jersey 07603.

VITAL DOCUMENT SAVES HUNDREDS!!! You own more than you can remember. Home inventory form guaranteed foolproof. Be prepared for fire or theft claims. Send \$2. EMS, 1386-Skywood Lane Northeast, Minneapolis, Minn. 55421.

MAGNETS. All types. Specials—20 disc magnets, or 2 stick magnets, or 10 small bar magnets, or 8 assorted magnets, \$1.00. Maryland Magnet Company, Box 192-A, Randallstown, Maryland 21133.

PROTECT Your family! With simple will form. Two blank forms, Instructions only \$1.50 Guaranteed! Kenlee, Dept. 1A3, 466 River Road, Bogota, New Jersey 07603.

PROTECT LOVED ONES! Don't Die Without A Will! Two parchment Will Documents, instruction booklet, \$2.00. Guaranteed! Avalon. Dept. 313-4, 1185 Washington Street, Newton, Massachusetts 02165.

ONE Hundred Sheets of quality Note-paper, with your Name, and Family "Coat-Of-Arms". Glowing colors. Only \$4.00. Including Research. Daynes, 6 Charles St, Toronto

TOOLS, EQUIPMENT & SUPPLIES! We List Over FOURTEEN-HUNDRED Different CATALOGS of Materials and Accessories for Arts, Crafts, Automotive, Electronics, Industry. Send \$3.00. MASTERLOG, Box 244132C, Oakland, California 94623.

"DISCONTINUED, Manufacturing Remote Sensational Television Speakers, Cheap. Sootin, 1700 Southwest 65th Avenue, Miami, Florida 33155."

NEVER WON ANYTHING? Anyone Can Win Sweepstakes! Free details. Services, Box 644-PCC, Des Moines, Iowa 50303.

MIRACLE TV Antenna \$3.00. Stud Enterprises, Box 772, Bayonne, N.J. 07002.

DON'T DIE Without a will! Blank Will form protects your family. Only \$2.00 guaranteed. Rojod Sales Co., Box 636, Santee, Calif. 92071 Dept. CB3.

12 TESTS \$4.00, I.Q., Personality, Character. Nocon, Box 183, Niles, Illinois 60648.

ATTENTION CREATIVE INVENTORS! Exciting New Ideas In A "Flash" With The "Magic Spark" Idea Computer. Program Your Mind For New Products! 30 Component System In Case \$5.00. BOB OLSON SYSTEM, 205 Chisholm Trail, Stagecoach Acres, Prescott, Arizona 86301.

EYEGLASSES Wholesale—Free Catalog. A-Z Optical Company, Box 175, Dept. R26, Bay Station, Brooklyn, N.Y. 11235.

FREE Samples—For Evaluations. No Fees Details—50¢. Designs, 220 PM 79th, Washington-20027.

KEEP Your copies of PM. . . They'll be even more valuable when you have a copy of the inexpensive Annual Index for 1972, available in January 1973. Price \$1.49. Send orders to: Popular Mechanics, Dept. HE, 224 W. 57th St., New York, N.Y. 10019.

PSORIASIS—Now. A new radical treatment that works. Wayne Research, Box 5753, Detroit, Michigan 48239.

BURGLAR ALARMS & HOME PROTECTION

FREE Catalog on Burglar-fire Alarm Equipment, Protecto Alarm Sales, Box 357-D, Birch Run, Michigan 48415.

1973 BURGLAR & FIRE ALARM EQUIPMENT CATALOG. 62 PAGES, JUST \$1.00. (Refunded With First Order). K-TRONICS INDUSTRIES, BOX 391, DEPT. PM, FAIRFIELD, CONN. 06430.

SCARE BURGLARS AWAY!! Authentic Alarm Decals. 4/\$1. —10/\$2. Andover Enterprises, 4729 Andover Square, Indianapolis, Indiana 46226.

BURGLAR-PROOF YOUR HOME Do-It-Yourself. "Home Security Manual" Shows How. Guaranteed. \$2.50 Postpaid, Information Free. Thrifty Shoppers, PM-100, 8749 South Marshfield Avenue, Chicago, Illinois 60620.

LOCKSMITHING Supplies—Wholesale Buying Guide \$1.00. Despubs, Box 22005E, Phoenix, Arizona 85028.

"HOME SECURITY MANUAL" Burglar-proof Your Home At Low Cost. Free Information. Olron (PM33), 3130 Amboy, Staten Island, New York 10306.

MARCH 1973

235

Unadorned power tools.



4' Wood Lathe
at \$29.95

They do the same job
as tools costing up to 5 times as much.

We skipped the chrome to save you money... but we did not skip anything on performance. Actually, we skipped more than just chrome, we cut out every costly frill that wasn't absolutely needed.

The lathe shown above isn't exactly flashy. We admit it. But in a recent article, Popular Science used it to demonstrate wood lathe technique and said: "You won't go wrong with this economical introduction to wood turning." It is typical of our tools which in spite of low prices, are full scale and offer full performance and precision. **HERE'S HOW WE DO IT...** First, we don't claim our tools should sell for five times the price! Just that our tools do the same job... with the same accuracy, ease and speed... and will last at least as long. AMT tools cost less to make and are sold direct. They are bona fide quality power tools used by serious amateurs and professionals alike and if sold in retail stores would be much higher in price. We use no magic, let's be specific: **SIMPLICITY...** AMT tools are soundly engineered to eliminate every frill and gimmick—to minimize material and production costs. Machined parts are used only where they're needed. Unadorned cast iron and aluminum save you a fortune.

DIRECT-FROM-FACTORY SAVINGS... You save a bundle, yet, we offer a double guarantee backed by a 38-year-old company with millions of satisfied customers... and hundreds of orders pour in daily.

LARGE VOLUME... Our own foundry and large mass production facilities plus large buying power all work to keep costs down.

STANDARD PARTS... Our designs use standard hardware items wherever possible. By avoiding custom-made parts we pass on tremendous savings to you.

If you are looking for power tools that perform like units costing many times our low prices, order today and you'll be one step closer to many hours of woodworking satisfaction.

Bill Murty

POWER SAW 8" tilt arbor saw ... crosscuts, rips,

mitres, cuts compound angles, dadoes, coves, moldings. Completely assembled with ground cast iron table, safety guard, splitter, mitre gauge. Less blade, motor. Rip fence for easier work alignment, \$3.50 add'l. Ball bearing model, \$5.00 add'l. Takes 1/2 h.p. motor or larger, standard blades, attachments. Wt. 26 lbs., f.o.b. factory



\$19.95



FREE OFFER, cabinet base plans... with one piece of 3/4" plywood, convert your \$19.95 saw into a floor model with a huge 27" x 24" top. Takes cabinet rip fence, \$4.50 add'l.

TWO GUARANTEES

10-DAY MONEY BACK GUARANTEE
Try any of these power tools and compare it with any similar machine at any price. If not satisfied, return it for prompt, no questions asked refund. We pay the return shipping charges.

10-YR. FULL SERVICE GUARANTEE
Any part or parts of these AMT power tools (except motor which carries a one year guarantee) which become inoperative for any reason within ten years after purchase date will be repaired or replaced by the factory with no cost to the purchaser other than postage.

AMERICAN MACHINE & TOOL CO.
4th & Spring St., Royersford, Pa. 19468

Brand new electric motor developing full 1 h.p. 17 lbs. (Purchased separately, \$24.85). With any AMT machine here. **\$19.90**

BUY DIRECT
... USE THIS HANDY ORDER COUPON NOW

AMERICAN MACHINE & TOOL CO., Dept. PM-33, Royersford, Pa. 19468

Please send me the units checked. Payment in full enclosed \$_____ or \$3 deposit each item enclosed, balance C.O.D. I must be fully satisfied or will return unit within 10 days for full refund. No questions asked.

- | | |
|---|--|
| <input type="checkbox"/> 8" Power Saw at \$19.95 | <input type="checkbox"/> Jointer Planer at \$29.95 |
| <input type="checkbox"/> Standard Rip Fence at \$3.50 | <input type="checkbox"/> Ball Bearing Spindle at \$5.00 |
| <input type="checkbox"/> Long Cabinet Rip Fence at \$4.50 | <input type="checkbox"/> Wood Shaper Kit at \$19.95 |
| <input type="checkbox"/> Ball Bearing Spindle at \$5.00 | <input type="checkbox"/> Opt. Hold Down Assembly at \$2.75 |
| <input type="checkbox"/> Belt Sander at \$19.95 | <input type="checkbox"/> 6" Swing 3' Lathe at \$14.95 |
| <input type="checkbox"/> Disc Sander Attachment at \$7.95 | <input type="checkbox"/> 12" Swing 4' Lathe at \$29.95 |
| <input type="checkbox"/> Mitre Gauge for Sander at \$1.95 | <input type="checkbox"/> Face Plate \$2.50 (either Lathe) |
| <input type="checkbox"/> Drill Press at \$34.95 | <input type="checkbox"/> Turning Chisels \$4.95 (either Lathe) |
| G.E. Motor <input type="checkbox"/> \$19.90 (with other item) | <input type="checkbox"/> \$24.85 (purchased separately) |

NAME _____

ADDRESS _____

CITY _____

STATE _____

ZIP _____

3' WOOD LATHE ... 6" swing.

Same precision and speed as \$40 units. Sturdy cast iron with tubular steel bed. Lever action tail stock, two-speed pulley, fits any motor. Set of 3 high speed turning chisels, \$4.95 add'l. 4" face plate, \$2.50 add'l. 15 lbs., f.o.b. factory



\$14.95

4' WOOD LATHE ... 12" swing.

Industrial size, does the same job as \$75 units. Tubular steel bed rails, screw action tail stock, three-speed pulley. Use any motor. 3 high speed turning chisels, \$4.95 add'l. 4" face plate, \$2.50 add'l. 30 lbs., f.o.b. factory



\$29.95

JOINTER-PLANER 4 1/8" x 22".

Cast iron and steel, precision ground adjustable tables. For planing, joints, bevels, Rabbits to 3/8" depth. Fence adjustable 0° to 50°. Steel knives, dual guards. Use any motor. Precision ball bearing industrial model, \$5.00 add'l. Wt. 19 lbs., f.o.b. factory



\$29.95

BELT SANDER

A precision unit. It changes from horizontal to vertical in seconds. Heavy, sander includes 4" x 36" sanding belt. Uses 1/3 h.p. or larger motor. V-pulley drive and multi-purpose drive spindle.



Disc sander accessory, \$7.95 add'l. Mitre gauge, \$1.95 add'l. 15 lbs., f.o.b. factory

\$19.95

DRILL PRESS

Precision 32" radial unit has standard features and many extras. Depth of throat up to 16". Head tilts and table stays level. Drills to center of a 32" circle. All cast iron and steel. Takes standard motor. 32 lbs., f.o.b. factory.



\$34.95

WOOD SHAPER KIT

Makes beads, coves, moldings, tongue-and-groove joints, etc. Accurate cuts at high speeds. Sealed greased-for-life ball bearings. Less wood. Takes 1/4 h.p. motor or larger, standard cutters. Optional hold down assembly, \$2.75 add'l. 15 lbs., f.o.b. factory



\$19.95



John Deere brings you two-step lawn care. Step on. Step off.

All around the house, around the year, your John Deere Lawn and Garden Tractor saves thousands of plodding steps. It'll trim your turf on weekday evenings and set your weekends free; and you can equip it to do more than two dozen other jobs. From your comfortable seat, you command real farm-tractor features with relaxing ease. Enjoy owning a machine built strong and sturdy from hood to hitch, for years of

faithful service. Find your John Deere dealer in the Yellow Pages. He has models from 7- to 14-h.p. Financing, too.

*For folder,
write John Deere,
Dept. LG, Moline,
Illinois 61265.
In Canada, write
John Deere Limited,
P. O. Box 638,
London, Ontario.*

**nothing
runs
like a
Deere**

100 ENGINEERING FIRSTS SINCE 1939. MERCURY. WHO ELSE?

Thirty-four years ago, our first Merc set an industry standard with its one-piece streamlined housing (which enclosed drive-shaft, cooling and exhaust muffling systems). In '73, the hot idea is our 1500: With 150 fire-breathing horses, the most powerful—most advanced—production outboard made. But every year is a Mercury year. Our record of industry "firsts" proves it. A few:

1941 INTERNAL REED VALVE INDUCTION

Eliminating disadvantages of external manifolding.

1952 FLO-TORQ SAFETY CLUTCH

Eliminates shear pins.

1957 JET-PROP UNDERWATER EXHAUST

For quieter operation, less underwater drag.

1958 FIXED-JET CARBURETORS

For perfect air/fuel mix, maximum power and fuel economy.

1966 THUNDERBOLT CD IGNITION

For sure, fast starts and smoother running.

1969 DIRECT CHARGE INDUCTION

For more horsepower per cubic inch, more miles per gallon.

1973 "POWER-PORTED" PISTONS—

Newest Mercury innovation for more efficient power.

Depend on Mercury to stay ahead. This year.
Next year. Our record proves it.

MERCURY OUTBOARDS

Complete range of power: 4, 7.5, 9.8, 20, 40, 50, 65, 85, 115, 150 HP.
For nearest Mercury Dealer, see the Yellow Pages under "Outboard Motors." Mercury Marine/Division of Brunswick Corporation, Fond du Lac, Wisconsin/Canada/Australia/Belgium



Mercury and Lloyd Bridges star again for 13 weeks in television's newest, most exciting boating series—"Water World II." See your local TV listings for time and station.



MERCURY
**THIS YEAR'S
MERC SET NEXT
YEAR'S STANDARDS.**