

Popular Mechanics

JAN. 1973 50 CENTS

**We show you how to build
this deluxe pool table for \$107**

Page 63

**How to fix
an automatic
washer**

Page 66

**How to cut your
heating bills**

Page 70

**How to make
wall and
ceiling cracks
disappear**

Page 72

**How to prevent
iced-up gutters**

Page 74

**How to have
a smokeless
fireplace**

Page 76

**How to service
a Vega**

Page 130

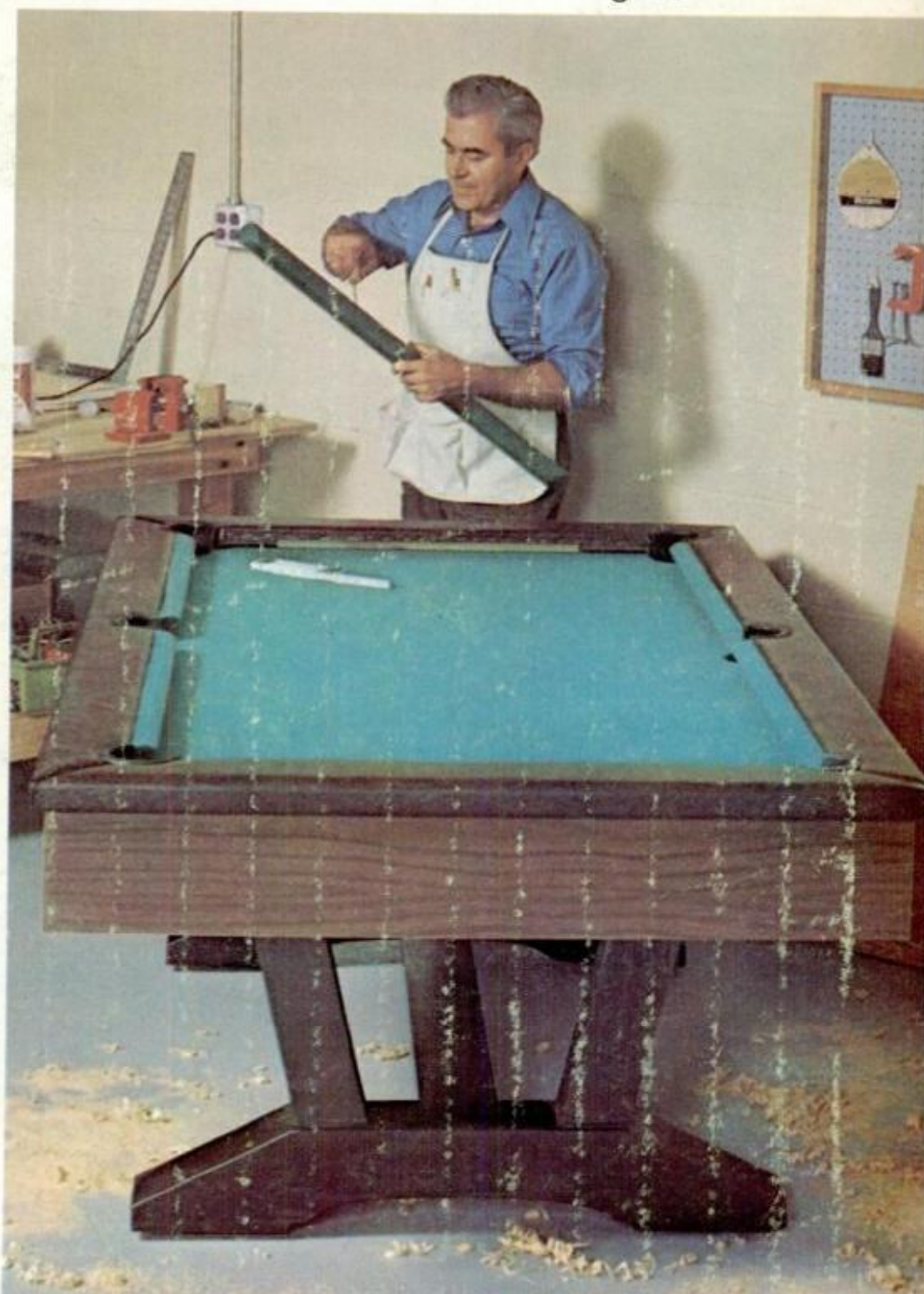



**Get away from the crowd.
Get the flavor you want in
Old Gold Filters.**



Warning: The Surgeon General Has Determined
That Cigarette Smoking Is Dangerous to Your Health.

20 mg. "tar," 1.3 mg. nicotine
av. per cigarette, FTC Report Aug. '72.

IF YOU OWN A PICKUP TRUCK, CAN YOU PASS THIS TEST?

- | | TRUE | FALSE |
|--|--------------------------|--------------------------|
| 1.) Most people who buy pickup trucks end up carrying heavier loads than they think they will. | <input type="checkbox"/> | <input type="checkbox"/> |
| 2.) Passenger car tires are designed to perform as well in truck service as they do on cars. | <input type="checkbox"/> | <input type="checkbox"/> |
| 3.) All pickup truck tires cost more than comparable size passenger tires. | <input type="checkbox"/> | <input type="checkbox"/> |

(Answers below)



- 1.) **True.** Many people who buy a pickup plan on carrying only light loads. But because it has the capacity, and is so readily available to them and their friends, its load limits, particularly its tire load limits, are often exceeded.
- 2.) **False.** Passenger car tires are designed for car use. Truck tires, like the Firestone Transport, with a combination of shock-fortified nylon cord body plies, rugged tread design and rubber compound, reinforced beads and sidewalls, are designed for the tougher requirements of pickup trucks. In addition, the Transport has a 6-ply rating instead of a 4-ply rating of passenger car tires.
- 3.) **False.** Some sizes of Firestone Transport truck tires actually cost less than passenger tires. And you can even get them with whitewalls at your Firestone Dealer or Store.



Transport[®] Truck Tire

Firestone

HOW COULD YOU FORGET

MILT MARION?

1936 was a very good year for a race fan. The very first race on the famous Daytona Beach-Road Course was held.

The purse was 5,000 bucks, and lest you think this was a minor-league affair, remember the price of groceries in '36. This kind of important money attracted a pretty hot field, including: the Indy 500 winner, Bill Cummings; the dirt track champions Bob Sall, Doc Mackenzie and Ben Shaw; Major Goldie Gardner; the Collier brothers, Miles and Sam; and an obscure service station operator named Bill France.

The winner? Good old boy Milt Marion, in a Ford V-8, the Permatex Special. (That France fellow was not only Milt's mechanic, but drove another Ford to fifth place.)

The interesting thing about Milt's car was that the engine was literally stuck together with Permatex products. To prove they worked, the engine was assembled without any gaskets, using our Form-A-Gasket products instead (Form-A-Gasket #1, hard-setting, and Form-A-Gasket #2, pliable-setting). Obviously, it held together.

It really wasn't much of a gamble for Permatex. After all, the company got its start helping Barney Oldfield, back in '09. And today, you'll find Permatex products in service stations, NASCAR garages, and wherever automotive products are sold.

You'll find the same Form-A-Gasket that helped Barney and Milt. And you'll find the latest additions to our long line. Like the new Silicone Form-A-Gasket. With this handy tube, you can actually *make* any size or shape gasket for any application. And being silicone rubber, it is resistant to a greater variety of chemicals, higher pressures, and higher and lower temperatures than anything else you can buy. It is the most versatile adhesive-sealant there is.

Want a free racing decal? You can have one if you promise to remember Milt. Just send us a self-addressed stamped envelope. Don't forget.



Permatex
our name is our bond

PERMATEX COMPANY, INC.
P.O. Box 1350, West Palm Beach,
Florida 33402 305/686-0880

Courtesy of Museum of Speed, Daytona Beach, Florida



CHANNELLOCK

Gives You More In Hand Tools Including

SNIPS THAT CUT
EVERYTHING,
EASY AS BUTTER
ON THE
FOURTH OF JULY

You don't need the grip of a gorilla to cut "tough stuff" such as sheet metal, leather, gaskets, plastics, screening, rubber, roofing materials . . . not with a CHANNELLOCK snip in your hand. With little more effort than you'd use on paper shears, you'll ease these perfectly mated, precision ground cutting edges through the "tough stuff" . . . smoothly, accurately, positively. And happy day! No more blisters . . . the grips are cushion coated with durable dipped plastic. Like all our hand tools, CHANNELLOCK snips are drop forged of highest grade tool steel, scientifically heat treated . . . your assurance that they'll be tough, dependable helpers for years to come.

COMPLETE CATALOG INFORMATION is yours for the asking.

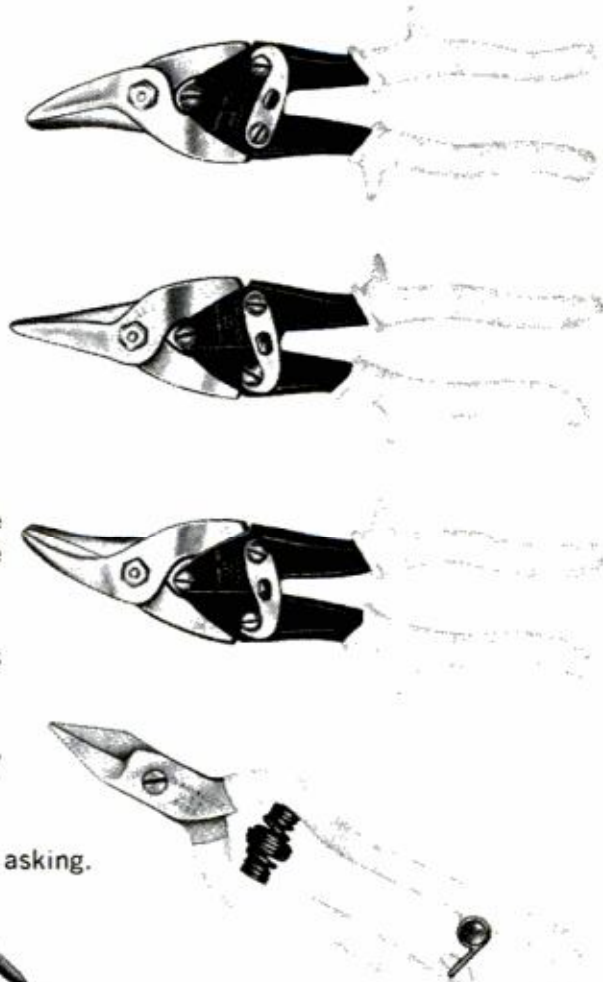

This One



QK0Y-7DC-X01T

TOOLS BY
CHAN NEL LOCK

MEADVILLE, PA. 16335

INTERNATIONAL EDITIONS
AUSTRALIA • CARIBBEAN
DENMARK • MEXICO • SWEDEN
SOUTHERN HEMISPHERE

HOW TO...

[Build a \\$300 pool table for \\$107 ... 63](#)



[Prevent ice dams on your roof ... 74](#)

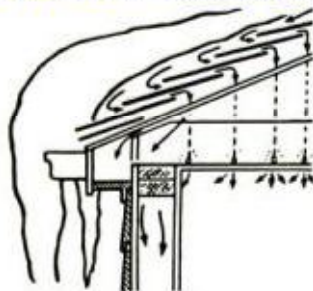

[Get more out of your sabre saw ... 148](#)



[Adjust Vega carb, emission control ... 130](#)

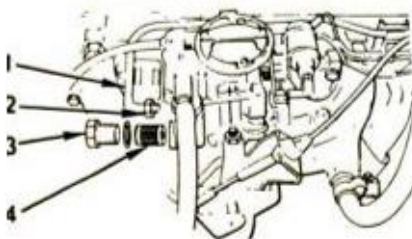

[Check out your real boat speed ... 116](#)



AUTOMOBILES, DRIVING

- [24 Imports and Motorsports](#)
- [36 Detroit Listening Post](#)
- [82 PM Owners Report: Datsun 240Z](#)
- [86 PM Owners Report: Toyota Celica](#)
- [93 Trucks for fun](#)
- [99 Let radar do the braking](#)
- [124 Rollin Armer's wooden wonder](#)
- [130 Saturday Mechanic: Simple way to adjust Vega carburetor, emission control](#)

HOME AND YARD

- [66 How to fix your automatic washer](#)
- [70 How to cut fuel bills](#)
- [72 Making cracks disappear](#)
- [74 Preventing roof ice dams](#)
- [76 Have a smokeless fireplace](#)
- [152 Better ways to do it!](#)

SCIENCE, INVENTIONS

- [78 Computerized commuting for San Francisco](#)
- [114 It's hard to rob a bank when you can't even get in](#)
- [119 Coming: offshore nuclear powerplants](#)
- [122 Now: Turn your car into a snowplow](#)

PHOTOGRAPHY

- [52 Grainless 8x10s from 35-mm? Absolutely!](#)
- [56 Photo hints](#)
- [156 Spray-can color prints](#)

SPACE, AVIATION, MILITARY

- [128 Homebuilt aircraft: Durable economy plane from Britain](#)

SHOP AND CRAFTS

- [20 Sawhorse 'workbench'](#)
- [56B This school turns out sharp grads](#)
- [63 \\$300 pool table for \\$107](#)
- [96 One-of-a-kind trinket boxes](#)
- [134 Number-guessing game](#)
- [137 Now: a 'cut-anything' band-saw blade](#)
- [138 Router know-how \(part 2\)](#)
- [144 Hints from readers](#)
- [146 Handy hold-down for your drill press](#)
- [148 For versatile cutting, you can't beat a sabre saw](#)
- [154 Hints from readers](#)
- [170 Wood brake handles 26-gauge metal](#)
- [172 Hints from readers](#)

BOATING, OUTDOORS

- [90 Trails—a solution for the snowmobile problem](#)
- [93 Trucks for fun](#)
- [94 Pleasure-craft preview '73](#)
- [116 How fast your boat really goes](#)

ELECTRONIC, RADIO, TV

- [166 FM kits: One super tuner, one super value](#)

EVERY MONTH

- [7 Letters](#)
- [32 Science Worldwide](#)
- [40 The Bicycle Shop](#)
- [44 Appliance Clinic](#)
- [48 All Outdoors](#)
- [60 Homeowners' Clinic](#)
- [102 It's New NOW: The latest products and developments \(A 12-page roundup\)](#)
- [122 New Inventions](#)
- [160 Automobile Clinic](#)

Cover photo by John Capotosto

WORTH WRITING FOR: SEE PAGE 56C

AS A SERVICE TO READERS, Popular Mechanics publishes newsworthy products, techniques and scientific and technological developments. Because of possible variance in the quality and condition of materials and workmanship, Popular Mechanics cannot assume responsibility for proper application of techniques or proper and safe functioning of manufactured products or reader-built projects that result from plans published in this magazine.

Stanley's Drill Guide has you going straight.

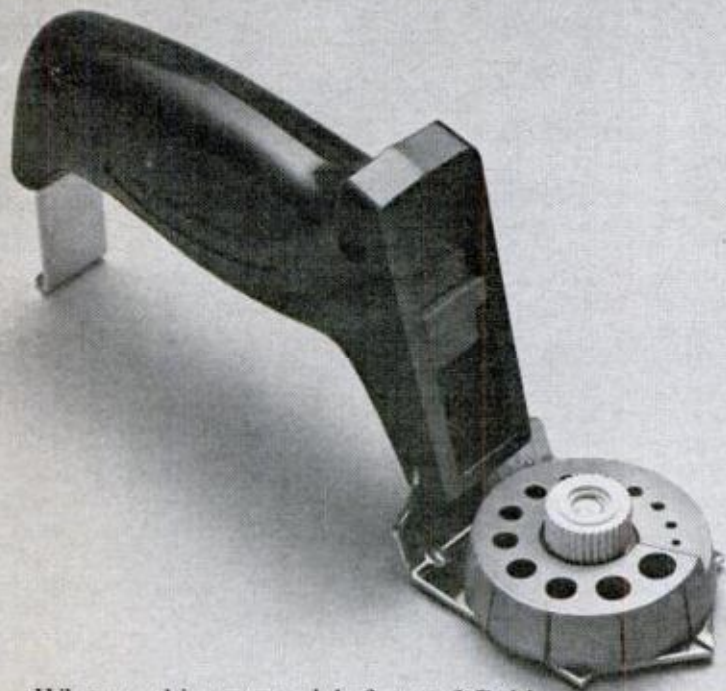

What can this new tool do for you? Guide your electric drill to a perfect right angle into metal, wood or plastic.

Just rotate the dial on the Drill Guide to the desired bit size. It accommodates 13 different bits, sized $\frac{1}{16}$ " to $\frac{1}{4}$ ". Lock in place, drill away!

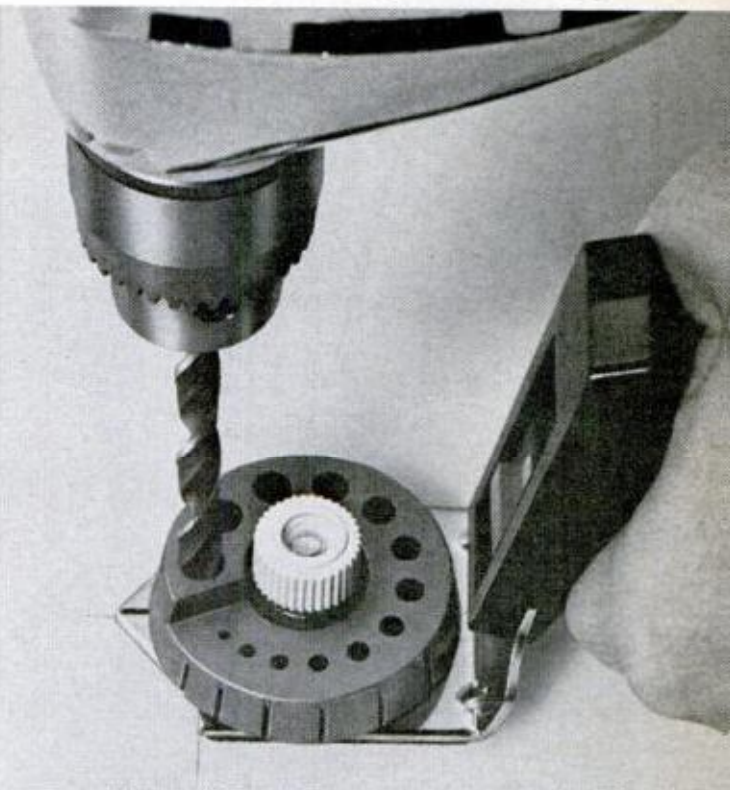

Draw a few grid lines — insert your drill bit and go to town! Drill Guide won't let the bit skitter about or mar the surface.

Handy sliding door storage in the handle keeps extra bits available. About \$2.99 for a tool every drill owner will appreciate.

STANLEY
helps you do things right

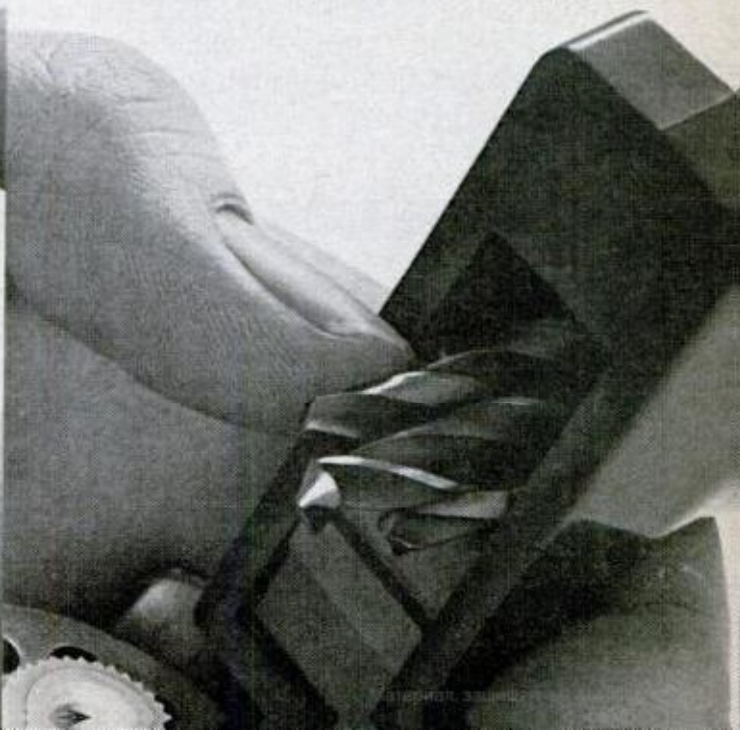
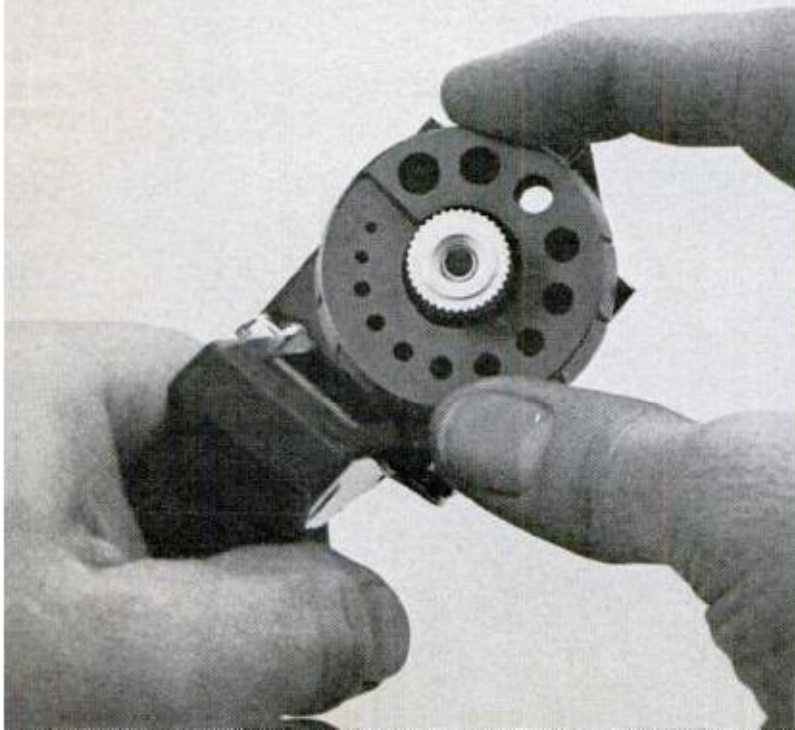



The real beauty
of Lindal Cedar Homes. . .

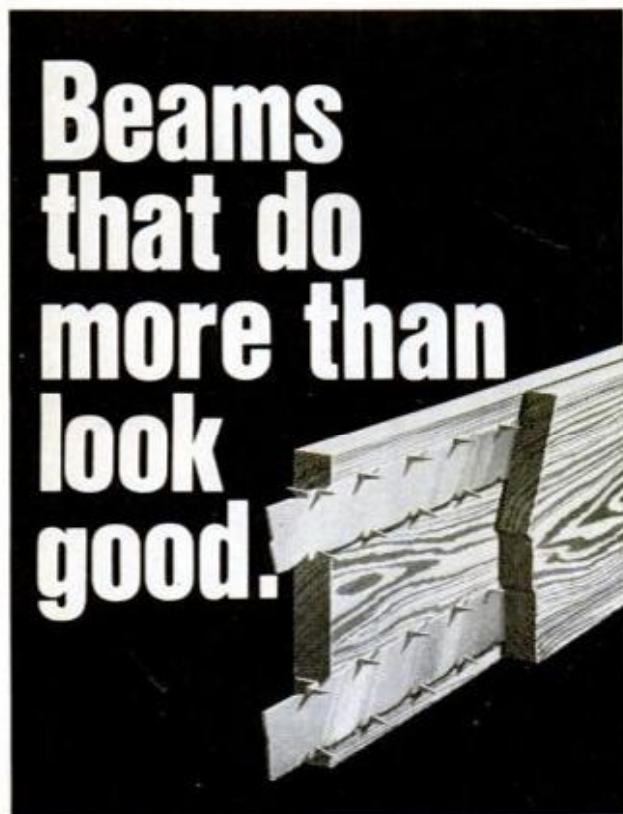

**Beams
that do
more than
look
good.**

Prestressed and precambered under 500,000 lbs. of pressure, our exclusive, 33%-stronger *Steelam*® beams lend strong support to the world's largest-selling pre-cut cedar homes. As does our extra-thick floor and roof decking. For details, prices and 82 house plans, send \$1 for your 44-page Lindal Planbook.

LINDAL CEDAR HOMES

10411 Empire Way S.
Seattle, Wa. 98178
Phone (206) 725-0900



PM 31

Enclosed is \$1. for my Lindal Cedar Homes Planbook.

Name _____

Address _____

City _____

State _____ Zip _____

Area Code _____ Phone _____

Lindal Homes are sold throughout the world.

JIM LISTON

Editor

SHELDON M. GALLAGER **JOHN A. LINKLETTER**

Executive Editor Managing Editor

WAYNE C. LECKEY

Home and Shop Editor

ALVIN KIETZ

Art Director

Published by The Hearst Corporation

RICHARD E. BERLIN, PRESIDENT

RICHARD E. DEEMS

President, Magazines Division

JOSEPH F. KERN

Publisher

BILL HARTFORD _____ Automotive
JOHN F. PEARSON _____ Science and Engineering
WM. T. McKEOWN _____ Boating and Outdoors
IVAN BERGER _____ Electronics and Photography
HARRY WICKS _____ Home Workshop
MICHAEL LAMM _____ West Coast
ROBERT LUND _____ Detroit Automotive
GARRY WINTER _____ Copy Chief
RICHARD H. FUNK _____ Production
ALFREDO VEGA _____ Assistant Production
DON EVANS _____ Technical Art Director
FRED A. LEERS _____ Assistant Art Director
JOSEPH P. BEATON _____ Assistant Art Director
DAVID KOMITAU _____ Assistant Art Director
CLIFFORD B. HICKS _____ Special Projects
SOPHIE GRONOWICZ _____ Director, Bureau of Information
EVERETT JOHNSON _____ Cabinetmaker

ADDRESS ALL EDITORIAL COMMUNICATIONS TO: 224 West 57th St., New York, N.Y. 10019. For additional sources of information on the articles and products in this issue, write to Bureau of Information, Popular Mechanics, for free "Where-to-Find-It" list.

DANIEL J. COLEMAN

Director of Advertising

ADVERTISING OFFICES: New York: 224 West 57th St., 765-6850; Chicago: 520 N. Michigan Ave., 527-2400; Detroit: General Motors Bldg., TRinity 5-8711; Cleveland: 20310 Chagrin Blvd., Shaker Heights, 283-7788; Los Angeles: 601 North Vermont Ave., 666-6263.

JOHN A. REGINA _____ Advertising Production Manager

SUBSCRIPTION SERVICE: Mail all subscription orders, changes of address, correspondence concerning subscriptions, and Postmaster notices of undeliverable copies to Popular Mechanics, Box 646, New York, N.Y. 10019. Please enclose your latest address label for quickest service when writing about your subscription.

POPULAR MECHANICS IS PUBLISHED MONTHLY by The Hearst Corporation, 57th St. at 8th Ave., New York, N.Y. 10019, U.S.A. Richard E. Berlin, President; Richard E. Deems, President of Magazines; John R. Miller, Executive V-Pres. of Magazines; Raymond J. Petersen, Senior V-Pres. of Magazines; William S. Campbell, V-Pres. of Magazines; Albert A. Rachol, V-Pres. and Director of Circulation; Joseph F. Kern, V-Pres. for Popular Mechanics; Frank Massi, Executive V-Pres. and Treasurer; Harvey L. Lipton, Secy. Single copy in the United States and Canada, 50 cents. Subscription prices: United States and Possessions \$5.00 for one year; \$9.00 for two years; \$12.00 for three years. Canada, add \$2.00 for each year. All other countries, add \$4.00 for each year. When changing address, give old address as well as the new, with postal-zone number, if any, and allow six weeks for change to become effective. Second-class postage paid at New York, N.Y., and at additional mailing offices. Authorized as second-class mail by the Post Office Department, Ottawa, and for payment of postage in cash, Registered as second-class matter at the Post Office at Mexico D.F., Mexico, June 20, 1950. © 1972 by The Hearst Corporation. All rights reserved. Printed in U.S.A.

POPULAR MECHANICS

LETTERS

TO THE EDITOR

Prone? No, soupine

In *Trick-wing glider gets a lift* (page 108, Nov. PM), the pilot shown in the lower picture is certainly not in a prone position. He is supine. You might point out to your writer the way to remember the difference: When you are supine you can hold soup in your navel; when you become prone, the soup runs out.

DRUMMOND, QUE.

FORD K. SAYRE

Backward roofer

Your September issue has a picture that's a classic of disregard of safety (*Be your own roofer*, page 176). You show a novice roofer straddling the ridge of his home while nailing capping shingles in place.

A roofer *never* works backward, but always faces the direction of travel. Otherwise, one sooner or later forgets himself and backs off the edge and leaves a widow with a half-finished roof!

I doubt if the shingler would want to sit on the tar seal tabs anyway, especially if the sun is out.

DE WITT, N.Y.

RAY PARFITT

You make an excellent point. In the case shown, though, the roof runs into a right-angle ridge (which, unfortunately, did not get into the picture), so he won't fall.

(Our Home and Shop Editor claims that roofers who straddle the ridges really created the term "hot pants.")

They're on the way

Please publish an article on electronic calculators—the different types and how they operate. I've been a subscriber for 45 years.

NEW YORK

OSCAR FRANK

Stick with us one more month and you'll have the article.

Versatile tool

Congratulations on the masterful article, *Now Surform makes anyone a sculptor* (page 81, Nov. PM). This kind of presen-

(Please turn to page 8)

New Tool Works Wonders With Wire WIREFORMER

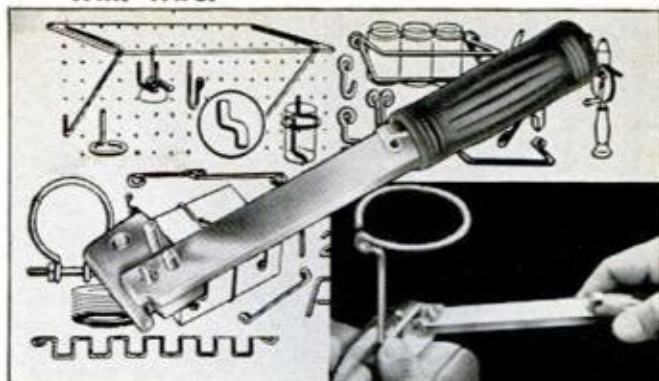

IT BENDS! IT CUTS! IT STRAIGHTENS!

WIREFORMER is a simple, precision made, vise-held tool of innumerable uses. Make your own peg board hooks, clamps, handles, braces, brackets, etc.—any shape you want. Forms an eye of 3-16" inside diameter (just right for any nail, screw, or bolt up to that size). Even uses coat hanger wire. No pliers needed. WIREFORMER does the work with the pressure of one finger. Straightens the wire if you make a mistake. Cuts the wire just where you want it. Forms any angle, arc or circle. Bends both right and left. Tool is case hardened, plated, with a plastic handle. Fits in your pocket. Complete instructions, illustrated brochure showing many things to make.

SOLE ONLY BY MAIL. MONEY BACK GUARANTEE. Four dollar bills will get you one, or send check or money order for just \$3.98 We pay postage and handling charges.

VINKEMULDER TOOL CO. Dept. PM13
2223 Estelle Dr., S.E. Grand Rapids, Mich. 49506



BUILD THIS UNIQUE HEATHKIT 6-DIGIT ELECTRONIC CLOCK... \$54.95*

New solid-state silent timepiece with computer-logic accuracy and high-visibility illuminated electronic readout tubes tells time to the second. Reads 12 or 24 hour time on 120 or 240 volts, 50 or 60 cycles. "Beeper" alarm automatically sounds every 24 hours; repeating "snooze" switch gives extra 7 minutes' sleep. Assembly manual guides you one easy step at a time to completion in 2 or 3 evenings. Black Cyclac® case with simulated walnut inserts. There's nothing like it at this low kit price.

Kit GC-1005, 4 lbs. \$54.95*

Over 350 Easy-To-Build Kits
SEND FOR FREE CATALOG



HEATH COMPANY, Dept. 17-1

Benton Harbor, Michigan 49022

Please send FREE Heathkit Catalog.

Enclosed is \$ _____, plus shipping.

Please send model GC-1005 Clock

Name _____

Address _____

City _____

State _____

Zip _____

Prices & Specifications subject to change without notice.

*Mail order prices; F.O.B. factory. GX-269

Best seller



...for 5 good reasons

The world's most popular pipe wrench. Known for the brutal punishment it takes and the long service it delivers. Here's why.

1. Every wrench is work tested before shipment.
2. Unconditional RIDGID guarantee: "If this housing ever breaks or distorts we will replace it free."
3. Full range of 10 sizes: 6" through 60".
4. One hand operation: Easy spin, non-stick adjusting nut sets quickly to pipe size with accurate scale. Full-floating hook jaw with patented spring suspension then assures instant grip . . . easy release.
5. Built-in massive strength: Jaws are made of special alloy steel; teeth are specially heat treated. Extra tough, comfort-grip, I-beam handle has enlarged end with handy hang-up hole.

Free Catalog: Covers the complete line of RIDGID Wrenches and famous Pre-Tested Work Saver Tools. Write Dept. PM-1, The Ridge Tool Company, Elyria, Ohio 44035, U.S.A.

RIDGID®

 Ridge Tool Subsidiary
Emerson Electric Co.

LETTERS

(Continued from page 7)

tation should make every latent wood carver reach for a tool.

We were especially interested because we use Surform tools in our educational program. The program encompasses instruction for senior citizens, vets, the incarcerated and the handicapped.

NATIONAL CARVERS MUSEUM HARRY MEECH
CHICAGO

They've been around

I am surprised at you. Here I read your November issue and find to my astonishment that something brand-new has appeared: wipers for headlights (*It's New Now*, page 134).

Your editors should certainly be aware that headlight wipers/washers have been standard equipment on Saabs in Europe for a couple of years now . . . and soon will be required on all cars in Sweden.

Unfortunately, these cannot be made available over here because of the requirement for round sealed-beam lights.
SAAB-SCANIA LENNART LONNEGREN
OF AMERICA, INC.
ORANGE, CONN.

Those British products we showed are on round lights. But in addition to Saab we should have mentioned (as we did on page 106, Oct. '70 PM) that a washer system is a Chrysler-Plymouth option.

Credit where it's due

In *Science Worldwide* (page 64, Oct. PM) you show a picture of an underwater oil-storage tank that was fabricated by Chicago Bridge & Iron Co. The first such tank was fabricated by CBI back in 1969 and acclaimed as one of the outstanding engineering achievements of the decade. Would it not be proper to mention CBI and give credit where it is due.
SOUTHAVEN, MISS. RON EVANS

It would be proper.

Intrigued by the dolly

Your recent series on *Bench-saw know-how* (July, Aug., Sept. and Oct PM) was interesting and informative.

What intrigues us in the pictures is the
(Please turn to page 10)

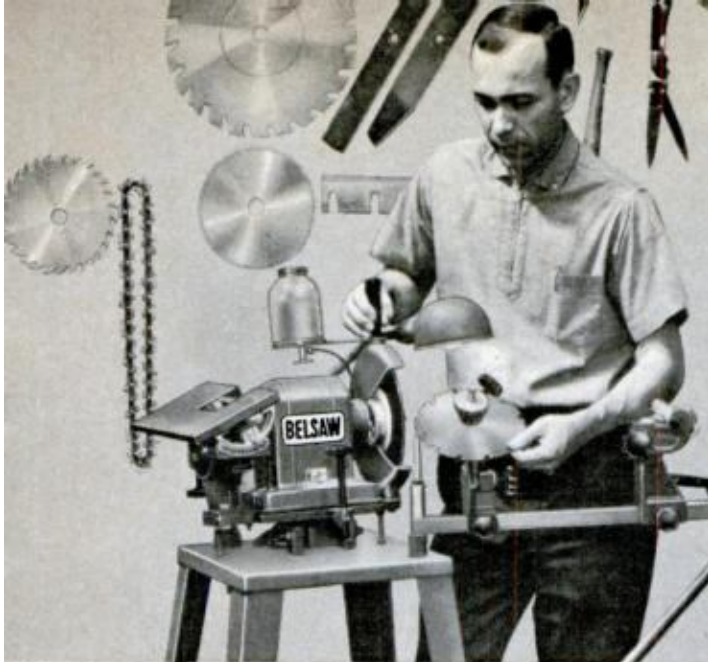

**Makes Over \$60.00 EXTRA
a Week In His Spare Time
Sharpening Shop!**

"My Belsaw Sharp-All made me
an extra \$3,500 last year.
Now I am going full time.
It's great to be your own boss."

DAVID SWANSON - Utica, Michigan

**Let Belsaw prove
YOU can do it, too! On our
30-DAY FREE TRIAL OFFER**

SEND FOR FREE FACTS!

You risk nothing by accepting this offer to see how easily you can turn your spare time into big Cash Profits with your own Complete Sharpening Shop. No selling . . . no previous experience needed. Our famous Sharp-All and show-how instruction set you up to make \$200, \$500, \$700 a month CASH sharpening Saws, Knives, Scissors, Lawnmowers, Shop and Garden Tools . . . all cutting edges.

CUT ALONG DOTTED LINES... FOLD IN HALF... SEAL AND MAIL

No Stamp Needed - Mail Today!

No Obligation . . . No Salesman Will Call

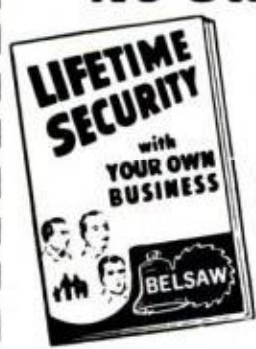

Please send my FREE copy of your book
"Lifetime Security" and full details on
your 30-Day Free Trial Offer!

**Does The Belsaw Pay?
YOU BET!**

**JOIN THESE SHARP-ALL
MONEYMAKERS**

"I average \$5.00 an hour part time and business gets better all the time."
*Robert Barrett, Jr.
W. Springfield, Mass.*

"My Sharp-All shop is now averaging me \$300.00 a month."
*Roy Jennings
Sandwich, Illinois*

"There's excellent profit in sharpening . . . we now do about \$600.00 a month."
*Ed Kistler, Jr.
Sarasota, Florida*

**No Selling, No Inventory...Year Round
Cash Profits and YOU Set The Hours!**

Our Free Book tells how to start a profitable, lifetime home sharpening business, how we help you grow, how we'll finance you.

MAIL THIS HANDY POSTAGE-PAID COUPON ENVELOPE...

**BELSAW SHARP-ALL CO.
713J Field Bldg.
Kansas City, Mo. 64111**

Name _____
Address _____
City _____ State _____ Zip _____

FOLD IN HALF HERE

FIRST CLASS
PERMIT NO. 1014
KANSAS CITY, MO.

BUSINESS REPLY MAIL
No Postage Stamp Necessary if Mailed in the U.S.

Postage will be paid by—
BELSAW SHARP-ALL CO.
713J Field Building
Kansas City, Missouri 64111



CUT ALONG DOTTED LINES

LETTERS

(Continued from page 8)

device to which the saw is mounted. We are most anxious to know how it was constructed so that we can make a duplicate when our new saw arrives.

SANTA BARBARA, CALIF. DAVE WILLIAMS JR.

The saw in our photos is mounted on a frame constructed by Workshop Editor Harry Wicks about 15 years ago. It consists of a pair of 2x6s, angle iron and four casters. He made the dolly for both portability and additional saw height.

So many readers have requested how-to instructions that we are planning to present the item in a future issue.

No workbench? Use the patio

Browsing through some old PMs, I came across the lovely *Jewelry Box* (page 124, July '71 PM). I knew constructing

such an intricate project would be a challenge, since I am not a craftsman and possess only a 6½-inch circular saw, an X-acto knife and eight small C-clamps. I made a makeshift table saw with my circular saw and, not having a workbench, used the patio

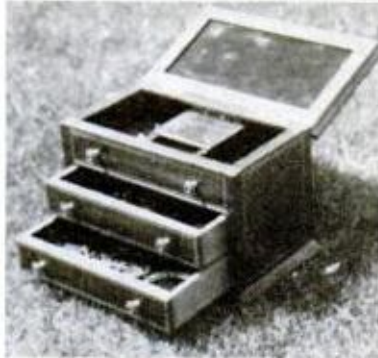

for sawing, rabbeting, dadoing, etc.

In spite of all the handicaps, the finished project was well worth the effort. But, oh, how much easier it would have been with a manufactured table saw!

EUGENE, ORE.

D. J. METZGER

'Encouraged' rightly

Having just purchased a radial saw last fall, I was wondering just what kind of project I might start. Then came the September 1971 issue with the *Spanish-Style Chest* (page 148). My familiarity with power tools was limited to my hand drill,



but I thought I could start this project without being set back too far if I botched it. The results are told in the picture.

My wife placed the chest in the entry-way of our home where everyone can see it (she helped build it). I am encouraged about woodworking from this excellent project.

SAN DIEGO

VANCE DAVIDSON

Electronic wheel balancing

As manufacturers of electronic wheel balancers, we were depressed to learn that your September issue proclaimed a mechanical, off-the-car balancer to be the best (*Wheel balancing: How to get your money's worth*, page 144) in the face of the facts that in off-the-car balancing:

1. A tire is not in a position that could be described as "true running."

2. A tire is balanced without regard for brake drum or disc, hubcap and trim ring.

Electronic on-the-car equipment balances the entire wheel assembly—both dynamically and kinetically.

We read in your article that the electronic balancer has as its primary disadvantage the skill the operator must have to use it. We submit that if one can tell time, he can balance wheels with an Alemite Electronic Balancer. It's that simple.

STEWART-WARNER CORP. WARREN COUGHLIN
CHICAGO ADVERTISING MGR.

Author John Miles responds: "Neither does 'on-the-car' balancing give a true running position. The tire in its true running position carries the car's weight;

(Please turn to page 12)

YOU GET ALL THIS with new NRI Master Automotive Technician home training. Included is the NRI Achievement Kit we send you the day you enroll . . . ten outstanding kits of automotive testing and repair equipment, plus educator-acclaimed NRI "bite-sized" texts — all yours to keep and use for years to come.



NRI announces a dramatic new way to learn Automotive Repair at home

Top auto experts praise NRI's new training plans

NRI's two new home training programs in Automotive Servicing and Repair have been acclaimed by three of America's foremost automotive experts. Richard Petty, America's winningest stock car racer says, "I especially like the way NRI has programmed essential training equipment they give you into step-by-step instruction." Tom McCahill, car tester and writer, commented, "The Master Automotive Technician

course gives ambitious guys a great start on a top dollar career. And that Tune-Up and Electrical Systems program can save do-it-yourselfers a bundle." William H. G. France, president of NASCAR reported, "The new NRI courses for mechanics are amazingly complete and seem to cover all major aspects of today's sophisticated cars. If you're at all interested in automotive training, I suggest you investigate NRI."

Professional equipment included at no extra cost

NRI gives you the choice of Master Automotive Technician training or a shorter Automotive Tune-Up and Electrical Systems course for the man seeking greater understanding of basic car repair. The Master course covers every major aspect of auto repair, from changing spark plugs to operating your own garage or car-care center. You not only learn the how and why with NRI's proved-in-use "bite-sized" texts, but you also get professional training equipment you need to actually do the work on your own or other cars as you move along in your home training. Equipment you get—at no extra cost—includes your own ignition-analyzer scope, as well as a dwell-tachometer, timing light, complete set of tools, volt-amp tester and assort-

ed gauges. You get ten kits in the Master Automotive Technician course, eight with the shorter Automotive Tune-Up and Electrical Systems Training program. The professional tools and equipment you get from NRI are yours to keep and use in the years to come, as you build a top-pay career as a Master Mechanic, or earn \$5 to \$7 an hour in spare time, or simply save money by repairing your own cars at home.

Train with the leader

The same pioneering home training methods and innovations which have made NRI the leader in other career training fields are now offered to ambitious men who want to turn their interest in cars into a solid, well-paying career. Take a tip from Richard Petty, Tom McCahill and Bill France, and train at home with the leader. Rush coupon now for free NRI Automotive Catalog. NRI, 3939 Wisconsin, Washington, D.C. 20016. NO SALESMAN WILL CALL.

APPROVED UNDER GI BILL—If you have served since January 31, 1955, or are in service now, check GI line in the coupon.

946-013

**Rush coupon
for FREE catalog**



NRI Training
3939 Wisconsin Avenue, N.W.,
Washington, D.C. 20016



Please send me your new Automotive Catalog. I understand there is no obligation. NO SALESMAN WILL CALL.

I am interested in Master Course Tune-Up Course.

Check here for facts on G.I. Bill

Name _____ Age _____
(Please print)

Address _____

City _____ State _____ Zip _____

ACCREDITED MEMBER NATIONAL HOME STUDY COUNCIL

THESE 3 BIG DRAFTING KITS* Included With Course

Coast-to-Coast Shortage of Trained Draftsmen Opens Thousands Big Salary Jobs for Beginners!

Now you can take your pick of thousands of big salary jobs open to Draftsmen (see "help wanted" sections of metropolitan newspapers). Huge nationwide demand... U.S. Dept. of Labor reports "42% more Draftsmen needed in next 10 years—not enough applicants to fill drafting jobs available now!" Our easy "Quick-Learn" Method has helped hundreds toward good income, security and prestige as Draftsmen. Why not you?

YOU NEED NO DRAWING SKILL... NO TECHNICAL ABILITY

NASD's staff of Professional Draftsmen guide you step-by-step. With our spare time home-study plan you work on actual projects. Makes learning fun—easy to remember, too. Many graduates have succeeded with only grade school training. Others report good earnings drafting part time while still learning!

... when you train at home with us for a **HIGH PAY JOB IN DRAFTING!**

RUSH COUPON FOR FREE KIT...

Mail coupon today for FREE "DRAFTING CAREER KIT," Sample Lesson, Drafting Aptitude Test including intriguing new 5-Way Drafting Instrument & 20-page Book "Your Future in Drafting"—jam-packed with revealing facts on your opportunities to win top pay and job security in Drafting. Approved for Veterans. Everything sent FREE and WITHOUT OBLIGATION. Write today!

431

North American School of Drafting, Dept. 34171
4500 Campus Dr., Newport Beach, CA 92663
Rush "DRAFTING CAREER KIT", including Book, Sample Lesson, Aptitude Test & Drafting Instrument — ALL FREE! No obligation. Approved for Veterans.

NAME _____ AGE _____
ADDRESS _____
CITY _____ STATE _____ ZIP _____
A home study program in association with Cleveland Engineering Inst.

1 **2** **3**

HERE'S WHAT STUDENTS SAY

2 Raises and \$300 Bonus!
"I've had 2 boosts in salary and a \$300 bonus in 11 months. Wish I could shake hands with your staff in person."
A. C., Calif.

Job Awaits Serviceman!
"Your Drafting Course has given me a good start. I already have a job waiting for me when I leave the service."
L. I., FPO, New York

ALL 4 FREE!
Rush Coupon today!

YOUR FUTURE IN DRAFTING
APTITUDE TEST
SAMPLE LESSON

* Precision Drawing Instrument Set, Professional Drafting Board Outfit & Fingertip Tilting Drafting Table are included with your North American Course in Drafting.

LETTERS

(Continued from page 10)

spinning on or off the car is the same.

"As for 'balanced without regard for brake drum or disc, hubcap and trim ring,' the article pointed out that seldom is it necessary to balance the entire assembly. However, off-the-car balancing can be done including everything but the hubcap if need be.

"And it is true that if one can tell time, he can designate the position of the reference mark on the wheel as being at 9:00 o'clock which indicates a weight at 3:00 o'clock. But it's not all that simple beyond that point. It is usually necessary to spin and stop the wheel five or six times to get the little needle to stay in the green area. All that time, the clock is running and the man down the street has already balanced two or three wheels effectively by his despised 'touch.'

"To summarize, I have never contended that the electronic balancer is not a good balancer. It is the only on-the-car balancer I know of that does dynamic balancing. But I do contend that it requires much practice to use and that it requires

much more individual 'intuition' than the 'touch' of others."

Nothing wears out

With the help of PM, I have a 1953 Buick running like a clock... shoes lasting 10 years or better... tools that never give out... toys from scrap... and a lot more.
NEW ORLEANS G.M. LABORDE

Panels, panels, panels

Looking through some old PMs, I noticed that in three different articles by Wayne Lecky (*Coffee Table for \$35*, page 174, Sept. '71; *Handsome Buffet*, page 140, Dec. '71; and *Octagonal Lamp Table*, page 154, Aug. '72) the author uses the same simulated wood panels. I realize that using these panels is an easy and fast way to make a project look elegant, but how about some new ideas?
CHATSWORTH, CALIF. CHIP BOLLIER

They are fast and easy and elegant. But don't worry: After Wayne finishes shingling his house with them, his supply will be exhausted. ★★★

FREE! *New* FUN-FILLED CATALOG 1600 UNUSUAL ITEMS

**Funmakers·Hobbies·Sports·Games·Imports
Jewelry·Emblems·Patches·Psychedelia
Science·Electronics·Photo·Optics
Jokes·Magic·Gifts·Gadgets**

PLAYBOY MAGAZINE says: "Johnson-Smith opened to me a world of fantastic wonders . . . fabulous."
NBC-TV TODAY program: "Thanks for 'vanishing money.' We used it on show on Income Tax Day." LIFE reprinted excerpts from catalog.
HARVARD CRIMSON: "JS book supplied humor for decades."

The Most Unusual Catalog in the World
MAD, NEW YORKER, CORONET, COLLIERS, TIDE, etc., have written stories about this interesting catalog. Some quotes: "Magic wish book - fabulous treasure trove of novelty goods." "Only concern of its kind in America." Ranks with Disneyland, carnivals and the world's fair in popularity over the years - over 10,000,000 customers since 1914 who range from Shirley Temple to the King of Nepal and Johnny Carson. (Johnny Carson often reminisces about Johnson-Smith with his guests.)



Which Things Listed Below Would YOU Like?

NEW 1973 EDITION

No Other Catalog Like It Anywhere!

Live Sea Monkeys
Spy Pen Radio
Swiss Computer Watch
Remote Control Ghost
Jackpot "Payout" Banks
1000 Things Free
Hypnotizing Spinning Coin
Secret Book Safe
"Xray Vision" Glasses
Las Vegas Casino Set
Fluorescent Shirt Emblems
Fluorescent Posters
Psychodelic Black Lights
Mod Cloth Patches
Playboy Decals & Emblems
Candles, Incense, Body Oil
Helium Gas & Balloons
Psychodelic Glasses
Fibre Optics - Strobe Light
Orbiting Space Ship Watch
Flashing Eyes Skull Ring
Wrist Radio Transmitter
"Big Ear" Sound Detector
1000 Magnets \$1.29
Mammoth 16-Ft. Balloon
Model Laser Pistol Plans
Master Skeleton Keys
Home Winemaking Sets
Home Made Beer, Wine, etc.
Comic "Ever Drinking" Man
Electronic Treasure Finders
200,000 Volt Generator
Leather Bull Whips
Hercules Wrist Bands
Pocket Muscle Builder
World's Smallest Bible
Be 2" Taller Instantly
No Electricity Light Bulbs
See-Thru Doors & Walls
Pocket Alarm Defender
Magic Money Maker
Mod Cloth Patterns
T-Shirts with Emblems
Decals, Emblems
Rubber Masks with Hair
Lifelike Wigs, Instant Hair
Electric Spinning Tie
Comic License Plates
Popul Tie, Jumping Hat
Solar Furnace & Litter
8 mm. Sound Films
Flying Spacecrafts
Optical Prism \$1.50
Solar & Steam Engines
Computers \$2.95 Up
Magnet Lifts 100 Pounds!
Disappearing Spy Paper
Sun Batteries
Stereo TV Specs
Sun Powered Radios
Induction Shocking Coil
Cordless Electric Drill
Loud Electronic Megaphone
Atomic Energy Lab
Projector Enlarges 100X
Receive Big Mails
5-Color Printing Set
Secret Money Belt
12 Color Ball Pen
Leather Sewing Awl
Electric Poker Game
Spanish Wine Flask
Pocket Dry Spaver
Doctor's Stethoscope
Blood Pressure Meter
Electric Water Heaters
Blackhead Remover
Teeth Whiteners

Joke-Magic Playing C.
Spirit Writing Slates
Finger Chopper
Miracle Wand
Phony Chicken
Black Eye Joke
Fake Bullet Holes
Crooked Cards
Ouija Board
Oriental Wood Puzzles
Candy Covered Bugs
Electric Shocker
Comic Jumbo Hat
Exploding Cigars
Drabble Glass
Foaming Sugar
"Red Hot" Joke Gum
Insult Cards
Talking Toilet
Famous Military Medals
Wrist Alarm Watch
Chinese Luck Rings
12 Rings in One!
Fireball Ring
Mammoth 16-Ft. Balloon
\$1.00 Pedometer
Replica Gold Coins
2-Headed Real Coins
\$1,000,000 U.S. Bill
Confederate Stamps
Replica U.S. Currency
Bank Vaults
Coin Changer & Purses
Truckers Wallet
Electroplating Set
Wankel Engine
Color Organs
Resurrection Plant
Fresh Eating Plant
Cactus Plants
Imported Mouth Organs
Ocarino, Jaw Harp
Ship in Bottle
Fluorescent Paints
Wind Chimes
Pocket Calculators
Computer Pen
Ventriloquist Dummies
Monsters & Skeletons
Gazing Crystal Balls
Home Repair Manuals
Forbidden Knowledge
Skin Blemish "Hide It"
Sure Sleep Aids
95¢ Rapid Hair Cutter
Non-Slip Foot Grippers
Pocket Stoves & Heaters
Tractable Hot Seat
Electric Shooting Gallery
Baseball Pitching Machine
Never Miss Fish Hooks
Luminous Fish Lures
Bowie & Survival Knives
11-Blade Army Knife
Permanent Matches
Live Animal Traps
Animat Pets
Electronic Insect Repeller
Police Handcuffs, Badges
Jujitsu, Karate, Defense
Silent Dog Whistle
Electric Alarm Mat
3-Piece Stereo \$34.95
Remote Hover Craft
Motorized Models
Surplus Telephones
Pocket Crime Lab



FREE CATALOG!

Johnson Smith Co. Dept. C101
Mt. Clemens, Mich. 48043

Name _____

Address _____ Apt. _____

City _____

State _____ Zip _____

Answers to Your Questions about this Free Catalog
Why is it Free? Read it for fun and entertainment, but it pays us to send it to you Free because most people find things they want and order them. **Is there any obligation?** Absolutely none!
Are there things to interest Me? Yes! We think you'll find plenty to amuse and amaze you. Every item guaranteed. No other catalog like it.
Johnson Smith Co., Dept. C101, Mt. Clemens, Michigan 48043

Tear Out & Mail Coupon Now for YOUR Free Catalog

A million jobs have disappeared since 1960

Will Your Job be Next

Shouldn't you start your own business NOW
...while still employed?

Before more jobs disappear through mergers, automation, and mechanization, shouldn't you at least investigate the way so many men have become owners of profitable businesses—starting spare time and now are independent of bosses, strikes, layoffs and automation? All that's needed is your name on the coupon. Facts mailed free. No salesman will call.

Here are facts: With some ambition and little over a thousand dollars, you start your own Duraclean business in spare time, without risking your job or paycheck!

It's a nationally advertised, worldwide business. It does not require skill, more than an average education, or traits except the willingness to work to start grossing \$12, \$19, or \$26 profit per hour. By return mail, we will explain how.

You build by adding servicemen and/or servicewomen . . . and we pay for their equipment so you can expand rapidly.

This is a service to homeowners as well as offices and stores and institutions—a sensationally improved method of cleaning carpets and upholstered furniture right on the customer's premises—the EXCLUSIVE DURACLEAN SYSTEM!

When you have had your own carpet and furniture cleaned, you know that ordinary methods grind fibers with harsh scrubbing, leaving carpet soggy for days.

This exclusive ABSORPTION METHOD lifts out dirt and greasy soil with a gentle, almost dry foam. Do-it-yourself "so-called" cleaning methods and scrubbing drive soil deeper. You TAKE IT OUT. Carpets and

furniture can be used again in a few hours! This is vital to stores, offices, motels.

You operate under a nationally known name—use an exclusive process recommended by the nation's leading carpet mills and in the editorial pages by House & Garden, McCalls, Parents, and House Beautiful. You receive our step by step guidance and help.

Your training shows you how to perform your 7 superior "on location" services . . . how to get customers, how to control your expenses, how to make the maximum profit. You become an expert in the care of furnishings. It is an interesting, exciting career.

Although in time you will wish to buy one or more trucks from your profits, no truck or office is needed to start. You can carry all equipment in your car trunk. Your phone calls can be received at home.

As a Duraclean Dealer you are the sole owner of an independent business and are your own boss. You keep all the net profits.

This business can pay you far more than most men earn—with only the talent and ambition you now possess, and you can operate in any one of three ways.

Many let servicemen do the work while they make a substantial profit on each.

to Go?



Some men operate permanently in spare time for the extra money they need. Some start in spare time and quit their jobs only after they see they can make a lot more money as a full time Duraclean Specialist.

Even small one-man businesses with one or two helpers can and do bring in \$30,000 and more annually. A very high percent is clear profit to you.

The Duraclean Business can be as small as you want or it can be expanded to the level your ambition dictates. There is no limit on income for an ambitious man.

We are about to appoint a limited number of men who are truly ambitious, and anxious to do something about their futures. We want men who will follow our proven plans for success and who want—with our help—their own successful businesses.

If this opportunity interests you, please send your name, on the coupon at the right, for a FREE 24-page booklet which gives complete details on the Duraclean Business. No salesman will call on you. After you've read the facts, decide in the privacy of your home if you wish to take the next step toward starting a business.

WE SWITCHED!

"For the first time in 20 years I've got security—without fear of losing my factory job."

H. E., Ohio

"When I was 40 I decided to retire before I was 50 years old. With Duraclean I gained financial security in only 8 years—then sold my business at a big profit."

J.H., Ill.

"Duraclean brought security and an education for my daughters. We've done as much as \$3000 on a single job."

Mrs. B.B., Mass.

"Life is happier and more prosperous for my family and me. Without Duraclean I'd still be going from layoff to layoff. Now moving to new 5-bedroom home."

R.J.B., Mich.

THESE ARE JUST A FEW OF THE LETTERS IN OUR FILES FROM MEN AND WOMEN WHO HAVE FOUND SUCCESS AS DURACLEAN DEALERS. (IN ANOTHER YEAR YOUR STATEMENT COULD BE HERE, TOO.)

Duraclean[®] International



3-161 Duraclean Bldg., Deerfield, Ill. 60015

WITHOUT OBLIGATION send me the free booklet which shows me how I can start a Duraclean Business in my spare time without risking my job. No salesman is to call.

Name _____

Address _____

City _____

State & Zip _____

NEWS BRIEFS



Movies in your hotel room

If you don't feel like going out to a theater, you can have a movie wheeled in at the Commodore Hotel, New York. The projector (top photo) looks something like a home TV set. The film, in a six-by-six-inch magazine (bottom photo), runs 2½ hours. The system is by Zeiss-Ikon of Germany.

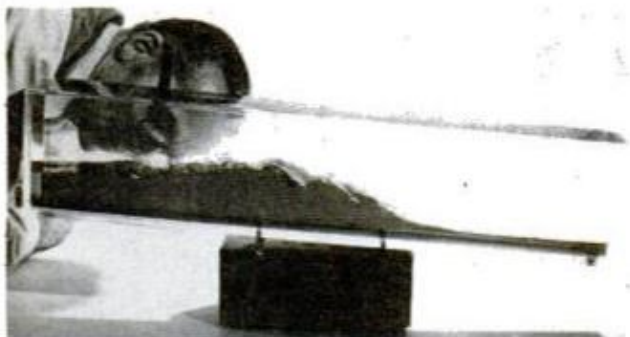

Waves in your living room

You can be soothed by "ocean" waves right in your living room. "The Wave," a clear, plastic tank, rocks gently back and forth, creating waves in a blue liquid inside. Sold by Hammacher Schlemmer, New York.



His point is safety

Convinced that conventional, flat-front cars are lethal in head-on collisions, Richard Ihm, a hairdresser in England, has added pointed steel-and-fiberglass noses to three cars. He says that a pointed nose deflects another car in a collision, minimizing the impact and damage. He recently demonstrated by driving one of his cars between two oncoming cars—all traveling 50 mph; the two other cars were only 18 inches apart, but all came out with only scratches.

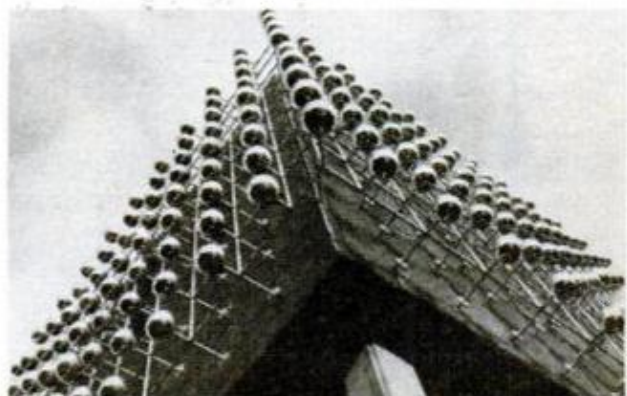

Globe-covered museum

Some 639 aluminum balls cover the exterior of the new County Museum in Munster, Germany, "creating the most unusual facade of any museum," according to the architect. Each ball has a colored light bulb shining through an opening toward the wall.



© 1970 LaSalle Extension University, A Correspondence Institution

The Accountant. You should earn his salary.

Learn how to become an Accountant in your spare time.

You are looking at an influential and often envied man in the world of business.

He is a special kind of authority. He usually knows more about a firm's financial affairs than anybody short of the highest company officers. There's hardly a single major decision made without calling on him for advice.

Obviously he is worth a lot of money—and he gets it.

Why don't *you* become an accountant?

Of all the professions, few offer a greater welcome to newcomers than the accounting profession. That's because there are frequently more fine positions open than there are trained people to fill them.

Do you know that, regardless of your present position or previous experience you can learn to be an accountant—or add accounting to your qualifications for advancement—through spare-time home study?

With the low-cost training offered by LaSalle, you study in privacy, during hours of your own choosing, without the need for travel or for taking time from your own job.

Your lessons are mailed to you. LaSalle's CPA-supervised faculty starts you right at the beginning, explains basic accounting principles and methods, gives you actual accounting problems with your lessons, then corrects and grades your work. By the time you are finished, you are well prepared for the major accounting tasks you will be expected to handle in the business world.

LaSalle has been a leader in home study for over 60 years. It has enrolled more than 2,000,000 students in that time. That is why a LaSalle diploma is a recognized and respected credential.

If you are truly seeking a more rewarding career with higher pay, a solid position in the business

world and the good things that affluence can buy, you owe it to yourself to read LaSalle's famous booklet "Opportunities in Accounting." Send for a free copy. You will also receive a free sample lesson in accounting which will demonstrate how LaSalle makes home study interesting and practical. No obligation. Mail attached card or write LaSalle, Dept. 85-057, 417 S. Dearborn Street, Chicago, Illinois, 60605.

Mail card for
FREE booklet
and sample
lesson





Sawhorse 'workbench'

A SAWHORSE need not be just a sawhorse; it can be the handiest home-repair "workbench" you ever saw. Fitted with a flat top, it provides a benchtop surface for all kinds of layout work, plus a place to clamp a vise.

When a shallow tray is fitted between the legs, you can keep your hand tools, nails and screws all in one handy place such as a toolbox.

When a piece of perforated hardboard is fastened to one side of the horse, you have a built-in tool panel on which to store countless small tools with clips.

And when you install a duplex receptacle in one of the sawhorse legs and wire it to a retractable

(Please turn to page 22)

TOP WORK SURFACE is simply bolted-on length of 2x6; ample for drilling, sawing, most other carpentry jobs. Horse is made of 2x4 stock. Commercially made brackets eliminate need for mitering legs at the top

BASIC SAWHORSE with a few easily added parts is handy work center at the job site. Perforated board and hooks will hold generous complement of tools and yardstick fits on top edge



By **KEN PATTERSON**

POPULAR MECHANICS

Can you spot the Camel Filters smoker?



©1972 R. J. Reynolds Tobacco Company, Winston-Salem, N. C.

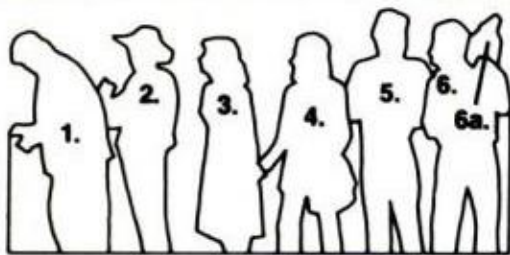

In this picture everybody has a gimmick... almost everybody. Try picking the one who doesn't go along. **1.** Nope. He's Alfonso Cliggitt, divorce lawyer. Gimmick: far out dress to intimidate the opposition. Smokes cigarettes made of dried tundra. **2.** Harold A. Baer, rare book expert. ("Books Old and Rare from Harry Baer.") Thinks rolling his own makes him look younger. A real dingbat. **3.** If she's the Camel Filters smoker, the guy with the beard is Jean Harlow. **4.** Gene Harlow. **5.** Right! He's just himself. And he sees through all the gimmicks. That's why he smokes an honest, no-nonsense cigarette. Camel Filters. Easy and good tasting. Made from fine tobacco. **6.** A. Boswell Farquar. Gimmick: a white (not green) parrot. Hasn't seen a movie in years. They won't let his parrot in. **6a.** Parrot. Smokes a meerchaum pipe but has trouble keeping it lit.

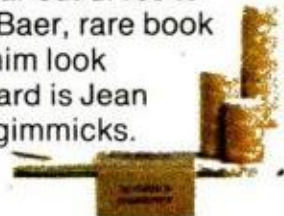

CAMEL

Camel Filters.
They're not for everybody
(but they could be for you).

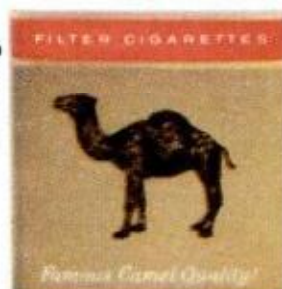

Warning: The Surgeon General Has Determined
That Cigarette Smoking Is Dangerous to Your Health.

20 mg. "tar", 1.4 mg. nicotine av. per cigarette, FTC Report AUG. '72.

SAWHORSE 'WORKBENCH'

(Continued from page 20)

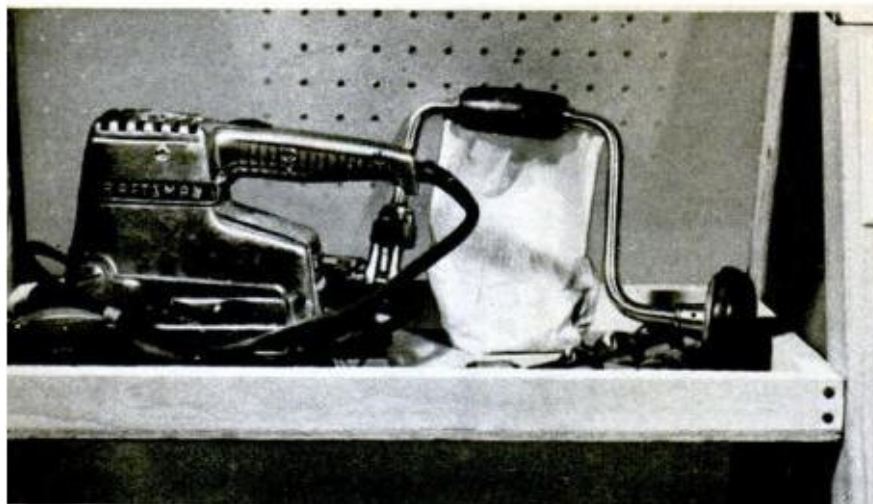

TOOL TRAY is permanently affixed—and adds rigidity—to the sawhorse legs. It offers a good storage area for portable power tools, small parts, screws, nails and the like

ELECTRICAL OUTLET BOX is installed in one leg, with line from a cord reel connected to the duplex receptacle. Other end of the line is simply plugged into nearest power source

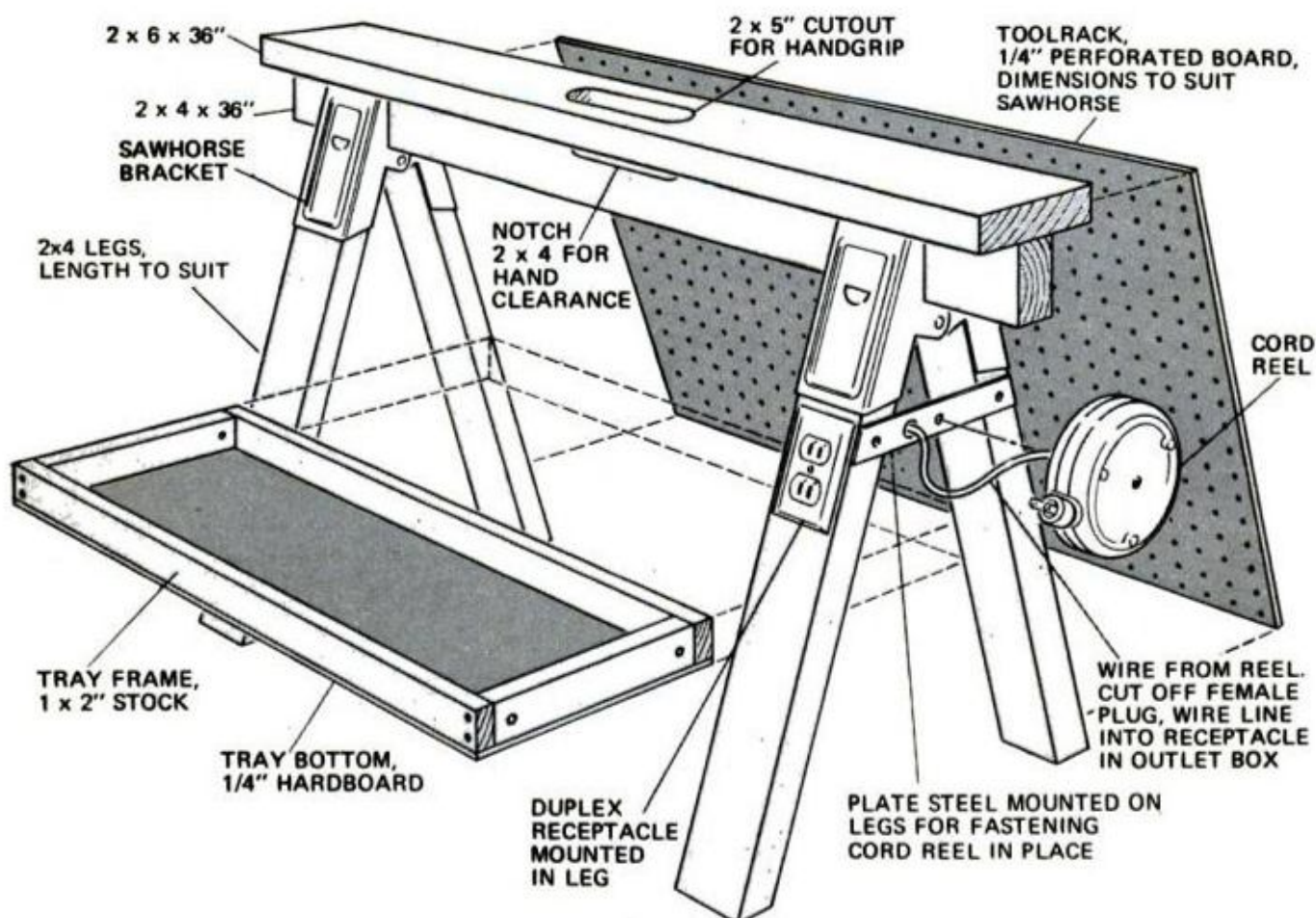

power-cord reel, you have convenience plus when plugging in power tools.

To add such a receptacle, an outlet box is first installed in the leg in a cutout made to receive it. The female plug is cut

off the end of the cord reel and the line is attached to the outlet box with a Romex connector. Finally, the receptacle is installed in the box, which is then fitted with

★★★

Meet the neighbors you never knew you had.

They're people very much like your other neighbors. Businessmen and maintenance men. Lawyers. Doctors. Bakers. And patternmakers. They live in your community. They work for your community.

They're your action neighbors in the Army Reserve. The kind of neighbors you'd like to meet and get to know.

They serve the community as they serve the nation. They get involved in more community projects than just about any other single group of people in the nation.

Like running hospitals on weekends, building parks and summer camps, and solving local environmental problems.

The Army Reserve. An opportunity to learn a skill, earn money in your spare time, and meet neighbors you never knew you had.



Army Reserve Opportunities
P.O. Box 6834
Philadelphia, Pa. 19132

Tell me more about how the
Army Reserve pays.

Name _____

Address _____

City _____

State _____ Zip _____

Phone _____ Age _____

PM 1-73

**The Army Reserve.
It pays to go to meetings.**

IMPORTS AND MOTORSPORTS

BY BILL HARTFORD

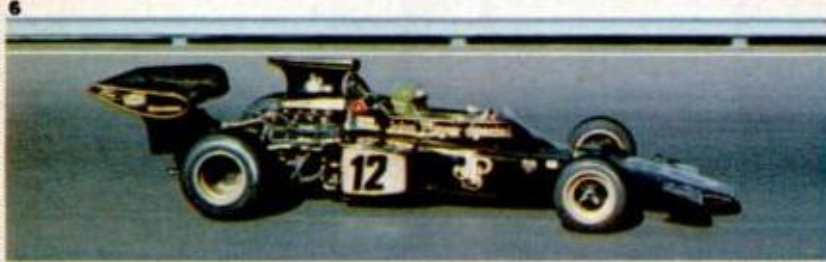

PHOTOS BY BILL HARTFORD

HALF THE FUN of the one and only U.S. Grand Prix at Watkins Glen is getting there. Speeding to New York's Finger Lakes region and idling into the Glen every year is an international parade of cars: Fast sports cars that are shipped to this country by boat and are driven by owners who like to fly; small economy cars, some tuned for mileage, others tweaked for all the performance possible from a liter and a half; cars that are classics and cars so exotic you may see them only once a year—if that.

There are so many imports in Watkins Glen at Grand Prix time you think you're in California. That's where almost one of every three (!) cars sold is from Europe or Japan. The other imports that buzz and bounce down the rutted roads at the circuit are motorcycles—some of the

(Please turn to page 26)

ON STARTING GRID for U.S. Grand Prix, Howden Ganley 1 buttons up while Jackie Ickx 2 in his red Ferrari focuses on three rows of cars ahead. Teammate Mario Andretti 3 discusses last-minute strategy and Derek Bell 4 steels himself for a drag-race start of 59 laps around 3.377-mile road course. But Jackie Stewart 5 dominated the field in his Tyrrell-Ford, turning 120.991 mph for the pole and 117.483 for the race. Emerson Fittipaldi had already wrapped up the 1972 World Driving Championship in the John Player Lotus 6, here driven by teammate Reine Wisell. The biggest-ever '73 season, with new races in Brazil and Sweden, starts Jan. 28 in Argentina

LET MOTOR'S NEW 1973 AUTO REPAIR MANUAL SHOW YOU How to fix almost any part of almost any car



**Shows You Where To Start...
Which Tools To Use...
Exactly What To Do!
Quickly...Easily...Right!**

Over 1,000 pages, over 3,000 pictures and diagrams cover 2,300 models (1967-1973) . . . 225,000 facts that make those "tough" repairs come easy

MOTOR's great new illustrated 1973 **AUTO REPAIR MANUAL!** Here is the "meat" of over 300 factory manuals, brought together for you in the most complete, up-to-date auto repair guide ever prepared! Here are the easy directions and "see-how" pictures that help you sail through virtually every auto repair... from a simple carburetor adjustment to a complete transmission overhaul! Here are over 1,000 almost-foot-high pages that can lick your toughest problems—quickly, easily, right the first time!

Yes — fix practically any part of any car! This revised, improved 1973 edition immediately identifies 2,300 models (1967-1973) for you. Just look up make, model, and repair in the handy Instant-Reference Index—and go to it! MOTOR's **AUTO REPAIR MANUAL** takes you all the way—shows where the trouble is, which tools to use, what to do to fix it fast. Over 3,000 pictures and diagrams detail the parts... clear, simple

language puts over 225,000 service and repair facts at your fingertips! A special Trouble-Shooter section and detailed trouble-shooting information thruout help pinpoint in a flash over 4,200 causes of car trouble: transmissions, brakes, engines, electrical systems.

Saves You Time, Money, Work

You get hundreds of compact tables... over 55,000 essential specifications and dimensions... tune-up and adjustment charts... tables of measurements and clearances... overhauling and replacement facts... adjusting and servicing guidance, and much, much more!

Here is the step-by-step help every beginner needs. And here are the labor-saving methods and shortcuts that get old pros over the "tight spots" and save time and money. No wonder more than 6,000,000 copies of this book have been sold to garages, schools, armed forces!

**New
Illustrated
1973
Edition**

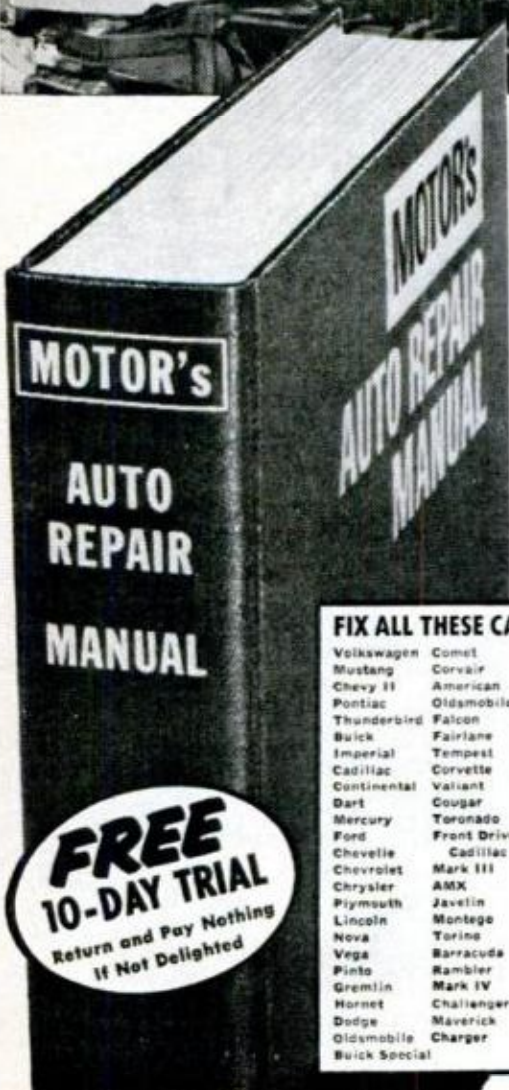

FIX ALL THESE CARS

- | | |
|---------------|----------------|
| Volkswagen | Comet |
| Mustang | Corvair |
| Chevy II | American |
| Pontiac | Oldsmobile F85 |
| Thunderbird | Falcon |
| Buick | Fairlane |
| Imperial | Tempest |
| Cadillac | Corvette |
| Continental | Valiant |
| Dart | Cougar |
| Mercury | Toronado |
| Ford | Front Drive |
| Chevelle | Cadillac |
| Chevrolet | Mark III |
| Chrysler | AMX |
| Plymouth | Javelin |
| Lincoln | Montego |
| Nova | Torino |
| Vega | Barracuda |
| Pinto | Rambler |
| Gremlin | Mark IV |
| Hornet | Challenger |
| Dodge | Maverick |
| Oldsmobile | Charger |
| Buick Special | |

Same Offer on MOTOR'S AUTO ENGINES & ELECTRICAL SYSTEMS



1,300 big pictures. Clear text explains how parts work; principles involved; design; construction; maintenance. Covers all parts of engines & entire electrical system. For FREE trial, check box in the coupon below.

SEND NO MONEY

Use Manual FREE For 10 Days

Put MOTOR's big new **AUTO REPAIR MANUAL** to work for you. See for yourself how quickly and easily it gets the work done! We'll send you this 1973 edition to use FREE for 10 days. If it doesn't start paying for itself in even this short time, return the **MANUAL** and owe nothing. Just mail the coupon below TODAY to MOTOR Book Dept., P.O. Box 2316, P.D.R. Station, New York, N.Y. 10022.

MAIL COUPON NOW FOR 10-DAY FREE TRIAL

MOTOR Book Dept., P.O. Box 2316, F.D.A. Sta., New York, N.Y. 10022

Please send me the Manuals checked below for ten days free examination:

- 11122 MOTOR's Auto Repair Manual, \$10.95
- 12526 MOTOR's Auto Engines & Electrical Systems, \$10.95

If I am not fully satisfied, I will return the shipment promptly and owe nothing. Or I will keep it and pay the total price in three monthly installments, plus a small shipping charge.

I WANT TO SAVE SHIPPING CHARGES.
 I am enclosing payment for \$..... in full and you will pay shipping charges. (Same return privileges, refund guaranteed.)

Prices slightly higher in Canada. Offer available in continental United States. Delivery will normally be within 3-4 weeks in Eastern U.S. Please allow longer west of the Mississippi.

Print Name.....

Address.....

City.....

State..... Zip.....

Signature Please..... Age.....

(H.M. Books)



COMPLETE AND SIMPLE. "I always rely on my MOTOR Books. They're well illustrated — and complete and simple."
—Mr. Erva Jones, Minnesota (Garage Owner)



DEPENDS ON IT. "MOTOR's Auto Repair Manual is invaluable to me. I depend on it for all makes and models."
—Mr. W. W. Forlines, Virginia (Mechanic)

IMPORTS AND MOTORSPORTS

(Continued from page 24)

more than 4-million dirt and street bikes in the country.

Millions of motorcycles, over a million imported cars each year and the million-dollar sport of auto racing. That's what *Popular Mechanics'* new column is all about.

BMW WITH BOUNCE. The foam nose and tail-pieces cover energy-absorbing hydraulic rams on the experimental Turbo from the Bavarian Motor Works. Turbo is the work of the same designer who did much of the Mercedes C-111, Paul Bracque, and proves that frumpy cars are not the necessary result of U.S. safety standards. (For



a closer look at a sharp, safe front bumper of the home-grown variety check the '73 Corvette.)

The Turbo gets its name from the fact that the two-liter, fuel-injected, four-cylinder engine, transversely mounted amidships, is turbocharged and good for 200 hp. The idea car has a built-in roll bar, and doors are the gull-wing type. Advanced instrumentation includes a radar warning system that automatically adjusts car speed (for more on this see the radar braking story on page 99).

BEST LOOKING BIKE among the '73s we've seen to date is the Kawasaki Z-1 900. You're right, the 900 stands for the displacement of Kawasaki's first four stroke—903 cubic centimeters to be exact. The volume is divided among the four cylinders of the transverse, in-line, air-cooled big



banger. Designed to be the ultimate touring machine, the 130-mph Z-1 was tested extensively before introduction.

Lots of pow and little pollution was the approach in designing a hot dohc with, of all things, a PCV system! Hp is 82 at 8500 rpm and torque, 54.3 ft.-lb. at 7500 rpm. A low, 8.5 compression ratio means regular gasoline can be used and is, in fact, recommended. The 506-pound machine has electric starter for quick starts and hydraulic front disc brake for quick stops. Expected to be less than \$2000 (\$1995?), the Z-1 is 86.8 in overall on a wheelbase of 58.7 in. Seat height is a comfortable 31.5 in. That's how it sizes up in dimensions; now we're looking to size it up in handling when production models become available.

NEW HALF-TON TOYOTA is successor to the earlier Hilux. The restyled model, a lot better looking, comes with wider, 7.00 x 14 white-wall tires as standard and larger, 13.5-gallon



fuel tank. Result is greater range and better handling and traction for the half-tonner. Payload is same 1400 pounds, engine the same two-liter ohc Four 18R-C. P.o.e. price is up only \$77, making the pickup an attractive \$2299.

RACING DRIVERS ONLY NEED APPLY. The Porsche Carrera is a limited-edition version of the 911 series. Only 500 of the 2.7-liter machines will be imported (the number needed to homologate



the car for GT racing this year). The sizzling performer (150-mph plus, 0-60 less than 6 seconds) doesn't meet safety and emissions standards so it can't be registered for the street. The horizontally opposed, six-cylinder air-cooled engine puts out 200 hp in a car that has been trimmed amazingly to 1984 pounds! Fiber-

(Please turn to page 30)

New square-cornered Sylvania picture tube

Handsome woodgrain cabinet, at no extra cost. (Offered only by NRI)

6-position detented UHF channel selector

Modular construction with plug-in circuit boards

Automatic color control

Automatic degaussing

Automatic tint control

100% solid state chassis

Automatic fine tuning



NOW... learn color TV servicing while building this NEW 25" SOLID STATE SET created by NRI for home training

NRI wanted more than a hobby kit TV . . . so we built one from the circuits up, specifically for teaching advanced electronics. You can only get this superb set from NRI . . . it's exclusive with NRI Color TV Servicing Course.

NRI was first to supply home study students with custom-designed training kits to give practical hands-on experience as you learn. Now NRI scores another first . . . with the exclusive 25" picture tube, solid chassis, color TV set designed-for-learning. You build it yourself with NRI's TV-Radio Servicing Course.



Kit for kit, dollar for dollar, you get more for your money from NRI.

The TV-Radio Servicing Course includes a wide-band service type oscilloscope and a color bar cross-hatch generator . . . along with

other valuable equipment you will use to perform experiments and make repairs on your own and other sets.



You'll soon find yourself earning \$5 to \$7 an hour, in your spare time . . . even before the course is completed.

Learning at home is easy . . . the simplified NRI way. Texts are "bite-size" and fully-illustrated, leading you step by step, stage by stage, to a thorough

knowledge of electronics. You can introduce defects into circuits, perform experiments, and discover the how and why of circuitry and equipment operation.



Train with the Leader—NRI.

The same training innovations which have made NRI the leader in career training at home are now available to you. Mail the insert card for a free full-color catalog which spells out the NRI "discovery" method of learning. There's no obligation. **NO SALESMAN WILL CALL.**

APPROVED UNDER NEW GI BILL. If you have served since January 31, 1955, or are in service, check GI line on reply card.



NRI TRAINING
3939 Wisconsin Avenue, N.W.
Washington, D.C. 20016



MAKE BIG MONEY IN EITHER OF THESE TWO FIELDS



TRACTOR-TRAILER DRIVER

We can train you to operate the big diesel rigs. Study at home followed by practical training at school-owned facilities in Miami, Fla. Accredited Member NHSC. Home Office—Miami, Fla.

APPROVED FOR VETERANS AND INSERVICE PERSONNEL

HEAVY EQUIPMENT OPERATOR

Learn to operate cranes, draglines, scrapers, clamshells, bulldozers, backhoes, trenchers. Study at home followed by practical training at school-owned facilities in Miami, Fla. Accredited Member NHSC. Home Office—Miami, Fla.



UNIVERSAL TRAINING SERVICE, Dept. PM
1901 N.W. 7 St., Miami, Fla. 33125 • Phone: (305) 642-0800

- TRACTOR-TRAILER DRIVER
 HEAVY EQUIPMENT OPERATOR

PLEASE PRINT

Name _____
Address _____
City _____ State _____
Zip _____ Phone _____ Age _____

NEW ANTI-SKID SAFETY DEVICE



SAFETY BRAKER

Straighter, Shorter, Safer
Stops under any road
condition. It could save
your life!

- EVERY VEHICLE THAT IS DRIVEN ON A FREEWAY SHOULD HAVE A SAFETY BRAKER!
- EVERY VEHICLE THAT TOWS A TRAILER SHOULD HAVE A SAFETY BRAKER!
- EVERY VEHICLE THAT IS DRIVEN IN HAZARDOUS ROAD OR WEATHER CONDITIONS SHOULD HAVE A SAFETY BRAKER!

Installation in less than 15 minutes

The Safety Braker is maintenance free and is easily installed at the master cylinder on the brakeline to the front connector and front wheels. In a panic stop situation, the lockup of one front wheel could be caused by one smooth tire, a drum out of round, one tire on a slippery surface, etc. and could result in a swerve or sideways skid of the vehicle. Safety Braker has been engineered to instantly absorb shock waves of the imbalanced reactions produced by one locked wheel, immediately releasing the locked wheel and preventing the dangerous swerve or sideways skid.

SPECIAL INTRODUCTORY OFFER only \$29.95
ppd. (Calif. residents add 5% Sales Tax.) Allow 14
days for delivery. MONEY-BACK GUARANTEE.

Mail today. Print clearly.

PRODUCT DEVELOPMENT CO.

P.O. Box 4125, Burlingame, Calif. 94010

Please send me _____ Safety Braker(s). Check or
Money Order Enclosed. (No C.O.D.s.)

 BANKAMERICARD Acct. #
 Exp. date _____

Make & Yr. of Car _____ Disc or Drum _____

Name _____

Address _____

City _____ State _____ Zip _____

IMPORTS AND MOTORSPORTS

(Continued from page 26)

glass and aluminum components are given the credit for bringing down the weight from the 2425 pounds of the street version 911.

A 2.0-liter version of the mid-engine 914 is the other significant news from Porsche Audi for the 1973 model year. The two-liter version also has as standard equipment forged alloy wheels and appearance group, front and rear stabilizer, center console with instrumentation and storage.

HARLEY HOGGED the motorsports spotlight by taking the Manufacturers' Championship of the American Motorcycle Assn.'s National Championship Series in 1972. Spotlight on its '73 line reveals the most changes in Harley-Davidson's 71-year history. All two-stroke street bikes now have oil-injection and the big V-twins have hydraulically-actuated front disc brakes, the 1200s with discs front and rear. If it's too cold to think of riding to your Harley dealer to catch the new bikes, you can get some fascinating reading in *The Story of Harley-Davidson*—a motorcycle history as well as a history of the company. The 55-page book is full of fascinating photos, starting with one of Walter Davidson Sr., after he won the Federation of American Motorcyclists' endurance run in 1908. It's free. Write to Harley-Davidson Motor Co., Inc., Milwaukee, Wis. 53201.

ROCKET RECORDS were set when driver Dave Anderson blasted to 158.842 mph in the quarter-mile from a standing start on the Bonneville Salt Flats. The Pollution Packer



rocket rail is the idea of speed-freak Tony Fox who has also posted speed records in snowmobiles and boats, and who owns a waste-compacting firm—therein lies the promotion gimmick of a "clean sweep" with the rocket dragster: Thrust gases were harmless superheated steam and pure oxygen.

The land speed record (LSR) stands at 622.407 mph—set by Gary Gabelich in the Blue Flame rocket car in 1970. Gary wants to go faster and break the sound barrier on land; Craig Breedlove wants to do the same in another Spirit of America. Who'll be first? Stay tuned. ★ ★ ★

There may be a great future in your past.



Think back to that time in your life when you felt like you belonged, had enthusiastic friendships, and a sense of contributing to your country's strength. When you could actually look forward to a secure and comfortable future.

Chances are, the last time you felt like that was when you were in the service. The question now is, is it too late to do something about bringing back the good old days of military life?

In a word, the answer is "No." The Air Force Reserve needs good men with their service skills intact. And, if you've got what we're looking for, you can look forward to a second income, specialized training, and rediscover what benefits and rewards an Air Force career can bring to your life.

Think it over. For one weekend a month and 15 active duty days a year, you could find yourself in the Air Force

Reserve with a great future to look forward to.

For more information, mail in the coupon below. Or, call 800-525-9984 toll free* for the address of your local Air Force Reserve unit.

Do it now. And let your future catch up to you. *In Colorado call 800-332-9952.

AIR FORCE RESERVE, BOX A RANDOLPH AFB, TX. 78148	3-PM-13
Please send me more information about joining the Air Force Reserve.	
I was formerly in the Air Force <input type="checkbox"/> Navy <input type="checkbox"/> Coast Guard <input type="checkbox"/> Marines <input type="checkbox"/> Army <input type="checkbox"/>	
My grade was _____	
My specialty was _____	
NAME _____ (please print)	
ADDRESS _____	
CITY _____ STATE _____ ZIP _____	
PHONE (area code) _____	
SOC. SEC. # _____ SEX _____ AGE _____	

The Air Force Reserve, your local Air Force.



Billy puffs 200 weeds a day

SOME 200 CIGARETS ARE SMOKED by "Puffing Billy" in the course of a working day. Billy is a machine in a government lab in London, and the cigarettes represent brands sold in stores in all parts of Britain. Cigaretts are fitted into rubber seals to simulate the pressure of human lips. Every 60 seconds the machine takes a two-second drag. The smoke is filtered and tested for tar and nicotine yields, the results to be published every six months. Puffing Billy's guardian is a reformed cigarette smoker who now puffs only on a pipe.



For a fast temperature reading

HOW MUCH MILK SHOULD YOU DRINK? It's all a question of heredity, says Stanford's Dr. Norman Kretchmer, a specialist in problems of human growth and development. If you come from northern European or white American stock, chances are that milk is okay for you. But if your ancestors came from parts of Asia or Africa, where cow juice is not a traditional food, milk may give you indigestion. The reason: Your body does not produce lactase, an enzyme that breaks down lactose, the milk sugar. The problem is greater with children between the ages of 2 and 4, according to Dr. Kretchmer. Their intolerance to milk sugar causes diarrhea and vomiting.

A NEW THERMOMETER FOR HOSPITAL USE is battery-powered and provides a digital display for temperature readings. The sensor that goes into the patient's mouth has a hygienic, disposable tip. Said to be more accurate than the standard type, the electronic thermometer is also fast, capable of producing a reading in about 10 seconds.

A HOLE NEARLY A MILE DEEP will be drilled into Antarctica's bedrock this winter to help trace the frozen continent's climatic and geologic history. Thirty scientists from Japan, New Zealand and the United States will work on the project, part of a three-year program that calls for the drilling of bore-holes at a minimum of 10 sites on Ross Island, along the Antarctic Coast and inland in the dry valleys. A diamond-bit rig will be used to extract a rock core with a diameter of 2½ inches. The project marks man's first deep geological probe in Antarctica.



Surfacing after a one-mile dive

THE NAVY'S NEW DSRV-2 (Deep Submergence Rescue Vehicle) has successfully completed a one-mile test dive. The vessel is capable of rescuing the crew of any submarine that becomes disabled as far down as 5000 feet. Operated by a crew of three, the DSRV-2 can take aboard as many as 24 persons on each dive. Like its

(Please turn to page 34)

LIVE IN THE WORLD OF TOMORROW...TODAY!

A BETTER LIFE STARTS HERE



FEATHERWEIGHT TREASURE FINDER

Best, easiest to use solid state metal detector at its price. U.S. made! Only 3 lbs. 6" search head detects penny at depth of 5", silver dollar at 8", bag of coins at 18". Easily works thru dirt, sand, wood, water (30" deep) and rock with no power loss. Detects your "find" sharply with "sound-off" loudspeaker. Comes ready to go. One tuner control; all transistor; adjust. stem; perfect balance. Includes 9v battery. **FREE TREASURE GUIDE** To 101 Treasure Sites.

Stock No. 80-175H \$39.95 Ppd.

"FISH" WITH A GIANT MAGNET

Go Treasure Hunting On The Bottom!

Fascinating fun, and sometimes very profitable! Tie a line to our 5-pound Magnet—drop it overboard in bay, river, lake or ocean. Troll it along the bottom. Your "treasured" haul can be outboard motors, anchors, other metal valuables. Five-pound Magnet is war surplus—Alnico V Type that cost the Government \$50. It lifts over 150 pounds on land—much greater weights under water!



Stock No. 70,571H \$14.00 Ppd.
 Stock No. 70,570H 3½ lbs. \$8.75 Ppd.
 Stock No. 85,152H 15¾ lbs. \$33.95 F.O.B.

GIANT WEATHER BALLOONS—8' OR 16' DIAMETER



"Balls of fun" for kids, traffic stoppers for stores, terrific for amateur meteorologists. Create a neighborhood sensation. Great backyard fun. An exciting beach attraction. Amateur meteorologists can use these balloons to measure cloud heights, wind speed and temperature. Made of heavy-duty neoprene. Inflate with vacuum cleaner or auto air hose; or locally available helium for high rise.

(8' Diam.)
 Stock No. 60,568H \$2.50 Ppd.
 (16' Diam.)
 Stock No. 60,632H \$7.00 Ppd.

(And our **FREE CATALOG** is packed with exciting and unusual ecological & physical science items—plus 4,000 finds for fun, study or profit . . . for every member of the family.)

130 EXPERIMENTS IN OPTICS ...



and photography! Optix® Experiments Kit is a complete optical & photography lab for 130 exciting experiments. Lets you recreate the periscope, telescope, microscope, kaleidoscope! . . . Build a 35mm reflex camera with interchangeable lens system! Make, develop photographic film! Enjoy the fun and fascination of having your own optics lab. Fully illustrated 112-pg. manual, 8½"x11", clearly explains usage of this stimulating kit's 114 precision engineered components.

Stock No. 71,646H \$21.00 Ppd.

Amazing New

WANKEL ENGINE KIT

General Motors recently paid \$50 million for rights to the Wankel. Ford just signed up! Now you can thrill to the fun of building your own see-through, 1/8 scale working motorized model. This revolutionary pistonless type engine replaces piston, cylinder and crank assemblies with rotating discs (sections removed to form firing chambers). Kit features flashing plugs, rubber fan belt, stick-shift, on-off switch, instructions. Requires two 1.5v batteries (not included).

Stock No. 71,424H (4½ x 5 x 9") \$6.75 Ppd.
 519-Page Wankel Engine Book
 Stock No. 9,439H \$15.25 Ppd.



TERRIFIC BUY!

AMERICAN MADE! OPAQUE PROJECTOR



Projects illustrations up to 3" x 3½" —enlarges them to 35" x 30" if screen is 6½ feet from projector. You get even larger pictures if screen is farther away. No film or negatives needed. Primarily intended for children, this unit projects charts, diagrams, in color or black & white. 115v A.C. . . . 6-foot cord and plug are included. Size is 12" x 8" x 4½" wide. Weighs just 1-lb. 2-ozs. Comes with a sturdy plastic case.

Stock No. 70,199H ... \$8.75 Ppd.



MAIL COUPON FOR GIANT FREE CATALOG!

164 PAGES • MORE THAN 4000 UNUSUAL BARGAINS!

Completely new Catalog. Packed with huge selection of telescopes, microscopes, binoculars, magnets, magnifiers, prisms, photo components, ecology and Unique Lighting items, parts, kits, accessories - - many hard-to-get surplus bargains. 100's of charts, illustrations. For hobbyists, experimenters, schools, industry.

EDMUND SCIENTIFIC CO.

300 Edscorp Building, Barrington, N. J. 08007

Please rush Free Giant Catalog "H"

Name _____

Address _____

City _____ State _____ Zip _____



ORDER TODAY! COMPLETE AND MAIL

EDMUND SCIENTIFIC COMPANY
 300 Edscorp Building, Barrington, N.J. 08007

How Many	Stock No.	Description	Price Each	Total

PLEASE SEND GIANT FREE CATALOG "H"

TOTAL \$ _____

I enclose check
 money order for \$ _____

NAME _____

ADDRESS _____

CITY _____ STATE _____ ZIP _____



MODEL MAKERS MACHINING CENTER

Versatile Maximat is *the* modelmakers machine, combining precision metal-turning lathe with vertical & horizontal mill, drill press, and grinder into one rugged and compact unit! Designed for labs and precision workshops, multi-purpose Maximat fills the machine tool needs of serious craftsmen and hobbyists throughout the world. Three models available: 7" x 18", 7" x 24", 10" x 26". Maximat is fun and easy to use. Anyone can machine like a "pro" with our fully illustrated Maximat instruction handbook, Precision Machining Techniques — only \$2. Use coupon for immediate information.

IS-5-MACHINES-IN-1



GIVE YOURSELF A REAL MAN'S HOBBY
You can make all kinds of working models: steam and gas engines, turbines, gun & rifle parts, model RR equipment, model car & boat parts, camera and clock works too.



edelstaal

American Edelstaal, Inc., Dept. BA-3
Tenafly, N.J. 07670

Please send me:

- Precision Machining Techn handbook \$2 encl
 Complete catalog information

Name _____

Address _____

City _____ St. _____ Zip _____

edelstaal

PRECISION MACHINING TECHNIQUES



If your car has rust spots use **NAVAL JELLY®**. Just brush it on. Wash rust off. No scraping or wire brushing.



DUPLO



For sale wherever fix-it products are sold.
Woodhill Chemical Sales Corp., Cleveland, Ohio 44128

World's Finest Fix-it Products

SCIENCE WORLDWIDE

(Continued from page 32)

twin, the DSRV-1, the new sub can also be used for oceanographic research.

The environment

HEAVY TRAFFIC at Vaals, a crossing point on the Holland-West Germany border, created such potent fumes that guards began to suffer from bouts of nausea. As an experiment, Dutch authorities made available a portable oxygen tank for the men at Vaals, permitting them to take a few beneficial



whiffs before the onset of illness. The oxygen therapy has proved to be so effective that the officials are now planning to supply oxygen tanks to all of their busy points along the border.

THE TOWN OF HUNTINGTON, N.Y., claims to be the first community in the country to install a sewer pipe made of recycled bottles. Huntington's unwanted bottles were shipped to nearby Brookhaven National Laboratory, where scientists crushed them and mixed them with liquid plastic. After it was poured into a form, the mix was cured, turning the plastic into a solid polymer. The glass-plastic pipe is said to be more than two times as strong as ordinary concrete and also to be more durable than the commonly used vitreous clay and asbestos-cement pipes. ★ ★ ★

If only you knew how to...

- start a stalled car
- refinish furniture
- build a room in your attic
- make a burglar alarm
- stop a leak in the basement
- soundproof a ceiling
- build a backyard barbecue
- repair broken appliances
- tile your bathroom
- do your own plumbing
- build your own sauna
- install your own switches
- letter your own signs
- build a patio or a porch

...you'd probably save a fortune!

TAKE THIS **FREE** VOLUME

with no obligation to buy . . . and let
**POPULAR MECHANICS DO-IT-YOURSELF
ENCYCLOPEDIA** show you how!

With this big FREE book you can make home repairs and improvements you never dreamed you could do so easily. You'll be guided step-by-step with illustrations that make each project crystal clear — even for beginners!

Start saving right away! Avoid high labor charges.

Learn how to cure 8 common car ailments with simple tools; decorate a child's room; burglar-proof your home; soundproof a room . . . save \$1,000 or more!

Vol. 1 of the Popular Mechanics Do-It-Yourself Encyclopedia, worth \$3.49, is yours **FREE**—to show you the fun and savings of "do-it-yourself."

Turn to this reference when your TV or toaster fails . . . build a Hi Fi center . . . plant a "lazy man's lawn" . . . or "antique" your favorite chair.

You'll learn basic techniques for building, painting, soldering, and power tools. You'll find detailed diagrams for cabinets, bunk beds, closets, kitchens, wiring and lighting. Expert advice on design and decor. Valuable tips on how to buy materials, select an appliance that will last, even what to look for when you buy a house. But that's not all!

Enjoy sports, hobbies, crafts, and save even more!

Your Popular Mechanics Do-It-Yourself Encyclopedia shows how to build midget cars, model planes, and how to soundtrack your own movies. You can even learn the ABC's of skiing, boating, fishing, and camping out.

Beautify your home for the holidays. Make your own gifts. Cane a chair. Bind a book. Keep the kids busy with special projects. It's all yours in the complete set . . . 16 volumes . . . 3,136 pages . . . over 10,000 illustrations . . . bound in handsome, washable, crimson bindings.

Mail this NO RISK coupon today!

We'll rush you Volume 1 absolutely FREE. You may then receive additional volumes for free examination and keep as many as you wish for only \$3.49 plus postage and handling. You may cancel the program at any time, or return any volume for full credit, and no more will be sent. In any case, Volume 1 is yours to keep.

Don't delay—fill out and return the coupon at the right to be sure of getting your FREE volume.

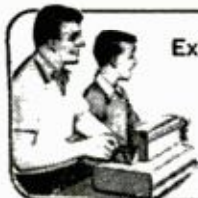

Exclusive Bonus With
Free Volume

PROJECT-A-PLAN

Included in your FREE volume. Lets you blow up small scale plans to full scale working plans right in your own living room or workshop.

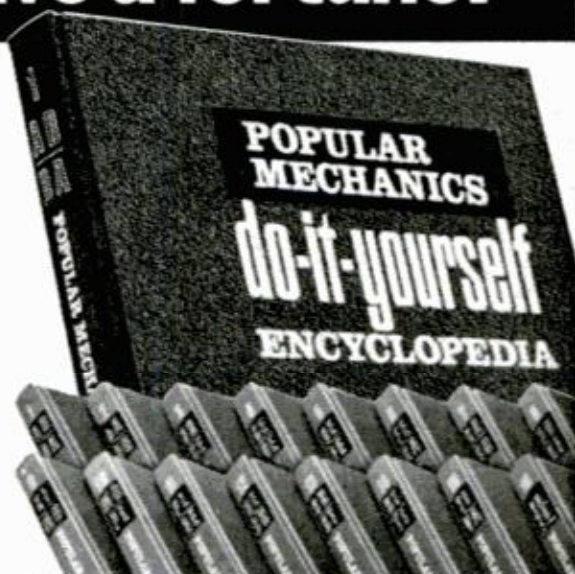

MAIL THIS COUPON NOW

Popular Mechanics Books
Box 2315, F.D.R. Station, N.Y., N.Y. 10022

This certificate entitles you to a free gift — Vol. 1 of the 16-vol. Popular Mechanics Do-It-Yourself Encyclopedia, with no obligation to buy anything ever.

As a subscriber in good standing, you'll enjoy free examination of the additional volumes as you receive them. In about 6 weeks we'll send you Vol. 2, and 4 weeks later Vol. 3. After that, at approximately monthly intervals, we'll send you shipments of Vols. 4-6, 7-9, and 10-16. Also, you'll receive annual supplementary volumes as they are published on free 14-day approval with no purchase obligation. This way you'll be able to complete the set in 6 months, and keep it up-to-date. You may cancel at any time or return any volume within 14 days for full credit and no more will be sent. Take as many volumes as you like — or none at all. For each volume you keep, you'll be billed just \$3.49 plus postage and handling. But you need never pay for more than 1 volume per month no matter how many you have received. There is no charge for this extended payment service.

F011

Name _____

(Please Print)

Address _____

City _____

State _____ Zip _____

Signature _____

HM Books

DETROIT

LISTENING POST

BY ROBERT LUND

PREDICTION 1: It's a fair bet, but short of a sure thing, all four American automakers will offer Wankel-engine cars by the fall of 1976, for the '77 model year.

Two companies, GM and American Motors, are already in the sure-thing column. The two holdouts, Ford and Chrysler, are gradually shifting from wouldn't-touch-it-with-a-10-foot-pole position on the rotary engine to a we'll-look-at-it attitude.

GM's all-out enthusiasm for the engine hasn't quite made believers out of anti-Wankel engineers at Ford and Chrysler, but now you can begin to see the ice melting; the skepticism is wearing off.

American Motors hopes to buy Wankels from GM, possibly in time to put the engine in a '76 model. Ford and Chrysler are getting too late a start to build their own rotaries, so the options they have are to buy engines overseas or to work a deal with a foreign company to put Ford/Chrysler nameplates on Wankel-powered cars for sale in the United States.

Ford and Chrysler still have strong reservations about the engine. At best, they see it as an interim power source between the conventional piston engine and a yet-to-surface something better. Maybe the turbine. But they don't buy the pitch that the Wankel will replace the piston.

You always leave yourself an out in making predictions like this, because the game plan is subject to change as conditions change. The out on this one is that if GM runs into serious problems with the Wankel, either preproduction or within the first year that the car is on the market, all bets are off. Meaning that the other car builders will back out on the Wankel faster than you can say, "None for me, thanks."

PREDICTION 2: Detroit's going to build a lot of things other than cars over the next decade. Motorcycles, snowmobiles, moving sidewalks, robot lawn mowers, farm machinery, construction equipment, new types of travel homes, monorail cars—everything except aircraft. The automakers aren't ready to confirm any of this, but it's quite obvious that this is the direction in which they're headed.

The car companies will have to turn to new

products to survive. That's the advice of their own economists and forecasters.

The seers see several factors working to limit the sale of cars. One, restrictions on use of automobiles in congested areas. Two, more durable cars, longer car life, a trend among motorists to trade less often. Three, a leveling-off of the birth rate to match the death rate, so there will not be a constant increase in the number of customers for cars.

Add 'em up, the forecasters say, and it's obvious car sales are going to slacken off. Not immediately, not sharply overnight, but tapering over a period of years as the negative forces come into play.

The private passenger car, in one shape or other, will continue to be Detroit's No. 1 product. But it's not going to dominate the way it has for the past 70 years. The automobile will have to move over to make room for a raft of new relatives.

The Automobile Manufacturers' Assn. (AMA) has even changed its name to the Motor Vehicle Manufacturers Assn. (MVMA) . . .

PREDICTION 3: Automakers are beginning to do some serious thinking about ultramini cars. But there'll be a long wait before you'll be able to buy one.

The serious thinking consists of studying the plans various cities have for building mass transit systems. The auto companies are trying to get a feel of when the time would be right to put one-seat, two-person cars in production. That's contingent on when the mass transit systems are completed, how many people will ride the systems, where they live, where they work, provisions for parking at the beginning and end of the transit line and a lot of other factors.

There's not much solid information available up to now. It's mostly speculative, your-guess-is-as-good-as-mine stuff. So it's tough for the auto companies to target on a time to bring out mini cars.

I've got a namesake (but no relation) at GM, Robert Lund, head sales hustler for Chevrolet. Chevrolet Bob is the first GM executive to talk publicly about the possibility of Detroit building true minis.

"To the extent that mass transportation be-

(Please turn to page 38)

Latest U.S. Government figures show

PALL MALL GOLD 100's

lower in 'tar'
than the
best-selling
filter king!



PALL MALL GOLD 100's... "tar" 20 mg.—nicotine, 1.4 mg.
Best-selling filter king..... "tar" 21 mg.—nicotine, 1.4 mg.
Of all brands, lowest..... "tar" 1 mg.—nicotine, 0.2 mg.

They're longer than king... yes, longer yet milder!

Warning: The Surgeon General Has Determined
That Cigarette Smoking Is Dangerous to Your Health.

20 mg. "tar" 1.4 mg. nicotine av. per
cigarette, FTC Report AUGUST '72.

DETROIT LISTENING POST

(Continued from page 36)

comes prevalent," Lund says, "we see increasing demand for little commuter-type, two-passenger cars, perhaps getting in the area of 50 to 60 mpg. They'll be used to transport people at either end of the mass transit line."

STYLING RACE WARMING UP. While there's more and more sameness in cars in concealed areas, as the auto companies conform to Federal standards, Detroit's making a real effort to get away from look-alike and develop more distinctive treatments for car exteriors. Designers are under heavy pressure to innovate and come up with styling kinks that will give cars more outward individuality.

This is true at all companies, but the pressure is greater on styling departments in reverse order to the size of the companies. This means the designers at American Motors have to work harder than their counterparts at Chrysler Corp., while the Chrysler crew has to attempt to top Ford, and the Ford troops must aim at one-upping General Motors. Ironically, there's probably more competition among automotive styling departments now than there was before government regulations.

FOUR-WHEELERS COMING. A three-way race is on between GM, Ford and American Motors to determine which one can be the first to turn out a sporty compact equipped with four-wheel drive.

GM and American Motors are running neck and neck, while Ford is coming on fast via a four-wheel system that's been developed by a supplier.

The experimental versions are said to have the handling characteristics and maneuverability of a dune buggy.

FEWER PLAIN JANES. You may get a lot more automobile for a little more money on the '74 cars. All companies, all divisions are reviewing sales of minor options—things like deluxe trim inside and out, wheel covers, lights in the trunk, glove box and engine compartment, all extra charge items—and estimating what it would cost to make the items standard.

There are two advantages to car manufacturers in changing an item from optional status to that of standard equipment: (1) the production process is simplified, and (2) the dealers don't have to wrestle with such a lengthy list of add-ons.

★★★

FINE WOOD KITS BEST GERMAN DIALS AND MOVEMENTS



\$17.15 ppd.
11½" high



\$19.50 ppd.
15" high

\$130-78" high
GRANDMOTHER
CLOCK
(Pre-cut wood parts)
Fruitwood (freight coll)

MINI SCHOOL
CLOCK (Pre-cut
wood parts)
Cherry, Maple,
Mahogany
(W/works & dial)
\$31.25 ppd

STEEPLE CLOCK
(Pre-cut wood parts)
Cherry, Maple, Mahog.

Send 50¢ for 68-page
catalog of full-size pat-
terns, dials, moulding,
hardware, barometers,
music box movements.

CRAFT PRODUCTS

Dept. 1
Elmhurst, Illinois 60126



FREE!

Trial lesson in DRAFTING & DESIGN

Prepare at Home In Spare Time

Check the want-ads in any city newspaper — SEE the opportunities open to you as a draftsman. Cars, bridges, buildings, machines—they all start at the tip of the draftsman's pencil. You need only a few spare time hours each week to learn drafting, and Chicago Tech has trained thousands since 1904. The cost? About \$3.00 a week. Everything is furnished. No extras.

FREE INFORMATION — BY MAIL

Can YOU learn drafting at home? Send for our FREE TRIAL LESSON and find out! No charge or obligation. No salesman will call. You make the decision. Approved for veteran's training.

CHICAGO TECHNICAL COLLEGE

Home Study Div., A208 Tech Building
2000 So. Michigan, Chicago, Ill. 60616

Mail me a FREE Trial Lesson and information in
 DRAFTING BUILDING CONSTRUCTION

Name _____ Age _____

Address _____

City _____ State _____ Zip _____

Veterans Check Here For Important Information

BUILDING CONSTRUCTION

Free Blueprints and Plan Reading Lesson

Learn blueprint reading, estimating, supervision at home in your spare time. Move up to foreman, superintendent, or contractor. Mail coupon above for free blue prints and lesson, or write CTC, Home Study Division.

2000 So. Michigan Ave., Chicago, Ill.

For Sparetime or Full Time
Income, There's Good

MONEY IN SHARPENING

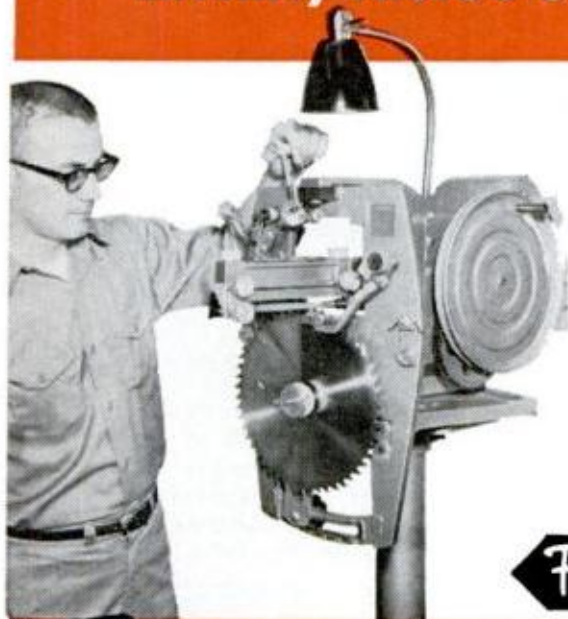

Here's a proven practical way to earn extra dollars in spare time—to develop a money-making repair business of your own. Investment is small. There's no overhead, no stock of goods to carry. No experience needed, no canvassing. You do it with the famous Foley Saw Filer that automatically sharpens all kinds of saws—and the Modern Lawn Mower Sharpener that precision sharpens all types of mowers.

EARN \$3 TO \$6 AN HOUR SPARETIME

Hundreds of people like yourself are making cash like this—\$20 to \$30 a week—right now in spare time. "My spare time saw filing business has made me \$952 these first ten months"—says R. T. Chapman. Many have built a complete sharpening service with such year-around profits. You can too, simply by following the sure, easy Foley Plan.



Foley

**MANUFACTURING CO.
MINNEAPOLIS, MINN.**



MONEY MAKING FACTS BOOKLET FREE!!!

This valuable book shows you how to start, how to get business from home owners, factories, carpenters, etc., and how to make profits fast. Mail coupon today. No salesman will call.

FOLEY MFG. CO. 116-3 Foley Bldg., Minneapolis, Minn. 55418

Saw Filer
information.

Lawn Mower
Sharpener information.

Money Making
Facts booklet.

NAME _____

ADDRESS _____

CITY _____

STATE _____

Get more
for your \$\$



with ATLAS 12" lathes

Quick change gear box with 54 threads and feeds. 16 spindle speeds — V-belt drive. Power cross feed — power longitudinal feed. Timken tapered roller bearings. 12 1/4" swing — big capacity. And more — from only \$675 f.o.b. factory.

Write for free catalog.
ATLAS PRESS CO.

12-24 N. Pitcher St. • Kalamazoo, Mich. 49001

537

MAXI-VAC® HEAVY DUTY VACUUM

FACTORY IRREGULARS
FULLY GUARANTEED
MECHANICALLY PERFECT



only
\$19.95
+ SHIPPING

Household Attachments Available

1 H.P. Motor
Big 2 1/2" dia. Hose • 5-Gal. Container

Slight imperfections that have no effect on the powerful Maxi-Vac efficiency enable us to make this startling money saving offer. You will appreciate this man-size vac for the big clean-up jobs—shop, patio, porch, fireplace, gutters, car, garage, boat, store, plus rugs and floors. Powerful suction or blowing action. Wood chips, sawdust, leaves, even small stones end up in super-strong polyethylene container—no bag to empty. Includes 8' 3-wire cord, 6' hose, 6" utility nozzle, two extension wands, and extra paper filters.

MONEY BACK GUARANTEE: If not completely satisfied with your Maxi-Vac after using it for 14 days, return it to us for refund of full purchase price. In addition, we guarantee your Maxi-Vac for one year against defects. UL/ Listed.



MAXI-VAC MANUFACTURING CO.
Dept. 21, P.O. Box 482, Palatine, Ill. 60067

Enclosed find check (or M.O.) for \$19.95 plus \$2.00 for shipping and handling (total \$21.95). (Illinois residents please add \$1.00 sales tax.)

Name _____

Address _____

City/State _____

Zip _____

THE
**BICYCLE
 SHOP**
 By EUGENE A. SLOANE

How to repair tubular tires



YOU'LL NEED (top row): waxed linen thread, thimble, rim cement, compound to fill tire cuts on outside, rubber cement to patch tube, talcum powder to put on finished patch so tube won't stick to tire, 3 or 4-sided needle. Bottom row: sandpaper, marker to locate puncture on tire, canvas patch for tire, rubber patch for tube, tweezers



1. INFLATE tire, insert in water. Bubbles will be concentrated around leak. Mark the location of leak with a yellow crayon



2. REMOVE outer canvas by prying up first inch or so with flat blade, then pull up about 3 inches on either side of puncture

TUBULAR TIRES, the kind that come on the more expensive bicycles (over \$250), make a bike easier to ride than "clinchers." But they're more prone to puncture and harder to fix.

Sometimes the tubulars are called "sew-ups" and sometimes less kindly names when these thin, ultralightweight tires exhibit their built-in tendency to puncture.

Tubular tires are different from the tires we knew as kids, or from the clinchers used today on three-speed bikes and on the less expensive 10-speeds. Clinchers are open on the inside so you can pull out the tube for repairs; tubulars are sewn up all the way around in the inside rim, so you must remove stitches for repair.

Tubulars are lighter than clinchers, more responsive and make riding easier, but they're thinner and almost any sharp object on the road will cause a flat.

Finally, clinchers are held onto the rim by a wired edge on the tire which clamps into a bend in the rim when the tire is inflated. Tubulars are held on the rim by rim cement, applied to both the inside of the tire and the rim.

Tubulars are far easier to remove than clinchers. A new one can be rolled onto the rim in a minute. They're so light and compact a spare can be rolled up and carried under the seat.

It's important to know how to fix tubulars because they're expensive (\$8 to \$16 or more). You can carry only three or four spares on a trip, so if you get more than a few flats, you could be without a tire unless you can fix them yourself.

Although tubular tire repair is simple, I've
(Please turn to page 42)



CARPET DETERGER



UPHOLSTERY DETERGER



WALL DETERGER

3 proven ways to your own money-making business

You offer a service everybody needs . . . work full time or part time . . . own your equipment . . . keep all you earn . . . start with just a small investment . . . and we help you every step of the way!

Have your own money-making business and make the kind of income you probably thought impossible. You can when you clean carpeting or upholstery or walls with Von Schrader professional cleaning equipment. Every home, every building, are potential customers. And every customer represents repeat business.

Moreover, we help you every step of the way . . . just as we have helped thousands of other Von Schrader Associates build money-making businesses for almost 40 years.

There are three easy-to-operate Von Schrader Detergers. Each offers a proven way to a growing income. (1) *Von Schrader Carpet Deterger* gives deep-level cleaning to carpeting. (2) *Von Schrader Upholstery Deterger* cleans fabrics and synthetics beautifully (3) *Von Schrader Wall Deterger* cleans walls (and ceilings) five times faster than by hand.

You can start with just one Deterger. Then, as your business keeps growing, you may want to add the other two and thus offer a complete cleaning service.

There are no fees, royalties, or contracts. You own your equipment, the finest of its kind. And your investment is so small you may find it hard to believe. For complete information—without any obligation—send for the free booklet described below.

“Let me send you our free booklet that gives all the facts”

—Francis von Schrader, President

Read about the big demand for on-location cleaning, see why Von Schrader Detergers are the finest of their kind, how easy they are to operate. Learn how other men have become financially independent, how Von Schrader helps you every step of the way. Fill in the coupon and send for free booklet.

Extra! Special Recorded Message included with booklet. Listen as Francis von Schrader talks to you personally about your growing future with Von Schrader Detergers.



VON SCHRADER company

1013 Place, Racine, Wisconsin 53403

Please send complete information on Von Schrader Detergers.

Name _____

Address _____

City _____

State _____ Zip _____



THE BICYCLE SHOP

(Continued from page 40)

found few cyclists willing or able to undertake repairs and, worse, almost no bike shops willing to fix them (at \$3.50 each).

So here are instructions that should make it easier for you to repair them. While you're fixing a puncture, check the tire casing and fill any cuts on the outside with the black rubber compound that comes with the patch kit. ★★★

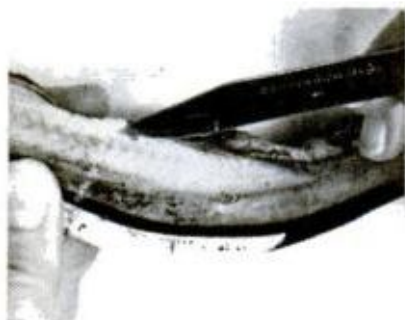

3. CUT away stitching with sharp knife (don't cut tube below) for 2 inches, both sides of puncture



4. PULL UP old stitching with ice pick (or sharpened spoke) so you can get at it with tweezers



5. USE the tweezers to remove all the old thread that you've pulled up in the preceding step



6. PULL away inner protective liner, pull out tube to find puncture. (Check both sides of tube)



7. SANDPAPER the tube lightly for about half an inch around the puncture to prepare it for cement



8. APPLY drop or two of rubber cement on sanded area, spread and wait till solution is tacky



9. PEEL off tube patch backing, apply firmly over puncture. (This tube had puncture on both sides)



10. CHECK tire for damage. This one was "wounded" by sharp rock author hit on recent Vermont trip



11. SAND tire casing damage, apply rubber cement, wait till it's tacky and apply canvas patch



12. PUT talcum powder over the patches on both tube and tire so they won't stick together



13. USING double thread, overhand stitching, run linen thread through original holes. Knot ends



14. DAB rubber cement over the protective casing and carefully lay it in its original position



What if I'm laid off?
 Will automation take my job?
 Am I too old to change jobs?
 Can I learn a new skill?
 Will my job ever pay more?

BE A SKILLED LOCKSMITH!

... and Solve ALL Your "FUTURE" Problems

No question about it... with Locksmithing skill YOU'LL HAVE IT MADE! You'll do light, clean, always-fascinating work in this fascinating security profession that urgently needs YOU — where your choice of steady, high-pay job opportunities, or a big-profit spare-time or full-time business of your own is virtually unlimited. As a Locksmith you have your own "built in" pension plan. You go on enjoying the work as long as you like, knowing that layoffs, automation, slack times, minor disabilities, forced retirement can't affect your ability to EARN MORE and LIVE BETTER in good times and bad.

Locksmithing is SO EASY TO LEARN — Enables You to EARN Extra Money RIGHT FROM THE START! The better, more secure future you want can be yours FAST as a Locksmith, regardless of age, education, previous experience, minor physical handicaps. Fun and earnings begin AT ONCE as you learn quickly, easily to CASH IN on all kinds of locksmithing jobs. As little as one hour a week at home working on all kinds of lock and key problems under the guidance of experts brings quick mastery—a quick lifetime solution to ALL your "future"

problems. All locks, keys, parts, picks, special tools and equipment as well as complete fully-illustrated lessons supplied with course.

FREE Illustrated Book, FREE Sample Lesson Pages Give Exciting Facts. Find out how being a skilled Locksmith can put a quick end to your worries. Locksmithing Institute graduates now earning more, enjoying life everywhere. You can, too. Send coupon TODAY for illustrated book and sample lesson pages without cost or obligation. No salesman will call.

LOCKSMITHING INSTITUTE

Division of Technical Home Study Schools
 Little Falls, N. J. 07424

Licensed by N.J. State Dept. of Education; Accredited Member,
 National Home Study Council. State Approved Diploma,
 Approved for Veterans.

LOCKSMITHING INSTITUTE, Dept. 1110-013
 Div. Technical Home Study Schools
 Little Falls, New Jersey 07424

Please send FREE illustrated book — "Your Big Opportunity in Locksmithing," complete equipment folder and sample lesson pages, FREE of all obligation, (no salesman will call).

Name _____
 (Please Print)

Address _____

City _____ State _____ Zip _____

Check here if eligible for veteran benefits

YOU LEARN ALL ABOUT

- KEY MAKING
- MASTER KEY SYSTEMS
- LOCK REPAIR
- PICKING LOCKS
- TUMBLER CHANGE
- COMBINATIONS
- CAR LOCKS
- SAFES
- VAULTS
- SECURITY SYSTEMS



Everything necessary:
 KEY MACHINE
 locks, picks,
 tools—supplied
 with course.
 State Approved Diploma



Complete guide to GARDENING

ALL THE FACTS YOU NEED TO GROW THE MOST BEAUTIFUL LAWN AND GARDEN IN TOWN!

only \$3.95

POSTPAID

This guide is crammed with basic easy-to-follow information! Planting dates and depths for seeds and bulbs; the 56 most popular shrubs and 21 best hedges; all about evergreens and ground covers; the 52 best trees for your yard; how and when to transplant or prune almost anything; lawn planting and renovation; how to lay a patio; even the court dimensions for many lawn games!

All this basic gardening know-how at your finger-tips, printed on heavy card stock, plastic-coated so it's washable, then spiralbound. What a gift for a gardener! Order a copy today!

POPULAR MECHANICS, Dept. GG
 Box 1014, Radio City, New York 10019

I am enclosing my check (or M.O.) in the amount of \$3.95. Please send me a copy of Complete Gardening Guide, postpaid.

Name _____
 Address _____
 City/State _____ Zip _____

FREE BOOK

Certified Mail Order millionaire shows beginners how to make a fortune in Mail Order. No obligation. Mail to: G.M. Turk, 120 Chestnut Ridge, Dept. 311, Montvale, N.J. 07645

Name _____
 Address _____
 City _____ State _____ Zip _____

inventors

MANUFACTURERS NEED NEW PRODUCTS

PATENTED & UNPATENTED IDEAS
 NEW PRODUCTS • INNOVATIONS

Developed and prepared for commercial appeal, sales, manufacturing and marketing.

Inquiries and consultation by Inventors, Manufacturers, Lawyers and Patent Attorneys invited.

For complimentary "Invention Record" and "Important Marketing Information" write:



Raymond Lee Organization, Inc.
 230-Z Park Avenue • New York, N.Y. 10017

Print Name _____
 Address _____
 City _____ State _____ Zip _____

Member United States Council International Chamber of Commerce

NEW YORK BOSTON CHICAGO GENEVA MONTREAL TORONTO VANCOUVER
 SAN FRANCISCO LOS ANGELES DENVER DALLAS KANSAS CITY ATLANTA

APPLIANCE CLINIC

By PAUL MANN

Drum roll

We own a Skuttle Drumatic power humidifier. The drum doesn't turn. Can you tell me why?—Peter Zink, Morris Plains, N.J.

There are several reasons. Make sure that the drum is engaged in the motor drive coupling and see to it that mineral deposits aren't stopping rotation.

Is electricity getting to the unit? If so, check for a bad wire connection, motor or transformer.

Also check that the trouble isn't being caused by having the humidistat, if there is one, set too low.

Dryer burns wires

I have a Westinghouse clothes dryer that has a habit of burning off its wires at the connector block. This occurs about once every three months, and I'd like to know what I can do about it.—James Whitehead, Birmingham, Ala.

This problem is familiar to servicemen and is caused by the relative closeness of the heater coil to the ceramic terminal block. Heat generated by the coil causes wires connected to the terminal block to start burning. The solution is to allow more space between the terminal block and heating coil.

Remove the coil (some dryers have two; if so, both should receive the same treatment) and stretch out some of the wire from the coil. Reconnect the coil. This extra bit of wire will give you the "cool" space that's needed to keep wires at the terminal block from burning.

Tracking down a switch

My Vornado window airconditioner is over 15 years old, but still in good running condition. However, it needs a new control switch and the manufacturer, A.O. Sutton of Wichita, Kans., has been out of business 10 years. How can I get a replacement switch?—H. J. Eisenberger, Kansas City, Mo.

Vornado is now the trade name of ap-

pliances, including airconditioners, sold by Two Guys From Harrison, a discount-store chain operating in the East. Although Sutton is out of business, you can get parts for its Vornado airconditioner. All Sutton did was assemble the units. The switches are (and were) manufactured primarily by General Electric and Ranco Controls.

Remove the switch from your airconditioner and copy all of the information from the switch housing. Take the information to a General Electric dealer and see if it is a GE switch, which he can supply. If not, mail the information to Ranco Controls, Ranco, Inc., 601 West Fifth St., Columbus, Ohio, and ask for the switch.

Squeaky brakes

I have a Maytag automatic clothes washer which a few months ago developed a loud screech when braking after the spin cycle. It took a serviceman five minutes to correct the noise, for which he was paid \$10. The noise is back as loud as ever. Why?—Gene Richardson, Pennsauken, N.J.

Probably because he did a slapdash lubrication. The noise sounds as if it's being caused by the brake itself—much like the brakes of a car screech when they get wet. The cure is to apply lubricant, but this must be done correctly or the problem will return.

Turn the machine on its side and remove the lower pulley. Apply a teaspoonful of 90-weight, gear-case lubricant on the brake housing and move the pulley up and down so the lubricant works its way into the housing. A Maytag dealer with a service shop can provide the proper lubricant.

Reattach the lower pulley and adjust the drive lug firmly. The lug must not be overtightened or the machine will spin when it is supposed to agitate.

Putting on the pressure

We have owned a Ward's Signature 700 water heater for about four years and have had a continuous problem with the pressure-relief valve. The valve will frequently open with a loud bang, and water will flow out the overflow. A serviceman has not solved our problem. What is your diagnosis?—Charles Arado, Glenview, Ill.

Assuming there is nothing wrong with the heater that would result in a sudden

(Please turn to page 47)

LEARN THE PROFESSIONAL METHOD OF APPLIANCE REPAIR

*For extra income, a job skill
in demand, a business of your
own—or to save money on
your own appliance repairs.*

SEND FOR FREE CATALOG

Appliance Division, National Radio Institute 600-013
Washington, D.C. 20016

Send me your illustrated free book that tells about opportunities
in Servicing Electrical Appliances, and gives details of NRI's
simplified training plan. I understand there is no obligation, no
salesman will call.

Name _____ Age _____

Address _____

City _____ State _____ Zip _____
Code _____

Check here for facts on New GI Bill.

Accredited Member National Home Study Council

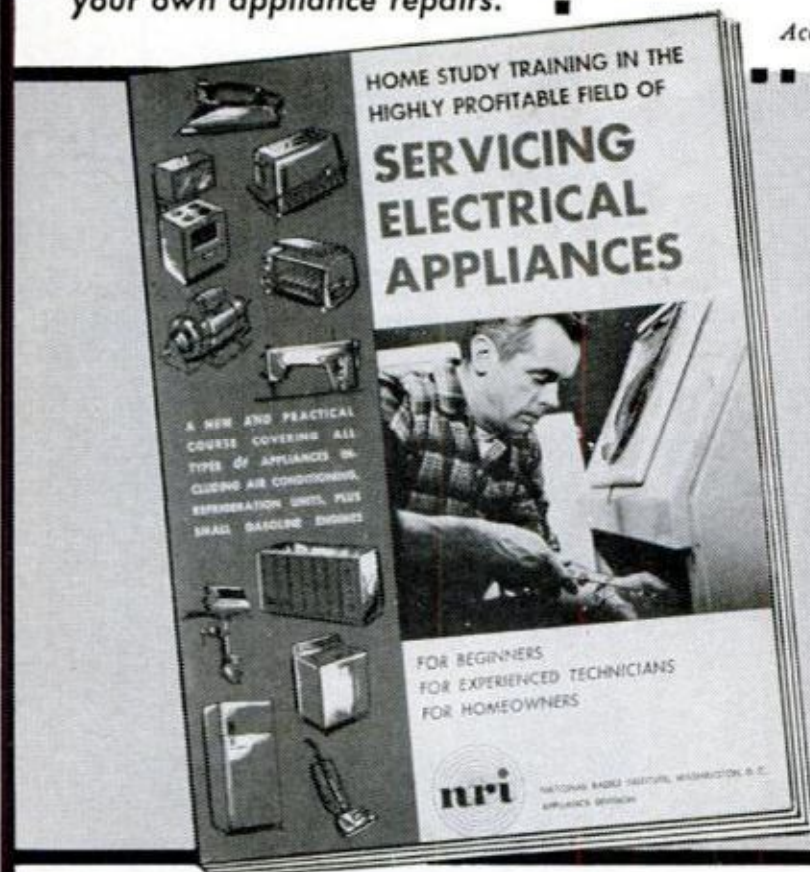

MAIL COUPON ABOVE
FOR THIS
FREE
NRI
CATALOG

AVAILABLE UNDER NEW GI BILL
If you served since January 31, 1955,
or are in service now, check GI line
in coupon above.

A new, short, easy course trains you at home

Now you can prepare quickly to do professional
appliance servicing at home in your spare time.

You are ready to start servicing appliances after
only a few lessons. The entire course can be finished
in a matter of months.

This is the fastest way to a new job or skill or
extra income or a business of your own. Wherever you
live or want to live, you'll find a demand for top-notch
appliance servicemen.

There are probably thousands of broken appli-
cances right in your neighborhood. These can mean
cash profits for you starting soon. Use your spare time

to make \$5 to \$7 an hour fixing appliances for friends
and neighbors.

Low-cost training plans cover —

- Small and large home appliances
- Farm and commercial equipment
- Portable electric tools
- Small gasoline engines

— there is even special training to prepare you
for air conditioning and refrigeration.

Special NRI appliance testing equipment is in-
cluded in your course at no extra cost. Mail coupon
for your FREE NRI Catalog. No salesman will call.



NATIONAL RADIO INSTITUTE • APPLIANCE DIVISION
Washington, D. C. 20016

THESE RADIO SHACK ARCHERKITS ARE "SWELL" ON WHEELS!

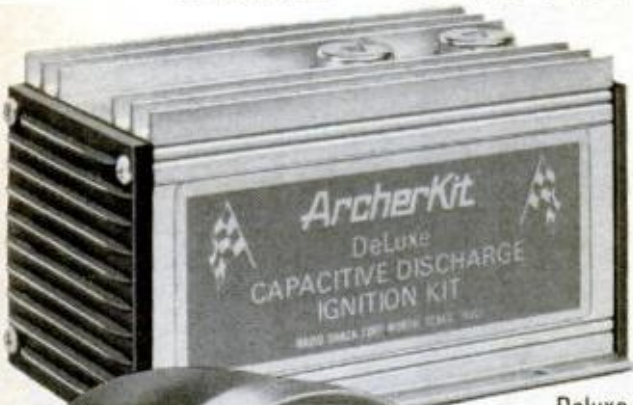

Deluxe Capacitive Discharge Ignition System Kit **39⁹⁵**

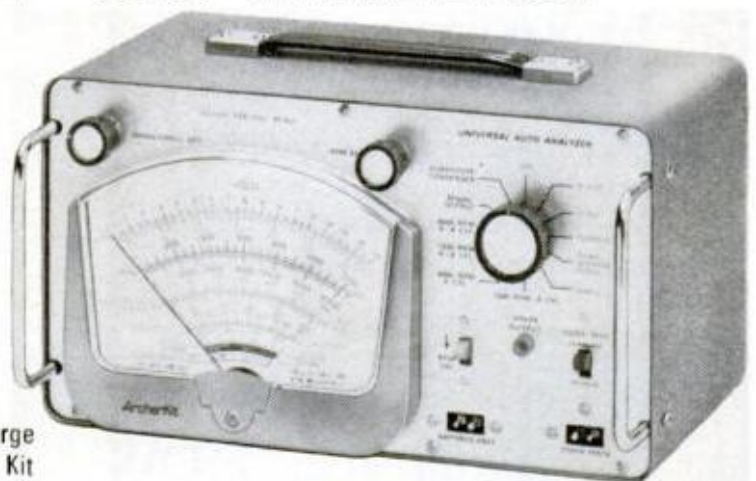

Portable Auto Analyzer Kit **54⁹⁵**

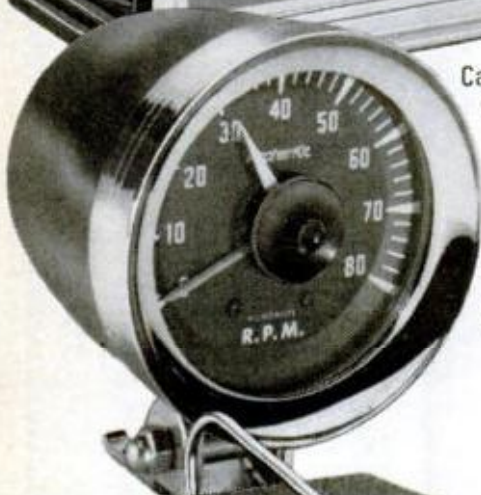

Auto/Marine Tachometer Kit **19⁹⁵**

Automatic Windshield Wiper Delay Control Kit **12⁹⁵**



Driver Alert Radar Sentry Kit **24⁹⁵**



SCR Electronic Ignition System Kit **12⁹⁵**

Capacitive discharge ignition system puts more power in your car, cuts maintenance and boosts gas mileage!

Auto analyzer measures rpm, volts, amps, ohms, dwell angle, plus spark output and leakage.

Tachometer is designed for all 12-volt systems, reads 0-8000 rpm with $\pm 2\%$ accuracy. 240° deflection angle.

Wiper delay control is an essential aid for driving safety. Ends "dry wiper" action in light rain or mist!

Driver alert sentry gives an audible warning of radar within a 1/2-mile range. Promotes safer driving. Clips on visor.

SCR ignition system electronically fires spark, extends dwell angle for improved power.



FREE '73 CATALOG! AT YOUR 121 NEARBY STORE OR SEND IN THIS COUPON

180 pages! Stereo Hi-Fi, CB, Ham, Kits, Radios, Recorders, Tools, More!

Name _____ Apt. # _____

Street _____

City _____ State _____ Zip _____

Radio Shack®

and ALLIED RADIO STORES

A TANDY CORPORATION COMPANY

P. O. Box 1052, Fort Worth, Texas 76107

APPLIANCE CLINIC

(Continued from page 44)

rise in pressure, high water pressure may be your problem if the relief valve is set too low for it. For example, if you have a 125-p.s.i. valve, it will let loose if pressure exceeds 125 p.s.i.

Some relief valves can be adjusted, but most are preset. In this case, I would think your ideal solution would be to install a pressure-reducing valve in your home water system. These valves reduce water pressure by as much as 45 pounds.

Gas-operated refrigerators

Are there any manufacturers who make refrigerators that operate on gas?—M. K. Bilderback, DuQuoin, Ill.

Try Norcold, Inc., 1501 Michigan St., Sidney, Ohio 45365; Instamatic Corp., 2321 Middleberry St., Elkhart, Ind. 46514; and Hadco Engineering, a division of Automatic Sprinkler Corp. of America, 2000 Camfield Ave., Los Angeles, Calif. 90040.

Ironing out a problem

We have a Westinghouse Fabricscope

iron 2½ years old. The sprinkler doesn't work. I tried putting a pin in the hole to clear out any foreign particles, but this hasn't helped. Does my use of tap water in the unit have anything to do with it? Can this be repaired?—Mrs. Gloria James, Houston.

Tap water won't hurt this spray. Westinghouse says you can use it. The spray is controlled by a pump bellows under the knob you depress to operate the mechanism. The pump may be damaged; if so, get a replacement from a Westinghouse appliance dealer. Snap off the dial plate, lift the old pump out and install the new one. Other reasons for spray-mechanism trouble include failure to fill the tank to the top, foreign deposits on the check ball and pump body seat, clogged pump-inlet tube, and improper positioning of the top of the pump (it must be seated in the recess on the underside of the spray knob). ★ ★ ★

If you have a question about any appliance, send it to *Appliance Clinic, Popular Mechanics, 224 West 57th St., New York, N.Y. 10019*. Sorry, but letters cannot be answered individually. However, problems of widest interest will be answered in this column.

MY WIFE AND I FOUND A GOLD MINE IN OLD DISCARDED FURNITURE



WE PICKED UP THIS OLD CHAIR AT A LOCAL THRIFT STORE! FIXED IT UP LIKE NEW!

BOUGHT IT FOR **\$5.00** SOLD IT FOR **\$150.00**

BETTER THAN \$10.00 PER HR. FOR OUR TIME!

IMAGINE!

A "gold mine" right in our own back yard! We never thought about it until M.U.I. showed us how to take old, beat up furniture, picked up in Salvation Army stores and thrift stores (they practically give it away!) and fix it up, re-upholster it, and sell it for fantastic profits. Up to \$10 an hour for our time PLUS 100% profit on the fabric too!

UPHOLSTERY IS BOOMING WITH A BOOMING AMERICA! JOIN THE "MUI" GROUP AND PROSPER!

Never in all American history has there been a boom to equal the current one. New homes, hotels, motels, restaurants, lounges, all need UPHOLSTERED FURNITURE! And within a few years it will all need reupholstering! America is restless, on the move with campers, trailers, boats, all needing upholstery and re-upholstering year after year! Autos — 26 million of them — in constant need of re-upholstered seats, headliners, door panels!

BUSINESS OF YOUR OWN? TOP-PAY JOB OPPORTUNITIES! MUI STEP-BY-STEP UPHOLSTERY TRAINING, QUALIFIED, YOU FOR BOTH!



HUSBAND-WIFE TEAMS IDEAL!

Start your own home upholstery business on a "shoe-string." Many begin in their garage, doing small jobs for friends and neighbors. Soon the word gets around and you may have more work than you can handle in a few short months. Often, the husband stays on his job temporarily, while the wife learns the easy MUI way! If you don't want your own business, TOP WAGES ARE OFFERED UPHOLSTERS BY INDUSTRY, with hundreds of automation-proof jobs going unfilled! Computers will never learn upholstery — but YOU can, easily, the MUI way!

BUILD A ROOMFUL OF FURNITURE WITH MUI'S 6 BIG KITS. KEEP IT — SELL IT! PROFIT BY IT!



APPROVED FOR VETERANS

MODERN UPHOLSTERY INSTITUTE
Box 899-GOK Orange, Calif. 92669

Please send FREE Upholstery Career Book, & Sample Lesson. I am under no obligation. I am just sending for the free facts on job and career opportunities in Upholstery, and details of the MUI home training program.

Name _____ Age _____
Address _____
City _____
State _____ Zip _____

AIRMAIL COUPON TODAY!

UPHOLSTERY NEEDS YOU! YOU NEED UPHOLSTERY!

AT LEAST SEND FOR THE FREE FACTS YOU CAN'T LOSE — YOU MUST GAIN!

A simple act — just clipping and mailing the coupon in this ad — brings you all the free information about UPHOLSTERY, the fascinating, automation-proof industry that offers ambitious men and women lifetime career insurance — better, far better than any form of Social Security! With MUI training you may earn as much — or more — than many college graduates! MUI is authorized by the California Superintendent of Public Instruction to issue a DIPLOMA in upholstery.



SEND FOR UPHOLSTERY CAREER BOOK & SAMPLE LESSON NOW!

FREE TOOLS TOO!



By Public in Upholstery



MODERN UPHOLSTERY INSTITUTE Box 899-GOK Orange, Calif. 92669

ALL By BILL McKEOWN OUTDOORS

NATIONAL HUNTING & FISHING DAY, 1973 seems assured of success, based on reports already in for 1972. Probably no one will ever know the total number of experienced and would-be sportsmen who got together last Sept. 23 to celebrate the appeal of the outdoors, though 4 million is the conservative estimate of Warren Page, president of the National Shooting Sports Foundation and sparkplug of the event.

At least 5000 fishing, shooting, hiking, camping, boating, archery, diving, scouting, mountain-climbing and assorted other clubs were involved, and such organizations as the National Wildlife Federation, Izaak Walton League, National Conservation Committee of the Boy Scouts, American Forestry Assn., the Forest Service of the Department of Agriculture, the Department of the Interior and the National Assn. of Conservation Districts were among participants and sponsors.

The observance, announced here for several months last summer, was the first national opportunity to display the enjoyments of field sports, and for sportsmen to receive the overdue credit we deserve as the country's leading conservationists. Funds from millions of hunting and fishing licenses pay to keep so many natural areas from being despoiled, and provide studies and careful supervision which prevent fish and wildlife game from becoming endangered species.

Growth of urban sprawl and pollution, rather than outdoorsmen, are the threats to the countryside. The Hunting & Fishing Day could be a good yearly reminder of what we have to lose and gain outdoors.

GOOD NEWS FOR FISH and fishermen alike was the announcement by Howard Larson, Boating Industry Assn. president, that first-year results of a two-year study show no trace of ecosystems damage from outboard motors. The research project, jointly sponsored by the Federal Environmental Agency and the outboard engine manufacturers' marine-exhaust research council, is being conducted by independent research firms in Florida and Michigan test lakes. Results so far show no fish kills, no water pollution, no detrimental side effects. The B.I.A. and Larson, an Outboard Marine Corp. v.p., undertook the

survey in advance of any prodding from public or government sources.

SLINGSHOTS will have their day again; in fact they'll have three on Jan. 19-21 at Las Vegas, during the first U.S. Open Indoor Slingshot Tournament. The event will be held in conjunction with the U.S. Open Indoor Archery Championships, being held at the same time at the Convention Center. The rules call a slingshot "any hand-held Y-configured device, with or without wrist brace, which propels a missile from a pouch by means of rubber power bands or tubes which are hand-drawn and released." That should rule out any Cromwells who try to enter with crossbows. Tournament information is available from Saunders Archery, Columbus, Neb.

FOR SNOWMOBILE CLUBS, it's not too late to get in on a trail-grooming plan that could make for a lot of smoother riding. Ski-dozer trail maintenance vehicles, along with a fund-raising program to pay for them, are being made available with long-term low-cost financing for interested organizations. Many so-called "trails" have too many overhanging branches, narrow stretches and obstructions to allow a grader to get through and will need further planning and work this coming summer. But for a club anxious to upgrade its trails, it could be worthwhile to contact Snoplan USA, Bombardier Ltd., 39th Floor, 221 North LaSalle St., Chicago, Ill., or for Canadian Clubs: Snoplan, Bombardier Ltd., 8600 Decarie Blvd., Montreal, Que., for details. Good trails will decrease the criticism and increase the fun.

Maps of 11 free snowmobile trails in Washington and Oregon are available from the Forest Service. Basic rules, notes recreation management branch chief Otis Foiles, include never touring alone, learning about avalanches, proper equipment and physical condition, and constant check of weather conditions. All litter must be packed out, wildlife wintering grounds respected and proper concern shown for other users. Competent leadership is always essential. There are already 19 National Forest snowmobile trails designated in the two Northwest states.

OUTDOORSMEN caught by unpleasant weather have written in recently with recommendations for useful products. One writer was nearly submerged last spring by flood waters in Pennsylvania. Fishing and hunting gear that he had locked in a basement storeroom got a bad dous-

(Please turn to page 50)



Good art at a price you can afford
 We tell where to get good, low-cost reproductions, how to make frames from stock moldings, how to make perfect mats.

Don't take chances with aerosols



Aerosol containers for paints, hairsprays and deodorants are now familiar household items. Their convenience leads to casual use and that may be dangerous. Here's what researchers are learning about the effects of aerosols.

Mini calculators make math fun



Some of these new mini electronic marvels will fit in a shirt pocket. All of them add, subtract and multiply faster than a speeding accountant. And they turn tedious tax, household and business accounting problems into fun.



18 pages of new boats and gear
 You'll see the best '73 boats (in color) and newest accessories—and learn about boatbuilding from an experienced hand.



Drum table you build from a drum
 There's no doubt about the origin of this unique coffee table—and there's no doubt it'll attract attention in your family room.

PLUS

Owners Report on the Volvo 140 series • "Tiger" homebuilt airplane • How to choose a slide projector • An injection molder for your drill press • Can Detroit save the internal-combustion engine? • How to do those jobs you hate to do: Add a wall outlet, replace a window pane, unclog a drain, unstick a door • Living-room aquarium • Shortwave antennas • More.

Buy it on your newsstand. Better yet, make sure you'll keep getting this kind of exciting fare. Send this coupon with your check to:

POPULAR MECHANICS
 250 West 55th Street
 New York, New York 10019

Please enter my subscription for 1 yr. \$5 or 2 yrs. \$9

Name _____ (Please print)

Address _____

City _____ State _____ Zip _____

Payment of \$_____ is enclosed. New Renewal

On new subscriptions, first copy will arrive in about 8 weeks.

(Above prices apply in U.S. and Possessions only. Canada, add \$2 per year. All other countries, add \$4 per year.)

WPM3A1

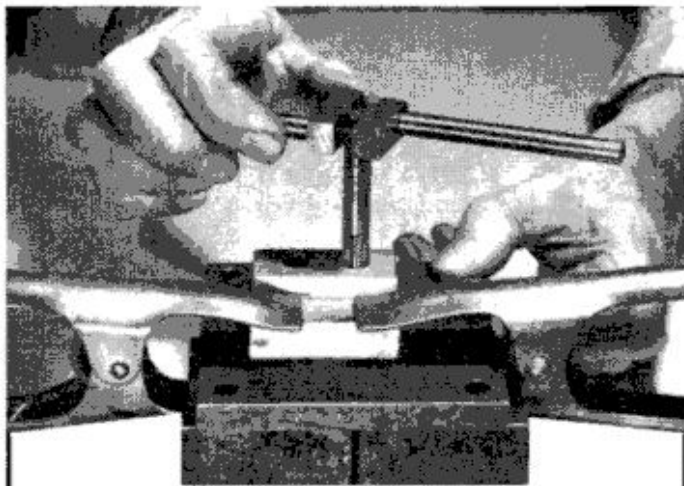

For the man who likes to do-it-himself.

With money-saving, "do-it-yourself" tips—more than in any other magazine—on how to maintain and repair your home, your car, your boat, your power mower, your TV and nearly everything that breaks down, wears out and needs fixing.

Plus feature articles on Automobiles and Driving, Shop and Crafts, Science and Inventions, Boating and Outdoor Recreation, Home and Yard, Electronics, Radio and TV, Photography...and much, much more!
ENTER YOUR SUBSCRIPTION NOW.

POPULAR MECHANICS

Simply fill in the form and mail it promptly.

POPULAR MECHANICS
 250 West 55th Street
 New York, New York 10019

Please enter my subscription for

1yr. \$5 or 2 yrs. \$9

Name (please print)

Address

City State Zip

Payment of \$_____ is enclosed.

New Renewal

On new subscriptions, first copy will arrive in about 8 weeks.

(Above prices apply in U.S. & Possessions only. Canada add \$2 per year. All other countries add \$4 per year.)

WSF3A1

ALL OUTDOORS

(Continued from page 48)

ing from muddy water. Items such as fishing reels, a shotgun and an electric trolling motor he washed with clean water, disassembled to get any grit out of the bearings and sprayed heavily with WD-40 penetrant lubricant. The treatment, he reports, seems to have prevented extensive rusting and loss of equipment.

Another sportsman had the boom on his small sailboat break during a squall a good distance out from shore. He wrapped the spar back together with 3M Scotch Strapping Tape he had along, and reports it probably would work equally well for temporary repairs to fishing-rod guides or the split handle of a hatchet.

IF EDUCATION CAN PREVENT boating accidents, a new \$1 book by the Coast Guard may be a long voyage in the right direction. It's called *The Skipper's Course* and the 96 pages are particularly lively for a government publication, probably as the result of a direct order from Admiral "Red" Wagner, chief of the Coast Guard's Office of Boating Safety and an officer who seems dedicated to getting things done. Many boat owners don't have Power Squadron, Coast Guard Auxiliary or Red Cross courses available nearby. Others would like, or certainly need, a refresher course in the basics of boat safety equipment and handling. This book is specifically designed for home study, at your own speed, and even includes a test at the end to be submitted to Coast Guard Headquarters for a certificate of completion. Numbered CG-433, and available by mail from the Superintendent of Documents, U.S. Government Printing Office, Washington, D.C. 20402, *The Skipper's Course* is a notable one-buck bargain.

THE GOLDEN EAGLE, that bargain passport for outdoorsmen, will fly again this year after being grounded in 1972.

Not until mid-July did Congress get around to putting him back in business as a prepaid ticket for National Park entry and selected service discounts. The Departments of Interior and Agriculture now agree the \$10 pass can be used for all of 1973 at designated national recreation areas, as of Jan. 1.

It's expected to be on sale at post offices and entrances to areas where a fee is charged. Another discount is available for persons 62 or older. Called the *Golden Age Passport*, it's free and, like the *Golden Eagle*, allows no-fee entrance at 75 National Park Service and Forest Service recreation areas plus lower user fees. ★★★



are you headed for a time-clock number?
 ...or a **BIG PAY** place in
AIR CONDITIONING

**40,000 new servicemen needed
 ...you can be one of them**

Air conditioning, refrigeration and heating is one of America's fastest growing fields. Service and installation technicians are in desperate demand.

And you can join this force of men making big money right now by becoming a skilled technician with our help.

Top men are making 2 and 3 times more than unskilled workmen. Yet we can teach you these skills so quickly you'll be earning money long before you've finished learning.

**AMERICA'S FOREMOST COURSE
 AT A MATCHLESS LOW PRICE**

Learning at home is hailed by educators as being far superior to classroom work with all its mass production and distractions.

In our fine, professional 100-lesson textbook course you will receive the clearest instructions in unmistakable simple language. Plus self-projects, self exams and graded exams.

Directed by Roy Anderson whose experience with home study and Army-Air Force training goes back to 1935, we

have prepared material that will turn out top-notch graduates. And we do it at a cost so much lower than any comparable course that you simply will not believe it possible.

One way we do it is by not loading our students with costly equipment and tools—most of which you probably already have, or can buy locally for less than some schools charge you!

The Liberty School is a fine, professional and very intimate institution of learning-at-home, supervised in every tiny detail by Mr. Anderson.

We can't begin to tell you all of the advantages in this small space—but we'll give you all the details if you send in your name and address. Remember, we have **NO** salesmen, so no one will bother you. In the privacy of your room you can study the description of our lessons and make up your own mind without any pressure whatsoever.

A big pay future is waiting for you—grab it now.

**LIBERTY SCHOOL Dept. J-1
 Technical Division, 1111 W. Park, Libertyville, Illinois 60048**

Be Your Own **BOSS** course includes directions on **How to Own YOUR OWN Business!**



Roy Anderson
LIBERTY SCHOOL, Dept. J-1
 Technical Division - 1111 W. Park
 Libertyville, Illinois 60048

**SEND ME YOUR NAME AND ADDRESS
 — I'll rush you FREE details by mail.**

Dear Mr. Anderson: Please send me description of your course on **AIR CONDITIONING, REFRIGERATION AND HEATING**. I understand this places me under **NO** obligation and that **NO** salesman will call.

Name _____ Age _____
 Address _____
 City _____ State _____ Zip _____

SUBSCRIBER'S

Change of Address Form

Please use this form to notify us at least six weeks before you move to your new address.

1. Present address: Attach address label from a recent issue, or print your name and address exactly as shown on the label.

NAME _____
 ADDRESS _____
 CITY _____ STATE _____ ZIP _____

2. Fill in new address:

NAME _____
 NEW ADDRESS _____
 CITY _____ STATE _____ ZIP _____

3. Mail this form to:

POPULAR MECHANICS
 Subscription Service Dept.
 Box No. 646
 New York, N.Y. 10019

JANUARY 1973

RECHARGE ALL BATTERIES

Only Everlite

- Charges 6 batteries
- Charges 3 times faster
- Charges all batteries

MODEL 75
 Including hearing aid, flashlight, lantern, radio, in fact any battery up to 12V. Save Money and have the convenience of fresh batteries always. Simple and 100% Safe. Plugs into any 115V. outlet. Guar. for one year. Send \$7.95 plus \$.65 for shipping. **795**



Model 75

MASTER MECHANIC MFG. CO., Dept. A-13 Burlington, Wis.
 Southern Customers write Dept. A-13, Box 65, Sarasota, Florida

SEND FOR NEW 144 PAGE CRAFTSMAN CATALOG

Over 3500 items

Discounts on Power Tools!



Finest Domestic and Imported HARDWOODS
 Veneers, Hardwood Plywoods, Hardware, Tools, Supplies
 all at Money Saving Prices

New! We've added Clock kits, marquetry picture kits, guitar and Dulcimer musical instruments. Everything you need in cabinet hardware, lamp and upholstery supplies . . . 3500 items! Save on power tools—name brands! For catalog, send name, address and 50c for handling, postage to

CRAFTSMAN WOOD SERVICE CO. Dept. A-13
 2729 S. Mary St., Chicago, Illinois 60608

Grainless 8x10s from 35-mm? Absolutely!

These 15X blowups show what new H&W control films and developer can do.



OUR TEST: 15X enlargements (far right) from indicated sections of frames like this

By IVAN BERGER, Photography Editor

GRAIN IS GREAT—if you like your enlargements with salt and pepper. But most of the time, you'd rather just see the picture you saw when you clicked the shutter, as grainless as it looked on your contact sheets.

You can't quite do that yet—but the H&W Co., up in Vermont, has a special developer and two matching films that, together, let you come darn close, as a look at the pictures on the right will show. Both are enlarged 15X (equivalent to a 14x21-inch full-frame print) from portions of 35-mm frames like the one above. They show tremendous differences in grain and detail—and even on 8x10 enlargements, 30 percent smaller than these blowups (and without our engraver's screen to contend with), grain should be just about invisible on the H&W film, but still quite noticeable on the Tri-X. Not that you'd know it from hand-held shots, but the H&W film's ability to resolve fine detail is considerably better, too, though Tri-X has well earned its reputation for sharpness.

It might seem more logical to compare H&W VTE Pan with Panatomic-X, the previous standard-setter for fine grain and sharpness—and we did, comparing Pan-X, Tri-X, Plus-X, H&W's VTE Pan and



GRAIN, BARELY VISIBLE on 15X enlargement of H&W Control VTE Pan, would be $\frac{1}{3}$ smaller on an 8x10



TRI-X, grainier (but not as much so as our engraving makes it look), is still sharp. And sharp grain, greater contrast make it look sharper than it is

H&W's slower VTE Ultra Pan. But though each film earned its own, definite place in the scheme of things, I found the Tri-X and VTE Pan films most generally useful (with Panatomic-X not far behind).

Of the ultrasharp films, VTE won my vote for its combination of usably high emulsion speed (80) with its exceptional sharpness and grain characteristics. VTE Ultra Pan was, if anything, a little finer-grained and sharper—but so slow (25) that the slow shutter speeds I needed on an overcast day wouldn't let me hold the camera steady enough to take advantage of the film's sharpness; I'd rate it as a slightly better film for use with a tripod-mounted camera, but no match for the faster of the two H&W films for hand-held shooting.

On a bright day, even VTE Ultra Pan would be usable (though still not preferable) for hand-held use. But bright days bring out the H&W films' mutual Achilles' heel: poor latitude and contrast. On flat, overcast days, the H&W films (especially VTE Pan) give noticeably less contrasty results than standard films. With more contrasty subjects, prints from the H&W films look snappier, but a new problem rears its head: poor tonal range. Highlights start blocking up and shadows turn to featureless black far sooner than on normal films—but the shadows are a very lovely black, because shadow areas of the two new films are clear and grainless.

Considering their origin, the H&W films' limited tonal range and clear "black" areas are no surprise, but their low contrast is surprising, for both are actually microfilms designed for high-contrast, high-resolution copying of documents. In their standard developers, these films yield crisp blacks and whites, but no middle tones; H&W Control developer (the only one recommended for the H&W films) was invented specifically to bring out the middle tones in these films, allowing ordinary photographers to take advantage of their grainlessness and sharpness. H&W Control developer can be used with other microfilms, too, but not as happily; though the company claimed an exposure index of 25 with Kodak High Contrast Copy film (in many areas, more readily available than H&W), photographers I know who've tried it found 8 to 17 more realistic; H&W's ratings for its "own" films, (actually Agfa Copex Rapid and Copex), though, seem more accurate. ★★ ★



You can make money in

WATCH REPAIR

Learn at home the low cost Sweazey Way

Develop your skill step by step in your spare time at home. Chicago School of Watchmaking's exclusive Sweazey System shows you how to repair all types of Swiss and American watches. Practical shop training. No previous experience needed. Age no barrier. Diploma awarded. Send today for free information and sample lesson. No obligation. No salesman will call.

CHICAGO SCHOOL OF WATCHMAKING

Dept. 113 Fox River Grove, Illinois 60021

FREE BOOK and SAMPLE LESSON

CHICAGO SCHOOL OF WATCHMAKING
Dept. 113, Fox River Grove, Illinois 60021
Please rush FREE BOOK and Sample Home Study Lesson.

Name _____ Age _____

Address _____

City _____ State _____ Zip _____

THE HEAVIEST HUMAN ON RECORD WEIGHED 1,069 LBS. AND WAS BURIED IN A PIANO CASE!

The Highest Divorce Settlement Ever Made Was \$9,500,000. A War That Lasted 38 Min. A Woman Who Bore 69 Children. The Largest Insect... a "Goliath Beetle." The World's Most Expensive Wine At \$300 Per Glass.

The biggest! The smallest! The richest! The highest! The oldest! The longest! The fastest! The greatest! The Guinness Book Of World Records contains over 3,000 records of science, nature, the achievements of man, the world of sports, the arts, entertainment and little known fantastic phenomena. Packed with unbelievable facts and over 350 photos.

◆◆◆◆ NEW ENLARGED EDITION: ◆◆◆◆
It contains all major Olympic Records recently broken at Munich, Germany.

Settle any argument! Amaze your friends! You will not be able to put it down. This 600 page hard covered volume is a must for any library. Nearly 10,000,000 copies sold worldwide. Only \$5.95 (plus postage and handling). moneyback guarantee.

***** please print *****
BOOK OF WORLD RECORDS, DEPT-G-83

1966 BROADWAY, NEW YORK, N.Y. 10023

Please rush me _____ Guinness Book Of World Records at \$5.95 each (plus 60¢ postage and handling). Enclosed is my check or money order for _____. If I am not completely satisfied, I will return the book within 15 days for a full refund.

name _____

address _____

zip _____

Make check/money order payable to
Book Of World Records Member Better
© Broadway Bookfinders, 1972 Business Bureau



Let ICS mail you a **FREE** demonstration lesson without obligation... to prove that you can learn **TV Servicing** at home.

Credit towards a Certified Electronic Technician (C.E.T.) rating will be granted by the National Electronics Association to ICS students upon completion of the ICS Career Program in TV Service/Repair.



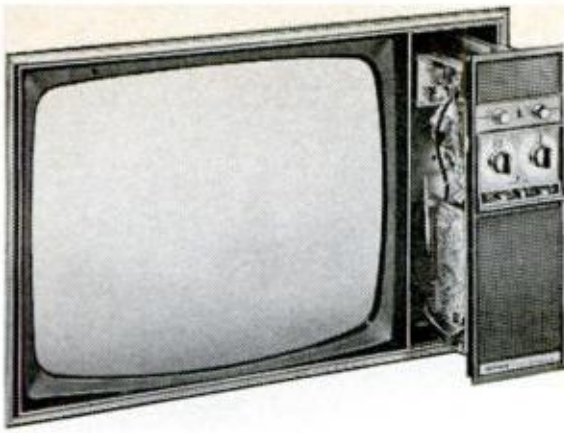

Practice on a new 25" MOTOROLA QUASAR II® chassis.

TV Servicing is a satisfying career . . . and the pay is great. Qualified men are needed now to maintain the 93 million sets in U.S. homes. And prospects for the future are even brighter.

Now . . . here's an opportunity for you to prove to yourself that *you* can learn TV Servicing . . . at home, in your spare time. ICS, the world's most experienced home-study school, will send you a **FREE** Demonstration Lesson (complete with sample questions) if you will merely fill out the coupon below and mail it to us.

In addition to your free demonstration lesson, we'll send you . . . also **FREE** . . . a brochure that describes the 25" (diagonally measured screen) MOTOROLA QUASAR II® Color TV chassis that we include in our TV Service Training Program.

This chassis with automatic fine tuning control is ideal for training purposes because it combines solid state devices with vacuum tubes to give you both kinds of practical experience. All parts carry Motorola's two year replacement guarantee!

The QUASAR II chassis comes to you in three basic sub-assemblies . . . **NOT AS A KIT** . . . because we want you to learn how to *repair* TV sets, not build them.

Our free literature also describes the fully assembled test equipment you receive such as the Deluxe 5" Solid State Oscilloscope, the tools and the learn-by-doing kits, all of the finest quality.

And we're going to tell you about eight other career opportunities in Electronics and the ICS Career Programs that can help prepare you for them.

All you've got to do is mail the coupon.

SEND IT TODAY!

ICS

International Correspondence Schools
Since 1890
School of Electronics
Scranton, Pa. 18515

Canadian residents use above address for service from ICS Canadian, Ltd. In Hawaii use Post Office Box 418, Honolulu.

Approved for veterans under the new GI bill/approved for federally insured loans/ Accredited by the Accrediting Commission of the National Home Study Council.

ICS School of Electronics
Scranton, Pa. 18515

Dept. XA224Q

YES, I want you to mail to me without obligation, the **FREE DEMONSTRATION LESSON** and complete literature on the career program checked below. (Please check one.)

- | | |
|---|--|
| <input type="checkbox"/> Color TV Servicing | <input type="checkbox"/> FCC License |
| <input type="checkbox"/> Computer Maintenance | <input type="checkbox"/> Communications/
Broadcasting |
| <input type="checkbox"/> CATV Installation | <input type="checkbox"/> Hi-Fi Sound Systems |
| <input type="checkbox"/> Telephony | <input type="checkbox"/> Industrial Electronics |

Name _____ Age _____

Address _____

City _____

State _____ Zip _____

Photo Hints

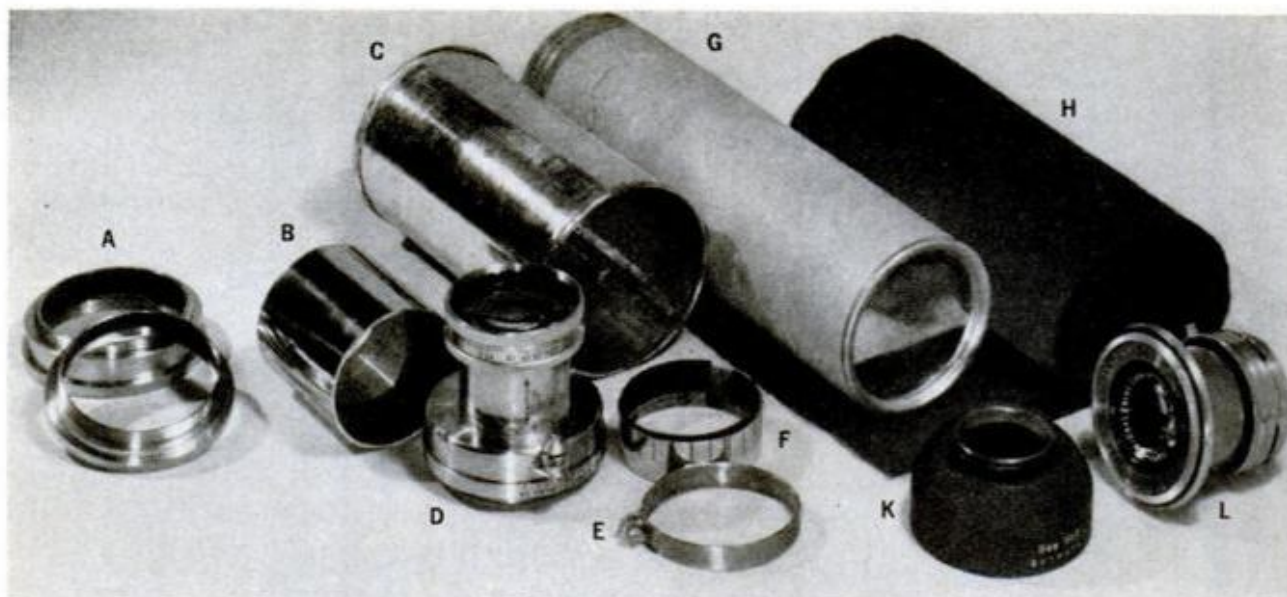

Make an adjustable extension tube for those extra-sharp close-ups

FOCUS-TUBE PARTS: Extension tubes (A) hold juice-can outer tube (C) to camera; lining of felt (H) inside C seals and cushions slide of inner cardboard tube (G). Lenses (D, L) can be fastened with lens flanges (not shown), with reversed lens-hood (K) to fit lens (L), or with toothed ring (F) made from brass pipe (B) and clamped to lens with clamping ring (E). For details, see diagram on page at right and text

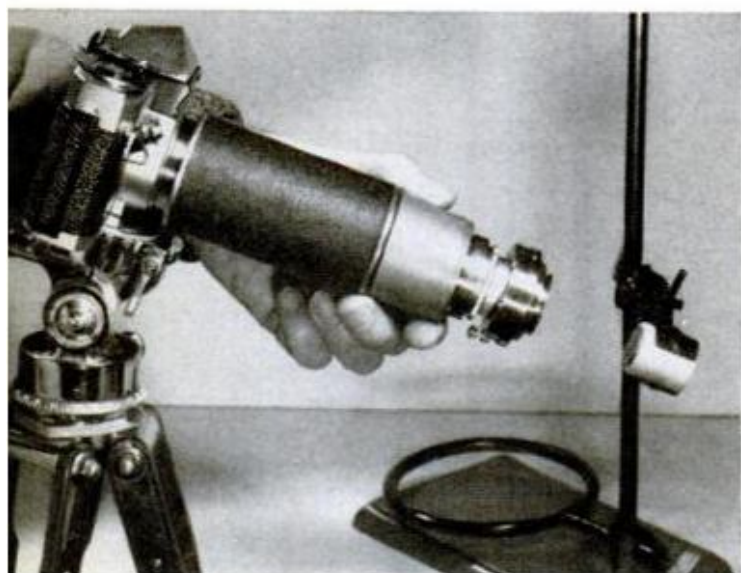

SHOOTING COIN (see facing page); note reversed lens

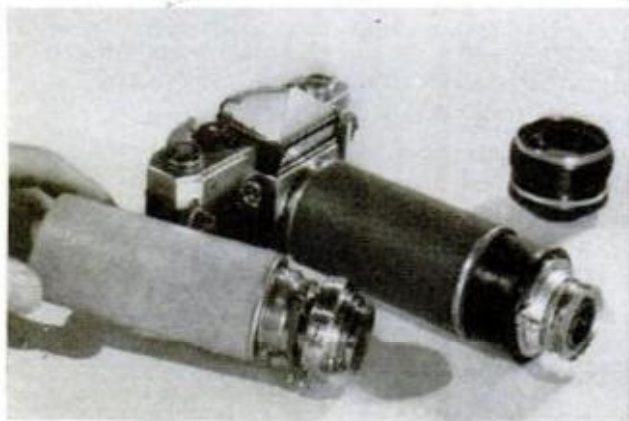

INTERCHANGEABLE inner tubes add versatility; here, to hold one lens normally and another lens reversed

INSTEAD OF A BELLOWS close-up attachment for my single-lens reflex, I built an adjustable focusing tube—from junk parts. Basically, it's just two tubes, one sliding within the other (see diagram on facing page). I made the outer tube (C in the diagram, also in photo above) from a small frozen-juice can, with one end removed. The inner tube (G in diagram and photo) could be another can, if you have one that fits, or a cardboard tube with a metal end cap (that's what I used).

Cement a lining of dark felt inside the outer tube, to provide a light-tight seal and a cushion for the inner tube to slide in. The felt should be thick enough to let the inner tube slide freely but without play. Cut a carefully centered hole in the back end of the outer tube, just large enough to clear your lens mount; then screw two short, extension-tube sections through the hole (see diagram) so you can mount the completed focusing tube to your camera. (If your camera has a bayonet mount, you may have to file or machine the extension rings to allow for the can-lid's thickness.)

Line the inner, sliding tube with black

velvet, or other nonreflecting material. Make another carefully centered hole in this tube's end cap, for a fitting to hold your lens. This could be a standard lens flange (J in the diagram) if one is available for your camera; it would either bolt on or screw on with a retaining ring. Reversing adapters, also available for many lenses, allow you to reverse the lens end-for-end for a little added sharpness in extreme close-ups; if you can't find one, you could make a clamping attachment like that shown as "F" in the diagram. Cut a ring from brass tubing, saw slots to form a series of clamping fingers, line it with plastic electrical tape and compress with a screw-tightened ring or hose clamp, to hold it on the lens barrel. This ring can be soldered or welded to the end cap. Or you can fasten a lens shade to the tube, and screw on the lens, reversed.

For safety's sake, make sure the lens is safely fastened to tube G, and link the two tubes to one another with a safety chain or cord. Cover the outer tube with leather or stick-on covering.—Walter E. Burton, Akron, Ohio.



SHARP CLOSE-UP made with setup on opposite page; this token has been enlarged four or five diameters

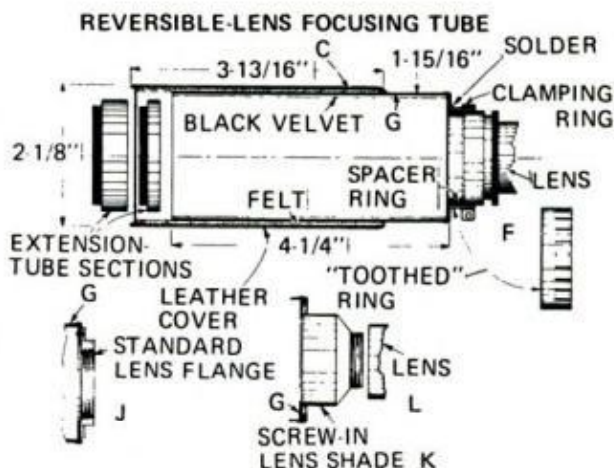

You can feel the difference.

Just holding this sturdy, lightweight little camera gives you the feeling that now, at last, you can take great pictures. Anywhere. Any time. The Minolta Hi-matic F has a balance, a construction, a "feel" that inspires confidence. Since the "F" is an amazing electronic instrument that does everything for you except focus, the results invariably prove worthy of the confidence it inspires.

For literature, write Minolta Corp., 200 Park Ave. So., N. Y., N. Y. 10003. In Canada: Anglophoto Ltd., P.Q.

The Electronic **Minolta Hi-matic F**





MONDAY'S SESSION starts with discussion of course objectives and saw-filing lecture by "Mac" McConnell

This school turns out sharp grads

In five days students learn how to make good money close to home.

By HARRY WICKS, Workshop Editor
Photos by George Miles Ryan



THOUGH ABSOLUTE QUIET is the norm in most classrooms, the din created by a dozen or more whirring and screeching machines running simultaneously brought a smile to School Director Joe Hussey's face as we walked into the room.

"The secret of our students' picking up professional skills so quickly is that we try to spend a minimum amount of time lecturing and maximum time doing," he shouted over the noise. "Actually," he added, "the only time it should be quiet in here is when one of our instructors is either introducing a technique or giving a demonstration." After spending several days at the Foley Saw and Tool Maintenance School, I can vouch that there is more "doing" than silence.

According to Hussey, the school is unique because "we're the only company making and selling saw and tool-sharpening equipment that runs a nonprofit school so that buyers—in a week's time—can learn to expertly handle the equipment they have just purchased."

Individuals who want to make money in their spare time, and decide that a sharpening business is the way to do it,

NO GENERATION GAP HERE. Boyd Pace, 14, Osseo, Minn., pinch-hit for his dad who couldn't make the seminar

WORTH WRITING FOR

LOOKING FOR IDEAS AND INFORMATION ON HUNTING, FISHING, CAMPING, BUILDING, TOOLS, ETC.? CHECK THESE LISTINGS, THEN USE THE COUPON BELOW.

105. SURFORM MAKES ANYONE A SCULPTOR

Fantastic brochure describes revolutionary new art, and tools that can help you create handsome wood carvings from solid stock, or free-form works of art from twigs and branches. From Stanley Tool Co. 25¢.

106. 1973 CRAFTOOL CATALOG

Craftool introduces its latest full-color catalog with 152 beautifully illustrated pages of fine crafts equipment. This is the most complete crafts catalog ever published. For craftsmen in all fields. Free.

107. A NEW RAINBOW FOR YOUR FLOORS

Glidden has developed a new color card for SPRED Urethane Florenamel, a tough floor coating for application inside or outside on wood, metal or concrete. Free.

108. "OUTDOOR TIPS"

No outdoor family should be without the 190 page Remington "Outdoor Tips" book. Over 1,000 tips on rec vehicles, camping, snowmobiling, archery, fishing, cooking, hunting. \$2.95.

109. GET ALL THE FACTS ABOUT UTAH

Write for detailed info, highway maps, color brochures; complete Utah Travel Kit and 52-page fact book. Free.

110. "HOMEOWNER'S GUIDE TO FAUCET SELECTION"

New 16-page booklet from Bradley Corp. explains what to look for in the various types of

faucets now available. Bright and factual. Free.

111. DO-IT-YOURSELF IDEAS WITH ALUMINUM

Here are 3 booklets from the Macklanburg-Duncan Co. full of wonderful and unusual decorator ideas with aluminum. Free.

112. TAKE THE PAIN OUT OF PAINT REMOVING

This new booklet offered by the Savogran Co. simplifies methods and procedures in paint removing. Send for this and remove paint and elbow grease. 25¢.

113. HOW TO DO IT WITH SKIL

Skil Power Tools offers a full-color, 48-page booklet loaded with instructions, tips and short cuts for home improvement. A "how-to" booklet for people who don't know how. 50¢.

114. KEEP YOUR EDGE

Learn how to sharpen a knife professionally for any purpose with this most informative booklet from Arkansas Abrasives. Free.

115. OPEN UP TO NEW IDEAS

Exciting new ideas to open up your home and let the sunshine in! Full-color booklet from Pella (Rolscreen Co.) is Free.

116. 1972 PM INDEX AND SHELF WRAPPER

Find that special PM article you've been looking for fast. The new 1972 PM Index has references and cross-references on all the thousands of items that have appeared through the year. Order now. \$1.49.

117. DICTIONARY OF METAL WORKING TERMS

What can you say about metal working . . . ? It's all here in this comprehensive guide by Gerald Cowell that covers any and all terms from drafting to heat treating. \$3.95.

118. MAKE YOUR HANDS MORE CREATIVE

This book from X-acto Inc. teaches the many uses of X-acto knives and tools and also illustrates interesting hobby projects that everyone can enjoy. 35¢.

119. TWO CATALOGS IN ONE!

This catalog from Birchwood Casey offers tips on wood and metal care plus many unique ideas. A must for all do-it-yourselfers. Free.

120. BATHROOMS CAN BE BEAUTIFUL

Learn how to decorate your bathroom with this booklet from Borg-Warner. Contains 25 plans and innumerable suggestions to help the homeowner be his own interior designer. 50¢.

121. QUITE A BIT ABOUT BITS

Irwin Auger Bit's "How to Select, Use and Care for Wood Bits" tells all there is to know. Recommended and Free.

122. LEARNING TO ARC WELD AT HOME . . .

Can be easy using the simple approach designed for non-professional or occasional weldors that is contained in this 16-page *Weldor's Guide* from the Lincoln Electric Company. Free.

**POPULAR MECHANICS 173
BOX 1718, SANDUSKY, OHIO 44870**

Please see that I receive the items checked below. I have enclosed 35¢ for the overall service charge, plus remittance for any priced items.

- | | | | |
|---------------------------------------|------------------------------------|---------------------------------------|------------------------------------|
| <input type="checkbox"/> 105 (25¢) | <input type="checkbox"/> 110 | <input type="checkbox"/> 115 | <input type="checkbox"/> 120 (50¢) |
| <input type="checkbox"/> 106 | <input type="checkbox"/> 111 | <input type="checkbox"/> 116 (\$1.49) | <input type="checkbox"/> 121 |
| <input type="checkbox"/> 107 | <input type="checkbox"/> 112 (25¢) | <input type="checkbox"/> 117 (\$3.95) | <input type="checkbox"/> 122 |
| <input type="checkbox"/> 108 (\$2.95) | <input type="checkbox"/> 113 (50¢) | <input type="checkbox"/> 118 (35¢) | |
| <input type="checkbox"/> 109 | <input type="checkbox"/> 114 | <input type="checkbox"/> 119 | |

Total items requested _____ Total money enclosed _____

Name _____
(Please Print)
Address _____

Town _____ State _____ Zip Code _____
(Please send cash, check or money order made out to POPULAR MECHANICS. No stamps, please.)

NOTE: POPULAR MECHANICS processes your requests for the above information and forwards these inquiries to the organization making the offer. Each company mails the material directly. Please allow 4 weeks for delivery.

purchase their equipment from Foley. Then they attend the school, set up so a novice can become proficient at his new trade in the least possible time. According to instructor Jerry Henricks, a great percentage of them do. He estimates that the average student who "isn't afraid to hustle a little" can add \$100 or more a week to his income in his spare time.

The five-day crash course costs \$195. For that price, each student gets meals and lodging during his stay in Minneapolis, plus daily transportation between his motel and the school.

Monday's session starts with an outline of course objectives, discussion on saw filing and instructor demonstrations of setters and filers; then students practice on the machines discussed during the day. On Tuesday, it's the lowdown on grinders and grinder techniques; Wednesday, general carbide sharpening is covered. Thursday morning is spent on lawnmower sharpening techniques and the afternoon is devoted to good business practices, advertising and how to get business. The week is reviewed Friday morning, and during a special lunch session, students receive their diplomas. After a VIP tour of the Foley plant on Friday afternoon, the class heads home.

Besides Hussey and Henricks, the team that has been turning out 10 to 12 students a week for three years consists of Andy Peterson and Duane "Mac" McConnell.

For more information about sharpening equipment and/or the school, write to Director Joe Hussey, Foley Saw and Tool Maintenance School, 3300 Fifth St. N. E., Minneapolis, Minn. 55418. ★ ★ ★

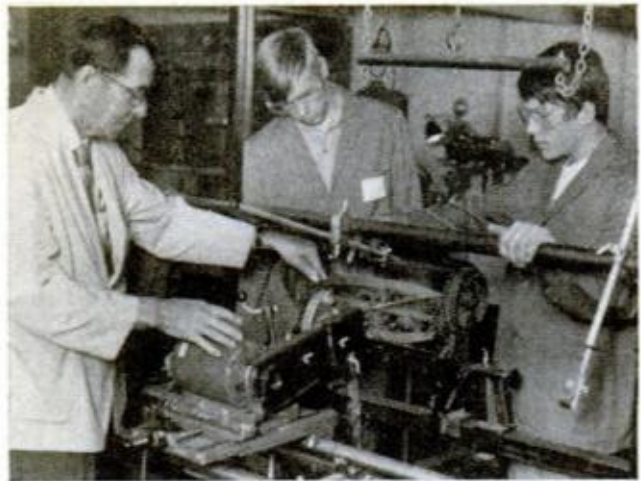

ON FOURTH DAY, students get thorough instruction in rotary-mower and reel-mower sharpening techniques

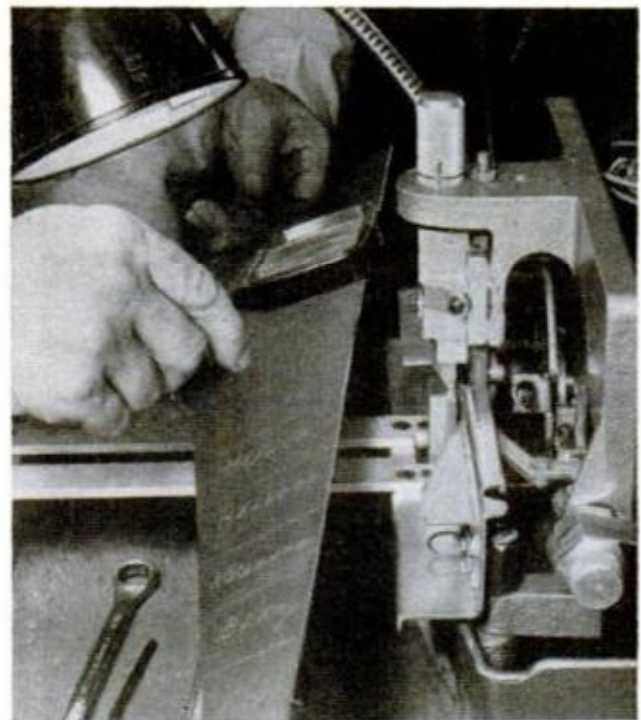

EACH STUDENT is assigned small section of handsaw to set. Then instructor inspects, criticizes, grades



GRINDER WHEEL on saw chain grinder is set with angle to assure definite hook when the chain is ground

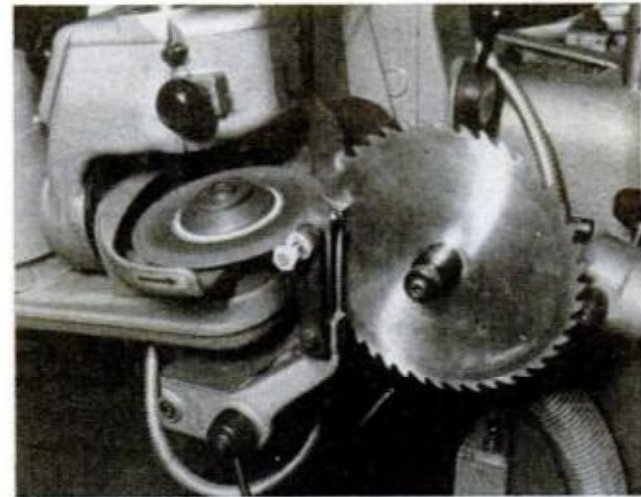

RIP SAW is ground with face of teeth straight with a 30° hook. Other blades require different settings

RCA Institutes introduces the CASSETTE SYSTEM

An exciting concept -
new in RCA Institutes'
electronics home training -

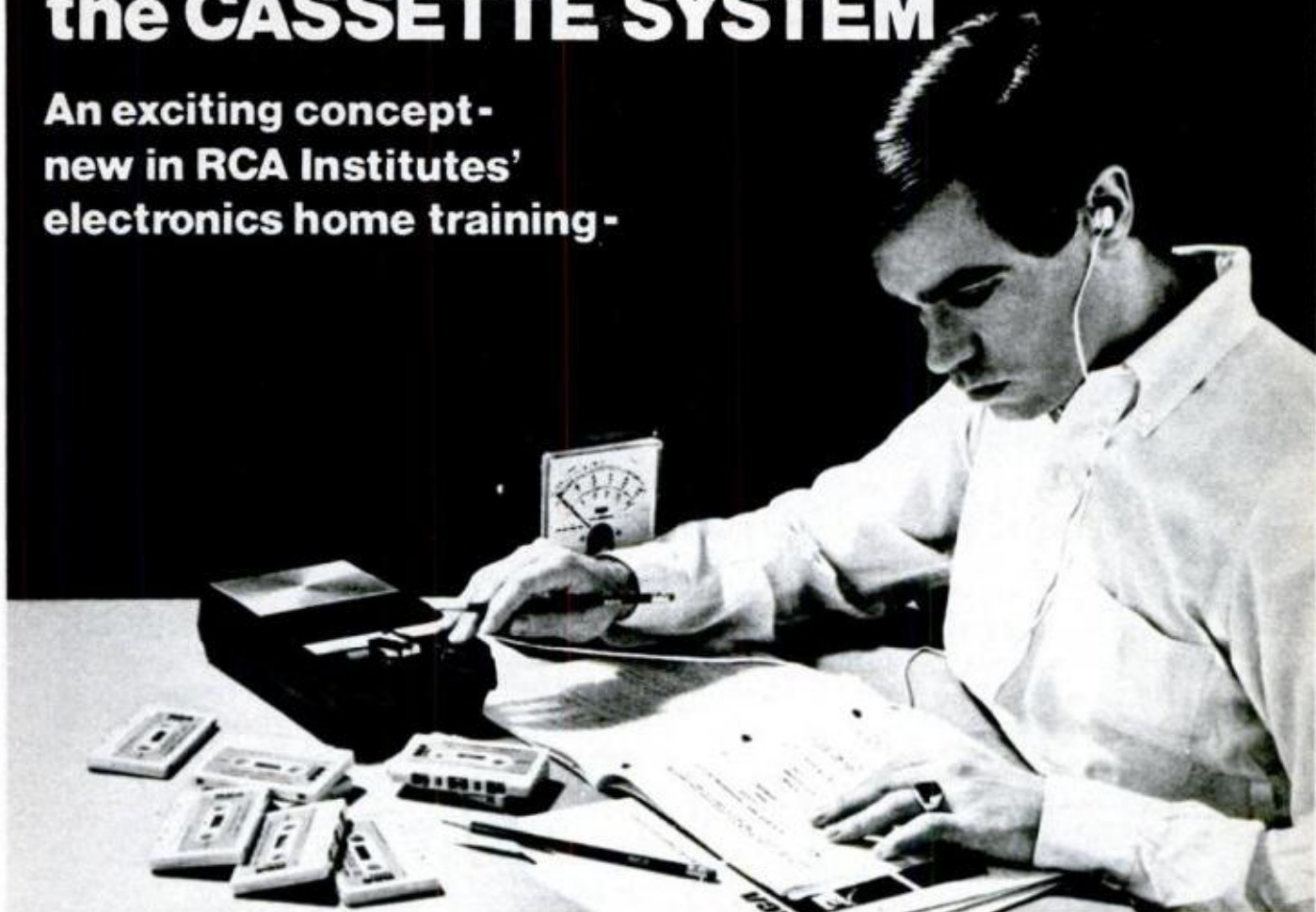

It's almost like having an instructor in your own home.

Now, another breakthrough from the company that brought you AUTOTEXT! It's the new RCA Institutes' CASSETTE SYSTEM, the innovative, learning-by-hearing approach designed to get you started more quickly and easily towards an electronics career. The CASSETTE SYSTEM adds an extra dimension to AUTOTEXT, RCA's step-by-step, planned instruction which simplifies the mechanics of learning. As you play the cassette tapes, you'll have an instructor guiding you through your AUTOTEXT lessons. Explaining the material as you read it. And now the CASSETTE SYSTEM is available as an optional extra to all students enrolling in basic, fundamental, and career programs.

"HANDS-ON" TRAINING

In addition, you get the all-important "Hands-On" training. You perform experiments and build a number of pieces of electronics test equipment that are yours to keep. In the Master TV/Radio Servicing program you build and keep an all solid-state black & white TV set and a color TV set, oscilloscope and multimeter.

CHOOSE FROM EXCITING CAREERS

Whether your career goal is Radio/TV Servicing, Digital Technology, Communications or Industrial Electronics, RCA Institutes gets you started towards that career with the training you might have thought was too expensive, too drawn-out, or too hard to learn.

NO SALESMAN WILL CALL

If you're interested in an exciting, rewarding career in electronics, discover which RCA course or program is for you. Send the attached card or fill in the coupon today.

RCA Institutes

RCA Institutes, Inc., Home Study Dept. 699-301-0
320 West 31st Street
New York, N.Y. 10001

Name _____ Age _____

Address _____

City _____ State _____ Zip _____

Veterans: Check here

HOMEOWNERS' CLINIC

BY W. CLYDE LAMMEY

Snow blows in attic louvers

Last winter snow blew through our attic louvers dampening, but not ruining, plaster in the room below. I'm told to close the louvers in winter, also not to close them. What do I do?—Ralph Larsen, Rochester, Minn.

There's a difference of opinion. I favor leaving the louvers open, principally because ventilation tends to keep frost from forming in the attic. This is fairly common, especially in ranch-type houses having low-pitched roofs. You can close the louvers against snow by stretching a burlap cloth over the screen on the inside, tacking the cloth in place. Since this does reduce air circulation I'd suggest that you watch that frost does not form anywhere in the attic. If it does, open louvers to allow free air circulation.

Table leaf warps seasonally

I have a rather old drop-leaf table. One leaf warps slightly, but straightens in winter when the heat's on. It appears to be a replacement. How can I prevent it from warping?—F.M. Wales, Philadelphia.

If the leaf is a replacement, it may stabilize in time. Thus, I'd let well enough alone for a time. But if it remains warped, you can usually correct this by cutting several 3/4-in.-wide dadoes crosswise on the underside to a depth about half the thickness of the wood. Space dadoes about 10 in. apart and don't extend them all the way across if the edges are decorative. Fasten strips of the same stock in the grooves, using glue and screws.

Preventing 'bubbles' in varnish

Recently I varnished a tabletop and ended up with what appear to be tiny bubbles on the surface. Steel-wooling doesn't take out the imperfections. What did I do wrong?—H. Stanley, Los Angeles.

If the top is of hardwood, did you remember to apply a filler before staining and varnishing? Possibly you stirred the varnish or shook the can before application. Though some modern clear finishes

do require stirring or agitating, varnish doesn't. Or, the bubbles could be particles of dust which were on the surface or in the brush at time of application.

Always clean a brush with compatible solvent and wipe the surface to be finished before you apply any finish.

Brass changes color

The brass weights and pendulum in my grandfather clock are changing color. It's not a very old clock—what can I do to restore the original bright brass?—B. Hanscom, Atlanta.

There is such a thing as "old brass" but it's more likely a special lacquer coating on the brass is changing color—rather than the metal itself. The lacquer tends to darken slowly with age—I wouldn't remove it as it protects the metal. If the metal is turning color, use a commercial cleaner intended for brass.

Making throw rugs nonslip

I have several rugs that slip on my hardwood floors. Is there a way to slip-proof these rugs—before somebody breaks bones in my home?—Mrs. J.B. Shell, Fresno, Calif.

There is a liquid-rubber backing that can be applied to nearly all types of fabric rugs. It comes in a container that also acts as a spreader. Or, you might try double-faced tape designed for this use. Most hardware and department stores stock both items.

Paint over wallpaper?

What type of paint should I apply over wallpaper?—Mrs. Jack Loomis, Detroit, Mich.

Think of the job of getting the paper off after you paint it—even one coat! I never suggest this procedure. In rare instances there may be a good reason for painting over paper; otherwise, no! Why not remove the old paper, even if it is several layers thick, and begin anew with the attractive and easily applied interior paints that are now available? You'll be pleased in the end. ★★★

Do you have a home maintenance or repair problem? Send it to Homeowners' Clinic, Popular Mechanics, 224 West 57th St., New York, N.Y. 10019. While letters cannot be answered individually, problems of wide interest will be discussed in this column.

Get away from hot taste.
Come up to KOOL, with pure menthol,
for the taste of extra coolness.



© 1972, BROWN & WILLIAMSON TOBACCO CORP.

Milds 14 mg. "tar," 1.0 mg. nicotine av. per cigarette,
by FTC method. Kings 18 mg. "tar," 1.5 mg. nicotine;
Longs 18 mg. "tar," 1.4 mg. nicotine
av. per cigarette, FTC Report Aug. 72.

Warning: The Surgeon General Has Determined
That Cigarette Smoking Is Dangerous to Your Health.



14 mg. tar,
1.0 mg. nicotine
Now, lowered tar KOOL Milds



I'd like to give this to my fellow men... while I am still able to help!

I was young once, as you may be—today I am older. Not too old to enjoy the fruits of my work, but older in the sense of being wiser. And once I was poor, desperately poor. Today almost any man can stretch his income to make ends meet. Today, there are few who hunger for bread and shelter. But in my youth I knew the pinch of poverty; the emptiness of hunger; the cold stare of the creditor who would not take excuses for money. Today, all that is past. And behind my city house, my

summer home, my Cadillacs, my winter-long vacations and my sense of independence—behind all the wealth of cash and deep inner satisfaction that I enjoy—there is one simple secret. It is this secret that I would like to impart to you. If you are satisfied with a humdrum life of service to another master, turn this page now—read no more. If you are interested in a fuller life, free from bosses, free from worries, free from fears, read further. This message may be meant for you.

By Victor B. Mason

I am printing my message in a magazine. It may come to the attention of thousands of eyes. But of all those thousands, only a few will have the vision to understand. Many may read; but of a thousand only you may have the intuition, the sensitivity, to understand that what I am writing may be intended for you—may be the tide that shapes your destiny, which, taken at the crest, carries you to levels of independence beyond the dreams of avarice.

Don't misunderstand me. There is no mysticism in this. I am not speaking of occult things, of innumerable laws of nature that will sweep you to success without effort on your part. That sort of talk is *rubbish!* And anyone who tries to tell you that you can *think* your way to riches without effort is a false friend. I am too much of a realist for that. And I hope you are.

I hope you are the kind of man—if you have read this far—who knows that anything worthwhile has to be *earned!* I hope you have learned that there is no reward without effort. If you have learned this, then you may be ready to take the next step in the development of your karma—you may be ready to learn and use the secret I have to impart.

I Have All The Money I Need

In my own life I have gone beyond the need of money. I have it. I have gone beyond the need of gain. I have two businesses that pay me an income well above any amount I have need for. And, in addition, I have the satisfaction—the deep satisfaction—of knowing that I have put more than three hundred other men in businesses of their own. Since I have no need for money, the greatest satisfaction I get from life is sharing my secret of personal independence with others—seeing them achieve the same heights of happiness that have come into my own life.

Please don't misunderstand this statement. I am not a philanthropist. I believe that charity is something that no proud man will accept. I have never seen a man who was worth his salt who would accept something for nothing. I have never met a highly successful man whom the world respected who did not sacrifice something to

gain his position. And, unless you are willing to make at least half the effort, I'm not interested in giving you a "leg up" to the achievement of your goal. Frankly, I'm going to charge you something for the secret I give you. Not a lot—but enough to make me believe that you are a little above the fellows who merely "wish" for success and are not willing to sacrifice something to get it.

A Fascinating and Peculiar Business

I have a business that is peculiar—one of my businesses. The unusual thing about it is that it is needed in every little community throughout this country. But it is a business that will never be invaded by the "big fellows." It has to be handled on a local basis. No giant octopus can ever gobble up the whole thing. No big combine is ever going to destroy it. It is essentially a "one man" business that can be operated without outside help. It is a business that is good summer and winter. It is a business that is growing each year. And, it is a business that can be started on an investment so small that it is within the reach of anyone who has a television set. But it has nothing to do with television.

This business has another peculiarity. It can be started at home in spare time. No risk to present job. No risk to present income. And no need to let anyone else know you are "on your own." It can be run as a spare time business for extra money. Or, as it grows to the point where it is paying more than your present salary, it can be expanded into a full time business—overnight. It can give you a sense of personal independence that will free you forever from the fear of lay-off, loss of job, depressions, or economic reverses.

Are You Mechanically Inclined?

While the operation of this business is partly automatic, it won't run itself. If you are to use it as a stepping stone to independence, you must be able to work with your hands, use such tools as hammer and screw driver, and enjoy getting into a pair of blue jeans and rolling up your sleeves. But two hours a day of manual work will keep your "factory" running 24 hours turning out a product that has a steady and

ready sale in every community. A half dollar spent for raw materials can bring you six dollars in cash—six times a day.

In this message I'm not going to try to tell you the entire story. There is not enough space on this page. And, I am not going to ask you to spend a penny now to learn the secret. I'll send you all the information, free. If you are interested in becoming independent, in becoming your own boss, in knowing the sweet fruits of success as I know them, send me your name. That's all. Just your name. I won't ask you for a penny. I'll send you all the information about one of the most fascinating businesses you can imagine. With these facts, you will make your own investigation. You will check up on conditions in your neighborhood. You will weigh and analyze the whole proposition. Then, and then only, if you decide to take the next step, I'll allow you to invest \$15.00. And even then, if you decide that your fifteen dollars has been badly invested I'll return it to you. Don't hesitate to send your name. I have no salesmen. I will merely write you a long letter and send you complete facts about the business I have found to be so successful. After that, you make the decisions.

Does Happiness Hang on Your Decision?

Don't put this off. It may be a coincidence that you are reading these words right now. Or, it may be a matter that is more deeply connected with your destiny than either of us can say. There is only one thing certain: If you have read this far you are interested in the kind of independence I enjoy. And if that is true, then you must take the next step. No coupon on this advertisement. If you don't think enough of your future happiness and prosperity to write your name on a postcard and mail it to me, forget the whole thing. But if you think there is a destiny that shapes men's lives, send your name now. What I send you may convince you of the truth of this proverb. And what I send you will not cost a penny, now or at any other time.

VICTOR B. MASON
1512 Jarvis Ave., Suite M-2-CA
CHICAGO, ILLINOIS 60626



\$300 pool table for \$107

By JOHN CAPOTOSTO
Technical art by Fred L. Wolff

A POOL TABLE is an expensive item to buy, but if you are good at making things, you can save almost \$200 by building this beauty. I spent about \$107 to build it, and that includes everything—even balls and cues. Such hard-to-get items as billiard cloth, cushion rubber and foam padding come in a kit (a source for which is given at the end of the article).

The table features a sturdy pedestal base, plastic-laminated aprons, drop pockets which simplify the construction, and padded rails—an extra usually found only on the more expensive tables.

The table is standard size (3½ x 7 ft.) and uses 2¼-in. balls.

● **Base.** All materials used in the table

are readily available. Except where noted, ¾-in. plywood is used. Even the pedestal legs and base are made of plywood, using box-type construction which adds much to rigidity and sturdiness. Leg uprights are rabbeted to minimize edge grain, and base sections are butt-joined.

To insure accuracy and to simplify assembly, the uprights should be temporarily mounted to the pedestal *before* the scallop at the bottom of the pedestal is cut. Mount the uprights individually before they are "boxed." You will note in the material list that extra length has been allowed for this reason.

Miter the uprights at 76° top and bottom, then at the center of the pedestal

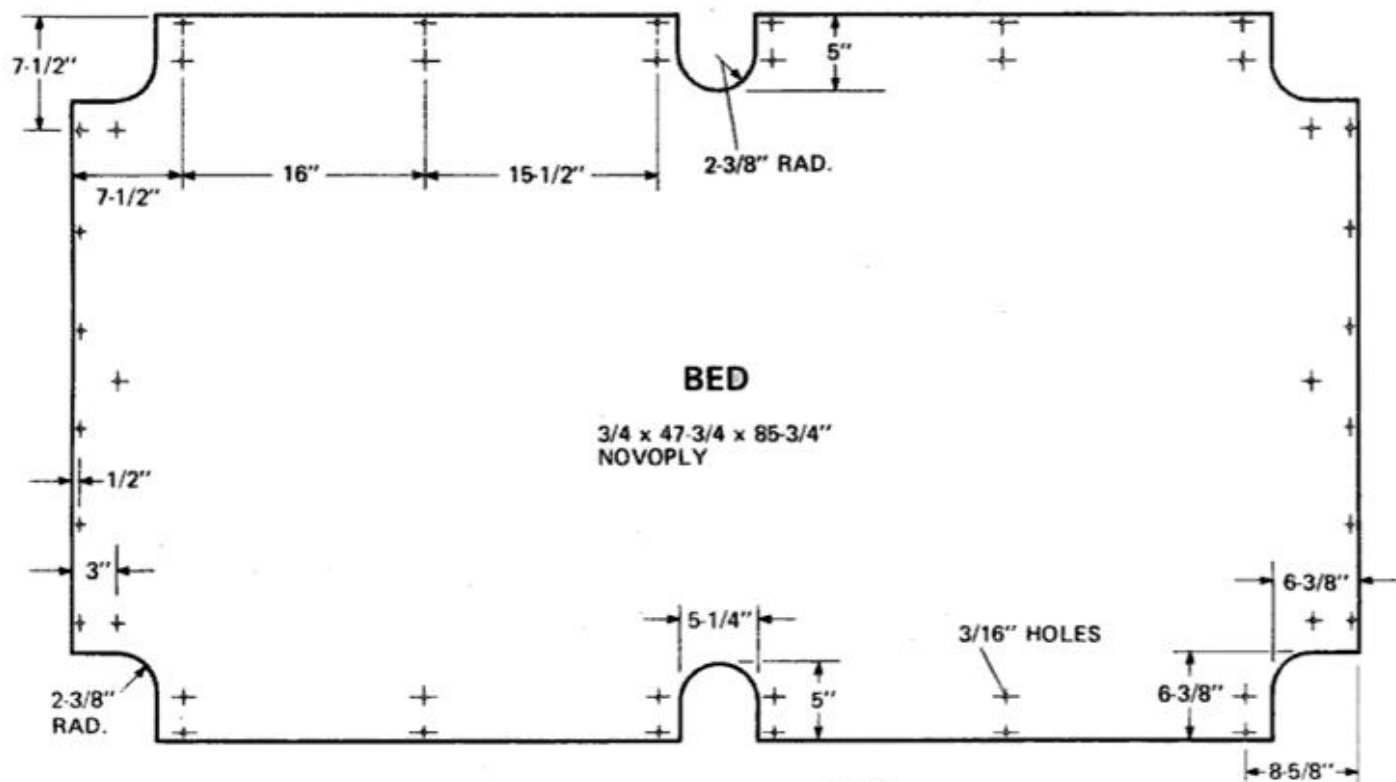

mark two lines $8\frac{15}{16}$ in. apart. Align the uprights on these marks, keeping the bottom even with the bottom edge of the pedestal. Tack the pieces in place with $\frac{1}{4}$ -in. brads, then drill pilot holes for the screws. Use four screws in each upright. Once located, you can remove the uprights and cut the scallop in the pedestal and recut the bottoms of the uprights to match the scallop. Uprights now may be permanently glued. The leg filler pieces are rabbeted, leaving $\frac{1}{8}$ in. of stock as indicated. These are glued just short of the top and extend slightly into the base.

Note: When gluing edge-grain stock, glue-size the edges. Apply thinned glue (thin with water if white glue) to edges and allow to dry before regular application of glue. This seals the edge, preventing excessive absorption of glue which would cause a weak joint.

Before installing the base pads to the scallops, drill a $\frac{1}{2}$ -in. hole at the center of each and insert a T-nut. These are for the leveling jacks. The flange of the nut must be to the outside when the pad is mounted.

When the pedestals are completed, add two furring strips to the upper ends; these will help support the table and simplify mounting the pedestal later.

The stretcher can be made now and the two pedestals connected to it. Lagscrews are driven from the inside to join the

(Please turn to page 176)

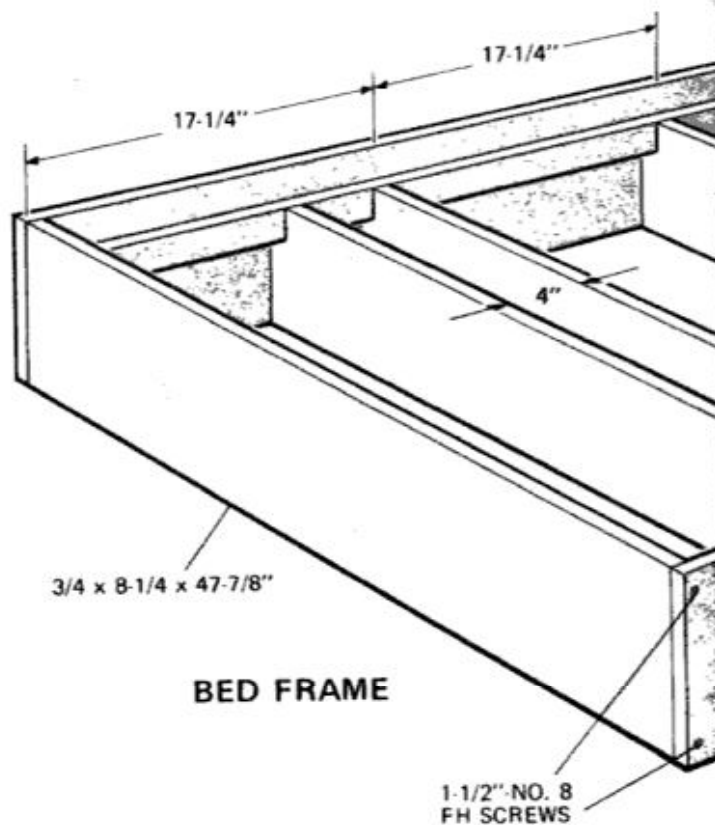
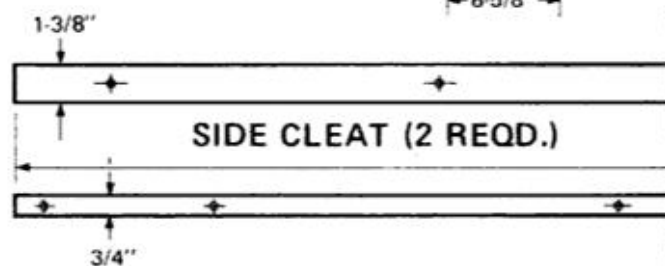

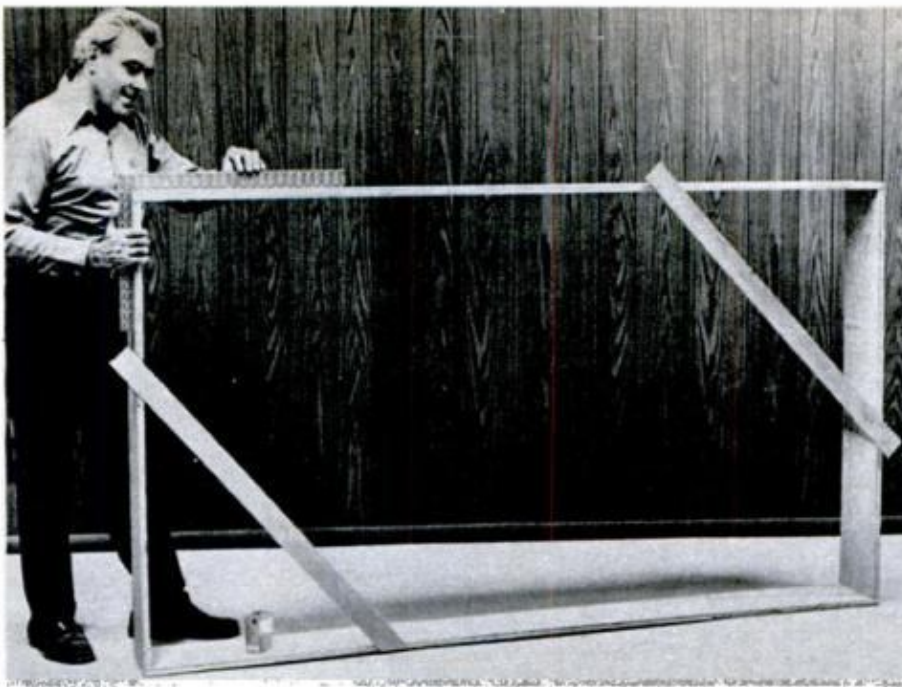

APRON ASSEMBLY is squared up with temporary diagonal braces of scrap placed across two corners

SCREWDRIVER BIT in a variable-speed drill makes quick work of driving home the many screws needed

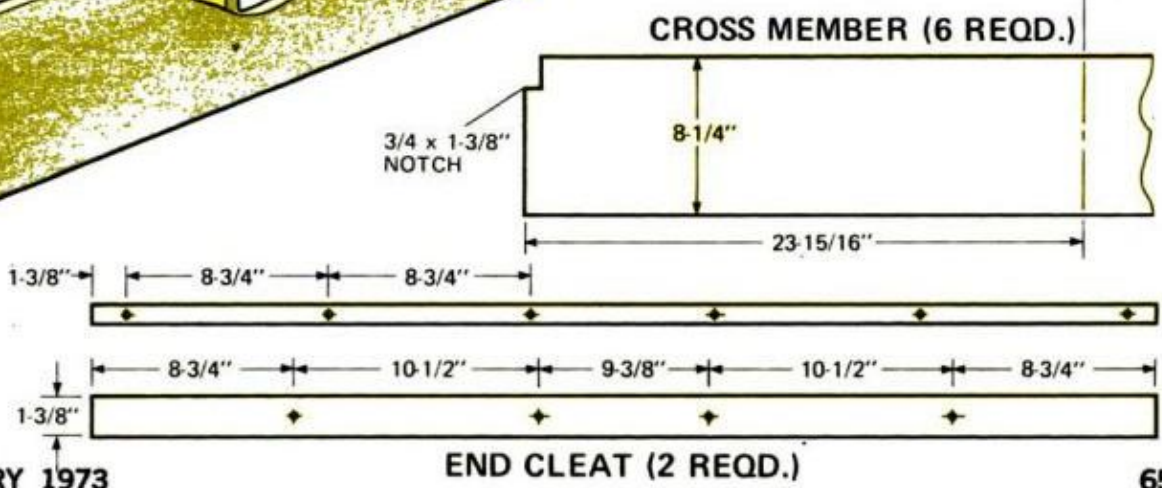
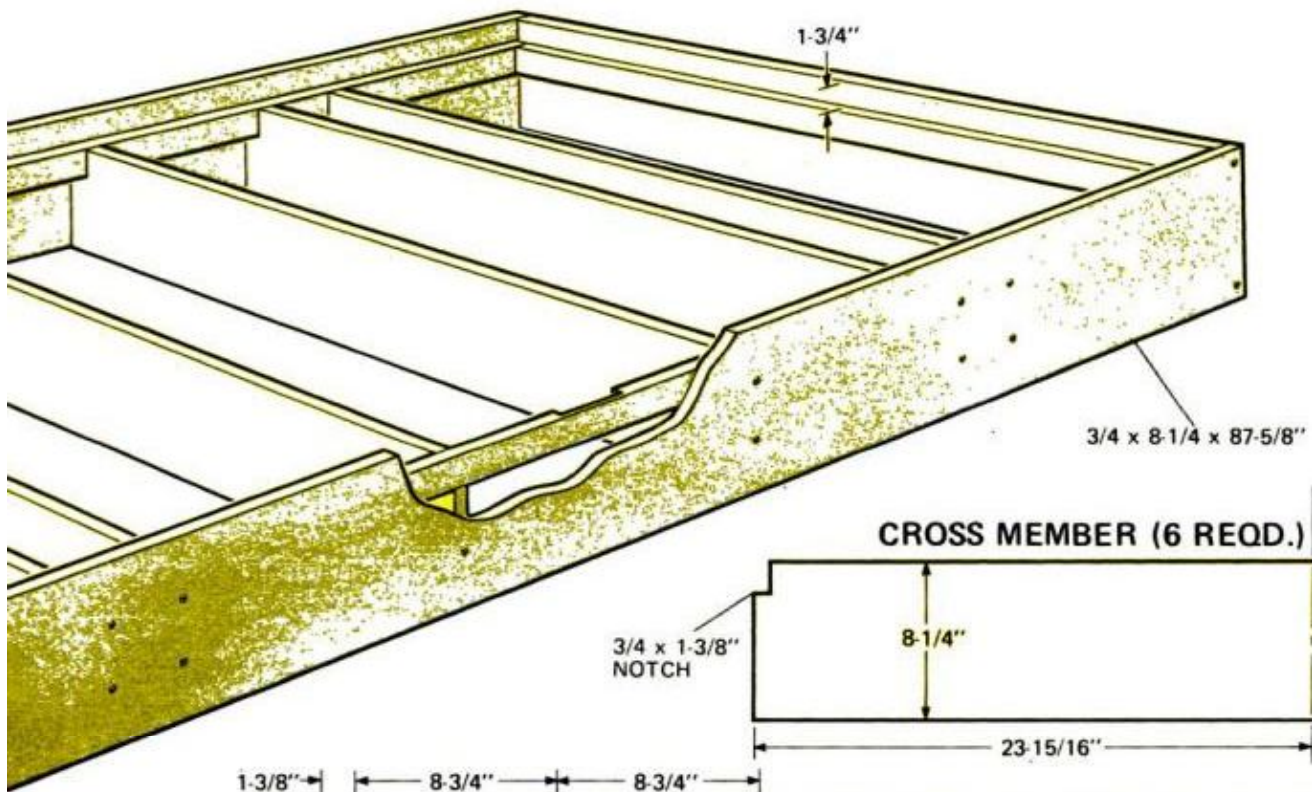
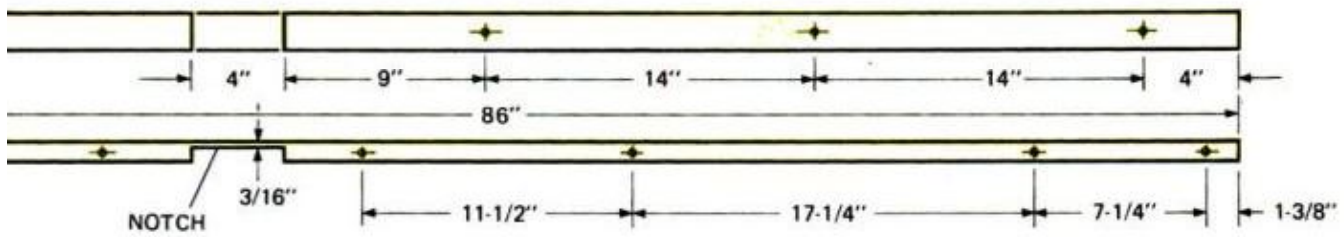

How to fix your automatic

A MALFUNCTION in your automatic washer usually affects a basic function: fill, wash (agitation), drain or spin.

The troubleshooting charts on these four pages will help you pinpoint a problem and correct it. To determine what the common components look like and their location, re-

fer to the illustration below. It's a composite that's typical of most machines.

When testing electrical components, consult your machine's wiring diagram, which is glued on the back of, or inside, the machine. The chart on page 69 will help you interpret the electrical symbols.

COMMON WASHER COMPONENTS

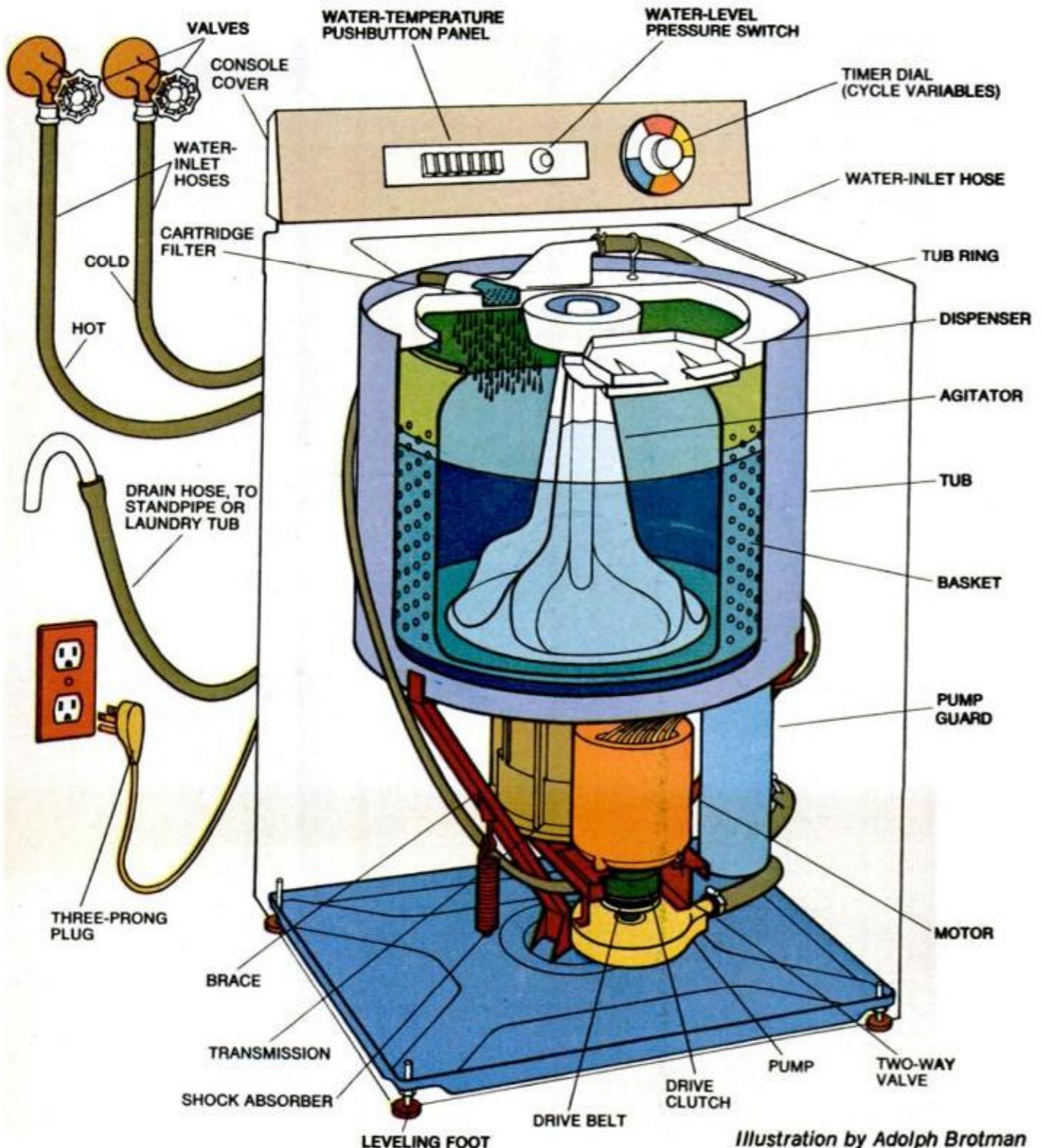

Illustration by Adolph Brotman

POPULAR MECHANICS

washer

To test the timer, turn the control knob slowly from the 'Off' position before the regular cycle to the spot in the cycle where the machine isn't working properly as you count the number of increments (clicks). Count the corresponding increments on the timer cam chart and determine which

terminals should be closed. Timer contact terminals are marked on the timer and timer cam chart by a letter or numerical code. Connect a 115-v. test light to the terminals and turn on the machine. If the test light fails to light, the timer is faulty in that model and should be replaced. ***

Washer doesn't fill

CAUSE	ACTION TO TAKE*
1. Water faucet(s) closed.	Open faucet(s).
2. Water inlet hoses kinked.	Straighten hoses.
3. Clogged water valve screens.	Remove screens and flush out sediment.
4. Damaged water valve solenoid.	Remove leads and connect a 115-v. test light across terminals, turn on electricity and move control knob to "Fill." No light signifies a bad solenoid. Replace.
5. Defective timer.	Test as described in text above.
6. Defective water temperature switch.	Remove leads and connect a 115-v. test light across terminals, turn on electricity and move control knob to "Fill." No light signifies a bad solenoid. Replace.
7. Defective water-level pressure switch.	The switch normally has three terminals. With switch in "Fill" position there is contact between two of the terminals with the third terminal "open." Make sure you connect a 115-v. test light across the terminals affecting "Fill." Consult the wiring diagram. Turn on electricity and move control knob to "Fill." No light signifies a bad solenoid. Replace.
8. Water valve internal malfunction.	Disassemble water valve and check each part for damage, paying particular attention to the guide assembly and diaphragm. Replace the bad part, if possible. If not, replace the whole valve.
9. Open circuit.	Using the wiring diagram as a guide, probe each wire connection with a 115-v. test light to determine if defective wiring or a loose connection is causing the problem. Be sure control knob is at "Fill" position.

*After taking each "action," reconnect power and test operation, but be sure to pull plug from wall receptacle before continuing.

Washer doesn't drain

CAUSE	ACTION TO TAKE
1. Kinked drain hose; clogged drain.	Straighten hose; clear drain.
2. Broken or slipping drive belt.	Replace or tighten.
3. Defective pump.	Usually pump is clogged or impeller goes bad. Pump may be taken apart for cleaning or replacement of defective parts, or it may be replaced as a unit.
4. Defective timer and open circuit.	If the motor doesn't kick into "Drain," test timer as described in text above. Also check for open circuit. Be sure the control knob is set to "Drain" position.

Water valve

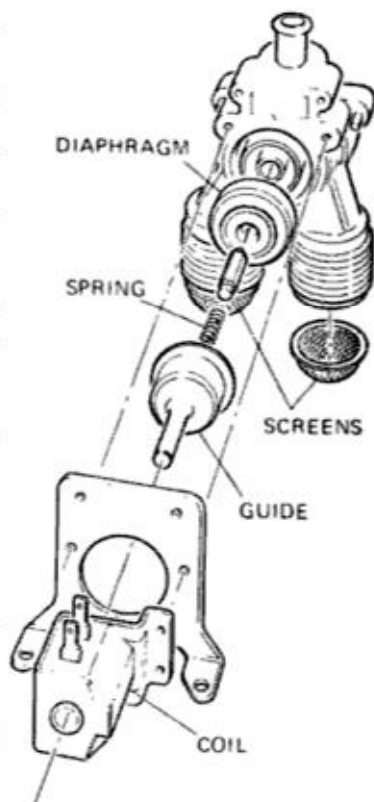

Water pump

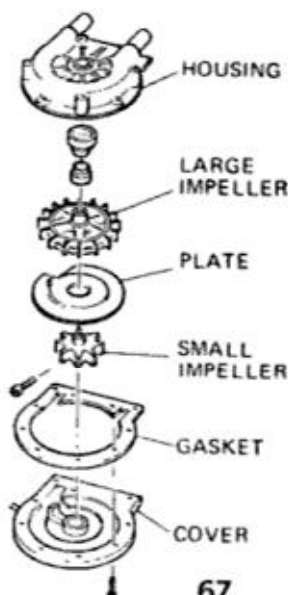

Washer doesn't agitate (wash)

CAUSE	ACTION TO TAKE*
1. Broken or slipping drive belt.	Replace or tighten.
2. Defective drive clutch.	Remove the drive belt and turn the clutch by hand with the control knob in the "Wash" (agitate) position. If there is no "grab," the clutch is defective and should be replaced.
3. Defective transmission.	With the drive belt off, manually rotate the transmission pulley in agitate direction (usually clockwise) with control knob in "Wash" (agitate) position. If this doesn't drive the agitator, the problem is in the transmission.
4. Defective timer.	Test as described in text (pages 66 to 67).
5. Faulty water-level pressure.	When water has filled the tub, contact reverts to the third terminal of this switch and to one of the other two terminals. The remaining terminal reverts to "Open" position. Make sure to connect a 115-v. test light across the terminals affecting "Filled." Consult the wiring diagram. Turn on the electricity and move the control knob to "Wash." No light signifies that you have a bad switch.
6. Open circuit.	Using the wiring diagram as a guide, probe each wire connection with a 115-v. test light to determine if either defective wiring or a loose connection is causing the problem. Make certain that the control knob is set at the "Wash" position.

*After taking each "action," reconnect power and test operation, but be sure to pull plug from wall receptacle before continuing.

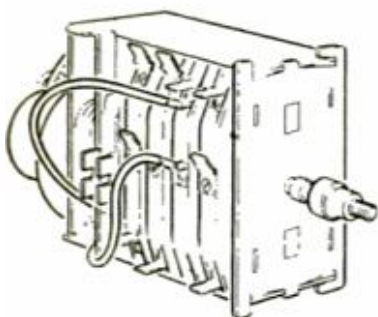

Timer

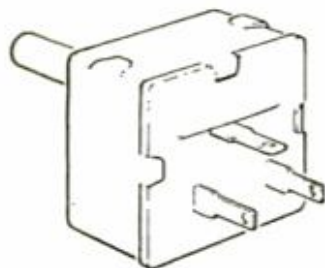

Water-temperature switch

Washer doesn't spin or spins slowly

CAUSE	ACTION TO TAKE
1. Broken or slipping drive belt.	Replace or tighten.
2. Loose motor pulley.	Tighten pulley.
3. Defective drive clutch.	Test as described under "Washer doesn't agitate," Cause 2 (above); be sure control knob is in "Spin" position.
4. Spin brake doesn't release or transmission is frozen.	The brake is not part of the transmission, but since they are attached and work together, they are checked as a unit. Set control knob in "Spin" position and remove drive belt. Turn brake stator; it should move freely. If not, the brake assembly or transmission is defective. Both units can be repaired.
5. Defective timer or open circuit.	If motor doesn't kick into "Spin," test timer as in text (pages 66-67). Also check for open circuit. Be sure the control knob is set to the "Spin" position.



Water-level pressure switch

Abide by the following precautions:

- Be sure that electricity is turned off before handling components.
- Turn off water when working on water-handling components, such as the water valve.
- Before replacing an electrical component you believe is faulty, make certain that a loose connection isn't causing the problem.
- After replacing an electrical component, tighten connections.
- Before reconnecting your electrical service, see to it that ground wires are tightly attached.
- Make sure that water connections are secure.
- Install replacement parts that meet factory specification. You can't go wrong using parts made by the manufacturer of the washer.

Motor doesn't run

CAUSE	ACTION TO TAKE*
1. Electrical service cord isn't plugged in; blown fuse or a tripped circuit breaker; possible malfunction in branch circuit.	Be sure that plug is connected and fuse or circuit breaker is okay. If there is no power at the wall receptacle, check the circuit.
2. Defective timer.	Test as described in text (pages 66-67).
3. Defective lid switch.	Many models have a switch in the lid which automatically turns the washer off if door is open during cycling. If the machine refuses to operate with the lid closed, connect a test light across the lid switch. No light indicates a faulty switch. Replace.
4. Defective motor.	<p>Most motors are protected by an internal overload circuit breaker that stops operation if the motor overheats. If this protective device halts motor operation, but the motor can be started again after about 30 minutes, consider the following conditions:</p> <p>(a) If the motor trips off when the machine goes into the spin cycle, the cause of trouble may be in the clutch, brake or transmission—not the motor. To find out, remove transmission drive belts and let the motor operate. If it doesn't trip off now, there is no motor problem.</p> <p>(b) If the motor operates in agitate position, but won't operate in spin position or vice versa, check timer and lid switch, and look for broken wire before condemning the motor.</p>
5. Open circuit.	This possibility always exists, so before you rip the motor out of the machine conduct continuity tests with your test light at each wire connection.

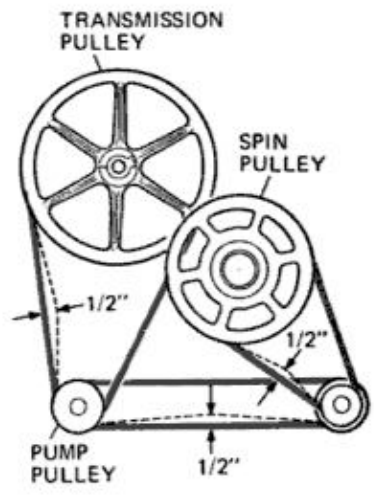

PROPER belt tension is reached when you can deflect it 1/2 in. Minimum belt tension after extended use should be 15 pounds. To check this, hook spring scale at mid-point and note what force is required to deflect the belt 1 in.

*After taking each "action," reconnect power and test operation, but be sure to pull plug from wall receptacle before continuing.

Symbols found in wiring diagrams

ITEM	OLD	NEW	ITEM	OLD	NEW	ITEM	OLD	NEW
Ballast			Terminal			Double-throw thermostat		
Adj. Thermostat			Timer motor			Internal conductor		
Thermocouple			Plug connector			Harness wire		
Neon light	None		Starter (automatic)			Permanent connection		
Transformer	None		Light (incandescent)			3-prong plug		
Thermistor	None		Pressure sw.			Timer sw.		
Transistor	None		Fluorescent			Automatic sw.		
Diode (rectifier)	None		Coil			Manual sw.		
Rectifier (controlled)	None		Capacitor			Double throw		
Coil and switches			Resistor			Crossover		
Motor, single speed			Centrifugal sw.			Heater (wattage shown)		
Motor, multispeed			Thermostat			Ground		

How to cut fuel bills

AS DEMAND for all types of energy rises, prices of bituminous coal, natural gas, fuel oil and electricity soar. According to the National Bureau of Standards, the federal government has instituted a program to cut back energy consumption in government buildings. Since conserving energy will also reduce environmental pollution as well as hold the price line, homeowners and industry are being urged to

follow suit and put the program to the test. Shown and described here are seven steps you can take to reduce energy consumption with little effort. Some of the methods you may already practice, while others might seem so obvious you'll wonder why you never thought of them before. All of the suggested steps will aid in the fight against environmental pollution and lower your heating costs.

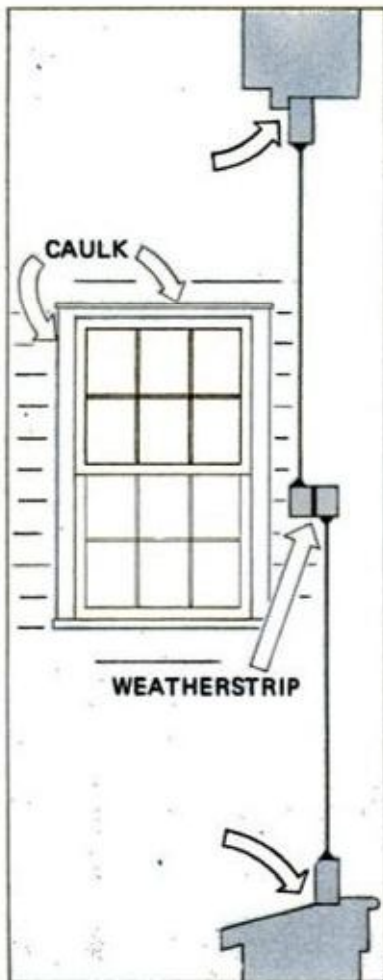

Eliminate window drafts

Next time you feel a cold draft from a door or window, think of it in dollars and cents. Warm-air leakage or cold-air infiltration can mean 15 to 30 percent of your heating bill is going "out the window." To stop drafts, install weatherstripping at meeting rails and other movable joints. Outside, apply caulk where windows meet siding.

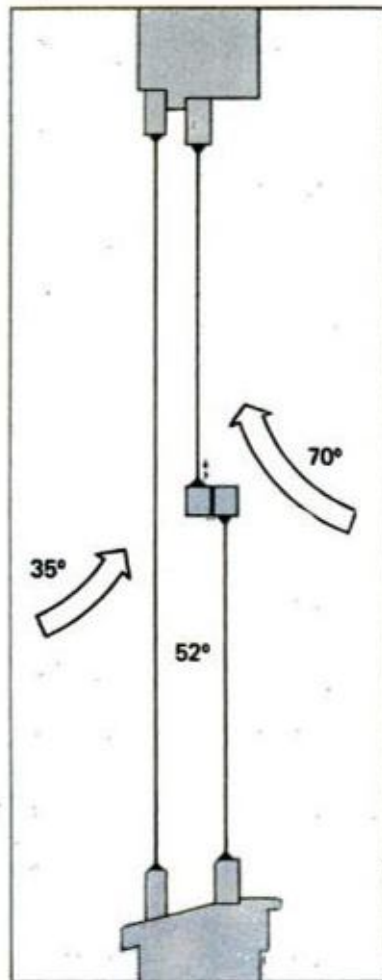

Install properly fitted storm windows

It's estimated storm windows will just about cut in half the amount of heat that is needlessly lost through the windows of a house. An investment in quality storm windows will pay for itself within 10 years (including 6 percent interest charges) and from then on, they pay a dividend of about 13 percent in fuel bill savings.

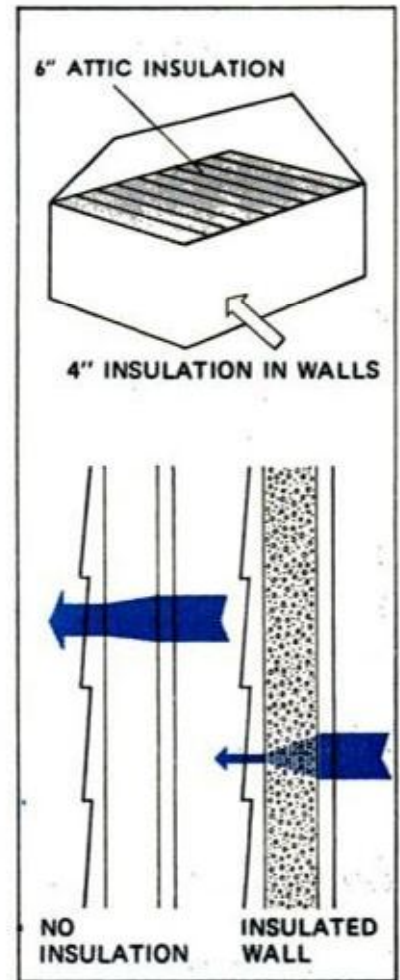

Insulate to cut down heat loss

At the least, an unused attic floor should have 6 in. of insulation between joists, whether you use batts or loose insulation. In an existing house, insulating sidewalls is tricky—and a job for a pro. Done improperly, without adequate venting, wall insulation could cause moisture problems on some buildings. For walls, use 4-in. material.

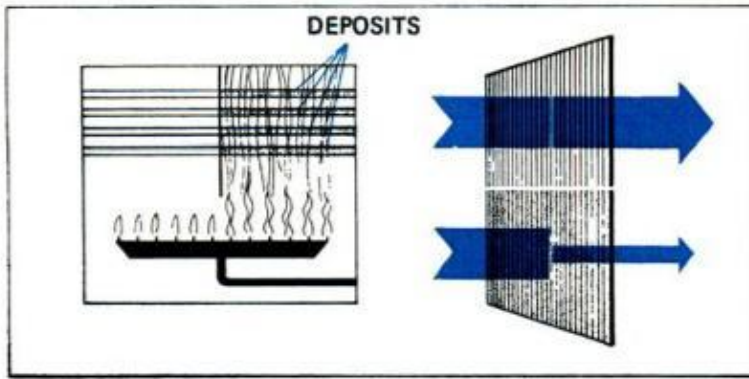

Maintain your heating plant's efficiency

Operating efficiency of your heating plant is extremely important in relation to fuel consumption. Be sure that heat-exchange surfaces are cleaned regularly by an expert. If your plant has air filters, make it a habit to clean them frequently or replace them when they become loaded with dust and lint.

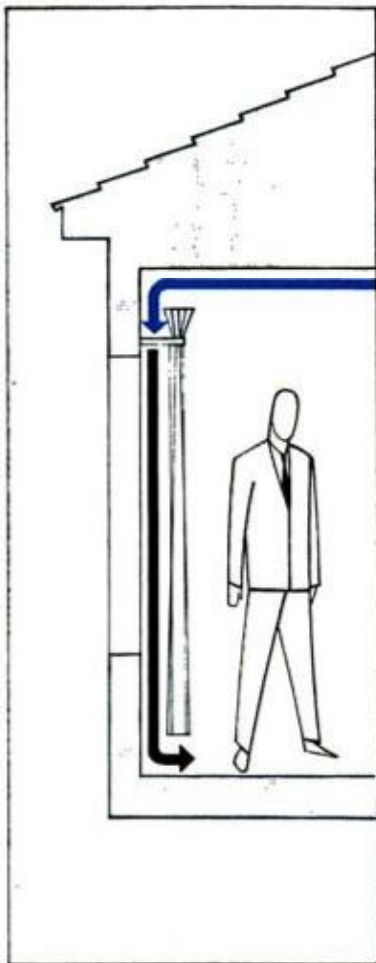

Close all draperies in the evening

Though no substitute for storm windows or double glazing, draperies (if closed at night) will reduce radiative heat loss of people sitting near windows—enough to increase comfort appreciably. Most draperies, however, are not tightly fitted; thus, room air moves freely by convection in and out of space between window and drapery.

JANUARY 1973

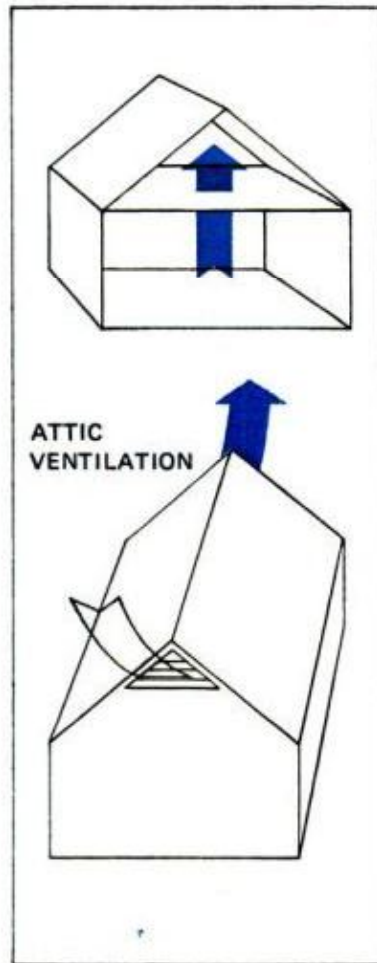

Stop warm-air leaks, assure attic venting

Since warm air rises, all spaces through which it can pass into the attic should be sealed to minimize heat loss. Look for such heat-loss spaces around loose-fitting attic doors, drop-down attic stairways, fans and ductwork. To prevent chance of moisture condensation in or on insulation, keep all vents open in the attic and crawlspaces.

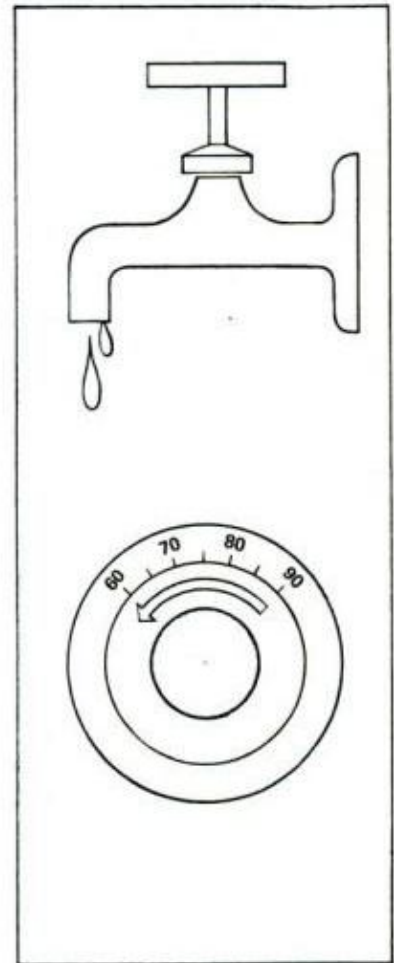

Check hot-water faucets, thermostat

Repair dripping hot-water faucets—a drop per second means 650 gallons a year of water you've paid to heat. You'll also save if you lower the thermostat for eight hours each night: Fuel savings can be $\frac{3}{4}$ of 1 percent for each degree Fahrenheit the setting is lowered. Thus, a 4° reduction would save \$1.80 on a \$60 monthly fuel bill.

How to make cracks disappear

ANY PAINT JOB is only as good as the surface preparation that went into it. In most cases—on inside paint jobs—this is not much more than a thorough surface cleaning before applying paint. But as a new home settles with age, cracks are sure to appear on the walls, especially if they're plaster. And cracks can show up in plasterboard walls too.



1 First patching step is to clean out the entire crack, making certain no loose particles remain. (Patching compound must be applied to a solid surface to be permanent.) Paint stores sell tools for gouging out cracks, but a punch-type can opener does the same job. If you're repairing plasterboard, you may have to cut away some paper on the surface. Dust off the crack with a dry brush.

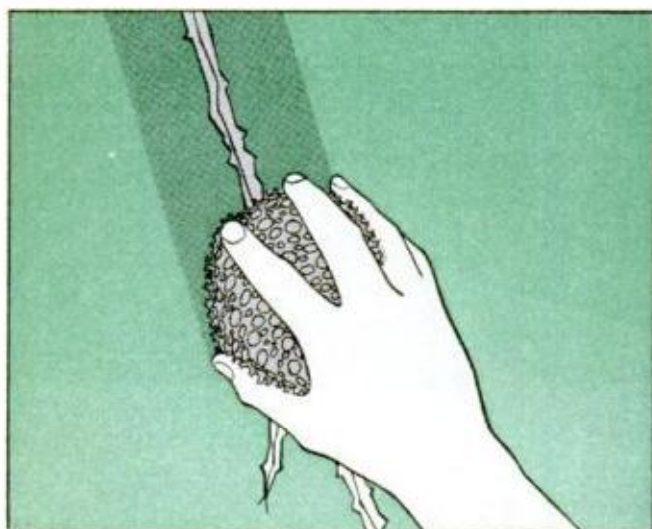

2 Soak a large sponge in water and squeeze out the excess. Then thoroughly dampen the surface to which the joint compound will be applied. The idea is to slow down moisture absorption and thus achieve a better bond between new material and old. To keep floor or carpeting underfoot free of damage during repairs, spread layers of newspaper to catch the scrapings, water and compound.

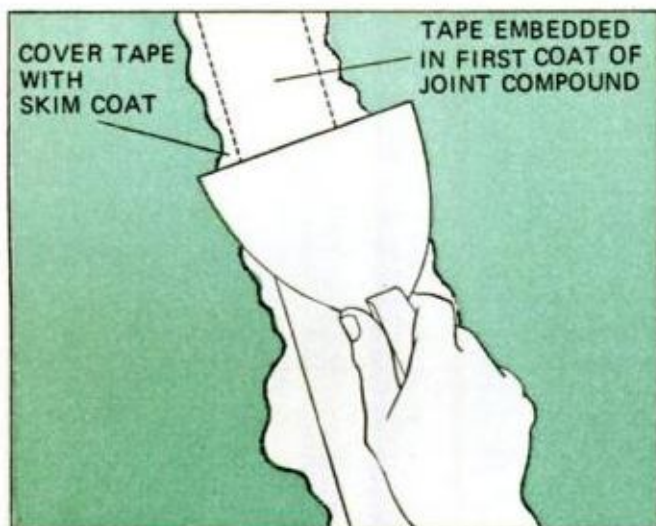

3 When entire crack has been covered with tape, take your wallboard knife and firmly press the tape into the bedding compound with the knife held at 45° angle. You'll know that pressure is correct if you squeeze out some compound from under the tape—but enough must be left for a good bond. When it's dry, if air pockets (bubbles) have formed under tape, cut them out with a sharp razor blade.

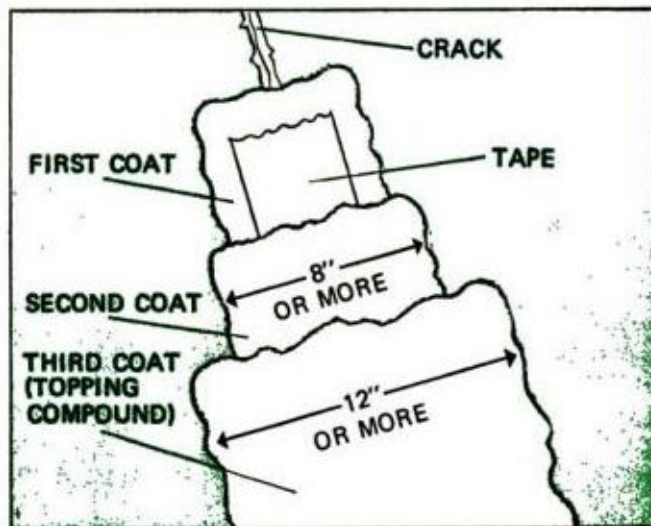

4 A minimum of three coats is recommended for all patches—embedding coat and two coats over tape. Last coat can be topping compound; it's extra smooth. Successive coats are progressively wider, allow each to dry thoroughly before applying the next. Check between coats and sand off any high spots. If patching plasterboard, don't oversand adjacent paper surfaces.

Regardless of how they got there in the first place, the chore is to eliminate them for good before you dip your brush or roller in the paint. As you'll see on these pages, you can. Some of the tricks have been around awhile; others are those used by professionals. Now, you can add them to your bag. ★★★

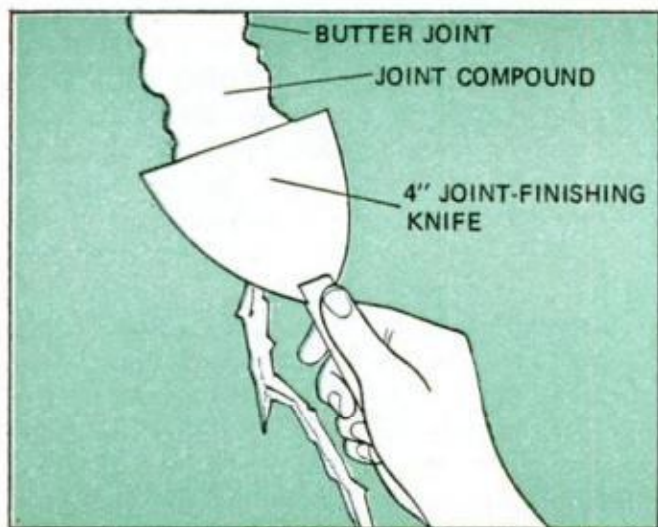

3 While gouged surface is still moist, apply the joint compound, forcing it into the cracks. You can use a dry compound that requires mixing with water, but to save time, a premixed compound is recommended. It comes in quart, gallon and 5-gallon sizes and, if kept covered and protected from freezing, lasts indefinitely. After buttering the cracks with compound, smooth off the surface.

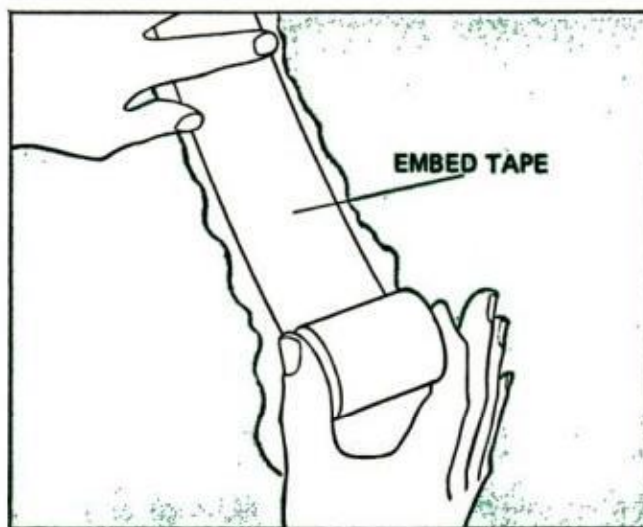

4 Apply wallboard tape to the buttered crack. Using your fingers, loosely press the tape in place. Basically, there are three types of tape you can use: heavy paper (one with perforations and one without) and a gauzelike material that is available at many paint stores. All do the job, but if you are patching plaster, gauze is the best. If desired, paper tape can be moistened slightly before use.

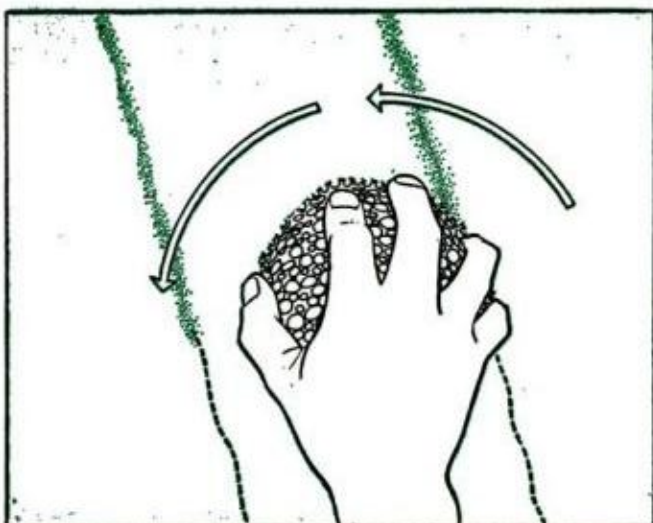

7 When dry—at least 24 hours after applying a topping coat—the surface can be sanded to feather into adjacent surfaces. One good way is to “sand” with a damp sponge. Since the joint compound is water soluble, don’t get the sponge too wet and don’t rub continuously in one spot. This prevents your breathing fine sandpaper dust and eliminates most dusting and cleanup afterward.



8 After patched area has been sanded, compound and the wall surface should be primed with a suitable sealer (vinyl or oil base primer/sealer, or shellac) to equalize (paint) absorption difference between existing wall and joint compound in old crack. You should now have a uniform surface texture ready for final decoration following the paint maker's instructions.

How to prevent roof ice dams

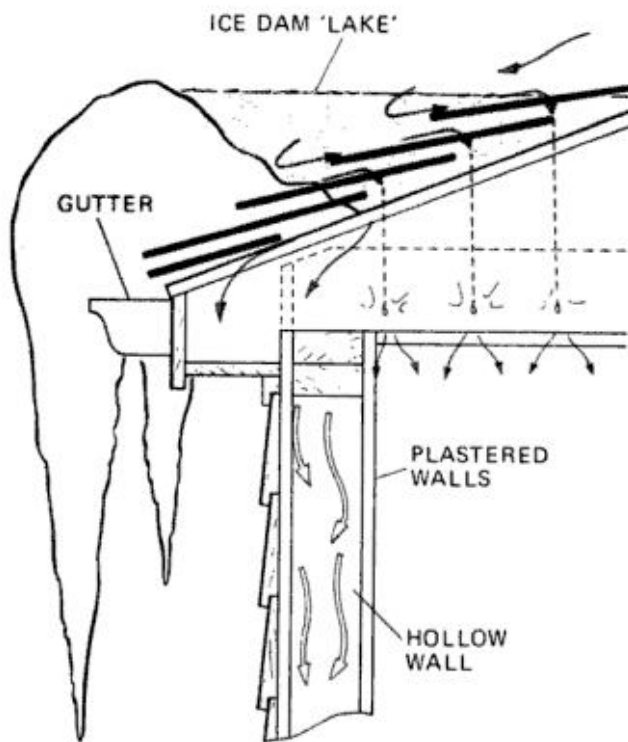

HOW ICE DAM CAUSES LEAKS

DRIFTING SNOW on a roof makes a pretty picture but it can wind up as water inside your home. How is this possible? Unless removed, mounds of snow along the roof gutters will alternately thaw and freeze over a period of sunny days and cold nights, resulting in the formation of a dam of ice and a pool of water. With gutters clogged with ice, melted snow trickling down the roof forms a puddle. With no other place to go, the water starts to back up between the shingles, leak into the attic and finally drip through the ceiling.

Once started, an ice dam builds up rapidly and the water often will flow over the dam to form huge icicles.

Low-pitch roofs are more prone to ice dams than steep roofs, and homes with roofs having little or no overhang are subject to greater interior leakage. But if weather conditions are right, ice-clogged gutters can be a problem on all roofs.

The simplest solution would be to clear

TYPICAL ARRANGEMENT OF CABLE

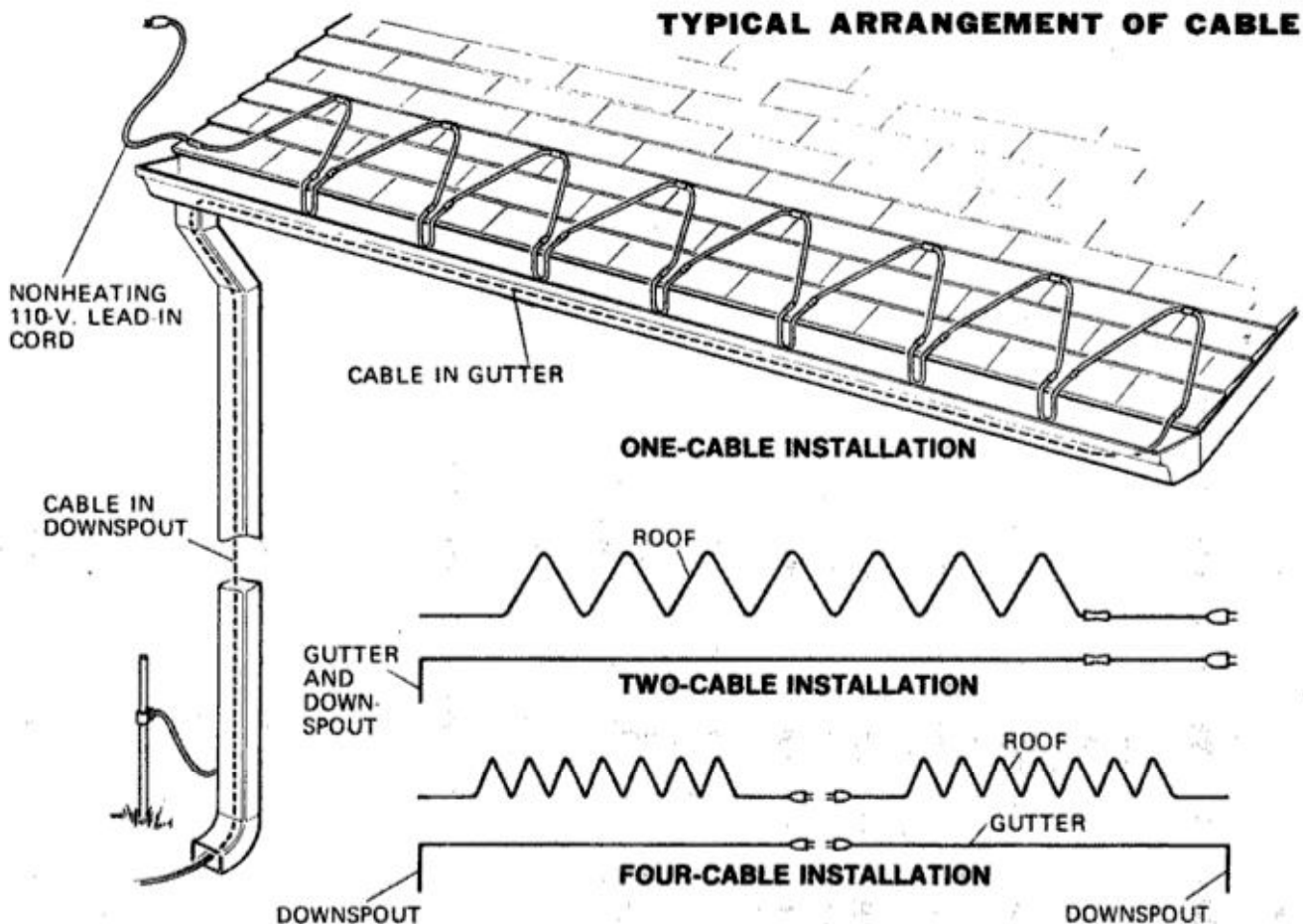

snow accumulations from the roof as they form, but no one in his right mind is going to get up on a slippery roof in winter. The safest and most practical solution is to install electric heating cables. They produce just enough heat to prevent ice from forming and can be turned off when not needed. Some are controlled by a thermostat which turns the cable on when the temperature dips to 40°F. They're installed in the gutters and along the "cold" edge of the roof where interior heat loss is less, and you can buy them in lengths of 20 to 200 ft. for 120-v. or 240-v. circuits. Electrical consumption ranges from 160 w. to 1650 w. depending on the size cable used.

The best time to install heating cables is during warm weather, of course, but where it has to be done during freezing weather the cable should first be unrolled on the ground and plugged in to allow it to warm up. This will make it more pliable and easier to install.

Heating cables are mounted with special clips zigzag fashion along lower edges of the roof. Clips must be pushed up under the shingles and then the shingles are pressed down so that tiny spurs in the clips will embed. Exposed ends of the clips have hooks to hold the cable. Clips can be attached to slate roofs with thick roofing compound.

The cable should project down past the edge of the roof, forming loops that dip into the gutter to within 1/2 in. of the bottom. Do not cross or overlap the cable, nor space it closer than 1/2 in. Use two clips to assure the right spacing where the cable loops into the gutter.

Once the electric heating cable is in place, the lead-in can be plugged into an outdoor receptacle on a properly fused circuit that won't be overloaded by the cable's power needs. Gutter and downspout should be grounded to a water pipe or rod. ★★★

HOW CLIPS HOLD CABLE

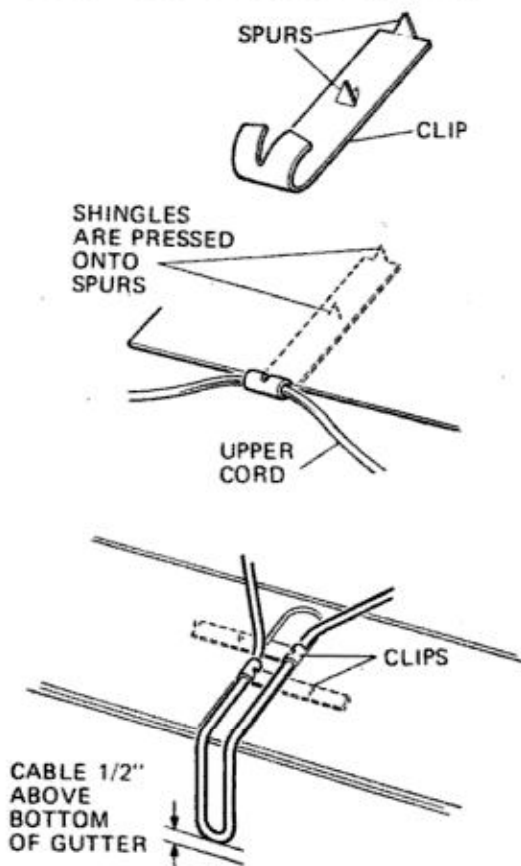

SPACING OF CABLE

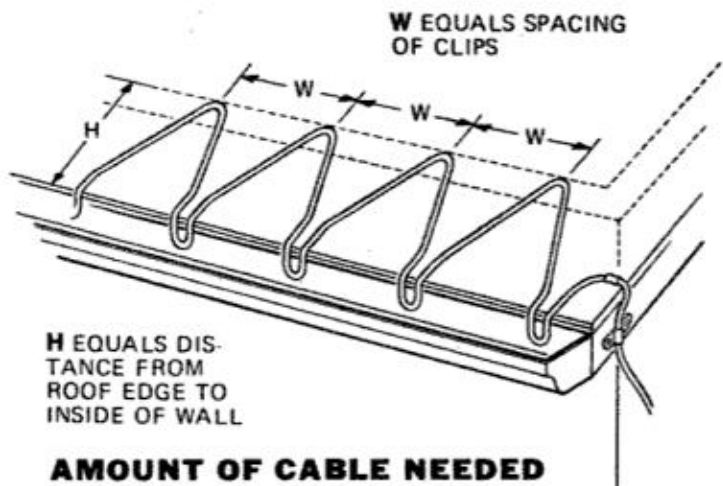

AMOUNT OF CABLE NEEDED

SNOWFALL	H. (in.)	CABLE LENGTH (ft.)
Light W = 24 in.	12	2.8
	24	3.6
	36	4.5
Medium W = 12 in.	12	3.8
	24	5.6
	36	7.0
Heavy W = 6 in.	12	6.0
	24	10.0
	36	14.0

How to have a smokeless

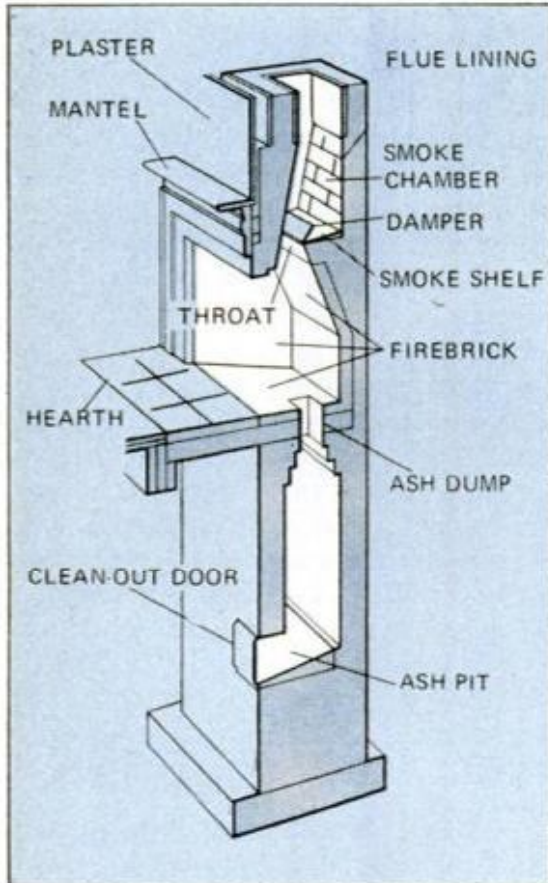

Fireplace construction

To function properly, a fireplace must be proportionally designed within certain limits: Size of throat, flue-effective area and firebox height, width and depth are all relative to each other for good draft. Often a design defect can be corrected by a simple alteration—for example, addition of a hood or lintel, as shown on these pages.

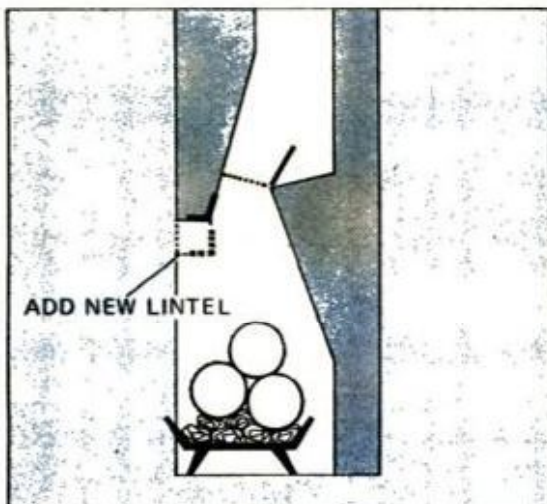

ONE OF WINTER'S GREAT PLEASURES is spending a cold evening in front of a well-laid fire. Too often, however, the spell is broken because the fireplace spills smoke into the room rather than curling it up the chimney. Smoking is one of the biggest complaints about fireplaces. Routine steps you can take to minimize this include periodic inspection of the flue to be sure there is no excessive soot and scale buildup and being selective as to what you burn. Do not burn too much pine or fir because they cause a disproportionate amount of soot buildup in the chimney. Rather, stick to hardwoods. Another cause of smoking is chimney blockage. Usually, it's a fallen nest or brick (in a new home) lodged in the throat. Other smoke-producing causes—and their cures—are described and illustrated here. ★★★

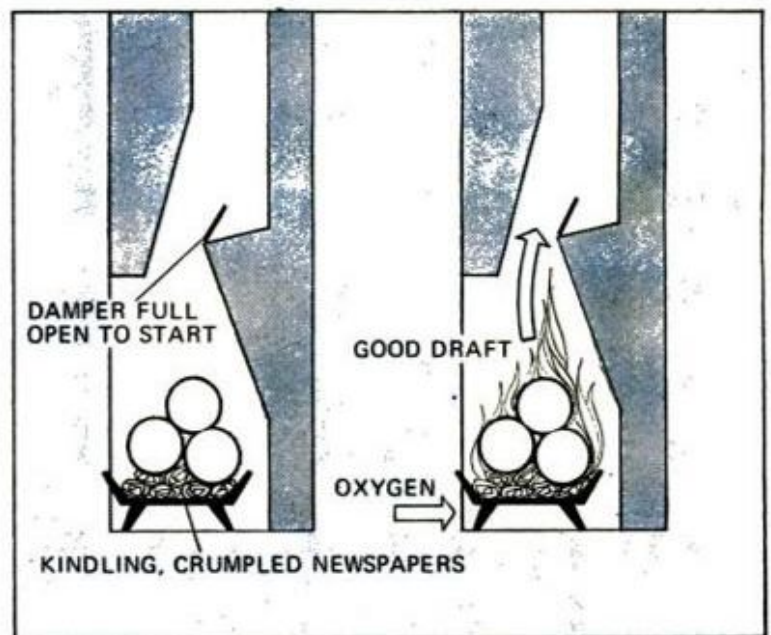

How to get (and keep) a good fire going

Place crumpled newspapers on the grate, add dry kindling, then stack logs so that flames can curl upward around them. (Three logs burn better than two.) Before lighting the fire, get a draft moving up the chimney. Open damper, insert three sheets of newspaper in the chimney and burn them completely. Now, light your fire. You may want to open a window slightly to keep oxygen coming in for good burning.

If the flue is too small

The flue should be about $\frac{1}{3}$ the area of the firebox opening (height x width). To replace it involves tearing down the chimney. Instead, try adding a metal hood or new lintel. To determine correct opening, with fire burning and smoke rolling out at top, hold a piece of metal across the top of the opening. Gradually lower the metal until there's a good draft and no smoke; that's the correct opening.

fireplace

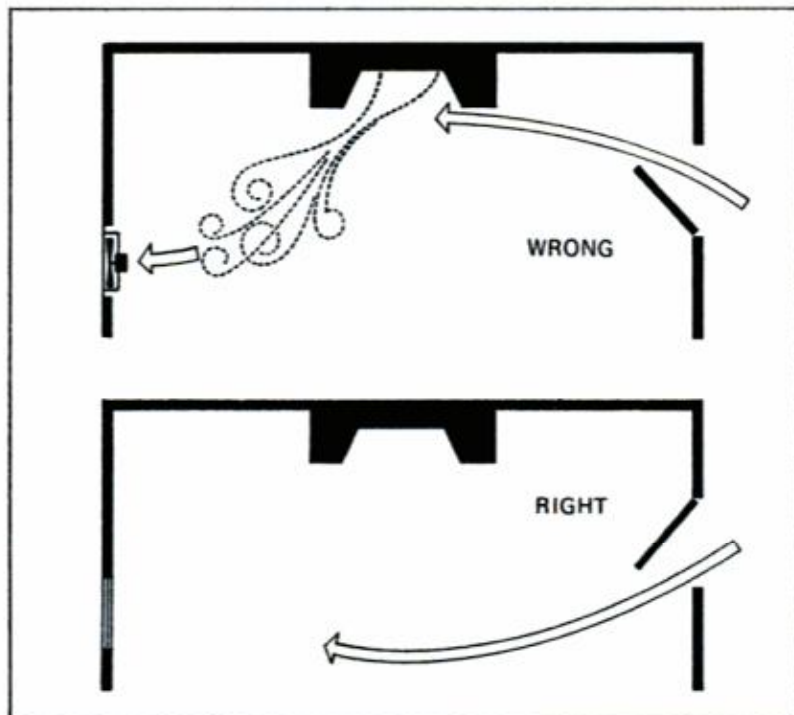

Check out the room's airflow

A door in the room may be so located that when open it causes a draft across the fire. Either re-hinge door on the opposite jamb or use a fire screen. Similarly, an exhaust fan in fireplace room causes smoking. Leave it off when using fireplace.

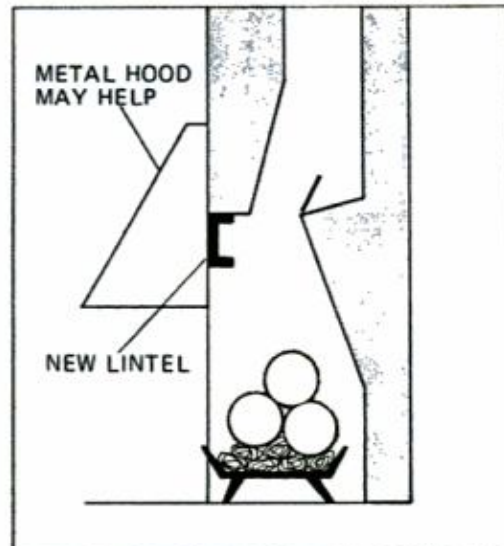

Damper located improperly

If front edge of damper is used as a lintel, the damper is too low. The lintel—a separate piece of angle iron—should be 6 to 8 in. lower than the damper. There's good chance a metal hood or a new, lower lintel may correct this fault. A much more drastic solution would be to rip out brickwork and raise damper to proper height, then rebuild back wall to line up with new damper position.

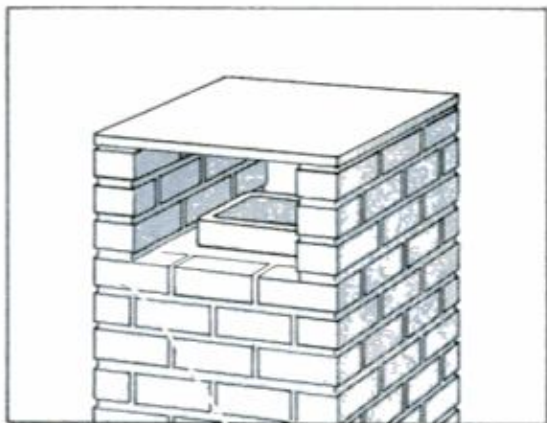

Chimney not high enough

On a house with a peaked roof, the chimney should be at least 2 ft. above the ridge; for flat or slightly pitched roofs the figure is 3 ft. If it's not, chimney should be raised, making certain that the extension is no smaller inside than the diameter of existing flue. Tall trees, surrounding hills and nearby chimneys cause downdrafts too. A shield hood and cap—with the shield toward the wind—usually will eliminate downdrafts from these causes.

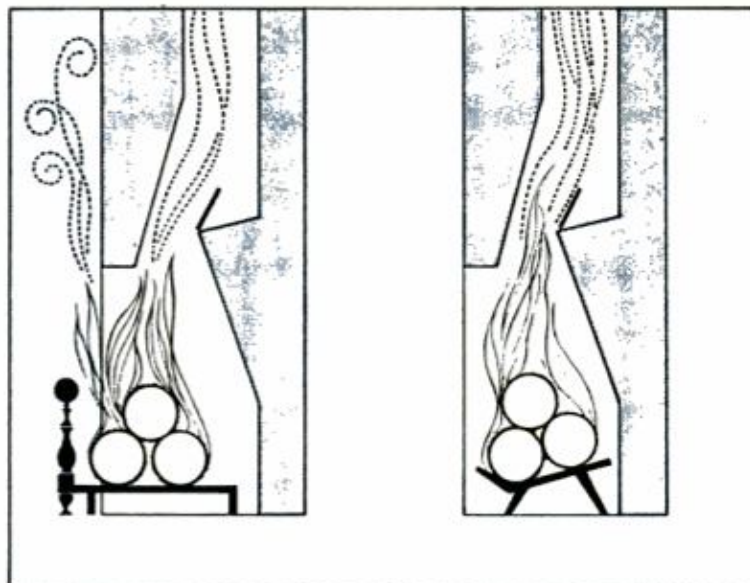

Firebox is not deep enough

The easiest correction for a too-shallow firebox is to use a narrower grate to keep fire well back in the firebox. Precaution: If you see smoke coming out of the chimney anywhere but at the top, don't use the fireplace until the leak is checked and, if necessary, repaired by an expert.

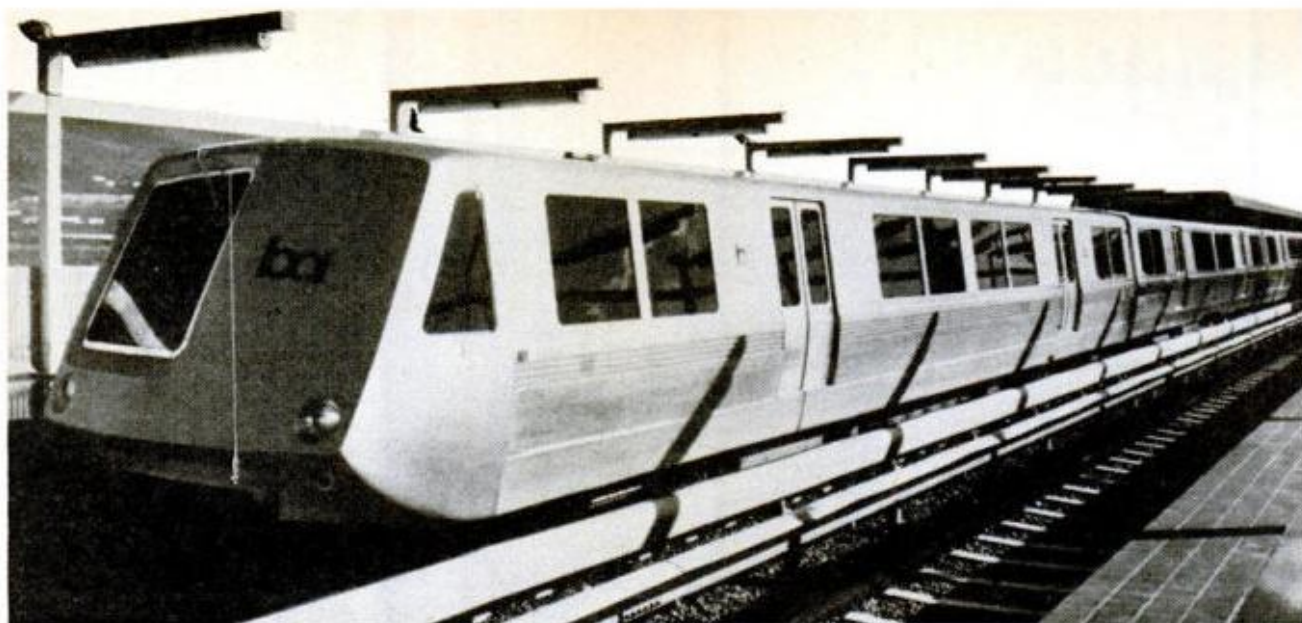

Computerized commuting for San Francisco

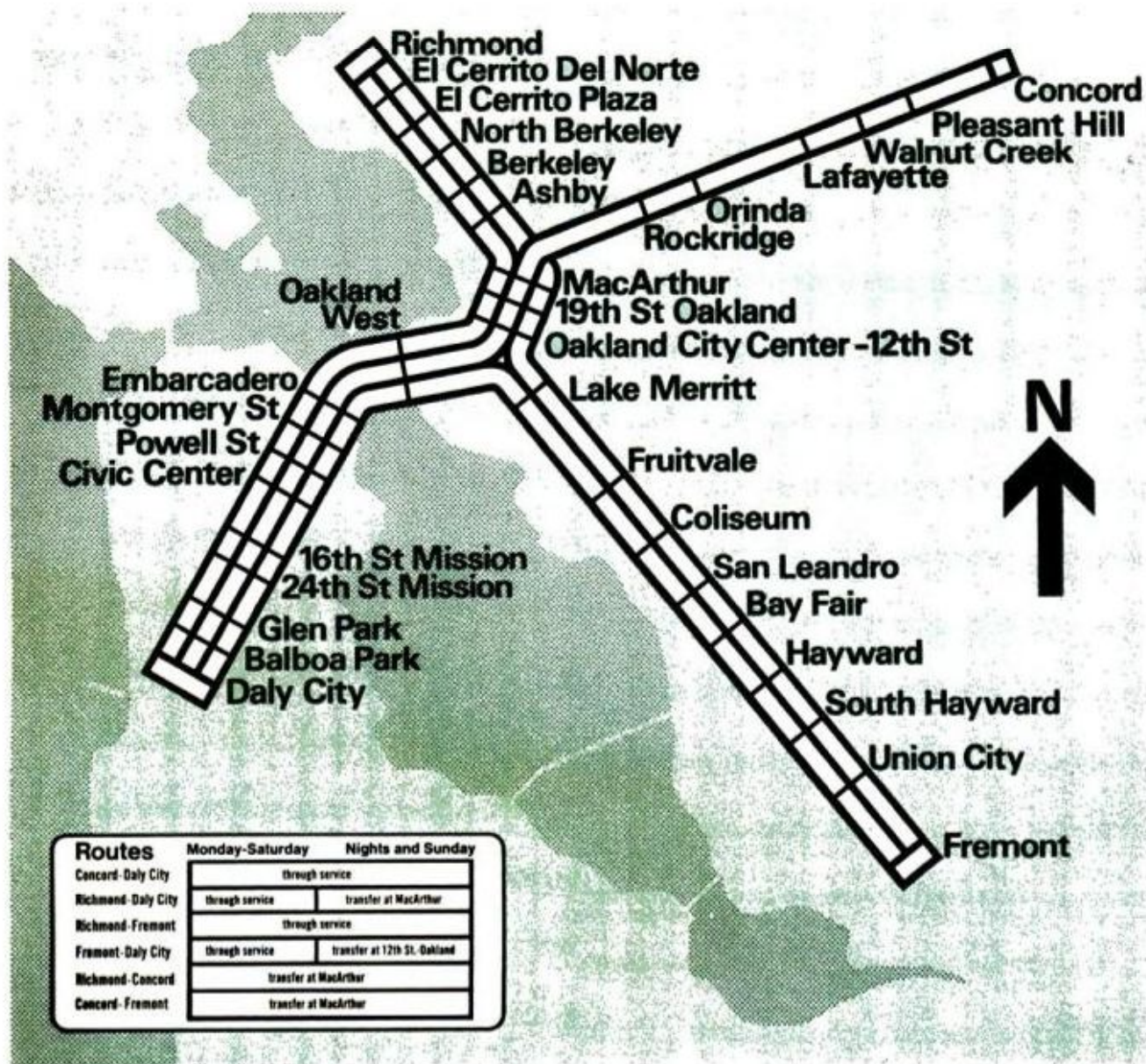

Bay Area Rapid Transit—BART—has automated trains, brainy ticket machines and well-designed stations that even have some signs in braille

By MICHAEL LAMM, West Coast Editor

BART HAS A LOT riding on it. If San Franciscans switch to it and leave their autos home in the garage, the city fathers will heave a sigh of relief. But if commuters shy away from BART (Bay Area Rapid Transit) there'll be a lot of second-guessing and grumbling about the \$1.4 billion cost and 20 years spent in planning and building.

BART is the first regional rapid transit system to be built in the United States in more than half a century. If it's a success, a number of other traffic-clogged cities will regard it as a possible solution to their own mass-transit problems and one way of minimizing the auto's contribution to air pollution. BART officials hope that by 1975 their trains will carry 200,000 people daily.

BART's first leg, a 28-mile run between Oakland and Fremont, was opened recently. The complete 75-mile system, linking cities and suburbs in the Bay area, is scheduled to be in operation this year. By then, BART boosters hope, all the bugs will have been eliminated from the automatic control system.

BART is a space-age railroad. Twin computers in Oakland can route and "drive" as many as 105 individual trains at the same time. Computers control train speeds, stopping and acceleration rates, station waits, even the length of time that doors stay open (ouch!). If anything goes haywire along any portion of the track, little local computers are designed to shut down that portion of the line. A master computer constantly scans and rates the

ATTENDANT SITS at console (top photo) in the lead car. If need be, he can override automated control

WHEN FULL LINE operates, all trains will be monitored from central control room (second from top)

CARS ARE BRIGHTLY LIT and provide comfortable seating for 72 passengers. Rush-hour capacity: 216

MODERN STATIONS (right) are clean and pleasant. They also contain devices to help the handicapped

JANUARY 1973





ALL SWITCHING, inventory and communications functions are directed by this computer in BART's big repair yard

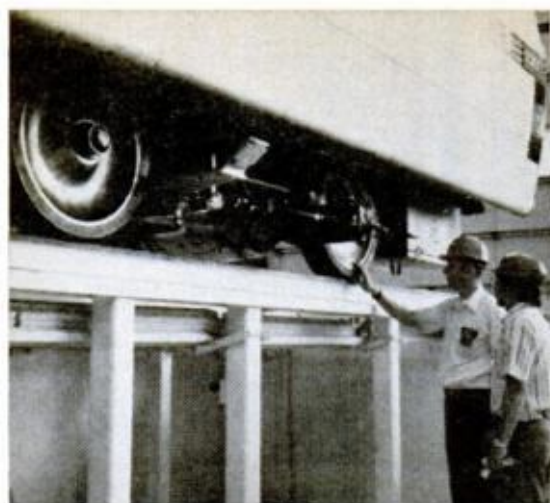

BART CARS have steel wheels with aluminum centers. The combination reduces weight

system to calculate the best combination of service and economy.

Each train has a control module up front, manned by a uniformed attendant. This attendant, according to BART officials, is there mostly to reassure passengers who otherwise might feel they were riding a ghost train. If the automated systems fail, the attendant can stop the train, open or shut doors manually, and move the cars forward at low speeds.

Another bit of cleverness involves the IBM automatic fare system. To ride BART, you buy a credit-card-sized ticket for any amount up to \$20. A machine sells you the ticket and accepts all coins except pennies. It also takes \$1 and \$5 bills. The amount you pay is encoded (printed) onto your ticket in magnetic ink.

To board a train, you pass through an entry gate, the ticket being the key to the turnstile. You put your ticket into a slot in the entry gate, and a gadget inside encodes location, date, and entry time on it,

then gives your ticket back. You pass through the turnstile.

At the end of your ride, you have to pass through an exit gate. Here you again shove the ticket into a slot. An electronic device reads the magnetic coding on your ticket, automatically subtracts the right amount of fare, prints on a new fare balance, and unlocks the turnstile. Fares range from 30 cents to \$1.25, depending on the trip length.

When your ticket is almost used up, with only odd change encoded on it, you can insert it into the ticket-vending machine and receive full credit on your purchase of a new ticket.

BART trains, with up to 10 cars in tandem, ideally maintain a 45-mph average speed, including train stops. Top speed is 82 mph, and full-bore acceleration gets 0-60 mph in 20 seconds. Stopping is accomplished by a combination of conventional Hurst/Airheart disc brakes plus reversing the dynamics of the electric

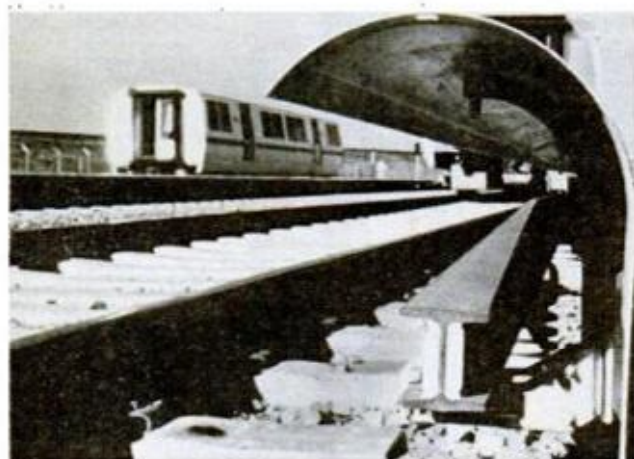

THE THIRD RAIL is steel-aluminum combination. Inserts made of the lighter metal carry the current

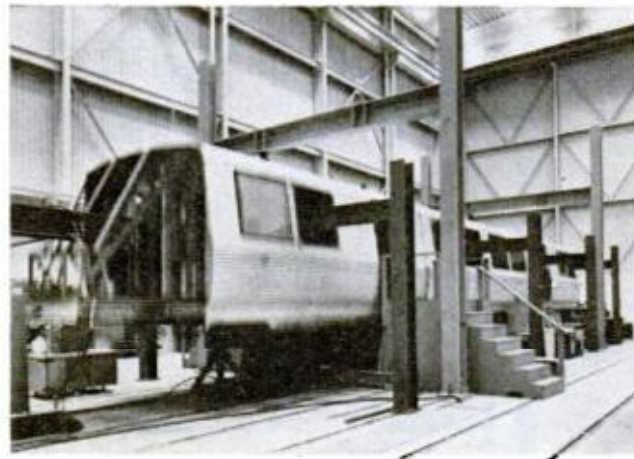

ALL CARS ARE GIVEN vibration tests to insure their ability to handle high loads during operation

POPULAR MECHANICS

drive motors. Power flows along a shielded third rail at 1000 volts d.c.

The computer-monitored power system uses what's called "chopper" control. This means that current to the traction motors is modulated by chopping it into pulses. Pulse lengths depend on the power. The more needed, the longer the pulses. Acceleration is smooth and steady. (This can't be said for older transit systems.)

BART's cars ride on air-suspension systems. To keep down noise and jostle, engineers have isolated the running gear from the passenger compartment. Rails are 1517 feet between expansion joints to give a lot less clack-clack. And the aluminum car bodies (on steel frames) use sound-

invested in this most modern of transportation systems. It isn't hard to imagine the reaction of BART officials and San Francisco's city fathers when—early last October and after less than a month's operation—a two-car train hurtled through the Fremont station (the line's southern terminus), ran off the tracks and plunged through a sand barrier. The lead car wound up nose down in an adjacent parking lot. Four passengers and the attendant were injured.

A preliminary investigation by BART engineers reportedly pinpointed the cause—a malfunctioning crystal in the electronic gear aboard the train. The tiny unit was supposed to "instruct" the train's motors

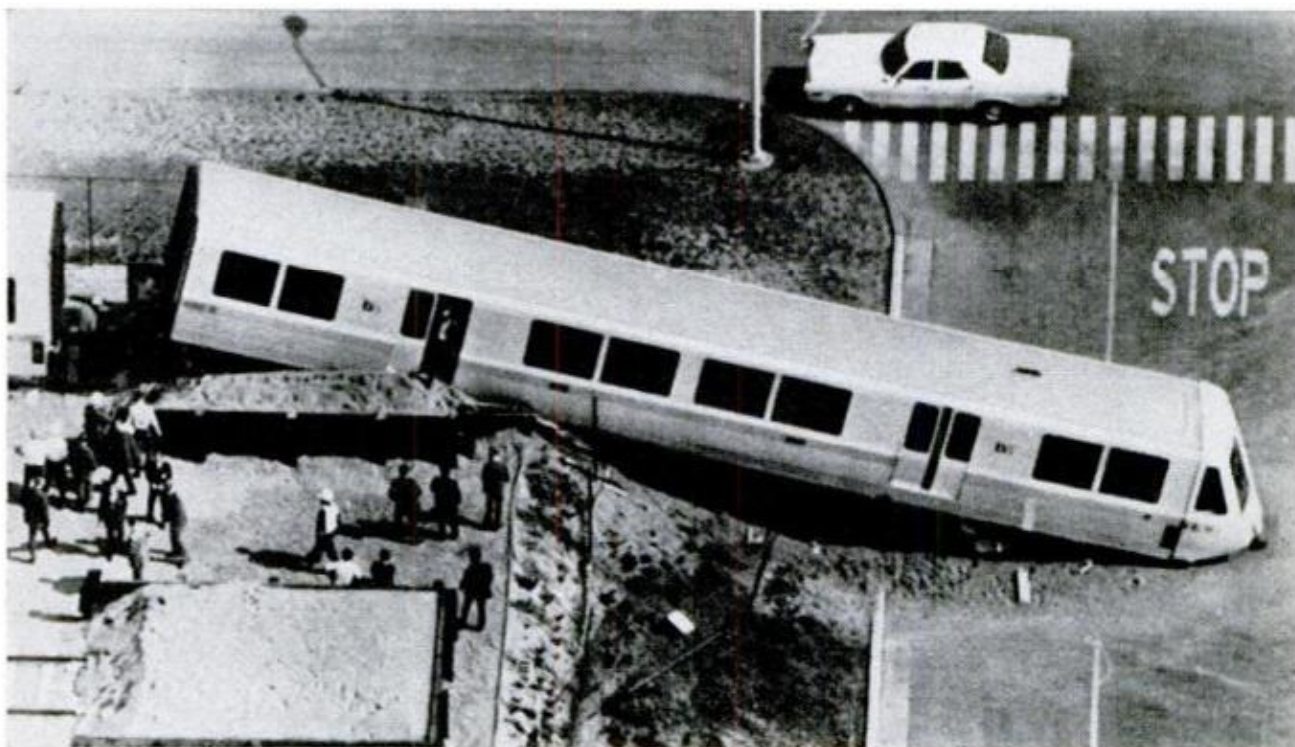

LESS THAN A MONTH after the BART system had gone into operation, this train hurtled past the Fremont station and ran off the tracks. The problem was traced to a malfunction in automated controls

deadening materials extensively. To minimize sidesway, tracks are 5.5 feet apart rather than the U.S. standard of 4.7.

Passengers sit in bucket seats, 72 to a car and upholstered in woven and solid vinyl. One car carries 120 passengers comfortably or up to 216 at rush hours.

Stations are thoroughly modern, clean (so far), and brightly lighted. They contain special equipment for the handicapped. Each station has lower-than-normal telephones for people in wheelchairs, elevators for the elderly, braille symbols on certain doors to aid the blind, and special phones for the hard-of-hearing.

Much thought and planning have been

to slow to 27 mph when signaled by way-side radio devices at station approaches. The crystal supposedly got the right message, but instructed the motors to speed up to 70 mph.

The attendant is said to have responded properly. He hit the "stop" button on the control console, activating the brakes. According to BART officials, the train was down to 26 mph when it hit the sand.

So BART is off to an uncertain start. But San Franciscans should take heart. BART has come through rough financial, political and engineering crises. In time, the gremlins sabotaging the automation system should be vanquished, too. ★★



PM OWNERS REPORT: DATSUN 240Z

Demand outpaces supply...

By MICHAEL LAMM, West Coast Editor

OWNERS APPRECIATE good dash layout, say it gives nice man/machine feel, report solid driving comfort

SPEEDOMETER and tach are highly visible and deeply recessed; passenger doesn't know how fast he's going!



GOOD LOOKS, good dollar value, high resale, brisk performance, fine handling, good gas mileage: These are just a few of the reasons why Datsun 240Z owners go down the road smiling. Occasionally you see one frowning, and chances are he's just snapped the head off his choke cable. It's a fairly common occurrence and one of the few little things that bug Z owners. The plastic head breaks off at the end of the cable.

When Datsun introduced its Z-car in 1970, buyers queued up in long lines around dealerships; in some towns there's still a wait for delivery. Dealers tend to load up their cars with accessories, figuring (correctly) that with demand as strong as it is, customers won't mind paying extra for things like mag wheels, air-conditioning, stereo tape, and so on. So most 240Zs are sold pretty well loaded.

Comments a Brooklyn bookkeeper. "The dealer wasn't interested in selling me the car, because he had more orders than he could handle. He was very nasty, and I was tempted to cancel my order." Obviously, though, she didn't. A Staten Island school teacher echoes, "The dealers I spoke with all had the same attitude, 'If you don't buy it now, we'll sell it to someone else in an hour.'"

Once they're bought, though, about half the 240s had to go back to their dealers

for repairs or adjustments of some sort—mostly minor. And 62.9 percent of the owners we surveyed rated their dealers good-to-excellent on service. This is quite good. "I wasn't able to get back to the dealer until 13,000 miles," says a California restaurateur, "but he fixed the odometer on warranty anyway."

A number of owners complained about waits for parts. "Still waiting for replacement for broken choke cable after seven-plus weeks," says a Harvard physicist. He's not alone. "Dealer had to replace a chipped gear in transmission," notes a New York attorney, "and the repair was fine except for a 2½-week wait for the new gear to come from California."

Quality control? An Ohio purchasing director observes, "Control at the Datsun plant has to be tight, because I can find only one small blemish on the entire car, and I've looked very closely." A Washington welder: "Outstanding workmanship that exceeds almost all American cars."

That's the majority view, but others disagree. "Good workmanship, but I have to qualify that by adding that the car was damaged in transit and needed bodywork and complete repainting."—Maine student. "The metal is too light a gauge, because carwashes put dents and ripples

A nationwide survey based on 899,000 owner-driven miles

for new choke cables, too!

Photos by the author

FINE HANDLING proved top reason for buying Z-car. "Spook" (spoiler) is said to aid stability at speed



SOME OWNERS add stiffer shocks to independent rear suspension and would like rear disc brakes optional



in the roof.”—Memphis priest. A number of owners found the paint too thin.

Performance and handling are two attributes 240Z owners expected from the start. Has the car delivered? “Stiffer shocks all around would greatly improve the car’s low and high-speed handling.”—Detroit student. A New York CPA counters, “Handles extremely well at both low and high speeds; disc brakes are ex-



CARGO DECK is fine for pets but not people. Tiedowns are designed to keep bags from sliding forward

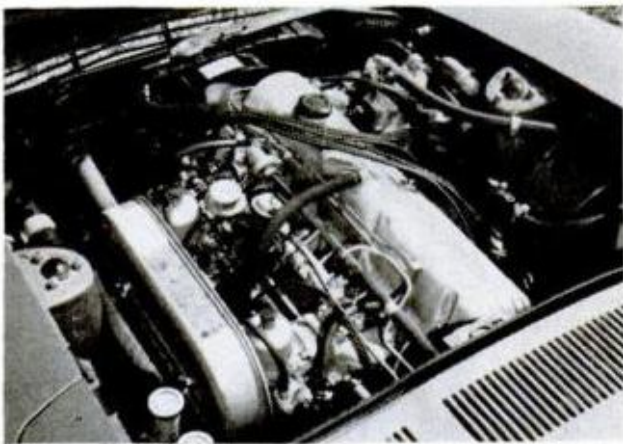

OHC SIX nets 151 bhp, gives sparkling performance with four-speed but tends to be slushy with automatic

cellent under all weather conditions.” A Washington secretary: “A little hard to handle above 85 mph, which I shouldn’t be doing anyway.” Apparently the 240Z does tend to wander and get windblown above about 70 mph, but below that speed it’s very stable.

Several owners added front spoilers (or “spooks”), and they say this gives better stability at higher speeds.

Acceleration from the six-cylinder, overhead-cam engine rates high with owners of manual-transmissioned cars, but others said the automatic tends to be sluggish. Either way, the Z-car’s performance doesn’t penalize anyone at the expense of poor gas mileage. Everyone agrees that 20-25 mpg is more than they’d expected. Here’s one of the few cars where you can have performance and economy too.

In the main, all owners are very pleased with their cars, and we can’t overstress that fact. Yet little things do crop up in any car, and here are a few random shots:

“Would like to see cheap plastic upholstery changed at sides of transmission hump.” “Plastic dash moldings and plastic button-type fasteners do not fasten very well.” “Though the workmanship is good, the materials used are rather poor; for instance, thin paint, thin metal, thin upholstery.” “Hood and decklid need to be stronger to prevent denting in closing.”

“Sticky accelerator pedal,” reports a handful of owners. Another handful isn’t happy with the air conditioner. It doesn’t put out enough cold air, say some, and others claim it helps cause engine overheating in hot weather.

EVERYONE LIKES 240Z’s styling. With demand running strong, some owners griped that dealers had loaded Zs with extras, notably mag wheels and air



Summary of Datsun 240Z Owners Reports*

Total miles driven	889,148
Average miles per gallon	
Local driving	20.3
Long trips	24.3
Transmissions:	
Four-speed manual	81.8%
Automatic	18.2
Why the 240Z?	
Styling	74.8%
Economy	23.7
Performance	23.0
Reputation	18.7
Handling	18.7
Specific likes:	
Style	67.6%
Handling	66.2
Economy	47.2
Comfort	40.1
Performance	39.4
Power	21.1
Specific dislikes:	
Poor quality of materials	15.8%
Rattles	12.2
Poor dealer service	10.1

Poor workmanship	10.1
Poor airconditioner	6.5
What changes would you like to see?	
Better materials	20.3%
Different seat shape	9.0
Better suspension	9.0
Better bumper guards	8.3
Bigger trunk	8.3
Had any mechanical troubles?	
No	50.7%
Yes	49.3
What kind of trouble?	
Choke	37.1%
Airconditioner	7.1
Speedometer cable	7.1
Accelerator	5.7
Transmission	5.7
Did you repair it yourself?	
No	91.4%
Yes	8.6
Dealer repairs satisfactory?	
Yes	64.6%
No	35.4

Dealer opinion:	
Excellent to good	62.9%
Average to poor	34.1
Is the 240Z your only car?	
No	52.1%
Yes	47.9
Other cars owned:	
Chevrolet	17.8%
Volkswagen	16.4
Ford	15.1
Pontiac	8.2
Workmanship opinion:	
Excellent to good	80.7%
Average to poor	18.6
Age distribution of owners:	
15-29 years	59.9%
30-49 years	32.2
50-plus	7.8
Would you buy another Datsun 240Z?	
Yes	80.0%
No	20.0

*Percentages might not equal 100% due to rounding and/or insufficient data.

Comfort? "Passengers can't believe there's so much legroom in so small a car," says a Texas helicopter pilot. "After driving 26 hours with only short breaks, it was still comfortable."—Colorado student. "Forget rear passengers, but dog loves that area."—West Virginia draftsman. "Bucket seats give good support; passengers like reclining seat feature."—California engineer.

Many owners kept on writing even after they'd answered all our questions. We always invite extra comments, and here are some of the more typical:

A New York hairdresser: "I traded a 1972 T-bird, which cost \$7200, for the Z, and the Z put pleasure back into my driving."

An Ohio RN/interior decorator: "This is the first car I can recommend to friends

and strangers without reservation. I've enjoyed every minute of driving it, and for the first time in my life, I feel I've made a good deal on a car."

And a 19-year-old engineering student at General Motors Institute: "I would like to tell you why I bought the 240Z and not another car. I considered the Fiat 124 Spyder, the Alfa Romeo Spyder and the Porsche 911T. The Porsche's price put it out of the question. For a few hundred dollars more than the Fiat, though, I reasoned I could get a better all-around car: power, handling, comfort, appearance and the safety of an enclosed GT. I can't complain about fuel economy nor the long list of standard equipment. The biggest problem I have is keeping people's fingerprints off the paint and their noseprints off the windows."

ACCESS DOORS flanking hood hide battery on right and master cylinder on left. Dome light (center)

turns on by pressing lens. Chained gas cap (right) would ding fender if it wasn't for the rubber apron



PM OWNERS REPORT: TOYOTA CELICA

ST is for Super and



HIGHLY AMERICANIZED styling catches most buyers' attention initially, and modest price plus good economy, long list of extras move in for the sell. Airscoops look fake but are functional and also help stiffen hood. Despite nominal room for four, it's essentially two-passenger car, with scant legroom in back. Owners report good driving comfort, enjoy long trips, boast plenty of power and good torque for holding speeds going up steep grades



By **MICHAEL LAMM**
West Coast Editor

Photos by Irv Dolin

MEEET TOYOTA'S CELICA, one among a group of several popular, small, imported ponycars. The imports are slick, glossy, economical, well put together and fun-to-drive automobiles. The Celica's competitors now include the Capri, Opel Manta and the Mazda RX-2 coupe. Soon the mini-Mustang will join that growing club.

Who buys a car like the Celica? And why? Young people, mostly. The biggest single age group in our

POPULAR MECHANICS

A nationwide survey based on 1,002, 000 owner-driven miles

Terrific, but dealers—!



1 HARD CORNERING brings out hearty understeer due to 59/41 weight distribution. Heavy engine also makes for the steering stiffness. **2** Celica includes very complete instrumentation, plus radio, tach, clock among standard items. **3** Shoulder harness cuts into neck, so most owners can't use it! This, of course is a problem with many shoulder rigs and their positioning should be given more attention by the car manufacturer. **4** Gas-filler location outfoxes most service station attendants because its hidden behind styled panel. **5** Handy door handles pull out to open; owners say they like them

Celica survey was 20-24. Owners are usually unmarried or newly wed, and since many expect to have families when they're ready to trade for another car, they realize they'll probably need bigger ones next time. That explains why 20.9 percent said they wouldn't buy a Celica again. It *wasn't* because of any inherent dislike of the car. Quite the opposite.

As to why they chose the Celica: "Because I couldn't afford a Datsun 240Z, and I don't like American cars;

the Celica was the next best thing."—Ohio lineman. "Because of its styling and good gas mileage. It's economical to repair as well as to insure."—Hoboken engineer. "Because of its sporty appearance, four seats, good-sized trunk, and low price."—Texas insurance salesman.

By far the biggest beef centered on dealer service. We asked the owners to rate their dealers two ways; first on general courtesy, sales policies and methods. Here owners gave their dealers a fine score: 77.6 percent rated them *good-to-excellent*. But when we asked for their opinions on dealer service alone, only 36.4 percent of the owners said *good-to-excellent*. A full 40.9 percent rated dealer service *poor*.

A Los Angeles inventory planner summed it up this way: "Toyota dealerships are the worst I've come across. The car in general is very good, but it's too bad the dealers can't live up to the standard." Most owners would say "hear, hear" here.

What are owners' specific praises of the Celica? An Ohio therapist says, "The speed is super, handling fantastic, brakes are sure, very comfortable on long trips, good gas mileage, plus lots of standard extras. Who could ask for more?" A Massachusetts electrician credits the "Beautiful interior and sharp exterior. It attracts attention and questions. People love the way it handles turns at high speeds and also the general smoothness of the ride. There's plenty of trunk space, and a handy tool kit comes with the car." And a New York advertising man reports, "I travel a lot. I find the Celica comfortable; the motor is big enough so the car

holds its speed on hills, and it's economical."

We also asked for specific complaints. Here are some of those. From an Oregon legal secretary: "Steering is hard in parking, and my car has more than its share of rattles and vibrations." An Illinois coal miner complains that it "maneuvers badly in tight corners and brakes squeal on cold mornings." A Chrysler Corp. test driver notes, "High cost of warranty tune-ups, and it could use wider standard tires." A Denver parts manager tells of "hard steering from understeer." And from a Virginia college professor: "The Celica has terrible front/rear weight ratio and awful understeer."

It's true that the Celica is front-heavy, with a weight distribution of 59/41. That's bound to give quite a bit of understeer, and it also accounts for complaints about hard parking. Yet owners were evenly divided in their opinions about handling.

Most people realized when they bought their Celicas that the rear seat was strictly for kids and short hops. One owner suggested remaking of this area for a two-passenger car and using the present rear-seat area to enlarge the trunk. Most others, though, found luggage capacity to be plenty big.

Toyota Celica owners give their cars a high rating on workmanship. Fully 88 percent of them marked workmanship as *good-or-better*, with 34.7 percent checking no less than *excellent*. That's quite a tribute to what is essentially designed as an economy car. It's the sort of mark that was previously reserved for Volkswagen alone.

In the realm of I'd-like-to-see came

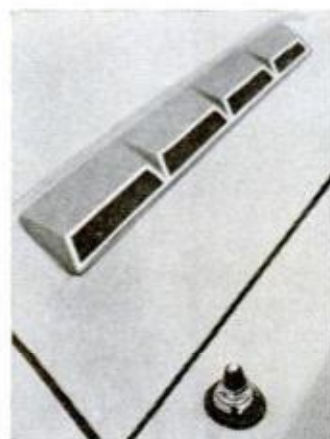
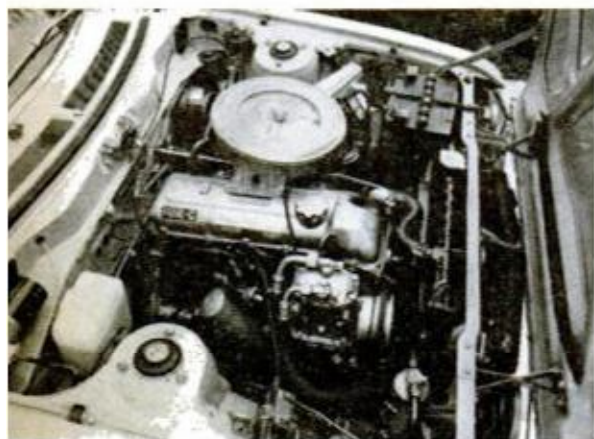

TOYOTA'S sohc-Four, with 97 bhp, powers Corona and Mark II as well as Celica. MacPherson-strut front suspension gives plenty of travel, helps soften ride

88

ANTISWAY BAR and standard radial tires compensate to some degree for understeer. Semiautomatic antenna pops up when radio goes on, pushes down by hand

POPULAR MECHANICS

Summary of Toyota Celica Owners Reports*

Total miles driven	1,002,829
Average miles per gallon	
Local driving	24.6
Long trips	29.0
Why the Celica?	
Styling	69.5%
Economy	48.2
Price	16.3
Performance	12.1
Reputation	7.1
Specific likes:	
Economy	60.6%
Style	59.9
Handling	45.1
Comfort	39.4
Performance	24.7
Power	18.3
Ride	16.2
Specific dislikes:	
Poor dealer service	10.6%
Rattles	9.2
Poor quality of materials	7.8
Too light on road	7.0
Brakes squeal	5.6

What changes would you like?	
Bigger engine	13.2%
Better suspension	10.9
Different styling	8.5
Better steering system	7.8

Had any mechanical trouble?	
No	54.6%
Yes	43.4

What kind of trouble?	
Carburetor	14.3%
Speedometer cable	11.1
Dieseling	7.9
Transmission	7.9
Muffler	7.9

Did you repair it yourself?	
No	95.2%
Yes	4.8

Dealer repairs satisfactory?	
Yes	55.9%
No	44.1

Is the Celica your only car?	
No	53.6%
Yes	46.5

Other cars owned:	
Chevrolet	19.7%
Toyota	15.3
Pontiac	11.8
Ford	11.8
Plymouth	10.5

Workmanship opinion:	
Good to excellent	88.1%
Average to poor	11.9

Dealer service opinion:	
Good to excellent	34.4%
Average to poor	63.5

Age distribution of owners:	
15-29 years	72.1%
30-49 years	18.2
50-plus	9.8

Would you buy another Celica?	
Yes	79.1%
No	20.9

*Percentages might not equal 100% due to rounding or insufficient data.

fairly strong pleas for a six-cylinder engine option to bolster the Four; and a number of the respondents said they'd also like to see Toyota make its five-speed gearbox available in the Celica models.

Other suggestions received included the offering of power steering, improving the design of the shoulder harness; adding removable roof panels in the same way Porsche, Triumph Stag and Corvette do; and using a heavier gauge metal. "I've got to be very careful when I wax the car, ha, ha," says a Texas airman wryly.

But by and large, all complaints concerned with the car itself are trifling. A New Jersey machinist's major gripe, for example, was "... that I didn't buy the car sooner."

Summing up some of the other owners'

feelings: "Dollar for dollar, I feel it's the best car in its class."—Staten Island correction officer. "That little car just overwhelmed me—love at first sight!"—retired Denver fireman. "Interior is well above the quality of U.S. cars."—North Carolina student. "All that standard equipment makes it nice, like the radio, reclining seats, tach, clock, rear-window defroster, and the good disc brakes. . . ."—California vintner.

And a 23-year-old New Jersey secretary who's thoroughly sold on her Celica states, "I have owned the car four months and 5300 enjoyable miles. It's very sporty, yet has ample room, amazing power on the highway, gas mileage is great, and the equipment they call standard makes me feel that I really got something for nothing." ★ ★ ★



STYLING AND ECONOMY of the Celica is the reason owners say they bought the car. Many owners are enthusiastic drivers and want to see bigger engine
JANUARY 1973

CELICA TRUNK is neat and commodious for small car. Some owners don't need rear seat and indicate a preference for a trunk running through to front seats

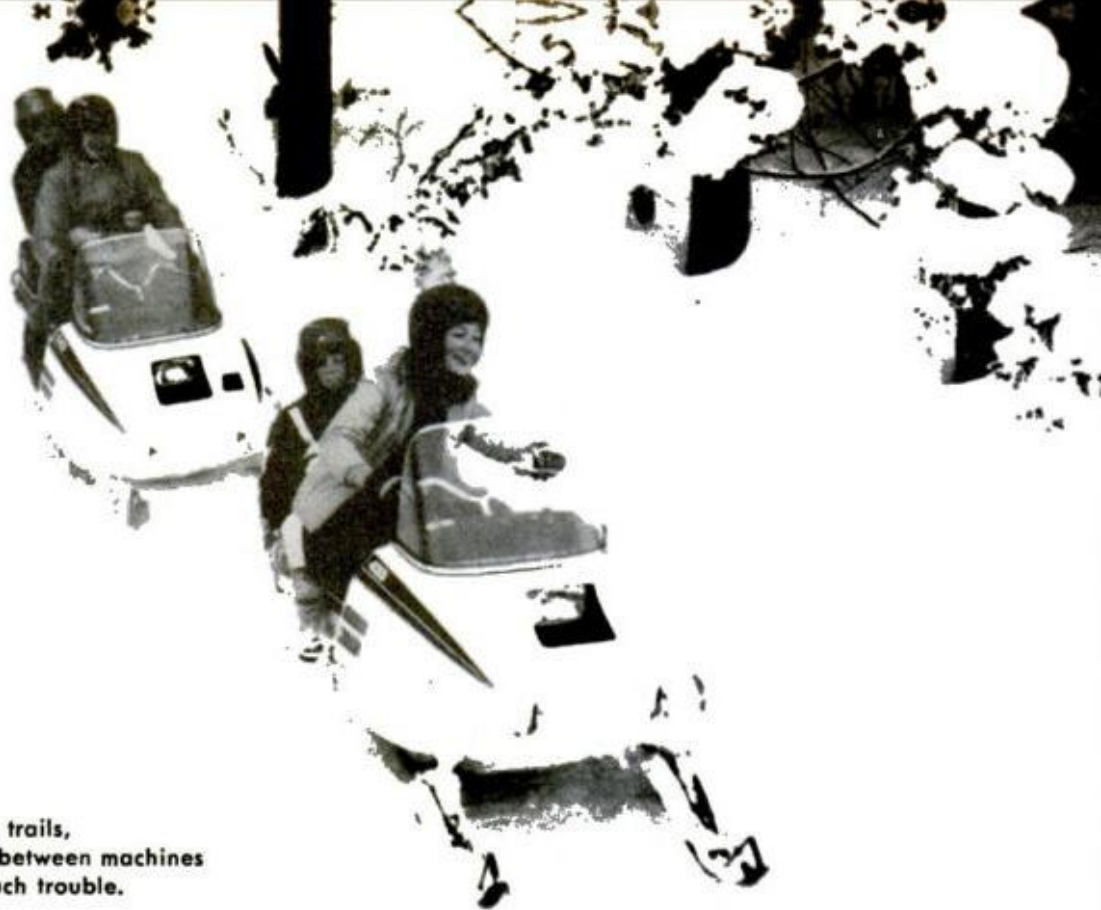

ON TRACK along assigned trails, a group—with more space between machines than shown—can avoid much trouble.

Trails—a solution for the snowmobile problem

New specially made paths across snow country may help steer 2-million snowgoers away from accidents, ecology damage—and even some critics

SNOWMOBILES MAY HAVE TURNED a corner this winter, heading out on a happier course across the snowbelt.

Anywhere the weather bureau says there is an average of one inch of snow 100 days a year (and even some places where there isn't), snowmobiles have been flourishing over the last decade—to the delight of their owners and the dismay of many stay-at-home critics. Complaints about the machines have cited noise, needless trespassing, damage of the countryside, drunken driving and drownings.

But now more and more drivers are off on a different track that is proving safer and more fun. It's estimated that this winter there are nearly 40,000 miles of trails set aside just for the snowmobiler. This is a remarkable development record

for a sport so young, but probably 100,000 miles would be more adequate for the number of machines in use.

Unfortunately, many trails are not yet properly maintained. Constant use creates moguls—those exaggerated washboard bumps that give you a roller-coaster rodeo ride at modest speed and pitch driver and machine out into the underbrush if you try to take them too fast. And many snowmo trails are not well marked. After a sprint across open meadows it is often hard to tell where the track re-enters a wall of woods, and long winding stretches don't yet have the recommended "reassurance" signs that tell a driver he hasn't wandered off course.

This year, however, a number of aids are available for the first time to help



MODERN TRAILS can now be graded and smoothed to take the washboard ride out of your snowmobile outing

SNOWDRIFT PICNIC SPOTS are now designed into new trails. Safe night operation is preplanned into layout



By **BILL McKEOWN**
Outdoors Editor

communities, clubs and even individuals set up excellent local trails. An old logging road or abandoned right-of-way can be converted, or a group can start from scratch. In Douglas County, Wis., in the northwest corner of the state, scenic Cut-A-Way Dam Trail was designed and bulldozed out two years ago for a 15-mile two-way trail at a cost of about \$8000. The money came from snowmobile registration fees paid into State Department of Natural Resources funds. Last winter Halvorsen, Inc., in Duluth, a Ski-Doo distributor, provided a Bombardier Skidozer dual-track machine, designed for grooming the trail. More than 10,000 snowmobilers used Cut-A-Way, and the county forest administrator termed the development a spectacular success. Complaints of snowmobile dis-

turbance in the county dropped to practically zero, and there was no evidence of snowmobilers leaving the designated trail.

A club operation that snowballed into a success story started at Old Forge, N.Y., in 1966. With the help of a local architect club member, trails were developed along old paths after permission was obtained from local, state and private property owners. Now 500 miles of well-maintained trails fan out from Old Forge along routes that do not conflict with the highways, ski runs or private homes. Local motels are filled on winter weekends, snowmobile rental is booming, and the township government has taken over trail maintenance.

How is a good trail established locally? First you need a snowmobile club so that town fathers know your spokesman repre-

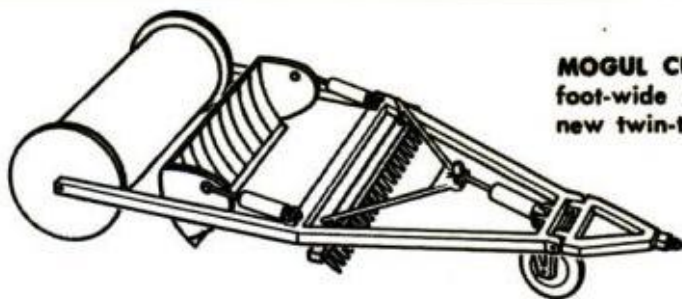

MOGUL CUTTER AND SCRAPER is 8-foot-wide accessory for Bombardier's new twin-track Skidozer to level trails

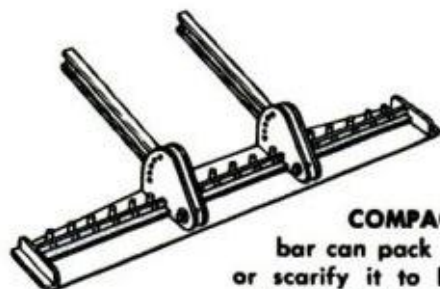

COMPACTOR bar can pack snow or scarify it to break hard-packed moguls, rough stretches

SEVERE DIP (left) stops snowmo dead, but after Trak-Pak (below) fills ditch the trail is level



SKI AND SNOWMO TRAILS can both be smoothed by Haugen Track Sled towed by snowmo or snowcat for 3-foot-wide trail

sents a responsible group. A booklet, *How to Organize a Local Snowmobile Club*, is available free from the International Snowmobile Industry Assn., 5100 Edina Industrial Blvd., Minneapolis, Minn. 55435. From the same source is *Basic Recommendations for Snowmobile Trails*, an eight-pager. From the SnoPlan Trail Study Manager, Bombardier Ltd., Valcourt, Que., Canada, clubs can get the 24-page *Guide to the Development of Good Snowmobile Trails*, a how-to-do it booklet that also gives illustrated success stories of trails in the United States and Canada. Minnesota, Michigan, Wisconsin, New York, Idaho, Washington, Utah, Wyoming are among 20 states offering snowmobile maps or directories for families that just want to see more of the snow country and groups studying trail development.

In general terms, depending somewhat on typical weather and terrain, a good modern snowmobile trail should be

planned where a minimum of three inches of snow can be expected. It should hopefully be at least 15 miles or more in length, with a minimum of five miles and maximum of 50. Ideally, trails will be one-way, 10 feet or more wide, and with shorter loops that can get a driver back to his starting point. It's estimated that a well-designed trail can handle eight machines per mile twice a day; thus a 50-mile trail could accommodate 800 machines a day. Safety patrols and rest stops should be provided.

Already, new trail-grooming aids that can be towed by snowmobiles or special vehicles are available from such companies as Bombardier, Trak-Pak Snow Grader division of Bullard Products, North Hyde Park, Vt. 05665; the Norwegian-built Track Sled from Haugen Co., 8 Henshaw St., Woburn, Mass. 01801, and others.

Trails will never silence all snowmobiles and their critics, but should keep them on separate sides of the snowdrifts. ★★★

ONCE A TRUCK was simply the replacement for workhorse and wagon. Now light trucks double as everything from pleasure car to backpacking mountain goat. Surveys show most presently will serve more than half their roadway hours as vehicles for fun. Small imports, too, are trying to join a trucking trend to recreation. Today more trucks are making like turtles as they add travel homes—it's an easy way to load a lot of living-on-the-go. ★★★

Trucks for fun

Camping conversions can make a happy switch-hitter out of your cargo carrier



INTERNATIONAL offers a three-way choice with new Travelall (front), Travelette (top), Scout (right)



DODGE calls it the new CB300 Kary Van, and a do-it-yourselfer may rate it ideal for conversions



CHEVY's C-30 pickup with "3+3 cab" is dual-rear-wheeled four-door suited to fifth-wheel trailer tow



FORD SUPER CAMPER SPECIAL F-350 has longer wheel base, higher GVW rating, new tie-downs, sway bars



JEEP COMMANDO, American Motors' old favorite, is available now as wagon (above), pickup or roadster
JANUARY 1973



GMC JIMMY, almost identical to Chevy's Blazer, here mounts Con-Ferr's Baja luggage rack as extra

Pleasure-craft preview '73

Boat shows are about to display more plastic and plush, power and performance

EACH YEAR, 'NEXT YEAR' comes earlier afloat with more builders announcing new lines ahead of the season. Our pre-boat-show selection here shows trends toward more speed, styling and color, using bigger horsepower in outboard motors, inboard engines, stern drives and increasingly popular water jets. Even electric outboards are getting stronger, and fish are due to get a bottom view of a great many new bass boats designed just for anglers trolling sheltered waters. ★★



1

2

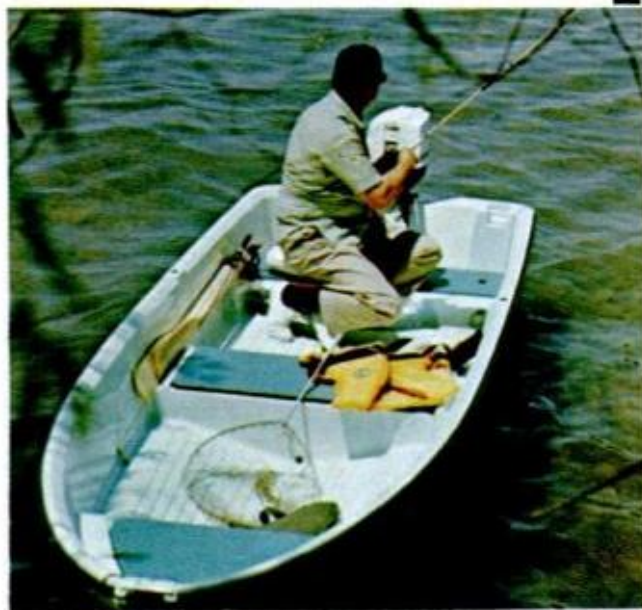

3



4



5



POPULAR MECHANICS



6

1. **MFG RUNABOUTS** add color to line that includes new I/Os, cruisers, sail
2. **SUPER GAMEFISHER**, 12-footer by Sears, will be joined by ABS 14-footer
3. **SLEEKEST AND FASTEST:** Aronow's high-performing Cigarettes from Miami
4. **BOSTON WHALER** newcomer is Bass Boat 16 with pedestal seats standard
5. **STARCRAFT** aluminum cruisers will come in 18, 21 and 24-foot I/O models
6. **GLASTRON'S GT-150**, sporty 15-footer from top outboard, jet, I/O lines
7. **CHRYSLER CONQUEROR SIII** mounts 340-cu.-in. V8 stern-drive or water jet
8. **LARSON 1650 SHARK**, new trihull, carries six with outboard or I/O power



7

8



Little box that can be a work of art

You can convert a throwaway lotion box into one of these handsome chests

By WAYNE C. LECKEY, Home and Shop Editor



Camelot



Byzantine

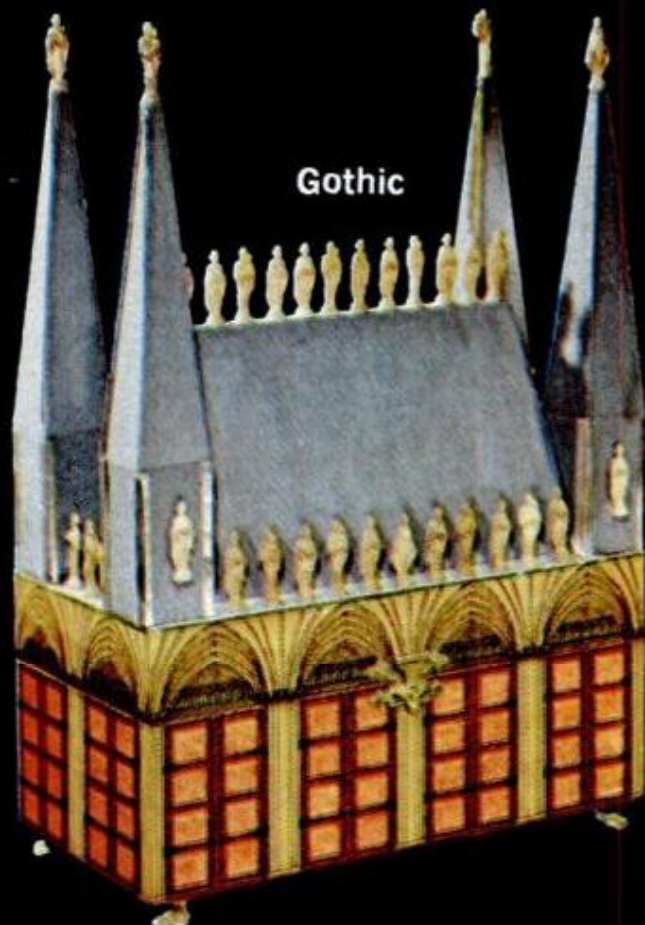

Gothic

IT ALL STARTED with a gift from his wife. That's when Al Mesnooh, New York artist and freelance art consultant, began "tinkering around" making these handsome one-of-a-kind trinket chests.

The gift was a bottle of English Leather cologne by Mem which came in such a nicely made wooden box that Al just couldn't throw it away.

Since that first bottle, Al has used a lot of cologne for he has created a lot of chests from the empty boxes. His works of art have been displayed at countless banks, museums and art fairs in and around New York City. Many have brought a handsome price.

Appropriately named Camelot, Byzantine and Gothic, the three chests shown here in color are good examples of how his interest in ancient history and architecture have been put to use.

Asked where he found the tiny plastic figures, he answered: "Here and there, in hobby stores, gift shops and souvenir counters. Finding enough of them is my biggest problem."

An artist, Al decorates most of his boxes with his own exclusive designs, but, as he explained, "You don't have to be an artist to produce a handsome chest. In the case of my Camelot chest I made use of the embossed metallic designs from

NICELY MADE OF REDWOOD, throwaway after-shave lotion box becomes "work of art" trinket chest when decorated and fitted with brass hardware as at left



PHOTOS BY ROBERT D. BORST



CALLED BEN HUR, this handsome chest is decorated with stately columns depicting the Colosseum and a chariot race of tiny figures to complete the theme

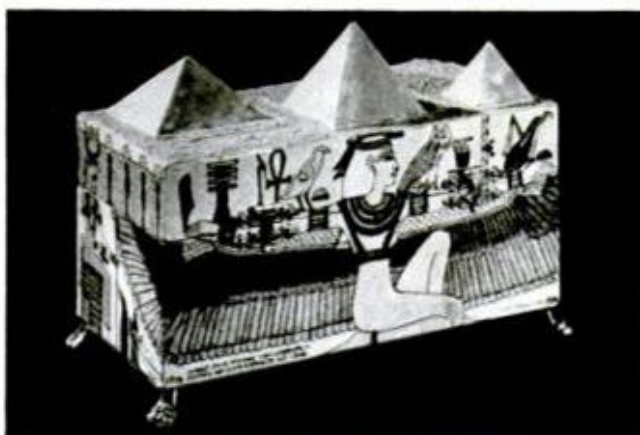

the carton of a bottle of Chivas Regal Scotch whisky, antiqued them gold and applied them to the sides, ends and top. Magazines are a good source of appropriate pictures; so are cards and gift-wrapping paper. That's the fun part of it all, starting out with a theme and tracking down suitable figures and illustrations. Of course, when you can make your own designs, the fun is ever greater."

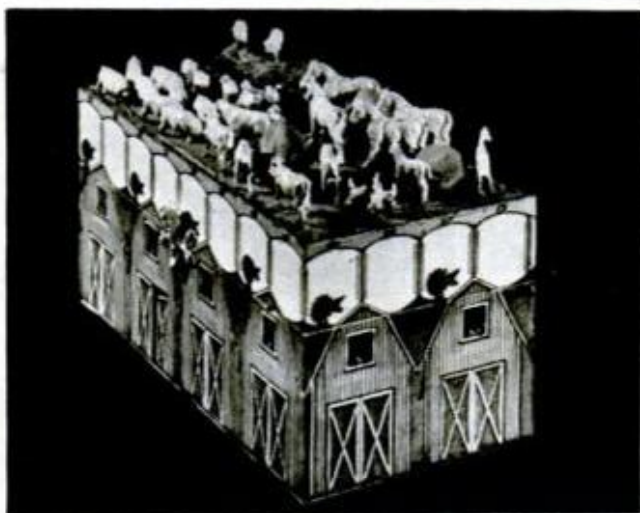

COMPLETE WITH PYRAMIDS resting in desert sand, this exotic chest (top photo) is decorated with appropriate pictures to give it an Egyptian motif. A country theme is achieved by adding tiny farm animals to cover of chest and barn illustrations to sides

Actually no specific box is required to start with. Anyone who is handy can make a suitable box from thin wood. Where the corners of the chest are left exposed, the "dovetailed" joints of the cologne box do add to the appearance of the completed chest as you see in Camelot. In cases where the box is to be completely covered, how the box is put together and what wood is used makes little difference as you see in the other examples.

The top of the cologne-bottle box actually becomes the bottom of the chest and the bottom, the lid; the cardboard liner is discarded. The lid is held in position by two tiny brass hinges. The latter, plus the feet and lid clasp, can be purchased from most well-stocked hardware stores. ★★



SPEED AND DISTANCE are shown on meters in RCA's experimental system. Reflector under plate of car ahead sends back radar signal at double frequency

Relax, let radar do the braking

There are several radar systems in operation right now, but the questions are: When will they become mandatory safety equipment? And which system will go into production at what cost?

By **ROBERT LUND**, Detroit Auto Editor

IF YOU'RE INVOLVED in an automobile accident this year, the chances are one in four it will be a rear-ender. You'll be hit from behind or you'll plow into the back of another car. Those odds are going to get better over the next few years. Auto manufacturers have two projects in the works to cut down, or even eliminate, bash-'em-from-behind accidents.

These devices are: 1) Radar brakes. 2) Headway controls that automatically maintain a safe distance between a lead car and following vehicles.

Radar brakes are about two years away;

TRANSMITTER of experimental system is adjusted by RCA engineer. System is explained on the next page

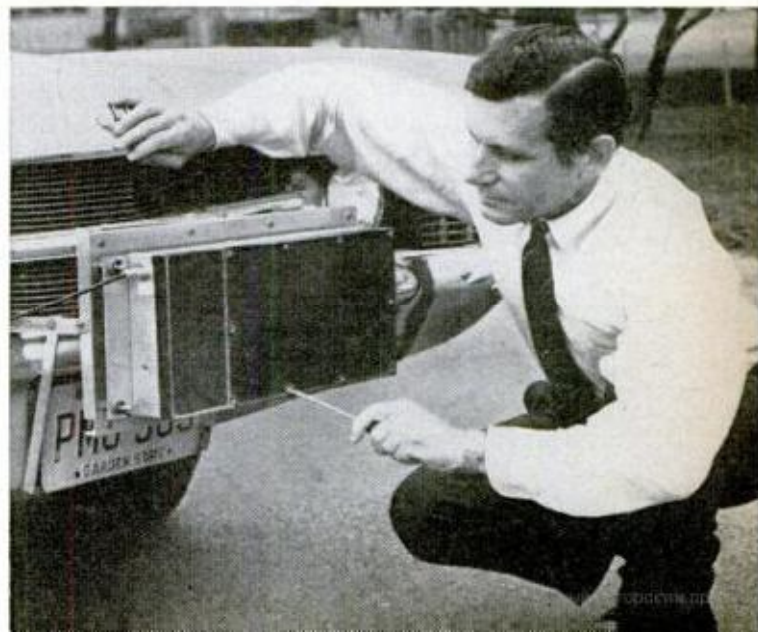

IN RCA SYSTEM, following car transmits a signal (F) which is reflected back at twice the frequency (2F) by a special reflector on the rear of the car ahead. The radar then calculates the distance between the two cars and sounds a buzzer and flashes a light if the separation distance is too small. The technique of doubling the frequency eliminates false targets created by signals bouncing off signs, bridges and other objects. It also prevents two radar-equipped cars traveling in the opposite directions from blinding one another as they pass

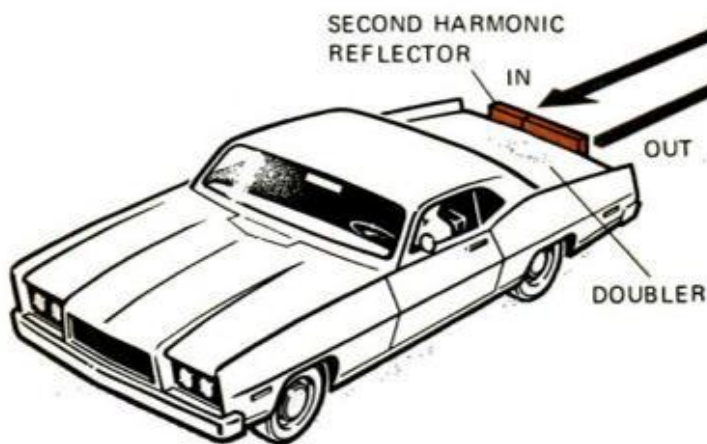

FLOW DIAGRAM OF HARMONIC COLLISION-AVOIDANCE RADAR SYSTEM

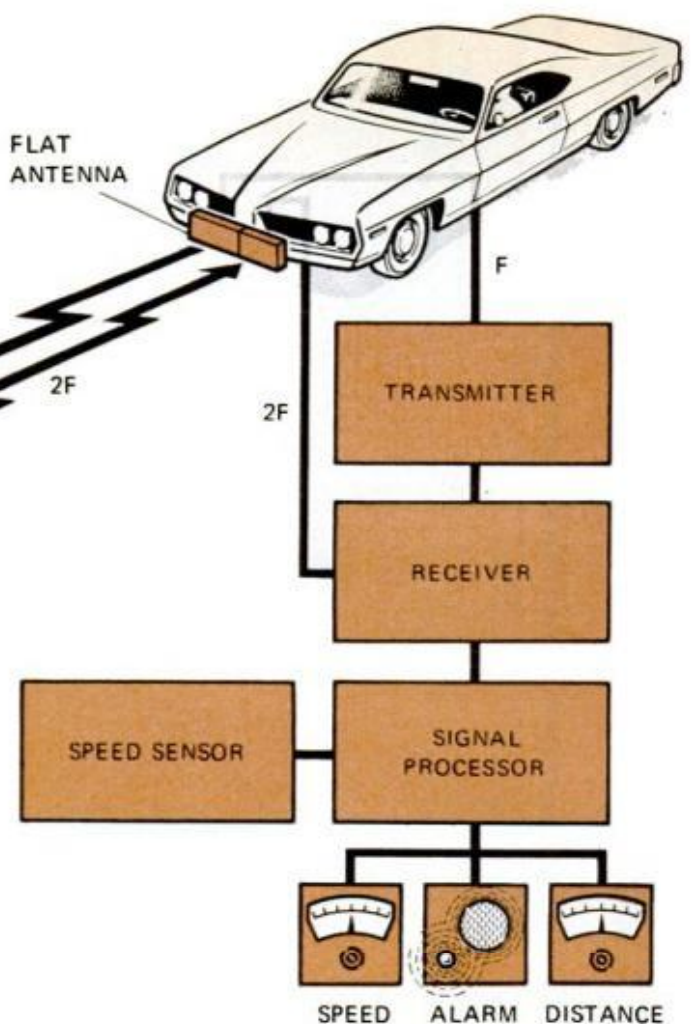

Technical Art by Peter Trojan

they'll come on the '75 or '76 models. The National Highway Safety Administration is now writing a standard that will make the use of radar brakes mandatory by mid-decade.

Headway control won't come until sometime later. As a guess, probably on the '77 or '78 cars. But the auto companies could be pressured into moving sooner.

Radar brakes are ready now. It's a matter of deciding which version to use and then putting the item in production.

Two types of radar brakes are under consideration. One version sounds a warning when a car gets dangerously close to the car ahead. The signal is in the form of a light or a buzzer or a light-and-buzzer combination. Radar measures the distance between cars based on speed and alerts the driver to back off when he gets too close to the lead car.

The second version of the radar brake is more sophisticated and performs a robot function. It alerts the driver of impending danger, eases up on the throttle and applies the brake. Automatically, without human intervention.

GM, Ford, RCA and several auto in-

dustry suppliers have working versions of both types of brakes, and the race is on to see which of the various systems will be adopted by the auto companies.

The only contender that has given a public demonstration of its system is RCA. In its version, both cars must be equipped with receivers and senders. The trailing car transmits a continuous signal which is received by a reflector on the rear of the vehicle ahead. The reflector doubles the frequency of the transmitted signal and relays it back to the radar. The radar measures the time required for the signal to make the round trip between the two cars. It then calculates the distance between cars and triggers a light buzzer warning if the separation distance falls below one car length for each 10 mph of speed between the vehicles. Range of the radar is a hundred yards.

The RCA unit corrects disadvantages inherent in earlier efforts to use radar on automobiles. It can distinguish between cars and such false targets as highway signs, bridges, trees and oncoming cars in the opposite lane of traffic. This is achieved because the radar is responsive

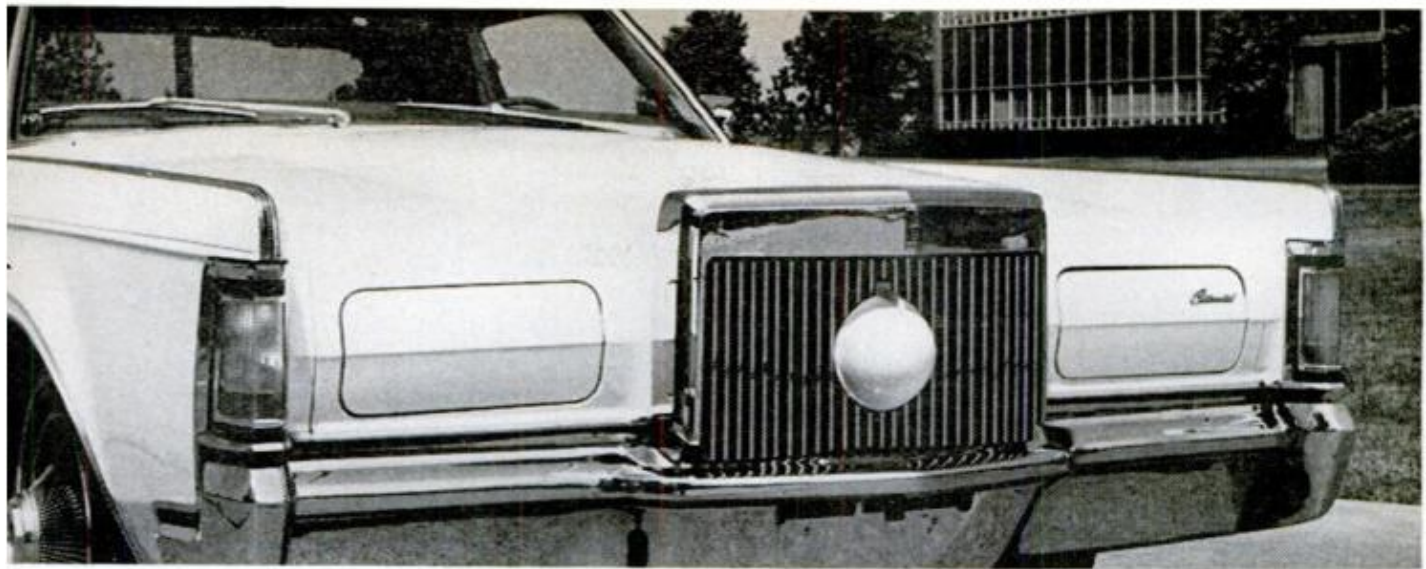

IN BENDIX SYSTEM brakes are applied automatically. Radar dome would be behind grille in production cars

only to signals produced by the reflector at double the transmitted frequency. But the RCA version could be used to detect bridges, trees and other objects simply by placing small reflectors on obstacles to be avoided.

RCA estimates its warning system radar—without the automatic braking feature—could be installed on a car for \$50 to \$100. The cost of producing only the reflector—that is, the receiving unit without the sending device—for installation on older cars would be less than \$10. RCA doesn't have a figure on what it would cost to include the automatic braking feature, but a long-time supplier to the auto companies estimates that linking the radar up to throttle and brakes would push the price up to \$200, give or take.

The auto companies are extremely cost-price conscious and will obviously opt for the less expensive version—a radar warning system without automatic braking—in the early stages. That's providing the government doesn't step in and order automakers to use the more expensive, safer unit incorporating both warning device and robot braking.

Car producers are already looking ahead to what comes after radar brakes. Next up: automatic headway control. When: probably not before 1978, according to Bendix, pioneer and leader in development of headway controls. How much: at today's prices, about what you'd pay for a factory-installed airconditioner. Say around \$400.

Headway control offers two advantages over a radar brake with automatic braking. With headway control, it's impossible

to tailgate another car without doing so intentionally. You can't get close enough to the car ahead to cause the brakes to slam on. The second advantage is that headway control operates independently of other vehicles. The car ahead doesn't require any kind of receiving device to maintain a safe distance between the two vehicles.

Two companies, Bendix in this country and Joseph Lucas, Ltd. in England, have built working versions of a headway control system.

The Lucas system uses two four-inch radar "horns" mounted on the grille; one for transmitting, another for receiving. Computers on the car continuously calculate the distance between the lead car and the trailing vehicle. Brakes and throttle adjust automatically to maintain a safe distance between cars. But the driver can override the system at any time by going to manual operation of brake or accelerator.

Bendix has been working on headway control since 1957, longer than any other automaker or supplier. The company's current test car with a headway control installation is a 1969 Continental Mark III. (The car will soon be retired, because Bendix wants to install the system in a smaller, less expensive automobile and incorporate changes it has made in the radar hardware since 1969.)

Bendix calls its system adaptive speed control. It uses a radar sensor to measure headway or range and closing velocity of the controlled car to the lead vehicle. A signal processor analyzes this information

(Please turn to page 186)

IT'S NEW NOW

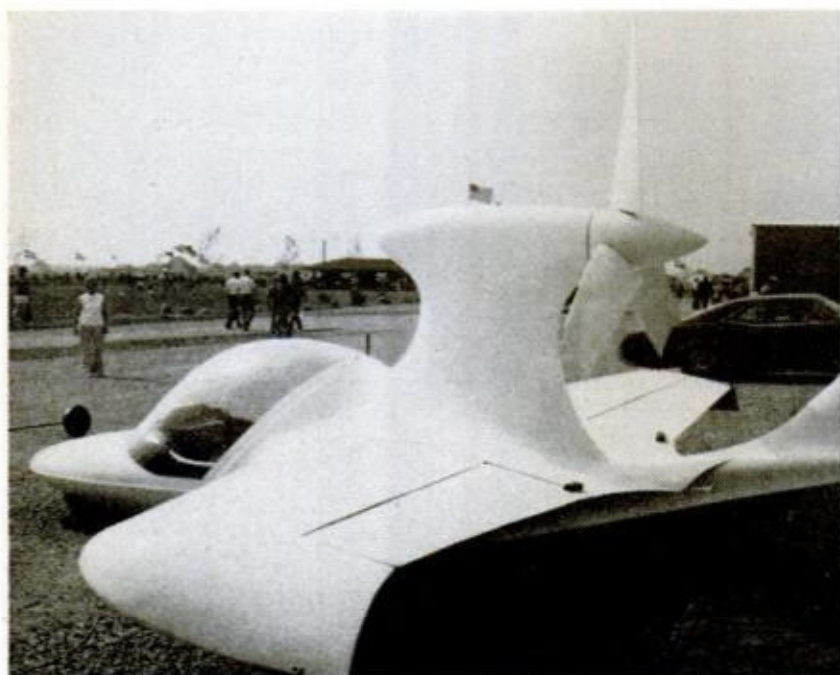

Kit-built plastic plane designed to take off in less than 100 feet

This futuristic-looking two-seater by Vertak was recently unveiled in full-scale mock-up. The S-221, expected to be the first in a series of certified and kit-built craft, has claimed takeoff capabilities under 100 feet. The plane is built mainly of plastics, for lower costs and greater strength. It sits low to the ground to allow a simpler landing-gear retraction system and to take advantage of ground effect on takeoff. The plane can be powered by a 130-hp Curtiss-Wright Wankel or a 210-hp Continental in two-seat configuration, or by twin Wankels as a four-seater. Powered by the 210-hp Continental, it is said to have a 273-mph top speed, and an 1120-mile range at 40 percent power (200 mph), with 32.5 mpg fuel consumption. Weight is 950 pounds; wingspan 24 feet. Kit price is expected to be as low as \$4500; certified model under \$5900. Vertak Corp., Box 658, Troy, Ohio 45373.

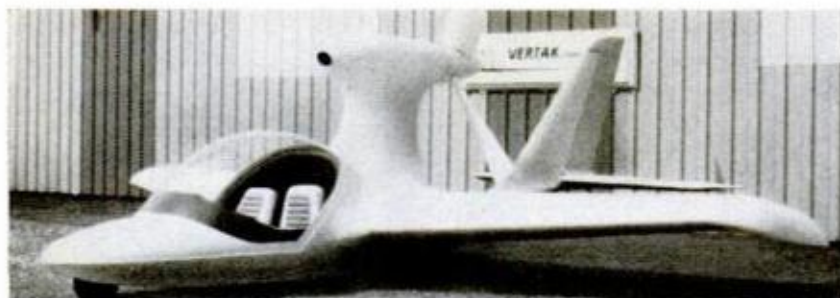

New shapes and colors for indoor-outdoor speakers

You have a choice of square, round and octagon shapes in a new group of loudspeakers offered by Sound West. In addition, the removable, weather-resistant grilles come in a color selection that includes rust, blue, gold, black and white. Housed in a tough white ABS-plastic enclosure, each speaker weighs only two pounds and can be located anywhere in your house or yard. Speaker dimensions are: 6 inches wide, 7½ inches high and 7 inches long. Retail price is \$14.95. The manufacturer is Sound West, Inc., 14201 Bessemer, Van Nuys, Calif. 91401.

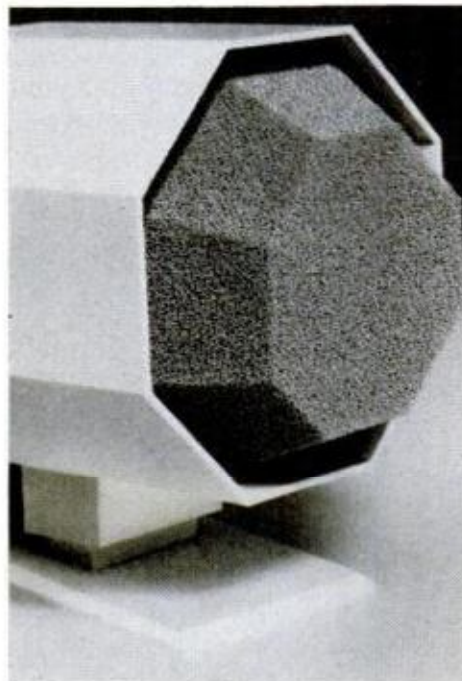
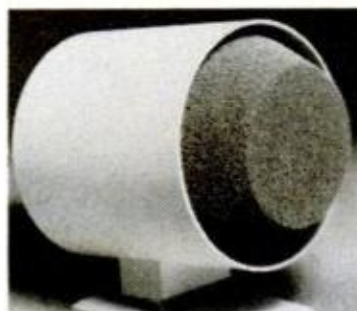
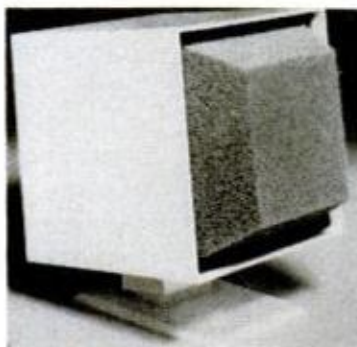

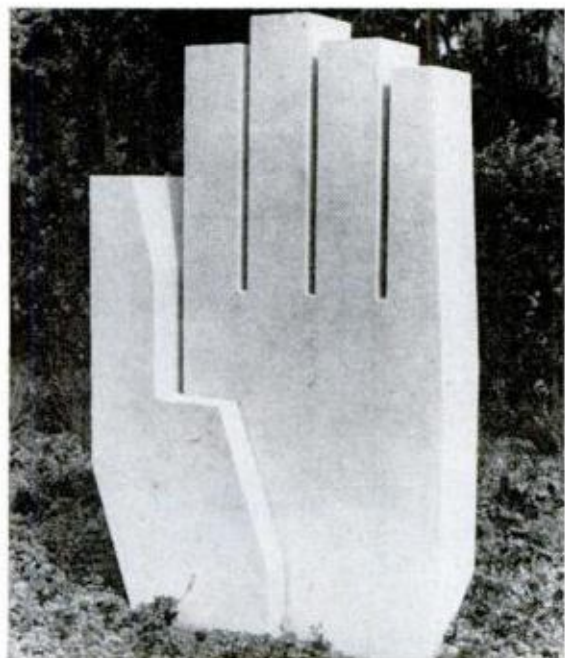

Futuristic headstones enliven Dutch cemetery

Modern headstones break the uniform solemnity of the Crooswijk graveyard in Rotterdam, Holland. To help bereaved families and others recognize the cemetery as "a vibrant, living place—a pleasant place for a stroll," Crooswijk allows the use of tasteful, futuristic headstones such as those shown above. Many of the stones (top) are based on the traditional oblong slab, but with their sides and faces rounded or carved for a more pleasing appearance; others are ultramodern. Representational art has its place, too, as with the gigantic hand (lower photo) which seems to some observers to point the way above, and seems to others a call for the respectful attention of the passer-by.

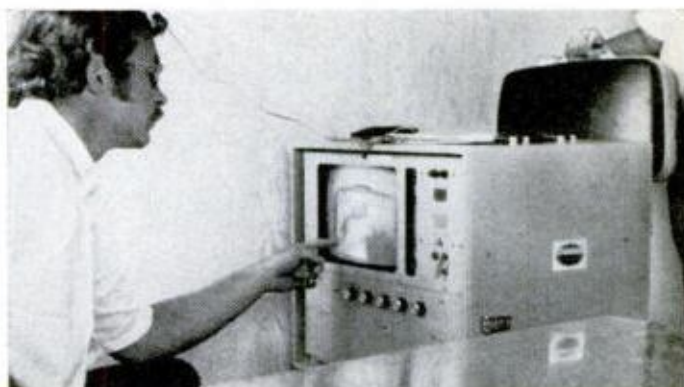

X-ray skyjack spotter

That's a gun in that innocent-looking suitcase, easily visible on the screen of the Norelco Saferay Detection System. A high-speed pulse lasting only 50 billionths of a second X-rays the bag and stores an image of its contents on the TV tube. The pulse is too short to be dangerous (small fraction of average daily dose of natural radiation) or to fog film. But commercial installations, now beginning, will X-ray bags as they pass down a conveyor, so passengers won't be exposed. Norelco, 100 East 42 St., New York, N.Y. 10017.

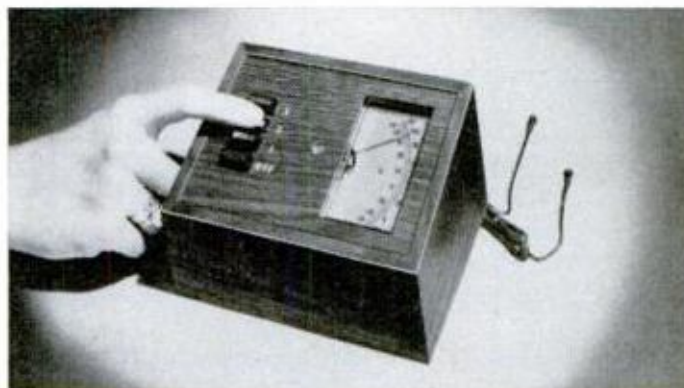

Electronic thermometer reads remote temperatures

This new, electronic thermometer reads the temperature at any of three different locations up to a thousand feet away. It covers temperatures from -20° to 122° F., and its "D" battery lasts a year. Two plug-in temperature probes with extendable, weatherproof cords are provided, and there is a socket for a third probe. Model 8600, \$39.95. James Electronics, Inc., 4050 North Rockwell St., Chicago, Ill. 60618.

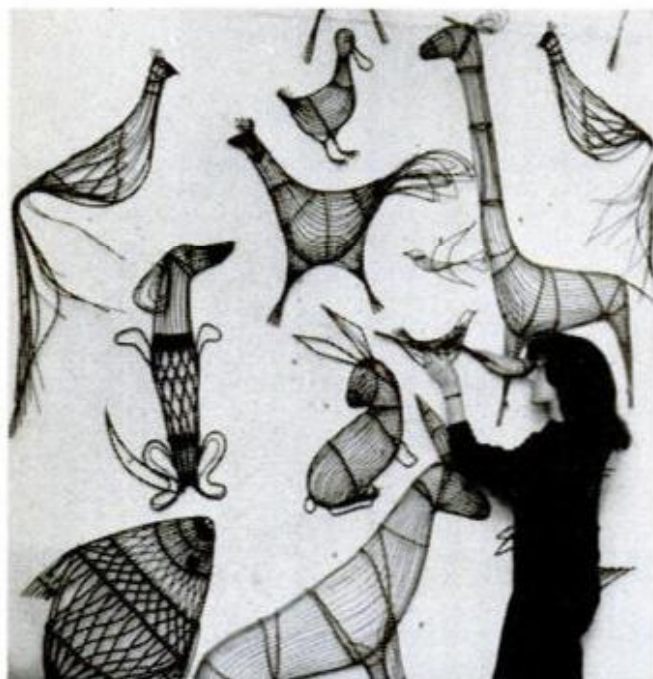

Parisian artist works in wicker

To most people, wicker is just the hard, stinky material from which porch furniture is made. But to Sylvia Meyer, a Swiss artist now in Paris, it's a new art medium. Visitors to her studio discover animals, people, wall decorations and vehicles all made of wicker—and her wicker display mannequins have been used by Fath, Dior, Balmain and others.



Spray-on repairs for fiberglass motor homes

Scratches and scrapes on fiberglass motor homes can now be repaired with an aerosol spray kit. Thirteen different colors are available in the new Valspar Armor-Spray Gel-Coat Repair Kit, which can be stored for a year. Half-pint kit covers 16 sq. ft., costs \$7.50 at marine stores.

POPULAR MECHANICS



From suitcase to sailboat

There's a Stowaway sailboat in those two duffel bags (far left). Unpack the 95-pound boat (that weight includes both sails and oars), assemble it, and in 45 minutes you can be out on the water, sailing or rowing happily. Airbags beneath the bow deck and stern seat, and foam in the aluminum ribs keep the boat unsinkable. \$695. Sport Skiff, Cedar Hill Ave., Nyack, N.Y. 10960.



Water-ski grips grip you back

Soft, but tough, rollers of Dow Ethafoam in these new EZ-Grip handles press against the back of a water skier's hands to help him (or her) keep a firm grasp without fatigue. When the rope goes slack or line is released, the roller pressure relaxes, so the skier can let go easily. Under \$14; Aqua Ski, Sacramento, Calif.



Turned-on heater cools it safely

Quick-lighting new propane catalytic heaters for sportsmen start without flare-up, and now Coleman's Model 5445-708 has an automatic safety shutoff for fuel if the flame goes out. Heat is adjustable from 2000 to 5000 B.T.U., and \$50 unit can use refillable tanks.



Next spring the riders will be out in force

If you have a big lawn, your next mower could be a rider. For '73 there's a wide choice of the "take-it-easy" machines. The 7-hp, rear-engine Toro shown is a good example of what some new models offer: adjustable steering post, parking brake, key starting. Price: \$499.95. Other Toro riders start at \$329.95.



At last: a museum for useless things

Need a tandem bicycle that faces two ways at once, for people who disagree on the direction they want to ride? A faucet that feeds back into itself, so that it positively can't drip? A snowshoe-tired bicycle (when it doesn't snow, you can play tennis)? You'll find them all—and anything else you've never dreamed of looking for—at the Museum of Useless Things. It's in Paris, now, but coming soon to Dallas. The table? Its for Ping-Pong players who don't level with each other.

World's fastest fire truck is race driver's best friend

This fire engine gets around race-courses in true sports-car time—because it is a true sports car, a 335-hp Maserati Ghibli, with two foam fire-extinguisher cannons on top. The outfit was demonstrated recently at the Hockenheim racing circuit in West Germany. So far it's just an experiment. But the 168-mph Ghibli is available, without extinguishers, for \$22,500.



Rolo goes boinggg! And your cassettes sit neatly on your shelf



Cassettes are the last word in musical convenience—until you try to store them neatly. Stack them, and you wind up with an untidy pile. Buy a cabinet for them, and the cabinet wastes space until it's full. So a British inventor came up with Rolo. It's a coiled ribbon that attaches to a shelf. Take out one cassette—or several—and it rolls back snugly, keeping the remaining cassettes in place. Made from a combination of acrylic and stainless steels, Rolo is available in two designs, to hold 17 cassettes or 12 cartridges. They sell in Britain for about \$3.60 and \$4.25, respectively. Top Secret, Ltd., Quest House Horley, Surrey, England.

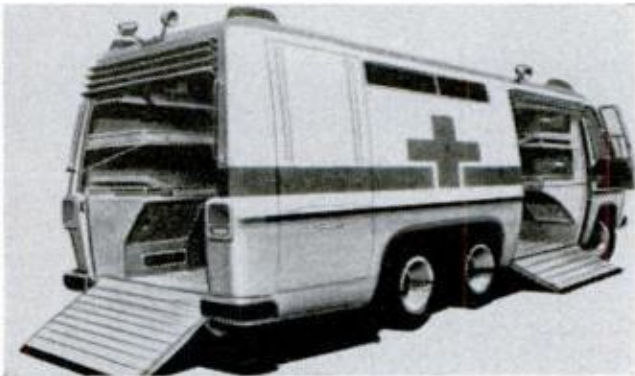

New GM motor home lends chassis to bus, ambulance

The small transit bus, emergency rescue vehicle and motor home above are all based on the same new GMC chassis. The new design has front-wheel drive, a low, wide frame, tandem rear wheels with independent air suspension, and bodies of aluminum and molded fiberglass; the motor home will be available this year. GM is thinking of a van version.



Using hands as fingerprints

Place your hand on the machine above, insert any identification card, and the machine will compare your hand measurements to data magnetically recorded on the card, to tell if you're really you or not. Users range from banks, to methadone clinics, to the Air Force. Lower photo shows the principle: hand points are plotted on a radial grid. Cost: about \$3000 to \$5000. System was developed by Identification Marketing, 408 Paulding Ave., Northvale, N.J. 07647.

Wristwatch strap carries medical emergency information



Pull the "SOS" medallion off this wrist-strap, and out comes a tale of medical woe: a complete list of the wearer's diseases, allergies, medication, shots, blood group—everything a doctor would need to know in an emergency. Cost is about \$5 to \$15, in Germany.

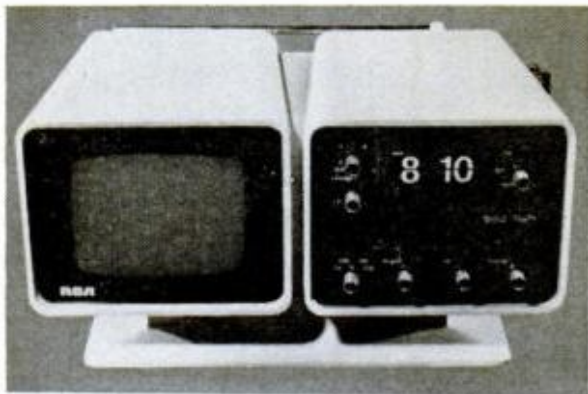

New styles in home electronics

RCA's new Lunar I (top) combines a solid-state, 5-inch TV receiver, FM/AM radio, and a digital clock in two matching pods; about \$160. Electrohome's 19-inch "Contour" color TV has equally unique styling: \$579.95. Also from Electrohome, the new "720" stereo holds 40-watt AM/FM-stereo receiver, and turntable under a plexiglass bubble. \$249.95. For information, write RCA, 600 N. Sherman, Indianapolis, Ind. 46201; Electrohome, Kitchener, Ont.



For your wall: a plastic gallery of wooden ships

Cutty Sark (above), the U.S.S. *Constitution* and a Spanish galleon are the first of Revell's new Olde Ships Gallery of wall-mounting models. Each ship rests against an "antique" map reflecting its history. \$6 each, at romance-minded model and hobby shops.

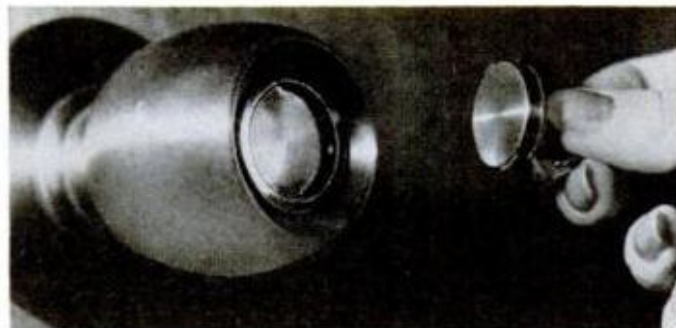

Lock without a keyhole

Dirt, dust, water and would-be lockpickers can't find the keyhole of the new Maglock now available in England. The key is a $\frac{3}{4}$ -inch disc whose magnetic pattern aligns tiny magnets within the lock. Only if the magnetic "combination" is right will the lock open.



Handsome knife for your desk or workbench

Well-made workbench or desk knife boasts a comfortable handle and a $1\frac{7}{8}$ -in.-long, high-carbon, manganese-alloy steel blade which takes and holds a razor-sharp edge. It's a good tool for whittlers, patternmakers and modelers. Specify catalog No. D-1527.1 Bench Knife. \$1.75 plus 70 cents postage from Brookstone Co., Dept. C-PM, 11 Brookstone Building, Peterborough, N.H.

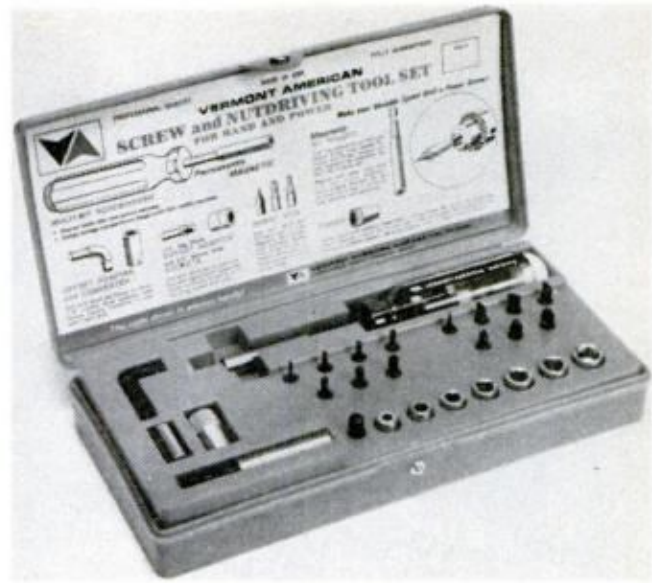

Tool set makes you a superdriver

This set offered by Vermont American, Box 340, Lincolnton, N.C. 28092, includes multi-bit magnetic hand screwdriver, magnetic bit holder, adapters, 14 insert bits and seven $\frac{1}{4}$ -in.-sq. drive sockets for driving 21 different sizes of Phillips, Allen and hexhead nuts and screws by hand. A 90° adapter included in set permits driving screws in hard-to-reach places; permanent magnets makes bit-changing fast and easy. About \$19.99.

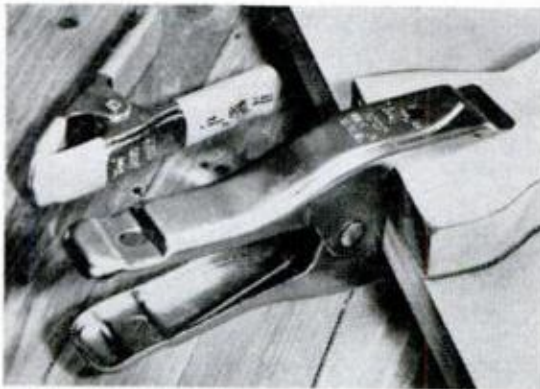

Better gripping spring clamps

When the jaws of these clamps are opened to full capacity they are parallel—rather than beyond parallel—and thus won't slip off work. The new-design Pony spring clamps come in four sizes, 1 to 4-in. jaw capacities, sell for 50 cents to \$3. Adjustable Clamp Co., Chicago, Ill. 60622.



Pedestrian cloverleaf crosses intersection

Pedestrians at this busy London intersection never need to wait for the light to change. Instead, an unusual pattern of four elevated walkways provides full-time access from any of the four corners to each of the others.

NOW



Binoculars you can hide in a cigaret pack

These 8x20 binoculars have 16-element optics, eyepiece focusing, rubber eyecups that fold away for eyeglass wearers. Only 5¼ ounces, they fold to 2½ x 1¾ inches (smaller than a 100-mm-cigarette pack). Konica Pocket Binocular, \$99.95. For information, write to Berkey, 25-20 Brooklyn-Queens Expressway West, Woodside, N.Y. 11377.



A warm massage that straps on

This belt has both heating elements and a vibrating massage unit. Fastened by adjustable Velcro strips, it can be strapped on almost anywhere. S1 belt, \$39.95; smaller S2 for arms and legs, \$34.95. Available from Florin, 28 Woodside Dr., Penfield, N.Y. 14256.



Detecting plaque on your teeth is easy with special light

Plaque is the gummy, colorless mass of bacteria manufactured in the mouth that's the cause of much gum infection and tooth decay. You can spot plaque—and thus know where to brush and use dental floss—with a Plak-Lite "disclosing" kit. You swish around in your mouth a water-soluble fluorescein solution that adheres to plaque. Then you beam white, filtered light on your pearls and view them with a special mirror. The plaque areas to be cleaned are all aglow! Plak-Lite kits are available at drugstores at a price of \$24.95.



Four channels from your car stereo

Add the Realistic Auto Quatravox to your car's stereo tape player or stereo FM radio, and you add a four-channel effect—rear-channel "concert-hall" ambience. \$9.95 from Radio Shack, 2725 West 7th St., Fort Worth, Tex. 76107.



Small tape, big counter

"Magically" changing tape counter on transparent lid of Panasonic's experimental RQ-4000S cassette recorder is easy to read. When off, the liquid crystal numbers are transparent, too.

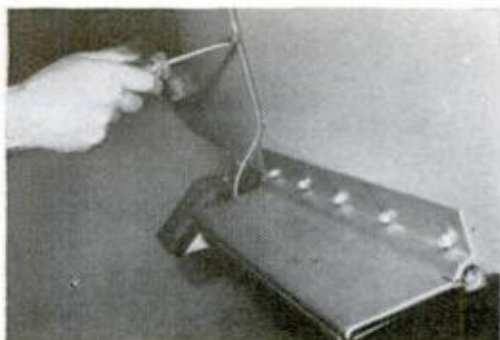

D-I-Y trim tabs

Porpoising prevention, quick planing and better balance for a boat are among advantages claimed by ICM Marine Products Ltd., 322 South Michigan Ave., Chicago, Ill., for its Insumatic Total-trims. Designed for owner installation, dash-controlled trim tabs are \$149 for 20-footers, \$300 for up to 35 feet.



Wristband totes tape

Trying to wrap a package with one hand, hold the tape dispenser with another, and pull off the tape with your remaining hand? Strap Tape Toter to your wrist and you can do it. \$1.29 plus 20 cents shipping from Alpine Valley Enterprises, 138 Maple St., Wilmington, Del. 19808.



Hop rod— world's first self-powered pogo stick

The world's simplest gasoline engine powers this one-cylinder pogo stick. Jumping on the footbar compresses the fuel/air mixture in the cylinder; when it fires, it adds extra boost to your rebound. Since the motion is linear, no crankshaft or connecting rods are needed. The four-ounce fuel tank holds gasoline and oil enough for nearly 600 hops, or 30 minutes of running time, even with a 280-pound rider. As a safety feature, the engine automatically stops when the rider dismounts. Priced under \$70. From Auto World, Inc., 701 North Keyser Ave., Scranton, Pa. 18508.



New enlargers have snappy features

Those L-shaped magnets on the new Paterson enlarger's baseboard (top) hold paper flat against the metal board for borderless enlargements up to 12.5X, from 35-mm or 126 negatives. \$89.95. Write: Braun, 55 Cambridge Pkwy., Cambridge, Mass. 02142. Durst's newest M601 model (bottom) has a movable head and negative-masking blades for easier cropping, head and lensboard tilts for perspective corrections, goes to 14X from 35-mm or 126 with 50-mm lens; to 9X on 2¼-square negatives, with 75-mm lens. \$199.50. EPOI, 623 Stewart Ave., Garden City, N.Y. 11530.

NOW

Handful of tests for car tune-ups

This new, hand-held engine tester from Micronta checks ignition dwell angle, engine speed and the condition of the points on U.S. or imported cars or trucks with four, six, or eight cylinders. It's \$17.95 from Radio Shack, 2725 West 7th St., Fort Worth, Tex. 76107.



Bobsled: A gravity-driven "snowmobile"

Now you can hit snowmobile speeds without the noise of snowmobiles—just find a steep snow-covered hill to whizz down on this new Gladding-Hedlund bobsled. The sled has a rugged steel frame and hood and hardwood slats and skis. Like the racing models, it has 40° steering and hand brakes. The 5-foot-long bobsled seats two adults or three to four children. About \$60. It's made by Gladding Corp., Box 250, South Paris, Me. 04281.

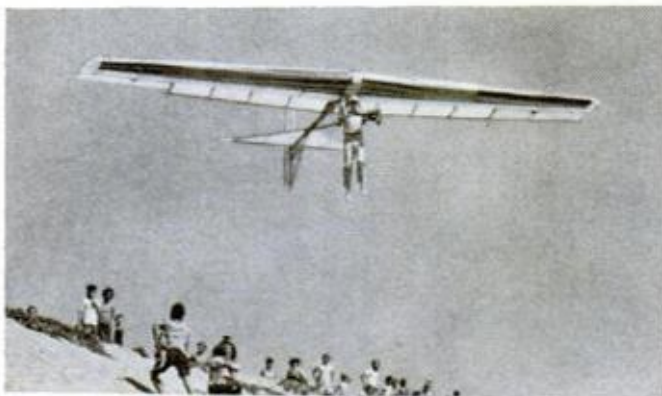

An advanced hang glider that even has controls

This sophisticated hang glider—the Jensen-Culver Swingwing VJ-23—has a cantilever wing and is guided by means of controls. It can make soaring flights in 15-mph breezes and has set records for altitude, distance and duration. It weighs 100 pounds, has a wingspan of 32 feet and is 15 feet long. The wheels flanking the pilot are handy for pushing the glider back to its launching spot. Plans are available. For an information kit, write: Volmer Aircraft, 104 East Providencia, Burbank, Calif. 91502.

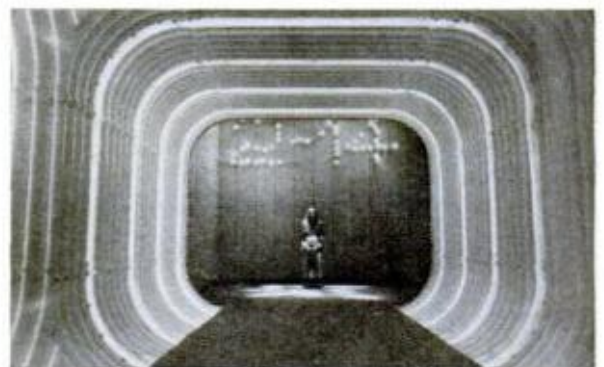

Tunnel into office

Welcome to the twilight zone? No, this plushly carpeted 58-foot tunnel, with its white fluted steel walls ringed with blue-glowing neon tubes, leads directly from the sidewalk into an office building in New York's financial district. The tunnel has no door, to ease lobby congestion. Elevators are to the right and left of the receptionist. "After New York's hard sidewalks, entering the tunnel is like entering a dream," said one visitor.

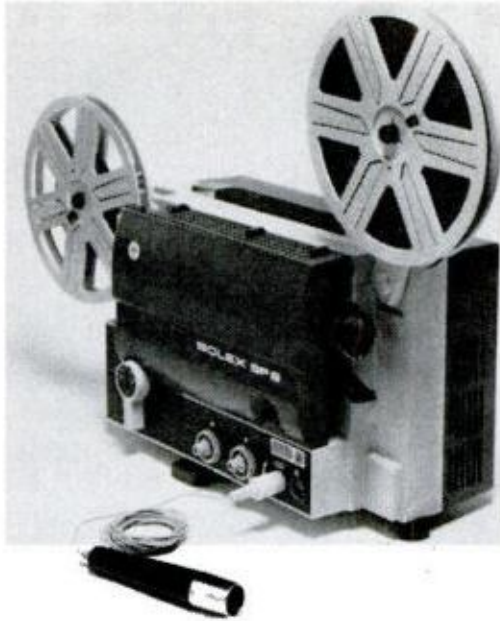

Blinking sound projector

Blinking lights show the sound level when you add soundtracks to home movies with this new Bolex SP8 Super-8 and 8-mm projector. Recording level is automatically or manually controlled. \$299.50. Information from Paillard, Inc., 1900 Lower Rd., Linden, N.J. 07036.



New garden tractor: Big on work but low on noise

You can cut noise pollution (while you're cutting the grass) with quieter garden equipment. One such machine is the new Bolens QT-16 tractor, equipped with a 16-hp, twin-cylinder opposed engine. Tests by an independent lab revealed a noise level of 69 decibels, below the limit of 70 decibels that will be the law in Chicago by 1975. In addition to a quieter engine, noise is reduced by the use of compound curves in the metal to diminish resonance, a big muffler, noise-damping materials under hood.



Better battery booster

Designed for 12-v. storage batteries, the 3-amp. Model BC-3 charger can also be used on 6 and 9-v. rechargeable batteries. Intended to restore batteries at lowest possible cost, it's \$7.95 postpaid from the maker, American Consumer Products Corp., 555 John Downey Dr., New Britain, Conn. 06051.



Long trip for tractor that never left test stand

Some manufacturers go to great lengths to test a product. This New Holland S-8 tractor was mounted on a dynamometer and run continuously for 425 hours. That's equal to a straight-line run of 1800 miles, say engineers. No problems were reported.

It's hard to rob a bank when you can't even get in

By SHELDON M. GALLAGER

NEEED MONEY? Well, you just walk up to a "money machine," identify yourself by inserting a magnetically coded card in a slot, dial the amount you want and out pops the cash. You can have the money any time, day or night, and you don't even have to go into a bank to get it.

Such sidewalk money dispensers are only one of many electronic banking aids that are making things easier for the customer and tougher for the potential thief. You can't rob a bank that isn't there. Not only are the machines burglarproof, but they can even detect identification cards that have been lost, stolen or canceled. If anyone tries to use such a card, the mechanical teller automatically "swallows" it. Among many banks already using the devices are Chemical Bank in New York and Marine Midland in Buffalo.

Another device to foil thieves is the TV teller. You never get to meet her in person. You watch a pretty face on a TV screen, and the face relays instructions over a microphone. Checks, cash, deposit slips, savings-account books and other papers are all passed back and forth be-

tween you and the teller through a pneumatic tube system. Meanwhile, the pretty face is safely protected behind locked doors several floors away, completely isolated from the public. It's hard to threaten a TV screen with a knife or gun. One of the most automated banks using such a "remote-control" money-exchange system is Surety National in Los Angeles.

In addition to money dispensers, there are also mechanical depositors. You feed your check and deposit slip into a machine and the amount is automatically added to the balance in your account without your having to wait in a long line for a teller.

Computers are also playing a new role in modern banking. In major cities, they enable banks to furnish customers with one comprehensive monthly statement listing savings and checking balances, installment loan and mortgage figures. Chicago's Beverly Bank even lists checks in the exact sequence they were written.

These are just a few of the modern banking methods being promoted by the Foundation for Full Service Banks with its 14,000 full-service members. ★★★



CUSTOMERS STAND (left) at two of the six "telestations" in Surety National Bank's new automated branch in Los Angeles. They conduct their banking via closed-circuit TV, pneumatic tubes and voice

transmissions with a pretty teller who's located several floors away (right-hand photo). The center photo shows what the customer sees, including a telephone handset for privacy. Mosler makes the system

POPULAR MECHANICS



24-HOUR CASH SERVICE is offered by Chemical Bank's money machine in New York. Customer inserts her magnetic card, punches personal identification on keyboard, presses button for \$25 or \$50—then scoops cash from drawer. Machine confiscates cards listed as stolen, canceled or lost

ELECTRONIC SCOREBOARD on far wall directs customers at Equitable Trust in Baltimore to open teller windows. Customers take a numbered check, wait in single master line or in a comfortable lounge area until their number blinks on the board. Elsewhere, banks have reduced teller-line congestion by installing automatic check depositors, signal systems and computerized teller systems

How fast your boat really goes

Try this miniature timing trap, plus shortcut calculations, for a quick measure of performance



CARRYING A STANDARD LOAD, including ice and beverages, boat approaches first marker (foreground) of timing trap

By JIM MARTENHOFF

HERE'S A SPEEDY boat-speed trick that works on any lake, bay, river or stream. You set up your own speed trap, and do it in a way that makes the arithmetic extra easy. You can check out your speedometer or get quick miles-per-hour without one, determine boat performance and calibrate a tachometer to read your boat speeds as well.

We'll be talking statute miles exclusively (most small-craft owners do since it makes their rigs seem faster than nautical-mile speeds do), but instead of calling a mile 5280 feet long we'll call it 3600 seconds, the number of seconds in an hour.

Run a measured mile. Time your boat in seconds. Divide seconds run into 3600 and the answer is your speed. If you run the mile in 100 seconds, you're going 36 miles an hour. It's that simple and a lot less work than any of the time-speed-

distance formulae that can be found in textbooks.

If a mile is 3600 seconds, then a half-mile is 1800, a quarter mile is 900 and so on. Measure off a distance of 440 feet which equals 300 seconds, run the trap, and if your time is 10 seconds your speed is 30 mph.

Your trap is measured along any handy beach or stretch of shoreline where you can run parallel to it, within easy sight of your markers. Make sure there are no shoals or rocks. Any respectable distance between easy-to-spot trees, boulders or other landmarks will work. If they don't stand out enough, a dab of paint can mark them. Stakes at right angles between them and the water can provide "ranges" for sighting.

A 100-foot tape measure will make trap measuring easy, but you can also use a measured length of 50 or 100 feet of an-

A SIMPLE 'SPEEDOMETER' DISTANCE ON SHORE



FOR SOLO SPEED TIMING, plant flags or markers ashore, one behind another at each end for a "range," and time a 440-foot stretch, for example. Divide seconds into 300. Ten would equal 30 mph

chor or ski-tow line plus a short tape. Laying out your trap makes a good boat club project. It must be accurate and parallel to the water, but it's a chore that has to be done only once.

When you have your trap length measured in feet, you convert it to "seconds" to simplify that math. To do this, multiply your trap length by .682, (a conversion factor derived by dividing 5280 into 3600). A seven-place answer is .6818181, but rounded off to three is plenty. Again, you only multiply trap length times .682 once. Then you can forget the foot-length of your trap and just remember the length in terms of time.

Suppose you measure between two trees and find they are 565 feet apart. Multiplying by .682 gives 385.33 which you

can round off to 385. Run your distance and time it. You'll need a stopwatch. You can round off long distances but you can't round off running times. Suppose you ran that 385-trap in 13.3 seconds. Divide 385 by 13.3 and your speed comes out to 28.9 statute miles per hour. To cancel out any wind or currents, run your trap both ways and average the speeds.

Don't worry about timing-lag errors as you punch the stopwatch. They tend to cancel out after several runs. To improve accuracy, sight across a windshield brace, seatback or even the top of the motor. Start and stop the watch when your range ashore lines up with your sighting line fixture aboard. Carrying an observer aboard to do this makes driving easier, and to determine useful speeds you



LINING UP BOAT windshield with in-line dockside landmarks provides accurate start and finish points for speed trap. Boat clubs can also station timers ashore at each end of measured course to clock and record up and downwind passes by member drivers

TAPE-MEASURE CHECK of distance between the trap markers is a tedious job, but once completed, can provide a permanent course for boating speed checks
JANUARY 1973

should load up first with the passengers and even the ice, drinks, gas and gear that you normally carry.

For determining true speeds at a variety of throttle settings, the simple division calculations can be made with pencil and paper, even though this is admittedly tedious.

For an easier way to do this, just buy or borrow one of the popular new little pocket-sized electronic calculators. Or try a dime-store substitute—a plastic slide rule. Use the "C" and "D" scales along the bottom. As shown in our illustration, we had a trap 440 feet long which con-

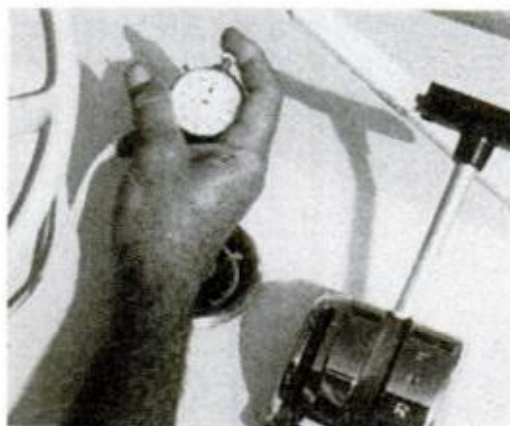

CALCULATIONS must be based on stopwatch timing (seconds cannot be rounded off), but a slide rule, shown here indicating 25 mph for a 440-foot range, makes figuring quick and easy. The speeds resulting can be pasted around tach to make it a speedometer

verts to 300 seconds. Running time was 12 seconds, and the mark for 12 on the "D" scale was placed directly under the 3 on the "C" scale, which stands for 300 seconds. (The only knack to using a slide rule is learning to insert your own zeros and decimals.) You read the answer directly above the 1 on the "D" scale—in this case, 25 miles per hour.

Slide rules come with simple directions, and as you can see, it takes only a few moments to compute speeds and it doesn't matter if your time is in fifths or tenths of a second.

Once you know your top speed, what next? Make at least two more runs, one at bare planing speed and another at moderate cruising speed. If you think you'll ever need it, make timed runs with the boat off plane at speeds such as you might use in nasty going during poor weather. Write down these speeds while noting the readings on the tachometer, which most

speedy outboards and stern drives have. On dime-store graph paper, write the rpm down the left side in units of 100 or 200, and write speeds across the bottom the same way. Plot your timed speeds on the graph opposite your recorded rpm numbers and connect your marks into a curve.

Now you have a table of speeds for various rpm settings. Yachtsmen might carry this around in a log book, which can be a pain in the neck in a small boat. Instead, use this trick. Pick suitable speeds for slow cruise, fast cruise, ski speed perhaps, and wide open. With a labelmaker,

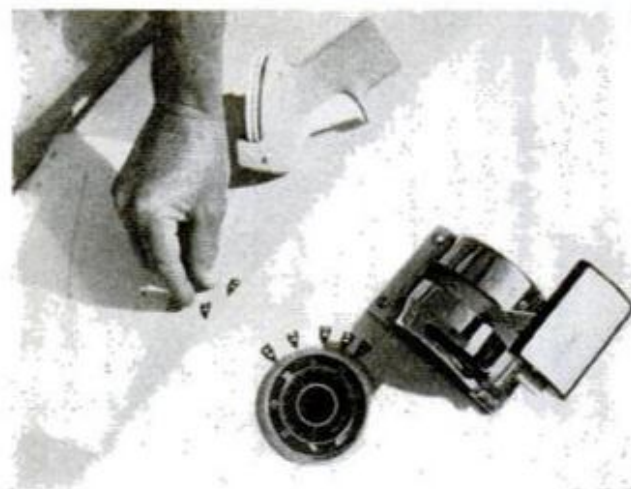

print these speeds, cut them with an arrow-point and paste them at proper rpm spots around the rim of your tach to make it into a speedometer. It will prove to be accurate enough for small-boat open-water navigation.

When using charts and nautical miles, multiply statute speeds by .8689 and they become knots—which are nautical miles per hour.

Sounds like a lot of work? Not really. You only measure your speed trap once, and many of your calculations, once figured, are good forever. ★★★

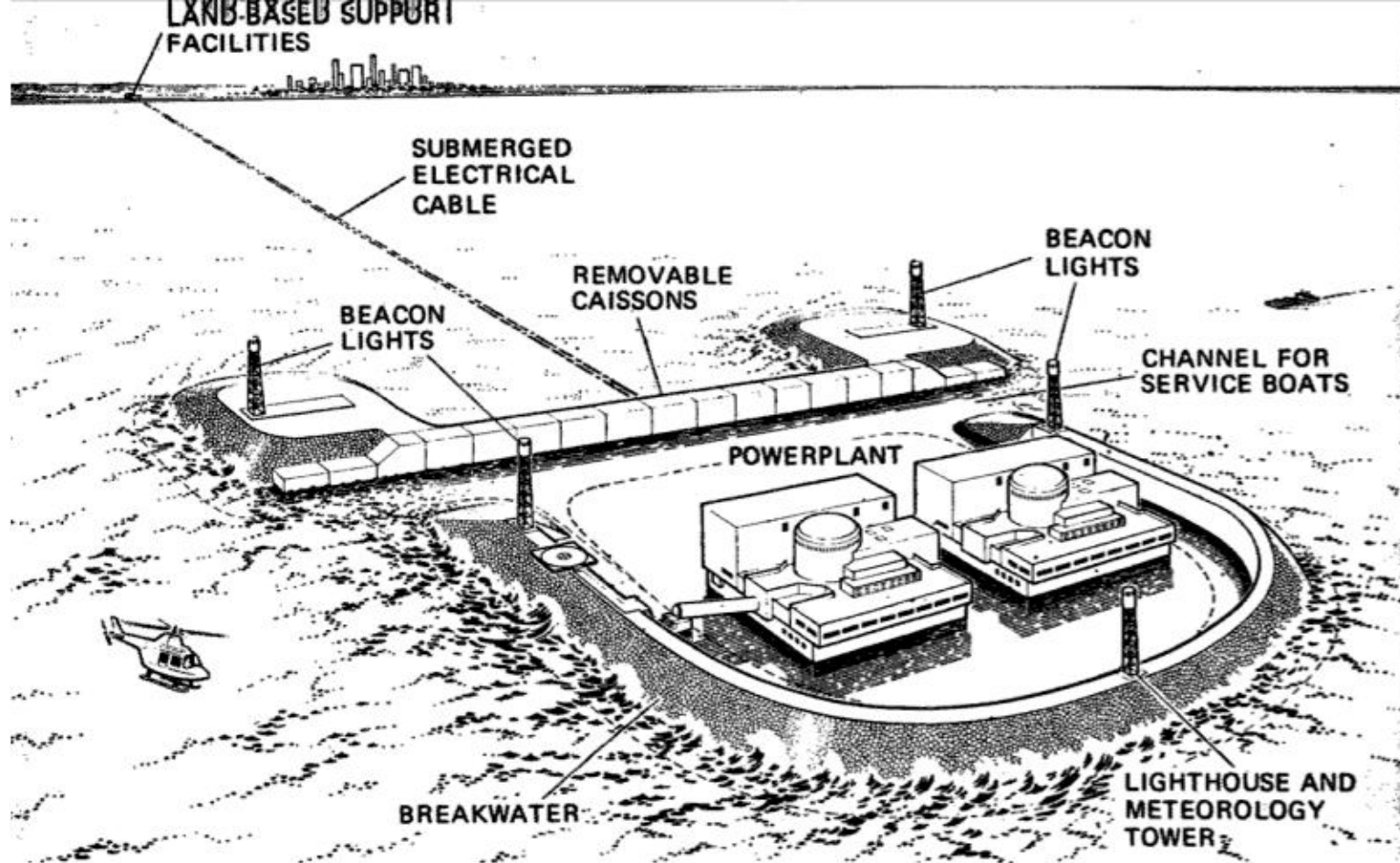

Coming: Offshore nuclear powerplants

By **JOHN F. PEARSON**, Science Editor
Technical illustrations by Peter Trojan

AN UNUSUAL CEREMONY took place last September aboard a yacht off the New Jersey coast. In the main salon, before several dozen witnesses, two men signed their names to a contract. One man represented the Public Service Electric and Gas Co. of New Jersey, the other, Offshore Power Systems—and the contract called for an outlay of \$750 million for the world's first floating, offshore nuclear powerplant.

The seaborne ceremony was held in the vicinity of the proposed site, a point in the Atlantic just under three miles east of the coast and 12 miles northeast of Atlantic City. (By keeping the plant within New Jersey's three-mile limit, legal aspects of the project are simplified.) At the site, in 40 feet of water, engineers will build a breakwater to shelter the two floating units—each capable of generating 1.15 million kilowatts—that will make up the powerplant. Power will be transmitted to shore via underwater cable.

Environmental problems on land have caused nuclear-power developers to look to the oceans. Plants sited on rivers and estuaries tend to cause ecological upheavals with the release of huge amounts of heated water. The same water supposedly would not cause much of a stir in the ocean. In addition, a plant located miles from the nearest shore would pose less of a threat in the event of a nuclear accident.

The project represents advanced thinking in more ways than

one. Offshore Power Systems—a joint venture of Westinghouse Electric Corp. and Tenneco, Inc.—will build the 140,000-ton PMNPs (Platform Mounted Nuclear Powerplants) on an assembly line.

Preliminary work on the manufacturing facility has already begun on a 900-acre site in Jacksonville, Fla. A major feature will be a broad slip leading to a nearby waterway. Honeycomb platforms—about 400 feet on a side—will be fabricated at the start of the slip. They will then be moved down the slip and stopped at assembly stations where 650-ton gantry cranes will load on board various components, some weighing as much as 600 tons.

A completed PMNP will be floated out at the end of the slip and into the waterway for mooring at a testing area. After it's checked out, it will be towed seven miles to the Atlantic and then to its final destination. The first such tow—to the New Jersey site—is planned for 1979. According to present schedules, PMNP production (at a rate of two units a year) will start in mid-1975.

Work on the breakwater will begin in 1976. The U-shaped section, which will face the ocean, will be built first. Then after the two PMNPs are moored, the straight section facing land will be installed.

Some 3 million tons of concrete and other material will go into the building of the breakwater. It will measure 30 feet across at the top and 300 feet at the bottom, and will have enough heft to withstand hurricane-force winds and 43-foot waves—those that occur once in 100 years. The powerplant should be able to continue operating even during such a storm.

The breakwater will also provide solid protection for the PMNPs in the event of a ship collision. Impact studies indicate that a 190,000-ton tanker would do relatively little damage to the breakwater. Ships larger than that would have too deep a draft to even get close. In addition, the facility is located away from the normal shipping lanes.

The cost of the breakwater—\$250 million—will shoot the total price tag to \$1 billion. But this outlay, according to Public Service officials, will help insure an adequate power supply for New Jersey in the 1980s. ★★★

PLATFORM-MOUNTED NUCLEAR POWERPLANT

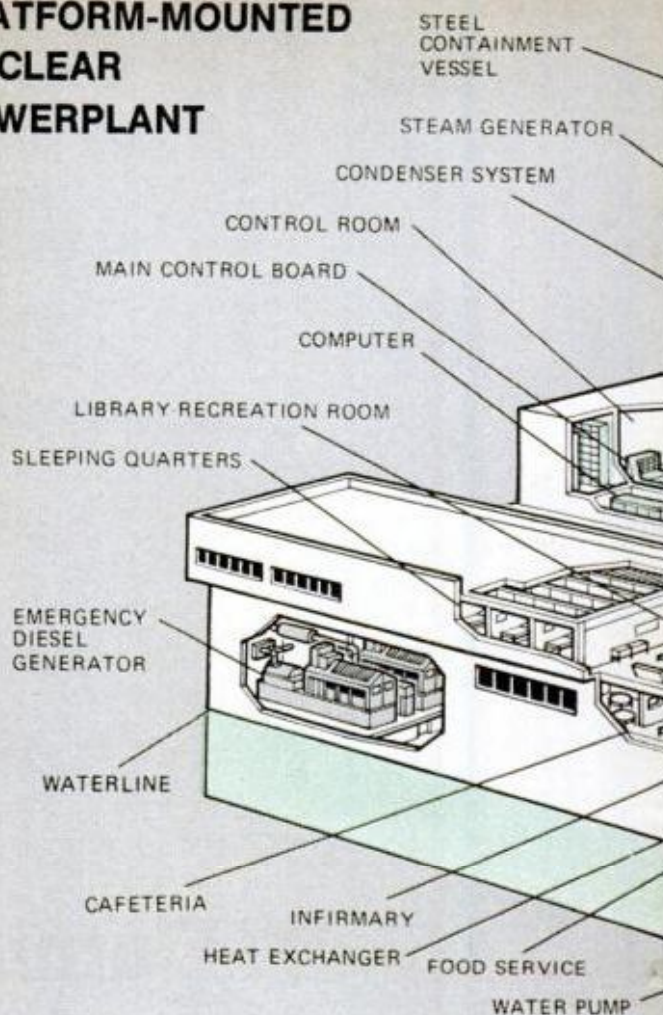

THE FLOATING PLANT'S equipment, facilities, safety systems and general layout are very similar to those of a conventional, land-based nuclear generating station. The supporting platform measures 400 feet long, 378 feet wide and 40 deep

SUPERSIZE ASSEMBLY FACILITY will be built in Jacksonville, Fla. Floating platforms will be fabricated at beginning of the slip. Then, at assembly stops, massive components will be swung aboard and positioned. At the start, production schedule calls for two finished units per year

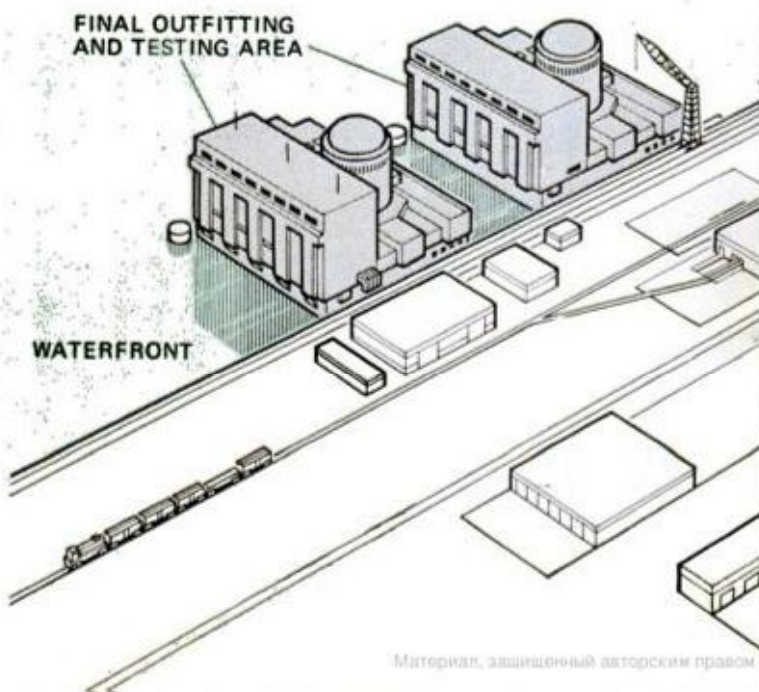

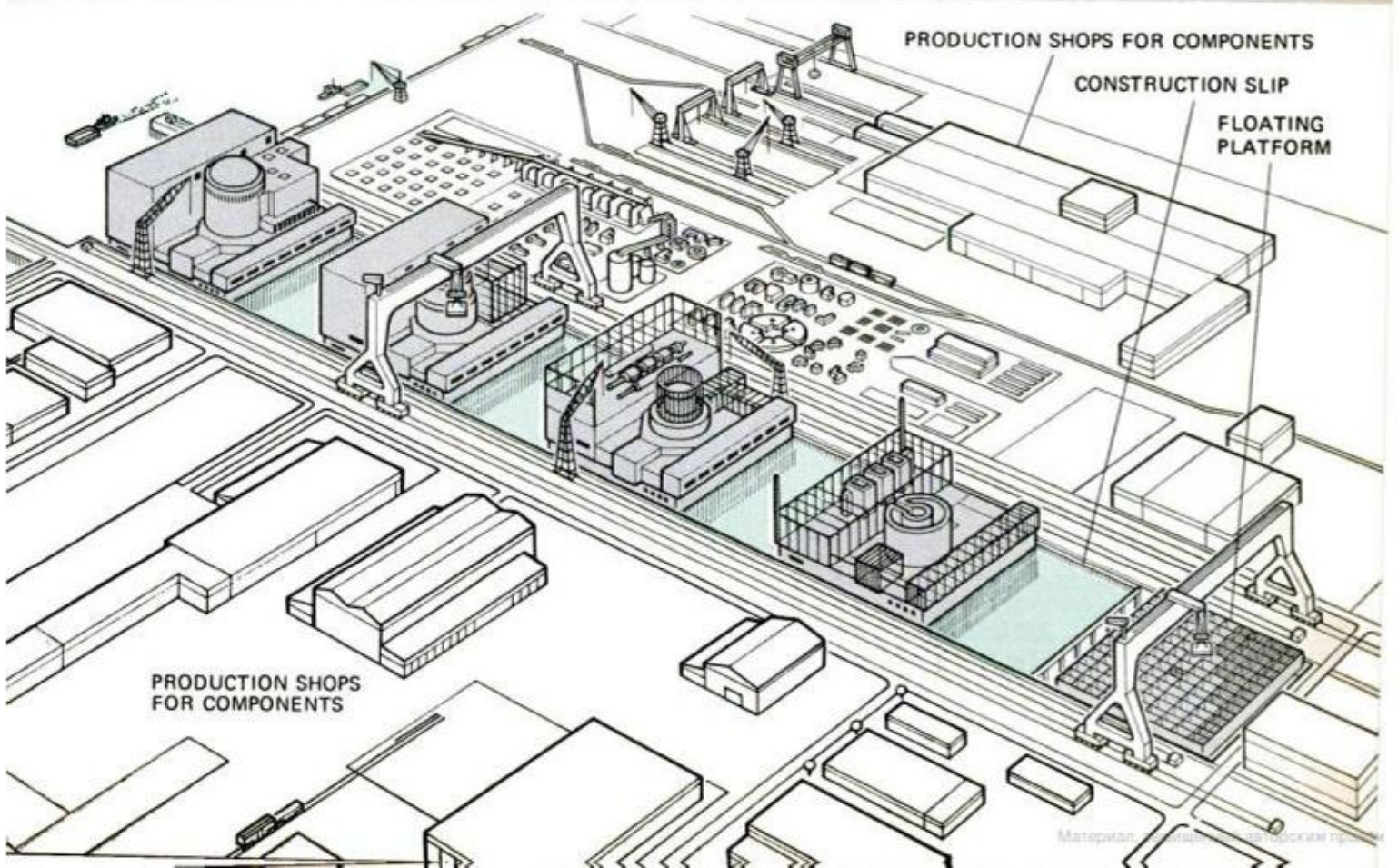
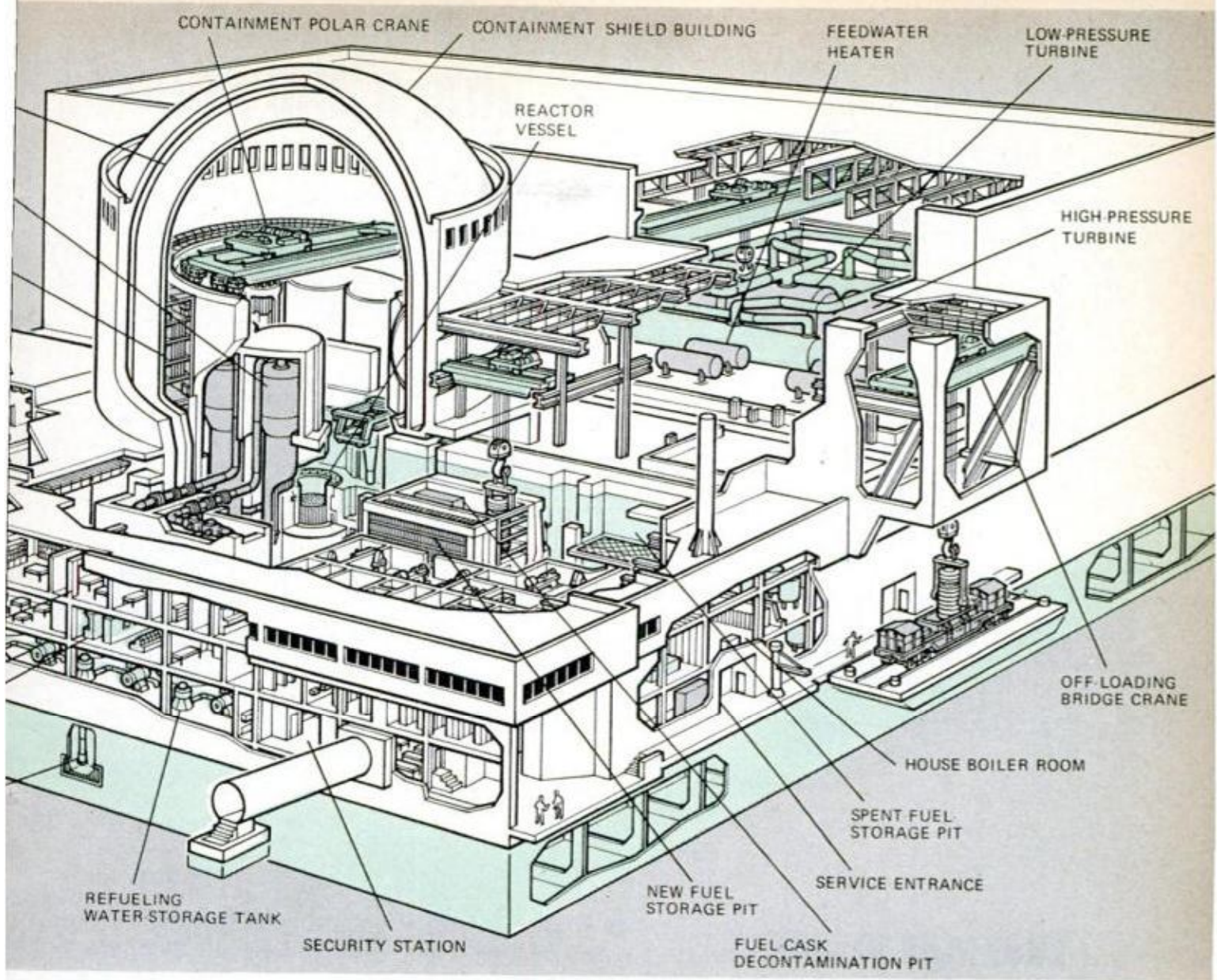

Now: Turn your car into a snowplow

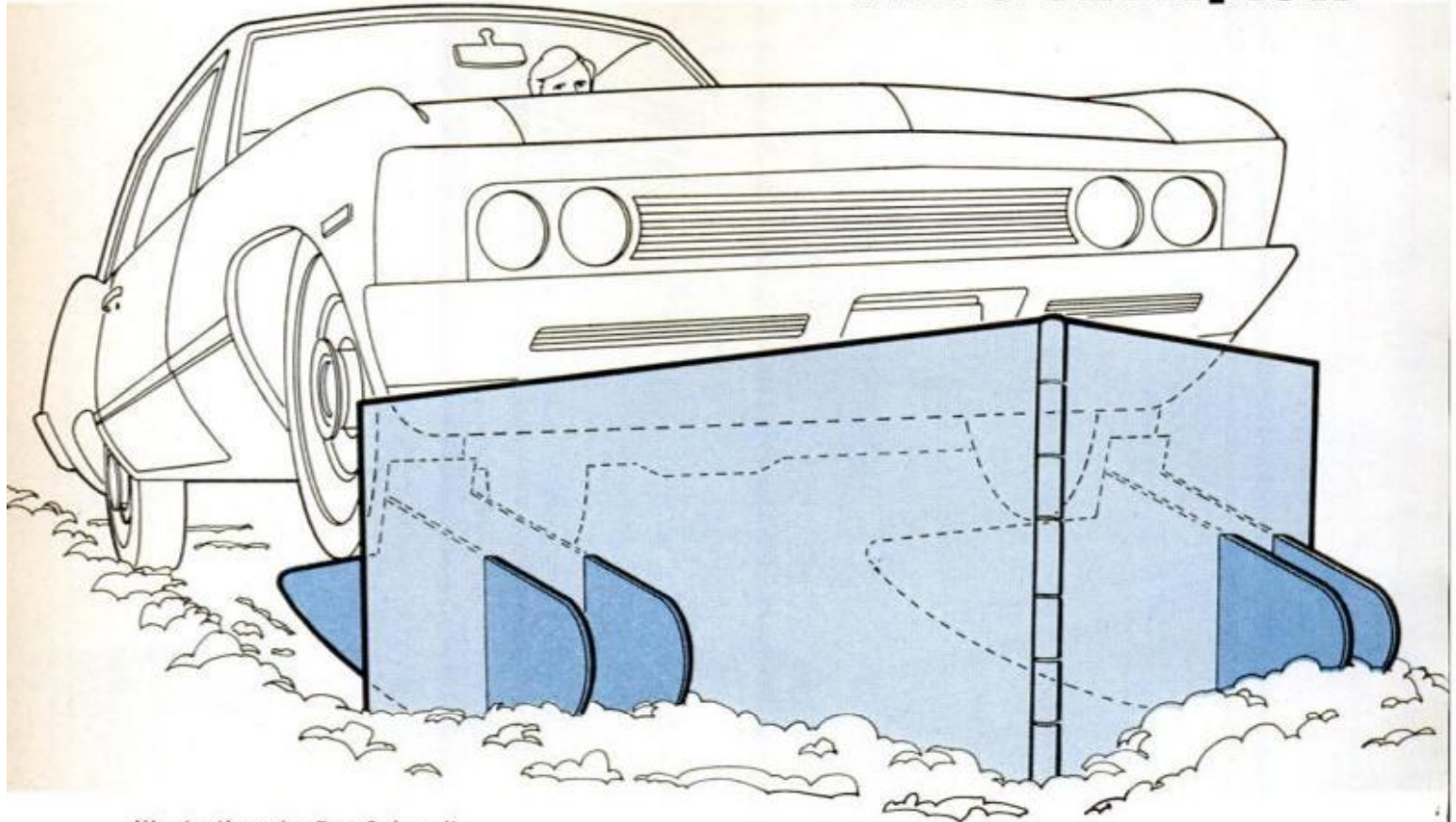

Illustrations by Roy Grinnell

Easy way to pick up a pickup camper: Just roll it on

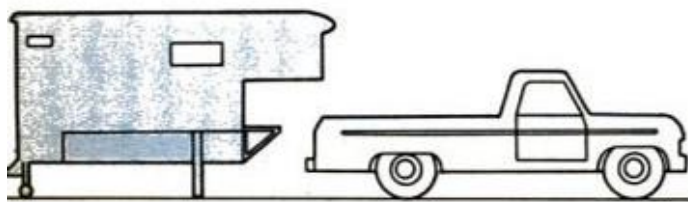

Sliding this camper aboard a pickup truck is a bit like running a cogwheel railway. In this case, though, the "rail" is mounted on the bottom of the camper and the toothed wheel is on an axle mounted over the rear bumper of the truck. By cranking a handle, the operator turns the toothed wheel to pull the camper aboard. A triangular bracket at the front end of the camper lifts the front to the level of the truck bed. The bracket folds to one side when the camper is in place, and the camper legs retract. The system was invented by H. V. Talbot, 301 South 98th St., Mesa, Ariz.

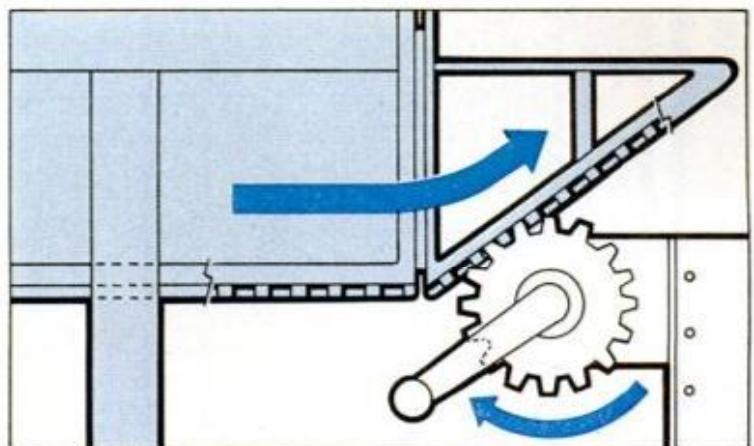
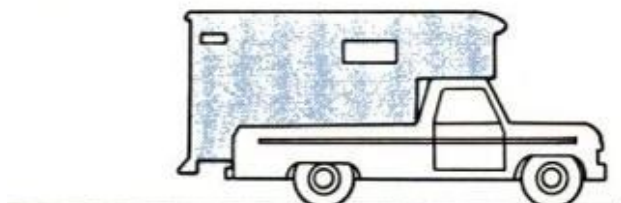
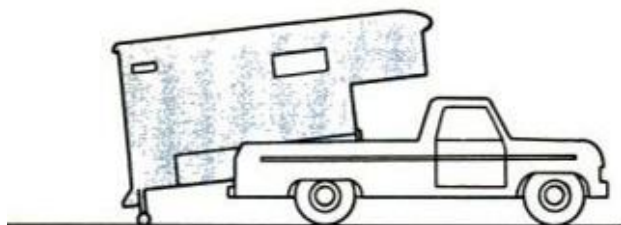

IF THERE'S A CHANCE of snow during the night, the only preparation the owner of this snowplow need take is to park his car so it can be driven forward out of his garage. Then if it snows, he merely sets up the foldaway snowplow in front of the car and drives the vehicle's front wheels up built-in ramps onto twin sleds (drawing below). The front wheels rest against stops, and the weight of the car causes the sleds to rock forward, lowering the V-shaped snowplow to driveway level. The plow is then pushed forward by the car's rear wheels, clearing a path slightly more than the width of the car. Since the plow is hinged in the middle and has slots that fit over the sleds to hold it in position, it's easy to take apart and store again. Inventor is Emerson B. Carlton, 942 Elliott Drive, Lewiston, N.Y.

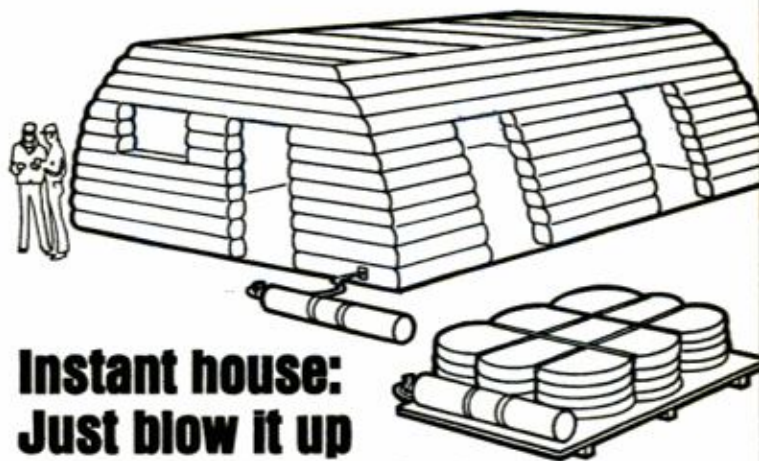

Instant house: Just blow it up with compressed air

Need a house in a hurry? You can have one in the length of time it takes to blow up the Perma-Flate Structure with compressed air. Once erected, the structure quickly hardens, becomes permanent and can be put into immediate use. Its surfaces are fiberglass-reinforced resin—the same material as boats are made from. Other uses envisaged for the inflatable structures include petroleum-storage tanks, mine-tunnel liners, emergency housing, field hospitals and even life-support structures on the moon. The Perma-Flate Structure is the invention of Arthur A. Turner, 4510 S.W. 112 Place, Miami, Fla.

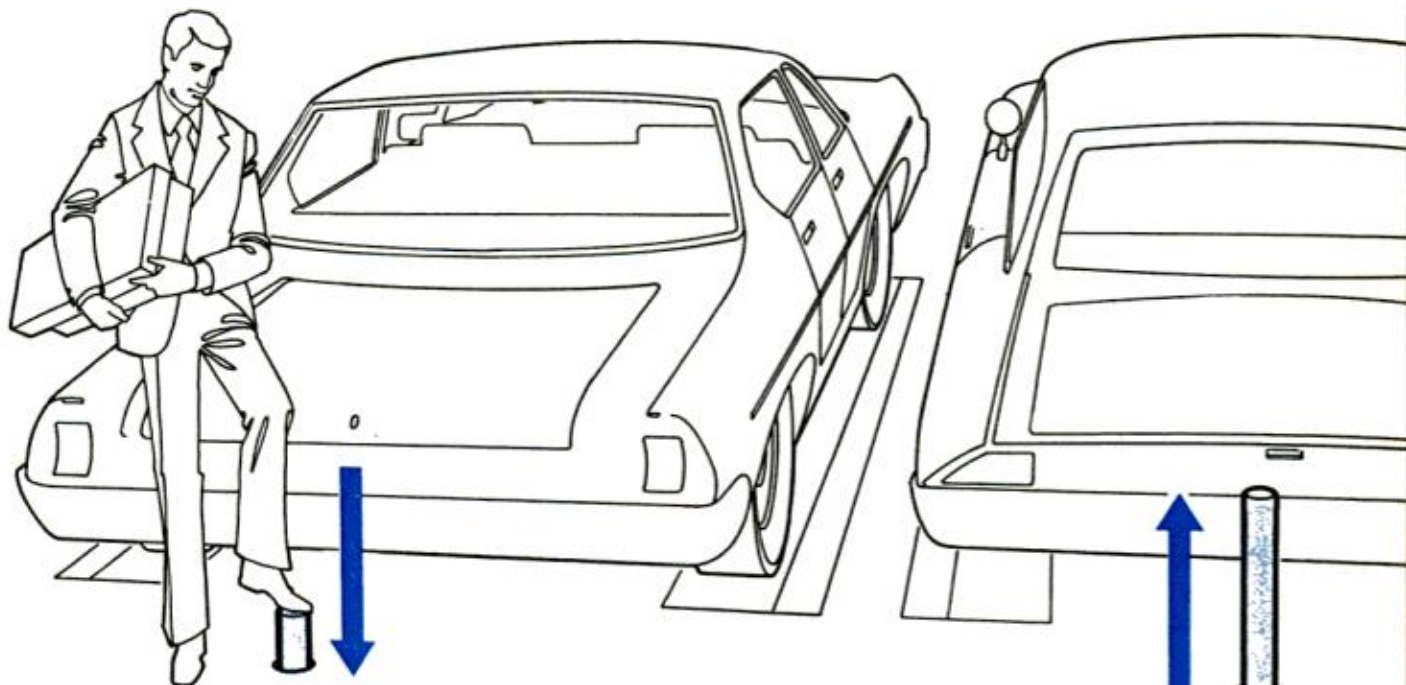
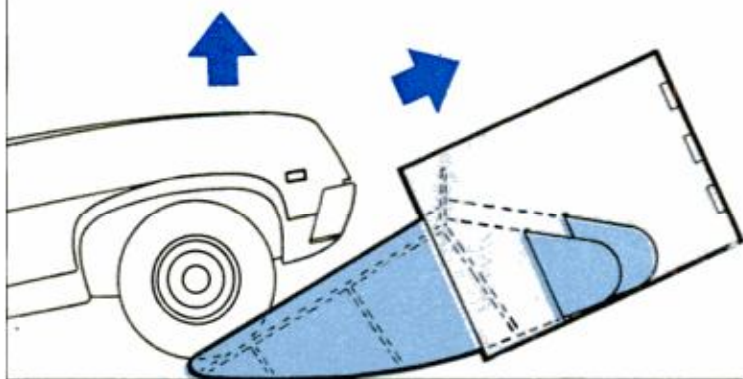

Pop-up post saves both your car and parking place

A metal post that pops up from ground level enables a motorist to reserve his parking space while using his car as well as keep his car from being stolen while it's parked. Post locks in its up and down

positions and must be unlocked with a key. Foot pressure lowers it; another push by foot causes it to return to up position. Inventor is Clark Kappelman, 1140 Colorado Blvd., Denver, Colo. ★★★

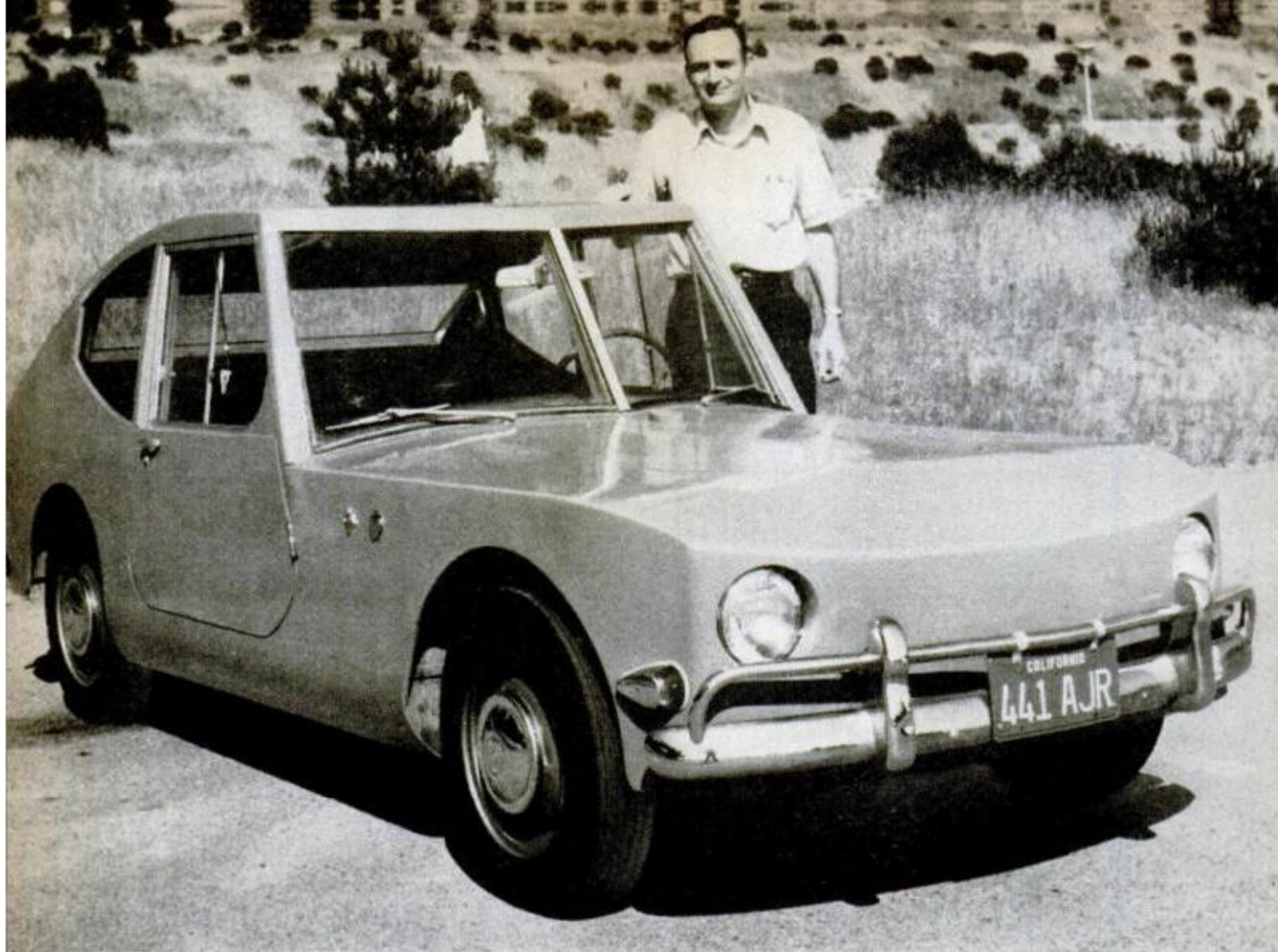

A FINE EYE FOR DESIGN: Door-hinge angle was selected so that the doors of the car would be self-closing

Rollin Armer's wooden wonder

By JOSEPH ZMUDA

Handcrafted from the ground up, this unique car is designed around an electric motor for clean and quiet running

ECOLOGY and the environment are truly electrifying issues for Rollin Armer of Kensington, Calif. Not content merely to pay lip-service to our problems with automotive smog and the growing energy crisis, this 42-year-old mechanical designer at the Lawrence-Berkeley Laboratory built a unique battery-operated car that:

- Carries two passengers up to 60 miles on a single charge and can hit top speeds in excess of 50 mph.
- Measures 12 feet 8 inches long by 53 inches high and weighs only 1600 pounds including 600 pounds of batteries.

- Costs \$1300 to handcraft in 18 months of spare time.

- Pollutes much less than a gasoline car, even after computing environmental damages produced at the generating station.

That last item might require elaboration for anyone as skeptical as I was. "First of all," says Rollin, "the small battery capacity of electric cars as well as their low speed and limited size understandably reduce power requirements. The less power you use, the less you pollute."

"But more important, electric generating plants are driven by low-pollution steam engines with an overall efficiency un-

known to any small thermal engine, about 45 percent. This means less wasted fuel to cause smog.”

The car was designed from the ground up to be battery-operated. Running gear (wheels, brakes, rear axle, torsion bars) were scavenged from a Morris Minor and the chassis and streamlined “ecology green” body made all of wood.

The compound-wound traction motor, built up on the carcass of an old bus generator, fits snugly into a small compartment between the front bucket seats. Directly coupled to the rear wheels, it is rated nominally at 15 hp but can supply up to 30 hp for short periods.

Power comes from six large, 12-volt truck batteries placed strategically to give the vehicle a low center of gravity and a 48-52 percent front-to-rear weight distribution (including driver). Three 96-pound batteries are nestled under the hood with an inboard charger that delivers 12-16 amperes from household line current. The

THE CLEAN GREEN MACHINE is right at home on curves and twisty roads, and, even in California, where strange cars proliferate, the car attracts the curious. Cutaway drawing below shows placement of batteries for good weight distribution and low cg



CURB WEIGHT: 1600 LBS.
TOP SPEED: 50 MPH PLUS
RANGE: 60 MILES
COST: \$1300

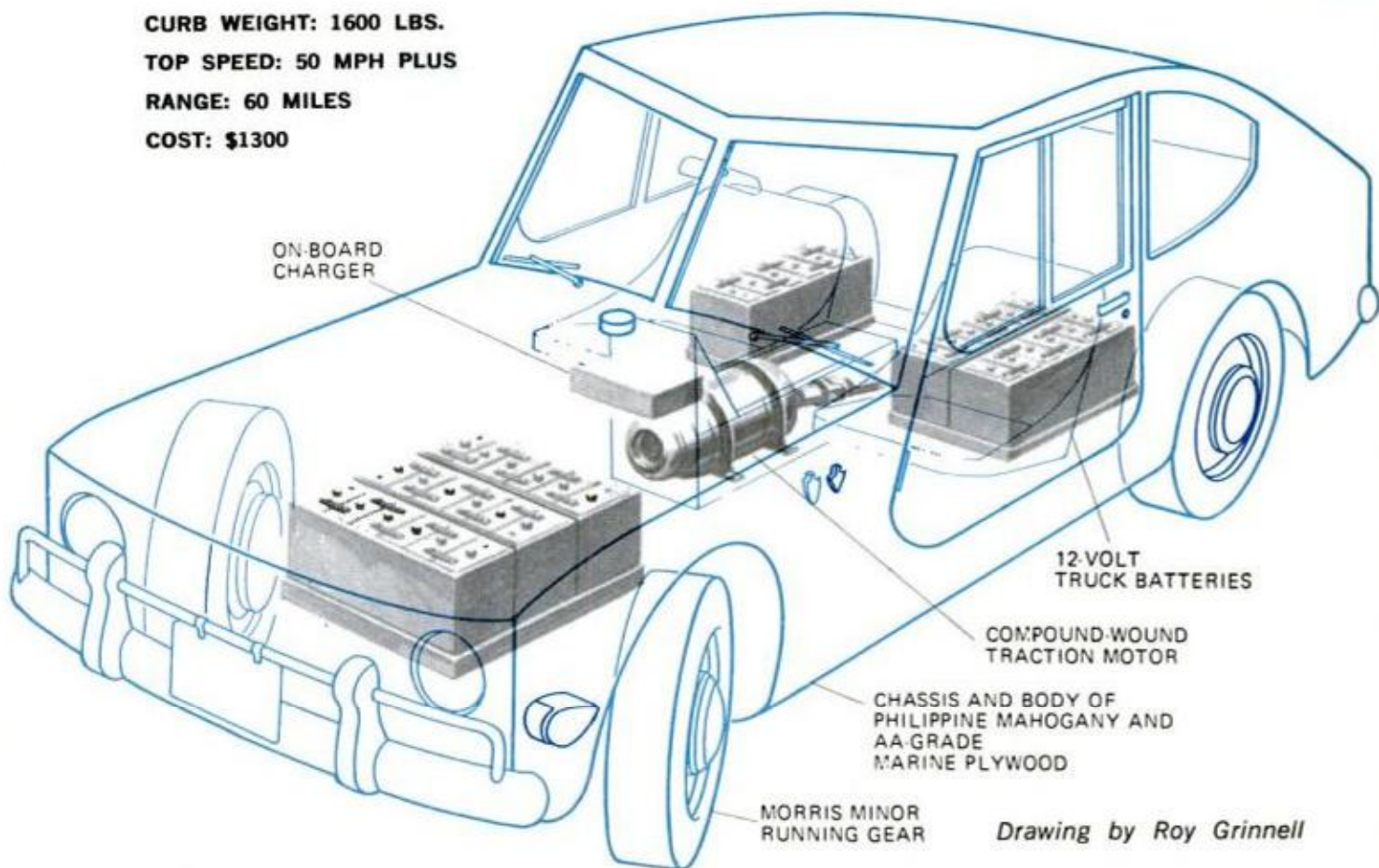

Drawing by Roy Grinnell

others are in back, out of sight. The batteries cost \$230 and last two years.

The controls are simple. The dash contains a voltmeter, ammeter, speedometer and two auxiliary ammeters for the charger. A key activates the system, starting a fan that draws air through the motor compartment. A toggle switch selects vehicle direction: Reverse is limited to half the forward speed at full torque.

The accelerator pedal is attached to a cam that operates microswitches connected to Cutler-Hammer power relays. The relays give different combinations of battery voltage and field current to change both the torque and motor speed.

The motor starts on 36 volts from both battery sets in parallel through a stainless-steel wire resistor that prevents excessive loads. A moment later the resistor is removed and further pressing of the accelerator varies the amount of shunt-field current. At zero field, the batteries are reconnected in series along with the wire resistor. With resistor removed, the shunt-field again varies from full current. At zero, the motor will run its fastest.

The cooling fan comes on with a slight whine. The sound of the motor reminded me of an electric bus, but this noise was acceptable considering that my left arm was actually resting on the uninsulated motor compartment. From outside, you hear only the wheels against pavement.

We sped down street with an occasional clack of power relays. A torque curve inverse to that of an i-c engine gives unbelievably fast and silent acceleration.

Our first 90° turn without slowing down flipped my camera case upside down; the next one righted it. When I commented on the car's cornering ability, Rollin gave a dramatic demonstration on a downhill horseshoe curve at 42 mph with only slight drift at the bottom. But I was too white around the gills to really notice.

Regenerative braking is a big feature. When you stop or go downhill, the shunt-field can be increased by easing the accelerator. When back electromotive force exceeds battery voltage, the motor acts as a generator, recharging batteries up to 100 amps. This increases vehicle range and saves the mechanical brakes for panic situations or full stops.

Recharging takes two to four hours after connecting an extension power cord to a jack on the right outside. A new charger

Rollin designed can now do the job in half the time. But he downplays any thought of doing it faster because of wear on the batteries and line-current limitations.

Driving range between charges can vary from 20 miles, with excessive starts and high speeds, to 60 miles and more—if you know what you're doing. An optimum cruising speed of 28 mph on a level road produces an 87-percent motor efficiency; and regard for motor efficiency is the conservative way to drive any electric. Upgrades should be taken slowly unless you can count on momentum from a prior downhill run to carry you up and over.

Although the Armer electric is a beauty to ride and behold, Rollin also gets a charge out of driving battery-operated motorcycles. His first was built frame and all for \$400 in four months. He drove it 9000 miles without a hitch, then sold it for \$375. His present cycle uses a Honda CB100 frame and required only two months to complete. A copyrighted do-it-yourself Electric Motorcycle Builder's Manual—and permission to build one vehicle—can be obtained for \$8.50 postpaid from Rollin Armer, 277 Purdue, Berkeley, Calif. 94708. ★★★

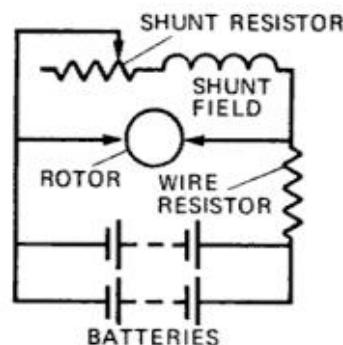

Pressing the accelerator pedal starts the rotor turning, with current coming from both battery sets in parallel through a wire resistor that prevents excessive loads.

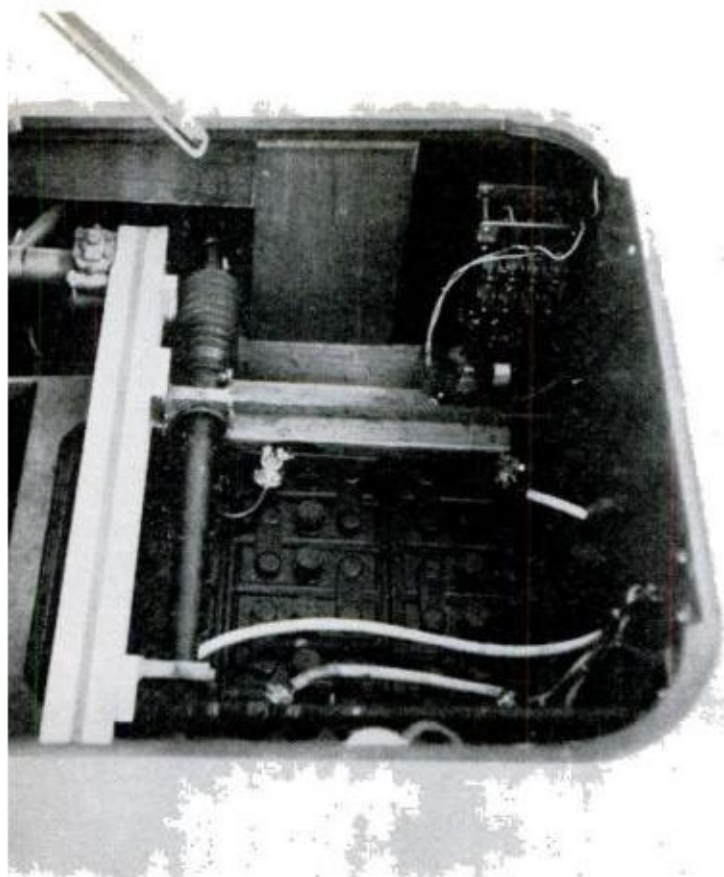

FRONT COMPARTMENT houses three of six batteries that power the vehicle. The on-board charger is mounted above them on the firewall. Steering linkage is visible as is part of the front wheel A arm

CONSOLE BETWEEN BUCKET SEATS is actually motor housing with a hatch for access. The 15-hp motor is coupled to rear wheels without transmission. Instruments are mounted in beautiful mahogany panel

HOW THE ARMER ELECTRIC OPERATES

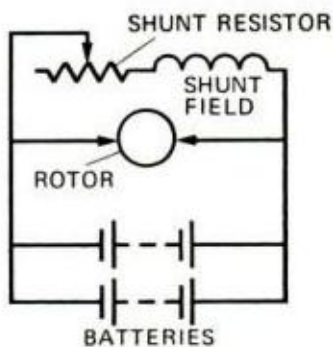

A moment later the resistor is removed from the circuit and further pressing of the accelerator varies the amount of the shunt-field current through the shunt resistor.

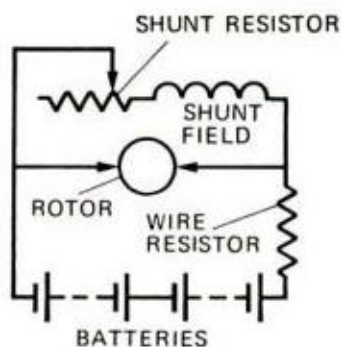

At zero field, the batteries are reconnected in series along with the wire resistor. (This diagram is a simplified approximation of what occurs. The actual circuitry has a patent pending.)

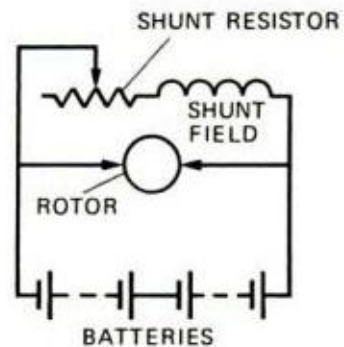

Further pressing of the accelerator removes the wire resistor and again varies the shunt-field current from full to zero. At zero shunt field, the motor will run its fastest.

A durable economy plane



THE PLANE THAT STARTED IT ALL—the original *Monoplane*—is shown with John Taylor at the controls. It has a wooden frame that's covered with plywood, a fixed main landing gear and a modified VW engine



LANDING GEAR MOUNTED on fuselage wing stubs and blunted wingtips were major modifications made by Canadian Geoffrey Broadwood. Plane cost \$1000 to build

UNDERBELLY POD on Ivan Bougie's version carries a small amount of luggage. A jazzy paint job creates an RAF look. This homebuilt was constructed in two years

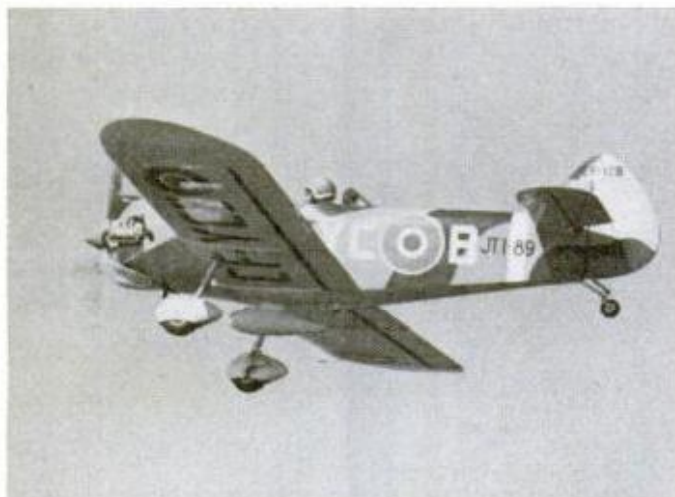

By **JOHN F. PEARSON** and **HOWARD LEVY**

Photos by Howard Levy

WHEN HE DREW UP plans for his *Monoplane*, John Taylor kept a major design limitation in mind: All components had to be of a size that could be accommodated within the confines of his 16 by 11 shop.

When assembled after 14 months' work, the single-seater had a wingspan of 21 feet and was 15 feet long. It was

ANNUAL MODIFICATIONS by Robert Ladd include blown canopy, retractable landing gear and handcarved, four-blade prop. Plane cost \$2000



from Britain

powered by a 38-hp engine that produced a top speed of 105 mph and a climb rate of 950 feet per minute. It weighed 410 pounds empty, had a gross weight of 620 pounds and a range of 230 miles. Its stall speed, with flaps down, was 38 mph.

The *Monoplane* was a no-frills, sturdy homebuilt that in time gained a reputation far beyond the boundaries of Essex, England, where Taylor made his home. Working with Taylor's plans, amateur builders in the United States, Canada, New Zealand, South Africa, Australia and Finland produced modified versions.

The simple design seems to invite modification, as is shown on these pages. A recently completed version (not shown), by a Long Island, N.Y., builder, reflects a radical change in the design. It is an all-metal job, and Taylor's prototype was constructed entirely of wood.

The first American version to get into the air, in 1964, was built by Hugh Beckham of Wichita, Kans. Beckham changed the wing structure and installed a converted VW engine.

A Canadian welder, Ivan Bougie, spent two years and \$1500 in putting together his *Miss Valleyfield*. It, too, is VW-powered.

Another sharp-looking version is the work of Robert W. Ladd, a 43-year-old Milwaukee engineer. He has made yearly modifications on his *Chihuahua* since completing it in 1967. A 50-hp VW engine gives him a maximum speed of 135 mph.

Shop foreman Jim Kerley of Redondo Beach, Calif., took 15 months to build his Taylor plane at a reported cost of only \$958. Jerry Higginson, a paving contractor from Clear Lake, Iowa, reports that his plane cost him about \$1500.

The man who started it all did not live to see the full flowering of his basic design. John Taylor died in an accident while flying a midget racer. But detailed plans for his *Monoplane* are still available at a price of \$25. Write to Mrs. J.F. Taylor, 25 Chesterfield Crescent, Leigh-on-Sea, Essex, England. ★★

JANUARY 1973



CESSNA SPRING GEAR and hydraulic brakes are among modifications made by Jim Kerley. His 25-hp engine eats only two gallons of fuel per hour. Range is 270 miles



WHEN HUGH BECKHAM finished his *Monoplane* in 1964, it had an open cockpit. Bubble canopy was added later. This was the first Taylor homebuilt made in America

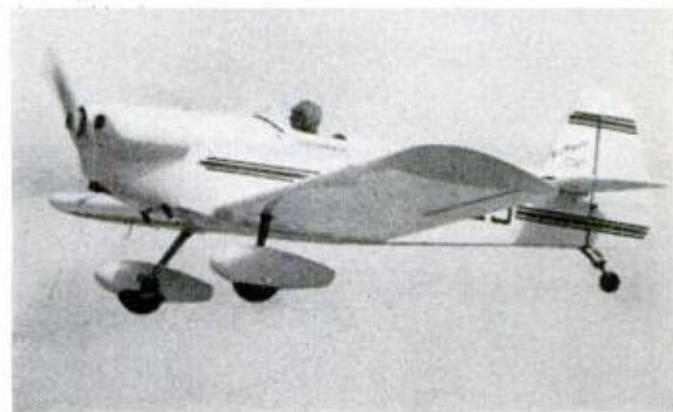

JERRY HIGGINSON put a 65-hp Lycoming in his plane, increased size of rudder and cut wingspan by a foot. Plane needs 500 feet for takeoff, has top speed of 130

129

The simple way to...

Adjust Vega carburetor and emission-control system

THIS PROCEDURE is condensed from a booklet in a new series offered by *PM*. The booklet shows how to do major maintenance jobs on a Vega. To order, send \$1.99 to Popular Mechanics, Dept. XYZ, Box 1014, Radio City, N.Y. 10019; include

your address and specify "Vega."

Other available booklets: VW Beetles 1966 through 1971 (\$1.99 each); a large booklet for all VW Beetles 1965 through 1971 (\$2.95); Toyota Corona (8R-C engine) booklet (\$1.99).

EMISSION CONTROL AND AIR CLEANER

This section shows how to remove and install the air cleaner and service the emission-control system. The air cleaner is of one-piece construction and cannot be cleaned. It should be replaced as a unit at 50,000-mile intervals under normal driving conditions. If vehicle is operated in dusty areas for prolonged periods, air cleaner should be replaced at more frequent intervals.

The emission-control system consists of a positive crankcase ventilation system and a vapor emission control system.

Crankcase ventilation system uses intake manifold vacuum to draw crankcase fumes and vapors through a regulating valve into the cylinders to be burned. The ventilation system draws clean air from the carburetor air cleaner and has a nonvented oil filler cap, thus forming a "closed system."

Since the crankcase ventilation system affects every part of the engine, it is important that the system be properly serviced.

The Positive Crankcase Ventilation (PCV) valve should be replaced at 24,000-mile intervals.

The vapor emission control system is designed to reduce fuel vapor emissions that are normally vented to the atmosphere from the fuel tank and carburetor fuel bowl.

The fuel evaporation vapors are stored in the evaporation emission canister and drawn from the canister into the cylinders to be burned.

The filter mounted on the bottom of the canister should be replaced at 12,000-mile intervals.

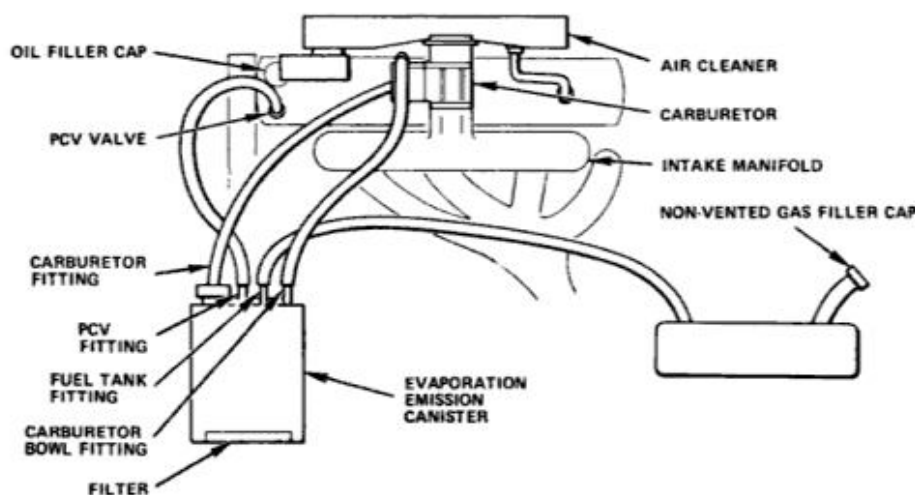

PART 1

Tools and Parts:

- 3/16-inch wrench
- Pliers
- PCV valve, AC type CV-758c (1)
- Air cleaner, AC type A-375c (2)
- Evaporation control canister filter

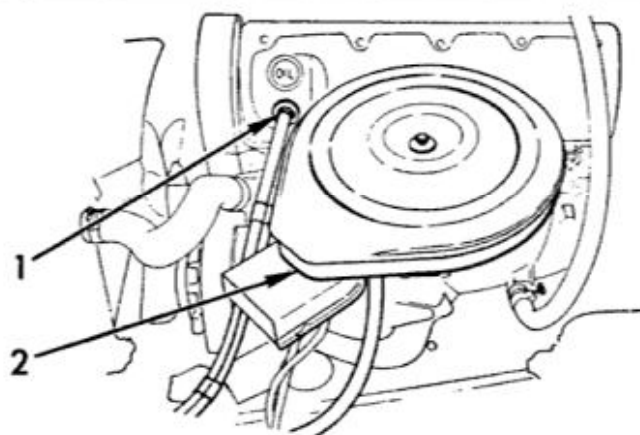

PART 2**Remove Air Cleaner**

1. Remove $\frac{7}{16}$ -inch bolt (5) and washers.
2. Lift end (1) of air cleaner (3) up and turn clockwise until crankcase vent pipe (6) is clear of valve cover (7).
3. Remove air cleaner (3).

If not replacing air cleaner (3), REMOVE ENDS HERE.

4. Remove vent pipe (6). Remove grommet (2). Dispose of air cleaner (3).

REMOVE ENDS HERE

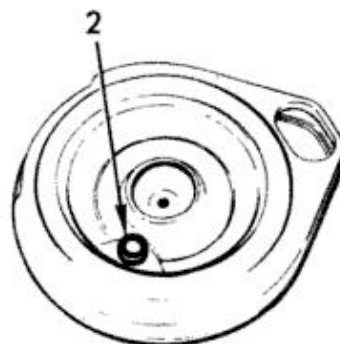
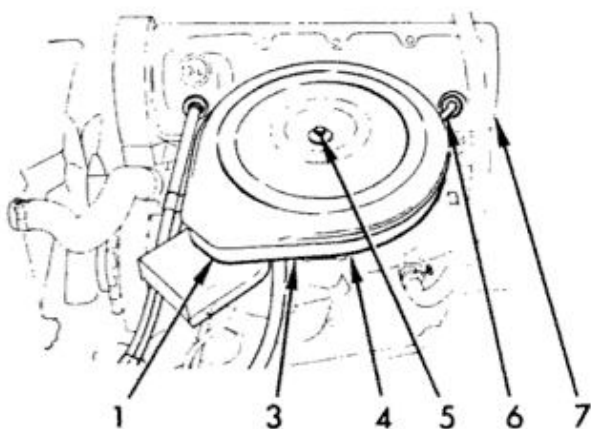
**Install Air Cleaner**

If not installing new air cleaner (4), go to Step 2.

1. Install grommet (2). Install vent pipe (6) in new air cleaner (4).
2. Place air cleaner (4) on carburetor (3). Turn end

(1) of air cleaner counterclockwise until vent pipe (6) can be installed in valve cover (7).

3. Install vent pipe (6).
4. Install washers and $\frac{7}{16}$ -inch bolt (5).

INSTALL ENDS HERE

PART 3**Replace PCV Valve**

1. Pull PCV valve (3) from valve cover (4).
2. Remove valve (3) by loosening retaining clamp (2). Dispose of valve.

3. Check that hose (1) is not cracked or deteriorated.

4. Install new valve (3). Tighten clamp (2).

5. Press valve (3) into valve cover (4).

REPLACE ENDS HERE

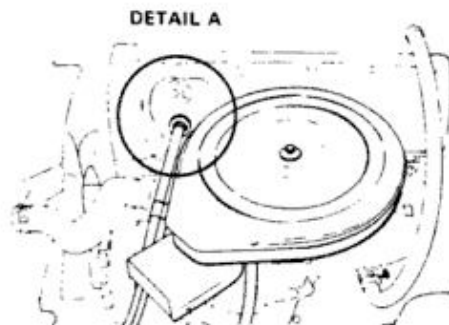
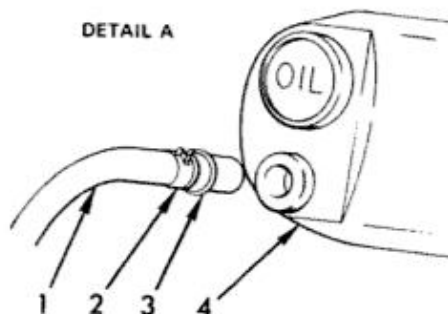
**PART 4****Replace Evaporation-control Canister Filter**

1. Label and disconnect four hoses (4) from canister (1) by loosening clamps (3).
2. Loosen $\frac{3}{8}$ -inch bolt (5). Remove canister (3) by pulling up.
3. Remove old filter (2) from bottom of canister (1). Place new filter at installed position.
4. Place canister (1) at installed position. Tighten $\frac{3}{8}$ -inch bolt (5).
5. Connect four hoses (4) to canister (1) by loosening clamps (3). Remove labels.

REPLACE ENDS HERE

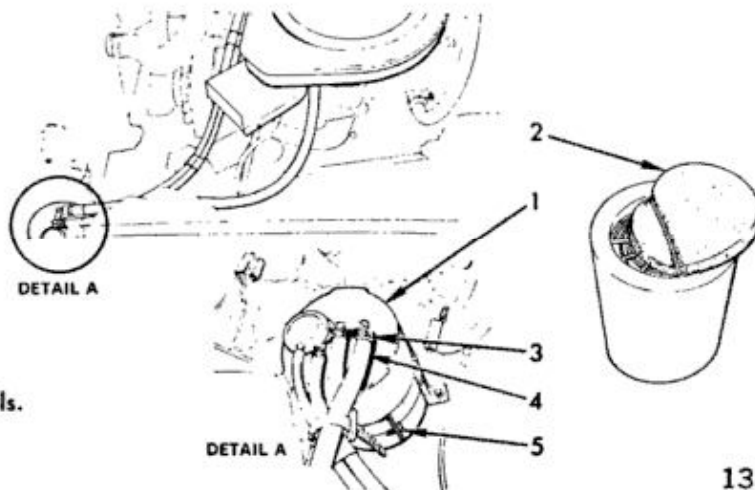

CARBURETOR AND FUEL FILTER

Instructions in this section show how to adjust the carburetor and replace the fuel filter.

Before performing instructions in this section, it is essential that the ignition system be properly timed.

The carburetor is a device which measures the volume of air being drawn into the engine and meters the proper amount of fuel that will mix with the air to form a combustible mixture.

The fuel/air mixture has been adjusted at the factory and should not be altered. If mixture adjustment is required, take car to a reputable service shop.

A throttle-closing solenoid is used on all Vega carburetor applications. The solenoid is electrically controlled through the ignition switch.

When the ignition switch is turned off, the solenoid is de-energized, allowing the throttle to close further than idle position, preventing engine from running after ignition has been turned off.

The fuel filter is mounted in the carburetor at the fuel inlet to give maximum filtration of incoming fuel. The fuel filter is a disposable type and should be replaced at 12,000-mile intervals.

PART 5

WARNING: Be sure to keep area well ventilated when working with fuel. Do not smoke or work with fuel near garage water heaters or electric heaters.

Be sure to keep hands and equipment clear of fan and drive belts when engine is running.

Emergency brake must be on.

All Vega engines have the same cubic-inch displacement; however, two types of carburetors are used. The two types of carburetors used are one-barrel and two-barrel.

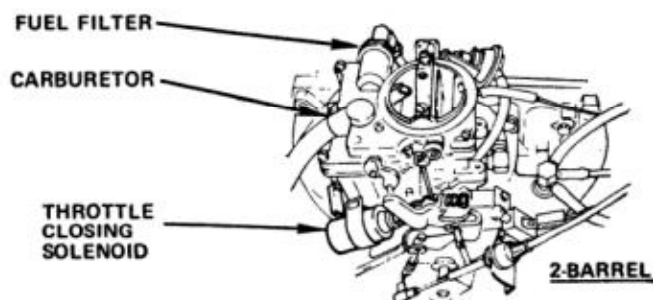
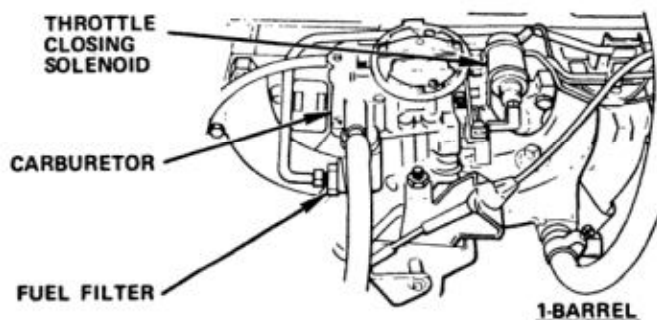

PART 6

Tools and Parts:

- 1-inch wrench (1)
- 1/2-inch wrench (2)
- 3/8-inch wrench (3)
- 1/4-inch wrench (4)
- 3-inch common screwdriver (5)
- Pliers (6)
- Tachometer (7)
- Fuel filter (8)

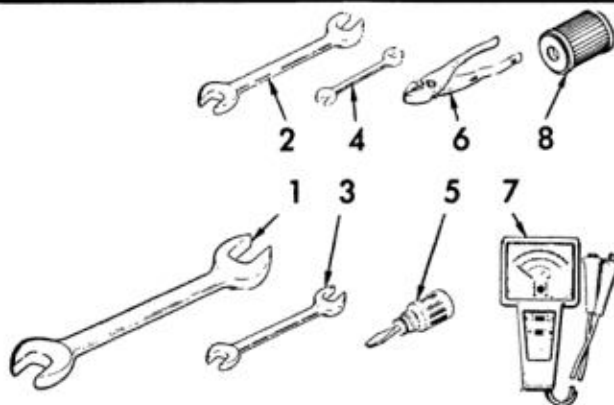

PART 7

Replace Fuel Filter

1. Remove air cleaner. See Part 2.
2. Using a 1-inch wrench to hold fuel filter nut (3, 5), loosen 1/2-inch fitting (2, 7). Disconnect fuel line (1, 8).
3. Remove 1-inch fuel filter nut (3, 5) and gasket. Remove fuel filter (4, 6).

(Part 7 continues top of following page)

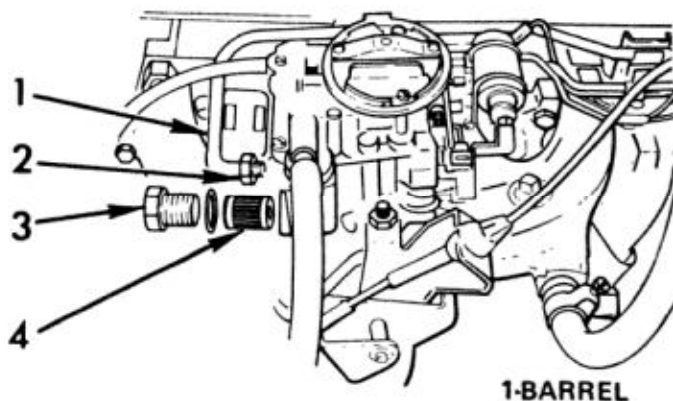

- Gasket end of filter (4, 6) faces 1-inch nut (3, 5).
4. Install new filter (4, 6). Install gasket and nut (3, 5).
 5. Connect fuel line (1, 8). Tighten fitting (2, 7).
 6. Install air cleaner. Part 2.

REPLACE ENDS HERE

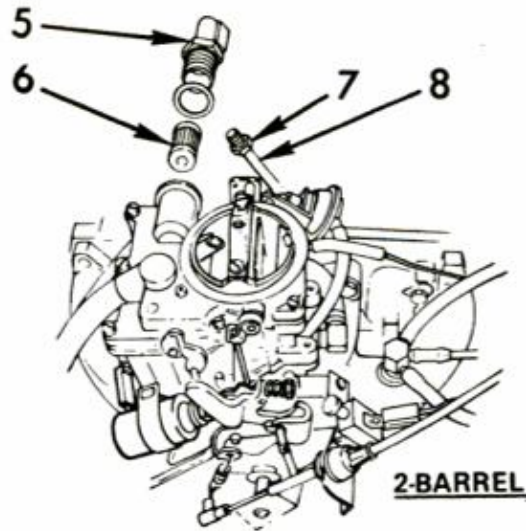

PART 8

Adjust Carburetor

See operator's manual supplied with tachometer for instructions on use of meter.

1. Connect meter to engine.
 2. Remove $\frac{7}{16}$ -inch bolt (1) and washer.
- Engine adjustments can be made with air cleaner (2) raised, but not removed, for access to adjusting screws.

After adjustment is made, air cleaner (2) must be lowered to make accurate readings on tachometer.

WARNING: Be sure area is well ventilated before starting engine.

Be sure to keep hands and equipment clear of fan and drive belts when engine is running.

3. Start engine. Turn on heater.

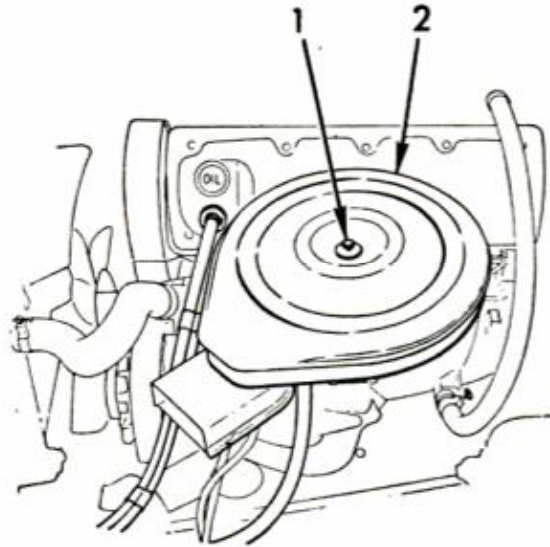

PART 9

1. Allow engine to run until warm air comes from heater. Turn off heater.
2. Disconnect fuel tank hose (4) from canister (3) by loosening clamp (5).
3. Disconnect vacuum hose (2) from distributor (1). Insert pencil in hose.
4. Disconnect solenoid quick disconnect (6, 7).

(Please turn to page 188)

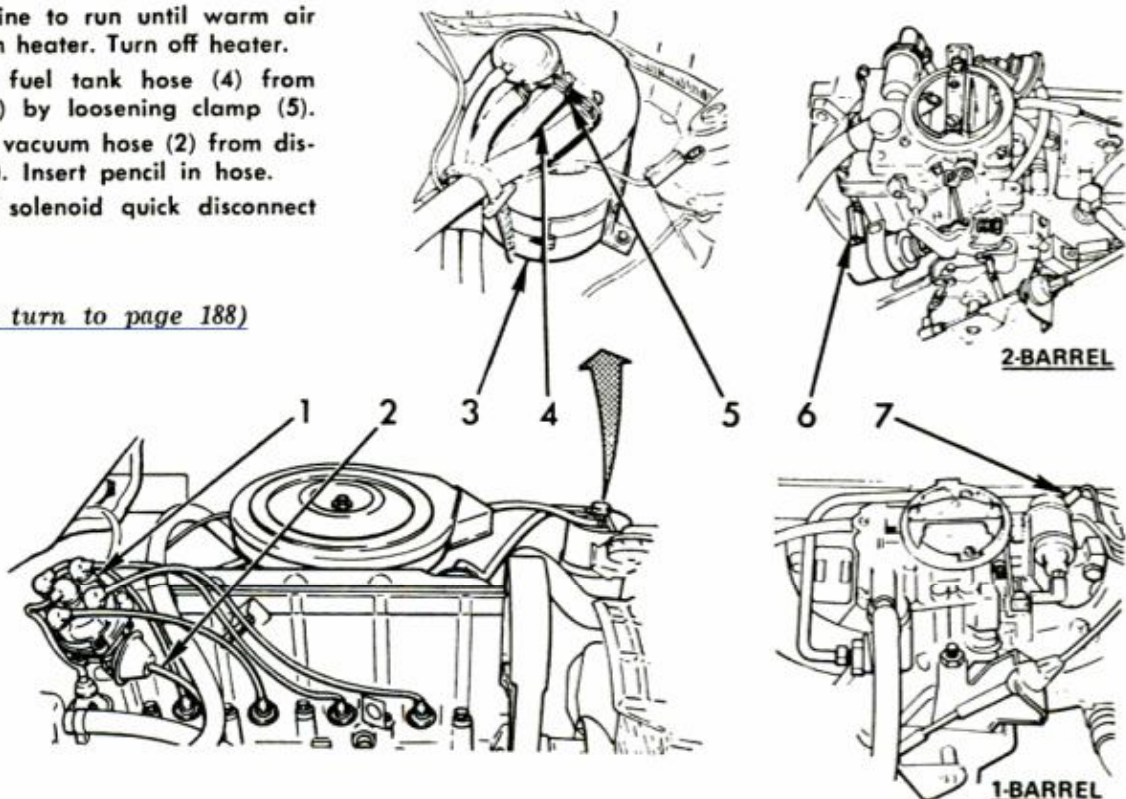

Number-guessing game

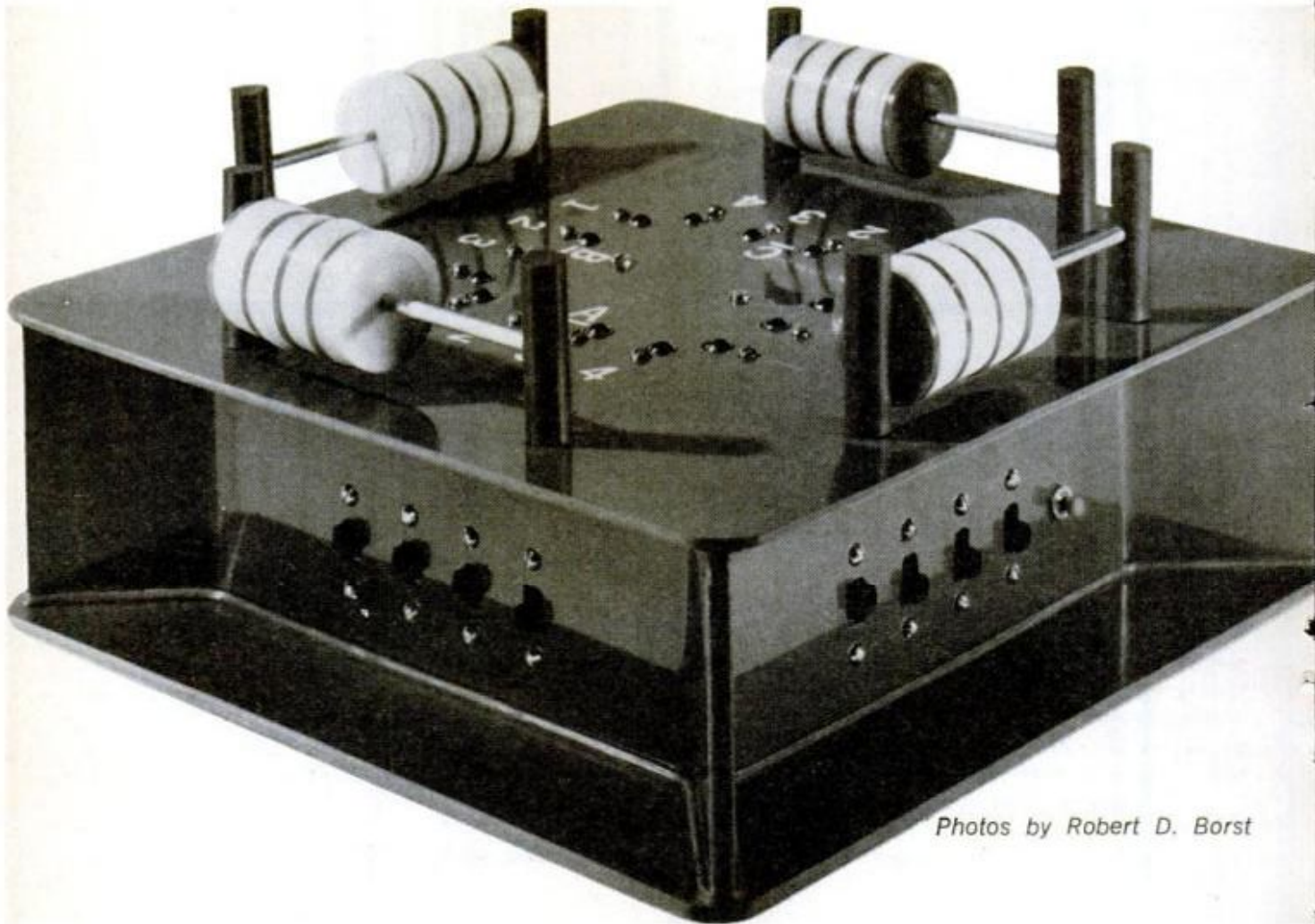

Photos by Robert D. Borst

OPENING IN BOTTOM of game provides access to batteries and bulbs when they need to be replaced

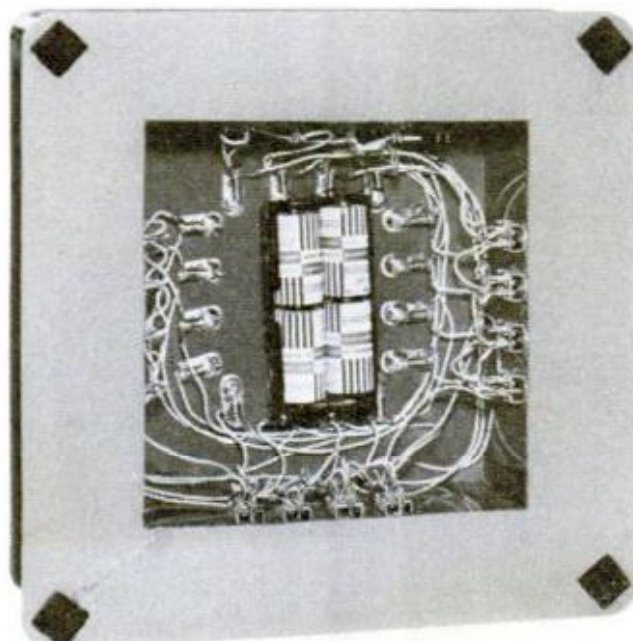

By **J. W. CALLENDER**

HERE'S A GAME that really keeps you guessing. It's a modern version of the old fingers game in which the "dealer" (in this case player X) tries to outguess his opponents. It can be played by two, three or four players, and each player has a turn at being player X.

The game is played as follows: Player X, who has the option of pressing either one or two of the four toggle switches in front of him, begins. Then players A, B and C do likewise, trying to guess the number or numbers player X picked. Now player X presses the pushbutton which lights the green and red bulbs on the top of the game to see if an opponent may have matched him. Individual scores are kept by moving discs left to right.

Let's suppose player X presses switch

HOW GAME IS MADE

Technical art
by Fred L. Wolff

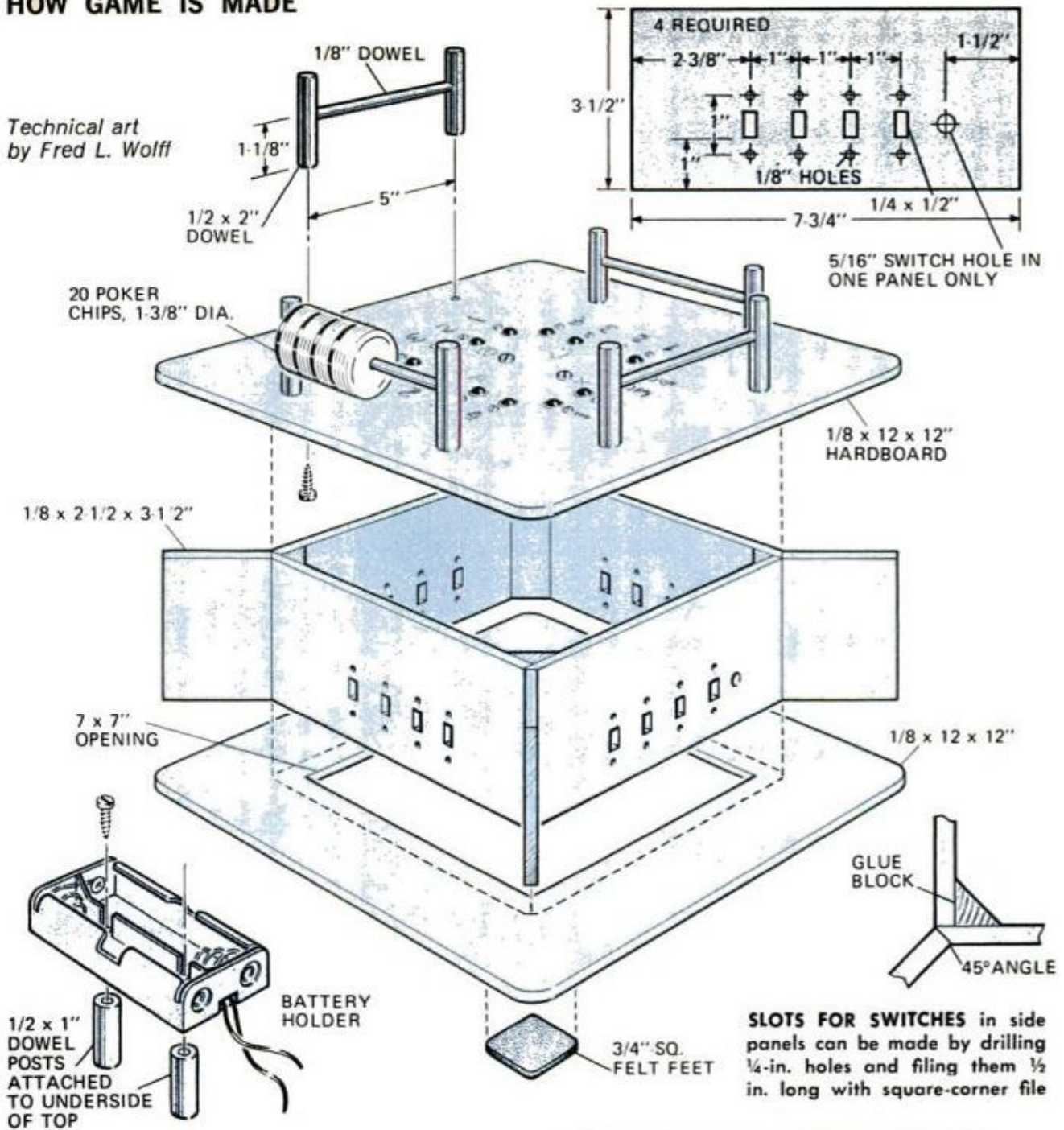

4, and player A presses 1 and 2, player B presses 2 and 3 and player C presses 3 and 4. Here No. 4 will light for player C only, allowing him to score one point.

If player A chose 1 and 4, player B, 2 and 4 and player C, 2 and 3, then players A and B would match player X and each score a point.

However, if players A, B and C had all pressed switches 1 and 2, player X would collect a total of three points.

The first player to score 5, 10, 15 or 20 points, whatever number agreed on, wins. All switches are turned off after each guess. Player X has the right to check each player's guess, if he so desires, before he presses the button to turn on the

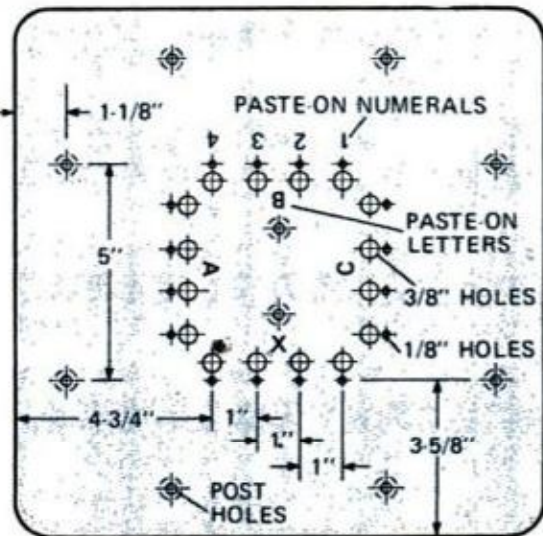

TOP PATTERN shows location of holes used for the lamps, poker-chip racks and battery-holder posts. Each row of holes is numbered

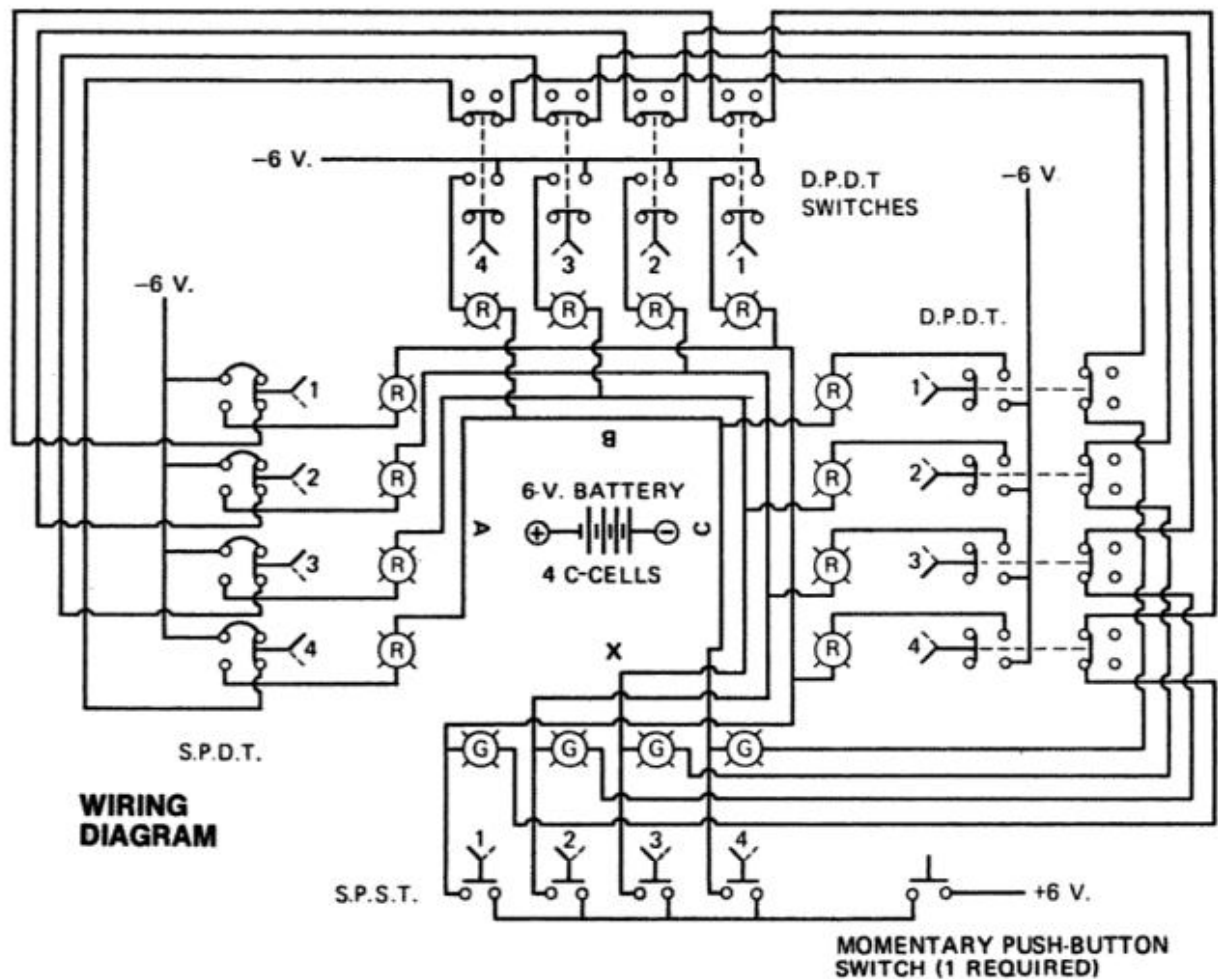

SWITCHES AND LAMPS REQUIRED

MOMENTARY PUSH-BUTTON SWITCH (1 REQUIRED)

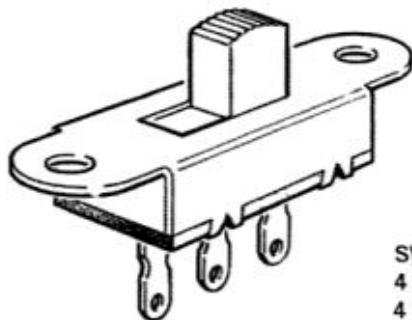
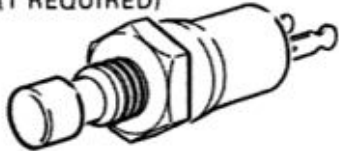

SWITCHES
4 S.P.S.T.
4 S.P.D.T.
8 D.P.D.T.

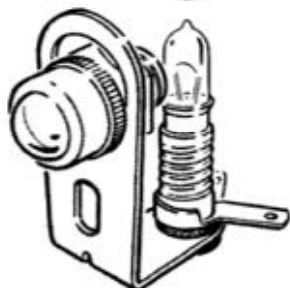

LAMP WITH PILOT
12 RED PILOTS
4 GREEN PILOTS

lights. Any combination of numbers may be used by all players.

The scoring discs are 20 poker chips with holes through their centers. Each fifth chip is a different color to make counting easier. All discs are moved to the left before the game begins.

The game can be made of 1/8-in. hard-board and painted, or of colored sheet plastic. Cut four panels 3 1/2 x 7 3/4 in. and drill and slot them following the pattern. Then bevel one end 45° on the face side. Notice that only one panel is drilled for a pushbutton switch. Glue panels together at the corners to form a box 7 7/8 in. square and back up each corner on the inside with a triangular glue block. Finally, glue the 2 1/2 x 3 1/2 in. wings at the four corners.

Now lay out the 12-in.-sq. top panel and drill the 3/8-in. holes for the 16 lamps which fit flush with the surface. The holes in each row are numbered 1, 2, 3 and 4 with paste-on letters, and each row is identified with letters A, B, C and X. Holes are also made in the top for the

(Please turn to page 190)

Now: a 'cut-anything' bandsaw blade

SAW BLADES edge-coated with tiny particles of tungsten carbide make it easy to cut a variety of "unsawable" materials, and Remington Arms Co. of Bridgeport, Conn., has been making them to fit your sabre saw, circular saw and hacksaw. Now Remington has one for your bandsaw.

Such extremely hard materials as tile, slate, hardened steel, glass and asbestos-cement saw almost as easily as hardwood. The endless, smooth-running blade will walk through glazed ceramic tile and snaggy wire grille, and a bandsaw lets you cut thick materials.

These new Grit-Edge bandsaw blades have a gulletted cutting edge for general use or a continuous edge for cutting very thin materials where chipping might occur. They come in $\frac{3}{8}$ and $\frac{1}{2}$ -in. widths for 12 and 14-in. home-workshop saws and up to $1\frac{1}{4}$ in. for bigger machines. Write Remington for prices.



Specifications • Nominal Kerf in Inches and Index Number

Width	Type Blade	Thickness in Inches	Fine -70 +100	Medium -50 +70	Med. Coarse -40 +50	Coarse -30 +40
3/8"	Gulletted	.025		.047 BS3-2M	.056 BS3-2MC	
	Continuous	.025	.039 BS3-1F	.047 BS3-1M		
1/2"	Gulletted	.025		.047 BS4-2M	.056 BS4-2MC	
	Continuous	.025	.039 BS4-1F	.047 BS4-1M		
3/4"	Gulletted	.032		.054 BS6-2M	.063 BS6-2MC	.076 BS6-2C
	Continuous	.032		.054 BS6-1M		
1"	Gulletted	.035			.066 BS8-2MC	.079 BS8-2C
	Continuous	.035			.066 BS8-1MC	
1-1/4"	Gulletted	.035				.079 BS10-D2C

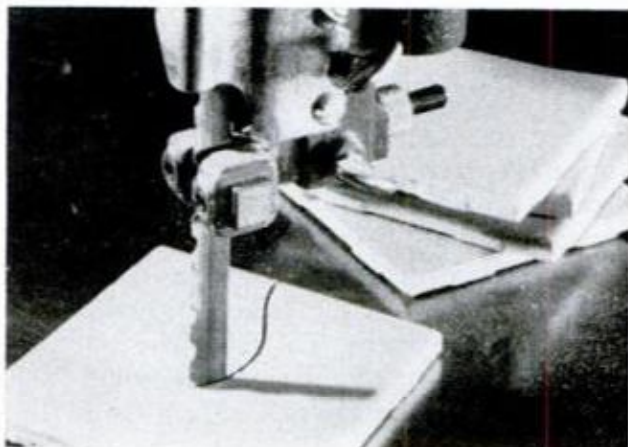
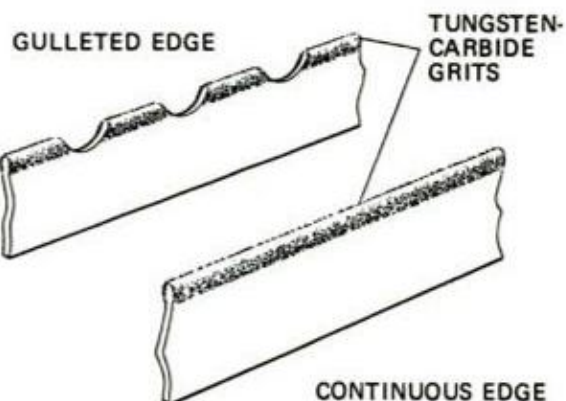

CERAMIC TILE cuts like butter with the tungsten-carbide blade, following a straight or irregular line

CARBIDE BLADE zips through a stamped metal grille with greatest of ease and without normal snagging

JANUARY 1973

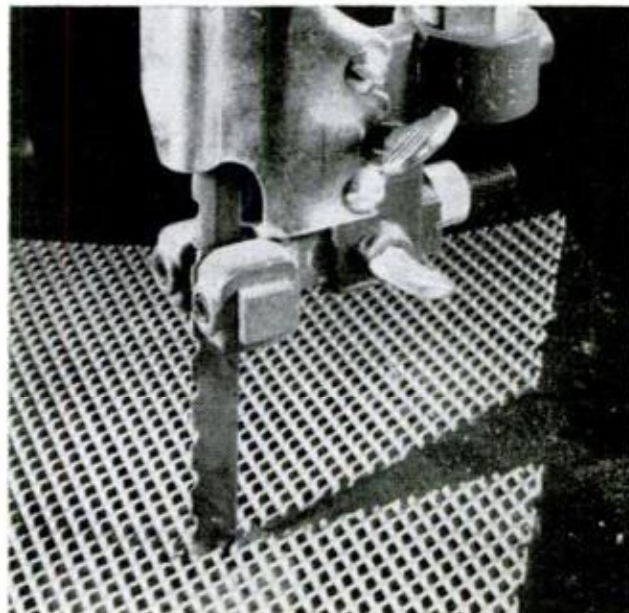

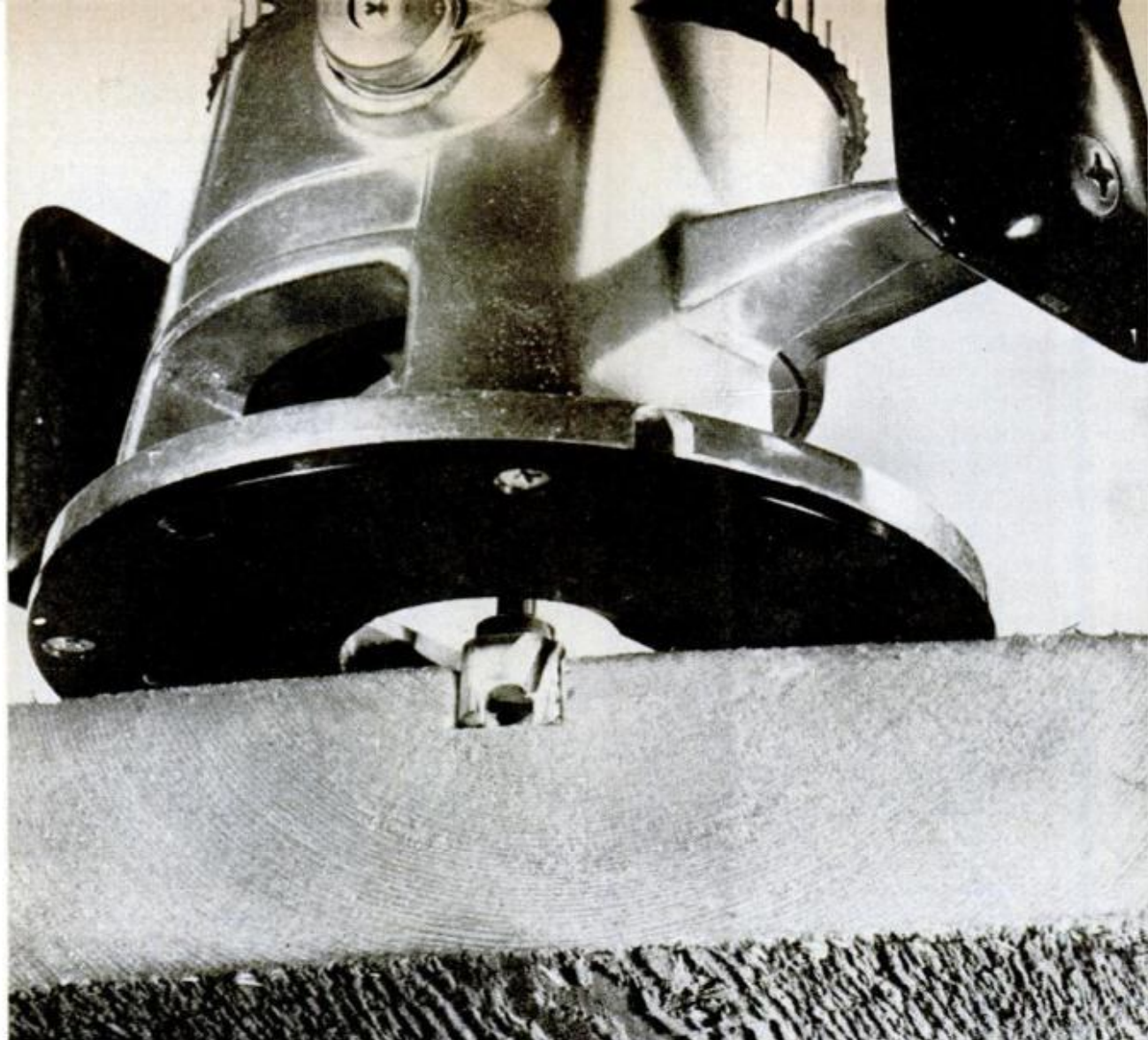

Router know-how

PART 2

How to get decorative edges, create circular work, handle plastic laminates, make dovetail joints and more

By **HARRY WICKS**, Workshop Editor

Photos by Robert D. Borst

CHANCES ARE you have wasted no time familiarizing yourself with your new router by making test grooves and dados. Now you're looking forward to some great workshop moments with this versatile tool.

The simplest and most common cutting done with a router (right behind the two cuts mentioned above) is decorative edging. It's about the quickest, surest way to add a professional touch to any project.

Decorative edging

A shaped edge, whether Roman ogee,

beaded or simply rounded-over (quarter round), improves the looks of just about any cabinet door, tabletop or drawer front. Actually, doing these edges goes so effortlessly that it is easy to give in to the temptation to put an edge on just about everything in sight. To avoid the mistake of *over-routing*, decide *which* edges will receive *what* treatment—and stick to the plan.

Direction of feed is as described last month in Part 1 (page 156); bit versatility can be increased by simply raising or lowering the cutter. You can put decora-

tive edges on circular workpieces, too. To do it, use the circle-cutting guide (shown in Part 1) and counterclockwise feed.

When in doubt, feed the router extra slowly. As you gain experience, you'll find that many woods have a tendency to splinter off large pieces ahead of the cutter. A slow feed rate and sharp cutter usually prevent this happening, but if it still happens, you should make the decorative edge with several passes. Lower the bit for each succeeding pass until the desired shape (depth) is achieved.

A lipped door is easily made using the

rounding-over and rabbet-cutter bits. But sequence is important: Make the rounded edge first, then the rabbet. Since the rabbet cutter's pilot will not have a surface to bear against, affix a guide for the router sub-base (shoe) when cutting the rabbets.

Circular work

Circles cut with a router will be absolutely accurate, as can be seen in the pair of photos at top of page 140. The first is a perfect circle being cut from plywood using a trammel point and panel-type bit; the other is a decorative plaque

How to cut decorative edges that improve your projects

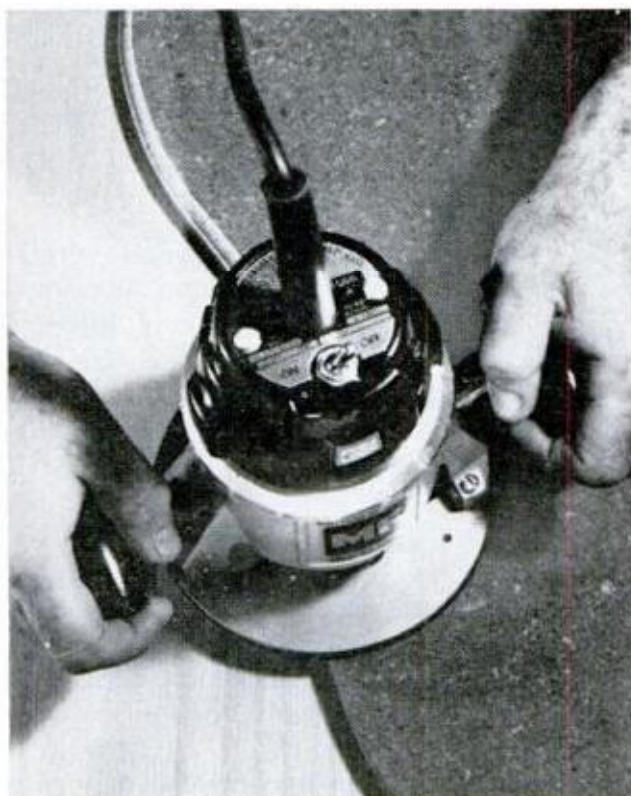

PILOT BIT (here, a beading cutter) can be used around edge of either square or free-form workpiece

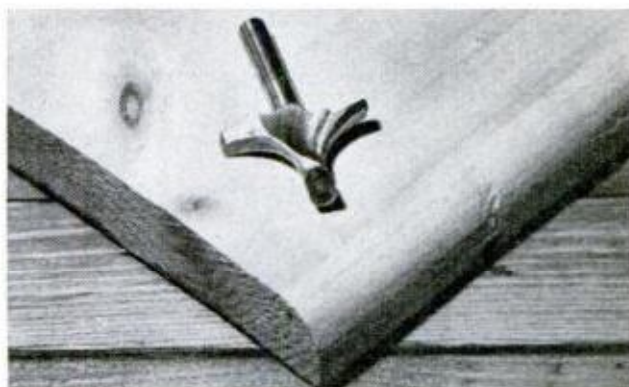

TYPICAL EDGES SHAPED using a pilot-type bit: rounded-over (quarter round) at top and beading

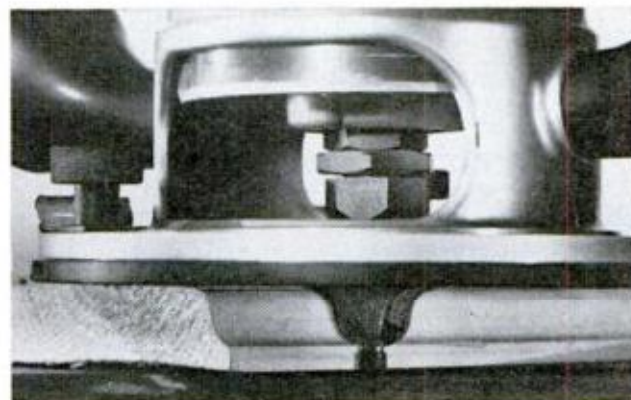

ROMAN OGEE illustrates how flutes do the cutting as the pilot at bottom ridges against the work edge
JANUARY 1973

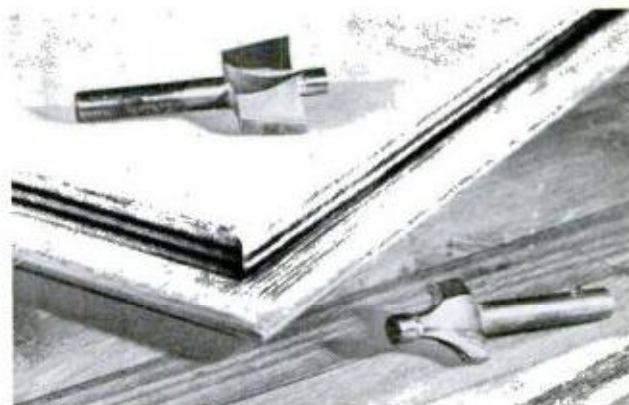

LIPPED DOOR is formed using rounding-over bit on the outside edges and $\frac{3}{8}$ -in. rabbet cutter on inside

How to handle circular work with no chance of error

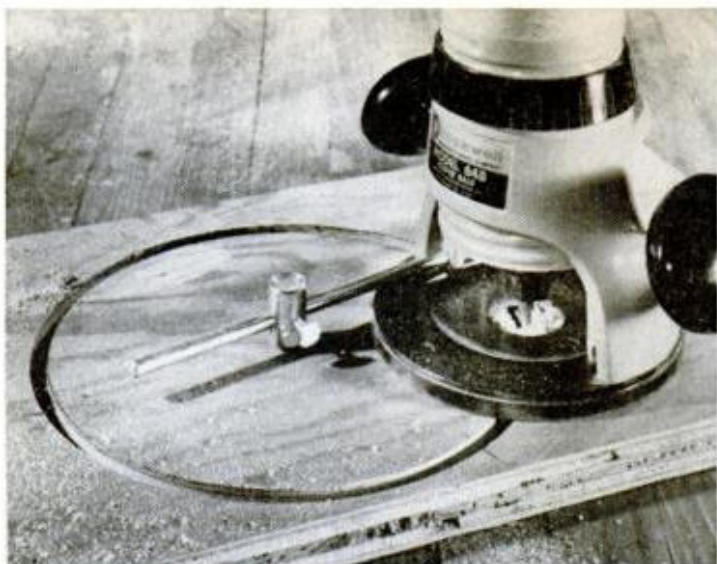

TRAMMEL POINT is affixed at the desired radius on guide bar secured in router shoe; straight bit does the cutting. The decorative plaque (right) was created with a core-box bit set at various depths for the concentric circles

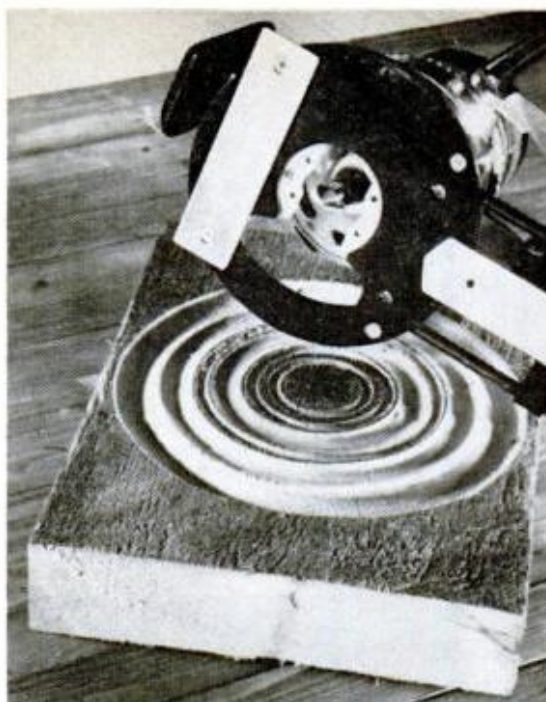

Working with plastic laminates

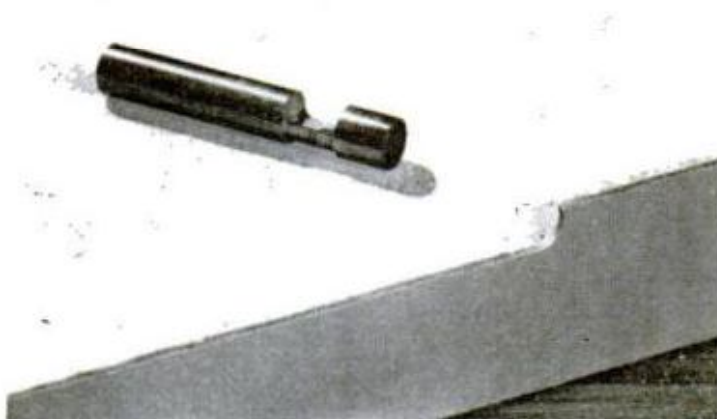

1. **SELF-EDGE** is applied to the top and trimmed with a straight carbide bit. Type shown is solid, one-piece trimmer

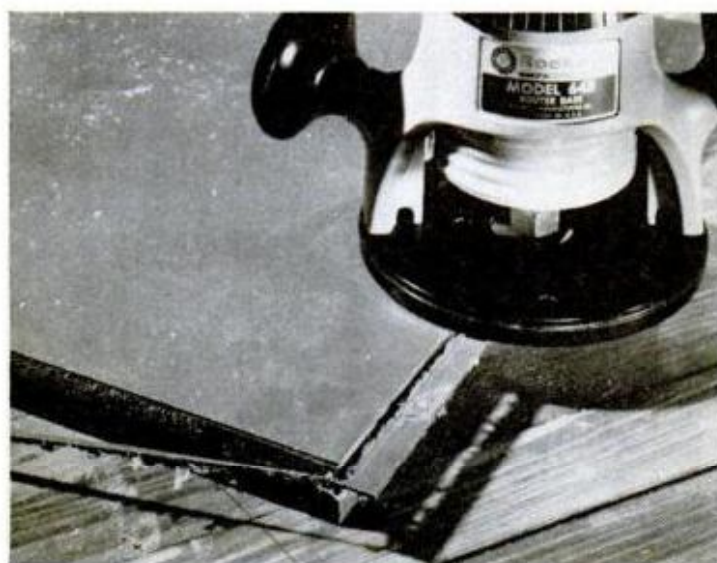

2. **LAMINATE TOP** is placed and trimmed, using the same cutter. See text for ways to prevent cutter burn marks
140

created by routing concentric circles with trammel point and core-box bits of various radii set at a different depth for each circle. Variations on this type of design are almost unlimited; each bit at a different cutting depth will provide a visual difference.

Plastic laminates

Because of looks and durability, plastic laminates are now commonly used by do-it-yourselfers. But plastic-laminate fabrication requires precise workmanship. Since plastic laminates are not cheap, it makes good sense to practice on scrap be-

CARBIDE-TIPPED LAMINATE TRIMMER

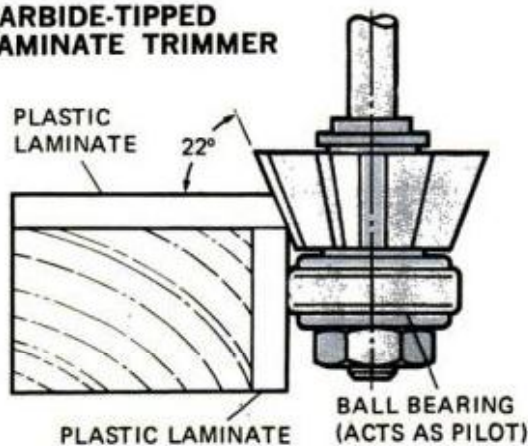

3. **EDGE** is finish-dressed with a bevel. Ball-bearing-type bit is also carbide-tipped

POPULAR MECHANICS

Dovetailing the easy way—with power

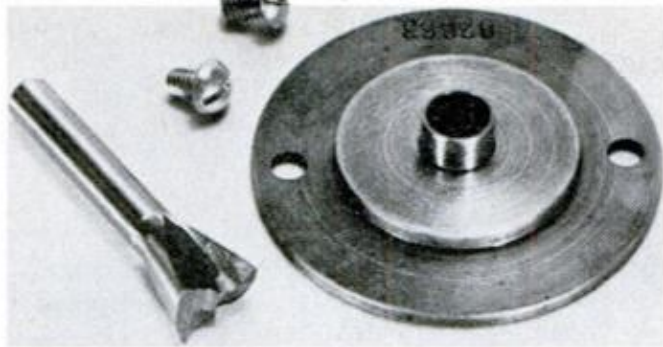

DOVETAIL BIT AND TEMPLATE GUIDE

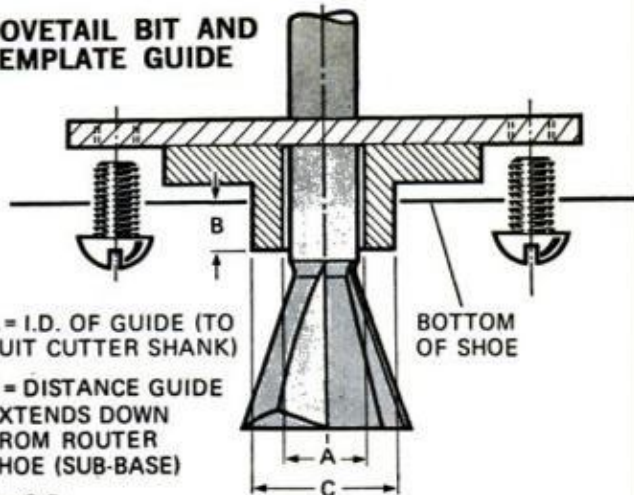

A = I.D. OF GUIDE (TO SUIT CUTTER SHANK)
 B = DISTANCE GUIDE EXTENDS DOWN FROM ROUTER SHOE (SUB-BASE)
 C = O.D.

BOTTOM OF SHOE

TO CUT DOVETAILS, you need a dovetail bit and template guide in router shoe and the dovetail template (below)

TEMPLATE GUIDE must be securely fastened to shoe and bit set at precise cutting depth

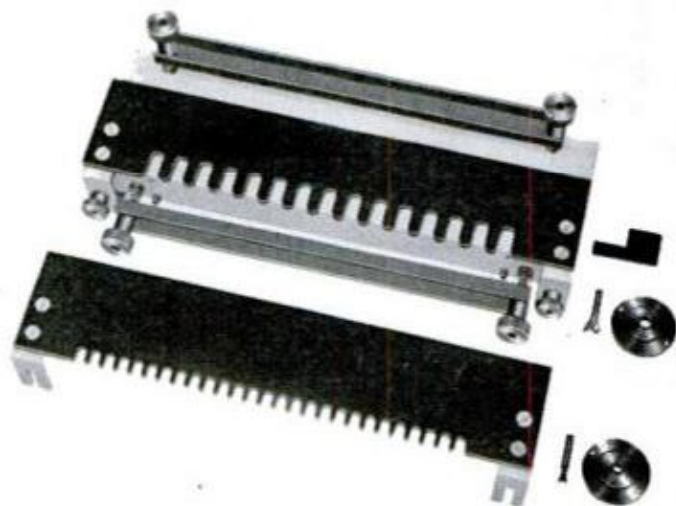

fore you put your router to an actual project.

Since conventional steel bits won't hold cutting edges if used on plastics, *always* use a carbide bit. Cutting edges on carbide-tipped bits hold up indefinitely and, more important, give neat, chipfree cuts. Of two types—one-piece solid and self-contained ball-bearing—you'll need two (of either design): a straight cutter for overhang trimming and a bevel bit (varying from 15° to 22°) to finish-dress the joint.

DOVETAIL TEMPLATE component parts: Notice that the main base is fastened to wood to provide positive clamping area

If you prefer the one-piece solid (as I do), smear petroleum jelly on the laminated self-edge to avoid any chance of the cutter creating a scorch

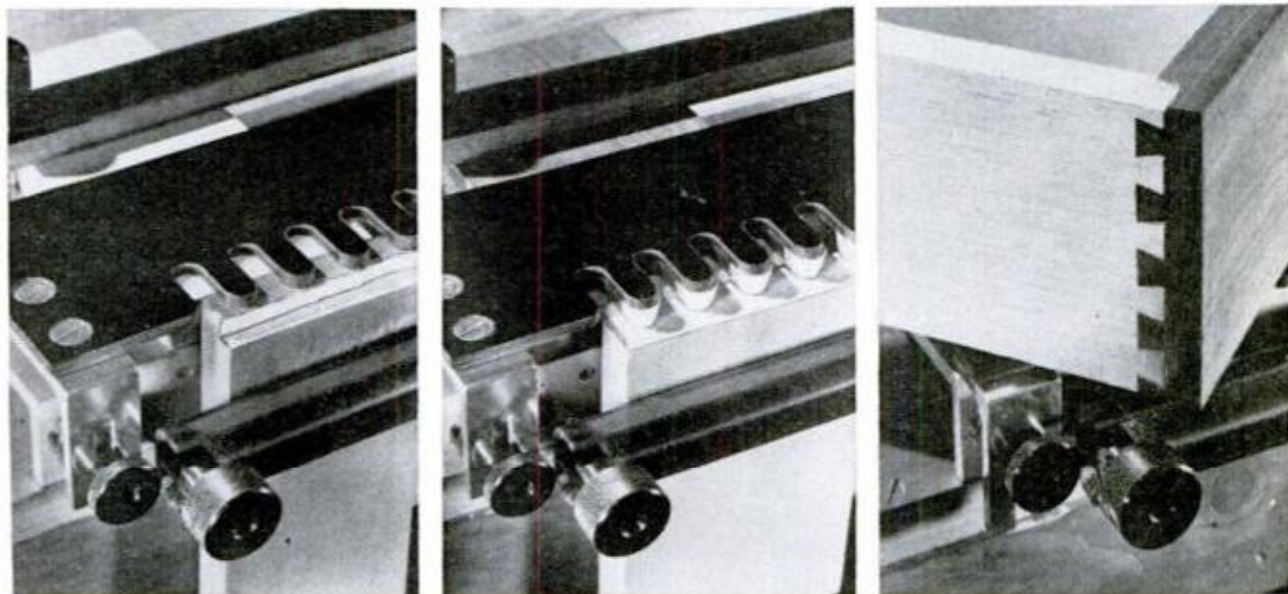

WITH BOTH PIECES clamped in template, router is moved left to right along complete edge (to prevent splintering). Second pass is also left to right, following fingers. The work is then test-fitted (right)

Template routing



TEMPLATE CUTTING is done using template guide and pattern cut slightly under the finish-work size

Freehand routing



A REAL CHALLENGE for a creative craftsman, free-hand routing is done without guides or templates

USE ROUNDING OVER AND COVE BIT OF SAME RADIUS. (FOR 3/4" STOCK, 1/2" RAD.)

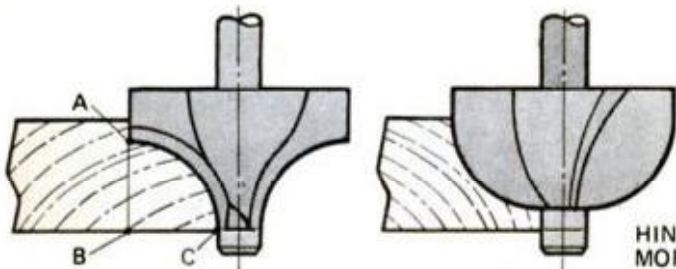

DIMENSION A-B = DIMENSION B-C
POINT B IS CENTER OF HINGE BARREL

142

mark. But if you have the ball-bearing type, acquire the habit of frequently disassembling parts and cleaning them with lacquer thinner. Then oil and reassemble. If you don't, the bearing eventually clogs with contact cement and spins at the same speed as the cutter—and then it will leave a burned line along the self-edge. The bearing *must* be free-spinning so it will rotate at the speed of router movement—not the cutting flutes.

Make sure that edges of the material to which the laminate will be cemented are square and true. (For complete information see *How to work with plastic laminates*, page 154, March '70 PM).

The self-edge is cut slightly larger than the surface to which it will be adhered; then affixed to the wood with contact cement. With the workpiece clamped to the workbench, the excess laminate is trimmed off with the straight bit.

Next, the top is bonded (again with slight overhang all around) and trimmed with the straight cutter. Finally, all edges are dressed with the bevel cutter. Beveling requires only a slight pass since very little stock is removed.

Dovetail joints

One of the strongest joints in wood-working, the dovetail is widely used in commercial furniture-making. With the help of a dovetail template and a suitable template guide, your dovetail joints will soon rank with the best. Dovetail templates sell for about \$50 and the guides for \$3 to \$5 depending upon size. No matter which brand you buy, make certain you read and understand the manufacturer's instructions.

To make dovetail joints, first install the template guide in the router sub-

DROP-LEAF TABLE JOINT (below) is created using two bits shown. The bits must have matching radii

DROP-LEAF TABLE JOINT

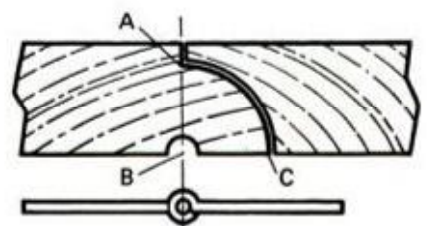
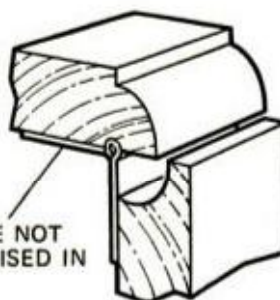

USE DROP-LEAF-TABLE-TYPE HINGE

POPULAR MECHANICS

base. (Note: Since the method of affixing guides varies from maker to maker, buy guides of the same make as your router.) Next, with the router installed in the sub-base (shoe), insert the dovetail bit so it extends exactly $\frac{19}{32}$ in. below the router base.

The base of the dovetail template is always affixed to a piece of wood (or the workbench). Use fh screws in screwholes provided in the base. When clamped in position, the front (overhanging) apron of the base should butt against the front edge of the workbench or board (see photo, page 141) fastened to the base.

With the template set up as instructed by the maker, always make a test dovetail joint first on scrap of the same material with which you will work. Make no mistake, dovetailing is precise work, so solve all problems—settings, cutter depth and the like—before pushing the router through your work. After obtaining a perfect cut on scrap, you can proceed on the work.

Since the boards are reversed after you make the cut, both boards are placed in the template with inside edges facing out and up. The top (horizontal) piece is first placed temporarily against the left-hand stop with its end extending about $\frac{1}{2}$ in. beyond the main template base. Then, the second piece is placed underneath the finger template and against the other left-hand stop. At the same time, move the first piece until it is flush with the second (see photo, page 141.) When both pieces are perfectly lined up, tighten all template thumbscrews.

When making the dovetail cut, never move the router on or off the template with motor running; there's too high a risk of damaging the template with the cutter. And always make your first cut along the entire edge of the workpiece—without sliding in and out of the fingers—to prevent chipping the edge.

After moving the router from left to right for this first cut, shape the dovetails carefully, moving in and out of the fingers. Again, the router should be walked from left to right. After the cut is completed, turn off the router. When the cutter stops spinning, remove router from the work.

Remove the boards from the template and test the joint. If your test work on scrap was accurate, you should have a

JANUARY 1973

Special-purpose bits for experts

Technical Art by Peter Trojan

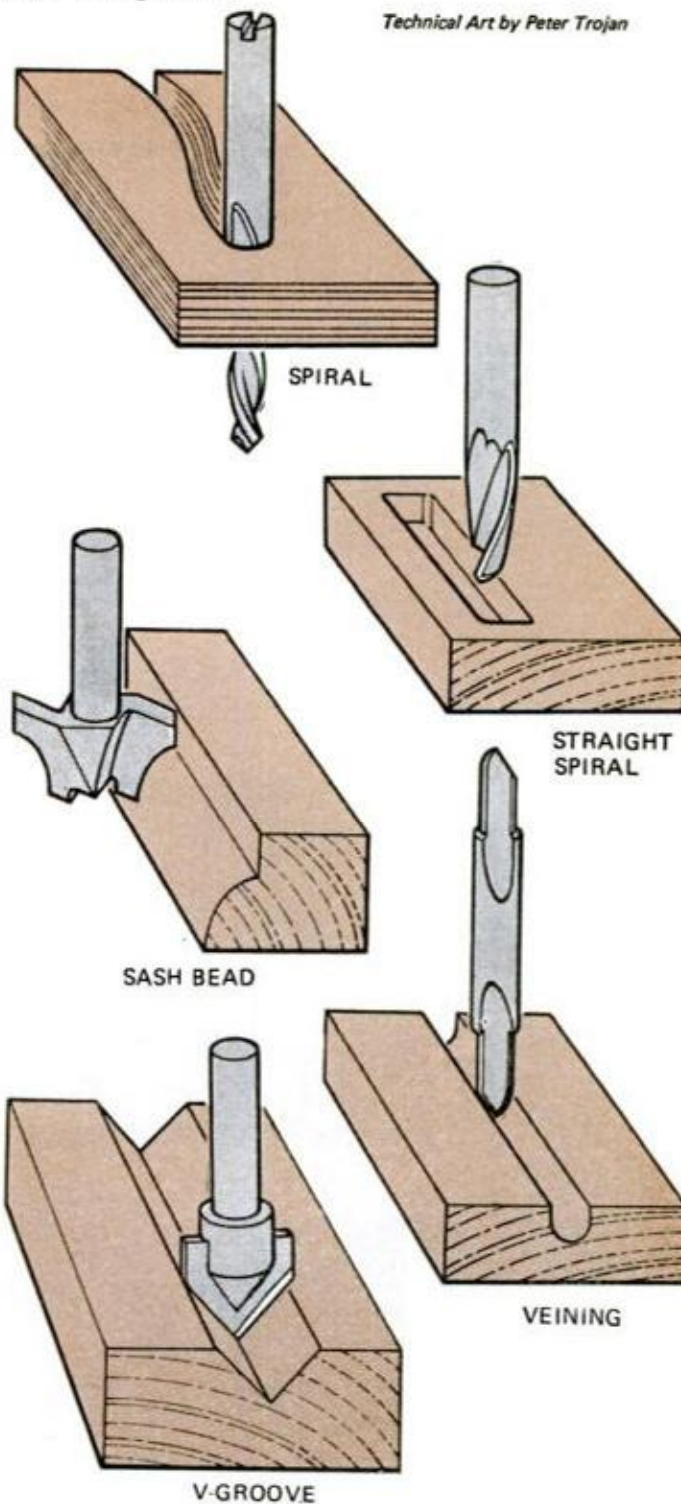

perfect joint. But if fit is loose, lower the bit slightly (perhaps $\frac{1}{64}$ in.), replace boards in template and re-rout. (If tight, raise the bit by that distance.) Once the template and router are set to produce a perfect dovetail joint, any number of dovetails can be cut accurately. Rabbeted drawer fronts, as well as the joint shown in the photos on page 141, can be dovetailed, too; it is necessary to reset the template stops, and you should refer to

(Please turn to page 191)

Hints from

Tape aids gluing

Filament tape, intended mainly for such tasks as securing packages, is particularly handy for holding glued joints immobile while the adhesive sets in either new construction or when doing repair work. I've found the tape is strong, sticks tightly when applied to a clean surface and resists stretching when pulled.

—B. W. Ervin, Kent, Ohio.

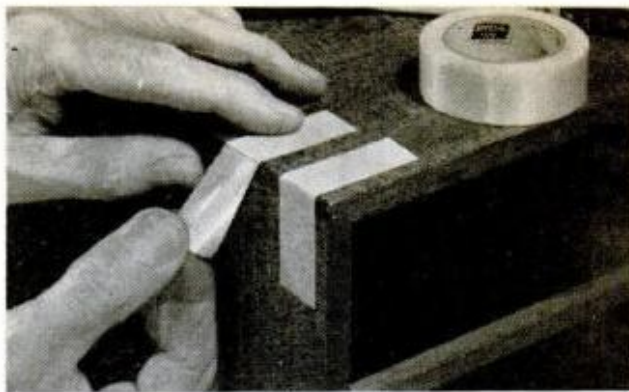

Wire 'connectors' from tubing

Short pieces of copper tubing can be literally "pressed into service" as electrical-wire connectors when other types are unavailable. The tubes are slipped over the bared wires, compressed with a Vise-Grip pliers, and the joints taped. For even greater strength, the connections can be soldered before being taped.

—Burt Web, Skokie, Ill.



U-bolt grinding guide

To grind opposing, parallel flat areas at the end of a metal rod, I clamped a U-bolt a short distance from the end and then placed the threaded ends of the bolt on the grinder's toolrest. This kept the rod in alignment while it was tilted forward to bring it against the sides of the grinding wheel.

—Walter E. Burton, Akron, Ohio.

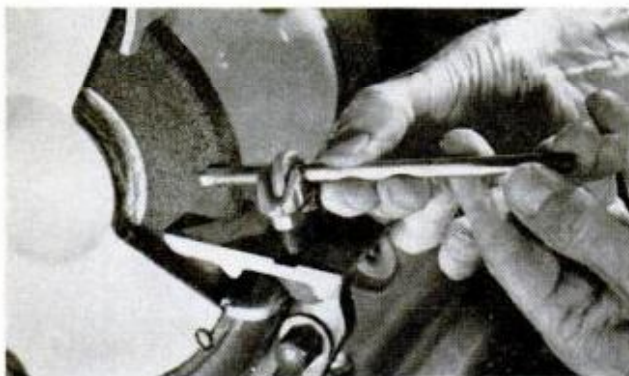

Self-closing hinge

Fabric tape and silicone sealing compound can be combined to make a self-closing hinge for a box lid. First, lid and adjacent strip to which it will be hinged, are positioned so the lid is *overclosed* by about 15°. (Beveling the edges makes this possible.) With lid closed, apply compound and immediately press in tape.

—W. B. May, Oak Park, Ill.

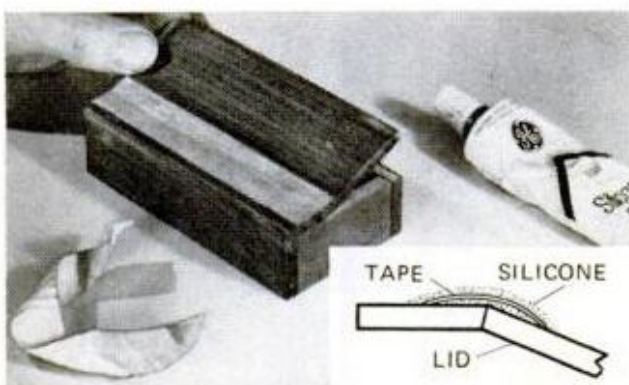

Cassette-tape rewriter

Here's a simple, effective way of winding a cassette tape either forward or backward, on or off the recorder. The rewriter is a 1-in. section of rubber hose slipped over the end of a pencil. With practice you'll soon discover just how many turns it takes to find the exact spot you want on the tape.

—Ken Patterson, Regina, Sask.



readers

Clamps from wire solder

Light pressure clamps can be made quickly from solid wire solder. The little C-clamps shown were bent so their ends were closer together than the thickness to be spanned, then carefully forced into position. After use, such clamps always can be returned to their original purpose—that of soldering metal.

—E. B. Walters, Chicago, Ill.

Felt 'brushes'

Disposable brushes or applicators for applying lacquer and other finishing materials are easily made from felt salvaged from old hats. For a typical brush, cut a felt strip 2½ in. long and ¾ in. wide. Fold it crosswise at the center and push it into a ⅝-in.-long slot in a ⅜-in. hardwood dowel "handle."

—Wm. T. Mayor, Philadelphia.

Tubing from clothesline

An emergency source of small-diameter flexible tubing can be a plastic-covered clothesline. A half inch or so of the cover is peeled from one end so the rayon core can be clamped between vise jaws. Then the tubular cover (usually vinyl) is pulled off. Pressing the tubing end back with a finger helps loosen it.

—Henry Jones, Houston.

Drawing multiple lines

When taped together side by side, two or more ballpoint refills make handy instruments for drawing parallel lines. Novel signs can be made by using such a setup as a lettering pen. After the letters have been roughed out, lines can be strengthened, shading added or other modifications made with a single ballpoint.

—Walter E. Burton, Akron, Ohio.

Hang it all

By replacing one bolt with an eyebolt, I made my drill easy to hang. To keep the chuck key handy, I have mine fastened to a length of monofilament fishline fed through a hole in the perforated board. A sinker—heavier than the key—is tied to the other end of the line to hold the key against the board.

—Don Anderson, Sunnyvale, Calif.

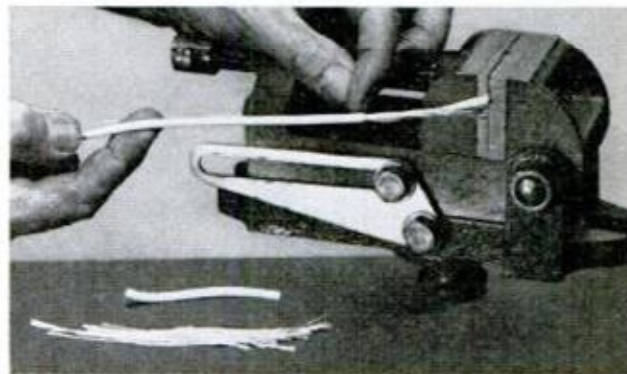
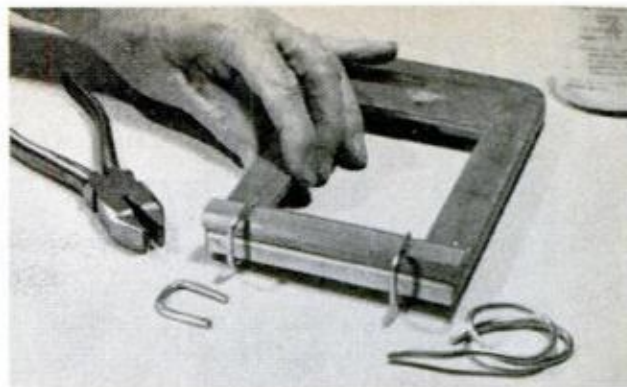

Handy hold-down for your

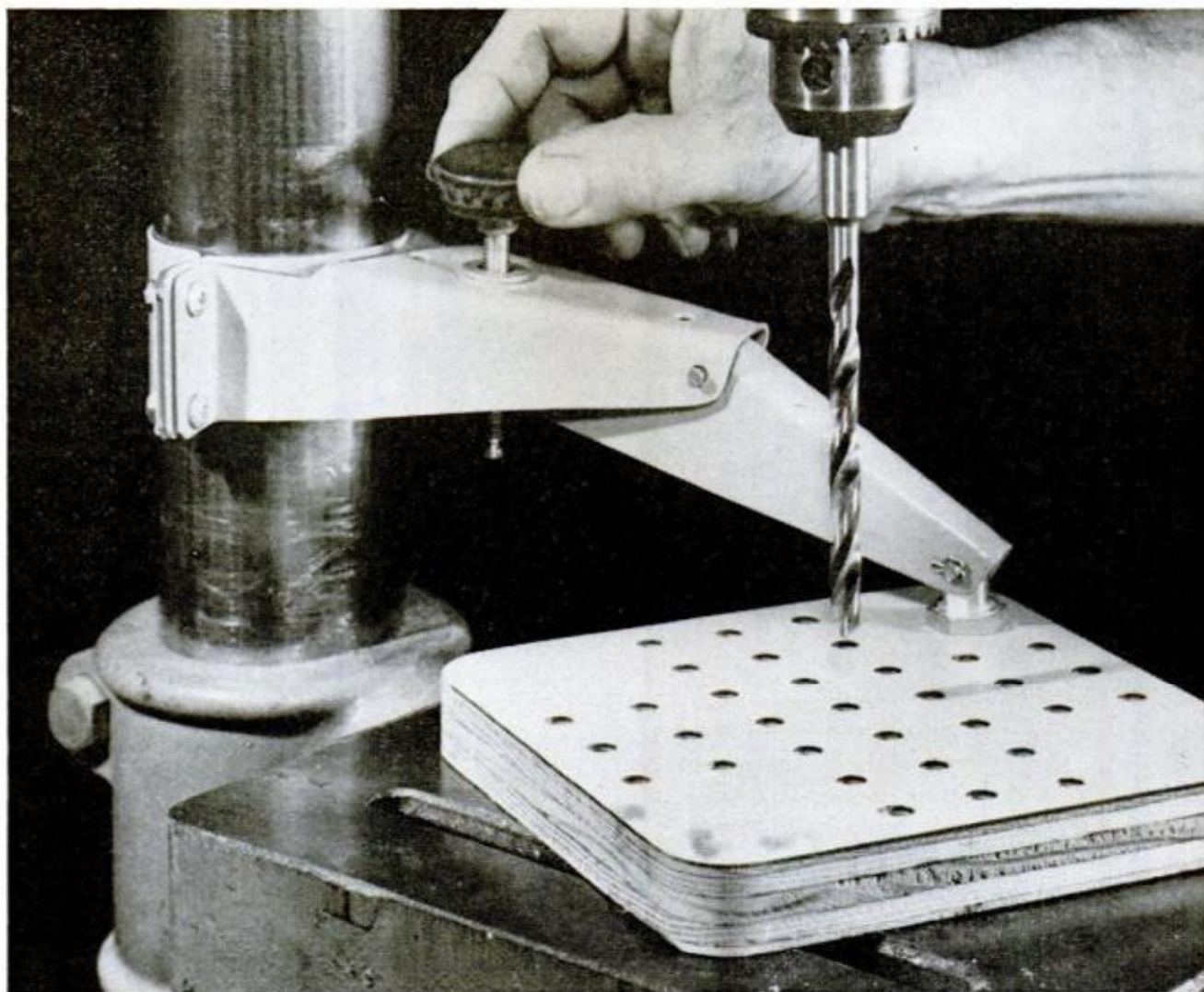

By C. A. ACKERMAN

Photo by Robert D. Borst

HERE'S a drill-press fixture that does away with C-clamps normally used to hold work firmly and safely for drilling. It clamps to the drill-press column and can be swung out of the way when not needed. Pressure is applied to the foot of the hold-down by tightening a knob.

The hold-down has four sheet-metal parts formed from .06-ga. low-carbon steel—a bracket, rocker and two-piece column clamp. To bend the bracket and rocker neatly, first cut tapered wooden forming blocks to fit the bending lines of the pattern. For the bracket the block must taper from $\frac{3}{4}$ to $\frac{1}{2}$ in.; for the rocker, from 3 in. to 1 in.

Make full-size patterns for the two parts, lay them on your sheet metal and cut out with tin snips and a cold chisel. Drill all holes while the parts are flat, being careful to spot them precisely when

center-punching. Start with a $\frac{1}{4}$ -in. bit to drill the $\frac{3}{8}$ -in. holes and work up to the final size with progressively larger bits; you'll have neat round holes. Use two C-clamps to hold the sheet metal to the tops of the forming blocks and press the metal against the sides of the blocks, tapping it as you go with a rubber mallet.

Matching holes in the column-clamp parts are made with both clamped together. The three sets of holes must align. Bend ends 90° and then bend both halves around the drill-press column. Dimensions are for a $2\frac{3}{4}$ -in.-dia. column. If parts are loose fitting, use shims.

The threaded knob passes through a hole in the rocker and a tapped hole in a trunnion nut turned from aluminum to pivot freely in the $\frac{3}{8}$ -in. bracket holes. A toggle action occurs when the knob is tightened against the rocker. ★★★

drill press

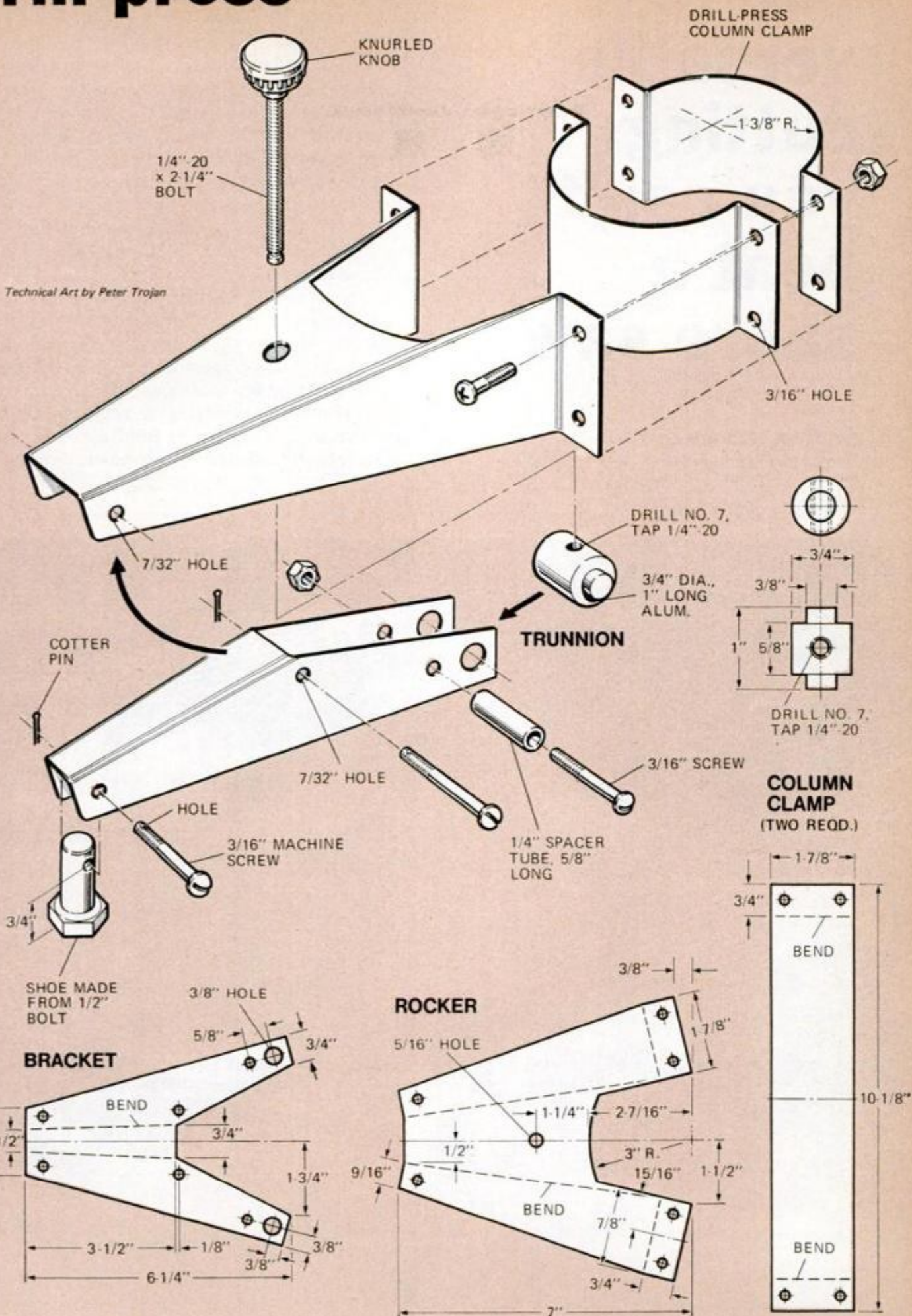

For versatile cutting, you can't beat a sabre saw

By JOHN BURROUGHS
Photos by the author

AS JIGSAWS, sabre saws aren't really very satisfactory. But as general-purpose power saws for cutting off lumber and ripping panel stock—the kinds of jobs that used to be done with arm-powered handsaws—the tools just can't be beat. Although sabre saws aren't as fast cutting as portable circular saws, they're lighter, easier to handle, safer and more versatile.

Their versatility has made them so popular, particularly with homeowners who don't have table or radial saws, that there are now more than 20 makes of sabre saws available, and most manufacturers offer several different models—in all, a good many saws to choose from.

All are similar mechanically. In each a brush-type, universal motor pinion-drives a reduction gear that has an eccentric stud. The stud operates a reciprocating saw bar with a chuck to hold a blade on its lower end. But in size, power, qual-

WHEN SAWING A CIRCLE with edge guide used as a trammel beam, wedge kerf as you near end of cut

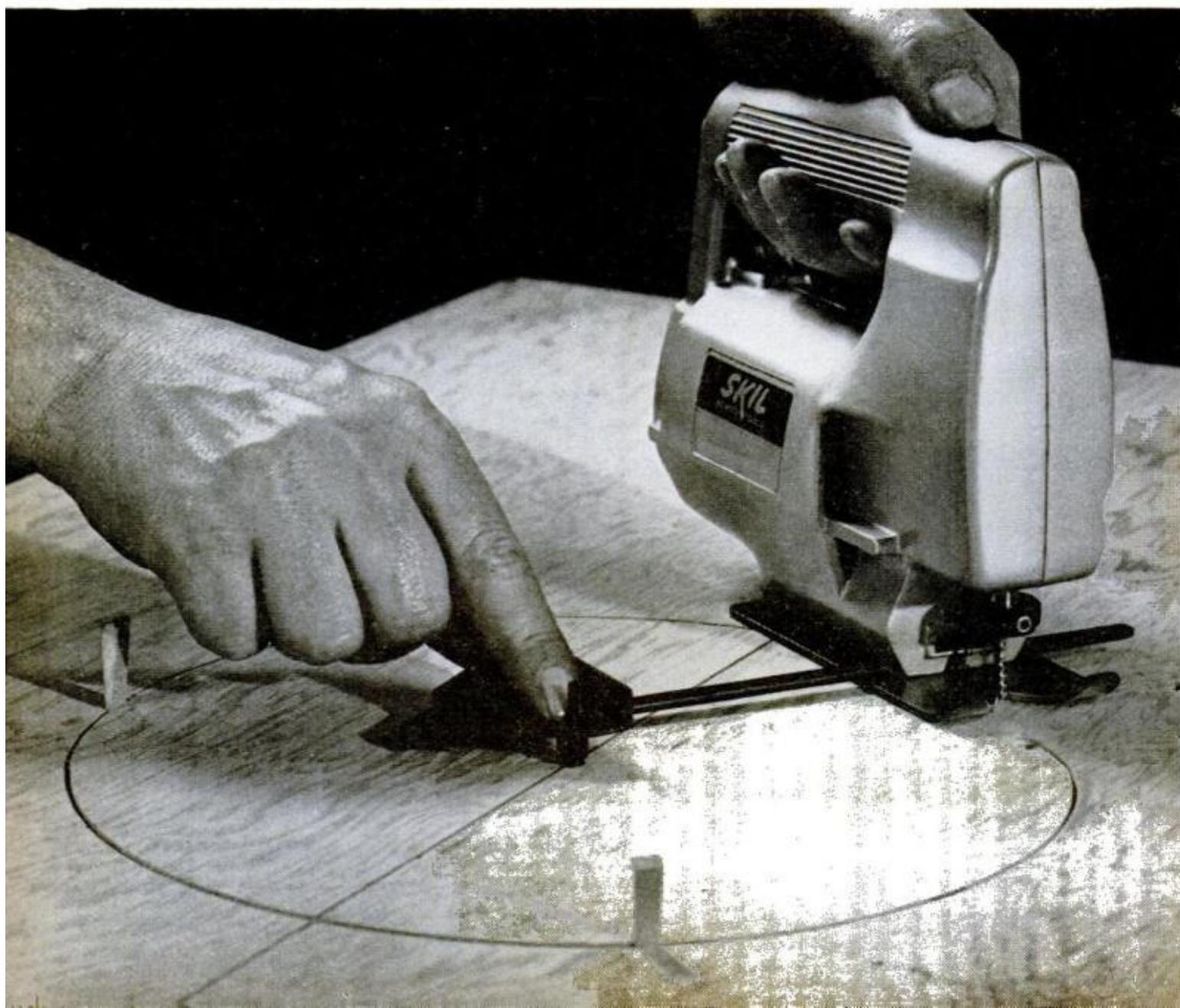

ity and price, the models differ widely. You can buy a sabre saw for under \$10, or you can pay more than \$100. Either tool may be well worth the money.

When considering which saw to buy, the real question is whether a more expensive tool's extra quality and features will prove, to *you*, worth the higher cost. The answer depends upon the work you'll do with the saw. In general, a better tool is a better buy, and for any given make, the model second from the top of the line is likely to be the best value.

● **Big or little?** Most light-duty saws with $\frac{5}{8}$ -in.-long strokes have motors that draw about 2.5 amps. and develop up to $\frac{1}{4}$ hp. Such saws readily cut 1-in. hardwood or $1\frac{1}{2}$ -in. softwood.

Heavier duty saws with 1-in.-long strokes have motors drawing up to about 4 amps. and developing around $\frac{1}{2}$ hp. These larger tools can rip 2-in. planks twice as fast as smaller models, and with

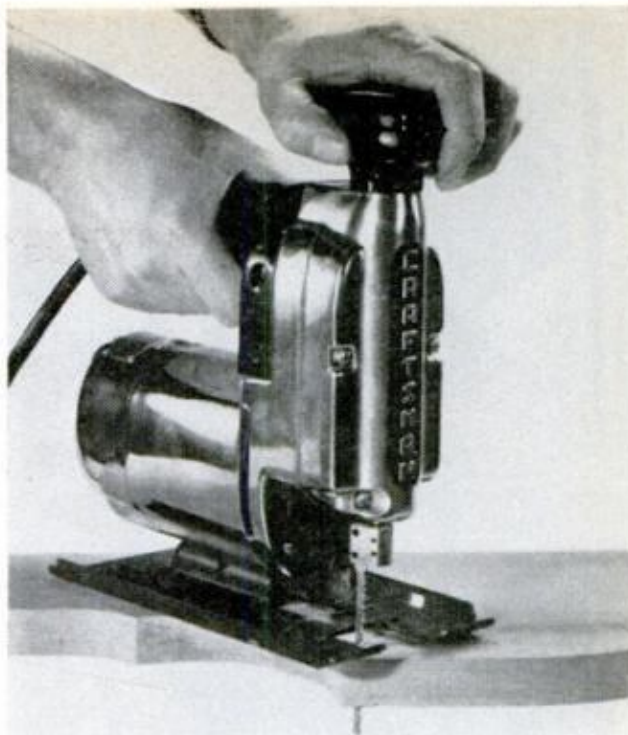

SEARS' 12-SPEED SAW has a knob for steering the blade in any direction without need to turn the saw



TO SAW SHEET METAL SMOOTHLY, use a 32-tooth, wave-set, metal-cutting blade with a slow, even feed



WHEN POWER-HACKING PIPE or angle iron, use the saw's slowest speed and flood the cut with light oil



FOR A PLUNGE CUT, rock saw forward, then gradually pivot tool backward until blade cuts through



SHOES ON SOME SAWS SLIDE BACK to permit cutting to a wall when sawing openings for ductwork



FOR PERFECTLY SQUARE CUTS when sawing lumber to length, use small try square to guide saw's shoe

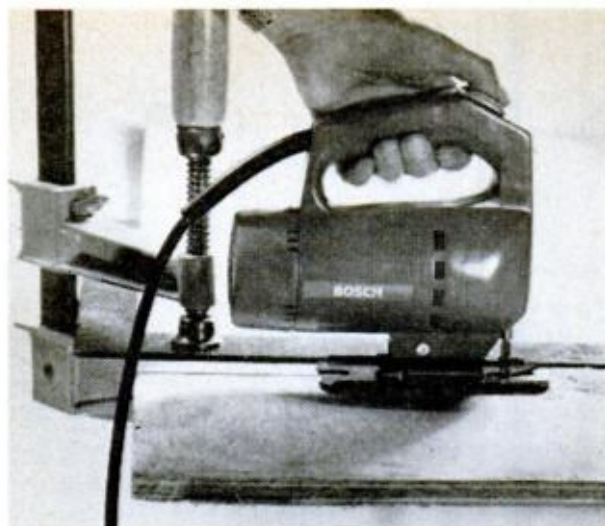

TO CUT PANEL STOCK with bench-saw accuracy, run the saw's shoe along a square clamped to the work



ON ALUMINUM, use a blade with teeth fine enough not to snag, but coarse enough to avoid any loading

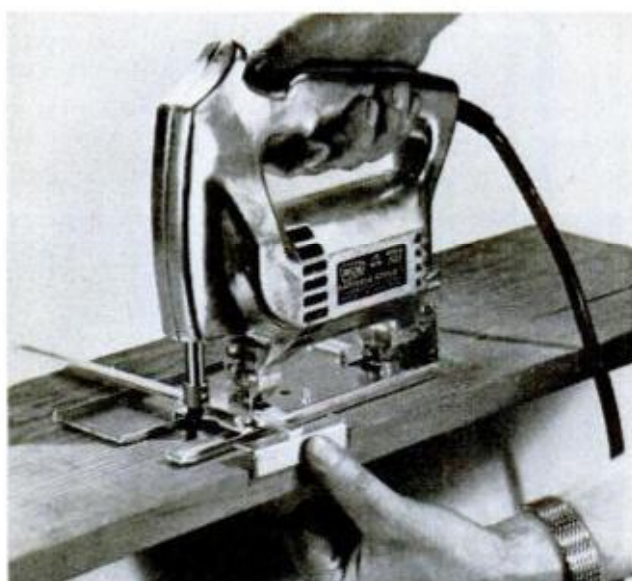

EDGE GUIDE ATTACHMENT keeps saw parallel with stock's edge and simplifies ripping of narrow strips

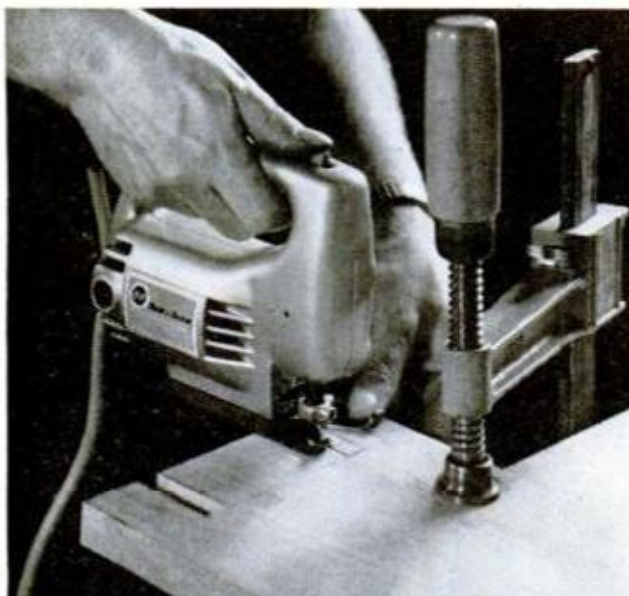

NOTCHED JOINTS can be fitted in minutes with a sabre saw. Tool is indispensable for boatbuilding
150

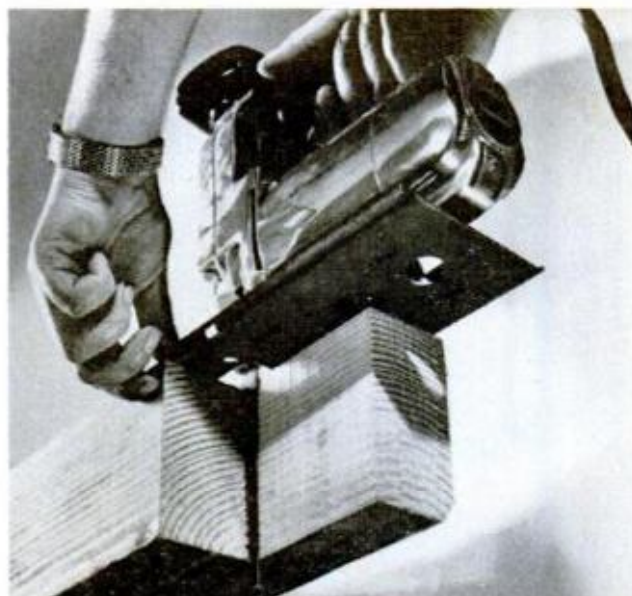

WITH A 6-IN. BLADE, a 1-in.-stroke saw can notch 4x4s, lop tree branches, saw openings in partitions
POPULAR MECHANICS

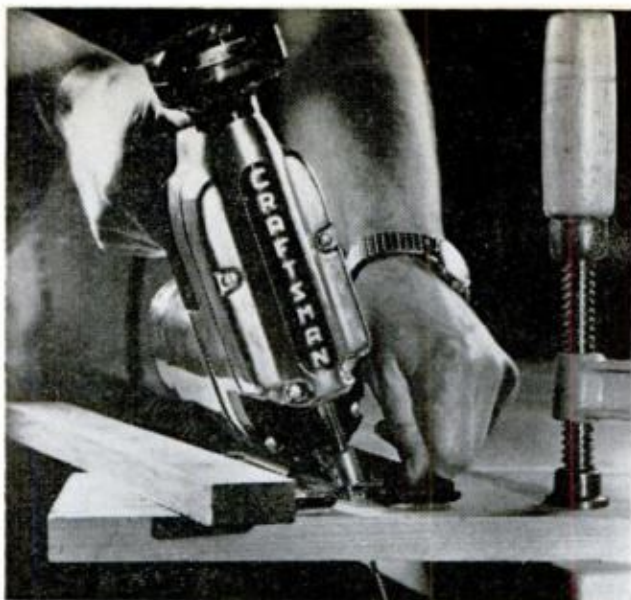

TO CUT COMPOUND-ANGLE MITERS with tilt-base saw, tilt the base and tack wood fence to the work

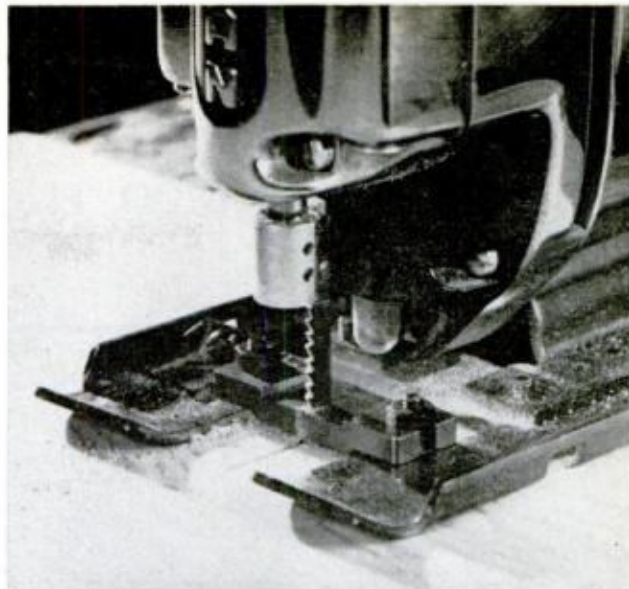

SHOE INSERT, an attachment available for some sabre saws, reduces splintering when you cut plywood

extra-length blades they can cut off or notch 4x4s.

A lightweight, light-duty sabre saw is perhaps easier to handle, and if you'll use it only for light woodwork—cutting off 2x4s and sawing plywood—it's just the tool for the work.

But if you'll use your saw in construction work, a larger, faster-cutting model will be worth the extra money. A heavy-duty saw is also preferable if you'll be sawing metal with the tool. Larger models have enough power to gradually hacksaw through mild-steel plate, and because the longer stroke utilizes more of the blade's teeth, metal-cutting blades give longer service.

● **Single or multiple-speed?** A single-speed saw operating at a no-load speed of around 3000 strokes per minute is fine for light woodwork—but not much else.

Two and three-speed models, while more expensive, are more versatile. A three-speed tool generally has a medium speed of about 2500 strokes per minute and a low speed of around 2250 strokes.

Several higher priced heavy-duty saws now have trigger-controlled continuously-variable speeds of from 0 to 3000 strokes per minute. Others have dial-type controls giving full-power speed ranges around 1300 to 3000 strokes per minute.

Slow speed is a considerable advantage. A saw chugging along smoothly at moderate speed is more pleasant to use and easier to guide than one chattering lickety-split. And slow speed makes the tool

(Please turn to page 192)

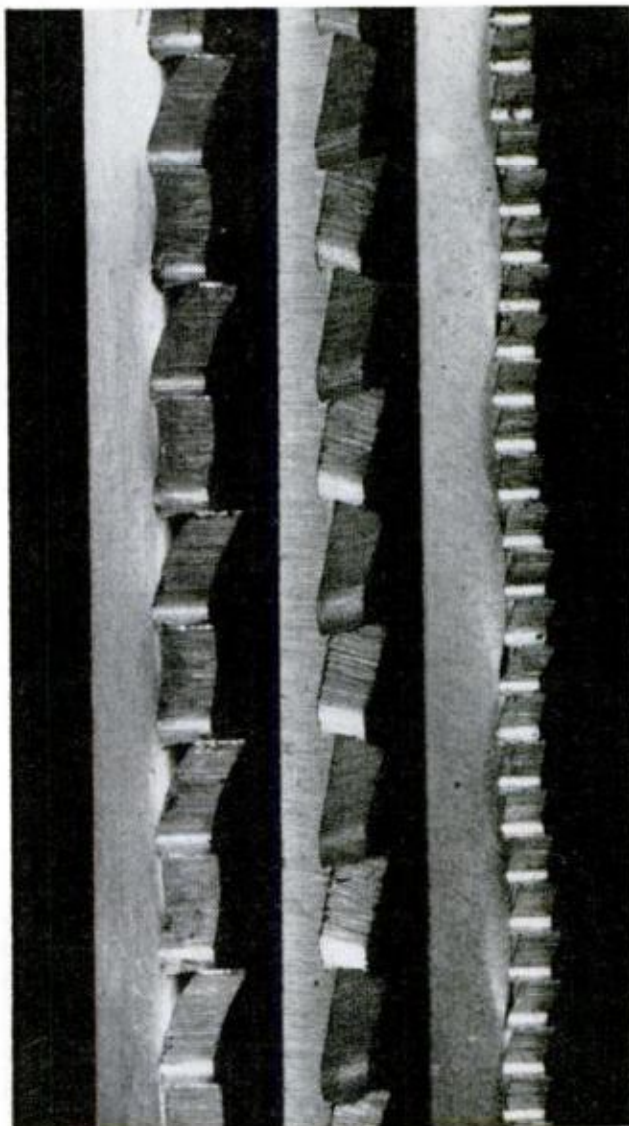

THREE KINDS OF BLADES handle most work. Fast-cutting blade with alternate-set teeth (left) saws a wide kerf. A smoother cutting, taper-ground blade (center) cuts more slowly and leaves a narrower kerf. The metal-cutting blade (right) is wave-set to minimize snagging and to produce a smooth cut

BETTER WAYS TO DO IT!

Illustrations by Adolf Brotman

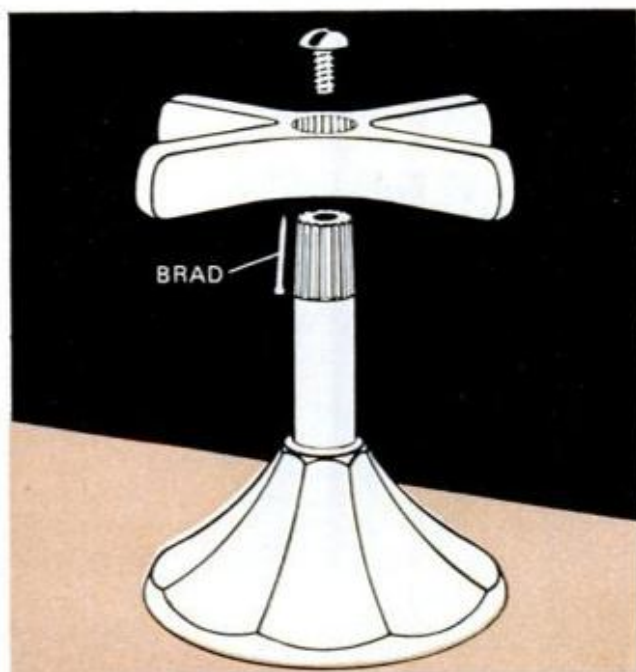

WORN SERRATIONS on a faucet stem will inevitably cause a loose handle. A good temporary repair is to place one or more brads along the serrations as shown to take up the slack.—*R.E. Murray, Circleville, Ohio.*

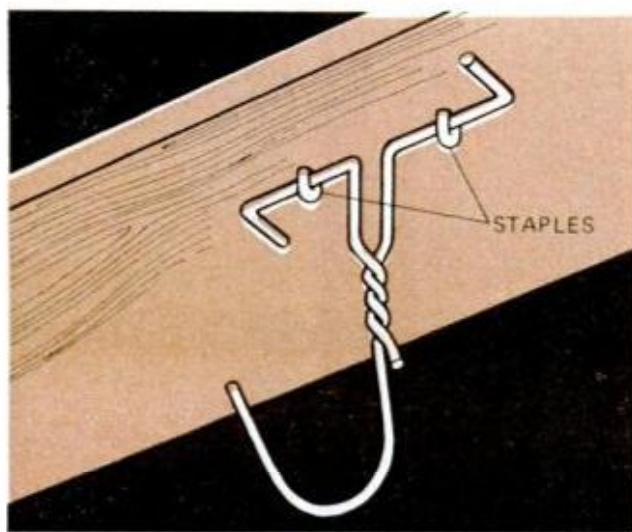

HOOK PORTION OF WIRE COATHANGER makes a good hanger for light tools such as C-clamps when fastened to bottom of workshop shelf. Use two big staples to fasten it.—*John Walker, Walnut Creek, Calif.*

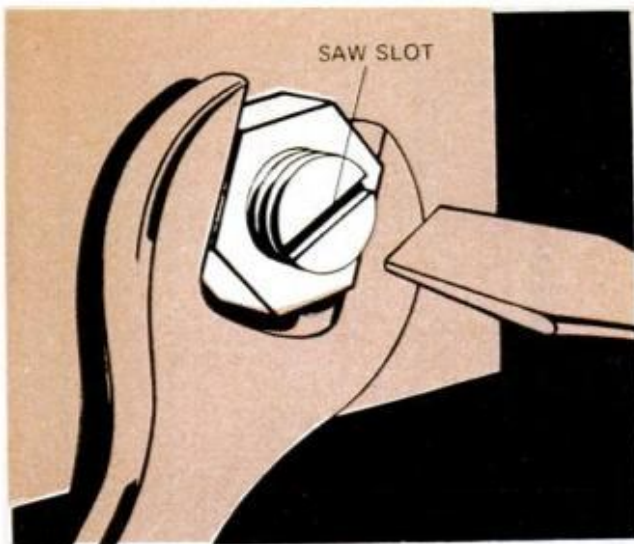

TIGHTENING A BOLT where it's impossible to reach the bolthead (to keep it from turning) is easy if you hacksaw a slot in the end. Hold the bolt with a screwdriver as you tighten it.—*E. Dussault, Oak Park, Ill.*



BICYCLE TUBE makes a dandy gluing clamp because it conforms to irregular shapes. Place the tube around the part to be glued; inflate it for holding power, deflate to remove it.—*John Walker, Walnut Creek, Calif.*



WHEN SOLDERING A CAN, bucket or the like, turn it over a lighted bulb. The light will shine through to show where the holes are, and you will know when the solder has them sealed.—*L.C. Schultz, Berwyn, Ill.*

POPULAR MECHANICS

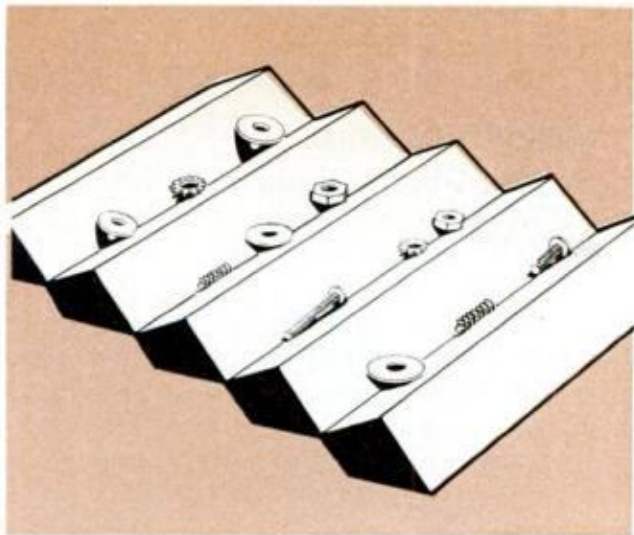

KEEP SCREWS and parts in sequence when disassembling an appliance by using a piece of heavy paper folded accordion-style. Place the parts in the valleys as they are removed.—*John Krill, North Lima, Ohio.*



WORKING ON A ROOF, I had to raise and lower a pail frequently. A clothespin clipped on each side of the pail near the handle kept the latter erect for hooking it from above.—*Andrew Vena, Philadelphia.*

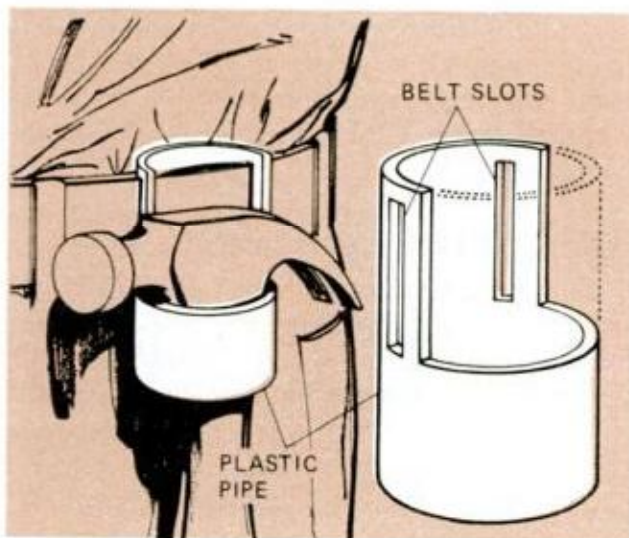

A SCRAP OF PLASTIC PIPING can be quickly made into a rigid-type hammer holster. Be sure that the pipe's inside diameter suits your hammer handle and cut pipe as sketched.—*John H. Wilson, Ottawa, Ont.*



PLASTIC BLEACH JUGS pour very slowly, usually with quite a lot of "glug-glugging." If you poke a small air hole through the jug's hollow handle, both problems will be corrected.—*John Krill, North Lima, Ohio.*

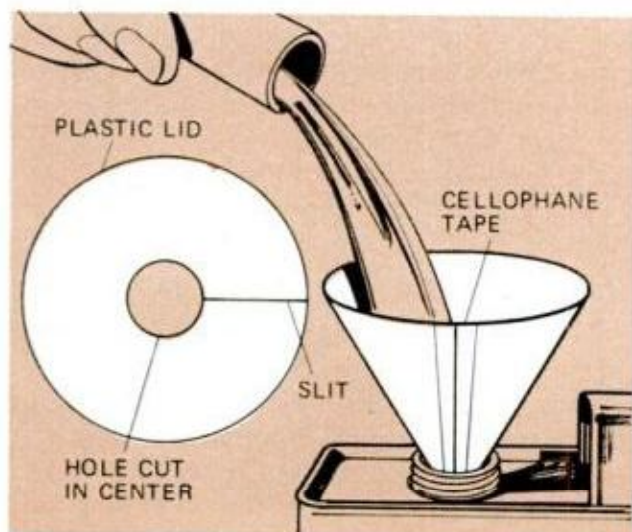

EMERGENCY FUNNEL can be made from the plastic lid of a coffee can. Cut a suitable hole at center, then cut through lid from hole to outside edge. Overlap cut, seal with tape.—*John Krill, North Lima, Ohio.*



TACK A BOTTLE CAP to the back of your shoe-polish dauber and you'll have a handy scraper for cleaning mud off the soles before polishing your shoes. Use small tacks to attach.—*William Swallow, Brooklyn.*



HINTS FROM READERS

Parer slices leather

A slotted-blade paring knife can be used to skive or bevel pieces of leather when you make a glued lap joint. Cutting edges must be sharp and used with a sawing action; noncutting edge can act as a guide to control movement of the cutting edge. Rest the leather on a block so the cutter can be held parallel.

—Walter E. Burton, Akron, Ohio.

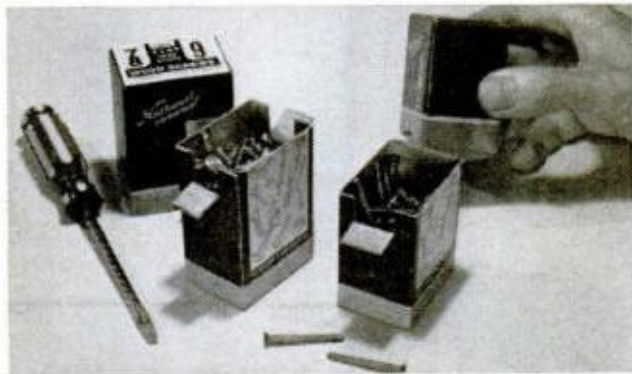

Save those boxtops

Sleeve-type covers on screw boxes are often such a loose fit that when the boxes are picked up the bottoms slip out. A good solution is to cut slots part way down the sides of the box bottoms and bend out tabs as shown. One or more of these "ears" will provide enough friction to hold the loosest cover.—John F. Pilznienski, Dearborn Heights, Mich.



Wire solder twice as useful

To keep the cord on my soldering gun neatly coiled, I use a length of wire solder. Besides keeping the line tanglefree, this means that I always have at hand a length of solder should my main supply be mislaid or in use elsewhere.

—Louis Hochman, Sherman Oaks, Calif.



Notebook rings in the shop

Next time you are throwing away a worn three-ring notebook, tear out and save any rings that still close. I've found these to be handy for storing sockets and wrenches in one place. And for on-the-job use, the ring can be snapped onto one of your belt loops. Three-inch rings are best because they hold more.

—Ken Patterson, Regina, Sask.



Inner tube is a clamping aid

When gluing on edge molding to hide plywood laminations, a simple way to clamp the trim in place while the glue dries is with spring clamps and strips of old inner tube. Each rubber strip is stretched tightly over the molding and plywood edge, and a spring clamp applied to hold the strip in its extended position so it continues to pull inward on the edging.

—Louis Hochman, Sherman Oaks, Calif.



**"For an amateur,
he's a whiz.
How'd he get
so good?"**

Whatever practical skills you've been wanting to develop, Audel has comprehensive, step-by-step Guides to help you. They show you all the professional tricks of the trades

in clearly diagrammed and illustrated "how-to" steps. They can save for you, over and over. Here are four of Audel's many fields . . .

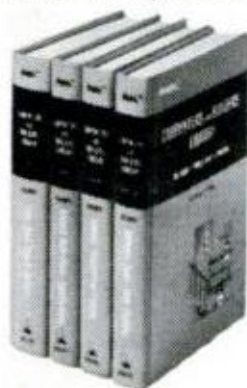

CARPENTERS AND BUILDERS LIBRARY

1612 pages of the latest information on modern construction in four volumes. They cover every phase of carpentry from foundations to finishing with easy-to-grasp, step-by-step instructions . . . all illustrated with thousands of diagrams, charts and photos. No. 23169 —4 Volumes—\$18.50

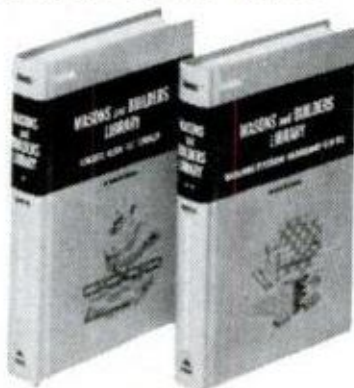

MASONS AND BUILDERS LIBRARY

Two illustrated volumes on the science of masonry and bricklaying. Packed with how-to information and directions, rules, processes, definitions, formulas, diagrams, tables, estimating. A complete and authentic trade reference library. 752 pages. No. 23185 — 2 Volumes — \$11.25

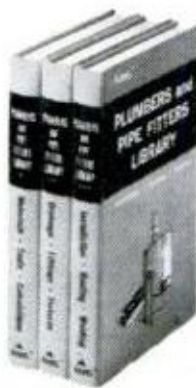

PLUMBERS AND PIPEFITTERS LIBRARY

A valuable 3-volume guide to the principles, methods and short cuts of modern plumbing. Tools, fittings, fixtures, installation, drainage, welding and much more are all covered in these fully illustrated, easy to understand volumes. No. 23155 — 3 Volumes — \$12.50

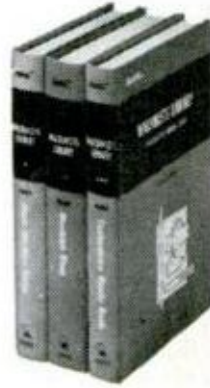

MACHINISTS LIBRARY

Three books covering the entire field—1216 profusely illustrated pages on practical fundamentals of basic machine shop operations, setup and operation of spot machines, down-to-earth data on toolmaking procedures, layouts, jigs and fixtures, etc. . . . equally valuable for beginners and experienced men alike. No. 23174—3 Volumes—\$16.95

MONEY BACK GUARANTEE

Send no money! We'll send you any Audel Guides for 10-day FREE EXAMINATION. If you keep them, you may use our easy payment plan. If not completely satisfied, return them for refund.

THEODORE AUDEL & CO.
Division of
Howard W. Sams & Co., Inc.
Indianapolis, Indiana 46268

SEND NO MONEY—10-day FREE EXAMINATION

Theodore Audel & Co.—Self Improvement Publishers since 1879
4300 West 62nd Street, Indianapolis, Indiana 46268

Please mail me for 10 day's FREE EXAMINATION the books I have checked at right. I agree to mail \$3 in 10 days for each set ordered and to further mail 1/3 of the purchase price 30 days later, with balance plus shipping costs to be mailed within another 30 days. I may return the books for refund if not completely satisfied.

Save shipping costs. Check here if you enclose full payment (plus sales tax, if any). We will pay postage charges. You have same return privilege.

Name _____
Address _____
City _____ State _____ Zip _____

- P103
 23169
 23185
 23155
 23174

COLOR PRINTING with Aeroprint spray chemicals is a lot less intimidating than you might expect. Not that it's that much quicker than ordinary home processing, or that much cheaper than drugstore prints of equal quality. But it is a lot simpler and easier than you might think, and it lets you try enlarging tricks (like custom cropping, burning in highlights and dodging shadows) that would cost a fortune in a commercial color lab.

But the big virtue of Aeroprint is its simplicity. To set up for conventional tray processing, you'd have to mix your chemicals (trying to mix just enough to last one printing session, since the shelf life of color chemicals is short), set out trays (as many as seven—all of which must be washed later), and bring all your solutions to the correct temperature (which must be accurate, in many processes, to within one-half degree). With Aeroprint, you set out a small grid

and three or four spray cans, and you're in business.

Actually, there are three Aeroprint processes: one for black and white prints, one for prints from color negatives, and one for color prints from slides. But there are only two Aeroprint kits: an \$8.50 kit for black and white which makes up to 40 8x10s, and a \$24.95 kit for up to 57 8x10 color prints from negatives. To print from slides, as I did, you'll need both the color kit and the developer from the black and white kit (available separately for \$4.95).

Printing from color negatives takes a lot less time than reversal printing from slides—11 minutes plus a 15-minute wash, as compared to 36 minutes and a 5-minute wash for reversal prints. It also costs a bit less: about 94 cents per 8x10 print, whereas reversal prints, using one more chemical and more expensive paper, will cost about \$1.18 per 8x10. Of course, these

Color prints from a spray can

By IVAN BERGER, Photography Editor



costs are based on the assumption that each print will come out perfectly; if you have to make some over (and you will), the three dollars or so you'll spend for commercial prints no longer looks much more expensive. Home color printing, obviously, is no way to save a lot of money, unless you're going to dodge, burn in and crop like custom labs do; it's just another way to enjoy yourself.

But reversal printing—though it costs a bit more and takes much longer than printing from negatives—does have some advantages: When you work from a slide, you know pretty well what your picture should look like. And when you print your slides with Aeroprint, you don't need to use color printing filters.

The process begins, of course, in your enlarger. If you're going to do a lot of reversal color printing, you may want to find out if your enlarger's manufacturer makes a negative carrier to hold slides in their standard 2x2-inch mounts. But most of the regular 35-mm negative carriers I've seen would work equally well, if less conveniently.

As with any other type of enlargement, you should make a test strip before your final print. Unfortunately, you can't really judge which part of the strip looks best until it's fully processed, and that takes more than half an hour. I suspect, though, that with familiarity you'd be able to judge exposure alone after the first developer and wash, which only take seven minutes.

After exposing the paper (Kodak Ektachrome RC), you spray it with the Aeroprint black-and-white developer, which brings up a negative image. Kodak recommends that this take place in total darkness, but Aeroprint recommends you use a No. 10 amber safelight while you spray, provided it's no brighter than seven watts, and at least three feet away. On the whole, I found it better to use the safelight—until you've had some practice, it's too easy to miss spots when you spray on the developer in the dark. Aeroprint tells you to spread the developer with your fingers, and that helps, but it still takes practice. Spraying too much doesn't hurt, though; it just wastes developer.

After spraying, you turn off the safelight, let the print develop for two minutes, then wash it for five. (I recommend a radio for company during those seven dark, boring minutes.)

JANUARY 1973

Now you can turn the light on and examine your print (a black-and-white negative at this point) for undeveloped or yellow spots. If you find any, you'll have to discard the print and start again. But from here on, everything is done in full room light, so you can catch your mistakes as you make them, and usually correct them, too.

The next step, though, is goofproof: Just expose the print, for 30 seconds on each side, to a floodlamp about a foot away. This step, common to all direct-



SPRAY ON CHEMICALS and out comes the picture—if you're careful through all 35 minutes of the process. Print rests on a \$2.75 Aero-grid accessory

positive (reversal) processes, exposes the silver grains that form the final image; the first development is only to chemically isolate the silver grains that *don't* go into the positive image.

The grains you've just exposed turn black when you spray on the color developer in the No. 1 can. Since the other silver grains were blackened by the first developer, this makes the whole print appear black, but the image is faintly visible if you look for it. The color developer is resprayed after three minutes, and allowed to sit another seven minutes before the next five-minute wash. But if some spots aren't darkening properly, you can

157

HOW TO MAKE AEROPRINTS

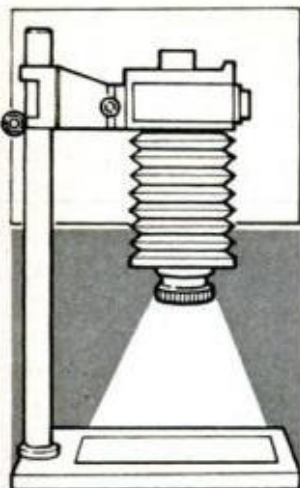

TEMPORARY, BLACK-AND-WHITE negative image appears after you enlarge slide onto Ektachrome RC paper (left) and spray with black-and-white developer



POSITIVE IMAGE is created by reversal exposure, brought out by color-developer spray. Combination of positive and negative images turns print black



BLEACH removes negative image, brings out pale, bluish color. The final stabilizer spray deepens color, but it's still blue until it's washed and dried

spray again, and no harm is done. (And you can be making another enlargement during those seven minutes, of course).

You'll get some idea of your finished print when you spray on the next can—not No. 2, as you might think, but can No. 3 (printing from negatives, though, you use the cans in their numbered order). This chemical bleaches out the black-and-white negative image, allowing the color positive image to come out. But it's not completely out, yet; normally, it's still washed-out and bluish at this point.

After spraying the bleach twice (and letting it sit three minutes for each spray), you wash again for five minutes, then spray on the stabilizer in can No. 2. Again you spray twice, this time for one minute per spray, before you put the print in for its last five-minute wash. The print will still have a slight bluish cast until it dries, but shining a light through the print will show the final colors with fair accuracy.

Kodak Ektachrome RC paper is resin-coated, so it can't be ferrotyped dry. Just sponge it off with a clean paper towel, let it air-dry, and it will develop its own soft, natural gloss—and will dry with negligible curl.

There are a few precautions you should take while using Aeroprint: 1) To prevent stains on the print, each time you switch to the next chemical you should thoroughly wash the print itself, your hands and the Aerogrid or whatever other nonmetallic grid you rest the print on while you spray it (you can also rest the print on paper, if you change it between sprays). 2) As with any aerosol, you should try to avoid breathing the chemicals; but since you spray just a few inches from the paper, that should pose no problem—the Aeroprint chemicals seemed to smell up my darkroom less than trays full of ordinary chemicals do. 3) And since the spray propellant in the cans is flammable butane, you shouldn't use it near an open flame (including, I'd suspect, the pilot light on your stove, if your kitchen doubles as your darkroom)—and it probably wouldn't be a bad idea to stop smoking while you spray.

As the instructions point out, Aeroprint is not intended for processing large volumes of prints at a time. But when you only want to make a print or two, it may be a godsend. ★★★

FIND BURIED TREASURE

Powerful electronic detector finds buried gold, silver, coins, etc. 5 new models. Write for free catalog.



RELCO, Dept. D-3 **19⁹⁵**
BOX 10839, HOUSTON, TEX. 77018

WRIST ROCKET[®]

AMERICA'S HARDEST HITTING SLING

Range 225 yd.—232 fps. Matched replacement rubbers and LEATHER pouch assembly \$1.00. At dealers or order direct.



WRIST ROCKET[®] Mfg. **\$3.00** Post. Pd. in U.S.A. No C.O.D.'s
P.O. BOX 21-B Columbus, Nebraska 68601



LEARN MEAT CUTTING

Train quickly in 8 short weeks at Toledo for a bright future with security in the vital meat business. Big pay, full-time jobs—HAVE A PROFITABLE MARKET OF YOUR OWN! Time payment plan available. Diploma given. Job help. Thousands of successful graduates. OUR 50th YEAR! Send illustrated FREE catalog. No obligation. No. 01972

NOW for big new illustrated FREE catalog. No obligation. G.I. approved. NATIONAL SCHOOL OF MEAT CUTTING Dept. 50-S Toledo, Ohio 43604

BLAST FURNACE—FOUNDRYETTE 2400 F



Since 1935
Hobbyists • Schools • Inventors, etc. Make your own castings of any metal from cast iron, down to lead and zinc. Available in 6 sizes, 1/2 to 50 lbs. Complete units from \$50.40 to \$162. Send 25¢ for circular—refundable.

KANSAS CITY SPECIALTIES CO. Dept. P-1 P.O. Box 193 Middleton, Wisc. 53562

TELLS HOW TO SELL YOUR INVENTION

If you have an invention that you believe has merit, write us at once for copy of copyrighted booklet "How to Go About Selling Your Invention." We work with manufacturers, and booklet reveals present markets, qualities of a saleable invention, current royalty rates being paid by manufacturers. Booklet is FREE, is offered to encourage new ideas we might submit to manufacturers. Just send name (no drawings, please) to **Kessler Sales Corp., Dept. D-51, Fremont, Ohio 43420**

locksmithing and key making

PRACTICAL UP-TO-DATE COURSE—ONLY \$7.95

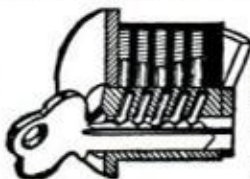

Teaches you how to pick locks, de-code, make master keys, repair, install, service, etc. New self-instruction lessons for every handyman, homeowner, carpenter, mechanic, service station operator, fix-it shop, hardware dealer, gunsmith. 53 easy illustrated lessons. Full price only \$7.95 post-paid. Satisfaction or refund guaranteed. Mail order today!

NELSON-HALL CO., Dept. 6AX-2 325 W. Jackson Blvd., Chicago 60606

FINISH CORNERS • CUT MOULDING WITH ANY ELECTRIC DRILL NO \$50 ROUTER OR \$6 BITS NEEDED!

You don't have to buy an expensive Router to finish corners, moulding & trim. ARCO Corner Finishing & Moulding Cutters do the work at a fraction of the cost. Simply slip the Cutter's 1/4" shank in any drill chuck and it's ready to produce! Special Dual Guides assure accurate cuts along entire length & width of workpiece. Cuts wood, plastics, soft metals. Quality-made in U.S.A. of hardened steel. These Cutters will fit & work with all Electric Routers, of course.

No. 6—3 PIECE CUTTER SET CUTS 3/16" CONTOURS \$495



FANCY COVE-CUTTER



ROMAN OGEE-CUTTER



RABBET-CUTTER

No. 7—3 PIECE CUTTER SET CUTS 3/16" CONTOURS \$495



BEADING-CUTTER



COVE-CUTTER

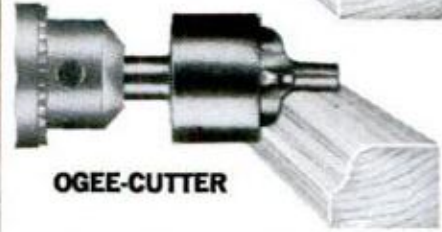

OGEE-CUTTER

No. 15—4 PIECE RADIUS & BEVEL CUTTER SET \$650



ADJUSTABLE BEVEL-CUTTER cuts 45° bevels from 1/2" to 3/4" wide.



RADIUS CUTTERS 3 SIZES for 1/8", 3/16", 1/4" Radius Cuts.

MAIL THIS COUPON TODAY!

ARCO TOOLS, INC. Dept. PM-1
421 West 203rd St., N.Y., N.Y. 10034
Ship on your 20-day Money Back Guarantee!

No. 6, 3-Piece Cutter Set\$4.95
 No. 7, 3-Piece Cutter Set 4.95
 No. 15, 4-Piece Cutter Set 6.50
 No. 6715, All 10 Cutters13.95
 I enclose Check. M.O.—SHIP PPD. (No C.O.D.'s)

Name _____
 Address _____
 City _____ State _____ Zip _____

SPECIAL SAVING!

Order all of above 3 Sets at our Special Money-Saving Price. No. 6715, total of 10 Cutters, only **\$1395**

These & over 300 other Arco Tools available at Hardware Depts. everywhere, or order direct on 20-day Money Back Guarantee!

SOLUTIONS FOR MECHANICAL HEADACHES

AUTOMOBILE CLINIC

BY MORT SCHULTZ

Common remote problem

The control operating the outside "remote control" rear-view mirror of my '70 Galaxie has loosened and is about to fall inside the door. Before I start tampering, I would like to know what to expect.—Jim Statler, Port Jervis, N.Y.

Remove the plate that covers the control. Examine it. You'll find that a small Allen screw which extends in the hole to hold the control housing has loosened. Withdraw the screw, refit the control housing firmly in the hole, tighten screw with an Allen wrench and reattach the plate.

One-way gasket

Please help me. My Plymouth Satellite with a six-cylinder engine is hard to start when cold. When I do get it started, it idles so badly that my bones rattle. It didn't start doing this until I had a garage man talk me into cleaning and overhauling the carburetor.—Terri Green, Miami Springs, Fla.

If I'm right in my diagnosis, this is an old story which applies to all three 6-cylinder engines used by Chrysler Corp.—170, 198 and 225 cu.-in. In doing overhauls, mechanics have been known to install the carburetor flange gasket improperly. If the notches on the inside diameter and the 1/4-in. hole aren't lined up properly, the function of the choke, economizer jet and air-cleaner air-control valve will be fouled up. Here's a diagram showing the right way to install that gasket.

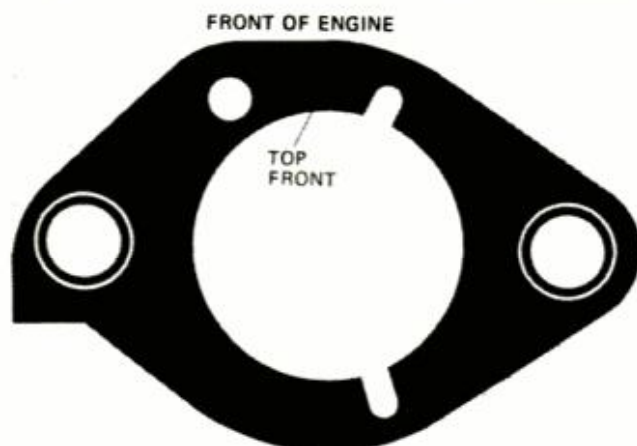

Repairing vent windows

I have a 1967 Chevrolet with vent windows that have loosened up and are rattling. Is there any way to resecure them without taking everything apart?—Howard Ferranti, Marlborough, Mass.

You're in luck. Recently, Loctite Corp. of Hartford, Conn., introduced a product called Quick-Set Adhesive that bonds glass and rubber. It sets in seconds and does the job nicely. See an auto-parts supply dealer or an auto glass shop. If neither can supply it, write directly to the company.

Datsun valve clearance

I can't seem to adjust the valves of my Datsun 240Z properly although I follow the manual. What do you figure is wrong?—Harold Joffe, Anaheim, Calif.

The manual. Instructions have been changed. Valves of all Datsun engines are to be set with the engine cold. This means that the engine must be allowed to sit still for several hours before the adjustment is made—otherwise you won't get the right clearance.

This holds true for the four-cylinder ohv A-12 engine used in the 1200 sedan, the four-cylinder ohc L-16 engine used in the 510 sedan and wagon and 521 pickup truck, and the six-cylinder ohc L-24 engines used in the 240Z sports car. To adjust each valve of the L-16 and L-24, place the feeler gauge between the cam and rocker arm. To adjust valves of the A-12, place gauge between the valve and rocker arm.

The latest specifications call for a clearance of 0.010 inch for the intake and exhaust valves of the A-12. Adjust the intake valves of the L-16 and L-24 engines for a clearance of 0.008 inch, and set the exhaust valves for 0.010-inch clearance.

Pulled pull strap

The door-pull strap of my 1970 Buick Riviera has pulled away from the door. Is there some way of repairing this without going through the sweat of removing the

(Please turn to page 162)



Get a taste of
what it's all about.
Get the full taste
of Viceroy.

Warning: The Surgeon General Has Determined
That Cigarette Smoking Is Dangerous to Your Health

18 mg. "tar," 1.3 mg. nicotine av. per cigarette, FTC Report Aug. 72.

© 1972. BROWN & WILLIAMSON TOBACCO CORP.

Материал, защищенный авторским правом

AUTOMOBILE CLINIC

(Continued from page 160)

door trim?—Gerry Jamison, Granite City, Ill.

Try this. Remove the pull strap emblem cover and the screws that hold the pull strap bracket. Turn the bracket clockwise. This will expose the screw hole, which is no doubt stripped. Drill out the hole with a $1\frac{3}{32}$ -inch drill and install a license plate plastic retaining nut. You can get this part from an auto supply dealer or the parts department of a new car dealer. Reinstall the screws, bracket, pull strap and cover.

Forward lateral

My 1971 Pontiac Grand Ville has developed a front brake shudder. What do you think is the cause and what must be done to correct it?—Sam Oradell, Peapack, N.J.

In all likelihood, one of the front disc brakes has developed a faulty lateral run-out condition. Lateral runout is the movement of the rotor from side to side as it rotates. To verify the existence of this condition, adjust wheel bearings to eliminate any play as a possible cause and hook up a dial indicator so that the stylus touches the face of the rotor about 1 inch from the rotor's edge.

With the dial set at 0, move the rotor one full turn. If the total indicator reading exceeds the allowable 0.004-inch limit for a Pontiac, the rotor should be refaced if possible—replaced if not.

To cap or not to cap

I disagree with an illustration that was published in PM awhile back which showed battery vent caps in place on a battery that was being charged. I contend that battery caps should be removed to avoid a buildup of internal pressure which can damage the battery.—Thomas P. Wright, Norfolk, Va.

According to the latest Federal safety standard, "When charging batteries, the vent caps should be kept in place to avoid electrolyte spray. Care shall be taken to assure that vent caps are functioning." I interpret the word "functioning" as mean-

ing to make certain that vent holes are not dirt-clogged. The standard is printed in the Federal register of May 29, 1971, Vol. 36, No. 105, Section 1910.178, page 10616.

Book idea

Have you ever put all of the Automobile Clinic items presented during the past into one volume? If so, I would be interested in buying this book.—Rev. Harold R. Wolfe, Clinton, Ohio.

For you and many others who have asked this, I'm sorry to say that we have not compiled Automobile Clinic items in one volume, but it is certainly worth considering. If we do it, you'll be one of the first to know.

Transmitting trouble

I have a 1971 Ford Custom 500 with 400-cu.-in. engine. Every morning when I first start the car and put the transmission in reverse, it doesn't engage completely. After the car moves back a bit, it starts jumping over the gears. When I put it into drive, it strains to shift from low to drive. As the car warms up, the trouble disappears. What can it be?—J.G. Hamilton, Maplewood, La.

One of several things, including a damaged valve body, a leak in the hydraulic system, or a bad rear clutch.

Service tips

● Chrysler Corp. car owners take notice. A rattle coming from the front door window of your '71 or '72 Chrysler, Dodge or Plymouth can probably be corrected by installing a jam nut on the end of the lower track-to-bracket attaching screw. Your dealer is authorized to do this according to Dodge service bulletin 23-20-72D and Chrysler-Plymouth service bulletin 23-25-72C.

● Replacement ignition keys that bind, stick or won't work is a frequent complaint. Usually, the ignition lock cylinder is not to blame. Instead, watch out for a replacement key which hasn't been cut properly. In today's cars with improved locks tolerances are critical. A new key must be cut exactly, using a quality key cutting machine and replacement blanks. A locksmith is best able to meet the requirements. ★★★

GOT A PROBLEM WITH YOUR CAR? Ask Mort about it. Send your question to Auto Clinic, Popular Mechanics, 224 West 57th St., New York, N.Y. 10019. Letters cannot be answered individually, but problems of general interest will be published in the column.

People pay a lot of money to these men. You can be one of them soon.



Electronics Technician.



Automotive Technician.



**Air Conditioning
Refrigeration Technician.**



**Home Appliance
Technician.**

You know what technicians charge to repair your TV set, your car, refrigerator or washing machine. The men who can do the job — and do it right — get paid very well indeed.

Join them! Be a technician and let people pay **you** for a change.

National Technical Schools will train you at home the professional way — with profes-

sional instruction, tools and test equipment, the kind of equipment you'll be using on actual jobs. It makes home training practical and more fun. And you get to **keep** all of the tools and equipment.

Choose the kind of technician you want to be. **Then** mail the card for free color catalog. No obligation. No salesman will call.



NTS Electronics Division

Multiply your income with space age skills in Computer Electronics. Color TV & Radio Servicing, Automation/Industrial Electronics or Electronic Communications. Courses include valuable kits such as 315 sq. in. Solid State Color TV, Solid State B&W TV, 2-way Radio Transceiver, Compu-Trainer, Oscilloscope, and more. Check card for new **FREE** Color Catalog, complete details.



NTS Mechanics Division

NTS puts you into America's #1 industry fast. Start earning almost as soon as you begin. You get 109-piece Socket Wrench & Tool Set with case and professional 8-unit diagnostic test equipment, yours to keep. Plus bonus Speed Shop lessons. Check card for new, free color catalog and complete details on all four courses and equipment.



NTS Air-Conditioning/ Refrigeration, Heating Division

Install and maintain today's complex air-conditioning, refrigeration, and heating systems. As an NTS master technician you can handle any job. Or you can go into your own business. "Project Method" makes your training interesting with all new Hermetic Analyzer, tester, and other valuable instruments. Send for new catalog. Check card today.



NTS Home Appliance Division

Boost your income, build a new career, start a business of your own. Learn the professional way to service ranges, washing machines, dryers, home air-conditioners, and other appliances. We'll supply everything you need, including the New Exclusive Circuit Trainer, 4 in 1 Appliance Tester and complete set of fine hand tools. Check Card.

**MAIL CARD NOW
FOR FREE
CATALOG &
SAMPLE LESSON**



Classroom Training at Los Angeles.

Train in sunny Southern California. NTS occupies a city block with over a million dollars in training facilities. Check special box on card.

APPROVED FOR VETERAN TRAINING

JANUARY 1973

NATIONAL TECHNICAL SCHOOLS

WORLD-WIDE TRAINING SINCE 1905

Resident & Home Study Schools

4000 So. Figueroa St., Los Angeles, Calif. 90037

Accredited Member: National Association of
Trade & Technical Schools,
National Home Study Council.



TUNERS for large and small appetites: Dyna's \$160 FM-5 (top) and Heath's \$540 AJ-1510

FM kits: One super

By IVAN BERGER, Electronics Editor

KIT-BUILDERS have an interesting choice these days: a \$160 tuner kit that takes five or six hours to build and delivers great performance—and a \$540 tuner that takes over 30 hours to put together, has just about the same performance, and enough state-of-the-art features to more than justify the difference.

The difference between them obviously isn't their performance, but the way they deliver it. The \$160 Dynakit FM-5 does it in a conventional, straightforward way: Turn the knob till you find your station, and listen. A small blue light glows when you've hit a station, but nothing else seems at all extraordinary.

Nothing seems ordinary about the \$540

HEATHKIT tunes without knobs or dials. The Digital display (upper right) shows station frequency numerically; numbered buttons let you dial the tuner like a pushbutton phone. Plastic cards (right) pre-select stations of your choice; slots hold three cards

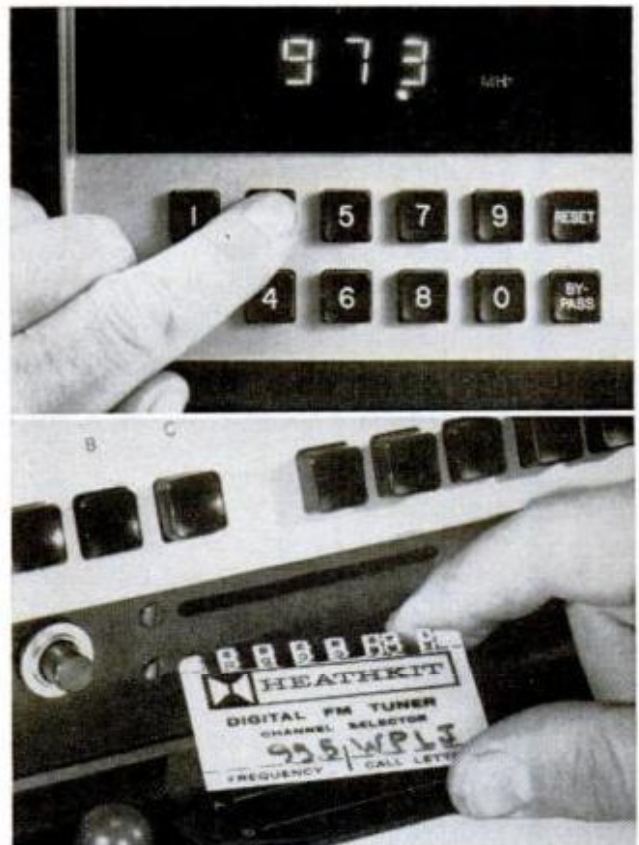

CONTRASTS IN COMPLEXITY, Dynakit took only 5 hours to build—Heathkit took 30. But Heath's complexity pays off in performance.

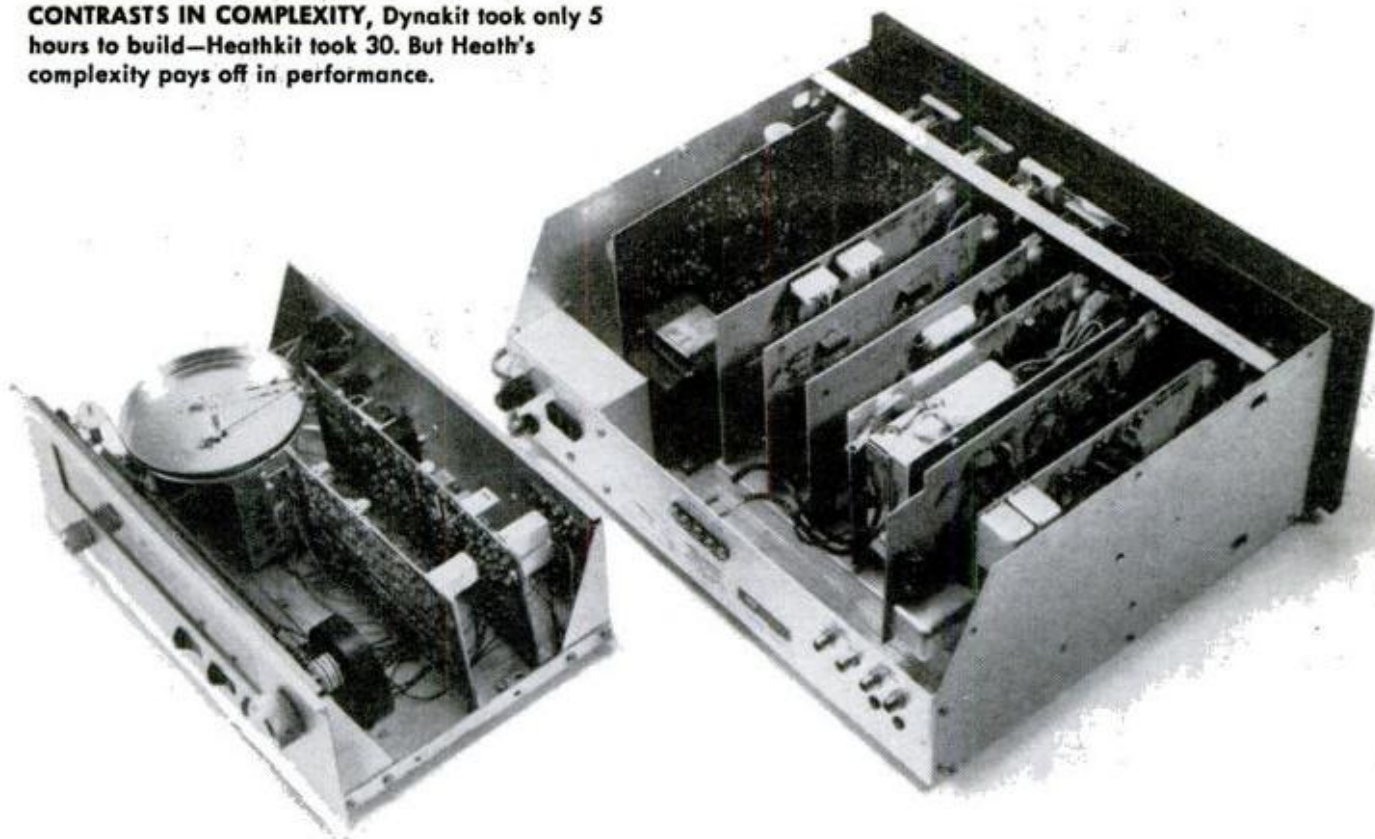

tuner, one super value

Heathkit AJ-1510 though. To tune it, you punch in your station's frequency the way you'd dial a pushbutton phone: push 9, 6 and 3, and 96.3 pops up on the dial in illuminated numbers. And you'll be tuned to 96.3 exactly (give or take 0.005 percent), even if there's no signal on that channel at the time. Or you can switch to **AUTO-SWEEP** mode, with the tuner skipping auto-

matically from one station to the next signal on the dial each time you push another button. Or switch to **PRE-PROGRAM**, and you can select any of your three favorite stations by pressing one button each. (The station preselects are plastic cards which you trim to the patterns of the wanted frequencies; 10 cards are supplied, but the slots in the tuner hold only three at a time.) The one thing you *can't* do is dial your station—the only knobs on the whole tuner are small, hidden ones which regulate the auto-sweep speed and the muting thresholds.

The knob is a bigger omission than it might at first appear. Good, old-fashioned, knob-twirl dialing is still the fastest, easiest way to scan across the dial and pick up all the major signals in your area—especially if you don't know the exact frequency of the station you want, just



TUNED LIGHT shows 1 percent station accuracy on Dyna; meter shows signal strength, not center channel

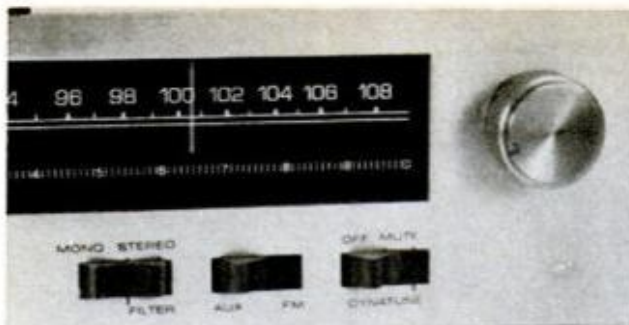

DYNA CONTROLS include mono/high-blend/stereo, auxiliary input selector, Dynatune and muting switch

that "it's a little below 91." And Dyna's TUNED light makes knob tuning even easier and faster—as does its Dynatune circuit, which locks each signal to the exact center of its channel without "pulling" away from weak signals toward stronger ones nearby on the dial, as conventional AFC circuits, which perform a similar centering job, do.

On the other hand, the Heathkit's pre-program mode is a faster way of finding your three favorite stations. Its auto-sweep mode is a little surer way of finding almost every signal on the dial. And its keyboard tuning mode is unsurpassed when it comes to picking up those stations you know are out there somewhere, but which you're not at all sure you can pick up: Punch in the station's frequency and you know you're perfectly tuned, whether you can hear something or not; then it's just a matter of fiddling with the antenna until you do hear something.

BUILDING THE TUNER KITS

By Andy Santoni

The Dynatuner is a simple kit, with only two circuit boards, both prewired, so it took only six hours to assemble. Although some patience and skill were needed to strip and tin the leads connecting its circuit boards and in stringing its dial cord, even a novice kit-builder could do it.

The Heathkit was more complex, but because it is divided into a dozen sub-kits, a novice could build it—if he wasn't discouraged by the 30 hours it takes to assemble, check out and align the kit. There were some difficulties soldering several wires into overstuffed eyelets (a problem the Dyna shared), and soldering to the chassis required a heavy iron and a steady hand. Both manuals were clear, without major errors.



HEATH CONTROLS include tuning modes, three station preselectors. Meter reads signal or multipath

Actually, there are probably no signals the Heath can pick up that the Dyna can't pick up equally well—if you can find them with the Dyna. I tried both tuners simultaneously in four locations (one urban, two suburban and one far fringe) and the farther out I got, the more I found that the Heath would pick up stations I'd missed when I tuned across the band with the Dyna—but I could find most of them with the Dyna once I knew just where to look. In my fringe location, for example, the Dyna picked up signals on 55 of the 100 FM channels, all but one or two listenably free of noise and distortion. (My host's five-year-old tuner picked up only about half as many). But the Heath picked up 88 signals, 72 listenable.

I probably could have bettered both tuners' scores if I'd had an antenna rotator, but that would have increased the Heath's lead even more. For openers, the Heath would find a few more stations through the tune-first-then-aim-antenna technique I described above. But it would also make it easier to orient the antenna for minimum distortion from the stations it found, because its signal-strength meter can be switched to read multipath levels, too. (There are also connections on the Heath's rear panel that let you monitor multipath even more critically, with an oscilloscope.) Though the Dyna has a signal-strength meter for antenna orientation (neither has—or needs—a center-channel meter), it has no multipath facilities; you have to judge minimum distortion by ear.

The Heath has a few more tricky features: For instance there's a stereo-only switch that automatically mutes all mono stations (and bypasses them on auto-sweep). I used it when listening through headphones, but I could have done as easily without it. On the other hand, I wish the

(Please turn to page 187)



A NEW BREED OF MAN!
MARTIN CAIDIN'S
CYBORG
 IN THE EXPLOSIVE
 TRADITION OF
THE ANDROMEDA STRAIN
 AND
THE TERMINAL MAN
 NOW IN PAPERBACK FROM
WARNER PAPERBACK LIBRARY
\$1.25  **\$1.25**

I-N-V-E-N-T-O-R-S
WE NEED INVENTIONS

Sell your invention for cash—need money for Patent?—Are technical problems holding you back? Universal Inventions has helped inventors all over the world—just like yourself—why not you? Inventions provide the magic spring-board to sudden riches. REMEMBER, we either sell your invention or pay you a cash bonus. Write for details. **UNIVERSAL INVENTIONS, Dept. 13, Marion, Ohio**

CATALOG of FULL-SIZE FURNITURE PLANS \$1.00

Wonderland for woodworkers! Over 150 full-size furniture plans! Tables, desks, curio cabinets, chairs—etc. Everything in full-size detail just like the plans fine furniture manufacturers use. Early American, Danish, Modern, Mediterranean, Spanish, English. Your dollar refunded with first order. Send today. **1425 Sherman Ave., FURNITURE DESIGNS, Dept. PF-13 Evanston, Ill. 60201**



EARN \$20/HOUR

by assembling unique 7 or 12 hp **MINI-DOZER®** bulldozer kit for yourself or resale. 20 attachments—Loader, Mower, Snowblower, Plow, etc. "Build-it-yourself" plans—\$5.00. Catalog of Dozer and 30 other assembly kits—\$1.00 (Refunded on any purchase). **STRUCK CORP., Dept. P10B3, Cedarburg, Wis. 53012**



IT'S ALMOST LIKE PRINTING YOUR OWN MONEY!

Since 1922, Warner has enabled thousands of men and women to establish a business of their own—to reap the benefits of their own labor and have the personal satisfaction, and independence, that comes with operating a business of their own.

Now, a revolutionary new machine makes it possible for an Independent Business Man with no "PULL" . . . **No Big Money to Invest . . . and, No Experience**—to start a business of his own, at home in his spare time. Here's what J. H. of Pennsylvania says:

\$7,280.00 for 1 to 1½ hours work an evening in my spare time—and without advertising. When I start to advertise I will have my own full-time business. Now the extra income gives my family the luxuries my present job does not afford.

Now you can get into this highly lucrative business, using your home as headquarters. No experience needed because we supply

BUILD YOUR OWN CAMPER
SAVE UP TO 50%



Complete, easy to follow plans, instructions, materials list.
 Camper Plans\$3.95
 Travel Trailer\$3.95
 Pickup Cover\$2.00
CONVERSION PLANS:
 Econoline Type Van..\$2.95
 Passenger Bus or Delivery Van.....\$2.95
 Satisfaction Guaranteed

VIKING CAMPER SUPPLY, INC.
 99-BP Glenwood Ave.,
 Minneapolis, Minn. 55403
 Please send _____ for which I enclose \$_____
 NAME _____
 ADDRESS _____
 CITY _____
 STATE _____ ZIP _____

EQUIPMENT CATALOG \$1.00
 Refundable on First Order. Send Dime for Details. Save 50% on Camper Kit. All items from catalog to build \$1,795. Camper, 8', 10', 10'6" or Chassis Unit.

LEARN SURVEYING AT HOME 

NAME _____ AGE _____
 ADDRESS _____
 CITY _____ STATE _____ ZIP _____

NORTH AMERICAN SCHOOL OF SURVEYING & MAPPING
 4500 Campus Drive • Dept. 34171 Newport, Calif. 92660

U.S. Bureau of Labor Statistics predicts shortage of 90,000 civil engineering technicians (Surveyors, etc.) by 1975. Send for FREE "SURVEYING CAREER KIT."

SAMPLE LESSON YOUR FUTURE IN SURVEYING & MAPPING APPROX. \$600 ALL 3 FREE!

GARAGE DOOR OPERATORS
 EASY HOME INSTALLATION
 RADIO CONTROLLED

 **\$89.95** 

Chain & Screw Drive Models
FOUR MODELS FROM THOUSANDS IN USE - FREE BROCHURE
HELPMATE EQUIPMENT COMPANY
 Dept. P-M-1, First & Lake St., Baroda, Mich. 49101 Shipped PP or UPS

APPLIANCE REPAIR BOOKS

Written in easy-to-understand language by experts in the service field with illustrations and diagrams! Acclaimed by instructors and professionals alike! How to diagnose and repair refrigerators, air conditioners, washers, dryers, ranges, dishwashers, vacuum cleaners, motors, water heaters, coffeemakers, hair dryers, food mixers, can openers, electric irons, floor polishers and many others. Also, fundamentals of solid state, setting up a shop, using test equipment and a lot more. Only \$2.65 to \$4.90 each!

SEND FOR FREE DESCRIPTIVE PRICE LIST
CHAROUS & NIEBERGALL INC., 5841 MONTROSE, CHICAGO 60634

9c WORTH OF RAW MATERIAL becomes \$1.25 in less than 60 seconds—and ANYONE can LEARN to do it in a FEW SHORT HOURS!

everything. The new Warner Success Program, "Engraving as a Profitable Business," is now ready for you. Send for your FREE illustrated brochure. No salesman will call. Send your name and address on the coupon or a postcard. Be first in your area to cash in on this ground floor opportunity. **SEND NO MONEY**

WARNER ELECTRIC CO., DEPT. E-2-CA
 1512 Jarvis Ave., Chicago, Ill. 60626

Engraving Division, Dept. E-2-CA
 1512 Jarvis Ave., Chicago, Ill. 60626
 Please rush your free illustrated brochure to:

Name _____
 Address _____
 City, State, Zip _____

Sheet-metal brake you make of wood

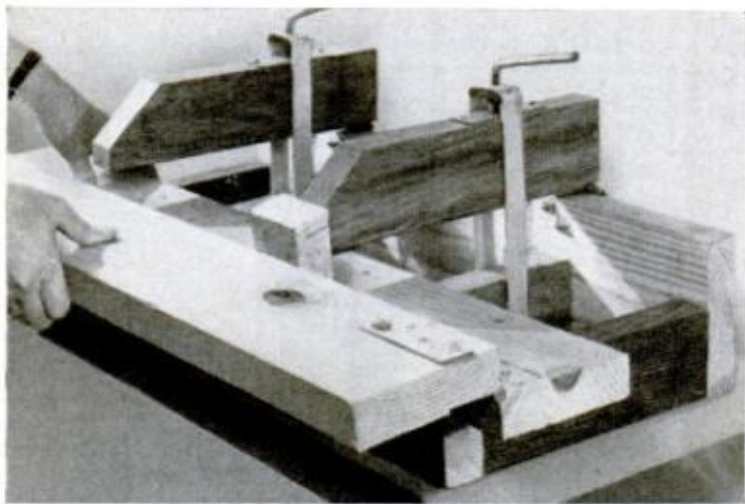

SHEET-METAL BRAKE, made of standard-size lumber, handles up to 26-gauge metal. Bolted to bench, rugged setup stays in place

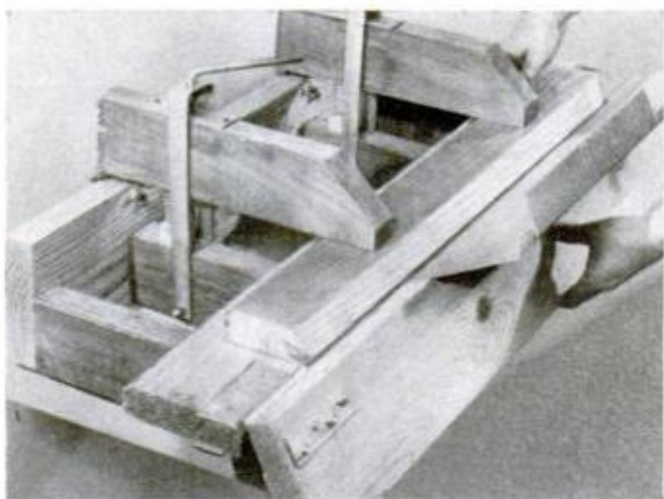

NEAT right-angle bends and flat folds are easy to make with this simple, benchtop, sheet-metal brake. The metal is inserted under the pressure plate, the two handles are tightened and the hinged forming bar across the front is brought up to make the desired degree of bend. To flat-fold an edge, you first bring the forming bar all the way up and against the beveled pressure plate; then the work is removed, flipped over and the bend is squeezed flat.

The brake is made mostly of wood of standard lumberyard sizes. Nuts, which are sweat-soldered in place, provide the tapped holes for each threaded handle, and the yokes are bent from strap iron to straddle the two hinged pressure arms. A compression spring under each arm raises the arms automatically when its handle is backed off.

To bend a metal box, the trick is to bend two opposite sides using the regular pressure plate. Then a special pressure plate is cut to fit the inside width of the box and only one pressure arm is used to hold the plate while making the bend. You can fashion boxes as small as 3x4 in.—*Ray M. Gates, St. Ann, Mo.*

LONG PIECES OF METAL are as easy to bend as smaller ones with this homemade brake. You simply change the pressure foot

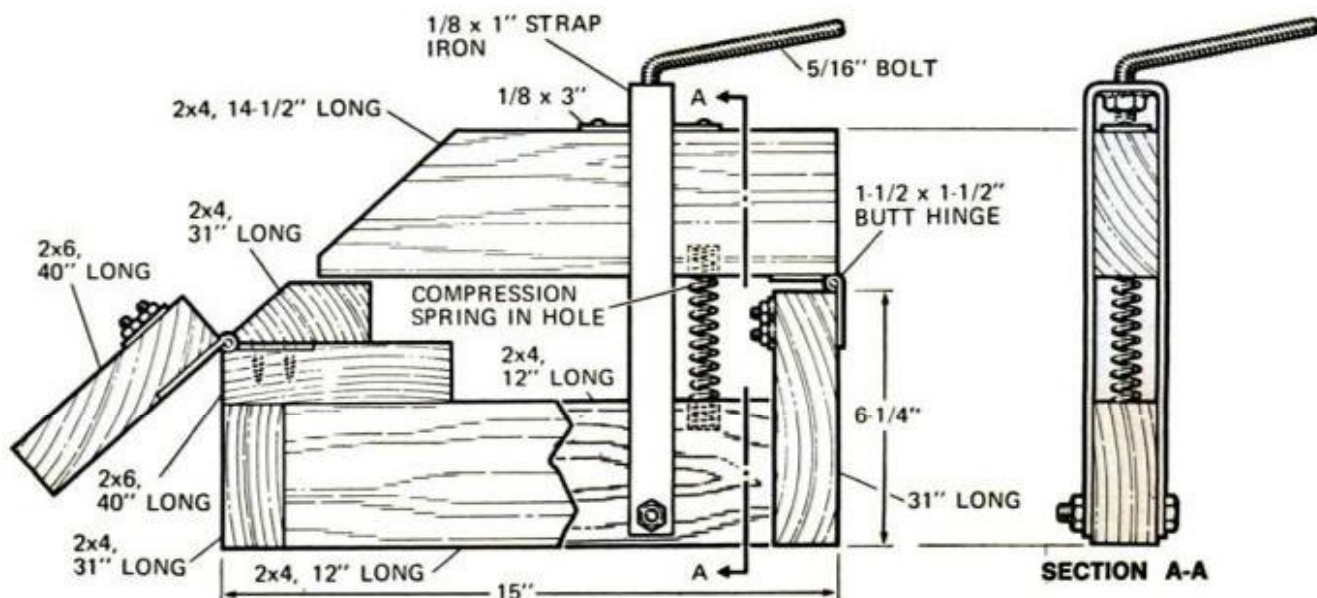

WHITE'S METAL DETECTORS

WHITE'S ELECTRONICS, INC. manufacture the World's Largest and Finest Line of Mineral and Metal Detectors. Ghosttowing, beachcombing, bottle hunting, coin hunting—all types of TREASURE HUNTING or PROSPECTING, amateur or professional. Detect conductive metals—Gold, Silver, Copper Nuggets—Coins—Rings—Jewelry, etc. Underwater or on the land. There are no finer at any price! 25 production models to choose from—T.R. or B.F.D.

Priced from **\$79.50 up**
 —Always specify the Blue & Gold
 ASK FOR WHITE'S BY NAME
 —Free Literature—
WHITE'S ELECTRONICS
 Rm. P.O. 512
 1011 Pleasant Valley Rd.
 Sweet Home, Oregon
 33194 Hazel Street
 Ahtahnsford, B.C., Canada
 Elk Air Industrial Park
 Dexter Drive, East
 Elkhart, Indiana 46514



"LISTEN IN" TO POLICE-FIRE RADIO CALLS IN YOUR CAR!

WORKS with ANY CAR—Portable or HOME RADIO! Just PLUGS in—No wiring—3 minute hookup! Switch instantly from regular to ALL POLICE-FIRE-EMERGENCY-COMMERCIAL-TAXICAB-STATE-CITY-GOV'T 2 way Radio calls in YOUR AREA. DUAL-HI-LOW BANDS TUNES 36-49 & 150-175 MHS. USE Everywhere—anytime—always works.

SEND ONLY \$2.00 (cash, Ck., M.O.) and pay post. man \$7.99 plus COD pstg. or send \$9.99 for ppd Del in USA. COMPLETE, ready to use with instructions. One Year service Warranty—10 DAY MONEY BACK TRIAL (if rtd). Sold Only—DIRECT FROM FACTORY at this Low Price!

WESTERN RADIO BPM-1 KEARNEY, NEBR. 63847



1¢ SALE
 GUARANTEED 10 YEARS

The knife for hunting, fishing and all around use. Mirror polished, imported stainless steel blade honed to a razor's edge. Rugged. Opens quickly, easily. Locks into position. Blade will not close when in use. Press button in handle to close. Safety finger guard. Sure-grip handle. Balanced for target throwing.

IF BROKEN WITHIN 10 YEARS WE WILL REPLACE AT NO CHARGE! Use 30 days. Money back if not pleased. Special 1c sale. REG. PRICE \$1.98. Send \$1.99 & receive 2 knives. Add 49c postage, handling. Remit TOTAL \$2.48 for 2 knives. ORDER NOW! Midwest Knife Co., 9043 S. Western Ave., Dept. DD-6008, Chicago, Ill. 60620. Est. 1936.



HEARING AIDS

Huge savings on tiny, all-in-the-ear, behind the ear, eye-glass and body models. New space age models are so tiny and well concealed your closest friends may never even notice. FREE HOME TRIAL. Low as \$10 monthly. Money back guarantee. Order direct and save. Write today for free catalog and confidential booklet.

PRESTIGE, Dept. T-29, Box 10947, Houston, Tex. 77018.



Magic Mail Plan—Make up to \$12 an Hour!



Get ORDERS and CASH from your mailman—do work in SPARE TIME at home—or expand into FULL TIME business. Send coupon for Free facts about the newest and most fascinating of all home operated businesses. For the first time a simplified machine brings the fabulous profits of Plastic Sealing and Plastic Laminating within the reach of the small operator. Anyone can learn to operate the machine with a few minutes practice—then with our Magic Mail Plan can get mail orders pouring in daily with cash in every envelope. No canvassing—no selling. We even

Get into PLASTIC LAMINATING at home

WE'LL HELP FINANCE YOU AT LESS THAN BANK RATES. supply the circulars you mail to bring back cash and orders, financing help, too. Rush name. We'll send you FREE and postpaid, pictures, prices, details, finance plan, all the facts you need. Mail coupon or send name on postcard. No charge. WARNER, 1512 Jarvis, Dept. L-2-CA, Chicago, Ill. 60626

Make Thousands of Beautiful Art Creations



WARNER ELECTRIC CO., 1512 Jarvis Av. Dept. L-2-CA, Chicago, Ill. 60626

At no cost to me, please rush full details and financing plan, postage prepaid. No obligation.

Name.....
 Address.....
 City..... State..... Zip Code.....

THIS MAN... is taking out of the machine a Plastic Sealing Job—ordered by mail—only 11c in material cost brings back \$2.58 in cash by mail. Capacity of machine: \$40.00 profit per hour of operation.

JANUARY 1973

Be an AIRCRAFT Mechanic

WIN TOP PAY, LIFETIME SECURITY—right out of school. Find out how you can qualify for an aviation career with big pay, excitement, and the respect of your community. Approved for Veterans. Financing available to others.

Licensed by Private School Board of Oklahoma

FREE BOOK YOUR FUTURE in AVIATION

SPARTAN School of Aeronautics Dept. 34171, International Airport, Tulsa, OK 74151

Name..... Age.....
 Address.....
 City..... State..... Zip.....
 Check here if eligible for G.I. Bill Benefits

New! 3-D Sight Magnifiers ENLARGES CLOSE WORK ONLY \$1.98 SMALL PRINT!

WORTH MUCH MORE!

See clearer, work faster, more accurately with less eye strain, less fatigue and tension with HEAD BAND MAGNIFIER. Wear like glasses, they'll magnify about 3x and leave hands free to work. Produces a 3-dimensional effect, where each detail appears to stand out. FOR CLOSE WORK, REPAIRS, SEWING, HOBBIES, etc. Sturdy, lightweight, adjusts to all sizes. With or without glasses. Powerful prismatic polished lenses. Only \$1.98 + 50c for Post. and Hdlg. PPD. (2 for \$3.50, 3 for \$5.00) WORTH MUCH MORE! MONEY BACK GUARANTEE.

Nu Find Prod., Dept. HB977 Box 205, Church, N.Y.C. 10008



EARN \$20/HOUR

by assembling unique 12 or 16 hp TUFF-RIDER tractor kit for yourself or resale. 20 attachments—57" Mower, Snowblower, Plow, Loader, etc "Build-it-yourself" plans—\$5.00. Catalog of Tuff-Rider and 30 other assembly kits—\$1.00 (Refunded on any purchase). STRUCK CORP., Dept. P1TM3, Cedarburg, Wis. 53012



HINTS FROM READERS



A better rotary rasp

A rotary rasp chucked in a hand drill is often difficult to hold against the material being worked. Adding a "stop" greatly improves your ability to keep the rasp firmly against the workpiece. As shown above, the stop is a syrup-can lid.—*Ken Patterson, Regina, Sask.*

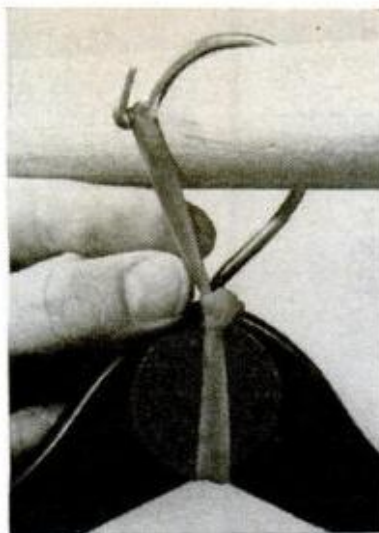

Hold that hanger

Tiring of coathangers dropping to the floor almost every time I removed a garment, I devised this stunt. It's a hefty rubber band fastened around the hanger with one end slipped over a hook formed in the top of the hanger. Now, hangers stay put.—*Henry Moore, Chicago.*



Switch for the better

To protect a switch controlling lights, motors and other shop equipment from being accidentally turned on if bumped against, I cover the switch with a metal drawer pull. It's protected, yet may still be operated without inconvenience.—*William W. Brown, Van Nuys, Calif.*

Get more storage with slings between garage collar beams

The wasted space between collar beams in my garage seemed to be a logical spot for storing lumber, piping and the like. So I screwed in heavy eyescrews on the bottoms of the beams, then passed through

a light-duty rope and fastened it at both ends. These slings, spaced at 3-ft. intervals, clear the car roof and provide extra handy access to the stored items.—*Virgil Gray, Portland, Ore.*

NEXT MONTH IN SHOP AND CRAFTS

GOOD ART AT A PRICE YOU CAN AFFORD. There's an easy way to frame pictures if you have the know-how. You'll learn how to select a frame to suit a picture; how to mat, mount and finish a picture so it looks like a professional job. All frames are made with simple tools and stock moldings sold at lumberyards. Pictures included in the story are available to readers.

JOBS YOU HATE TO DO—MADE EASY. Four nitty-gritty problems that annoy most homeowners—trimming doors to clear carpets, reglazing windows, making simple electrical and plumbing repairs—spelled out so a beginner can understand them.

A \$50 AQUARIUM that's really different. Better described as an indoor fishpond, it consists of a king-size plexiglass bowl cradled in a wooden base, and features a foliage-covered waterfall operating from a hidden submersible pump.

MINIATURE LAUNCH STEAM ENGINE designed for the beginning machinist is this working model of engines that powered chugging steam launches in the 1800s. (Remember the African Queen?) You can make it on any small lathe, such as the Unimat, from a parts kit that includes blank turning stock.

Who'd have thought I'd make so much money without going to college?

I still have to pinch myself every time I see my paycheck — it seems too good to be true!

Especially when I remember how sorry everyone felt for me because I couldn't go on to college. "Without college, it's a losing battle!" they all said.

Well, the college boys left for school, and I found a job. I worked hard, too, but never made it big.

Then I happened to read an announcement like this... about the exciting job opportunities in Electronics.

I discovered that with proper training I could qualify for a job in many of the fields where the action is today... computers, medical science, pollution control, radio and TV broadcasting, to name just a few. I found out that once I had some experience, I could earn \$12,000 a year or more... the kind of money any college man would be proud of.

Most important — I realized how easy it would be for me to get this training. Right at home. In my spare time.

With a home-study course from Cleveland Institute of Electronics.

It looked like a terrific deal, so I enrolled with CIE... and did I learn fast! I'm happily employed in Electronics now, earning good money in a career that **means** something. It's all so unreal that every once in a while I have to pinch myself.

Without college, I never thought I could do it. But, thanks to CIE there are now some college guys who envy me!

CIE Grads Report Success



"My CIE course gave me the technology I needed to understand many of the electronics concepts I never dreamed I could learn. I'm already earning 30% to 40% more than I could have without my CIE training."

Joe Perry, Cambridge, Mass.



"When I started my CIE training, I worked on a tug-boat. Then I landed a broadcast engineering job at a TV station. During my first year in broadcasting, I finished my CIE course and got two raises."

Richard Kihn, Anahuac, Texas



This composite story is typical of hundreds told by CIE graduates who are now enjoying exciting new careers in Electronics.

Send for 2 FREE BOOKS

So find out for yourself. Ask for CIE's 2 FREE BOOKS, "Succeed in Electronics" and "How to Get a Commercial FCC License." They describe the opportunities open to men with electronics training and show you how CIE courses can prepare you for a meaningful, rewarding career in the Science of the Seventies.

Both books are FREE...send for them today! For your convenience, we will try to have a representative call. Mail reply card or coupon to CIE...or write: Cleveland Institute of Electronics, Inc., 1776 E. 17th St., Cleveland, Ohio 44114.

APPROVED UNDER NEW G.I. BILL

All CIE career courses are approved for educational benefits under the G.I. Bill. If you are a Veteran or in service now, check box for G.I. Bill information.

CIE Cleveland Institute of Electronics, Inc.

1776 East 17th Street, Cleveland, Ohio 44114
Accredited Member National Home Study Council

Please send me 2 FREE BOOKS describing opportunities in Electronics and how to prepare for them.

Name _____
(Please print)

Address _____

City _____

State _____ Zip _____ Age _____

Veterans and Servicemen:

Check here for G.I. Bill information.

PM-74

\$300 POOL TABLE FOR \$107

(Continued from page 65)

pedestals. Do not use glue as you may need to disassemble the table to move it to its final destination.

● **Apron.** The apron consists of a rectangle
(Please turn to page 178)

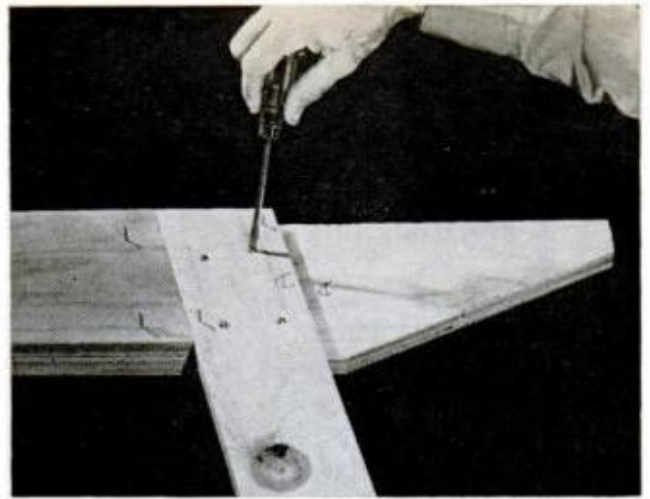

TEMPORARY JIG nailed between uprights of base assure accuracy during assembly. Forget glue for now

LAGSCREWS attach the table to base. But do not use glue here so the table can be dismantled for moving

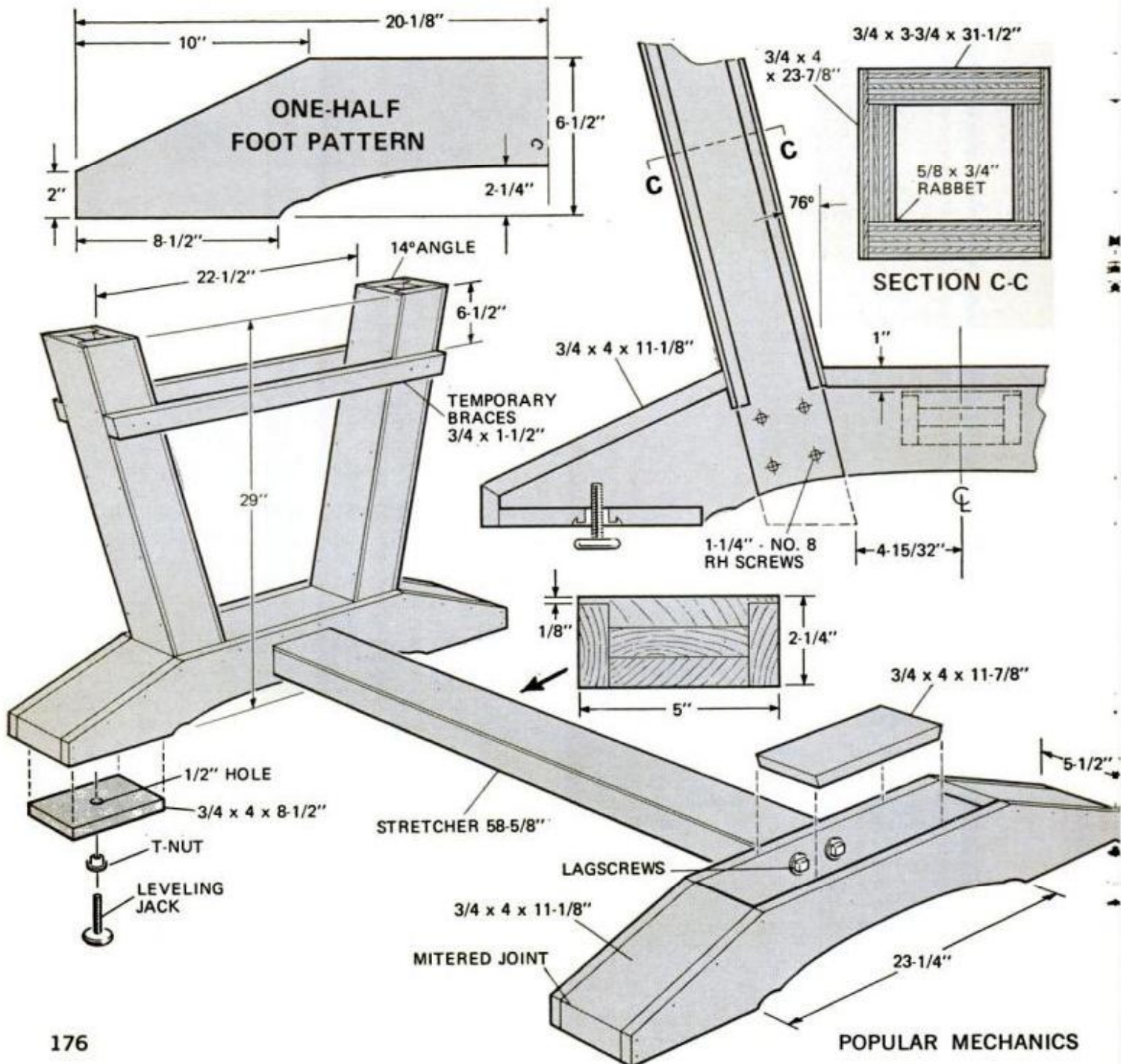
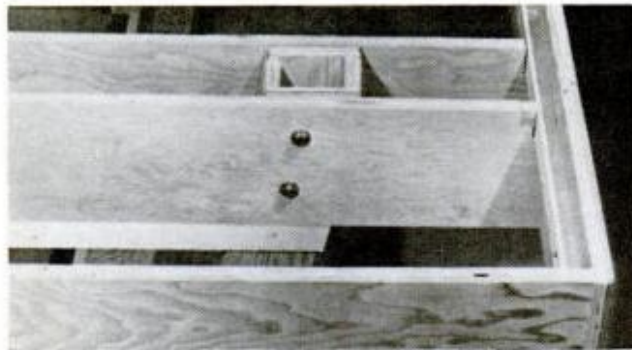

A BUSINESS OF YOUR OWN REPAIR HYDRAULIC JACKS



Earn while you learn at home. Millions of jacks in gas and auto service stations, trucking firms, body shops, riggers, factories and farms need servicing... most of which you can learn to repair. We show you HOW. Start spare time in your basement or garage. Big opportunity for mechanics. ACT NOW! Write for folder PM-1, and free bonus offer

HYDRAULIC JACK REPAIR MANUAL CO., INC.

G. P. O. BOX 3 • STATEN ISLAND, N. Y. 10314

BE A LANDSCAPE CONTRACTOR

LEARN MODERN LANDSCAPING for exciting hobby or profit. Thousands of spare or full time money making opportunities. Start a profitable business—we show you how. Study and earn your certificate at home.

Write today for Free Book.

LIFETIME CAREER SCHOOLS

Dept. A-271

2251 Barry Ave.
Los Angeles, Calif. 90064

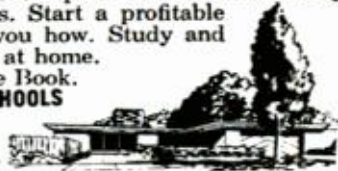

U. S. Surplus High Speed Rotary Files. Hardened Steel, use on any metal or wood for filing, drilling, milling, carving, routing—a thousand uses in every shop. Sets assorted in sizes from 1/8" shanks. All brand new in air-tight, G.I. packs. Order now!

36-pc. Tool Set, G. I. cost \$265.00, now

\$15.00

16-pc. Tool Set, G. I. cost \$109.00, now

\$ 9.00

Save Even More, Both Sets, now

\$22.00

U. S. SURPLUS CENTER

C-1790 Nason Avenue
COLUMBUS, OHIO 43207

BASEMENT TOILET FLUSHES UP



TO OVERHEAD SEWER OR SEPTIC TANK. NO DIGGING UP FLOORS. INSTALLS EASY. Write

McPHERSON, INC., BOX 15133, TAMPA, FLORIDA 33614

GOVT. SURPLUS SAVE UP TO 98%!!



JEEPS, TRUCKS & CARS
Typically From \$75.00 ... Typewriters, Auto Parts, Tools, Aircraft, Clothing, Boats, Camping, Sports, Photographic, Electronics Equipment, Wide Variety And Condition ... 100,000 Amazing Big Bargains Direct From The Government Nationwide. Complete Sales Directory And Surplus Categories Catalog \$1.00 (Deductible On Your Orders From Our Separate Included Surplus Catalog).

SURPLUS SERVICE

Box 820-AX Holland, Michigan 49423

WESTERN HAIG

.12 CALIBER
SPECIAL FACTORY
OFFER!



\$3.00
post-paid

USES POWDER CHARGE

This small bore gun shoots .12 cal. steel bullets fired by small 4.4 mg. powder charge. Not a CO₂ gun. You'll like the handsome lines, grip, and balance. Western in style, but patented ball and cap action allows this low price. 9 1/2" steel barrel cased in knurled styrene stock, overall 13 1/2". Develop pistol form, accuracy at a fraction of cost of large cal. pistols. Comes with 50 steel bullets. Satisfaction guaranteed. Send \$3.00 to:

HAIG MFG. CO., P.O. Box 26-B Alhambra, Calif. 91802



IF YOU CAN SING, WHISTLE, OR HUM A TUNE...

you can play the Musical Saw. No notes to read, no musical knowledge required. Since 1921 we have furnished the entire world this unusual, sweet-toned instrument. If you are 10 or 70, you play or no pay. Musical Saw, soft hammer, bow, resin and lessons mailed on 5 days' trial. Write today for details and free copy of "Sawing News of the World," picturing successful saw musicians. **MUSSEHL & WESTPHAL**, 107 Fort St., Fort Atkinson, Wisconsin. 53538.

Are you missing half the joy of your guitar?

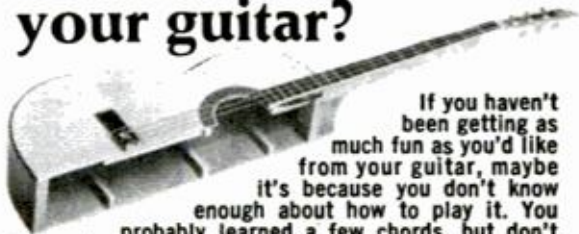

If you haven't been getting as much fun as you'd like from your guitar, maybe it's because you don't know enough about how to play it. You probably learned a few chords, but don't know how to go further. If so, let us help you. We'll teach you to read music and play pick style with both notes and chords—the way a teacher would. The difference is we teach with lessons by mail, and it costs a lot less. Courses in other instruments too—piano, spinet organ, accordion, violin, saxophone. If 17 or over, write for free booklet with more details. Send your name, address, zip code and list instrument you want to learn. Write U.S. School of Music, Studio A301, Port Washington, N.Y. 11050.

ACCREDITED MEMBER NATIONAL HOME STUDY COUNCIL

© 1973 U.S. SCHOOL OF MUSIC

396



**BUILD THIS POPULAR
19 ft. MOTORHOME
AND SAVE \$\$\$**

Designed especially as a do-it-yourself project. (See cover story Jan 1971 PM) Twenty pages 18 x 24 blueprints, step by step INSTRUCTION BOOK with many in-process photos. Includes CUTTING LISTS for wood and steel parts and KIT CATALOG. \$35.00. Plans also available for 23 and 25 ft models. All materials available at big discount.

LariDel Enterprises, Rt. 2, Box 123,
Gaston, Oregon 97119. Ph 503-985-7273.

Be a VETERINARY ASSISTANT

... Lab Aide, Zookeeper, Pet Shop/Kennel Owner

MEN - WOMEN! Train at Home in Spare Time...

Send for Career Kit—ALL FREE!

Name _____ Age _____

Address _____

City _____ State _____ Zip _____

North American School of Animal Sciences, Dept. 34171

Careers by Home Study

4500 Campus Dr., Newport Beach, CA 92663



Emergency First Aid For Pets
Careers in Animal Care

100% FREE STEEL DARTS

SURVIVAL HUNTING BLOWGUN

100% legal No Permit

USA made

lifetime weapon

\$9.95 NOW ONLY

\$5.88

SILENT, POWERFUL, ACCURATE, HITS LIKE A RIFLE BULLET. Improved version of most effective native weapon—Malaysia's hunting blowgun. Thrilling sport! Kills rabbits, squirrels, pests. Tranquilizes. Survival. Defense. Ideal gift. Compressed breath gives amazing power. 200 ft. range. Astound friends! Rugged .38 cal. precision aluminum. Pierces 1/2" plywood. Speed 300 ft./sec. Not a toy! Has 100-5" & 8" steel darts (kit), targets, instructions. Compact 3 1/2 ft. model \$5.88! Popular 4 1/2 ft. \$6.88! Magnum 6 ft. \$8.88! Extra darts \$2.50 per 100! \$10 per 500. BUY 2 GUNS GET 400 "BONUS" DARTS FREE (\$10 value)! BUY 3 GUNS GET 1000 DARTS FREE (\$20 value)! Add .65¢ postage EACH gun. Moneyback guarantee. **UNAVAILABLE ELSEWHERE.** HOUSE OF WEAPONS, Box 7285-V1, Univ. Sta., Provo, Utah 84601.

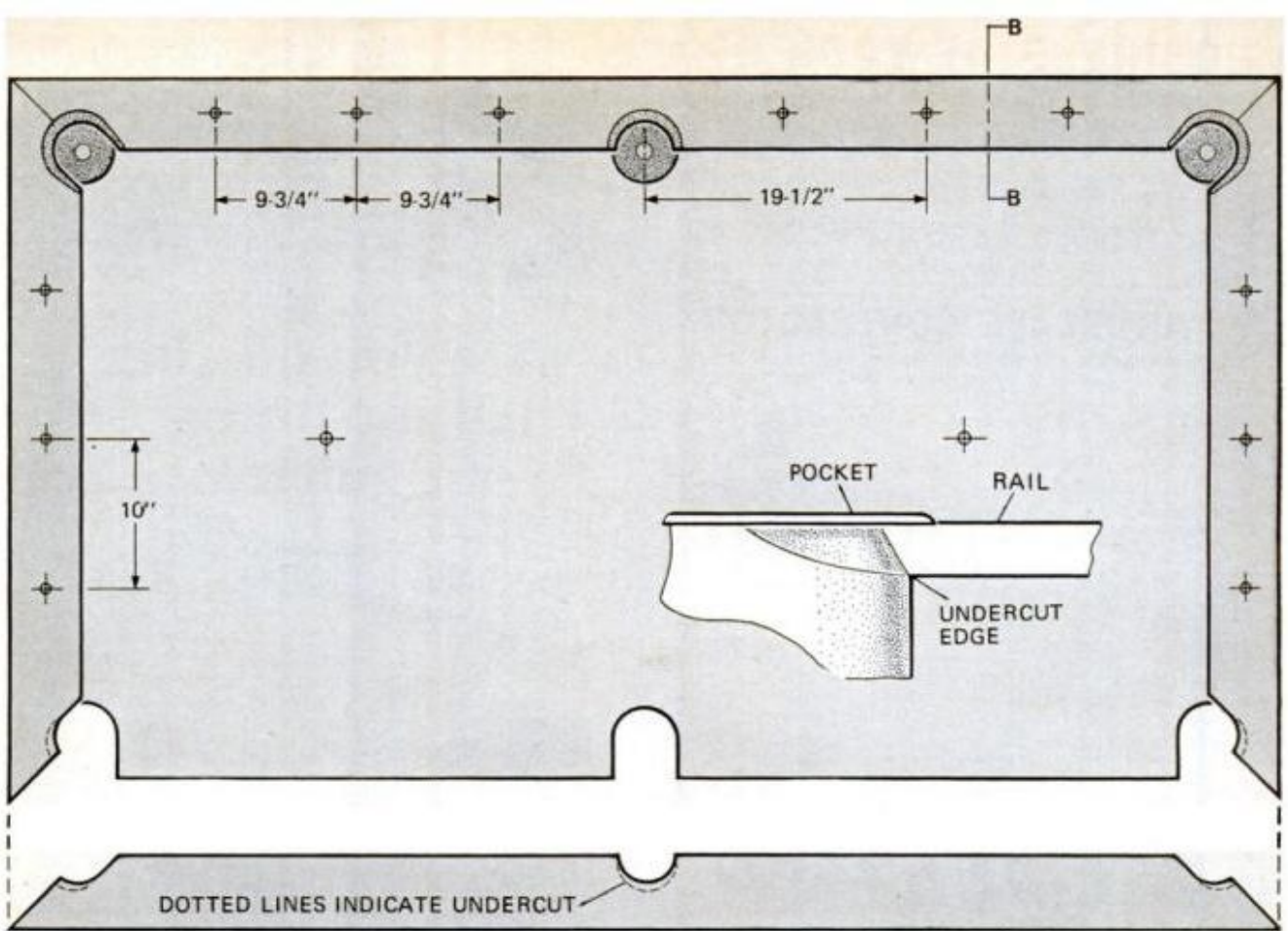

SIDE RAIL 3/4 x 4-5/16 x 87-1/2" (2 REQD.)

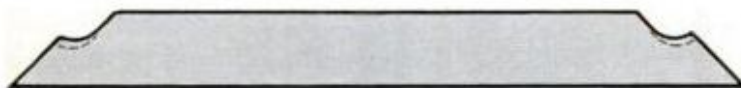

END RAIL 3/4 x 4-5/16 x 49-3/8" (2 REQD.)

\$300 POOL TABLE FOR \$107

(Continued from page 176)

gular frame to which the bed, cleats and cross members are attached with screws. To maintain accuracy of the frame, use diagonal strips while the glue sets.

The bed support cleats are drilled for screws before mounting. Locate the holes as indicated and drill the holes straight and square. The two side cleats must be notched to allow clearance for the side pockets. The notch may be made with a router or by several overlapping passes on the radial-arm saw. Install cleats exactly 1 3/4 in. down from the apron's top. A scrap strip of wood 1 3/4 in. wide will aid in installing cleats. Temporarily nail the strip even with the top edge, then butt cleat to it and screw in place after gluing. Top edge of the six cross members must be flush with top edge of the bed support cleats as shown.

I covered the aprons on my table with an inexpensive, wood-grained laminate called Conolite, which is applied with

(Please turn to page 180)

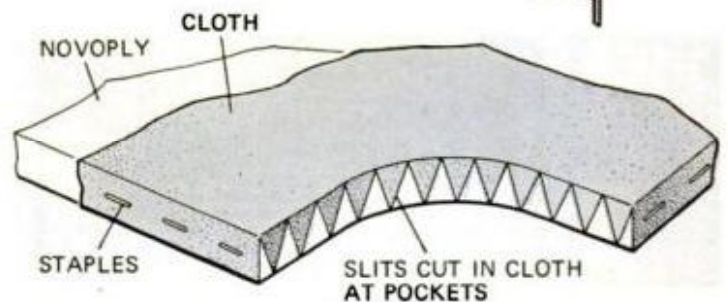
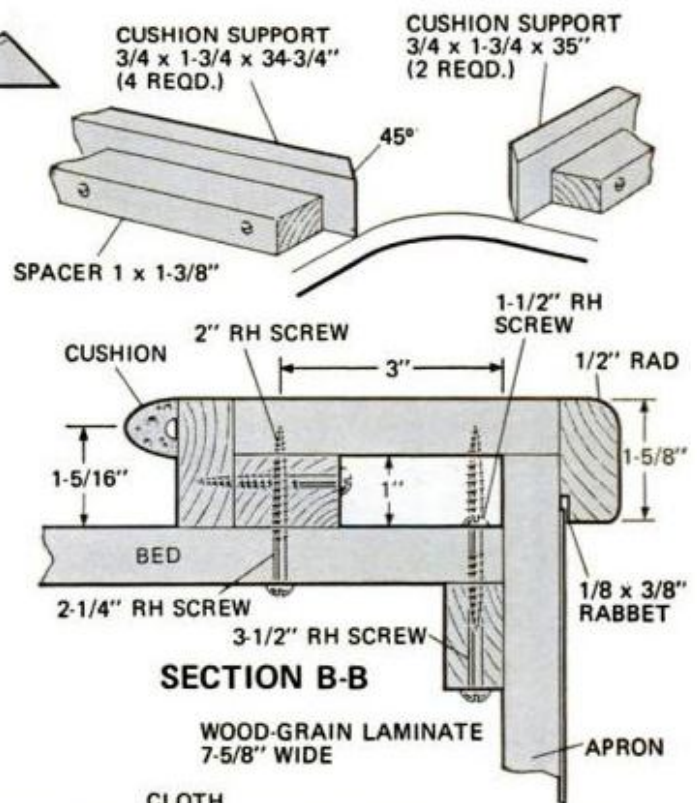

POPULAR MECHANICS

Do-It-Yourself Siding



Learn how you can earn up to \$1000.00 for a single order showing our quality aluminum, steel, and vinyl siding on your home. Small investment required for your own siding. No further investment. Mail coupon for free information without obligation.

ALUMINUM INDUSTRIES
of ARKANSAS, Dept. P-13
Little Rock, Arkansas 72205

Please send me free information concerning your quality do-it-yourself kits.

name _____
street _____
city _____ state _____ zip _____

PUMP DRAINS pools, cellars, laundry tubs IRRIGATES — CIRCULATES — SPRAYS



Heavy duty ball bearing pump. All metal, rust-proof Type XB. Stainless shaft. Use 1/4 HP or larger. 1 HP 1,200 GPH 60" high or 3,000 GPH 25" well. 5,200 GPH max. 1 1/4" in. 1" out. Belt or direct drive. \$14.95
Type P won't rust or clog. Bronze bearing. To 2,400 GPH. 1" in; 3/4" out. \$9.95
P'pd cash with order. Money back Guarantee.

LABAWCO, Box 40, Belle Mead, N.J. 08502



HOW TO BECOME A LOCKSMITH

COMPLETE BOOK OF INSTRUCTIONS

How To Fit Keys, Change Combinations, Master Key Locks, Keys By Number, Tools To Use, etc. Detailed illustrations. Satisfaction guaranteed. Get started! Order today. **Only \$3 ppd.**

A.O. Ancele, P. O. Box 69234, Los Angeles, Ca. 90069

ENGLISH

INSTANT

2-WAY

CONVERSION

METRIC

OUR THIRD EDITION

1 TO 9 COPIES	\$2.00 ea	1 TO 3 COPIES	\$6.00 ea
10 TO 19 COPIES	1.80 ea	4 TO 6 COPIES	5.50 ea
20 TO 49 COPIES	1.60 ea	7 TO 9 COPIES	5.00 ea
50 OR MORE	1.50 ea	10 OR MORE	4.50 ea

MASS (WEIGHTS). VOLUME (LIQUIDS). TEMPERATURE. CULINARY MEASURE, MILEAGE, FRACTIONS. DRILLS AND VARIOUS LINEAL MEASURE, PLUS 25 PAGES OF .001 TO 10,000 INCHES & .1 TO 254.0 mm. ALL IN BOTH BOOKS.

Try your bookstore, or E. Joe Penn 4910 Carson Avenue Indianapolis, Ind. 46227

MUCH OF INDUSTRY, AND MANY SCHOOLS ARE ALREADY GOING

METRIC

OUR CONVERSION BOOKS HAVE BEEN SIMPLIFYING THE JOB SINCE 1961 — NOW 2 BOOKS

OUR FOURTH EDITION

1 TO 3 COPIES	\$6.00 ea
4 TO 6 COPIES	5.50 ea
7 TO 9 COPIES	5.00 ea
10 OR MORE	4.50 ea

The 4th edition has 127 extra pages of .0001 to 10,000 inches & .01 to 254.00 millimeters.

Postpaid, at bookrate

NEW RUBBER STAMP BUSINESS PAYS BEGINNERS UP TO \$16.50 AN HR. START AT HOME IN SPARE TIME

The multi-million dollar Rubber Stamp business—once controlled by a few big companies—is now being taken over by small operators—one in each community throughout the United States. Men and Women who have this inexpensive machine can turn out huge quantities of Rubber Stamps with special wording that buyers once were forced to buy from big cities. Material costing only 27c makes a stamp that sells for \$2.75. The machine that does the work is simple and easy to operate and it turns out as many as six Rubber Stamps at a time, each with different wording such as names, addresses, notices, stock numbers, prices and other "copy" needed by offices, factories and individuals. Working full capacity, it can earn as much as **\$33.00 an hour for the operator!** Now you can get into the big-pay business yourself, with your own home as headquarters. You don't need experience. We supply everything, including complete instructions and eight ways to get business coming in fast. **We even help finance your start.** Start making up to \$16.50 an hour from the very beginning. Cash in on the profitable Rubber Stamp business in your community, right away. We'll mail full particulars **FREE** and no salesman will call. Be first in your locality. Rush coupon or send your name on postcard now to:

RUBBER STAMP DIV., Dept. R-2-CA
1512 Jarvis Ave. • Chicago, Illinois 60626

JANUARY 1973

THIS LITTLE TABLE TOP MACHINE MAKES EVERYTHING SIMPLE & EASY

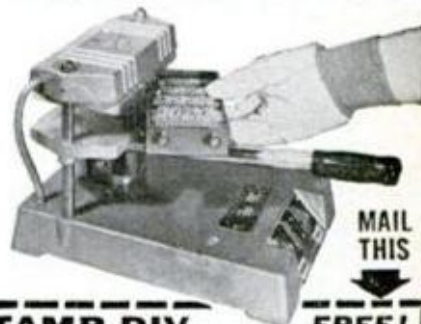

MAIL THIS

RUBBER STAMP DIV. FREE!
1512 Jarvis Avenue Dept. R-2-CA, Chicago, Ill. 60626

Please rush full particulars about your financing plan and the little machine that can get me started in the profitable Rubber Stamp business at home in spare time. Everything you send me is **FREE** and no salesman will call.

Name _____
Address _____
City _____
State _____ Zip Code _____



FABRIC IS SLIT at drop-pocket cutouts and stapled to underside of the rail, then along the rail edges

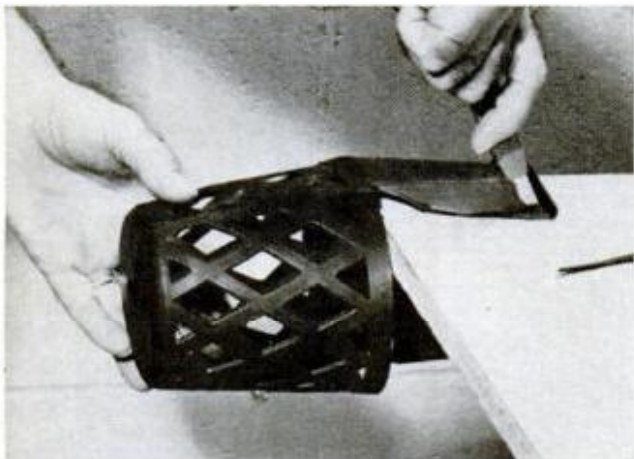

POCKETS ARE TRIMMED TO FIT—differently at the sides than at the corners. See drawing, above right

\$300 POOL TABLE FOR \$107

(Continued from page 178)

contact cement. It's offered in rolls 36 in., wide and sold by the foot. Various colors, patterns and grains are available. It can be cut with scissors, but you may find it easier to score the surface with an awl and snap it along the scored line.

Cut the laminate slightly oversize and apply contact cement to it and to the wood surface. Allow the cement to dry until it loses its tackiness, then apply carefully. Once in place, it cannot be moved. The top edge of the laminate is set $\frac{11}{16}$ in. below the top edge of the apron. The sides and bottom should overhang slightly. Trim excess with a router fitted with a laminate trimmer or by hand with a plane. Cover the end aprons first, then the longer sides.

● **Bed.** The bed is cut from a sheet of $\frac{3}{4}$ -in. particleboard. Notice that $\frac{1}{4}$ in. is trimmed from the 48-in. dimension. The length of the bed is $85\frac{3}{4}$ in. The material is dense and tough, but it is easily cut with ordinary tools such as a portable

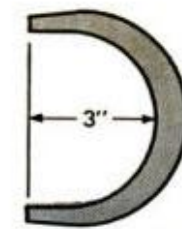

SIDE (2 REQD.)

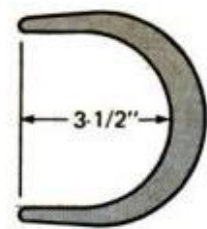

CORNER (4 REQD.)

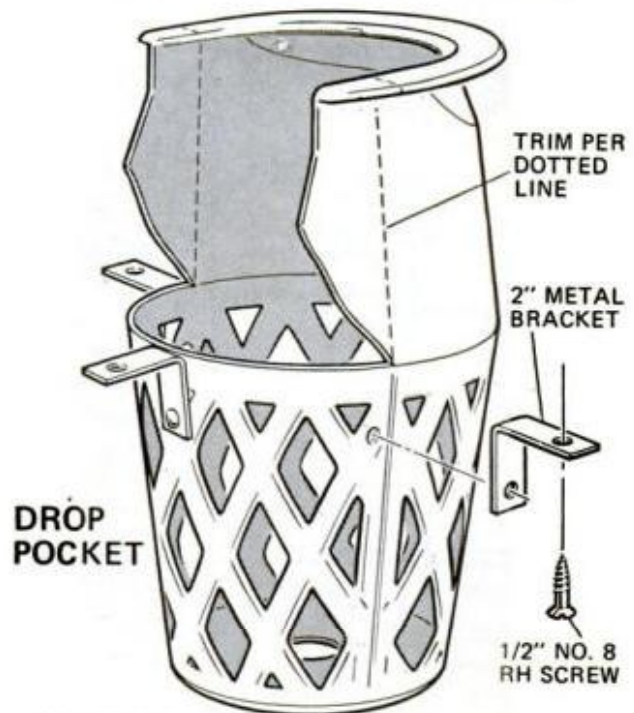

BRACKETS ATTACHED TO POCKETS WITH RIVETS

METAL ANGLE BRACKETS are used to attach drop pockets in table cutouts after pockets are trimmed

saw, sabre saw, or even a handsaw. Lay out the corner and side-pocket cutouts according to the diagram. After cutting, break all sharp edges with sandpaper. Drill the mounting holes, then cover with billiard cloth. The cloth is stapled to the underside of the bed. Do the long sides first, then the ends. Slit the cloth at the pockets, stopping the slits just short of the cutouts. Pull the cloth evenly around the pockets and staple to the underside of the bed. (Before installing the cloth remove wrinkles with a steam iron).

● **Rails.** The rails require some tricky sabre-saw cutting. Cut the sections to size and miter the ends 45° . Place the four pieces on a flat surface and lay out the $4\frac{1}{8}$ -in.-dia. cutouts. If you want full-size patterns for the pockets, we will send them free. Write Pool Table, Popular Mechanics, 224 West 57th St., New York, N.Y. 10019 and be sure to include a self-addressed, stamped envelope.

Make cutouts in the usual manner using a sabre saw. After all corner and side-

(Please turn to page 182)

The bargain hunter

WINDWATCH™ ANEMOMETER - WIND VANE \$19.95



Neon lights in indoor indicator show wind speed and direction. Decorative indicator with gold dial in dark mahogany case. Designed for desk use or wall mount. Outdoor instruments of durable aluminum with electrical parts enclosed in rigid vinyl housings. Easy to assemble and install. Attach directly to roof or pole. Comes with wire and materials for installation up to 60 feet. Uses regular 120V AC. Unique low amp circuit assures absolute safety. A fascinating addition to any home. Five year guarantee. 15 day trial. Your satisfaction or money back. Only \$19.95 postpaid.

DEPT. F10, 104 HEIMANN SAN ANTONIO, TEXAS 78205

FIX CLOCKS, WATCHES

FOR FUN & PROFIT! Fascinating new Handbook by master craftsman H. Harris gives you the knowledge skilled watchmakers learn. **OVER 200 ILLUSTRATIONS** show how to install hands, dials, crystals, mainsprings, stems—rehouse old movements in modern cases—clean timepieces, etc.

INSTRUCTIONS COVER every popular watch and clock, chimes, grandfathers, cuckoo, everyday alarm and electric clocks. Handbook tells you where to buy parts... where to send "overflow" work for repairs at wholesale prices as business expands!

Friends gladly pay \$5 to \$50 for restoring cherished timepieces. Try the **HANDBOOK OF WATCH AND CLOCK REPAIRS**. Rush only \$4.95, plus 30¢ handling, on 10-day money-back guarantee. **EMERSON BOOKS, Inc.**, Dept. 547-X, Reynolds Lane, Buchanan, N.Y. 10511

AUTOMATIC SAW SET
Set saw teeth automatically—400 per minute without effort. Perfect hammer and anvil action sets teeth uniformly—no tooth breakage.



FOR HAND SAWS AND BAND SAWS
Write for details
BURR MANUFACTURING CO.
8931 Venice Blvd.
Los Angeles, Calif. 90034

GLASS BLOWER KIT \$23.95 ppd.

Make Glass Miniature SHIPS-BIRDS-BOTTLES ILLUSTRATED
Instruction Book \$3.00
Willis Glass Supply Co.
P.O. Box 3460, Studio A
Anaheim, Calif. 92803

BUILD YOUR OWN CANOE

WOOD & CANVAS OR FACTORY MOLDED FIBERGLASS
MANY MODELS TO CHOOSE FROM \$19.50 (BASIC WOOD KIT) FREE CATALOG
TRAILCRAFT, INC.
Box 60679, Concordia, Kansas 66901

PERMANENT MATCH

AMAZING INVENTION SELLS LIKE MAD!



Lights up to 15,000 times. Pull this ingenious metal wonder out of its case, strike on side, and presto!—it's lit. Amazes everyone who sees it. **MAKE BIG PROFITS.** Show to friends, fellow-workers, in stores, offices, taverns, factories. Sells on sight for \$1.00. Order at low wholesale prices ONLY \$4.90 per doz.; \$14.25 for 3 doz.; \$49.20 for 12 doz. (2 samples \$1.00). Catalog of 100 other fast sellers included free! **Lakeside Company, Dept. PP-13, 6800 N. Campbell Ave., Chicago, Ill. 60645.**

MIRACLE FLASHLIGHT

ONLY 1" LONG—LIGHTS 50,000 TIMES!



New space age flashlight only 1" long. Gives a brilliant beam that lights over 50,000 times! Powered by a deluxe silver energy cell (replaceable) that lasts for years. Comes with gold snake style key chain. Ideal for finding house or car keyholes on the darkest nights. MANY other uses. You can make \$50, \$100, \$150 or more showing Miracle Light to friends, neighbors, people at work. Sell hundreds at only \$1.00 each. Your low cost: 1 doz. \$5.40; 3 doz. \$14.40; 12 doz. \$49.20 (2 samples \$1.00). We pay postage. **Lakeside Co., Dept. PY-13, 6800 N. Campbell, Chicago, Ill. 60645.**

The Metric System is Coming

Use the New

DIAL-A-CON®
ANGLO-MET
CONVERTER
(Reversible)

In heavy duty plastic-6" Post Paid \$5.95 Each

Check or money order NO C.O.D.

Order from manufacturer
FELSENTHAL INSTRS. CO.
7450 W. WILSON AVE.
CHICAGO ILL. 60656

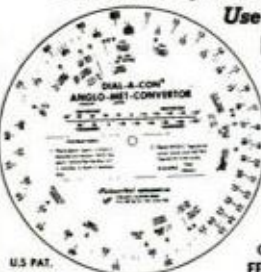

U.S. PAT. 3,544,754

Metric to English on back side

NAME _____

ADDRESS _____

ZIP _____

LITE JET THE WORLD'S MOST DEPENDABLE FLASHLIGHT



No bulb or battery replacement ever, months, if not years of bright fail-proof light, powerful beam, compact, two-tone, 3 1/2" X 2 1/2", guaranteed, send \$1.98 plus .30¢ postage & handling. **Lorjon, Dept. 1PM, 19 Mt. Pleasant Ave., Belleville, N.J. 07109**

CONVENIENT CASSETTE TAPE CAROUSEL



Holds 25 cassette tapes in ready access. Turns freely. Designed to be stackable. 10" diameter, 6" high. High impact plastic. \$9.95 each + 55¢ postage in Continental USA. Cash, check or money order. 10 day money-back guarantee.

Kalyn Enterprises, 7298 Cloverdale Rd., Cygnet, Ohio 43413

B. L. Mellinger
famous world trader,
invites you to read and examine his home business plan.

I'll show you HOW TO START a

BIG PROFIT Home Import Business

My Plan starts you fast... no experience or product investment. Buy direct—cut out middleman—keep all profits.



BUY BELOW WHOLESALE
1000's of dazzling bargains like these

FIELD GLASSES \$2.55

7 x 35 G.C.F. Clear and powerful. Duty and all shipping included. Quantities of 1000. Samples available.

CALENDAR WATCH \$4.45

Swiss movement. Real leather band. Mfg. guaranteed 2 yrs. Buy one. Price includes postage & duty.

METAL DETECTOR \$7.85

Sensitive. Finds metal—treasure. Quantities 200 duty. Included, plus 20¢ shipping. Sample \$13.95 duty & postage paid.

MOVIE PROJECTOR \$1.92

Popular 8mm movie projector. Quantities of 500, including duty. Shipping 15¢.

ELECTRIC RAZOR \$2.51

Swiss craftsmanship. This single sample price includes all duty, add postage 85¢. Shave reduced price and shipping in quantities.

ORIENTAL REAL JADE RING \$1.28

Full price for one, including all duty and postage.

MINK COAT \$285

Smart Scandinavian styling. Includes all postage and duty.

FLASH CAMERA \$2.62

Complete set including duty. Quantities of 500, plus 5¢ shipping. Sample \$1.30 delivered to you.

A great idea for men and women. The question you've probably been asking is what kind of a home business and how do I get started? A few years ago I was asking the same questions. A friend suggested Import-Export to operate from home in spare hours. My total capital was \$100. Starting with such meager resources and learning the hard way... I've made a fortune in Import-Export. My business employs dozens of people and takes in millions of dollars each year.

Important facts I learned along the way I put into my new home business plan. I will show you how to make your dreams of a fine "second income" or retirement business come true. My Plan intro-

duces you to leading suppliers abroad... shows you how and what to import for big profits... how to buy below wholesale and cut out U.S. middleman... how to buy imports in quantities or many just one at a time... how to offer imports by mail order and to local buyers who are ready for bargains.

Don't worry if you are short of money. So was I and I made it big. You operate from anywhere. Age no barrier. See for yourself how the import boom works. I will help finance you and get you off to a fast start! My book, "How to Import and Export" is free. Coupon brings book to you at once. No obligation and no salesman will call. Airmail reaches me overnight.

Mail Coupon Today - Get my FREE BOOK!

\$98.83 GENUINE DIAMONDS from Belgium. Six sparkling diamonds. Total full carat. All duty and postage included.

ELECTRIC 60¢

TOOTHBRUSH Four nylon bristle brushes. Price includes all duty and shipping. Quantities of 420.

Send no money... Do not order from us. I show you how to get these bargains and hundreds of others. Prices shown are direct from suppliers abroad.

GET DETAILS ABOUT 8 FREE IMPORTS

The Mellinger Co., Dept. G2251

6100 Varlet, Woodland Hills, CA. 91364

Send free book showing how I can buy imports below wholesale. Show me how to start a business of my own and make big profits. (If under 21, state age.)
Name _____ Age _____
Address _____
City _____
State _____ Zip _____
Save 3 days... Give Zip No. for Fastest Rest!

THE MELLINGER CO., Dept G2251 6100 Varlet, Woodland Hills, CA. 91364



FABRIC-BACKED VINYL is stapled to underside of rails with $\frac{3}{16}$ -in. staples spaced about 1 in. apart



CUSHIONS ARE COVERED with 5-in.-wide strips of billiard cloth, pulled taut and stapled to rear side

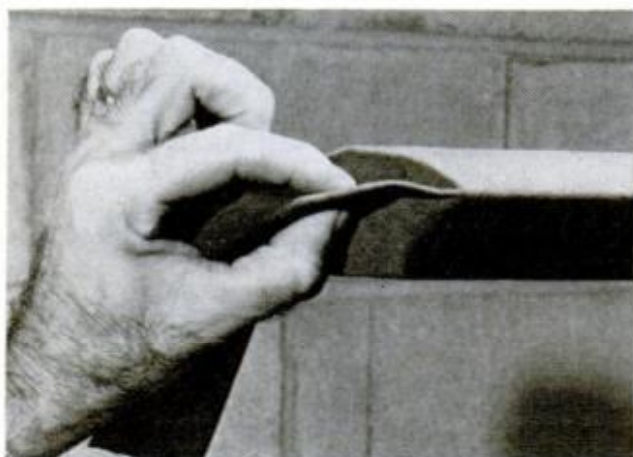

ENDS OF CUSHIONS are glued as shown, then cloth is pinched and finally trimmed neatly with razor blade

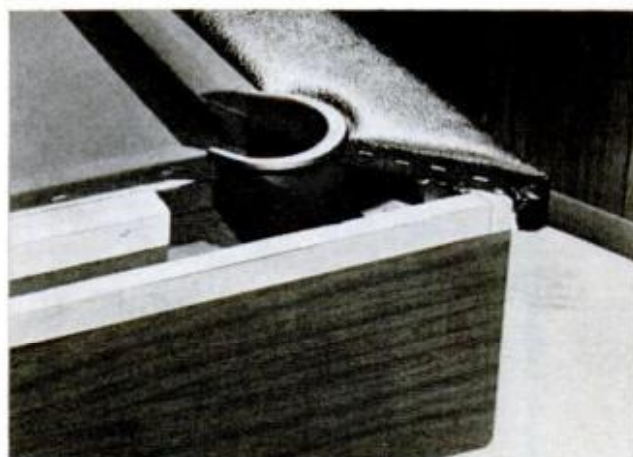

HERE'S HOW A DROP POCKET fits corner hole. The front padded rail has been removed for sake of clarity

\$300 POOL TABLE FOR \$107

(Continued from page 180)

pocket cutouts have been made, tilt your saw's base to 30° and recut the section of the cutout from points A and B. Undercutting is needed to clear the drop pockets.

The outer edging for the rails is cut and rabbeted as in the drawing. Two passes on the table saw will form the rabbet—or use a router. Round off top and bottom edges, miter the ends, then nail and glue edge pieces to the four rails.

Padding the rails is not too difficult. Glue a 5-in.-wide strip of foam to the rear edge of the rail just before the round starts. Use rubber cement or Pliobond *only*. Contact cement, white glue and animal glues destroy the foam. If you use rubber cement (sold at stationery and art stores), apply it to both surfaces and let it air-dry about five minutes before joining the parts. Apply a narrow strip of cement about $\frac{1}{2}$ in. wide.

Cover the rails with a strip of fabric-

(Please turn to page 184)

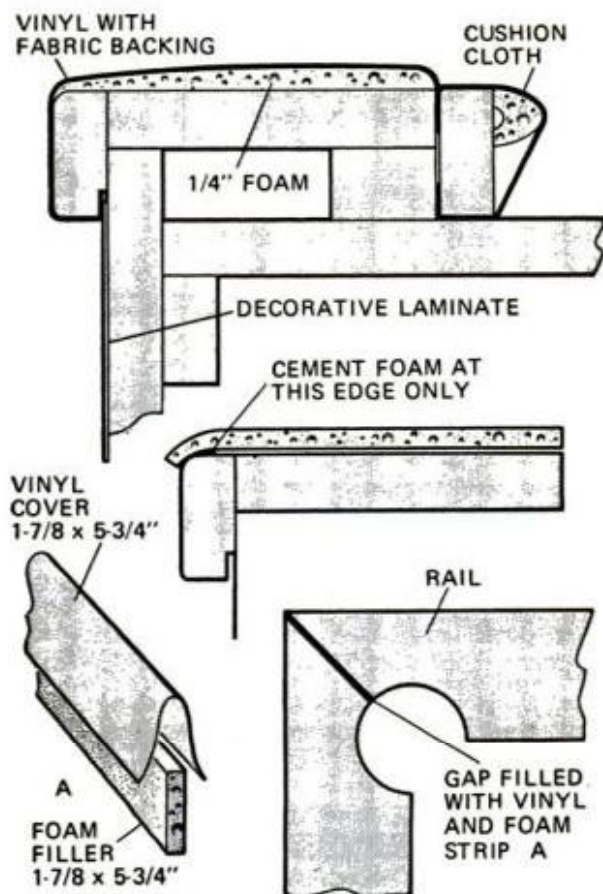



FREE!!! POWERFUL MUSCLES FAST!
 Fantastic New Discoveries in the science of bodybuilding. Now, in the privacy of your bedroom, our method will add inches of powerful muscles to arms, chest, shoulders & legs. Learn secrets on trimming the waist with ultra-modern methods—fast! Results Guaranteed! Send for free brochure. Universal Bodybuilding, Box 485-MI, Dearborn, Mich. 48121.

New! PIPE and FITTING WRENCH

Rotating handle, for instant jaw control. Up to 2" O.D. cap. One-hand operation: speeds-up plumbing and auto jobs on pipe, coils, bolts & fittings... esp. in close quarters. PIPELOK™ ratchets on pipe; can't jam! Money-back guarantee. \$9.90 ppd.

PORTAGE SPECIALTY CO.
 Box 314-A, Portage, Michigan 49081

Easy to Build PLANS AND INSTRUCTIONS for

- Go Kart\$2.00
- Mini Bike\$2.00
- Mini Car\$3.00
- Pedal Boat\$4.00
- Sail Boat\$2.00
- Snowmobile Sleigh \$3.00

Mini Vehicles Plans Dept.-C P.O. Box 92 Chazy, N.Y. 12921

DETROIT APPROVED—PICKUP TANKS

Original equip. type poly. now avail. in aux. tanks for pickups. Increase gas capacity 40 gals. Easy 1 hour installation—completely hidden—no body work necessary. Let truck discounts pay for tanks.

R.P.M. INC., Dept. PM-173
 P.O. BOX 7936, Waco, Texas 76710

How to Get Rich in MAIL ORDER

FREE REPORT! Tells how I start you fast at home, spare time. How to find big selling products; how to buy below wholesale for bigger profits; how to advertise for quick results. Ideal "second" business, retirement income, husband-wife team.

FREE report, "How to Make Money in Mail Order."
 No obligation. Write: B. L. Mellinger,
 Dept. GC251, 6100 Varrel, Woodland Hills, CA 91364

THE AUTO ELECTRIC

110V D.C. electricity from a vehicle alternator

- Light Bulbs
- Power Tools
- Battery Charging

\$14⁹⁵

with 150 V.D.C. meter Postage \$1.25

Auto Air Equipment, Inc.
 P.O. Box 2886—Amarillo, Tex. 79105

POPULAR MECHANICS PM-BEE! Plan for a radio-controlled model that flies on CO₂. Fuel is nonflammable and odorless. Sophisticated and simple to build! To obtain full-scale pattern from which you can trace off the parts directly, send \$3.49 to **POPULAR MECHANICS Dept. FA, Box 1014 Radio City, New York, N.Y. 10019.**

HANDY DANDY Storage JARS



Handy Dandy plastic caps hook onto 1/8" peg-board to hold popular, quarter-twist food jars (such as baby food) with 1-15/16" neck. Unbreakable, clear plastic jars are also available.

QTY	CAPS	JARS	CAPS & JARS
10	\$1.00	\$2.00	\$2.75
24	-	4.50	-
36	3.50	6.25	8.75
72	6.00	11.50	16.00
144	11.50	22.00	30.00

PPD USA. No C.O.D.'s
WICKLIFFE INDUSTRIES
 P. O. Box 286, PM-1
 Wickliffe, Ohio 44092

SAVE! BUILD YOUR OWN POWER TOOLS

METAL PARTS KITS AT FACTORY DISCOUNT PRICES

- 10-in. TILT/ARBOR SAW
- 6-in. BELT SANDER
- SPINDLE SHAPER
- 18-in. BANDSAW
- 12-in. BANDSAW
- COMB. DRILL PRESS-LATHE

SAVE \$50 OR MORE with FULL-SIZE PATTERNS \$200 per Plan Inductible

Kits from \$19.99 to \$49.99

Featured in Popular Science, Mechanix Illustrated. Sold for 26 years. Thousands in use. Satisfaction guaranteed. Send \$2 each for Plans (state tool wanted). Catalog included. Or, send 25¢ for Catalog!

GILLIOM MFG. CO.
 Dept. PMT-1 St. Charles, Mo. 63301

NEARSIGHTED? FARSIGHTED?

No more glasses to wear! Latest discoveries! Eye training course will improve your vision. Are your eyes worth \$3.95? Mail cheque to:

SEE-WELL COMPANY, Box 1010-PM1
 Postal Station "A" Toronto 1, Ont., Canada
GUARANTEE: Results within ten days or your money back.

WATER WATER WATER WATER WATER WATER

"HOW TO DRILL YOUR OWN WATER WELL"

\$1.00ppd

SATISFACTION GUARANTEED

DEEPROCK CO.
 OPELIKA, ALA. 36801

Thousands of exciting tool values!

SILVO (BRAND NAME) TOOL CATALOG

Thousands of Exciting Tool Values! Stanley, Millers Falls, Skil, Thor, Wen, Disston, Wiss, Wellisaw, Dremel, Speedy Sprayers, Plumb, Huot, Kennedy, Channellock, Porter-Cable, Rockwell, Helios, Vise-Grip, Crescent, Ridgid Pony Clamps, Unimat, Foredom and many other Nationally Advertised brands of Tools & Supplies. We ship Coast to Coast at prices Hard to Beat. Send \$1.00 for our big 152 page tool catalog today Silvo Hardware Co., PM-1 107 Walnut St., Philadelphia, Pa. 19106.

YOUR OWN RADIATOR BUSINESS

"\$70,000 LAST YEAR"

says D. Carter, Lemoyne, Pa.

Complete turn-key package: training school in radiator repair technology and business management plus special power-equipped auto radiator shop.

Don Carter writes: "Averaging \$30 an hour, expect to hit \$80,000 next year." Mail this coupon for complete story.

NAME _____
 ADDRESS _____
 CITY _____ STATE _____
 ZIP _____ PHONE _____

INLAND MFG. CO. Dept. PM-1
 1108 Jackson Street • Omaha, Nebr. 68102

110 Volt A.C. GENERATORS

60 cycles. Fanbelt driven from car or gas engine. Operates T.V., refrigerators, radios, all power tools, projectors, P.A. systems and fluorescent lights. Over 12,000 in service. Guaranteed six months. 1500-watt \$65.00 postpaid. 3600-watt \$105.50 postpaid. Special X-1000 watt self-excited generator \$85.00 postpaid.

TOOL POWER™ patent pending

115 volts D.C. 5000-watts. 50 amps from your car's alternator. **Guaranteed 20 years.** Install in ten minutes. Operates all power tools, electric motors up to 2 h.p. Arc welding, fast battery charging. Any like device by any name is an infringement of our patent pending. All copiers are notified. Be safe, buy from the inventor and developer. \$25.00 postpaid. Attractive dealer plan.

VIRDEN PERMA-BILT CO.,
 P.O. Box 7160PM
 2821 Mays, Amarillo, Texas 79109

SINGLE TWIN-JET OUTBOARD

Dual jet outlets with separate controls give exceptional slow speed maneuverability to small boats. BUILD UR OWN plans allow using locally available auto & hardware store parts. Also PLANS available for PORTABLE ELECTRIC POWER PLANT using auto alternator & ALT POWER. 110 volt power in your car. FREE illustrated literature.

B-UR-O CO., Dept. PM
 34161-B Coast Hwy., Dana Point, Calif. 92629

HEARING AIDS

1/2 PRICE CATALOG FREE!

SUPER SAVINGS! Newest. Finest.

All types. Buy DIRECT & save up to HALF! No salesmen. Sold by AIR MAIL on HOME TRIAL. FREE Catalog. Write: **MONEYSAVERS,** Dept. PM-1, 9530 Langdon Ave., Sepulveda, Cal. 91343

IMPORTED LOCK BLADE KNIFE

ONLY \$275 each

9" Overall Length
 5" When Closed

- Sharp and Tough
- Stainless Steel Blade

Locks into position to prevent accidental closing. Razor sharp tough stainless steel blade for reliable use and hard, long service. Money back in 5 days if not satisfied. Send \$2.75 plus 25¢ to cover postage and handling.

WESTBURY SALES CO.
 P.O. Box 434, Westbury, N.Y. 11590 Dept. L-234-PM

\$300 POOL TABLE FOR \$107

(Continued from page 182)

backed vinyl. This is upholstery material; two well-known trade names are Naugahyde and Boltaflex. Cut it in 9-in.-wide strips and let the ends overhang the rails slightly. Staple one edge of the vinyl to the rabbeted part of the rail back. Pull this taut toward the front of the rail and staple it again on the front edge, with staples about 1 in. apart. At the cutouts, slit material and staple it to the underside as shown on page 180. At the ends of the rails, trim the excess and where impractical to staple, use cement.

When all rails are covered and mounted to the table, there will be a slight gap at the miters. This is rectified by inserting corner fillers made by folding a piece of vinyl over a foam strip. Insert in corners before permanently mounting the rails.

● **Cushions.** The rubber cushions are cemented to the wood cushion supports with rubber or contact cement. The cushion rubber is not symmetrical, but has a top and bottom. It's mounted right when the nose of the rubber is $1\frac{3}{16}$ in. from bottom edge of the support. Miter the supports as indicated, then mount the rubber. Let rubber extend past the miter, then trim it flush with a sharp knife. It's easy to cut if the blade is dipped in water first.

Covering the cushions is next. Cushion cloth in the kit is 10 in. wide, with a small slit at the 5-in. mark. Grasp the cloth at one end and pull apart at the slit into two 5-in.-wide strips. Cover the cushions by stapling the cloth to the rear side, a trifle above center. Pull the opposite end taut and again staple at rear of the support. Work from the center out. Be sure the staples set flush. If not, hammer them all the way home. Do likewise with the rail. Ends of the cushion cloth are cemented. Pull the cloth toward the center, then carefully cut the excess with a razor blade. Pull loose ends to the back and cement.

The support spacer is attached to the cushion support with five 2-in. rh screws in each piece. Drive the screws tightly.

● **Final assembly.** Place the support spacer under the rail and screw rail into place with $3\frac{1}{2}$ -in. rh screws. Force the cushion as tight as possible against the rail and attach with the $2\frac{1}{4}$ -in. screws. Have an assistant help you. If you can't get $2\frac{1}{4}$ -in. screws, use $2\frac{1}{2}$ -in. ones with

several washers under the heads to keep points from penetrating the nail top.

● **Drop pockets.** The molded-rubber pockets are made slightly oversize so they may be trimmed to fit various tables. Pockets in the kit are cut with a sharp knife or scissors. Three metal brackets hold each pocket in place, using Pop-rivets. The other end of each bracket is attached to the table with a $\frac{1}{2}$ -in. screw. Since bracket holes vary, no dimensions are given. If too large or too far in from edge, drill new holes as necessary. Press top of the pocket down firmly against the padded rail when positioning brackets.

Rail markers are $\frac{3}{8}$ in. pressure-sensitive paper discs available at art and stationery shops. Peel off protective backing and press them in place. Paint the base as desired.

The kit, with four leveling jacks, 22 ft. of cushion rubber, billiard cloth, six drop pockets and a $\frac{1}{4} \times 5 \times 280$ -in. urethane-foam strip can be bought from The Armor Co., Box 290, Deer Park, N.Y. 11729. ★★

MATERIAL LIST

Note: Except where indicated, all lumber is fir plywood

No.	Size and description—Use
2	$\frac{3}{4} \times 4\frac{5}{16} \times 87\frac{1}{2}$ "—Side rails
2	$\frac{3}{4} \times 4\frac{5}{16} \times 49\frac{3}{8}$ "—End rails
2	$\frac{3}{4} \times 1\frac{1}{2} \times 89$ "—Side-rail back
2	$\frac{3}{4} \times 1\frac{1}{2} \times 50\frac{3}{4}$ "—End-rail back
6	$1 \times 1\frac{3}{8} \times 33$ " pine—Support spacers
2	$\frac{3}{4} \times 1\frac{3}{4} \times 35$ " pine—End-cushion supports
4	$\frac{3}{4} \times 1\frac{3}{4} \times 34\frac{3}{4}$ " pine—Side-cushion supports
2	$\frac{3}{4} \times 1\frac{1}{2} \times 46\frac{3}{8}$ " pine—End bed supports
2	$\frac{3}{4} \times 1\frac{1}{2} \times 85\frac{3}{4}$ " pine—Side bed supports
1	$\frac{3}{4} \times 47\frac{3}{4} \times 85\frac{3}{4}$ " Novaply—Bed
2	$\frac{3}{4} \times 8\frac{1}{4} \times 47\frac{7}{8}$ "—End aprons
2	$\frac{3}{4} \times 8\frac{1}{4} \times 87\frac{7}{8}$ "—Side aprons
6	$\frac{3}{4} \times 6\frac{1}{2} \times 47\frac{7}{8}$ "—Cross members
2	$\frac{1}{32} \times 7\frac{3}{8} \times 52$ "—End laminate
2	$\frac{1}{32} \times 7\frac{3}{8} \times 88$ "—Side laminate
4	$\frac{3}{4} \times 6\frac{1}{2} \times 40\frac{1}{4}$ "—Base
4	$\frac{3}{4} \times 4 \times 8\frac{1}{2}$ "—Bottom pads
4	$\frac{3}{4} \times 4 \times 2$ "—Base ends
4	$\frac{3}{4} \times 4 \times 11\frac{1}{8}$ "—Base diagonals
2	$\frac{3}{4} \times 4 \times 11\frac{7}{8}$ "—Base tops
8	$\frac{3}{4} \times 3\frac{3}{4} \times 31\frac{1}{2}$ "—Uprights
8	$\frac{3}{4} \times 4 \times 23\frac{7}{8}$ "—Upright fillers
4	$\frac{3}{4} \times 1\frac{1}{2} \times 28$ "—Temporary supports
1	$\frac{3}{4} \times 5 \times 58\frac{3}{8}$ "—Stretcher top
1	$\frac{3}{4} \times 3\frac{1}{2} \times 58\frac{3}{8}$ "—Stretcher center
1	$\frac{3}{4} \times 3\frac{1}{2} \times 58\frac{3}{8}$ "—Stretcher bottom
2	$\frac{3}{4} \times 2\frac{1}{8} \times 58\frac{3}{8}$ "—Stretcher sides
18	2" angle brackets—Pockets
18	No. 8 x $\frac{1}{2}$ " rh screws with washers—Brackets
32	No. 8 x $\frac{1}{4}$ " fh screws
32	No. 8 x $\frac{1}{4}$ " rh screws
18	No. 8 x $1\frac{1}{2}$ " rh screws
20	No. 8 x 2" rh screws
18	No. 8 x $2\frac{1}{4}$ " rh screws
28	No. 8 x $3\frac{1}{2}$ " rh screws
20	$\frac{5}{16} \times 1\frac{1}{2}$ " lagscrews with washers

White glue, contact cement, staples, rubber cement

SAVE UP TO 92%



JEEP and Gov't. Surplus Buying Manual (Jeeps Pictured) 75c. Surplus Bargain Catalogue 60c. Both for \$1. Surplus Jeeps, Dept. P1, Box 789, York, Penna. 17405

LICKITY SPLITTER

ENDS WOOD SPLITTING DRUDGERY

New low cost COMPACT MODEL... for farmers, camps, cottagers. 10 ton ram, 2 cycles per min., splits logs 25" x 18". Carried in car trunk, placed upright or hung for storage. For details write: 295 lbs. with gas and oil

PIQUA ENGINEERING, INC., Dept. P, Box 605 Piqua, O. 45356

Build POPULAR MECHANICS' little CARRIAGE HOUSE! Simply great! A back-yard building that isn't an eyesore. Styling blends in with most homes. It will take your mower, lawn furniture and tools—or the kids' overnight guests. Use it as your shop or home office. Overall outside dimensions 10-ft. 4 in. x 12-ft. 4 in. For one complete set of plans send \$3.95 to POPULAR MECHANICS, Dept. FA, Box 1014 Radio City, N.Y. 10019. For two sets of plans (you may need one for your local building department) send \$5.49.

\$30 to \$50 A DAY with TREYCO 6-in-1 Sharpener

- Sharpen
- HAND SAWS
- CIRCULAR SAWS
- CHAIN SAWS
- KNIVES
- PLANER BLADES
- PAPER CUTTERS
- SCISSORS
- PINKING SHEARS
- CLIPPER BLADES
- ROTARY MOWERS
- SKATES

Write for Factory-to-You Prices

Money Back Guarantee

TREYCO Products, Inc. Est. 1945

332-A Niagara St. N. Tonawanda, N.Y. 14120



For 3" to 48" circular saws



GIANT MAGNIFIER

Read the finest print on any map, even in the dark. The giant magnifier enlarges and illuminates by built-in light. Perfect for reading car maps or boating charts. Terrific for stamp and coin collectors, and finding listings in the phone book. Attractive chrome plated handle supplies the power with 2 C batteries. No. 586 Giant Magnifier \$4.95. Brucon Co., 1239 Virginia Ave., Redwood City, Calif. 94061

WEB GUARANTEES IMMEDIATE, LASTING RUPTURE RELIEF



OR YOUR MONEY BACK IN FULL!

Enjoy a stronger, happier life. Wear a Web for strong support and lasting relief of reducible inguinal rupture. If not completely satisfied, return within 30 days for full refund of purchase price.



Write for FREE book on rupture care.

WEB TRUSS

Dept. PM-1 Hagerstown, Md.

HEARING AIDS

UP TO 50% OFF COMPARABLE AIDS *

BUY DIRECT • 20 DAYS FREE TRIAL Body Aids \$39.95 up. Tiny All-in-the-Ear: Behind-the-Ear; Eye Glass Aids. No salesman will call. Write LLOYDS * Dept. PM, 905 9th St., Rockford, Ill. 61108 *

"NU-THRED" FILES

\$3.25 ea.

No. 1 for 11, 12, 13, 14, 16, 18, 20 and 24 T.P.I.

No. 2 for 9, 10, 12, 16, 20, 27, 28 and 32 T.P.I.

Satisfaction Guaranteed Order now! Get Both for \$6 Ppd.

JAW MFG. CO. Box 213. Reading, Pa. 19603

This is the original 8 in 1 rethreader tool. Renews damaged, right or left-hand threads of any diameter fast!

= 8 Metric \$4 ppd.

GRANDFATHER CLOCKS

SAVE 50% BUILD YOUR OWN GRANDFATHER AND GRANDMOTHER WEIGHT DRIVEN CLOCKS

- Highest Quality Imported Movements from Germany
- Tubular or Rod Chimes
- Moving Moon Dials
- Pre-cut Semi-assembled Handcrafted Case Kits (No power tools required)
- Dials, Barometers, Hygrometers, Templates and Case Plans.

All movements and dials in stock. Send 50c for complete catalog

H. DeCOVNICK & SON, P.O. Box 68, Dept. M13 Alamo, Calif. 94507 EST. 1947

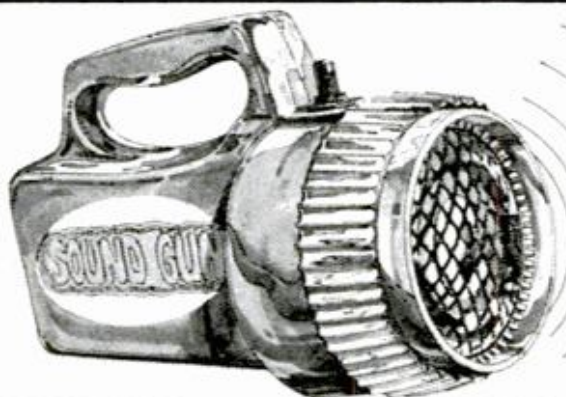

Animal Problems?

Solid State "Sound Gun"

LAWN and GARDEN PROTECTOR

- Effectively discourages all animals from approaching and violating your property.
- Emits flashes of ultra high frequency sound waves.
- Effectively protects an area up to 3,600 square feet.
- Not harmful to animals or humans.
- Solid State Modular construction.

A MUST FOR EVERY HOME OWNER & GARDENER

AS ILLUSTRATED ONLY

\$29.95

HAND HELD PERSONAL DEFENSE UNIT Only \$13.95

SOUND GUN INC. 425 BROADWAY, BUFFALO 14204, N.Y.

PLEASE RUSH ME

- LAWN AND GARDEN "SOUND GUN" \$29.95
- HAND HELD "SOUND GUN" \$13.95
- CHEQUE OR MONEY ORDER ENCLOSED.

SIGNATURE.....
 NAME (PRINT).....
 ADDRESS.....
 CITY.....
 STATE..... ZIP.....

LET RADAR DO THE BRAKING

(Continued from page 101)

in relation to the speed of the controlled car and computes the safe interval distance, then automatically applies brakes or throttle to keep the cars a safe distance apart. The Bendix version includes a fail-safe feature. A calibrated signal is periodically injected into the system by the signal processor. If the system responds erroneously, a warning light tells the driver there's been a failure and the system automatically disconnects.

With Bill Harokopus, manager of electromagnetic systems and technology, as my guide, I took the Bendix car for a trial run on Detroit freeways.

The car starts, handles and stops like any other automobile. The headway control system doesn't cut in until you attain a speed of 20 mph. Harokopus said this was an arbitrary decision and the unit could be adjusted to cut in at any designated speed.

The Bendix test car is equipped with a

It was almost as if the lead car was pulling me along by an invisible chain . . .

speed-control device on which Bendix holds the patent but does not manufacture. Once you attain the desired speed, you press a button mounted on the end of the directional signal lever and the car will maintain that speed until you reset the button. I experimented with the car at various speeds, first at 55 mph, then at 60 and 70 as we pulled out of city traffic into the country.

There are no buttons to push or levers to pull to activate the headway control. It works automatically and indefinitely once you get above 20 mph.

I started out by fixing on a car in the center lane and let the headway control take over. My car remained a consistent five to six lengths behind the lead car without braking or applying pressure to the accelerator. It was almost as if the lead car was pulling me along by an invisible chain, something like the "drafting" effect you get in racing.

I wanted to see what would happen if another car sandwiched in between my car and the lead car, but nobody cut in. I

didn't trust the headway control enough at this point to jump from the center lane behind a faster moving car in the left lane, so I pulled up within a car length or two of a slower moving car in the right-hand (slow) lane and moved over. Keep in mind all this is done without a foot on the brake or gas pedal.

The reaction was instantaneous as I moved from the center lane to the slow right lane. My car slowed down immediately to adjust the distance between the new lead car and my car.

The application of the brakes was very smooth, probably smoother than I would have accomplished by manual control. If you can imagine a giant hand grasping the back bumper to slow the car, that's what it was like.

I tried other maneuvers after this, moving back and forth from the slow lane to the fast lane. The only conscious effort I had to make was to kick down on the accelerator when I wanted to fix on a faster car.

On the return trip, there was a point where the speed limit drops from 70 to 55 mph. The lead car I was fixed on continued to go 70 and our car followed at the same speed. "You have to watch that," Bill Harokopus cautioned, "because you can get a ticket by assuming the guy ahead of you is observing the speed limit."

We got off the freeway at one point and were loping along on a side road at 30 to 35 mph behind a slow-moving lead car. A truck waiting at a crossroad gunned it and scooted directly across the road, between the lead car and my car. I hit the brakes. It wasn't a panic stop. Just moderately fast. I asked Harokopus what would have happened if I hadn't applied the brakes.

"In that situation, you would have hit the truck, because there wasn't enough time for the system to make the proper adjustment in spacing."

Ironically, with speed control, headway control and robot braking, there isn't much for the driver to do. "And that's the problem we're working on now," Harokopus acknowledged. "We've almost made driving too easy, so the driver isn't as attentive as he should be. We're going to run some studies to see what we can do to give him the benefits of these developments while making him a more attentive driver." ★★ ★

FM KITS

(Continued from page 168)

Heath's STEREO/HIGH-BLEND/MONO control were out on the front panel, like the Dyna's, instead of buried behind a trapdoor with the preprogram card slots and the other seldom-used controls. Also behind the trapdoor are the SIGNAL-MULTIPATH selector for the meter and a test button that lights all display segments at once.

But the Dyna has a few tricks up its own sleeve. Add a power amplifier, and you have a complete FM stereo system for less than an integrated amp and tuner would cost. And the FM-5's auxiliary input lets you add tape to your system, too—or phono, if you build in the \$30 PPM-5 phono preamp module.

The FM-5 has a TAPE output, too, which can be used for rear-channel outputs, should a four-channel broadcast system eventually require it (the Heath has holes for future outputs). Both Heath and Dyna feel they've left enough extra space and reserve power supply capacity to accommodate any adapters you may need.

The Heath requires a \$35 wood cabinet, unless you're going to panel-mount it. The Dyna, which looks fine in its standard, vinyl-clad metal case, also has a wood cabinet available, for \$18.

Specifications for the tuners are quite close: IHF sensitivity (the minimum signal for which the tuner can deliver a 30 db signal-to-noise ratio—unlistenable noisy) is 1.75 microvolts for the Dyna, "under 1.8 μV " for the Heath. More important, the Dyna delivers 40-db S/N with 2 μV of input, the Heath with 2.3; and for a reasonably quiet 50-db ratio, the Dyna takes only 5.0 μV , the Heath a mere 3.6 μV .

Both tuners have capture ratios of 1.5 db, to discriminate against co-channel interference. Both have very low distortion, too (0.25-0.5 percent in mono, 0.5-0.9 percent in stereo for the Dyna; 0.4 percent and less than 0.5 percent respectively for the Heath), and are equally quiet, at an ultimate 65 db. Selectivity is high, too: alternate-channel signals are down 65 db in the Dyna, 95 db in the Heath.

Of the two, the Heath emerges as the super-tuner, especially in difficult reception areas. But the Dyna is the more convenient, and a bigger bargain, too. Dyna is at 3060 Jefferson St., Philadelphia, Pa. 19121; Heath is in Benton Harbor, Mich. 49022.

JANUARY 1973

BELSAW PLANER • MOLDER • SAW

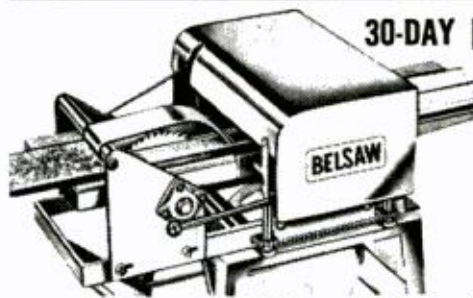

30-DAY FREE Trial!

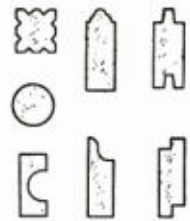

Now you can use this ONE power-feed shop to turn rough lumber into moldings, trim, flooring, furniture...ALL popular patterns. RIP...PLANE...MOLD—separately or all at once with a single motor. Free 30-Day Trial. Low Cost—only \$35 down.

Send Postcard Today—No Salesman Will Call.

BELSAW POWER TOOLS, 903J, Field Bldg., Kansas City, Mo. 64111

\$1 Puts you in Business!



COSTUME JEWELRY

Exquisite pin and earrings! Makes for \$1.00! Sells for \$4.00! PROFIT \$3.00! It's that easy to earn big money, spare time at home with costume jewelry. Rush \$1.00 for kit and exciting details. DON BAR COMPANY, Dept. A193, 2934 W. Fullerton Ave., Chicago, Ill. 60647



MASONS!

Send today for free catalog of Masonic & Eastern Star books and rituals

EZRA A. COOK PUBLICATIONS, INC.

P.O. BOX 796, DEPT. A-119, CHICAGO 60690



20 WOOD SAMPLES with woodworkers Catalog

ENJOY woodworking more! Let Constantine's big picture-packed Catalog-Manual help you build new furniture — refinish, restore beat-up cabinets, chairs, chests, tables, etc. Find instantly whatever you need. Buy at money-saving prices from world's largest catalog source for imported and domestic woods. Cabinet lumber, carving blocks, veneers, plywood, pipe briar, inlays and more!

Newest Catalog features new tools, materials, shop devices. Fabulous all-purpose clear finish. Glue that needs no clamps. Inlay picture kits, 99c. Needed products found nowhere else. Plus wood-working instructions, plans, patterns!

Catalog & Wood Samples Only \$1
Dollar Fully Refunded on First Order

Accept this offer to own fascinating set of 20 2x4 specimens of world's glamorous veneers — Rosewood, Satinwood, Lacewood, Teak, etc! Compare! Then instantly identify finest woods wherever you go. Send only \$1 for Wood Samples and Woodworkers Catalog. Dollar refunded on first order.

CONSTANTINE

2051 Eastchester Rd., Bronx, N.Y. 10461

Enclosed \$1 for Wood Samples & Woodworkers Catalog. (\$1 refunded)

Catalog only 50c



2,000

PRODUCTS FOR SHOP & HOME
Woods — Veneers — Finishes
Furn. Hardware — Lamp Parts
Cane — Upholstery — Tools
Picture Molding — Clock Kits

FREE WITH CATALOG
"101 PROJECT IDEAS"



Name _____

Address _____

Zip _____

VEGA CARBURETOR ADJUSTMENT

(Continued from page 133)

PART 10

See Table (1) to identify rpm specifications for your car.

A Vehicle Emission Control Information specification sticker (2) is mounted in the engine compartment. If the specifications on the sticker (2) are different from those in Table (1), use the specifications as called out on the sticker.

1. Turn on airconditioner, if installed.
2. Adjust carburetor speed screw (5, 6) to specified rpm.
3. Connect solenoid quick disconnect (3, 7). Press accelerator pedal down once.
4. Adjust $\frac{3}{8}$ -inch solenoid nut (4, 8) to specified rpm.

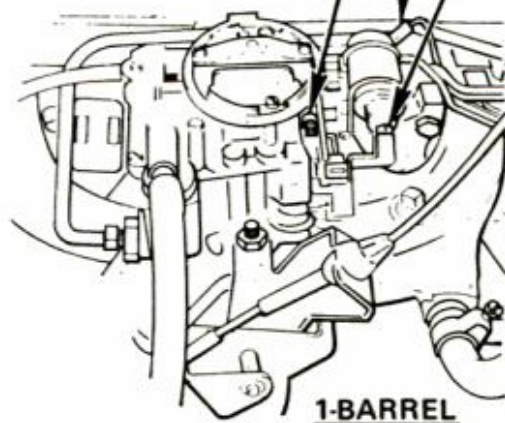
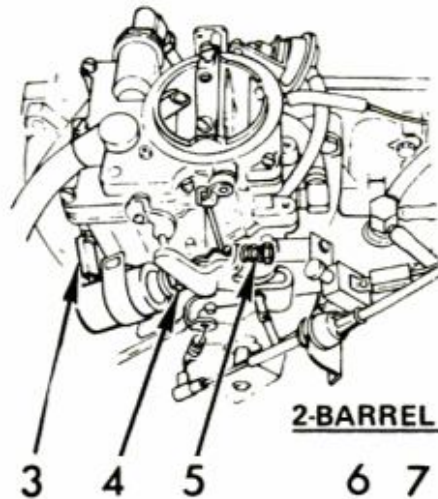
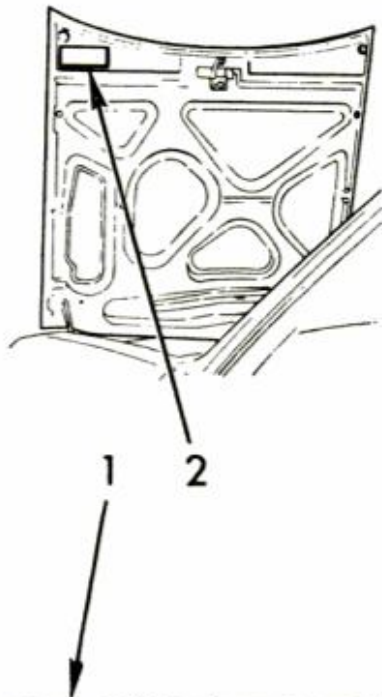

	1-BARREL		2-BARREL	
	Manual	Powerglide Torque Drive	Manual	Powerglide Torque Drive
Solenoid RPM	850	650 ^a	1200	650 ^a
Carb Speed Screw RPM	700	550 ^a	700	550 ^a

^aAutomatic transmission in gear, wheels blocked, emergency brake on

PART 11

1. Turn off airconditioner, if installed. Stop engine.
2. Connect fuel tank hose (5) to canister (4) by loosening clamp (6).
3. Remove pencil from vacuum hose (2). Connect

- hose to distributor (1).
4. Disconnect tachometer.
5. Install washer and $\frac{7}{16}$ -inch bolt (3).

ADJUST ENDS HERE

★★★

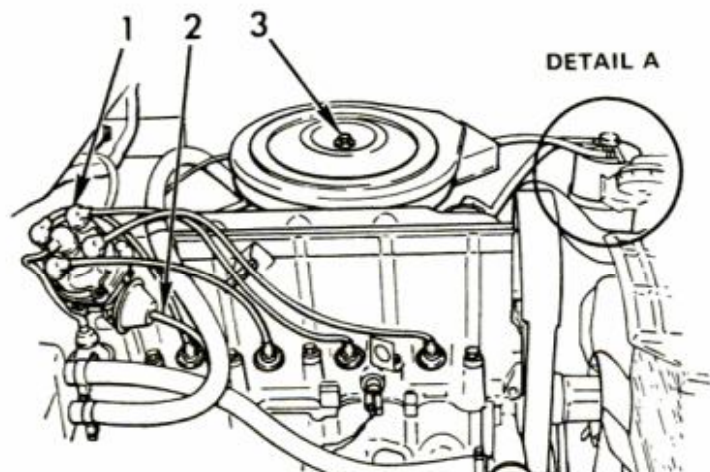
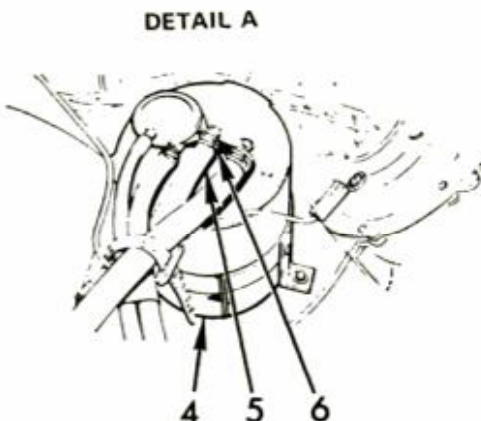

Announcing— The Popular Mechanics Index and Shelf Wrapper

Here's a great idea that will multiply the value of your back issues of PM. Reserve your copy now!



Want to find an article on 17 ways to thiefproof your car? How to build a colonial footstool? The latest bicycle touring gear? How to remodel your bath, or how to take the high cost out of hi-fi?

Your copies of *PM* are chock-full of such information. *PM* publishes literally thousands of ideas and items each year. Sometimes, though, it can be frustrating to find an exact article that you recall appeared several months ago.

The new *PM Index and Shelf Wrapper* solves that problem. Each of those thousands of items which appears in *PM* throughout the year is not only referenced, but thoroughly cross-referenced as well. You can find *any* article you want in seconds! Or you can find *all* the articles on broad categories such as auto repair, electrical wiring, plumbing, photography and other subjects at a glance!

Best of all, the *Index* is bound into a handsome wrapper made of heavy board. The wrapper precisely encloses the 12 issues which are cross-referenced in the *Index*, and makes a beautiful and useful addition to your bookshelves.

Reserve *now* your copy of the 1972 *Index and Shelf Wrapper* listing and cross-listing all *PM* articles published throughout 1972. We'll rush it to you just as soon as it becomes available in December.

The entire handsome package—*Index and Shelf Wrapper*—is yours for only \$1.49. Write for your copy today!

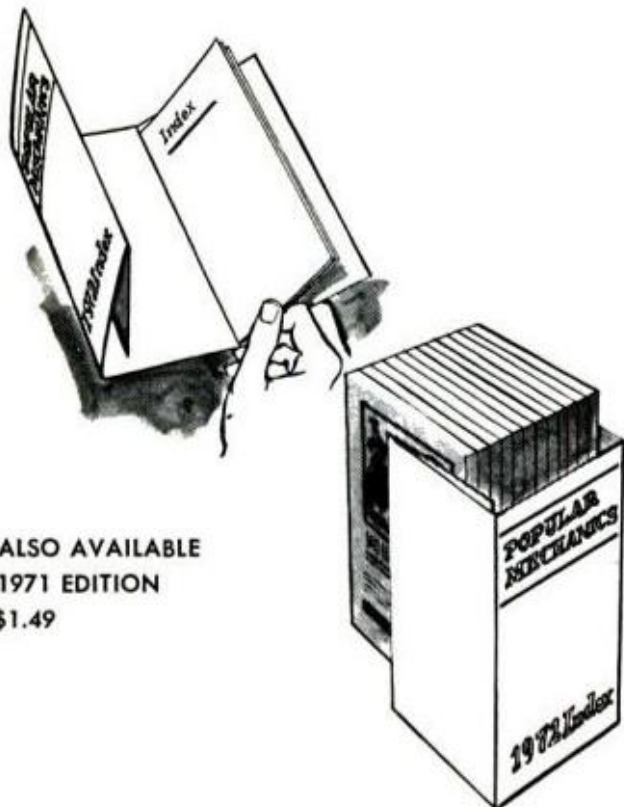

ALSO AVAILABLE
1971 EDITION
\$1.49

Popular Mechanics, Dept. PMIU,
Box 1014, Radio City,
New York, N.Y. 10019
Rush me, just as soon as it
becomes available, a copy of the
PM Index and Shelf Wrapper.
I enclose check or money order
for \$1.49.

NAME _____
ADDRESS _____
CITY _____ STATE _____ ZIP _____

OPERATE YOUR OWN BUSINESS...

in Profitable Service Field

Be your own boss, regardless of age, in a highly profitable service business. Every manufacturer, carpenter, handyman, and hardware store in your town can be your customer. A steady year-round business. We help you set up your own business and will finance you.

Factory Training School

Complete instruction-packed 5 day course in the factory teaches you all about famous Foley sharpening equipment. Proven program and 40 years' experience assures you of success.

For further information and booklet write:

FOLEY SAW and TOOL MAINTENANCE SCHOOL

Dept. 143-3 • 3300 N. E. 5th Street
Minneapolis, Minnesota 55418



FREE BOOKLET

Get the complete facts about this new training school in fact-filled booklet — Write today!



See New York
"MR. PERFECT PHYSIQUE"

Yes! Now you can gain weight, muscle-up all over. No gimmicks or gadgets. Just a brand new scientific body-building principle that packs on pounds of healthy body weight, slims flabby waistlines and gives you a brand new appearance. Add powerful muscles to your arms, chest, shoulders and legs. Send 25¢ coin to cover postage and handling costs, for FREE easy-to-follow plan.

now you can GAIN WEIGHT!

ABSOLUTELY FREE! MUSCLE-BUILDING INFORMATION write
HERCULES II[®], Dept. 15825
P.O. Box 89, Caledon East,
Ontario, Canada.

FREE!

NAME _____ AGE _____
PLEASE PRINT
ADDRESS _____
STATE _____ ZIP _____

In England: Post Commerce, 24 Princes Road, London W11.



BUILD THESE BEAUTIFUL CLOCKS

NOW AT BIG SAVINGS!

Send just \$1 for plans & instructions to build choice of: (A) Grandfather, (B) Steeple, (C) Grandmother—plus information-packed catalog of movements, dials, parts & kits to build these & 16 other fine clocks. All 3 plans—\$2.50. Catalog alone—25¢.

MASON & SULLIVAN COMPANY
Dept. PM, Osterville, Mass. 02655



NUMBER-GUESSING GAME

(Continued from page 136)

battery-holder posts, and for the posts which hold the poker chips. Glue the top to the center assembly, but wait until the game is completely wired before gluing the bottom.

You'll need eight double-pole, double-throw (d.p.d.t.), four single-pole, double-throw (s.p.d.t.) and four single-pole, single-throw (s.p.s.t.) switches, plus one momentary pushbutton switch and 16 miniature pilot lights (4 green and 12 red). All can be purchased at Radio Shack stores. The Philmore battery holder costs 52 cents. The lights come in packages of three (two red and one green) and sell for \$1.19 per package. The 16 toggle switches cost about \$3.65.

Tiny screws ($\frac{3}{8}$ -in. x $\frac{6}{32}$) hold the switches and lights in place. The battery holder for four C-cells is attached to the dowel posts fastened to the underside of the top. Use 20-ga., plastic-covered wire, and solder all connections. Study the wiring diagram carefully before you start. ★★★



"I've never had such a handy tool organizer!"
"Helps me decide the next tool to buy."

PM PICTURE TOOL KIT

\$3.95

POSTPAID

That's the kind of feedback we get from readers who have bought the PM PICTURE-TOOL KIT. PM PICTURE-TOOLS are a great new idea to take the confusion out of what goes where in your shop. They are beautiful die-cut drawings of the 74 most-used hand and portable power tools. You just peel the drawings from their backing and press them into place on any painted or unpainted surface—even perforated hardboard. A glance tells you when a tool is missing. The kit also contains a big, colored sheet of matching adhesive-backed paper so you can cut silhouettes of any special tools you may have. See how dramatically PICTURE-TOOLS enhance the appearance of your shop!

POPULAR MECHANICS Dept. PT
Box 1014, Radio City, N.Y., N.Y. 10019
Enclosed is my check (or M.O.) for \$3.95.
Please rush my PM PICTURE-TOOL KIT to:

Name _____
Address _____
City/State _____ Zip _____

POPULAR MECHANICS

ROUTER KNOW-HOW

(Continued from page 143)

the manual packed with your template.

Template routing

Template guides are available in various sizes. A typical one is shown at the top of page 141. The B dimension of the guide must be less than the thickness of the template you are using or the router will not sit flat on the template. The i.d. of the guide (A) should be slightly larger than the diameter of the router bit to assure clearance. Work being cut will vary in size, by the distance between the cutting edge of the bit and the o.d. of the guide (C). Be sure to allow for this offset when cutting your template (master pattern).

To make the cut, clamp the template to the piece to be routed. With a straight bit in the router, plunge the spinning cutter into the work until the router base is flat on the template. Then, follow the pattern, making certain that the template guide is *always in contact with the pattern*. Since there is no wear and tear, the template can be saved for future use.

Freehand routing

Once you've gained experience and confidence, you'll find the router an extremely efficient shaping and carving tool when used freehand. It can be used to turn out decorative items, lettered signs and the like in minimum time. Remember that the deeper the depth of cut, the slower the rate of feed (there's more resistance to your movements).

You can rout out the design proper as illustrated in the photo on page 142 or raise the design by routing out the background. Frequently, in freehand routing it is a must to affix a long board to the router base so that the router will straddle the routed-out sections in the work. Simply cut the board to desired length, drill two holes to suit the router shoe and countersink them for screws.

Drop-leaf table joint

A cove bit is used to make the concave cut on the table leaf; a rounding-over bit—of the same radius properly extended—makes the cut in the tabletop. Use a core-box bit for the barrel hinge mortise; its location must be precise. This is a tricky joint, so first test on scrap before routing the work. ★★★

GOVT. SURPLUS
and other bargains
SAVE to 90%



Send for this catalog

The world-famous Airborne Catalog. Fully illustrated. Contains 1000's of bargains in hydraulics, electrical, marine, automotive & hardware items... and more! A must for mechanics, machinists, hobbyists, sportsmen, inventors, etc. Send 35¢ to cover postage & handling. In a hurry? Send \$1 for airmail delivery. Must include zip.

AIRBORNE SALES CO. Dept. PM73
8501 Steller Dr., Box 2727, Culver City, Ca. 90230
Satisfying world-wide customers since 1945

INSTALL ALARM SYSTEMS

Beginners Make Big Money — Your Own Boss

New plan opens multi-million dollar burglar fire alarm business to small home operators. Guides beginners step by step.

Starts you full or spare time without previous experience or big investment. See how to cash in on invisible web of protection that stops crooks cold, makes big profits. No salesman will call. Write for free details!

NASCO, 6100 Variel Avenue, Dept. G2251, Woodland Hills, Calif. 91364



HEAVY DUTY WELDER

with special \$7.00 gift offer to

Popular Mechanics readers

10-DAY FREE TRIAL

Lifetime Guarantee

Brand New 18⁹⁵

Model POST PAID

Fits ordinary 110V outlet

Not one • but 6 welding heats



Weld, braze, solder or cut most anything made of metal. No experience necessary. Follow simple instructions to make repairs on cars, trailers, farm and lawn equipment, bicycles, appliances, etc. Make campers, boats, furniture, hundreds of valuable items. **NOTHING ELSE TO BUY!** Comes complete with full face shield, pack of welding and brazing rods, heavy duty power cables, special electric torch attachment, ground clamp, flux, easy-to-follow illustrated instructions, rod holder, etc. Uses standard 1/8" rods to weld iron, steel, brass, bronze, aluminum, other metals. New improved HEAVY DUTY circuit gives more welding power. Gives 4 times the heat needed to melt toughest iron. Plugs into ordinary 110V outlet. 6 WELDING HEATS plus continuously variable carbon-arc heat regulation control lets you weld anything from "tough" jobs to light-weight metals with ease. This important feature saves you money and time. Makes it possible for even beginners to start welding professionally the very first day. Pays for itself quickly. An excellent gift for any occasion. **IT'S AUTOMATIC:** Current is turned ON when arc is struck, OFF when rod is lifted from work. Eliminates need for troublesome foot switch. Speeds up work.

FREE! Mention that you saw this ad in Popular Mechanics and receive a \$7.00 gift pack assortment of "touch weld" welding rods. Automatic arc striker. Weld with "push button" ease. Lifetime guarantee.

10 day MONEY BACK GUARANTEE. You must be satisfied or return for refund. Send only \$2.00 and pay postman \$16.95 plus postage when delivered or send \$18.95 cash, check or money order for immediate postpaid shipment.

WEL-DEX MFG. CO., Dept. W-203, Box 10776, Houston, Texas 77018



Print For Profit

Cards, Stationery, Envelopes, Advertising, labels, tickets, announcements, Q.S.L. cards, greeting, sympathy, prayer cards, tags, etc. Good Profits. Pays for itself in a short time.

Own a Printing Business

We supply everything direct from factory only. Easily followed rules. Also raised printing like engraving. Have home shop. Add to income. Send 25¢ for catalogue. **KELSEY PRESSES Meriden, Conn. 06450**

MAIL THIS COUPON TODAY!

KELSEY PRESSES, DEPT. 73-D, Meriden, Conn. 06450

I enclose 25¢ send big catalog and samples.

Name _____

Address _____

City _____ State _____ Zip _____

VERSATILE SABRE SAW

(Continued from page 151)

more suitable for metalwork. Even the slowest speed of some multispeed sabre saws is really too fast for heavy-duty hacksawing because even top-quality, metal-cutting blades dull rapidly when used at more than 1500 strokes per minute. Slow speed is also useful for power-filing.

● **Saw-bar action.** In most portable sabre saws the blade travels straight up and down. A mechanism in some models rocks the blade slightly as it reciprocates, giving an orbital cutting action. Orbiting, the blade bites into the work on the upstroke and clears on the downstroke. This provides better chip clearance.

In an industrial-model saw designed for fastest possible cutting, orbital action is a significant advantage. For a saw used in a home shop, it's less important. Orbital saws are more complex mechanically and higher priced, and in home shopwork the added cutting speed is hardly worth the extra cost. Besides, you can have similar fast-cutting action with a straight-line saw by using a canted blade (angled or curved slightly forward).

Smooth saw-bar action, however, is important, since a well-counterbalanced saw is much more comfortable to use than one that vibrates excessively. To check the balance of a saw you're considering, switch the tool on and feel the action.

● **Metal or plastic casing?** Some saws have die-cast aluminum casings; others have casings of injection-molded ABS plastic. Even though the new plastics used by toolmakers are remarkably tough and stable, a metal case makes a longer lasting tool. But any portable electric tool with a metal case should be grounded electrically to protect the operator in the event the tool should short, and this means a three-wire cable with a three-prong plug.

If your shop area is properly wired with grounded receptacles, a metal-cased sabre saw is undoubtedly preferable. But if you'll be plugging into ungrounded outlets, a double-insulated plastic-cased saw is safer. Too, a plastic-cased tool is somewhat quieter.

Some manufacturers compromise, using a metal motor casing with a plastic handle—a combination used for many industrial saws. This makes the tool safe, yet satis-

fies anyone who still feels prejudice against plastic tools.

● **Tilt or no tilt?** Several sabre-saw models, light or heavy-duty, are available with a tilting or fixed base shoe. While a tilting shoe can be a convenience, it's a feature you'll seldom use. Sabre-sawing bevels isn't especially common.

Depending on saw design, a fixed shoe may be preferable. A nontilting shoe is more solid and lowers the saw's profile. A low-handled sabre saw is easier to guide than a high-handled one.

● **Selecting blades.** Since the blades do the cutting, it pays to buy quality ones. An inexpensive saw with a fine blade will give better performance than a more expensive saw with a cheap blade.

Many specialty blades are available for portable sabre saws, but three kinds handle most work: alternate-set blades, taper-ground blades and wave-set metal-cutting blades.

Alternate-set blades, with teeth swaged alternately right and left, are general-purpose blades used for rough cutting. Blades with six teeth per inch are suitable for stock more than 1 in. thick; blades with 10 teeth per inch are preferable for wood less than 1 in. thick. Alloy-steel blades stay sharp longer than carbon steel blades.

Taper-ground blades are something like hollow-ground circular saw blades. Their back edges are ground thinner than their front edges. They cut narrower kerfs than set blades and are more difficult to turn. They do make beautiful finish cuts in hardwood.

Wave-set, metal-cutting blades, though thicker, are much like hand hacksaw blades. Liberal use of cutting oil when hacksawing steel prolongs their life.

While most sabre saws use blades with standard-pattern shanks, Rockwell, Bosch and a few other makes have improved-design chucks using special blades. They grip the blade more securely, but limit your choice of blades to those supplied by the manufacturer.

In all, it's well worth shopping around before you buy a sabre saw. Look at industrial-model tools sold through industrial supply firms as well as home-shop saws sold through hardware stores. Get the best model you can afford, for your sabre saw will be one shop tool you'll use most.

★★★

AIR CAR FOR KIDS

- BUILD IT YOURSELF FOR LESS THAN \$10.00 out of household items.
- Build it in less than one hour with common hand tools
- Operates on any hosed vacuum cleaner
- Glides across any smooth surface
- Can carry over 200 pounds
- Same principle used in real air-cushioned vehicles
- Great father-son project • Great gift



SEND FOR PLANS • HOURS & HOURS OF FUN

Illustrated step-by-step, easy to follow, easy to build. FOR PLANS—send only \$3.00 cash or money order, plus self-addressed, stamped envelope to:

VALE ENTERPRISES, P.O. Box 98155 Des. Br., Seattle Washington 98188



UPHOLSTERING AND DECORATING FOR PROFIT!

Men & Women All Ages!

At home, we show you how, incl. tools, kits to make and sell. Accredited NHSC. Approved Veteran Training. No salesmen. Creative Upholstery & Decorating School Div. Technical Home Study Schools, Dpt. 5110-013, Little Falls, N. J. 07424

At Last a New Amazingly Simple

GAS TURBINE JET ENGINE



Build from easy to follow plans. Length 15", Dia. 8 1/2", Wt. 15 lbs. Fuel: Gasoline or Kero.

"Screamin Demon" develops 20 H.P. Ideal project for serious-minded hobbyists, students; scientific and industrial arts classes. Make on 9" metal cutting lathe with milling attachment. For use on small racing boats, midget cars, etc. Full size assembly drawings with critical dimensions, bill of materials and photos. Price \$5.00. No C.O.D. SAVOY SCIENTIFIC, BOX 1398, SANTA MONICA, CALIF. 90406

ELECTRIC ARC WELDER \$11.99

\$18.95 VALUE!—NOW ON SALE! WELDS—BRAZES—SOLDERS—CUTS—MOST METALS! Plugs into ANY 110 volt socket. MAKE—REPAIR MOST ANYTHING FOR CAR—HOME—BUSINESS. Lifetime BURNOUT GUARANTEE 10 day money back trial (if retnd).



HEAVY DUTY MADE! No experience needed—FREE WELDING INSTRUCTIONS! SEND ONLY \$2.00 (cash, ck, M.O.) and pay postman \$9.99 COD postage or send \$11.99 plus \$1.00 postage for paid del. in U.S.A.! COMPLETE READY TO USE—Includes BIG pack Steel, Brazing, Solder, Carbon "touch" rods and ELECTROFLAME ARC TORCH! BEST EVER MADE! OFFER LIMITED—Order TODAY! MIDWAY WELDER Dept. FPM-1 Kearney, Nebr. 68847

Use Zip Codes When Answering Ads

POWER HACKSAW KIT ONLY \$24.95



Also 51 other money-saving projects to be built in the home workshop. Lathes, drill presses, vises, etc. Send 50¢ for 28 pg. Catalog.

C. F. STRUCK CORP., Dept. PIP3, Cedarburg, Wis. 53012



5 DAY HOME TRIAL

DISCOUNT BREAKTHROUGH ON ACCORDIONS

SAVE 1/2 OFF retail prices of comparable accordions. Buy direct from world's largest dealer. Over 40 models for Student, Teacher, Professional. Electronic, Standard & Button Models—Amplifiers too! All Big Names. Try before you buy. Free accessories. E-Z Terms. Trades. Lifetime Performance Policy. FREE Color Catalogs/Discount price list. Rush coupon.

FREE Color Catalog

Discount Prices 42 Models

Accordion Corp. of America—Dept. R18 5535 W. Belmont Ave., Chicago, Ill. 60641

Send FREE accordion catalogs and discount prices. Include special information checked:

Accordion Amplifiers Button Accordions

Name _____

Address _____

City _____ State _____ Zip _____

BIG MONEY

- LIGHTNING TECHNOLOGY
- GET IN ON GROUND FLOOR
- BE YOUR OWN BOSS
- LEARN AT HOME

WRITE:

Lightning Protection Institute School
122 W. Washington Ave.
Madison, Wis. 53703

No obligation.

WHAT'S HE DOING?

Making a Concrete Flower Pot! . . . and SO CAN YOU!



Make and sell your own Ornamental Concrete items. Rush \$3.00 for Book about Aluminum Molds with prices and production trade secrets direct from world's largest mold manufacturer. Over 350 designs to select from.

Send \$3.00 CONCRETE MACHINERY COMPANY Today To > P. O. BOX A99 - HICKORY, N. C. 28601

SUPER TRAIL GRABBER



With its BIG 12" wide rear tire and husky 7H.P. engine, the Heald VT-7 Super Bronc GRABS the trail! It features a load sensing torque converter;

9" ground clearance; welded steel front and bottom engine skid plate; large, contoured, shock-mounted seat; telescoping front shocks; folding foot pegs; and chrome fenders.

Super Bronc features savings too — up to \$160 over a pre-assembled bike. Semi-kit assembles in 6 hours with standard tools.

Power, performance, ride, appearance — Heald VT-7 is the SUPER TRAIL GRABBER. Kits from \$169.95. Super Bronc from \$269.95. For FREE color brochure with more information, write:

Heald, Inc.

Dept. PM-1, P.O. Box 1148, Benton Harbor, Mi. 49022

CLASSIFIED ADVERTISEMENTS

Rate: \$2.20 per word payable in advance each insertion. Capitalized words—75¢ per word additional. Minimum insertion ten words. To be inserted under the proper classification, copy must be in our office by the 10th of the second month preceding date of issue. The next available issue to place an advertisement in America's No. 1. Classified Section is March. The closing date is January 10th. Send remittance and order to H. E. Kappel, Popular Mechanics, 224 West 57th Street, New York, New York 10019. Please make remittance payable to Popular Mechanics.

WHEN ANSWERING ADVERTISEMENTS PLEASE USE THE ZIP CODE NUMBER

AUTOMOBILES

WANTED To Buy: Old Automotive Literature. David Ficken, Box 11, Babylon, New York 11702.

NEW! PREVENT DEAD CAR BATTERIES! Solid State Monitor buzzes when ignition key turned off and headlights left burning. Free Information! Dealers Samples \$4.95. York House, Box 1006-M, La Habra, Calif. 90631.

PROTECTION! Most cars can become own burglar alarm. Easy, Dependable, Inexpensive. Detailed instructions—\$1.00, self-addressed, stamped envelope. Box 394, Bergenfield, N.J. 07621.

"TEK-GARD" Protects Automobiles, People or Homes From Theft. Mail \$1.00 Today. Avison Company, Box 18210, Cleveland, Ohio 44118.

WANTED, Showroom Catalogs, Owners Manuals for all Pre-1960 Automobiles. Roy Vaughn, Anton, Colorado 80801.

REVOLUTIONARY BATTERY ADDITIVE developed by **AUTO ELECTROLITE ENGINEERS** GUARANTEES BATTERY FOR LIFE OF CAR! **INDUSTRIAL BREAKTHROUGH—"COBALT BLUE"**—means **BETTER BATTERY PERFORMANCE**. Only \$3.25. Send Immediately! **ATLANCO**, 928 Hawkins Avenue, Lake Grove, N.Y. 11755.

40%-60% Automotive Savings. Nationwide, Free Brochure, CRA/NASCO, Box 262, Dallas, Texas 75221.

AUTOMOBILE SIXTY SECOND TIRE FIX. NO TOOLS—NO JACK-DEALERS INVITED. SAMPLE, DETAILS, PPD. \$3.98—WARNE, 6922 CONGRESS, DETROIT, MICHIGAN—48207.

AUTO SUPPLIES AND EQUIPMENT

ALTERNATOR BRAND NEW 60 AMP. Fits All American Cars, Trucks. 6 Months Warranty. \$37.00 Postpaid. Boystrom, 200-11 Burnett, Morgan Hill, Calif. 95037.

REPAIR Automatic Gasoline Shut-Off Nozzles—Details Free—Vass, Box 102, Tamiami Station, Miami, Florida 33144.

PARTS: Army jeep and truck parts. Spare Parts & Equipment Co., P.O. Box 751, Lexington, Kentucky 40502.

ALTERNATOR/Generator Rebuilder's Course; includes Tooling & Test Equipment; Write: Hedelund Engineering, P.O. Box 2127, Sepulveda, California 91343.

RING-Valve Job while driving, \$6.50 postpaid. (Two-\$12.00). . . . Established 1951. . . . Results Guaranteed!! Motaloy, Grantham, Penna. 17027.

NOVEL Inexpensive Glowing Gage Continuously Checks Ignition Performance. **QARC**, Box 47876, Los Angeles, Calif. 90047.

WIN Over thieves! Auto Guard Electronic Protector foils theft. \$6.95. **HEG** Sales Company, 1892 Queens Way, PM173, Chamblee, Georgia 30341.

\$1.00 BALANCES 4 Car wheels perfectly. Instructions \$2.98. Fletcher—906M Lindale—Richardson, Texas 75080.

MOTALOY—Ring-Valve Job While Driving. \$6.00. Guaranteed. Free Information. James Bryant—2133 Arcadia Place—Jacksonville, Florida 32207.

HYDRAULIC Jack repair kits, parts and supplies. Catalog 50¢ (in coin). Hydraulic Jack Packing & Tool Co. Inc., General P.O. Box 3, Staten Island, N.Y. 10314.

RING-VALVE JOB While You Drive!!! Fully Guaranteed \$6.00 . . . Two \$11.00 . . . Motaloy, Box 1149-MI, Midland, Texas 79701.

MOTALOY, Ring—Valve job while driving—\$6.00. Free literature. **E&G** Sales, Box 18384-P, Memphis, Tenn. 38118.

TOW TRUCK Build Your Own 5 Ton Winch Telescopic Boom. Only \$25.00 for a Complete Set of Drawings. 10 Day Free Examination, or Order a Complete Kit for \$1,495.00 F.O.B. Siegel Engineering Company, 4507 South Lake Drive, Cudahy, Wisconsin 53110.

SAVE Money, End Expensive Auto Repairs. You do the job yourself. Nationally—Known Auto Expert Shows you How Easy it can be. Send \$2.25 To: **DUTCH-WAY ENTERPRISES**, 1155 East 35th Street, Suite A—20, Dept.—AC, Brooklyn, New York 11210.

SNOWMOBILES

YOUR AD IN POPULAR MECHANICS WILL BE SEEN By More than 5,000,000 active buyers for your products and services. It costs only \$2.00 per word. And, if you wish to run all or part of your ad in bold capital letters—you can do so for as little as 75¢ per word additional. Act now! Send your Classified ad to: **POPULAR MECHANICS, CLASS. DEPT., 224 WEST 57th STREET, NEW YORK, N. Y. 10019.**

AUTO TRAILERS

PICKUP, CAMPER OWNERS. Change flats fast, easy with new kit. Details **FREE**. Homecraft, 10276 Tams Drive, Baton Rouge, Louisiana 70815.

MOTORCYCLES, BICYCLES MOTORSCOOTERS & SUPPLIES

BUILD "Popular Mechanics" **MINIBIKE** Featured June 1967. Detail plans, photographs, illustrated parts catalog \$2.00 refundable or catalog 25¢. Gilliom Minibike, St. Charles, Missouri 63301.

ILLUSTRATED Catalog 25¢. Parts And Accessories, Custom And Stock, For Most Makes And Models. Motorcycle Supply, Box 159M, Fairbury, Ill. 61739.

HONDA! \$25 Other Bargains. Send 50¢. Motorscooter, P443, Bend, Oregon 97701.

BOLT-ON TORQUE CONVERTER Makes out-dated, out-classed, mini-bikes competitive, mean machines. More Low end muscle—more high end hustle. Fits B&S, Tecumseh, most engines. 35 minute installations. \$34.95 ppd. No C.O.D. Information + decal 25¢. **MAX-TORQUE**, Inc. 7300 Monticello, Skokie, Illinois 60076.

DISCOUNT Harley Parts. Details \$1.00. HD Supply, 5603 West National, Milwaukee Wisconsin 53214.

KIDS Look E-Z-Build **GO-KART** Plans & Instructions \$1.00. E.J. Sales, Box PM84, Centerline, Michigan 48015.

MOTORBIKES. Sno-Karts. Wholesale. Catalog 25¢. Lorencio, 1014 May, Danville, Illinois 61832.

SPACE, ROCKETS AND ASTRONAUTS

ROCKETRY!!! 2,600 Feet Altitudes! Free Catalog—Kits, Parts, Motors, Accessories! Technical Information. Centuri Rockets—Box 1988—Phoenix, Arizona—85001.

ROCKETS: Real flying models—flights up to 2500 ft. New illustrated catalog 25¢. Single and multistage kits, cones, engines, launchers, trackers, rocket aerial cameras, technical information. Fast service. Estes Industries, Dept. 7ES, Penrose, Colorado 81240.

ANTIGRAVITY DEVICE. Brochure rushed free. AGD, Box 3062 PM, Bartlesville, Oklahoma 74003.

FREE. Flying **MODEL ROCKET** Kit. Act Now. Offer Limited. Send 25¢ for Packet of Iron-ons, Decals, Literature and "Free Rocket" Details. Aerospace Vehicles, Inc., Mineral Point, Wisconsin 53565.



AVIATION

DELTA ROGALLO PLAN, Kite Hang—Glider, **SELF—SOAR ASSOCIATION**, Ask for "E—2", Send \$5.00. Membership includes #13-24 **LOW & SLOW**, \$6.00; or #1-24, \$12.00; information \$1.00. Self—Soar Association, 59 Dudley, Venice, California 90291.

AIRBOAT, Propellers, Engines, Hubs, Mounts, Plans, Supplies. Corvair, V-W conversions. 15, 20, 25 H.P. removeable air drives. Kit airboats \$450.00 up. Hovercraft engines, hubs, propellers. Gyrocopter propellers. Catalog \$1.00. Banks-Maxwell, Box 3301E, Ft. Worth, Texas 76105.

AVIATION Surplus Big Bargain Catalogue 60¢. Box 52PM4, Thomasville, Penna. 17364.

ALL About Ballooning. Handbook \$3.00. Aerostation, Box 141, Long Sault, Ontario, Canada. KOC 1PO.

(Continued on next page)

AVIATION

(Continued from preceding page)

BUILD—One-Man jet helicopter. Easy inexpensive. Detailed plans, drawings—\$5.00. Helicraft, Box 7153, Baltimore, Maryland 21218.

HUNDREDS Aircraft Photos. Past, present. Illustrated catalogue 25¢. Astro Photographers, Box 243, Kennedy Airport, New York 11430.

TWIN Engine Hovercraft Plans, \$10.00; Airboat Plans, \$5.00; Small Hovercraft Plans, \$5.00. Catalog \$2.00. Airboats, Engines, Propellers. Arrowcraft, Pearland, Texas, 77581.

JET Strap-On Helicopter Plans \$2.00. Information 20¢. Compco, Inc., Box 1267, Redwood City, California 94064.

HOVERCRAFT

AERO-CAR. Amazing Hovercraft built easily with ordinary tools. Lawnmower engine power. Carries one man plus. Hovers, flies forward, backward. Sideways over land/snow/water. Complete construction plans and brochure. \$5.95. Aero-Projects, Box 5118PM, Clinton, New Jersey 08809.

FIBERGLASS Kits/Dealerships/Plans. Complete Catalog—\$2.00. Refundable. Hoversport, 313 Balsam, Palm Beach Gardens, Florida 33403.

BARTLETT Flying Saucer, Ultra-Light Hovercraft Powered By Lawn Mower Engine—Easy To Build—Fun To Fly—Complete Plans Kit Brochure And Photo Review \$4.00. (Air Mail Return) Write: Herb Bartlett, Box 3339-M, Scottsdale, Arizona 85257.

ECONOMICAL Hovercraft uses Lawnmower, Kart or Snowmobile Power. Plans, Instructions, \$6.00. Airboat Plans, Instructions, \$5.00. Practical Design Guide for Airboats and ACV's, \$5.00. (Information, \$1.00, Refundable). Palmer Aerosystems, P.O. Box 1891M, Coral Gables, Fla. 33134.



BOATS AND TRAILERS

FIBERGLASS BUILDERS MATERIALS Lowest factory prices in cloth, matt, roving, resin, epoxy, foam, nails, fittings. Send \$1.00 for literature (refundable) or \$2.00 for literature plus booklet on Mold-making and "How to Fiberglass". Clark Craft 16-P1 Aqua Lane, Tonawanda, N. Y. 14150.

BOAT KITS-PLANS AND PATTERNS-FRAME KITS. World's largest catalog. Over 300 top designs from 7-77' in plywood, ferro cement and fiberglass. Sailboats include: Windmill, Snipe, Motor Sailer, Trimarans, Catamarans. Powerboats include: Cruisers, Houseboats, Deep V's, Fishin'ski, Runabouts, Hydroplanes, Canoes, Kayaks, inboards, outboards. Send \$1.00 for large catalog or \$2.00 for catalog plus "Boat Builders Guide". Clark Craft, 16-P Aqua Lane, Tonawanda, N. Y. 14150.

BOAT PLANS, FULL-SIZE PATTERNS, FRAME KITS With step by step written and pictorial instructions especially for amateurs. Easy to build. Send \$1.00 for **HUGE 100 PAGE** Illustrated Catalog. Over 125 modern designs from 8 to 49'. Includes Sail, Jets, Inboards, Outboards, Cruisers, Houseboats, Hot Boats, Catamarans, Hydros. Also available—"Boat Building With Plywood" Hard cover—219 pages \$7.50. **GLEN L.** 9152 MP Rosecrans, Bellflower, Calif. 90706.

CANOE Kits—Wood Canvas, Molded Fiberglass—Free catalog. Canoe—Camping Log Book \$1.00 Trailcraft, Inc. Box 60686, Concordia, Kansas 66901.

FREE 112-Page Catalog! Backpacking, Camping, Boating Supplies, Clothing, Wildwood Tents, Laacke & Joys, 1439 N. Water, Milwaukee, Wisconsin 53202.

FIBERGLASS Cloth, matt, polyester and epoxy resins. Wholesale catalog 25¢. Boat Molding book 30¢. Seifert's, Box 1206-M, Green Bay, Wis. 54305.

FIBERGLASS Canoes, Kayaks, and Duckboats. Many exciting models. Easily assembled kits. \$39.95 up. Free Literature. Riverside Canoes, Box 5595P, Riverside, Calif. 92507.

FIBERGLASS Cloth and resin. World's finest cloth and non-run resin, at direct mill prices flotation foam. Complete line of plastics, silicon bronze and brass screws, save 60%. No sales tax. Boat Plans. Catalog 25¢. Freight prepaid. Stiles Boat Supply, Box 11P, Linden Ave., Mantua Heights, N.J. 08051.

CANOE! Kayaks! Factory-direct quality kits, from \$25.00. Many different models. Canvas hulls. Strongest construction materials. Free literature. Sportsraft, Box 636-P, Allentown, New Jersey 08501.

LIGHTS Of all kinds, electrical accessories, portable power, cook and tableware. Free catalog. Bass, Box 901PM, Marblehead, Mass. 01945.

FREE Catalogue—plans, patterns: Canoes, sailing canoes, kayaks, 14-17' trailable cruising sailboats. Quicksilver, 255A Shamrock Blvd., Venice, Florida 33595.

FIBERGLASS Cloth, mat, resin. Flotation foam. Complete supplies. Catalog 25¢. Kick-Shaw, Inc., 3511 Hixson Pike, Chattanooga, Tenn. 37415.

SAILBOAT KITS New all glass 16 ft. Catamaran, Penguin, OK, Blue Jay, Windmill, Snipe, Lightning, and El Toro. Free catalog. Taft Marine Corporation, Dept. PM-1, 6512 Shingle Creek Parkway, Minneapolis, Minn. 55430.

BOAT Kits. Molded Fiberglass. Save money-assemble yourself. Factory molded sections bond into one-piece craft. 20 models—14' to 32' Cruisers, Runabouts, Sailboats, Accessories, Motors, Trailers. Easy terms, Free Catalog. Luger, Dept. BC-73, 3800 West Highway 13, Burnsville, Minnesota, 55337.

280 PLANS, PATTERNS, SOME KITS. Catalogs: Powerboat, \$1.00. Sailboat 50¢. 8 & 10 Ft. Pram Kits \$49.50 & Up. Marinecraft, Box 161-M, Brighton Mass. 02135.

UNDER Water Boat Handle, Supports 300lb, \$4.95, Write For Brochure. Tolliver, 1634 Sterns, Los Angeles, Calif. 90035.

CAMPERS AND TRAILERS—KITS—PLANS—

PLANS & Kits—Motor Homes, Chassis mounts, Pickup Campers, Covers, Trailers, Bus & Van Conversions, Modifications & Bultins. Complete easy to follow large scale plans, patterns and detailed instructions. Supplies, parts & accessories, all your needs at low discount prices. Details Free. Lucky, Box 8657A1 White Bear Lake, Minnesota 55110.

MARINE EQUIPMENT AND SERVICES

MARINE Engines, conversions, parts, equipment. Catalog Free! Stokes Marine Industries, Coldwater, Michigan 49036.

CONVERT Auto engines to marine. 68 Page Catalog, 50¢. Lehman Manufacturing Company, 800 Elizabeth Avenue, Linden 4, New Jersey 07036.

MARINE Supplies, Ignition Parts. Free literature. Michael's, 991 Broadway, Bayonne, New Jersey 07002.

ATHLETIC AND BODY BUILDING COURSES

"GIANT Arms." Dr. Young's. D.C. revolutionary discovery. \$3.00. Satisfaction or refund. Gaucho, 1769-A-7, Chicago 60690.

POWERFUL Muscles fast! Free brochure! Universal Bodybuilding, Box 4327-C, Dearborn, Michigan 48126.

BE A LEAPER! Amazing Booklet Increases Jumping Ability 6 Inches in 6 Weeks! **FREE** Prototype Wristbands. **BONUS** Basketball Poster! \$2.75. All Star Sports, Dept. B, 55 Wishing Well, Penfield, New York 14526.

BARBELL Course \$1.00. Booklet 10¢. Good Barbell, B-542, Seneca, Missouri 64865.

18—20 INCH Arms in 90 Days or Refund! Miraculous Revelation!! \$3.00. Phenoministica, Box 281, Gresham, Oregon 97030.

DESTRUCTIVE Power Punch Professional Secrets by Registered Black Belt plus Membership Card \$3.00. Karate Academy, Highway 35, Wannamassa, New Jersey 07712.

"BUILD Muscles Faster!" 24 Nutritious Food Concentrates, 3 months supply \$7.00. Moneyback Guarantee. Better Health Club, Box 332-PM, Devon, Pennsylvania 19333.

SPORTING GOODS AND EQUIPMENT

FREE Catalog low direct factory prices, fishing, Hunting, Archery, reloading Camping supplies. Send today. Harters Inc., Dept. CPM, Waseca, Minn. 56093.

FREE WHOLESALE CATALOG. Lure parts, Molds, Rod Blanks, Reels, Archery, Metal Detectors, Rare Hardwoods. Finnsports (ME), Toledo, Ohio 43614.

AIR GUNS! Most name brands. At discount prices. Free price list. Toby's, Box 3100-D, Miami, Fla. 33169.

FREE 1973 Catalog! Guaranteed lowest prices! Rods, Reels, Lures, Accessories—Thousands of items. Cabela's, Inc., Dept. S-13, Sidney, Nebraska 69162.

BILLIARD CUES & Accessories. Catalog Free. Murphys' 31, Box 5352, Santa Monica, California 90406.

PLAY Better Pool! 50 Diagrams with instructions by expert-beginner to advanced—shows table, object and cue ball positions—cue ball hit points for correct english—reference angles etc. Will improve game of beginner or advanced player. Money back if not more than satisfied! \$1.00 postpaid. Madco Publications, P.O. Box 7268, North End Station, Detroit, Michigan 48202.



FISHING, TACKLE, LURES

MOLDS For fisherman's sinkers, jigs, squids, casting and spinning lures. Free catalog. Sweet Molds, Tonawanda 1, New York 14150.

MOLDS—For casting your own fishing sinkers. Free illustrated booklet. Reading Instrument Co., Box P-78, Reading, Pa. 19603.

FISHERMAN'S DREAM BOOK—FREE, 170 page catalog just loaded with Hard-To-Find Fishing Tackle Specialties and Do-It-Yourself Goodies. Our 29th year. **NETCRAFT** Inc., Box 5510, Dept. PM-12, Toledo, Ohio 43613.

FISH With The Winner—Mepps Original French Spinners took 57 awards in latest Field & Stream and Sports Afield contests—more than next 4 lures combined. Discover why in 1973 Mepps Fisherman's Guide. Send 25¢ with name, address to: Sheldons', Inc., Box 706, Antigo, Wisconsin 54409.

EARTHWORMS, LIVE BAIT

HYBRID Redworms, 5000—\$12.00; 20,000—\$24.00. Postpaid with raising instructions. Brazos Bait Farms, Route 4, Waco, Texas 76705.

EARN Money raising fishworms for us! Exciting details free! Oakhaven—56, Cedar Hill, Texas 75104.

RAISE Earthworms For Profit. Details .25. Wray, 2511 Iowa, Carlsbad, New Mexico 88220.



HUNTING, GUNS, DECOYS

THROWING Knife, 10". Pierces metal. Balanced, Hard-hitting. Double edge. Cutlery steel. Leather handle. \$1.25 (2/\$1.95). Sheath, 65¢. Johnsonsmith. D10., Mt. Clemens, Mich. 48043.

(Continued on next page)



DOGS AND KENNELS

LOOKING For a Special Puppy—Send \$2.00 for catalog with prices and information on more than 100 breeds. Hoppe's Kennels—Rt. 2A—Hill City, Kansas 67642.

RABBITS—CHINCHILLAS—FUR BEARING ANIMALS

RAISE Rabbits Successfully by knowing Facts. 48 Page Illustrated Book describing 25 Breeds. Housing, Breeding, Feeding, Markets, Marketing, etc. 25 cents. American Rabbit Association. 36 Arba Building, Bloomington, Ill. 61701.

RAISE Chinchillas. Guaranteed income. Catalog \$1.00. DeShon Chinchilla, Route 2H, Roanoke, Indiana 46783.

AMAZING PROFITS! \$10,000 Yearly Raising Rabbits for Wool and Breeding. Details 25c coin. American Angora, Malta 12, Montana 59538.

\$500-\$1000 MONTH Plan Raising Rabbits For Us. Free Details. White's Rabbitry, Mt. Vernon, Ohio 43050.

CHINCHILLA INCOME GUARANTEED Color Informative Booklet \$2.00 (Refundable) Information 25c. Chinchilla, 11 PMB, Port Richey, Florida 33568.

MAKE Big Money Raising Chinchillas, Cavies, Rabbits for us. Catalog 25c. Keeney Brothers, New Freedom, Pa. 17349.

PETS—BIRDS, CATS, HAMSTERS, ETC.

LIVE Seahorses, marine specimens, aquarium supplies. Illustrated catalog 35c. Marine, Box 23158-G, Ft. Lauderdale, Florida 33307.

PETS, Reptiles, raccoons, skunks, squirrels. Catalogue 25c. Trails End Zoo, St. Stephens, S.C. 29479.

HORSES, LIVESTOCK

"HOW TO TRAIN HORSES"—FREE Book tells how to break, train, make money with horses. Beery School, 1101, Pleasant Hill, Ohio 45359.

CAMPING EQUIPMENT AND TENTS

FREE Outdoorsman's Catalog. Features outdoor clothing, boots, tents, packs, hunting, fishing, hiking equipment, government surplus, etc. Satisfaction Guaranteed. Write for free copy today. P & S Sales, Dept. P-1, Box 45095, Tulsa, Okla. 74145.

CAMPING

PAK TENTS—Inexpensive. Free Literature. Martins—Box 141, Fremont, Calif. 94537.

ELECTRICAL SUPPLIES

METERS—Surplus, new, used, panel and portable. Send for list. Hanchett, Box 5577, Riverside, Calif. 92507.

LAMP Parts. Catalog, prices, wiring instructions. 50c. Refunded first order. Gyro, 5218P N.W. 35 Ave., Miami 42, Florida 33142.

BATTERIES, GENERATORS

BATTERY Reconditioning Kit, includes molds, material, instructions. Battery Shop, Box 820, La Quinta, California 92253.

BATTERY Terminal Protectors Stop Battery Corrosion. Free Literature. Pracna's, 3301 Buchanan Road, #83, Antioch, California 94509.

COMPLETE Hydraulic Jack Repairing Manual \$3.00. Moneyback Guarantee. Bayerco, 938-Dr Betty Avenue, Neenah, Wisconsin 54956.

ENGINES, MOTORS, MAGNETS

WINDING Data, 275 motors, \$1.25. Data Company, 512 Kensington, Kansas City, Mo. 64124.

STEAM Engine Kits, Catalog-Handbook \$1.00. Reliable Industries, New Baltimore, Mich. 48047.

REPAIR Your own electric motors new book copyrighted, \$4.95. Money Back Guarantee. Gift House, Dept. PM, Blacksburg, S.C. 29702.

MOTOR REWINDING INFORMATION! Supplies! Equipment Plans! Motequip, Box 7266, Kansas City, Mo. 64113.

WANKEL Engine in your future. Illustrated Pamphlet clearly explains Operation, Comparison with Gas, Diesel Engines. Present and Future Applications. Send \$2.00 today. Wankel, Box 716, Kingston, N.Y. 12401.

MACHINERY, TOOLS AND SUPPLIES

UNIMAT, Specially designed Precision Accessories. Also, Parts and Plans for building a **GEMSTONE** faceting machine. Send 25c for brochure. Mechtronics Research, 104 ViaSego, Redondo Beach, Calif. 90277.

WINCHES And **HOISTS.** Choice of 12 volt or 110. Reversible, compact, fast. 1/4 ton to 1 ton capacity, from \$49.95. 50c brings 16 page full color catalog. Refundable. Superwinch, Inc., Dept. PM, Pomfret, Connecticut 06258.

SURPLUS 4" Metal Cutting Lathe, Ball Bearing Spindle—\$39.50. Taig Mfg., 15048 Proctor, Industry, Calif. 91746.

MICROMETERS—Indicators. Steel—Aluminum—Brass. Maximat, Unimat Lathes. Complete mailing—50c. Campbell, 1424 Barclay, Springfield, Ohio 45505.

SMALL Foundry furnaces. Supplies. Free literature. Pyramid Products, 3736 South 7th Avenue, Phoenix, Arizona 85041.

END Mills. Lathe Milling Attachments: Information. Potter, Box 73, Cedar Rapids, Iowa 52406.

MAXIMAT, UNIMAT, Micro-Flame Torches, Dremel, Flexible Shaft Tools, Riffler Files. Save At Our Low Discount Prices. Pioneer Electric, Box 7X, Brentwood, New York. 11717.

FINEST Woodcarving Tools, Supplies. Catalog 50c. Woodcarvers Supply, 3112 West 28th, Minneapolis, Minn. 55416.

MAXIMAT, Unimat Sale. Amazingly low prices. Deco-M, 562 Howard Avenue, Staten Island, N.Y. 10301.

CHAIN Saw Service Manual—step-by-step care, repair of 360 models. 240 pages, profusely illustrated. \$5.95 postpaid. Chain saw parts catalog free. Zip-Penn, Box 179-S2, Erie, Pennsylvania 16512.

SANDBLASTING Outfit \$29.95 (Air-compressor required). Free brochure. Inka, Box 66573-X, Houston, Texas 77006.

TOOLS, EQUIPMENT & SUPPLIES! We List Over **FOURTEEN-HUNDRED** Different **CATALOGS** of Materials and Accessories for Arts, Crafts, Automotive, Electronics, Industry. Send \$2.00. **MASTERLOG,** Box 24413-AA, Oakland, California 94623.

MICROMETERS—Indicators. Steel—Aluminum—Brass. Maximat, Unimat Lathes. Complete mailing—50c. Campbell, 1424 Barclay, Springfield, Ohio 45505.

WELDING, SOLDERING, PLATING

PLATING Equipment, Portable Platers, Supplies, and "Know-How". Build your own tanks for nickel, chrome, etc. Easy-to-install PVC liners. Rectifier components—all sizes. Schematics, parts lists, formulas, operating instructions for all plating. \$10.00 post-paid. Guaranteed to save you 25%-75% or immediate refund. Some good used units for sale. Platers Service Company, 1511-A Esperanza, Los Angeles, California 90023.

LEARN TO WELD. Certified Welder tells how to: Learn at home. Select Equipment, Open Shop for \$300.00. Plus Valuable Information Learned through experience. \$4.00 Postpaid. Daves Welding, 1005 South 19th, Fort Smith, Arkansas 72901.

ELECTROPLATING Methods! New Manual! Containing Diagrams, Instructions, Formulas, Secrets! \$3.00. Absolutely Guaranteed. Qrew, Box 8-PE, Bourbonnais, Illinois, 60914.

BRASS Plate Mix \$4.00 Gal. PP. Hummel, 1615 Blair, Little Rock, Ark. 72207.

GOVERNMENT SURPLUS

GOVERNMENT LANDS . . . Low as \$3.50 acre! Vacationing . . . Homesteading . . . Investment! Exclusive "Government Land Buyer's Guide" . . . plus "Land Opportunity Review" listing lands throughout U.S. Send \$1.00 Surplus Lands, Box 19107-AM, Washington, D.C. 20036.

JEEPS!! Trucks! 100,000 amazing bargains direct from Uncle Sam nationwide. How, where your area. Complete Sales Directory \$2.00. Moneyback guarantee. Diversified Surplus, Box 27177-F, San Antonio, Texas 78227.

JEEPS!!! PICKUPS!!! 100,000 Items direct from government. Your area. Latest information & surplus categories: \$2.00 **MONEYBACK GUARANTEE.** Order manual #120 from "Dependable Products". Box 113, Vista, California, 92083.

NO CATCHES. Buy any surplus direct from U.S. gov't. All information \$2.00. Bridgeworth, P.O. Box 2292-C, Vancouver, Washington 98661.

JEEPS Typically From \$53.90 . . . Trucks From \$78.40 . . . Airplanes, Typewriters, Boats, Clothing, Camping, Sporting, Photographic, Electronics Equipment. Wide Variety, Condition. 100,000 Bid Bargains Direct From Government Nationwide. Complete Sales Directory and Surplus Categories Catalog \$1.00 (Deductible First \$10.00 Order From Our Separate included Catalog). Surplus Service, Box 820-A, Holland, Michigan 49423.

GOVERNMENT Surplus. How and Where to buy in Your Area. Send \$2.00. Surplus Information, Headquarters Bldg., Box 30177-PM, Washington, D.C. 20014.

MILITARY Surplus-Direct From Our Warehouse. Illustrated Catalog \$1.00; Lea Surplus, Dept-50, Box 679, Fairlawn, New Jersey 07410.

"U.S. GOVERNMENT SURPLUS Directory." How, Where to buy 100,000 items (including Jeeps) . . . low as 2c on dollar! Most complete information available . . . \$1.00. **SURPLUS DISPOSAL,** Box 19107-AA, WASHINGTON, D.C. 20036.

JEEPS . . . Buses . . . Vans . . . Trucks . . . Automobiles from \$52.50. Airplanes, Boats, Typewriters. Direct From Government. Directory and Surplus catalog \$1.00 (Refundable). Southern Surplus, Box 262PM, Manchester, Ky. 40962.

JEEPS, Trucks . . . Guns . . . 100,000 bargains from Government. Latest howto, your area. Guaranteed. Dealerlist included. \$2.00. Ross, Box 476311, Caseyville, Illinois 62232.

1973 SURPLUS Army, Navy store, 52 Page illustrated catalog. Send 50c. Ruvel, 3037 North Clark, Dept. 1-J, Chicago, Illinois 60614.

WIN BIDS! Be Successful Bidding Against Commercial Buyers, Subscribe to Surplus Buying Management. Write: Box 52, Severna Park, Maryland 21146.

YOUR Area Rich in U.S. Government Surplus. Get Advance Notice of Sales. Complete "Guaranteed" Guidebook, \$1.00. Surplus Guide, 1181-P Vintner, Pleasanton, California 94566.

JEEPS From—\$52.50; Typewriters from—\$4.15; Cars from—\$31.50. Walkie-talkies, motorcycles, airplanes, boats. Typical "As Is" bid bargains from Uncle Sam. Tremendous variety. Exciting free list. Write: Enterprises, Box 402X-84, Jamaica, New York 11430.

(Continued on next page)

HOBBIES AND COLLECTIONS

PRICE Guide To Modern Bottles. Pocket Size Listing 1,700 Valued From \$1.00 To \$3,000.00. Only \$1.00. Fred's Bottles, P.O. Box 1423PM, Cheyenne, Wyoming 82001.

HOBBI-CARVE—Home workshop wood carver—create beautiful wood reproductions of sculptures, plaques, figurines, scones and bookends. Hundreds of work patterns available. Send 25¢ for "How To Make Quality Wood Carvings" booklet. Refunded with order. Write: Hobbi-Carve, 930 Duluth Street, Dept. PM, St. Paul, Minnesota 55106.

COLLECT Military Medals, list 25¢. Vernon, Box 387PM, Baldwin, N.Y. 11510.

NAZI War Souvenirs Free illustrated catalog. Delta, Box 361PS, Lafayette, Calif. 94549.

GOLD 10 Small Nuggets Panned From Oregon Streams. \$1.00. Robert Brandt, Sweet Home, Oregon 97386.

NAZI Medals, Photos, and Jewelry. Also War Mementos from Other Countries. Catalog and War Poster, 25¢. Hutchinson House, Box 6411, Chicago, Illinois 60680.

FREE American Amateur Winemakers Association Membership. Roles Remain Open To Adults Till Spring. Rush Request To: Suite 569, 1629 K Street N.W., Washington, D.C. 20006.

NAZI War Souvenirs! Illustrated Catalog \$3.00 Cash. Disco, Box 331-P, Cedarburg, Wisconsin, 53012.

50 GORGEOUS Jungle Butterflies \$2.90. Collectors Wonderland, Box 1170, New York 10008.

DECALS, EMBLEMS, PATCHES

NASA Astronaut Patches, (30), \$39.95. Banner Supplies, Box 125-P, Jamaica, New York 11414.

CUSTOM Designed Embroidered Emblems, Decals. Inexpensive. Free catalog, details. Southern Emblem, Box 8PMB, Toast, North Carolina 27049.



STAMP COLLECTING

88 COUNTRIES—ONLY 10¢!

Worth \$5.00 at catalog prices!! Incredible collection of genuine postage stamps from 88 different countries—from Afghanistan to Zambia, North to South Pole! British, French, Portuguese, Spanish Colonies. Old 19th Century, New Issues, Moon and Outer Space stamps, etc. All for only 10¢! Also, other exciting stamps to examine free. Buy any or none, return balance, cancel service anytime. Plus Wonderful Free Catalog! H. E. Harris, Dept. SS-46, Boston, Mass. 02117.

FREE! Big Bargain Catalog—New Edition listing thousands of bargains including U.S. & B.N.A. stamps, packets, albums, accessories and supplies. Also, fine stamps from our approval service which you may return without purchases and cancel service at any time. Jamestown Stamp, Dept. E13PM, Jamestown, New York 14701.

SPORT Stamps of the World. Ten different 25¢. Approvals! Sets! Chateau Stamps. P. O. Box 1643, Indianapolis, Indiana 46241.

BEAUTIFUL TOPICAL COLLECTION—Includes Olympic sport stamps, wild animals, bicolor triangles, colorful birds, outer space stamps, Poland Kitten stamp and others. 10¢ With Approvals. Sunny Stamps, Dept. 57A, Fruitport, Mich. 49415.

50 DIFFERENT Old U.S. Revenue stamps \$1.00. Winchester Stamps, Box 3594, Mansfield, Ohio 44907.

ADVANCED COLLECTORS!!! Top Quality United States and Foreign Stamps on Approval. Please State Your Interests. References Requested. Edward Roth, Dept. #2G, Walker, W. Va. 26180.

FREE! \$10.00 Giant Stamp Collection of 300 all different colorful, valuable postage stamps from Africa—Europe—Asia—British Empire—Worth \$10.00—\$12.00 at catalogue prices. Also money-saving Booklet. All yours as a Get-Acquainted Gift. Adults only. Other fine stamps enclosed for your inspection. Frasek Co. Inc., PM1, White Plains, New York 10601.

AUSTRALIA—50 Different-10¢ With Approvals, Value Company, 10209A Tenbrook, Silver Spring, Maryland 20901.

FREE 50 Stamps including Grenada, British Honduras, St. Kitts. Approvals accompanying. Moulblow 1834P, Bassett, Anaheim, Calif. 92805.

USED Clean USA, 200 Commemoratives Plus 50 Regular Issues Only \$2.00. Write: M. Stone, 130 Summit Ave, Neptune City, New Jersey 07753.

YEMEN LPU Set-Free to Approval Applicants. W-B Stamp Co., Wilkes-Barre, Pa. 18703.

NEW AFRICAN Stamp collection including Burundi, Guinea, Mali, Rwanda, Togo and others. A colorful addition to your collection, 10¢ with approvals. Modern Stamps, Dept. 57B, Ferrysburg, Mich. 49409.

UNUSED—Used U.S. Stamps 100-25¢. Superioex, Avon Lake, Ohio 44012.

50 BRITISH EMPIRE 10¢. Approvals. Becker, Box 8993-M, Portland, Oregon 97208.

SOUVENIR Sheets Czechoslovakia 1937 Plus Japan 1947 Plus Yugoslavia Set 25¢ Approvals. Kingman, 65 Page, Yonkers, N.Y. 10704.

OLDER U.S. stamps, covers, on approval to adults only. Surprisingly good. ENGLE, Box 208P, Lowell, Michigan 49331.

FREE Mammoth Collection, Scott's International or Master Global Albums When You Buy Our Approvals. Bargain Service, Box 5345, Santa Ana, Cal. 92704.

AMERICANS On Foreign Stamps, Presidents Kennedy, Roosevelt, Lincoln, U.S. Spacemen, Princess Grace and others 10¢ with approvals. Roseland Stamps, Dept. 57, Spring Lake, Mich. 49456.

WOW! 110 All Different Germany 10¢. Commemoratives, Airmails, High Values, Big Catalog, bargain lists. Also, fine stamps from our approval service, which you may return without purchases and cancel service at any time. Jamestown Stamp, Dept. A13PM, Jamestown, New York 14701.

WOW! 1000 Different Worldwide Stamps (\$35.00 Cat. Value) \$2.00 with profit sharing approvals. Universal, Box 6MA, Kenosha, Wisconsin 53141.

FAR EAST ASSORTMENT—Viet Nam, Japan, Korea, Formosa and others. Only 10¢ with world wide approvals. Clark Stamps, Dept. 57V, Muskegon, Michigan. 49444.

ANTIGUA, Cayman, Turks, Grenada—over 100 different British Commonwealth, 10¢ with low-priced approvals. KAYCO, P.O. Box 437, Flushing, N.Y. 11367. Dept. M-3.

WOW! 100 Different Canadian Stamps Used 50¢ With Approvals. Stamps, Box 1405, Kingston, Ontario, Canada.

SENSATIONAL Clearance, Forty Different Packets only \$1.00. Norge, Wyckoff, New Jersey 07481.

50 DIFFERENT Canada 10¢ with Approvals. Oroszky, P.O. Box 1, Sarnia, Ontario, Canada.

U.S. Collection with Oldies 10¢. Approvals, Miller, Box 2084M, Falls Church, Virginia 22042.

FREE, Mint Worldwide Packet. Approvals. Hildebrand, Box 5645, Redwood City, California 94063.

FREE New used Congo animal set, Approvals included. Alpaughco, Highbridge, N.J. 08829.

TEN Different Nudes: 20¢. Approvals. Stamp Farm, 2-M50, Oxford, Wis. 53952.

50 DIFF. U.S. COMMEMORATIVES 25¢. Fine U.S. Approvals Accompany. Craig Stamps, Box 425-N, Bellmore, N.Y. 11710.

FOREIGN Approvals! Gigantic values! 3¢ each. ABC, Dept. 3301-A, Box 6000, San Francisco 94101.

3¢ PLATE Block 25¢ with comprehensive U.S. stamp and Supply catalog. Schultheis, Box 2151C, New Hyde Park, N.Y. 11040.

FREE World Collection. Over 100 stamps. Approvals. Global, Box 427, Livermore, Cal. 94550.

APOLLO 11 Moonlanding. Seven multi-colored giants from Guinea, catalog value \$3.41. Only 10¢. Topical approvals. LeBlanc, Box 110-P1, Glen Cove, New York 11542.

ONE CENT STAMPS. Write for jumbo books of stamps at 1¢ each, mounted in Scott order. BULLOT APPROVALS, 6815 Bay Pkwy, Brooklyn, N.Y. 11204.

"AFRICA" 25 Beauties, 10¢. Approvals, Gorliz, Box 28765 PM, Memphis, Tennessee 38128.

100 DIFFERENT United States Stamps, 25¢ With U.S., Foreign Approvals. ShelRon, Box 547C, North Miami, Fla. 33161.

U.S. MINT Specials! Flag set, complete \$1.00. 1¢, 2¢, 3¢ famous Americans (21 different) \$1.00. Free list. Brooks, 2601 Avenue "U," Brooklyn, N.Y. 11229.

PENNY! Approvals! Regardless catalogue! Kloster, 4164 52nd St., San Diego 5, Calif. 92105.

U.S. BARGAIN, 50 Different 10¢, with beautiful worldwide, approvals. Stamp Center, Kennebunk, Maine 04043.

FREE Surprise collection sent with approvals. Gould, 1784 Union, San Francisco 94123.

PENNY Stamps! 1000 Mounted in book at 1¢ each! Trust Stamp Company. P.O. Box 100-P, Jamaica, New York 11435.

ABSOLUTELY Free United States Mint Souvenir Sheet When Requesting United States Approvals. K&B, Box 70, Brooklyn, N.Y. 11223.

500 DIFFERENT Stamps, \$1.00. Smith, 508-A Brooks, College Station, Texas 77840.

FREE Duplicate Exchange—2¢ Approvals. Belden, Box 4175B, Dearborn, Michigan 48126.

100 DIFFERENT British Empire 15¢. Approvals. Gibson, Box 34, Lansdowne, Pa. 19050.

60 DIFFERENT United States (30 Commemoratives) 25¢. Seidenberg, Salem 169, Oregon 97308.

LOOK! Over 100 different strange and valuable stamps for just 10¢ with approvals, plus big bargain lists. Continental, Box 9413, North Hollywood, Calif. 91609.

"INVERTED Error" Dag Hammarskjold, 10¢ with approvals. Belmont Stamps, Washington, D. C. 20015.

100 OLD United States between 1861 and 1935. \$1.00. Ed Roush, 423 Shepard, Mansfield, Ohio 44907.

225 STAMPS For only 10¢! Airmails. Pictures: stamps from strange countries cataloging up to 25¢ each! Plus unusual stamps to examine. Buy any or none return balance, cancel service anytime. Mystic Stamp Co., Camden 80, New York 13316.

NEW Issues—Free Weekly Illustrated list. Brooks, 2601N Avenue "U," Brooklyn, N.Y. 11229.

RUSSIAN Space collection 25¢. Russian Approvals. Snedco, Box 68-P, Waldwick, N.J. 07463.

12,000 DIFFERENT! AMAZING New Plan Builds Your Collection Systematically. Country By Country. Only 50¢ Weekly. Ware, Monroe, Conn. 06468.

(Continued on next page)

STAMP COLLECTING

(Continued from preceding page)

YOURS FREE! 20 Almost Rare Stamps from 12 Lost Nations—Most a Half-Century Old! Nations overrun by invaders and never freed again. Stamps so appealing that experienced and beginning collectors alike will want them. You get 110 other stamps from Britain's Lost Empire plus illustrated Album to keep as a Bonus should you buy \$1 from our Approval Selection. Or return Album and 110 stamps with selection and buy nothing. Cancel Service anytime. But Lost Nations stamps are yours to keep! Send 10¢ for mailing while supplies last. Kenmore, Milford LN-293, New Hampshire 03055.

FREE! 10 African Beauties! 30 Others! Approvals. Cambridge, Box 2311, Heath, Ohio 43055.

WORLDWIDE Philatelic—Numismatic Publications! Free List. Bedard, #5215-A, Detroit, Michigan 48236.

TEN Beautiful Diamonds, 10¢ Approvals. Big M Enterprises, Box 10902-A-1, Ferguson, Missouri 63135.

LIECHTENSTEIN 356-\$19.00; France #1100-\$4.00; UN 29-30-\$15.00; NH, CWO. Submit Lists Western Europe Only. All NH. Franklin, Box 467F, Jamaica, 11434.

VALUABLE Collection! Get scarce Red China, Pope John, Apollo 14, Antigua military costume, Iwo Jima memorial stamps, many more. 100 Different new and old issues from the world over—savage warriors, wild beasts, famous people, exotic scenes. Also stamp selections to examine. Buy any or none, return balance. Cancel service anytime. Rush 10¢ handling. Garcelon Stamp Co., OPMX, Calais, Maine 04619.

CANADA Sports Complete 10¢, Canadian Approvals. Harley Boardman, Little Valley, New York 14755.

100 CANADA 25¢. Excellent value. Approvals. Continental, Georgetown, Ontario, Canada.

CANADA 50 Different 15¢ To Approval Applicants. Lewis, 339 Beaconsfield Crescent, Saint John, New Brunswick.

1000 PRE-1939 USA, contains dues, revenues, commemoratives, presidentials, high values, older issues, etc. \$3.00; 5000 \$12.00. 300 pre-1940 USA commemoratives \$2.00; 700 \$4.00. 5000 foreign \$3.00; 9000 \$5.00. No approvals. Meyers, 5321 Fleming, Richmond, California 94804.

20 HISTORICAL U.S. Commemoratives 10¢. Bargain U.S. Approvals. PINTO, Box 111, Park Ridge, Illinois 60068.

WATERMARK Detektor, perforation gauge, 100 different stamps, packet of hinges, all for 25¢ to approval applicants, state preferences. H & L Stamp Co., Box 3099, Stn. B, Calgary, Alberta, Canada T2M4L6.

FREE—Colonial collection. Approvals accompany. Gains, Box 788-FLG, Mattoon, Ill. 61938.

CANADA 1957 Sports issue, 40¢ Value, only 20¢, Approvals. Rheum, 91 Valois, Vimont, Laval, Que. Canada.

FREE 100 Different With Approvals. Shill, 8511 Cedel, Houston, Texas 77055.

RED CHINA! FREE Ping Pong Commemorative Set Plus Assorted Red Chinese Stamps, With Approvals. Send 10 Cents For Mailing To: Price Associates, Dept. PM, P.O. Box 1186, Nashua, N.H. 03060.

1,008 DIFFERENT World Stamps Over 40 Countries! Commemoratives! Airmails! Giant Spectacular New Issues! Some over 50 years old! Catalogue value nearly \$50.00! Sale Price \$2.98, 2,008 different \$7.95, 3,008 different \$10.95, 5,008 different \$29.95, 10,008 different \$97.50. Send now! ABC Stamps, Department 4170, Box 6000, San Francisco, California 94101.

MILLIONS Of stamps 2¢ each. Write today for gigantic selection. CSC, Box 9384, No. Hollywood, Calif. 91609.

500 DIFFERENT World Wide 50¢! Approvals. Gordon Davison, Hillsboro, New Hampshire 03244.

BETTER GRADE U. S., Canadian Stamps. Borgen, Box 502, Alturas, California 91601.

RARE Stamp Free! Also new packet Aden to Urundi, with Kennedy, Triangles, Space, Sports, Ships, Dogs, Cats, Reptiles, plus others. All free. Send 10¢ for mailing. Empire Stamp Co., Dept. 1, Toronto, Canada.

FREE Beautifully Designed Space Selection, Approvals, House of Hoke, Sebring, Florida 33870.

SIERRA LEONE Diamond-Shaped Scout Stamp, Bhutan Steel Foil, Apollo Moon-landing, Dominica Animal, Virgin Islands Pirate, Cook Islands Christmas Painting plus 100 others. Only 10¢ when requesting approvals; select those desired, return balance. Cancel service anytime. Douglas Cook, Dept. PM-8, Las Vegas, Nevada 89112.

100 DIFFERENT Large Pictorials \$1.00. Penniston, Box 7253, Arlington, Va. 22205.

U.S. Plate Blocks 7 different 3¢ commemoratives \$1.00! Approvals. Gordon Davison, Hillsboro, New Hampshire 03244.

2 NUDE Sets Plus 100 Others Only 25¢. Paschall, 3035 McGowan, Marion, Iowa 52302.

HUNGARY, 100 Different plus Bonus Nudes only 15¢ when requesting our worldwide approvals. Free Duplicate Exchange Plan. Markwell Stamp Mart, PO Box 921, Schenectady, New York 12301.

500 DIFFERENT \$1.— With Pick Pack approvals. Pick Large Commemoratives @ 2¢ Each. Philexport, 72 Breton, Lava-des-Rapides, Quebec.

200 BEAUTIFUL BRITISH ASIAN And WORLDWIDE Issues Sent To Approval Applicants For 25¢. Trans-Global Stamp Co., Dept. E, P.O. Box B, Baltimore, Maryland 21228.

WORLDWIDE COLLECTION, 2,000 Different \$7.00. Larbig, Box 2617, Lakewood, Ohio 44107.

300 DIFFERENT World collection!!! Only 40¢ with World approvals!!! Carpenterprises!!! 446 Carpenter, Eagle River, Wis. 54521.

EXCHANGE. Send 100-200 different foreign with 35¢. Receive different. Patterson, Lancaster, New York 14086.

YOUR Choice—40 Different U.S. Commemoratives or Packet Interesting World Pictorials 10¢ with FOREIGN Approvals. R. Hadley, 564 Market, San Francisco 94104.

RICHARD NIXON Inauguration Day Souvenir Cover. Addressed any name your choice. Special Postal markings. 50¢ each. K.M. WALSH, Box 308A, TUCKAHOE, New York 10707.

CAPTIVATING ANIMAL STAMPS—Collection of 25 Different With Approvals And Bonus Offers 10¢. Wentz, Box 2439P, Newark, New Jersey 07114.

307 DIFFERENT triangles, Sports, topicals, etc. Worth near \$8.00. Only 25¢. Bargain approvals. Jayto Stamps, East Syracuse, New York 13057.

RARE! Mint set issued by Russia during Berlin occupation or 25 U.S. Either 25¢ with approvals. Middle Earth Stamps, Box 1173-P, Evansville, Ind. 47713.

STAMPS WANTED!!! United States And Foreign Collections, Old Letters, Accumulations, etc. Ship by Insured or Registered Mail for prompt airmail offer. Stamps held intact pending acceptance. Edward Roth, Dept. #2H, Walker, W.Va. 26180.

704 U.S.A. (Plenty Commemoratives)—25¢ Approvals. Horace Gatewood, Winston-Salem, N. C. 27102.

VIETNAM 25 Different 10¢ approval. Sam Chazen, Box 95, Ozone Park, N.Y. 11417.

FREE—Worldwide \$1.00 Value. Approvals. Stamps Unlimited, 101 W. Inkster, Kalamazoo, Mich. 49001.

\$200.00 DAILY PROFIT From Stamps! Your Chance to Copy Mailorder Experts. Information Free. Bureau 3SM, 2 Deepdale, Great Neck, New York 11021.

400 MIXED U.S. 25¢ Approvals. Wright, Box 753-M, Hagerstown, Maryland 21740.

7 COMPLETE SETS Poland—25¢ With Approvals, Duncan Stamps, RR #1, Duncan, B.C., Canada.

50 FAMOUS PAINTINGS 50¢ When requesting approvals. C. F. Stamps, 655 Forbes St., East Hartford, Conn. 06118.

FREE—Gift Set. Approvals accompany. Chapmans, Box 487-G, Galesburg, Michigan 49053.

MILLIONS Of Stamps—2¢ Each!!! Hermann, 2064 Lomavista, Pasadena 91104.

"CONQUEST Of Mars". Yemen's Latest Collection. 10¢ With Space Approvals. Potomac Stamps, Washington, D.C. 20015.

WORLDWIDE Collection 222 Different Plus 55 U.S., 25¢ Approvals. Casto, Box 927, Largo, Florida 33540.

FREE!! 25 US Commemoratives, 2" Diameter Magnifier—10¢ Approvals. Mixdrak, 5630 Wilson, Chicago 60630.

FREE "Space", Moon Landing—Others. 110 Different! 10¢ Mailing. Approvals. Shaw, Drawer E-74, Montevallo, Alabama 35115.

MUNICH Olympics, Rwanda's latest Bi-colored Gigantic Commemoratives—Free! Approvals Plus 101 Bonus Sets. William Deems, 226 Race, Ravenswood, West Virginia 26164.

CLOSEOUT Sale: Large Assortment \$1.00 High Value Packet \$2.00. Schollmeyer, 436 New York Ave., Brooklyn, N.Y. 11225.

50 DIFFERENT Argentina—10¢ Approvals. Gobestamps, Box 402, Biddeford, Maine 04005.

MINT STAMPS—25 All different, Worldwide, Large and Beautiful only 10¢, approvals. Cornett, P.O. Box 711, Miami Springs, Florida, 33166.

BRITISH Bonanza! 107 exciting Colonials, magnificent commemoratives. 25¢ Approvals. Castle, Box 15-PM1, Flushing, New York 11352.

WORLDWIDE Mixture. 200 Unsorted Stamps 10¢ Approvals. White, 6808-E Chrysanthemum, Indianapolis, Indiana 46224.

FREE BARGAIN LISTS! U.S. Mint singles—Plate Blocks. No approvals. Scotco, Box 855-PMD, Miami, Fla. 33147.

80 DIFFERENT U.S. Stamps. Includes 1943 flag stamp of occupied nations. Only 25¢. Approvals included. Willett Co., Box 338-M, Yorktown Heights, N.Y. 10598.

WE BOAST A LOT about our quality approvals. Our clients agree, so order a selection now and convince yourself. P. E. ROY, Dept. C, Box 9723, Quebec 10, Canada.

COLLECTOR SELLING OUT 250,000 UNITED STATES—FOREIGN STAMPS 1¢ EACH. ORDER ANY AMOUNT. G. MIX, 120 EAST 2ND, HOISINGTON, KANSAS 67544.

FREE! To Approval Applicants. 55 Different, including Space, Triangles, Others. L. Baird, PM-33, Box 8128, Portland, Oregon 97207.

GIANT Stamp Collection including: Astronauts, Satellites, Moonrockets, Boy Scout issue. Complete U.N. Set, recent Olympic and Sport issues from many countries, etc. Plus Big Stamp Dictionary and approvals. Everything 10¢! Stampex, Box 47-RM, White Plains, N.Y.

50 YEARS Old, fifteen different United States, over fifty years old—10¢ with approvals. Jaxon, Box 145-P, Brooklyn, New York 11230.

(Continued on page 202)

If you've ever said...

"There must be a better way to earn a living.."

one of our free Career Guidance Booklets may provide the opportunity you've been looking for.

It happens to all of us, sooner or later. No matter what kind of job we have.

One day, it suddenly strikes home that—like it or not—we're going to have to work for a living, the rest of our lives. And most of us are horrified at the thought of forever being locked into the jobs we now hold.

"Surely," we tell ourselves, "there must be a way to earn enough extra dollars each month to balance the family budget. Surely, there must be a way to get the kind of position where you don't have to worry about job security. Surely, there must be a way to get a job that offers greater opportunity for advancement, and more job satisfaction."

"Surely," in other words, "there must be a better way to earn a living!"

If you, too, have been thinking these thoughts lately, you'll find one of our free Career Guidance Booklets very helpful at this time. We invite you to send for one.

Your free booklet will describe the opportunities for higher income and greater job security you might



expect in one of the career fields listed on the coupon below. It will also explain why ICS can prepare you for this new career field... right in your own home...in your spare time...*regardless of your education or past experience.*

In addition, you will receive a free "Demonstration Lesson" that lets you see for yourself why preparing for a more rewarding career—the ICS way—may be a lot easier than you think.

Please bear in mind, as you check off your career choice on the coupon below, that ICS has a long and distinguished record of success as a career training organization. In fact, more than 8,500,000 men and women have turned to ICS for career training, since 1891.

ICS has provided training programs for various divisions and branches of companies like Ford; U.S. Steel; Chrysler; Mobil; DuPont; etc.

ICS Career Training is approved for Veterans and Servicemen under the new G.I. Bill, and is Accredited by the Accrediting Commission of the National Home Study Council.

In short, ICS training methods are valued and respected not only by ICS graduates...but also by leaders in Business, Industry, Government, and Education.

Now it's your turn to discover how ICS training can start *you* in a rewarding new profession. Just fill in the coupon below and mail it today for your free Career Guidance Booklet and free "Demonstration Lesson."

Keep this certificate when you mail the coupon for your free Career Guidance Booklet and "Demonstration Lesson"

This certificate symbolizes the long and distinguished record of success that ICS has enjoyed as a Career Training Institute. It is your assurance that ICS stands ready to serve you, just as it is serving individuals, business and industry of the world.

ICS International Correspondence Schools
Scranton, Pennsylvania 18515 XA623Q

Please send me a free Career Guidance Booklet, and a free "Demonstration Lesson" for the field I have checked. I understand I am under no obligation.

<input type="checkbox"/> Accounting	<input type="checkbox"/> Computer Servicing	<input type="checkbox"/> Engineering	<input type="checkbox"/> Restaurant/Club Management
<input type="checkbox"/> Automotive Mechanics	<input type="checkbox"/> Communications/Broadcasting/Electronics Specialist	<input type="checkbox"/> FCC Licensing	<input type="checkbox"/> TV Repair and Servicing
<input type="checkbox"/> Business Management	<input type="checkbox"/> Drafting	<input type="checkbox"/> Hotel/Motel Management	<input type="checkbox"/> High School Division (For students who want to earn a High School Diploma.)
<input type="checkbox"/> CATV/MATV Electronics Specialist	<input type="checkbox"/> Apartment/Community Management	<input type="checkbox"/> Income Tax Specialist	
<input type="checkbox"/> Computer Programming	<input type="checkbox"/> Electrician	<input type="checkbox"/> Interior Decorating and Design	
	<input type="checkbox"/> Electronics	<input type="checkbox"/> Production Management	

Name _____

Address _____ Apt. no. _____

City _____ State _____ Zip _____

ICS Career Training is: Approved for veterans under the new GI BILL/Approved for federally insured loans
Accredited by the Accrediting Commission of the National Home Study Council

STAMP COLLECTING

(Continued from page 198)

255 DIFFERENT Worldwide: 15¢. Approvals. Tibbets, 8675 Meadow, Downey, California 90242.

CHINA Doves 10¢ With Approvals. Lawrence, Box 7511M, Baltimore, Maryland 21207.

FREE MINT Set with approvals. **ALLEN'S, BOX 1796, FAIRMONT, WEST VIRGINIA 26554.**

COINS, TOKENS, CURRENCY

FREE COPY Interesting Coin Publication. Wholesaler, Box 893, Chattanooga, Tenn. 37401.

MEXICO: Silver Dollars Dated 1957 To 1967 In Nice Condition, Ten For \$3.95 Delivered Postpaid. El Paso Coin Co. Inc. Suite 108, El Paso National Bank Bldg., El Paso, Texas 79952.

\$1000.00 Banknote 25¢ with comprehensive U.S. coin and Supply catalog. Schultheis, Box 2151C, New Hyde Park, N.Y. 11040.

SILVER DOLLARS Uncirculated, 1880-81—1883-84-85 \$5.00 Ea. Catalogue 50¢. Shultz, Salt Lake City, Utah 84110.

PRICE Lists of Thousands of Stamps and Coins. Send 25¢ Refundable with purchase. No Approvals. Bryson, 612M White, Toledo, Ohio 43605.

LINCOLNS 1909-1958 Every year including 1909VDB, 1922D. 50 different (Regularly \$12.60.) **SPECIAL \$6.95. HARRIS, Box 2037P, Santa Cruz, California 95060.**

COINS At Discount Prices! Free Brochure. Gene Carlton, Chandler, Okla. 74834.

BARGAIN Coin List, 10¢. Economy. Sales, Box 92, Buzzard's Bay, Massachusetts, 02532.

PENNIES 30 Different "S" Mints 1919S, 1972S Includes 1955S Plus Reprocessed 1943PDS \$2.00. Free List. Krileich, Box 34273, San Francisco, Calif. 94134.

GOLD—(1865) Mexican Maximilliano Peso. Bu \$1.95. Northwoods, Bigfork, Minn. 56628.

5 V-NICKELS, Good, \$1.25. Free Catalog. Village Coin Shop, Dept. P. Plaistow, N.H. 03865.

UNCIRCULATED Bargains + Carver, Washington \$4½ = Each \$5.49: 1950-D Nickel \$8.89; 1938-D Buffalo \$3.49. Latest Redbook \$2.48; Bargain Lists 15¢. Bebee's Incorp., Omaha, Nebraska 68111.

CLEARANCE Ten Canada Silver Dollars \$15.00. Lee Ltd., 331 W. Pender, Vancouver, Canada.

TEN Foreign Coins, 35¢. Royal Coins, 2401 Chuckanut, Bellingham, Washington 98225.

100 INDIAN And Lincoln Cents 1920's And Older \$5.00. Free Catalog. Wesley Rood, Box 9, West Union, Iowa. 52175.

1949-S LINCOLN 10¢. FREE Bargain List. Ron Farley, Metamora, Ill. 61548.

REPLICA \$1,000 Bill 35¢. Christopher, Box 244M, Fishkill, N.Y. 12524.

ANTIQUES, RELICS, INDIAN GOODS & CURIOS

FREE!! Lists Antiques, Indian Relics. 10 Arrowheads \$4.00. Hyde's, Box 2304, Santa Fe, New Mexico 87501.

EVERYBODY LIKES DIXIE GUN WORKS.

TONS Of antique gun parts and supplies. All reproduction muzzle loading guns. Send \$2.00 for enlarged illustrated catalog No. 121. Dixie Gun Works, Union City 12, Tennessee.

TELEPHONES, Original 1910 Pre Dial French Style Desk Telephones. Working Order with Plug. \$38.00. Satisfaction Guaranteed. Telephone Co., Turtle Lake, Wisc. 54889.

APACHE ARROWHEAD COLLECTIONS— Perfect, 25—\$5.00, 100—\$15.00. **GERONIMO**, PMD1239, Apache Junction, Arizona 85220.

PERFECT Flint Knife, 4 Perfect Arrowheads, Hide Tanner, \$4.00. List Free. Lear's, Glenwood, Ark. 71943.

INDIAN Relic list, Arrowheads \$4.00. doz. Folsom. \$5.00 each. C. Secrist, Deerfield, Missouri 64741.

ORIGINAL ANTIQUE Telephones. Illustrated Catalog—30¢. Telephone Company, Turtle Lake, Wisconsin 54889.

ARROWHEAD Price List 25¢. Smith, 9825 Conway Drive, Indianapolis, Indiana 46236.

BARGAIN! Much Sought after Official Guide to Antiques, Curios. Featuring prices to buy and sell thousands of Antiques in massive 416 page volume with 1500 illustrations. Low price \$5.90 postpaid. Decamps Specialties, 356A Princeton, San Francisco, California 94134.

BOW and **ARROWS ORIGINAL** From a Amazonas Tribe. \$42.00 set. Taboada, Box 125, Riverside Station, Miami, Fla. 33125.

OFFICIAL Guide to Antiques, 224 Pages, Hundreds of Illustrations. Prices to Buy and Sell \$1.99. Country Lane House, Route 1, Box 193, Riddle, Oregon 97469.

MODELS—CARS, SHIPS, TRAINS, PLANES ETC.

LIVE Steam Engine Kits. Fascinating Hobby For Model Mechanics. Boilers. Fittings. Accessories. Pictured Catalog \$1.00. H.P.K. Models, Centuck 34, Yonkers N, New York 10710.

SHIP Models Kits, fittings, plans, books, tools, engines, motors. Big illustrated catalog 50¢. Mass. residents add 3% tax. James Bliss & Co., Dept. SM, Route 128, Dedham, Mass. 02026.

MODEL Airplanes—Big 220 Page Catalog \$1.00. Sig Company, Montezuma, Iowa 50171.

SHIP Models Catalog 25¢. Scientific, Inc., 340 Snyder, Berkeley Heights, N. J. 07922.

LIVE Steam powered backyard railroads! All sizes. Complete "bolt-together kits." and rough castings. Excellent drawings. 100 page catalog \$1.00. Little Engines, Lomita, California 90717.

SHIP And yacht model fittings: Pine construction hull kits; blueprints. Send 75¢ for illustrated catalog. A. J. Fisher, Inc., 1002 Etowah Avenue, Royal Oak, Michigan 48067.

SCALE Model cannons, ships, tanks, airplanes, autos, trains and accessories. New Catalog \$1.00. Frontier Models, 1583 West Washington Blvd., Los Angeles, California 90007.

ROCKETS: Real flying models—flights up to 2500 ft. New illustrated catalog 25¢: Singles and multistage kit, cones, engines, launchers, trackers, rocket aerial cameras, technical information. Fast Service. Estes Industries, Dept. 7EM, Penrose 7, Colorado 81240.

SHIP MODEL Kits, Plans, Fittings from our own Workshop. Big Illustrated Catalog: 50¢. Blue jacket, Shipcrafters, 145-V Water Street, So. Norwalk, Conn. 06854.

AUTHENTIC Scale Model Cars—Not Toys! **COMPLETELY ASSEMBLED!** Antique, Classic, Contemporary. Catalog 25¢ (Refundable). Richard's Auto Models, Box 8-W, Parsippany, New Jersey 07054.

MODEL Ships and Cannons. Illustrated Catalog 20¢. Studio House, Dept-1013, Box 185, Deer Park, New York 11729.

LIONEL TRAINS, Used. Buy-Sell-Repairs. Details free. Toby's, Box 3100-PMTA, Miami, Fla. 33169.

FREE. Flying **MODEL ROCKET** Kit. Act Now. Offer Limited. Send 25¢ for Packet of Iron-Ons, Decals, Literature and "Free Rocket" Details. Aerospace Vehicles, Inc., Mineral Point, Wisconsin 53565.

MODEL, Hot Air Engines, Plans, Kits, Information. Send Stamped Envelope. Model Engine Specialties, Box 9221, Lansing, Mich. 48909.

GAMES, TOYS, PUZZLES, NOVELTIES

FREE! Illustrated brochure of Beautiful Chess Sets! Write! Armchair Shopping, Dept. 325, Pinole, California 94564.

NOVELTIE Catalog, Send 8 cent stamp. Tam Enterprises, Box 66278, Los Angeles, California 90066.

LEARN CHESS!!! "Chess Made Easy" 150 pages, \$2.00 postpaid. Satisfaction guaranteed. Free list other "How-To" books. Crown House, 19212 Santa Maria, Suite 1A1, Hayward, California 94546.

BRAINY? Try our Wood Triangular Puzzle. \$1.00. Solution: \$1.00. James Puzzles, Box 47-AR2, Canonsburg, Pennsylvania, 15317.

MAGIC TRICKS, JOKES, VENTRILOQUISM

HOUDINI'S Greatest Magic! You can do them all!! Giant illustrated catalog 25¢. House Of 1000 Mysteries, P.O. Box 2026P, Pompano Beach, Florida 33061.

FREE! World's leading novelty catalog. 1600 Funmakers, Jokes, Tricks, Science, Sports, Hobbies, Jewelry, Psychedelia. Johnson-Smith, C-10, Mt. Clemens, Mich. 48043.

VENTRILOQUISTS—Free Dummy Catalogue. Storyteller Studios, P.O. Box 633, Bellflower, California 90706.

COMPLETELY Illustrated catalog. 84 pages. 25¢. Manhattan Magic, Box 334-M, N.Y.C. 10011.

WORLD'S Finest professional magic tricks. Joker's Novelties. Giant illustrated catalog 10¢. Top Hat, Evanston, Illinois.

FABULOUS MAGIC'S New 1973 catalogue 25¢. Our specialty orders shipped same day no substitutes. Fabulous Magic, 3319 East Charleston, Las Vegas, Nevada 89104.

MAGIC! Great hobby. Start with Genii monthly magazine. Dealers, tricks, news, 4 month trial \$2.00. Genii, Box 36068M, Los Angeles, Cal. 90036.

BE A Magician! Two booklets explaining 156 tricks plus large professional catalog. \$1.00. Magic, Inc., 5082 Lincoln, Chicago, Illinois 60625.

THREE! Different Catalogs. Two #26, #19, 25¢, #21, 25¢. Miami Magic, Box 1047, Miami 33133.

LARGE Catalog—Latest Magic for pocket, parlor, stage. Send 25¢. Be popular. Entertain. Fastest service. Jefferies Magicland. Dept 11, Dallas, Texas 75201.

HOUDINI'S Original Magic Shop. Established 1856. Send 25 cents for illustrated Catalog containing 5000 Tricks. Mindreading, Puzzles, and Jokes. Flossie-Hornmann, 304 West 34th St., New York 10001.

CATALOG 25¢. 1,500, 399 Tricks, jokes, novelties. Elbee, 7408-P San Antonio, Texas 78207.

LARGE Magic Catalog. Plus Free Trick—25¢. Kenin, Inc., 1834-C N.E. 163 Street, N. Miami Beach, Fla. 33162.

BOOKS, CATALOGS, NEWSPAPERS

PUBLISH Your Book! Join our successful authors: All subjects invited. Send for free appraisal and detailed booklet. Carlton Press, Dept. PMM, 84 Fifth Avenue, New York 10011.

"HOW-To Prepare For The Coming Crash!" Revealing!!! \$2.25. Sanders Mail-Order, 2243-PM Northwest Flanders, Portland, Oregon 97210, Free How-To Book Lists!

MILITARY Manuals/Books Catalog 25¢. Hillcrest Military Publications (K-18), McDonald, Ohio 44437.

(Continued on next page)

BOOKS, CATALOGS, NEWSPAPERS

(Continued from preceding page)

FREE Atheist journal, Catalog, Truth Seeker, Box 2832 San Diego, Cal. 92112.

BARGAIN! Books on Poker, Chess, Bowling, Success, Popularity, Dreams and Omens, Marriage, Self-Improvement. Free list. Nolan's, Dept PM, Box 1114, Paducah, Ky. 42001.

FREE! Big New Illustrated Discount Catalog. Bargains, Gifts, Books, Amazing Values! Post, 163 West Vine, San Bernardino, California 92401.

WIRETAPPING and the Laws—Your Privacy Invaded—Free Brochure—Don-Q, Box 548, Seattle, Washington 98111.

NATIONAL Geographic Magazines, 1888-1971, any issue. Buxbaum, Box 465-PM, Wilmington, Delaware 19899.

CO-PUBLISH "Timely Tips" a mail order man's magazine. Diane Gargas, 4719 Kennedy Ave., East Chicago, Ind. 46312.

FREE BOOK. Prophet Elijah Coming Before Christ. Megiddo Mission, Dept. 63, 481 Thurston Road, Rochester, N. Y. 14619.

RACING FANS America's Most Profitable Systems Subscription Rate \$5.00 1 YR. Systems Catalog, 78 Merchant Street, Newark, New Jersey 07105.

YES! I have the book you are looking for. Free brochure. John A. Pradere, 860 N.W. 1st St, Miami, FL. 33128.

FREE Catalog. How-To-Books, Bargain Guides, Blue Books. Elston House, Centerville, Mass. 02632.

RELAX! Always tense and on edge? Nervous and irritable? Dr. Gutwirth's 114 page book, "You Can Learn to Relax", reveals how to avoid stress and attain complete relaxation in a short time! Book #WB-119, only \$1.00. International Mail Order, P.O. Box 157, Waipahu, Hawaii 96797.

IMPROVE Your Personality, 110 page book—"Dynamic Thinking" shows how. \$1.00. ANDERSON, 831 ESCUELA, SAN DIEGO, California 92102.

HOW TO MAKE MONEY WITHOUT REALLY TRYING! I did! Read my book and you can too! Send \$2.00. H&H Enterprises, P.O. Box 2103, H. Canoga Park, Calif., 91306.

FREE List. All Fields. Name Subject. Book Finders, Box 341, Northbrook, Illinois 60062, Dept. AA1.

NOW! FANTASTIC BARGAINS! Fabulous Selections! Discount Book Catalog. Free! Sunni's, PM4, Box 511, Augusta, Georgia 30901.

FREE 306 Magazines Monthly. Write: Diamond, Box 15473J, San Diego, California 92115.

IMPROVE Your Health, Live Longer. Natural Foods Book Provides Vital Facts. \$1.95. Karey Samsons, Box 607, Hollywood, Calif. 90028.

BOOKS Up to 85% off, choose from over 700. 25¢. Velcro, Box 572, Lowellville, Ohio, 44436.

PLAYS, SONGS, MANUSCRIPTS

RECORDS Made. Publishing Contract Guaranteed On Accepted Songs, Poems. Send: Talent Searchers Of Hollywood, 6311-X Yucca, Hollywood, Calif. 90028.

SONGS, SONGPOEMS Wanted For Radio Show, Hollywood Music Productions, 6425-PM, Hollywood Boulevard, Hollywood, California 90028.

WHY HIDE YOUR TALENT? Send your Songs, Poems for FREE Examination, Possible Recording/Publishing, 50-50 Agreement. Betty's Music Makers, 1417B Park Bldg., Pittsburgh, Penna. 15222.

PUBLISHING Contract Guaranteed on selected songs and poems. Free evaluation. Hollywood Songwriters', 6253 Hollywood, 1117-PM, Hollywood, California 90028.

BUSINESS SERVICES

PROFITS FROM CLASSIFIED ADVERTISING! Booklet shows you how to start your own business with Classified Advertising. Only \$1.00 (Refundable with first order.) C. A. MARTIN, POPULAR MECHANICS, DEPT. P, 224 WEST 57 STREET, NEW YORK, N.Y. 10019.

CHECKING Account—4½% Interest. F.D.I.C. Chicago Address: 50¢. 714W Janisch, Houston, Texas 77018.

PERSUASIVE Letters-Circulars Written. Sales dynamite. Samples-Book \$1.00 deposit. P. Birken Advertising, Box 8846, Pine Bluff, Ark 71601.

SAVE Cash! Advertising copy, Layout, Production. Sales-Clinching Letters, Coupons, Catalogs. Data \$1.00. Baughan Creative Services, Box 1426-W, Plainfield, New Jersey 07061.

BUSINESS OPPORTUNITIES

... BIG, BIG, BIG MONEY IN MINUTES! New patented process-repairs, renews vinyl or leather tears, cuts, burns, stains, ENORMOUS Market. HUGE Profits! Furniture, autos, mobilhomes, restaurants, bars, hotels, offices! Colors, patterns match perfectly! Fantastic profits too in **CUSTOM UPHOLSTERING**—Sofas, chairs, footstools—all furniture. No experience needed, we show you how to acquire **BOTH** Big, money-making, money-saving skills in spare time, at home. **FREE** 32 Page booklet gets you started **FAST!** No salesman will call. Modern Upholstery Institute, Box 899-GTH, Orange, Calif. 92669.

BUILD Custom Cases at home for profit. Get orders by mail. We supply materials, instruction—everything. Free home business details. Custom Case Supply Co., 6075 CPA, De Soto Avenue, Woodland Hills, California 91364.

INSTALL Burglar alarms without previous experience or costly equipment. Big profit. Free details. Nasco, Dept. G2701, Woodland Hills, California 91364.

\$500 WEEKLY Possible! Mail Order! Free Details! Xcito Orders, 5715 N. Mozart, Chicago, Illinois 60659.

HOW And Where to get capital. \$5000 + possible in one day. Free details. JPA, Box 101-BA, Park Ridge, N.J. 07656.

BOOKKEEPING Service Operators needed everywhere. Earn \$10.00 hour We train. Details free. Universal Bookkeeping, Box 664-M, Springfield, Missouri 65801.

OWN YOUR OWN Light manufacturing business. Operate full or part time from home. Free information. Box 11214, Charlotte, N.C. 28209.

\$2,000 MONTHLY IN FABULOUS NEW BUSINESS. J & J Gift Company, Box 699P, Rimpau Station, Los Angeles, Calif. 90019.

MAILORDER PAYS BIG! Your Own OPPORTUNITY CATALOG Business. Details—Samples, 25¢. Mann, 7-MA Wilste, Hillsdale, New Jersey 07642.

"DISTRIBUTORS"

"For Wrought Iron Home Workshops" Used by Schools, Hospitals, Men and Women of All Ages. Continual Repeat Business. Investment \$5,000.00 Secured by Inventory No Fees. Send for Free Color Brochure. Wrought Iron Tool Company, Box 663, West Caldwell, New Jersey 07006.

OPERATE Your own Charm and Modeling business by mail. Everything furnished. Write: Royce, 14603 Dorchester, Dept. GM-13, Dolton, Illinois 60419.

FABULOUS, Fascinating, Profitable World of Mailorder easily yours. Find out how! Write: Wall, PM, Route 5, Jefferson City, Missouri 65101.

311 FAST, Easy ways to make money! Free! Rush name, address, zip. Perry, 13263-D Ventura Blvd. Studio City, Calif. 91604.

EARN \$2,000 Monthly. Amazing, Interesting Businesses. Write: Mycohouse, 7106B Hillisboro, Houston, Texas 77020.

YOUR FUTURE AND THE THINGS you want selling Office Supplies, machines, furniture, equipment plus much more. If you're ready to advance, write: OSECO, 3505-PM Elston, Chicago, Ill. 60618.

FANTASTIC PROFITS!! Import Outstanding Quality Jewelry, Gifts. Sell direct, wholesale. Dropshipments available. 18 Popular Samples (Typical Retail Value—\$30.00) just \$5.00 Seamail; \$7.00 Airmail. Remit US Postal, Bank Money Order. Satisfaction Guaranteed. Catalog 1,000+ items included. Without order, \$1.00. Taiwan Variety, Box 24-29PM1A, Taipei, Formosa.

JUNIOR HIGH, HIGH SCHOOL BOYS! \$46.00 or more possible weekly working after school and on weekends. For complete information send \$3.00 TODAY to: Marketing Corporation Associates, P.O. Box 21151, Phoenix, Arizona 85036.

EASY-To-Start rubber stamp business at home in spare time. Make up to \$16.50 an hour without experience. Facts free! Write to: Roberts, Room RC-2-CC, 1512 Jarvis, Chicago, Illinois 60626.

IMPORT-Export Opportunity, profitable world-wide mail order business from home, without capital or travel abroad. We ship plan for no risk examination. Experience unnecessary. Free Report. Mellinger, Dept. G2701, Woodland Hills, California 91364.

HERBALISM! The home gold mine! Free lesson. Herbalism Institute-B, 1339 Remuda, Glendora, Calif. 91740.

\$200 WEEKLY! Make, Sell Bricks! Free Information! Xcito Bricks, 5715 N. Mozart, Chicago, Ill. 60659.

RIDICULOUS Repeating profits simply mailing paper. Vendall, 3825 Elcajon Blvd. San Diego, California 92105.

WORLD Import Directory \$3.00. Woodrow Wilson, 1812-PM Halifax Road, Woodbridge, Virginia 22191.

OPPORTUNITY Knocks Only Once—Invite It!!! Free Information For Stamp. TBOR, Box 1692-D, F.D.R. Station, New York 10022.

\$500-\$1000 MONTH Plan raising rabbits for us. Free details. White's Rabbitry, PM, Mt. Vernon, Ohio 43050.

WORLD'S Largest supply, Merchandise 25% to 40% under wholesale. Bankrupts. Closeouts 10¢ on dollar. Imports. Hong Kong clothes. Automobile discounts. Free details. International Buyers, Box 16386 MM, Portland, Oregon 97233.

SECRETS! Mail Order Success. Internationally famous expert reveals how to make home business fortunes. Beginners: Get free report "Make Money By Mail." Discloses free advertising profitable products. Mailco, Dept. GC701, Woodland Hills, California 91364.

INSTANT Mailorder!! Complete. Profitable. Proven. Starter kit 25¢. KS Promotions, 8156AE, Milwaukee, Wisconsin 53224.

\$15,000 JOBS In CIVIL SERVICE Details Free. Jackson's Supply, Mt. Liberty, Ohio 43048.

MILLIONAIRE MONEY-SECRETS! Remove Debts, Raise Money, AAA Credit, Lifetime Income. Free Advisors, Box 616, Beverly Hills, Calif. 90213.

SELL Books by mail. Complete dealer set-up—25¢. Midwest Mail Sales, Box 44R2-PM, Shawano, Wisconsin 54166.

1000+ Profit Bronzing Baby Shoes. Free Literature. NBC, Box C-4-PM, Coral Springs, Florida 33065.

MAILORDER Millionaire helps beginners make \$500 weekly. Free report reveals secret plan! Executive (1A1), 333 North Michigan, Chicago 60601.

MAKE A Years Income in 8 weeks Camping. No selling. Capital or Land necessary. Write: Edrus, Route 5, Box 5733, Gig Harbor, Washington 98335.

(Continued on next page)

BUSINESS OPPORTUNITIES

(Continued from preceding page)

BECOME "Mortgage Broker." Lucrative! Capital Sources, Box 99-A, Uleta, Florida 33164.

MAILERS Needed! Big money! Send 10¢ for information. Andrew Sales, Box 152, Blue Island, Ill. 60406.

MAKE Magnetic signs, Machineless method. Profits enormous. Write: R1B49APM, Bardstown, Ky. 40004.

PIANO Tuning Learned Quickly At Home! Tremendous field! Musical knowledge unnecessary. GI approved. Information free. Empire School, Box 327, Miami, Florida 33145.

HOLLYWOOD CEMENTCRAFT: Offers Highly Profitable Home Business. Experience Unnecessary. Unlimited Unique Pottery Designs Easily Made Without Moulds. Bird-baths, Fountains, Wishing-Well, Waterfalls, etc. Chemical Coloring Formulas. Marble-glazing. FREE Illustrated Brochure. **CONCRETE FACTS**, 602 Athens Street, Altadena, California 91001.

ADVERTISING BUSINESS—YOU Own it. \$350 First Week or Money Back. Electric Neon Action Ad Clock, 229 W. Illinois, Chicago 60610.

COPUBLISH "Mail Sale Advertiser," leading mailorder paper. Copy and details 25¢. U.S.A. only. Vanroy Shirk, Lebanon, Pa. 17042.

VENDING Machine big catalog. Rake, 523 A Spring Garden, Philadelphia, Pa. 19123.

DRAFTSMEN! Operate own **DRAFTING SERVICE!** Full, Part Time; Experience unnecessary. Details: Roberts Drafting, 1741 Circle Road, Baltimore, Maryland 21204.

FREE Catalogs. Repair air conditioning refrigeration. Tools, supplies, full instructions. Doolin, 2016 Canton, Dallas, Texas 75201.

I MADE \$40,000.00 Year by Mailorder! Helped others make money! Start with \$10.00—Free Proof. Torrey, Box 318-Y, Ypsilanti, Michigan 48197.

MAIL Baby Catalogs Imprinted with your address to New Mothers for Big Profits! Details 25¢. Volz PM, Ypsilanti, Michigan 48197.

MAKE \$46 From square foot plywood: jigsaw or bandsaw necessary. Free details. Woodar, Bridgewater, Mass. 02324.

\$25.00 HUNDRED Addressing. Possible Year 'round. Complete instructions 25¢ for registration, postage. Cove, Box 1348-B, Clearwater, Florida 33517.

\$70 TO \$200 WEEKLY—Home, Spare Time Simplified Mail Bookkeeping. Immediate Income. Easy. Auditax, Box 34741A, Los Angeles, Calif. 90034.

ADDRESSERS And Mailers Needed. Details 10¢. Lindbloom, 3636 West Peterson, Chicago 60659.

VENDING Machines. No selling. Routes earn amazing profits. Big catalogue Free. Parkway Corporation, 715PBM Ensor Street, Baltimore, Maryland 21202.

\$60.00 DAY. Manufacturing Concrete Posts. Blocks. Mold Equipment Catalog \$1.00 refundable. Carlayne, Route One, Box 95, Rapid City, South Dakota 57701.

MAIL Order Collection Agency can make you \$1000.00 monthly. Free Details. Continental, Box 2023-A, Des Moines, Iowa 50310.

SELL Books by mail. 400% profit. Royal, Box 450-X, Cleveland, Ohio 44127.

CLIP Short newspaper items. To \$10.00 each. Details free. Foster, 272-M-1, Brooklyn 11235.

MAILORDER Records help get increased business! Complete 32 page Record Book shows your inquiries, orders, advertising, expense, etc. Only \$1.00. C. A. MARTIN, POPULAR MECHANICS, DEPT. R, 224 WEST 57TH STREET, NEW YORK, NEW YORK 10019.

BIG PROFITS!! SELL ENGRAVED, METAL, SOCIAL SECURITY PLATES. FREE SALES KIT! MYERS, 928-PM CRESCENTHILL, NASHVILLE, TENNESSEE 37206.

HOMEWORKERS. \$100.00 Weekly Addressing for firms. Begin immediately. Details—send stamped, addressed envelope. Hamilton, 272-TMA1, Brooklyn 11235.

\$200.00 DAILY In your mailbox! Your opportunity to do what mailorder experts do. Free details. Associates, Box 136-A, Holland, Michigan 49423.

TAKE Catalog orders. We drop-ship 1001 best selling specialty products. Guaranteed lowest below wholesale prices. Fantastic spare-full time home business. Free book show you how. SMC, 6061 SPA, De Soto Avenue, Woodland Hills, California 91364.

REPAIR Hydraulic Jacks—Details Free. Write: Hydraulic Parts Supply, Box 295, Port Isabel, Texas 78578.

EARN \$60.00 Daily manufacturing Concrete Fence Posts. Practically no investment. Send stamped-addressed envelope. American, Excelsior Springs, Mo. 64024.

RECEIVE MAIL Galore! Your name on our national mailing lists, 50¢. Sullins, Box 1313, Brunswick, Georgia 31520.

\$50.00 PLUS 50% COMMISSION Stuffing 200 already stamped, addressed envelopes, our circulars. Information 25¢ with stamped, self-addressed envelope. Brewster-PB, Clearwater, Florida 33517.

JOIN The professionals. Profitable Gift Catalog Distributorship. Giffair, 1430-40 Wells, Milwaukee, Wisconsin 53233.

MAILORDER Catalogs. Your Name Imprinted. Merchandise Drop-Shipped. Details 25¢. AM Sales, 32-28 100th, East Elmhurst, N.Y. 11369.

START Profitable Mailorder Business!! Details explained free. Write: Great Lakes, Box 555D1, Rochester, Michigan 48063.

PROFITABLE BUSINESS—Molding Rubber, Hobby Supplies. Details 10¢. Chaney's, 5415 L San Jose Blvd., Jacksonville, Fla. 32207.

400,000 BARGAINS Below wholesale! Many free. Liquidations . . . closeouts . . . job lots . . . single samples. Free details. Bargainhunters Opportunities, Box 730A, Holland, Michigan 49423.

\$200.00 SPARE Time earnings with your Tablesaw. Write: Workshop Five, 3800 Harney, Vancouver, Washington 98660.

HOMEWORKERS Wanted. Details 16¢ Stamps. Brodin Company, 28P Rainbow Village, Columbia, Mo. 65201.

ESCAPE Daily Grind. Retire Without Money. Details Free. Naggo, Box 11478, Chicago, Illinois 60611.

ASSEMBLE Products At Home, \$600.00/Week. Nieman, One Forsythia, Hamburg, New York 14075.

MAKE Big Money In Your Own Business, By Mailorder, Without Capital. Free Details. Unique, P.O. Box 6094 P, Duluth, 55806.

BIG PROFITS SELLING BURGLAR ALARMS! Small investment Required. Lee Specialties, P.O. Box 32-P, Dobbs Ferry, N. Y. 10522.

PIANO Tuning Instructions With Tools. Only \$22.50. Information Free. Stamm, 905, Washington, Oregon, Ill. 61061.

TRANSPARENCIES Wanted. Learn **FREE-LANCING**. American Color, Box 2193, Sepulveda, California 91343.

\$400.00 MONTHLY Raising giant fishworms. Soilless method. Charlie Morgan, Bushnell, Florida 33513.

REUPHOLSTERY. Profitable Home Business. Illustrated Manual \$2.00. M. Russell—P-13, 1566 So. Burkhardt, Evansville, Indiana 47715.

EARN Money raising fishworms for us! Write: Oakhaven-38, Cedar Hill, Texas 75104.

MANY New Plans. Details Free. Homecraft, 2350 W47N. Denver, Colo. 80211.

BIG PROFITS LEARN Underground Lawn Sprinkler Business Using Plastic Pipe, No Costly Equipment, Write For Details, Sprinkler, Box 121, Dunedin, Fla. 33528.

MAKE To triple times your cost. Hundreds of products, gifts, novelties, toys, many others. \$1.00 brings giant catalog, refundable with first order. **DONMAR PM-D**, 809 Ravenwood, Arlington, Texas 76013.

FREE SECRET BOOK "2042 Unique, Proven Enterprises." Largest successful, moneymaking collection! Beat inflation with fabulous "Little Knowns." Work home! Haylings-T5, Carlsbad, Calif. 92008.

HOMEWORKERS—Mailing Wanted! Free Information. A-Allen, 2418 Lori, Santa Ana, California, 92706.

RUBBER Stamp Business. Starting Outfits. Free Manufacturing Catalog. Northwest Stamp, Box 16417-PM1, Portland, Oregon 97233.

FREE NEWSLETTER Shows "Little Fellow" how to start, finance, build profits in his own business. Visivox-P2, 210 Fifth Avenue, New York, New York 10010.

900% PROFIT In Magnetic Signs, Candle Molds, Packaging plus 1000s of plastic items. Free details. NPC, Dept. 290, 4200 Panamint, Los Angeles, California 90065.

ONLY \$39.00 Starts proven successful mailorder business selling books. (Drop-ship method) Sample imprint circulars free. Neil H. Tasker, Shamokin, Pennsylvania 17872.

HAITI—Shopper's Paradise. We'll help you obtain items you want—arts—crafts, find source for your manufacturing needs, sell your merchandise, almost anything you desire. Send request. Islands, 19 West 34th Street, New York 10001.

MEN-Women Make Big Profits At Home! In Plastics, part or full time! Unique process teaches you with equipment we give you free to make hundreds of 3-D plastic products, candy and candle molds, plaques, signs, Skin and Bubble package. Also resin casting. Write today for free details. Nationwide Plastics, Dept. ATV, 4140 Eagle Rock Blvd., Los Angeles, Calif. 90065.

MAILORDER Book Publisher Wants Dealers. Details 25¢ (refunded). Jan Enterprises, 76P, Wild Rose, Wisconsin 54984.

NEW Manual, How To Manufacture Concrete Floor Tiles For Fun, Profit. Very Small Investment, Easy Method. Complete Instructions, \$6.00, Guaranteed. Hilmar, Route One, Box 347-D, Valrico, Florida 33594.

FREE Millionaire Book "990 Successful Little One-Man Businesses. Work home! SBI-7, Kerrville, Texas 78028.

LET Others make money for you. Start home business. I show you how. Free Report. Morgan, Dept. G2701, 6100 Variel, Woodland Hills, California 91364.

SELL LIFETIME METAL SOCIAL SECURITY PLATES. BIG PROFITS! SAMPLE AND SALES KIT FREE. RUSSELL PRODUCTS, MAURY COUNTY SHOPPING CENTER, DEPARTMENT P41, COLUMBIA, TENNESSEE 38401.

MONEY MAKING OPPORTUNITIES GALORE! Read Mail Order's **TIMELY TIPS** Magazine. 48th year! Sample copy 25¢. Major, 1310 Bloomfield, Hoboken, New Jersey 07030.

MAILORDER SUCCESS Can Be Yours. Get The Facts. Start The Right Way. Free Details. Mister Unique Mail, Box 555, Dept. PM1, Los Alamitos, California 90720.

HOW To Finance Your Own Business. Get \$500 to \$2 million. Free offer. Capital-17, Kerrville, Texas 78028.

400+ WORLD Class athletes, pro stars, coaches, teams among Sportabs 1000's of customers. Unique multivitamin supercharged with 200 I.U. Vitamin E. Send for amazing athletic performance study, free sample, information. Sportabs International, P.O. Box 3192, Dept A-18, Van Nuys, Calif. 91407.

(Continued on next page)

BUSINESS OPPORTUNITIES

(Continued from preceding page)

FREE 1973 100-Page Catalog waiting to bring you Big spare-time cash commissions. Sell Advertising Book Matches. Every business a prospect . . . complete selling instructions furnished. Steady, repeat business. Dept. MX-173, Superior Match Company, 7530 South Greenwood Avenue, Chicago, Illinois 60619.

"HOW I Made \$1,000,000.00 In Mail-order" Rush stamped envelope! Alvin Whitmore—PM-1 Clinton, South Carolina 29325.

TYPIST? Secretary? Operate Local Stenographic Service. Home Literature Roberts, Box 4633, Lincoln, Nebraska 68504.

"MAILORDER Laws And Regulations." Know The Facts. \$2.00. "Bill" Lambertson, 132 Tamiami Station, Dept. PM13, Miami, Florida 33144.

MAIL LETTERS!!! Make \$8.00 Profit Every Order. Everything Furnished. Write: Stayer Enterprises, 3704 Warwick, Peoria, Illinois 61614.

STUFF Envelopes. \$25 Hundred. Immediate Earnings! Beginner's Kit, \$1.00 (refundable). Lewcard, P392M, Brea, Calif. 92621.

HOW To Raise \$100.00 to \$1,000.00!! Drawer 77009-A, Atlanta, Georgia 30309.

DROP Ship Your way to a Mail Order Fortune with "Drop Ship Buyers Guide". \$3.00. Cazin, 526 Maple, Redwood City, Calif. 94063.

\$10,000-\$50,000 YEAR Possible Send \$1.00 For Book "Raising Catfish For Us" Money Back Guarantee. Southern Fish Farm, Dept. PM-1, Manchester, Kentucky 40962.

CHECK US if you want to make big money within 30 days. High security in Building Maintenance. Easy to learn. Reasonable. Hart Enterprises, Dept. A, Box 5245, Mission Hills, Calif. 91340.

MAILORDER LAWS And Regulations. Only \$2.00. Rehberg, Box 812, Dept. A, Evanston, Illinois 60204.

CLOCK Fixing Simplified, Instructions, Tools. Free details. Thiese, Genoa, Illinois 60135.

FREE "Money In The Mail", Milan, Box 32284, Decatur, Georgia 30032.

FREE Collection Agency Details. \$1000.00 Monthly Possible. Master, Drawer 77009-PM, Atlanta, Georgia 30309.

EARN \$2,000.00 Monthly in Astonishing Spare Time Business. Details Write: James Carmack, 233 1/2 N. Main Street, Manteno, Illinois 60950.

MAILORDER Catalogs—Puts You in Your Own Business, No Inventory, Full Profits. Free Details. London House, 2566 Colden Avenue, Bronx, N.Y. 10469.

WATCHMAKING Makes every day a payday. Learn this cash business at home. Free details. Chicago School of Watchmaking, YNA, Fox River Grove, Illinois 60021.

MEN—Women! Fill out income tax forms at home in own business. We show you how. Simple, easy to learn. \$700 per month earnings. possible. Details mailed free. No salesmen. Hurry. Federated Tax Home Training School, 2065 Montrose, Chicago 60618.

MAKE Durable building plastic easily. Waterproof, fireproof, economical. Bays Laboratory, Cedaredge, Colo. 81413.

FREE RENT. Your City. Broker tells how. Surprising facts. Free information. Lucas, Box 33000B, San Diego, California 92103.

EXTERMINATING-LEARN Profitable Occupation At Home! Approved school. Beckwith Schools, Dept. 20, 515 U.S. Highway 46, Fairfield, N.J. 07006.

MAILORDER!! Enjoy Wonderful Income. Financial Security! Everything furnished. Start making money now. Write: Allen, 554CS-6 Spruce, Garwood, New Jersey 07027.

FRUSTRATED? Unique Publication Guides Opportunity Seekers. Free details. Sherwood Publishing, Box 517, Brundidge, Alabama 36010.

MAILORDER Dealers Wanted. Earn outstanding profits using tested promotions! Executive type business. Details Free. Rutward, Box 735-PD, Norwalk, Conn. 06852.

FRANCHISE. Information for any Company or entire industry. Write now: Box 262, Hicksville, New York 11802.

FREE Booklet, "How To Sell By Mail." Write: Ransone, Box 1719, Richmond, Virginia 23214.

FREE Sample. Sell Lifetime Social Security Plates. Big Profits! Ultis, 10716 Francis, 1PM, Los Angeles, California 90034.

\$2,000 MONTHLY in Fabulous New Business. Free Details. Nielsen's, Box 15894-P, Salt Lake City, Utah 84115.

"PROFITABLE ENGRAVING". New Manual Gives Complete Instructions. Ideal Home Business. Trend Craftsmen, 4901E Perrine, Midland, Michigan 48640.

DOUBLE Your Income! Part Time Plan Really Works! Details. 24c (Stamps). Venture, Box C-13, Kensington, Connecticut 06037.

MAILORDER Treasure Books. Free Information. Amerasian, Box 776-CA, La Canada, California 91011.

SELL Books!! Complete Mailorder Plan. Vikari's, Box 1312PM2, Salt Lake City, Utah 84110.

BUMPER Sticker Printer Kit puts you into bumper sticker and T-shirt printing business fast! Great at swap meets, churches, organizations and for anyone who wants to say their own thing. No stencils to cut, easy to operate. Enough materials to earn \$200! Write: Bumper Sticker Printer, Dept. 39, Box 234, Torrance, California 90501.

FREE BOOK "999 Successful, Little-Known Businesses." Work Home! Plymouth-B1, Box K, Brooklyn, New York 11204.

BUY Below Wholesale, Hundreds of Items. Catalog \$1.00, Refundable First Order. The Hobby Shop, Dept. 1-F-1, 219 N. Church St., Hudson, Mich. 49247.

\$75 DAILY Working only 5 minutes a day. Guaranteed, Professional Method. Details Free. NeWorld, Box 1446, Lafayette, Indiana 47901.

DON'T DELAY, Write today. Start your own mail-order business. Send inquiries to: Remos, Box B1-3, Garden Grove, Cal. 92640.

\$500 WEEKLY. Mail Order Plans. Free. Raney, 18 Oneida, Centereach, New York 11720.

EARN \$10.00 Hour. High Profit. Toys, Novelties, Catalog. \$1.00 Refundable. LM, 101, E4201 Twelfth, Spokane, Wash. 99202.

FREE Booklet "How To Successfully Sell By Mail." C. Mertz, 3123 Harvard, Granite City, Ill. 62040.

DEVELOP SALES OUTLETS For Your Crafts, Hobbies, Antiques, Small Business. Send Product Information To: Conestoga Supply House, 1014B Willow St. Pike, Lancaster, Pa. 17602.

WE NEED GINSENG GROWERS! \$3,000-\$30,000 Annually! We Buy Your Crop. Send \$2 for Seed Sample and Information. Glass's Ginseng Exchange, Box 336, Rochdale Station, Jamaica, NY 11434.

MAKE Gorgeous original candles for all holidays and special occasions. Learn expert Candle decorating, candlemaking, use of professional molds. Free details on home instruction method. Candle Institute, Dept. C-71, 1600 Cabrillo, Torrance, Calif. 90501.

MAKE MONEY With Stained Glass Reproduction Jewelry. Dealers Wanted. Free Details! Coby, Box 923, Selma, Alabama 36701.

MAILORDER: How to prepare your own catalog for pennies! Free Catalog! Obie-B1, Brooklyn, New York 11219.

COPYWRITING, Ghostwriting for Mail-order Dealers. Goutell, 175 Fifth Avenue, N.Y.C. 10010.

INTERNATIONALLY KNOWN MANUFACTURER 1972 SALES 357 MILLION DOLLARS OFFERS YOU A Chance To Be In Your Own Business High Profits—New mobile auto parts distribution—152 Now Operating Nationwide. Valley Forge Products, Div. Avnet Inc. Dept. S, Box 96, Inwood, N.Y. 11696.

PREPARE Tax Returns—Housewife Jo Ann Netzley made \$5,500 last season. Train at home. VA Approved. National Tax School, Monsey 2HB, New York 10952.

\$1000 MONTHLY From your own home, write: Jordan, 27495 Road 176, Dept. PM1, Exeter, Calif. 93221.

TAKE In \$200.00! . . . Your own social security plate business! (Machine, supplies —\$24.95 complete!) Free details. Ideaco, Box 69828PM, Los Angeles 90069.

HOMEWORKERS—MAKE UP TO \$10 IN AN HOUR ALL PROFIT, doing Invisible Reweaving/Reknitting on holes, cuts, tears in any fabric, even knits. Oldest, largest home study reweaving school shows you how, helps you get customers fast. Details mailed free. FABRICON, 2008 Montrose, Chicago 60618.

MONEY In Mail Order. Free Details. Island, Box 157-F, Bayside, N.Y. 11361.

UNIQUE New Business. Earn \$1500 Monthly at Home. Wemco, Box 294, Pawtucket, R.I. 02861.

MAIL ORDER DISTRIBUTORSHIPS available for \$150 investment Free brochure. Dept. 104, Audit Controls, 28 Brookside Ave., Fair-Lawn, New Jersey 07410.

MY Wife and I made \$300.00 Weekly. Part Time. We'll show you how—FREE. Jacquet Laminations, 203 West Palatine Road, Palatine, Illinois 60067.

CALIFORNIA MANUFACTURER NEEDS Man to assemble our product and be local agent, experience unnecessary. May start while presently employed. Five-figure income for responsible applicant. S.K.R.M. Manufacturers, 2347 West 238 Street, Torrance, California 90501.

BULLFROG Raisers needed—new, easy and profitable. Guaranteed market. Backyard fine, no noise or odor, space 34 ft. x 34 ft. needed. Minimum cash investment \$2,995. Potential annual gross \$21,600. For details write: "BULLFROGS", 1974 Downey Ave., Ft. Worth, Texas 76112. Include phone number.

MAILING ORDER, That's the Booming Business Today. \$1000, \$2000 a Month, or More; No Limit. R.R. Smith, P.O. Box 2202, San Francisco, Calif. 94126.

MONEYMAKING OPPORTUNITIES

HOW Much Does being your own boss or making \$25,000.00 per year interest you? The Warner breakthrough in the Engraving field could be your future. Write: Warner, Room EC-2-CC, 1512 Jarvis, Chicago Illinois 60626.

MAKE Extra money mailing circulars for mailorder firms. Details 30c with stamped, self-addressed envelope. Davis-A2, 3406 Dell Road, Jeffersonville, Kentucky 40299.

MAKE MORE MONEY—Start your own Home Business. Our publications show you how. Books—by—Mail. 333 N. Michigan, Chicago, Illinois 60601.

CAMERA Owners! Earn \$100.00 to \$700.00 From Your Photos. \$1.00 Booklet tells you how. Jackson Mail Order Sales, 411 E. Coleman Street, Crothersville, Ind. 47229 Dept. 11.

HOMEWORKERS. Make \$1.67 each, mailing envelopes. Rush 10c. Gemco, B-21244A, Indianapolis, 46221.

(Continued on next page)

MONEYMAKING OPPORTUNITIES

(Continued from preceding page)

HIGHER INCOME SECURITY AND POWER. 256 Page Book "Thinking Big" reveals secrets that make men rich. Send \$2.00 **HEDGEROW HOUSE OF GIFTS**, Route 5, Mansfield, Ohio 44903.

FREE SOCIAL SECURITY PLATE. Send us your Name and Number. Kern Products, 246A Richmond Avenue, N. Massapequa, N.Y. 11758.

INEXPENSIVE Burglar, Fire, Smoke, Auto Alarms, Extinguishers, Supplies. Watchdog Alarms, Williamsburgh, Ohio 45176.

WE BUY NEWSPAPER CLIPPINGS of Wedding Announcements for 50¢ each. Details \$1.00. Clippings, Box 3146DC, Odessa, Texas 79760.

MAKE MONEY Writing Short Articles, Selling Photos, Collecting Coins, Reports Reveal How, Where! Send \$1.00 Each Today. Revere Enterprises, 990 Ellington Lane, Pasadena, Calif. 91105.

HOMEWORKERS FOR TELEPHONE SALES. \$2.25 COMMISSION EACH SALE. NO INVESTMENT! Apply: Esse Enterprises, 18059 San Juan, Detroit, Michigan 48221.

PROFITABLE MAILORDER IMPORT Dropped. Showcase, 107 Upper Ferry, Trenton, N.J. 08628.

3,000 IN 60 Days—Legally—No Fees or Investments. Details \$2.00. Guaranteed. Brodin Company, 28 Rainbow Village, Columbia, Missouri 65201.

\$10 DAILY Writing Short Articles at Home. Begin immediately! Copyrighted Report Reveals How and Where. Send \$1.00. Cherokee House Of Gifts, 3130 Blue Springs Road, Cleveland, Tenn. 37311.

MONEY Magic! Use Photo Business Cards. Details Free. Schneider Co., 1951H Shenandoah, Los Angeles, Calif. 90034.

MAKE MONEY Drawing and Painting Sparetime. Learn what is in demand and where to sell. Send \$1.00 for Art-15. Restek Publications, 525 Copper Ridge, Richardson, Texas 75080.

SPARE Time Cash. Sell Famous Hanover Shoes. Actual Samples and sales kit Free. No experience needed. No age limit. Lowest prices for highest quality makes selling easy. Every man a prospect. Big daily commissions. For full details, write: Hanover Shoe, 972 Carlisle, Hanover, Pa. 17331.

BIG Money Writing Jokes. Enormous demand. We show you how. Free Facts. Laffs, Dept. G91, Pleasant Hill, Ohio 45359.

\$2.40 HOURLY Making simple wood novelties. Free details! Gene's, 55 Boxwood, Falmouth, Mass. 02540.

LEARN The secrets of repairing junk batteries "Fabulous Profits" at home. Battery Shop, Box 820, La Quinta, Cal. 92253.

MAKE \$1.00 PER SALE Selling engraved metal Social Security plates. **FREE SALES KIT.** Engravaplates, Box 10460-199, Jacksonville, Florida 32207.

CONTEST REPORT Complete Information About Cash Prizes Offered Monthly. Send 25¢ for Current Issue, Box 307A, Ypsilanti, Michigan 48197.

WORLD'S Leading contest magazine, 25¢. Year, \$4.00. Prizewinner, 1315 Central, St. Petersburg, Fla. 33705.

CLIP Newspaper Items. \$1.00-\$25.00 Each. Free Details. James, Box 124M, Inglewood, California 90306.

MAKE Statuettes, novelties, imitation marble. Sell to stores or start gift shop. Free details. Marbleizing, 41 Waverton, St. Louis, Mo. 63124.

HOW TO GET RICH!! Free "Money-making Brochure"! Success International, Box 2447-C, Livonia, Mich. 48151.

VENDING Machines. No selling. Routes earn amazing profits. Big catalogue Free. Parkway Corporation, 715PMM Ensor Street, Baltimore, Maryland 21202.

FREE—Easy Ways to make money selling exciting new products—Full—spare time. Send name, age, for 5 months free subscription. Salesman's Opportunity Magazine, 1460 Hancock Center, Dept. 17-AM, Chicago 60611.

\$200.00 FROM Sheet 1/4" plywood (scrap). Details 25¢. Novelties, 610 So. 24th, Elwood, Indiana 46036.

GET World's Biggest Wholesale Import Catalog. Write: World, Medina, Washington 98039.

CLIP Newspaper items. \$1.00-\$5.00 each. Details free. Walter, Box 1360PA, Erie, Pa. 16512.

HOW To Make Money Writing Short Paragraphs. Information Free. Barrett, Dept. C-27-S1, 6216 N. Clark, Chicago 60660.

PENNY STOCKS Have Profit Potential. Free Information. Analyst-P.M., Box 214, Redondo Beach, California 90277.

200% PROFIT Selling Rings. Triple Money in 30 Days or Money Back. Free Details, Anka, P.O. Box 8036-PM, Cranston, Rhode Island 02920.

BECOME Notary Public! Have dignified sideline. Free details. Stationers Exchange, Box 617, Kilgore, Texas 75662.

ADDRESSERS And Mailers Needed! Free Details! Splendid Opportunity! Delta, Box 24-P, Chalmette, Louisiana 70043.

ATTENTION Homeworkers! Make \$400.00 monthly in your spare time. For details, send 35¢ self-addressed, stamped envelope. William T. Clarke, Dept. PM, 11 Watson Avenue, East Orange, New Jersey 07018.

EARN MONEY, learn mailorder, sparetime, at home, reading leading (since 1929) trade magazine, product sources, stories, tips. Sample 50¢, year \$5. Mail Trade, Box 1302, Springfield, Illinois 62705.

MAKE MONEY AT HOME—WE PAY TOP RATES FOR ADDRESSING OUR SALES LETTER. IT'S FUN AND EASY ALL YOU HAVE TO DO IS ADDRESS ENVELOPES, INSERT OUR LITERATURE AND MAIL. EARN AS HIGH AS \$150 PER WEEK OR MORE. Send 25¢ FOR DETAILS AND APPLICATION. CUR-JON MAILING SERVICE, P.O. Box 523-PM, MAPLECREST STATION, MAPLEWOOD, NEW JERSEY 07040.

RUBBER Stamp Business. Starting Outfits. Free Manufacturing Catalog. Northwest Stamp, Box 16417-PM2, Portland, Oregon 97233.

\$125.00 WEEKLY Correcting pupils' lessons! Samples, \$1.00! Castle's, 507-ML Fifth, New York 10017.

BIG Easy Quick Profits, assembling costume jewelry at home, spare time. Simple to do; easy selling. Create family business. Details free! Don-Bar, 2934 Fullerton, Dept. A-743, Chicago 60647.

MONEYTREE Puts \$500 In Your Pocket. Get gifts, money, aids, other free offers. Free details. Moneytree-6, Kerrville, Texas 78028.

TELEPHONE REPORTERS Needed immediately. Set own fees. Enjoy prestige. Information \$1.00. Dollarsavers, 10 Paddock, Hudson, N.Y. 12534.

HAVE FUN Making Extra Money in your Spare Time. Potential unlimited. We provide your start. Send \$5 To: J&G Enterprise, P.O. Box 667, Sierra Vista, Arizona 85635.

FREE Catalog Money-making. Mailorder. Civil Service Course Books. Robert Ober, 660 Groff Ave., Elizabethtown, Pa. 17022.

25¢ EACH, Guaranteed. Stuffing Envelopes. Names, Postage Supplied. Complete Setup \$1.00 (refundable). Danzig, Postbox 255PM13, Brooklyn, NY 11218.

HOME Addressing! \$75.00 Thousand Profit. Information 50¢. Rausch, Box-H, Port Jefferson Station, New York 11776.

NET \$397.50 Weekly Mailing Brochures. Information 35¢. Camala, Box 841-M, Florissant, Mo. 63033.

MONEYMAKING Manuals—Largest List Available! Mears, 2PM73, 5363 Essex Court, Alexandria, Virginia 22311.

NEED MONEY?? Easy, Smart-Money Methods to Skyrocket Your Income! Write: Stayer Enterprises, 3704A Warwick, Peoria, Illinois 61614.

EARN \$\$\$\$ Assembling Clock Kits For Stores and Decorators. No Power Tools Needed. Catalog 25¢. Newport, Box 6848A Burbank, Calif. 91505.

START YOUR OWN PROFITABLE WHOLESALE BUSINESS. Gifts, Specialties, Toys, 1000 Others. Free Details. Redd's, Box 555-A, Colton, California 92324.

MAKE Money on Government Surplus. How and Where to Buy. Directory of Surplus Offices. Sales Terms. Send \$1.00. Spectra Gifts, Dept. PM-1, 309 Old Eagle School Road, Wayne, Pa. 19087.

HOW To Make Money Asking Questions. Interviews, Surveys, Polls... No Selling! Free Information. Vector, Box 4451-P1, Santa Barbara, California 93103.

FREE Practical Program to Eliminate Car Payments write: American Taxpayers Association, 37 Limerick Road, Royersford, Pa. 19468. Non-Profit Association.

HOW To Earn At Home Addressing Envelopes. Rush 10¢. Nozuye P.M., 60 Massey, Toronto, Canada.

HIGHER INCOME, Security and Power, 256 page Book "Thinking Big" reveals secrets that make men rich! Send \$2.00 Ronnie's, 188 Bogert Road, Box 27, River Edge, N. J. 07661.

\$1153 LAST Month. You Can Too Rebuilding Auto Batteries. Write: Powerhouse, 914 Gengler, Marysville, California, 95901.

500% PROFIT From Scrap Lumber. Details 35¢ What—Not Shop, P. O. Box 149, Waterloo, New York 13165.

HOW To Clip Newsitems For Cash. \$1.00 Brings complete manual. Confidential Reports, Box 147-AG, Hanson, Mass. 02341.

FREE Catalog Listing low cost books on Money-making Opportunities & Self Improvement. Heavner & Company, Box 12182-B, Gastonia, N.C. 28052.

\$40 DAILY Possible tying fishing flies at home. Details 25¢. Flyco, Box 481PM, Albany, Oregon 97321.

30% RETURN Plus protection against inflation, devaluation! **ARGAU**, Box 4, Boonton, New Jersey 07005.

\$100.00 POSSIBLE Using \$2.00 glue. Regluing Chairs etc. for self, extra income, my methods \$6.00. Hettinger, 3823 N. Southport, Chicago 60613.

COLLECT COINS For Profits! How To Start, Where To Sell, Lists Of Valuable Coins, Details \$1.00. Good investment. R. Cyr, 191 Pond Rd., Lewiston, Maine 04240.

MAILORDER, Sell Engraved Social Security Plates. Complete Dealer Set-up. AM Sales, 3228 100th, East Elmhurst, N.Y. 11369.

HOW To Make Money Writing Short Paragraphs. Information Free. Write: Mailosav, Dept PP2, 226 S. 16th, Philadelphia, Penna. 19102.

NEW! Profits Making Wooden Toys. Easy! Income. Gifts. Details Free! Toys, 4213MA Castle, Midland, Michigan 48640.

EARN Extra Income! Selling by mail. Free Information! Tradin' Post, Box 190PA, Flint, Texas 75762.

\$1000 MONTHLY Possible Dog Grooming. Be your Own Boss. Work in Home. Free Details. Walter's, Dept. D-53, Waseca, Minn. 56093.

(Continued on next page)

MONEYMAKING OPPORTUNITIES

(Continued from preceding page)

MAKE, Sell Imitation Honey. Very delicious. Formula \$2.00 Brooks, B171M, Arkansas, Wisconsin 54721.

START Small, Highly Profitable Electronic Production in Your Basement. Investment, Knowledge Unnecessary. Postcard Brings Facts. Barta-PME, Box 248, Walnut Creek, California 94597.

PROFITABLE OCCUPATIONS

BAKE New greaseless doughnuts in kitchen. Sell stores. Free recipes. Michael Ray, Waseca, Minn. 56093.

BECOME A Mortgage Broker. Highly respected, interesting, lucrative prestige business. For complete information write: United, Box 6284-F, Marietta, Georgia 30060.

HOW To Make Money Writing Short Paragraphs. Information Free. Barrett, Dept. C-27-S2, 6216 N. Clark, Chicago 60660.

HOW And Where To Get Capital. Get \$500 to \$2 million. Free information. Counselor-25, Kerrville, Texas 78028.

RETIRE ANYTIME IN LUXURY! Be Independent. Easy, Legitimate. Free Details. Premier Enterprises, Box 10597-V, Pittsburgh, Pa. 15235.

FT. SMITH Auction School, Ft. Smith, Ark. 72901. Resident & Home study. Veteran approved.

WE MAKE Over 650 Fiberglass Molds for Ornamental Concrete Products. Catalog \$2.00. Plycrete Mold Co., Elk Rapids, Michigan 49629.

PLASTERCRAFT!!! Profitable Home Business. Molds available. Details: Lynnette, 6251C Mentor Park, Mentor, Ohio 44060.

LEARN GUN REPAIR GUNSMITHING In spare time. Book, details 10¢. Modern Gun Repair School, Dept. 2008, 4225 N. Brown, Scottsdale, Arizona 85251.

HUGE PROFITS! Become associate publisher, successful money-makers magazine. No experience. Details 8¢ stamp. DACS Publishing, 14E1, Williamston, Michigan, 48895.

SPARETIME Bicycle Repair. Catalogue \$2.50. Earnings Unlimited. Brookcleva Cycle Supply, 3510 West 105th, Cleveland, Ohio 44111.

SALESMEN-DISTRIBUTORS

SELL Advertising Ball Pens, Calendars, Ad-Specialties—Build Own Repeat Business—Free Details—Fleming, Dept. A, 6535 Cottage Grove, Chicago 60637.

PUBLICATIONS for local wholesale distribution, higher profits. Details, sample, \$1 refundable. Publisher, 404 West Jefferson, Springfield, Illinois 62702.

\$100.00 EXTRA A week easy! Spare time! Double Air Cushion shoes. Men's, women's line. Dress, work, play. Highest commissions. Shoes for yourself. Outfit Free. Bronson, Dept. H-13, Minneapolis, Minnesota 55408.

EARN Big Commission Full or Part Time. Show America's largest line Low Priced Business Printing and Advertising Specialties Plus Calendars in season. No experience. No investment. No collections or Deliveries. On-the-spot commissions. Big Free Sales Kit Samples hundreds items used daily by businessmen. Merchandise bonuses for you. Build profitable repeat business. Start now. National Press, Dept. 73B, North Chicago, Ill. 60064.

LONG Needed Invention. Want man contact service stations. Full or part time. Huge Profits. Write: Cyclo Mfg., 3816 Dahlia, Dept. 117, Denver, Colo. 80207.

HOUSEHOLD PRODUCTS ROUTE. EARN \$25 or more daily. Also Party Plan opportunities for men, women full, part time. McNess, Freeport (2613) Illinois 61032.

BIG EARNINGS Showing Exquisite Brass Antique Finish Lamps and Clocks. **TAL-GLO**, 2A Washington Street, East Orange, New Jersey 07017.

CRIME Deterrent Personal Security Weapons. Distributors earnings unlimited. Sheriff Protection Devices, Box 113, Twinsburg, Ohio 44087.

GET RICH! Industrial-Home Chemicals. Free Samples. We Love You. Eagles, Box 2411, Palos Verdes, Calif. 90274.

BIBLE PROFIT BONANZA Sell famous Herlet reference edition Bible. New profit sharing "bonanza" plan boosts earnings. Exclusive 3-dimension full color cover commands instant attention. Sells on sight to families, church groups. Easy credit plan. No investment. Demonstrator furnished. Write: International Book, Dept. PM, Box 118, Wichita, Kansas 67201.

BECOME A Successful Manufacturers' Representative. Manufacturers' Agents Newsletter tells you which firms are looking for representatives, the firms products line and territories available. For information write: Manufacturers' Agents' Newsletter, Dept. 152A, 23573 Prospect Ave., Farmington, Michigan 48024.

NEW, Compact fire extinguisher. Fantastic profits. Exclusive territories. Norwich Chemical, Norwich, Connecticut 06397.

AGENTS WANTED

EVERY Man a prospect. Refundable sales kit offer showing line belt buckles, tie clasps, money clips, cuff links, lapels, identification badges, individualized with customer's name and emblems. Cap badges for trucking, bus, taxi, police, firemen, also postal, letter carriers and heavy construction emblems. Choice 4000 emblems. Hook-Fast, Box 1088-PM, Providence, R.I. 02901.

YOUR Own business—Used Suits \$1.50; Overcoats 65¢; Mackinaws 35¢; Shoes 12½¢; Ladies' Coats 30¢; Dresses 15¢. Enormous profits. Catalog Free. Nathan Portnoy Assoc., 2109-AA Roosevelt Road, Chicago, Illinois 60608.

PRINTING, Advertising Salesmen—Excellent moneymaking sideline selling Decalcomania Name Plates, small quantities. Advertising Specialties, sign letters. Free Samples. Ralco XL, Boston, Mass. 02119.

TOOL POWER 110 Volts 5000 Watts from your cars alternator. Guaranteed 20 years. Install 10 minutes \$25.00 postpaid. Good discounts. Permabilt, Box 7160, Amarillo, Texas 79109.

WILL You test new items in your home? Surprisingly big pay. Latest conveniences for home, car. Send no money, just your name. Kristee 139, Akron, Ohio 44308.

SELL Engraved Metal Social Security Plates. Details: PermaPlates, P. O. Box 41112, Indianapolis, Ind. 46241.

WANT TO MAKE UP TO \$100 A WEEK Spare time, and get free shoes for life, too? No investment. Rush Card for free details. Mason Shoes, K-930, Chippewa Falls, Wisconsin 54729.

MAKE MONEY IN SPARE TIME. As a subscription sales representative for leading national magazines, you can earn generous commissions while learning the art of selling. Instructions and supplies will be sent to you free. Send this ad with your name and address to **POPULAR MECHANICS**, Room 1107L, 250 W. 55th St., New York, N.Y. 10019.

DO Friends A Favor—Make good money. Sell Home Products, Cosmetics to friends in spare time. Buy wholesale. We send 4 full-size products plus sample Rug Cleaner for Free Trial. Rush Name, Address to: Blair, Dept. 31AB, Lynchburg, Va. 24505.

FAST Selling air tool. City Motors, Box 27333-A, Houston, Texas 77027.

MAKE \$50.00 Daily Commissions! Every Home a Prospect for **NEW** Novelty, "A Kitchen Must" GMC-536PM, 152 West 42, New York 10036.

MONEY Opportunity representing oldest, largest manufacturer of magnetic signs. **TRIMETRIC**, 337 ElRoblar, Ojai, California 93023.

EMPLOYMENT INFORMATION

OVERSEAS JOBS—NOW HIRING, 103 Countries, All Occupations, High Pay, Free Transportation, Tax Benefits, Latest Computerized Reports—\$2.00. **TRANSWORLD**, International Airport, Box 90802-E, Los Angeles, California 90009.

AUSTRALIA—NEW ZEALAND! FREE DETAILS! 50,000 Jobs! Paid Transportation! 1973 Information and Forms. Send Age, Occupation. Austco, Box 3623-EX, Long Beach, California 90803.

AUSTRALIA!! AUSTRALIA!! FREE DETAILS!! Paid Transportation. Latest Information on Jobs. Send age, occupation. Write: Associated, Box 17-B134, Lafayette, California, 94549.

AUSTRALIA. . . Most Comprehensive Information . . . From Americans Now Living And Working In Australia . . . Send for Brochure . . . Enclose \$2.00 For Return Overseas Air Mail . . . Ausco Inquiry, Box 29, Burra, Burra 5417 South, Australia.

AUSTRALIAN FACTS, 634 Pages, 357 Photographs—\$2.25. **AUSTRALIAN NEWS-PAPERS**, Recent Arrivals: 3 pounds—\$3.00, 10 pounds—Includes Magazines—\$7.00, 30 pounds—Includes Books—\$15.00, 35 pound Deluxe Combination—\$35.00. Australasian News, Box 6428, Torrance, California 90504.

LEARN MOTEL Business, Great Career Opportunities Worldwide. For Placement Details Send \$2.00. Crest Motel, Box 65, Bayard, Fla. 32224.

AUSTRALIA CALLING YOU Latest Details about Wages, Housing, Schools. Employment Directory and Application. Guaranteed \$2.00. Trade, Box 568, Anaheim, California 92802.

JOBS-NATIONWIDE Only Directory. Top 2270 Placement Services All Specialties. \$3.00. NEA/JOBS, 2000 K NW, Washington, D.C. 20006.

FLORIDA Employment Opportunities! Disneyworld! Newspaper Classifieds! Booklet \$1.00. Sunshine, 4512N Jamaica, Tampa, Florida 33614.

BRITISH Columbia Employment and Immigration Information. Complete details; \$3.00. Doyle Associates, Box 2702, Williams Lake, B.C., Canada.

ARIZONA Relocation Service. Send \$1.00 for Current Opportunities and Relocation Service Details. Bolco, PO Box 26083, Tempe, Arizona 85282.

HELP WANTED

OVERSEAS EMPLOYMENT . . . Australia, Europe, South America, Asia! All Occupations! \$700-\$3,000 monthly! Write: Employment International, Box 29217-AA, Indianapolis, Indiana 46229.

OVERSEAS Jobs—Europe, South America, Australia, Far East, etc. 2000 openings all trades. Construction, Office, Engineering Sales, etc. \$700 to \$3,000 month. Expenses paid. Free Information. Write: Overseas Jobs, International Airport, Box 536-M, Miami, Florida 33148.

EARN At Home Addressing Mail. Details 25¢ and Stamped Envelope. Deeco-151, Box 9308, North Hollywood, Cal. 91609.

WORLD-WIDE . . . U.S.A. JOBS GALORE!! All occupations. Enjoy: Asia, Europe, Africa, South America, Florida, California. \$700.00 to \$3,500.00 monthly. Paid Overtime. Travel Allowance. Free Details! Send age, occupation. Write: Global Employment, Box 706-B134, Orinda, California 94563.

FREE DETAILS! . . . **AUSTRALIA** . . . Paid Transportation!! Jobs Galore!! Send age, occupation. Write: Associated, Box 17-BA134, Lafayette, California 94549.

(Continued on next page)

EMPLOYMENT Resumes IBM typed/printed, \$7/100. "How to Prepare Your Resume" \$1.00. Resumes, P392M, Brea, Calif. 92621.

REAL ESTATE AND FARMS

NEW! FREE CATALOG! Big **SPRING** edition! Over 5,200 Properties described, pictured—Land, Farms, Homes, Businesses—Recreation, Retirement, Selected Best throughout U.S.! 73 Years' service, 648 Offices, 40 states Coast to Coast. Mailed **FREE** from the World's Largest! **STROUT REALTY**, 60-MX E. 42nd ST., NY, NY 10017; 7-MX S. Dearborn, Chicago, Ill. 60603; 521-MX E. Green, Pasadena, Cal. 91101.

CANADIAN LAND FROM \$19.00 AN ACRE CHOICE Properties available across Canada. Low monthly payments. Ideal for farming, cottages, hunting, fishing. Free Catalogue. Canadian Estate Land, Dept. PMC-1, 286 Lawrence Ave. West, Toronto 20, Ont., Canada.

CENTRAL Ontario—Choice 640 acre Sportsmen's paradises still available—\$20.00 plus \$6.50 taxes yearly. Maps, pictures. \$2.00 (Refundable). Information Bureau, Norval 4, Ontario, Canada.

ARIZONA—1¼ Acres, Heart Of Hunting And Farming Centers. \$1,095—Low Terms. Mrs. Anna Young, Glenarm Land Co., 2233 North 7th St., Phoenix 85006

CANADIAN Vacation lands: Full price \$385.00. 40 acres. \$10 month. Suitable cottage sites, hunting, fishing, investment. Free information. Land Corporation, 3768-C Bathurst, Downsview, Ontario, Canada.

BOILING Spring Lakes—America's Greatest Real Estate Value. ½ acre vacation or retirement homesites only \$900 cash price. Ten-year terms available. Money-back inspection guarantee. Carolina coast, multi-million dollar, 14,000 acre development. 50 fresh water lakes, private ocean beach, golf course, motel, and country club. Free literature, Dept. 1-D, Boiling Spring Lakes, North Carolina 28461. (Registered under Federal Land Sales act but not offered to residents of states requiring separate registration.)

GOVERNMENT LANDS FROM \$3.50 ACRE! Vacating, Homesteading, Investment! Exclusive "U.S. GOVERNMENT LAND BUYER'S GUIDE" plus "LAND OPPORTUNITY REVIEW" listing lands throughout U.S. Send \$1.00. Surplus Lands, Box 19107-AA, Washington, D.C. 20036.

\$1 ACRE—Canadian border—hundreds campsites, islands, farmlands, directly from tax authorities. (Non-profit). Lists, photographs mailed. Register, Room 10, 110 Church Street, Toronto 1, Canada.

IDEAL 5-ACRE RANCH. Lake Conchas, New Mexico. \$2,975. No Down. No Interest. \$25/mo. Vacation Paradise. Money Maker. Free Brochure. Ranchos: Box 2003P, Alameda, California 94501.

OWN YOUR OWN FORESTED ACREAGE Better quality 5 to 40 acre parcels forested recreation land in North Minnesota. Selected for 1972 sale by Timber Country, Inc., a subsidiary of First Federal Savings and Loan Ass'n., Hibbing, Minnesota. Direct access township/county roads. 1971 offerings sold out. 1 Year full money back guarantee. Camping, well stocked fishing lakes and canoeing rivers. Priced \$150 to \$250 acre. Reasonable terms available. For photos, references and maps by mail, write: Ellen Uebel, Dept. PM, Timber Country, Inc., 2015 3rd Ave. E., Hibbing, Minn. 55746. (Member: Nat'l Ass'n. Real Estate Boards.)

MICHIGAN 10 TO 160 ACRE TRACTS Lake Superior-Marquette Area from \$99.00 Acre. Cabins, Trailers, camping welcome. (Acreage anywhere in Michigan). **FREE PICTURES.** Any terms A-OK with **BLOCH BROTHERS.** Write: 3650 Dixie, Drayton Plains 16, Michigan 48020.

JOIN FLORIDA Land rush, at home! Profit Plan: \$5. Owners, Box 1436PM, Crystal River, Florida 32629.

FREE Catalog! PHOTOS! Coast to coast farms, business, retirement. All types, sizes & prices. **SAFE-BUY** Real Estate, Box 589-PM, Little Rock, Ark. 72203.

FREE... NEW... Big... Spring Catalog. Hundreds of top real estate values coast to coast! **UNITED FARM AGENCY**, 612-PM West 47th St., Kansas City, Mo. 64112.

DRINKING WATER—PURIFIER

STAINLESS Steel home water distillers. Recycle tap water to pure spring fresh drinking water for pennies a gallon. Remove Chlorine, Fluoride, Iron, Nitrates, all impurities, bad taste. Portable, no plumbing. Free information. United Vito-Way, Box 1705-A, Bellevue, Washington 98009.

ECOLOGY AND ENVIRONMENT

ECOLOGY and ENVIRONMENT Improvement. Practical Projects and Action Ideas for you and your Family or Club. List of Places to write for information. Send \$2.00 today. Ecology, Box 716, Kingston, N.Y. 12401.



FLOWERS, PLANTS & NURSERY SUPPLIES

LEARN Landscaping and the growing of plants. Start a profitable business part or full time. Free information without obligation. Lifetime Career Schools, Dept. A-358, 2251 Barry Avenue, Los Angeles, California 90064.

LEARN Flower Arranging and Floristry. Start full or part time business or hobby. Free information on home study course. Lifetime Career Schools, Dept. B-697, 2251 Barry Avenue, Los Angeles, California 90064.

GREENHOUSES, 12' Fiberglass and UltraViolet Shielded from \$109.95. Free catalog. Greenhouseman, Box 2666-M-1, Santa Cruz, California 95060.

CONSTRUCTION PLANS, BLUEPRINTS

HOME PLANS Custom Drawn. Free Quotations. Homebuilders, 136-45 Scott, Dundee, Illinois 60118.

FREE information on Building A \$600 "A" Frame Cabin. "A" Frame—PM1, 1701 Juliet Ave., St. Paul, Minnesota 55105.

HOUSE EXPANSION PLANS And detail instruction book provide anything from an extra room to 1000 s/f addition. Build what you need at big do-it-yourself saving. Book with 1 set working blueprints \$14.50! With 4 sets (required by contractors) \$20.00. Money-Saver Projects, Box 303-44B, Chappaqua, New York 10514. Information available.

LOG CABINS & HOMES

BUILD Log Cabins, rustic furniture, fireplaces!! Complete manual, \$3.00... "A" Frame plans, \$2.00... **Guaranteed.** ...Beels, 956 Springdale, Atlanta, Georgia 30306.

"A" FRAME CABIN. \$500. Material. Purchase locally. Completely illustrated instruction manual & material list: \$2.00 Moneyback Guarantee. Order plan #1915 from: "Dependable Products", Box 113, Vista, California 92083.

HOME CRAFTSMEN

PICTURE Framing—Profitable full or spare-time business. Easy to learn with handbook-course "Guide To Picture Framing Profits." \$1.50 Guaranteed. Free framing-supplies catalog included. Japs, 126-PM Seventh North, Hopkins, Minnesota 55343.

WOODWORKING Catalog and Manual 50¢. Plus free "101 Project Ideas." World's most beautiful veneers, lumber, plywood! Wood finishing, upholstery supplies, Cane, Lamp Parts, Furniture hardware, Animal whittling blocks, 2,000 workshop products. Constantine, 2051-C Eastchester Road, Bronx 10461.

MAKE Money Building and selling Bird Houses. Send \$1.90 for 39 page book of plans covering 19 projects. Yeager, 1665 Linden, Homewood, Ill. 60430.

CABINETMAKING MADE EASY And "How to Make Formica Counter Tops." Two excellent guides let you build kitchen cabinets and counter tops like professionals. Extraordinary guides bring master craftsmen's shortcut methods. Satisfaction guaranteed. Write: Japs, 126-P Seventh North, Hopkins, Minn. 55343.

WALNUT Bowls, Legs, Round Picture Frames, Gun-Stocks Lumber Moulding, Midland Walnut, Box 262, Savannah, Missouri 64485.

SKIL-CRAFTS Current 200 plus page catalog with world's largest, finest selection of Hobbycraft, leathercraft, artist supplies. Send \$1 for postage and handling; refunded on first \$15 minimum catalog order. Skil-Crafts, Box 105-P, Joplin, Mo. 64801.

CHOICE Of Plans—Early American Dry Sink Or Kitchen Cupboard \$2.00. Walter Hamilton, 60 Schoen Beck, Wheeling, Illinois 60090.

101 PATTERNS Of Smart Gifts, Novelties, Shelves, Action Windmills, Plus "Make Money Jig Sawing". \$2.00. Mastercraft, J5M, 7041 Olcott, Chicago 60631.

WOOD—Domestic and Imported Hardwoods, 3500 items! Clock, musical instrument kits. Tools... discount prices. Hard-to-find hardware. 144 page catalog, 50¢. Craftsman, Dept. AX-13, 2729 Mary, Chicago, Illinois 60608.

NEW Ever Sharp Pocket Size Cutter \$1.00. Hundreds of uses. Kitco, 808 Broadway, Kansas City, Mo. 64105.

BUILD A Grandfather Clock Case 5/7" Tall for Under \$10.00. For drawings and dimensions send \$1.00 to—C. H. Hintz, 15509 Domart Ave., Norwalk, Calif. 90650.

20 PLANS—Full Size—Early American Novel Items for Fun or Profit. Send \$2.50. Carbone—Box 18099—Philadelphia, Penna. 19147.

C.D.I. LAMP BUTLER—Complete Plans—Control both Bedside Lamps from Either Side of the Bed. Especially nice for King and Queen Size Bedroom Suites. Special Achievement Certificate included Worth 50¢. Complete Plans \$2.00. Craftsman's Dreamprints, Inc., P.O. Box 16232, Charlotte, N.C. 28216.

TOOLS, EQUIPMENT & SUPPLIES! We List Over **FOURTEEN-HUNDRED** Different **CATALOGS** of Materials and Accessories for Arts, Crafts, Automotive, Electronics, Industry. Send \$2.00. **MASTERLOG**, Box 24413-BA, Oakland, California 94623.

CATALOG FULL SIZE FURNITURE PLANS—\$1.00 Refund with first order. Traditional, Early American, over 135! Furniture Designs, 1425 Sherman, Dept. CP-13, Evanston, Illinois 60201.

BEST WORKBENCH PLAN Ever. Plus Free Lumber Conversion Chart. \$1.00. **WAY-MAR**, Dept. 45, 58 Underhill Road, Scarsdale, New York 10583.

DO-IT-YOURSELF

DECORATIVE Brick Using Waste Material And Cement. Instructions \$2.00. WB Talmage, P.O. Box 8132, Fresno, Calif. 93727.

BURGLAR-FIRE Alarm Supplies and Information. Free Catalog. Protecto Alarm Sales, Box 357A, Birch Run, Michigan 48415.

REPAIR MINIBIKES, LAWNMOWERS, BICYCLES, Sewing Machines, Auto Engines. Build concrete, Plywood, boats, trailers. Over 100 How-To-Do books. Free brochure. Sincere, Box 10422, Phoenix, Arizona 85016.

REDECORATE YOUR HOUSE NOW—Before moving or buying anything. New! Home Decorator's Easy Color Book shows how. Every room picture detailed for professional results. Write: Bookmark, Box 5275-PM1, Kansas City, Missouri 64112.

(Continued on next page)

DO-IT-YOURSELF

(Continued from preceding page)

CONVERT MOWER Engines into air compressors. Write: Showalter, Box 409, Abilene, Kansas 67410.

RE-ROOF YOUR HOME And SAVE hundreds of dollars! Complete step-by-step instructions by roofer in business. 45 YEARS experience in manual. Send \$3.00. Roofs, Box 655, Schoharie, New York 12157.

SAVE MONEY! "How-To" books. Free details. Vernco, Box 121, Whittier, Calif. 90608.

CENTRAL Air Conditioning, Equipment, Humidifiers, Ductwork, Electronic Air Cleaners, Free Catalogue. Air-Ways, 32 Washington Ave., Port Jeff. Sta., N.Y. 11776.

FREE CATALOG! Hundreds of Unusual Items And "How To Do It" Books. Toppins Mail Order, 3230 Centennial #151, Sylvania, Ohio 43560.

NEW Painting Aid gets Professional Results, Paint Brush Wiper and Drip Control Device Prevents Messy Paint Spilling. Reusable, fits gallon can, easier cleaning up time. Send Check or M.O. \$1.49 plus .20¢ Handling. Conn. Residents Add 10¢ Tax. Paul Richards Co., 3320 Main Street, Stratford, Conn. 06497.

END EXPENSIVE Auto Repairs! Book by auto expert explains how. Order now. Save! \$1.95. Ben-Mar Gifts, 8 Woodrow Avenue, Staunton, Virginia. 24401.

SAVE MONEY! End Expensive Auto Repairs! Nationally known Auto Expert shows you how easy it can be with the help of Auto Repair Book. \$1.95, add .50¢ postage. Satisfaction Guaranteed. Florian Gabor, Dept-K., 150 W. Girard, Philadelphia, Pa. 19123.

STUD-FINDING, Simple foolproof method. No more banging, drilling walls. Amazing method works every time! Requires no special equipment. Send \$1.00 today. Stud-finder, Box 716, Kingston, N.Y. 12401.

CHAIN SAW POWER TAKE OFF. OPERATE Pumps, Compressors, Generators, Mini Bikes. \$12.95 up Free Brochure. **PORTA POWER**, 8004 TALBOT ROAD, EDMONDS, WASH. 98020.

COMPLETE WATERBED Frame Building Instructions. Photos included. \$2.00. Inovaco, Box 89, Glen Ellyn, Ill. 60137.

STEAM Powered Lawn Mower. Flash Boiler, Burners, Engines send \$2.00 for Descriptions, Pictures, Drawings, Travis Tool Co., Sidney, Iowa 51652.

PLAY Chord Piano in 10 Days. Free Detail. Davis Associates, 823 Morrell, Dallas 75203.

FIRE PROTECTION. SELF-CONTAINED ALARM Detects smoke as well as **INVISIBLE GASES OF COMBUSTION**. Mounts to ceiling, no outlet required. **U.L. LISTED**, \$79.95. Complete fire alarm kit protects four separate rooms, Instructions, \$99.95. Postpaid. Free literature, Maran Systems, Box 125, Meacham Branch, Elmont, N.Y. 11003.

ARTS AND CRAFTS

"GETTING Started in Stained Glass" 25¢. Whittmore, Box 2065Y, Hanover, Mass. 02339.

MAKE Figurines, plaques, lawn ornaments. Molds, plastercraft kits, liquid rubber. Sample and catalogue 10¢. Wooley Company, Box 29-B, Peoria, Illinois 61601.

FREE LITERATURE For sculptors showing how to make molds, cast plastics. Adhesive Products Corporation, 1660 Boone Avenue, Bronx, N.Y. 10460.

LEARN Arts & Crafts at home. Excellent full or part time business opportunities, or hobby. Free booklets. Lifetime Career Schools, Dept. E-797, 2251 Barry Avenue, Los Angeles, California 90064.

FREE: New handicraft catalog. Supreme Handicrafts, Box 395-PM, Sioux Falls, South Dakota 57101.

BINOCULARS, TELESCOPES, MICROSCOPES, MAGNIFIERS

FREE Binocular, Riflescope catalog. Discount sale. Save 50%. Free gift with order. Write, United Binoculars, BN-6308, 9043 So. Western, Chicago 60620.

TELESCOPES (Reflectors) Complete Kits. Other accessories, request free literature. Criterion Manufacturing, Dept. PM-37, Hartford, Connecticut 06101.



CAMERAS AND EQUIPMENT

FREE CATALOG! Lowest price, all brands, Dickson Company, Box K-3979, Kowloon, Hong Kong.

MAKE Money With Your Camera. Sensational report tells How, Where, Slide Markets. \$1.00. Moreland Enterprises, #8 Sweetbrush, Texarkana, Texas 75501.

DEVELOP Your own photographs! Complete Kit includes Enlarger, Chemicals, Paper, Trays, Tank, Thermometer, Graduate, Safelight, Accessories, Complete Instructions. \$21.95, postpaid. PhotoGraphics, Box 5502B, Hamden, Conn., 06518.

PHOTOGRAPHY FOR pleasure or profit. Learn at home. Practical basic training. Long established school. Free booklet. American School of Photography, 555 E. Lange St., Dept. 820-00, Mundelein, Illinois 60060.

FREE! FREE! BARGAIN BOOK Central Camera Co., Dept. 311, 230 S. Wabash, Chicago, Ill. 60604.

PHOTO FINISHING

CAMERA FANS! Expert photofinishing by one of Country's largest labs at lowest prices. Fast service and free "Foto-Fan" Stamps you quickly redeem for valuable Photo Supplies. 8MM Kodachrome \$1.29; 8 Exp. Kodacolor \$1.79; 35MM Kodachrome 20 Slides \$1.39; 8 Exp. Black White 69¢. Satisfaction guaranteed. Send exposed film or request free mailers, complete Price List and Gift Catalog. Direct Mail Photo, Box 8352-PM, Pittsburgh, Pa. 15218.

COLOR SLIDES

35MM COLOR Slides, 10,671 Individually sold. Described. Encyclopedia catalog 10¢. Wolfe Worldwide, Dept. 14-13, Los Angeles, Calif. 90025.

MOTION PICTURES AND SOUND EQUIPMENT

UNUSUAL Movie supplies. Free circular. Esor, 47th Holly, Kansas City, Missouri 64112.

FREE! 64-Page catalog. 8-16MM film supplies, processing equipment. Superior, 448 N. Wells, Chicago 60610.

CLASSIC 8MM. MOVIES . . . 35MM. 2"x2" Color Slides. . . largest selection anywhere! Silent classics, comedy, history, sport, news, documentaries, features, others! 16MM films also. Free catalog. Blackhawk Films, 569 Eastin-Phelan Bldg., Davenport, Iowa 52808.

8MM-SUPER 8-16MM MOVIES! Biggest Selection! Lowest Prices! Free Catalog! Cinema Eight, Box 245-PM, N.Y.C. 10028.

16MM, 8MM Sound and Silent Classic Films. Free Catalog. Niles, 1019-PM So. Michigan, South Bend, Indiana 46618.

CASTLE HOME MOVIES 8mm 16mm Free Catalog. G & G Film Library, Box 321, Syosset, New York 11791.

MOVIES 8mm-16mm Super. Sound/Silent. Specify Size. Used 16mm Projectors. Enterprise Films 561 N.E. 79th St. Miami, Fla. 33138.

RADIO, TELEVISION AND HAM EQUIPMENT

36¢ RADIO & TV Tubes. Free catalog. Cornell, 4213-17 University, San Diego, California 92105.

HEAR POLICE/FIRE Dispatchers. Catalog Shows Receivers; Exclusive Directories Of "Confidential" Channels. Send 8¢ Stamp. Communications, Box 56-PM, Commack, N.Y. 11725.

GOVERNMENT Surplus receivers, transmitters, snooperscopes, parts. Catalog. 25¢. Meshna, Nahant, Mass. 01908.

RESISTOR Color Coder 50¢. Norvex Co., 3920 Larkin St., Norfolk, Va. 23513.

GIANT Canadian Electronics Surplus Catalog. \$1.00. Etco-PM, Box 741, Montreal

TV-7D Tube Tester—Gov't. Surplus—Just Released—Mutual Conductance Type—Has Own Carrying Case—Takes All Standard Bases Also, Adapters For 2C39 4x150 Price Of Unit \$59.95. Adapters \$4.95 Each. Full Details Available. Wire, Write, Call: Artko Corporation, 6401 S. Tucson Blvd., Tucson, Ariz. 85706 Phone Area 602 294-7611.

SAVE Money on parts and Transmitting—receiving tubes, Foreign—domestic. Send 25¢ for giant catalog. Refunded first order. United Radio Company, 56-PM Ferry Street, Newark, N.J. 07105.

HIFI TAPES, RECORDS AND ELECTRONICS

FREE Catalogues, 2000 hard to find unusual records. Rose's Records, Box 7216, Louisville, Ky. 40207.

FREE Catalog—Electronic Kits—Amplifiers—Preamplifiers—Psychedelic Strobes—SCA Adaptors—Color Organs—Digital Instruments—Guitar Amplifiers. **FREE** Subscriptions. SWTPC, Box PM32040, San Antonio, Texas 78284.

MEMOREX Audio & Video Recording Tape. BSC, INC., Box 1181PM, Melrose Park, Illinois 60161.

8 TRACK Tapes!! Regularly \$6.98. Some as low as \$1.00. Choose from top names in Rock, Jazz, and Western. Distributors inquiries invited. Send \$2 for a sample and list. Tape World, Dept. 11, PO Box 4119, Houston, Texas 77014.



MUSIC AND MUSICAL INSTRUMENTS

FREE CATALOG—30% DISCOUNT. Best Names In Musical Instruments. Dial For Music, 90 North Main Street, Spring Valley N.Y. 10977.

EASY To Play And Make. Quality Dulcimers, Banjos, Thumb Pianos; Instruments And Kits. Can Be Profitable Hobby. **HERE, Inc.**, #P. 410 Cedar Avenue, Minneapolis, Minn. 55404.

ELECTRIFY Player Pianos, Pump Organs Quickly, Inexpensively with Lee Silent Section Units. Write: Lee Music, 525F Venezia Avenue, Venice, California 90291.

GUITAR MAKING Books. Imported Woods, Supplies, Accessories. Catalog 25¢. Guitar Center, Box 15444, Tulsa, Okla. 74115.

30% TO 50% DISCOUNT! Any Model: Guitar, Amp, Drum, Banjo, Dobro! Free Catalog! Warehouse P29, Box 16399, Fort Worth, Texas 76133.

ACCORDION Top brands. Buy direct. Tremendous discounts. Trades accepted. Free brochure PM. Accordion-O-Rama, 874 Broadway, N.Y.C. 10003.

PLAYER Piano Rebuilding—get details from: Vestal Press, Vestal 11, N.Y. 13850.

POEMS Wanted for songs. Nashville Music Productions, Box 40001-P, Nashville, Tennessee 37204.

VIOLIN And Guitar makers—send for latest Free Catalogue of woods & accessories. International Violin, PM1, 414 East Baltimore St., Baltimore, Md. 21202.

30% DISCOUNT Name Brand Musical Instruments. Free Catalog. Freeport Music, 455F Route 110, Melville, N.Y. 11746.

(Continued on next page)

MUSIC AND MUSICAL INSTRUMENTS

(Continued from preceding page)

WHOLESALE! Professional Guitars, PA Systems, Altec Speakers, 240W RMS Amplifiers. Free Catalog. Carvin, Escondido, Calif. 92027.

ACCORDION Manufacturing, 6846-P North Avenue, Chicago, Illinois 60635. Concertinas, Hohners, Chromatics, Guitars, Drums. New, Used, Tuning, Repairing. Wholesale Catalogs Free.

NEW FREE CATALOG! Musical Instruments, Accessories, Instruction Books. Marina Music, Box 718-C, Marina Del Rey, California 90291.

SWISS Music Boxes, Movements. High-quality. Spielman, 55 West 42nd, New York 10036.

ACCORDIONS And Amplifiers! New—Used. Cordovox, Excelsior—Top Makes! Save to 50%. Direct factory dealer. Terms. Trades accepted. 5 day home trial. Free catalog—Discount prices. Write: Accordions Unlimited, Dept. R, 3147 North Luna, Chicago 60641.

LEARN Faster. Guitar or dulcimer. Without reading music. Hour-long instructional **CASSETTE** Plus illustrated fingering guide, \$5.49. State instrument. Only **SOUND** Can teach tuning. Improve seven days or money back. Hobbs Productions, 1000 Sanchez, Edgewater, Florida 32032.

FREE Song Selling Information. Peerless Publications, Box 193-A, Bloomfield, Conn. 06002.

POEMS, Songs wanted for hit recording, guaranteed Publishing, radio release. America's most popular new talent studio. Broadway Music Productions, 11647PM Bee Ridge, Sarasota, Florida 33578.

WHOLESALE. Musical Instruments—Accessories. Allied, 573 Route 17, Paramus, New Jersey 07652.

CONSERVATION TRAINING

GAME WARDEN, Government Hunter, Forestry, Park & Wildlife Service announce job openings regularly. Prepare at home for outdoor work, good pay, security. Approved for Veterans! Free! "Conservation Career Kit." North American School of Conservation, MPW, Newport, California 92663.

MOTEL HOTEL MANAGEMENT TRAINING

MOTEL MANAGERS Wanted by leading chains, resorts, motels-hotels everywhere. Men, women, couples enjoy free rent, plenty of free time. Easy home-study plan. Approved for Veterans. Free! "Motel Career Kit." North American School of Motel-Hotel Management, AZW, Newport, California 92663.

EDUCATION AND INSTRUCTION

LEARN Sewing Machine Repairing. Men, Women. Lucrative profits. Profession with bright future. Gresslin Correspondence School, Box 927, Spencer, Iowa 51301.

SIMPLIFIED Interior, exterior decorating course. Including making paint that can't peel. Just-\$10. Decorator, Box-2471 Detroit, Mich. 48231.

LEARN Auctioneering. Term soon. Free catalog. Relsch Auction College, Box 850. Mason City, Iowa 50401.

AUCTIONEERING. Resident or home Study Course. Free Catalog. Nashville Auction School, 1921 West End, Nashville Tennessee 37203.

USED Courses! Books! List 10¢. Smith's, 124 Marlborough, Salem, Massachusetts 01970.

RELIGIOUS VOCATION? Write: Church Of Holy Light Inc., P.O. Box 4478, Pittsburgh, Pa. 15205.

OWN Collection agency. "Little Gold Mine!" Franklin Credit, Roanoke, Virginia 24004.

GET A British Degree. Divinity. Philosophy, Radionics. 35 Courses. Prospectus free. Brantridge Forest School, Highfield, Dane Hill, Sussex, England.

COLLEGE Degree at home. Your choice of subjects incl. law. Easy tuition plan. Williams College, 445 East Second South, Salt Lake City, Utah 84111.

ORDINATIONS, Lifetime! Church chartered 1887! Write! 708 Bragg, Monroe, North Carolina 28110.

PENMANSHIP Corrector. Improve Poor Penmanship Quickly. Details Free. Ozment, Box 2344-34, St. Louis, Missouri 63114.

EXTENSION And Post-Graduate Awards in Philosophy, Art, Sciences, Botanic Medicine, Homeopathy, Radionics and others. 30 subjects. Curricular free (airmail \$1.00 refundable). Registrar, Sussex College of Technology, Highfield, Dane Hill, Sussex, England.

SERVE God's Ministry. Free. Ordination, Bible Institute, Box 744, McKeesport, Pa. 15134.

LEARN Massage. Home Study Course. Free Details. Massage, Box 190-PM, Quincy, Mass. 02169.

LEARN Asleep or awake! Records, tapes, equipment! Free catalog! Drawer PM-400, Ruidoso, New Mexico 88345.

PIANO Technology—Electronic organ servicing, learned easily at home. G. I. Approved. Free booklet. Niles Bryant School, Dept. P, 3631 Stockton, Sacramento, California 95820.

GRAPHOANALYSIS—Learn scientific handwriting analysis for profit, pleasure. Free sample lesson, catalog, reveals plan. Write: Igas Inc., 325 Jackson, Dept. 2AX-2, Chicago 60606.

DETECTIVE Profession. Easy home study; free tie-tack or lapel pin, certificate, future. GI approved. Professional Investigators, Box 41345, Dept. CP, Los Angeles Calif. 90041.

AUTOSUGGESTION. Sleep-learning headquarters! Tapes, records, books, Gigantic catalog free. Research Association, Box 24PM, Olympia, Washington 98511.

GAME WARDEN, Government Hunter, Forestry, Park & Wildlife Service announce job openings regularly. Prepare at home for outdoor work, good pay, security. Approved for Veterans! Free! "Conservation Career Kit." North American School of Conservation, AZW, Newport, California 92663.

HIGHLY Effective college-level home study programs in Electronics Engineering and Engineering Mathematics. (Our 27th Year). Free Literature. Cook's Institute, Dept. 10, Box 10634, Jackson, Miss. 39209.

DETECTIVE Course. Free Information. Universal Detectives, Box 8180-F, Universal City, California 91608.

USED Courses! Books. Catalog 10¢. (Courses Bought). Lee Mountain, Pisgah, Alabama 35765.

HIGH SCHOOL DIPLOMA For Adults. Earn State Diploma. Accepted by Civil Service, business, colleges. Low cost. No tedious study. Money-back guarantee. Details: H-S Program, Suite 2505, 1221 Avenue of Americas, New York, N. Y. 10020.

DETECTIVE And Fingerprinting Courses. Write. Detectives, Box 185-P, Fairfield, Alabama 35064.

SHORTCUTS To Success! Highly Effective, Profitable Short Courses. (75 Choices). Study At Home. Diploma Awarded. Our 27th Year. Free Literature. CIEE-25, Box 10634, Jackson, Miss. 39209.

VETERINARY ASSISTANT—Train at home for exciting animal care career. Send for **FREE** "Career Kit". North American Home-Study School of Animal Sciences, AZW, Newport Beach, California 92663.

FREE Book tells how you can learn camera repair and service. Home study or classroom. Write today! National Camera, Dept. EAD Englewood, Colorado 80110.

AVIATION JOBS—Train at nation's largest aeronautics school for pilot license, helicopter pilot, aviation technician, maintenance, powerplant, airframe technician, radio telephone operator, aircraft accident insurance adjuster, aviation electronics or instrument technician. Indicate if eligible for G.I. Benefits. Write for free "Career Kit": Spartan Airschool, International Airport, Dept. AZWM, Tulsa, Oklahoma 74151.

PIANO Tuning quickly learned with home study course. Diploma granted. American Tuning School, 17050 Telfer Dr., Morgan Hill, California 95037.

DEGREES Without residence requirements! Catalog: \$3.00. **UNITED STATES UNIVERSITY OF AMERICA**, Box 4552-PM, Washington, D.C. 20017.

PIANO TUNING—A PRACTICAL GUIDE. ILLUSTRATED Book only \$3.95. Kurk Publications, 2567 North Dunlap, St. Paul, Minn. 55113.

DEGREE—Granting Correspondence School Directory; Fabulous Government Publications Catalogue; Secret Societies Guide. Free Details. Aureap, Allenhurst, New Jersey 07711.

LEARN ACCOUNTING! U.S. Labor Department reports "33,000 NEW Accountants, 78,000 NEW Bookkeepers needed EACH YEAR for next ten years". Easy home-study plan prepares you. Approved for Veterans. Send for **FREE** "Accounting Career Kit". North American School of Accounting, AZW, Newport Beach, California 92663.

FREE Introductory Course. God's Great Salvation. Home Bible Studies, Box 370PM, Elkhart, Ind. 46514.

FREE! Illustrated List of Self-Improvement Books. Bargain Prices! Investigate! Write: H.M. Martin, 6 Hampton, Olanda, South Carolina 29114.

FINGERPRINTING—Investigation. Exciting, secure career. Learn at home. Free book. State age . . . Institute of Applied Science, 1920 Sunnyside, Dept. 161, Chicago, Illinois 60640.

LEARN Fast as Geniuses! \$3.95! Arsenault's, 910 Old Orchard, Montreal, Canada. Simons', R2, #570, Goldsboro, North Carolina 27530. Midgett's, 119-S Valley Road, Hendersonville, Tenn. 37075. Kester's, 807-E 85th, Tacoma, Washington 98445. Gill's, 109-15 142nd Street, Jamaica, New York 11435.

COMPLETE YOUR HIGH SCHOOL At home in spare time. Texts furnished. No classes. Diploma. Our 76th year. Free Brochure. American School, Dept. X145, Drexel at 58th, Chicago 60637.

UNLOCK Your Future. Become professional Locksmith with spare time home-study. Make up to \$6 per hour. All tools, equipment inc. Facts free. Send name. Locksmithing Inst., (homestudy), Dept. 1310-013, Little Falls, New Jersey 07424.

(Continued on next page)

EDUCATION AND INSTRUCTION

(Continued from preceding page)

GRAPEFRUIT DIET Look Better, Feel Better, Live Longer. Complete Programmed Diet Book \$3.00 **SPECRUM-AAA**, P.O. Box J, Euless, Texas 76039.

SUPERIOR Auction School. Nation's top Auctioneers own and instruct. Box 1281, Decatur, Ill. 62525.

PERFECT Husband-Wife Business. Learn Upholstery at home. Make \$10 in an hour. Buy-repair-sell for even bigger profits. Kits, tools, included. Free Booklet. Upholstery & Decorating School, (homestudy), Dept. 5310-013, Little Falls, New Jersey 07424.

COMPUTER PROGRAMMING Opportunities Unlimited. H.S. Grad. Send name, age, addr. employer, type of work and \$1.00. Details. **KLOCKER**, 63-47th St., S.E., Washington, D.C. 20019.

PIANO/Tuning Instructions With Tools. Only \$22.50. Information Free. Stamm, 903 Washington, Oregon, Ill. 61061.

WATCH REPAIRING. Learn at home in spare time. Diploma awarded. Free sample lesson. Chicago School of Watchmaking, Dept. YN, Fox River Grove, Illinois 60021.

LEARN To Fix Typewriters. Desperate shortage trained men. Hundreds needed. Make up to \$25 in one hour. Learn at home in spare time. Industry Approved course. Facts Free. Send name. Typewriter Repair School, (homestudy), Dept. 3310-013, Little Falls, New Jersey 07424.

MISSOURI Auction School. Veteran Approved. Free catalog. 1600-03 Genesee, Kansas City, Missouri 64102.

SELF-Help Books. Write: Pam Edwards, Box 1461, Lawton, Oklahoma 73501.

FOR INVENTORS

INVENTORS: Your ideas and inventions (patented: unpatented) expertly searched, developed for commercial appeal and cash/royalty sales to manufacturers by professional Invention Developer with excellent record of experience. B. S. Industrial Engineering; United States Patent Office former Patent Examiner, United States Government former Patent Advisor, Second decade reliable service! Member: United States Council International Chamber Commerce. Free "Invention Record" and "Recommended Protection Procedure." Airmailed! Write: Raymond Lee, Invention Developer, 230P-Park Ave., New York, New York 10017.

INVENTORS! Either I Will sell your Invention for cash and/or royalties or pay you cash bonus. For Free Invention Evaluation and information. Write: Gilbert Adams, Invention Broker, Dept. 15, 81 Wall St., N.Y., N.Y. 10005.

U.S. PATENT Office Searches, 234 Broadway, Room 3615, New York 10007. Free invention certificates.

FREE PAMPHLET: "Tips on Safeguarding Your Invention." Write: United States Inventors Service Company, 501-P Thirteenth Street N.W., Washington, D.C. 20004.

INVENTIONS Wanted immediately for promoting on cash or royalty. Patented, Un-Patented. Free booklet outlines royalty rates, requirements. Write: Kessler Corporation, C-51F1 Fremont, Ohio 43420.

IMMEDIATE Cash, for patent applications. Free patent searches. Write for details. Universal Patents, 184-D, Marion, Ohio.

INVENTORS! Don't sell or license your Invention until you receive our offer. Eagle Development Company, Dept. H, 83 Wall Street, New York City 10005.

SYNTHESIS MAGAZINE—About Invention. Write: Box 157, Manhattan, California 90266.

INVENTORS—United States Patent Office Searches, Patent Development Engineering, marketing of inventions—ideas by Licensed Professional Engineer—Patent Engineer and United States Patent Office Former Examiner. Inventions developed for patenting and marketing. We are contacted by many manufacturers seeking to purchase appropriate new products invented by our clients. Send for Free Invention Certificate and Invention Information. Serving Inventors since 1948. George Spector, Licensed Professional Engineer—Patent Engineer—3615 Woolworth Bldg., New York, N.Y. 10007.

PATENT Application Financing. Free patent search plan. Global Patent Division, 2420 77th, Oakland, Calif. 94605.

PATENT Searches including maximum speed, full airmail report and closest patent copies. Quality searches expertly administered with complete secrecy guaranteed. Free Invention Protection Form and "Patent Information." Write: Dept. 15, Washington Patent Office Search Bureau, Benjamin Franklin Substation, P.O. Box 7167, Washington, D.C. 20044.

INVENTIONS WANTED

INVENTIONS Wanted. Patented: unpatented. Tremendous manufacturers lists. Global Marketing Service, 2420G 77th, Oakland, California 94605.

INVENTORS! Protect your ideas! Free "Recommended Procedures." Washington Inventors Service, 422F Washington Building, District of Columbia 20005.

WE Either sell your invention or pay cash bonus. Write for details. Universal Inventions, 28-E, Marion, Ohio.

FREE "Directory of 500 Corporations Seeking new Products." For information regarding developments, sale, licensing of your patented/unpatented inventions. Write: Raymond Lee Organization, 230-N Park Avenue, New York, New York 10017.

MR. INVENTOR: Inventions Urgently Needed by Manufacturers. Idea Developed. Patent Searches \$10. Patent Application Financing if Desired. Charles S. Prince, Invention Consultant, 353 West 57th St., New York, New York 10019.

INVENTIONS Needed immediately for manufacturers. For additional information write: Kessler Corporation, C-511W, Fremont, Ohio 43420.

CONSUMER Product Specialists. Toys, Tools, Housewares, Etc. Marketing details free. New Products Division, 1803 North Westshore, Tampa, Florida 33607.

PATENTS FOR SALE

PROFITS FROM CLASSIFIED ADVERTISING! Booklet shows you how to start your own business with Classified Advertising. Only \$1.00 (Refundable with first order.) **C. A. MARTIN, POPULAR MECHANICS, DEPT. PMP, 224 WEST 57th STREET, NEW YORK, N. Y. 10019.**

MANUFACTURING

INVENTORS Ideas Developed. Research. Models. Manufacturing. Sales. Free Brochure. Since 1942. William Parker, Box 6305, Orlando, Fla. 32803.

BUYING AND SELLING

PROFITS FROM CLASSIFIED ADVERTISING! Booklet shows you how to start your own business with Classified Advertising. Only \$1.00 (Refundable with first order.) **C. A. MARTIN, POPULAR MECHANICS, DEPT. PMP, 224 WEST 57th STREET, NEW YORK, N. Y. 10019.**

BUY IT WHOLESALE

HEARING Aids, batteries, Wholesale. Catalog 25¢. Fiston, Box 1444, New Preston, Conn. 06777.

165 FREE Wholesale Catalogs! Mailorder Dropshippers. Your Business Imprint, Automobile Discounts. Free "Digest." Vault International, Box 7284W, Lexington, Kentucky 40502.

WORLD'S Largest wholesale dropship sources. U.S., foreign. Factory suppliers dropship direct to you or customers. Now!, have your own catalog for pennies. Free details. International Buyers, Box 16386-M, Portland, Oregon 97233.

FABULOUS Wholesale Club!! Save on thousands of famous brands: jewelry, tools, appliances, stereos, etc. 40-50% off retail; same wholesale prices retailers pay! Purchase for yourself or resell for fantastic profits. Free information. Homestead, Dept. 73A, 18 Westcliff Drive, Mount Sinai, New York 11766.

FREE Catalog. Over 100 Specialties And Gifts. Buy Below Wholesale For Tremendous Profits. House Of Pender, Box 334, PM31, South Easton, Mass. 02375.

BARGAIN DIRECTORY 50,000 Low Items \$2.00 Winchester Enterprises, 2807 PM Hargrave Street, Philadelphia, Penna. 19136.

FREE CATALOG. Gifts, Specialties, Toys. Buy Below Wholesale. Martin, 5275 DeLongpre, Hollywood, Calif. 90027.

EXPORT-IMPORT

JAPAN: 1200 Products directory. Illustrated Manufacturers' names, addresses. \$4.00. Send cash. Yamagata Office, 814 Togin Bldg., Marunouchi, Tokyo.

DIRECT From Scandinavia: Grandfather's clocks, wrist watches, Pencils, Telephones, Playing cards, colour films, colour magazines, color slides. Catalog \$2.00. Write to: Ado-Mail, Gothergade 97, DK 1123, Copenhagen, Denmark.

IMPORT At factory prices—**CLOCKS** from Germany's Black Forest. Catalogue airmailed, \$1.00. **PRECISA**, 899 Lindau, P.O. Box 1465, West Germany.

PRODUCTS—Gifts From Mexico. \$1.00 For Catalog. The Parlor Shop, P.O. Box 14367, San Antonio, Texas 78214.

FOR THE HOME

SAVE Fuel, Sleep Better, Lower Thermostat Five to 10 Degrees at Nite Without Touching Thermostat—Normal Before Arising—Automatically—Instructions—\$2.00. Williams Variant Heat, 5707 Tulip Street, Philadelphia, Pennsylvania 19135.

DRIP Dry Rack, Rust Proof, Heavy Duty, Seven Rods, One Meter Wide, Expands, Folds For Toting. \$10.95. Bruening, 1511 First 1H1, Detroit, Mich. 48226.

NEW See-thru Cutting Board. Invisible, heatproof, unbreakable plexiglass. (8x11) \$3.00, (12x16) \$5.99 Postpaid. Giftworthy. Guaranteed. Free catalogue. Gilmohouse, Box 1175AX, Denver, Colorado 80201.

OF INTEREST TO WOMEN

1000% PROFIT Bronzing Baby Shoes. Free literature. NBC, Box C-4PM-8, Coral Springs, Florida 33065.

WANT A new car, color TV, new clothes? Learn hundreds of ways to make money. 5 month subscription **FREE**. Write: Salesman's Opportunity Magazine, Dept. 17-AO, 1460 Hancock Center, Chicago 60611.

\$6.00 DOZEN Paid lacing baby boots! Cowboy, Warsaw 9, Indiana 46580.

(Continued on next page)

OF INTEREST TO WOMEN

(Continued from preceding page)

\$100 WEEKLY Possible addressing mailing. Sparetime. Free details. Send self-addressed stamped envelope. Newby Publications, Box 20427-PM, San Antonio, Texas 78220.

HOW To Make Money Writing Short Paragraphs. Information Free. Barrett, Dept. C-27-S3, 6216 N. Clark, Chicago 60660.

HOMEWORKERS! \$100.00 Weekly addressing for firms. Begin immediately. Details—send stamped, addressed envelope. Hamilton, 272-TM-1, Brooklyn 11235.

HOME Newspaper clippers needed. \$500 monthly possible. Details free. Foster, 272-MA-1, Brooklyn 11235.

\$500 MONTHLY Possible addressing—stuffing envelopes (longhand—typing) at home. \$500 monthly Clipping news items from your newspaper. Information: Send stamped self-addressed envelope. American, Excelsior Springs, Missouri 64024.

NEW magazine, foods, decorating, household tips, family living. Sample 25¢. Homemaker Magazine, 404 West Jefferson, Springfield, Illinois 62702.

EARN UP TO \$150.00 WEEKLY . . . Home addressing for us. Details 25¢. Smith's, Box 2469-PM, Newark, New Jersey 07114.

\$100 WEEKLY Possible! Sewing At Home—Spare Time. Unlimited Need For Hand-sewn Items. Details Free! Enterprises, Box 8-PM, East Rockaway, N. Y. 11518.

BIG Profits from Dolls! Start your own hobby-business dressing, making, repairing and selling dolls. Free information. Lifetime Career Schools, Dept. D-242, 2251 Barry Avenue, Los Angeles, California 90064.

\$25.00 DAILY Possible Addressing—Stuffing Envelopes. Typewriter-Longhand. Also Clipping News Items At Home. Information: Send Stamped Addressed Envelope. Ame-38, Box 310, Le Mars, Iowa 51031.

HOMEWORKERS And Addressers Needed. \$100 Weekly Possible. Details: Send Self-addressed, Stamped Envelope. National, 14-2LA, Brooklyn 11214.

SELL Custom Made Children's Dresses. Brochure 25¢. Spooner, 3213 Bruner, Bronx, N.Y. 10469.

HOW To Make Money Writing Short Paragraphs. Information Free. Write: Mailosav, Dept. PP3, 226 S. 16th, Philadelphia, Penna. 19102.

SPARE TIME Profits for Women! Free Details. Stayer Enterprises, 3704 Warwick, Peoria, Illinois 61614.

\$100 WEEKLY Possible! Typing—Addressing Envelopes. Free Bonus: \$50 per 1000 Addressing Plan. Send Stamped-Addressed Envelope. Service, Box 721-A, Lynbrook, N. Y. 11563.

INCOME Unlimited in Homework of Your Choice. Write: Williamsons, Dept. 17B, 9323 Spring Arbor Road, Spring Arbor, Mich. 49283.

LEARN Expert Cake Decorating, Candy Making. Free details to housewives. Candy & Cake Institute, Dept. BOK, 1600 Cabrillo Avenue, Torrance, California 90501.

GIFT SHOPPING

FREE CATALOG—Imports, Gifts, Toys, Novelties. Write: Worldwide, 4266 Washington, Oak Park, Illinois 60302.

WORLD Shopper 6 issues year \$4.50. Bakers, 313 Harrison, Sullivan, Illinois 61951.

PERSONALIZED Hand-laced billfold. 3 Initials. \$12.00 Postpaid. Box 4141, El Paso, Texas 79914.

FREE! Gift Catalog-Distinctive gifts for the whole family. House of Values, 2052 Albatross Street, San Diego, California 92101.

FREE Illustrated Catalog. Quality Merchandise, Purchase Specials Year-round. Send Nothing, Send Now! E. W. Rhomar's, 107 Seminary Avenue, Binghamton, N.Y. 13905.

FREE Gift Catalog, Marlo's Imports, Dept P, 2397 Clinton Road, Jackson, Mich. 49202.

FREE FANTASTIC GIFT CATALOGUE. FREE SILVER DOLLAR BONUS GIFT. TREASURE CHEST, 9321PM1 CAPE VIEW AVENUE, NORFOLK, VIRGINIA 23503.

QUALITY Gift Catalogs. Free! Bargains Galore! The Mailbasket, 27350 Bradford, Southfield, Michigan 48076.

GIFT Shopping made easy—Illustrated color catalogue 25¢. S&E Sales Co., Box 48-PM, Brooklyn, N.Y. 11226.

HAWAIIAN Calendar 1973. Beautiful Colourful Scenic Pictures. Hawaiian English Languages. 17"x11". \$2.65. Jaye's Gifts, 7667 Cullen Street, San Diego, California 92111.

WATCHES, OLD GOLD, JEWELRY

FREE Catalogue—Ancient Replica Clocks. Masters, 82 Doudeauville, Paris 18, France, (Airmail \$1.00).

WANTED . . . Gold, Silver, Platinum (any form), Coins. Information Free. Wilmot's, 1067-A Bridge, Grand Rapids, Mich. 49504.

HIGHEST CASH For Gold, Jewelry, Gold Teeth, Rings, Diamonds, Watches, Silver, Platinum, Mail Articles Today. Free gift with information. Chicago Gold & Precious Metals, 6 E. Monroe, Dept. 558, Chicago 60603.

DIAMOND RINGS \$15.00. LIFETIME WRITTEN GUARANTEE. FREE BROCHURES. BROWN, BOX 295, JAMAICA, NEW YORK 11434.

WATCH And Clock repairing books. Free list. North American, Box 77-AA, Fox River Grove, Illinois 60021.

WEARING APPAREL

PROFITS FROM CLASSIFIED ADVERTISING! Booklet shows you how to start your own business with Classified Advertising. Only \$1.00 (Refundable with first order.) C. A. MARTIN, POPULAR MECHANICS, DEPT. PMP, 224 WEST 57th STREET, NEW YORK, N. Y. 11019.



SCIENCE AND CHEMISTRY

LABORATORY Supplies at discount prices. Catalogue—35¢. Deluxe Scientific, Manitowoc, Wisconsin 54220.

AMAZING! Scientific Catalog—Apparatus—Glassware—Chemicals. Catalog—50¢. Hagen Laboratories, Manitowoc, Wisconsin 54220.

CHEMISTRY And Biology Catalog 35¢. Boulevard Laboratories, Suite 302, 3114 E. 83rd St., Chicago, Ill. 60617.

CHEMICALS Apparatus, Biology and Model Rockets. Both Catalogs for 50¢. Sheard Science, Dept. PM, Columbus, Wisconsin 53925.

CATALOGUE Of those very hard-to-find chemical products, things that go boom, multi-stage rockets, 500 How-To books, 10,000 formulas of every conceivable mixture in science and industry. 50¢. Kenrus-C, Box 158M, Staten Island, New York 10309.

FREE. Flying MODEL ROCKET Kit. Act Now. Offer Limited. Send 25¢ for Packet of Iron-ons, Decals, Literature and "Free Rocket" Details. Aerospace Vehicles, Inc., Mineral Point, Wisconsin 53565.

HEARING AIDS

HUGE SAVINGS. Eliminate dealer mark-ups. Free Trial. Batteries Wholesale. Terms Arranged. Lloyds-PMC, Rockford, Ill. 61108.

WHOLESALE Discounters! Famous Aids! Batteries! Repairs! AidMart, Box Z, St. Petersburg, Florida 33731.

BATTERIES Discounted! **FREE** Hearing Information. Madison, Box 53-C, Hopkins, Minnesota 55343.

HEARING Aids—Huge savings on tiny, all in the ear, eyeglass, behind the ear and body models. Free home trial. Low as \$10 monthly. Write for free catalog. Prestige, Dept. R-6, Box 10947, Houston, Texas 77018.

FORMULAS, PLANS, ETC.

PREVENT BEE STINGS. Lifetime Formula. \$5.00. "Antisting," Box 7, Bessemer, Ala. 35020.

PLASTICS

LARGEST Handicrafts Supply Catalogue \$1.00 (Refundable). R.P.H. Manufacturing, 24-M-1, Winter, Stamford, Connecticut 06905.

CASTOLITE Pours like water, hardens like glass without heat. Crystal clear or colors. Embed natural flowers, other objects. Make fine gifts. Reproduce your own designs in plastics, wax, metal, plaster, cement, etc. Make flexible molds over any pattern, any size. Profitable. Manual 25¢. CASTOLITE, 73A/PM, Woodstock, Illinois 60098.

TREASURE FINDERS

TREASURE Hunters! Prospectors! Relco's New Instruments Detect Buried Gold, Silver, Coins, Minerals, Historical Relics. Transistorized. Weights 3 Pounds. \$19.95 up. Instant Financing Available. Free catalog. Relco, Dept. A-40, Box 10839, Houston, Texas 77018.

POWERFUL Metrotech locator detect gold, silver, coins, relics. Moneyback guarantee, terms. Free information. Underground Explorations, Dept. A, Box 793, Menlo Park, California 94025.

FREE 156 Page Detector Catalog. General Electronic Detection Co., Box 67, Bellflower, California 90706.

SEARCH Treasure Finders. Locate gold, silver, coins, relics. Operate underwater. Money back guarantee. Free information. Search Electronics, Box 8396-A, St. Petersburg, Florida 33738.

FIND Buried treasure with revolutionary patented, analytical metal detector. Features push button and automatic tuning, negligible ground pickup, greatest range. Free catalogue. Gardiner Electronics, Dept. 9, 4729 N. 7th Avenue, Phoenix, Arizona 85013.

FISHER DETECTORS. You deserve the best! Free literature. FRL, Dept. PM-1, P.O. Box 490, Belmont, California 94002.

SUCCESSFUL Treasure Hunters. Use White's Detectors From: Paul B. Marvel, R.D. 1, Box 83PM, Frankford, Delaware 19945.

TREASURE Locators. Most complete line. Free information. Book "All you need to know about Treasure" \$4.95. Twelfth Edition. Tesoros, Apartado 7-905. Mexico 7, Mexico.

(Continued on next page)

TREASURE FINDERS

(Continued from preceding page)

DISCOVER AMERICA'S FASTEST GROWING HOBBY. White's Electronics, Inc., would like to send you—absolutely FREE, their 42 page, fact-filled catalog on Mineral and Metal Locating Equipment. Amateurs or Professionals select from the world's largest line of metal detectors priced as low as \$79.50, up. Detect Gold, Silver, Copper—Nuggets, Coins, Jewelry, etc. Budget terms available. For your convenience we have three major factory locations in the U.S. and Canada, as well as over 1,000 authorized dealers to serve you. See your local Yellow Pages under "Metal Locating Equipment", or write: White's Electronics, Inc. Room No. 381, 1011 Pleasant Valley Road, Sweet Home, Oregon 97386—Elk-Air Industrial Park, Dexter Drive, East, Elkhart Indiana 46514—or White's Electronics Ltd., 33784 Hazel Street, Abbotsford, British Columbia, Canada.

FORTUNE, FUN, HEALTH—Find Money, Gold, Silver, All Metals With Super Sensitive 1973 Excelsior Models. Transistorized For Hi-Performance, Least Weight, Compact Design, Long Life. Best Guarantee, Lower Cost. Write For FREE Literature Now! Excelsior Electronics—The Detector Center—7448 Deering, Canoga Park, Calif. 91303.

PROSPECTORS: Fantastic New Machine Makes Gold Extraction efficient, profitable. Using Redox Process, 100% Extraction Possible. Simplified Construction, Inexpensive, Portable. Plans \$4.00 check or money order. Kits available. Can be easily adapted for silver extraction. Centaur Systems Engineering, P. O. Box 5003, Oxnard, Calif. 93030.

COLLECT Abandoned Silver—\$20,000 yearly! Fortunes, Box 548, Woodville, Texas 75799.

HOW TO PAN GOLD With sample. \$1.00. Mining, Box 64-PM, Nampa, Idaho 83651.

GOLDAK Treasure locators—Pleasure and profit in a hobby you'll enjoy. Find coins, relics, gold, silver. Charge on BankAmericard. **GOLDAK**, Dept. PM 1101-A Air Way, Glendale, California 91201.

PRECIOUS STONES & MINERALS

GET Free catalog no serious rockhound, gem cutter, jewelry maker, hobbyist or craftsman can be without. Full of bargains, exclusive items, low prices from largest suppliers and authorities in the field. Free new catalog just off the press, yours for the asking. Write: Grieger's, Dept. C-12, 900 South Arroyo Pkwy., Pasadena, California 91105.

500 POLISHED Gemstones \$5.00. Tumblers. 5401 James North, Minneapolis, Minn. 55430.

EARTH Science Rockhound Magazine. Subscription \$3.00. Sample \$4.00. Box-550-PM, Downers Grove, Ill. 60515.

ROCKHOUNDS Special: thirty different large polished gemstones, \$3.00. Includes Jade, Opal, Moonstone, Bloodstone, Tigereye, Amethyst, etc. All named. Jim's Rock Shop, 5822 Sunland, Louisville, Ohio 44641.

DIAMONDS, Opals, Gems, Jewelry. Wholesale Prices. 25 Cents For Catalog. Klar, P.O. Box 91, Tarzana, Calif. 91356.

CARTOONING, COMMERCIAL ARTS, SHOWCARD & SIGN PAINTING

"HOW TO MAKE MONEY WITH SIMPLE CARTOONS"—Informative book sent FREE tells way to big income. Cartoonists' Exchange 91, Pleasant Hill, Ohio 45359.

FASCINATING Systems. Sign Painting-Cartooning. Straley, 1704 South Center, Springfield, Ohio 45506.

COMPACT 23 lesson Cartoon Course and Cartoonist's Magazine. \$2.00. Hartman, Box 30367, Lincoln, Nebraska 68510.

MODERN Cartooning taught by mail. Write for free brochure. Cartoonorama—Box 263-2L, Branford, Conn. 06405.

CARTOON For Money!! Big Free Book: Success, Box 885-C, Dearborn, Mich. 48121.

SIGNS! Make-your-own! **SIGN-RITE** Self-Adhering Letters and numbers! 4 Types! 5 large Sizes! 8 material Styles! Choice of Colors! Inexpensive! Prompt service! **FREE BROCHURE!** Americraft Mfg. Co., Box 25034 Northgate, Seattle, Wash. 98125.

SIGN Painting—\$1000 per Month Part-Time. Free Catalogue. Kaufmann Supply, Centertown, Missouri 65023.

ADVERTISING AGENCIES, ADV. SERVICES, MAILING LISTS

ADVERTISING Ratebook leading newspapers, magazines, 25¢. Chicago Advertising Agency. 28-E Jackson. Chicago 60604.

MAILING List, Most all Kinds, \$9.00 1000 Gummed, Circulars mailed \$5.00 1000. Dixmailers, King, North Carolina 27021.

10,000 MAILORDER Buyers on gummed labels. \$9.00 per 1,000. Gemco., B-21244AA, Indianapolis, 46221.

MAILING Lists. Fresh Daily. \$7.00 thousand on gummed labels. Diversified Mailing Lists, Box 3051, Fort Worth, Texas 76105.

RUBBER STAMPS

FREE 48 Page Catalog. Rubber stamps, printing, office supplies. Youngers Stamp Shop, Princeton, Iowa 52768.

ADDRESS Stamp \$1.43, Signature Stamp \$2.95. Catalog. Carol's, McCloud, Okla. 74851.

DELUXE Address Stamp \$1.00 Catalog. Rush Stamps, 132 Farmcrest, Rush, N.Y. 14543.

FREE Catalog! Great Expectations, Box 473, Eastwood Station, Syracuse, New York 13206.

FREE Stamp catalog. 45 type styles. Fast service. Catalog. Jackson, Box 443A, Franklin Park, Ill. 60131.

RUBBER Stamps, 3 Lines, \$2.50. Catalog 25¢. Tabco, Tomkins Cove, New York 10986.

OFFICE SUPPLIES

MAILORDER RECORDS Help get increased business! Complete 32 Page Record Book shows your inquiries, orders, advertising, expense, etc. Only \$1.00. C. A. MARTIN, POPULAR MECHANICS, DEPT. PMR, 224 WEST 57 STREET, NEW YORK, N.Y.

PRINTING PRESSES, RUBBER STAMP OUTFITS

SIMPLE-X RUBBER STAMP PRESSES, Hydraulic operated, electrically heated. Sizes 5"x8", 8"x12", 10"x15". Starting outfits Orders for presses, supplies shipped day received. Free catalog low supply prices. Send \$1.00 for postage and handling (refundable on first order). Custom Manufacturers, 406-P East Elm, Springfield, Missouri 65801.

LOW Priced Rubber Stamp Manufacturing Supplies. Starting Outfits. Martin, 1432 Major, Jefferson City, Missouri 65101.

SAME Day shipment on rubber stamp supplies. Revised wholesale price list No. 9 free. Star Stamp Supply, 732 Federal, Chicago, Ill. 60605.

RUBBER Stamp outfits, supplies. Kiewiet, 2025 Barney Road, Kalamazoo, Michigan 49007.

NEW Catalog No. 13, 120 Pages, hand printing presses, type fonts, supplies. Send \$1.00 deductible first order. Acme Type, 732 Federal, Chicago, Illinois 60605.

RUBBER Stamp Manufacturing Supplies. Equipment. Free Catalog. Northwest Stamp, Box 16417-PM, Portland, Oregon 97233.

BARGAINS Used Offset Letterpresses, Mimeograph, Multigraph and adding machines. Write: Dixiegraph, King, North Carolina 27021.

TYPE, Presses, Supplies. Barco Type Mfg., 237 S. Evergreen, Bensenville, Ill. 60106.

RUBBER Stamp manufacturers supplies. Presses, starting outfits. Best prices, service. Catalog. Jackson Supply, Box 443A, Franklin Park, Ill. 60131.

MAKE Your own self-molding Rubber Stamps and Printing Cuts. Plexirubber, Argyle A Wisconsin.

PRINTING Presses, type, supplies. Lists, 10¢. Turnbaugh Service, Mechanicsburg, Pennsylvania 17055.

PRINTING AND SUPPLIES

BUSINESS CARDS Raised Letters \$5.65 Thousand. Like Engraved. Free Samples. Kavanagh, Box 1222, Brooklyn, N.Y. 11202.

BUSINESS Cards, Rubber Stamps, Printing. Free Literature. Jordan's, 552 West O'Connor, Lima, Ohio 45801.

OFFSET Printing, Rubber Stamps. Free Catalog. McCoy Enterprises, Dept. B1, Burnet, Texas 78611.

500 QUALITY Business Cards, \$2.95. Other Printing Values, Free List. Sprint, P.O. Box 6044, Sherwood, Arkansas 72116.

DISTINCTIVE Embossed Letterheads, Envelopes, Cards. Inexpensive. Postpaid. Universal. 226-A. Myrtle, Scotch Plains, New Jersey 07076.

50 AIRMAIL ENVELOPES. Printed with your name and address in corner, \$1.00. Satisfaction Guaranteed. **JEANART STUDIOS**, Dept. P2, 715 E. 19 St., Brooklyn, N.Y. 11230.

FREE Offset Catalog. Fast-Economical. Seaview, 212-26P 48th, Bayside NY 11364.

EMBOSS Business Cards \$5.95/M, Letterheads, Envelopes. Business Forms, Labels, Rubber Stamps. G&M, Box 1336-PM3, Sun Valley, California 91352.

PRINTING, Business Cards, Stamps, Labels. Also Opportunity Manuals. Burnfin, Weaubleau, Mo. 65774.

ORDER WITH CONFIDENCE (Our 37th Year), 250 Bristol or Enamel Business Cards. Printed in Two Brilliant Colors, \$3.00 Postpaid. Samples \$1.00. Lefty Gandy, Lyons, Georgia 30436.

2000 NAME Labels \$1.70, 1000 \$1.00. Vincee, 189 Maple St., New Bedford, Mass. 02740.

PRINTING By Mail Supermarket. 1000 Copies \$5.95. 5000 Copies \$22.50. 100 Copies \$2.50. 1000 Envelopes \$7.50. 200 Letterheads and Envelopes \$5.50. 1000 Letterheads and envelopes \$13. Business Forms, 10 pads, 100 sheets each \$6.25. 1000 Adv. Flyers. Free layout, typesetting, color paper \$25. 3000 with one photo \$39.50. Take extra 10% if order equals \$30. Min. order \$7.50, plus \$1.25 shipping for each 1000. We ship in 9 hours. Enclose 2 Originals with Remittance. Full Money Back Guarantee. Get Free Book, "Do you make these 18 Mistakes when you buy printing." Speedy Offset Printers, 23811 Aurora, Bedford, Ohio 44146.

200 BUSINESS Letterheads Plus Envelopes! BOTH \$6.00. Total! Fast! Haldeman's Girard, Kansas 66743.

MULTIGRAPH, MIMEOGRAPH

PROFITS FROM CLASSIFIED ADVERTISING! Booklet shows you how to start your own business with Classified Advertising. Only \$1.00 (Refundable with first order.) **C. A. MARTIN, POPULAR MECHANICS, DEPT. PMP, 224 WEST 57th STREET, NEW YORK, N. Y. 10019.**

(Continued on next page)

GUMMED LABELS

1,000 GUMMED ADDRESS LABELS \$1.00 FREE CATALOG. Acme, 1238 Voskamp, Pittsburgh, Pennsylvania 15212.

500 PRESSURIZED Address Labels \$2.00. Wait's, Box 966A, South Bend, Indiana 46624.

1,000 GUMMED Address Labels \$1.00. Many other Styles. Free Catalog. Slater, Route 2, PM1, So. Whitley, Indiana 46787.

1000 LABELS \$1.00. Eldee Printing, 152 W. 42 St., N.Y.C. 10036.

FREE Catalog . . . Great Expectations. Box 473, Eastwood Station, Syracuse, New York 13206.

REMAILING SERVICE

MIAMI Remails 25¢. Monthly Rates. Remails-View Cards From 55 Foreign Cities. Remails From Any U.S. City 75¢. Marle, Box 1266, Coral Gables, Florida 33134.

EUROPEAN Cities reairmail singles \$1.00 Postcards 5/\$1.00. Masters, 82 Doudeauville, Paris 18, France.

SECRET. Receiving—forwarding. Discreet and confidential. Remail 25¢ single. Mail Forwarding Service, 8050 S. Main, Houston, Texas 77025.

CONFIDENTIAL New York City mail address \$3.00 month. Remails 25¢. Details Free. Birnhan, 152 W. 42, New York City 10036.

LET A Disabled Veteran Do Your Remails 25¢ Each. \$3.00 Monthly. Chas. W. Miller, Michigan Veterans Facility, Grand Rapids, Michigan 49505.

RECEIVING — Forwarding — Remailing, Monthly Rates. Nortex, Drawer 5370, Ft. Worth, Texas, 76108.

CONFIDENTIAL Remails 25¢ each. Elrose, Box 313, Wabash, Indiana 46992.

OHIO Remails 25¢ Single. Monthly rates. Amcar Enterprises, 6081 Burnley Sq. East, Columbus, Ohio 43229.

ST. LOUIS Confidential 25¢, Monthly \$3.00. 8812 Signature, St. Louis, Mo. 63126.

CONFIDENTIAL Remails 25¢ Monthly \$3.00. Box 23921, St. Louis, Mo. 63119.

YOUR Correspondence Sent, Received, Forwarded. Write: **SPECTRUM** P.O. Box 3574, Charleston, S.C. 29407.

IDAHO REMAILS—Receiving-Forwarding. Singles 25¢, \$2.50 Monthly. Stellar, Box 1086, Lewiston, Idaho 83501

ATLANTA REMAILS 25¢. R. Nance, Box 1265, Smyrna, Georgia 30080.

YOUR Mail Received—Forwarded. Hedgpath, 324-M South First, Alhambra, Calif. 91802.

SCOTTSDALE Remails, 25¢. \$3.00 monthly. Remfor, Box 1541P, Scottsdale, Arizona 85252.

CONFIDENTIAL Receiving—Forwarding \$3.00 Monthly. Remails 25¢. Doug, Box 165, Schenectady, N.Y. 12301.

HAWAII Reairmails, \$1.00. Houston, 25¢. Allstate, 714W Janisch, Houston, Texas 77018.

FLORIDA Remails 25¢. Information Confidential. Macks Products, Box 1562, Ft. Lauderdale 33302.

WASHINGTON, D.C. Remails 25¢ Single. Sharp Services, Box 697, Bowie, Maryland 20715.

FREE: First Month's Remailing Services. Wright, Box 2112-M, Asheville, N.C. 28802.

MEXICO Remails 15¢, Airmail 20¢. Munroe, 1318 Felton, San Diego, Calif. 92102.

FORT BRAGG Remails, 25¢ Plus Postage. CEM, Box 1302, Fayetteville, N.C. 28301.

REMAILS From Pennsylvania 25¢, Single \$3.00. Monthly. McWilliams, 560 North Darby, Sharon, Pennsylvania 16146.

IRELAND: Airmails \$2—3 for \$5. Postcards, Gifts supplied. A. R. Watson, 5Lr. Kilmacud Road, Stillorgan, Co. Dublin, Ireland.

REPAIRS AND SERVICING

MAILORDER RECORDS Help get increased business! Complete 32 Page Record Book shows your inquiries, orders, advertising, expense, etc. Only \$1.00. **C. A. MARTIN, POPULAR MECHANICS, DEPT. PMR, 224 WEST 57 STREET, NEW YORK, N.Y. 10019.**

SPECIAL SERVICES

INFORMATION On anything. Ferguson Specialists, 72-25 Woodside, Woodside, New York 11377.

AUTHORITATIVE Information On Anything! \$2.00 (Deductible). Metzler Research, Box 2206PT, Long Island City, New York 11102.

PERSONAL

RECEIVE Phony Degrees! Write: University Of Eastern Florida, Dept. PM, Box 7268, Tampa, Fla. 33603.

PSORIASIS Sufferers: Discouraged? Write for Free important information that is helping thousands! Pixacol, Box 38-PM, Avon Lake, Ohio 44012.

INSTANT DEBT RELIEF Without borrowing. Without Bankruptcy. Have excellent credit in 45 days. Free!!! Wealth Building, Box B-1, 8840, Hoyt Drive, Thornton, Colorado 80229.

BIBLE Questions answered. Stamped envelope. Bylon, 17167 Bentler, Detroit, Michigan 48219.

RECORD Telephone conversations automatically. Leave recorder unattended. Write—Robert's, Box 49-PM-1, Parkridge, Illinois 60068.

CASH LOANS by mail! Up to \$2,500 on signature alone. No collateral! Secret! Union Finance Company, 3608 No. 16th St., Dept. PM, Phoenix, Ariz. 85011.

WHO Else Wants Credit Cards? Learn how to get credit cards fast, easy! Get new credit without investigation, Box J-27, Hallandale, Florida 33009.

INTERIOR Decorating Guide \$4.95. Inform. Catalog 35¢. Save. Start Business. M & J Sales, 4452 No. Tripp, Chicago Illinois 60630.

ASTROLOGY, Send Birthdate Birthtime, Birthplace \$3.00. **FIFTEEN PAGE PERSONAL HOROSCOPE.** Fawn Harte, Box 711, Smithtown, New York 11787.

INVESTIGATORS. Latest electronic Aids. Free Literature. Clifton, 11500-P NW 7th Ave., Miami, Florida 33168.

RUPTURED. Relief and comfort. No understraps, elastic or steel. Write: Hand-Lock Products, Preston 4, Ont., Canada.

FREE Gospel Literature foretelling second coming of Christ. Scheall, Box 263-PM, Duluth, Minn. 55801.

WOW! Illustrated Occult Catalogue—Free! Stanray, Dept-A2, GPO Box 3317, NYC 10001.

NEW False Dental Plate, low as \$31.95. 24 Hour Service. No impression. Lightweight DuPont Beauty Pink Plastic. Satisfaction or money back. Free details, shipping box. West, Dept. F-203, 3816 W. Lawrence, Chicago, Illinois 60625. Not available to Illinois residents).

DREAMER Learn their Mysterious Inner Meanings. 110 page book How To Understand Your Dreams. Send \$2.00. Parkway Sales, 3100 Georgia Ave. N.W. Dept. 5, Washington, D.C. 20009.

BEAUTIFUL Goldtone Metal Social Security Nameplate Inside Flip Wallet, \$1.50. Gold Star, Box 7066P, Commerce, California 90022.

MATHEMATICS STUMP YOU? Startling Revelation Teaches You How To Do Lightning Mathematical Equations **FAST.** My System Works. Write, I'll Prove It. Marlos, Dept. PM, Box 111, Harwinton, Conn. 06790.

BORROW By Mail! Up to \$1500.00. Convenient terms. State Licensed. Postal Finance, Dept. 17-A, 6018 Military Ave., Omaha, Nebraska 68104.

SECRET LOANS BY MAIL. Borrow \$100 to \$3000 for any good reason in absolute privacy. No interviews, no endorsers, no co-signers. Fast service. Write: Dial Finance Co., Dept. 1269, 405 S. 16th Street, Omaha, Nebraska 68102.

CRYSTAL GAZING. Directions for Constructing and using your own Inexpensive Scrying Mirror. Use it to Contact your own Clairvoyance. Send \$2.00 or Complete Kit and Instructions \$5.95 Postpaid. Mario's Imports, 2397 Clinton Road, Jackson, Michigan 49201.

SECRET Plan Wipes Out All Debts. \$500 to \$25,000 in as little as 90 minutes. Clear credit. Free details. Counselor-7, Kerrville, Texas 78028.

SELF-SCORING I.Q. Test. Only \$2.00. Improvement booklet \$2.00. Order Today!! Paramont, Box 9664, Dept. One-A2D, Little Rock, Ark. 72209.

IMPROVE YOUR LIFE With Self-Help Books. Start With "DYNAMIC THINKING", Only \$1.25. **FREE** Catalog. Gift Bag. 10730 White Oak, Granada Hills, Calif. 91344.

CANCER! You May Be Next! Stop Smoking! New Book reveals medical and psychological method. Money Back Guarantee. \$2.00. Evans Enterprises, Dept. 11PM13, 77 May Street, Irvington, New Jersey 07111.

MAKE YOUR OWN WILL 4 Will Forms and Attorney's Instructions protect your Family. Only \$2.00—guaranteed! Order today!! Masterman, Department 1B13, 1544 Red Cedar, St. Paul, Minnesota 55121.

SMOKERS. I Did, Now Don't, You Shouldn't. Need Help? \$2.00. Box 251, Brighton, Illinois 62012.

REDUCE Dental Bills! Prevent Gum Disease, Tooth Decay and Loss! Copyrighted Publication By Prominent Dentist Only \$1.00. L. C. Smith, Box 583, Cornwells Heights, Penna. 19020.

DON'T DIE Without A Will! Blank Will Form protects your family. Only \$2—Guaranteed! Order Today!! J & J Associates, Box 82568-3PI, Atlanta, Georgia 30354.

STOP SMOKING For GOOD! Proven method, really works—guaranteed! Only \$2.00—order today!! Masterman, Department 3B13, 1544 Red Cedar, St. Paul, Minnesota 55121.

KOREAN GINSENG Legendary body and mind rejuvenator. Brochure 25¢. Herbal Holding, Box 5854PM, Sherman Oaks, California 91413.

NOW Others Earning More. Why Not You? Publication tells why. **FREE** information. Prentice Productions, 238 Utica, Buffalo, New York 14222.

HOW To Make Money Writing Short Paragraphs. Information Free. Write: Mailosav, Dept. PP4, 226 S. 16th, Philadelphia, Penna. 19102.

NEW Family Planning Calendar for Young Parents. Newlyweds, \$1.00. Terri's, Box 334, Melfort, Sask.

(Continued on next page)

PERSONAL

(Continued from preceding page)

DON'T DIE Without A Will! \$2.00 Protects your family—Guaranteed!! Fiath Enterprises, Box 37M2, Crozet, Virginia 22932.

STOP SMOKING!! FEEL GREAT!!! World-famous five-day plan has helped millions. Try it! \$1.00. Emmaus Book Service, Box 433 Cathedral Station, New York City 10025.

KICK The Habit, Quit Smoking Permanently. Booklet tells how, \$1.00 (Guaranteed) Reynex, Box 1164, Marietta, Ga. 30060.

SAFEGUARD CREDIT CARDS & SECURITIES . . . This Fingertip Information Form Reduces Misuse Possibility. Send \$1.00—GRYCO, P.O. Box 4652, Philadelphia, Pa. 19127.

NEED Money-Debts Too Big? Quick Cash, Secret Emergency Loans. Free Consolidation Plan. Interstate, 28 E. Jackson, Suite 1204-X3, Chicago 60604.

TELL Fortunes accurately—Immediately! ESP Aids, Box 21-PM, Olympia, Washington, 98507.

WANTED-MISCELLANEOUS

MERCURY, Gold, Silver, Platinum; Ores assayed. Wholesale Terminal, Norwood, Mass. 02062.

WINEMAKING & OTHER RECIPES

HOMEWINE MAKING SUPPLIES And INGREDIENTS CATALOG With RECIPES For Year Round Winemaking. It's A Fascinating Hobby. We Also Have Supplies And Concentrates For Your Wine Kit. Send For Free Catalog. Danenberger, Box 276-M, New Berlin, Illinois 62670.

WINEMAKERS. Free illustrated catalog of yeasts, equipment. Semplex, Box 12276R, Minneapolis, Minn. 55412.

WINEMAKERS . . . Free Illustrated Supply Catalog of Yeast, Equipment, Recipes. Continental, Box 18223-PM, Indianapolis, Ind. 46218.

WINEMAKERS Yeast, Recipes & Catalog 25¢. Kraus, Box 451-L, Nevada, Missouri 64772.

WINEMAKERS!! Fermentation locks—3/\$1.00. Free Illustrated Catalog plus \$5.00 Credit Coupon. Werth Wine, Box 1902AV, Cedar Rapids, Iowa 52406.

WINEMAKING Kit—\$4.98 Free Catalog and Recipes. JIMDANDY, Box 30230M, Cincinnati, Ohio 45230.

WINEMAKER'S Supply Catalog—Free. Bacchanalia, 273 Riverside Ave., Westport, Conn. 06880.

MAKE Delicious Wines, Champagnes! Step By Step Methods Revealed Using Standard Kitchen Items. Satisfaction Guaranteed. Send \$2.95 to: Gene Goddard Associates, Dept. P., 144 Warren Avenue, East Providence, Rhode Island, 02914.

WINEMAKER'S! Free Illustrated Catalogue of Quality Products. Brant's Wine Rack, Box 3256-M, Orange, California 92665.

FANTASTICALLY DELICIOUS CHAMPAGNE-WINES! Copyrighted, Proven Instructions (\$3.50-Guaranteed) Show How To Make—Save—Enjoy Quality Wines! McGuire Sanders, Drawer 2485, Orcutt, Calif. 93454.

WINEMAKERS FREE Supply Catalog—Our Book of Delicious Wine Recipes Using Easy Single Methods and Kitchen Equipment \$2.00. Unconditionally Guaranteed—Vintner, Box 611F, Pomona, Calif. 91769.

HYDROMETER USERS: Take the pain out of measuring gravities with the radically new VINTECH hydrometers. **NO POURING!** Precision plus temperature compensation. Complete information on request or \$7.50 postpaid. Litho Research, 28 N. Halsted St., Chicago, Ill. 60606.

WINEMAKERS: Free informative catalog, recipes. Arbolyn, Box 663, West Columbia, S.C. 29169.

DELICIOUS Homemade Wines, Champagnes! New 150 Page Handbook Includes Over 100 European Recipes. Easy Instructions Using Standard Kitchen Utensils. Guaranteed. Only \$3.00. Winestein, 4196 Highland, Richmond, Indiana 47374.

DELICIOUS Champagne and Wine—Made In Your Home. Using kitchen utensils. Many Recipes. Guaranteed. April, Box 403, Jamestown, No. Dak. 58401.

MISCELLANEOUS

HEARING Aid batteries wholesale. Free list. Habs, Box 51, York, Penna. 17405.

SECURITY FOR FAMILY Legal Will Form Protects Family. FREE Informative Instruction Booklet. **GUARANTEED.** Only \$2.00. Order Today. Corrigan, Box 603, Dept. PM-1, Tyler Park Station, North Bergen, New Jersey 07047.

COMPLAIN On Anything That Bothers You. Self-Mailer TELEGRIP Forms Explain What To Say And Who To Complain To. Send \$1.29 Plus 50¢ Mailing Costs To: C. E. Kelsic Associates, 383 Morris Avenue, Newark, N.J. 07103.

BOOKS On antiques and their prices. Free circular!! P. Warman Publishers, Uniontown, Penna. 15401.

SUFFERING From Arthritis? Try Ginseng: Information Free. Write: Ginseng, Asheville 53, North Carolina.

ORNAMENTAL Iron designs. Book of 1600 beautiful, practical designs for railings, columns, etc. Free literature. Cunningham, 3881 South 3200 West, Salt Lake City, Utah 84119.

PRE-PACKAGED Toys complete with free self-selling display rack. Free Details. Toys, 1916 Fifth, Sacramento, California 95814.

BIRTH Certificates, Marriage Certificates, Diplomas! 2 blank forms \$1.00. Sample 10¢. Standard Forms, Box 482-M, Washington, D.C. 20044.

SLEEPATRON. New device for inducing sleep. Gardiner Electronics, Dept. C, 4729 North 7th Avenue, Phoenix, Arizona 85013.

YOUR FAMILY TREE . . . Trace It Yourself. Easy—Fun. Free Catalog. Formco, Box 3828-XE, Long Beach, California 90803.

BEER COOKBOOK—Delicious Recipes using standard kitchen items. \$2.00 postpaid. Ashby Enterprises, Dept. PMB-1, 8511 Nicholson Street, Hyattsville, Maryland 20784.

BARRELS. Round, Ovals, Lowest Prices. Send 25¢ For List. Barrel Winery, 1201 University Ave., Berkeley, Calif. 94702.

WALL-SIZED TV . . . Build a 72-INCH TV PROJECTOR for under \$10.00. Free details: Macrocoma, Dept. PM-1, Washington Crossing, Pennsylvania 18977.

POCKET Check Writer a must! Checks cannot be altered, looks neat and professional. Prints businesslike up to \$9,999.99. Order today. \$5.95 Each. Paramont, Box 9634, Dept. One-A2A, Little Rock, Ark. 72209.

MILLEFIORI GLASS Cane for making Beautiful Jewelry. Also Adaptable for Pot and Lamp Workers. Samples \$1.00. Allen, Schools St., Marion, Mass. 02738.

LIGHTED MAGNETIC TWEezer! Mechanics, Hobbyists, seamstress—Magnified, concentrated beam. Only \$2.25—Guaranteed! Order today! Michelle of Miami, 10020 S.W. 213th St., Dept 1A12, Miami, Florida 33157.

CERTIFICATES!!! Driver License, Birth, Marriage, Divorce, High School, College Diplomas! Rushed Airmail! Two—\$1.00. Goldsealed versions \$1.00 each. Catalogue (forty different documents) 10¢. Filiforms, Box 1332-BL, Albany, N.Y. 12201.

MANUFACTURE Delicious WINE and CHAMPAGNE At Home! Complete Instructions, \$2.00. A.Q. Sales, P.O. Box 44066, Cleveland, Ohio 44144.

STRAIGHT Ladder to Compact Folding Ladder. Converter Invention for Sale or Lease. C. Ljohn, 5118 Dorchester, Chicago, Ill. 60615.

STOP AUTO THEFT!! Auto Guard makes Theft Impossible. Guaranteed. Easy Installation, Full Warranty, Only \$6.99. Geno Enterprises, Box 459, Xenia, Ohio 45385.

MAGNETS, All types. Specials—20 disc magnets, or 2 stick magnets, or 10 small bar magnets, or 8 assorted magnets, \$1.00. Maryland Magnet Company, Box 192-A, Randallstown, Maryland 21133.

WHERE Were You When The Lights Went Out? New Portable Fluorescent Light! Details. Gifts 'n Gadgets (1A1), Box 312, Carrollton, Texas 75006.

TREMENDOUS Profits, Selling Books By Mail. Lakeside, Dept. B1, Silver Lake, Minn. 55381.

DELICIOUS WINE And CHAMPAGNE! Homemade, proven Recipes using Standard Kitchen Utensils. Only \$2.00—guaranteed! Order today!! Masterman, Department 2B13, 1544 Red Cedar, St. Paul, Minnesota 55121.

EYEGASSES Wholesale—Free Catalog. A-Z Optical Company, Box 175, Dept. R26, Bay Station, Brooklyn, N.Y. 11235.

DON'T PAY INCOME TAX. Legally, No Matter What Your Income. Rich Men's Methods Adapted for Anyone's Use. Free Details. Trauhhaus—41, Box 3004, Duluth, Minnesota 55803.

U.S. \$1000 Bills!! Obsolete Exact Replica's 5 For \$4.00. National, Box 1391-X, Clearwater, Florida 33517.

OBSERVE Invisibly! Useful, Exciting! Adults only. Guaranteed—\$2.00. Phenoministics, Box 281, Gresham, Oregon 97030.

PROSECUTE Your Own Patent Application. All Material Necessary—Write: Inventors Service, Box 3574, Washington, D.C. 20007.

PLAY CHESS BY MAIL For Names and Addresses of Players Who Want to Play By Mail, Send Your Name, Address and \$2.00 To: PEOPLELINK, 435 North Roxbury Drive, Suite 105, Beverly Hills, California 90210. Indicate Beginner, Advanced, Expert.

DON'T DIE Without a Will. 4 BLANK WILL forms protect your family. **FREE** booklet, "How to make and break a will", only \$2.00, guaranteed. Order today. Ruiz Gift Enterprise, 943-G South Vanness, San Francisco, Calif. 94110.

CASSETTE Carousel holds 25 tapes. They stack and turn. \$9.95!! JKB, Box 422, Dept. 211J, Springfield, Ill. 62705.

WINEMAKERS/BEE-KEEPERS: Ancient Medieval Irish Mead recipes—wine of contentment—\$3.00. D-P, 5 Lr. Kilmacud Road, Stillorgan, Co. Dublin, Ireland.

BURGLAR ALARMS & HOME PROTECTION

FREE Catalog on Burglar-fire Alarm Equipment. Protecto Alarm Sales, Box 357-D, Birch Run, Michigan 48415.

LOCKSMITHING Supplies—Wholesale Buying Guide \$1.00. Despubs, Box 22005A, Phoenix, Arizona 85028.

NEW HOME SECURITY MANUAL By Former CIA Expert. Fully Illustrated. Dozens of tips for Homes, Apartments. \$2.50 Postpaid. Mitchell's, 456 Marlow Ave., Spring Hill, Florida 33512.

1973 BURGLAR & FIRE ALARM EQUIPMENT CATALOG. 62 PAGES. JUST \$1.00. (Refunded With First Order). K-TRONICS INDUSTRIES, BOX 391, DEPT. PM, FAIRFIELD, CONN. 06430.

Unadorned power tools.

4' Wood Lathe
at \$29.95

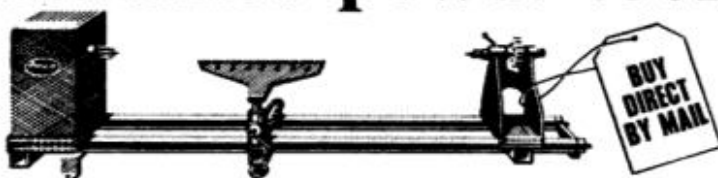

They do the same job as tools costing up to 5 times as much.

We skipped the chrome to save you money . . . but we did not skip anything on performance. Actually, we skipped more than just chrome, we cut out every costly frill that wasn't absolutely needed.

The lathe shown above isn't exactly flashy. We admit it. But in a recent article, Popular Science used it to demonstrate wood lathe technique and said: "You won't go wrong with this economical introduction to wood turning." It is typical of our tools which in spite of low prices, are full scale and offer full performance and precision.

HERE'S HOW WE DO IT . . . First, we don't claim our tools should sell for five times the price! Just that our tools do the same job . . . with the same accuracy, ease and speed . . . and will last at least as long. AMT tools cost less to make and are sold direct. They are bona fide quality power tools used by serious amateurs and professionals alike and if sold in retail stores would be much higher in price. We use no magic, let's be specific:

SIMPLICITY . . . AMT tools are soundly engineered to eliminate every frill and gimmick—to minimize material and production costs. Machined parts are used only where they're needed. Unadorned cast iron and aluminum save you a fortune.

DIRECT-FROM-FACTORY SAVINGS . . . You save a bundle, yet, we offer a double guarantee backed by a 38-year-old company with millions of satisfied customers . . . and hundreds of orders pour in daily.

LARGE VOLUME . . . Our own foundry and large mass production facilities plus large buying power all work to keep costs down.

STANDARD PARTS . . . Our designs use standard hardware items wherever possible. By avoiding custom-made parts we pass on tremendous savings to you.

If you are looking for power tools that perform like units costing many times our low prices, order today and you'll be one step closer to many hours of woodworking satisfaction.

Bill Morley



POWER SAW 8" tilt arbor saw . . . crosscuts, rips,

mitres, cuts compound angles, dados, coves, moldings. Completely assembled with ground cast iron table, safety guard, splitter, mitre gauge. Less blade, motor. Rip fence for easier work alignment, \$3.50 add'l. Ball bearing model, \$5.00 add'l. Takes 1/3 h.p. motor or larger, standard blades, attachments. Wt. 26 lbs., f.o.b. factory



\$19.95



FREE OFFER, cabinet base plans, . . . with one piece of 3/4" plywood, convert your \$19.95 saw into a floor model with a huge 27" x 24" top. Takes cabinet rip fence, \$4.50 add'l.

TWO GUARANTEES

10-DAY MONEY BACK GUARANTEE

Try any of these power tools and compare it with any similar machine at any price. If not satisfied, return it for prompt, no questions asked refund. We pay the return shipping charges.

10-YR. FULL SERVICE GUARANTEE

Any part or parts of these AMT power tools (except motor which carries a one year guarantee) which become inoperative for any reason within ten years after purchase date will be repaired or replaced by the factory with no cost to the purchaser other than postage.

AMERICAN MACHINE & TOOL CO.
4th & Spring St., Royersford, Pa. 19468



Brand new electric motor

developing full 1 h.p. 17 lbs. (Purchased separately, \$24.85).

With any AMT machine here. **\$19.90**

BUY DIRECT
...USE THIS HANDY
ORDER COUPON
NOW

AMERICAN MACHINE & TOOL CO., Dept. PM-13, Royersford, Pa. 19468

Please send me the units checked. Payment in full enclosed \$ or \$3 deposit each item enclosed, balance C.O.D. I must be fully satisfied or will return unit within 10 days for full refund. No questions asked.

- | | |
|---|--|
| <input type="checkbox"/> 8" Power Saw at \$19.95 | <input type="checkbox"/> Jointer Planer at \$29.95 |
| <input type="checkbox"/> Standard Rip Fence at \$3.50 | <input type="checkbox"/> Ball Bearing Spindle at \$5.00 |
| <input type="checkbox"/> Long Cabinet Rip Fence at \$4.50 | <input type="checkbox"/> Wood Shaper Kit at \$19.95 |
| <input type="checkbox"/> Ball Bearing Spindle at \$5.00 | <input type="checkbox"/> Opt. Hold Down Assembly at \$2.75 |
| <input type="checkbox"/> Belt Sander at \$19.95 | <input type="checkbox"/> 6" Swing 3' Lathe at \$14.95 |
| <input type="checkbox"/> Disc Sander Attachment at \$7.95 | <input type="checkbox"/> 12" Swing 4' Lathe at \$29.95 |
| <input type="checkbox"/> Mitre Gauge for Sander at \$1.95 | <input type="checkbox"/> Face Plate \$2.50 (either Lathe) |
| <input type="checkbox"/> Drill Press at \$34.95 | <input type="checkbox"/> Turning Chisels \$4.95 (either Lathe) |
| G.E. Motor <input type="checkbox"/> \$19.90 (with other item) | <input type="checkbox"/> \$24.85 (purchased separately) |

NAME _____

ADDRESS _____

CITY _____

STATE _____

ZIP _____

3' WOOD LATHE . . . 6" swing.

Same precision and speed as \$40 units. Sturdy cast iron with tubular steel bed. Lever action tail stock, two-speed pulley, fits any motor. Set of 3 high speed turning chisels, \$4.95 add'l. 4" face plate, \$2.50 add'l. 15 lbs., f.o.b. factory

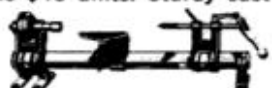

\$14.95

4' WOOD LATHE . . . 12" swing.

Industrial size, does the same job as \$75 units. Tubular steel bed rails, screw action tail stock, three-speed pulley. Use any motor. 3 high speed turning chisels, \$4.95 add'l. 4" face plate, \$2.50 add'l. 30 lbs., f.o.b. factory



\$29.95

JOINTER-PLANER 4 1/8" x 22".

Cast iron and steel, precision ground adjustable tables. For planing, joints, bevels. Rabbits to 3/8" depth. Fence adjustable 0° to 50°. Steel knives, dual guards. Use any motor. Precision ball bearing industrial model, \$5.00 add'l. Wt. 19 lbs., f.o.b. factory



\$29.95

BELT SANDER A precision unit.

It changes from horizontal to vertical in seconds. Heavy, sander includes 4" x 36" sanding belt. Uses 1/3 h.p. or larger motor. V-pulley drive and multi-purpose drive spindle.



Disc sander accessory, \$7.95 add'l. Mitre gauge, \$1.95 add'l. 15 lbs., f.o.b. factory

\$19.95

DRILL PRESS

Precision 32" radial unit has standard features and many extras. Depth of throat up to 16". Head tilts and table stays level. Drills to center of a 32" circle. All cast iron and steel. Takes standard motor. 32 lbs., f.o.b. factory.



\$34.95

WOOD SHAPER KIT Makes beads, coves, moldings, tongue-and-groove joints, etc. Accurate cuts at high speeds. Sealed greased-for-life ball bearings. Less wood. Takes 1/4 h.p. motor or larger, standard cutters. Optional hold down assembly, \$2.75 add'l. 15 lbs., f.o.b. factory



\$19.95

'73 Ford pickups
start the better
ideas coming
all over again!



Behind seat is stor-
age, not gas tank.



Ford box cover fits
right, looks right.



Full-foam seat 5 in.
deep is standard.



Optional "air" is all
neatly built in.

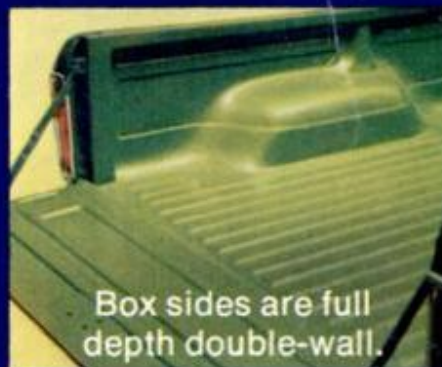

Box sides are full
depth double-wall.

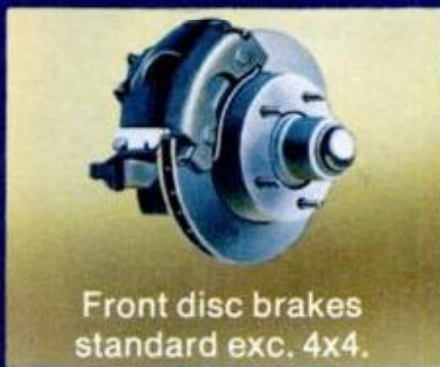

Front disc brakes
standard exc. 4x4.

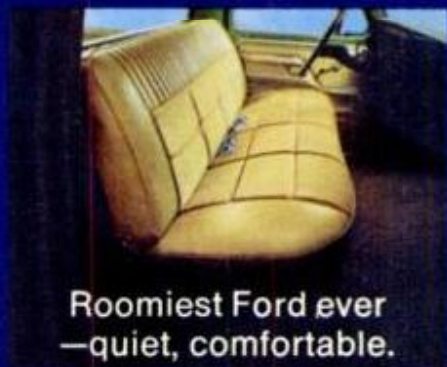

Roomiest Ford ever
—quiet, comfortable.



Twin-I-Beam, start
of Ford's great ride.



A better idea for safety:
Buckle up.

FORD PICKUPS

FORD DIVISION



Works like a truck/rides like a car.

* Availability may be subject to Environmental Protection Agency certification

“Up With the Sun”



How good it is

with **Winston's finer flavor**

Ask any Winston man why he smokes Winston
and he'll tell you ... *how good it is!*
Yes, Winston tastes good like a cigarette should.



Warning: The Surgeon General Has Determined
That Cigarette Smoking Is Dangerous to Your Health.

© 1972 R. J. REYNOLDS TOBACCO CO.
20 mg. "tar", 1.3 mg. nicotine av. per cigarette, FTC Report AUG. '72.