

Popular Mechanics

SEPT. 1972
50 CENTS

ELECTRIC RENT-A-CARS

You can drive before you buy Page 131

The Russian Navy—
and what's
happening
to ours

Page 98

Mini-Hawk:
Slick little
homebuilt
airplane

Page 114

Driver's
report:
Renault 15

Page 142



PM's versatile
PIANO BAR

Page 74

Wraps around
a piano...



Rolls
anywhere...



Serves as a buffet
under
shelves

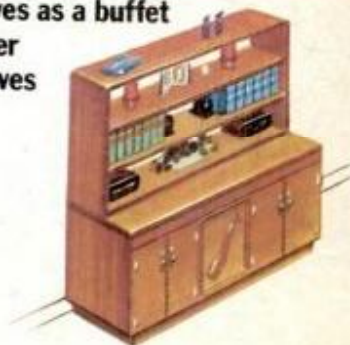

Dry is no way to smoke.

Come all the way up to KOOL.
The only one with
the taste of extra coolness.



Warning: The Surgeon General Has Determined
That Cigarette Smoking Is Dangerous to Your Health

King Size, 18 mg. "tar," 1.4 mg. nicotine; Long Size, 19 mg. "tar,"
1.4 mg. nicotine av. per cigarette, FTC Report Apr. 72

Inside 35.

Four reasons why the Nikkormat is one of the most respected names in 35mm photography.

What goes into a camera has a lot to do with the quality of what comes out. Case in point: the Nikkormat FTN 35mm single lens reflex. Here are four interior design features that you might never know about unless you cut the camera in half with a laser beam (which is just what we did, above). They're four of the very best reasons why Nikkormat can consistently turn out more great photographs in more situations.

The focal plane shutter

A focal plane shutter utilizes a slit of varying size in a curtain, which moves across the film plane to effect the exposure. Curtains are usually cloth or foil or both. But not in a Nikkormat. It's metal, and it moves up and down. The advantage of metal is obvious: durability. Now think a little about the up and down part. Distance up and down is *shorter* than side to side: 24mm vs. 36mm. So less time is required for shutter to complete its trip. Which is crucial to accuracy and especially electronic flash synchronization. Most focal plane shutters can't synch above 1/60th. The Nikkormat goes to 1/125th.

All meters are not created equal

Just about every built-in exposure meter on the market reads through the lens. But just about everyone does it differently. "Averaging" meters read the whole scene (fine, but easily fooled by contrasty scenes, back-lighting), "Spot" meters read a little piece of it (reverse situation; difficult to use with normal scenes). And some cameras even have both (known as working at making life hard!). Nikon engi-

neers discovered that if you read the whole scene but concentrate the meter's sensitivity in the center (60% of the sensitivity in 12½% of the area), you get correct readings in just about any situation. Sounds too simple to be true, but it is.

Flatter film means sharper photographs

The first time you load film into a Nikkormat you may be a little surprised by the way the film winds. It's a reverse wind. If you're used to an ordinary 35mm camera, it'll seem backwards. But film naturally curls in on the emulsion side. It's a persistent enough curl that a pressure plate just isn't enough to keep it flat. In a Nikkormat, the film is pulled around a sprocketed roller, under tension, (getting more teeth in the sprocket holes in the process) effecting the finishing, flattening touch that can make the difference between almost-sharp and razor-sharp.

The lens mount can make or break the lens

The finest lens can operate in second-rate fashion if its lens mount doesn't hold it firmly and precisely in the plane in which it belongs. The time-honored way to do it is with an ordinary screw-mount. The problem is that interchanging lenses can take an eternity when you're in a hurry. Then there is the breech-lock system,

with the locking ring. It's faster... but turn the wrong ring...and suddenly you're lensless. The Nikkormat uses a bayonet lens mount that lets you change lenses with a 1/6 turn twist of the wrist. And when it's locked, it's *locked*. And very precisely too. Fact is, Nikkormat is one of the very few cameras that can accept a wide aperture f/1.2 lens which requires extremely precise mounting to assure accurate focus.

Not surprisingly, all this sophisticated engineering adds up to a camera which is amazingly simple to use. Most people merely center the needle in the viewfinder of the Nikkormat to take consistently outstanding photographs. See it at your dealer, or write, Dept. PM, Nikon Inc., Garden City, N.Y. 11530. Subsidiary of Ehrenreich Photo-Optical Industries, Inc.  (In Canada: Anglophoto Ltd., P.Q.)

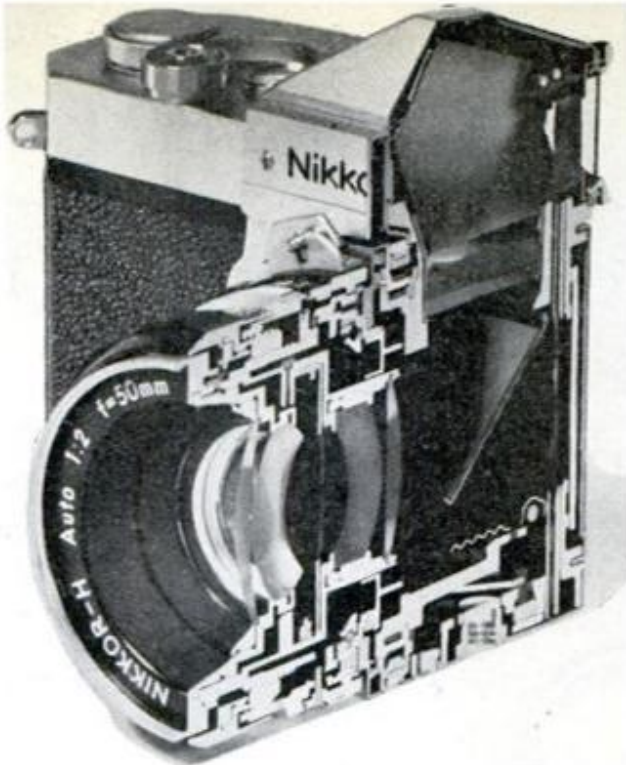

Nikkormat

CHANNELLOCK

Gives You More In Hand Tools Including

The Smooth Jaw Tongue-N-Groover



**CAN'T
GOUGE
CHROME
FITTINGS**

Fast, smooth-working, never-slip adjustments . . . tremendous leverage in hard-to-reach spots . . . full two-inch parallel-jaw capacity . . . all this **plus** smooth jaws that grip firmly without biting or gouging into the surface. No wonder plumbers and appliance service men hail this CHANNELLOCK Smoothjaw as one of the handiest tools in the kit. You will, too.

YOURS FOR THE ASKING. Our handy tool guide catalog. Write us.

TOOLS BY
CHAN NEL LOCK[®]

MEADVILLE, PA. 16335



"Being a good mechanic takes more than knowing how."

"I was trained as an aircraft mechanic. And believe me, they teach you to *care* about what you do," says Mike Todd, of Denver, Colorado.

"The truth is, they've

always stocked Champions at the garages and service stations where I work. And they are a good plug for any car.

"I run my Chevy El Camino with Champion

and I think it runs better with 'em."

"It's as simple as that."

This One



BFDK-EYK-YWH8

7 million Chevrolet owners have switched to Champion Spark Plugs.

Popular Mechanics®

INTERNATIONAL EDITIONS
 AUSTRALIA • CARIBBEAN
 DENMARK • MEXICO • SWEDEN
 SOUTHERN HEMISPHERE

HOW TO . . .

Be your own roofer 176



Build PM's piano bar-buffet 74



Rate wheel-balancing work . . 144

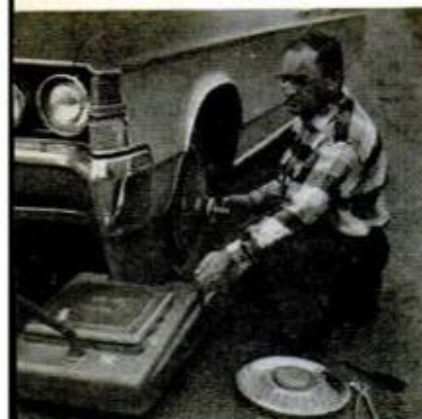

Make stacking tray tables 94



AUTOMOBILES, DRIVING

- 22 Drivin' with Dan
- 131 Your first electric car may be an Avis!
- 142 Renault 15:
It won't go unnoticed . . . and go it does!
- 144 Saturday Mechanic:
Wheel balancing—How to get your money's worth

HOME AND YARD

- 73 Quick-change ideas for easy entertaining
- 74 PM's versatile piano bar
- 78 For party fun
- 80 Swivel hi-fi center
- 84 Basement spruce-up
- 90 Hideaway home theater
- 94 Stacking tray tables
- 156 Better ways to do it
- 176 Be your own roofer

SPACE, AVIATION, MILITARY

- 98 The growing threat of Soviet sea power
- 114 Mini-Hawk: A bird for the bargain hunter
- 138 Terror in our skies . . . can we stop the growing menace of air piracy?

ELECTRONICS, RADIO, TV

- 102 How to unsnarl the great quadraphonic muddle
- 110 How TV puts you on the 18th green

PHOTOGRAPHY

- 14 Photo hints

ON THE COVER: Transit IV electric car built by Anderson Power Products
 Photo by Irv Dolin; drawings by Roy Grinnell

SHOP AND CRAFTS

- 148 Nice—and easy
- 148 Contemporary sofa
- 150 Modular stacking cubes
- 151 Modern hall clock
- 152 Pot-and-pan rack for island work counter
- 153 Hand scraper uses lathe bits
- 154 Hand-operated arbor press
- 158 Bench-saw know-how (Part 3)
- 164 Hints from readers
- 166 Workshop setup fit for a pro
- 182 Hints from readers

BOATING, OUTDOORS

- 107 Now they're pampering the pellet pushers
- 134 Tracking: This Indian art still saves lives

SCIENCE, INVENTIONS

- 116 Let it rain, let it pour—in a roof-covered city
- 128 The satellite that may save your life

EVERY MONTH

- 6 Letters
- 28 Automobile Clinic
- 34 Science Worldwide
- 38 The Bicycle Shop
- 42 Appliance Clinic
- 46 All Outdoors
- 70 Detroit Listening Post
- 116 New Inventions
- 118 It's New Now: The latest products and developments (A 10-page roundup)
- 172B Homeowners' Clinic

WORTH WRITING FOR: SEE PAGE 16

AS A SERVICE TO READERS, Popular Mechanics publishes newsworthy products, techniques and scientific and technological developments. Because of possible variance in the quality and condition of materials and workmanship, Popular Mechanics cannot assume responsibility for proper application of techniques or proper and safe functioning of manufactured products or reader-built projects that result from plans published in this magazine.

JIM LISTON

Editor

SHELDON M. GALLAGER **JOHN A. LINKLETTER**
Executive Editor Managing Editor

WAYNE C. LECKEY **ALVIN KIETZ**
Home and Shop Editor Art Director

Published by The Hearst Corporation
RICHARD E. BERLIN, PRESIDENT

RICHARD E. DEEMS
President, Magazines Division

JOSEPH F. KERN
Publisher

BILL HARTFORD _____ Automotive
JOHN F. PEARSON _____ Science and Engineering
WM. T. McKEOWN _____ Boating and Outdoors
IVAN BERGER _____ Electronics and Photography
HARRY WICKS _____ Home Workshop
MICHAEL LAMM _____ West Coast
ROBERT LUND _____ Detroit Automotive
GARRY WINTER _____ Copy Chief
RICHARD H. FUNK _____ Production
ALFREDO VEGA _____ Assistant Production
DON EVANS _____ Technical Art Director
FRED A. LEERS _____ Assistant Art Director
JOSEPH P. BEATON _____ Assistant Art Director
DAVID KOMITAU _____ Assistant Art Director
CLIFFORD B. HICKS _____ Special Projects
SOPHIE GRONOWICZ _____ Director, Bureau of Information
EVERETT JOHNSON _____ Cabinetmaker

ADDRESS ALL EDITORIAL COMMUNICATIONS TO: 224 West 57th St., New York, N.Y. 10019. For additional sources of information on the articles and products in this issue, write to Bureau of Information, Popular Mechanics, for free "Where-to-Find-It" list.

DANIEL J. COLEMAN
Director of Advertising

ADVERTISING OFFICES: New York: 224 West 57th St., 765-6850; Chicago: 520 N. Michigan Ave., 527-2400; Detroit: General Motors Bldg., TRinity 5-8711; Cleveland: 20310 Chagrin Blvd., Shaker Heights, 283-7788; Los Angeles: 601 North Vermont Ave., 666-6263.

JOHN A. REGINA _____ Advertising Production Manager

SUBSCRIPTION SERVICE: Mail all subscription orders, changes of address, correspondence concerning subscriptions, and Postmaster notices of undeliverable copies to Popular Mechanics, Box 646, New York, N.Y. 10019. Please enclose your latest address label for quickest service when writing about your subscription.

POPULAR MECHANICS IS PUBLISHED MONTHLY by The Hearst Corporation, 57th St. at 8th Ave., New York, N.Y. 10019, U.S.A. Richard E. Berlin, President; Richard E. Deems, President of Magazines; John H. Miller, Executive V-Pres. of Magazines; Raymond J. Petersen, Senior V-Pres. of Magazines; William S. Campbell, V-Pres. of Magazines; Albert A. Rachol, V-Pres. and Director of Circulation; Joseph F. Kern, V-Pres. for Popular Mechanics; Frank Massi, Executive V-Pres. and Treasurer; Harvey L. Lipton, Secy. Single copy in the United States and Canada, 50 cents. Subscription prices: United States and Possessions \$5.00 for one year; \$9.00 for two years; \$12.00 for three years. Canada, add \$2.00 for each year. All other countries, add \$4.00 for each year. When changing address, give old address as well as the new, with postal-zone number, if any, and allow six weeks for change to become effective. Second-class postage paid at New York, N.Y., and at additional mailing offices. Authorized as second-class mail by the Post Office Department, Ottawa, and for payment of postage in cash. Registered as second-class matter at the Post Office at Mexico D.F., Mexico, June 20, 1950. © 1972 by The Hearst Corporation. All rights reserved. Printed in U.S.A.

SEPTEMBER 1972

Build yourself a better drink.



WINDSOR CANADIAN

Canada's smoothest whisky

CANADIAN WHISKY - A BLEND • 90 PROOF • IMPORTED BY NATIONAL DISTILLERS PRODS. CO., N. Y.

RIDGID Tools

make pipe and conduit installation easy!

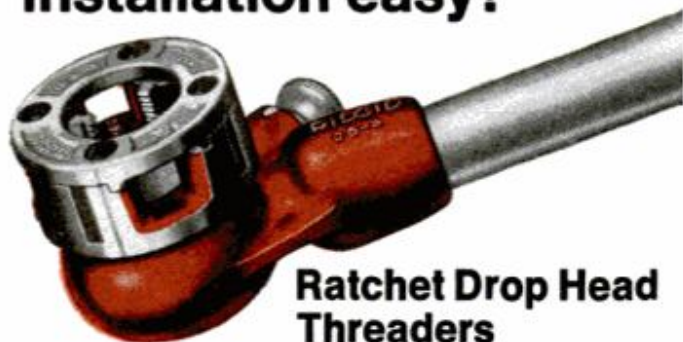

Ratchet Drop Head Threaders

Capacities: 1/8" through 2", 5 models

Easiest-to-operate hand threader around! Every threader and set of dies work-tested at our factory. Dies reverse for close-to-wall threading. Interchangeable die heads lock in; release easily. All RIDGID threaders cut perfect threads every time. And be sure to use RIDGID Thread Cutting Oil.

Heavy Duty Pipe Cutters



Capacities: 1/8" through 2", 2 models

Perfectly balanced professional design. Smooth tracking, specially tempered cutter wheel gives straight, burr-less cuts every time — even on rough surfaces. Factory tested for perfect tracking. For close-quarter work, convert to 3-wheel cutter by replacing rollers with cutter wheels.



No. 2-S Spiral Ratchet Pipe Reamer

Capacity: 1/8" through 2"

Self-feeding spiral design and razor sharp cutting edges make reaming fast and smooth. No chatter . . . even on sheet metal conduit box outlets. Reamer Unit, available separately, fits No. 00-R Drop Head Threader ratchet and handle.

Buy these RIDGID Tools at your quality Hardware Store. And be sure to see the other RIDGID Work Saver Tools from The Ridge Tool Company, Elyria, Ohio 44035, U.S.A.

RIDGID®

 Ridge Tool Subsidiary
Emerson Electric Co.
EMERSON

LETTERS

TO THE EDITOR

Say it isn't so

Did Abbie Hoffman really and truly report for *Popular Mechanics* [on the Democratic convention] as the enclosed front-page article [from a Wilmington, N.C., newspaper] states? If so, why is this considered correct by you?

WILMINGTON, N.C. WESTCOTT CLINTON

Lots of people apparently were taken in by Abbie's hoax—though we're surprised that the reporter who wrote the wire story for UPI was also fooled. The answer is an emphatic no—Abbie Hoffman does not write for PM.

Swiss cheese and dominoes

Why put what resembles a North Vietnamese flag on something you call a 'Swiss-cheese' mountain game (page 144, July PM)? Isn't that carrying the so-called "domino theory" a bit far?

PORTLAND, ORE.

BOB MEYER

July cover

I think that your July cover is out of order. If I wanted *Playboy* I would have sent my application to them instead of you. I really don't think the national colors should be used in such a fashion.

WAUWATOSA, WIS.

WILLIAM M. HAYES

Our July cover shows water skier Christie Freeman wearing the uniform the American team wears in international competition for the Women's World Slalom Championships. Competitors wear their national colors, just as they do in the Olympics.

For better thiefproofing

Articles like *17 ways to thiefproof your car* (page 112, July PM) provide a great service by informing the public of the variety of security devices available.

While the auto store might seem a logical source for these items, I feel that a progressive locksmith is better able to advise as to which of these devices are effective and which are a waste of money.

Anyone with a basic knowledge of lock picking can pick those locks that use disc

(Please turn to page 8)

POPULAR MECHANICS

"Look who's smiling now!"

Sometimes a man sets his ambitions high enough to make skeptics smile. But how often he gets the last laugh! "At the time I started studying with LaSalle, I was working as a factory clerk. Before completing the course I was transferred to cost accounting and my salary was increased by \$1800. Now, having completed the course, I'm in charge of the department and headed for the five figure bracket. LaSalle's course helped me pull myself out of a boring and ill-paid job into a position of almost unlimited opportunity."

The words in quotes come directly from one of the pleased reports that are sent to us by LaSalle graduates. LaSalle files contain many letters from men and women who have increased their earnings with the help of LaSalle training. You, too, can prepare for the career opportunity of your choice through LaSalle home study—without interfering with your present work—and by devoting only a little of your spare time.

LaSalle has been a leader in home education for more than sixty years, enrolling over 2,000,000 ambitious men and women in its many courses. You study under the supervision of LaSalle's experienced faculty. Upon satisfactory completion of your study, you receive the LaSalle diploma—a recognized and respected credential.

Mailing the LaSalle coupon below may be the first step toward preparing yourself for a better job, higher pay, and the many good things that go with success. Simply check the program in which you are most interested, and we will send you a valuable free booklet describing the opportunities in that field. There is no obligation. LaSalle, 417 S. Dearborn Street, Chicago, Illinois 60605.

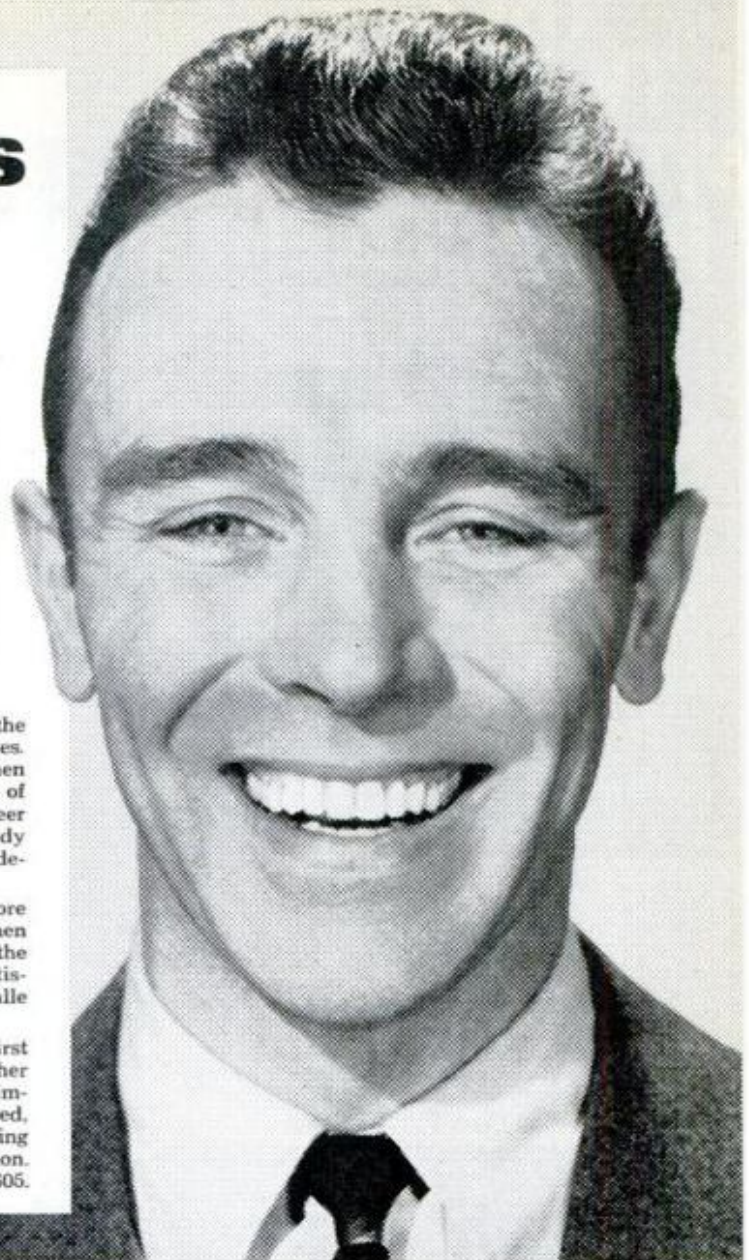

© 1972 LaSalle Extension University

LA SALLE EXTENSION UNIVERSITY

A Correspondence Institution • 417 S. Dearborn Street, Dept. 81-074, Chicago, Illinois 60605

Please send me, without cost or obligation, FREE booklet and full information on the field I have checked below:

ACCOUNTING*

- Complete Accounting
- Income Tax
- CPA Training
- Bookkeeping

BUSINESS MANAGEMENT*

- Management Training

REAL ESTATE*

- Complete Real Estate
- Real Estate Brokerage

TRAFFIC & TRANSPORTATION*

- Complete Training

STENOTYPE

- Machine Shorthand

LANGUAGE INSTRUCTION

- French
- Spanish

COMPUTER PROGRAMMING*

- Basic Training

DRAFTING*

- Complete Training

DIESEL MECHANICS*

- Basic Training

AIR CONDITIONING & REFRIGERATION*

- Basic Training

INTERIOR DECORATING*

- Complete Training

DENTAL OFFICE ASSISTANT*

- Complete Training

ART TRAINING

- Complete Training*

SECRETARIAL*

- Complete Training

LAW COURSES*

- Bachelor of Laws Degree
- Business Law
- Insurance Law
- Claim Adjusting Law
- Law for Police Officers

No state accepts any law home study course, including LaSalle's, as sufficient education to qualify for admission to practice law.

Mr.

Mrs. Age....

Miss (Circle title and please print)

Address..... Apt. No....

City & State..... Zip.....

000

5

*APPROVED FOR VETERANS TRAINING

WINEGARD. THE ONE TV ANTENNA WITH A TWO YEAR REPLACEMENT POLICY*

Rain—snow—sleet—a Winegard all-channel color TV antenna stands up against all of them! Extra rugged construction and gold vinyl-coated elements make it possible to offer our special rate (about half-price!) direct-from-the-factory replacement policy on every outdoor model Winegard makes! No matter how it's damaged! See your dealer or write for details.

And how these antennas perform! Sharp, clear pictures on all channels in your area . . . good sound on all channels, too . . . performance that's designed in and built in!

That's the kind of performance that makes Winegard's two-year replacement policy possible . . . and that's why you should choose a high performance antenna for your rooftop. Then look forward to years of trouble free viewing!

*If your Winegard antenna is damaged by severe weather or other occurrence over which the manufacturer has no control, Winegard Company, within the period of 24 months from date of purchase, will replace the antenna with an identical (or newer) model at a special replacement rate (approximately one-half of the original suggested retail price) with all shipping charges prepaid. No costs of labor, installation, wire, mounting hardware, etc. will be borne by Winegard Company.



Can't use
an outdoor
antenna?



Use a Winegard high-styled indoor antenna!

WINEGARD
TELEVISION SYSTEMS

WINEGARD COMPANY—3000 Kirkwood Street—Burlington, Iowa 52601

LETTERS

(Continued from page 6)

tumbler lock cylinders as fast as they can be opened with a key.

Your owner-made hood lock is an excellent device except that the padlock illustrated is the cheapest, simplest type of warded lock. Three or four different "pick" keys will open all of these locks.

The Chapman hood lock would seem to be the most effective on the market.

The ultimate solution to better auto security is better factory-installed locks. The steering/transmission lock was a step in the right direction. What is needed now is hood latches located inside the car; direct-acting bolt-type locks on doors with no linkage which can be tripped; and lock cylinders made of quality materials and to closer tolerances (quality pin tumbler locks have a plus or minus .002 inch in tolerance in the tumblers and keys). Also needed is the adoption of a different locking principle, such as the General Motors "sidebar" lock, which defies attempts at picking by ordinary means.

PARSONS, KANS.

CURTIS L. ROBISON

Cheaper in Japan

That was a good story in the July issue on the mini-trucks (*Are they all the same?* page 96). I have one question: The PL-620, Hilux, B-1600 and Courier prices are p.o.e. Los Angeles, while the LUV price is f.o.b. Japan, isn't it? That would put the comparable LUV price on the dock at Los Angeles at about \$2375. Am I right?

FORD TRUCKS AND DAVID W. SCOTT

RECREATIONAL VEHICLES

DEARBORN, MICH.

You're right. The price we list, \$2184, is the list price; \$2375 is the West Coast p.o.e. price.

Bunk bed/desk measurements

Just a note to anyone building the bunk bed/desk (*This kid studies under his bed*, page 156, June PM): It is impossible to cram 89 inches of material into a space 86½ inches wide. (I like the idea and am currently completing the project.)

BROOKINGS, S.D. BERNARD E. HIETBRINK

When you add up all the measurements, it's obvious the overall length of the bed

(Please turn to page 10)

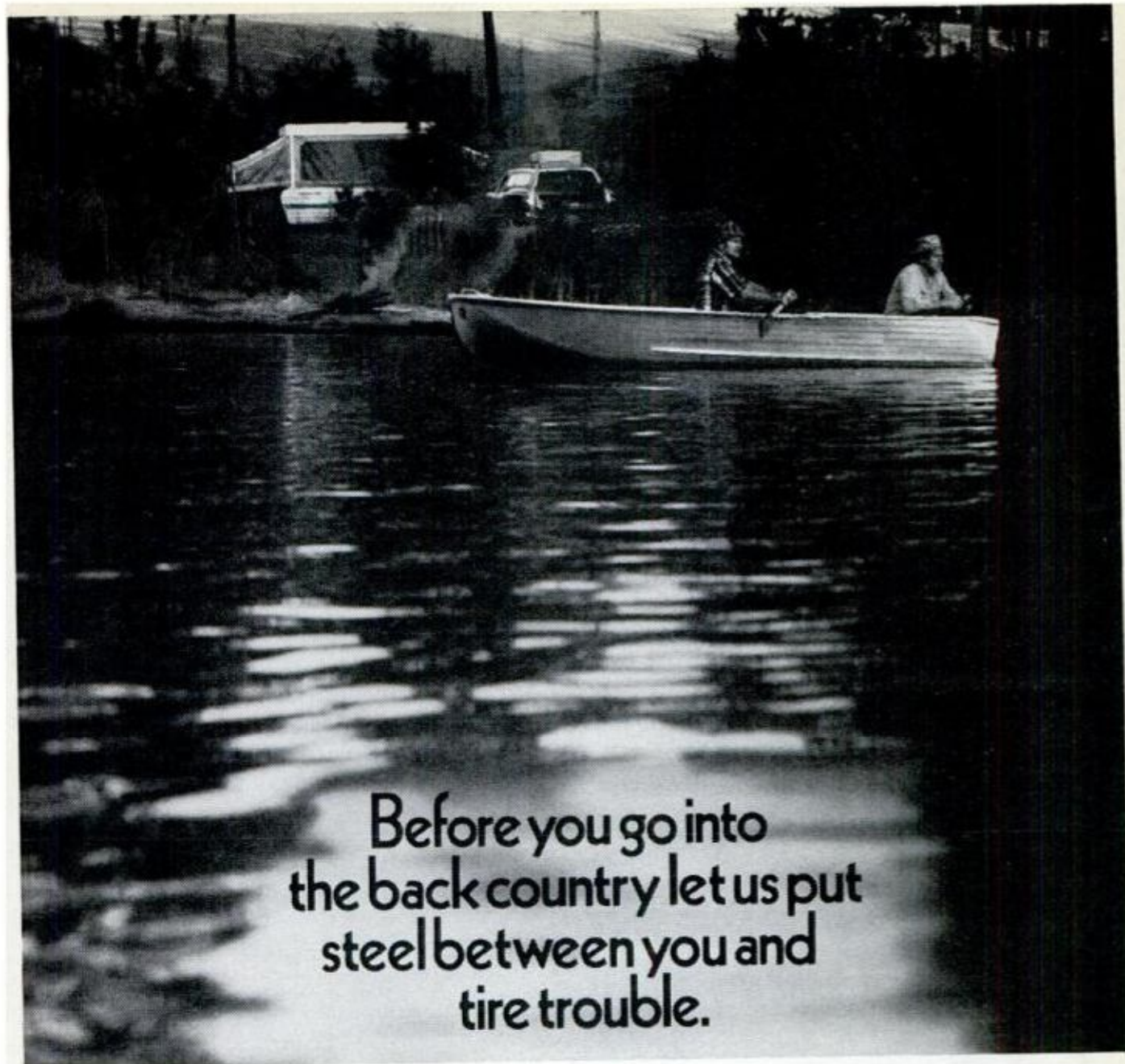

Before you go into
the back country let us put
steel between you and
tire trouble.

If you like to go places that highways don't go, you can get into lots of tire trouble.

But we've come up with a way to help you get out.

The engineers call it the Firestone 500 Steel Belt. We call it simply, The People Tire.

Because it gets people like you back where you want to go.

And when the going gets really tough, over rocky camp sites and rough back



country roads, it keeps going.

Because Firestone makes it tough. Just under the tread, we put two belts of steel over smooth-riding polyester body plies. Steel cord so strong a single one can pull a car.

We don't say it's a tire you shouldn't take care of. We say that, with a little care, it will really take care of you.

So stop in wherever you see the Firestone sign and ask all about The People Tire.

Firestone
500 Steel Belt

the people tire

LETTERS

(Continued from page 8)

can't be 86½ inches, as our plan shows. The overall dimension is 89 inches.

Not a spin-off

You refer favorably to improved eyeglasses we are making by a chemical strengthening process (*Science Worldwide*, page 42, May PM). While we appreciate the "boost" for what we truly believe to be superior toughened lenses, the development is not a spin-off from the U.S. space program.

We have been chemically strengthening glasses for many years. Our work led to the adoption of lightweight strengthened windows for the Apollo lunar modules.
CORNING GLASS WORKS CAMPBELL RUTLEDGE CORNING, N.Y.

Colonial dry sink

My father-in-law and I built the dry sink (*Colonial charmer you can build for \$45*, page 138, Feb. PM) in about two months of spare time. It was an interesting project, and the raised-panel doors were a



real challenge to cut on a radial-arm saw. We used pine from packing crates and left over from previous projects.

PALATKA, FLA.

R. T. SUNDERLAND

Cam dwell meter

I have read the *Car Repair Annual* for a number of years, and during that time it has saved me considerable time and

(Please turn to page 12)

THESE 3 BIG DRAFTING KITS*
Included With Course

... when you train at home with us for a

HIGH PAY JOB IN DRAFTING!

RUSH COUPON FOR FREE KIT...

Mail coupon today for FREE "DRAFTING CAREER KIT," Sample Lesson, Drafting Aptitude Test including intriguing new 5-Way Drafting Instrument & 20-page Book "Your Future in Drafting" — jam-packed with revealing facts on your opportunities to win top pay and job security in Drafting. Approved for Veterans. Everything sent FREE and WITHOUT OBLIGATION. Write today!

432

North American School of Drafting, Dept. 24179
4500 Campus Dr., Newport Beach, CA 92663
Rush "DRAFTING CAREER KIT", including Book, Sample Lesson, Aptitude Test & Drafting Instrument — ALL FREE! No obligation. Approved for Veterans.

NAME _____ AGE _____
ADDRESS _____
CITY _____ STATE _____ ZIP _____
A home study program in association with Cleveland Engineering Inst.

2 Raises and \$300 Bonus!
"I've had 2 boosts in salary and a \$300 bonus in 11 months. Wish I could shake hands with your staff in person."
A. C., Calif.

Job Awaits Serviceman!
"Your Drafting Course has given me a good start. I already have a job waiting for me when I leave the service."
L. I., FPO, New York

ALL 4 FREE!
Rush Coupon today!

YOUR FUTURE IN DRAFTING
APTITUDE TEST
SAMPLE LESSON

*** Precision Drawing Instrument Set, Professional Drafting Board Outfit & Fingertip Tilting Drafting Table are included with your North American Course in Drafting.**

Coast-to-Coast Shortage of Trained Draftsmen Opens Thousands Big Salary Jobs for Beginners!

Now you can take your pick of thousands of big salary jobs open to Draftsmen (see "help wanted" sections of metropolitan newspapers). Huge nationwide demand... U.S. Dept. of Labor reports "42% more Draftsmen needed in next 10 years — not enough applicants to fill drafting jobs available now!" Our easy "Quick-Learn" Method has helped hundreds toward good income, security and prestige as Draftsmen. Why not you?
YOU NEED NO DRAWING SKILL... NO TECHNICAL ABILITY
NASD's staff of Professional Draftsmen guide you step-by-step. With our spare time home-study plan you work on actual projects. Makes learning fun — easy to remember, too. Many graduates have succeeded with only grade school training. Others report good earnings drafting part time while still learning!

The secret of teaching yourself music

It may seem odd at first—the idea of teaching yourself music. You might think you need a private teacher at \$4 to \$10 an hour to stand beside you and explain everything you should do—and to tell you when you've made a mistake.

But the fact is, you don't. Thousands have taught themselves to play with the lessons we give by mail. And you can too. Guitar, piano, accordion—you can learn any of ten popular instruments.

The secret lies in the step-by-step way our lessons teach you. Starting right from scratch, they show you with simple words and pictures exactly what to do. You'll learn to play the right way—by note, from sheet music. Without any gimmickry.

But how do you know you're doing it right? Easy. A lot of the tunes you'll practice first are simple songs you've heard many times. Since you know how they're supposed to sound, you can tell right away when you've "got them right."

By the time you go on to more advanced pieces, you'll be able to tell if your notes and timing are right, even without being familiar with the songs. Sooner than you may think you'll be able to play whatever kind of music you like. Popular. Classical. Folk music. Hymns.

For more information, just mail the coupon. We'll send you our free booklet, *Be Your Own Music Teacher* and a free Piano "Note-Finder." No obligation. *U.S. School of Music. Estab. 1898. Lic. by N.Y. State.*

© 1970 U.S. SCHOOL OF MUSIC

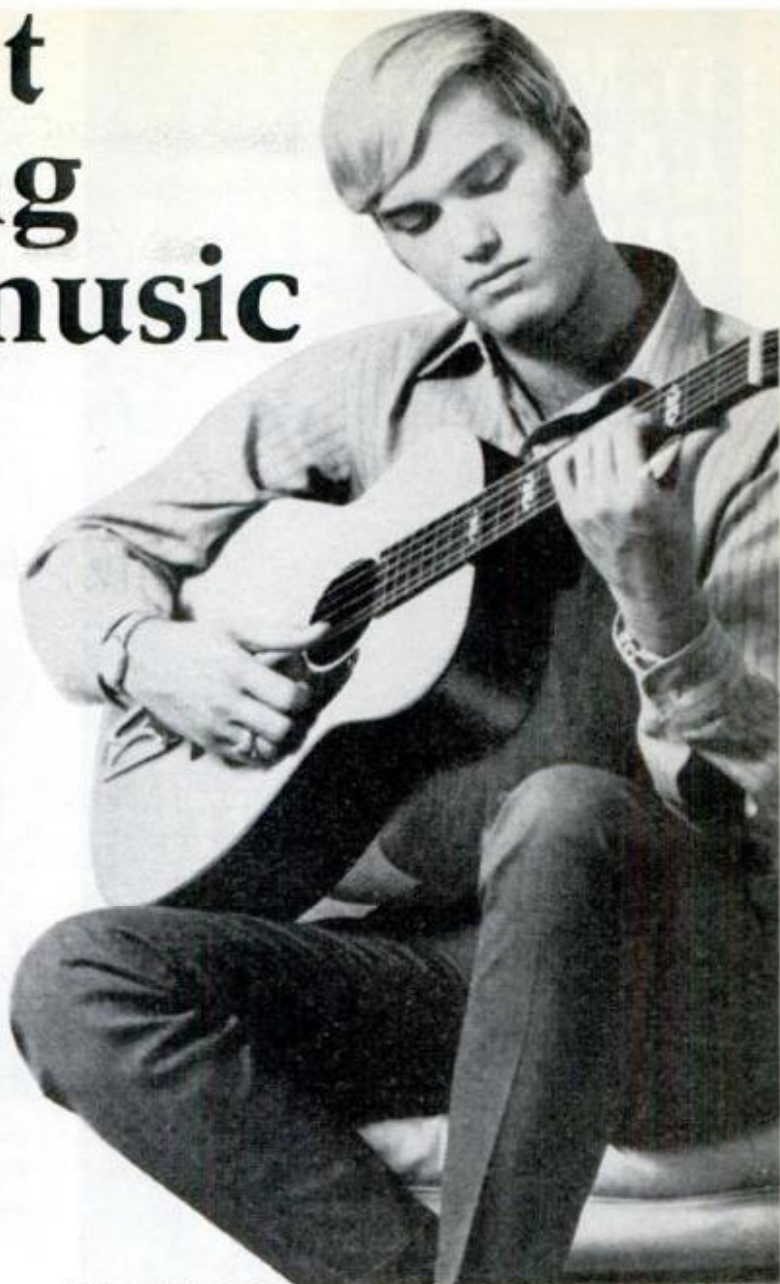

U.S. School of Music

Port Washington, New York 11050

I'm interested in learning to play the instrument checked below. Please send me, FREE, your illustrated booklet, *Be Your Own Music Teacher* and a free "Piano Note-Finder." I am under no obligation. Check the instrument you would like to play: (check only one)

- | | | |
|---|---------------------------------------|------------------------------------|
| <input type="checkbox"/> Piano | <input type="checkbox"/> Steel Guitar | <input type="checkbox"/> Accordion |
| <input type="checkbox"/> Guitar | <input type="checkbox"/> Saxophone | <input type="checkbox"/> Mandolin |
| <input type="checkbox"/> Organ—pipe, electronic, reed | <input type="checkbox"/> Violin | <input type="checkbox"/> Clarinet |
| | | <input type="checkbox"/> Ukulele |

Print Name _____ Age _____

Address _____

City _____

State _____ Zip _____

Accredited Member National Home Study Council

309

**IT MAKES
CARS
RUN
BETTER**

**PROBABLY
YOURS,
TOO**

**TEST DRIVE IT
YOU'LL LIKE IT!**



SPECIAL OFFER

Rislone National Championship Racing Jacket only \$7.95 prepaid. Durable nylon-cotton Rislone yellow with red, black racing stripes. S, M, L, XL. Send check or money order to: Rislone National Champion Jacket, P.O. Box 457, Bonner Springs, Kansas 66012.



THE SHALER CO.

Waupun, Wisconsin 53963
In Canada: The Canadian Shaler Products Co. Ltd. Ontario

NEW 80 AMP DYNAMIC MARK 88 INDUSTRIAL TRANSFORMER ARC WELDER

IDEAL GIFT—EDUCATIONAL, ENJOYABLE, PROFITABLE

WELD, BRAZE, CUT, SOLDER, HEAT STEEL, BRASS, ALUMINUM, AND MOST OTHER METALS.

Build and repair anything of metal. Save time & money with this **BRAND NEW, PROFESSIONAL ARC WELDER!** Rugged metal cabinet, baked Hammerloid finish. Ideal for home, shop, farm and industrial use. **POWERFUL** glass insulated transformer welds most metals up to 1/2" thickness with multi-pass weld, with 1/8" rods. 1 heat settings 20 to 80 amps. Operates on 110 Volt AC line fused for 30 amps. Complete with fibre glass helmet, electrode holder, ground clamp and cables, solder, assorted rods and simplified welding manual. **DOUBLE PROTECTION GUARANTEE.** 10 day money back trial plus full 5-yr. warranty. If inoperative return prepaid, we will repair or replace without charge & reship collect. **ORDER TODAY.** Complete ready to weld. Only \$59.50 F.O.B.

SEND ONLY \$6.00. Pay Balance plus C.O.D. and Delivery Charges **FREE** Write for illustrated color literature and welder details



DYNAMIC WELDER CO.

1808 S. FEDERAL ST.
Dept. PM92
CHICAGO, ILL. 60616

LETTERS

(Continued from page 10)

money. Recently I built a tachometer and would like to match it with a dwell meter. Do you have plans for one?

WESTCHESTER, ILL. ROBERT KOSATKA

We printed a cam-dwell meter project in Feb. '64 PM (page 196). You can order a Xerox copy for 75 cents from Popular Mechanics, Box 1014, Dept. JL, Radio City, N.Y. 10019. And, incidentally, the next issue of the Car Repair Annual will be on the newsstands Sept. 28.

Handsome hall clock

The October and November 1969 issues

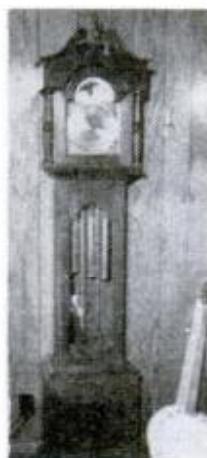

of PM have caused me to spend many enjoyable hours of spare time building seven "grandmother" clocks (PM's handsome hall clock, page 124, Oct. '69 PM) in my basement workshop. Your plans were excellent. Six of the clocks have been made of black walnut and one of mahogany. I strayed from your plans a bit: a raised panel was

used in the base front, four fluted columns were used, and the overall dimensions were expanded. They stand 80 inches.

ONEIDA, TENN. W. O. WEST JR.

Saucy Shingle

My son and I have just completed *Saucy Shingle* (page 144, March '65 PM). We are pleased with the way it handles. Incidentally, we both can ride in it. With this much weight, it comes close to sinking at the dock, but with an 18-hp engine we pull out and plane at about 30 mph.

NASHUA, N.H. HERB JEAN

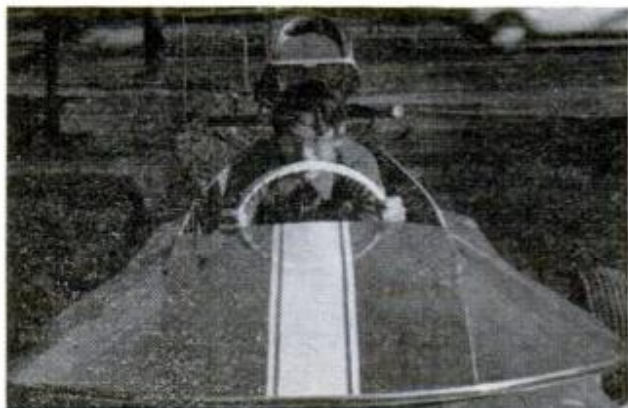

RICHARD PETTY says:

"If you want to really learn how to repair cars... check out NRI home training"

"NRI provides the most up-to-date complete course in Auto Mechanics I've ever seen."

"My dad made auto mechanics out of us long before he'd let us enter a race. I know the importance of a good mechanic... and the opportunities that are out there for men with the right training. That's why I'm sure glad to see home training like the NRI courses come along. With NRI training behind you, when you open that hood, hands-on experience is going to come fast, and come right. It's a lot of training for a very few bucks."

Earn \$5 to \$7 an hour in your spare time.

As a trained mechanic you can command good money working for yourself or doing spare time jobs. And you'll save a lot on your own car upkeep. NRI gives you a choice of a complete Master Automotive Technician course or a shorter Automotive Tune-up and Electrical Systems training program. Both courses give you the essential training and diagnostic equipment you need for good car repairs. No other school gives you as much training and equipment for your money.



APPROVED UNDER GI BILL
If you have served since January 31, 1955, or are in service now, check GI line in the coupon.

You will especially like the bite-size lesson texts, and how NRI has programmed shopwork into them. You can learn with your hands, lesson by lesson, at your own speed. Your NRI instructor carefully hand grades each test and returns it to you with his suggestions. You get more personalized attention than you'd get in lots of classrooms. And you learn the "why" as well as the "how to" . . . from changing plugs to running your own garage.

SEPTEMBER 1972



Richard Petty, America's Winningest Stock Car Racer

All the equipment and training you need.

In the Master Course, you receive ten pieces of auto service equipment, including a dwell-tachometer, timing light, complete set of tools, a volt-amp tester, an ignition-analyzer and assorted gauges. Tune-Up home training includes eight important service items. You pay nothing extra for the professional tools and equipment, and they're yours to keep.

Train with the leader—NRI.

Richard Petty says: "I'm a great believer in being number one. That's why I look to the school that's out in front. And no other school has NRI's experience in home training with professionally developed educational kits. They've graduated hundreds of thousands of students." Mail the coupon and learn how you can keep your present job while training in your spare time. **NRI AUTOMOTIVE DIVISION, Washington, D. C. 20016**
NO SALESMAN WILL CALL.

SEND FOR **FREE**
NRI CATALOG



NRI TRAINING

3939 Wisconsin Avenue, N.W.
Washington, D.C. 20016



Please send me your new Automotive Mechanics catalog. I understand there is no obligation. **NO SALESMAN WILL CALL.**

I am interested in Master course Tune-Up course

Name _____ Age _____

Address _____

City _____ State _____ Zip _____

Send me facts on GI Bill.

ACCREDITED MEMBER NATIONAL HOME STUDY COUNCIL

PHOTO HINTS

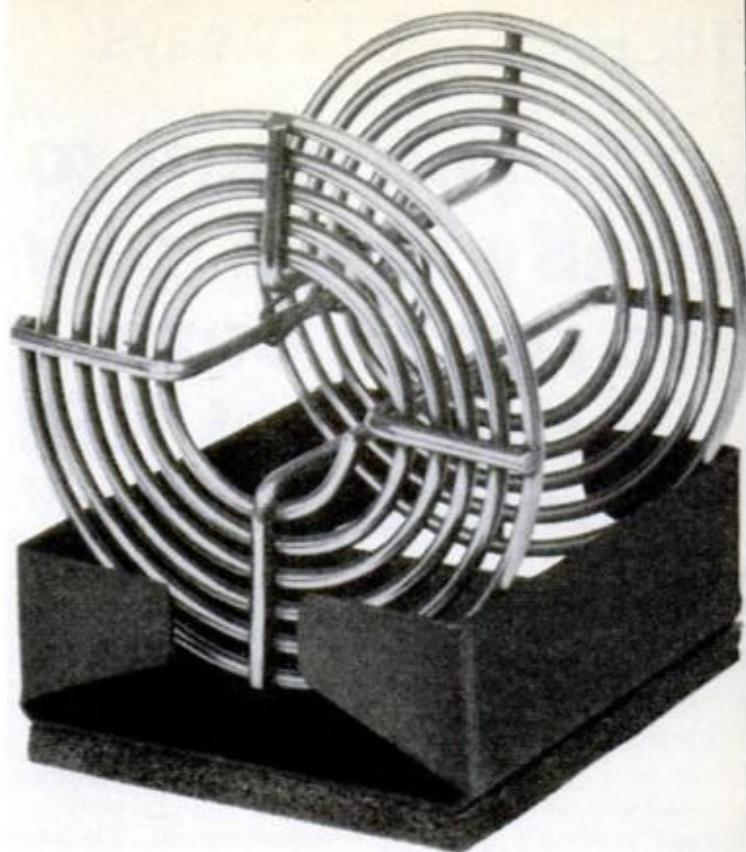
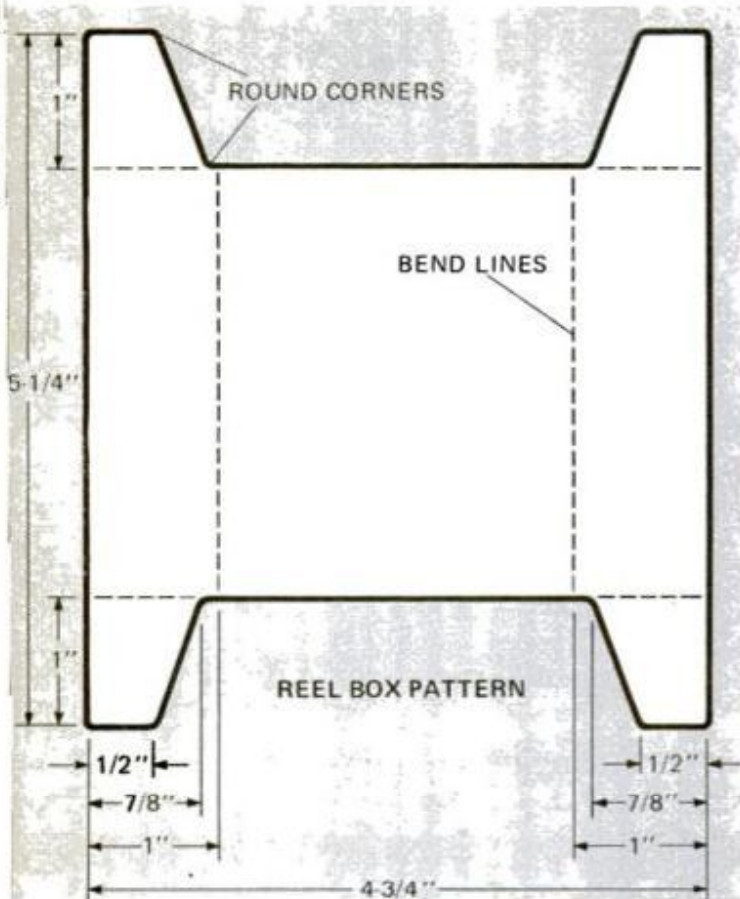

Two solutions to a reel problem: fumble-free loading in the dark

Easy as those stainless developing reels are to load, they could be easier. Here are two simple gadgets that can help.

The upper one, from G.W. Shalkhauser, of El Paso, Tex., holds the film reel steady as you load it, and keeps it from rolling away in the dark. To keep the box from slipping, you can build it from heavy, 14-gauge metal, with a nonskid rubber pad cemented underneath; for easier working, you could use lighter stock, and add a weighted base. Dimensions shown are for reels up to No. 116/616. You might prefer to build your box just wide enough to hold the largest reels you use.

The lower gadget, from Louis Hathaway of Rock Island, Ill., holds the film spool instead of the developing-tank reel. It's easy to make: Just bend from coathanger wire, and gun-staple or clinch-nail it to a plain plank base. Dimensions are omitted—bend to fit your film spool. If spools with large holes wobble, add bushings of insulation stripped from house wire.

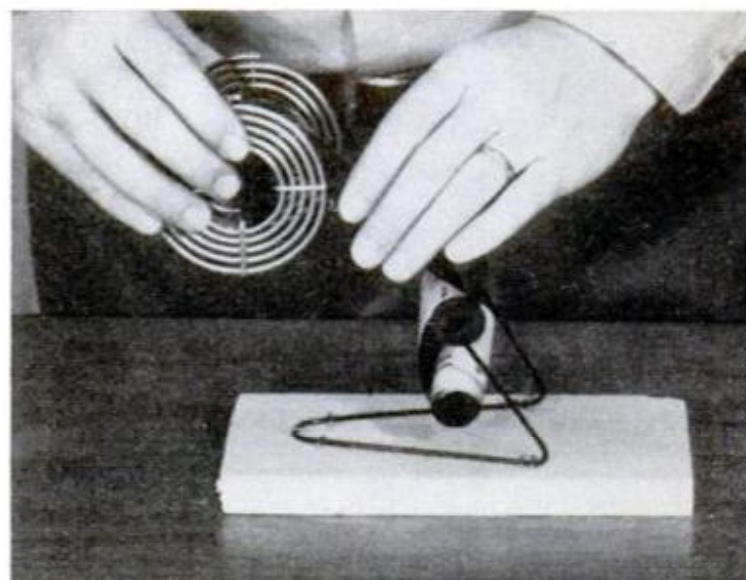
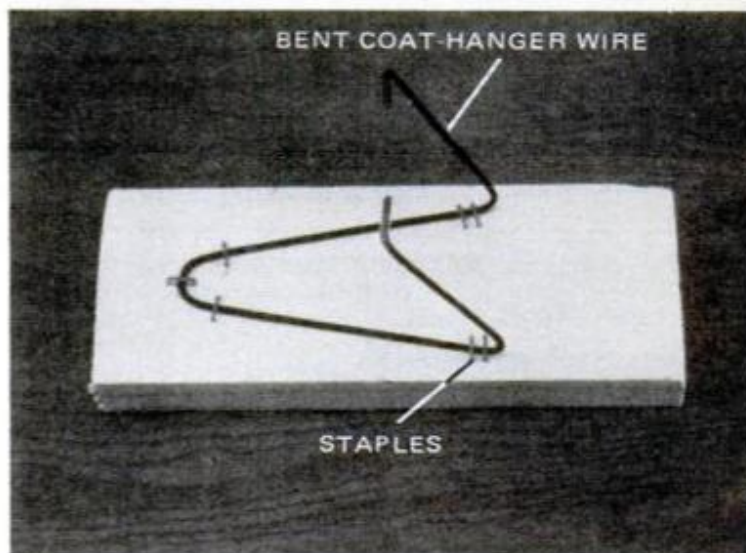

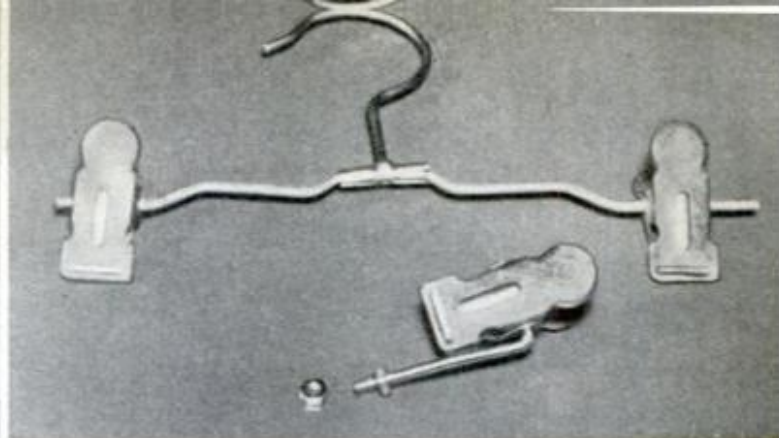
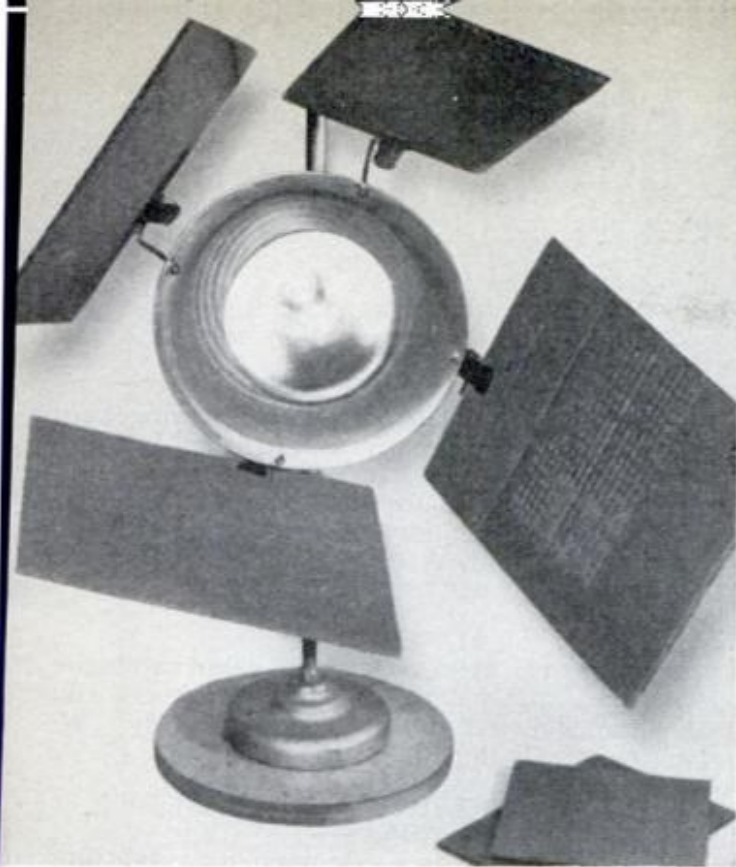

Add barn doors for light control

Keep your floods' light where you want it with these simple barn doors. Cut and thread the ends of a clip-type skirt hanger, then fasten with two nuts to holes drilled just behind your reflector's rim. Clips hold and position flaps of Masonite, sheet metal, or other fire-resistant material. For unusual shadows, cut irregular flaps.—William Waggoner, Sacramento, Calif.

The easy-to-use fine camera. For weddings, graduations, vacations



or just plain horsing around.

A Minolta SR-T 101 makes it easy to capture all kinds of memories. Even silly ones.

To set shutter speed and lens opening, simply align two indicators in the viewfinder. You never have to look away. A Minolta SR-T 101 lets you frame, focus, and adjust exposure without losing sight of your subject.

The Minolta SR-T 101 starts around \$300, depending on lens. Minolta SR-T 100, about \$250. For details, write to Minolta Corp., 200 Park Ave. So., N.Y., N.Y. 10003. In Canada: Anglophoto Ltd., P.Q.



Minolta

When identified by a factory-sealed "M" tag, Minolta 35mm reflex cameras are warranted by Minolta Corporation against defects in workmanship and materials for two years from date of purchase, excluding user-inflicted damage. The camera will be serviced at no charge provided it is returned within the warranty period, postpaid, securely packaged and including \$2.00 for mailing, handling and insurance.

WORTH WRITING FOR

LOOKING FOR IDEAS AND INFORMATION ON HUNTING, FISHING, CAMPING, BUILDING, TOOLS, ETC.? CHECK THESE LISTINGS, THEN USE THE COUPON BELOW.

67. TWO BLADES ARE BETTER THAN ONE

To introduce their new two-bladed razor, the Trac II, Gillette is offering a special demonstrator model. Like the permanent model, it has two separate blades to get what one blade could miss. For 50¢ you can't miss.

68. WHAT'S WATTS?

General Electric offers a most useful collection of do-it-yourself tips for minor electrical repairs and improvements around the house. Free.

69. SPORTSMAN'S CAMERA

Ricoh Hi Color 35 Underwater and Sportsman's Camera. Pocket sized and takes 10 shots in 10 seconds, automatically. Send for Free lab test reports and four-color literature.

70. BATHROOM PLANNING BOOK

This new book is full of ideas on how to put more room in your bathroom. Features 10 innovative designs—from powder rooms to luxury baths. From Eljer Plumbingware. \$1.

71. SAFETY FIRST

This booklet from the Service Tools Institute offers some helpful tips on proper uses and common abuses of tools. It can save you some pain! 25¢.

72. MOTORCYCLE ACCESSORIES

A brand new catalog from Flanders Company has more than 130 pages full of goodies for motorcycle and trailbike owners. \$3.

73. FISHING?

1973 Catalog—brand new 76-page catalog of all fishing equipment available from Wright & McGill, one of the best! Free.

74. WOOD FINISHING TIPS—

Floors, furniture, interior walls, paneling, trim, antiques, exterior surfaces, boats. All the tips are here in this 36-page book from McCloskey Varnish. 25¢.

75. GET MORE OUT OF (AND INTO) YOUR HOMES

This colorful 20-page booklet has great ideas and suggestions to convert your basement into a liveable, functional area for your family's enjoyment. From the Bilco Company. 25¢.

76. DO-IT-YOURSELF—

With Plexiglas acrylic sheet. Here's a booklet full of details on working with those clear plastic sheets. From Rohm & Haas. 25¢.

77. THE RACING WORLD AND TRW

In 84 pages, this all-important racing handbook and technical manual takes the beginner or all-out-pro into an atmosphere of auto racing. Factual and concise. \$1.50.

78. MORE GUN FOR THE MONEY

O. F. Mossberg & Sons offers an attractive 24-page catalog presenting their entire line for the new sports season. Free.

79. MONROE'S 1972 CATALOG

New catalog that takes all the guesswork out of buying shock

absorbers. Essential for all performance enthusiasts. \$1.

80. A REAL DEAL

The United States Playing Card Company offers the "Official Rules of Card Games", an authoritative compendium that includes all the games you can think of as well as many you can't. 75¢.

81. NIKON F

A complete, 28-page catalogue listing the Nikon F camera and all of its accessories and attachments. Free.

82. HERE'S A BUNCH OF IDEAS—

"Home Remodeling and Restyling Guide" from Alcoa. 26 pages of ideas, information and help. Full color. Free.

83. GOOD FENCES MAKE GOOD NEIGHBORS

You can build your own with this helpful booklet. Also includes plans and useful ideas for decks, furniture, patio covers, and sheds. From Georgia-Pacific. 25¢.

84. HEXAGON AQUARIUMS?

Custom Build your own with this colorful, illustrated handbook from Dow Corning. Includes full step-by-step directions as well as plans for other decorative aquariums. 49¢.

85. PERFORMANCE PLUS!

Accel's new catalog features their complete line of ignition components . . . "for stockers to fuelers". \$1.

POPULAR MECHANICS 972
BOX 1718, SANDUSKY, OHIO 44870

Please see that I receive the items checked below. I have enclosed 35¢ for the overall service charge, plus remittance for any priced items.

- | | | | |
|-----------------------------------|-----------------------------------|--------------------------------------|-----------------------------------|
| <input type="checkbox"/> 67 (50¢) | <input type="checkbox"/> 72 (\$3) | <input type="checkbox"/> 77 (\$1.50) | <input type="checkbox"/> 82 |
| <input type="checkbox"/> 68 | <input type="checkbox"/> 73 | <input type="checkbox"/> 78 | <input type="checkbox"/> 83 (25¢) |
| <input type="checkbox"/> 69 | <input type="checkbox"/> 74 (25¢) | <input type="checkbox"/> 79 (\$1) | <input type="checkbox"/> 84 (49¢) |
| <input type="checkbox"/> 70 (\$1) | <input type="checkbox"/> 75 (25¢) | <input type="checkbox"/> 80 (75¢) | <input type="checkbox"/> 85 (\$1) |
| <input type="checkbox"/> 71 (25¢) | <input type="checkbox"/> 76 (25¢) | <input type="checkbox"/> 81 | |

Total items requested _____ Total money enclosed _____

Name _____
(Please Print)
Address _____

Town _____ State _____ Zip Code _____

(Please send cash, check or money order made out to POPULAR MECHANICS. No stamps, please.)

This coupon expires November 30, 1972

If you've ever said...

"There must be a better way to earn a living.."

one of our free Career Guidance Booklets may provide the opportunity you've been looking for.

It happens to all of us, sooner or later. No matter what kind of job we have.

One day, it suddenly strikes home that—like it or not—we're going to have to work for a living, the rest of our lives. And most of us are horrified at the thought of forever being locked into the jobs we now hold.

"Surely," we tell ourselves, "there must be a way to earn enough extra dollars each month to balance the family budget. Surely, there must be a way to get the kind of position where you don't have to worry about job security. Surely, there must be a way to get a job that offers greater opportunity for advancement, and more job satisfaction."

"Surely," in other words, "there must be a better way to earn a living!"

If you, too, have been thinking these thoughts lately, you'll find one of our free Career Guidance Booklets very helpful at this time. We invite you to send for one.

Your free booklet will describe the opportunities for higher income and greater job security you might



expect in one of the career fields listed on the coupon below. It will also explain why ICS can prepare you for this new career field... right in your own home... in your spare time... *regardless of your education or past experience.*

In addition, you will receive a free "Demonstration Lesson" that lets you see for yourself why preparing for a more rewarding career—the ICS way—may be a lot easier than you think.

Please bear in mind, as you check off your career choice on the coupon below, that ICS has a long and distinguished record of success as a career training organization. In fact, more than 8,500,000 men and women have turned to ICS for career training, since 1891.

ICS has provided training programs for various divisions and branches of companies like Ford; U.S. Steel; Chrysler; Mobil; DuPont; etc.

ICS Career Training is approved for Veterans and Servicemen under the new G.I. Bill, and is Accredited by the Accrediting Commission of the National Home Study Council.

In short, ICS training methods are valued and respected not only by ICS graduates...but also by leaders in Business, Industry, Government, and Education.

Now it's your turn to discover how ICS training can start you in a rewarding new profession. Just fill in the coupon below and mail it today for your free Career Guidance Booklet and free "Demonstration Lesson."

Keep this certificate when you mail the coupon for your free Career Guidance Booklet and "Demonstration Lesson"

This certificate symbolizes the long and distinguished record of success that ICS has enjoyed as a Career Training Institute. It is your assurance that ICS stands ready to serve you, just as it is serving individuals, business and industry of the world.



ICS Scranton, Pennsylvania 18515

Please send me a free Career Guidance Booklet, and a free "Demonstration Lesson" for the field I have checked. I understand I am under no obligation.

| | | | |
|---|---|---|--|
| <input type="checkbox"/> Accounting | <input type="checkbox"/> Computer Servicing | <input type="checkbox"/> Engineering | <input type="checkbox"/> Restaurant/Club Management |
| <input type="checkbox"/> Automotive Mechanics | <input type="checkbox"/> Communications/Broadcasting/Electronics Specialist | <input type="checkbox"/> FCC Licensing | <input type="checkbox"/> TV Repair and Servicing |
| <input type="checkbox"/> Business Management | <input type="checkbox"/> Drafting | <input type="checkbox"/> Hotel/Motel Management | <input type="checkbox"/> High School Division (For students who want to earn a High School Diploma.) |
| <input type="checkbox"/> CATV/MATV Electronics Specialist | <input type="checkbox"/> Apartment/Community Management | <input type="checkbox"/> Income Tax Specialist | |
| <input type="checkbox"/> Computer Programming | <input type="checkbox"/> Electrician | <input type="checkbox"/> Interior Decorating and Design | |
| | <input type="checkbox"/> Electronics | <input type="checkbox"/> Production Management | |

Name _____

Address _____ Apt. No. _____

City _____ State _____ Zip _____

RA 303T

ICS Career Training is: Approved for veterans under the new GI BILL/Approved for federally insured loans
Accredited by the Accrediting Commission of the National Home Study Council

A woman with blonde hair, wearing a white short-sleeved top and a brown patterned skirt, is wading barefoot in a shallow, rocky stream. She is holding a white object in her right hand and has her left hand on her skirt. The stream is surrounded by lush green foliage and rocks.

Salem refreshes

Warning: The Surgeon General Has Determined That
Cigarette Smoking Is Dangerous to Your Health.

KING: 19 mg. "tar", 1.4 mg. nicotine, SUPER KING: 20 mg. "tar", 1.5 mg. nicotine, av. per cigarette, FTC Report APR. '72.



naturally!

Natural Menthol™ is why.

Salem uses only natural menthol, not the kind made in a laboratory. Like our rich, full-flavored tobaccos, our menthol is naturally grown.

Then we blend natural menthol with our superb golden tobaccos. It is a unique blend found in no other cigarette. A blend that gives Salem a taste that's never harsh or hot...a taste as naturally cool and fresh as Springtime.



Drivin' with Dan

Where did you grip the wheel during a race? Is there a certain speed beyond which racers will not be able to go? Why don't racers use the Wankel engine? Dan Gurney answers these and other automotive questions

Q. At what positions on the wheel did you have your hands during a race? What grip position would you suggest for the everyday driver? Why? —Jerry Gast, Pierz, Minn.

A. My right hand (I'm right-handed) was usually at about the 1:30 position; left hand at about 8:30. Normally on the road I use various positions while cruising, although I revert to my above grips if things become demanding or if I am pressing or hurrying. I always keep two hands on the wheel, regardless of positions.

Q. As far as I can tell, race drivers in 500-mile races like Indy run the entire event with nothing more than a cup or two of water they take during pit stops—if they're lucky! They sit in a cockpit that's red hot and they're literally wrapped up in Nomex fireproof clothing. How do they do it?—Jessie Chaplin, Little Neck, N.Y.

A. Heat and dehydration are big problems in racing. Big enough to have mothered an invention: the "water" tank (below). Most drivers are using a reservoir, more often than not

filled with Gatorade, that's placed forward in the car—ideally in the airstream to keep it cool. A suction tube leads to the cockpit so the driver can refresh himself while "relaxing" on the straights where he doesn't have to be thinking about his line through the turns. It's one of the few things, incidentally, that have escaped the USAC rules committee. A driver can carry as much of it as he wants!

Q. Do you think that race drivers will attain a certain high speed and then not be able to go any faster than that?—Steven Gustafson, Decatur, Mich.

A. No, they shall continue to break records if history is any indication.

Q. What do you think of Michelin X radials?—Edgar A. Charlton III, Newport News, Va.

A. They are excellent. Michelin has led the way with radials, and the other tire manufacturers have been forced to hurry and catch up.

Q. Why isn't the Wankel engine being used in racing? It is light, compact, has few moving parts and still has high horsepower and rpm. Who do you feel is or was the greatest driver of all time?—Chris Kotowski, Covina, Calif.

A. We will probably see more attempts to race the Wankel in the future. It is still relatively new compared to the old piston engines.

Juan Manuel Fangio was mighty good. I don't want to start an argument. There may not be one greatest driver because there are many different forms of racing: Troy Ruttman had a special touch on an oval. Richard Petty is very tough in stock cars. A.J. Foyt has done a lot of winning. Jim Clark and Jochen Rindt had tremendous talent. Mario Andretti is mighty good, and so are Al and Bobby Unser. Jackie Stewart is extraordinary. Stirling Moss had the utmost respect from his peers, if he had any! Curtis Turner was a real-life legend



and oozed talent. My idol as a kid was a fellow named Phil Walters. I cannot judge men from different eras. It's a great question, but just about impossible to answer!

Q. Can a rear spoiler be of any help on a Super Vee? May I have the address of the Indianapolis Motor Speedway?—*Gillis Genereux, Ottawa, Ont.*

A. Yes, a rear spoiler will definitely increase adhesion of a Super Vee. Indianapolis, Ind.; no street address is required.

Q. I want to build a go-kart, but I'm having trouble finding information on that and names of kart and accessory parts manufacturers. Also, where can I get the February and March issues of Popular Mechanics for 1967 besides a library?—*Brian Hulse, Circleville, Ohio*

A. I'm sure you can get help from the International Kart Federation, 733 East Edna Pl., Covina, Calif. 91723, which publishes the monthly magazine, *Karter News*.

The Popular Mechanics Bureau of Information no longer has 1967 issues to send, but if you request reprints of a certain story it will send copies for 20 cents per page.

Q. Where can I get information on what sports

cars have to run together in what classes?—*Thomas Reed, Denver*

A. Write the Sports Car Club of America right there in your own home town—at Box 22476, Denver, Colo. 80222.

Q. My dad says that race drivers are the craziest people in sports, including bull fighters. Can you help me argue with him?—*Jimmy Westmoreland, Houston*

A. He may be right, Jimmy, but I'd say that a bit of craziness is a good thing. Of course, too much of a good thing is bad. Everyone in the world cannot be the same. As a father who loves his son, I can certainly understand why he would try to discourage his son's interest in race driving. It all boils down to the fact that it is extremely dangerous. I have loved it in spite of the dangers, because it is for me an extremely fulfilling sport that exercises your coordination and balance, mechanical ability and feel for how a car is behaving. It may seem insanely competitive and brutal from the stands, but in the cockpit it's all finesse and timing and precision.

Q. A little old lady wants to know why a Volks
(Please turn to page 26)

Everything you need to fix practically everything.



It's a fix-it kit in a tube. Caulk. Seal. Repair. Weatherproof windows and doors. Repair gutters and downspouts. Mend canvas. Mount wall fixtures. Stop plumbing leaks. Seal ducts and vents. Use *Dow Corning Silicone Bathtub Caulk and Sealers* for just about anything. Make or repair gaskets.

Insulate electrical connections. Seal fiberglass. Use it for hobby-craft applications, or in the garage. Buy the Caulk in white or decorator colors. Buy Silicone Sealers in clear, black and aluminum. Look for other quality Dow Corning home maintenance products in your favorite hardware department.

Get your free idea booklet, today. Write Dow Corning Corp., Dept. G-2102, Midland, Michigan 48640.

DOW CORNING

DOW CORNING



Learn to drive.

In today's Army, you can learn to handle anything on wheels or treads. Right out of high school. No experience necessary.

Tractors. Graders. Semi's and dozers. Everything from jeeps to cranes.

Just tell us what you'd like to drive. And if you qualify, we'll guarantee your choice of training, in writing, before you enlist.

The kind of professional training you'll receive free in the Army would cost you hundreds of dollars elsewhere. And the job you learn in the Army is yours to keep. No matter what career you choose.

Today's Army pays while you learn. Starting at \$288 a month, with promotions and raises as you move up in your job. Along with free meals, free housing, free clothing, free medical and dental care. And 30 days paid vacation each year.

Ask around. You'll find that lots of equipment operators learned to drive in the Army. If you'd like to join them, send the coupon. Or see your nearest Army Representative.

**Today's Army
wants to join you.**

| | |
|---|------------------------|
| Army Opportunities Dept. 200, Hampton, Va. 23369 | Date _____ 2PM 9-72 |
| I'd like to know more about job-training and promotion in today's Army. | |
| Name _____ | Date of birth _____ |
| Address _____ | |
| City _____ | County _____ |
| State _____ | Zip _____ Phone _____ |
| Education _____ | |

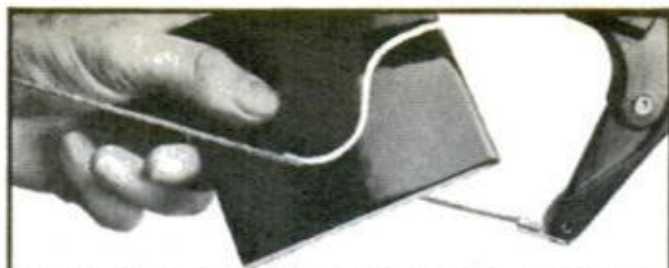

THE TOOTHLESS WONDER.

GRIT EDGE Our amazing saw blades are perfect for the tough cutting jobs you may have—ceramic tile (shown above), wire rope, fiberglass, tempered hardboard, even cola bottles.

The brand name "Grit-Edge" signifies our exclusive process of permanently bonding tungsten carbide particles to steel. So our blades have no teeth to snag, dull or break. "Grit-Edge" blades are available in rod saws, hacksaws, saber saws and circular saws. For more information, see your hardware dealer or write: Remington Arms Company, Inc., Dept. 538, Bridgeport, Conn. 06602.

Remington **DUPONT**

"Remington" is a trademark registered in U.S. Pat. Off.
"Grit-Edge" is a trademark of Remington Arms Co., Inc.

Fix it
to stay fixed with

LOC-KIT[®]

positive lock washers



Use on
nut and bolt joints in:

- Cars
- Bicycles and motorcycles
- ATVs and off-the-road vehicles
- Boats
- Recreational vehicles and trailers

Hundreds of
home and shop uses.

Even extreme vibration will not
loosen nut and bolt joints
"locked" with

LOC-KIT
positive lock washers

Get them at automotive, hardware and other
retail stores. 372-33

DRIVIN' WITH DAN

(Continued from page 23)

doesn't ride like a Caddy?—P. Stevens, Manitoba, Canada

A. Wow! That's not an easy question. It has a lot to do with the wheelbase and track width (longer on Caddy), the suspension frequency (lower on Caddy), the seats (softer on Caddy), the center of gravity, the polar movement of inertia and many more things that would take advanced mathematics to explain!

Q. Could "rear-axle steering" cause my Chevy wagon with belted tires to shimmy constantly? Steering and alignment check out okay.—W. Pickvance, Marlin, Tex.

A. I don't think that is causing the shimmy. Keep looking because there may be something broken or loose.

Q. Whatever became of the supercharger for improving combustion? We had three Grahams and got 21 mpg. Wouldn't they help fight pollution?—John Brauer, McKinleyville, Calif.

A. The turbocharger is gaining in popularity all the time, and definitely shows advantages when it comes to pollution.

Q. When making a turn at Indy, drivers will often cut completely inside the yellow marker stripe. Shouldn't there be some rule against this like in track events? Maybe this is one reason why lap times were so fast at Indy this year.—Robert Reeder, Los Angeles.

A. Drivers are often reminded not to cross the lines but as far as I know never disqualified. I don't think doing it affects lap time very much; Bobby Unser set the lap record without going below the line.

Q. How much horsepower do the Turbo-Offy and Turbo-Ford put out and why aren't they used in other types of racing besides Indy?—P. Johnson, Paradise, Pa.

A. Between 750 and 900 hp. They use methanol fuel exclusively. They would probably have trouble with predetonation using gasoline if the rules so required. They are also very expensive and don't meet any other racing formula. ★★★

If you have questions on racing, high-performance and everyday driving techniques, send them to "Drivin' with Dan," c/o Popular Mechanics, 224 West 57th St., New York, N.Y. 10019. Questions cannot be answered by individual letters. Questions on maintenance and repair should be addressed to the Auto Clinic (see page 28).

Here's our line of 100 Paks.



And here's the cabinet for the empties.

Great News. Now Remington "Hi-Speed", "Target" and Rifle Match 22 ammunition, and Peters "High Velocity" and "Target" are available in handy plastic 100 Pak dispenser boxes. (Ask for "Target Pak", "Power-Pak" or "Match Pak".) And to make these boxes even more practical, we have a special offer for you.

If you've used "Hi-Speed" ammunition in the "Power-Pak", you know how convenient these 100 Pak boxes are. The specially designed plastic case helps keep moisture and dust out and the cartridges securely in place. You can dispense five or ten cartridges — or however many you need — at one time. No more fumbling with loose cartridges. And no more bulky packages. This one fits neatly in the pocket of a hunting shirt or jacket. One added plus for the target shooter — the ammo tray when empty makes an excellent loading block.

When the 100 Pak itself is empty, the box becomes a great place to keep spare parts, bolts, nails, fishing lures or what-have-you. And now, we're offering a specially designed cabinet to keep them in. All the



plastic 100 Pak boxes of our 22 ammunition fit in the cabinet-like drawers. The cabinet can stand by itself, be stacked on top of another cabinet, or hung on a wall. It makes a good-looking, handy utility cabinet for your workroom or den. To get you started filling it, we'll include an empty plastic 100 Pak box with your order. (Stick-on labels are also included for identifying the contents of each drawer.)

To order your cabinet and empty starter box, send \$1.25 and one label from any Remington or Peters 100 Pak 22 ammunition to: Remington Arms Company, Inc., Box 7400,

Bridgeport, Connecticut 06602.

(P.S. Maybe you should order one for your wife, too. She'll have a hundred uses for it.) Offer expires May 31, 1973.

Remington DU PONT PETERS
Great guns deserve great ammunition. We make both.

"Remington", "Peters" and "Hi-Speed" are trademarks registered in the U.S. Patent Office. "Target", "Target Pak", "Power-Pak", "Match Pak", and "High Velocity" are trademarks of Remington Arms Company, Inc.

SOLUTIONS FOR MECHANICAL HEADACHES

AUTOMOBILE CLINIC

BY MORT SCHULTZ

Camshaft runaround

After I drove my 1971 Pinto for approximately 2000 miles, a loud tapping developed in the 2000-cc engine. The dealer replaced the camshaft and eight rockers. The mileage now is 4880 and the noise has reappeared. The dealer says it needs another new camshaft. Is it possible for two camshafts to go bad in such a short time, or am I getting the run-around?—Dorothy Shubeck, Roselle, N.J.

You have probably been the recipient of two camshafts which contained flaws. Some earlier production Pinto shafts were not correctly manufactured. Let the dealer do the job again. By this time, the problem is so widely recognized that once the repair is made you should have no further trouble.

How loose is too loose?

When I took my 1965 Oldsmobile Jetstar 88 with 79,000 miles to have its front end aligned, I was told that it would not be possible to do the job without first replacing the tie-rod ends. They have 1/8-inch to 3/16-inch play. Is this amount excessive? What are the consequences of not replacing them?—George A. Knobloch, St. Louis.

Your questions are actually tough to answer without having the car in front of me, because it's a story of when is loose too loose. Some movement is to be expected, but every mechanic has his own idea of how much. I am not aware of any special specification which tells how much free play is permissible on your car. Your mechanic may not be able to set the toe-in of your car to specification because of the amount of play existing. Too much tie-rod end play will result in excessive tire wear and play in the steering.

Shocking ride

I've just put Monroe Super 500 shock absorbers on my Dodge Challenger V8. The ride is a killer during street use. Can I get a more tolerable ride without losing most of my performance?—Art Trimble, Polk, Pa.

The Monroe Super 500 is designed for severe load, road and speed requirements. The standard shock—Monro-Matic—gives cushioned ride at low speeds, such as in city driving on smooth pavement. I think you put "too much" shock absorber on your car; but what now? I would take off the two 500s in the front and replace them with Monro-Matics. Store them for use later when the shocks on the rear wear out. If this ride doesn't please you, you will either have to live with it or put Monro-Matics on all corners.

Unruly Rallye

I own a 1969 Opel Rallye with the craziest set of instruments. When I turn on my windshield wipers, the gas and temperature gauges change readings. The temperature gauge registers hot and pulsates in time with the wipers. The gas gauge drops. The speedometer, too, gives me no peace. It moves erratically all over the place. Help!—A. Thomas Weaver, Pottstown, Pa.

Let's start with the speedometer, because it is coincidental to the main problem. The gauges are acting up because of an electrical condition, but the speedometer is cable driven. If the trouble isn't being caused by the cable, then it's centered in the meter itself. As for the gauges, it sounds to me like you have a bad ground condition. The wires for the instruments are grounded on the windshield-wiper motor. Check out the grounds for cleanliness and tight connections. Incidentally, the later-model Opels have a constant voltage regulator beneath the dash which controls the gauges. Yours doesn't, so don't go looking for it.

Spotted Cougar

A few months after I bought my 1968 Cougar, the paint started blistering and flaking off the left-rear quarter panel. After it was damaged in a collision, the metal was straightened and repainted. A few months later, it began to crack and

(Please turn to page 30)

A man in a white racing suit with orange and red accents is shown in profile, smoking a cigarette. He is wearing a watch on his left wrist and holding a racing helmet. In the background, a race track is visible with other people and a small open-wheel car.

**Get a taste of what it's all about.
Get the full taste of Viceroy.**

Warning: The Surgeon General Has Determined
That Cigarette Smoking Is Dangerous to Your Health

17 mg. "tar," 1.3 mg. nicotine av. per cigarette, FTC Report Apr. 72.

© 1972, BROWN & WILLIAMSON TOBACCO CORP.



AUTOMOBILE CLINIC

(Continued from page 28)

blister again in the same spot. The body shop did the job again, thinking that maybe it hadn't allowed the primer to dry sufficiently. It's been 10 months and again I see paint cracking and blistering on the same panel. What's causing my trouble?—Michael English, Iowa City, Iowa.

If the paint were cracking and blistering over the entire car, I would have to conclude that you got one of those vehicles with metallic paint which caused people with 1967 and 1968 models so many fits. But since the trouble is isolated in one particular spot, the fault must be placed on those who have painted and repainted the spot. First of all, maybe they didn't take the area down to bare metal before repainting. All old paint and primer must be removed. Or perhaps the primer and the paint they used weren't compatible. There is, for example, a lacquer primer that should be used with an acrylic lacquer paint and an enamel primer intended for use with an acrylic enamel paint.

How can I explain the fact that the paint started flaking before the collision? I can't, because I don't know what happened to the car before you bought it. Maybe the previous owner was smacked in the same spot. All I can advise is that you try again. Good luck.

Tow ahead

I own a 1969 Ford LTD and a 1962 Chrysler Newport, both with automatic transmission. I have to get both cars from Raleigh, N.C., to Kansas City, Mo. Can I tow one with the other? If so, which would be the best car to tow? What precautions should be taken?—Owen T. Reeves, Raleigh, N.C.

It doesn't matter whether you tow the Ford or the Chrysler. Consult local classified directories under "towing equipment" or "trailers" for a place that will rent (not sell) you a tow bar which will allow you to pull either one of the cars. The towing equipment sets the wheels so that the towed vehicle will go wherever

the towing vehicle steers. The only real advice I can give you is to watch your speed. Don't go over 45 mph.

Rim worries

I have a 1972 Chevrolet ¾-ton truck and want to equip it with a camper. The truck has drop center rims with 16½ x 9.50 tubeless tires. Someone told me that it isn't safe to put a camper on a truck possessing drop center rims, because they will split. Is this true?—Wilson Sawyer, Oswego, N.Y.

It's news to me. This truck is used for campers and many of them have 16½-inch tires. I stress this because the only type of rim on which you can put a 16½-inch tire is a drop center rim. The other type of rim, a split rim which has a ring around it, is made for smaller-size tires. Here's a tip, however: Determine whether your truck has 6, 8, or 10-ply tires and seek out a dealer who sells the make. He can give you information concerning the safe way to carry a camper, such as what the maximum load should be and the correct tire air pressure.

Service Tips

● **Bugs with air:** Most manufacturers advise the same thing, but here it is from Volkswagen: If your VW is equipped with an air-conditioner, turn it on at least once a week, even during the winter, to keep seals and fittings properly lubricated.

● **If your '72 Oldsmobile is equipped with a low fuel-indicator light, it may flash when you use a turn signal if the fuel is low, but not low enough to switch the fuel-indicator light on. This is normal, so don't worry about it. A feedback voltage occurs when the flasher opens to turn off the signal lights. This momentarily activates the low fuel-indicator light.**

● **Chevrolet owners:** If automatic transmission fluid is leaking at the fill pipe-to-case area of your Chevrolet, remove the pipe and check the O-ring seal and pipe for damage. If there is none, clean the spot below the stop flange, reposition the O-ring against the stop flange and apply a liberal coat of silastic silicone rubber sealer around the pipe between the O-ring groove and O-ring. ★ ★ ★

GOT A PROBLEM WITH YOUR CAR? Ask Mort about it. Send your question to Auto Clinic, Popular Mechanics, 224 West 57th St., New York, N.Y. 10019. Letters cannot be answered individually, but problems of general interest will be published in the column.



Any one of these four oils is right for your car.

Sunoco Special takes all the worry and confusion out of buying the right oil for your car. You see, Sunoco Special 10W-40 is really four oils in one.

It does all the work of a 10W, 20, 30 and 40 motor oil. Sunoco Special is one oil you can use in both summer and winter—in fact, all year round. Sunoco Special meets or

exceeds the warranty standards of all car manufacturers.

What's more, it gives you extra protection against thickening or breaking down under heavy-load, high-speed driving conditions. So change to Sunoco Special and know you're getting the right oil for your car...the right oil for all seasons, all driving conditions.

Sunoco Special. The long mileage motor oil.

Find the answers to 1001 workshop questions

quickly, easily with the POPULAR MECHANICS MASTER SHOP GUIDE

24 hangup boards, coated with wipe-clean plastic keep vital how-to-do-it information always at your finger tips.

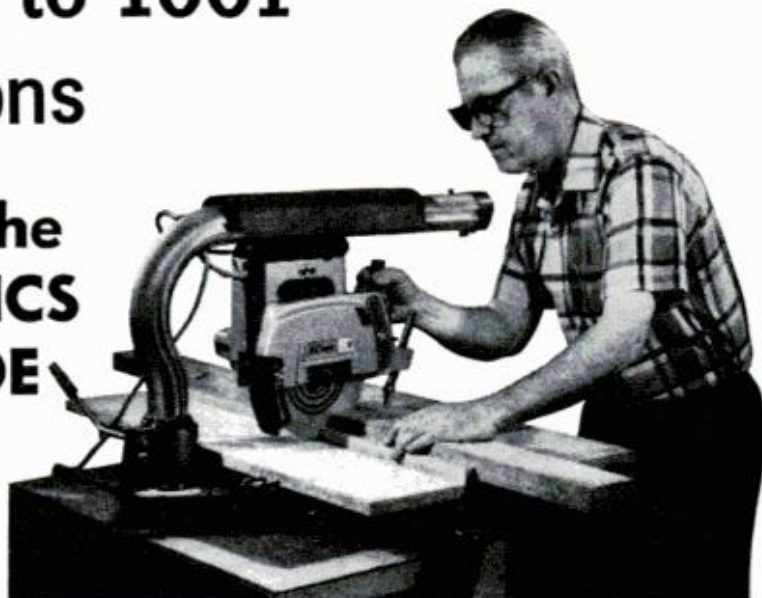

Here in an easy to use, last-forever format are the answers to everything you'll ever need to know about: nails, screws, bolts, wall-fasteners, drills, abrasives, lumber, hardwoods, moldings, plywood, hardboard, gypsum, adhesives, plumbing, electrical work, floor and wall tile, glass. Facts on remodeling measurements, gutters, concrete, garden chemicals. Plus—all on one board—a ruler, protractor, 45-degree triangle, and compass for accurate circles! You'll reach for the MASTER SHOP GUIDE for every job you tackle!

What nail should you use? How many pounds will a 1/4-inch toggle bolt hold? How can you save money ordering lumber? What size quarter-rounds are available? How do you bleach close-grained hardwoods? What glue is best?

Repairs, too! Illustrations on plumbing, electrical, floor or wall tile, plastic laminates, glass, remodeling. All the basic dimensions you'll need!

By the editors of *Popular Mechanics*—order yours now—you'll use it the rest of your life!

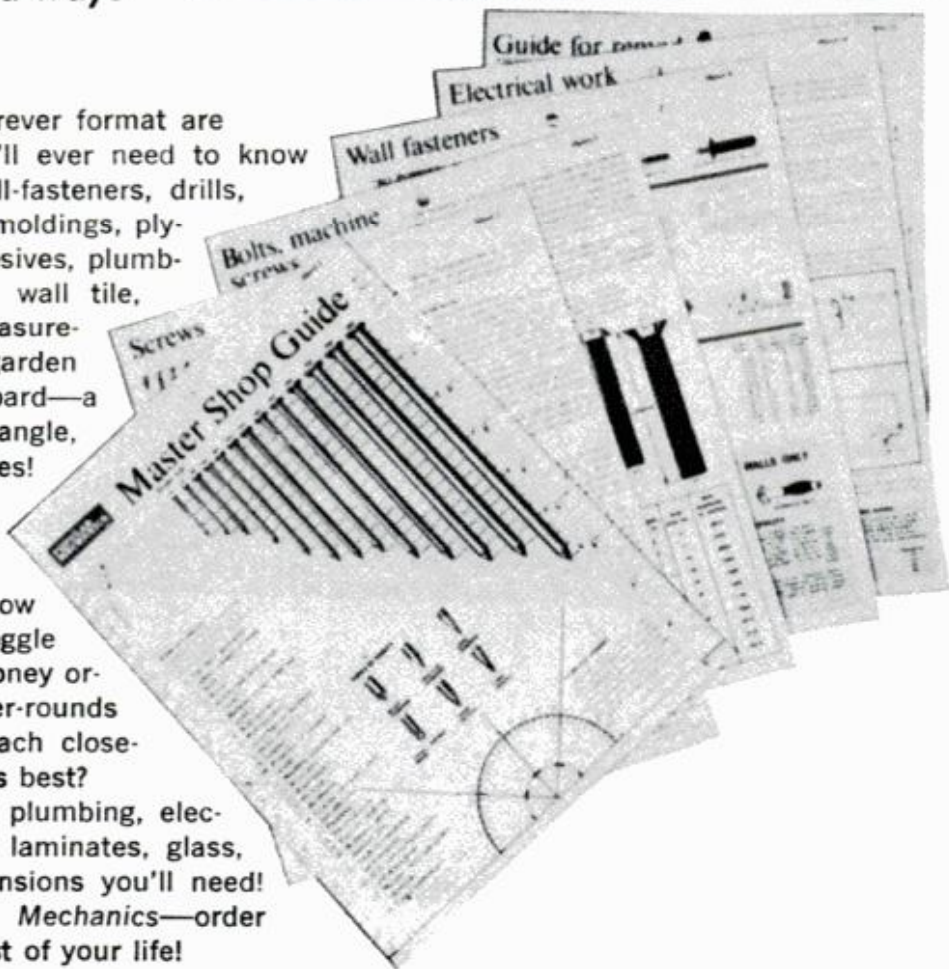

Popular Mechanics
P.O. Box 1014 Dept. SG
Radio City, New York 10019

Rush me _____ sets of the
MASTER SHOP GUIDE.

I enclose check or money order
for \$3.95 for each set ordered.

30B

NAME _____

ADDRESS _____

CITY _____ STATE _____ ZIP _____

POPULAR MECHANICS

They've taken more game than any other scope.

Can you think of a better reason to buy a Weaver-Scope?

Most people can't. Because performance is what counts in a hunting scope. That's why thousands of shooters count on Weaver-Scopes. For good reason. Each delivers consistent accuracy. At long or short range. In good or bad

weather. And they keep on delivering the goods year after year. That's all there is to it. Except to say that there are eight fixed-power and four variable-power models. Prices start at \$29.95. That hasn't hurt their popularity either.



WEAVER-SCOPES

Write for free 32-page catalog: W. R. Weaver Co., Dept. 91, El Paso, Texas 79915.



are you headed for a time-clock number?
...or a BIG PAY place in

AIR CONDITIONING

140,000 new servicemen needed
...you can be one of them

Air conditioning, refrigeration and heating is one of America's fastest growing fields. Service and installation technicians are in desperate demand.

And you can join this force of men making big money right now by becoming a skilled technician with our help.

Top men are making 2 and 3 times more than unskilled workmen. Yet we can teach you these skills so quickly you'll be earning money long before you've finished learning.

**AMERICA'S FOREMOST COURSE
AT A MATCHLESS LOW PRICE**

Learning at home is hailed by educators as being far superior to classroom work with all its mass production and distractions.

In our fine, professional 100-lesson textbook course you will receive the clearest instructions in unmistakable simple language. Plus self-projects, self exams and graded exams.

Directed by Roy Anderson whose experience with home study and Army-Air Force training goes back to 1935. we

have prepared material that will turn out top-notch graduates. And we do it at a cost so much lower than any comparable course that you simply will not believe it possible.

One way we do it is by not loading our students with costly equipment and tools—most of which you probably already have, or can buy locally for less than some schools charge you!

The Liberty School is a fine, professional and very intimate institution of learning-at-home, supervised in every tiny detail by Mr. Anderson.

We can't begin to tell you all of the advantages in this small space—but we'll give you all the details if you send in your name and address. Remember, we have NO salesmen, so no one will bother you. In the privacy of your room you can study the description of our lessons and make up your own mind without any pressure whatsoever.

A big pay future is waiting for you—grab it now.

LIBERTY SCHOOL Dept. J-9
Technical Division, 1111 W. Park, Libertyville, Illinois 60048

Be Your Own BOSS course includes directions on How to Own YOUR OWN Business!



Roy Anderson
LIBERTY SCHOOL, Dept. J-9
Technical Division - 1111 W. Park
Libertyville, Illinois 60048

SEND ME YOUR NAME AND ADDRESS
— I'll rush you FREE details by mail.

Dear Mr. Anderson: Please send me description of your course on AIR-CONDITIONING, REFRIGERATION AND HEATING. I understand this places me under NO obligation and that NO salesman will call.

Name _____ Age _____
Address _____
City _____ State _____ Zip _____

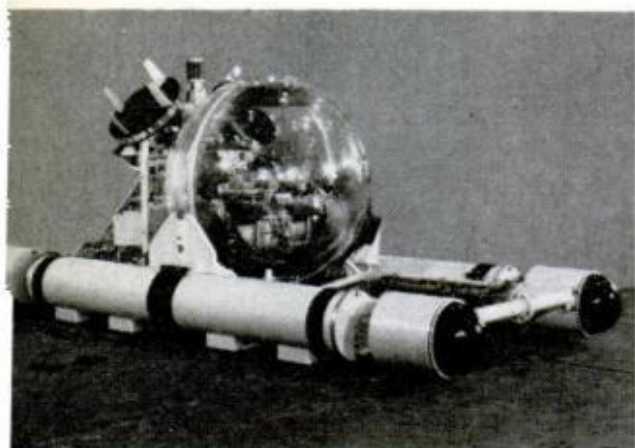

Deep-diving bubble for two



Glowing bands over the Earth



Hangout for Caesar's secret agents?

DESPITE ITS FRAGILE LOOK, the Navy's newest transparent-hull submersible is said to be capable of diving to depths of 600 feet. Called *Makakai* ("eye in the sea," in Hawaiian), the vehicle consists of a 66-inch acrylic bubble mounted on two pontoons. It has an electric propulsion system powered by lead-acid batteries carried in the pontoons. Ballast tanks in the pontoons are used for controlling buoyancy and pitch trim when diving. *Makakai* permits an operator and an observer to function in a shirt-sleeve environment for dives of 12 hours' duration.

FAT PEOPLE MAY EAT MORE because they are genuinely hungrier than persons of normal weight, says Prof. Richard E. Nisbett, a University of Michigan psychologist who long has studied human eating habits. Just as some persons are destined to be tall or bald, others are "biologically programmed" to be fat, Prof. Nisbett suggests. They have a higher baseline of adipose tissue—or fat cells—than slim folks, and obesity represents their "normal" or "ideal" body composition. When they diet to hold their weight below its "set point," Prof. Nisbett explains, they suffer a chronic energy deficit.

ULTRAVIOLET PHOTOS OF THE EARTH, taken by a special camera carried to the moon by the Apollo 16 astronauts, reveal two glowing bands over our planet's night side. Scientists say that the bands may be caused by electric currents. As seen in photo, the lower belt follows the Earth's magnetic equator, dividing the planet's night side into almost equal areas. The bands are at wavelengths invisible to the eye.

EYE-OPERATED SWITCHES and devices activated by breath controls will be incorporated in a specially equipped Huntsville, Ala., hospital room designed to test applications of NASA-developed technology in aiding quadriplegics—patients with no use of their arms or legs. It's hoped that "space" hardware will give patients a measure of independence, enabling them to regulate room temperature, open and close windows, and switch TV channels.

TWO ROOMS RECENTLY UNEARTHED beneath the foundations of St. Stephens-in-the-Round, a church near Rome's Colosseum, are thought to have been part of a secret headquarters for the Caesars' undercover agents. Members of the hush-hush group posed as grain inspectors and traveled with the imperial legions, watching out for anti-Roman activities. After

(Please turn to page 36)

NGK Flattens Pikes Peak.

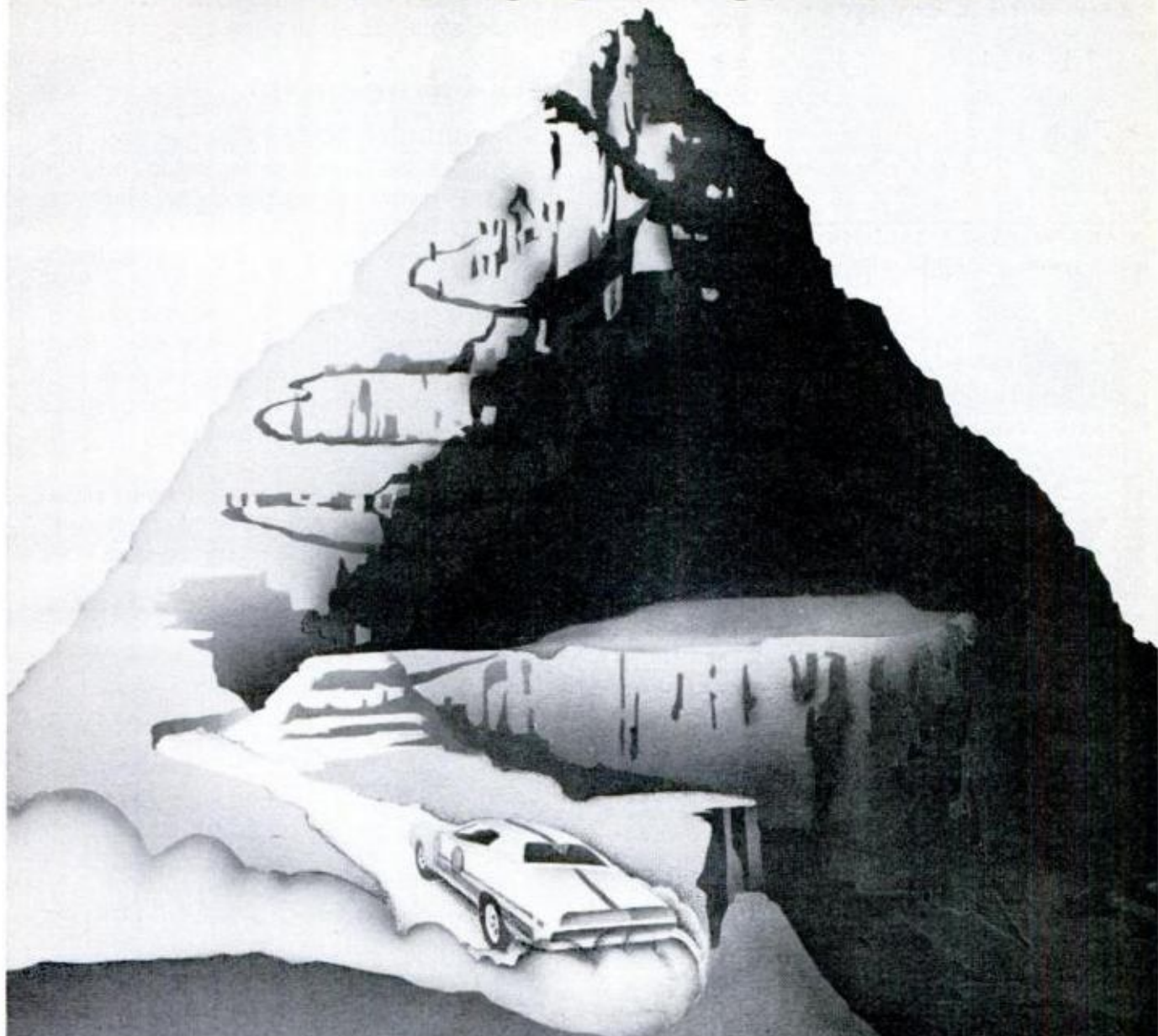

The Pikes Peak Hill Climb slips, slides and spins from 5,000 to 14,000 feet in under 15 minutes. This flat-out climb does strange things to the air and fuel mix. Which in turn fouls spark plugs.

But NGKs wide heat range "Heart of Copper"—its highly conductive copper core—dissipates heat quicker than old-fashioned iron cores. Helps cut fouling and pre-ignition.

Last year, with stock, street-type NGKs in his Mustang, overall winner Ak Miller powered up the course in just 14:19. In fact, out of a field of 35 domestic-type stock cars, 33 ran NGKs.

Then the win, place and show spots in the Dune Buggy and Four-Wheel Drive classes, plus all three motorcycle events went to NGK-equipped machines.

Similar super reliability and performance by NGKs in big American machines put the Mitchell-Christiansen Camaro out front in Touring Class at the 1972 Daytona Continental.

What does this mean to you? Plenty. City stop-and-go and turnpike touring in smog-proofed American V-8's are tough on spark plugs, too. And the same wide heat range "Heart of Copper" construction that captured Daytona and dominated Pikes Peak for the second year running, tames deserts, arctic blasts and tropic damp for all kinds of motorists in all kinds of cars.

There's an NGK for every American car. Ask for NGKs at your service station, parts dealer or department.

NGK for a Long and Zappy Life.
NGK SPARK PLUGS (U.S.A.), INC.
12511 Beatrice Street
Los Angeles, California 90066



LIVE IN THE WORLD OF TOMORROW . . . TODAY!

UNUSUAL BARGAINS

NEW PRODUCTS • NEW MATERIALS • NEW IDEAS

"FISH" WITH A MAGNET

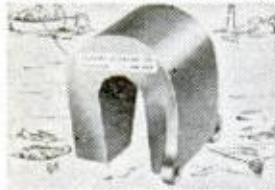

Go treasure hunting on the bottom! Fascinating fun & sometimes profitable! Tie a line to our 5½-lb. Magnet—drop it overboard in bay, river, lake or ocean. Troll it along bottom—your "treasure" haul can be outboard motors, anchors, other metal valuables. 5½-lb. Magnet is war surplus—Alnico V Type—Gov't cost \$50. Lifts over 150 lbs. on land.

Stock No. 70.571H \$14.00 Ppd.

Stock No. 60.215H 1½ lbs. . . . \$ 5.75 Ppd.
Stock No. 70.570H 3½ lbs. (lifts 40 lbs.) . . . \$ 8.75 Ppd.
Stock No. 85.152H 15½ lbs. (lifts 350 lbs.) . . . \$33.95 FOB

GIANT WEATHER BALLOONS



"Balls of fun" for kids, traffic stoppers for stores, terrific for amateur meteorologists. Create a neighborhood sensation. Great backyard fun. Exciting beach attraction. Amateur meteorologists use to measure cloud heights, wind speed and temp. Made of heavy-duty neoprene, inflate with vacuum cleaner or auto air hose or locally available helium for high rise.

Stock No. 60.568H (8' size) . \$2.00 Ppd.

Stock No. 60.632H (16' size) \$7.00 Ppd.

PLASTIC MODEL V-8 ENGINE

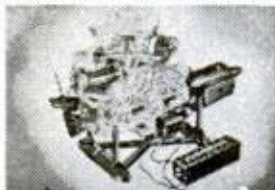

Hours of fun! Get thrill of building your own easily assembled engine from over 350 parts. Then push starter and watch it run. Crankshaft revolves, pistons move, valves open and close in sequence with spark plugs. Does everything but burn oil. ¼ scale, molded in 4 colors. Used in many auto-mechanic courses. Excellent, easy-to-understand "tech manual."

Stock No. 70.448H \$13.95 Ppd.

ASTRONOMICAL TELESCOPE KITS



Grind your own mirror for powerful telescopes. Kit contains fine annealed pyrex mirror blank, tool, abrasives, diagonal mirror, and eyepiece lenses. Instruments you build range in value from \$7.00 to hundreds of dollars.

Stock No. 70.003H

4¼" diam. ¾" thick . . . \$10.75 Ppd.

Stock No. 70.004H

6" diam. 1" thick \$16.95 Ppd.

Stock No. 70.005H

8" diam. 1½" thick \$24.50 Ppd.

Stock No. 70.006H . . . 10" diam.

1¾" thick . . . 30 lbs. . . \$44.50 FOB

Stock No. 70.007H . . . 12½" diam. 2½" thick. . . 46 lbs. . \$72.50 FOB

AMAZING NEW WANKEL ENGINE KIT!



Thrill to the fun of building your own see-through motorized model of revolutionary pistonless type engine . . . only engine experts think economically modifiable to meet new pollution standards. Replaces piston, cylinder, crank assemblies with rotating discs (sections removed for firing chambers). Smaller than conventional; fewer parts, greater reliability, same speed w/less horsepower. Feet; flashing plugs, rubber fan belt, stick-shift on-off switch. Req. 2-1.5V batt. (not incl.).

No. 71.424H (4½"X5"X9") \$6.75 Ppd.

519-Page Wankel Engine Book \$15.25 Ppd.

Stock No. 9.439H \$15.25 Ppd.

"Bright Ideas" in Unique Lighting Big, new 100-page handbook packed with facts, loaded with illustrations. All latest developments, applications, equipment. 8½" x 11" looseleaf paper to fit 3 rings. Stock No. 9100 H \$3.00 Ppd.



MAIL COUPON FOR GIANT FREE CATALOG!

164 PAGES • MORE THAN 4,000 UNUSUAL BARGAINS!

Completely new 1973 Catalog. Packed with huge selection of telescopes, microscopes, binoculars, magnets, magnifiers, prisms, photo components, Ecology and unique lighting items, parts, kits, accessories—many hard-to-get surplus bargains. 100's of charts, illustrations. For hobbyists, experimenters, schools, industry.

EDMUND SCIENTIFIC CO. 300 Edscorp Building, Barrington, N. J. 08007
Please rush Free Giant Catalog "H"

Name _____
Address _____
City _____ State _____ Zip _____

EDMUND SCIENTIFIC CO. 300 EDSCORP BLDG. BARRINGTON, NEW JERSEY 08007
ORDER BY STOCK NUMBER • SEND CHECK OR MONEY ORDER • MONEY BACK GUARANTEED

SCIENCE WORLDWIDE

(Continued from page 34)

long periods of service in the field, the weary agents are said to have returned to the secret headquarters for a bit of R&R.

The Environment

UNDERGROUND WATER that has been polluted by acid mine drainage can now be detected from the surface by electrical methods. Borrowing a technique long used to identify ore bodies, scientists at Pennsylvania State University have used a form of electric "shock" to map polluted groundwater channels. The technique could lead to surer location of drainage sources and to better monitoring of the effectiveness of pollution-abatement measures.

HEAVY EARMUFFS are a must when David and Scott Renfrew go out to play. Reason: They live within spitting distance of a busy



runway at London's Heathrow Airport. The noise generated by departing jets is loud enough to drown out speech. "I find myself bursting into tears while I'm doing housework," their mother says. "It's hard to explain. The noise of some of the planes hits you in the stomach as well as the head." A local health official notes that noise over 90 decibels is generally regarded as a health hazard. "Yet," he says, "these people are facing much, much worse."

There may be a great future in your past.



Think back to that time in your life when you felt like you belonged, had enthusiastic friendships, and a sense of contributing to your country's strength. When you could actually look forward to a secure and comfortable future.

Chances are, the last time you felt like that was when you were in the service. The question now is, is it too late to do something about bringing back the good old days of military life?

In a word, the answer is "No." The Air Force Reserve needs good men with their service skills intact. And, if you've got what we're looking for, you can look forward to a second income, specialized training, and rediscover what benefits and rewards an Air Force career can bring to your life.

Think it over. For one weekend a month and 15 active duty days a year, you could find yourself in the Air Force

Reserve with a great future to look forward to.

For more information, mail in the coupon below. Or, call 800-631-1972 toll free* for the address of your local Air Force Reserve unit.

Do it now. And let your future catch up to you. *In New Jersey call 800-962-2803.

U.S. AIR FORCE RECRUITING SERVICE ^{3-PM-92}
DIRECTORATE OF ADVERTISING (APV)
RANDOLPH AIR FORCE BASE, TEXAS 78148
Please send me more information about joining the Air Force Reserve.

I was formerly in the Air Force Navy Coast Guard Marines Army

My grade was _____

My specialty was _____

NAME _____

ADDRESS _____

CITY _____ STATE _____ ZIP _____

PHONE (area code) _____

I understand there is no obligation.

**Find yourself
in the Air Force Reserve.**

THE BICYCLE SHOP

By EUGENE A. SLOANE

Proper lubrication and adjustment of your bicycle's headset is important for stability at high speed

A BICYCLE HEADSET should be dismantled, cleaned and relubricated about once a year, or if you do a lot of cycling or ride in the rain a couple of times, twice a year. Headset maintenance is simple, but you need to know how to do it to avoid damaging fork threads and bearings.

To lubricate the headset, you have to dismantle it completely. To do this:

1. Unscrew stem bolt about one-quarter inch. Tap bolt down with wood or plastic mallet to loosen stem bolt, and pull stem, complete with handlebars, out of fork. With a large crescent wrench or monkey wrench, remove fork locknut. Then remove washer. If the bicycle has center-pull brakes, remove front brake cable bracket. At this point, since headset bearings are loose, lay the bicycle headset area down on a large rag to catch loose bearings as they spill out of headset.

2. Remove headset cone nut from fork and remove top set of loose bearings (some headsets have bearings in a nylon or metal race so you don't have to worry about losing individual ball bearings).

3. Remove fork by sliding it down from head tube. Catch bearings in rag as fork is removed. Clean all parts in kerosene.

To reassemble: 1. Put a layer of grease in bottom cone, holding bicycle upside down. Roll loose bearings in a dab of grease so they clump together (if headset has bearings in a race, push grease thoroughly into race).

2. Pick up loose bearings and put them into the bottom cone. You can tell you

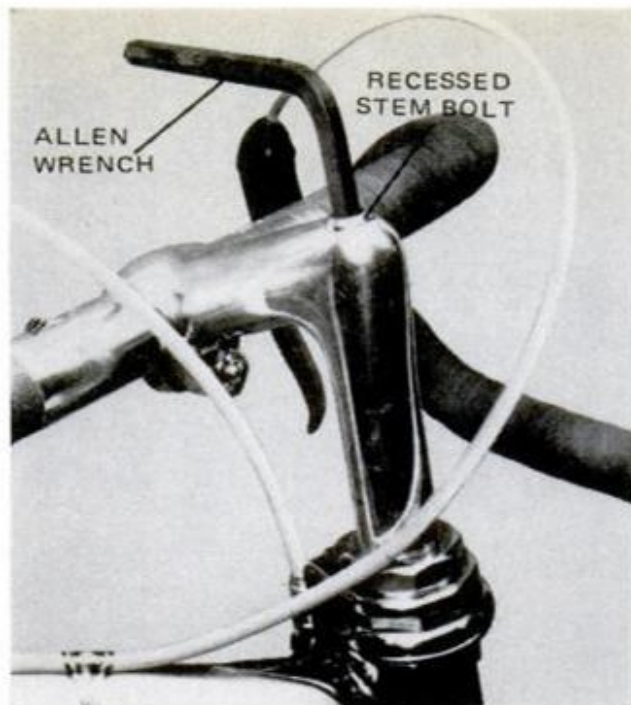

HEADSET DISASSEMBLY starts with loosening of the stem bolt so stem and handlebars can be removed

have all the bearings back in place when the last bearing fills the remaining gap, with a little room on each side. If you try to put in one more bearing, you will squeeze out one already in place. Before putting bearings back in the bottom cup of the headset, turn the bicycle over so the bottom cup is on top.

3. Insert bearings in a layer of grease, and carefully put the fork back into the head tube and down on the bearings.

4. Holding the bicycle and fork firmly together, turn the bicycle on its side, and, after putting a layer of grease on the top cup of the headset, stuff all the remaining bearings into this cup. (As an alternate to putting the bicycle on its side before putting remaining bearings back, you can set the bicycle so the fork is on the ground, to hold the fork in place. If you do, be careful not to scratch paint or chrome on the fork, and be sure that the derailleur, if there is one, is not resting on the ground supporting the bicycle, and that the chainwheel gear teeth are not digging into the ground).

5. With top bearings in place, screw the cone nut all the way down on the fork, threading it on the bearings as hard as you can twist with your hand. Then replace the washer, the center pull brake bridge (if there is one) and the locknut.

6. Take the locknut up tight with the

(Please turn to page 40)

Clean air: good reason to use a great oil.

Today's anti-pollution systems are making the temperature of your motor oil higher than ever before. And if your system isn't working properly, that makes it even tougher on your oil and your engine. Today you should name your oil. By type. By SAE Grade. By brand.

Briefly, here's what's happening.

When the PCV valve is working properly, your car's engine is running cleaner than ever. Blowby

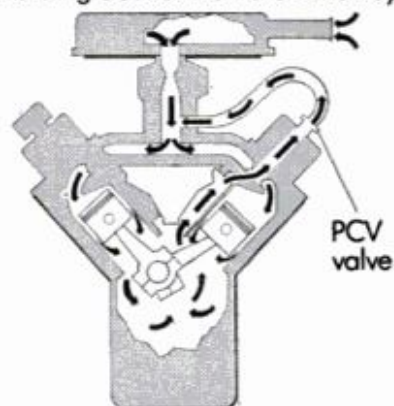

gasses that once seeped into the crankcase are recycled back to the combustion chamber. This not only keeps the air cleaner; it also keeps your oil cleaner.

Keep your PCV Valve clean. On the other hand, if the PCV valve gets clogged, combustion or blowby gasses are trapped in your crankcase and form damaging corrosive acids. What's more, today's engines must operate on a leaner fuel/air mixture than did engines in cars without anti-pollution devices. So today, your engine, and its motor oil, are operating under much higher temperatures.

Other systems, more heat. Today's improved combustion systems, supplemental air injection systems, lower compression ratios, air conditioning and power equipment are all "hot items." They put extra stresses on your engine that can send your motor oil's temperature over the 300° level.

What heat can do to motor oil. Heat is motor oil's number one enemy. Because, when heated, oil has a tendency to oxidize. Excessive oxidation causes oil to thicken—and not lubricate properly.



The newest service designation — see the chart — is "SE." It meets 1972 requirements and it's vitally important that you use it when recommended.

Then, especially these days, ask for the highest quality brand you can find. By name.

| Old designation | New designation | Oil description |
|------------------------|-----------------|--|
| ML (Motor Light) | SA | Oil without additive, except that it may contain pour and/or foam depressant |
| MM (Motor Medium) | SB | Provides some antioxidant and antisuck capabilities |
| 1964 MS (Motor Severe) | SC | Oil meeting the 1964-67 requirements of the automobile manufacturers. Provides low-temperature antisludge and antirust performance |
| 1968 MS (Motor Severe) | SD | Oil meeting the 1968-71 requirements of the automobile manufacturers. Provides greater low-temperature antisludge and antirust performance |
| 1971-72 (none) | SE | Oil meeting the 1972 requirements of the automobile manufacturers. Provides high-temperature antioxidation, plus greater low-temperature antisludge and antirust performance |

Remedy #1. Change oil frequently. Consider your car manufacturer's oil change recommendations as absolute minimums — under ideal conditions. Take careful note of the warnings against severe operations — such as heavy loads, sustained high-speed driving, constant heavy traffic, dusty roads, and extra cold weather. You might not be changing your oil often enough.

Remedy #2. Know your motor oils. First ask for the service designations and viscosity recommended in your owner's manual.

Why Quaker State offers quality protection: Quaker State is refined from 100% Pure Pennsylvania Grade Crude Oil, the world's choicest. Then it's put through an elaborate refining process.

Finally, it's fortified with a blend of additives, scientifically selected to retard oxidation, clean and disperse harmful deposits and to neutralize acids.

So ask for it, by name: Quaker State.



Quaker State your car to keep it running young.

(continued from page 38)

STEM-AND-HANDLEBAR ASSEMBLY

comes right out of fork top once stem bolt is loosened and tapped down with a mallet. Take care not to scratch chrome plating on the hardware or paint on bicycle frame

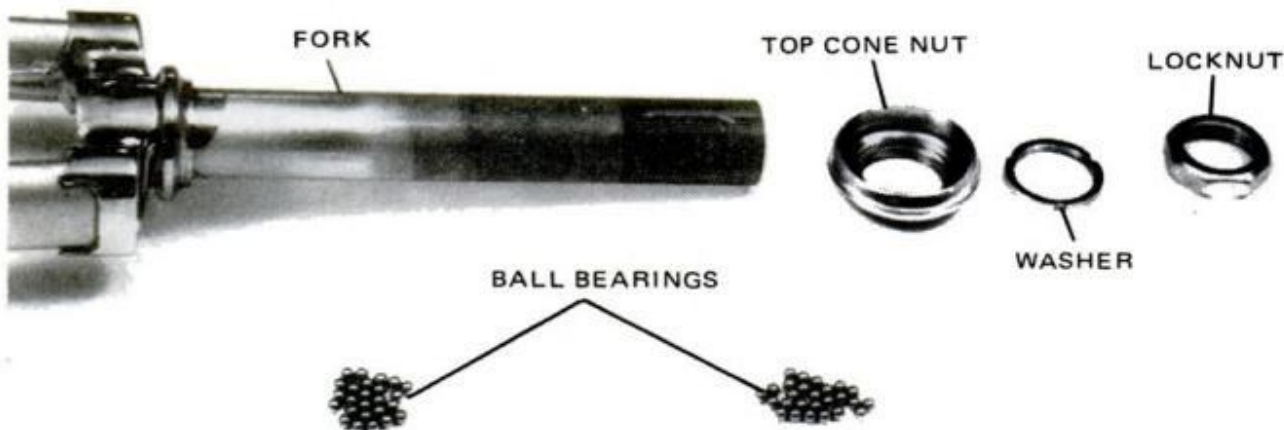
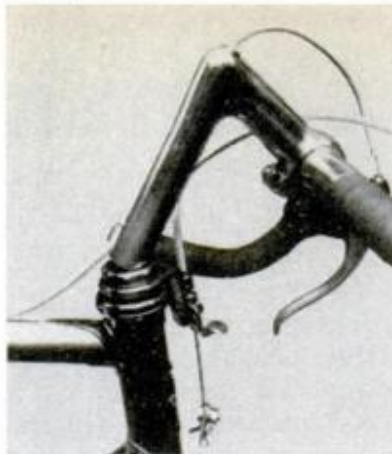

PARTS OF A HEADSET. Inset photo shows how grease holds the loose bearings in place for reassembly

crested wrench; and check fork for side-play.

It's crucial that the headset top cone nut be adjusted so the fork turns freely, and that there is no end or side play. To check for side or end play, hold the frame firmly and, with one hand on the end of the fork near the dropouts (where the front-wheel axle goes in), jiggle the fork from side to side *without twisting* it. If you feel any side play, loosen the locknut and tighten the cone nut about a quarter turn, retighten locknut and check again for side play. The fork should turn freely around 360° or as far as it can go. To test, hold the bike so the fork is off the ground and, with one or two fingers on the fork, slowly turn it all the way left, then all the way right. At no point in this circumference of the fork should there be any feeling of tightness. If the fork feels tight, loosen the locknut, back off the cone nut one-quarter turn and retighten the locknut. Continue this process until all side play or tightness is adjusted out of the fork.

It's vital there be no end or side play in the fork headset; any play may start a "shimmy" that can cause the bike to get

totally out of control riding downhill at speed. This happened to me last fall while on a bike trip through Austria. I was going down a small Alpine hill at about 45 mph when all of a sudden my front wheel developed a shimmy which grew worse on every cycle of the side-to-side movement. I was barely able to stop before the shimmy tore the handlebars right out of my grasp. I just sighed as I looked over the sheer, unfenced drop off the right side of the road; I guess it was about 2000 feet straight down! I had neglected to check this new bicycle thoroughly, and the factory had not adjusted the steering head assembly properly. A bicycle has a natural tendency to shimmy at high speed in any case; a loose fork can amplify it to potentially disastrous proportions.

If you have put one too many bearings in place—for example, one too few on top and one too many in the bottom cup—you won't be able to adjust the headset at all. You'll find there is either a lot of side play or the fork binds. I have found that in some cases a "mechanic" put the wrong-size bearings in the steering head, which again makes it impossible to adjust for no side play, without binding. ★★★

The Super Doer

The Power Gun 1000

If you're a homeowner you've got to own the new Swingline Power Gun 1000, the first extra heavy duty staple gun that does it all. It's a cinch to put up ceiling tile or cork. Power Gun 1000 drives into harder wood with less effort and greater force.

There's a Power Lever for heavy duty drive, Power Dot for Super Drive, Load-a-matic one piece loading chamber, Swing-open bottom loading, At-a-glance window to check load and a built-in staple extractor. No jam problem—easy to clear.

Suggested Retail
Price \$13.95
Kit \$19.25



Power Gun 1000 is sold separately . . . or as a kit with three attachments—one to grip and hold wire, one to repair or make screens, one to repair or make shades. Kit comes in handsome carrying case.

2 More Super Doers!

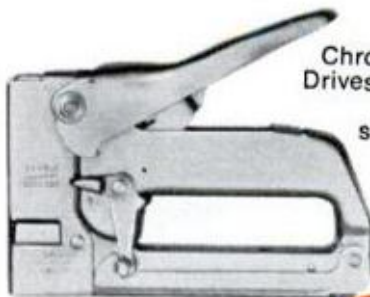

The 800X Heavy Duty Chrome Finished Staple Gun. Drives 5 sizes of staples. Open channel loading for easy staple replacement. Power Dot for extra penetration. New improved handle lock. Suggested Retail Price \$10.50

The 101 Fastens fabric to walls or woodwork. Easy to use. Lets the wife pitch in. Thousands of uses around the home, from fix-it to decorating. Suggested Retail Price \$6.95



Swingline

Write for FREE "Tips for Tackers" booklet.
Consumer Products Division 32-00 Skillman Avenue, Long Island City, New York 11101

APPLIANCE CLINIC

By PAUL MANN

Can't swim

Why do manufacturers of electric coffee-makers instruct you not to immerse these appliances in water when washing them?

—Terri Aker, El Paso, Tex.

Most electric coffeemakers are not perfectly sealed, and some water is bound to leak into the heating chamber at the bottom. This will eventually cause parts to corrode and break down in operation. Some rather expensive coffeemakers are completely sealed and can be immersed in water. The makers stress this feature in the owner's manual and advertising literature that come with the appliance.

In search of a gasket

Our Toastmaster steam iron fell to the floor and immediately started leaking from the supply tank at the point of connection to the steam unit. The gasket material, which obviously ruptured, is a white mastic-like substance that is sticky to the touch. What is it and where can I get it?

—Donald N. Botsford, Racine, Wis.

It's a high-temperature adhesive that comes in a tube. You can get it at a small-appliance service center. Specifically, General Electric makes this material under the name of Silastic (GE part No. XA 12 x 80). Follow directions concerning its application carefully.

Hot stuff

I hope my experience with a clothes dryer will help others. The dryer was getting warm, but not hot enough to dry clothes adequately. After going through the trouble of dismantling the unit, I found I'd wasted a lot of time. The problem was easily corrected. Here's how:

A clothes dryer is wired for 220 volts (three-wire). The heating element is hooked up for 220-volt operation, but the motor and timer use only 110 volts, which they get from one of the hot wires and the ground. Both hot wires are fused. Eventually I found that one of the fuses had blown; the other was still good. This per-

mitted motor and timer to work, but the heating element was only getting warm, because it was operating on 110 volts instead of 220.

—James R. Berger, Tiffin, Ohio.

Thank you, J. R. B., for your valuable tip to clothes-dryer owners.

Plenty cold—no hot

I have a Kenmore washing machine that will not pump in hot water—only cold. Can you suggest how to correct the situation?—Jack M. Roland, Hollywood, Calif.

First, make sure the valve on the hot-water line feeding the machine has not been shut off accidentally. If the valve is open, you probably have a clogged hot-water hose leading into the machine, or a clogged or inoperative hot-water valve in the machine. Other possibilities are a faulty hot-water control switch or a breakdown in the circuit that controls valve operation when the switch is activated.

Cool-less cooler

Although I replaced the filter in a bedroom window airconditioner a couple of weeks ago, it still doesn't seem to give enough cold air. What can be wrong?

—William R. Loesser, Cleveland.

No airconditioner can be hopped up to give you more cold air than it was originally manufactured to give. Since cold air is being provided, I don't think that the problem is major, such as an undercharge of refrigerant due to a leak.

However, one thing that can cut down on cold-air output is dust. Frequent washing of a renewable filter or replacing one that can't be washed is an important maintenance task. But dust can collect on other parts of an airconditioner and reduce cooling efficiency. Not everyone is aware of this. For instance, condenser air is not usually filtered. In time, enough dust can build up on the condenser to clog it and reduce heat-transferring efficiency.

Don't overlook the possibility that the evaporator can also clog with dust, especially if a unit is ever run without its filter in place. The coils and fins get slightly damp during normal operation, and dust will stick to them.

On a chance that this has happened to your appliance, I would have the whole thing blown clean. For this purpose, servicemen carry so-called air bottles—con-

(Please turn to page 44)

TOM McCAHILL says: "If your pay check's thinner than a 10 cent hamburger...fatten it up by earning extra money repairing appliances."

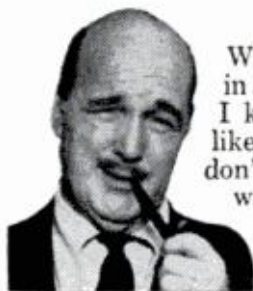

When a fellow tells me his wallet's in about the same shape as my hair, I know how he feels. Salaries are like \$50 Caribbean cruises . . . they don't go very far. But I know one way a guy with get up and go can make himself some real money . . . by learning Appliance repair.

Earn \$5 to \$7 an hour in your spare time.

NRI has a low-cost, home study plan that covers every type of Appliance repair in detail. Even if you're all thumbs and don't know a soldering iron from a steam iron, NRI can lead you through the course one step at a time. Before you know it, you'll be servicing electric appliances for cold, hard cash.

The lessons come to you fully illustrated . . . and the NRI staff of experts gives you more personal attention than you'd get in many classrooms. You learn basic electricity and how to use test instruments, at your own speed. The course covers the electrical and mechanical operation of every type of appliance from toasters and coffee makers to dishwashers; from vacuum cleaners and automatic laundry equipment to air conditioning and refrigerators.

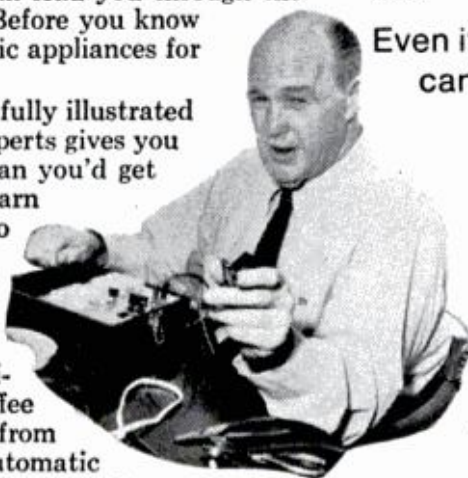

They even show you how to fix farm and commercial appliances and small, one-lung engines. Their staff of experts work with you every step of the way. NRI even includes a professional Appliance tester in the low tuition.

Turn off the TV and learn at home in your spare time, the easy NRI way.

You won't make a buck off the boob tube, but you can make a bundle in the Appliance repair field. (If you're really out to learn, they've got a special course on air-conditioning and refrigeration repair, too.)



Even if you can't wire a plug, NRI experts can teach you all you need to know.

Thousands of guys like yourself have studied with NRI, and they all had one thing in common. They were looking for a way to learn a new skill that would pay off. The Appliance Division of NRI can teach you that skill. Just send in the coupon below for the free catalog that gives you all the details. Send it today and they'll have the book in your hands in no time. Then, it'll be up to you. No salesman will call. The only knocking you'll hear will be opportunity.

Tom McCahill

Grab this FREE BOOK and see what NRI can do for you



NRI TRAINING

3939 Wisconsin Avenue, Washington, D.C. 20016

Send me the free book on Professional Appliance Servicing. NO SALESMAN WILL CALL.

Name _____ Age _____

Address _____

City _____ State _____ Zip _____

Accredited Member National Home Study Council Check for facts on GI Bill

600-092

AVAILABLE UNDER NEW GI BILL
If you served since January 31, 1955 or are in service, check GI line below.

Enjoy Independence



**With A Sparetime
BUSINESS
OF YOUR OWN**

Here's a proven, practical way to earn sparetime cash while you develop a money-making business of your own. Investment is small. There's no overhead, no stock to carry, no selling involved. Automatic Foley Saw Filer, easy to operate, files combination saws, hand, band and circular saws. No experience needed.

Earn \$3 to \$6 An Hour In Sparetime

Get started now and watch your business grow! Thousands are earning cash this easy way—many build a complete sharpening service with year around profits. You can, too, with the easy-to-follow Foley Plan—write us today!



FREE BOOKLET SHOWS HOW

Fact filled booklet tells you how to start a sparetime business; how to get new business. Rush coupon, get "Money Making Facts" and details on Easy Payment Plan. No salesman will call.

Foley Manufacturing Co.
916-2 Foley Bldg., Minneapolis, Minn. 55418

Send FREE BOOK—"Money Making Facts", and Time Payment Plan.

Name _____
Address _____
City _____ State _____ Zip Code _____

Stick 'em up with Macco Liquid Nails®

a waterproof
general-purpose
construction adhesive for

paneling • pegboard
shelves • molding • drywall
ceramic tiles • veneer brick

Do it yourself easier and better with the complete line of Macco adhesives and sealants. At lumber stores, hardware stores, and home improvement centers.

Available in cartridges,
quarts and gallons.

PM-29



MACCO ADHESIVES

SCM CORPORATION, WICKLIFFE, OHIO 44092

APPLIANCE CLINIC

(Continued from page 42)

tainers of compressed air—which are directed into the unit. If you have a compressor, you can do the job yourself.

Downright upright

I have an upright food freezer that has acquired a bad odor which is being imparted to the food. What can I do about it?—Carl Sutheimer, Appleton, Wis.

I doubt if the cause is a malfunction of the unit. If there was a refrigerant leak you wouldn't get an odor since refrigerant is odorless. Also, a leak would result in a loss of freezing action.

The interior of a freezer will begin to smell if the unit isn't defrosted often enough. Frost absorbs odor from food, especially if it isn't wrapped properly. I suggest you defrost and wash the interior with a solution of baking soda.

Missing nameplate

My Eureka Traveler hair dryer needs repair, but it has no nameplate. To whom can I write for service information?

—Lester E. Moser, Muncie, Ind.

Eureka Williams Co., division of National Union Electric Corp., Bloomington, Ill. 61701.

Maintenance tips

- The amount of detergent or soap specified by the manufacturer of your washing machine should not be exceeded. Using too much will cause foaming that can put a strain on the motor and cause the spin basket to vibrate.

- The cord of a small appliance suffers more abuse than any other part because of carelessness. Never pull on the wire. To disconnect it from a receptacle, grasp it by the plug.

- I have often been asked what one piece of equipment is essential for troubleshooting appliance problems. Without doubt, it is the volt/ohmmeter, commonly referred to as the VOM, which shows a.c. and d.c. voltages and resistance values. There are many good instruments on the market, available at electrical-supply and electronics equipment shops, also department and discount stores. ★★★

If you have a question about any appliance, send it to Appliance Clinic, Popular Mechanics, 224 West 57th St., New York, N.Y. 10019. Sorry, but letters cannot be answered individually. However, problems of widest interest will be answered in this column.

This is the ad the Racing Form refused to print!

Winning at the Races May Not Be Your Idea of Fun, But...

ere I sit, trying to write about Larry Voegele. And all the while I'm working and sweating, the guy I'm writing about is out at the racetrack. Not a worry in the world—and probably making more money in a day than I make a week.

What's his secret? *He knows how to bet at the races. Really knows.* Knows so much that he runs a school for handicappers. (It's the only one of its kind in the world. Which is why he was asked to appear on "What's My Line.") He charges his "students" two hundred bucks apiece. He tells them that they're not completely satisfied he'll turn every cent they've paid, and *body* has ever asked for his money back.

What's more, he went on a live radio show (The Pete Smith Show on MPC, February 20, 1971) and did something that had never been done before. Mr. Smith really threw it to him: asked him to pick the winners in the 7 races that were being run at Santa Anita, while the program was on the air. Two out of seven would have been good enough to show a profit. Three would have been phenomenal. Larry Voegele picked *five!*

He'd been at the track betting, say 20 on each race, he would have picked up a cool \$404... net profit! Not bad for an afternoon's "work."

And all the knowledge that Larry publicly *proved* that day... *every* fact that he teaches in his \$200 course... is in his book.

If you've never bet on a horse in your life, you'll read and enjoy every word. And end up understanding more than most guys who have been following the ponies all their lives.

If you're an oldtimer, you'll skip the background and get right down to the gritty gritty. If you can forget what you think you know, if you have the nerve and the *discipline*—to follow his methods to the letter, you could make more money than you ever dreamed possible.

Why? Because you'll *know* more than 95% of the people who go to the track—and you're betting against *them!* The money they lose, *you'll* win! The track and the state take their cut, but there's plenty to go around.

At Santa Anita, for example, over *two million dollars* is bet every day. And it's a statistical fact that only one out of 20 walks out a big winner. You can be one of them!

Larry Voegele doesn't look like a race-track tout. He's not.

He's a college graduate. He was the editor of a newspaper. He was a legislative assistant to a congressman.

He was a stockbroker, working for a major Wall Street firm. *Was* because he found out that investing in horse races was *safer*—and more profitable—than trying to beat the Bulls and the Bears at their own game.

And that's the secret of his book. He approaches handicapping as a *professional*. It's *scientific*. No "hunches." No "tips." No so-called "systems."

It isn't even "inside information." Just simple, hard *facts*. Facts that *anyone* could see if they knew what to look for. In short, if they knew what Larry Voegele knows—and tells in his book. It'll take you about an hour to read it. Another hour to practice what he preaches.

Then if you do *exactly* as he says, step by step... if you don't get reckless or greedy... you'll be on your way to the kind of life you want.

Is that worth a 2-hour investment? Because that's all you're risking. Just time. Not money.

Here's why: your check or money order will *not* be deposited for two weeks *after* your copy of the book is mailed. That'll give you plenty of time to receive your book, read it thoroughly, and put the principles into *action*.

If you're not thrilled with what you've gained, just send the book back within 14 days. Your *uncashed* check or money order will be in the return mail!

Ever heard of an offer like that? No. But there's never been a book like this either.

As to the price—if you decide to keep the book. Frankly, we didn't know what to charge. It isn't just paper and ink. It's *information*. Facts that dozens of people have paid \$200 to gain—and were satisfied to pay.

Verified Results of the Voegele Professional Method of Winner Selection

Hollywood Park (75 days)
675 Races, 222 Winners
Avg. Win Price: \$9.00 32% Winners
Net Profit \$20 Flat Bet to Win: \$6,480.00

Atlantic City (80 days)
540 Races, 183 Winners
Avg. Win Price: \$9.60 33% Winners
Net Profit \$20 Flat Bet to Win: \$6,666.00

Bay Meadows (64 days)
576 Races, 178 Winners
Avg. Win Price: \$8.90 31% Winners
Net Profit \$20 Flat Bet to Win: \$4,356.00

Santa Anita (75 days)
675 Races, 218 Winners
Avg. Win Price: \$8.68 32% Winners
Net Profit \$20 Flat Bet to Win: \$6,237.00

Pimlico, Winter 1971 (30 Days)
270 Races, 97 Winners
Avg. Win Price: \$9.84 35% Winners
Net Profit \$20 Flat Bet to Win: \$4,140.00

Hialeah (40 days)
400 Races, 147 Winners
Avg. Win Price: \$7.80 37% Winners
Net Profit \$20 Flat Bet to Win: \$3,148.00

Aqueduct (42 days)
378 Races, 127 Winners
Avg. Win Price: \$9.10 33% Winners
Net Profit \$20 Flat Bet to Win: \$3,807.00

But there aren't many people who can afford that kind of money. Even for a sure thing.

So what do you think about 10 dollars? That's all—10 dollars. And you have something *better* than a money back guarantee. Because your check or money order won't even be cashed unless—and until—you decided to keep the book because it's worth a *lot* more.

Winning at the horse races, traveling first class and living in the best hotels may not be your idea of fun. As for me, I think it sure beats working for a living. See you at the track.

©1972 Financial Publishers, 466 N. Western Avenue, Los Angeles, California 90004.

Financial Publishers, Dept. 551-A
466 N. Western Avenue
Los Angeles, California 90004

OK—I'll take you up on your offer. Send me Larry Voegele's book. Enclosed is my check or money order for ten dollars, but **DO NOT DEPOSIT IT FOR 14 DAYS AFTER YOU SEND MY ORDER.**

If I return the book within that time, you'll return my payment, uncashed, by return mail. Please send Air Mail! I enclose an extra dollar.

(Please print or type shipping information. The book will be mailed in a plain wrapper)

Name

Address

City

State

Zip

ALL By BILL McKEOWN OUTDOORS

SPORTSMEN of all types may now have an outfit speaking up for them—with the organization of a new association called The Outdoor Nation. Already there are many small groups with large voices (and often undersize axes to grind) all clamoring for attention. But who speaks for the average camper who just wants more quiet, clean and pleasant places to visit? Or the recreational-vehicle owner who longs for laws that will be sensible and consistent all the way across the country? And how about citizens who want environmental planning designed so the largest number of people can enjoy our natural resources with the least damage over the longest period of time?

To fill this need, Bob Honke, sales manager for Ford's recreational vehicles, started The Outdoor Nation. Ford will not sponsor the organization, however. Consumer groups and outdoor recreation industry members hope, instead, to work together to tackle major problems and suggest solutions that reflect the opinions of millions of concerned Americans.

AS OUTDOORSMEN KNOW and inside types should suspect if they ever look out a window, this year has already had its share of storms and hurricanes, rains and floods. On the chance that there still might be a traditional wet weekend this fall, however, here are some new books particularly recommended for anyone unwillingly indoors.

Zane Grey, Outdoorsman commemorates the 100th anniversary of the birth of this great fisherman, hunter and author. Just published by Prentice-Hall, the collection brings together the best hunting, fishing, boating and camping remembrances of this unexcelled writer of the outdoors, plus photos of his 1040-pound blue marlin, 758-pound bluefin tuna (both world's records), treks after mountain lion in the Grand Canyon, fishing voyages off Tahiti and camping expeditions while getting the background for his famous Western novels. The stories were selected by George Reiger, former boating and outdoors editor of *Popular Mechanics*. The \$9.95 collection should make a fine gift for sportsmen friends as well as good reading for you.

How do you rewrite the Bible? If it's the



WORLD'S LONGEST POWERBOAT RACE, 2700 miles from London to Monte Carlo, was won by little 28-foot Ford-diesel H.T.S., number 358 above, in a 20-day passage over the 14-leg course

boatman's gospel according to Chapman, better known as *Piloting, Seamanship and Small Boat Handling*, I'd only want it done by Tom Bottomley, resident expert of Motor Boating & Sailing magazine's book division. This is the 50th anniversary edition of the volume that is the U.S. Power Squadrons' textbook and a classic reference for pleasure boatmen since 1922. Now 639 pages long and still only \$8.95, it remains one of the bargains in the field.

In more compact form, the same smart publishers have issued Bottomley's *Boatman's Handbook*, a keep-aboard almanac in paperback that covers emergency procedures, rules of the road, piloting, navigation, federal and state laws, weather, state registration data and fees, and a sea-chest load of additional useful information and references for anyone going afloat.

New good books for boatmen with specialized interests include volumes on *Searunner Trimarans* (\$4), and *Searunner Construction* (\$8), from Jim Brown, Box 2627, Santa Cruz, Calif. 95060; *Boat Maintenance by the Amateur* by Michael Verney, published at \$6.95 by Winchester Press; and *Yacht Log*, a \$5.95 guest register and radio-telephone log from Motor Boating & Sailing.

ALL-AROUND SPORTSMEN will want *Outdoor Tips*, a new \$2.95 paperback that covers everything from shooting to snowmobiles, with archery, hiking, camping, recreational vehicles, salt and fresh-water and ice fishing, canoeing and even cooking chapters in between. One of the set that includes volumes on skeet, trap, historical guns and cooking wild game, it can be obtained from sporting goods dealers or Remington Sportsman's Library, Box 731PM, Bridgeport, Conn. 06601. Maintenance of outdoor equipment is well detailed and diagrammed by Monte Burch in *Out-*

(Please turn to page 48)



**"For an amateur,
he's a whiz.
How'd he get
so good?"**

Whatever practical skills you've been wanting to develop, Audel has comprehensive, step-by-step Guides to help you. They show you all the professional tricks of the trades

in clearly diagrammed and illustrated "how-to" steps. They can save for you, over and over. Here are four of Audel's many fields . . .

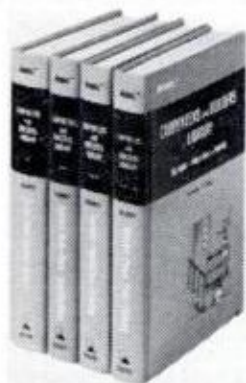

CARPENTERS AND BUILDERS LIBRARY

1612 pages of the latest information on modern construction in four volumes. They cover every phase of carpentry from foundations to finishing with easy-to-grasp, step-by-step instructions . . . all illustrated with thousands of diagrams, charts and photos. No. 23169 — 4 Volumes — \$18.50

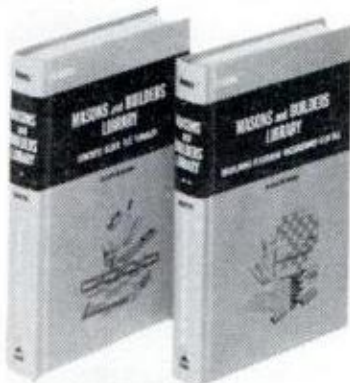

MASONS AND BUILDERS LIBRARY

Two illustrated volumes on the science of masonry and bricklaying. Packed with how-to information and directions, rules, processes, definitions, formulas, diagrams, tables, estimating. A complete and authentic trade reference library. 752 pages. No. 23185 — 2 Volumes — \$11.25

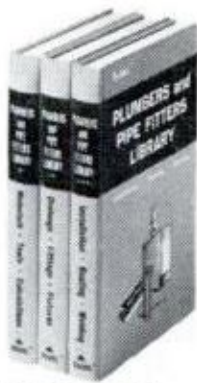

PLUMBERS AND PIPEFITTERS LIBRARY

A valuable 3-volume guide to the principles, methods and short cuts of modern plumbing. Tools, fittings, fixtures, installation, drainage, welding and much more are all covered in these fully illustrated, easy to understand volumes. No. 23155 — 3 Volumes — \$12.50



MACHINISTS LIBRARY

Three books covering the entire field—1216 profusely illustrated pages on practical fundamentals of basic machine shop operations, setup and operation of spot machines, down-to-earth data on toolmaking procedures, layouts, jigs and fixtures, etc. . . . equally valuable for beginners and experienced men alike. No. 23174—3 Volumes—\$16.95

MONEY BACK GUARANTEE

Send no money! We'll send you any Audel Guides for 10-day FREE EXAMINATION. If you keep them, you may use our easy payment plan. If not completely satisfied, return them for refund.



THEODORE AUDEL & CO.
Division of
Howard W. Sams & Co., Inc.
Indianapolis, Indiana 46268

SEND NO MONEY—10-day FREE EXAMINATION

Theodore Audel & Co.—Self Improvement Publishers since 1879
4300 West 62nd Street, Indianapolis, Indiana 46268

Please mail me for 10 day's FREE EXAMINATION the books I have checked at right. I agree to mail \$3 in 10 days for each set ordered and to further mail 1/3 of the purchase price 30 days later, with balance plus shipping costs to be mailed within another 30 days. I may return the books for refund if not completely satisfied.

Save shipping costs. Check here if you enclose full payment (plus sales tax, if any). We will pay postage charges. You have same return privilege.

Name _____
Address _____
City _____ State _____ Zip _____

- P092
 23169
 23185
 23155
 23174

**EARN
HIGH
WAGES**
as a **HEAVY
EQUIPMENT
OPERATOR**



Train your way to high pay in the booming construction industry! Learn the skills you need to qualify, by actual field training on machines like the ones used by the industry. Huge training grounds in North Carolina, a million dollars worth of school-owned diesel-engined machines, experienced instructors, full 220-hour and 440-hour courses. National, the original school of heavy equipment operation, is a recognized leader. Member American Road Builders Assn., Services and Supply Division. Associate Member A.G.C. Full-time Job Advisory and Counseling Director on staff. Approved for veterans. For men ages 17 and up. Train Now-Pay Later plan . . . other payment plans also available. Write TODAY for FREE catalog and FREE copy of school newspaper reporting news of National School graduates. Accredited member National Association of Trade and Technical Schools.

NATIONAL SCHOOL Phone 704/392-1359
OF HEAVY EQUIPMENT OPERATION, Dept. D-66

P. O. Box 8529, Moores Chapel Road, Charlotte, N. C. 28208

Please send me FREE illustrated school catalog and complete information. I understand there's no obligation.

Name _____ Age _____

Address _____ Phone _____

City _____ State _____ Zip Code _____

BE YOUR OWN BOSS!
EARN \$200 to \$600 A WEEK
PART OR FULL TIME

ANY CAR WAXED and POLISHED
with world famous
SIMONIZE®
PASTE WAX

only **5⁹⁵** In 30 Minutes
or Less

A gleaming Simonize job completed in less than 30 minutes. New amazing portable (15 lb.) machine makes it all possible. Even a 10 year old child can operate it with better than professional results. Customers are everywhere! Getting customers is the easiest part of this business.

For further information write or CALL COLLECT today . . . Mr. Leads (516) 938-3540

NATIONAL WAX SYSTEMS

Division of Gulfport Chemical Corp.

Dept. 8 PLEASANT AVE.

987 PLAINVIEW, N.Y. 11803

ALL OUTDOORS

(Continued from page 46)

doorsman's Fix-it Book, recently published at \$6.95 by Harper & Row.

RECREATIONAL-VEHICLE BODIES we've previewed for '73 are getting bigger and smaller, better and occasionally cheaper. Some pickup trucks can carry a heavier camper and seat more in a passenger crew-cab up front. Chopped-van mini-motor homes are flourishing. Split-level fifth-wheel trailers that hitch to the cargo bed of a truck, semi-style, are booming. We found about 52 manufacturers turning them out last time we



DUAL REAR WHEELS are feature of Chevy Cheyenne



CLUB CAB adds rear seats to new 1973 Dodge pickup



CHOPPED VANS favor chassis like Ford's Econoline



FOUR-WHEEL-DRIVE makes Jeep camper a climber
POPULAR MECHANICS

counted. Nearly every family should find a new rig to suit their needs.

WHERE-TO-BUY queries are usually best handled by local sporting goods stores and the ads in this magazine. Which lure a fish will prefer today, or what bottom paint works best in your harbor, is likely to require on-the-spot advice. We can't personally answer reader questions, but here are some a number of people have recently wanted to know about. Manufacturers can give dealer sources if they don't supply through the mail.

A booklet called *All About Lures*, available at stores that sell Garcia fishing equipment, suggests not only what lures to use but why they tempt the fish. Two mail-order sources for rod replacement parts and fly-tying gear are Cabela's, 812 13th Ave., Sidney, Neb. 69162, and Herter's, Waseca, Minn. 56093, among others.

An old-fashioned razor hone for really stropping a hunting knife? Brookstone Co., Peterborough, N.H. 03458, has it and a catalog of hard-to-find tools.

A fishing reel with automatic transmission? Some investigation turned up the Sabra, a model from Johnson Reels, Mankato, Minn. 56001, that is reported to downshift from direct retrieve to drag setting when the crank handle is released.

Prewired switch panel mounted in solid mahogany, ready for installation in your boat? It's one of the accessories listed in a new nautical whatnot catalog from Boston Whaler, 1150 Hingham St., Rockland, Mass. 02370. Chris-Craft also has an extensive new marine accessories catalog, from Detroit Road, Algonac, Mich. 48001.

Yes, class sailboats are available in kit form. The Penguin, Blue Jay, Snipe and Lightning (all of them in wood) and an El Toro (in wood or fiberglass) are offered to build-it-yourself sailors by Taft Marine, 636 39th Ave. N.E., Minneapolis, Minn. 55421.

Goose-down clothes are still warmer, lighter (and more expensive) than man-made synthetic imitations of the gander's insulation, and a number of outfits make or stock them. Sears, Montgomery Ward, Eddie Bauer and others are well-known sources. But specialists are also branching out. Browning, of Morgan, Utah, and Montreal, Que., may mean guns to most sportsmen, but now it's also down hunting clothes, knives, archery equipment, Silaflex fishing tackle, boats and canoes, Wind River backpack tents and golf carts—and, would you believe, fiberglass vaulting poles and trained hunting dogs? For sew-it-yourselfers, there are kits from Frostline, Box 2190, Boulder, Colo. 80302, to assemble into down sleeping bags and clothes, plus tents and backpacks, for half the price. ★ ★ ★

Frame-Up!

**FOR A
PERFECT
FRAME
EVERY
TIME.
PROFITABLE!
ENJOYABLE!**



Constructed of heavy black chromate steel tubing and anodized aluminum clamps, FRAME-UP produces beautiful picture frames as large as 48" x 36" or as small as 6" x 6". Size adjustments are made quickly at each corner. The no-slip jig, held firmly by brackets, produces a perfectly formed corner each and every time.

**ORDER YOURS TODAY!
SATISFACTION GUARANTEED!**

Send only \$5.00, then pay \$34.95 plus C. O. D. and delivery charges or, send \$44.95 for prepaid shipment in Continental U. S. A. North Carolina residents add 4% sales tax. Check or money-order please.

Name _____
 Address _____
 City _____
 State _____ Zip _____
 BLANK-IT CORP. • P. O. BOX 569, MONROE, N. C. 28110



MOST FLYING FUN — AT LOWEST COST!

Get in the pilot's seat of your own personal Bensen Gyrocopter and go aloft when you like — high and fast or low and slow. Pros and beginners alike praise it as the greatest thrill in flying. Wheels interchange with floats or snow skis for extra fun. Costs no more to operate than a car. Designed for building with ordinary hobbyshop tools. Make your first move now — send \$5 for Copter (\$3 for Glider) colorful "Info Packet", with 3-View Drawings; General Specifications; Design and Piloting Information; Construction Hints; in-flight photo; 6-page "Bulletin" with numerous pictures plus descriptions of Plans, Kits, Engines; Condensed Price List . . . and a Certificate for \$5 (or \$3) toward the purchase of Construction Plans.

SEND BENSEN AIRCRAFT CORP., Dept. PM-92
 \$5 RDU Airport, P. O. Box 2746, Raleigh, N. C. 27602
 OR NAME _____
 \$3 ADDRESS _____

Get a little in the Navy.

More job.

If you qualify, we can guarantee you any one of 68 job fields. What's more, we'll send you to a school that will make you a real pro. That way, you get more jobs in the Navy and when you get out, you've got somewhere to go.

More choice.

There's a new 3 year Navy enlistment. So you can come in for 6 years or 4 years or now, 3 years.

More guarantees.

You can be guaranteed East or West Coast and choice of sea duty or airman recruit work.

More travel.

See Africa. See Europe. See Japan. Join the Navy and see the world. (It's still true.)

More bread.

New guys now earn \$288 a month. (Congress gave us a raise.)

more

More hair.

You can wear a beard (nicely trimmed) if you want to. It's a Naval tradition. It's also a brand new Navy.

More freebies.

Besides free travel and free education and that \$288 a month, you get free food and free clothing and free housing and free health care and 30 paid vacation days per year.

If you think you've got what it takes to make it in the new Navy,

Call:
800-424-8880

It's toll free, there's no obligation, and a real live Navy recruiter will answer all your questions 24 hours a day, seven days a week. In Washington, D. C. call 433-2000.

Or:

See your Navy man right now. He's listed in your phone book under U.S. Government, Navy. He's got all the answers—or he knows where to find them.

Or:

Send to: Captain Donald E. Oglevee
Building 157, Fourth Floor,
Washington Navy Yard,
Washington, D.C. 20390

87

I want to know more about:

- More job, training, education.
- The new 3 year enlistment.
- More travel.
- Guaranteed East or West Coast home port.
- More bread.
- Enlisting now, reporting 6 months later.
- I want to know more right away. Call me.
My phone No. (_____).
- If you really don't want to wait, call us
toll free right now at: **800-424-8880**
In Washington, D. C. call: 433-2000

Name _____ Age _____

Address _____

City _____

State _____ Zip _____



Aerial tramway for cities

An aerial tramway, with self-propelled gondolas that travel over a fixed, elevated cable, is the answer to urban traffic congestion, says inventor Byron T. Brown of Scottsdale, Ariz. His prototype Sky-Tram system features a 23-passenger car, which can be expanded to carry 100. An engine in the car would drive hydraulic motors that, in turn, would drive rubber-tired wheels over the cable.



Zigzags are safer

Zigzag markings at approaches to pedestrian crossings are cutting down accidents, say London traffic researchers. Drivers and pedestrians notice the lines more readily and exercise caution.

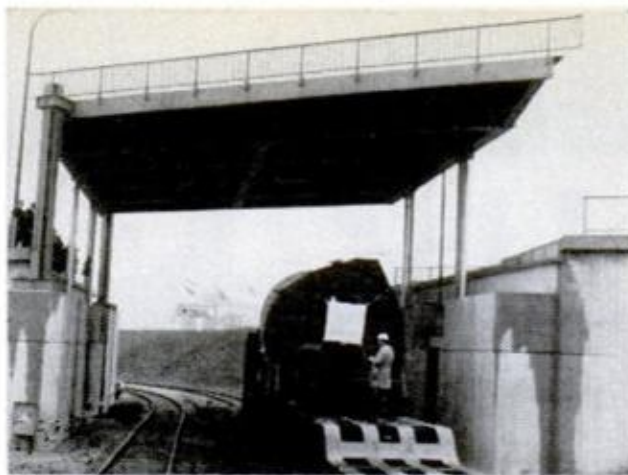

Hydraulic bridge lifter

A hydraulic lift that raises a 200-ton bridge section enables railroad cars up to 30 feet in height to pass under the highway above. Lowered, the bridge allows only a 16-foot clearance.



Heated rescue stretcher

A portable 12-volt battery keeps this heated rescue stretcher warm while the injured person is being carried to safety. The stretcher is a British development.



She sleeps in an 'egg'

A reinforced-cement "egg" in a wall is the bed of a young Californian. It features a porthole window to the outdoors.

WHAT WE DID FOR BARNEY OLDFIELD...



we can do for you

That's the real Barney Oldfield, standing next to *The Golden Submarine*—sort of a forerunner of today's NASCAR iron.

Barney's biggest problem was keeping his head gaskets from blowing out. In 1909, he took the problem to a young chemist in Sheepshead Bay, New York. The result was the first Form-A-Gasket®. It worked so well for Barney, the Permatex Company was formed to market the stuff to the automobile trade.

It is still being sold, under the name Form-A-Gasket #1. It has been sold longer than just about any product in the business, except gas and oil. And it still works. In point of fact, people use it for all kinds of things.

Everything from fixing cracked batteries to repairing leaky plumbing.

Form-A-Gasket #2 came along when we discovered there was a need for a sealant that remained flexible, instead of setting hard. It's had the same success and the same multiplicity of uses.

Aviation Form-A-Gasket was invented when we were asked if it were possible to make a sealant in brushable form, instead of a paste. We could, and we did.

The rest is history. You'll find Form-A-Gasket #1, Form-A-Gasket #2 and Aviation Form-A-Gasket in NASCAR garages, service stations, and wherever automotive products are sold. They are Permatex Part

Numbers 1, 2 and 3. We're up to Part Number 1372. But that's another story.

Want a free Permatex racing decal? It's yours for reading this ad. Just send us your name.



our name is our bond **Permatex**

PERMATEX COMPANY, INC.
P.O. Box 1350 West Palm Beach, Florida 33402

LEARN TO BE A SKILLED LOCKSMITH



Change combination of pin tumbler cylinder—EARN \$1.50 in 15 MIN.

TYPICAL JOBS EARN YOU \$271 PART TIME (in only 53 hours!)

Owner loses key; pick car trunk—EARN \$5.50 in 10 or 20 MIN.



Install new knob door lock—EARN \$15.00 in 30 MIN.

After-hour emergency opening—EARN \$2.50 to \$5.50 in 20 MIN.

Hundreds have succeeded like these Belsaw Graduates:

R. W. Davis, St. Louis, Mo.: "I am doing a wonderful business thanks to your course in locksmithing. Last Saturday I took in \$110.00."

Pierson Crook, Los Angeles, Calif.: "I am making \$200 a month extra income with the Belsaw Locksmith Course. I would recommend your course to anyone."

Big demand for skilled Locksmiths! Earn big money spare time in your own home. Be your own boss. No layoffs. Steady year 'round income. Age and schooling are no handicap.

BELSAW INSTITUTE training...approved by master locksmiths...helps you start faster with easy picture lessons guided by your own mail instructor.

Get thorough job training on all types of locks. We supply tools, equipment and business help: how to start, how to charge, how to get jobs, how to earn while you learn and build a lifetime cash-profit business. Accredited Member National Home Study Council. Approved by State Board of Education. Approved for Veterans.



This \$125 key machine is yours to keep!

MAIL COUPON—NO SALESMAN WILL CALL

BELSAW INSTITUTE, 103S Field Bldg.
Kansas City, Mo. 64111

Send FREE book, "Keys To Your Future!"



Name _____

Address _____

City _____ State _____ Zip _____

NEWS BRIEFS

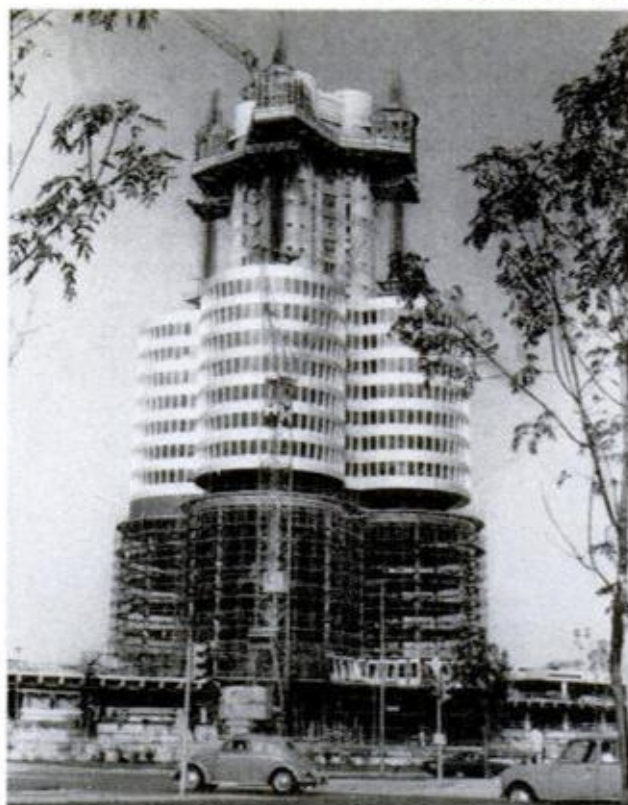

Building by hoisting

Each floor of this new building in Munich is being built at ground level, then lifted hydraulically so that the next level can be built below it. When finished, the structure will be 18 stories high.



Flash for a refill

When your glass is empty and you want your host to notice, all you need do is attach a Drink Lite to the edge. Its flashing light quickly conveys the message.

MIRACLE **Drainz** SOLVES cesspool, septic problems... OR YOU PAY NOTHING!

drainz, an amazing new formula, eliminates the cause of cesspool or septic back-up . . . and the costs of frequent "pump outs."

Before **drainz**, even the best-kept cesspools and septic tanks did back up due to clogged ground pores around and beneath valuable drainage areas as a result of detergent residues, hardened fats, and other stubborn solids that choke these ground pores. Water had no place to go. Now, this revolutionary discovery, **drainz**, effectively and safely opens these choked ground pores and allows water to drain away freely . . . your cesspool or drain field can now drain free and easy all the time.

• No more torn up lawns, shrubs, gardens • No more "buying time" with pumping • No sewage back-up on grounds or in homes • No stench, health hazard, embarrassment, inconvenience.

drainz, heavier than water, is simply applied through any drain in the house. It sinks right through to the drainage areas, sending tiny, effective beads through your system into outer drain fields past your septic tank.

Why resort to costly temporary measures that fail in the long run? Caustics and acids add to the trouble, literally hard-glaze sand into glass . . . enzymes

and bacteria miss the trouble, since they can't dissolve detergents . . . and pumping only removes fluids leaving the clogged system to fill right up again soon. **drainz** succeeds where other methods fail, eliminating old problems, preventing new ones. Safe to handle and harmless to plumbing, pipes, lawns, gardens, cement and mortar, **drainz** is more than a startling formulation. Its effectiveness has been proved again and again by delighted homeowners in many areas.

You can buy **drainz** with confidence on our famous **MONEY-BACK GUARANTEE**

This product is guaranteed for a maximum of two gallons over a maximum time period of 30 days. If the product does not perform after a total of 30 days, money will be refunded on both gallons. Read guarantee affixed to gallon can, for detailed explanation.

Order 2 gallons of **drainz**. Chances are the first gallon will unclog your system. If not, add the second gallon as directed. Once your system is functioning properly, keep it that way with a "booster shot". Add a quart of **drainz** four times a year, from then on. It's a small price to pay for security.



drainz liquefies hardened grease and detergents, clears the surrounding ground, restores flow of water into drainage area.

Get **drainz** at your local hardware or plumbing supply dealer . . . or if he doesn't yet have it on his shelves, send direct, using the coupon below.

JANCYN MANUFACTURING CORP.
Dept. PM9, 155 Oval Drive
Central Islip, N. Y. 11722

Drainage Systems Maintenance Specialists
RESIDENTIAL • COMMERCIAL • INDUSTRIAL

Please send complete INITIAL TREATMENT, 2 one-gallon cans of DRAINZ \$19.90 plus \$3.00 to assist with postage and handling (N. Y. residents, add sales tax). Enclosed check money order. No C.O.D.'s.

Name _____
Address _____
City/State/Zip _____

What's so amazing is...

That it took a man named Don Gladden 8 long years to perfect a magnetic filter attachment!

Don had worked on cars and engines for 22 years, learning all he could about engines. About 8 years ago, he began to wonder **why** there was so much powdered steel in the oil pan.

He discovered that since engines are tight and have very little clearance, large amounts of powdered steel begin to mix with engine oil, and are pumped back through the engine oil system and every engine wears more during the first 12,000-15,000 mile break-in period.

As a result, all moving ferrous parts wear out faster. There's wearing or sealing of rings to cylinder walls; timing-gear or chain to crankshaft gears; pushrod on valve lifters and pushrods on rocker arms. All these moving parts suffer "friction wear."

how can you protect your engine?

By installing "Magna-Cup" on your oil filter! **Magna-Cup** is made of a Dupont Nordel compound with complete resistance to temperature extremes. It's serviceable at temperatures up to 350 degrees Fahrenheit and weather resistant to cold as low as -60 degrees.

what is "magna-cup"?

MAGNA-CUP is universal in size—for all American made passenger cars and trucks with standard size disposable oil filters.

Helps reduce engine wear of vital parts.
Extends life of your oil filter.

Traps ferrous metal particles the filter misses, holds them in bottom of can.

Both oil and filter—more effective.



Helps eliminate one of the major causes of valve lifter noise.

Installs quickly without tools. Fits any standard screw-on and throw-away oil filter.

Transfers to new filter at replacement time.

Durable patented design.

Buy 2 and save up to 25%.

how magna-cup works.

Powdered steel and iron particles are present in the oil system of every internal combustion engine. Many of these particles are too fine to be trapped by the regular equipment filter. **MAGNA-CUP'S** strong magnetic fields reach through the oil filter can, thus gripping the particles and holding them securely at the bottom until the filter is replaced.

MAGNA-CUP stays good so long—it is not uncommon for you to remove **MAGNA-CUP** for future use when you replace your old vehicle with a newer model. Laboratory tests show that **MAGNA-CUP** will remove over 85% of damaging ferrous metal from oil.

The results of Don Gladden's 22 years of work on engines with the last 8 years concentrated solely on development of **MAGNA-CUP** enabling the trapping of these particles from your engine, is **REALLY AMAZING!**

We want to share this lifetime oil filter attachment with you. **The price is only \$5.95!** Don't you agree that \$5.95 (plus \$1.00 mailing and handling) is a small investment for the life-span of your vehicle? **ORDER 2 AND SAVE UP TO 25%! ONLY \$10.45 for 2, plus \$1.00 postage and handling.**

ORDER NOW Send check or money order only. No COD's

Mail to Magna-Cup, Eunice, New Mexico 88231

Send one magna-cup @ \$5.95 plus \$1.00 postage and handling
 Send 2 magna-cups for \$10.45 plus \$1.00 postage and handling

Print Name _____

Address _____

City _____

State _____

Zip _____



Be a technician people

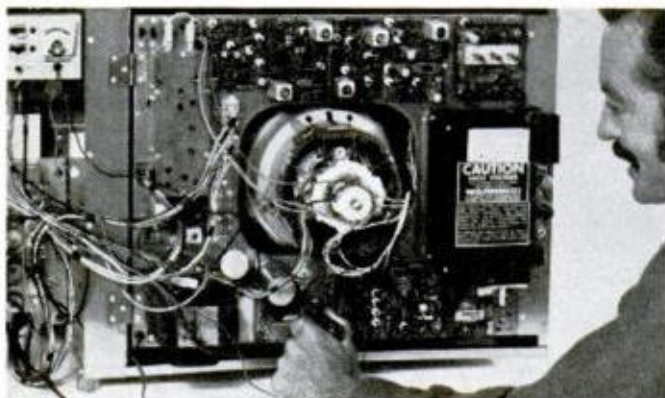

Be an NTS Trained Electronics Technician

Join the fast-growing world of electronics! NTS "Project Method" prepares you at home for a rewarding career in Color TV & Radio Servicing, Computer Electronics, Electronic Communications, or Industrial/Automation Electronics. Build-operate new Solid-State, Ultra-Rectangular Color TV, NTS Compu-Trainer, Transceiver, Oscilloscope, and more. Yours to keep. Check card for FREE, full color catalog, complete details.

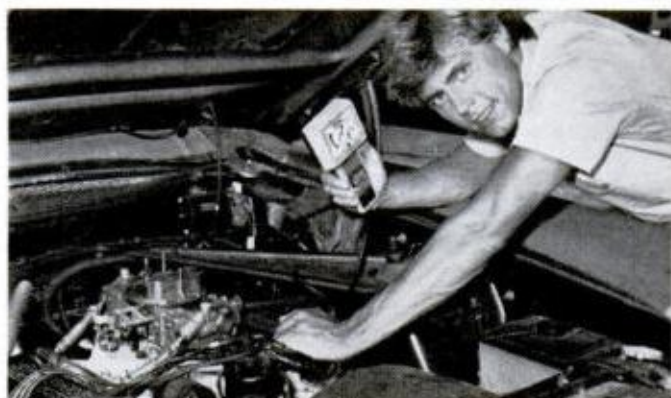

Be an NTS Trained Automotive Technician

America's largest industry needs 200,000 mechanic-technicians! Learn at home to perform complete engine diagnosis and tune-up, on the NTS Eight-Unit Test 'N Tune Center. Also, receive-keep professional 109-piece Socket Wrench and Tool Set. All included in your tuition. "Project Method" courses cover many new developments in Auto, Truck, and Diesel Mechanics. Check card for FREE color catalog today!



NATIONAL TECHNICAL SCHOOLS

Resident and Home Study Schools
World-Wide Training Since 1905
4000 So. Figueroa St., Los Angeles, Calif. 90037

SEND FOR FREE BOOK & SAMPLE LESSON

APPROVED FOR VETERANS

Accredited Member: National Association of Trade and Technical Schools; National Home Study Council.

CLASSROOM TRAINING AT LOS ANGELES

You can take classroom training at Los Angeles in sunny Southern California. NTS occupies a city block with over a million dollars in training facilities. Check box in coupon.



can't get along without

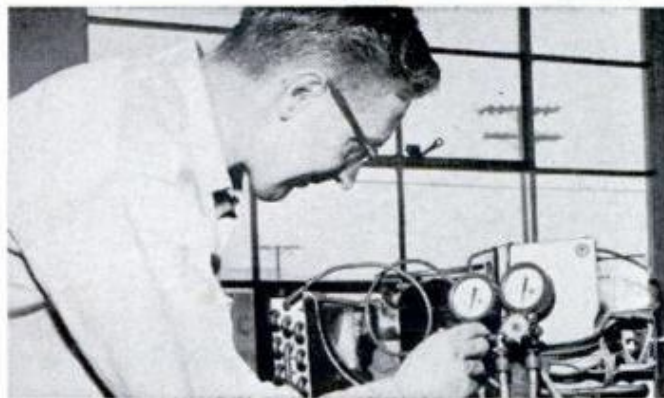

Be an NTS Trained Air-Conditioning, Refrigeration, Heating Technician

The demand is quickly increasing for technicians to install and maintain today's complex air-conditioning, refrigeration, and heating systems. NTS "Project Method" home-training makes it easy! Receive and keep the NTS Hermetic Analyzer, Leak Detector Soldering Kit, Gauges, professional Tool Set, and more. No extra costs. Check card for new, FREE catalog!

Be an NTS Trained Home Appliance Technician

Cash in on the huge appliance boom! Learn to service ranges, washing machines, dryers, home air-conditioners, and more. The exclusive NTS Circuit Trainer simulates for you circuitry commonly found in many appliances. "Project Method" course also includes Solid-State Motor Speed Control, Tester, and Hand Tools. No extra cost. Yours to keep. Check card for FREE catalog!



NATIONAL TECHNICAL SCHOOLS

Resident and Home Study Schools

World-Wide Training Since 1905

4000 So. Figueroa St., Los Angeles, Calif. 90037

Dept. 201-092

Please rush FREE CATALOG and SAMPLE LESSON for division checked below. No obligation. No salesman will call.

- Electronics Division
- Mechanics Division
- Air-Conditioning, Refrigeration, Heating Division
- Home Appliances Division

Name _____ Age _____

Address _____

City _____ State _____ Zip _____

- Check for veteran training under new G.I. Bill.
- Check if interested ONLY in classroom training at Los Angeles.

Who manufactures the newest, premium-quality rim fire rifles built the way you want 'em? Winchester... with brand new Model 9422 and 9422M rim fires carved from solid steel and rich walnut.

Side ejection port permits low scope mounting on solid, grooved receiver top.

Heat-treated chrome molybdenum steel bolt and bolt slide.

Solid American walnut stock with traditional Western styling.

Checked, non-skid butt plate inscribed "Winchester Repeating Arms."

Frontier heritage in your choice of the Model 9422 Standard for Shorts, Longs, Long Rifles . . . or Model 9422M Magnum for 22 Winchester Magnum Rim Fires: To be sure both these new Winchesters had all the rugged durability you could ask for, we first designed a magnum 9422M model, built specifically to handle all the extra power of the 22 Winchester

Magnum Rim Fire load. From that we developed the 9422 Standard . . . to handle all other 22 Shorts, Longs, or Long Rifles. We think this inherent extra strength will mean something to men who know guns . . . and who enjoy all the 22 rim fire sports. Choose the 9422M for 22 Magnum power that carries all the clout of Super-X, accurately, out where other rim fires give up. Choice of Jacketed Hollow Points, or full metal case.

New 9422M Magnum chambered for powerful 22 Winchester Magnum Rim Fires.

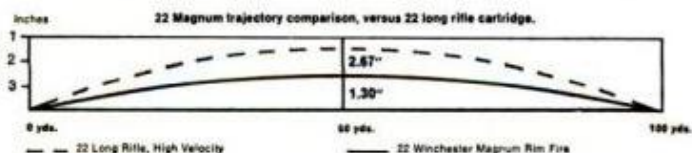



Ramp front sight with dovetail bead and hood.

Cold-forged Winchester Proof Steel barrel for strength and accuracy.

Adjustable semi-buckhorn rear sight.

9422 Standard tube magazine holds 21 Shorts, 17 Longs, 15 Long Rifles, 9422M Magnum holds eleven 22 Winchester Magnums.

Solid American walnut fore-arm, with Western-style barrel band.

Highly-polished, richly-blued receiver and frame machined from steel forgings.

Smooth lever action, machined from forged steel.

A choice of Standard or Winchester Magnum models available... each a 22 rim fire repeater with the unmistakable look and feel of the durable Winchester Model 94.

Astounding rim fire power at a price you'll want to pay. Or, select the 9422 Standard, chambered for Shorts, Longs, or Long Rifles, and made to work best with Super-X or T22s. Either way, the 9422s are Winchester the way you want 'em.

Forged Steel Construction: A reputation like the Model 94's means that any Winchester made like one had better be made right. That meant that only rugged, steel forgings could be used for the 9422 receiver, frame, finger lever and barrel. Strong, durable forged steel to take a mirror-smooth polish, to hold the deep, rich bluing, and to provide the lifetime of trouble-free performance you expect from a Winchester.

Strength-proved: The 9422s were put to the test against the most thorough and exacting standards ever devised by Winchester. We strength-proved these tough new rim fires with more than 1,000 special high-pressure loads, and then endurance-tested them all over again with 35,000 standard rounds. Then we turned the 9422s over to some of the toughest, most knowledgeable gun critics we could find... the Winchester men in the field who sell them for a living. We wanted to find fault. We wanted to make the 9422s quit. We couldn't. Today Winchester challenges you to find a finer pair of rim fire lever actions on the market at any price.

Winchester Proof Steel Barrel: Cold forged on custom-designed machines, Winchester Proof Steel barrels have created a standard of accuracy that is famous throughout the sporting arms industry. Winchester Model 70 and Model 52 target rifles with Winchester Proof Steel barrels have won more trophies than all other rifles in the world combined.

When we say the 9422s are all Winchester, from butt-plate to muzzle, we mean it.

Solid American Walnut Stock: Any sporting arm carved from solid steel calls for the finishing touch of rich, finely-grained walnut. The 9422 and 9422M have the unmistakable Western styling of straight-grip stock and carbine-style fore-arm... both of solid walnut... and with a wood-to-metal fit that says quality runs deep on these new Winchester. A new, four-coat satin finish compliments the rich, dark wood tones on both stock and fore-arm.

Side Ejection Port: The forged steel receiver has a solid top, with a right-hand ejection port. This means a low scope mounting on the grooved receiver top. Adjustable semi-buckhorn rear sights are standard. Front ramp sight with dovetail bead and hood.

Improved Lever Action: Both these handsome young rim fires have a smoother, easier-to-work lever action that makes follow-up shots an exercise in pure pleasure. And for extra-safe operation, the Model 9422 has a two-piece firing pin mechanism that operates only when the action is completely closed and locked. See the 9422 and 9422M at your Winchester dealers. **WINCHESTER**, 275 Winchester Ave., New Haven, Conn. 06504.



1972 | winchester
the way you
want it

How to get rich

START YOUR OWN BUSINESS RIGHT FROM YOUR HOME—AND MAKE A FORTUNE IN MAIL ORDER!



Mail Order Beginners Get Cash By Mail

Have you ever thought of operating a little mail order business of your own? Something you could start on a shoestring right from home in your spare time. It's a fabulous business!

Bob Carter of Newark, N.J. ran his first small mail order ad in *House Beautiful* magazine—offering an auto clothes rack. *Business Week* reported that his ad brought in \$5,000 in orders. By the end of his first year in Mail Order, he had grossed over \$100,000!

Another beginner—a lawyer from the midwest, sold a mail order item to fishermen. *Specialty Salesman* magazine reveals, "he made \$70,000 the first three months!"

There is no other business where you can make a fortune so fast. Come up with a 'hot' new item . . . and WHAM!

It strikes like a bolt of lightning!

Millions of people read your ad and suddenly, you are swamped with cash orders from all over the country . . . MORE MONEY in 60 days than you could earn in a lifetime!

Like the Vermont dealer who ran one ad in *Sports Afield* magazine. His ad pulled 22,000 orders—over A HALF MILLION DOLLARS IN CASH!

Yes, Mail Order is the fastest-growing, most profitable business in America! And now with the population explosion . . . the huge teenage market . . . and more people moving to the suburbs—we are on the verge of the BIGGEST BOOM in Mail Order history!

Free

If you are sincerely interested in starting a lucrative business of your own ACT NOW! We can help you get rich in Mail Order just as we've helped others. Mail the coupon or send a postcard. We'll send you a free book, catalog, ads and complete facts about our offer. No salesman will call. No obligation. You don't need previous experience but you must be over 21. Write to:

Mail Order Associates, Inc., Dept. 255
Montvale, New Jersey 07645

Mail Order Associates, Inc., Dept. 255
Montvale, New Jersey 07645
Please rush full details immediately.

Name
Address
City
State Zip.....

NEWS BRIEFS



Scaled-down penny-farthing

When a Londoner built a scaled-down version of the old penny-farthing bicycle for his daughter, so many people wanted copies that he now manufactures them. The bikes sell for about \$50.



Hardware-store art

How do common hardware-store objects look in a different scale and in different materials? Artist Claes Oldenburg set out to answer that, and the results—including this saw—were displayed at the new Pasadena Art Museum.



**Makes Over \$60 EXTRA a Week In
His Own Sharpening Shop**

"My Belsaw Sharp-All made me an extra \$3,500 last year. Now I am going full time. It's great to be your own boss."

DAVID SWANSON — Utica, Michigan



**Let Belsaw prove
YOU can do it, too! On our
30-DAY FREE TRIAL OFFER**

**JOIN THESE SHARP-ALL
MONEYMAKERS**

"I average \$5.00 an hour part time and business gets better all the time."

*Robert Barrett, Jr.
W. Springfield, Mass.*

"My Sharp-All shop is now averaging me \$300.00 a month."

*Roy Jennings
Sandwich, Illinois*

"Think the world of my Sharp-All. Am grossing \$4,000 a year on a part-time basis."

*Lawrence Stevenson
E. Syracuse, New York*

"There's excellent profit in sharpening . . . we now do about \$600.00 a month."

*Ed Kistler, Jr.
Sarasota, Florida*



You risk nothing by accepting this offer to see how easily you can turn your spare time into big Cash Profits with your own Complete Sharpening Shop. No selling . . . no previous experience needed. Our famous Sharp-All and show-how instruction set you up to make \$200, \$500, \$700 a month CASH sharpening Saws, Knives, Scissors, Lawnmowers, Shop and Garden Tools . . . all cutting edges.

**SEND FOR
FREE FACTS!**

Our Free Book tells how to start a profitable, lifetime home sharpening business, how we help you grow, how we'll finance you.

BELSAW SHARP-ALL CO.
713-S Field Bldg.

Kansas City, Mo. 64111

RUSH COUPON TODAY!

No Obligation . . . No Salesman Will Call

BELSAW SHARP-ALL CO. 713-S Field Bldg., Kansas City, Mo. 64111
Send details of FREE TRIAL OFFER and Free Book "Lifetime Security"

NAME _____

Address _____

City _____ State _____ Zip _____

**If you don't get copper plumbing,
don't buy the house.**

If you're building or buying, you owe it to yourself to insist on copper plumbing. Here's why:

Some newer plumbing materials are being promoted now as an answer to rising building costs. They may save you \$150-or-so on the initial cost of your home, but copper is still your best choice. Copper will not burn and decompose to toxic gases, or conduct fire through floors, walls, and ceilings. It will not sag with heat, or get brittle with cold. In the long run, copper plumbing saves money.

Copper plumbing is a quality product, backed by years of proven service. Your real estate agent or mortgage banker can tell you that copper is your best buy, and adds resale value to a house.

For a booklet with details, write: Copper Development Association Inc., 405 Lexington Avenue, New York, N.Y. 10017.



Announcing

Popular Mechanics Picture-Tools— the handiest shop-organizers ever designed

POPULAR MECHANICS PICTURE-TOOLS are a great new idea to take the confusion out of *what goes where* on workshop tool panels.

The complete PM PICTURE-TOOL KIT consists of seven big sheets (9¾ x 11¾ in.) of a special heavyweight paper with a pressure-sensitive adhesive on the back. On each sheet are beautiful drawings of hand tools and portable power tools—all (74 in total) you're likely to have in your shop. Most are full size; the others, only slightly reduced.

Also enclosed in the kit is a blank sheet of the same special paper, printed in an overall color to match the tools. This sheet enables you to design your own drawings or silhouettes of any special tools you have.

Each of the PM PICTURE-TOOLS is carefully die-cut. You simply peel it off the backing paper and apply it to the proper spot on your panel. You can apply PICTURE-TOOLS to any painted or unpainted wood, plywood, hardboard and even perforated-hardboard surface.

Later if you want to move a few tools or rearrange the entire panel, you can peel off

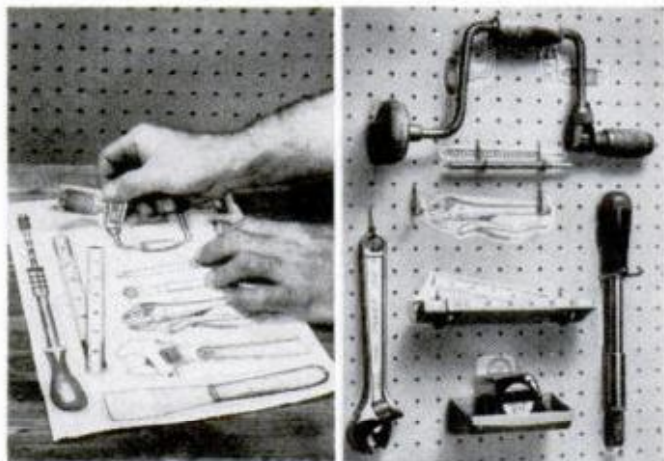

the PM PICTURE-TOOLS and move them to new locations. They are reusable!

Once your PICTURE-TOOLS are in place, you'll know at a glance exactly where each tool in your shop belongs. You'll also know—again at a glance—what tools are missing.

Best of all, you'll be surprised how PM PICTURE-TOOLS will instantly and dramatically enhance the appearance of your shop!

Order your PM PICTURE-TOOL KIT today!

Only
\$3.95

Popular Mechanics, Box 1014 (Dept. PT), Radio City, N.Y., N.Y. 10019

Enclosed is my check or money order for \$3.95.

Send my PM PICTURE-TOOL KIT to:

Name _____

Address _____

City _____

State _____

Zip _____

ITT Credit Reserve gives you the security of knowing \$3,000 is available to you within 24 hours.

ITT Credit Reserve is a personal financial service funded and established by America's eighth largest company, International Telephone and Telegraph Corporation.

By joining, you establish for yourself and your family a \$3,000 line of credit, all or any part of which may be drawn upon in less than 24 hours.

Interest rates are reasonable, and payment schedules are flexible. ITT Credit Reserve meets all credit standards for lending services.



ITT CREDIT RESERVE

a service of International Telephone and Telegraph Corporation



Please send information on ITT Credit Reserve. No obligation.

NAME _____

ADDRESS _____

CITY _____ STATE _____ ZIP _____

Mail to: K. B. Leverly, Service Director
2183 First Security Building, Salt Lake City, Utah 84111 or phone toll-free 800-453-5316

JOCK ITCH ISN'T SOMETHING TO BE TREATED LIGHTLY.



Jock Itch is a fungous infection. It can become serious. It can keep coming back even though you try all manner of "remedies," from baby powder to petroleum jelly.

But you can get fast relief with Cruex®, the spray-on medicated powder specifically made to fight Jock Itch.

Cruex soothes itchy, inflamed skin. Cushions against further irritation. And absorbs perspiration

(an important factor in the growth of Jock Itch fungi—tinea cruris). Its medication directly attacks susceptible fungi. And because you spray Cruex on, you can reach into hard-to-get-at places and avoid the sting or burn of rubbing, dabbing, or smearing. So fight Jock Itch seriously (and help keep it from recurring) with cooling, soothing Cruex. Guaranteed to work or your money back.

CRUEX, THE MEDICATED SPRAY SPECIALLY FORMULATED TO FIGHT JOCK ITCH.

©1972 Pharmcraft Division Pennwalt Corporation

Pharmcraft
PHARMACRAFT

OCTOBER **Preview** OF POPULAR MECHANICS



A BUSY SHOP WITH A LIVING ROOM LOOK

A PM reader in Winchester, Va., shows us his shop that's neat enough to double as a study. And it does; it's a wing of his house.



'73 CARS: ANNUAL NEW-CAR ISSUE

PM previews the new models from Detroit—and adds an exciting array of mid-engine machines from overseas for those who really love cars. Beyond the glamor: a close look at safety.



HOW PLUG-IN TROUBLESHOOTING WILL SAVE YOU MONEY

VW's computerized analysis gives the owner a print-out of what his car needs to bring it up to specs. Other manufacturers will follow VW's lead.



NEW TAKE-DOWNS THAT PUT IT ALL TOGETHER FOR ARCHERS

The take-down, a new kind of bow, is revolutionizing the sport of archery. It makes possible more fun for less money for the whole family.



HOW TO GET A PEELPROOF PAINT JOB

No better month to paint your house, but do the job right. Here's how to get rid of moisture that causes paint to peel and blister.

PLUS

What they're doing to prevent football injuries • A new kind of trail bike that goes in snow • The Mini-Mustang, a 250-mph homebuilt plane • Expandable gateleg table that seats 12; you can build it for \$100 • How to make beautiful spiral candlesticks • How to get special effects with your camera.

Buy it on your newsstand. Better yet, make sure you'll keep getting this kind of exciting fare. Send this coupon with your check to:

POPULAR MECHANICS
250 West 55th Street
New York, New York 10019

Please enter my subscription for 1 yr. \$5 or 2 yrs. \$9

Name _____ (Please print)

Address _____

City _____ State _____ Zip _____

Payment of \$_____ is enclosed. New Renewal

On new subscriptions, first copy will arrive in about 8 weeks.

(Above prices apply in U.S. and Possessions only. Canada, add \$2 per year. All other countries, add \$4 per year.)

WPM211

New square-cornered Sylvania picture tube

Handsome woodgrain cabinet, at no extra cost. (Offered only by NRI)

6-position detented UHF channel selector

Modular construction with plug-in circuit boards

Automatic color control

Automatic degaussing

Automatic tint control

100% solid state chassis

Automatic fine tuning



NOW... learn color TV servicing while building this NEW 25" SOLID STATE SET created by NRI for home training

NRI wanted more than a hobby kit TV . . . so we built one from the circuits up, specifically for teaching advanced electronics. You can only get this superb set from NRI . . . it's exclusive with NRI Color TV Servicing Course.

NRI was first to supply home study students with custom-designed training kits to give practical hands-on experience as you learn. Now NRI scores another first . . . with the exclusive 25" picture tube, solid chassis, color TV set designed-for-learning. You build it yourself with NRI's TV-Radio Servicing Course.



Kit for kit, dollar for dollar, you get more for your money from NRI.

The TV-Radio Servicing Course includes a wide-band service type oscilloscope and a color bar cross-hatch generator . . . along with

other valuable equipment you will use to perform experiments and make repairs on your own and other sets.



You'll soon find yourself earning \$5 to \$7 an hour, in your spare time . . . even before the course is completed.

Learning at home is easy . . . the simplified NRI way. Texts are "bite-size" and fully-illustrated, leading you step by step, stage by stage, to a thorough

knowledge of electronics. You can introduce defects into circuits, perform experiments, and discover the how and why of circuitry and equipment operation.

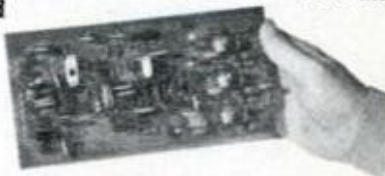

Train with the Leader—NRI.

The same training innovations which have made NRI the leader in career training at home are now available to you. Mail the insert card for a free full-color catalog which spells out the NRI "discovery" method of learning. There's no obligation. **NO SALESMAN WILL CALL.**

APPROVED UNDER NEW GI BILL. If you have served since January 31, 1955, or are in service, check GI line on reply card.



NRI TRAINING

3939 Wisconsin Avenue, N.W.
Washington, D.C. 20016



LISTENING POST

BY ROBERT LUND

DON'TS FOR DO-IT-YOURSELFERS. Don't modify your car or hang doodads on it unless you know what you're doing. You could be buying trouble—an accident, invalidating your warranty, voiding your insurance. Wilton Nelson, a GM safety engineer, has cataloged some horrors resulting from car-owner alterations. Some of his no-nos:

- Don't mount tachs, trailer brake controls or stereo tape decks on the steering column. They can interfere with compression of the column in a collision.
- Don't put a spinner knob on the wheel. Despite popular belief, it makes handling more difficult during cornering.
- If you alter the rear end to give your car a dragster look, don't get the back so high that the gas tank is exposed. The tank should be protected from direct contact by another car if you get clobbered from the rear.
- Don't clip hard objects to sun visors. One driver had to have 21 stitches for a facial laceration after being propelled into a garage-door control hung on the visor.

GM FIRST WITH FUEL INJECTION? *It looks that way. Report is that GM will introduce electronic fuel injection as a running change—first on Pontiac, possibly on Olds—during the middle of the '73 model run. Say along about February. This is a beat-you-to-the-draw victory by GM over Ford, which has been ready to go with EFI for more than a year. The reason Ford's been slow getting off the mark is because it has been looking at second and third generation systems, which are so far advanced over the original device that the company figured it would hold off until it could go with one of the improved versions.*

WANKEL WON'T SELL FOR A SONG, believe the money men at GM and Ford, hard at it figuring what it will cost to get the Wankel out of the lab and onto a line. Their estimates are pretty wild, ranging from \$300 over the cost of producing a conventional engine of comparable power up to a premium of \$600. Those are blockbuster numbers, even for Detroit. You can forget that stuff you've heard about the Wankel selling for a low price because of its simplicity and the fact it uses fewer parts than a conventional engine.

As GM points out, the Wankel has to be re-

lated to other components. It's not just a matter of putting a smaller engine in the same space and hooking it up with the same ancillary hardware on cars now. When you buy a Wankel, you'll get a car that's been re-engineered throughout. And you'll be charged for it.

BLUE-JEAN SEATS for the '73 Gremlin are sure to give American Motors dealers a lot of questions they didn't bargain for. "You just don't jump into your 'Levi's' Gremlin without washing that blue denim right off—can you throw those covers in the machine? They



shrink? Got a quick-fade kit? How do you sew on patches? Or tie-dye 'em? What's the market for used seats, you know, really faded, lots'a character?" Dealers weren't put against the wall with the Gucci Sportabout or the Pierre Cardin Javelin. Good luck, guys!—B.H.

NEW PREMIUM BATTERY'S COMING from GM. *It will be a throwaway, guaranteed for a specified number of months, and completely maintenance free from installation to disposal. No word when it will go on sale.*

THE SPY THAT FAILED. Remember how Sherlock Holmes could look at the angle of a guy's bowler and tell he'd taken tap-dancing lessons in Pretoria, had kippers for breakfast and always voted Tory? Then after the legendary sleuth ex-

plained how he'd reasoned it out, it seemed so simple? Well, it isn't. I tried it.

An advice-to-management outfit the auto companies subscribe to warned them that they may be leaking secret information by requiring visitors to sign a register at the reception desk. All auto plants ask you to sign in before admitting you to the back room. "To an observant visitor," the advisory service cautioned, "the names of individuals and companies on the register could reveal future plans, trends in production, equipment being considered, pending acquisitions or mergers." I figured that here was an idea worth investigating.

On visits to nine different plants and offices, I scored zero. Seven places had no register books. Instead, they get you to sign a slip of paper, which the receptionist hides under the blotter on her desk. Where sign-in books were used, most of the signatures and identifications were illegible. I could make out only the names of a salesman representing a paper-towel company and an auto writer for a trade magazine. If they had kippers for breakfast, you couldn't prove it by me.

BIG CARS COMING BACK? The auto companies talk a good line about giving car buyers what they want, but the line has a couple of hooks. Carbuilders give the customer what he wants, big IF (1) it suits Detroit's purpose and, (2) the auto firms can make money on it. Case in point: Detroit's decided most people want bigger cars, even though all the sales figures and indicators point to smaller cars. Detroit's never been sold on small cars—not enough profit in them.

How do you sell big cars if people want small cars? Engineers are the first to say they can't continue to design small cars because of safety regulations coming after 1974. The argument is that the only way more energy-absorbing capacity can be built into bumpers and frames is by going to bigger, bulkier cars.

The imported-carmakers can meet the safety requirements with sensibly sized vehicles. Domestic manufacturers can do the same.

YOURS FOR THE ASKING. Do you really need new parts? Or is the service guy trying to hustle you? Firestone's put out a book that'll help you decide. Write to J. B. Scarcliff, Director Consumer Affairs, 1200 Firestone Pky., Akron, Ohio 44317, for "Facts on Car Care." It's surprising to find a company in the service business saying you may not need new parts, that rebuilds may be just as good. Good tip, good book. ★★ ★

How to make the freshest filter cigarettes ever for less than

20¢ a pack*



1. The Laredo Filter Blend Kit contains a can of fresh vacuum-packed tobacco, a cigarette-making machine and the makings for your first five packs. Cost: less than \$2.*



2. Place one of the paper tubes over the metal spout of the cigarette-making machine. The machine is simple and easy to use. Yet, it's so sturdy, it's guaranteed for two years.



3. Next, fill the large slot with Laredo tobacco, then drop a filter in the small slot. Now you're all ready to make the freshest tasting filter cigarette you've ever smoked.



4. Push the lever forward, pull back, push again and there you have a filter cigarette that looks factory-made, tastes factory-fresh...in just seconds. Easy, wasn't it?

Refills contain filters, paper tubes, carry-around packs...and enough vacuum-fresh Laredo tobacco to make five more packs. The cost: under \$1.* Less than 20¢ a pack!*

MENTHOL SMOKERS: Make the freshest menthol filter cigarettes ever for less than 20¢ a pack.*

* In most areas of the country—based on manufacturer's suggested retail price.

LAREDO FILTER BLEND



Regular

Menthol

© 1971 BROWN & WILLIAMSON TOBACCO CORP.

Isn't it nice to know
that while you're
taking care of her,
High Seas is taking care
of your face?



Sometimes you don't
have time to take care of your
face the way you should.

To protect it against
the things a face runs up
against during the day.

Well now you can
with High Seas, the new
conditioning after shave.
High Seas has emollients.

It feels different than
other after shaves. These emollients
soothe and smooth your face and
help keep it from drying out.
High Seas®. The new conditioning
after shave. It takes care of your face.
While you take care of other things.



High Seas is a trademark ©1972 S.C. Johnson & Son, Racine, Wisc. 53403

Quick- change ideas for easy entertaining

Autumn—a great time for entertaining. You're all for having a party. Or the kids want to have their friends over on Saturday night. But your basement or family room isn't finished—yet. What can you do that will make a big difference in a hurry—but won't cost a bundle?

You can work wonders with homebuilt screens that hide basement clutter; make a king-size, low-cost buffet table that comes apart for easy storage; get compliments on clever cube-type seating and tray tables that cost very little; brighten the scene with novel party lighting and a new kind of hi-fi center. You'll find many such quick-change ideas on the pages that follow.

**P.M.'s versatile
piano bar**

**For party
fun**

**Swivel hi-fi
center**

**Basement
spruce-up**

**Hideaway
home theater**

**Stacking
tray tables**

PM's versatile piano bar

By WAYNE C. LECKEY, Home and Shop Editor

Color photo by Robert D. Borst
Cabinetry by Everett Johnson

BBENDING AN ELBOW while singing *Sweet Adeline* around a piano can be twice the fun at a party when there's a place to make or park a drink. PM's handsome wraparound bar adds a handy mar-proof counter to any spinet-size piano. And since the bar hides the unfinished back of the piano, no longer must the piano remain against a wall—it now can be in the center of the party in the middle of the room.

Doors in the front of the bar provide handy access to glasses and all the fixings. In addition, there are storage compartments for sheet music at each end,



It's a buffet



It's a headboard

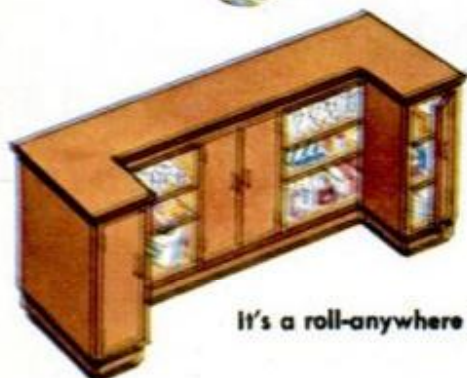

It's a roll-anywhere bar





SEPTEMBER 1972

75

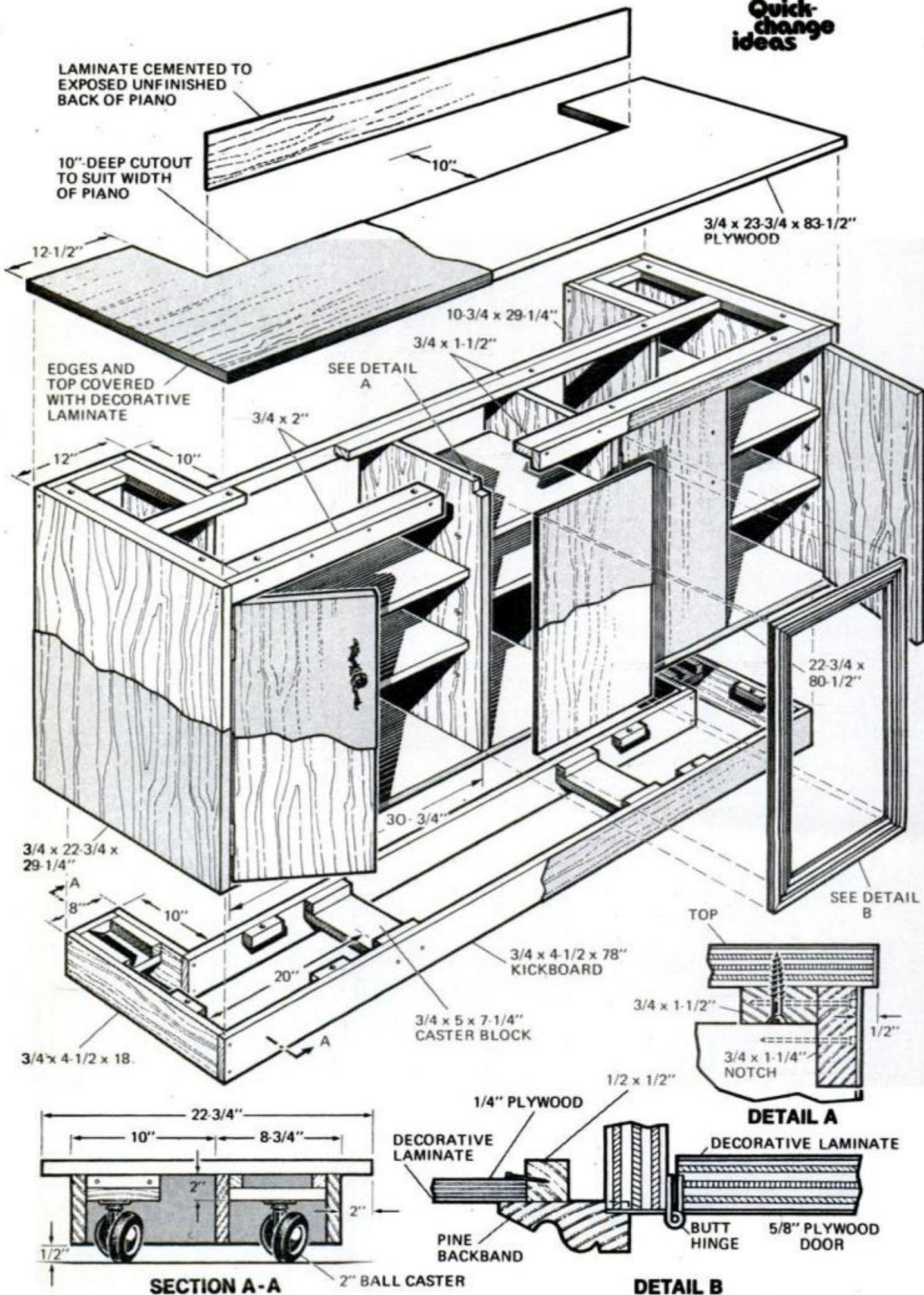

readily accessible from the piano side.

You can use this versatile U-shaped cabinet in several other ways. It will serve as a roll-anywhere bar, equipped with open shelves on the back for glasses and a roomy liquor cabinet you can lock. It makes a practical headboard for a bed, a perfect serving counter for a buffet dinner and, when it is parked under a permanent wall-mounted shelf unit, the bar becomes a handsome buffet.

Except for rails, the bar is made from fir plywood, $\frac{3}{4}$ -in. thick for the sidewalls, top and bottom and $\frac{5}{8}$ -in. for all doors. You'll also need a scrap of $\frac{1}{4}$ -in. plywood for the center panel.

Because all exposed surfaces are eventually covered with a wood-grain laminate (Formica), plain butt joints are used throughout and fastened simply by nailing. The cabinet, identical on each side, is made to fit the piano. The original bar required a wraparound cutout of $57\frac{1}{2}$ in. which provided $\frac{1}{4}$ in. clearance.

As you'll see in studying the plans on the opposite page, the bar consists of three separate assemblies, a caster-fitted base, the main cabinet and a top. All shelves are fitted loosely so they can be raised or lowered to suit. The two end walls lap the U-shaped bottom, while the liquor-cabinet walls rest on the bottom and are nailed to it from below. Pine rails ($\frac{3}{4}$ x2-in.) join the members at the top, front and back, and a second rail ($\frac{3}{4}$ x1 $\frac{1}{2}$ in.)



BAS-RELIEF CARVING is cemented to center frame as decorative touch. Contact cement secures it to slick laminate, or it can be screwed on from back

provides a way to attach the top with short screws. Similarly, glue blocks are provided for attaching the caster base to the bottom of the cabinet.

Notice in section A-A that the four
[\(Please turn to page 186\)](#)

APPLYING LAMINATE

Laminates come in sheets that range from 2x5 to 5x12 ft. and in a wide choice of wood grains and finishes. We picked cherry and a suede (no-gloss) finish. While you can apply contact cement with a brush, a notched spreader assures an even coat. The cement is applied to both the wood and the laminate in a well ventilated room and allowed to dry for 20 minutes. To test when cement is dry enough, touch the coated surfaces with shopping-bag paper; if no glue sticks to it, surfaces are ready for bonding.

Contact cement requires only momentary pressure. Light tapping with a hammer and wooden block will assure that surfaces will bond well. For more detailed instructions, refer to *How to Work With Plastic Laminates*, page 154, March '70 PM

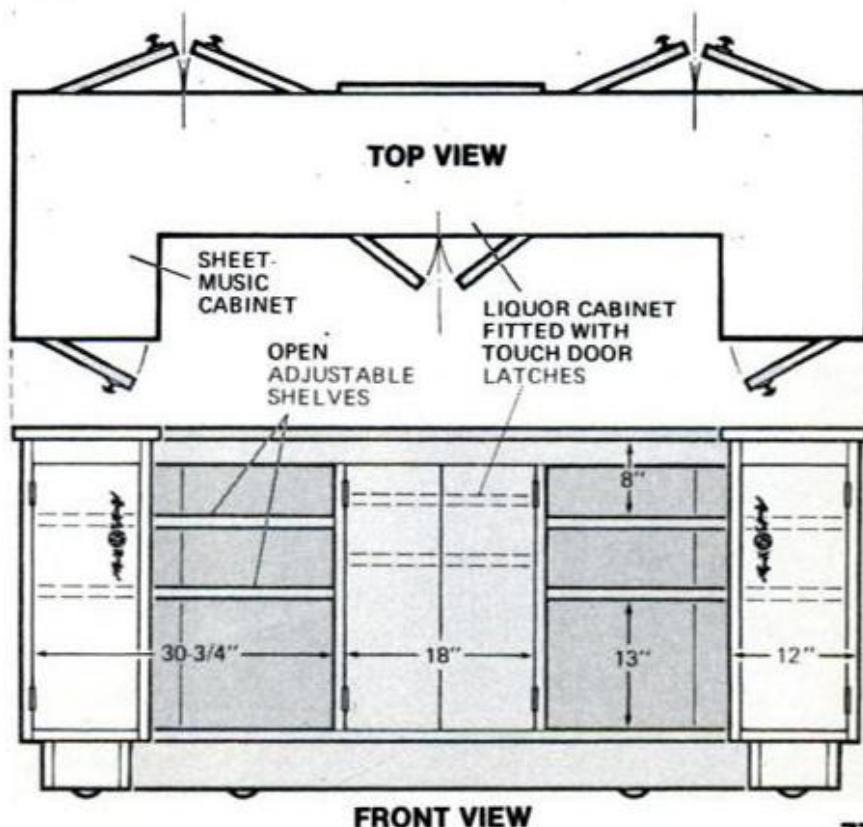

Quick-change
ideas

for party fun

GOLF-IN-A-BOX consists of a 3 x 9-ft. strip of synthetic turf and everything needed to "putter" around indoors at a party or out on the patio and driveway. Recessed cups are flush with the green to avoid tripping and turf rolls up for storage. Kit includes cups, flags, reversible putter and ball. Made by Ozite, the game is sold nationally at golf shops, department stores and discount houses. The price tag is \$39.95.

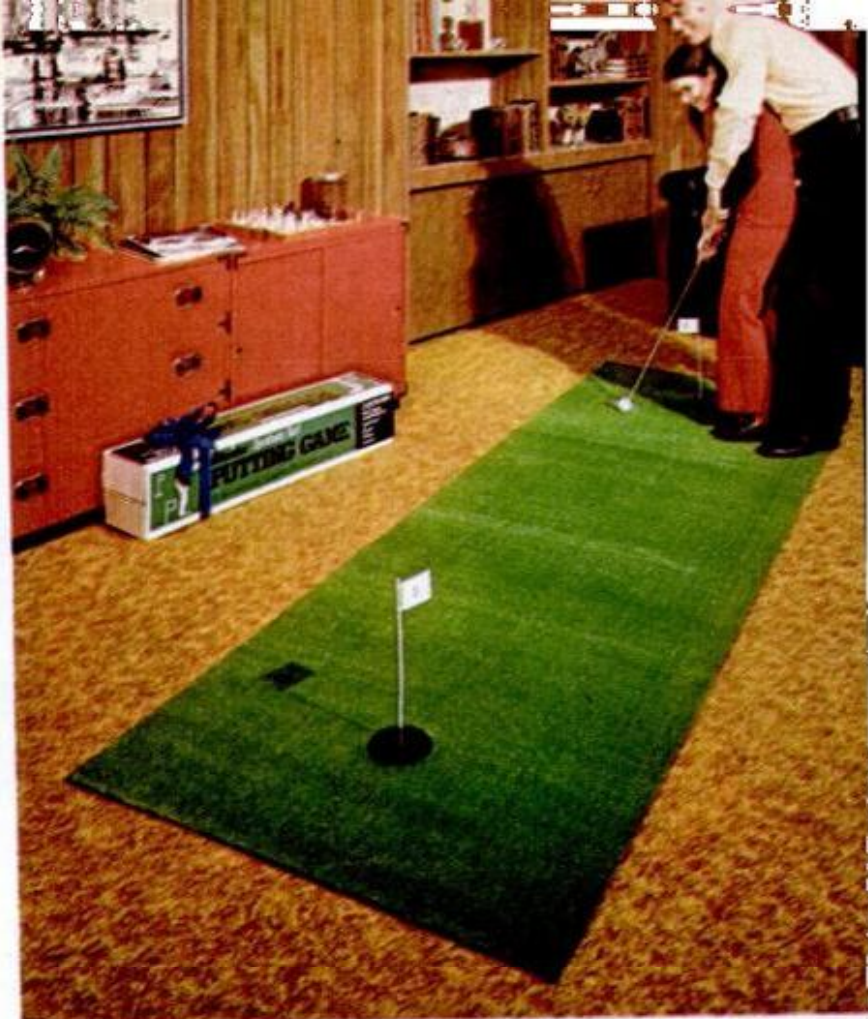

PERFECT FOR A PARTY, this electric grill on wheels lets you char-broil mouth-watering steaks right in the center of things without a trace of smoke or fumes in the room. Cooking odors are ducted and whisked outdoors by a powerful below-the-surface fan. You build the cabinet and drop in the grill which you buy. To obtain instructions for building it send \$1 to Popular Mechanics, Dept. CO, Box 1014, Radio City, N.Y. 10019.



MINI TENNIS is made to order for a party. Measuring only 30x60 in. it's just the right size to set up in a crowd, and special foam-covered paddles reduce flight of ball in proportion to size of table. Card-table size when folded, it stores in a closet, weighs only 32 pounds. Remove net, and the table doubles as handy food server. Made by AFCOA, Dearborn St., Chatsworth, Calif., 91311. Retail for \$24.95. Available through dealers.

78





INFLATABLE LIGHTS add colorful, festive atmosphere on party occasions. Each consists of doughnut-like balloon you blow up around a central plastic cylinder. Bulb hangs in center (lower photo at right), illuminating the ball from inside without actually touching it. Kit (upper photo at right) includes balloon, cylinder, socket with 15-foot cord and ceiling hanger. Globes are 19 inches in diameter, come in four colors—red, yellow, blue and white. Price each \$5.99 from Sears.

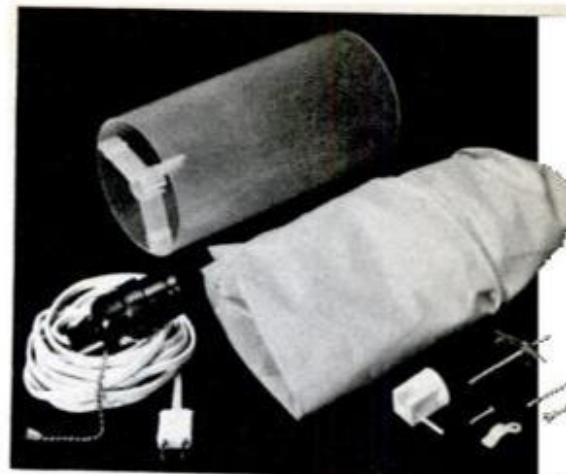

PORTABLE BAR parks in closet between parties behind louvered "saloon" doors, rolls out on casters. Easy to build from plywood, bar has spillproof top, "brass" rail and shelf space. For photo copy of article, published as *Build a bar just for the fun of it* (page 136, Aug. '67 PM) with full instructions for making bar, send \$1 to Popular Mechanics, Dept. CO, Box 1014, Radio City, N.Y. 10019.

Swivel hi-fi center: Now you see it, now you don't

By **SHELDON M. GALLAGER**
Photos by Robert D. Borst

A SMART PIECE of furniture by day, an active entertainment center at night—that's the quick-change convenience you get from these stacking enclosures on rotating swivels. Each unit is designed to house one type of equipment on one side and another on the opposite side. Each swings freely on its own pivot, independently of the others. Turned one way, the units provide spaces for books, knick-knacks, pictures and other decorative objects. Swung the other way, the stack changes magically into a hi-fi center with speaker, tape deck, tuner, amplifier, record changer, television set and other electronic gear.

The units are simple boxes—in most cases, open at both ends—so there's no complicated carpentry involved. Three basic modular sizes can be combined in any order and number you wish to handle the particular equipment you have. All have an inside width of 19 inches with a choice of three heights—10½, 14 and 17½ inches. If you like to rack-mount your hi-fi components, you'll note that these dimensions correspond exactly to standard rack-panel sizes—another feature of the modular design. The shallowest unit is handy for small bookshelf-type speakers, receivers, amplifiers and similar low equipment. The middle-sized 14-inch module handles taller items such as a vertically mounted tape deck, table-model television set or record storage. The still larger 17½-inch unit

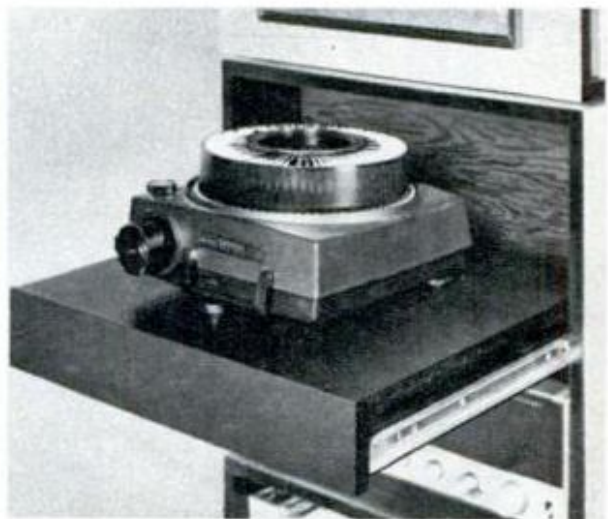
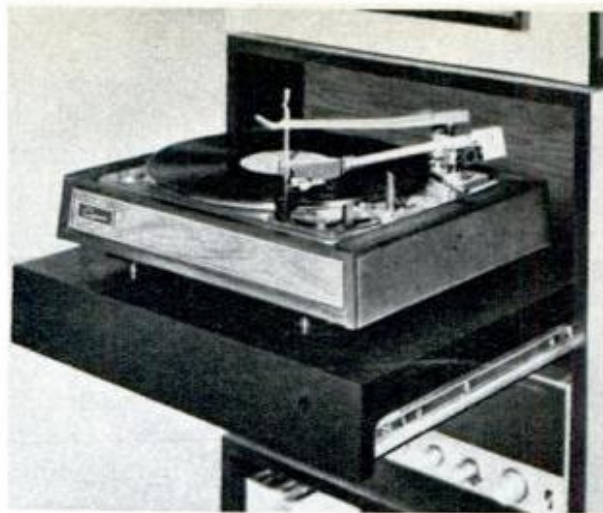

SLIDE-OUT SHELF is versatile accessory that can make normally hard-to-reach equipment easily accessible. At top, it holds Garrard record changer; at center, Panasonic cassette tape deck; at bottom, Kodak Carousel slide projector. On facing page, it doubles as a handy snack server for party guests, sporting one of Panasonic's colorful electric fondue cookers. Shelf is easy to make using standard 18-inch roller-bearing drawer slides available at hardware stores. Front lip and recessed side rails hide most of hardware from view. One helpful hint: Rear edges of shelf must be notched out so you can press down on release catches to disengage rails and remove unit from cabinet. Otherwise, shelf will remain locked in once it is inserted in the tracks

provides extra overhead clearance for record players with swing-up covers and compact receivers with a turntable on top.

The column shown here is made up of five modules—one 10½-inch size at the top for a speaker, three 14-inchers for general use and one 17½-incher for bulky gear. Their total height comes to 82 inches—just short of 7 feet and about maximum for good appearance in an 8-foot room. All modules are square so they automatically line up with each other no matter which way they're turned. Only the bottom unit doesn't rotate. This rests on a recessed

kickboard and forms a fixed, stable base for the swiveling units above it.

All sorts of variations are possible, depending on the particular features you want. You'll note that one unit incorporates a colorful telephone niche, another a sloping magazine rack. The large unit houses a slide-out shelf, handy for quick access to equipment that needs to be reached from the top, such as a turntable, cassette tape deck or slide projector. The shelf can even be used as a mini pull-out bar or snack server for party fun. Internal partitions can be installed wherever needed to divide the units into double-sided en-



SWIVEL ACTION permits TV set to be turned for best viewing angle, along with speaker unit at top. When not in use, TV can be hidden from view. Light fixture is one of many dress-up touches you can add

THREE BASIC SIZES OF STACKING UNITS

¾" REGULAR OR LUMBER CORE PLYWOOD

Quick-change ideas

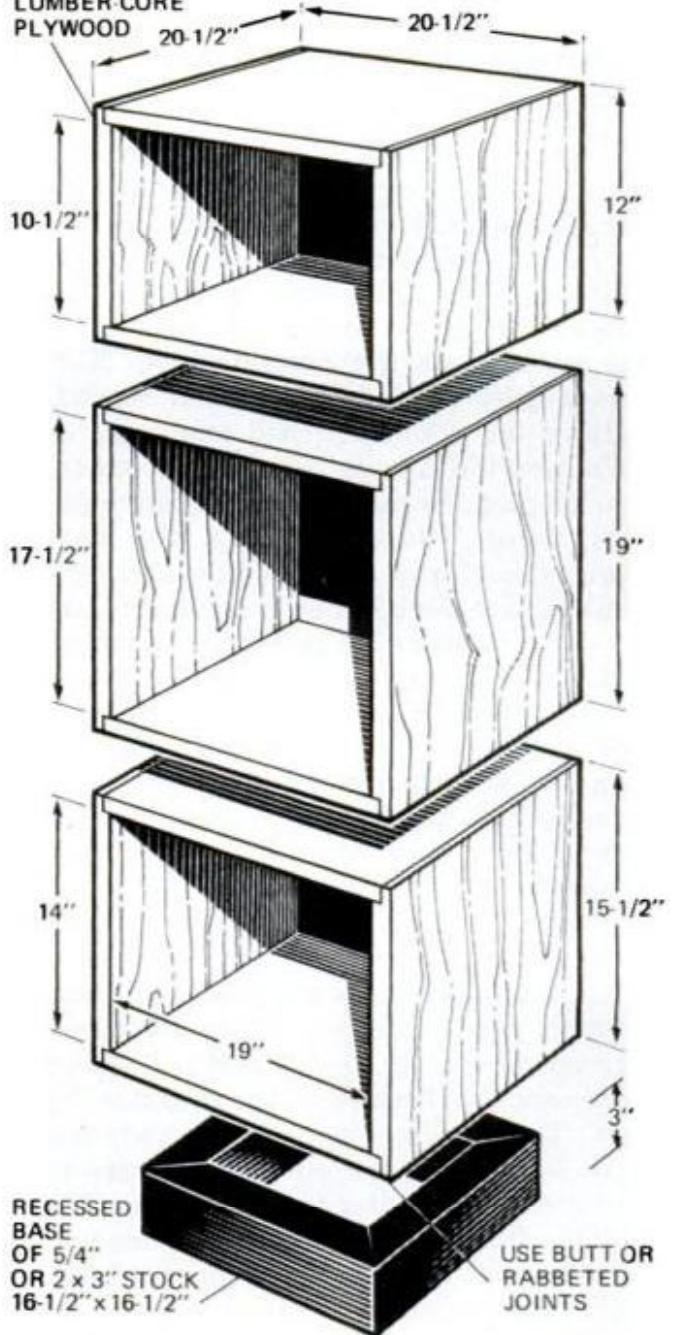

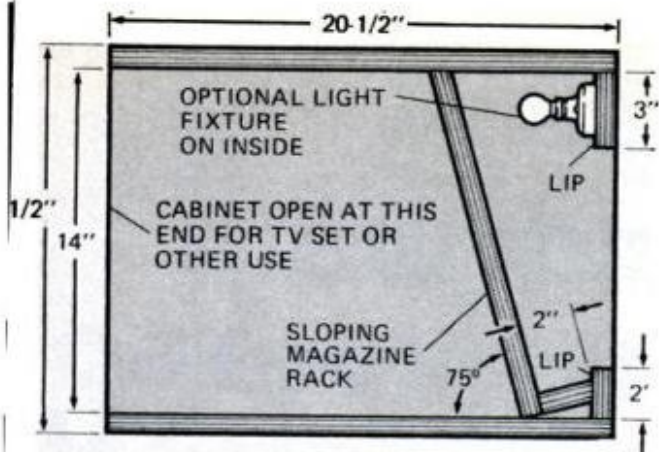

MAGAZINE RACK is shown in detail view above

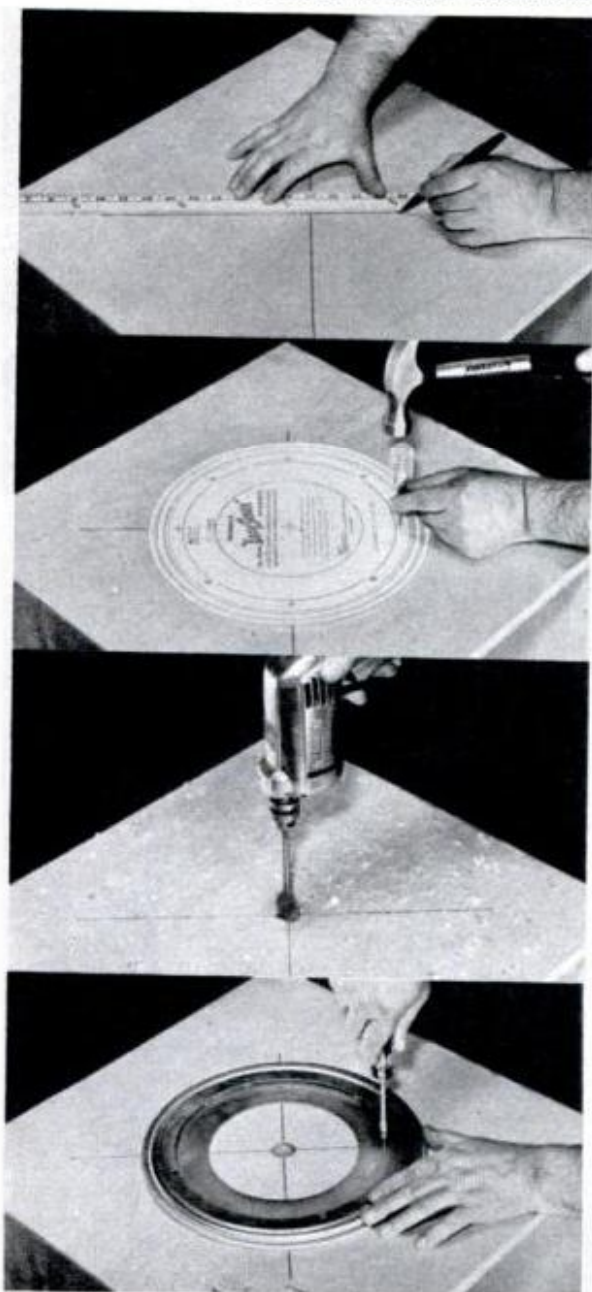
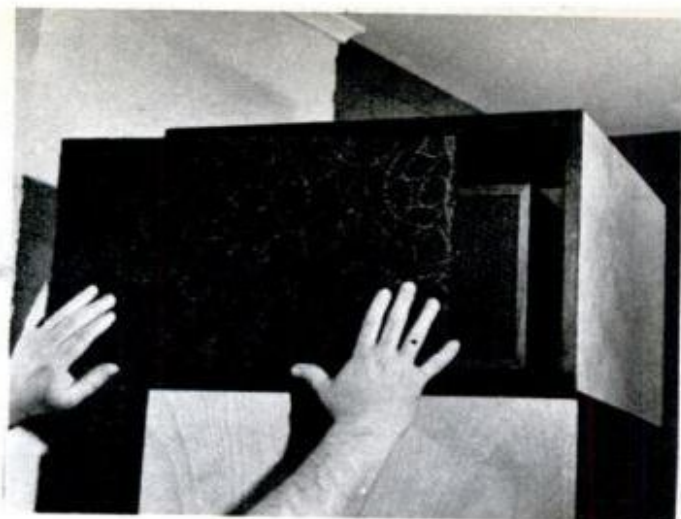

SWIVELS ARE EASY TO MOUNT because they come with marking templates. At top, center is found by crisscrossing diagonals from corners, then template is used to mark screw holes with hammer and punch. Center hole is drilled for wires, then swivel is screwed on (bottom photo). Photo at top right shows Heath speaker and slip-in grille of speaker cloth stapled to 1x2 frame

SEPTEMBER 1972

closures open at either end. The top unit, for instance, houses a speaker on one side, a shallow knickknack shelf on the other. The magazine rack hides a TV set in back; an innocent-appearing bookshelf conceals a reel-to-reel tape deck on the opposite side.

The swivels are standard 12-inch-diameter ball-bearing types used for making lazy-Susan tables, rotating kitchen shelves and the like. They're available for \$3.95 each postpaid from Edmund Scientific Co., 300 Edscorp Building, Barrington, N. J. 08007. The swivels can support up to 1000 pounds apiece and turn with surprising ease, even when weighted with heavy hi-fi gear. Attaching them is easy because each comes with a cutout marking template to simplify the location of mounting screws. Power cords, speaker leads, audio cables and antenna wires all run down through 1-inch-diameter center holes drilled in the top and bottom of each module. To avoid excessive twisting of the wires, simply remember not to turn the units constantly in the same direction. Rotate them one way to get at one side, then the other way to reach the opposite side.

Constructing the modules is easy because they fit so closely together (the swivels are only $\frac{3}{8}$ inch thick) that corner joints are scarcely visible. You can use rabbeted joints if you wish, but simple butts will also do, using glue and small finishing nails. The units shown here are made of $\frac{3}{4}$ -inch solid-core birch plywood finished natural on the outside. Less expensive ordinary plywood could also be used, especially if you prefer a painted exterior. In any case, painting the edges will adequately hide exposed end grain. Most units here are painted with satin black enamel inside to contrast smartly with the natural birch exteriors. However, for an even gayer, more colorful effect, each module could be painted a different hue. ★★

Quick-
change
ideas

Quick ways to spruce up the basement

Hide furnace, workshop, washer, dryer with quick-change walls and screens, add some quick-made accessories—that 'impossible' basement will take on a party look with minimum effort and money

ARMSTRONG CORK CO. PHOTOS



PARTY FURNITURE that you can make yourself from inexpensive plywood can include these two clever card tables. One above is simple box with playing-card designs added to sides; table below is supported by Lally column



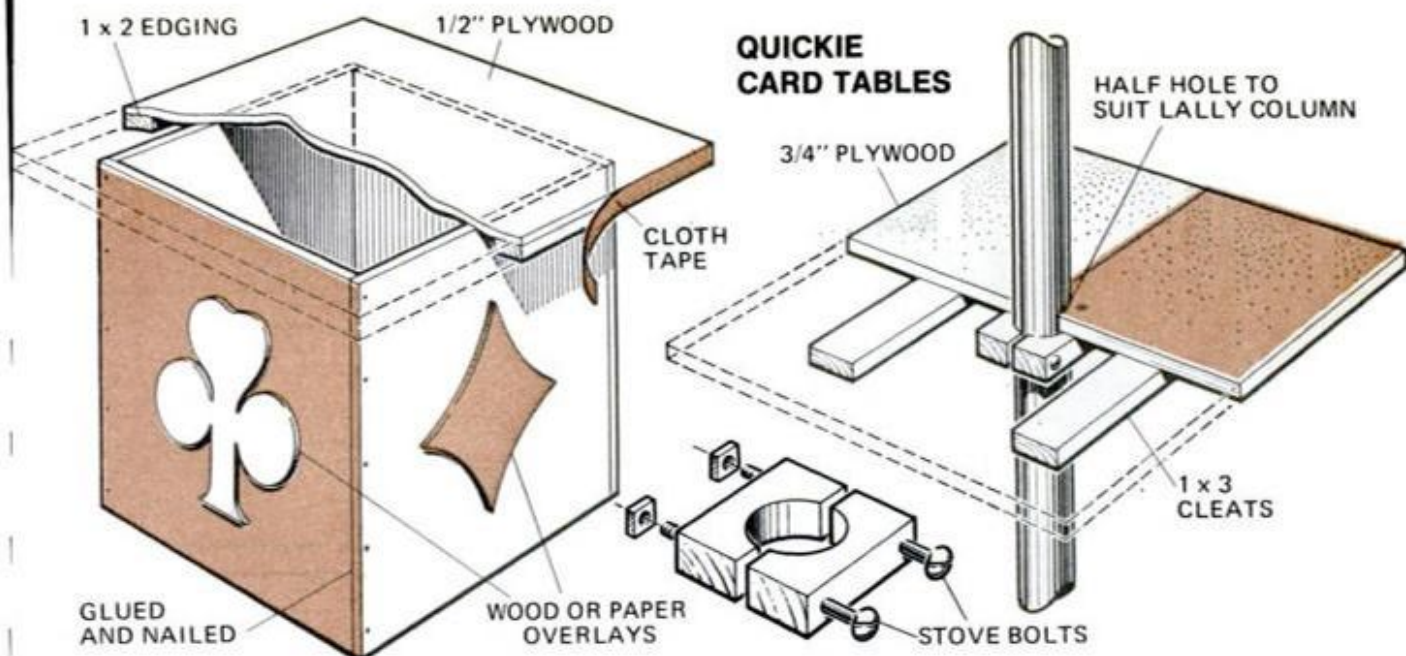

YOU'VE BEEN THINKING it would be fun to have a party—perhaps a big gang of 10 or more couples. But where will you put them all? Your wife suggests the basement, if you fix it up a bit. But you shudder at the thought of trying to make it presentable without spending a bundle or a month of Sundays. You'll be surprised at what improvements you can accomplish for a few dollars and a minimum of effort.

Mostly, it's a case of "cover up"—hiding the furnace, oil tank, water heater; screening a washer and dryer from view, concealing your workshop or just covering up general basement clutter. Concealment alone covers a multitude of sins in sprucing up the most impossible basement.

There are other things you can do to give a party atmosphere to a dingy area.

You can put Lally columns (the steel posts that support the floor above) to work supporting home-built tables. You can slap a coat of quick-drying latex paint on drab concrete walls to brighten things up. You can solve a problem floor with a roll of gaily-striped indoor-outdoor carpeting. You can round up travel posters and photo blowups to help cover up and add a festive touch. And if you don't have the right kind of furniture, you can make it.

A typical small-home basement is shown below, and on this and the following four pages you'll find instructions for making the various cover-ups and accessories suggested.

LEGEND

- | | |
|----------------------------|---------------------------|
| 1. Quickie card tables | 6. Decorative divider |
| 2. Folding screen | 7. Cube stools |
| 3. Quick-change wall | 8. Buffet table |
| 4. Dummy louvered window | 9. Fuel-tank screen |
| 5. Game divider and screen | 10. Indoor-outdoor carpet |

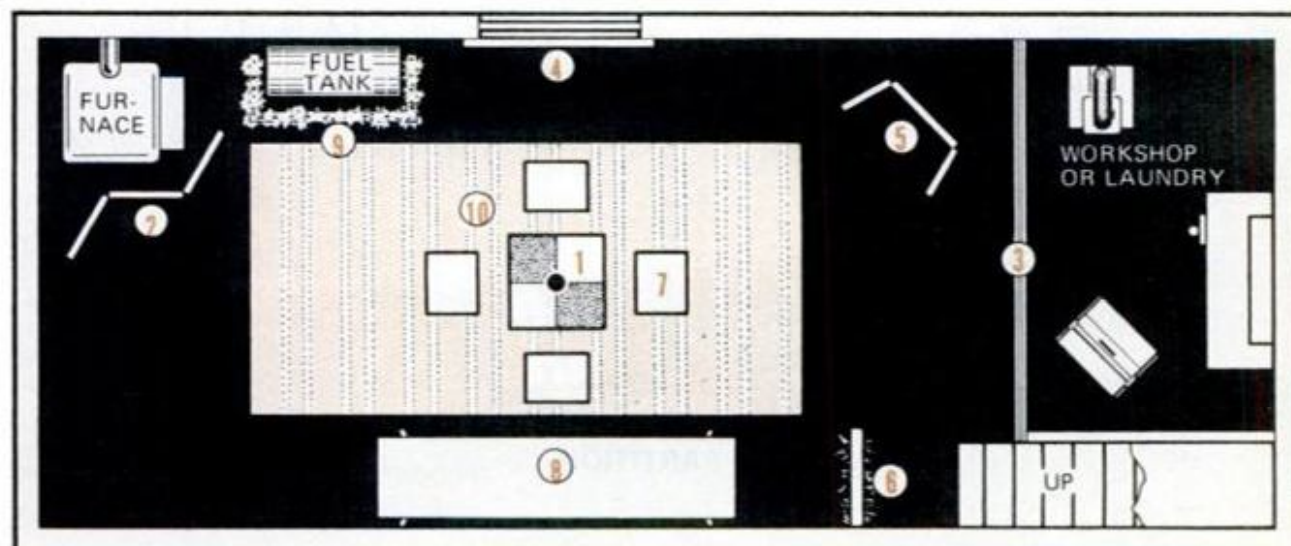

Quick-change walls

There are two kinds of quick-change partitions you can build—and later remove—to hide a workshop or basement clutter. One makes use of inexpensive flush doors that lap and pivot in holes in floor and ceiling. The second uses bypassing, prefinished panels set in grooved 2x4 tracks anchored to floor and ceiling. The bottom track can be anchored with small dabs of mastic so it can be taken up and stored.

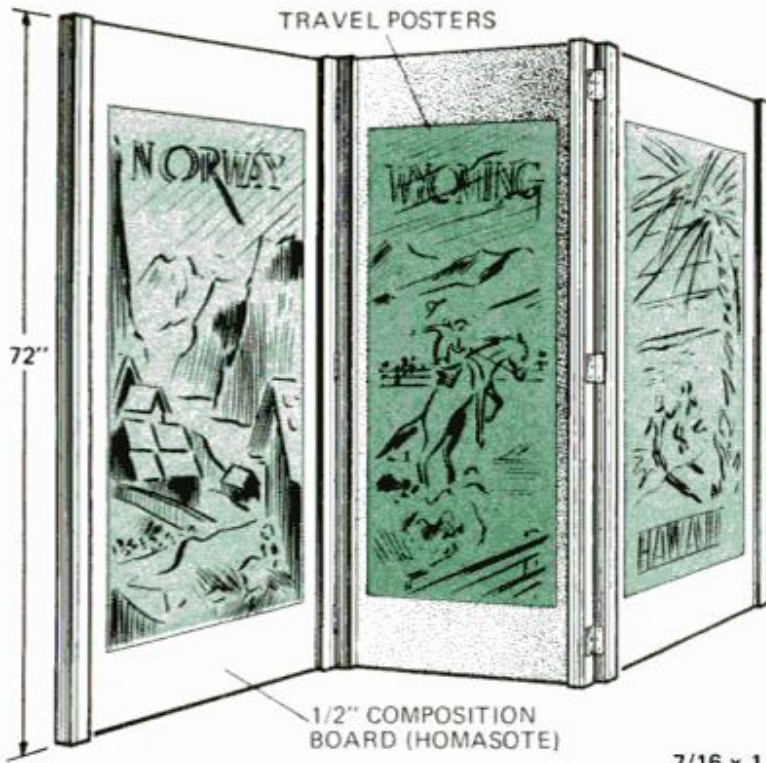

FOLDING LAUNDRY OR FURNACE SCREEN

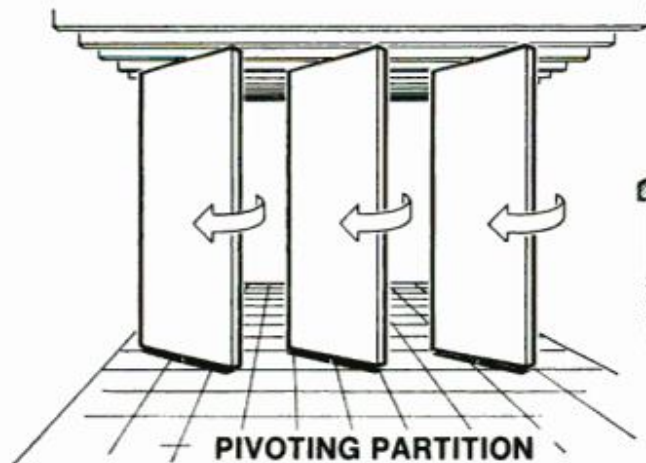
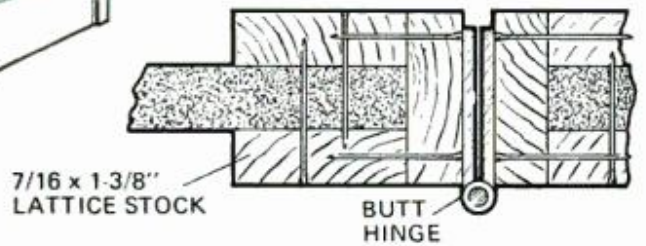

PIVOTING PARTITION

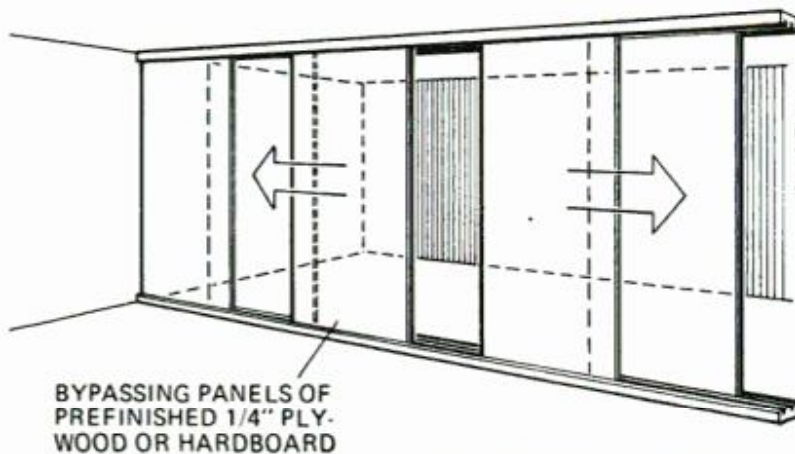
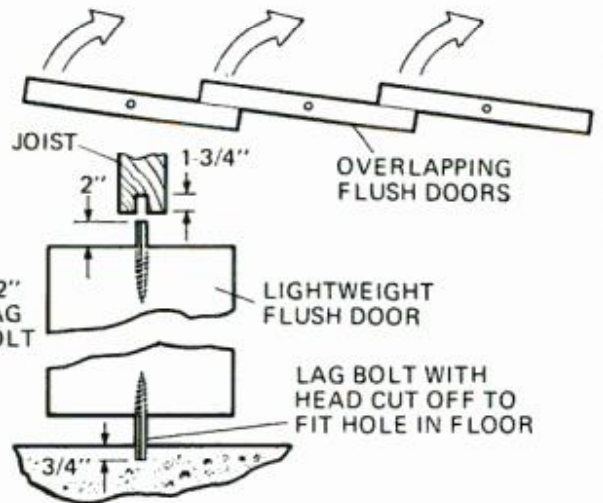

SLIDING PARTITION

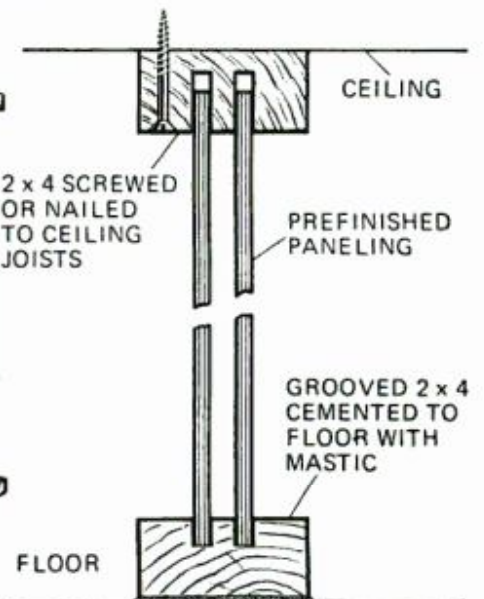

Dummy windows

For basement windows, curtains are the easy way out, but a more novel treatment uses narrow-louver shutters installed in dummy full-window frames. Attached to the wall, they take away the "basement look." If upper shutters are hinged, windows can be opened for ventilation.

Game dividers, screens

Folding game dividers such as this dartboard add fun to a party while hiding a washer and dryer or water heater. Legs grooved to fit plywood or hardboard are hinged to fold flat.

A conversation screen (lower right) also adds to an evening's fun when covered with humorous cartoons and pictures. Its shelves provide handy places to set a drink or ashtray.

DUMMY LOUVER WINDOW

STOCK WINDOW CASING

MOVABLE LOUVER SHUTTERS

Quick-change ideas

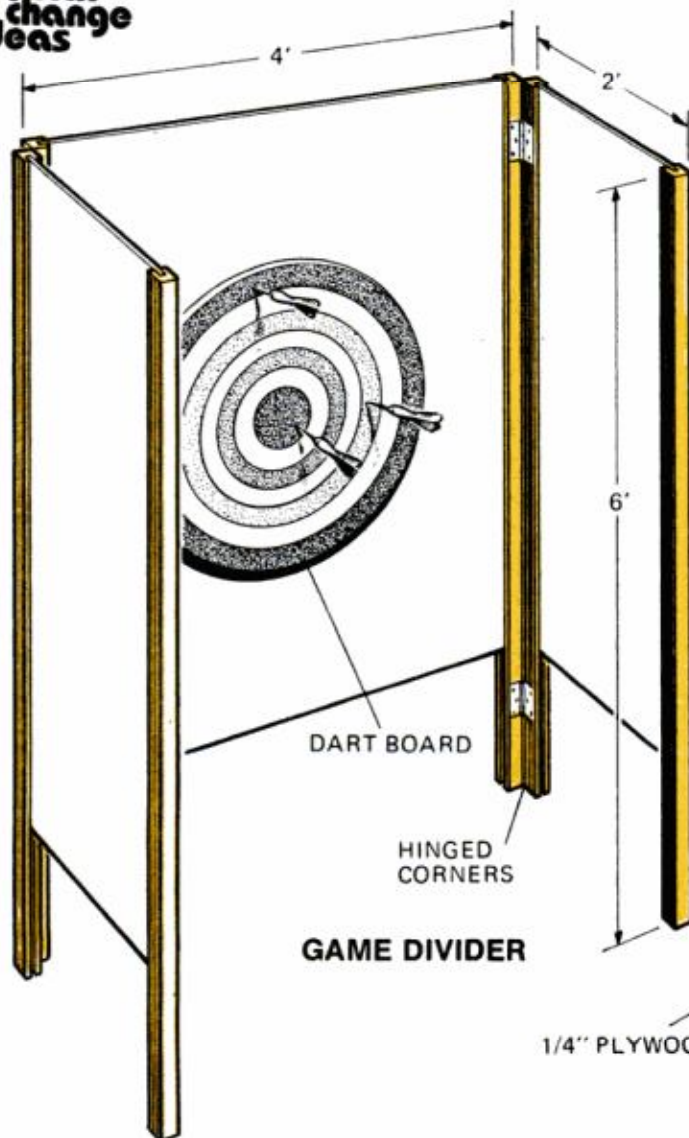

PHOTOS, POSTERS



1/4" PLYWOOD

1/4 x 1/2" GROOVE

3/4" PLYWOOD

3/4 x 1" PINE

PLAN VIEW



DECORATIVE DIVIDERS

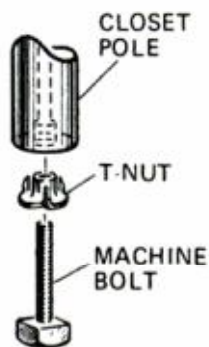

1/2" PLYWOOD HANDHOLD

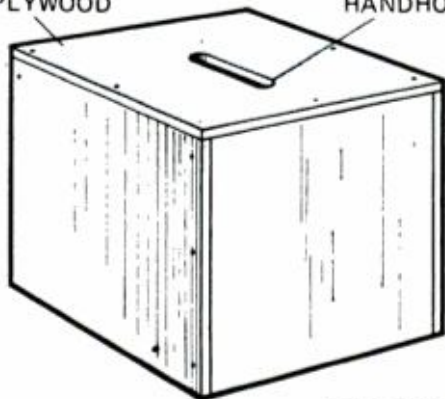

CUBE STOOLS

CHECKERBOARD TOP

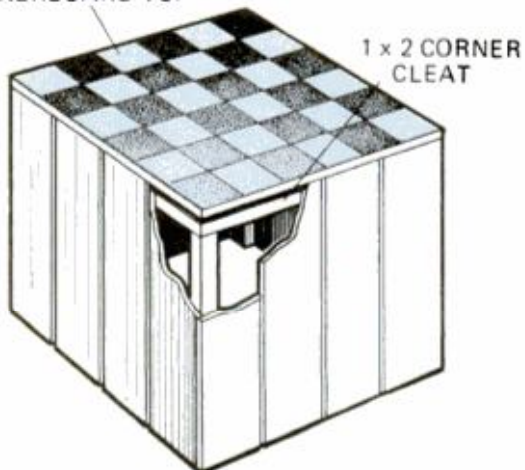

Decorative dividers

Blocking the view of basement stairs or partitioning off an unwanted area with a ceiling-high divider will help spruce up a room and provide handy shelf space. The see-through one of closet poles is designed to wedge between floor and ceiling. Ends of poles are drilled for T-nuts and machine bolts. A wedging action is the result when the bolts are backed out to bear against the floor.

The bookcase divider offers shelves for a record player and hi-fi equipment, with album storage below. The whole thing is made from pine in standard lumberyard sizes, the back being a piece of prefinished paneling.

Cube stools

When chairs run out, cube stools help provide extra seating. They can also double as sit-on-the-floor game tables when the tops are checkerboards. They're mere plywood boxes, for the most part, wildly painted in red, blue and yellow to add a gay party look to the occasion.

KNOCKDOWN BUFFET TABLE

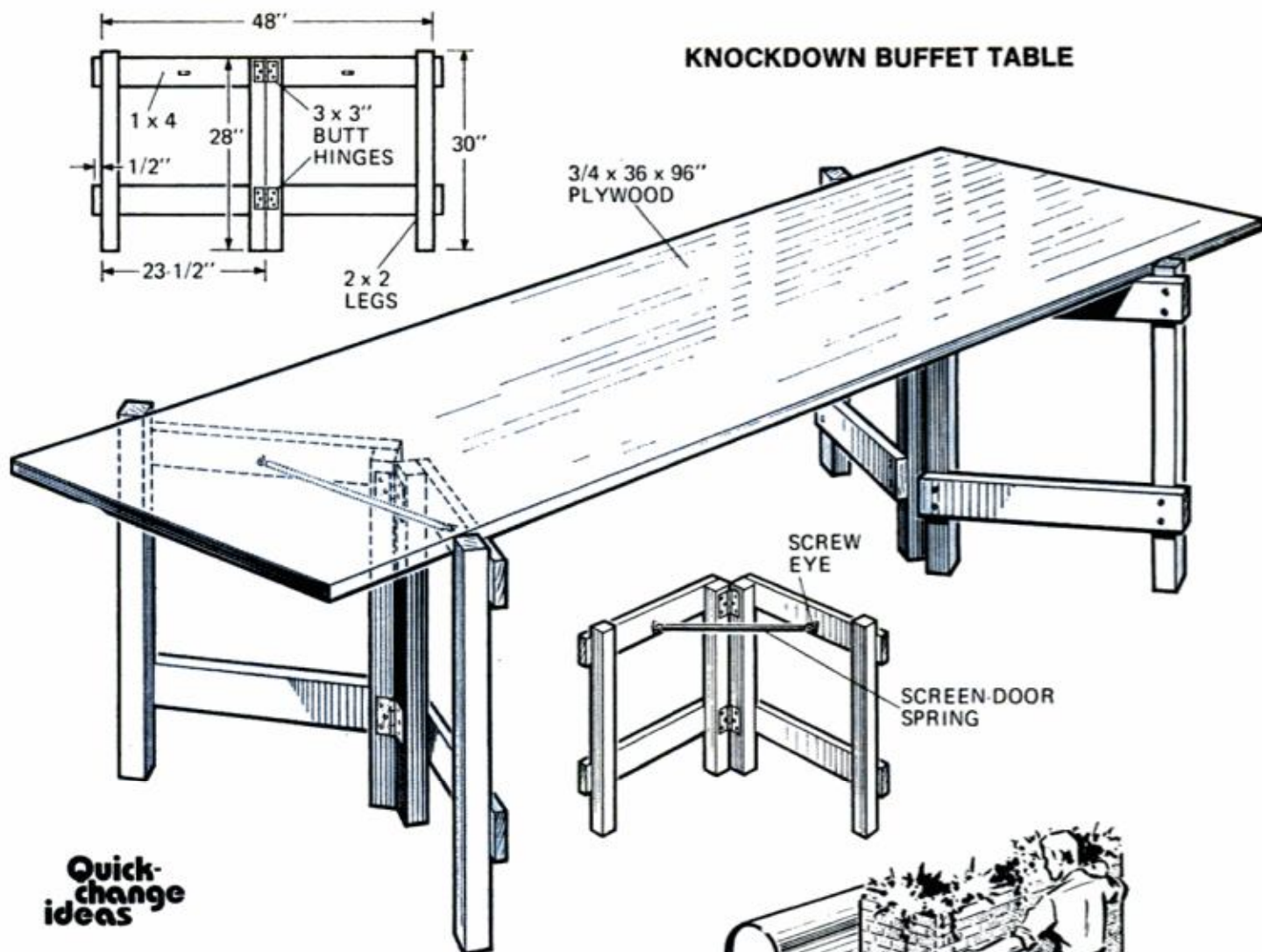

Quick-change ideas

Knockdown buffet table

The easiest way to serve your guests is buffet-style and this is where you need a long, "help-yourself" table that can be taken apart and stored easily when the party is over.

This buffet table fills the bill perfectly. The top is a 3x8-ft. piece of plywood, and each pair of hinged legs is assembled from 2x2 and 1x4 material. Screen-door springs make the legs hug the top when they are spread apart.

Fuel-tank screen

No one would suspect that this attractive "brick" planter is actually hiding an ugly fuel-oil tank; you may want to leave it in place long after the party.

The rough framework consists of 2x2s covered with Celotex and then faced with simulated white brick, such as Decro-Wall, glued or stapled in place. Casters may be added, after which some artificial greenery is stuck in the holes around the top to create the planter effect. ★★★

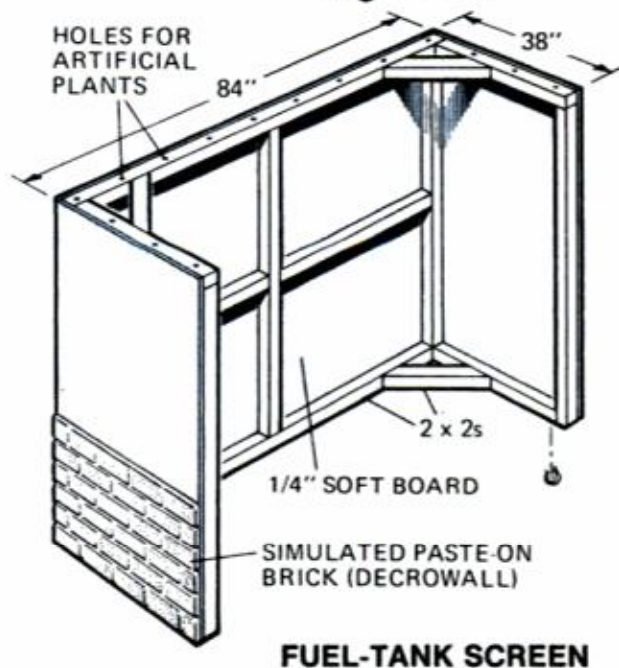
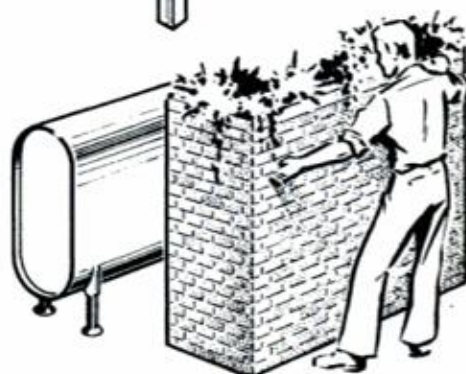

FUEL-TANK SCREEN

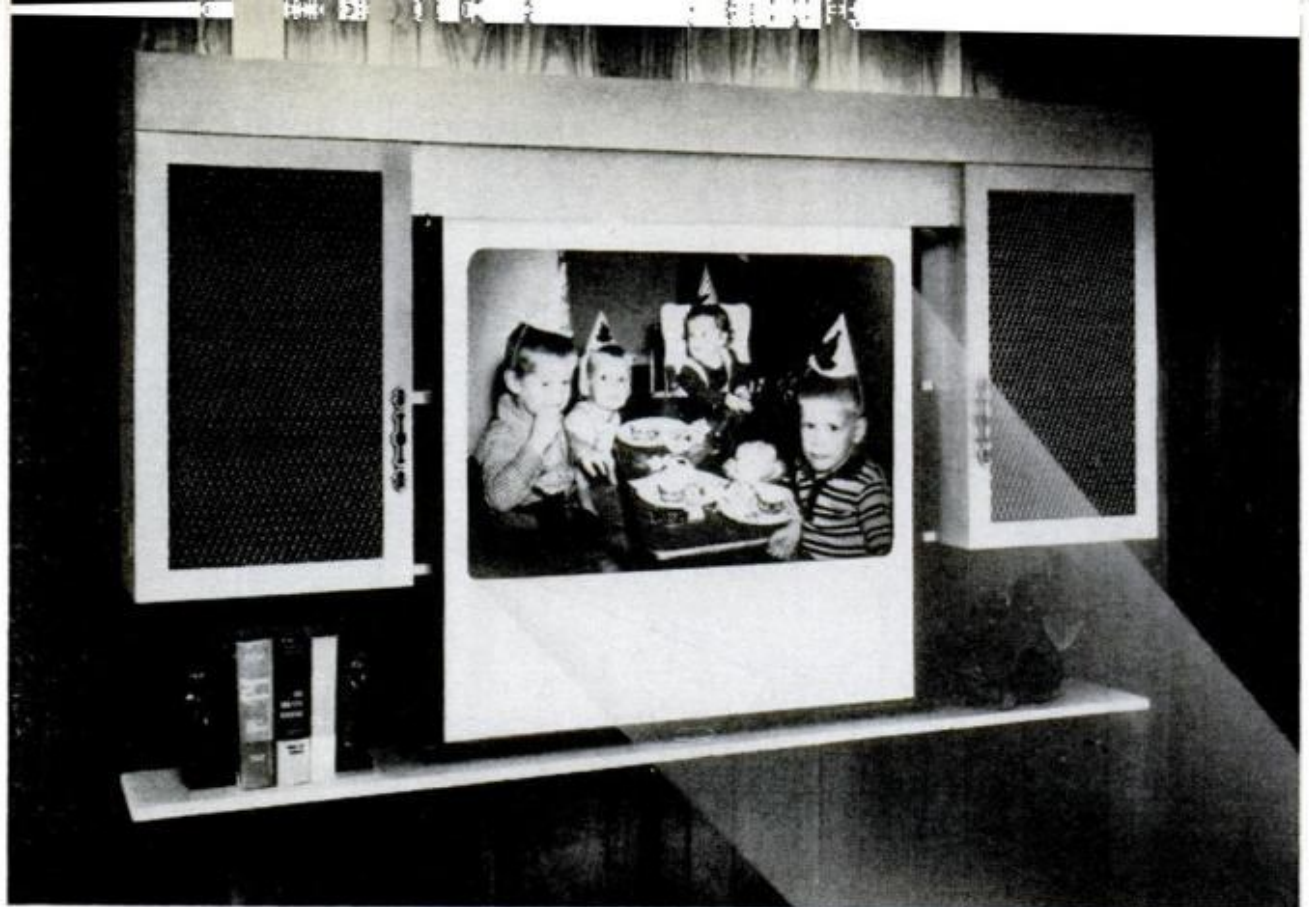

WITH SCREEN RETRACTED (left), unit looks like ordinary wall cabinet with storage cupboards and knickknack shelves. Conversion to home theater takes only seconds, makes showing slides or movies fun instead of a nuisance. Unit can be anchored directly to wall or suspended on standard shelf brackets

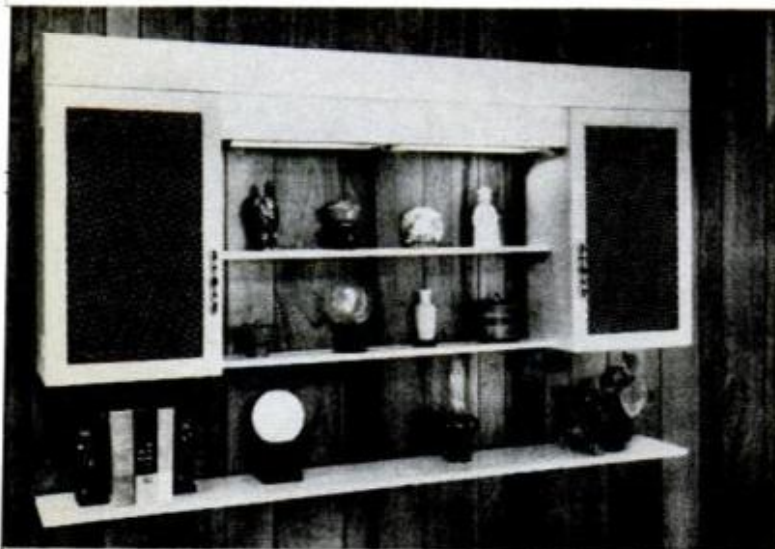

By **SHELDON M. GALLAGER**

Photos by Robert D. Borst

BY THE TIME you haul out all the gear required to put on a slide or movie show, a lot of the fun has gone for you and your guests. This hideaway wall unit is designed to end the fuss and put the fun back into showing slides and movies. There's no screen to get out and set up because it's already built into the unit—you just pull it down, slip the projector out of one of the side cabinets and you're ready to go. Everything needed for putting on a show is right at your fingertips.

When the screen is not in use, it disappears up into a recess at the top and is completely hidden from view. In its place are shelves for displaying decorative objects, giving the unit an attractive appearance when it's not serving as an instant home theater. The cabinets, besides storing photographic gear, can also house hi-fi equipment, making the unit an all-around home entertainment center. The cabinets are spaced apart just right for

**Quick-
change
ideas**

Hideaway home theater

good stereo listening from small bookshelf-type speakers placed inside the cupboards. The doors have mesh-covered openings designed to let sound through even when the cupboards are closed.

If you go in for sound movies or sound-synced slide shows, the setup is ideal because the accompanying sound, filtering out through the mesh doors, will appear to come right from the projection screen, creating a realistic movie-theater effect. For added convenience, you can install one of NuTone's flush-mounting music/intercom systems, as shown in the photos below. These systems come in a variety of types and price ranges and offer a complete home communication center in a single, smartly styled unit with built-in radio, speaker and intercom controls.

The wall unit is built around a 40x40-inch pull-down screen made by Da-Lite. This type is designed expressly for wall or ceiling mounting and has brackets on the case that permit the screen to be hung from hooks or attached with screws. Such screens cost about the same as the regular floor-stand type and are available at most photo shops and department stores.

Dimensions of the unit can be altered as desired, but the 10-inch depth was chosen because it enables all parts except the back panels to be ripped from stock 1x12-inch lumber with little waste. The unit can be screwed directly to the wall, just as you would mount a kitchen cabinet,

HANGING SIDE CABINETS can house a variety of equipment depending on your needs. Here, one is fitted with NuTone's in-a-wall music/intercom system designed especially to mount in shallow spaces. Upper unit (left, below) is AM/FM radio with 10-station intercom and built-in speaker. Lower unit is fold-up record changer that swings out horizontally for use (center). Opposite cabinet (right) holds a Kodak cartridge-loading Super-8 movie projector, extra film reels and a Model AS-18 Heathkit speaker

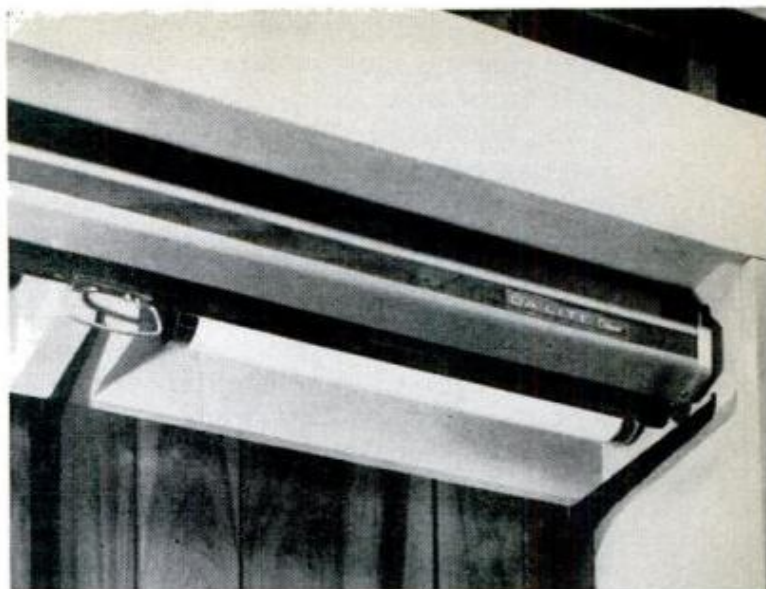

UNDERSIDE VIEW with fascia board removed shows how screen mounts at top of unit between cabinets. With fascia board in place, screen is completely hidden from view. Screen shown here is 40x40-inch model made by Da-Lite. Two-way end brackets permit it to be hung from hooks or attached with screws

or it can be supported on metal shelf brackets of the type that hook into slotted wall standards. The 10-inch depth enables the unit to fit perfectly on standard 10-inch-long shelf brackets.

If you decide on wall brackets, one construction pointer is important. Since the unit gets rather heavy when filled with equipment, it should be supported on no fewer than *three* brackets—one at each end and one at the middle. The center bracket can't extend the full cabinet depth, however, or it would obviously block the screen from coming down. The answer here is to build up a small supporting framework at the center of the span just behind the screen. This framework is 6 inches deep and rests on a 6-inch shelf bracket, supporting the middle of the unit without interfering with the operation of the screen. The knickknack shelves also

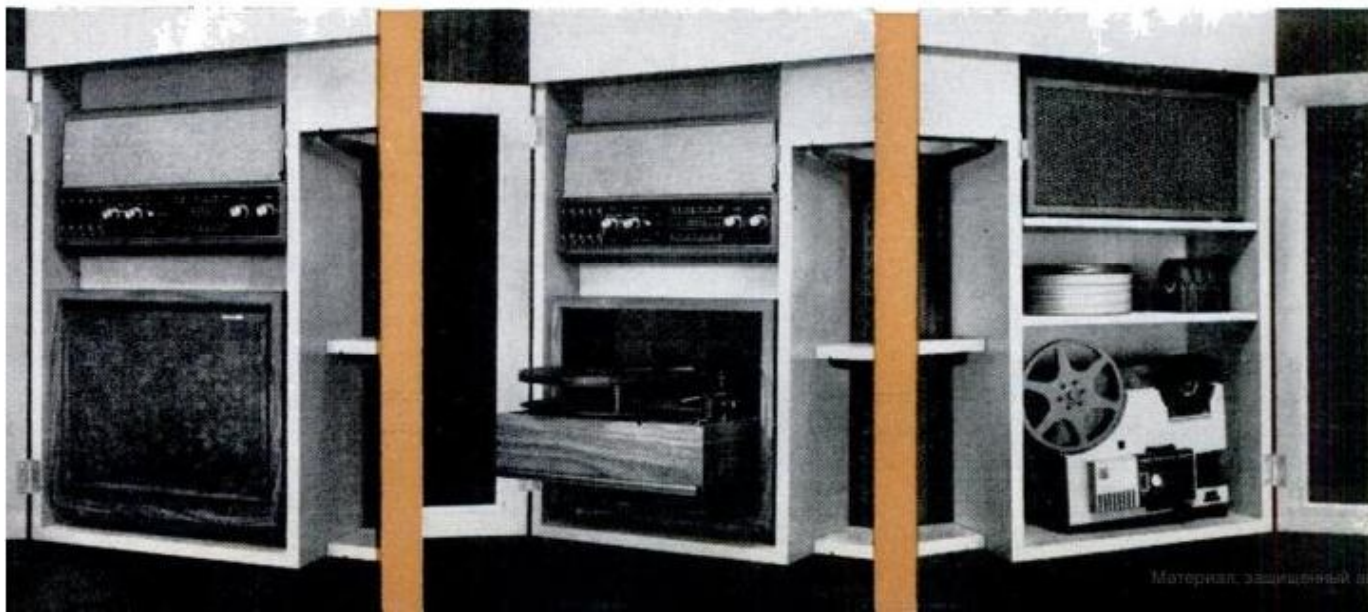

rest on 6-inch brackets, providing sufficient clearance for the screen to pull down in front of them.

For maximum strength, the main strut running across the back at the top should extend the full 80-inch width—behind the cabinets as well as the screen—since it supports the entire weight of the unit when hung on shelf brackets. If you plan to mount the unit directly on the wall, you can, of course, eliminate the strut and center supporting framework.

Other options and variations are possible, too. As shown here, the unit incorporates a recess at the top for installing fluorescent lighting fixtures. These provide a soft, pleasing cove lighting effect, but can be eliminated if you wish. You can also build just the screen enclosure without the hanging side cabinets. Several alternate versions of this type are shown. Further information on screens can be obtained from Da-Lite Screen Co., Warsaw, Ind. 46580. For more details on Nu-Tone's in-a-wall music/intercom systems, write to NuTone Div., Madison and Red Bank Rds., Cincinnati, Ohio 45227. ★★

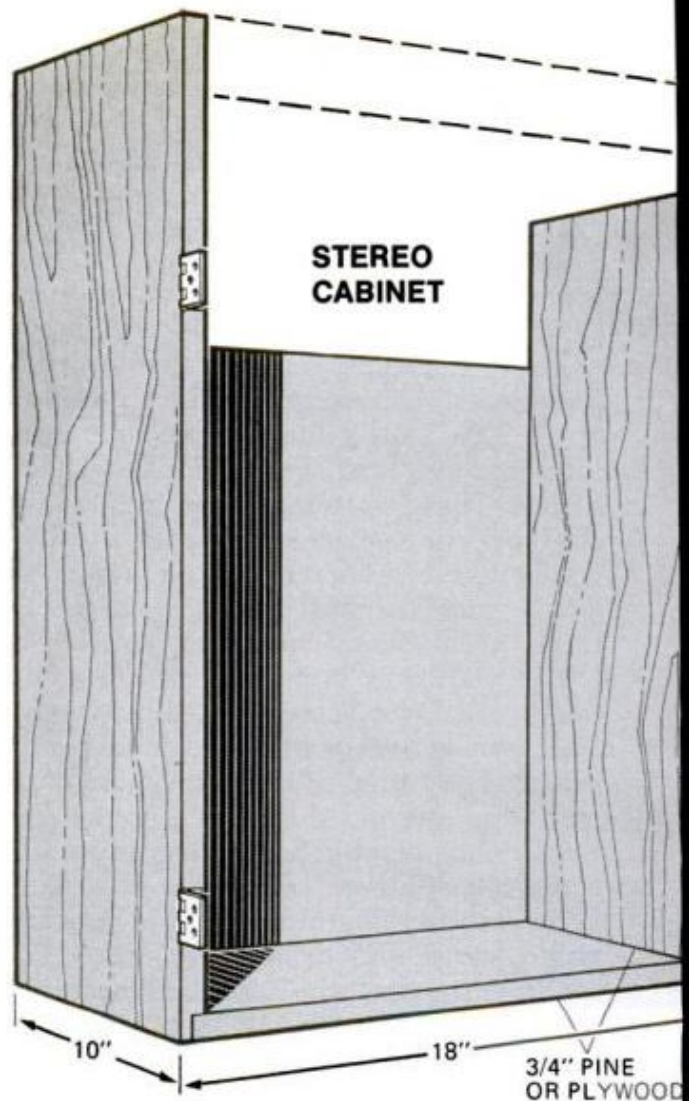
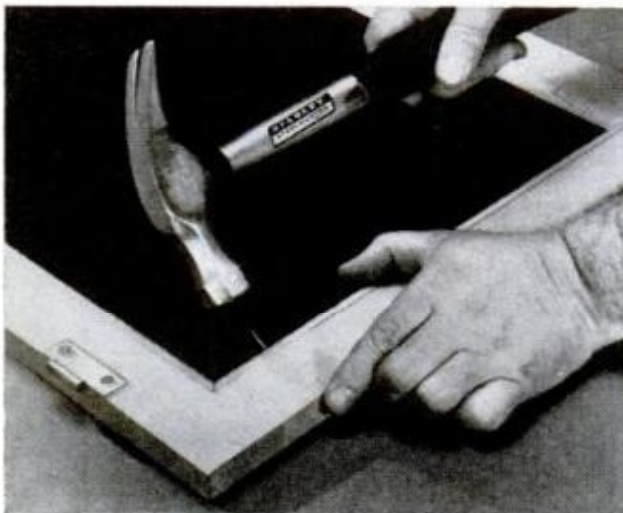
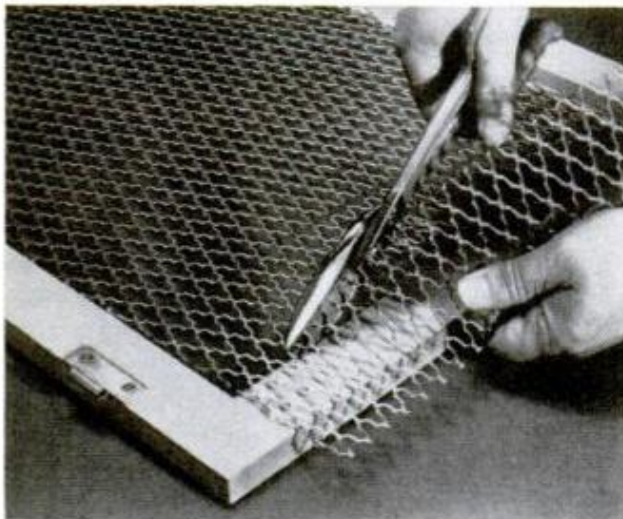

Technical art by Peter Trojan

EXPANDED METAL GRILLE
BACKED WITH SPEAKER CLOTH

RABBET
DOOR
FRAME
1/2 x 1/2"

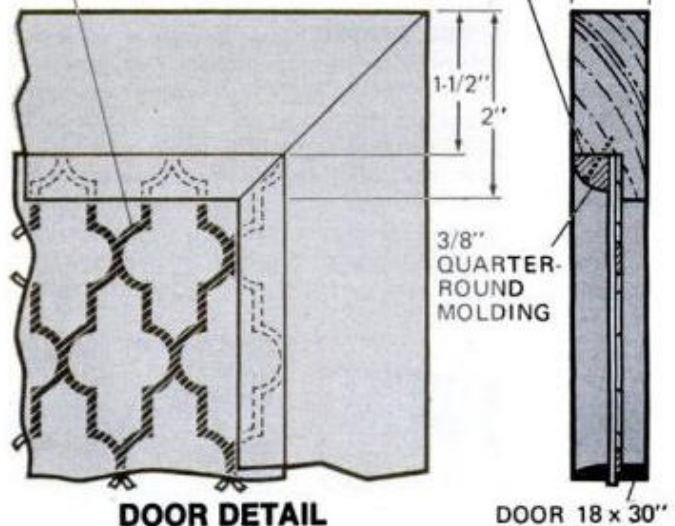

GRILLE-COVERED OPENINGS in doors are designed to let sound through even when doors are closed. Door rails are rabbeted to form recess on back side, then decorative Reynolds brass mesh is trimmed with tin snips to fit inside (top photo at left). Mesh is backed with black speaker cloth, and both are held in place with 3/8-inch quarter-round molding strips tacked in with small brads (bottom photo)

POPULAR MECHANICS

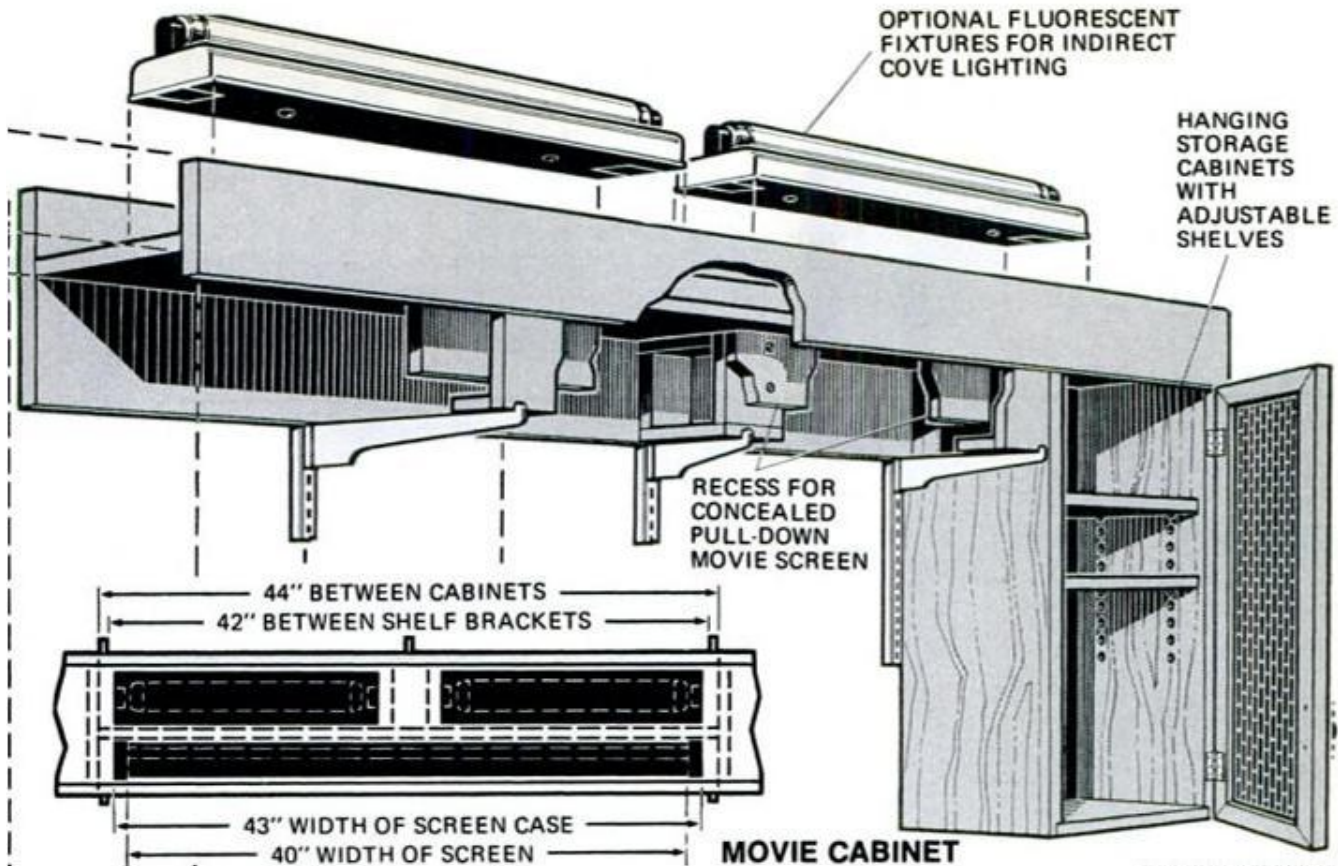

MOVIE CABINET

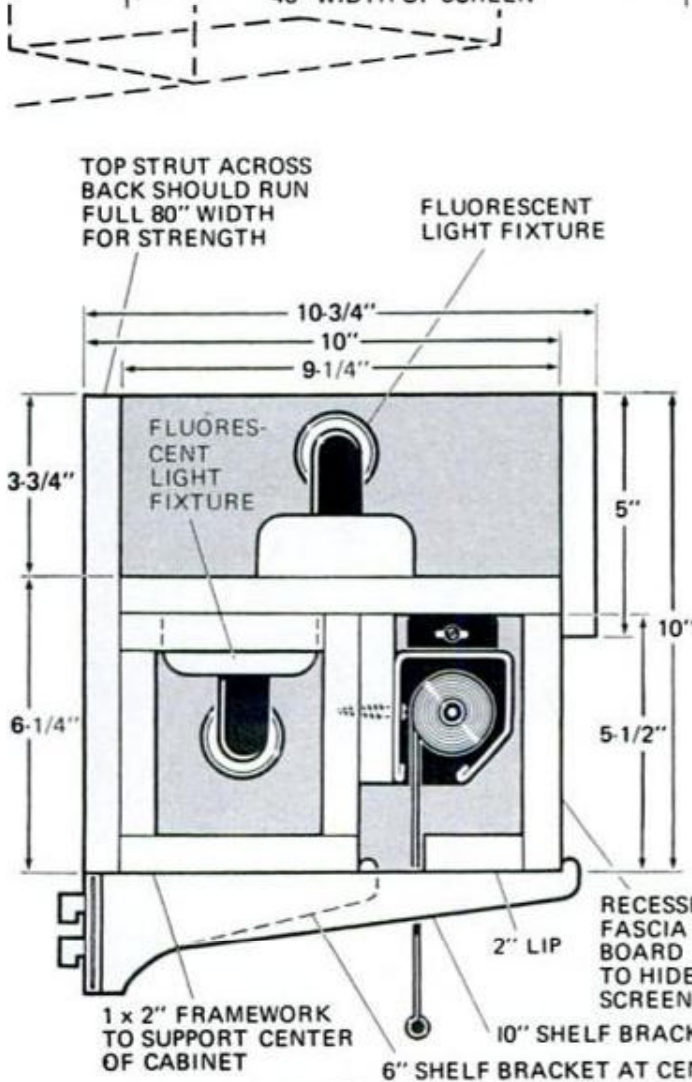

CROSS SECTION DETAIL THROUGH CENTER

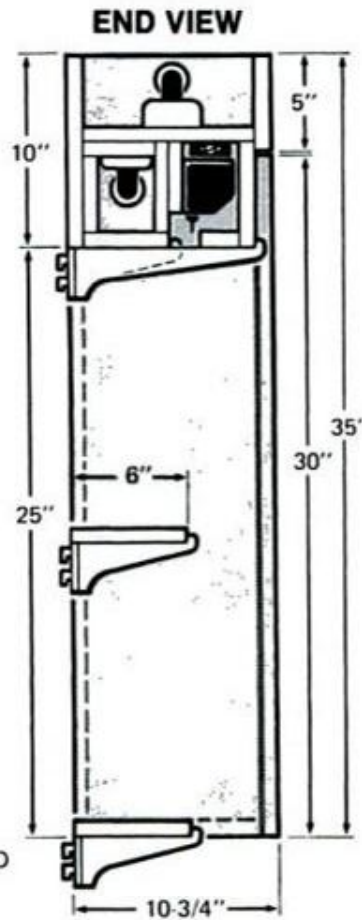

HEIGHT TO SUIT BOOKS, DECORATIVE OBJECTS, ETC.

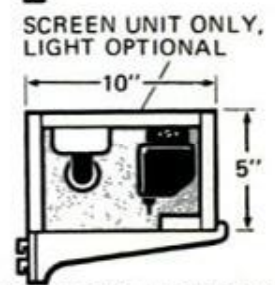
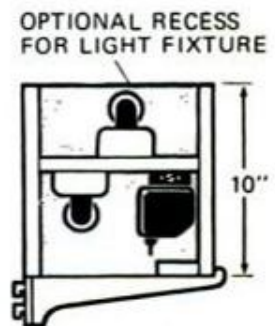
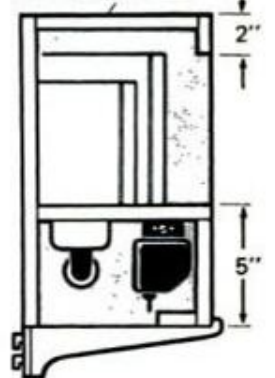

THREE ALTERNATE VERSIONS WITHOUT HANGING CABINETS

Stacking tray tables

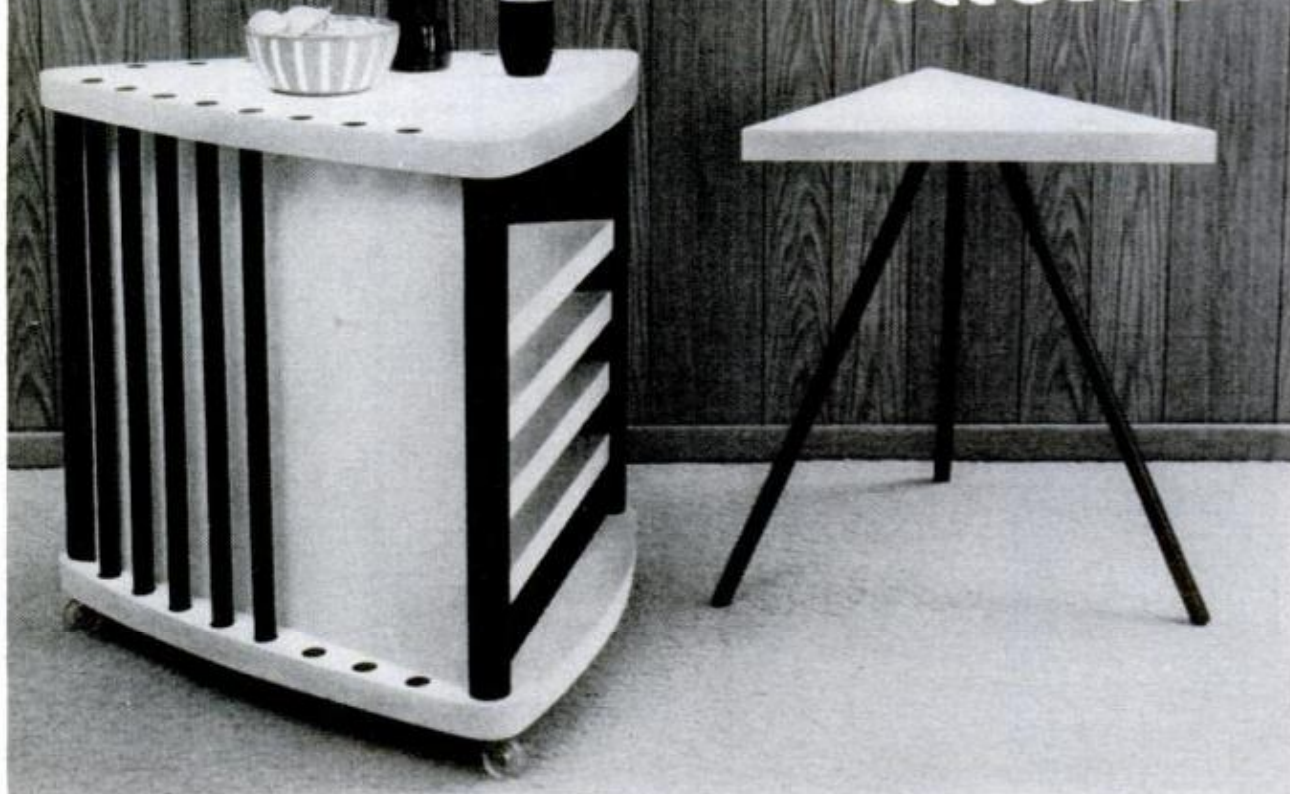

By ROSARIO CAPOTOSTO

THIS HANDSOME SERVING TABLE will prove to be a conversation piece at a party as well as a very functional piece of furniture when it comes time for snacks. Five good-sized triangular tables store conveniently to add to the striking design, as do the legs, which are contained along the sides of the table. The construction is sturdy— $\frac{3}{4}$ -in. plywood surfaced with Conolite flexible plastic laminate in a smart white, leather-textured pattern.

The legs are simply 1-in. dowels cut to length and sanded smooth. Sixteen dowels are used in the interest of symmetry;

MAKE THE LEGS A PRESS FIT in the slanting holes. If fit is too tight, sand the dowels before painting

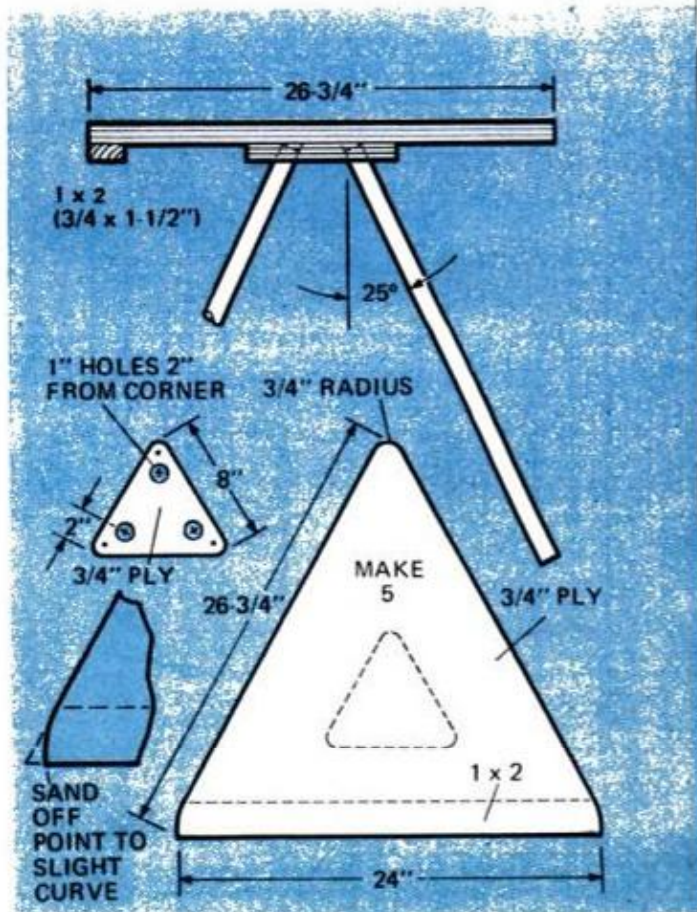
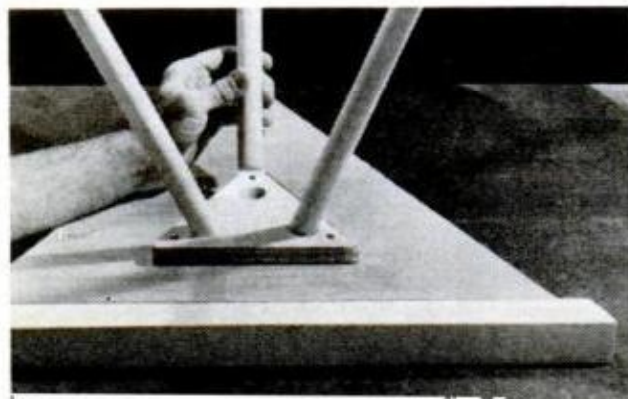

only 15 are required for the 5 tables. The tables are set up by simply inserting three legs borrowed from the main table. The unit has swivel casters for easy mobility.

Make the brackets for the legs by drilling three 1-in.-dia. holes at a 65° angle in triangles of plywood and glue them to the underside of the tables in the center. Add five pairs of cleats to the inside and three swivel casters on the bottom to complete construction.

Use a plywood blade to cut the five triangular tabletops to minimize sanding of the side edges, which will be left exposed and simply painted. Double up the table fronts by adding 3/4 x 1 1/2-in. strips after jointing the front edges smooth. Cut the laminate (with knife or scratch awl) about 1/4 in. oversize. Apply contact cement to both surfaces; apply the laminate.

If you haven't worked with contact cement, be advised that once the two coated surfaces touch it is virtually impossible to move the laminate. This means you have to work carefully in positioning it. To play it safe, you can use two pieces of kraft paper as separators to assure accurate alignment.

Here's how it works: When both cement-coated surfaces are dry but a bit tacky to the touch, lay two pieces of paper, over-

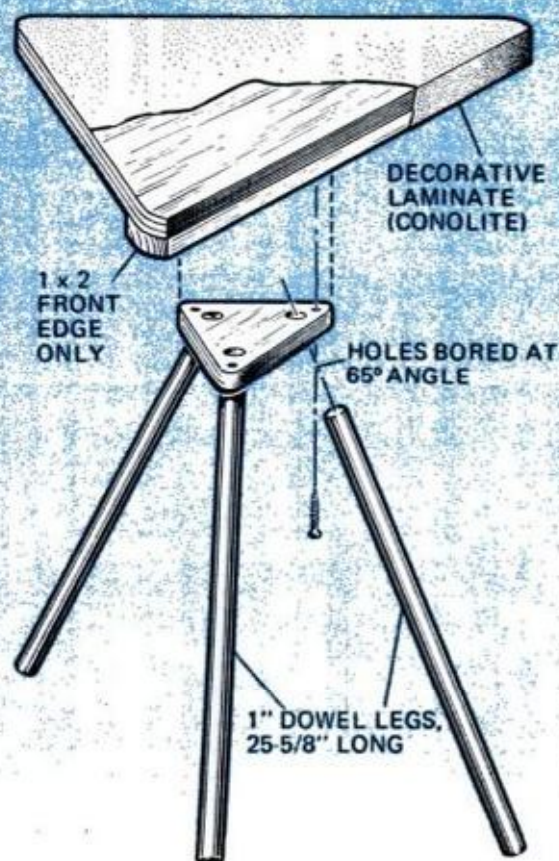

95



CLAMP GUIDE TO WORK and use smooth-cutting plywood blade. You can get two tops from 2x4-ft. panel

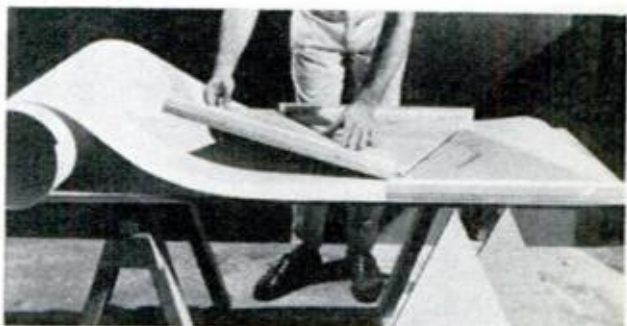

LAY OUT TRIANGULAR PATTERNS on laminate; allow at least 1/4 in. waste all around for final trimming



WHILE CONOLITE IS TOUGH, it can be cut with sharp utility knife or scored with an awl and snapped off



APPLY CONTACT CEMENT with notched spreader, let set 30 minutes. Tap laminate with block for bond

FINISH OFF THE EDGES with router and bevel cutter set for very slight cut. (Can also be done with file)



**Quick-
change
ideas**

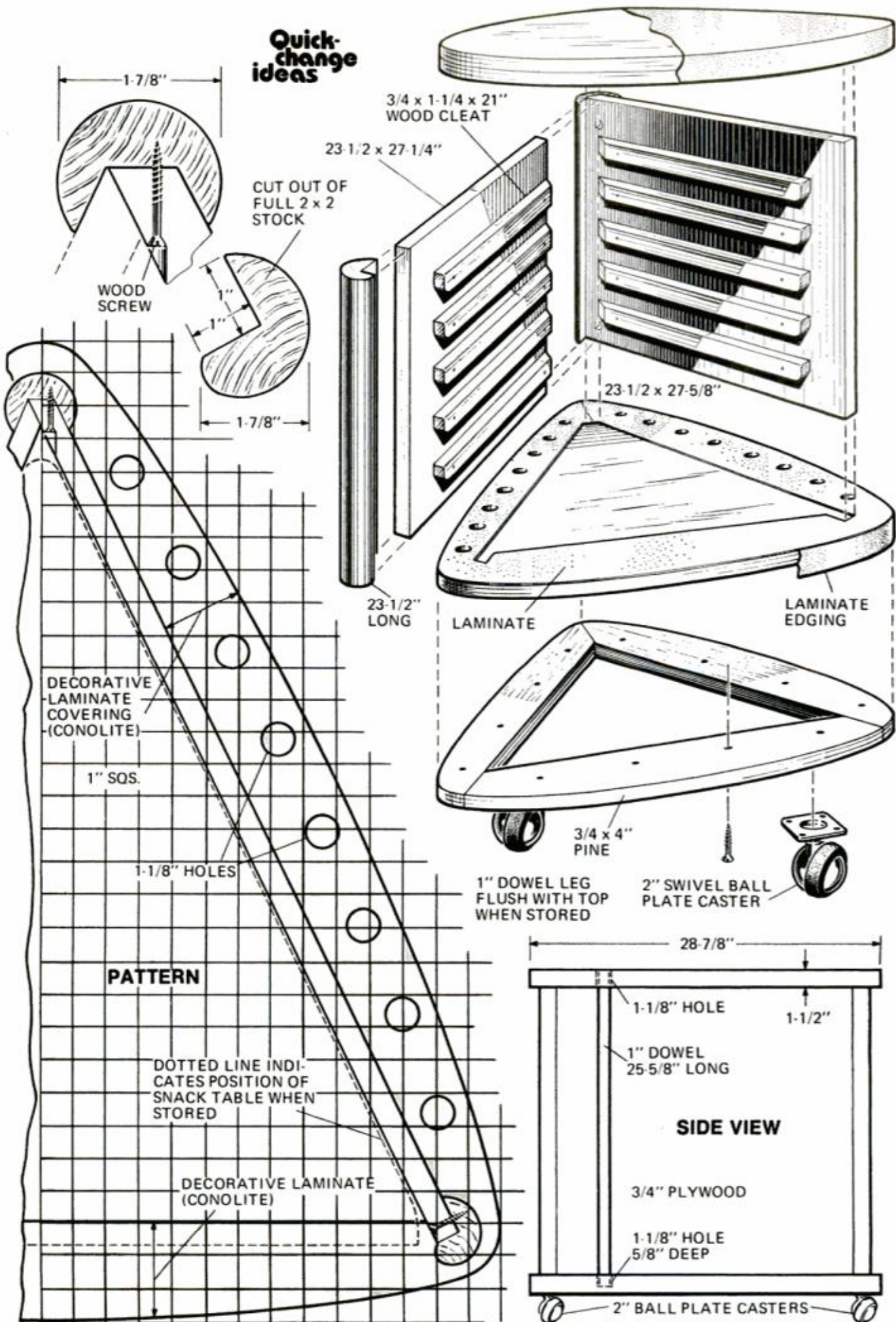

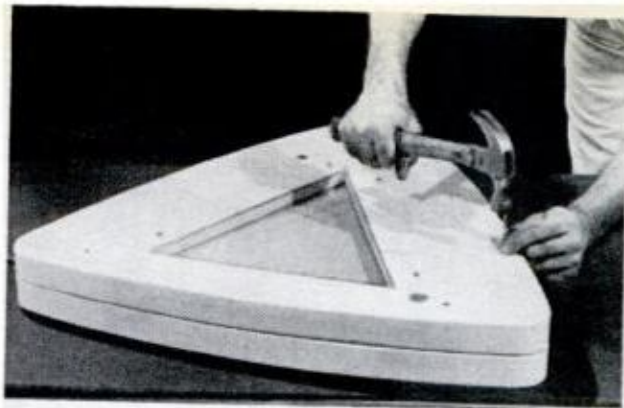

MARK OFF AND DRILL pilot holes through top and bottom at same time to align dowel holes in base



SUPPORT THE HEAVY PIECES on drill press for neat drilling job. Holes in the base are only $\frac{3}{8}$ in. deep



HOLD OFF LAMINATING plywood top until it's glued and nailed to the sides with $2\frac{1}{2}$ -in. finishing nails

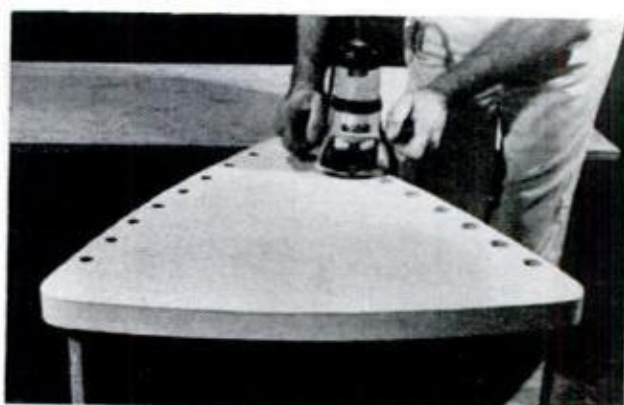

BORE UNDERSIZE HOLES in plastic covering 1-in. holes, rout to conform to diameter of holes below

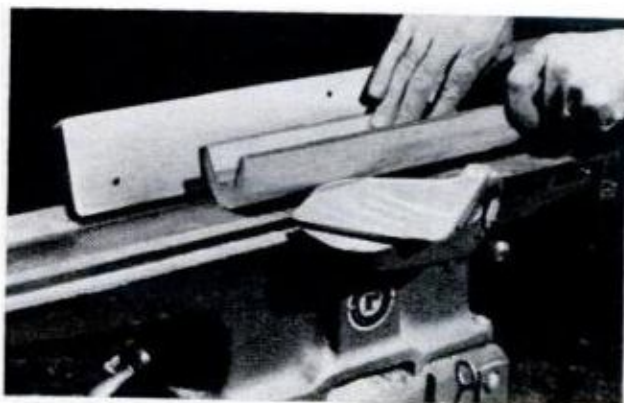

FORM THE TRIM PIECES on the jointer, being careful not to trim fingers. Complete shaping with sander

lapping at the center, on the tabletop and, without pressing, position the laminate. Pull out one paper to allow that section to make contact, then remove the remaining paper to allow full contact.

Apply laminate to the front edges first, then the top surfaces. Tap with a hammer and a block of wood to make a thorough bond. Trim off excess material flush to the surface of the workpiece using a router with a straightedge-cutting bit, or use a square-edge file. Apply laminate to the tops; then trim off the excess with a bevel-cutting bit (or file) to produce a finished edge.

The top and base of the main table are built up to double thickness around the edges to provide a "thick look." You can rough-cut the top and bottom panels, glue on the extra strips, and then cut to the required dimensions. A bandsaw is best for this, but you can do it with a sabre saw. In either case, the edges must be trued up with a stationary disc or belt sander. Since the edges are curved, it

(Please turn to page 191)

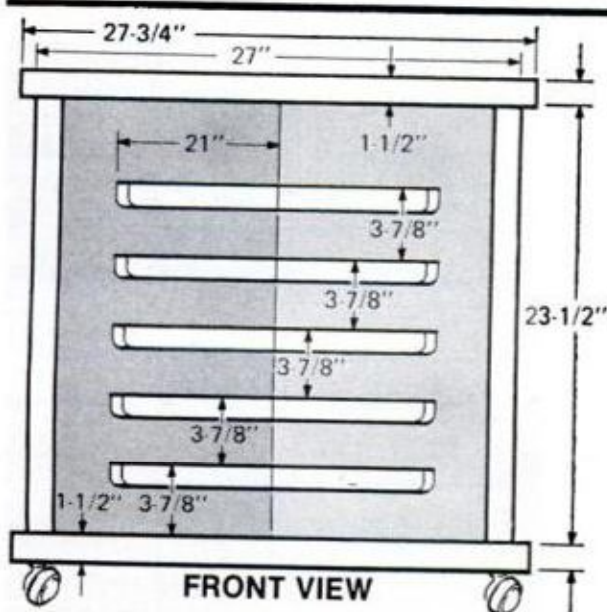

The Russians are moving full speed ahead to match the United States as a naval power. In some ways, they've already passed us.

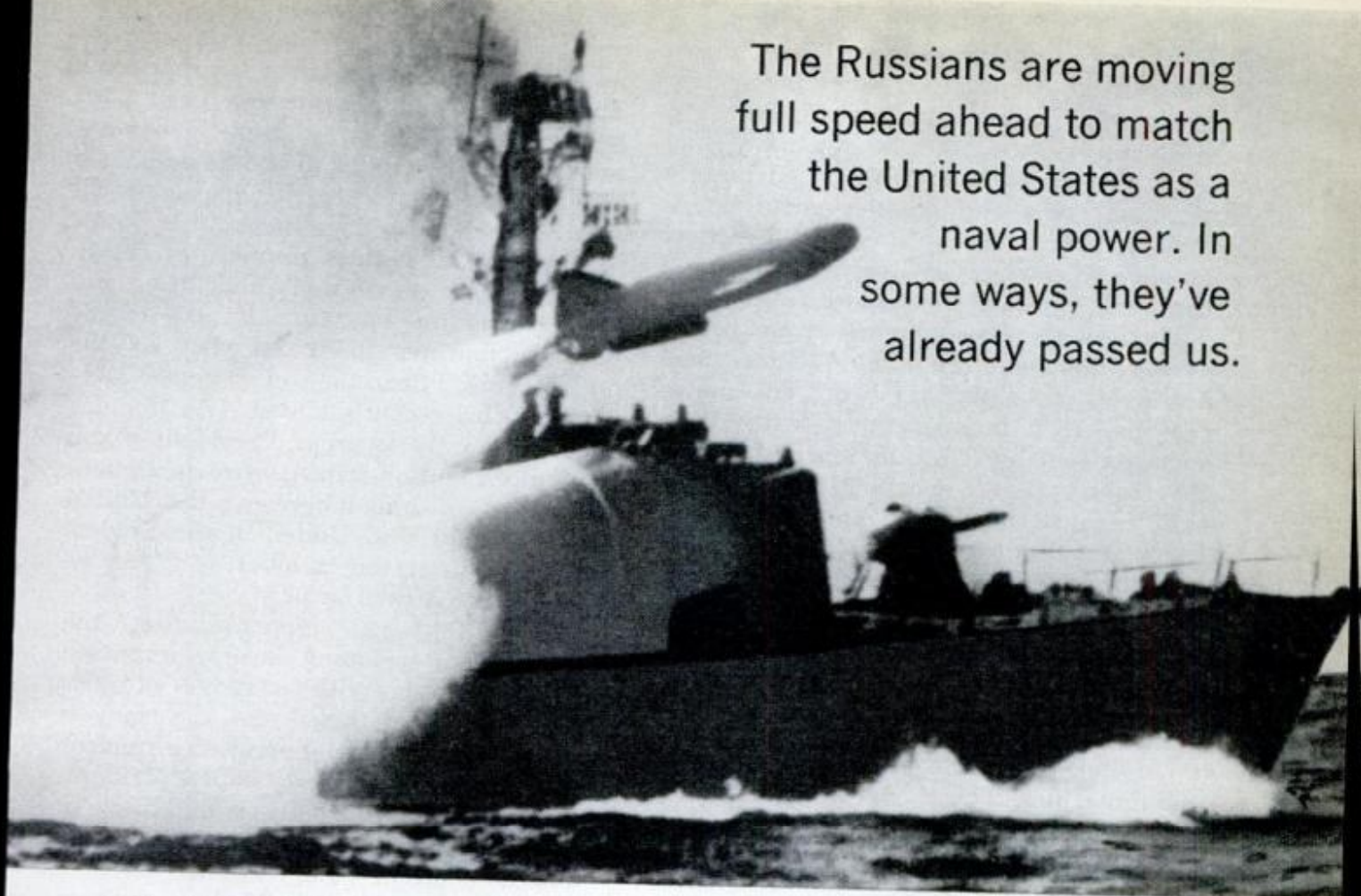

STYX CRUISE MISSILE BLASTS OFF from launcher aboard an Osa-class patrol boat. It was this type of boat—and missile—that in 1967 sank the Israeli destroyer *Eilat* at a range of approximately 12 miles

SOVIET DESTROYER trails escort ship *USS Bradley* in Philippine Sea during worldwide Okean exercise

ANOTHER ENCOUNTER—this time between two guided-missile destroyers. American ship is in foreground

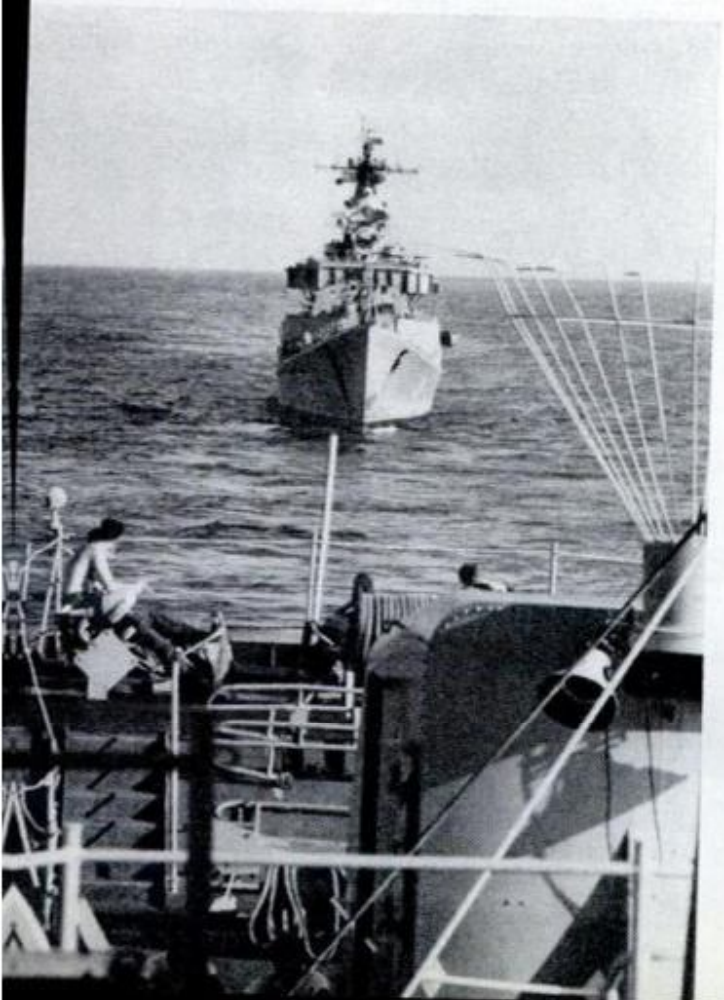

SOVIET NUCLEAR SUB was photographed in Atlantic by U.S. Navy. Vessel appears to be in distress



crisis in 1962. In that confrontation our Navy forced the Russians to back down and remove the missiles. Once again they learned the value of a powerful fleet.

Up until then, the Soviet navy had been a defensive force, composed largely of submarines and coastal patrol boats. Today, it's a different story, as the chart on page 98 shows. The Russians now have the world's second most powerful fleet.

Though the two navies seem pretty evenly matched, the United States still has a big edge in firepower. The major reason: 14 attack carriers with their squadrons of hard-hitting planes. So far, the Soviets have spurned this type of ship because of their emphasis on defense. But that situation may be changing. U.S. intelligence agencies report that the Soviets may be building a flattop in the Nikolayev shipyard on the Black Sea. Our government is keeping a close eye on this one via satellite photos.

But let's see how the two navies stack up in some other categories:

Submarines. The Soviet sub fleet is by far the world's largest—some 340 nuclear and conventional craft. The United States has a total of 137 subs. In this case, sheer numbers are not significant because the two countries are pretty evenly matched in nuclear submarines, Russia with 100, the United States with 96.

Russia's most formidable undersea weapon is the Y-class sub, referred to as "Yankee" by our navy men. In size, speed and ballistic missile capability it's

the equivalent of America's Polaris submarines. The United States is said to have 41 of these subs at the present time. The majority of them are equipped with missiles that can carry a nuclear warhead almost 3000 miles. If the Soviets keep building at their present pace, they'll match the Polaris fleet in about a year.

"At least 17 Y-class submarines are in various stages of assembly and fitting and could bring the operational force of Y-class submarines to 42 as early as the end of 1973," Secretary of Defense Melvin R. Laird recently stated. (As *Popular Mechanics* went to press, President Nixon announced that an arms control agreement had been concluded between the United States and Russia. Under it, the Soviets agreed to limit the number of Yankee-class subs to a total of 62.)

In addition, it's reported that the Soviets are developing a new undersea ballistic missile with a range of 3000 miles. To counter this threat, the Navy is pushing for the development of a nuclear sub and missile system called Trident. These missiles reportedly would have a range of more than 4000 miles.

Cruisers. Here the Soviets have a fairly big edge—25 to 9. Modern cruisers such as the *Sverdlov* class started to appear in the Soviet navy as early as 1953. Today, this ship is considered out of date. In contrast, the flagship of America's Sixth Fleet, the USS *Springfield*, was 10 years old when the first *Sverdlov* slid down the ways.

KRESTA-CLASS CRUISER is about 6000 tons and reportedly has cruising speed of better than 30 knots

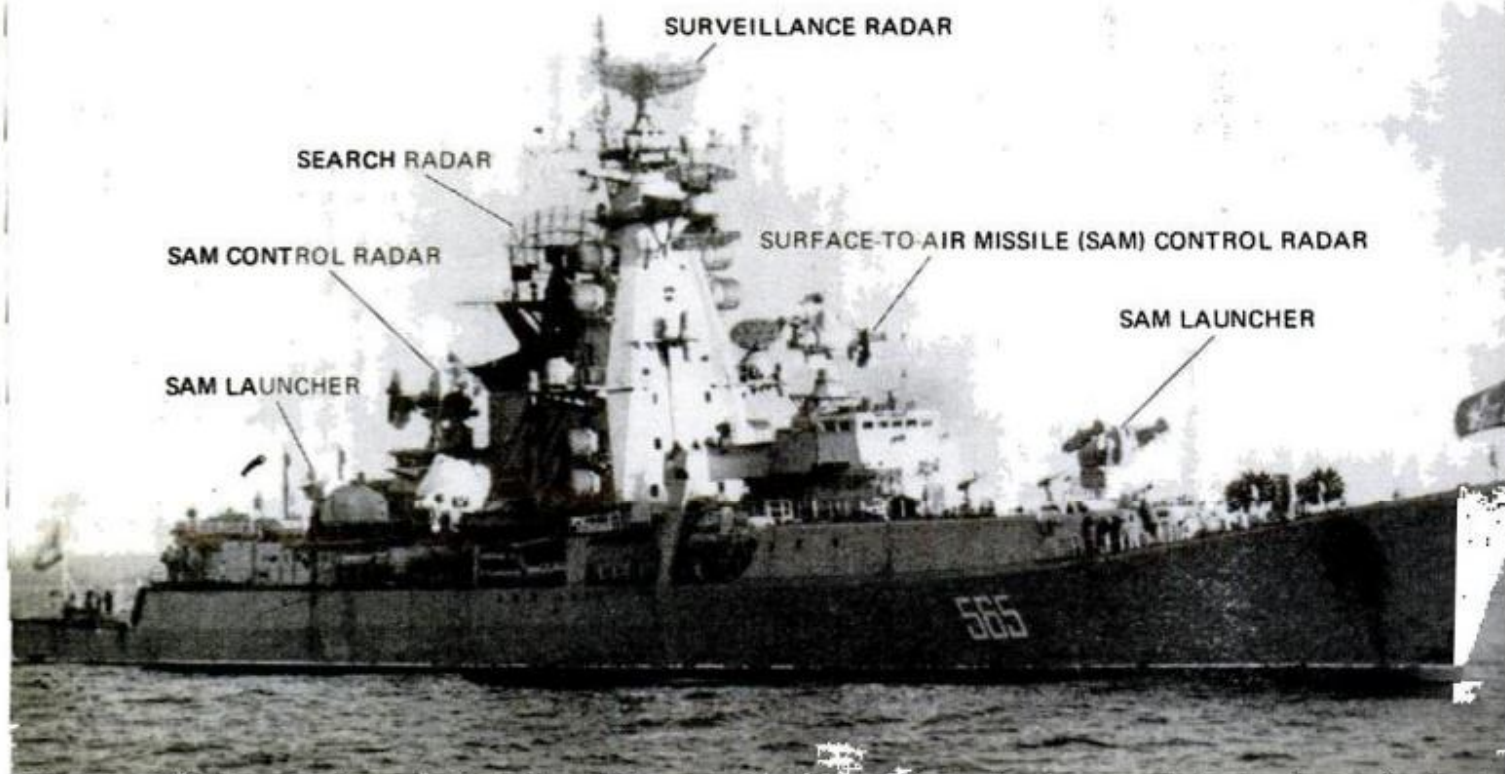



PRIMARY MISSION of Moskva is antisubmarine warfare. Carrier is loaded with electronic hardware

BETWEEN 15 and 20 choppers are carried aboard the Moskva. Long-distance photo shows the ship's stern

In 1961 the *Kynda*-class guided-missile cruiser was first seen carrying bulky Shaddock missile batteries. With surface-to-surface cruise missiles, the Russians have tried to duplicate the range the U.S. Navy has with its carrier aircraft. These ships also are armed with surface-to-air missiles (SAMs), guns, torpedoes and antisubmarine (ASW) weapons. The *Kynda* was the first Soviet warship to mount both SAMs and cruise missiles.

Cruise missiles resemble small pilotless planes. The Russian Styx missiles that sank the Israeli destroyer *Eilat* in 1967 were launched from Egyptian-operated patrol boats in Port Said. The Styx cruise missiles are said to be 20 feet long, with a wingspan of almost 9 feet, and are powered by a rocket engine that gives them a high subsonic speed. The Styx has a range of almost 15 miles, which means it can outshoot the U.S. Navy's ship-based guns.

The American Navy turned its back on cruise missiles some years ago. The "flying bombs" are relatively slow and are vulnerable to aerial attack. But they enjoy the advantage of a low flight profile, which keeps them below defense radars of surface ships. The intended target has little time in which to react.

The turbojet-powered Shaddock missile is described as having a range of 400 miles. And now the Russians reportedly are testing a cruise missile with a potential speed of Mach 4.

The Shaddock is part of the muscle of Russia's latest class of cruisers, the *Kresta*, which first appeared in 1964. At that time American admirals called her a "beautiful and formidable ship, as

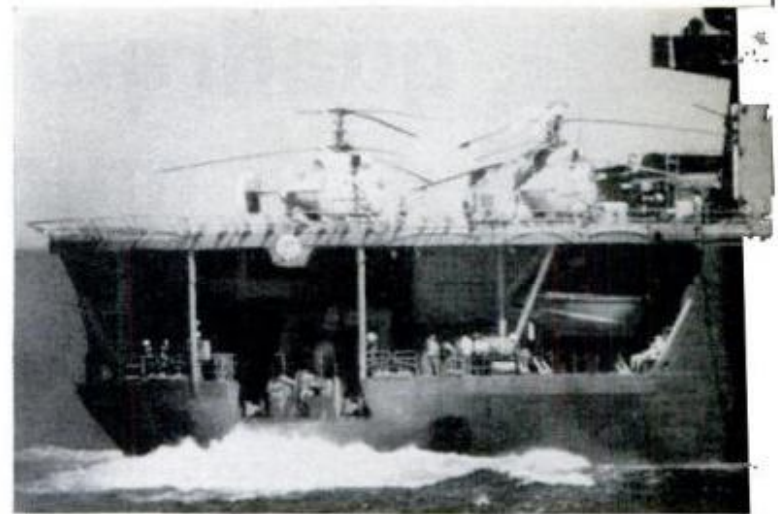

sophisticated as anything we have afloat."

Destroyers. Soviet destroyers have gone through an evolution similar to that of their cruisers. They, too, rely heavily on cruise-missile technology.

Helicopter carriers. The Soviets have two, compared with 10 for the United States. The *Moskva* and the *Leningrad*, designed for antisubmarine warfare, were completed in the late '60s. It's thought they can also serve as command centers for cruise-missile assaults, their helicopters guiding missiles launched from fast patrol boats of the *Osa* (Wasp) and *Komar* (Mosquito) classes. The Russians are said to have about 150 of these boats.

Today, the Soviet navy is divided into four blue-water fleets—Black Sea, Baltic, Pacific and Arctic, each composed of several hundred vessels. In the Mediterranean, once "owned" by the U.S. Sixth Fleet, there are today more Russian naval vessels than American. Not long ago there were over 60 Soviet ships to

(Please turn to page 187)

How to unsnarl the great quadraphonic muddle

FINDING FOUR-CHANNEL systems and recordings won't be any problem this year. But picking the right system could be. Every manufacturer is going quadraphonic—but they're not all going the same way.

With four channels, you naturally get more than with stereo's two: a greater sense of "being there" when listening to concert recordings, more intimacy and excitement from surrounding yourself with music, and more scope for dramatic action in operatic and dramatic recordings.

The big news—and the big controversy—this year is the four-channel phonograph record. Faced with the problem of fitting four signals into the same record groove

Confused about 4-channel systems like SQ, Q8, EV-4, QS, Quadradisc? Here's how to tell them apart — and how to add them to your stereo system.

By **IVAN BERGER**, Electronics Editor

*Technical illustrations
by Fred L. Wolff*

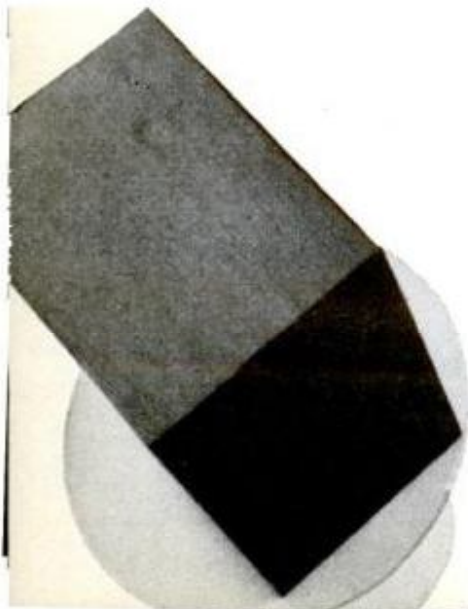
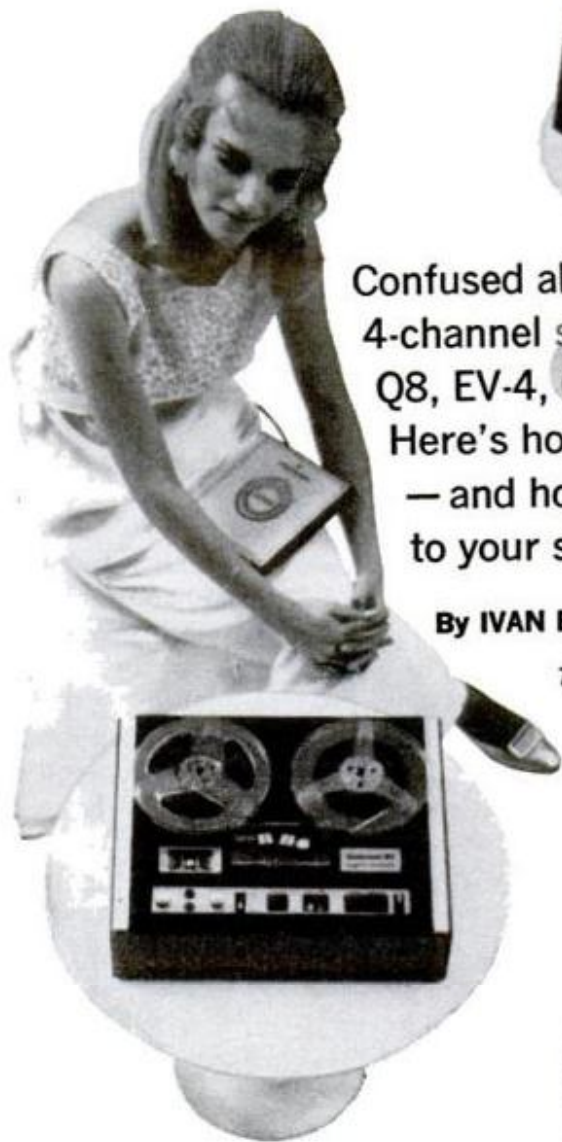

ADAPTERS FOR FOUR-CHANNEL DISCS

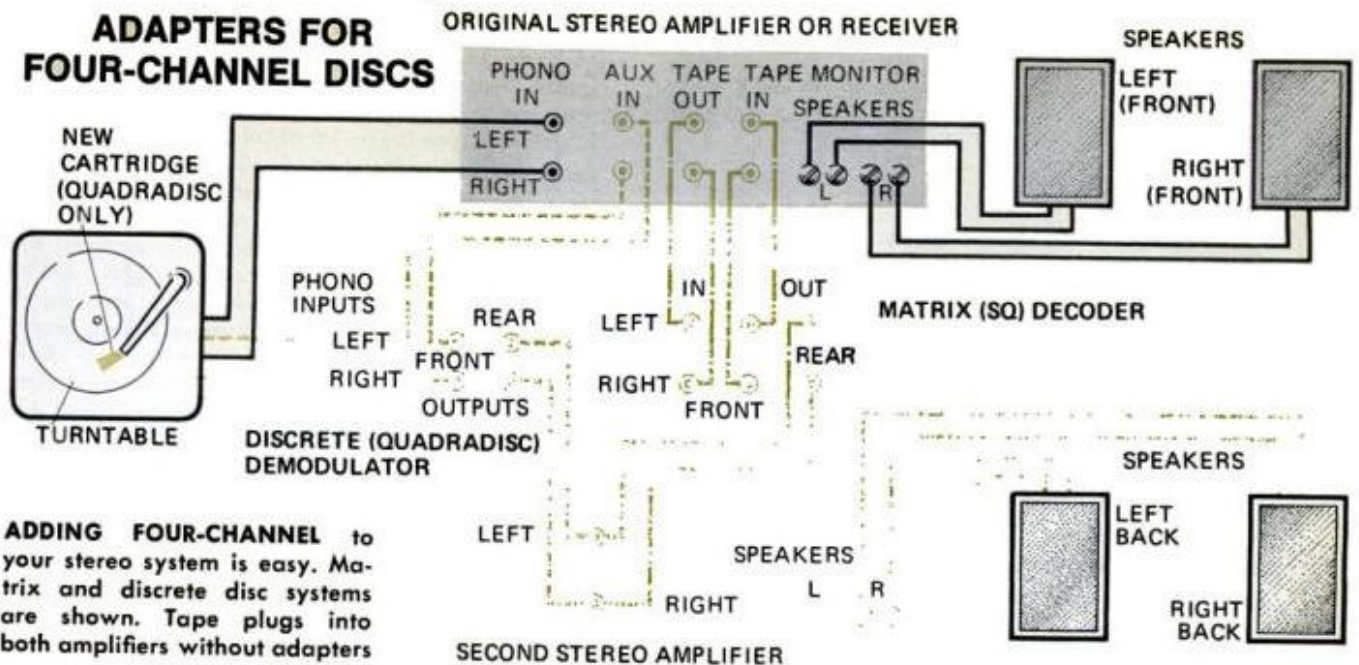

ADDING FOUR-CHANNEL to your stereo system is easy. Matrix and discrete disc systems are shown. Tape plugs into both amplifiers without adapters

that had held two, engineers have turned up two totally dissimilar approaches: the matrix and discrete disc systems.

Simplest to make, but hardest to describe, are the *matrix* systems advanced by CBS (SQ), Sansui (QS), Electro-Voice (EV-4) and Dynaco. By manipulating phase and amplitude relationships, they mix four signals into two in a way that permits them to be decoded later. Played on ordinary stereo equipment, matrix discs sound just about like regular stereo recordings. All the instruments—front and rear—are heard, though just through two speakers. To hear these discs quadratically, you add a decoder, a second amplifier (which may be built into the decoder) and two additional speakers. (The Dynaquad system, though, requires no extra amplifier—just the decoder and speakers.)

The decoder will also produce a reasonable degree of four-channel enhancement (sometimes called "derived" four-channel) from the complex phase and amplitude relationships between the channels of a regular stereo disc. Matrix units were selling for that purpose even before four-channel records were available.

Records made for one matrix system can be played through another system's decoder. At best, you'll hear the same four channels, but distributed differently around the room; at worst, the result should still be as good as the random enhancement you'd get from stereo discs. And Electro-Voice claims its new de-



DECODER SWITCH and connections on this Sony stereo amplifier let you conceal an SQ or similar decoder and control it from the amplifier's front panel

PUSHBUTTONS on Toshiba matrix decoder change the four-channel effects; the rear amplifier is built in

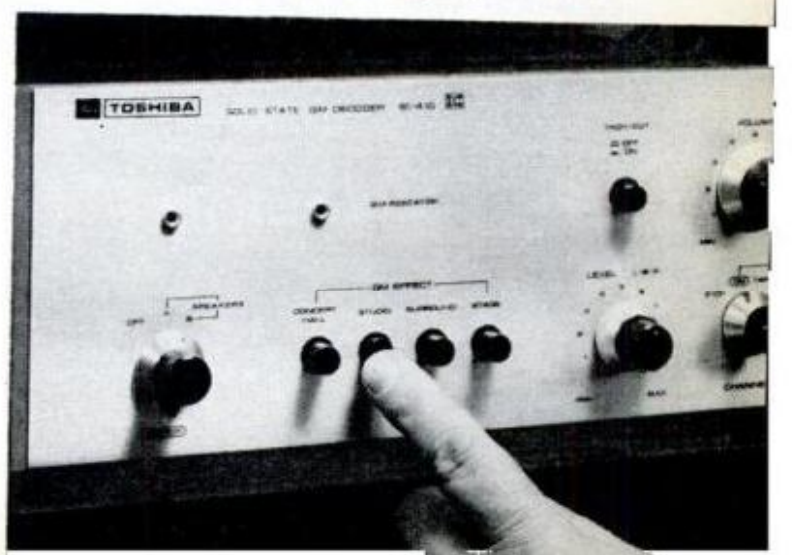

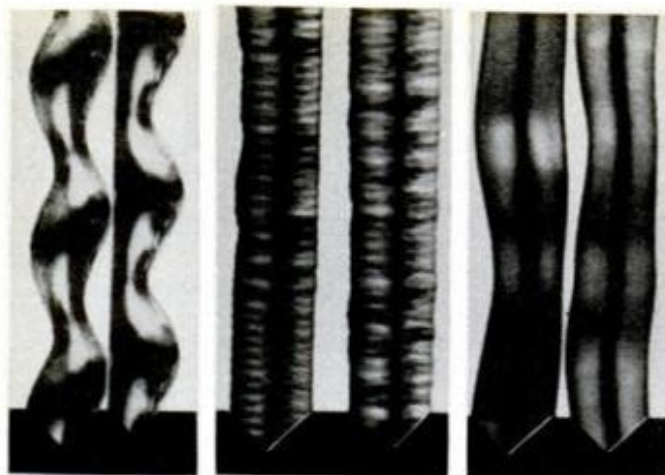

RECORD GROOVES (magnified 100 times) show differences between new four-channel disc systems. Stereo grooves (left) carry two channels, one on each groove wall. Grooves of RCA's Quadradisc (center)—identical to JVC and Panasonic four-channel systems—carry left-front and left rear signals on one groove wall, right-front and right-rear on other. Decoding information is carried by 30-kHz signal (ripples in groove), too high to be heard. SQ grooves (right), unlike others shown, are modulated with one signal each; left groove shows right-rear signal modulation; other, right-front signal. With four channels playing, such grooves look like more complex versions of regular stereo grooves. They can be played by regular stereo cartridges. Quadradiscs need special cartridge for four-channel listening.

coder is "universal," automatically decoding all four channel matrices within two percent of their makers' specifications. In addition, much of this fall's new Japanese equipment will have two matrix positions: one "regular," which Sansui says is virtually identical to its matrix, and one for SQ.

Records are available for all of the matrix systems. At this writing, nearly 100 recordings had been announced in Columbia's SQ system, about 35 in the Electro-Voice system, about 20 to 25 in the Sansui matrix, and a few in the Dynaco system as well (though the Dynaco system is primarily sold for enhancement of standard stereo material).

Matrix systems have a big advantage: they can be broadcast over conventional

stereo stations, taped and played back, all without losing their latent quadraphonic qualities; it takes only the right decoder to restore the original four channels.

But there's also a disadvantage: that restoration isn't perfect. Mixed with the signals you want to hear in each of the four channels are undesired leakages from two or three of the remaining signals. Special "logic" circuits have been designed to monitor and correct this, but they apparently cannot restore the full channel-to-channel separation of the original master tape.

That's where RCA's new Quadradisc system (actually developed by JVC, who call the system "CD-4") comes in. The demodulator that separates its four channels is controlled by an inaudibly high 30-kHz signal in the groove. Because it has this extra source of information to tape, the demodulator is able to separate the four channels completely. On some recordings, the difference between this and a matrix system is imperceptible; on others, the "discrete" Quadradisc's separation makes a subtly impressive difference.

But to accommodate this extra signal

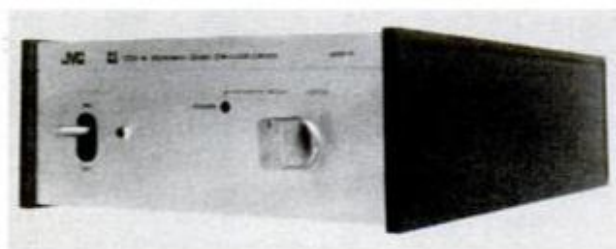

FOUR-CHANNEL CONVERTERS styled to match other components are available from many makers. RCA Quadradiscs require a demodulator adapter like the JVC unit above. Columbia and other SQ records require matrix decoders like Sony's SQD-2000 (below)



FOUR-CHANNEL SPEAKER SETUPS vary widely. Angled speakers here let you sit at rear wall, with proper volume balancing (front speakers should be louder, so they sound as loud to you as nearer rear ones)

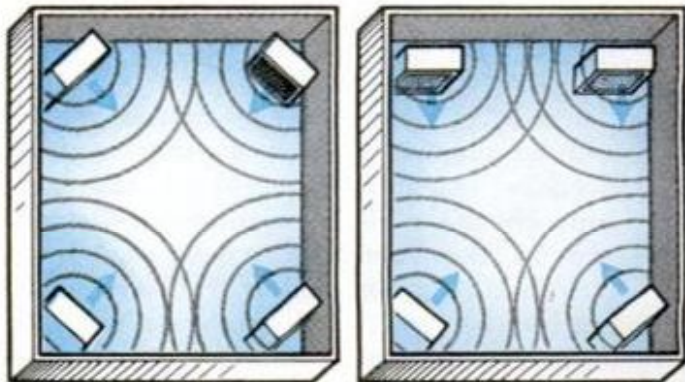



in the groove, the Quadradisc must apparently be recorded at a lower signal level, making noise (due to dust, record wear or inexpensive phonographs) more of a problem than with stereo or SQ discs. And the Quadradisc's total playing time is barely more than 20 minutes per side, compared to a maximum of over 35 minutes for stereo or SQ.

Quadradiscs are also compatible with ordinary stereo equipment (RCA, in fact, plans to offer no stereo equivalent of Quadradisc releases, which will sell for the same price as stereo records). But to play these records quadratically, you'll need not only a demodulator but a new cartridge capable of tracking signals up to 50,000 Hz (cycles) in frequency—and such cartridges have already been announced.

Matrix decoders and discrete-disc demodulators are not as closely compatible as the different matrix systems are. Each system will play the other system's discs precisely as though they were the stereo variety; matrix decoders would probably "enhance" the discrete disc, but the discrete system's demodulators would have

MID-WALL location of rear-channel speakers preferred by some gives surprising depth for rear-room listening. Bouncing sound off wall gives wider dispersion. Angle speakers for best sound at your chair

ALL-IN-ONE receiver from Toyo has "universal" matrix decoder, Q8 four-channel cartridge player and "joystick" control with a balance indicator scope



VERSATILE Panasonic unit plays four-channel tape cartridges in car, or at home through adapter unit

absolutely no effect on the matrix records.

You can tape or broadcast Quadradiscs, but because the carrier frequency is above the range of most tape and all broadcast systems, you won't be able to receive or play back the result quadratically. (And the carrier frequency might create interference on some tape systems.) Discrete quadrasonic FM broadcast systems are already being studied, but it will probably be quite

OMNIDIRECTIONAL speakers give widest, least critical listening area; can be used for front, rear or both channels. Even with them, quadrasonic perspective is best when you're not too near any speaker

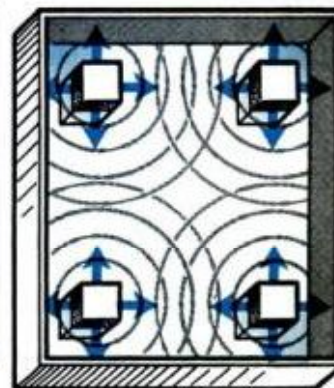
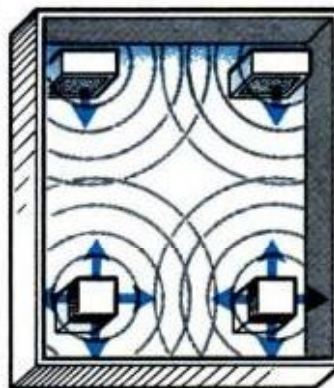
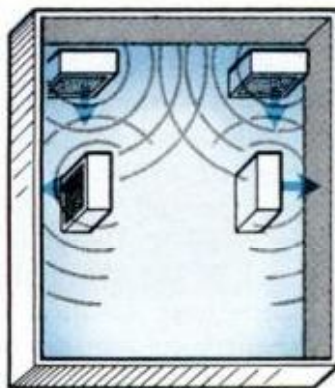
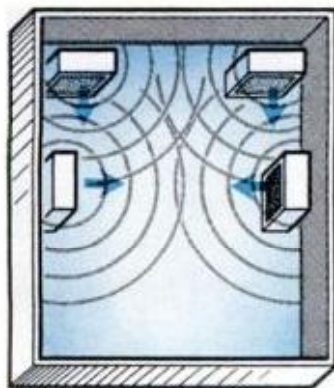

FOUR-CHANNEL TAPE: WHERE THE EXTRA CHANNELS COME FROM

QUADRAPHONIC TAPE recordings use the same tracks as stereo tapes—but use twice as many of them. Instead of two stereo tracks going one way and two the other (you reverse or flip the tape to play the second pair of tracks), open-reel quadraphonic tapes have four tracks going the same way—and only half as much music per tape. Q8 tape cartridges have two sets of four tracks each instead of the stereo-8 cartridge's four stereo track pairs. But the tape length is doubled, so there's just as much music per cartridge. Cassette formats are not shown, since two different quadraphonic cassette formats have been suggested, but neither is accepted as a four-channel standard yet

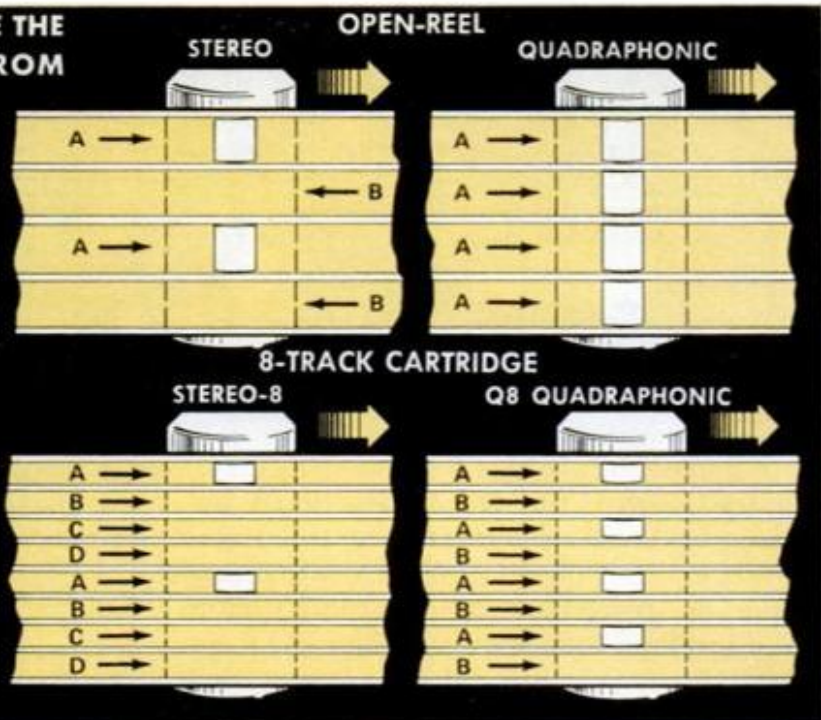

some time before one of them is adopted.

Which system to buy? You can make a case for either one. What it boils down to is that matrix discs are more compatible with tape, broadcast and other systems, allow more recording time per disc, and can enhance stereo materials—but the discrete disc does yield a more accurate four-channel signal. And proponents of both systems hope, of course, to find a way around their disadvantages.

Whichever you pick, you can add it to most existing stereo systems easily. Matrix adaptors plug into a stereo system's

tape monitor connections; discrete disc demodulators connect between the turntable and the stereo system's high-level (AUX or TUNER) inputs, and the new phono cartridge required mounts in place of the old one.

What if you buy a quadraphonic disc system now, only to see another system become the eventual standard? If so, you're out part of the cost of your decoder or demodulator—but only part, since you'll still want it to play the records you've already bought for the old system. Your investment in rear-channel speakers and amplifiers (unless the amplifier is built into the decoder) is still good, of course. And most of the four-channel components incorporating one record system have enough flexibility to let you add the other at a later date.

The records themselves, of course, won't become obsolete. Since they're stereo-compatible, you'll always be able to play them, even if you can't always play them quadraphonically.

Tape is a different story. Here, the standards are pretty well established, at least on open-reel and 8-track cartridge tapes. That's because no technical trick is needed to get four channels onto tape—just spread out and use as many tracks as needed. Using one magnetic track for each of the channels, home tapes can produce four distinct signals as easily as the record company's master tapes do. Tape

(Please turn to page 188)



OPEN-REEL quadraphonic tapes are excellent, but expensive. This TEAC deck lets you record your own

Now they're pampering the pellet-pushers

By JERRY GIBBS



CONVERTIBLE PUMP is High Standard's name for its \$114.95 20-gauger that includes a second, shorter stock

Scatterguns, ranging from kid to king size, have been improved in appearance, accuracy, ease of use and durability

SHOTGUNS ARE SLICKER this year. To traditional function, makers are adding smoother, safer operation underneath elegant appearance. Prices are reasonable to almost out of sight—if your budget lets you choose collector's items.

So many selections are around that a beginning trap, skeet or hunting sports-

man could get confused. But no need to start scattergunning with the traditional single-barrel knockabout "farm gun." Enough reasonably priced doubles (side-by-side barrels) have appeared to put the old classic back in the picture. Why lose out for want of a second fast shot?

Consider the Savage Fox and Stevens

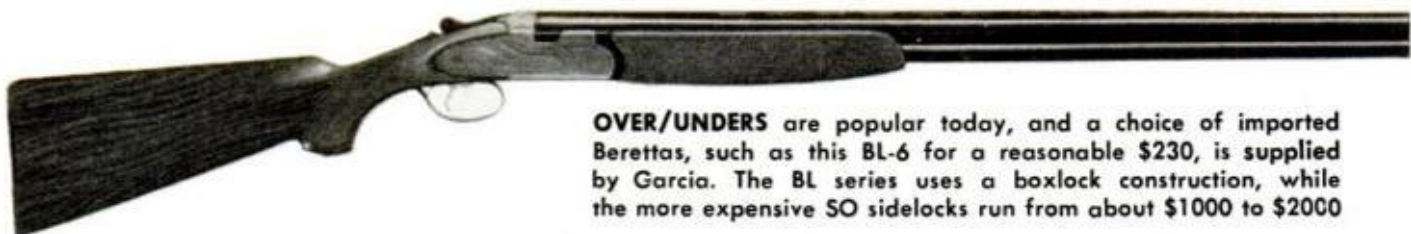

OVER/UNDERS are popular today, and a choice of imported Berettas, such as this BL-6 for a reasonable \$230, is supplied by Garcia. The BL series uses a boxlock construction, while the more expensive SO sidelocks run from about \$1000 to \$2000

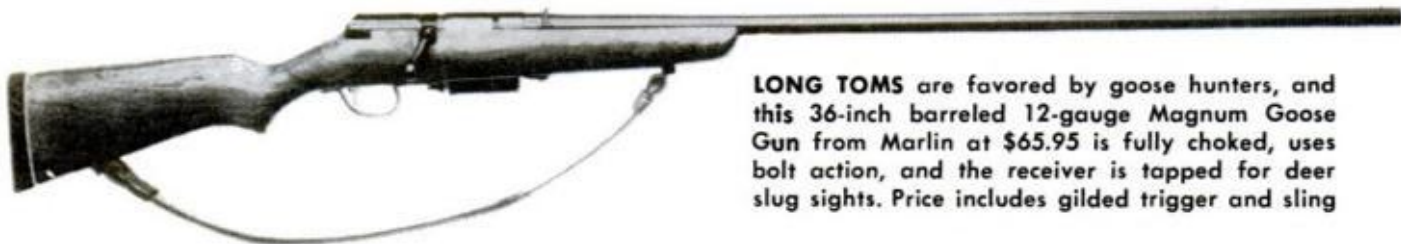

LONG TOMS are favored by goose hunters, and this 36-inch barreled 12-gauge Magnum Goose Gun from Marlin at \$65.95 is fully choked, uses bolt action, and the receiver is tapped for deer slug sights. Price includes gilded trigger and sling



IMPORTED from Italy by Stoeger Arms, the Franchi Falconet is available in various field, trap and skeet models with prices starting at \$295.95. Easy cocking is a feature, with a short, fast hammer fall. Gauges of 12 and 20 are offered in barrel lengths of 26, 28 and 30 inches with optional stocks



BOLT-ACTION Slugster from Mossberg, the 12-gauge deer and bear gun with a 24-inch barrel and a Partridge front sight plus folding-leaf rear, holds three shells and is \$62

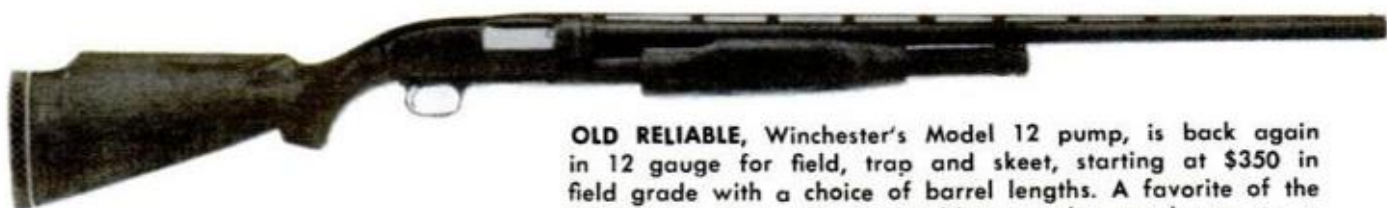

OLD RELIABLE, Winchester's Model 12 pump, is back again in 12 gauge for field, trap and skeet, starting at \$350 in field grade with a choice of barrel lengths. A favorite of the slide-action fans, the new old-timer also graduates to a Super Pigeon model with special options and engraving at \$900



RIFLE-SHOTGUN COMBO, the Savage Model 24C Camper's Companion has a .22 rimfire barrel on top and 20 gauge below. The \$75 gun takes down to fit into a 5x20-inch carrying case. It stores four shot and ten .22 shells in stock compartment for multipurpose hunting, plinking



SIDE-BY-SIDE DOUBLE from the firm of superposed over/under fame is Browning's new Model B S/S. Available in 12 gauge only, this latest double barrel from the Morgan, Utah, manufacturer is \$234.50. A feature of new O/U models is an extra-wide $\frac{5}{8}$ -inch Broadway vent rib that is reported to prevent canting gun, make sighting easier. Superposed Broadway models are \$540 up; single-barrel BT-99, \$339.50

models (the 311 now comes in 12-gauge with 30-inch barrel for 3-inch magnum shells, by the way) from about \$109.95 to \$164.95. Also in this category falls Harrington & Richardson's Model 404, at around \$100. Somewhat higher is Ithaca's SKB Model 100 at \$209.95. Ithaca's brand-new SKB 150, for \$239.95, has all features of the 100 plus a beavertail fore end and fancier etching. Then there are Rossi Overland models from Garcia, with old-timey outside barrels but modern steel (not Damascus) to handle today's high-pressure loads. Offered in 12, 20 and .410 gauge, the Rossi is about \$90. And new from the firm of superposed fame is a side-by-side double for \$234.50—it's a Browning, Model B S/S, in 12 gauge.

Slide-action repeaters make fine, tough first guns, and also serve experienced trap shooters and hunters admirably. I'd recommend autoloaders for the older beginners, not youngsters. Skeet shooters have been happily using semiautomatics like Remington's 1100 for years.

New repeater models and improvements include Ithaca's 51 series 3-inch magnum duck-goose gun, plus three new lightweight SKB autoloaders. Magnum is \$204.95 and SKB-XLs \$170 to \$210. Dedicated slide-gun fans have been cheering the return of Winchester's Model 12. Un-



HANDWORK by craftsmen is typical of fine guns. Marlin's president, Frank Kenna Jr., checks the finish

changed in style and function, the 12-gauge new old-timer sells for \$350 in field grade with choice of barrel lengths. Garcia's handsome trap auto, the AL-2 with hand-engraved receiver, comes with new wider rib (as does its BL-6 over/under). Cost: about \$210.

This year Remington has come up with *(Please turn to page 196)*



LIGHT GAME MODEL, this new Perazzi over/under from Ithaca has characteristic Schnable fore end. Perazzi MX-8 won both men's and women's international trap world championships in '69, Olympic Gold Medal. Prices to \$1795



COLLECTOR'S ITEM for trapshooters is the Remington All American. Added to this Model 870 is fancy engraving, custom-cut checkering, beautifully grained American walnut stock, a gold pistol-grip cap plate for the owner's initials, and gold-plated shield with eagle on receiver. Optional Monte Carlo stock. \$550

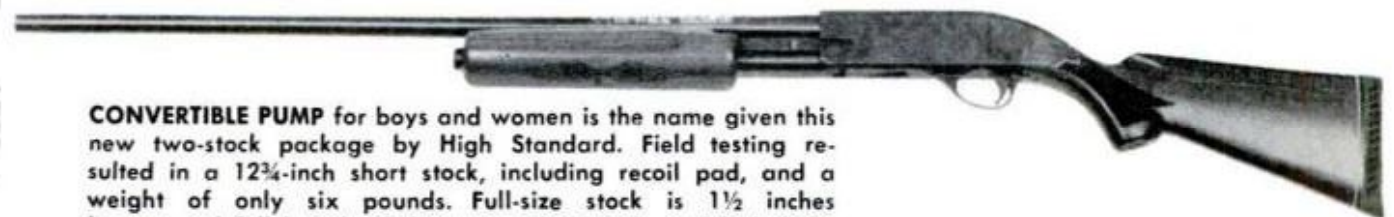

CONVERTIBLE PUMP for boys and women is the name given this new two-stock package by High Standard. Field testing resulted in a 12¾-inch short stock, including recoil pad, and a weight of only six pounds. Full-size stock is 1½ inches longer, and full length of the gun with 28-inch modified choke barrel is 47¾ inches. Conversion from short to full-size stock is reported to be simple. Five-shell capacity. \$114.95

How TV puts you on the 18th green

It isn't as easy as it looks. Televising a top golf match takes a small army of technicians, van-loads of intricate gear and some fantastic teamwork

By FRANK A. TINKER

NOW LET'S GO OVER to the 18th green," says the television announcer, "and see how Lee Trevino sank that last putt."

To the viewer, the switch in picture looks automatic. But it's far from that. The know-how and technology involved in televising championship golf matches are almost as remarkable as the skill displayed by the golfers themselves.

To cover a tournament on the Professional Golfers Assn. tour, the Dean Martin Tucson Open, NBC sent five huge equipment vans rushing to Arizona from Mobile, Ala., where they had been used in covering the Senior Bowl football game the previous week. Simultaneously, several truck-mounted cranes were dis-

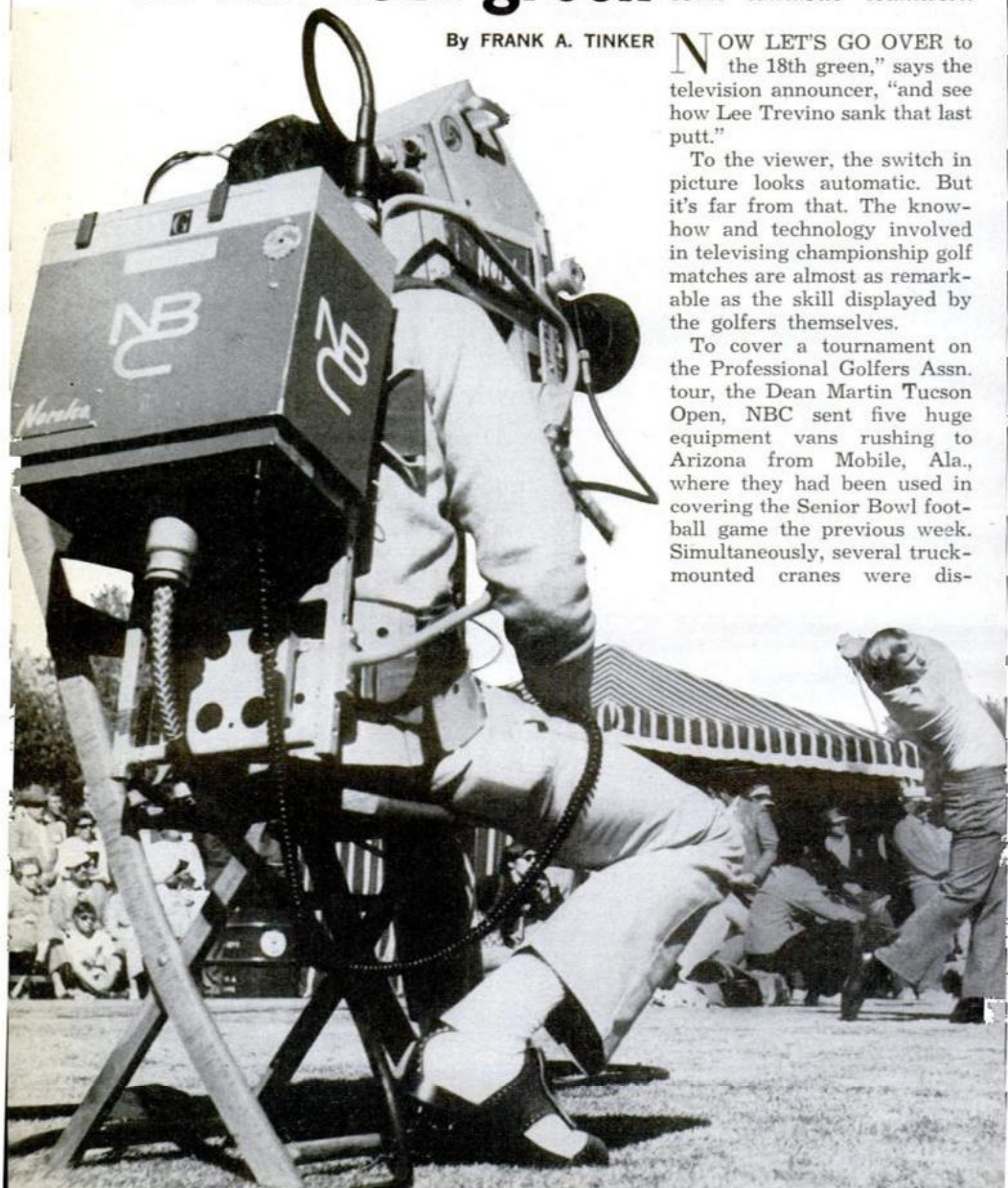

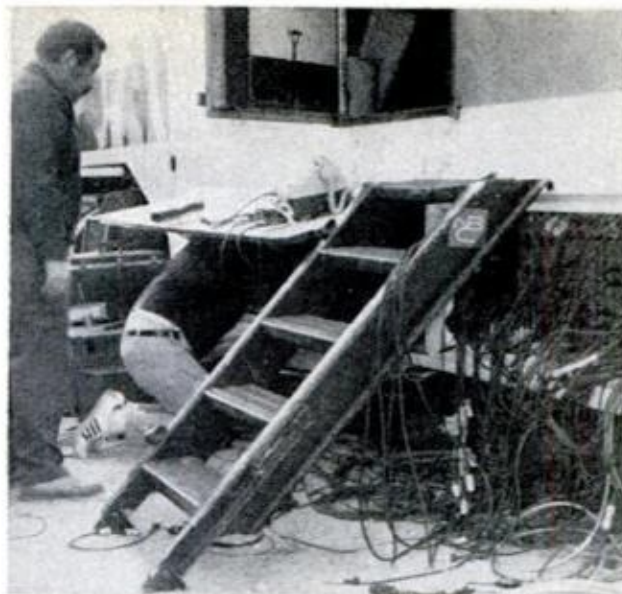

MASS OF CABLES linking control vans with cameras gives an idea of system's complexity. Connections are made under lift-up side panels on the vans

RIDING HIGH, dolly-mounted camera at left follows action along course on top of traveling crane. Some cranes extend to 300 feet to clear tall trees



MONITOR SCREENS in control van show as many as a dozen camera views for director to pick from. Actual pictures transmitted appear on center screens



GIANT TRACTOR-TRAILER VANS, accompanied by up to 100 technicians, travel country from coast to coast, carrying equipment for NBC sports telecasts

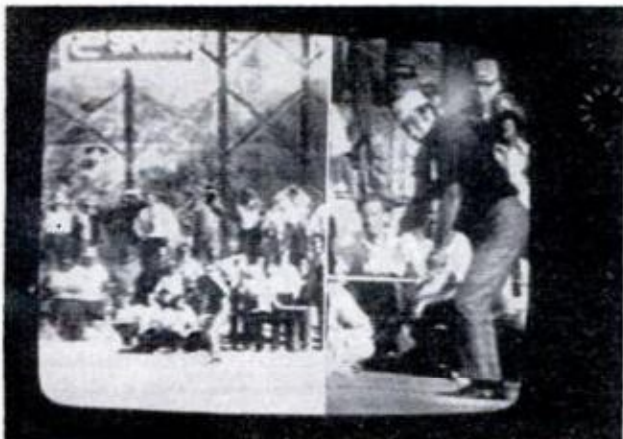

SPLIT SCREEN shows George Archer in close-up on right; distant shot on left will follow flight of ball in air. Such "wipes" combine two camera views

patched from California. Forklifts, generators, and other heavy gear were rented locally.

Nearly 100 technicians and staff members either accompanied these caravans or were flown in later. By the time the first round of the tourney was played, the last four holes had, in effect, been converted into a huge TV stage. A dozen cameras, on scaffolds, cranes, or camera-men's shoulders, were in position to cover the action. Twice as many microphones were deployed to pick up announcers' voices as well as the smack of club against ball. If you've ever wondered why that sound comes through so sharply, the an-

Typical TV layout at Tucson

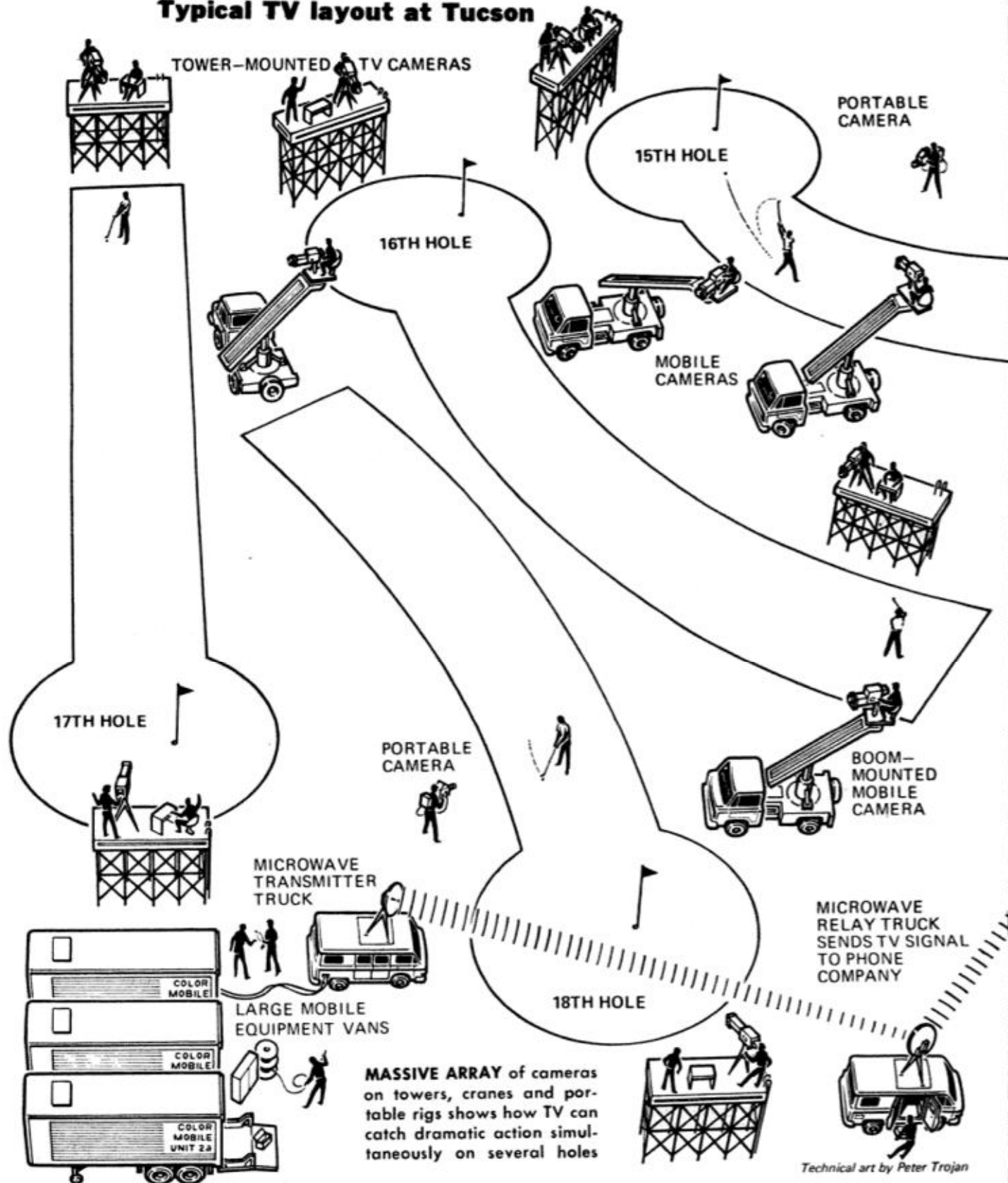

swer is that a highly directional microphone is aimed right at the player.

Two basic color cameras, made by Norelco, are used by NBC for such sports events—one a heavy, complex dolly-mounted model and the other a smaller, portable backpack version for shoulder carrying. Handling this intricate equipment is no job for the inexperienced. NBC

cameraman Jack Bennett has spent 21 years mastering his craft, and Cory Leible, a specialist with the portable backpack unit, has been around almost as long. Both had been on the road for six hectic weeks by the time they finished at Tucson. Harry Coyle, senior NBC sports director, may travel 150,000 miles a year in his job.

The cables that lead from the cameras and mikes along the easements of the golf course all converge on the nerve center of the operation, the control truck. In this studio, producers, directors and technical chiefs take the raw material piped into them from the course and shape it into an understandable program. Before them are a dozen monitor screens showing the picture obtained from each camera, a preview screen on which the director can arrange his "shots" before releasing them for actual telecast, and the program monitor, which shows what is actually being transmitted to the home screen.

By punching the appropriate button, the director can put any camera's picture (or combination of pictures) on the preview screen, see what he has or what needs changing, and then put the result on the air by punching the program button.

Since a single course may provide a variety of settings, golf presents a special problem: Light intensity frequently ranges from deep shade to bright sky. Technicians try to maintain a balance between the many incoming pictures to avoid jarring the watchers' sensibilities by a sudden shift in color as the director switches cameras. At Tucson, the fairways to be shown had to be dyed green, since the dormant winter Bermuda grass was a dull beige—simply not the color the fan, or the chamber of commerce, believes golf fairways should be.

On the audio end, there are two separate lines—one for internal communications and one for the program material that goes out over the air. The private line (PL), wryly called the "pandemonium" line by the crew, carries a constant



TALL TOWERS put camera crews high above spectators, trees and other obstacles to get a clear view of action on golf course for viewers at home
SEPTEMBER 1972



MOBILE MICROWAVE TRANSMITTER relays TV signal from golf course to distant receiver. Signal then goes over telephone lines to TV broadcast stations

stream of information from assistant directors and commands from the director. This mixture of messages goes into one side of the headset worn by crew members. The opposite earphone carries the program audio. Do these two channels ever become a jumble when the action is fast?

"Not really," says Bennett. "When you get used to the system, you use the program line to anticipate commands. Say that one golf pro uses an unusual stance or grip. The announcer is tipped off to this, mentions it, and I can move right in on the golfer's hands or feet before the director has to tell me."

Experience has also taught these crews techniques that the average fan has come to take for granted.

"We used to 'back off' immediately from a golfer hitting toward us," explains Leible. "But we found that we lost the ball by going to a wide view. Now we leave the picture tight and get the ball in the center of the screen. We widen the coverage gradually so when the ball hits the ground we have the whole green or surrounding area in the picture."

All this experience, equipment and effort on the course and in the control truck results in a single picture on the

(Please turn to page 190)

Mini-Hawk:



IF YOU HAVE a power drill, hacksaw and tin snips—and the skills of a Saturday Mechanic—you can build the all-metal Mini-Hawk. So says Tom Maloney, the industrial engineer who constructed the prototype.

“The skin for the wings, for example, comes in six-foot sheets in the kits we sell,” he explains. “The pattern is laid out on each sheet. All the builder has to do is get his tools and start cutting.”

Maloney worked with two fellow Californians in developing the Mini-Hawk. Designing was done by William Taylor, a mechanical engineer and industrial designer who has had a long association with the aircraft and recreational-vehicle industries. Edward Treffinger, a former fighter pilot who has logged thousands of hours as an instructor, served as test pilot and flight-test manager.

The single-seater is only 13 feet 6 inches long and has a wingspread of 18 feet. It was designed to be transported on a small

trailer. The wings, which weigh but 20 pounds each, can be removed in a matter of minutes for trailering or garaging. With its wings off, the Mini-Hawk easily fits into a standard-size garage.

The plane has an empty weight of 500 pounds and a gross weight of 800. Powered by a modified VW engine that develops 65 hp, the Mini-Hawk cruises at 120 mph and can hit a top speed of 140. It can climb 1000 feet per minute and take off after a roll of 500 feet. The plane requires only 600 feet to land, making it ideal for operating from small fields.

The perky plane has a ceiling of 10,000 feet and a range of better than 500 miles. It reportedly burns only 2.5 gallons of premium automobile fuel per hour.

Tom Maloney estimates that by using surplus materials the homebuilder can construct the airframe for from \$500 to \$600. A used VW engine may be picked up for about \$250. The cost of rebuilding and modifying it would be at least \$150, which

A bird for the bargain hunter

Surplus materials, a rebuilt engine and basic tools can get you into the air in this all-metal plane.

By **JOHN F. PEARSON** and **HOWARD LEVY**
Photos by Henry Artol

would raise the total cost to about \$1000. Construction plans sell for \$35.

The easy way out is to build the plane from the kit sold by Mini-Hawk International, the company set up by the plane's developers. A complete kit, including engine, costs \$2225. Components such as the landing gear assembly, the windshield or basic instruments can be purchased separately.

The low cost and simplicity of construction has created a worldwide interest in this sporty plane. If you're interested, you can get further information by writing: Mini-Hawk International, Inc., 1930 Stewart St., Santa Monica, Calif. 90404. ★★

IT'S A NO-SWEAT JOB to jockey the Mini-Hawk from a trailer (top photo). The plane has a simple instrument panel and a cockpit that's insulated with fiberglass batts. The third photo down shows the wing root and the tapered pins that anchor wings. Pins are tapped into place by reaching through drop-hatch opening. Modified VW engine can push this small plane at a top speed of 140 mph

SEPTEMBER 1972

115

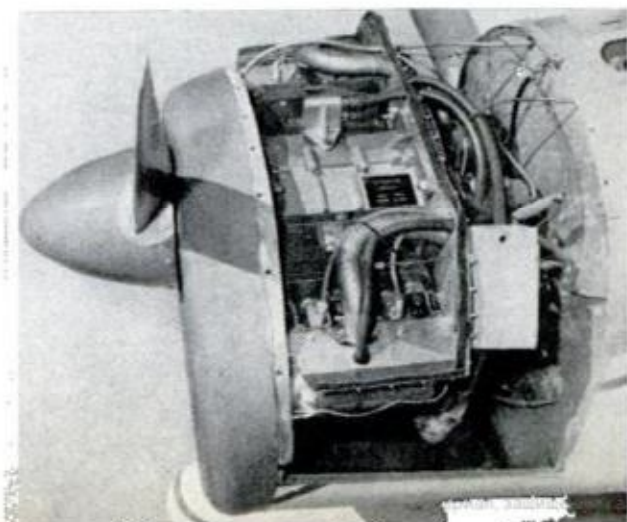
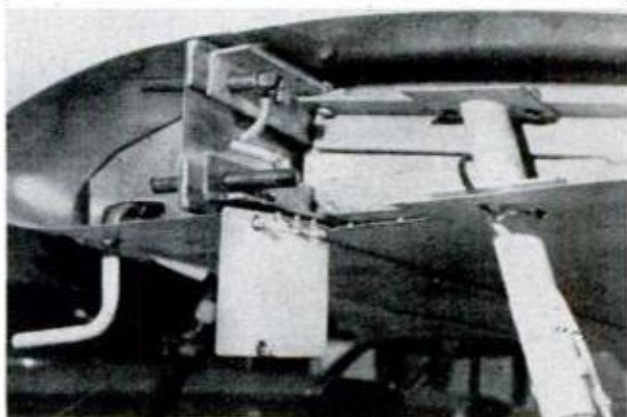

NEW INVENTIONS

IMAGINE LIVING IN A CITY where it never rains or snows, the weather is always pleasantly balmy and you can't find a speck of dust anywhere. The idea of roofing over entire cities to provide such a controlled climate is not new; what is new is that somebody is actually doing something about it. Domed cities to house 20,000 persons are already being planned by a group of architects and engineers headed by West Germany's Institute for Lightweight Structures at the University of Stuttgart. Initially, the structures will be small and designed for use primarily in arctic and tropical regions where extremes in climate make living difficult. The first will be two-mile-diameter, air-supported plas-



**Let it rain, let it pour:
In a roof-covered city,
you won't care anymore**

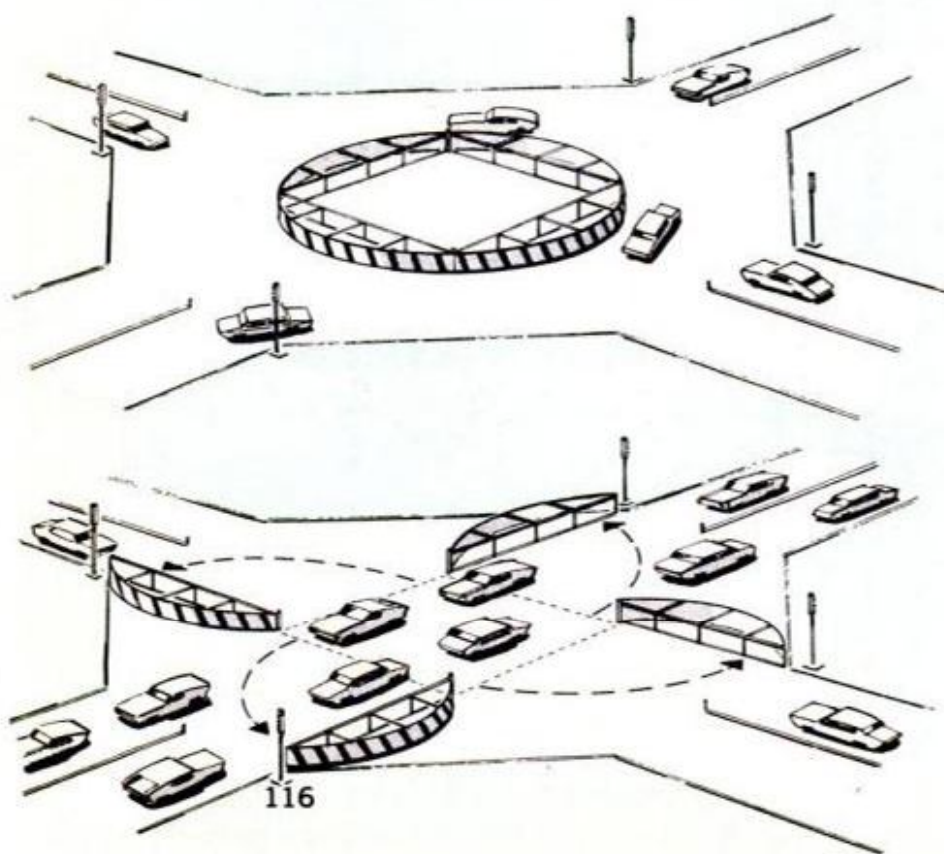

Two-way crossing eases traffic jams

First it's a circle, then it's not in this convertible highway crossing designed by British bus driver Donald Elworthy of London. During light traffic periods, the round barrier in the center functions as a conventional traffic circle, and cars feed in from all directions at once. During commuting rush hours or holiday outings, the circle swings open like four large gates. This permits the more heavily traveled main route to become a high-speed turnpike, while access from lesser-used side roads is controlled by traffic lights.

POPULAR MECHANICS

tic domes inflated by huge blowers. Later models may be of rigid, self-supporting design large enough to enclose communities of major size. Power would be supplied by underground nuclear reactors, whose thermal discharge would also provide heat. Massive airconditioning systems would keep the atmosphere fresh and free of dirt. To simulate the normal day/night cycle, an artificial sun would move slowly across the "sky" and lights would dim and go out in the evening—so you can live inside and still think you're outside. Construction is to begin in Alaska in the next few years.

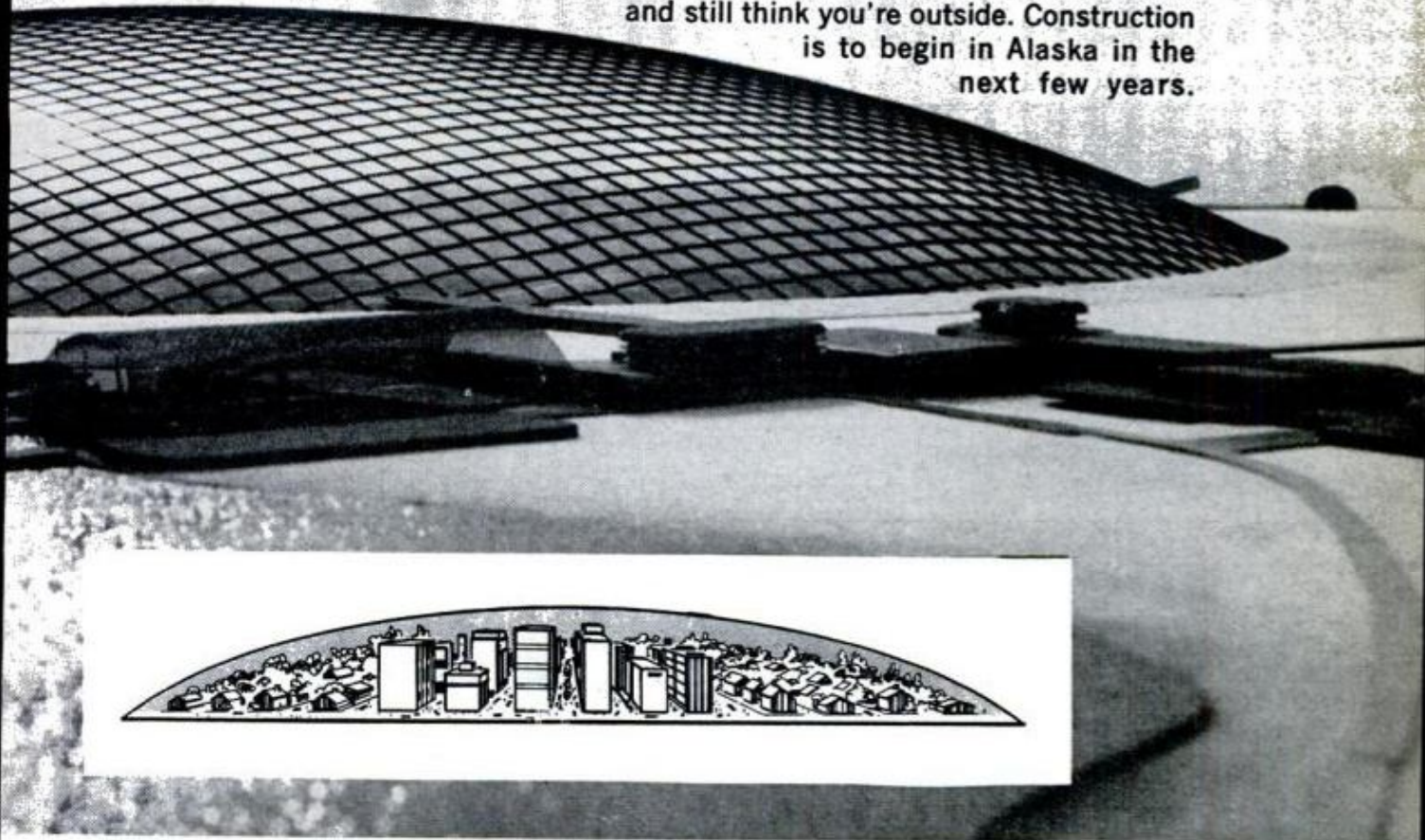

Golf trainer puts you in the groove

You can swing only one way—the right way—with this mechanical golf trainer. The club head is attached to a small wheeled dolly (inset photo) that rides on a curved rail. A golfer who tends to hook or slice feels a sideward pull on the club, indicating his swing is incorrect, so he makes adjustments until his swing becomes smooth and automatic. Invented by British golf pro Kenneth Wilson, the device is said to reduce the time of teaching students substantially, also to help eliminate faults found in experienced golfers. The club shaft telescopes to suit golfers of different size and mechanism reverses for left-handers.

SEPTEMBER 1972

117





Flying low: New jet-powered turbo train hits up to 200 mph

It's driven by four aircraft-type turbojet engines, but doesn't get off the ground—quite. The sleek, streamlined train at left is France's latest answer to fast, safe rail travel. The experimental turbine-powered locomotive, called the T.G.V.001, is capable of speeds approaching 200 mph. Its long, swept-back front cowl is aerodynamically designed, like a racing car's, to hold the engine down on the track at high speeds.

Swimmers and skiers can climb up the stern

Reboarding too many boats is a too-slick trick without a ladder. Now several builders are adding fixed steps as convenience and safety feature for the man overboard. This model from Mark Twain Marine, West Frankfort, Ill., is a 16-foot trihull, the 162T, with foam flotation, bilge pump, blower, lay-down and jump seats, plus 120 or 140 Mer-Cruiser stern drive with power trim, about \$5000.



Puff up your car with a no-huff, pushbutton jack

Air pressure from a compact air supply quickly inflates a pneumatic bellows, lifts up to 3000 pounds. Bulldog Airjack, by Clayco Automotive Products, Costa Mesa, Calif., fits under frame or axle of car and lifts it high enough to remove wheel. Lift height is 18½ inches for standard cars, 15 inches for compacts and sports cars. Bellows is strong polyvinyl resin made by Firestone Plastics Div., Firestone Tire & Rubber.

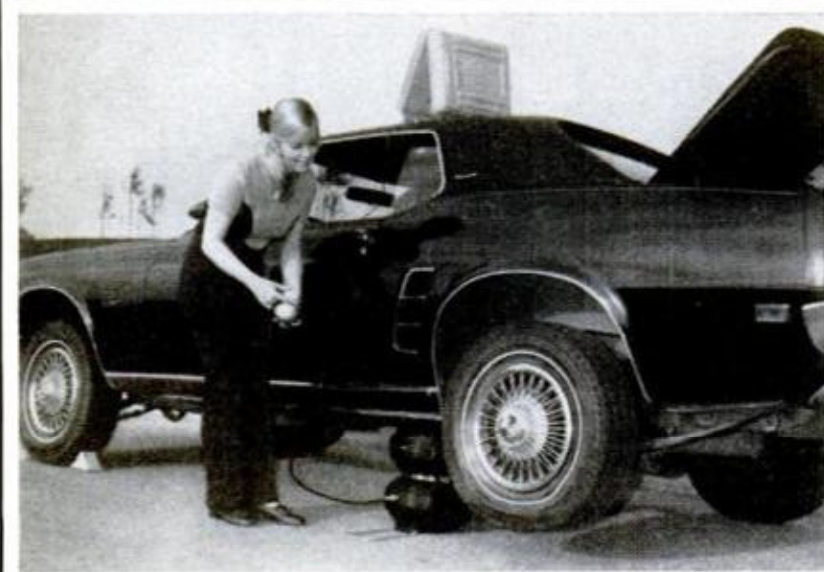

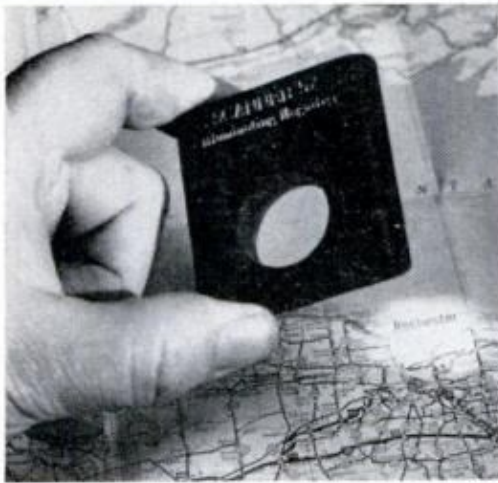

Bigger—and brighter, too

This handy pocket magnifier not only enlarges what you see, but shines a tiny spotlight on it for better visibility. Ideal for map reading and close hobby work, the battery-powered viewer comes in two powers—5X and 10X—for \$3.95 and \$4.95. Flex Electric Products, 40-14 24th St., Long Island City, N.Y. 11101.

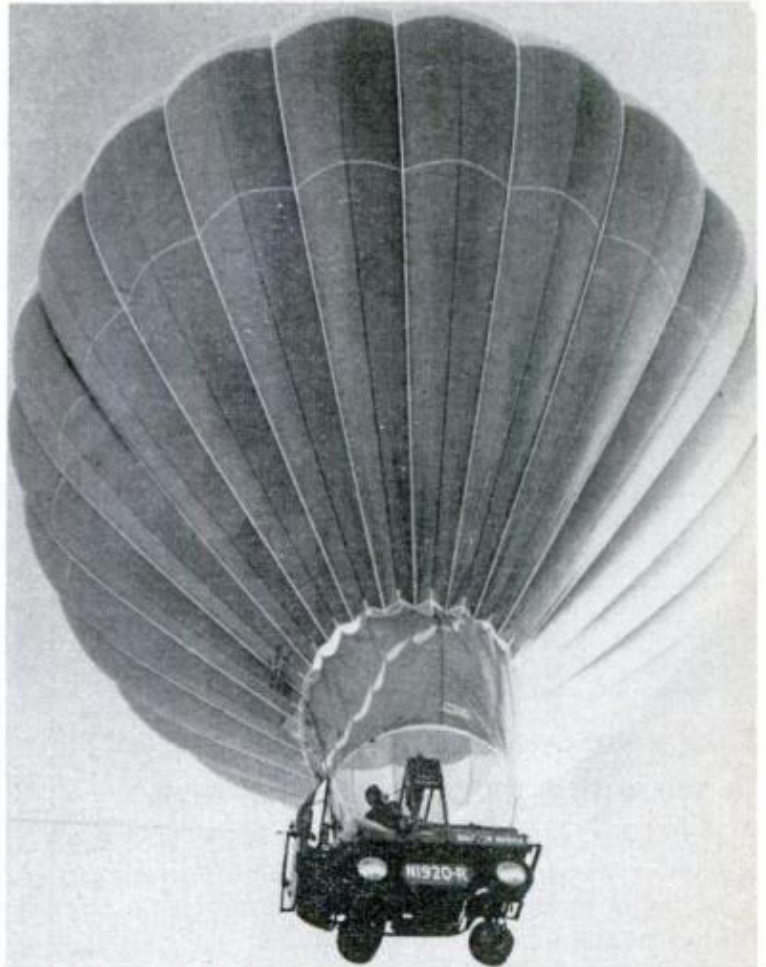

Play games with your TV

Bounce a ball of light across your TV screen to play electronic Ping-Pong, or any of 11 other games of skill and chance. Just hook the battery-powered Odyssey game to your set's antenna terminals (it won't interfere with reception), plug in the program card and apply the screen overlay for the game you want. Players control light-spot "ball." Under \$100. Magnavox, Fort Wayne, Ind.

Well, it beats walking anyway

Caught in a traffic jam? Just blow up a balloon and take off for the skies, leaving the crowd behind. You could if you had this balloon-powered flying truck conceived by two Los Angeles, Calif., inventors, Bill Berry and John Doyle. The balloon is inflated by gas burners that heat the air inside to create lift. Landings are made by slowly shutting off the burners until the air cools and the balloon gradually descends. On the ground, the vehicle provides conventional road transportation. To prove its practicality, the fearless inventors are planning a transatlantic flight in their strange craft.

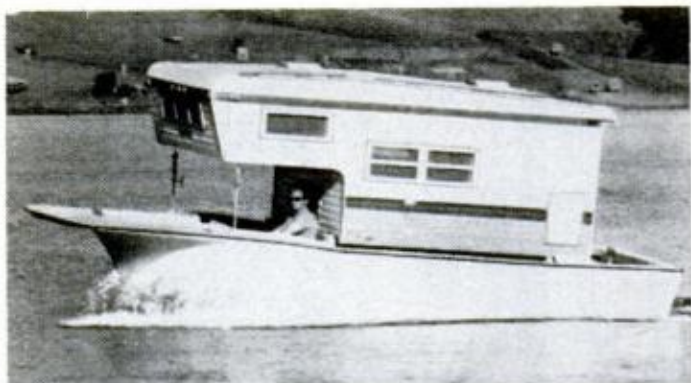

Take your own camper, trailer (or tent) to sea with a multipurpose marine RV

If you can lead your pickup rig to water, you can launch it aboard one of the instant houseboat hulls being made to order. The Champion Camp-A-Boat, at top, from Champion Boats, North Hollywood, Calif., can handle an 8 or 9-foot cabover—or more by leaving less cockpit space. The 23-foot hull, at \$2875, will take outboard or I/O power. Bigger and with twin hulls, the Magicisle below is 28 feet overall, has 12x26 feet of cockpit space, needs only 7 to 10 inches of water. Built by Arcmarine, 2370 North Flower St., Santa Ana, Calif., the \$5250 craft can carry a 2¼-ton load.

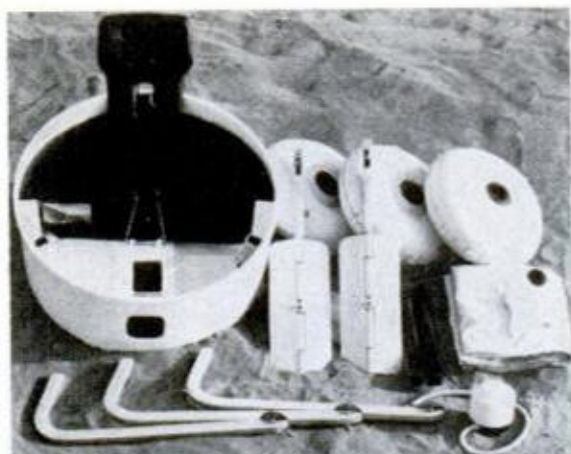

Baby-bathtub boating is Japanese invention for single-seater sailors

In Tokyo, the Act-A-Corp. division of Honda Motors has created this no-motor web-footed Amen Boat using a pump-up tube for flotation. Three aluminum and stainless pods act as tripod stabilizers, while twin fins provide propulsion. The little boating buckets are said to be safe and fun for children, weigh 42 pounds, are only 33,000 yen (or \$107.99 to you).

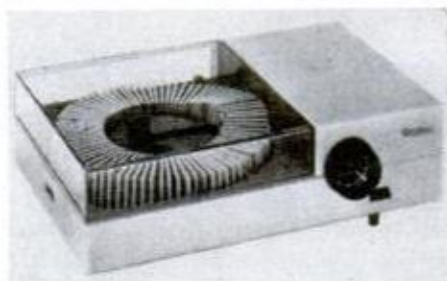

Projectors as pretty as the slides you show

Low-slung and streamlined, these latest slide projectors are handsome enough to leave out between shows. Both Kodak's new Carousel Custom line (left) and Rollei's new "Theatre in the Round" (above) feature plastic covers to keep out dirt and add trim look. Most models have auto-focus, remote control. Rollei P37, \$150; Kodak Carousels, \$179.50 to \$244.50.

Disston brings new dimension to outdoor cooking with cordless electric rotisserie

Back-yard rotisserie cooking is no longer a tangle of extension cords to trip over or fear of getting a shock with this new self-contained power supply that can be used anywhere and on almost any grill. A long-life, nickel-cadmium battery, which can be recharged overnight, drives a 16-ounce motor more than six hours on one charge. Complete with spit rod, skewer forks and two sets of mounting brackets, plus charger, \$25.95. H.K. Porter Co., Inc., Porter Building, Pittsburgh, Pa. 15219.



Airless spray gun requires no compressor

Operating on hydrostatic pressure, Sav-Cote's airless spray gun sprays a specially formulated polyacrylic finish without compressed air. High-speed built-in pump, synchronized with 60-cycle a.c. current oscillations, furnishes 120 piston strokes per second. Ideal for painting boats and cars, gun delivers finely atomized, cone-shape spray pattern to produce a glass-smooth finish with minimum overspray. Acrylic comes in 17 colors in quarts and gallons. Gun sells for \$99.50. Sav-Cote Chemical Labs., Box 770, Lakewood, N.J. 08701.

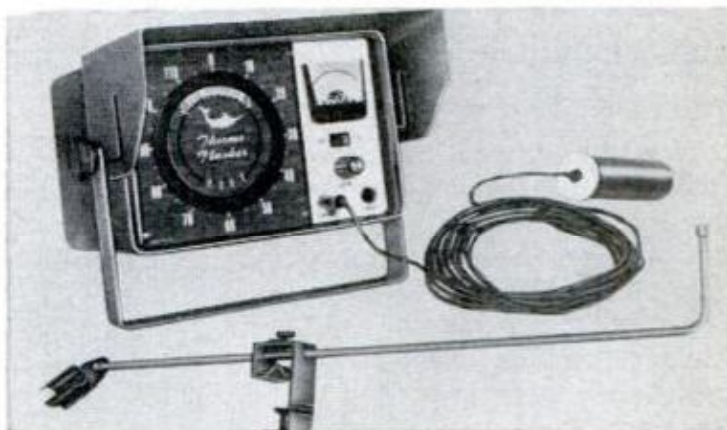

New fish finder tells temperature, too

The Thermo-Flasher won't catch a fish, but it can tell its depth, take water temperature, and aim the finder transducer to tell in which direction that lunker is waiting. From Ray Jefferson Div., Jetronic Industries, Main and Cotton Sts., Philadelphia, Pa., Model 5090 has depth dial, temperature gauge, 125 feet of cable, adjustable transducer bracket. \$199.95.



Molded patio urn looks like stone

Until you lift it, Lady Grecian Urn in natural stone color seems like the real thing—but it's molded in polyethylene to make it lightweight, chip-proof and practically indestructible. Stands 13 inches. \$9.95 postpaid from Cedar Hill Services, Foristell, Mo. 63348.



The wheelchair you 'fly' like a plane

A single airplane-like "joystick" controls speed, steering, forward, reverse and braking in this motorized wheelchair developed by Britain's Lord Snowdon. Designed for easier use by handicapped persons, electric-powered device is demonstrated by Raymond Burr, famous chair-bound TV detective in *Ironsides*.

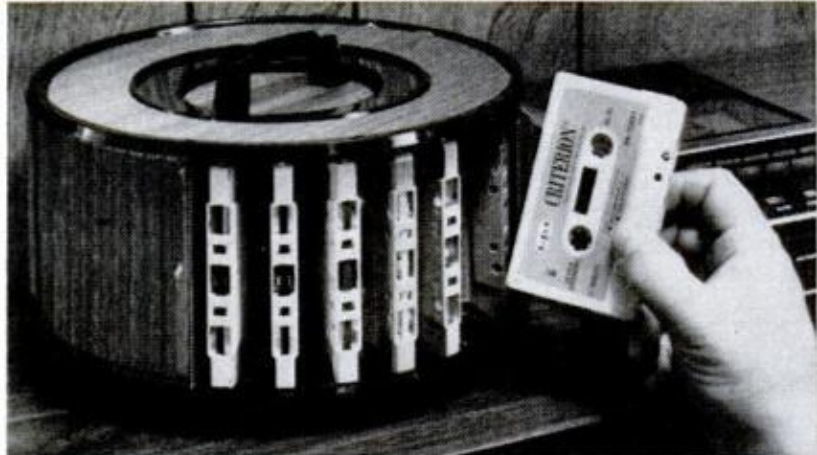

Storing cassettes is simple with this rotating carousel caddy

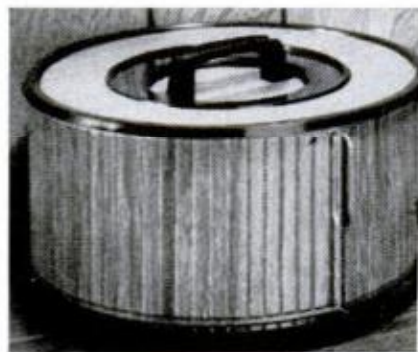

Easy storage of cassette tapes is the object of this trim, swivel-based carousel caddy holding up to 25 selections. Each tape slips into a numbered slot for quick identification. The walnut-finished circular plastic units are 10 inches in diameter, have handles for carrying and can be stacked in tiers. Sliding tambour doors keep out dust. Price each is \$10.60 postpaid. T. Enterprises, 813 Clover Dr., Symsonia, Ky. 42082.

At last—a snug-fitting camera harness that's really easy and versatile to use

Most camera harnesses suffer from one of two problems—they're either so loose they let the camera jiggle and jounce around, or so tight they make it hard to raise the camera to eye level when you want to shoot. This clever new design provides the best of both worlds—it holds your camera snugly, yet lets you free it instantly for use. The rig consists of elastic straps that cross over your shoulders and encircle your chest. The camera is held firmly between heavy rubber bands crisscrossed around the lens to lock it in place (near right). To release the camera, you simply flick off the bands (far right, opposite page). Called the Kuban Hitch, the handy harness also holds binoculars, is ideal for hiking, hunting, cycling, skiing. \$7.50, Kuban Hitch Co., 5280 N.E. Main St., Minneapolis, Minn. 55421.





From jet to jitney

Riding a four-seat electric car is the way to go if you're elderly or disabled and you fly into London's Heathrow Airport. The six-mph vehicle runs between aircraft and the main customs hall to save the long trek by foot. The car joins a wide assortment of other electric vehicles in London. If you don't qualify for a ride, you have to use the moving sidewalk, a scooter—or walk!



New Bronica SLR features electronic shutter and unique mirror hinge

Push the shutter button on Bronica's new EC 2 $\frac{1}{4}$ x2 $\frac{1}{4}$ -inch single-lens reflex, and the mirror splits in two: the lower piece swings down and forward, while the upper piece swings backward, then forward again on its way up to cover the ground glass. The result: less vibration, and a mirror path that clears even very wide angle lenses easily. Other features include the first electronically timed shutter of its size, and a through-the-lens exposure meter attachment in the finder hood to control shutter speed. Bronica EC camera with 75-mm, f/2.8 Nikkor lens, \$975; meter, \$289. Ehrenreich, Stewart Ave., Garden City, N.Y. 11530.

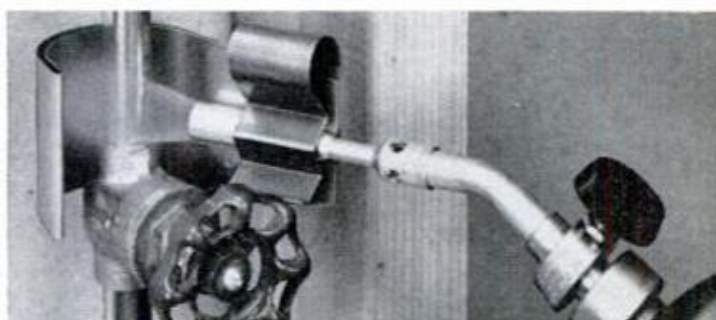

Flame shield prevents fire

Designed to clip over the nozzle of any propane torch, Multi-Nozzle Shield confines the flame to the joint when sweating, brazing or thawing copper pipes; guards against fire in combustible areas. Stainless steel, fits work to 1 $\frac{1}{2}$ -in. dia. \$4.95 postpaid from North Shore Labs, Box 568, Peabody, Mass. 01960.

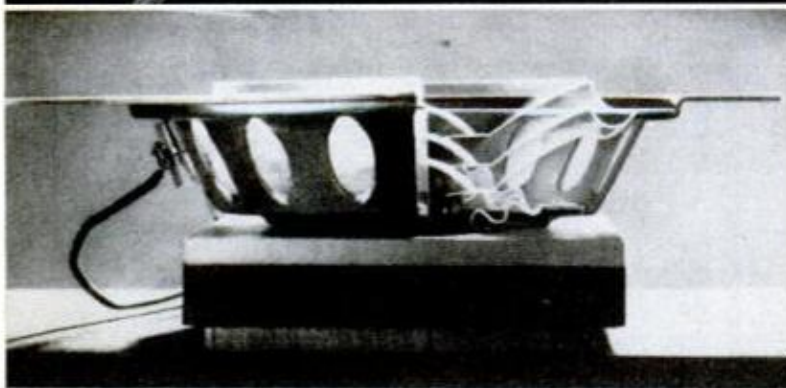

Can a lowly table radio be real hi-fi? You bet it can!

For such a little box, KLH's Model 21 FM radio put out an amazing amount of astonishingly good sound; the new 21/II puts out even more and better sound—from more stations. That box is actually a sealed enclosure (note rubber sealing caps over rear-panel jacks, center photo) for a compact, acoustic-suspension speaker (bottom) with an ultraheavy magnet and a long throw to push a lot of sound. The speaker's bass is clean, but weak—so the 4-watt amplifier (2½ watts more than the old model) puts out just enough extra bass to compensate. Features include bass and treble controls, extension speaker jacks and provision for use as a tuner—no bad idea, since the 21/II gives you 60 db of quieting (that's quiet!). For a weak, 4-microvolt signal, that's performance comparable to moderate-price tuners. Costs \$99.95; with extension speaker, add \$24.95. KLH, 30 Cross St., Cambridge, Mass. 02139.

**Two new TV ideas:
For fun,
but not for sale**

Fresh from the drawing (and dreaming) boards of RCA's new Design Center in Indianapolis come these experimental TVs. Lounge Module (near right) has AM/FM stereo radio, 8-track tape and color TV in a two-man cockpit setup perfect for watching *Sky King* reruns. Video Satellite (far right) puts a 5-inch color screen at end of boom, tuning controls at other end, antenna atop column and circuits in base.



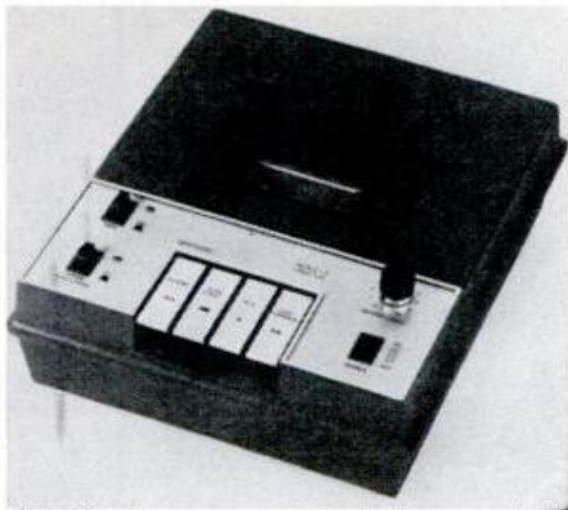

Now: A cassette player with a Dolby system

It doesn't record, but this new cassette deck does everything else: A Dolby circuit reduces noise. An equalization switch adjusts for chromium dioxide tapes. And automatic shutoff works on all tapes. Model 202, \$195.95. Advent Corp., 195 Albany St., Cambridge, Mass. 02139.

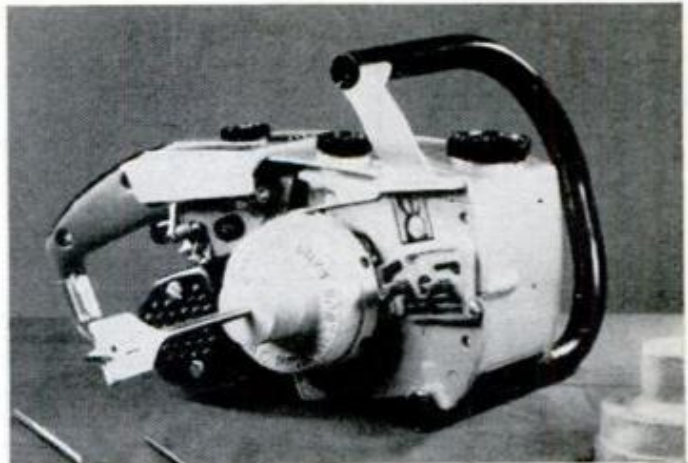

Chain saw becomes a drill

A power-takeoff accessory invented by a New Hampshire chain-saw dealer lets you convert a chain saw into a drill that will bore a 1½-in. hole in hardwood at the rate of an inch per second. The chuck-holding casting slips over the clutch plate and is locked into place by six Allen screws. The conversion takes three minutes, is accomplished with Allen and chain-saw wrenches. \$30 postpaid. Nelson Maine, Drawer O, Hillsboro, N. H. 03244.



Coming: While-you-wait prints from your slides

Drop a color slide into this machine and you'll have an 8½x11-inch color print in half a minute. At \$15,000, you won't buy the machine, but 3M hopes that stores will so they will be able to sell you prints for about \$2.50 each. Watch for it. 3M, St. Paul, Minn. 55101.

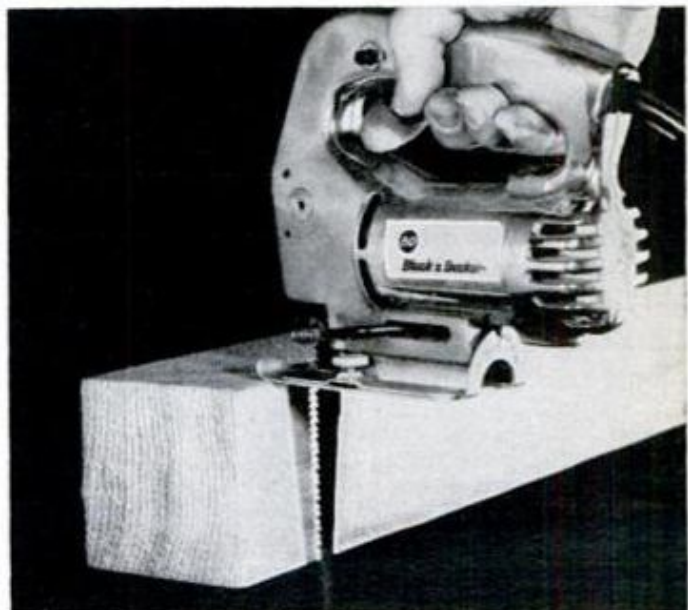

King-size saw blade

Two new 6-in.-long saw blades, designed for sabre saws having a 1-in. or longer stroke, permit irregular cuts in plastic and wood up to 4 inches thick. Special tooth design with extra large gullets makes for fast cutting; extra thick backs resist breakage. Blade for wood and plastic is 99 cents; that for wood alone sells for \$1.19. Black & Decker Manufacturing Co., Towson, Md. 21204.



Plumber's tool works great for carpenters and home handymen

Latest version of a handy saw called a "jab saw" by most professional plumbers is made by Estwing Manufacturing Co., Rockford, Ill. Sold at hardware stores for \$4.50, model EH-80 uses any hacksaw blade—even broken pieces. The tool is ideal when it is necessary to remove asbestos shingles without breakage because blade can be extended and firmly clamped to stay put. Nails holding shingles can be severed below head and shingles removed with minimum effort. Tool's usual function is for reaching into tight spots.

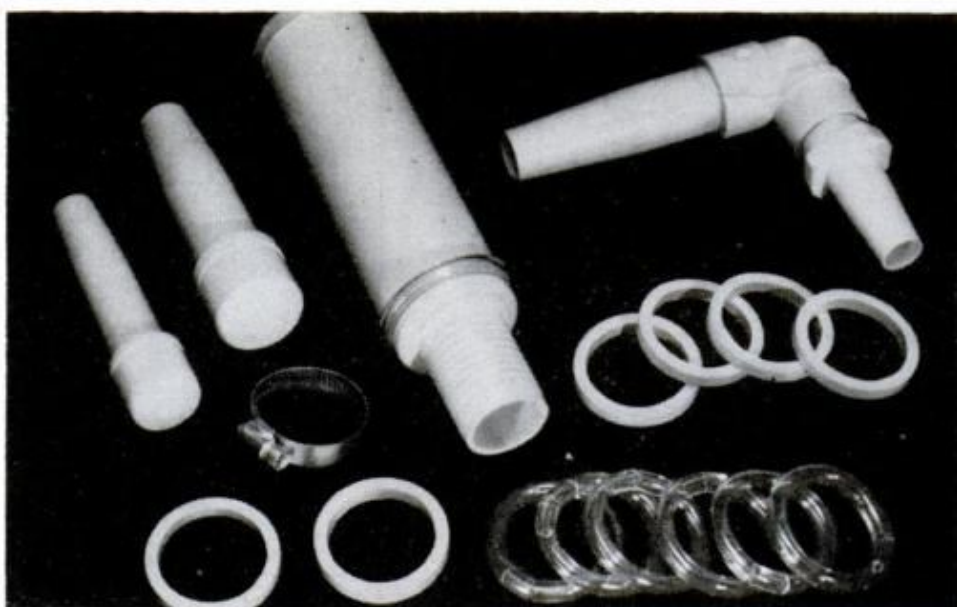

Hydro brush saves vacuuming in-ground pool

Utilizing a pool's filtering pump, this new hydro brush automatically sweeps, brushes, and cleans swimming pools with water pressure to eliminate tiresome vacuuming. Brush fits original vacuum hose, goes to work when timer turns on. Kit includes 3/4 and 1-in. return plugs, flexible hose cuff, universal hose adapter, stainless-steel hose adapter, six hard and six soft hose wear rings. \$49.95 plus postage. Peter Dudek Co., Box 1403, Covina, Calif. 91722.



Antitheft for outboards

Getting a lock on an outboard motor is easier with the Sher Lock from the Brandon Co., Route 1025, St. Paul, Minn. Fitting over turndown clamp handles of the motor mount, the two-piece die-cut unit of heavy steel secured with a cylinder lock prevents unscrewing the clamps. Claimed as rustproof and saltwater resistant, the Sher Lock costs \$8.95



Potent power

Horsepower of "150 plus" is the potent boast for Johnson's new high-performance mill. With 99.6-cu.-in. displacement, four twin-barrel carbs, remote trim and height control and 14:23 ratio, this latest line leader is muscular.

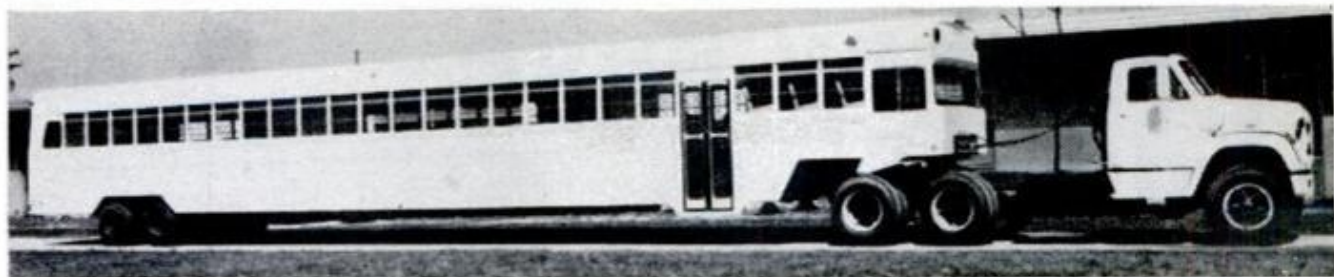

Longest bus in the world lets workers relax on the way to the oil fields

This gigantic bus body, 62 feet long, weighing 22,500 pounds, with seats for 121 adults, was designed to be towed by a Chevrolet diesel tandem tractor. The bus interior has two levels, the higher front level being over the tractor hitch. It was built by the Wayne Transportation Div. of the Wayne Corp., Richmond, Ind., for oil-well workers. Overall length of the mammoth mover is 76½ feet.



Take two along at a time—you can with new oversize cartopper for canoes

Brackets for cartop boats are nothing new, but the trend toward taking the family along for an outside outing is helping develop larger toters. Grumman Boats, Marathon, N.Y., has widened its 60-inch canoe crossbars to 75 inches for more capacity. Vinyl rub strips plus crossbars to prevent high-speed noise and vibration also strengthen carriers. Tie-downs are also available. Grumman canoe dealers now stock carriers to cartop-portage a pair, \$29.95.



'Saddlebag' airconditioner

Hanging like a saddlebag, Montgomery Ward's new window airconditioner straddles the sill to provide an unobstructed view and put compressor noise outside. In 6000 and 9000-B.T.U. sizes with pushbutton controls. Available through Ward's catalog, stores.

Match caddy masquerades as decorative coaster on your coffee table

Six boxes of wooden matches sandwiched between an authentic tile from Monterrey, Mexico, and a teakwood base make this coffee-table accessory a most practical gift. It serves as coaster and/or paperweight; comes in a choice of predominantly blue, green, brown or yellow. It's \$3 postpaid from Bruno's of Palos Verdes, 30816 Via Rivera, Palos Verdes, Calif. 90274.



The satellite that may save your life

Whether you're lost in the woods, shipwrecked at sea or injured in an air crash, a friendly orbiting satellite can speed help—literally in minutes—in this bold new search and rescue plan

By D. J. HOLFORD

RESCUE IS AN EASY BUSINESS—compared to the problem of finding those who need rescuing. Search-and-rescue lore is filled with ironic tragedies of rescue forces that arrived hours after a downed plane was spotted, but weeks after its unharmed occupants had starved to death. A projected U.S. Navy satellite system could change that in a few years.

Electronic rescue aids already exist: aircraft-borne Emergency Locator Transmitters, and more sophisticated Crash Position Indicators that are automatically turned on and thrown from a plane in the event of a crash. But their range is so short (typically 100 miles under ideal conditions, much less if in woods or valleys) that rescue depends on the lucky chance of an airplane passing within range while monitoring the distress channel. That chance is often uncomfortably slim.

What the Navy's Global Rescue Alarm Net (GRAN) system promises is a swift, sure way of telling search and rescue who is in trouble and where he is, no matter what the weather and location. The beacon that will relay all this information to the orbiting GRAN satellites will be small and economical enough to be carried on every aircraft, boat and snowmobile, and in the pack of every hunter, fisherman or mountain climber.

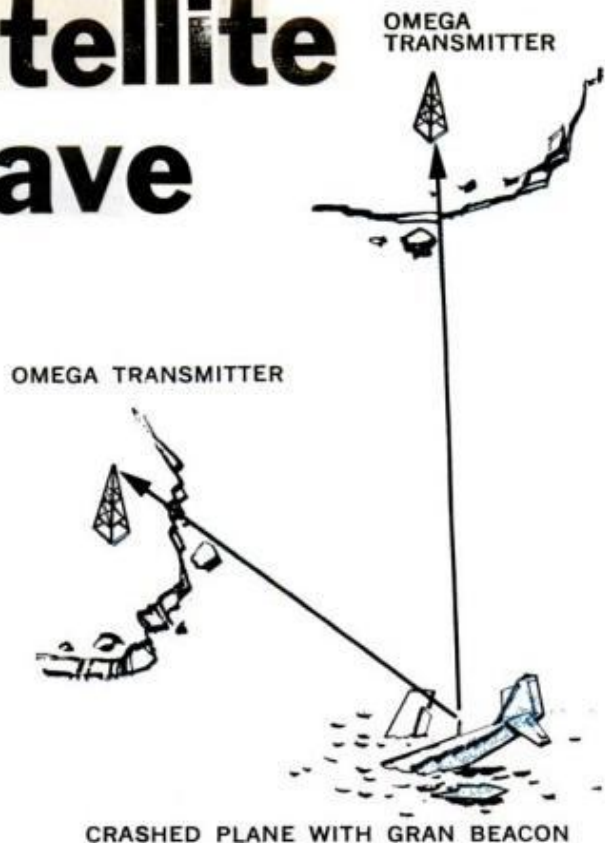

The initial idea came from Leroy F. Field, a staff member of the Naval Air Test Center's aero-medical branch, in Patuxent River, Md. Field surprised the experts by proving that a small, portable transmitter could reach a satellite with less than one watt of power.

That left the problem of telling the satellite where help was needed, and who needed it. But the answers were surprisingly simple.

The Navy's answer was ready-made: a network of Omega navigation stations, already covering the earth with overlapping signals from which suitably equipped ships and planes can determine their posi-

CRASH POSITION INDICATOR radio, now available, gives rescuers something to home in on. In a crash it's ejected upward and to left to fly clear of plane

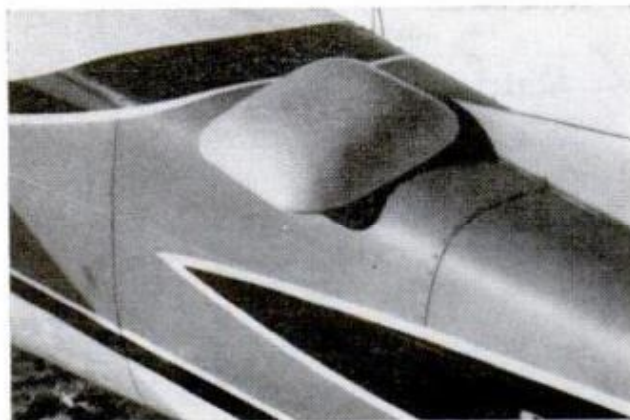

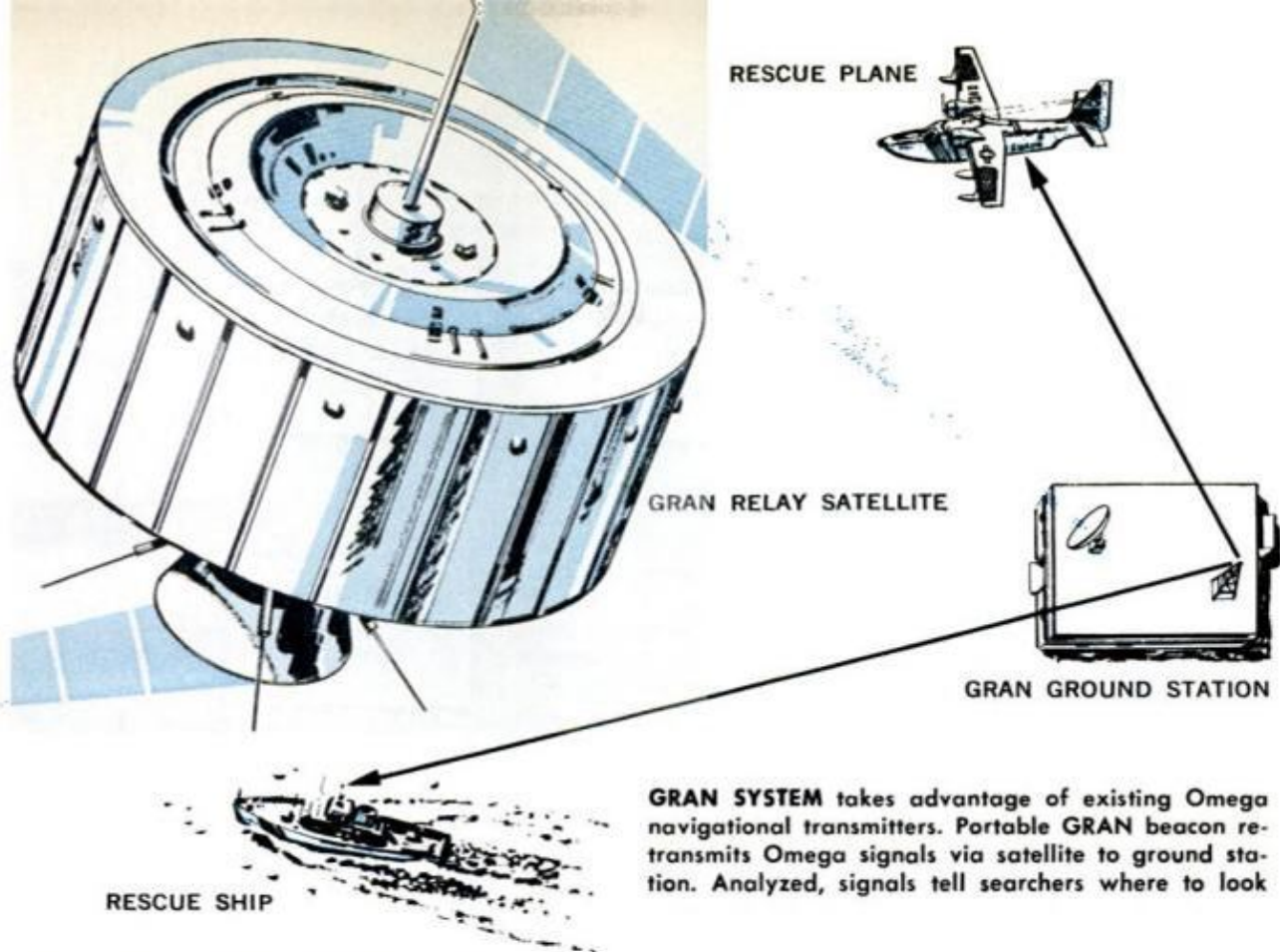

GRAN SYSTEM takes advantage of existing Omega navigational transmitters. Portable GRAN beacon retransmits Omega signals via satellite to ground station. Analyzed, signals tell searchers where to look



SEARCH AND RESCUE planes, ships and other vehicles can reach a crash site within hours after it has been found. But locating those who need rescue can take days or longer—precious time, especially if they are injured. GRAN may cut search time to a few, short hours—sometimes, perhaps, to minutes

SEPTEMBER 1972

tions accurately, wherever they are. Omega location equipment is too bulky and expensive for inclusion in a GRAN beacon: so instead of analyzing these signals, the beacon will retransmit them, on a different frequency, to the nearest of three orbiting satellites. The satellite will then relay the distress signal to a ground monitoring station, whose computers will unscramble the Omega signals and print out the beacon's location for search-and-rescue use. The same computer will identify a nine-digit identity code built into each GRAN beacon (nine-digit coding lets you match your personal beacon to your social security number).

So far, the system looks practical. International radio channels are already set aside for satellite rescue operation, and the beacons have passed all their tests to date. The beacons can be made smaller and lighter than most portable cassette recorders (with batteries taking up most of the space and weight). Operation will involve only the pressing of a single button—especially useful if the person in distress is injured or panicky.

If large-scale tests this year succeed, GRAN could become a reality by 1975—if the money can be found. GRAN's cost is estimated at \$60 million. But the Coast Guard alone figures it could save \$8 mil-

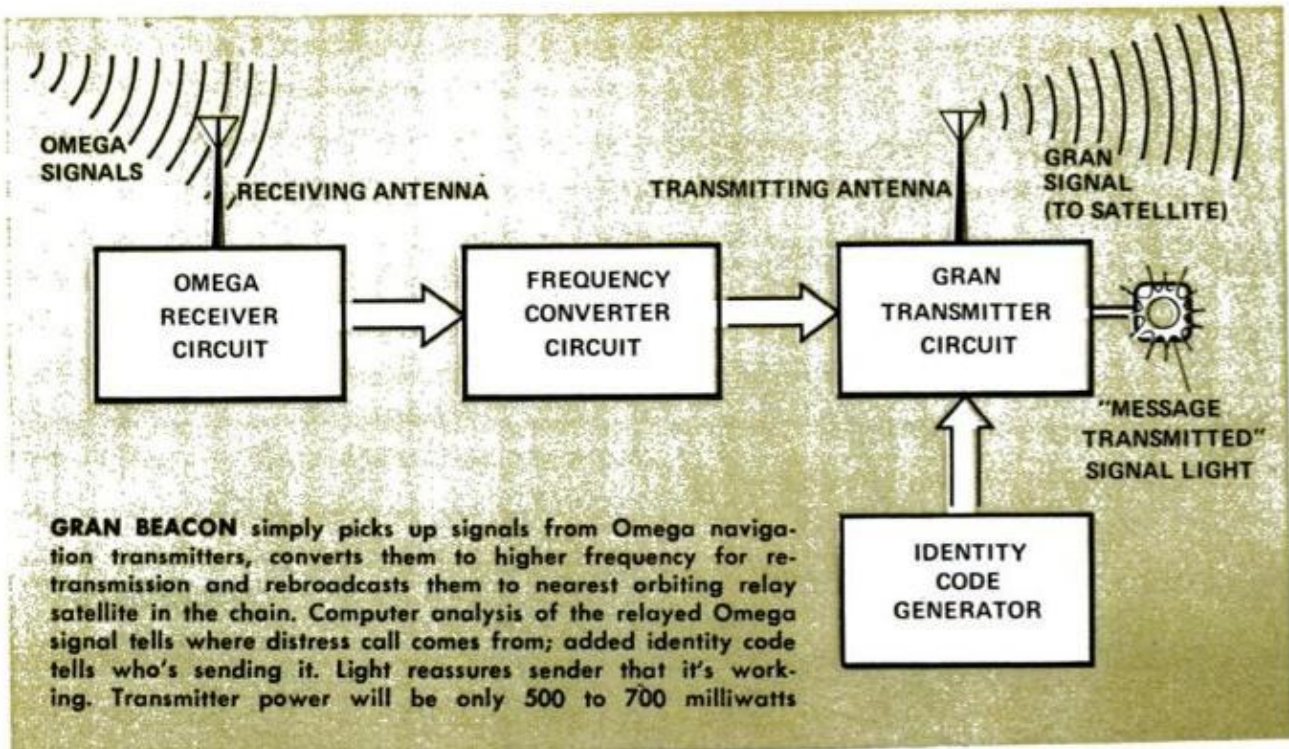

COMPACT GRAN BEACON will weigh less than two pounds—with most weight in batteries. Production versions will be simpler than this Navy prototype, with no controls except an on-off switch. Thanks to satellite receivers, the range will be greater than that for today's larger Crash Position Indicators

130

lion a year from its current costs for extensive conventional searches. Add in the savings made by the U.S. Aerospace Rescue and Recovery Service, the Civil Air Patrol and all other agencies involved in major searches, and GRAN starts to look like a bargain for the taxpayer. The Canadian Armed Forces, responsible for search and rescue over more than 5¼-million square miles of rugged territory (more than continental United States and Alaska combined) are also intrigued. Over a 25-year period, they figure GRAN would save them an astronomical sum. Other countries would make similar savings, since GRAN would be available to all. Even the beacons would not be too expensive: Taking inflation into account, today's best estimates indicate a 1975 price of just over \$200 each.

But impressive as cost savings may be, the aim of GRAN is to save lives. Military and Coast Guard statistics show that GRAN could save 237 lives a year in the United States alone, assuming the ability to locate a beacon's position within two miles; if, as now seems possible, the system's resolution can be increased to half a mile, the total would rise to 425 lives a year. And on a worldwide scale, it should save thousands of lives by eliminating the "search" from search and rescue.

So if you have a plane, small boat or snowmobile, or if you ever go on foot into the wilderness, start saving for a GRAN beacon. It's very cheap insurance. ★★

POPULAR MECHANICS

Your first electric car may be an AVIS!



BATTERY PACK in experimental Transit IV runs through center of chassis. It can be charged in place or slid out for change



You can't drive an electric car away from your dealer's yet, but maybe soon from your local rent-a-car office!

By **BILL HARTFORD**, Auto Editor

Photos by Irv Dolin

ELECTRIC CARS are long overdue. They should have run the overgrown, smelly and noisy internal-combustion vehicle out of our cities years ago. What has kept them stalled in the development stage is anticipation of the "big battery breakthrough" that would make them overwhelmingly superior to gasoline powered cars in cost, maintenance and performance, and open up the market. But

they can be practical now—in short-range urban use. Existing battery power sources can do the job, as they have been for years in delivery vehicles in England.

The proof needed for public acceptance of the electric car as a practical mode of transportation may be nigh. The convincer may be the opportunity to try before you buy. This isn't the reason that rental companies are investigating the



ELECTRIC CARS in various stages of design and assembly at Anderson Power Products, Bedford, Mass. Above is the chassis of the Transit IV; in the background and in the photo below is a fiberglass body for a four-passenger, 25-mph resort vehicle. Also in the works are an electric delivery vehicle intended for postal use and a design for an electric rent-a-car. Car-rental companies are investigating the economics of an electric car in fleet use. Such application would speed the acceptance of electric cars



possibility of adding electric cars to their metropolitan fleets. They'd prefer you always rent! But the opportunity to drive a practical electric car would introduce many people to the vehicle's advantages.

Anderson Power Products of Bedford, Mass., is one of the many companies well aware of the electric car's advantages—especially for the urban environment. The Transit IV electric sports car, shown on the cover, is only one of its designs. A more practical passenger vehicle is a less glamorous endeavor but has more potential.

Avis Rent-A-Car, for example, is one car-rental company that has recognized this potential, and it has shown great interest in research at Anderson Power Products. How and when the car rental companies will go electric is still a secret—and talk about the idea is almost as hushed as the sound level of an electric vehicle at speed. Still, it's easy to speculate on renting a small electric car and being charged (that is the right word) by the amount the battery pack is discharged rather than by mileage.

Or, perhaps, a city would electrify some of its parking meters and they would serve as hitching posts. The driver's charge card (there's that word again) would identify the customer or car. This would give him a longer range if his day consisted of many short journeys.

An urban, electric rent-a-car need not have the performance required of an intercity family car. By way of comparison, the Transit IV has a range of 60 miles at 30 mph. Its 12 lead-acid storage batteries weigh 750 pounds, cost \$300 and hold about 10 kilowatt-hours of energy. They have a limited number of deep discharge cycles—about 400—which means a life of about 20,000 miles. The set of batteries is expensive, but on a mileage basis comes to about one cent per mile! Charging costs would boost this figure, of course. In rent-a-car use, the whole battery pack would be pulled out and replaced with a fresh pack. The discharged battery pack is charged for about four to five hours with charging done in off-peak hours for the lowest cost per kilowatt hour.

One of the limits of the lead-acid battery, no matter what its capacity, is internal resistance. This means that even if you put a dead short across its terminals, the current flow will be limited—large enough to melt an ordinary cable, but still

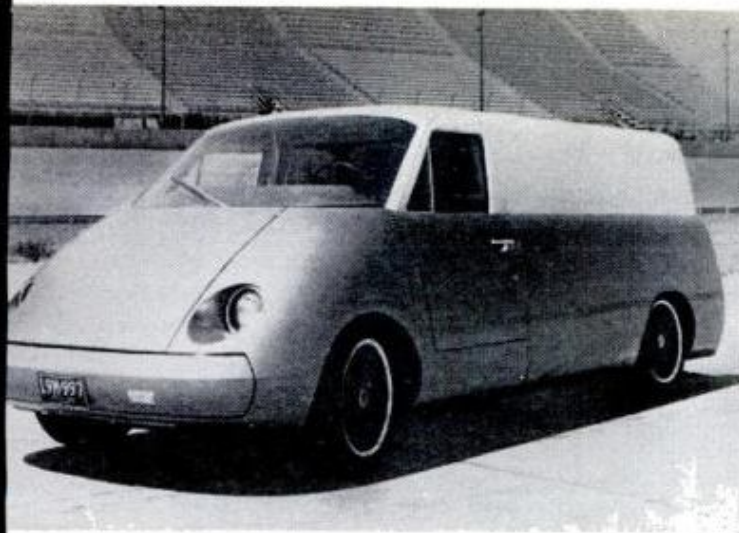

POLLUTION SOLUTION FOR CITIES: The commercial electric van has long been in use in England as a truly economical alternative to internal-combustion vehicles. At left is the Copper Development Assn.'s idea of a van for U.S. cities. The Copper Electric Van III was designed from the ground up aerodynamical-



ly and functionally for electric propulsion. At the right, the author starts out on a test drive of Volkswagen's experimental van at the VW Research and Development Center. Use in commercial fleets is regarded to be one of the first big markets for the electric vehicles before their wide use as private cars

limited. This internal resistance is like the limitation of an internal-combustion engine's fuel line or carburetor throat diameter. Each puts a definite limit on the rate at which energy, or fuel, can be passed and therefore the power that can be developed. Lead-acid batteries are high in internal resistance as well as weight, compared especially to some experimental types under development. Other improvements being sought are improved life and low cost.

The "hottest" batteries in research right now are the molten-salt types. Sodium and sulfur salts are dirt cheap compared to lead: As little as 25 cents worth will store a kilowatt hour compared to \$8

worth for lead. Weight is less and internal resistance is very low.

The promise of molten-salt batteries is so great that even an arm of the government, the Atomic Energy Commission, has begun research in an effort to accelerate the transition from gasoline-powered to battery-powered cars. It's the first non-atomic project undertaken by the AEC.

While researchers continue the battle to break the battery barrier, you may have the opportunity to drive your first electric car—at \$7 a day, and . . . "how much did you say, per kilowatt-hour?" (For more information about electric cars, write the Electric Vehicle Council, 90 Park Ave., New York, N.Y. 10016.) ★★★

WHAT'S IT LIKE TO DRIVE?

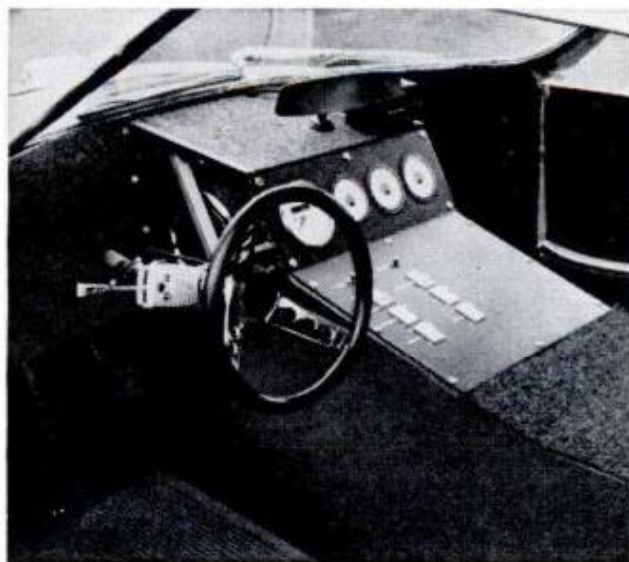

INSTRUMENTS AND CONTROLS of the Transit IV engineering test vehicle, at left, are more than would be needed on a production electric car. A state-of-charge gauge and a motor-temperature gauge, plus accelerator and brake pedals would be all you need. When you turn on the ignition of the Transit IV all is quiet; only a small, red light tells you you're in a "go" condition. Acceleration is brisk and the 2350-pound car reaches its 65-mph top speed in eerie silence. The only sounds are the whirr of the 20-hp, series-wound d.c. motor and the hiss of the tires on the road. As an urban car it sure makes a lot of sense.

This Indian art

Today's vanishing scout uses the oldest of tools and techniques—plus newest psychology—to track down the lost. Yet tracking is a skill every family camper, hunter and outdoorsman needs to practice.

DUST HAS DARKENED your family campsite as tragedy threatens. Suddenly your wife asks, "Where's Bobby?" Missing is your toddler of five. Beyond the campfire lie miles of night woods, streams and jagged terrain. In your mind is one of the outdoors' ugliest four-letter words—LOST. Can you find Bobby, find him in time?

"You can—with a basic knowledge of tracking, and a good flashlight, in perhaps 30 minutes," declares George B. Birdsell, one of the nation's top "cold trail" trackers, a fast-vanishing breed.

Birdsell's specialty is among the rarest of tracking's lost arts. He can pick up a days-old "cold" trail. Thus has grown the Birdsell legend as a tracker of last resort. When others run out of track and luck, it's Birdsell they often summon.

Now 71 and still ace tracker for the San Bernardino, Calif., sheriff's department which patrols what may be the nation's largest and most rugged county, Birdsell has "cold trailed" after lost boys, campers, fugitives, hunters and wounded game. Seldom during the past 55 years and 130 major "tracks" have their trails—in dense forests, across sizzling deserts, through snow and sand hills—escaped his all-perceiving blue eyes.

And neither, with just a little insight, need a "lost trail" escape yours. If you camp, hunt or vacation anywhere outdoors, you owe it to your own and your family's safety to learn the ABCs of Indian tracking. Quickly picking up the trail of a family member, or retracing your own, can be the margin between life and death.

Fortunately the trail you will be following will usually be a "hot track" only minutes or perhaps a few hours old. Almost any camper, self-schooled in the basics, can follow a "hot track." How, then, would you find Bobby, your lost child? You've got three things going for you, analyzes Birdsell: *Time*—he's only been gone a short while; *intimate personal knowledge*—you know his weight, which can be important, his habits, and even the kind of shoes he's wearing. And, oddly, the *darkness*. Tracks "shadow" better by flashlight than by sunlight.

Quickly you'd circle your campsite's perimeter "cutting track"—to read the ground for tracks which, heading out and away, might be Bobby's. "Cutting track"

BRUISED GRASS, blurred footprints, and depth of impressions may be all that tell this ace tracker a lost boy has passed . . .

*Illustrations by
Ed Valigursky*



still saves lives

By JAMES JOSEPH

is the expert's shortcut for finding a track fast, and establishing in which direction a lost person has gone. Birdsell contends that the test of a tracker is his skill in "placing the search" to put search parties on the right track. In cutting track, the tracker searches along an imaginary line around a campsite, along a ridge or parallel to an existing road or trail that he is sure the man or animal which he is following has crossed.

"A 'cut line' is best run some distance from local track congestion," explains Birdsell, "50 to 100 feet and all the way around a campsite, for example. Almost any track crossing and leading away from your cut line is a transient track worth closer study." But how can you be sure that one set of tracks crossing your cut line is Bobby's?

First, by the kind of shoes, and wives more often than husbands know what shoes every family member is wearing. "The male species," shrugs the leader of a Nevada search-and-rescue team, "is clothes-blind." Recently the team found a member of a lost hunting twosome. Though one partner had camped for a week with his hunting buddy, he hadn't the foggiest notion whether his lost friend was wearing shoes, boots—or was barefoot. But the lost hunter's wife, 500 miles away in Los Angeles, knew when searchers phoned her. "John is wearing his old beat-up hunting boots with worn-down heels," she advised. Put quickly on track, searchers almost as quickly found their man.

Second, by depth and age of tracks. Youngsters under 10 tread lightly, but tend to drag their feet and their tracks may be elongated. Except for shallowness, these can be mistaken for a larger foot. Adults, until they tire, step more precisely. Footprint age is also telltale. New-made prints (like Bobby's) will be dark and sharply defined when the foot has disturbed fresh moist earth. Within a few hours they begin to dry out and lighten.

Third, by width and length. To assure that the print is Bobby's, measure it. Birdsell uses straight twigs or sticks cut to heel-to-toe length and width. "Your

measurements must be accurate to within a quarter inch at least," he explains. "Down trail another set of prints may intersect, but your length and width sticks tell you which to follow." Where dozens of prints converge in a camping area, Birdsell squats and "measures" his way through the congestion. Checking print pattern, depth, age and measurements, you can follow Birdsell's meticulous methods.

"You'd also call Bobby's name," notes Birdsell, "but don't bet on his answering. At night, approaching lights terrify children and they may hide or actually run from searchers." The recent headlined hunt for Kevin Dye, a 9-year-old epileptic, was not untypical. For 11 days Kevin apparently played hide-and-seek with a 3000-man search force combing Wyoming's rugged Casper Mountains. When finally found, he was asleep on a knoll which had been searched repeatedly.

Obviously, there's more to tracking than tracks, and you need insight into what some call the "behavioral pattern of the lost." Lost children (and some adults) expect *you* to find *them*. Trackers tell of children huddling all night within sight of a rescue team's campfires, but never venturing close. Tracking a child and faced with two tracks, one headed uphill and the other down, the expert follows uphill. He knows that toddlers nearly always go uphill; they find it easier to keep their

... and the hiding place where he may be asleep



balance while climbing, and also tend to go on a straight course.

Adults wander in circles, usually favoring the strongest leg. Right-handed (so presumably "right-legged") adults circle to the right. Lefties go the other way.

Animals, especially deer—and every hunter should know how to track down game he may have wounded—do the logical thing and pick the easiest route.

The lost person's mental and physical condition are often found in his tracks:

Panic is sometimes revealed by a "heel-and-toe" track as the lost alternately run, showing just toe marks, and then tire and walk with much weight on heels. A trail strewn with clothing by a panicking adult might indicate presence of mind in a child. Once, tracking a 6-year-old girl, Birdsell suddenly found a second set of footprints joining the first. A more careful "reading" showed the little girl had removed her shoes to rid them of rocks and carefully put them back on—on the wrong feet.

Shock is often shown when a lost track unhesitatingly crosses well-trodden trails. Dazed, the lost have been known to stumble past direction signs, ignore railroad tracks and cross busy highways without seeing them.

Exhaustion tells itself in many ways, from a weaving stumbling gait to body-mark depressions when the lost, exhausted, have fallen or thrown themselves to the ground.

Trailing techniques and speed depend on track, terrain, the quarry and the weather. Where Bobby's trail, for example is intermittently visible, you'd "skip-track," posting an "anchor man" to mark the last distinct track, and then moving ahead rapidly, skipping faint footprints.

MEASURING STICKS or twigs, notched or broken to exact size, are Birdsell's key to footprint identity

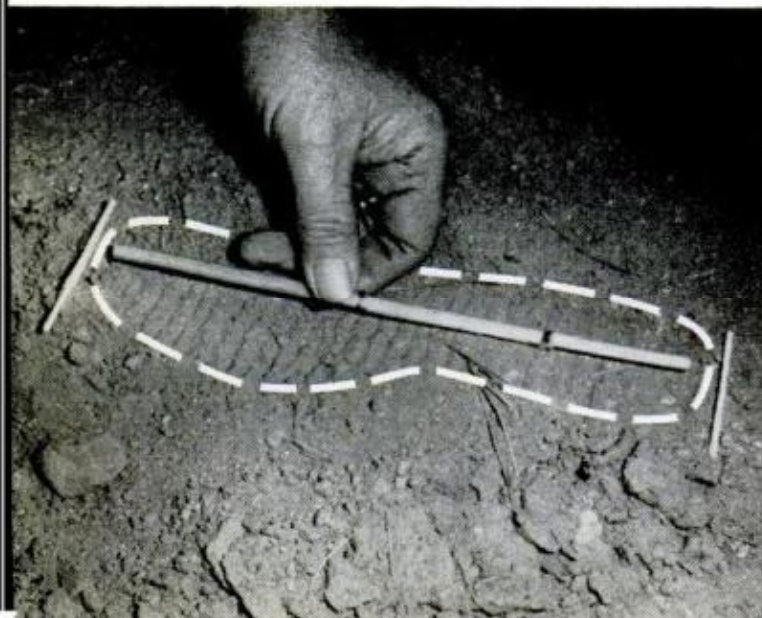

George B. Birdsell—cold trail tracking ace

The fame of George Birdsell, a living legend in an almost lost art, has spread far from his San Bernardino Mountains. His six basic tools include a metal ski pole with basket removed, to use as a walking stick, scribe around tracks or ward off brush and rattlers. He also carries measuring sticks, pocketknife, canteen, widebeam searchlight to shadow footprints and matches in a waterproof container. (A quick fire can warm searchers and the exposure victim when the latter is found)

If the terrain is steep and hard-packed or weather and time critical factors, trackers may "sweep" the trail. Half a dozen or more hold hands in roughest terrain or spread out about 15 feet apart to form a sweep line covering every inch of ground.

Might not helicopters, jeeps or bloodhounds track faster? Planes do spot the lost sometimes, but their usefulness is limited to fairly open terrain. Bloodhounds, if brought in early and given proper scent, have turned the trick. "The foot tracker," admits Birdsell, "is usually called after all the quick methods have failed."

Afoot in the desert, veterans—and even a "weekend tracker"—can make about 1½ miles an hour. In mountains where you must ferret out the track, half a mile an hour is likely. On one blistering desert track, Birdsell once led a search party 12 miles in 9 hours. On another he kept going 93 hours with only catnaps. His most dramatic recent track, following a man whose mental impairment kept him from speaking or calling for help, took less than three hours once Birdsell had pulled searchers off the wrong track they'd been following.

"Night is probably the best time to track after kids like Bobby," says Birdsell. In the chill darkness kids tend to keep moving to stay warm. Come daylight they may curl up in some hard-to-find place and

BUTTOCKS IMPRESSIONS
BY LOST PERSON
SEATED AND
RESTING



TWIGS BENT OR
BROKEN BY
PERSON
PASSING



TRACKING SIGNS

IMPRESSIONS LEFT
BY SOMEONE
JUMPING
STREAM



PROMINENT
TOE
DEPRESSION
INDICATES
RUNNING



HEEL DEPRESSION
WITH SLIDE
MARK
SHOWS
PERSON
IS TIRED

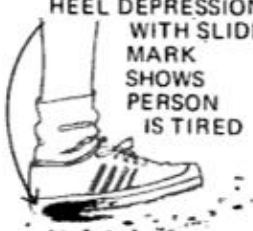

SLIGHTEST CLUE can tell searchers the age, weight, physical and even mental condition of a lost person, if they are on the right track, how long ago he had passed, and if he is now in danger of exhaustion

sleep. A moving target is easier to spot, and so are faint prints "shadowed" by a searchlight. Pursuing the same faint trail is often impossible during high-noon hours. Following fast on Bobby's hot track, chances are you'd find him within a quarter mile of camp. Lost children seldom travel very fast or far.

Neither may some adults, Birdsell learned when, as a California ranch kid of 16, he took part in his first search. An elderly neighbor, having bagged a buck, borrowed one of the Birdsell's burros to help fetch it. A day later when he hadn't returned, a posse was formed. The burro's tracks were easy to follow, but not until 3:00 a.m. did the posse find the burro hobbled to a tree on a trail high above a mountain stream. The deer lay nearby.

In the glare of lanterns, they read the story from the ground. The old man had tried to heft the heavy deer aboard the burro, had tired, and headed down to the stream. Lantern in hand, young Birdsell followed. Suddenly the tracks dead-ended at a log. "The old man's 'rest marks' with heels dug into the soil showed he sat there

getting his wind." Beyond, the hill dropped 300 feet to the stream below. "Getting up to go," Birdsell diagnosed, "he stumbled. We'll find him down there somewhere." And they did: face up, half submerged in the stream, unconscious but alive.

Not all Birdsell tracks have ended so happily. Deep in the sweltering Mojave desert on a Marine Corps search, Birdsell gasped in 120° heat. A young marine had become lost the previous night. The track was distinctive with a right foot toed-in. Plain, too, was the evidence. Time and again the youth had tracked back from desert scrub and cactus. The quick reversals were all but time-clocked to the night's moonless hours. They also told that the youth had panicked, exhausted and scared with the coming of the day's furnace heat. "He was dead when we found him," Birdsell notes quietly, yet he might have saved his own life—as you can, should you become lost—by retracing his own tracks.

Next time you're hiking or jogging, practice it: Retrace your own tracks for a quarter mile or so. "Backtracking teaches a man a lot about himself and about the fellow he may someday be tracking," says Birdsell.

Such insight led Birdsell in 1970 on one of his briefest, most publicized searches. Ten-year-old Marcell Strong, a mentally retarded boy, had wandered from his mountain campground. A 200-man party had searched 20 miles around for five days before Birdsell was called. Birdsell picked six men, including his 21-year-old expert son Bruce, gave them walkie-talkies, and began to cut trail a good mile away. Birdsell almost immediately picked up a track, recognized by its age, size, shallowness and beeline course that mentally retarded often walk. The trail led straight through heavy brush which had been thrashed aside, rather than parted by a more logical mind. And at the edge of a canyon the trail went straight down 1200 feet to the bottom. There they found him huddled in an abyss so steep he had to be brought up (alive and surprisingly well) by litter basket. "Just 30 minutes after we'd cut his track, and not a mile from the campground," Birdsell recalls.

But the boy had more than youth and pluck going for him during his five-day survival. He had George B. Birdsell, a living legend among cold-trail trackers. ★ ★ ★

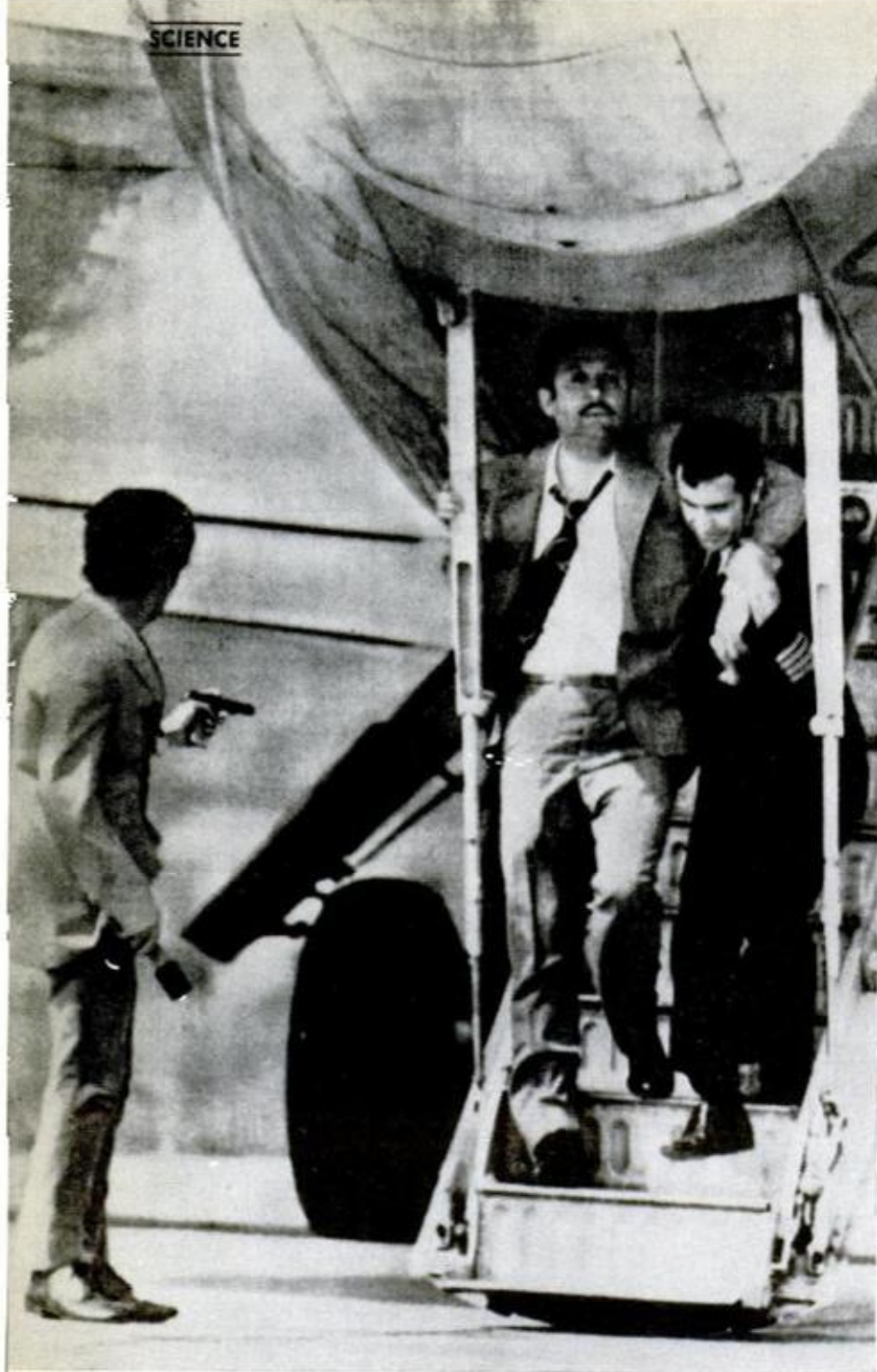

Terror in our skies...can we stop it?

The growing menace of air piracy endangers all who fly. While officials ponder what to do about it, a PM reporter personally tested airport security and tells what he found

138

ARMED HIJACKER, with a pistol in one hand and hand grenade in the other, stands guard at left as a wounded passenger is helped from pirated Turkish airliner in Sofia, Bulgaria, last May 3. Hijacker threatened to blow up plane and passengers until his demands for release of condemned terrorists held prisoner in Turkey were met. Passengers were eventually freed, but not without sustaining injuries

By **MORT SCHULTZ**

NO ONE STOPPED ME when I boarded United Air Lines Flight 733, a DC-8 bound from Kennedy International Airport in New York for Cleveland Hopkins Airport in Ohio. As I walked through the entrance gate, I passed between the two poles of a magnetometer—the magnetic screening device supposed to detect guns, bombs, knives and other metallic objects that might be weapons of a potential hijacker. I was deliberately carrying 20 pounds of tools and hardware in two tote bags. The magnetometer needle must have soared off the scale as I passed through. Yet no one even raised an eyebrow.

I boarded the plane, stashed the tote bags under my seat, then told the stewardess I was getting off to make a phone call. I went back to one of the federal marshals monitoring the magnetometer, identified myself as a reporter for *Popular Mechanics*, and asked why I hadn't been stopped and searched. The marshal admitted that the needle shot up, but said: "You weren't stopped because you didn't look like a hijacker."

On another occasion, I was seeing my son off on a flight from Newark Airport near New York and noticed that the

POPULAR MECHANICS



NO PASSENGERS WERE HURT, but these incidents show seriousness of the current hijacking emergency. A wrecked TWA 707 stands on runway above at Las Vegas, Nev., its nose blown out by a bomb planted in cockpit by a would-be extortionist on March 8. Fortunately, the plane had landed and been evacuated before bomb went off. At right, in one of most dramatic of recent rescues, an FBI sharpshooter, perched precariously atop a high fence and using a powerful scope-mounted rifle, successfully shoots and kills hijacker holding a TWA jet and a stewardess captive at Kennedy Airport. Below, another foiled hijacker lies dead in a pool of blood, shot by police after attempting to leave a pirated Mohawk Vista jet at Poughkeepsie, N. Y., on Jan. 26





IN TENSE MOMENT last winter, a national guardsman pitches tear gas grenade into rear door of hijacked Lancia jet as it refueled in San Jose, Costa Rica, for trip to Havana. Hijackers were flushed out by the gas. Below, a dog trained to sniff out explosives is used to search baggage aboard Northwest Orient Airlines jet halted at Detroit on March 8. Only one day earlier, similar dog discovered bomb in cockpit of TWA jet at Kennedy in New York. One problem: While such dogs are effective, too few are available to handle all of the country's needs



magnetometer poles were set off to one side, out of use. I asked an attendant why and he said there were other ways of identifying suspicious persons. Is the magnetometer merely window dressing?

Such incidents were terrifyingly typical of what was going on at many airports across the nation and around the world when this article was written. While some progress is being made and new security measures are being proposed every day, it was clearly evident at the time *PM* went to press that some airlines were still dragging their feet on the installation and use of equipment that could help stop skyjacking. Some airports had magnetometers, but weren't monitoring them properly; many had none at all. At best, a magnetometer screens out only metallic objects, not materials like plastic explosive and nitroglycerin that might slip through undetected.

The rash of bombings last March prompted the Federal Aviation Administration to order airlines to maintain maximum security, yet in April five hijackings occurred. As a result, two airlines involved were charged by the FAA with failing to screen passengers properly before boarding. Still, the bombings and hijackings continued. The tragic massacre at Tel Aviv's Lod International Airport in May could have been prevented if the



SPREADING MENACE of extortion recently included bomb scare in mid-ocean aboard Cunard's QE-2 luxury liner, shown above as it picked up special bomb disposal experts parachuted into sea from a plane

POPULAR MECHANICS

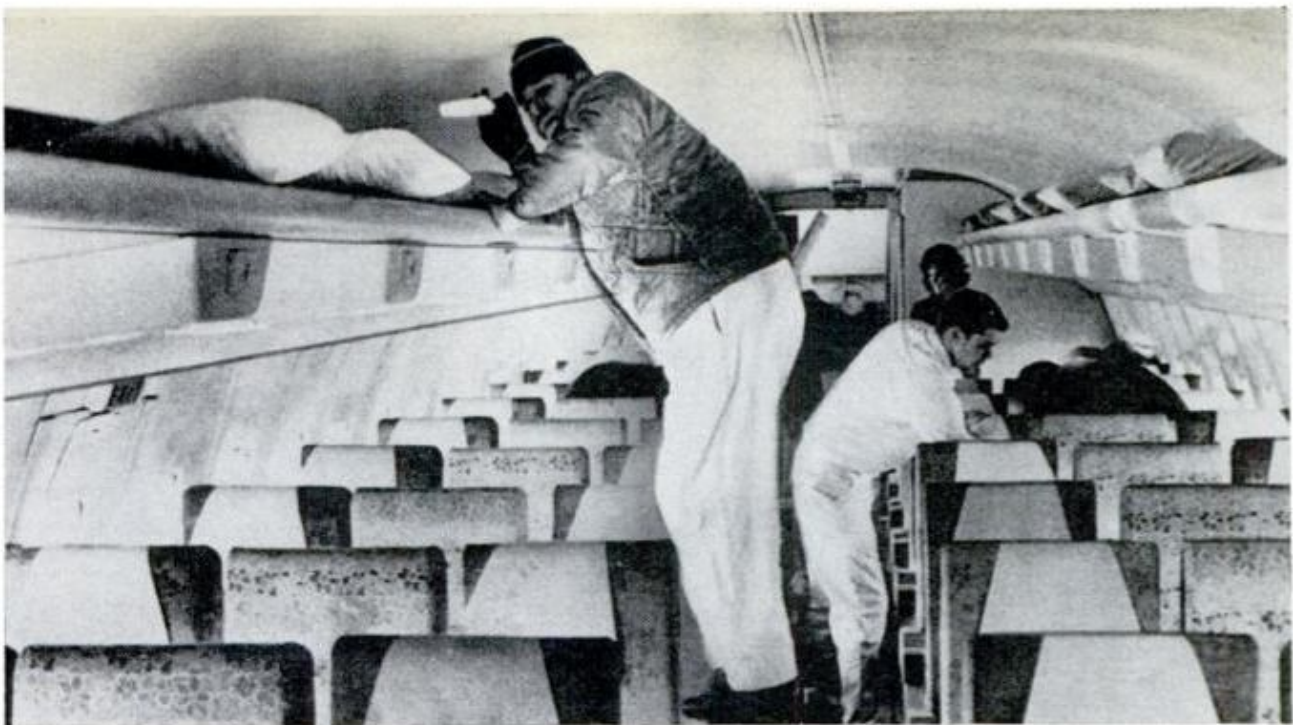

SEARCHING FOR BOMB, TWA crews carefully check all flights in and out of Kansas City on March 8

after extortionist made a \$2-million ransom demand. Scare touched off similar searches all over world

terrorists' luggage had been adequately screened before the gunmen were permitted to board the Air France jetliner that landed at Lod. Instead, the killers calmly debarked from the plane and drew automatic rifles and hand grenades from their bags, killing 24 and wounding more than 60.

lar Mechanics sent me around the country to find out. I found antihijacking measures dangerously lax at some air terminals and totally lacking at others. One problem is that the pattern of air piracy has changed radically in a few years. We are no longer dealing with a few disgruntled nuts diverting planes to Cuba or

What makes possible such terror? *Popu-*

(Please turn to page 192)



IMPROVED MAGNETOMETER not only indicates presence of metallic objects, but also pinpoints their location by lighted area on small nearby screen. At left, light shows girl is carrying gun concealed

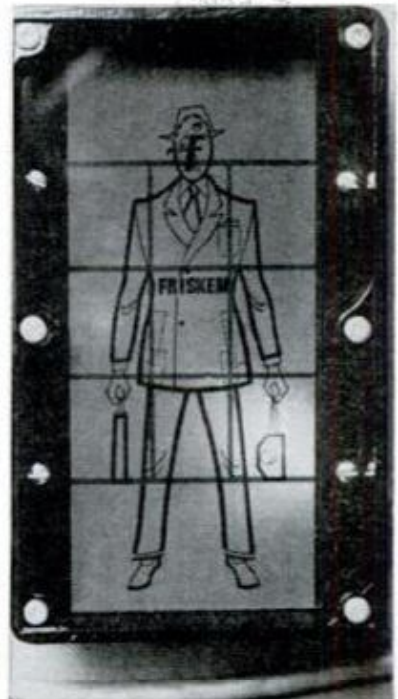

in waistband of her skirt. At right, light indicates hidden metal in passenger's suitcase. Such new Mark III Friskem devices speed search of air travelers, are being installed by Eastern Airlines



INITIAL IMPRESSION on seeing the 15 for the first time is that it's longer and lower than pictures show

Renault 15: It won't go unnoticed...and go it does!

This new front-wheel-drive sports coupe caused more rubbernecking than any other new car we've tested

By **BILL HARTFORD**, Auto Editor

Photos by the author



I PICKED UP THE CAR and didn't get far before the staring started: A Triumph GT6 driver closed on me and dropped back only after he satisfied his curiosity and read "Renault 15" on the tailgate; soon after, a motorcyclist, a knowledgeable car buff as he turned out, buzzed around the car until we slowed enough for him to ask if the body was by the European designer, Frua. After I told him that it was done by Renault's own design studios, he disappeared ahead, his helmet bobbing approvingly. And so it went for the week I drove the sport coupe—lots of attention, lots of questions.

Several friends who drove the car found the noise level too high. The deep resonant sound will probably be more appealing than annoying to the more enthusiastic driver—the type of driver the sport coupe, however roomy, will attract.

The 15 invites hard driving. The four-speed synchromesh transmission ratios are beautifully matched to engine torque, and shifting is precise. I did find the floor-mounted gearshift lever just a mite far

COMING AND GOING, the 15 has a unity of styling theme. Rubber insert rings the front bumper/grille
142 **POPULAR MECHANICS**



PERFORMANCE of longitudinally placed, aluminum-alloy Four is as exhilarating as it is economical



SCULPTURED REAR SEATS are so comfortable, deep and cradling that it's hard to climb out of them!



INSTRUMENTS AND CONTROLS are, in French fashion, a bit different and take a little getting used to



THIRD DOOR LIFTS to swallow 8.5 cu. ft. of luggage. Overall, usable capacity of the trunk is 10.5 cu. ft.

forward for my driving position, however.

It feels as if the engine (same as that in the Renault 12: See *Front-Wheel Drive to the Fore!* page 126, Nov. '71 PM) puts out more than its rated 69 hp. Handling is characteristic of good fwd sedans and then some, because of the 15's low center of gravity, suspension and use of standard radial tires.

The 15 is a car that should be in the running for a small family with sporty ideas. If these ideas are matched by a willingness to spend \$4000 plus, they should look at the step-up model, the 17. It's almost the same outside, but underneath are performance boosts like fuel injection, four-wheel disc brakes and tach. I haven't driven it yet, but I can't wait. I don't mind being stared at. ★★★

SEPTEMBER 1972

RENAULT 15 SPECIFICATIONS

DIMENSIONS AND WEIGHT

Wheelbase, 96.0 in.
Overall length, 167.7 in.
Overall width, 64.0 in.
Overall height, 51.5 in.
Front/rear tread, 51.5 in.
Curb weight: (with manual trans.) 2172 lbs.
(with auto trans.) 2238 lbs.

ENGINE AND TRANSMISSION

Type: In-line ohv Four; aluminum head and block
Displacement: 1565 cc (95.5 cu. in.)
Compression ratio: 8.6:1
Net hp: 69 @ 5000 rpm
Transmission: Four-speed synchromesh
(Automatic optional)

SUSPENSION, BRAKES AND TIRES

Front: Independent, coil springs, telescopic shocks, stabilizer bar
Rear: Rigid axle, coil springs, telescopic shocks, stabilizer bar
Brakes: Vacuum-assist front discs, rear drums
Tires: 155x13 steel-belted radials

PRICE

East Coast: \$3325. Automatic transmission: \$230



ON-THE-CAR WHEEL BALANCER spins the wheel while the operator tunes indicator for minimum vibration

WHEEL BALANCING:

Before you pay for the job, you should know the different

BAD VIBRATIONS caused by out-of-balance wheels put undue stress on car and driver alike. The cure is simple: Get 'em balanced. This is a job you have to "buy" because wheel-balancing equipment is expensive.

Cheapest and simplest of the balancers is the bubble balancer. It has a stepped cone upon which the wheel is placed, and

a small spirit level in the center. If the tire does not have its weight evenly distributed, the heavy side will drop. You simply place weights in increments on the rim opposite the heavy spot to center the bubble and balance the wheel. The balancer is cheap, takes up little space, is quick and easy to use, and takes little or no experience to operate. Consequently, it

HOW A WHEEL IS BALANCED

Technical art by Peter Trojan

- A Heavy spot
- B Rim weight
- C Rim weight

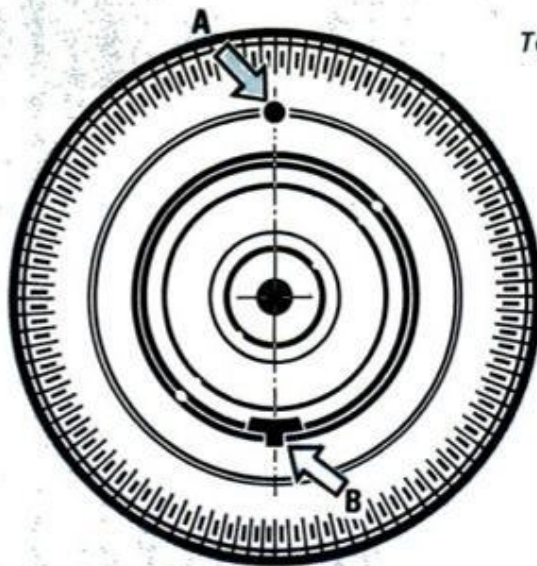

- 1 Static balance—
heavy spot at A
balanced by rim
weight at B



Ball joint
Spindle
Pivot point
Ball joint

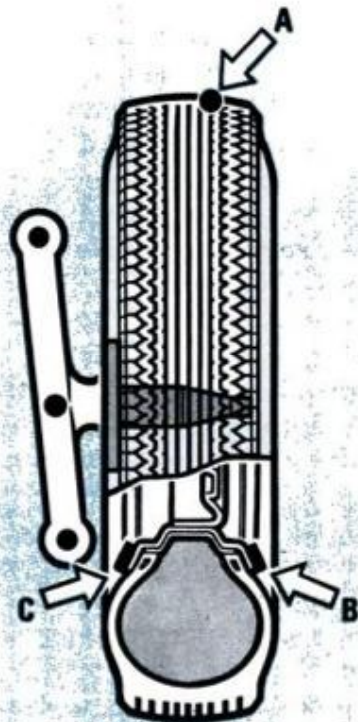

- 2 Rim weight should
be opposite heavy
spot. It's placed at
B to be in nearly
the same plane as
heavy spot A

- 3 Dynamic balancing
attempts to cancel
centrifugal forces
on spindle when
wheel is spinning
(see text)

- 4 Perfect dynamic
balance may
require weights on
inside and outside
of rim to cancel
heavy spot at A

How to get your money's worth

methods used and how they work

By JOHN H. MILES

has been the choice of most service stations that do a little wheel balancing.

The bubble balancer, however, has some shortcomings. As Bear Manufacturing Co. points out, the bubble balancer will correct only about 70 percent of balancing problems. The other 30 percent is the result of dynamic unbalance; a bubble balancer accomplishes only static balance.

SEPTEMBER 1972

The terms "static" and "dynamic" cause some confusion. Static means at rest, and dynamic means in motion. So it is a common misconception that a balancer that spins the wheel is dynamic and one that does not is static. Actually there are balancers that dramatically spin the wheel over 90 mph and yet do only static balance. But no balancer which does not spin

145

the wheel can accomplish dynamic balance.

To understand static balance, see the illustration on page 145. In drawing 1, if a heavy spot exists on the tire at point A, the wheel will rotate until point A falls to the bottom. But a weight of the correct size placed on the rim at B acts as a counterbalance, and the wheel will remain in any position in which it is placed. The wheel is in static balance.

Looking at the tire from the front in drawing 2 you can see that the weight may or may not be exactly opposite (in the same plane as) the tire's heavy spot. The weight should be placed on the rim at B to be as nearly as possible in the same plane as the heavy spot it is balancing. Examination of drawing 3 shows why. Consider the spindle to be a lever with pivot point as indicated. Spin the wheel at, say, 60 mph. Now there are centrifugal forces that did not exist when the wheel was at rest.

Dynamic unbalance, then, is a leverage problem that exists only when the wheel is spinning. At 60 mph a one-ounce weight exhibits about 20 pounds of centrifugal force on a 14-inch rim. Twenty pounds at A cannot balance 20 pounds at B because the two forces are not in the same plane and therefore act at slightly different points on the spindle. In fact, both centrifugal forces will not even be the same since A travels in a larger circle and thus at higher speed than the weight on the rim.

Actually, as drawing 4 shows, it is practically impossible to balance both statically and dynamically with one weight. The weight must be added in the plane of the rim edge while the irregularity in the tire can be anywhere on its cross section. In practice, after balancing statically, two weights are usually added on opposite sides of the rim—rim weights B and C—and exactly across from each other. A sophisticated balancer is needed to determine the amount and exact placement of the weights.

So a basic fault of the bubble balancer is its utter inability to indicate anything about dynamic balance. It cannot even indicate to which side of the rim the weight should be added. It is a custom, when more than an ounce or so is called for, to place two equal weights symmetrically on either side of the heavy spot and shift

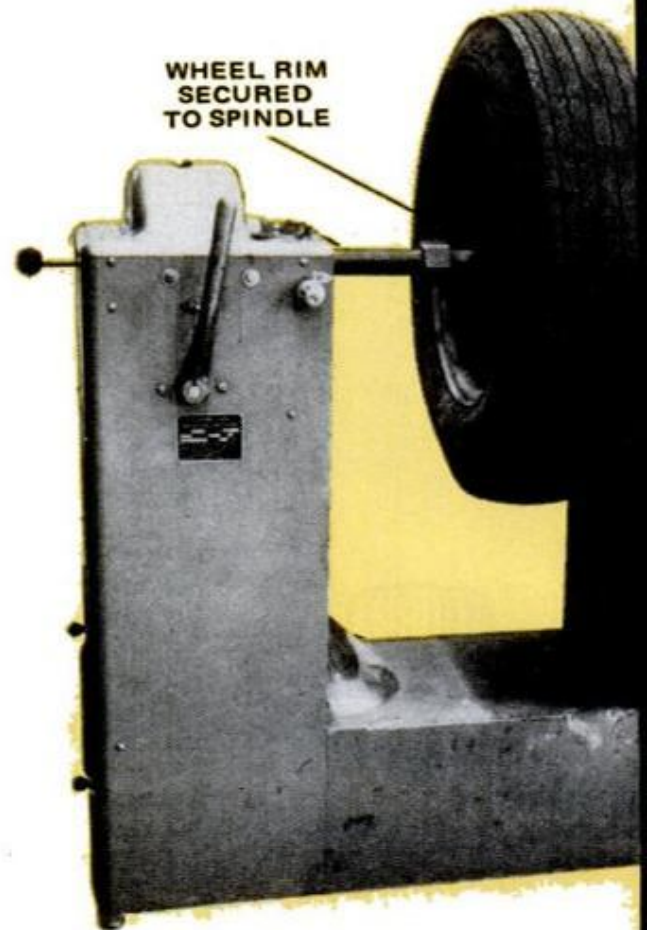

DYNAMIC BALANCER spins tire and wheel off car

them until balance is achieved. Actually if three ounces is called for, you may just as well put on a three-ounce weight and let it go at that. Distributing the weight is guesswork at best.

After the bubble balancer, the next most common type is one which spins the wheel in place on the car. This type of balancer has a couple of fringe benefits. Spinning makes it possible to detect out-of-round tires or a crooked wheel. In addition, bad wheel bearings can be audibly detected by spinning on the car. Also, any unbalance of the hub or brake drum is compensated for.

Bear and Hunter make balancers of this type. With both, a balancing head is placed on the wheel and the wheel is spun at speeds of 60 to 90 mph. By manipulating two pairs of knobs on the balancing head the operator can add or subtract weight and move the weight around the wheel while it is spinning. He "tunes" the knobs to a point of minimum vibration. When the wheel is stopped, a dial indicates the exact amount of weight needed and a pointer indicates the correct location. It is dra-



STATIC BALANCER, which is good for about 70 percent of balance problems, is just a seesaw in principle

matic to watch the vibration suddenly stop when balance is achieved.

These balancers are fast, dependable, simple in principle and easy to operate. It does take considerable practice to develop a "touch" but a skilled operator can do excellent balancing with almost unbelievable speed. If he takes more than about a minute to zero-in on the point of minimum vibration, he either has a tire that is difficult or he lacks experience. Beware of the operator who spends five minutes passing back and forth across the point of least vibration.

Another type of balancer is the so-called electronic wheel balancer. Actually it's simply a strobe light that's triggered each time the heavy spot reaches bottom. The electronic balancer has the advantage of not requiring any apparatus to be attached to the wheel. Its primary disadvantage is the skill an operator must have to use it.

The very best balancers are the dynamic balancers that require removal of the wheel from the car. The Bear model 330 does both static and dynamic balancing

with laboratory precision and has been the official balancer at the Indianapolis 500 since 1931.

Several factors should be considered in deciding how to have balancing done. Among these are size of the tire and type of driving done. The narrower a tire, the less likelihood of dynamic problems. So if you have small tires on a small car to be driven at moderate speeds, the bubble balancer at the convenient neighborhood service station may be the way to go. For larger, wider tires and high-speed turnpike driving, the spinner type is much more reliable. For tires that are highly sensitive to balance, or if laboratory precision is desired the lab-type dynamic balancers are the answer. These balance either the wheel alone or the entire hub. Usually it is sufficient to balance only the wheel. While hubs and drums can be out of balance the condition is rare.

It is interesting to note that it generally costs no more to have a wheel balanced on a \$1200 dynamic balancer than on a \$24.95 bubble balancer. Another factor

(Please turn to page 188)

Nice—and easy

For young homemakers:
three well-designed, easy-to-build pieces
of furniture plus a practical kitchen accessory

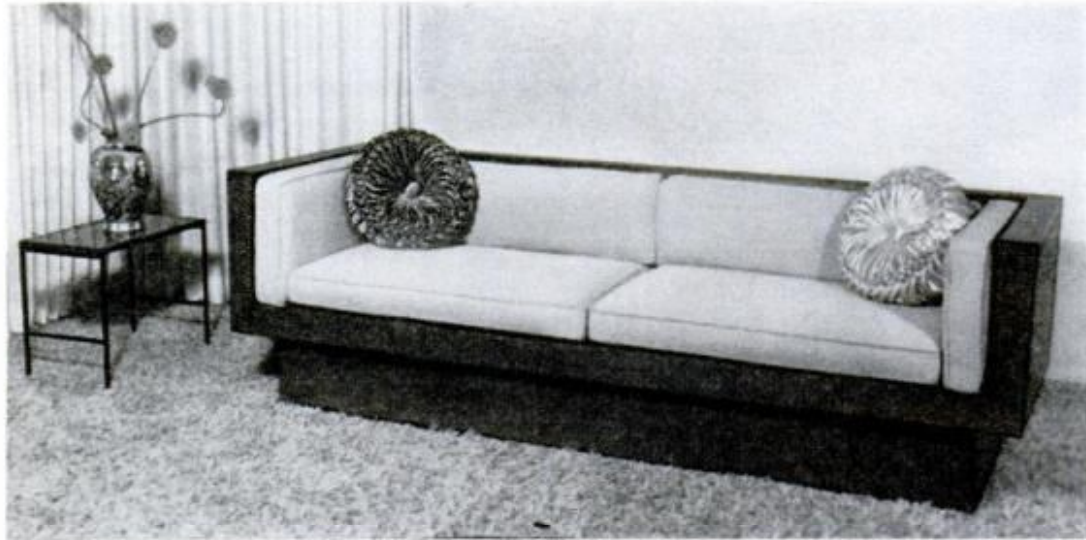

Contemporary sofa

If your wife wants to help you build this modern sofa, you can put her to work sewing the cushions while you take on the wood part. Together you can make it for less than \$100, which is about \$200 less than what it would cost you in a store.

You can make it a chummy 78 in. long, or a king-size 90 in. The latter size will cost about \$35 for plywood and clear pine, \$3 for hardware and \$3 more for wood stain. The cushions will run about \$32 for top-grade foam and another \$25 for fabric. If your wife is not handy with needle and thread, add another \$20 for sewing.

As you'll see after studying the drawing, it is a simple thing to build. Its boxlike construction requires the better part of three full sheets of plywood, two $\frac{3}{4}$ in. thick and one $\frac{3}{8}$ in.

Both arms are made alike except for being right and left-hand assemblies. The 8 and 10-ft. lengths of clear 1x4 are used for the fronts and tops of the arms, the top of the slanting back and the apron along the front.

—Winston S. Goo, Rowland Heights, Calif.

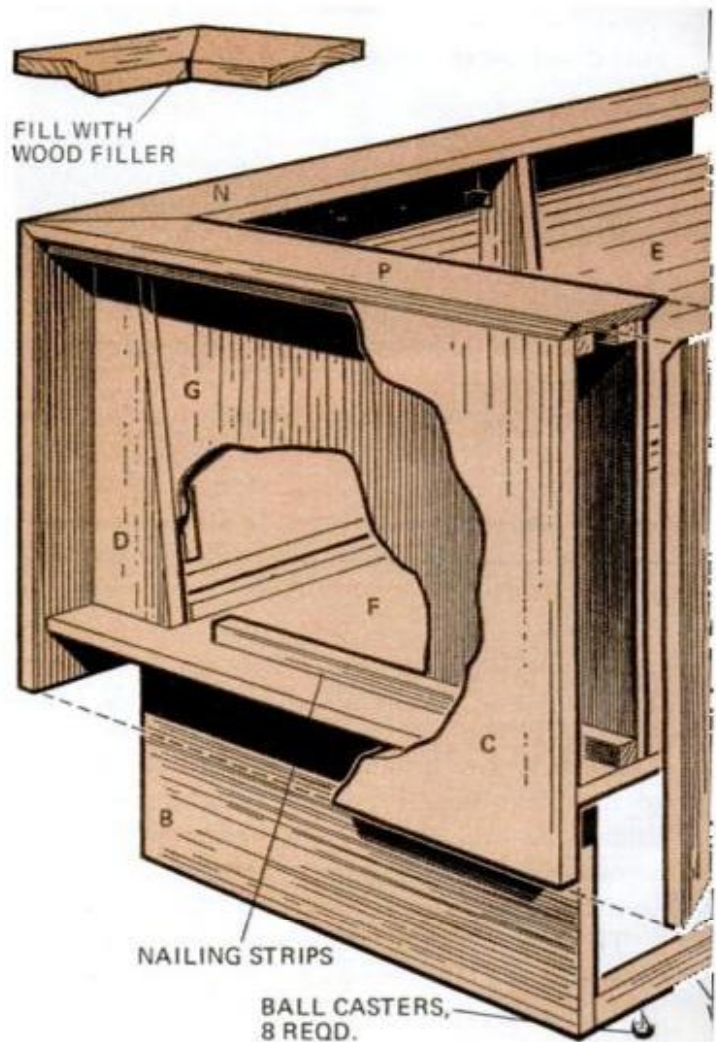

POPULAR MECHANICS

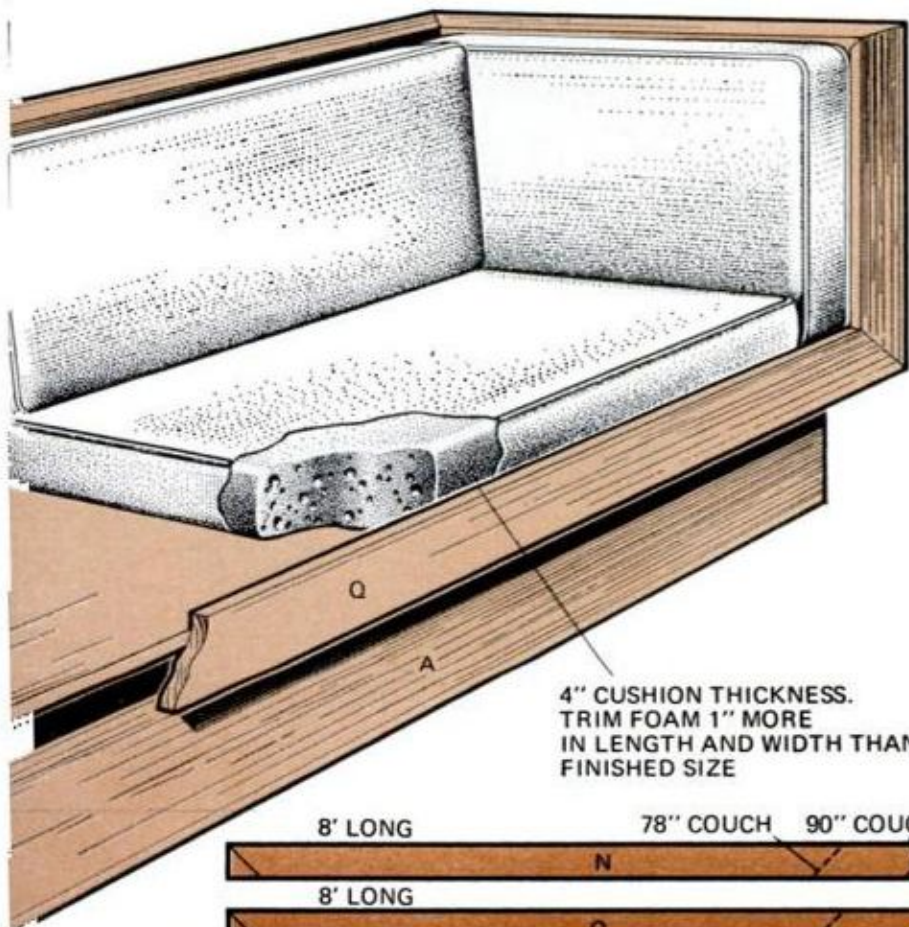
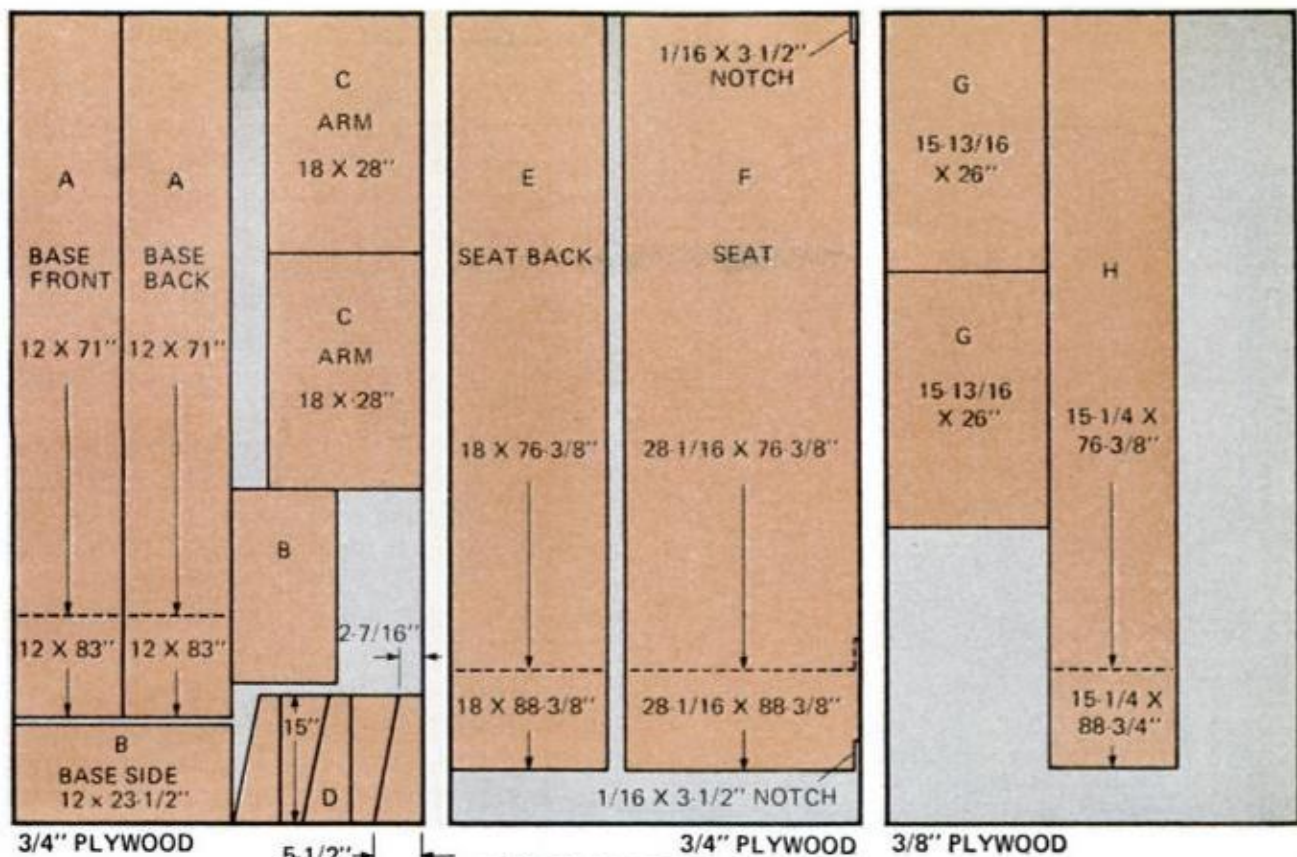

4" CUSHION THICKNESS.
TRIM FOAM 1" MORE
IN LENGTH AND WIDTH THAN
FINISHED SIZE

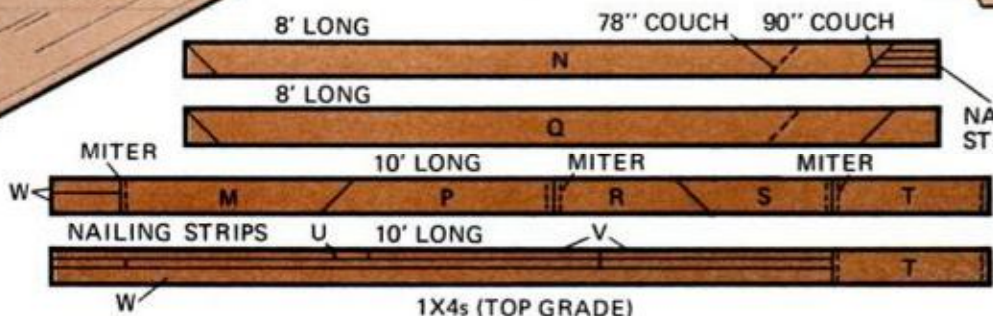
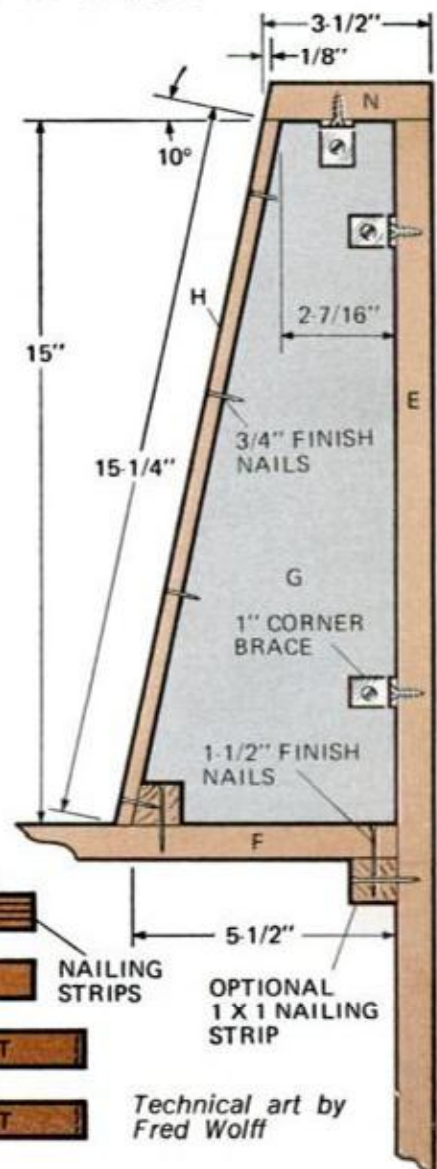

Technical art by
Fred Wolff

CUBE CONSTRUCTION

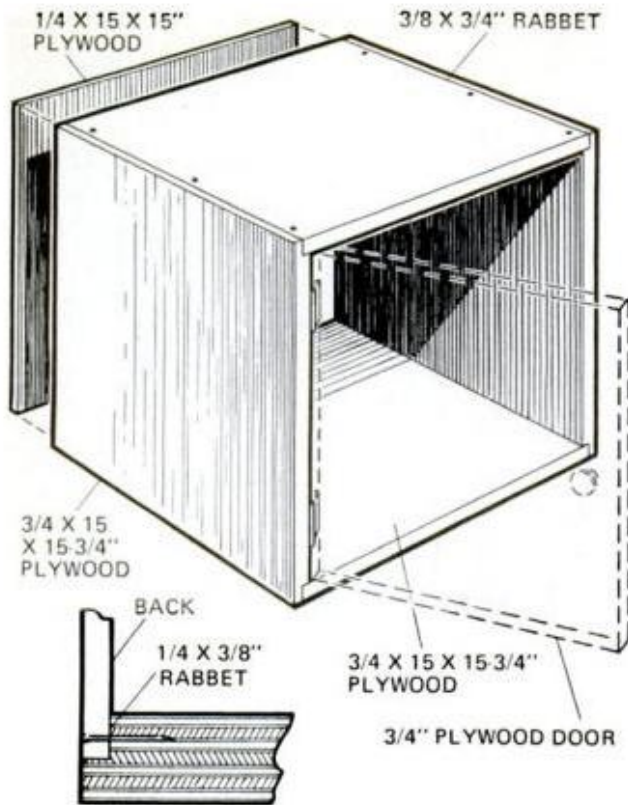

FOR A PAINTED FINISH, A-D fir plywood will do fine, but if you want to stain the cubes, you should use hardwood lumber-core plywood for best results

Modular stacking cubes

Like toy building blocks in that they can be stacked and grouped in so many different ways, these modular plywood cubes let you create furniture arrangements to your heart's content.

Placed end to end and fitted with foam-rubber cushions, they serve as comfortable benches and stools with built-in storage. Piled in tiers they form handy niches for books, telephone and a place to store bulky big-city directories like the Yellow Pages. They're ideal for apartment dwellers because the cubes can also serve as handy packing boxes when it comes to moving.

Some of the cubes can be fitted with doors, others left open, but all should have backs of $\frac{1}{4}$ -in. plywood set in rabbeted edges. Rabbeted joints throughout make the best and neatest assembly, of course, but if you must, you can nail the cubes together with mere butt joints. The cubes are locked together by passing stovebolts through mating holes. A couple of $\frac{1}{4}$ -20x 2-in. stovebolts per cube will be adequate for the job.

ALTERNATE ARRANGEMENTS

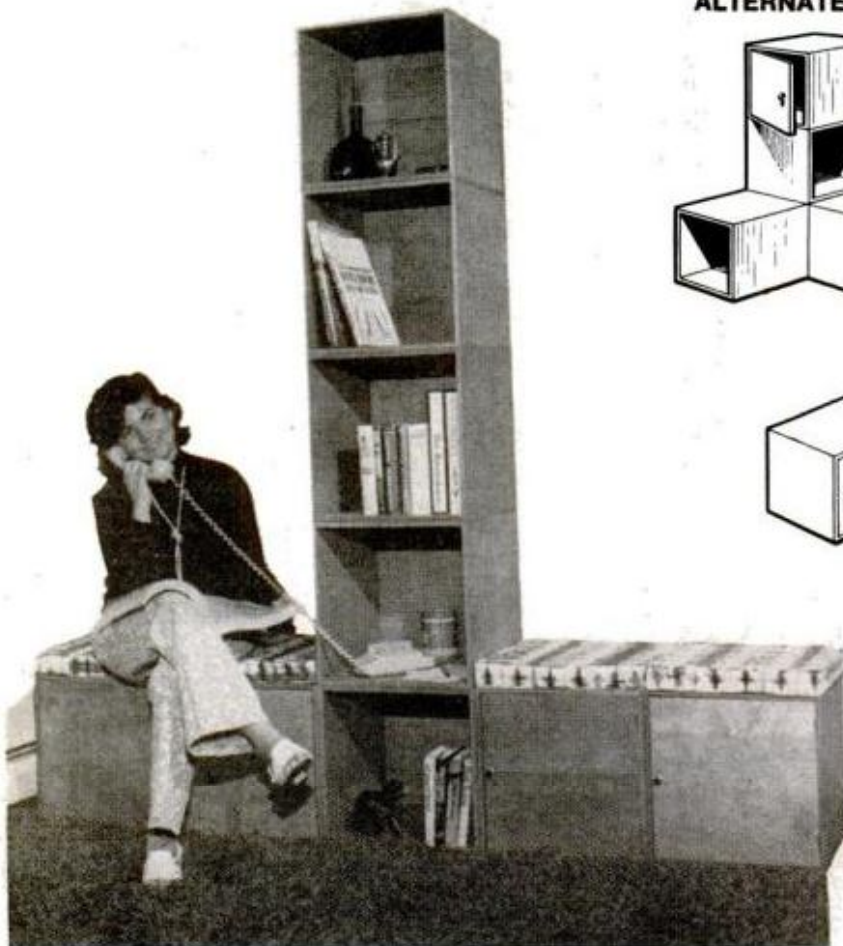
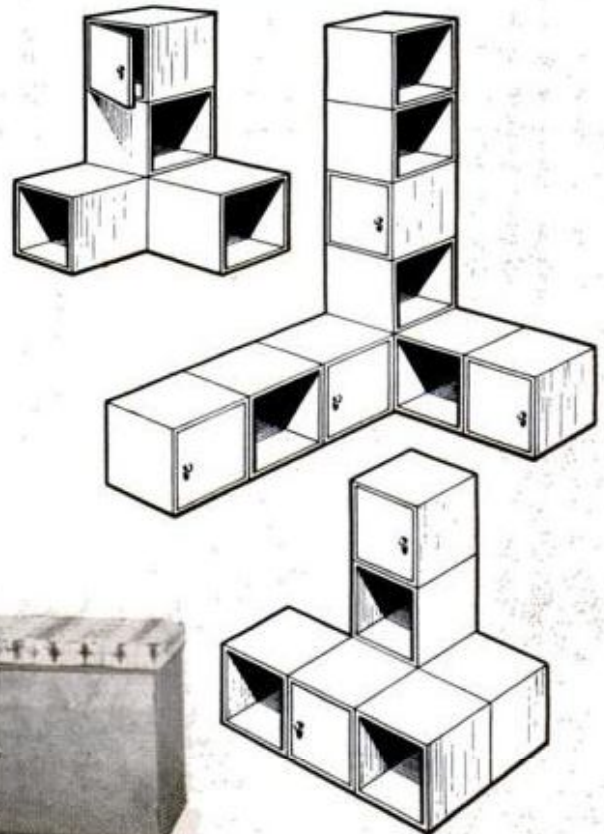

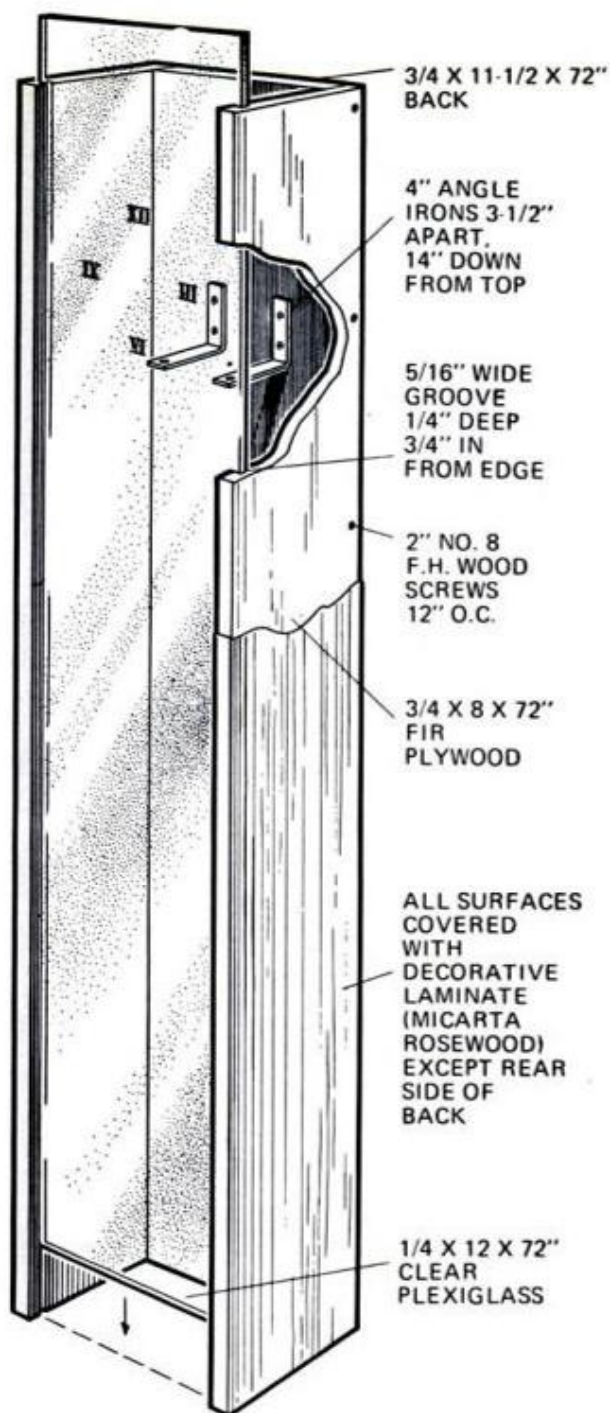

Modern hall clock

This handsome, simple, ultramodern hall clock with a see-through plexiglass front is a striking piece in more than one way. Its U-shape case of inexpensive fir plywood takes on a rich look when all surfaces and edges are covered with rosewood decorative laminate.

Side members are grooved inside for the sliding plastic front before being glued and nailed to the back. If you have no bench saw or router, you can create grooves by facing 1/2-in.-thick side members with separate pieces of 1/4-in. plywood as detailed on page 152. Form the grooves before you apply the laminate

SEPTEMBER 1972

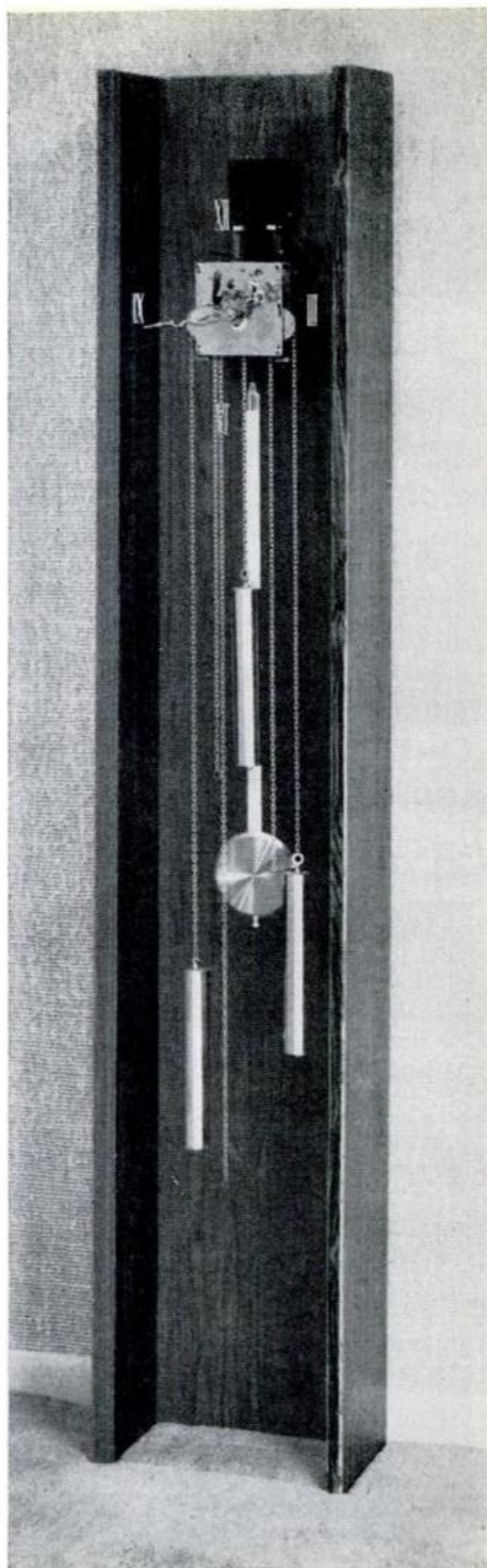

151

TWO WAYS TO FORM GROOVE FOR PLEXIGLASS FRONT

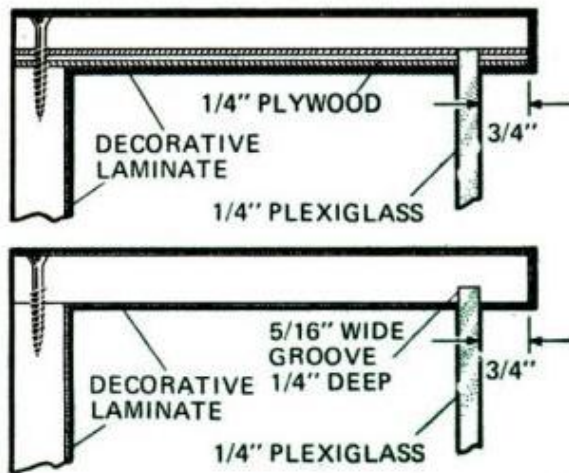

with contact cement. The movement usually determines height of the case. I used Mason and Sullivan's Nathan Hale grandmother movement (made for a 6-ft. case), mounting it on two 4-in. angle brackets attached to the case 14 in. down from the top. Top and bottom surfaces of the brackets were covered with scraps of laminate.

HOW MOVEMENT IS SUPPORTED

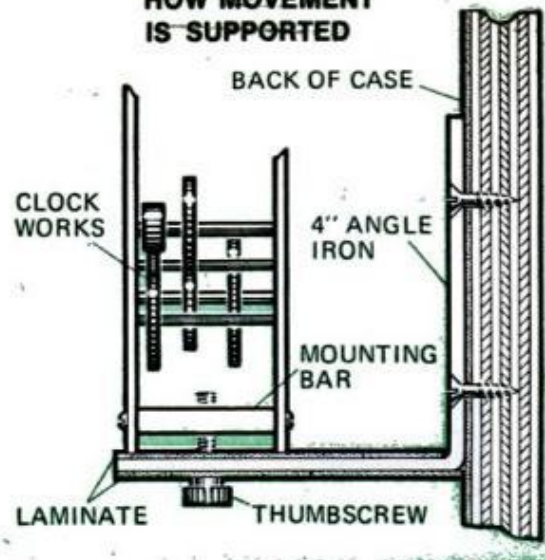

Slide the plexiglass in place after the movement is installed, with the case flat on the floor. To wind the eight-day movement, raise the plastic front as much as the ceiling permits and pull down the weights. The dial consists of four decal numerals applied to the plastic.

—Bill Schremp, Huntington, N.Y.

Chef's pot-and-pan rack for island work counter

A chef's hanging pot-and-pan rack is a handy kitchen accessory, particularly when hung over an island work counter. The rack shown below was made from metal wall molding (angle) left over from a Conwed suspended-ceiling installation, but any suitable angle could be used. One leg is cut at 24-in. intervals and bent at a right angle to form a square frame. Holes are drilled through the angle for a small

stovebolt, eight S-hooks and four 12-in. hanging chains, then the frame and chains are spray-painted.

To attach chains to the ceiling, install plastic screw anchors in the plaster and turn cup hooks into them. Or, if you have a suspended ceiling with 24-in. grid pattern, just form small wire loops around the four intersections of the molding for attaching the chain. ★★★

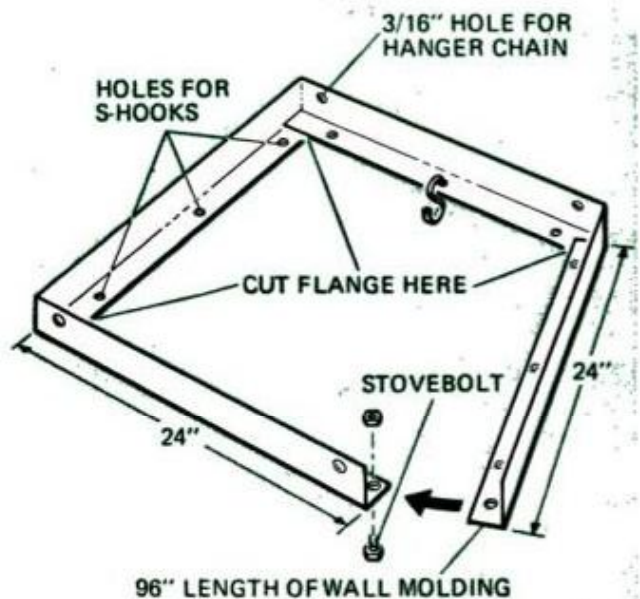

Hand scraper uses lathe bits

By WALTER E. BURTON



AN AVERAGE COLLECTION of conventional metal-lathe bits usually contains some that can be adapted for use as hand-manipulated scrapers or cutters.

The bit holder shown was designed for adapting $\frac{1}{4}$ -in. bits. It's made from a 7-in. length of $\frac{1}{2}$ -in. steel rod. After chucking the rod, drill a centerhole in one end. At a point $\frac{1}{4}$ in. from the same end, drill a $\frac{1}{4}$ -in. cross hole and file it into a square hole. Next return the rod to the lathe with the undrilled end clamped in a chuck; the other end is steadied by the tailstock center. Turn the shank to the diameter shown, drill out the centerhole with a No. 7 twist drill and tap for a $\frac{1}{4}$ -in.-20 setscrew. Cut off the excess rod, bend the shank as indicated and fit it with a wooden handle.

To use the bit, position it so it cuts or scrapes on the pull stroke. ★★★

SQUARE-END BIT (above) serves as a scraper for smoothing bottom of channel in steel bar. At the right: Machining shank of bit holder. Square hole is made in the head first because the rod is easier to hold in the vise before the shank is formed

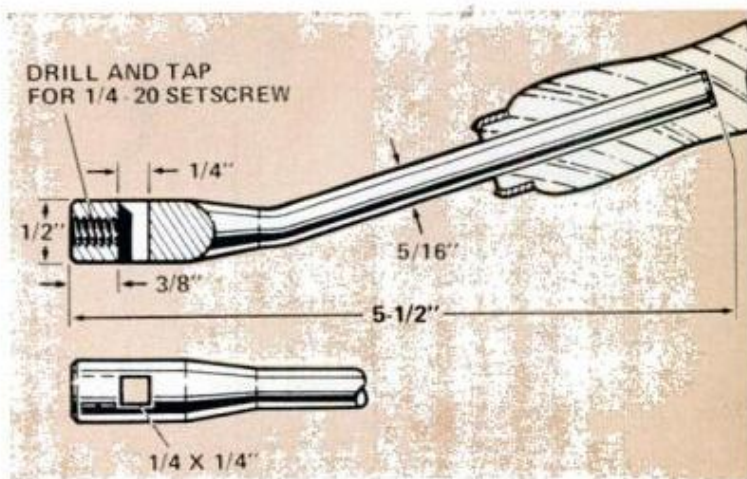

Hand-operated arbor press

By LOUIS ASHLEY

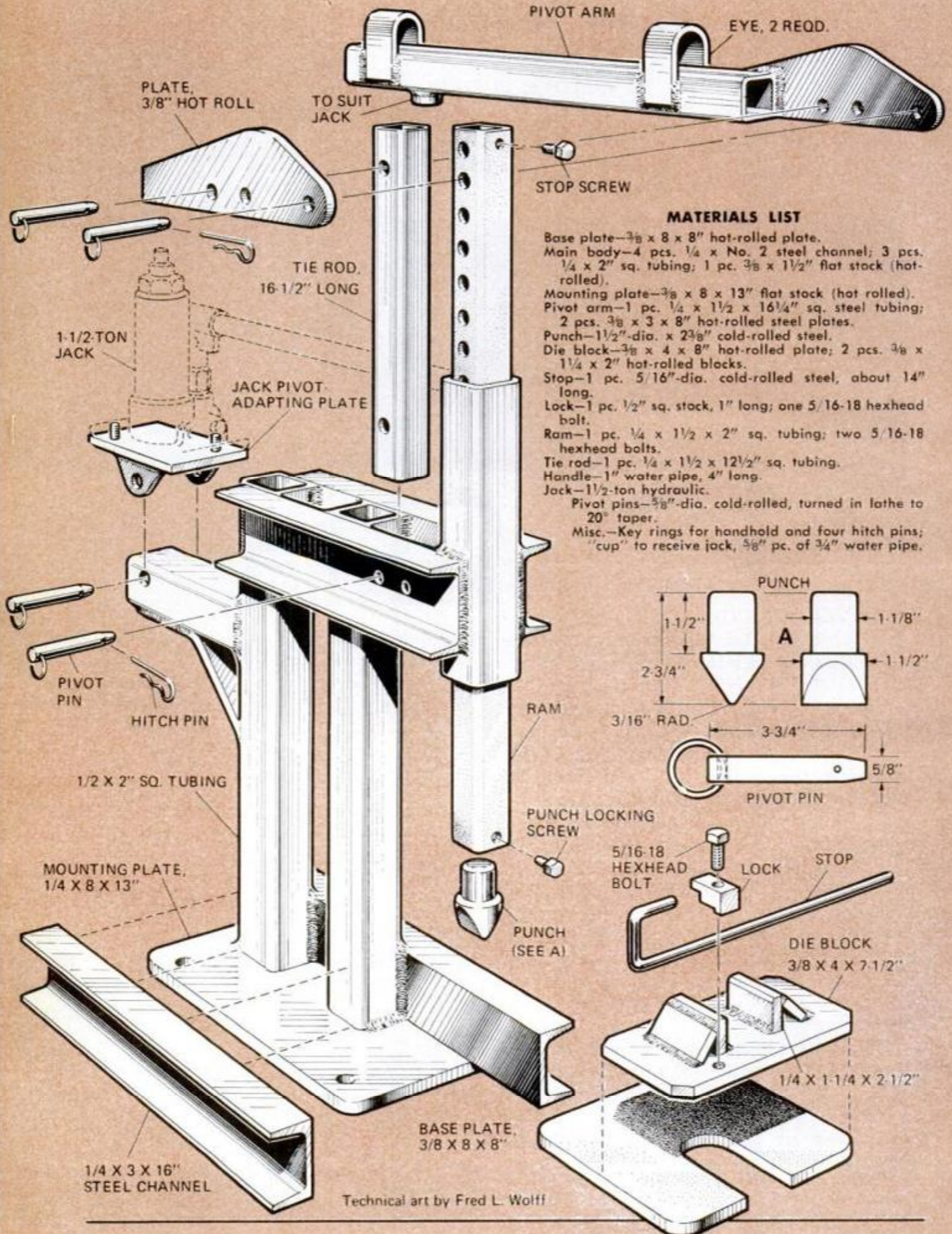

MATERIALS LIST

Base plate— $\frac{3}{8}$ x 8 x 8" hot-rolled plate.
 Main body—4 pcs. $\frac{1}{4}$ x No. 2 steel channel; 3 pcs. $\frac{1}{4}$ x 2" sq. tubing; 1 pc. $\frac{3}{8}$ x $1\frac{1}{2}$ " flat stock (hot-rolled).
 Mounting plate— $\frac{3}{8}$ x 8 x 13" flat stock (hot rolled).
 Pivot arm—1 pc. $\frac{1}{4}$ x $1\frac{1}{2}$ x $16\frac{1}{4}$ " sq. steel tubing;
 2 pcs. $\frac{3}{8}$ x 3 x 8" hot-rolled steel plates.
 Punch— $1\frac{1}{2}$ "-dia. x $2\frac{3}{8}$ " cold-rolled steel.
 Die block— $\frac{3}{8}$ x 4 x 8" hot-rolled plate; 2 pcs. $\frac{3}{8}$ x $1\frac{1}{4}$ x 2" hot-rolled blocks.
 Stop—1 pc. $\frac{5}{16}$ "-dia. cold-rolled steel, about 14" long.
 Lock—1 pc. $\frac{1}{2}$ " sq. stock, 1" long; one 5/16-18 hexhead bolt.
 Ram—1 pc. $\frac{1}{4}$ x $1\frac{1}{2}$ x 2" sq. tubing; two 5/16-18 hexhead bolts.
 Tie rod—1 pc. $\frac{1}{4}$ x $1\frac{1}{2}$ x $12\frac{1}{2}$ " sq. tubing.
 Handle—1" water pipe, 4" long.
 Jack— $1\frac{1}{2}$ -ton hydraulic.
 Pivot pins— $\frac{5}{8}$ "-dia. cold-rolled, turned in lathe to 20° taper.
 Misc.—Key rings for handhold and four hitch pins; "cup" to receive jack, $\frac{5}{8}$ " pc. of $\frac{3}{4}$ " water pipe.

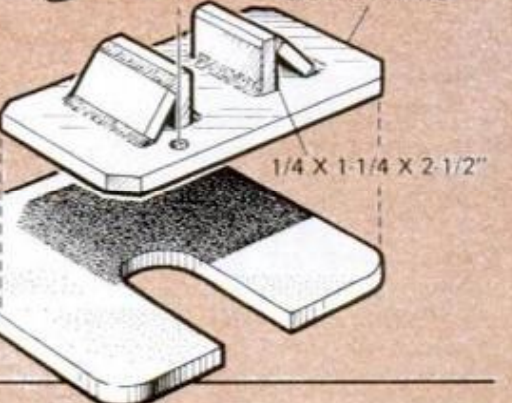
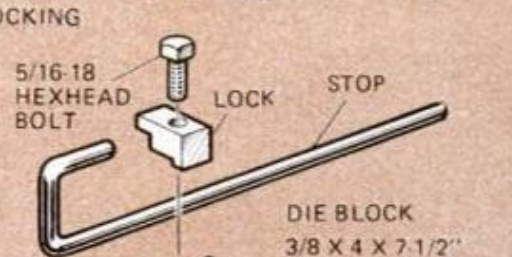
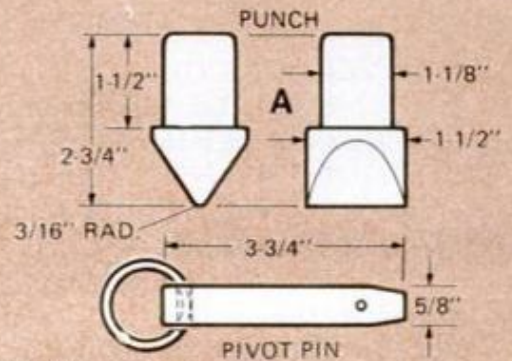

Technical art by Fred L. Wolff

IF YOUR SHOP ACTIVITIES include pressing on bushings or bearings, or bending steel bar stock and the like, you don't have to be sold on the advantages of having a professional-quality arbor press.

The version I built has the following capacities: Fully extended, the press opens up to 12 $\frac{1}{4}$ in. from ram to base plate. The ram has 14 holes for easy adjustment, and when the tie rod is in the holes closest to the ram, the ram will compress 10 tons. And, used with a hydraulic jack, the press will bend up to $\frac{3}{8}$ x 1 $\frac{1}{2}$ -in. rectangular bar stock.

To adjust the ram, pull the pivot pins out of the ram, slide it up or down to

correct position, and replace the pins. To use by hand, remove both pivot pins, turn the arm around and replace the pins. A 1-in. water pipe (into the eyes of the pivot arm) serves as a handle.

Notice that there are two sets of holes for the tie rod; put the tie rod in the holes nearest the ram for high pressure, into the farthest holes for low pressure. To bend stock, use a die block and punch. ★★

JACK USED IN PRESS shown is a 1 $\frac{1}{2}$ -ton Western Auto jack that costs about \$11 (right). To use press by hand (below), pull both pivot pins, turn arm around, replace pins. Ample leverage is supplied by water-pipe handle inserted into eyes of pivot arm

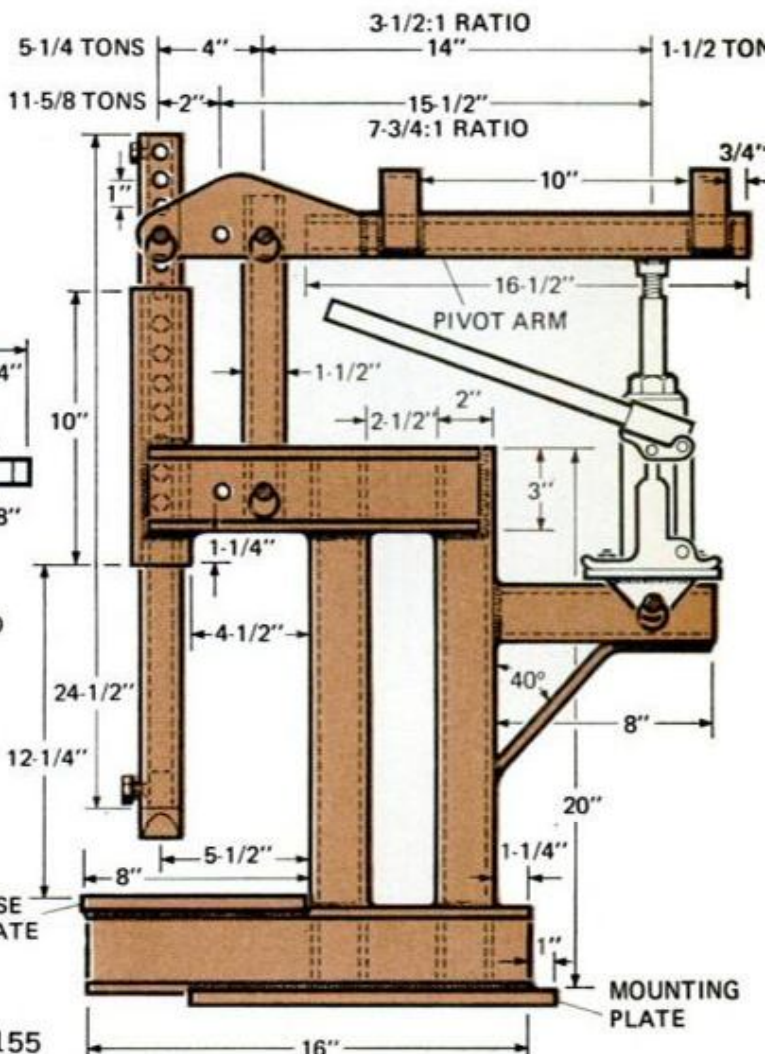
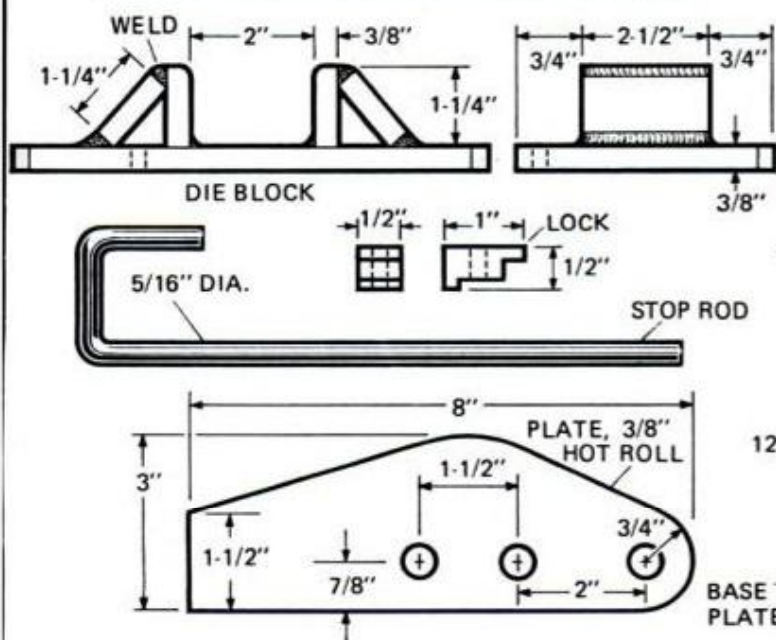
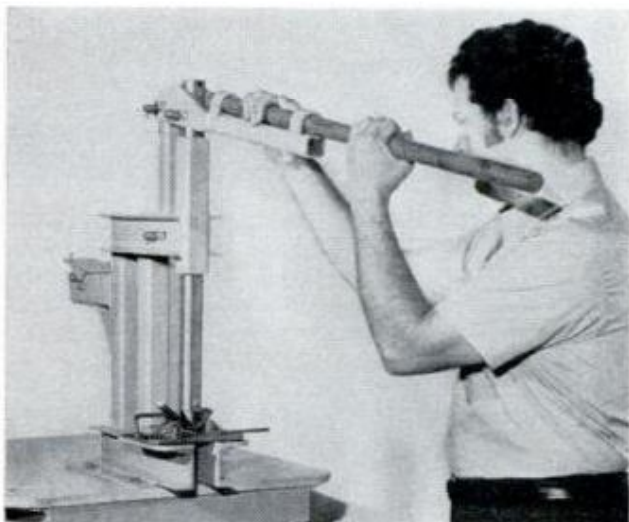
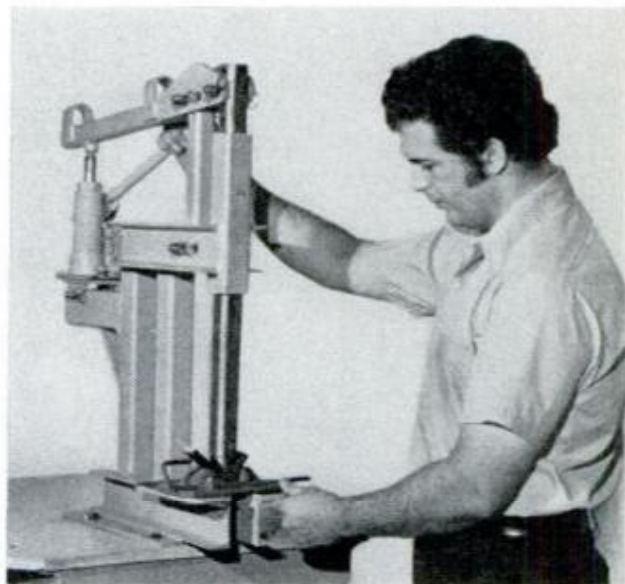

BETTER WAYS TO DO IT!

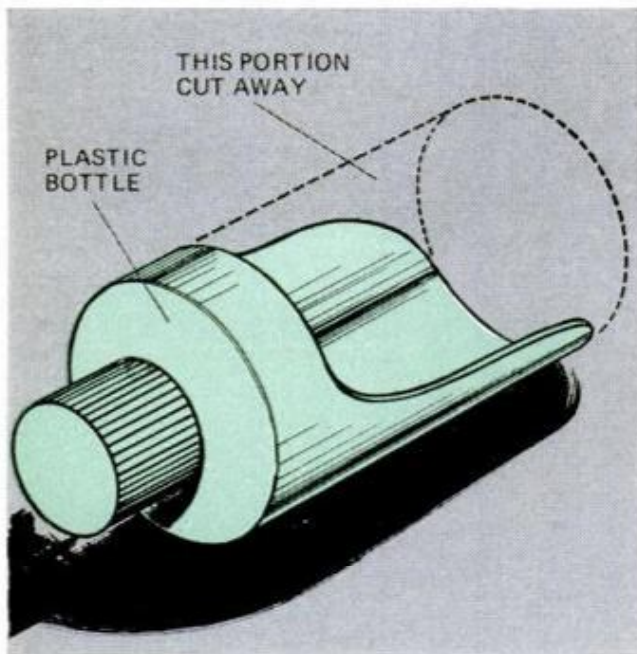

A PLASTIC BOTTLE can be cut to form a scoop for sugar, flour and other kitchen needs. After cutting the bottle, wash the scoop thoroughly before you start to use it.—*Joe Braunstein, Forest Hills, N.Y.*

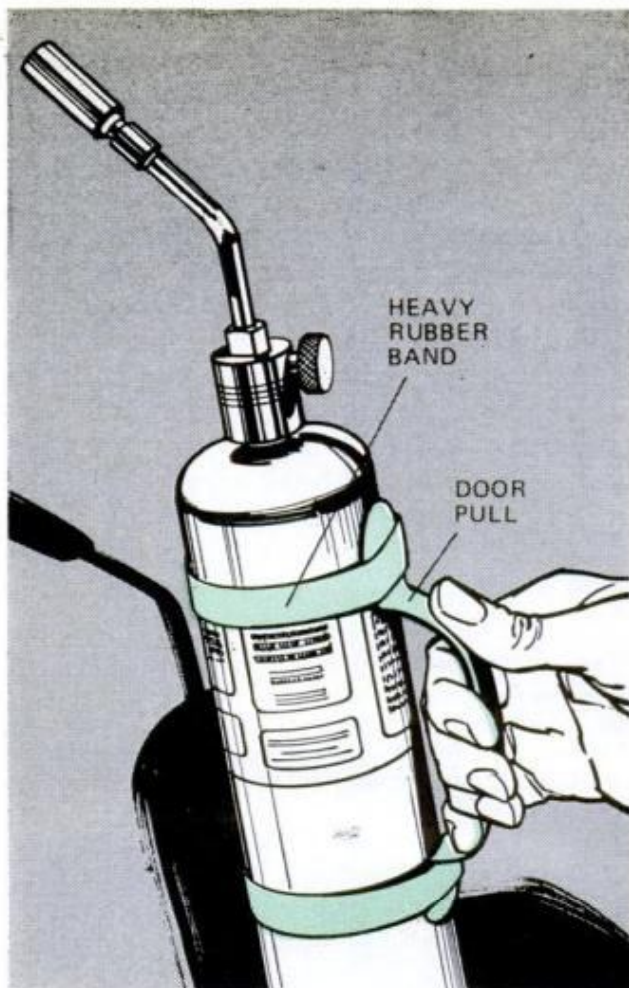

QUICK HANDLE for your shop propane torch can be created using two heavy rubber bands and a discarded drawer pull. Position the handle for the best balance and hand comfort.—*Ken Patterson, Regina, Sask.*

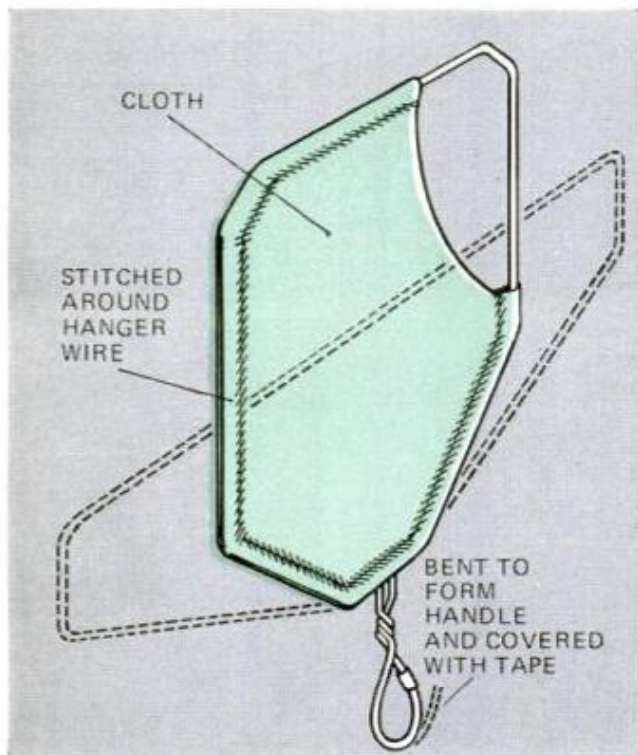

A SIMPLE FAN for breezeless days can be made with a wire coathanger and a piece of colorful cloth. For safety, twist the hook to form a handle and cover joint with adhesive tape.—*Frank Shore, New York*

156

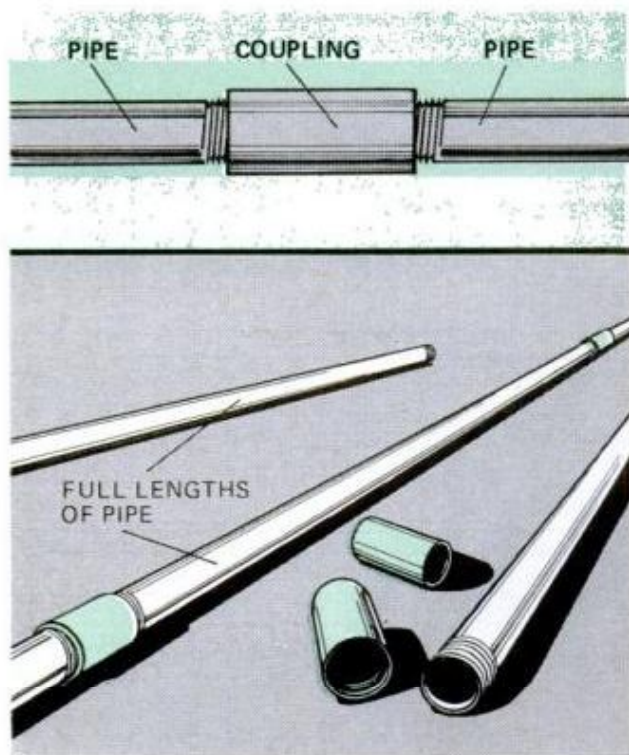

AN EASY WAY to align and connect full-length pipe is to turn a coupling on only a few threads so that it stays loose. After joining, tighten it with pipe wrenches.—*Herbert E. Serold, New Braunfels, Tex.*

POPULAR MECHANICS

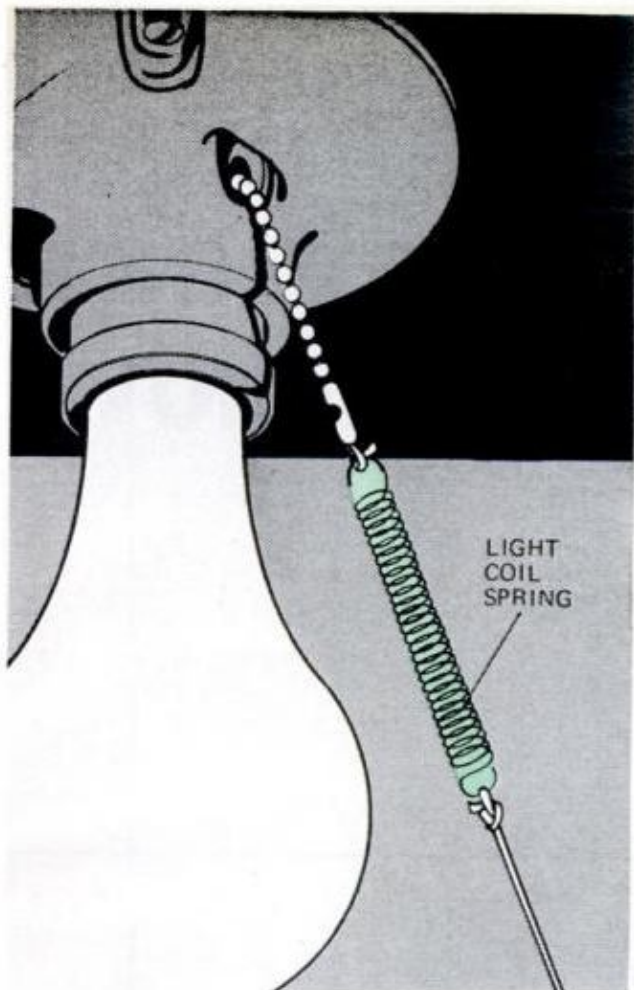

PULL CHAIN on a ceiling fixture will last longer if you add a small spring between the pull cord and the chain. The spring acts as a "shock absorber" when the chain is pulled.—William Swallow, Brooklyn



PAINT GARDEN-TOOL HANDLES bright red or yellow and you'll find them quickly at the end of your gardening stints. They will also be more distinguishable from your neighbors'.—William Swallow, Brooklyn



A PIPE CLEANER makes an excellent bookmark. It can be placed out of sight between the pages of a book, yet you can open that book promptly to the desired page.—Don R. Wilhelm, Chula Vista, Calif.

Illustrations by Adolph Brotman

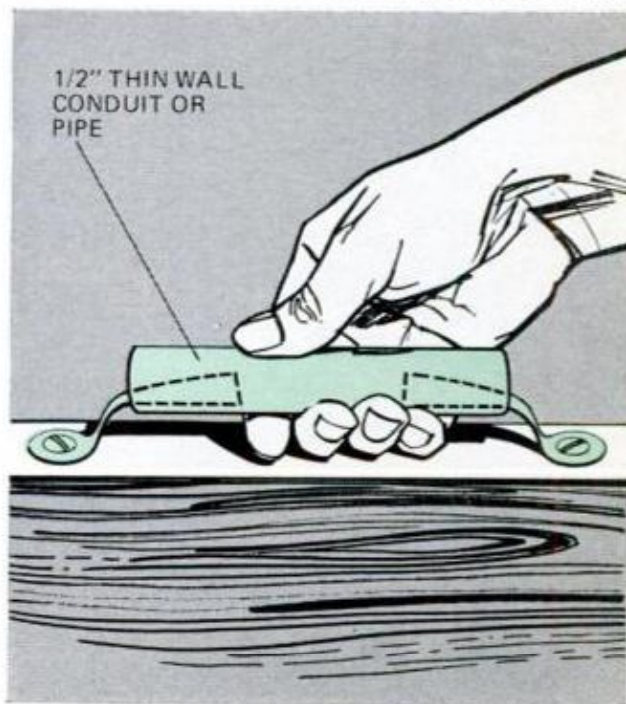

HANDLE'S LENGTH can be increased by cutting the pull in half and inserting a section of pipe as indicated. This new handle can be made to almost any length you desire.—Ken Patterson, Regina, Sask.

Here are several sophisticated sawing tricks—cutting of coves, edge-rabbeting round work, use of a molding head

Bench-saw know-how

PART 3

By HARRY WICKS, Workshop Editor

Photos by Robert D. Borst

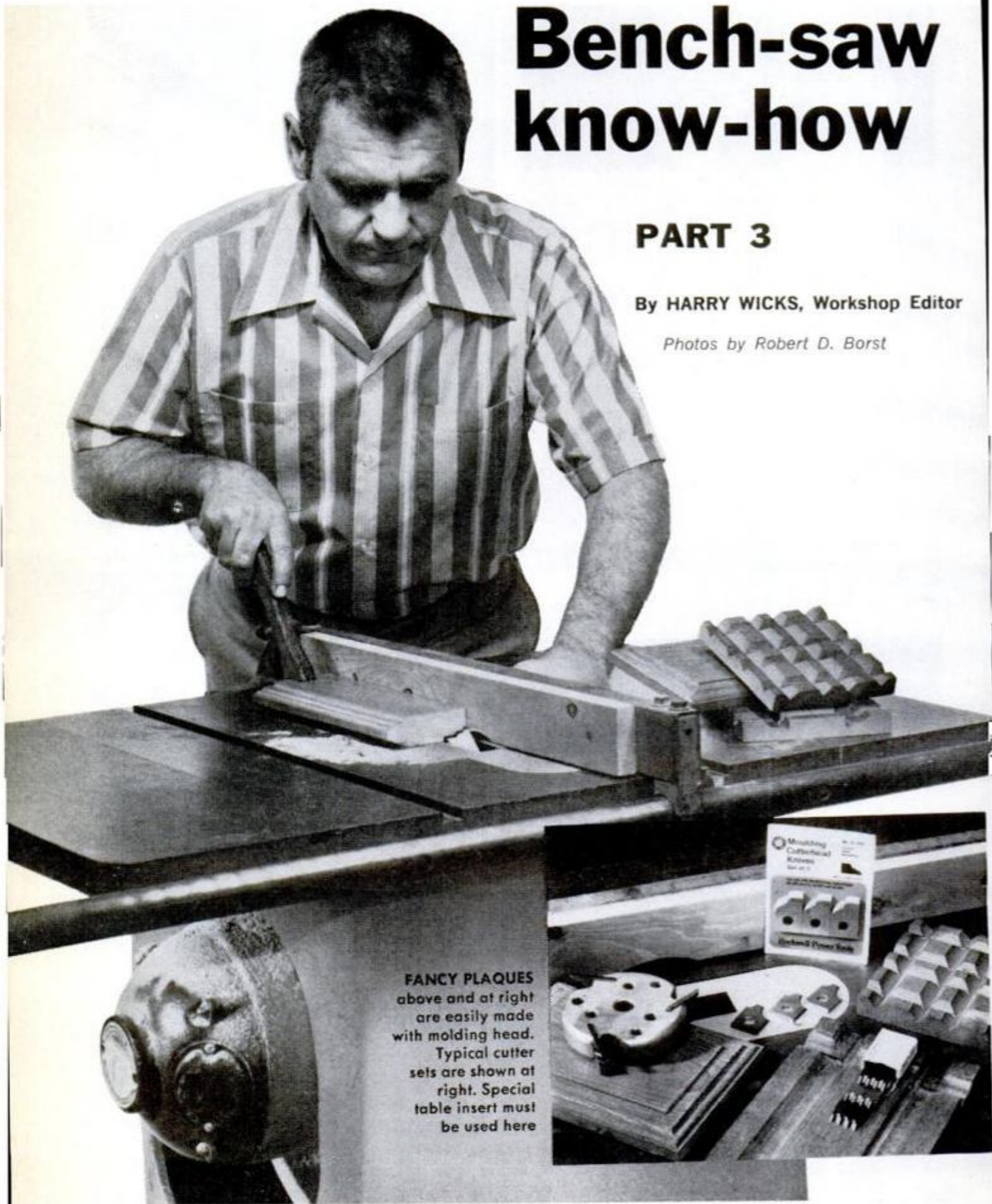

FANCY PLAQUES above and at right are easily made with molding head. Typical cutter sets are shown at right. Special table insert must be used here

IN CONTINUING TO LEARN the many trick cuts you can make with your bench saw, you'll find it fun to try your hand at oblique sawing—which is the creation of half-round slots (grooves) in a workpiece.

You can use any blade intended for conventional cutting, but experienced shop men prefer a hollow-ground combination, fine-tooth plywood, carbide-tipped, chisel-tooth combination or dado-head blade. Each leaves a slightly different finished surface, and you are advised to test all blades on scrap to find the one that best suits your purpose.

The important point is to make certain that the depth and angle of cut are such that the front and *not the sides* of the teeth will do the cutting. As can be seen in the drawing, the angle of cut will determine the cove shape. And no matter which

blade you use, because coving is done by scraping rather than cutting, you can expect a fair share of sanding to finish any coved piece.

To design a cove, raise the blade to the height of the finished cove (maximum radius). Place the workpiece on the saw table and angle it relative to the blade so that the cove width you desire will be achieved. Then clamp a straightedge to the table for the work to ride against as it is fed to the spinning blade.

To cut the cove, lower the blade so that there is a $\frac{1}{16}$ -in. projection. Feed the work slowly and after each pass raise the blade $\frac{1}{16}$ in. for the next pass. Continue making such passes until the desired depth is reached.

Bowls can be coved (saucered) too. After cutting the stock to circular shape on a jig or bandsaw, make a V-notched

Cutting coves

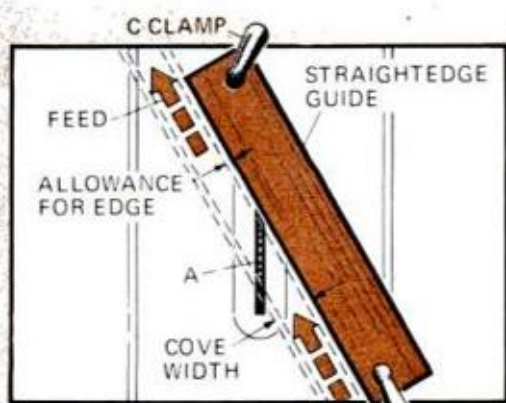
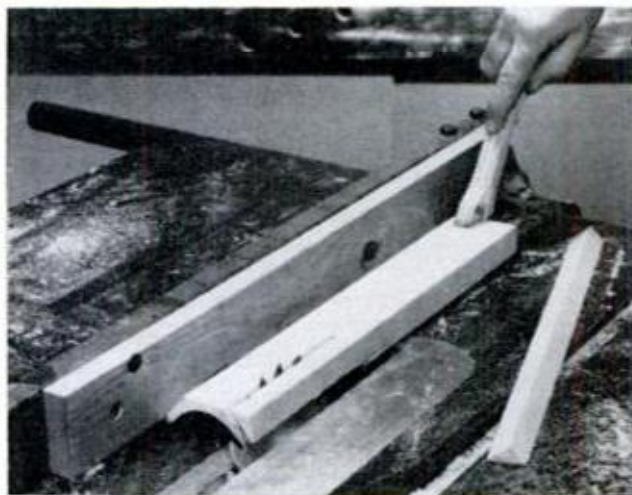

A: SAW BLADE RAISED TO EQUAL RADIUS (GREATEST DEPTH) WHEN LAYING OUT STRAIGHTEDGE GUIDE

ANGLE OF FEED DETERMINES COVE SHAPE

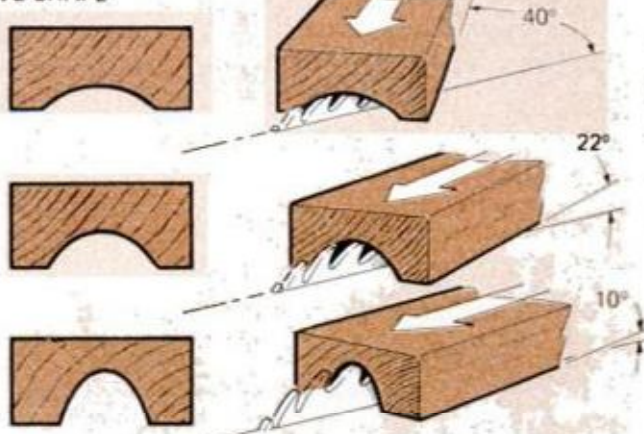

AFTER ANGLE IS DETERMINED, a straightedge is held in position on the table with pair of C-clamps. You must make repeated passes when coving

CORNERS ARE SLICED OFF the cove molding by using the saw blade set at 45° angle with the help of conventional rip fence and a push stick

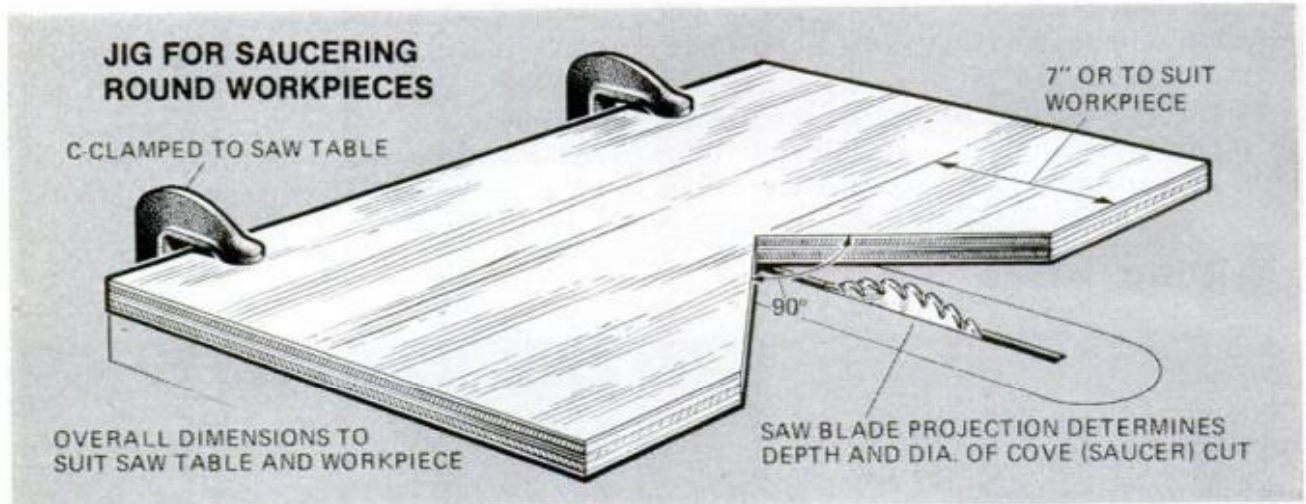
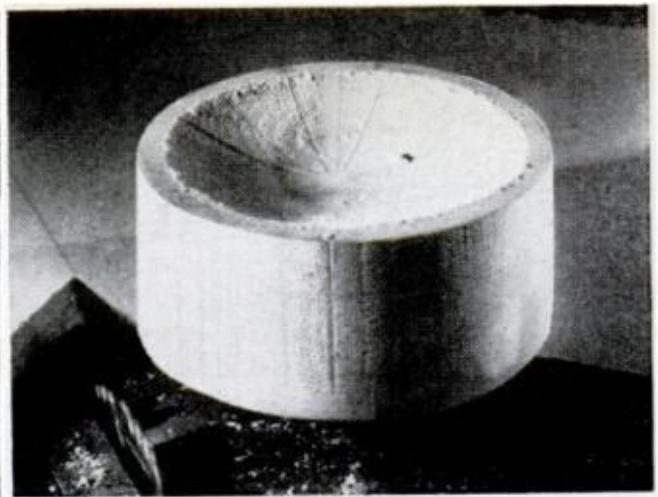

ROUND PIECES CAN BE SAUCERED using a V-jig clamped to table. Workpiece is centered over a combination blade, and after each rotation the blade is raised $\frac{1}{16}$ in. Hold the work securely as you raise the blade

jig out of plywood or particleboard. Clamp it to the table so that the bowl will be centered over the blade and start with the bowl firmly held in position. With your other hand, slowly raise the spinning blade until it projects about $\frac{1}{16}$ in. Rotate the bowl—in the direction of the arrow shown in the photo—until you have made a full revolution. Here, matching marks on work and jig will let you know when you have turned the piece 360° . Continue feeding, raising the blade after each revolution, until the desired depth is reached. Make certain that you make a complete revolution at each blade depth before raising the blade for the next revolution.

You should be aware that the final saucer depth is related to the diameter; the deeper the saucer, the larger the bowl diameter.

The molding head

There are two types of molding head. One uses a single knife; the other employs three. The latter type, as can be

seen in the photos, was used in this story. A molding head can be used instead of the saw blade to create any number of groove patterns. Actually, the method of cutting with a molding head is much the same as with a dado head. The guard and splitter must be removed from the saw and a large-slot molding insert used in place of the standard saw-table insert. These are available commercially or can be shaped of plywood as shown. And, if the fence will be used for end or edge molding, it must be fitted with an auxiliary wood fence, as shown on page 161. The larger cutout is a must; it provides clearance for partial or full exposure of the cutters. The safest way to make it is with the cutter you plan to use. Just be sure that the fence is tightly wedged so any chance of chatter is eliminated.

A variety of cutter shapes is available. They can be used singly or in combination with other cutters to create custom shapes. To do the latter, simply keep a file of inked tracings of the cutter knife shapes

Working with molding-head cutters

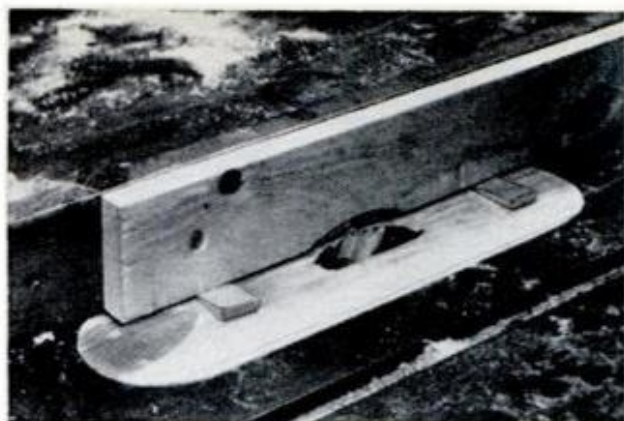

TWO SAFETY MUSTS for working with a molding head are shown at the left: a wood auxiliary fence and the large-slot table insert. If you don't own a metal insert (see photo, page 158), you can make one of plywood. Cut the outside shape to fit the table opening and, after placing at least two wood shims between the locked fence and the insert, slowly raise the spinning cutter knives. These knives will pierce both the insert and wood fence to provide the necessary clearance for the cutters and for the work to be fed through. *Caution:* You should make certain that the metal rip fence is not directly over the knives. The screw holes in the wood fence should be countersunk on both sides in order that the auxiliary can be used on either side of the rip fence

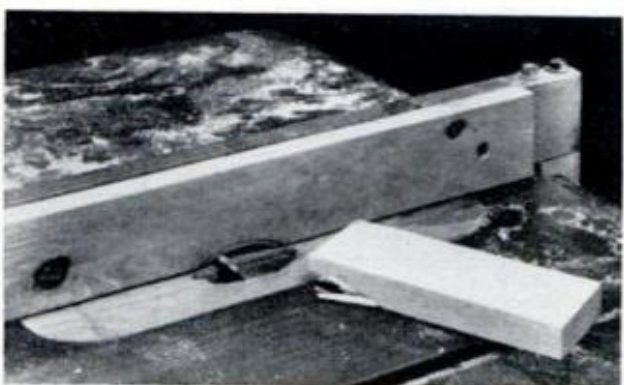
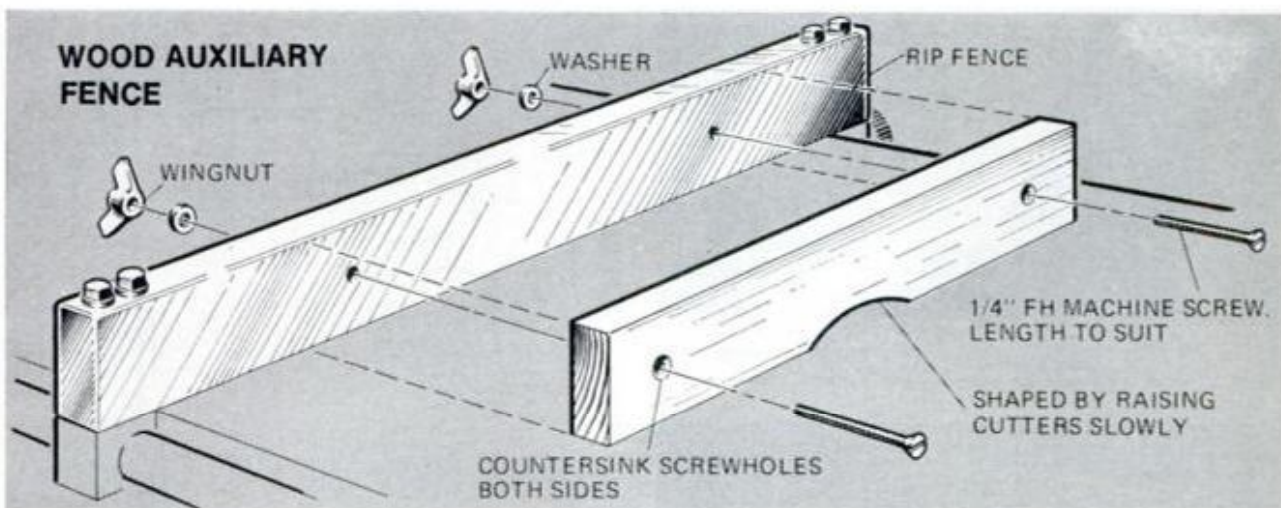

IN SPITE OF A SLOW FEED RATE, when the cutters leave end grain, the edge inevitably is splintered

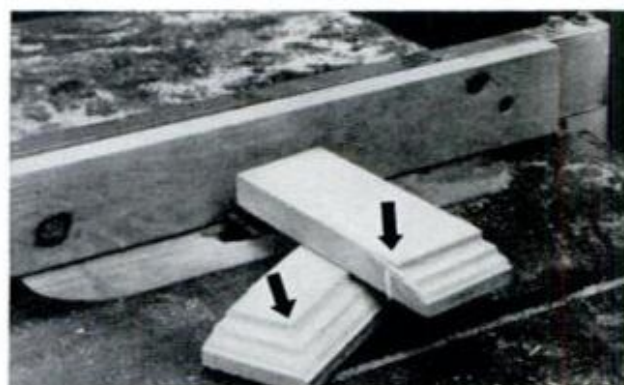

RUPTURED EDGE is cleaned by following a pass with the grain (see arrows). The knives must be sharp

BOTH END GRAINS SHAPED, THEN PASSES WITH THE GRAIN ARE MADE

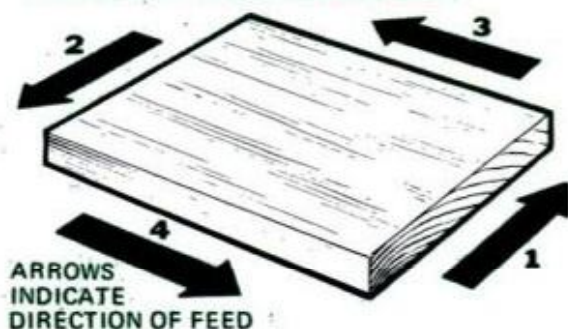

CORRECT SEQUENCE for shaping: First and second passes are across end grain; next two are with grain

that you own. Then, when you want to plan a pattern, these can be laid one over the other until you're satisfied with the design.

Important: Always make certain that the cutter knives are mounted in the cutterhead following the manufacturer's instructions.

The auxiliary-equipped fence should be used for all straightedge molding. It is possible to cut an outboard edge, but a slip will mean overcutting and a ruined work-piece and, possibly, injury to the operator. It is far safer to support the edge as



EDGE BEING SHAPED must have maximum support. Here, fence shifted to left of the blade provides it



CRISSCROSS DESIGNS are typical examples of decorative effects that were achieved with molding head

shown. The work can be either flat on the table or on edge, depending on the design, but for small or narrow workpieces, use your work hold-down and a push stick.

To mold a circular piece, you will have to first make the two triangular jigs shown in the photo and sketch. As with coving round pieces, you must make repeat passes with the blade raised about $\frac{1}{16}$ in. for each pass.

The same split jig can be used to mold the workpiece edge as well. To do it, the V-jig is clamped with the plywood against the rip fence instead of on the

TYPICAL MOLDING-HEAD CUTTERS

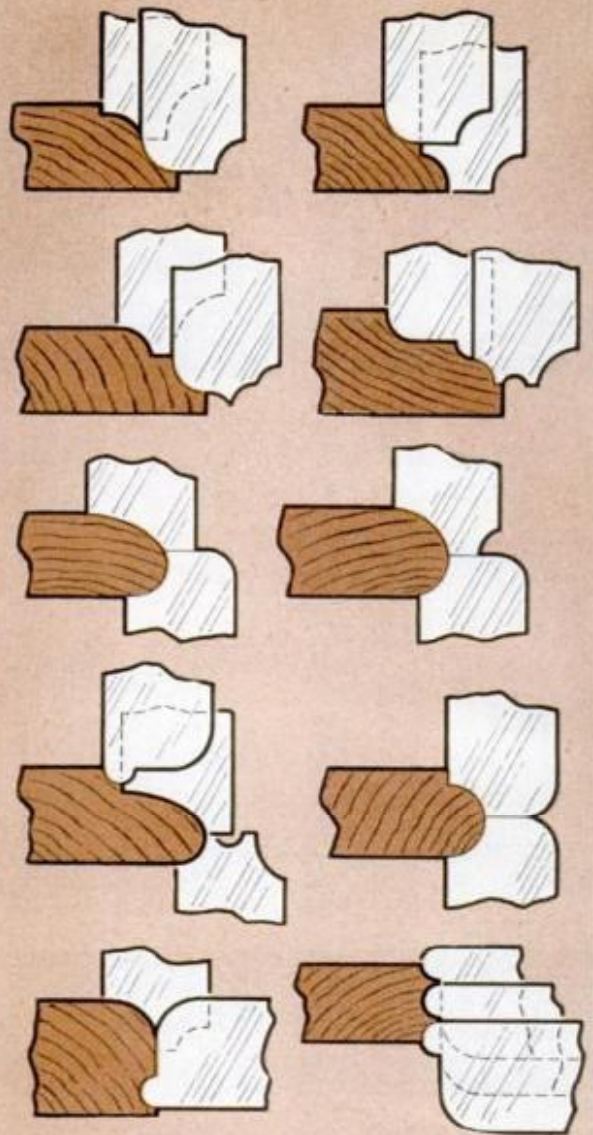

NOTE: BY COMBINING CUTTERS, OR BY USING A PORTION OF A SINGLE CUTTER, VARIETY OF EDGES IS VIRTUALLY UNLIMITED

CUSTOM EDGES can be made using two or more cutters. By varying depths, versatility is even greater

table. The shaping can then proceed in the same manner.

Edge-rabbeting round workpieces

Though edge-rabbeting of a round workpiece could be done with a dado head, it is safer to use a combination blade and slow feed. The "jig" in this case is simply a rectangular piece of $\frac{3}{4}$ -in. plywood (sized to suit your saw and the workpiece) clamped to the locked fence. The pivot is actually a hefty common nail which passes through a predrilled hole in the workpiece into the jig.

The nail must be centered over the saw

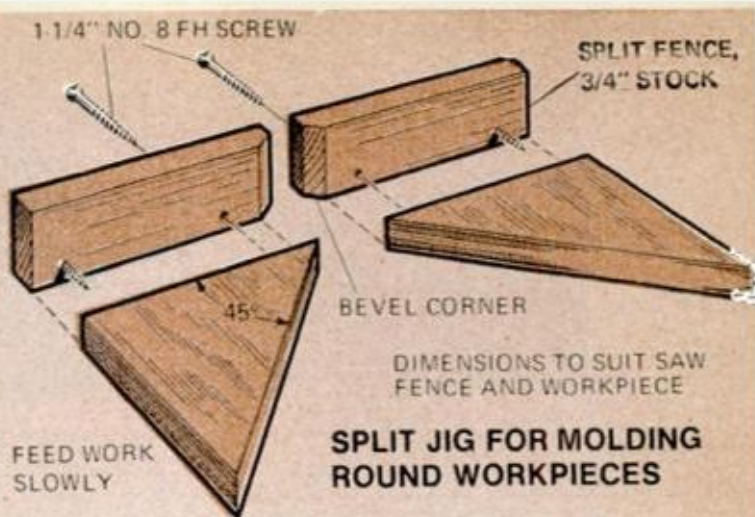

ADJUSTABLE V-GUIDE used for molding of round workpieces can be made of plywood or particleboard. Work is positioned over the cutters, then the jig is clamped to the locked rip fence. As with saucering, work must be securely held while the blade is raised the initial $\frac{1}{16}$ in. This is to be followed by repeat passes

Edge-rabbeting round workpieces

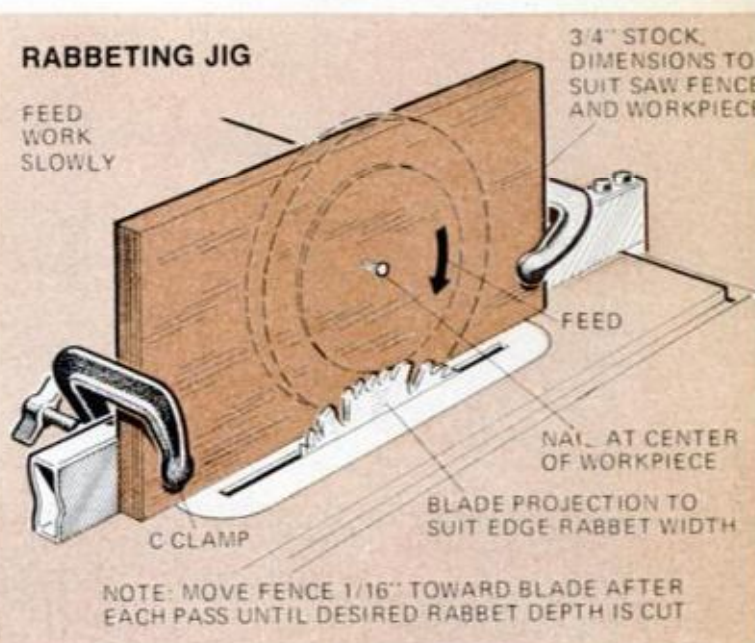
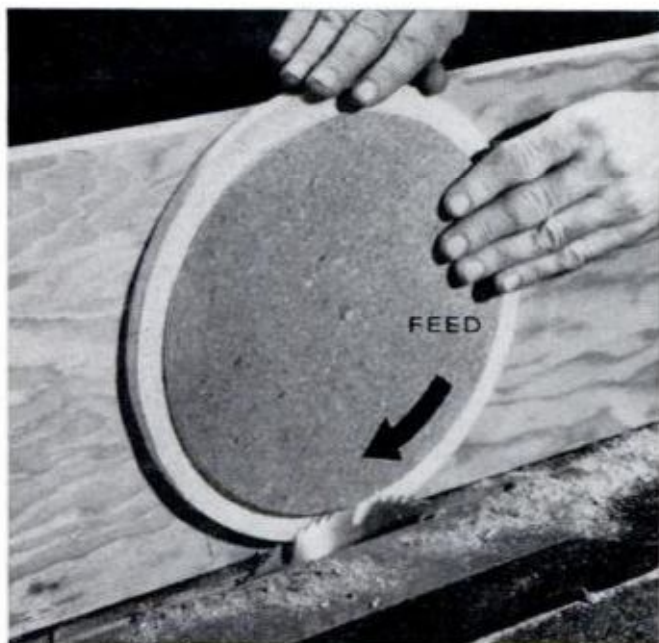

ROUND PIECE to be edge-rabbeted pivots on jig clamped to fence. Nail is positioned directly over centerline of blade. After rabbet width is reached, fence is moved toward blade and the procedure is repeated

arbor and rigidly fixed so that there is no chance of workpiece slop. The workpiece, of course, must rotate freely on the pivot nail and be securely held by the operator at all times.

It's best to reach the desired rabbet width with several passes, raising the blade for each pass. When you're satisfied with rabbet *width*, move fence toward the blade so that the next cut will overlap the previous one. Starting again with a $\frac{1}{16}$ -in. projection, repeat the procedure. Make the necessary fence moves to achieve desired rabbet *depth*, usually no more than half the thickness of the stock being

worked. By now, it should be obvious that in all cases of sophisticated sawing with accessories there are two precautions you should always take: Never saw freehand (always use a guide) and always use a slow feed rate and multiple (repeat) passes.

PM's short course in bench-saw know-how will conclude next month with part 4. The final article will show you how you can bend wood without steaming (by kerfing) and other tricks you should know about such as pattern sawing, chamfer cutting, making raised panels, and more. ★★★

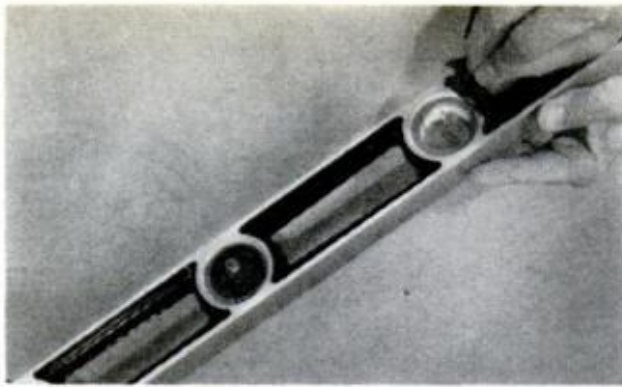

HINTS FROM READERS

Protect level from other tools

If you carry a carpenter's level in your toolbox as most do-it-yourselfers do, there's a good chance of a tool bumping it and breaking the glass over the vials. To protect this often-irreplaceable glass, just press a small suction cup to each of the glass surfaces.

—Ken Patterson, Regina, Sask.

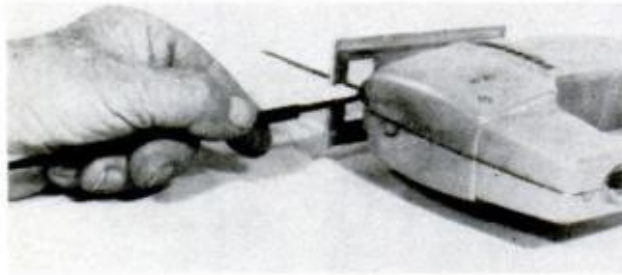

File is an emergency 'wrench'

In a pinch, you can use a three-cornered file as a wrench to tighten or remove a recessed (Allen-head) setscrew. Grind the tang until it fits the setscrew. The handle removed from the tang can be used on the other end of the file. If necessary for a good fit, you can enlarge the hole in the handle by drilling.

—W. H. McClay, Pasadena, Calif.

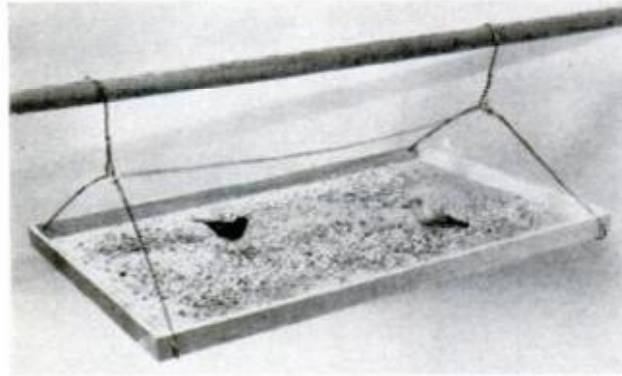

Bird feeder from scraps

Using two coathangers and a couple of pieces of scrap wood, you can fashion a bird feeder, as at left. For your own enjoyment, hang the feeder from a clothesline, tree or other support so that feeding birds may be observed from a window. Squeeze ends of the coathangers so that wind won't blow the feeder off.

—Ken Patterson, Regina, Sask.

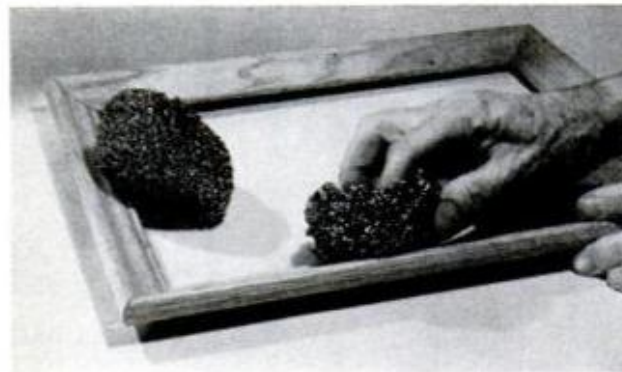

Pot cleaners sub for steel wool

A stainless-steel sponge of the type sold for kitchen use has a smoothing action somewhat like that of very fine steel wool. One I used on wood showed no tendency to break up rapidly or corrode appreciably when used in wet operations. Similar copper pot cleaners could be used for rubbing without digging in.

—Walter E. Burton, Akron, Ohio.

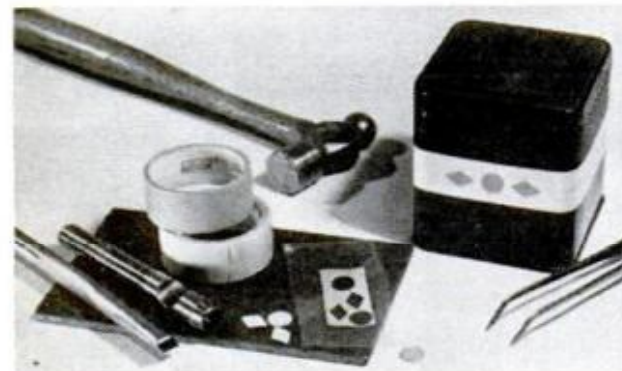

Inlaid tape decorations

Colored self-sticking tape can be embellished with the aid of a hollow drive punch, sharp knife or chisel. The decorative inlays can be round, square, diamond or some other shape, depending upon what tools are available. One way of achieving inlays is to cut two of these tapes simultaneously. When using punches, however, the separate cuts can be matched.

—B. W. Ervin, Kent, Ohio.

The clean team

Take a typically dirty carburetor (like yours maybe) clean it...and get easier starting, smoother idling, no stalling, faster take-offs and better mileage.

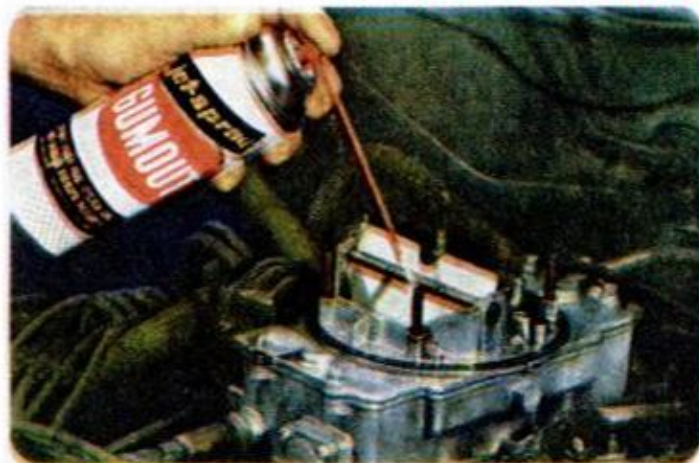

1 Clean it outside in seconds with Jet-Spray Gumout. Takes less than a minute to get this! Throat, choke valve, linkage, throttle plate—all clean like new. Grime and gum that can foul up the carburetor's job are gone. Completely.



2 Now pour a pint of Gumout in your gas tank. It does the same great job inside your carburetor as you drive. Cleans out all the jets and passages, removes the gum and varnish.

GUMOUT Division
PENNSYLVANIA REFINING COMPANY, Cleveland, Ohio 44104

ALL-TIME GREAT

A workshop setup fit for a pro

This workbench was near perfect in '51. Now, by adding some fresh ideas, new materials and a light fixture, we've made it even better

By **HARRY WICKS**, Workshop Editor

Photos by Robert D. Borst

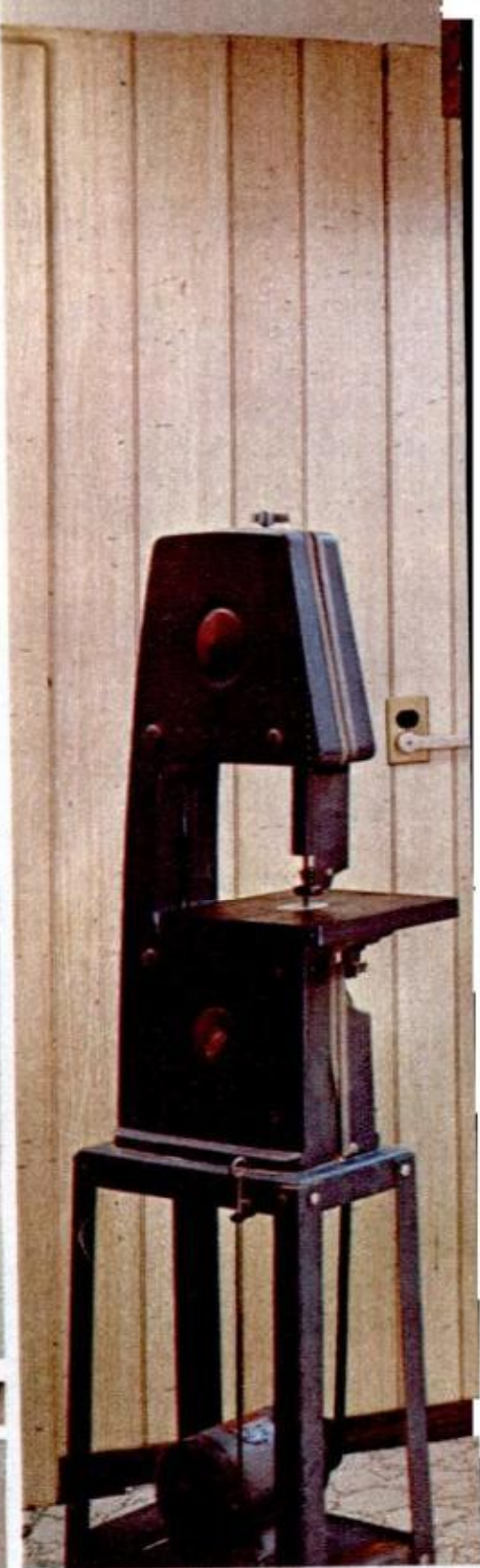
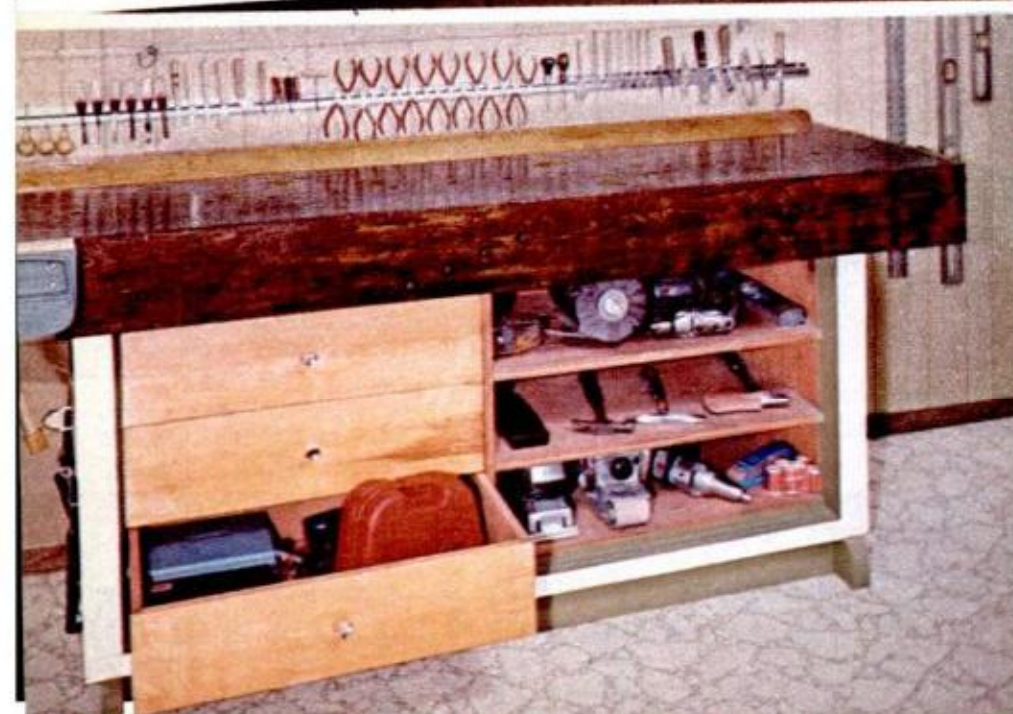
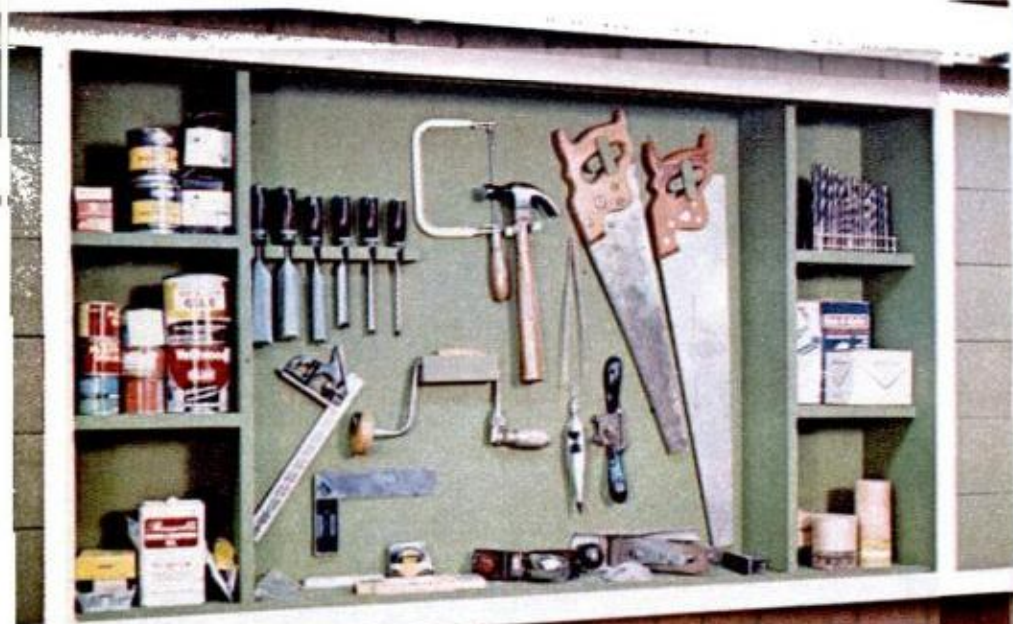

WELL-LIGHTED SETUP in pleasant surroundings is a pleasure to work in. End vise and bench board-stops let user keep both hands on power tools where they belong. Roomy wall cabinet (above left) is pretty much the way it was shown 20 years ago except that the rails, stiles, doors and drawer fronts are covered with plastic laminate. Sturdy workbench boasts two vises, three roomy drawers and good-size shelves for portable power-tool storage. The kickplate is also new feature

POPULAR MECHANIC

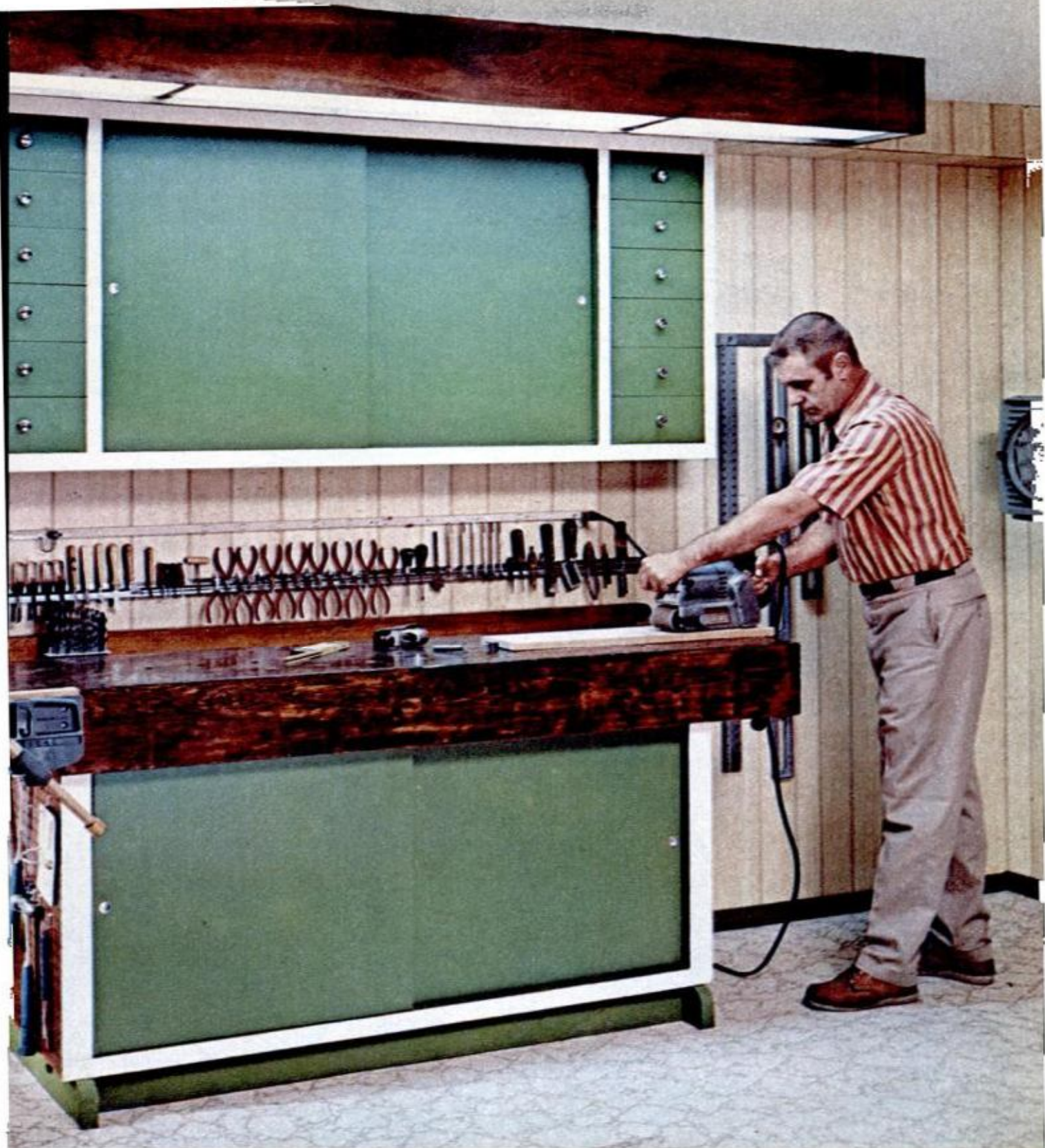

A WELL-PLANNED WORKBENCH is what a good shop is all about, regardless of whether you are fortunate enough to have more than enough space or are shoehorned into a small work area. The bench is where your projects—big and little—will start, be labored over and, in all probability, be finished. Because a poor bench can easily diminish your interest as well as craftsmanship, use foresight when you build. Know what comprises a

good shop setup and, if necessary, vary details and dimensions so it suits your own needs and preferences. Considered by most experts to be the heart of the shop, a good workbench will include:

- A spacious, smooth work surface atop a sturdy and rigid base.
- At least one woodworking vise.
- Maximum small-parts and tool storage.

Because PM's approach to building a workbench has been total—a setup rather

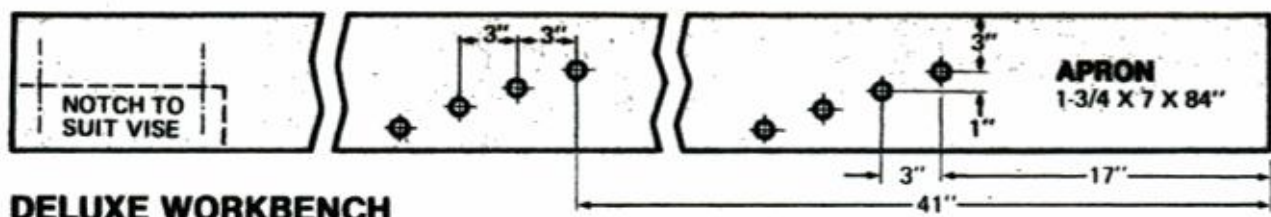

DELUXE WORKBENCH

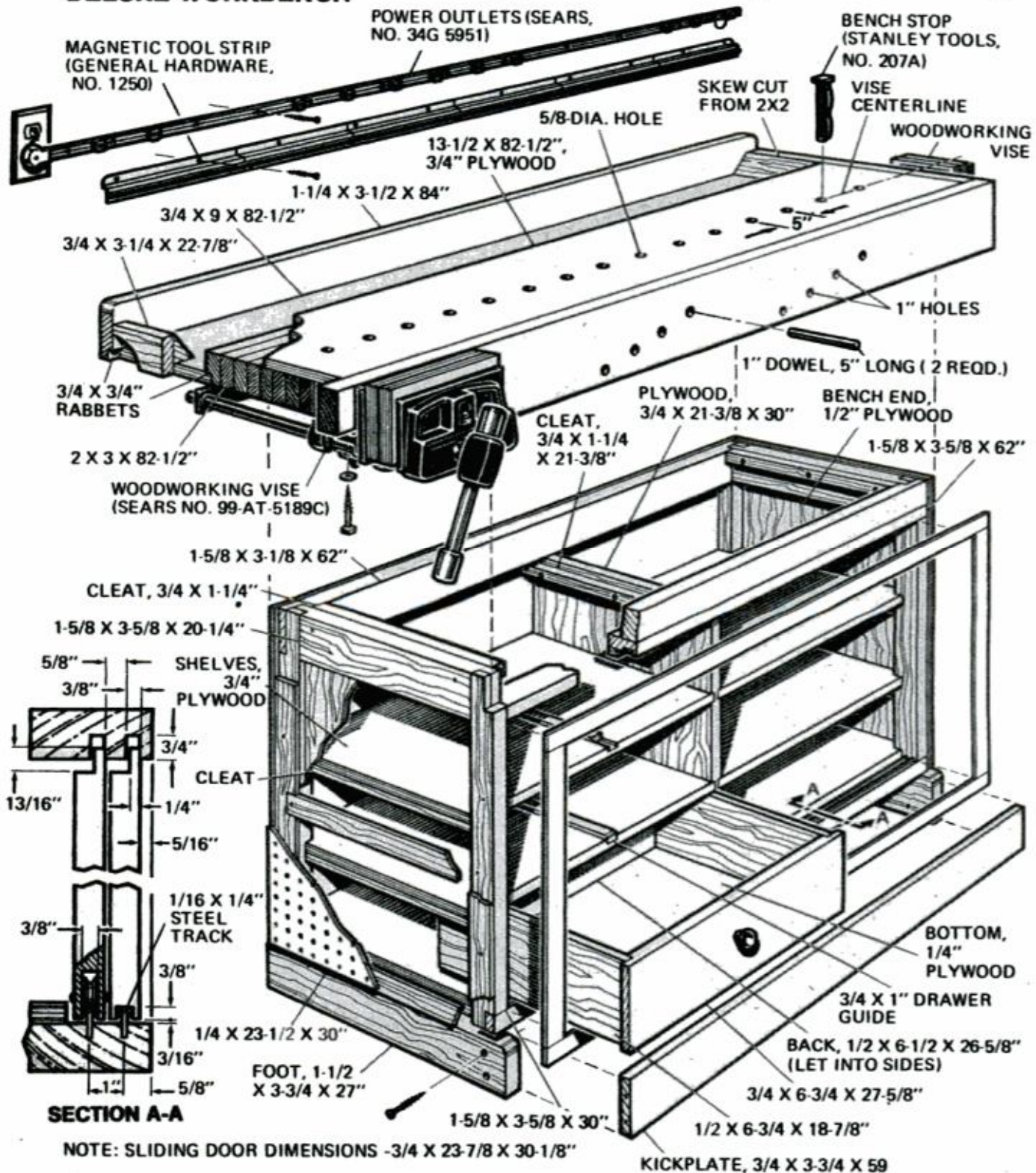

than a workbench alone—you'll see more features than the three points just mentioned, including:

- A smooth top of more than 1100 sq. in., with an 8-in.-wide shaving trough.
- Two vises, provisions for bench dogs in the top and dowel supports in the apron

to support long, vise-held workpieces.

- Storage galore. The base has three roomy, compartmentalized drawers and three shelves for portable-tool storage. Each end is finished with perforated board for extra tool hanging. The wall cabinet has 12 drawers, 6 shelves and a tool panel

We'll pay you \$42.76 to go to meetings.

There's more money today in the Army Reserve. As a private with over four months service, you'll earn \$42.76 a weekend. And your pay goes up as you go up.

In the Reserve things are happening faster these days. It's easier to get in—the waiting lists have vanished. It's easier to get promoted—the men who served in World War II are retiring.

It's always paid to go to meetings in the Army Reserve. Now it pays more.

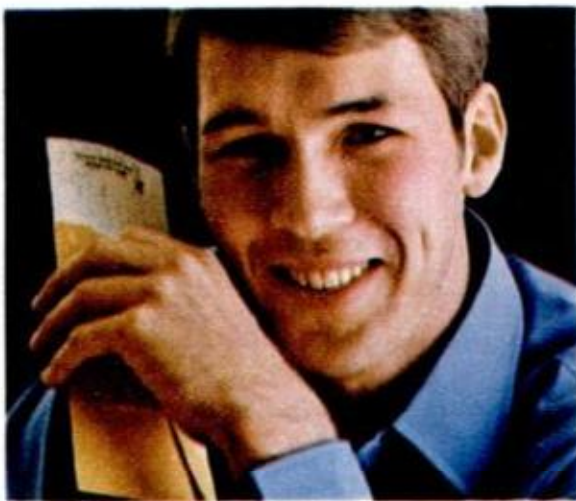

Army Reserve Opportunities PM 9-72
P.O. Box 6834
Philadelphia, Pa. 19132

Tell me more about how the
Army Reserve pays.

Name _____

Address _____

City _____

State _____ Zip _____

Phone _____ Age _____

**The Army Reserve.
It pays to go to meetings.**

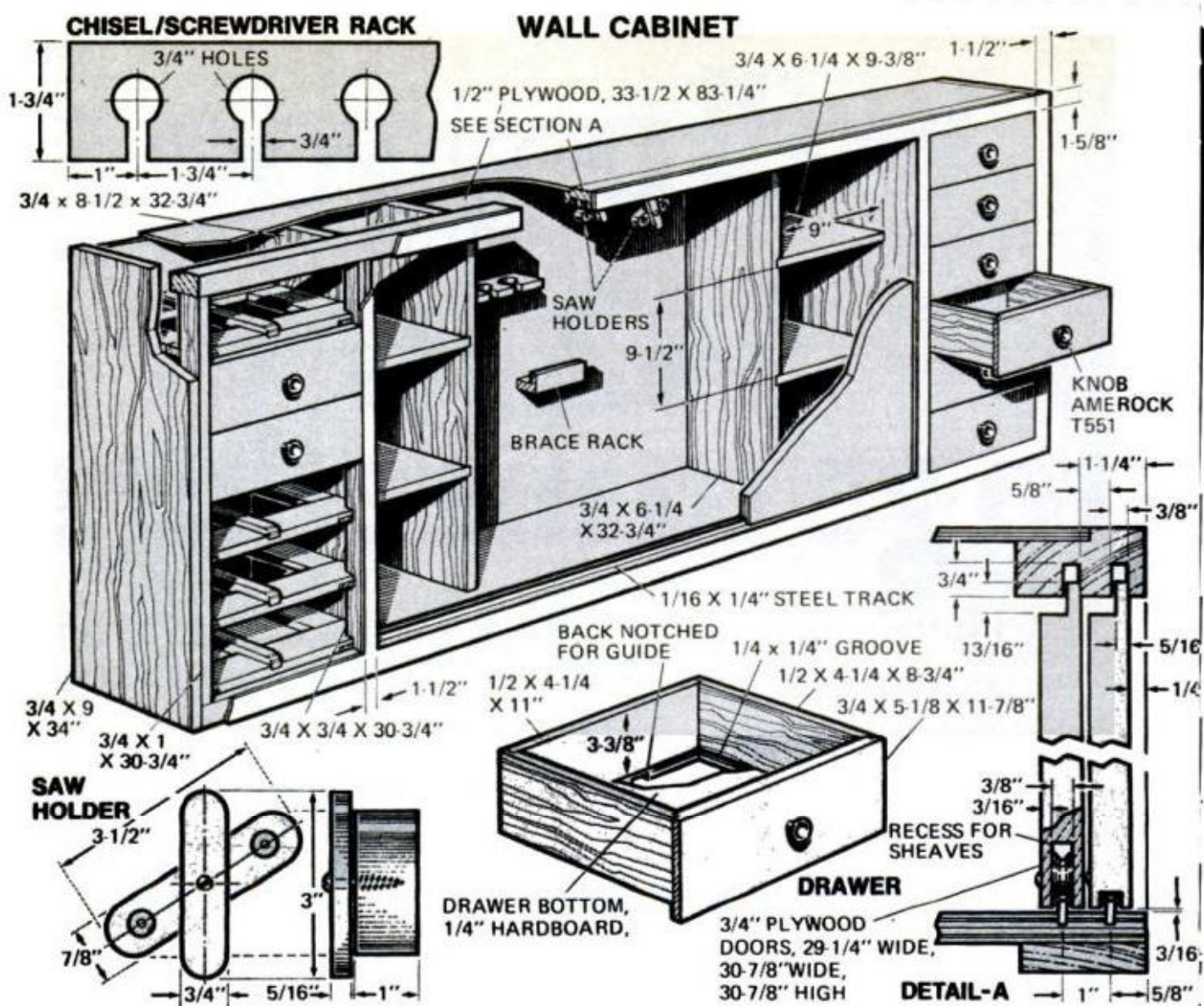

for fingertip convenience. There's also an overhead shop-built light fixture, a kick-plate between bench feet to prevent dropped tools from rolling under the bench and plastic laminate on all exposed surfaces to minimize maintenance.

With minimum upkeep in mind, cabinet, bench and drawer interiors were left

natural, merely varnished to make less obvious those inevitable smudge marks from tools and hands. Johns-Manville Melamite plastic laminate was used on exposed surfaces; marks and dirt will sponge off. For better shop appearance we applied the same avocado green and white laminate used on the radial-saw cabinet

BOTH WORKBENCH ENDS are furred and covered with perforated board for extra tool storage. Two rolls of diagonal holes drilled in the bench apron receive 1-in. dowels for supporting long, vise-held boards

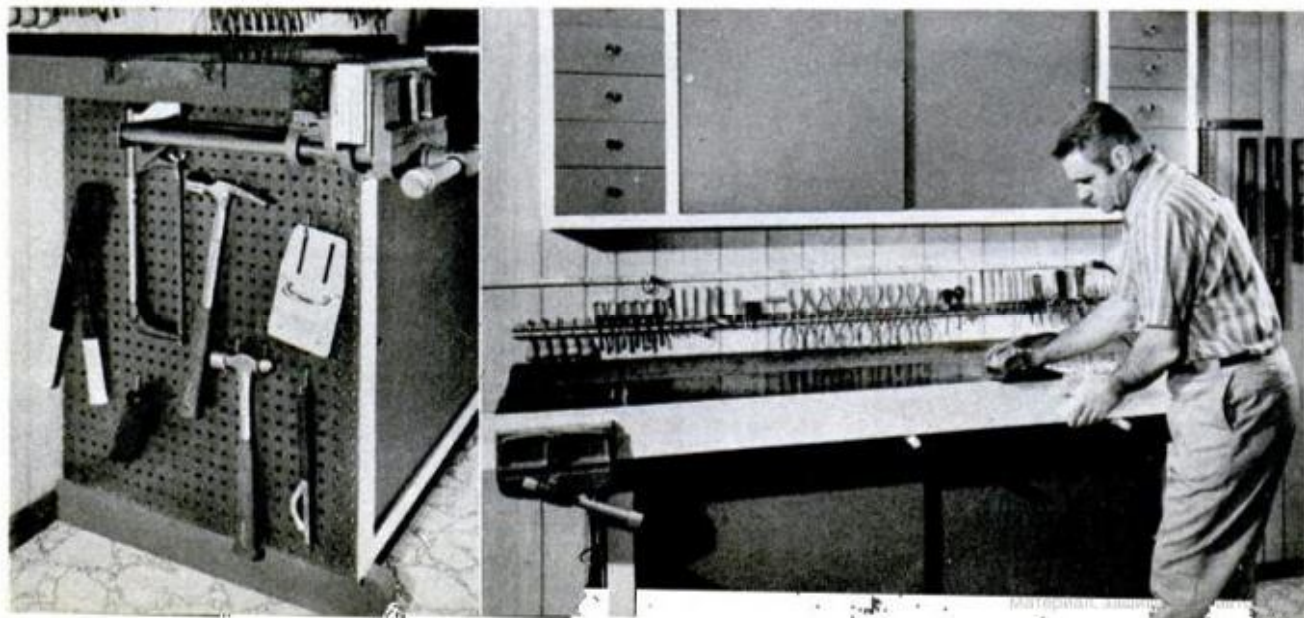

It's Like Having Auto Factory Experts Right Beside You...

when you use this famous illustrated step-by-step guide that shows you

HOW TO FIX ALMOST ANY PART OF ALMOST ANY CAR

Now—Whether You're a Beginner or Pro Mechanic—You can "Breeze Through" ANY Repair Job on Any Popular-Make Car—1966-1972!

MOTOR's AUTO REPAIR MANUAL shows in step-by-step words and pictures all the factory-approved repair procedures you'll ever need for fixing practically ANY part of ANY car listed here—1966-1972.

**OVER 1,000 BIG PAGES—
OVER 3,000 PICTURES!**

This GIANT NEW, 1972 edition covers everything you need to know to fix almost any car model from 1966 through 1972. Over 1,000 giant pages. Over 3,000 pictures. Hundreds of "Quick-Check" charts, 55,000 essential repair specifications. Over 225,000 service & repair facts.

PLUS Adjustment Tables, Tune-Up Charts, Tables of Measurements and Clearances, Overhauling and Replacement Facts, Carburetor Adjustment, etc. Special Trouble-Shooter Section and detailed trouble-shooting information throughout help pinpoint the cause of any of 4,200 car troubles in a jiffy.

Same Offer on
**MOTOR's AUTO ENGINES
& ELECTRICAL SYSTEMS**

Over 700 pages. 1,300 big pictures. Clear text explains how parts work; principles involved; design; construction; maintenance. Covers all parts of engines & entire electrical system. For FREE trial, check coupon.



No guesswork! Even a green beginner mechanic can do a good job with this giant MANUAL before him. And if you're a top-notch mechanic, you'll profit from the time-saving and work-cutting procedures you'll find. The MOTOR MANUAL makes almost every operation on any car—from Volkswagen to Cadillac—as easy as A-B-C! Eliminates trial and error — saves you time, work and money.

**OVER 6
MILLION
COPIES SOLD**

**SEND NO MONEY
Try MANUAL at OUR
Risk—FREE**

See for yourself why U.S. Armed Forces, Schools, and garages everywhere "swear" by MOTOR. Just mail the coupon. Try MANUAL for 10 full days—FREE! If it doesn't pay for itself in those 10 days, just return it and pay nothing, owe nothing. Mail the coupon AT ONCE to MOTOR Book Dept., P. O. Box 2316, F.D.R. Station, New York, N. Y. 10022.

**TRY BOOK
FOR TEN DAYS
FREE**

FIX ALL THESE CARS

| | |
|-------------|---------------|
| Volkswagen | Maverick |
| Mustang | Buick Special |
| Barracuda | Gremlin |
| Nova | Comet |
| Chevy II | Corvair |
| Pontiac | American |
| Thunderbird | Olds F-88 |
| Buick | Falcon |
| Imperial | Fairlane |
| Cadillac | Tempest |
| Continental | Corvette |
| Dart | Valiant |
| Mercury | Cougar |
| Ford | Tempo |
| Chevolt | Lincolt |
| Chevrolet | Front-Drive |
| Fairlane | Cadillac |
| Chrysler | Mark III |
| Plymouth | AMX |
| Rambler | Javelin |
| Dodge | Montego |
| Oldsmobile | Torino |
| Pinto | Hornet |
| Vega | Challenger |

...and more



**MOTOR'S
AUTO
REPAIR
MANUAL**

**TROUBLE-SHOOTER Section
Helps Spot 4,200 Car Troubles**
Trouble-Shooter section & detailed trouble-shooting info thruout help pinpoint 4,200 causes of car trouble: transmissions, brakes, engines, electrical systems, much more!

MAIL COUPON NOW FOR 10-DAY FREE TRIAL

MOTOR BOOK DEPT.

P.O. Box 2316, F.D.R. Sta., New York, N.Y. 10022

Please send me the Manuals checked below for ten days free examination:

- 11122 MOTOR's Auto Repair Manual, \$10.95
 12526 MOTOR's Auto Engines & Electrical Systems, \$10.95

If I am not fully satisfied, I will return the shipment promptly and owe nothing. Or I will keep it and pay the total price in three monthly installments, plus a small shipping charge.

I WANT TO SAVE SHIPPING CHARGES

I am enclosing payment of \$.....in full and you will pay shipping charges. (Same return privileges, refund guaranteed.) **E119**

Print Name

Address

City & State

Zip Code

Signature Please

Age

Prices slightly higher in Canada. Offer available only in continental United States. Delivery will normally be within 3-4 weeks in Eastern U.S. Please allow longer west of the Mississippi. (N. M. BOOKS)

CEILING FIXTURE

CEILING CLEAT, 3/4 X 1-1/4 X 96"
(2 REQD.)

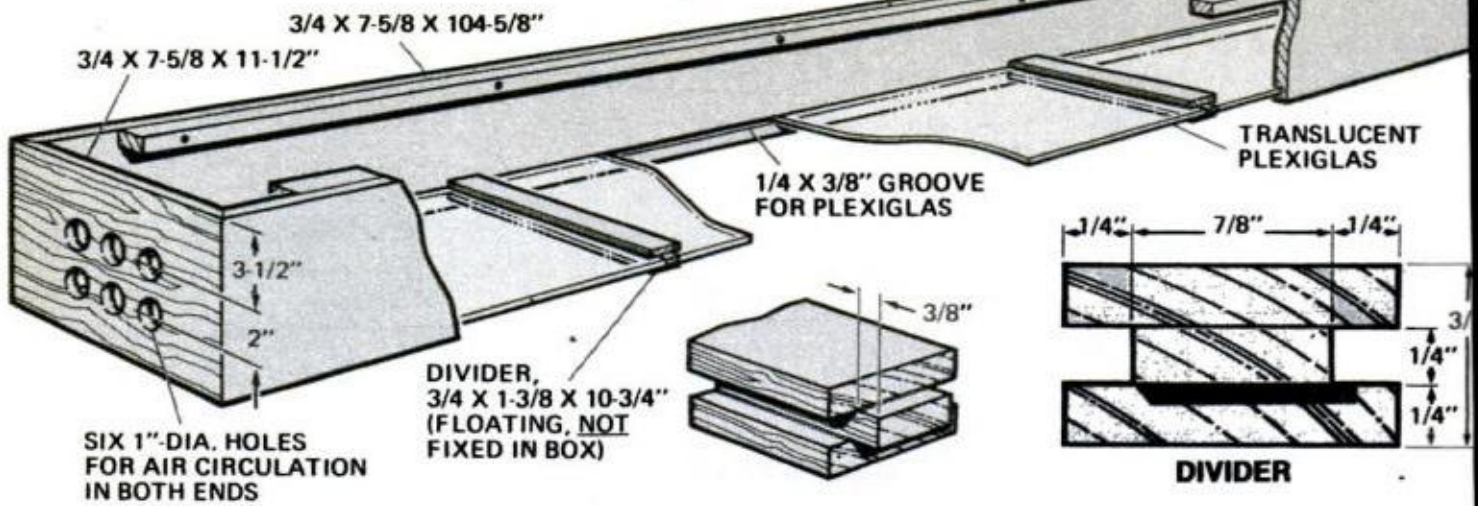

SIX 1"-DIA. HOLES FOR AIR CIRCULATION IN BOTH ENDS

DIVIDER, 3/4 X 1-3/8 X 10-3/4"
(FLOATING, NOT FIXED IN BOX)

DIVIDER

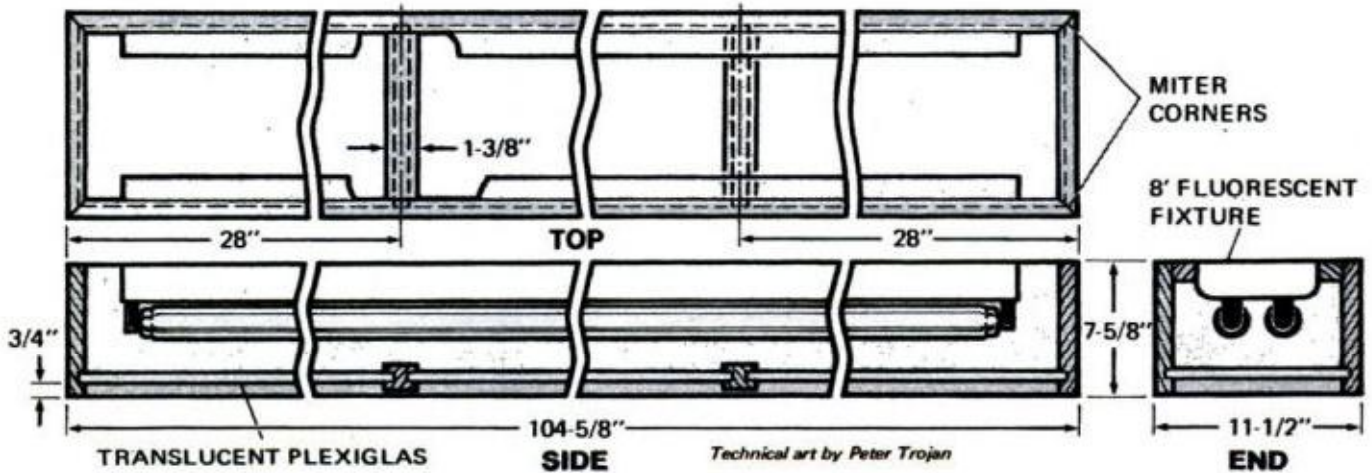

MITER CORNERS

8" FLUORESCENT FIXTURE

TRANSLUCENT PLEXIGLAS

SIDE

Technical art by Peter Trojan

END



(From PM's workshop: a radial-saw accessory cabinet, page 148, March '72 PM).

The bench, cabinet and light fixture were built from stock lumberyard items. For parts you may have to order, such as Plexiglas and board stops, check the source list on page 186.

Sliding doors of the bench ride sheaves that roll on steel tracks that parallel the full length of the bottom front rail. Each door is fitted with two sheaves set in 2 in. from the ends. Its top edge is rabbeted to engage grooves along the underside of the top front rail. The 3/4-in.-deep grooves allow ample clearance to place sheaves on the tracks when you install the doors. If you wish, you could alter dimensions and install commercially available sliding-door hardware packaged in kits. But don't skimp on quality; these doors will get considerable hard use. The original design of the workbench and wall cabinet illustrated, published in the Sept. '51 PM, had square holes in the benchtop. We've replaced these with 5/8-in.-dia. holes for use with bench board stops. You may not find these stops readily at hardware stores but they can be ordered through your local hardware dealer. Essentially, they are industrial-school-shop items.

Unused space at the ends of the bench made little sense so we furred both ends and covered

(Please turn to page 186)



I'd like to give this to my fellow men...

while I am still able to help!

I was young once, as you may be—today I am older. Not too old to enjoy the fruits of my work, but older in the sense of being wiser. And once I was poor, desperately poor. Today almost any man can stretch his income to make ends meet. Today, there are few who hunger for bread and shelter. But in my youth I knew the pinch of poverty; the emptiness of hunger; the cold stare of the creditor who would not take excuses for money. Today, all that is past. And behind my city house, my

summer home, my Cadillacs, my winter-long vacations and my sense of independence—behind all the wealth of cash and deep inner satisfaction that I enjoy—there is one simple secret. It is this secret that I would like to impart to you. If you are satisfied with a humdrum life of service to another master, turn this page now—read no more. If you are interested in a fuller life, free from bosses, free from worries, free from fears, read further. This message may be meant for you.

By Victor B. Mason

I am printing my message in a magazine. It may come to the attention of thousands of eyes. But of all those thousands, only a few will have the vision to understand. Many may read; but of a thousand only you may have the intuition, the sensitivity, to understand that what I am writing may be intended for you—may be the tide that shapes your destiny, which, taken at the crest, carries you to levels of independence beyond the dreams of avarice.

Don't misunderstand me. There is no mysticism in this. I am not speaking of occult things, of innumerable laws of nature that will sweep you to success without effort on your part. That sort of talk is *rubbish!* And anyone who tries to tell you that you can *think* your way to riches without effort is a false friend. I am too much of a realist for that. And I hope you are.

I hope you are the kind of man—if you have read this far—who knows that anything worthwhile has to be *earned!* I hope you have learned that there is no reward without effort. If you have learned this, then you may be ready to take the next step in the development of your karma—you may be ready to learn and use the secret I have to impart.

I Have All The Money I Need

In my own life I have gone beyond the need of money. I have it. I have gone beyond the need of gain. I have two businesses that pay me an income well above any amount I have need for. And, in addition, I have the satisfaction—the deep satisfaction—of knowing that I have put more than three hundred other men in businesses of their own. Since I have no need for money, the greatest satisfaction I get from life is sharing my secret of personal independence with others—seeing them achieve the same heights of happiness that have come into my own life.

Please don't misunderstand this statement. I am not a philanthropist. I believe that charity is something that no proud man will accept. I have never seen a man who was worth his salt who would accept something for nothing. I have never met a highly successful man whom the world respected who did not sacrifice something to

gain his position. And, unless you are willing to make at least half the effort, I'm not interested in giving you a "leg up" to the achievement of your goal. Frankly, I'm going to charge you something for the secret I give you. Not a lot—but enough to make me believe that you are a little above the fellows who merely "wish" for success and are not willing to sacrifice something to get it.

A Fascinating and Peculiar Business

I have a business that is peculiar—one of my businesses. The unusual thing about it is that it is needed in every little community throughout this country. But it is a business that will never be invaded by the "big fellows." It has to be handled on a local basis. No giant octopus can ever gobble up the whole thing. No big combine is ever going to destroy it. It is essentially a "one man" business that can be operated without outside help. It is a business that is good summer and winter. It is a business that is growing each year. And, it is a business that can be started on an investment so small that it is within the reach of anyone who has a television set. But it has nothing to do with television.

This business has another peculiarity. It can be started at home in spare time. No risk to present job. No risk to present income. And no need to let anyone else know you are "on your own." It can be run as a spare time business for extra money. Or, as it grows to the point where it is paying more than your present salary, it can be expanded into a full time business—overnight. It can give you a sense of personal independence that will free you forever from the fear of lay-off, loss of job, depression, or economic reverses.

Are You Mechanically Inclined?

While the operation of this business is partly automatic, it won't run itself. If you are to use it as a stepping stone to independence, you must be able to work with your hands, use such tools as hammer and screw driver, and enjoy getting into a pair of blue jeans and rolling up your sleeves. But two hours a day of manual work will keep your "factory" running 24 hours turning out a product that has a steady and

ready sale in every community. A half dollar spent for raw materials can bring you six dollars in cash—six times a day.

In this message I'm not going to try to tell you the entire story. There is not enough space on this page. And, I am not going to ask you to spend a penny now to learn the secret. I'll send you all the information, free. If you are interested in becoming independent, in becoming your own boss, in knowing the sweet fruits of success as I know them, send me your name. That's all. Just your name. I won't ask you for a penny. I'll send you all the information about one of the most fascinating businesses you can imagine. With these facts, you will make your own investigation. You will check up on conditions in your neighborhood. You will weigh and analyze the whole proposition. Then, and then only, if you decide to take the next step, I'll allow you to invest \$15.00. And even then, if you decide that your fifteen dollars has been badly invested I'll return it to you. Don't hesitate to send your name. I have no salesmen. I will merely write you a long letter and send you complete facts about the business I have found to be so successful. After that, you make the decisions.

Does Happiness Hang on Your Decision?

Don't put this off. It may be a coincidence that you are reading these words right now. Or, it may be a matter that is more deeply connected with your destiny than either of us can say. There is only one thing certain: If you have read this far you are interested in the kind of independence I enjoy. And if that is true, then you must take the next step. No coupon on this advertisement. If you don't think enough of your future happiness and prosperity to write your name on a postcard and mail it to me, forget the whole thing. But if you think there is a destiny that shapes men's lives, send your name now. What I send you may convince you of the truth of this proverb. And what I send you will not cost a penny, now or at any other time.

VICTOR B. MASON

1512 Jarvis Ave., Suite M-2-BK
CHICAGO, ILLINOIS 60626

HOMEOWNERS' CLINIC

BY W. CLYDE LAMMEY

Noisy condominium

I live in a "condo" and can hear sounds made by my neighbor; I suppose he can hear any I may make, night and day. Isn't there some simple way to minimize sounds passing through the wall?—John Densen, Omaha.

I'm happy you used the word "minimize," as this is all you can do—reduce or minimize sound to some extent. Many condominium owners have resorted to wall hangings, such as rugs and draperies. A rug, especially a shag, offers some degree of sound damping, but I'd say that a drapery, hanging with fairly tight folds and clear of the wall, would be more effective. Such hangings are relatively expensive and can be effective only to a degree. In some rooms the loss of space may be a factor. But in many instances such loss and expense may be justified.

When to prune mock orange

I have received conflicting opinions on the best time to prune back a large mock orange shrub. Is there any "best" time?—Harry Gray, Peoria, Ill.

It can be pruned lightly any time, but the best time is soon after flowering, especially if much cutting is needed to reduce it to a desirable shape. Sometimes it's best to prune old or neglected shrubs in two stages: the first, right after flowering and second, wait until the next season to finish the job.

Log-cabin chinking

I'm going to build a small log cabin using straight logs about 4 inches in diameter, with the bark removed and corners notched. What should I use to close the spaces between the logs?—H. Cable, Bismarck, N.D.

Judging from your description, I assume the spaces will be minimal. If so, I'd force butyl caulking compound between the logs with a caulking gun. Do this inside and out, taking care to apply the material uniformly.

Raveling cord ends

How can I prevent the cut ends of braided and twisted cord from unraveling?—Irving Arnham, St. Louis.

Usually by dipping the cut ends in white glue or shellac. Cut the ends off square and dip them about ½ inch into the liquid; then wipe off the excess and let the ends harden before using the cord.

Air-curing walnut planks

I'm having two walnut trees in our yard cut down and the logs sawed into planks 2 inches thick. What is the best and surest way to cure this lumber for a home-shop project I have in mind? How long should the planks cure?—R. D. Jordan, Lexington, Ky.

Have the planks kiln-dried where temperature and moisture can be controlled. Lacking the facilities to do this, you could air-dry the wood overhead in your garage or attic. In the latter procedure, ends of the planks must be coated with asphalt—preferably hot—to prevent checking. Then the planks should be stacked with ¾ x ¾-inch strips in between to permit air circulation. Keep strips no more than 2 feet apart. Normal curing time will vary from one to two years, depending on the drying conditions that prevail. It's well to turn the planks occasionally during this period.

Resticking cove base

A section of cove base in my bathroom has come loose and won't restick, though I've tried this twice with the recommended cement. Do you have a suggestion?—Ray Cameron, Atlanta.

Probably dust and other debris have collected in back of the cove to prevent the cement from bonding. This dirt must be removed completely by light scraping and thorough washing with a mild detergent or soapy solution. Make sure that the surface is clean and dry before you apply the new cement, then devise some temporary means of exerting pressure on the cove across the width and length until the cement has cured. ★★

Do you have a home maintenance or repair problem? Send it to Homeowners' Clinic, Popular Mechanics, 224 West 57th St., New York, N.Y. 10019. While letters cannot be answered individually, problems of wide interest will be discussed in this column.



Spend a milder moment with Raleigh.

Highest quality tobaccos—specially softened for milder taste.

What a catch! A Shakespeare Rod and Reel just like the one shown above for free B&W Raleigh Coupons, the valuable extra on every pack of Raleigh.

To see over 1000 valuable gifts, write for your free Gift Catalog: Box 12, Louisville, Ky. 40201.



Filter Kings, 17 mg. "tar," 1.3 mg. nicotine; Longs, 19 mg. "tar," 1.4 mg. nicotine, av. per cigarette, FTC Report April '72.

Warning: The Surgeon General Has Determined That Cigarette Smoking Is Dangerous to Your Health

© 1972 BROWN & WILLIAMSON TOBACCO CORP.

Материал, защищенный авторским правом

No other tool does so much

It's a clamp, wire cutter, super pliers, locking wrench, hand vise. Used everywhere. Adjusts to any size work. Locks with tremendous grip. Releases easily. Keep one in home, shop, car, boat, etc. Most useful tool ever made.



WISE-GRIP®

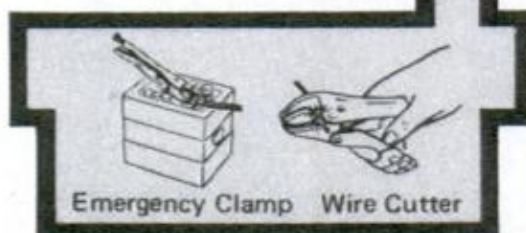
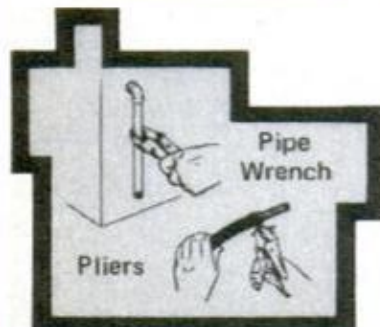

Petersen Mfg. Co., Inc., 2021 William St., DeWitt, Nebraska 68341

THE AUTO ELECTRIC

Power-For-Tools. 110 V.D.C. Electricity from a car's alternator. Installs on—Most late model cars, trucks or tractors. Will operate power tools, light bulbs, heating devices, etc. Operates any brush-type 110 V. A.C.-D.C. electric motor. Battery charging. Easily installed.



Checks or Money Order:

\$16.95 Without 150 V. D.C. Meter
\$19.95 With 150 V. D.C. Meter

Plus Postage
\$1.25 & Texas Sales Tax ONLY

Auto Air Equipment Inc., P.O. Box 2886PM, Amarillo, Texas 79105

Two or four-wheel drive
JEEP OR SCOUT
owners

REPOWER with a 6 or V-8. H.D. ADAPTORS for using Car, Compact and some Truck engines. "State year & model, Jeep or Scout." Want fast action? Give us **FULL INFORMATION**. Send \$25.00 Dep. and we will ship correct kit, bal. COD. Send full amount for prepaid shipment. Wire, phone or write today. Details **FREE**

HOOSIER MACHINE PRODUCTS CO.

312 S. E. 6th St., Phone 276-3442. Pendleton, Oregon 97801



IT IS EASY TO APPLY ALL TYPES SIDING TRY IT

Do-It-Yourself Siding

Learn how you can earn up to \$1000.00 for a single order showing our quality aluminum, steel, and vinyl siding on your home. Small investment required for your own siding. No further investment. Mail coupon for free information without obligation.

ALUMINUM INDUSTRIES
of ARKANSAS, Dept. P-92
Little Rock, Arkansas 72205

Please send me free information concerning your quality do-it-yourself kits.

name.....

street.....

city..... state..... zip.....

Now! In just 2 minutes, find out how you can SAY GOODBYE FOREVER TO DULL, LOW-PAY WORK

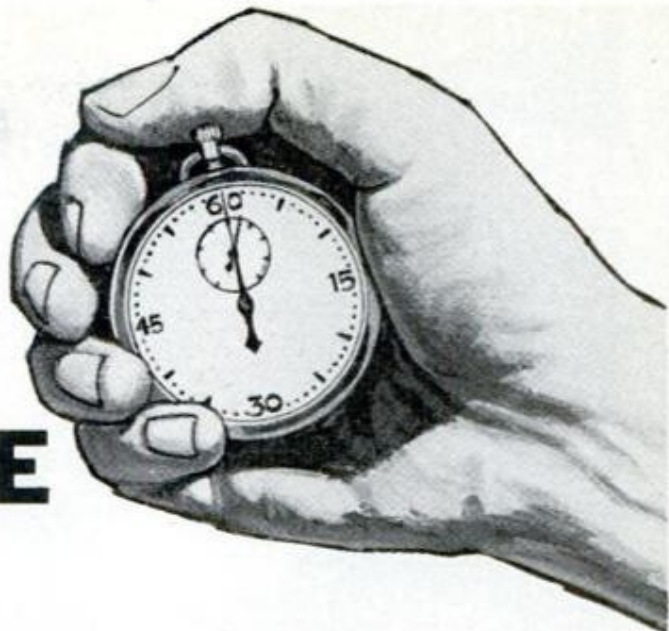

Discover for yourself how easily you can prepare in your spare time, at home, for an exciting high-pay career in one of today's "blue chip" professions... Electronics

ARE YOU fed up with being stuck in a dull, routine job that pays peanuts? If so, here's your opportunity to get out of "dead end" work for good... and to start on the road to an exciting, high-pay career.

Even as you read this, there are career openings just waiting for qualified men in one of today's big "growth" professions... Electronics. With training, you can be one of these men. It's true! You can

qualify for interesting, rewarding jobs in radio and TV broadcasting, computer technology, aerospace, mobile communications... just to name a few.

Getting the training you need to break into Electronics is easier than you might have thought. You don't need college... or even a high school diploma. As a matter of fact, you can prepare right at home, in your spare time.

Then you'll be ready to take a crack at these exciting career opportunities. Just think, you'll be doing interesting work, and you'll be bringing home a paycheck *any* man would be proud of.

For full details, send TODAY for 2 FREE books. For your convenience, we will try to have a representative call. Just mail card or coupon, or write: Cleveland Institute of Electronics, Inc. 1776 E. 17th St., Cleveland, Ohio 44114.

2 FREE BOOKS



CIE Cleveland Institute of Electronics, Inc.

1776 East 17th Street, Cleveland, Ohio 44114
Accredited Member National Home Study Council

Please send me 2 FREE books describing opportunities in Electronics and how to prepare for them.

Name _____ Age _____
(please print)

Address _____

City _____ State _____ Zip _____

Veterans and Servicemen: check here for G.I. Bill information. PM-70

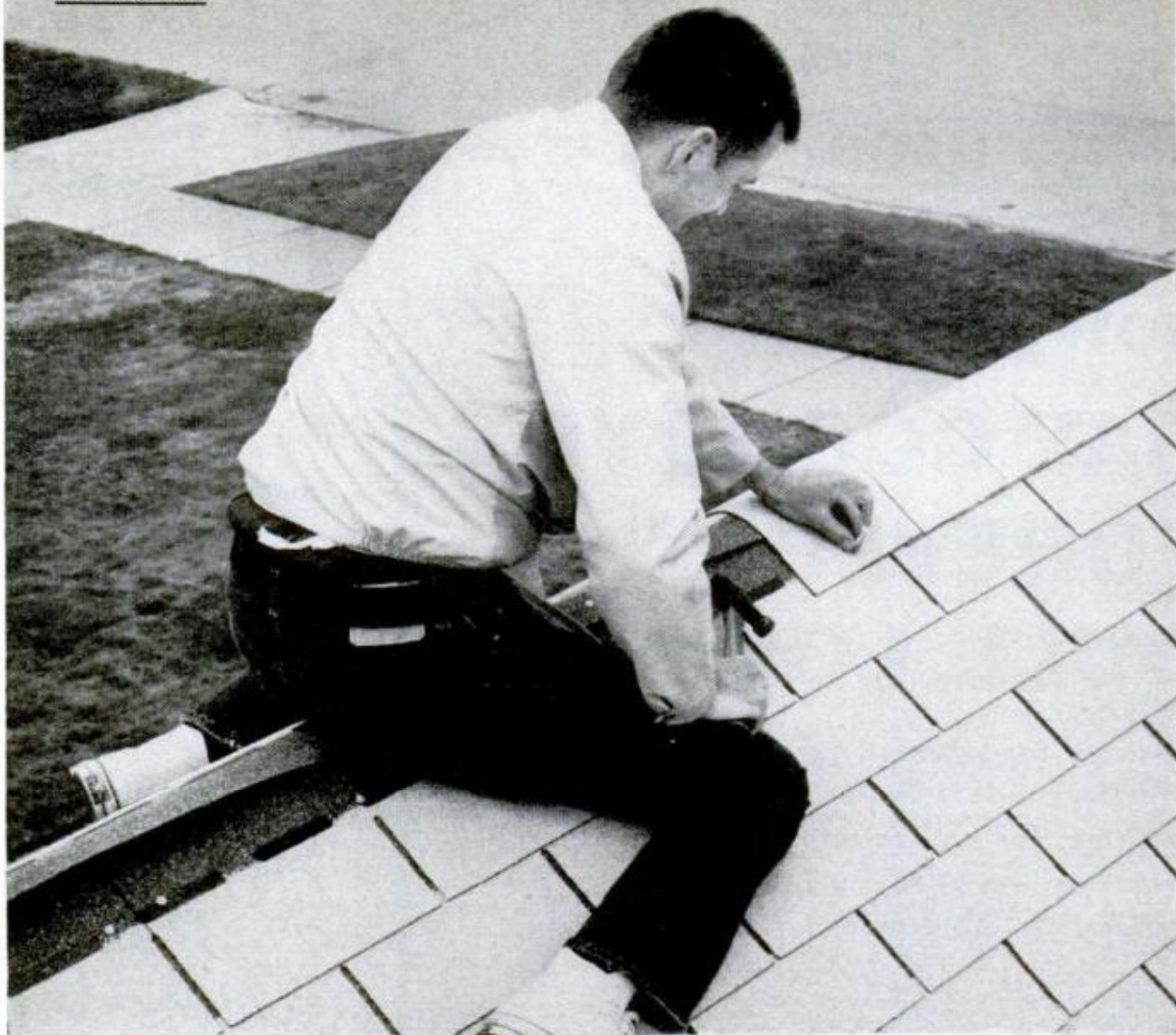

HOMEOWNER applying ridge shingles here saved \$250 by doing his own reroofing

Be your own roofer and save half the cost

Photos by Mitch Pieronek

THE WORST ASPECT of shingling a roof is having to work *up there*. But, if you are fortunate enough to have a roof with a reasonable pitch—a ranch or Cape Cod home, for example—you might consider taking on the job and pocketing at least half of what a professional would charge.

Even if you decide to call in a pro, a good knowledge of how a roof should be applied will put you in a position to make sure that you get the job you are paying for. It's okay to put the new roof over the old, but if there are already two layers of shingles up there, the roof should be stripped and the job started from scratch. On a new roof, use 1¼-in. galvanized nails. If installing a second layer over asphalt shingles, up the size to 1¾-in. galvanized nails. You'll need that extra length to assure good holding power.

About asphalt shingles: The square-butt shingle measures 12x36 in., has three tabs and is normally laid with 5 in. exposed to the weather. There are 27 strips in a bundle and three bundles make up a square (100 sq. ft.). Store the bundles of shingles flat or the strips are likely to curl as the bundles are opened for use.

Begin by checking the old roof, nailing down any loose shingles and replacing any that are damaged. If warped or rotten boards (sheathing) are present, usually under bumps or bulges, remove the shingles, replace the boards and weave in replacement shingles.

Start the reroofing by laying the valleys in first. Measure for length and cut the roll roofing. Roll the pieces up and place a roll at each valley. (Your local code might require the use of metal flashing instead of roll roofing.) Width of flashing to use in a valley is determined by roof pitch. The usual is 12 in. wide for slopes of 7 in. in 12 and over; 18 in. wide for 4 in. in 12 to 7 in. in 12 slopes and 24 in. for slopes less than 4 in. in 12.

After applying 15-lb. felt with staples, the starter course can go down. It can be either wood or asphalt shingles (applied upside down) as in the drawing. In any event, the starter course should be applied so it projects at least 1/2 in. over the eaves. This will prevent water from running back up under the shingles. A 1/2-in. shingle

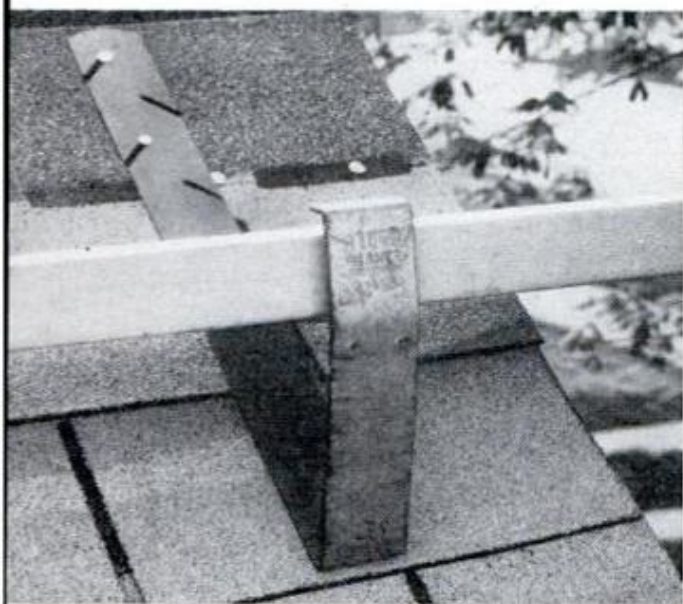
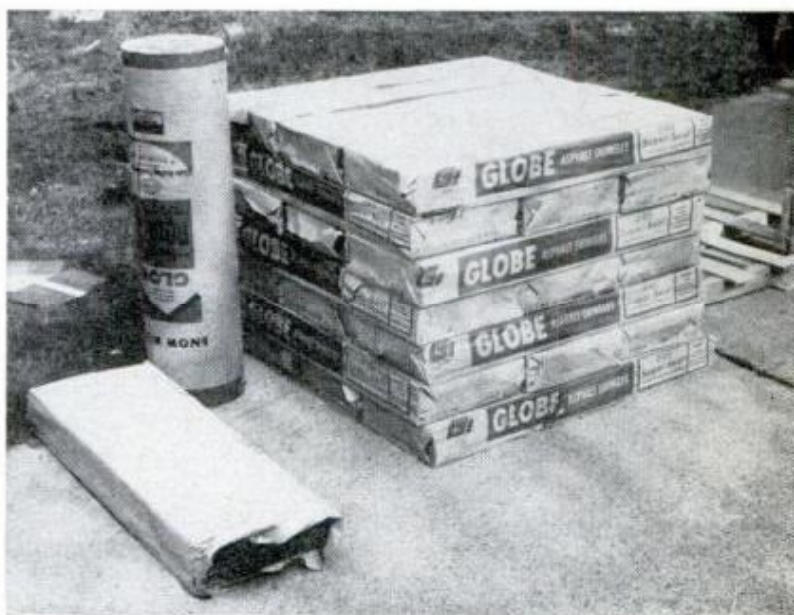

SCAFFOLD HANGERS are necessary for safety. You'll need at least two pairs to work your way up the roof safely. They are attached by driving in 8d common nails after locating the bracket so that shingling can continue. To move bracket to new position, it is simply tapped up and the nails that held it are driven home. Use at least a 2x6 plank with such brackets

ROOFING TOOLS (top) are few, may now be in your toolbox: square, chalkline, 50-ft. tape, hammer, utility knife and putty knife. Materials (center) are shingles, roof cement and roll roofing. The correct way to walk on a pitched roof (shown directly above) is with weight concentrated on edge of feet toward down side. Rubber-soled shoes are recommended

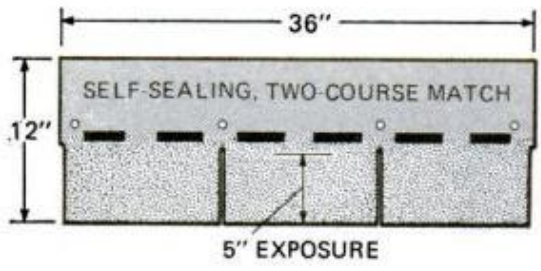
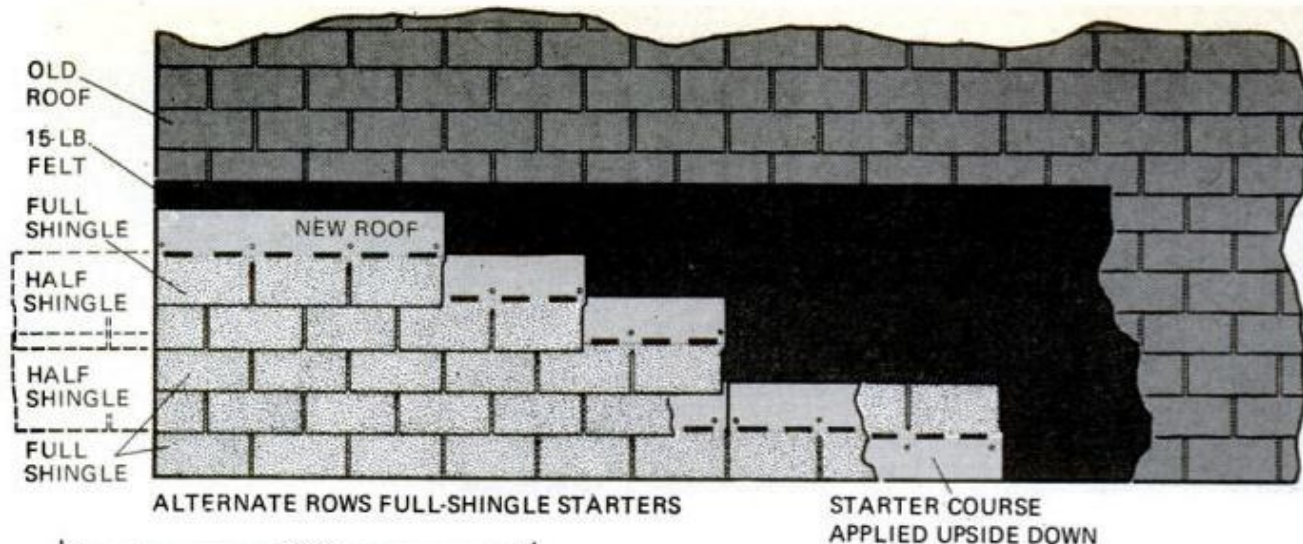

TAB SHINGLES are always applied so that full tab is centered over a slot below. If length of roof requires a narrow piece to finish first course, start the second row with piece of same width. Then continue alternating narrow pieces in each succeeding row

VALLEY TREATMENT

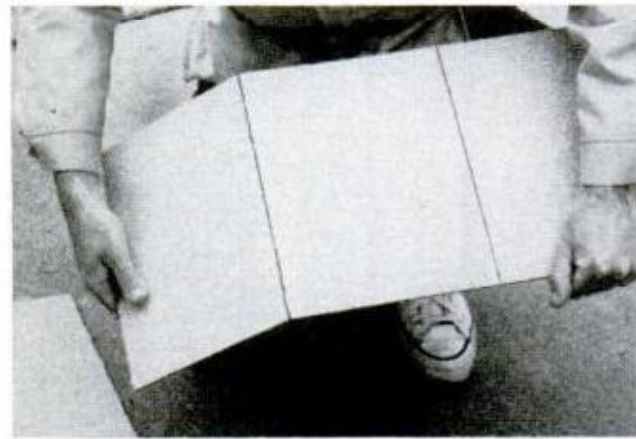

TO CUT AN ASPHALT SHINGLE, score a line with your utility knife, then bend and snap off the piece

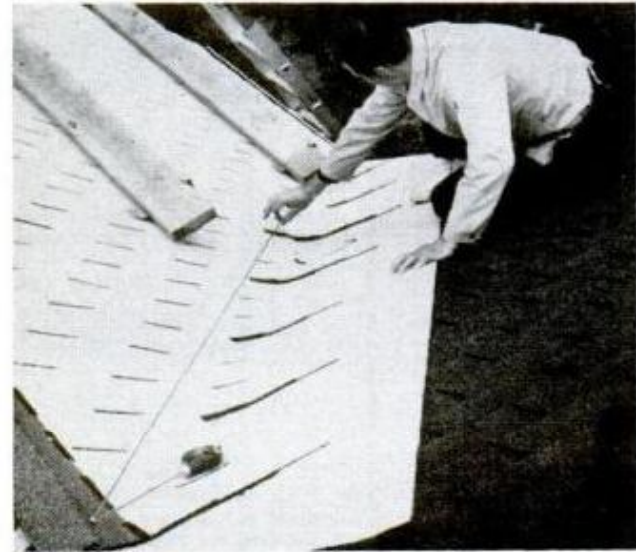

A TYPICAL OPEN VALLEY goes quickly if you use a chalkline to determine the angle cutoffs on shingles

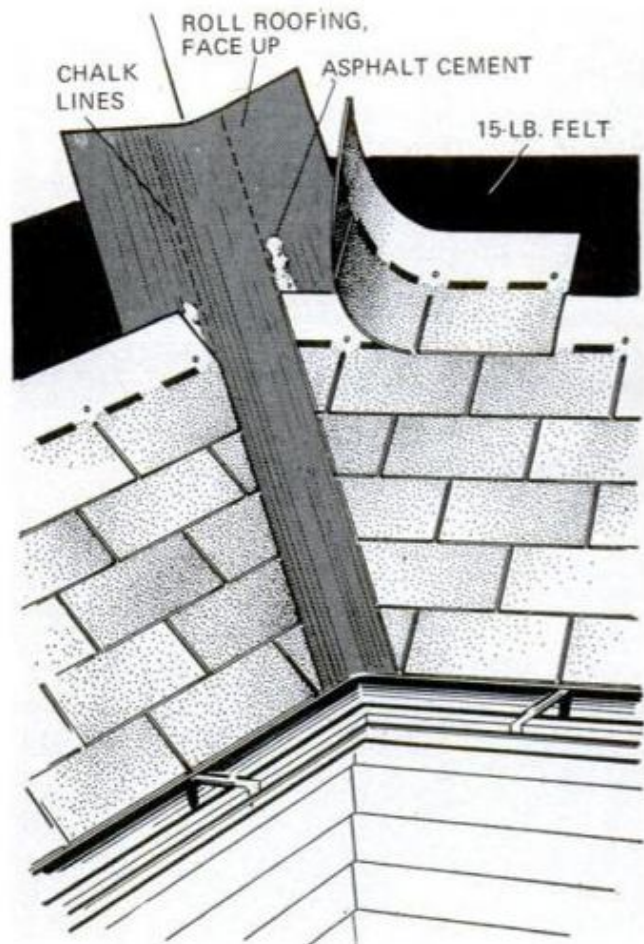

OPEN VALLEY is flashed with 38-in.-wide roll roofing before you move up the roof with the shingle courses. (Note: Some building codes require the use of metal flashing; see text.) Width of the valley between courses should increase from top to the bottom. Minimum open width at top is 4 in. between courses

SAVE! BUILD-UR-OWN PORTABLE ELECTRIC POWER

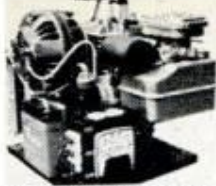

Build-ur-Own 110 Volt Electric Plant from used parts. Will operate lights, power tools, heating units, brush-type elect. motors plus charge batteries and ARC WELD. Ideal for boats, campers and portable shops. NO special knowledge of Electronics REQUIRED!

110 VOLT "ALT-POWER" ON YOUR CAR

Your Auto Alternator plus \$3 in Hardware Store parts with our easy-to-follow PLANS give 3000-watts to operate electric tools, lights, heating units, charge batteries and ARC WELD. Simple to build in about 2 hours. INCLUDED: Alternator Conversion Plans.



PLANS \$5 each, ppd. Both Plans \$10 ppd. with FREE (\$1 value) info/pic's.

B-UR-O COMPANY, Dept. PI
34161-B Coast Hwy., Dana Point, Calif. 92629

GRIND-O-FLEX Flexible Abrasive FLAP WHEEL

Unique abrasive action polishes or grinds all metals. Removes paint, rust, shapes wood. Unlimited applications on flat or irregular surfaces.

MERIT ABRASIVE PRODUCTS, INC.
201 W. Marville, Compton, California 90224

ORDER 6" DIA. WHEEL BY MAIL \$7.95
Fits 1/2" drill also 1/2" or 3/8" Arbor. Special offer price includes postage and handling. Specify coarse, medium or fine grit. No C.O.D.'s.
FREE Home Workshop Brochure



20 WOOD SAMPLES with woodworkers Catalog

ENJOY woodworking more! Let Constantine's big picture-packed Catalog-Manual help you build new furniture — refinish, restore beat-up cabinets, chairs, chests, tables, etc. Find instantly whatever you need. Buy at money-saving prices from world's largest catalog source for imported and domestic woods. Cabinet lumber, carving blocks, veneers, plywood, pipe briar, inlays and more! Newest Catalog features new tools, materials, shop devices. Fabulous all-purpose clear finish. Glue that needs no clamps. Inlay picture kits. 99c. Needed products found nowhere else. Plus wood-working instructions, plans, patterns!



Catalog & Wood Samples Only \$1
Dollar Fully Refunded on First Order
Accept this offer to own fascinating set of 20 2x4 specimens of world's glamorous veneers — Rosewood, Satinwood, Lacewood, Teak, etc! Compare! Then instantly identify finest woods wherever you go. Send only \$1 for Wood Samples and Woodworkers Catalog. Dollar refunded on first order.

2,000 PRODUCTS FOR SHOP & HOME
Woods — Veneers — Finishes
Furn. Hardware — Lamp Parts
Cane — Upholstery — Tools
Picture Molding — Clock Kits

FREE WITH CATALOG "101 PROJECT IDEAS"

CONSTANTINE
2051 Eastchester Rd., Bronx, N.Y. 10461

Enclosed \$1 for Wood Samples & Woodworkers Catalog. (\$1 refunded) Catalog only 50c



Name _____
Address _____
Zip _____

IT'S ALMOST LIKE PRINTING YOUR OWN MONEY!



9¢ WORTH OF RAW MATERIAL becomes \$1.25
in less than 60 seconds—and ANYONE can LEARN to do it in a FEW SHORT HOURS!

Since 1922, Warner has enabled thousands of men and women to establish a business of their own—to reap the benefits of their own labor and have the personal satisfaction, and independence, that comes with operating a business of their own. Now, a revolutionary new machine makes it possible for an Independent Business Man with no "PULL" . . . No Big Money to Invest . . . and, No Experience — to start a business of his own, at home in his spare time. Here's what J. H. of Pennsylvania says:

Now you can get into this highly lucrative business, and use your own home as headquarters. No experience needed because we supply everything. The new Warner Success Program, "Engraving as a Profitable Business," is now ready for you. We will send you a FREE illustrated brochure and no salesman will call. Send no money — just your name and address on the coupon or on a postcard. Be the first in your locality to cash in on this ground floor opportunity.

\$7,280.00 for 1 to 1½ hours work an evening in my spare time—and without advertising. When I start to advertise I will have my own full-time business. Right now I am using the extra income to give my family the luxuries my present job does not afford.

Warner Electric Co., Dept. E-2-BK
1512 Jarvis Ave., Chicago, Ill. 60626

Engraving Division, Dept. E-2-BK SEND NO MONEY
1512 Jarvis Ave., Chicago, Ill. 60626
Please rush your free illustrated brochure to:

Name _____
Address _____
City, State, Zip _____

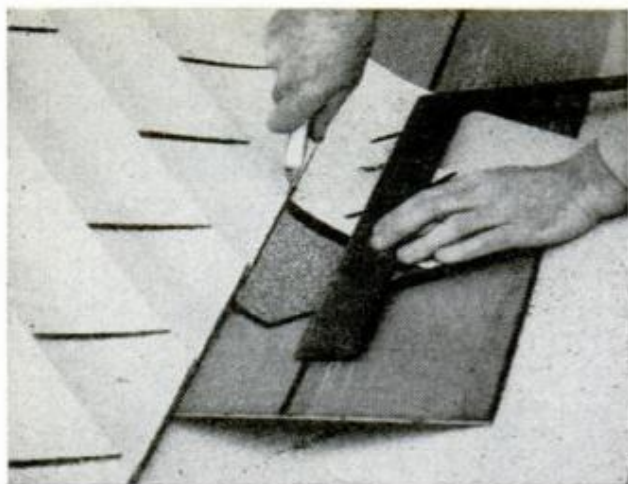

VALLEY SHINGLES are trimmed at one time using straightedge on the chalkline and a utility knife

projection should also be used at the rake (gable) ends.

The shingles are applied on up to the ridge and once all shingles are in place, they can be trimmed at the valleys. Measure at least 2 in. either side of the valley center at the top and 3 or 4 in. both sides at the bottom (eaves). Drive a nail at each of these four spots, attach a chalkline and snap to determine where shingles should be cut.

Use a piece of $\frac{3}{8}$ -in. plywood *under* the shingles along the valley. Place the carpenter's square along the chalkline on top of the shingles and cut with your utility

(Please turn to page 186)

WATERPROOFING A STACK

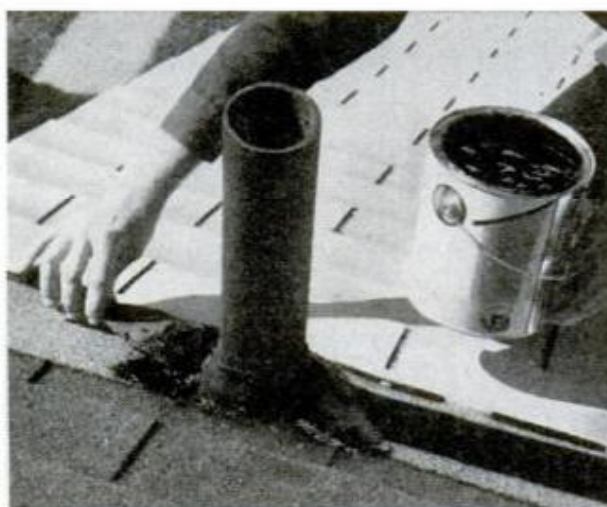
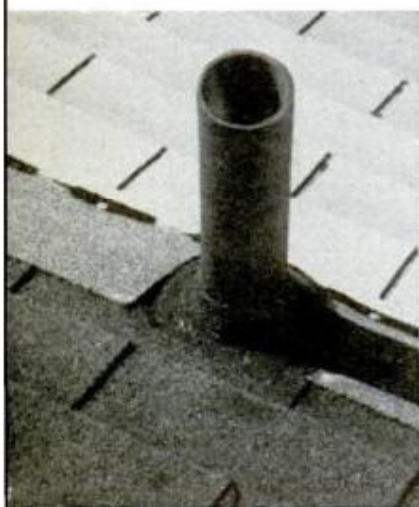

PLASTIC ROOF CEMENT is used to seal the joint around stack in roof. Cement is applied with a putty knife (a wood shingle will work fine) after shingles are trimmed for a neat job. If desired, paint cement

RIDGE TREATMENT

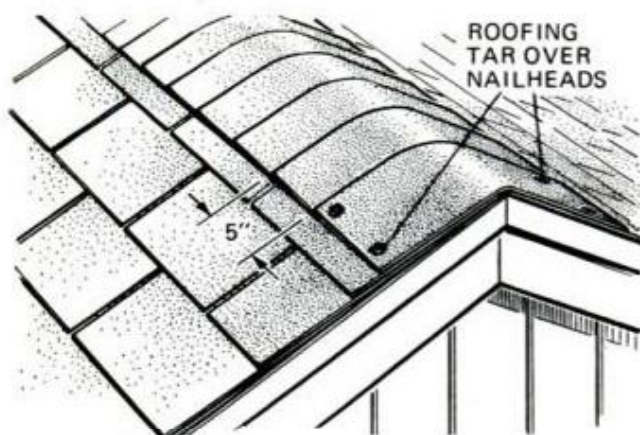

USUAL RIDGE CAP is made up of 12-in.-sq. tabs laid with 5-in. exposure to the weather. These can be cut on the ground and carried up by the armful. Each tab is applied with two nails—except for the last shingle. Here, four nails are used and exposed heads are then waterproofed with dabs of cement

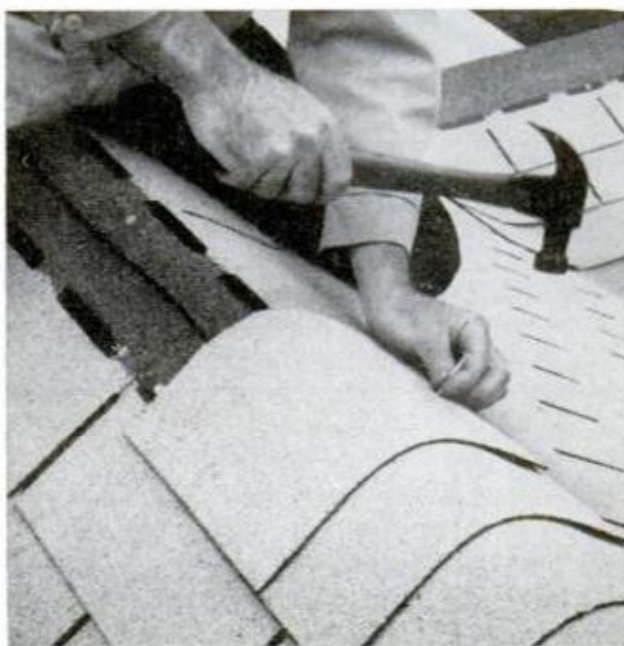

Send for this FREE CATALOG

of products & tips on
**WOOD & METAL
Finishing & Refinishing**

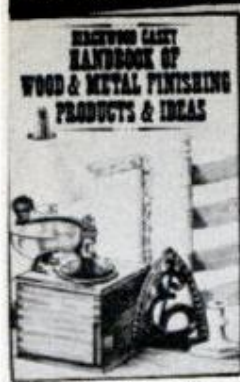

Really 2 Mini-Catalogs in 1
... tips on Wood and Metal
Care plus many unique
products! A must for:

- Woodworkers
- Metalworkers
- Homeowners
- Home Craftsmen
- Refinishers
- Antique Buffs
- Hobbyists
- Model Builders
- Creative Arts & Crafts
- Do-It-Yourselfers

Packed with latest ideas, techniques, special, hard-to-find products for finishing and refinishing wood... restoring metal finishes, antiquing metals... you name it! Your name and address on a postcard brings your copy FREE—send today!

BIRCHWOOD CASEY, Dept. 227
7900 Fuller Rd., Eden Prairie, Minn. 55343

WELDING PERFORMANCE YOU CAN'T BEAT AT A PRICE THAT CAN'T BE MATCHED.

Only **\$18.95**

for this heavy-duty welder from Four-Way.



We've sold hundreds of thousands over the last 35 years. This rugged complete Four-Way Welder operates on 110V 30A for pennies. Yet it can weld, cut, braze or solder just about anything made of metal. It comes complete in a heavy-duty cabinet with heavy-duty cables and ground clamp, full face helmet, adjustable torch and rod holder and two big bonus packs of instant arc welding rods, brazing rods, 1/4" carbons, solder and flux. Also included is a complete, simplified welding manual. Use it free for ten days and get your money back if not satisfied. Just send \$2.00 and then pay \$16.95 C.O.D. and delivery charges. Or send \$18.95 prepaid. Shipment in Continental U.S.A. Illinois residents add 5% sales tax. **FOUR-WAY WELDER COMPANY, 1810 Federal Street Dept. PM92, Chicago, Illinois 60616**

FIND BURIED TREASURE

Powerful electronic detector finds buried gold, silver, coins, etc. 5 new models. Write for free catalog.



RELCO, Dept. D-3 19.95
BOX 10839, HOUSTON, TEX. 77018

WRIST ROCKET

AMERICA'S HARDEST HITTING SLING
Range 225 yd.—232 fps.
Matched replacement rubbers and LEATHER pouch assembly \$1.00
At dealers or order direct.



WRIST ROCKET Mfg. **\$3.00** Post. Pk. in U.S.A. No C.O.D.'s
P.O. BOX 21-B
Columbus, Nebraska 68601
Orders outside U.S.A. add \$1.50 for postage and handling.



Be Your Own Boss New Business Opportunity FILING SAWS



Start a steady repeat CASH business in your basement or garage. Earn \$3 to \$6 an hour in your spare-time! Excellent profits in saw sharpening business! Automatic Foley Saw Filer, easy to operate, files combination saws, hand, band, and circular saws. No experience needed. H. C. Delbert wrote us: "Since I got my Foley Filer 5 years ago, I have averaged 4 1/2 saws each day since I started."

Every saw you sharpen brings you more customers. "I rented a two-car garage and have all the work I can do," writes Charles H. Smith.

FREE BOOK Shows How to Start

Fact filled booklet tells you how to start a sparetime business immediately; how to get new business, how to advertise. Rush coupon now; get "Money Making Facts" and details on Easy Payment Plan. No Salesman will call.

Send Coupon for FREE BOOK Money Making Facts

FOLEY MANUFACTURING CO.
943-2 Foley Bldg. Minneapolis, Minn. 55418
Send FREE BOOK—"Money Making Facts", and Time Payment Plan.



Name _____
Address _____

BUILD YOUR OWN CAMPER SAVE UP TO 50%



Complete, easy to follow plans, instructions, materials list.

Camper Plans\$3.95
Travel Trailer\$3.95
Pickup Cover\$2.00

CONVERSION PLANS:
Eeoline Type Van..\$2.95
Passenger Bus or Delivery Van.....\$2.95
Satisfaction Guaranteed

VIKING CAMPER SUPPLY, INC.
59-8P Glenwood Ave.,
Minneapolis, Minn. 55403
Please send _____ for which I enclose \$ _____
NAME _____
ADDRESS _____
CITY _____
STATE _____ ZIP _____

EQUIPMENT CATALOG \$1.95
Refundable on First Order. Send Dime for Details. Save 50% on Camper Kit. All items from catalog to build \$1,795. Camper, 8', 10', 10'6" or Chassis Unit.

VIKING

Repair any watch

... SWISS OR AMERICAN

Unique, modern Sweazey System starts you making repairs right away. Develops skill step by step at home in spare time. Diploma awarded. Free sample lesson. No obligation.

CHICAGO SCHOOL OF WATCHMAKING
Dept. 192, Fox River Grove, Ill. 60021



5 DAY HOME TRIAL

DISCOUNT BREAKTHROUGH ON ACCORDIONS

SAVE 1/2 OFF retail prices of comparable accordions. Buy direct from world's largest dealer. Over 40 models for Student, Teacher, Professional. Electronic, Standard & Button Models—Amplifiers too! All Big Names. Try before you buy. Free accessories. E-Z Terms. Trades. Lifetime Performance Policy. FREE Color Catalogs/Discount price list. Rush coupon.

FREE Color Catalog
• Discount Prices
• 42 Models

Accordion Corp. of America—Dept. R-92
5535 W. Belmont Ave., Chicago, Ill. 60641
Send FREE accordion catalogs and discount prices. Include special information checked:

Accordion Amplifiers Button Accordions
Name _____
Address _____
City _____ State _____ Zip _____

HINTS FROM READERS



Grease eases problem

Glass jugs used for distilled water, photo solutions and the like can be troublesome if the fluid corrodes metal caps. If you apply petroleum jelly to the cap's threads, the problem is eliminated. But don't use for liquids that dissolve grease.—*Walter E. Burton, Akron, Ohio.*



Fence-wire stirring rod

A piece of plastic-coated, link-type fence wire can be used in the shop next time you need a slender but sturdy and noncorrosive stirrer. First, straighten the wire, then cut it to length and seal the ends by filing them smooth and applying a dab of plastic cement.—*B. W. Ervin, Kent, Ohio.*

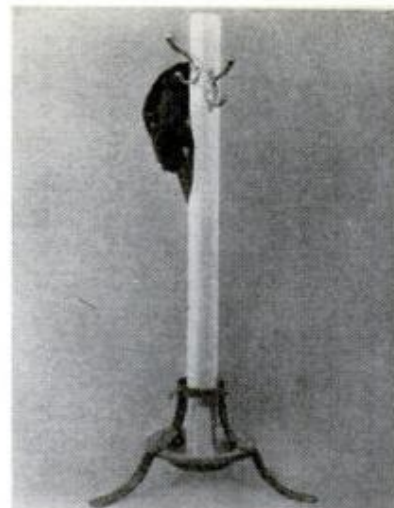

Kid's coat rack

A Christmas-tree stand plus 30 in. of 2x2 stock and four coat hooks, assembled as shown above, makes a sturdy and useful clothes tree for youngsters. This tree was put together with screws, then given two coats of semigloss varnish.—*Ken Patterson, Regina, Sask.*

Eliminate bent bristles

Store used paintbrushes in discarded tin cans with plastic lids—the type coffee comes in. Cut slits in plastic, push brush handles through, suspend bristles in thinner.—*B. Jane Kulp, Plumsteadville, Pa.*

Better chair repair

A handyman friend repairs a loose chair rung—without removing it—by drilling a small hole at an angle through the tenon into the leg. He then squeezes glue into this hole.—*John Krill, North Lima, Ohio.*

NEXT MONTH IN SHOP AND CRAFTS

GREAT SHOP NO 5: WINCHESTER, VA. When PM learned of this dream workshop, we dispatched our workshop editor to the Blue Ridge Mountains of Virginia for a first-hand look. You will be as impressed as he was when you see the well-planned setup and the craftsmanship that the owner displays in his projects. Bonus: You'll find complete plans in the October *PM* for duplicating one of his great workbenches. You won't want to miss this exciting shopful of ideas.

BENCH SAW, PART 4. Next month's installment wraps up this series, with instructions for bending wood without steaming by kerfing, chamfer cutting, making compound miters and more. The article features two charts you'll want to keep for handy reference; one gives bevel and miter degree settings for compound cuts and the second is for kerf spacing.

MINI-MAXI GATELEG TABLE YOU CAN BUILD FOR \$100. When it's compacted and standing alongside a wall, it takes only 9 in. of space. In use, you can set it up to comfortably seat three, six, seven or even nine. Designed for young homemakers to follow, the complete plans are in October *PM*.

Plus: *PM* shop-tests Sears' newest lathe, and a report on two new paints that you should know about.

10 Reasons why RCA Home Training is

your best investment for a rewarding career in electronics:

1 LEADER IN ELECTRONICS TRAINING

RCA stands for dependability, integrity, and pioneering scientific advances. For over half a century, RCA Institutes Inc. has been a leader in technical training.

2 RCA AUTOTEXT TEACHES ELECTRONICS FASTER, EASIER

Beginner or refresher — AUTOTEXT, RCA Institutes' own Home Training method helps you learn electronics faster, easier, almost automatically.

3 WELL PAID JOBS ARE OPEN TO MEN SKILLED IN ELECTRONICS

There are challenging fields that use electronics technicians... careers in communications, digital electronics, industrial electronics, automation, television, space electronics where the work is interesting and the earnings are greater.

4 WIDE CHOICE OF CAREER PROGRAMS

Select from a wide choice of career programs, each of which starts with the amazing AUTOTEXT method of programmed instruction. Check over the attached card.

5 SPECIALIZED ADVANCED TRAINING

For those working in electronics or with previous training, RCA Institutes offers advanced courses. No wasted time on material you already know.

6 PERSONAL SUPERVISION THROUGHOUT

All during your program of home study, your training is supervised by RCA Institutes experts who become personally involved in your efforts and help you over any "rough spots" that may develop.

7 HANDS-ON TRAINING

To give practical application to your studies, a variety of kits are included in your program. In RCA's Master TV/Radio Servicing Program you actually build and keep an all solid-state black and white TV set, and a color TV set. You also construct an oscilloscope which is yours to keep and use on the job.

8 FCC LICENSE TRAINING— MONEY BACK AGREEMENT

Take RCA's Communications Career Program—or enter with advanced standing and prepare immediately for

your 1st, 2nd, or 3rd class FCC Radiotelephone License exams. RCA Institutes' money-back agreement assures you of your money back if you take and fail to pass the FCC exams taken within 6 months after completing the course.

9 CONVENIENT PAYMENT PLANS

You get a selection of low-cost tuition plans. And, we are an eligible institution under the Federally Insured Student Loan Program.

10 RCA INSTITUTES IS FULLY ACCREDITED

RCA Institutes is licensed by N. Y. State and is accredited by the Accrediting Commission of the National Home Study Council. Its courses of study, faculty, and instructional facilities are approved by the State Education Department. In addition, all RCA Institutes courses and programs require the approval of the RCA Institutes Board of Technical Advisers who represent various technical, research and educational activities of RCA Corporation.

Approved by the N.Y. State Education Dep't. for the training of Veterans.



ACCREDITED MEMBER National Home Study Council

Construction of Oscilloscope.

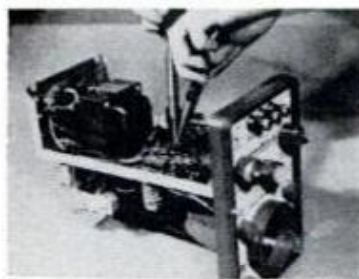

Construction of Multimeter.



RCA

CLASSROOM TRAINING ALSO AVAILABLE. FREE CATALOG ON REQUEST.

If Reply Card Is Detached—Send This Coupon Today

RCA INSTITUTES, INC.

Home Study Dept. 699-209-0
320 West 31st Street
New York, N.Y. 10001

Name _____

Address _____

City _____

State _____

Zip _____

Check here if interested in Classroom Training

BE YOUR OWN ROOFER

(Continued from page 180)

knife. Remove cutaway pieces, finish nailing the trimmed shingles and apply roof cement to the edges.

Capping at the ridge can be done with a 12-in.-wide strip of roll roofing. But it is more common to use full shingles cut into thirds. These are then applied as shown in the photos. Notice that the final ridge shingle receives four nails. Make certain you seal the exposed nailheads with roof cement.

Notice that the shingles shown have adhesive patches above the tabs. These are a sealer-type shingle that will withstand greater wind and rain forces than non-sealer-type shingles. This built-in advantage makes them well worth the few extra dollars of cost.

Several words of caution. For maximum traction, use rubber-soled shoes or sneakers when roofing. And don't walk on the edges of the shingles because you are apt to crack them. Instead, place your feet squarely on shingle centers. ★★

WORKSHOP SETUP FIT FOR PRO

(Continued from page 172)

them with perforated board. After applying two coats of semigloss varnish, we used the boards to hold tools and supplies that are needed infrequently.

As originally designed, the wall cabinet met all shop requirements, using every bit of space for some kind of tool or parts storage. The 12 drawers have eliminated much of my shop clutter. But before you place tools on the tool panel, check your setup to determine which tools are best to store there. After convenience, you should give prime consideration to favorite handsaws, fine chisels and the like.

About 10 years ago, I invested a large sum in four 8-ft. fluorescent light fixtures with hooded shades. This proved a bad choice for an active dust-producing woodworking shop. A vast improvement, the fixture shown on page 167 was purchased without a hood and fastened directly to the ceiling. The surrounding box of 1x8 pine was grooved to receive removable Plexiglas panels. The wood was simply stained and given two coats of semigloss varnish.

Consider adding a power outlet strip and magnetic toolholders to the wall be-

tween bench and cabinet. You can plug in several tools while you work on a project without having to switch power back and forth, and the holders keep your frequently used tools at hand in full view.

To assure a pleasant workshop atmosphere, we applied Masonite's antique white hardboard panels to the walls. Their slightly distressed finish is ideal here—when you occasionally bump work into the walls, resulting nicks and scratches are virtually invisible. Floor tiles shown were picked up at a local discount house. ★★

SPECIALTY ITEMS USED IN CONSTRUCTION

Drawer knobs, Amerock Corp., Rockford, Ill. No. 1551
Board stops, Stanley Tools, New Britain, Conn. No. 207A
Power outlets, Sears, Roebuck and Co. Cat. No. 34G 5951
Magnetic tool strip, General Hardware, 80 White St., New York, N.Y. 10013. No. 1250
Plastic laminate, Johns-Manville, 300 Canal St., Lawrence, Mass. 01840. Melamite
Woodworking vise, Sears. Cat. No. 99-AT-5189C
Sheet acrylics (light fixture), Rohm & Haas, Box 9730, Philadelphia, Pa. 19140. Translucent Plexiglas Walls, Masonite Corp., 29 North Wacker Dr., Chicago, Ill. 60606. Georgetown White 1900

PM'S VERSATILE PIANO BAR

(Continued from page 77)

caster blocks are positioned so the base rides $\frac{1}{2}$ in. off the floor. Common pine backband molding, which you can buy at any lumberyard and stain to match the laminate, is used to make the mitered center frame. Detail B shows how the molding is first rabbeted along the outer edges to center over edges of sidewalls.

Since the bar is lower than the top of the piano, a narrow strip of laminate is cemented to the exposed unfinished back. The bar top overhangs $\frac{1}{4}$ in. all around; the base is set in 2 in. all around. When fitting the $\frac{5}{8}$ -in. plywood doors, remember to allow a minimum of $\frac{1}{8}$ in. in width for the laminate to be applied to the edges. This is in addition to normal clearance.

All eight doors are covered with laminate on both sides and three edges. Band the edges first, then surfaces. Do the same with the top, except for the underside.

Cut 1-in.-wide strips of laminate to band all exposed plywood edges so you'll have excess to trim flush after bonding. Trimming can be done with a router or by hand with a flat mill file. Also cut the laminate for surface areas $\frac{1}{8}$ -in. oversize for trimming.

Touch-type latches are used on the liquor-cabinet doors so as not to interfere with the piano. Suitable knobs are used on all other doors. Friction catches hold the doors shut. ★★

SOVIET SEA POWER

(Continued from page 101)

about 40 of ours. And the U.S. ships are facing younger adversaries.

According to Adm. Isaac C. Kidd Jr., former commander of the Sixth Fleet, "The average age of U.S. combatant ships assigned to the Sixth Fleet is about 19 years. The average age of the Soviet force in the Mediterranean is about seven years. The disheartening thing is that the Soviets have already begun to phase out certain types of ships which they apparently consider obsolete... These 'obsolete' ships are about 10 years old."

Soviet vessels are making their presence felt in many areas. Russian subs, armed with nuclear missiles, are on regular patrol off both U.S. coasts. And the almost constant presence of a Soviet submarine tender at Cinfuegos, Cuba, gives the Russians a sub base there.

But the situation is not altogether bleak. The U.S. Navy is still the world's most powerful and we are said to be far ahead of the Russians in the technology of submarine detection.

Though the Russians are outbuilding us, we are far from having reached a standstill. During 1973 and 1974, two new nuclear carriers, the *Nimitz* and the *Eisenhower*, plus their nuclear escorts, the *South Carolina* and *California*, will join the fleet.

By 1974, the first of 30 fast new destroyers (DD 963s) will be delivered. In 1976, the first gas-turbine patrol frigate will become available. The 688-class anti-submarine submarine is now being built, and the Navy is pushing the development of hydrofoils, surface-effect craft and new escort ships, among others. Adm. Elmo R. Zumwalt, chief of naval operations, has expressed this view of the situation:

"I recognize that comparing the two navies principally on the basis of numbers of ships, weapons and aircraft may not constitute an accurate assessment of their relative strengths. Many intangibles must be considered—maritime tradition, battle experience, esprit-de-corps, battle readiness, logistic support... In many of these areas, the Soviet navy is largely untested, while the U.S. Navy has proven itself in World War II, and in the almost constant, high tempo operations, including combat, that we have conducted in the postwar years." ★★★

GOVT. SURPLUS AND OTHER BARGAINS SAVE UP TO 90%



TITAN WINCH

Airborne's own! Lightweight, compact. 2-way free spooling with safety brake. All ball bearing. Motor & gear train with hardened steel gears. Spool cap. 280' of 1/4" cable. 3000 lb. pull @ 12 V.D.C. Remote control operation with cab switch. 25" L x 9" H x 8" W. Drum speed 60 RPM no load. New, improved design. Shpg. wt. 65 lbs. 90 day guarantee. A \$450 value. \$149.50. *Cable 1/4" dia. 6000 lb. test @ 16c per ft.



400 AMP JET GENERATOR

Exc. for use as arc welder. Rated 400 amps @ 3000 RPM @ 30 VDC. Produces up to 600 amps intermittently. Has 1 1/4"-24 tooth splined drive shaft. Mounting flange 11" dia. with 10 bolt mounting holes. 15" L x 8" dia. Turns C.C.W. facing drive shaft end. Mfg. by Jack & Heintz. GOVT. COST \$353. Like NEW. Shpg. wt. 90 lbs. \$49.50. (Stk. #2637)



HEAVY DUTY GEAR MOTOR

All ball bearing construction. 3 H.P. @ 24 V.D.C. Turns 400 RPM no load on 12 VDC. 750 RPM on 24 V.D.C. Contains magnetic clutch. Free wheels with power off. Reversible. Shaft is 1 1/8" dia. Motor 16 1/2" L x 6" Dia. Approx. GOVT. COST \$250. Shpg. Wt. 40 lbs. \$34.50 (Stk. #2410)



NEW! BIG 1972 CATALOG

Send 35c (\$1 for airmail). Catalog contains 1000's of bargains in hydraulics, electrical, marine, automotive items, etc. 90 day guarantee. ORDER FROM AD. Prices FOB Culver City, 50% dep. for COD. Cal. res. add 5% sales tax. Must incl. zip code. Satisfying customers world-wide since 1945.

AIRBORNE SALES CO.

Dept. PM972

8501 Steller Dr. • P.O. Box 2727 • Culver City, Ca. 90230

Wear the Badge of a LAW OFFICER

Enjoy an exciting and rewarding career protecting lives and property against criminals, maintaining law and order. Train at home in your spare time. Learn scientific crime detection, modern criminal law, police methods and investigation, self-defense, etc. Opportunities for full-time careers and part-time extra-pay jobs. Send for FREE "Career Kit" on LAW ENFORCEMENT. National School of Police Science, 2008 Grand, Dept. 24179, Kansas City, Mo. 64108.

We tell it Like it is...

OVER \$30,000.00 PER YEAR

"My income from my Warner Shop now exceeds \$30,000.00 annually. And, my supply orders to your firm will bear me out." S.D.M.

I want you to be able to send me a letter just like this one...but you never will, until you take that first step by sending in the coupon below. Get the facts...including details, pictures, prices, profit margins and our less-than-bank-rate financing plan... FREE and postpaid. Learn how you can start at home in your spare time and expand into a full-time business just like S. D. M. Mail the coupon today—you owe it to yourself to get the facts, NOW!

Jim B. Warner, Dept. L-2-BK
1512 Jarvis Avenue, Chicago, Illinois 60626

Jim B. Warner, Dept. L-2-BK SEND NO MONEY
1512 Jarvis Ave., Chicago, Ill. 60626

Please rush your FREE illustrated brochure to:

Name _____

Address _____

City, State, Zip _____

THE QUADRAPHONIC MUDDLE

(Continued from page 106)

also has the advantage that it doesn't scratch or wear like records do, and that it lets you make your own recordings (though that will probably mean less to you in four-channel).

Open-reel tapes were the first quadrasonic recordings on the market, but cost kept them from becoming popular or plentiful; only about 50 or so quadrasonic open-reel albums are currently available. The decks are big and costly, and (as with all tape) you have to shuttle the tape back and forth to find the selection you want on an album. Threading the tape is also less convenient than putting on a record. But if you're a perfectionist who wants to make your own four-channel recordings, you'll want a quadrasonic open-reel deck in your system. And if you're just a perfectionist who doesn't want to record quadrasonically, you'll find four-channel decks that just play back without recording, or that just record on two of their four channels.

Tape cartridges in their Q8 quadrasonic form are far more popular than open-reel for the same reasons they're more popular in Stereo-8—lower cost and more convenience. Q8 tapes and equipment cost about half as much as open-reel, and the cartridges don't have to be threaded into the recorders. This is also the only system that lets you hear true four-channel sound in your car.

And Q8 cartridges are the most widely available four-channel recordings—so far. At this writing, about 200 Q8 cartridges are available—about twice as many as all quadrasonic discs combined. And the coming flood of discs will probably be duplicated in Q8 form.

As with Stereo-8, with no rewind and no (or very slow) fast-forward, the Q8 format does make it hard to pinpoint the start of the selection you want. And when the special lubricant wears off the tape, (though that may take some time), the cartridge jams. But those annoying track-change interruptions have been cut: Q8 players pause to change tracks just once per tape, to Stereo-8's three changes.

Four-channel open-reel and cartridge players can play both stereo and quadrasonic tapes (most Q8 players even switch automatically from stereo to quadrasonic when you push the car-

tridge in). But if you play quadrasonic tapes on a stereo player, you won't hear the instruments on the rear channels of the tape.

Whether you choose four-channel discs, tape, or both, there are two ways to build your four-channel sound system: by converting equipment you already own, or replacing it with new, four-channel gear.

Conversion may be the most flexible and least expensive method. For a small investment, you can add two speakers and a matrix converter with a built-in, low-power amplifier to drive the new rear speakers. For a bit more, you can get a plain converter plus a more powerful two-channel amplifier. Such converters will let you listen to four-channel matrix discs, to other four-channel sources such as discrete disc or tape (by plugging the demodulation on tape player into inputs provided), and give you some quadrasonic pleasure from your stereo records, too. Most such adapters have master volume knobs that control all four channels at once.

If you replace your system with a new four-channel amplifier or receiver, you'll get even more convenience, more modern circuitry and a neater-looking installation—though the loss you incur when you trade in your old amplifier will usually make this a more expensive approach. And even if you're skeptical about four-channel, there are quadrasonic units made for you. Quite a few of this fall's new receivers are convertible: You can use them as medium-power, four-channel receivers, or convert them to high-powered stereo models at the flick of a switch. ★★

WHEEL BALANCING

(Continued from page 147)

here is that labor turnover often is not as great in a large service shop and the chance of having a competent experienced operator may be greater in these shops than in the average service station. However it is usually less convenient to get an appointment for balancing in a large and busy shop.

Within a given area the charges for a balance job will be pretty consistent. Over a large part of the country it will run from \$2 to \$2.50 per wheel plus weights which might add another half dollar per wheel. In some areas, however, expect to pay around \$4 per wheel. ★★

WHAT'S HE DOING!

Making a Concrete Flower Pot! ... and **SO CAN YOU!**



Make and sell your own Ornamental Concrete items. Rush \$2.00 for book about Aluminum Molds with prices and production trade secrets direct from world's largest mold manufacturer. Over 350 designs to select from.

Send \$2.00 **CONCRETE MACHINERY COMPANY**
Today To ➔ P. O. BOX 99 • HICKORY 2, N. C. 28601

BELSAW PLANER • MOLDER • SAW



30-DAY FREE Trial!

Now you can use this ONE power-feed shop to turn rough lumber into moldings, trim, flooring, furniture... ALL popular patterns. RIP... PLANE... MOLD—separately or all at once with a single motor. Free 30-Day Trial. Low Cost—only \$35 down. Send Postcard Today—No Salesman Will Call. BELSAW POWER TOOLS, 903S, Field Bldg., Kansas City, Mo. 64111

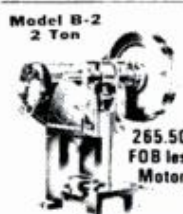

ALVA ALLEN Power Punch Presses 1 to 150 Ton Capacity

265.50 Complete line in hundreds of different style and model combinations. Write for FREE literature on Presses and complete line of Punch Press accessories as — Feeds, Dies, etc. FOB less Motor

Meets OSHA specifications
ALVA ALLEN INDUSTRIES Dept. PM, Clinton, Mo. 64735



GARAGE DOOR OPERATORS EASY HOME INSTALLATION RADIO CONTROLLED

\$89⁹⁵

Chain & Screw Drive Models
FOUR MODELS FROM THOUSANDS IN USE - FREE BROCHURE HELPMATE EQUIPMENT COMPANY Dept. PM-20, First & Lake St., Baroda, Mich. 49101

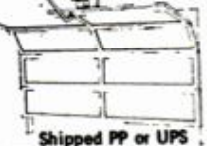

Print For Profit



Cards, Stationery, Envelopes, Advertising, labels, tickets, announcements, Q.S.L. cards, greeting, sympathy, prayer cards, tags, etc. Good Profits. Pays for itself in a short time. Own a Printing Business We supply everything direct from factory only. Easily followed rules. Also raised printing like engraving. Have home shop. Add to income. Send 25c for catalogue. **KELSEY PRESSES Meriden, Conn. 06450**

MAIL THIS COUPON TODAY!
KELSEY PRESSES, DEPT. 72-Y, Meriden, Conn. 06450

I enclose 25c send big catalog and samples.

Name _____
Address _____
City _____ State _____ Zip _____

HEAVY DUTY WELDER



with special \$7.00 gift offer to Popular Mechanics readers
10-DAY FREE TRIAL Lifetime Guarantee
Brand New **1895** POST PAID
1972 Model
Fits ordinary 110V outlet
Not one • but 6 welding heats

Weld, braze, solder or cut most anything made of metal. No experience necessary. Follow simple instructions to make repairs on cars, trailers, farm and lawn equipment, bicycles, appliances, etc. Make campers, boats, furniture, hundreds of valuable items. **NOTHING ELSE TO BUY!** Comes complete with full face shield, pack of welding and brazing rods, heavy duty power cables, special electric torch attachment, ground clamp, flux, easy-to-follow illustrated instructions, rod holder, etc. Uses standard 1/8" rods to weld iron, steel, brass, bronze, aluminum, other metals. New improved HEAVY DUTY circuit gives more welding power. Gives 4 times the heat needed to melt toughest iron. Plugs into ordinary 110V outlet. 6 WELDING HEATS plus continuously variable carbon-arc heat regulation control lets you weld anything from "tough" jobs to light-weight metals with ease. This important feature saves you money and time. Makes it possible for even beginners to start welding professionally the very first day. Pays for itself quickly. An excellent gift for any occasion. **IT'S AUTOMATIC:** Current is turned ON when arc is struck, OFF when rod is lifted from work. Eliminates need for troublesome foot switch. Speeds up work.

FREE! Mention that you saw this ad in Popular Mechanics and receive a \$7.00 gift pack assortment of "touch weld" welding rods. Automatic arc striker. Weld with "push button" ease. Lifetime guarantee.
10 day MONEY BACK GUARANTEE. You must be satisfied or return for refund. Send only \$2.00 and pay postman \$16.95 plus postage when delivered or send \$18.95 cash, check or money order for immediate postpaid shipment.
WEL-DEX MFG. CO., Dept. W-203, Box 10776, Houston, Texas 77018

TERRIFIC "BUY" IN 75 POWER TELESCOPE—\$4⁹⁸

3 telescopes in one —25 power for ultrabright images, 45X and 75X for extra long range. Guaranteed to bring people, sports, ships, moon, etc. 75 times closer. (Also use as strong microscope.) Most power for the money. NOT A KIT—ready to use, 4 ground, polished lenses; 5 sections, brass bound, 3 feet long, closes to 1 foot. Directions for use. Money back guarantee. Postpaid. Order now!
Busse Sales, Dept. PM67, 331 Church St., Hartford, Conn. 06101



Free. How to save money tuning up your car with Krylon.

It's all in our how-to booklet "The Engine Protectors". It'll show you how to save time and money for almost any tune-up job. From cleaning your choke, to sealing your ignition. (You can buy Krylon® automotive sprays individually or in the handy Muscle Spray pack.) Just mail in this coupon with a stamped, self-addressed envelope and we'll send you the how-to booklet "The Engine Protectors" to get things humming again. Krylon, Borden Chemical, Division of Borden Inc, Dept. PM-9, 50 West Broad Street, Columbus, Ohio 43215.

Name _____
Street _____
City _____ State _____ Zip _____



TV ON THE 18TH GREEN

(Continued from page 113)

program line. This is usually delivered on the spot to Telco, trade name for the local telephone affiliate and its nationwide network of lines. In Tucson, the typical method of getting the picture to a main circuit is by way of a small van equipped for microwave transmission. Since the golf course here sits in a valley, another similar van is parked atop a nearby hill. The picture, arriving at the first van from the control truck, is beamed to the receiving dish of the second van. From there it goes to the phone company's main installation.

The "control point" for such a telecast can be far away. The Tucson picture goes from golf course to Telco to Chicago, where it is mixed with commercials and announcements, then placed on NBC's leased lines for transmission throughout

"I saw three crewmen tossed like Coke bottles when lightning hit them . . ."

the country. The countdown begins from Chicago as the exact second for the start of the program arrives.

"Roll the bird!"

The "bird" is NBC's colorful peacock. This appears on the crew's monitors and is acknowledged by the cry, "The bird's up!"

The director's voice comes over the PL line. "Fade up on camera 2. Stand by inserts. Jim, come in now over the music. Stand by tape and stand by 3 when we have 2 on the line. . . ."

After tapes of preliminary action have been played and the course described by announcer Jim Simpson, the grind starts. Cory Leible, who may carry his backpack for the next two hours, is designated camera 3 and is in position on the 18th green.

"Camera 3, tighten up your shot a little," the director commands, punching Cory's picture onto the preview monitor. "Just the ball. Hold it right there. Jim, take it on the 18th green when you have a break. Camera 2, move in on the guy driving. . . ."

Meanwhile, the director has already set up the next scene.

"Now give me a wipe on 5. Camera 5, keep the golfer on the right, 6 will follow the ball. . . ."

The technical director "wipes" away half the screen of camera 5; the blank space is filled by camera 6. This gives a split screen showing two phases of the same action. As Lee Trevino steps up to drive, the right portion of the screen is ready to show him swatting the ball. The left will follow the ball's flight, then zoom in to show its exact lie.

Trevino drives and the play is followed perfectly. Before he makes his approach shot, however, an alert assistant advises the director of a special effect that can be made available.

"Video," a voice says over the PL, "we have that shot of Lee approaching close to the hole here yesterday. Is it ready?"

The video man punches in the proper data for the Trevino tape. The announcer is cued.

"Trevino is about 180 yards out," says Simpson. Then, almost casually, "And you might be interested in seeing how he played this same approach yesterday. . . ."

The tape works in smoothly, then is cut off just before the golfer makes his approach shot, this time live. And so it continues for the next two hours. If all the action can't be squeezed onto the screen immediately, it's taped for replay later.

Televising golf, as opposed to other sports, has its unique problems. When the announcer cautions that he must speak quietly because a pro is about to play a shot, he is not trying to create a dramatic effect.

"We've had several guys chew us out for talking or moving," explained a crew chief. "If they make a bad shot, they're sure to blame us."

Another problem is caused by the spiked shoes worn by many spectators. At Tucson, two main microphones at the 18th tee were put out of commission by spikes slicing into cables.

Of more immediate concern to the crews perched in the towers are thunderstorms.

"I saw three crewmen tossed like Coke bottles when lightning hit them during the Buick Open," recalls Jack Bennett. "The rule is that when the first thunder sounds nearby, we lock the cameras in position and get off the tower."

Hot weather can create problems, too. The camera circuits are transistorized

and, at about 82° F., the transistors begin to lose power.

"The picture in my viewfinder simply gets darker and darker," explains Bennett. "We have had to rush out and get dry ice from the soda-pop vendors and pack it around the camera to stay on the air."

Sports telecasting involves its own special blend of skill, ingenuity, sweat and stamina. Nowhere else in television does more effort go into a show. Judging by the popularity of such programs, the effort is well appreciated. ★★★

STACKING TV TABLES

(Continued from page 97)

will be easier to apply the edge trim in two or even three sections, rather than work with one continuous strip.

After the edge trim is applied to the top and base, proceed to add the laminate to the outer portions of the base top surface. Do *not* laminate the tabletop until after the unit is completely assembled. Mark off the positions of the dowel holes and bore small pilot holes through both base and top at the same time to guarantee

Stamp out glue repair problems

Sticks tight. Duratite® White Glue by DAP. Dries clear. Quick and clean to use. Does dozens of household glue-fixing jobs. Mends wood, paper, cloth, other materials. Comes with handy applicator nozzle.

the glue fixer from **DAP**

DAP Inc.,
Dayton, Ohio 45401
Subsidiary of *Plough, Inc.*



Stamp out tough paint problems

Amazing. Incolac Primer-Sealer by DAP. It can seal off stains as tough as creosote, prime over "hot" plaster and even varnished surfaces before painting. Dries flat white. For interior and exterior work.

the stain fixer from **DAP**



DAP Inc.,
Dayton, Ohio 45401
Subsidiary of
Plough, Inc.

alignment. Then bore 1 1/8-in. holes for the dowels; 5/8 in. deep in the base, and all the way through the top. Add the laminate to the side panels.

The reason the plastic is not applied to the top until after final assembly is to permit nailing the top into the sides. Use glue and 2-in. finishing nails. Although the dowel holes are already bored in the top panel, the laminate is applied in a solid piece without attempting to predrill and align the holes. When the top is laminated, simply bore holes just large enough to allow the router bit to penetrate; then rout them to size.

Make the vertical wood trim for the front and back corners by first doing the required inside cuts, followed by a few angled cuts on the table saw. You can further shape them close to size on the jointer by continually changing the angle of the fence. But watch your fingers.

Some tips on painting: Tack lengths of wire to the bottoms of the dowels and hang them on a line for easy spraying semigloss black. Give edges of individual tables a coat of wood sealer before you paint them with a brushing lacquer. ★★★

TERROR IN OUR SKIES

(Continued from page 141)

other lands to escape personal problems or seek political refuge.

Today, air piracy has become, in many instances, a grim and deadly scheme to extort money from airlines under the threat of blowing up whole planeloads of innocent victims. Measures that might have been effective during earlier hijackings simply do not apply in such cold, carefully calculated plots. The so-called "behaviorial profile"—a set of personality traits allegedly characteristic of the typical hijacker—is hardly reliable now. While details of the profile are secret, it is known to rely heavily on ethnic traits and was devised primarily to single out possible Cuban hijackers. If you have a dark-skinned, swarthy appearance, are shabbily dressed, wear long hair, act nervous or otherwise look suspicious, you may be questioned. But if you're the average well-scrubbed, neatly dressed tourist or

More hijackings occurred in the first half of this year than in all of 1971 . . .

businessman, the chances are that you won't.

When the marshal at Kennedy said I didn't "look" like a hijacker, he was referring to the behaviorial profile. The fact that I didn't happen to fit the profile is, of course, ridiculous. Last fall, a man described as "middle-aged, distinguished, nice-looking and not Latin or black" hijacked a Northwest Airlines jet and parachuted from the plane over Oregon with \$200,000 in extortion money, after threatening to blow up the ship. He hasn't been found yet and presumably has made a safe getaway.

What has been overlooked is that cold-blooded professional extortionists are not likely to be seedy-looking characters with long beards slinking suspiciously around airport corridors. In most cases, they're cool, calm, highly skilled experts with extensive knowledge of aircraft design and airport procedures. Or they may be desperate, mentally deranged persons who act normal but have hidden homicidal tendencies—often without regard for their own personal safety. This is what makes

apprehending a potential hijacker so difficult and dangerous.

The abortive sky marshal program—in which armed guards "rode shotgun" on jetliners—lasted only a few months and eventually had to be abandoned because a shootout at 40,000 feet in a pressurized cabin could do more harm than good—probably resulting in the killing of passengers along with the hijacker and possibly even blowing up the entire ship. In any case, the plan hasn't been much of a success—one plane was hijacked to Cuba with three sky marshals on board.

Other proposals have been made by government and airline officials. One is that Congress forbid airlines to pay extortion money on the theory that this might deter extortion attempts. But in practice, with the lives of passengers at stake, an airline that ignored such a law would undoubtedly have strong public support.

Another proposal is that airlines send dual flights on every run—one plane carrying passengers only and the other their baggage. Not only would double flights be prohibitively expensive; they would hopelessly clog our already overcrowded air lanes and airport facilities. And the plan wouldn't work anyway. An extortionist could simply carry a small, concealed bomb aboard the passenger-only plane, hide it in the men's room or other likely location, then get off at the next stop, with the bomb set to explode later in the flight. Still another suggestion is that all airports be ringed by high, impenetrable fences to keep out unauthorized personnel. Aside from the tremendous cost, a fence would hardly bar the bold hijacker who intends to walk right in through the regular boarding gate or use the convenient curbside check-in service.

Meanwhile, despite the fact that relatively few hijackings have succeeded, the number of *attempts* has risen alarmingly. More hijackings occurred in the first half of this year than in all of 1971—a jump of more than 100 percent. Of these, four took place between April 7 and 13. In the previous month, bombs were planted on three aircraft. One, a five-pound package of plastic explosive, was discovered only minutes before it was set to go off after the plane, a TWA 707, had been ordered back to Kennedy International Airport following a phone call received from an ex-

tortionist. If the bomb had exploded in flight, the crew and 52 passengers would have perished.

The second bomb actually did explode, but fortunately not until after the TWA jet had landed safely at Las Vegas, Nev. The force of the blast blew out the nose of the ship. Again, if it had occurred during flight, all aboard would have been killed. The third bombing involved a United Air Lines jet that landed in Seattle carrying two aerosol cans of dynamite in the luggage compartment.

This sudden flurry of criminal activity touched off a nationwide reaction verging on panic. Airport security was tightened, luggage was inspected, armed marshals guarded waiting aircraft and curbside baggage check-in was temporarily suspended. But it didn't last long. As the furor died down, so did the willingness to take precautions. Airlines, reluctant to alarm or embarrass passengers, relaxed luggage screening procedures. Some even reinstated curbside check-in service. At least one, Northwest Airlines, advertised the service on radio.

Curbside check-in—a possibly serious loophole in airport security—could provide an extortionist with an easy means of placing a bomb on a plane without boarding it. He could simply pull up at a busy terminal, ask a porter to check his baggage on such-and-such a flight, then drive off, presumably to park. Theoretically, if the baggage manifest didn't match the passenger manifest, suspicions would be aroused and the flight held up. However, expecting harried airport personnel to catch such a discrepancy is asking a lot, especially at crowded terminals where flights leave every few seconds. Also, some airlines may make such checks; others may not. At several terminals I visited, the porter asked only my flight number and destination, not my name or other information. There would have been no way of telling whether I actually got aboard the flight.

Another questionable practice is the sealing off of the rear access door on 727 jets, ordered by the FAA in May. The hatchway, opening under the tail, provides a reasonably safe exit for parachuting extortionists and has made the 727 a favorite choice of many hijackers for this reason. Bailouts from side doors are risky because the slipstream may carry a chutist

into the plane's tail section. The use of a pressure-sensitive switch enables the door to be opened on the ground but not in flight. Critics of the scheme point out that a malfunction of the switch or a wheels-up belly landing could deny passengers the use of the exit in an emergency. The FAA contends there are a sufficient number of other emergency exits even without the rear door. In any case, however, the arrangement offers no guarantee that a desperate extortionist might not resort to some more dangerous means of escape in a moment of frenzy after finding the rear door unopenable.

On the night of April 21, just days after the outrageous series of bombings and hijackings of the previous two months, I again boarded a flight carrying my two bags of tools and iron weights as a test of security. It was United Air Lines flight 446 bound for Kennedy from O'Hare International Airport in Chicago—the nation's busiest air terminal and supposedly one of the most carefully guarded.

***At the smaller airports . . .
I saw no magnetometers
in use at all.***

Again, no one stopped me or any of the 100 other passengers, including people of all types—dark, light, clean, dirty, nervous, calm, gay and grim. Magnetometers were present, but they weren't operating or no one was paying much attention to them. At the smaller airports of Hopkins in Cleveland and Midway in Chicago, I saw no magnetometers in use at all.

Such unbelievably slipshod security seemed inexcusable. Yet government and airline officials were saying that, while skyjacking attempts were on the rise, the rate of actual successes had declined. This was true, at least early this year. Of 12 tries through April 13, only three succeeded, compared to 11 successes out of 25 attempts last year. Such figures have led Assistant Secretary of Transportation Benjamin O. Davis Jr. to call skyjacking a "poor criminal risk." So is murder. This is of little comfort to the air traveler caught aboard a pirated liner wondering if *his* flight is to be one of the successes.

Whether skyjackings are or aren't suc-

(Please turn to page 194)

TERROR IN OUR SKIES

(Continued from page 193)

cessful is not the point. The point is they have been increasing, and each attempt subjects passengers and crew to frightening dangers. They're also spreading to other forms of transportation. Cunard's luxury passenger liner, *The Queen Elizabeth 2*, was recently the target of an extortion bomb plot and had to be stopped and searched in mid-ocean by a special team of bomb disposal experts parachuted in by plane. The Penn Central Railroad has reported several bomb scares on its deluxe high-speed expresses operating between Boston and Washington, D.C.

Where will it end? It won't end until security measures are tightened—and kept tight—at small as well as at large air terminals. An extortionist does not need an overseas flight. Any plane, going anywhere, will serve his purpose.

On Jan. 26, a hijacker took over a relatively small Mohawk Vista jet shortly

An extortionist does not need an overseas flight. Any plane, going anywhere, will serve . . .

after it left Albany, N.Y., forced it to land at Westchester County Airport near White Plains, N.Y., then ordered it on to Poughkeepsie, N.Y.—all local, short-run air terminals. The man was eventually shot and killed as he attempted to leave the plane at Poughkeepsie, but the point is he had chosen a short-run flight as his target. On April 8, only a little more than two months later, I watched some 70 people board Mohawk flight 542 from Newark to Albany without being screened. During the past year, I have personally flown on dozens of Eastern Airlines shuttle flights from Newark to Boston and Washington, D.C. Never did I have to walk through a magnetometer at any of the three terminals. Yet such short-run shuttle flights are not immune from hijacking. The Mohawk incident proves this.

According to the latest figures, only 87 of the country's 531 airline terminals have magnetometers. Also, if magnetometers are effective, how come they permitted an armed hijacker to board a United Air Lines jet in Denver on April 7, another, a Pacific Southwest Airlines jet on April

9 and still another, a Frontier Airlines jet on April 13?

Magnetometers are one answer, but to be a truly useful deterrent, they must be installed at *all* airports and properly monitored. The iron I was carrying on my various test flights should have immediately triggered suspicion on the part of monitoring agents. Another measure that may become necessary is the admittedly distasteful personal search of all passengers and their luggage, regardless of their appearance. Most airlines have avoided this step out of fear of annoying passengers and scaring away business.

To find out how air travelers feel about being searched, I made an on-the-spot survey of 100 passengers boarding various flights from Newark. More than three quarters—76—said they would have no objection. Others indicated reluctance, but would probably go along with it. The response would seem to indicate that the great majority of today's air travelers would readily submit to search to insure greater safety for themselves and fellow passengers. Two airlines that have instituted personal search with spectacular antihijacking success and few passenger complaints are Israel's El Al and Britain's BOAC. Eastern Airlines has resorted to this in some instances.

Mounting concern over the hijacking emergency led angered members of the International Federation of Airlines Pilots Assns. to call a brief worldwide strike in June as a protest, with the possibility of more strikes to come. While results of the action were not yet known at the time of this writing, what the pilots want is an international agreement, established through the United Nations, for airlines to boycott any country harboring hijackers or otherwise failing to cooperate fully in their apprehension. This, it is hoped, will force nations to discourage hijacking to avoid the loss of vital air service.

Some authorities are "talking tough" about the need for dealing harshly with hijackers instead of going along with their demands. However, just recently on July 5 one passenger was killed and two others were wounded when FBI agents stormed aboard a hijacked jet held captive at San Francisco International Airport. The hijackers were stopped, but at the cost of an innocent victim's life,

(Please turn to page 196)

PYRO5

\$3995
complete

Revolutionary new concept uses solid oxygen sticks and propane to produce the 5000° plus temperatures required for welding, brazing and soldering.



Pays for itself in a hundred ways! Metal Sculpture • Model Making • Auto Repair • Plumbing • Wrought Iron • Toys
See your dealer or write factory for complete information.
Pyronetics. (A Cordon International Company)
10025 Shoemaker Ave., Santa Fe Springs, Calif. 90670.



THE CHAMPION \$149.50

The Champion — 1200 watts 115 volts AC for only \$149.50
Unbelievable but true—Brand new production methods now make possible world's finest design in a service free alternator light plant at this unprecedented price. Plant puts out a steady 1200 watts of 115 volt AC power to run power tools, oil burners, pumps, TV, or anything that requires up to 1200 watts. Powered by a rugged 3 HP, 4 cycle, easy start gas engine with 1 year factory warranty. Complete with carry handle and shock mounts. Why fool with short life 2 cycle plants when you can buy this rugged top quality machine at our factory price. **\$149.50**
Item # 1265 wt. 65 lbs. SEND 25¢ FOR BIG CATALOG

MASTER MECHANIC MFG. CO., Dept. A-92 Burlington Wis.
Southern Customers write Dept. A-92, Box 65, Sarasota, Florida

be a TAX CONSULTANT

income unlimited in ever growing profession. Our students are earning lucrative fees in dignified full or part time home-office business preparing income tax returns during busy tax season. Many operate profitable Business Tax Service with steady monthly fees of \$10-\$50. No bookkeeping experience necessary. We train you at home and help you start. Licensed by N.Y. Education Dep't. No agent will call. Write for free literature. Accredited Member NHSC. Apprv'd For Vet Trng. **NATIONAL TAX TRAINING SCHOOL, Monsey, 20CD, N.Y. 10952**



BUILD THESE BEAUTIFUL CLOCKS

NOW AT BIG SAVINGS!

Send just \$1 for plans & instructions to build choice of: (A) Grandfather, (B) Steeple, (C) Grandmother—plus information-packed catalog of movements, dials, parts & kits to build these & 16 other fine clocks. All 3 plans—\$2.50. Catalog alone—25¢.

MASON & SULLIVAN COMPANY
Dept. PM9, Osterville, Mass. 02655

Be a MOTORCYCLE MECHANIC

Now's the time to "grab a piece of the action" in America's fast-growing motorcycle industry. Millions of new cycles have created huge demand for trained mechanics who understand high-performance miniature engines. You can learn at home in your spare time to qualify as a Motorcycle Mechanic, as well as becoming a repairman on outboard motors, power mowers and other small 2 and 4-cycle engines. Earn steady pay, or start your own business. Write today for FREE "Career Kit". **National School for Motorcycle Mechanics, 2008 Grand, Dept. 24179, Kansas City, Mo. 64108.**



NOW IN 2nd PRINTING

Why pay \$50/hr for consultants when this 64p. guide tells HOW TO Develop, Protect, Mfg., Package, Price & Sell your money ideas. Only \$2.25 ppd. Sold to: Industry, Colleges, Advisers, Inventors & Idea People

Recmd by: Popular Mechanics Jan. '72
Compact Products Company
907A Nottingham Rd
Newark, Del. 19711

TELLS HOW TO SELL YOUR INVENTION

If you have an invention that you believe has merit, write us at once for copy of copyrighted booklet "How to Go About Selling Your Invention." We work with manufacturers, and booklet reveals present markets, qualities of a saleable invention, current royalty rates being paid by manufacturers. Booklet is FREE, is offered to encourage new ideas we might submit to manufacturers. Just send name (no drawings, please) to **Kessler Sales Corp., Dept. D-59, Fremont, Ohio 43420**

PUZZLES

ENJOY SOLVING PUZZLES?

One of the most ingenious puzzles ever devised. Combined with many new designs in wood and metal to truly test your skills.

No Age Limit—Equal Justice for All! Happiness is... solving these puzzles! Present 'em to a friend with the directions removed. For 2 large and 6 smaller wire puzzles send \$4.95 plus 50¢ for post. & handling to:

N.Y.S. Residents Add 4% Tax
D.J. COOK & CO. INC., 3479 Lake Rd. Dept. X 14, Bliss, N.Y. 14024



MAKE BIG MONEY IN EITHER OF THESE TWO FIELDS

TRACTOR-TRAILER DRIVER



We can train you to operate the big diesel rigs. Study at home followed by practical training at school-owned facilities in Miami, Fla. Accredited Member NHSC. Home Office—Miami, Fla.

APPROVED FOR VETERANS AND INSERVICE PERSONNEL

HEAVY EQUIPMENT OPERATOR

Learn to operate cranes, draglines, scrapers, clamshells, bulldozers, backhoes, trenchers. Study at home followed by practical training at school-owned facilities in Miami, Fla. Accredited Member NHSC. Home Office—Miami, Fla.



UNIVERSAL TRAINING SERVICE, Dept. PM
1901 N.W. 7 St., Miami, Fla. 33125 • Phone: (305) 642-0800

- TRACTOR-TRAILER DRIVER
- HEAVY EQUIPMENT OPERATOR

PLEASE PRINT

Name _____
Address _____
City _____ State _____
Zip _____ Phone _____ Age _____

TERROR IN OUR SKIES

(Continued from page 194)

proving that such "harsh" measures may not be in the best interests of public safety.

Meanwhile, U. S. government and airline officials are wrangling over who should take primary responsibility for air safety. The Federal Aviation Administration believes the airlines should adopt and enforce proper security measures regardless of the cost and inconvenience they may entail. The Civil Aeronautics Board disagrees, arguing that "airline passenger agents are not cops" and can't be expected to provide security in such potentially lethal situations as hijackings and bomb threats.

If we're going to stop this growing national menace, we need to resolve the question quickly. The seriousness of the situation would seem to require a cooperative effort by government and private parties. We also need a combination of security measures, each to help supplement the other. We need magnetometers really used, not just put in for show.

We need personal search to ferret out nonmetallic weapons that present magnetic detectors are not able to spot. We need to eliminate curbside check-in, or at least see to it that the practice is carefully conducted to avoid the chance of a slipped-in bomb. We need, above all, the willingness to make maximum use of the measures we have—and keep on using them—until the menace has passed. ★★

EDITOR'S NOTE

In a dramatic move underscoring the seriousness of PM reporter Mort Schultz's findings, the Federal Aviation Administration, acting under direct Presidential order, has now directed all airlines operating short-run shuttle and commuter flights to institute rigid passenger-screening measures immediately to stem the rising tide of hijackings. Such flights have been particularly vulnerable to extortion attempts because they are relatively easy to board, often requiring no reservations. Under the new rulings, all baggage will be searched at airports where magnetometers are not in use, and in some cases passengers may be personally searched.

PAMPERING PELLET-PUSHERS

(Continued from page 109)

left-hand actions on its 12 and 20-gauge Model 1100s—a skeet shooter's favorite at about \$215. The firm also lightened its old favorite 870 pumps in 20 gauge. A plain barrel is \$139.95. And Rem has introduced the All American for trapshooters, an 870 with fancy engraving and checkering, gold trim details and beautiful walnut-stock options, at \$550. Marlin's new 12-gauge Model 120 magnum pump is all steel, \$150.

Long known for high-quality rifles, Weatherby has introduced the Patrician Pump at \$170 with the shortest stroke made, and the \$240 autoloading Centurion; both in 12-gauge, three-barrel lengths. Harrington & Richardson has an economy slide-action Model 440 in 12, 16 or 20 gauge at \$105. Fanciest and fastest loading of the automatics are probably Brownings, from \$245 up.

A recent trend has made side-by-side doubles more reasonable, over/under models more costly. So it's nice to find Savage with an O/U, the Model 330, with a 12-gauge barrel team plus interchangeable 20-gauge set plus case for \$288, as well as a .410 adapter for \$10. Ithaca's \$360 field O/U 1600 and 700 O/U trap have new and notable styling changes. Customers waiting for Winchester's well-known 101 O/U should now be able to get one in 12 or 20 gauge for \$315.

In imports, there's a gourmet's choice of Berettas from Garcia; Ithaca's world-championship Perazzis (to \$1795); nine fine Miida O/Us from \$441 to \$1283 from Japan; the Charles Daly line at \$370 to \$815; Franchi Falconet, \$296 up from Stoeger; a Spanish .410 double that folds up, \$55 from Century Arms, and others.

For bolt-actioners, Mossberg's \$62 Slugster 395S is a top deer and bear gun with slugs. And for Long Tom lovers, the \$66 Marlin 12-gauge Magnum Goose Gun has a 36-inch full-choked barrel.

Multipurpose chokes and barrels are popular, as are rifle-shotgun combinations. The \$75 Savage Camper's Companion tops a 20 gauge with a .22 rimfire, and other caliber combos are available. Ithaca's new 12-gauge \$230 Turkey gun has a .222 barrel underneath.

Looking ahead, rumors report Sturm, Ruger's long anticipated shotgun, out in a year or so. Judging from the variety available, scattergunners are in luck. ★★

Now prepare exterior surfaces for painting
— in half the time!

New muralo® Exterior Spackle®



Practically eliminates burning, sanding, scraping. Patching compound, putty, glazing compound, caulk — all in one. Easy to apply, instantly dry. Won't flash through latex. Use on blisters, cracks, nailholes — any paintable surface. But be sure you ask for and get new EXTERIOR SPACKLE.

the muralo company inc.
AT PAINT AND HARDWARE STORES

New York/Bayonne/Chicago/Los Angeles

NEW - Ninth Edition of the Universally Accepted Small Engines Service Manual



\$495
9th Edition

Factory "know-how" at your finger tips! Complete repair information on over 1,000 models of small engines that power lawn mowers, tillers, go-karts, etc. 328 pages with hundreds of photos and exploded view drawings. Step-by-step, easy to follow instructions for everything from minor tune-up to major overhaul. Over 300,000 copies sold to mechanics and do-it-yourselfers. Save time... make money. Order your copy today.

Money Back Guarantee
Send check or money order
and we pay postage.

Technical Publications Div. Dept. PM-972
1014 Wyandotte, Kansas City, Mo. 64105

5-in-1 MINIATURE MACHINE SHOP

UNIMAT

VERSATILE UNIMAT converts from precision lathe to vertical mill, drill press, grinder or polisher. Easy to use. Make all small precision parts—for models, guns, cameras, inventions \$149.50, ready-to-use. Send for free details (Available in Canada.)



AMERICAN EDELSTAAL, INC DEPTBI-2,1 ATWOOD AVE., TENAFLY, N J 07670

USE ZIP CODES
WHEN ANSWERING ADS

NEW RUBBER STAMP BUSINESS PAYS BEGINNERS UP TO \$16.50 AN HR. START AT HOME IN SPARE TIME

The multi-million dollar Rubber Stamp business—once controlled by a few big companies—is now being taken over by small operators—one in each community throughout the United States. Men and Women who have this inexpensive machine can turn out huge quantities of Rubber Stamps with special wording that buyers once were forced to buy from big cities. Material costing only 27c makes a stamp that sells for \$2.75. The machine that does the work is simple and easy to operate and it turns out as many as six Rubber Stamps at a time, each with different wording such as names, addresses, notices, stock numbers, prices and other "copy" needed by offices, factories and individuals. Working full capacity, it can earn as much as \$33.00 an hour for the operator! Now you can get into the big-pay business yourself, with your own home as headquarters. You don't need experience. We supply everything, including complete instructions and eight ways to get business coming in fast. We even help finance your start. Start making up to \$16.50 an hour from the very beginning. Cash in on the profitable Rubber Stamp business in your community, right away. We'll mail full particulars FREE and no salesman will call. Be first in your locality. Rush coupon or send your name on postcard now to:

RUBBER STAMP DIV., Dept. R-2-BK
1512 Jarvis Ave. • Chicago, Illinois 60626

THIS LITTLE TABLE TOP MACHINE
MAKES EVERYTHING SIMPLE & EASY



MAIL
THIS

RUBBER STAMP DIV. FREE!
1512 Jarvis Avenue Dept. R-2-BK, Chicago, Ill. 60626

Please rush full particulars about your financing plan and the little machine that can get me started in the profitable Rubber Stamp business at home in spare time. Everything you send me is FREE and no salesman will call.

Name _____
Address _____
City _____
State _____ Zip Code _____

AT TEX. THE ONE ALL-TERRAIN VEHICLE THAT REALLY MEANS ALL-TERRAIN.



An Attex will go anywhere, do anything. Climb steep hills, blast over sand dunes, fly through the snow and even navigate lakes and streams with ease. Think you'd like to be an Attex Dealer? We have a complete line of six dependable models for you to sell. Prices range from \$995. to \$1695. There's one just right for your customer. That's Attex. Write us.

ATV Manufacturing Company PM 9
1215 William Flynn Highway—Route 8
Glenshaw, Pa. 15116.

Name _____
Address _____
City _____ State _____ Zip _____



LEARN MEAT CUTTING

Train quickly in 8 short weeks at Toledo for a bright future with security in vital meat business. Big pay full-time jobs — HAVE A PROFITABLE MARKET OF YOUR OWN! Time payment plan available. Diploma given. Job help. Thousands of successful graduates. OUR 40th YEAR! Send now for big new illustrated FREE catalog. No obligation. G.I. Approved. NATIONAL SCHOOL OF MEAT CUTTING #01977
Dept. 50N, Toledo, Ohio 43604

WHITE'S ELECTRONICS INC.

THE
WORLDS LARGEST
LINE OF MINERAL
& METAL DETECTORS



Goldmaster 66 TR
\$269.50

PRICES START AT \$9.50 AND UP.
BUDGET TERMS — BANK AMERICARD — MASTER CHARGE

WHITE'S ELECTRONICS
INC., U.S.A. Room 512 LTD., CANADA Room 512
1511 Pleasant Valley Road Sweet Home, Oregon 97385
33784 Hazel Street Abbotsford, B.C. Canada



THERE ARE NO FINER AT ANY PRICE.

Find the answers to 1001 workshop questions

quickly, easily with the **POPULAR MECHANICS MASTER SHOP GUIDE**

24 hangup boards, coated with wipe-clean plastic keep vital how-to-do-it information always at your finger tips.

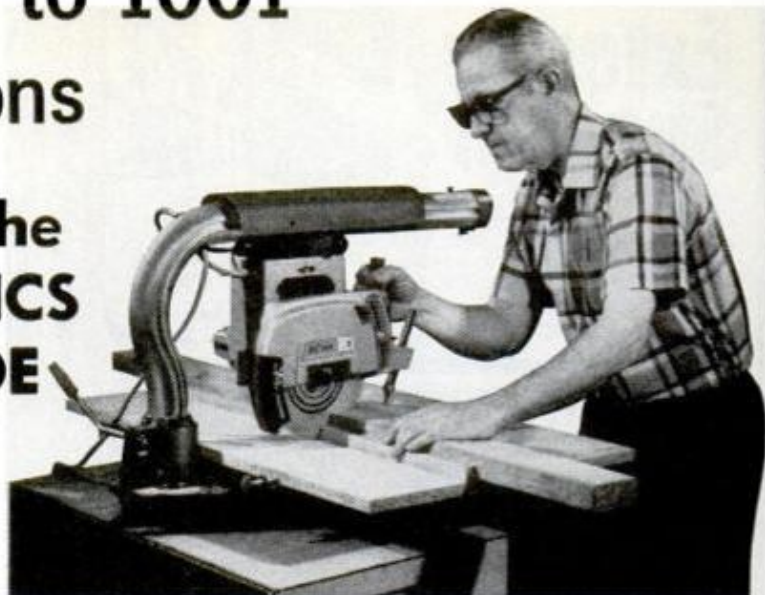

Here in an easy to use, last-forever format are the answers to everything you'll ever need to know about: nails, screws, bolts, wall-fasteners, drills, abrasives, lumber, hardwoods, moldings, plywood, hardboard, gypsum, adhesives, plumbing, electrical work, floor and wall tile, glass. Facts on remodeling measurements, gutters, concrete, garden chemicals. Plus—all on one board—a ruler, protractor, 45-degree triangle, and compass for accurate circles! You'll reach for the **MASTER SHOP GUIDE** for every job you tackle!

What nail should you use? How many pounds will a 1/4-inch toggle bolt hold? How can you save money ordering lumber? What size quarter-rounds are available? How do you bleach close-grained hardwoods? What glue is best?

Repairs, too! Illustrations on plumbing, electrical, floor or wall tile, plastic laminates, glass, remodeling. All the basic dimensions you'll need!

By the editors of *Popular Mechanics*—order yours now—you'll use it the rest of your life!

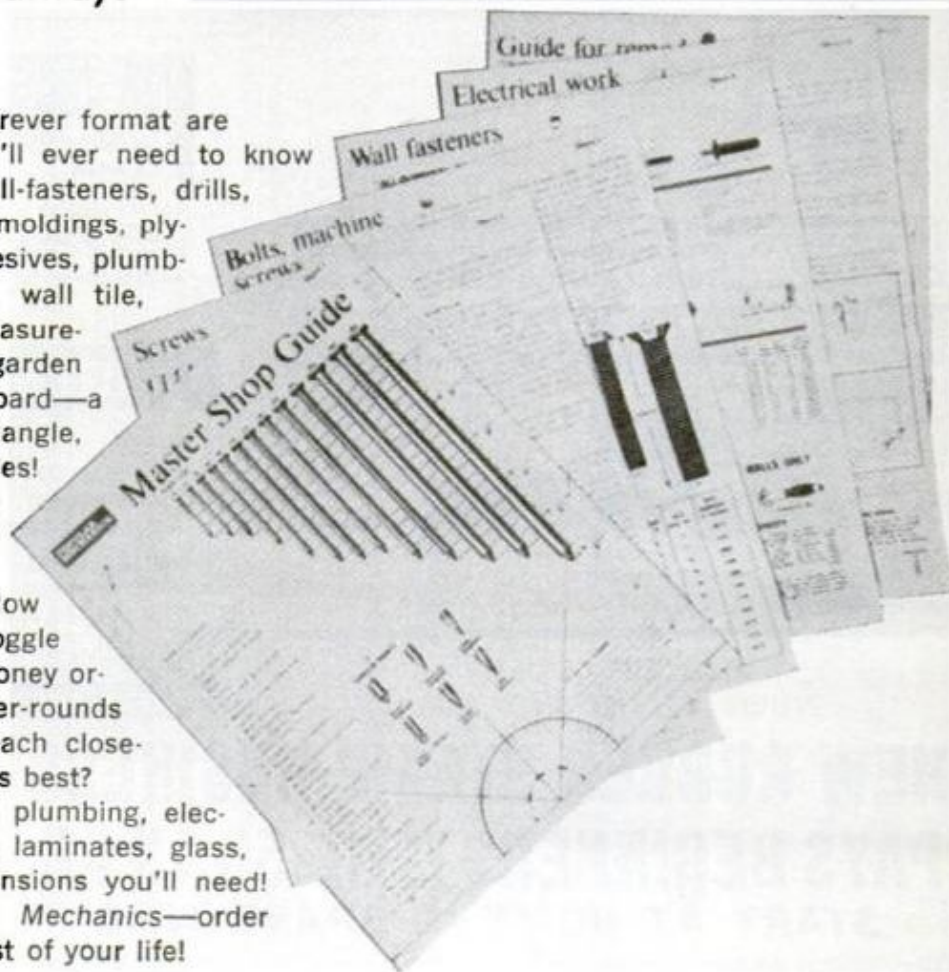

Popular Mechanics
P.O. Box 1014 Dept. SG-9
Radio City, New York 10019
Rush me _____ sets of the
MASTER SHOP GUIDE.
I enclose check or money order
for \$3.95 for each set ordered.

NAME _____

ADDRESS _____

CITY _____ STATE _____ ZIP _____

REVISED EDITION

Popular Mechanics Catalog Plans, Publications, Projects

Want to build a boat, garage, sidewalk classic, plane or a clock, kayak, fireplace, kite, patio, coffee table aquarium, kitchen cabinet, organ, swimming pool, telescope, children's play furniture, camping trailer, science project, electronic project?

Send for the NEW Popular Mechanics illustrated catalog! 32 pages crammed full of fascinating and useful projects you can build yourself!

For more than 67 years, Popular Mechanics has been the world's leading authority on how-to information. In this **h e l p f u l** catalog you'll find the very best of Popular Mechanics plans and publications. In step-by-step text, photos and drawings, these plans show you how to build something for everyone in the family.



Above are shown a runabout boat you can build for less than \$75; a four-place plane you can construct yourself; a patio-garage and the famous sidewalk classic for youngsters that rolls along at 5 m.p.h.

For information on scores of other exciting projects, order the new catalog today! Send only 25c to cover postage and handling.

Enclose 25c in coin, no stamps please, to cover postage and handling.

Mail to: **Popular Mechanics**
Box 1014, Dept. CO9
Radio City, N.Y. 10019

Please Print:

Name _____

Address _____

City _____ State _____

Zip _____

SURVEYING PAYS BIG

U. S. Dept. of Labor reports "openings for 26,000 Surveyors in next 10 years." Easy home-study plan guides you. Send for FREE "Surveying CAREER KIT." APPROVED FOR VETERANS.

Name _____ Age _____

Address _____

City _____ State _____ Zip _____

NORTH AMERICAN SCHOOL OF SURVEYING
4500 Campus Dr., Dept. 24179, University Plaza, Newport Beach, CA 92663



GERSTNER CHESTS
are for the
FEW TRUE Craftsmen

GERSTNER TOOL CHESTS
Dept. 12 20 Cincinnati Street
Dayton, Ohio 45407

Send 25¢ for Catalog

Learn PIANO TUNING



New Illustrated Self-Instruction Course

There's an acute shortage of piano tuners. Some earn up to \$20 an hour. New course by a master craftsman tells trade secrets. No musical training needed! Shows how to make pin, string, hammer repairs, use tools, etc. Includes piano repair and rebuilding; also electronic piano and organ tuning. Complete, only \$19.95. Money-back guarantee.

Est. 1909 **Nelson-Hall Co., Dept. 7JY-2**
325 W. Jackson Blvd., Chicago 60606

WOOD EVERYTHING FOR THE WOODSHOP TOOLS-SUPPLIES



World's Largest Selection of Finest Domestic and Imported Hardwoods, Veneers, Hardware—
at MONEY SAVING PRICES

Over 2000 items! Your money saving hardwood and woodshop buying guide. We've added new Clock kits, wood picture kits, musical instrument kits, many more. Complete selection of hard-to-find hardware, lamp and upholstery supplies, etc. Big savings on name brand power tools. Send name, address and 50¢ for handling and postage to:

CRAFTSMAN WOOD SERVICE CO.
DEPT. A-92
2729 S. Mary St., Chicago, Illinois 60608

New Catalog!
Write Today!...

A BUSINESS OF YOUR OWN REPAIR HYDRAULIC JACKS



Earn while you learn at home. Millions of jacks in gas and auto service stations, trucking firms, body shops, riggers, factories and farms need servicing... most of which you can learn to repair. We show you HOW. Start spare time in your basement or garage. Big opportunity for mechanics. **ACT NOW!** Write for folder PM-9 and free bonus offer

HYDRAULIC JACK REPAIR MANUAL CO., INC.

G.P.O. BOX 3 • STATEN ISLAND, N.Y. 10314

"LISTEN IN" TO POLICE-FIRE RADIO CALLS IN YOUR CAR!

WORKS with ANY CAR—Portable or HOME RADIO! Just PLUGS in—No wiring—3 minute hookup! Switch instantly from regular to ALL POLICE-FIRE-EMERGENCY-COMMERCIAL-TAXICAB-STATE-CITY-GOV'T 2 way Radio calls in YOUR AREA. DUAL-HI-LOW BANDS—OVER a MILLION Radio Cars/stations. USE Everywhere—anytime—always works.

SEND ONLY \$2.00 (cash, Ck., M.O.) and pay postman \$7.99 plus COD pstr or send \$9.99 for ppd Del in USA. COMPLETE, ready to use with instructions. One Year service Warranty—10 DAY MONEY BACK TRIAL (if retrnd). Limited offer includes "Plug in" for All RADIOS

WESTERN RADIO Dept. BPM-9 KEARNEY, NEBR. 68847



200

POPULAR MECHANICS

1¢ SALE GUARANTEED 10 YEARS



The knife for hunting, fishing and all around use. Mirror polished, imported stainless steel blade honed to a razor's edge. Rugged. Opens quickly, easily. Locks into position. Blade will not close when in use. Press button in handle to close. Safety finger guard. Sure-grip handle. Balanced for target throwing. **IF BROKEN WITHIN 10 YEARS WE WILL REPLACE AT NO CHARGE!** Use 30 days. Money back if not pleased. Special 1¢ sale. REG. PRICE \$1.98. Send \$1.99 & receive 2 knives. Add 49¢ postage, handling. Remit TOTAL \$2.48 for 2 knives. **ORDER NOW!** Midwest Knife Co., 9043 S. Western Ave., Dept. DD-5808, Chicago, Ill. 60620. Est. 1936.

ELECTRIC ARC WELDER \$9.99!



NATIONALLY ADVERTISED \$18.95 VALUE!—NOW 1/2 PRICE! WELDS—BRAZES—SOLDERS—CUTS—ALL METALS! Plugs into ANY 110 volt socket. MAKE—REPAIR 1001 items for CAR—HOME—BUSINESS. Lifetime BURNOUT GUARANTEE 10 day money back trial (if retrnd).

HEAVY DUTY Design—No experience needed—FREE WELDING LESSONS! **SEND ONLY \$2.00** (cash, ck, M.O.) and pay postman \$7.95 COD postage or send \$9.99 plus \$1.00 postage for paid del. in U.S.A.: **COMPLETE READY TO USE—Includes BIG pack steel. Brazing. Solder. Carbon "touch" rods. ELECTROFLAME ARC TORCH! OFFER LIMITED—Order TODAY!** **MIDWAY WELDER Dept. EPM-9 Kearney, Nebr. 68847**

BUILD YOUR OWN SAVE 50%

You'll enjoy making this handsome octagonal clock, replica of an antique that once hung in little red school-houses around the country. We supply wood in solid cherry or walnut plus movement & dial. You cut and put the parts together. Send \$1 for plans & instructions plus information-packed catalog of movements, dials, parts & kits to build this & 17 other fine clocks. Catalog alone 25¢.



CATALOG ALONE 25¢

MASON & SULLIVAN
Dept. PMSL, Osterville, Ma. 02655

At Last a New Amazingly Simple

GAS TURBINE JET ENGINE

Build from easy to follow plans. Length 15", Dia. 8 1/2", Wt. 15 lbs. Fuel: Gasoline or Kero.

"Screamin' Demon" develops 20 H.P. Ideal project for serious-minded hobbyists, students; scientific and industrial arts classes. Make on 9" metal cutting lathe with milling attachment. For use on small racing boats, midget cars, etc. Full size assembly drawings with critical dimensions, bill of materials and photos. Price \$5.00. No C.O.D. **SAVOY SCIENTIFIC, BOX 1398, SANTA MONICA, CALIF. 90406**



PUMP DRAINS pools, cellars, laundry tubs IRRIGATES — CIRCULATES — SPRAYS



Heavy duty ball bearing pump. All metal, rust-proof Type XB. Stainless shaft. Use 1/4 HP or larger. 1 HP 1,200 GPH 60" high or 3,000 GPH 25" well. 5,200 GPH max. 1 1/4" in; 1" out. Belt or direct drive. \$13.95 Type P won't rust or clog. Bronze bearing. To 2,400 GPH. 1" in; 3/4" out. \$9.95 p'pd cash with order. Money back Guarantee.

LABAWCO, Box 40, Belle Mead, N.J. 08502

Travel the SHORT way

avoid wrong turns — save time, money and frustration with



AIRWAY COMPASS



... at leading stores everywhere!

AIRWAY COMPASS, Mexico, Indiana 46958

POPULAR MECHANICS PM-BEE! Plan for a radio-controlled model that flies on CO₂. Fuel is nonflammable and odorless. Sophisticated and simple to build! To obtain full-scale pattern from which you can trace off the parts directly, send \$3.49 to **POPULAR MECHANICS Dept. FA, Box 1014 Radio City, New York, N.Y. 10019.**

INVENTORS

INVENTIONS—NEW PRODUCTS—IDEAS
DEVELOPED & PREPARED

For Commercial appeal & sales

DESIGN—MARKETING—PATENT RESEARCH—DRAWINGS

Second Decade of Reliable Service To

INVENTORS—MANUFACTURERS—ATTORNEYS

Director: United States Patent Office Former Examiner

United States Dept. of Army Former Patent Adviser

Member: United States Council Int'l Chamber of Commerce

FREE CONSULTATION

THE RAYMOND LEE ORGANIZATION

230-Z Park Ave., New York 10017 (212) MU 6-8500

"Invention Record" Form &

SEND FREE "Product Marketing" Brochure

Name.....

Address.....

City.....State.....

Zip.....

New! 3-D Sight Magnifiers
ENLARGES CLOSE WORK ONLY
SMALL PRINT! \$1.98

WORTH MUCH MORE!

See clearer, work faster, more accurately with less eye strain, less fatigue and tension with **HEAD BAND MAGNIFIER**. Wear like glasses, they'll magnify about 3x and leave hands free to work.



Produces a 3-dimensional effect, where each detail appears to stand out. **FOR CLOSE WORK, REPAIRS, SEWING, HOBBIES**, etc. Sturdy, lightweight, adjusts to all sizes. With or without glasses. Powerful prismatic polished lenses. Only \$1.98 + 50c for Post. and Hdg. PPD. (2 for \$3.50, 3 for \$5.00) **WORTH MUCH MORE! MONEY BACK GUARANTEE.**

Nu Find Prod., Dept. HB973, Box 205, Church, N.Y.C. 10008

**USE
WHAT THE
PROS USE!**



- LUBRICATES
- PENETRATES
- PREVENTS RUST

Available wherever automotive products are sold.

CRC CHEMICALS
Div. C. J. Webb Inc.
Dresher, Pa.



Calendar Watch \$4.45



Metal Detector \$13.95

Field Glasses \$5.24

**HOME-IMPORT
BUSINESS—Make Big Profits**

Men-Women, new Drop Ship Plan. Fast profits without product investment! Deal direct with overseas sources. Buy small quantities. Prices include duty & postage. Full or spare time. Write for **FREE PLAN**, state age.

QUANTITY PRICES
EVEN LOWER

MELLINGER, Dept. F2259, 6100 Varie!, Woodland Hills, CA 91364

locksmithing and key making

PRACTICAL UP-TO-DATE COURSE — ONLY \$7.95



Teaches you how to pick locks, de-code, make master keys, repair, install, service, etc. New self-instruction lessons for every handyman, homeowner, carpenter, mechanic, service station operator, fix-it shop, hardware dealer, gunsmith. 53 easy illustrated lessons. Full price only **\$7.95** post-paid. Satisfaction or refund guaranteed. Mail order today!

NELSON-HALL CO., Dept. KY-2
325 W. Jackson Blvd., Chicago 60606

SEPTEMBER 1972

Add-A-Volt for portable electricity



Provides a practical conversion unit to use the voltage generated by most types or kinds of alternators on cars, trucks or other vehicles. Case is made of durable plastic design only for Add-A-Volt. Ideal for campers, contractors, fleet owners, farmers, ranchers, fishermen, garages and others. Operates lights, many tools and small heating equipment with meter and fuse protection. Fully charges any 6, 12, 24, or 32 volt battery. 5 yr. guarantee.

**NOW
\$19.95**

Write for details on other electrical items.

ADD-A-VOLT
P.O. Box 2083
Amarillo, Texas 79105

AAMCO® And You Can Make It!

The world's largest transmission chain is still growing strong after eight years. Over 500 of our franchises located from coast to coast. New openings in some markets mean you too might qualify. For further information write:

AAMCO TRANSMISSIONS Dept. 92
408 E. Fourth St., Bridgeport, Pa. 19405

I-N-V-E-N-T-O-R-S

WE NEED INVENTIONS

Sell your invention for cash—need money for Patent?—Are technical problems holding you back? Universal Inventions has helped inventors all over the world—just like yourself—why not you? Inventions provide the magic spring-board to sudden riches. **REMEMBER**, we either sell your invention or pay you a cash bonus. Write for details.

UNIVERSAL INVENTIONS, Dept. 13, Marion, Ohio

BASEMENT TOILET FLUSHES UP



TO OVERHEAD SEWER OR SEPTIC TANK.
NO DIGGING UP FLOORS. INSTALLS EASY. Write
McPHERSON, INC., BOX 15133, TAMPA, FLORIDA 33614



BUILD IT YOURSELF

Save \$20 per hour by assembling our unique **TURF-RIDER®** tractor kit. Full line of attachments. "Build-it-yourself" Plans — \$5.00. Catalog of Turf-Rider and 30 other Assembly Kits \$1.00. (Refunded with any purchase.)

12 hp Kit
\$598.95

STRUCK CORP., Dept PM-92, Cedarburg, Wis. 53012

NOW! BUY 1970-71 Chevys, Fords, Dodge (From \$799 to \$999)

Delivery arranged anywhere.
Free catalog. Send 25¢ handling to:
PAN AM CAR DIST. CORP. Dept. ME-39
31 Hanse Ave., Freeport, N.Y. 11520

**Use Zip Code
When Answering Ads**

The bargain hunter

One Bit Drills 13 Holes.

1/8" to 1/2" Dia.

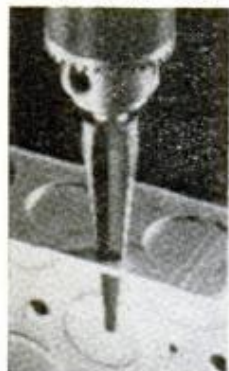

New Unibit works on metal, wood, plastic. Drills material up to 1/8" thick in thirteen 1/32" steps. Unlike conventional twist drills, Unibit's point design stops skidding and need for center punching. Unique single flute design helps stop chatter and vibration. Eliminates "hogging-in." Cutting edge automatically de-burrs hole. Made from rugged, high-speed steel, it's easy to keep sharp.

\$4.95 PM-92-
plus 25¢ postage and handling

Order from Harry C. Oakes, Inc.,
P.O. Box 331, Dept. PM-92,
Wyoming, New York 14591

Unibit



SAVE HUNDREDS OF DOLLARS . .

Build this attractive Little Red Barn for work shop, garden kennel, tool storage, play house, dog kennel, motorcycle garage. 8 ft. x 12 ft. x 9 ft. high. Mounted on skids for portability. 4 ft. sliding door. Quick to build using 1/2 in. exterior plywood. No expensive tools needed. Simple step by step plans. Send \$2.50 for barn plans and material list. Also petite 6 ft. x 8 ft. x 8 ft. high with dutch doors for \$2.50. Both plans for \$4.00.

HAMMOND BARN
Dept. PM4, Box 39027
Indianapolis, Indiana 46239

KWICK POWER FOR TOOLS

110 volts D.C. 3000 watts anywhere from any vehicle with an alternator. Installs permanently in 15 minutes. Operate heavy duty saws, drills, lights, heaters. Arc weld, quick charge batteries. Will not harm alternator. **\$14.95** postpaid, check or money order.



Only **\$14.95**

AUTO QUICK
10914 4th St., N.E.
Minneapolis, Minn. 55434

FIND BURIED TREASURE

FIVE PATENTED MONEY SAVING DETECTORS

TRANSISTORIZED FROM **17.95** to **49.95**



3 SEARCH HEADS
INCREASE RANGE

Finds Coins, Jewelry, Gold, Silver, Bronze

Write For **FREE** Catalog

SOLIDTRONICS DEPT PA2' TENNENT, NJ 07763

BURGLARPROOF YOUR HOME FOR JUST \$7.98

You can now protect your home easily and inexpensively with the new PLAY IT SAFE record-system. Simple, easy-to-follow instructions show you how to adjust your automatic phonograph for continuous play of our special stereo record. Sounds just like people at home. And nothing frightens away burglars faster than people at home. Stops only when you turn it off. Send \$7.98 today for the PLAY IT SAFE record-system or 8-track tape cartridge.

10-day trial, moneyback guarantee
PENTA Sales Corp. Dept. 5B9
13 East 9th St. N.Y., N.Y. 10003

STOP LEAKING FAUCETS FOREVER



90% of faucet leaks are due to bad seats. The brass pits and corrodes. Obtaining the correct seats with washers and installing them is very difficult. There are over 100 different sizes and thread combinations available. **THIS UNIVERSAL KIT FITS ALL MAKES AND SIZES OF CONVENTIONAL FAUCETS THAT WE HAVE EVER BEEN ABLE TO FIND.** The stainless seats are unconditionally guaranteed to never wear out, corrode, or need replacing in your faucet. Special washer design compensates for worn moving valve stem parts and gives a smooth, soft action on any faucet. Also ends the frustration of hot water shutdown caused by expanding rubber washer.

KIT INCLUDES: 8 seats with washers (Do the whole house and garden), recessing tool, anaerobic adhesive, **EASY** pictorial instructions, \$4.95 + 50¢ shipping & handling. Quantity discounts available.

Vulcan Mfg. Co. Box 33
Dept. PM9, Grand Valley, Colo. 81635
Pats. Apl. For



POWER OUTLET

EASILY INSTALLED IN YOUR CAR
YOU DO IT YOURSELF IN MINUTES WITH SIMPLE TOOLS.

CAR POWER

3000 WATTS FROM YOUR ALTERNATOR

POWER FOR: HEAVY DUTY DRILLS • SAWS • LIGHTS
• COFFEE POTS, ETC. YOU CAN EVEN CHARGE DEAD BATTERIES OR ARC WELD

• GUARANTEED 5 YRS. • WILL NOT DAMAGE ALTERNATOR

\$16.95 POSTPAID

HOLLY L.P.
P.O. BOX 5321
PHOENIX, ARIZ. 85010

FOR MOTOROLA ALTERNATORS
AMERICAN MOTORS & JEEP
CAR POWER II **\$18.95** POSTPAID
PLEASE SPECIFY WITH YOUR ORDER

HEARING AIDS UP TO 50% OFF COMPARABLE AIDS *

BUY DIRECT • 20 DAYS FREE TRIAL Body Aids \$39.95 up. Tiny All-in-the-Ear; Behind-the-Ear; Eye Glass Aids. No salesman will call. Write **LLOYDS** * Dept. PM, 905 9th St., Rockford, Ill. 61108 *

Make your own gems!

Fun - Easy - Profitable



Write for literature.

Kit includes Gem Maker with 6" iron lap wheel, all grinding, shaping and polishing wheels, diamond blade, accessories, instr.

\$49.90 less motor, fob Fctry.

B & I MFG.

Box 1267-P, Galesburg, IL 61401



FOOT LONG

BOWIE KNIFE

\$5.95 ppd

With hand-tooled cowhide sheath. Hand-forged and individually engraved heavy steel blade. Hand-made EAGLE grip with genuine horn inserts. Perfect for camping & hunting. We import these knives — they're made one at a time! You can't find this knife in any collection outside of a museum.

Add 5% tax in Calif
BOWIE KNIFE, Dept. PM9
4535 Huntington Dr. So.
Los Angeles 90032

GRANDFATHER CLOCKS SAVE 50% BUILD YOUR OWN GRANDFATHER AND GRANDMOTHER WEIGHT DRIVEN CLOCKS

• Highest Quality Imported Movements from Germany
• Tubular or Rod Chimes
• Moving Moon Dials
• Pre-cut Semi-assembled Handcrafted Case Kits (No power tools required)
• Dials, Barometers, Hygrometers, Templates and Case Plans.
All movements and dials in stock.

Send 50¢ for complete catalog
H. DeCOVNICK & SON,
P.O. Box 68, Dept. M92
Alamo, Calif. 94507
EST. 1947

DETROIT APPROVED—PICKUP TANKS

Original equip. type poly. now avail. in aux. tanks for pickups. Increase gas capacity 40 gals. Easy 1 hour installation—completely hidden—no body work necessary. Let truck discounts pay for tanks.



R.P.M. INC., Dept PM-972
P.O. BOX 7936, Waco, Texas 76710

WINDWATCH™ ANEMOMETER—WIND VANE \$19.95



Neon lights in indoor indicator show wind speed and direction. Decorative gold panel indicator comes factory wired and sealed in black finished wood frame. Designed for desk use or wall mount. Outdoor instruments of durable aluminum with electrical parts enclosed in rigid vinyl housings. Easy to assemble and install. Attach directly to roof or pole. Comes with wire and materials for installation up to 60 feet. Uses regular 120V AC. Unique low amp circuit assures absolute safety. A fascinating addition to any home. Five year guarantee. 15 day trial. Your satisfaction or money back. Only \$19.95 postpaid.

WINDWATCH Dept. F8, 104 Heimann San Antonio, Texas 78205

WATER WATER "HOW TO DRILL YOUR OWN WATER WELL" WATER WATER WATER WATER WATER
\$1.00ppd
 SATISFACTION GUARANTEED
DEEPROCK CO.
 OPELIKA, A.L.A. 36801



FREE!!! POWERFUL MUSCLES FAST!
 Fantastic New Discoveries in the science of bodybuilding. Now, in the privacy of your bedroom, our method will add inches of powerful muscles to arms, chest, shoulders & legs. Learn secrets on trimming the waist with ultra-modern methods—fast! Results Guaranteed! Send for free brochure. Universal Bodybuilding, Box 485-M1, Dearborn, Mich. 48121.

PREVENT ENGINE DAMAGE. Ten second Oil-Chekr test accurately measures motor oil contaminates and molecular breakdown point. Fits glove compartment. Use over and over. Detect pollutants before they wear on engine parts. Send \$1.89 for Oil-Chekr plus 50¢ for postage and handling. Fine gift item. Write Oil-Chekr.

CLIFF GRANBERRY CORP.,
 P.O. Box 9505, Dallas, Texas 75214.

BOAT PLANS-KITS



World's largest catalog, over 200 top designs for the amateur. Inboards, outboards, sail, deep vees, 8' to 57'—hydros, cruisers, house boats, ferro cement, plywood. Send \$1.00 for catalog or \$2.00 for catalog plus Boat Builder's Guide.

Other helpful books: Fiberglass-Boat Builder's Material, \$1.00 or send \$2.00, we include book, How to Fiberglass; Motor Installation—Boat Trailer Book with free plan, \$5.00; Ferro Cement-Plywood boat building book, \$6.00.

CLARK CRAFT BOAT CO.
 16PP Aqua Lane Tonawanda, N.Y. 14150

RAZOSHARP®

U.S. Pat. 3,608,195

\$2.25



PRECISION TOOL HANDLE FOR INJECTOR RAZOR BLADES

IDEAL POCKET KNIFE—EXCELLENT OFFICE AND HOUSEHOLD UTILITY TOOL—Only holder to use standard injector-type razor blades. Only holder allowing for varying blade length exposure. Only holder allowing blade to be completely sheathed and protected. Only razor blade holder to give precision tool feel.

ALWAYS RAZOR SHARP—When blade dulls—pop in new blade. Re-use injector type razor blades. **SHAVE AND SAVE.** Inexpensive injector type razor blades always available. To expose new sharp edge—reverse blade or clip dull edge. Excellent for cutting clippings, cardboard, trimming. Ideal for opening packages, cartons, boxes. Use for carving, whittling, sharpening, erasing, etc. Shape blade to suit use—snip edge, grind or break with pliers. Nothing to break or wear out.

RAZOSHARP® Dept. A-9
 421 Stockholm St., Bklyn., N.Y. 11237

WORLD WAR II STYLE COMBAT KNIFE
 Only \$2.75



Replica of the hated Nazi **COMBAT KNIFE** of World War II. Now made into a real man's hunting knife. 5½" blade, 9¾" over all length. Razor sharp high quality cutlery steel blade. Comes with Leather Sheath. Your treasure for only \$2.75 plus 25¢ handling charge.

WESTBURY SALES CO. Dept. NM-22
 P.O. Box 434, Westbury, N.Y. 11590

Easy to Build **PLANS AND INSTRUCTIONS** for
 Go Kart \$2.00
 Mini Bike \$2.00
 Mini Car \$3.00
 Pedal Boat \$4.00
 Sail Boat \$2.00
 Snowmobile Sleigh \$3.00

Mini Vehicles Plans Dept.-C P.O. Box 92 Chazy, N.Y. 12921

YOUR OWN RADIATOR BUSINESS

"\$70,000 LAST YEAR"

says **D. Carter, Lemoyne, Pa.**

Complete turn-key package: training school in radiator repair technology and business management plus special power-equipped auto radiator shop.

Don Carter writes: "Averaging \$30 an hour, expect to hit \$80,000 next year." Mail this coupon for complete story.

NAME _____
 ADDRESS _____
 CITY _____ STATE _____
 ZIP _____ PHONE _____

INLAND MFG. CO. Dept. PM-9
 1108 Jackson Street • Omaha, Nebr. 68102



Thousands of exciting tool values!

SILVO (BRAND NAME) TOOL CATALOG

Thousands of Exciting Tool Values! Stanley, Millers Falls, Skil, Thor, Wen, Diaston, Wiss, Wellsaw, Dremel, Speedy Sprayers, Plumb, Huot, Kennedy, Channellock, Porter-Cable, Rockwell, Melios, Vise-Grip, Crescent, Ridgid Pony Clamps, Unimat, Foredom and many other Nationally Advertised brands of Tools & Supplies. We ship Coast to Coast at prices hard to beat. Send 50¢ for our big 146 page tool catalog today. Silvo Hardware Co. PM-9 107 Walnut St., Philadelphia, Pa. 19106.

1600 FUN ITEMS

FREE! World famous catalog of hard-to-get Novelties, Jokes, Tricks, Hobbies, Sports, Science, Electronics, Funmakers, Psychedelia, Emblems, Posters, Magic, Games, Gifts, Models, Money Makers, Jewelry, Bargains, Gadgets, Books, Photo & Optical, Tools, etc. No letter necessary. Send name, address, Johnson Smith Co., Dept. C109, Mt. Clemens, Mich. 48043

Compressed air from car lighter!



auto-flator

● Now have air wherever you go! Even remote areas. Emergency air for tires, air jacks, space-saver spare. Inflate mattresses, boats, rafts, pools, Plugs into 12-volt system in auto, trailer, truck, boat. Space-age size . . . only 6½ inches long. Amazing pressure up to 60 lbs. Only \$29.95 (plus \$1.00 shipping) with air hose and inflator attachments. Send check or money order on 10-day, money-back, guarantee.

W. R. BROWN CORPORATION
 2773 N. Normandy Ave., Chicago, Ill. 60636

TOOL POWER™ 110 VOLTS D.C.

3,000 Watts 0-50 amps from your car's alternator. Operates heavy duty drills, saws, and lights, battery charging. Are welding. Does not operate A.C. motors on refrigerators and air conditioners. Installed in 10 minutes. Guaranteed 5 years. \$25.00 Postpaid. Dealerships available.

A.C. Generators 60 Cycles, 110 Volts,
 Fanbelt driven. Runs power tools, T.V.'s, refrigerators, radios, A.C. motors to ½ H.P. Cannot operate air conditioners. 1,500-watt \$60.00 plus \$5.00 postage. 3,000-watt \$99.50 plus \$6.00 postage. P.O. Box 7066. 2821 Mays St.

VIRDEN PERMA-BILT CO.
 PM Amarillo, Texas 79109

**NEW
HIGHWAY
SAFETY KIT**



Here is the Kit that's a must for every driver on the road. Packaged in a handsome reusable all purpose travel kit, contains the most essential Safety and Emergency items to meet the hazards and obstacles of driving. Guaranteed for one year against defects and workmanship. Price \$12.95 + 1.00 shipping charge.

Western Co. 1440 Iola G
— 8 Aurora, Colo. 80010

**FREE
FEL-PRO
GASKET MANUAL**

... for top performance in all gasket applications

Learn about the latest gasket materials and trouble-free gasket installation techniques from Fel-Pro... for 50 years a leader in gasketing improvements. Improve engine... transmission... and rear end performance with these helpful tips. 36 fact-filled pages.

Write: **FEL-PRO, INC.**

FEL-PRO

7452 N. McCormick
Blvd. Dept. PM
Skokie, Illinois 60076

**BE YOUR OWN BOSS
OWN YOUR OWN
VACUUM FORMING
BUSINESS**

Make 3-D Magnetic Signs for Cars and Trucks—Gift Plaques, Candle-molds, Bubble Packaging . . . and many, many more items. Earn 85 to 90% profit. Start in your home, garage or trailer . . . Full or spare time

Send For FREE Information

Name _____

Address _____

City _____ State _____

Zip _____ Phone _____

Vac Sign

959 Cheney Ave.
Marion, Ohio 43302.

COMMERCIAL FINANCING

Commercial financing anywhere in the U.S.A. and Canada. Loans from \$50,000 to \$50,000,000. Contact:

Larned Capital Corporation
515 Larned Building
114 S. Warren Street
Syracuse, New York 13202
(315) 422-0449

ELECTRIC-PAK

110 Volts from your car, truck.



30 amps power for saws, drills, lights, etc. charges batteries in 8 minutes, or welds light metal.
Assembled 19.95 ppd.
Kit & plans 12.95 ppd.
Plan only 3.95 ppd.
ARROW ELECTRIC CO.
1129 S. Bend Ave.,
South Bend, Ind. 46617

**THIS
IS
IT!**



Popular Mechanics said in July, 1969 (p. 166):

**"Handiest Tool
You Can Have
in Your Shop"**

It sands, grinds, polishes, sharpens. It's portable. Take it on the job. Use with any 1/4 hp motor. Model 165. Factory direct special.

\$26.95 less motor

ARCO MFG. CO.

P.O. Box 817, Grand Forks, N. Dak. 58201

DON'T PAY INCOME TAX.

Legally.

No matter what your income.

Rich men's methods adapted for Any-one's use. Free details.

TRAUHAUS

Dept. 37, Box 3004,
Duluth, Minnesota 55803



With a Lindal cedar home you've got it made.

The homes that blend with the scenery wherever you build. We use only the finest Canadian Cedar in more than 70 different designs. Parts are pre-cut and numbered for quick, easy assembly. And, Lindal tailors shipping costs to meet competition anywhere. So whether you want a home in the mountains or in the suburbs, let Lindal show you the natural way!

Send for your 36-page full-color plan book and get the details. Only \$1.



LINDAL CEDAR HOMES

Dept. PM29
10411 Empire Way S.
Seattle, Wa. 98178
(206) 725-0900

Enclosed is \$1 for my Lindal Cedar Homes Plan Book.

Name _____

Address _____

City _____ State _____

Zip _____

Area Code _____ Phone _____

Lindal is represented throughout the world.

Build POPULAR MECHANICS' little CARRIAGE HOUSE! Simply great! A back-yard building that isn't an eyesore. Styling blends in with most homes. It will take your mower, lawn furniture and tools—or the kids' overnight guests. Use it as your shop or home office. Overall outside dimensions 10-ft. 4 in. x 12-ft. 4 in. For one complete set of plans send \$3.95 to POPULAR MECHANICS Dept. FA, Box 1014 Radio City, N.Y. 10019. For two sets of plans (you may need one for your local building department) send \$5.49.

POPULAR MECHANICS

CLASSIFIED ADVERTISEMENTS

Rate: \$2.00 per word payable in advance each insertion. Capitalized words—75¢ per word additional. Minimum insertion ten words. To be inserted under the proper classification, copy must be in our office by the 10th of the second month preceding date of issue. The next available issue to place an advertisement in America's No. 1 Classified Section is November. The closing date is September 10th. Send remittance and order to H. E. Kappel, Popular Mechanics, 224 West 57th Street, New York, New York 10019. Please make remittance payable to Popular Mechanics.

POPULAR MECHANICS

WHEN ANSWERING ADVERTISEMENTS PLEASE USE THE ZIP CODE NUMBER

AUTOMOBILES

PATCHES Color Catalog 25¢. Shows Hundreds. Quotes Your Design. Patches, Dept. 99, RFD 1, Littleton, N.H. 03561.

****AUTOMOBILE FIRE EXTINGUISHERS**** \$2.98 & \$3.98—Distributors QTY. Price 87½¢ & 99½¢ Sample of Each. \$3.50 Pre-paid. Warne, 6922 Congress, Detroit, 48207.

SAVE \$20.00 To \$30.00, Recondition Your Shock Absorbers Better Than Original. No Special Tools or Skills. Satisfaction Guaranteed, Instructions—\$2.00. Advance Research, Box 8834, St. Louis, Missouri 63102.

\$1,159.97 AUTOMOBILE Savings. Guaranteed. Free Booklet. NASCO, P. O. Box 262, Dallas, Texas 75221.

FOR The Lowest Prices on 1972 Pontiacs, Mercurys and Lincoln Continentals, Write: Earl Shell, Jim Causley Pontiac, 17677 Mack, Detroit, Michigan 48224 (313) 886-1700.

ELECTRIC CAR Convert car to battery power 50 MPH, SCR solid state control, 30 page plans \$10. Seecom, Box 1274, Tustin, Cal. 92680.

GAUGES—INSTRUMENTS—All Types, Auto, Aircraft, Marine, Motorcycle—Head, Oil, Water, And Exhaust Temps. Tachometers, Speedometers (Etc). Guaranteed. Gateway-6184, General Tinker, Sarasota, Florida 33580.

120 VOLTS At 3000 WATTS Of electricity from ANY alternated vehicle! Operate drills, saws, wrenches, heaters, and many more AC devices! Arc weld ¼" steel! Series or parallel charge 6, 12, 24 volt batteries! Will not harm alternator! Ten minute installation! Guaranteed Five Years! Send only \$14.95 post paid for adapter—\$3.00 extra with indicator (comes on automatically when alternator produces 120 volts!) Build it yourself! Plans only \$5.00—Plus many more products!—Ask for FREE catalog—Creative Products, 1551 East Loop 820, Dept. M-972, Fort Worth, Texas 76112.

SAVE Money—End expensive repairs! Booklet can save you hundreds of dollars. Experts show you how. \$1.95 Postpaid. Cum-Shop, 10907 S.E. Third Street, Bellevue, Washington 98004. Booklet PMA—118.

AUTO SUPPLIES AND EQUIPMENT

HYDRAULIC Jack repair kits, parts and supplies. Catalog 50¢ (in coin). Hydraulic Jack Packing & Tool Co. Inc., General P.O. Box 3, Staten Island, N.Y. 10314.

STOP CAR THIEVES This electrical protector will make car impossible to start, even if thief has key. \$5.00 Satisfaction Guarantee. D. J. Bird, 2700 Chartres St., New Orleans, La. 70017.

VACU-Shine Amazing New Product "Washes" And Shines Your Car In Minutes Without Water Or Soap Day Or Night, Year Around. Saves You \$100.00 A Year. Lasts For 2 Years. Guaranteed. Only \$2.98 Postage Paid. Rick's Value Mart, Merriman Rd., Island Falls, Maine 04747.

PARTS: Army jeep and truck parts. Spare Parts & Equipment Co., P.O. Box 751, Lexington, Kentucky 40502.

ALTERNATOR/Generator Rebuilder's Course: Includes Tooling & Test Equipment; Write: Hedelund Engineering, P.O. Box 2127, Sepulveda, California 91343.

MOTALOY, Ring—Valve job while driving—\$6.00. Free literature. E&G Sales, Box 18384-P, Memphis, Tenn. 38118.

RING-Valve Job while driving. \$6.50 postpaid. (Two-\$12.00). . . . Established 1951. . . . Results Guaranteed!! Motaloy, Grantham, Penna. 17027.

RING-Valve job while driving. Motaloy Pellets—\$6.00. Guaranteed!! Havasau Products, 23311-B Demley, Mt. Clemens, Michigan 48043.

ANTI-SWAY BARS For all popular domestic and import autos. Front & Rear, Street and Heavy Duty. Enjoy the safety of flat taut, balanced cornering & Highway stability. Free stock list. \$1.00 for handling booklet. Mastercharge & Bank Americard phone orders O.K. ADDCO, Watertower Road, Lake Park, Florida 33403.

VW OWNERS . . . Gain 7-15 M.P.H. and More Power. Patented. Guaranteed. \$14.95. Lasts 15,000 miles. CMI Sales, Inc., 2154 S. Jason St., Denver, Colo. 80223.

AUTO Enthusiast! Pocket computer ends all guess work. Provides fast accurate readouts. Weight; power ratio; elapsed time; gear ratio; etc. Send \$1.97. Calculator, Dept. 269, 302 Robinhill Drive, Altamonte Springs, Fla. 32701.

ALTERNATOR ADAPTER Electric power from car's alternator. Assembled units \$12.50 P.P. Lowest price anywhere. Bird, 2700 Chartres St., New Orleans, Louisiana 70117.

IMPROVE MILEAGE: Recycle Unburned Gas Through Miracle Fluid. Complete Assembly \$4.95 Postpaid. Resource Distributing, P.O. Box 9333, Neville Island, Pa. 15225.

SAVE Money—Nationally Known Auto Expert shows how in Auto Repair Book. Save hundreds of Dollars. Rush \$1.95. Lochala, 1407 Cypress, Crossett, Arkansas 71635.

MOTALOY . . . \$6.00 (Two—\$11.50) Postpaid. . . . Guaranteed!! Free Gift With Order . . . Targus, 2113 Atlantic, Virginia Beach, Virginia 23451.

RING-VALVE JOB While Driving. . . . Fully Guaranteed—\$6.00—Two \$11.00. . . . Motaloy, Box 1149-MS, Midland, Texas 79701.

UNBELIEVABLE DIRECTORY—950 Wholesalers And Manufacturers Sell To You Direct By Mail. Everything From Automobile Equipment, To Zippers. \$2.00. Wholesale Cooperative, 8616 Hull Drive, Philadelphia, Pa. 19118.

NOVEL Inexpensive Glowing Gage Continuously Checks Ignition Performance. QARC, Box 47876, Los Angeles, Calif. 90047.

WINDSHIELD Polishing Kit. Complete scratch remover kit with necessary polishing powder and polishing wheels. Directions complete. Send \$5.50. ESCO Optical Products, 168 Oak Ridge Rd., Oak Ridge, N.J. 07438.

DO-IT-YOURSELF! SAVE MONEY! 484-page, big, illustrated catalog/guide. Latest parts, tools, supplies, electrical equipment. \$1.95 ppd., refundable. **DO-IT-YOURSELF SUPPLY**, Box 1196C, El Monte, Calif. 91734.

JEEP Owners—V8 conversions. Read Jeep Owner's ad, page 1720.

SNOWMOBILES

SNOWMOBILE Hop up accessory CATALOG. Speed and performance equipment—manifolds, exhaust systems. Send 25¢. G.E.M. PRODUCTS, Box 845, Carol Stream, Ill. 60187.

DECALS, Bumper Strips, Pressure Sensitive: Vinyl, Mylar, Metaflake: Your Design: Embroidered Patches Too: Tallon, 3136 Lone Pine Road, Schenectady, New York 12303.

AUTO TRAILERS

PICKUP Camper, Trailer or Pickup—Cover . . . Build yourself. Save! Complete plans \$3.95 each cover plans \$2.00 Conversion Plans—econoline type van \$2.95; passenger bus or delivery van \$2.95. Satisfaction guaranteed. Equipment catalog \$1.00 (refundable). Details 10¢. Viking Camper Supply, 99-F Glenwood, Minneapolis, Minnesota 55403.

MOTORCYCLES, BICYCLES MOTORSCOOTERS & SUPPLIES

BUILD "Popular Mechanics" MINIBIKE Featured June 1967. Detail plans, photographs, illustrated parts catalog \$2.00 refundable or catalog 25¢. Gilliom Minibike, St. Charles, Missouri 63301.

HONDA! \$25 Other Bargains. Send 50¢. Motorscooter, P443, Bend, Oregon 97701.

FUN—BUGGY Catalog. Just out. World's first, biggest, featuring ATV's, Mini-bikes, Karts. \$2.00. "How-to" plans \$1.00. Complete parts stock. Bargain prices. Brown's Motorsports, 19P Central St., Worcester, Mass. 01608.

(Continued on next page)

MOTORCYCLES, BICYCLES MOTORSCOOTERS & SUPPLIES

(Continued from preceding page)

ILLUSTRATED Catalog 25¢. Parts, Accessories, Custom Stock, most makes, models, Cycle Supply, Box 192M, Fairbury, Ill. 61739.

MINI-BIKE, Sno-Kart, Plans 75¢. Parts Catalog 25¢. Loren Products, Danville, Illinois 61832.

EZWELD Minibike & Kart Plans with Buyer's/Buyer's Discount Catalog—\$1.00. A-1 Service, Claypool, Indiana 46510.

SPACE, ROCKETS AND ASTRONAUTS

ANTIGRAVITY DEVICE. Brochure 35¢. AGD, Box 3062-PM, Bartlesville, Oklahoma 74003.

ROCKETS: Real flying models—flights up to 2500 ft. New illustrated catalog 25¢; Singles and multistage kit, cones, engines, launchers, trackers, rocket aerial cameras, technical information. Fast service. Estes Industries, Dept. 7-J, Penrose 7, Colorado 81240.

MOON Landing Pictures, other historic space fantasies! Free Brochure! Cape Kennedy Medals, 723 North Courtney Parkway, Merritt Island, Florida 32952.

ROCKET Kits, engines, launchers, accessories. Send 25¢ for packets of iron-ons, decals, literature. Fast service. Aerospace Vehicles, Inc., Box 77E, Mineral Point, Wisconsin 53565.



AVIATION

BUILD—One-Man jet helicopter. Easy inexpensive. Detailed plans, drawings—\$5.00. Helicraft, Box 7153, Baltimore, Maryland 21218.

AIRBOAT, Propellers, Engines, Hubs, Mounts, Plans, Supplies. Corvair, V-W conversions. 15, 20, 25 H.P. removeable air drives. Kit airboats \$450.00 up. Hovercraft engines, hubs, propellers. Gyrocopter propellers. Catalog \$1.00. Banks-Maxwell, Box 3301E, Ft. Worth, Texas 76105.

HANGGLIDER CRONKITE 5. High Aspect Rogallo Type. Needs no wind, supersoarable, 50 lbs. complete plans \$5.00. D. Cronk, P.O. Box 1362, Torrance, Calif. 90505.

HOVERCRAFT

PRACTICAL DESIGN GUIDE For Airboats and ACV's. Send \$5.00 To: Palmer Aero., P.O. Box 1891, Coral Gables, Fla. 33134.

AERO-CAR. Amazing Hovercraft built easily with ordinary tools. Lawnmower engine power. Carries one man plus. Hovers, flies forward, backward, sideways over land/snow/water. Complete construction plans and brochure. \$5.95. Aero-Projects, Box 5118PM, Clinton, New Jersey



BOATS AND TRAILERS

FREE 112-Page Catalog! Backpacking, Camping, Boating Supplies, Clothing, Wild-wood Tents, Laacke & Joys, 1439 N. Water, Milwaukee, Wisconsin 53202.

KAYAKS, Canoes, Kits, Building plans, Instructions. Guaranteed. Free Catalog. Outdoor Sports, Box 1213P, Tuscaloosa, Alabama 35401.

FIBERGLASS Cloth, matt, polyester and epoxy resins. Wholesale catalog 25¢. Boat Molding book 30¢. Seifert's, Box 1206-M, Green Bay, Wis. 54305.

FIBERGLASS Canoes, Kayaks, and Duck-boats. Many exciting models. Easily assembled kits. \$39.95 up. Free Literature. Riverside Canoes, Box 5595P, Riverside, Calif. 92507.

FIBERGLASS Cloth and resin. World's finest cloth and non-run resin, at direct mill prices Flotation foam. Complete line of plastics, silicon bronze and brass screws, save 60%. No sales tax. Boat Plans. Catalog 25¢. Freight prepaid. Stiles Boat Supply, Box 11P, Linden Ave., Mantua Hts., N.J. 08051.

CANOE! Kayaks! Factory-direct quality kits, from \$25.00. Many different models. Canvas hulls. Strongest construction materials. Free literature. Sportscraft, Box 636-P, Allentown, New Jersey 08501.

PLANS, FULL-SIZE PATTERNS, FRAME KITS With step-by-step instructions specially for amateurs. Send \$1.00 for new catalog just off press—nearly 100 pages, over 100 designs 8' to 42': Sail, Jets, Inboards, Outboards, Cruisers, Houseboats, Hot Boats, Catamarans, Hydros, Glen Designs, 9152 Rosecrans, Bellflower, Calif. 90706.

CANOE Kits—Wood Canvas, Molded Fiberglass—Free Catalog, Canoe—Camping Log Book \$1.00. Trailcraft, Inc., Box 60686, Concordia, Kansas 66901.

LIGHTS Of all kinds, electrical accessories, portable power, cook and tableware. Free catalog. Bass, Box 901PM, Marblehead, Mass. 01945.

BOAT KITS-PLANS AND PATTERNS-FRAME KITS World's largest catalog. Over 200 top designs. Sailboats 7'-45' Windmill, Snipe, etc. Motor sailers, trimarans, catamarans, power cruisers, houseboats, deep-V's, fishing boats, runabouts, hydroplanes, inboard and outboard. Ferro cement 33'-57' sail and power. Send \$1.00 for Plan Kit Catalog or \$2.00 for catalog plus Boat Builders Guide to: Clark Craft, 16-P Aqua Lane, Tonawanda, N. Y. 14150.

FIBERGLASS And BOAT BUILDERS' MATERIAL At factory to you prices. Cloth, resin, foam, plywood, boat nails, screws, marine equipment. Send \$.35 for catalog or \$1.00 for catalog plus book on fiberglass uses, mold making etc. to: Clark Craft, 16-P2 Aqua Lane, Tonawanda, N. Y. 14150.

NEW 1972 Outboards . . . Top Brands . . . 6 H.P. \$282.00, 18 \$414.00, 40 \$558.00, 50 \$708.00, 65 Selectric \$958.00. All sizes, Literature 50¢. Scott-McCulloch Parts. Electra Marine, 675 Merrick Road, Lynbrook, N.Y. 11563.

FREE Catalogue—plans, patterns, supplies; canoes, sailing canoes, kayaks, trailable cruising sailboats. Quicksilver, 255A Shamrock Blvd., Venice, Florida 33595.

FREE Auto, Boat Compass Brochure. Cazin, 526 Maple, Redwood City, Calif. 94063.

FREE Catalog—Boatbuilding Supplies at discount prices. Fastenings, fiberglass, resin, etc. Glen Designs, 9152 Rosecrans, Bellflower, California 90706.

FIBERGLASS Cloth, mat, resin. Flotation foam. Complete supplies. Catalog 25¢. Kick-Shaw, Inc., 3511 Hixson Pike, Chattanooga, Tenn. 37415.

CAMPERS AND TRAILERS— KITS—PLANS—

CABOVER Campers, Pick-Up Covers, 10' & 20' Trailers. Build and Save. Large scale Plans and Full-size Patterns with written & pictorial instructions. Complete accessory and aluminum covering kits. Free Literature. Glen L, 9152 PM-9 Rosecrans, Bellflower, Calif. 90706.

FREE Pick-up camper lift. New patent pending concept utilizes power of pick-up and unique cam action to load and unload camper in minutes. Eliminates muscle-straining winches, cranks, and jacks. New program lets you get lift free for limited time. Dealerships available. Write: Bradshaw Incorporated, 1708 South Gate Road, Montebello, California 90640.

MARINE EQUIPMENT AND SERVICES

MARINE SURVIVAL KIT Contains all items necessary for emergency use by boaters. Compact 33 item kit! Just \$20.00 ppd—Guaranteed. Details upon request . . . M. Robbins Enterprises, Dept. L1PM10, Box 686, Pebble Beach, Calif. 93953.

MARINE Engines, conversions, parts, equipment. Catalog Free! Stokes Marine Industries, Coldwater, Michigan 49036.

CONVERT Auto engines to marine. 68 Page Catalog, 50¢. Lehman Manufacturing Company, 800 Elizabeth Avenue, Linden 4, New Jersey 07036.

MARINE Supplies, Ignition Parts. Free literature. Michael's, 991 Broadway, Bayonne, New Jersey 07002.

FREE Brochure Conversion Kits, Propellers, gears V-Drives 1/0 Drives Gas, Diesel. Starmarine, 1931 Embarcadero, Oakland, Calif. 94606.

ATHLETIC AND BODY BUILDING COURSES

"GIANT Arms." Dr. Young's. D.C. revolutionary discovery. \$2. Satisfaction or refund. Gaucho, 1769-A-7, Chicago 60690.

POWERFUL Muscles fast! Free brochure! Universal Bodybuilding, Box 4327-C, Dearborn, Michigan 48126.

NEW!!! Mr. Universe Bodybuilding catalogue—25¢. WFH, 18959 Inkster, Livonia, Michigan 48152.

"BUILD Muscles Faster!" 24 Nutritious Food Concentrates, 3 months supply \$7.00. Moneyback Guarantee. Better Health Club, Box 332-PM, Devon, Pennsylvania 19333.

NUNCHAKU FOR SELF-DEFENSE. An Effective And Fantastic Method Of Self-Defense Completely Illustrated. Easy To Learn. Book \$4.25, Nunchaku \$4.25, Postpaid. Kaneshiro, Box 651, Chicago 60690.

PUSHED AROUND? Stop tough guys instantly with amazing new Police Jujitsu Karate. Complete method \$1.00 Success or refund. Kingco, 2 Deepdale, Great Neck, New York 11021.

SPORTING GOODS AND EQUIPMENT

FREE 1972 Catalog! Guaranteed lowest prices! Rods, Reels, Lures, Accessories—Thousands of items. Cabela's, Inc., Dept. S-9, Sidney, Nebraska 69162.

FREE Catalog low direct factory prices, fishing, Hunting, Archery, reloading Camping supplies. Send today. Herbers Inc., Dept. CPM, Waseca, Minn. 56093.

FREE WHOLESALE CATALOG. Lure parts, Molds, Rod Blanks, Reels, Archery, Metal Detectors, Rare Hardwoods. Finnysports (ME), Toledo, Ohio 43614.

CROSSBOWS Powerful Accurate. Catalog 25¢. Crossbowman, Box 723PM-9, Manteca, California 95336.

NYLON JUNGLE HAMMOCK—Fits in your pocket, yet holds 500 lbs. Perfect for hunters, campers, hikers. 6.95 ea. Aries, Dept. PM, P.O. Box 2174, Rockville, Maryland 20852.

PERMANENT MATCH—HUNTERS, CAMPERS, FISHERMEN. 10,000 lights fits key-chain, \$1.25. Unique Products, Box 226, Worcester, Mass. 01606.

AIR GUNS! Most name brands. At discount prices. Free price list. Toby's, Box 3100-A, Miami, Fla. 33169.

BILLIARD CUES & Accessories, Detail's Free. Murphys' 39, Box 5352, Santa Monica, California 90406.

(Continued on next page)

SPORTING GOODS AND EQUIPMENT

(Continued from preceding page)

FREE CATALOG! New fall edition. Over 1,000 products for the sportsman. Backpacking, camping, hunting clothing and equipment. Exclusive men's and women's sportswear. Ideal sportsmens' gifts for home and outdoors. Gokey handmade boots and moccasins. Write today: Gokey Co., 21 West 5th St., Dept. PMC, St. Paul, Minn. 55102.

BACK Strengtheners! Stomach Slimmer! Tension Reliever! "Wonder Wheel," Free Information! Order \$2.98 Plus 35¢ Postage. Wamoth, Box 5381-189, Shermanoaks, California 91413.



FISHING, TACKLE, LURES

FISHERMAN'S DREAM BOOK—FREE, 170 page catalog just loaded with Hard-To-Find Fishing Tackle Specialties and Do-It-Yourself Goodies. Our 28th year. **NETCRAFT Inc.,** Box 5510, Toledo, Ohio 43613.

MOLDS—For casting your own fishing sinkers. Free illustrated booklet. Reading Instrument Co., Box P-78, Reading, Pa. 19603.

EARTHWORMS, LIVE BAIT

EARN Money raising fishworms for us! Exciting details free! Oakhaven—56, Cedar Hill, Texas 75104.

GROW Fishworms. Outstanding new breed produces great profits. Free Literature. Fain's Hatchery-31, Edison, Ga. 31746.



HUNTING, GUNS, DECOYS

BE A Two Season Hunter! Hunt with a bow first during bow season then with your gun during gun season. Double your enjoyment of the great outdoors! Send 25¢ (for postage and handling) for our full color catalog of archery equipment. Bear Archery, Dept. PM, Rural Route One, Grayling, Michigan 49738.

DOGS AND KENNELS

LOOKING For a Special Puppy—Send \$1.00 for catalog with prices and information on more than 100 breeds. Hoppe's Kennels—Rt. 2A—Hill City, Kansas 67642.

POULTRY AND GAME BIRDS

QUAILS, Incubators, cages, supplies catalog. Marsh, 14216 Brookhurst, Garden Grove, Calif. 92643.

GAMEBIRDS: Started And Adult. Pheasant, Quail, Chukar, Mallards, Turkeys; Game And Ornamental. Free Catalogue. Northwest Farms, Inc., Box 3003-PM, Portland, Oregon 97208.

RABBITS—CHINCHILLAS—FUR BEARING ANIMALS

RAISE Chinchillas. Guaranteed income. Catalog \$1.00. DeShon Chinchilla, Route 2H, Roanoke, Indiana 46783.

RAISE Rabbits for us. \$500 month home facts. 48 page illustrated book describing 25 breeds. Housing, breeding, feeding, markets, marketing etc. 25 cents. American Rabbit Association. 36 Arba Building. Pittsburgh, Penn. 15217.

AMAZING PROFITS! \$10,000 Yearly Raising Rabbits for Wool and Breeding. Details 25¢ coin. American Angora, Malta 12, Montana 59538.

MAKE Big Money Raising Chinchillas, Cavies, Rabbits for us. Catalog 25¢. Keeney Brothers, New Freedom, Pa. 17349.

RAISE Commercial Rabbits for us! Complete details \$2.00. J. B. Breeders Association, Box 6432, Rochester, Minn. 55901.

\$500-\$1000 MONTH Plan Raising Rabbits For Us. Free Details. White's Rabbitry, Mt. Vernon, Ohio 43050.

CHINCHILLA INCOME GUARANTEED. Terms. 25¢. Bulletin \$1.00. Chinchilla, 11PM, Port Richey, Fla. 33568.

PETS—BIRDS, CATS, HAMSTERS, ETC.

PETS, Reptiles, raccoons, skunks, squirrels. Catalogue 25¢. Trails End Zoo, St. Stephens, S.C. 29479.

LIVE Seahorses and all types of salt water fish. Illustrated catalog 25¢. Tropical Premium, Box 3234, Pompano Beach, Florida 33060.

HORSES, LIVESTOCK

"HOW TO TRAIN HORSES"—FREE Book tells how to break, train, make money with horses. Beery School, 1109, Pleasant Hill, Ohio 45359.

CAMPING

PAK TENTS—Inexpensive. Free Literature. Martins—Box 141, Fremont, Calif. 94537.

ELECTRICAL SUPPLIES

METERS—Surplus, new, used, panel and portable. Send for list. Hanchett, Box 5577, Riverside, Calif. 92507.

SURPLUS Electronic Parts List \$375.00. Unit yours \$25.00. Postpaid List \$1.00. Jay Surplus, 1606 Madison, Kansas City, Missouri 64108.

LAMP Parts. Catalog, prices, wiring instructions. 50¢. Refunded first order. Gyro, 5218P N.W. 35 Ave., Miami 42, Florida 33142.

TRANSVERTER CHANGE FOREIGN ELECTRICITY TO U.S.A. ELECTRICITY. Operates All American Electrical Equipment Overseas. Send \$28.00 or Model 50-123. Terado Corporation, 1068 Raymond Avenue, St. Paul, Minn. 55108.

DO-IT-YOURSELF! SAVE MONEY! 484-page, big, illustrated catalog/guide. Latest parts, tools, supplies, electrical equipment. \$1.95 ppd., refundable. **DO-IT-YOURSELF SUPPLY,** Box 1196C, El Monte, Calif. 91734.

TRAVEL & RESORTS

PROFITS FROM CLASSIFIED ADVERTISING! Booklet shows you how to start your own business with Classified Advertising. Only \$1.00 (Refundable with first order.) **C. A. MARTIN, POPULAR MECHANICS, DEPT. P, 224 WEST 57 STREET, NEW YORK, N.Y. 10019.**

BATTERIES, GENERATORS

BATTERY Reconditioning Kit, includes molds, material, instructions. Battery Shop, Box 820, La Quinta, California 92253.

BATTERY Terminal Protectors Stop Battery Corrosion. Free Literature. Pracna's, 3301 Buchanan Road, #83, Antioch, California 94509.

ENGINES, MOTORS, MAGNETS

WINDING Data. 275 motors, \$1.25. Data Company, 512 Kensington, Kansas City, Mo. 64124.

STEAM Engine Kits, Catalog-Handbook \$1.00. Reliable Industries, New Baltimore, Mich. 48047.

OPERATE Three Phase Motors From Single Phase. Many Ways. \$3.00. Don Howell, Barnesville, Ohio 43713.

MACHINERY, TOOLS AND SUPPLIES

SPECIAL Left hand or right hand taps, extra long drills are our business. Allen Supply, Box 788, Cedar Rapids, Iowa 52406.

FINEST Woodcarving tools, supplies—catalog 50¢. Woodcarvers Supply, 3112 West 28th, Minneapolis, Minn. 55416.

UPHOLSTERY Sewing Machines re-manufactured. Singers New Motors \$359.95. Free Shipping. Sewmachines, 109 Drake, Modesto, California 95350.

MICROMETERS—Indicators. Steel—Aluminum—Brass. Maximat, Unimat Lathes. Complete mailing—50¢. Campbell, 1424 Barclay, Springfield, Ohio 45505.

SMALL Foundry furnaces. Supplies. Free literature. Pyramid Products, 3736 South 7th Avenue, Phoenix, Arizona 85041.

WINCHES And **HOISTS.** Choice of 12 volt or 110. Reversible, compact, fast. 1/4 ton to 1 ton capacity, from \$49.95. 50¢ brings 16 page full color catalog. Refundable. Superwinch, Inc., Dept. PM, Pomfret, Connecticut 06258.

MAXIMAT, Unimat Sale. Amazingly low prices. Deco-M, 562 Howard Avenue, Staten Island, N.Y. 10301.

MAXIMAT, UNIMAT Save at our low prices. Pioneer Electric, Box 7X, Brentwood, New York 11717.

END Mills. Lathe Milling Attachments: Information. Potter, Box 73, Cedar Rapids, Iowa 52406.

METAL Cutting Lathe \$62.50. Milling Drilling Attachment \$27.50. Tool, Material Bargains. Complete Listings 50¢. Refundable. Taig Mfg., 15048 Proctor, Industry, Calif. 91746.

GERSTNER Tool chests new **SECONDS** Catalog 25¢. Gerstner & Sons, Dayton, Ohio 45407.

SCREWS, Nuts, Bolts, Tools, Catalog 25¢. Nutty Co., Box 1576, SMSP, Fairfield, Conn. 06430.

SEND 10¢ Postage For Free Drill, And Surplus Tool Lists. Save Up To 90%. Salme, 15 Briarcliff Lane, Holden, Mass. 01520.

WELDING, SOLDERING, PLATING

MORRIS Welders—110/220, 170, Amperes, \$59.50. 1070 Inner, Schenectady, New York 12303.

WELDER. Variable amps for motors, etc. Costs pennys. Plans \$1.00. Lacey, Box 21, Yorba Linda, Cal. 92686.

PLATING Equipment, Portable Platers, Supplies, and "Know-How". Build your own tanks for nickel, chrome, etc. Easy-to-install PVC liners. Rectifier components—all sizes. Schematics, parts lists, formulas, operating instructions for all plating. \$10.00 post-paid. Guaranteed to save you 25%-75% or immediate refund. Some good used units for sale. Platers Service Company, 1511-A Esperanza, Los Angeles, California 90023.

CHROME! Nickel! Copper! New illustrated electroplating manual! Includes all formulas, instructions! \$3.00. Absolutely guaranteed. Qrew, Box 8-PA, Bourbonnais, Illinois 60914.

WELDERS, Convert To Heliarc. Weld All Kinds Of Metals. You Can Build This O-225AMP High Frequency Heliarc Unit From Junk Box And Approximate \$9.00. Picture Of Completed Unit. Plans And Where To Get Parts. Send \$4.00 To: Information Supply Company, Box 166, College Park, Maryland 20740.

GOVERNMENT SURPLUS

GOVERNMENT Surplus. Complete Sales Directory \$1.00. Surplus Publications, Box 26062-M, Los Angeles, California 90026.

JEES!!! Pickups!!! 100,000 items direct FROM GOVERNMENT. How? Where? YOUR AREA. Latest information: \$2.00. **MONEY-BACK GUARANTEE.** Dependable, Manual #116, Box 113, Vista, California 92083.

(Continued on next page)

GOVERNMENT SURPLUS

(Continued from preceding page)

NO CATCHES. Buy any surplus direct from U.S. gov't. All information \$2.00. Bridgworth, P.O. Box 2292-C, Vancouver, Washington 98661.

GOVERNMENT Surplus. How and Where to buy in Your Area. Send \$1.00. Surplus Information, Headquarters Bldg., Box 30177-PM, Washington, D.C. 20014.

1972 SURPLUS Army, Navy store. 52 Page illustrated catalog. Send 50¢. Ruvel, 3037 North Clark, Dept. 9-J, Chicago, Illinois 60614.

JEeps \$52.40. Airplanes \$75.01. Typewriters \$6.70. Boats \$7.50. Direct from Government, Directory and Surplus Catalog \$1.00 (Refundable). Midwest Surplus, Box 401-PM, Dayton, Ohio 45401.

GOVERNMENT Surplus Official Guide How And Where To Buy Government Surplus Only \$1.00. Enterprises, 3263 Lucerne Ave., Lake Worth, Florida 33460.

JEeps Typically From \$53.90 . . . Trucks From \$78.40 . . . Airplanes, Typewriters, Boats, Clothing, Camping, Sporting, Photographic, Electronics Equipment. Wide Variety. Condition. 100,000 Bid Bargains Direct From Government Nationwide. Complete Sales Directory and Surplus Categories Catalog \$1.00 (Deductible First \$10.00 Order From Our Separate included Catalog). Surplus Service, Box 820-A, Holland, Michigan 49423.

1000 KNIVES, All Kinds!!!! Government Surplus, clothing, tents . . . Illustrated catalog . . . Send five 8¢ stamps . . . B.W.T., Box 692-49, Newark, Ohio 43055.

JEeps . . . Buses . . . Vans . . . Trucks . . . Automobiles from \$52.50. Airplanes, Boats, Typewriters. Direct From Government. Directory and Surplus catalog \$1.00 (Refundable). Southern Surplus, Dept. PM-4, Manchester, Kentucky 40962.

JEeps From—\$52.50: Typewriters from —\$4.15; Cars from—\$31.50. Walkie-talkies, motorcycles, airplanes, boats. Typical "As Is" bid bargains from Uncle Sam. Tremendous variety. Exciting free list. Write: Enterprises, Box 402X-80, Jamaica, New York 11430.

JEeps! BARGAINS!! How, Where To Buy Wide Variety Of Surplus From Government. Latest Information: \$2.00. **MONEYBACK GUARANTEE.** Surplus, 1181-S2 Vintner, Pleasanton, California 94566.

SURPLUS BARGAINS—War, government, Industrial surplus at savings to 80%! Clothes, boots, coats, tents—bargains for farm, home, outdoors. **SEND FOR FREE CATALOG—**must give zip code. **SURPLUS STORE,** Sioux Falls, S.D. 57102.

GOVERNMENT Surplus Buying MANUAL 75¢. Surplus **BARGAIN** Catalogue 60¢. **BOTH,** plus Free **JEEP** Story \$1.00. Surplus Bargains, Box 789PM3, York, Pa. 17405.

YOUR AD IN POPULAR MECHANICS WILL BE SEEN By More than 5,000,000 active buyers for your products and services. It costs only \$2.00 per word. And, if you wish to turn all or part of your ad in bold capital letters—you can do so for as little as 75¢ per word additional. Act now! Send your Classified ad to: **POPULAR MECHANICS, CLASS. DEPT., 224 WEST 57TH STREET, NEW YORK, N.Y. 10019.**

JEEP And Gov't. Surplus Buying Manual (Jeeps Pictured) 75¢. Surplus Bargain Catalogue 60¢. Both \$1.00. Surplus Bargains, Box PM1, Spring Grove, Penna. 17362.

HOBBIES AND COLLECTIONS

GEM Making Book, Illustrated, \$1.00. Covington's, 112 First St., Redlands, Calif. 92373.

50 GORGEOUS Jungle Butterflies \$2.90. Collectors Wonderland, Box 1170, New York 10008.

COLLECT Military Medals, list 25¢. Vernon, Box 387PM, Baldwin, N.Y. 11510.

BUILD Your own reflector telescope. ESCO is back. Do-it-yourself reflector telescope kits. Send for details. See the moon and stars. Mirrors and lens kits. ESCO Products, 161 Oak Ridge Road, Oak Ridge, N.J. 07438.

WE List over ONE THOUSAND CATALOGS of Materials, Supplies, & Unusual Items for Hobbyists, Craftsmen, Experimenters, Sportsmen, etc. Send \$2.00. **MAST-R-LOG,** Box 24413 M, Oakland, Cal. 94623.

DISCOVER AMERICA'S FASTEST GROWING HOBBY. White's Electronics, Inc., would like to send you—absolutely FREE, their 42 page, fact-filled catalog on Mineral and Metal Locating Equipment. Amateurs or Professionals select from the world's largest line of metal detectors, priced as low as \$79.50, up. Detect Gold, Silver, Copper—Nuggets, Coins, Jewelry, etc. Budget terms available. For your convenience we have three major factory locations in the U.S. and Canada, as well as over 1,000 authorized dealers to serve you. See your local Yellow Pages under "Metal Locating Equipment", or write: White's Electronics, Inc. Room No. 381, 1011 Pleasant Valley Road, Sweet Home, Oregon 97386—Elk-Air Industrial Park, Dexter Drive, East, Elkhart Indiana 46514—or White's Electronics Ltd., 33784 Hazel Street, Abbotsford, British Columbia, Canada.

NAZI Relics Illustrated Catalog \$1.00 (Refundable). Delta, Box 361PS, Lafayette, Calif. 94549.

COLLECTOR'S Guides. 3 Volume Set (192 Pages each). Lists exact date, buying and selling prices of every valuable United States Stamp, coin and paper money. Set \$2.98 Postpaid. Cum-Shop, 10907 S.E. Third Street, Bellevue, Washington 98004. Order PMA-871.



STAMP COLLECTING

STAMPS FROM 88 COUNTRIES—ONLY 10¢! Worth \$5.00 at catalog prices: Incredible collection of genuine postage stamps from 88 different countries—from Afghanistan to Zambia, North to South Pole! Stamps nearly 100 years old. New Issues, Moon and Outer Space stamps, etc. All for only 10¢. Also, other exciting stamps to examine free. Buy any or none, return balance, cancel service anytime. Plus Wonderful Free Catalog! **H. E. HARRIS,** Dept. AS-11, Boston, Mass. 02117.

YOURS FREE! 40 RED CHINA Postage Stamps banned to American collectors for a generation by U.S. Gov't. Now at last you can legally own them; and these stamps are so worth having that experienced and beginning collectors alike want them—so act fast, because supplies are strictly limited! You also get 110 other stamps from Britain's Lost Empire plus illustrated Album to keep as a Bonus should you buy \$1 from our Approval Selection. Or return Album and 110 stamps with selection and buy nothing. Cancel service anytime. But Red China stamps are yours to keep! Send 10¢ for mailing while supplies last. Kenmore, Milford RC-200, New Hampshire 03055.

SEND Only 10¢ for the most wonderful catalog of stamp offers in America. You will also receive a special bonus collection of 150 different stamps from St. Vincent, Rwanda, Russia, etc. Littleton Stamps, Dept. MN-1 Littleton, N.H. 03561.

GIANT Stamp Collection including: Astronauts, Satellites, Moonrockets, Boy Scout issue. Complete U.N. Set, recent Olympic and Sport issues from many countries, etc. Plus Big Stamp Dictionary and approvals. Everything 10¢! Stampex, Box 47-RM, White Plains, N.Y.

ISRAEL 25 Diff. Hard-To-Get Israel only 10¢ to Worldwide & U.S. Approval Applicants. **KAYCO,** P.O. Box 437, Flushing, N.Y. 11367 Department M.

50 DIFF. U.S. COMMEMORATIVES 25¢. Fine U.S. Approvals Accompany. Craig Stamps, Box 118-N, Bellmore, N.Y. 11710.

RARE Stamp Free! Also new packet Aden to Urundi, with Kennedy, Triangles, Space, Sports, Ships, Dogs, Cats, Reptiles, plus others. All free. Send 10¢ for mailing. Empire Stamp Co., Dept. 1, Toronto, Canada.

FOREIGN Approvals! Gigantic values! 3¢ each. ABC, Dept. 3301-A, Box 6000, San Francisco 94101.

U. S. COMMEMORATIVES 50 Different 10¢. Approvals. Gordon Davison, Hillsboro, New Hampshire 03244.

FREE! Big Bargain Catalog—New Edition listing thousands of bargains including U.S. & B.N.A. stamps, packets, albums, accessories and supplies. Also, find stamp from our approval service which you may return without purchases and cancel service at any time. Jamestown Stamp, Dept. E92PM, Jamestown, New York 14701.

3¢ PLATE Block 25¢ with comprehensive U.S. stamp and Supply catalog. Schultheis, Box 2151A, New Hyde Park, N.Y. 11040.

WOW! 110 All Different Germany 10¢. Commemoratives, Airmails, High Values, Big Catalog, bargain lists. Also, fine stamps from our approval service, which you may return without purchases and cancel service at any time. Jamestown Stamp, Dept. A92PM, Jamestown, New York 14701.

FREE. 100 World wide stamps to all new approval applicants. Send sase to: Park West Stamps, Box 2471, E. Cleveland, Ohio 44112.

"OLYMPICS." 20 Different. 10¢ Approvals. Cohen, Box 830, New York, New York 10010.

FREE 50 Stamps to Approval Customers. Moublow, 1834M Bassett, Anaheim, Calif. 92805.

200 DIFFERENT 15¢ With Approvals. Polze, Box 5215, Milwaukee, Wisc. 53204.

TEN Different Nudes; 20¢ Approvals. Stamp Farm, 2M46, Oxford, Wis. 53952.

FREE World Collection. Over 100 stamps. Approvals. Global, Box 427, Livermore, Cal. 94550.

5000 Foreign \$3.00; 9000 \$5.00; 5000 USA, contains airs, presidentials, revenues, 19th century, high values, commemoratives, etc. \$3.00; 300 pre-1940 USA commemoratives \$2.00; 700 \$4.00. No approvals. Meyers, 5321 Fleming, Richmond, California 94804.

APOLLO 11 Moonlanding. Seven multi-colored giants from Guinea, catalog value \$3.41. Only 10¢. Topical approvals. LeBlanc, Box 110-P1, Glen Cove, New York 11542.

ONE CENT STAMPS. Write for jumbo books of stamps at 1¢ each, mounted in Scott order, **BULLOT APPROVALS,** 6815 Bay Pkwy, Brooklyn, N.Y. 11204.

"AFRICA" 25 Beauties, 10¢ Approvals, Gorliz, Box 28765 PM, Memphis, Tennessee 38128.

100 DIFFERENT United States Stamps, 25¢ With U.S. Foreign Approvals. ShelRon, Box 547C, North Miami, Fla. 33161.

U.S. MINT Specials! Flag set, complete \$1.00. 1¢, 2¢, 3¢ famous Americans (21 different) \$1.00. Free list. Brooks, 2601 Avenue "U," Brooklyn, N.Y. 11229.

PENNY! Approvals! Regardless catalogue! Kloster, 4164 52nd St., San Diego 5, Calif. 92105.

U.S. BARGAIN, 50 Different 10¢, with beautiful worldwide, approvals. Stamp Center, Kennebunk, Maine 04043.

FREE Surprise collection sent with approvals. Gould, 1784 Union, San Francisco 94123.

PENNY Stamps! 1000 Mounted in book at 1¢ each! Trust Stamp Company, P.O. Box 100-P, Jamaica, New York 11435.

(Continued on next page)

STAMP COLLECTING

(Continued from preceding page)

ABSOLUTELY Free United States Mint Souvenir Sheet When Requesting United States Approvals. **K&B**, Box 70, Brooklyn, N.Y. 11223.

500 DIFFERENT Stamps, \$1.00. Smith, 508-A Brooks, College Station, Texas 77840.

210 DIFFERENT U.S. Commemoratives \$1.00. Stamps, 7607 Larchview, Dallas, Texas 75240.

FREE: First UN Stamps Issued. Approvals. Chapman, Box 487N, Galesburg, Mich. 49053.

FAR EAST ASSORTMENT—VIET NAM, JAPAN, KOREA, Formosa and others only 10¢ with world wide approvals. Clark Stamps, Dept. 57V, Muskegon, Michigan 49444.

FREE Duplicate Exchange—2¢ Approvals. Belden, Box 4175B, Dearborn, Michigan 48126.

100 DIFFERENT British Empire 15¢. Approvals. Gibson, Box 34, Lansdowne, Pa. 19050.

80 DIFFERENT U.S. Stamps. Includes 1943 flag stamp of occupied nations. Only 25¢. Approvals included. Willett Co., Box 338-M, Yorktown Heights, N.Y. 10598.

50 YEARS Old, fifteen different United States, over fifty years old—10¢ with approvals. Jaxon, Box 145-P, Brooklyn, New York 11230.

307 DIFFERENT Triangles, Sports, Topicals, etc. Worth near \$8.00. Only 25¢. Bargain approvals. Jayto Stamps, East Syracuse, New York 13057.

60 DIFFERENT United States (30 Commemoratives) 25¢. Seidenberg, Salem 169, Oregon 97308.

QUALITY AND LOW PRICE. EXCELLENT For advanced or beginner. Mounted approvals 2¢ up, all countries in Scott's Order. Preview Stamps, P.O. Box 20667, San Diego, California 92120.

SENSATIONAL Clearance Sale. 10 packets-.25, 20 packets-.50, 40 packets-\$1.00. No Approvals. Norge, Wyckoff, N.J. 07481.

NEW AFRICAN STAMP COLLECTION Including Burundi, Guinea, Mali, Rwanda, Togo and others. A colorful addition to your collection, 10¢ with approvals. Modern Stamps, Dept. 57B, Ferrysburg, Michigan 49409.

LOOK! Over 100 different strange and valuable stamps for just 10¢ with approvals, plus big bargain lists. Continental, Box 9413, North Hollywood, Calif. 91609.

"INVERTED Error" Dag Hammarskjold, 10¢ with approvals. Belmont Stamps, Washington, D. C. 20015.

SENSATIONAL Free Offer. 20 Outer Space Stamps. Selected Approvals. Louis Morrison, 1027 Maryland, Cape May, New Jersey 08204.

100 OLD United States between 1861 and 1935. \$1.00. Ed Roush, 423 Shepard, Mansfield, Ohio 44907.

WORLD Wide stamps 2¢ each! Write for exceptional approvals. Pan Pacific, Box 1895F, Studio City, Calif. 91604.

MILLIONS Of stamps 2¢ each. Write today for gigantic selection. CSC, Box 9384, No. Hollywood, Calif. 91606.

225 STAMPS For only 10¢! Airmails. Pictorials: stamps from strange countries cataloging up to 25¢ each! Plus unusual stamps to examine. Buy any or none return balance, cancel service anytime. Mystic Stamp Co., Camden 80, New York 13316.

WANTED—New Issue Subscribers. Specialty Israel, Western Europe, Great Britain. Advise your references, small advance over **FACE VALUE**. Franklin, P.O. Box 467 B, Jamaica, New York 11434.

PIONEERS Of the Air Age—first flight covers. Postal markings tell historic data. Real collectors' items now. \$1.00 each or 4 all different flights for \$3.25. K.M. Walsh, Box 308-F, Tuckahoe N.Y. 10707.

COLLECTION Free: Pictorials-Commemoratives. Approvals. Ross, Box 564-PM, Yonkers, New York 10702.

"WHOLESALE" U.S.—Foreign Pricelist and catalog Free! Everything Guaranteed. Schneider, Box 1240, Grand Rapids, Michigan 49501.

300 DIFFERENT 30¢ Bargain lists. No approvals. Stamps, Box 27, Fremont, Michigan 49412.

FREE: Mint Worldwide Packet. Approvals. Hildebrand, Box 5645, Redwood City, California 94063.

200 DIFFERENT Large pictorials \$1.00. Worldwide approvals. Quynn's, Scotland, Penna. 17254.

NEW Issues—Free Weekly Illustrated list. Brooks, 2601N Avenue "U," Brooklyn, N.Y. 11229.

"ZODIAC"—Complete set of multi-colored stamps from Ajman 25¢ with approvals. Judi's Stamp Company, 32 Arbor St., Lynn, Mass. 01902.

RUSSIAN Space collection 25¢. Russian Approvals. Snedco, Box 68-P, Waldwick, N.J. 07463.

START Your own stamp business!! Write: International, 6767LG South Atlanta, Tulsa 74136.

PREMIUM 25¢. With approvals. Murphy's Stamps, 542 Harvie Ave., Toronto 341, Ontario, Canada.

COLLECT Country by country. Quality 1¢, 2¢, 3¢ Approvals. Systematic, 11019 Sharpview, Houston, Texas 77072.

BARGAIN LISTS! U.S. Mint singles—Plate Blocks. No approvals. SASE. Silman, Box 3100-PMA, Miami, Fla. 33169.

FREE! \$10.00 Giant Stamp Collection of 300 all different colorful, valuable postage stamps from Africa—Europe—Asia—British Empire—Worth \$10.00—\$12.00 at catalogue prices. Also money-saving Booklet. All yours as a Get-Acquainted Gift. Adults only. Other fine stamps enclosed for your inspection. Frasek Co. Inc., PM9, White Plains, New York 10601.

107 BRITISH Colonies. Terrific Bargain. 25¢. Approvals. Castle, Box 15-PM9, Flushing, New York 11352.

EUROPE—120 Different 10¢! Bargain Approvals Accompany. Arnim Beike, 1824 Gates, Ridgewood, New York 11227. (Established 1960).

WORLDWIDE Collection 222 Different Plus 55 U.S., 25¢ Approvals. Casto, Box 927, Largo, Florida 33540.

100 CANADA 25¢. Excellent value. Approvals. Continental, Georgetown, Ontario, Canada.

200 BEAUTIFUL BRITISH ASIAN And **WORLDWIDE** Issues Sent To Approval Applicants For 25¢. Trans-Global Stamp Co., Dept. E, P.O. Box B, Baltimore, Maryland 21228.

FREE! 10 African Beauties! 30 Others! Approvals. Cambridge, Box 2311, Heath, Ohio 43055.

50 OLD U.S. Revenue stamps \$1.00. Winchester Stamps, Box 1592, Mansfield, Ohio 44907.

SAN MARINO'S Latest 1972 Gigantic "Bicolored Bird" Commemoratives—Free! Approvals plus 101 Bonus Sets. William Deems, 226X Race, Ravenswood, West Virginia 26164.

FREE! Special Bargain List with Savings Galore! Also fine Stamps from our Beginner to Advanced Approval Service. Request Dept. A. Worldwide—Dept. B, U.S. or Both. Stamp-A-Nanza, 1904 Broad, Schenectady, New York 12306.

12,000 DIFFERENT! AMAZING New Plan Builds Your Collection Systematically, Country By Country. Only 50¢ Weekly. Ware, Monroe, Conn. 06468.

PICK And Choose, 2¢ Each. Pickrell, Box 10129P, Norfolk, VA. 23513.

200 WORLDWIDE Stamps 10¢. Approvals. White, 6808E Chrysanthemum, Indianapolis, Indiana 46224.

VIETNAM 25 Different 10¢ approval. Sam Chazen, Box 95, Ozone Park, N.Y. 11417.

FREE Worldwide Packet. Penny Approvals. Froehlich, Box 7, Waukegan, Illinois 60085.

FREE 100 Different With Approvals. Shill, 8511 Cedel, Houston, Texas 77055.

255 DIFFERENT Worldwide: 15¢ Approvals. Tibbets, 8675 Meadow, Downey, California 90242.

OLDER U.S. stamps, covers, on approval to adults only. Surprisingly good. **ENGLE**, Box 208P, Lowell, Michigan 49331.

50 FAMOUS PAINTINGS 50¢ When requesting approvals. C. F. Stamps, 655 Forbes St., East Hartford, Conn. 06118.

COINS, TOKENS, CURRENCY

SEND Only \$1.00 for Coin Collecting Outfit. Contains 25 new coins from 25 countries. Plus Magnifier, wooden nickel, "How To Collect Coins" booklet, special coin envelopes, foreign banknote And big catalog of coins, paper money, collectors supplies. Littleton Coins, Dept. GH-1, Littleton, New Hampshire 03561.

FIVE Indianhead Cents and Three Libertyhead Nickels, plus illustrated list, all for \$3. Eagle, Box 25231, Richmond, Va. 23260.

SILVER War Time Nickel Set, In Display Holder, \$3.25. . . . 1943 PDS Processed Steel Cents, .65. . . . Both For Only \$3.50. **CHARLES COIN**, Box 164-M, Midtown, New York 10018.

\$1000.00 Banknote 25¢ with comprehensive U.S. coin and Supply catalog. Schultheis, Box 2151A New Hyde Park, N.Y. 11040.

UNITED STATES Silver Half Dollar, only 75¢. Stevens, Box 546F, North Miami, Fla. 33161.

SILVER DOLLARS Uncirculated, 1880-81—1883-84-85 \$4.50 Ea. Catalogue 50¢. Shultz, Salt Lake City, Utah 84110.

PRICE Lists of Thousands of Stamps and Coins. Send 25¢ Refundable with purchase. No Approvals. Bryson, 612M White, Toledo, Ohio 43605.

LINCOLNS 1909-1958 Every year including 1909VDB, 1922D. 50 different (Regularly \$12.60.) **SPECIAL \$6.95.** HARRIS, Box 2037P, Santa Cruz, California 95060.

LINCOLNS: 50 mixed 1909-40 \$2.00. 35 different uncirculated \$2.00. Nayko, 172-15D Effington, Flushing, New York 11358.

BARGAINS—1972-S Proof Set \$6.89. 1972 Complete Uncirculated Set \$3.89. Bargain Lists 18¢. Bebee's Incorp., Omaha, Nebraska 68111.

SEND Only 10¢ for sample copy, "World's Greatest Coin Collector's Monthly Magazine!" Nothing like it, quoting thousands of prices, buy and sell, United States and foreign coins pictures, articles, everything. Coin News, Anamosa, Iowa 52205.

UNCIRCULATED Mercury Dime, \$1.50. Catalog 25¢. Village Coin Shop, Dept. P, Plaistow, N.H. 03865.

40 MIXED Indianhead And Lincoln Cents, 1890's To 1930's \$2.00. Anthony, Box 9852D, San Jose, California 95117.

100 LINCOLNS, Everyone Different. 1909 up, \$5.00 Postpaid-Insured. Free Price List. Sprague, Rt. 2, Box 205-C, Nekoosa, Wis. 54457.

LIBERTY Nickels Three Different \$1.00. Eagle, Box 53041, Minneapolis, Minnesota 55435.

(Continued on next page)

COINS, TOKENS, CURRENCY

(Continued from preceding page)

HOW To Collect Coins for Investment and Profit! One roll of 1926S Buffalo nickels are now worth \$13,000.00! Where to buy and sell coins. How to find fortunes in buried treasure! How to become a franchised coin dealer. Why coins are a better investment than stocks and bonds! How to get started. This booklet is worth its weight in gold—coins of course! Booklet #MO-53CA only \$1.00. Maitland Gifts, 2001 Sunderland Road, Maitland, Fla. 32751.

10% DISCOUNT! Lincolns, Morgans, Mercuries, Roosevelts, Washingtons. Listing 25¢. Fairway, Box 685-K, White Plains, New York 10602.

UNCIRCULATED Silver Dollars 1878-1935, our selection \$4.75 each. Ten Different \$46.50. Aurora Coin, 507 Third Ave. #5, Seattle, Washington 98104.

WHITE Gorilla!!! Little Snowflake Medals \$1.00 Each. 10-\$6.50, 100-\$50.00. Glenn Dawes Coins, 3200 W. 93rd Ave., Westminster, Colorado 80030.

WARNICKEL Sets Complete In Holder. \$3.50. Pricelist Included. Kedzie Coins, 5909 South Kedzie, Chicago, Illinois 60629.

ANTIQUES, RELICS, INDIAN GOODS & CURIOS

INDIAN Relic list, Arrowheads \$4.00. doz. Folsom. \$5.00 each. C. Secrist, Deerfield, Missouri 64741.

LIST Indian relics. 10 Arrowheads \$3.00. Hyde's, Box 2304, Santa Fe, New Mexico 87501.

SELLING 20,000 Indian relics. Arrowheads, spearheads, tomahawks, ceremonials, etc. List 10¢. Lear's, Glenwood, Arkansas 71943.

EVERYBODY LIKES DIXIE GUN WORKS.

TONS Of antique gun parts and supplies. All reproduction muzzle loading guns. Send \$2.00 for enlarged illustrated catalog No. 121. Dixie Gun Works, Union City 12, Tennessee.

10 BEAUTIFUL Arrowheads \$2.00. Guajardo's, 8713 Shaver, El Paso, Texas 79925.

ANTIQUE Buyers And Sellers Guide Book. Hundreds Of Illustrations And Prices. \$1.98 Plus .50 Handling. Send Check Or Money Order To: LaGuire Gifts, 835 South 27th Street, Lafayette, Indiana 47904.

APACHE ARROWHEAD COLLECTIONS—Perfect. 25—\$5.00, 100—\$15.00. GERONIMO, PMD1239, Apache Junction, Arizona 85220.

MODELS—CARS, SHIPS, TRAINS, PLANES ETC.

LIVE Steam Engine Kits. Fascinating Hobby for Model Mechanics. Boilers. Fittings, Accessories. Pictured Catalog \$1.00. H.P.K. Models, Centuck 34, Yonkers, "J" New York 10710.

MODEL Ships and Cannons. Free catalog. Studio House Dept-1092, Box 185, Deer Park, New York 11729.

SHIP Models Kits, fittings, plans, books, tools, engines, motors. Big illustrated catalog 50¢. Mass, residents add 3% tax. James Bliss & Co., Dept. SM, Route 128, Dedham, Mass. 02026.

MODEL Airplanes—Big 220 Page Catalog \$1.00. Sig Company, Montezuma, Iowa 50171.

SHIP Models Catalog 25¢. Scientific, Inc., 340 Snyder, Berkeley Heights, N. J. 07922.

LIVE Steam powered backyard railroads! All sizes. Complete "bolt-together kits," and rough castings. Excellent drawings. 100 page catalog \$1.00. Little Engines, Lomita, California 90717.

ROCKETS: Real flying models—flights up to 2500 ft. New Illustrated catalog 25¢. Single and multistage kits, cones, engines, launchers, trackers, rocket aerial cameras, technical information. Fast service. Estes Industries, Dept. 2-J, Penrose, Colorado 81240.

SHIP And yacht model fittings: Pine construction hull kits; blueprints. Send 75¢ for illustrated catalog. A. J. Fisher, Inc., 1002 Etowah Avenue, Royal Oak, Michigan 48067.

SCALE Model cannons, ships, tanks, airplanes, autos, trains and accessories. New Catalog \$1.00. Frontier Models, 1583 West Washington Blvd., Los Angeles, California 90007.

ROCKET Kits, engines, launchers, accessories. Send 25¢ for packet of iron-ons, decals, literature. Fast service. Aerospace Vehicles, Inc., Box 77E, Mineral Point, Wisconsin 53565.

BUILD 1910 Maxwell Roadster. Authentic scale replica. No plastic! Metal fenders and lowered hood, cast metal radiator, springs and wheels. Wood body like original. Kit includes plans, all parts and stand. (7¼"x5¼"). \$13.95 Postpaid. Cum-Shop, 10907 S.E. Third Street, Bellevue, Washington 98004. Order PMA-422.

GAMES, TOYS, PUZZLES, NOVELTIES

NOVELTIE Catalog, Send 8 cent stamp. Tam Enterprises, Box 66278, Los Angeles, California 90066.

SENSATIONAL Wiggly Hula Doll, Plus Catalog \$2.00. Catalog 25¢. Dutz, Box 284P, Lincoln, Illinois 62656.

TWENTY Assorted WWII Fighter Planes That Really Fly. Send only \$2. Direct Importing, Box 34503, Dallas 75234.

MAGIC TRICKS, JOKES, VENTRILOQUISM

HOUDINI'S Greatest Magic!! You can do them all!! Giant Illustrated Catalog 25¢ with Free Trick!! Vick Lawston, Box 2026P, Pompano Beach, Florida 33061.

NEW 1972 Large Catalog. Be popular! Amaze! Have fun! Send 10¢. Latest Magic for pocket, parlor, stage. Jeffries Magicland, Dept. 11, Dallas, Texas 75201.

VENTRILOQUISM! Learn at home! Guaranteed! Write! Information Free! Dummy Catalog 25¢. Maher, Box 9037P, Denver, Colorado 80209.

HOUDINI'S Original Magic Shop. Established 1856. Send 25 cents for illustrated Catalog containing 5000 Tricks. Mindreading, Puzzles, and Jokes. Flosso-Hornmann, 304 West 34th St., New York 10001.

MAGIC, NOVELTIES, MASKS; Catalog 15¢. Magic, 3746 West 63rd Street, Chicago, Illinois 60629.

COMPLETELY Illustrated catalog. 84 pages. 25¢. Manhattan Magic, Box 334-M, N.Y.C. 10011.

BE A Magician! Two booklets explaining sixty-eight tricks plus large professional catalog. \$1.00. Magic Inc., 5082 Lincoln, Chicago, Illinois 60625.

WORLD'S Finest professional magic tricks. Joker's Novelties. Giant illustrated catalog 10¢. Top Hat, Evanston, Illinois.

FABULOUS MAGICS New 1972 catalogue 25¢. Our specialty orders shipped same day no substitutes. Fabulous Magic, 3319 East Charleston, Las Vegas, Nevada 89104.

MAGIC MAGAZINE—Monthly since 1936. 44 pages. All phases. 3 month trial \$1.00. Genii, P.O. Box 36068, Los Angeles, Calif. 90036.

LEARN VENTRILOQUISM! Dummies, Puppets, Marionettes. Catalog 15¢. Izzy Rizzys Ventriloquism School, 3746 West 63rd Street, Chicago, Illinois 60629.

1,500,399 TRICKS, Jokes, Novelties. 165 Page Catalog 25¢. Elbee, 7408-P, San Antonio, Texas 78207.

VENTRILOQUIST Dummies, Professional Type, Dummy Catalogue 25¢. Write: 5918 Ibbetson, Lakewood, California 90713.

BAFFLING. Tie Yourself Securely in Seconds. Simple: \$1.00. Howdidi, 12522 Martha Ann, Los Alamitos, Calif. 90720.

FREE! World's Leading Catalog. 1600 Novelties, Jokes, Tricks, Knives, Science, Sports, Jewelry, Psychodelia. Johnson Smith, C-10, Mt. Clemens, Mich. 48043.

BOOKS, CATALOGS, NEWSPAPERS

PUBLISH Your Book! Join our successful authors: All subjects invited. Send for free appraisal and detailed booklet. Carlton Press, Dept. PMI, 84 Fifth Avenue, New York 10011.

CONTROL OTHERS SECRETLY. Be dominating, forceful, magnetic. This powerful book can make your dreams come true, \$2.00. Quality, Possum Run, Annandale, N.J. 08801.

BOOK SALE! FREE List of Low Cost Books. Success, Happiness, Personality, Business, Wealth, Personal Problems. The Top Drawer, 1515 159th Ave., San Leandro, California 94578.

BOOKS: All Subjects! Genealogies. Send wants! (Mail only). Roy Hutchins, 39 Hopedale Street, Allston, Massachusetts 02134.

FREE LIST! Low Cost Books! Success, Happiness, Wealth Health, Gladys Seiler, 1032 Coronet Road, Warminster, Pa. 18974.

BOOKS! Free list. Home improvement, cars, sports, hobbies, sciences, others. Shurlaine Sales, 1939P Guernsey, Beaverton, Mich. 48612.

SERVICE MANUALS. All Kinds. Send \$1.00 to: Magna Enterprises, Box 127, Mt. Vernon, Ohio 43050.

BOOK SALE! For entire family 20¢ to 50¢. Free brochure. Winchester Enterprises, 2807PM Hargrave Street, Philadelphia Penna. 19136.

FREE Listings. NEW Books. Moneymaking Opportunities, Self Improvement, Personal And Others. The Source, Box 92C, Whiting, New Jersey 08759.

\$2.00 DISCOUNT Coupon With Book Bargains Catalog. 25¢. Mailmart, Box 55-M, Richmond, Virginia 23201.

BIG FREE CATALOGUES ON HEALTH, REFERENCE, CLASSICS and SELF IMPROVEMENT BOOKS. Box 736, Norwalk, Cal. 90650.

U.S. Marines "Hand To Hand Combat" manual \$1.50. Catalog of manuals 25¢. Hillcrest Publications PM-9, McDonald, Ohio 44437.

FREE BOOK. Prophet Elijah Coming Before Christ. Megiddo Mission, Dept. 63, 481 Thurston Road, Rochester, N. Y. 14619.

NATIONAL Geographic Magazines, 1888-1971, any issue. Buxbaum, Box 465-PM, Wilmington, Delaware 19899.

FREE CATALOGS!! Directory Lists Hundreds. \$1.00. CATALOGS, Box 24PM, Staten Island, New York 10304.

INTERNATIONAL Bookfinding. You Name It, We Find It. Search Service, Squaw Rock, Danielson, Conn. 06239.

FREE List! Wealth of self-improvement books. Ann-Scott, Dept. PM9, 808 Main, Texarkana, Texas 75501.

SELF IMPROVEMENT, HOW TO BOOKS, List, Wood, 10821 Scotsman Way, Rancho Cordova, California 95670.

FREE Nutrition Pamphlet With Purchase! "Secrets Losing Fat." \$2.00. "Quick Gain Weight," \$2.50. Snodgrass, Box 404, Cerritos, California 90701.

CO-PUBLISH "Timely Tips" a mail order man's magazine. Diane Gargas, 4719 Kennedy Ave., East Chicago, Ind. 46312.

(Continued on next page)

BOOKS, CATALOGS, NEWSPAPERS

(Continued from preceding page)

HOW TO BOOKS—Auto And Home Repairs—Improvements. List 25¢. Benmac, Box 5284M, Arlington, Texas 76011.

FREE! List of Low Cost Popular Books. Self-improvement, Moneymaking Opportunities. Amazing values! Chartier, 945 Knoll Drive, San Bernardino, California 92410.

FREE Distinctive Gifts Catalog. Grover's Gifts, 3076-1 Wiltse Road, Placerville, California 95667.

FREE LIST. Low Cost Popular Books. Success, Happiness, Personality, Wealth, Self Improvement. Basehore, 603 Shepherdstown Road, Mechanicsburg, Penna. 17055.

1001 THINGS Free!! Amazing source-book! \$1.00. Agmoe, Box 1256-A, Alhambra, Calif. 91802.

EASY Christmas Shopping! Free Film! Bonus Gifts! Catalog 25¢. Pierdale, 126A Kent, Martinsburg, W.VA. 25401.

PENNIES SAVE DOLLARS! Discount Book Catalog. All Subjects. 25¢. Sunni's, Box 511, Augusta, Georgia 30902.

PLAYS, SONGS, MANUSCRIPTS

SONGWRITER! Poets! Spiritual and religious poems, songs wanted for recording by Chapel Symphony Orchestra and Choir. We pay all recording costs! Dept. PM, Chapel Recording, P.O. Box 162, Wollaston, Mass. 02170.

SONGS, SONGPOEMS Wanted For Radio Show. Hollywood Music Productions, 6425-PM Hollywood Boulevard, Hollywood, California 90028.

SONGS, Poems Wanted! For publishing, recording at our expense! Talents, 17-PM Longwood Road, Quincy, Mass. 02169.

RECORDING Bonus of songs from accepted poems by America's most popular studios. Send Poems, Tin Pan Alley, Box 11647-PM, Sarasota, Florida 33578.

SONGPOEMS, SONGS! Urgently Needed. Possible Recording/Publishing, 50-50 Agreement. Betty's Music Makers, 1417 Park Building, Dept. B, Pittsburgh, Penna. 15222.

RECORDS Made. Publishing Contract Guaranteed On Accepted Songs, Poems. Send: Talent Searchers Of Hollywood, 6311-X Yucca, Hollywood, Calif. 90028.

BUSINESS SERVICES

PROFITS FROM CLASSIFIED ADVERTISING! Booklet shows you how to start your own business with Classified Advertising. Only \$1.00 (Refundable with first order.) C. A. MARTIN, POPULAR MECHANICS, DEPT. P, 224 WEST 57 STREET, NEW YORK, N.Y. 10019.

BUSINESS OPPORTUNITIES

SECRETS! Mail Order Success. Internationally famous expert reveals how to make home business fortunes. Beginners! Get free copy "Make Money By Mail." Discloses free advertising, profitable products. Mailco, Dept. FC709, Woodland Hills, California 91364.

PREPARE Tax Returns—Policeman Albert Myers made \$2000 his very first season. Train at home. VA Approved. National Tax School, Monsey, 2CD, N.Y. 10952.

EARN \$240.00 A month at home, spare time, doing only two \$5.00 Invisible Re-weaving/Reknitting jobs a day. Big money paid for service that makes cuts, tears disappear from fabrics. Steady demand. Details free. Fabricon, 2065 Montrose, Chicago 60618.

"MAILORDER Beginners Library." Seven outstanding books. \$6.50. Wonderful drop-ship proposition. Sample imprint circulars absolutely free. Neil H. Tasker, Shamokin, Pennsylvania 17872.

311 FAST, Easy ways to make money! Free! Rush name, address, zip. Perry, 13263F Ventura Blvd., Studio City, Calif. 91604.

PORTABLE Sandblaster \$29.95. Distributor wanted. Free brochure, Inka, Box 66573-A, Houston, Texas 77006.

HOW To Get Capital. \$2500 In One Day. Hundreds sources. Free proof. Counselor-17, Kerrville, Texas 78028.

EARN Money raising fishworms for us! Write: Oakhaven-38, Cedar Hill, Texas 75104.

MAILORDER!! Enjoy Wonderful Income, Financial Security! Everything furnished; Start making money now. Write: Allen, 554CS-1 Spruce, Garwood, New Jersey 07027.

FORTUNES In Herbalism! \$10,000-\$50,000 yearly in small back yard possible! Lesson on Business Know-how \$1.98. Herbalism Institute-B, 1339 Remuda, Glendora, California 91740.

HOW To Earn At Home Addressing Envelopes. Rush Self-Addressed, Stamped Envelope. Wesley House, P.M., Box 704, Lindale, Texas 75771.

FREE Booklet, "How To Sell By Mail." Write: Ransone, Box 1719, Richmond, Virginia 23214.

OUR NEW MOBILE HOME PRODUCT Can make you \$60.00 per day in your own little business at home. Act now!!! For information mail \$1.00 to: Mobile Home Portable Products, P.O. Box 21306, Indianapolis, Indiana 46221.

ATTENTION Fishermen! You can join 1,000's cashing in on the current fishing craze. New Book describes Full and Part time opportunities in Sport and Commercial fishing. Send for your copy today. Only 2.00. Moneyback Guaranteed. Qualico, 1311 Marleen, Houston, Texas 77034.

\$150 DAILY Possible! Wholesale Business! Free Details! Xcito Wholesalers, 5715 N. Mozart, Chicago, Illinois 60659.

1000% Profit Bronzing Baby Shoes. Free Literature. NBC, Box C-4-PM, Coral Springs, Florida 33065.

\$15,000-\$30,000 Year profit potential. Send \$2.00 Book, "Raising Rabbits for Us." Satisfaction Guaranteed or money back. Rabbit Ranchers of America, Box 118-X, Braman, Oklahoma 74632.

PROFITABLE Mailorder Is Yours!! Proven 7 Point Program Assures Your Success. Everything Furnished. Write: Stramiello, 54 Clinton, Spring Valley, New York 10977.

SELL Books by Mail. Complete Dealer Set-up—20¢. Midwest Mail Sales, Box 44R2, Shawano, Wisconsin 54166.

MAKE THOUSANDS \$\$\$! WOMEN LOVE OUR MAGNETIC GROCERY CHECKER. SAMPLE, DETAILS \$2.00. IMAGINATION, BOX 469H, SAN JOSE, CALIFORNIA 95103.

BE MAILORDER DEALER. Catalogs furnished—your name on them. Profitable products drop-shipped. Mailing lists. Free details. J. S. Enterprises, 42-70 Kissena Boulevard, Flushing, New York 11355.

OPERATE Your own Charm and Modeling Business by mail. Everything furnished. Write: Royce, 14603 Dorchester, Dept. GM-92, Dolton, Illinois 60419.

MAKE To Triple Times Your Cost. Hundreds Of Products. Gifts, Novelties, Toys, Many Others. \$1.00 Brings Giant Catalog, Refundable With First Order. **DONMAR, PM-B, 809 Ravenwood, Arlington, Texas 76013.**

BIG Profits Possible!!! Mail Always Popular Gift Catalogs. Particulars, Sample Catalog 25¢. Tobin, 2221D, Norfolk, Houston, Texas 77006.

40% PROFIT—Mail Baby Catalogs to New Mothers. Details 25¢—Oliveras, P-809, 12430 Persimmon, Marlboro, Maryland 20870.

HOW To Succeed in Mailorder! Write: Fimex, Box 1461-PM29, Ogden, Utah 84401.

EARN \$1,500 A Month at Home with New Business. Beacon House, 1406-F Beacon Street, Cincinnati, Ohio 45230.

MAIL LETTERS FEATURING REAL MERCHANDISE Get \$12.00 orders in EVERY MAIL, \$8.00 PROFIT! Everything furnished! Write: James Schiappacasse, 2256 Waterbury Avenue, Bronx, New York 10462.

\$1,000 MONTHLY Possible! Mailorder. Write: Hollien's, Dept. 2PM, Many, Louisiana 71449.

INSTALL Burglar Alarm Systems. Big profit home business. Beginners start spare time without mechanical experience or costly equipment. Free starter plan. Nasco, Dept. F2709, Woodland Hills, California 91364.

EARN Thousands at home. How to sell books by mail. Free details. Wisdom House, Box 1106P, Largo, Florida 33540.

\$300 Up part time, house, computerized Bookkeeping. We teach, age no barrier. Experience unnecessary. Calektronik, 5606 Paramount Blvd. Department 1035, Long Beach, Cal. 90805.

OPPORTUNITY Knocks Only Once—Invite It!!! Free Information For Stamp. TBOR, Box 1692-D, F.D.R. Station, New York 10022.

\$128.00 IN Sales from \$12.00 material. New, Different, everything furnished. Details 25¢. Newton, Box 08036, Detroit, Michigan 48208.

BECOME "Mortgage Broker." Lucrative! Capital Sources, Box 99-A, Uleta, Florida 33164.

50% RETURN On Safe Investment. Financial Insiders Make Millions. Success Clinic, P. O. Box 334P, Quincy, Mass. 02169.

BIG Profits In becoming a supplier to major industry through electroplating small parts and metalizing non-metallics. Write for free particulars: Mason, Room MC-2-BK, 1512 Jarvis, Chicago, Ill. 60626.

RACING Editor, 45 years racetrack experience, reveals first time "My Four Winning Systems." Kearney-FI, 30 East 42nd, New York 10017.

HOW And where to get capital. \$5000+ possible in one day. Free details. James Peter, Box 571-AM, Westwood, N.J. 07675.

FREE 1972 100-Page Catalog waiting to bring you Big spare-time cash commissions. Sell Advertising Book Matches. Every business a prospect... complete selling instructions furnished. Steady, repeat business. Dept. MX-972, Superior Match Company, 7530 South Greenwood, Chicago, Illinois 60619.

MAILORDER Millionaire helps beginners make \$500 weekly. Free report reveals secret plan! Executive (1A9), 333 North Michigan, Chicago 60601.

MAILERS Needed! Big money! Send 10¢ for information. Andrew Sales, Box 152, Blue Island, Ill. 60406.

MAKE Magnetic signs, Machineless method. Profits enormous. Write: R1B49APM, Bardstown, Ky. 40004.

MAKE A Years Income in 8 weeks Camping. No selling, Capital or Land necessary. Write: Edru's, Route 5, Box 5733, Gig Harbor, Washington 98335.

HOLLYWOOD CEMENTCRAFT: Offers Highly Profitable Home Business. Experience Unnecessary. Unlimited Unique Pottery Designs Easily Made Without Moulds, Bird-baths, Fountains, Wishing-Wells, Waterfalls, etc. Chemical Coloring Formulas. Marble-glazing. FREE Illustrated Brochure. **CONCRETE FACTS, 602 Athens Street, Altadena, California 91001.**

PIANO Tuning Learned Quickly At Home! Tremendous field! Musical knowledge unnecessary. GI approved. Information free. Empire School, Box 327, Miami, Florida 33145.

(Continued on next page)

BUSINESS OPPORTUNITIES

(Continued from preceding page)

WORLD'S Largest supply. Merchandise 25% to 40% under wholesale. Bankrupts. Closeouts 10¢ on dollar. Imports. Hong-Kong clothes. Automobile discounts. Free details. International Buyers, Box 16386 MM, Portland, Oregon 97233.

ADVERTISING BUSINESS—YOU Own it. \$350 First Week or Money Back. Electric Neon Action Ad Clock, 229 W. Illinois, Chicago 60610.

SELL Lifetime, Metal, Social Security Plates. Big Profits! Sample and Sales Kit Free. Russell, Box 286-PM, Pulaski, Tennessee 38478.

COPUBLISH "Mail Sale Advertiser," leading mailorder paper. Copy and details 25¢. U.S.A. only. Vanroy Shirk, Lebanon, Pa. 17042.

DRAFTSMEN! Operate own **DRAFTING SERVICE!** Full, Part Time; Experience unnecessary; Details: Roberts Drafting, 1741 Circle Road, Baltimore, Maryland 21204.

FREE Catalogs. Repair air conditioning refrigeration. Tools, supplies, full instructions. Doolin, 2016 Canton, Dallas, Texas 75201.

I MADE \$40,000.00 Year by Mailorder! Helped others make money! Start with \$10.00—Free Proof. Torrey, Box 318-Y, Ypsilanti, Michigan 48197.

VENDING Machine big catalog. Rake, 523 A Spring Garden, Philadelphia, Pa. 19123.

MAIL Baby Catalogs Imprinted with your address to New Mothers for Big Profits! Details 25¢. Volz PM, Ypsilanti, Michigan 48197.

MAKE Money from old tires. Operators clearing \$800, weekly. Equipment costs \$1500. Get facts. S & S Patents, Inc., 3752 N. Damen, Chicago 60618.

MAKE \$46 From square foot plywood: Jigsaw or bandsaw necessary. Free details. Woodar, Bridgewater, Mass. 02324.

SUPERIOR Auction School. Nation's top Auctioneers own and instruct. Box 1281, Decatur, Ill. 62525.

\$200.00 SPARE Time earnings with your Tablesaw. Write: Workshop Five, 3800 Harney, Vancouver, Washington 98660.

\$25.00 HUNDRED Addressing. Possible Year 'round. Complete instructions 25¢ for registration, postage. Cove, Box 1348-B, Clearwater, Florida 33517.

\$70 TO \$200 WEEKLY—Home, Spare Time Simplified Mail Bookkeeping. Immediate Income. Easy. Auditax, Box 34741A, Los Angeles, Calif. 90034.

VENDING Machines. No selling. Routes earn amazing profits. Big catalogue Free. Parkway Corporation, 715PBM Ensor Street, Baltimore, Maryland 21202.

\$60.00 DAY. Manufacturing Concrete Posts. Blocks. Mold Equipment Catalog \$1.00 refundable. Carlayne, Route One, Box 95, Rapid City, South Dakota 57701.

MAIL Order Collection Agency can make you \$1000.00 monthly. Free Details. Continental, Box 2023-A, Des Moines, Iowa 50310.

ADDRESSERS And Mailers Needed. Details 10¢. Lindbloom, 3636 West Peterson, Chicago 60659.

SELL Books by mail. 400% profit. Royal, Box 450-X, Cleveland, Ohio 44127.

WATCHMAKING Makes every day a payday. Learn this cash business at home. Free details. Sweazey, YJA, Fox River Grove, Illinois 60021.

HOMEWORKERS. \$100.00 Weekly Addressing for firms. Begin immediately. Details—send stamped, addressed envelope. Hamilton, 272-TMA-9, Brooklyn 11235.

MAILORDER Book Publisher Wants Dealers. Details 25¢ (refundable). Jan Enterprises, 76P, Wild Rose, Wisconsin 54984.

EARN \$40.00 DAILY, Manufacture Concrete Bricks. Very Small Investment. Send Stamp. Free Details-Hilmar, Rt. One, Box 347-D, Valrico, Florida, 33594.

CLIP Short newspaper items. To \$10.00 each. Details free. Foster, 272-M-9, Brooklyn 11235.

900% PROFIT For Men And Women with your own Magnetic Sign Shop! Big demand for 3-D magnetic signs on cars and trucks. Start in garage. Kitchen or camper. Spare or full time. Financing available. Write today for free details. Nationwide Plastics, Dept. 258, 4200 Panamint, Los Angeles, Calif. 90065.

SELL Beautifully Colored Social Security Plates. Big Profits! Free Samples! Paul Wright, 1075 Ringwood Avenue, Pompton Lakes, N. J. 07442.

\$200.00 DAILY In your mailbox! Your opportunity to do what mailorder experts do. Free details. Associates, Box 136-A, Holland, Michigan 49423.

MEN-Women Make Big Profits At Home! In Plastics, part or full time! Unique process teaches you with equipment we give you free to make hundreds of 3-D plastic products, candy and candle molds, plaques, signs. Skin and bubble package. Also resin casting. Write today for free details. Nationwide Plastics, Dept. ARY, 4140 Eagle Rock Blvd., Los Angeles, Calif. 90065.

MAILORDER Records help get increased business! Complete 32 page Record Book shows your inquiries, orders, advertising, expense, etc. Only \$1.00. C. A. MARTIN, POPULAR MECHANICS, DEPT. R, 224 WEST 57TH STREET, NEW YORK, NEW YORK 10019.

BIG Profits!! Mail Baby Gift Catalogs. Tremendous, Continuous Market! Complete Money-making Details; Write: Carl Lass Co., Box 1416, Chicago, Illinois 60690.

MEN—Women Needed Now to fill out income tax forms at home. We show you how. Simple, easy to learn. \$700 per month earnings possible. Details mailed free. No salesmen. Hurry. Federated Tax Service, 2065 Montrose, Chicago 60618.

\$1000 Day-150% Profit. Selling by mail. No investment in inventory. Part time—full time. Unlimited potential. Complete details \$1.00. National, Box 7212ZAG, Chicago, Illinois 60680.

MEN—Women! Start money-making Plastic Laminating business at home in spare time. Material costing 11¢ brings back \$2.58. No canvassing or selling but mail orders bring in \$20 a day. Write for full particulars free. Rush name on postcard to: Warner, Room LC-2-BK, 1512 Jarvis, Chicago, Ill. 60626.

TAKE Catalog orders. We drop-ship 1001 best selling specialty products. Guaranteed lowest below wholesale prices. Fantastic spare-full time home business. Free book show you how. SMC, 6061 SPI, De Soto Avenue, Woodland Hills, California 91364.

BUILD Custom Cases at home for profit. Get orders by mail. We supply materials, instruction—everything. Free home business details. Custom Case Supply Co., 6075 CPI De Soto Avenue, Woodland Hills, California 91364.

I'VE Got the horseraces beat! Proved over four years. Will reveal. Strauss-FI, Brooklyn, New York 11219.

1100% PROFIT, Bronzing or Pearl Finishing Anything. Free Proof! Kiktavi, Box 2127D, Inglewood, Calif. 90305.

MAILORDER Money-making Kit. Home Business. Valuable lists, concrete information, detailed steps. Capital unnecessary. Free Details, Pictures, Meadows, Box 327-PM9, Boston 02199.

REPAIR Hydraulic Jacks—Details Free. Write: Hydraulic Parts Supply, Box 295, Port Isabel, Texas 78578.

EARN \$60.00 Daily manufacturing Concrete Fence Posts. Practically no investment. Send stamped-addressed envelope. American, Excelsior Springs, Mo. 64024.

MAIL Letters Featuring Real Merchandise! Get \$12.00 orders every mail, \$8.00 profit. Everything furnished. Free details; write: Stayer Enterprises, 3704 Warwick, Peoria, Illinois 61614.

RECEIVE MAIL Galore! Your name on our national mailing lists, 50¢. Sullins, Box 1313, Brunswick, Georgia 31520.

FABULOUS SECOND INCOME. Deal in gold. New manual shows how. Information, write, Research, Box 804, Hammond, Ind. 46325.

165 FREE Wholesale Catalogs! Mailorder Dropshippers. Your Business Imprint, Automobile Discounts. Free "Digest." Vault International, Box 7284W, Lexington, Kentucky 40502.

GUARANTEED INCOME!!! Home Mail-order Business can make you rich! Everything furnished—even national advertising. Details \$1.00. Galaxy (2P9), 15307 Nevada Street, Woodbridge, Virginia 22191.

400,000 BARGAINS Below wholesale! Many free. Liquidations . . . closeouts . . . job lots . . . single samples. Free details. Bargainhunters Opportunities, Box 730A, Holland, Michigan 49423.

CALIFORNIA MANUFACTURER NEEDS Man to assemble our product and be local agent, experience unnecessary. May start while presently employed. Five-figure income for responsible applicant. S.K.R.M. Manufacturers, 2347 West 238 Street, Torrance, California 90501.

MAILORDER—Profitable products, drop-shipped. No merchandise investment. Everything supplied—catalogs, ads, mailing lists. Gif-Guide, 1137½ Crenshaw, Dept. 283, Los Angeles 90019.

\$75 DAILY Working only 5 minutes a day. Guaranteed, Professional Method. Details Free. NeWorld, Box 1446, Lafayette, Indiana 47901.

STARTING And Succeeding in mail order Details Free. Robert Coombs, 24 Sherwood Ave, Franklin Square N.Y. 11010.

UP Your OWN Organization! A complete guide on how to start and finance your own business. Free brochure. Entrepreneur Press, Dept. A-88, Drawer 2759, Santa Clara, Calif. 95051.

MAKE \$1,000,000.00 In 10 years. Free information, House of Hoke, Department 101-PM, Sebring, Florida 33870.

MAILORDER! MAIL Your Own IMPRINTED BABY CATALOGS To New MOTHERS. Sample CATALOG. Details 20¢. RUS-MAR SALES, P.O. BOX 1113, THOMASVILLE, NORTH CAROLINA 27360.

MAILORDER. Sell Books. Details. Sources \$3. Guaranteed. Nats, Rt1 Box 601, Gonzales, Louisiana 70737.

MY NEW Business can easily make you \$1,500 per month. Galathea Enterprises, 923 Fruit Ave. N.W., Albuquerque, New Mexico 87102.

MAILORDER BEGINNERS: Avoid Costly Mistakes! Free Details! Jezuit, 116-AJ Mooney, Olyphant, Penna. 18447.

FREE Sample. Sell Lifetime Social Security Plates. Big Profits! Ultis, 10716 Francis, 1PM, Los Angeles, California 90034.

NEW Mothers Buy On Sight. Big Profit, Details, Sample, 25¢. Panmar, Box 115PM, Riverside, Conn. 06878.

HOW To Start RETAIL CLOTHING BUSINESS. \$2.00 or write: Bruce's Family Clothing, 897 E. Base Line, San Bernardino, California. 92410.

LEARN MAIL ORDER BUSINESS Write for free information. Horizon Enterprise, Dept. 200, 2300 S. 9th Street, Arlington, Va. 22204.

GROW GINSENG For Profit. Write for free growing information & seed prices, Pulvermacher's Produce, Dept. C., Richland Center, Wisconsin 53581.

(Continued on next page)

BUSINESS OPPORTUNITIES

(Continued from preceding page)

TRANSPARENCIES Wanted. Learn **FREE-LANCING**. American Color, Box 2193, Sepulveda, California 91343.

\$50.00 PLUS 50% COMMISSION Stuffing 200 already stamped, addressed envelopes, our circulars. Information 25¢ with stamped, self-addressed envelope. Brewster-PB, Clearwater, Florida 33517.

MAIL ORDER BEGINNERS, Directories, needed Suppliers, Drop-Shippers, American Importers, Gift Shops. Wood, 10821 Scotsman Way, Rancho Cordova, California 95670.

SELL Books!! Complete Mailorder Plan. Vikari's, Box 1312PM2, Salt Lake City, Utah 84110.

ADDRESSERS-Mailables needed. Extra profitable. Information for stamped addressed envelope. Foster's, 24712-P Chestnut, Newhall, California 91321.

MAILORDER Dealers Wanted. Earn outstanding profits using tested promotions! Executive type business. Details 25¢. Rutward, Box 735-PL, Norwalk, Conn. 06852.

START Own business. Terrific opportunity! Sensational marketing programs reveal **SECRETS**—Five **NEW** products: pricing, advertising, manufacturing, packaging, **EVERYTHING!** \$3.00. Satisfaction guaranteed. Omega PM9, Box 4178, Trenton, New Jersey 08610.

HOMEWORKERS-Mailables Wanted! Free Information. Allen, 2418A Lori, Santa Ana, Calif. 92706.

JOIN The professionals. Profitable Gift Catalog Distributorship. Giftfair, 1430-40 Wells, Milwaukee, Wisconsin 53233.

FREE Collection Agency Details!! \$1000.00 Monthly Possible. Master-6, Drawer 77009, Atlanta, Georgia 30309.

BIG PROFITS! SELL BOOKS By Mail write: Shafer Enterprises, 5031 57th Avenue, Bladensburg, Maryland 20710.

HOW To Raise \$100.00 to \$1,000,000.00!! Free Details. Drawer 77009-PM, Atlanta, Georgia 30309.

AMAZING NEW Home Business. Make \$1,000 monthly! Details \$1.00, refundable. Investigate today! Tega Co., Box 56, EDM Station, Des Moines, Iowa 50315.

FREE Report!!! Mailorder—400% Profit—Hottest... "Newest"... Easiest... Promotion—Ever!! Sel-More, Box 126PM, Brooklyn 11229.

I MADE \$2,000.00 MONTHLY in Mail-order... Evenings only. You can too—Free Proof! Kingman-JJ, 239 Main, Conneaut, Ohio 44030.

BUY BOOKS WHOLESALE! Thousands. Directory, \$2.00. Books, Box 11052-M, Phoenix, Arizona 85061.

BIG PROFITS YOURS From Commission Mailings. Everything furnished. Learn how! Write: Slater, 217B Pearl, Redondo Beach, California 90277.

MAILORDER Dropship catalog program offers you extra income in your spare time. Send 50¢ for complete details: Gardentek, 1414 Sandburg, Chicago 60610.

MAKE MONEY AT HOME We pay top rates for addressing our sales letters. It's fun and easy all you have to do is address envelopes. Insert our literature and mail. Earn as High as \$150 Per Week or more Send 25¢ for details and application. **CUR-JON MAILING ENTERPRISES**, P.O. Box 523, Maplecrest Sta., Maplewood, N.J. 07040.

"MAILORDER Course! Home Study," 24 Easy Lessons, \$2.00. "Bill" Lambertson, 132 Tamiami Station, Dept. PM92, Miami, Florida 33144.

EXTRA MONEY Low Investment. Set-up and Operate your own Furniture Stripping Business. Large demand in Antique Trade. Everett, Box 7, Cameron, N.Y. 14819.

IMPORT-EXPORT Opportunity, profitable world-wide, mail order business from home, without capital or travel abroad. We ship plan for no risk examination. Experience unnecessary. Free details. Mellinger, Dept. F2709, Woodland Hills, California 91364.

FREE Millionaire Book. Get hundreds of wonderful, little businesses. Work home! Millionaire-7, Kerrville, Texas 78028.

\$400.00 MONTHLY Raising giant fish-worms. Soilless method. Charlie Morgan, Bushnell, Florida 33513.

FREE Information!! Earn Extra Money without Selling or hard work. Wessales, Box 93-P, Charleston, South Carolina 29402.

START Your Own Mailorder Business. Get 22 lesson home study course only \$2.00. Free details. ACE, P57, Marlboro, Mass. 01752.

2000 PROFITABLE And unusual home businesses. Which one will be your steppingstone to riches? Booklet and complete list \$2.00. Future Unlimited, Box 5109, Ft. Wayne, Ind. 46805.

HIGHER INCOME, Security And Power. 256 Page Book "Thinking Big" Reveals Secrets That Make Men Rich! Book WB-123, \$2.00. Hansen House, Rt. 3, Box 22, Springfield, Oregon 97477.

FREE—Five Successful Lifetime Money-making Plans—Continental Associates, Dept. J392, Lake Katrine, N.Y. 12449.

"MAILORDER SUCCESS SECRETS!!!" Invaluable Manuscript, \$3.00. Mailmart, Box 7014PM92, Miami, Florida 33155.

PROFIT With Your Camera. Booklet Showing How, Only \$1.00. Jem Mail Order Supply, 6116 Orinoco Avenue, Indianapolis, Indiana 46227.

FREE Confidential Report!!! \$10,000 Year Possible. 400% Profit. Guaranteed. "Hottest," moneymakingest mailorder promotion ever. Selmar, Box 126PM, Brooklyn 11229.

MAILORDER Catalogs, Your Name Imprinted. Merchandise Drop-Shipped, Details 25¢. AM Sales, 32-28 100th East Elmhurst, N.Y. 11369.

MONEY—How Its Made! Work Home, Easy, Profitable, Fun. Details 25¢. LEE, Box 4198PM, South Daytona, Florida 32021.

MAILORDER BEGINNERS!! EARN WHILE LEARNING!!! Details, Mailbag-(2PM9), 2024 Orchard, Orange, California 92668.

UNIQUE Publication spotlights opportunity field. Information rushed. Sherwood Publishing, Box 517, Brundidge, Alabama 36010.

RUBBER Stamp Business. Easy Home Profits. Free Catalog. Presses, Supplies. Northwest Stamp Supply, Box 16417-PM1, Portland, Oregon 97233.

MAILORDER Book. Learn The Facts. **SCHROEDER'S**, Box 205, Greendale, Wisconsin 53129.

SUCCESSFUL BUSINESSMEN Know Advertising On Shoestring Budgets. Data \$1.00. BCS, 1426-A, Plainfield, New Jersey 07060.

MAILORDER. Prepare your own catalogs. Save big money. Portfolio 25¢. Metrographics, 529-AM Farview, Ridgewood, N.J. 07450.

INCREASE Your Income! Mail Baby Catalogs To New Mothers With Your Name. Information And Catalog Free! Vento, 1734-60th, Brooklyn, New York 11204.

\$20,000 DISTRIBUTORSHIP Wholesaling Famous Title "Home Study Courses" By Mail! 85% off direct. No Competition! Start with \$12.00 Details Free! Promotions, R7, Rome, Georgia 30161.

\$20,000.00 YEAR Possible! **COMPLETE** details \$2.00—Guaranteed!! Additional information free. McCoy Enterprises, 1A10, 9665 Varna, Arleta, California 91331.

MAKE Your Own Products. Details Free. McDaniel, 17886 Jos Campau, Detroit 12, Michigan.

MONEY In Mail Order. Details Free. Island, Box 157F, Bayside, New York 11361.

MAIL-ORDER Profits. Starter Booklet \$2.00. H. Romano, Box 403, Ft. Shelby Station, Detroit, Mich. 48226.

FREE CATALOG Of Gifts. Specialties Money-making Manuals, Buy Below Wholesale. Gillsun, 5275 DeLongpre, Hollywood, Calif. 90027.

LATEST Mailorder Secrets Revealed! What Works—What Doesn't! Free Proof. Jeffries, Box 101-P, Wilmette, Illinois 60091.

OPPORTUNITIES Unlimited! Learn how to operate successful spare-time service businesses. Details Free. Trend Craftsmen, 4901PM Perrine, Midland, Michigan 48640.

\$2,000 MONTHLY Spare Time Free Details. G & B Sales, P.O. Box 782, Niagara Falls, Ontario, Canada.

FREE Details! Home Study Mail Order Course. "How To Import?" Miley, Box 1533, Decatur, Georgia 30031.

\$1,000 DAILY Possible, Mailing Gift Catalogs, Free Proven Plan, Lakeside Industries, Box B, Silver Lake, Minnesota 55381.

\$20,000 YEAR (Easy)! Operate Computer Tax Service. Experience Unnecessary. Details: Omar, Box 2702-A, Riverside, California 92506.

MAKE Gorgeous original candles for all holidays and special occasions. Learn expert Candle decorating, candlemaking, use of professional molds. Free details on home instruction method. Candle Institute, Dept. C-47, 1600 Cabrillo, Torrance, Calif. 90501.

INSTALL BURGLAR ALARMS! Free—Profit Details. Gaurdian, Box 4192B, Mountain View, California 94040.

MAILORDER! Establish Profitable Home Business. Details 10¢. Marshall, Box 38R1-129, Walker, W.Va. 26180.

MY NEW BUSINESS Can Easily Make You \$1,500 Per Month. Rayford A. Williams, 1213 N. 29th Street, Philadelphia, Pa. 19121.

MAILORDER! Unlimited Opportunities, Fascinating, Profitable. Start Now. RSVP, Box 104, Springfield, New Jersey 07081.

TYPEWRITER Owners! You already have only equipment needed to begin \$25,000 mailorder business immediately. Guaranteed plan. Free details. Meadows, Box 327-PMT9, Boston 02199.

YOUR Own Social Security Plate Business—\$24.95! (Machine included.) Free Details. Ideaco, Box 69828PI, Los Angeles 90069.

MAKE Money sewing at home. Instructions plus proven method for selling your products—fast! Free details.—K. E. NOWELL, Dept. PM-B9, 1267 Vanderbilt, Ormond Beach, Florida 32074.

MAILORDER OPPORTUNITIES, GENEROUS Big Mails, Magazines, Circulars, 25¢. Raymon Brooks, 7147, St. Petersburg, 33734.

FREE REPORT!!! Greatest Gold Mine of easy "Small Businesses" ever crammed into one big book. Write: Report, Box 238-B130, Lafayette, California 94549.

WE NEED GINSENG GROWERS! \$3,000-\$30,000 Annually! We Buy Your Crop. Send \$2 For Seed Sample And Information. Glass's Ginseng Exchange, Box 336, Rochdale Station, Jamaica, NY 11434.

SUCCEED In Mail Order! Build Business Paying \$5,000-\$50,000 Yearly! Specialties, Box 1461-PM2A, Ogden, Utah 84401.

\$100 WEEKLY Profit From Home. Write: Box 220, Vienna, Virginia 22180.

(Continued on next page)

BUSINESS OPPORTUNITIES

(Continued from preceding page)

BE INDEPENDENT NOW!!! QUIT THE RACE!!! \$1500.00 Monthly possible. Inexpensive Home Business. Start spare time. Amazing **FREE REPORT**. Consultant, Box 1966-A, Beverly Hills, California 90213.

FREE Book "2042 Unique, Proven Enterprises." Largest Successful, Money-making Collection In World! Fabulous Ways Used To Beat Inflation! Work Home . . . Sparetime! Haylings-T, Carlsbad, Calif. 92008.

\$300.00 DAILY In Your Mailbox!!! Copy the Experts. Free Starter Plan. S. B. White, 855 Third, Santa Monica, California 90403.

FREE BOOK "999 Successful, Little-known Businesses." Work Home! Plymouth-ADI, Brooklyn, New York 11218.

HOMEWORKERS, Get \$25.00 Orders in Every Mail, \$20.00 Profit For Yourself, Everything Furnished, Telesis, Highway 71 South, Winslow, Arkansas 72959.

MAILORDER! How to prepare your own catalog for pennies! Free catalog! Obie-ADH, Brooklyn, New York 11219.

MONEYMAKING OPPORTUNITIES

MONEYTREE is \$500 In Your Pocket. Get gifts, money, aids, other free offers. Free details. Moneytree-6, Kerrville, Texas 78028.

SPARE Time cash. Sell Famous Hanover Shoes. Actual samples and sales kit Free. No experience needed. No age limit. Lowest prices for highest quality makes selling easy. Every man a prospect. Big daily commissions. For full details, write: Hanover Shoe, 905 Carlisle, Hanover, Pa. 17331.

FREE! Catalog listing low cost books on money making opportunities and self improvement. Hitchcocks Gifts, 1705 Rainier, Summer, Wash. 98390.

RAISE Funds Sell Tulips From Holland Write: Bulbhome, Sassenheim Holland.

MAKE \$1,000. Month easily from your home, write: Shickman, 726A Carrol, Harlingen, Texas 78550.

\$2.40 HOURLY Making simple wood novelties. Free details! Gene's, 55 Boxwood, Falmouth, Mass. 02540.

MAKE MONEY Writing fillers, other short pieces. Free details. Sigma, P.O. Box 91033, Cleveland, Ohio 44101.

MAKE MONEY In mail order imports. Fabulous New Method. Start your own business from home. No Merchandise Investment. U. S. Government will help you! Includes Directory Mail Order Items. \$1.00 to: 512B Annabell's Corner, 1605 N.W. 2nd Ave., Boca Raton, Florida 33432.

MAKE Money with your Camera. Learn where to sell your pictures, what photographs are in demand, how to prepare and submit them. Send \$1.00. **LUMAC GIFTS**, 58P Sejon Drive, Sayville, New York 11782.

LEARN The secrets of repairing junk batteries "Fabulous Profits" at home. Battery Shop, Box 820, La Quinta, Cal. 92253.

SELL GIFTS BY MAIL WITH YOUR OWN CATALOG. Details: 25c. Huss, 505 Penryn, East Chicago, Ind. 46312.

MAKE Money with your camera. Over one million photos and color slides are bought by newspapers and magazines yearly. Let your camera provide a second income. All information available in book-let MO-54P send \$1.00. **PARAPHERNALIA**, 8 Price Street, Bellport, New York 11713.

HOMEWORKERS. Make \$1.60 each, addressing envelopes. Rush 25c. Gemco, B-21244, Indianapolis, 46221.

MUSHROOM LOVERS—Like To Save Money—Read Miscellaneous Column Advertisement.

LEARN The art of selling. Earn generous commissions as a part-time subscription representative for leading magazines. For free details, send this ad with your name and address to: **POPULAR MECHANICS**, Room 1107S, 250 W. 55th St., New York, N.Y., 10019.

SCIENTIFIC Messages: Big Earnings uncrowded profession. Learn spare time at home. Diploma awarded. Free catalog. Write: Anderson School, Dept. L-1C, Princeton, Illinois 61356.

MAKE \$1.00 PER SALE Selling engraved metal Social Security plates. **FREE SALES KIT.** Engravaplates. Box 10460-199, Jacksonville, Florida 32207.

BEGINNER'S Moneymaking Mailorder Kit . . . \$1.00. May's, Box 802-H, Natchez, Mississippi 39120.

CONTEST REPORT Complete Information About Cash Prizes Offered Monthly. Send 25c for Current Issue, Box 307A, Ypsilanti, Michigan 48197.

WORLD'S Leading contest magazine, 25c. Year, \$4.00. Prizewinner, 1315 Central, St. Petersburg, Fla. 33705.

FIX Typewriters from home. Repairs available. Easily learned. Athey, Tarentum, Pa. 15084.

MONEY. Make Hundreds extra Spare-time home by mail. Opportunities, tips in magazine that tells how, leading mail-order magazine since 1929. Sample \$1. Year \$5 with free what is mailorder opportunities folio. Mail Trade, P.O. Box 1302, Springfield, Illinois 62705.

CLIP Newspaper Items. \$1.00-\$25.00 Each. Free Details. James, Box 124M, Inglewood, California 90306.

FREE—Easy Ways to make money selling exciting new products—Full—spare time. Send name, age, for 5 months free subscription. Salesman's Opportunity Magazine, 1460 Hancock Center, Dept. 17-JM, Chicago 60611.

MAKE Statuettes, novelties, imitation marble. Sell to stores or start gift shop. Free details. Marbleizing, 41 Waverton, St. Louis, Mo. 63124.

HOW TO GET RICH!! Free "Money-making Brochure"! Success International, Box 2447-C, Livonia, Mich. 48151.

\$200.00 FROM Sheet 1/4" plywood (scrap). Details 25c. Novelties, 610 So. 24th, Elwood, Indiana 46036.

GET World's Biggest Wholesale Import Catalog. Write: World, Medina, Washington 98039.

VENDING Machines. No selling. Routes earn amazing profits. Big catalogue Free. Parkway Corporation, 715PMM Ensor Street, Baltimore, Maryland 21202.

HOW To Make Money Writing Short Paragraphs. Information Free. Barrett, Dept. C-27-K1, 6216 N. Clark, Chicago 60660.

CLIP Newspaper items. \$1.00-\$5.00 each. Details free. Walter, Box 1360PA, Erie, Pa. 16512.

PENNY STOCKS Have Profit Potential. Free Information. Analyst-P.M., Box 214, Redondo Beach, California 90277.

BIG Money Writing Jokes. Enormous demand. We show you how. Free Facts. Laffs, Dept. G-99, Pleasant Hill, Ohio 45359.

MAKE Money!! Use "The Money Makers System". Free Details. Elwing, Box 1427, Fremont, Cal. 94538.

"HOW To **MAKE MONEY WRITING** **FILLERS**"—Articles And Short Paragraphs Tells What To Write And Where To Sell It. Directory Included. #MO-51F \$1.00. Southall Distributors, 638 Idlewild Circle, Apt. #7, Birmingham, Alabama 35205.

DO YOU WANT TO MAKE MONEY! Sell Perma-Cards. Write Lifetime Plate Distributors, Dept. 707, Grovetown, Ga. 30813. Free Sample & Sales Kit.

MAKE Money At Home . . . mailing circulars. Details free. Smith Mailers, Box 2469-PM, Newark, New Jersey 07114.

TAKING PICTURES THIS SUMMER?? Turn them into **CASH!!** Detailed report tells how. \$1.00. Delphi-1C9, Box 31072, San Francisco, California 94131.

200% PROFIT Selling Rings. Triple Money in 30 Days or Money Back. Free Details, Anka, P.O. Box 8036-PM, Cranston, Rhode Island 02920.

MAKE Money with "Instant Art"! Fantastic details: Jiffy Portrait, 1315 Ronan, Wilmington, Calif. 90744.

THINK BIG! SKYROCKET Your income and gain financial security. **LEARN** The **SECRETS** That make **MEN RICH.** For Anyone who wants to get ahead. 256 PAGES Of Inside facts. **BOOK #W.B. 123** only \$2.00. **LOGAN GIFT HOUSE, R #3, PM-9, LOGANSPOUT, INDIANA 46947.**

LIST Yourself For Opportunities! \$1.00. Great, PostBox 5272-PM, San Francisco 94101.

MAKE Money With Your Camera—Details Free! Mears, Dept. PM972, 5363 Essex Court, Alexandria, Virginia 22311.

MAKE US PROVE IT. You make 200 to 300% on hundreds of items. \$2.00 (re-funded on 1st order) brings jumbo catalog. Worldwide Associates, 426-A Washington Blvd., Oak Park, Illinois 60302.

DO FRIENDS A Favor and make good money. Sell Home Products, Cosmetics to friends in spare time. You buy wholesale. We send 4 full-size products plus sample Rug Cleaner for Free Trial. Rush name, address to: Blair, Dept. 31MT, Lynchburg, Va. 24505.

NET \$397.50 WEEKLY MAILING BROCHURES. Information 25c. Camala, Box 841-M, Florissant, Missouri 63033.

EARN MONEY At Home. Big profits possible. Details \$2.00. B. Horn, 1026 Mirabelle Ave., Westbury, N.Y. 11590.

RUBBER Stamp Business. Easy Home Profits. Free Catalog. Presses, Supplies. Northwest Stamp Supply, Box 16417-PM2, Portland, Oregon 97233.

NEW! "77 Japanese Money-Making Plans" direct from Japan! Little or no capital needed. Send \$2.00. Success Research Associates, Box 328; Paducah, Ky. 42001.

EARN \$2,000 Monthly in Amazing Interesting Businesses. Free Details. Enterprises, Box 181PM, United, Pa. 15689.

START Small, Highly Profitable Electronic Production in your Basement. Investment, Knowledge unnecessary. Postcard brings Facts. Barta-PMA, Box 248, Walnut Creek, California 94597.

MAKE EXTRA MONEY! Sell Personalized Metal Social Security Plates. Free Sales Kit! Anchor, Box 3958-PM, North Providence, Rhode Island 02911.

LET A.T.A. Help Make Life Easy For You. Write: American Taxpayers Association, 37 Limerick Road, Royersford, Pa. 19468.

TREMENDOUS Earning Potential. Three Unique Businesses Operated From Home. Jeboco, Box 6542MJ, Surfside, Fla. 33154.

COMPLETE ALL Time Winning Horse Racing System Yours For 25c Handling. Allan Weiser, 160 Broadway, Suite 1102, New York, New York 10038.

HIGHER INCOME, Security And Power. 256 Page Book "Thinking Big" Reveals Secrets That Make Men Rich! Send \$2.00. Lancer Products Company, RR3, Mason City, Iowa 50401.

SAVE! 1001 Things Free! Listing \$2.00. Elston House, Centerville, Mass. 02632.

EXTRA Dollars! Save scarce coins from shopping change. Details \$1.00. John, Box 2611P, Sioux City, Iowa 51106.

\$1.50 INTO \$20,000! Millionaires' proven secrets. Work home! M.L.N., 1713 Summit-8, Seattle, Washington 98122.

(Continued on next page)

MONEYMAKING OPPORTUNITIES

(Continued from preceding page)

FANTASTIC Bargain Guides, How-To-Books, Blue Books, Catalog 25¢. Elston House, Centerville, Mass. 02632.

BECOME Notary Public! Have dignified sideline. Free details. Stationers Exchange, Box 617, Kilgore, Texas 75662.

SWEEPSTAKES Contests. How to win. Write for free information. General Contests, 1609-18 East 5th., Duluth 12, Minnesota.

MAILORDER IMPORTS. Report Reveals Foreign Drop Ships Sources. World Traders' Digest. One-Deal Mailorder Items \$1.00. Florestano Pagano, Dept. PM1, 56 Parker Ave., Hawthorne, New Jersey 07506.

GAIN FINANCIAL SECURITY And **PRES-TIGE.** Learn Secrets That Make People Rich. **FREE** List Of Low Cost Books On Business Opportunities And Self Improvement. Write: Redd's, Box 555-A, Colton, California 92324.

BIG Profit—Sell Books By Mail, Details Free. Sykes, Box 5250, Newport News, Va. 23605.

\$600.00 WEEKLY In Your mailbox!!! Free Moneymaking Plan. Consultant, Box 1966-B, Beverly Hills, California 90213.

PROFITABLE OCCUPATIONS

BAKE New greaseless doughnuts in kitchen. Sell stores. Free recipes. Michael Ray, Waseca, Minn. 56093.

HOW TO Borrow \$500 to \$2 million. Get 2,618 cash offers. Free details! Capital-25, Kerrville, Texas 78028.

RETIRE ANYTIME In Luxury! Be Independent. Easy. Legitimate. Free Details. Premier Enterprises, PostBox 10597-R, Pittsburgh, Pa. 15235.

LEARN GUN REPAIR GUNSMITHING In spare time. Book, details 10¢. Modern Gun Repair School, Dept. 1808, 4225 N. Brown, Scottsdale, Arizona 85251.

BECOME A Mortgage Broker. Highly respected, interesting, lucrative prestige business. For complete information write: United, Box 6284-F, Marietta, Georgia 30060.

HOW To Make Money Writing Short Paragraphs. Information Free. Barrett, Dept. C-27-K2, 6216 N. Clark, Chicago 60660.

MAKE \$300 CLEAR MONTH Few hours from 10 customers, representing us in your community. No individual selling. Repeats forever. Customers waiting, \$1 for sample, details. Our 40th year. Progressive, Box 1302, Springfield, Illinois 62705.

SHARPEN Scissors, Pinkers. Inexpensive equipment, tools, supplies. Blackhawk's, Sheldahl, Iowa 50243.

FT. SMITH Auction School, Ft. Smith, Ark. 72901. Residents & Home study. Veteran approved.

500 FIBERGLASS Molds for Casting Ornamental Concrete Products. Catalog \$1.00. Plycrete Mold Co., Elk Rapids, Michigan 49629.

NO FRANCHISE Electrostatic Flocking Equipment and Materials. Make over 1000% profit "velvetizing" walls, boats, auto tops, motorcycles, etc." Tempo Industries, 5206 E. 25 Street, Indianapolis, Indiana 46218.

PLASTERCRAFT . . . Profitable home business. Molds available. Details: Lynnette, 6251-C Mentor Park, Mentor, Ohio 44060.

\$100 WEEKLY With Magnetic Signs! SPN, Box 15, Murray Hill, New Jersey 07974.

HOW TO SUCCEED IN MAIL ORDER! Free Details! Alexander's, 4101 Wadsworth, #202-AN, Annandale, Virginia 22003.

SELL Books by mail. Work home. Puckett, Box 906, Lexington, Kentucky 40501.

SALESMEN-DISTRIBUTORS

SELL Hertel Bibles—Part Time. Finest reference Bible available. Demonstrator and supplies furnished. Excellent commissions. Write: International Book, Dept. PM, Box 118, Wichita, Kansas 67201.

EARN Big Commission Full or Part Time. Show America's largest line Low Priced Business Printing and Advertising Specialties Plus Calendars in season. No experience. No investment. No collections or Deliveries. On-the-spot commissions. Big Free Sales Kit samples hundreds items used daily by businessmen. Merchandise bonuses for you. Build profitable repeat business. Start now. National Press, Dept. 72D, North Chicago, Ill. 60064.

SELL Advertising Ball Pens, Calendars, Ad-Specialties—Build Own Repeat Business—Free Details—Fleming, Dept. A, 6535 Cottage Grove, Chicago 60637.

CRIME Personal Protection Devices. Mass Demands. Tremendous Profits. Sheriff, Box 113, Twinsburg, Ohio 44087.

SELL Stores Profitable Items. Kitco, 808 Broadway, Kansas City, Missouri 64105.

HOUSEHOLD PRODUCTS ROUTE. EARN \$25 Or more daily. Also Party Plan opportunities for men, women full, part time. McNess, Freeport (2692) Illinois 61032.

MAKE Extra \$25 to \$75 spare time! Double air cushion shoes. Men's, women's line. Dress, work, play. Highest commissions. Shoes for yourself. Outfit Free. Bronson, Dept. H-92, Minneapolis, Minnesota 55408.

BIG Steady Income! Leader in business printing/advertising specialties will start you in business. No experience. No stock investment. Full, part time. Everything furnished. Write: Kaeser, Dept. B1009, 953 Martin Place, Cincinnati, Ohio 45202.

INCREASED SALES My Pamphlet Demonstrates How To Get The Best In Home Or Office. Sales Pitches **WITHOUT YEARS OF EXPERIENCE INVESTED.** My Method Is Very Simple And I'll **GUARANTEE** It Works. Send \$2.00 To: **GLOBAL AFFAIRS**, Box 335, Toledo, Ohio 43691.

SELL Chain Lock Burglar Alarm for \$3.98. Sample \$2.00, \$18 Dozen without Batteries. Nardelec, 8 Hartford, Natick, Mass. 01760.

DISTRIBUTORSHIP Free! Big earnings distributing health products. Distributor's kit \$2.00 (refundable). Better Health Club, Box 332PM9, Devon, Pennsylvania 19333.

UNIQUE Snow Shovel; No Lifting. Vine, Box 566M, Willoughby, Ohio 44094.

AGENTS WANTED

CHRISTMAS CARDS—For use by families, individuals and business firms. Personalized—your customer's name printed on the cards. Thousands have made extra money from Process cards during our 51 years in business. Lots of mechanically oriented hobbyists have used this money to help support their hobby. Many have been with us 10, 20 years or more. Beat inflation and earn unusually high commissions from this medium- and high-priced line. Customer satisfaction 100% guaranteed. No investment. No inventory. Free Sample Album. Best selling time starts right now. The Process Corporation, Dept. X227, 3450 S. 54th Ave., Chicago, Ill. 60650.

WILL You test new items in your home? Surprisingly big pay. Latest conveniences for home, car. Send no money, just your name. Kristee 134, Akron, Ohio 44308.

NEED More Money? Represent largest manufacturer of magnetic signs for business vehicles. Write: **TRIMETRIC**, 337 ElRoblar, Ojai, California 93023.

SELL Office Supplies—Machines—Furniture—Equipment. Oseco, 3505-PM Elston, Chicago 60618.

SELL Unique Prison Reform Booklet. Free Sample. Dal, 31 Ramsdell, Boston 02131.

WANT TO MAKE UP TO \$100 A WEEK Spare time, and get free shoes for life, too? No investment. Rush card for free details. Mason Shoes, K-911, Chippewa Falls, Wisconsin 54729.

EVERY Man a prospect. Refundable sales kit offer showing line belt buckles, tie clasps, money clips, cuff links, lapels, identification badges, individualized with customer's name and emblems. Cap badges for trucking, bus, taxi, police, firemen, also postal, letter carriers and heavy construction emblems. Choice 4000 emblems. Hook-Fast, Box 1088-PM, Providence, R.I. 02901.

YOUR Own business—Used Suits \$1.50; Overcoats 65¢; Mackinaws 35¢; Shoes 12½¢; Ladies' Coats 30¢; Dresses 15¢. Enormous profits. Catalog Free. Nathan Portnoy Assoc., 2109-AA Roosevelt Road, Chicago, Illinois 60608.

PRINTING, Advertising Salesmen—Excellent moneymaking sideline selling Decalcomania Name Plates, small quantities. Advertising Specialties, sign letters. Free Samples. Ralco XL, Boston, Mass. 02119.

LIFETIME Income. Be our loan representative. Free Copy "Financial Freedom". Send \$1.00 refundable. Financial, Suite 1204-X3, 28 E. Jackson, Chicago 60604.

ESTABLISH Your own business. Low prices on used clothing, shoes, household goods. Unlimited profits. Free catalog. Northwestern Distributors, 2129 No. Western Avenue, Chicago, Illinois 60647.

NEW Patented Product Need Agents. Details 50¢. Insharp Corporation, Box 321, Sanborn, New York 14132.

EMPLOYMENT INFORMATION

BRITISH COLUMBIA Employment and immigration information. Complete details, \$3.00. Doyle Associates, Box 2702, Williams Lake, B. C. Canada.

AUSTRALIA WANTS YOU!!! NEW Complete Details, Employer's List, Immigration Information. Satisfaction Guaranteed! Send \$2.00. Ventures, Box 832-M7, Kingsport, Tennessee 37662.

CANADA Fantastic Employment Opportunities! 1972 Report plus Employers Directory \$2.00. Canadian Information Service, Box 4045 Station A, Toronto 1, Canada.

AUSTRALIA WANTS YOU!!! Free Passage. 50,000 Jobs—Most Comprehensive Information Anywhere—Employment Directory, Business Directory, Teaching Opportunities, Education, Housing, Taxation, Ranching, Maps. Only \$1.00. **AUSTCO**, Box 3623-E, Long Beach, California 90803.

AUSTRALIA NEEDS YOU NOW!! Government assisted passage, settling allowance. Handbook and employment directory describes jobs, housing, transportation, taxes, education, social life—much more. Send \$1.00 (refundable) to: **RANDOLPH**, Box 563-A, Montgomeryville, Pa. 18936.

COMPLETE OVERSEAS DIRECTORY! CURRENT Job openings plus contact and resume information. **RESULTS GUARANTEED.** \$3.00. I.D.S., Box 4900 B, Palm Springs, Calif. 92262.

AUSTRALIA NEEDS YOU! Detailed Handbook On Job Opportunities \$2.00. Includes Employers, Application Forms And Procedures. Housing, Taxes, Transportation And Government Assisted Passage Guaranteed. Cooper, 1040 South Elmora Avenue, Elizabeth, N.J. 07202.

AUSTRALIA! JUST RELEASED! Most Complete Information. Paid Transportation. Employer's List. Facts On Employment, Investments, Education, Prices, Wages, Taxes, Housing. \$2.00. Guaranteed. Australian Fortune, Box 37819, Clayton, Calif. 94517.

FLORIDA Employment Opportunities! Disneyworld! Newspaper Classifieds! Booklet \$1.00. Sunshine, 4512N Jamaica, Tampa, Florida 33614.

(Continued on next page)

EMPLOYMENT INFORMATION

(Continued from preceding page)

AUSTRALIA WANTS YOU!!! Government Paid Transportation. Thousands Of Jobs! Most Complete 1972 Report Available—\$1.00. Employment Directory, Business Directory, Farming, Education, Housing, Taxes, Maps. **SERENA**, Box 2186-P921, Oxnard, Calif. 93030.

AUSTRALIA!! AUSTRALIA!! FREE DETAILS!! Paid Transportation. Latest Information on Jobs. Send age, occupation. Write: Associated, Box 17-B130, Lafayette, California, 94549.

AUSTRALIA Needs You. Latest Employment Directory. Government assisted transportation. Immigration Information. Application \$1.50. Satisfaction Guaranteed. Australia, Box 1, Bourbonnais, Illinois 60914.

ATTENTION! Australia needs good Evangelists. Up-to-date hand book \$1.00. P.O. Box 6944, Jackson, Miss. 39212.

HELP WANTED

OVERSEAS Employment directory lists many foreign jobs, immigration information. Send \$2.00. Employment Agents, Box 3966, Lafayette, Louisiana 70501.

OVERSEAS EMPLOYMENT . . . Australia, Europe, South America, Asia! All Occupations! \$700-\$3,000 monthly! Write: Employment International, Box 29217-A1, Indianapolis, Indiana 46229.

OVERSEAS Jobs—Europe, South America, Australia, Far East, etc. 2000 openings all trades. Construction, Office, Engineering Sales, etc. \$700 to \$3,000 month. Expenses paid. Free Information. Write: Overseas Jobs, International Airport, Box 536-M, Miami, Florida 33148.

"AUSTRALIAN OPPORTUNITIES KIT" . . . FREE DETAILS! Paid Transportation! Handbook, Special Reports, Forms! Australian Services, Box 29263-A1, Indianapolis, Indiana 46229.

OVERSEAS Jobs—Australia, Europe, South America, Far East openings in all trades and professions. Free information. Write: Foreign Jobs Co., Box 2235 AMF, Miami, Florida 33159.

EARN At Home Addressing Mail. Details 25¢ and Stamped Envelope. Deeco-151, Box 9308, North Hollywood, Cal. 91609.

FREE DETAILS! . . . AUSTRALIA . . . Paid Transportation!! Jobs Galore!! Send age, occupation. Write: Associated, Box 17-BA130, Lafayette, California 94549.

KEEP Your copies of PM. . . . They'll be even more valuable when you have a copy of the inexpensive Annual Index for 1971, available in January 1972. Price \$1.49. Send orders to: Popular Mechanics, Dept. HE, 224 W. 57th St., New York, N.Y. 10019.

WORLD-WIDE. . . . U.S.A. JOBS GALORE!! All occupations. Enjoy: Asia, Europe, Africa, South America, Florida, California. \$700.00 to \$3,500.00 monthly. Paid Overtime, Travel Allowance. Free Details! Send age, occupation. Write: Global Employment, Box 706-B130, Orinda, California 94563.

REAL ESTATE AND FARMS

CANADIAN LAND FROM \$19.00 AN ACRE CHOICE Properties available across Canada. Low monthly payments. Ideal for farming, cottages, hunting, fishing. Free Catalogue. Canadian Estate Land. Dept PMC-8, 286 Lawrence Ave. West, Toronto 20, Ont., Canada.

PRESCOTT, Arizona. 2 Acres for finest country living. \$1,995. Low terms. Mrs. Anna Young, Gienarm Land Co., 2233 North 7th St., Phoenix, 85006.

FREE! Real Estate Catalog! **RECREATIONAL**, Retirement and Investment Properties, Farms, Ranches, Businesses. Central States, Banner Advertising, P.O. Box 3333 (19 A), Springfield, Missouri 65804.

MICHIGAN 10 TO 160 ACRE TRACTS Lake Superior-Marquette Area from \$99.00 Acre. Cabins, trailers, camping welcome. (Acreage anywhere in Michigan). **FREE PICTURES.** Any Terms **A-OK** with **BLOCH BROTHERS** write 3650 Dixie, Drayton Plains 16, Michigan 48020.

OCALA FOREST CAMPSITES Deep in the heart of the Great Ocala National Forest. Excellent hunting and fishing. Free maps and photos. (Unavailable in States requiring separate registration): AD70LB710E. W. H. Vernor, Inc., P.O. Box 760, Dept. E, DeLand, Florida 32720.

FREE Catalog! PHOTOS! Coast to coast farms, business, retirement. All types, sizes & prices. **SAFE-BUY** Real Estate, Box 589-PM, Little Rock, Ark. 72203.

CANADIAN Vacation lands: Full price \$385.00. 40 acres. \$10 month. Suitable cottage sites, hunting, fishing, investment. Free information. Land Corporation, 3768-C Bathurst, Downsview, Ontario, Canada.

\$1 ACRE—Canadian border—hundreds campsites, islands, farmlands, directly from tax authorities. (Non-profit). Lists, photographs mailed. Register. Room 10, 110 Church Street, Toronto 1, Canada.

CENTRAL Ontario—Choice 640 acre Sportsmen's paradises still available—\$20.00 plus \$6.50 taxes yearly. Maps, pictures. \$2.00 (Refundable). Information Bureau, Norval 4, Ontario, Canada.

BONDS. Buy on installments from 'Selective List'. Maximum safety. Earn higher interest. Free information. Insurance Premium Corp., 7771-A Bernard, Lasalle 660, Canada.

BOILING Spring Lakes—America's Greatest Real Estate Value. 1/2 acre vacation or retirement homesites only \$900 cash price. Ten-year terms available. Money-back inspection guarantee. Carolina coast, multi-million dollar, 14,000 acre development. 50 fresh water lakes, private ocean beach, golf course, motel, and country club. Free literature. Dept. 1-Z, Boiling Spring Lakes, North Carolina 28461. (Registered under Federal Land Sales act but not offered to residents of states requiring separate registration.)

FREE CATALOG! Giant Fall-Holidays Edition! Over 5,100 New properties described, pictured—Land, Farms, Homes, Businesses—Recreation, Retirement. Selected Best throughout the U.S.! 72 Years' service—633 Offices, 41 states Coast to Coast. Mailed Free from the World's Largest! Strout Realty, Inc., 60-MX E. 42nd St., NY, NY 10017; 7-MX S. Dearborn, Chicago, Ill. 60603; 521-MX E. Green, Pasadena, Cal. 91101.

GOVERNMENT LANDS FROM \$3.50 ACRE! Vacationing, Homesteading, Investment! Exclusive "U.S. GOVERNMENT LAND BUYER'S GUIDE" plus "LAND OPPORTUNITY REVIEW" listing lands throughout U.S. Send \$1.00. Surplus Lands, Box 19107-A1, Washington, D.C. 20036.

FREE. . . . NEW FALL Catalog. Hundreds of top real estate values Coast to Coast! **UNITED FARM AGENCY**, 612-PM West 47th St., Kansas City, Mo. 64112.

IDEAL 5-ACRE RANCH. Lake Conchas, New Mexico. \$2,975. No Down. No Interest. \$25/mo. Vacation Paradise. Money Maker. Free Brochure. Ranchos: Box 2003P, Alameda, California 94501.

HOUSE PLANTS

FASCINATING. World's Most Unusual house plant. Exotic Venus Fly Trap catches and eats insects; Even eats raw meat. Show your children this miracle of nature for only \$1.98 plus 25¢ handling. Complete with bulbs, soil and instructions. Grows easily. Marvelous gift idea. Guaranteed. Peitler Educational Oddities, 286 Wanser, Inwood, New York, 11696.



FLOWERS, PLANTS & NURSERY SUPPLIES

GREENHOUSES From \$110! Fiberglass and U.V.I. designs (12' long) attractive, sturdy. Accessories. Free Catalog. Greenhouseman, Box 2666-MI, Santa Cruz, California 95060.

GINSENG Bringing \$20.00 pound. Have seeds roots. Goldenseal. Full Information. K. Collins, Viola, Iowa 52350.

LEARN Flower Arranging and Floristry. Start full or part time business or hobby. Free information on home study course. Lifetime Career Schools, Dept. B-461, 2251 Barry Avenue, Los Angeles, California 90064.

LEARN Landscaping and the growing of plants. Start a profitable business part or full time. Free information without obligation. Lifetime Career Schools, Dept. A-144, 2251 Barry Avenue, Los Angeles, California 90064.

CONSTRUCTION PLANS, BLUEPRINTS

HOUSE EXPANSION PLANS And detail instruction book provide anything from an extra room to 1000 s/f addition. Build what you need at big do-it-yourself saving. Book with 1 set working blueprints \$14.50! With 4 sets (required by contractors) \$20.00. Money-Saver Projects, Box 303-44B, Chappaqua, New York 10514. Information available.

LOG CABINS & HOMES

"A" FRAME CABIN. \$500. For Material. Purchase Locally. Completely illustrated **INSTRUCTION MANUAL**, including material list: **\$2.00. MONEYBACK GUARANTEE.** Dependable, Plan #1911, Box 113, Vista, California 92083.

BUILD Log Cabins, rustic furniture, fireplaces!!! Complete manual, \$3.00 . . . **"A" Frame plans, \$2.00 . . . Guaranteed** . . . Beels, 956 Springdale, Atlanta, Georgia 30306.

HOME CRAFTSMEN

101 PATTERNS of Smart Gifts, Novelties, Shelves, Action Windmills, plus "Make Money Jig Sawing". \$1.50. Mastercraft, 95M, 7041 Olcott, Chicago, 60631.

PICTURE Framing—Profitable full or spare-time business. Easy to learn with handbook-course "Guide To Picture Framing Profits." \$1.50 Guaranteed. Free framing-supplies catalog included. Japs, 126-PM Seventh North, Hopkins, Minnesota 55343.

WOODWORKING Catalog and Manual 50¢. Plus free "101 Project Ideas." World's most beautiful veneers, lumber, plywood! Wood finishing, upholstery supplies, Cane, Lamp Parts, Furniture hardware, Animal whittling blocks. 2,000 workshop products. Constantine, 2051-C Eastchester Road, Bronx 10461.

CABINETMAKING MADE EASY And "How to Make Formica Counter Tops." Two excellent guides let you build kitchen cabinets and counter tops like professionals. Extraordinary guides bring master craftsmen's shortcut methods. Satisfaction guaranteed. Write: Japs, 126-P Seventh North, Hopkins, Minn. 55343.

FOUNDRYETTE 2400 F. 1 1/2 to 48 lb. capacity. Circular 25¢. Kansas City Specialties, Box 193-P-9, Middleton, Wisconsin 53562.

WALNUT Bowls, Legs, Round Picture Frames, Gun-Stocks Lumber Moulding. Midland Walnut, Box 262, Savannah, Missouri 64485.

SKIL-CRAFTS Current 200 plus page catalog with world's largest, finest selection of Hobbycraft, leathercraft, artist supplies. Send \$1 for postage and handling; refunded on first \$15 minimum catalog order. Skil-Crafts, Box 105-P, Joplin, Mo. 64801.

CLOCK Kits, Movements, Dials, Frames. Catalog 25¢. Newport, Box 6848A, Burbank, Calif. 91505.

(Continued on next page)

HOME CRAFTSMEN

(Continued from preceding page)

CATALOG FULL SIZE FURNITURE PLANS—\$1.00. Refunded with first order. Traditional, Early American, over 135! Furniture Designs, 1425 Sherman, Dept. CP-92, Evanston, Illinois 60201.

FLASHING Tiny lights accurately show wind direction on small 3½x6 attractive indoor display panel. Send for full scale plans. \$1.00. Windcheck Products, Stockton Springs, Maine 04981.

BEST WORKBENCH PLAN Ever. Plus Free Lumber Conversion Chart. \$1.00. WAY-MAR, Dept. 45, 58 Underhill Road, Scarsdale, New York 10583.

POPULAR MECHANICS MASTER SHOP GUIDE. Greatest product offered to a man with a workshop. All information printed on heavy boards, punched and ready to hang above his workbench. Covers wall fasteners, nails, screws, bolts, twist drills, abrasives, lumber, moulding patterns, plywood grades, hardboard, dry-wall plumbing supplies, electrical supplies. Plus information on score of other subjects. Send \$3.95 to: **POPULAR MECHANICS**, Dept. HE, 224 West 57th Street, New York, New York 10019.

HOME REMODELING

CERAMIC Wall Tile Instructions \$3.00. Don Haskins, Union Street, E. Bridgewater, Mass. 02333.

DO-IT-YOURSELF

SAVE Money, repair your car. Auto Repair Book \$2.45. Moyer-P, Raymond Street, Milton, Penna. 17847.

STEAM Powered Lawn Mower, Flash Boiler, Burners, Engines send 2.00 for Descriptions, Pictures, drawings, Travis Tool Co., Sidney, Iowa 51652.

CONVERT MOWER Engines into air compressors. Write: Showalter, Box 409, Abilene, Kansas 67410.

BURGLAR-FIRE Alarm Supplies and Information. Free Catalog. Protecto Alarm Sales, Box 357A, Birch Run, Michigan 48415.

REPAIR MINIBIKES, LAWNMOWERS, BICYCLES, Sewing Machines, Auto Engines. Build concrete, Plywood, boats, trailers. Over 100 How-To-Do books. Free brochure. Sincere, Box 10422, Phoenix, Arizona 85016.

BAROMETER Make for under \$2.00. Educational, conversation piece, plans 50¢. Send Stamped, Self Addressed Envelope. Thomas, Box 104, Millbury, Mass. 01527.

HOUSEHOLD Electrical Guide \$1.00. Bert Moon, Box 69, Central Islip, New York 11722.

SAVE MONEY! "How-to" books—Appliance repair, Home improvement, automotive, crafts, hobbies, etc. Free details. Vernco, Box 121, Whittier, Calif. 90608.

WORKABLE Artificial Fireplace Decorative Cabinet New Space Saver 55" long, 20¼" wide, 46½" high. Different, contains over 17 cubic feet usable space for TV, Stereo, Bar, Desk, Storage, whatever. Build using plywood, material list, instructions, complete easy to follow plans \$4.95. M.M.P. Fireplaces, P.O. Box 1069, San Fernando, California 91341.

REPAIR ROTTED WOOD, Kit \$4.95. Calahan, Box 178, Mamaroneck, New York 10543.

DO YOUR OWN GENUINE 22 KARAT GOLDFLEAFING—on picture frames, glass, ceramics, furniture! Send \$8.50 (check or money order), postpaid, for kit (285 square inches 22k gold leaf, brush, cloth, easy-following instructions). Enhance Gilding Enterprises, Inc., 142-12 41st Avenue, Flushing, N.Y. 11355.

IMPROVE Preschoolers Alphabet Understanding. Plans \$1.00. Greiner, Bluepoint, Forest, Ontario.

SAVE! \$\$\$ Hundreds of inexpensive "HOW TO" Booklets in stock! Free list!! **YANKEE INGENUITY INC.**, 303 Lamartine St., Boston, Mass. 02130.

SMOKING Yet? Fool-Proof Quitting Method. \$1.00 Dec. Ori, 953 West Lincoln, Belvidere, Ill. 61008.

BUILD Table and Chair Set for your Children. Attractive, sturdy, simple design using conduit and plywood. \$2.00 for Plan 777. Precision Products & Services Ltd., Millerton, N.B., Canada.

PROJECTION TV—CONVERT Your Portable To 72 INCH TV PROJECTOR For Under \$10.00. Free Details, The Macrocoma Company, Dept. PM9, Washington Crossing, Pennsylvania 18977.

BOXES—Make sturdy, self-locking boxes to your size requirements from store cartons. Two types—plans & instructions \$1.00. Boxer Products, 8406 Houston St., Silver Spring, Md. 20910.

HANDY? Make sweet smoking pipes. Pimob, Box 59211, Chicago, Illinois 60659.

DO-IT-YOURSELF! Save Money! 484-page, big, illustrated catalog/guide. Latest parts, tools, supplies, electrical equipment. \$1.95 ppd., refundable. Do-It-Yourself Supply, Box 1196XI, El Monte, Calif. 91734.

POOL TABLE Plans and Kits. Professional quality. Specifications, 3-View drawing and information \$1.00 (Refundable). Tiercraft, P.O. Box 6117, Erie, Penna. 16512.

ARTS AND CRAFTS

JEWELRY MAKING For hobby or profit. Send for free brochure showing complete kits and easy instructions. V. F. Ausura, 1565 Reservoir Ave., Roslyn, Pennsylvania 19001.

FREE: New handicraft catalog. Supreme Handicrafts, Box 395-PM, Sioux Falls, South Dakota 57101.

MAKE Figurines, plaques, lawn ornaments. Molds, plastercraft kits, liquid rubber. Sample and catalogue 10¢. Wooley Company, Box 29-B, Peoria, Illinois 61601.

FREE LITERATURE For sculptors showing how to make molds, cast plastics. Adhesive Products Corporation, 1660 Boone Avenue, Bronx, N.Y. 10460.

BINOCULARS, TELESCOPES, MICROSCOPES, MAGNIFIERS

FREE Binocular, Riflescope catalog. Discount sale. Save 50%. Free gift with order. Write, United Binoculars, BN-4908, 9043 So. Western, Chicago 60620.

MINIATURE Binoculars—Powerful 6x15 wide angle fully coated lens, lens caps, leather carrying case. \$34.95. Taylor House, 9021 Fourth Avenue, Inglewood, Calif. 90305.

MANON MEANS FINE BINOCULARS! SALE! Write: "Manon PM," 17171 Beach Blvd., Huntington Beach, Calif. 92647.

TELESCOPES (Reflectors) complete kits. Other accessories, request free literature. Criterion Manufacturing, Dept. PM 33, Hartford, Connecticut 06101.



CAMERAS AND EQUIPMENT

POPULAR Brands Equipments! Bargain Prices! Mandarin, 214 Shaws Building, Hong Kong.

FREE! FREE! BARGAIN BOOK Central Camera Co., Dept. 391, 230 S. Wabash, Chicago, Ill. 60604.

PHOTO FINISHING

CAMERA FANS! Expert photofinishing by one of Country's largest labs at lowest prices. Fast service and free "Foto-Fan" Stamps you quickly redeem for valuable Photo Supplies. 8MM Kodachrome \$1.29; 8 Exp. Kodacolor \$1.79; 35MM Kodachrome 20 Slides \$1.39; 8 Exp. Black White 69¢. Satisfaction guaranteed. Send exposed film or request free mailers, complete Price List and Gift Catalog. Direct Mail Photo, Box 8352-PM, Pittsburgh, Pa. 15218.

COLOR SLIDES

35MM COLOR Slides. 10,671 Individually sold. Described, Encyclopedia catalog 10¢. Wolfe Worldwide, Dept. 14-92, Los Angeles, Calif. 90025.

MOTION PICTURES AND SOUND EQUIPMENT

UNUSUAL Movie supplies. Free circular. Esor, 47th Holly, Kansas City, Missouri 64112.

16MM SOUND Features, Shorts, New used for Sale. Free Catalog. National Cinema, 333 W 57th St.—N.Y.C., N.Y. 10019.

FREE! 64-Page catalog. 8-16MM film supplies, processing equipment. Superior, 448 N. Wells, Chicago 60610.

CLASSIC 8MM. MOVIES . . . 35MM. 2"x2" Color Slides. . . largest selection anywhere! Silent classics, comedy, history, sport, news, documentaries, features, others! 16MM films also. Free catalog. Blackhawk Films, 569 Eastin-Pheasant Bldg., Davenport, Iowa 52808.

16MM-8MM Movies Sound, Silent. Free catalog. Imperial, 15 Park Row, N.Y.C. 10038.

CASTLE FILMS—Free catalogue. G & G Film Library, Box 321, Syosset, N.Y. 11791.

RADIO, TELEVISION AND HAM EQUIPMENT

SIGNAPROBE The signal tracer you carry in your pocket like a pen. \$29.95 postpaid. Details, 8¢ stamp. Bitting, Box 13, New Cumberland, Pa. 17070.

36¢ RADIO & TV Tubes. Free catalog. Cornell, 4213-17 University, San Diego, California 92105.

SAVE Money on parts and Transmitting—receiving tubes, Foreign—domestic. Send 25¢ for giant catalog. Refunded first order. United Radio Company, 56-PM Ferry Street, Newark, N.J. 07105.

GOVERNMENT Surplus receivers, transmitters, snooperscopes, parts. Catalog. 25¢. Meshna, Nahant, Mass. 01908.

NOW YOU CAN Turn The Sound Off Or On To Your Television By Remote Control. Kit, Easy-To-Do Instructions, \$2.00. You'll Be Pleased. Aitenburg, 1140 Canterford, Westlake Village, Calif. 91361.

TV-7D Tube Tester—Gov't. Surplus—Just Released—Mutual Conductance Type—Has Own Carrying Case—Takes All Standard Bases Also, Adapters For 2C39 4x150 Price Of Unit \$59.95, adapters \$4.95 Each. Full Details Available. Wire, Write, Call: Artko Corporation, 6401 S. Tucson Blvd., Tucson, Ariz. 85706 Phone Area 602 294-7611.

TRANSISTORIZED Detectors—\$19.95 to \$79.95. Finds coins, gold, silver, and metals. Catalog write: Treasureprobe, (PA 22), Tennent, N.J. 07763.

HIFI TAPES, RECORDS AND ELECTRONICS

FREE Catalogues, 2000 hard to find unusual records. Rose's Records, Box 7216, Louisville, Ky. 40207.

GOLDEN Age Radio. Complete taped shows. Box 8404-M, St. Louis, Missouri 63132.

FREE Catalog—Electronic Kits—Amplifiers—Preamplifiers—Psychedelic Strobes—SCA Adaptors—Color Organs—Digital Instruments—Guitar Amplifiers. **FREE** Subscriptions. SWTPC, Box PM32040, San Antonio, Texas 78284.

OLD Radio On Tape. Catalog \$1.00. (Refundable). Radio Vault, Box 9032-PM, Wyoming, Michigan 49509.

(Continued on next page)

HIFI, TAPES, RECORDS & ELECTRONICS

(Continued from preceding page)

TELEPHONE PICK-UP For cassette recorders; \$2.00. **MONITOR EARPHONE**; \$1.00. Mardon Enterprises, Department PM9, Box 97, Rockwood, Michigan 48173.

FREE CATALOG—40% To 70% Off-Top Label Rock-Country-Jazz Records, Cassettes, 8-Track Tapes. Regal House, 2568 East 21 Street, Brooklyn, N.Y. 11235.

RECORDS, Sound track. Record Albums from Films. Whalon, 2321-A-Hill, Redondo Beach, Calif. 90278.

STOP Your 4 Track—8 Track And Cassette Tapes From Dragging. A Must For Every Tape Deck Owner. Send \$3.98. U.S.A., P.O. Box 524, Costa Mesa, Calif. 92627.



MUSIC AND MUSICAL INSTRUMENTS

ELECTRIFY Player Pianos, Pump Organs Quickly, Inexpensively with Lee Silent Suction Units. Write: Lee Music, 525F Venezia Avenue, Venice, California 90291.

YOU Can Read Music In One Evening! Free Brochure. Earlee Diehl, Route #5, Staunton, Virginia 24401.

ACCORDIONS And Amplifiers! New-Used. Cordovox, Excelsior—Top Makes! Save to 50%. Direct factory dealer. Terms. Trades accepted. 5 day home trial. Free catalog—Discount prices. Write: Accordions Unlimited, Dept. R, 3147 North Luna, Chicago 60641.

GUITAR MAKING Books. Imported Woods, Supplies, Accessories. Catalog 25c. Guitar Center, Box 15444, Tulsa, Okla. 74115.

EASY To Play And Make. Quality Dulcimers, Banjos, Thumb Pianos; Instruments And Kits. Can Be Profitable Hobby. **HERE**, Inc., #P, 410 Cedar Avenue, Minneapolis, Minn. 55404.

GUITARISTS!!! Fantastic Savings—Guitars: Amplifiers—Popular name brands, largest selection. Money Back Guarantee!!! 32 page illustrated discount catalog. Send 25c today: Guitars Unlimited, Box 343, Dept. PI, Richland, Washington 99352.

30% TO 50% DISCOUNT! Any Model: Guitar, Amp, Drum, Banjo, Dobro! Free Catalog! Warehouse P25, Box 16399, Fort Worth, Texas 76133.

ACCORDION Top brands. Buy direct. Tremendous discounts. Trades accepted. Free brochure PM. Accordion-O-Rama, 874 Broadway, N.Y.C. 10003.

PLAYER Piano Rebuilding—get details from: Vestal Press, Vestal 11, N.Y. 13850.

ACCORDION Manufacturing, 6846-P North Avenue, Chicago, Illinois 60635. Concertinas, Hohners, Chromatics, Guitars, Drums, New, Used, Tuning, Repairing. Wholesale Catalogs Free.

POEMS Wanted for songs. Nashville Music Productions, Box 40001-P, Nashville, Tennessee 37204.

LEARN Banjo. 5-String Bluegrass. No music. Makes learning easy. Free details. Blaylock, Box 25-M, Marietta, Georgia 30060.

WHOLESALE. Musical Instruments—Accessories. Allied, 573 Route 17, Paramus, New Jersey 07652.

WHOLESALE Professional Guitars, Amplifiers, PA Systems, Free Catalog. **CARVIN**, Escondido, Calif. 92027.

PSYCHEDELIC And Sexodetic Lamps Tremendous \$5.00 Each. Guaranteed. Insharp, Box 321, Sanborn, New York 14132.

30% DISCOUNT Name Brand Musical Instruments. Free Catalog. Freeport Music, 455F Route 110, Melville, N.Y. 11746.

POEMS Set to music. Songs recorded. Send poems, songs. Crown Music, 49-C West 32, New York 10001.

VIOLIN And Guitar makers—send for latest Free Catalogue of woods & accessories. International Violin, PM1, 414 East Baltimore St., Baltimore, Md. 21202.

ACCEPTED Poems recorded free. (50/50) TDS, 108 LaRoche, Harrington Park, N.J. 07640.

LEARN GUITAR FAST. Play Any Song Using Only Five Simple Chords. Satisfaction Guaranteed. \$1.98. Jamie, Box 179, Lake Jackson, Texas 77566.

PIANO Repairs: Refinish hammers with time saving tool used by professionals. Information: Oscar Rule Sons, 403 Dallas Road, Knoxville, Tennessee 37914.

ACCORDIONS And Amplifiers Selected Group Of Models At Special Factory Close-Out Prices. Write For Details. Excelsior Accordions, Inc., 333-6th Ave., New York, N.Y. 10014.

LEARN GUITAR—NO MUSICAL NOTES! New-Different-Easy-Fast-Sure! You'll Love It. Free Information Or \$4.95 Postpaid. Del-Way, Box 292, Twin Falls, Idaho 83301.

WHOLESALE! Professional Guitars, PA Systems, Aitec Speakers, 240W RMS Amplifiers. Free Catalog. Carvin, Escondido, Calif. 92027.

AMAZING 8-Track, cassette offer. **SAVE!** Only \$2.85 each. Satisfaction Guaranteed. **FREE** catalogue. Dean David Recordings, 377½ 7th Street, Idaho Falls, Idaho 83443.

CONSERVATION TRAINING

GAME WARDEN, Government Hunter, Forestry, Park & Wildlife Service announce job openings regularly. Prepare at home for outdoor work, good pay, security. Approved for Veterans! Free! "Conservation Career Kit." North American School of Conservation, MP, Newport, California 92663.

EDUCATION AND INSTRUCTION

FINGERPRINTING—Investigation. Exciting, secure career. Learn at home. Free book. State age. Institute of Applied Science, 1920 Sunnyside, Dept. 169, Chicago, Illinois 60640.

WATCH REPAIRING. Learn to repair American and Swiss watches in spare time at home. Diploma awarded. Free sample lesson. No obligation. Chicago School, Dept. YJ, Fox River Grove, Illinois 60021.

UPHOLSTERY Earn while learning by mail. Send \$2.00 for booklet. Shaw, 109 Drake, Modesto, California 95350.

FREE Book tells how you can learn camera repair and service. Home study or classroom. Write today! National Camera, Dept. EAD Englewood, Colorado 80110.

EARN College degrees at home. Many Subjects. **FLORIDA STATE CHRISTIAN COLLEGE**, Post Office Box 1674, Fort Lauderdale, Florida 33302.

DRAFTING—Blueprint Reading (Mechanical, Electronic, Architectural). Home Courses \$25.00. Send \$2.00 first lesson. Prior Inc. 23-09 169th Street, Whitestone, New York 11357.

LEARN Auctioneering. Term soon. Free catalog. Reich Auction College, Box 850, Mason City, Iowa 50401.

BIG Profits—Real Estate. Invest, sell. Broker. Free Booklet. Prepare at home. Approved. Veterans. Weaver School, 3519-PB Broadway, Kansas City, Missouri 64111.

HIGHLY Effective, Profitable Short Courses. (75 Choices). Study At Home. Diploma Awarded. Our 27th Year. Free Literature. CIEE-25, Box 10634, Jackson, Miss. 39209.

DETECTIVE Course. Free Information. Universal Detectives, Box 8180-F, Universal City, California 91608.

PIANO Tuning quickly learned with home study course. Diploma granted. American Tuning School, Gilroy, Calif. 95020.

PIANO Technology—Electronic organ servicing, learned easily at home. G. I. Approved. Free booklet. Niles Bryant School, Dept. P, 3631 Stockton, Sacramento, California 95820.

LEARN To Fix Typewriters. Desperate shortage trained men. Hundreds needed. Make up to \$25 in one hour. Learn at home in spare time. Industry Approved course. Facts free. Send name. Typewriter Repair School, Dept. 3310-092, Little Falls, New Jersey 07424.

HIGHLY EFFECTIVE Home study courses in Electronics Engineering Technology and Electronics Engineering Mathematics. Earn your Degree. Write for Free Descriptive literature. Cook's Institute of Electronics Engineering, (Dept. 10), P.O. Box 10634, Jackson, Miss. 39209. (Established 1945).

AUCTIONEERING. Resident or home Study Course. Free Catalog. Nashville Auction School, 2004 West End, Nashville, Tennessee 37203.

AUTOSUGGESTION. Sleep-learning headquarters! Tapes, records, books, Gigantic catalog free. Research Association, Box 24PM, Olympia, Washington 90851.

USED Courses! Books! List 10c. Smith's, 124 Marlborough, Salem, Massachusetts 01970.

UNLOCK Your Future. Become professional Locksmith by spare time home-study. Make up to \$6 per hour. All tools, equipment incl. Facts Free. Send name. Locksmithing Inst., Dept. 1310-092, Little Falls, New Jersey 07424.

GRAPHOANALYSIS—Learn scientific handwriting analysis for profit, pleasure. Free sample lesson, catalog, reveals plan. Write: Igas Inc., 325 Jackson, Dept. 2JY-2, Chicago 60606.

PERFECT Husband-wife business. Learn Upholstery at home. Make \$10 in an hour. Buy—repair—sell for even bigger profits. Kits, tools included. Free Booklet. Upholstery & Decorating School, Dept. 5310-092, Little Falls, New Jersey 07424.

RELIGIOUS VOCATION? Write: Church Of Holy Light Inc., P.O. Box 4478, Pittsburgh, Pa. 15205.

DETECTIVE Profession, Easy home study; free tie-tack or lapel pin, certificate, future. GI approved. Professional Investigators, Box 41345, Dept. CP, Los Angeles, Calif. 90041.

USED Courses! Books. Catalog 10c. (Courses Bought). Lee Mountain, Pisgah, Alabama 35765.

DETECTIVE And Fingerprinting Courses. Write. Detectives, Box 185-P, Fairfield, Alabama 35064.

LEARN TO WELD—Arc, Pipe, Gas, TIG, MIG, Plasma. Free Bulletin. Write, phone or visit. Approved Ohio No. 70-12-0064-HT. **HOBART SCHOOL OF WELDING TECHNOLOGY**, BOX 72, TROY, OHIO 45373.

THOMAS A. EDISON COLLEGE Master's & Doctor's "OFF CAMPUS" Degree Programs in Religion & General Education. Write: TAEC, Box 688, Palm Beach, Fla. 33480. For Catalogue send \$1.00.

GET A British Degree. Divinity. Philosophy, Radionics. 35 Courses. Prospectus free. Brantridge Forest School, Highfield, Dane Hill, Sussex, England.

OWN Collection agency. "Little Gold Mine!" Franklin Credit, Roanoke, Virginia 24004.

LEARN Asleep or awake! Records, tapes, equipment! Free catalog! Drawer PM-400, Ruidoso, New Mexico 88345.

COLLEGE Degree at home. Your choice of subjects incl. law. Easy tuition plan. Williams College, 445 East Second South, Salt Lake City, Utah 84111.

ORDINATIONS, Lifetime! Church chartered 1887! Write! 708 Bragg, Monroe, North Carolina 28110.

LIFETIME Ordination. **DOCTOR** Of DIVINITY. Church Charters. Details 25c. Life Science Church, 2207 Cardinal, Rolling Meadows, Illinois 60008.

(Continued on next page)

EDUCATION AND INSTRUCTION

(Continued from preceding page)

IF YOU Really want to succeed at life, my **LETTER FROM A FRIEND** Will help you as it has helped so many others. Send \$1.00 for this indispensable guidance. ERB, Box 21008, Philadelphia, Pa. 19154.

VETERINARY ASSISTANT—Train at home in spare time for animal care career. Unlimited opportunities—hospitals, shelters, zoos, pet shops, kennels, laboratories, etc. Send for **FREE "Career Kit"**, North American School of Animal Sciences, AZ, Newport Beach, California 92663.

SURVEYING PAYS BIG!!! United States Department of Labor reports "Openings, for 26,000 Surveyors in next ten years." Easy home-study plan guides you. Send for Free "Surveying Career Kit." North American School of Surveying, AZ, Newport Beach, California 92663.

LAUNCH New Career in 48 Hours. Management Studies, Box 17-434, West Hartford, Conn. 06117.

GAME WARDEN, Government Hunter, Forestry, Park & Wildlife Service announce job openings regularly. Prepare at home for outdoor work, good pay, security. Approved for Veterans! Free! "Conservation Career Kit." North American School of Conservation, AZ, Newport, California 92663.

LEARN BEGINNING ALGEBRA. Four workbooks and answers only \$3.00. Key Project, Box 2304A, Berkeley, California 94702

BOOKKEEPING Service. Operate your own. We train you. Universal Bookkeeping, Box 664-M, Springfield, Missouri 65801.

INSTANT High School Diploma, for lost Diplomas. Free Birth Certificate, only \$2.00. Steele, Box 122, Dept. 128, Cana, Virginia 24317.

COMPLETE YOUR HIGH SCHOOL At home in spare time. Texts furnished. No classes. Diploma. Our 75th Year. Free Brochure. American School, Dept. X645, Drexel at 58th, Chicago 60637.

WRITERS: Need critical help? Satisfaction guaranteed. Send manuscript, return postage, and \$10: Creative Ink, 532 Grand Blvd., Venice, Calif. 90291.

HIGH SCHOOL DIPLOMA For Adults. Earn State Diploma. Accepted by Civil Service, business, colleges. Low cost. No tedious study. Money-back guarantee. Details: H-S Program, Suite 2505, 1221 Avenue of Americas, New York, N. Y. 10020.

ORIGINAL \$100.00 Real Estate Course \$17.95. Free literature. School, Box 8585-A, Kansas City, Missouri 64114.

SELF SCORING 45 MINUTE IQ TEST \$2.00!!! Brainbuster \$4.00!!! Guaranteed!!! Mailbag (3PM9), 2024 Orchard, Orange, California 92668.

INTELLIGENT?? I. Q. Revealed In Minutes!! Self Scoring Test! Only \$1.98, 3 for \$5.00. Money Back Guarantee! Getco, PM9, Ridgeland, Ill. 61870.

"AUCTIONEERING" Learn at home. Invest a six cent post card for lifetime career. Send name and address to: Auctioneering, Box—3514, San Bernardino Calif. 92413.

LEARN Sewing Machine, Vacuum Cleaner Repairing. Men, Women. Lucrative Profits. Profession With Bright Future. Gresslin Correspondence School, Box 927, Spencer, Iowa 51301.

IMPROVE YOUR SPELLING. "Commonly Misspelled Words." \$1.00. Robar, 30 Cypress Street, Watertown, Mass. 02172.

PENMANSHIP Corrector. Improve Poor Penmanship Quickly. Details Free. Ozment, Box 2344-34, St. Louis, Missouri 63114.

LEARN Expert Cake Decorating, Catering, Candymaking. Free details on home instruction. Candy & Cake, Dept. BMU-P, 1600 Cabrillo, Torrance, Calif. 90501.

LEARN Slide Rule on Cassette \$5. General Cassette Corporation, 1324 N. 22nd Avenue, Phoenix, Arizona 85009.

BECOME Your Own Boss In Less Than A Month. American Truck Driving Academy Can Make You A Pro In Just A Few Weeks. Home Study Plus On The Road Training. Approved For Veteran Training. Student Loans Available. Effective Job Placement Service. Write Now. No Obligation. American Truck Driving Academy, Dept. PM, 645 North Meridian, Oklahoma City, Oklahoma 73107.

EXTENSION And Post-Graduate Awards in Philosophy, Art, Sciences, Botanic Medicine, Homeopathy, Radionics and others. 30 subjects. Curricular free (airmail \$1.00 refundable). Registrar, Sussex College of Technology, Highfield, Danehill, Sussex, England.

DETECTIVE INVESTIGATOR. Homestudy Course. Free Details. Write: Global Detectives, Box 415-B130, Lafayette, California 94549.

SERVE God's Ministry. Free. Ordination, Bible Institute, Box 744, McKeesport, Pa. 15134.

FOR INVENTORS

INVENTIONS Needed immediately for manufacturers. For additional information write: Kessler Corporation, C-59FI, Fremont, Ohio 43420.

U.S. PATENT Office Searches, 234 Broadway, Room 3615, New York 10017. Free invention certificates.

PATENT Application Financing. Free patent search plan, Global Patent Division, 2420 77th, Oakland, Calif. 94605.

INVENTORS: Your ideas and inventions (patented; unpatented) expertly searched, developed for commercial appeal and cash/royalty sales to manufacturers by professional Invention Developer with excellent record of experience. B. S. Industrial Engineering; United States Patent Office former Patent Examiner. United States Government former Patent Advisor. Second decade reliable service! Member: United States Council International Chamber Commerce. Free "Invention Record" and "Recommended Protection Procedure." Airmailed! Write: Raymond Lee, Invention Developer, 230P-Park Ave., New York, New York 10017.

FREE PAMPHLET: "Tips on Safeguarding Your Invention." Write: United States Inventors Service Company, 501-P Thirteenth Street N.W., Washington, D.C. 20004.

INVENTORS—United States Patent Office Searches, Patent Development Engineering, marketing of inventions—ideas by Licensed Professional Engineer—Patent Engineer and United States Patent Office Former Examiner. Inventions developed for patenting and marketing. We are contacted by many manufacturers seeking to purchase appropriate new products invented by our clients. Send for Free Invention Certificates and Invention Information. Serving inventors since 1948. George Spector, Licensed Professional Engineer—Patent Engineer—3615 Woolworth Building, New York, N.Y. 10007.

WHERE To Find Out About Patents. \$1.00. L. Toliver, 329 Shepherd St., N. W., Washington, D. C. 20011.

IMMEDIATE Cash, for patent applications. Free patent searches. Write for details. Universal Patents, 184-D, Marion, Ohio 45750.

PATENT Searches including maximum speed, full airmail report and closest patent copies. Quality searches expertly administered with complete secrecy guaranteed. Free Invention Protection Form and "Patent Information." Write: Washington Patent Office Search Bureau, Benjamin Franklin Substation, P.O. Box 7167, Washington, D.C. 20044.

SYNTHESIS MAGAZINE Is about the business of invention. Write: Box 157-F, Manhattan Beach, California 90266. For our brochure.

INVENTORS Get professional, independent objective evaluation of your ideas, inventions before investing in costly patent and marketing services. Write: Invention Evaluation Services, Box 665-M, Marion, Ohio 43302.

PROSECUTE Your Own Patent Application. All Material, Three Booklets Including Step-By-Step Procedure—\$9.00. Inventors Service, Box 3574, Washington, D.C. 20007.

INVENTORS. No obligation for free particulars on how you can earn big money, recognition, and respect for your inventions or ideas. Dept. PM, Universal Patent Development, Ltd., 501 5th Ave., New York, N.Y. 10017.

DISPLAY PLAQUE For U.S. Letters Patents. Metal Plate On Walnut Board. Send For Free Literature, Certi-Plak, Box 2277-P, Sunnyvale, California 94087.

INVENTIONS WANTED

INVENTORS—If you have an invention for sale, patented or unpatented, write for free brochure outlining manufacturers requirements, royalty rates. Kessler Corporation, C-59IW, Fremont Ohio 43420.

INVENTIONS Wanted. Patented: unpatented. Tremendous manufacturers lists. Global Marketing Service, 2420G 77th, Oakland, California 94605.

FREE "Directory of 500 Corporations Seeking new Products." For information regarding developments, sale, licensing of your patented/unpatented inventions. Write: Raymond Lee Organization, 230-N Park Avenue, New York, New York 10017.

INVENTORS! Protect your ideas! Free "Recommended Procedures." Washington Inventors Service, 422F Washington Building, District of Columbia 20005.

INVENTORS! Don't sell your invention, patented or unpatented until you receive our offer. Eagle Development Company, Dept. H, 83 Wall Street, New York, New York 10005.

INVENTORS! Sell your invention for cash or royalties! Our client manufacturers eagerly seek new items. Patented, Unpatented. Financial assistance if needed. 25 years proven performance. For free information, write: Dept. 15, Gilbert Adams, Invention Broker, 81 Wall St., New York, N.Y. 10005.

INVENTORS! We will develop, sell your idea or invention. Our national manufacturer-clients are urgently seeking new items for highest outright cash sale or royalties. Financial assistance available. 15 year proven performance. For free information write: Dept. 47, Wall Street Invention Brokerage, 79 Wall Street, New York, N.Y. 10005.

WE Either sell your invention or pay cash bonus. Write for details. Universal Inventions, 28-E, Marion, Ohio 45750.

MANUFACTURER Of established reputation in novelties, gifts; wants inventions of highly humorous content. Freed Novelty, 682 Broadway, New York N.Y. 10012.

PATENTS FOR SALE

FIGHT AUTO POLLUTION YOURSELF! BUILD YOUR OWN EXHAUST CONTROL SYSTEM! New! Patented By Me. Tailpipe Device That Can Be Made For Less Than Ten Dollars In Your Own Workshop! Laboratory Tested. Reduces Hydro-Carbons, Leads And Other Pollutants Up To 70% Using Changeable Fiberglass Filter That Costs Only Pennies. Fits Any Automobile New Or Old. Quiets Noisy Motors. No Back Pressure. Materials Available Everywhere. Patent Copies And Drawings Along with Full Instructions Mailed Prepaid For Only \$3.00. System Can Be Adapted To Power Motors Or Other Internal Combustion Engines. I Own All Patent Rights. This Is Not A Gimmick. **M. J. MCKENZIE, 1014 SOUTH MASSACHUSETTS, SEDALIA, MO. 65301.**

(Continued on next page)

MANUFACTURING

INVENTORS Ideas Developed. Research. Models. Manufacturing. Sales. Free Brochure. Since 1942. William Parker, Box 6305, Orlando, Fla. 32803.

NEW PRODUCT IDEAS—Royalty Free, No Inventor Pay Off, 200 Plastic, Metal Products, Toys, Office, Household, Auto Products, Free Of Patent, Order "Profits From Patents" Send \$7.95 To: Dept. M, Patent Record Publications, Box 985, Station "K", Toronto, Canada, Or Send S.A.E. For Free Leaflet.

BUY IT WHOLESALE

BUY 1000 Products below wholesale; Giant Catalog \$2.00 (Refundable). Daco-2PM, 3415 West 62, Cleveland, Ohio 44102.

JAPAN'S Fishing Equipment Information. \$1.00 Refundable. OHGA, PM-138, SIGAKENKUSATU, JAPAN-525.

FREE Membership. Wholesale Buying Club. Join Now. Renlee, 215P Golf Lane, Hewlett Harbor, N.Y. 11557.

HEARING Aids, batteries, Wholesale. Catalog 25¢. Fiston, Box 1444, New Preston, Conn. 06777.

WORLD'S Largest wholesale dropship sources. U.S., foreign. Factory suppliers dropship direct to you or customers. Now! have your own catalog for pennies. Free details. International Buyers, Box 16386-M, Portland, Oregon 97233.

BARGAINS! Buy wholesale and below. Name brands. Appliances, furniture, sports equipment, televisions, cameras, watches, jewelry, thousands more. Huge discounts to \$1,000.00 on new automobiles. All makes. Free details. Write today: Worldwide Bargainhunters, Box 730-A, Holland, Michigan 49423.

FABULOUS Wholesale Club!! Save on thousands of famous brands: jewelry, tools, appliances, stereos, etc. 40-50% off retail; same wholesale prices retailers pay! Purchase for yourself or resell for fantastic profits. Free information. Homestead, Dept. 731, 18 Westcliff Drive, Mount Sinai, New York 11766.

HANDMADE Leather Billfolds, Wholesale, Otto, Box 848, Asheboro, North Carolina 27203.

EXPORT-IMPORT

JAPAN: 1200 Products directory. Illustrated Manufacturers' names, addresses. \$3.00. Send cash, Yamagata Office, 814 Togin Bldg., Marunouchi, Tokyo.

FOR THE HOME

DRIP Dry rack, rust proof, heavy duty, seven rods, one meter wide. Expands, folds for storing, toting, \$9.95!! Bruening Company, 1511 First, Detroit, Mich. 48226.

OF INTEREST TO WOMEN

WOMEN! Make big money at home. \$10.00 profit in an hour possible with Invisible Reweaving/Reknitting. Make holes, tears disappear from fabrics. Steady year-round demand from cleaners, laundries, homes. Details free. Fabricon, 2073 Montrose, Chicago 60618.

PROFITABLE Craft business or hobby. Learn at home. Free Information. Lifetime Career Schools, Dept. E-743, 2251 Barry Ave., Los Angeles, Calif. 90064.

1000% PROFIT Bronzing Baby Shoes. Free literature. NBC, Box C-4PM-4, Coral Springs, Florida 33065.

SPARE TIME Profits. 25 Different Plans. \$2.00. H. Romano, Box 403, Ft. Shelby Station, Detroit, Mich. 48226.

ATTENTION Homeworkers! Make \$400.00 monthly in your spare time. For details, send 35¢, self-addressed, stamped envelope. William T. Clarke, Dept. PM, 11 Watson Avenue, East Orange, New Jersey 07018.

WANT A new car, color TV, new clothes? Learn hundreds of ways to make money. 5 month subscription **FREE**. Write: Salesman's Opportunity Magazine, Dept. 17-JO, 1460 Hancock Center, Chicago 60611.

\$100 WEEKLY Possible addressing mailing. Sparetime. Free details. Send self-addressed stamped envelope. Newby Publications, Box 20427-PM, San Antonio, Texas 78220.

\$6.00 DOZEN Paid lacing baby boots! Cowboy, Warsaw 9, Indiana 46580.

HOW To Make Money Writing Short Paragraphs. Information Free. Barrett, Dept. C-27-K3, 6216 N. Clark, Chicago 60660.

HOMEWORKERS! \$100.00 Weekly addressing for firms. Begin immediately. Details—send stamped, addressed envelope. Hamilton, 272-TM-9, Brooklyn 11235.

HOME Newspaper clippers needed. \$500 monthly possible. Details free. Foster, 272-MA-9, Brooklyn 11235.

WOMEN Needed Now to fill out income tax forms at home. We show you how. Simple, easy to learn. \$700 per month earnings possible. Details mailed free. No salesmen. Hurry. Federated Tax Service, 2039 Montrose, Chicago 60618.

\$500 MONTHLY Possible addressing—stuffing envelopes (longhand—typing) at home. \$500 monthly Clipping news items from your newspaper. Information: Send stamped self-addressed envelope. American, Excelsior Springs, Missouri 64024.

HOMEWORKERS, Addressers Needed. Highest earnings. Information—send self-addressed, stamped envelope. National, 14-2LJ, Brooklyn 11214.

BIG Easy Quick Profits assembling costume jewelry at home, spare time. Simple to do; easy selling. Create family business. Details free! Donbar, 2934 Fullerton, Dept. H-742, Chicago 60647.

NOW, Turn spare time into **CASH!** Fascinating report reveals 25 ways. **ONLY** \$1.00. Delphi-1C9, Box 31072, San Francisco, California 94131.

AMAZING, Easy to keep yearly expense record for the family budget. No book-keeping experience needed. **KNOW** where your money goes! In attractive binder. Only \$2.00. Maryland residents add sales tax. R. K. Lawler, 5101 River Road #315, Chevy Chase, Maryland 20016.

WANTED: Homemakers and addressers \$122.40 weekly salary. Send \$2.00 and snapshot for supplies. Cash, 28 E. Jackson, Suite 1204, Chicago 60604.

SECRET Addressing Method Using Common Tape (Starter Roll Furnished). No Equipment To Buy. Address 300 + Envelopes Per Hour At Home Or Office. Just Follow Illustrated Directions In Kit. \$2.00 Ppd. **TRANSITAPE**, Box 2277, Sunnyvale, California 94087.

GIFT SHOPPING

FIVE FREE GIFTS, Retail price over \$37.50, when ordering catalog costing \$7.50, which amount may be deducted from any order over \$50.00. Must be satisfied or return all gifts in original condition to receive refund. Get-acquainted offer only! M.G.A. Mail Order Co. 106B N. Elder Ave., Indianapolis, Ind. 46222.

FREE Color Catalog fine quality gifts. Variety House, Dept. 50, SunCity, Calif. 92381.

HOLLAND GIFTS! Brochure 25¢. Rocha's, 266A West Prosperity, Tulare, Calif. 93274

FREE! 15 Personalized erasure tipped pencils with purchase of 5 personalized retractable ball point pens (five ink colors). One name and 24 characters and spaces allowed—please print! \$2.00. Hinsdale House, Dept. A12, 9117 Hasty Ave. Downey, California 90240.

FREE New Catalog Gifts by Mail. Walker's, Dept. PM92, Robbinston, Maine 04671.

FREE CATALOG Of Sensational Gifts and Novelties. J. & L. Co., 73-B Main St., New Paltz, New York 12561.

FREE Spectacular Catalog, **NEWEST** Exciting and Useful Gift Ideas. Delphi-1C9, Box 31072, San Francisco, California 94131.

MAILORDER RECORDS help get increased business! Complete 32 Page Record Book shows your inquiries orders, advertising, expense, etc. Only \$1.00. **C. A. MARTIN, POPULAR MECHANICS, DEPT. R, 224 WEST 57 STREET, NEW YORK, N.Y. 10019.**

FREE Catalog of Gift Items. Alicia Company, Pelzer, South Carolina 29669.

FREE! Distinctive Jewelry Catalog. Rosebud's Gifts, 1902 Center, Crest Hill, Illinois 60435.

FOR Christmas. 25% Discount Catalog. Continental, 3425G North Detroit, Toledo, Ohio 43610.

NEW AND UNUSUAL GIFTS For Any Member Of The Family, Your Home, Or Friends. Latest Catalog 25¢. Redd's, Box 555-A, Colton, California 92324.

WATCHES, OLD GOLD, JEWELRY

HIGHEST CASH For Gold, Jewelry, Gold Teeth, Rings, Diamonds, Watches Silver, Platinum. Mail Articles Today. Free gift with Information. Chicago Gold & Precious Metals, 6 E. Monroe, Dept. 158, Chicago 60603.

WANTED . . . Gold, Silver, Platinum (any form). Coins. Information Free. Wilmot's, 1067-A Bridge, Grand Rapids, Mich. 49504.

COMPLETE Watchmakers'—Jewelers' Catalog \$1.00. Snell-Bengal, 205 Helm Building, Fresno, California 93721.

WATCH And clock repairing books. Free catalog. North American, Box 77-AW, Fox River Grove, Illinois 60021.

CASH Immediately for Old Gold, Jewelry, Gold Teeth, Watches, Diamonds, Spectacles, Silver, Platinum, Mercury. Free Information. Rose Industries, 29-A East Madison, Chicago 60602.

FREE Catalog. Diamond Look Alikes! Beautiful Mountings. \$15.00 Carat. Ree Company, Box 667, La Puente, Calif. 91747.

NEW! See-Thru Watch Calendar. Transparent on crystal. Black or white. 18 months supply, \$1.00 Postpaid. Unlimited Uses. Gilmorehouse, Box 1175P, Denver, Colorado 80201.

RINGS Merlite Gems 1/2 to 3 Carat \$6.00-\$30.00. Replacement Guarantee, Box 155, Hartsville, S.Car. 29550.

BEAUTIFUL Synthetic Diamonds—Gems—Jewelry. Lowest possible prices. Free Catalog. Write: Gems, Box 217P, Oakridge, Tenn. 37830.

WEARING APPAREL

SHOPPERS' Paradise! Sensational Savings! International Suppliers, Box K-3705, Hong Kong.

PROFITS FROM CLASSIFIED ADVERTISING! Booklet shows you how to start your own business with Classified Advertising. Only \$1.00 (Refundable with first order.) **C. A. MARTIN, POPULAR MECHANICS, DEPT. P, 224 WEST 57 STREET, NEW YORK, N.Y. 10019.**

HEARING AIDS

HUGE SAVINGS. Eliminate dealer mark-ups. Free Trial. Batteries Wholesale. Terms Arranged. Lloyds-PMC, Rockford, Ill. 61108.

IMPROVE YOUR HEARING Information Absolutely Free. Rhodes, Box 518-PM, Paducah, Ky. 42001.

WHOLESALE Discounters! Famous Aids! Batteries! Repairs! AidMart, Box Z, St. Petersburg, Florida 33731.

(Continued on next page)



SCIENCE AND CHEMISTRY

CHEMISTRY And Biology Catalog 35¢. Boulevard Laboratories, Suite 302, 3114 E. 83rd St., Chicago, Ill. 60617.

CHEMICALS And apparatus for industrial, analytical, and private laboratories. Catalog 50¢. Dept. M-50. Biological Supply Co., 1176 Mt. Hope Ave., Rochester, N.Y. 14620.

CATALOGUE Of those ver-ry hard-to-find chemical products, things that go boom, multi-stage rockets, 500 How-To books, 10,000 formulas of every conceivable mixture in science and industry. 50¢. Kenrus-C, Box 158M, Staten Island, New York 10309.

LABORATORY Supplies at discount prices. Catalogue—35¢. Deluxe Scientific, Manitowoc, Wisconsin 54220.

BIOLOGICAL FUEL CELL. Amazing cell makes electricity from bacteria. Science Fair Winner. Complete Kit \$14.95 plus 90¢ postage, send 25¢ for Big Science Catalog! **ROWLAB**, Dept. PM 672, 345 East Forsyth Street, Jacksonville, Florida 32202.

AMAZING! Scientific Catalog—Apparatus—Glassware—Chemicals. Catalog—50¢. Hagenow Laboratories, Manitowoc, Wisconsin 54220.

CHEMICALS Apparatus, Biology and Model Rockets. Both Catalogs for 50¢. Sheard Science, Dept. PM, Columbus, Wisconsin 53925.

ROCKET Kits, Engines, launchers, accessories. Send 25¢ for packet of iron-ons, decals, literature. Fast service. Aerospace Vehicles, Inc., Box 77F, Mineral Point, Wisconsin 53565.

PLASTICS

FIBERGLASS Resins, Mat Cloth. Roving For Molding, layup. **PLEXIGLASS** Sheets, Rods, Tubes, Marine Plastics, P. O. Box 1844, St. Louis, Mo. 63118.

LARGEST Handicrafts Supply Catalogue \$1.00 (Refundable). **R.P.H.** Manufacturing, 24-M-9 Winter, Stamford, Connecticut 06905.

CASTOLITE Pours like water, hardens like glass without heat. Crystal clear, colors. Embed natural flowers, photos, coins, anything; in paperweights, keytags, desksets; for gifts, profits. Make flexible molds of your own designs over any pattern, any size. Reproduce them in Castolite, candlewax, plaster, cement. New Manual, 300 photographs, only \$1.00 postpaid. Dept. 72K/PM, Castolite, Woodstock, Ill. 60098.

TREASURE FINDERS

TREASURE Hunters! Prospectors! Relco's New Instruments Detect Buried Gold, Silver, Coins, Minerals, Historical Relics. Transistorized. Weights 3 Pounds. \$19.95 up. Instant Financing Available. Free catalog. Relco, Dept. A-40, Box 10839, Houston, Texas 77018.

POWERFUL Metrotech locator detect gold, silver, coins, relics. Moneyback guarantee, terms. Free information. Underground Explorations, Dept. A, Box 793, Menlo Park, California 94025.

FREE 140 Page Detector Catalog. General Electronic Detection Co., Box 67, Bellflower, California 90706.

SEARCH Treasure Finders. Locate gold, silver, coins, relics. Operate underwater. Money back guarantee. Free information. Search Electronics, Box 8396-A, St. Petersburg, Florida 33738.

FIND Buried treasure with revolutionary patented, analytical metal detector. Features push button and automatic tuning, negligible ground pickup, greatest range. Free catalogue. Gardiner Electronics, Dept. 9, 4729 N. 7th Avenue, Phoenix, Arizona 85013.

TREASURE Hunters! Prospectors! Rockhounds! Hobbyists! Find gold, silver, relics with world famous Detectron Metal Detectors. Free information. Delivery immediate. Detectron, Dept. 9PM, Box 243, San Gabriel, California 91778.

FISHER DETECTORS. You deserve the best! Free literature. **FRL**, Dept. PM-9, P.O. Box 490, Belmont, California 94002.

FREE—VALUABLE TREASURE FINDER Catalog sent by return mail. Find Coins, Rings, Gold, Silver, Metals, Relics, Write Today. **JETCO**, Dept. CPM, Box 26669, El Paso, Texas 79926.

GOLDAK Treasure locators—Pleasure and profit in a hobby you'll enjoy. Find coins, relics, gold, silver, Charge on BankAmericard. **GOLDAK**, Dept. PM 1101-A, Air Way, Glendale, California 91201.

PRECIOUS STONES & MINERALS

GOLD 10 Small nuggets panned from Oregon Streams \$1.00. Robert Brandt, Sweethome, Oregon 97386.

500 POLISHED Gemstones \$5.00. Tumblercraft, 5401 James North, Minneapolis, Minn. 55430.

EARTH Science Rockhound Magazine. Subscription \$3.00. Sample 5.40. Box-550-PM, Downers Grove, Ill. 60515.

GET Free catalog no serious rockhound, gem cutter, jewelry maker, hobbyist or craftsman can be without. Full of bargains, exclusive items, low prices from largest suppliers and authorities in the field. Free new catalog just off the press, yours for the asking. Write: Grieger's, Dept. C-12, 1633 E. Walnut, Pasadena, California 91106.

CARTOONING, COMMERCIAL ARTS, SHOWCARD & SIGN PAINTING

FASCINATING Systems. Sign Painting-Cartooning. Straley, 1704 South Center, Springfield, Ohio 45506.

COMPACT 23 lesson Cartoon Course and Cartoonist's Magazine. \$2.00. Hartman, Box 30367, Lincoln, Nebraska 68510.

MODERN Cartooning taught by mail. Write for free brochure. Cartoonorama—Box 263-5G, Branford, Conn. 06405.

SIGN Painting—\$1000 per Month Part-Time. Free Catalogue. Kaufmann Supply, Centertown, Missouri 65023.

CARTOON For Money!! Big Free Book: Success, Box 885-C, Dearborn, Mich. 48121.

LEARN Sign painting at home. Free Talent test. Ben Kerns, Box 812-PM, Greenville, S.C. 29601.

"HOW TO MAKE MONEY WITH SIMPLE CARTOONS"—Informative book sent **FREE** tells way to big income. Cartoonists' Exchange, 99, Pleasant Hill, Ohio 45359.

SIGNS! Make-your-own! **SIGN-RITE** Self-Adhering Letters and numbers! 4 Types! 5 large Sizes! 8 material Styles! Choice of Colors! Inexpensive! Prompt service! **FREE BROCHURE!** Americraft Mfg. Co., Box 25034, Northgate, Seattle, Wash. 98125.

ADVERTISING AGENCIES, ADV. SERVICE, MAILING LISTS

ADVERTISING Ratebook leading newspapers, magazines, 25¢. Chicago Advertising Agency, 28-E Jackson, Chicago 60604.

MAILORDER BUYERS' NAME LISTS. Gummed Labels \$9.00 per 1,000. N. D'Amato, Box 385, Port Jefferson Station, New York 11776.

RUBBER STAMPS

FREE 48 Page Catalog. Rubber stamps, printing, office supplies. Youngers Stamp Shop, Princeton, Iowa 52768.

PICTURE Catalog. Lowest Fastest Best. Newton Industries, 1071 Prosser Avenue, Prosser, Wash. 99350.

RUBBER Stamps, 3 lines, \$2.00. Catalog 25¢. Tabco, Tomkins Cove, New York 10986.

THREE LINES—\$1.50, Four Lines—\$2.00 Maximum 27 Letters Per Line. T-Gordon's, Box 741P, Reseda, Calif. 91335.

ADDRESS Stamp \$1.43, Signature Stamp \$2.95. Catalog. Carol's, McCloud, Okla. 74851.

FREE Stamp catalog. 45 type styles. Fast Service, low prices. Jackson's, Box 443A, Franklin Park, Ill. 60131.

OFFICE SUPPLIES

MAILORDER RECORDS help get increased business! Complete 32 Page Record Book shows your inquiries orders, advertising, expense, etc. Only \$1.00. **C. A. MARTIN, POPULAR MECHANICS, DEPT. R, 224 WEST 57 STREET, NEW YORK, N.Y. 10019.**

PRINTING PRESSES, RUBBER STAMP OUTFITS

SAME Day shipment on rubber stamp supplies. Revised wholesale price list No. 9 free. Star Stamp Supply, 732 Federal, Chicago, Ill. 60605.

SIMPLE-X RUBBER STAMP PRESSES, Hydraulic operated, electrically heated. Sizes 5"x8", 8"x12", 10"x15". Starting outfits Orders for presses, supplies shipped day received. Free catalog low supply prices. Send \$1.00 for postage and handling (refundable on first order). Custom Manufacturers, 406-P East Elm, Springfield, Missouri 65801.

RUBBER Stamp outfits, supplies. Kiewiet, 2025 Barney Road, Kalamazoo, Michigan 49007.

PRINTING Presses, type, supplies, Lists, 10¢. Turnbaugh Service, Mechanicsburg, Pennsylvania 17055.

LOW Priced Rubber Stamp Manufacturing Supplies, Starting Outfits. Martin, 1432 Major, Jefferson City, Missouri 65101.

RUBBER Stamp manufacturers supplies. Presses, starting outfits. Best prices, service. Catalog. Jackson Supply, Box 443A, Franklin Park, Ill. 60131.

RUBBER Stamp Manufacturing Supplies, Equipment. Free Catalog. Northwest Stamp Supply, Box 16417-PM, Portland, Oregon 97233.

NEW Catalog No. 13, 120 Pages, hand printing presses, type fonts, supplies. Send \$1.00 deductible first order. Acme Type, 732 Federal, Chicago, Illinois 60605.

PRINTING AND SUPPLIES

ECONOMICAL Printing: Stationery, Labels, Business Cards, Forms. Burnfin, Weaubleau, Mo. 65774.

1000 BUSINESS Cards . . . \$5.95 . . . Postpaid!!! "Raised Lettering". . . . Samples . . . Noble, PM9, 505 Briggs, Bellmore, New York 11710.

PHOTO OFFSET Printing, 500 (8½" by 11") copies \$6.50, 1,000 copies \$9.50. Nationwide Printing, Atlanta, Ill. 61723.

1,000 BUSINESS Cards, Letter Heads, Note Heads, And Call Notes \$4.95. Superioex, Avon Lake, Ohio 44012.

BUSINESS CARDS Raised Letters \$5.65 Thousand. Like Engraved. Free Samples. Kavanagh, Box 1222, Brooklyn, N.Y. 11202.

BUSINESS Cards, Rubber Stamps, Printing. Free Literature. Jordan's, 552 West O'Connor, Lima, Ohio 45801.

FREE Information about personalized printing. Longwood Press, D-4712, Fort Johnson, N.Y. 12070.

(Continued on next page)

PRINTING AND SUPPLIES

(Continued from preceding page)

LETTERHEAD AND LOGO DESIGN. Professional Service For Prestige And Impact. Free Catalog. Typodesign, 6039 Valley Drive, Box 1047-A, Felton, Calif. 95018.

DISTINCTIVE Letterheads, Cards, Statements. Samples. Fast! Graphics East-PM, Westerly, R.I. 02891.

200 BUSINESS Letterheads AND 200 Envelopes BOTH for \$6.00 total! Standard style. Fast! Haldeman's, Girard, Kansas 66743.

PRINTING—\$2.00 Per 1,000. Minimum order \$20.00. Allstate Press, 3733-P North Kimball, Chicago 60618.

GUMMED LABELS

1,000 GUMMED ADDRESS LABELS \$1.00 FREE CATALOG, Acme Supply, Dept. PM-92, 1238 Voskamp, Pittsburgh, Pennsylvania 15212.

1,000 GUMMED Address Labels \$1.00. Walt's, Box 966A, South Bend, Indiana 46624.

2000 LARGE GUMMED ADDRESS LABELS \$1.75!!! 1000/\$1.00!!! Mailbag (5PM9), 2024 Orchard, Orange, California 92668.

1000 ADDRESS Labels \$1.00. Eidee, 152 W. 42, N.Y.C. 10036.

REMAILING SERVICE

PARIS Reairmails singles \$1.00. Postcards 5/\$1.00. Masters, 82 Doudeauville, Paris 18, France.

REMAILS From Pennsylvania 25¢ single. \$3.00 monthly. McWilliams, 560 North Darby, Sharon, Pa. 16146.

MIAMI Remails 25¢. Monthly rates. Remails from 40 foreign cities. Marle, Box 1266, Coral Gables, Florida 33134.

FORT BRAGG Remails, 25¢ Plus Postage. CEM, Box 1302, Fayetteville N.C. 28301.

WASHINGTON DC Remails 25¢. Receiving-Forwarding. Gabriel, Box 4552, Washington, D.C. 20017.

SECRET. Receiving—forwarding. Discreet and confidential. Remail 25¢ single. Mail Forwarding Service, 8050 S. Main, Houston, Texas 77025.

TEXAS—Economic, Receiving-Forwarding-Remailing. Nortex, Drawer 5370, Fort Worth, Texas 76108.

DENVER Receiving—Forwarding. 25¢, \$3.00. Details free. Rich, Box 26099, Denver, Colorado 80226.

EXOTIC HAWAII, Remails 25¢ each. \$3.00 Monthly. Dorcliff, Inc., 736 South Street, Honolulu, Hawaii 96813.

FREE Address Stamp to new remail subscribers. \$3/mo. SPECTRUM, 1619 Pineview Rd., Charleston, S.C. 29407.

CONFIDENTIAL. Remails 25¢. Monthly \$3.00. Box 9581, BALTIMORE, MARYLAND 21237.

PARIS London Remailing letters post cards, \$5.00. West, 1403 South Third, Wilmington, N.C. 28401.

ALBUQUERQUE Remails Single 25¢-Monthly \$3.00. Free Information. 2400 Shasta Rd. S.W., Albuquerque, New Mexico 87105.

REMAILING Service South America Receiving Forwarding 50¢ Single. Narvaez, Apartado Aereo 29280, Bogota, Colombia.

CONFIDENTIAL Remails 25¢. Raibl Enterprises, 2355 Scenic Highway, Pensacola, Florida 32503.

CONFIDENTIAL Receiving-Forwarding. Monthly Rates. Wright, Box 2112-M, Asheville, N.C. 28802.

PALM SPRINGS REMAILS—25¢—GUARANTEED CONFIDENTIAL—Receiving—Box 4227B, Palm Springs, Calif. 92262.

CHOICE New York City or Long Island. Single Remails 25¢. \$2.50 Monthly. Box 262, Hicksville, N.Y. 11802.

MEXICO Remails 20¢, Airmails 40¢. Gonzalez, 2692 Apartado, Monterrey, Mexico.

YOUR Mail Received—Forwarded. Hedgpeth, 324-M South First, Alhambra, Calif. 91802.

REMAILS 25¢—Monthly \$3.00. C & C, Box 6091, Evansville, Indiana 47712.

FORWARDING—Receiving. 25¢. Monthly Rates. Mosher, Box 2544, Santa Clara, Calif. 95051.

CONFIDENTIAL New York City mail address \$3.00 month. Remails 25¢. Details Free. Birnhan, 152 W. 42, New York City 10036.

ISRAEL Remails \$4.00, Holy Soil \$5.00. Holy Jordan Water \$10.00. Olive Wood, 43 Chefetzchaim, Petatikvs, Israel.

REPAIRS AND SERVICING

DENTAL PLATES And Repairs. Save \$\$\$.

Arronlab, 4117 So. 6th Avenue, Tucson, Ariz. 85714.

SPECIAL SERVICES

INFORMATION On anything. Ferguson Research Specialists, 83-45 Vietor Ave., Elmhurst, N.Y. 11373.

TOBACCO

BUY Direct Samples 10¢ Sweet Chewing Smoking Twist. Jolley Farms, Dresden, Tenn. 38225.

PROFITS FROM CLASSIFIED ADVERTISING! Booklet shows you how to start your own business with Classified Advertising. Only \$1.00 (Refundable with first order.) C. A. MARTIN, POPULAR MECHANICS, DEPT. P, 224 WEST 57 STREET, NEW YORK, N.Y. 10019.

PERSONAL

PAY Bills! Borrow to \$1500 by mail! Convenient terms! State licensed. Postal Finance, 6018 Military Avenue, Dept. 17-N, Omaha, Nebraska 68104.

CHEMIST FOR HIRE By the job. Trouble Shooting, Formulas, Advice, Research. Free Information. Burchette, Box 1114, Spring Valley, California 92077.

I HELPED Thousands Wipe Out Debts. Clear credit. Immediate relief to \$25,000. Free details. Counselor-7, Kerrville, Texas 78028.

STOP SMOKING! Complete satisfaction or money back. Instructions \$2.00. Bocanegra, P.O. Box 585-A, San Jose, California 95106.

DON'T DIE Without a WILL!!! 5 Blank Wills—\$2.00. Guaranteed!!! Plus—FREE—Gift Catalog. Order now! S & T, Box 28039, Dept. PM9, San Antonio, Texas 78228.

TATTOO Removing—Chemical Do-It-Yourself Method—Free Details: Atlanta, 907P Beachpoint, Pickering, Ontario.

RECEIVE Phony State Chartered University Degrees Immediately. Box 7268, Tampa, Florida 33603.

INSTANT DEBT RELIEF Without borrowing. Without Bankruptcy. Have excellent credit in 45 days. Free!!! Wealth Building, Box 89—8840 Hoyt Drive, Thornton, Colorado 80229.

BIBLE Questions answered. Stamped envelope. Bylon. 17167 Bentler, Detroit, Michigan 48219.

RECORD Telephone conversations automatically. Leave recorder unattended. Write—Robert's, Box 49-PM-9, Parkridge, Illinois 60068.

MAKE YOUR WILL. Get 4 Will Forms and attorney's informative book. \$1.50. Legal Forms Company, Department 124, 1830 Guardian Building, Detroit, Michigan 48226.

PSORIASIS Sufferers: Discouraged? Write for Free important information that is helping thousands! Pixacol, Box 38-PM, Avon Lake, Ohio 44012.

INVESTIGATORS. Latest electronic Aids. Free Literature. Clifton, 11500-P NW 7th Ave., Miami, Florida 33168.

"RULE Others With Thoughts." (Telepathy) write: Clarion, Box 1769-S7, Chicago, 60690.

CASH LOANS by mail! Up to \$2,500 on signature alone. No collateral! Secret! Union Finance Company, 3608 No. 16th St., Dept. PM, Phoenix, Ariz. 85011.

SMOKING Can Be STOPPED. Money back Guarantee! \$1.00. Varner, 132-1 Rolph Drive, Forest Heights, Md. 20021.

4 WILL Forms, Attorney's Instructions. Guaranteed!! \$2.00. Dept. 1P29, Wayman House, 2024 Orchard, Orange, Calif. 92668.

ACNE? Clear your skin—or pay nothing! Write "CLEAR-A-SKIN", Box 213, Glen Oaks, New York 11004.

BILLS PRESSING? Let us help you now! Not a loan company so bad credit no problem. Write: Budget, 534B Danube, Atlanta, Georgia 30342.

HAIRGROWER That works! Proven. Send \$3.00. Hair, Box 11052-M, Phoenix, Arizona 85061.

HIGH School Diploma—Birth Certificate—Will, including 64 page Instructions!! \$1.50 per blank form. Coastforms, 3A9, Box 6433, Santa Barbara, California 93111.

IMPROVE Your Personality. 110 Page Book Tells You How. \$1.00. Mary Alice White, 130 Ronald, R2, Mechanicsville, Maryland 20659.

TRIPLE YOUR WORKING CAPITAL IN 3-6 MONTHS! This new book shows how. Money back guarantee. Send \$2.95. Investment Counselors, 10924 West 65th Terrace, Shawnee, Kansas 66203.

CAREER PROFILE—Computerize analysis of you. For questionnaire: Alert, Box 1662, Newport News, Va. 23601.

CANCER! You may be next! Stop Smoking! New Book Reveals Medical And Psychological Method. Money Back Guarantee. Book WB-106. \$2.00. Hansen House, Rt. 3, Box 22, Springfield, Oregon 97477.

TELEPATHY. Beginners Course, Exercises. \$2.00. Worthington, Box 144, Newtown Square, Penna. 19073.

WILL Making Booklet And Forms \$2.00. Regal, Box 182, Mt. Pleasant, South Carolina 29464.

GUIDE TO HAPPINESS! Banish fear. Meet Problems. \$2.00. J. Carr, 34 Western Drive #3, Watsonville, California 95076.

SMOKING?? INDIANS Quit Easily!! Ancient Secret Rediscovered! Astonishing! \$2—Guaranteed. ExSmokers, Box 3353, Santa Monica, California 90403.

REFRESH Every Room With Petite. Only \$2.98, Guaranteed. William Bland, III, Route 2, Box 136, The Plains, Va. 22171.

YOU Can Stop Smoking! New Booklet Tells How. Send \$1.00 To: Berger Agency, Box 6205, Ft. Wayne, Indiana 46806.

HOW To have confidence and power with other people. Make them say "Yes", 164 page book reveals ways. Send \$2.00. Sawyer Enterprises, Dept. PM-2, 735 Crestmoor Dr., San Jose, Calif. 95129.

ARTIFICIAL Larynx users, write for information on handy carrier; avoids forgetting or misplacing. William Dely, Box 821-P, Biloxi, Miss. 39533.

REDUCE, Lose 10 lbs. In 10 Days Eat All You Want. AMAZING GRAPEFRUIT DIET. Guaranteed. \$2.00. R. Warfield, 436 Cozine Ave., Brooklyn, N.Y. 11208.

THE Last Book In Our Bible Is Wonderful, But Is Principally Written In Symbols. An Explanation Is Worth Millions. 60 Pages \$1.00. P.O. Box 6944, Jackson, Miss. 39212.

(Continued on next page)

PERSONAL

(Continued from preceding page)

INTERIOR Decorating Guide, Descriptive Catalog 35¢. Learn Business. M & J Sales, Box 11052, Chicago, Illinois 60611.

QUIT SMOKING! Proven Method \$2.00. Williams, 635 Chestnut, Richland, Wash. 99352.

ASTROLOGY, Thousands Amazed With Prepared Horoscope. If Not Afraid Of What You May Read, Send \$1.00. Name, Birthdate, Addressed Stamped Envelope. Le Fu, PM-Dept., P. O. Box 24673, San Jose, California 95154.

LUCKY Number Forecast. Enclose \$1.00. Name, Birthdate, Addressed Stamped Envelope, S. O. S., PM-Dept., P. O. Box 24673, San Jose, California 95154.

WANTED-MISCELLANEOUS

MERCURY, Gold, Silver, Platinum; Ores assayed. Wholesale Terminal, Norwood, Mass. 02062.

WINEMAKING & OTHER RECIPES

WINEMAKERS. Free illustrated catalog of yeasts, equipment. Semplex, Box 12276R, Minneapolis, Minn. 55412.

WINEMAKERS . . . Free Illustrated Supply Catalog of Yeast, Equipment, Recipes. Continental, Box 18223-PM Indianapolis, Ind. 46218.

DELICIOUS Homemade Wine, Champagne! Easy Instructions \$1.00. Junior, Box 102, New Wilmington, Pennsylvania 16142.

WINEMAKERS Yeast, Recipes & Catalog 25¢. Kraus, Box 451-L, Nevada, Missouri 64772.

DELICIOUS MEXICAN COFFEE LIQUEUR You make at home. Send \$1.00 for recipe to: Viva Tomar, P.O. Box 17650, San Diego, California 92017.

QUALITY WINE! Inexpensive and fun to make. FREE Recipe and catalog; write: Slater's Wine Supply, Box 525, Olympia, Wash. 98501.

HOMEWINE MAKING SUPPLIES And **INGREDIENTS CATALOG** With RECIPES For Year Round Winemaking. It's A Fascinating Hobby. We Also Have Supplies And Concentrates For Your Wine Kit. Send For Free Catalog. Danenberger, Box 276-M, New Berlin, Illinois 62670.

WINEMAKERS!! Fermentation locks—3/\$1.00. Free Illustrated Catalog plus \$5.00 Credit Coupon. Werth Wine, Box 1902AV, Cedar Rapids, Iowa 52406.

WINEMAKING Kit—\$4.98 Free Catalog and Recipes. JIMDANDY, Box 30230M, Cincinnati, Ohio 45230.

WINE AND CHAMPAGNE! Recipes for many of the world's most delicious wines and champagnes both in this one booklet. Use standard kitchen utensils. \$3.00 Guaranteed. Velcro, Box 572(JR), Lowellville, Ohio 44436.

WINEMAKER'S Supply Catalog—Free. Bacchanalia, 273 Riverside Ave., Westport, Conn. 06880.

"DISCOVER" WINEMAKING. Easy, Compact Kits Include Materials, Instructions, Recipes. Gallon Tank Kit—\$4.99. Kit With 2 1-Gallon Tanks—\$7.99. GRAYSON, Box 3312S, Portland, Maine 04104.

WINEMAKER'S! Free Illustrated Catalogue of Quality Products. Brant's Wine Rack, Box 3256-M, Orange, California 92665.

WINEMAKERS: Free informative catalog, recipes. Arbolyn, Box 663, West Columbia, S.C. 29169.

WINEMAKERS: Free Catalog. Intepace Winery, P.O. Box 11186, Phoenix, Arizona 85061.

WINEMAKERS—New illustrated catalog of supplies and equipment. Wollersheim Winery, Prairie-du-Sac, Wisconsin 53578.

MISCELLANEOUS

CUSTOM Blended Pipe Tobacco—Finest Tobaccos, Expertly blended, Factory fresh. Write for free samples. Green River Tobacco Company, Since 1914, Box 991, Owensboro, Kentucky 42301.

ARE YOU INTELLIGENT? Self-scoring test reveals I.Q. in 45 minutes. Send \$2 today—guaranteed!! Tests, Dept. S-1, Box 27357, Valley-Hi, Texas 78227.

HEAVENLY Prize winning Candy Recipe, 10¢. Rainbow, 180-CP Liveoak, Bridge City, Texas 77611.

U.S. \$1000 Bills!! Obsolete Exact Replica's 5/\$4. National, Box 1391-X, Clearwater, Florida 33517.

STOP SMOKING. Medically sound step by step method, no fads or gimmicks. "How You Can Stop Smoking" may save your life. Make up your mind! Send \$1.00 today. Melglo Specialties, Gridley, California 95948. Dept. A329.

DIPLOMAS—High School, College, Psychology, Technical, Doctorate. Documents: Driver License, Birth, Karate, Marriage, Electrician, Carpenter, Rushed Airmail!!! Two-\$1.00. Deluxe "Goldseal" versions \$1.00 each. Moneyback Guarantee!!! Samples 10¢. Filforms, Box 1332-BH, Albany, New York 12201.

MUSHROOM LOVERS Save money—learn new ways to find, purchase, freeze, dry, can, cook mushrooms \$2.00. Donna Myer, Box 856M, Battle Creek, Michigan 49015.

LIQUEUR Liquor recipes 4 favorites 2.00. Box 5220, Oakland Calif. 94605.

BOOKS On antiques and their prices. Free circular!! P. Warman Publishers, Uniontown, Penna. 15401.

SACK Of Hops, Plus Wine Yeast. With 101 Winemaking And Sourdough Recipes, Including Catalog—Send Only \$1.00. Nichols Hops, 1190PM North, Albany, Oregon 97321.

SUFFERING From Arthritis? Try Ginseng: Information Free. Write: Ginseng, Asheville 53, North Carolina.

ORNAMENTAL Iron designs. Book of 1600 beautiful, practical designs for railings, columns, etc. Free literature. Cunningham, 3881 South 3200 West, Salt Lake City, Utah 84119.

PRE-PACKAGED Toys complete with free self-selling display rack. Free Details. Toys, 1916 Fifth, Sacramento, California 95814.

SOLID Gold-Plated Eisenhower Silver Dollars 1971 or 1972 \$2.95. Owen Cox, 514033 U.S. 31, South Bend, Indiana 46637.

BIRTH Certificates, Marriage Certificates, Diplomas! 2 blank forms \$1.00. Sample 10¢. Standard Forms, Box 482-M, Washington, D.C. 20044.

SLEEPATRON. New device for inducing sleep. Gardiner Electronics, Dept. C, 4729 North 7th Avenue, Phoenix, Arizona 85013.

BECOME Successful Wine-Champagne Maker! Easy Directions. Use Kitchen Utensils. Guaranteed. \$1.95. Win-net, Box 15423, Lakewood, Colo. 80215.

BEFORE YOU DIE!! Make a will. Protect your family 2 forms original, duplicate Only \$2.00 Guaranteed! Order today!! L-B Sales, 316 North River Street, Aurora, Ill. 60506.

IDENTIFICATION Cards, Send stamped self-addressed envelope for samples. Nipcom, 727 North Main, Las Vegas, Nevada 89101.

SAVE A Tree! 100% recycled stationery. 24 note sheets, envelopes only \$1.50 box. White or "Earth" colors. Postpaid. E.T. Claires, 36E9-1409 South Harrison, Grand Island, Nebraska 68801.

PROTECT Your Family!! Blank Will Form Instructions—Guaranteed! Only \$2.00—Palentco, PM9, 2014 Cardinal, Lgshore, Peoria, Ill. 61614.

\$35,000.00 In prizes! Winning secrets. \$2.00. Contest, Box 11052-M, Phoenix, Arizona 85061.

3000—NAME And Address Labels. \$2.00—Urbanich, 712 Gunhill, Bronx, New York 10467.

LORD'S LAST SUPPER Tablecloth 54" x 54". \$4.00. L. Ward, Box 154, Union Bridge, Maryland 21791.

CIGARETTES 15¢ A pack. Improved roller makes 20 filtertip, plain, king or regular for 15¢. Facts free. Green River Tobacco, Box 954, Owensboro, Kentucky 42301.

DON'T DIE Without a will! Blank Will forms plus information booklet protects your family! Only \$2.00—guaranteed!! Order today! HENCCO, Dept. PM-1, 3274 Lawrence Avenue, Oceanside, N.Y. 11572.

SILENT MAJORITY EMBLEMS. . . At last! Unique! Pressure-sensitive; non-political. . . strictly American! Descriptive included. Send \$1.00 to: Desertland, Dept. AL, Box 8653, Phoenix, Arizona 85040.

ELECTRONIC Miracle turns house wiring system into **SUPER POWER TV ANTENNA!!** Money-Back Guarantee! . . . and \$2.95. Enterprises, Dept. 209, 16026 Carleton, Fountain Valley, California 92708.

LIFETIME Plastic Social Security Plate: Permanently Embossed, Colorful \$1.00. Lou-Ann Sales, 1451 Dixwell Avenue, Hamden, Conn. 06514.

PROTECT THOSE YOU LOVE! DON'T DIE Without A Will! Attorneys And Courts Are Expensive. Legal Will Forms \$2.00. Guaranteed. Hale, 1612 Willow, Anaheim, California 92805.

LOOK!! VERSALIGHT Is a portable battery charged light that gives to 1200 hours bright fluorescent light!! Use anywhere. Rechargeable battery included. Guaranteed. Order Today!! \$37.50. Sharbono Enterprises, 214 Main, Box 106A, Stevensville, Montana 59870.

MAGNETS, All types. Specials—20 disc magnets, or 2 stick magnets, or 10 small bar magnets, or 8 assorted magnets, \$1.00. Maryland Magnet Company, Box 192-A, Randallstown, Maryland 21133.

CHAMPAGNE WINEMAKING New Wine-master's Handbook Reveals Delicious Illustrated Recipes. Requires Only Kitchen Utensils. \$2.98 Complete. C&E Associates, P.O. Box 653, Wayne, Michigan 48184.

STEAM Away clothing wrinkles with Stanley Steamer. Safe for all fabrics. \$9.98. Moneyback Guarantee! Rosebud Enterprises, 13741 Joaquin Lane, Cerritos, Calif., 90701.

SAVE 50%. New books, guaranteed, free catalog. Enterprises, Silver Lake, Minnesota 55381.

WILL Instructions and two forms. Guaranteed! \$2.00. Rosebud Enterprises, Dept. PM9, 13741 Joaquin Lane, Cerritos, Calif., 90701.

HEARING Aid batteries wholesale. Free list. Habs, Box 51, York, Penna. 17405.

BURGLAR ALARMS & HOME PROTECTION

DOUBLE Protection. Chain doors windows. Alerts with loud alarm. No wiring. Battery operated. \$4.95 each. \$1.00 postage. Benefields, 2916 Elmhurst, Oklahoma City, Okla. 73120.

FREE Catalog on Burglar-fire Alarm Equipment. Protecto Alarm Sales, Box 357-D, Birch Run, Michigan 48415.

STOP Burglaries! Protection For Doors, Windows. No Wiring. Battery Operated \$5.95. E. Johnson Co., 97 Grandview Ave., Great Neck, N.Y. 11020.

PLANS For ALARM And EMERGENCY POWER For Lights And Alarm Backup. Complete Set \$4.00. AMERICAN CONFLUX, Inc., P.O. Box 5704M, Redwood City, Calif. 94063.

Unadorned power tools.

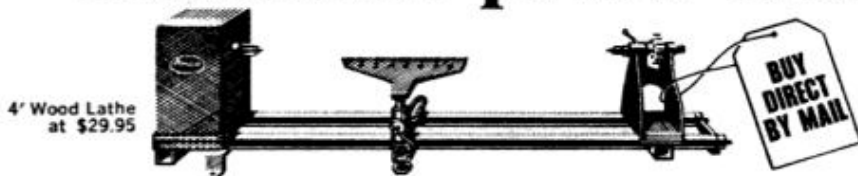

4' Wood Lathe at \$29.95

They do the same job as tools costing up to 5 times as much.

We skipped the chrome to save you money . . . but we did not skip anything on performance. Actually, we skipped more than just chrome, we cut out every costly frill that wasn't absolutely needed.

The lathe shown above isn't exactly flashy. We admit it. But in a recent article, Popular Science used it to demonstrate wood lathe technique and said: "You won't go wrong with this economical introduction to wood turning." It is typical of our tools which in spite of low prices, are full scale and offer full performance and precision.

HERE'S HOW WE DO IT . . . First, we don't claim our tools should sell for five times the price! Just that our tools do the same job . . . with the same accuracy, ease and speed . . . and will last at least as long. AMT tools cost less to make and are sold direct. They are bona fide quality power tools used by serious amateurs and professionals alike and if sold in retail stores would be much higher in price. We use no magic, let's be specific: **SIMPLICITY . . .** AMT tools are soundly engineered to eliminate every frill and gimmick—to minimize material and production costs. Machined parts are used only where they're needed. Unadorned cast iron and aluminum save you a fortune.

DIRECT-FROM-FACTORY SAVINGS . . . You save a bundle, yet, we offer a double guarantee backed by a 38-year-old company with millions of satisfied customers . . . and hundreds of orders pour in daily.

LARGE VOLUME . . . Our own foundry and large mass production facilities plus large buying power all work to keep costs down.

STANDARD PARTS . . . Our designs use standard hardware items wherever possible. By avoiding custom-made parts we pass on tremendous savings to you.

If you are looking for power tools that perform like units costing many times our low prices, order today and you'll be one step closer to many hours of woodworking satisfaction.

Bill Monte

POWER SAW 8" tilt arbor saw . . . crosscuts, rips, mitres, cuts compound angles, dados, coves, moldings. Completely assembled with ground cast iron table, safety guard, splitter, mitre gauge. Less blade, motor. Rip fence for easier work alignment, \$3.50 add'l. Ball bearing model, \$5.00 add'l. Takes 1/3 h.p. motor or larger, standard blades, attachments. **\$19.95**
26 lbs., f.o.b. factory



FREE OFFER, cabinet base plans, . . . with one piece of 3/4" plywood, convert your \$19.95 saw into a floor model with a huge 27" x 24" top. Takes cabinet rip fence, \$4.50 add'l.

TWO GUARANTEES

10-DAY MONEY BACK GUARANTEE
Try any of these power tools and compare it with any similar machine at any price. If not satisfied, return it for prompt, no questions asked refund. We pay the return shipping charges.

10-YR. FULL SERVICE GUARANTEE
Any part or parts of these AMT power tools (except motor which carries a one year guarantee) which become inoperative for any reason within ten years after purchase date will be repaired or replaced by the factory with no cost to the purchaser other than postage.

AMERICAN MACHINE & TOOL CO.
4th & Spring St., Royersford, Pa. 19468



Brand new electric motor developing full 1 h.p. 17 lbs. (Purchased separately, \$24.85). With any AMT machine here. **\$19.90**

BUY DIRECT
... USE THIS HANDY ORDER COUPON NOW

AMERICAN MACHINE & TOOL CO., Dept. PM92, Royersford, Pa. 19468

Please send me the units checked. Payment in full enclosed \$_____ or \$3 deposit each item enclosed, balance C.O.D. I must be fully satisfied or will return unit within 10 days for full refund. No questions asked.

- | | |
|---|--|
| <input type="checkbox"/> 8" Power Saw at \$19.95 | <input type="checkbox"/> Jointer Planer at \$29.95 |
| <input type="checkbox"/> Standard Rip Fence at \$3.50 | <input type="checkbox"/> Ball Bearing Spindle at \$5.00 |
| <input type="checkbox"/> Long Cabinet Rip Fence at \$4.50 | <input type="checkbox"/> Wood Shaper Kit at \$19.95 |
| <input type="checkbox"/> Ball Bearing Spindle at \$5.00 | <input type="checkbox"/> Opt. Hold Down Assembly at \$2.75 |
| <input type="checkbox"/> Belt Sander at \$19.95 | <input type="checkbox"/> 6" Swing 3' Lathe at \$14.95 |
| <input type="checkbox"/> Disc Sander Attachment at \$7.95 | <input type="checkbox"/> 12" Swing 4' Lathe at \$29.95 |
| <input type="checkbox"/> Mitre Gauge for Sander at \$1.95 | <input type="checkbox"/> Face Plate \$2.50 (either Lathe) |
| <input type="checkbox"/> Drill Press at \$34.95 | <input type="checkbox"/> Turning Chisels \$4.95 (either Lathe) |
| G.E. Motor <input type="checkbox"/> \$19.90 (with other item) <input type="checkbox"/> \$24.85 (purchased separately) | |

NAME _____

ADDRESS _____

CITY _____

STATE _____

ZIP _____

3' WOOD LATHE . . . 6" swing. Same precision and speed as \$40 units. Sturdy cast iron with tubular steel bed. Lever action tail stock, two-speed pulley, fits any motor. Set of 3 high speed turning chisels, \$4.95 add'l. 4" face plate, \$2.50 add'l. 15 lbs., f.o.b. factory **\$14.95**



4' WOOD LATHE . . . 12" swing. Industrial size, does the same job as \$75 units. Tubular steel bed rails, screw action tail stock, three-speed pulley. Use any motor. 3 high speed turning chisels, \$4.95 add'l. 4" face plate, \$2.50 add'l. 30 lbs., f.o.b. factory **\$29.95**



JOINTER-PLANER 4 1/8" x 22". Cast iron and steel, precision ground adjustable tables. For planing, joints, bevells. Rabbets to 3/8" depth. Fence adjustable 0° to 50°. Steel knives, dual guards. Use any motor. Precision ball bearing industrial model, \$5.00 add'l. Wt. 19 lbs., f.o.b. factory **\$29.95**



BELT SANDER A precision unit. It changes from horizontal to vertical in seconds. Heavy, sander includes 4" x 36" sanding belt. Uses 1/3 h.p. or larger motor. V-pulley drive and multi-purpose drive spindle. Disc sander accessory, \$7.95 add'l. Mitre gauge, \$1.95 add'l. 15 lbs., f.o.b. factory **\$19.95**



DRILL PRESS Precision 32" radial unit has standard features and many extras. Depth of throat up to 16". Head tilts and table stays level. Drills to center of a 32" circle. All cast iron and steel. Takes standard motor. 32 lbs., f.o.b. factory **\$34.95**



WOOD SHAPER KIT Makes beads, coves, moldings, tongue-and-groove joints, etc. Accurate cuts at high speeds. Sealed greased-for-life ball bearings. Less wood. Takes 1/4 h.p. motor or larger, standard cutters. Optional hold down assembly, \$2.75 add'l. 15 lbs., f.o.b. factory **\$19.95**



What cheese did for Wisconsin, Old Crow did for Bourbon.



You know how tangy cheddar made Wisconsin famous. But maybe you didn't know how Old Crow made Bourbon famous.

The first Bourbons were virtually homemade. There were no standards of quality. Early Bourbon-makers never knew if one day's batch would taste as good as the next.

In 1835, Dr. James Crow became the first distiller to use scientific principles to make good Bourbon. His process, once and for all, took the guesswork out of distilling good Bourbon.

Soon, other distillers tried to make their Bourbons the way Dr. James Crow made his. But there was, and still is, only one Old Crow.

KENTUCKY STRAIGHT BOURBON WHISKEY. 86 PROOF. DISTILLED AND BOTTLED AT THE FAMOUS OLD CROW DISTILLERY CO., FRANKFORT, KY.

The latest gimmick at Maxine's
Massage Parlor is to offer customers
her own brand of roll-your-own
filter cigarettes.

Now everybody will be smoking
Maxine's roll-your-own filter cigarettes ...almost everybody.



©1972 R. J. Reynolds Tobacco Company, Winston-Salem, N.C.

Camel Filters.
They're not for everybody.
(But then, they don't try to be.)

Warning: The Surgeon General Has Determined
That Cigarette Smoking Is Dangerous to Your Health.

19 mg. "tar", 1.3 mg. nicotine av. per cigarette, FTC Report APR. '72.

