

Popular Mechanics

**THIEFPROOF
YOUR CAR** Page 112
17 of the best ways

JULY 1972
50 CENTS

★ **20-foot travel trailer you can build**

Page 136

★ **How to see the country—on a bicycle**

Page 162

★ **Save money: MOWER REPAIRS**

Page 108

BICYCLE REPAIRS

Page 34

★ **Hot little homebuilt plane**

Page 92

★ **How Sears' new video recorder works**

Page 74

★ **New lightweight pickups**

Page 96

★ **WOW 'EM ON SKIS**
World's champion slalom and trick skier
Christie Freeman shows you how

Page 69



Whatever you drive, wherever you go,
Pennzoil is worth asking for.



Now, drill straight as an arrow every time.

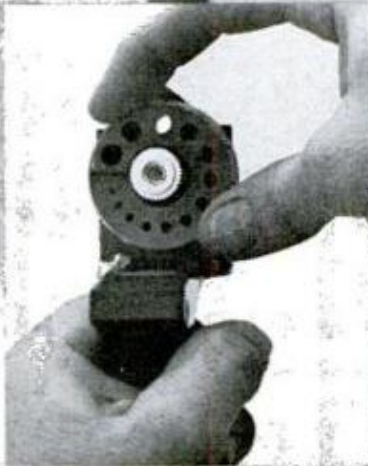

This One



5F9D-GYH-W6HZ

New Drill Guide helps your electric drill go straight and on the mark into metal, wood, plastic. No skidding in the wrong direction.

All you do is rotate the dial to the desired bit size (handles 13 bits, sized 1/16" to 1/4"), lock it in place and drill away.

Non-slip surface on the face keeps guide firmly in place and keeps bit from scratching and marring surface.

Sliding door storage keeps extra bits handy. Stanley's Drill Guide — at only \$2.99, a must for every drill owner.

STANLEY
helps you do things right

CHANNELLOCK

Gives You More In Hand Tools Including
Handcrafted...High Polished
PRECISION PLIERS
(wonderful for fine work)

Beautiful? They'd grace a jeweler's window.

Practical? Thousands of precision work craftsmen—
professionals and hobbyists alike—buy them
every year and swear by them.

Precision made of high grade drop forged steel.
Beautiful polished finish. Blue dipped
plastic comfort grips.

Ask for CHANNELLOCK Little Champ
precision pliers. You'll like 'em.

LET US SEND YOU OUR CATALOG showing
Little Champs and their equally fine big cousins.

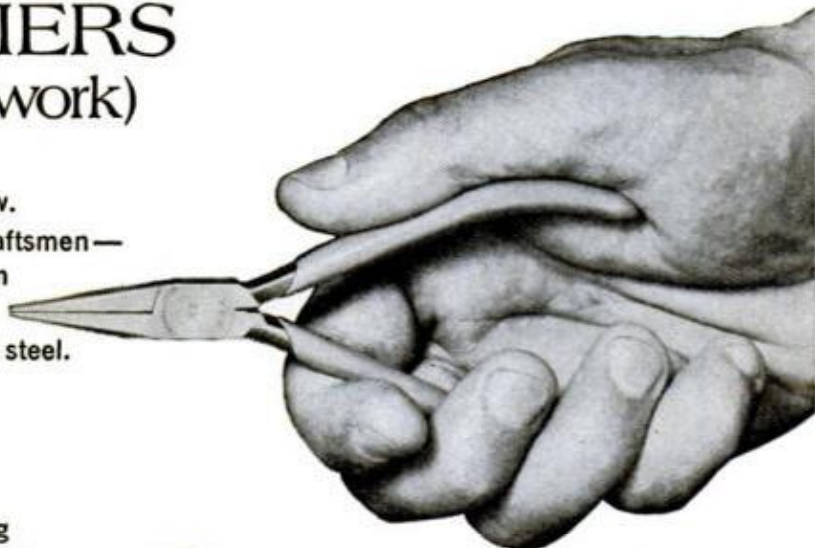

TOOLS BY
CHAN NEL LOCK
MEADVILLE, PA. 16335



2,000 miles in a weekend.

Gary Thronson got up at 5 am (as usual), piled his pretty wife, Glenda, and his son, Eric-the-tiger (who is the 5th generation of Thronsons to be born on the Thronson farm in Hayfield, Minnesota) into their Toyota, and headed south.

Gary did most of the driving, Glenda did some. The

Toyota and little Eric just kept on going.

And, at 5 am the next morning, they were in the middle of Arkansas.

They met some friends, saw the drag races, got back in the Toyota, and drove back. Another 1,000 miles, virtually nonstop.

"What's so special about that?" said Gary. "That little Toyota, she goes."

And goes, and goes. On Champion Spark Plugs.



Toledo, Ohio 43601

20 million people have switched to Champion Spark Plugs.

HOW TO . . .

Build your own 20-ft. travel trailer . . . 136



Keep your power mower in shape . . . 108

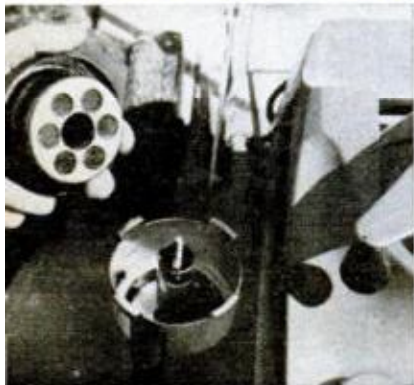

Sharpen pictures with a gunstock mount 120



Thiefproof your car 17 ways . . . 112



AUTOMOBILES, DRIVING

- [20 Drivin' with Dan](#)
- [42 Supertire lets you ride a blowout!](#)
- [86 PM Owners Report: Buick Skylark](#)
- [96 Lightweight pickups: Are they really all the same?](#)
- [104 PM Owners Report: Plymouth Fury](#)
- [112 17 ways to thiefproof your car](#)
- [123 New for your car](#)
- [124 Saturday Mechanic: Remember your filters!](#)

BOATING, OUTDOORS

- [69 Spectacular ski tricks you can do](#)
- [111 New for boatmen](#)
- [136 A 20-foot travel trailer you can build yourself](#)
- [143 One-man dinghy dolly you can build for \\$8](#)
- [162 Bicycle touring: better than ever](#)
- [168 New bicycle-touring gear](#)

SCIENCE, INVENTIONS

- [80 The mountain they climb from the top down](#)
- [90 Will solar farming solve our power crisis?](#)
- [102 Half train, half plane it 'flies' at 400 mph!](#)

HOME AND YARD

- [108 Power mowers: How to avoid a \\$30 repair bill](#)
- [128 Exciting new products](#)
- [130 A colonial footstool you can build](#)
- [150 Better ways to do it](#)

SHOP AND CRAFTS

- [140 High-style table from construction-grade lumber](#)
- [144 Little projects—lots of kicks](#)
- [148 Tools you should know about](#)
- [149 Now: small-parts drawers by the dozen](#)
- [152 Bench-saw know-how \(Part 1\)](#)
- [158 Deluxe wallcase for circular-saw blades](#)
- [160 Hints from readers](#)
- [172 A lathe milling-machine table for about \\$10](#)
- [176 'Ugly duckling' sands like crazy](#)

SPACE, AVIATION, MILITARY

- [76 'You have to go out, but you don't have to come back'](#)
- [92 Pazmany homebuilt plane](#)

ELECTRONICS, RADIO, TV

- [74 Sears' new video recorder](#)
- [112 17 ways to thiefproof your car](#)

PHOTOGRAPHY

- [14 Photo hints](#)
- [120 Sharpen your shooting with a gunstock mount](#)
- [122 New in photography](#)

EVERY MONTH

- [6 Letters](#)
- [30 Science Worldwide](#)
- [34 The Bicycle Shop](#)
- [38 Appliance Clinic](#)
- [46 Automobile Clinic](#)
- [56 Detroit Listening Post](#)
- [60 All Outdoors](#)
- [66 Homeowners' Clinic](#)
- [102 New Inventions](#)

Cover photo taken at Cypress Gardens, Fla., by Jerry Imber
Christie Freeman, world's champion slalom and trick skier, shows you how to wow 'em with spectacular tricks on skis

AS A SERVICE TO READERS, Popular Mechanics publishes newsworthy products, techniques and scientific and technological developments. Because of possible variance in the quality and condition of materials and workmanship, Popular Mechanics cannot assume responsibility for proper application of techniques or proper and safe functioning of manufactured products or reader-built projects that result from plans published in this magazine.

JIM LISTON

Editor

SHELDON M. GALLAGER **JOHN A. LINKLETTER**
Executive Editor Managing Editor

WAYNE C. LECKEY **ALVIN KIETZ**
Home and Shop Editor Art Director

Published by The Hearst Corporation
RICHARD E. BERLIN, PRESIDENT

RICHARD E. DEEMS
President, Magazines Division

JOSEPH F. KERN
Publisher

BILL HARTFORD _____ Automotive
JOHN F. PEARSON _____ Science and Engineering
WM. T. McKEOWN _____ Boating and Outdoors
IVAN BERGER _____ Electronics and Photography
HARRY WICKS _____ Home Workshop
MICHAEL LAMM _____ West Coast
ROBERT LUND _____ Detroit Automotive
GARRY WINTER _____ Copy Chief
RICHARD H. FUNK _____ Production
ALFREDO VEGA _____ Assistant Production
DON EVANS _____ Technical Art Director
FRED A. LEERS _____ Assistant Art Director
JOSEPH P. BEATON _____ Assistant Art Director
DAVID KOMITAU _____ Assistant Art Director
CLIFFORD B. HICKS _____ Special Projects
SOPHIE GRONOWICZ _____ Director, Bureau of Information
EVERETT JOHNSON _____ Cabinetmaker

ADDRESS ALL EDITORIAL COMMUNICATIONS TO: 224 West 57th St., New York, N.Y. 10019. For additional sources of information on the articles and products in this issue, write to Bureau of Information, Popular Mechanics, for free "Where-to-Find-It" list.

DANIEL J. COLEMAN
Director of Advertising

ADVERTISING OFFICES: New York: 224 West 57th St., 765-6850; Chicago: 520 N. Michigan Ave., 527-2400; Detroit: General Motors Bldg., TRinity 5-8711; Cleveland: 20310 Chagrin Blvd., Shaker Heights, 283-7788; Los Angeles: 601 North Vermont Ave., 666-6263.

JOHN A. REGINA _____ Advertising Production Manager

SUBSCRIPTION SERVICE: Mail all subscription orders, changes of address, correspondence concerning subscriptions, and Postmaster notices of undeliverable copies to Popular Mechanics, Box 646, New York, N.Y. 10019. Please enclose your latest address label for quickest service when writing about your subscription.

POPULAR MECHANICS IS PUBLISHED MONTHLY by The Hearst Corporation, 57th St. at 8th Ave., New York, N.Y. 10019, U.S.A. Richard E. Berlin, President; Richard E. Deems, President of Magazines; John R. Miller, Executive V-Pres. of Magazines; Raymond J. Petersen, Senior V-Pres. of Magazines; William S. Campbell, V-Pres. of Magazines; Albert A. Rachol, V-Pres. and Director of Circulation; Joseph F. Kern, V-Pres. for Popular Mechanics; Frank Massi, Executive V-Pres. and Treasurer; Harvey L. Lipton, Secy. Single copy in the United States and Canada, 50 cents. Subscription prices: United States and Possessions \$5.00 for one year; \$9.00 for two years; \$12.00 for three years. Canada, add \$2.00 for each year. All other countries, add \$4.00 for each year. When changing address, give old address as well as the new, with postal-zone number, if any, and allow six weeks for change to become effective. Second-class postage paid at New York, N.Y., and at additional mailing offices. Authorized as second-class mail by the Post Office Department, Ottawa, and for payment of postage in cash. Registered as second-class matter at the Post Office at Mexico D.F., Mexico, June 20, 1950. © 1972 by The Hearst Corporation. All rights reserved. Printed in U.S.A.

JULY 1972

Build yourself a better drink.



CANADIAN WHISKY—A BLEND • 80 PROOF • IMPORTED BY NATIONAL DISTILLERS PRODS. CO., N. Y.

WINDSOR CANADIAN Canada's smoothest whisky

Best seller



...for 5 good reasons

The world's most popular pipe wrench. Known for the brutal punishment it takes and the long service it delivers. Here's why.

1. Every wrench is work tested before shipment.
2. Unconditional RIDGID guarantee: "If this housing ever breaks or distorts we will replace it free."
3. Full range of 10 sizes: 6" through 60".
4. One hand operation: Easy spin, non-stick adjusting nut sets quickly to pipe size with accurate scale. Full-floating hook jaw with patented spring suspension then assures instant grip... easy release.
5. Built-in massive strength: Jaws are made of special alloy steel; teeth are specially heat treated. Extra tough, comfort-grip, I-beam handle has enlarged end with handy hang-up hole.

See the complete line of RIDGID pipe and special duty wrenches at your quality Hardware Store. He carries the famous RIDGID line of Pre-Tested Work Saver Tools and parts from The Ridge Tool Company, Elyria, Ohio 44035, U.S.A.

RIDGID®

 Ridge Tool Subsidiary
Emerson Electric Co.

LETTERS TO THE EDITOR

Speedometer won't spot bad vibes

Maybe you can find prop-shaft vibration with a tachometer, but *how* with the speedometer (*Troubleshooting by the seat of your pants*, page 120, May PM)? Almost no cars have transmission integral with the differential back at the rear end. Consequently, no matter what the gear range used, the prop shaft is going to make the same number of rpm per mile traveled.

THREE RIVERS, MICH.

A. MAHNKE

You're right. Author Mort Schultz really wasn't asleep at the wheel; he was just trying too hard to make it easy for car owners without tachs. The procedure he gave for isolating engine-caused vibrations from driveshaft vibrations can be followed if you have a tach, but you can't do it using your speedometer. Use of two different gear ranges lets the engine, and not the prop shaft, operate at different speeds.

Home improvement—keep the porch!

The many articles on house improvement were impressive and informative (*Better ways to get a better home*, page 110, April PM). Thank you for the publication of such helpful material.

BETHESDA, MD.

DENNIS G. BURDETTE

I was glad to see the April issue. I had been trying to convince my husband I need a bigger kitchen.

"Whoever heard of it downstairs?" says he. "PM." I said—so he at least will consider it now.

SNOHOMISH, WASH.

MRS. G. J. HINDS

How does anyone get the idea that a house is more functional and a better home if it does not have a front porch?

Some of your new "charm" sketches don't even show plans for a small roof to protect a person from the elements as he reaches for a key to the front door. Friends have to stand in the rain while waiting for someone to welcome them.

Finally, where can a person relax and

(Please turn to page 8)

LA SALLE EXTENSION UNIVERSITY

A Correspondence Institution • 417 S. Dearborn Street, Dept. 79-075, Chicago, Illinois 60605

Please send me, without cost or obligation, FREE booklet and full information on the field I have checked below:

ACCOUNTING

- Complete Accounting
- Income Tax
- CPA Training
- Bookkeeping

BUSINESS MANAGEMENT

- Introduction to Business Management

DRAFTING

- Complete Drafting

REAL ESTATE

- Complete Real Estate
- Real Estate Brokerage
- Real Estate Management

TRAFFIC & TRANSPORTATION

- Complete Traffic Management

COMPUTER PROGRAMMING

- Basic Training

INTERIOR DECORATING

- Complete Training

DIESEL MECHANICS

- Basic Training

ART TRAINING

- Commercial Art
- Oil, Water Color Painting
- Complete Training

MUSIC INSTRUCTION

- Piano Guitar

LANGUAGE INSTRUCTION

- French Spanish

DENTAL OFFICE ASSISTANT

- Complete Training

LAW COURSES

- Bachelor of Laws Degree
- Business Law
- Insurance Law
- Claim Adjusting Law
- Law for Police Officers

No state accepts any law home study course, including LaSalle's, as sufficient education to qualify for admission to practice law.

Mr.

Mrs..... Age.....

Miss

(Circle title and please print)

Address..... Apt. No.....

City &

State..... Zip.....

HIGH SCHOOL

- High School Diploma

HOTEL/MOTEL MANAGEMENT

- Hotel Executive Training
- Motel Management

RESTAURANT MANAGEMENT

- Executive Training

STENOTYPE

- Machine Shorthand

If you had mailed this coupon a year ago, perhaps your salary would be up too!



WHY NOT MAIL IT TODAY?

Look at these pleased reports from LaSalle students. Many success stories of this kind come to us every year—from people who began their career planning by mailing the LaSalle coupon for information.

Yes, many graduates attribute their increases in income largely to their LaSalle spare-time training.

LaSalle students have one ambition in common—to get out of the ranks of the untrained and earn more money and respect in a better job. Isn't that your goal too?

Without interfering with your present work—and by devoting only a little of your spare time—you too can prepare for advancement in the field of your choice through LaSalle home study. The cost is low.

LaSalle has been a leader in home education for more than sixty years, enrolling over 2,000,000 ambitious men and women in its many courses. You study under the supervision of LaSalle's experienced faculty. Upon satisfactory completion of your study, you receive the LaSalle diploma—a recognized and respected credential.

Check the subject you are interested in—then send the coupon above for FREE booklet. No obligation.

"Since enrolling with LaSalle my salary has doubled."
Robert Kubec,
St. Cloud, Minnesota.

"In the past three years my income has jumped over \$6,500."
Norbert Kaiton,
Ridgewood, N.Y.

"My salary has quadrupled since starting the course."
George R. Kelly,
W. Bridgewater, Mass.

"Thanks to LaSalle training... my salary has doubled."
Mrs. Mary M. Nyberg,
Los Angeles, Calif.

LA SALLE EXTENSION UNIVERSITY

A Correspondence Institution • 417 S. Dearborn Street, Chicago, Illinois 60605



THE CARBURETOR CLEANER.

Clean your carburetor and what do you get? Easier starting. Smoother idling. No stalling. Faster take-offs. Better mileage.

It's all yours when you add a pint of Gumout to your gas tank.

Try it. It works.

GUMOUT

Pennsylvania Refining Company, Cleveland, Ohio 44104
Also available in Canada

LETTERS

(Continued from page 6)

"watch the world go by" if there is no porch?

When I was a child, we lived in the country in Maryland. We had a large porch similar to the one shown on page 134. It was a "fun" porch for all seasons.

Our home now has a porch. Bettering your home should *not* include doing without a porch.

LONG BEACH, CALIF. ROLLAND TRUMAN

A bit different from PM's

I made my table slightly different from that in 'Glass-top' wagon-wheel table (page 182D, Feb. '71 PM). I made the stand straight instead of slanted, didn't cut notches for the spokes to rest in and

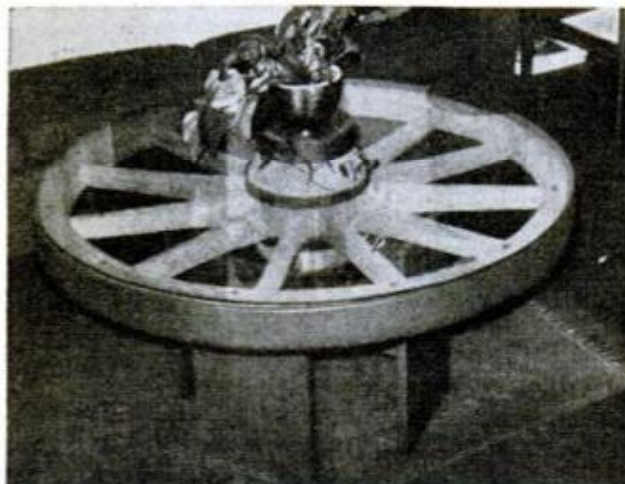

used quarter-inch plate glass for the top rather than plexiglass. (The glass was salvaged and very cheap.)

Everyone who sees the table likes it, and I am real pleased with the way it turned out.

WATSEKA, ILL.

FRED BOHLMANN

Source of electronic stopper

In the "Interior treatment of slab floor" portion of *What you should know before termites put the bite on you* (page 124, March PM), the third step involves use of an electronic stop device that will turn off a drill when it nears a conduit. What company supplies the unit?

MULBERRY, IND.

DONALD W. KELLER

Lots of readers are asking that question. The device, the Stop N'Time, is available from York Chemical Co., 195 Atlantic Ave., Garden City Park, N.Y. 11040. Model

(Please turn to page 10)

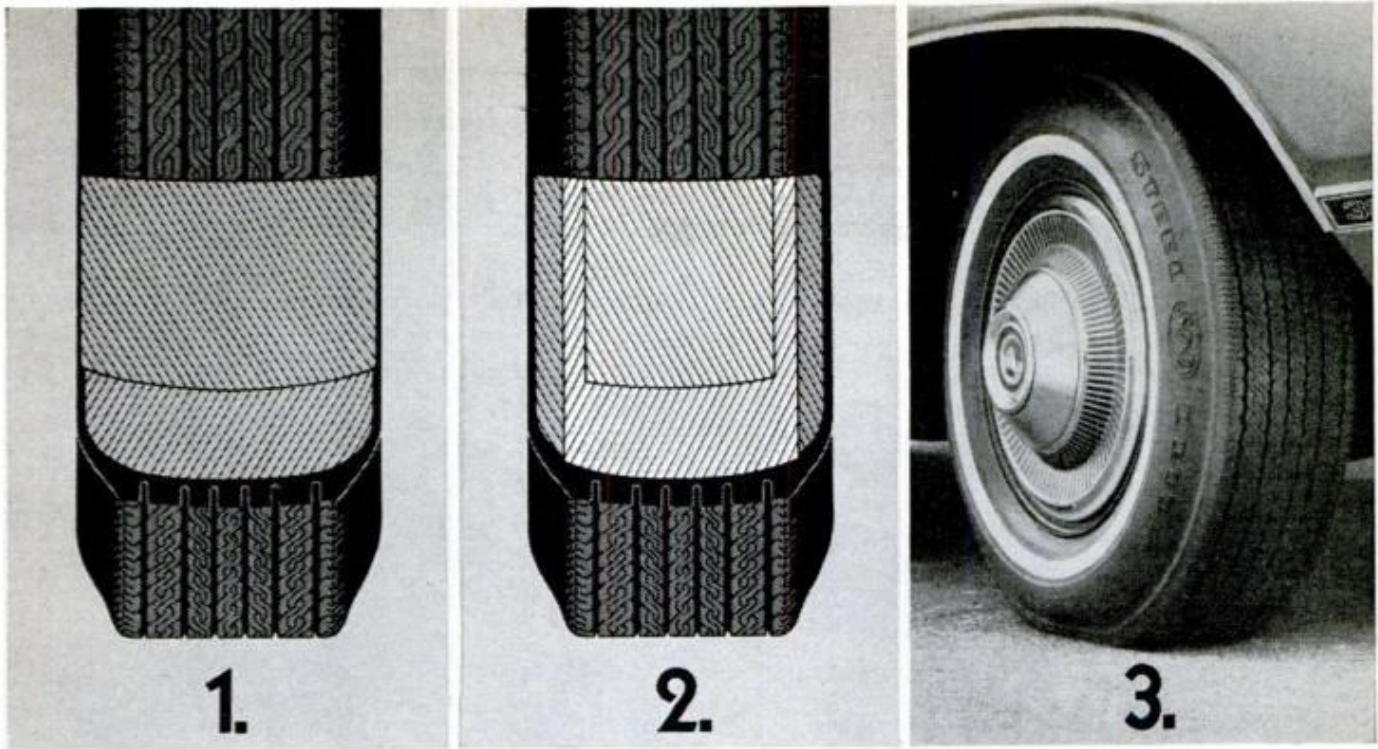

How to build the people tire.

The problem? Design a tough tire for a new world that has more driving for people to do, more curbs for people to run over, more people who are too busy to check their tires.

- 1.** Give it strong polyester body plies, full tread depth, and a concave molded tread.
- 2.** Put two armor belts of steel under the tread. Steel cords so strong a single cord will pull a car. Cords set so close together you'll need 805 feet for each tire.
- 3.** Or simply see your Firestone Dealer, Store, or service station. You'll find we've already built The People Tire and it's ready for you.

We're not saying it's a tire you *shouldn't* take care of. We're saying that, with a little care, it will really take care of you.

Firestone
500 Steel Belt

the people tire

ANTI-POLLUTION AUTO ENGINES NEED SPECIAL VALVE PROTECTION

RISLONE
GIVES
IT...



Test Drive it!



FREE Get some hints from a REAL engine expert, Smokey Yunick. Send large, self-addressed, stamped envelope and we will send 32-page booklet.

THE SHALER CO.

Waupun, Wisconsin 53963
In Canada: Canadian Shaler
Products Co., Toronto 9, Ontario

IT'S YOUR MONEY...

but shooters who want and expect maximum performance from an AIR RIFLE will find the

Great New BENJAMIN

combines new standards of ACCURACY AND SAFETY with SMASHING PEAK POWER AND RELIABILITY to make it the logical choice of those hankering for a BB or Pellet Gun you can trust.

A thumb operated top safety for better fire control plus a new ramp-type front sight and adjustable stepped leaf rear sight for improved target alignment are combined with Benjamin's time-tested action and adjustable power to make this exciting new Super Single Shot a plinker's dream come true. Safe, quiet, odorless. It's expertly made. Embodies other traditional Benjamin quality features which contribute to its dependability and shooting excellence. Use indoors or out. 3 calibers. Reasonably priced. Model 340 BB. Model 342 Cal. 22 Pellet. Model 347 Cal. 177 Pellet. At sporting goods dealers. Use Benjamin H-C Pellets—Sized and Lubricated for Greater Accuracy.

BENJAMIN AIR RIFLE COMPANY **FREE Catalog**
896 Marion St., St. Louis, Mo. 63104

You Can **DEPEND** on BENJAMIN

NEW WALNUT MONTE
CARLO STOCK.

LETTERS

(Continued from page 8)

10, which will handle up to 10 amps., sells for \$89.50; Model 30, which handles up to 30 amps., sells for \$104.50. Both prices are f.o.b. Garden City Park.

Both units cut off the power to the tool being used when the bit strikes a grounded piece of metal, such as a water pipe, oil pipe, or conduit.

Etching in soot

Here's a photo from *The Daily Telegraph* of Napier, New Zealand, about my art form in soot. A few years ago I was reading an old PM that described this



technique (*Etching in soot*, page 151, Aug. '56 PM). So I thought I would try it. It has made a tremendous difference in my life and brought me great joy.

MRS. F.M. SANDERSON
MEEANEE, NEW ZEALAND

Round 2: VW vs Fiat

Just ran across Chris Kotowski's letter (*Letters*, page 6, March PM) saying he thinks the VW Beetle a better car than the Fiat. I disagree vehemently. I own a Fiat and have owned a Beetle.

About commercials—I think Chris has it the wrong way around. I was one of the victims of the carefully propagated myth that German engineering is better than Italian. My considered judgment is that anything the Germans can do, the Italians can do better—except advertise, maybe.

ANSONIA, CONN. ALAN MACFAWN

Has had one for eight years

The Wide Sweep Lawn Rake (*Exciting New Products*, page 126, May PM) is not a new product. I've had one for about eight years. It's named Sweep Rake and is made by Gardex, Inc., Michigan City, (Please turn to page 12)



**This
head
won't
loosen.**

**This
handle
won't
break.**

WE GUARANTEE IT!

The head won't pull off, won't even work loose because Plumb's patented PERMABOND® locks it to the handle permanently. A 2-ton pull test couldn't get them apart.

The handle won't break, bend or collapse because it's made of tough fiber-glass. And shaped like a regular hickory handle. So get the FA57. It's the best hammer money can buy.

® Registered trademark of the McDonough Co.

PLUMB®
△ AMES Division of McDonough Co.
Parkersburg, W. Va. 26101

These great minds were Rosicrucians . . .



Francis Bacon Benjamin Franklin Isaac Newton

WHAT SECRET POWER DID THEY POSSESS?

Why were these men great?

How does anyone—man or woman—achieve greatness? Is it not by mastery of the powers within ourselves?

Know the mysterious world within you! Attune yourself to the wisdom of the ages! Grasp the inner power of your mind! Learn the secrets of a full and peaceful life!

Benjamin Franklin, statesman and inventor . . . Isaac Newton, discoverer of the Law of Gravitation . . . Francis Bacon, philosopher and scientist . . . like many other learned and great men and women . . . were Rosicrucians. The Rosicrucians (NOT a religious organization) have been in existence for centuries. Today, headquarters of the Rosicrucians send over seven million pieces of mail annually to all parts of the world. Address: Scribe C.L.Z.

THIS BOOK FREE

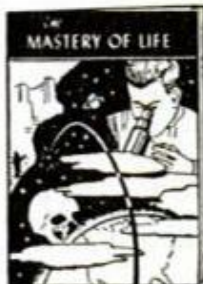

The ROSICRUCIANS

San Jose (AMORC) California, 95114, U.S.A.

SEND THIS COUPON

Scribe C.L.Z.
The ROSICRUCIANS
(AMORC)

San Jose, California, 95114 U.S.A.

Please send me the free book, *The Mastery of Life*, which explains how I may learn to use my faculties and powers of mind.

Name _____

Address _____

City _____

State _____ Zip Code _____

Please Include
Your Zip Code

LETTERS

(Continued from page 10)

Ind. Mine varies slightly from the one shown. It has 47 steel spring teeth on a 30-inch head with a 60-inch handle.

Turned upside down, it's excellent for leveling new topsoil.

WEST HAVEN, CONN. THOMAS W. GIBBONS

Not the only ones

How to be your own minibike mechanic (page 104, Jan. PM) is well written, but contains a misleading statement on page 106.

The writer has properly instructed readers to use grade 5 bolts or better, but he improperly advises that "the only nationwide suppliers of grade 8 bolts are Caterpillar Tractor dealers."

Grade 8 bolts are available from auto-parts dealers, automobile dealers, industrial parts-supply houses and, in fact, any one of more than 10,000 outlets sold by manufacturer/expeditors such as Kar Products, Inc., of Des Plaines, Ill. (I mention Kar products because the No. 8 bolt shown in the photo on page 106 bears the Kar mark on the head.

ELK GROVE VILLAGE, ILL. JAMES H. HURLEY

Sander builder

I just finished making my disc sander (*Salvaged motor makes a handy shop sander*, page 172, Dec. '71 PM). I chose the "alternate design," and instead of wheels, made a removable dolly so my machine won't move while I work. I added a door on the back for storage needs.

My sander was made in my eighth grade industrial arts class at Plaza Park School with the help of William E. Miller, my instructor. Let's have more articles like that one!

EVANSVILLE, IND.

EDDIE DELAU

Puzzled for two years

Two years ago my neighbor cleaned his attic and found an old board filled with holes and a bag of pegs. I was fascinated and made my own board. On and off, I've tried to find the solution to the puzzle.

You can imagine my surprise when reading the March PM I saw the peg puzzle (*Jump-a-peg puzzle*, page 137) and, to my great pleasure and satisfaction, the solution on page 145. Thank you!

PAWCATUCK, CONN.

A. A. BARBER

TAKE OFF...STRAIGHT UP

in a Scorpion Too



***Have you heard about sport flying?
Did you know that you can participate
in your own personal helicopter***

The Scorpion Too is RotorWay's answer to backyard flight.

Remember, the Scorpion is a true vertical take-off helicopter, it takes off straight up.

Using a 140 h.p. engine, it cruises at 75 m.p.h. and can carry over 400 lbs. The most exciting news about the twin-seat Scorpion is its low cost, but then it's about time a helicopter became a recreational vehicle.

The twin-seat Scorpion is designed to be built and flown for the same price as its successful single-seat predecessor.

Find out about the complete Rotorway story . . . a truly exciting adventure in vertical flight.

Send \$5 for the full color introductory package and special offer.

RotorWay
INCORPORATED

ROTORWAY, INC.
Dept. C6/14805 S. Interstate 10
Tempe, Arizona 85281

Name _____
Address _____
City _____ State _____ Zip _____

PHOTO HINTS

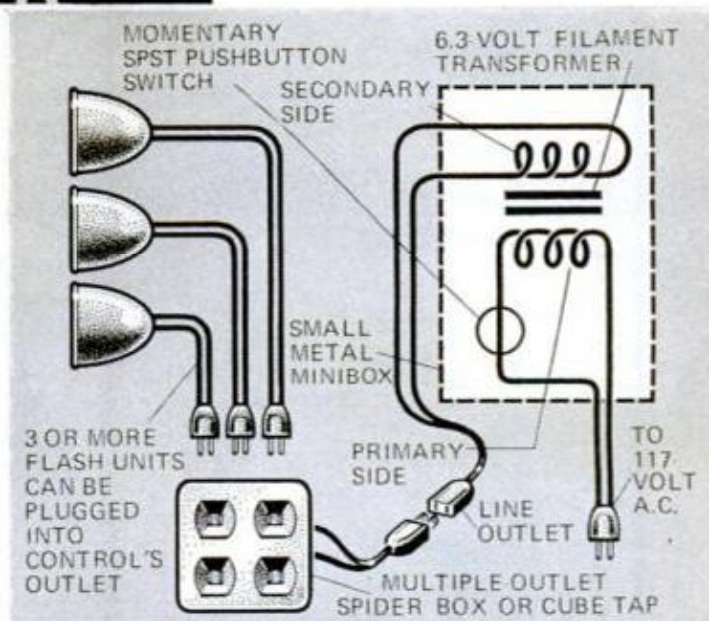

Low-voltage flash control lets you shoot without batteries

With this low-voltage control, you don't have to worry about having a fresh supply of batteries on hand every time you want to make a flash shot. The control provides a limitless source of power right from your nearest wall outlet and can be used whenever you're shooting indoors with flashbulbs. A small radio-type filament transformer steps down line current to a tame six volts for firing the bulbs. (Firing flashbulbs directly on house current is not recommended as the high voltage occasionally causes the glass to shatter with explosive force.)

The control is designed primarily for open-flash shooting in a darkened room where you open the camera's shutter, fire the flash separately, then close the shutter. You just plug your flashgun into the

control, press a pushbutton switch, and the bulb fires. Simple flash holders can be improvised cheaply by fitting standard photoflood reflectors with screw-in flashbulb adapters, as shown at lower left, above. The adapters are available at photo shops. The transformer and pushbutton switch can be obtained from radio-parts stores or mail-order houses like Lafayette Radio and Allied Radio Shack.

If you want to control your flash with the camera's shutter release, wire a sync cord in series with one lead from the transformer. Pressing the release will thus fire the flash at the same time it trips the shutter. In this case, the pushbutton will have to be held down during the operation or replaced with a toggle switch.

—Norman Fallon, New York, N.Y.



See-through storage for film

A clear-plastic shoebox is ideal for storing film, especially if you keep it in the refrigerator to prolong its life. The box protects the film from spills and makes the contents readily visible for keeping tabs on your supply.—*John F. Pilznienski, Dearborn Heights, Mich.*



Mix chemicals with an eggbeater

An ordinary kitchen eggbeater makes a perfect tool for mixing powdered dark-room chemicals that must have water added. Use a stainless steel beater and mixing bowl, and neither the metal nor the chemicals will be affected by the other.—*Robert Hertzberg, Flushing, N. Y.*

You'd drive the ball farther if you could slow down your swing.



A Minolta Autopak®, with its variable filming speed feature, can show you—in excruciating slow motion — what everybody's been telling you is wrong with your swing.

But that's just the beginning. With the Autopak's unique features and system of accessories, you can create cartoons out of children's drawings, or make a rose seem to bloom in two minutes.

No matter what the scene, an Autopak gives

you the correct exposure automatically, instantly.

Minolta Autopak-8 cameras start at around \$182, plus case, with optical-glass Rokkor zoom lens. Accessories extra.

For literature, write Minolta Corporation, 200 Park Avenue South, New York, N.Y. 10003. In Canada: Anglophoto Ltd., P.Q.



Start to see life differently with a Minolta Autopak.

AUGUST **Preview** OF POPULAR MECHANICS



15 GREAT IDEAS FOR BETTER BACK-YARD LIVING

New-type swimming pool, putting green, conversation corner, privacy fence, play equipment, deck, lighting—any one of these ideas will pay off handsomely.



POCKET-SIZE TV CAMERA

While still in the prototype stage, the mini TV camera is here. It gives you a good idea of the camera you'll be using in the future.



8000 MILES IN A MODEL-T CAMPER

What it's like to tour coast to coast in a 50-year-old Ford. It still calls for a sense of adventure—and mechanical ability.



A \$700 RECEIVER IN A \$400 KIT

PM tests Heathkit's AM-FM stereo receiver and gives it a top rating. It takes 40 hours to build—you save \$7 an hour.



ELECTRONIC 'EYE' FOR THE BLIND

Radarlike detection devices send out beams that reflect off obstacles so the blind can walk with confidence. Several remarkable technical developments offer new hope for sightless people.

PLUS

What owners think of the Dodge Charger and the Saab 99 • Things you didn't know you could do with a bench saw • One man's paddlewheel riverboat • Slip-in slide-out mounts for car tape players • How to build a drum table, hobby desk or weather station

Buy it on your newsstand. Better yet, make sure you'll keep getting this kind of exciting fare. Send this coupon with your check to:

POPULAR MECHANICS
250 West 55th Street
New York, New York 10019

Please enter my subscription for 1 yr. \$5 or 2 yrs. \$9

Name _____ (Please print)

Address _____

City _____ State _____ Zip _____

Payment of \$_____ is enclosed. New Renewal

On new subscriptions, first copy will arrive in about 8 weeks.

(Above prices apply in U.S. and Possessions only. Canada, add \$2 per year. All other countries, add \$4 per year.)

WPM2G1

If you've ever said...

"There must be a better way to earn a living.."

one of our free Career Guidance Booklets may provide the opportunity you've been looking for.

It happens to all of us, sooner or later. No matter what kind of job we have.

One day, it suddenly strikes home that—like it or not—we're going to have to work for a living, the rest of our lives. And most of us are horrified at the thought of forever being locked into the jobs we now hold.

"Surely," we tell ourselves, "there must be a way to earn enough extra dollars each month to balance the family budget. Surely, there must be a way to get the kind of position where you don't have to worry about job security. Surely, there must be a way to get a job that offers greater opportunity for advancement, and more job satisfaction."

"Surely," in other words, "there must be a better way to earn a living!"

If you, too, have been thinking these thoughts lately, you'll find one of our free Career Guidance Booklets very helpful at this time. We invite you to send for one.

Your free booklet will describe the opportunities for higher income and greater job security you might



expect in one of the career fields listed on the coupon below. It will also explain why ICS can prepare you for this new career field... right in your own home... in your spare time... *regardless of your education or past experience.*

In addition, you will receive a free "Demonstration Lesson" that lets you see for yourself why preparing for a more rewarding career—the ICS way—may be a lot easier than you think.

Please bear in mind, as you check off your career choice on the coupon below, that ICS has a long and distinguished record of success as a career training organization. In fact, more than 8,500,000 men and women have turned to ICS for career training, since 1891.

ICS has provided training programs for various divisions and branches of companies like Ford; U.S. Steel; Chrysler; Mobil; DuPont; etc.

ICS Career Training is approved for Veterans and Servicemen under the new G.I. Bill, and is Accredited by the Accrediting Commission of the National Home Study Council.

In short, ICS training methods are valued and respected not only by ICS graduates...but also by leaders in Business, Industry, Government, and Education.

Now it's your turn to discover how ICS training can start you in a rewarding new profession. Just fill in the coupon below and mail it today for your free Career Guidance Booklet and free "Demonstration Lesson."

Keep this certificate when you mail the coupon for your free Career Guidance Booklet and "Demonstration Lesson"

This certificate symbolizes the long and distinguished record of success that ICS has enjoyed as a Career Training Institute. It is your assurance that ICS stands ready to serve you, just as it is serving individuals, business and industry of the world.

Ford, Mobil, DuPont, USS

ICS Scranton, Pennsylvania 18515

Please send me a free Career Guidance Booklet, and a free "Demonstration Lesson" for the field I have checked. I understand I am under no obligation.

<input type="checkbox"/> Accounting	<input type="checkbox"/> Computer Servicing	<input type="checkbox"/> Engineering	<input type="checkbox"/> Restaurant/Club Management
<input type="checkbox"/> Automotive Mechanics	<input type="checkbox"/> Communications/Broadcasting/Electronics Specialist	<input type="checkbox"/> FCC Licensing	<input type="checkbox"/> TV Repair and Servicing
<input type="checkbox"/> Business Management	<input type="checkbox"/> Drafting	<input type="checkbox"/> Hotel/Motel Management	<input type="checkbox"/> High School Division (For students who want to earn a High School Diploma.)
<input type="checkbox"/> CATV/MATV Electronics Specialist	<input type="checkbox"/> Apartment/Community Management	<input type="checkbox"/> Income Tax Specialist	
<input type="checkbox"/> Computer Programming	<input type="checkbox"/> Electrician	<input type="checkbox"/> Interior Decorating and Design	
	<input type="checkbox"/> Electronics	<input type="checkbox"/> Production Management	

Name _____

Address _____ Apt. No. _____

City _____ State _____ Zip _____

ICS Career Training is: Approved for veterans under the new GI BILL/Approved for federally insured loans. Accredited by the Accrediting Commission of the National Home Study Council

Drivin' with Dan

Why is webbing on the driver's side of stock cars? Why do radiators have to be changed so often in racing cars? Do race drivers need extra strength? Dan Gurney answers these and other automotive questions

Q. In the scenes in which cameras were mounted inside the cockpits of the race cars in Grand Prix and Le Mans the tachometer needles moved in discrete steps, much like the sweep hand of a stopwatch rather than the more familiar smooth arc. Are these special tachometers, or are the engines in these cars actually capable of exceptionally fast and accurate changes in rpm?—C.M. Hansen, Red Bank, N.J.

A. Racing tachs are usually mechanical, and they do move in snatches or leaps, particularly in the lower gears where the revs go up and down rapidly. Another type of tach is the chronometric where a second needle moves up with rpm but never drops back. It "sticks" to indicate the highest revs you've turned. You have to reset to zero.

Q. Why the webbing on the driver's side of stock cars at Daytona?—Don Moore, Tuscaloosa, Ala.

A. In the event that a driver runs the car with the window down for any reason, the webbing is intended to keep him from being thrown out the window in a violent crash or roll. The famous NASCAR and motorcycle ace



YANKEE 500Z is a new enduro machine from the Yankee Motor Co. in Schenectady, N. Y. The 500-cc two-stroke twin has simultaneous firing for off-the-road use and a conventional 180° setup for the road

Joe Weatherley was killed at Riverside when he was thrown partly out the window after he hit the wall because his brakes didn't function properly.

Q. In the last race at Phoenix last season, I noticed Mark Donohue left due to overheating. He said that the radiator had not been changed from Indianapolis. I believe the same thing happened to A.J. Foyt at the first race in Phoenix last season. Why is it necessary to change radiators on these cars for different tracks? Where is the Offy engine made for Indy cars and do they make engines for any other purpose, such as cars, trucks or industrial use?—Pat Parish, Fort Worth, Tex.

A. Most radiators lose cooling efficiency from being drained and filled often. When empty they seem to corrode faster. Aluminum radiators seem to require the most care. In Mark's case, I believe that small stones and gravel from the deteriorating race track were kicked up by the front tires and they bent the cooling fins closed, blocking off the airflow. Cooling 800 hp in a small car is a big problem. Offies (Drake) are made in Costa Mesa, Calif. They also make midget race car engines but none for passenger cars or trucks.

Q. Is Harley-Davidson the only American motorcycle manufacturer?—Linda Robbins, North Merick, N.Y.

A. No, it's not, but it's certainly the best known. A new American bike is the Yankee (appropriately named, isn't it?) As with Harley, not all of the machine is made in the United States; many components are imported. See the accompanying photo for the bike in action.

Q. I've noticed that some Championship and Formula One drivers wear shoes that look a lot like boxing shoes. Could you tell me what kind of shoes they are and what the advantages are

(Please turn to page 22)

Salem refreshes naturally!

Natural Menthol™ is why.

Warning: The Surgeon General Has Determined That Cigarette Smoking Is Dangerous to Your Health.

KING: 19 mg. "tar", 1.4 mg. nicotine,

SUPER KING: 20 mg. "tar", 1.5 mg. nicotine, av. per cigarette, FTC Report APR. '72.



© 1972 R. J. REYNOLDS TOBACCO COMPANY, WINSTON-SALEM, N.C.

Материал, защищенный авторским правом

**EARN
HIGH
WAGES**
as a **HEAVY
EQUIPMENT
OPERATOR**



Train your way to high pay in the booming construction industry! Learn the skills you need to qualify, by actual field training on machines like the ones used by the industry. Huge training grounds in North Carolina, a million dollars worth of school-owned diesel-engined machines, experienced instructors, full 220-hour and 440-hour courses. National, the original school of heavy equipment operation, is a recognized leader. Member American Road Builders Assn., Services and Supply Division. Associate Member A.G.C. Full-time Job Advisory and Counseling Director on staff. Approved for veterans. For men ages 17 and up. Train Now-Pay Later plan . . . other payment plans also available. Write TODAY for FREE catalog and FREE copy of school newspaper reporting news of National School graduates. Accredited member National Association of Trade and Technical Schools.

NATIONAL SCHOOL Phone 704/392-1359
OF HEAVY EQUIPMENT OPERATION, Dept. D-64

P. O. Box 8529, Moores Chapel Road, Charlotte, N. C. 28208

Please send me FREE illustrated school catalog and complete information. I understand there's no obligation.

Name _____ Age _____

Address _____ Phone _____

City _____ State _____ Zip Code _____

Fix it
to stay fixed with

LOC-KIT®
positive lock washers



Use on
nut and bolt joints in:

- Cars
- Bicycles and motorcycles
- ATVs and off-the-road vehicles
- Boats
- Recreational vehicles and trailers

Hundreds of
home and shop uses.

Even extreme vibration will not
loosen nut and bolt joints
"locked" with

LOC-KIT
positive lock washers

Get them at automotive, hardware and other
retail stores. 372-33

DRIVIN' WITH DAN

(Continued from page 20)

to wearing them? Do all drivers (including those who race on other circuits) wear that kind of shoe?—N.J. O'Reilly, Batesville, Ind.

A. There is a lot of variety in shoes in racing. Some drivers do wear boxing shoes although most wear shoes designed and made for racing, and they often are made of fire-resistant materials.

Q. Do race drivers develop unusual strength in their arms, or isn't race driving that tough?—Cal Draper, Corbin, Ky.

A. Race drivers do not need unusual strength. It's using the right muscular tension and concentration that is so exhausting. You are always straining for the "feel" of what the car is doing through the wheel. That requires extraordinary effort, but it's not totally muscular.

Q. I am presently a mechanic. While I realize that it may take considerable time and effort, my ambition is to become a mechanic on the racing circuit. What steps should I take to accomplish my goal (training, books to read, people to contact, gaining recognition in the field)?—Nelson Haggerty, Flagstaff, Ariz.

A. I suggest that you seek out Clint Brawler, who lives in Phoenix and ask him. He has one of the best records in Championship USAC racing as a chief mechanic. Reading is important and so is actual racing experience. Relating theory to practice is very important. You must be in the field before you gain recognition. Also, have you considered handling a friend's car in SCCA club racing?

Q. Approximately, what is the purse of the U.S. Grand Prix held at Watkins Glen?—Steven Prensky, Arverne, N.Y.

A. Approximately \$200,000 with \$50,000 to the winner.

Q. Last year FIA rules for the manufacturer's Championship stated that this year all 12-cylinder cars, including the Porsche 917 and the Ferrari 512, would be banned from the track. Recently I learned that a Ferrari 512 had won this year's Daytona. Porsche has quit competition because of rules; Ferrari hasn't. How can this be?—Eric Baker, Colorado Springs, Colo.

A. They haven't been banned because of the cylinders; the maximum displacement has been limited to 183 cu. in. Ferrari has a good engine in this limit (3 liters), but Porsche's

(Please turn to page 24)

Chevrolet. Building a better way to see the U.S.A.



GM

MARK OF EXCELLENCE

Chevelle Malibu Sport Coupe at Six Flags Park, Atlanta.

Have you noticed how many young families get carried away with Chevelle?

They got carried away to places like the Six Flags amusement park in Atlanta with over 250 acres of history and fantasy and fun.

"To get carried away with" implies purely an emotional reaction. With Chevelle, that's only partly true.

Fits more families.

The reasons more young families get carried away with Chevelle, the reasons it's become America's most popular mid-size car are solid, quite solid indeed.

The Chevelle interior is spacious for a mid-size car (or any size car, for that matter). It fits a family of six nicely.

Fits more vacations.

And the Chevelle body provides your family with protection wherever you travel. It's an all-welded superstructure, incorporating solid steel side guard beams in each door and a steel cargo guard that walls off the passenger com-

partment from the luggage in the trunk.

That trunk, incidentally, holds 12 cubic feet of overnight bags, two-suiters, golf clubs, balloons or whatever.

And even if you run into some bad roads or have to take a detour, you'll travel smoothly on Chevelle's Full Coil suspension.

Fits more budgets.

Price, of course, is terribly important when you're planning on both a new car and a vacation.

Don't worry. Chevelle's price is also mid-size. And its resale value is full-size—traditionally higher than other cars in its field.

One more thing. The readers of *Car and Driver* magazine recently picked Chevelle as the year's "Best Intermediate Sedan."

So please give our best to your family. And have a nice trip.

Chevrolet

Highway safety begins at home. Buckle up before you leave.

Enjoy Independence



**With A Sparetime
BUSINESS
OF YOUR OWN**

Here's a proven, practical way to earn sparetime cash while you develop a money-making business of your own. Investment is small. There's no overhead, no stock to carry, no selling involved. Automatic Foley Saw Filer, easy to operate, files combination saws, hand, band and circular saws. No experience needed.

Earn \$3 to \$6 An Hour In Sparetime

Get started now and watch your business grow! Thousands are earning cash this easy way—many build a complete sharpening service with year around profits. You can, too, with the easy-to-follow Foley Plan—write us today!



FREE BOOKLET SHOWS HOW

Fact filled booklet tells you how to start a sparetime business; how to get new business. Rush coupon, get "Money Making Facts" and details on Easy Payment Plan. No salesman will call.

Foley Manufacturing Co.
716-2 Foley Bldg., Minneapolis, Minn. 55418

Send FREE BOOK—"Money Making Facts", and Time Payment Plan.

Name _____

Address _____

City _____ State _____ Zip Code _____

THE HEAVIEST HUMAN ON RECORD WEIGHED 1,069 LBS. AND WAS BURIED IN A PIANO CASE!

The Highest Alimony Ever Paid Was \$11,550,000. A War That Lasted 38 Min. A Woman Who Bore 69 Children. The Largest Insect... a "Goliath Beetle." The World's Most Expensive Perfume At \$370 An Ounce.

The biggest! The smallest! The richest! The highest! The oldest! The longest! The fastest! The greatest! The Guinness Book Of World Records contains over 3,000 records of science, nature, the achievements of man, the world of sports, the arts, entertainment and little known fantastic phenomena. Packed with unbelievable facts and over 350 photos.

Settle any argument! Amaze your friends! You will not be able to put it down. This 600 page hard covered volume is a must for any library. Over 5,000,000 copies sold worldwide. Only \$5.95 (moneyback guarantee).



BOOK OF WORLD RECORDS, DEPT-G-17 1966 BROADWAY, N.Y., N.Y. 10023

Please rush me... Guinness Book Of World Records at \$5.95 each (plus 60¢ post. & hand). Enclosed is my check or money order for _____. If not completely satisfied, I will return the book within 15 days for a full refund.

Mr. _____

Mrs. _____

Miss _____

Address _____

City _____ State _____ Zip _____

Make check/M.O. payable to Book Of World Records
© Broadway Bookfinders, 1972

DRIVIN' WITH DAN

(Continued from page 22)

powerplant displaces 5 liters so it has decided to run its engines in the Can-Am Series instead.

Q. I own a 66 Tempest Custom and am interested in setting up the chassis and other suspension components for improved handling characteristics similar to those demanded by Trans-Am type racing. I would appreciate any information you could provide.—Paul Covey, Cincinnati.

A. Start with antiroll bars front and rear, and wider wheels and tires. Competition-style shocks also help.

Q. I overheard a British mechanic at Lime Rock and could hardly understand a word he said! I remember him referring to "tick over." What's that?—Bob Wright, Bridgeport, Conn.

A. Indeed it's a different language—especially the auto and racing terms. I had to learn to communicate in American English and British English when I was first racing there. "Tick over" is simply idling rpm. Here are other terms that come to mind: dampers (shocks), wings (fenders), gudgeon pin (wrist pin), dynamo (generator), bonnet (hood), boot (trunk), track rod (tie rod). If you ever drive in England, old chap, make sure your "windscreen" is clean and your "tyres" are inflated properly. Really, you wouldn't want to run into any "flyover" abutments while you're driving on the left side of the "motorway!"

Q. Recently you said Phil Hill was the only "American" world champion. Where do you suppose the magnificent Juan Manuel Fangio comes from if not "America"?—Ed Krans, Salem, N.H.

A. I stand corrected and I hope you'll excuse my Yankee oversight. The Argentine, Juan Manuel Fangio, is certainly the acknowledged king of Grand Prix racing drivers of the Americas. He was five times World Grand Prix Champion and I believe he counts me as one of his many friends and admirers. I am also nevertheless very proud of the Norte Americano Phil Hill's achievement of winning the Grand Prix World Championship in an Italian Ferrari in 1961. I'm a Norte Americano myself! ★ ★ ★

If you have questions on racing, high-performance and everyday driving techniques, send them to "Drivin' with Dan," c/o Popular Mechanics, 224 West 57th St., New York, N.Y. 10019. Questions cannot be answered by individual letters. Questions on maintenance and repair should be addressed to the Auto Clinic (see page 46).

**DURACELL® GIVES YOU MORE SYMPHONIES,
ROCK, FLASH PICTURES, NEWS REPORTS,
PERFECT EXPOSURES, TALK SHOWS, HOME
MOVIES AND TOY TRACTOR MILES THAN ANY
ORDINARY BATTERY IN THE WORLD.**

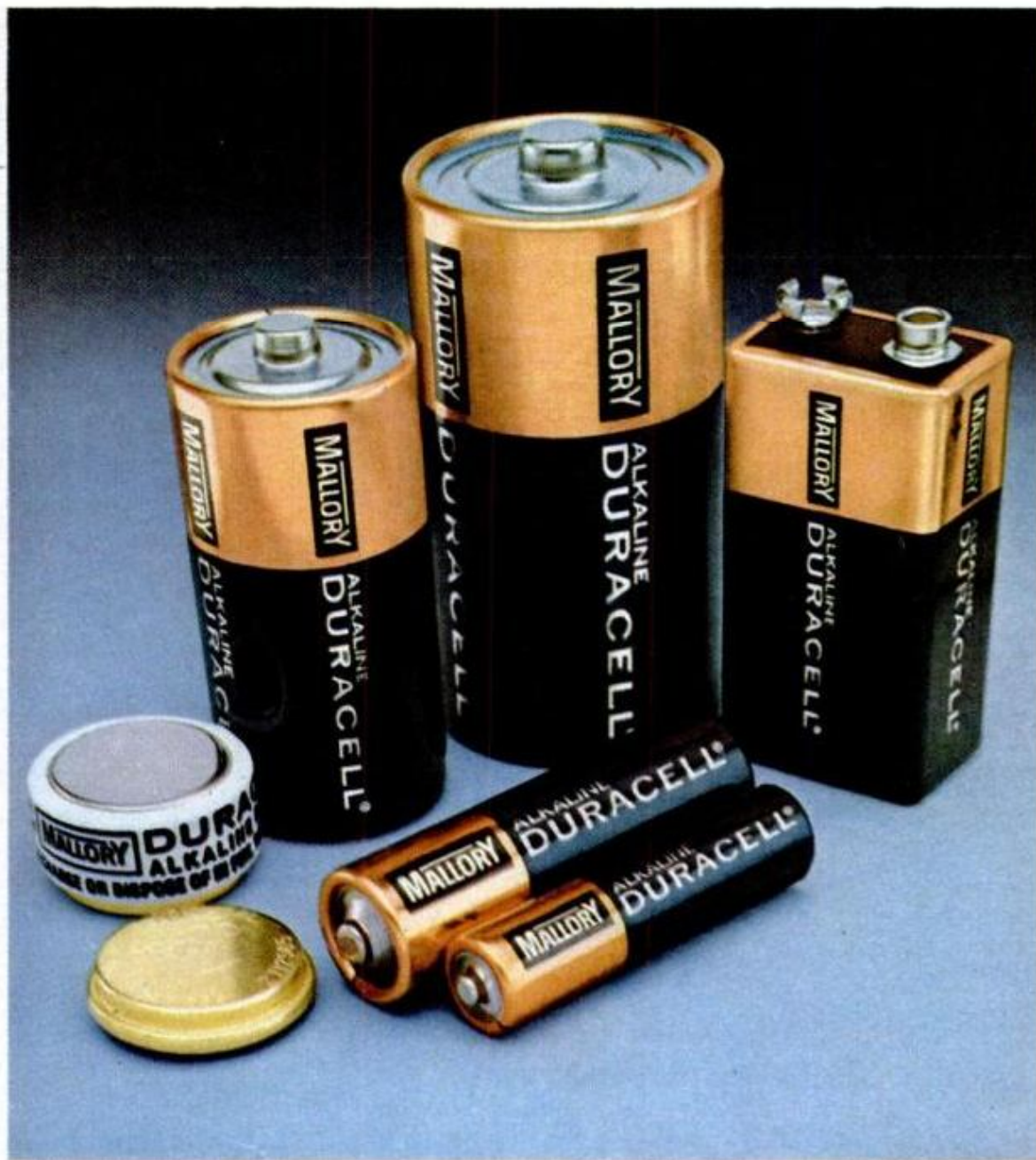

MALLORY

®Registered trademark of P. R. Mallory & Co. Inc.



I'd like to give this to my fellow men... while I am still able to help!

I was young once, as you may be—today I am older. Not too old to enjoy the fruits of my work, but older in the sense of being wiser. And once I was poor, desperately poor. Today almost any man can stretch his income to make ends meet. Today, there are few who hunger for bread and shelter. But in my youth I knew the pinch of poverty; the emptiness of hunger; the cold stare of the creditor who would not take excuses for money. Today, all that is past. And behind my city house, my

summer home, my Cadillacs, my winter-long vacations and my sense of independence—behind all the wealth of cash and deep inner satisfaction that I enjoy—there is one simple secret. It is this secret that I would like to impart to you. If you are satisfied with a humdrum life of service to another master, turn this page now—read no more. If you are interested in a fuller life, free from bosses, free from worries, free from fears, read further. This message may be meant for you.

By Victor B. Mason

I am printing my message in a magazine. It may come to the attention of thousands of eyes. But of all those thousands, only a few will have the vision to understand. Many may read; but of a thousand only you may have the intuition, the sensitivity, to understand that what I am writing may be intended for you—may be the tide that shapes your destiny, which, taken at the crest, carries you to levels of independence beyond the dreams of avarice.

Don't misunderstand me. There is no mysticism in this. I am not speaking of occult things, of innumerable laws of nature that will sweep you to success without effort on your part. That sort of talk is *rubbish!* And anyone who tries to tell you that you can *think* your way to riches without effort is a false friend. I am too much of a realist for that. And I hope you are.

I hope you are the kind of man—if you have read this far—who knows that anything worthwhile has to be *earned!* I hope you have learned that there is no reward without effort. If you have learned this, then you may be ready to take the next step in the development of your karma—you may be ready to learn and use the secret I have to impart.

I Have All The Money I Need

In my own life I have gone beyond the need of money. I have it. I have gone beyond the need of gain. I have two businesses that pay me an income well above any amount I have need for. And, in addition, I have the satisfaction—the deep satisfaction—of knowing that I have put more than three hundred other men in businesses of their own. Since I have no need for money, the greatest satisfaction I get from life is sharing my secret of personal independence with others—seeing them achieve the same heights of happiness that have come into my own life.

Please don't misunderstand this statement. I am not a philanthropist. I believe that charity is something that no proud man will accept. I have never seen a man who was worth his salt who would accept something for nothing. I have never met a highly successful man whom the world respected who did not sacrifice something to

gain his position. And, unless you are willing to make at least half the effort, I'm not interested in giving you a "leg up" to the achievement of your goal. Frankly, I'm going to charge you something for the secret I give you. Not a lot—but enough to make me believe that you are a little above the fellows who merely "wish" for success and are not willing to sacrifice something to get it.

A Fascinating and Peculiar Business

I have a business that is peculiar—one of my businesses. The unusual thing about it is that it is needed in every little community throughout this country. But it is a business that will never be invaded by the "big fellows." It has to be handled on a local basis. No giant octopus can ever gobble up the whole thing. No big combine is ever going to destroy it. It is essentially a "one man" business that can be operated without outside help. It is a business that is good summer and winter. It is a business that is growing each year. And, it is a business that can be started on an investment so small that it is within the reach of anyone who has a television set. But it has nothing to do with television.

This business has another peculiarity. It can be started at home in spare time. No risk to present job. No risk to present income. And no need to let anyone else know you are "on your own." It can be run as a spare time business for extra money. Or, as it grows to the point where it is paying more than your present salary, it can be expanded into a full time business—overnight. It can give you a sense of personal independence that will free you forever from the fear of lay-off, loss of job, depressions, or economic reverses.

Are You Mechanically Inclined?

While the operation of this business is partly automatic, it won't run itself. If you are to use it as a stepping stone to independence, you must be able to work with your hands, use such tools as hammer and screw driver, and enjoy getting into a pair of blue jeans and rolling up your sleeves. But two hours a day of manual work will keep your "factory" running 24 hours turning out a product that has a steady and

ready sale in every community. A half dollar spent for raw materials can bring you six dollars in cash—six times a day.

In this message I'm not going to try to tell you the entire story. There is not enough space on this page. And, I am not going to ask you to spend a penny now to learn the secret. I'll send you all the information, free. If you are interested in becoming independent, in becoming your own boss, in knowing the sweet fruits of success as I know them, send me your name. That's all. Just your name. I won't ask you for a penny. I'll send you all the information about one of the most fascinating businesses you can imagine. With these facts, you will make your own investigation. You will check up on conditions in your neighborhood. You will weigh and analyze the whole proposition. Then, and then only, if you decide to take the next step, I'll allow you to invest \$15.00. And even then, if you decide that your fifteen dollars has been badly invested I'll return it to you. Don't hesitate to send your name. I have no salesmen. I will merely write you a long letter and send you complete facts about the business I have found to be so successful. After that, you make the decisions.

Does Happiness Hang on Your Decision?

Don't put this off. It may be a coincidence that you are reading these words right now. Or, it may be a matter that is more deeply connected with your destiny than either of us can say. There is only one thing certain: If you have read this far you are interested in the kind of independence I enjoy. And if that is true, then you must take the next step. No coupon on this advertisement. If you don't think enough of your future happiness and prosperity to write your name on a postcard and mail it to me, forget the whole thing. But if you think there is a destiny that shapes men's lives, send your name now. What I send you may convince you of the truth of this proverb. And what I send you will not cost a penny, now or at any other time.

VICTOR B. MASON
1512 Jarvis Ave., Suite M-2-BH
CHICAGO, ILLINOIS 60626

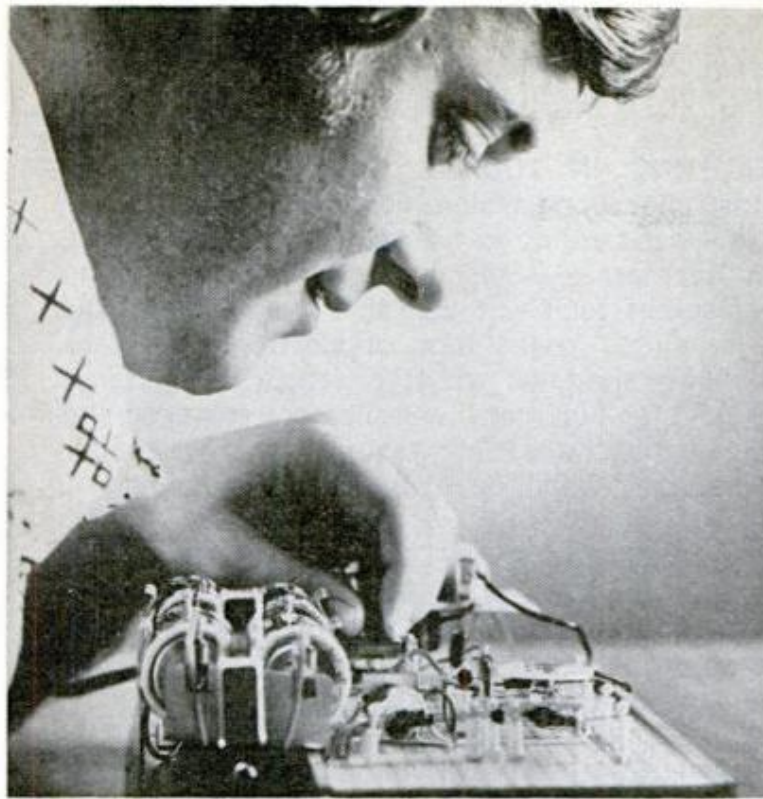

You Learn to Make Money ...with CIE's Electronics Laboratory!

Now you can learn Electronics by performing more than 200 practical, skill-producing experiments...with authentic industrial components...at home...in your spare time.

You learn by doing! This 161-piece Laboratory includes the up-to-date equipment you'll need — such things as an IC (integrated circuit), printed circuit board, FET (field effect transistor), photovoltaic cell, DC motor, microphone, multimeter, soldering iron and power supply.

You put theory into *practice* right in your own home... in your spare time...while you go right on pulling down your present pay. It's CIE's exciting space-age "Electronics Technology with Laboratory" program... a unique combination of CIE's exclusive AUTO-PROGRAMMED® Lessons and laboratory equipment. It is the *practical* way to learn the fundamentals and principles of Electronics!

Prepare for a High-paying Career

You see, when you "learn by doing," you're *ready to do*...you're *armed* with the know-how to meet the challenges of a high-paying career in Electronics... prepared to go after an exciting, relevant job in a growing field such as medical technology, pollution control, radio and TV broadcasting, computers...just to name a few. Once you have some experience, you can make \$12,000 a year or more.

But that's not all! When you successfully complete your Electronics Laboratory course, you'll get a CIE Diploma. And, you'll be able to pass the Government FCC examination or *be entitled to a full refund of all tuition paid!* CIE's Money-Back Warranty is valid during the completion time allowed for your course.

CIE's 2 FREE BOOKS will get you started! To get our school catalog *plus* a special book on how to get your FCC License, send reply card or coupon to CIE now, or write: Cleveland Institute of Electronics, 1776 E. 17th St., Cleveland, Ohio 44114.

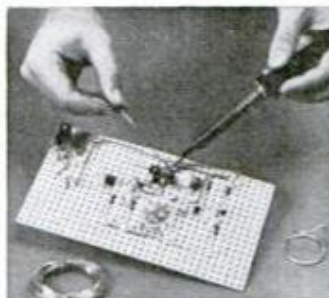

You learn how to construct circuits and connect them with a soldering iron, which is part of your CIE laboratory equipment. This "hands on" experience is extremely valuable.

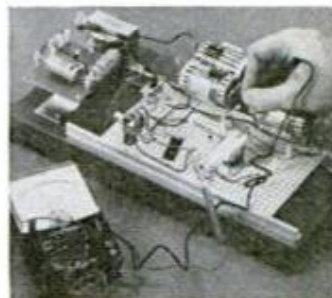

Testing and troubleshooting are an important part of your learning experience. Your laboratory has a precision multimeter to diagnose electronic troubles quickly and accurately.

GET 2 FREE BOOKS — SEND COUPON

CIE Cleveland Institute of Electronics

1776 East 17th Street, Cleveland, Ohio 44114

Please send me without cost or obligation your illustrated school catalog, "Succeed in Electronics," and your book, "How To Get A Commercial FCC License!"



Name _____ (Please Print)

Address _____

City _____

State _____ Zip _____ Age _____

APPROVED UNDER G.I. BILL

Check box if you served on active duty since Jan. 31, 1955, OR are in service now with more than 180 days active duty. You may qualify for educational benefits.

Accredited Member National Home Study Council PM-68

science worldwide

By JOHN PEARSON



Sight moves with pilot's head

DOGFIGHTING IN TODAY'S SUPERSONIC PLANES calls for split-second aiming. For greater accuracy, the Navy is experimenting with a helmet-mounted sighting system that provides instant elevation and azimuth-angle readings for any target that the pilot eyeballs. These readings, in the form of electronic impulses, automatically aim radar and other sensors at the target before guns or Sidewinder missiles are triggered. Immediate goal of the test program is to improve the air-to-air combat capabilities of the F-4J Phantom.

SOME 500 PERSONS ARE KILLED EACH YEAR by stings from bees, wasps, hornets and yellow jackets, according to Dr. Marion C. Collins, president of the Medic Alert Foundation. He reports this is more than double the number of fatalities attributable to snake bites. "Swelling in an area other than the site of the bite indicates the person has an allergy to the sting—an allergy that could prove fatal if not promptly treated," says Dr. Collins. He advises persons with such an allergy to wear a Medic Alert bracelet or necklace, which carries the phone number of the Foundation's computerized answering file. The file contains emergency information on each member.

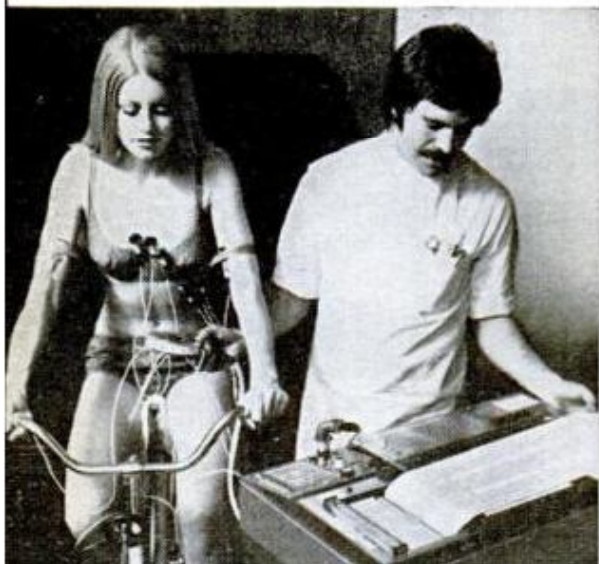

Pedaling helps heart research

HOW AGE AFFECTS THE HEART'S RESPONSE to physical stress may be determined by "bicycle" tests being conducted at a laboratory in New York City. The ultimate object is to try to develop information that would provide a basis for devising an "early warning system" for heart attacks. Volunteers ranging in age from 18 to 80 ride a stationary bike while hooked up to an electrocardiograph machine and a computer. Several hundred measurements a minute are made, with a total of several thousand being recorded for each participant in the test.



Bending light with fiber optic

"GOOD QUALITY" GASOLINE WITHOUT LEAD and with an octane rating of 89 has been refined from crude shale oil, according to U.S. Bureau of Mines researchers. The octane number and low nitrogen-sulfur content of the shale oil fuel compare favorably with regular gasolines, say the scientists. A major drawback: Production costs are relatively high.

A NEW TYPE OF OPTICAL FIBER that may prove useful for communications systems of the future has been developed at the New Jersey labs of Bell Telephone. The fiber is a liquid-filled fused quartz tube that provides an efficient medium for transmitting light signals. These signals, in turn, can carry telephone, television and digital data transmissions. Light-guiding fibers are

(Please turn to page 32)

Clean air: good reason to use a great oil.

Today's anti-pollution systems are making the temperature of your motor oil higher than ever before. And if your system isn't working properly, that makes it even tougher on your oil and your engine. Today you should name your oil. By type. By SAE Grade. By brand.

Briefly, here's what's happening.

When the PCV valve is working properly, your car's engine is running cleaner than ever. Blowby

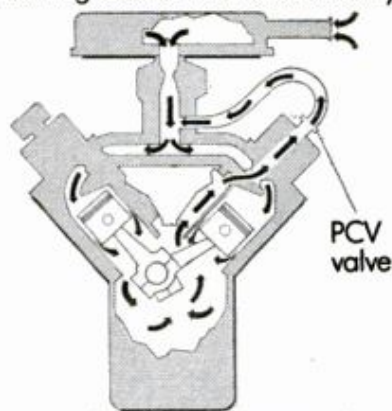

gasses that once seeped into the crankcase are recycled back to the combustion chamber. This not only keeps the air cleaner; it also keeps your oil cleaner.

Keep your PCV Valve clean. On the other hand, if the PCV valve gets clogged, combustion or blowby gasses are trapped in your crankcase and form damaging corrosive acids. What's more, today's engines must operate on a leaner fuel/air mixture than did engines in cars without anti-pollution devices. So today, your engine, and its motor oil, are operating under much higher temperatures.

Other systems, more heat. Today's improved combustion systems, supplemental air injection systems, lower compression ratios, air conditioning and power equipment are all "hot items." They put extra stresses on your engine that can send your motor oil's temperature over the 300° level.

What heat can do to motor oil. Heat is motor oil's number one enemy. Because, when heated, oil has a tendency to oxidize. Excessive oxidation causes oil to thicken—and not lubricate properly.



The newest service designation — see the chart — is "SE." It meets 1972 requirements and it's vitally important that you use it when recommended.

Then, especially these days, ask for the highest quality brand you can find. By name.

Old designation	New designation	Oil description
ML (Motor Light)	SA	Oil without additive, except that it may contain pour and/or foam depressant
MM (Motor Medium)	SB	Provides some antioxidant and anticuff capabilities
1964 MS (Motor Severe)	SC	Oil meeting the 1964-67 requirements of the automobile manufacturers. Provides low-temperature antisludge and antirust performance
1968 MS (Motor Severe)	SD	Oil meeting the 1968-71 requirements of the automobile manufacturers. Provides greater low-temperature antisludge and antirust performance
1971-72 (none)	SE	Oil meeting the 1972 requirements of the automobile manufacturers. Provides high-temperature antioxidation, plus greater low-temperature antisludge and antirust performance

Remedy #1. Change oil frequently. Consider your car manufacturer's oil change recommendations as absolute minimums — under ideal conditions. Take careful note of the warnings against severe operations — such as heavy loads, sustained high-speed driving, constant heavy traffic, dusty roads, and extra cold weather. You might not be changing your oil often enough.

Remedy #2. Know your motor oils. First ask for the service designations and viscosity recommended in your owner's manual.

Why Quaker State offers quality protection: Quaker State is refined from 100% Pure Pennsylvania Grade Crude Oil, the world's choicest. Then it's put through an elaborate refining process.

Finally, it's fortified with a blend of additives, scientifically selected to retard oxidation, clean and disperse harmful deposits and to neutralize acids.

So ask for it, by name: Quaker State.



Quaker State your car to keep it running young.

LIVE IN THE WORLD OF TOMORROW . . . TODAY!

UNUSUAL BARGAINS

NEW PRODUCTS • NEW MATERIALS • NEW IDEAS

"FISH" WITH A MAGNET



Go treasure hunting on the bottom! Fascinating fun & sometimes profitable! Tie a line to our 5 1/2-lb. Magnet—drop it overboard in bay, river, lake or ocean. Troll it along bottom—your "treasure" haul can be outboard motors, anchors, other metal valuables. 5 1/2-lb. Magnet is war surplus—Alnico V Type—Gov't cost \$50. Lifts over 150 lbs. on land.

Stock No. 70.571H . . . \$14.00 Ppd.

Stock No. 60.215H . . . 11 1/2 lbs. \$ 5.75 Ppd.
 Stock No. 70.570H . . . 31 1/2 lbs. (lifts 40 lbs.) . . . \$ 8.75 Ppd.
 Stock No. 85.152H . . . 153 1/2 lbs. (lifts 350 lbs.) . . . \$33.95 FOB

GIANT WEATHER BALLOONS



"Balls of fun" for kids, traffic stoppers for stores, terrific for amateur meteorologists. Create a neighborhood sensation. Great backyard fun. Exciting beach attraction. Amateur meteorologists use to measure cloud heights, wind speed and temp. Made of heavy-duty neoprene. Inflate with vacuum cleaner or auto air hose; or locally available helium for high rise.

Stock No. 60.568H (8' size) . \$2.00 Ppd.

Stock No. 60.632H (16' size) \$7.00 Ppd.

AMERICAN MADE OPAQUE PROJECTOR



Projects illustrations up to 3" x 3 1/2" —enlarges them to 35" x 30" if screen is 6 1/2 ft. from projector, larger pictures if screen is farther away. No film or negatives needed. Primarily intended for children. Projects charts, diagrams, color or black-and-white in darkened room. 115 v. A.C. . . . 6 ft. cord and plug included. Size 12" x 8" x 4 1/2" wide. Weight 1 lb. 2 ozs. Plastic case.

Stock No. 70.199H . . . \$8.75 Ppd.

BIG BOOM & FLASH CANNON

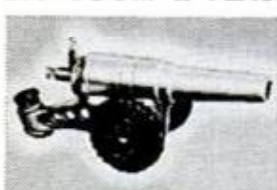

Perfectly safe giant noisemaker for sports, games, the 4th and just plain fun produces brilliant flash and loud bang. Completely harmless—no gun powder, matches or recoil. Easily operated. Beautiful reproduction of regular Army 60 MM cannon in hefty cast iron. "Ammo" is pulverized Bangsite combined with water in cannon producing harmless gas. Cannot be ignited by hottest flame or heaviest concussion. Incl. ammo for 200 shots, instr. Wt. 2 1/4 lbs. Stock No. 70.898H . . . \$6.95 Ppd. 25" "Big Bertha" cannon (5 1/2 lbs.) Stock No. 71.654H . . . \$16.50 Ppd.

ASTRONOMICAL TELESCOPE KITS



Grind your own mirror for powerful telescopes. Kit contains fine annealed pyrex mirror blank, tool, abrasives, diagonal mirror, and eyepiece lenses. Instruments you build range in value from \$75.00 to hundreds of dollars.

Stock No. 70.003H

4 1/4" diam. 3/4" thick . . . \$10.75 Ppd.

Stock No. 70.004H

6" diam. 1" thick . . . \$16.95 Ppd.

Stock No. 70.005H

8" diam. 1 1/2" thick . . . \$24.50 Ppd.

Stock No. 70.006H . 10" diam.

13 1/2" thick. 30 lbs. . . \$44.50 FOB

Stock No. 70.007H . 12 1/2" diam. 2 1/2" thick. 46 lbs. \$72.50 FOB

AMAZING NEW WANKEL ENGINE KIT!



Thrill to the fun of building your own see-through motorized model of revolutionary pistonless type engine. . . only engine experts think economically modifiable to meet new pollution standards. Replaces piston, cylinder, crank assemblies with rotating discs (sections removed for firing chambers). Smaller than conventional; fewer parts, greater reliability. same speed w/less horsepower. Feat: flashing plugs, rubber fan belt, stick-shift on-off switch. Req. 2-1.5V batt. (not incl.).

No. 71.424H . . . (4 1/2" X 5" X 9") . . . \$6.75 Ppd.

519-Page Wankel Engine Book . . . \$15.25 Ppd.

Stock No. 9.439H . . . \$15.25 Ppd.

MAIL COUPON FOR GIANT FREE CATALOG

148 PAGES! MORE THAN 4,000 UNUSUAL BARGAINS



Completely new 1972 Catalog. Packed with huge selection of telescopes, microscopes, binoculars, magnets, magnifiers, prisms, photo components. Ecology and unique lighting items, parts, kits, accessories—many hard-to-get surplus bargains. 100's of charts, illustrations. For hobbyists, experimenters, schools, industry.

EDMUND SCIENTIFIC CO.
 300 Edscorp Building, Barrington, N. J. 08007
 Please rush Free Giant Catalog "H"

Name

Address

City State Zip

EDMUND SCIENTIFIC CO. 300 EDSCORP BLDG.
 BARRINGTON, NEW JERSEY 08007

ORDER BY STOCK NUMBER • SEND CHECK OR MONEY ORDER • MONEY BACK GUARANTEE

SCIENCE WORLDWIDE

(Continued from page 30)

potentially cheap, adding to their promise as a high-capacity optical transmission medium. Up to now, fiber research has focused on solid-core fibers.

The environment

WORN-OUT TIRES, now being discarded in the United States at a rate of 200 million a year, will be used as fuel to generate steam for new tire production at a Goodyear Tire & Rubber Co. plant in Jackson, Mich. Scheduled for completion late this summer, the facility will burn 3000 tires a day. Smoke and odor molecules are consumed in the burning process, according to a Goodyear executive. All that finally remains of the tires is a sterile, inert ash. The process reportedly has been used successfully in England.

THE MAJOR PORTION OF PESTICIDES added to the environment can't be accounted for, according to University of California researchers. Scientists think that the chemicals pass into the atmosphere where they are broken down and altered under the influence of sunlight, oxygen and humidity. But the possibility exists, according to the scientists, that a presumably safe pesticide may be transformed into a harmful substance that will increase air pollution.

BILLED AS THE WORLD'S BIGGEST, a 175-ton stainless steel scrubber will be installed at a power-generating plant in Cohasset, Minn. Measuring 18 by 26 by 126 feet, the unit is a three-phase scrubber. Exhaust containing fly ash, sulfur dioxide and other pollutants is sprayed with water in one chamber, then pressurized in a second. In a third chamber the water is atomized and separated from particles of foreign matter. The moisture that remains is then evaporated as steam.

SIGNIFICANT AMOUNTS of gold and mercury have been found in certain Chesapeake Bay oysters, report University of Maryland researchers. The oysters come from an area that is affected by industrial pollution and is not fished commercially. The scientists indicate it's safe to eat commercially harvested oysters from the bay. ★★



**Makes Over \$60 EXTRA a Week In
His Own Sharpening Shop**

"My Belsaw Sharp-All made me an extra \$3,500 last year. Now I am going full time. It's great to be your own boss."
DAVID SWANSON — Utica, Michigan



Let Belsaw prove
YOU can do it, too! On our
30-DAY FREE TRIAL OFFER

**JOIN THESE SHARP-ALL
MONEYMAKERS**

"I average \$5.00 an hour part time and business gets better all the time."

*Robert Barrett, Jr.
W. Springfield, Mass.*

"My Sharp-All shop is now averaging me \$300.00 a month."

*Roy Jennings
Sandwich, Illinois*

"Think the world of my Sharp-All. Am grossing \$4,000 a year on a part-time basis."

*Lawrence Stevenson
E. Syracuse, New York*

"There's excellent profit in sharpening . . . we now do about \$600.00 a month."

*Ed Kistler, Jr.
Sarasota, Florida*

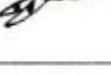

You risk nothing by accepting this offer to see how easily you can turn your spare time into big Cash Profits with your own Complete Sharpening Shop. No selling . . . no previous experience needed. Our famous Sharp-All and show-how instruction set you up to make \$200, \$500, \$700 a month CASH sharpening Saws, Knives, Scissors, Lawnmowers, Shop and Garden Tools . . . all cutting edges.

**SEND FOR
FREE FACTS!**

Our Free Book tells how to start a profitable, lifetime home sharpening business, how we help you grow, how we'll finance you.

BELSAW SHARP-ALL CO.
713K Field Bldg.
Kansas City, Mo. 64111

RUSH COUPON TODAY!

No Obligation . . . No Salesman Will Call

BELSAW SHARP-ALL CO. 713K Field Bldg., Kansas City, Mo. 64111
Send details of FREE TRIAL OFFER and Free Book "Lifetime Security"

NAME _____
Address _____
City _____ State _____ Zip _____

undercover job

The purpose of a sealant is simple: to keep what is in the engine in, and to keep what is out of the engine out. The problem has been the same since the first Form-A-Gasket was developed for Barney Oldfield.

New Silicone Form-A-Gasket rubber base adhesive-sealant will last longer, resist more gases and compounds, resist higher temperatures, resist higher pressures, resist lower temperatures, than any of our previous products, and *they* are the standards of the industry.

It probably has a lot more uses than we've figured out for it yet. But one thing we do know, once you use it, you can forget it. It's a real undercover worker.

New Silicone Form-A-Gasket from Permatex . . . the great seal of the United States.

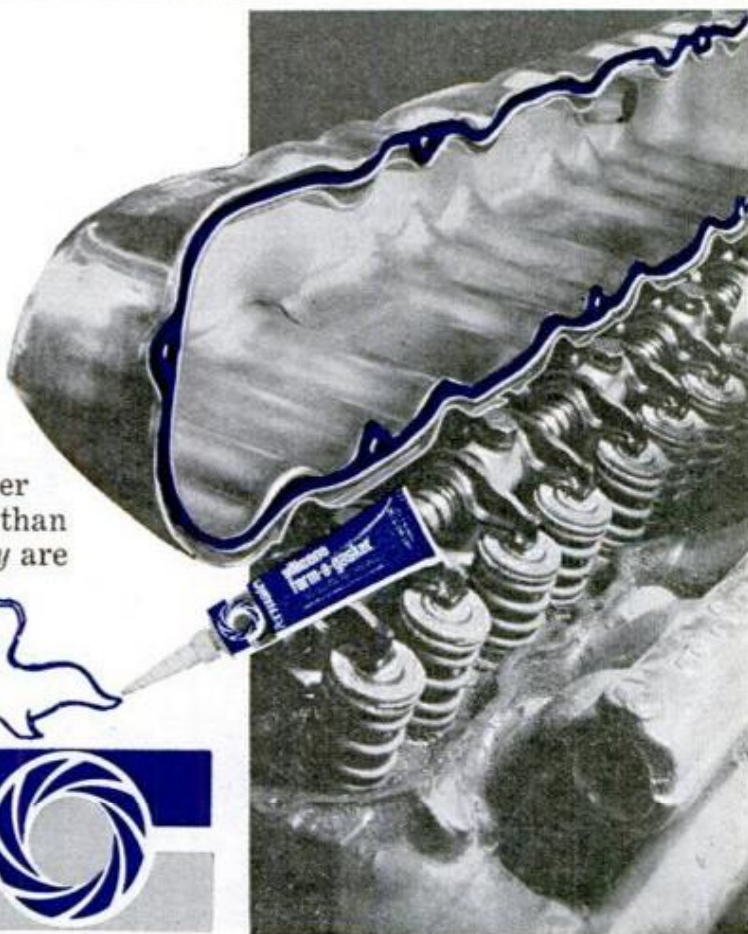

The Permatex Company, Inc.
P.O. Box 1350, West Palm Beach, Florida 33402

Permatex® our name is our bond

THE BICYCLE SHOP

By EUGENE A. SLOANE

Tiny pedal bearings that take a lot of stress need periodic maintenance just as do all other moving parts of your bike

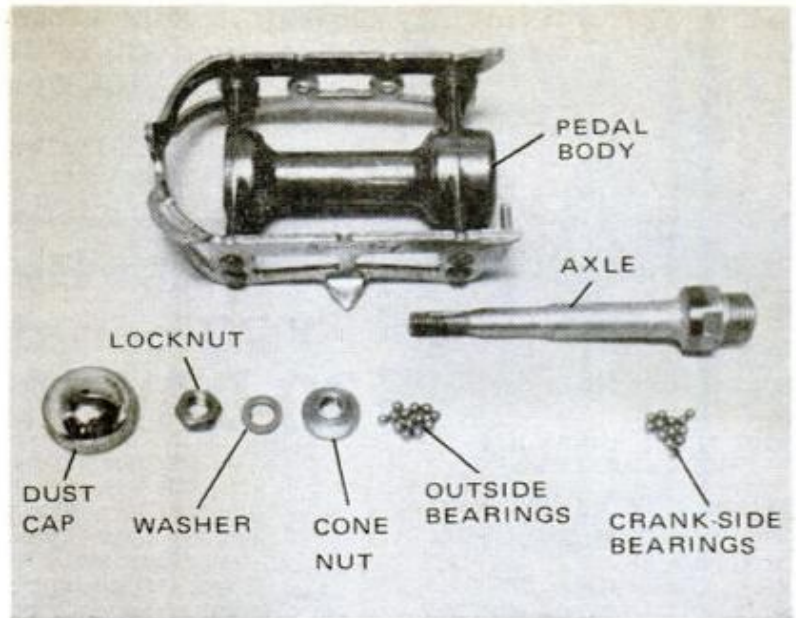

RATTRAP-TYPE PEDAL is disassembled to show two sets of bearings that are used at either end of axle. Lubricate them periodically

BICYCLE PEDALS need maintenance to prevent pedal bearings from wearing out prematurely. Pedal failure on inexpensive bicycles isn't too critical since new pedals cost only around \$7.50 a pair. Still, preventive maintenance could forestall failure indefinitely. Good pedals, such as Lyotard, cost upward of \$15 a pair; top-grade ones made by Campagnolo of Italy, list at a rather staggering \$30. It pays to care for your pedals, both in terms of cycling efficiency and replacement cost.

Pedal maintenance is simple. Remove them from the bicycle, disassemble, clean parts in kerosene, reassemble and adjust cone play. Some pedals can't be taken

apart, such as some German, Japanese and Italian rubber-tread types on less expensive bicycles. Your only maintenance is an occasional dash of medium heavy oil—No. 30 S.A.E. automotive oil, for example.

Pedals that can be disassembled should be lubricated every three or four months, depending on how often you ride. After a 1000-mile jaunt, pedals (and everything else) should come apart for a re-lube job.

Bicycle pedals are of two types: conventional rubber-tread pedals and racing type "rattrap" pedals. Maintenance procedures are similar, with one difference: To get at rubber pedal bearings, [\(Please turn to page 36\)](#)

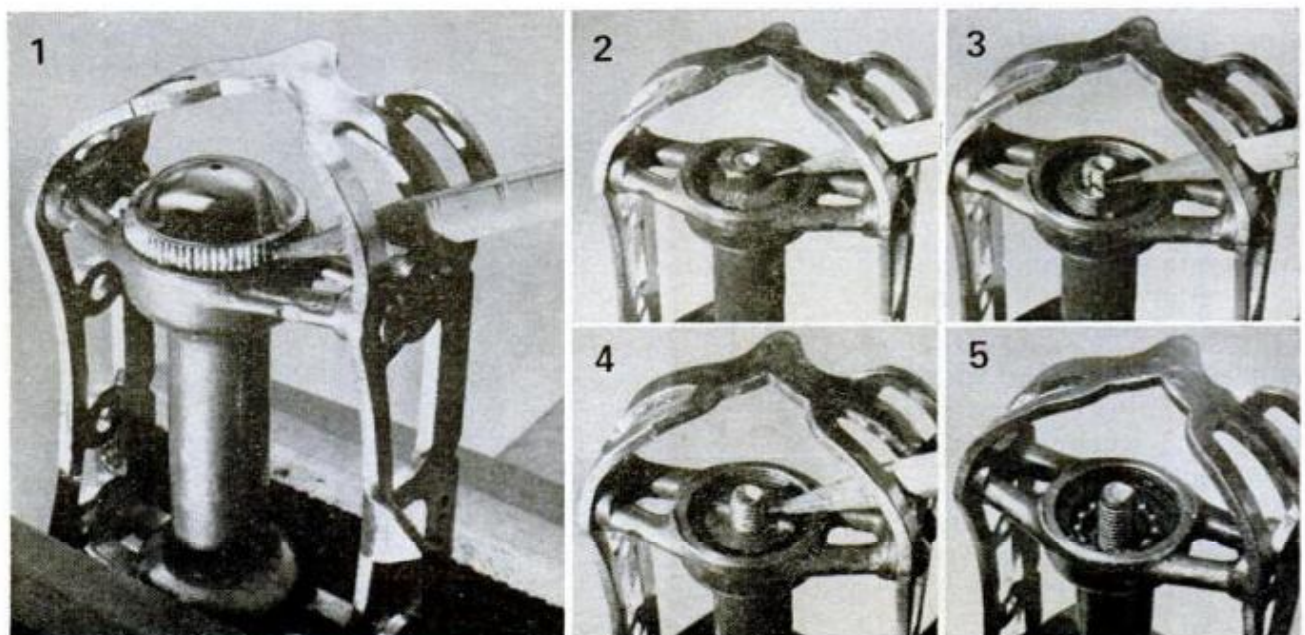

TO DISASSEMBLE RATTRAP PEDAL, pry off dust cap shown in 1. Locknut, 2, is removed with wrench. Lift out locknut washer, 3. The cone nut, 4, is slotted; remove with a screwdriver. Ball bearings, 5, are in cup

There may be a great future in your past.



Think back to that time in your life when you felt like you belonged, had enthusiastic friendships, and a sense of contributing to your country's strength. When you could actually look forward to a secure and comfortable future.

Chances are, the last time you felt like that was when you were in the service. The question now is, is it too late to do something about bringing back the good old days of military life?

In a word, the answer is "No." The Air Force Reserve needs good men with their service skills intact. And, if you've got what we're looking for, you can look forward to a second income, specialized training, and rediscover what benefits and rewards an Air Force career can bring to your life.

Think it over. For one weekend a month and 15 active duty days a year, you could find yourself in the Air Force

Reserve with a great future to look forward to.

For more information, mail in the coupon below. Or, call 800-631-1972 toll free* for the address of your local Air Force Reserve unit.

Do it now. And let your future catch up to you. *In New Jersey call 800-962-2803.

U.S. AIR FORCE RECRUITING SERVICE ^{3-PM-72}
DIRECTORATE OF ADVERTISING (APV)
RANDOLPH AIR FORCE BASE, TEXAS 78148
Please send me more information about joining the Air Force Reserve.

I was formerly in the Air Force Navy Coast Guard Marines Army

My grade was _____

My specialty was _____

NAME _____

ADDRESS _____

CITY _____ STATE _____ ZIP _____

PHONE (area code) _____

I understand there is no obligation.

**Find yourself
in the Air Force Reserve.**

THE BICYCLE SHOP

(Continued from page 34)

take the pedal rubbers out by unscrewing the rubber axle nut. Once the nut is off, the axles can be pulled out, revealing the pedal cone assembly. To get at rattrap pedal bearings, just remove the dust cap.

Pedal maintenance is a lot easier to do at your workbench. When you take off pedals, bear in mind that both unscrew toward the rear of the bicycle. So that you will never get threads caught and possibly stripped by trying to screw pedals on the wrong way, remember that pedals *always* thread on the bicycle toward the front. As you cycle, pedals should rotate in the direction they tighten; otherwise, they'll soon work loose and fall out.

Follow these simple steps to complete the dismantling of your pedals:

1. Unscrew pedal locknut.
2. With a small screwdriver, pry off the washer underneath the locknut. Note washer is splined.
3. With a screwdriver, unscrew the cone nut all the way off the axle. At this point, the pedal axle hub, where it screws into the crank, should be in a vise.
4. With pedal axle in vise, grasp pedal-axle top with your fingers so it can't slip back out the pedal body. Loosen the vise, and, with your fingers holding the pedal axle in the pedal body, lay pedal sideways on a rag, where the loose pedal bearings can't get away. This done, you can pull the axle out of the crank end of the pedal body and remove all the loose ball bearings from their cups. In the pedal illustrated there are 13 bearings in each cup. It's a good idea to count bearings in the cup before removing them to see if you've lost any. (If so, take a sample to your bike shop for an exact replacement.)

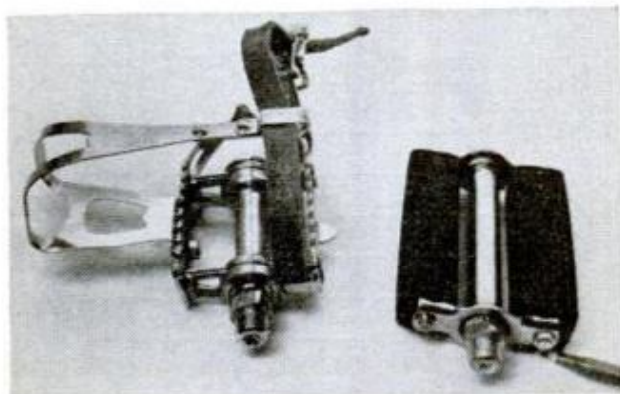

RUBBER-TREAD PEDAL compared to the rattrap type. The pencil is pointing to the rubber-tread axle nut

5. Clean everything in kerosene. Then put a light layer of grease (such as Lubriplate Type A) on both cups inside the pedal body, and roll bearings around in a dab of grease until they're lightly covered and clump together.

6. Put one set of bearings back in the crank side of the pedal body (the side opposite the dust cap, or opposite from where you unscrewed the cone locknut). Then tamp more grease around these bearings (the grease will hold bearings in place temporarily) and slide the axle, small side first, into the pedal body on the crank side. Pick up the axle sticking out of the pedal body side *without* bearings in the cup and, holding in this manner, put crank side of the pedal axle in the vise.

7. Stick the remaining bearings back into the cup on the locknut side, smear some grease over them, screw the cone nut back on the axle and hand-tighten until snug against bearings. Make sure the convex or rounded side of the cone nut goes first, with the flat side facing up. If axle threads are rough, you may need a screwdriver to screw the cone nut back on; either way, the cone nut should be brought *gently* snug against bearings, then backed away about one-quarter turn.

8. Insert the splined washer back on the axle, and then thread the locknut back on. Tighten the locknut snugly with a wrench, but be careful not to overdo it. A pedal axle shaft is not like an automotive headbolt; too much torque and you can strip the pedal axle nut.

9. Remove the reassembled pedal (dust cap or rubbers are not reinstalled at this point) from the vise. Grip the pedal body firmly in one hand, and twist the pedal axle shaft with the other. The axle should rotate freely, without binding or sensation of roughness or resistance. Twist it rapidly to and fro until grease is worked in well. Then twist the axle from side to side, up and down and in and out, to test for looseness and sideplay. If it binds, loosen the locknut, back off the cone nut about a quarter turn, retighten the locknut and check again for binding. The opposite procedure should be done if cones are too loose. With a little experience (say about 100 pedals) you will be able to get the cones just right the first time. Now thread the pedal back into the crank. ★★

A plug for people who change their own

We figure you power buffs have lots of interests and lots of equipment to go with them. So NGK builds a plug for practically every internal combustion engine made.

Also, being mechanically hip, you appreciate quality and efficiency. So we build the most efficient, toughest plug we can. The kind you'd want to put in your own car, bike, outboard, buggy...whatever.

But all our plugs — and it takes the company computer to keep track of them — have one thing in common: a never-say-die "Heart of Copper".

Used in place of ordinary iron cores, this highly conductive copper core delivers maximum performance under all conditions.

It dissipates heat fast, cuts down plug damaging hot spots and piston-popping pre-ignition. A long-nosed insulator holds just the right amount of heat to reduce tip fouling. In hot engines or cold, under easy or hard use, NGK's fire on time, every time.

If you're a motorcycle owner, you probably know all about NGK performance. You sports car types do, too. But NGK's work just as great in utility and recreational vehicles. And they'll fire-up your hairy V-8 as quick as your one-lunger saw.

Take our tip. Screw in a set of "Heart of Copper" NGK's. They're a change for the better.

NGK, the long life, hi-performance plug.



NGK SPARK PLUGS (U.S.A.), INC., 12511 Beatrice St., Los Angeles, Calif. 20066

APPLIANCE CLINIC

By PAUL MANN

Sluggish toaster

The slide of our Hamilton Beach toaster drags and sticks, causing the toaster to remain on and toast to burn when it should have popped up. How do I repair something like this?—Michael Shay, Freehold, N.J.

This condition is usually caused by a buildup of foreign deposits on the slide mechanism or by a lack of lubrication. After a while, the accumulation of this foreign material, such as crumbs and grease, may interfere with the operation of the slide.

After disconnecting the cord from the power source, remove the toaster's cover for cleaning (a job you should do periodically). To do this, you first remove the light-dark adjustment knob, the screws from the bottom plate, and the handle; then you can lift off the cover.

Now, scrape off deposits on the slide mechanism and wash the mechanism with a nonflammable grease solvent and small paintbrush. Allow the solvent to air-dry, plug in the toaster and operate it for about four cycles to let the remaining solvent evaporate. Allow the toaster to cool and then lubricate the sliding parts with a heat-resistant grease having a silicone base. Such lubricant is available at hardware stores. Don't overlubricate; a thin film is sufficient.

Thunderclap

We have a 50-gallon natural-gas water heater almost 11 years old. Recently, when a hot-water faucet in the house is turned on, we hear a rumble from the heater that sounds like thunder. A plumber told me that particles have formed in the tank and when water moves there, it jiggles them. Can this be true?—Howard Moster, University Heights, Ohio.

According to technicians of the New Jersey Public Service Electric & Gas Co., deposits of particles can form on the bottom of a hot-water tank. When water en-

ters the tank, it does so with enough force to agitate particles, causing them to bounce off the sides of the tank. Intake tubes of many tanks extend almost to the tank floor—near enough to the particles to really stir them up. Particles can be a result of rust forming in the tank, a first sign that the unit is in the process of failing. In hard-water areas, particles may also result from calcium in the water. Calcium particles won't harm a tank, and the unit may remain serviceable for many years, although the noise may be annoying.

Getting replacement parts

We have a Hotpoint upright freezer 14 years old. It's in good shape, but the handle and latch broke and we haven't been able to get another. They say that after 10 years the company stops making parts. Is this true?—Warren Lowry, Colfax, Wis.

Who is "they"? Certainly not the major manufacturers of appliances, which maintain parts supply depots in every state to keep stocks of replacement parts. For example, General Electric's policy is to make operating parts available for 15 years from the last production date of a model. The company will even supply parts beyond this period if there is a continuing demand. Their warehouses are often in the largest city of a state.

In addition, there are independent appliance-parts supply houses that stock the most popular replacement parts for major brands of appliances. Do a little detective work and find out where these parts depots are located. Then write or phone them. I'm quite sure you'll get what you need.

Wash and tear

I'm almost certain that our washing machine is tearing our clothes. On a few occasions, clothes that I am sure were in good condition had tears in them when removed from the machine. Is there anything that can do this?—Mrs. Jack Engel, Columbus, Ohio.

This is not common, but it can happen if the agitator has developed burrs, sharp spots or rough areas. I suggest that you remove the agitator from the washer and examine it carefully for damage. Also look for rough spots in the drum. If you find any carefully sand them down with a

(Please turn to page 40)

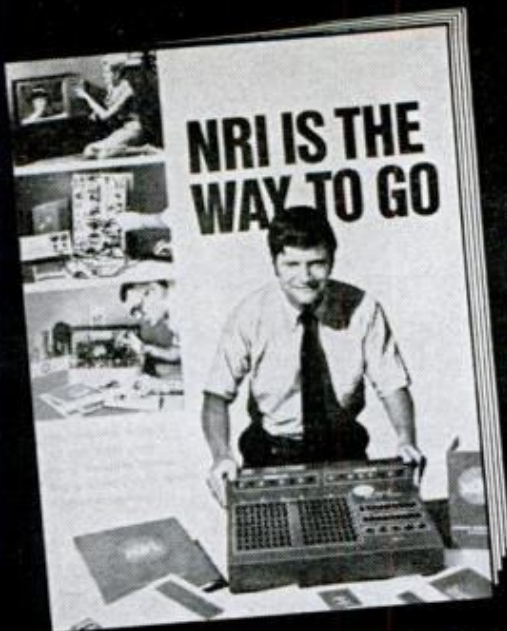

1

3 needed skills NRI can teach you at home...

NRI courses use easy "bite-size" texts to show you how to service TV-Radio Repair Cars or Appliances

"Hands-on" Training pays off

NRI was the first to supply home study students with custom designed training kits to give practical hands-on experience as you learn. You get more value from the exclusive Achievement Kit sent the day you enroll, to "bite-size" texts and custom training equipment. Learning TV-Radio, Automotive Servicing and Appliance repair at home is easy, exciting, the NRI simplified way. With NRI's TV-Radio servicing course you receive your choice of black & white or color TV kit. Other courses include necessary testing equipment free.

Earn \$5 to \$7 an hour spare or full time Tens of thousands of NRI graduates are proof it is practical to train at home in your spare time. Keep your present job while preparing for a better one and earn \$5 to \$7 an hour extra in spare time. Fix your own equipment, or earn money making repairs for friends and neighbors.

Train with the leader-NRI The same training innovations which have made NRI the leader in career training at home is now available to you. Mail the coupon today for a free full-color catalog in the field of your choice. No obligation. No salesman will call.



2



3

FREE NRI CATALOG!



NRI TRAINING
3939 Wisconsin Avenue, N.W.
Washington, D.C. 20016

Please rush me the catalog indicated below. I understand no salesman will call.

CHECK FOR ONLY ONE CATALOG.

- TV-Radio Servicing (100-072) Appliance Servicing (600-072) Automotive Mechanics (946-072)

Name _____ (PLEASE PRINT) Age _____

Address _____

City _____ State _____ Zip _____

Check for facts on GI Bill

ACCREDITED MEMBER NATIONAL HOME STUDY COUNCIL



UPHOLSTERING AND DECORATING PAYS BIG MONEY

Make money even while you learn as you build attractive new furniture from kits supplied. These you can keep or sell to make money! We send you all tools and materials, fillings, fabrics, frames—show you step-by-step how to do custom upholstery—gain skill quickly. Many thousands of men and women now enjoy secure futures with Upholstering skills that bring TOP PROFITS, HIGH-PAY JOB OPPORTUNITIES, INDEPENDENCE—part-time or full-time!



Creative UPHOLSTERY & DECORATING SCHOOL
Little Falls, N.J. 07424 Dept. 5110-072

Rush me full information on success opportunities in upholstery. No obligation—no salesman is to call.

Name

Address

City State & Zip

(Inquiries serviced only in U.S.A. and Canada)

Check here if eligible for Vet Benefits.

Put the world in your Pocket.



New Kodak pocket Instamatic® camera.



APPLIANCE CLINIC

(Continued from page 38)

piece of fine emery cloth. And check what goes into that machine. Something had to damage the agitator—maybe something that was inadvertently left in a pants pocket or such.

Power shortage

After changing the motor brushes in a Lewyt Model 88 vacuum cleaner, I find that there has been no increase in the power. Why not?—Warren E. Fassy Jr., Nola, La.

Changing of the motor brushes will not change the performance unless, of course, the old brushes were so completely worn out that the motor wasn't operating. There is no way to improve the performance of a vacuum cleaner over and above its original performance.

However, your unit may be clogged with dirt. To find out, just place your hand over the end of the hose while the appliance is running. If the vacuum cleaner is operating satisfactorily, you will hear a change in speed and noise. If there is no change, the unit is probably clogged and should be cleaned out.

Help is available

I think I've been cheated. A repairman charged me \$60 to install a new thermostat in a refrigerator which was running three hours at a time. There has been no relief. Is there any consumer group around that can help people who must rely on professionals for appliance repair?—Mrs. Robert Franco, Newark, N.J.

Try the Major Appliance Consumer Action Panel (MACAP) at 20 North Wacker Dr., Chicago 60606. This group comprises a panel of experts that has recently been established by the Assn. of Home Appliance Manufacturers, the Gas Appliance Manufacturers' Assn. and the American Retail Federation. Anyone who thinks he has been victimized by a serviceman or who buys an appliance that is faulty may find it worthwhile to get in touch with MACAP. ★★★

If you have a question about any appliance, send it to Appliance Clinic, Popular Mechanics, 224 West 57th St., New York, N.Y. 10019. Sorry, but letters cannot be answered individually. However, problems of widest interest will be answered in this column.

MAKE EXTRA \$\$\$ EVERY DAY!

Get into the big, year-round
EXTRA MONEY BUSINESS
that's EASY to learn—EASY to
do—and EASY ON YOU!

Be a LOCKSMITH!

You Can Make Up to \$10 an Hour—even while learning!
Train FAST at Home!

Never before have money-making opportunities been so great for qualified Locksmiths. Now lucrative regular lock and key business has multiplied a thousandfold as millions seek more protection against zooming crime. Yet there's only one Locksmith for every 17,000 people!

Start Collecting CASH PROFITS Right Away

You're "in business" ready to earn \$5 to \$10 an hour a few days after you begin Belsaw's shortcut training. Take advantage of today's unprecedented opportunities in Locksmithing for year-round EXTRA INCOME in spare-time—or fulltime in a high-profit business of your own. Hundreds we've trained have done it. So can YOU! All tools plus professional Key Machine given you with course. These plus practice materials and equipment,

**THIS PRO
KEY MACHINE—
YOURS TO KEEP—**

can add \$25 to \$40 a week to your income . . . and it won't cost you a cent with your training.



FREE



Tells how to make money in Locksmithing almost from the start!

ALL TOOLS, MATERIALS AND PRACTICE EQUIPMENT COME TO YOU WITH YOUR COURSE.

plus simple, illustrated lessons, plus expert supervision, plus business-building guidance will enable you to KEEP THE MONEY COMING IN! Ideal for retirement—good jobs, too.

SEND FOR EXCITING FACTS—No Obligation

Discover what's in Locksmithing for you—how Belsaw's master-locksmith-approved training can give you the skill you can depend on to EARN MORE—ENJOY LIFE MORE. Just fill in and mail the coupon below to receive full information by return mail. Do it TODAY!

BELSAW INSTITUTE, 103K Field Bldg., Kansas City, Mo. 64111
Accredited Member National Home Study Council
Approved for all Veteran Training

MAIL THIS COUPON—NO SALESMAN WILL CALL

**BELSAW INSTITUTE, 103K Field Bldg.
Kansas City, Missouri 64111**

Please send me free of cost or obligation your publication "Keys to Your Future" on how Belsaw can quickly train me to make money in Locksmithing and how all tools and Key Machine are given me to keep.

Name _____

Address _____

City _____ State _____ Zip _____

Check here if eligible Veteran.

**MAKE \$20,000 TO
\$30,000 A YEAR!**

**Combination AUTO
RADIATOR REPAIR/
AIR CONDITIONING
SHOP!**

(part, full-time, or
add to your shop)

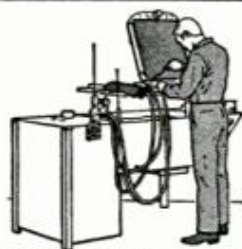

**NEW!
C-600
Radiator
Shop
takes
only
3½' x 6'
space**

Now is the time to get in on the ground floor with two of the newest and most profitable auto services. There are not enough trained and equipped people to do the work. Invest little as \$2,000. Inland factory training makes you an Auto Temperature Control Specialist! Complete package includes all equipment, training & business management, easy-learn manuals... works just like a franchise, except you are the boss. Immediate profits, year-around work. Write for free catalog. Inland Mfg. Co., Dept. PM-7, 1108 Jackson St., Omaha, Nebr. 68102.

**NEW - Ninth Edition of the Universally Accepted
Small Engines Service Manual**



\$495
9th Edition

Factory "know-how" at your finger tips! Complete repair information on over 1,000 models of small engines that power lawn mowers, tillers, go-karts, etc. 328 pages with hundreds of photos and exploded view drawings. Step-by-step, easy to follow instructions for everything from minor tune-up to major overhaul. Over 300,000 copies sold to mechanics and do-it-yourselfers. Save time . . . make money. Order your copy today.

Money Back Guarantee
Send check or money order
and we pay postage.

Technical Publications Div. Dept. PM-772
1014 Wyandotte, Kansas City, Mo. 64105

**NEW 1972 ARC
WELDER**

19⁹⁵ 5
WELDING HEATS



Plugs in any ordinary 110 volt outlet. Buy direct from the factory and save \$\$\$. Complete—nothing else to buy. Includes *heavy duty cables *electrode holders *ground clamp *extra welding rods *full face mask. Heavy duty—5 heats for welding, soldering, cutting and heating. Easy to operate; step-by-step instructions included. Ideal for the home handyman or craftsman—pays for itself repairing cars, trailers, lawn equipment, boats, etc.

10-DAY MONEY BACK GUARANTEE. Send only \$2 and pay postman \$17.95 plus postage when delivered, or send \$19.95 for prompt postpaid shipment. Return within 10 days for refund if not completely satisfied. Orders filled promptly—check or money order. **LIFETIME GUARANTEE.**

MINI 5 ARC WELDER Department A, 2635 Main Street, Houston, Texas 77002

**JUST PICK THE KIND
OF BODY YOU WANT**

—and you can have it easily almost overnight

Dear Charles Atlas—Here's the kind of body I want: Broad chest, Big shoulders. Powerful arms, grip. Powerful legs. Slimmer waist, hips. More weight, solid. More energy.

Send me a free copy of your famous 32-page book showing how **DYNAMIC-TENSION** can make me a new man.

Send name and address to:
CHARLES ATLAS, Dept. 87
115 East 23rd St., New York, N.Y. 10010





Supertire lets you ride a blowout!

Dunlop's 'total mobility tire' lets you maintain complete control of your car and ride without ruining the flat tire!

By DAVID LAMPE

YOU'RE DRIVING FAST, speedometer is nudging 80 mph and your full concentration is on the car—on the hum of the engine, the road noise of the tires and on your own reflexes as you click off the miles. Suddenly, up front—a loud bang. If you're quick, cool—and lucky—you can wrestle the car to a safe stop using up the whole road to do it.

Blowouts are hazardous with today's tires, but in just two years—in 1974—things will be different. High-speed blowouts—even at 100—will signal themselves to you gently by a minor steering shudder, a slight heaviness on the steering wheel and a slight pull toward the blown tire. But you'll still be in control of your car, and if you ease back to 50, you'll be able to drive on for at least 100 miles without damaging either your tire, your vehicle or your nerves. Indeed, if your blowout is less than a quarter inch in diameter, it'll seal itself while you drive. And your tire will partially reinflate as you go along.

TOTAL MOBILITY TIRE, as Dunlop calls it, is designed to stay in position on the wheel rim after a blowout with the wheel rim resting on the cushioned tread areas. Conventional tire will dislodge from the rim and is badly damaged very quickly. Extensive testing has shown that the tire can run up to 100 miles at speeds up to 50 mph after a blowout and still allow driver control of the car

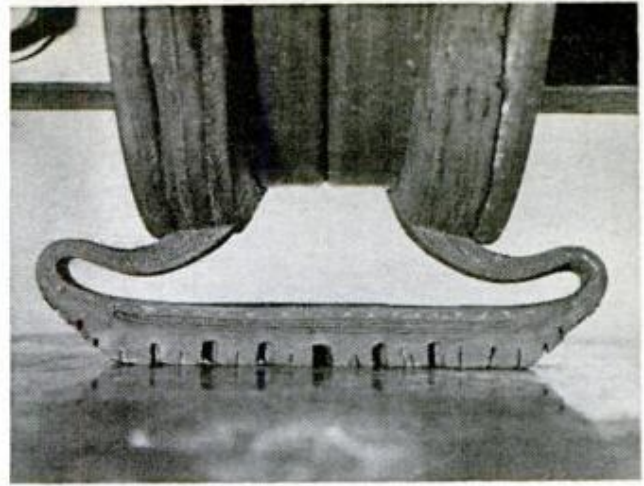
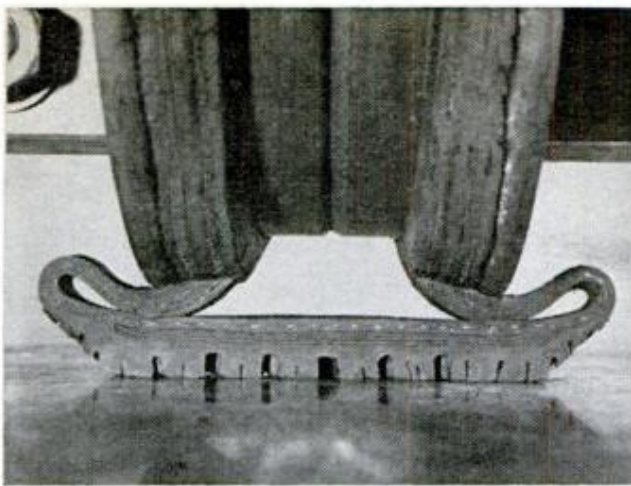

CUTAWAY OF TIRE at left shows tire after a blowout. Note the wide bead that remains in place. A special fluid inside the tire vaporizes immediately after the blowout to lubricate against friction, to seal small punctures and to partially reinflate the tire as you continue to drive on it as shown in the photo at right

This isn't just a "maybe" proposition. Five years ago somebody at Rolls-Royce suggested to a design engineer employed by Dunlop, Europe's biggest tire manufacturer, that fail-safe tires would add a final touch of perfection to "the world's best" autos. The Dunlop man agreed—and said that "lesser" cars should also be shod more safely. And so the firm that produced the world's first pneumatic tires almost 100 years ago—for bicycles—decided to apply its more recent experience in designing Grand Prix racing tires to the ultimate tires for everyday autos.

Dunlop engineers already knew that a blowout causes havoc—even at comparatively low speeds—because a burst tire's beading jumps from the flat outer edge of the rim into the well at the center. The distorted tire then quickly shreds away to nothing. To keep this from happening on Grand Prix racers, Dunlop had worked out a way to peg tire casings to wheel rims. In 1970, champion driver Jackie Stewart had barreled a Matra-Ford around South Africa's Kyalami racing circuit at a blistering 130 miles an hour—with one of his pegged-on Dunlops absolutely flat.

Like most modern racing tires, the treads on Stewart's were wider than their sidewalls were high. Their low profiles, extra-stiff sidewalls and pegging kept them within 60 percent of their inflated shape even with no air inside.

For a passenger-car version of this "Total Mobility Tire," Dunlop produced a low-profile tubeless casing of conventional radial construction but with extra stiff sidewalls. To keep this new tire from abrading inside when it blows—and from generating rubber-destroying heat—Dun-

lop chemists concocted a liquid lubricant (they still won't say what's in it, but it's thin, oily, brown) which is released automatically inside their new tire when it bursts. This liquid, beside lubricating the rubber to ease abrasion, dissipates heat. It also happens to be a rubber solvent—and seals holes up to a quarter inch in diameter. Finally, as it warms up, this liquid vaporizes, expands and begins to reinflate the blown tire. It builds up only five to ten pounds per square inch of pressure—but that's sufficient to lift the car a little, and so stop further scrubbing inside the tire.

Dunlop technicians plan to encapsulate the multipurpose liquid in the rim of their new tire or, possibly, in the walls of the tire itself. "You need about a wine-glassful for a small tire," a Dunlop man told me. He also explained that 16 different systems of encapsulation are being considered.

Pegging a tire casing to a rim—as Dunlop did on Jackie Stewart's Matra-Ford—is expensive and complicated. So for its new tire, Dunlop—which also is Europe's biggest manufacturer of auto wheels—has invented a new flat-bottomed rim section that has no well a tire's beading can sink into. Its new tire beading is so fat that no amount of lateral pushing and pulling will draw it out of position.

To get the feel of the Total Mobility Tire, I drove a small, British Leyland Mini fitted with them. I let all the air out of one front tire, then steered into a cobblestone roadway and gunned up to 50. I zigzagged. I bounced the little car in and out of gutters. I took corners foolishly fast. I braked like a lunatic. Yet except

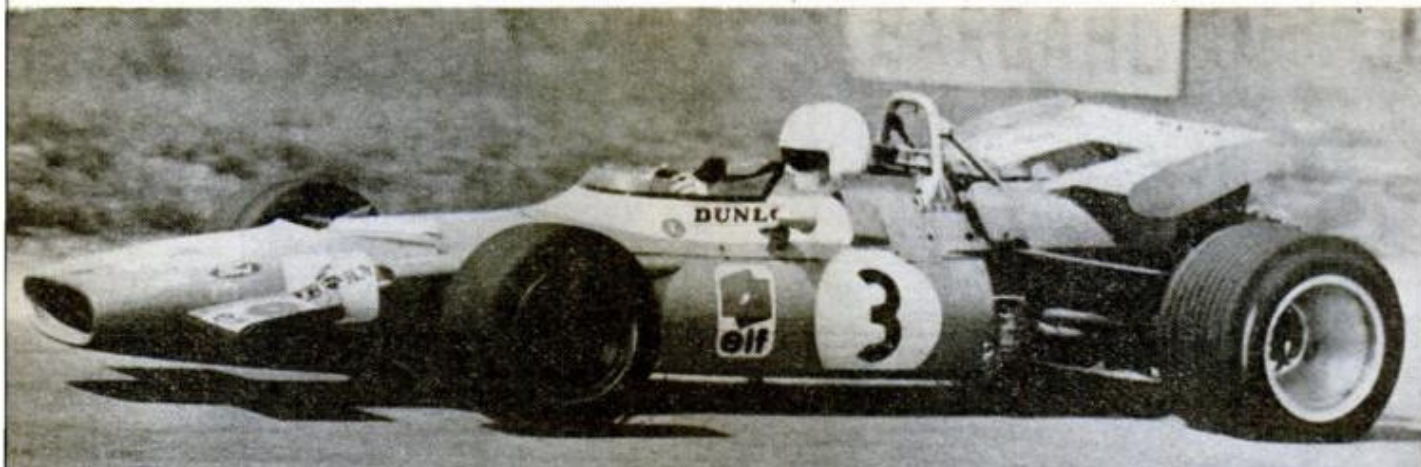

BEAD-RETAINING DEVICES were used on rear tire of Jackie Stewart's Matra-Ford during these early tests by Dunlop engineers who developed the super-tire. Car handled even at 130 mph with tire flat

for a very slight pull of the steering toward the flat tire, I wasn't even aware I was driving on anything unusual. At the end of my test the flat tire, by then partially inflated by the miracle liquid inside it, was in as safe a condition as it'd been at the start.

More than 30 international patents already protect this new invention, but Dunlop technicians admit it's not yet past the prototype stage. "Next step," Ian Mills, a member of the design team, told me, "is to design a specific tire and wheel for a specific production car." And so early this year, the Total Mobility Tire was shown to automakers in Britain, France and Italy. Interest was considerable, and the first production autos shod for total mobility should be in European showrooms in 1974. Several European tiremakers, anxious to get into the act, are negotiating with Dunlop to make the tires under license, an arrangement I suspect we'll also see here.

Not all the big problems have been solved. Although the new tire can be vulcanized as easily as conventional radials, getting it on and off rims remains a factory operation. To replace a Total Mobility Tire at present, you also have to replace the rim it's wedded to. But Ian Mills assured me that a number of different tire-mounting methods are being studied. At the same time, he explained, Dunlop market researchers are trying to determine whether motorists will be willing to take full advantage of the innovation, buying cars without spare wheels and buying new rims with their new tires.

Initially, Total Mobility wheel and tire

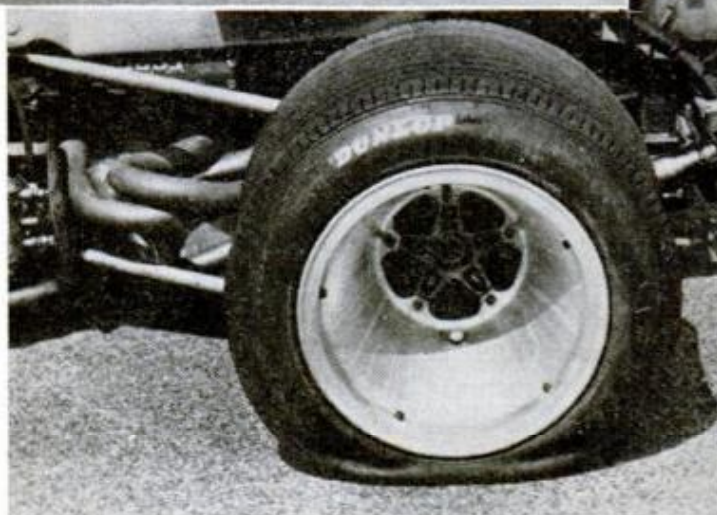

AUTHOR DEFLATED SUPERTIRE on this Mini and tortured it without losing control or damaging tire



units will cost marginally more than conventional radial tires—if drivers will forego carrying spare tires. And since the new tires will last a lot longer, give much greater road adhesion and immeasurably greater safety and convenience, their per-mile cost at slightly more than radials' shouldn't upset most motorists.

The biggest bug of all that Dunlop planners face is a law not one British driver in a thousand is aware of. Over there it happens to be an offense to drive on a public road with a flat tire! ★★★

What Ham did for Virginia, Old Crow did for Bourbon.

Even before Virginia's George Washington became President, Virginia was famous for the good taste of her country hams. Not long after, the good taste of Old Crow made Bourbon famous.

Before 1835, Bourbon was made every which way. That year, Dr. James Crow took it out of the hit-or-miss league and created the process that gave Bourbon its mellow taste—and good name: Old Crow.



KENTUCKY STRAIGHT BOURBON WHISKEY. 86 PROOF. DISTILLED AND BOTTLED BY THE FAMOUS OLD CROW DISTILLERY CO., FRANKFORT, KY.

SOLUTIONS FOR MECHANICAL HEADACHES

AUTOMOBILE CLINIC

BY MORT SCHULTZ

Freeze up

When I drive my 1971 Dodge Monaco with the airconditioner on for four or five hours steady, the unit freezes up and no air will come through. I shut it off for 15 or 20 minutes, which apparently allows the freezing condition to subside, because the unit will work again. What's wrong?—Robert Deer, Adrian, Mich.

Possibly a frozen evaporator coil, which can be caused by excessive dirt on the fins or a malfunctioning part related to the evaporator, such as the expansion valve. Before having the evaporator dismantled, however, run the unit and look into the sight glass of the receiver-dryer, which is that large cylinder you'll find near the condenser. If you see bubbles, it means that there is moisture in the system that is probably causing your problem. Evacuate and vacuum the system, replace the receiver-dryer with a new unit, and recharge the system with refrigerant.

Hole in the head

I have a 1961 Buick Special with an aluminum head that has had a couple of its sparkplug holes stripped. Can this be corrected without replacing the head?—Earl Stiles, Casper, Wyo.

Kits are available for both aluminum and cast-iron heads. One major maker is the K-D Manufacturing Co. of Lancaster, Pa. The kit contains solid steel inserts of various sizes and a tap-and-reamer. Repairs can be made with the head remaining on the engine. If you can't find the kit locally, I suggest that you write the manufacturer.

Dwell awhile

We are running 1965 and 1967 Volkswagen Beetles. Both have the Bosch distributor. What is the dwell angle? No one seems to know, including the local dealer.—C. R. Hullihen, Bloomfield Hills, Mich.

The nominal dwell for the Bosch distributor—that is, the dwell at which new points should be set—is 44° to 50°. The wear limit dwell specification is 42° to 58°. Used points need not be reset as long as

the dwell is within this range. Tell your dealer. He can use the information.

Turn off dieseling

The 429-cu.-in. engine of my 1970 Mercury Colony Park often continues to run after I turn off the ignition. I have to sit and wait for it to sputter, cough and finally die out. It happens in any kind of weather. My mechanic says the car's idling is too fast and he keeps slowing it down. Pretty soon, there will be no idle left. Please help us.—Harvey M. Tuckman, Norwalk, Conn.

It's time to settle this once and for all, because *Automobile Clinic* is receiving so many letters concerning this problem. The condition is called dieseling or after-running. It prevails primarily in late-model engines, which, because of emission control equipment, operate on lean fuel mixtures and retarded ignition-timing settings. We've discussed the theoretical aspects before (see *Saturday Mechanic: How to stop a dieseling engine*, page 154, Oct. '69, PM).

For now, let me emphasize that to control dieseling the carburetor and ignition timing settings must be exactly to manufacturer's specifications. Many models are equipped with a throttle solenoid and other controls, such as time delay and recovery relays, that help reduce exhaust emissions by eliminating distributor advance in the low forward gears. If these components are not adjusted properly or are inoperative, dieseling will occur. Also, remember to keep your foot off the throttle before turning off the ignition. As a last resort to get an engine to cut out without dieseling, shut the ignition off with the transmission in gear.

The search goes on

I have a 1966 Chevrolet with a 283-cu.-in. V8 engine that cuts out and backfires terribly when I take off from a dead stop or try to accelerate. I've taken the car to two Chevy dealers and two independent mechanics. They have replaced the fuel
(Please turn to page 48)

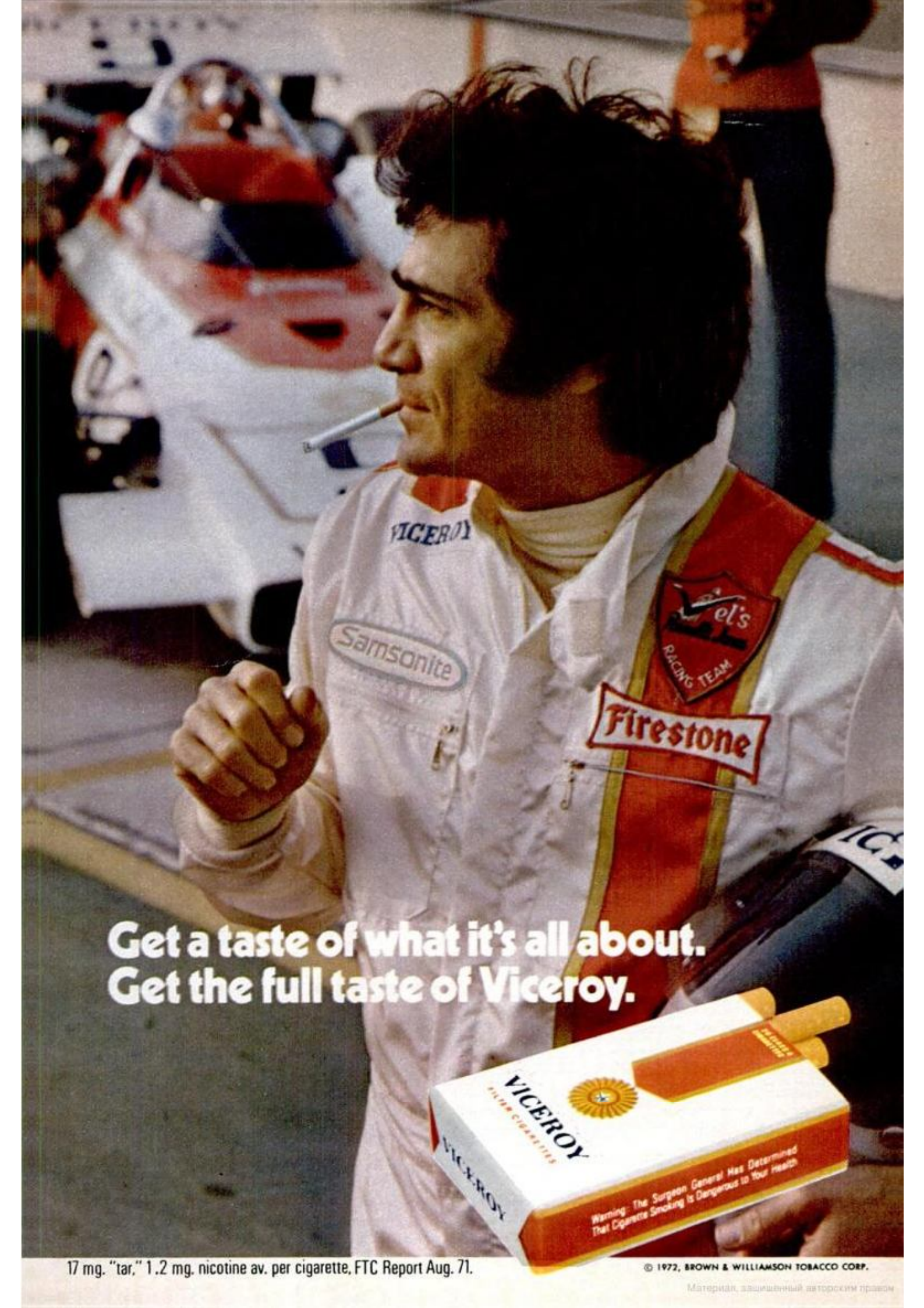

**Get a taste of what it's all about.
Get the full taste of Viceroy.**

17 mg. "tar," 1.2 mg. nicotine av. per cigarette, FTC Report Aug. 71.

© 1972, BROWN & WILLIAMSON TOBACCO CORP.

Материал, защищенный авторским правом

AUTOMOBILE CLINIC

(Continued from page 46)

pump, fuel filter, coil, sparkplugs, breaker points and condenser. The carburetor is new and plug wires have been checked. What have we missed?—Dave Hill Jr., St. Elmo, Ill.

There are two other possibilities. Just on a hunch: Have the engine checked carefully for a vacuum leak. But the more likely cause of the trouble is a leaking or sticking valve, or a weak or broken intake valve spring. I'd get some diagnostic work done on the innards of the engine—you've done everything on the outside.

Clutching for a solution

My 1966 Oldsmobile Dynamic 88 wears out one clutch after another. I'm now about to have the fourth one installed in 14 months. All have shown definite wear. Do you have any ideas why this is happening?—William Gleim, Fresno, Calif.

The two most common reasons for rapid clutch wear are improper adjustment and riding the clutch pedal. Many car owners think a new clutch doesn't require adjustment. They're wrong. A new clutch requires readjustment soon after it is installed, because parts are new and "tight." A clutch will wear out if there isn't ample tolerance. There should be about one inch of free play in the clutch pedal. To be on the safe side, have the clutch readjusted 30 days after installation and again 30 to 60 days after that. Riding a clutch—that is, depressing the pedal part way or simply resting your foot on the pedal—will wear out a clutch faster than anything else. Many drivers ride a clutch pedal unconsciously. Stay aware of what you're doing, and keep your foot off that pedal except when actually shifting.

Forced retirement

My 1967 Plymouth with a slant Six has 50,000 miles on it and is using quite a bit of oil. The oil is coming out of the filler neck. My mechanic checked the PCV valve, and it's okay. He took the oil filler cap off and raced the engine. Oil smoke came out the filler neck, which prompted

him to say that I have a tired engine and should get rid of the car. Should I follow his advice?—Earl G. Aker Sr., West Greenwich, R. I.

That depends on how much you trust your mechanic's judgment and how much money you are prepared to spend. Assuming the worst—that the engine needs a complete overhaul because of worn rings, piston and bearings—can you purchase a car for the few hundred dollars it will cost to replace or overhaul the engine? But maybe things aren't as bad as you think. This is why I say that it may be worthwhile to get the opinions of a couple of other mechanics. "Oil smoke" and oil loss can be caused by other things, such as bad valve-guide seals, which are relatively inexpensive to replace.

Window woes

I own a 1969 Jeep. It has a white vinyl top and plexiglass windows. I keep the windows clean with wax, but the back window has become badly stained with road oil and salt. I can hardly see through it. I have tried every household product to get it clean, but nothing helps. Have you any suggestions?—Richard Froehlich, Johnstown, Pa.

Frankly, no, other than to have the window replaced. Dirt and grime eat into these windows, and it is most difficult to get them clean. If any other Jeep owners have had the same problem and have found a solution, let us know!

Service Tips

● **Chrysler spells it out** in no uncertain terms . . . the only recommended lubricant for power-steering units of 1972 and prior-model cars is Chrysler Approved Power Steering Fluid (part No. 2084329) or equivalent. Other types, such as transmission fluid, will cause deterioration of pressure hoses, especially under high temperature conditions.

● **Wheel covers can be bent** if they aren't removed properly. According to Oldsmobile, the way to do the job is to insert the blade end of a jack handle or a large screwdriver as far as possible under the lip of the disc and pry or sharply strike against the wheel or tire. Don't pull up on the tool. ★★★

GOT A PROBLEM WITH YOUR CAR? Ask Mort about it. Send your question to Auto Clinic, Popular Mechanics, 224 West 57th St., New York, N.Y. 10019. Letters cannot be answered individually, but problems of general interest will be published in the column.

The phone company wants more operators like Rick Wehmhoefer.

Rick Wehmhoefer of Denver, Colorado, is one of several hundred male telephone operators in the Bell System.

Currently, Rick is a directory assistance operator. "So far, my job has been pleasant and worthwhile," he says. "I enjoy assisting people."

We have men like Rick in a lot of different telephone jobs. Both men and women work as Bell System mechanics, truck drivers, installers and engineers.

We want the men and women of the telephone company to do what they want to do, and do best.

Today, when openings exist, local Bell Companies are offering applicants and present employees some jobs they may never have thought about before. We want to help all advance to the best of their abilities.

AT&T and your local Bell Company are equal opportunity employers.



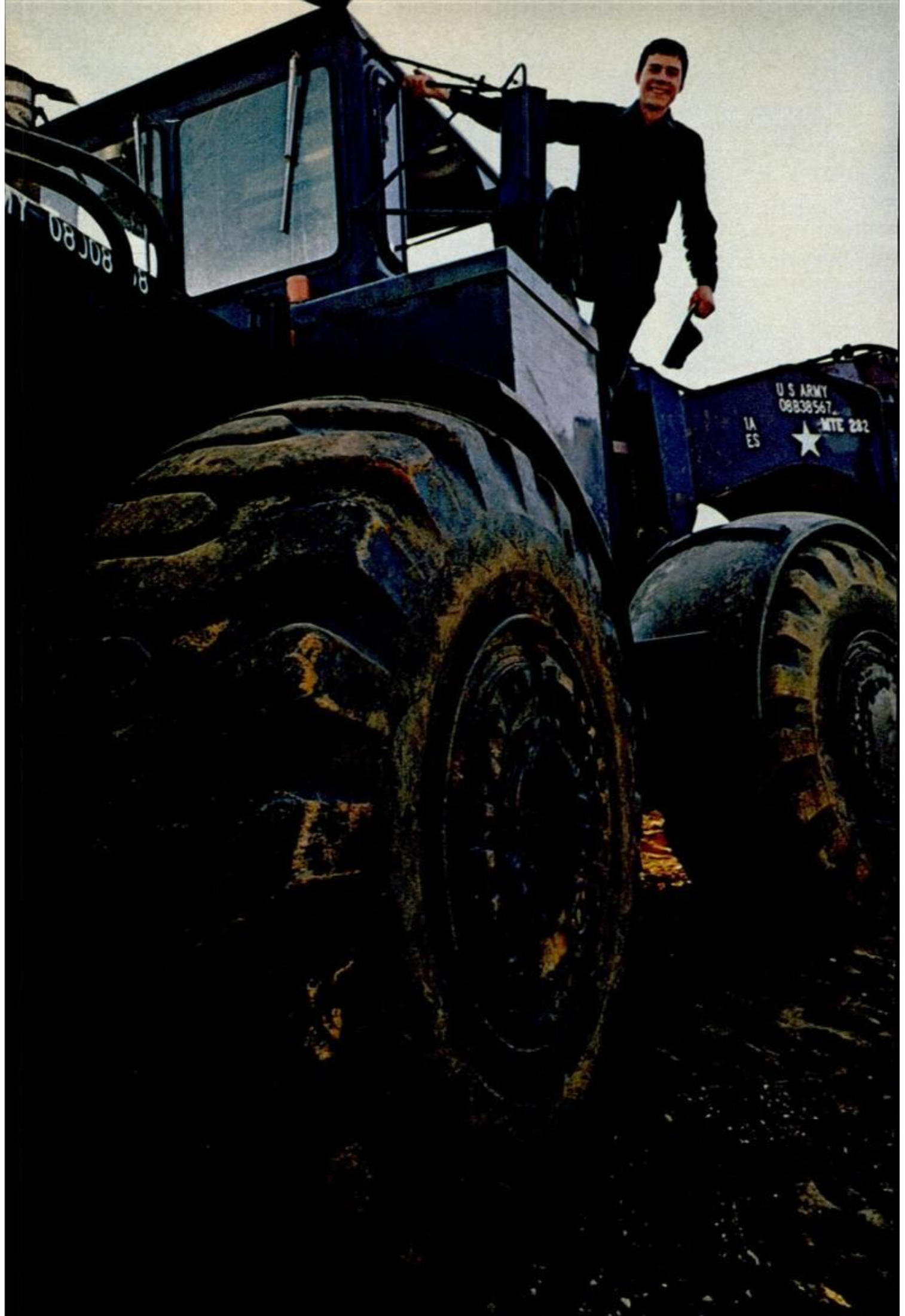

Your own rig at 18.

Construction engineering is a solid, well-paying career. As a civilian, it could take years and money to get the training and experience needed to put you in the driver's seat. But not in today's Army.

We need the best heavy equipment operators, now. So we train them. At our expense.

Within months after starting your training, you could be on the job. Clearing fields. Grading roadbeds. Building dams and river basins.

You'll also learn to maintain every hard working inch of your rig. Which is why Army trained operators are so much in demand.

And unlike the civilian schools that teach heavy equipment operation at your expense, we'll be paying you while you learn. \$288 a month to start.

And that's on top of free meals, free clothing free housing, and 30 days paid vacation a year.

So if you'd like to operate your own rig at 18, send the coupon. Or see your nearest Army Representative.

The job you learn in the Army is yours to keep.

**Today's Army
wants to join you.**

Army Opportunities Dept. 200, Hampton, Va. 23369	Date _____
Please send me more information about job-training and promotion opportunities in today's Army.	
Name _____	Date of birth _____
Address _____	
City _____	County _____
State _____	Zip _____ Phone _____
Education _____	

MAKE BIG MONEY

OPERATING HEAVY EQUIPMENT



**BULLDOZERS
CLAMSHELLS
TRENCHERS
DRAGLINES
BACKHOES
SCRAPERS
GRADERS
CRANES**

The Construction Industry is Booming! Earn top money in this fast moving, action-packed field. Keep present job and train at home in spare time followed by practical training on our machines under project conditions at our facilities. Nationwide placement assistance. For FREE information fill out and mail coupon today!
Member American Road Builders' Assn.

APPROVED FOR VETERANS AND INSERVICE PERSONNEL

UNIVERSAL HEAVY CONSTRUCTION SCHOOLS, Dept. PM
1901 N.W. 7 STREET / MIAMI, FLORIDA 33125
Phone: (305) 642-0800 (24 Hours)

Please Print

Name _____ Age _____

Address _____

City _____ State _____

Phone _____ Zip _____



PLANER • MOLDER • SAW



30-DAY FREE Trial!



Now you can use this ONE power-feed shop to turn rough lumber into moldings, trim, flooring, furniture...ALL popular patterns. RIP...PLANE...MOLD—separately or all at once with a single motor. Free 30-Day Trial. Low Cost—only \$35 down.

Send Postcard Today — No Salesman Will Call.

BELSAW POWER TOOLS, 903K Field Bldg., Kansas City, Mo. 64111

SEND FOR
FREE
FACT KIT



A BONAIR INFLATABLE BOAT travels in car trunk, inflates and launches in 10 easy minutes from any shore. Choose from 7 portable models BIA rated 7½ to 40 H.P.

Write NOW for direct factory prices, full information free.

Bonair BOATS, INC.

5957 Merriam Dr., Merriam, Kansas 66203
(913) 432-9451 • Dept. C-3

TREASURE

FIND BURIED TREASURE



GARDINER
model 210 \$36.00

Find buried treasure coins, jewelry, gold and silver bullion etc. with Gardiner metal detectors. Some Gardiner models can distinguish bottle caps and pop top lids from coins and other treasure and have push button and automatic tuning and many other valuable and exclusive features.

Send for our free catalog describing our many patented metal detectors. Eleven models priced from \$36 to \$785

GARDINER ELECTRONICS

4729 North 7th Avenue
Phoenix, Arizona 85013
Department A 1

WHAT'S HE DOING?

Making a Concrete
Flower Pot! ... and
SO CAN YOU!



Make and sell your own Ornamental Concrete items. Rush \$2.00 for book about Aluminum Molds with prices and production trade secrets direct from world's largest mold manufacturer. Over 350 designs to select from.

Send \$2.00 CONCRETE MACHINERY COMPANY
Today To → P. O. BOX 99 • HICKORY 2, N. C. 28601

NEW DYNAMIC MARK 88 80 AMP INDUSTRIAL TRANSFORMER ARC WELDER

IDEAL GIFT—EDUCATIONAL, ENJOYABLE, PROFITABLE

WELD, BRAZE,
CUT, SOLDER, HEAT
STEEL, BRASS, ALUMINUM,
AND MOST OTHER METALS.



Build and repair anything of metal. Save time & money with this BRAND NEW, PROFESSIONAL ARC WELDER! Rugged metal cabinet, baked Hammeroid finish. Ideal for home, shop, farm and industrial use. POWERFUL glass insulated transformer welds most metals up to ½" thickness with multi-pass weld, with ¼" rods. 4 heat settings 20 to 80 amps. (Operates on 110 Volt AC line fused for 30 amps. Complete with fibre glass helmet, electrode holder, ground clamp and cables, solder, assorted rods and simplified welding manual. DOUBLE PROTECTION GUARANTEE. 10 day money back trial plus full 5-yr. warranty. If inoperative return prepaid, we will repair or replace without charge & reship collect. ORDER TODAY. Complete ready to weld. Only \$59.50 F.O.B.

SEND ONLY \$6.00. Pay Balance plus C.O.D. and Delivery Charges

FREE Write for illustrated color literature and welder details

DYNAMIC WELDER CO.

1808 S. FEDERAL ST.
Dept. PM72
CHICAGO, ILL. 60616

Great careers begin at home

Join the high-paid technicians who got their start through NTS Home Training

Build a new and successful career with a leading industrial company. NTS graduates have been employed by Burroughs, Sears, Carrier, Ford, and many others — and these men started at home.

NTS turns your home into your own private classroom-workshop. See your skills and confidence grow as you train at home on professional equipment we send you. Tools, test equipment, lessons and manuals are all included in your tuition, yours to keep. You test what you learn as you learn it on the same kind of equipment technicians use. You learn at your own pace, keep your own schedule, save precious time.

For the successful career you want, begin at home with NTS. Check coupon for the course that interests you, and we'll rush you a free color catalog. No obligation; no salesman will call.



Electronics Division

Cash in on the growing fields of Color TV & Radio Servicing, Computer Electronics, Electronic Communications or Industrial & Automation Electronics. Each course includes valuable kits such as new Solid-State Color TV, NTS Compu-Trainer, Transceiver, Oscilloscope, and more. Check coupon today for new, free color catalog!



Air-Conditioning, Refrigeration, Heating Division

As an NTS master technician, you'll install and maintain today's complex air-conditioning, refrigeration, and heating systems. Earn high wages with a service company, or go into business for yourself! Receive tools, tester, gauges, and instruments, included in your tuition. Check coupon now for new, free color catalog.



Mechanics Division

America's largest industry pays top money for top skills — and NTS prepares you fast! Professional diagnostic test equipment and 109-piece Tool Set included in your tuition. Plus bonus "hot shop" lessons. Four big automotive fields to choose from. Check coupon for new, free color catalog, receive complete details.



Home Appliance Division

Start earning extra money even before you finish the course! Open your own shop, or join a first-class company. Service ranges, washing machines, dryers, home air-conditioners, and other major and small appliances. "Project Method" features exclusive Circuit Trainer, Appliance Tester, and tools. Check coupon for free color catalog!

High School at Home

NTS offers accredited High School programs. Take only subjects you need. Study at your own pace. Everything included at one low tuition. Check special box in coupon for full information and free catalog.

Classroom Training at Los Angeles

You can take classroom training at Los Angeles in sunny Southern California. NTS occupies a city block with over a million dollars in training facilities. Check box in coupon.

APPROVED FOR VETERANS

Accredited Member: National Association of Trade and Technical Schools; National Home Study Council.

SEND FOR FREE CATALOG & SAMPLE LESSON
NATIONAL TECHNICAL SCHOOLS

Worldwide Training Since 1905
 4000 So. Figueroa St., Los Angeles, Calif. 90037



CHECK ONE ONLY!

NATIONAL TECHNICAL SCHOOLS

4000 So. Figueroa St., Los Angeles, Calif. 90037

Please rush FREE CATALOG and SAMPLE LESSON for course checked below. No obligation. No salesman will call.

Electronics Division

- Master Course in Color TV Servicing
- Color TV Servicing (for Advanced Technicians)
- Master Course in B&W TV & Radio Servicing
- Practical TV & Radio Servicing
- FCC License Course
- Master Course in Electronic Communications
- Master Course in Electronic Technology
- Industrial Electronics
- Computer Electronics
- Basic Electronics
- Stereo, Hi-Fi & Sound Systems

Air Conditioning/Refrigeration/Heating Division

- Master Course in Air Conditioning, Refrigeration & Heating
- Air Conditioning & Heating Refrigeration

Mechanics Division

- Master Course in Auto, Truck & Diesel Mechanics
- Automotive Mechanics
- Truck, Heavy Duty & Diesel Mechanics
- Engine Tune-up & Electricity

Home Appliance Division

- Home Appliance Master Technician's Course
- Home Appliances Servicing
- Handyman Appliance Repair

High School Department High School at Home

Name _____ Age _____

Address _____

City _____ State _____ Zip _____

- Check here if interested in veteran training under new G.I. Bill.
- Check if interested ONLY in classroom training at Los Angeles.

DEPT. 201-072

DETROIT LISTENING POST

BY ROBERT LUND

THE 'INTERIM CAR' is something you'll be hearing a lot about over the next couple of years, so you might as well learn the lingo now. What's an "interim"? Sounds like another name for the intermediates or mid-size cars. But Detroit's using the word in the dictionary sense—meaning provisional or temporary. The auto companies say they just can't cut it on the government regulations coming in 1975-76. The antipollution standard in particular.

The best they claim they can do is a patch job—one that's in partial compliance with the regulations.

Car producers are going on the prayer that the government will ease the rules or grant an extension when the time comes to put the '75-'76 cars in production. If the reprieve comes, cars built during the grace period will be known as interims—meaning they satisfy some of the regulations. Meanwhile, the car firms are in a state of limbo. They don't know what to do for '75 and beyond. What kind of cars to build, what to put on 'em. What the government will accept, what will be turned down. This explains the layoffs of car designers and why the tool and die companies aren't getting orders for production equipment for '75-and-future model cars.

It's a strange pickle for an industry that normally knows exactly where it's going five and six years ahead.

AIRPLANE BRAKES FOR CARS? Ford's put an order out to a supplier to rework an aircraft-type



1973 PLYMOUTH DUSTER comes on strong with a new, bold front end in this sneak sketch out of Detroit

brake—scale it down in size—so it can be used on an automobile. Ford has some military contracts and may be thinking of the brake for Army vehicles. It could be used on civilian cars, too, but the price would be pretty steep.

HOTTEST THING ON WHEELS right now, in terms of how much sales have shot up over last year, isn't a car. It's the minitruck introduced into the United States by the Japanese. If you think you've seen a lot of 'em around, wait a couple of months. The invasion has hardly begun. There are five that are available now: The Datsun PL-620, Toyota Hilux, Ford Courier, Chevy LUV (Light Utility Vehicle) and the Mazda B-1600. The Mazda is made by Toyo Kogyo who also makes the almost-identical Courier for Ford. The LUV is made for Chevy by Isuzu Motors.

Chrysler's trying to swing a deal with Mitsubishi to market a mini-pickup through Dodge dealers. International Harvester is thinking about building its own. American Motors may go that route too, via its Jeep Div., if it can't line up an import. Olds and Lincoln-Mercury would like to get on the bandwagon, but have to get approval from GM and Ford headquarters. VW would like to have an entry but figures the boom's likely to level off before it could put a pony pickup in production. (See page 96 for a report on the minitrucks that you can buy right now.)

STRAIGHT FROM THE HORSE'S MOUTH—but the horse doesn't want his name used—here are the numbers on the modified Nova (re-named Omega) coming from Olds this fall. Three models: a two-door, four-door and a hatchback. Olds' lowest rated V8 will be standard. There won't be a Six. First-year production: 45,000 to 50,000 copies.

CHRYSLER LIKES FORD'S BETTER IDEAS. Two of 'em, anyway. Chrysler has confirmed that Ford will make dies for some '74 Chrysler cars. In another area, Chrysler's picking up on a project where Ford's pulling out. Ford has been working with Bendix on electronic fuel injection. Bendix will supply 10,000 EFI systems for the '73 or '74 Thunderbird. But Ford figures EFI for a hot item and is on a crash program to develop its own system. So Bendix has turned to Chrysler, or the other way around—Chrysler came to Bendix, and

(Please turn to page 58)

Spend a milder moment with Raleigh.

Highest quality tobaccos—specially softened for milder taste.



You'll enjoy a day in the backwoods more if you take along an Igloo Cooler Chest like his. You can get one for free Raleigh Coupons, the valuable extra on every pack of Raleigh.

To see over 1000 other practical and valuable gifts, write for your free Gift Catalog: Box 12, Louisville, Ky. 40201.

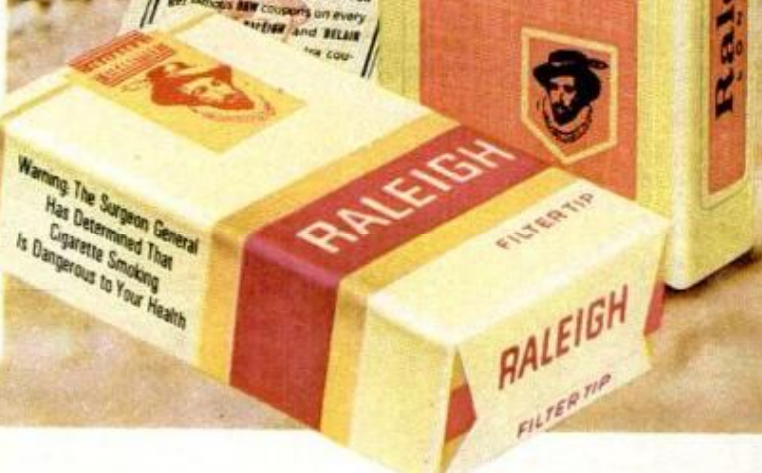

Filter Kings, 17 mg. "tar," 1.2 mg. nicotine; Longs, 18 mg. "tar," 1.3 mg. nicotine, av. per cigarette, FTC Report Aug. '71

© 1972 BROWN & WILLIAMSON TOBACCO CORP.

Материал, защищенный авторским правом

DETROIT LISTENING POST

(Continued from page 56)

Big C is in line to get the Bendix unit. Musical chairs, Motown version.

GM'S REPORTEDLY REVVING UP to turn out more than 1.5 million Wankels a year within four years. Why so many? GM doesn't expect the rotary to catch on that fast. Why the big push on production? Suppliers who hope to be cut in on the GM program offer the explanation that GM may supply the engine to other automakers—specifically Chrysler and American Motors. Chrysler is negotiating to produce the engine on its own. But Big C is a late starter and if it wants to go Wankel the same year that GM and Ford do, it may have to buy a batch of engines from an outsider.

Supplier sources also report that another GM division is cutting itself in on the action on the Wankel. Information is that Detroit Diesel Allison is developing a two-stage diesel rotary.

ROTARY RADIATORS, just like rotary engines, are on the way. These spinning heat exchangers are more efficient than the cumbersome radiators that now take up so much

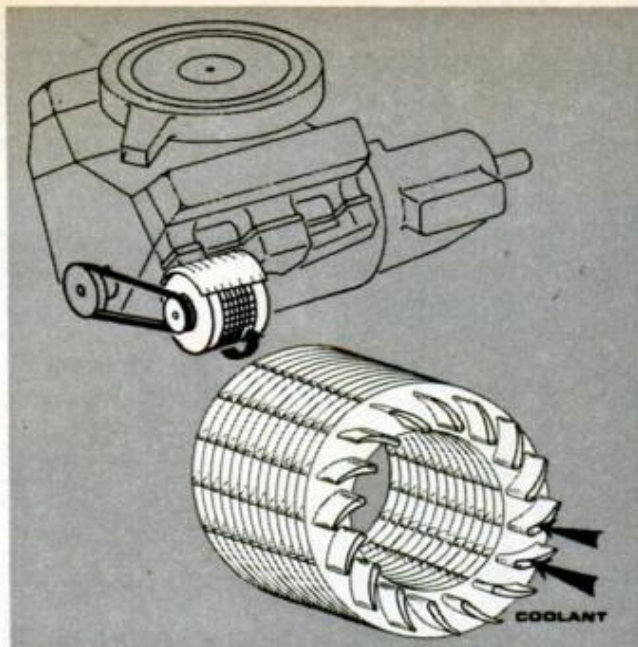

ROTARY HEAT EXCHANGER would replace conventional radiator. Driven by the fan belt, the unit spins while the engine coolant passes through the blades

space and dictate frontal area of today's cars. The accompanying drawings show how the rotary would be installed and how it works. Donbar Development Co. is championing the device for automotive use as well as other applications. ★★★

Everything you need to fix practically everything.



It's a fix-it kit in a tube. Caulk. Seal. Repair. Weatherproof windows and doors. Repair gutters and downspouts. Mend canvas. Mount wall fixtures. Stop plumbing leaks. Seal ducts and vents. Use Dow Corning Silicone Bathtub Caulk and Sealers for just about anything. Make or repair gaskets.

Insulate electrical connections. Seal fiberglass. Use it for hobby-craft applications, or in the garage. Buy the Caulk in white or decorator colors. Buy Silicone Sealers in clear, black and aluminum. Look for other quality Dow Corning home maintenance products in your favorite hardware department.

Get your free idea booklet, today. Write Dow Corning Corp., Dept. G-2102, Midland, Michigan 48640.

DOW CORNING

DOW CORNING



**"For an amateur,
he's a whiz.
How'd he get
so good?"**

Whatever practical skills you've been wanting to develop, Audel has comprehensive, step-by-step Guides to help you. They show you all the professional tricks of the trades

in clearly diagrammed and illustrated "how-to" steps. They can save for you, over and over. Here are four of Audel's many fields . . .

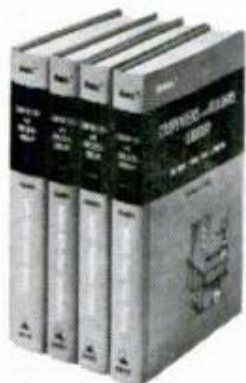

CARPENTERS AND BUILDERS LIBRARY

1612 pages of the latest information on modern construction in four volumes. They cover every phase of carpentry from foundations to finishing with easy-to-grasp, step-by-step instructions . . . all illustrated with thousands of diagrams, charts and photos. No. 23169 — 4 Volumes — \$18.50

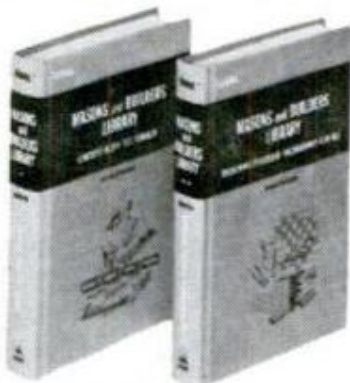

MASONS AND BUILDERS LIBRARY

Two illustrated volumes on the science of masonry and bricklaying. Packed with how-to information and directions, rules, processes, definitions, formulas, diagrams, tables, estimating. A complete and authentic trade reference library. 752 pages. No. 23185 — 2 Volumes — \$11.25

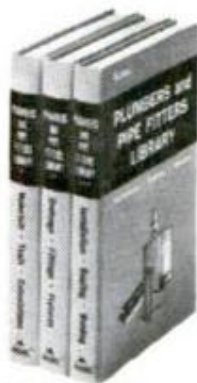

PLUMBERS AND PIPEFITTERS LIBRARY

A valuable 3-volume guide to the principles, methods and short cuts of modern plumbing. Tools, fittings, fixtures, installation, drainage, welding and much more are all covered in these fully illustrated, easy to understand volumes. No. 23155 — 3 Volumes — \$12.50



MACHINISTS LIBRARY

Three books covering the entire field—1216 profusely illustrated pages on practical fundamentals of basic machine shop operations, setup and operation of spot machines, down-to-earth data on toolmaking procedures, layouts, jigs and fixtures, etc. . . . equally valuable for beginners and experienced men alike. No. 23174—3 Volumes—\$16.95

MONEY BACK GUARANTEE

Send no money! We'll send you any Audel Guides for 10-day FREE EXAMINATION. If you keep them, you may use our easy payment plan. If not completely satisfied, return them for refund.

SEND NO MONEY—10-day FREE EXAMINATION

Theodore Audel & Co.—Self Improvement Publishers since 1879
4300 West 62nd Street, Indianapolis, Indiana 46268

P072

Please mail me for 10 day's FREE EXAMINATION the books I have checked at right. I agree to mail \$3 in 10 days for each set ordered and to further mail 1/2 of the purchase price 30 days later, with balance plus shipping costs to be mailed within another 30 days. I may return the books for refund if not completely satisfied.

Save shipping costs. Check here if you enclose full payment (plus sales tax, if any). We will pay postage charges. You have same return privilege.

- 23169
- 23185
- 23155
- 23174

Name _____
Address _____
City _____ State _____ Zip _____



THEODORE AUDEL & CO.
Division of
Howard W. Sams & Co., Inc.
Indianapolis, Indiana 46268

ALL By BILL McKEOWN OUTDOORS

THIS MONTH is as good as any not to drown. More people take to the water this time of year, however, and living it up afloat while cooling down too often means falling overboard. National Safe Boating Week, July 2-8, is a timely reminder that careful boating can make the sport more pleasant for 51 additional weeks each year as well.

"What recommendations would you make for PM's six million readers?" Rear Adm. Austin Wagner, chief of the Coast Guard's Office of Boating Safety, was asked. Pleasure boating is fun and seems simple, the admiral pointed out, but too many small-craft owners take to the water without learning the hazards involved and how to handle them. Statistics the Coast Guard has been collecting indicate important facts: 68 percent of all boats in use are 10 to 16 feet long with a 12½-footer the most popular average size. "Over 70 percent of the annual fatalities occur in craft in this size range," Admiral Wagner notes. "It is apparent why standards should be established for proper construction and capacity of passengers, load, motor power and flotation for these small craft, and why owners must learn to handle them properly. In an automobile accident, if you survive the first minute you are probably going to be all right. But in a boating accident, when you find yourself in the water, your troubles have just begun."

Thousands of new boatmen are going afloat every year who do not even know that U.S. Power Squadron and Coast Guard Auxiliary courses are available, the admiral observes, yet a large percentage of accidents are found to be caused by lack of knowledge of basic boat operation. Pleasure skippers must learn proper handling—or mandatory education is likely to be required.

ONE BENEFIT for all boatmen in the recent Federal Boat Safety Act of 1971 is the requirement that all passengers in any size boat have an approved life preserver available. Even a water-ski towboat must carry "personal flotation devices" (as the Coast Guard calls them) for the skiers out behind the boat as well. And no longer are tippy little sailboats and dinghies exempt from this worthwhile safety requirement. Punt, skiff, raft, dory,

johnboat, kayak, pram, canoe—name it and you now need a preserver. Needless sinking is practically illegal.

THE NEXT BIG SNOWFALL is months away, but already announcements are being made about next winter's new snowmobiles. Look for quieter engines and more sizes and varieties of power. Outboard Marine has announced it will have a low of 72 decibels as well as U.S.-made rotary combustion engines for some of its Evinrude and Johnson models.

FOR A COOL MIDSUMMER VACATION that can really beat the heat, Braniff now has direct flights to South America's winter sports areas and the snowfield ski resorts of the Andes. Or for the sportsman or club that wants to be sure of hunting and fishing results, it's possible to practically reserve a Panama black marlin or Argentine red stag, Colombian trout or a dorado in Paraguay on a planned tour. Braniff International, 135 East 42nd St., New York, N.Y. 10017, has booklets covering outdoor adventure and hunting and fishing tours free for the asking.

RECREATIONAL-VEHICLE OWNERS have long had complaints about the difficulty in getting service for the clutter of conveniences a modern travel trailer, pickup camper or motor home is likely to have aboard. When a stove, refrigerator or toilet malfunctions, an owner doesn't want to have to figure out who originally made it to get it fixed. The word seems to be getting through to several RV manufacturers. Coachmen Industries, for instance, of Middlebury, Ind. (and branches in Texas and Georgia), now provides a one-year warranty for all the appliances and gadgetry it supplies aboard. A buyer gets an owner registration card that he can take, along with his troubles, to the nearest dealer. If it works, a system like this could help the whole industry grow up.

ADVENTURE on foot with backpack, on a bicycle, in a canoe or even underwater is available through an increasing number of planned trip tours. While many scheduled for midsummer are already full-up, others have openings for later in the season, and it's not too soon to start planning for next year. Among excellent sources of information are the Sierra Club, 220 Bush St., San Francisco, Calif. 94104; American Youth Hostels, 20 West 17th St., New York, N.Y. 10011; and the Adventure Trip Guide, a book listing family pack trips, float trips, and canoe, hiking and jeep trips into wilderness areas. It is \$3.45 by first class mail from Farm &

(Please turn to page 62)

CANADA AT ITS BEST



Canada at its best is tranquil lakes set amid soaring mountains. Canada. A profound sense of peace and stillness. A feeling so palpable, you can almost taste it. Like the smooth, light mellowness of this great Canadian whisky. Try it. Tonight. It's the fastest growing whisky south of the Canadian border.

IMPORTED



CANADIAN MIST

CANADIAN WHISKY — A BLEND 80-86.8 PROOF, BROWN-FORMAN DISTILLERS IMPORT COMPANY, N.Y., N.Y. ©1971.

APPROVED BY VETERANS

These 3 BIG DRAFTING KITS GIVEN TO YOU!

... when you train at home with NASD for a **HIGH PAY JOB IN DRAFTING!**



Take your pick of 1000s big salary jobs open to Draftsmen. U.S. Labor Dept. reports "42% more Draftsmen needed in next 10 years—not enough applicants to fill jobs available now." Easy home-study plan has helped 100s beginners toward \$\$\$\$\$, security, prestige as Draftsmen—many with only grade school training. Others report good earnings drafting part time while still learning. Why not you?

RUSH COUPON FOR FREE KIT!

Mail coupon for FREE "DRAFTING CAREER KIT," Sample Lesson, Drafting Aptitude Test including new 5-Way Drafting Instrument & 20-Page Book, "Your Future in Drafting"—ALL FREE. No salesman will call. G.I. approved. Write today



NORTH AMERICAN SCHOOL OF DRAFTING, Dept. 24177
4500 Campus Drive, Newport, California 92660

Rush "Drafting Career Kit," including Book, Sample Lesson, Aptitude Test & Drafting Instrument—All Free!

NAME _____ AGE _____
ADDRESS _____
CITY _____ STATE _____ ZIP _____

WELDING PERFORMANCE YOU CAN'T BEAT AT A PRICE THAT CAN'T BE MATCHED.

Only **\$18.95**

for this heavy-duty welder from Four-Way.

We've sold hundreds of thousands over the last 35 years. This rugged complete Four-Way Welder operates on 110V 30A for pennies. Yet it can weld, cut, braze or solder just about anything made of metal. It comes complete in a heavy-duty cabinet with heavy-duty cables and ground clamp, full face helmet, adjustable torch and rod holder and two big bonus packs of instant arc welding rods, brazing rods, 1/4" carbons, solder and flux. Also included is a complete, simplified welding manual. Use it free for ten days and get your money back if not satisfied. Just send \$2.00 and then pay \$16.95 C.O.D. and delivery charges. Or send \$18.95 prepaid. Shipment in Continental U.S.A. Illinois residents add 5% sales tax. FOUR-WAY WELDER COMPANY, 1810 Federal Street Dept. PM72, Chicago, Illinois 60616



ALL OUTDOORS

(Continued from page 60)

Ranch Vacations, 36 East 57th St., New York, N.Y. 10022.

SEE THE U.S.A. in your you-know-what is easier, thanks to a new book prepared by Chevrolet called *National Parks & Monuments* and available for \$1.95 from Chevy dealers. The large-format paperback has photographs of nearly every national park in the 50 states, plus recreational areas and historical sites in each park. Visiting hours, fees, attractions and distances to nearby towns are also given. The booklet was issued to celebrate the 100th anniversary of the U.S. National Park System this year.

One of the most useful features, however, may be the commercial: On each state map are marked the locations of Chevrolet dealers. A traveler who needs some service can spot the nearest place at a glance, rather than wondering how far it is to the next place he can find a part or repairs. Chevy has also produced a noncommercial half-hour movie, *Our National Parks—Yours to Enjoy*, that should be appearing on local TV this centennial year.

A FINE PAMPHLET discussing the responsibilities of off-road vehicle owners in protecting the ecology, *Your Land, Your Jeep and You* has been written by humorist-conservationist Ed Zern and is being distributed by American Motors. Every new Jeep owner will receive one, and copies are available from dealers. Boatmen can get a helpful booklet from Evinrude outboard motor dealers that is called *The R.P.M. System*. It gives instructions for the important job of matching the right propeller diameter and pitch to obtain best boat performance.

NATIONAL HUNTING AND FISHING DAY will be Saturday, Sept. 23rd.

5-in-1 METAL LATHE

UNIMAT

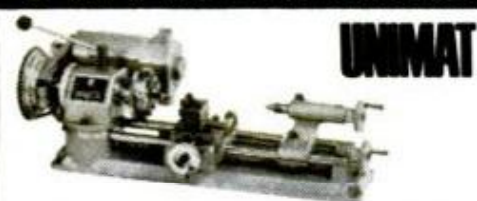

Easy for modelmakers, gunsmiths, inventors to precision machine small parts. Lathe converts in seconds to vertical mill, drill press, grinder & polisher. AC/DC motor, 11 speeds, 3" swing, 17" overall. 90,000 in use. \$169.50. Send for free details, or \$1 for 48-page "Miniature Machining Techniques" handbook. (Available in Canada.)

AMERICAN EDELSTAAL, INC. DEPT BG-2
1 ATWOOD AVE., TENAFLY, N.J. 07670

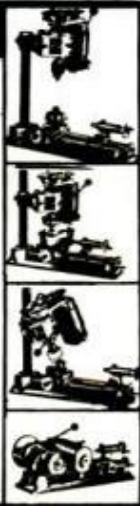

BUSHCRAFT, a book written by Richard Graves and published by Schocken Books, 200 Madison Ave., New York, N.Y. 10017 (\$10 hardcover/\$3.95 paperback), may be the most detailed camper survival book available. Start with a sharp tool and you can eat, drink, build a loom and weave your own cloth for clothes or build your own house or boat and navigate home by the stars. Occasionally tips remind you of the author's Australian outback, but the result is a book of the information every camper wants to know—and hopes he will never need to depend on. ★ ★ ★

GET A LITTLE MORE IN THE NAVY

MORE OF A JOB, MORE TRAINING: The Navy can guarantee you your job (there's over 65 to choose from) or the Navy can guarantee you get to a school where you'll learn one.

MORE CHOICE—NEW 3 YEAR ENLISTMENT: You can come in for 6 years or 4 years or now, 3 years.

MORE GUARANTEES: You can be guaranteed East or West Coast and choice of sea duty or airman recruit work.

MORE TRAVEL: See Africa. See Europe. See Japan. Join the Navy and see the world. (It's still true.)

MORE BREAD: New guys now earn \$288 a month. (Congress gave us a raise.)

MORE HAIR: You can wear a beard (nicely trimmed) if you want to. It's a Naval tradition; it's also a brand new Navy.

MORE FREEBIES: Besides free travel and free education and that \$288 a month, you get free food and free clothing and free housing and free health care and 30 paid vacation days per year.

**CALL THIS NUMBER:
800-424-8880**

It's toll free and a real live Navy recruiter will answer all your questions 24 hours a day, seven days a week. In Washington, D.C. call 433-2000.

**OR SEE YOUR NAVY
MAN RIGHT NOW.**

He's listed in your phone book under U.S. GOVERNMENT, NAVY. He's got all the answers—or he knows where to find them.

HOMEOWNERS' CLINIC

BY W. CLYDE LAMMEY

Basement wall 'leak'

I have an outside entrance to my basement. There are drops of water on the concrete-block wall near the floor—even when weather is dry. What could cause such a leak?—G. R. Waud, Elmira, N.Y.

I don't think it's a leak; I'm quite sure it's condensate. If you place your hand on the wet surface, you no doubt will find that it's noticeably cold. Moisture condenses here because of the variation in temperature. Though it is hard to diagnose from this distance, it is also possible that these drops of water are caused by sweating cold-water pipes overhead. If so, you can correct the problem by wrapping the pipes with a pipe insulation that comes in rolls, and is carried by well-stocked hardware stores.

Faded spot on headboard

A small area on the headboard of my maple bed has faded or turned a lighter color. Is there a way to match it back to the original color?—Leonard Houser, Redwood City, Calif.

If the area is slightly rough to touch, go over it very lightly with medium-fine steel wool and then coat it with artist's color (the kind that comes in tubes). Spread this with your fingertip, mixing and blending several colors until you get a matching tone. Let this dry thoroughly—at least 72 hours—and then spray on a clear finish, such as that sold in pressurized containers. Make certain the spray you select is compatible with the existing finish on the headboard. If you are not sure of this finish, ask your paint dealer to recommend what to apply over the repaired area.

Finishing chest in white lacquer

I have a Victorian chest with a black marble top and want to finish it in a white lacquer with gold. Can you start me on the procedure?—B. M. Daly, Dallas.

I'll assume the chest has been stripped of all old finish and sanded smooth and that all necessary repairs have been made.

Borrow or rent power-spray equipment (from a local paint dealer) and spray on a white lacquer undercoat. Consult *Popular Mechanics Do-It-Yourself Encyclopedia* for spray-painting procedures. If you don't own a set, check your local library. Follow the undercoat with at least two coats of lacquer. Then lay the gold paint on vertical and horizontal beadings and moldings with a camel's-hair brush. Use masking tape to assure gold lines of uniform width. Finally, apply a mist coat of semigloss clear finish (lacquer).

Oil spilled on asphalt tile

I spilled a small amount of lubricating oil on asphalt tile in my basement. Although I wiped it up immediately, the oil seems to have softened the three tiles affected. Is there any coating I can apply to prevent further deterioration?—R. Thorsen, Moline, Ill.

Oil and asphalt tile just don't mix. There is no practical alternative to replacing the affected tiles with new ones. Heat damaged tiles with a propane torch and remove them with a wide-blade scraper. Remove all hardened cement and make certain the subfloor is thoroughly clean. Lay the new tiles over fresh adhesive; press them down firmly and hold them with weights until the cement sets.

Loose register vanes

Two wall registers in my warm-air heating system won't remain open. The vanes drop to their closed position as soon as the control level is released. Can these be repaired?—R. Hanscom, Joplin, Mo.

Chances are the pivots at the ends of the vanes have become worn through usage. Turn out the two screws holding the unit in place, lift it out and you'll see the vanes are pivoted on rivets that normally are set with just enough friction to hold them in place at the desired setting. Stand unit on end with heads of several rivets resting on a sturdy metal surface and tap each lightly. Test for free movement as you go to make sure you don't overtighten them, which would make the vanes difficult or impossible to adjust. ★★★

Do you have a home maintenance or repair problem? Send it to Homeowners' Clinic, Popular Mechanics, 224 West 57th St., New York, N.Y. 10019. While letters cannot be answered individually, problems of wide interest will be discussed in this column.

Get away from the crowd.
Get the flavor you want in
Old Gold Filters.



Warning: The Surgeon General Has
Determined That Cigarette Smoking
Is Dangerous to Your Health

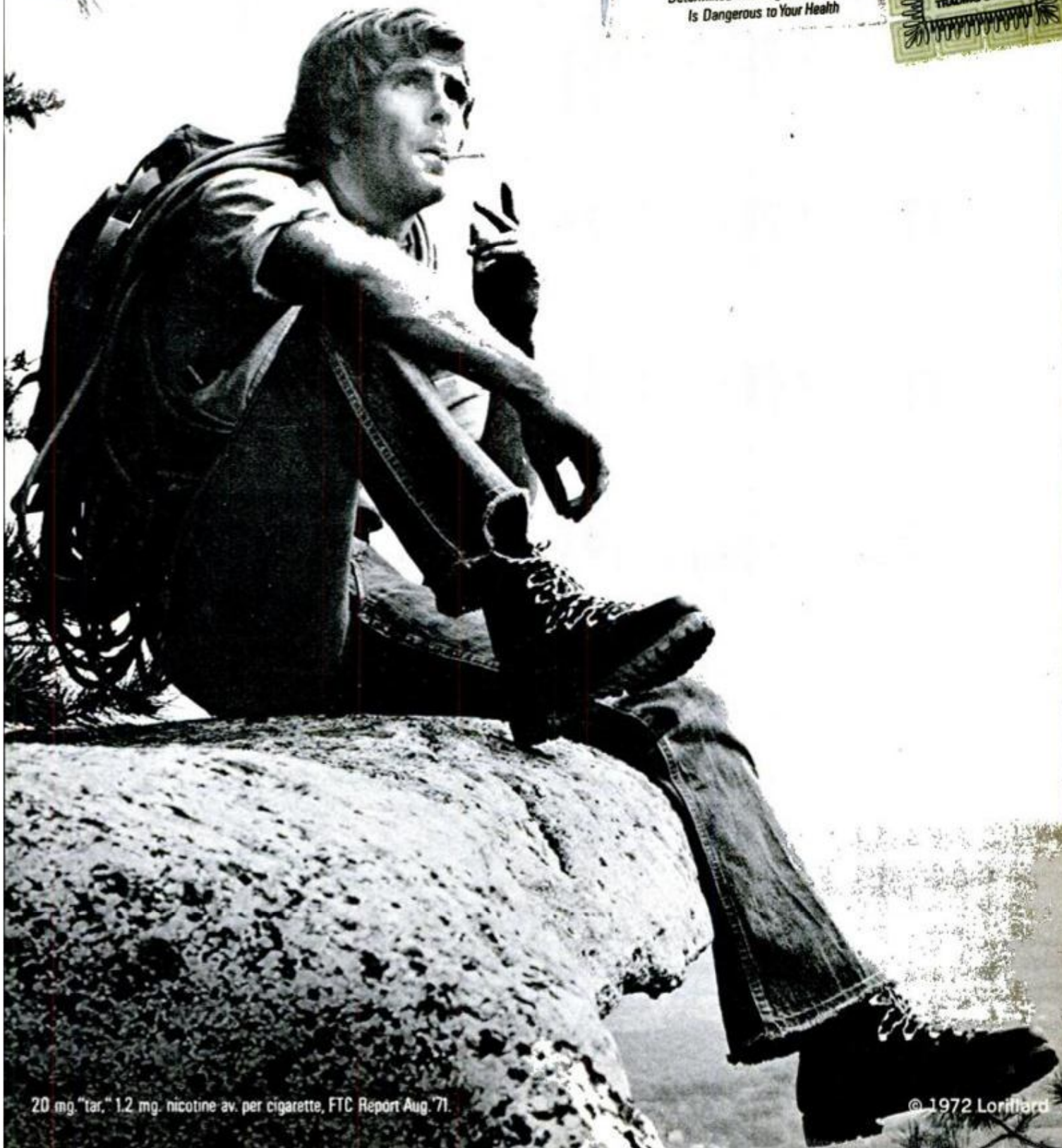

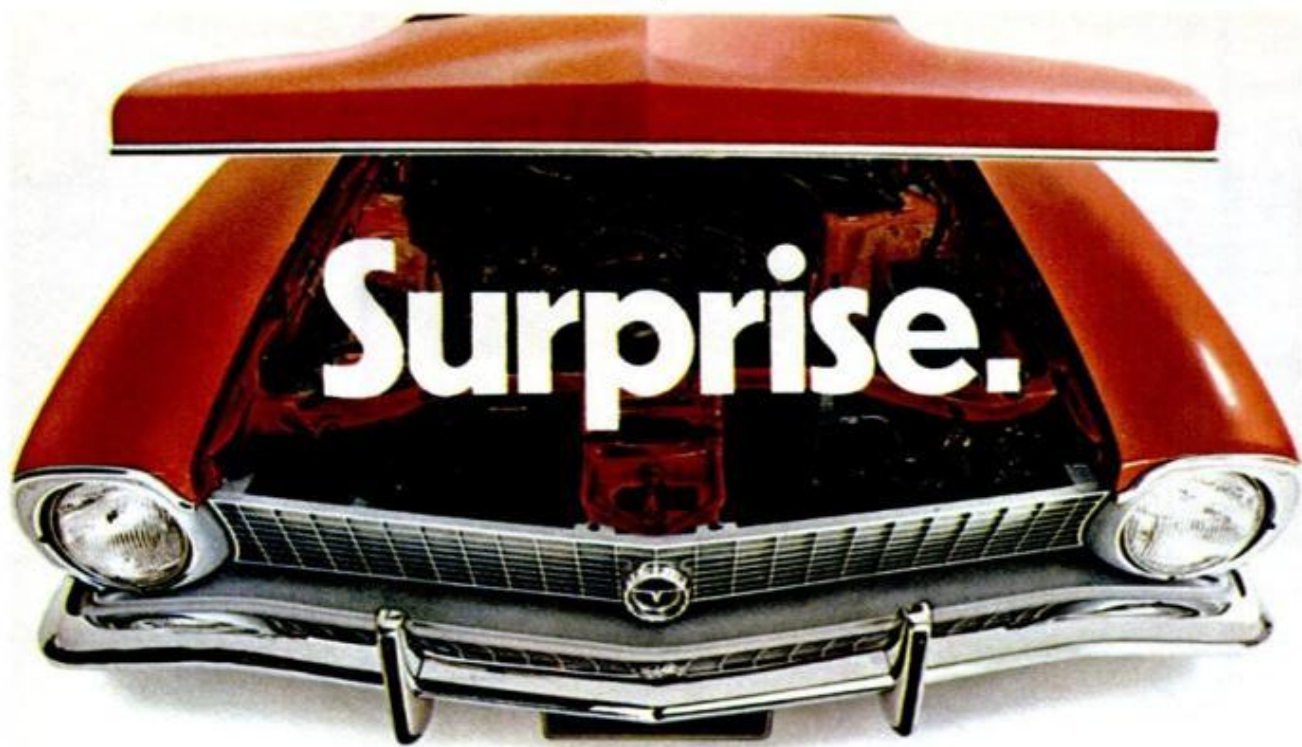

A machine famous for not breaking down.



1972 Maverick 2-door Sedan shown with optional Accent and Protection Groups, white sidewall tires and tinted glass.

Seems like most machines you buy today end up costing you more money just to keep them running. That's what makes Ford Maverick so exceptional. Maverick is a simple, uncomplicated machine—so there's less chance of *anything* going wrong. What's more, a good-looking, family-sized Maverick can be yours for surprisingly little money. Standard 6 or optional V-8. 2-door, 4-door or sporty Grabber.

FORD MAVERICK
FORD DIVISION 

**If reliability
is important to you.**



Spectacular ski tricks you can do

World's champion gold medalist
Christie Freeman shows you how

By HARRIS E. DARK

*Photographed at Cypress Gardens, Fla.,
by Jerry Imber*

SPEEDING ALONG on slats over the water is probably one of the safest of all outdoor sports—even if you try such spectacular tricks as skiing backwards, jumping wakes or holding onto the ski rope with your toes.

That's the word from vivacious, 20-year-old Christie Freeman of Thayer, Mo., champion trick and slalom skier who's been skiing since she was 5.

If you're doubtful that you can learn anything about trick skiing from words and pictures, just look at Christie. She picked up most of the basic tricks from publications of the American Water Ski Assn.—until she took second place in



SKIER'S SALUTE is an early exercise for practice on one ski

TWO-SKI SIDE SLIDE uses the trick skis without bottom fins

LEG TOW is an easy trick and exercise for balance practice

her first contest at age 12. Tournaments and titles have followed, and at 18 last year Christie took first place in tricks and set a new world female record in slalom at the California International Cup tournament, only to break her own record twice and win the Women's World Slalom Gold Medal at the World Water Ski Championships in Spain.

A beginning skier, Christie advises, should fit on his skis ashore first to learn using the legs to stand while keeping back and arms straight. Practicing the deep-water start, seated back on the skis with knees to chest and ski tips up, comes next. Once you have skied, zigzagged across the wake of the towboat (and fallen) enough to feel at ease and secure on

DOCK START must be prepared for by carefully coiling line so it feeds freely on "hit it" command



your skis, why not try some advanced maneuvers?

● **The skier's salute**, with one ski raised from the water and almost vertical to it, is your introduction to one-ski tricks and slalom. With knees slightly bent to act as shock absorbers and weight well back, your lift foot is arched to keep the forward tip of your ski well up and your knee raised toward your chest. Any dip of the ski tip can trip you or pull off the ski.

Once you can lift one ski easily, ride on it and practice lifting the other until you are equally at ease on either foot. Again, practice ashore before trying it on the water. Eventually, Christie points out, you will find one foot which feels more comfortable for advanced one-ski tricks. Slalom and tricks require development of real strength in both legs, however, so she recommends alternate left and right practice.

● **Two-ski side slide** is the basis for a number of more complicated turns. Trick skis are necessary, with no fin on the bottom. They are usually shorter and more rounded than beginners' skis. At between 15 to 20 mph, take a slightly crouching position with arms partially bent. As the tow handle is pulled in, turn body in direction of the turn. Outside ski comes around and in front of inside ski while inside hand releases grip on tow handle; the inside shoulder is lowered slightly while skis have small slope away from the towboat and are wide enough apart for firm stance. To return to forward skiing, waist-high handle is moved out from inline with feet toward ski tips as body turns skis to point ahead again.



BACKWARD ON TWO is first tried on flat, then across wakes

SINGLE SKI BACKWARD takes more lean and weight forward

TOE-TOW ON ONE requires an exact balance, much practice

● **Front-to-back turn** is a continuation of the side slide but through 180°. With the handle pulled in waist-high toward the body in a partial crouch, the skier turns and reaches behind his back to grab tow handle with hand on inside of turn as the outside ski comes around. Skis are kept farther apart for better balance until reverse tracking position is reached. While traveling backward, the skier leans away from the pull of the tow rope, keeps knees slightly bent, and holds tow handle in middle of back with arms bent to absorb tow shock. Procedure is reversed to return to forward skiing position.

Skiing backward can commence from a deep-water start. With towboat in gear and moving forward fast enough to keep

towline taut, the skier turns in the water so that he faces away from boat with rear ski tips above the surface and towline held with both hands behind hips. To signal for the boat to accelerate, the skier drops his head under water while lowering hand-grip level with his heels. Skier must straighten up from crouch slowly after boat speed lifts him into skiing position.

● **One-ski tricks** require some of the same turning techniques as with two, but with a different balance. About 60 percent of body weight will be on the rear foot while the skier travels forward. Running backward, however, it is necessary to place 75 percent of body weight on the forward foot away from the towboat and to

REAR-VIEW MIRROR is now required by law in some states and must give driver view of skier's signals



lean well forward toward the front tip of the backward-running ski. Slower tow speeds, down to about 15 mph with light skiers, make balance easier, but the full weight on one ski causes it to track in a deeper groove. For the quick turns which tricks require, the skier will drop smoothly into a deeper crouch, pull in on the tow handle, and then spring up and turn, all in one continuous motion while shifting weight as necessary. A lot of practice is necessary, of course, but the rewards come when you can perform one-ski side slide, front-to-back turn and one-ski 360° turns as easily as you did on two skis.

● **Wake turns** can be your next challenge if you haven't tried them already. Shortening your 75-foot line to about 50 feet will bring you closer to the wake of your towboat. Now you will be doing your turns more quickly and in the air as you leap from the lip of the wake. The back-to-front wake turn provides an added problem since you cannot see the wake coming and must time your leap as you feel the slope of the wake from your skis. For one-ski wake turns a left-footed skier will usually cut for the left wake and make a left turn, while the skier with right foot forward will turn right.

ADVANCED TRICKS like one-ski slide, toe hold, and forward and reverse step-overs can be performed with flotation jacket or belt in tow boat but should always be practiced with preserver worn. Below, cover-girl Christie gives her driver-brother Pat final instructions on speeds and tricks scheduled before run off photo stadium, Cypress Gardens, Fla.



One-ski side slide

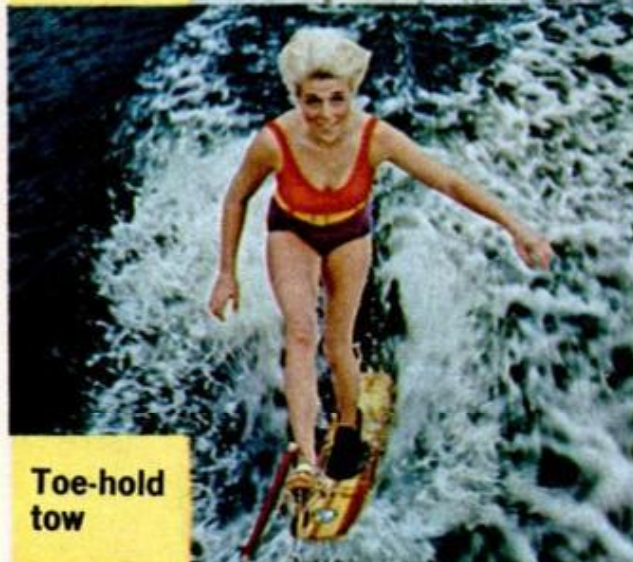

Toe-hold tow



Front-to-back stepover



Back-to-front stepover





SKI SAFETY includes life jacket, line clear of motors, alert observer, before heading for jumps

The full 360° wake turn is usually started from outside the wake. The skier cuts in with the towline partially wrapped around him as one hand grips the handle behind the back and the other holds the rope in front until time for the leap, release and turn.

● **Two-ski stepover turns** look simple when Christie performs them but offer an easy opportunity for the beginner to trip himself. Again, practicing ashore with the towline secured is the first step in

learning. Expect a few spills when you take to the water and try the hop-up from a crouch, turn and step over to reverse position with the line between the legs all in the same moment. Back-to-front stepover is the reverse procedure.

● **Swan maneuvers** can be attempted with regular tow handles and the heel hooked over the grip for traveling forward or the toes for reverse, but added toe and heel loops or slings are preferable. Swan turns, also known as toehold turns, are a suitable challenge for the advanced skier to perform gracefully, since the arms are not used to ease the strains of the towline and recovery from backward maneuvers requires leg muscles not ordinarily used. For tricks like the 360° swan turn, the skier benefits from the help of an experienced instructor, although even here the beginner can learn much from booklets such as the "ABC's of Trick Skiing," 35 cents from the American Water Ski Assn., Seventh St. and Avenue G, S.W., Winter Haven, Fla. 33880. Memberships and additional instruction pamphlets are available from the organization.

The driver and observer in the towboat are also members of any trick ski performance, Christie Freeman notes, and should know all safety procedures and hand-signal instructions from the skier. To pick up a fallen skier, the driver will circle right if the steering wheel is on the right side of the boat, and will always keep the skier in sight. ★ ★ ★

HOW TO SIGNAL YOUR DRIVER



Sears' new video recorder: How it works



SIMPLE CONTROLS (above) and drop-in loading (below) make operation easy



The inside story of the first video cartridge recorder you can actually buy.

By IVAN BERGER, Electronics Editor

WHAT GOES ON INSIDE the cabinet of Sears' new cartridge television recorder? For the answer, I went to the Chicago plant of Warwick Electronics, maker of Sears sets.

In the lab, I found the video cartridge mechanism mounted on a test rack, leaving a gaping hole in the TV console cabinet behind it. This set had been through the wringer, constantly torn down and re-

assembled by the men who were preparing the manuals and training programs for Sears servicemen. But that hardly showed in the results on the screen.

After I turned the knob to "Play," the screen was blank for five seconds. This is deliberate—a muting circuit keeps streaks and squiggles off the screen until the tape nears clear-picture speed.

Inside, a lot was happening. As I closed the door to its compartment, the cartridge's lid opened, revealing the half-inch tape. Because the two reels are stacked hub to hub, the tape crosses the cartridge at a diagonal (photo below, center).

Closing the door positions the tape over two tape-lifter arms that wrap the tape around the rotating head wheel (below, right) during play.

The heads revolve because color video recording demands that tape move at high speed past the heads, while tape economy demands the tape move slowly. With the tape moving at an economical 3.8 inches per second, you can tape 100 minutes of color on less than 2200 feet of tape for about \$40—much less than 100 minutes' worth of color movie film and processing.

By turning the head assembly 1200 rpm in the opposite direction from the tape's movement, the effective head-to-tape speed becomes 545 i.p.s. Even this wouldn't be enough if Sears didn't use another economy technique called "skip-field." TV cameras scan each scene 60 times per second, interlacing the lines from two

(Please turn to page 182)

Coming next year: Some competition from RCA?



Two days after I saw the Sears set, RCA announced its SelectaVision MagTape video cassette system, due late next year. To fit all color sets, the RCA unit includes a tuner for off-the-air recording, and a digital clock timer. It is expected to sell for \$700, due to a simple, inexpensive design developed by an RCA engineer in his basement workshop. Start-up time is said to be shorter than Cartrivision's, and both head and tape life are claimed to be longer. A one-hour cartridge will hold 900 feet of 3/4-inch tape running at 3 inches per second, will be about the size of a hardcover book and should sell for about \$30. Magnavox and Bell & Howell will also have MagTape machines.

SEARS CARTRIVISION mechanism, mounted in laboratory test rack, is surrounded by sample movies, blank cartridges. Note tape counters (arrow) on cartridges

COVER REMOVED, tape head wheel (with three heads) is visible. Lid of cartridge opens for threading, exposing tape's diagonal path across cartridge

AS HEAD WHEEL ROTATES at 1200 rpm, arms (arrow) lift tape, wrap it 120° around wheel. Sensing head shown against tape stops machine if tape breaks

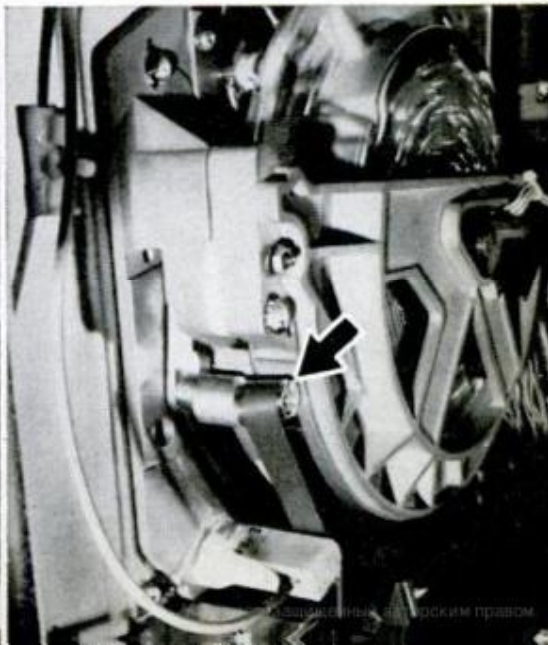
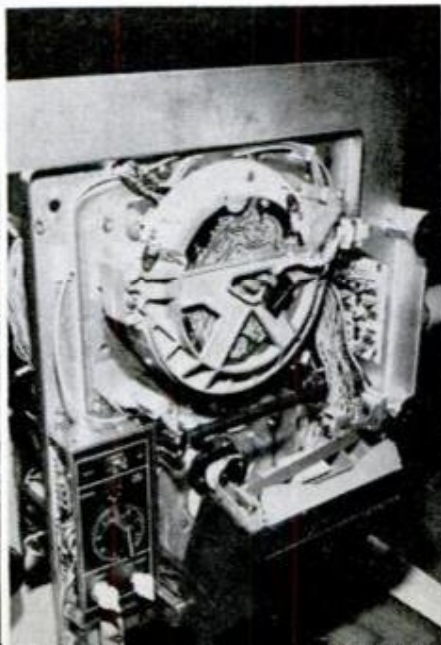



LOWERING BASKET, a Coast Guard rescue copter prepares to pick man off wave-lashed rocks after his boat was dashed against reef by heavy seas. Bystander on beach tries to aid stranded victim, but is unable to reach him.

'You have to go out, but you don't have to come back'

That's the slogan of Coast Guard helicopter rescue teams that go out daily to save the lives of others—and don't always come back

By JOHN ENNIS

LIEUTENANT COMMANDER DONALD ADDISON stared out the plastic canopy of his Coast Guard HH-52A helicopter at the angry gray thunderheads blanketing the sky. Below him gale-force winds lashed savagely at the seas off Cape Hatteras, an area known as the "graveyard of the Atlantic" because of the many ships and lives its treacherous waters have claimed. Addison had flown six missions during the past eight hours and was glad to be heading home. He was tired. Very, very tired.

Then it came. "CG 1388," crackled a voice in his earphones. "This is Coast Guard Elizabeth City. Request you divert five miles south of Diamond Shoals Light Tower and assist crew of burning tug." Addison rogered the message and glanced wearily



at the empty copilot seat next to him. Except for one inexperienced crewman, he was alone. It was Dec. 23, 1971—a Christmas week he will never forget.

The wind was on the port quarter of the *Palmer Gaylord* when Addison reached the blazing vessel. The crew huddled on the fantail, trying to escape flames being whipped toward the stern by 45-knot gusts. The tug was bobbing like a cork in 18-foot seas. Addison dropped a smoke flare, then, reciting a silent prayer, placed his helicopter in a hover 40 feet above the after deck and ordered Petty Officer Richard Hanson to lower the rescue basket.

Leaning out the craft's side door, Hanson repeatedly tried to place the basket on the tug's fantail. Suddenly, two frightened seamen lunged for it together, and Addison felt the helicopter sink sickeningly under the weight of the overloaded basket. He grabbed for the throttle to increase engine power and sighed with relief as the altimeter needle moved slowly



ADMITTEDLY PRIMITIVE, the use of chalkboard is often the only way to communicate with those below

from 30 feet up to 40. Hanson finally got the men on board, but it was totally dark by now. Addison could see nothing from his pilot's seat because he was directly over the burning ship. Hanson had to serve as his eyes.

"Come right 10 degrees, skipper—no,

RUSHING TO AID of burning freighter, a copter flies in firefighting equipment to surface CG vessels

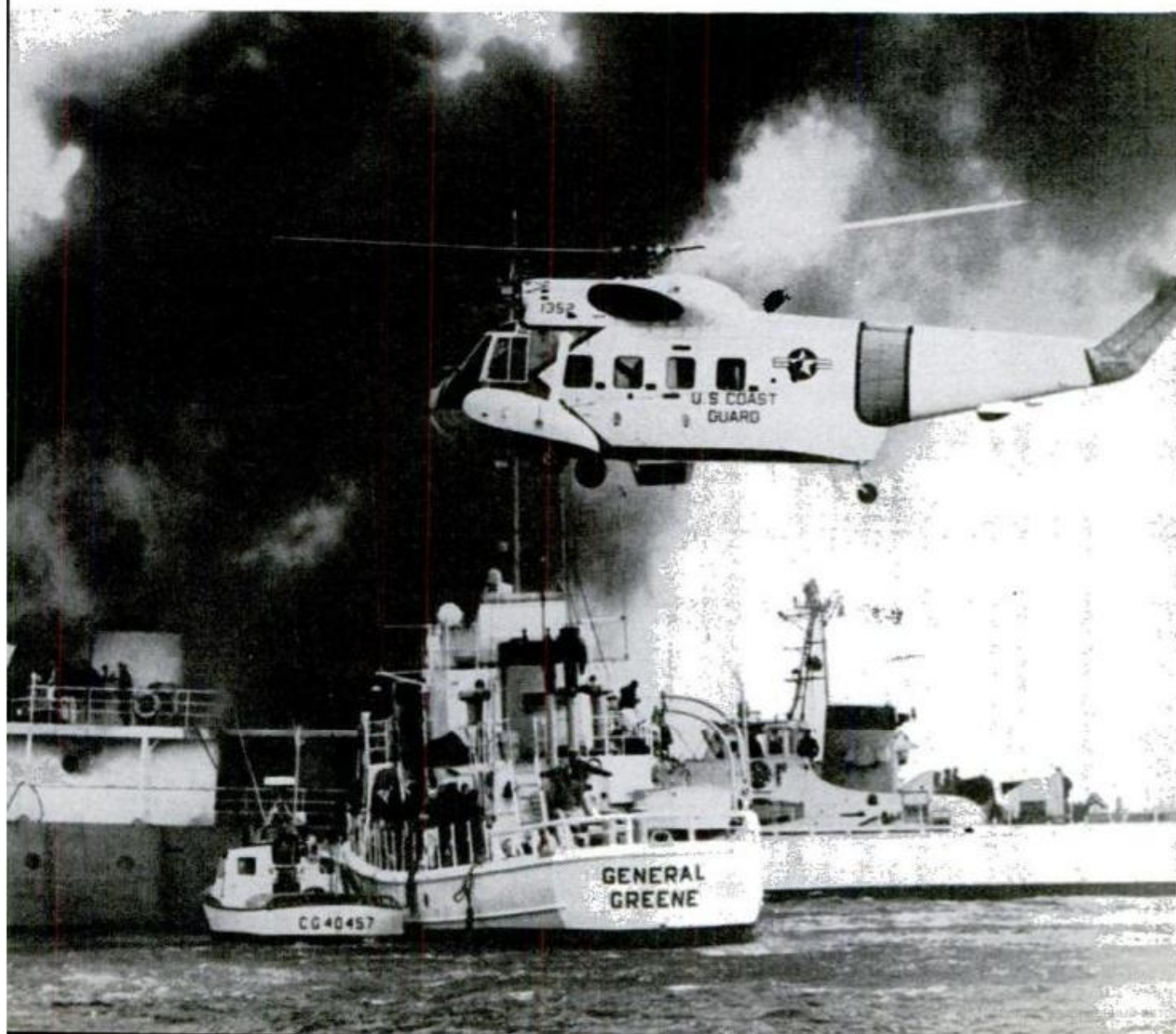

no, you're drifting left. Bring her right 15 and I think I can hit the target."

Twenty minutes later, they had plucked three more survivors off the flaming deck, but fatigue was taking its toll. Both were exhausted, and Hanson was near collapse from exposure to the icy winds. The chill factor was 20 below zero. The basket went down for another load, then another. Suddenly, Hanson felt a cold wave of terror sweep through him as he lowered the basket for the final time. There was one more man left on the stern, and the fire-gutted ship was now almost fully in flame. It could blow at any moment. If it went up while the helicopter was still overhead, the blast would rip the aircraft to shreds.

When the last survivor was hauled on board, Hanson asked him nervously how much fuel still remained in the tug. "Forty thousand gallons, son, forty thousand gallons!" As they touched down at the Elizabeth City Coast Guard Air Station, Addison and Hanson saw the flashing red lights of waiting ambulances. They also noticed another red light. It was on the instrument panel and it told them that their copter was out of fuel.

Such hazardous missions are all in a day's work for the small band of unsung heroes who form the Coast Guard's helicopter rescue service. The men in this little-known group have a saying: "You have to go out, but you don't have to come back." And some don't. Since 1952, 10 helicopters have been involved in fatal

crashes, and 23 pilots and crewmen have lost their lives. Just recently, three rescue personnel were killed when their craft crashed into a mountain while searching for a missing boatman.

The two biggest problems helicopter teams face are their inability to communicate with survivors below and the pilot's inability to see what he's doing because his craft is almost always directly above the point of trouble. In most cases, a crewman leaning precariously out a side door must act as the pilot's eyes, as Hanson did for Addison, but this is risky at best. The sensitive nature of helicopter control and the time required for a crewman to relay instructions to the pilot can be disastrous when a copter operates in close quarters and a difference of inches can spell death.

In one instance, a rescue copter had to hover a few feet above the water with its whirling rotor blades almost touching a vertical cliff face while crewmen pulled survivors from a downed airliner being dashed against jagged rocks by 20-foot seas. This is no situation for a "blind" pilot to be in. In another instance, a crewman had to jump into the water to calm panicking survivors from a sinking ship because there was no way to reassure them from the air that help was coming and they were in no real danger.

Crewmen often use messages written on a chalkboard to communicate with survivors below, but this is admittedly a crude and primitive method. Sometimes a

DRAMATIC RESCUE SCENES below show seamen being airlifted to safety from sinking fishing trawler just seconds before boat went down. At left, Guardsman prepares to lower stretcher-like basket as cop-

ter pilot skillfully holds machine steady over the pitching deck in heavy gale winds. Photos at center and right show an injured crewman being hauled up in basket to copter above. Inside copter, medic ad-





FLOOD SURVIVOR is plucked from roof of his home after being stranded by rising storm-driven tides

telephone on a 100-foot extension cord is dropped from the copter so crewmen and survivors can talk back and forth, but this raises problems, too. The long cord acts as an antenna and frequently picks up radio broadcasts from nearby stations. "The last time we used it," chuckles Addison, "the cord picked up a hard rock program and the fishermen we were trying to rescue thought we had lost our minds."

One proposal is for a closed-circuit TV camera to be mounted below the copter, aimed downward, with a monitor screen in front of the pilot to give him a view of the scene below. Sikorsky, which builds the Coast Guard's helicopters, is working on such a system. One problem is that the

ministers temporary first aid (left, below) as copter continues rescue of other seamen. Doctors are carried on some missions, but not all, so the copter crew must have medical training, too. After rescue

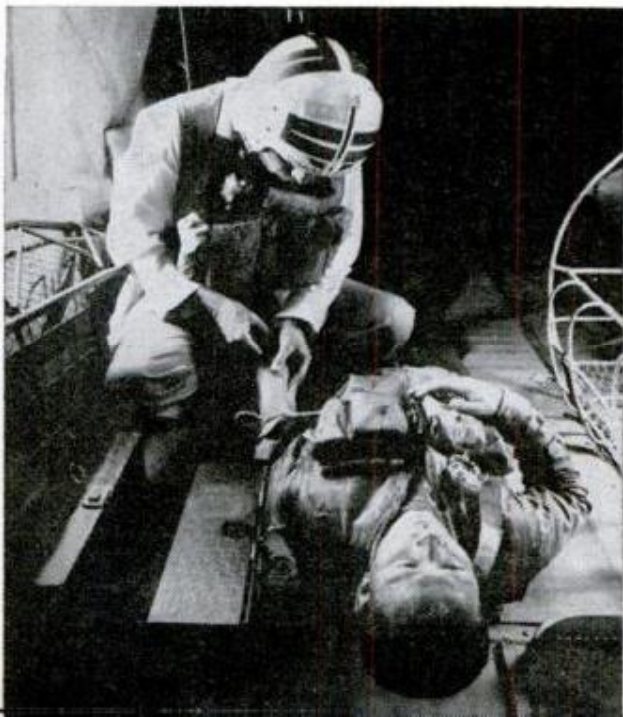

TV camera must be able to operate at very low light levels, such as in bad weather and at night. As an additional aid, the Coast Guard is also exploring the use of high-intensity lights for night rescues. So far, the most promising device is an intensely brilliant xenon searchlight produced by Spectrolab.

Another aid being studied is an automatic distress detector known as DALS for "Distress, Alerting and Locating System." Heart of the system is a small inexpensive transmitter every boatman would be required to carry. The transmitter could be operated manually by a boatman in trouble or would sound off automatically under impact or submersion in the event a boatman is injured and unable to operate it himself. Signals from the transmitter would be picked up by shore stations and the boat's position radioed immediately to the nearest Coast Guard helicopter in the area. Such a system would speed rescues and save countless more lives, say Coast Guard spokesmen.

Despite present difficulties, however, the Coast Guard rescue service has a remarkable record. During 1971 alone, its 87 operational helicopters responded to 4877 emergencies and saved 841 lives. In the aftermath of Hurricane Betsy's savage destruction along the Louisiana coast, helicopter crews rescued 1192 flood victims during 72 hours of nonstop flying—just one of the fantastic feats routine for the men of this unique service. ★★

is complete, copter flies to nearest landing point (right, below) and injured are rushed to waiting ambulances. Machines have wheels as well as sea-plane-like hulls, can land on either ground or water



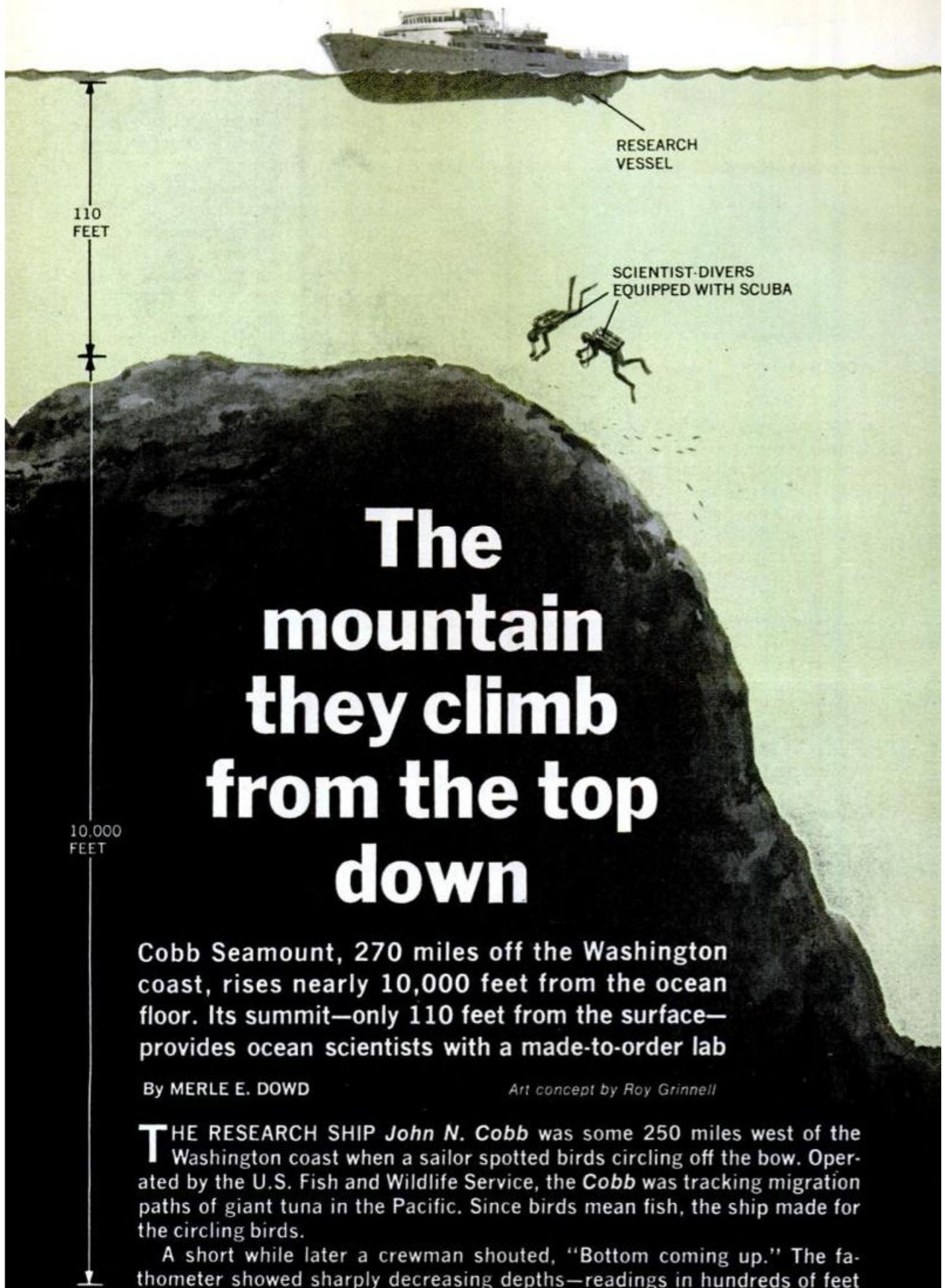

The mountain they climb from the top down

Cobb Seamount, 270 miles off the Washington coast, rises nearly 10,000 feet from the ocean floor. Its summit—only 110 feet from the surface—provides ocean scientists with a made-to-order lab

By MERLE E. DOWD

Art concept by Roy Grinnell

THE RESEARCH SHIP *John N. Cobb* was some 250 miles west of the Washington coast when a sailor spotted birds circling off the bow. Operated by the U.S. Fish and Wildlife Service, the *Cobb* was tracking migration paths of giant tuna in the Pacific. Since birds mean fish, the ship made for the circling birds.

A short while later a crewman shouted, "Bottom coming up." The fathometer showed sharply decreasing depths—readings in hundreds of feet

instead of thousands, as is normal for the area, the Cascadia Basin.

A series of depth measurements showed that the *Cobb* had come upon an uncharted seamount, a mountain peak rising to within almost 100 feet of the ocean's surface. The discovery—on Aug. 1, 1950—eventually went on the charts as the Cobb Seamount, in honor of the founder of the University of Washington College of Fisheries.

Seamounts are not unusual. More than 2000 are charted along North America's western coast, mostly in Alaskan waters. But Cobb is unusual. It rises higher than most, nearly 10,000 feet above the ocean floor. Its summit, only 110 feet below the ocean's surface, is well within diving range. This is what makes it a made-to-order sea lab.

Seamounts, scientists say, are created by volcanos. Lava bubbles up through cracks in the ocean floor to build what may become a mountain. The many seamounts off the West Coast point to an outburst of volcanic action 25 to 30 million years ago. Cobb's age has been put at 27 million years.

What does an ancient, drowned volcano look like close up? "Startling," says Chuck Blackstock, a scientist-diver who is working on the development of ocean instrumentation for Honeywell. "The astronauts must see something like Cobb's surface when they fly close to the

moon. You see a lot of craters—some only three to five feet deep and maybe six across. Others are bigger—about 30 feet deep and up to 150 across. Then there are deep fissures, probably extinct fumaroles or steam vents. Nothing is smooth on that surface—it's a forbidding place."

Scientific interest in Cobb centers on opportunities for learning more about how the sun, ocean and air interact, wave actions and their effects on ship structures, and marine biology. Research programs are coordinated by the SEA-USE Council. Project SEA-USE (for Seamount Exploration and Undersea Scientific Expedition) is supported by the states of Washington, Oregon, Alaska and Hawaii, plus Canada's province of British Columbia, and various federal agencies and private companies.

"What we want to know, for example, is how the energy exchange between the ocean surface and air affects weather," explains Dr. Franklin I. Badgley, profes-

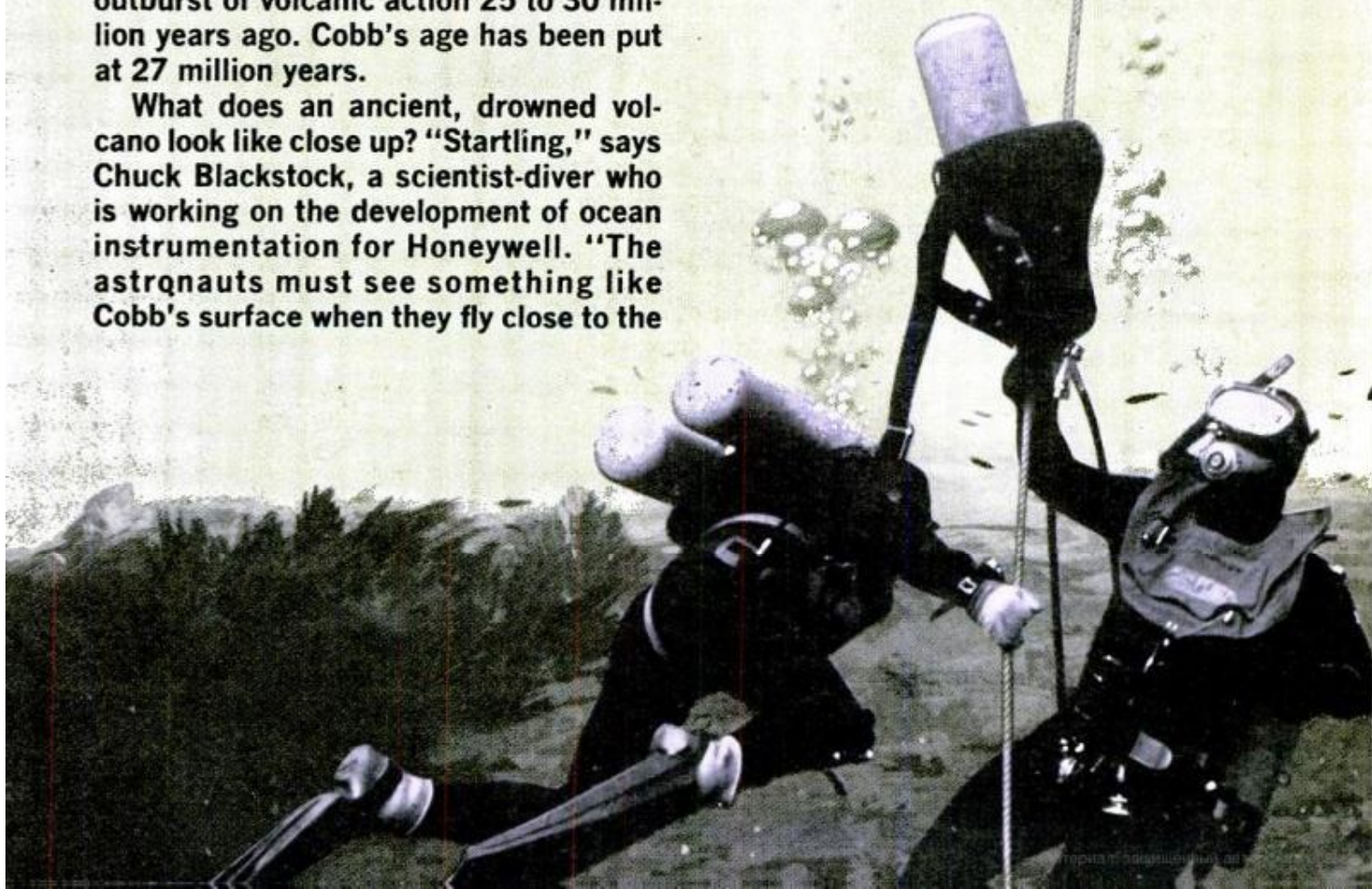

sor of atmospheric sciences at the University of Washington. "We'd like to find out what controls the exchange of carbon dioxide and oxygen by plankton and seaweed. One of the difficulties in getting measurements at the air-sea interface is finding something stationary to hang instruments on. Ships are very bad because they interfere with the things we want to measure—wave patterns, air currents and air temperatures. Buoys are tossed around by the waves."

Cobb offers a base for a fixed research tower in an open-ocean environment. But building a tower strong enough to withstand 60-foot waves and 80-mph winds poses a formidable challenge.

One mast, called the Totem Tower, was placed on Cobb in 1968 by a team from Oregon State University. "It was a long cylinder, possibly 15 feet in diameter," reports Chuck Blackstock. "It was erected in the bottom of a 30-foot crater after being towed to the site. Apparently, the guy-lines that were to support it failed, and a lower section of the cylinder buckled. Then the tower collapsed."

How to anchor a ship at the seamount has proved another tough problem. There is nothing on Cobb's summit—no sand or even rubble—for an anchor to bite into. In 1969, attempts to implant an explosive anchor failed. The hard basaltic rock cracked the anchor. "It's like firing a banana into a brick wall," reported one diver.

Another approach was tried the following summer. A coring rig was used to bore three holes in the rock. Ring bolts two and a half inches in diameter and five feet long were grouted into the holes. Three days later, after the concrete had set, one bolt was tested to destruction. It finally failed at 110 tons of vertical pull, indicating plenty of strength for mooring surface ships or anchoring cables to steady a tower.

In the summer of '71 a team of divers aboard the Coast Guard buoy tender *Cactus* were given the task of securing a mooring line from the ship to a ring bolt. They ran into turbulent conditions on Cobb's summit.

"If you weren't hanging on to something down there, the sea surge would carry you 25 feet one way, then 25 feet back again," the lead diver reported. "There was a school of red snappers moving back

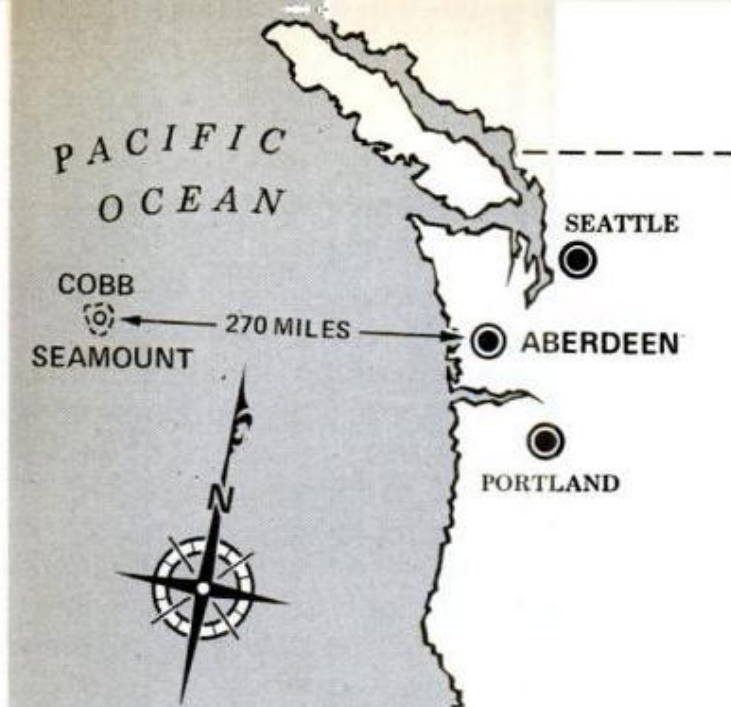

AN ABUNDANCE of sea life and an isolated location make Cobb an ideal "lab" for biological studies

and forth with us. They didn't even try to fight it."

The divers finally succeeded in threading a light line through one of the rings. This was used to pull an anchor chain into position so that it could be linked to the bolt. Later, heavy seas hit. The anchor chain broke—but the ring bolt, slightly bent, remained fixed in the rock.

For the most part, ships have tried to maintain position through the adroit use of power and steering.

"When we arrive," says Chuck Blackstock, "we locate the summit with sonar and drop weighted lines with cork floats to mark the edges of the area. We use scuba and a safe-line system when diving. As we dive, we pay out a thin nylon line from a reel. The upper end is attached to a float. As we move around the summit, the float follows us, and a surface crew keeps an eye on the float from a dinghy. About 30 feet below the surface, a safety tank of air is attached to the safe-line in case we run out of air during decompression.

"Diving at Cobb is different from diving in inland or coastal waters. In open ocean the ship becomes your only reference. The water is clear, an azure blue rather than the green we see nearer shore where dirt and marine organisms cloud the water. On my first dive, I remember looking up and seeing the whole bottom of the ship, from bow to propeller. I felt as big as an ant."

Currents create an upwelling, especially

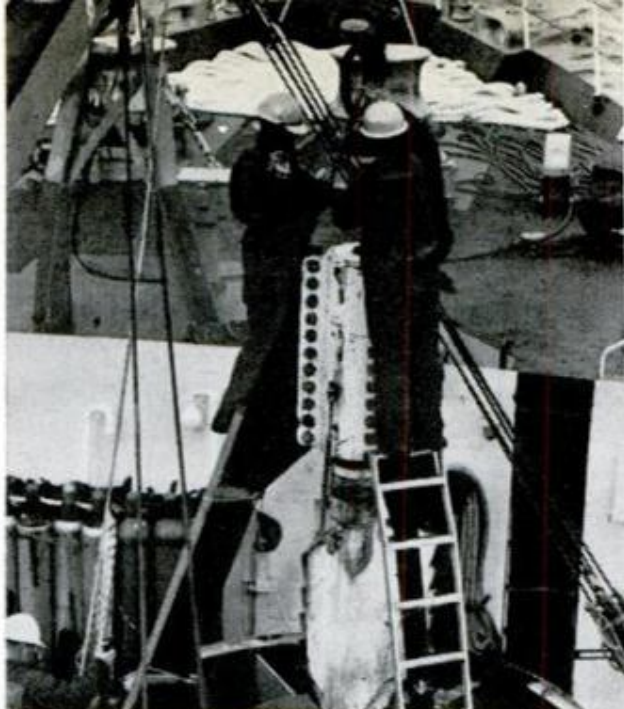

EXPLOSIVE ANCHOR is readied aboard Coast Guard cutter. It broke when fired into seamount surface

around Cobb's northern face. The upward surge of water carries mineral nutrients up toward the surface. Plankton feed on the nutrients, starting a marine food chain that extends to big fish.

There are plenty of rockfish, cod and red snapper and occasional blue sharks that swim lazily over the summit. Scallops grow on all vertical walls, and there is also an abundance of sea urchins, starfish and tubeworms.

"Cobb furnishes an ideal laboratory for studying marine life because of its isolation," explains a University of Washington biologist.

The first big payoff from research at Cobb may involve new knowledge about wave spectra—wave height, period, direction. Tanker breakups that spew thousands of tons of oil into the sea have sent ship architects back to their drawing boards. Designers want data instead of guesses at wave heights and distances between troughs and peaks so they can relate hull stresses to ship motion.

"In the past, ships ran about 450 feet long," explains Rear Adm. Emory D. Stanley, USN (Ret.), secretary of the SEA-USE Council. "When they encountered 1000-foot-long waves, they took a bit of a beating, but structurally there was no problem. A ship 1000-foot long is something else. When it suddenly finds itself supported by waves at both ends but with no support in the middle, that's rough. And they *have* been breaking up."

This summer or fall, according to Adm.

JULY 1972



SURGE METER was fixed to summit with explosive bolts. Instrument was damaged by fishing trawlers



"PINGER" WAS PLACED on Cobb to provide directional data for ships equipped with sonic sounders

Stanley, there will be a two-ship expedition to Cobb for the purpose of placing a pressure-sensor wave gauge on Cobb's pinnacle. Information obtained from this gauge and from other instruments installed in ships could eventually open the door to new wave-gauging techniques that could be used anywhere in the world.

Another project that may be carried out this summer would involve a two-man sub. As part of a geological study, scientists would use it to explore Cobb's 300-foot terrace.

Weather and rough seas are a problem at this exposed ocean research outpost. But scientists seem very willing to put up with lurching ships and queasy stomachs in exchange for the privilege of working at the unusual "lab." ★★★

83

NEWS BRIEFS



'DB' doesn't mean 'Der Beetle'

Looking a little like the rear end of a Volkswagen, this new electric high-speed rail coach of the German Federal Railway will begin op-

erating between Munich and Bremen in 1973. The front car pulls four others at a top speed of 120 mph. Each car seats 183 passengers.



Competition for Rolls?

Two British garage owners, Derek Skilton and Jack Perkins, are custom rebuilding vintage cars of the 1930s for those who can afford them. Each model has modern performing parts—engine, brakes, suspension, and such. This SP Highwayman sells for about \$15,000.



A dog's life—saver

Shouldn't man's best friend be safe, too? Pet Care Products of England thinks so and has developed a car seat belt which is also a leash collar. The harness protects Fido in an accident and also keeps him from jumping about, creating a distraction to driving.



All-terrain vehicles all over the place

That's the way it was recently during a one-day ATV rally held by the National ATV Assn. at Treasure Lake, Pa. There were 48 vehicles

and 110 participants—mostly family groups. The sloshy drive (it was rainy) over the Treasure Lake trail took about 3 hours.

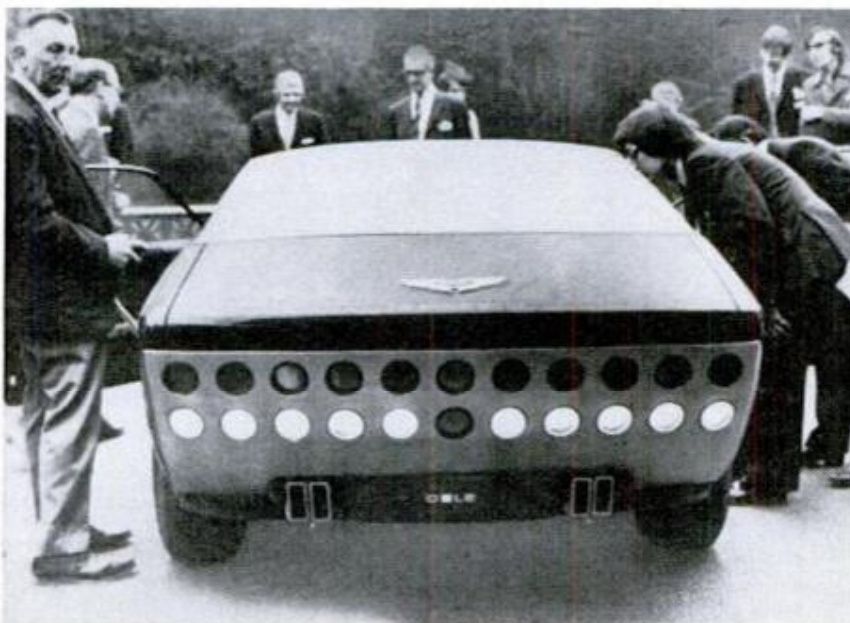
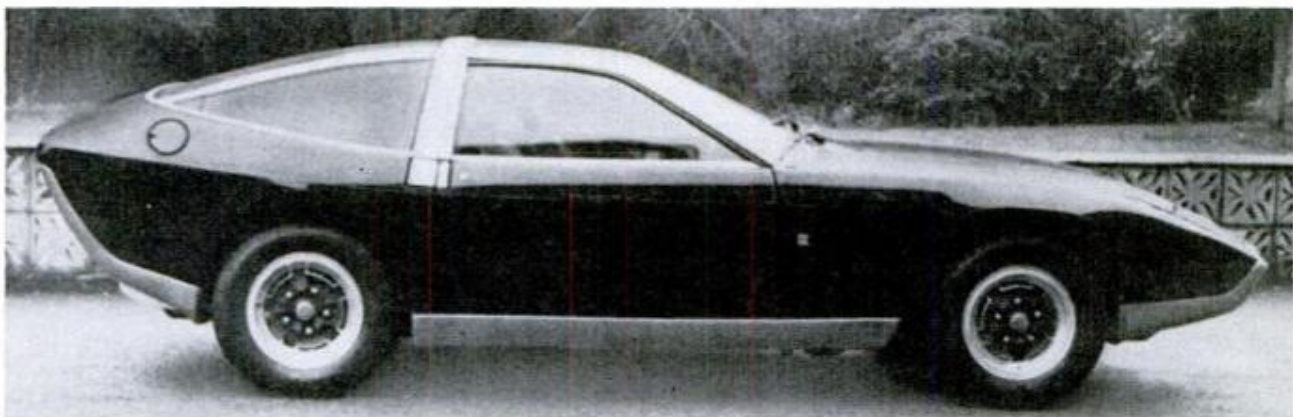

Not for sale

It cost \$53,000 to build, but you can't buy this sleek-looking job for any price. It's a one-and-only model which was created by Ogle of Great Britain. Based on the design of the Aston Martin D86, the car will be employed to promote a famous brand of cigarettes in England. What a pity! The three-seat gem will not only hit 170 mph, but sparkles at that. As you can see, it sports a battery of 22 rear lights, including four directional lights on each side. Ogle designed the Bond Bug and the Reliant Scimitar GTE.

PM BUICK SKYLARK OWNERS REPORT...

A nationwide survey based on
960,000 owner-driven miles



Handles like a dream, but gas mileage is a rude awakening!

BY MICHAEL LAMM, West Coast Editor
Photos by the author

"OUR LAST BUICK was a 1966 Special," says a Findlay, Ohio, sales manager, and he adds: "It went 120,000 miles without any problems. Buicks have quality."

But it doesn't have the economy that owners want. Gas mileage is the one thing Skylark owners are most unhappy about. They're talking about an average 11.9 mpg around town and 14.5 mpg out on the road. That's with the 350-cu.-in. V8 engine which 98 percent of all owners surveyed have in their Skylarks. Fuel mileage averages were not available on the 455 V8 because of the small sampling obtained in the *PM* survey. The comment, "Not enough miles per gallon" appeared again and again. Alongside that complaint came, "Gas tank hard to fill; should also be larger."

Several drivers griped about high

rough idle and stalling. A Milwaukee professor of electrical engineering expressed it this way: "It's a California car. By that I mean engine idle speed is too high and fuel mixture too lean for cold Wisconsin winters. Almost always stalls in cold and is difficult to control on ice because of high engine idle."

Since Buick gets quite a few repeat customers (almost 40 percent in our survey) they tend to compare the '72 Skylark with previous models. "Our 1969 Special had better rear visibility and more items that are now options were standard then," notes a Maryland attorney. "Handling and suspension are greatly improved over 1971 models," says a California planning estimator. A San Francisco shipping clerk avers, "There was more room in our 1967 Skylark than in our 1972."

An area that comes in for all sorts of



SKYLARK TRUNK includes tie-down, a clever touch, but owners feel trunk light should be standard. A map light on rear-view mirror is optional. Rubber

bumper strips cost \$24 extra, are good only in very light taps. Semisealed cooling system uses large Teflon box to catch, recirculate radiator overflow

praise is the Skylark's handling. "It's so easy to handle," says a West Virginia maintenance man. "Good handling, holds the road well," comments a Denver clergyman. "Has plenty of power when I need it," says a Texas mathematician. "I feel more confident driving in bad weather because of the Skylark's handling and the heaviness of the car."—Wisconsin stenographer. "Good handling in tight curves plus good acceleration at 60 mph and over."—Tennessee mechanical engineer.

What improvements do Skylark owners suggest? "Trunk is too small—spare tire takes up most of the room," says a New York sales representative and this

complaint is echoed by 12.4 percent of all the respondents. Judging from the comments, trunk space is tighter in sedans than in convertibles and coupes, but it's tight in those, too.

"The two skimpy little horn buttons on the steering wheel spokes have already caused me to come close to two collisions. Bring back the horn ring," says a Pittsburgh real-estate appraiser. Many other owners feel the same way. The trouble is that when they are forced to turn the wheel in quick emergency situations, the recessed horn buttons are rather hard to find.

Other recommendations for improve-

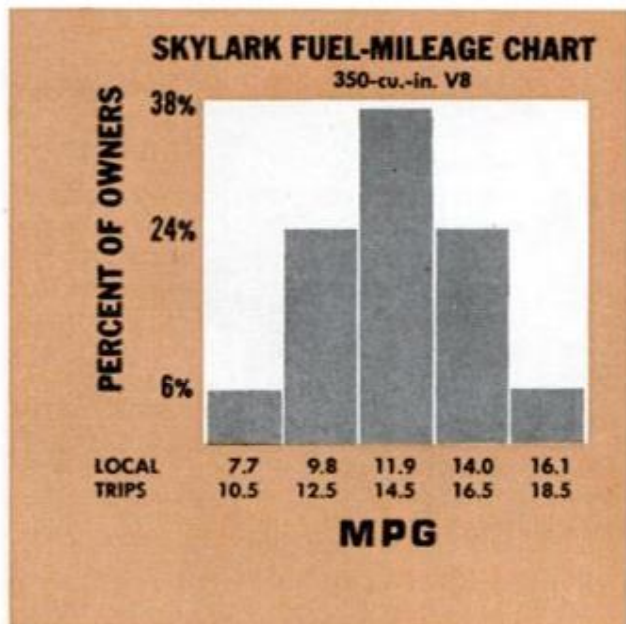

HEADRESTS have only two positions—up and down. Rear-seat riders say it's hard to see out windshield



SKYLARK HANDLING is well liked. Variable-ratio adds only \$15 to price of optional power steering

ments: "Rear-view mirror obstructs forward vision, should be raised." "Front-seat latches are terrible, ought to be relocated." "At 55 mph and above, there's too much wind roar around the windshield. Design should be changed." "Trunk should be larger and lower for better access." "I'd like to see a car about this size with front-wheel drive for better traction on ice and snow." "There is a lot of unused space between the radiator and the front of the car. Part of this space could well be used to give a bit more room for long-legged passengers in the rear seat." "Would like better visibility for backing up." "Glovebox and ashtrays need to be bigger."

How do the Skylark owners rate the cars on comfort? "Needs more headroom and more legroom in the rear seat," says the West Virginia owner of a two-door

TRUNK TOO SMALL, say owners. Spare tire, tools cut into space. Sedan owners are the hardest hit



HORN BUTTONS in steering-wheel spokes are hard to locate in emergencies. Owners would like ring back

hardtop. But an Illinois supervisor with a two-door hardtop doesn't find comfort to be a problem: "On a trip to Florida, passengers reported both front and rear very comfortable." A Chicago city employee reports, "Ride is nice, and the nonpower steering feels comfortable to handle on the road." "Seats could be a bit more firm," writes a New York manager. And a Wisconsin engineer: "Very comfortable front and rear, although my rear-seat passengers are normally children."

What do Skylark owners think of their dealers? "It is refreshing to deal with someone who treats you like a customer *after* you buy the car." "Superior." "Very satisfactory." "Dealer is very courteous. I complained about poor gas mileage, and he explained it was due to the antipollution mechanism." "My dealer's reputa-

WORKMANSHIP GOT GOOD RATINGS, but owners are annoyed by minor things. Loose panel is on PM car





LOW GAS MILEAGE rankled many owners, but ride and comfort scored high, also looks and workmanship

tion was the main reason I chose my Skylark over the Cutlass." "The service advisers are rude and stupid; service is very sloppy and impersonal. I'm only glad I haven't had any serious mechanical difficulties."

Most owners reported no mechanical difficulties at all—61.9 percent said they hadn't yet needed to have any repairs. Actually that's about average (59.1 per-

cent is average for our last 10 Owners Reports, and ironically the Pontiac Grand Ville showed one of our best no-repairs-needed records at 76.3 percent). Capping the repair question, an Ohio plant engineer commented, "You can't beat Buick for mechanical dependability. This is my fifth new Buick, and I've never had a serious mechanical problem."

Those owners who did have mechanical problems cited carburetor maladjustments as their headache No. 1. We've already covered high idle speed and stalling. The other carb complaints centered on leaks, hard starting and a tough-to-set automatic choke.

Overall, Skylark owners endorse their cars more enthusiastically than most. Problems tend to be minor; dealer relations are good; the car excels in handling and workmanship; and nobody complained too much about price. The one big gripe is gas mileage, and here owners really let Buick have it. It should be better. ★★★

Summary of 1972 Buick Skylark Owners Reports*

Total miles driven	963,353
Average miles per gallon	
350-cu.-in. V8	
Local driving	11.9
Long trips	14.5
Engines:	
350-cu.-in. V8	98.0%
455-cu.-in. V8	2.0
Transmissions:	
Automatic	98.1%
3-speed manual	1.9
4-speed manual	0.0
Body styles:	
2-door hardtop	38.3%
4-door sedan	28.0
2-door coupe	20.1
4-door hardtop	10.7
Convertible	2.8
Why the Skylark?	
Past experience	38.1%
Styling	20.9
Size	19.1
Price	9.8
Reputation	9.3
Handling	7.9
Specific likes:	
Handling	51.5%
Ride	35.4

Styling	33.0
Comfort	25.2
Performance	16.5
Size	12.6
Power	12.6
Specific dislikes:	
Low gas mileage	31.7%
Rattles	12.0
Poor rear visibility	5.8
Small trunk	5.8
Dealer service	5.3
Poor workmanship	4.8
What changes would you like?	
More trunk space	12.4%
Better gas mileage	7.3
Different styling	6.7
Different seat shape	5.6
Better quality materials	5.6
More rear legroom	5.6
Had any mechanical trouble?	
No	61.9%
Yes	38.1
What kind of trouble?	
Carburetor	17.9%
Transmission	13.2
Electrical	7.2
Brakes	7.2
Gas gauge	7.2
Did you repair it yourself?	
No	98.7%
Yes	1.3

Dealer repairs satisfactory?	
Yes	52.8%
No	47.2
Is the Skylark your only car?	
No	51.4%
Yes	48.6
Other cars owned:	
Buick	34.8%
Chevrolet	17.9
Ford	15.2
Volkswagen	12.5
Dodge	6.3
Pontiac	6.3
Accessories/power options:	
Automatic transmission	98.1%
Power steering	68.2
Airconditioning	67.2
Radio	60.1
Power brakes	55.6
Tinted glass	30.8
Vinyl top	21.7
Age distribution of owners:	
15-29 years	24.1%
30-49 years	45.3
50-plus	30.1
Would you buy another Skylark?	
Yes	88.4%
No	11.6

*Percentages might not equal 100% due to rounding and/or insufficient data.

SKYLARK'S SIZE is well liked by owners. Wheelbase is 116 in.



Will solar farming solve our power crisis?

Plant a few thousand square miles of useless desert with heat-producing sun traps and you have a solar furnace big enough to run the whole country, say the inventors of this fantastic system for generating electrical power.

By FRANK A. TINKER

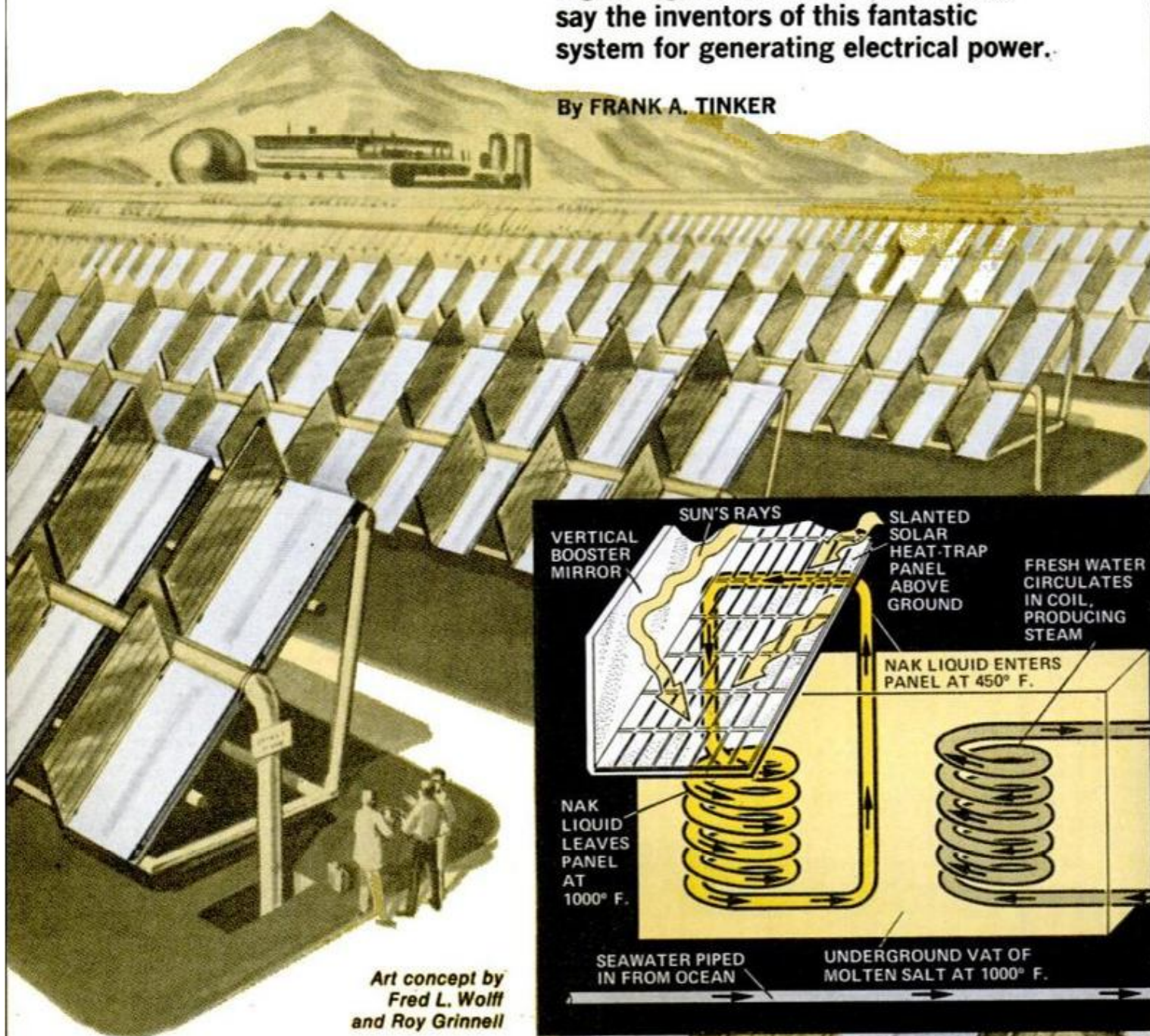

Art concept by
Fred L. Wolff
and Roy Grinnell

THEY MIGHT BE FIELDS of corn or wheat stretching for miles as far as the eye can see—but they aren't. In a bold new scheme to harness the sun's energy, these seemingly endless fields would be "solar farms" planted with heat-trapping devices to "grow" electrical power from sunlight. Sound fantastic? Not according to a husband-and-wife team of research scientists, Dr. and Mrs. Aden B. Meinel, who have already demonstrated a pilot model of their proposed system.

What's so remarkable about the Meinels' plan is not only that it works, but that it could be put into large-scale operation relatively quickly—a vital point in view of the desperate power crisis we now face. Those blackouts and brownouts are no accident. The fact is, we—along with the rest of the world—are simply running out of power sources. Oilmen estimate there are enough petroleum reserves to last only 11 years. Coal, though abundant, is costly to

mine and a major polluter. Nuclear reactors of the size and type needed to produce meaningful power are a long way off.

That leaves the sun—cheap, plentiful and pollution-free. Doctor Meinel, director of the Optical Sciences Center at Arizona University, and his wife, Marjorie, based their system on the heat-trapping ability of microthin layers of gold, hafnium, quartz and other minerals and elements bonded together in sandwich-like panels. The panels work something like a greenhouse, letting solar heat in, then keeping it from escaping. Sunlight is absorbed by the panels, then the infrared portion is trapped inside by the reflective gold or other metallic layers. These imprisoned infrared rays build up intense heat, reaching temperatures of 1000° F.

Each panel is about 3 feet wide by 10 feet long and is angled to catch the sun's rays. A "booster" mirror is attached at a

(Please turn to page 184)

INVENTORS DR. AND MRS. MEINEL examine tiny sample of solar panel at right

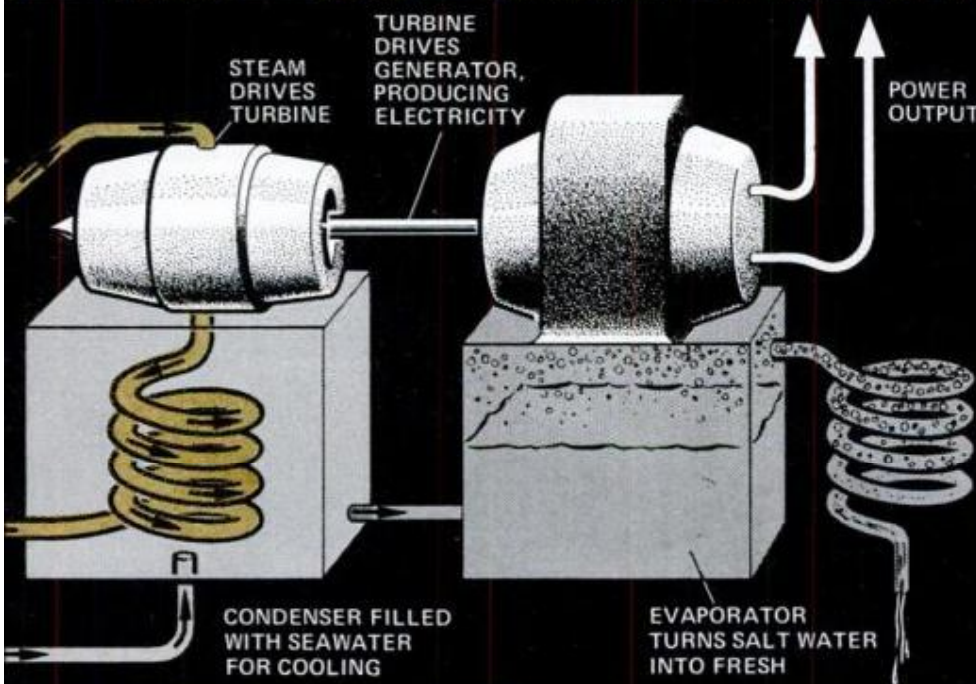
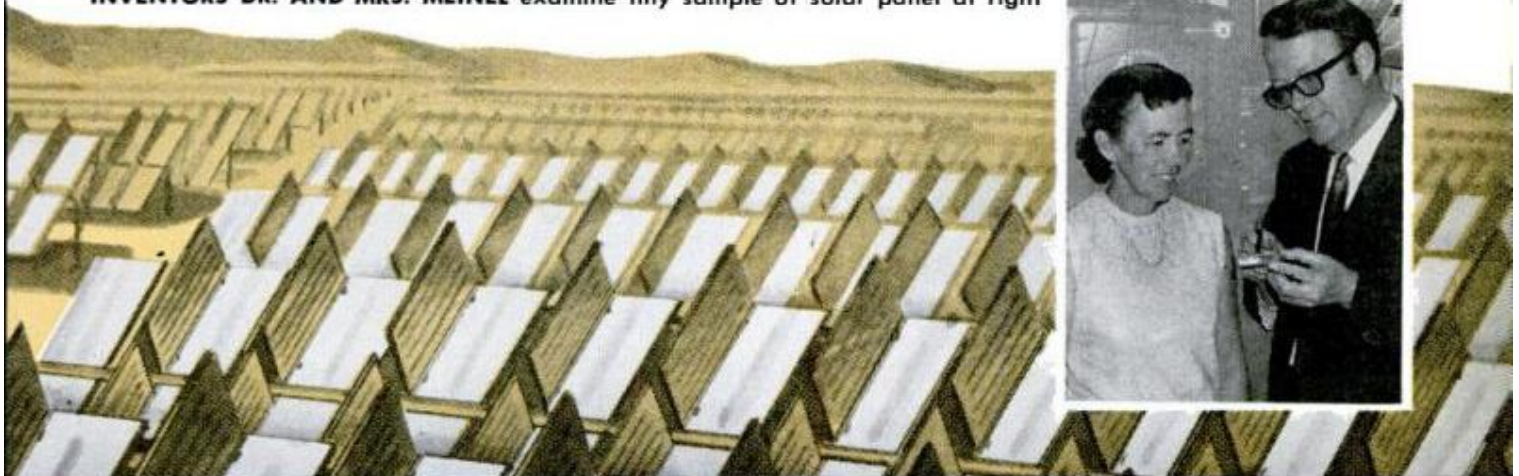

HOW SOLAR HEAT is transformed into electrical power is shown in drawing at left. Literally hundreds of sloping panels catch sun's rays, heating special NAK liquid of sodium and potassium. This, in turn, heats water to create steam to drive turbine that runs generator to produce electricity. In process, seawater for cooling is turned into valuable fresh water



The homebuilt plane



TAKEOFF REQUIRES about 550 feet. Equipped with 150-hp engine, the PL-2 climbs 1700 feet per minute



BIG SPINNER and prominent air inlets add to the PL-2's fast look. Top speed is said to be 150 mph

TWO WINGTIP TANKS hold total of 25 gallons of gas. Navigation light nestles in nose of each tank

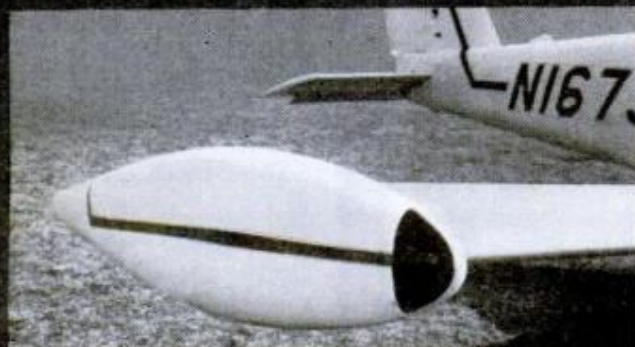

that's going commercial

The Pazmany two-seater is an all-metal plane that's rugged enough for aerobatics. The Nationalist Chinese built 35 of them for use as trainers.

By JOHN F. PEARSON
and HOWARD LEVY

Photos by Howard Levy
Technical illustration by Fred L. Wolff

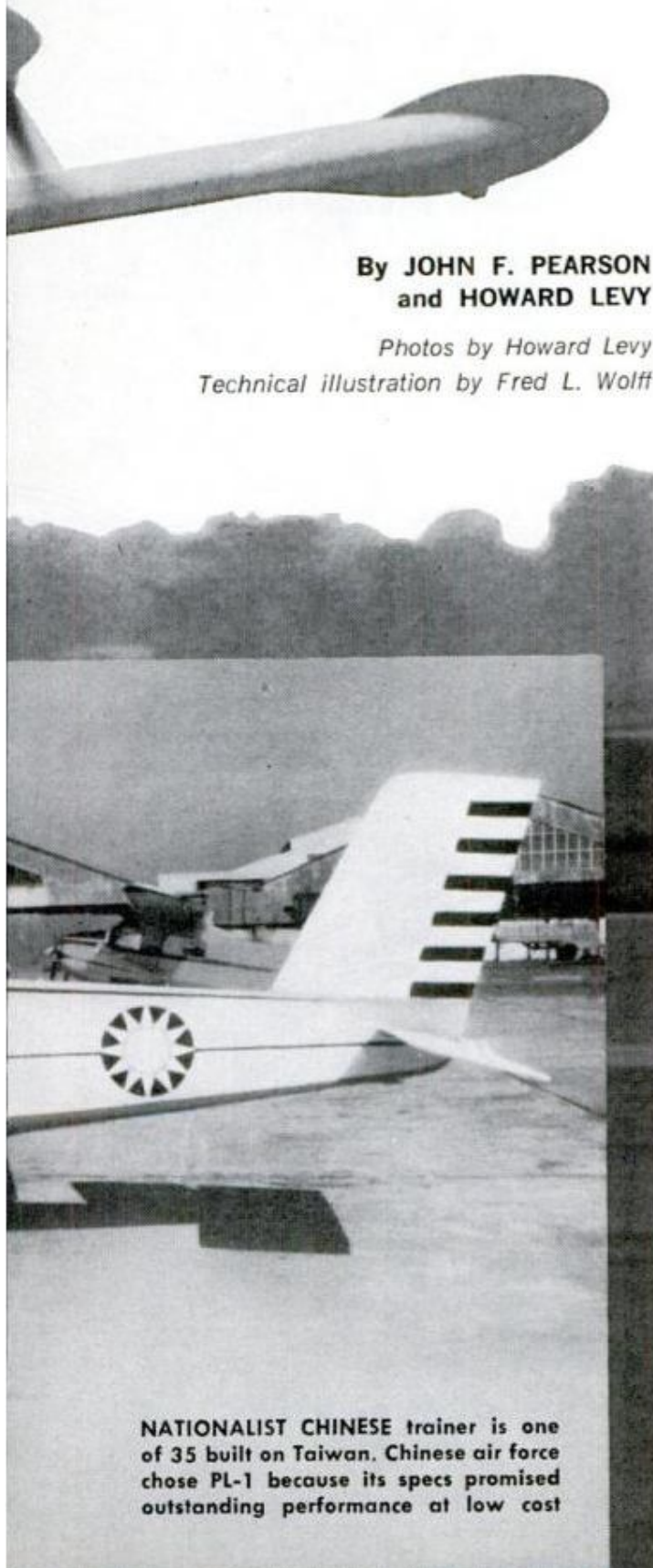

NATIONALIST CHINESE trainer is one of 35 built on Taiwan. Chinese air force chose PL-1 because its specs promised outstanding performance at low cost

THE PAZMANY MUST be one of the most successful aircraft of homebuilt design ever to come off the drawing board.

A prototype of the Pazmany PL-1, the work of two California amateur builders, was first flown in 1962. It performed so well in tests and in actual use—one of the builders commuted to work in it—that its reputation spread. When the air force of the Republic of China chose a primary trainer in 1968, factory-builts were passed over in favor of the PL-1.

Now the South Korean air force is building a PL-2, an improved version of the basic plane, for evaluation, and commercial production by a manufacturer in Japan is in the offing.

The plane has qualities that make it ideal as a trainer: It has side-by-side seating, is what pilots call a "forgiving" plane, and is a rugged hunk of flying machinery that will stand up under student abuse. What appeals to flying enthusiasts is that it is also fully aerobatic and a smooth-looking plane.

It's not surprising that a craft of this caliber was designed by a professional—Ladislao Pazmany, a San Diego aeronautical engineer and an expert in the light-plane field. He estimates that he spent some 12,000 hours over a period of 12 years to work out the engineering and detailed plans for the PL-1 and PL-2.

Plans for the PL-2 are available in sets of 48 drawings. A set costs \$150.

The second PL-1 to be built was the work of Robert L. Miller of Alberta, Canada, who had no knowledge of aircraft construction or even a pilot's license. To educate himself he spent evenings studying the Pazmany blueprints and weekends hanging around a local airport and watching mechanics make repairs.

The airport also was a source of scrap metal, including rivets. Advice and assistance from other homebuilders—a most cooperative breed—helped keep the final cost down to \$2600. It took Miller and his



LANDING GEAR is attached directly to wing spar. Hefty shocks take the bumps out of rough landings

wife, who became a skilled riveter, 26 months to build the PL-1. This plane, too, proved rugged and reliable, and a really good aerobatic performer.

Constructing the Pazmany was a completely satisfying experience for Miller, who later wrote about it in a magazine article.

"The way I see it, the building of an airplane is a challenge, and must be met as such," Miller observed. "One must realize the intricacies involved and be willing to labor for a long, tedious period of time, as delicate work cannot be hurried. If this is clearly understood, there is little chance of becoming discouraged and therefore blaming the design . . ."

According to Miller, there is nothing quite like being able to rub your hand over your plane's wing and "recall the

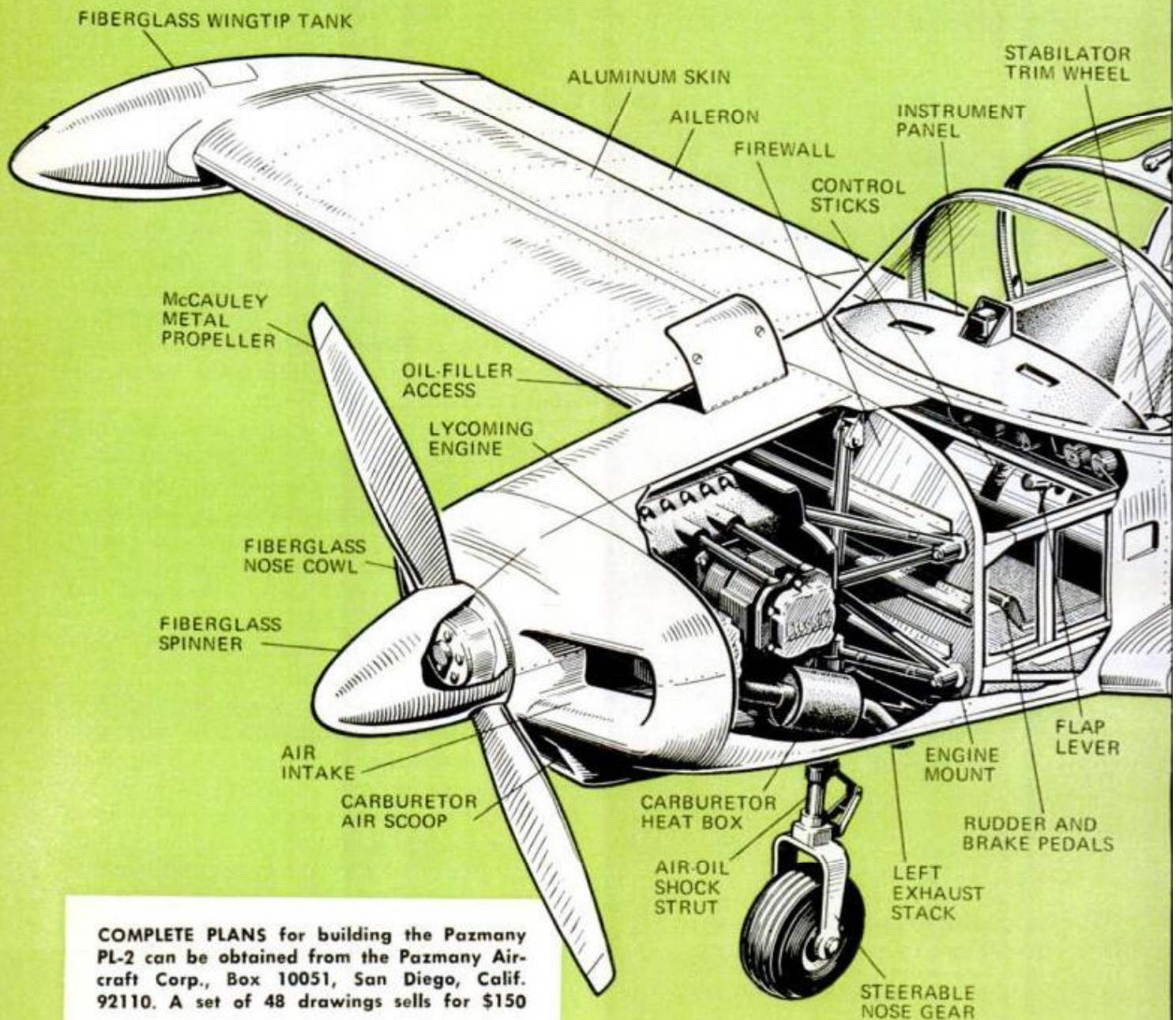

COMPLETE PLANS for building the Pazmany PL-2 can be obtained from the Pazmany Aircraft Corp., Box 10051, San Diego, Calif. 92110. A set of 48 drawings sells for \$150

exact placing of each and every nut, bolt and rivet." The man who buys a factory-built is denied this satisfaction.

The PL-2, like the earlier version, is an all-metal two-seater. It has a wingspan of 28 feet, is 19 feet long and 8 feet 8 inches high. Empty weight is about 900 pounds. It can be powered by engines ranging from 108 to 150 hp. With the biggest engine it has a range of almost 400 miles, cruises at 136 mph and has a top speed of 153 mph. Its rate of climb is 1700 feet per minute.

The fuselage has a conventional structure of frames, longerons and stressed skins. The bubble canopy opens backward on telescopic ball-bearing slides, remaining flush with the fuselage in the closed

position. Behind the two seats is a compartment that can hold about 40 pounds of baggage.

It's estimated that the average builder can expect to lay out about \$4000 for the plane. To date, Pazmany has sold 375 sets of plans to purchasers in all parts of the world. ★ ★ ★

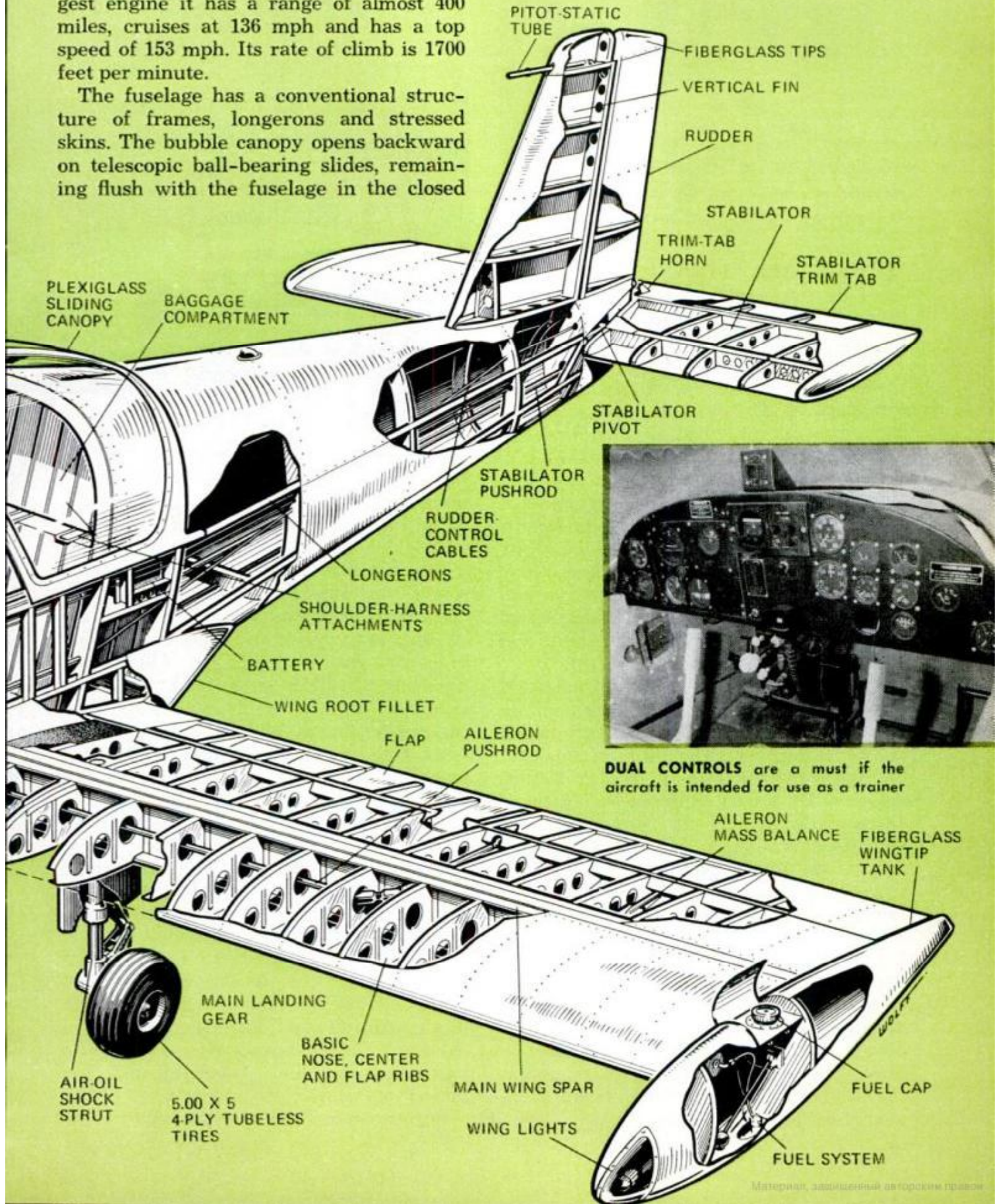

DUAL CONTROLS are a must if the aircraft is intended for use as a trainer



DATSUN PL-620 is successor to the Li'l Hustler—the lightweight pickup that opened up the market

THEY ALL LOOK ALIKE, those lightweight pickups. There are some differences the eye can see, but the similarities are greater than the differences. They were designed, and all start down the assembly line, in Japan: Nissan makes the Datsun; Toyota, the Toyota Hilux; Toyo Kogyo, the Ford Courier and the Mazda B-1600; Isuzu, the Chevy LUV.

Datsun has been the leader in the field since the company made a big success of a sedan that wasn't selling well in Japan: It cut off the rear of the car, added a box and found a growing market. Since then, it has dominated the Japanese market, with over 60 percent of early 1972 pickup sales. Toyota has almost 30 percent, and Toyo Kogyo and Isuzu split the rest.

It was in 1959 that Datsun first imported the Li'l Hustler to the West Coast, selling 159 units in all. It should have been called the Little Sleeper: The estimated market for lightweight pickups in 1972 is 200,000 vehicles! Datsun is shooting for 78,000 of those sales, and its just-introduced second-generation pickup, shown here, will be the lightweight target of second-place Toyota and the growing number of latecomers.

The sales figures have whet appetites at Ford and Chevrolet. Both started importing the Japanese half-tonners under their own names for West Coast and some eastern coastal markets early this spring, and Mazda started bringing in its B-1600 in May. The on-again, off-again rumor is that Dodge will soon import a pickup version of its Mitsubishi-made Colt.

The Are they

By **BILL HARTFORD**, Auto Editor,
and **MICHAEL LAMM**, West Coast Editor



TOYOTA HILUX is the half-tonner that arrived here several years ago to give Datsun some competition

The big market is on the West Coast where you see the minitrucks used for absolutely everything—as campers, for hauling motorcycles and other recreational equipment, reworked by filling stations and small businesses for utility roles, as second cars for outdoorsmen and first cars for teenagers. With mag wheels, wide tires and fancy paint, they're "tough" trucks, the latest "in" wheels for the enthusiasts.

All of the minitrucks, unloaded, ride like fat-farm machines—pretty jouncy. Many owners lay in four 60-pound bags of sand just behind the cab, which they say, helps quite a bit. That extra weight also improves traction and braking, both of which tend to be skittish otherwise.

All the engines use single overhead cams, aluminum heads and cast-iron blocks. All but the Courier and Mazda are oversquare. All come with all-synchro four-speed manual transmissions, but none (yet) come with automatic.

Performance of all is very similar. Don't

lightweight pickups: really all the same?

Datsun, Toyota, Ford, Chevy and Mazda. You can tell them apart by the name that appears on the tailgate! But what are the differences and where should you put your money?

let the Courier's and LUV's lower horsepower figures fool you. Detroit purposefully underrates output these days. We didn't do any side-by-side hillclimbing or hauling comparisons, but it was easy to feel that the four are very closely matched.

Same goes for load capacity—all about a half-ton (plus 300 pounds for driver and passenger). And although these pickups don't take up much garage space, their beds are within four square feet of equaling the El Camino and Ranchero.

As for gas economy, expect 19 to 25 mpg overall. What you get will depend more

Dealers can help you pick and choose. Here's a closer look at each lightweight.

Datsun PL-620. The 521 Datsun's popularity and entrenched position as field leader give it a solid resale value. That should be even more true for the new 620 pickup with its many improvements and refinements. Drive train remains the reliable L16 engine and four-speed synchro gearbox, but under the all-new sheet metal are components that help driveability. Vacuum-assist added to the braking system gives 30 percent more stopping power with the same pedal pressure. Two-stage leaf springs in the rear give a softer ride with light loads, and a new mounting system for cab and bed cuts passenger compartment noise and vibration. The airconditioner can be fitted to the same radiator and the fuel tank is 10 percent larger. Seatback has been reclined for better driving position and a slightly longer cab gives more legroom. Flow-through ventilation is another addition. There are lots of bright colors available, but the best



FORD COURIER is a newcomer made in Japan by Toyo Kogyo, maker of the almost-identical Mazda

on how you drive than on the truck itself. The LUV has the deepest rear-axle ratio and the smallest tank, so you might find yourself pulling into gas stations a bit more often with that than with the rest.

Usable cargo space in all four is chopped up by the rear-wheel houses, but there's little you can do about it. A wide variety of camper bodies and shells is available.

JULY 1972

CHEVROLET LUV, also from Japan, is a Light Utility Vehicle made to United States specs by Isuzu Motors





DATSUN PL-620 interior is neat and functional. Re-design of the side glass eliminates wind wings. There's more legroom, thanks to slightly longer cab

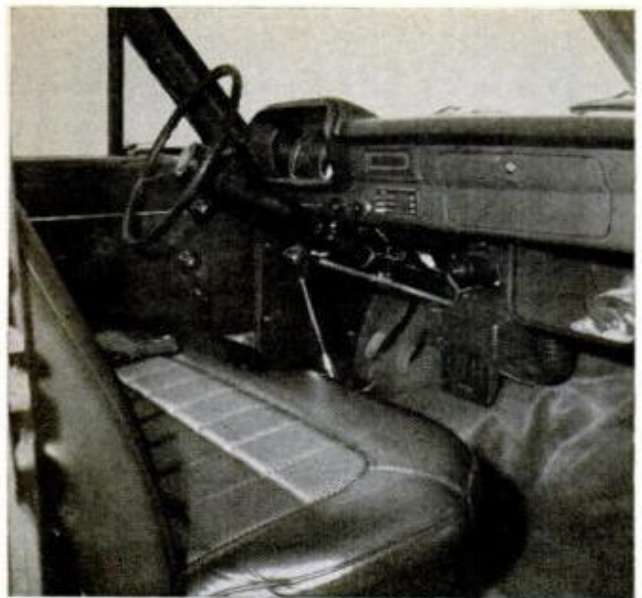

FORD COURIER has bench seat notched for gearshift; lights, other controls on steering column. Automatic transmission is not an option with pickups



CHEVY LUV interior has the most unusual dash design. And like all the other lightweight pickups, it has a convenient parcel shelf below the glovebox

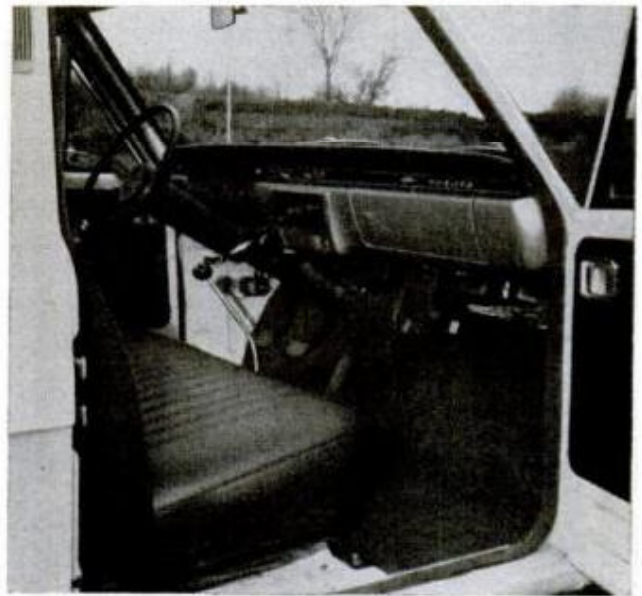

TOYOTA HILUX has a large glovebox, passenger-car-type dash. Seatback rake is good, bench too firm. Steering in all pickups is recirculating-ball type

part of all is that the \$2236 sticker from the 521 carries over to the 620!

Toyota's Hilux, only pickup in its class with a double-wall tailgate standard, is similar to Datsun, yet Hilux lines lack personality. Seatbacks have a good rake, but the bench is thin and too firm. Turn-signal lamps atop the fenders are unnecessarily distracting. The coil-spring front suspension incorporates a torsional stabilizer bar for good handling. Clutch is hydraulic and brakes get vacuum assist (it's been found a lot of women are jockeying these pickups and the power brakes are welcomed). Shifting is not as crisp as we'd like, but the gearbox is strong.

Ford Courier. The grille shows a definite Ford influence and keeps identity in line with other Ford pickups.

The Courier boasts the biggest cargo bed and longest wheelbase in this class. It also has the best ride when unloaded and it does seem to be quieter than the other pickups.

Lights, wipers, washer, dimmer and turn-signal controls on the steering column take some getting used to. The transmission is excellent, but the gearshift lever comes back too far in second and high. To accommodate it, there's a notch in the middle of the seat!

Mazda B-1600. Toyo Kogyo sells it in

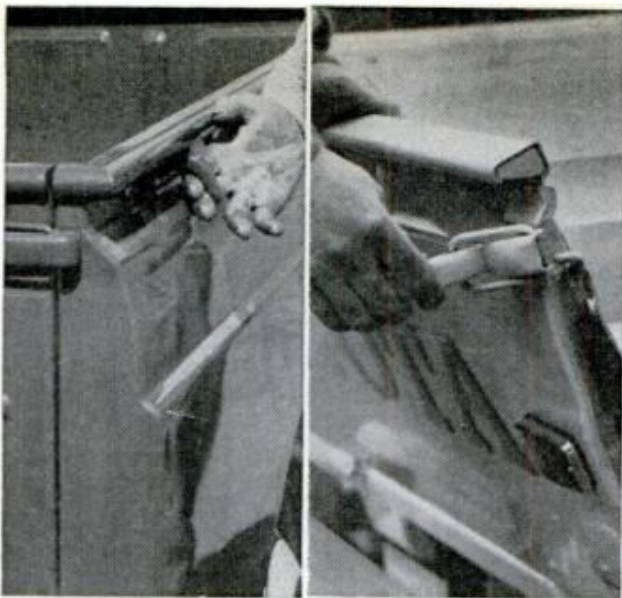

TIE-DOWN HOOKS are standard on all the pickups, as are full-width, bottom-hinged tailgates with latches at the sides and support chains that unhook



CARGO BOXES of the lightweights all have ribbed construction of floor, but not all have a double-walled tailgate. All have a full-width rear window



SPARE TIRE under the cargo bed behind rear axle cranks down from either the side or the rear of all trucks. When up, tire is held by safety chain

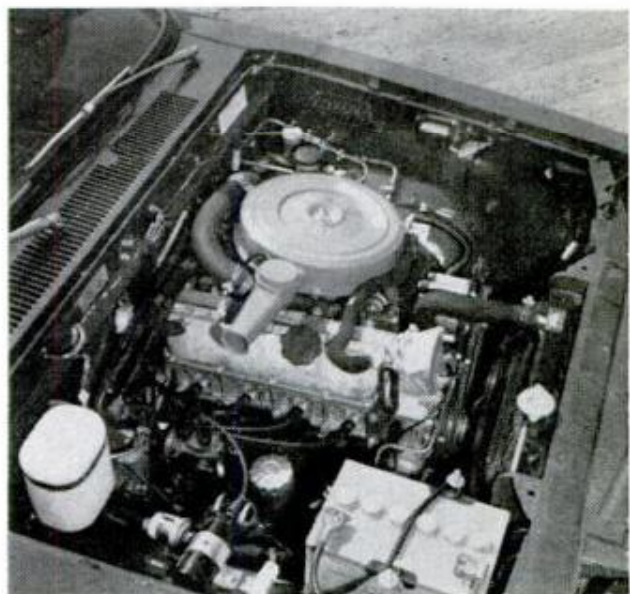

ENGINE CONFIGURATION is single-overhead-cam, in-line four for all trucks. All use two-barrel, downdraft carburetors and operate on regular fuel



CONVENIENT STORAGE for tools and jack is behind backrest of bench-type seat used in all the minitrucks. The bench is on runners but the backrest is not adjustable for rake. Head restraints are not required by government on vehicles in the truck category. Rear window is close behind seat. Helmet is must for off-road racing!

EXTRACTOR VENTS mark lightweight pickup trucks that have flow-through ventilation. Location of the functional louvers is on rear quarter panel of the cab. Datsun, Toyota and Chevy feature the flow-through system. Ventilation system of Ford and Mazda is not the flow-through type. Heaters, of course, are standard in all the trucks

JULY 1972



NEW DATSUN details show the absence of ridge at the tailgate of cargo bed for easy washing out. View of the rear suspension shows the two-stage leaf spring that will give softer ride when pickup is unloaded, and heavier springing that is needed when truck is fully loaded (1440 pounds)

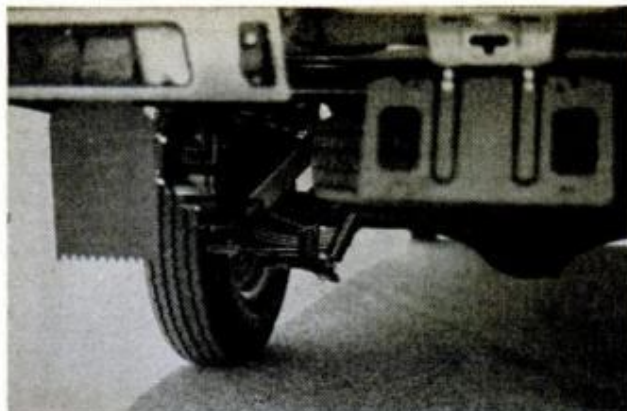

Japan. As of May, Mazda of America began selling it here. It's the same pickup Ford imports as the Courier—the biggest difference being the engine. The Mazda's smaller ohc Four displaces 96.8 cu. in., axle ratio is slightly steeper, curb weight a little less. Like others, Mazda is looking to whittle away some of the Datsun domination of the market, and is doing it with a solid, but conventional pickup: Wait'll they blitz us with a rotary pickup! It's just a matter of time.

Chevy's LUV, basically a Japanese KB-30 Isuzu pickup, is restyled and trimmed to look more like bigger Chevy pickups. Its front torsion bars are adjustable, and there's a 0.71-inch-diameter front stabilizer bar to aid cornering, plus an extra

helper leaf around back. Brakes have vacuum assist. Steering is light and precise, and the stick snaps into each gear with a positive click. The flow-through ventilation system lacks volume. The sloping hood gives great forward vision, and the spare lowers via an insertable crank from the side.

Pricing out all of these pickups with the options you need or want is a tough, nit-picking job. For example: Do you like door armrests? Not all of the trucks have them. You'll have to put them on yourself or consider a different truck—if you live where you have a choice. Not all have national distribution. Selecting one may—alas—come down to dependency on a local dealer. ★★★

LIGHT PICKUP TRUCK SPECIFICATIONS

	Datsun PL-620	Toyota Hilux	Ford Courier†	Chevrolet LUV
Price	West Coast P.O.E. \$2236	\$2222	\$2222	\$2184
Engine and drive train	Engine type	Sohc I4 4	Sohc I4 4	Sohc I4 4
	Bore and stroke	3.27 x 2.90 in.	3.48 x 3.15 in.	3.07 x 3.70 in.
	Displacement	97.3 cu. in.	120.0 cu. in.	109.5 cu. in.
	Net bhp @ rpm	92 @ 5600	97 @ 5500	74 @ 5000
	Net torque @ rpm	99.8 @ 3600	106 @ 3600	92 @ 3500
	Compression ratio	8.5:1	8.5:1	8.6:1
	Transmission type	4-speed synchro	4-speed synchro	4-speed synchro
Hauling	Rear-axle ratio	4.38:1	4.11:1	4.11:1
	Curb weight	2127 lbs.	2447 lbs.	2510 lbs.
	Payload*	1440 lbs.	1400 lbs.	1400 lbs.
Dimens.	Bed length/width/height (inches)	73/56/16	73/56/16	75/62/16
	Wheelbase	100.1 in.	99.8 in.	104.3 in.
	Overall length	169.2 in.	165.9 in.	172.0 in.
	Overall width	62.5 in.	63.2 in.	63.0 in.
General	Overall height	60.8 in.	61.8 in.	61.6 in.
	Front suspension	Torsion bar	Coils, stabilizer	Coils, stabilizer
	Rear suspension	Leaf springs	Leaf springs	Leaf springs
	Tire size	6.00 x 14	6.00 x 14	6.00 x 14
	Brakes	Drum/drum with vacuum assist	Drum/drum with vacuum assist	Drum/drum
Fuel capacity	11.8 gal.	12.2 gal.	11.9 gal.	10.0 gal.

*With 300 lbs. for driver and passenger. †Mazda B-1600 specs same except: Price, \$2195; bore and stroke, 3.07x3.27; displacement, 96.8 cu. in.; hp, 70@5000; torque, 82@3500; rear-axle ratio, 4.375:1; weight, 2470; payload, 1200 pounds; bed width, 57 inches.

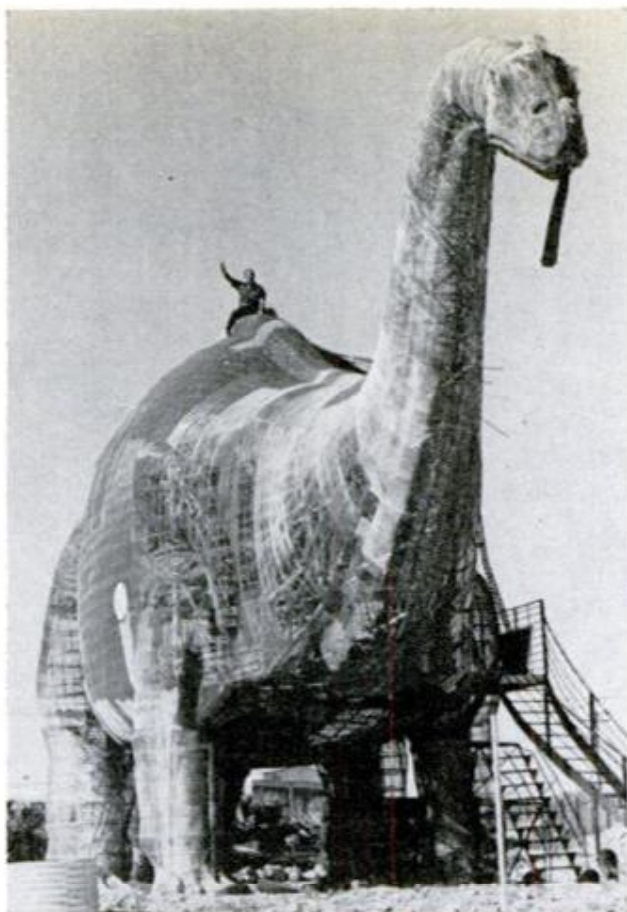

Prehistoric beast appears near Palm Springs

A steel-framed dinosaur, which will be given a "skin" of cement, has been built over the past five years by Claude Bell and Norman

Carner near Palm Springs, Calif. The giant is 150 feet long, 60 feet high and weighs some 150 tons. It'll be a tourist attraction.



'Hover dinghy' designed to explore Himalayan rivers

Testing his air-cushion dinghy in Paris is Michel Peissel, who took the specially made vehicle on an exploration of the river country

of the Himalayas this spring. The British-made dinghy floats on an air cushion created by the horizontal fan behind the operator.

Half train, half plane, it 'flies' at 400 mph!

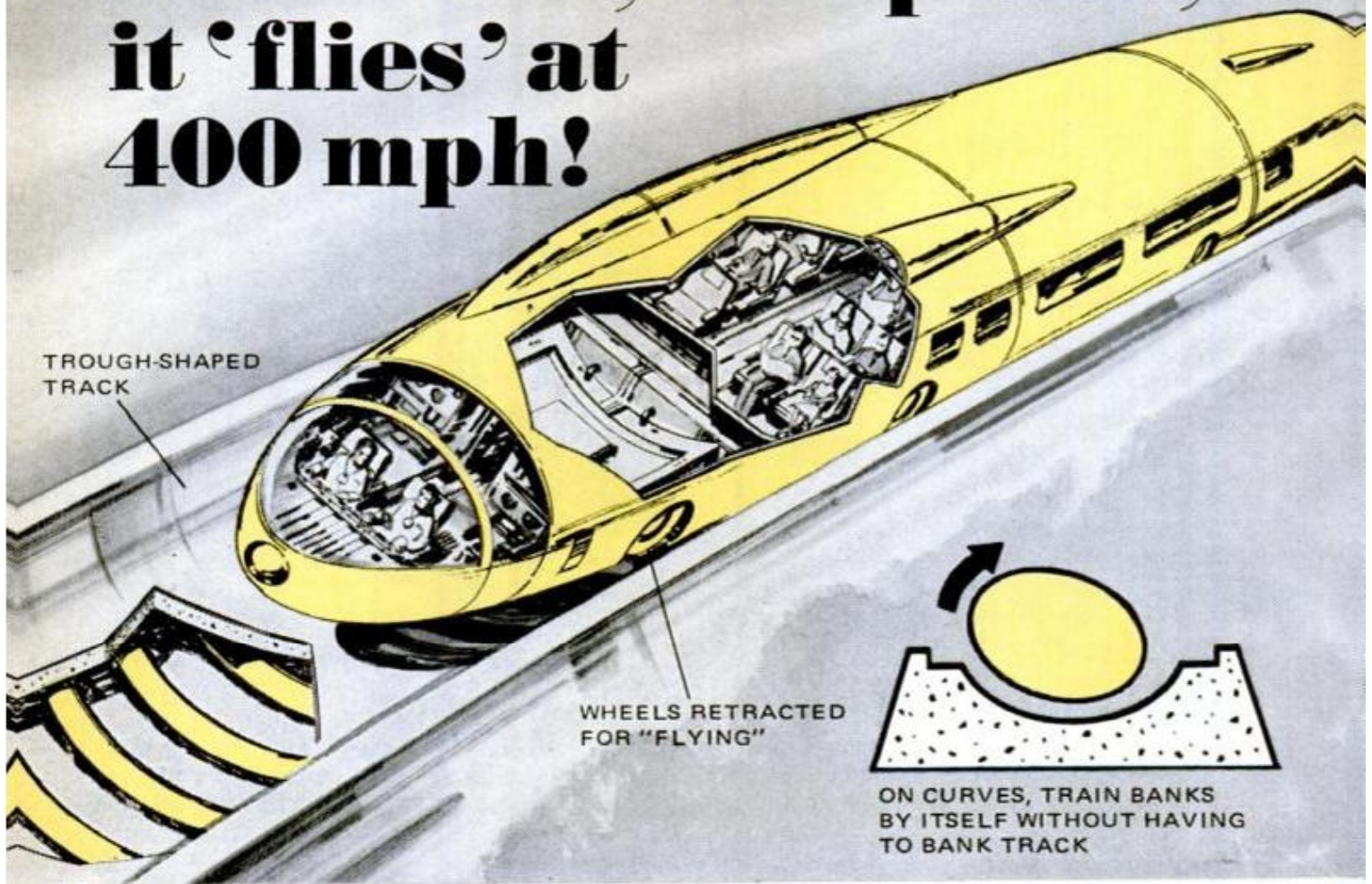

Electronic 'ear' helps make driving safer

Driving along with the windows closed and radio blaring often makes it difficult to hear warning signals such as train whistles, sirens and the horns of other motorists. With this outside "ear," there'd be no problem. An amplifying device hidden in the

rear-view-mirror housing picks up sounds and triggers a dash-mounted indicator inside the car. A light flashes on and an audible warning sounds to tell you danger is approaching. Inventor is James R. Thomas, Fort Worth, Tex.

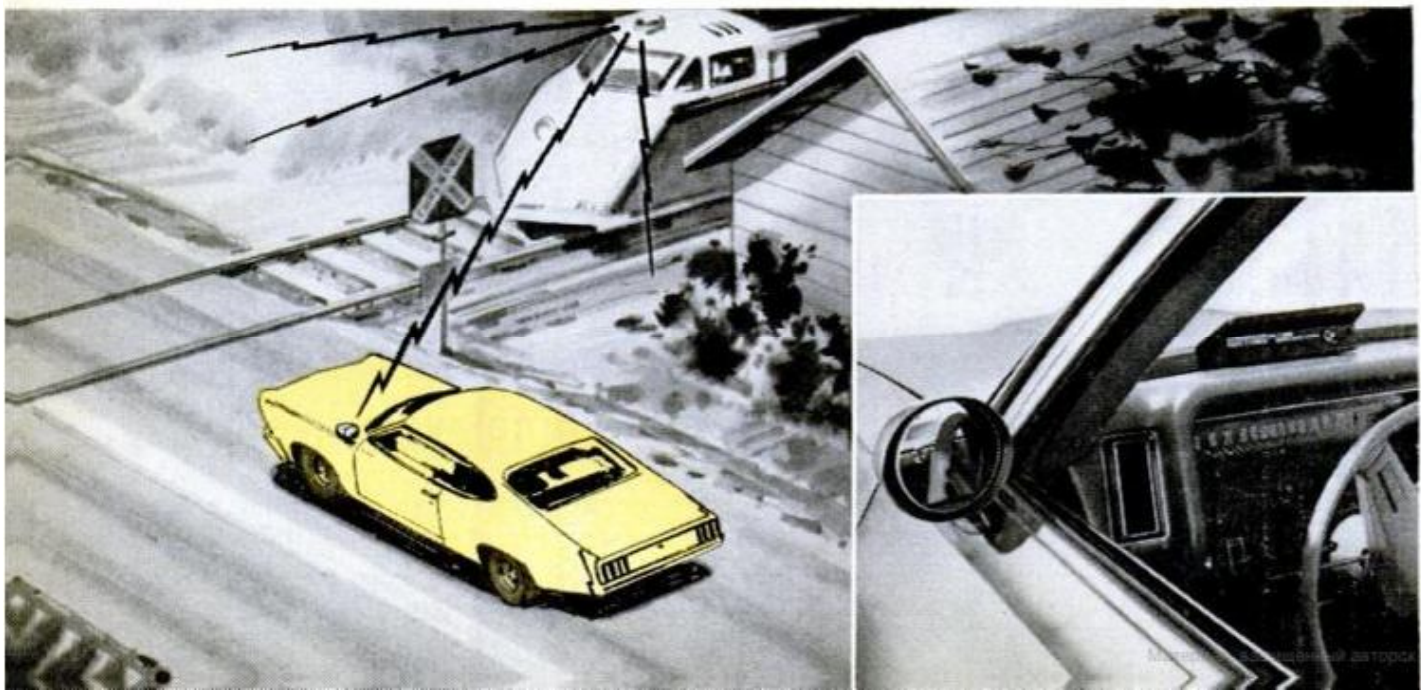

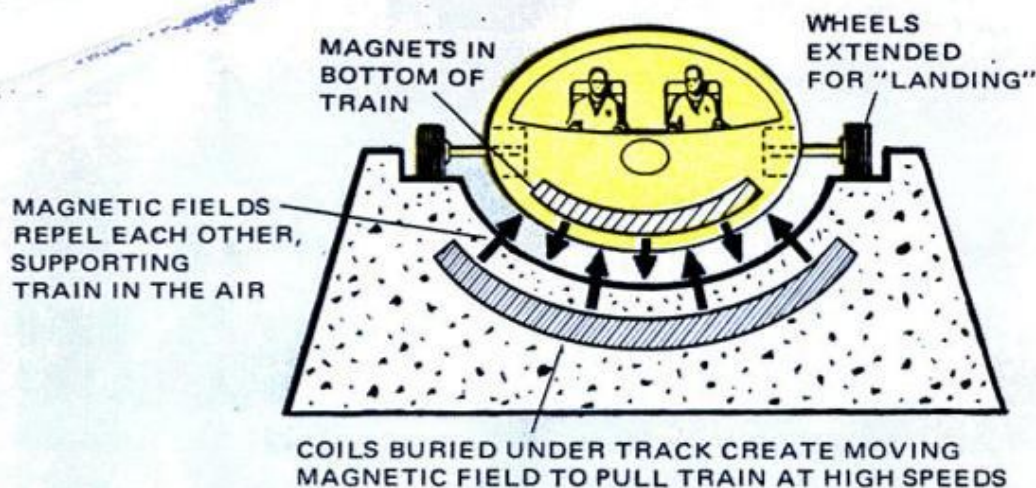

IT DOESN'T FLY ON AIR, yet it zooms along at up to 400 mph without touching the ground. Called the Magneplane, it's designed to combine the speed and comfort of air travel with the greater safety and lower cost of land travel. The 200-passenger wingless craft is actually supported on a magnetic field as it rides in a troughlike track. Magnets in the floor interact with coils embedded in the trough to produce a field of opposing forces that keep the vehicle suspended virtually friction-free a few inches above the track. At the same time, the magnetic field moves rapidly from coil to coil, pulling the craft along

with it. The speed can be controlled merely by varying the rate of the moving magnetic field along the track.

The track doesn't even have to be banked at curves because the craft banks itself like a plane, automatically assuming the correct angle proportional to speed and curvature. By contrast, rail roadbeds must be banked to a fixed angle and are limited in speeds they can safely handle. Small retractable wheels on the Magneplane are used only for "landings" and "takeoffs" at station stops. The project is currently under study by scientists at Massachusetts Institute of Technology.

Flip-top can turns into a disposable mug

They've added a new wrinkle to flip-top beer and soft-drink cans. As you pull a tab, a metal strip peels open the top and at the same time curves outward to form a convenient handle for easy drinking directly

from the container. Handy for camping trips and picnics where glasses often aren't available, the self-handled can was invented by David E. Russell, 110 Riverside Ave., Jacksonville, Fla.



A nationwide survey based on
1,200,000 owner-driven miles



PM
PLYMOUTH FURY
OWNERS
REPORT

Owners stick with a good thing, but bite bullet on gas mileage

By MICHAEL LAMM, West Coast Editor / Photos by the author

THE REASON owners keep coming back for more is that they've had such good service from Plymouths in the past. Nearly 55 percent list "past experience" as their No. 1 reason for buying the 1972 Fury.

Meanwhile, the thing owners gripe about most is poor fuel economy. Says a Michigan retiree, "Gas mileage is too low. I got at least 16 mpg around town with the old Belvedere; am now lucky to get 10 mpg." A Virginia housewife adds, "It's an easy rider and handles great, but it gives the worst gas mileage we've ever had." By "worst," she means 13-14 mpg average from the 360-cu.-in. V8.

Here are some other reasons people gave for choosing Plymouth over its competition. "Because Chrysler Corp. has the best-engineered cars today."—Maryland retired plumber. "I think Chrysler builds a good product; all my previous Chrysler Corp. cars gave me good service with normal maintenance."—New York accountant. "I liked the style, and I've gotten better service from Plymouth than from Ford or Chevrolet."—South Carolina textile tradesman. "90 percent for its appear-

ance and 10 percent for its quality."—Ohio engineer. "I thought it was good on engineering and would give me long, care-free service."—Bronx packer. "A sporty-looking car in the lower price ranges."—Detroit autoworker.

Once they've lived with their Furies for awhile, what do their owners think of

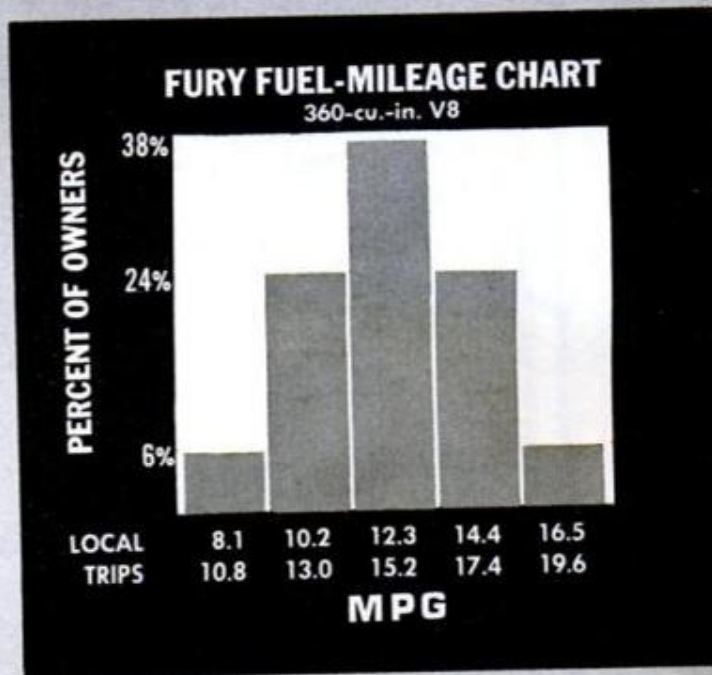

them? Here are representative comments:

"I don't think there is any car on the road that drives as nice as the Fury III. Dealer is good—I go in, they take care of me quick. I never need an appointment."
—Ohio truck driver.

"Very roomy, very good dealer. I bought a new 1966 Sport Fury, liked it so well I got hooked on Plymouths. I like everything about mine but the gas mileage and the rough idling, both caused by the smog control."—North Carolina mechanic.

"Very courteous and fair salesmen but poor service. The car is good mechanically but poor bodywise. I purchased this car last November. First time it rained I ended up with a 3-inch puddle in the left-rear foot well. I've brought the car back to the dealer four times, but it's still the same. Otherwise it's very comfortable, easy-riding, easy-handling."—New York postman.

"I got sick of the trouble I was having with GM cars. This Fury is the best-riding, best-handling car I've ever had. I have no complaints except gas mileage."—Pennsylvania railroader.

"It's a shame I couldn't wait—I just had to be the owner of one of the first 1972 Plymouths built. Workmanship is lousy. The body isn't tight, the instrument panel isn't arranged correctly, the trunk lid keeps falling shut. I've installed 2½ sets of new shocks to try to correct a knocking noise in the rear end. I also get a lot of wind roar from the side windows at turn-pike speed. Among inherent flaws, the



ELECTRONIC IGNITION (on firewall) uses no points, can't wear, keeps emissions low and engine in tune

front seatback isn't straight enough. I hit my knees on the dash. The brake and hood releases are too close together. Rain drips off the roof when you open the door. And the dealer keeps stalling on service."
—Missouri salesman.

"I am a high-speed driver," says a Des Moines commercial artist and sometime flyer. "To me, a car has one function and that is to run and furnish transportation when I want it. I'm driving my seventh Chrysler product, and none has ever failed me. What I expect from my Fury is dependability, power, lasting qualities, styling, lack of high maintenance costs, plus acceleration and speed when I need it. My one complaint is the lap-belt locks. They're hard to fasten and would be rough to release in a wreck. Belts should release with a flick of the finger—like releases on a parachute."

"Workmanship is good when you com-



RELEASE PULLS for hood and emergency brake stand too near each other. Drivers often confuse the two



REAR-BUMPER RUBBER, supposedly permanent, pulls away. Platers say it makes bumper hard to straighten



BIG TRUNK has high loading sill. Owners appreciate roominess, say they like the lock offset to right



POWER DISC BRAKES cost only \$63 extra, give excellent stopping. Fury's clean styling turns heads



SOME OWNERS feel interior design lacks verve, is uninspired compared with car's flashier exterior styling

pare it with other American cars. I'm very satisfied with my Fury III in all areas, but I'd like to see them bring back vent windows, and the 400-cu.-in. V8 really doesn't get good gas mileage. It's good-looking, the airconditioning is excellent, and it's comfortable."—Georgia construction firm owner.

"After driving a short distance and then stopping, the engine is hard to restart. My dealer is okay, but he hasn't been able to correct the hard starting. We traded a 1969 Fury and got a fair deal. I'd like better mileage and a vent on the right side. It rides and handles well, and although it's no fault of the car, I find it a little large. The middle seat belt is too short. I complained to Chrysler about this, and they told me it was a government law. If so, it's stupid, because I'll never use the belt and I'm sure lots of other people won't either."—Ohio retiree. [Chrysler Corp. dealers tell us they recognize the short seat-belt problem, and most will correct it free of charge.]

"I bought my Fury on the strength of quality and performance observed in Chrysler products owned by friends, family, police and taxis. I'm very pleased with my car's durability, performance, and styling, but what bothers me is the steady decline from year to year of gas mileage. I also think the interior looks crude in comparison with GM and Ford cars. When I got my Fury, the rear wheels sounded loose, and there was a popping noise in the left-front suspension when driven over uneven surfaces. Also water leaks around both front doors. The dealer fixed the leaks, but the noises persist."—Texas parole supervisor.

"Hard starting when warm. Cold, she starts the instant you hit the key. The dealer has tinkered with the carburetor, choke settings and timing, but it seems to get worse. I've always owned Plymouths, and I like my Gran Coupe overall—the ride, performance, convenience, comfort, and options, particularly the disc brakes and rear-window defroster."—Illinois salesman.

"I owned two Fords and two Dodges, but this Fury is the best. I like the unitized body, good visibility, styling, gauges instead of lights (but I would like an oil-pressure gauge). Workmanship is excellent—good paint job and all chrome and trim fit well. Right after I got the car, the



MORE THAN HALF of Fury buyers have owned Plymouths before. Age distribution is very even, meaning that car appeals to all age groups. Unit body and torsion-bar suspension are among car's technical advances

left-front disc brake locked, causing the car to spin completely around. This was fixed promptly at no charge—a very courteous, friendly, understanding dealer. No runarounds.”—Louisiana teacher.

“Windows leak air, don't seal right,” says a self-employed Illinois man, “but that's my only major complaint. I do think my 1969 Fury was built a lot better, yet the 1972 is comfortable, handles well, and I like the fan that keeps fresh air circu-

lating.” [Most owners said they didn't like the fan.]

Finally, from a pleased Brooklyn sales representative: “It's one big, beautiful auto. It handles well and stops on a dime. The dealer replaced a cracked head gasket and adjusted the trunk lid. Otherwise everything has been fine. Mechanically, I think Plymouth is far superior to GM and Ford. It's a very comfortable car front and rear.” ★ ★ ★

Summary of 1972 Plymouth Fury Owners Reports*

Total miles driven 1,200,262

Average miles per gallon
 318-cu.-in. V8, local driving . 12.5
 long trips . 15.2
 360-cu.-in. V8, local driving . 12.3
 long trips . 15.2
 400-cu.-in. V8, local driving . 11.3
 long trips . 14.2

Engines:
 318-cu.-in. V8 35.6%
 360-cu.-in. V8 52.7
 400-cu.-in. V8 11.7

Transmissions:
 Automatic 99.1%
 3-speed manual 0.4
 4-speed manual 0.4

Body styles:
 2-door hardtop 38.3%
 4-door hardtop 32.4
 4-door sedan 29.3

Why the Fury?
 Past experience 54.6%
 Styling 17.5
 Price 13.3
 Dealer service 7.1

Specific likes:
 Handling 47.0%
 Ride 42.9
 Styling 34.6
 Comfort 34.1
 Performance 16.6
 Economy 11.5
 Power 8.3

Specific dislikes:
 Poor gas mileage 23.1%
 Rattles 15.0
 Short seat belts 7.3
 Poor workmanship 5.1

What changes would you like?
 Exterior design 10.1%
 Add vent windows 9.7
 Improve rear vision 9.2
 Use better materials 6.8
 Better workmanship 5.8
 Change seat shape 5.3

Had any mechanical trouble?
 No 51.2%
 Yes 48.7

What kind of trouble?
 Carburetor 19.7%
 Electrical 11.1
 Cold starts 9.4
 Brakes 6.0
 Power steering 5.1
 Transmission 5.1
 Shock absorbers 5.1

Did you repair it yourself?
 No 95.7%
 Yes 4.3

Dealer repairs satisfactory?
 Yes 72.1%
 No 27.9

Is the Fury your only car?
 Yes 52.5%
 No 47.5

Other cars owned:
 Plymouth 36.0%
 Chevrolet 14.9
 Dodge 11.4
 Ford 8.8
 Chrysler 7.0
 Volkswagen 6.1

Accessories/power options:
 Automatic transmission 99.1%
 Power steering and brakes 86.3
 Airconditioning 57.9
 Radio 57.9
 Vinyl top 21.5
 Tinted glass 20.2
 Remote sideview mirror 13.9
 Power steering (alone) 12.0
 Light groups 9.9
 Cruise control 9.9
 Power seats 3.9
 Power windows 3.5
 Sunroof 0.4

What options/accessories would you order next time?
 The same 68.4%
 Airconditioning 7.9
 Power windows 6.1
 Rear defroster 4.8

Age distribution of owners:
 15-29 years 15.4%
 30-49 years 44.7
 50-plus 40.0

Would you buy another Fury?
 Yes 86.0%
 No 14.0

*Percentages might not equal 100% due to rounding and/or insufficient data.

How to avoid a \$30 repair bill

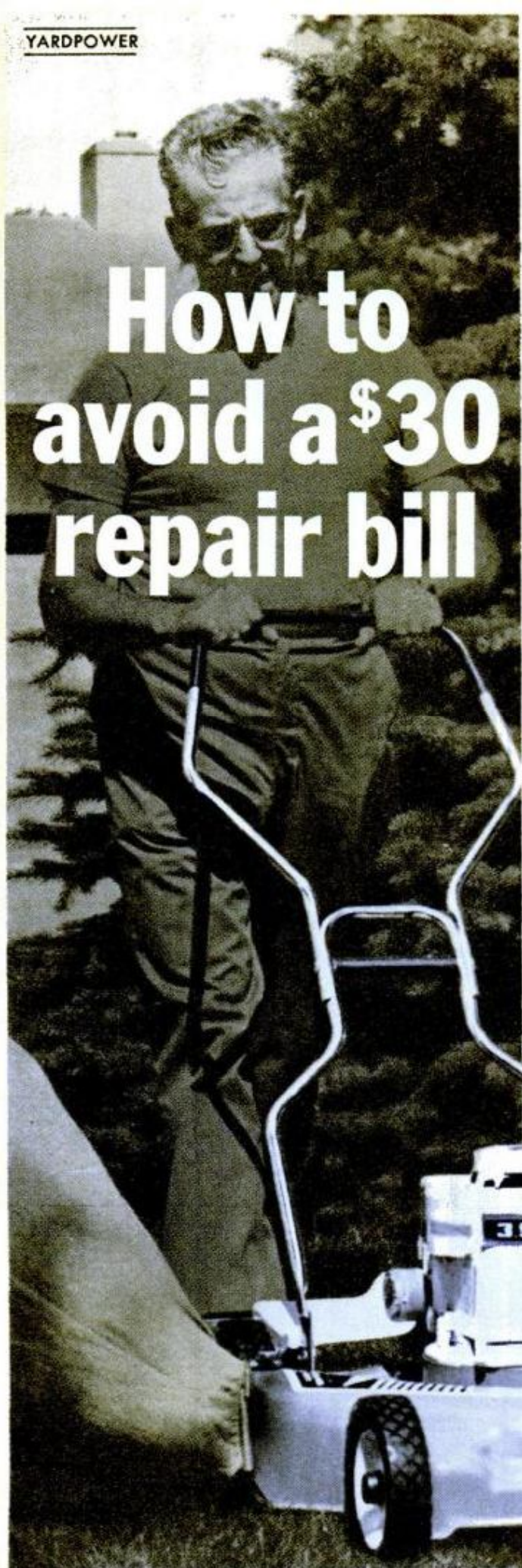

WILL IT COST YOU \$30 and an hour's time to mow your lawn some day this summer? It could, if you neglect preseason preparation for your mower and then skimp on preventive maintenance during the season.

In less than an hour, an engine running on a contaminated or low oil supply, or with an improperly serviced air cleaner, can score a crankshaft, connecting rod, cylinder wall and piston.

For an average 3½-hp engine this would add up to a new crankshaft at \$13.95; connecting rod, \$3.95; piston rings, \$4.50; gasket set, \$3. Add the cost of an hour's labor—at \$8 an hour—and you would have a total bill of \$33.40.

The engine is the heart of power lawn equipment and, like the motor in your car, requires periodic checks. Most small air-cooled engines run between 3200 and 3600 rpm, which adds up to a lot of spinning and possible wear through friction.

For the most part, concentrate your maintenance work on three major systems—intake, lubrication and fuel. Check each system in a step-by-step procedure. *Caution:* Before working on a mower, disconnect the sparkplug wire to prevent accidental starting.

Intake system. This is the component through which the engine breathes—it draws in air to mix with the gas. Dirty air entering the engine through an improperly serviced air cleaner is frequently the cause of hard starting, loss of power and complete engine failure.

Neglected maintenance can easily cost you that much in parts and labor

By JOHN L. O'ROURKE
POPULAR MECHANICS

There are three common types of air filter; each should be cleaned after every other mowing.

● **Polyurethane sponge.** This type should be washed in a detergent solution or solvent. Squeeze the sponge dry, then pour new engine oil into it. Work in the oil and squeeze out any excess. Clean the container that holds the element before putting it back. Check to make sure that the cover fits securely.

● **Paper element.** This very effective type of filter can be cleaned by tapping it gently and blowing low-pressure air through it. The element should be inspected for holes that would allow dirt to enter the engine. If severely clogged or distorted, replace with a new element.

● **Oil bath.** Basically, this is a container that uses a layer of oil to trap dirt particles. Wash the element in a solvent such as kerosene and add fresh oil to the proper level indicated.

If an air cleaner is doing its job, it will collect enough dirt to restrict the flow of air to the carburetor, and the engine will begin to run rough. Check the condition of the air cleaner before attempting a carburetor adjustment. Never run the engine without an air cleaner.

Lubrication system. Two types of air-cooled engines are used on lawn equipment: two-cycle and four-cycle. Each requires a different method of lubrication.

The four-cycle engine carries its oil supply in its base. The oil is pumped or splashed to the moving parts. Most manu-

facturers of four-cycle engines recommend an SAE 30 MS grade oil. The MS stands for "motor severe," indicating that this oil will withstand high engine heat. Oils designated ML (motor light) or MM (motor medium) will not hold up.

Oil should be changed on a regular basis, at least every 25 hours of running time; more often if there's dust in the air. An oil change is your cheapest insurance against engine failure.

To change oil, run the engine until it is at operating temperature. Turn it off, remove the filler and the drain plugs, and let the oil run out. Replace the drain plug and, after making sure that the engine is level, add fresh oil. Consult your owner's manual for the correct amount of oil. Because of the small capacity of these engines, you must maintain the proper oil level for cooling as well as lubrication.

If you have a large garden tractor that's used the year round, be sure you're using the proper weight oil for the season. When it's above 40°F. use MS 30; when it's below, use MS 5W-20.

Two-cycle engines get their lubrication from oil mixed with gasoline, and the ratio varies for almost every make. Once again—check your owner's manual. Mix the oil and gas thoroughly and use all the mixture from the storage can before preparing a new batch. This will prevent a buildup of the oil ratio and assure you of having fresh gas.

Fuel system. It requires little service, but be sure that what you pour into the

AFTER CLEANING an oil-bath filter element, add fresh oil to the container, following instructions in owner's manual. Sponge element (center) should

be squeezed to remove any excess oil. Too much oil will restrict air. Improperly serviced air cleaner resulted in the worn piston pictured at right



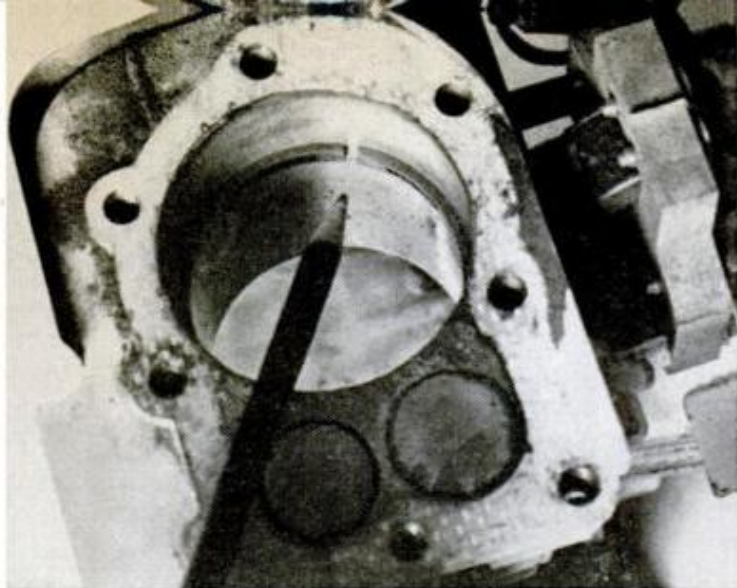

ACCUMULATION OF DIRT IN OIL SUMP (upper left) is the prime cause of premature wear in engine

DIRT CAUSED this excessive piston-ring gap (above) which results in low power and high oil consumption

WEAR ON UPPER MAIN BEARING (far left) resulted from dirty oil. Be sure to clean around oil filler plug before removing it to keep dirt from entering



Here are additional tips for keeping your mower healthy:

- *Keep cutter blades sharp and balanced.* If the blade on your rotary is badly nicked, replace it.
- *Clean grass cuttings* from engine cylinder fins and head after each mowing.
- *Keep all belts at proper tension.* Be sure that gear boxes and pulleys are well lubricated.
- *Operate the engine at proper speed,* usually between 3200 and 3600 rpm. This will assure proper lubrication and cooling. If engine runs hot, check to see that you are using the oil specified by the manufacturer. If it's a two-cycle engine, make sure you are using the correct mixture of gas and oil.
- *Scan the area to be mowed for obstacles* that could cause a bent crank, sheared flywheel key or possible injury to yourself or others. ★★★

tank is gasoline. Many a tank and carb have gotten fouled up by kerosene, paint thinner and other liquids. Use a clearly marked can for your gasoline. If you have two-cycle and four-cycle engines, it's doubly important to use gas cans that are readily identified.

Buy gas—regular, not premium—in limited quantities so that it will be fresh. This prevents gum and varnish deposits that could plug the carb.

When storing the engine, drain all the fuel from the tank. Then run the engine until it stops. Or you can buy a commercial additive that will prevent the gas from going stale.

REGULARLY LUBRICATE all controls and check for travel on linkages and levers. Good maintenance can prevent breakdowns

CHECK THE BLADE and hub assembly for wear, tightness (far right). Replace a badly worn, nicked blade. Be sure you remove spark-plug lead before you start work on the blade assembly

110



New for boatmen



PAPOOSE is an 8-foot 20-pound aluminum canoe with Dow Ethafoam lining and sponsons for stability and flotation. Small enough to fit in the back of a station wagon and light enough to portage through the woods, the little craft from Sportspal Inc., Emlenton, Pa. 16373, could prove popular for packing in to remote fishing hot spots. It is \$185 f.o.b.

SAILOR SET of rigging knife, marlin spike and fitted leather sheath provides an old salt's standby at a new low price: \$7.95 plus postage. Both marlin spike and 3 $\frac{3}{4}$ -inch blade are stainless steel; sheath is rivet-reinforced. Goldbergs' Marine, 202 Market St., Philadelphia, Pa. 19106, offers 6000 more boating items in \$1 mail-order catalog.

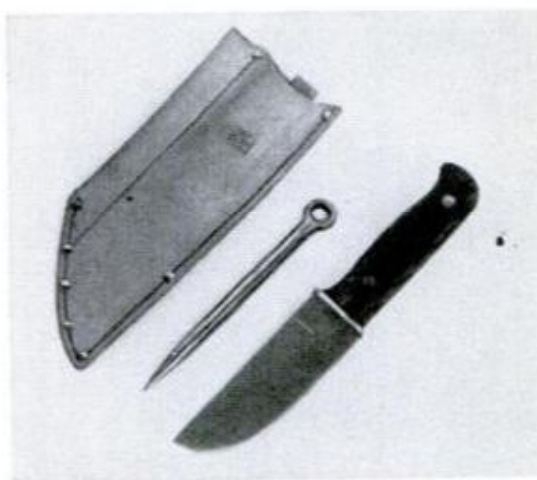

PACK/RAFT, a \$120 inflatable boat from American Safety Recreation Products Group, 16055 Ventura Blvd., Encino, Calif. 91316, is said to weigh in at under five pounds, fit in a 20x8-inch stuff sack, and blow up to 72x43 inches for floating two full-sized fishermen. Wilderness bed, bathtub and shelter as well as boat are other recommended uses. Neoprene-coated nylon meets military specs.



FLEX-A-TRIM trim tabs are claimed to adjust continually and automatically to boat speeds when installed on the transom of any power craft up to 24 feet. By flexing to water conditions and speed, tabs are reported to help prevent squatting, pounding and porpoising, raise the hull more quickly onto plane, improve and level running angle, and reduce power and rpm necessary for most speeds. From Scott Molding Co., Box 2958, Sarasota, Fla. 33578, the Flex-A-Trim tabs list at \$17.50 per pair.



ODDS ARE 10,000 TO 1 that thieves who dial this ignition system get a wrong number. See page 118

MAKE THIEVES CRAWL with this do-it-yourself accelerator lock. See types on page 117

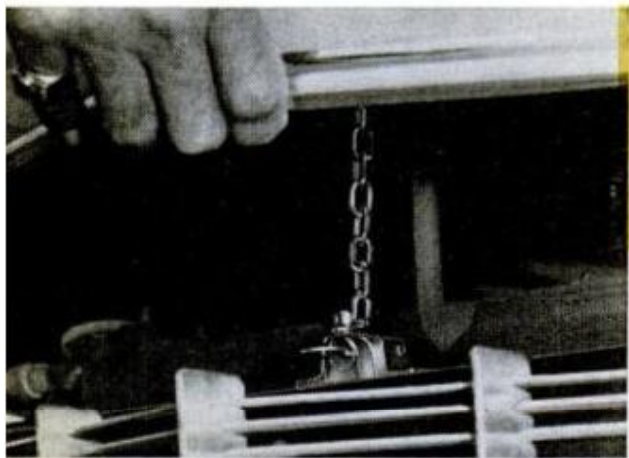
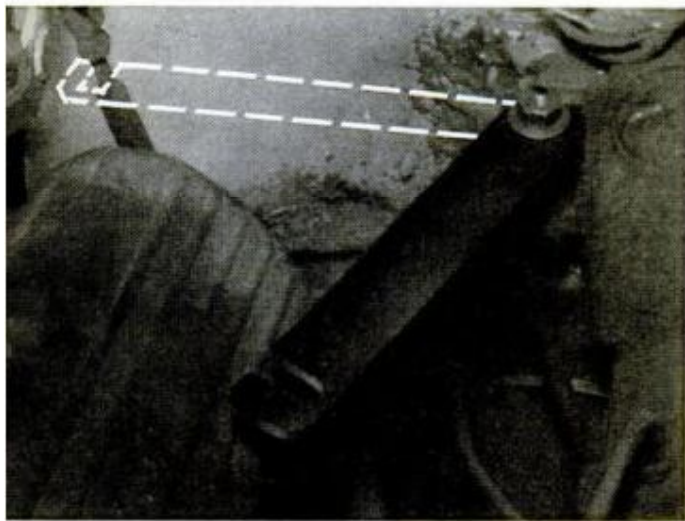

YOUR RADIATOR CAP is all you'd lose with this hood lock on. See page 115

PUT THEM ALL TOGETHER and they scream, "Stop, thief!" For more alarms, see page 116

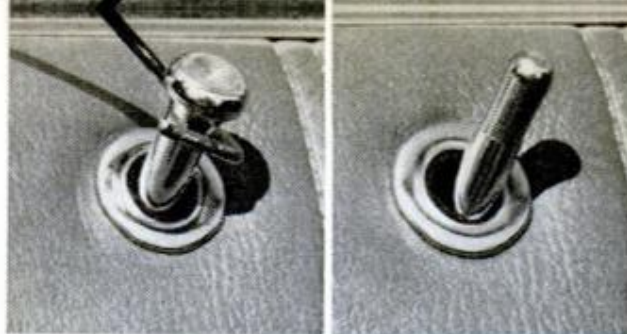

ONE WAY TO NIP mushrooming auto thefts: Replace your car's mushroom door-lock buttons. See page 115

17 ways to

By **FRED W. SCHLUETER**

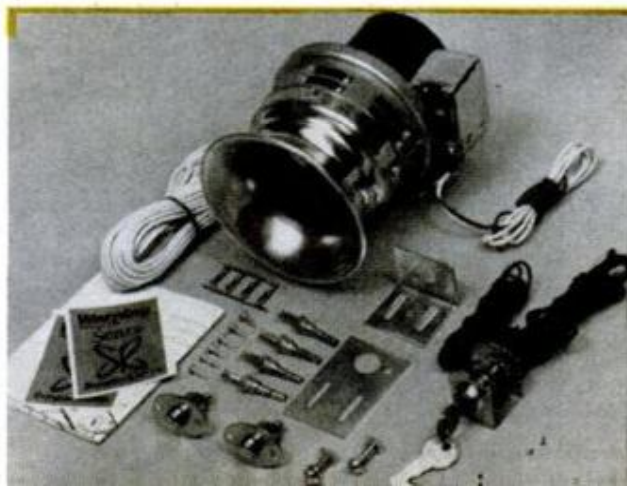

IF YOUR CAR has never been stolen, stripped or broken into, it might seem a bit extreme to equip it with all the safeguards illustrated here. But with thieves taking one out of every 99 U.S. cars last year—and with countless thefts from car interiors—it's all too likely that you either have been a victim or will be sometime in the future. And once you have, no amount of theftproofing may seem enough.

So here are 17 basic types of theftproofing gadgets for your car, with a few variations on the basic themes, and some hints and tips thrown in for good measure. You probably won't try them all at once, but if you do, the odds against your car's being stolen or broken into will go up dramatically.

There's a lot you can do to discourage thefts without spending a penny on gad-

thiefproof your car

*Technical illustrations
by Peter Trojan*

getry. When you park, always lock the doors, ignition, trunk and windows, and remove the ignition key—even if you're "just leaving the car for a minute"; the average thief takes just minutes to get a car opened, started and away. Do this even if your car breaks down and you leave it to look for help. Just because you can't start it doesn't mean a more knowledgeable thief might not be able to.

Don't leave your license, registration, or other identification in your car (unless your state requires it), or you'll help a thief "prove" ownership if he's stopped. And even if a thief doesn't take your car, he may take your registration papers, license plates, or Vehicle Identification Number (VIN) plate, to cover the theft of some other car.

When you return to your parked car, check to make sure your plates, VIN and papers are intact. You and every driver in your family should also carry complete information on your car's make, model, year, color, license plate and VIN, at all times. Then, if your car is stolen, you'll be able to tell the police, on the spot, just what to look for.

When you park in public lots or garages, don't tell the attendants when you expect to be back. Unscrupulous attendants can drive your car away to replace your new, saleable parts with old and worn ones, if they know they have time. When you pick your car up at a garage, check its mileage—a few miles added since you parked it may indicate just such a parts swap. At the least, it means your car has gone on an unauthorized joy ride.

Marking your car unobtrusively won't prevent theft, but it may help you get your car back (and help authorities con-

HOOK THIS LOCK onto your wheel and pedals, and the thieves may not hook your car. See page 117

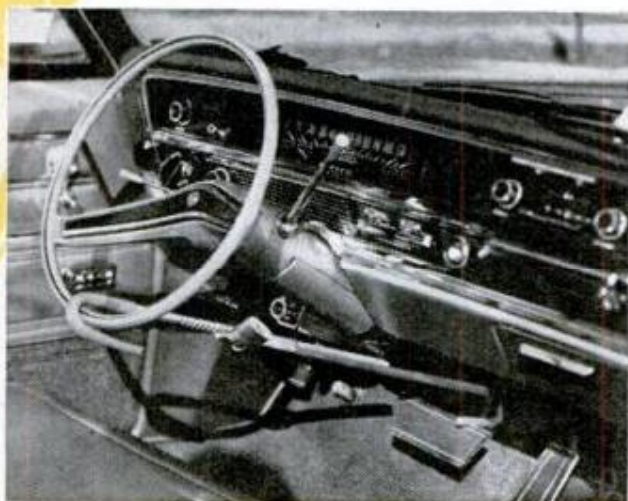

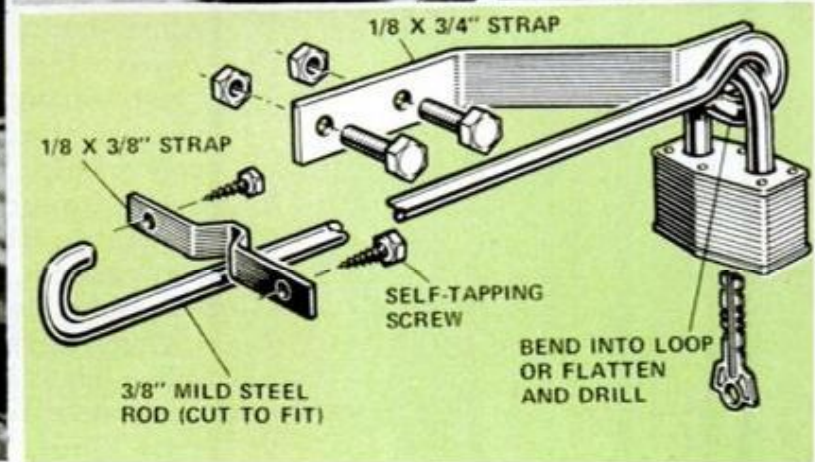
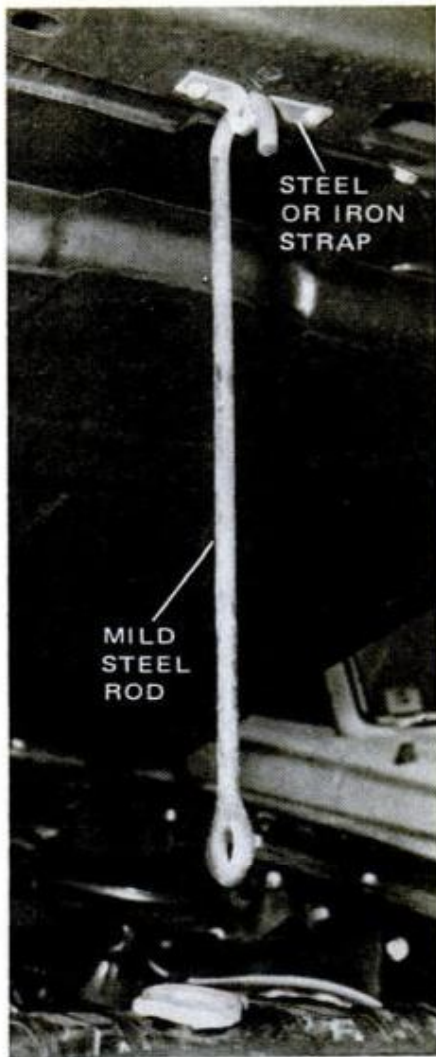

LOCKING YOUR HOOD will keep thieves away from your valuable engine parts and accessories—also from any alarms, locks or other safeguard devices you install in your engine compartment. The home-made lock shown above is just a suggestion; you'll have to adapt it, or design your own, to fit whatever car you have. This lock is made of a 3/8-in. mild-steel rod (left), suspended from a bracket of 1/8 x 3/4-in. flat stock. Another flat-steel bracket is attached to the grille frame (center), and bent so its tip will be near the lower end of the

lock rod, and parallel to it. The bottom of the lock rod can either be bent into a loop, as shown, or flattened and drilled for the lock. Place your parts so the lock will hold the assembly under tension to prevent rattles. Any noise that remains can be damped with rubber hose or tubing. Before you build it, make sure that your design will let you get at the padlock once the hood is closed. If you don't want to roll your own, there are commercial hood locks by the dozens, available at every auto supply store. For three examples, see the facing page



LOCKING WHEELS AND TIRES to your car can save you the embarrassment and expense of attempting to drive off without them. Just replace a lug on each wheel with a key lock. Models for most U.S. and many foreign cars are four for \$9.95 from On-Guard, Gotham Pkwy., Carlstadt, N.J. 07072, and others

vict the thieves), should the police ever find it again. A business card dropped in the window slot may be enough. Some owners make tin-can templates with irregular hole patterns, then "fingerprint" their cars with patterned marks made with a punch or nail. This is especially useful in identifying parts of cut-up or dismantled cars. (But be sure to keep the template to identify the hole patterns.)

Locking your car discourages casual pilfering. But some thieves will still break in when they know they'll find something of value. So leave nothing stealable where a thief can see it. Even articles of little value may encourage a thief to break in, causing greater loss from damage to your car than from the theft itself.

LINE OF DEFENSE

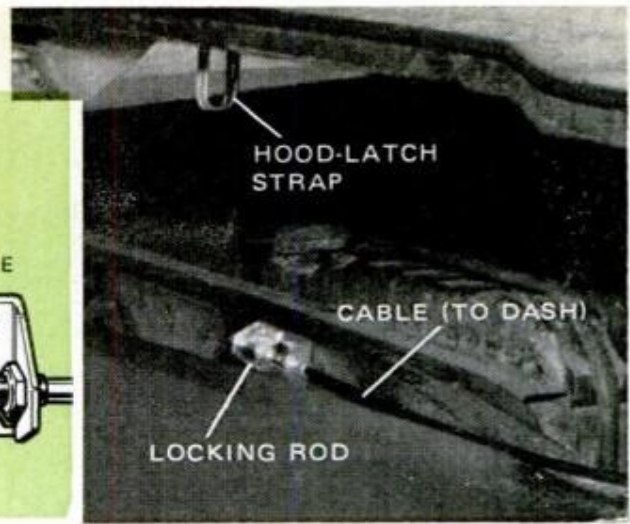
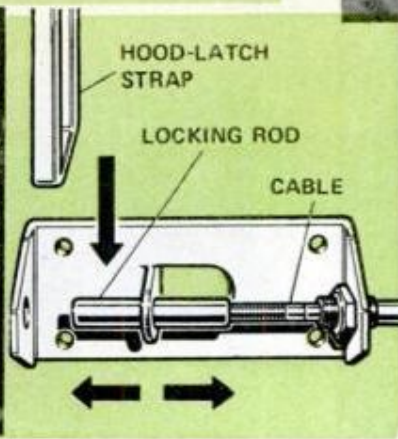

IGNITION AND HOOD are both protected with Chapman Kar-Lok. Single button beneath your dashboard shorts out the ignition and locks the hood; a key lock in the button releases it. Armored cable protects both the ignition wire and hood-latch release. Even if the wires are cut, the ignition is inoperative, so a thief can't "hot wire" the system without going under the hood. But cutting the cable won't unlock the hood, either. The lock is rela-

tively pickproof, and thousands of key patterns are available. The installation is time-consuming, but fairly simple, requiring only a screwdriver and drill. The installation kit includes a lump of clay to take impressions of the space beneath the hood, so you can find where there is sufficient clearance for the new lock bolt. \$29.95. Made by Chapman Performance Products, Inc., 5567 North Elston Ave., Chicago, Ill. 60630. Auto stores stock it

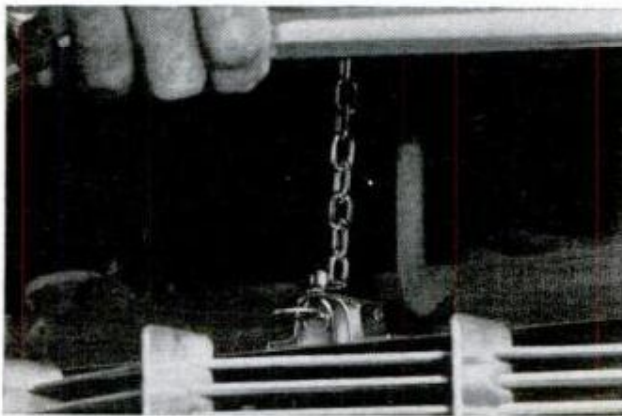

THIS CHAIN LOCK will not change your car's appearance, since it can't be seen when the hood is closed. Available for \$4.95 from Lustre Line Products, Richmond and Norris Sts., Philadelphia, Pa. 19125

FOR A SPORTY LOOK, these locks appear to be race-car hood pins; they're also a more visible deterrent. Sold for \$8.50 by Eelco, Box 4095, Inglewood, Calif. 90309; similar types by other manufacturers

Transfer valuables to your trunk before you reach your parking place, rather than where local thieves can see you. If you must leave your belongings under glass—in a station wagon, for example, or a hatchback coupe—try to hide the most valuable under the seat, in the glove compartment, or under less valuable objects.

Eighty percent of all car thefts are made by nonprofessionals between 15 and 21 years of age. Many of these cars are eventually recovered, though often after severe damage (a stolen car is many times more likely to be involved in an accident than an average car). Many more are stolen and stripped of all marketable parts, including not only accessories, but engines, fenders and entire front or rear

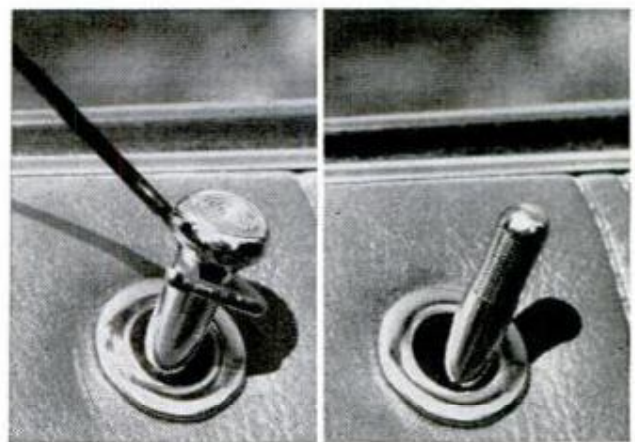

CYLINDRICAL LOCK BUTTONS will eliminate the classic trick of fishing door locks open with wire or string (a problem in hot weather when you'd like to leave your windows open a crack). Just unscrew the factory-supplied mushroom buttons and screw on the new ones. About \$1.50 per pair at auto stores

ALARMS SCREAM 'STOP, THIEF!' BEFORE HE REALLY STARTS

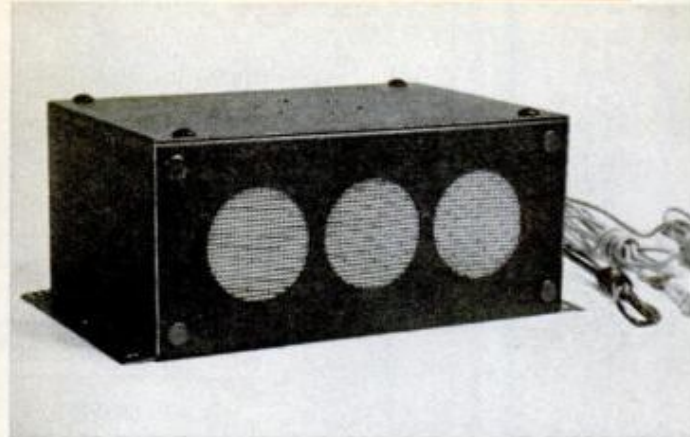

FOR EASIER INSTALLATION, there are alarms that sense the voltage drops that occur when courtesy lights turn on as doors, hoods or trunks are opened; also when the thief starts the car, steps on the brake or even switches on the radio. This \$39.95 alarm has an electronic siren. An optional time-delay switch saves fender-drilling for external key switches. RFM Industries, Farmingdale, N.J. 07727

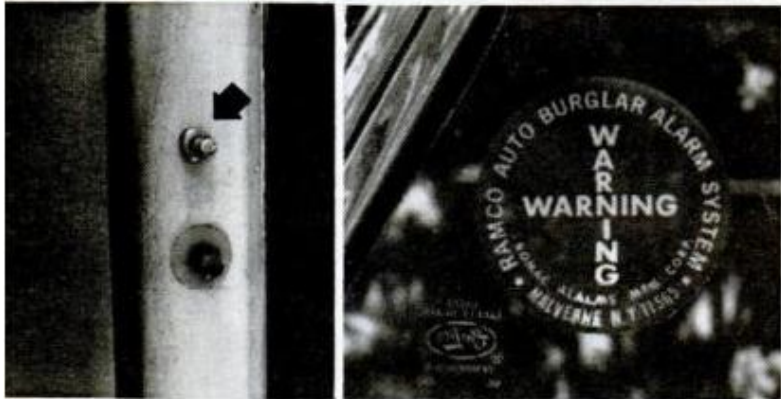
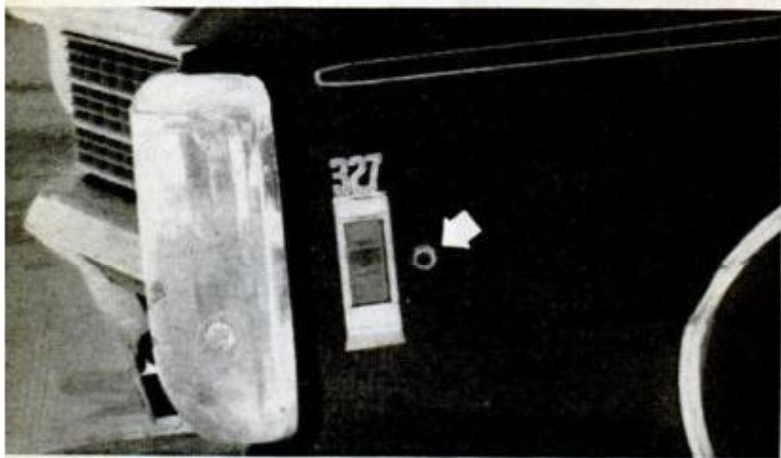

ALARM SYSTEMS won't always stop a thief from breaking into your car, but may keep him from hanging around to jump the ignition, strip the car or take any but your most accessible possessions from the interior. Some alarms blow your car's horn to attract attention; other, more expensive systems such as this one are wired to sirens. When the siren is mounted under the hood (top), a nearby fender (center) becomes a convenient place to mount the lock switch. Most people mount it on driver's side to save steps when they enter the car; others prefer side away from traffic. Switches installed on each door post (lower left) and on brackets under hood and trunk lid trigger alarm if an intruder breaks in. Warning stickers in your window (lower right) may deter a thief from trying, but don't rely on them alone. The alarm shown here is \$29.95, made by Ramco Industries, 10 Broadway, Malverne, N.Y. 11565. Similar units are generally available

sheet-metal assemblies. Even if recovered, stripped cars are just about worthless. And all these are in addition to the cars stolen for outright resale.

You can help cut the toll by resisting suspicious "bargains" in used cars or parts. But it's even more important to protect your own car from theft as much as possible. You can't be absolutely sure your car won't be a victim. But every obstacle you throw in a thief's path will at least tempt him to try some other car.

Hood locks are basic to any car protection program. Once under your hood, a thief can easily start your engine, disable most alarms and other safeguards, and steal whatever engine accessories he pleases. Keep him out, and you make all your other precautions more effective. Car manufacturers can't provide hood locks, due to fire laws in some areas (some do, at least, put their hood-latch releases in the passenger compartment). But if your fire laws permit, you can choose from a wide variety of hood locks to install—even make your own. In general, the harder the lock is to break into, the more it will cost; so don't economize unduly.

Locks are also available to protect your battery, wheels and tires (including models for outside-mounted spares), gas tanks, glove compartments, and even to lock dune-buggy engines to their chassis. Accessories as simple as straight-sided door-lock buttons (page 115) can also help keep intruders at bay.

CONTROL LOCK YOU CAN MAKE

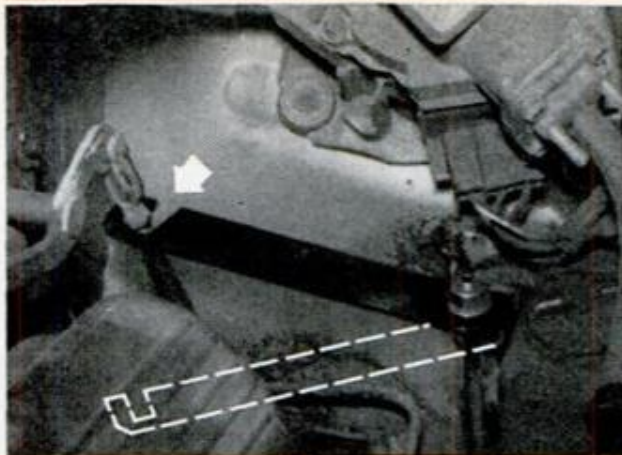

3 TYPES OF ACCELERATOR LOCK

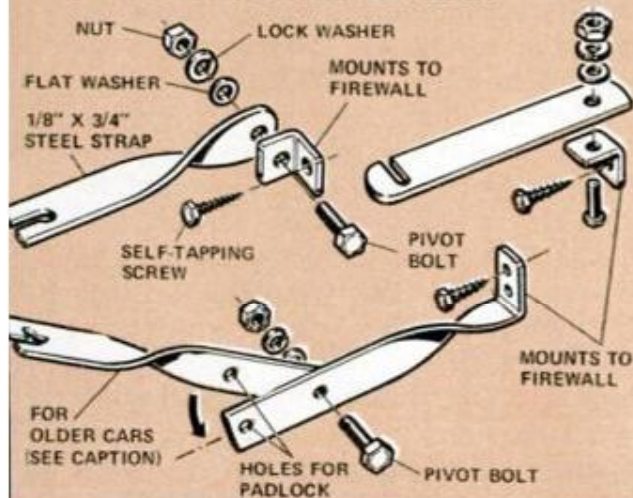

LOCKING YOUR CAR CONTROLS won't keep a thief from looting or stripping your car, but it may stop him from driving it away. Homemade accelerator locks shown here can supplement the steering locks found on today's cars, and thieves will be even less well prepared for them. Hook one over your accelerator linkage and your car won't move faster than its idle speed. A flat, notched bar (top), swinging sideways from a bracket on the firewall, will lock many linkages, depending on their direction of movement. Others require an end-notched bar with a half twist (bottom), mounted to swing down over the linkage. For older cars, where the linkage is so far from the firewall that the locking bar might flex under pressure on the pedal, make the bracket longer and drill overlapping holes for a padlock (center). Dimensions will vary from one car to another. But whichever lock you install, make sure it leaves no play in the pedal or linkage

JULY 1972

... AND THREE YOU CAN BUY

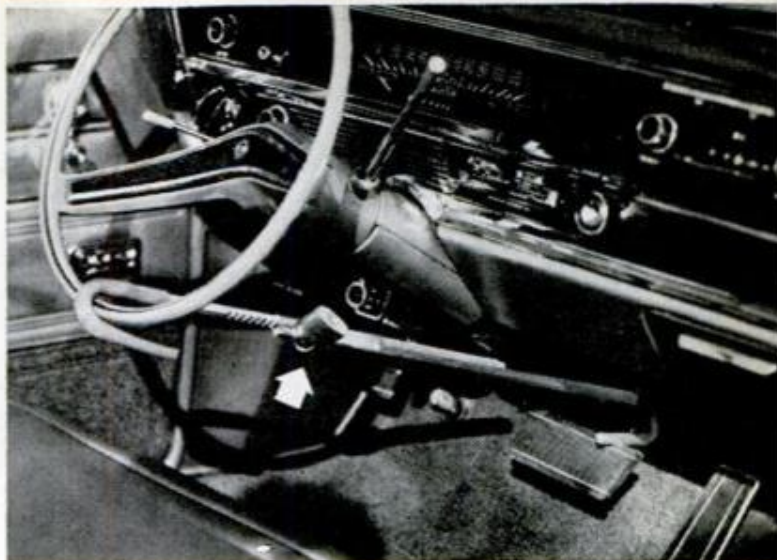

FOR PRE-1970 CAR WITHOUT A STEERING LOCK, a rigid bar can be locked over the brake pedal and the steering wheel to immobilize both of them. The Auto-Lok, shown, costs \$7.95, including a padlock (RMS Electronics, 50 Antin Pl., Bronx, N.Y. 10453). Auto-Hook Lok with built-in key lock (not shown) works similarly (\$13.95 by mail from Comm Industries, Box 505, Newton, Mass. 02158). Numerous manufacturers have made similar designs widely available through most auto-parts or supply stores

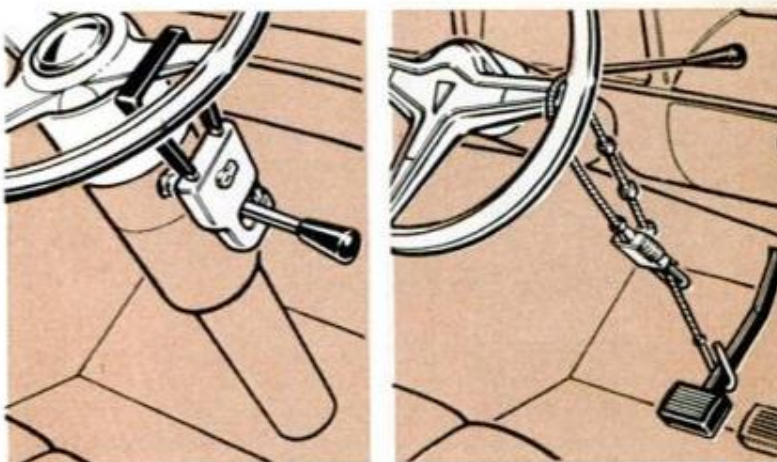

YOUR GLOVE COMPARTMENT can hold either of these steering locks, making them handier than the rigid versions shown at top (though possibly not as secure). Crowley's Car Lok (\$5) fits over the wheel and automatic transmission lever of most U.S. cars, but it won't work in a car with a tilting steering wheel or telescoping steering column. Brenner Kabelock (\$7.50) fits all cars, coils compactly when you're not using it. You can obtain them from Hamilton Import, 303 Fifth Ave., New York, N.Y. 10016

Much as these locks protect your car's accessories and contents, they do not prevent thieves from driving your car away. But locks on your cars' controls—or, better yet, on its operating systems—do help. Congress had this in mind when it mandated steering or transmission locks and

117

BRAKE, IGNITION, GAS LOCKS

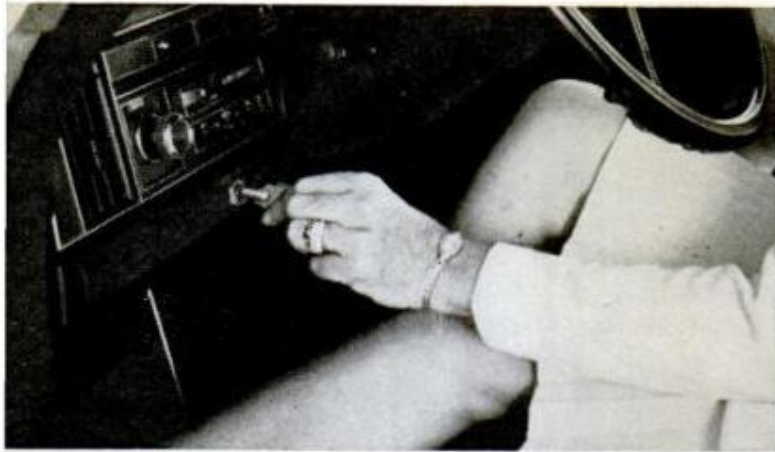

THIS KEY LOCKS YOUR BRAKE SYSTEM, which immobilizes your car so that it not only can't be driven away, but can't be towed, either. Since it hooks into your hydraulic brake line, it should also work on trailers—or even motorcycle sidecars—having hydraulic brakes. The dashboard lock uses a special, tubular key (a type often used for alarms, too) that's hard to duplicate. It's \$49.95. Sta-Lok Co., Ltd., 1647 Monrovia Ave., Costa Mesa, Calif. 92627

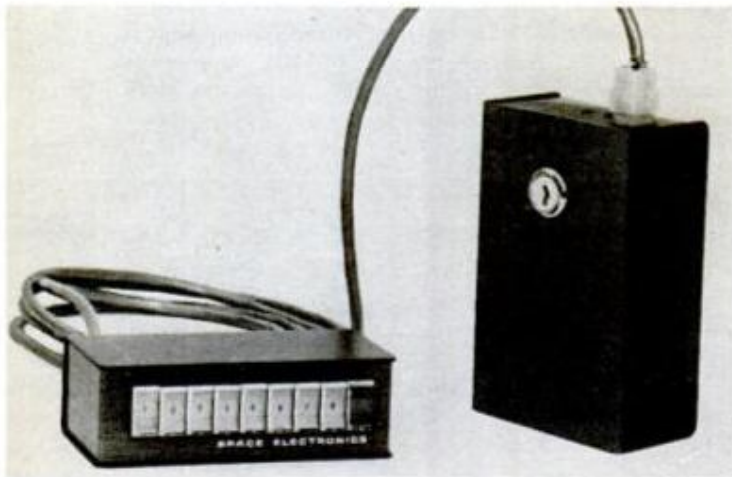

ANTITHEFT IGNITION SYSTEM is a solid-state electronic combination lock. You can select any of 10,000 different three-digit combinations, yet even if a thief should stumble on the right combination, the car won't start if he's hit one wrong digit. The maker claims this \$89.50 system is virtually impossible to jump or hot-wire. Offered by Space Electronics, Inc., Box 634, Littleton, Colo. 80020

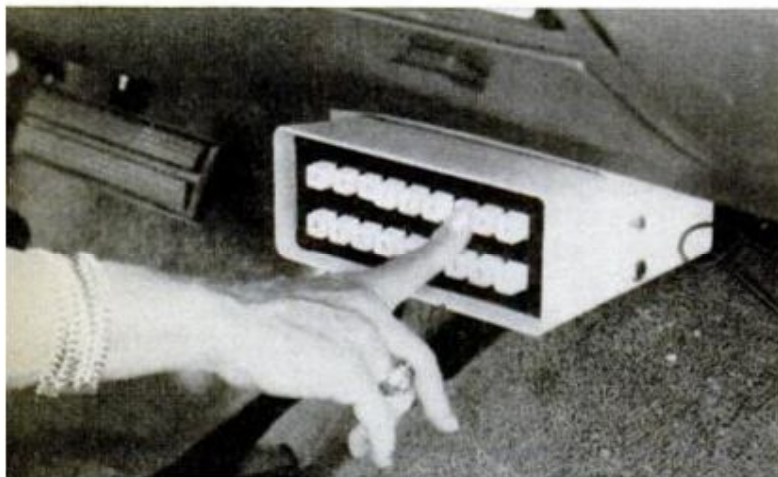

118

buzzers reminding us to remove our ignition keys.

Accessory steering locks are now widely available for cars without these built-in safeguards (or as additional protection for cars that do have them—thieves don't find the built-in kind too hard to beat). Highly visible, such control locks warn thieves they'll have to work a little harder to get your car than the next one.

But operating systems locks are claimed to baffle them completely. Simplest of these are hidden ignition switches, like those on page 119. Dashboard combination locks like those shown below also serve as deterrents. Other variations on these include: the Deweko Electronic Lock (about \$35 installed, C&W Manufacturing, 235-N Robbins Lane, Syosset, N.Y. 11791), with combination-coded electronic plugs that supplement your ignition key; and the Keyless Key (\$4.95 from MG Mitten, Box 4156 Catalina Station, Pasadena, Calif. 91106), an ultracompact combination lock for the ignition, which sets off your horn if tampered with.

Blowing horns, flashing lights and noisy bells or sirens make cars—and car thieves—uncomfortably conspicuous. A nervy thief can still work on your car until he shuts off the alarm. But most thieves aren't that nervy.

There are dozens of alarms in addition to those on page 116. And now Detroit is offering them, too. Alarms are standard on Corvettes, and '73 Chryslers will offer a system built into the car's basic wiring (which makes it harder to detect and disable). The Chrysler unit doubles as an occupant distress alarm—push a button on the dash, and it locks the doors and hood, blows the horn, and starts the emergency flashers. It shuts off after three minutes, so neighbors aren't "serenaded" all night. But it resets itself, so you're protected.

If Chrysler's alarm sells—and it should—other makers are certain to follow. The safeguards that looked so extreme at the start of this article may be standard on one of the next cars you buy. ★★★

THIS COMBINATION LOCK SHUTS OFF THE GAS instead of the ignition—which makes it harder to install, also harder to jump. The pushbutton console is armored and the control cable holds hundreds of wires, so the thieves won't know which pair to jump. And the solenoid shutoff valve cannot be removed without the right combination. About \$160. Safetech, 10 Industrial Rd., Fairfield, N.J. 07006

POPULAR MECHANICS



BAFFLE THIEVES WITH HIDDEN SHUTOFFS

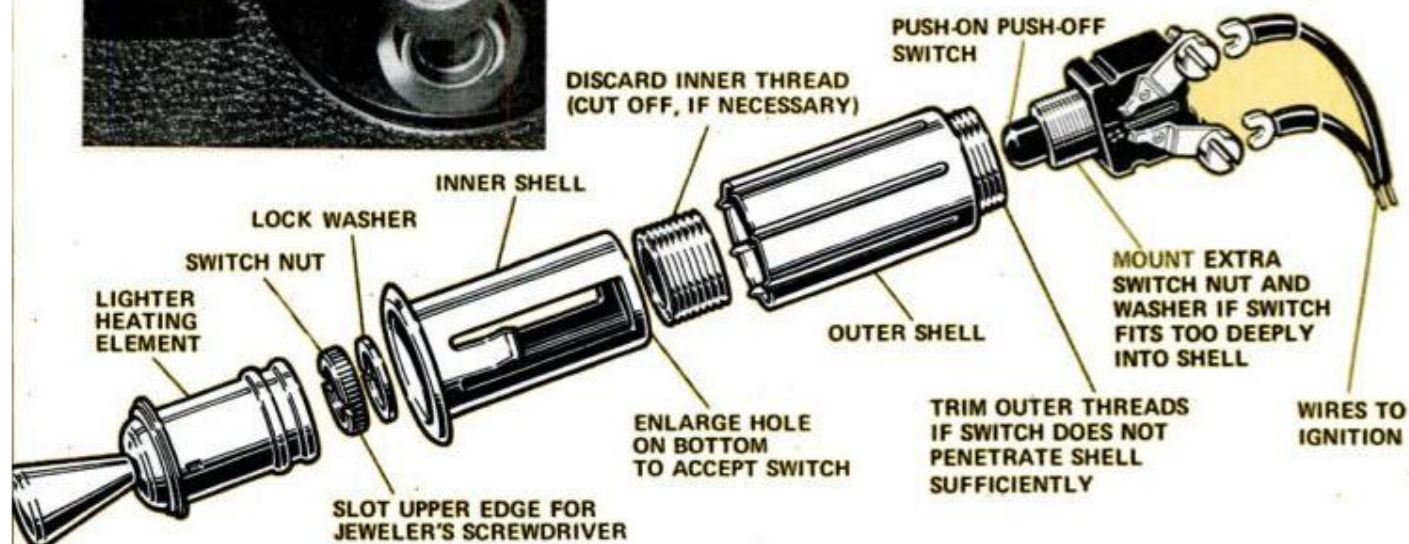

SNUFF OUT THE IGNITION with your cigaret lighter and your car can't be started until you push the lighter knob. The secret is a switch hidden deep in the lighter's body. Connect it between the "hot" terminal of your fuse box and the negative side of your coil (or vice versa for cars with positive-ground ignition); a push-push switch is preferable to a momentary-contact type. When driving, you carry the lighter element in your pocket, so an unknowing passenger won't accidentally stop the car; replace the element when you park. The switch nuts and washers (including the optional ones not shown here) position the switch just far enough into the lighter to be actuated when the element is pushed in. Hacksaw a slot in the face of one switch nut, so that you can tighten it with a small screwdriver after it is inside the lighter's shell. The lighter's original inner contact (not shown) is discarded

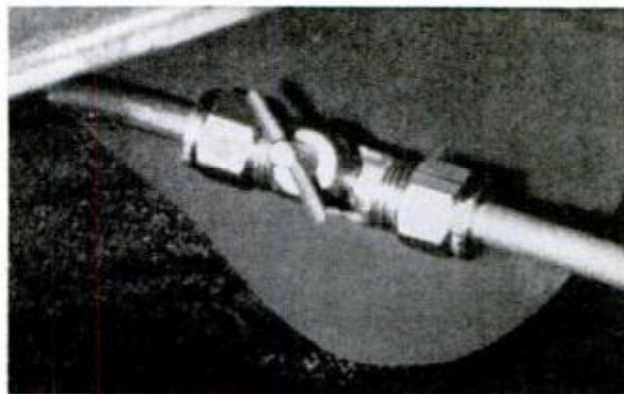

HIDE A FUEL SHUTOFF under your hood, and the thief will be able to move your car only as far as the gas in the carburetor will carry him. Simply install a needle valve (about \$2.50 at auto stores) in the fuel line and lock the hood. If your lines are of hose instead of copper, you'll also need nipples and hose clamps. Marine-type solenoid valves (\$5) are even more convenient and easier to hide

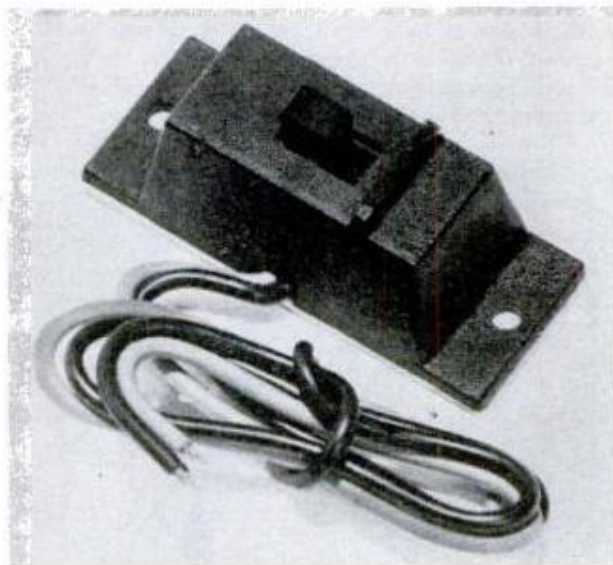

AUTO-GUARD SWITCH disables your ignition, preventing unauthorized shorts even if the wires are jumped. Small, black and unmarked, the switch is easy to conceal, hard for thieves to comprehend if they stumble across it. It fits all cars and causes no battery drain, sells for \$6.95. Raney Sales Co., Box 2112, Decatur, Ala. 35601; Transcontinental Enterprises, Box 191, Kent, Ohio 44240 and many others

JULY 1972



TIME-DELAY FUSE IN Buss Auto Protector (and the similar Taroda Steal n'Stall) cuts out the ignition shortly after an unauthorized start. With the car stalled in traffic near the spot where it was stolen, a thief isn't likely to stay and investigate. But you can restart the car easily. \$4.98. Bussman, University at Jefferson, St. Louis, Mo. 63107; Taroda, 3525 West Peterson Ave., Chicago, Ill. 60645

119

Sharpen your shooting

By BOB CORLEY

WHEN SHOOTING ACTION SHOTS with a long lens, a tripod is out of the question and it's often difficult to hand-hold the camera steady enough to avoid blur. The answer is a gunstock mount that gives you a solid shoulder rest and a stable two-hand grip for firm camera control. Readily portable, such a rig is ideal for grabbing fast sports and nature shots on the run.

The stock shown here has several features not found on most homemade or commercial models. The camera platform is deliberately offset to the side so your eye lines up easily with the viewfinder window without your having to twist your head. Any 35-mm still camera or lightweight movie camera having a tripod socket can be used. By removing the platform, a 35-mm camera can be turned sideways and fastened directly to the stock for making vertical shots. The stock is light and maneuverable, being less than 20 inches long.

In cutting the parts, follow the squared pattern on the facing page. Virtually any wood will do, though the tougher, the better. You can use plywood and paint it or, for a really slick job, a natural-finished hardwood. The side-mounted camera platform is attached to the stock with only two bolts, making it easy to remove. One bolt passes straight through, while the other is angled at 45°. The camera is fastened to the platform with a short 1/4-20 bolt threaded into the tripod socket. A screw with a knurled thumb wheel is handiest for this, or you can use an ordinary bolt with the head cut off and a wingnut threaded on for tightening the camera in place.

The platform is shown on the left side of the stock for right-handed shooters. For lefties, mount it on the right side. Note that the rear edge is rounded off to match the curve on the end of the stock's upper rail. The gun's "trigger" is merely a length of bent coathanger wire arranged so it depresses the camera's shutter release when you pull down on the lower end with your thumb. ★★★



TRIGGER MECHANISM consists of bent coat-hanger wire that hooks into top-mounted shutter release (upper photo above). Wire passes down through camera platform and trips shutter when pressed by thumb from underneath (lower photo). For cameras with front-mounted shutter controls, a release cable can be run through hole in forward hand grip and operated by squeezing plunger with finger

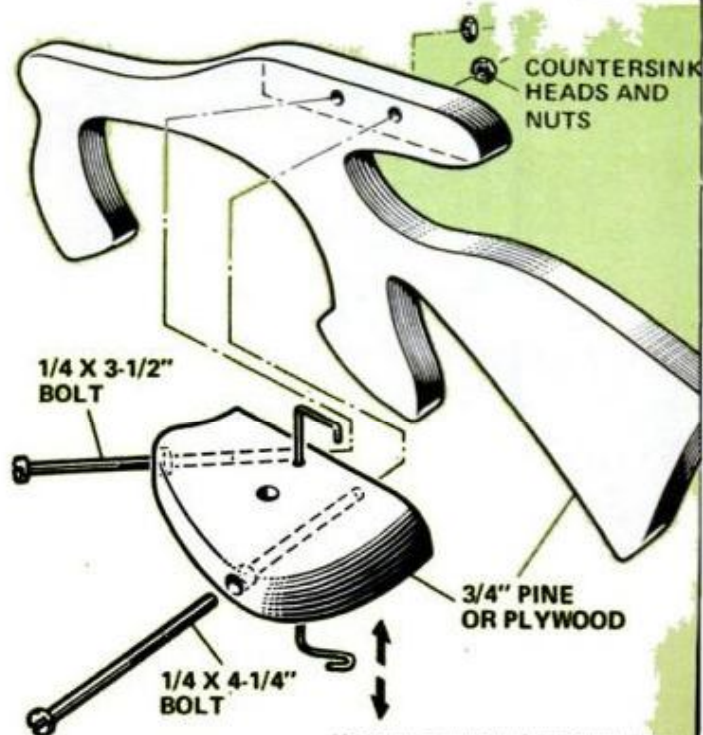

with a gunstock mount

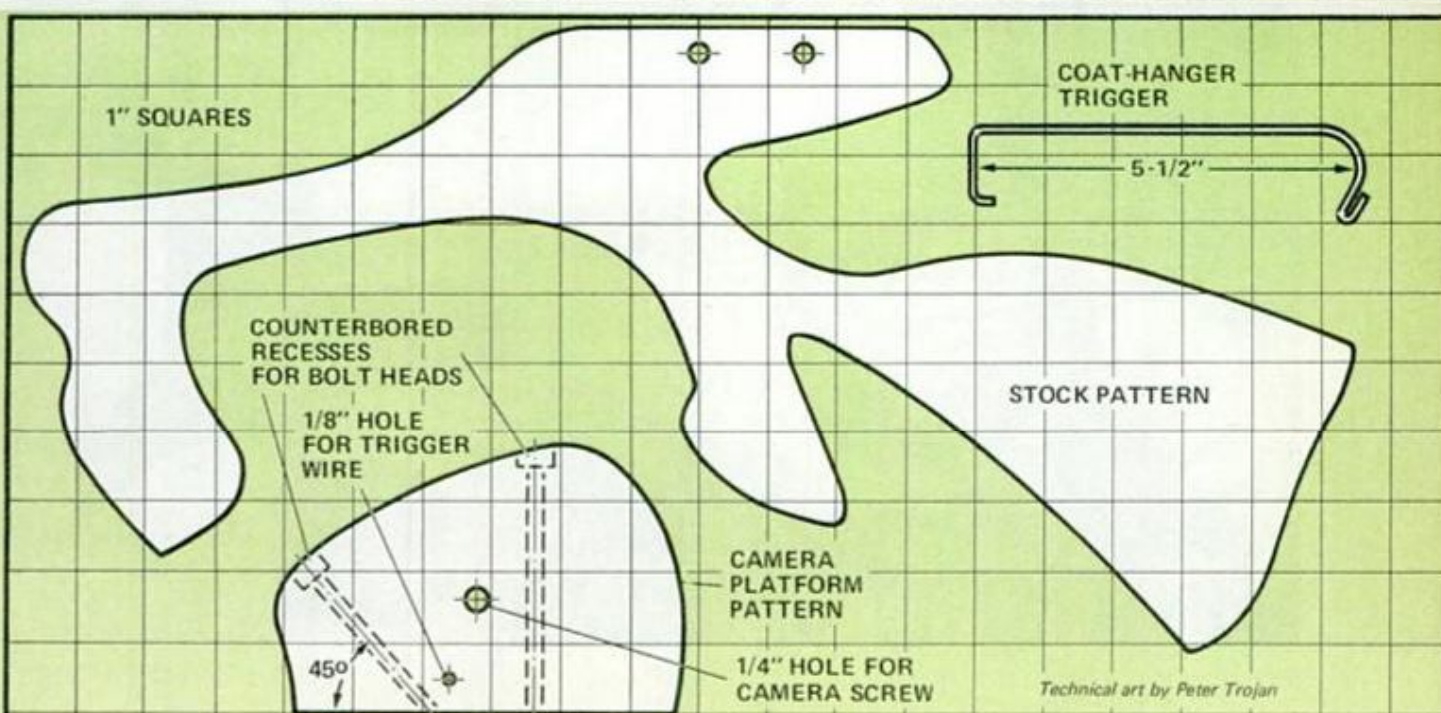
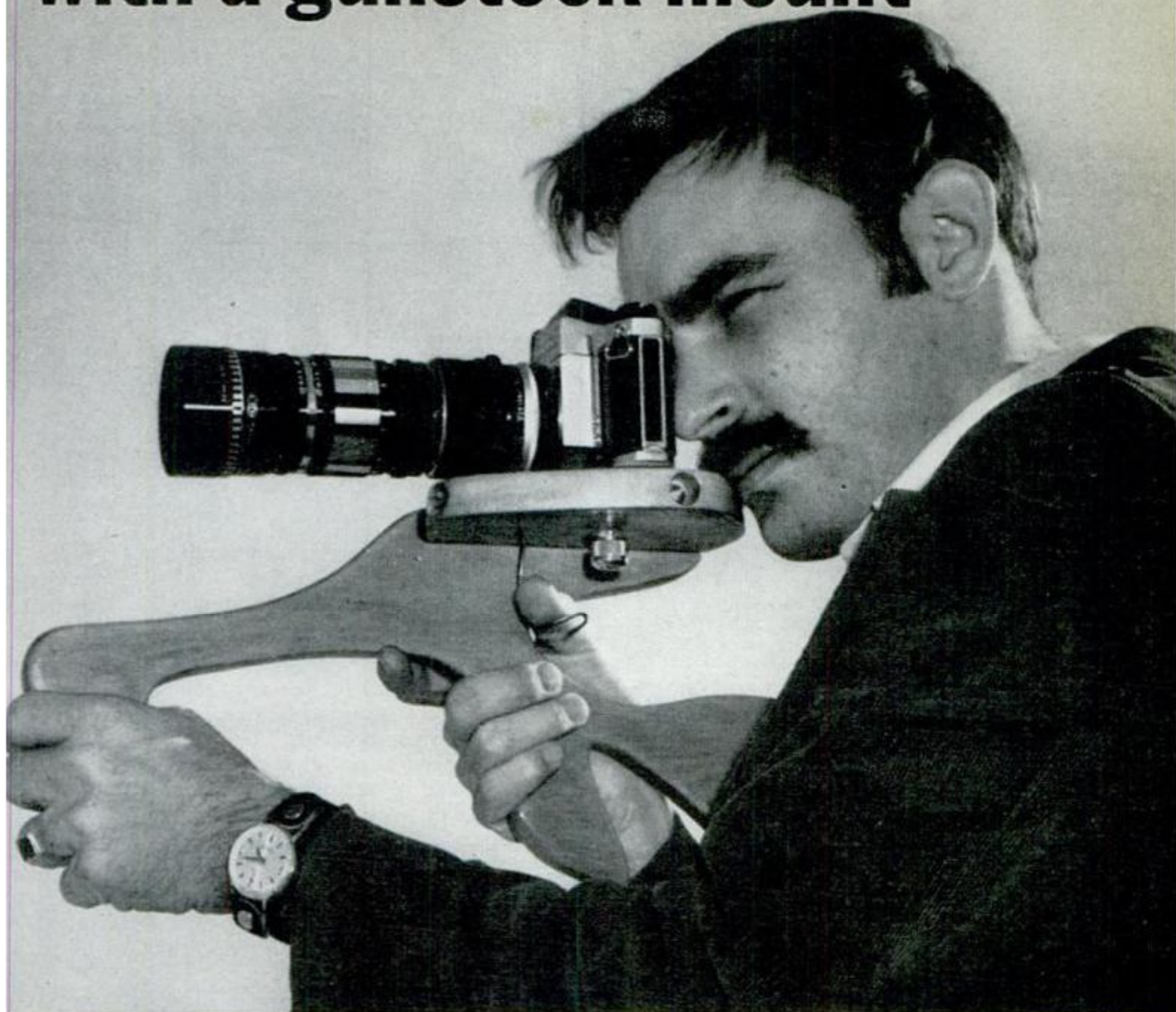

NEW IN

PHOTOGRAPHY

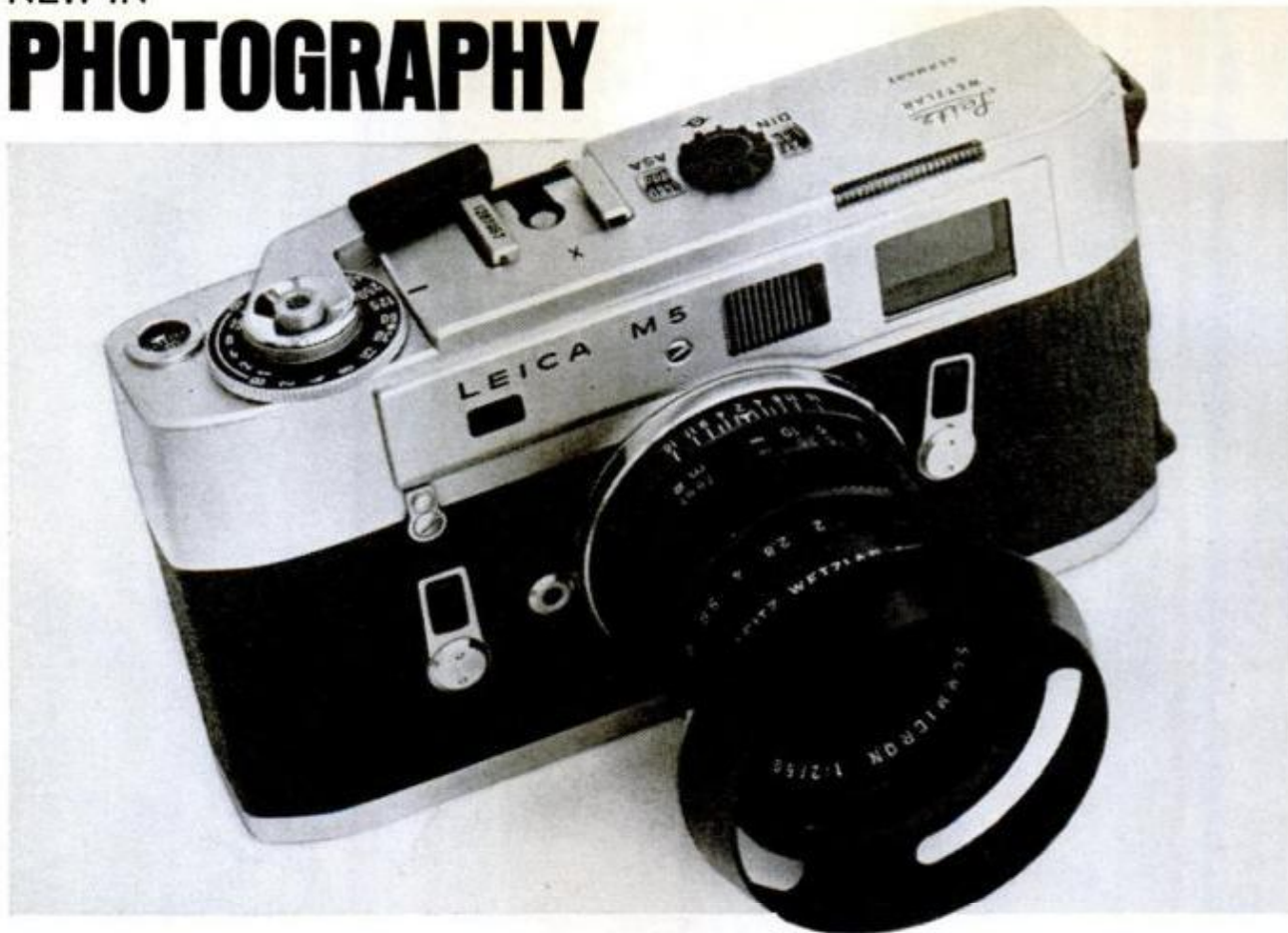

FIRST THROUGH-THE-LENS METER in a production rangefinder camera is featured in the new Leica M5. The meter cell, on a hinged arm, swings up in front of the focal plane shutter when you wind the film. As you click the shutter, it swings down again. The meter scale is visible in the viewfinder, together

with a shutter speed scale, viewfinder frames for 35-mm, 50-mm, 90-mm and 135-mm lenses (as in previous Leica "M" models, changing lenses brings the correct frame into place), and a meter battery check. With f/2 lens, \$849; with f/1.4, \$948. E. Leitz, Inc., Rockleigh, N.J. 07647.

FOR SPARE FILM, Klip-Pack plastic cans clip to your belt, camera strap, or pocket. Weather-proof, they float. They can even be sterilized for medical photography; won't stick

to your fingers in freezing weather, either. Three for \$2 postpaid from the Kessinger Co., R.R.2, South Bunn St., Bloomington, Ill. 61701.



NEW FOR YOUR CAR

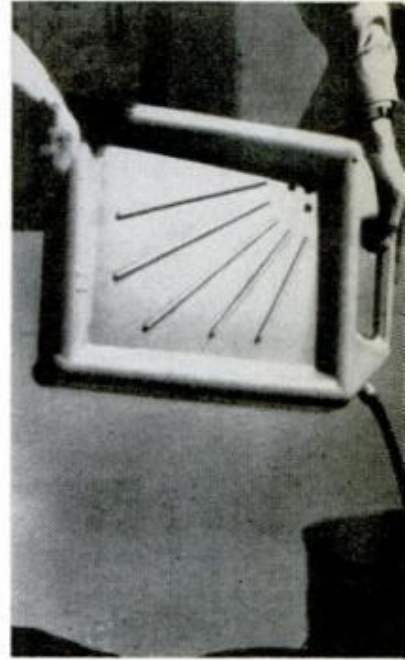
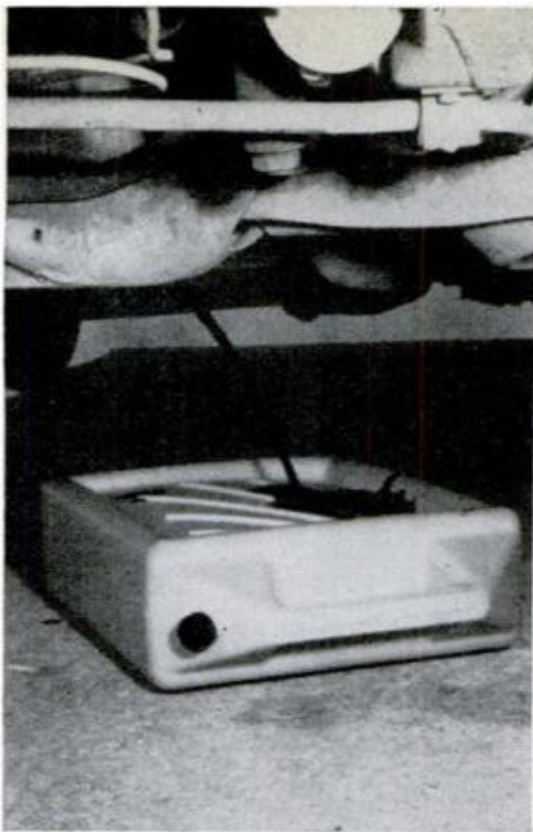

DRAINING ENGINE OIL is a snap with this plastic container that forms its own catch basin. Oil runs down its sloping side and in through small holes in one corner. Once filled, the container can be turned upright and its contents poured out a spout without messy spills. Called Drain-eze, it holds 18 quarts, sells for about \$5. Gott Manufacturing Co., Winfield, Kans.

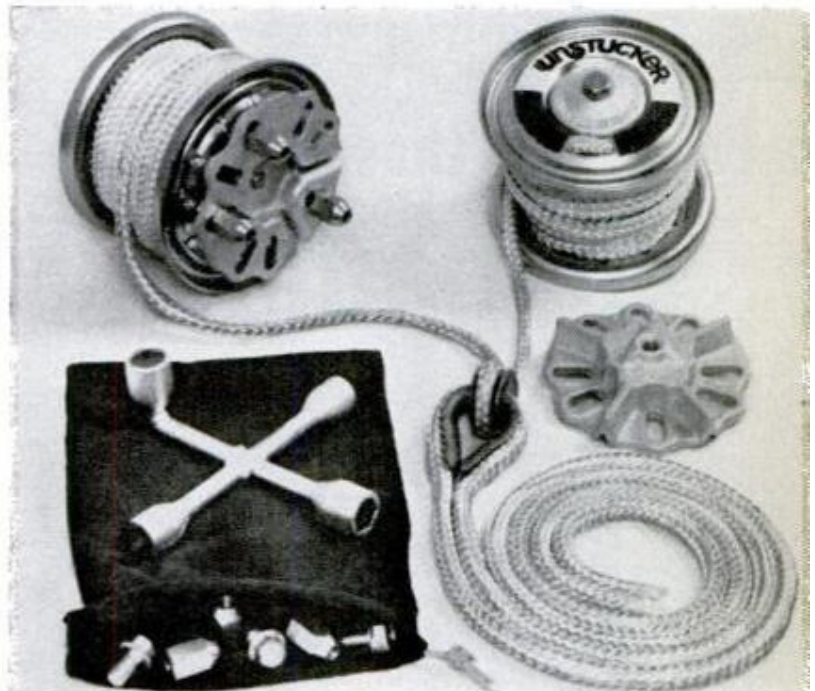
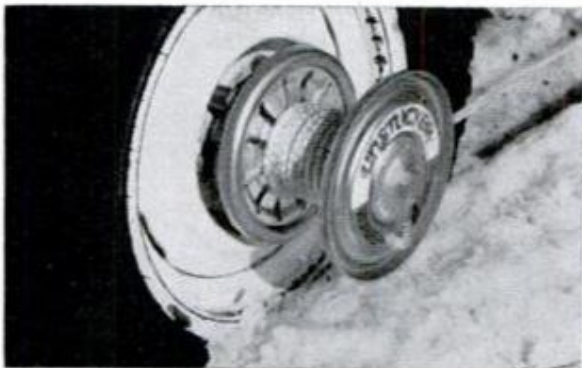

YOUR OWN WHEELS do the work in this clever system for pulling a mired vehicle out of mud, sand or snow. Twin drums bolt on the rear wheels with lines anchored to a nearby tree, pole or rock. As you spin the wheels, the ropes wind around the drums, pulling you free. Adapter plates permit the drums to fit most cars, trucks and campers and can be left permanently attached for quick use. About \$90. Sports Innovations, 5301 Edina Ind. Blvd., Minneapolis, Minn.

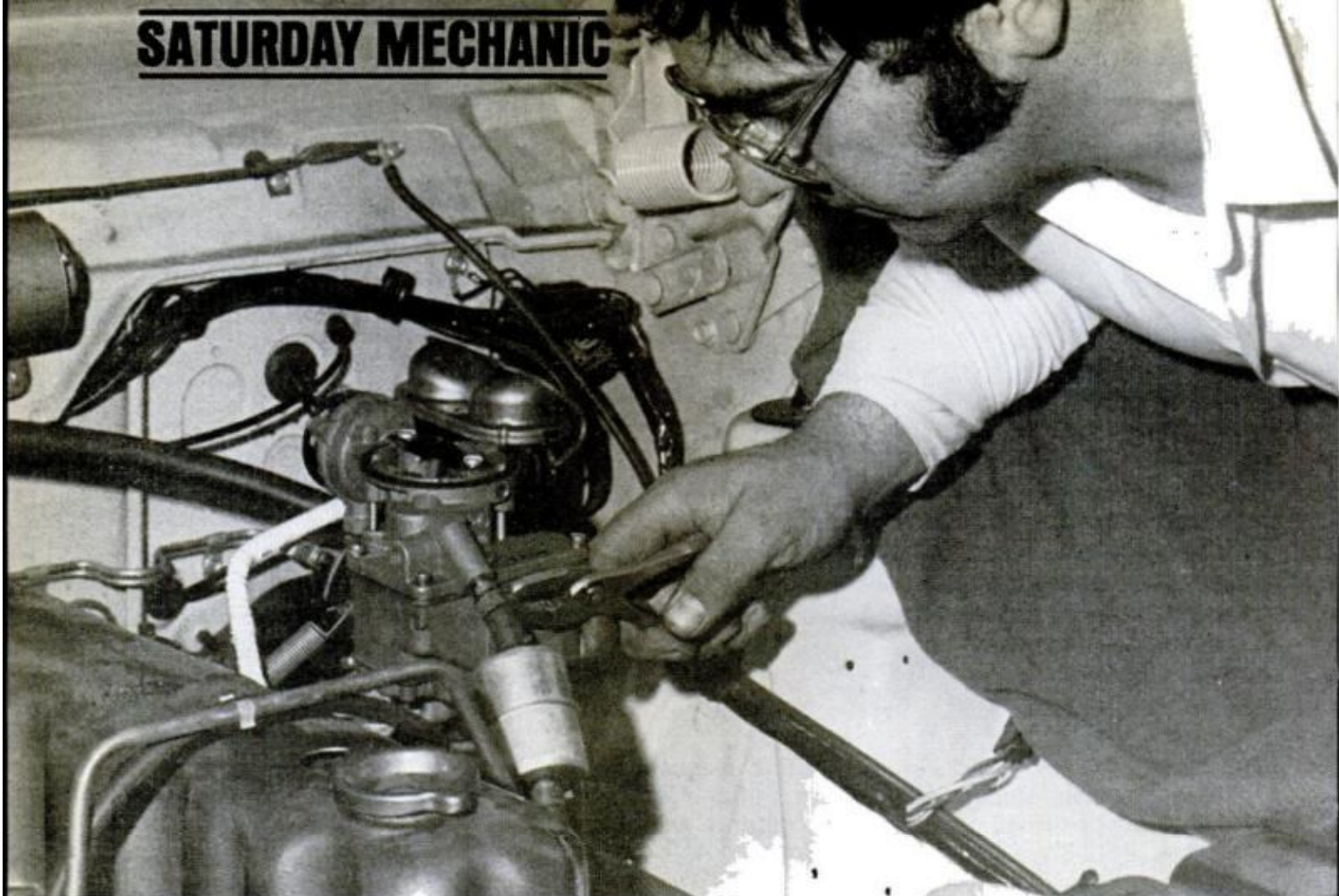

FUEL FILTER MAY BE EXTERNAL TYPE found in fuel line to the carburetor and secured with removable clamps

Forget those big repair bills: Remember your filters!

By MORT SCHULTZ

DIRTY OR CLOGGED FILTERS can cause your car to run rough or stall completely, can cause premature wear of engine and transmission, and generally result in unnecessary aggravation and expense. All cars have at least three important filters: oil, fuel and air cleaner. Those with automatic transmissions have an automatic-transmission-fluid filter.

Mandatory on later-model cars are evaporation-control-system canisters, which are charcoal-filled containers that trap gasoline vapors that would be discharged into the atmosphere. They, too, incorporate a filter.

Later-model cars also have a positive-crankcase-ventilation filter in the air

cleaner. It removes particles from crankcase vapors while the vapors are making a circuit back into the engine for reburning.

When a PCV filter is not used, the oil filler cap may act as a filter. It requires periodic cleaning.

There are still other filters, but the ones mentioned need servicing most often. Others, such as the one in the power-brake-assist unit and the receiver-dryer of an air conditioner, are serviced less frequently, usually when the system is disassembled. Don't forget them. Check your owner's manual to determine which filters you have in your car and how often they should be serviced.

Service intervals assume that the car is

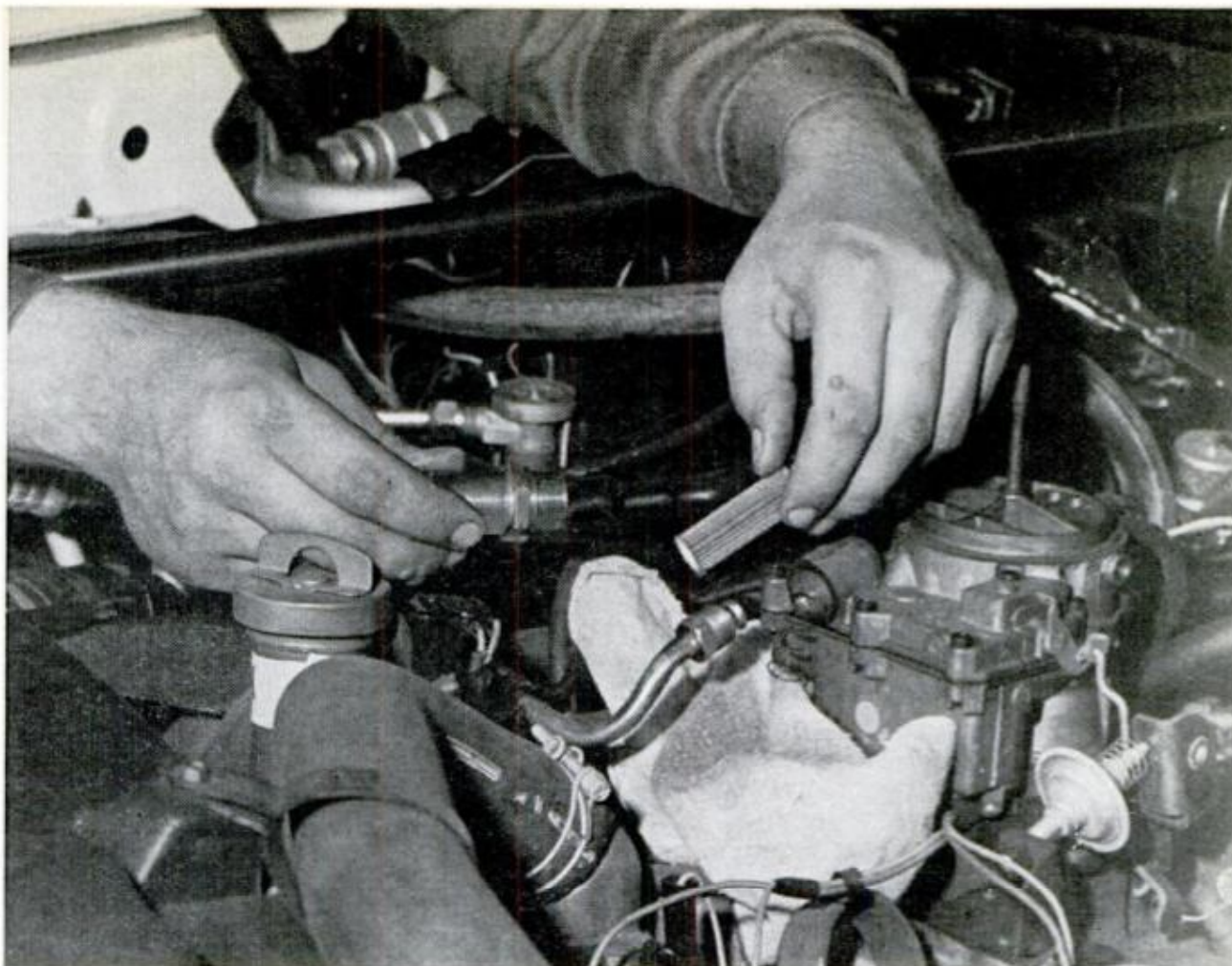

FUEL FILTER OF INTERNAL TYPE is found in carburetor. Disconnect the fuel line and filter retaining nut

being used under normal conditions. More frequent servicing will be needed if you operate in dusty areas, if the car is idled for long periods, if you tow a trailer or if you make short runs that prevent the engine from reaching its ideal operating temperature.

Under these rough conditions, cut the service interval in half. For instance, if a 12/12 interval is recommended, cut it to 6/6.

Before shopping for a filter, copy the part number off the old filter. If there is no number, tell the auto-parts dealer the exact make and model of your car, and its engine designation. His parts catalog will list the right filter. To be on the safe side, however, take your old filter with you to make certain that you get the right one.

● *Oil filter.* Most engines are protected by a full-flow, throw-away oil filter. All oil from the pump must pass through the filter before it can enter the engine oil galleries.

In the filter, oil passes through an element where dirt and particles are re-



OIL FILTER GASKET should be coated with oil before installation. Do not overtighten the filter

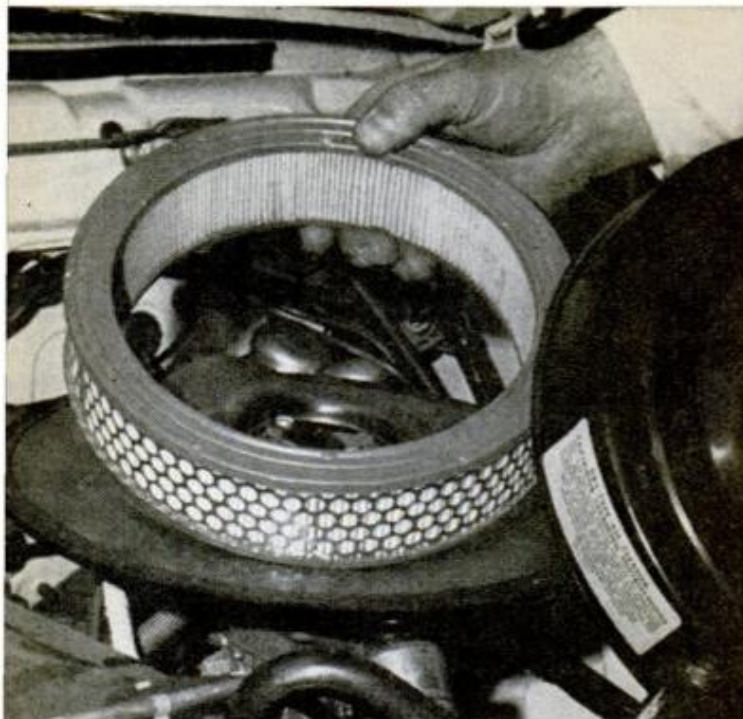

AIR-CLEANER PAPER ELEMENT is easily replaced. Often service intervals are on sticker on the cover

moved. Filters are always designed with a bypass valve so that the engine will receive ample lubrication if the filter element becomes restricted.

One indication of a restricted filter is a momentary flashing of the oil-pressure warning light (or an indication of low oil pressure on a gauge) as the car is accelerated in low gear. This can also be a warning of a clogged oil screen.

The procedure for replacing an oil filter is pretty much the same from car to car. After the crankcase has been drained, you simply turn the filter counterclockwise to remove it.

Since you probably don't have the use of a lift, it may be easier to remove the filter from topside. If it's too difficult, you'll have to do it from below.

Wipe the engine flange and the base of the new filter with a clean cloth. Coat the gasket of the filter with a light film of engine oil.

Now screw the filter onto its seat by hand until the gasket contacts the seat—then turn it half to two-thirds of a turn more.

Don't use a wrench, and don't overtighten the filter. Tighten the filter slowly so that the gasket isn't pinched, resulting in a leak.

With the filter in place and fresh oil in the crankcase, start the engine, run it at fast idle and check around the filter to make sure that oil isn't leaking.

Remove the oil filler cap. If it's the type with a mesh filtering material, wash it thoroughly in kerosene, shake off excess solvent and allow to air dry.

● *Fuel filter.* There are three types of fuel filter installations.

One is a bronze or paper element that is inside the carburetor inlet. It's generally used on GM models. To remove it, you must disconnect the fuel line at the carburetor and wrench loose the large retaining nut. These filters usually have a small spring which can be reused if it hasn't lost tension.

Another type of fuel filter is inserted into the fuel line between the fuel pump and carburetor. Most Chrysler Corp. and AMC models are equipped with this kind. To replace this filter, detach the retaining clips and pull the filter connectors off the fuel line.

The third type of fuel filter, which Ford uses on some models, is external but is screwed directly into the carburetor. To replace it, loosen the fuel inlet hose and unscrew the fuel filter from the carburetor.

After installing a new filter, start the engine and check for fuel leaks.

● *Air-cleaner element.* In most cars, a paper element is standard. It should be replaced according to the service interval recommendations.

Note that Chrysler and AMC suggest that the air-cleaner element be cleaned to extend its life. Cleaning is done with compressed air. Hold the nozzle at least 2 inches away from the *inside* of the element and blow out dirt around the element's entire circumference. Be sure that compressed air is not used on the element's outside surface. This will only serve to force dirt deeper into the filtering material.

If you don't have compressed air available to clean the filter, shorten the replacement time for Chrysler and AMC air cleaner elements to 12/12.

Some cars have a polyurethane air-cleaner element that can be washed in kerosene and reused.

In securing the air-cleaner cover, don't exert full force on the wingnut. Make it secure, but don't bear down. Overtightening could cause distortion.

● *Automatic-transmission-fluid filters.* Does an automatic transmission require service? It depends upon the manufac-

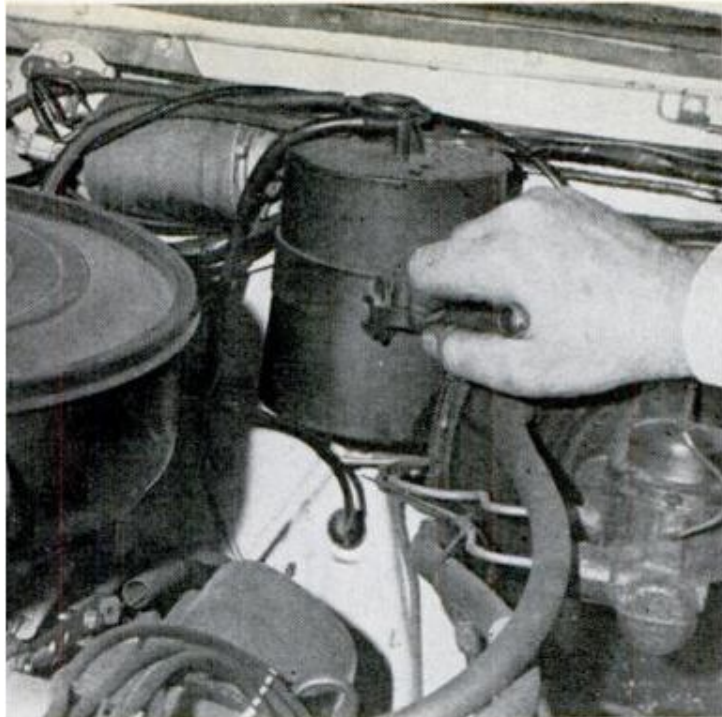

EVAPORATIVE CONTROL CANISTER is secured with a clamp. Remove from the clamp and detach the hoses

turer and model year. Even so, manufacturers have changed their minds on the subject many times. As long as you're doing your own work, replace the fluid and filter every 24,000 miles.

Start by placing a wide-mouth container beneath the transmission oil pan, loosen the pan bolts at one corner, and tap the pan to break it loose. Allow fluid to drain, remove the pan and discard the gasket.

Unscrew the old filter, which is attached to the valve body, and install a new one. Clean the oil pan and reinstall it, using a new gasket. Be sure that oil-pan bolts are tight and install fresh automatic-transmission fluid.

● *ECS canister filter.* Many cars built from 1970 on have an evaporation control system that traps fuel vapors which normally escape from the fuel tank. This is done by using a charcoal-filled canister that adsorbs vapors and stores them until they can be dispersed to the engine for burning.

Most canisters have a filter in their base. To remove it for replacement, first detach hoses from the canister and loosen the bracket that holds the canister in place. Then you can remove the canister, turn it upside down and pull the filter from the base.

● *PCV valve and filter.* The PCV system used by all cars since 1963 helps control air pollution caused by crankcase blowby

JULY 1972

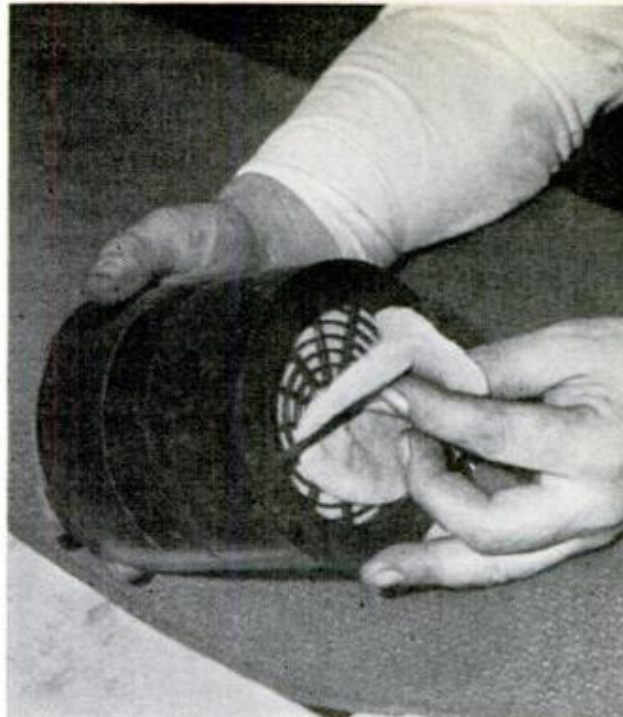

CANISTER FILTER is usually found in the base. With some canisters you must detach the base to remove

gases. Gases are redirected back into the engine for reburning.

For maximum engine efficiency and to keep the engine from using oil, thoroughly clean the system as often as called for by the manufacturer: Do this by disconnecting all hoses and carefully pushing a clean cloth patch through them.

Remove the PCV valve and discard it for a new one. Replace the PCV filter. If your car has one, you'll find it in the air cleaner. One type is a snap-out kind made of material resembling cotton. The kind shown in the accompanying photo is a mesh screen. ★★★

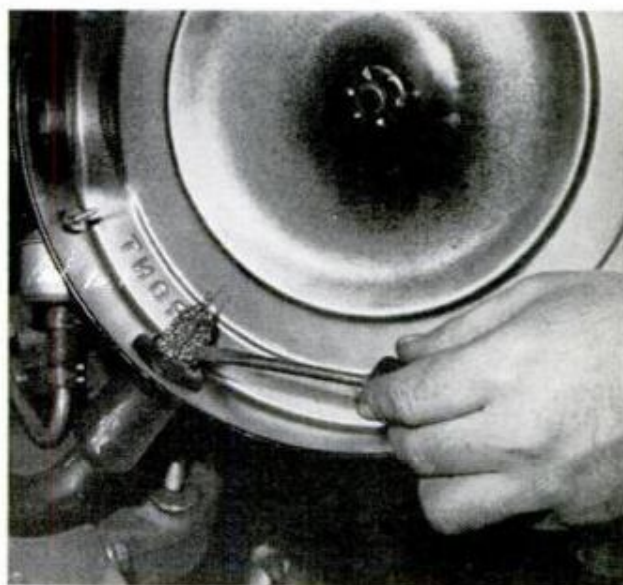

MESH FILTER used in some PCV systems is found where the hose attaches to the air-cleaner housing

127

EXCITING NEW PRODUCTS

BY CATHERINE BILSKI



CHANGE DESIGN of the new Airguide Indoor-Outdoor Thermometer to suit your taste and decor. Four pressure-sensitive panels come with the basic white instrument, let you use photos, fabrics, original art—almost anything—on its face when desired. Twin tubes show indoor, outdoor temperatures; bold numbers enhance modern design, are easy to read. \$5.95. Airguide Instrument Co., 2210 Wabansia Ave., Chicago, Ill. 60647.



RICH WOODGRAIN FINISH on this Paragon 24-hour timer will complement any decor. This home-security device turns lamps, radios and the like on and off at preset intervals to give your home that "lived in" appearance while you're away. With it you can also control a regular on-off pattern automatically. Also available in harvest gold, poppy red or avocado, \$14. AMF Paragon Electric Co., 1600 12th St., Two Rivers, Wis. 54241.



ALL-PURPOSE Revere Inflator inflates or deflates just about everything from beach toys to inflatable boats. It features a high-volume, low-pressure, fast-inflation pump and quick-deflation capability. Model RA-2 (shown), designed to operate on 12-volt d.c. power, plugs into the cigaret lighter in your car. Retailing for \$29.95, it's made by Revere Survival Products, 605 West 29th St., New York, N.Y. 10001.

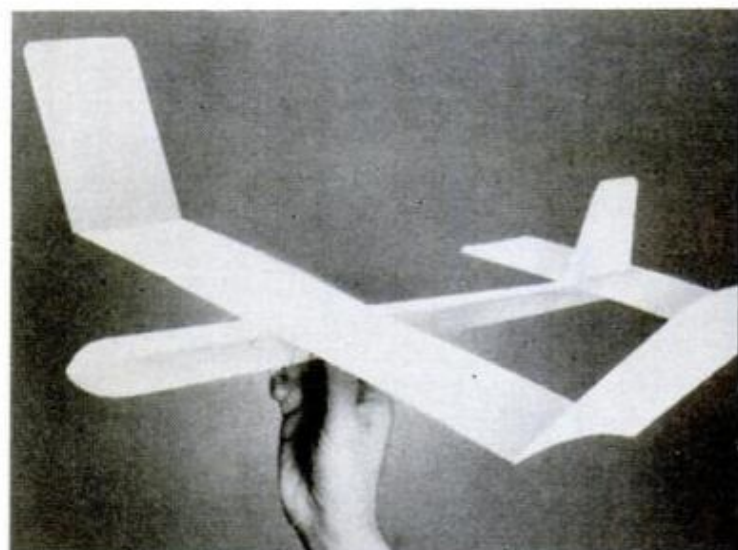

FUN TO FLY for children and adult aircraft modelers, the Mesmera is a towline glider made completely of sheet foam. It features a 30-inch wingspan, is lightweight, waterproof, weather-resistant and requires no finishing. It assembles easily with adhesive tabs included with the kit and retails for \$2.50 from Mason Renshaw Industries, 6315 East Coast Highway, Box 445, Carpinteria, Calif. 93013.



FINGERTIP CONVENIENCE and modern styling are combined in the Moen liquid dispenser. Designed for the fourth hole of most kitchen sinks, it's easy to install and holds a full 8-ounce supply of liquid soap, detergent or hand lotion. The base fits all standard sink drillings and a washer and nut locks it tightly in place. \$6.95. Moen, Div. of Standard Screw Co., 377 Woodland Ave., Elyria, Ohio 44035.

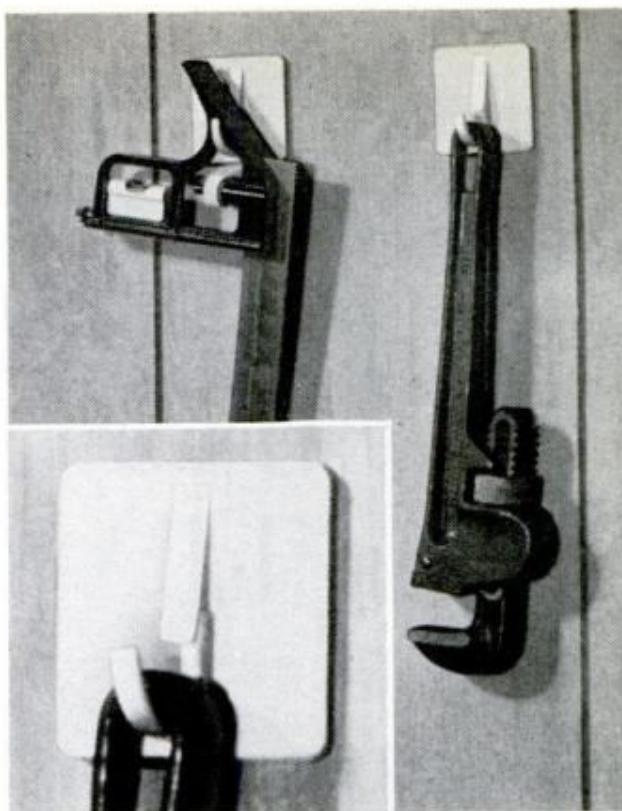

HOLD HEAVY OBJECTS such as tools and winter coats with Magic Mount Utility Hooks, which are handy to have around the home, camper, shop, office, or wherever you need neat "hang ups." There's no nailing, drilling, moistening or gluing—just peel off the protective back and press the hook instantly into place. Two hooks retail for 39 cents from Miller Studio, Box 310, New Philadelphia, Ohio 44663.

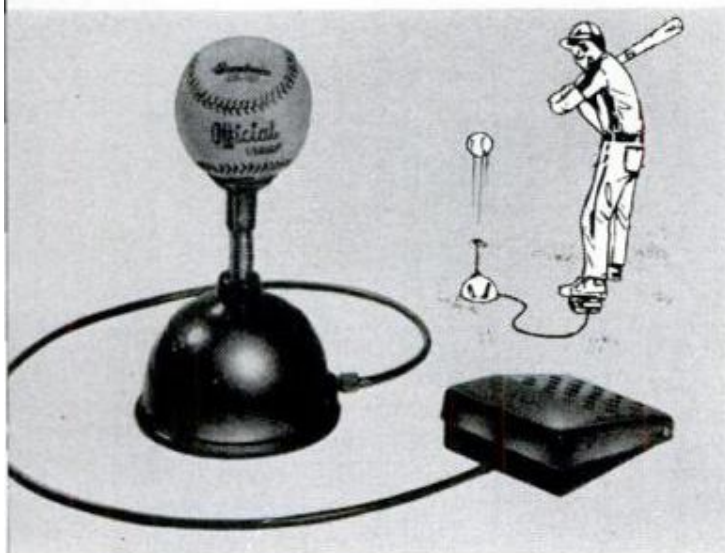

IMPROVE YOUR BATTING, timing and coordination with the Pop-Up Batting Trainer. Ball pops up to strike-zone height for any size batter by a simple spring-tension adjustment. Consists of a spring-loaded tee, foot-trigger pedal and extension cable. The base is made of rugged cast metal. Instructions are included. Unit sells for \$5.98 (ball not included) from Mail Order Games Co., Box 10547, Knoxville, Tenn. 37919.



UNIQUELY DESIGNED, the Space Saucer Clock Radio adds contemporary beauty to your room, office or just anywhere. Consists of AM solid-state radio, ballpoint pen in holder, automatic and manual clock controls and exclusive twist-a-dial alarm setter that gently wakes you. Height is 5 inches; diameter, 7. Sells for \$26.95 postpaid from A. J. Tomaszewski, 115-14 224th St., Cambria Heights, N.Y. 11411.

A colonial footstool you can build

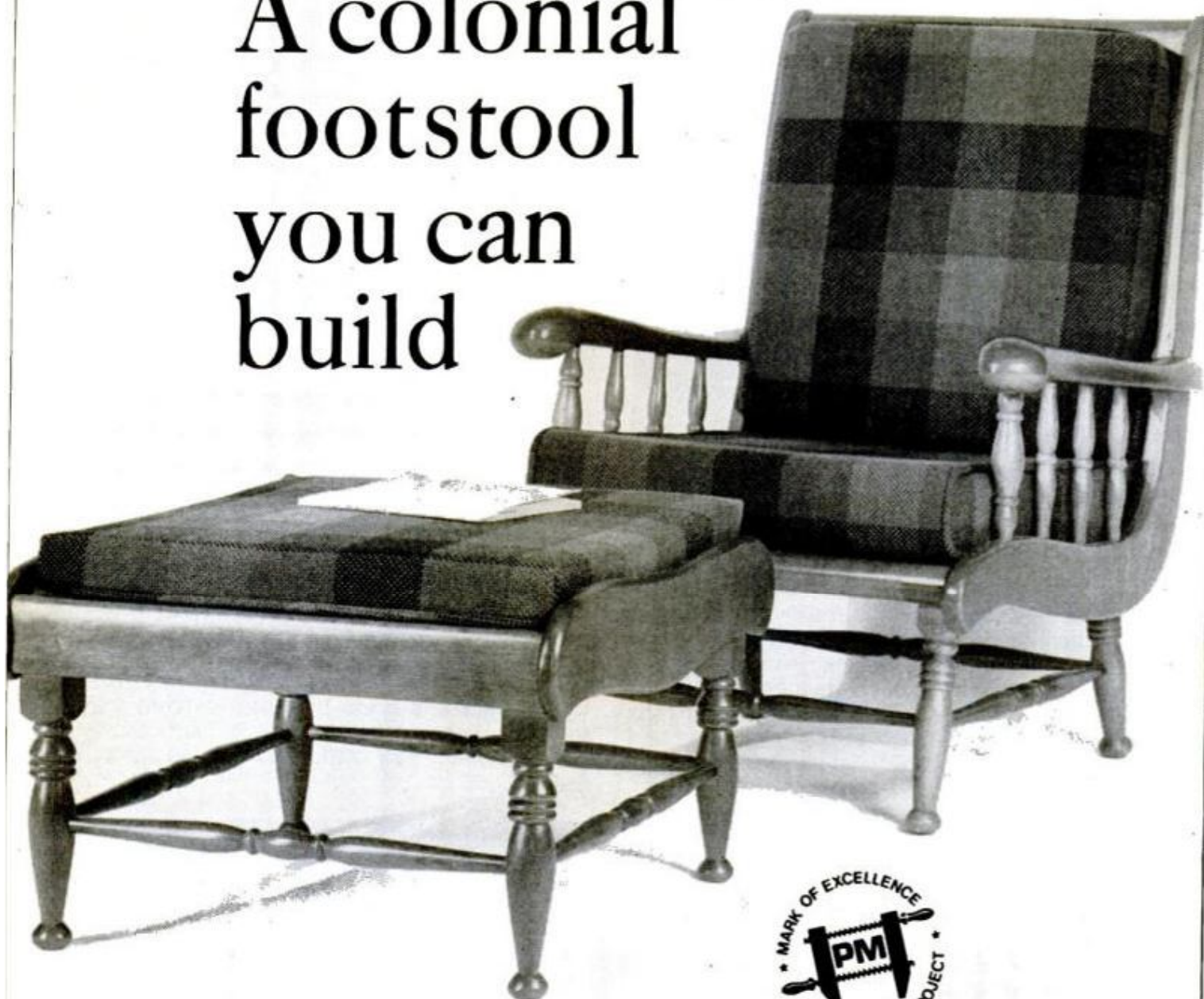

Now you can have a companion piece to match that handsome chair recently featured in *PM*.

By **ROSARIO CAPOTOSTO**
Photos by the author

ANYONE WHO BUILT the handsome colonial chair featured in our December and January issues (*A colonial chair you can build for \$53, page 144, Dec. '71 PM*) has had many months of comfortable sitting. Now it's about time to get out of the chair and back into the workshop—this time to make a companion footstool for the chair.

Even if you haven't built the chair and never intend to, the stool will be a welcome addition to most living rooms and family rooms. Simply by selecting different material to cover the cushion, you can match it to any decor.

Its basic design, with some minor differences, is very similar to the chair. It

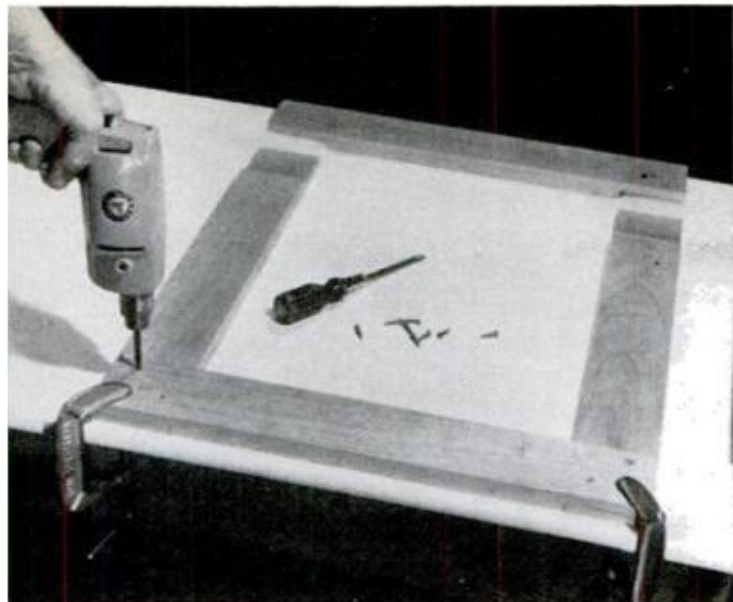

SEAT-FRAME MEMBERS are readied for assembly by boring two holes for $\frac{3}{4}$ -in. screws at each corner

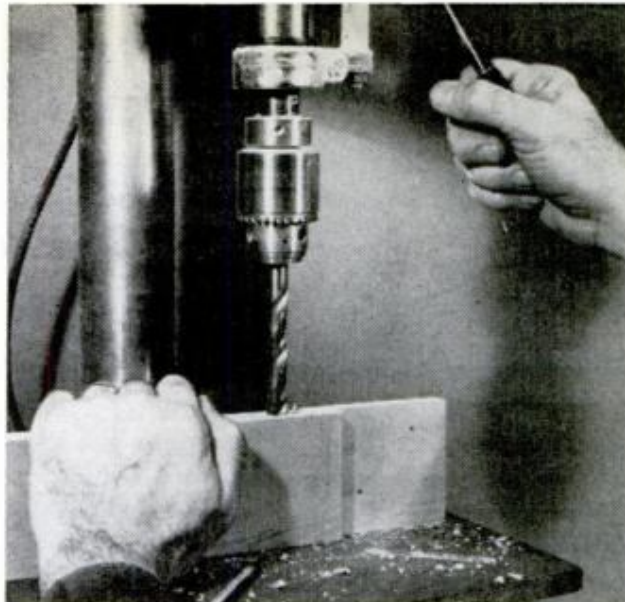

COUNTERBORE screw holes in seat-frame members, then use glue and the screws to assemble the frame



ROUT RABBET FOR HARDBOARD INSERT before sides are attached. Clamped 2x4 limits width of the cut

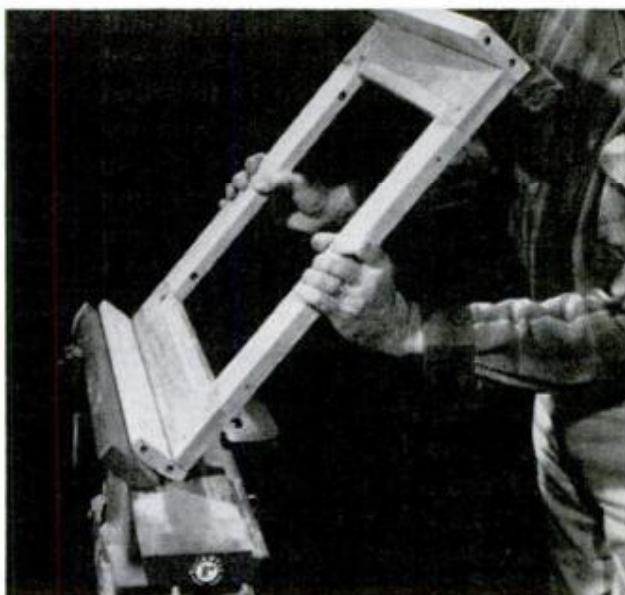

AFTER FASTENING ENDPieces to the frame, you can shape the curved profile freehand on the jointer

varies in that the legs are perpendicular, the seat frame is not as heavy and a hardwood panel—not webbing—is used for the seat. But if your stool will be used mostly for sitting, you might prefer webbing because it has “give.” (See the December article for webbing how-to.)

The boxed-in seat utilizes the back section of Sears’ two-piece Replacement Cushion Set (No. 24K 19211 LH). It’s sold only as a two-piece set, so plan to use the extra cushion as a throw pillow. Depending on the price of cherry lumber in your area, cost of materials (including cushion set) should be about \$28.

Use seasoned cherry lumber and begin with the seat frame by dadoing the end lap joints. Assemble the pieces with

clamps to hold corners square while you bore a pair of pilot screw holes in each corner. The screws are needed only to prevent sliding during gluing. Make certain you locate these screws clear of the area reserved for the leg tenon holes. The side and endpieces are attached with screws and glue, so bore and counterbore the screw holes through the four boards first. After the seat frame is glued, bore the four blind holes for the leg tenons and rout the rabbet for the panel.

Glue up only the two endpieces, leaving the patterned sides until the curved cross sections of the ends have been shaped. Finish-sand the ends prior to assembly of the sides.

Cut the sides, sand them smooth and

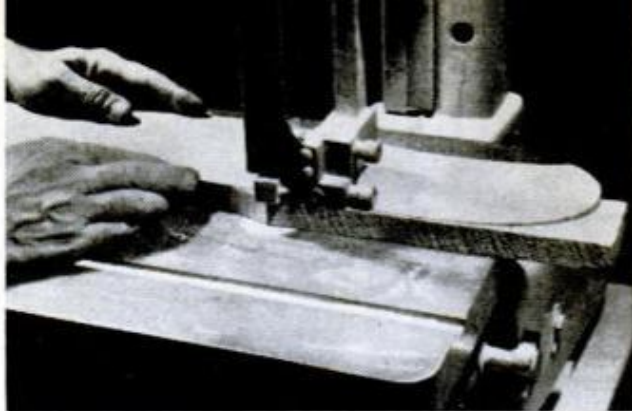

SHAPED SIDEPieces are easiest to cut on a band-saw, but you could also use a jigsaw or a sabre saw

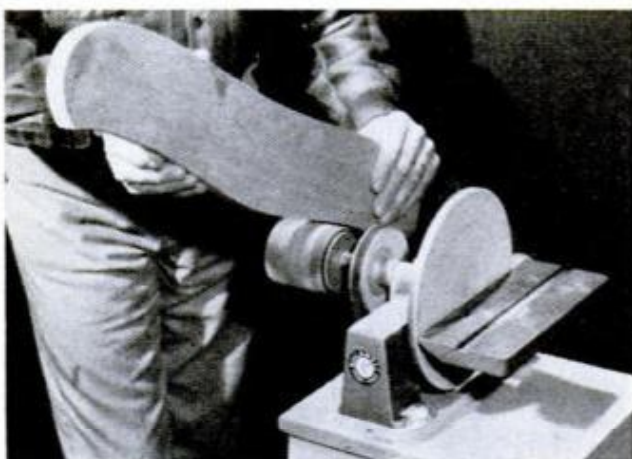

SAW MARKS AND BUMPS ON EDGES must be sanded smooth before the sidepieces get corners rounded

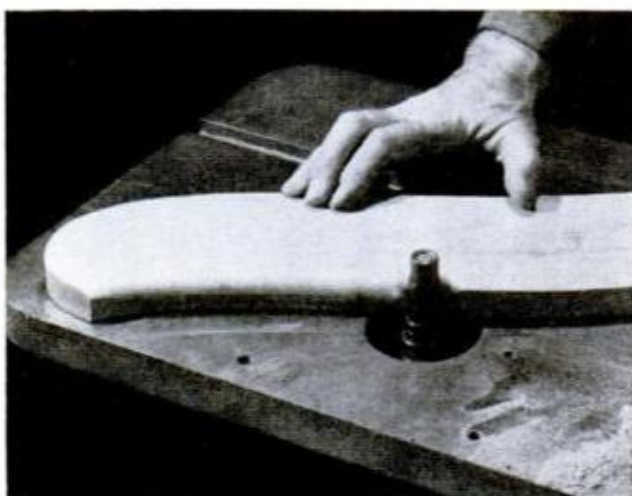

HALF-ROUND CUTTER AND SHAPER are used to shape radius on sides. Bottom inside part is not rounded

SIDEPieces are attached to the frame with glue and dowels. Use dowel-centers to locate hole positions

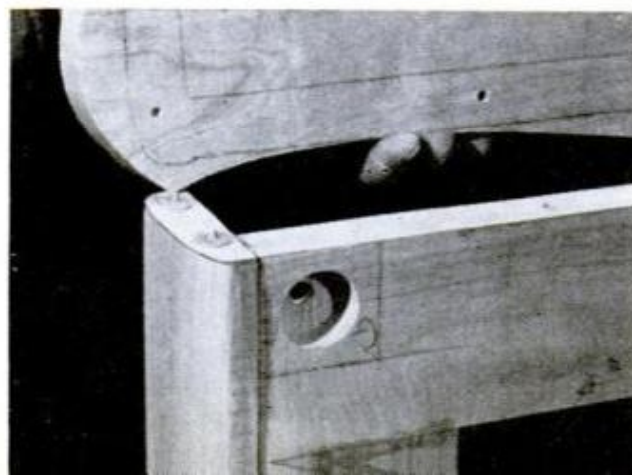

shape a half round on both sides. Do not round the inside bottoms, which are left square. Locate the position for the dowel holes and glue on the sides using bar clamps to pull in the ends.

Next, turn the legs. Since the tops of the legs are square-shouldered, joint the turning blocks true and smooth. Carefully mark the lathe centers on the blocks so the shoulders will form symmetrically. Turn a 1 1/8-in.-dia. tenon at the top and leave a square section in the scrap area beyond the foot of the leg to facilitate accurate boring of spindle holes. And set up a simple jig to be sure to get holes that are uniformly located on each leg.

The spindles are turned from 1 1/8-in.-

LEG-TURNING DETAIL

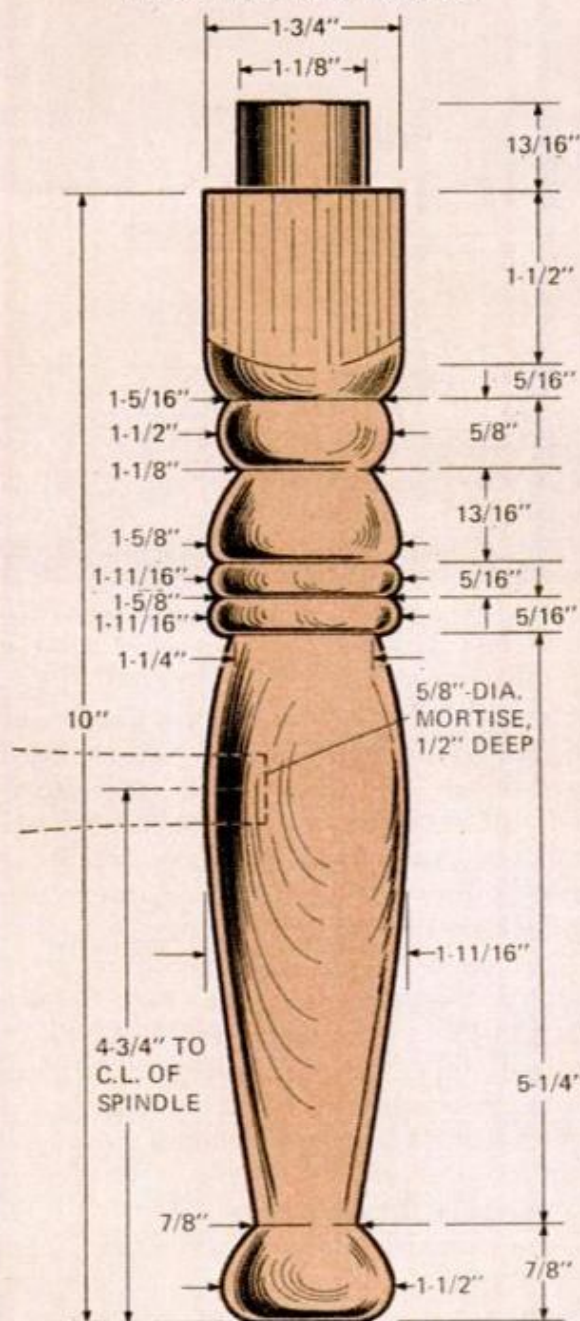

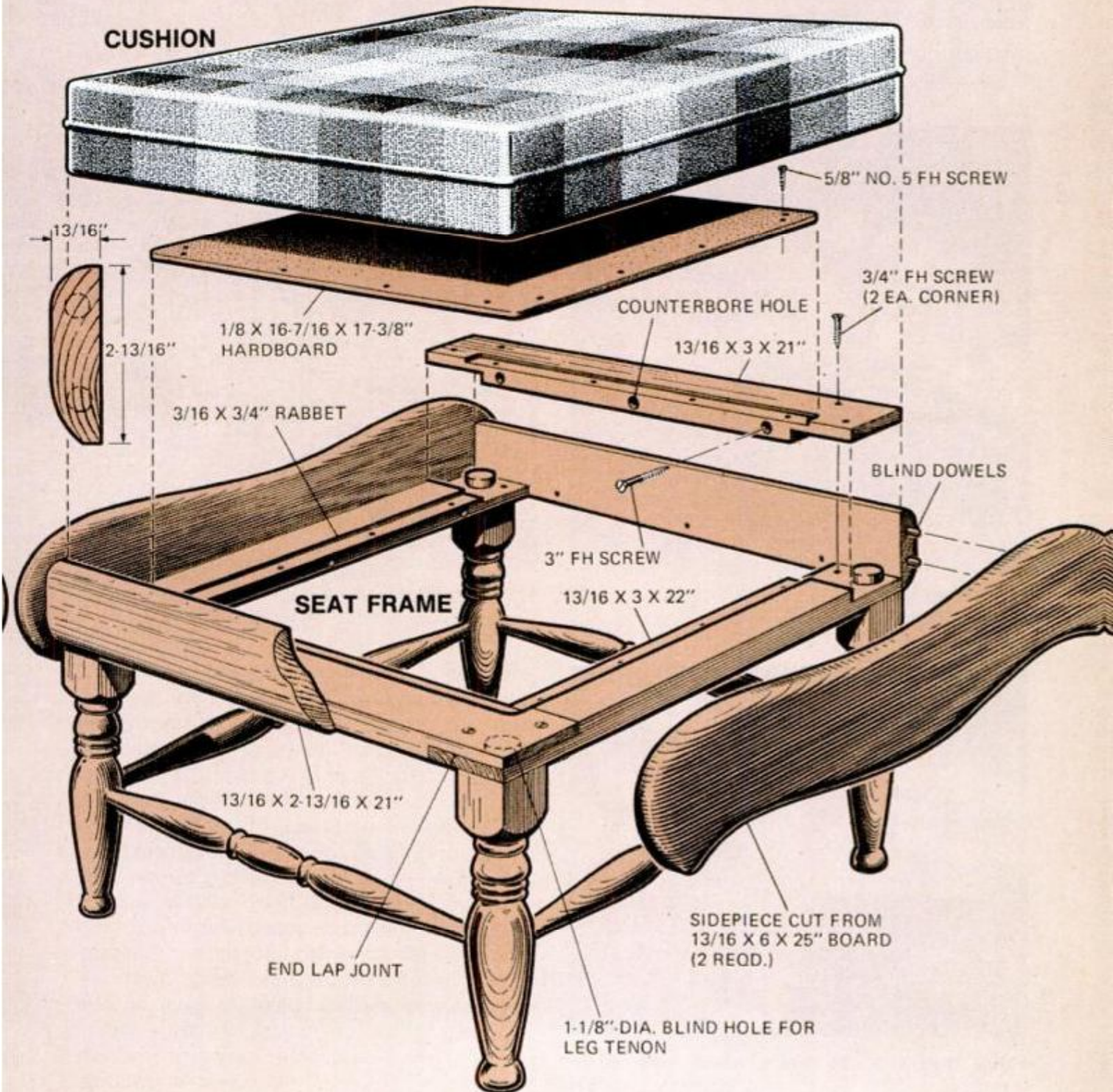
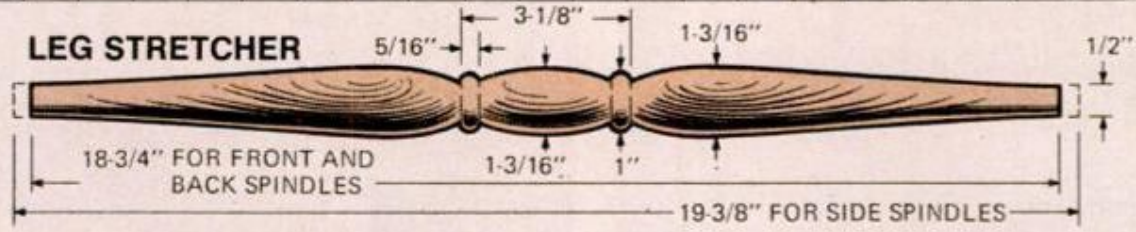
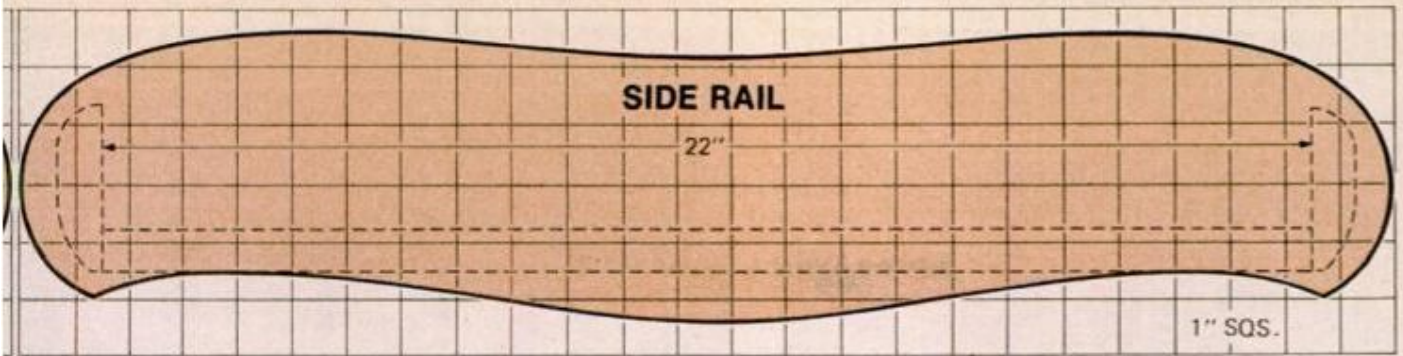

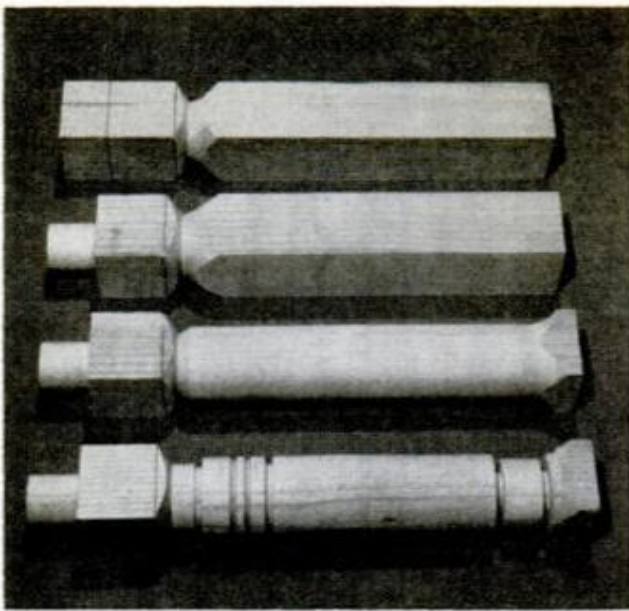

LEG-TURNING PROGRESSION, top to bottom: Chamfer cut, tenon, rough cylinder, then parting cuts

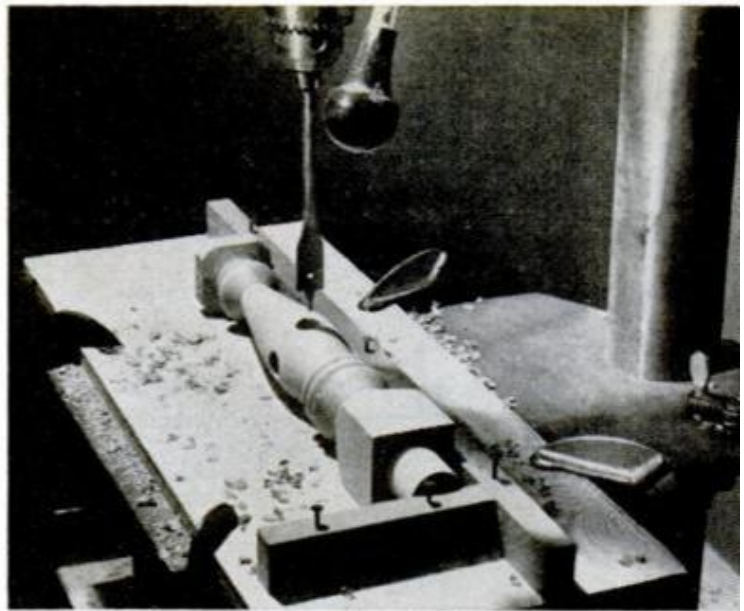

TWO FLATS keep leg positioned for boring spindle holes. Next step is to cut off waste at the bottom

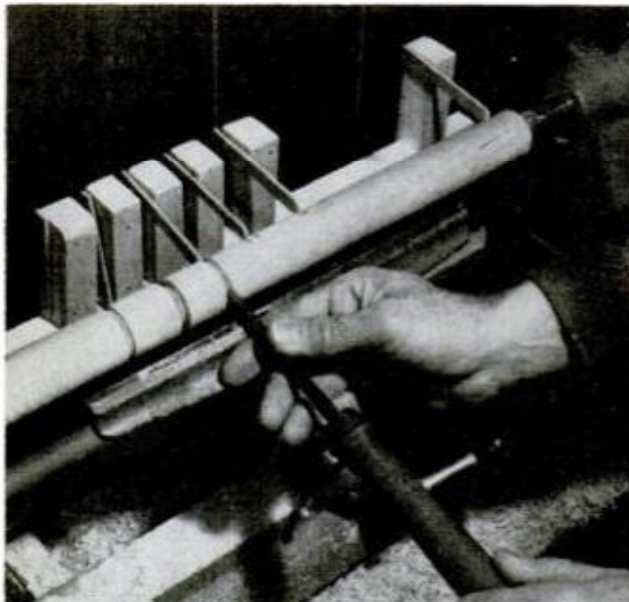

SEMAPHORE JIG is easy to make; it simplifies the task of obtaining accurate diameter of sizing cuts

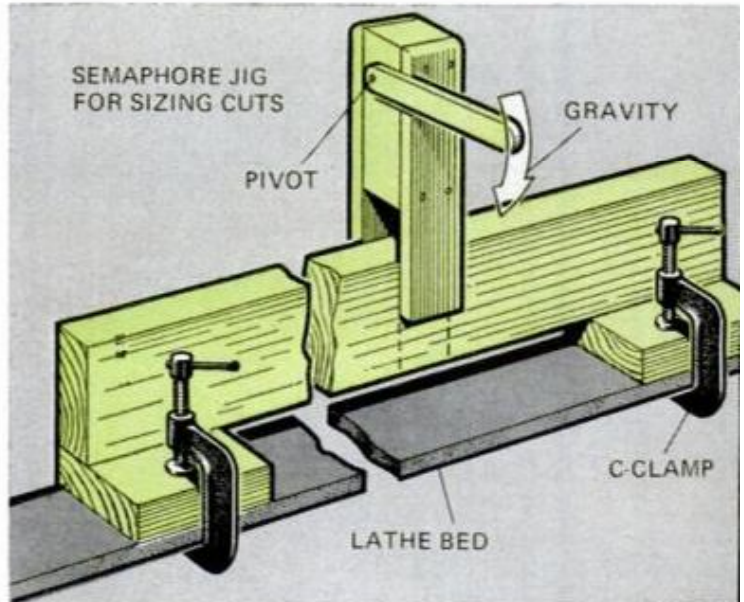

SCRAP MATERIAL is adequate for making a semaphore jig. See text for information on how to use it



LONG, THIN SPINDLES tend to vibrate, so work the center area first. Thick ends minimize bouncing

sq. stock. Due to length and small diameter, you may encounter whip (vibration). Overcome this by use of a backstick—a simple notched piece of wood mounted to support the workpiece from behind. Or, keep it simple as shown in the photos.

The important phase of repeat turning is the making of the sizing cuts (parting-tool cuts which “plot” the diameter at various locations). The caliper serves quite well, but it requires continual stop and go. You may want to set up a semaphore jig for making these cuts. There are only four of each pattern to turn on the legs and spindles—no production run—but you may enjoy the ease with which you can get absolutely accurate diameters.

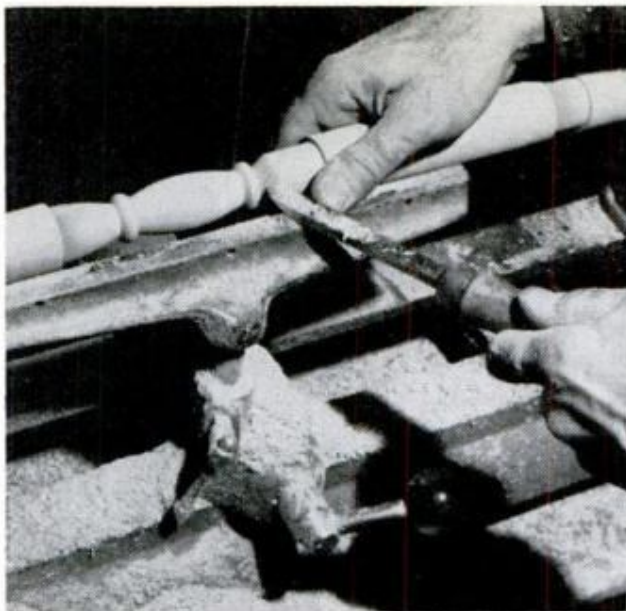

EASY WAY TO BEAT WHIPPING: Grasp work lightly with one hand while your thumb guides turning tool

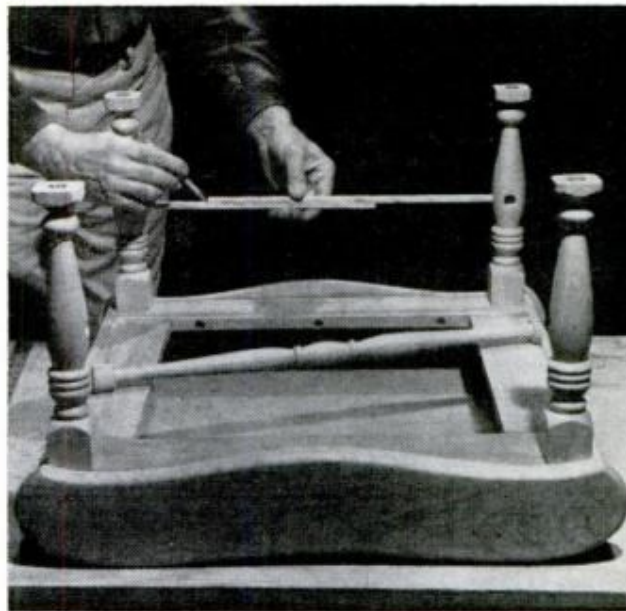

DETERMINE SPINDLE LENGTH by inserting legs and using two sticks (in spindle holes) as depth gauge

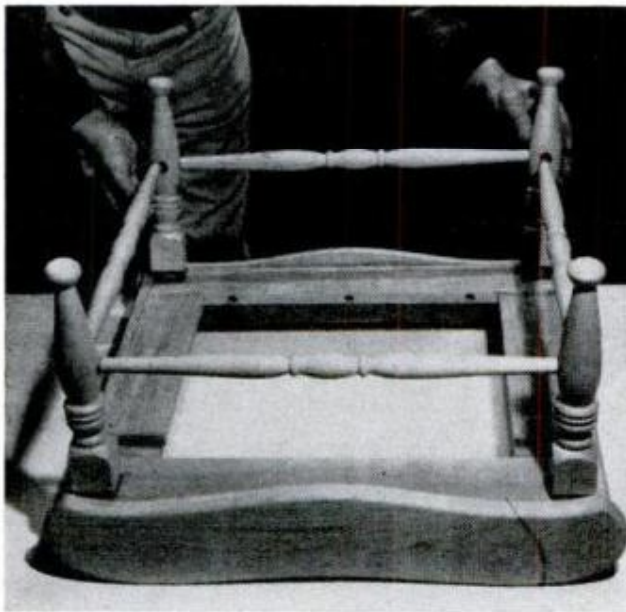

TO GLUE LEG ASSEMBLY, insert first pair of legs part way so they'll "give," ease in the second pair

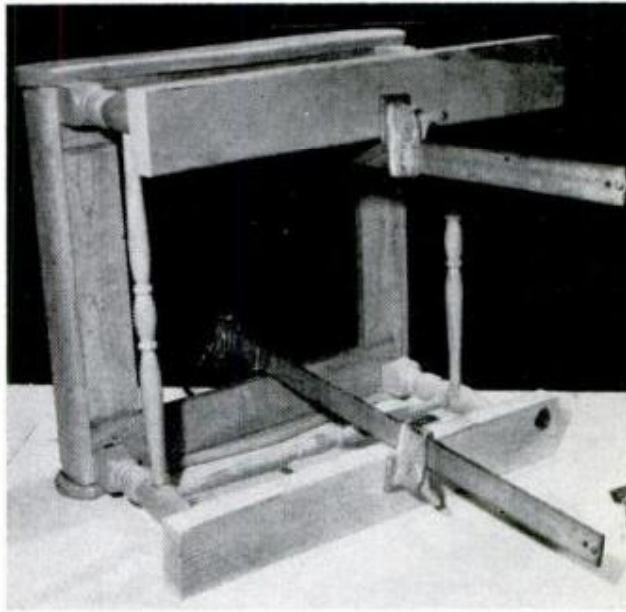

MINIMAL CLAMPING is required. Legs are bridged with two lengths of lumber to seat the leg tenons

This jig is a length of board mounted on edge in back of the lathe. Make a series of notched-out blocks which ride snugly along the top edge of this board. Pin a thin strip of metal or wood to the side of the block. The strip is pivoted near one end so the outer end can swing down against the workpiece. Determine the length of each strip after making the initial sizing cuts on the first piece using a caliper. Using the model as the guide, position the blocks and pin the strips so they will just drop down past the work when the proper diameter of parting cut has been reached. On the subsequent turning, simply lay the arms over the top of the turning. Then just feed in the parting tool

in line with the arm until it drops down.

Turn the ends of the spindles down to a diameter of $\frac{5}{8}$ -in., then finish-sand them on the lathe before you cut off the waste ends.

If you use a spade bit to bore the blind holes in the seat bottom, the point of the drill bit will penetrate the frame and form small holes on the top side. Plug these holes with wood putty so glue in the tenon joint cannot escape. Cut spindles to length and test all parts for fit. Work turnings into the base, then clamp legs to the seat with a pair of bar clamps and two boards as shown. Screw the hardboard panel into the recess after applying several finish coats of lacquer or varnish. ★★ ★



LUXURY TRAILER provides comfortable living, no matter where you vacation. To order plans, see page 138

Now: a 20-ft. travel trailer you can build yourself

This beauty has all the comforts of home, from convenience cooking to complete bath with shower. Starting with plans we offer, you can assemble Laguna-20 for less than \$2000

LAGUNA-20 FLOOR PLAN

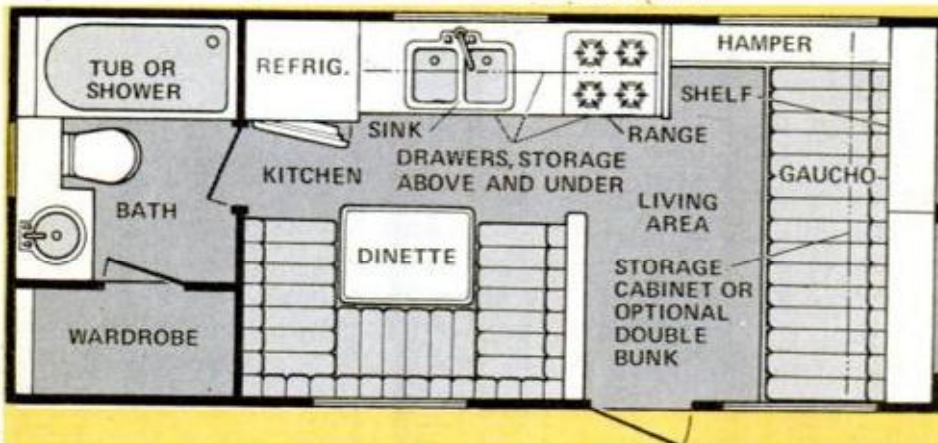

LAGUNA-20 looks just like a commercial trailer, inside as well as outside. Floor plan at left reveals an important planning point—total self-containment. Prototype trailer above and on the facing page was built in the same way a do-it-yourselfer would build his own at home. The design conformed to California's stringent travel-trailer code. After the unit was completed, it was inspected, approved and registered by state of California



GAUCHO at front of trailer provides spacious comfort by day, sleeping for two at night. An optional bunk can be built above gauchos to sleep two more

THERE'S NO ARGUING that, dollar for dollar, camping in your own trailer is just about the best family-vacation bargain around. But, until now, a trailer vacation—with all the comforts of home or vacation spa—meant you had to lay out anywhere from \$3500 to \$8000, or settle for traveling with the barest essentials and conveniences.

An aggressive and creative firm in California—Glen L Recreational Vehicles—has changed that picture. It has designed a comfortable, luxurious trailer that can be assembled for about \$2000, using tools of the type builders probably already own. And it has agreed to sell plans, full-size



LOTS OF DRAWER SPACE and cabinets, plus pullout cutting boards are in dream camping kitchen. Plumbing fixtures are connected to a 6-gal. water tank and a 30-gal. waste-holding tank (to make the unit independent during extended on-the-road time). Comfortable dinette at the left converts into a roomy bunk to sleep two adult-size vacationers



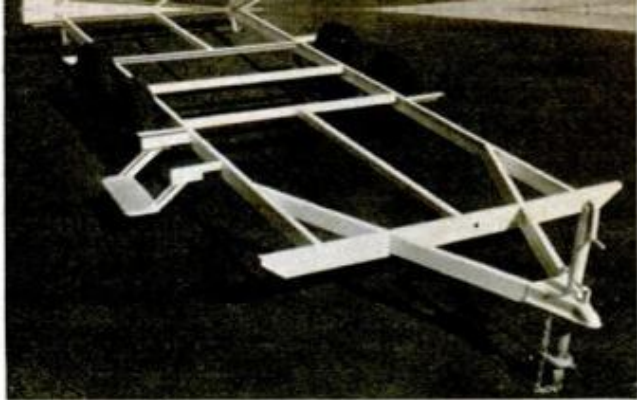

COMPLETED TRAILER FRAME for 20-ft. Laguna-20 with tandem axles. Note the coupler with jack stand



WALLS ARE ASSEMBLED on the trailer floor. It is a must that all studs be exactly the same length

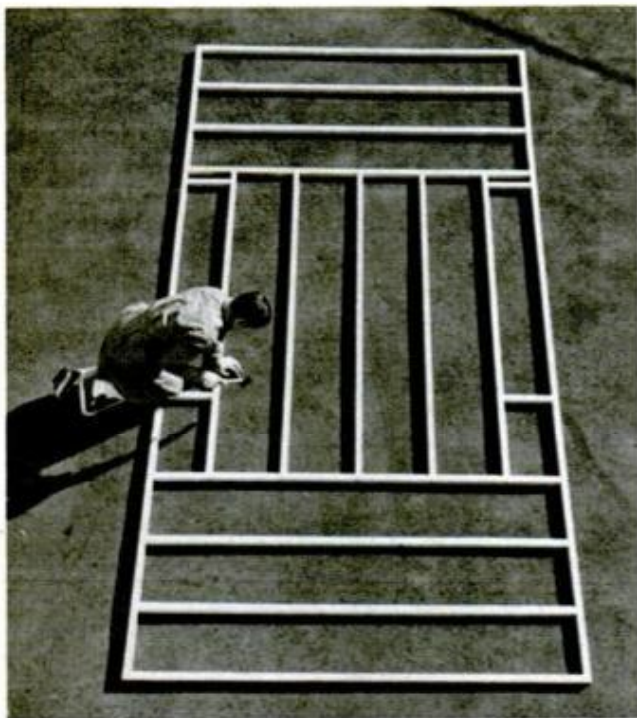

FLOOR FRAMEWORK consists of 2x2 stock. Continuous sidepieces are cut to length after the assembly

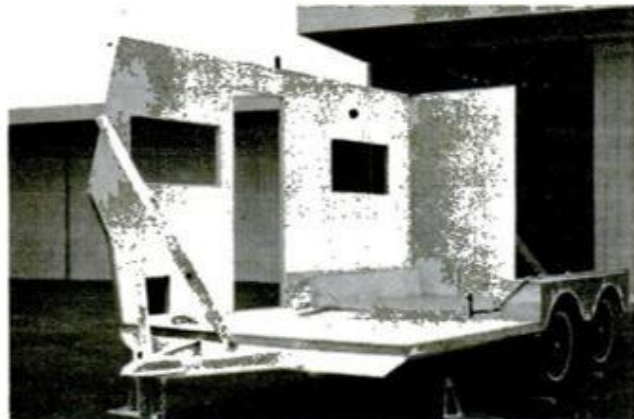

FIRST WALL is erected and braced in position. Next, crosswise partitions will hold the wall in place

patterns and a construction manual that will let *PM* readers build one for themselves in the least possible time. (See *How to order plans*, at left).

The rugged 20-footer has a lot more going for it than is immediately obvious in the photos. Perhaps its strongest design feature is the fact that it is totally self-contained. There's even a complete bathroom with space for an optional tub or shower.

The lighting system runs through a converter which takes in 110-volt power whenever it's available and converts it to 12 volts. At other times, the system simply runs off the trailer battery. The converter also charges the trailer battery

HOW TO ORDER PLANS

Five large plan sheets, 32-page construction manual, full-height patterns giving contour and position of sidewall members at front and rear ends, full-size patterns for wheel-well cutout and cambered roof beams. Complete for \$15 postpaid via parcel post. Order from Glen L. Recreational Vehicles, Dept. PM, 9152 East Rosecrans, Bellflower, Calif. 90706.

NAIL 3/8-IN. PLYWOOD FLOORING to framework after coating latter liberally with waterproof glue



BOLT WALL in position to the floor through the lower wall plate. Notice clamps are holding wall

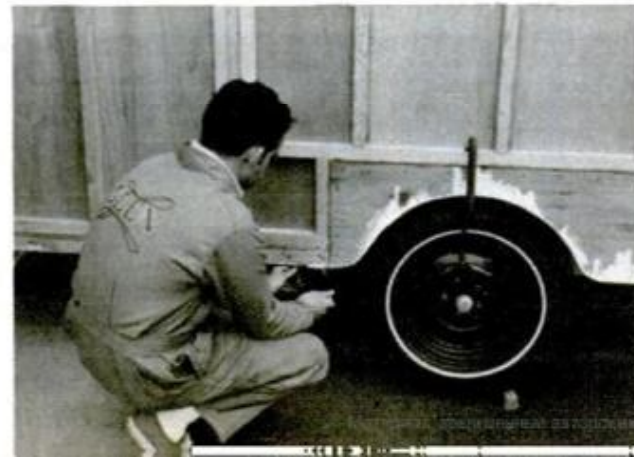

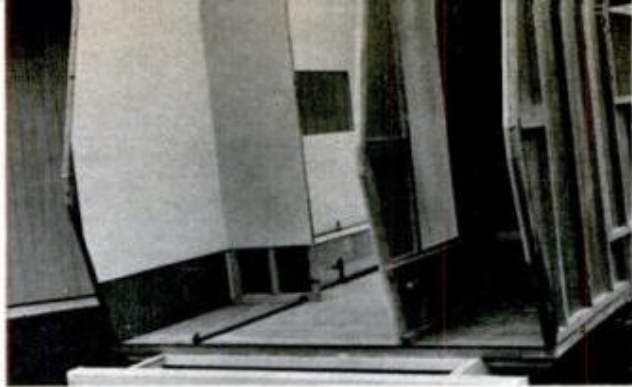

BATHROOM AREA with partitions installed. Interior of closet at right can be covered with paneling

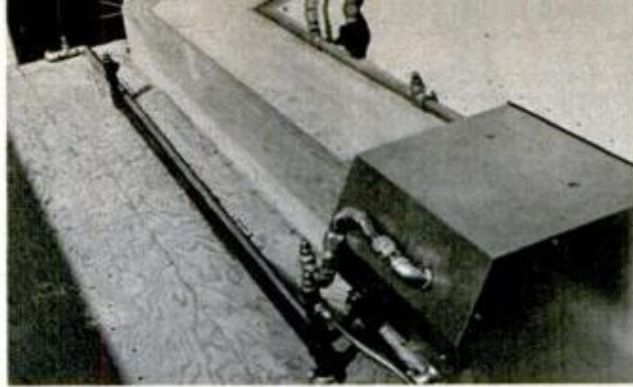

WATER HEATER connected to LP-gas, hot and cold-water lines. At center, the connection for city water



WHERE TOP AND BOTTOM parts of front wall butt, V-cavity is filled with wedge-shape piece of wood



PLASTIC-PIPE DRAIN FITTINGS are taped and a line is drawn to locate relative position of the fittings

automatically when connected to a 110-volt power source.

The prototype shown sleeps four: The dinette and gauchó both convert into double beds. If you wish, the cabinet area above the gauchó can be fitted with a convertible double bunk. Details for this option are included in the plans. Other good features are the full-height, hanging wardrobe closet and many storage compartments.

Experienced over-the-roaders will appreciate the tandem axles which provide steady tracking.

Features to keep all trail-cooks happy abound in the kitchen setup. There is a 6-gal. water heater, a four-burner range

with power vent hood and a double-sink that will let the fussiest chef prepare near-banquet-size meals for the family. And, as all campers know, that 30-gal. waste-holding tank will minimize stops at sanitary disposal stations.

The plans, patterns and manual are clear, concise and easy to follow. The manual is profusely illustrated with step-by-step photographs which will simplify your work. (*Editor's note:* The manual is not available separately. It is offered only as a part of the complete package.) Finally, to make building the Laguna-20 as easy as possible, Glen L incorporates standard recreational vehicle equipment throughout. ★★★

KITCHEN SINK CABINET is shop-assembled, positioned in trailer after rough-in plumbing is installed

CONTINUOUS ROLL ROOFING is started at front above windows. Latter inserts into "Pittsburgh" lip



High-style table from construction-grade lumber

This sturdy, contemporary 'butcher-block' furniture is constructed to take punishment from youngsters

By HARRY WICKS, Workshop Editor

Data: Annette Sukov
Color photo by Les Turnau

BUTCHER-BLOCK FURNITURE is riding a wave of popularity these days and it's not difficult to figure why. It is sturdy and can be used practically anywhere in the home. These features motivated the builder of the handsome furniture shown to create a small dining set for his own kitchen.

He selected inexpensive construction-grade stock to build the set; his thinking was that if it was sanded and finished correctly the set would have the looks—without the price tag—of sets selling for \$150 or more.

Ted McLaren of Minneapolis (who also designed the *Do-it-yourself paper furniture* (page 132, June *PM*), accomplished exactly what he set out to do. His cash outlay was a mere \$35, and by using building construction techniques—rather than sophisticated cabinetmaker's joinery—he completed the set in a couple of weekends. You can build the table and benches factory-fashion. For example, all parts can be gang-cut, sanded and as-

sembled, and all the assembled pieces can be finished simultaneously. To avoid confusion, keep bench and table parts in separate stacks and label each part.

Since it is not uncommon for construction-grade lumber to come with rough edges and/or with knots missing, select the lumber personally if you can. For the bench and tabletops, try to use only 2x4s with marfree edges. Because these are left natural, any filler used would show through and lessen the butcher-block effect. In all likelihood, you will have to accept some nicked lumber; save these pieces for members that will be painted. These can be filled and sanded; the paint will hide the filler.

The only dimensions that can (and should, if necessary) be altered, are the lengths of the benches and table. Heights and widths are standard architectural dimensions. With size of set determined, cut all parts at one time and label them as mentioned.

Most two-by stock has slightly rounded

BENCH, TABLETOPS are assembled with glue and 8d common nails (8d finishing nails in outside boards)

BLOCK IS PLANED and sanded after glue has dried, then is stained and finished with semigloss varnish

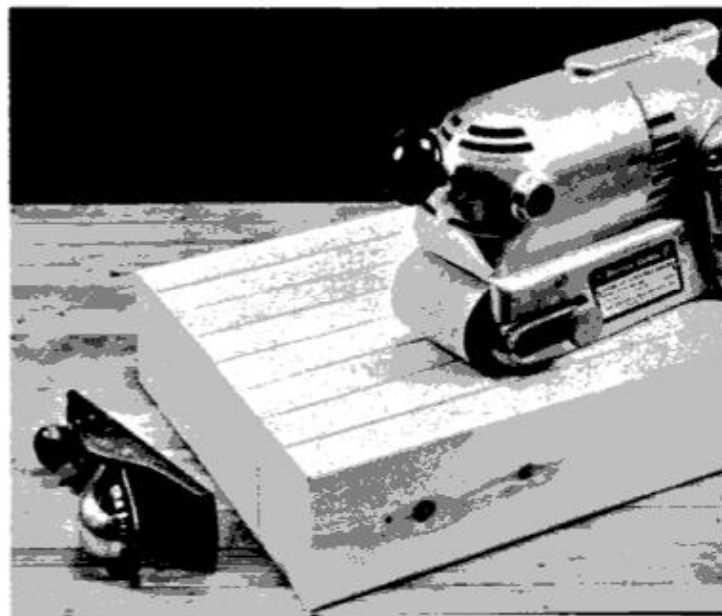

BUILT TO TAKE IT, this rugged
"butcher-block" table and bench
set is ideal for young families



BUTCHER-BLOCK TABLE

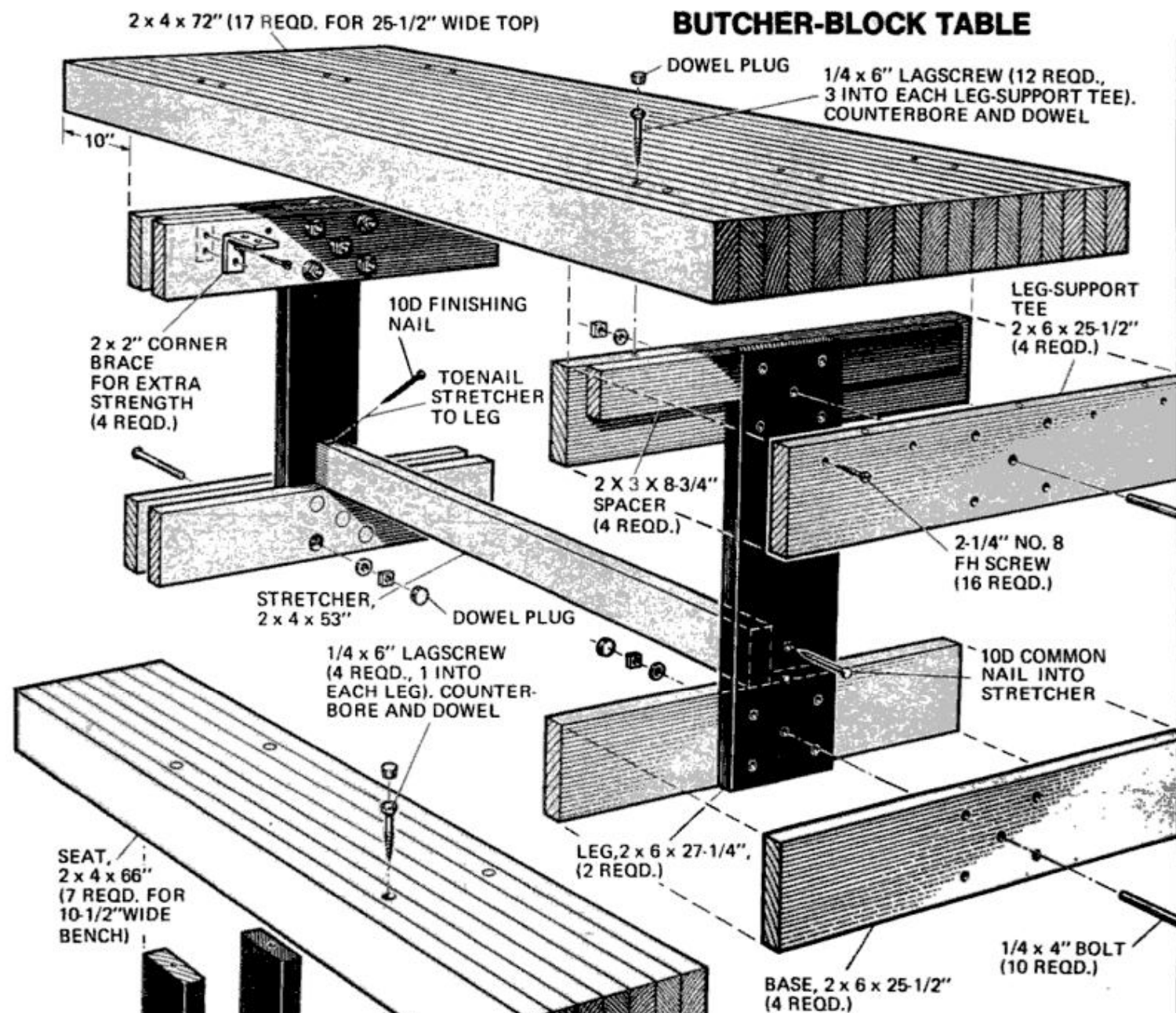

Technical art by Peter Trojan

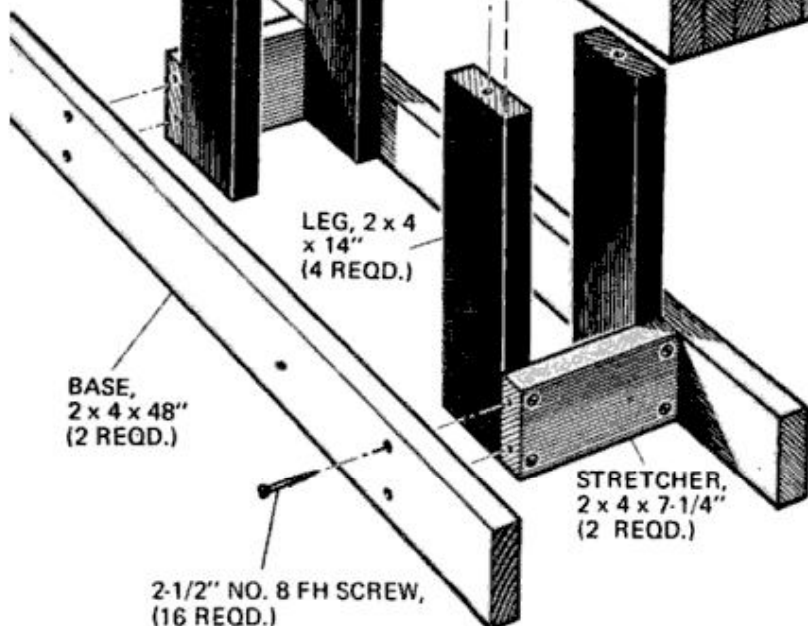

BUTCHER-BLOCK BENCH

edges. If you plane and sand these before assembly, the job goes faster. To assemble the tops, use glue and 8d nails. Apply white glue to the first 2x4 and drive 8d common nails through the second 2x4 into the first. Continue doing this until the last (outside) board. Here, use 8d finishing nails because you can set the cupped heads and fill the small indents so they are practically invisible. You can, of course, drill the 2x4s and fasten them together with threaded rods, washers and nuts and then hide the hardware with dowel plugs.

Finally, assemble the benches and table as shown in the drawing above. McLaren finished the original with two coats of polyester resin on the tops and enamel on the bases. ★★★

A one-man dinghy dolly you can build for \$8

ORDINARILY, getting a dinghy from storage down to the big boat (or any maneuvering on land for that matter) can be a backbreaking chore for even two men. Happily, with about eight bucks worth of standard hardware-store items and a weekend in the shop, you can build this lightweight dolly and be rid of the problem.

I built the dolly shown here for exactly \$7.97 in a single work session and, since, have been able to handle my small boat—alone—without any grunting and groaning. It's helped to move other bulky items as well.

Constructed mostly of angle and strap iron, the pieces are sized, bent and assembled as shown below. Dimensions can be altered to fit your particular boat. You should check your transom measurements before drilling and bolting the C-clamps in place. The wheels, too, could be varied if you already have a pair. The dolly was designed for average home construction using a hacksaw, bench vise, electric drill and machine screws. If you own, or have access to, welding equipment, the strap and C-clamps could be welded on for a more permanent job.

—Bill Baugham, Garden Grove, Calif.

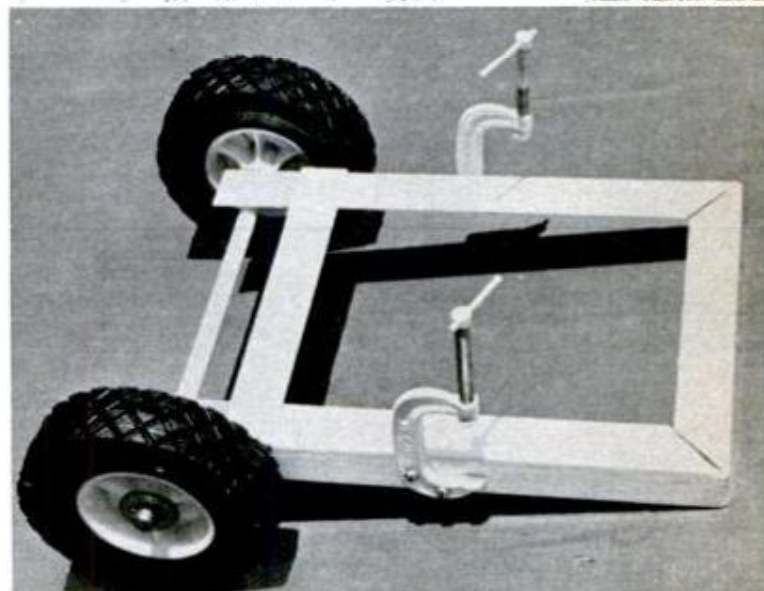

WITH LIGHTWEIGHT TOTOER you can single-handedly haul your small boat from storage to the big boat

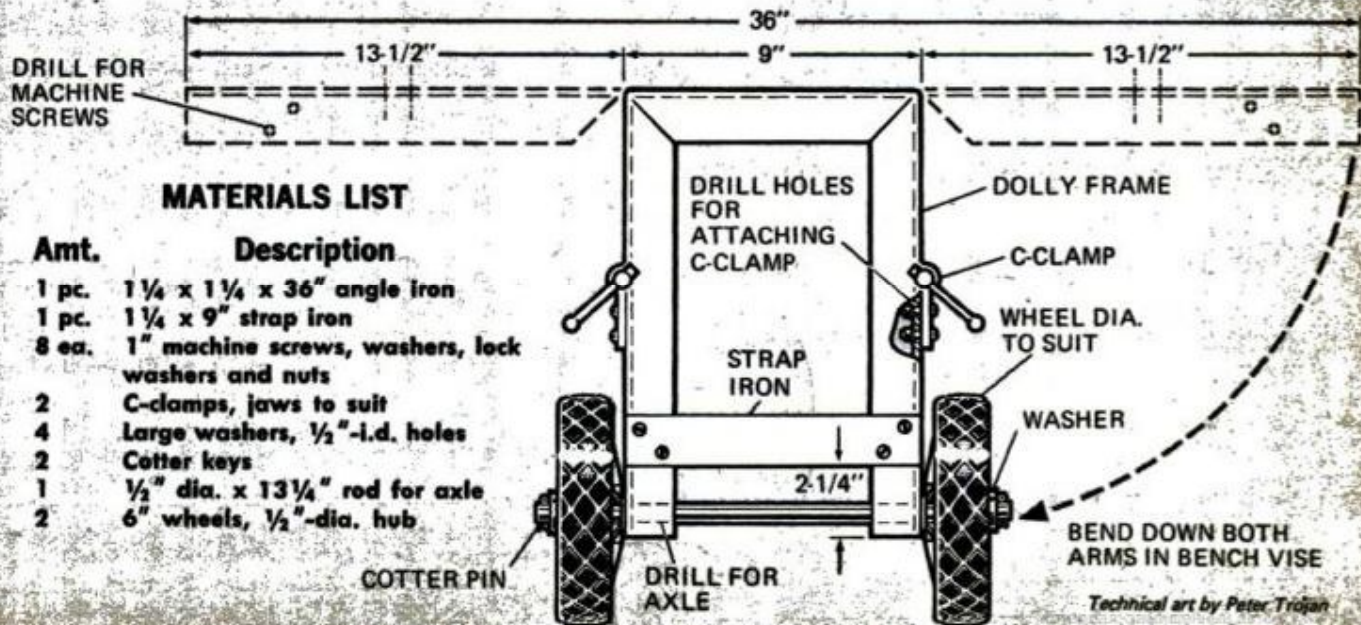

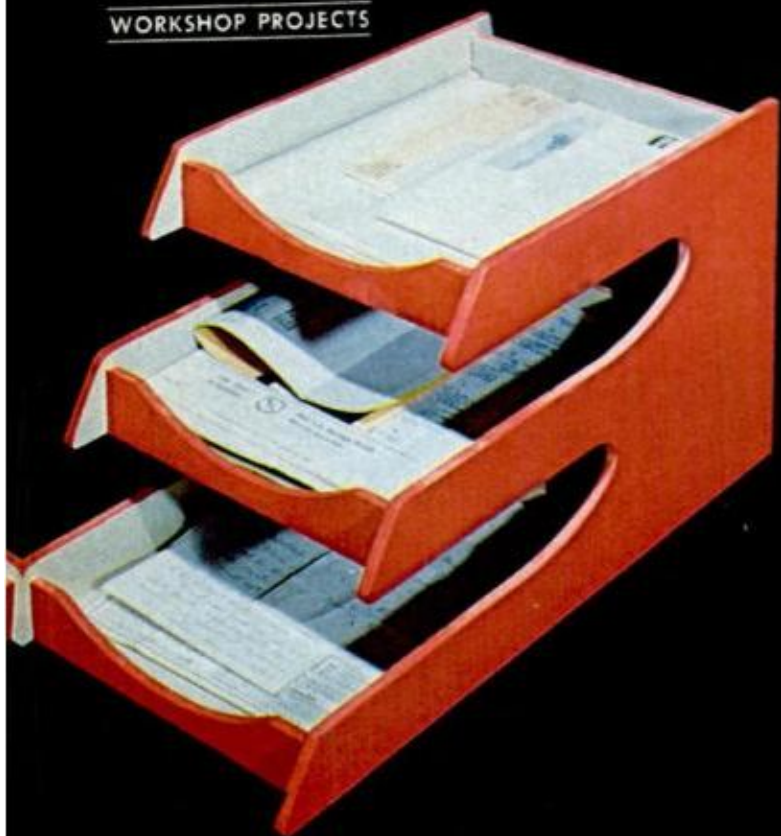

Modern mail organizer

'Swiss-cheese' mountain game

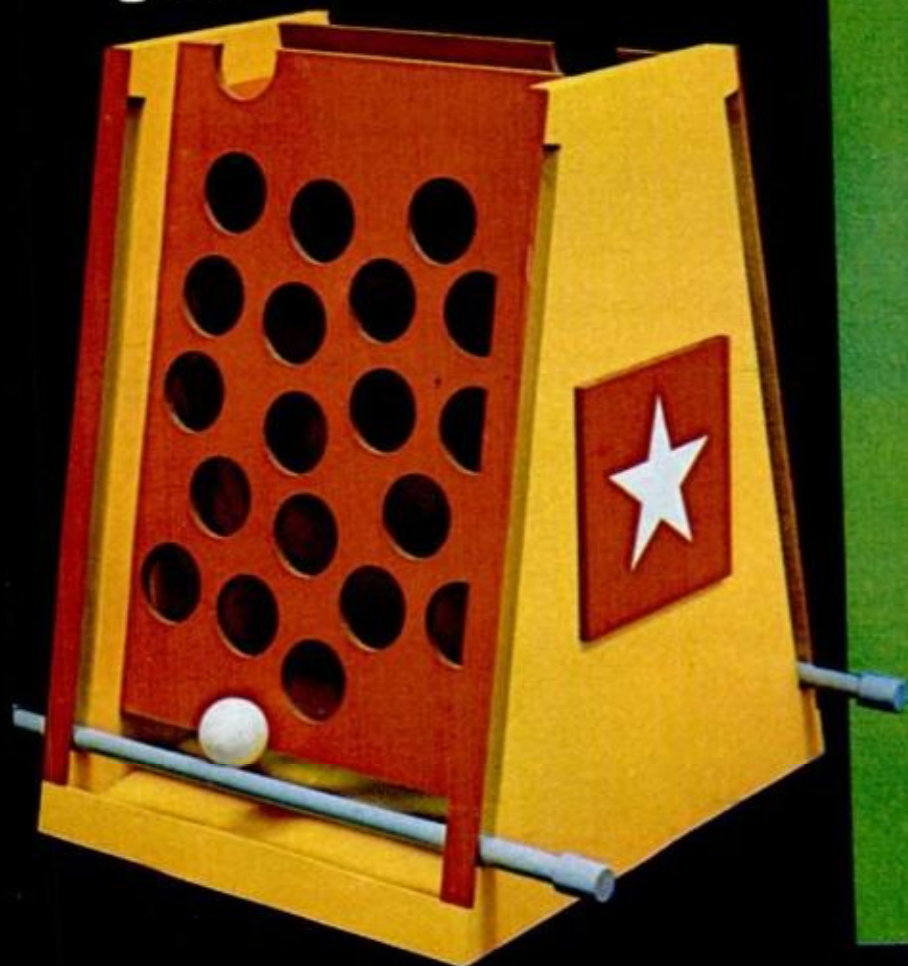

Little projects—lots of kicks

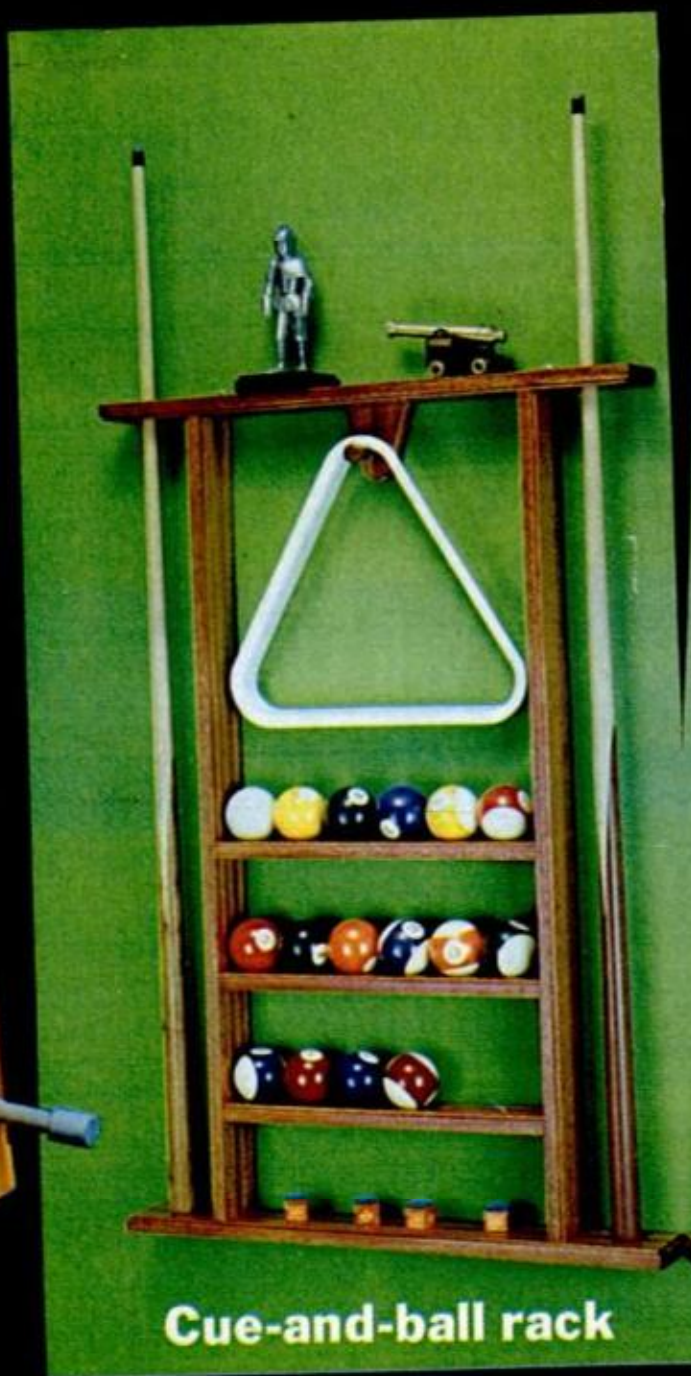

Cue-and-ball rack

Cue-and-ball rack

ROUNDING UP THE BALLS and cues when you're ready to "rack 'em up" is no problem when you store them in a handy wall rack. While this handsome one of walnut holds two cues, it can be built to hold four by making the outboard ends longer and boring extra holes top and bottom. Except for the size of the holes, the top and bottom pieces are alike, as are the sides and the three shelves. Make ball grooves in the shelves by passing the work diagonally across the blade of your table saw. Clamp a wood fence to the table and start with the blade only $\frac{1}{16}$ in. high. Raise the blade $\frac{1}{16}$ in. with each successive pass until you have a concave

groove 1 in. wide. Hand-finish the rough cut by wrapping sandpaper around a large dowel.

If you don't have a lathe, a length of dowel can be substituted for the turned rack peg. All parts are blind-doweled and glued together. Finishing is a lot easier if you do it before the rack is glued together. Apply strips of masking tape to the pieces at the glue joints to keep the wood free of stain. When the finishing is completed, peel off the tape and apply glue to the dowels. Glue and clamp the shelves to the sidepieces first, then add the top and bottom pieces and finally the peg bracket. Add two flat, metal hanging hooks to the rear edge at the top.

—Wayne C. Leckey.

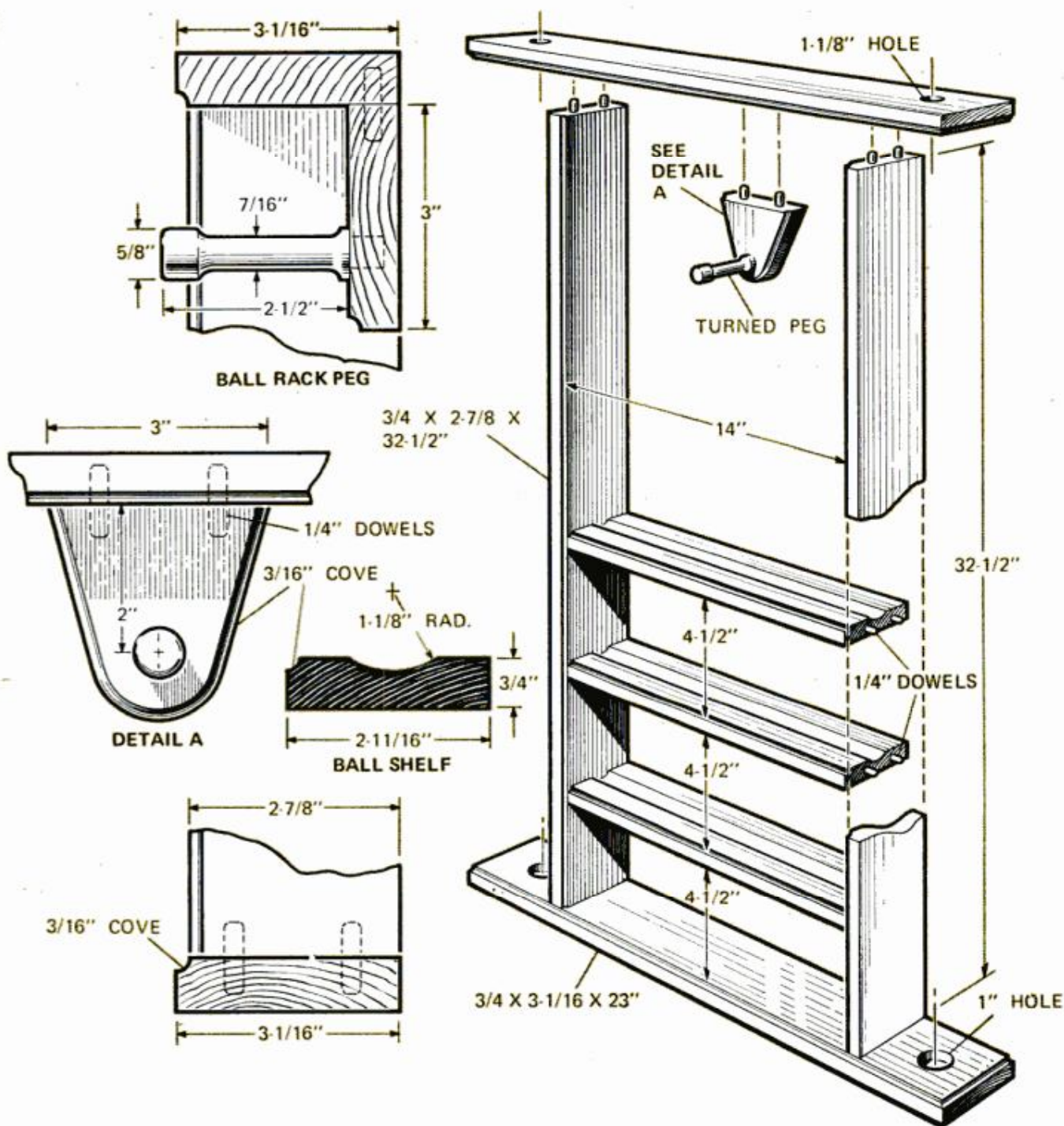

Mod mail organizer

IN TODAY'S "PAPER WORLD," almost everyone can use a mail organizer—the chief executive of the house, the housewife, students and, of course, the office worker. For you fellows in the latter category, imagine the impression you'll make with this sleek IN and OUT box on your desk, especially if you paint it fireball fluorescent red.

Use $\frac{3}{8}$ -in. plywood to make it. Tack-nail together the two side pieces and jig-saw or bandsaw both at once. Cut the three shelves, glue and nail the ends to them, then glue on the side panels. Sand a slight soft radius on all edges and corners. Set and putty the nailheads before painting.—*Ro Capotosto, Greenlawn, N.Y.*

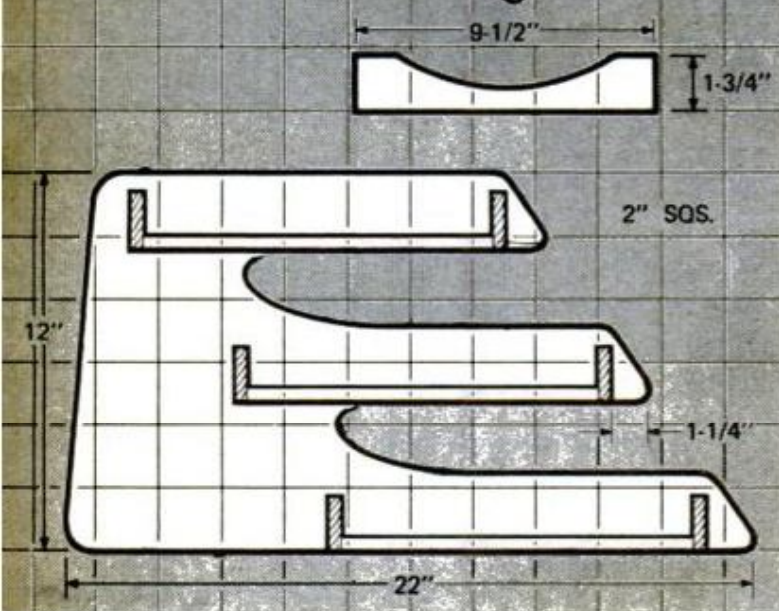

BALL HOLES are bored in hardboard sides with a $1\frac{1}{4}$ -in. hole cutter in a drill press

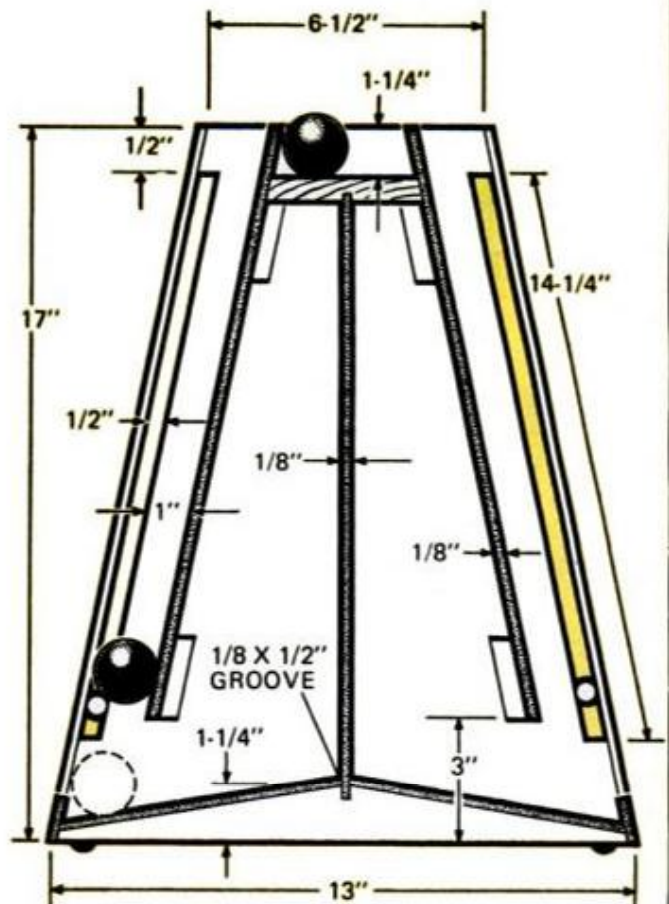

END VIEW SECTION

'Swiss-cheese' mountain game

IN A RACE TO SCALE this "Swiss-cheese" mountain, climbers on opposite sides must watch their step in maneuvering a table-tennis ball up the treacherous slopes. A slight miscue will send the ball through a hole in the "cheese" and back to the starting point. It's a game for two or four players (two to a team), and the climber (or team) who reaches the summit tray first wins.

Made in the shape of a wedge of cheese, the game consists of two 1/8-in. (or 1/4-in.) hardboard sides that have 19 holes in them. Notice that the side holes are bored 1/4-in. in from the edges and that no hole

is more than 1/2 in. from each adjacent one. The section view shows how ramp cleats, glued to the 3/4-in. plywood ends, support a center partition and a sloping floor of 1/8-in. hardboard. A saw groove in the bottom of the summit tray fits over the partition so it is 1/4 in. down from the top.

To cut the slots for the dowels in the edges of the slanting plywood ends, set the saw fence a scant more than 1/2 in. from the blade. Then turn on the saw and carefully lower the work over the blade. Run the cut as far as you can, then stop and square it off with a hand or sabre saw. Hardboard strips cover the notches to hold the 1/2-in. dowel handles in place. Short sections of 3/4-in. dowel cap the ends. The dowels should slide freely in the slots.—Merton H. Slutz, Chattanooga, Tenn.

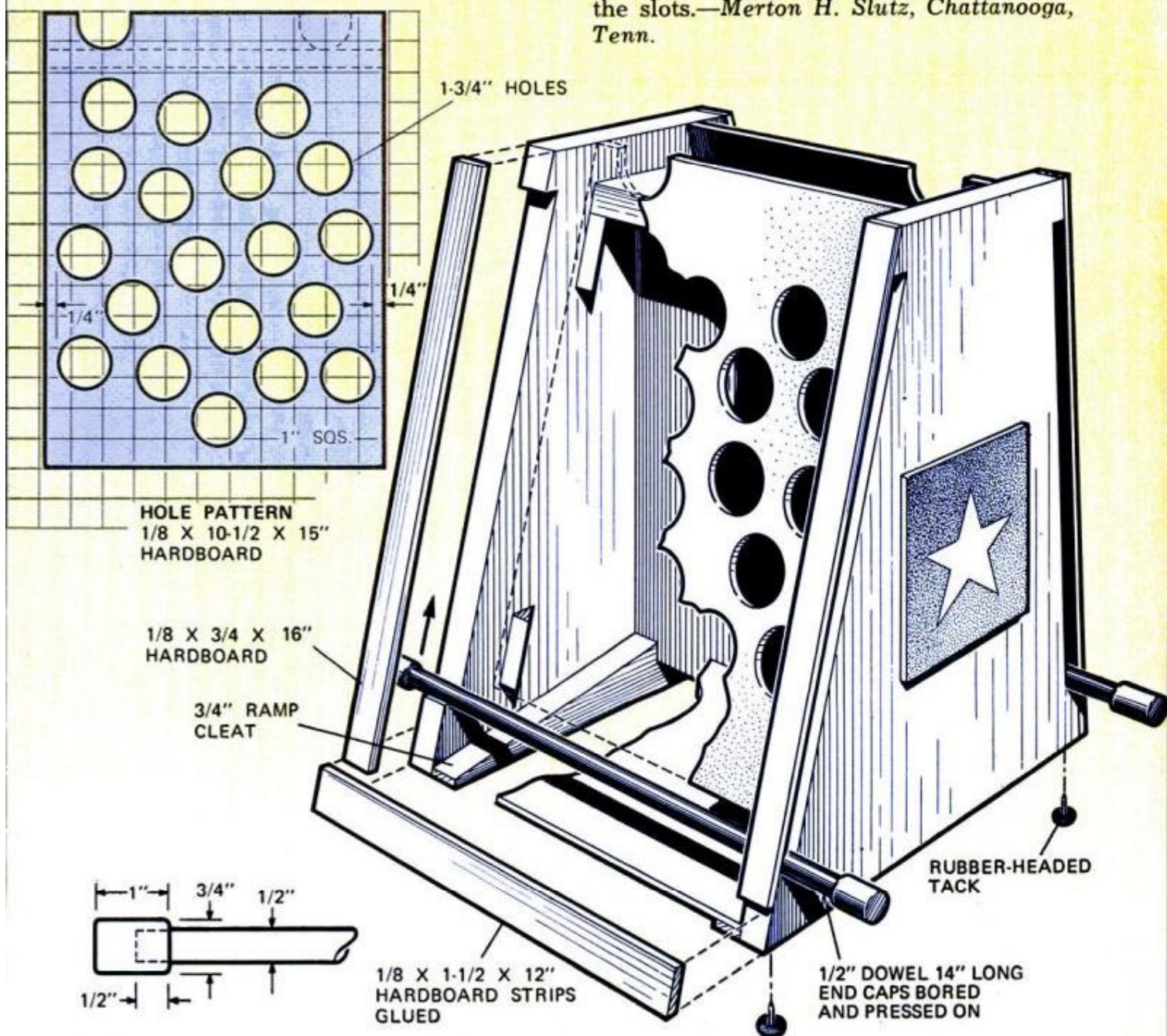

New tools you should know about



YOU CAN ETCH GLASS quickly and easily with the Diamond Stylus Pencil. Simply tape the art to be copied below glass and scratch on the surface. \$4.95. Robert-Allan Co., 17 Acorn Lane, Plainview, N.Y. 11803, makes it.



SOLDERING-GUN KIT by Wen Products, 5810 Northwest Hwy., Chicago, Ill. 60631, has 20 soldering lugs, comes in light plastic carrying case. Gun delivers 200 watts of heat on current draw of only 55 watts. About \$7.95.

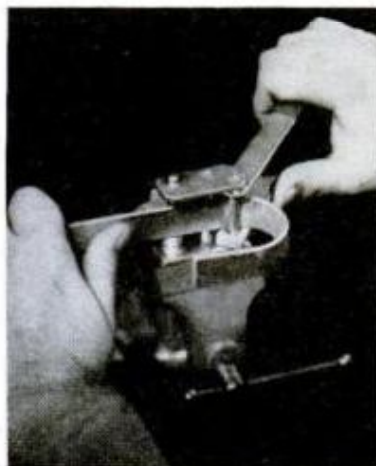

WITH FLATFORMER TOOL and an ordinary vise, flat metal strips can be bent to almost any shape. For material to 1 in. wide and $\frac{1}{8}$ -in. thick, \$7.98. Vinkemulder Tool Co., 2223 Estelle Dr. S.E., Grand Rapids, Mich. 49506.



CARBIDE-TIPPED router trimming set is designed for use with plastic laminates. Three-piece set, No. 76-350, gives straight, bevel and flush cuts, sells for \$19.99. At retail outlets handling Black & Decker tools.



LIGHT RUST can be rubbed off with Rust Eraser from Brookstone Co., Dept. C-PM, 10 Brookstone Building, Peterborough, N.H. 03458. Eraser is advanced as tip wears. \$1.60 postpaid; refills, 50 cents each.

Now: small-parts drawers by the dozen

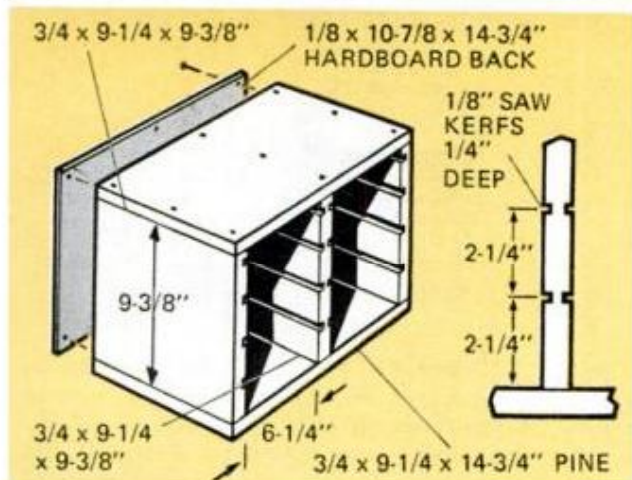

IF YOU WISH you could keep track of countless screws, bolts, nails and other small parts in one handy place, Baumbach Engineering Co., 126 Caldren Ave., Mountain View, Calif., has made it easy to have a small-parts cabinet with as many drawers as you want. Its Dandy Drawers of

high-impact plastic slide in $\frac{1}{8}$ -in. saw kerfs that you cut on your table saw. The 5x9-in. drawers come in red, green, yellow and gray, can be labeled with a felt-tip pen and divided into two, three or six compartments. Twelve drawers cost \$8.60 postpaid.

Contour gauge as jig

I solved the problem of supporting a quartet of evenly spaced dowels while cross strips were glued to them by using a contour gauge as a jig. First I laid the dowels on a bench, with spacer blocks between them, and pressed the gauge over them. Then I clamped the gauge in a vise and placed the dowels in the notches.

—Walter E. Burton, Akron, Ohio

By adding Styrofoam (drinking cups, egg cartons and packing material) to regular lacquer thinner until the thinner will no longer dissolve it, you'll get a plastic paint you can use as a wood sealer.

—Robert W. Miller, Lompoc, Calif.



BETTER WAYS TO DO IT!

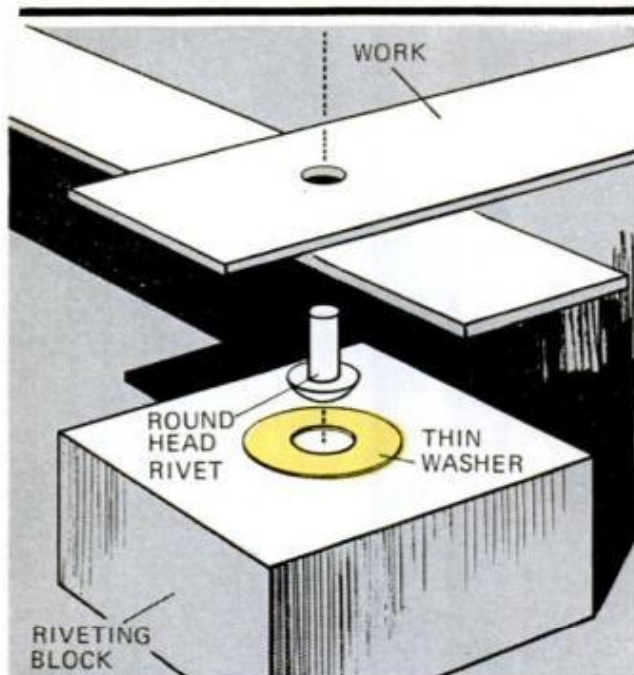

WHEN RIVETING several parts together that must pivot, place the rivet head in a thin metal washer. The trick spaces the head for minimum friction between the parts.—*Harry Josephs, Gardenville, Pa.*

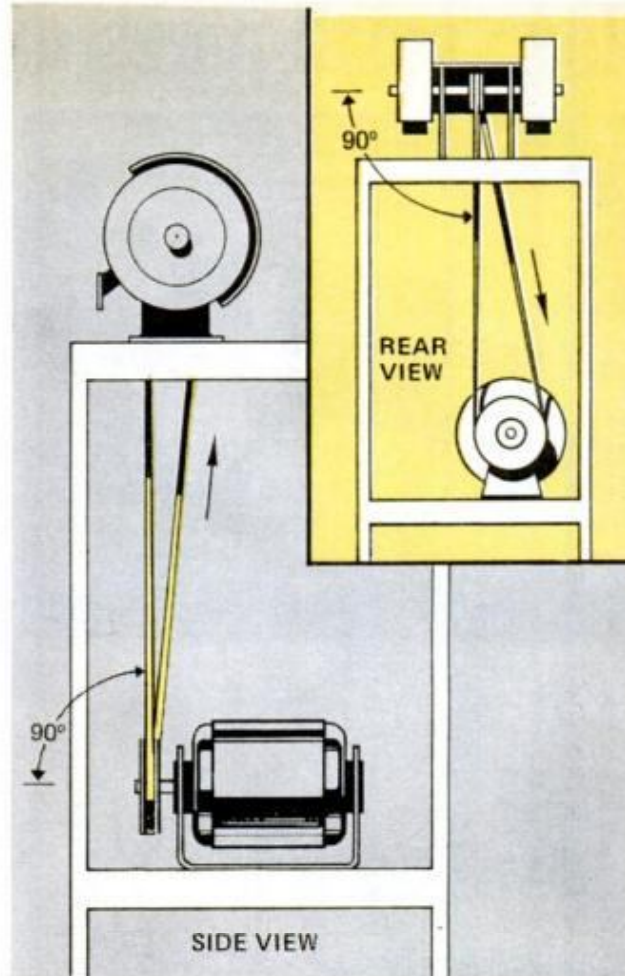

CORRECT GRINDER ROTATION can be obtained by remounting the motor. The important point is to make certain that belt coming onto the pulley is at 90° to the pulley's axis.—*Ivan Washburn, Arlington, Va.*

Illustrations by Adolph Brotman



WAX BUILDUP around chrome parts is almost inevitable when you wax your car. To remove it, try a small shoebrush. This will save a lot of armwork, making your job a snap.—*Daniel Dandio, Berlin, N.J.*

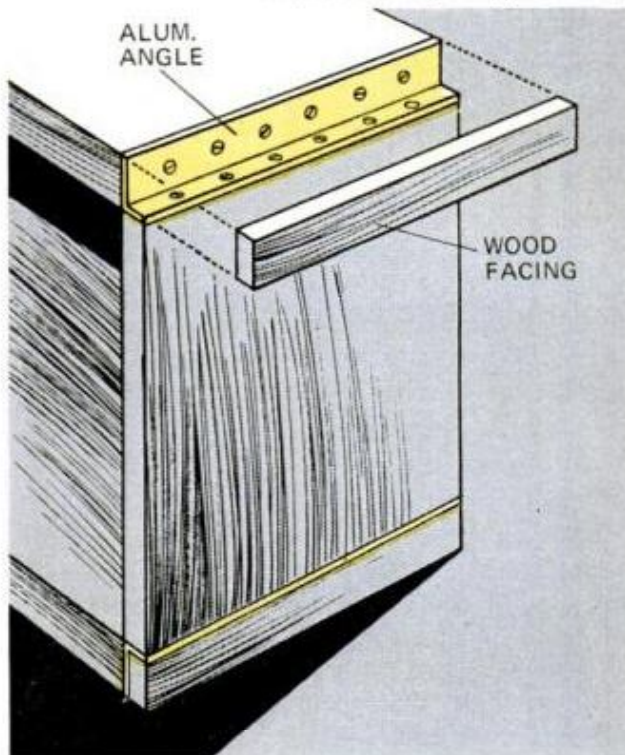

TO ASSURE strong joints and avoid end grain when building a cabinet, use aluminum angle to attach the top and bottom to the sides. Wood facing is cemented to the angle.—*Harry A. Jorgensen, Washington, D.C.*

POPULAR MECHANICS

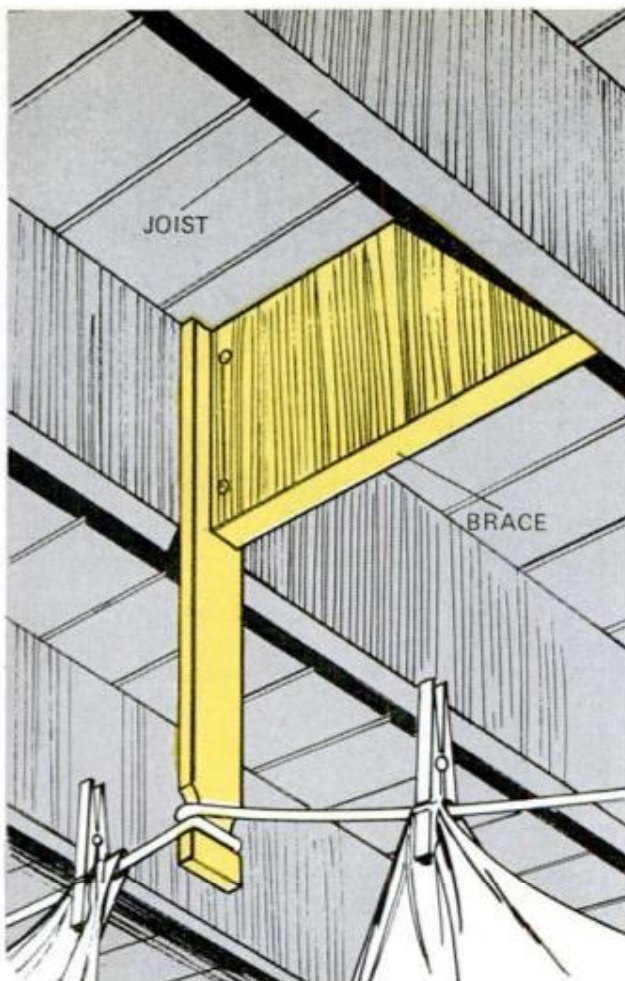

INDOOR CLOTHESLINE SUPPORTS will stay where you want them if they are braced as shown above. The bridging can be toenailed or held by nails driven through the joists.—R. E. Murray, Circleville, Ohio

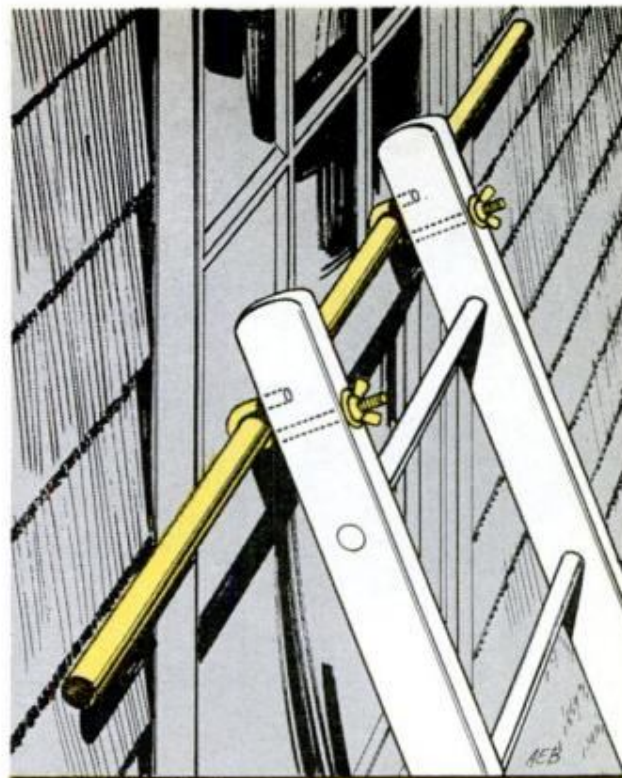

MAKE A WINDOW "SPANNER" for your ladder by bending two J-hooks from 5/16-in. rods threaded at one end. Short leg goes in blind hole; the long one receives washer, wingnut.—Andrew Vena, Philadelphia

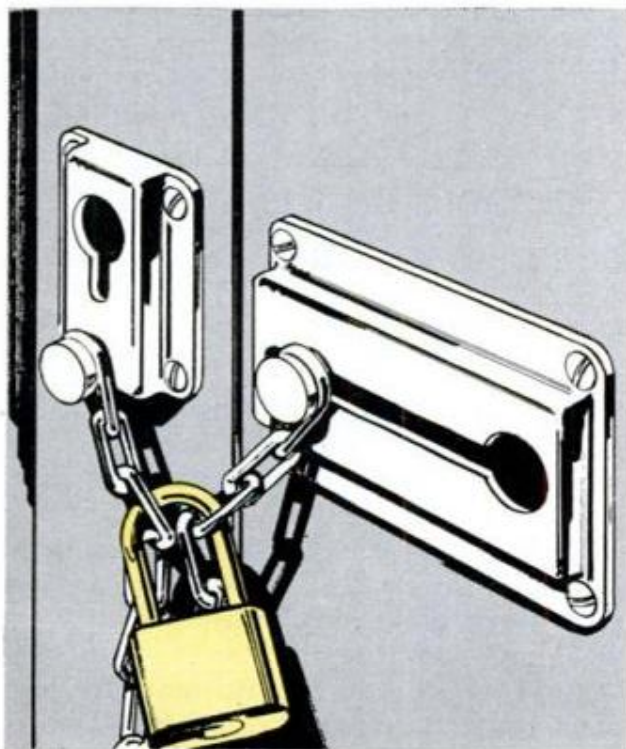

DOOR-CHAIN EFFECTIVENESS can be increased by use of a small, strong padlock fastened to top links. The lock reduces the gap so that a tool can't be inserted for prying.—Opie Read Jr., Pasadena, Calif.
JULY 1972

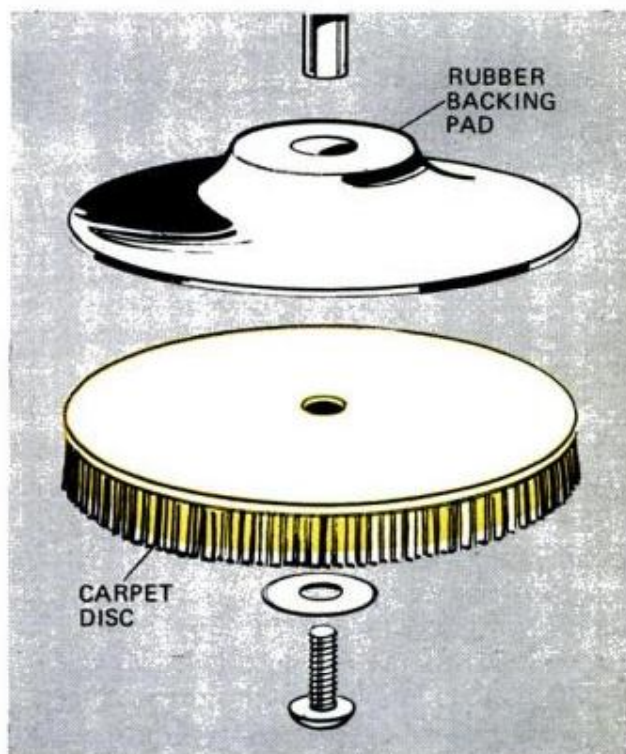

DISPOSABLE BUFFING PADS for power polishers can be fashioned from scraps of wool carpet. Just use the backing pad as a template; cut and assemble it like a sanding disc.—Lawton P. Evans, Seattle, Wash.

Bench-saw know-how

PART 1

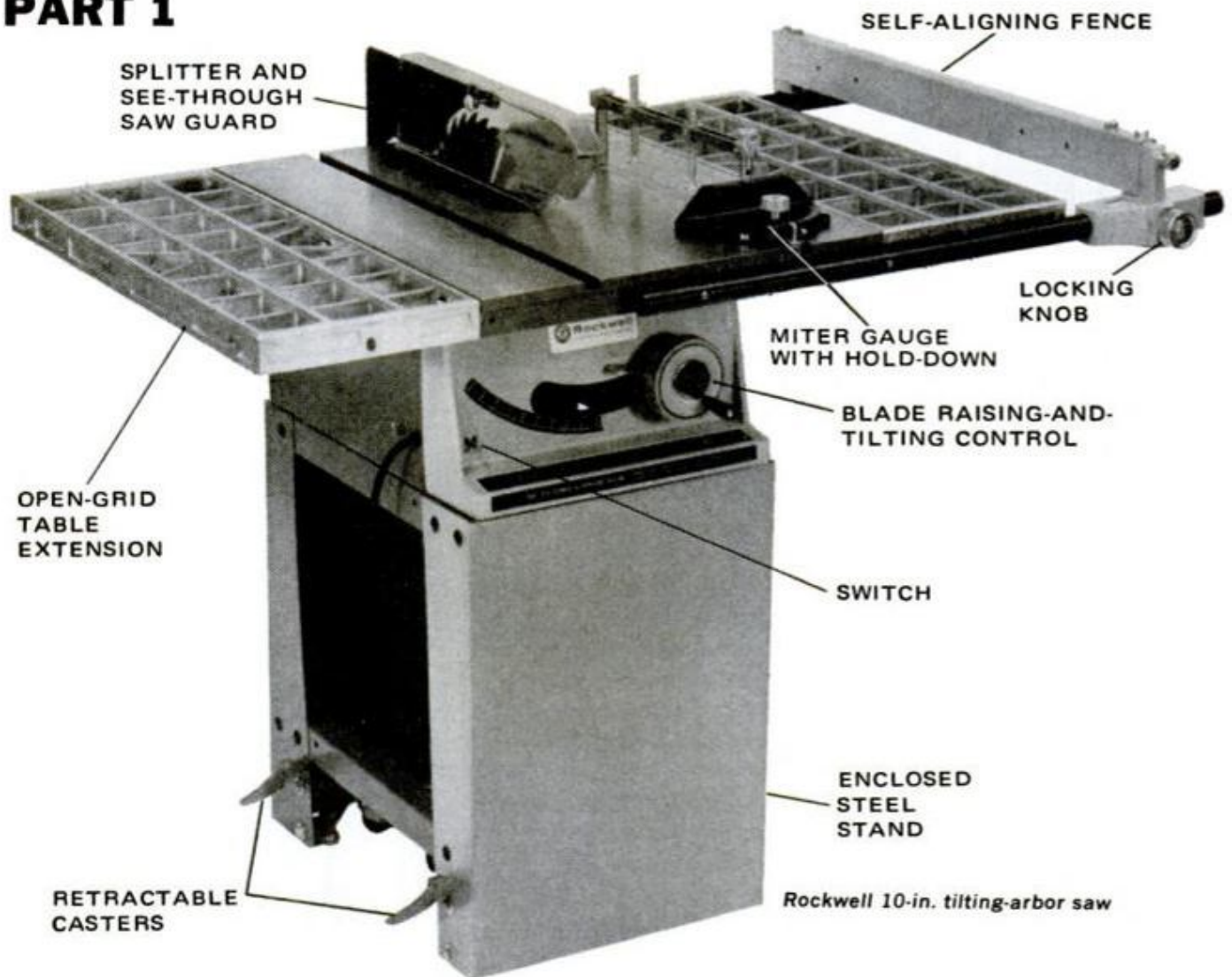

Rockwell 10-in. tilting-arbor saw

A short course for beginners on the operation of this basic shop tool

By **WAYNE C. LECKEY**, Home and Shop Editor

Photos by Robert D. Borst

A BENCH SAW is not a difficult tool to run—plain ripping and crosscutting come naturally to most beginners, and other techniques are easily learned. But, as in operating any power tool, there is a right way and a wrong way. Using it before you are fully familiar with its mechanical features is as unwise as dashing off in a strange car without first learning what and where the controls are.

The bench saw (which is also called a "table saw") is not to be feared, but since you can't always operate it with the guard over the blade, you have to regard it as

potentially dangerous. You have to respect its whirling blade, keep your mind on what you're doing and not become overconfident. If you always remain a bit "afraid" of the saw each time you flip the switch, chances are you'll never get cut. My best advice is to learn the safety rules (see facing page) and obey them.

All bench saws have a rip fence for use when you want to cut a board lengthwise, and a miter gauge when you want to cut it crosswise. How perfect these cuts will be depends on how accurately the fence and miter gauge are set in relation to the blade.

Make these initial checks before you saw a board

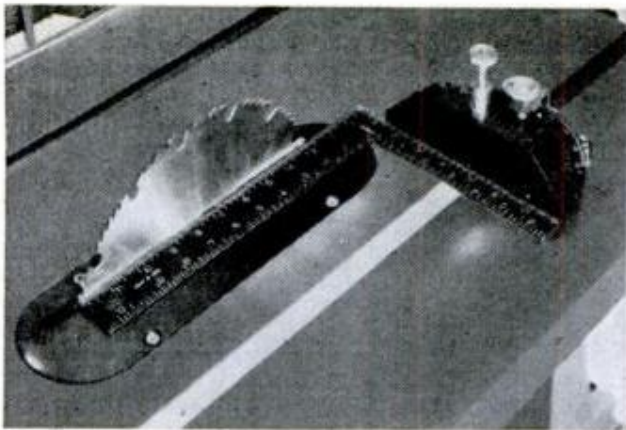

CHECK MITER GAUGE with square to see if it is at a 90° angle to blade, thus assuring a square cut

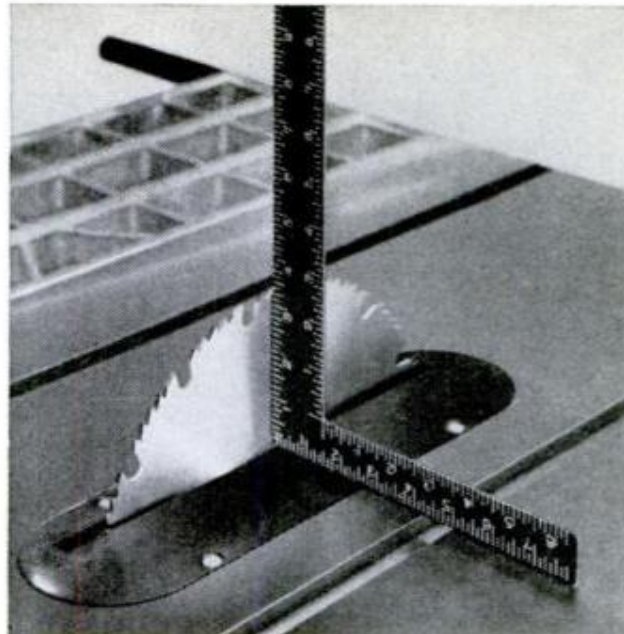
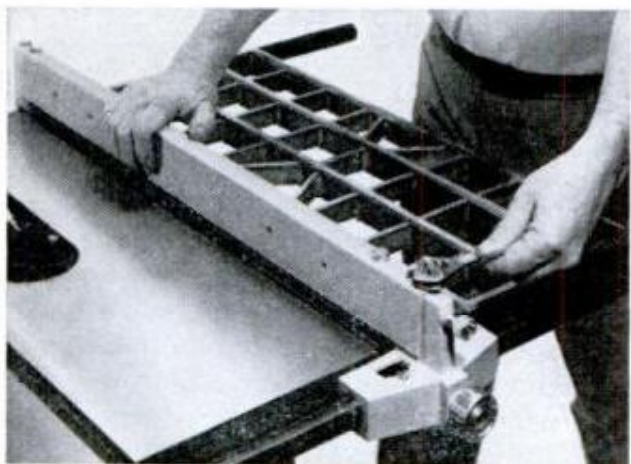
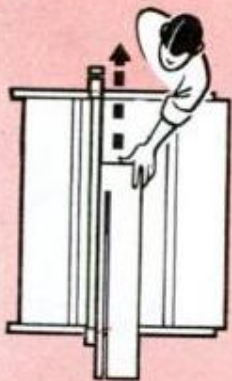

TABLE MUST BE SQUARE with the blade. If it isn't, follow manufacturer's instructions for adjusting table



MAKE SURE that rip fence is parallel with saw-table slots so work will not bind against the blade

So before you cut a board, there are three initial alignment checks to be made: 1. table slots, rip fence and blade must be parallel; 2. rip fence, miter gauge and blade must be perpendicular to the table; 3. miter gauge must be at a right angle to blade and fence. Each is easily checked with a square as shown above. The instruction manual for your particular saw



KICKBACK will happen when fence is out of alignment. Adopt safe practice of standing to one side so you won't be hit by flying work.

SAFE WORK HABITS AND PRACTICES

1. Keep floor clean in front of the saw—sawdust can be slippery.
2. Roll up your shirt sleeves to the elbow, and remove tie, rings and wristwatch.
3. Pull out plug at electrical outlet when leaving machine at end of a work session.
4. Never reach across the blade while the saw is running.
5. Always use a push stick when ripping narrow work.
6. Keep the blade just high enough to clear stock when ripping.
7. Stand to one side of the blade—never directly behind it.
8. Never rush or force work into the blade.
9. Don't hold both ends of the work when crosscutting.
10. Always return the miter gauge to the starting point when crosscutting.
11. Keep the blade sharp and properly set at all times.
12. Never rip against the fence when edge of the work is irregular.
13. Wear goggles or a face shield when you're doing close work.
14. Always use a guard and a splitter whenever practical.
15. Never saw freehand; always use a fence, miter gauge or jig.
16. Never use the fence itself as a stop when you're cutting duplicate work.
17. Keep your mind on what you're doing.

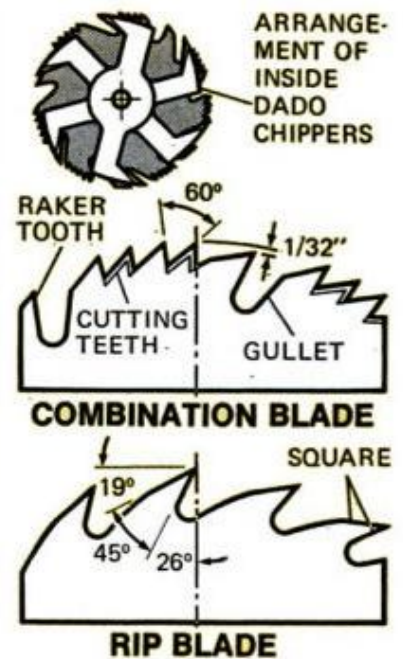
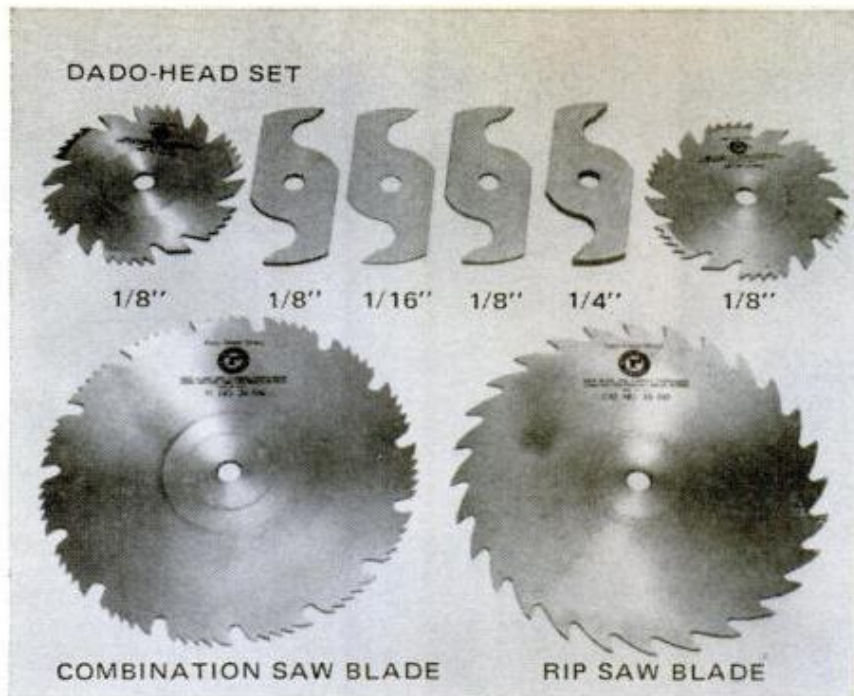

BASIC BLADES. Combination blade, which both rips and crosscuts, is most popular in home shop. Rip blade is used for ripping only. Dado head consists of two outside cutters and four interchangeable inside chippers

will show what to loosen and adjust to correct any misalignment.

Your saw will probably come equipped with a combination blade, a general all-purpose blade that rips, crosscuts and miters, and handles most common cutting jobs. You can add other special-purpose blades, such as a rip blade, a coarse-

tooth saw for faster ripping; a hollow-ground planer blade that makes smoother crosscuts, and a fine-tooth plywood blade that's best for cutting laminated woods with minimum splintering.

Another special-purpose cutter, called a dado head, has various combinations of saws and chippers for cutting grooves $\frac{1}{8}$

First projects—a push stick and a wood facing

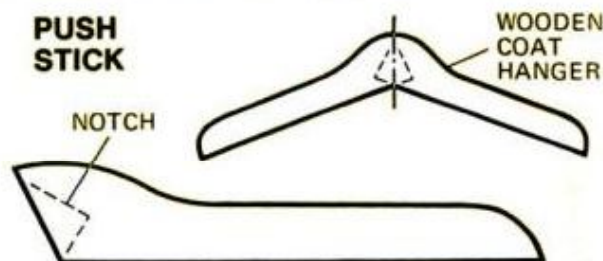
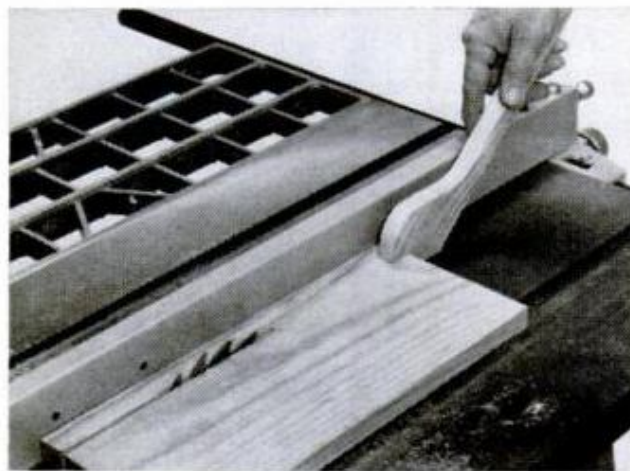

WOODEN COATHANGER provides two ready-made push sticks to rip work less than 3 in. wide safely

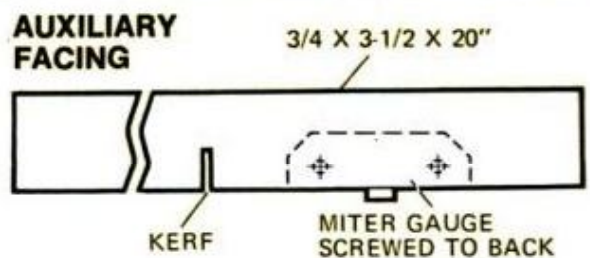
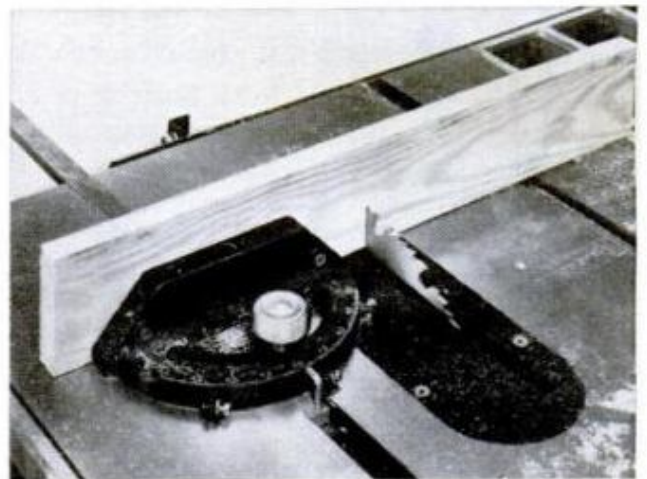

WOOD FACING added to miter gauge provides extra work support, lets you align saw mark with the kerf

POPULAR MECHANICS

Safe and unsafe bench-saw practices

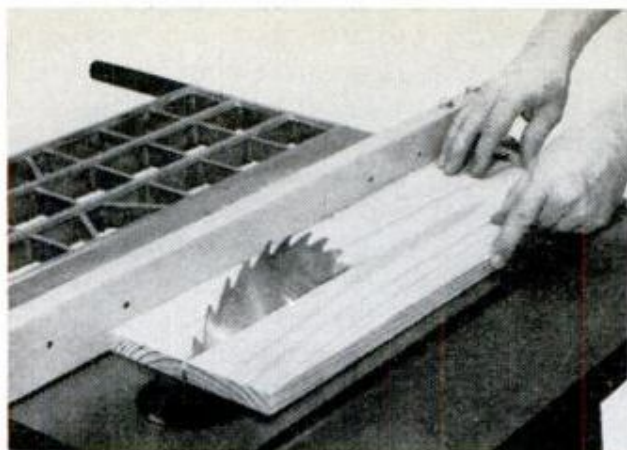

DON'T SAW WITH BLADE THIS HIGH when it's not practical to use guard; there's too much chance of injury. The less the blade is exposed the better. Blade should project no more than $\frac{1}{4}$ in. when ripping

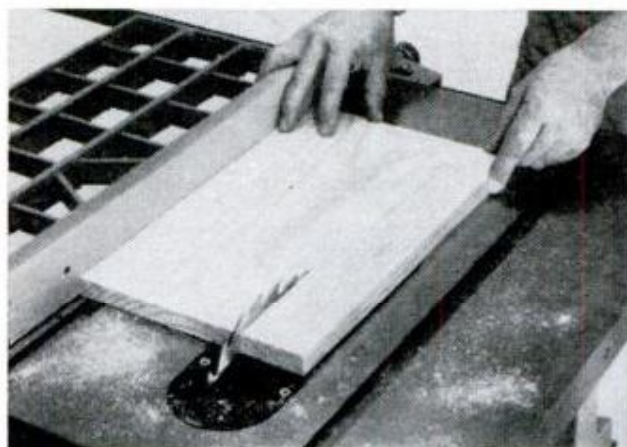
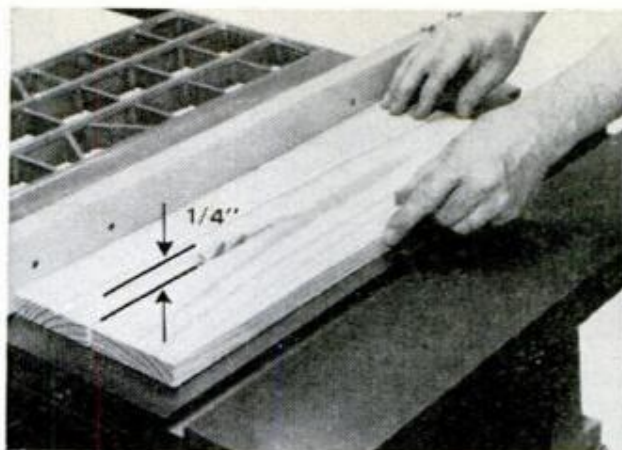

GOOD RIPPING HABIT is to hook little finger over fence to keep hand safe distance from the blade



WHEN CROSSCUTTING a wide board on a small saw, place the miter gauge backwards in saw-table slot

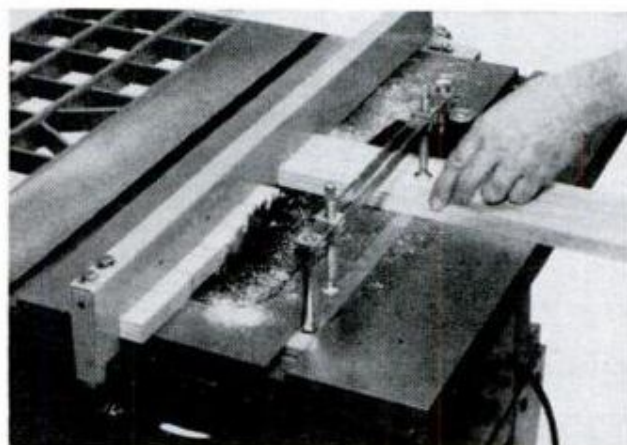

NEVER USE FENCE as stop when mass-cutting duplicate work lengths. Work will wedge between fence and blade and be thrown with force. Play it safe and first clamp block to fence so there will be ample clearance

to $\frac{1}{16}$ in. wide. It is usually made up of two outside blades and four swaged chip-pers so arranged on the arbor that the swaged ends fall in the gullets of the two outside blades.

Two of the first things you should make for your saw are a push stick and a wood facing extension for the miter gauge. A push stick is a must for pushing narrow

work safely past the blade. All crosscutting is done more conveniently and with greater safety if the miter gauge has a wood facing. With the kerf in the facing, you can line up the saw mark precisely with the blade. Drawings on the facing page show how to make both push stick and wood facing.

The photos above give graphic examples

Ways to prevent creeping

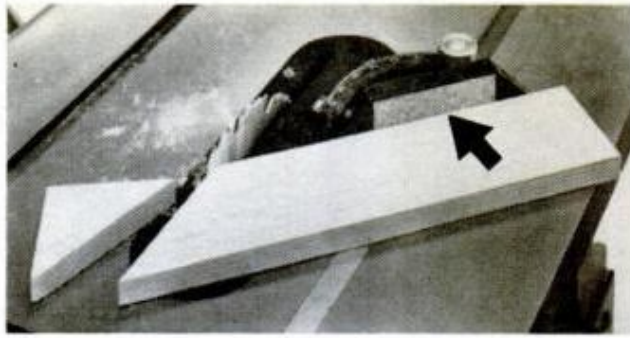

SANDPAPER GLUED to face of miter gauge will provide noncreep work surface when making miter cuts

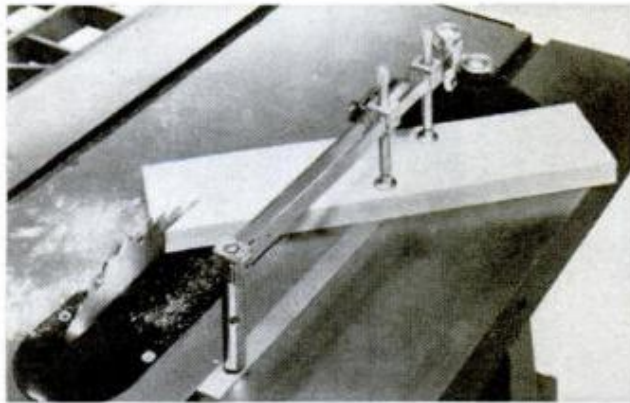

HOLD-DOWN ATTACHMENT fitted to miter gauge will keep workpiece from creeping during miter cuts

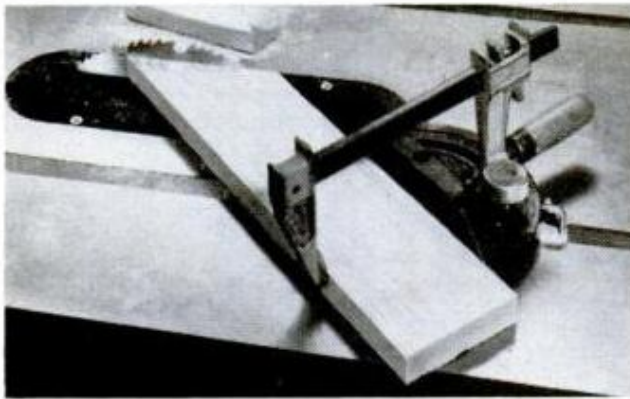

ANOTHER WAY to prevent creeping when cutting miters: Hold work to miter gauge with a bar clamp

of the right and wrong ways to perform common rip and crosscut operations. It's always good practice to expose the saw blade as little as possible above the work when it's not practical to operate the saw with the guard in place. A high blade cuts faster, but it's not as safe.

A good habit to follow when ripping is to hook the little finger over the rip fence as you feed work. This keeps the hand from wandering toward the blade.

When you wish to crosscut a wide board whose size forces the miter gauge off the table, reverse the gauge. Cut about halfway through the board, back up an inch and turn off the saw. Then reverse the gauge—leaving workpiece untouched—start the saw and complete the cut.

When you want to use the rip fence as a stop in mass-cutting pieces of identical length, don't make the mistake of butting the work against the fence. Clamp a block

(Please turn to page 186)

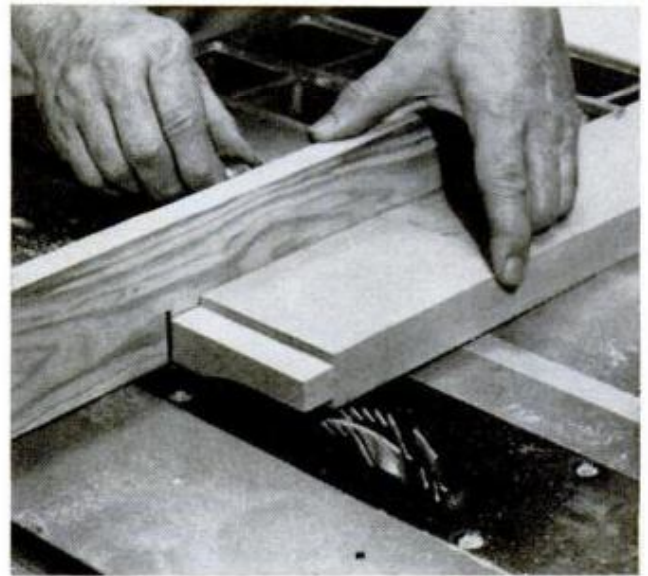

SHORT TENONS are made with one pass, each side, by switching from regular saw blade to a dado head

Two setups for mass-cutting duplicate lengths

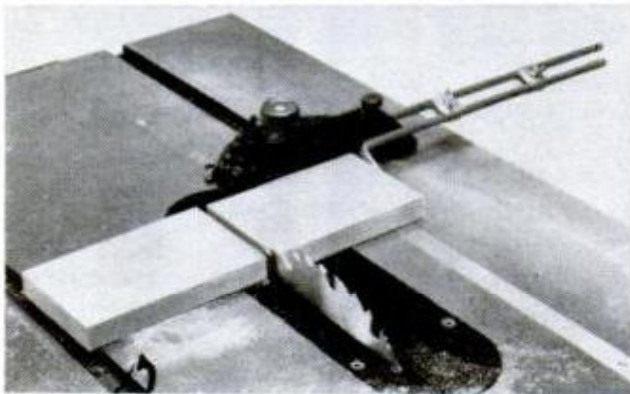

SPECIAL STOP ROD, designed to fit miter gauge, will assure identical cutoffs up to 27½ in. long

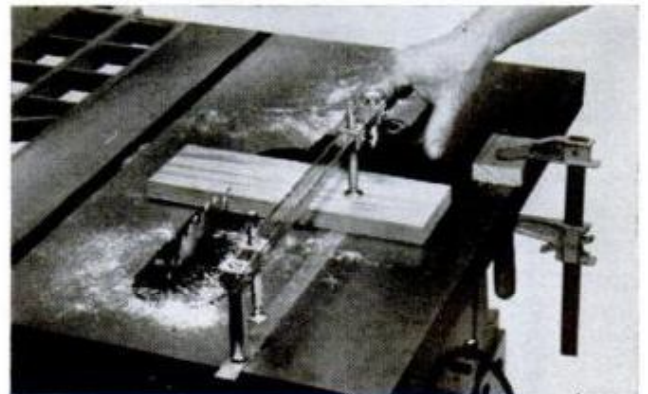

BLOCK OF WOOD clamped to saw table will serve as a stop for mass-cutting short lengths of stock

POPULAR MECHANICS

Simple jigs and fixtures to use with your saw

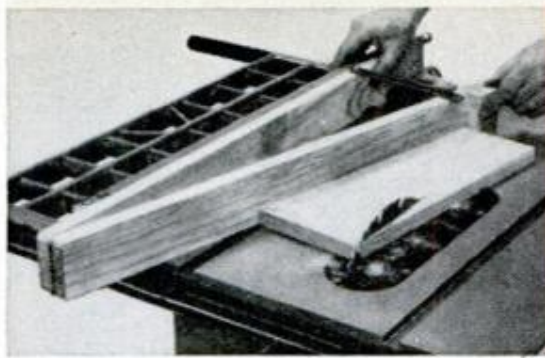

ADJUSTABLE TAPER JIG

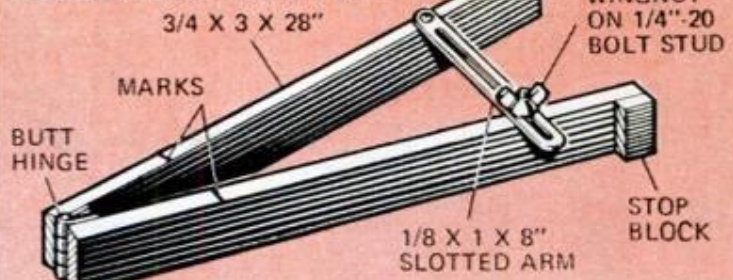

TAPER JIG lets you rip at angle. Work is hooked on stop block and jig is guided along fence to make cut

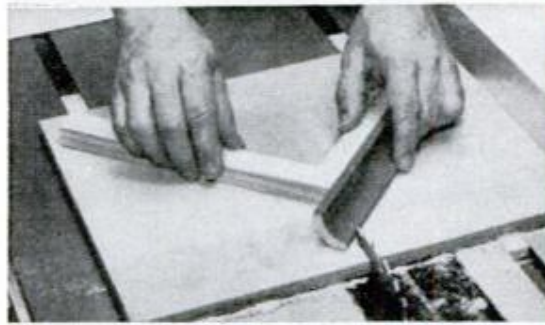

MITER BOARD

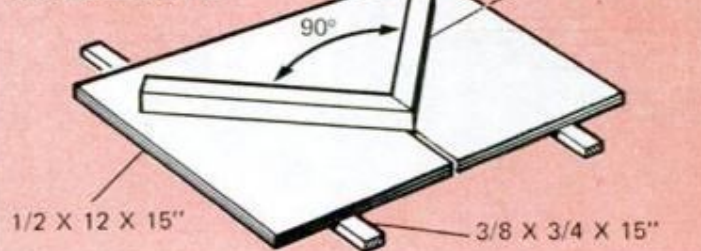

MITER BOARD is better, more accurate, than saw's miter gauge when making right and left-hand miter cuts



SQUARING BOARD



SQUARING BOARD permits straight rip cuts to be made on bandsawed leftovers that have irregular edges



WEDGE BOARD

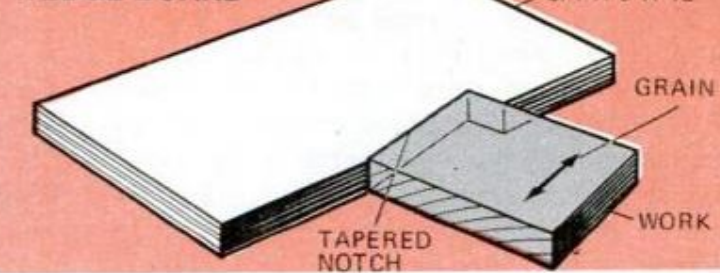

WEDGE BOARD makes fast work of mass-cutting wedges. Flop work in notch each time to cut next wedge



STEPPED STOP BLOCK

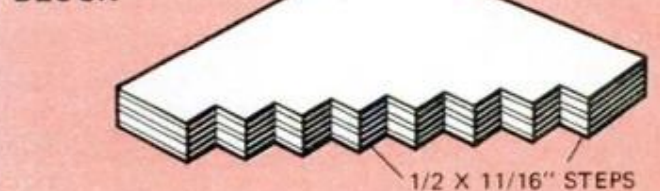

STEP BLOCK clamped to saw table sets width of each pass automatically when cutting duplicate dados

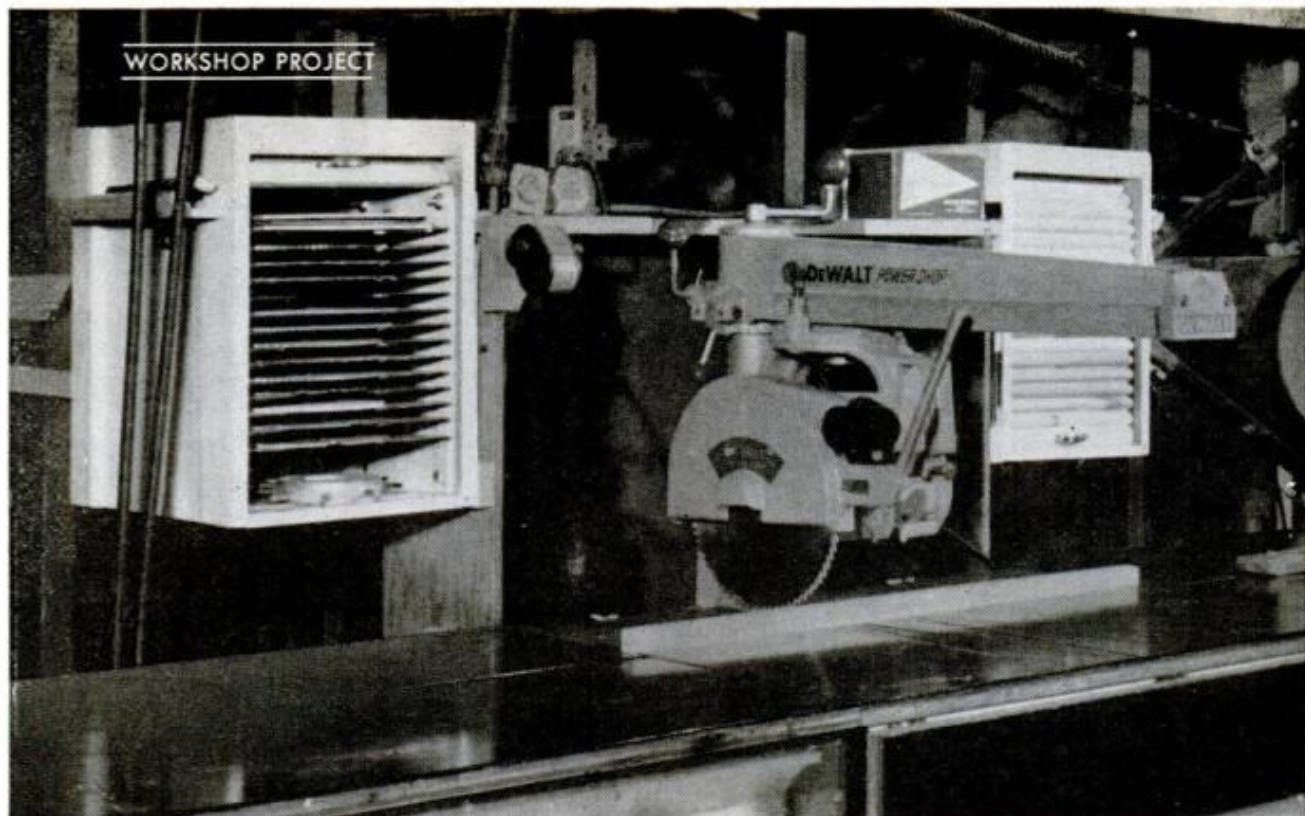

In June we presented a fabulous workshop with some great shop ideas. The owner's plans are duplicated here so you can make your own. . . .

Deluxe wallcase for circular-saw blades

LAST MONTH we presented the fourth in *PM's* new series of Great Workshops (*This shop paid for itself . . . and grew and grew*, page 63). It was loaded with good shop furniture—executed in craftsmanlike style—by owner C. E. “Doc” Banister of Pomona, Calif. But one feature in particular caught our eye: a pair of handsome circular-saw-blade boxes that Doc built and installed flanking his radial saw (see photo above). Doc agreed to draw plans so others could build one.

Since the cabinet holds 14 10-in.-dia. blades and a dado-head set, one cabinet is sufficient for an average home workshop. Besides the box's storage capacity, it's good looking, a fine exercise in wood-working and, because of the tambour door, blades are kept clean.

The box requires a minimum of material. Sides are of $\frac{3}{4}$ -in. stock, base and top

of $\frac{1}{2}$ -in. material and inner and outer backs of $\frac{1}{8}$ -in. hardboard and $\frac{1}{4}$ -in. plywood respectively. The tambour door is made up of stock screen moldings with canvas glued on the back side.

Start by cutting the box parts to size. Next, set up your router with a $\frac{1}{8}$ -in. grooving bit to make the grooves for the blade shelves. Then, with a rabbet cutter, make the edge rabbets as required. Glue up sides, top and bottom (minus the front rail so you can get the door in later). Check box for square and tack on diagonal braces to hold it while the glue dries.

Cut the 14 shelves, slip them in place and install the shelf back and box back using glue. Cut the 24 molding pieces and door bottom rail to length and lay out the door using clamps and strips of wood to hold it square and flat. Next, cut a piece of canvas $10\frac{1}{2}$ x 12 in. Spread contact ce-

HINTS

FROM READERS

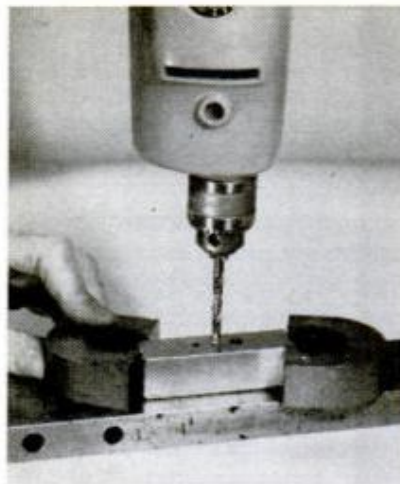

Magnetized drilling aid

A guide block steadied by two strong, permanent magnets makes it easier to start a straight hole with an electric drill. Place magnets to hold the guide where wanted to resist any tendency to twist.—*B. W. Ervin, Kent, Ohio*



Workbench-desk caddy

A discarded distributor cap makes a handy holder for small shop tools and desk items. After cleaning the cap, drill holes slightly deeper (where necessary) and spray-paint for looks.—*C. Wayne Close, Grants Pass, Ore.*

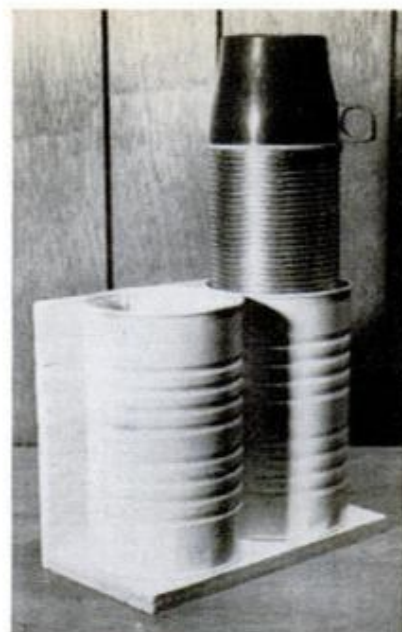

Thermos toter

To keep my Thermos bottle from tipping while traveling in my car, I made this carrier by screw-fastening a pair of suitable tin cans to two plywood pieces joined at right angles.—*Marshall Lincoln, Wickenburg, Ariz.*

How to hang pictures without driving nails in paneling

A simple method of hanging pictures in a paneled room that has a suspended ceiling is to use monofilament fishing line. The fishline is pushed up behind the suspended-ceiling wall angle and into the

panel grooves. Nails are driven into the wall above the suspended ceiling to hold the lines, which are almost invisible. There's no damage to the paneling.

—*Donald Rosenquist, Bay City, Mich.*

NEXT MONTH IN SHOP AND CRAFTS

OUTDOOR FAMILY LIVING '72: A 19-page special section packed with better ways to use your back yard. You'll find a Dutch minibarn lawn building for yard-tool storage that will be the envy of your neighbors, playground equipment you assemble quickly and easily, creative ideas for your garden, homebuilt lighting for accent and function, the newest of fine outdoor-living products and even a putting green you can install to put the 18th hole right at your door.

A BEAUTY—AND SO SIMPLE TO MAKE—it's a Spanish-styled octagonal "drum" table. The inexpensive "hand-carved" panels, plywood construction, plastic laminates and PM's detailed how-to drawings make it so much easier to build than its good looks suggest.

SHORT COURSE IN CRAFTSMANSHIP: THE BENCH SAW—Part 2. After we've taken you through all the basics of working with your table saw (pages 152-157), you'll be all set for the vast collection of sophisticated techniques in Part 2, August PM. Too, you'll learn how to work with a dado-head set and how to build supports to solve cutting problems. You'll also see how to make a trivet and "carved tower" from solid blocks of wood.

PLUS: Weekend projects, a really new paint can, a low-cost circular-saw shop test, a stand you can make for converting your router to a "shaper," and more.

The latest craze on Muscle Beach is to show off your puffing strength with the new tasteless cigarettes.

Now everybody will be showing off their strength by puffing new tasteless cigarettes



...almost everybody.



©1972 R. J. Reynolds Tobacco Company, Winston-Salem, N. C.

Camel Filters.
They're not for everybody.
(But then, they don't try to be.)



20 mg. "tar", 1.3 mg. nicotine av. per cigarette, FTC Report AUG. '71.

JULY 1972

161

Материал, защищенный авторскими правами



HOMEMADE CARTOP CARRIER holds our four Raleigh Sprites safely for motoring across stretches of country between scenic bicycle-touring areas. Mountains in background are New York's Adirondacks

Bicycle touring: better than ever

Mapped tours, light tents and packs, hostels and—best of all—easy-pedaling bikes make it a great way to go!

By **JOHN A. LINKLETTER** / *Photos by the author*

TODAY'S BICYCLE BOOM is a nice, quiet kind of boom that doesn't drown out the sounds and fragrances of the countryside.

If you haven't joined the millions of cyclists yet and your last pedaling was in the days of balloon tires and coaster brakes, you'll find things have changed.

Lightweight bicycles, 5, 10, and even 15-speed gearing, featherweight camping equipment, bicycle paths and comfortable hostels make touring by two-wheeler a great way to vacation with a family.

We—John, Scott, my wife and I—loaded four new bicycles on a homemade cartop carrier last August and drove from

AYH SADDLEBAGS hold lots of gear, keep weight low, fit almost any rear carrier and slip off easily at destination. Here, Scott, John and my wife load up at Star of the Sea Hostel on Nantucket





HISTORIC TOWN of Nantucket has lots to see, plus picturesque cobblestone streets that aren't really for cycling. But the island's smooth bike paths (above) make up for the bumpy ride in town. After leaving Nantucket, we drove to New York State and set up camp (below) with two L.L. Bean backpacker tents. Four-man tent in the foreground weighs 7 pounds, 4 ounces; two-man in background weighs 4 pounds, 13 ounces



ONE OF MOST ENTICING of 90 tours mapped out in *North American Bicycle Atlas* by American Youth Hostels is 178-mile "Banff-Jasper Traverse." There is a hostel (triangle) every 20 to 25 miles. Besides mapped tours in 47 states, Canada, Mexico and the Caribbean, the book describes 62 shorter bicycle trips

To Edmonton
Maligne Canyon
Jasper

ALBERTA

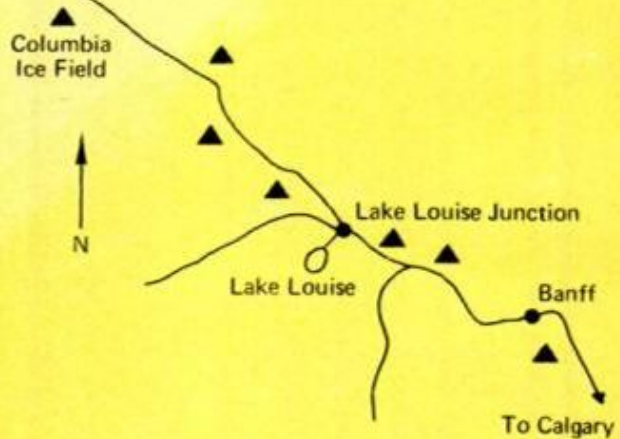

HOSTEL supplies the pots, pans, stove and kitchen while cyclists bring the food. Here my wife and other tourers fix evening meal at Star of the Sea

Connecticut to the Nantucket ferry and then sampled an American Youth Hostels (AYH) tour of the island by bicycle. Armed with advance reservations and packing our own food (as all hostelers do), we pedaled to Surfside to spend a night in the family room of the Star of the Sea hostel. After the Nantucket tour, we carried the bicycles to New York State where we tried our lightweight camping gear.

Hosteling, because it was new to us, turned out to be the most interesting part of the trip. Preparing a meal and eating in a community kitchen and dining room with 50 or 60 of the peppiest kids I've met was an exhilarating experience. Surprisingly—to our sons, anyway—the youngsters spent a lot of time talking with us. No generation gap that I could detect. As a matter of fact, the only such gap I could find was that our "house parents," Mr. and Mrs. Charles Martucci, were considerably younger than two members of their brood that night. But, no matter; they were knowledgeable and experienced cyclists who supervised the hostel with admirable calm.

For our week-long car-and-bicycle tour, we found the four-bike cartop rack the ideal way to get the vehicles across those long stretches of country to the areas we wanted to see close-up by bike. Ours was homemade, but commercial

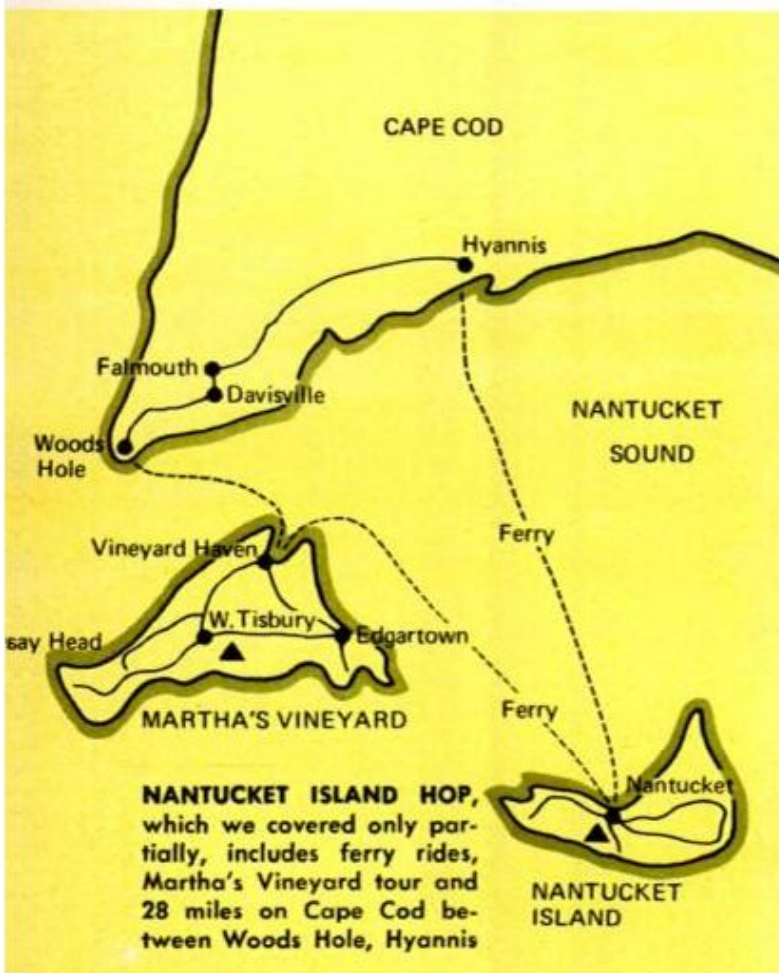

NANTUCKET ISLAND HOP, which we covered only partially, includes ferry rides, Martha's Vineyard tour and 28 miles on Cape Cod between Woods Hole, Hyannis

Dodge. The only all-new pickup for 1972...with no cover charge.



Buy this specially equipped '72 Dodge Sweptline, and the Dodge Boys can offer you a Winnebago Kap Cover at no extra cost.

FOR '72, ONLY DODGE GIVES YOU ALL THIS:

- All-new styling, inside and out
- New, improved independent front suspension
- More cab room
- Bigger payload capacities in most models
- New car-style cab comfort
- Easy-off tailgate.

PLUS A \$300 VALUE AT NO EXTRA COST.

The Winnebago Kap Cover is constructed of aluminum with insulated

walls and plywood paneling inside. Participating Dealers can offer you this great value FREE because Dodge gives it to them free. See the specially equipped Dodge D100 V8 131-inch wheelbase Sweptline Topper today.

SPECIAL EQUIPMENT INCLUDES:

- Automatic transmission
- Adventurer Package
- Power steering
- Tinted windshield
- Electronic Ignition System
- Bright rear bumper
- 15-inch wheel covers
- Mirrors, bright, dual, 5" x 7"
- Heavy-duty rear springs
- Front bumper guards.



*Winnebago and Kap are registered trademarks of Winnebago Industries, Inc.

Dodge brings you the best in baseball Saturdays on NBC. See your local TV listing.

DODGE SWEPTLINE TOPPER

...IT'S A GREAT DEAL BECAUSE DODGE STARTED WITH A GREAT PICKUP.



THE STAR OF THE SEA Youth Hostel on Nantucket was built in 1833 as a U.S. Coast Guard station

models are available at bicycle shops.

If you haven't selected a bicycle yet, seek an expert's opinion—for example, Eugene Sloane in *The Complete Book of Bicycling* (\$9.95, Trident Press, 630 Fifth Ave., New York, N.Y. 10020). Sloane, in giving a great deal of helpful information about bicycle selection, makes two observations that particularly helped us: Frame size should be such that you can straddle the top bar with comfort, and the saddle should be adjustable to the ideal height—so that you are “able to just reach the pedals comfortably with the heels. . .”

My wife and I selected five-speed Raleigh Sprite 27 models; the two boys took 10-speeds of the same make. They performed beautifully for us. We adults found the five-speeds are certainly adequate for the touring we did and are fine for hometown use. We all selected “flat” handlebars (as opposed to racing-style “dropped” handlebars), and I find that I continue to feel more comfortable with the flat style. I should point out that one son—a real enthusiast—has now switched to dropped handlebars in the fashion of most earnest and experienced cyclists. (On this point, Eugene Sloane offers an excellent discussion concerning the superiority of dropped handlebars.)

166

We did some experimenting, too, with packs. There's no question that saddlebag-type carriers and handlebar bags make up the best carrying combination. We also found that a lightly filled day pack (a “soft” backpack) works well. But a couple of upright packs that we carried on the bikes' rear carriers tended to fall over and unbalance the bicycles.

If you're interested in touring, you'll find 152 tours listed, plus much other information, in the *North American Bicycle Atlas* from American Youth Hostels, 20 West 17th St., New York, N.Y. 10011. It's \$1.95

(Please turn to page 184)

ABOUT HALF of bikes at hostel had conventional “flat” handlebars; the rest were “dropped” style



POPULAR MECHANICS

Материал, защищенный авторским правом



Come out ahead on a Kawasaki.

At Kawasaki, we figure you're ready for a bike that looks big.

But maybe you're not quite ready for a bike that is big.

Enter the Kawasaki 100cc G5.

For the first time, here's a first-time bike that doesn't ride like one.

Or handle like one. Or, least of all, look like one.

The G5 enduro hits 66 mph.

Climbs 33°. Takes on any terrain: track, trail, highway.

On top of which, it's got all the features you are

ready for: rotary valve engine... five-speed, wide-ratio transmission... five-way adjustable rear shocks.

See the G5 at any Kawasaki dealer

—along with the Kawasaki 90,

world's best-buy street bike. The

Kawasaki 100 G4, world's first 10-

speed trail bike. The Kawasaki

750, world's fastest production

machine. In fact, compare our whole

line-up with anybody else's—spec for

spec, style for style, price for price.

We know who'll come out ahead.



Kawasaki
MOTORS CORPORATION

New gear for bicycle touring



WATERPROOF CAPE (\$11.95) and chaps (\$6.50) fold into ditty (95 cents); total weight, about 13 oz. Cape, held in place by thumb loops, allows air to circulate. Tough, 6-layer nylon taffeta-urethane-zepel fabric can be repaired with hot iron. Trail Tech, 108-02 Otis Ave., Corona, N.Y. 11368.



CASE-HARDENED SECURITY CHAIN, extremely resistant to hacksaw or file, is rubber coated. Four-foot length lets you secure bicycle properly—through wheels and frame to solid post. About \$7.30 at hardware, sports stores. Campbell Chain, Box 1667, York, Pa.

BICYCLE BAG (\$19.95), made of urethane-coated oxford nylon, weighs 1 lb., 5 oz. Brilliant orange nylon vest (\$4.50) and safety ditty (\$1), both with reflective stripes, offer high visibility; weights: 2½ oz. and ¾ oz. Trail Tech, 108-02 Otis Ave., Corona, N.Y.

Season's greetings.

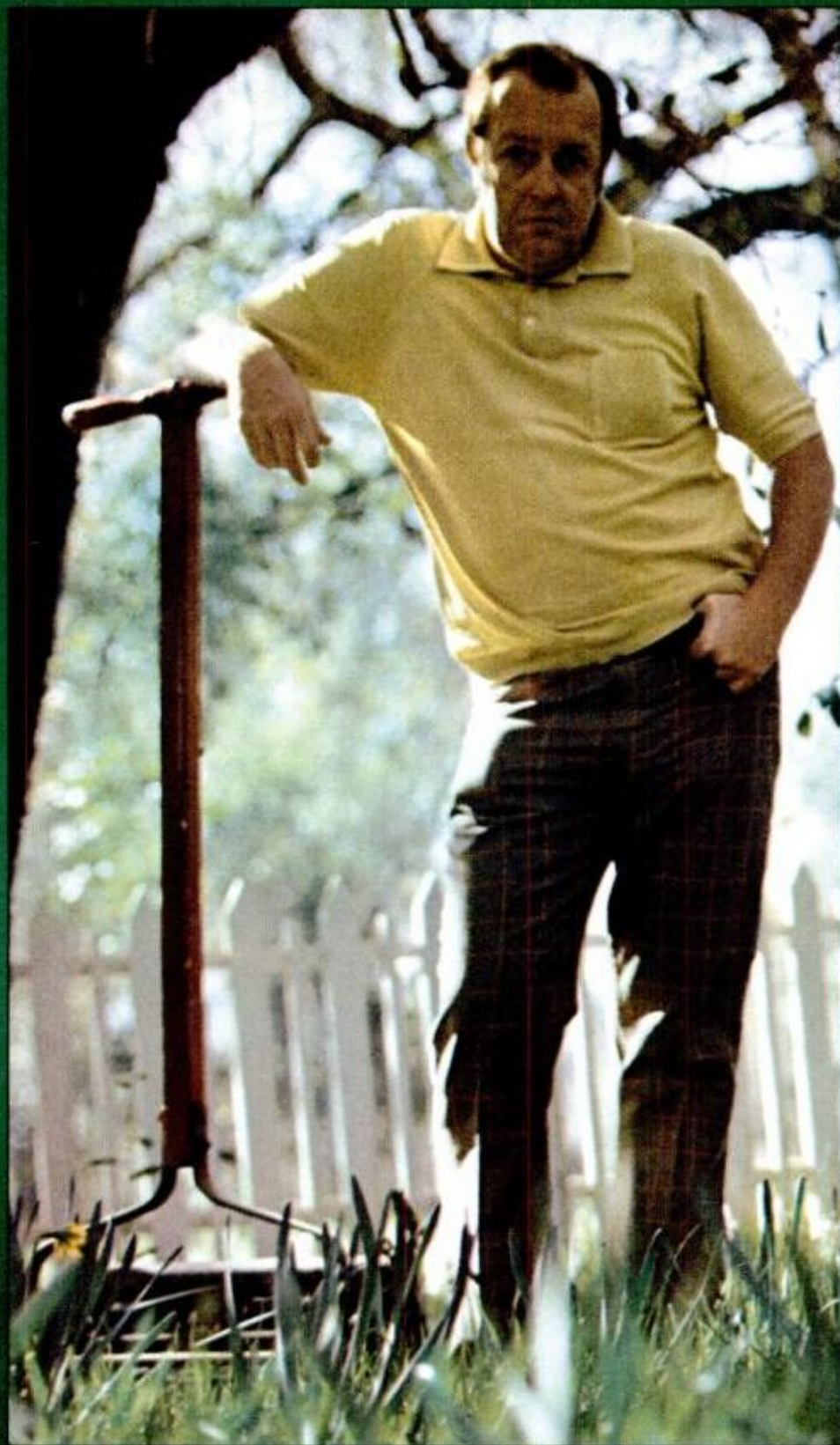

International Harvester

Ah, summer. Isn't it beautiful? So nice and green and birdies singing, and here comes the grass again, growing like a wild plant from outer space, swallowing up your weekends.

This year, cut it down to size with power lawn mowing equipment from International Harvester. Choose from big, strong, reliable Cub Cadet® tractors, riding mowers, walk behind power mowers. There's a model with just the right power for you and your grass, from the wide open spaces to a city backyard.

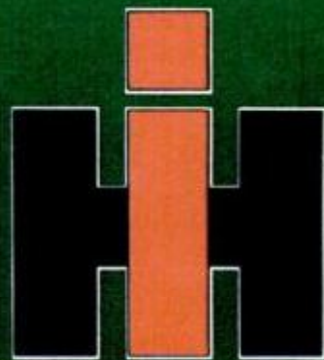

Any way you cut it.

REVISED EDITION

Popular Mechanics Catalog Plans, Publications, Projects

Want to build a boat, garage, sidewalk classic, plane or a clock, kayak, fireplace, kite, patio, coffee table aquarium, kitchen cabinet, organ, swimming pool, telescope, children's play furniture, camping trailer, science project, electronic project?

Send for the NEW Popular Mechanics illustrated catalog! 32 pages crammed full of fascinating and useful projects you can build yourself!

For more than 67 years, Popular Mechanics has been the world's leading authority on how-to information. In this **h e l p f u l** catalog you'll find the very best of Popular Mechanics plans and publications. In step-by-step text, photos and drawings, these plans show you how to build something for everyone in the family.



Above are shown a runabout boat you can build for less than \$75; a four-place plane you can construct yourself; a patio-garage and the famous sidewalk classic for youngsters that rolls along at 5 m.p.h.

For information on scores of other exciting projects, order the new catalog today! Send only 25c to cover postage and handling.

Enclose 25c in coin, no stamps please, to cover postage and handling.

Mail to: **Popular Mechanics**
Box 1014, Dept. CO
Radio City, N.Y. 10019

Please Print:

Name _____

Address _____

City _____ State _____

Zip _____

LET MOTOR'S AUTO REPAIR MANUAL SHOW YOU How to fix almost any part of almost any car



**Shows You Where To Start...
Which Tools To Use...
Exactly What To Do!
Quickly...Easily...Right!**

Over 1,000 pages, over 3,000 pictures and diagrams cover 2,300 models (1966-1972) . . . 225,000 facts that make those "tough" repairs come easy

MOTOR's great new illustrated 1972 **AUTO REPAIR MANUAL!** Here is the "meat" of over 300 factory manuals, brought together for you in the most complete, up-to-date auto repair guide ever prepared! Here are the easy directions and "see-how" pictures that help you sail through virtually every auto repair... from a simple carburetor adjustment to a complete transmission overhaul! Here are over 1,000 almost-foot-high pages that can lick your toughest problems—quickly, easily, right the first time! Yes — fix practically any part of any car! This revised, improved 1972 edition immediately identifies 2,300 models (1966-1972) for you. Just look up make, model, and repair in the handy Instant-Reference Index—and go to it! **MOTOR's AUTO REPAIR MANUAL** takes you all the way—shows where the trouble is, which tools to use, what to do to fix it fast. Over 3,000 pictures and diagrams detail the parts... clear, simple

language puts over 225,000 service and repair facts at your fingertips! A special Trouble-Shooter section and detailed trouble-shooting information thruout help pinpoint in a flash over 4,200 causes of car trouble: transmissions, brakes, engines, electrical systems.

Saves You Time, Money, Work

You get hundreds of compact tables... over 55,000 essential specifications and dimensions... tune-up and adjustment charts... tables of measurements and clearances... overhauling and replacement facts... adjusting and servicing guidance, and much, much more!

Here is the step-by-step help every beginner needs. And here are the labor-saving methods and shortcuts that get old pros over the "tight spots" and save time and money. No wonder more than 6,000,000 copies of this book have been sold to garages, schools, armed forces!

New Illustrated 1972 Edition

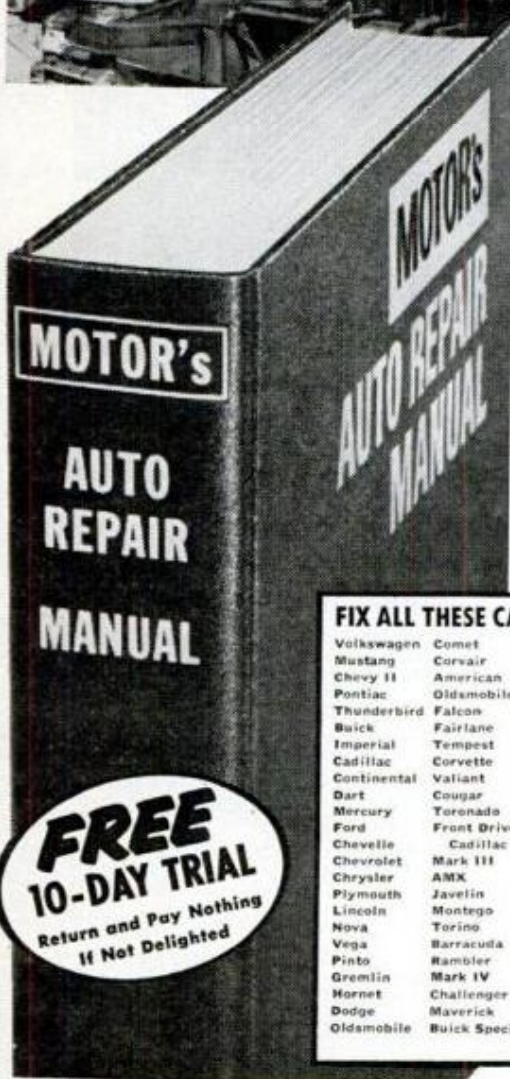

FIX ALL THESE CARS

Volkswagen	Comet
Mustang	Corvair
Chevy II	American
Pontiac	Oldsmobile F85
Thunderbird	Falcon
Buick	Fairlane
Imperial	Tempest
Cadillac	Corvette
Continental	Valiant
Dart	Cougar
Mercury	Toronado
Ford	Front Drive
Chevelle	Cadillac
Chevrolet	Mark III
Chrysler	AMX
Plymouth	Javelin
Lincoln	Montego
Nova	Torino
Vega	Barracuda
Pinto	Rambler
Gremlin	Mark IV
Hornet	Challenger
Dodge	Maverick
Oldsmobile	Buick Special

Same Offer on MOTOR's AUTO ENGINES & ELECTRICAL SYSTEMS



1,300 big pictures. Clear text explains how parts work; principles involved; design; construction; maintenance. Covers all parts of engines & entire electrical system. For FREE trial, check box on card (or coupon.)

SEND NO MONEY

Use Manual FREE For 10 Days

Put **MOTOR's** big new **AUTO REPAIR MANUAL** to work for you. See for yourself how quickly and easily it gets the work done! We'll send you this 1972 edition to use FREE for 10 days. If it doesn't start paying for itself in even this short time, return the **MANUAL** and owe nothing. Just mail card (or coupon) TODAY to **MOTOR Book Dept., P.O. Box 2316, F.D.R. Station, New York, N.Y. 10022.**

IF CARD HAS BEEN REMOVED, USE THIS COUPON TO ORDER

MOTOR Book Dept., Desk E117, P.O. Box 2316, F.D.R. Sta., N.Y.C. 10022

Please send me the Manuals checked below for ten days free examination:

- MOTOR's Auto Repair Manual, \$10.95**
- MOTOR's Auto Engines & Electrical Systems, \$10.00**

If I am not fully satisfied, I will return the shipment promptly and owe nothing. Or I will keep it and pay the total price in three monthly installments, plus a small shipping charge.

- I want to save shipping charges. I am enclosing payment in full and you will pay shipping charges. (Same return privileges, refund guaranteed.)

Prices slightly higher in Canada. Offer available in continental United States. Delivery will normally be within 3-4 weeks in Eastern U.S. Please allow longer west of the Mississippi.

Print Name.....
Address.....
City.....
State..... Zip.....
Signature Please..... Age.....
(H.M. Books)

COMPLETE AND SIMPLE. "I always rely on my MOTOR Books. They're well illustrated — and complete and simple."
—Mr. Erve Jones, Minnesota (Garage Owner)

DEPENDS ON IT. "MOTOR's Auto Repair Manual is invaluable to me. I depend on it for all makes and models."
—Mr. W. W. Fortline, Virginia (Mechanic)

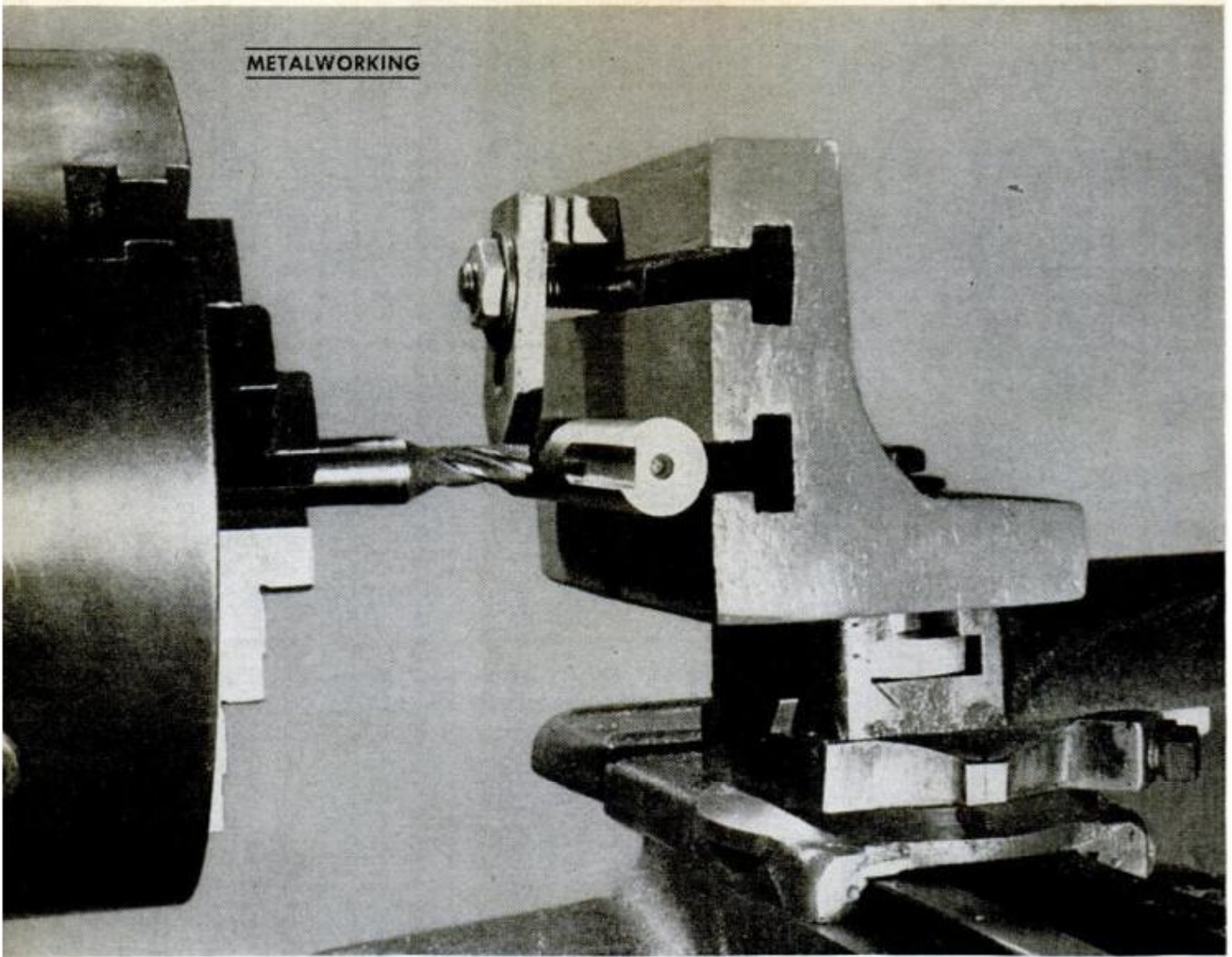

A lathe milling-machine table

YOU CAN BUY a lathe milling-table attachment for about \$50, but I made a versatile one from a common angle plate for less than \$10.

Angle plates are available from lathe manufacturers and tool-supply houses. Pick a plate that has a 5x6-in. face. Drill two holes in the plate for attaching it to the lathe compound rest with two cap-screws and two shouldered T-shaped nuts. To turn the T-nuts, use stock $\frac{1}{2}$ in. larger in diameter than the largest width of the T-slot in the rest. The finished length of the T-nuts should be about $\frac{1}{64}$ in. less than the distance from the top of the compound rest to the bottom of the T-slot. The neck of the nuts should be of a diameter that will slide freely in the T-slot. Each nut is drilled and tapped, and parallel flats are filed on opposite sides to prevent the T-nuts from turning. If the

machine-finished surface of the compound rest is not slightly above the finished surface of the casting that houses the feed screw of the rest, shim with about $\frac{1}{16}$ -in.-thick metal strips.

The angle plate and the lathe compound rest must make solid contact without interference.

To mill the T-slots in the angle plate, you bolt the plate to the top of the compound rest. It's advisable to screw a faceplate on the lathe spindle to serve as a lining-up method so that the angle plate is properly set. The compound rest is first set at the degree mark that makes it movable in a direction parallel to the ways of the lathe bed. Now if you move the lathe carriage so the angle plate is flush against the lathe faceplate, you can judge by slipping paper feelers at different places between faceplate and angle plate

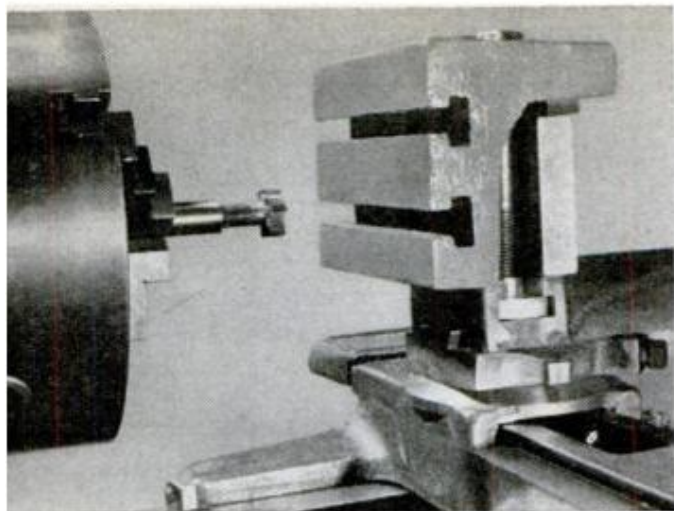
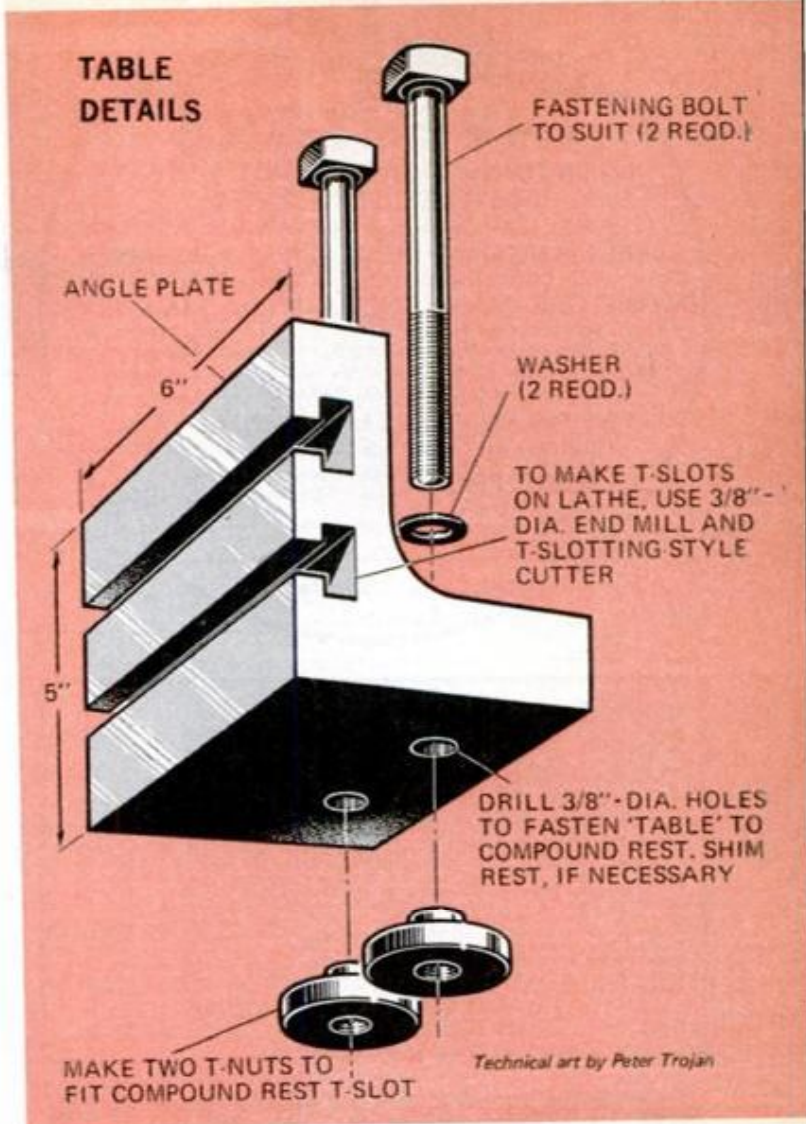
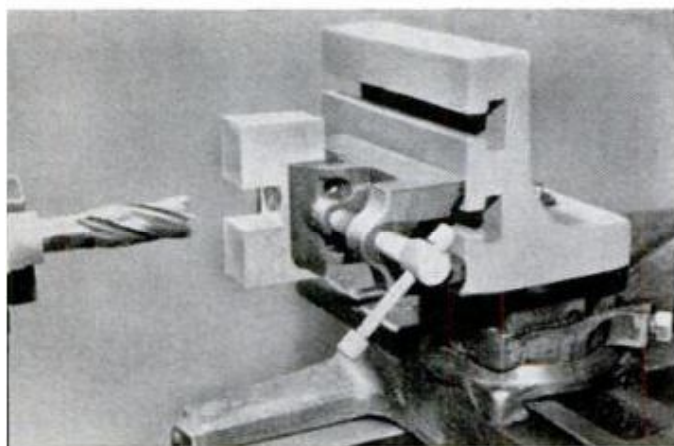

TABLE (left) is being used to make a keyway slot in a $\frac{3}{8}$ -in.-dia. shaft. Above: T-slot cutter used to make a cut on the table face. Below: Small drill-press vise fastened directly to the angle-plate face



for about \$10

By FREDERICK C. LURZ

how well the angle plate is aligned for square cutting.

Cutting one or more T-slots in the angle plate may be done by first using a $\frac{3}{8}$ -in.-dia. end mill or a drill that is flat-face sharpened to make a two-lipped end mill. The larger end of the T-slot is cut with a T-slotting-style cutter.

With the angle plate slotted, you have almost the same advantages of a regular milling machine. Work may be strapped to it in various positions by the use of square-headed bolts with the heads set in the T-slot. For variations of the position of the workpiece, tapped holes may be made in the edges of the angle plate that run parallel to the T-slots. After a cut is taken, various-width spacers can be measured by relating to an approximately $\frac{3}{16}$ -in. metal strip fastened to the edge of the angle plate by means of the tapped

holes. Measuring to the edge of the angle plate takes the place of the up-and-down positioning of a milling-machine table.

In other words, after the part to be milled has a cut taken upon it, if it is necessary to take another cut alongside the first cut, the part is moved over on the angle plate and the dimensions to be obtained are determined by measuring to the edge of the metal strip temporarily fastened to the angle plate edge.

Depth of cut can be measured in thousandths of an inch by moving the micrometer dial upon the compound rest of the lathe.

Depending upon your inventiveness, you'll find that many setting operations may be made on this angle-plate milling table. For openers, consider fastening a small milling or drill-press vise to the angle as shown in the above photo. ★★★

INVENTORS

INVENTIONS—NEW PRODUCTS—IDEAS
DEVELOPED & PREPARED

For Commercial appeal & sales

DESIGN—MARKETING—PATENT RESEARCH—DRAWINGS

Second Decade of Reliable Service To

INVENTORS—MANUFACTURERS—ATTORNEYS

Director: United States Patent Office Former Examiner

United States Dept. of Army Former Patent Adviser

Member: United States Council Int'l Chamber of Commerce

FREE CONSULTATION

THE RAYMOND LEE ORGANIZATION

230-Z Park Ave., New York 10017 (212) MU 6-8500

SEND FREE "Invention Record" Form &
"Product Marketing" Brochure

Name.....

Address.....

City.....State.....

Zip.....



- IMPORTERS
- WHOLESALERS
- DISTRIBUTORS
- MANUFACTURERS
- MAIL ORDER HOUSES

IF YOU BUY TO SELL—YOU NEED THIS MAGAZINE. "TRADE WORLD", a new monthly trade magazine scans the world, revealing the sources for Watches, Radios, Clothing, Jewelry, Cameras, Novelties, Housewares, Wigs and hundreds of other products you can purchase direct from Manufacturers and exporters in Germany, England, Austria, Hong Kong, Switzerland, India, France, Italy, Japan, Africa and many, many more. Watches and Radios for under \$3.00 are only two of the fantastic import opportunities that have been advertised in Trade World. Unlock the door to a profitable import business. Subscribe today. Year (12 issues) \$6.00. Two months \$1.00.

TRADE WORLD MAGAZINE

Dept. P #209-1075 Nelson St., Vancouver 5, B.C.

FREE PLAN

Be Your Own Boss

New Business Opportunity

FILING SAWS

Start a steady repeat CASH business in your basement or garage. Earn \$3 to \$6 an hour in your spare-time! Excellent profits in saw sharpening business! Automatic Foley Saw Filer, easy to operate, files combination saws, hand, band, and circular saws. No experience needed. H. C. Delbert wrote us: "Since I got my Foley Filer 5 years ago, I have averaged 4½ saws each day since I started."

Every saw you sharpen brings you more customers. "I rented a two-car garage and have all the work I can do," writes Charles H. Smith.

FREE BOOK
Shows How to Start

Fact filled booklet tells you how to start a sparetime business immediately; how to get new business, how to advertise. Rush coupon now; get "Money Making Facts" and details on Easy Payment Plan. No Salesman will call.

Send Coupon for FREE BOOK Money Making Facts

FOLEY MANUFACTURING CO.
743-2 Foley Bldg. Minneapolis, Minn. 55418

Send FREE BOOK—"Money Making Facts",
and Time Payment Plan.

Name.....

Address.....



KIDS!

Learn how you can buy used engines \$15 up, new engines \$30 with FREE confidential list and coupons when you order your plans

- BUILD THIS MINI-BIKE!
Plans reveal step by step details!
- BUILD A RACING KART!
Build frame for less than \$10!



RUSH \$2 (refundable) for complete plans (indicate type) or \$3 for both to Sullivans Mfg. Co., Dept. PM7, 1199 Broadway, New York, New York 10001.

New Gas Engine Sale

Briggs & Stratton, Lauson, Wisconsin, Kohler, etc. as low as \$29.50. New surplus. Send 25¢ for 100 page catalog listing 100's of items.

MASTER MECHANIC MFG. CO., Dept. A-72 Burlington, Wis.

WRIST ROCKET

AMERICA'S HARDEST HITTING SLING

Range 225 yd.—232 fps.
Matched replacement rubbers and LEATHER pouch assembly \$1.00
At dealers or order direct.

WRIST ROCKET Mfg.
P.O. BOX 21-B

Columbus, Nebraska 68601



\$3.00 Post. Pk. in U.S.A. No C.O.D.'s
Rates outside U.S.A. add \$1.50 for postage and handling

PROFIT IN YOUR SPARE TIME

SMALL ENGINE REPAIR PAYS BIG!

Outboard • Powermower • Chain Saw • Tractor
MAKE EXTRA MONEY — or fix your own engines and SAVE! Illustrated, easy-to-learn Home Study Course trains you expertly. Approved for Veterans. Write today!



LINCOLN TECHNICAL INSTITUTE
SUITE 7E, 2299 VAUXHALL RD., UNION, N.J. 07083

LEARN

MEAT CUTTING



Train quickly in 8 short weeks at Toledo for a bright future with security in vital meat business. Big pay full-time jobs — HAVE A PROFITABLE MARKET OF YOUR OWN! Time payment plan available. Diploma given. Job help. Thousands of successful graduates. OUR 49th YEAR! Send now for big new illustrated FREE

catalog. No obligation. G.I. Approved.
NATIONAL SCHOOL OF MEAT CUTTING #0197T
Dept. 50L, Toledo, Ohio 43604

SAILBOAT KITS

Free color catalog of the largest selection of popular sailboats, iceboats, and sail making supplies.

TAFT MARINE, Dept. PM-7

6512 Shingle Creek Parkway
Minneapolis, Minnesota 55430



1¢ SALE

GUARANTEED 10 YEARS



The knife for hunting, fishing and all around use. Mirror polished, imported stainless steel blade honed to a razor's edge. Rugged. Opens quickly, easily. Locks into position. Blade will not close when in use. Press button in handle to close. Safety finger guard. Sure-grip handle. Balanced for target throwing.

IF BROKEN WITHIN 10 YEARS WE WILL REPLACE AT NO CHARGE! Use 30 days. Money back if not pleased. Special 1¢ sale. REG. PRICE \$1.98. Send \$1.99 & receive 2 knives. Add 49¢ postage, handling. Remit TOTAL \$2.48 for 2 knives. ORDER NOW! Midwest Knife Co., 9043 S. Western Ave., Dept. DD-5608, Chicago, Ill. 60620. Est. 1936.

UNTOLD WEALTH

Yours for the FINDING!

Find buried gold, silver, coins, relics, treasure with a sensitive new Relco computerized detector. More penetrating power than ever before. All models are fully transistorized and powered by one inexpensive 9 volt battery. Rugged, easy to use. Only about 3 pounds operating weight. Works through earth, wood, concrete, brick, water, etc. Made in U.S.A. by World's largest detector manufacturer.

Get a Successful Start With A New TX60 Detector . . .
Let Relco Lead the Way!

Highly sensitive to gold, silver, coins, rich veins, iron, etc. Maximum range about 4 ft. Sensitive earphones give a loud, clear signal when object is detected. Don't let the TX60's low price fool you. It's sensitive, rugged and gets the job done. A truly professional quality detector at a low, low cost.

Sensitive search coil is cast in solid, tough fiberglass

69⁹⁵

© MCMLXXII
RELCO



Protect Your Detector With
A Sturdy Carrying Case

TX60 Case \$10.90
Frontiersman Case \$18.00
Pacesetter Case \$19.95



FIND BURIED GOLD, SILVER, COINS, TREASURES WITH THE SENSITIVE FRONTIERSMAN

FRONTIERSMAN . . . An Outstanding Metal-Mineral Detector . . . Rugged and Sensitive

Fully transistorized. Built in loud speaker "sounds off" and sensitive meter gives reading when object is detected. Shipped complete with both 6" and 12" detection heads that can be attached together or used separately as illustrated below. Highly sensitive to metal objects as small as a single coin or gold nugget. All Relco detectors are excellent for use on the beach and easily detect through beach sand or salt water. Use them anywhere. The Frontiersman detects a silver dollar up to 12" and larger objects up to about 6 feet.

Our most popular model

129⁹⁵

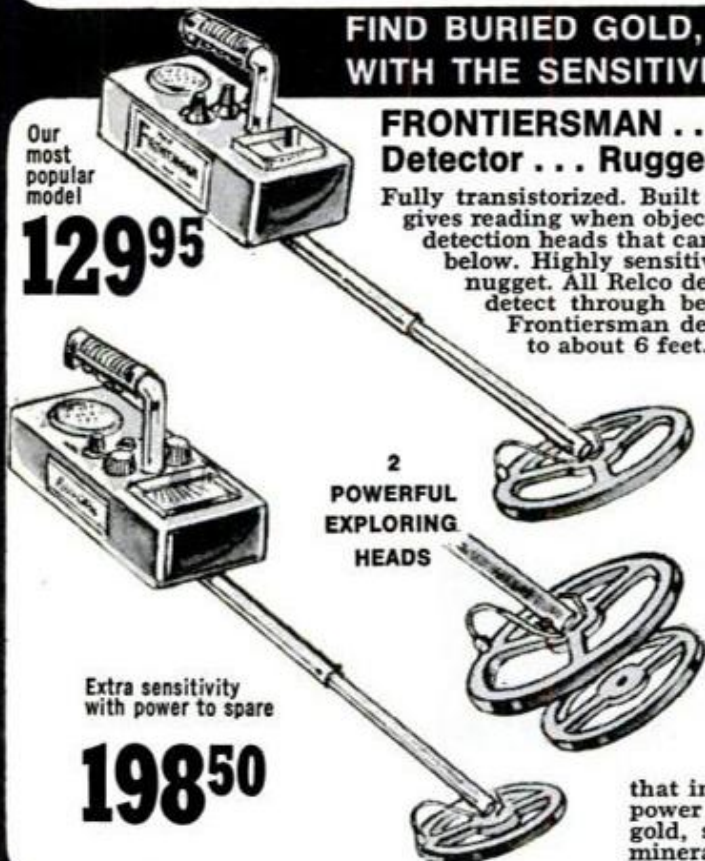

2
POWERFUL
EXPLORING
HEADS

Extra sensitivity with power to spare

198⁵⁰

Both the Frontiersman and Pacesetter Come With the Famous Patented Dual Search Heads. Dual search heads can be used separately or attached together. 6" head has maximum sensitivity to small objects such as coins, rings, etc. while the 12" head gives a broad, deep penetrating field. Both heads are permanently tuned, cast in tough fiberglass and powered by modern transistorized circuitry

for maximum depth penetration, extra sensitivity, pinpoint accuracy.

PACESETTER . . . the Space Age Detector That's Far Ahead of its Time

The finest detector at any cost. Has powerful "sound off" speaker and large sensitive meter that indicates instantly when you have made a find. Has power boost circuit for extra depth penetration. Detects gold, silver, coins and other metals with ease. Also has mineral-metal control, and battery test switch.

FULL 10 YEAR GUARANTEE

All Relco detectors are quality engineered and warranted against original defects in parts and workmanship for 10 years. In addition, there will be no charge for parts or service if your Relco detector needs service through normal use for a period of 2 years.

RELCO, DEPT. #D310, BOX 10839, HOUSTON, TEXAS 77018

Enclosed is \$ _____ check, M.O.

Please rush the following

Pacesetter, Frontiersman, TX60
 Send free catalog only

NAME _____

ADDRESS _____

CITY _____ STATE _____ ZIP _____

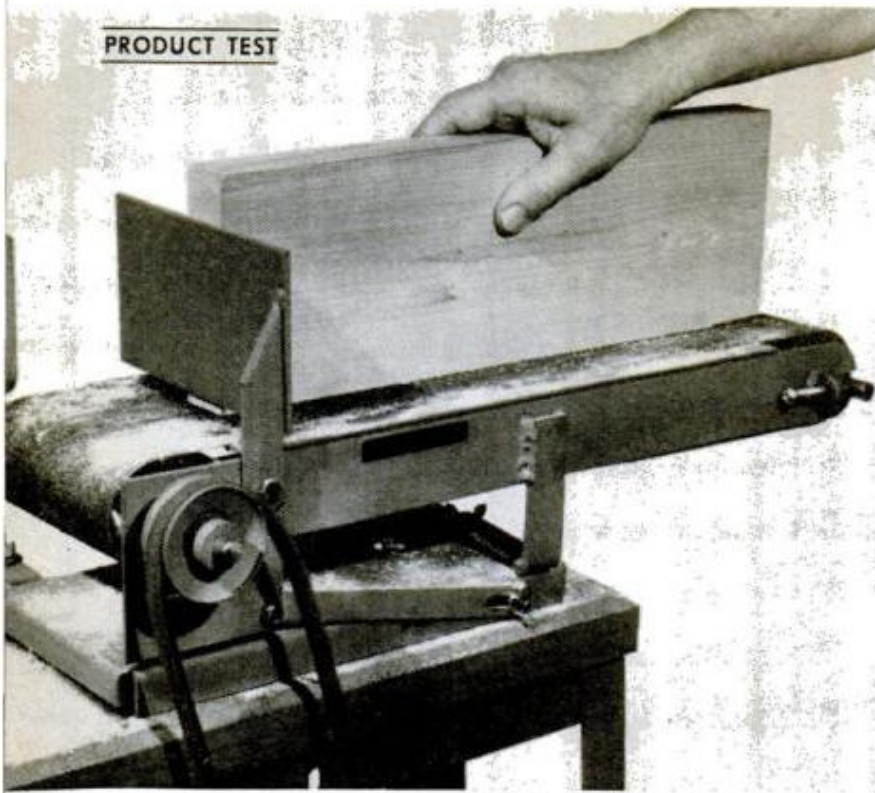
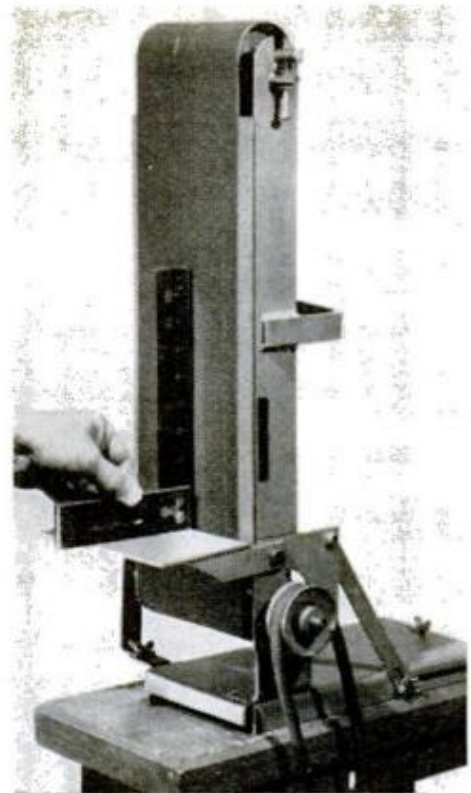

TABLE PROVIDES WORK STOP when the belt is used horizontally. The 4-in. motor pulley drives the 6-in.-wide belt at a 3450-rpm clip



PHOTOS BY ROBERT D. BORST

USE TRY SQUARE to check for right-angle sanding; a bevel square for angles

'Ugly duckling' sands like crazy

THERE'S NOTHING FANCY about this combination vertical-and-horizontal sander. The tilting table has no degree scale, there are no handy knobs to turn for proper belt tracking and tension, and there are no shiny chrome parts. In fact, its welded construction makes it look homemade. But simple as it is, this "poor man's" sander sands like crazy.

Nor does it have a fancy price. If you already have a 1/3 or 1/2-hp motor you can

own this 6-in. workhorse for \$34.95 f.o.b. It's made by Arco Manufacturing Co., 1701 13th Ave. North, Grand Forks, N.D. 58201, and comes with one medium 120-grit belt. It takes a 1/2-hp, 1725-rpm motor with a 4-in. pulley. To swing it from a horizontal to a vertical position you remove one wingnut and loosen two others. With the right belt you can also use it to polish and deburr metal.

—Wayne C. Leckey, *Home and Shop Editor*

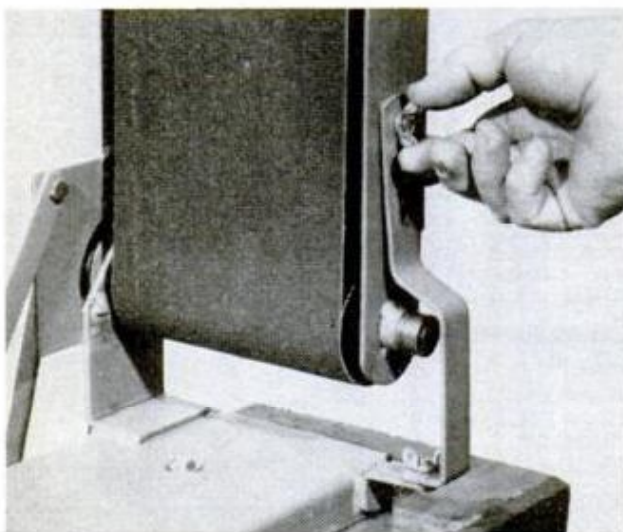

SLOTTED STANDBY BRACE helps support machine when swung to vertical position. Wingnut holds it

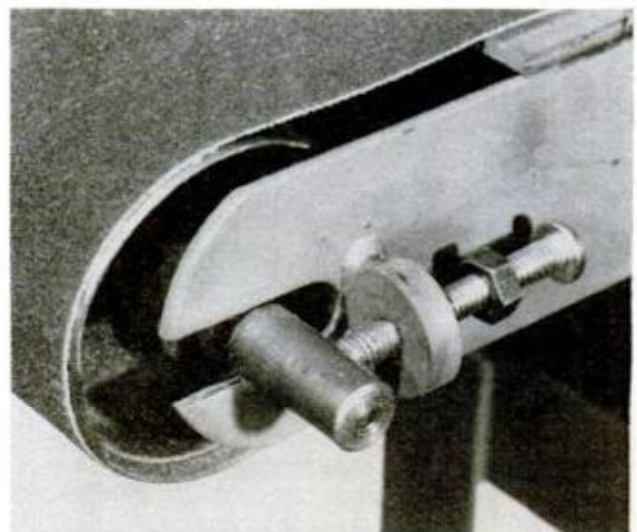

BELT TENSION AND TRACKING adjustment is made simply by turning a stovebolt against idler front roller

Prosperity ^{can be} yours for 50¢ a day!

THE LAND BUY OF A LIFETIME...
SAN LUIS VALLEY RANCHES
IN BOOMING COLORADO!

\$ 395 PER ACRE*

- GUARANTEED INVESTMENT PLAN
- NO INTEREST
- NO DOWN PAYMENT
- NO SALESMAN'S COMMISSIONS

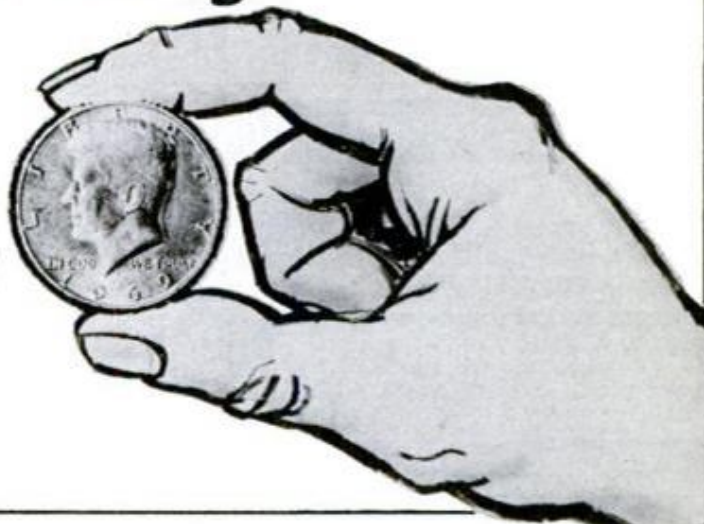

COLORADO IS BOOMING

Early buyers reaped fortunes in the Denver area. Land bought for \$200.00 an acre was sold for \$20,000.00. The opportunity for profits like this in Denver are gone... but a new area of Colorado is opening for public sale for the first time...

SAN LUIS VALLEY RANCHES

The future here is unlimited. The San Luis Valley Ranches are located in the heart of the beautiful San Luis Valley, surrounded by ranges of the Rocky Mountains. This is beautiful land, level to rolling. The air is clean; the climate healthy. All Ranches are accessible by graded roads. This is a perfect place for raising children, retirement or as a vacation paradise.

RECREATION

Every outdoor recreation is here. Hunting for duck, elk, deer and bear. Camping and exploring in the Rio Grande National Forest. You'll find great fishing, boating and water skiing within 3 miles of your property. Wolf Creek Pass, only 60 miles away, offers wonderful skiing and winter sports. Yes, the San Luis Valley is truly a scenic and recreation wonderland.

ALL THIS AND MODERN CONVENIENCES TOO!

The cities of Alamosa and Blanca are friendly neighbors, with stores, supermarkets, schools, churches and a hospital. Blanca is less than 3 miles and Alamosa 14 miles from San Luis Valley Ranches. Alamosa is the home of Adams

State College, one of Colorado's fastest growing Institutions of higher learning.

YOU CAN BUY WHERE THE GIANTS INVEST!

You can feel a lot better about buying land where you know large corporations are investing. In the San Luis Valley, Forbes, Inc., publishers of the world's most respected financial magazine, recently bought a giant 168,000 acre ranch nearby San Luis Valley Ranches. Malcolm Forbes, their president, publicly stated that he will turn the ranch into the largest and best known game preserve in the country, leaving the natural beauty untouched.

THE PRICE IS STILL LOW — NO DOWN PAYMENT!

Just \$395.00 per acre in 5 acre parcels. Your total monthly payment is \$15.00, LESS THAN 50¢ A DAY. There is no down payment, no interest, no salesman commissions, no carrying charges of any kind. Every cent you pay is applied to the purchase price of your land.

WATCH YOUR DOLLARS GROW...

Remember, this is acreage, not just a little plot of ground. Your 5 acre ranch will be equal in size to 20 city lots. We all know about the fortunes made by original investors in Denver. So...

ACT NOW — RANCHES ARE GOING FAST

As you might imagine, property at this price and these terms is going fast. Return the Reservation Form and a 5 acre parcel will be reserved in your name. No obligation, ACT NOW!



GUARANTEED INVESTMENT PLAN

BUYER MAY AT ANY TIME, WITHIN ONE YEAR FROM DATE OF THE CONTRACT, COMPLETE A COMPANY GUIDED TOUR OF THE SAN LUIS VALLEY RANCHES AREA, AND, IF NOT SATISFIED, REQUEST IN WRITING A REFUND OF ALL MONIES PAID ON THE CONTRACT. THIS REQUEST MUST BE EXECUTED IMMEDIATELY UPON COMPLETION OF SAID TOUR.

SAN LUIS VALLEY RANCHES / BOX 836 / ALAMOSA, COLORADO 81101

YES, RESERVE a 5 acre Ranch for me. I understand the price is \$395 per acre (total price \$1,975) and my total monthly payment for the 5 acres will be \$15... no down payment... no interest nor carry charges. Please rush complete details, FEDERAL LAND REGISTRATION REPORT, purchase contract and map showing the exact location of my property. Enclosed is my \$1 reservation deposit which will be credited to my account or fully refunded at my request within 30 days. Reservations subject to prior sale. PM-1-72

THIS OFFER IS SUBJECT TO ALL LOCAL, STATE AND FEDERAL REGULATIONS.

Name _____

Address _____

City _____ State & Zip _____

BUILD, FLY YOUR OWN COPTER!

It's great sport to fly a Bensen Gyrocopter — lowest cost, too. Fly high or low, fast or slow. Adapts to floats. Pilot ages range from teens into 60's. Enjoy flying this easy way! Plans, parts and factory kits available. Get colorful info packet with photo, specs, 3-View Drawings. Send \$5 today!

BENSEN AIRCRAFT CORP., Dept. PM-72
RDU Airport, Raleigh, N. C. 27602

NAME _____

ADDRESS _____



WHITE'S ELECTRONICS INC.

THE
WORLD'S LARGEST
LINE OF MINERAL
& METAL DETECTORS



Goldmaster 66 TR

\$269.50

PRICES START AT 69.50 AND UP.

BUDGET TERMS — BANK AMERICARD — MASTER CHARGE

WHITE'S ELECTRONICS
INC., U.S.A. Room 512 LTD., CANADA Room 512
1711 Pleasant Valley Road 33784 Hazel Street
Sweet Home, Oregon 97386 Abbotsford, B.C. Canada



THERE ARE NO FINER AT ANY PRICE.

Calendar Watch 4.45



Trail
Cycle
149.

QUANTITY PRICES
EVEN LOWER

MELLINGER, Dept. F2257, 6100 Variel, Woodland Hills, CA 91364

HOME-IMPORT BUSINESS—Make Big Profits

Men-Women, new Drop Ship Plan offers fast profits without product investment! Deal direct with overseas sources.

Buy small quantities. Prices shown include duty & postage. Full or spare time. Write for FREE PLAN, state age.

LEARN UPHOLSTERY AT HOME!



Men & Women All Ages! Send for free book on learning to reupholster chairs, divans, footstools, all furniture for BIG MONEY in spare or full time. No experience needed, no age or educational limits. We show you how and provide EVERYTHING needed to start: (1) Home training covering all phases, (2) all tools and 6 big furniture kits for practice, (3) free supplies, frames & materials to build \$300 worth of furniture, yours to keep or sell. Write TODAY for big free upholstery career book. No obligation, no salesman will call. Veteran Approved. Modern Upholstery Institute Box 899 FPF, Orange, Calif. 92669.

FREE
BOOK!

HEARING AIDS

Huge savings on tiny, all-in-the-ear, behind the ear, eye-glass and body models. New space age models are so tiny and well concealed your closest friends may never even notice. FREE HOME TRIAL. Low as \$10 monthly. Money back guarantee. Order direct and save. Write today for free catalog and confidential booklet.

PRESTIGE, Dept. T-29, Box 10947, Houston, Tex. 77018.



HOW TO GET RICH -- AT HOME!



There is no other business like mail order. Start on a shoestring in your spare time and make a fortune fast. It strikes like a bolt of lightning! Millions read your ad and suddenly you are swamped with cash orders from all over the country. MORE MONEY in 60 days than you could earn in a lifetime! Write for free book and complete details. Mail Order Associates, Inc. Dept. 224, Montvale, N.J. 07645

locksmithing and key making

PRACTICAL UP-TO-DATE COURSE — ONLY \$7.95

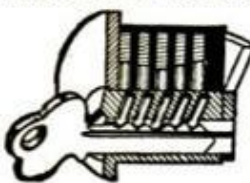

Teaches you how to pick locks, de-code, make master keys, repair, install, service, etc. New self-instruction lessons for every handyman, homeowner, carpenter, mechanic, service station operator, fix-it shop, hardware dealer, gunsmith. 53 easy illustrated lessons. Full price only \$7.95 postpaid. Satisfaction or refund guaranteed. Mail order today!

NELSON-HALL CO., Dept. GY-2
325W. Jackson Blvd., Chicago 60606

PUMP DRAINS pools, cellars, laundry tubs IRRIGATES — CIRCULATES — SPRAYS

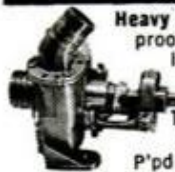

Heavy duty ball bearing pump. All metal, rust-proof Type XB. Stainless shaft. Use 1/4 HP or larger. 1 HP 1,200 GPH 60' high or 3,000 GPH 25' well. 5,200 GPH max. 1 1/4" in; 1" out. Belt or direct drive. \$13.95 Type P won't rust or clog. Bronze bearing. To 2,400 GPH. 1" in; 3/4" out. \$9.95 P'pd cash with order. Money back guarantee.

LABAWCO, Box 40, Belle Mead, N.J. 08502

HYDRAULIC JACK REPAIRS



Earn While You Learn at Home

Earn while you learn at home. Millions of jacks in gas and auto service stations, trucking firms, body shops, riggers, factories and farms need servicing... most of which you can learn to repair. We show you HOW. Start spare time in your basement or garage. Big opportunity for mechanics. ACT NOW!

Write for folder No. PM-7 and free bonus offer.

HYDRAULIC JACK REPAIR MANUAL CO., INC.

P.O. BOX 3 • STATEN ISLAND, N.Y. 10314

Make Rubber Stamps for BIG PAY



Need more money? Earn \$60-\$75 a week, spare time, at home making rubber stamps for offices, factories, individuals. Hundreds of uses. Hundreds of prospects—everywhere. Right in your own community. Turn out special stamps for names, addresses, notices, prices, etc., in minutes with table-top machine. We furnish everything and help finance you, at less than bank rates. Write for free facts. No salesman will call.

Rubber Stamp Div., 1512 Jarvis, Dept. R-2-BH, Chicago 60626

HEAVY DUTY WELDER

with special \$7.00 gift offer to

Popular Mechanics readers
10-DAY FREE TRIAL
Lifetime Guarantee

Brand New 1895
1972 Model 18^{POST PAID}

Fits ordinary 110V outlet
Not one • but 6 welding heats



Weld, braze, solder or cut most anything made of metal. No experience necessary. Follow simple instructions to make repairs on cars, trailers, farm and lawn equipment, bicycles, appliances, etc. Make campers, boats, furniture, hundreds of valuable items. NOTHING ELSE TO BUY! Comes complete with full face shield, pack of welding and brazing rods, heavy duty power cables, special electric torch attachment, ground clamp, flux, easy-to-follow illustrated instructions, rod holder, etc. Uses standard 1/4" rods to weld iron, steel, brass, bronze, aluminum, other metals. New improved HEAVY DUTY circuit gives more welding power. Gives 4 times the heat needed to melt toughest iron. Plugs into ordinary 110V outlet. 6 WELDING HEATS plus continuously variable carbon-arc heat regulation control lets you weld anything from "tough" jobs to light-weight metals with ease. This important feature saves you money and time. Makes it possible for even beginners to start welding professionally the very first day. Pays for itself quickly. An excellent gift for any occasion. IT'S AUTOMATIC: Current is turned ON when arc is struck, OFF when rod is lifted from work. Eliminates need for troublesome foot switch. Speeds up work.

FREE!

Mention that you saw this ad in Popular Mechanics and receive a \$7.00 gift pack assortment of "touch weld" welding rods. Automatic arc striker. Weld with "push button" ease. Lifetime guarantee. 10 day MONEY BACK GUARANTEE. You must be satisfied or return for refund. Send only \$2.00 and pay postman \$16.95 plus postage when delivered or send \$18.95 cash, check or money order for immediate postpaid shipment.

WEL-DEX MFG. CO., Dept. W-203, Box 10776, Houston, Texas 77018

INVENTIONS WE NEED INVENTIONS

Sell your invention for cash—need money for Patent?—Are technical problems holding you back? Universal Inventions has helped inventors all over the world—just like yourself—why not you? Inventions provide the magic spring-board to sudden riches. REMEMBER, we either sell your invention or pay you a cash bonus. Write for details. **UNIVERSAL INVENTIONS, Dept. 13, Marion, Ohio**

THE AUTO ELECTRIC

Power-For-Tools. 110 V.D.C. Electricity from a car's alternator. Installs on—Most late model cars, trucks or tractors. Will operate power tools, light bulbs, heating devices, etc. Operates any brush-type 110 V. A.C.-D.C. electric motor. Battery charging. Easily installed.



Checks or Money Order:
Without 150 V. D.C. Meter \$16.95
With 150 V. D.C. Meter \$19.95

Plus Postage \$1.25 & Texas Sales Tax ONLY

Auto Air Equipment Inc., P.O. Box 2886PM, Amarillo, Texas 79105

At Last a New Amazingly Simple

GAS TURBINE JET ENGINE

Build from easy to follow plans. Length 15", Dia. 8 1/2", Wt. 15 lbs. Fuel: Gasoline or Kero.

"Screamin Demon" develops 20 M.P. Ideal project for serious-minded hobbyists, students, scientific and industrial arts classes. Make on 9" metal cutting lathe with milling attachment. For use on small racing boats, midget cars, etc. Full size assembly drawings with critical dimensions, bill of materials and photos. Price \$5.00. No C.O.D.

SAVOY SCIENTIFIC, BOX 1398, SANTA MONICA, CALIF. 90406



Travel the SHORT way

avoid wrong turns — save time, money and frustration with



AIRWAY COMPASS, Mexico, Indiana 46958



... at leading stores everywhere!

LOCKS AND KEYS MADE EASY!

COMPLETE ILLUSTRATED BOOK OF FACTS

Shows how to fit keys, change combinations, master key locks, keys by number, tools to use, etc. Fascinating trade explained in simple words, clear and complete illustrations. Satisfaction guaranteed. Get started! Order today. Dept. 1410-072

ONLY \$3 PPD.

I. B. Ancele, P. O. Box 69234, Los Angeles, Calif. 90069



GRIND-8-FLEX Flexible Abrasive FLAP WHEEL

Unique abrasive action polishes or grinds all metals. Removes paint, rust, shapes wood. Unlimited applications on flat or irregular surfaces.

MERIT ABRASIVE PRODUCTS, INC.
201 W. Marville, Compton, California 90224

ORDER 6" DIA. WHEEL BY MAIL \$7.95

Fits 1/4" drill also 1/2" or 3/4" Arbor. Special offer price includes postage and handling. Specify coarse, medium or fine grit. No C.O.D.'s.

FREE Home Workshop Brochure



Print For Profit



Cards, Stationery, Envelopes, Advertising, labels, tickets, announcements, Q.S.L. cards, greeting, sympathy, prayer cards, tags, etc. Good Profits, Pays for itself in a short time.

Own a Printing Business

We supply everything direct from factory only. Easily followed rules. Also raised printing like engraving. Have home shop. Add to income. Send 25c for catalogue. **KELSEY PRESSES Meriden, Conn. 06450**

MAIL THIS COUPON TODAY!

KELSEY PRESSES, DEPT. 72-S, Meriden, Conn. 06450

I enclose 25c send big catalog and samples.

Name _____

Address _____

City _____ State _____ Zip _____

"LISTEN IN" TO POLICE-FIRE RADIO CALLS IN YOUR CAR!

WORKS with ANY CAR—Portable or HOME RADIO! Just PLUGS in—No wiring—3 minute hookup! Switch instantly from regular to ALL POLICE-FIRE-EMERGENCY-COMMERCIAL-TAXICAB-STATE-CITY-GOV'T 2 way Radio calls in YOUR AREA. DUAL-HI-LOW BANDS —OVER a MILLION Radio Cars/stations. USE Everywhere—anytime—always works.

SEND ONLY \$2.00 (cash, Ck., M.O.) and pay post. (man. \$7.99 plus COD post. or send \$9.99 for ppd Del in USA. COMPLETE, ready to use with instructions. One Year service Warranty—10 DAY MONEY BACK TRIAL (if retnd). Limited offer includes "Plug in" for ALL RADIOS. **WESTERN RADIO Dept. BPM-7 KEARNEY, NEBR. 68847**



Do-It-Yourself Siding

Learn how you can earn up to \$1000.00 for a single order showing our quality aluminum, steel, and vinyl siding on your home. Small investment required for your own siding. No further investment. Mail coupon for free information without obligation.

**ALUMINUM INDUSTRIES
of ARKANSAS, Dept. P-72
Little Rock, Arkansas 72205**

Please send me free information concerning your quality do-it-yourself kits.

name _____

street _____

city _____ state _____ zip _____



GOVT. SURPLUS AND OTHER BARGAINS SAVE UP TO 90%



400 AMP JET GENERATOR
Exc. for use as arc welder. Rated 400 amps @ 3000 RPM @ 30 V.D.C. Produces up to 600 amps intermittently. Has 1 1/4"-24 tooth splined drive shaft. Mounting flange 11" dia. with 10 bolt mounting holes. 15" L x 8" dia. Turns C.C.W. facing drive shaft end. Mfg. by

Jack & Heintz. GOVT. COST \$353. Like NEW. Shpg. wt. 90 lbs. \$54.50. (Stk. #2637)



HYDRAULIC CYLINDER 32 1/2" stroke, 2" bore, 1" shaft. Operating pressure 3000 P.S.I. Top and bottom of cylinder contain 1/4" ID mounting hole with self-aligning bearings. Closed 43". Inlet and outlet ports 9/16 - 18 (#6). Will produce 9000 lbs. thrust. GOVT. COST \$269.60. Govt. overhaul cond. Shpg. wt. 16 lbs. (Stk. #2932) \$32.50.



DUAL DRIVE GEAR MOTOR

Heavy duty. Rated 5 HP @ 26 V.D.C. @ 270 RPM under load. Turns 125 RPM @ 12 V.D.C. Top shaft turns @ twice straight shaft speed. Shaft dia. 5/8". Gear reduction 33 to 1. Reversible. 18" L x 5" dia. Exc. for winches, capstans or small elect. car motors. Shpg. wt. 39 lbs. GOVT. COST \$580. Like NEW. \$34.50. (Stk. #2398)



NEW! BIG 1972 CATALOG

Send 35c (\$1 for airmail). Catalog contains 1000's of bargains in hydraulics, electrical, marine, automotive items, etc. 90 day guarantee. ORDER FROM AD. Prices FOB Culver City, 50% dep. for COD. Cal. res. add 5% sales tax. Must incl. zip code. Satisfying customers world-wide since 1945.

AIRBORNE SALES CO. Dept. PM772
8501 Steller Dr. • P.O. Box 2727 • Culver City, Ca. 90230

ELECTRIC ARC WELDER \$9.99!



NATIONALLY ADVERTISED \$18.95 VALUE!—NOW 1/2 PRICE! WELDS—BRAZES—SOLDERS—CUTS—ALL METALS! Plugs into ANY 110 volt socket. MAKE—REPAIR 1001 items for CAR—HOME—BUSINESS. Lifetime BURNOUT GUARANTEE 10 day money back trial (if retrnd)

HEAVY DUTY Design—No experience needed—FREE WELDING LESSONS! SEND ONLY \$2.00 (cash, ck, M.O.) and pay postman \$7.95 COD postage or send \$9.99 plus \$1.00 postage for paid del. in U.S.A.! COMPLETE READY TO USE—Includes BIG pack steel, Brazing, Solder, Carbon "touch" rods. **ELECTROFLAME ARC TORCH! OFFER LIMITED—Order TODAY!** MIDWAY WELDER Dept. EPM-7 Kearney, Nebr. 68847

Build
The **BIG ONE**
For **BIG FUN**
NEW VT-7
Super Bronc



Check these leadership features carefully! 7 h.p., 4-cycle engine plus automatic load-sensing torque converter assures all-terrain, all-season performance. Big 21x21x8 super-trac flotation rear tire puts the power to work on sand, snow, slope. Shock mounted 18x8.50x8 front tire provides easy handling and ride. 2-man cushion seat on heavy-duty shocks and 2 pairs of folding foot pegs. Many accessories. Kits from \$169.95. VT-7 kit, \$269.95. Free literature.

HEALD, Inc. Dept. PM-7 P.O. Box 1148
Benton Harbor, Mich. 49022

BUY BELOW WHOLESALE

Buy at factory prices! Why pay more? We buy direct from a thousand factories. And you, dealing thru us, can buy practically anything at factory price plus a small 6% service charge. All the best known name brands at unbelievable savings. You deal only with us! Send card for free details. No obligation. **AMERICAN BUYERS**, Dept. PM, P.O. Box 848, Buffalo, N.Y. 14240

SEARS' NEW VIDEO RECORDER

(Continued from page 75)

scans to make one complete "frame." To save tape, the Sears unit records only one field in three, repeating each field three times. This cuts the picture's effective "shutter speed" from 1/60 second per field to only 1/20, which can blur some motions—but fast football action looked okay. This technique is a hallmark of all Cartrivision recorders, including Sears' unit and those available soon from Admiral, Emerson, DuMont, Montgomery Ward and Teledyne Packard-Bell. All will use the same tapes interchangeably.

"Play," "Record," "Fast-Forward" and "Rewind" controls are like those on many audio recorders; correct recording level, color balance and the like are maintained automatically. (Even if you set your screen controls for green faces, you'll get a normal tape.) You can set a timer to record shows up to eight hours after you leave the house, and you can make "home movies" with the optional (\$250) camera—or use it to keep an eye on things in another room, without rolling the tape. Only the "Lock" and "Hold" controls ("Tune" and "Fine Tune" on other Cartrivision sets) are unfamiliar; adjust them for best picture when you start each tape.

Tapes are available blank in lengths from 15 minutes (about \$13) to 100 minutes (\$40). Cartridges with recorded entertainment will cost about \$13 to \$40 each, and full-length movies rent for about \$3 to \$5. Sears stores can get any tape in the 600-title catalog within 48 hours.

Blank cassettes have a tab you knock out after you record them, to prevent accidental erasure; recorded tapes you rent or buy have it already knocked out. Rental cartridges won't rewind on home machines; you can play them only once per rental.

The tapes have two sound tracks, for stereo or bilingual use, which play together through the set's speaker; but rear-panel jacks let you plug in external amplifiers for stereo, or mute one track of a bilingual tape. Tape time counters are built into cartridges, not the set.

Sears sells the complete 25-inch color console unit for \$1350. This fall, it will add a video cartridge attachment (about \$750) for recent Sears color sets followed by a tuner (about \$150) that lets the attachment record off the air. ★★ ★

The bargain hunter

Tiller Users!



If the tiller you've been using has its revolving blades in **FRONT** and **NO** power to the wheels (See 'TORTURE!' above left), you won't ever be happy with it again once you try the **TROY-BILT® Roto Tiller-Power Composter** which has its revolving blades in the **REAR** and **POWER DRIVEN WHEELS** — and is **SO EASY** to use you guide it with **just ONE HAND!** (See 'JOY' above right). You do **NOT** have to walk behind it, leaving footprints! It does **NOT** shake you half to death! It leaves **NO** wheelmarks! There's **NO** unbearable tangling! The **TROY-BILT®** is now in its 11th great year. **SO** if you want tilling to be a **JOY** instead of **TORTURE** from now on, please clip this ad now and send today for the whole story of this wonderfully different and better design in tillers! We'll send complete details, including prices and **OFF-SEASON SAVINGS** now in effect for a limited time! Just ask for **FREE BOOKLET**.

TROY-BILT® Roto Tiller-Power Composters
Dept. 1917
102nd St. & Ninth Ave., Troy, N.Y. 12180

WATER WATER WATER WATER WATER

"HOW TO DRILL YOUR OWN WATER WELL"

\$1.00 ppd

SATISFACTION GUARANTEED

DEEPROCK CO.
OPELIKA, ALA. 36801

ELECTROPLATING EQUIP.

Portable Platers, Supplies & "Know-How." Build your own tanks for Nickel, Chrome, etc. Easy-to-install PVC liners. Rectifier components—all sizes. Schematic parts lists, formulas, operating instructions for all plating. Guar. to save 25%-75%. Some good used units for sale.

Send for **FREE** details.

PLATERS SERVICE CO.

1511-A1 Esperanza Los Angeles 90023

STOP DRIPPING FAUCETS FOREVER



90% of faucet leaks are due to bad seats. The brass pits and corrodes. Obtaining the correct seats with washers and installing them is very difficult. There are over 100 different sizes and thread combinations available. Install **VULCAN UNIVERSAL FOREVER PREASSEMBLED STAINLESS STEEL SEATS WITH DELRIN WASHERS**. Also ends the frustration of hot water shut-down caused by expanding rubber washer.

KIT INCLUDES: 8 Seats with washers (Do the whole house and garden), Recessing tool, Anaerobic Adhesive, **EASY Pictorial Instructions**. \$4.95 + 50¢ shipping & handling.

Vulcan Mfg. Co., Box 33,

Dept. PM7, Grand Valley, Colo. 81635

Pat. Apl. For

CHINA DOLLAR only 10¢



Uncirculated nickel silver dollar minted in 1960 to Commemorate 50th anniversary of the Republic of China (Formosa)...only one to a customer...a beautiful coin and **ONLY 10¢. SUPPLY LIMITED! SEND TODAY.** You will also receive the most wonderful catalog of coin offers in America. It lists hundreds of coins and collector's accessories to make your hobby more enjoyable. Send name, address & zip number and 10¢ for your **China Dollar** to: **LITTLETON COIN CO.**
Dept. C-40, Littleton, N. H. 03561.

WHO READS THOSE "LITTLE ADS"?

Just about Everybody reads the "Little Ads" . . . **MEN, WOMEN (AND YOUNGSTERS!)** . . . **PROSPECTS-BY-THE-MILLIONS**—who regularly respond to "Want-Ads" . . . scheduled by most of the nation's Direct-Response Ad-Agencies, and Direct Advertisers . . . in the **CLASSIFIED Market Place** Sections that appear in 93 leading National Magazines with more than 42-million monthly circulation . . . a **BIG** potential market for your "Offers"

HERE'S HOW YOU GET M-A-I-L

To get full information about those big-pulling "Little Ads" write today: **S. Omessi, Adv. Mgr., CLASSIFIED, INC.** 100 E. Ohio St., Dept. 72, Chicago, Illinois 60611.

NEW! PROP TOOL

for Repair - Maintenance

Works fast! Saves you money! Simple, 1-pc. tool designed for removal of Mercury propeller. Removes and installs prop tab washer without damage to defuser ring. Easy to use in or out of water.

\$2.50 plus 25¢ handling charge.

ARIZONA PROPELLER SERVICE

3340 E. Washington St., Phoenix, Az. 85034

NEW BATTERY CHARGER IS FULLY AUTOMATIC



Just what car, boat, recreational vehicle owners and week-end vacationers have been looking for: a 10-amp., 12-v. charger that can be left operating and connected to the battery indefinitely. Positively protects against over-charging and damage while maintaining battery in fully charged condition. Just hook up and forget.

Attractive steel case. Easy to read, accurate indicating meter. Light weight. Convenient carrying handle.

Don't settle for less than the best. Only \$24.95 shipped prepaid Continental U.S.A.

WRIGHT INDUSTRIES

4517 Wrightwood Ave., Chicago, Ill. 60639



FREE!!! POWERFUL MUSCLES FAST!
Fantastic New Discoveries in the science of bodybuilding. Now, in the privacy of your bedroom, our method will add inches of powerful muscles to arms, chest, shoulders & legs. Learn secrets on trimming the waist with ultra-modern methods—fast! Results Guaranteed! Send for free brochure. **Universal Bodybuilding, Box 485-MI, Dearborn, Mich. 48121.**

LICKITY SPLITTER

ENDS WOOD SPLITTING DRUDGERY

New low cost **COMPACT MODEL . . .** for farmers, camps, cottagers. 10 ton ram, 2 cycles per min., splits logs 25" x 18". Carried in car trunk, placed upright or hung for storage. For details write:

PIQUA ENGINEERING, INC., Dept. P, Box 605 Piqua, O. 45356

BUILD YOUR OWN BOAT & SAVE

- ★ BOAT PLANS
- ★ PATTERNS
- ★ FRAME KITS

SEND \$1 FOR 96 PAGE CATALOG NOW!

GLEN-L
9152 ROSECRANS' ST

BELLFLOWER, CA 90706

Kirsten

The pipe that never loses its cool.

Kirsten's exclusive radiator stem tames the smoke . . . makes it milder . . . cooler. It also traps impurities and allows you to remove moisture with a flick of your wrist.



\$9

postpaid.

Imported aged Mediterranean briar. Hand finished vulcanite bit. Order your Kirsten pipe and you'll keep your cool forever.

KIRSTEN PIPE CO., INC.

Dept. PM7, P.O. Box 5227, Seattle, Wn. 98107

Please send me your 1972 catalog showing all of the Kirsten Pipes and accessories.

Name _____

Street _____

City _____ State _____ Zip _____

BICYCLE TOURING

(Continued from page 166)

plus 65 cents handling. In it is an application for membership (which you'll need in order to stay in hostels). Family membership is \$12; individual junior (under 18), \$5; senior, \$10. With membership you get a handbook listing all hostels. The hostels charge an overnight fee; at Star of the Sea it was \$1.50 per person.

The Metropolitan New York Council of American Youth Hostels, 535 West End Ave., New York, N.Y. 10024, offers an *Equipment Catalog* free. We bought our saddlebags (\$15.50) and toolkit (\$3) there.

Our backpacker tents and hiker stove and cooking unit came from L.L. Bean, Inc., Freeport, Me. 04032. The two-man tent was \$40; the four-man, \$66; gasoline-fueled campstove (18 ounces), \$10.95; and nesting cooking unit (18 ounces), \$9.95. Write the company for a free catalog.

Another excellent source of equipment is Trail Tech, 108-02 Otis Ave. Corona, N.Y. 11368. We didn't carry any Trail Tech gear, but I had a chance to use some of it later. It's well-designed and ultra lightweight (see page 168). The firm will send a free catalog on request.

If you're ready for a jaunt in Europe, American Youth Hostels can help you there, too. In addition, there are a number of appealing "package tours" offered by Swissair and Sabena. Both airlines include a bicycle in the cost of the tour—and you keep the bike afterwards. Swissair tours start at \$599 for two weeks. Write to Swissair, Wings & Wheels, 608 Fifth Ave., New York, N.Y. 10020, attention David Haron. Sabena tours range from 16 to 27 days and start at \$689. Write Sabena Belgian World Airlines, Adventure on Wheels, 150 S.E. Second Ave., Suite 1104, Miami, Fla. 33131, attention Richard McGill.

On any tour, you'll want to be prepared to make repairs. In addition to *PM's* regular *Bicycle Shop* and the already-mentioned *The Complete Book of Bicycling*, you'll find help in these books: *Derailleur (5, 10 and 15-Speed) Bicycle Repair* (\$4.95) and *Coaster and 3-Speed Repair* (\$4.95), both from Xyzyx Information Corp., 21116 Vanowen, Canoga Park, Calif. 91303; and *Anybody's Bike Book* (\$3, plus 25 cents postage and 5 percent local tax), Ten Speed Press, 2510 Bancroft Way, Berkeley, Calif. 94704. ★★

SOLAR FARMING

(Continued from page 91)

right angle to the panel along one edge. Light is reflected onto the face of the panel by the mirror as well as striking the panel directly. Thus the booster mirror, in effect, doubles the light-gathering surface of each panel, intensifying the heat generated. The heat is transferred to a liquid mixture of sodium and potassium flowing through the panels. This liquid, called NAK after the elements' symbols (NA for sodium plus K for potassium), circulates through coils in a huge vat of molten salt. The salt acts as an energy-storing reservoir, remaining hot through nights and sunless days to provide a constant source of heat.

Water flowing through the molten salt is turned instantly into superheated, high-pressure steam to drive turbines that, in turn, power generators to produce electricity. A cluster of several thousand panels feeding their heat into a single salt vat could provide a 1000-megawatt powerplant. A thousand such plants could thus produce a colossal one million megawatts of power. Present national consumption, about 300,000 megawatts, is expected to double in 20 years. Even so, the million megawatts eventually provided by the Meinels' plan could easily handle the country's power needs by the end of the century—with plenty to spare.

The ideal location for the Meinels' solar farm is a 75-mile square of arid desert along the Colorado River between Arizona and California. Its big advantage: It practically never rains there. Skies are cloudless an average of 330 days a year. From this mammoth power complex, electricity would be piped to towns and cities all over the country through underground transmission lines. One valuable bonus is the staggering amount of fresh water the system would supply as a by-product. Seawater pumped in from the nearby Gulf of California to cool condenser coils for the steam turbines would be desalted at the same time during evaporation. The resulting fresh water—an estimated 50 billion gallons a day—could turn normally barren desert into rich, fertile farmland. How soon the project will get underway is not yet known, but several large power companies studying the plan are prepared to put up funds for an operating prototype to be built within a few years—and none too soon. ★★



POWER OUTLET

EASILY INSTALLED IN YOUR CAR
YOU DO IT YOURSELF IN MINUTES WITH SIMPLE TOOLS.

CAR POWER

3000 WATTS FROM YOUR ALTERNATOR

POWER FOR: HEAVY DUTY DRILLS • SAWS • LIGHTS
• COFFEE POTS, ETC. YOU CAN EVEN CHARGE
DEAD BATTERIES OR ARC WELD

- GUARANTEED 1 YEAR
- WILL NOT DAMAGE ALTERNATOR

\$16.95

POSTPAID

HOLLY & PM-6
P.O. BOX 5321
PHOENIX, ARIZ.
85010

FOR MOTOROLA ALTERNATORS
AMERICAN MOTORS & JEEP

\$18.95

POSTPAID

PLEASE SPECIFY WITH YOUR ORDER

THIS IS IT!



Quik-Sand

Popular Mechanics said in July, 1969 (p. 166):

"Handiest Tool You Can Have in Your Shop"

It sands, grinds, polishes, sharpens. It's portable. Take it on the job. Use with any 1/4 hp motor. Model 165. Factory direct special.

\$26.95 less motor

ARCO MFG. CO.

P.O. Box 817, Grand Forks, N.Dak. 58201

DETROIT APPROVED—PICKUP TANKS

Original equip. type poly. now avail. in aux. tanks for pickups. Increase gas capacity 40 gals. Easy 1 hour installation—completely hidden—no body work necessary. Let truck discounts pay for tanks.



R.P.M. INC., Dept. PM-772
P.O. BOX 7936, Waco, Texas 76710

CASSETTE CAROUSEL



HOLDS
25
TAPES

Cassettes in ready access and numbered for easy reference. Handle nests inside base of next unit and turns freely. Tambour sliding doors & wood-grain trim enhance ebony tone. Molded of high impact plastic. Unique design 10" dia. 6" high. Now eliminate awkward tape box.

(10-Day money back Guarantee)
Only \$9.95 plus 65¢ postage

T-CAROUSEL Dept PM
Clover Dr., Symsonia, KY 42082

IMPORTED LOCK BLADE KNIFE

ONLY \$275 each

- 9" Overall Length
- 5" When Closed
- Sharp and Tough
- Stainless Steel Blade

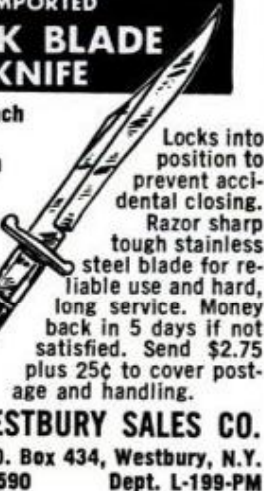

Locks into position to prevent accidental closing. Razor sharp tough stainless steel blade for reliable use and hard, long service. Money back in 5 days if not satisfied. Send \$2.75 plus 25¢ to cover postage and handling.

WESTBURY SALES CO.
P.O. Box 434, Westbury, N.Y. 11590
Dept. L-199-PM

BOAT PLANS-KITS



World's largest catalog, over 200 top designs for the amateur. Inboards, outboards, sail, deep vees, 8' to 57' - hydros, cruisers, house boats, ferro cement, plywood. Send \$1.00 for catalog or \$2.00 for catalog plus Boat Builder's Guide.

Other helpful books: Fiberglass-Boat Builder's Material, \$1.00 or send \$2.00, we include book, How to Fiberglass; Motor Installation - Boat Trailer Book with free plan, \$5.00; Ferro Cement-Plywood boat building book, \$6.00.

CLARK CRAFT BOAT CO.
16PP Aqua Lane Tonawanda, N.Y. 14150

\$4.50 worth of Kurust can stop \$200 worth of damage.



KURUST is a patented formula that changes rust into a new metal that cannot rust again.

It is easy to use; it really works! One jar gives over 30 square feet of complete protection... for cars, boats, around the house—everywhere.

Yes! I want the protection of KURUST.

- Please send me: _____
- _____ jars of Kurust @ \$4.50 ea.
- Payment enclosed: _____
- (check or money order)

Name _____
Address _____
City _____ State _____ Zip _____



ALTAIR INTERNATIONAL CORP.
P. O. Box 647/Westbury, N.Y. 11590



Thousands of exciting tool values!

SILVO (BRAND NAME) TOOL CATALOG

Thousands of Exciting Tool Values! Stanley, Millers Falls, Skil, Thor, Wen, Daston, Wiss, Wellsaw, Dremel, Speedy Sprayers, Plumb, Huot, Kennedy, Channellock, Porter-Cable, Rockwell, Helios, Vise-Grip, Crescent, Ridgid Pony Clamps, Unimat, Freedom and many other Nationally Advertised brands of Tools & Supplies. We ship Coast to Coast at prices Hard to Beat. Send 50¢ for our big 146 page tool catalog today. Silvo Hardware Co., PM-7 107 Walnut St., Philadelphia, Pa. 19106.

Make your own gems!

Fun - Easy - Profitable



Kit includes Gem Maker with 6" iron lap wheel, all grinding, shaping and polishing wheels, diamond blade, accessories, instr.

\$49.90 less motor, fob Fctry.

B & I MFG.

Box 1267-P, Galesburg, IL 61401



TOOL POWER™ 110 VOLTS D.C.

Patent Pending

3,000 Watts 0-50 amps from your car's alternator. Operates heavy duty drills, saws, and lights. battery charging. Arc welding. Does not operate A.C. motors on refrigerators and air conditioners. Installed in 10 minutes. Guaranteed 5 years. \$25.00 Postpaid. Dealerships available.



A.C. Generators 60 Cycles, 110 Volts.

Fanbelt driven. Runs power tools, T.V.'s, refrigerators, radios, A.C. motors to 1/2 H.P. Cannot operate air conditioners. 1,500-watt: \$60.00 plus \$5.00 postage. 3,000-watt: \$99.50 plus \$6.00 postage. P.O. Box 7046, 2821 Mays St.

VIRDEN PERMA-BILT CO.
PM Amarillo, Texas 79109

COUNTERFEIT GUNS

Authentic machined metal replicas of famous firearms disassemble like originals.

#300
U.S. .45
\$19.50



Precision machined metal models look, feel, weigh, disassemble like real guns - Over 30 hand finished parts Perfectly legal - CANNOT be fired. Great for decorating den, office, rec. room. Send for free color brochure of 28 models of famous historical to modern military firearms.

REPLICA MODELS, Inc.
Dept. PM7, 610 Franklin Street
Alexandria, Virginia 22314

Send #300 Enclosed \$ _____
Name _____
Address _____
City _____ State _____ Zip _____
 SEND FREE COLOR BROCHURE

BENCH-SAW KNOW-HOW

(Continued from page 156)

of wood to the fence; then butt work against it. Then the cutoffs won't jam between fence and blade and be thrown back at you with great force. Too, it's good practice to stand to one side of the blade (normally, left) and not directly behind it when ripping. You'll not be struck by severed work should it be kicked back at you. Usually, this happens when the fence is not parallel to the blade, causing the workpiece to bind.

There are several tricks to follow when sawing a plain or compound miter to prevent the work from creeping as it is cut. Three ways are shown on page 156. Where your miter gauge isn't designed to accept a work hold-down, a piece of medium-coarse sandpaper can be glued to the face of the miter gauge to provide a noncreep surface. Or you can simply clamp the workpiece to the miter gauge.

As you become more proficient in the use of your saw, you'll find that it's far from limited to just plain ripping and crosscutting. When teamed up with simple

Stamp out rust and corrosion

Prevents rust—stops rust. Derusto® Enamelized Spray by DAP. Each coat primes, finishes and protects new or rusted metal surfaces. Push-button spray application. Comes in 24 beautiful decorator colors. For interior or exterior use.

the rust fixer from
DAP

DAP Inc., Dayton, Ohio 45401
Subsidiary of *Pittsburgh* Inc.



Stamp out peeling problems

Grips tight. Derusto® Galv-A-Grip by DAP gets its teeth into galvanized metal and aluminum surfaces. Primes and protects gutters, downspouts, flashings. Won't peel, crack or chip like ordinary paint.

the spouting fixer from
DAP

DAP Inc.,
Dayton, Ohio 45401
Subsidiary of
Pittsburgh Inc.



wooden jigs you can make yourself, your saw can take on new jobs in a production-like manner.

Five such jigs are pictured and detailed on page 157. In the case of the adjustable taper jig, two marks made 12 in. from the hinged end permit you to set the jig to any given angle by measuring across the marks. For example, if you open the legs 1 in. at the 12-in. marks, the jig will produce a tapered cut of 1 in. per foot.

Nothing is more accurate and faster than a miter board when it comes to mitering picture-frame molding on a bench saw, and the sliding squaring board makes quick work of squaring up the edges of odd-size scraps with uneven edges. You can produce tapered wedges of any size and amount in jig time with a wedge board. A stepped stopblock takes all the guesswork out of producing perfect fitting half-lap joints with a dado head.

Next month, we'll take you beyond the basics and fundamentals of operating a bench saw and show you how to build a "third-hand" support for holding long rip and crosscut work, and create fancy "waffle" cuts with a dado head. ★★

FIND BURIED TREASURE
FIVE PATENTED MONEY SAVING DETECTORS
 TRANSISTORIZED FROM **1795** TO **4995**

3 SEARCH HEADS INCREASE RANGE
Finds Coins, Jewelry, Gold, Silver, Bronze
 Write For FREE Catalog
SOLIDTRONICS DEPT PA2G, TENNENT, NJ 07763

COMMERCIAL FINANCING
 Commercial financing anywhere in the U.S.A. and Canada. Loans from \$50,000 to \$50,000,000. Contact:
Larned Capital Corporation
 320 Larned Building
 114 S. Warren Street
 Syracuse, New York 13202
 (315) 422-0449

BOILED YOUR OWN
 Cabover Campers • Covers
 16' & 20' Travel Trailers
 • PLANS •
PATTERNS • KITS
 ★ FREE CATALOG ★
GLEN L Recreational Vehicles

 9152 P7 Rosecrans, Bellflower, Calif. 90706

DEALERS WANTED
 Install Folding Steel Gates
 Your Own Business

High Profits
 Low Investment

Complete Kits Ready for Easy & Fast Installation

PROTECT ANY SIZE OPENING

Apt's. Homes Garages Stores W'hse

Stock Custom Sizes Prompt Shipment

SELL SECURITY FOR PROFIT DEALERS ONLY

Details from: **GATE GUARD**
 1137 South California
 Chicago, Illinois 60612

GRANDFATHER CLOCKS
 SAVE 50%
BUILD YOUR OWN GRANDFATHER AND GRANDMOTHER WEIGHT DRIVEN CLOCKS

- Highest Quality Imported Movements from Germany
- Tubular or Rod Chimes
- Moving Moon Dials
- Pre-cut Semi-assembled Handcrafted Case Kits (No power tools required)
- Dials, Barometers, Hygrometers, Templates and Case Plans.

All movements and dials in stock.
 Send 50c for complete catalog
H. DeCOVNICK & SON,
 P.O. Box 68, Dept. M72
 Alamo, Calif. 94507
 EST. 1947



YOU CAN BE TALLER!

If you could grow 2-6 inches taller in one month would you spend 25¢ to discover how?
 Fantastic, new breakthrough method of increasing height quickly, safely and naturally. No exhausting exercise, appliances, drugs or elevators. PLUS, results guaranteed. Air mailed Proof 25¢ only.
HEIGHT INCREASE BUREAU:
 Dept. 15819
 P.O. Box 146,
 Brampton, Ont. Canada



BE TALLER! Girls go for tall Men.

NAME _____
 ADDRESS _____
 CITY _____
 STATE _____ ZIP _____

2000 NOVELTIES
 Free Catalog

FREE! World famous catalog of hard-to-get Novelties, Tricks, Jokes, Pranks, Hobbies, Sports, Science, Electronics, Peace & Love Gear, Mod, Psychedelic, Cloth Patches, Shirt Transfers, Lights, Jewelry, Bargains, Gadgets, Books, Games, Photo & Optical, Tools, etc. No letter necessary. Send ad, name address. Johnson Smith Co., Dept. C-107, Mt. Clemens, Mich. 48043

SAVE WATER

STOP WASTING 4 GALLONS OF WATER EVERY TIME YOU FLUSH A TOILET! UNIQUE PATENTED DEVICE CONTROLS THE FLUSH—USE ONLY WHAT'S NECESSARY. ALSO PREVENTS FLOODING. INSTALLS IN SECONDS. FITS ANY STANDARD TOILET.

SEND \$1.00, PLUS .25 FOR POSTAGE AND HANDLING. MONEY BACK GUARANTEE.

Control-A-Flush-Box 264-Edison, N.J. 08817



SUBSCRIBER'S

Change of Address Form

Please use this form to notify us at least six weeks before you move to your new address.

1. Present address: Attach address label from a recent issue, or print your name and address exactly as shown on the label.

NAME _____
 ADDRESS _____
 CITY _____ STATE _____ ZIP _____

2. Fill in new address:

NAME _____
 NEW ADDRESS _____
 CITY _____ STATE _____ ZIP _____

3. Mail this form to:

POPULAR MECHANICS
 Subscription Service Dept.
 Box No. 646
 New York, N.Y. 10019

POPULAR MECHANICS CARRIAGE HOUSE PLAN. A backyard storage building that isn't an eyesore. Styling blends with most homes. 10ft., 4" x 12ft., 4". For one complete set of construction plans, send \$3.95 to **POPULAR MECHANICS Dept. FA, Box 1014 Radio City, New York, N.Y. 10019.** For two sets (you may need one for your local building department) send \$5.49.

FIRE & BURGLAR ALARMS
 1972 Handbook & Catalog

Save Hundreds of Dollars



Professional equipment from famous manufacturers, not readily available from local sources. **NEW & EXPANDED** to include laser photo-electronic systems, dialers, electronic sirens, perimeter controls, and a **NEW RADIO ACTIVATED SYSTEM** that installs in less than 2 hours. Also includes, switches, bells, control panels, wire and hardware. Save up to 75%. This handbook is a must for every homeowner and businessman. Just \$1. cash, check or M.O. \$1 refunded with first order.
ALARM COMPONENT DISTRIBUTORS
 33 New Haven Ave., Dept. P.M.
 Milford, Conn. 06460

Two or four-wheel drive
JEEP OR SCOUT
 owners

REPOWER with a 6 or V-8 H.D. ADAPTORS for using Car, Compact and some Truck engines. "State year & model, Jeep or Scout." Want fast action? Give us **FULL INFORMATION.** Send \$25.00 Dep. and we will ship correct kit, bal. COD. Send full amount for prepaid shipment. Wire, phone or write today. Details **FREE**

HOOSIER MACHINE PRODUCTS CO.
 312 S. E. 6th St., Phone 276-3442. Pendleton, Oregon 97801

BASEMENT TOILET FLUSHES UP



TO OVERHEAD SEWER OR SEPTIC TANK.
 NO DIGGING UP FLOORS. INSTALLS EASY. Write
McPHERSON, INC., BOX 15133, TAMPA, FLORIDA 33614

CLASSIFIED ADVERTISEMENTS

Rate: \$2.00 per word payable in advance each insertion. Capitalized words—75¢ per word additional. Minimum insertion ten words. To be inserted under the proper classification, copy must be in our office by the 15th of the second month preceding date of issue. The next available issue to place an advertisement in America's No. 1 Classified Section is September. The closing date is July 10th. Send remittance and order to H. E. Kappel, Popular Mechanics, 224 West 57th Street, New York, New York 10019. Please make remittance payable to Popular Mechanics.

POPULAR MECHANICS

WHEN ANSWERING ADVERTISEMENTS PLEASE USE THE ZIP CODE NUMBER

AUTOMOBILES

OLD CAR FINDERS WANTED. We show you how to turn spare-time into spare dollars. Send \$2.00 for instructions to: **OLD CARS**—Box 367, GALT, CALIFORNIA 95632.

****AUTOMOBILE FIRE EXTINGUISHERS**** \$2.98 & \$3.98—Distributors QTY. Price 87½¢ & 99½¢ Sample of Each. \$3.50 Pre-paid. Warne, 6922 Congress, Detroit, 48207.

FOR The Lowest Prices on 1972 Pontiacs, Mercurys and Lincoln Continentals. Write: Earl Shell, Jim Causley Pontiac, 17677 Mack, Detroit, Michigan 48224 (313) 886-1700.

CD-Ignitions. Discount Prices. Rodgers, Son, Box 3583, Anaheim, Cal. 92803.

ELECTRIC CAR Convert car to battery power 50 MPH, SCR solid state control, 30 page plans \$10. Seecom, Box 1274, Tustin, Cal. 92680.

PATCHES Worlds Largest Emblem Catalog. Free. Funny, Unusual Emblems You've Never Seen! Please Send 25¢ For Postage/Handling. **FLINT MODEL**, 7190-PM Grand, Chicago, 60635.

SAVE Money—End expensive Auto Repairs. Auto expert explains how to do job yourself. Book \$2.00. K. E. Nowell, Dept. PM-A, 1267 Vanderbilt Drive, Ormond Beach, Florida 32074.

MIDGET CARS

GO-Karts Factory Direct \$19.95 Catalog 25¢. Schmieder Motors, R.D. #1, Doylestown, Pa. 18901.

AUTO SUPPLIES AND EQUIPMENT

120 VOLTS at 3000 WATTS Of electricity from ANY alternated vehicle! Operate drills, saws, wrenches, heaters, and many more AC devices! Arc weld up to ¼" steel! Series or parallel charge 6, 12, 24 volt batteries! Will not harm alternator! Ten minute installation! Guaranteed one year! Send only \$6.95 for complete construction plans—only \$19.95 postpaid for assembled adapter with light (automatically comes on when alternator produces 120 volts!)—plus many more useful products!—Ask for **FREE** Catalog—Creative Products, 1551 East Loop 820, Dept. M7, Fort Worth, Texas 76112.

"NO MORE FLATS! ALL Tires Protected Completely. Even Against Slow Leaks. Send \$3.48 Today. Guaranteed! Blainsquith Sales, 4640 Sheridan, Dept. 3C, Chicago 60640."

AMAZING MOTALOY Replates Rings and Valves While Driving! \$6.00 Guaranteed. Parker, 89 Evergreen, Bradford, Mass. 01830.

HYDRAULIC Jack repair kits, parts and supplies. Catalog 50¢ (in coin). Hydraulic Jack Packing & Tool Co. Inc., General P.O. Box 3, Staten Island, N.Y. 10314.

THUNDERBIRD-HEADQUARTERS 1955-7 Classics. "Everything for the Birds." New Complete Illustrated Parts, Accessories and Information Catalog. How to Buy, Sell, Swap Cars and Parts. Send \$5, will be credited on purchases. **SHELL'S**, Box 767P, Santa Monica, Cal. 90401 (213) 393-9840.

NEW 14-Piece Highway Safety-Emergency Kit: essential for all motorists. Contains extinguisher, tire inflator-sealer, flares, "Help" flag, handcleaners. Only \$12.85. Guaranteed!! Marcellin, 421-Z Crown St., Brooklyn 11225.

PARTS: Army jeep and truck parts. Spare Parts & Equipment Co., P.O. Box 751, Lexington, Kentucky 40502.

ALTERNATOR, Generator, Starter Rebuilding Kits and Rebuilding Instructions. Write: Gold Coast Alternator, P.O. Box 2127, Sepulveda, Calif. 91343.

ALTERNATOR/Generator Rebuilder's Course; includes Tooling & Test Equipment; Write: Hedelund Engineering, P.O. Box 1134, Reseda, Calif. 91335.

MOTALOY, Ring—Valve job while driving—\$6.00. Free literature. **E&G** Sales, Box 18384-P, Memphis, Tenn. 38118.

RING—Valve Job while driving, \$6.50 postpaid, (Two-\$12.00). . . . Established 1951. . . . Results Guaranteed!! Motaloy, Grantham, Penna. 17027.

NOVEL Inexpensive Glowing Gage Continuously Checks Ignition Performance. Qarc, Box 47876, Los Angeles, Calif. 90047.

OPERATE Lights, Tools, Hotplate, Kettle From Your Car's Alternator. Evening Project. Plans \$2.00. Savaday Products, Box 237, Rock Island, Quebec Canada.

MOTALOY . . . \$5.30 . . . Two Treatments \$9.45 . . . Postpaid . . . Targus Enterprises, 2113 Atlantic . . . Virginia Beach, Virginia, 23451.

100,000,000 AUTOMOBILE SHOCKS, Can Be Restored To Like New Condition. Simple, Inexpensive. Details \$2.00. Earnlees, P.O. Box 365, LaMesa, Calif. 92041.

STOP CAR THEFT. AUTO GUARD Electronic Protector Gives Protection Against Master Keys, Hot Wiring ignition, jump Starting, and Other Common Theft Techniques. Easily Installed. No Wire Splicing or Drilling. Send \$6.95. Market Place, 95 Laurel Street, Ridgefield Park, New Jersey 07660.

IGNITION Kit points condenser rotor \$1.95 guaranteed. Add 10% state make year cylinders send check or money order. David Pittel, 37 Harrison Street, Oakpark, Illinois 60304.

JEOP Owners—V8 conversions. Read Jeep Owner's ad, page 187.

NEW! New! Auto Alarm protects entire car and contents. Fast, **EASY**, installation. Resets **AUTOMATICALLY**. **ONLY** \$9.95. 10 year guarantee. Prospect Vending Company, Department 237-2, 511 Winston, Palatine, Illinois 60067.

JUDSON ELECTRONIC MAGNETO, Ignition System. Cars, Trucks, Boats. \$39.50, postage \$2.00. Calif. residents add tax. Emco Distributors, Box 6142-P, Hayward, Cal. 94545.

MAP HOLDER Keeps maps, instructions, Etc. directly in view. \$2.95 Ppd. Shelton Industries, Rt. #2 Box 420D, Burlington, Wisc. 53105.

AUTO TRAILERS

PICKUP Camper, Trailer or Pickup—Cover . . . Build yourself. Save! Complete plans \$3.95 each Cover plans \$2.00 Conversion Plans—econoline type van \$2.95; passenger bus or delivery van \$2.95. Satisfaction Guaranteed. Equipment catalog \$1.00 (refundable). Details 10¢. Viking Camper Supply, 99-F Glenwood, Minneapolis, Minnesota 55403.

SNOWMOBILES

SNOWMOBILE Hop up accessory **CATALOG.** Speed and performance equipment—manifolds, exhaust systems. Send 25¢. **G.E.M. PRODUCTS**, Box 845, Carol Stream, Ill. 60187.

MOTORCYCLES, BICYCLES MOTORSCOOTERS & SUPPLIES

BE A Motorcycle Repair Specialist. Big earnings. Free details. Professional Institute, Box 1524-M, Kansas City, Missouri 64141.

GO-CARTS, Motorcycles, Supplies. Wholesale Catalog 25¢. Loren Products. Danville, Illinois 61832.

HONDA! \$25 Other Bargains. Send 50¢. Motorscooter, P443, Bend, Oregon 97701.

FUN—BUGGY Catalog. Just out. World's first, biggest, featuring ATV's, Mini-bikes, Karts. \$2.00. "How-to" plans \$1.00. Complete parts stock. Bargain prices. Brown's Motorsports, 19P Central St., Worcester, Mass. 01608.

"BUILD Popular Mechanics" **MINIBIKE** featured June 1967 issue. Detail plans, photographs \$2.50 refundable. Kits, parts, engines; factory discount prices. Catalog 25¢. Gilliom Mfg.; PMC; St. Charles, Missouri 63301.

MINIBIKE Kart parts. Discount Catalog & Plans 25¢. A-1 Service, Claypool, Indiana 46510.

MINI BIKE PLANS FREE With Purchase of Our Fully Illustrated Discount Parts Catalog. Send \$1.00 to: **MOTO CROSS ENTERPRISES**, P.O. Box 57, Phila. Pa. 19105.

(Continued on next page)

MOTORCYCLES, BICYCLES MOTORSCOOTERS & SUPPLIES

(Continued from preceding page)

ILLUSTRATED Catalog 25¢. Parts, Accessories. Custom Stock, most makes, models. Cycle Supply, Box 192M, Fairbury, Ill. 61739.

SPACE, ROCKETS AND ASTRONAUTS

BUILD A flying mini-missile and launcher for less than 10¢. Send \$1.00 to: MFP Missile, P.O. Box 6653, Torrance, Calif. 90504.

ROCKETS: Real flying models—flights up to 2500 ft. New illustrated catalog 25¢; Singles and multistage kit, cones, engines, launchers, trackers, rocket aerial cameras, technical information. Fast service. Estes Industries, Dept. 7-G, Penrose 7, Colorado 81240.



AVIATION

BUILD—One-Man jet helicopter. Easy inexpensive. Detailed plans, drawings—\$5.00. Helicraft, Box 7153, Baltimore, Maryland 21218.

AIRBOAT, Propellers, Engines, Hubs, Mounts, Plans, Supplies, Corvair, V-W conversions, 15, 20, 25 H.P. removable air drives. Kit airboats \$450.00 up. Hovercraft engines, hubs, propellers. Gyrocopter propellers. Catalog \$1.00. Banks-Maxwell, Box 3301E, Ft. Worth, Texas 76105.

STRAP-ON WING One Man. Flown Alot, But IN GOOD CONDITION, \$195 Delivered. Details \$1. Shannon, Box 53, Paramount, Cal. 90723.

AMAZING Device Ascends Thermals Like A Hawk! Completely Assembled, \$1.25. B.C. Duvall, 394 Military Rd., North Little Rock, Arkansas 72118.

FREE PLANS For Hot Air Balloon. Aerostatic Design, Box 2764, New Brighton, Minnesota 55112. Include 50¢ for postage, handling.

HOVERCRAFT

AERO-CAR. Amazing Hovercraft built easily with ordinary tools. Lawnmower engine power. Carries one man plus. Hovers, flies forward, backward, sideways over land/snow/water. Complete construction plans and brochure. \$5.95. Aero-Projects, Box 5118PM, Clinton, New Jersey 08809.

PRACTICAL DESIGN GUIDE For Airboats and ACV's. Send \$5.00 To: Palmer Aero., P.O. Box 1891, Coral Gables, Fla. 33134.



BOATS AND TRAILERS

FREE 112-Page Catalog! Backpacking, Camping, Boating Supplies. Clothing. Wildwood Tents. Laacke & Joys, 1439 N. Water, Milwaukee, Wisconsin 53202.

AIR-MOTORS 6 H.P. Tecumseh 23 H.P. Kohler Fish those way out spots with a proven unit. Travel King, 1510 W. Bristol, Elkhart, Indiana 46514.

FIBERGLASS Cloth, matt, polyester and epoxy resins. Wholesale catalog 25¢. Boat Molding book 30¢. Seifert's, Box 1206-M, Green Bay, Wis. 54305.

AUTOMATIC Boat Bailer: Small Craft: No power Required. \$5.95. Note: Specify bottom hull thickness. De Persia Automatic Bailer, Grand Haven, Michigan 49417.

COMPETITION MARINE EQUIPMENT. Over 300 items for complete auto conversions and installations in high performance SK and ski boats. Mail \$1.00 for new 72 catalog complete with photos, specifications and prices. Glenwood Marine, Dept. PM, 1627 W. El Segundo Blvd., Gardena, Calif. 90249.

FIBERGLASS Canoes, Kayaks, and Duckboats. Many exciting models. Easily assembled kits. \$39.95 up. Free Literature. Riverside Canoes, Box 5595P, Riverside, Calif. 92507.

NEW 1971 Outboards . . . Top Brands
.. 4 H. P. \$139 . . . 6 . . . \$273 . . . 18 . . .
\$399 . . . 40 Selectric \$638 . . . 60 Selectric
\$899 . . . All Sizes . . . Literature 50¢ . . .
Scott-McCulloch Parts. Electra Marine, 675
Merrick Rd., Lynbrook, New York 11563.

FIBERGLASS Cloth and resin. World's finest cloth and non-run resin, at direct mill prices Flotation foam. Complete line of plastics, silicon bronze and brass screws, save 60%. No sales tax. Boat Plans. Catalog 25¢. Freight prepaid. Stiles Boat Supply, Box 11P, Linden Ave., Mantua Hts., N.J. 08051.

CANOES! Kayaks! Factory-direct quality kits, from \$25.00. Many different models. Canvas hulls. Strongest construction materials. Free literature. Sportscraft, Box 636-P, Allentown, New Jersey 08501.

PLANS, FULL-SIZE PATTERNS, FRAME KITS With step-by-step instructions specially for amateurs. Send \$1.00 for new catalog just off press—nearly 100 pages, over 100 designs 8' to 42'; Sail, Jets, Inboards, Outboards, Cruisers, Houseboats, Hot Boats, Catamarans, Hydros, Glen Designs, 9152 Rosecrans, Bellflower, Calif. 90706.

KAYAKS, Canoes, Sailboats, Surfboards, Complete plans, instructions. Free catalogue. Outdoor Sports, Box 1213-P, Tuscaloosa, Alabama 35401.

CANOE Kits—Wood Canvas, Molded Fiberglass—Free Catalog, Canoe—Camping Log Book \$1.00. Trailcraft, Inc., Box 60686, Concordia, Kansas 66901.

PRAM Kits \$49.95, Canoe, Kyak Kits. 250 Plans, Patterns, Kits. Catalogs: Powerboat (2) \$1.25. Sailboat 50¢. Marinecraft, Box 161-M, Brighton, Mass. 02135.

BOAT Kits. Molded Fiberglass. Save money—assemble yourself. Factory molded sections bond into one-piece craft. 20 models—14' to 32' Cruisers, Runabouts, Houseboats, Sailboats. Big line accessories, motors, trailers. Easy terms. Free 80 page catalog. Luger, Dept. BF-72, 3800 West Highway 13, Burnsville Minnesota 55378.

LIGHTS Of all kinds, electrical accessories, portable power, cook and tableware. Free catalog. Bass, Box 901PM, Marblehead, Mass. 01945.

BOATS YOU BUILD FOR \$15.00. Prints & Patterns \$2.00. Send To: MYERS ENTERPRISE, 314 HEIZER STREET, GREAT BEND, KANSAS 67530.

BOAT KITS-PLANS AND PATTERNS-FRAME KITS World's largest catalog. Over 200 top designs. Sailboats 7'-45' Windmill, Snipe, etc. Motor sailers, trimarans, catamarans, power cruisers, houseboats, deep-V's, fishing boats, runabouts, hydroplanes, inboard and outboard. Ferro cement 33'-57' sail and power. Send \$1.00 for Plan Kit Catalog or \$2.00 for catalog plus Boat Builders Guide to: Clark Craft, 16-P Aqua Lane, Tonawanda, N. Y. 14150.

SKIMMER Airboat, 34 H.P., \$995.00. Portable airdrives, 8, 14 Horsepower. Engines, Propellers, Plans, Accessories. Catalog \$1.00. Arrowcraft-PG, Pearland, Texas 77581.

FIBERGLASS And BOAT BUILDERS' MATERIAL At factory to you prices. Cloth, resin, foam, plywood, boat nails, screws, marine equipment. Send \$.35 for catalog or \$1.00 for catalog plus book on fiberglass uses, mold making etc. to: Clark Craft, 16-P2 Aqua Lane, Tonawanda, N. Y. 14150.

CAMPERS AND TRAILERS— KITS—PLANS—

CABOVER Campers, Pick-Up Covers, 10' & 20' Trailers. Build and Save. Large scale Plans and Full-size Patterns with written & pictorial instructions. Complete accessory and aluminum covering kits. Free Literature. Glen L, 9152 PM-7 Rosecrans, Bellflower, Calif. 90706.

MARINE EQUIPMENT AND SERVICES

MARINE Engines, conversions, parts, equipment. Catalog Free! Stokes Marine Industries, Coldwater, Michigan 49036.

CONVERT Auto engines to marine. 68 Page Catalog, 50¢. Lehman Manufacturing Company, 800 Elizabeth Avenue, Linden 4, New Jersey 07036.

MARINE Supplies, Ignition Parts. Free literature. Michael's, 991 Broadway, Bayonne, New Jersey 07002.

FREE Brochure Conversion Kits, Propellers, gears V-Drives 1/0 Drives Gas, Diesel. Starmarine, 1931 Embarcadero, Oakland, Calif. 94606.

ATHLETIC AND BODY BUILDING COURSES

"GIANT Arms." Dr. Young's D.C. revolutionary discovery. \$2. Satisfaction or refund. Gaucho, 1769-A-7, Chicago 60690.

POWERFUL Muscles fast! Free brochure! Universal Bodybuilding, Box 4327-C, Dearborn, Michigan 48126.

NEW!!! Mr. Universe Bodybuilding catalogue—25¢. WFH, 18959 Inkster, Livonia, Michigan 48152.

"BUILD Muscles Faster!" 24 Concentrated Natural Food Nutrients. 3 months supply \$7.00. Satisfaction Guaranteed. Better Health Club, P.O. Box 332M, Devon, Pennsylvania 19333.

BEST Of Judo—Karate—Self Defense. Complete instructions \$1.00. Bargain Books Company, Box 131PM, Auburn, New York 13021.

FANTASTIC Isometric Rope Exerciser System. 5 Minutes Day Slims, Trims, Reshapes. Pocket Size \$3.95. Dorsam, 12763, Las Vegas, Nevada 89112.

SPORTING GOODS AND EQUIPMENT

FREE 1972 Catalog! Guaranteed lowest prices! Rods, Reels, Lures, Accessories—Thousands of items. Cabela's, Inc., Dept. S-7, Sidney, Nebraska 69162.

FREE Catalog low direct factory prices, fishing, Hunting, Archery, reloading Camping supplies. Send today. Herters Inc., Dept. CPM, Waseca, Minn. 56093.

FREE WHOLESALE CATALOG. Lure parts, Molds, Rod Blanks, Reels, Archery, Metal Detectors. Rare Hardwoods. FinnySports (ME), Toledo, Ohio 43614.

CROSSBOWS Powerful Accurate. Catalog 25¢. Crossbowman, Box 723PM-7, Manteca, California 95336.

DON'T MISS THE ACTION. Sports Glasses. 3X30 power for comfortable viewing. \$2.95. Redd's, Box 555, Colton, Calif. 92324.

BIG DISCOUNTS. Sporting books. Free brochure. Ken's Bookcase, 5005 Ironwood Drive, Madison, Wisconsin 53716.

AMAZING 'Swing Wonder' Teaches Golf Pro Swing Instantly \$5.00. Booklets: 'Golf Swing,' 'Secret of Putting' \$1.50 ea. Golf Enterprises, Box 1317 P, Kissimmee, Fla. 32741.



FISHING, TACKLE, LURES

FISHERMAN'S DREAM BOOK—FREE, 170 page catalog just loaded with Hard-To-Find Fishing Tackle Specialties and Do-It-Yourself Goodies. Our 28th year. NETCRAFT Inc., Box 5510, Toledo, Ohio 43613.

CATCH YOUR LIMIT ANYTIME. Hand Tied Fishing Flies. 25 assorted and tested. \$2.95. Red's, Box 555, Colton, Calif. 92324.

(Continued on next page)

FISHING, TACKLE, LURES

(Continued from preceding page)

UNIVERSAL Anglers Kit Unique Fishing Tool Scale/Measure Leather Case. Details Free. Abate Sales, 2222 Wilson Road, Pt. Pleasant, New Jersey 08742.

LURES And Things Fishermen Want. Free Brochure House Of Peres, 2026 Staples, Key West, Florida 33040.

EARTHWORMS, LIVE BAIT

EARN Money raising fishworms for us! Exciting details free! Oakhaven—56, Cedar Hill, Texas 75104.

GROW Fishworms. Outstanding new breed produces great profits. Free Literature. Fain's Hatchery-31, Edison, Ga. 31746.

GROW Larger Earthworms Free—Faster—Easier—Fishing—Composting. Nonbetter Hybrid Redworms—2000—\$5.00 . . . 5000—\$10.00 . . . With Proven—Buy Nothing—All Profit Method. \$7.50—\$12.50. Organics, Route #1-M, Texarkana, Arkansas 75501.

BIG Profits Raising Worms, Soilless Method. Three Oaks, Dresden, Tennessee 38225.

FROGS, FISH, REPTILES

\$20,000 POSSIBLE RAISING BULLFROGS! Free Information! Bravco-A, Box 3511, Victoria, Texas 77901.

DOGS AND KENNELS

LOOKING For a Special Puppy—Send \$1.00 for catalog with prices and information on more than 100 breeds. Hoppe's Kennels—Rt. 2A—Hill City, Kansas 67642.

POULTRY AND GAME BIRDS

QUAILS, Incubators, cages, supplies catalog. Marsh, 14216 Brookhurst, Garden Grove, Calif. 92643.

RABBITS—CHINCHILLAS—FUR BEARING ANIMALS

RAISE Chinchillas. Guaranteed income. Catalog \$1.00. DeShon Chinchilla, Route Two, Roanoke, Indiana 46783.

\$600-UP MONTHLY. People needed. Raise rabbits, other laboratory animals for us. Huge market. We supply equipment, breeders and instructions. Details 25¢. National Research Farms, PNMA-7, Box 37, Palatine, Illinois 60067.

RAISE Rabbits for us, \$500 month home facts. 48 page illustrated book describing 25 breeds. Housing, breeding, feeding, markets, marketing etc. 25 cents. American Rabbit Association, 36 Arba Building, Pittsburgh, Penn. 15217.

AMAZING PROFITS! \$10,000 Yearly Raising Rabbits for Wool and Breeding. Details 25¢ coin. American Angora, Malta 12, Montana 59538.

MAKE Big Money Raising Chinchillas, Cavies, Rabbits for us. Catalog 25¢. Keeney Brothers, New Freedom, Pa. 17349.

\$500-\$1000 MONTH Plan Raising Rabbits For Us. Free Details. White's Rabbitry, Mt. Vernon, Ohio 43050.

CHINCHILLA INCOME GUARANTEED. Terms. 25¢. Bulletin \$1.00. Chinchilla, 11PM, Port Richey, Fla. 33568.

PETS—BIRDS, CATS, HAMSTERS, ETC.

PETS, Reptiles, raccoons, skunks, squirrels. Catalogue 25¢. Trails End Zoo, St. Stephens, S.C. 29479.

GERBILS—Newest Friendliest Cage Pet. \$5.98 Complete With Cage and Instructions. Pet Farm, 325G Massachusetts Avenue, Pensacola, Fla. 32505.

BUY Direct—Save: Mammals, Birds, Reptiles, Wildlife Books. Catalog 25¢. Exotic Animal Importers, Inc., Box 1675, Miami, Florida 33138.

HORSES, LIVESTOCK

"HOW TO TRAIN HORSES"—FREE Book tells how to break, train, make money with horses. Beery School, 1107, Pleasant Hill, Ohio 45359.

CAMPING

PERMANENT Matches, \$1.00. M. Price, 407 Newport Avenue, Wollaston, Massachusetts 02170.

FREE Catalog, 1400 Camping Items. I. Goldberg & Company, 902 Chestnut Street, Philadelphia, Pa. 19170.

ELECTRICAL SUPPLIES

METERS—Surplus, new, used, panel and portable. Send for list, Hanchett, Box 5577, Riverside, Calif. 92507.

LAMP Parts. Catalog, prices, wiring instructions. 50¢. Refunded first order. Gyro, 5218P N.W. 35 Ave., Miami 42, Florida 33142.

SURPLUS Electronic Parts List \$375.00. Unit yours \$25.00. Postpaid List \$1.00. Jay Surplus, 1606 Madison, Kansas City, Missouri 64108.

BATTERIES, GENERATORS

VX-6 PREVENTS Battery Killing Sulphation, Increases Capacity. Guaranteed! \$2.00, Rudolf Herford, 2729 Midvale, Los Angeles, Calif. 90064.

BATTERY Reconditioning Kit, includes molds, material, instructions. Battery Shop, Box 820, La Quinta, California 92253.

BATTERY Terminal Protectors Stop Battery Corrosion. Free Literature. Pracna's, 3301 Buchanan Road, #83, Antioch, California 94509.

ENGINES, MOTORS, MAGNETS

USE 3-Phase Motors on Single Phase no Ballasts, Condensers, Rewiring. Send \$3.00 for Technical Knowhow. Strang Electric, Box 555, Hawthorne, Calif. 90250.

WINDING Data, 275 motors, \$1.25. Data Company, 512 Kensington, Kansas City, Mo. 64124.

ELECTRIC MOTOR SUPPLIES! Rewinding data! Catalog! Modequip, Box 7266, Kansas City, Mo. 64113.

MACHINERY, TOOLS AND SUPPLIES

CEILING FANS. Completely assembled. Install yourself. Lowest prices. Guaranteed. Delaware Electric, 111 South Delaware, Yardley, Penna. 19067.

MICROMETERS—Indicators. Steel—Aluminum—Brass. Maximat, Unimat Lathes. Complete mailing—50¢. Campbell, 1424 Barclay, Springfield, Ohio 45505.

SMALL Foundry furnaces. Supplies. Free literature. Pyramid Products, 3736 South 7th Avenue, Phoenix, Arizona 85041.

WINCHES And **HOISTS.** Choice of 12 volt or 110. Reversible, compact, fast. ¼ ton to 1 ton capacity, from \$49.95. 25¢ brings 16 page full color catalog. Refundable. Superwinch, Inc., Dept. PM, Pomfret, Connecticut 06258.

MAXIMAT, Unimat Sale. Amazingly low prices. Deco-M, 562 Howard Avenue, Staten Island, N.Y. 10301.

PORTABLE Sandblaster \$21.00 (air-compressor required). Free brochure. Inka, Box 66573-A, Houston, Texas 77006.

MAXIMAT, UNIMAT Save at our low prices. Pioneer Electric. Box 7X, Brentwood, New York 11717.

END Mills. Lathe Milling Attachments: Information. Potter, Box 73, Cedar Rapids, Iowa 52406.

WHOLESALE Chainsaw Supplies. Name Brand Products—Fast Service. Mfg. Supply, Box 157, Rochester, Wis. 54425 Dept PM.

BEARINGS, Oil-Impregnated, discount price information write: Roll, Box 52, Warrington, Pa. 18976.

SCREWS, Washers, Bolts, Nuts Assortments, Plumbing, Tools, Drills, 25¢ For Catalog. Nutty Co., Box 1576 SMSP, Fairfield, Conn. 06430.

WRENCH—Echa Spanner Obsoletes the 8" crescent. More Efficient Adjustment. Unique New Racktooth System. Drop Forged Swedish Steel. \$4.20. R & J World Enterprises, Box 2584-B, Pomona, Calif. (91766).

WELDING, SOLDERING, PLATING

WELDERS, Convert To Heliarc. Weld All Kinds Of Metals. You Can Build This 0-225AMP High Frequency Heliarc Unit From Junk Box And Approximate \$9.00. Picture Of Completed Unit. Plans And Where To Get Parts. Send \$4.00 To: Information Supply Company, Box 166, College Park, Maryland 20740.

MORRIS Welders—110/220, 170, Amperes, \$59.50. 1070 Inner, Schenectady, New York 12303.

WELDING Gas and Oxygen outfit \$39.95. for Shop or Home. Details. Box 275, Chatsworth, Calif. 91311.

WELDGUN Arc/Spot Welder (Patented) Use Any Welder For Power. Drawings, Parts List—\$3.00. Speedline, Box 458, Woodriver, Ill. 62095.

GOVERNMENT SURPLUS

JEEPS!!! Pickups!!! 100,000 items direct FROM GOVERNMENT. How? Where? YOUR AREA. Latest information: \$2.00. **MONEY-BACK GUARANTEE.** Dependable, Manual #114, Box 113, Vista, California 92083.

GOVERNMENT SALES. How and Where to Buy SURPLUS. NATIONWIDE Locations. Post Card Brings particulars. AUCTIONEERS, 1698 North Lexington, St. Paul, Minnesota 55113.

GET Instructions on Government Surplus Buying. Information 50¢. Write: Huerta, Box 26313, Tempe, Arizona 85282.

NO CATCHES. Buy any surplus direct from U.S. gov't. All information \$2.00. Bridgeworth, P.O. Box 2292-C, Vancouver, Washington 98661.

GOVERNMENT Surplus. How and Where to buy in Your Area. Send \$1.00. Surplus Information, Headquarters Bldg., Box 30177-PM, Washington, D.C. 20014.

1972 SURPLUS Army, Navy store, 52 Page illustrated catalog. Send 50¢. Ruvel, 3037 North Clark, Dept. 7-J, Chicago, Illinois 60614.

JEEPS \$52.40, Airplanes \$75.01, Typewriters \$6.70, Boats \$7.50. Direct from Government, Directory and Surplus Catalog \$1.00 (Refundable). Midwest Surplus, Box 401-PM, Dayton, Ohio 45401.

JEEPS . . . Buses . . . Vans . . . Trucks . . . Automobiles from \$52.50. Airplanes, Boats, Typewriters. Direct From Government. Directory and Surplus catalog \$1.00 (Refundable). Southern Surplus, Dept. PM-2, Manchester, Kentucky 40962.

JEEPS! BARGAINS! How, Where to Buy Wide Variety of Surplus Bargains from Government. Rush \$2.00 Now for Manual #L2. Surplus, 1811 Vintner, Pleasanton, California. 94566.

GOVERNMENT Surplus Official Guide How And Where To Buy Government Surplus Only \$1.00. Enterprises, 3263 Lucerne Ave., Lake Worth, Florida 33460.

JEEPS Typically From \$53.90 . . . Trucks From \$78.40 . . . Airplanes, Typewriters, Boats, Clothing, Camping, Sporting, Photographic, Electronics Equipment. Wide Variety. Condition. 100,000 Bid Bargains Direct From Government Nationwide. Complete Sales Directory and Surplus Categories Catalog \$1.00 (Deductible First \$10.00 Order From Our Separate included Catalog). Surplus Service. Box 820-A, Holland, Michigan 49423.

(Continued on next page)

GOVERNMENT SURPLUS

(Continued from preceding page)

JEEPS From—\$52.50; Typewriters from—\$4.15; Cars from—\$31.50. Walkie-talkies, motorcycles, airplanes, boats. Typical "As Is" bid bargains from Uncle Sam. Tremendous variety. Exciting free list. Write: Enterprises, Box 402/78, Jamaica, New York 11430.

HOBBIES AND COLLECTIONS

HOBBIES The Magazine for Collectors. Tells where to buy or sell everything old, historic or antique. Sample 65¢. Yearly subscription \$6.00. **HOBBIES** Dept. PM, 1006 South Michigan Ave., Chicago, Ill. 60605.

COLLECT Military Medals, list 25¢. Vernon, Box 387PM, Baldwin, N.Y. 11510.

50 GORGEOUS Jungle Butterflies \$2.90. Collectors Wonderland, Box 1170, New York 10008.

EXOTIC Artifacts and Tribal Art. Old cultural and ceremonial objects from around the world. Highly detailed lists \$2.00 (refundable first order). M. Koehler, P.O. Drawer 56160, Harwood Heights, Ill. 60656.

EXCHANGE Ideas! Send \$2.00, Name, Address, Hobby to: Contacts, Box 478, Bloomingdale, Illinois 60108.

SHOULDER PATCHES—Collectors Items Official Apollo patches one dollar each Postpaid. U. S. Army and Air Corps patches 10 assorted patches, price list and catalog \$3.50. Catalog only 50¢. Special Patches made to order. Minimum 114 patches. Catalog \$1.00. Patches By Springer, Box 1771-PM, El Paso, Texas 79949.

BUILD Your own reflector telescope. ESCO is back. Do-it-yourself reflector telescope kits. See the moon and stars. Mirrors and lens kits. Send for details, Esco Products, 171 Oak Ridge Road, Oak Ridge, N.J. 07438.

LIVE Steam, gasoline, traction engines, castings, "MTP" fittings, tools, books, numerous misc. items. **REVISED CATALOG #21**, \$1.50. **COLES' POWER MODELS**, VENTURA, CALIF. 93001.

COLLECTOR'S Guides coins Stamps Currency 3 160 Page Books. Send \$2.98. Dept 2A, Wilcox's Inc., 107 Harrison, Delavan, Wisc. 53115.



STAMP COLLECTING

WOW! 110 All Different Germany 10¢. Commemoratives, Airmails, High Values. Big Catalog, bargain lists. Also, fine stamps from our approval service, which you may return without purchases and cancel service at any time. Jamestown Stamp, Dept. A72PM, Jamestown, New York 14701.

SEND Only 10¢ for the most wonderful catalog of stamp offers in America. You will also receive a special bonus collection of 150 different stamps from St. Vincent, Rwanda, Russia, etc. Littleton Stamps, Dept. MN-1, Littleton, N.H. 03561.

5000 Foreign \$3.00; 9000 \$5.00; 5000 USA, contains airmails, presidentials, revenues, 19th century, high values, commemoratives, etc. \$3.00; 300 pre-1940 USA commemoratives \$2.00; 700 \$4.00. No approvals. Meyers, 5321 Fleming, Richmond, California 94804.

COUNTRY By Country All Kinds. Low Prices. 10¢ Approvals. Send To: Stamp Company, Box 254, BUFFALO, NEW YORK 14212.

200 BEAUTIFUL BRITISH ASIAN And **WORLDWIDE** Issues Sent To Approval Applicants For 25¢. Trans-Global Stamp Co., Dept. E, P.O. Box B, Baltimore, Maryland 21228.

PICK And Choose, 2¢ Each. Pickrell, Box 10129P, Norfolk, VA. 23513.

FREE! Big Bargain Catalog—New Edition listing thousands of bargains including U.S. & B.N.A. stamps, packets, albums, accessories and supplies. Also, find stamps from our approval service which you may return without purchases and cancel service at any time. Jamestown Stamp, Dept. E72PM, Jamestown, New York 14701.

ASTRONAUTS On Moon: American Space Heroes on Souvenir Sheet, plus other foreign stamps in Gold and Multicolors, all for 10¢ to approval applicants. Scott Service, 22 Strathearn Boulevard, Toronto 349, Canada.

FREE 50 Stamps Including: Cayman Islands, Grenada, British Honduras, Approvals. Moulblow, 1834G Bassett, Anaheim, Calif. 92805.

TEN Mint Cayman Islands 25¢. Penniston, Box 7253, Arlington, Va. 22207.

FOREIGN Close-Out Bargains, Write: M. Stone, 130 Summit Ave., Neptune City, N.J. 07753.

APOLLO 11 Moonlanding. Seven multi-colored giants from Guinea, catalog value \$3.41. Only 10¢. Topical approvals. LeBlanc, Box 110-P1, Glen Cove, New York 11542.

ONE CENT STAMPS. Write for jumbo books of stamps at 1¢ each, mounted in Scott order. **BULLOT APPROVALS**, 6815 Bay Pkwy, Brooklyn, N.Y. 11204.

50 DIFFERENT U.S. Commemoratives 25¢ Approvals. We pay postage. Craig Stamps, Box 118-N, Bellmore, New York 11710.

"AFRICA" 25 Beauties, 10¢. Approvals. Gorliz, Box 28765 PM, Memphis, Tennessee 38128.

GIANT Stamp Collection including: Astronauts, Satellites, Moonrockets, Boy Scout issue. Complete U.N. Set, recent Olympic and Sport issues from many countries, etc., Plus Big Stamp Dictionary and approvals. Everything 10¢! Stampex, Box 47-RM, White Plains, N.Y.

100 DIFFERENT United States Stamps, 25¢. With U.S., Foreign Approvals. Shelron, Box 547C, North Miami, Fla. 33161.

U.S. MINT Specials! Flag set, complete \$1.00. 1¢, 2¢, 3¢ famous Americans (21 different) \$1.00. Free list, Brooks, 2601 Avenue "U," Brooklyn, N.Y. 11229.

PENNY! Approvals! Regardless catalogue! Kloster, 4164 52nd St., San Diego 5, Calif. 92106.

U.S. BARGAIN, 50 Different 10¢, with beautiful worldwide, approvals. Stamp Center, Kennebunk, Maine 04043.

FREE Surprise collection sent with approvals. Gould, 1784 Union, San Francisco 94123.

PENNY Stamps! 1000 Mounted in book at 1¢ each! Trust Stamp Company, P.O. Box 100-P, Jamaica, New York 11435.

ABSOLUTELY Free United States Mint Souvenir Sheet When Requesting United States Approvals. **K&B**, Box 70, Brooklyn, N.Y. 11223.

500 DIFFERENT Stamps, \$1.00. Smith, 508-A Brooks, College Station, Texas 77840.

210 DIFFERENT U.S. Commemoratives \$1.00. Stamps, 7607 Larchview, Dallas, Texas 75240.

14,000 DIFFERENT! AMAZING New plan builds your collection systematically, country by country. Only 50¢ weekly. Ware, Monroe, Conn. 06468.

TEN Different Nudes: 20¢. Approvals. Stamp Farm, 2M44, Oxford, Wis. 53952.

AMERICANS On foreign stamps, Presidents, Kennedy, Roosevelt, Lincoln, U.S. Spacemen, Princess Grace and others. 10¢ with approvals. Roseland Stamps, Dept. 57, Spring Lake, Michigan 49456.

FAR EAST ASSORTMENT—VIET NAM, JAPAN, KOREA, Formosa and others only 10¢ with world wide approvals. Clark Stamps, Dept. 57V, Muskegon, Michigan 49444.

100 CANADA 25¢. Excellent value. Approvals. Continental, Limehouse, Ontario, Canada.

FREE Duplicate Exchange—2¢ Approvals. Belden, Box 4175B, Dearborn, Michigan 48126.

100 DIFFERENT British Empire 10¢. Approvals. Gibson, Box 34, Lansdowne, Pa. 19050.

80 DIFFERENT U.S. Stamps. Includes 1943 flag stamp of occupied nations. Only 25¢. Approvals included. Willett Co., Box 338-M, Yorktown Heights, N.Y. 10598.

50 YEARS Old, fifteen different United States, over fifty years old—10¢ with approvals. Jaxon, Box 145-P, Brooklyn, New York 11230.

307 DIFFERENT Triangles, Sports, Topicals, etc. Worth near \$8.00. Only 25¢. Bargain approvals. Jayto Stamps, East Syracuse, New York 13057.

MILLIONS Foreign Stamps! 2¢ each! Send for gigantic approvals! **ABC**, Box 6000-MB, San Francisco, California 94101.

NEW! Get scarce Vietnam, Tanzania, Cook Islands Royal Visit, Monaco Royal Wedding plus F.D.R., Stalin, Churchill memorial issues, many more. Valuable collection of 100 different stamps from far-away places. Strange beasts, famous people, rare paintings. Also stamp selections to examine. Buy any or none, return balance. Cancel service anytime. Rush 10¢ handling. Garcelon Stamp Co., PM9K, Calais, Maine 04619.

60 DIFFERENT United States (30 Commemoratives) 25¢. Seidenberg, Salem 169, Oregon 97308.

QUALITY AND LOW PRICE. EXCELLENT For advanced or beginner. Mounted approvals 2¢ up, all countries in Scott's Order. Preview Stamps, P.O. Box 20667, San Diego, California 92120.

RUSSIAN Space collection 25¢. Russian Approvals. Snedco, Box 68-P, Waldwick, N.J. 07463.

BEAUTIFUL TOPICAL COLLECTION—Includes Olympic sport stamps, wild animals, bicolor triangles, colorful birds, outer space stamps, Poland kitten stamp and others. 10¢ with approvals. Sunny Stamps, Dept. 57A, Fruitport, Mich. 49415.

200 DIFFERENT 10¢ With Approval. Polze, Box 5215, Milwaukee, Wisc. 53204.

SENSATIONAL Clearance Sale. 10 packets—25, 20 packets—50, 40 packets—\$1.00. No Approvals. Norge, Wyckoff, N.J. 07481.

FREE U.N. Mint Set. Approvals. Hildebrand, Box 5645, Redwood City, California 94063.

NEW AFRICAN STAMP COLLECTION Including Burundi, Guinea, Mali, Rwanda, Togo and others. A colorful addition to your collection, 10¢ with approvals. Modern Stamps, Dept. 57B, Ferrysburg, Michigan 49404.

LOOK! Over 100 different strange and valuable stamps for just 10¢ with approvals, plus big bargain lists. Continental, Box 9413, North Hollywood, Calif. 91609.

"INVERTED Error" Dag Hammarskjold, 10¢ with approvals. Belmont Stamps, Washington, D. C. 20015.

SENSATIONAL Free Offer. 20 Outer Space Stamps. Selected Approvals. Louis Morrison, 1027 Maryland, Cape May, New Jersey 08204.

100 OLD United States between 1861 and 1935. \$1.00. Ed Roush, 423 Shepard, Mansfield, Ohio 44907.

FREE: First UN Stamps Issued. Approvals. Chapman, Box 487N, Galesburg, Mich. 49053.

WORLD Wide stamps 2¢ each! Write for exceptional approvals. Pan Pacific, Box 1895F, Studio City, Calif. 91604.

(Continued on next page)

STAMP COLLECTING

(Continued from preceding page)

SELL stamps by mailorder to collectors! Earn Big Profits! Free details. International, 6767LC South Atlanta, Tulsa 74136.

FREE! \$10.00 Giant Stamp Collection of 300 all different colorful, valuable postage stamps from Africa—Europe—Asia—British Empire—Worth \$10.00—\$12.00 at catalogue prices. Also money-saving Booklet. All yours as a Get-Acquainted Gift. Adults only. Other fine stamps enclosed for your inspection. Frasek Co., Inc., PM7, White Plains, New York 10601.

MILLIONS Of stamps 2¢ each. Write today for gigantic selection. CSC, Box 9384, No. Hollywood, Calif. 91606.

WORLDWIDE mixture, five bonus coupons, mint sets. Everything 10¢ with foreign packet approvals. White, 6808-EB Chrysanthemum, Indianapolis, Indiana 46224.

WANTED—New Issue Subscribers, Specialty Israel, Western Europe, Great Britain. Advise your references, small advance over **FACE VALUE**. Franklin, P.O. Box 467 B, Jamaica, New York 11434.

500 DIFFERENT Worldwide Stamps, \$1.00. No approvals. LIFE, Dept. PM-1, P.O. Box 5515, Lawton, Oklahoma 73501.

25 FAMOUS PAINTINGS 10¢. Approvals. Phipps, 10906½ Wilshire, Los Angeles 90024.

WANTED—Stamp collections, Murray Gold, 67-70P Yellowstone, Forest Hills, N.Y. 11375.

200 DIFFERENT 20¢ Bargain lists. No approvals. STAMPS, Box 27, Fremont, Michigan 49412.

RWANDA'S Latest Bicolored Animals—Buffalos, Zebras, Rhinoceros—Free! Approvals plus 101 Bonus Sets. William Deems, 226 Race, Ravenswood, West Virginia 26164.

107 British Colonies. Terrific bargain. 25¢. Approvals. Castle, Box 15-PM7, Flushing, New York 11352.

PIONEERS Of the Air Age—first flight covers. Postal markings tell historic data. Real collectors' items now. \$1.00 each or 4 all different flights for \$3.25. K.M. Walsh, Box 308-F, Tuckahoe N.Y. 10707.

50 DIFFERENT Argentina-10¢. Approvals. Gobestamps, Box 402, Biddeford, Maine 04005.

COLLECTION Free: Pictorials-Commemoratives. Approvals. Ross, Box 564-PM, Yonkers, New York 10702.

TEN Beautiful Diamonds, 10¢. Approvals. Big M Enterprises, Box 10902—A7, Ferguson, Missouri, 63135.

72 DIFFERENT US- 10¢, with approvals, Album Service, Soledad 6, Calif. 93960.

225 STAMPS For only 10¢! Airmails. Pictorials: stamps from strange countries cataloging up to 25¢ each! Plus unusual stamps to examine. Buy any or none return balance, cancel service anytime. Mystic Stamp Co., Camden 80, New York 13316.

50 U. S. COMMEMORATIVES 15¢. Approvals. Cambridge, Box 2311, Heath, Ohio 43055.

COINS, TOKENS, CURRENCY

SEND Only \$1.00 for Coin Collecting Outfit. Contains 25 new coins from 25 countries, Plus Magnifier, wooden nickel, "How To Collect Coins" booklet, special coin envelopes, foreign banknote And big catalog of coins, paper money, collectors supplies. Littleton Coins, Dept. GH-1, Littleton, New Hampshire 03561.

COIN Price List. Send 25¢, Aurora Coin, Box 724-PM, Lynnwood, Washington 98036.

SILVER DOLLARS Uncirculated, 1880-81—1883-84-85 \$4.50 Ea. Catalogue 50¢. Shultz, Salt Lake City, Utah 84110.

192 POPULAR MECHANICS

COMPLETE U.S. Coin List 25¢, Lincoln Starter Sets 50 Different \$1.75, 100 Different \$3.50. Schultheis, Box 151M, New Hyde Park, N.Y. 11040.

PRICE Lists of Thousands of Stamps and Coins. Send 25¢ Refundable with purchase. No Approvals. Bryson, 612M White, Toledo, Ohio 43605.

GOLD: Mexican 1865 Maximilliand Peso .900F Uncirculated \$1.95. Olmsted, Terrace, Franklin, New Hampshire 03235.

SILVER Dollar \$3.10; Large Cent \$4.50; Ten Buffaloes \$2.60; Listing 25¢. Nelson, 346-J, Rye, New York 10580.

FIVE Indianheads \$1.90; Five V-Nickels \$1.85; Silver Certificate \$1.95; Listing 25¢. Fairway, Box 685-K, White Plains, New York 10602.

40 MIXED, Indianhead And Lincoln Cents 1890's To 1930's \$2.00. Pavley, Box 518, Cupertino, California 95014.

15 COINS From 15 countries. \$1.00. Robert Getts, 250 Mamaroneck Ave., White Plains, New York 10605.

UNITED STATES Coins, Super Surprise Package only \$3.00. CHARLES COIN, Box 164M—Midtown, New York 10018.

1971-S PROOF Kennedy Half, \$4.50. Catalog 25¢. Village Coin Shop, Dept. P, Plaistow, NH 03865.

BEAUTIFUL Uncirculated Silver Dollars, 1878 to 1904—Our Selection: Each \$4.98, Ten Different Dates \$46.89. Bargain Lists 18¢. Bebebe's, Inc., Omaha, Nebraska 68111.

INDIAN CENTS (1859-1909). 20 Different, including Scarce 1863cn. \$12.00. Free List. Rodney Tuttle, 3946 58th, San Diego, Calif. 92115.

LINCOLNS 1909-1958 Every year including 1909VDB, 1922D. 50 different (Regularly \$12.60.) SPECIAL \$6.95. HARRIS, Box 2037P, Santa Cruz, California 95060.

CLEARANCE Ten Silver Dollars \$15.00. Lee LTD., 331 W. Pender Street, Vancouver, Canada.

33 LINCOLN Pennies, Different Dates, \$1.00. 9 Jefferson Nickels, Different Dates, \$1.00. 10 Roosevelt Dimes, Different Dates, \$2.00. Dryz, Box 9209A, Treasure Island, Fla. 33740.

INDIANHEADS; 6 Different \$2.00. Free Pricelist. Kedzie Coins, 5909 South Kedzie, Chicago, Illinois 60629.

GENUINE Coins from 25 different foreign countries \$1.25. R & L Coins, P.O. Box 686, Moline, Ill. 61265.

ANTIQUES, RELICS, INDIAN GOODS & CURIOS

10 BEAUTIFUL Arrowheads \$2.00. Guajardo's, 8713 Shaver, El Paso, Texas 79925.

IROQUOIS Masks, Eskimo sculpture. Catalogue 25¢. Iroqrafters, Ohsweken, Ontario, Canada.

APACHE Arrowhead Collection 9, \$2.00. 25 for \$5.00. Epanco, PM 1239, Apache Junction, Arizona 85220.

INDIAN Relic list, Arrowheads \$4.00. doz. Folsom. \$5.00 each. C. Secrist, Deerfield, Missouri 64741.

EVERYBODY LIKES DIXIE GUN WORKS.

TONS Of antique gun-parts and supplies. All reproduction muzzle loading guns. Send \$2.00 for enlarged illustrated catalog No. 121. Dixie Gun Works, Union City 12, Tennessee.

LIST Indian relics. 10 Arrowheads \$3.00. Hyde's, Box 2304, Santa Fe, New Mexico 87501.

SELLING 20,000 Indian relics, Arrowheads, spearheads, tomahawks, ceremonials, etc. List 10¢. Lear's, Glenwood, Arkansas 71943.

MODELS—CARS, SHIPS, TRAINS, PLANES ETC.

SHIP Models Kits, fittings, plans, books, tools, engines, motors. Big illustrated catalog 50¢. Mass. residents add 3% tax. James Bliss & Co., Dept. SM, Route 128, Dedham, Mass. 02026.

SHIP And yacht model fittings: Pine construction hull kits; blueprints. Send 50¢ for illustrated catalog. A. J. Fisher, Inc., 1002 Etowah Avenue, Royal Oak, Michigan 48067.

MODEL Airplanes—Big 220 Page Catalog \$1.00. Sig Company, Montezuma, Iowa 50171.

SHIP Models Catalog 25¢. Scientific, Inc., 340 Snyder, Berkeley Heights, N. J. 07922.

LIVE Steam powered backyard railroads! All sizes. Complete "bolt-together kits," and rough castings. Excellent drawings. 100 page catalog \$1.00. Little Engines, Lomita, California 90717.

ROCKETS: Real flying models—flights up to 2500 ft. New illustrated catalog 25¢. Single and multistage kits, cones, engines, launchers, trackers, rocket aerial cameras, technical information, Fast service. Estes Industries, Dept. 2-G, Penrose, Colorado 81240.

GAMES, TOYS, PUZZLES, NOVELTIES

TWO Fantastic Jumping Discs \$1.00. Box 2567, Lancaster, California 93534.

STOP If Puzzle's Are Your Game. I Challenge You To The Wagon Wheel Puzzle. Only \$1.00. Hardy Puzzle's, 1120 East Voorhees, Danville, Illinois 61832.

SQUAWKER Fits shoe, makes walking a riot! \$1.00. David Tomich, 136 Marian, Oak Park, Illinois 60301.

FEMALE FORM Plastic Tag, Gold Locking Key Chain, \$1.25. Gold Star, Box 7066P, Commerce, California 90022.

MAGIC TRICKS, JOKES, VENTRILOQUISM

HOUDINI'S Greatest Magic!! You can do them all!! Giant illustrated Catalog 25¢ with Free Trick!! Vick Lawston, Box 2026P, Pompano Beach, Florida 33061.

FREE! World's Leading Catalog 2000 Novelties, Jokes, Tricks. Scientific Gadgets, Hobbies. Johnson-Smith, C-10, Mt. Clemens, Michigan 48043.

NEW 1972 Large Catalog. Be popular! Amaze! Have fun! Send 10¢. Latest Magic for pocket, parlor, stage. Douglas Magicland, Dept. 11, Dallas, Texas 75201.

VENTRILOQUISM! Learn at home! Guaranteed! Write! Information Free! Dummy Catalog 25¢. Maher, Box 9037P, Denver, Colorado 80209.

COMPLETELY Illustrated catalog. 84 pages. 25¢. Manhattan Magic, Box 334-M, N.Y.C. 10011.

BE A Magician! Two booklets explaining sixty-eight tricks plus large professional catalog. \$1.00. Magic Inc., 5082 Lincoln, Chicago, Illinois 60625.

WORLD'S Finest professional magic tricks. Joker's Novelties. Giant illustrated catalog 10¢. Top Hat. Evanston, Illinois.

FABULOUS MAGIC New 1972 catalogue 25¢. Our specialty orders shipped same day no substitutes. Fabulous Magic, 3319 East Charleston, Las Vegas, Nevada 89104.

VENTRILOQUISM! Complete course—\$2.00. Nothing else required. C&H Specialties, 4113 LaMirada, Bakersfield, Cal. 93309.

HOUDINI'S Original Magic Shop. Established 1856. Send 25 cents for illustrated Catalog containing 5000 Tricks. Mindreading, Puzzles, and Jokes. Flossio-Hornmann, 304 West 34th St., New York 10001.

(Continued on next page)

MAGIC TRICKS, JOKES, VENTRILOQUISM

(Continued from preceding page)

MAGIC MAGAZINE—Monthly since 1936. 44 pages. All phases. 3 month trial \$1.00. Genii, P.O. Box 36068, Los Angeles, Calif. 90036.

BOOKS, CATALOGS, NEWSPAPERS

PUBLISH Your Book! Join our successful authors: All subjects invited. Send for free appraisal and detailed booklet. Carlton Press, Dept. PMG, 84 Fifth Avenue, New York 10011.

HISTORIC NEWSPAPER FRONT PAGES Thirty different \$2.25. Agents wanted. Excellence, 1625 25th Street, Southeast, Washington, DC 20020.

BOOKS, BOOKS, BOOKS' HUNDREDS OF TITLES, SUBJECTS. Free Catalog. Basehor, 603 Shepherdstown Road, Mechanicsburg, Penna. 17055.

U.S. Marines "Hand To Hand Combat" manual \$1.50. Catalog of manuals 25¢. Hillcrest Publications PM-7, McDonald, Ohio 44437.

FREE BOOK. Prophet Elijah Coming Before Christ. Megiddo Mission, Dept. 63, 481 Thurston Road, Rochester, N. Y. 14619.

NATIONAL Geographic Magazines, 1888-1971, any issue. Buxbaum, Box 465-PM, Wilmington, Delaware 19899.

FREE Catalog, Self Improvement Books, Many Others. Total Company, 6609 Kindred, Philadelphia, Penna. 19149.

FREE CATALOGS!! Directory Lists Hundreds. \$1.00. CATALOGS, Box 24PM, Staten Island, New York 10304.

TERRIFIC Book Values! Home improvement, Science, Crafts, etc. Free Details. Vernco, Box 121-A, Whittier, California 90608.

LEARN Why and how of natural massage. Lifelong benefits in work, play, sex. Illustrated booklet \$1.00. Webbco #3A, Box 6358, Honolulu, Hawaii 96818.

FREE List Valuable Low-Cost Books. Mears, Dept. PM772, 5363 Essex Court, Alexandria, Virginia 22311.

BOOK SALE! For entire family 20¢ to 50¢. Free brochure. Winchester Enterprises, 2807PM Hargrave Street, Philadelphia, Penna. 19136.

HORSE RACING BOOKS—Old & New—Unique Assortment—List Available For \$1.00—T. Ryan, 642 55th St., Brooklyn, N.Y. 11220.

FREE AMAZING CATALOG. Gifts And Novelties. Fred Wise Company, 1381 South Hermosa Ave., Banning, Calif. 92220.

FREE Surprise Comes With Fun Catalog. 25¢ Postage. Box 11368, San Diego, Calif. 92111.

SELF-Development, Metaphysical Books are Informative, Inspiring, Rewarding. Free Lists. Lloyd Collins, B67, Appalachia, Va. 24216.

FREE Listings. NEW Books. Moneymaking Opportunities, Self Improvement, Personal And Others. The Source, Box 92C, Whiting, N.J. 08759.

EVERYTHING From Howard Hughes to Fiction, Cars, Sports. Discount book catalog 10¢. Sunni's, Box 511, Augusta, Ga. 30901.

SAVE MONEY AUTO REPAIR BOOK Do it yourself. Only \$1.95 plus 50¢ postage. **SATISFACTION GUARANTEE.** FUTURAMA GIFTS, Dept. 1-A, 26-39 93 St., EAST ELMHURST, NEW YORK 11369.

BOOKS! Books! Books! Hundreds at lowest prices. Free brochure! Jenco, Department F-1, 624½ South Pearl, Columbus, Ohio 43206.

PLAYS, SONGS, MANUSCRIPTS

SONGWRITER! Poets! Spiritual and religious poems, songs wanted for recording by Chapel Symphony Orchestra and Choir. We pay all recording costs! Dept. PM, Chapel Recording, P.O. Box 162, Wollaston, Mass. 02170.

SONGS, SONGPOEMS Wanted For Radio Show. Hollywood Music Productions, 6425-PM Hollywood Boulevard, Hollywood, California 90028.

SONGS, Poems Wanted! For publishing, recording at our expense! Talent, 17-PM Longwood Road, Quincy, Mass. 02169.

WRITERS—Blockbuster pay for blockbuster manuscripts. Details \$1.00. (refundable). Apartado 540-P, Cuernavaca, Morelos, Mexico.

SONGWRITERS: Here's your golden opportunity. Co-write songs and share royalties. All costs for recording, publishing, record pressings, promotion to DJ's paid for by record company. Details, sample record and writer's agreement for \$1.00 postage and handling. Master Productions, 115 Garner Road, Lilburn, Ga. 30247.

POEMS Accepted For New Songs Recorded Without Charge. Songs/Poems Examined Free. Tin Pan Alley, Box 11647, Sarasota, Florida 33578.

BUSINESS OPPORTUNITIES

INSTALL Burglar Alarm Systems. Big profit home business. Beginners start spare time, without mechanical experience or costly equipment. Free starter plan. Nasco, Dept. F2707, Woodland Hills, California 91364.

PREPARE Tax Returns—Housewife Jo Ann Netzey made \$5,500 last season. Train at home, VA Approved. National Tax School, Monsey 2AD, New York 10952.

250,000 NEW MOTHERS EVERY MONTH! **BONANZA** For Bronzed Baby Shoes! \$50.00 a day profit. No investment, no inventory. Full or spare time. Exciting details Free. Senti-Metal, 1919 Memory Lane, Dept. 8G, Columbus, Ohio 43209.

BIG Profits in becoming a supplier to major industry through electroplating small parts and metalizing non-metallics. Write for free particulars: Mason, Room MC-2-BK, 1512 Jarvis, Chicago, Ill. 60626.

RACING Editor, 45 years racetrack experience, reveals first time "My Four Winning Systems." Kearney-FG, 30 East 42nd, New York 10017.

\$400.00 MONTHLY Raising giant fishworms. Soilless method. Charlie Morgan Bushnell, Florida 33513.

SELL Books by Mail. Complete Dealer Set-up—20¢. Midwest Mail Sales, Box 44R2, Shawano, Wisconsin 54166.

EARN \$2,000 Monthly in Amazing Interesting Businesses. Free Details. Enterprises, Box 181-PM, United, Pa. 15689.

\$128.00 IN Sales from \$12.00 material. New, different, everything furnished. Details 25¢. Newton, Box 08036, Detroit, Mich. 48208.

TRANSPARENCIES Wanted. Learn **FREE-LANCING**, American Color, Box 2193, Sepulveda, California 91343.

GUARANTEED BIG PROFITS. Famous hair trimmer 14¢. Wrist watches under \$5.00. Send \$1.00 for information and sample. K.D. Enterprises, P.O. Box 1072-A, Bellflower, California 90706.

RUBBER Stamp Making Presses. Supplies, Descriptive Folder. Barco Mfg., 237 S. Evergreen, Bensenville, Ill. 60106.

15,000-WORD Encyclopedic manual about mailorder, plus custom answers bonus, only \$3.00. Free details. Dynamic Sounds, 1404 Grant, Denver, Colorado 80203.

FREE Millionaire Book . . . Get A Fortune in successful little business. Work home! SBI-7, Kerrville, Texas 78028.

MAILORDER SECRETS REVEALED! Start Home Business. High Profits, Little Capital. No Inventory. Free Details. Write Emery, Box 366PM, St. Ann, Mo. 63074.

BOOKKEEPERS Operate profitable Bookkeeping Tax Service. Simplified Plan. Universal Bookkeeping, Box 664-M, Springfield, Missouri 65801.

CHECK US, If You're Really Interested In Business Of Your Own. Be A Building Maintenance Contractor. Professional Office Cleaning Service. Easy To Learn. Reasonable. Hart Enterprises, Dept. A, Box 5245, Mission Hills, Calif. 91340.

1000% Profit Bronzing Baby Shoes. Free Literature. NBC, Box C-4-PM2, Coral Springs, Florida 33065.

HOMEWORKERS—Mailers Wanted. Free Information for stamp. Allen, 2418-A Lori, Santa Ana, California 92706.

HOW And where to get capital. \$5000+ possible in one day. Free details. James Peter, Box 571-AM, Westwood, N.J. 07675.

FREE 1972 100-Page Catalog waiting to bring you Big spare-time cash commissions. Sell Advertising Book Matches. Every business a prospect . . . complete selling instructions furnished. Steady, repeat business. Dept. MX-772, Superior Match Company, 7530 South Greenwood, Chicago, Illinois 60619.

MAILORDER Millionaire helps beginners make \$500 weekly. Free report reveals secret plan! Executive (1A7), 333 North Michigan, Chicago 60601.

MAILERS Needed! Big money! Send 10¢ for information. Andrew Sales, Box 152, Blue Island, Ill. 60406.

MAKE Magnetic signs, Machineless method. Profits enormous. Write: R1B49APM, Bardstown, Ky. 40004.

HOLLYWOOD CEMENTCRAFT: Offers Highly Profitable Home Business. Experience Unnecessary. Unlimited Unique Pottery Designs Easily Made Without Moulds. Bird-baths, Fountains, Wishing-Wells, Waterfalls, etc. Chemical Coloring Formulas. Marble-glazing. **FREE** Illustrated Brochure. **CONCRETE FACTS,** 602 Athens Street, Altadena, California 91001.

MAKE A Years Income in 8 weeks Camping. No selling. Capital or Land necessary. Write Edu's, Route 5, Box 5733, Gig Harbor, Washington 98335.

PIANO Tuning Learned Quickly At Home! Tremendous field! Musical knowledge unnecessary. GI approved. Information free. Empire School, Box 327, Miami, Florida 33145.

WORLD'S Largest supply, Merchandise 25% to 40% under wholesale. Bankrupts. Closeouts 10¢ on dollar. Imports. Hong-Kong clothes. Automobile discounts. Free details. International Buyers, Box 16386 MM, Portland, Oregon 97233.

ADVERTISING BUSINESS—YOU Own it. \$350 First Week or Money Back. Electric Neon Action Ad Clock, 229 W. Illinois, Chicago 60610.

SELL Lifetime, Metal, Social Security Plates. Big Profits! Sample and Sales Kit Free. Russell, Box 286-PM, Pulaski, Tennessee 38478.

COPUBLISH "Mail Sale Advertiser," leading mailorder paper. Copy and details 25¢; U.S.A. only. Vanroy Shirk, Lebanon, Pa. 17042.

DRAFTSMEN! Operate own **DRAFTING SERVICE!** Full, Part Time; Experience unnecessary; Details: Roberts Drafting, 1741 Circle Road, Baltimore. Maryland 21204.

FREE Catalogs. Repair air conditioning refrigeration. Tools, supplies, full instructions. Doolin, 2016 Canton, Dallas, Texas 75201.

I MADE \$40,000.00 Year by Mailorder! Helped others make money! Start with \$10.00—Free Proof. Torrey, Box 318-Y, Ypsilanti, Michigan 48197.

(Continued on next page)

BUSINESS OPPORTUNITIES

(Continued from preceding page)

VENDING Machine big catalog. Rake, 523 A Spring Garden, Philadelphia, Pa. 19123.

MAIL Baby Catalogs imprinted with your address to New Mothers for Big Profits! Details 25¢. Volz PM, Ypsilanti, Michigan 48197.

MAKE Money from old tires. Operators clearing \$800, weekly. Equipment costs \$1500. Get facts. S & S Patents, Inc., 3752 N. Damen, Chicago 60618.

MAKE \$46 From square foot plywood: jigsaw or bandsaw necessary. Free details. Woodard, Bridgewater, Mass. 02324.

SUPERIOR Auction School. Nation's top Auctioneers own and instruct. Box 1281, Decatur, Ill. 62525.

\$200.00 SPARE Time earnings with your Tablesaw. Write: Workshop Five, 3800 Harney, Vancouver, Washington 98660.

\$25.00 HUNDRED Addressing. Possible Year 'round. Complete instructions 25¢ for registration, postage. Cove, Box 1348-B, Clearwater, Florida 33517.

\$70 TO \$200 WEEKLY—Home, Spare Time Simplified Mail Bookkeeping. Immediate Income. Easy. Auditax, Box 34741A, Los Angeles, Calif. 90034.

VENDING Machines. No selling. Routes earn amazing profits. Big catalogue Free. Parkway Corporation, 715PBM Ensor Street, Baltimore, Maryland 21202.

"MORTGAGE Brokerage." Lucrative Profits! Obtain Capital Sources. Chase, Uleta, Florida 33164.

\$60.00 DAY. Manufacturing Concrete Posts. Blocks. Mold Equipment Catalog \$1.00 refundable. Carlyne, Route One, Box 95, Rapid City, South Dakota 57701.

MAIL Order Collection Agency can make you \$1000.00 monthly. Free Details. Continental, Box 2023-A, Des Moines, Iowa 50310.

SELL Books by mail. 400% profit. Royal, Box 450-X, Cleveland, Ohio 44127.

WATCHMAKING Makes every day a payday. Learn this cash business at home. Free details. Sweazey, YGA, Fox River Grove, Illinois 60021.

ADDRESSERS And Mailers Needed. Details 10¢. Lindbloom, 3636 West Peterson, Chicago 60659.

\$100.00 WEEKLY Selling magnetic signs! SPN, Box 15, Murray Hill, New Jersey 07974.

\$2,000.00 MONTHLY With Your Own Business. Write, Robar, 100A School Street, Watertown, Mass. 02172.

MAILORDER Book Publisher Wants Dealers. Details 25¢ (refunded). Jan Enterprises, 76P, Wild Rose, Wisconsin 54984.

MONEYMAKING Is An Art! Free Information. House of Hoke, Dept. 101-PM, Sebring, Florida 33870.

HOMEWORKERS. \$100.00 Weekly Addressing for firms. Begin immediately. Details—send stamped, addressed envelope. Hamilton, 272-TMA-7, Brooklyn 11235.

EARN \$40.00 DAILY, Manufacture Concrete Bricks. Very Small Investment. Send Stamp. Free Details-Hilmar, Rt. One, Box 347-D, Valrico, Florida, 33594.

CLIP Short newspaper items. To \$10.00 each. Details free. Foster, 272-M-7, Brooklyn 11235.

900% PROFIT For Men And Women with your own Magnetic Sign Shop! Big demand for 3-D magnetic signs on cars and trucks. Start in garage. Kitchen or camper. Spare or full time. Financing available. Write today for free details. Nationwide Plastics, Dept. 256, 4200 Panamint, Los Angeles, Calif. 90065.

AVOID Get-Rich-Quick Schemes! Try Delta's Mailorder Method for safe, steady results! Delta, Box 19281-P, New Orleans, Louisiana 70179.

EXPORT-IMPORT Profitable mail order business work at home. Experience unnecessary **FREE DETAILS.** Morgan-Weisel Company, 227 Hollis, Dept. P42, Campbell, California 95008.

\$2000.00 MONTHLY POSSIBLE. Details. Write: Walker, 1510 Meridel, Tampa, Fla. 33612.

SELL Beautifully Colored Social Security Plates. Big Profits! Free Samples! Paul Wright, 1075 Ringwood Avenue, Pompton Lakes, N. J. 07442.

\$200.00 DAILY In your mailbox! Your opportunity to do what mailorder experts do. Free details. Associates, Box 136-A, Holland, Michigan 49423.

MEN-Women Make Big Profits At Home! In Plastics, part or full time! Unique process teaches you with equipment we give you free to make hundreds of 3-D plastic products, candy and candle molds, plaques, signs. Skin and bubble package. Also resin casting. Write today for free details. Nationwide Plastics, Dept. ARW, 4140 Eagle Rock Blvd., Los Angeles, Calif. 90065.

MAILORDER Records help get increased business! Complete 32 page Record Book shows your inquiries, orders, advertising, expense, etc. Only \$1.00. C. A. MARTIN, POPULAR MECHANICS, DEPT. PMR, 224 WEST 57TH STREET, NEW YORK, NEW YORK 10019.

COMPLETE Mail Order Business For Sale. Free Details. A M Sales, 32-28 100 Street, East Elmhurst, N.Y. 11369.

50% PROFIT—No investment! Sell lifetime golden metal social security cards. Free sample and sales kit. Write Emmert, Dept. 2PB7, P. O. Box 246, Gambriils, Maryland 21054.

GET RICH! Exciting Mail Order Business—Evenings only. Free proof! Success, P.O. Box 641, Lake Alfred, Fla. 33850.

EARN \$2000 monthly in AMAZING, interesting businesses, free details: Enterprises, Box 4462-M, Rockford, Ill. 61110.

\$5,000-\$25,000 Year Raising Catfish for us. We Stock, Buy Your Crop. Price List, Instruction Book \$2.00 (Refundable). Sothern Fish Farms, Dept. PM-2, Manchester, Kentucky 40962.

\$1000 A Month Possible From Home. Write: RIZZO COMPANY, Box 119 A, Hingham, Mass. 02018.

IMPORT-Export from home. Sell below wholesale, friends, stores, mailorder. Over \$300 quality merchandise and overseas sources \$93.00. Terms \$10.00 down. Not a "Gimmick" but legitimate moneymaking business. United Import-Exports, Box 4571P, Columbus, Ga. 31904.

BIG Profits!! Mail Baby Gift Catalogs. Tremendous, Continuous Market! Complete Moneymaking Details; Write: Carl Lass Co., Box 1416, Chicago, Illinois 60690.

BURGLAR ALARMS—Professional Equipment, Instructions—Big Money. Profits. Security Research Manufacturing, Box 443, Union Lake, Michigan 48085.

"GUARANTEED \$25,000 1st year mail order earnings. Free details. Glenwood, 4721C Indiana, Salem, Oregon 97303."

MEN—Women Needed Now to fill out income tax forms at home. We show you how. Simple, easy to learn. \$700 per month earnings possible. Details mailed free. No salesmen. Hurry. Federated Tax Service, 2065 Montrose, Chicago 60618.

VACUUM Sign Machine 24"x24", \$175.00. Homecraft, 2350 W47, Denver, Colo. 80211.

BUILD Custom Cases at home for profit. Get orders by mail. We supply materials, instruction—everything. Free home business details. Custom Case Supply Co., 6075 CPG De Soto Avenue, Woodland Hills, California 91364.

TAKE Catalog orders. We drop-ship 1001 best selling specialty products. Guaranteed lowest below wholesale prices. Fantastic spare-full time home business. Free book show you how. SMC, 6061 SPG De Soto Avenue, Woodland Hills, California 91364.

FREE Details. Money Making Opportunity. No investment. Gaymar, D-7, 3332 N. Seeley, Chicago, Ill. 60618.

MEN—Women! Start money-making Plastic Laminating business at home in spare time. Material costing 11¢ brings back \$2.58. No canvassing or selling but mail orders bring in \$20 a day. Write for full particulars free. Rush name on postcard to: Warner, Room LC-2-BK, 1512 Jarvis, Chicago, Ill. 60626.

I'VE Got the horseraces beat! Proved over four years. Will reveal. Strauss-FG, Brooklyn, New York 11219.

IMPORT-EXPORT Opportunity, profitable world-wide, mail order business from home, without capital or travel abroad. We ship plan for no risk examination. Experience unnecessary. Free details. Mellinger, Dept. F2707, Woodland Hills, California 91364.

\$1000 Day-150% Profit. Selling by mail. No investment in inventory. Part time—full time. Unlimited potential. Complete details \$1.00. National, Box 7212ZAG, Chicago, Illinois 60680.

1100% PROFIT. Bronzing or Pearl Finishing Anything. Free Proof! Kiktavi, Box 2127D, Inglewood, Calif. 90305.

MAILORDER Moneymaking Kit. Home Business. Valuable lists, concrete information, detailed steps. Capital unnecessary. Free Details, Pictures. Meadows, Box 327-PM7, Boston 02199.

UNUSUAL EARNING Opportunities! Details 10¢. Walker's, 5302 First Street, Northwest, Washington, D.C. 20011.

NOW! Make money on the booming baby market. Mail catalogs to new mothers with your name. Start immediately! Vento, 1734-C-60th Street, Brooklyn, New York 11204.

REPAIR Hydraulic Jacks—Details Free. Write: Hydraulic Parts Supply, Box 295, Port Isabel, Texas 78578.

MAIL Letters Featuring Real Merchandise! Get \$12.00 orders every mail, \$8.00 profit. Everything furnished. Free details; write: Stayer Enterprises, 3704 Warwick, Peoria, Illinois 61614.

EARN Money raising fishworms for us! Write: Oakhaven-38, Cedar Hill, Texas 75104.

SELL MAILORDER BOOKS. Directories. We Drop-Ship. Mailorder Wholesalers, Box 83-B, Anderson, Alabama 35610.

SECURE YOUR FUTURE By Owning Your Own Vending Machine Business. First Book—"How To Do It From Start To Finish". Proven Methods. Send \$5.00—Robot Inns, Box 456, Agnew Station, Santa Clara, California 95054.

MAILORDER Book. Learn The Facts. SCHROEDER'S Box 205, Greendale, Wisconsin. 53129.

HOW And where to get Capital. Get loans, grants, cash. \$500 to \$2 million. Free information. Counselor-17, Kerrville, Texas 78028.

"MAILORDER Course: Home Study," 24 Easy Lessons, \$2.00. "Bill" Lambertson, 132 Tamiami Station, Dept. PM72, Miami Florida, 33144.

SPARETIME Mailorder Business. Make Extra Money. Experience Not Necessary. Literature Free. Handi-Way, 9-P7 Kuiken Court, Wayne, New Jersey 07470.

SECRETS! Mail Order Success. Internationally famous expert reveals how to make home business fortunes. Beginners: Get free copy "Make Money By Mail." Discloses free advertising, profitable products. Mailco, Dept. FC707, Woodland Hills, California 91364.

(Continued on next page)

BUSINESS OPPORTUNITIES

(Continued from preceding page)

\$15,000-\$30,000 Year. Send \$2.00 Book "Raising Rabbits for Us". Rabbit Ranchers of America, Box 265-X, Haysville, Kansas 67060.

FREE Collection Agency Details. \$1000.00 Monthly Possible. Master, Drawer 77009-PM, Atlanta, Georgia 30309.

INCOME Opportunity as LPI Associate Free Information, catalog 35¢. Write today. 11611 Sharpcrest, Houston 77072.

MAILORDER-Carry No Stock. Companies will pack, ship under your label. One-man operation capable of \$10,000-\$20,000 year. Details Free! Distributors, Box 9-A, East Rockaway, New York 11518.

HOMEWORKERS DESPERATELY NEEDED IMMEDIATELY. For instructions, send 25¢ and stamped, self-addressed envelope. GWM, 6550 Pyramid Road #59, Sparks, Nevada 89431.

EARN \$60.00 Daily manufacturing Concrete Fence Posts. Practically no investment. Send stamped-addressed envelope. American, Excelsior Springs, Mo. 64024.

RECEIVE MAIL Galore! Your name on our national mailing lists, 50¢. Sullins, Box 1313, Brunswick, Georgia 31520.

\$500-\$5000 Yearly spare-time income! Start Mail Order Business without capital. Particulars free. Elite, Box 715-A, Lynbrook, New York 11563.

FABULOUS SECOND INCOME. Deal in gold. New manual shows how. Information, write, Research, Box 804, Hammond, Ind. 46325.

165 FREE Wholesale Catalogs! Mailorder Dropshippers. Your Business Imprint, Automobile Discounts. Free "Digest." Vault International, Box 7284W, Lexington, Kentucky 40502.

GUARANTEED INCOME!!! Home Mail-order Business can make you rich! Everything furnished—even national advertising. Details \$1.00. Galaxy (2P7), 15307 Nevada Street, Woodbridge, Virginia 22191.

HOW To Raise \$100.00 To \$1,000,000.00!! Complete Details Free. Drawer 77009-MC, Atlanta, Georgia 30309.

MAIL ORDER Sell Books. Fascinating Profitable. Details. Jobre, Box 27, Great Neck N.Y. 11023.

MANUFACTURE And Paint signs. Template makes any size letter or number. Instruction Book and drawings \$2.00. Insta-Sign, Box 337, Carrollton, Texas 75006.

FREE Catalog. 100 Mail Order Specialties And Gifts. Buy Below Wholesale. We Show You How To Make Sensational Profits. BERLENS, 1700 20th, Charleston, Illinois 61920.

JOB ADVISORS Needed! Independence. New, rewarding field. Qualification test and details \$1.50 (refundable). Greenpat, 2336 Hamilton, Allentown, Pa. 18104.

"YOU'RE CRAZY To risk one cent in mailorder business unless you know. 25¢ for sample newsletter. Mailorder News, Dept C2, 1846 Palisade, Teaneck New Jersey 07666."

PROFITABLE BUSINESS-Molding Rubber, Hobby Supplies. Details 10¢. Chaney's, 5415 L San Jose Blvd., Jacksonville, Fla. 32207.

BRAND New! The Worlds Best! Millions of prospects everywhere with profits galore! Get big money making facts free! Bonners Products, P. O. Box 575-PM, Bonners Ferry, Idaho 83805.

FINDER'S KATALOG Lists 500 hard-to-find suppliers of tools, materials, equipment for home businesses, handicrafters, hobbyists. Name, address, description, 60 categories. \$1.00 Refundable. F-K, 521 Rosewood, Ohio 43070.

SELL BOOKS!! Complete Mailorder Plan. Vikari's, Box 1312PM2, Salt Lake City, Utah 84110.

MAKE Money 2 to 3 times your cost. \$2.00 Bring giant below wholesale catalog. Refundable on first order. Birkemark Co, 14362 Bushard, A140, Westminster Calif. 92683.

100 STEREO 8 Track Tape Cartridges \$150.00. 10 Different \$19.00. State Favorite Music And Artists. Free Lists. Sound Sales, Box 14, West Union, Iowa, 52175.

OPERATE Profitable Home Business With Money Making Instruction Manuals: (1) Fibre Flower Profits (2) Typing Income (3) Advertising Cash (4) Sewing Profits (5) Research (6) Newspaper Clips (7) Telephone (8) Cartooning. Each Manual Only \$4.00, 2 For \$7.00, 4 For \$13.00, 8 For \$25.00. Order any 8, Get 6 Different Mail Order Books Absolutely Free! Send Remittance To: Harry Romano, Box 403, Fort Shelby Station, Detroit, Mich. 48226.

INSTANT FORTUNE Selling by Mail 21 Ways. Grant, 14413 Herron, Sylmar, Cal. 91342.

WE NEED GINSENG CROWERS! \$3,000-\$30,000 Annually! We Buy Your Crop. Send \$2 for seed sample and information. Glass's Ginseng Exchange, Box 336, Rochdale Station, Jamaica, NY 11434.

MAILORDER Dealers Wanted. Earn outstanding profits using tested promotions! Executive type business. Details 25¢. Rutward, Box 735-PJ, Norwalk, Conn. 06852.

FREE Book "999 Successful, Little-known Businesses." Work Home! Plymouth-ADG, Brooklyn, New York 11218.

BE INDEPENDENT! . . . Make 100% Profit supplying Gifts, Novelties, Toys to Retailers . . . 1001 fastest sellers! Write Today for Confidential Pricelist . . . \$2.00 (Refundable). DSC, Box 2263-7A4, Muncie, Indiana 47302.

MAILORDER! How to prepare your own catalog for pennies! Free catalog! Obie-ADF, Brooklyn, New York 11219.

BIG Profits, Sell Sell, Lifetime Social Security Plates. Goldthwaite, 220-PM Lawrenceburg, Tennessee 38464.

\$1500 MONTHLY, Your own part time business. \$2.00 Brings everything needed. Arkay, Charleston, R.I. 02813.

FREE BOOK "How To Fail or Succeed in Mailorder!" Plymouth, MMDG, Box 111, Brooklyn, N.Y. 11223.

DOES YOUR Graduate need job this summer? Easiest money you ever made by mailorder! Give your Graduate a business. Second income! \$4.95. SUCCESSSYSTEMS, Box 162, Pueblo, Colo. 81002.

BECOME PROFESSIONAL DRIVING INSTRUCTOR. Your own Business. \$400.00 Weekly, Big Demand, Write: Howard David, 1818 Everts, Philadelphia, Pa. 19152.

400,000 BARGAINS Below wholesale! Many free. Liquidations . . . closeouts . . . job lots . . . single samples. Free details. Bargainhunters Opportunities, Box 730A, Holland, Michigan 49423.

YOUR Own Social Security Plate Business—\$24.95! (Machine Included.) Free Details. Idea Products, Box 69828PG, Los Angeles 90069.

COMPLETE Instructions bronzing shoes. \$1.00. Box 441, Vermilion, Alberta, Canada.

CALIFORNIA MANUFACTURER NEEDS Man to assemble our product and be local agent, experience unnecessary. May start while presently employed. Five-figure income for responsible applicant. S.K.R.M. Manufacturers, 2347 West 238 Street, Torrance, California 90501.

I MADE \$100.00 an Hour Selling Information By Mail. You Can Too! Roohan, Box 5341P, Sherman-Oaks, Calif. 91413.

\$65.47 PROFIT, \$10.63 Investment, \$76.10 sales. Mailorder dealer opportunity. Proof, 10¢. Torrey-RF, Clearwater, Florida 33517.

CLEAN UP ON GARBAGE In Profits of Course!! Sample \$2.00. Gib's, Box 22096, Sacramento, Calif. 95831.

MAILORDER—Profitable products, drop-shipped. No merchandise investment. Everything supplied—catalogs, ads, mailing lists. Gif-Guide, 1137 1/2 Crenshaw, Dept. 283, Los Angeles 90019.

MONEYMAKING OPPORTUNITIES

BUY BELOW WHOLESALE! Thousands of name-brand items at factory prices plus small service charge! Directly thru us. Free details! American Buyer's, P.O. Box 848-P, Buffalo, New York 14240.

FREE CATALOG THOUSAND Items. Guaranteed Lowest Wholesale Prices. Your Own Business. No Investment. Earn Highest Profits With An Established, Reliable Company. Since 1950. Free Details. Write Western-Pacific Exchange, 4069-30th St., San Diego, Cal. 92104.

\$650.00 WEEK MAILING CATALOGS Details \$1.00. (refundable). HAROLD, P.O. Box 22313, Cleveland, Ohio 44122 Dept. M.

CONTEST REPORT Complete Information About Cash Prizes Offered Monthly. Send 25¢ for Current Issue. Box 307A, Ypsilanti, Michigan 48197.

BECOME PUBLISHER'S REPRESENTATIVE Salary, auto, expenses. Detailed treatise and contacts \$2.00. Rigsby, 1044 P Yellowstone, Xenia, Ohio 45385.

"AMAZING"—Home Money-making Opportunities! Free Illustrated—Informative Brochure! Stamp Appreciated. Mann, 7-R-4, Wilste, Hillsdale, New Jersey 07642.

AMAZE Your friends. Electro-GOLD-Plate for fun and huge profits. Send for information or send \$9.85 for complete kit. Guaranteed. K.D. Enterprises, P.O. Box 1072-A, Bellflower, California 90706.

MONEY In Mailorder Fantastic Profits Proven Method. Free Information. The Partridge Family, Center Moriches, New York 11934.

UNPAINTED FURNITURE Finish in your own home and sell to decorators. Wipe on finishes make it easy. Catalog and details \$1.00. The Wood Works, 8861 Ladue Road, St. Louis, Mo. 63124.

BEGINNER'S Money-making Mailorder Kit \$1.00. May's, Box 802-H, Natchez, Mississippi 39120.

WIN Contests—Learn How. Amazing New Method. Satisfaction Guaranteed or Refund. Details \$1.00. Vonco, Box 1901, Longview, Texas 75601.

HOW To make money in Mail Order Imports. No investment in merchandise. Directory of drop ship items. Booklet MO-521 \$1.00. Foster's of Vandalia, Box 235M, 356 Tionda Drive, Vandalia, Ohio 45377.

WORLD'S Leading contest magazine, 25¢. Year, \$4.00. Prizewinner, 1315 Central, St. Petersburg, Fla. 33705.

FIX Typewriters from home. Repairs available. Easily learned. Athey, Tarentum, Pa. 15084.

SELL Sensational Car Thief Signal. Lightning Seller. Samples for trial. Northwest Electric, Ave. 861, Mitchell, S. Dak. 57301.

\$600-UP MONTHLY. People needed. Raise rabbits, other laboratory animals for us. Huger market. We supply equipment, breeders and instructions. Details 25¢. National Research Farms, PNM-7, Box 37, Palatine, Illinois 60067.

SWEEPSTAKES Contests. How To Win. Write For Free Particulars. General Contests, 1609-18 East Fifth, Duluth, Minnesota 55812.

MONEY. Make Hundreds extra Spare-time home by mail. Opportunities, tips in magazine that tells how. Leading mail-order magazine since 1929. Sample \$1. Year \$5 with free what is mailorder opportunities folio, Mail Trade, P.O. Box 1302, Springfield, Illinois 62705.

(Continued on next page)

MONEYMAKING OPPORTUNITIES

(Continued from preceding page)

CLIP Newspaper Items. \$1.00-\$25.00 Each. Free Details. James, Box 124M, Inglewood, California 90306.

FREE—Easy Ways to make money selling exciting new products—Full—spare time. Send name, age, for 5 months free subscription. Salesman's Opportunity Magazine, 1460 Hancock Center, Dept. 17GM, Chicago 60611.

MAKE Statuettes, novelties, imitation marble. Sell to stores or start gift shop. Free details. Marbleizing, 41 Waverton, St. Louis, Mo. 63124.

HOMEWORKERS. Makes \$50 every 150 envelopes you mail. Rush 25¢. Gemco, B-21244A, Indianapolis 46221.

LEARN The secrets of repairing junk batteries "Fabulous Profits" at home. Battery Shop, Box 820, La Quinta, Cal. 92253.

HOW TO GET RICH!! Free "Money-making Brochure"! Success International, Box 2447-C, Livonia, Mich. 48151.

\$200.00 FROM Sheet 1/4" plywood (scrap). Details 25¢. Novelties, 610 So. 24th, Elwood, Indiana 46036.

GET World's Biggest Wholesale Import Catalog. Write: World, Medina, Washington 98039.

VENDING Machines. No selling. Routes earn amazing profits. Big catalogue Free. Parkway Corporation, 715PMM Ensor Street, Baltimore, Maryland 21202.

HOW To Make Money Writing Short Paragraphs. Information Free. Barrett, Dept. C-27-K1, 6216 N. Clark, Chicago 60660.

CLIP Newspaper items. \$1.00-\$5.00 each. Details free. Walter, Box 1360PA, Erie, Pa. 16512.

PENNY STOCKS Have Profit Potential. Free Information. Analyst-P.M., Box 214, Redondo Beach, California 90277.

BIG Money Writing Jokes. Enormous demand. We show you how. Free Facts. Laffs, Dept. G-97, Pleasant Hill, Ohio 45359.

SELL Your Photos . . . Report Tells How, Where. Color Slide Markets . . . \$1.00. E. Johnson Co, 97 Grandview Ave, Great Neck, New York 11020.

MAKE Money!! Use "The Money Makers System". Free Details. Ewing, Box 1427, Fremont, Cal. 94538.

DO YOU WANT TO MAKE MONEY! Sell Perma-Cards. Write Lifetime Plate Distributors, Dept. 707, Grovetown, Ga. 30813. Free Sample & Sales Kit.

BIG PROFITS YOURS From Commission Mailings!! Everything Furnished. Learn how! Write: Slater, 217B Pearl, Redondo Beach, Cal. 90277.

UNUSUAL Products, bargains, interesting opportunities. Free Details. Sunrise, Dept. PM, Box 53072, Houston, Texas 77052.

"HOW TO MAKE MONEY WRITING FILLERS"—Articles And Short Paragraphs Tells What To Write And Where To Sell It. Directory Included. #MO-51F \$1.00. Southall Distributors, 638 Idlewild Circle, Apt. #7, Birmingham, Alabama 35205.

\$25.00 HUNDRED Home Mailing! Postage supplied. Sample, instructions, plus your listing with 1,000 additional firms, year \$1.00. Dix-PG, B-38, Hallandale, Florida 33009.

\$10,000 ANNUALLY Growing Plants in your backyard. Details. Nagaho Publishing, Box 56, East Douglas, Massachusetts 01516.

SUCCESS METHOD: Make \$1,000,000-10 Years. Start with \$10. Free Proof. Opportunities, Box 721-A, Lynbrook, New York 11563.

BECOME Notary Public! Have dignified sideline. Free Details. Stationers Exchange, Box 617, Kilgore, Texas 75662.

COMPLETE ALL Time Winning Horse Racing System Yours For 25¢ Handling. Allan Weiser, 160 Broadway, Suite 1102, New York, New York 10038.

TREMENDOUS Earning Potential. Three unique businesses operated from home. Jeboco, Box 6542MG, Surfside, Fla. 33154.

HOW To Make money with your typewriter! Write. Coach Publishers, Box 834J, Bangor, Maine 04401.

GET BEST MONEYMAKING OFFERS. We mail your name 100 firms seeking homeworkers (Satisfaction Guaranteed) only \$2.00. Hundredmark, Box 24, Melbourne, Fla. 32901.

BIG Profits Selling Engraved Metal Social Security Cards. Free Sample! EZ-Read Plates, Box 612, Murfreesboro, Tennessee 37130.

TERRIFIC Mail Order Opportunity. Free details. Merit, Box 3446A, Akron, Ohio 44307.

"FREE! Catalog Listing low cost books on money making opportunities and self improvement." Sleight Studios, 5235 Castor Avenue, Philadelphia, Pa. 19124.

WE NEED AKC PUPPIES! BUY Puppies for us in your area. Make \$50 to \$250 per week. No cash or experience necessary. Write for free details. AKC Dogs, Box 211, Orchard Lake, Michigan 48033.

NEVER Won Anything? Anyone Can Win Sweepstakes Contests! Find out how. Services, Box 644-PC7, Des Moines, Iowa 50303.

FREE! Catalog listing low cost books on money making opportunities and self improvement. Jem Mail Order Supply, 6116 Orinoco Avenue, Indianapolis, Indiana. 46227.

SELL Our Lifetime Metal Social Security Plates. Big Profits. Bonuses. No Obligations. National Engravers, P.O. Box 2221, Anderson, S.C. 29621.

EARN \$5,000 to \$50,000 year, on hours you want, learn credit collection business. Free Details. Bob, The Number One Company, Box 254, Milton, Mass. 02187.

\$125.00 WEEKLY Correcting Pupils' Lessons! Samples, \$1.00! Stepps, 252 Cambridge, Buffalo 14215. Lumley's, 1346 Plimpton, Bronx 10452. Jones, 242 Maple, Shafter 93263. Warfield, #9452 (Lake Forest), Jacksonville 32208.

NOW! How to get rich. Amazingly easy!! Guaranteed. Free details: Kenco, Box 741B, Newark, Delaware 19711.

HIGHER INCOME Security and Power. 256 Page Book: "THINKING BIG" reveals secrets that make men Rich: Send \$2.00 to: Dialer Products—55 Elm Ave., Farmingdale, N.Y. 11735.

MAKE Big Money! Up to \$200 weekly possible! Be your own boss! Candlemaking! Free details! Write: Innovations, Inc., Box 533-A, Joliet, Illinois 60431.

ADDRESSERS And mailers needed. Details 10¢. Slack's, Box 375, Toronto 19, Ontario.

PROFITABLE OCCUPATIONS

HOW To Finance Your Own Business. Get \$500 to \$2 million. Free offer. Capital-25, Kerrville, Texas 78028.

LEARN GUN REPAIR GUNSMITHING In spare time. Book, details 10¢. Modern Gun Repair School, Dept. 1608, 4225 N. Brown, Scottsdale, Arizona 85251.

BECOME A Mortgage Broker. Highly respected, interesting, lucrative prestige business. For complete information write: United, Box 6284-F, Marietta, Georgia 30060.

HOW To Make Money Writing Short Paragraphs. Information Free. Barrett, Dept. C-27-K2, 6216 N. Clark, Chicago 60660.

MAKE \$300 CLEAR MONTH Few hours from 10 customers, representing us in your community. No individual selling. Repeats forever. Customers waiting. \$1 for sample, details. Our 40th year. Progressive, Box 1302, Springfield, Illinois 62705.

ENTER Profitable Spare-Time Service Boom! Free details. Trend Craftsmen, 4901-PM Perrine, Midland, Michigan 48640

MAKE Money at home! 49 Ways. Write-Coach Publishers, Box 834H - Bangor, Maine, 04401.

SHARPEN Scissors, Pinkers. Inexpensive equipment, tools, supplies. Blackhawk's, Sheldahl, Iowa 50243.

FT. SMITH Auction School, Ft. Smith, Ark. 72901. Residents & Home study. Veteran approved.

500 FIBERGLASS Molds for Casting Ornamental Concrete Products. Catalog \$1.00. Plycrete Mold Co., Elk Rapids, Michigan 49629.

RETIRE ANYTIME In luxury. Easy, legitimate. Free details. Premier Enterprises, Postbox 10597-G, Pittsburgh, Pa. 15235.

EARN Money with your camera. Booklet explains how where to sell your pictures. Only \$1.00. Gifts Galore, 102 Hilltop Drive, Algonquin, Ill. 60102.

SALESMEN-DISTRIBUTORS

LONG Needed Invention. Want man contact service stations. Part time. Huge profits. Write Cyclo, 3816 Dahlia, Dept. 171, Denver, Colo. 80207.

HOT!!! Tool Costs 40¢, Sells \$2.00 Sample—\$1.50. (50¢ Postage) Speedline, Box 458, Woodriver, Ill. 62095.

MAKE Extra \$25 to \$75 spare time! Double air cushion shoes. Men's, women's line. Dress, work, play. Highest commissions. Shoes for yourself. Outfit Free. Bronson, Dept. H-72, Minneapolis, Minnesota 55408.

SELL Advertising Ball Pens, Calendars, Ad-Specialties—Build Own Repeat Business—Free Details—Fleming, Dept. A, 6535 Cottage Grove, Chicago 60637.

EARN Big Commission Full or Part Time. Show America's largest line Low Priced Business Printing and Advertising Specialties Plus Calendars in season. No experience. No investment. No collections or Deliveries. On-the-spot commissions. Big Free Sales Kit samples hundreds items used daily by businessmen. Merchandise bonuses for you. Build profitable repeat business. Start now. National Press, Dept. 72D, North Chicago, Ill. 60064.

HOUSEHOLD PRODUCTS ROUTE. EARN \$25 Or more daily. Also Party Plan opportunities for men, women full, part time. McNess, Freeport (2672) Illinois 61032.

CRIME Personal Protection Devices. Mass Demands, Tremendous Profits. Sheriff, Box 113, Twinsburg, Ohio 44087.

SELL Hertel Bibles—Part Time. Finest reference Bible available. Demonstrator and supplies furnished. Excellent commissions. Write International Book, Dept. PM, Box 118, Wichita, Kansas 67201.

BIG Steady Income! Leader in business printing/advertising specialties will start you in business. No experience. No stock investment. Full, part time. Everything furnished. Write: Kaeser, Dept. B1007, 953 Martin Place, Cincinnati, Ohio 45202.

AUTO Thief Alarm. Fast seller. Samples for trial. A.A.P., 300 N.E. 44 Street, Fort Lauderdale, Florida 33308.

AGENTS WANTED

WANT TO MAKE UP TO \$100 A WEEK Spare time, and get free shoes for life, too? No investment. Rush card for free details. Mason Shoes, K-911, Chippewa Falls, Wisconsin 54729.

(Continued on next page)

AGENTS WANTED

(Continued from preceding page)

SELL Office Supplies—Machines—Furniture—Equipment. Osoco, 3505-PM Elston, Chicago 60618.

EVERY Man a prospect. Refundable sales kit offer showing line belt buckles, tie clasps, money clips, cuff links, lapels, identification badges, individualized with customer's name and emblems. Cap badges for trucking, bus, taxi, police, firemen, also postal, letter carriers and heavy construction emblems. Choice 4000 emblems. Hook-Fast, Box 1088-PM, Providence, R.I. 02901.

YOUR Own business—Used Suits \$1.50; Overcoats 65¢; Mackinaws 35¢; Shoes 12½¢; Ladies' Coats 30¢; Dresses 15¢. Enormous profits. Catalog Free. Nathan Portnoy Assoc., 2109-AA Roosevelt Road, Chicago, Illinois 60608.

PRINTING, Advertising Salesmen—Excellent moneymaking sideline selling De-calcomania Name Plates, small quantities. Advertising Specialties, sign letters. Free Samples. Raico XL, Boston, Mass. 02119.

LIFETIME Income. Be our loan representative. Free Copy "Financial Freedom". Send \$1.00 refundable. Financial, Suite 1204-X3, 28 E. Jackson, Chicago 60604.

SELL Unique Prison Reform Booklet. Free Sample. Dal, 31 Ramsdell, Boston 02131.

ESTABLISH Your own business. Low prices on used clothing, shoes, household goods. Unlimited profits. Free catalog. Northwestern Distributors, 2129 No. Western Avenue, Chicago, Illinois 60647.

STEREO TAPES Low as \$1.99, Regular \$5.98, Catalogs 50¢, Dealership Available. Mincher, Box 807, Roanoke Rapids, North Carolina 27870.

NEW Patented Product Need Agents. Details 50¢. Insharp Corporation, Box 321, Sanborn, New York 14132.

SELL Beautiful Engraved Metal Social Security Cards. All Kinds. Big Profits. Permaplates, 631 Lyons Ave., Indianapolis, Ind. 46241.

PROFIT \$1.25, Every \$2.00, selling convincing crime protection. Details 25¢. BHL-AM, Box 2021, San Diego, 92112.

EARN AS YOU LEARN. Sell in your spare time. As a subscription representative for leading national magazines, earn generous commissions while developing skills of salesmanship. Instructions and supplies are yours free of cost. Send this ad with your name and address to **POPULAR MECHANICS**, Room 1107L, 250 W. 55th St., New York, N.Y. 10019.

200% PROFIT Selling Rings. Triple Money in 30 Days or Money Back. Free Details, Anka, P.O. Box 8036-PM1, Cranston Rhode Island 02920.

NEED More Money? Represent largest manufacturer of magnetic signs for business vehicles. Write **TRIMETRIC**, 337 El Roblar, Ojai, California 93023.

EMPLOYMENT INFORMATION

AUSTRALIA EMPLOYING Now. Assisted Passage. High Salaries, 43 Job Addresses. Complete Guide, VanRiper, Box 220T, Afton, Va. 22920.

AUSTRALIA WANTS YOU!!! Government Assisted Passage. 1972 Government Information and Forms—Most Complete Information Available—\$1.00. Reports on Employment, Business, Taxes, Education, Teaching, Housing, Ranching, Maps, etc. **AUSTCO**, Box 3623-E, Long Beach, California 90803.

ANNOUNCER/DISC JOCKEY TRAINEES NEEDED NATIONWIDE. Payroll Training Status. Break into Broadcasting Regardless of Age or Educational Background. Free Details. Write: Program Director, 431 E. Nelson, Cadillac, Michigan 49601.

BRITISH COLUMBIA Employment and immigration information. Complete details, \$3.00. Doyle Associates, Box 2702, Williams Lake, B. C. Canada.

OVERSEAS Job Placement Directory. 32 pages Current Worldwide Openings. Moneyback Guarantee. \$3.00. Overseas, Box 29902-A, Los Angeles 90029.

AUSTRALIA WANTS YOU!!! NEW Complete Details, Employer's List, Immigration Information. Satisfaction Guaranteed! Send \$2.00. Ventures, Box 832-M7, Kingsport, Tennessee 37662.

AUSTRALIA!! AUSTRALIA!! FREE DETAILS!! Government Paid Transportation. Latest Handbook and Forms. Write: Associated, Box 17-B128, Lafayette, California 94549.

HELP WANTED

EARN At Home Addressing Mail. Details 25¢ and Stamped Envelope. Deeco-151, Box 9308, North Hollywood, Cal. 91609.

OVERSEAS EMPLOYMENT . . . Australia, Europe, South America, Asia! All Occupations! \$700-\$3,000 monthly! Write: Employment International, Box 29217-AG, Indianapolis, Indiana 46229.

OVERSEAS Jobs—Europe, South America, Australia, Far East, etc. 2000 openings all trades. Construction, Office, Engineering Sales, etc. \$700 to \$3,000 month. Expenses paid. Free Information. Write: Overseas Jobs, International Airport, Box 536-M, Miami, Florida 33148.

"AUSTRALIAN OPPORTUNITIES KIT" . . . FREE DETAILS! Paid Transportation! Handbook, Special Reports, Forms! Australian Services, Box 29263-AG, Indianapolis, Indiana 46229.

WORLD-WIDE. . . U.S.A. jobs Galore!! Students, all professions and occupations. Enjoy Paris, Rome, Tokyo, Mexico City, Miami, San Francisco. \$700.00 to \$3,000.00 monthly. Paid Overtime, Travel Allowance, Sightseeing. Free Details!! Write: Global Employment, Box 706-B128, Orinda, California 94563.

FREE DETAILS . . . AUSTRALIA . . . Government assisted transportation. Latest Handbook and forms . . . Free Details . . . Write: Associated, Box 17-BA128, Lafayette, California 94549.

REAL ESTATE AND FARMS

FREE CATALOG! Giant SUMMER Edition! Over 5,100 properties described, pictured—Land, Farms, Homes, Businesses—Recreation, Retirement. Selected Best thruout the U.S.! 72 Years' service, over 600 Offices, 41 States Coast to Coast. Mailed FREE from the World's Largest! **STROUT REALTY, INC.**, 60-MX E. 42nd St., N.Y., N.Y. 10017; 7-MX S. Dearborn, Chicago, Ill. 60603; 521-MX E. Green, Pasadena, Calif. 91101.

IDEAL 5-ACRE RANCH, Lake Conchas, New Mexico. \$2,975. No Down, No Interest, \$25.00 Monthly. Vacation Paradise. Money Maker. Ronchos, Box 1095PM, Alameda, California 94501.

PRESCOTT, Arizona. 2 Acres For Finest Country Living. \$1,995. Low terms. Mrs. Anna Young, Glenarm Land Co., 2233 North 7th St., Phoenix 85006.

OCALA FOREST CAMPSITES Deep in the heart of the Great Ocala National Forest. Excellent hunting and fishing. Free maps and photos. (Unavailable in States requiring separate registration). AD70LB710E, W. H. Vernor, Inc., P.O. Box 760, Dept. E, DeLand, Florida 32720.

FREE Catalog! PHOTOS! Coast to coast farms, business, retirement. All types, sizes & prices. **SAFE-BUY Real Estate**, Box 589-PM, Little Rock, Ark. 72203.

CANADIAN Vacation lands: Full price \$385.00. 40 acres. \$10 month. Suitable cottage sites, hunting, fishing, investment. Free information. Land Corporation, 3768-C Bathurst, Downsview, Ontario, Canada.

GOVERNMENT LANDS Low as \$3.50 acre. Millions Acres! For exclusive "Copyrighted Report" . . . plus "Land Opportunity Digest" listing lands throughout U.S.; and **VALUABLE 17 X 22 TREASURE MAP OF U.S.;** send \$1.00. Land Disposal, Box 9091-PM, Washington, D.C. 20003. Satisfaction Guaranteed.

\$1 ACRE—Canadian border—hundreds campsites, islands, farmlands, directly from tax authorities. (Non-profit). Lists, photographs mailed. Register, Room 10, 110 Church Street, Toronto 1, Canada.

GOVERNMENT Lands . . . low as \$1.00 Acre! Millions Acres! For exclusive "Government Land Buyer's Guide" . . . plus "Land Opportunity Review" listing lands available throughout U.S., send \$1.00. Satisfaction Guaranteed! United Lands, Box 19107-AG, Washington, D.C. 20036.

CENTRAL Ontario—Choice 640 acre Sportsmen's paradises still available—\$20.00 plus \$6.50 taxes yearly. Maps, pictures. \$2.00 (Refundable). Information Bureau, Norval 4, Ontario, Canada.

BOILING Spring Lakes—America's Greatest Real Estate Value. ½ acre vacation or retirement homesites only \$750 cash price. Ten-years to pay. Money-back inspection guarantee. Carolina coast, multi-million dollar, 14,000 acre development. 50 fresh water lakes, private ocean beach, golf course, motel, and country club. Free literature. Dept. 1-X, Boiling Spring Lakes, North Carolina 28461. (Registered under Federal Land Sales act but not offered to residents of states requiring separate registration.)

COLORADO LAND KIT! SHOWS You the most spectacular land you've ever seen . . . in the heart of Colorado's famed high country! Contains brochure with 17 full color photos, map, information on fishing, hunting, riding, camping. Explains how you may own 5 acres with no down payment, no interest, just \$20.00 a month! This could be your investment and recreation dream come true. Send for free land kit to: Aspen Lakes Ranch, Dept. PM-3, 1108 Alvarado N.E., Albuquerque, New Mexico 87110.

MICHIGAN 10 TO 160 ACRE TRACTS Lake Superior-Marquette Area from \$99.00 Acre. Cabins, trailers, camping welcome. (Acreage anywhere in Michigan). **FREE PICTURES.** Any Terms A-OK with **BLOCH BROTHERS** write 3650 Dixie, Drayton Plains 16, Michigan 48020.

CANADIAN LAND FROM \$19.00 AN ACRE CHOICE Properties available across Canada. Low monthly payments. Ideal for farming, cottages, hunting, fishing. Free Catalogue. Canadian Estate Land, Dept PMC-7, 286 Lawrence Ave. West, Toronto 20, Ont., Canada.

BEAUTIFUL Ozark Land. Unspoiled By Man. \$55.00 Per Acre. Mill Creek Real Estate, Box 121, Melbourne, Arkansas 72556.

HAWAII REAL ESTATE NEWSLETTER. Homes, condominiums, land, prices, rentals, economic summaries. 6 months \$5.00. Dorcliff, Inc., 736 South Street, Honolulu, Hawaii 96813.

FREE . . . 248-Page SUMMER Catalog. Hundreds of top Real Estate values Coast to Coast! **UNITED FARM AGENCY**, 612-PM West 47th St., Kansas City, Mo. 64112.

BONDS. Buy on installments from "Selective List". Maximum safety. Earn higher interest. Free information. Insurance Premium Corp., 7771-A Bernard, Lasalle 660, Canada.

FREE! Real Estate Catalog! RECREATIONAL, Retirement and Investment Properties, Farms, Ranches, Businesses. Central States, Banner Advertising, P.O. Box 3333 (19-A), Springfield, Missouri 65804.

(Continued on next page)

DRINKING WATER-PURIFIERS

HEALTHFUL! New Tapwater Purifier with Drinking Fountain. Fits any faucet. Handy, economical. \$5.99 Postpaid. Gift-worthy. Guaranteed. Free brochure. **GILMORHOUSE**, Box 1175-PX7, Denver, Colorado 80201.



FLOWERS, PLANTS & NURSERY SUPPLIES

LEARN Flower Arranging and Floristry. Start full or part time business or hobby. Free information on home study course. Lifetime Career Schools, Dept. B-459, 2251 Barry Avenue, Los Angeles, California 90064.

LEARN Landscaping and the growing of plants. Start a profitable business part or full time. Free information without obligation. Lifetime Career Schools, Dept. A-142, 2251 Barry Avenue, Los Angeles, California 90064.

BUILDING AID BOOKS

BUILD Your own home! Fifty chapter building manual and our most popular plan \$5.00. Brochure 25¢. **HOMEBUILDERS**, 136-35 Scott, Dundee, Illinois 60118.

CONSTRUCTION PLANS, BLUEPRINTS

HAVE Your Home Designed By Mail. For Information Write: Home Design Studio, P.O. Box 6916, Fort Worth, Texas 76115.

DO YOUR OWN CONTRACTING AND SAVE THOUSANDS BUILDING YOUR OWN HOME! Copyrighted book shows how experts plan, estimate costs, schedule work, and pay accounts. Easy to follow. Send \$10.00 to: Home Consultant, Box 448, Library, Pa. 15129.

VACATION HOME PLANS

HUNTING CAMPS—\$1 Brings Portfolio. C. Fulton, East Division, North East, Penna. 16428.

LOG CABINS & HOMES

"BUILD Log Cabins, rustic furniture, fireplaces!!! Complete manual, \$3.00 . . . "A" Frame plans, \$2.00 . . . Guaranteed . . . Beels, 956 Springdale, Atlanta, Georgia 30306."

"A" FRAME Cabin. \$500 for material. Any lumber yard. Completely illustrated instruction manual, including material list. Moneyback guarantee. Send \$2.00 to Dependable, Plan #1909, Box 113, Vista, California 92083.

HOME CRAFTSMEN

WOODWORKING Catalog and Manual 50¢. Plus free "101 Project Ideas." World's most beautiful veneers, lumber, plywood! Wood finishing, upholstery supplies, Cane, Lamp Parts, Furniture hardware. Animal whittling blocks. 2,000 workshop products, Constantine, 2051-C Eastchester Road, Bronx 10461.

101 PATTERNS of smart Gifts. Novelties, Shelves, Action Windmills, plus "Make Money Jig Sawing". \$1.50. Mastercraft, 75M, 7041 Olcott, Chicago 60631.

PICTURE Framing—Profitable full or spare-time business. Easy to learn with handbook-course "Guide To Picture Framing Profits." \$1.50 Guaranteed. Free framing-supplies catalog included. Japs, 126-PM Seventh North, Hopkins, Minnesota 55343.

CABINETMAKING MADE EASY And "How to Make Formica Counter Tops." Two excellent guides let you build kitchen cabinets and counter tops like professionals. Extraordinary guides bring master craftsmen's shortcut methods. Satisfaction guaranteed. Write: Japs, 126-P Seventh North, Hopkins, Minn. 55343.

198 POPULAR MECHANICS

BEST WORKBENCH PLAN Ever, Plus Free Lumber Conversion Chart, \$1.00. **WAY-MAR**, Dept. 45, 58 Uuderhill Road, Scarsdale, New York 10583.

SKIL-CRAFTS Current 200 plus page catalog with world's largest, finest selection of Hobbycraft, leathercraft, artist supplies. Send \$1 for postage and handling; refunded on first \$15 minimum catalog order. Skil-Crafts, Box 105-P, Joplin, Mo. 64801.

FOUNDRYETTE 2400 F. 1½ to 48 lb. capacity. Circular 25¢. Kansas City Specialties, Box 193-P-7, Middleton, Wisconsin 53562.

BERNZCUTTER—Cuts sheet materials easily, cleanly—perfect for formica, metals, plastics, panelling, etc. \$7.95. Vista Products, Dept. 172, RD 1, Norwalk, Ohio 44857.

CATALOG FULL SIZE FURNITURE PLANS—\$1.00. Refunded with first order. Traditional, Early American, over 135! Furniture Designs, 1425 Sherman, Dept. CP-72, Evanston, Illinois 60201.

WALNUT Bowls, Legs, Round Picture Frames, Gun-Stocks Lumber Moulding. Midland Walnut, Box 262, Savannah, Missouri 64485.

BUILD Pool filter for under \$5.00. Plans, drawings, \$1.00. Poolcraft, 135 N. 9th St., Zionsville, Ind. 46077.

20 PLANS—Full Size—Novel Items For Fun or Profit. Send \$2.50. Carbone—Box 18099—Philadelphia, Penna. 19147.

HOME REMODELING

CERAMIC Wall Tile Instructions \$3.00. Don Haskins, Union Street, E. Bridgewater, Mass. 02333.

DO-IT-YOURSELF

FABRICATE concealed door lock, simplified specifications \$2.00. Lurz, 94 Christian, Stony Brook, New York 11790.

SAVE! Build-your-own Plans. Portable Electric Power Plant from used parts and 110 Volt power on your car. Information/photos \$1. B-UR-O, 34161-B-JG-Coast Hwy., Dana Point, Calif. 92629.

YOU Can PAINT Your HOUSE. My 30 years experience can help you. Save time and money, get professional results. Each area detailed. Easy way is right way. Send \$2.00. Fred Morrison, 8047 Dorian Way, Fair Oaks, Calif. 95628.

CONVERT MOWER Engines into air compressors. Write: Showalter, Box 409, Abilene, Kansas 67410.

BURGLAR-FIRE Alarm Supplies and Information. Free Catalog. Protecto Alarm Sales, Box 357A, Birch Run, Michigan 48415.

PROTECT FAMILY AND POSSESSIONS. Send \$59.95 for your Do-It-Yourself Burglar or Fire alarm system kit. Accessory catalog 25¢. CDS, P.O. Box 790, Pearland, Texas 77581.

MAKE Inexpensive molds. Cast your own fishing sinkers. Plans \$1.00. Hylands, 9535 Kensington Dr., Huntington Beach, Calif. 92646.

HOT Water from the sun. Plans, instructions, material List, \$10.00. Solar-Pak, P.O. Drawer 23585, Tampa, Florida, 33622.

REPAIR MINIBIKES, LAWNMOWERS, BICYCLES, Sewing Machines, Auto Engines. Build concrete, Plywood, boats, trailers. Over 100 How-To-Do books. Free brochure. Sincere, Box 10422, Phoenix, Arizona 85016.

BAROMETER Make for under \$2.00. Educational, conversation piece, plans 50¢. Send Stamped, Self Addressed Envelope. Thomas, Box 104, Millbury, Mass. 01527.

SUPERIOR WORKBENCH PLANS—Five, new designs, plus toolpanels. \$1.50. Diko, Dept. 91-G, Rowayton, Conn. 06853.

UPHOLSTERY Step By Step Instructions for Making and Repairing all Types of Furniture ONLY \$3.50. Hoosier Specialties, Dept. 91B, ELWOOD, INDIANA 46036.

AUTO REPAIR BOOK—End expensive labor charges on auto repairs. Do the job yourself. Auto expert shows you how. **WONDERLAND**, 323 CALADIUM, LAKE JACKSON, TEXAS 77566.

HOUSEHOLD Electrical Guide \$1.00. Bert Moon, Box 69, Central Islip, New York 11722.

POOL TABLE For home use. Professional Quality. Specifications, 3-View drawing and information \$1.00. Tiercraft, P. O. Box 6117, Erie, Pa. 16512.

ARTS AND CRAFTS

FREE: New handicraft catalog. Supreme Handicrafts, Box 395-PM, Sioux Falls, South Dakota 57101.

MAKE Figurines, plaques, lawn ornaments. Molds, plastercraft kits, liquid rubber. Sample and catalogue 10¢. Wooley Company, Box 29-B, Peoria, Illinois 61601.

"GETTING Started in Stained Glass" 25¢. Whittemore, Box 2065Y, Hanover, Mass. 02339.

JEWELRY MAKING For hobby or profit. Send for free brochure showing complete kits and easy instructions. V. F. Ausura, 1565 Reservoir Ave., Roslyn, Pennsylvania 19001.

FREE LITERATURE For sculptors showing how to make molds, cast plastics. Adhesive Products Corporation, 1660 Boone Avenue, Bronx, N.Y. 10460.

HAVE FUN! DO-IT-YOURSELF! Make useful-Decorative Items For Home-Gifts-Profits . . . From the Largest Selection Of RESINCRAFT, CANDLECRAFT AND RELATED SUPPLIES Available Anywhere. Illustrated Catalog \$1. (Refundable.) Specialty Products, Dept. B, 731 Brooks Road, Muskegon, Michigan 49442.

BINOCULARS, TELESCOPES, MICROSCOPES, MAGNIFIERS

FREE Binocular, Rifle scope catalog. Discount sale. Save 50%. Free gift with order. Write, United Binoculars, BN-4708, 9043 So. Western, Chicago 60620.

TELESCOPES (Reflectors) Complete Kits. Other accessories, request free literature. Criterion Manufacturing, Dept PM 31, Hartford, Connecticut 06101.



CAMERAS AND EQUIPMENT

FREE! FREE! BARGAIN BOOK—Central Camera Co., Dept. 371, 230 S. Wabash, Chicago, Ill. 60604.

35MM OWNERS: If interested in earning good money part time and if you are good photographer with 35mm camera, write for full details of new business. James McEvoy, 535 Worcester Road, Framingham, Massachusetts 01701.

POPULAR Brands Supplied! Best Prices! Mandarin, 214 Shaws Building, Hong Kong.

35MM Surveillance movie cameras. Used. \$49.95 each includes 115vac power connection information. Electro-Photo Mfg. & Sales, Box 1924, Glendale, California 91209.

PHOTO & PHOTO SUPPLIES

POWERLITE: Twice the light, longer life for your enlarger lamp. Other inexpensive electronic darkroom equipment available assembled or in kit form. For information send 10¢ to: Electro-Photo Mfg. & Sales, Box 1924, Glendale, California 91209.

FILM—Agfa Color Rapid. **CASE CRAFT**, 33 Laurel Park, Butler, New Jersey 07405.

(Continued on next page)

PHOTO FINISHING

CAMERA FANS! Expert photofinishing by one of Country's largest labs at lowest prices. Fast service and free "Foto-Fan" Stamps you quickly redeem for valuable Photo Supplies. 8MM Kodachrome \$1.29; 8 Exp. Kodacolor \$1.79; 35MM Kodachrome. 20 Slides \$1.39; 8 Exp. Black White 69¢. Satisfaction guaranteed. Send exposed film or request free mailers, complete Price List and Gift Catalog. Direct Mail Photo, Box 8352-PM, Pittsburgh, Pa. 15218.

FREE! PHOTOSTAMPS INFO (50 Prints \$3.00) Dave's Developments, R1, 761PM, Ludington, Mich. 49431.

COLOR SLIDES

35MM COLOR Slides. 10,671 Individually sold. Described, Encyclopedia catalog 10¢. Wolfe Worldwide, Dept. 14-72, Los Angeles, Calif. 90025.

MOTION PICTURES AND SOUND EQUIPMENT

UNUSUAL Movie supplies. Free circular. Esor, 47th Holly, Kansas City, Missouri 64112.

16MM SOUND Features, Shorts, New used for Sale. Free Catalog. National Cinema, 333 W 57th St.—N.Y.C., N.Y. 10019.

FREE! 64-Page catalog. 8-16mm film supplies, processing equipment. Superior, 448 N. Wells, Chicago 60610.

CLASSIC 8MM. MOVIES . . . 35MM. 2"x2" Color Slides. . . largest selection anywhere! Silent classics, comedy, history, sport, news, documentaries, features, others! 16mm. films also. Free catalog. Blackhawk Films, 569 Eastin-Phelan Bldg., Davenport, Iowa 52808.

RADIO, TELEVISION AND HAM EQUIPMENT

SAVE Money on parts and Transmitting—receiving tubes, Foreign—domestic. Send 25¢ for giant catalog. Refunded first order. United Radio Company, 56-PM Ferry Street, Newark, N.J. 07105.

TV TUNER REPAIRS V.H.F. \$9.50 U.H.F. \$7.50, Combination \$15.00. Includes all parts except tubes and transistors. Shipped C.O.D. Prompt, reliable service, 1 year warranty. Triple T. Tuners, Box 93, Bowling Green, Ind. 47833.

HIFI TAPES, RECORDS AND ELECTRONICS

IRISH Cassette Promotion Buy 4 261-C60 for \$4.40 get **FREE** Plastic Storage Case. Holds 12—add 50¢ for Shipping. Send to: Direct Mail Corp., P.O. Box 71, Plainview, New York 11803.

INSTANT TAPE DECK: Play your cassette player/recorder thru your car radio. Simply plug in. No wired installation. Brochure-25¢ refunded with order. Guaranteed only \$16.95ppd. **MACKS GIFT SHOPPE**, Box 377, Dept. J23, Aurora, Ill. 60507.

OLD Radio Programs. Catalog \$1.00. (Refundable). Radio Vault, Box 9032, Wyoming, Michigan 49509.

REVOLVING Cassette Carousel holds 25 Cassettes \$10.95. Romco Sales, Box 407, Youngsville, Louisiana 70592.

FREE Catalogues, 2000 hard to find unusual records. Rose's Records, Box 7216, Louisville, Ky. 40207.

GOLDEN Age Radio. Complete taped shows, Box 8404-M, St. Louis, Missouri 63132.

OLDIES! 45 RPM Original Hits Catalog 50¢. C. & S. Record Sales, Box 197, Wampsville, New York 13163.

BEST Buy! Unrecorded Cartridges, Cassettes, and Supplies for those who load their own. **PLAYTRADE**, Box 5562, Toledo, Ohio 43613.

FREE Catalog—Electronic Kits—Amplifiers—Preampifiers—Psychedelic Strobes—SCA Adaptors—Color Organs—Digital Instruments—Guitar Amplifiers. **FREE** Subscriptions. SWTPC, Box PM32040, San Antonio, Texas 78284.

8-TRACK STEREO TAPES New! Guaranteed! Original Artists. Only \$2.00 Ea! Catalog And Sample Tape \$2.00. Wesley's Enterprises-M., Box 5093, Charlotte, N.C. 28205.

REMEMBER RADIO??? Catalog 50¢. . . TBOR, Box 1692-D, FDR Station, New York 10022.

POLICE/Fire Monitors, 8-Track Players And Tapes, Free Discount Catalogue. Mail Order Promotions, 400 West Lombard Street, Baltimore, Maryland, 21201.

FILM Sound Track Albums. Whalon, 2321 Hill, Redondo Beach, Calif. 90278.



MUSIC AND MUSICAL INSTRUMENTS

LEARN To Read Music In One Evening, Exciting New Book Tells How, Only \$3.95, Bishop's Books And Music, P. O. Box 21203, Phoenix, Arizona 85036.

FREE Recording. Details. Newart Publications, Box 693, Syracuse, New York 13201.

LEARN TO READ MUSIC In one Evening. Amazing New Book Shows How! \$3.00 Postpaid. Cliff Bantel, Box 2086, Capistrano Beach, Calif. 92624.

ACCORDIONS And Amplifiers! New-Used. Cordovox, Excelsior—Top Makes! Save to 50%. Direct factory dealer. Terms. Trades accepted. 5 day home trial. Free catalog—Discount prices. Write: Accordions Unlimited, Dept. R, 3147 North Luna, Chicago 60641.

GUITARISTS!!! Fantastic Savings—Guitars: Amplifiers—Popular name brands, largest selection. Money Back Guarantee!!! 32 page illustrated discount catalog. Send 25¢ today: Guitars Unlimited, Box 343, Dept. PG, Richland, Washington 99352.

30% TO 50% DISCOUNT! Any Model: Guitar, Amp, Drum, Banjo, Dobro! Free Catalog! Warehouse P23, Box 16399, Fort Worth, Texas 76133.

ACCORDION Top brands. Buy direct. Tremendous discounts. Trades accepted. Free brochure PM. Accordion-O-Rama, 874 Broadway, N.Y.C. 10003.

EASY To Play And Make. Quality Dulcimers, Banjos, Thumb Pianos; Instruments And Kits. Can Be Profitable Hobby. **HERE, Inc.**, #P, 410 Cedar Avenue, Minneapolis, Minn. 55404.

PLAYER Piano Rebuilding—get details from: Vestal Press, Vestal 11, N.Y. 13850.

ACCORDION Manufacturing, 6846-P North Avenue, Chicago, Illinois 60635. Concertinas, Hohners, Chromatics, Guitars, Drums. New, Used, Tuning, Repairing. Wholesale Catalogs Free.

VIOLIN And Guitar makers—send for latest Free Catalogue of woods & accessories. International Violin, PM1. 414 East Baltimore St., Baltimore, Md. 21202.

ELECTRIFY Player Pianos, Pump Organs Quickly, Inexpensively with Lee Silent Suction Units. Write: Lee Music, 525F Venezia Avenue, Venice, California 90291.

LEARN Banjo. 5-String Bluegrass. No music. Makes learning easy. Free details. Blaylock, Box 25-M, Marietta, Georgia 30060.

POEMS Wanted for songs. Nashville Music Productions, Box 40001-P, Nashville, Tennessee 37204.

"LEARN To Read Music In One Evening! Amazing New Book Shows How. Only \$3.00. Money-Back Guarantee." Kelly, 1182 Market Street, Suite 404, San Francisco, California 94102.

WHOLESALE. Musical Instruments—Accessories. Allied, 573 Route 17, Paramus, New Jersey 07652.

SWISS Music Boxes, Movements. Tunes To Order. Spielman, 55 West 42nd. New York 10036.

LEARN Guitar Fast. Play Any Song Using Only Five Simple Chords. Satisfaction Guaranteed. \$1.98. Jamie, Box 179, Lake Jackson, Texas 77566.

GUITAR MAKING Books. Imported Woods, Supplies, Accessories. Catalog 25¢. Guitar Center, Box 15444, Tulsa, Okla. 74115.

30% DISCOUNT, Name Brand Musical Instruments, Free Catalog. Freeport Music, 455F, Route 110, Melville New York 11746.

WHOLESALE Professional Guitars, Amplifiers, PA Systems, Free Catalog. **CARVIN**, Escondido, Calif. 92027.

FASCINATING 4-HOUR MUSIC READING METHOD! INFORMATIVE "BROCHURE 1-G" **FREE!** Write **DANCO**, Box 436-P, Watertown, New York, 13601.

NEW Sliderule Device Teaches Guitar Chord Changes in all Keys Quickly and Accurately. Satisfaction Guaranteed. \$1.95. Select-O-Chord, Dept. Y3, 1121 Villaret, San Antonio, Texas 78224.

AUDIO Equipment plans! Guitar, bass amplifiers, P.A.'s, Stereos. Catalog \$1.00. **AUDIOQUIP**, 1719 Mole St. Phila., Pa. 19145.

SONGPOEMS, SONGS! Urgently Needed, Possible Recording/Publishing, 50-50 Agreement, Betty's Music Makers, 1417 Park Building, Dept. B, Pittsburgh, Penna. 15222.

AMAZING 8-Track, cassette offer. **SAVE!** Only \$2.85 each. Satisfaction Guaranteed. **FREE** catalogue. Dean David Recordings, 377½ 7th Street, Idaho Falls, Idaho 83443.

CONSERVATION TRAINING

GAME WARDEN, Government Hunter, Forestry, Park & Wildlife Service announce job openings regularly. Prepare at home for outdoor work, good pay, security. Approved for Veterans! Complete information Free! Write: North American School of Conservation—MPS—Newport Beach, California 92663.

EDUCATION AND INSTRUCTION

FINGERPRINTING—Investigation. Exciting, secure career. Learn at home. Free book. State age . . . Institute of Applied Science, 1920 Sunnyside, Dept. 167, Chicago, Illinois 60640.

WATCH REPAIRING. Learn to repair American and Swiss watches in spare time at home. Diploma awarded. Free sample lesson. No obligation. Chicago School, Dept. YG, Fox River Grove, Illinois 60021.

LEARN ACCOUNTING! U.S. Labor Department reports "33,000 new Accountants, 78,000 new Bookkeepers needed each year for next ten years." Easy home-study plan prepares you. Send for **FREE** "Accounting Career Kit." North American School of Accounting, AZS, Newport Beach, California 92663.

CHAPLAIN'S Wanted. Men-women. Your area. We train, Ordain, employ. Registrar, 1911 Samada, Worthington, Ohio 43085.

COMPLETE YOUR HIGH SCHOOL At home in spare time. Texts furnished. No classes. Diploma. Our 75th year. Free Brochure. American School, Dept. XB45, Drexel at 58th, Chicago 60637.

CERTIFICATE Awarded Study Electro Biology. Educational Bureau, P.O. Box 281, Essex Sta., Boston, Mass. 02112.

LEARN Chinese at home. Chinese Language Institute, 10 Tunghai Road, Taichung, Taiwan.

LIFETIME Ordinations. Doctor of Divinity, church charters. Details 25¢. Life Science Church, 2207 Cardinal, Rolling Meadows, Illinois 60008.

(Continued on next page)

EDUCATION AND INSTRUCTION

(Continued from preceding page)

PIANO Technology—Electronic organ servicing, learned easily at home. G. I. Approved. Free booklet. Niles Bryant School, Dept. P, 3631 Stockton, Sacramento, California 95820.

LEARN To Fix Typewriters. Desperate shortage trained men. Hundreds needed. Make up to \$25 in one hour. Learn at home in spare time. Industry Approved course. Facts free. Send name. Typewriter Repair School, Dept. 3310-072, Little Falls, New Jersey 07424.

EXTENSION And Post-Graduate Awards in Philosophy, Art, Sciences, Botanic Medicine, Homeopathy, Radionics and others. 30 subjects. Curricular free (airmail \$1.00 refundable). Registrar, Sussex College of Technology, Highfield, Dane Hill, Sussex, England.

HIGHLY EFFECTIVE Home study courses in Electronics Engineering Technology and Electronics Engineering Mathematics. Earn your Degree. Write for Free Descriptive literature. Cook's Institute of Electronics Engineering, (Dept. 10), P.O. Box 10634, Jackson, Miss. 39209. (Established 1945).

PIANO Tuning quickly learned with home study course. Diploma granted. American Tuning School, Gilroy, Calif. 95020.

LEARN Auctioneering. Term soon. Free catalog. Reisch Auction College, Box 850, Mason City, Iowa 50401.

DETECTIVE Course. Free Information. Universal Detectives, Box 8180-F, Universal City, California 91608.

AUCTIONEERING. Resident or home Study Course. Free Catalog. Nashville Auction School, 2004 West End, Nashville, Tennessee 37203.

AUTOSUGGESTION. Sleep-learning headquarters! Tapes, records, books, Gigantic catalog free. Research Association, Box 24PM, Olympia, Washington 90851.

USED Courses! Books! List 10¢. Smith's, 124 Marlborough, Salem, Massachusetts 01970.

UNLOCK Your Future. Become professional Locksmith by spare time home-study. Make up to \$6 per hour. All tools, equipment incl. Facts Free. Send name. Locksmithing Inst., Dept. 1310-072, Little Falls, New Jersey 07424.

GRAPHOANALYSIS—Learn scientific handwriting analysis for profit, pleasure. Free sample lesson, catalog, reveals plan. Write: Igas Inc., 325 Jackson, Dept. 2EY-2, Chicago 60606.

PERFECT Husband-wife business. Learn Upholstery at home. Make \$10 in an hour. Buy—repair—sell for even bigger profits. Kits, tools included. Free Booklet. Upholstery & Decorating School, Dept. 5310-072, Little Falls, New Jersey 07424.

RELIGIOUS VOCATION? Write: Church of Holy Light Inc., P.O. Box 4478, Pittsburgh, Pa. 15205.

DETECTIVE Profession. Easy home study; free tie-tack or lapel pin, certificate, future. GI approved. Professional Investigators, Box 41345, Dept. CP, Los Angeles, Calif. 90041.

FREE Bible Course! Degree! Request information! 708 Bragg, Monroe, North Carolina 28110.

HIGHLY Effective Specialized Home Study Courses. Fast, Inexpensive, and Complete. Many Categories: Electrical, Electronics, Mechanical, Building Trades, Etc. Diplomas Awarded. Our 27th Year. FREE Literature. CIEE—Dept. 25—Box 10634, Jackson, Miss. 39209.

USED Courses! Books. Catalog 10¢ (Courses Bought). Lee Mountain, Pisgah, Alabama 35765.

DETECTIVE And Fingerprinting Courses. Write. Detectives, Box 185-P, Fairfield, Alabama 35064.

LEARN TO WELD—Arc, Pipe, Gas, TIG, MIG, Plasma. Free Bulletin. Write, phone or visit. Approved Ohio No. 70-12-0064-HT. HOBART SCHOOL OF WELDING TECHNOLOGY, BOX 72, TROY, OHIO 45373.

GAME WARDEN, Government Hunter, Forestry, Park & Wildlife Service announce job openings regularly. Prepare at home for outdoor work, good pay, security. Approved for Veterans! Complete information Free! Write: North American School of Conservation-AZS-Newport Beach, California 92663.

PENMANSHIP Corrector. Improve Poor Penmanship Quickly. Details Free. Ozment, Box 2344-34, St. Louis, Missouri 63114.

THOMAS A. EDISON COLLEGE Mast & Doctor's "OFF CAMPUS" Degree Programs in Religion & General Education. Write: TAEC, Box 688, Palm Beach, Fla. 33480. For Catalogue send \$1.00.

VETERINARY ASSISTANT—Train at home for exciting animal care career. Send for FREE "Career Kit". North American School of Animal Sciences, AZS, Newport Beach, California 92663.

MATHEMATICS MADE EASY. We show you how with over 400 quick ways to find answers to all types of problems \$2.00. M & D Supply Co., Box 4315, Pontiac, Michigan 48057.

RETIRED At 49! Secrets? No! Plain Facts. Everyone Can Profit By Applying Basic Ideas. FAPS, PM-7, Box 500, Victorville, California 92392.

GET A British Degree. Divinity. Philosophy, Radionics. 35 Courses. Prospectus free. Brantridge Forest School, Highfield, Dane Hill, Sussex, England.

DEGREES Without residence requirements! Comprehensive tutorships. Catalog: \$3.00. UNITED STATES UNIVERSITY OF AMERICA. Box 5171-PM, Clearwater, Florida 33518.

OWN Collection agency. "Little Gold Mine!" Franklin Credit, Roanoke, Virginia 24004.

"SEWING Machine Repairing. Unique instructions. Lucrative profits. Diploma awarded. Gresslin Correspondence School, Box 927, Spencer, Iowa 51301"

FREE B.D., M.D., D.D. with Lifetime Ordination. Box 744 PM, McKeesport, Penna 15134.

PIANO TUNING—A PRACTICAL GUIDE. ILLUSTRATED Book only \$3.00. Kurk Publications, 2567 North Dunlap, St. Paul, Minn. 55113.

CIVIL Service Handbook \$4.95—Complete Guide to Civil Service Jobs \$4.95—Home Study Course in Civil Service Jobs \$11.95—No postage—Jackson Supply, Mt. Liberty, Ohio 43048.

I.Q.? What's yours?? Find out fast with self-scoring test. Only \$2.00—Guaranteed!! Delta Sales, Dept. 1A7, Box 50463, New Orleans 70150.

MEN, Women break barrier now. Earn \$9,000-\$20,000 annually. Automobile Sales Industry needs thousands. Free Aptitude Test, Job Assistance. FVASS, Box 628P, Botsford, Conn. 06404.

COLLEGE Degree at home. Your choice of subjects incl. law. Easy tuition plan. Williams College, 445 East Second South, Salt Lake City, Utah 84111.

LEARN Expert Cake Decorating, Catering, Candymaking. Free details on home instruction. Candy & Cake, Dept. BLL-PM, 1600 Cabrillo, Torrance, Calif. 90501.

PRACTICAL Educational Books, Free Details: I.D.C., P.O. Box 133 PM, Caldwell, New Jersey 07006.

FREE Book tells how to gain profitable skill in understaffed field as camera repair technician. APPROVED FOR VETERANS TRAINING. Home study or classroom. National Camera, Dept. EAC, Englewood, Colo. 80110.

LEARN Asleep or awake! Records, tapes, equipment! Free catalog! Drawer PM-400, Ruidoso, New Mexico 88345.

HOW To DEVELOP YOUR E.S.P. POWERS! Amazing Record Series now Available. Send for FREE Information. No Obligation. Hallstrand Enterprises, 12221 Whittier Blvd. Dept. P7, Whittier, Calif. 90602.

IF YOU Really want to succeed at life, my LETTER FROM A FRIEND Will help you as it has helped so many others. Send \$1.00 for this indispensable guidance. ERB, Box 21008, Philadelphia, Pa. 19154.

HOW INTELLIGENT Are You? Self-scoring test reveals IQ in 15 minutes! Send \$2.00 today—guaranteed! G. E. Sales, Box 553, Sterling, Ill. 61081.

EARN College degrees at home. Many Subjects. FLORIDA STATE CHRISTIAN COLLEGE, Post Office Box 1674, Fort Lauderdale, Florida 33302.

FOR INVENTORS

IF YOUR Invention is adaptable to promoting we will contract for selling on cash or royalty. Free booklet outlines royalty rates, requirements. Kessler Corporation, C-57FI, Fremont, Ohio 43420.

INVENTORS—Save unnecessary patent and marketing expenses by getting professional, independent evaluation of your ideas, inventions. Write: Invention Evaluation Services, Box 665, Marion, Ohio 43302.

SAVE MONEY! Get Patent and/or Copyright Protection without paying Attorney Fees! Details \$1.00. Ross Enterprises, 116 West Ellis, Inglewood, Calif. 90302.

U.S. PATENT Office Searches. 234 Broadway, Room 3615, New York 10017. Free invention certificates.

PATENT Application Financing. Free patent search plan. Global Patent Division, 2420 77th, Oakland, Calif. 94605.

IMMEDIATE Cash, for patent applications. Free patent searches. Write for details. Universal Patents, 184-D Marion, Ohio 45750.

PROMOTE IT YOURSELF—Complete guide for inventors. Development thru sale: Quantum Group, 1529 Greenleaf, Evanston, Illinois 60202.

INVENTORS: Your ideas and inventions (patented: unpatented) expertly searched, developed for commercial appeal and cash/royalty sales to manufacturers by professional Invention Developer with excellent record of experience. B. S. Industrial Engineering; United States Patent Office former Patent Examiner. United States Government former Patent Advisor. Second decade reliable service! Member: United States Council International Chamber Commerce. Free "Invention Record" and "Recommended Protection Procedure." Airmailed! Write: Raymond Lee, Invention Developer, 230P-Park Ave., New York, New York 10017.

PATENT Searches including maximum speed, full airmail report and closest patent copies. Quality searches expertly administered with complete secrecy guaranteed. Free Invention Protection Form and "Patent Information." Write: Washington Patent Office Search Bureau, Benjamin Franklin Substation, P.O. Box 7167, Washington, D.C. 20044.

FREE PAMPHLET: "Tips on Safeguarding Your Invention." Write: United States Inventors Service Company, 501-P Thirteenth Street N.W., Washington, D.C. 20004.

INVENTORS—United States Patent Office Searches, Patent Development Engineering, marketing of inventions—ideas by Licensed Professional Engineer—Patent Engineer and United States Patent Office Former Examiner. Inventions developed for patenting and marketing. We are contacted by many manufacturers seeking to purchase appropriate new products invented by our clients. Send for Free Invention Certificates and Invention Information. Serving inventors since 1948. George Spector, Licensed Professional Engineer—Patent Engineer—3615 Woolworth Building, New York, N.Y. 10007.

(Continued on next page)

FOR INVENTORS (Continued from preceding page)

"MONTHLY Information, news, analysis of invention business. Subscription \$12.00, copy \$1.50 Write SYNTHESIS Magazine, Box 157-F, Manhattan Beach, Calif. 90266."

SERVICE For Inventors By Inventor-Engineer. M. Fabish, 675 E. Granville Rd., Columbus, Ohio 43229.

PROSECUTE Your Own Patent Application. All Material, Three Booklets Including Step-By-Step Procedure—\$9.00. Inventors Service, Box 3574, Washington, D.C. 20007.

INVENTORS CONSULTANT SERVICE. Sample Patent and Informative Bulletin send \$6.00. Consultant Service, Rt. 1, Box 212, Haleyville, Alabama 35565.

INVENTIONS WANTED

INVENTORS—Do you want to sell or license your invention on cash or royalty basis. Write: Kessler Corporation, C-571W, Fremont, Ohio 43420.

INVENTORS!!! 25 "No Advance Fee" Patent Brokers/Buyers \$2.00. Speedline, Box 458, Woodriver, Ill. 62095.

INVENTIONS Wanted. Patented: unpatented. Tremendous manufacturers lists. Global Marketing Service, 2420G 77th, Oakland, California 94605.

WE Either sell your invention or pay cash bonus. Write for details. Universal Inventions, 28-E, Marion, Ohio 45750.

FREE "Directory of 500 Corporations Seeking new Products." For information regarding developments, sale, licensing of your patented/unpatented inventions. Write: Raymond Lee Organization, 230-N Park Avenue, New York, New York 10017.

INVENTORS! Protect your ideas! Free "Recommended Procedures." Washington Inventors Service, 422F Washington Building, District of Columbia 20005.

INVENTORS! We will develop, sell your idea or invention. Our national manufacturer-clients are urgently seeking new items for highest outright cash sale or royalties. Financial assistance available. 15 years proven performance. For free information write: Dept. 47, Wall Street Invention Brokerage, 79 Wall Street, New York, N.Y. 10005.

INVENTORS! Don't sell your invention, patented or unpatented until you receive our offer. Eagle Development Company, Dept. H, 83 Wall Street, New York, New York 10005.

INVENTORS! Sell your invention for cash or royalties! Our client manufacturers eagerly seek new items. Patented. Unpatented. Financial assistance if needed. 25 years proven performance. For free information, write: Dept. 15, Gilbert Adams, Invention Broker, 81 Wall St., New York, N.Y. 10005.

INVENTORS—Our factory in HONG KONG can manufacture and package your invention at unbelievable low costs, ready for the market. We are anxious to finance good commercial ideas and can provide marketing services. RS & Assoc., Box 149-H, Tustin, Calif. 92680.

MANUFACTURING

INVENTORS Ideas Developed. Research. Models. Manufacturing. Sales. Free Brochure. Since 1942. William Parker, Box 6305, Orlando, Fla. 32803.

MASTER MACHINIST, ANYTHING MANUFACTURED, REPAIRED. Line, 6112 Rinke, Warren, Michigan 48091.

BUY IT WHOLESALE

BUY BELOW WHOLESALE! Thousands of name-brand items at factory prices plus small service charge! Directly thru us. Free details! American Buyer's, P. O. Box 848-P, Buffalo, New York 14240.

UNIQUE Wholesale Club!! Save on thousands of famous brands: jewelry, tools, appliances, stereos, etc. 40-50% off Retail; same wholesale prices retailers pay! Purchase for yourself or resell for fantastic profits. Free information. Homestead, Dept. 50G, 18 Westcliff Drive, Mount Sinai, New York 11766.

HEARING Aids, batteries, Wholesale. Catalog 25¢. Fiston, Box 1444, New Preston, Conn. 06777.

WORLD'S Largest wholesale dropship sources. U.S., foreign. Factory suppliers dropship direct to you or customers. Now!, have your own catalog for pennies. Free details. International Buyers, Box 16386-M, Portland, Oregon 97233.

TELEPHONE Answering Machines. Robinson Associates, Box 2049-PM, Peabody, Mass. 01960.

PURE SILK—Assorted Colors—3 yds., 75¢ per yard. Millends, Inc., P.O. Box 804, Clinton, Louisiana 70722.

FREE CATALOG Of gifts specialties money-making manuals, buy below wholesale. ERNEST, 5275 DeLongpre, Hollywood, Calif. 90027.

BARGAINS! Buy wholesale and below. Name brands. Appliances, furniture, sports equipment, televisions, cameras, watches, jewelry, thousands more. Huge discounts to \$1,000.00 on new automobiles. All makes. Free details. Write today: Worldwide Bargainhunters, Box 730-A, Holland, Michigan 49423.

EXPORT-IMPORT

JAPAN: 1200 Products directory. Illustrated Manufacturers' names, addresses. \$3.00. Send cash, Yamagata Office, 814 Togin Bldg., Marunouchi, Tokyo.

WORLD-Wide Import Drop-Ship Directory. 7 Money Making Directories in 1 illustrated 8 1/2 x 11. Unexpensive Import Course. Only \$3.00. Pye Enterprises, 2026 El Camino, Santa Clara, California 95051.

FOR PARENTS

DI-D-KLIP Diaper Fasteners, Stainless Steel, Gold Plated. No sharp edges or points. Gift Boxed. \$2.95. Money Back Guarantee. Wheelers, PM-772, 2511 Oregon S.W., Roanoke VA. 24015. Dealers wanted.

IF YOU SMOKE I Have A Book You Should Read. Only \$1.00. Satisfaction Guaranteed. Harry Brandt, 377 Seventh Street, Sharpsville, Pa. 16150.

OF INTEREST TO WOMEN

GREAT Grand'ma's Delicious taffy candy recipe \$5.00. Kimbrough, Box 1091, Hollywood, Calif. 90028.

1000% PROFIT Bronzing Baby Shoes. Free Literature. NBC, Box C-4-PM-2, Coral Springs, Florida 33065.

WANT A new car, color TV, new clothes? Learn hundreds of ways to make money. 5 month subscription FREE. Write: Salesman's Opportunity Magazine, Dept. 17-GO, 1460 Hancock Center, Chicago 60611.

\$100 WEEKLY Possible addressing mailing. Sparetime. Free details. Send self-addressed stamped envelope. Newby Publications, Box 20427-PM, San Antonio, Texas 78220.

\$6.00 DOZEN Paid lacing baby boots! Cowboy, Warsaw 9, Indiana 46580.

HOW To Make Money Writing Short Paragraphs. Information Free. Barrett, Dept. C-27-K3, 6216 N. Clark, Chicago 60660.

HOMEWORKERS! \$100.00 Weekly addressing for firms, Begin immediately. Details—send stamped, addressed envelope. Hamilton, 272-TM-7, Brooklyn 11235.

HOME Newspaper clippers needed. \$500 monthly possible. Details free. Foster, 272-MA-7, Brooklyn 11235.

FURNITURE SLIPCOVERS! 426 Grand Street, Brooklyn, New York 11211. Free Information Chart.

WOMEN Needed Now to fill out income tax forms at home. We show you how. Simple, easy to learn. \$700 per month earnings possible. Details mailed free. No salesmen. Hurry. Federated Tax Service, 2039 Montrose, Chicago 60618.

\$500 MONTHLY Possible addressing—stuffing envelopes (longhand—typing) at home. \$500 monthly Clipping news items from your newspaper. Information: Send stamped self-addressed envelope. American, Excelsior Springs, Missouri 64024.

WANTED: Homeworkers to mail our salesletters. \$79.20 Weekly Salary. Send \$1.00 for registration and material. Cash, 28 E. Jackson, Suite 1204, Chicago, Illinois 60604.

"HOMEWORKERS: \$75.00 Thousand Home Addressing Possible! For information send 25¢ and self-addressed, stamped envelope. William T. Clarke, Dept. PM, 11 Watson Avenue, East Orange, New Jersey 07018."

GIFT SHOPPING

FREE CATALOG Of Sensational Gifts and Novelties. J. & L. Co., 73-B Main St., New Paltz, New York 12561.

RARE Bargains Catalog. 25¢. Continental, 3425 North Detroit, Toledo, Ohio 43610.

PERSONAL ZODIAC Self-Adhering gold seals (72) in convenient folder. Send \$1.75 each plus 25¢ handling. Give sign or birthday. CREATIVE MAIL, Box 655, Glen Ellyn, Ill. 60137.

FREE! Distinctive Gift Catalog. ROSEBUD'S Gifts, 1902 Center, Crest Hill, Illinois 60435.

FREE Onyx Gift Catalog. BALE'S, Box 15123, San Diego, Cal. 92115.

FREE Spectacular Catalog, NEWEST Exciting and Useful Gift Ideas. Delphi-1C7, Box 31072, San Francisco, California 94131.

WATCHES, OLD GOLD, JEWELRY

HIGHEST CASH For Gold, Jewelry, Gold Teeth, Rings, Diamonds, Watches, Silver, Platinum. Mail Articles Today. Free gift with information. Chicago Gold & Precious Metals, 6 E. Monroe, Dept. 1158, Chicago 60603.

AUSTRALIAN Opals, Watches, Jewels. International Supplies, Box K-3705, Hong Kong.

COMPLETE Watchmakers'—Jewelers' Catalog \$1.00. Snell-Bengal, 205 Helm Building, Fresno, California 93721.

WATCH And clock repairing books. Free catalog. North American, Box 77-AT, Fox River Grove, Illinois 60021.

CASH Immediately for Old Gold, Jewelry, Gold Teeth, Watches, Diamonds, Spectacles, Silver, Platinum, Mercury. Free information. Rose Industries, 29-A East Madison, Chicago 60602.

WANTED . . Gold, Silver, Platinum (any form). Coins. Information Free. Wilmot's, 1067 Bridge, Grand Rapids, Mich. 49504.

HEARING AIDS

HUGE SAVINGS. Eliminate dealer mark-ups. Free Trial. Batteries Wholesale. Terms Arranged. Lloyds-PMC, Rockford, Ill. 61108.

IMPROVE YOUR HEARING Information Absolutely Free. Rhodes, Box 518-PM, Paducah, Ky. 42001.

"HEARING Aids—Huge savings on tiny, all in the ear, eyeglass, behind the ear and body models. Free home trial. Low as \$10 monthly. Write for free catalog. Prestige, Dept. R-6, Box 10947, Houston, Texas 77018."



BIOLOGICAL FUEL CELL. Amazing cell makes electricity from bacteria. Science Fair Winner. Complete Kit \$14.95 plus 90¢ postage. send 25¢ for Big Science Catalog! **ROWLAB**, Dept. PM 672, 345 East Forsyth Street, Jacksonville, Florida 32202.

CHEMISTRY And Biology Catalog 35¢. Boulevard Laboratories, Suite 302, 3114 E. 83rd St., Chicago, Ill. 60617.

CHEMICALS And apparatus for industrial, analytical, and private laboratories. Catalog 50¢. Dept. M-50, Biological Supply Co., 1176 Mt. Hope Ave., Rochester, N.Y. 14620.

CHEMICALS Apparatus, Biology and Model Rockets. Both Catalogs for 50¢. Sheard Science, Dept. PM, Columbus, Wisconsin 53925.

CATALOGUE Of those ver-ry hard-to-find chemical products, things that go boom, multi-stage rockets, 500 How-To books, 10,000 formulas of every conceivable mixture in science and industry. 50¢. Kenrus-C, Box 158M, Staten Island, New York 10309.

UNIFIED Theory of Matter and Energy. Easy Reading. Simple Math. Includes Gravitation, Relativity, Evolution. \$4.95. Genie, Box 872, Lancaster, Pa. 17604.

LABORATORY Supplies at discount prices. Catalogue—35¢. Deluxe Scientific; Manitowoc, Wisconsin 54220.

FORMULAS, PLANS, ETC.

SMOKE MEAT FISH GAME. Instructions remodel used refrigerator—Make Smokehouse. Recipes Lunchmeat, Weiners, Pepperoni, Salami, Turkey. \$2.00 to: Meats Smoker, 2009 West 7800 South, West Jordan, Utah 84084.

PLASTICS

CASTOLITE Pours like water, hardens like glass without heat. Crystal clear or colors. Embed natural flowers, other objects. Make fine gifts. Reproduce your own designs in plastics, wax, metal, plaster, cement, etc. Make flexible molds over any pattern, any size. Profitable. Manual 25¢. **CASTOLITE**, 72H/PM, Woodstock, Ill. 60098.

FIBERGLASS Resins, Mat Cloth, Roving For Molding, layup. **PLEXIGLASS** Sheets, Rods, Tubes. Marine Plastics, P. O. Box 1844, St. Louis, Mo. 63118.

LARGEST Handicrafts Supply Catalogue \$1.00 (Refundable). R.P.H. Manufacturing, 24-M-7 Winter, Stamford, Connecticut 06905.

TREASURE FINDERS

POWERFUL Metrotech locator detect gold, silver, coins, relics. Moneyback guarantee, terms. Free information. Underground Explorations, Dept. A, Box 793, Menlo Park, California 94025.

TREASURE Hunters! Prospectors! Relco's new instruments detect buried gold, silver, coins, minerals, historical relics. Transistorized. Weighs 3 pounds. \$19.95 up. Free catalog. Relco-A40, Box 10839, Houston, Texas 77018.

FREE 140 Page Detector Catalog. General Electronic Detection Co., Box 67, Bellflower, California 90706.

SEARCH Treasure Finders. Locate gold, silver, coins, relics. Operate underwater. Money back guarantee. Free information. Search Electronics, Box 8396-A, St. Petersburg, Florida 33738.

TREASURE Hunters! Prospectors! Rockhounds! Hobbyists! Find gold, silver, relics with world famous Detectron Metal Detectors. Free information. Delivery immediate. Detectron, Dept. 7PM, Box 243, San Gabriel, California 91778.

NOW! Enjoy the great outdoors in comfort with your pocket size electronic Skeeter Skat mosquito repeller. \$9.95 postpaid. U.S.A. Satisfaction guaranteed. Detectron, Dept. F-7, P.O. Box 243, San Gabriel, California 91778.

"FIND Buried treasure with revolutionary patented, analytical metal detector. Features push button and automatic tuning, negligible ground pickup, greatest range. Free catalogue. Gardiner Electronics, Dept. 9, 4729 N. 7th Avenue, Phoenix, Arizona 85013."

FISHER DETECTORS. You deserve the best! Free literature. FRL, Dept. PM-7, P.O. Box 490, Belmont, California 94002.

FREE—VALUABLE TREASURE FINDER Catalog sent by return mail. Find Coins, Rings, Gold, Silver, Metals, Relics, Write Today. **JETCO**, Dept. CPM, Box 26669, El Paso, Texas 79926.

TREASURE MAP OF FLORIDA—Includes treasure description, approximate locations. Millions in treasures still unfound. \$5.00. M. B. 2 Enterprises, Box 1941, Cincinnati, Ohio 45201.

GOLDAK Treasure locators—Pleasure and profit in a hobby you'll enjoy. Find coins, relics, gold, silver. Charge on BankAmericard. **GOLDAK**, Dept. PM 1101-A, Air Way, Glendale, California 91201.

PRECIOUS STONES & MINERALS

500 POLISHED Gemstones \$5.00. Tumblecraft, 5401 James North, Minneapolis, Minn. 55430.

EARTH Science Rockhound Magazine. Subscription \$3.00. Sample \$.40. Box-550-PM, Downers Grove, Ill. 60515.

GET Free catalog no serious rockhound, gem cutter, jewelry maker, hobbyist or craftsman can be without. Full of bargains, exclusive items, low prices from largest suppliers and authorities in the field. Free new catalog just off the press, yours for the asking. Write: Grieger's, Dept. C-12, 1633 E. Walnut, Pasadena, California 91106.

GOLD 10 Small Nuggets Panned From Oregon Streams, \$1.00. Robert Brandt, Sweethome, Oregon 97386.

CARTOONING, COMMERCIAL ARTS, SHOWCARD & SIGN PAINTING

COMPACT 23 lesson Cartoon Course and Cartoonist's Magazine. \$2.00. Hartman, Box 30367, Lincoln, Nebraska 68510.

MODERN Cartooning taught by mail. Write for free brochure. Cartoonorama—Box 263-3G, Branford, Conn. 06405.

SIGN Painting—\$1000 per Month Part-Time. Free Catalogue. Kaufmann Supply. Centertown, Missouri 65023.

CARTOON For Money!! Big Free Book: Success, Box 885-C, Dearborn, Mich. 48121.

SIGNS! Make-your-own! **SIGN-RITE** Vinyl Self-Adhering Letters and Numbers! 5 Large Sizes! 4 Types! 8 Colors! Over 20,000 to select from! Inexpensive! Prompt Service! **FREE BROCHURE!** Aircraft Mfg. Co., Box 25034 Northgate, Seattle, Wash. 98125.

LEARN Sign painting at home. Free Talent test. Ben Kerns, Box 812-PM, Greenville, S.C. 29601.

"HOW TO MAKE MONEY WITH SIMPLE CARTOONS"—Informative book sent FREE tells way to big income. Cartoonists' Exchange, 97, Pleasant Hill, Ohio 45359.

ART Talent? Don't waste it. Self-teaching Manuals \$23.95. Free brochure. CC&CA Studios, Dept. 4, Spring Park, Minn. 55384.

ADVERTISING AGENCIES, ADV. SERVICE, MAILING LISTS

ADVERTISING Ratebook leading newspapers, magazines, 25¢. Chicago Advertising Agency, 28-E Jackson, Chicago 60604.

MAILORDER BUYERS' NAME LISTS. Gummed Labels \$9.00 per 1,000. N. D'Amato, Box 385, Port Jefferson Station, New York 11776.

RUBBER STAMPS

ADDRESS Stamp 85¢. Signature \$2.80. Catalog. Carol's. McCloud, Okla. 74851.

FREE 48 Page Catalog. Rubber stamps, printing, office supplies. Youngers Stamp Shop, Princeton, Iowa 52768.

NAME Stamp 75¢. Free Catalog. Rush Stamps, 132 Farmcrest, Rush, New York 14543.

PICTURE Catalog. Lowest Fastest Best. Newton Industries, 1071 Prosser Avenue, Prosser, Wash. 99350.

FREE Rubber Stamp Price List. Cross, 1212 Lynch, St. Louis, Mo. 63118.

RUBBER Stamps, 3 lines, \$2.00. Catalog 25¢. Tabco, Tomkins Cove, New York 10986.

FREE Stamp catalog. 45 type styles. Fast Service, low prices. Jackson's, Box 443-A, Franklin Park, Ill. 60131.

PRINTING PRESSES, RUBBER STAMP OUTFITS

TYPE, Presses, Supplies. Barco Type Mfg., 237 S. Evergreen, Bensenville, Ill. 60106.

SAME Day shipment on rubber stamp supplies. Revised wholesale price list No. 7 free. Star Stamp Supply, 732 Federal, Chicago, Ill. 60605.

SIMPLE-X RUBBER STAMP PRESSES, Hydraulic operated, electrically heated. Sizes 5"x8", 8"x12", 10"x15". Starting outfits Orders for presses, supplies shipped day received. Free catalog low supply prices. Send \$1.00 for postage and handling (refundable on first order). Custom Manufacturers, 406-P East Elm, Springfield, Missouri 65801.

RUBBER Stamp outfits, supplies. Kiewiet, 2025 Barney Road, Kalamazoo, Michigan 49007.

PRINTING Presses, type, supplies, Lists, 10¢. Turnbaugh Service, Mechanicsburg, Pennsylvania 17055.

TYPE Catalog No. 12, 120 pages. Send One Dollar. Deductible First Order. Acme Type, 732 Federal, Chicago, Illinois 60605.

LOW Priced Rubber Stamp Manufacturing Supplies, Starting Outfits. Martin, 1432 Major, Jefferson City, Missouri 65101.

MAKE Your Own self molding Rubber Stamps and printing cuts. Plexirubber, Argyle A, Wisconsin.

RUBBER Stamp manufacturers supplies. Presses, starting outfits. Best prices, service. Catalog. Jackson Supply, Box 443-A, Franklin Park, Ill. 60131.

PRINTING AND SUPPLIES

FREE Offset Catalog. Fast-Economical. Seaview, 212-26P 48th, Bayside, N.Y. 11364.

PHOTO Offset Printing, 100 (8½ by 11) Copies \$3.00, 500 Copies \$6.50, 1,000 Copies \$9.50. Same Day Shipment, Nationwide Printing, 75 Chester, Champaign, Ill. 61820.

1,000 BUSINESS Cards, Letter Heads, Note Heads, And Call Notes \$4.95. Superioex, Avon Lake, Ohio 44012.

BUSINESS CARDS Raised Letters \$5.65 Thousand. Like Engraved. Free Samples. Kavanagh, Box 1222, Brooklyn, N.Y. 11202.

BUSINESS Cards, Rubber Stamps, Printing. Free Literature. Jordan's, 552 West O'Connor, Lima, Ohio 45801.

ORDER WITH CONFIDENCE (our 37th Year) 250 two color business cards \$3.00 Postpaid. Samples \$1.00 deductible. Lefty Gandy, Lyons, Ga. 30436.

(Continued on next page)

PRINTING AND SUPPLIES

(Continued from preceding page)

EMBOSS Business cards, personalized printing. Brennen, 1404 Carolina, Middletown, Ohio 45042.

FREE Information about personalized printing. Longwood Press, D-47G2, Fort Johnson, N.Y. 12070.

GUMMED LABELS

1,000 GUMMED ADDRESS LABELS \$1.00 FREE CATALOG, Acme Supply, Dept. PM-72, 1238 Voskamp, Pittsburgh, Pennsylvania 15212.

1,000 GUMMED Address Labels \$1.00, Walt's, Box 966A, South Bend, Indiana 46624.

REMAILING SERVICE

CONN. Or **OHIO** Remails 25¢. **PRATT**, R.F.D. #3, Guilford, Conn. 06437.

SAN FERNANDO, California, Confidential Remailing Only 25¢. Moser, Box 1102, Sylmar, Calif. 91342.

WASHINGTON DC Postcards 5/\$1.00. Remails 25¢. Gabriel, Box 4552, Washington D.C. 20017.

TACOMA/SEATTLE Remails 25¢, \$3.00 monthly. Opportunities Unlimited, 10610 Bridgeport Way, Tacoma, Washington 98499.

CHICAGO Remailings, 25¢ Singles, \$3.00 Monthly. MoDern, Box P-27056, Chicago 60627.

CLEVELAND Remails 25¢, Confidential, Details Free, Rod, P. O. Box 02182, Cleveland, Ohio 44102.

REMAILING And Forwarding. Very personal, Monthly rates, or 35¢ a letter. Kaye Sales, Box 674-M, Chicago, Ill. 60690.

RECEIVING-Forwarding. Monthly rates. Hedgpath, 324-M South First, Alhambra, Calif. 91802.

CONFIDENTIAL New York City mail address \$3.00 month. Remails 25¢. Details Free, Birnhan, 152 W. 42, New York City 10036.

SECRET. Receiving—forwarding. Discreet and confidential. Remail 25¢ single. Mail Forwarding Service, 8050 S. Main, Houston, Texas 77025.

ALBUQUERQUE Remails. Single 25¢, monthly \$3.00. Airmail \$1.00. 2400 Shasta Rd. S.W. Albuquerque, New Mexico 87105.

PARADISE, Angels Camp, Smartville, Rough 'n Ready, Remails. Your choice 50¢. Monthly rates. Rose, 3068 Warrington, San Jose, Calif. 95127.

CONNECTICUT Remails 25¢ \$3.00 Monthly, Schaller, 49 Brookside Ave., Torrington, Conn. 06790.

CONFIDENTIAL Receiving-forwarding. Monthly rates. Wright, Box 2112-M, Asheville, N.C. 28802.

TEXAS—Economic, Receiving-Forwarding-Remailing. Nortex, Drawer 5370, Fort Worth, Texas 76108.

DENVER Receiving—Forwarding. 25¢, \$3.00. Details free. Rich, Box 26099, Denver, Colorado 80226.

EXOTIC HAWAII, Remails 25¢ each. \$3.00 Monthly. Dorcliff, Inc., 736 South Street, Honolulu, Hawaii 96813.

REMAILING Service South America. Receiving-Forwarding. 50¢. Single. Narvaez, Apartado Aereo 29280, Bogota, Colombia.

FORWARDING-RECEIVING. 25¢. Monthly Rates. Mosher, Box 2544, Santa Clara, Calif. 95051.

FREE Address Stamp to new mail subscribers. \$3/mo. **SPECTRUM**, 1619 Pineview Rd., Charleston, S.C. 29407.

MIAMI BEACH-MIAMI 25¢. Receiving-Forwarding Monthly. Famailco, C-7, Box 543, Miami, Florida 33145.

NIAGARA FALLS DAILY REMAILS—50¢. Barlow, Box 265, Fort Erie, Canada.

CONFIDENTIAL. Remails 25¢, Monthly \$3.00. Box 9581, **BALTIMORE, MARYLAND** 21237.

PARIS London Remailing letters post cards, \$5.00 West, 1403 South Third, Wilmington, N.C. 28401.

SPECIAL SERVICES

CHEMIST FOR HIRE By the job. Trouble shooting, formulas, consultation, research. Free estimates. Kenneth Burchette, Box 1114, Spring Valley, California 92077.

INFORMATION On anything. Ferguson Research Specialists, 83-45 Vietor Ave., Elmhurst, N.Y. 11373.

TOBACCO

WANT TO STOP SMOKING? Plan shows you how, results guaranteed or money back. Send only \$2.00 to: Stop Smoking, Box 131-B, Marlboro, Mass. 01752.

PERSONAL

SECRET PLAN Wipes Out All Debts. Get \$600 to \$25,000 relief. Clear credit. Free details. Counselor-7, Kerrville, Texas 78028.

MAKE YOUR WILL. Get 4 Will Forms and attorney's informative book. \$1.50. Legal Forms Company, Department 124, 1830 Guardian Building, Detroit, Michigan 48226.

WHAT'S YOUR I.Q.? Educator's designed test sharpens your observation, analysis, and reasoning powers. Send \$2.00 today! G/L Tests, 893 Meadview, Cleveland, Ohio 44131.

LET Expert Arrange Swiss Account. Devaluation History Repeats. Prepare Immediately! Sixty Pages, Silver Profits, Secret Procedures. Forward Two Defrayment Dollars. Advisors, 943 Fair, Prescott, Arizona 86301.

PSORIASIS Sufferers: Discouraged? Write for Free important information that is helping thousands! Pixacol, Box 38-PM, Avon Lake, Ohio 44012.

HAPPINESS. Send for article, "The Art of Achieving Happiness." Mail one dollar. Bernard Putnam, Box 12462, Seattle, Wash. 98111.

PAY Bills! Borrow to \$1500 by mail! Convenient terms! State licensed. Postal Finance, 6018 Military Avenue, Dept. 17-N, Omaha, Nebraska 68104.

SWEET-FEET Sweetens Sweaty, Odious Feet. \$2.00. Paragon Products, 939 S St., N.W., Washington, D.C. 20001. Money-back guaranteed.

DEBTS WIPED OUT! Anyone (bankrupts included) can have excellent credit in 45 days. Free!!! Wealth Building, Box B-7, 8840 Hoyt Drive, Thornton, Colorado 80229.

BIBLE Questions answered. Stamped envelope. Bylon, 17167 Bentler, Detroit, Michigan 48219.

INVESTIGATORS. Latest electronic Aids. Free Literature. Clifton, 11500-P NW 7th Ave., Miami, Florida 33168.

IMPROVE YOUR PERSONALITY, Write for free information: **PERSONALITY SUCCESS**, Dept. C-14, Box 1946, El Paso, Texas 79950

"**RULE** Others With Thoughts." (Telepathy) write: Clarion, Box 1769-S7, Chicago, 60690.

HAVE Triple-A credit in thirty days! Get new credit without investigation! Continental, Box J-24, Hallandale, Florida 33009.

ADULTS! Free Brochure Unusual Books! (Not Smut). PPW, 2030 South Shenandoah, Los Angeles, Calif. 90034.

REDUCE Cholesterol and heart attack risk. What to eat. What to avoid. Very detailed. \$2.00. Andel, Box 32002, Cincinnati, Ohio 45232.

CASH LOANS by mail! Up to \$2,500 on signature alone. No collateral! Secret! Union Finance Company, 3608 No. 16th St. Dept. PM, Phoenix, Ariz. 85011.

RUPTURED. Relief and comfort. No understraps, elastic or steel. Write Hand-Lock Products, Preston 4, Ont., Canada.

ACNE? Clear your skin—or pay nothing! Write "CLEAR-A-SKIN", Box 213, Glen Oaks, New York 11004.

MAKE YOUR WILL TODAY!! Protect loved ones! Blank form, instruction booklet—\$2.00. Moneyback Guarantee!! Coastforms-1A7, Box 6433, Santa Barbara, California 93111.

STOP SMOKING—PRIZE METHOD EMPLOYS UNIQUE Stunning STOPPER. Booklet Unconditionally Guaranteed \$1.00. Camala, Box 841M, Florissant, Mo. 63033.

FREE! List of Low Cost Popular Books. Success, Happiness, Personality, Wealth, Personal Problems. Richard Glover, PM4, 351 West 10th. Avenue. Eugene, Oregon 97401.

IMPROVE Your Personality. Fascinating 110 page Book reveals Techniques. Use your subconscious mind. Makes you a new personality. Be a lively one. Begin to live. Read how! Send \$1. Powell Bros., Dept. P-1, 3916 Bateman Ave., Baltimore, Md. 21216.

SMOKING Can Be STOPPED. Money back Guarantee \$1.00. Varner, 132-1 Rolph Drive, Forest Heights, Md. 20021.

AT LAST . . . A Bible YOU can understand. **THE LIVING BIBLE**. Billy Graham says: "I believe that this paraphrase communicates the message of Christ to our generation." Deluxe Padded Green Binding. \$9.95 postpaid. **THE LIVING BIBLE**, the world's most readable Bible. Mail to: The Christian Library Service, Box 1243-PM, Arlington, Texas 76010.

UNDERSTAND Your dreams. 110 page booklet analyzes innocent dreams and reveals their mysterious inner meanings. You'll be amazed! Send \$2.00. Gifts Galore, 102 Hilltop Drive, Algonquin, Ill. 60102.

4 WILL Forms, Attorney's Instructions, Guaranteed!! \$2.00. Dept. 1P27, Wayman House, 2024 Orchard, Orange, Calif. 92668.

ASTROLOGIST—DR. FINE Answers Your Questions Per 1-hr. C-Tape With Forecast; Send Birthdate & \$25.00. Box 221, Montreal 260, Canada.

WANTED-MISCELLANEOUS

COMIC Books, Kids Radio Premiums, Pulp Magazines. Paying \$200 for one comic. Check your attics. Wooley, Box 290, Peoria, Ill. 61601.

MERCURY, Gold, Silver, Platinum: Ores assayed. Wholesale Terminal, Norwood, Mass. 02062.

MISCELLANEOUS

SAVE Up to \$200.00 year—on costly **PLUMBING REPAIRS**. You can! Amazing new booklet—by Master Plumber with 25 years experience—shows how. Send \$2.00 today! Satisfaction guaranteed. Crown House, 19212 Santa Maria, Dept. PPM7, Hayward, Calif. 94546.

DOG CHASER, protect yourself! **POCKET**-size, ultrasonic, \$49.95. PCM Industries, Inc., 7239 Columbia Pike, Annandale, Virginia 22003.

CIGARETTES 15¢ a pack. Improved roller makes 20 filtertip, plain, king or regular for 15¢. Facts free. Green River Tobacco, Box 954, Owensboro, Kentucky 42301.

DON'T DIE Without A Will! Will form kit protects your family! Will form, instructions. . . only \$2.00! Guaranteed! Order Today! Security, Box 457, Dept. 167 Albany, Louisiana 70711.

MISCELLANEOUS
(Continued from preceding page)

ONE DOLLAR—Buys engraved metal Social Security plate. Please print. Variety Sales, P.O. Box 59, Vinton Va. 24179.

DON'T DIE WITHOUT A WILL! BLANK WILL FORM PROTECTS YOUR FAMILY. ONLY \$2.00—GUARANTEED! ORDER TODAY!! CAMPBELL, 2079 WOODBOURNE, DEPT. 1PM, BALTIMORE 21239.

CHAMPAGNE & WINE Complete Illustrated Instruction Manual with recipes. Enjoy making and tasting it—use kitchen equipment. Send \$2.00. G & M Products, Box 830-PM, La Canada, Calif. 91011.

NAZI Souvenirs! Illustrated catalog \$3.00 cash. Disco, Box 8035, Milwaukee, Wisconsin (53223).

ROUT RATS, Rodents. Easy, sanitary, Ultrasonic **RATICATOR.** \$139.50. PCM Industries, Inc., 7239 Columbia Pike, Annandale, Virginia 22003.

WINE, CHAMPAGNE! Homemade, inexpensive! Secret methods revealed only \$2.97! Max Moser Enterprises, Box 1102P, San Fernando, California 91341.

PROTECT YOUR CHECKS!!! Pocket Check Writer. Prints businesslike numbers. Cannot be altered!! Small, compact. Guaranteed \$5.95. Ruth Enterprises, Route 3, Owensville, Missouri 65066.

WOODEN Nickels 10¢ each. 50¢ Minimum. Dynamic Sounds, 1404 Grant, Denver, Colorado 80203.

PROTECT Your family! Legal will forms with 63-page booklet & new legal format information \$2.00 postpaid. Satisfaction Guaranteed. Crown House, 19212 Santa Maria, Dept. WPM7, Hayward, Calif. 94546.

MAKE GREAT WINES AND CHAMPAGNES! Delicious. Fun to make using home utensils. Simple, step by step instructions. Excellent, proven recipes. Guaranteed. \$3.00. Sigma, P.O. Box 91033-B, Cleveland, Ohio 44101.

SACK Of Hops, Plus Wine Yeast. With 101 Winemaking And Sourdough Recipes, Including Catalog—Send Only \$1.00. Nichols Hops, 1190PM North, Albany, Oregon 97321.

WINEMAKER'S Supply Catalog—Free. Bacchanalia, 273 Riverside Ave., Westport, Conn. 06880.

WINEMAKERS!! Fermentation locks—3/\$1.00. Free Illustrated Catalog Plus \$5.00 Credit Coupon. Werth Wine, Box 1902AV, Cedar Rapids, Iowa 52406.

WINEMAKING Kit—\$4.98 Free Catalog and Recipes. JIMDANDY, Box 30230M, Cincinnati, Ohio 45230.

SUFFERING From Arthritis? Try Ginseng! Information Free. Write Ginseng, Asheville 53, North Carolina.

WINEMAKERS Yeast, Recipes & Catalog 25¢; Kraus, Box 451-L, Nevada, Missouri 64772.

ORNAMENTAL Iron designs. Book of 1600 beautiful, practical designs for railings, columns, etc. Free literature. Cunningham, 3881 South 3200 West, Salt Lake City, Utah 84119.

WINEMAKERS. Free illustrated catalog of yeasts, equipment. Semplex, Box 12276, Minneapolis, Minn. 55412.

IDENTIFICATION Cards, Send stamped self-addressed envelope for samples. Identification, Box 12117, Las Vegas, Nevada 89112.

HEARING Aid batteries wholesale. Free list. Habs, Box 51, York, Penna. 17405.

WINEMAKERS. . . . Free Illustrated Supply Catalog of Yeasts, Equipment, Recipes. Winemaker, Box 11211-PM, Indianapolis, Ind. 46201.

CREDIT Cards! Receive all kinds fast, easy. Get new credit without investigation! Continental, Box J-23, Hallandale, Florida 33009.

LOSING HAIR? BALDING? DANDRUFF? Get Dr. Shiffer's free copyrighted booklet, "Are You Washing More Face". **DR. SHIFFER LABORATORIES,** Dept. 536, P.O. Box 398, Punta Gorda, Florida 33950.

WINEMAKERS: Free informative catalog, recipes. Arbolyn, Box 663, West Columbia, S. C. 29169.

PRE-PACKAGED Toys complete with free self-selling display rack. Free Details. Toys, 1916 Fifth, Sacramento, California 95814.

QUIT Smoking! New Ideas! Follow instructions. Within two months finish cigarettes for good. Money back Guarantee. \$1.00. Junior, Box 102, New Wilmington, Penna. 16142.

SOLID Gold-Plated Eisenhower Silver Dollars 1971 or 1972 \$2.95. Owen Cox, 514033 U.S. 31, South Bend, Indiana 46637.

BIRTH Certificates, Marriage Certificates, Diplomas! 2 blank forms \$1.00. Sample 10¢. Standard Forms, Box 482-M, Washington, D.C. 20044.

SLEEPATRON. New device for inducing sleep. Gardiner Electronics, Dept. C, 4729 North 7th Avenue, Phoenix, Arizona 85013.

HOMEWINE MAKING SUPPLIES And INGREDIENTS CATALOG With RECIPES For Year Round Winemaking. It's A Fascinating Hobby. We Also Have Supplies And Concentrates For Your Wine Kit. Send For Free Catalog. Danenberger, Box 276-M, New Berlin, Illinois 62670.

PAINT Life-Size Oil Portraits of Anyone in Minutes or Double Your Money Back! Fantastic Method, \$3.98; Jiffy Portrait, 1315 Ronan, Wilmington, Calif. 90744.

SAVE 50%. New books, guaranteed, free catalog. Enterprises, Silver Lake, Minnesota 55381.

ATTENTION WINEMAKERS! Make delicious grape, cherry, elderberry wines & champagne. Recipes \$3.00. Arnold, Box 94307, Oklahoma City, Okla. 73109.

RENT \$7 Monthly. Newest Telephone Answering Machine. Will Answer Your Phone When You Can't. Courteously In Your Own Voice. Records Each Message Clearly, 24 Hours A Day. No Installation! Just Plugs In. Small Deposit. Spots, 4880 49 St. N., St. Petersburg, Florida 33709 813 525-5586.

EXCELLENT DOCUMENTS!!! Birth—Marriage—Divorce—Karate—Locksmith—Up-holsterer—Welder—Carpenter—Electrician Licenses. High School—College Diplomas. Rushed Airmail!!! Two—\$1.00. Five—\$2.00. Deluxe (Goldseal) Documents \$1.00 each. Moneyback Guarantee!!! Filiforms, Box 1332-BF, Albany, New York 12201.

WOOD BARRELS AND KEGS. Wine Barrels, Oak Planters. Send 25¢ For Illustrated Catalog. Cordell Enterprises, 1622 West Morse, Chicago, Illinois 60626.

SIGHT-LIGHT Puts a Bright Beam of Light Along Your Line of Sight. Lights Gun Barrels, Pipes, Auto Parts, Etc. \$4.95. Brooks Enterprises, Dept CB7, 6405 West 82nd Drive, Arvada, Colorado 80003.

CUSTOM Blended Pipe Tobacco—Finest Tobaccos, Expertly blended, Factory fresh. Write for free samples. Green River Tobacco Company, Since 1914, Box 991, Owensboro, Kentucky 42301.

STANLEY STEAMER Steams away wrinkles, hang up clothing, jet-powered steam makes wrinkles disappear. **SAFE** for synthetics. \$10.98 **ANDERSEN ENTERPRISES 7 PLYMOUTH W. BABYLON, N.Y. 11704.**

DON'T DIE WITHOUT A WILL!! Will forms and instruction book \$1.98! Guaranteed! Wills, Dept. 7PM1, 3406 Sands, El Paso, Texas 79904.

WINEMAKERS HANDBOOK Make Marvelous Wines Sparkling Champagne Guaranteed finest available. Send \$3.00 **FOX ENTERPRISES, Box 211, Marion, Ky. 42064.**

U.S. \$1000 Bills!! Obsolete Replica's 5/\$4. Genuine Quarter-Heads On Both Sides!! \$3.95. National, Box 1391-X, Clearwater, Florida 33517.

DON'T Die without a will! Instructions, Blank Will Forms, and Pen! \$2.00 Guaranteed! Order today! Sheller, 2446 Birch Street, Easton, Pa. 18042.

350 NOVELTY Buttons, T-Shirts,—Patches, Posters. Catalogue 10¢. Novelty Mart, Box 233PM, Bethpage, New York 11714.

WINEMAKERS Our Vintners Proven Methods, Time Tested Recipes And Supply Catalog. \$1.00. Vintner, Box 611-D, Pomona, California 91769.

ILLUSTRATED Repair Manuals, Volkswagen and Cycles. Honda, Harley, BSA, Yamaha, Triumph, Suzuki, \$5.50. Lumsden, 330 Pleasant, Petaluma, California 94952.

MAGNETS, All types. Specials—20 disc magnets, or 2 stick magnets, or 10 small bar magnets, or 8 assorted magnets, \$1.00. Maryland Magnet Company, Box 192-A, Randallstown, Maryland 21133.

WINE CHAMPAGNE Easily made using standard kitchen utensils. **BONUS** book FREE. Other successful recipes. Guaranteed \$3.00. **MARWOOD,** Box 585, Troy, Ohio 45373.

DEATH Comes Unexpectedly! Be Prepared! Make a will. Forms, instructions—\$2.00. Willco, Box 6025, Athens, Ga. 30604.

MAKE WINE And CHAMPAGNE At home. **COMPLETE EASY INSTRUCTIONS.** Satisfaction Guaranteed. Send \$2.00. Ventures, Box 832-M7, Kingsport, Tennessee 37662.

WOULD YOU LIKE TO KNOW HOW TO— Stop Stuttering,—Stop Cesspool Troubles,—Sand An Old Floor. Easy, Cheap, Each Question For \$1.00. Please Send Enclosed With Your Question A Self-Addressed Stamped Envelope And Your \$1.00—To: Robert P. Hayes, 47 Island Street, Brant Rock, Mass. 02020. I Have Stopped Many From Stuttering.

WATER FURNITURE—COUCHES, CHAIRS, BEDS—KITS—PLANS Build your own durable, comfortable, colorful, and inexpensive water furniture. Suitable for family rooms, living rooms, patios, or pools. Kits contain couch, chair, or bed in 20 gauge blue or gold vinyl, with plans for easily constructed support frames. Nine-foot couch kit, \$35. Chair, \$15. Lounge chair, \$25. Six-foot couch, \$25. Bed, \$20. Fully guaranteed. Florida Waterbed Corporation, 148 N. Brevard Avenue, Cocoa Beach, Florida 32931.

BOOKBINDING Send 25¢ for information. P.O. Box 1008G, Fremont, Cal. 94538.

CAPITALISTS Should open Schools in Shopping Centers using closed Circuit TV. Private Tutoring. For free plan send stamped envelope: Box 552, Pomona, Cal. 91769. No buying, selling.

WINEMAKERS—New illustrated catalog of supplies and equipment. Wollersheim Winery, Prairie-du-Sac, Wisconsin 53578.

BURGLAR ALARMS & HOME PROTECTION

FREE Catalog on Burglar-fire Alarm Equipment. Protecto Alarm Sales, Box 357-D, Birch Run, Michigan 48415.

ALARM SYSTEM Plans For Building Effective Protection Against Burglary, Fire, Freezer Failures, Etc. Includes Instruction Plans For: 7 Different Systems; 2 **EMERGENCY POWER SYSTEM** Plans For Lighting Inside Outside Home, And Alarm Backup Using Storage Battery During Power Failures; And 3 Cabinets. Includes Materials List. Complete Set \$4.00. American Conflux, Inc., Box 5704M, Redwood City, California 94063.

ANTI-BURGLARY Protection Plan—proven amazingly effective. Free details. Write: Arnon & Assoc., 6427-P Fairland, Indianapolis, Ind. 46259.



**Works
like a truck.**

Ford pickups ride like no other pickup because no other pickup has Twin-I-Beam suspension. Each front wheel has an I-beam axle that works independently to step over bumps. Steering is precise. Cornering is flat. And there is practically no nosedive when braking. In the rear, a unique leaf-spring suspension is offered that automatically adjusts spring stiffness to loads.

**Rides
like a car.** And loads are what Fords thrive on—92 out of every 100 Ford trucks sold in the past 12 years are still on the job. Get a fully detailed catalog as well as a revealing test drive at your Ford Dealer's.

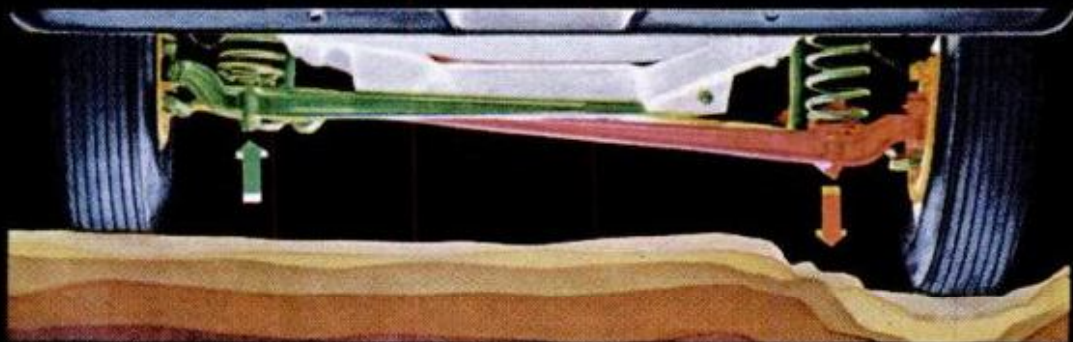

FORD PICKUPS





Pure menthol. In just the right amount. It gives KOOL that taste of extra coolness. Come all the way up to KOOL.



Warning: The Surgeon General Has Determined That Cigarette Smoking Is Dangerous to Your Health

18 mg. "tar," 1.4 mg. nicotine av. per cigarette, FTC Report Aug. 71.