

4 GREAT VACATION HOMES

29 pages | New vehicles
New gear
New ways to go
MOTOR CAMPING

Popular Mechanics

MAY 1972
50 CENTS

HOMEBUILT AIRCRAFT

17 of the best homebuilt planes in the U.S.

A great new series begins on page 88

American Motors' 'Buyer Protection Plan'—is it all they say it is? Page 94

Bill Warwick's W-3 Bantam

How to repair appliances

Bicycle repairs: An expert shows you how

What Lobster did for Maine, Old Crow did for Bourbon.

The good taste of Lobster put Maine on the map. And the good taste of Old Crow made Bourbon famous. Before 1835, Bourbon was made every which way. That year,

Dr. James Crow took it out of the hit-or-miss league and invented the process that gave Bourbon its mellow taste—and good name: Old Crow.



KENTUCKY STRAIGHT BOURBON WHISKEY, 86 PROOF, DISTILLED AND BOTTLED AT THE FAMOUS OLD CROW DISTILLERY CO., FRANKFORT, KY.

CAR BUYING MADE EASIER

Second Edition

TABLE OF CONTENTS

SECTION I CAR BUYING IN GENERAL

Car Models and Features		Page
Chapter 1	What Kind of Car to Buy	1
Chapter 2	Options	10
Chapter 3	The Interior	18
Chapter 4	The Exterior	25

Buying Your New Car

Chapter 5	The Dealer	30
Chapter 6	Personal Check Lists	32
Chapter 7	Test-Driving Before You Buy	33
Chapter 8	Your Present Car	35
Chapter 9	Financing	38
Chapter 10	Insurance	

New Car Ownership

Chapter 11	Operating Tips	
Chapter 12	Maintenance	

SECTION II FORD MOTOR COMPANY

Chapter 1	1972 Ford Division Car Line	
Chapter 2	1972 Lincoln-Mercury Division	
Chapter 3	Engines	
Chapter 4	Transmissions and Rear Axles	
Chapter 5	Suspensions, Ride and Handling	
Chapter 6	Brakes	
Chapter 7	The Basic Options	
Chapter 8	Interior Options	
Chapter 9	Exterior Trim Options	
Chapter 10	Wheels and Tires	
Chapter 11	Safety Features	
Chapter 12	Anti-Pollution Advancements	
Chapter 13	Trailer Towing	
Chapter 14	Prices	

And Space for Notes

**We've sent out over 750,000
copies of our free book.
Interested?**

For your copy, write:
Ford Motor Company Listens; P.O.
Box 1958, The American Road-CM;
Dearborn, Michigan 48121.

Mr. Miss
 Mrs. Dr.

Phone _____

Name _____

Address _____

Apt. No. _____

City _____

State _____

Zip _____



...has a better idea
(we like it)

This One



ZFD7-A6Z-AG9Z

Allstate can't
But we can sure help give



stop it.

you a new start.

Allstate Homeowners Insurance gives you more protection at less cost than similar policies from many other companies.

We not only protect your home against loss from windstorm . . . but many other hazards, such as . . .



Robbery



Lightning



Personal liability



Hail



Explosion



Smoke damage



Fire



Vandalism



Fire on Contents

Allstate[®]
You're in good hands.

Available in most states. Standard rates in Texas.

Материал, защищенный авторским правом

HOW TO ...

Convert your van
to a camper ... 154



Make a handsome
occasional table ... 140



Get good sound
for home movies ... 110



Build a jungle-gym
tree house ... 131



AUTOMOBILES, DRIVING

- [21 Psss-s-s-t! Wanna build a steam minibike?](#)
- [58 Drivin' with Dan](#)
- [94 PM Owners Report: AMC Ambassador—a 'Guaranteed Car'?](#)
- [114 PM Owners Report: Chrysler Town and Country](#)
- [120 Saturday Mechanic: Troubleshooting vibrations](#)
- [166 MPG meter: Constant measure for driving economy](#)

HOME AND YARD

- [77 Vacation homes: year-round casual living](#)
- [102 Riding mowers for '72](#)
- [106 New hinged tractor with front-wheel drive](#)
- [108 Jacobsen GT-14: The frame makes the difference](#)
- [126 Exciting new products](#)
- [128 Things to make](#)
- [136 Better ways to do it](#)
- [138 Anyone can lay this new stick-down shag](#)

SPACE, AVIATION, MILITARY

- [50B How satellites put you on the scene—instantly!](#)
- [88 A high-flying hobby really takes off](#)
- [89 Bantam—a homebuilt beauty](#)

ELECTRONICS, RADIO, TV

- [48 New in electronics](#)
- [99 Taking the high cost out of hi-fi](#)
- [180 Have music wherever you go](#)

SCIENCE, INVENTIONS

- [118 Just patented: Rocker-wing plane almost flies itself](#)

'72 RV CAMPING SPECIAL

- [150 Recreational vehicles: How to pick your new one](#)
- [154 Convert your van to an inside-outside camper](#)
- [160 Twenty questions motor campers ask most](#)
- [162 How to be a savvy RV pilot](#)
- [166 MPG meter: Constant measure for driving economy](#)
- [170 You have a wide choice in rolling rigs this summer](#)
- [172 Mini-trailers](#)
- [174 Mini-motor homes](#)
- [176 Fifth-wheel trailers](#)
- [180 Have music wherever you go](#)
- [182 Accessories](#)

SHOP AND CRAFTS

- [140 Make this tambour-doored occasional table for \\$41](#)
- [144 Hints from readers](#)
- [145 Tools you should know about](#)
- [146 Make aluminum cutters and knurls from helical gears](#)
- [148 Hints from readers](#)

PHOTOGRAPHY

- [46 Photo hints](#)
- [110 New home movies can sound good, too](#)
- [124 Now: A no-miss flash you can shoot from anywhere](#)

EVERY MONTH

- [6 Letters](#)
- [26B Automobile Clinic](#)
- [26F All Outdoors](#)
- [35 Appliance Clinic](#)
- [38 Detroit Listening Post](#)
- [42 Science Worldwide](#)
- [55 Homeowners' Clinic](#)
- [67 The Bicycle Shop](#)
- [118 Just patented](#)

Cover photo by Henry Artof

Bill Warwick's W-3 Bantam—first in a great new series of homebuilt aircraft to appear in Popular Mechanics (see page 89)

AS A SERVICE TO READERS, Popular Mechanics publishes newsworthy products, techniques and scientific and technological developments. Because of possible variance in the quality and condition of materials and workmanship, Popular Mechanics cannot assume responsibility for proper application of techniques or proper and safe functioning of manufactured products or reader-built projects that result from plans published in this magazine.

JIM LISTON

Editor

SHELDON M. GALLAGER **JOHN A. LINKLETTER**
Executive Editor Managing Editor

WAYNE C. LECKEY **ALVIN KIETZ**
Home and Shop Editor Art Director

Published by The Hearst Corporation
RICHARD E. BERLIN, PRESIDENT

RICHARD E. DEEMS
President, Magazines Division

JOSEPH F. KERN
Publisher

BILL HARTFORD _____ Automotive
JOHN F. PEARSON _____ Science and Engineering
WM. T. McKEOWN _____ Boating and Outdoors
IVAN BERGER _____ Electronics and Photography
HARRY WICKS _____ Home Workshop
MICHAEL LAMM _____ West Coast
ROBERT LUND _____ Detroit Automotive
GARRY WINTER _____ Copy Chief
RICHARD H. FUNK _____ Production
ALFREDO VEGA _____ Assistant Production
DON EVANS _____ Technical Art Director
FRED A. LEERS _____ Assistant Art Director
JOSEPH P. BEATON _____ Assistant Art Director
DAVID KOMITAU _____ Assistant Art Director
CLIFFORD B. HICKS _____ Special Projects
SOPHIE GRONOWICZ _____ Director, Bureau of Information
EVERETT JOHNSON _____ Cabinetmaker

ADDRESS ALL EDITORIAL COMMUNICATIONS TO: 224 West 57th St., New York, N.Y. 10019. For additional sources of information on the articles and products in this issue, write to Bureau of Information, Popular Mechanics, for free "Where-to-Find-It" list.

DANIEL J. COLEMAN
Director of Advertising

ADVERTISING OFFICES: New York: 224 West 57th St., 765-6850; Chicago: 520 N. Michigan Ave., 527-2400; Detroit: General Motors Bldg., TRinity 5-8711; Cleveland: 20310 Chagrin Blvd., Shaker Heights, 283-7788; Los Angeles: 601 North Vermont Ave., 666-6263.

JOHN A. REGINA _____ Advertising Production Manager

SUBSCRIPTION SERVICE: Mail all subscription orders, changes of address, correspondence concerning subscriptions, and Postmaster notices of undeliverable copies to Popular Mechanics, Box 646, New York, N.Y. 10019. Please enclose your latest address label for quickest service when writing about your subscription.

POPULAR MECHANICS IS PUBLISHED MONTHLY by The Hearst Corporation, 57th St. at 8th Ave., New York, N.Y. 10019, U.S.A. Richard E. Berlin, President; Richard E. Deems, President of Magazines; John E. Miller, Executive V-Pres. of Magazines; Raymond J. Petersen, Senior V-Pres. of Magazines; William S. Campbell, V-Pres. of Magazines; Albert A. Rachol, V-Pres. and Director of Circulation; Joseph F. Kern, V-Pres. for Popular Mechanics; Frank Massi, Executive V-Pres. and Treasurer; Harvey L. Lipton, Secy. Single copy in the United States and Canada, 50 cents. Subscription prices: United States and Possessions \$5.00 for one year; \$9.00 for two years; \$12.00 for three years. Canada, add \$2.00 for each year. All other countries, add \$4.00 for each year. When changing address, give old address as well as the new, with postal-zone number, if any, and allow six weeks for change to become effective. Second-class postage paid at New York, N.Y., and at additional mailing offices. Authorized as second-class mail by the Post Office Department, Ottawa, and for payment of postage in cash, Registered as second-class matter at the Post Office at Mexico D.F., Mexico, June 20, 1950. © 1972 by The Hearst Corporation. All rights reserved. Printed in U.S.A.

MAY 1972

Build yourself a better drink.



WINDSOR CANADIAN

Canada's smoothest whisky.

CANADIAN WHISKY—A BLEND • 80 PROOF • IMPORTED BY NATIONAL DISTILLERS PRODS. CO., N. Y.

BUILD IT YOURSELF

MINI-DOZER®

Rugged, compact bulldozer. Smooth lawn or cleared dozer tracks. Unique transmission allows 360° turns in its own length. 7 & 12 hp engine models. Attachments include lawn mower, dozer blade, snow blower, etc. "Build-it-yourself" Plans — \$5.00.



12 hp Kit
\$698.95



12 hp Kit
\$598.95

TURF-RIDER®

Man-sized tractor for tough lawn and garden use. Attachments include lawn mower, snow blower, plow, cultivator, etc. Complete kit with 12 hp electric start engine — \$598.95. Plans — \$5.00.

TS-5 TRAIL BIKE®

Rugged 7 hp 'two-wheeler' with 12" wide x 21" dia. low pressure tires to take you there and back with safety. Plans — \$2.00.

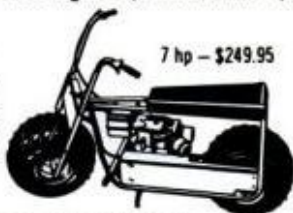

7 hp — \$249.95

COMPLETE 48-PG CATALOG

of all 30 tractor assembly kits — \$1.00.
(Note: Plans and Catalog prices refunded on any purchase.)



POWER HACKSAW — KIT \$24.95

Also 51 other money-saving projects to be built for the home workshop. Lathes, drill presses, vises, etc. Complete 28-pg 'homeshop' Catalog — 50¢.

\$24.95

STRUCK CORP., Dept. PM52, Cedarburg, Wis. 53012

FREE H&R COLOR CATALOGS FOR HUNTERS AND FISHERMEN



Great double catalog offer for all-around sportsmen. Full-color, 44-page Harrington & Richardson Firearms Catalog features H&R sporting rifles, shotguns, revolvers plus famous Webley shotguns from Britain, an H&R exclusive. Also 44-page H&R Angler's Catalog on full line of internationally-known Hardy fly fishing rods, reels and accessories, another U.S. exclusive from H&R. Mail coupon today for your free copies.

HARRINGTON & RICHARDSON, INC.
Dept. PM572 320 Park Ave.
Worcester, Mass. 01610, U.S.A.

- Please send free copy of H&R Firearms Catalog, postage paid.
 Please send free copy of H&R Angler's Catalog, postage paid.

NAME _____
(please print)

ADDRESS _____

CITY _____

STATE _____ ZIP _____

LETTERS

TO THE EDITOR

If sugar doesn't work . . .

Regarding the item, "Stop hiccups with sugar," in *Science Worldwide* (page 36J, March PM), I have a pet cure that really works. Several spoonfuls of gelatin, any brand or flavor, swallowed rapidly, will do the trick. In the absence of gelatin, yogurt makes a pretty good substitute.
DALLAS, TEX. E. P. ALDREDGE

When my husband was in the hospital, he developed hiccups that lasted 11 days. Doctors and nurses tried everything they could think of. Finally, one nurses' aide suggested he take bites of peanut butter. Within an hour his hiccups left. He did get them back once or twice but always kept a supply of peanut butter on hand; after two days, they disappeared forever.
HUDSON, IOWA MRS. KENNETH SCHLICHT

Handsome buffet

I built the roll-out bar (*A handsome buffet that leads a double life*, page 140, Dec. '71 PM) and am very satisfied with it. I'm one of those guys who never seem to be able to do anything right with wood and am constantly learning from my first mistakes. Anyway, the bar cost me about



\$90, and it's an item anyone would be proud to have in his house.

The interior is a beautiful cherry red. I did not put in the bottom pieces for the wine rack, and I put a back on the cabinet, painted a flat black.
COURCELETTE, QUE. TOM McANENEY

There's one made in America

In *PM tests the Flottjet* (page 158, March PM) you erroneously state that no
(Please turn to page 8)

LA SALLE EXTENSION UNIVERSITY

A Correspondence Institution • 417 S. Dearborn Street, Dept. 77-076, Chicago, Illinois 60605

Please send me, without cost or obligation, FREE booklet and full information on the field I have checked below:

ACCOUNTING

- Complete Accounting
 Income Tax
 CPA Training
 Bookkeeping

BUSINESS MANAGEMENT

- Introduction to Business Management

DRAFTING

- Complete Drafting

REAL ESTATE

- Complete Real Estate
 Real Estate Brokerage
 Real Estate Management

TRAFFIC & TRANSPORTATION

- Complete Traffic Management

COMPUTER PROGRAMMING

- Basic Training

INTERIOR DECORATING

- Complete Training

DIESEL MECHANICS

- Basic Training

ART TRAINING

- Commercial Art
 Oil, Water Color Painting
 Complete Training

MUSIC INSTRUCTION

- Piano Guitar

LANGUAGE INSTRUCTION

- French Spanish

DENTAL OFFICE ASSISTANT

- Complete Training

LAW COURSES

- Bachelor of Laws Degree
 Business Law
 Insurance Law
 Claim Adjusting Law
 Law for Police Officers

No state accepts any law home study course, including LaSalle's, as sufficient education to qualify for admission to practice law.

Mr.

Mrs..... Age.....

Miss

(Circle title and please print)

Address..... Apt. No.....

City & State..... Zip.....

010

5

If you had mailed this coupon a year ago, perhaps your salary would be up too!



WHY NOT MAIL IT TODAY?

Look at these pleased reports from LaSalle students. Many success stories of this kind come to us every year—from people who began their career planning by mailing the LaSalle coupon for information.

Yes, many graduates attribute their increases in income largely to their LaSalle spare-time training.

LaSalle students have one ambition in common—to get out of the ranks of the untrained and earn more money and respect in a better job. Isn't that your goal too?

Without interfering with your present work—and by devoting only a little of your spare time—you too can prepare for advancement in the field of your choice through LaSalle home study. The cost is low.

LaSalle has been a leader in home education for more than sixty years, enrolling over 2,000,000 ambitious men and women in its many courses. You study under the supervision of LaSalle's experienced faculty. Upon satisfactory completion of your study, you receive the LaSalle diploma—a recognized and respected credential.

Check the subject you are interested in—then send the coupon above for FREE booklet. No obligation.



"Since enrolling with LaSalle my salary has doubled."
 Robert Kubec,
 St. Cloud, Minnesota.



"In the past three years my income has jumped over \$6,500."
 Norbert Kaitan,
 Ridgewood, N.Y.



"My salary has quadrupled since starting the course."
 George R. Kelly,
 W. Bridgewater, Mass.



"Thanks to LaSalle training... my salary has doubled."
 Mrs. Mary M. Nyberg,
 Los Angeles, Calif.

LA SALLE EXTENSION UNIVERSITY

A Correspondence Institution • 417 S. Dearborn Street, Chicago, Illinois 60605

LETTERS

(Continued from page 6)

U.S. manufacturer has ever made a combination jointer and thickness (surface) planer. I have used the 12-inch planer-jointer combination made by the Parks Woodworking Machine Co., Cincinnati, Ohio, and it is okay.

BRADENTON, FLA.

JOSEPH KEIL

I have one I bought new from Parks in 1939 and I still get good service from it—and with all the original flat rubber belts!

BROADWAY, VA.

E. C. LYNCH

'Hundreds of dollars of fun'

This winter I built this one-third-size stagecoach from the plans in 18-inch model of overland stagecoach (page 115, Jan. '46 PM). It is mostly made of oak,



and it took me about 250 hours. The wheels in front are 28 inches and 32 inches in the rear. It cost me around \$130 and provided hundreds of dollars of fun.

GRAFTON, N.D.

SIG JAGULSKI

'Too rich for my blood'

PM is too rich for my blood! The March *Detroit Listening Post* (page 30) states that you might not make money on the new energy-absorbing bumpers . . . that if your insurance is \$500 and you save 20 percent, then you will just pay for the bumper. This implies you intend to trade in the car every year. What about those of us who must keep the car three or more years? Won't we save this \$100 every year we keep the car?

RICHARDSON, TEX.

LEO B. MARX

Yes, you will. Guess we got swept along by that *Detroit* thinking: a new one every year.

Shoes on backwards

In the *March Bicycle Shop* (page 76) Eugene Sloane stated that when you're

replacing brake shoes, you should "be sure that the closed end of the block faces toward the rear of the bicycle." Shouldn't this be the other way around?

WORCESTER, MASS.

MICHAEL MARTIN

Yes, it should be the other way around. A critical line was dropped from the manuscript during typing. The line should read: When replacing, be sure that the closed end of the block faces toward the front and that the open end of the block faces toward the rear of the bicycle. Otherwise, the brake shoe will slide right out of the block when brakes are applied.

Remote lift for snowplow

Since I did not have an outside tire carrier to anchor the lift chain of the snowplow I built (*Clear your drive the easy way*, page 166, Dec. PM), I decided to add a remote lift.

I added cleats to an eight-foot 2x4 to make it pivot on the tailgate 24 inches from the end of the 2x4. I removed the rear seat so this lever could travel from the floor to the roof between front bucket seats. A length of chain was used to attach the plow to the lever. This arrangement gives about 16 inches of lift to the plow with about 20 pounds of effort. I



hook the left and right seat belts together and loop the connected belts over the lever to hold the plow in a raised position.

FORT WAYNE, IND. HOWARD R. PLETCHER

Mooring assembly, not air valve

You made one small error in regard to Goodyear airships in *Up, up and away! Very slowly* (page 76, Feb. PM). The small inset picture is not an air valve, as you stated, but a mooring assembly similar to that on the nose. It is used as a secondary secure point should the weather conditions prevent the use of the portable mast; we would secure the blimp to the

(Please turn to page 10)



Mr. & Mrs. Tom Logan of Bel-Air, California
and the new Mazda RX2.

Sparking the car of tomorrow today.

The revolutionary rotary engine* is running on the streets of the U.S. right now.

We at Champion developed spark plugs specifically for the unique Mazda rotary engine. And they were the first American spark plugs factory-approved for use in the Mazda rotary.

Now, Mazda's manufacturer, Toyo Kogyo, is installing our Champions (four in each engine) in many of their rotary-powered Mazdas—right at the factory.



Toledo, Ohio 43601

20 million people have switched to Champion Spark Plugs.

*The Mazda rotary engine is licensed by NSU/Wankel.

Lincoln AC 225-amp welder pays for itself quickly, costs only \$95*



The versatile Lincoln 225-amp transformer-type welder welds, brazes, solders, hardsurfaces, heats metal for bending. It handles electrodes as large as $\frac{3}{16}$ " diameter. Will handle up to $\frac{1}{2}$ " diameter low hydrogen and stainless electrodes. Use the AC-225 for a wide variety of building tasks and for quick repairs. It will pay for itself many times over during its long, dependable service life.

Easy to Install. Operates on standard 230-volt, single-phase current, just like an electric range.

Easy to Operate. Simply set 12-position selector switch for the heat needed. Electrode selection guide affixed to top of machine.

Arc Stability. Steady welding arc with a wide range of electrodes.

Rugged, Reliable. Built to heavy-duty industrial quality standards in high volume to bring you a tremendous value at a low price.

Mobile. Lightweight, easy to move. Optional wheels increase mobility.

Comes complete with accessories, electrode kit, power cable, instruction book. Underwriter Laboratory approved and NEMA rated.

**(Suggested Zone 1 list price, subject to change without notice. Optional features, taxes, local delivery and Zone 2 freight charges will alter this price.)*

MAIL COUPON FOR FREE LITERATURE

The Lincoln Electric Company
Dept. PM-1, Cleveland, Ohio 44117



- I am interested in a 225 AC welder.
 Send free copy of bulletin E320.

Name _____

Address _____

City _____ State _____ Zip _____

LETTERS

(Continued from page 8)

top of the Goodyear bus and lock it in place.
SPRING, TEX. CREW, GOODYEAR AIRSHIP AMERICA

'Grandmother' clock in spare time

Here's a photograph of a "grandmother" clock recently completed by my father, Barney B. Grigg, from instructions in the October and November 1969 issues of *PM* (*PM's handsome hall clock*, page 124, Oct. '69 *PM*). The wood used is wormy chestnut, and it is finished with a chestnut stain. Needless to say, I and other members of our family are quite proud of the clock. My father has subscribed to and been an avid reader of *Popular Mechanics* for quite some time.



This clock was made entirely in his spare time as he is a barber by profession.
RALEIGH, N.C. MRS. BLENDA HARPER

Shame on you!

Shame on you for not warning your readers to put the car on stands when working underneath it (*Replace mufflers yourself—and save*, page 112, March *PM*). Granted, the screw-type jack supplied by Volvo is better than a bumper jack, it is still a safety hazard to work under a car without using stands.

SCOTT AFB, ILL. CAPT. JAMES SHANAHAN

I find I can save still more by putting brass nuts on the clamps or U-bolts. That way your bolts and nuts are never frozen, and you can always use the same clamps and nuts. Get heavy-duty brass nuts at any hardware store.

RIDLEY PARK, PA. HAROLD A. MILLER

Don't sacrifice for show ring

I must protest the statement regarding steadiness and reliability being sacrificed for the physical standards needed to win blue ribbons at dog shows (*How to get a well-trained dog*, page 84, Feb. *PM*).

Very seldom will a breeder of quality

(Please turn to page 12)

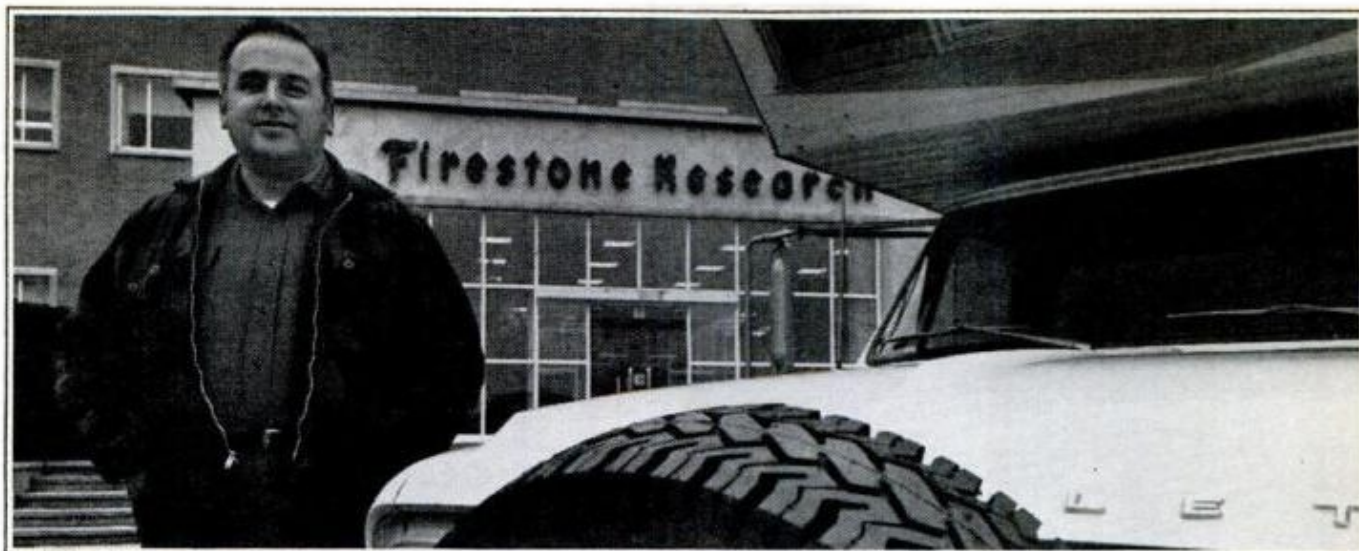

**STEVE PETRASEK, TIRE ENGINEER,
COULD PUT ANY TIRE WE'VE GOT ON HIS CAMPER.
HERE'S WHY HE'S SWITCHED TO FIRESTONE'S
WIDE OVAL TIRE SYSTEM.**



Steve ran our racing tire engineering division for 12 years. He knows high-speed tires. And today as head of our tractor tire engineering team, he understands off-the-road driving problems.

Every year Steve and two buddies leave Akron in a light camper pickup with a jeep in tow. 31 hours later they're isolated in the wilds of Montana hunting elk.

Now with his knowledge of tires Steve *could* even design special tires for his equipment if he thought they'd work best.

But what Steve recommends is what you should use on your camper. Here's how it works:

On the front, you put Firestone's Transport 500 Wide Oval® truck tires. They're the *steering* part of The System. These tires have a wide, wide tread to grip the road for more mileage under normal conditions than the tires they replaced in our line. (The Transport Wide Oval.)



On the rear, you put Firestone's Traction All Season™ Wide Oval™ truck tires. They're the *drive* part of The System. Their computer-designed tread lets you run along at turnpike speeds, then pull off the road (even into snow or mud or sand) and keep on going.

Two pairs of Firestone tires teamed together to provide your camper with stability, traction, and long tire life.

They work! Take it from Steve (write to him C/O Firestone, Akron, Ohio 44317 for more information). Or ask your local Firestone Dealer, the man with The System.

**The Wide Oval Tire System
for Campers.**

Firestone



Free. 1972 New York State Travel Guide.

96 pages. More than 200 color photographs. More than 900 resorts and attractions.

Here's practically all you need to know about vacationing in New York State. This comprehensive guide tells you where to go, how to get there, time schedules and admission prices (if any). All you have to do is send in this coupon.

New York State

Department of Commerce
Vacationlands Distribution Center
P.O. Box 490-630
Latham, New York 12110

Name _____

Address _____

City _____

State _____ Zip _____

LETTERS

(Continued from page 10)

dogs—that is, dogs bred to conform to a set standard—"sacrifice" temperament (soundness, steadiness, reliability) for physical structure. A dog, particularly a German shepherd (as you have pictured), is nothing in the show ring if he lacks steadiness. A serious breeder studies the backgrounds of his animals and knows the temperament expected in the puppies.

BETENBIL KENNELS ELIZABETH A. SAVOCA
ALTAMONT, N.Y.

Works with d.c., not a.c.

The wiring diagram on page 151 of the February issue (*Make this shaper for \$60*) would work only with a d.c. motor. Any change of wiring connections to alter direction of an a.c. motor would have to be done internally to the motor itself. Some a.c. motors would require a change of starting brush position.

GRAND RAPIDS, MICH. JAMES BUFFINGTON

Credit unions make loans, too

Mort Schultz apparently didn't do his legwork before he wrote *How to save money on your next car loan* (page 78, March PM).

We're amazed that credit unions got only passing mention as a favorite source for car loans. That's like talking about the auto industry and leaving out one of the Big Three manufacturers.

Credit unions make one out of every five new-car auto loans in Michigan. They offer a maximum 12 percent annual percentage rate, and a great many give interest rebates ranging to 35 percent. Credit unions offer free loan protection insurance.
MICHIGAN CREDIT UNION LEAGUE G. A. CHARBONNEAU
MANAGING DIRECTOR
DETROIT, MICH.

In addition, a credit union does not "discount" (deduct interest in advance). Therefore you can make prepayments at any time and without penalty. This gives you the advantage stated for a life insurance loan without the disadvantage, as you still have to make your regular monthly payment even after a prepayment. The banks' form of discounting increases the rate of interest for longer periods of loans, and since the average auto loan is for 36 months instead of the sample table shown for 24 months, a true comparison would show the banks generally much higher than the average credit union.

SIXTH AVENUE CREDIT UNION, NEW YORK

HARRY JACOBY
MANAGER

POPULAR MECHANICS

Escape to a world where there's still room for man-size adventure.

Open any book on this page, and return to a world of red-blooded action. A world of rawhide and gunsmoke, where a strong man has room to carve out his own destiny.



You can ride into this world right now with The Western Writers of America — a book club whose members are guaranteed a bonanza of Western reading. Every book you choose is endorsed by the WWA, the association of the country's leading Western authors. Which means you can count on every book to deliver exciting action, vivid characters, and authentic Western detail.

Choose your exciting introductory selection of great Western reading

right now, and mail the coupon today. About every 4 weeks thereafter you'll receive *Spurs*, the monthly WWA bulletin which describes the two new books selected for our members. Most selections are priced at just \$1.69 plus shipping and handling. (Occasional extra-value selections are slightly more.) You accept only the books you want — as few as four a year. And you get quality, hardcover editions that you'll be proud to add to your permanent library of Western Americana.

ANY 6 BOOKS FOR 99¢

if you join and agree to accept only 4 books in the coming year

0018 THE APPLE DUMPLING GANG By Jack M. Bickham. Sheriff's reelection is complicated by 3 outlaw gangs planning the same crime. To be a film. (Pub. ed., \$4.50)

0893 THE WHITE MAN'S ROAD By Benjamin Capps. How does a Comanche on a reservation become a man? Joe Cowbone decides to lead a magnificent horse-stealing raid. (Publisher's ed., \$6.95)

1040 THE WILD BUNCH AT ROBBERS ROOST By Pearl Baker. True history and lore of Butch Cassidy's stamping ground. Illus. (Publisher's ed., \$6.95)

1644 LITTLE BIG MAN By Thomas Berger. Wild, sad, funny modern classic about 111-year-old Jack Crabb, sole survivor of Little Big-horn. Dustin Hoffman film. (Publisher's ed., \$5.95)

0869 GREAT STORIES OF THE WEST Ed. by Ned Collier. 14 classic tales by all-time great Western writers, selected from *West Mag.* (Pub. ed., \$5.95)

0133 THE LAST DAYS OF WOLF GARNETT By Clifton Adams. WWA Spur Award for best novel; man driven by revenge is out to find out how top outlaw died — or get killed trying. (Pub. ed., \$4.50)

1461 TRUE GRIT By Charles Portis. All-time action-adventure favorite; 14-year-old out to avenge her father's murder. John Wayne's Oscar-winning film. (Pub. ed., \$4.95)

1081 BUNKHOUSE PAPERS By John Upton Terrell. True reminiscences of pre-WWI life as cowboy, shepherd, hobo. Authentic Americana. 20 drawings. (Pub. ed., \$6.95)

0729 CONCERNING THE DEATH OF CHARLIE BOWMAN By Michael Hammonds. A drifter's chance encounter with wounded stranger triggers tale of violence and vengeance. (Publisher's ed., \$4.50)

0968 THE SEARCHERS By Alan Le May. Classic, realistic story of life on the Great Plains after the Civil War. "Authentic... hair-raising!"—*N.Y. Times.* (Pub. ed., \$4.50)

0794 TRAILS PLOWED UNDER By Charles M. Russell. 43 great stories of the Old West by the famous cowboy-artist. With 5 color paintings and 50 drawings. (Pub. ed., \$9.95)

0992 THE COWBOYS By William Dale Jennings. New bestseller—rustlers, murder threaten pack of "greenhorns" on cattle drive. New Wayne film. (Publisher's ed., \$5.95)

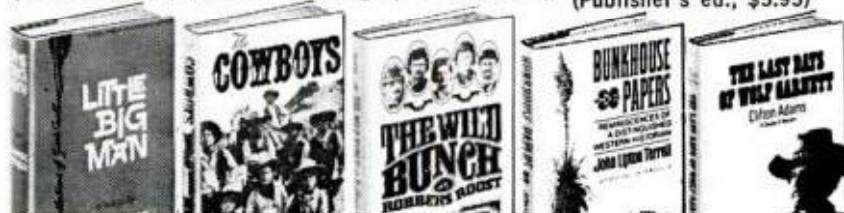

THE WESTERN WRITERS OF AMERICA

Dept. AL687, Garden City, New York 11530



Please accept my application for membership in The Western Writers of America Book Club and send me the 6 books whose numbers I have written in the boxes. Bill me 99¢ plus shipping and handling costs for all 6.

About every 4 weeks, send me the club's bulletin, *Spurs*, describing the forthcoming two Featured Selections and a variety of Alternate choices. If I wish to receive the Selections I need do nothing; they will be shipped to me automatically. Whenever I want an Alternate or no book at all, I will notify you by the date specified by returning the convenient form always provided.

I need take only 4 Selections or Alternates during the coming year, and may resign any time thereafter. Most Selections are only \$1.69 plus a modest charge for shipping and handling. Occasional extra-value Selections are slightly higher.

NO-RISK GUARANTEE: If not delighted, I may return the entire introductory package within ten days. Membership will be cancelled. I will owe nothing.

--	--	--

MR. _____
MRS. _____
MISS _____ (please print)

ADDRESS _____

CITY _____

STATE _____ ZIP _____

Office use only:

Book club editions are sometimes reduced in size, but they are all full-length, hardcover books. Members accepted in U.S.A. and Canada only. Canadian members will be serviced from Toronto. Offer slightly different in Canada.

1-WW-1



Hidden in this picture, is the secret

As you can see, we build our pickups along the same lines as our LOADSTAR® trucks.

That fact brings to light several other hidden facts: they share the same engineering. The same careful assembly.

And most importantly, the same engines.

Order our pickup's optional 345 or 392 V-8, and get our Loadstar's optional 345 or 392 V-8.

Since the Loadstar can haul up to 65,000 pounds, using one of its engines in one of our pickups is hardly using it at all.

We can't fit other Loadstar parts into our pickups. But we put in a lot of Loadstar ideas.

Like building our pickups with electrical systems, cooling systems, transmissions and suspensions specifically designed for truck use.



of our pickup's durability.

Like offering options that include air conditioning, power steering, power brakes, AM-FM and luxurious interiors specifically designed for passenger comfort.

Like keeping the ride smooth. And the handling easy.

We'll give you everything everyone else promises you in their advertising line.

Plus the one thing we deliver on our assembly line. Durability.

INTERNATIONAL® pickup. The truck-built pickup. It's at your International dealer's now.

International Harvester Company,
401 North Michigan Avenue, Chicago, Illinois 60611.



IH International Pickup



CHANNELLOCK

Gives You More In Hand Tools Including

STANDARD "SPECIALS"

(at standard prices)

Every one of these special purpose tools is a standard item in the CHANNELLOCK line, at standard price.

Why show these "specials"? To tell you that you can get CHANNELLOCK quality in a wide range of both standard and special purpose pliers.

GET THE WHOLE STORY in our three-color catalog. Yours for the asking.



ELECTRICIANS' WIRING PLIER. Patented notches strip insulation from 14 and 12 gauge wire slick as a whistle.



WIREMASTER PLIER. High leverage design provides 40% more cutting power than standard design wire cutting pliers.



CURVED LONG NOSE PLIER. Goes 'round the corner to get to work.



PLASTIC CUTTING DIAGONAL. Flush-trims molded plastic sprues clean, fast.



SHORT NOSE SHEARING PLIER. High leverage design for easy cutting of channel iron flanges.



CURVED DIAGONAL CUTTER. Jim-dandy for pulling cotter pins.

TOOLS BY
CHAN NEL LOCK
MEADVILLE, PA. 16335

You're a pretty important guy

...when you know Electronics. And now you can learn enough to break into this exciting field right at home in your spare time.

How would you like to be the kind of guy other men come to for advice and "know-how"?

The kind of guy businessmen and scientists lean on — and listen to?

With a salary that can bring a guy respect? And an impressive title like Technical Representative or Customer Engineer.

People admire a man like that. His success really shows. He doesn't have to be timid in business or social situations any more... because he's important.

And you can be that man!

How? By breaking into one of the most exciting growth fields of the Seventies... Electronics.

Today, whole industries are built upon Electronics. It's Electronics that makes computers and automated production lines and modern aerospace developments possible. And to keep all these electronic miracles running — to see that problems don't occur, and to solve them when they do — the world depends on a new breed of professional: the Electronics specialist.

The demand for people with technical skills is growing twice as fast as any other group, while jobs for the untrained are rapidly disappearing. There just aren't enough trained electronics specialists to go around.

With this kind of demand for qualified people, you can earn the kind of

salary you've always dreamed about. Once you have some experience, you can make \$12,000 a year or more... but beyond tangible rewards, is the satisfaction of working in interesting and vital new fields.

You might think you need college to break into this great field. But you don't. You don't even have to leave home to go to technical school.

The Cleveland Institute of Electronics can teach you all you need to know, at home, in your spare time.

CIE is the largest school in the country specializing exclusively in Electronics home training. The Institute's methods make learning Electronics easier, even for men who once had trouble studying.

It's all spelled out in two informative books that CIE will send you FREE. To get them, just mail the reply card. If the card is missing, use the coupon below or write Cleveland Institute of Electronics, 1776 E. 17th St., Cleveland, Ohio 44114.

It could be your first step toward becoming a mighty important guy in this fast changing world.

Approved Under New G.I. Bill

All CIE career courses are approved for training and full tuition refund under the G.I. Bill. If you served on active duty since January 31, 1955, or are in service now, check box in coupon for G.I. Bill information.

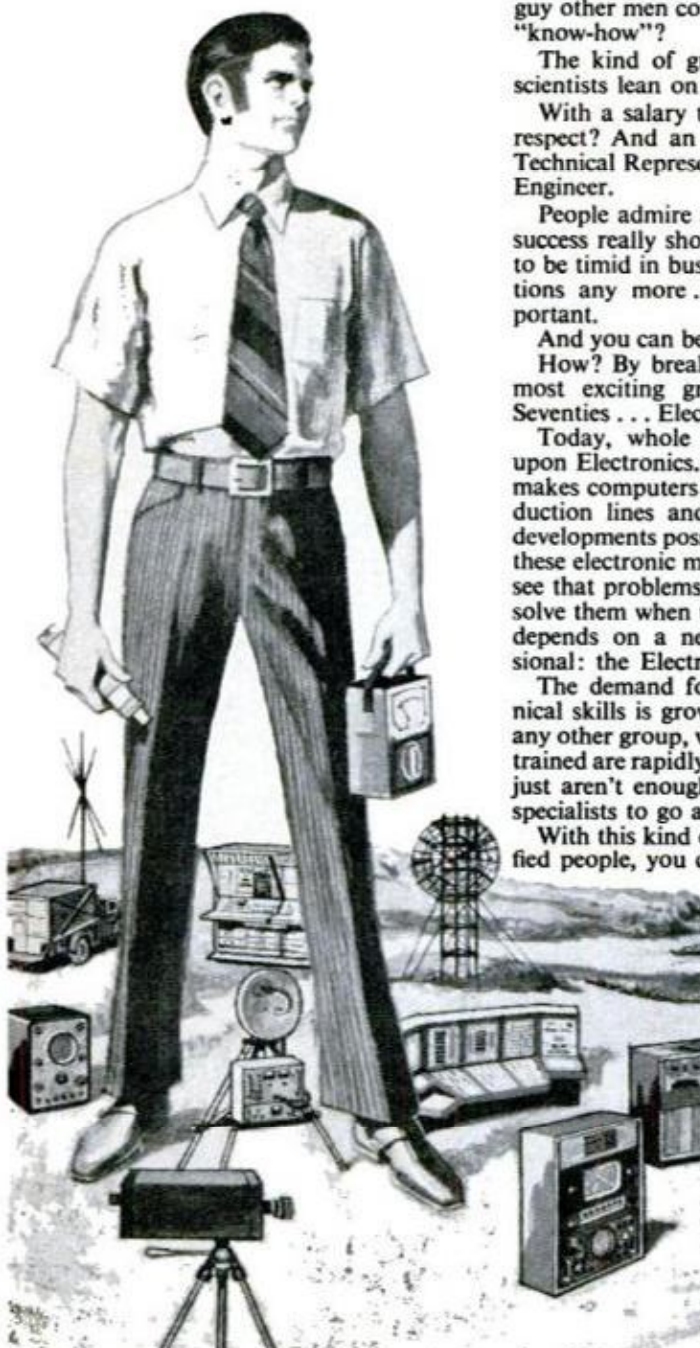

CIE Cleveland Institute of Electronics
1776 East 17th Street, Cleveland, Ohio 44114

Please send me 2 FREE books describing opportunities in Electronics and how to prepare for them.

Name _____ Age _____
(Please print)

Address _____

City _____ State _____ Zip _____

Veterans and Servicemen:

Check here for G.I. Bill information.



Accredited Member National Home Study Council

PM-66

It's only natural.



Only NATURAL MENTHOL™...

not the artificial kind. That's what gives Salem a taste that's never harsh or hot. That's why Salem tastes as fresh as Springtime.

It happens every Salem.



19 mg. "tar", 1.3 mg. nicotine av. per cigarette, FTC Report AUG. '71.

© 1971 R. J. REYNOLDS TOBACCO COMPANY, WINSTON-SALEM, N. C.

Материал, защищенный авторским правом

PSSSSSSSSSS-S-S-S-t Wanna build a **STEAM** minibike?

**Compact and lightweight,
this two-wheeler is safe
and simple enough
for a child to operate**

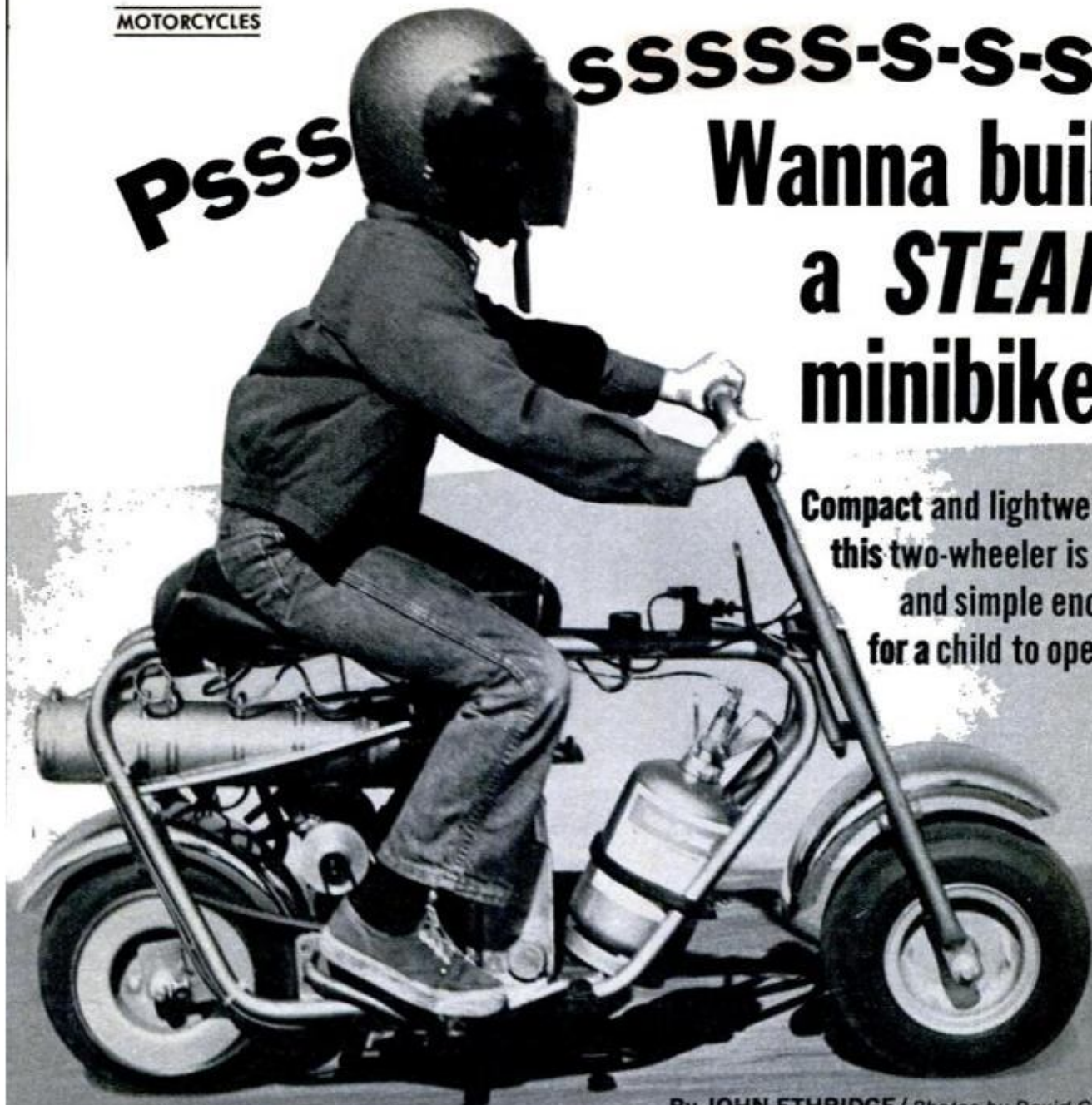

By JOHN ETHRIDGE / Photos by David Gooley

THE FASTER YOU GO, the better the engine seems to run—right up to the 6000-rpm red line. The designer, Richard J. Smith, revved it all the way up to 8000 rpm and still couldn't break it.

This minibike was custom-built for Robert Noble, chairman of the Western Div. of the Steam Automobile Club of America, and may still be the only steam minibike on the road. Smith has used his steam system in a variety of vehicles during years of full-time innovation with steam engines, but this is his first steam minibike.

Combustion and steam generation take place in a cylindrical housing not much bigger than a motorcycle muffler mounted under the seat. The housing, open at the rear to exhaust burned gases, encloses the flash boiler, a long piece of .031-inch-wall steel tubing, coiled and folded many times

upon itself to expose a large area to the burner flame. The housing is lined with refractory fiber to prevent heat loss, and is made from stainless-steel sheet held together at joints with stainless hose clamps. This construction permits rapid access to the burner and boiler tube for cleaning and inspection.

Propane fuel passes from a commercially available bottle of three-pound, four-ounce capacity through two valves that automatically control combustion within safe operating limits by regulating fuel flow.

The first valve is operated by boiler pressure and controls fuel flow so that a pressure of 400 to 450 p.s.i. is maintained. The second senses temperature and thermostatically keeps temperature in the 650 to 750° F. range. This double safety

(Please turn to page 22)

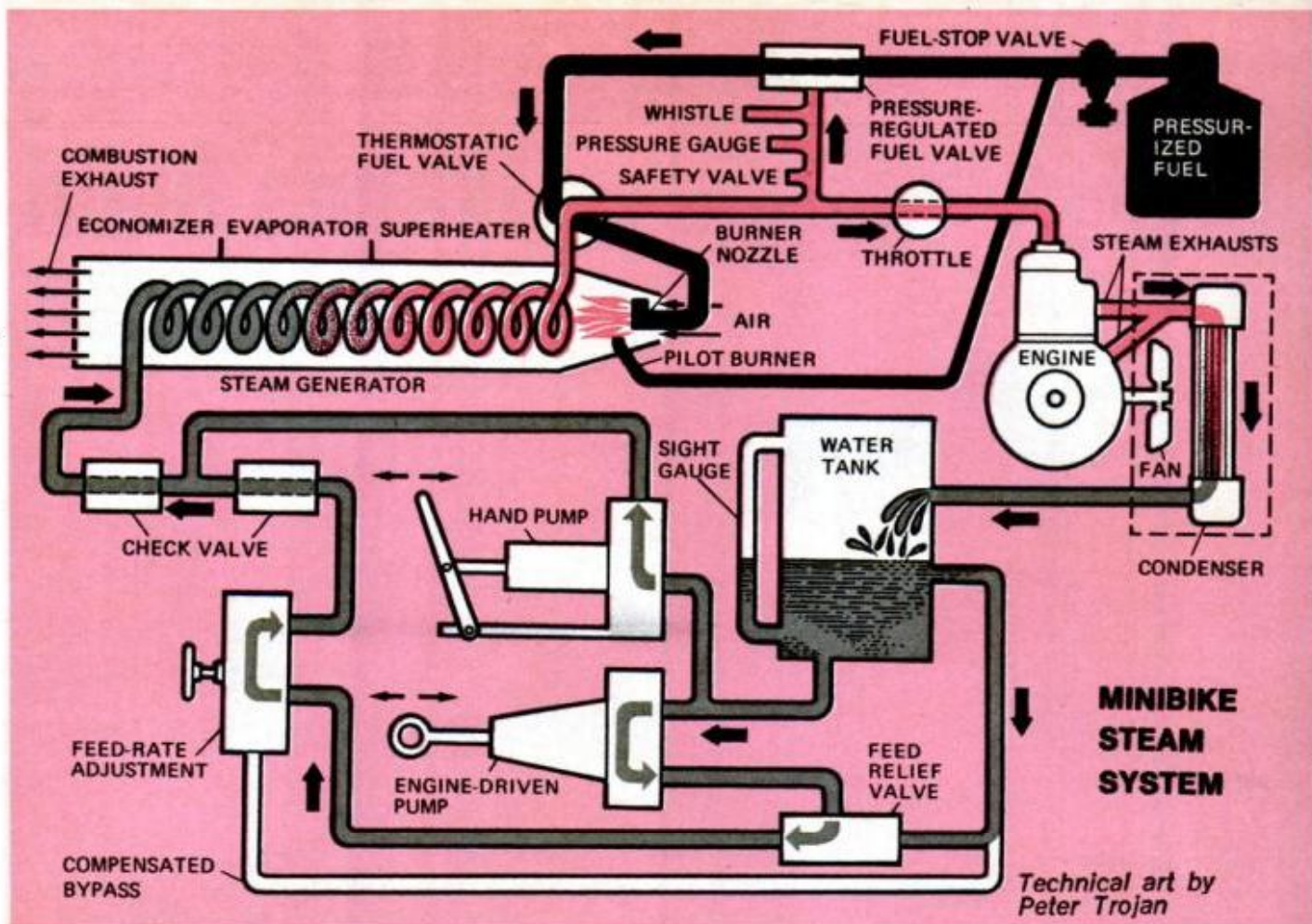

STEAM MINIBIKE

(Continued from page 21)

feature guards against overpressurization and assures that heat damage to the boiler tube will not result, even if the water supply fails.

Feedwater (in this case a 5 percent mixture of steam-cylinder oil and water with an emulsifier) is normally supplied by a pump driven by the engine via an eccentric on the primary shaft. However, a hand-operated auxiliary pump can also be used when starting from cold or if the engine stops. Check valves to prevent back flow, bypasses and a feed-rate adjustment (set initially to match boiler demand and then left alone) complete the feed system.

Steam vehicles don't require, and usually do not have, clutches. For the sake of practicality, however, this one does. The engine is single-acting, meaning that steam only pushes the piston down, with the momentum of the crankshaft and flywheel required to return it, and is therefore not self-starting. So, both for convenience of operation and running the feedwater pump, it was desirable to have the engine running while the vehicle is stopped. Smith accomplished this by driving through a centrifugal clutch of

(Please turn to page 24)

STEAM SYSTEM is diagrammed above. Condensing system, including fan, condenser and tubing, is shown in dashed box. Actual hardware was not yet installed on minibike at the time photos were made



CANADA AT ITS BEST



Canada at its best is tranquil lakes set amid soaring mountains. Canada. A profound sense of peace and stillness. A feeling so palpable, you can almost taste it. Like the smooth, light mellowness of this great Canadian whisky. Try it. Tonight. It's the fastest growing whisky south of the Canadian border.

IMPORTED

CANADIAN MIST

CANADIAN WHISKY — A BLEND 80-86.8 PROOF, BROWN-FORMAN DISTILLERS IMPORT COMPANY, N.Y., N.Y. ©1971

STEAM MINIBIKE

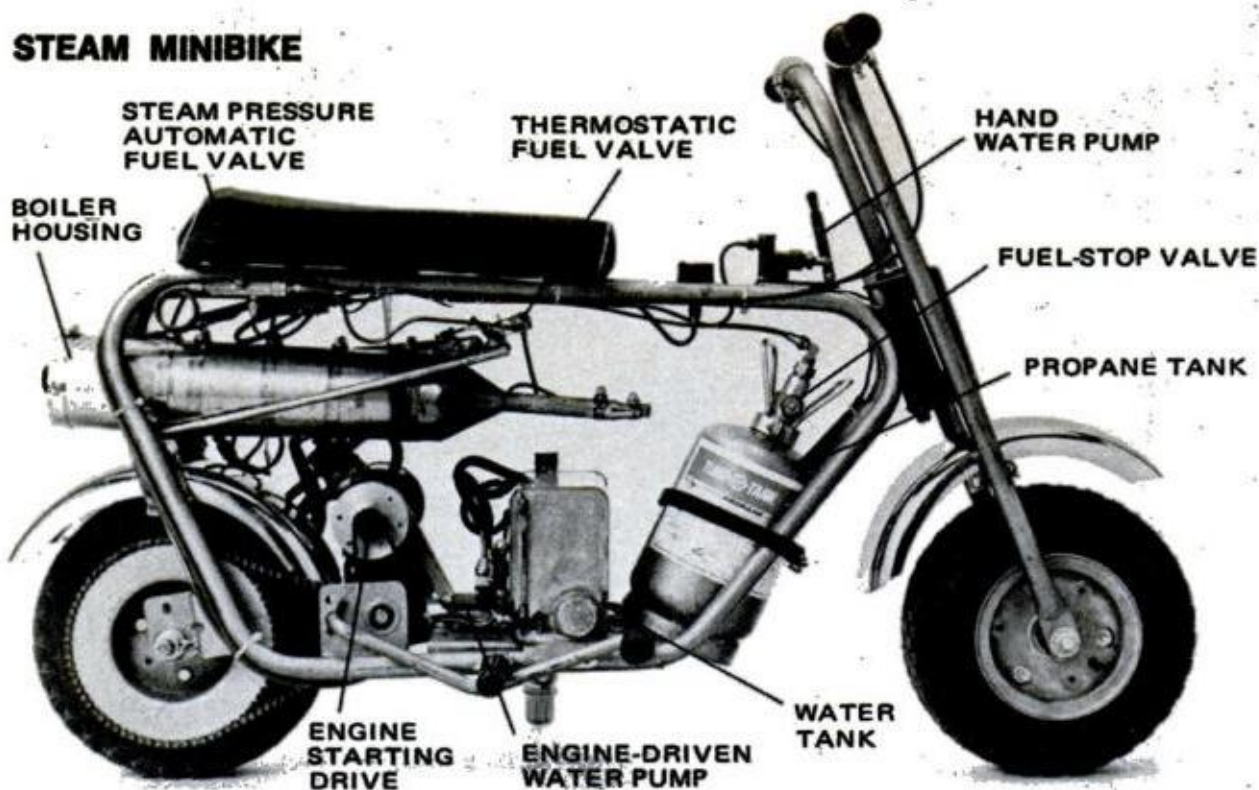

COMPONENTS OF STEAM SYSTEM are easily accommodated on even the smallest conventional bike frame

STEAM MINIBIKE

(Continued from page 22)

the type normally used on simpler gasoline-engine minibikes.

An overrunning, or one-way, clutch installed in a chain drive working between the engine crankshaft and the primary driveshaft is used for starting. The one-way clutch is installed so that when the bike is pushed, the engine turns. With steam up, starting is simply a matter of cracking the throttle and nudging the bike forward.

The engine is based on an Ohlsson & Rice 1.2-cubic-inch, two-stroke miniature engine. Superheated steam is fed through a fitting screwed into the spark-plug hole. Incorporated in the fitting is a piston-actuated poppet valve that cuts off admission of steam at around one-twelfth of cylinder stroke. This means the steam is expanded approximately 12 times its original volume during the working stroke, which Smith says accounts for the high efficiency of the engine.

Expanded steam was exhausted through both the original intake and exhaust ports into the atmosphere when pictures of the minibike were taken. But a condensing system has been added. Spent vapor is piped to a fan-cooled condenser (an automotive heater core) where it becomes liquid and is returned to the water tank. Lubrication is by oil droplets in the working fluid, very similar to premix two-stroke practice.

Even without the condensing system, the minibike will run for about an hour on just less than one gallon of water/oil mixture, which isn't any great inconvenience or expense. The bottle of propane is good for nearly two hours running, depending on how fast the bike is driven.

Starting from cold is easier than with most miniature steam locomotives and tractors. You just turn on the fuel and light the burner, which can be done with a match or cigaret lighter, but Smith finds a spark igniter of the kind used to light acetylene torches is the handiest. Lighting takes place at the rear of the boiler housing, and it catches with a whoosh about like that of a gas hot-water heater. A pilot flame relights the burner on subsequent demand cycles as long as the fuel is left on. Full pressure and temperature are reached in only 15 seconds after lighting, but if you're in a big hurry, you can get underway as soon as 200-250 p.s.i. shows on the gauge.

At 6000 rpm, speed of the bike is about 30 mph. Smith estimates the output of the engine at 1.5 hp, but as is characteristic of piston steam engines, it feels like at least twice that amount. The throttle, controlled by the right twist-grip, has a nice progressive feel and requires no getting used to. The muffled nutt-putt of the exhaust isn't noticeably different from that of small internal combustion engines, but a twist of the left grip produces a shriek from the whistle just to let the

(Please turn to page 190)

10W-50

New Shell Super X motor oil is for your car.
No matter where, when or how you drive.



Use this coupon to get one quart free with oil change.

Offer good only at stations displaying this sign.



NEW 10W-50

The Motor Oil.

No matter where, when or how you drive.

Dear Customer: This coupon entitles you to one free quart of Shell Super X 10W-50 on your next oil change using this motor oil. Coupon to be signed and dated by you. Offer expires July 31, 1972, and void where restricted or prohibited by law.

Customer signature

Date

Dealer signature

Date

Shell Dealer: Present signed coupons to your Shell Dealer/Jobber Representative by September 30, 1972. You will receive full wholesale price applied toward your next motor oil order.

PM-5



Change to new
**Shell Super X
Motor Oil**

ATTEX. THE ONE ALL-TERRAIN VEHICLE THAT REALLY MEANS ALL-TERRAIN.



An Attex will go anywhere, do anything. Climb steep hills, blast over sand dunes, fly through the snow and even navigate lakes and streams with ease. Think you'd like to be an Attex Dealer? We have a complete line of six dependable models for you to sell. Prices range from \$995. to \$1695. There's one just right for your customer. That's Attex. Write us.

ATV Manufacturing Company PM 5
1215 William Flynn Highway—Route 8
Glenshaw, Pa. 15116.
Name _____
Address _____
City _____ State _____ Zip _____

LEARN TO FLY IN YOUR OWN BENSEN

Lowest cost—most fun too, pros and novices agree. Pilot ages range from teens on up. Economical to operate. Easier, quicker to build than an airplane. Wheels interchange with floats. Send \$5 for Copter (\$3 Glider) INFO PACKET—see why the Bensen is the world's most popular homebuilt.



SEND \$5 OR \$3
BENSEN AIRCRAFT CORP., Dept. PM-52
RDU Airport, P. O. Box 2746, Raleigh, N. C. 27602
NAME _____
ADDRESS _____

TREASURE

FIND BURIED TREASURE

Find buried treasure coins, jewelry, gold and silver bullion etc. with Gardiner metal detectors. Some Gardiner models can distinguish bottle caps and pop top lids from coins and other treasure and have push button and automatic tuning and many other valuable and exclusive features.



GARDINER
model 210 \$35.00

Send for our free catalog describing our many patented metal detectors. Eleven models priced from \$35 to \$785

GARDINER ELECTRONICS

4729 North 7th Avenue
Phoenix, Arizona 85013
Department A 1

INVENTORS

INVENTIONS—NEW PRODUCTS—IDEAS
DEVELOPED & PREPARED
For Commercial appeal & sales
DESIGN—MARKETING—PATENT RESEARCH—DRAWINGS
Second Decade of Reliable Service To
INVENTORS—MANUFACTURERS—ATTORNEYS
Director: United States Patent Office Former Examiner
United States Dept. of Army Former Patent Adviser
Member: United States Council Int'l Chamber of Commerce
FREE CONSULTATION
THE RAYMOND LEE ORGANIZATION
230-Z Park Ave., New York 10017 (212) MU 6-8500
SEND FREE "Invention Record" Form &
"Product Marketing" Brochure
Name.....
Address.....
City.....State.....
Zip.....

Use Zip Codes When
Answering Ads

drafting as a career

Train in everything from basic technical drawing through graphic arts and engineering mechanics. Associate degree in Machine Design Technology received upon graduation. Tri-State College also offers degrees in Engineering, Business Administration, Secondary Education, Liberal Arts, Computer Technology and Secretarial Science. Accredited. Co-educational. Approved for Veterans. For information, write Director of Admissions.



TRI-STATE COLLEGE

452 College Ave., Angola, Ind. 46703

MAN-SIZE TRACTOR

Works faster, saves you time



Whiz through tough jobs with this big, powerful tractor. Mow 3 acres an hour; plow, till, bulldoze, remove snow fast with 21 big attachments. 14 H.P. More work-power with all-gear drive (no fluid power loss), automotive clutch, transmission and differential. Free catalog, prices.

**ECONOMY
TRACTOR**
1005 K-5 Anoka Avenue
Waukesha, Wis. 53186

POPULAR MECHANICS

4 WAYS TO GET RICH! AND HAVE FUN

Join America's exciting new hobby—Treasure Finding. These sensitive instruments work through dirt, sand, wood, water, and even rock with no loss of power. Quality engineered lightweight and fully transistorized. Operates many hours on an inexpensive 9 volt battery. Order Now... all models in stock.



FREE BONUS

This \$4.00 value is yours free when you order a Jetco Treasure Finder.



Made in USA
Full 5 year Warranty

THE MUSTANG "330"

Detects a penny to 5 inches. Detects sharply with "Sound off" loud speaker. Very powerful, comes complete, ready to go.



ONLY **\$39⁹⁵***

FIND LOST COINS, RINGS, GOLD, SILVER, AND RELICS.
WHERE: SCHOOL YARDS, PARKS, BEACHES, OLD HOUSES,
VACANT LOTS VIRTUALLY ANYWHERE. DETECT ALL METALS.

THE SEARCHMASTER "550"

Detects a penny to 6 inches. Has sensitive Vernier tuning for detecting fringe items.



ONLY **\$69⁹⁵***

THE TREASURE HAWK "990"

Detects a penny to 8 inches and silver dollar to 12 inches. Has view meter loud speaker, sensitivity switch, battery tester, dual search loops. Power to spare.



ONLY **\$129⁹⁵***

THE HUNTMASTER "770"

Detects a penny to 7 inches. Has view meter, loud speaker, dual search loops, extra sensitivity.



ONLY **\$99⁹⁵***

TO: JETCO ELECTRONIC INDUSTRIES, INC. PM
P. O. Box 26669
EL PASO, TEXAS 79926

I enclose \$ _____ + \$2.00 shipping cost for \$ _____ total—
Rush me a

- MUSTANG SEARCHMASTER
 HUNTMASTER TREASURE HAWK
 Send me a free detailed catalog only

Name _____

Address _____

City _____ State _____ Zip _____

*Texas residents add 5% sales tax

SOLUTIONS FOR MECHANICAL HEADACHES

AUTOMOBILE CLINIC

BY MORT SCHULTZ

Lighting bug

The left directional signal light of my 1967 Chevrolet Impala is giving me fits. Sometimes it works—sometimes it doesn't. When it doesn't, I get no green light from the indicator. Different mechanics have done different things. One looked for loose connections. Another put in a new bulb. Now a third says I need a new switch, which requires removal of the steering wheel. He says the job will take about two hours. Do you agree?—M.H. Schnakenberg, Kansas City, Mo.

About the switch—yes! I think the car needs one. But he sure is a slow worker. The job should take about an hour. . . that's what the flat rate manual says. The manual is used by mechanics to judge time requirements of mechanical tasks.

Hes-i-ta-tion

I have a 1968 Ford Mustang with a 289-cu.-in. engine, two-barrel carburetor, automatic transmission and a very serious hesitation problem between start and warm-up. When I step on the accelerator, the engine dies way down or cuts out completely. After it warms up, it runs great. The engine has been tuned up many times and has had three new carburetors. The automatic choke has been adjusted and readjusted from here to Sunday. Is there a solution or am I spinning my wheels?—Max McComb, Monsey, N.Y.

Okay, let's assume it's not the automatic choke. Has the engine ever been checked for vacuum leaks when cold? Also, you should have the accelerator pump in the carburetor set for maximum stroke.

Where has all the current gone?

When my battery failed not long ago, I replaced it with a new one. Now the new one has discharged, too. What causes a good battery to run down like this?—Edmund Kellerer, Fort Wayne, Ind.

I can think of a half-dozen good reasons. Look for a faulty alternator and voltage regulator unit, a short circuit in the car's wiring, a stuck stoplight switch that allows stoplights to burn continuously, a slipping fan belt that isn't turning the alternator at the correct speed, operational

errors such as forgetting to turn off lights, and not enough driving to keep the battery sufficiently charged.

Dropped digit

In the Jan. 1972 Automobile Clinic (Service Tips), you mentioned that Ford service bulletin 16 (7/2/71) provides revised front-wheel alignment specifications for 1971 models. My dealer is not familiar with this bulletin. Can you tell me what it contains?—Ken Williamson, Kansas City.

It should have contained another digit! Ford issued no service bulletin 16 on July 2, 1971. The number is 168.

Shiftless Cad

My 1968 Cadillac Eldorado has become very hard to shift. The shift lever seems to bind, and I have to actually force it into gear. Is something wrong with the transmission?—James F. Vesey, Tucson, Ariz.

Not likely. However, the shift linkage bellcrank assembly of Eldorados does require a little lubrication to keep it moving freely. If the part isn't lubricated, water running down the bellcrank shaft can cause corrosion that hampers operation. Disassemble, clean and repack the bellcrank with a multipurpose grease. When reinstalling the part, make sure whoever does the job readjusts the neutral switch.

Trouble by the numbers

During the 18,000-mile warranty check of my 1970 Ambassador (360-cu.-in. V-8, two-barrel carburetor), I complained of spark knock during acceleration. I have tried many different grades of gasoline with no relief. My dealer's "fix" was to remove the dual-diaphragm vacuum unit from the distributor, plug the inlet hose at the carburetor and replace it with a single diaphragm unit. Since that time I have experienced (1) no relief from spark knock, (2) a drop of five miles per gallon of gasoline, (3) choke stuck closed, causing "flame out" on the open highway, (4) an inability to kick the automatic choke off the last fast-idle notch until the temperature is up to normal and (5) a flooding effect during cold starts. I asked that the
(Please turn to page 26D)

**Get a taste of what it's all about.
Get the full taste of Viceroy.**

17 mg. "tar," 1.2 mg. nicotine av. per cigarette,
FTC Report Aug. 71.

© 1972, BROWN & WILLIAMSON TOBACCO CORP.

Материал, созданный авторским правом

AUTOMOBILE CLINIC

(Continued from page 26B)

dual-diaphragm vacuum unit be reinstalled, but was told the factory recommends only the single diaphragm unit. Is this true? What is the solution to all my problems?—H. Jolly Jr., Burlington, N.C.

It is true that an American Motors service bulletin has recommended that the dual-diaphragm unit be replaced with the single-diaphragm unit. However, I think it is coincidence that you are experiencing problems other than spark knock. If you analyze these other troubles you will see that you can't attribute them to the vacuum-unit—they are carburetor-related conditions. Perhaps when you had the car serviced a carburetor adjustment wasn't made properly. . . maybe the automatic choke isn't functioning as it should. . . perhaps a bad job was done in plugging the inlet hose at the carburetor and you have a vacuum leak at this point. As for the spark knock, you may be able to get rid of it by retarding the timing 2° - 4°. But no more.

Bearing down

My car is a 1968 Tempest station wagon with 350 V8 engine and automatic box. It has gone 45,000 miles. The rear-wheel bearings have had to be replaced on both sides a number of times. The car always has to carry a load of about 400 to 500 pounds in the rear, but I don't think this weight is the cause of the trouble. Do you?—Gordon M. Edwards, Califon, N.J.

Not weight alone, but something is probably combining with it to give you the problem. I'd say it is a bad axle or a bent axle housing. If the axle housing is bent, for example, an additional load would be placed on the bearings.

Oil strike

I have the last of the 1969 Corvair Monzas, and it's giving me a pain. It throws oil all over the back of the car because of leaking push rods. The dealer has replaced the seals twice. It's just the right side—the left's okay. I called the dealer again today. He's stunned, doesn't know what to do. Can you help?—Henry W. Konopka, Woodbury, N.J.

Look for distorted push-rod tubes or a

thermostat on the right side that's not opening. If the thermostat is bad, it will get real hot on the right side, and the heat could be ruining the seals.

Another wearing bearing

The left rear-wheel bearing of my 1970 Chrysler Newport burned out. The dealer suggested I have both the bad bearing and the one on the opposite side replaced. Okay—I went along. Now, 110 days and 5000 miles later the same thing has happened. The dealer says, "Sorry—out of warranty." What's wrong?—Stephen Feinberg, Atlanta.

Other than your timing being bad—this job is covered by warranty only for 90 days or 4000 miles—probably one of three things: the bearing wasn't installed properly, it wasn't greased correctly, or you have a bent axle on the left side.

Service Tips

● Chevrolet has emphasized that cleaning a brake master cylinder or wheel cylinder with a cleaning solvent is absolutely forbidden. These solvents—including gasoline, kerosene, carbon tetrachloride, acetone and paint thinner—cause the rubber parts to become soft and swollen. Nothing but denatured alcohol or brake fluid should be used.

● AC Spark Plug Div. of General Motors gives good advice here that every mechanic—professional or amateur—will want to heed. Watch that sparkplug gap setting when installing plugs in 1971 and 1972 models. After years of recommending a gap of .030 to .035 in., some manufacturers have now switched to .040 in. in certain applications. The wider gap is needed in some engines for more complete combustion of the leaner fuel mixture. According to AC engineers, "exposure of the mixture to a larger spark increases the probability of ideal combustion at each ignition cycle." If gaps are set too tight, low speed misfiring may occur.

● 1972 Chrysler, Plymouth or Dodge owners with the 340 or 440-cu.-in. engine and four-barrel Thermoquad carburetor may have difficulty with hot starting and in rough running at high speed. For a cure, have your dealer apply service bulletin 14-01-72C (Chrysler and Plymouth) or 14-02-72D (Dodge). The trouble is caused by incomplete sealing between the carburetor air horn main well casting and the plastic main body. ★★

GOT A PROBLEM WITH YOUR CAR? Ask Mort about it. Send your question to Auto Clinic, Popular Mechanics, 224 West 57th St., New York, N.Y. 10019. Letters cannot be answered individually, but problems of general interest will be published in the column.

The Master Wax[®] shine. It survived the snows of Minnesota, the sun of Arizona, and the son of William Bailey.



What snow-melting road chemicals and blazing-hot sun do to a car's finish is nothing compared to what Bill Bailey's boy can do. Some guys baby their car. He tortures his. On dirt tracks, back roads, no roads at all. The dirt and grime he picks up are enough to tear the finish off any car. Any car not protected by Master Wax.



Master Wax protects against the worst driving conditions imaginable. Man-made, nature-made or Bailey-made. Easy-to-use Master Wax is detergent proof, too. So when he washes off the dirt he won't wash off the shine. Simoniz Master Wax has it all. The protection your car needs and the shine you want. Plus a very strong will to survive.

Simoniz[®] Master Wax

© 1972 Morton-Norwich Products, Inc. SIMONIZ and Master Wax are registered trademarks.

ALL By BILL McKEOWN OUTDOORS

SEPTEMBER 23RD, the fourth Saturday of the month, has been named National Hunting and Fishing Day—a date that, hopefully, indoorsmen and outdoorsmen alike will hear a lot about before it arrives.

It's to be an outdoor open-house affair. Members of fishing, hunting, boating, camping, bicycling and hiking clubs—and, for that matter, any group from sky-diving to skin-diving—should begin now to take an active part. Every individual who likes outdoor action should start asking his local sportsmen's clubs, sporting goods stores, scout troops and chambers of commerce where the activities are going to be.

Warren Page, one of the country's premier shooters and now president of the National Shooting Sports Foundation, previewed some of the possibilities for the occasion in an exclusive interview with *Popular Mechanics*.

"This will be an opportunity for hunters, fishermen and other outdoorsmen to explain their

sport," he pointed out, "and receive some of the conservation recognition they deserve as wildlife's best friends." It's no secret that the press of population growth, together with the growth of communities and industries, has resulted in the pollution of waterways and the reduction of wilderness areas for wildlife. Sportsmen aren't the cause of it. On the contrary, money from hunting and fishing licenses, game permits, ammunition taxes and camping permits, in fact, and the fish and game limits that prevent both overgrazing and overharvesting, have made outdoor sportsmen the leading contributors to ecology improvement in the last decade.

"NHF Day should give people a chance to try archery and skeet," says Page, "learn how to set up a tent or hook up a recreational vehicle, watch the fine points of fly casting or a fine gun dog retrieving, look over the latest in camping gear or the proper way to start a youngster with an air rifle. The local rod and gun club can demonstrate

Before you put wood outside...

UNTREATED WOOD SIDING

put Woodlife® into it.

WOODLIFE TREATED

Actual side-by-side test, exposed 11 years.

Water-repellent Woodlife penetrates deep, protects from within. Prevents cracking, splitting, rot and decay. Extends paint life for years—dries clear for natural wood beauty. For siding, fences, decking, patio furniture, shutters—all exterior wood. Ask your painter, hardware, or lumber dealer—he knows!

Weldwood
PACKAGED PRODUCTS
U.S. Plywood—Champion Papers Inc., Kalamazoo, Michigan 49003

Woodlife
WOOD PRESERVATIVE
CLEAN • PAINTABLE • WATER REPELLENT
Protects Against Rot, Termites, Warping
DANGER: HARMFUL IF SWALLOWED
KEEP OUT OF REACH OF CHILDREN

NATIONAL HUNTING & FISHING DAY

September 23, 1972

its activities, the Boy Scouts show how their SOAR (Save Our American Resources) program works."

Already this open house day to explain conservation and outdoor skills for the general public has the support of such groups as the National Wildlife Federation, Izaak Walton League of America, National Assn. of Conservation Districts, Keep America Beautiful, Trout Unlimited, National Recreation and Park Assn., National Con-

servation Committee of Boy Scouts of America, The Wildlife Society, International Assn. of Game, Fish and Conservation Commissioners, and many others. Groups can obtain planning suggestions in an Open House Manual for \$1, Page reports, from various sponsoring associations or NHF Day, 1075 Post Road, Riverside, Conn. 06878.

Reasons for the observance were well summed up by Sen. Thomas McIntyre in a Congressional resolution he introduced. Due to the congestion, complexities, tensions and frustrations of today's life, he stated, and the need for outdoor recreation and a chance to "get away from it all," plus the fact that over 15,000,000 hunting licenses and 24,000,000 fishing licenses were sold last year for \$200,000,000, recognition of the hunter and angler was very much in order. Outdoor sportsmen, he recalled, have traditionally led conservation and wildlife preservation efforts, promotion of respect for private property, courtesy in field and forest, and in boating and firearm safety.

A YOUTH CONSERVATION CORPS program will be sponsored again this year by the Departments of Agriculture and the Interior. Starting late in June, 95 youth camps will be opened for eight weeks and employ
(Please turn to page 26H)

**New
Home Safe
Contact
Cement**
laminates
without danger
at half
the cost

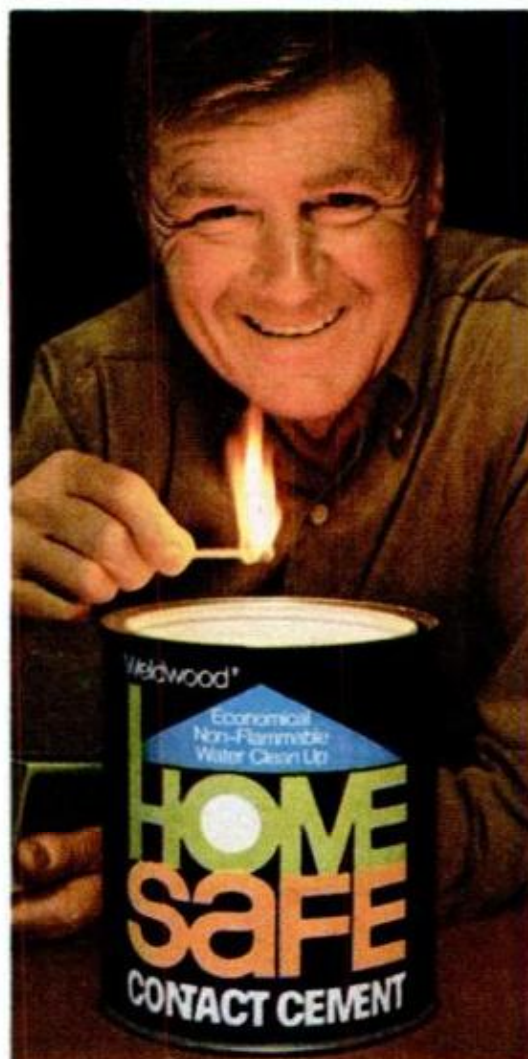

Now you can laminate with a non-flammable, non-sniff contact cement that really works. At half the cost.

Weldwood's new Home Safe contact cement forms as strong a bond as you could want, yet goes on at half the cost of any other contact cement.

New Home Safe contact cement. Safe. Economical. Water clean-up. And it works. You'll find it at hardware, paint and building supply stores.

Weldwood.
PACKAGED PRODUCTS
U.S. Plywood-Champion Papers Inc.
2305 Superior Avenue
Kalamazoo, Michigan 49003

1/2 THE COST

LEARN TO BE A SKILLED LOCKSMITH



Change combination of pin tumbler cylinder
EARN \$1.50 in 15 MIN.

Owner loses key; pick car trunk—
EARN \$5.50 in 10 or 20 MIN.



Install new knob door lock—**EARN \$15.00 in 30 MIN.**

After-hour emergency opening—**EARN \$2.50 to \$5.50 in 20 MIN.**

Hundreds have succeeded like these Belsaw Graduates:

R. W. Davis, St. Louis, Mo.: "I am doing a wonderful business thanks to your course in locksmithing. Last Saturday I took in \$110.00."

Pierson Crook, Los Angeles, Calif.: "I am making \$200 a month extra income with the Belsaw Locksmith Course. I would recommend your course to anyone."

Big demand for skilled Locksmiths! Earn big money spare time in your own home. Be your own boss. No layoffs. Steady year 'round income. Age and schooling are no handicap.

BELSAW INSTITUTE training...approved by master locksmiths...helps you start faster with easy picture lessons guided by your own mail instructor.

Get thorough job training on all types of locks. We supply tools, equipment and business help: how to start, how to charge, how to get jobs, how to earn while you learn and build a lifetime cash-profit business. Accredited Member National Home Study Council. Approved by State Board of Education. Approved for Veterans.



This \$125 key machine is yours to keep!

MAIL COUPON—NO SALESMAN WILL CALL

**BELSAW INSTITUTE, 103B Field Bldg.
Kansas City, Mo. 64111**

Send **FREE** book, "Keys To Your Future!"

FREE BOOK

Name _____

Address _____

City _____ State _____ Zip _____

ALL OUTDOORS

(Continued from page 26G)

about 3000 young men and women, age 15 to 18. About half the YCC participants will work in National Forests operated by the Dept. of Agriculture's Forest Service. The other half will be under the direction of the Department of the Interior's Bureaus of Indian Affairs, Land Management, Reclamation, Sport Fisheries and Wildlife, National Park Service and Office of Territories.

KAMPGROUNDS OF AMERICA, largest of the private campsite chains with 700 campgrounds open or under construction in the United States, Canada and Mexico, have announced a public offering of stock in the corporation, Kamper Klub, and packaged camping tours in Europe this summer. Campers on the budget tour fly TWA to Frankfurt, Germany, pick up a Fiat 238 camping bus from Avis, and head out at their own speed through France, Spain, Italy and Switzerland. Tour information is available from KOA headquarters, Box 1139, Billings, Mont. 59103.

A RESORT COMMUNITY with a resident environmentalist is the claim of Marco Island on the Gulf Coast of Florida. In order to prevent dredging from damaging the notable fishing on the edge of the Everglades, a barrier dike was installed under the direction of conservation manager George Spinner after approval was received from the Corps of Engineers. Reefs of automobile tires were used to stimulate growth of mangrove islets, and first reports indicate the famous snook and tarpon catches have not diminished. An experimental artificial aerie for eagles was also constructed on a high pole as a substitute for rickety nests they had built in aging tottering trees. Late reports indicate Marco eagles have carefully inspected the ersatz roost—and will have none of it.

IF THIS SUMMER'S OUTDOORSMAN looks like equipment manufacturers hoped he would last February in Chicago at the National Sporting Goods Assn. trade show, we'll be overloaded with some of the following assorted gear. Probably we should be wearing backpacks. Suppliers have noticed the booming sales of this item of duffel and a wide variety is offered. Lightweight sleeping bags, foam pads, tents and freeze-dried foods go in them. You're likely to have a rubber inflatable boat, and a light-action fiberglass rod along to land the lunkers. For cooking them, all trends point to LP gas to power the campstove, with batteries or LP popular for lights as well. ★★ ★

APPLIANCE CLINIC

By PAUL MANN

Won't spin

I have a Maytag top-fill washing machine that stalls as it is about to go into the spin cycle. To get the spin cycle going, I must get behind the machine, reach under and grab the two pulleys, and pull them back. I have been told my problem is caused by a bad transmission and that the cost of repair will be considerable. Does this explanation sound reasonable to you?—Samuel S. Carideo, Everett, Mass.

Possibly the transmission has incurred damage, such as a broken spring, that would prevent the spin cycle from engaging. However, from your description, I'd say your trouble may be no more serious than a very loose belt that is slipping and needs to be tightened or replaced, or some other friction-part malfunction far less serious than transmission trouble. For example, if your machine employs motor reversal for cycle changes, a centrifugal clutch may be used to allow the motor to pick up the load of the spinner gradually. This clutch may be slipping, causing your problem. Other factors to check out before the transmission is tackled include a faulty solenoid, a bad timer and loose wiring.

Compressor complaint

Our 8-year-old upright frostless Cold-spot freezer stopped freezing. The Sears Roebuck repairman said the compressor had failed and that a new one would cost \$125. What causes this part to go bad? Is there no way of repairing it?—Mrs. Carolyn Pratt, South Haven, Mich.

Among the causes of compressor failure are low voltage, high voltage, dirty condenser, defective condenser fan, defective thermostat, and location where the temperature is too cold. Compressors are sealed units, and repair would be more expensive than replacement. The unit would have to be cut open with a torch and then re-welded after repairs are made. This task is usually beyond the capability of local repair shops. According to Sears, that \$125 you mentioned should cover the cost of parts and labor.

Sticking waffles

Our waffle iron is only three years old, but it appears the Teflon has deteriorated, for the waffles stick. Is there some way of restoring Teflon?—N. M. Dietrich, Redwater, Tex.

If you believe the Teflon has deteriorated just because waffles are sticking, you may be wrong. One sure way of knowing whether the coating is damaged is to actually see it peeling off so that metal is exposed. The waffle iron just may need a Teflon cleaner you can buy in a hardware or appliance store. Use it as directed; apply cooking oil to relubricate the grids.

Teflon can be restored, but this is expensive. All the old Teflon must be removed by sandblasting. It would probably be more economical to order a new set of grids from an appliance dealer.

Loss of pep

I have a GE dishwasher (model SD306C1 NP). It began losing its action (flow of water) about three weeks ago. The soap dispenser would open, but the water jet wasn't strong enough to rinse the soap away. Now there's no action at all—water leaks out on the floor when I turn on the unit. What do you figure—pump failure? Can I replace the part myself?—Alfred Atkins, Bronxville, N.Y.

The loss of water pressure at first was probably caused by a clogged screen in the water valve. Continued operation, in turn, caused the seal in the pump mechanism to become damaged, since it depends on water for lubrication. When there is a lack of water in the dishwasher, this seal runs hot and deteriorates.

To replace the seal you must remove the impeller from the motor shaft. This isn't too tough if you have the proper puller. You should also make sure that every sealing "O" ring is replaced with a new one. Failure to do this will result in possible leakage through the motor. The water-valve screen that likely started the trouble is easily removed for cleaning—just turn off the water and remove the nylon valve body from the mounting bracket. If the screen is so clogged that it nearly stops the water flow, replace it.

Coming apart

I repair small appliances and often find that ceramic insulators of thermostats used on irons, baking ovens and other "heat-up" units are loose or have fallen off. They are usually cemented on with a white ce-

(Please turn to page 36)

RIDGID

Tubing Tools...

Professional quality... easy to use!

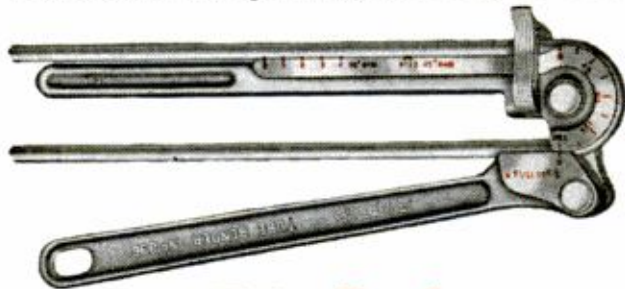

Lever-Type Tube Benders

Six Sizes: $\frac{3}{16}$ " through $\frac{1}{2}$ " O.D.

For soft and hard copper, brass, aluminum, steel, and stainless steel tube. All wearing surfaces hardened for lasting accuracy. Bend tubing accurately to $\pm \frac{1}{32}$ ".



Spring-Type Tube Benders

Eight Sizes: $\frac{1}{4}$ " through $\frac{7}{8}$ " O.D.

For easy free-form bending of soft copper and aluminum tube. Spring fits tube snugly, prevents deformation at bend point. Plated to last for years.

Flaring Tools

The ultimate in quality, simplicity and smooth operation! No vise or wrench needed! Bars snap into yoke — parts can't get lost. Cone is eccentrically mounted, rolls tubing evenly against bar. Tubing is anchored securely during flaring, releases easily. Complete range of sizes for all materials.

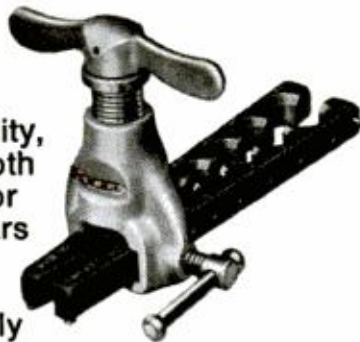

By these RIDGID tools at your Dealer's. For free literature, write The Ridge Tool Co., Dept. KM, 400 Clark St., Elyria, Ohio 44035, U.S.A.

RIDGID®

Ridge Tool Subsidiary
Emerson Electric Co.
EMERSON

APPLIANCE CLINIC

(Continued from page 35)

ment. Where can I get this product? Would a two-part epoxy adhesive work as well?—Leon G. Wurtz, Elmwood, Wis.

The small-appliance makers that I know of prefer that when a ceramic insulator breaks loose from a thermostat you replace the thermostat. If you can find a two-part epoxy that will withstand a temperature of around 500° F., it will probably work. However, adhesives that I know of that are generally available, including epoxy, can withstand only 250°.

Continuous power

What's the difference between testing an appliance for power and for continuity?—Bert Kline, Phoenix, Ariz.

A power test tells you if the appliance is getting the power it needs to operate. An appliance designed to run on 115 volts a.c. has to have that line voltage available. You can check this with a voltmeter.

A continuity check tells you whether power is flowing continuously through the circuit, which is a closed loop. If an "open" circuit (no continuity) exists, the appliance won't work. You can check this with an ohmmeter.

Correction

Word comes from Kelvinator, Inc., that contrary to what we said in the January *Appliance Clinic* Kelvinator is no longer an American Motors division. Should you have to write, the company is now located at 1545 Clyde Park, S.W., Grand Rapids, Mich. 49509. Concerning the addition of an automatic icemaker to a refrigerator that doesn't have one, the company feels it is best not to attempt this unless the refrigerator is designed to accept one.

Maintenance tips

● Check an electric fan guard if a rattling noise suddenly begins. A weld can give way. If you find a loose rod, repair it with a dab of epoxy resin cement.

● When you replace worn brushes in an appliance with a universal motor, "run" them in. The contact end of a new brush is flat, preventing full contact with the commutator. You can file the new brush to shape, but it's easier to put the brushes in place and let the motor run about 10 minutes. ★ ★ ★

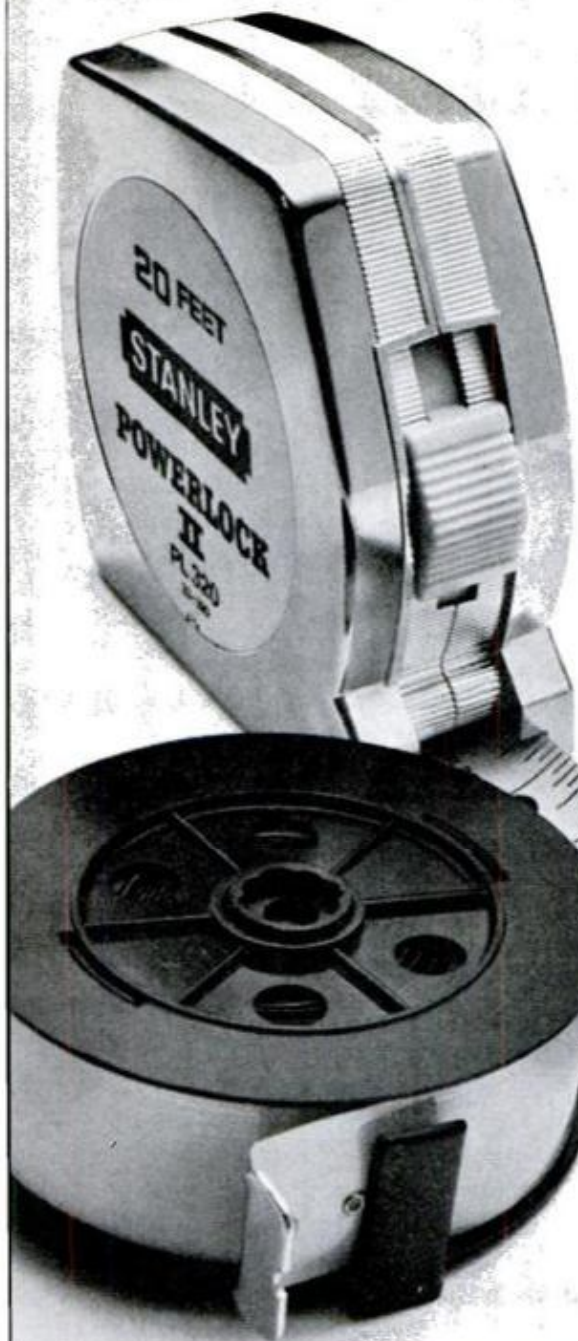

Now, a rule with a drop-in cartridge.

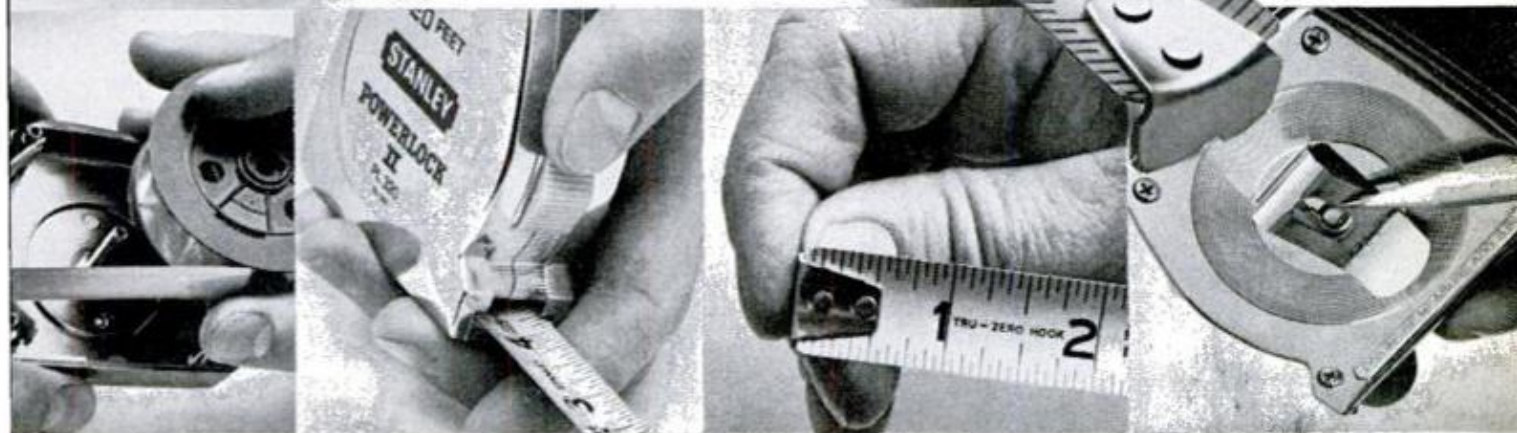

Great idea! Stanley improved its best-selling Powerlock® rule with a drop-in replacement tape. Do it in seconds, on the job.

Other famous features stay. New Powerlock II has the same power return. Locks, unlocks with your thumb.

"True Zero" hook helps measure both outside and cramped inside areas. Bold, easy-read numbers on Lifeguard® yellow blade, Mylar® protected for long life.

Clip on the back of your Powerlock II snaps tightly over belt or apron pocket, so you can't lose it.

STANLEY
helps you do things right

Материал, защищенный авторским правом

DETROIT

LISTENING POST

BY ROBERT LUND

MAJOR VISUAL CHANGES ON THE '73s—here is a rundown of what you'll see:

From GM: all new intermediates and top-of-the-line cars from Chevrolet and Pontiac. Mid-size machines will have thick center pillars. Olds will have its something-new, something-old small car—a carriage-trade version of the Nova. All A-body cars will have new wagons, but with conventional tailgates—not the clamshell, which has been a service headache.

From Ford: new front ends—hoods, grilles and fenders—on Mustang, Torino, Montego and T-bird. Front ends get a heavier styling treatment to balance the more massive 5-mph bumpers for '73.

From Chrysler: Valiant and Dart will be reworked above the beltline; other cars will get minor modifications in the rear and on identification trim. Chrysler's said to have done an impressive job prettying up its two-doors.

From American Motors: a honey of a Hornet, a three-door hatchback.

Not what you'd call a blockbuster of a year in styling, but still a fair number of changes, considering the carmakers say they can't afford to plunge on reshaping the metal because they have to save the big money for gear to satisfy government decrees.

NEW TYPE OF CAR-DOOR HINGE, supposedly a two-way improvement on that used now, is being checked out by engineers at one of the Big Three. First, it's stronger. Where two hinges are required now, one of the new ones will do the job better. Second, the new version has a tricky mechanical action that tilts the door forward and

outward when in the open position so it's easier to get in or out of the car. There's still some testing to be done before the new hanger can be used, but it could show on some '73s.

COMPLETE RE-ENGINEERING OF INTERIORS

is coming in the fall of 1973. Carmakers will have to comply with at least five new standards covering interiors when they begin producing '74 models. Steering gear will have to be improved two ways; more padding on the wheel itself and a five-inch limit in the amount of rearward travel of the steering column in a 30-mph collision. The government wants better seat and head restraints. Another standard calls for a ventilation system that'll prevent toxic fumes from building up in the passenger compartment. Finally, there will be a specification on fireproofing fabrics—establishing a burn rate on seats, carpeting and headlining.

NO TOOLING UP FOR WANKELS YET? Companies making tools used by carbuilders say they're getting no orders from GM that would indicate it's anywhere near ready to roll with a Wankel. Machine tools are usually ordered 18 to 36 months before a new piece is put in production. Wankel enthusiasts are worried. As they read machine-tool-firm reports, GM won't have a rotary for '74. But this doesn't mean that GM's behind schedule. GM never promised a Wankel for 1974 or any other specific year.

GM may still put a few two-rotor rotaries on the road in '74—without the machine tools. That's no double-your-money-back prediction

(Please turn to page 40)



1972 BRUBAKER looks like a one-of-a-kind show car, but it's in production and coming off the assembly line at Brubaker Industries in California. The fiberglass body, which sits on a '72 VW Beetle engine and chassis, was designed for versatility: It can be set up as a passenger car, delivery van, camper or in almost any other special-interest configuration. The rear-engined vehicle is slightly longer than the Beetle, a little lower and two feet wider. Production began at five per week and it is expected to be around 50 this summer. Price of the new nameplate is \$3950.

The oil that stands up for the little guy.

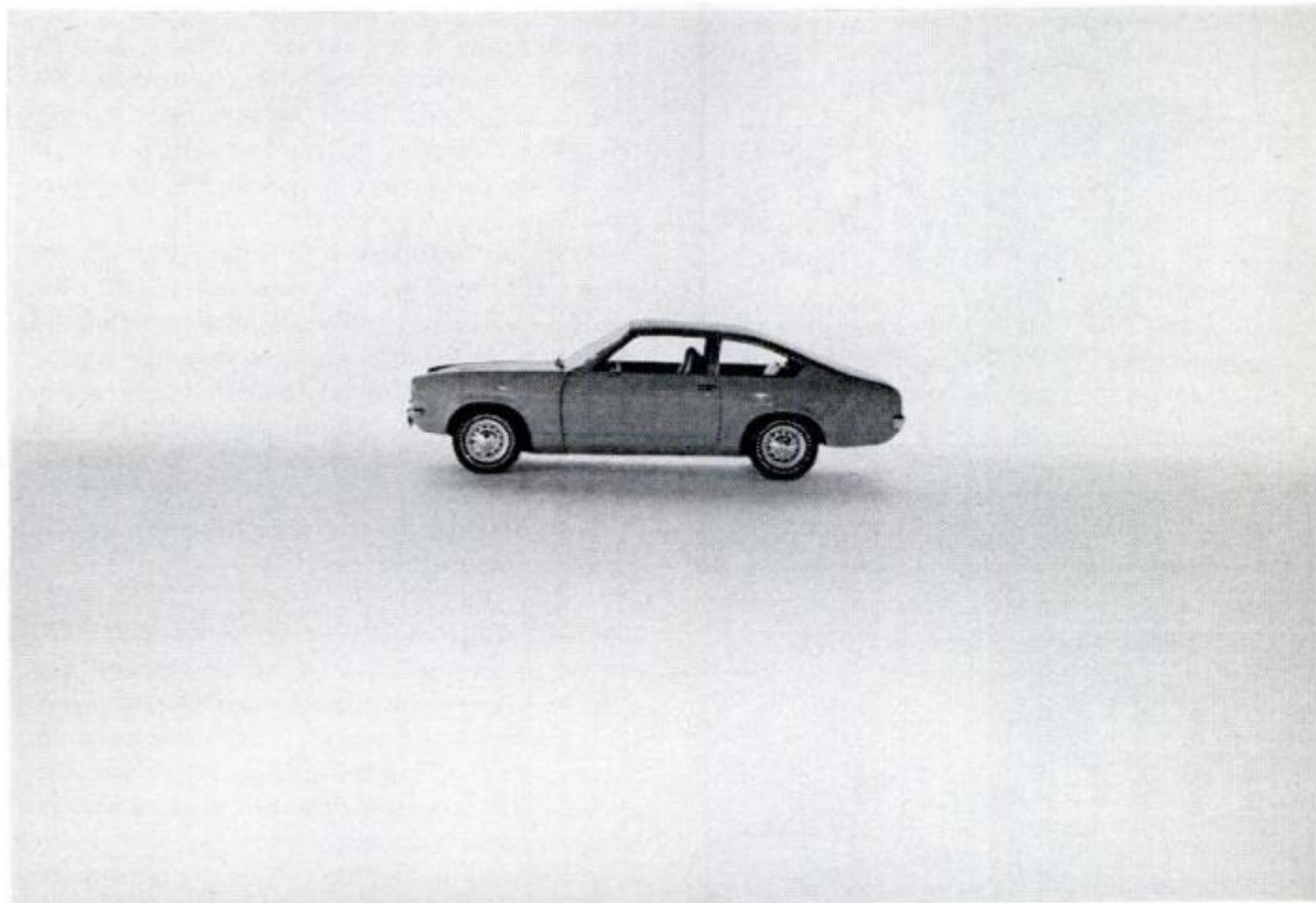

Little cars need extra protection when they take on hills and super highways that were made for the big cars.

Little cars strain harder. So their engines need a hard-working motor oil: Quaker State. It's refined from 100% Pure Pennsylvania Grade Crude Oil. Then it's fortified by oil experts to protect hard-working engines from the wear caused by heat and heavy loads.

If you're driving a little car that's straining to keep pace, buy yourself some real peace of mind. Next oil change, be sure to ask for Quaker State by name. It's sold wherever they care about cars.

Quaker State your car to keep it running young.



MAXIMAT 7

GEARED HEAD LATHE & MILL

Turn, face, bore, thread, drill, mill, grind—to accuracies within .0002" on famous Maximat combination metal-working lathe/mill/drill machine shop! Features geared lathe & mill heads, 2 built-in 115V motors. Swings 7", 18" between centers. (10" x 26" quick-change model available.) Max. vertical cap. 10". Drill to center 12" circle. NOW YOU CAN MACHINE ALL PARTS YOURSELF!

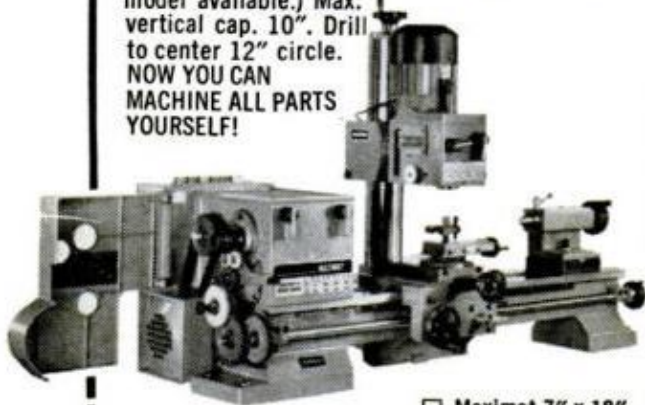

Maximat 7" x 18"
Send FREE literature Maximat 10" x 26"

AMERICAN EDELSTAAL, INC. TENAFLY, N.J. 07670
DEPT. BD-2

Name _____

Address _____

City _____

State _____

Zip _____

EARN HIGH WAGES as a HEAVY EQUIPMENT OPERATOR



Train your way to high pay in the booming construction industry! Learn the skills you need to qualify, by actual field training on machines like the ones used by the industry. Huge training grounds in North Carolina, a million dollars worth of school-owned diesel-engined machines, experienced instructors, full 220-hour and 440-hour courses. National, the original school of heavy equipment operation, is a recognized leader. Member American Road Builders Assn., Services and Supply Division. Associate Member A.G.C. Full-time Job Advisory and Counseling Director on staff. Approved for veterans. For men ages 17 and up. Train Now-Pay Later plan . . . other payment plans also available. Write TODAY for FREE catalog and FREE copy of school newspaper reporting news of National School graduates. Accredited member National Association of Trade and Technical Schools.

NATIONAL SCHOOL Phone 704/392-1359

OF HEAVY EQUIPMENT OPERATION, Dept. D-62

P. O. Box 8529, Moores Chapel Road, Charlotte, N. C. 28208

Please send me FREE illustrated school catalog and complete information. I understand there's no obligation.

Name _____ Age _____

Address _____ Phone _____

City _____ State _____ Zip Code _____

DETROIT LISTENING POST

(Continued from page 38)

if it doesn't pan out. It's based on speculation that the first Wankels from GM will be toolroom assemblies—not hand-made engines but the next thing. In other words, this will represent an interim step between hand-made and mass production.

GM will have between \$75 and \$100-million riding on the Wankel before it produces Job 1. But that's pocket change stacked against the investment the company will have to make to get revved up for mass production. Before putting more chips on the board, GM would like to supplement its testing of the Wankel by placing a few cars in the hands of owners to get a feel of in-use situations.

If GM will sell you a toolroom special, the price will probably be around \$3500. But you'll have to get in line. GM wants to keep close tab on the first cars, so it might decide to deliver the entire lot to fleet operators or other mass users who'll agree to let GM technicians come in periodically to strip 'em down for examination.

The Wankel's on the way—but not in substantial volume before 1975.

BACK-OF-DASH COMPONENTS IN CLUSTERS

are being worked on in a standardization program for Chrysler by a special engineering group. The project has two goals: (1) to develop uniform components that can be used in all of the company's U.S.-made cars, and (2) to isolate the different clusters from each other, so that if one unit has to be pulled out for any reason (to redesign, repair or relocate it), there's access to the individual cluster without disturbing any of the others.

EVER HAD THE ACCELERATOR PEDAL STICK

so you had to bang down on the brake to override it? Doesn't happen very often, but once in a lifetime is enough for most drivers. The auto companies are trying to develop a fail-safe pedal in order to deny you even a once-in-a-lifetime experience.

It's not just a matter of installing an automatic cutoff to prevent the car from racing out of control. The device must also have a secondary feature to prevent a sudden loss of power in high-speed traffic, because you can get in just as much trouble slowing too rapidly going 70 on a freeway as in a reverse situation—going too fast in slow traffic. Different devices are being worked up and you'll probably see this item installed on some '74 cars.

★★★

Winchester and Western T22 rim fires put 'em right where you hold 'em for the 22 rim fire sports you enjoy most: targets, tin cans, or tough game.

Discover for yourself that T22s are the biggest breakthrough in years for standard velocity, low cost, rim fire fun.

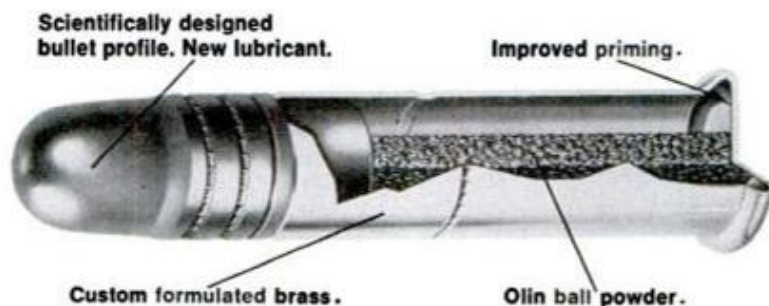

What does T22 stand for? The "T" in "T22" stands for "Target" as in "Accuracy." That's because Winchester and Western people know from many lifetimes of plinking pleasure that no matter what you're aiming at . . . a tin can on a log . . . a wily crow in a cornfield . . . or the standard NRA target in a formal match . . . every shooter expects a high degree of accuracy from a 22 rim fire load. That's where new T22s come in, with performance and accuracy that's strictly premium . . . but at a price that gives you plenty of opportunity for practice. T22s are available in either Winchester or Western brands, and come in both Short and Long Rifle. And they come through with what every 22 shooter wants most: Target-like accuracy for every 22 rim fire sport you enjoy most . . . at no increase in price.

All-around performance and accuracy.

You have to try T22s for yourself to realize how perfectly they measure up to the game you're gunning for. Both the 29-grain Short and the 40-grain Long Rifle lead solids deliver the velocity you need for all small



game or pests. You get a lot of action, too, when you're just popping cans in a safely-backstopped sandpit. And you stay in top form for the big target matches, without top expenditure. T22s are the finest all-purpose rim fires you can buy.

Target-quality components. The reason for T22s' outstanding value and performance can be found in the top-quality components that make up every cartridge . . . and the same quality-control precision that helps make Super-X power loads, and our largest center fire ammunition. Bullets are exactly shaped for superior wind-bucking accuracy. A special, dry lubricant keeps T22s clean and ready, even if you pick 'em out of your pocket to chamber up. Powerful, clean-burning Olin Ball Powder provides all the zip you need. And consistent, non-corrosive priming ensures both instant ignition, and tight groups at all reasonable rim fire 22 ranges. Slip a box of T22s into your shooting jacket today.

WINCHESTER-Western, 275 Winchester Avenue, New Haven, Connecticut 06504.



1972 | winchester
the way you
want it

science worldwide

By JOHN PEARSON



Braille text from a computer



Covering a 150-foot-wide swath



Robots know their way around

BOON FOR THE BLIND. The slow process of printing braille has been speeded through the use of a new method developed at MIT. A computerized system translates text—at the same time it's being typed the standard way—into clusters of raised dots on paper. These are the braille letters that can be read by the fingertip touch of a trained blind person. In the past, a hand-operated embossing machine could turn out one page of braille text every six or seven minutes. The new system can process from 20 to 30 pages a minute.

IMPROVED EYEGLASSES MAY BE A SPIN-OFF from our space program. The chemical process that strengthens the glass windows of the Apollo lunar landing module may be used to make stronger and safer lenses for eyeglasses. Tests at the Corning Glass Works, maker of the "lunar" glass, show that the chemically strengthened lens is four times stronger than a standard glass or plastic lens. Basically, the Corning process involves a chemical exchange of large potassium ions for small sodium ions in the surface of the glass.

AN EFFICIENT WAY TO CAST FERTILIZER over a large area is with a helicopter and an airborne spreader. Rotating vanes in the spreader, which is powered by its own engine, broadcast a 150-foot-wide swath of dry chemical plant food as the copter moves up and down a field. Some 3000 pounds of fertilizer can be spread during a single flight. The system is used on farmlands in the Pacific Northwest and Alaska.

FIRST FULLY AUTOMATIC LANDINGS by a full-scale, manned helicopter were made recently at a NASA facility at Wallops Island, Va. The accomplishment is considered a milestone in a continuing research program aimed at enabling helicopters and future VTOL (vertical takeoff and landing) aircraft to fly their routine missions under poor visibility conditions. An Army CH-46 copter was used. Guidance for approaches and landings was provided by a ground-based tracking radar linked by telemetry with onboard equipment. Landing approaches were fully automatic from a point about three miles from the intended landing spot.

ROLLING ROBOTS, roughly the size of a large filing cabinet, deliver meals, linens and medical supplies at a hospital in Fairfax, Va. Powered by three 12-volt batteries, the unmanned steel carts follow courses set on a control panel. On a typical trip, a cart rolls from the basement kitchen or laundry to the nearest elevator. It signals for an elevator and rides to whatever floor has been programmed, continuing its journey

(Please turn to page 44)

**Ron Fisher was out all day
giving his car a beautiful shine.
Now he's out for the night.**



Poor guy. Worked so hard shining his car today, that it outshines him tonight. Too bad he didn't use Vista Soft and Easy. Soft and Easy's special formula of high-gloss silicones and jeweler's polish glides on like a liquid and buffs up to a dazzling, hard-wax kind of a shine. With none of the hard-wax kind of work.

Next time you want a shine, pick up a can of pre-softened Vista Soft and Easy. Because a shiny car is no substitute for a dull date.

Simoniz® Vista® Soft and Easy

© 1972 Morton-Norwich Products, Inc. SIMONIZ and Vista are registered trademarks.



LIVE IN THE WORLD OF TOMORROW . . . TODAY!

UNUSUAL BARGAINS

NEW PRODUCTS • NEW MATERIALS • NEW IDEAS

3" ASTRONOMICAL TELESCOPE



See moon shots, orbits, stars, phases of Venus, planets, close up. 60 to 180 power. Aluminized, overcoated 3"-diam. $f/10$ primary mirror, ventilated cell. Equatorial mount with locks on both axes. 60x eyepiece and mounted Barlow lens. 3x finder telescope, hardwood tripod. FREE: "Star Chart," "Handbook of the Heavens."
 Stock No. 85.050H \$32.95 Ppd.
 DEL. UXE 3" ASTRON. REFL. TELESC.
 Stock No. 80.162H \$59.50 Ppd.
 4 1/4" TELESCOPE
 Stock No. 85.105H \$94.50 FOB
 6" TELESCOPE \$239.00 FOB

3-HEADED TREASURE FINDER!

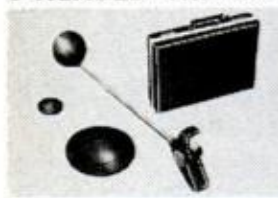

Best value solid-state metal detector we've seen. Extremely versatile—3 easily attached search heads: 10"—for quick, large area coverage; 5"—general search; 3"—extreme sensitivity. Telescoping aluminum rod (15" to 30"). Sep. volume, tuning control set for 1 hand operation. All fit snugly in handsome locking foam-lined attache case. Incl: 9V trans. batt., earphones, instruct., 196pp. Book.
 Stock No. 71.446H \$49.95 Ppd.
 SAME BUT ONE 5" HEAD, NO CASE,
 Stock No. 71.447H \$29.95 Ppd.

AMAZING NEW WANKEL ENGINE KIT!



Thrill to the fun of building your own see-through motorized model of revolutionary pistonless type engine . . . only engine experts think economically modifiable to meet new pollution standards. Replaces piston, cylinder, crank assemblies with rotating discs (sections removed for firing chambers). Smaller than conventional: fewer parts, greater reliability, same speed w/less horsepower. Feat: flashing plugs, rubber fan belt, stick-shift on-off switch. Req. 2—1.5V batt. (not incl.).
 No. 71.424H (4 1/2" X 5" X 9") \$6.75 Ppd.

GIANT WEATHER BALLOONS



"Balls of fun" for kids, traffic stoppers for stores, terrific for amateur meteorologists. Create a neighborhood sensation. Great backyard fun. Exciting beach attraction. Amateur meteorologists use to measure cloud heights, wind speed and temp. Made of heavy-duty neoprene. Inflate with vacuum cleaner or auto air hose; or locally available helium for high rise.
 Stock No. 60.568H (8' size) . . . \$2.00 Ppd.
 Stock No. 60.632H (16' size) \$7.00 Ppd.

AMERICAN MADE OPAQUE PROJECTOR

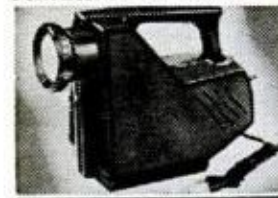

Projects illustrations up to 3" x 3 1/2" —enlarges them to 35" x 30" if screen is 6 1/2 ft. from projector, larger pictures if screen is farther away. No film or negatives needed. Primarily intended for children. Projects charts, diagrams, color or black-and-white in darkened room. 115 v. A.C. . . . 6 ft. cord and plug included. Size 12" x 8" x 4 1/2" wide. Weight 1 lb. 2 ozs. Plastic case.
 Stock No. 70.199H \$8.75 Ppd.

"FISH" WITH A MAGNET



Go treasure hunting on the bottom! Fascinating fun & sometimes profitable! Tie a line to our 5 1/2-lb. Magnet—drop it overboard in bay, river, lake or ocean. Trawl it along bottom—your "treasure" haul can be outboard motors, anchors, other metal valuables. 5 1/2-lb. Magnet is war surplus—Alnico V Type—Gov't cost \$50. Lifts over 150 lbs. on land.
 Stock No. 70.571H \$14.00 Ppd.
 lbs. \$ 5.75 Ppd.
 Stock No. 70.570H 3 1/2 lbs. (lifts 40 lbs.) \$ 8.75 Ppd.
 Stock No. 85.152H 15 1/4 lbs. (lifts 350 lbs.) \$33.95 FOB

'Bright Ideas' in Unique Lighting Big, new 100-page handbook packed with facts, loaded with illustrations. All latest developments, applications, equipment. 8 1/2" x 11" looseleaf paper to fit 3 rings. Stock No. 9100 H \$3.00 Ppd.

MAIL COUPON FOR GIANT FREE CATALOG

148 PAGES! MORE THAN 4,000 UNUSUAL BARGAINS.

Completely new 1972 Catalog. Packed with huge selection of telescopes, microscopes, binoculars, magnets, magnifiers, prisms, photo components. Ecology and unique lighting items, parts, kits, accessories—many hard-to-get surplus bargains. 100's of charts, illustrations. For hobbyists, experimenters, schools, industry.

EDMUND SCIENTIFIC CO.
 300 Edscorp Bldg., Barrington, N. J. 08007
 Please rush Free Giant Catalog "H"

Name
 Address
 City State Zip

EDMUND SCIENTIFIC CO. **300 EDSCORP BLDG.**
 BARRINGTON, NEW JERSEY 08007
 ORDER BY STOCK NUMBER • SEND CHECK OR MONEY ORDER • MONEY-BACK GUARANTEE

SCIENCE WORLDWIDE

(Continued from page 42)

there. After unloading by attendants, the cart returns to base. The vehicle, called an Amscar, stays on course by means of sensors that react to wires embedded in floors. It travels at 1 mph.

The Environment

THE NEXT ECOLOGICAL DISASTER to hit the Great Lakes may be the spread of arsenic. That warning comes from the University of Michigan's Prof. Edward Callender, who says that nuggets containing the deadly poison, as well as iron, manganese and other metals, have accumulated over thousands of years. Formed through natural processes, the BB-sized chunks are harmless in their present state. But increasingly polluted water threatens to dissolve them. "I'm not screaming that doomsday is upon us," the geologist emphasizes, "but I am pointing out this potential hazard exists and should be faced up to before it becomes a reality."

A NEW PROCESS FOR RECYCLING metal lathe turnings and machining chips was recently announced by the General Motors Research Laboratories. The plant-generated scrap is converted into a coarse powder suitable for making powder-metal parts. Called Macro-Mesh, the powder is said to exhibit nearly the same properties as conventional iron powder but is considerably less expensive.

A POLLUTANT DETECTOR developed for NASA is thought to have real potential in monitoring big-city smog. Called a high-speed interferometer, the device can detect traces of ozone, carbon monoxide, carbon dioxide, sulfur dioxide, ammonia, acetylene, methane and a number of other pollutants. The instrument is so sensitive it can "sniff out" as little as five parts of carbon monoxide per one billion parts of atmosphere. As this is written, plans are under way for using the sniffer to check smog in Los Angeles.

RAINWATER is not as pure as most people think, says Undersecretary William T. Pecora, Department of the Interior. Annual rainfall in the United States brings down more than 44-million tons of sulfates, chlorides, nitrates and bicarbonates. ★★

Caught without enough education?

Home study could be the way to catch up.

Find out today. Free.

You realize it by now: What you don't know *can* hurt you. Today. Tomorrow even more.

But you're not sure where to go for specialized education or training. And still have the job and family life you want.

Perhaps you're wondering. About going back to school. About competing again for attention in a classroom. And maybe you're wondering about the real value of home study as an alternative. About its fit to your exact needs, your life style.

Take a look at the 12 careers outlined on this page. Each of these careers offers excitement, growth, satisfaction—for those who are prepared. Select a career which turns you on—the one for which you'd like to prepare. Then fill out the coupon and send it to us. We'll give you complete details on the new ICS Career Program in the field of your choice. We'll tell you how you can fill in the gaps in your education and training, without having to go back to the classroom.

If you have good, sound, career preparation you greatly boost your chances for job success, for security

... promotion... and the satisfaction that comes with getting ahead. Mail the coupon today. It could be a real turning point in your life.

Accounting

Public Accounting and Industrial Accounting offer many excellent opportunities with high-income potential for the trained man or woman.

Business Management

To be a successful executive in industry or in your own business, you should be trained in many areas—accounting, law, labor relations, production controls, etc.

Computers

A marvel of the electronic age... but people are needed to make them work. Designing programs for modern computers is one of the most exciting, expanding career fields today.

Secretarial

Industry and the legal and medical professions offer exciting and rewarding careers and opportunities for high income to well-qualified secretaries.

Electrician

Qualify for any one of several jobs in this exciting, fast-moving field. There's plenty of opportunity in a wide variety of areas.

Electronics

Skilled, trained men and women are needed who can plan, design, build,

install, maintain and repair the electronic machines that run the world.

TV Servicing

Learn TV and Color TV Servicing/Repair. Test and troubleshoot your own 25" (Diagonal) Motorola Quasar II Color TV training chassis.

Engineering

Prepare for a career in the basic profession, engineering. Every major area of endeavor begins with engineering... civil, mechanical, industrial, chemical and electronic.

Drafting

With ability and interest in drawing, and a technical or mechanical aptitude, you can chart your own unlimited career opportunities in the drawing field.

Auto Mechanics

There won't be any shortage of work for trained automobile mechanics in the foreseeable future! Already there is a critical lack of skilled workers.

Hotel-Motel Management

If you like traveling, meeting new people, living in exotic places, variety in your daily routine... you'll certainly enjoy a career in this exciting field.

Interior Decorating & Design

There are many rewards for you in the field of interior design. Use your skill to decorate your own home or to help your friends.

ICS Scranton, Pa. 18515

GET THIS FREE!

1. **Demonstration lesson**—including sample questions, showing you exactly what it's like to learn at ICS.
2. **"Turning Point"**—a fascinating self-evaluation booklet, helpful in planning your future.
3. **Career booklet**—look at present and future prospects in the field of your choice... plus a description of the ICS Program in this field. All free—and without obligation! Send the coupon today!



ICS...help is here.

Mail to **ICS** Scranton, Pa. 18515

YA121Y

Rush me free details, plus demonstration lesson, on preparing for one of these exciting careers in the comfort of my home:

Name _____ Age _____

Address _____ Apt. _____

City _____ State _____ Zip _____

Hotel/Motel

Accounting

Engineering

Computers

Business Management

Drafting

Electronics

TV Repair & Servicing

Secretarial

Electrician

Interior Decorating & Design

Auto Mechanics

High School (For those who would like to earn an ICS High School Diploma)

Approved for Veterans Training

Approved for Federally Insured Loans.

Accredited Member

National Home Study Council.

PHOTO HINTS



FLOATING LIDS will prolong the life of photo solutions by keeping them airtight as they're used. You can make perfect-fitting lids by casting them in place with wax. Fill a container with hot water and set in a pan also filled



with hot water (right). Drop in a cake of canning paraffin and let it melt. As it cools, stick in a thread spool for a handle. Hold can briefly under warm water to release it when hard.—*Jackson Hand, Westport, Conn.*



A SAFE, EASY WAY to store extra lenses is in a rack like the one above. Obtain rear lens caps to fit your particular lenses and mount them on a small wood base with two screws in each. If there's any danger the rear lens elements will touch screwheads when racked in, use flathead screws countersunk flush.—*Frederick C. Bourbeau, Manchester, N. H.*

Tripod Light Mount



PHOTOFLOOD HOLDERS of the spring clamp type don't grip well on round tripod legs and frequently slip out of place just when you're all set to make a shot. This split block, easily made from a scrap of two-by-four stock, clamps around a tripod leg and gives the floodlight a firm, flat surface to clip onto.

—*Peter Legon, Malden, Mass.*

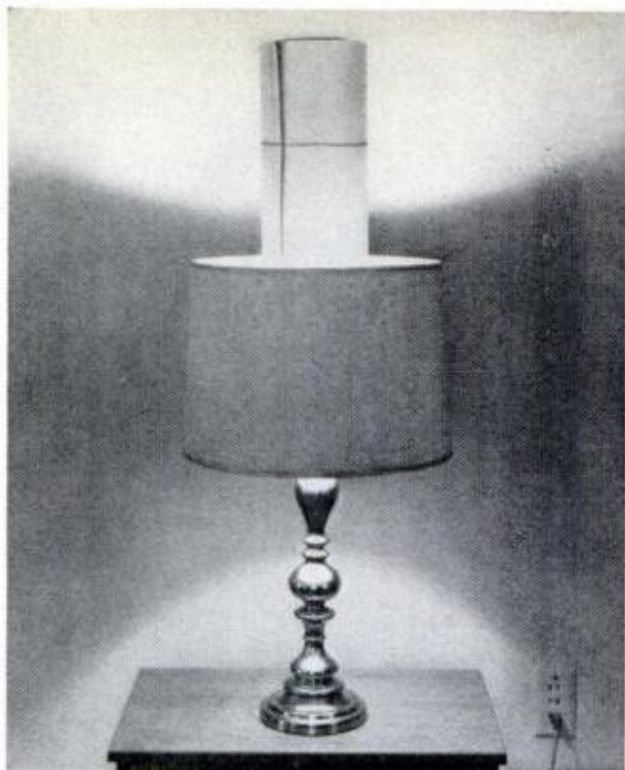

YOU CAN SPEED PRINT DRYING by placing the blotter roll over a lighted table lamp. The warm rising air cuts drying time to a fraction of what it would normally be.

—E. B. Silsby, Granby, Mass.

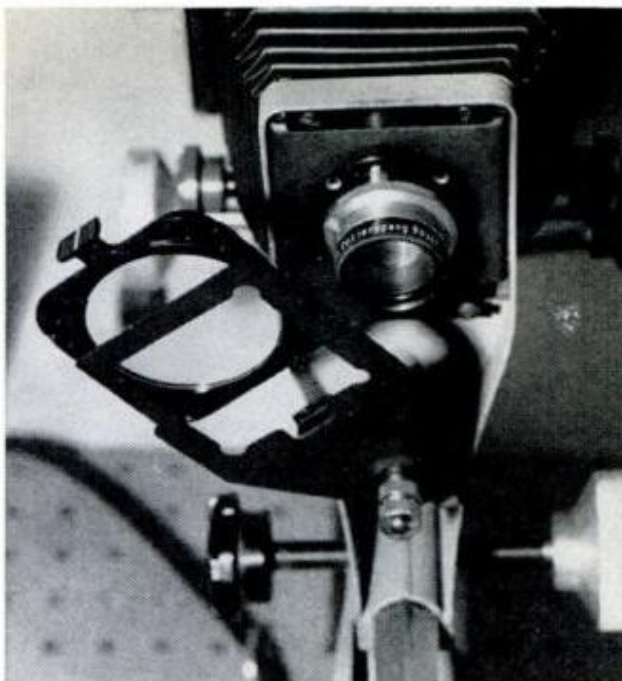

A HANDY SWING-OUT HOLDER for variable-contrast filters can be made like the pivoted red filter on most enlargers. Use the existing holder as a pattern for making a similar one from light aluminum to fit the contrast filters. The red filter can be mounted in a cardboard frame so it can also be used in the new holder.—Arthur L. Ramos, San Anselmo, Calif.

Freeze-a-Ferrari.

Not all 35mm reflexes let you keep up with the action. When you look away to adjust the camera, you lose the race.

With a Minolta SR-T 101, you never lose sight of your subject. Because you set shutter speed and lens opening by simply aligning two indicators in

the viewfinder. So you can frame, focus, adjust exposure and (Varroom!) get the shot, fast and easy.

Minolta SR-T 101, from about \$300. The Minolta SR-T 100, about \$250. For literature, write Minolta Corporation, 200 Park Avenue South, New York, New York 10003. In Canada: Anglophoto Ltd., P.Q.

When identified by a factory-sealed "M" tag, Minolta 35mm reflex cameras are warranted by Minolta Corporation against defects in workmanship and materials for two years from date of purchase, excluding user-inflicted damage. The camera will be serviced at no charge provided it is returned within the warranty period, postpaid, securely packaged and including \$2.00 for mailing, handling and insurance.

Minolta



NEW IN ELECTRONICS

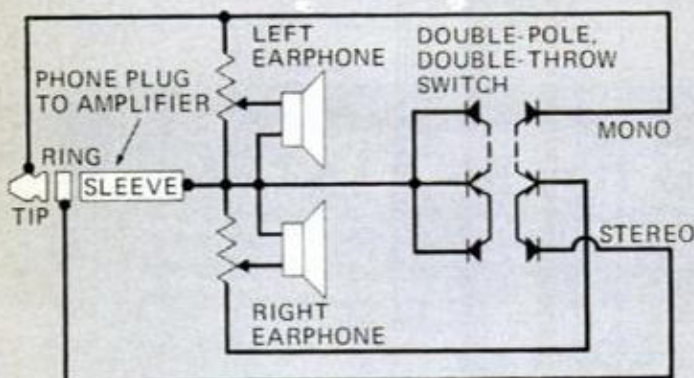

THREE HEADPHONES that do special tricks reflect rising interest in private listening. Latest Audiotex stereo model (upper left) has slider-type volume control on each ear-cup for balancing sound without leaving your chair. It's \$29.95. With "wireless" headset at upper right, you can walk around listening to radio or television without trailing a cord. Tiny battery-powered receiver in this monaural type picks up sound by induction. Made by Superex, \$29.95. Two-way headset at lower right lets you switch to stereo or monaural. With switch in monaural position, a mono source is channeled into both ears (see diagram, left). Made by Koss, the \$45 KO-747 phones also have individual volume controls.



NEW RECHARGEABLE BATTERY is said to combine power of a wet cell with convenience of a dry cell. Using electrolyte in gelled form, it costs one-fifth as much as nickel cadmium batteries, can be recharged 300 to

1000 times. Still experimental, the Burgess Gelyte battery is being tested for use in portable power tools like electric hedge trimmer above. Gould, Inc., Box 3140, St. Paul, Minn.

(For more New in Electronics see page 50)

GLAS-GUARD, the double fiberglass belted tire specially made for panels and vans...

It can keep your business running



Bruise and cut-resistant rubber in sidewalls



The pickup and delivery business runs on tires.

And it's rough on tires. With fast starts, sudden stops, plenty of hard knocks.

Goodyear tire engineers studied this kind of driving, and built a tire for it. **GLAS-GUARD.**

It has a combination of features no other Goodyear tire has ever had before, for long mileage, stability and strength.

Ask your Goodyear Dealer or Goodyear Service Store for **GLAS-GUARD**, the tire that means business.

GOODYEAR

...big on the road

NEW IN ELECTRONICS

(Continued from page 48)

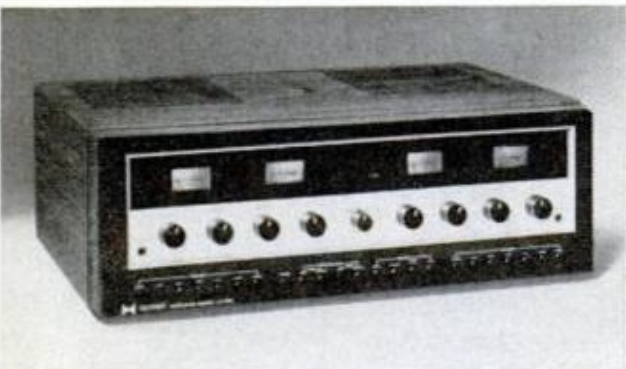
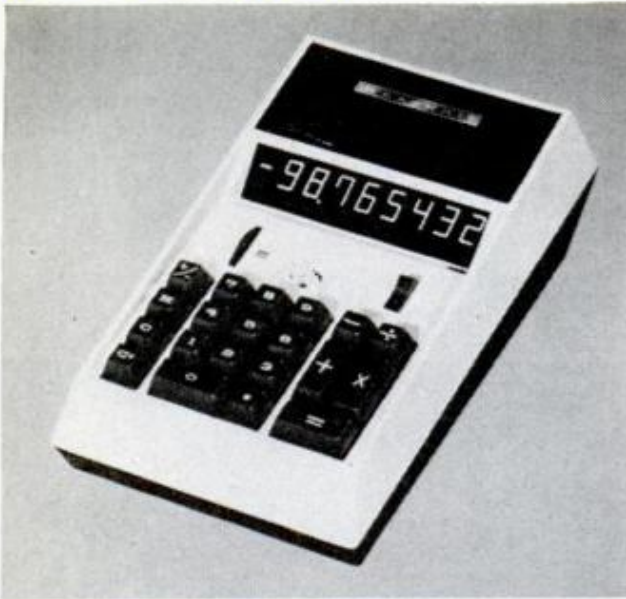

THREE UNUSUAL NEW KITS from Heath above are digital calculator for home use (top), digital FM stereo tuner (center) and four-channel amplifier (bottom). The trim little desktop calculator, Model IC-2008, adds, subtracts, multiplies and divides electronically, is \$129.95. For the quadraphonic enthusiast, the AA-2004 four-channel amplifier is a versatile, all-in-one package providing four modes of operation: monaural, standard stereo, discrete four channel and matrixed four-channel with built-in decoder. Kit price, \$349.95. The AJ-1510 digital FM tuner lets you punch out desired station frequencies on a pushbutton keyboard and displays them in lighted numbers on the tuning dial. Kit price, \$539.95. Heath Co., Benton Harbor, Mich.

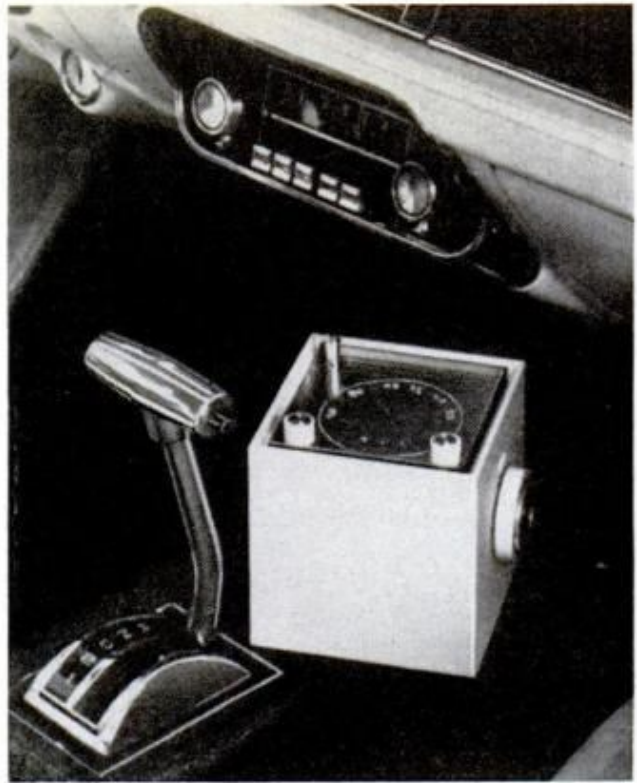

YOU CAN LISTEN TO TV even when you can't watch it with the special FM receiver above. Designed to let you hear your favorite TV programs when you're away from a set, the portable battery radio picks up VHF frequencies used to broadcast video sound and plays the programs through a built-in speaker. Called Video-Voice, it will play in a car, boat or other remote locations. \$29.95, Concept Plus, 12509 Beatrice St., Los Angeles, Calif.

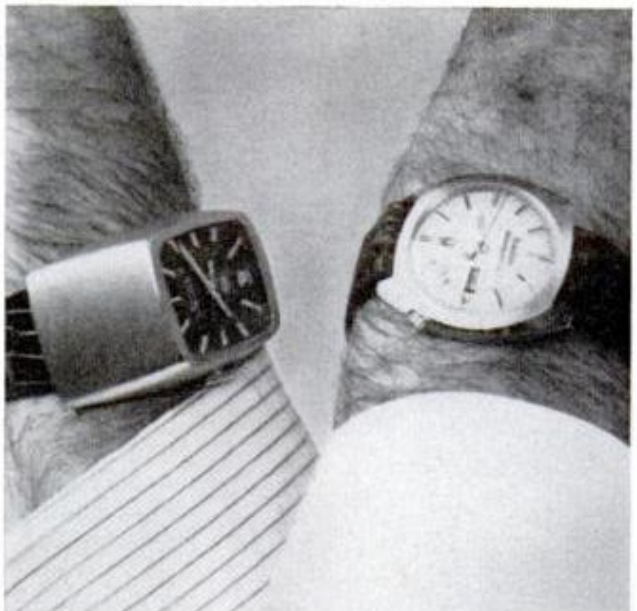

FIRST QUARTZ WRISTWATCH in conventional size (right) is one-third as big and almost one-third the price of costly, bulky earlier model (left). The slim Bulova Accuquartz timepiece is \$395 compared to \$1000 for previous version. A tiny quartz crystal vibrating 32,768 times a second keeps the watch accurate to within a second or two a week.

There may be a great future in your past.



Think back to that time in your life when you felt like you belonged, had enthusiastic friendships, and a sense of contributing to your country's strength. When you could actually look forward to a secure and comfortable future.

Chances are, the last time you felt like that was when you were in the service. The question now is, is it too late to do something about bringing back the good old days of military life?

In a word, the answer is "No." The Air Force Reserve needs good men with their service skills intact. And, if you've got what we're looking for, you can look forward to a second income, specialized training, and rediscover what benefits and rewards an Air Force career can bring to your life.

Think it over. For one weekend a month and 15 active duty days a year, you could find yourself in the Air Force

Reserve with a great future to look forward to.

For more information, mail in the coupon below. Or, call 800-631-1972 toll free* for the address of your local Air Force Reserve unit.

Do it now. And let your future catch up to you. *In New Jersey call 800-962-2803.

U.S. AIR FORCE RECRUITING SERVICE ^{3-PM-52}
DIRECTORATE OF ADVERTISING (APV)
RANDOLPH AIR FORCE BASE, TEXAS 78148
Please send me more information about joining the Air Force Reserve.

I was formerly in the Air Force Navy Coast Guard Marines Army

My grade was _____

My specialty was _____

NAME _____

ADDRESS _____

CITY _____ STATE _____ ZIP _____

PHONE (area code) _____

I understand there is no obligation.

**Find yourself
in the Air Force Reserve.**



GROUND STATION was flown to Peking prior to the President's visit. Made by Hughes Aircraft, the facility boasts a 24-foot-diameter antenna and enough electronics to transmit 1 color TV broadcast, 9 voice commentaries and 60 two-way phone conversations. It beamed transmissions to Intelsat IV, as shown in the drawing



How satellites put you on the scene—instantly!

By RONALD SCHILLER

ON A JULY MORNING IN 1969, television broadcasting faced what could have been an operational disaster. The long-awaited ceremony at Caernarvon Castle in which the heir to the British throne would be invested as the Prince of Wales was about to get under way.

Across the Atlantic Ocean over 200 U.S. and Canadian television stations had reserved an hour of expensive time to broadcast the event live—when, suddenly, the Atlantic communications satellite that was to transmit the pictures suffered a temporary “outage,” or malfunction.

But there was no panic. When the “trouble light” flashed red at the operations center of the Global Satellite System in Washington, D.C., engineers quickly coordinated a rerouting plan with Earth stations in the Pacific and Indian Ocean areas.

After a brief conference, various small

POPULAR MECHANICS

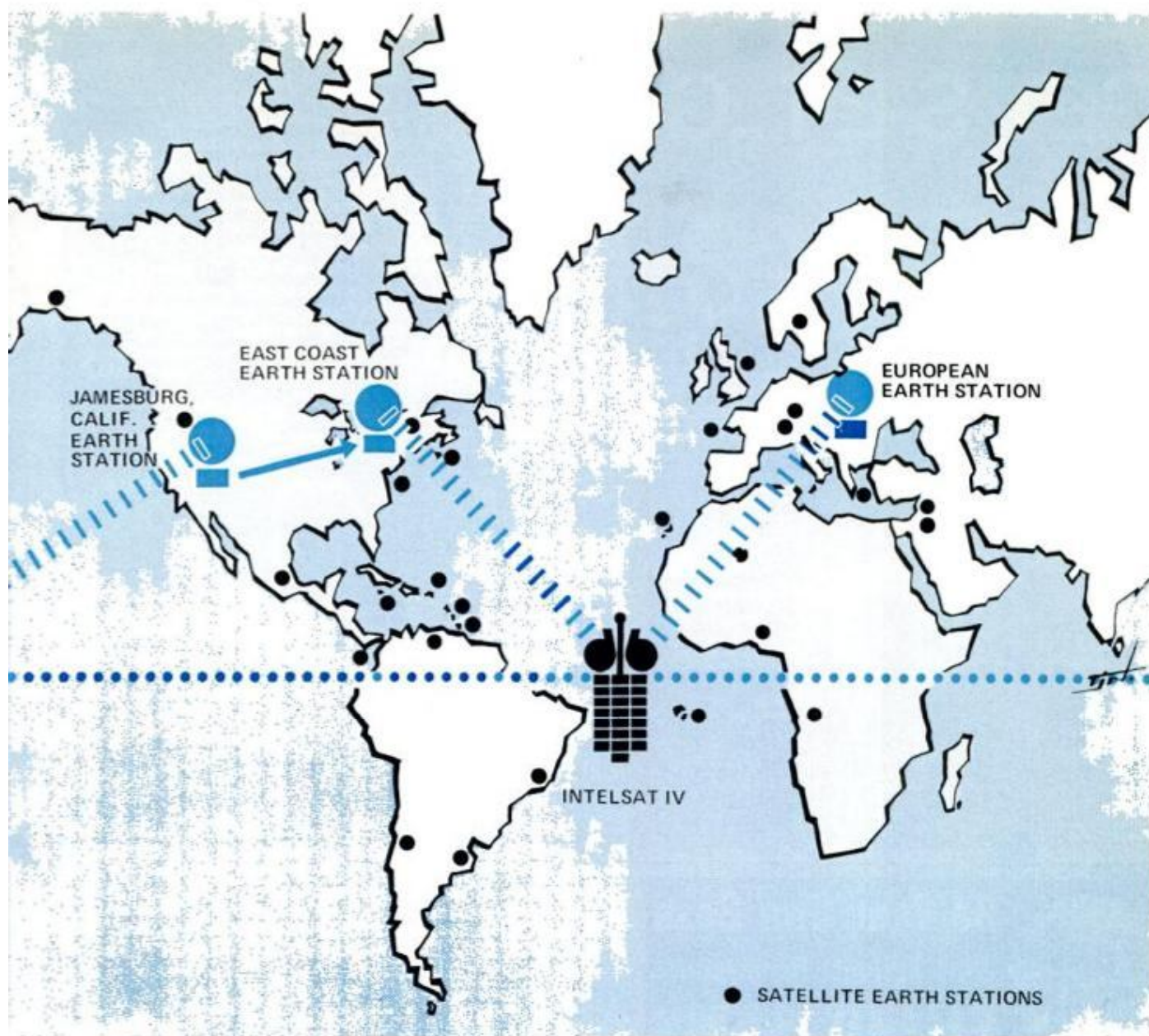

switches were thrown, whereupon the electronic signals that were to have been beamed westward over the Atlantic reversed direction and began flowing toward the east. Traveling at the speed of light, they shot across Europe and western Asia to strike a small metal dish 22,300 miles above the Indian Ocean, from which they caromed progressively down to another dish-shaped antenna in Yamaguchi, Japan, up to another satellite above the Pacific, down to the Earth station in Jamesburg, Calif., across the United States via microwave to New York, then out to the stations of the broadcast network. North American viewers watched the start of the mounted parade without missing a hoofbeat.

The distance those television signals traveled was 113,000 miles. Elapsed time: six-tenths of a second. Unusual? Not in the least. In fact, the exercise was almost trivial as compared with the vastly more intricate procedures that enabled one-

sixth of the human race to watch American astronauts walk on the moon or witness President Nixon's historic visit to China. They involved every communications satellite and Earth station of the globe. Indeed, without the little "talking birds" to relay messages and computer data, these electronic achievements would have been impossible.

So routine has instant global voice and picture communication become that we are apt to forget that it was unavailable just seven years ago. Live television stopped at the water's edge. Nations could talk to one another only if connected by strands of copper wire, by 100-foot-high microwave relay towers strung out in line-of-sight intervals every 30 miles across the continents, or, when the static was endurable, by high-frequency radio. Telephone messages between adjoining nations of Africa had to be relayed through London. A call from Chile

(Please turn to page 186C)

GET S-E-T...GO!

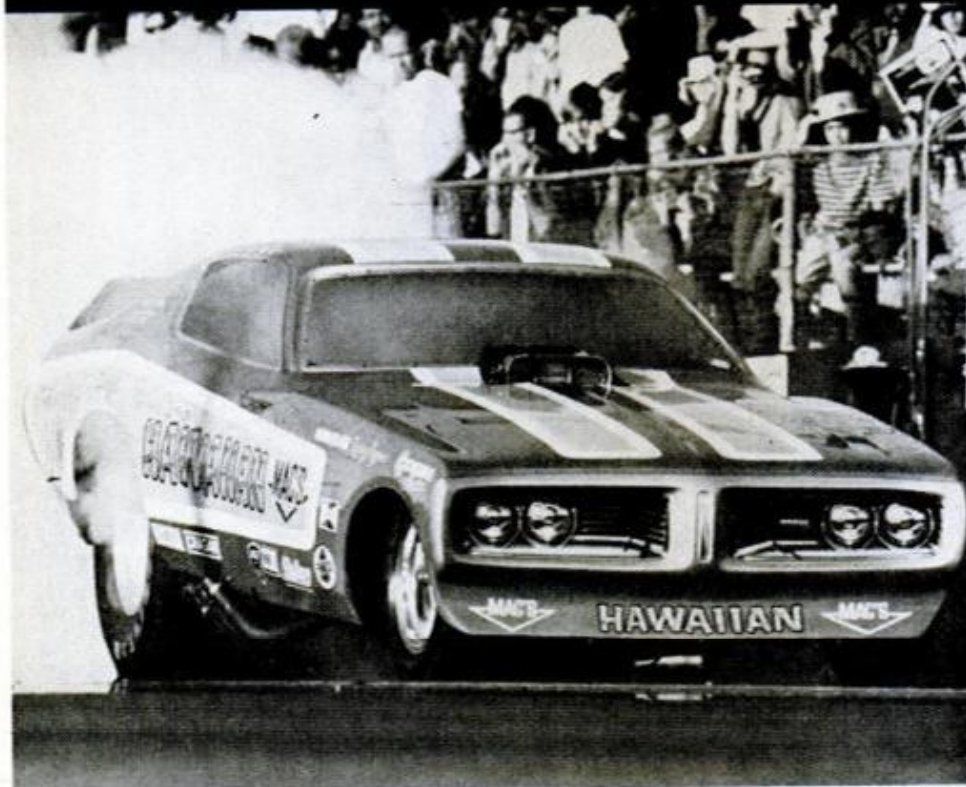

Roland Leong and the Mac's Hawaiian are a winning combination on the Funny Car circuit. Now Mac's has a winning combination for your car. Mac's S-E-T Super Engine Treatment products. Mac's S-E-T Gasoline Booster keeps the fuel system clean including emission devices, boosting power. Mac's S-E-T Carburetor Tune Up improves performance as it cleans and lubricates carburetors, automatic chokes and P.C.V. valves.

Mac's S-E-T Oil Booster retards wear, rust and corrosion in engines and meets all manufacturers' standards.

Available at service stations and your NAPA or independent jobber.

MAC'S
AUTOMOTIVE CHEMICALS



Be Your Own Boss New Business Opportunity **FILING SAWS**



Start a steady repeat CASH business in your basement or garage. Earn \$3 to \$6 an hour in your spare-time! Excellent profits in saw sharpening business! Automatic Foley Saw Filer, easy to operate, files combination saws, hand, band, and circular saws. No experience needed. H. C. Delbert wrote us: "Since I got my Foley Filer 5 years ago, I have averaged 4½ saws each day since I started."

Every saw you sharpen brings you more customers. "I rented a two-car garage and have all the work I can do," writes Charles H. Smith.

FREE BOOK Shows How to Start

Fact filled booklet tells you how to start a sparetime business immediately; how to get new business, how to advertise. Rush coupon now; get "Money Making Facts" and details on Easy Payment Plan. No Salesman will call.

Send Coupon for FREE BOOK Money Making Facts

FOLEY MANUFACTURING CO.
543-2, Foley Bldg, Minneapolis, Minn. 55418

Send FREE BOOK—"Money Making Facts",
and Time Payment Plan.

Name _____

Address _____



New Tool Works Wonders With Wire **WIREFORMER**

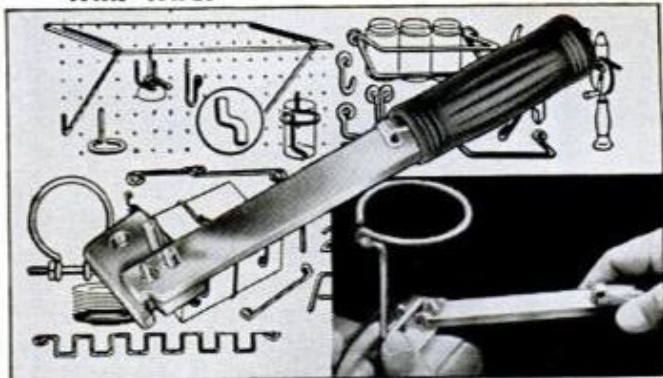

IT BENDS! IT CUTS! IT STRAIGHTENS!

WIREFORMER is a simple, precision made, vise-held tool of innumerable uses. Make your own peg board hooks, clamps, handles, braces, brackets, etc.—any shape you want. Forms an eye of 3-16" inside diameter (just right for any nail, screw, or bolt up to that size). Even uses coat hanger wire. No pliers needed. WIREFORMER does the work with the pressure of one finger. Straightens the wire if you make a mistake. Cuts the wire just where you want it. Forms any angle, arc or circle. Bends both right and left. Tool is case hardened, plated, with a plastic handle. Fits in your pocket. Complete instructions, illustrated brochure showing many things to make.

SOLD ONLY BY MAIL. MONEY BACK GUARANTEE. Four dollar bills will get you one, or send check or money order for just \$3.98 We pay postage and handling charges.

VINKEMULDER TOOL CO. Dept. PM5
2223 Estelle Dr., S.E. Grand Rapids, Mich. 49506

Ariens



has the answer!

It's the all new Fairway with electric starting for 1972. Fairway's built to take it! Lightweight, compact, yet engineered for solid dependable service year after year. The Fairway is designed for both purpose and safety . . . a new dimension in riding mowers. It drives like a car with a separate clutch and brake, and has geared steering for quick, sure turns. The Fairway features four speed Disc-O-Matic drive, reverse, adjustable cutting height and a 26" Flex-N-Float mow-

ing pan which prevents scalping and gouging. Altogether, Fairway's got it! Take a close look at the reinforced all-steel frame, wide pneumatic tires, baked-on enamel finish and front fenders that serve as foot rests. Other models available in 5 and 7 H.P. with recoil starting. Get carried away on a Fairway for '72. See Ariens complete line of Gard-N-Yard equipment at your nearby dealer . . . (He's listed in the Yellow Pages.) ARIENS COMPANY • BRILLION, WISCONSIN



A plug for people who change their own

We figure you power buffs have lots of interests and lots of equipment to go with them. So NGK builds a plug for practically every internal combustion engine made.

Also, being mechanically hip, you appreciate quality and efficiency. So we build the most efficient, toughest plug we can. The kind you'd want to put in your own car, bike, outboard, buggy...whatever.

But all our plugs—and it takes the company computer to keep track of them—have one thing in common: a never-say-die "Heart of Copper".

Used in place of ordinary iron cores, this highly conductive copper core delivers maximum performance under all conditions.

It dissipates heat fast, cuts down plug damaging hot spots and piston-popping pre-ignition. A long-nosed insulator holds just the right amount of heat to reduce tip fouling. In hot engines or cold, under easy or hard use, NGK's fire on time, every time.

If you're a motorcycle owner, you probably know all about NGK performance. You sports car types do, too. But NGK's work just as great in utility and recreational vehicles. And they'll fire-up your hairy V-8 as quick as your one-lunger saw.

Take our tip. Screw in a set of "Heart of Copper" NGK's. They're a change for the better.

NGK, the long life, hi-performance plug.



NGK SPARK PLUGS (U.S.A.), INC., 4010 Sawtelle Blvd., Los Angeles, California 90056

Introducing:

A great new breed of staple gun...

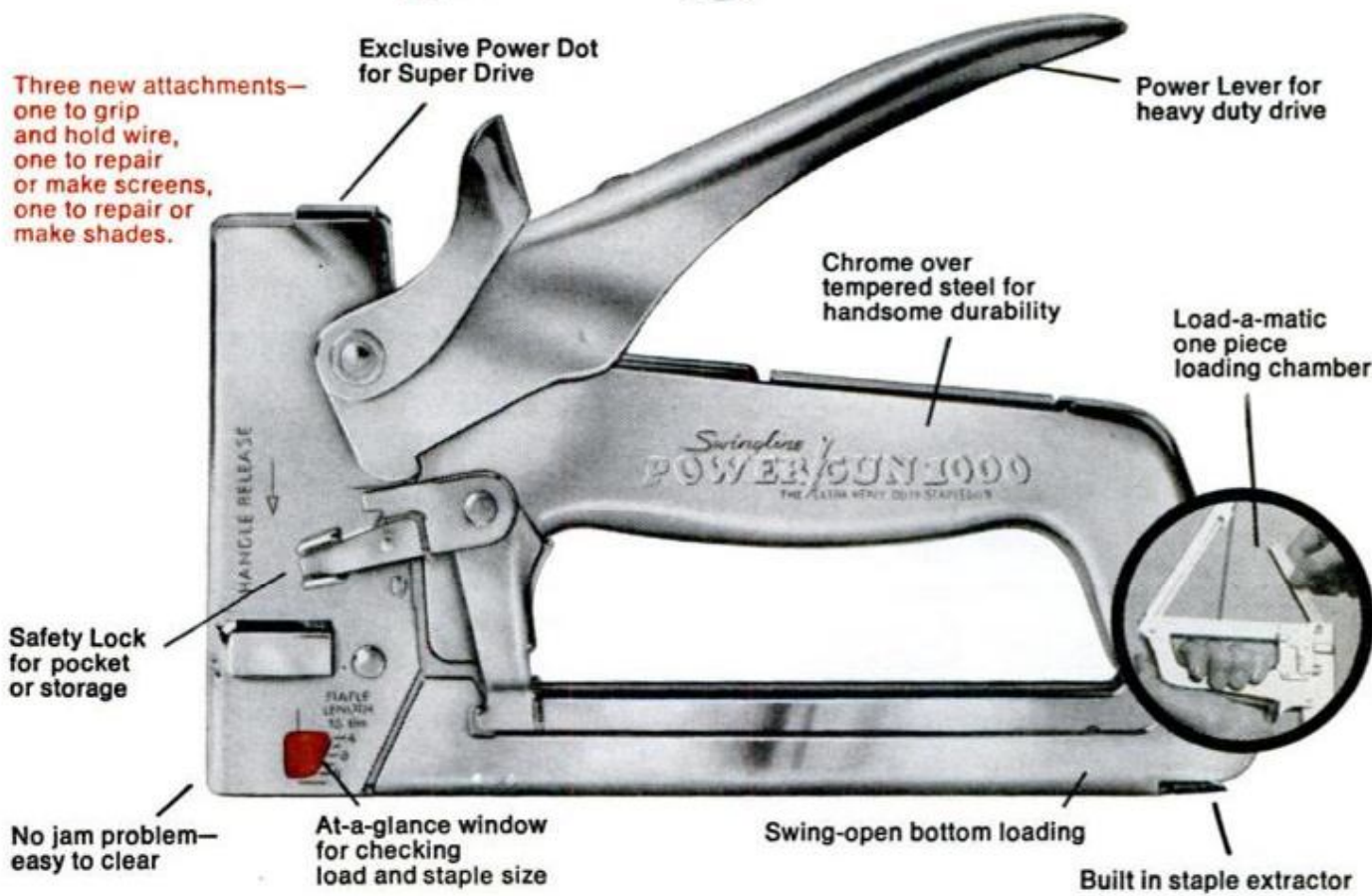

new Power Gun 1000 does more:

If you're a homeowner you've got to own the new Swingline Powergun 1000, the first extra heavy duty staple gun that does it all. You name it. You'll find hundreds of uses, indoors and out.

Suggested retail price.



THE FIRST EXTRA-HEAVY DUTY STAPLE GUN NEW FROM

Swingline

Write for FREE "Tips for Tackers" booklet. Dept. PM

Consumer Products Division 32-00 Skillman Avenue, Long Island City, N.Y. 11101

MAY 1972

50G

JUNE **Preview** OF POPULAR MECHANICS



AIR SURFING: A NERVY NEW SPORT

Young people are leaping off sand dunes and cliffs to get a free flight in kites and hang gliders.



THE WORKSHOP THAT PAID FOR ITSELF

Year by year this workshop grew as the custom-built furniture it produced paid for new equipment.



DURABLE FURNITURE— MADE OF CARDBOARD

This furniture, which you can make of inexpensive cardboard, can take daily use for years.



THE TRUTH ABOUT MONDAY AND FRIDAY CARS

According to the best-selling novel, *Wheels*, cars built at the beginning and end of the week are often "dogs." PM separates fiction from the facts.



OUR GREAT VIETNAM GOOF

Col. David H. Hackworth, the Army's most decorated officer, reveals how gadgets and untested equipment handicapped our fighting men in Vietnam.

PLUS

Your car goes with you on a train to Florida
• A two-place amphibian amateurs can build for \$3500
• A combination bunk bed/desk ideal for a boy's room
• The new trash compactors
• A cartridge tape player you can build from a kit

Buy it on your newsstand. Better yet, make sure you'll keep getting this kind of exciting fare. Send this coupon with your check to:

POPULAR MECHANICS
250 West 55th Street
New York, New York 10019

Please enter my subscription for 1 yr. \$5 or 2 yrs. \$9

Name _____ (Please print)

Address _____

City _____ State _____ Zip _____

Payment of \$_____ is enclosed. New Renewal

On new subscriptions, first copy will arrive in about 8 weeks.

(Above prices apply in U.S. and Possessions only. Canada, add \$2 per year. All other countries, add \$4 per year.)

WPM2E1

Great careers begin at home

Join the high-paid technicians who got their start through NTS Home Training

Build a new and successful career with a leading industrial company. NTS graduates have been employed by Burroughs, Sears, Carrier, Ford, and many others — and these men started at home.

NTS turns your home into your own private classroom-workshop. See your skills and confidence grow as you train at home on professional equipment we send you. Tools, test equipment, lessons and manuals are all included in your tuition, yours to keep. You test what you learn as you learn it on the same kind of equipment technicians use. You learn at your own pace, keep your own schedule, save precious time.

For the successful career you want, begin at home with NTS. Check coupon for the course that interests you, and we'll rush you a free color catalog. No obligation; no salesman will call.

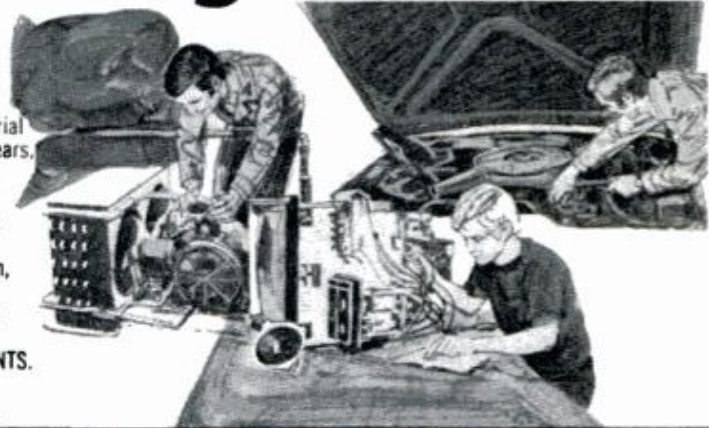

Electronics Division

Cash in on the growing fields of Color TV & Radio Servicing, Computer Electronics, Electronic Communications or Industrial & Automation Electronics. Each course includes valuable kits such as new Solid-State Color TV, NTS Compu-Trainer, Transceiver, Oscilloscope, and more. Check coupon today for new, free color catalog!



Air-Conditioning, Refrigeration, Heating Division

As an NTS master technician, you'll install and maintain today's complex air-conditioning, refrigeration, and heating systems. Earn high wages with a service company, or go into business for yourself! Receive tools, tester, gauges, and instruments, included in your tuition. Check coupon now for new, free color catalog.



Mechanics Division

America's largest industry pays top money for top skills — and NTS prepares you fast! Professional diagnostic test equipment and 109-piece Tool Set included in your tuition. Plus bonus "hot shop" lessons. Four big automotive fields to choose from. Check coupon for new, free color catalog, receive complete details.



Home Appliance Division

Start earning extra money even before you finish the course! Open your own shop, or join a first-class company. Service ranges, washing machines, dryers, home air-conditioners, and other major and small appliances. "Project Method" features exclusive Circuit Trainer, Appliance Tester, and tools. Check coupon for free color catalog!

High School at Home

NTS offers accredited High School programs. Take only subjects you need. Study at your own pace. Everything included at one low tuition. Check special box in coupon for full information and free catalog.

Classroom Training at Los Angeles

You can take classroom training at Los Angeles in sunny Southern California. NTS occupies a city block with over a million dollars in training facilities. Check box in coupon.

APPROVED FOR VETERANS

Accredited Member: National Association of Trade and Technical Schools; National Home Study Council.

SEND FOR FREE CATALOG & SAMPLE LESSON
NATIONAL TECHNICAL SCHOOLS

Worldwide Training Since 1905

4000 So. Figueroa St., Los Angeles, Calif. 90037



CHECK ONE ONLY!

NATIONAL TECHNICAL SCHOOLS

4000 So. Figueroa St., Los Angeles, Calif. 90037

Please rush FREE CATALOG and SAMPLE LESSON for course checked below. No obligation. No salesman will call.

Electronics Division

- Master Course in Color TV Servicing
- Color TV Servicing (for Advanced Technicians)
- Master Course in B&W TV & Radio Servicing
- Practical TV & Radio Servicing
- FCC License Course
- Master Course in Electronic Communications
- Master Course in Electronic Technology
- Industrial Electronics
- Computer Electronics
- Basic Electronics
- Stereo, Hi-Fi & Sound Systems

Air Conditioning/Refrigeration/Heating Division

- Master Course in Air Conditioning, Refrigeration & Heating
- Air Conditioning & Heating Refrigeration

Mechanics Division

- Master Course in Auto, Truck & Diesel Mechanics
- Automotive Mechanics
- Truck, Heavy Duty & Diesel Mechanics
- Engine Tune-up & Electricity

Home Appliance Division

- Home Appliance Master Technician's Course
- Home Appliances Servicing
- Handyman Appliance Repair

High School Department High School at Home

Name _____ Age _____

Address _____

City _____ State _____ Zip _____

Check here if interested in veteran training under new G.I. Bill.

Check if interested ONLY in classroom training at Los Angeles.

DEPT. 201-082

If your menthol doesn't make it,
make your menthol KOOL.

Come all the way up to KOOL.
The only one with the taste of extra coolness.

© 1977 BROWN & WILLIAMSON TOBACCO CORP.



Warning: The Surgeon General Has Determined
That Cigarette Smoking Is Dangerous to Your Health

18 mg. "tar," 1.4 mg. nicotine
av. per cigarette, FTC Report Aug. 71.

Материал, защищенный авторским правом

HOMEOWNERS' CLINIC

BY W. CLYDE LAMMEY

Removing moss from brick wall

Moss is appearing on the brick walls of my home in several shaded areas. How can I remove it?—Edward Lassiter, Charleston, S. C.

Try to eliminate the condition that encourages growth of this objectionable plant, perhaps by removing or pruning shrubbery to let air circulate more freely and sunlight penetrate to the wall.

You can usually remove the existing moss by a vigorous scrubbing, first with a wire brush and then with a stiff-bristle scrubbing brush dipped in full-strength laundry bleach. Then hose the wall to remove all residues of the bleach. Wear rubber gloves when applying the bleach; also protect your eyes from spatters.

Spreading lawn 'weed'

A patch of what appears to be a new "weed" is spreading in my lawn. No one seems to know what it is and I seem to be the only victim. The leaves are shorter than lawn grasses and light green in color. The stuff pulls up easily, but eliminates the lawn grass where it's growing. What is it and what will kill it?—Bert Phillips, Bloomington, Ind.

Without a sample, I'll guess it's a variety of "creeping bent" grass. To kill it, cover it with a sheet of opaque or translucent plastic, or just pull it up, taking care to get all the root systems. Then spade the soil, rake out all remaining debris, add peat moss and a little sand, and reseed with a lawn grass. Keep the seeding well watered, but not too wet, until growth is well along into the season.

Pictures 'print' papered walls

How can I eliminate the lightened areas that hanging pictures leave on papered walls? The wallpaper has a colonial pattern on a tan background.—Mrs. John Tate, Racine, Wis.

I have no positive remedy; repapering is probably the only practical solution. However, I once tried this stunt: I squeezed an artificial sponge nearly dry after dipping it in water to which were added a few drops of vegetable coloring

that matched the exposed areas of the paper as nearly as possible. I sponged this colored water onto the areas, then dried them by "pouncing" the surface with cotton. The procedure very nearly eliminated the lightened areas. You might try it experimentally.

Old finish bleeds through

Woodwork in my old home has a dark finish. I applied an enamel over it in one room and now the old finish is bleeding through, making an unsightly mess. What do I do now?—F. S., Miss.

You should have first used a sealer such as B. I. N. Try it on the rest of the job and you'll likely have no more trouble. As for the woodwork you treated, take off the enamel with a wash-off paint remover and start over, using the sealer as an undercoat for the first application. Or, a lazy man's approach would be to sand the gloss off the enamel, apply the sealer and then re-enamel.

Easing screws into hardwood

What can I use to make screws easier to drive into hardwood?—Harlow O'Brian, Trenton, N. J.

Beeswax is best as it leaves no objectionable stain on light-colored woods. Just rub the threaded portion of the screw across the surface of a beeswax cake. Be sure to remove any wax that may extrude around the head of the screw with a solvent.

Most finishing materials and stains won't "take", or bond, if applied over wax. So I'd suggest you use a counterbore of a size to fit the screw you are driving. Counterbores are inexpensive and usually make the use of wax unnecessary.

Musty odor in chest

I have a fairly old chest with lid which is painted. Paint is still good but the interior has a musty odor. How can I "sweeten" it?—A. R. Parks, Boston.

Washing it with a mild to medium detergent solution, and drying it in the sun for several hours usually will do it. When it's thoroughly dry treat the interior with several fine coats of a spray lacquer. ★★

Do you have a home maintenance or repair problem? Send it to Homeowners' Clinic, Popular Mechanics, 224 West 57th St., New York, N.Y. 10019. While letters cannot be answered individually, problems of wide interest will be discussed in this column.

"THE BEST PUT-TOGETHER CARS OUT OF DETROIT THIS YEAR MAY COME OUT OF WISCONSIN.



AMBASSADOR

Still the only car in its class to offer air-conditioning, V-8 engine, power brakes and automatic transmission as standard equipment.



HORNET

The tough little compact that made a 38,000-mile endurance run throughout North and South America.



GREMLIN

The original American subcompact. Still heavier, wider and more horsepower than any car near its price.



JAVELIN

The car that Mark Donohue and Roger Penske modified to win 7 of 9 Trans-Am races and the 1971 Season Championship.



SPORTABOUT

The only wagon made in America that offers 60.8 cubic feet of cargo space, a rear lift gate, four doors and sleek, racy looks.



MATADOR

The mid-size car chosen for a 500-car fleet by the Los Angeles Police Department on the basis of quality, performance and price.

THAT'S WHERE AMERICAN MOTORS MAKES THEM."—Popular Mechanics

Popular Mechanics made that statement in their new car issue several months ago. What impressed them was our whole approach to our 1972 cars.

Rather than spend a lot of money on new chrome, gimmicks and gadgetry, we set out to produce cars as defect-free as man and machine could possibly make them.

CAR-BUILDING SIMPLIFIED.

We cut the number of models from 21 to 15. We eliminated "stripped" models and concentrated on the models people really wanted.

Starting from scratch with each model, we looked at 17 areas of function, from design to final assembly.

Altogether, we made 102 engineering changes. Some big, some little, but all designed to make the cars work better.

Then we put in more quality control steps, more tests and more people to be sure the cars are right when they leave the factory.

Overall, we put more time, men and money into this program than anything else we're doing this year.

This is the kind of commitment Popular Mechanics was talking about.

Then we made another commitment.

AMERICAN MOTORS BUYER PROTECTION PLAN.

Since we're building our cars better than ever before, we're going to back them better.

With what we call American Motors Buyer Protection Plan.

It comes with all our '72's, from the

smallest Gremlin to the biggest Ambassador we make.

Here's how it works.

Before the dealer delivers your '72, it's checked over, road-tested and so thoroughly prepared that we make this promise:

If anything goes wrong with your '72, and it's our fault, you won't have to pay for the parts or the labor. We will.



When you buy a new 1972 car from an American Motors dealer, American Motors Corporation guarantees to you that, except for tires, it will pay for the repair or replacement of any part it supplies that is defective in material or workmanship.

This guarantee is good for 12 months from the date the car is first used or 12,000 miles, whichever comes first.

All we require is that the car be properly maintained and cared for under normal use and service in the fifty United States or Canada and that guaranteed repairs or replacements be made by an American Motors dealer.

If you make an appointment and we can't fix your '72 in a day, over 1,900 dealers will loan you a car. Free.

Finally, if you have a problem, you have a name and toll-free number to call in Detroit. And we promise you'll get action, not a runaround.

Nobody in the business does all this for you after you buy a car.

SOMETHING TO THINK ABOUT.

This, along with the way we're putting our cars together, makes for a very simple proposition. Before you buy a '72 from anybody else, see an American Motors dealer.

When you're going to spend several thousand of your hard-earned dollars on a car, it would be foolish not to.



American Motors

Drivin' with Dan

Why do some drivers oppose road-racing guard rails? Is the Wankel engine quieter than a piston engine? When is an engine called 'square'? 'Over square'? Dan Gurney answers these and other automotive questions

Q. Dan, who will win the Indy 500 this Memorial Day weekend?—Andy Golon, Euclid, Ohio.

A. It's hard to be objective about that one! Let me just say that at this writing (beginning of March), our Championship car (see photo below) hasn't seen competition yet but it has broken a couple of track records—not only at Ontario but now also at the fast Phoenix track. Bobby Unser circled the mile in 25.35 seconds. That clipped time from the track record of 26.68 seconds and was even faster than Mike Mosley's 26.1-second practice run.



READY FOR INDY! All American Racers' 1972 Eagle is on its way to Indianapolis for the May qualifying runs. The car's sensational performance in the early tests at Ontario and Phoenix promise a top spot in the lineup for Dan's AAR team and driver Bobby Unser. Roman Slobodinskyj, chief design engineer, and Phil Remington, chief fabricator, are confident not only of that top spot in the lineup but of top finish for the most prestigious 500-miler!

58

Q. Why don't some racing drivers want guard rails alongside road-racing courses? Don't they make racing safer?—Sam Wolf, Tulsa, Okla.

A. Not according to detractors who feel that wide grassy areas on either side of the track would be better. The argument is that when spinouts or accidents occur, the cars involved are confined to the racing circuit, endangering other cars. Advocates of guard rails for entire course lengths are mainly the Grand Prix Drivers Assn. and the safety committee of the Commission Sportive Internationale (CSI). They feel that with the barriers a car that leaves the groove doesn't have far to go. It'll glance a barrier and not wind up in a head-on with something else.

Q. It is true, Dan, that the Wankel engine runs much quieter than a conventional, reciprocating piston engine? I know it has less vibration because the rotors spin and there isn't the up and down motion of the pistons, but what about noise level?—Al Levin, Merrick, N.Y.

A. With fewer parts clicking and thrashing about and changing direction inside the engine, it is indeed a lot quieter. In fact it's so quiet that one of the few Wankel-powered cars made, the German NSU Ro 80, now has as standard equipment an audible alarm that goes off when engine rpm goes over 7000. Without the valve chatter that normally tells an enthusiast that he's revving high and better check his tach, drivers of the "too-quiet" Ro 80 have been unintentionally over-revving.

Q. I've heard the guys in the motorcycle shop talking about "over square" engines on some bikes. I couldn't see they were "square" at all. How do you tell?—Bill Clark, Iowa City, Iowa.

A. You can't tell how "square" an engine is
(Please turn to page 60)

POPULAR MECHANICS

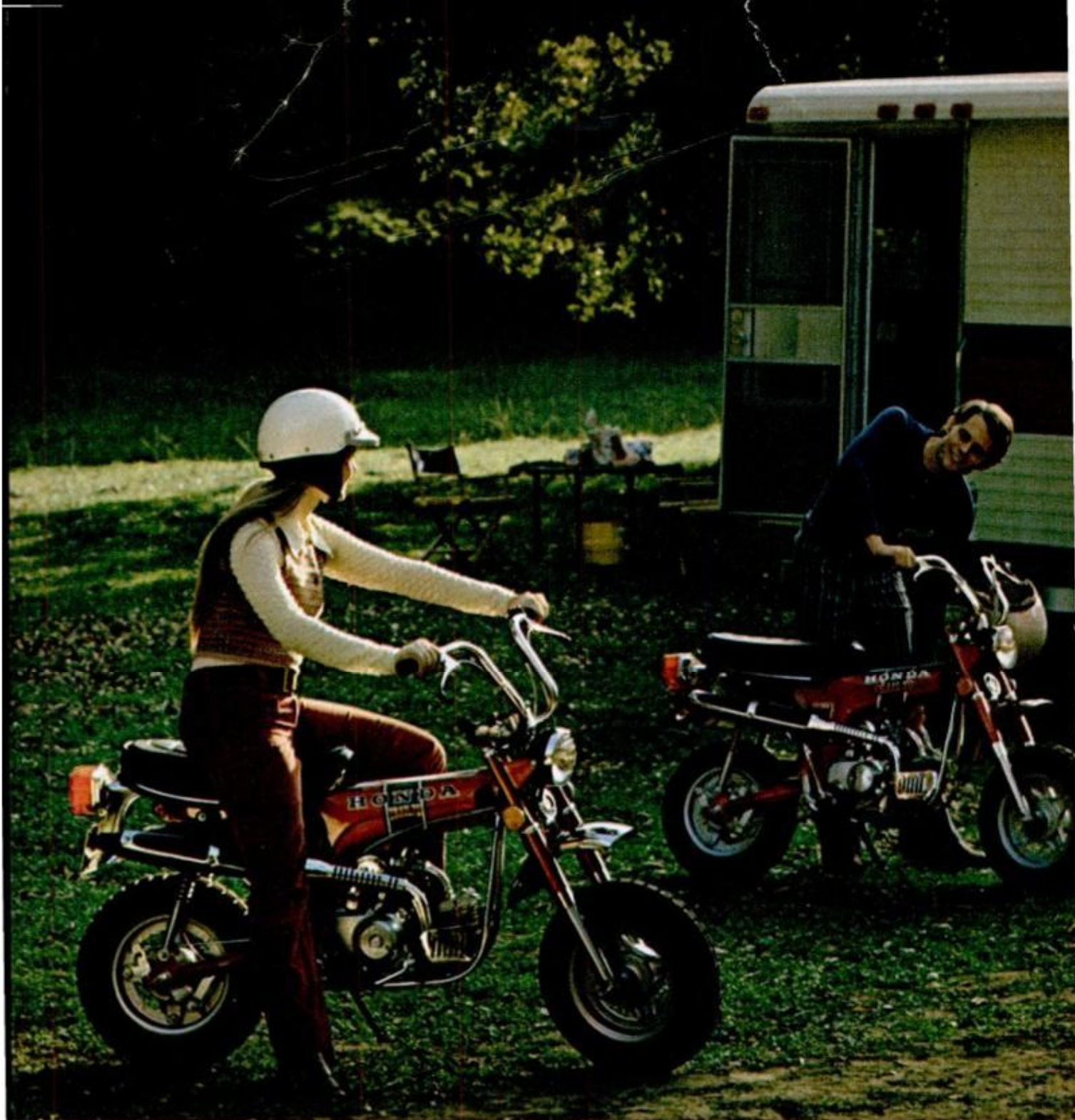

How to get around after you get away.

Take the Honda Trail 70's to the country. Just fold down the handlebars and fold up the foot pegs to pack them easily in your car or camper. When you reach the end of the road, set them up and begin exploring.

The compact single-cylinder overhead cam four-stroke engine is surprisingly powerful. Plenty of pep to cruise along country lanes or climb mountain trails. And it's Honda dependable.

Always ride safely. Wear a helmet and observe all rules of the road. For a free color brochure, write: American Honda Motor Co., Inc. Dept. JX, Box 50, Gardena, Calif. 90247 ©1972 AHM.

Backed by that very strong Honda warranty.

You ride smooth. New telescopic oil-dampened shocks in front make sure of that. And you ride with confidence. The USDA-approved spark arrestor/muffler helps protect the peace and quiet of the countryside.

There are two models of the popular Honda Trail 70. The automatic clutch, three-speed CT-70. And the hand-clutch, four-speed CT-70H. Your Honda dealer has both. Get in to see him. Then get away. And really get around.

The New Honda Trail 70.

START A MONEY-MAKING BUSINESS FOR LESS THAN \$50!



You can have your own lifetime business right at home . . . work in spare time . . . and make up to \$200 a month CASH! My FREE PLAN gives you all the facts: How to start, how to grow. You don't need previous experience. You don't have to sell. I'll even finance you. People bring you the work and pay cash. Over 90¢ of every dollar you collect is clear cash profit. And you work when you want to. Let me prove you can't find a more certain, lower cost, higher paying business of your own.

Just Mail Coupon—No Salesman Will Call
BELSAW SHARP-ALL CO., Stan Field, Pres.
713B Field Bldg., Kansas City, Mo. 64111

FREE
BOOK

Name _____
Address _____
City _____ State _____ Zip _____

Radio Shack DOUBLES Your Bike Riding Fun!

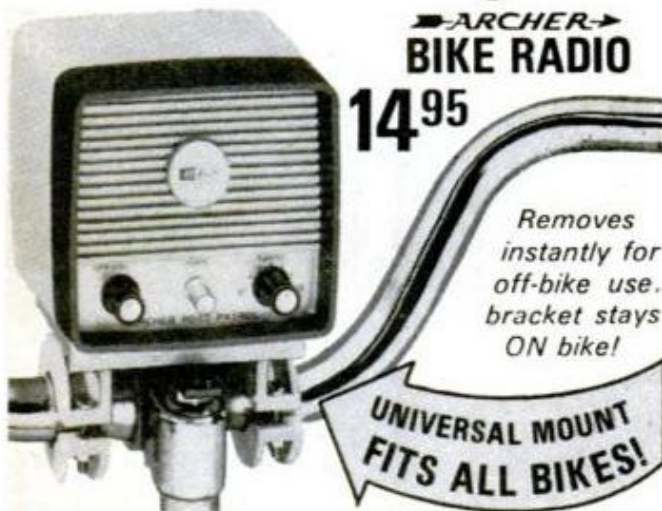

➔ ARCHER ➔
BIKE RADIO

14⁹⁵

Removes
instantly for
off-bike use.
bracket stays
ON bike!

UNIVERSAL MOUNT
FITS ALL BIKES!

Our "Road Patrol" is a weatherized AM radio that leads two lives—on the handlebars of any bike or as an indoor/outdoor portable. Built-in electric horn, 3" safety reflector out front. At our 1400 stores or postpaid anywhere in USA.



radio shack

and ALLIED RADIO STORES

A TANDY CORPORATION COMPANY

2725 W. 7th St. Ft. Worth, Texas 76107

DRIVIN' WITH DAN

(Continued from page 58)

by looking at it. "Over square" is a term referring to the ratio of bore to stroke in both motorcycle and automotive piston engines. It's one of many factors the engine designer has to consider. Cylinder displacement depends on both bore (diameter of the piston) and stroke (distance the piston travels in going up and down). A square engine is one where bore and stroke are equal measurements. Over square is when the bore measurement is greater than that of the stroke. A typical over-square spec (given in both inches and millimeters) would look so: Bore x stroke . . . 3.50 x 3.15 in., 88.9 x 80.0 mm.

Q. On new Porsche cars, a flap on the right rear fender opens up so you can reach the dipstick and check the oil in your crankcase. Why is there such a clumsy arrangement on this supposedly finely engineered car?—Jim Ralston, Syracuse, N.Y.

A. Because in the Porsche 911 series there is no crankcase! The 2.4-liter, flat-Six engine uses "dry sump" lubrication. That means that the engine lubricating oil is in a separate tank or sump and is pumped through the engine and back to the tank. This positive system is different from the wet-sump arrangement where the oil lies in a crankcase under the block.

Q. What's the difference between "net" and "gross" horsepower and why did manufacturers change to the lower, net horsepower?—Jeff Oldenburg, Laramie, Wyo.

A. The old way manufacturers used in advertising—gross horsepower—was measured in the laboratory with fan and air cleaners removed, low exhaust back pressure with carburetor and ignition set for maximum power! The automakers now give a more realistic, net figure, which is the output of the engine when it is operating normally in your car. Horsepower figures have been downgraded by as much as 35 percent when measured this way. ★ ★ ★

If you have questions on racing, high-performance and everyday driving techniques, send them to "Drivin' with Dan," c/o Popular Mechanics, 224 West 57th St., New York, N.Y. 10019. Questions cannot be answered by individual letters. Questions on maintenance and repair should be addressed to the Auto Clinic (see page 268).

Audel Practical Guides.. You can't pick one up without learning something.

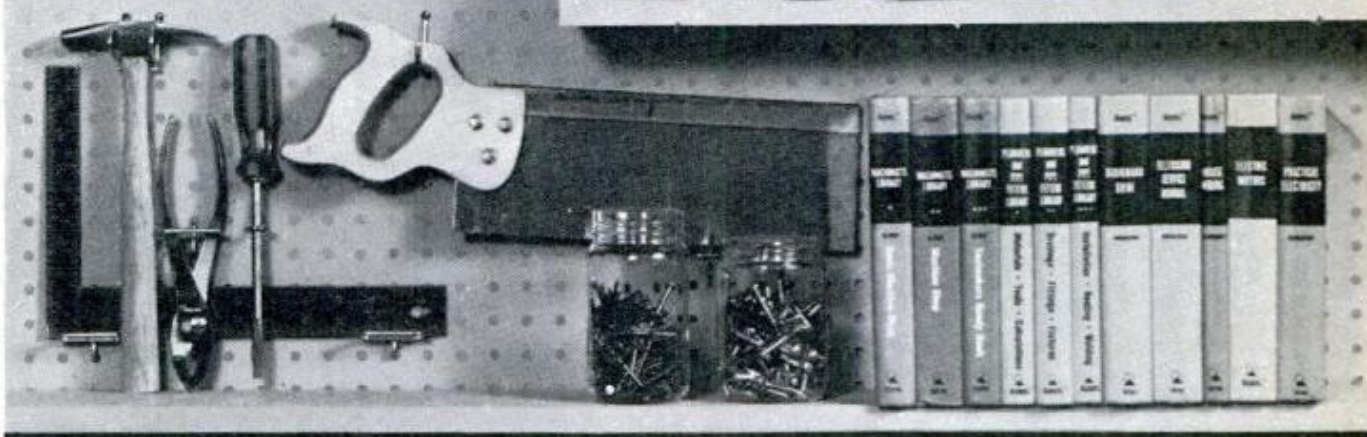

For years Audel has published some of the most helpful do-it-yourself books that any homeowner could own. Here's a partial list. You're sure to find a book or books here that can save you plenty!

HOME APPLIANCE SERVICING

Handy and practical "how-to" instructions for servicing, repairing, assembling, wiring and testing practically all home appliances. No. 23016\$6.95

HOME REFRIGERATION & AIR CONDITIONING

Useful and practical information on operation, servicing and repairing of modern household refrigerators and air conditioners. Covers auto air conditioners, too. No. 23133\$6.95

AUTO ENGINE TUNE-UP (2ND EDITION)

Shows how each system in an engine works and how to maintain it at its best. This practical how-to-do-it manual can save money for you, over and over. No. 23181\$5.95

AUTOMOBILE GUIDE (3RD EDITION)

A practical reference and guide

for servicemen and owners. Hundreds of working diagrams covering construction, service and repairs of modern cars. No. 23192\$8.95

OUTBOARD MOTORS AND BOATING

Essential knowledge for every outboard motor operator. Contains all data needed for maintenance, adjusting and repairing all types of outboard motors. No. 23168\$4.95

CARPENTERS & BUILDERS LIBRARY (3RD EDITION)

Four profusely illustrated volumes covering tools, steel square, joiners, builders math, plans, specifications, layouts, foundations, framing, millwork, power tools, paint. Here's how to do all forms of home carpentry, building construction and woodworking with short cuts and solutions from the experience of top carpenters. No. 23169 (4-volume set) ..\$18.50

MACHINISTS LIBRARY

This practical 3-volume textbook and reference set covers all facets of modern machine shop principles and practices and the machines and tools used in metal machining and toolmaking. Valuable for both beginning and ex-

perienced workers. Completely up-to-date. Hundreds of diagrams and photos. Written in terms anyone can understand.

No. 23174 (3-volume set) ..\$16.95

PLUMBERS AND PIPE FITTERS LIBRARY

A valuable 3-volume set of guides that covers every aspect of modern plumbing and pipe fitting practices with easy-to-understand instructions, pictures, diagrams and charts. Here are all the principles, advances and short cuts of the plumbing and heating trade to save you time and money.

No. 23155 (3-volume set) ..\$12.50

RADIO AND TV LIBRARY

A two-volume library that covers all you need to know about radio and TV. The Books—Radioman's Guide (3rd Edition) and Television Service Manual (3rd Edition) — provide basic step-by-step guidance for the operation, troubleshooting and repair of radio, black and white and color TV sets. The books may be bought in combination, or separately.

No. 23161—the 2-book Library\$11.50

No. 23162—Television Service Manual (3rd Edition)\$5.95

No. 23163—Radioman's Guide (3rd Edition)\$5.95

HOUSE WIRING

Easy-to-understand directions for all phases of house wiring. Interprets rulings contained in the National Electrical Code. An equally valuable guide for home owners as well as professionals.

No. 23190\$5.95

ELECTRIC MOTORS (2ND EDITION)

An updated guide to the installation, maintenance and repair of all types of electric motors. Covers AC and DC motors, control apparatus, motor starters and controllers, testing, calculations, meters, wiring diagrams. Includes trouble charts that list symptoms, causes and remedies.

No. 23150\$5.95

PRACTICAL ELECTRICITY (2ND EDITION)

A completely practical handbook that presents the fundamentals of electricity in clear, concise terms. Making use of easily grasped explanations and over 1300 illustrations and diagrams, it has opened the way to success for countless electrical workers and apprentices.

No. 23160\$5.95

Audel publishes many other books for mechanics, engineers, students, hobbyists and do-it-yourselfers. Some may fit your needs better than the ones we offer here. They're all fully described in our free catalog. Send for it.

MONEY-BACK GUARANTEE

Send no money! We'll send you any Audel Guides for 10-day FREE EXAMINATION. If you keep them, you may use our easy payment plan. If not completely satisfied, return them for refund.



THEODORE AUDEL & CO.
Division of
Howard W. Sams & Co., Inc.
Indianapolis, Indiana 46268

SEND NO MONEY — 10-DAY FREE EXAMINATION

Theodore Audel & Co.—Self Improvement Publishers since 1879
4300 West 62nd Street, Indianapolis, Indiana 46268

Please mail me for 10 days' FREE EXAMINATION the books I have checked at right. I agree to mail \$3 in 10 days for each book or set ordered and to further mail 1/2 of the purchase price 30 days later, with balance plus shipping costs to be mailed within another 30 days. I may return the books for refund if not completely satisfied.

Save shipping costs. Check here if you enclose full payment (plus sales tax, if any). We will pay postage charges. You have same return privilege. Canadian prices slightly higher.

Name _____

Address _____

City _____ State _____ Zip _____

- | | |
|--------------------------------|--------------------------------|
| <input type="checkbox"/> 23016 | <input type="checkbox"/> 23155 |
| <input type="checkbox"/> 23133 | <input type="checkbox"/> 23161 |
| <input type="checkbox"/> 23181 | <input type="checkbox"/> 23162 |
| <input type="checkbox"/> 23192 | <input type="checkbox"/> 23163 |
| <input type="checkbox"/> 23168 | <input type="checkbox"/> 23190 |
| <input type="checkbox"/> 23169 | <input type="checkbox"/> 23150 |
| <input type="checkbox"/> 23174 | <input type="checkbox"/> 23160 |

POS2

Custom Camper

This nameplate on the side means a solid foundation underneath.

That "Custom Camper" nameplate's important on your $\frac{3}{4}$ - or 1-ton Chevy pickup. It means your truck's specially equipped to carry a particular camper. You get all the long-life features built into every Chevy pickup. Plus a front stabilizer bar to minimize sway, improve handling. And extras like heavy-duty shock absorbers and extra-large tires. It's a basic camper

package at a basic price. You add just what you need, no more.

Also available for Chevy campers: auxiliary battery, extra fuel tank, sliding rear window, camper wiring harness and enough other things to fill a small book. You'll find the book at your Chevrolet dealer's, and people who know how to use it.

We want your Chevy Custom Camper to be the best pickup you ever owned.



Chevrolet. Building a better way to see the U.S.A.

Chevrolet

лучший автор

THE BICYCLE SHOP



By EUGENE A. SLOANE

PM's newest columnist, the author of *The Complete Book of Bicycling*, offers many valuable tips for the care and repair of bottom brackets

THE BOTTOM-BRACKET ASSEMBLY holds the axle, to which are attached the cranks and chainwheel. Bottom brackets should be regreased once every six months to a year, depending on how much you ride and in how much dust, dirt and sand.

To tell if your bottom bracket needs cleaning and a re-lube, slip the chain off the chainwheel, spin the cranks and listen for grinding noises. Then rotate the crank slowly with fingers on the bottom of the bottom bracket. If you feel any sign of rough operation, the bottom bracket is overdue for overhaul.

There are three types of bottom brackets: three-piece steel cottered, one-piece steel cotterless and three-piece light-weight alloy cotterless.

One-piece assemblies are on more bicycles than either of the other two types. They are used on most Schwinn and other American-made bicycles, and on some models made in Sweden and Norway. The only tools you need to disassemble a one-

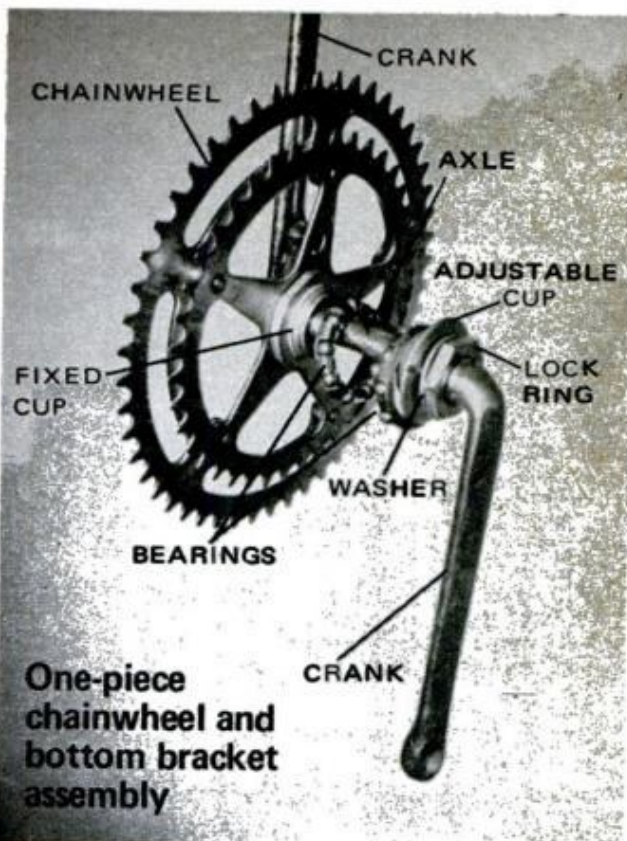

One-piece chainwheel and bottom bracket assembly

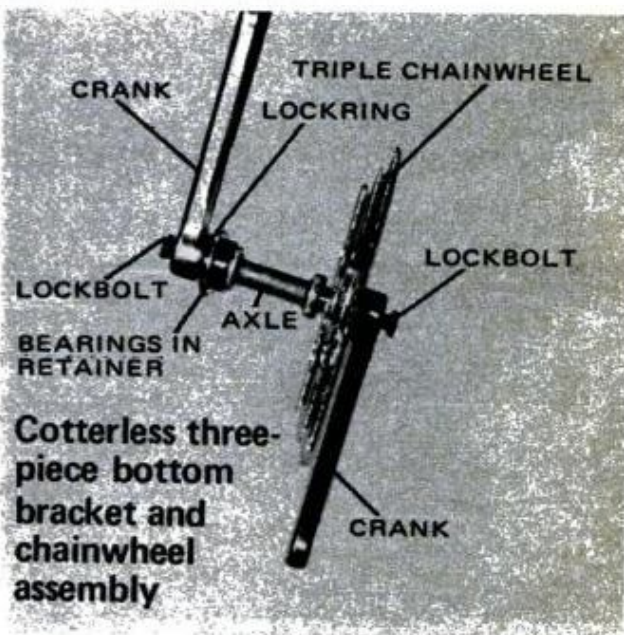

Cotterless three-piece bottom bracket and chainwheel assembly

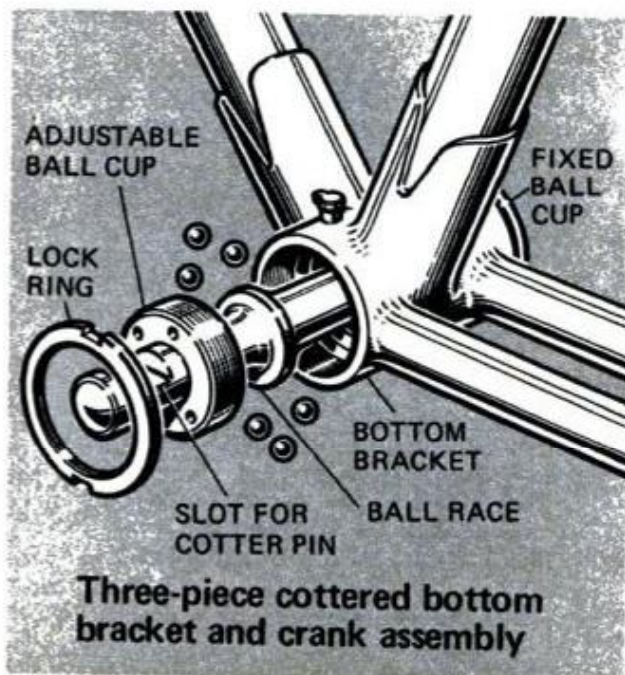

Three-piece cottered bottom bracket and crank assembly

piece bottom bracket are a 6-inch crescent wrench, 10-inch crescent wrench, 12-inch screwdriver and light hammer.

Follow these steps: 1. Remove both pedals. 2. Slip the chain off the chainwheel. 3. With the 10-inch crescent wrench, remove the lock ring (clockwise). 4. Remove the adjustable ball cup. This is splined and threaded into the bottom-bracket hanger. The ball cup also comes off clockwise, with just a screwdriver pushed into the spline or notch. 5. Remove the bearings. 6. With the left-hand bearing race removed, slide the bottom-bracket assembly gently out the right-

(Please turn to page 68)

BICYCLE SHOP

(Continued from page 67)

hand side. Make sure the bearings on the right side of the bottom-bracket axle come out at the same time. 7. Slide the right-hand bearing set off the axle, down the crank into a pan of kerosene. Clean all bearings and bearing surfaces. Be sure to wash all grit and dirt out of the bottom-bracket hanger. Inspect bearings. If the race is so worn that the bearings fall out, you need a new set of bearings.

To reassemble: 1. Pack bearings with grease, such as Lubriplate Autolube type "A" sold in auto supply stores, or Lubriplate Marine Lube sold in marine supply houses. 2. Slide bearing back over crank and axle, making sure the correct bearing race curvature faces the right-hand side of the axle. The bearing race should fit very snugly against the curvature or "land" of the axle. If not, slide the bearing off, reverse it and slide it back on again. The same holds true for the left-hand bearing. 3. Slide bottom-bracket assembly back the way it came out, through the right-hand, bottom-bracket hanger. 4. Slide remaining bearing set down the left crank and in place on the left side of the axle. Screw adjustable ball cup counterclockwise into the bottom bracket until snug; then back away $\frac{1}{8}$ turn. Screw locknut on counterclockwise and tighten with the crescent wrench. Check for side-play by twisting cranks. Readjust if necessary by loosening lock ring, backing off or tightening adjustable cone, retightening lock ring. 5. Reinstall pedals, slip chain back on and you're ready to roll.

Three-piece cotted assemblies are the most difficult to disassemble. But the job must be done yearly to avoid ruining the axle and bearing cup. Tools you need are a Raleigh-type bottom-bracket spanner for the locknut, Raleigh bottom-bracket wrench, machinist's ball-peen hammer, a good vise and a piece of 2x4 long enough to reach from the floor to about 4 inches above the jaws of your vise. You may also need a steel center punch if your adjustable cup has small holes in it instead of a squared protrusion you can grab with a bottom-bracket wrench. The wrenches come with Raleigh bikes and are sold at most bike stores.

To disassemble follow these steps: 1. Remove both pedals. 2. Remove both wheels to lighten the bicycle. 3. Cut a V-notch $1\frac{1}{2}$ inch wide tapering to $1\frac{1}{2}$ inch deep on one end of the 2x4. Put the 2x4, notched end up, in the vise. 4. Have someone hold the bike with the left-hand crank over the V-notch (not the *bottom-bracket hanger*) so that when you

hammer out the cotter pin, the stress of hammering is through the crank, not the hanger and bearings which could be damaged. 5. Unscrew the cotter-pin nut about four turns. With the ball-peen hammer hitting *squarely* on the nut, hammer the cotter pin until the nut is flush with the crank. Loosen nut two more turns and hammer it flush with the crank again. Remove the nut and washers and, with a piece of hardwood over the pin to protect the threads, hammer the pin down flush

(Please turn to page 70)

NEW FOR YOUR BIKE

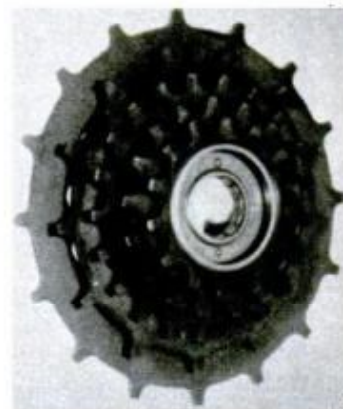

HILL CLIMBING IS EASY with the new, wide-range derailleur and five-speed gear cluster. High speed gear has 14 teeth; low gear, 34. In the two lowest gears, every other tooth is missing to make it easier to shift into these gears for hill-climbing. The new Crane hardware is made by Shimano American Corp.

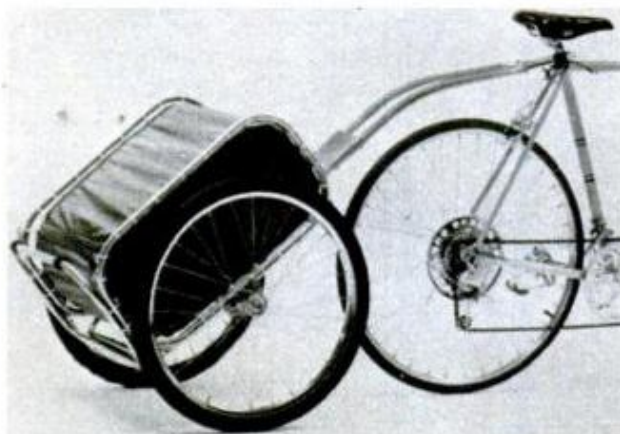

BICYCLE TRAILER will hold all the gear you'll need for your next touring or camping trip. The new, lightweight carrier connects to the seat post with a special torsional hitch that prevents swaying and lets the trailer track perfectly through any maneuvers. The "Bugger" BR1, with its water-repellent, zippered-nylon pack, rides on 24-in. tires. Wheel spokes are chrome-plated, and heavy-duty hubs house shielded ball bearings. The BR1, from the Cannondale Corp., is \$49.95 at bike stores. A BR2 model, slightly different, costs \$39.95

POPULAR MECHANICS

Palco. For people who camp a lot.



People who camp a lot need good sturdy equipment that isn't going to give out 35 miles from the nearest store.

They need us. Palco.

See, we organized a Family Camping Council to test our products on actual camping trips with camping families just like yours.

And they prove that every Palco product you can buy holds up. Because every Palco product

is designed exclusively for better and longer camping use.

That's why we're the only company that offers a satisfaction guarantee on every one of our camping products. If we couldn't guarantee them, we wouldn't sell them.

Look, if our 2-quart Aluminum Canteen, Stainless Steel Campsite Cookout Set, Deluxe Palco/Optimus Propane Stove, Camper's Coffee Boiler/Utility

Pot, Camper's Aluminum Cook Kit, and Palco/Optimus Propane Lantern can keep Zoltan's family camping all around the country, we can get you through a lifetime of 3-day weekends.

palco

Palco Products
Division of Worcester
Pressed Aluminum Corp.,
15 Hope Avenue
Worcester, Massachusetts 01603



"You can have the perfect money-making business with Von Schrader Detergers"

—Francis von Schrader, President

Perfect because with Von Schrader Detergers you provide a service everybody needs: on-location cleaning of carpeting, upholstery and walls. Perfect because every home and building are potential customers—your business keeps growing.

Perfect because the equipment you use is the finest; proven to clean quickly, completely, professionally. And so easy to operate you need no special skills. (1) Von Schrader Carpet Deterger gives deep-level cleaning to carpeting; (2) Von Schrader Upholstery Deterger cleans fabrics and synthetics beautifully; (3) Von Schrader Wall Deterger cleans walls (and ceilings) five times faster than by hand.

Perfect because you can start with one Deterger. Then, as your business grows, add the other two and thus offer a complete cleaning service. Perfect because you are the boss, own your equipment, work your own hours. Perfect because there are no fees, royalties or contracts.

Perfect because your investment is so small you'll find it hard to believe. And perfect because we help you every step of the way, just as we've helped thousands of other men to financial independence for almost 40 years.

For details (without obligation) send coupon.



CARPET DETERGER



UPHOLSTERY DETERGER



WALL DETERGER

Free booklet gives you full information

Get the facts about your future in on-location cleaning. See how well Von Schrader Detergers are built, how easy they operate. Read how other Associates became financially independent, how we help you every step of the way. **Extra! Special Recorded Message from Francis von Schrader to you included.**



VON SCHRADER company

1052 Place, Racine, Wisconsin 53403

Please send complete information on Von Schrader Detergers

Name _____

Address _____

City _____

State _____ Zip _____

BICYCLE SHOP

(Continued from page 68)

with the crank. If it does not fall out at this point, use a center punch carefully in the center of the cotter pin and punch it out the rest of the way. 6. Now remove the cotter pin from the right-hand crank.

7. Remove the left-hand bottom-bracket lock ring with the Raleigh spanner, which has a notched projection to fit the lock ring notches. With the hammer, tap the wrench lightly to loosen the lock ring. If it won't loosen clockwise, reverse the spanner and try turning it counterclockwise. Some bikes have right-hand bottom-bracket threading, others left-hand. The bottom-bracket assembly of most Raleigh bicycles is threaded so the lock nut and adjustable cup unscrew clockwise. Remove the lock ring and unscrew the adjustable cup about 10 turns. Lay the bike on its left side over a rag, to catch the loose ball bearings, and unscrew the adjustable cup the rest of the way. Pull the axle out of the left-hand side. 8. Clean bearings, cups and bottom-bracket hanger in kerosene. Check balls and cups for cracks, rust or galling (shiny spots which are flatter than the rest of the cup). Replace cups or bearings as necessary. If you have to replace the right-hand cup (rare), take the bike to a professional shop: special tools are needed.

To reassemble: 1. Put a light layer of grease inside each cup and roll the loose bearings around in a spot of grease and set them inside the fixed cup, leaving a small space between each bearing. 2. When the balls are in the right-hand cup, stick a layer of grease over the balls and gently push the axle, long end in first, into the left-hand side of the hanger. 3. With the balls stuck in a layer of grease in the adjustable cup, thread the cup counterclockwise into the bottom bracket carefully and take it up snug by hand, with a wrench or center punch and light hammer. Back off $\frac{1}{8}$ turn. 4. Thread the lock ring counterclockwise on the left-hand axle and tighten with the spanner. Use hammer to tap spanner to bring the lock ring tight. 5. While someone holds the bike frame, install the right-hand crank on the axle and hold the base of the crank over the V-notched 2x4 as you did when you removed the cotter pin. Reinstall the cotter pin, and hammer the blunt end (not threaded end) down until it can go no farther. Thread washer and nut on the pin and tighten. Install the left-hand crank the same way. 6. Check for side play and binding.

Next month we'll treat cotterless three-piece bottom-bracket assemblies. ★★★

Come out ahead on a Kawasaki.



We're about to make a very powerful statement:
Kawasaki Mach II.

For this is the 350 with more guts, more go
than any other 350 in the world.

Think about it. Does any other
350 burn up the road at 112 mph?
Or clock 13.6 for the quarter mile
—from a standing start? Or pack
45 horses into just 329 pounds?
Or handle like a good 125 in traffic?

On second thought, it's the
kind of performance you expect from the people



who build the world's fastest production machine, the
Kawasaki Mach IV. And the world's first trail
bike with 10 speeds, the Kawasaki G4. And
what has to be the world's best buy in a
street bike, the Kawasaki 90.

Think it over and head for a Kawasaki
dealer. Compare the Kawasaki line-
up with anybody's...for every-
thing from putt-putt to POW!
Go ahead;
do it. We

know who'll come out ahead. **Kawasaki**
MOTORS CORPORATION

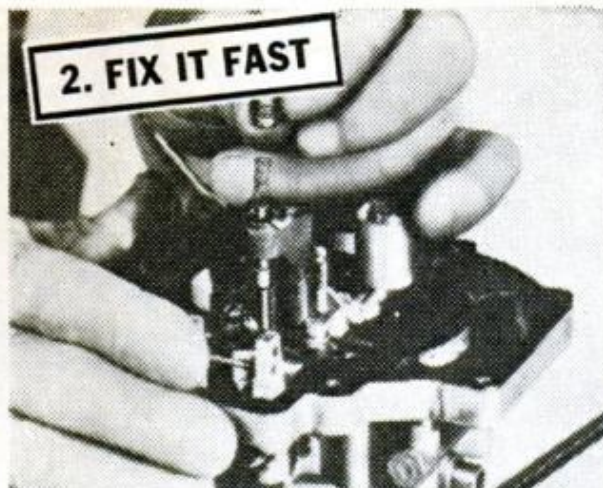

MOTOR's easy "2-step" repair method helps you

Fix almost any part of almost any car... FAST

So clear, you'll breeze through tune-ups, air conditioning, brake jobs, engine overhauls — practically any repairs on cars listed.

You just can't make mistakes with the "2-step" method in MOTOR's New 1972 AUTO REPAIR MANUAL. First the special "Trouble Shooter" section helps pinpoint in a flash the cause of trouble. Next, over 3,000 "How-To-Fix-It" close-up pictures (and plain-talk directions) show how to lick repair problems — fast and right! Even green beginner mechanics find the MANUAL so clear and easy to follow, they speed through the toughest jobs like real pros!

Auto Repairman's "Bible"

Every job, from installing distributor points to front end jobs, is covered in minute detail for 2,300 car models, 1966-1972. The over 1,000 oversize pages of the giant MANUAL contain 55,000 specifications, thousands of illustrations, diagrams and charts—the "meat" of 300 official shop manuals.

You get service data on Transmissions, Steering, Brakes, Universals, Alternators, Fuel Pumps, Ignition Systems, much more! It's no wonder MOTOR's illustrated MANUAL is called the auto repairman's

SAME FREE 10-DAY OFFER on AUTO ENGINES & ELECTRICAL SYSTEMS



1,300 big pictures, over 700 pages. Clear how-to text explains how parts work, principles involved, design, construction, maintenance, etc. Covers all parts of engines and electrical systems. High performance hints. For FREE trial, check box in coupon.

Indispensable "Bible." It's no wonder that more than 6,000,000 copies of the MANUAL have been purchased by repairmen, service station operators, the U.S. Armed Forces, schools and students all over the world. Here is the help every beginner or "pro" needs to fix almost any part of any car right the very first time. And save time, work, money!

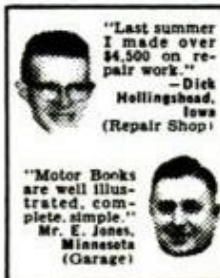

SEND NO MONEY

The MANUAL costs \$10.95, but we'll send it to you for 10 days FREE trial, so you can see for yourself how it makes auto repairs go quick and easy. Use it for 10 days. If it doesn't give you complete satisfaction, return it and owe nothing. Mail the coupon today.

Mail coupon now for
FREE
10-DAY TRIAL

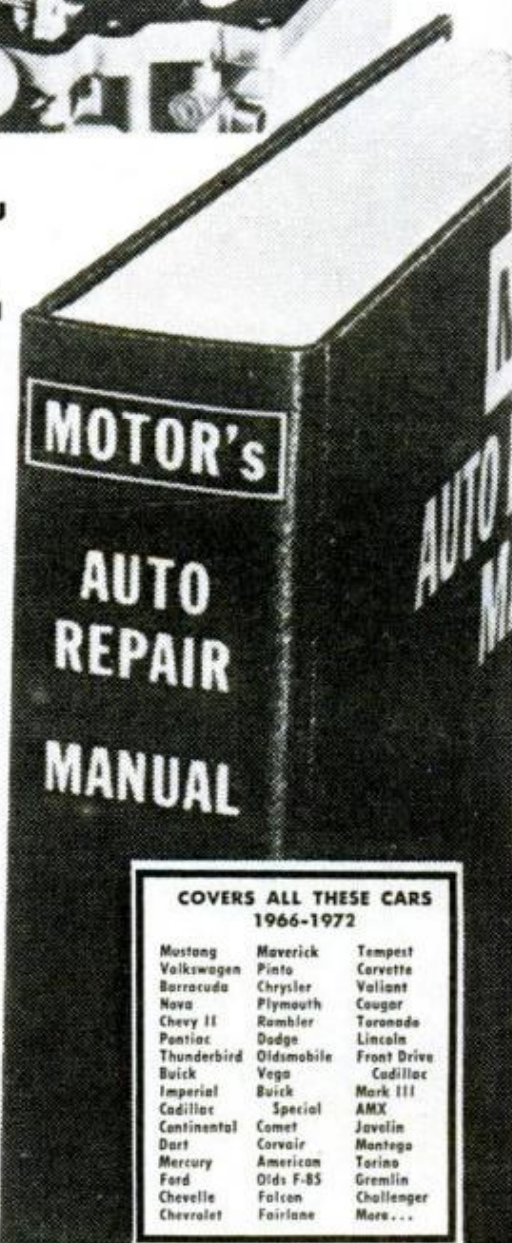

COVERS ALL THESE CARS 1966-1972

Mustang	Maverick	Tempest
Volkswagen	Pinto	Corvette
Barracuda	Chrysler	Valliant
Nova	Plymouth	Cougar
Chevy II	Rambler	Toronado
Pontiac	Dodge	Lincoln
Thunderbird	Oldsmobile	Front Drive
Buick	Vega	Cadillac
Imperial	Buick	Mark III
Cadillac	Special	AMX
Continental	Comet	Javelin
Dart	Corvair	Montego
Mercury	American	Torino
Ford	Olds F-85	Gremlin
Chevelle	Falcons	Challenger
Chevrolet	Fairlane	More...

MOTOR Book Dept., Desk D115, P.O. Box 2316, F.D.R. Sta., New York, N. Y. 10022

Please send me the Manuals checked below for ten days free examination:

- MOTOR's Auto Repair Manual, \$10.95
 MOTOR's Auto Engines & Electrical Systems, \$10.00

Print Name.....

If I am not fully satisfied, I will return the shipment promptly and owe nothing. Or I will keep it and pay the total price in three monthly installments, plus a small shipping charge.

Address.....

I want to save shipping charges. I am enclosing payment in full and you will pay shipping charges. (Same return privileges, refund guaranteed.)

City & State..... Zip Code.....

Signature please..... Age.....

Prices slightly higher in Canada. Offer available only in continental United States. Delivery will normally be within 3-4 weeks in Eastern U.S. Please allow longer west of the Mississippi.

ITT Credit Reserve gives you the security of knowing \$3,000 is available to you within 24 hours.

ITT Credit Reserve is a personal financial service funded and established by America's eighth largest company, International Telephone and Telegraph Corporation.

By joining, you establish for yourself and your family a \$3,000 line of credit, all or any part of which may be drawn upon in less than 24 hours.

Interest rates are reasonable, and payment schedules are flexible. ITT Credit Reserve meets all credit standards for lending services.

ITT CREDIT RESERVE
a service of International Telephone and Telegraph Corporation



Please send information on ITT Credit Reserve. No obligation.

NAME _____

ADDRESS _____

CITY _____ STATE _____ ZIP _____

Mail to: K. B. Leverly, Service Director
2181 First Security Building, Salt Lake City, Utah 84111 or phone toll-free 800-453-5316

SEND FOR
FREE
FACT KIT



A BONAIR INFLATABLE BOAT travels in car trunk, inflates and launches in 10 easy minutes from any shore. Choose from 7 portable models BIA rated 7½ to 40 H.P.

Write NOW for direct factory prices, full information free.

Bonair BOATS, INC.

5957 Merriam Dr., Merriam, Kansas 66203
(913) 432-9451 • Dept. C-1

NOW! BUY 1970-71 Chevys, Fords, Dodges (From \$699 to \$999)

Delivery arranged anywhere.
Free catalog. Send 25¢ postage and handling to:

PAN AM CAR DIST. CORP. ME-38
31 Hanse Ave., Freeport, N.Y. 11520



HOME-IMPORT
BUSINESS-Make Big Profits

Men-Women, new Drop Ship Plan offers fast profits without product investment! Deal direct with overseas sources. Buy small quantities. Prices shown include duty & postage. Full or spare time. Write for FREE PLAN, state age.

Calendar Watch 4.45
Field Glasses 5.24
Trail Cycle 149.
QUANTITY PRICES EVEN LOWER
MELLINGER, Dept. F2255, 6100 Varie!, Woodland Hills, CA 91364

MAKE BIG MONEY
OPERATING
HEAVY
EQUIPMENT



**BULLDOZERS
CLAMHELLS
TRENCHERS
DRAGLINES
BACKHOES
SCRAPERS
GRADERS
CRANES**

The Construction Industry is Booming! Earn top money in this fast moving, action-packed field. Keep present job and train at home in spare time followed by practical training on our machines under project conditions at our facilities. Nationwide placement assistance. For FREE information fill out and mail coupon today!
Member American Road Builders' Assn.

APPROVED FOR VETERANS AND INSERVICE PERSONNEL

UNIVERSAL HEAVY CONSTRUCTION SCHOOLS, Dept. PM
1901 N.W. 7 STREET / MIAMI, FLORIDA 33125
Phone: (305) 642-0800 (24 Hours)

Please Print
Name _____ Age _____
Address _____
City _____ State _____
Phone _____ Zip _____

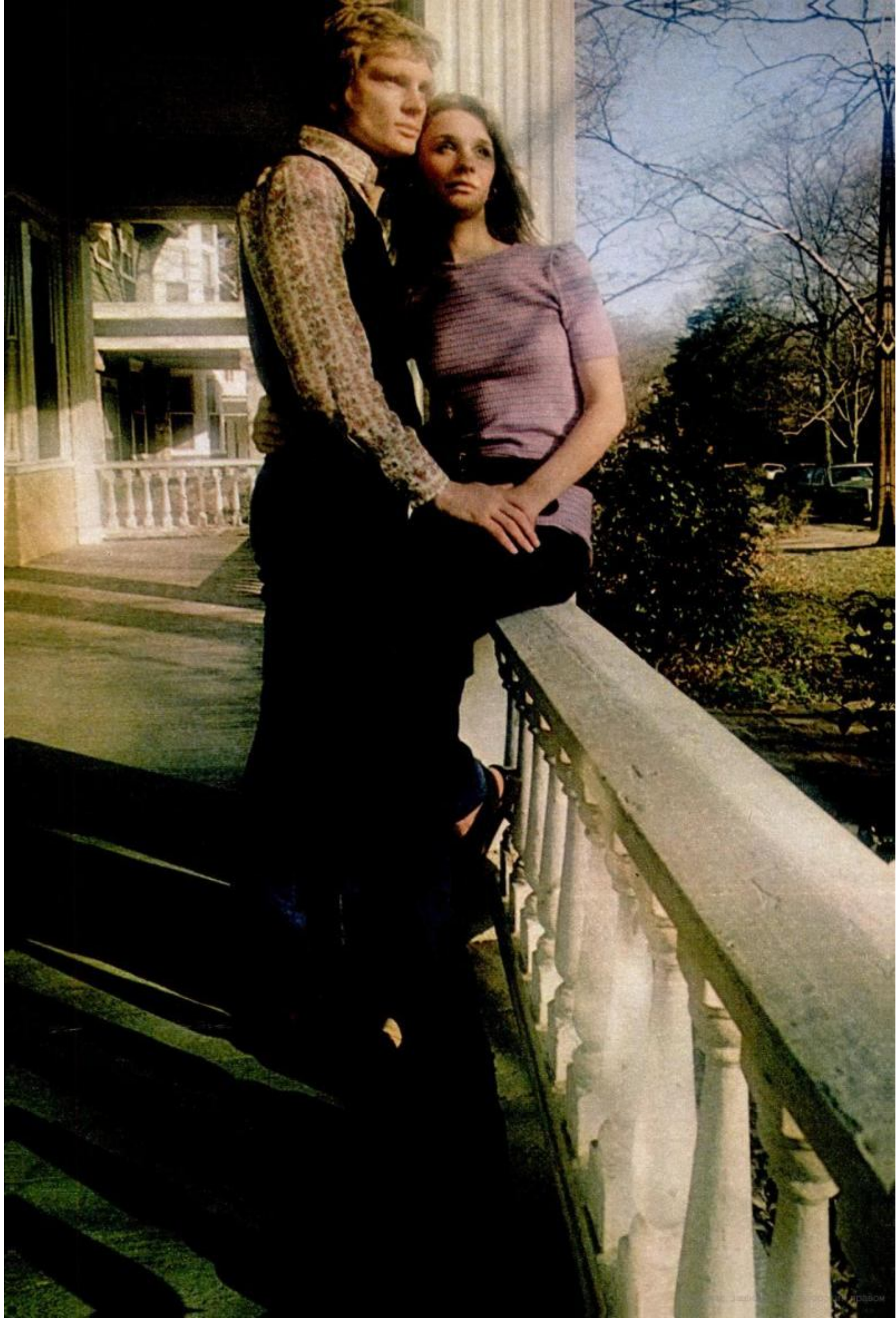

Some guys need 6 months to say good-bye.

After four years of high school, you've got a right to relax. Enjoy your summer. Hack around with your friends.

But wouldn't you enjoy your summer much better if you knew where you'd be in the fall? Like starting a great new job.

Today's Army can arrange it. With our Delayed Entry Option, you can enlist today and report within the next six months, depending on the job-training course you choose. And then step into a whole new future.

Job training in the skill you want. At a starting salary of \$288 a month. Along with free meals, free housing, free clothing, free medical and dental care, and 30 days paid vacation.

A chance to meet people, travel, mature.

The Army's Delayed Entry Option. Talk it over with your local Army Representative. It's a pretty neat way of wrapping up a lot of unfinished business.

**Today's Army
wants to join you.**

Army Opportunities Dept. 200, Hampton, Va. 23369	Date _____
I'd like to know more about job-training and other opportunities in today's Army	
Name _____	Date of birth _____
Address _____	
City _____ County _____	
State _____ Zip _____ Place _____	
Education _____	

The latest gimmick at Maxine's Massage Parlor is to offer customers her own brand of roll-your-own filter cigarettes.

Now everybody will be smoking Maxine's roll-your-own filter cigarettes

...almost everybody.



©1972 R. J. Reynolds Tobacco Company, Winston-Salem, N.C.

Camel Filters.
They're not for everybody.
(But then, they don't try to be.)



20 mg. "tar", 1.3 mg. nicotine av. per cigarette, FTC Report AUG. '71.

Vacation homes: Year-round casual living

Here are four handsome houses you can live in during the hunting, skating and skiing seasons as well as in summer

OUR COLLECTION of vacation homes this year includes four delightful houses of varied architectural styles; two are of contemporary design and the others are new versions of perennial favorites. Each one shown, in addition to offering a year-round vacation site, is a home you can count on for retirement years. The designs are by architect Ralph Rittenour. Two of the houses (plan Nos. 4 and 6L) were created to suit specific design criteria originated by the Western Wood Products Assn. Plans are available for all four; to order them see page 87.

THE POLE HOUSE The first home, shown below and through page 81, is somewhat of an



PLAN NO. 863-1

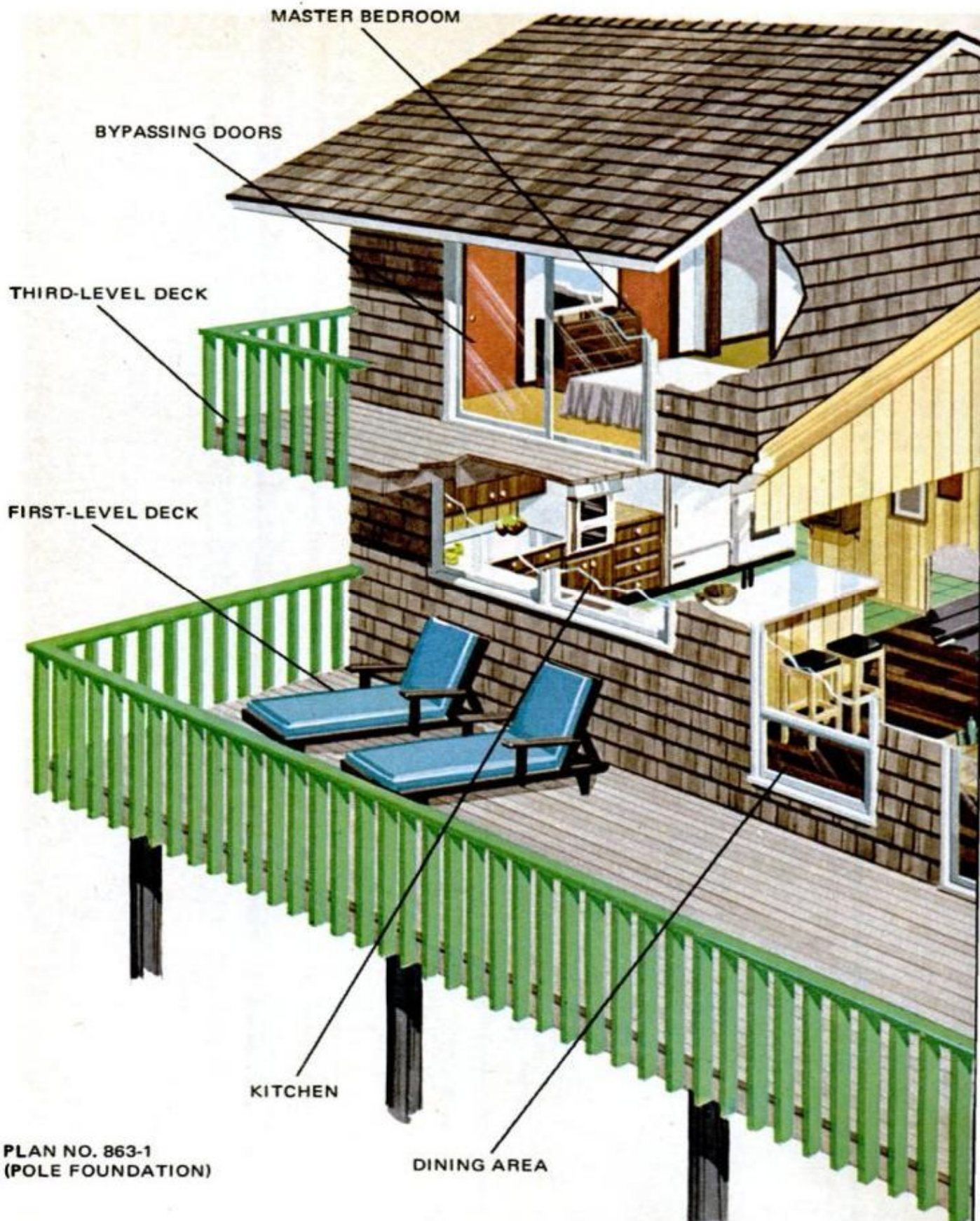

PLAN NO. 863-1
(POLE FOUNDATION)

innovation in recreation home design. It is used to particular advantage where the owner prefers to leave the landscape undisturbed or wishes to take full advantage of irregular contours on his building site. It is a dramatic structure, though modest in size.

If you study the plan, you'll notice there are three floor levels. The lowest includes the main living area and kitchen with dining facilities. A few steps lead to the second level with two bedrooms and a full bath. The third level (a separate dormer) is ample

POLE HOUSE FOR HILLY TERRAIN

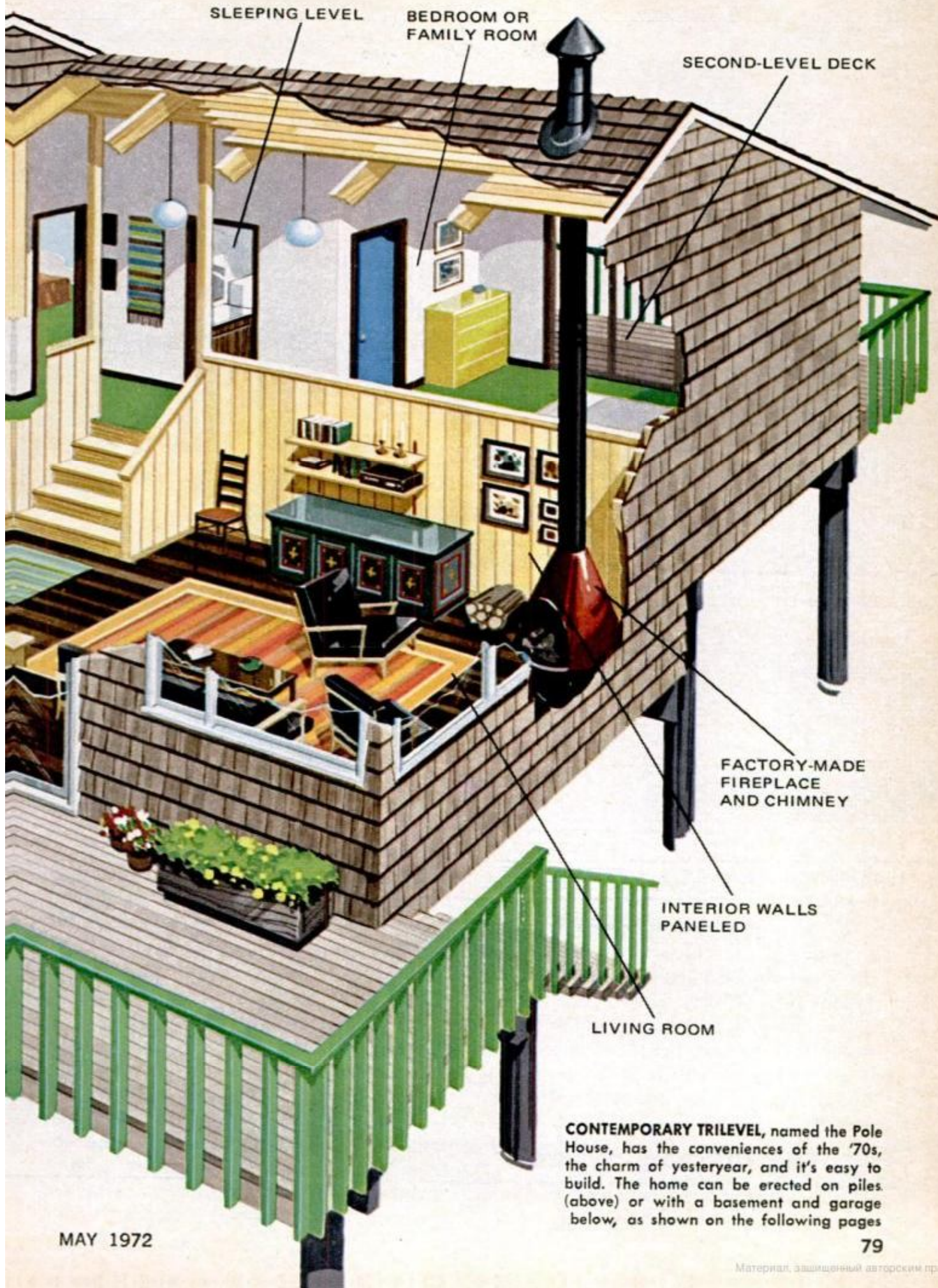

SLEEPING LEVEL

BEDROOM OR
FAMILY ROOM

SECOND-LEVEL DECK

FACTORY-MADE
FIREPLACE
AND CHIMNEY

INTERIOR WALLS
PANELED

LIVING ROOM

CONTEMPORARY TRILEVEL, named the Pole House, has the conveniences of the '70s, the charm of yesteryear, and it's easy to build. The home can be erected on piles (above) or with a basement and garage below, as shown on the following pages

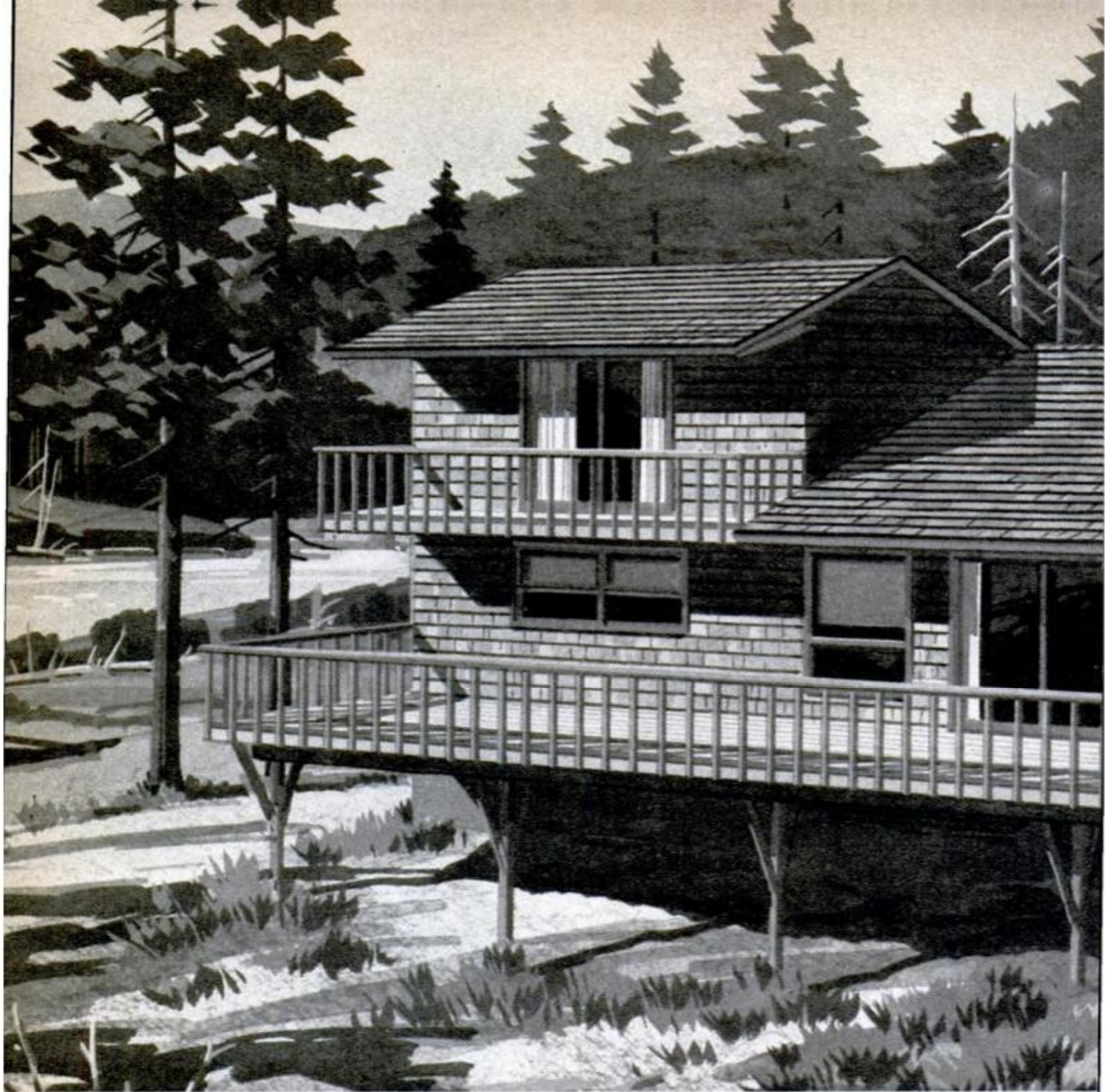

for a third bedroom and a complete bath. The plan number for this home is 863-1.

If you prefer, and the site will accept a standard foundation, you can build the Pole House variation shown above (plan No. 863-2). Here you gain a basement and garage (instead of the carport). Overall depth of the house is 26 feet and width is 36 feet, less projection of decks. The total living area is 1192 sq. ft.

THE CONTEMPORARY

The pleasing appearance of the home on page 82 is the result of a combina-
80

tion of open planning, site development and building sculpture. Without formal designation of hallways to direct traffic, the kitchen, dining and living-room areas flow into each other to give a feeling of spaciousness.

Several obvious convenience (and practical) details include proximity of the front entry to the kitchen work area, breakfast bar that doubles as a counter for quick snacks and the handy half-bath at the center of these activities. The spacious deck can be entered from the dining or living room through sliding glass doors. There's convenient storage for sundeck furni-

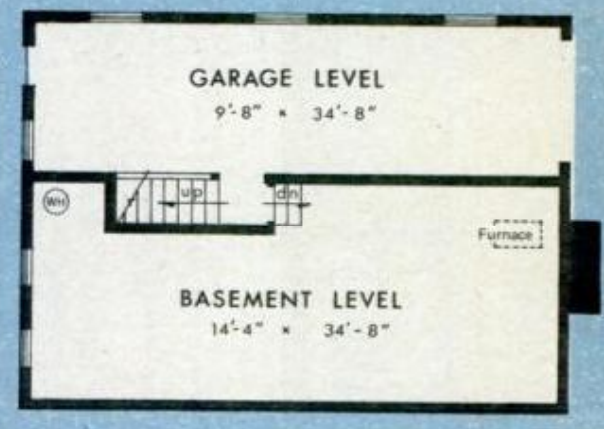
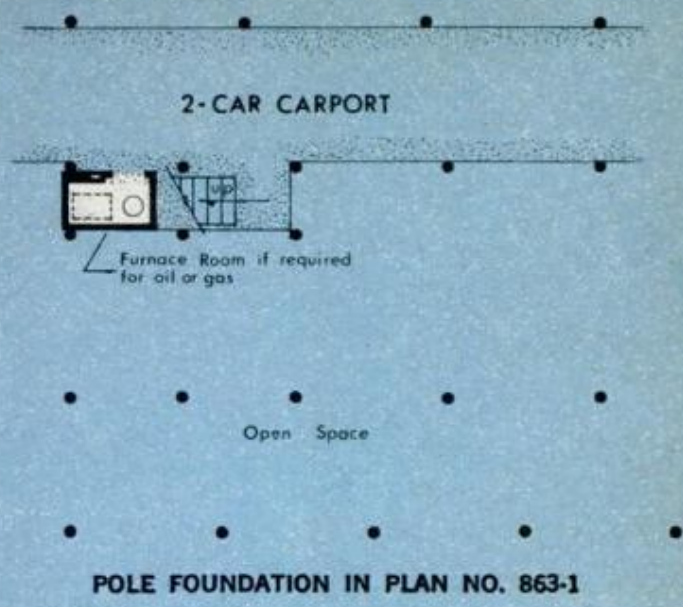
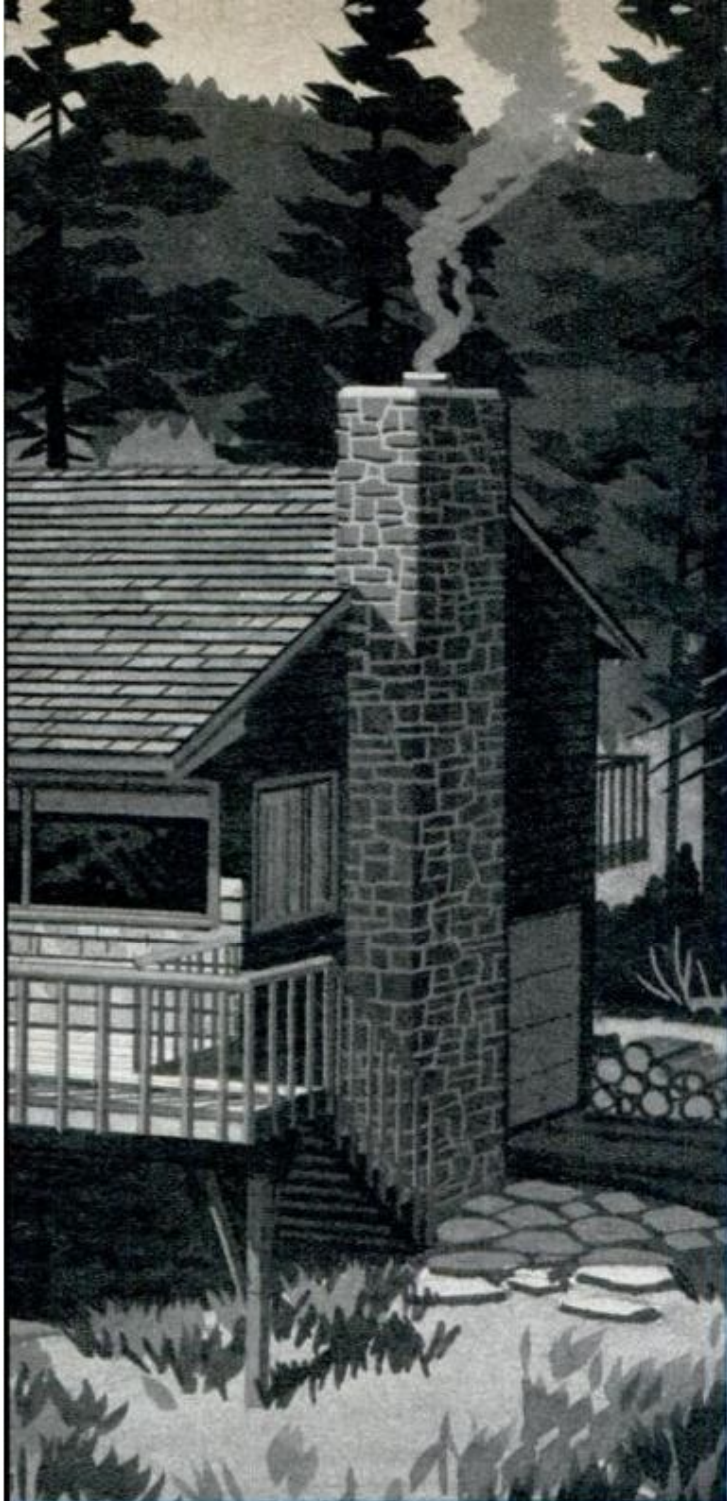

GARAGE-BASEMENT VARIATION IN PLAN NO. 863-2

PLAN NO. 863-2

POLE HOUSE is designated Plan No. 863-1 for structure with carport or No. 863-2 for basement-garage version. Other good design features include spacious outdoor living area and deck that extends across the complete frontage of the home parallel to the kitchen and living room. Notice that the carport, or garage, is accessible through an interior hallway and stairway leading from the kitchen alcove

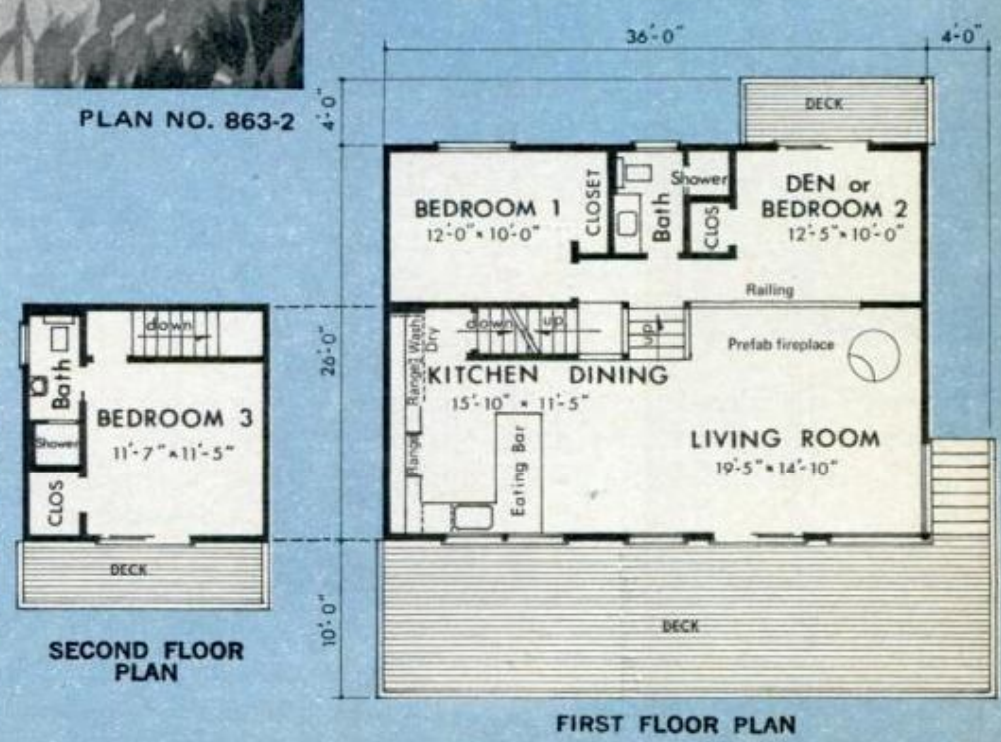

A good view— both indoors and out

SLIDING DOORS and windows flanking the living-room fireplace make this wall of the house the side that should face the most spectacular scenery



ture in the closet outside. The interior wall of this unit acts as a backdrop for a prefab metal fireplace in the living room.

Perhaps the most singular feature of this design is the balcony extending the width of the house and connecting all rooms on the second floor. A complete bathroom with shower is located on

this level. From this balcony loft, there is a clear view through the glass outer wall of the living room to the countryside beyond.

The strong interior form matches the dramatic exterior appearance of this home and is typical of good contemporary design.

Overall width of this dwelling is 40



PLAN WWPA NO. 4

feet; its greatest depth is slightly over 29 feet. The deck extends 20 feet in front of the house and runs along its complete width. To order this home, specify plan No. WWPA-4.

THE CHALET

Often compared with the Cape Cod for its efficient and space-saving floor

MAY 1972

plans, the chalet has become one of the most popular types of vacation and recreation housing. The plan at the top of pages 86 and 87 includes all the comforts for a large family without wasting space. Four generous-sized bedrooms have ample closet and storage space. Two complete bathrooms are tucked in convenient, readily accessible loca-

83

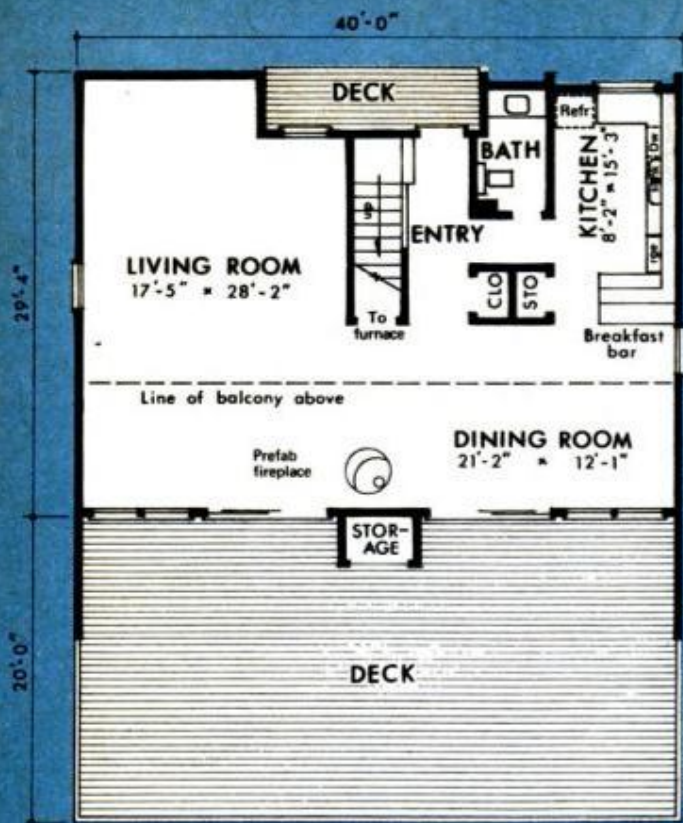

FIRST FLOOR PLAN

A GOOD VIEW often means a lot of heat, too. Here, because sidewalls and roof are extended, glassed areas are shielded from the rays of a midday sun

SECOND FLOOR PLAN

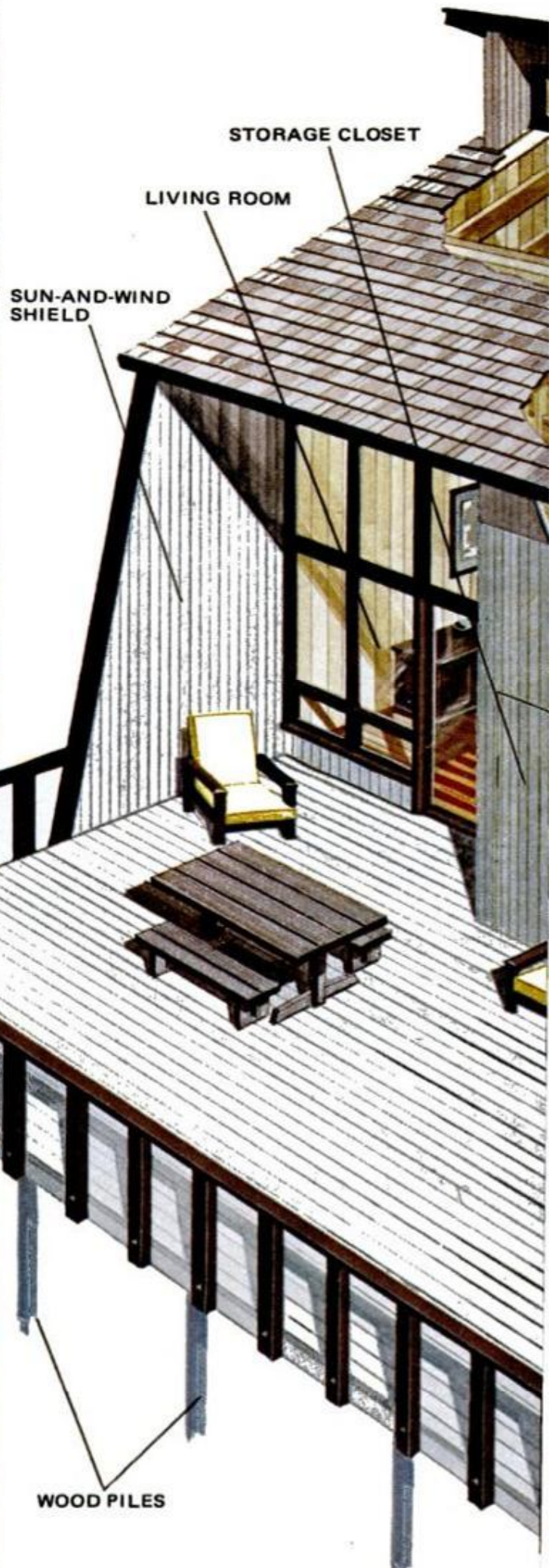
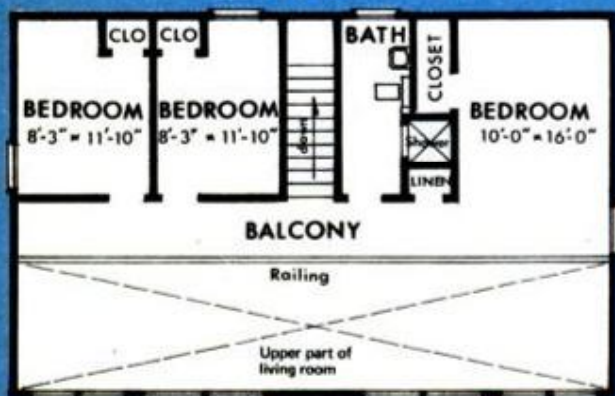

WOOD PILES

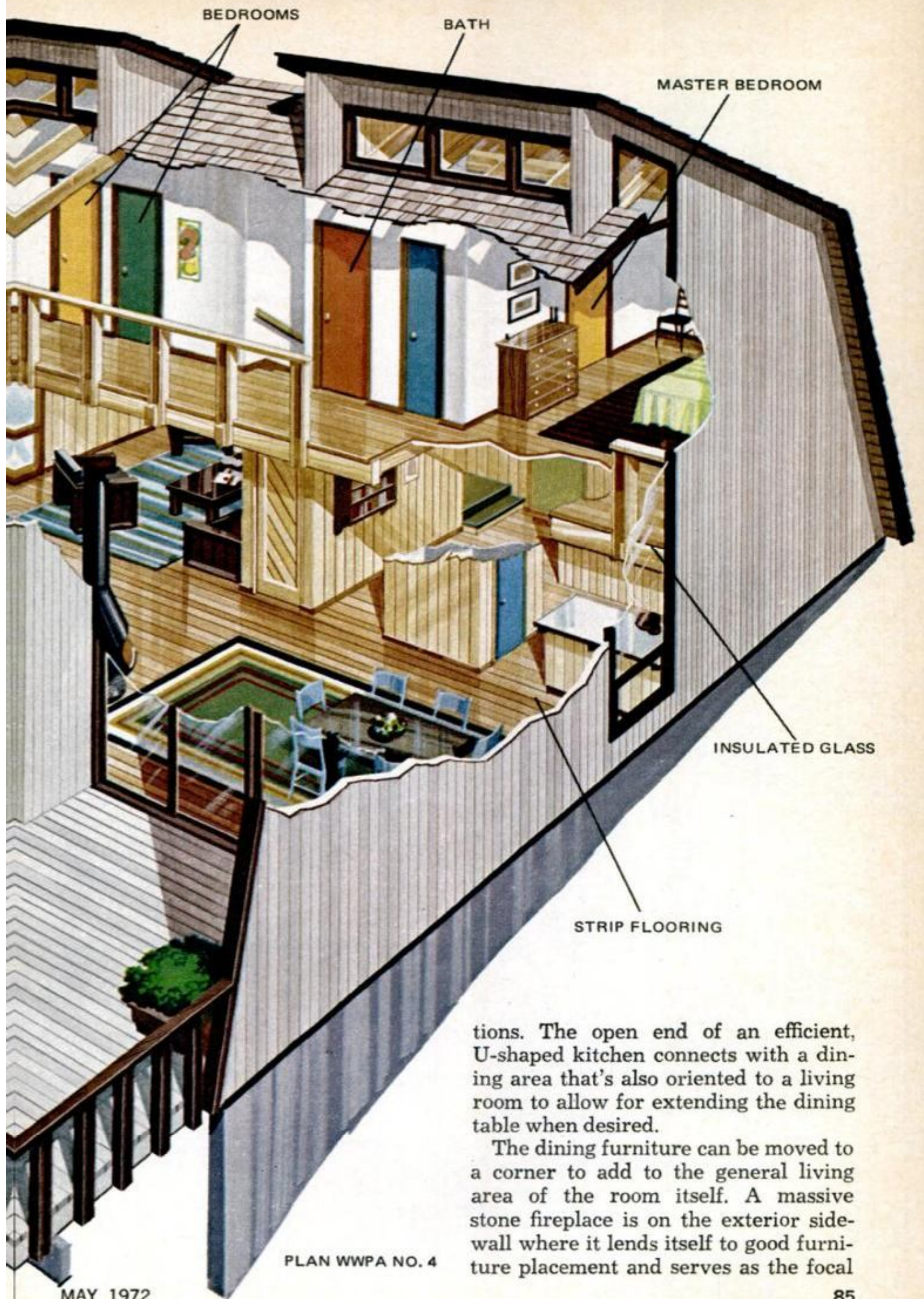

BEDROOMS

BATH

MASTER BEDROOM

INSULATED GLASS

STRIP FLOORING

tions. The open end of an efficient, U-shaped kitchen connects with a dining area that's also oriented to a living room to allow for extending the dining table when desired.

The dining furniture can be moved to a corner to add to the general living area of the room itself. A massive stone fireplace is on the exterior sidewall where it lends itself to good furniture placement and serves as the focal

PLAN WWPA NO. 4

MAY 1972

85



Spacious chalet near the slopes

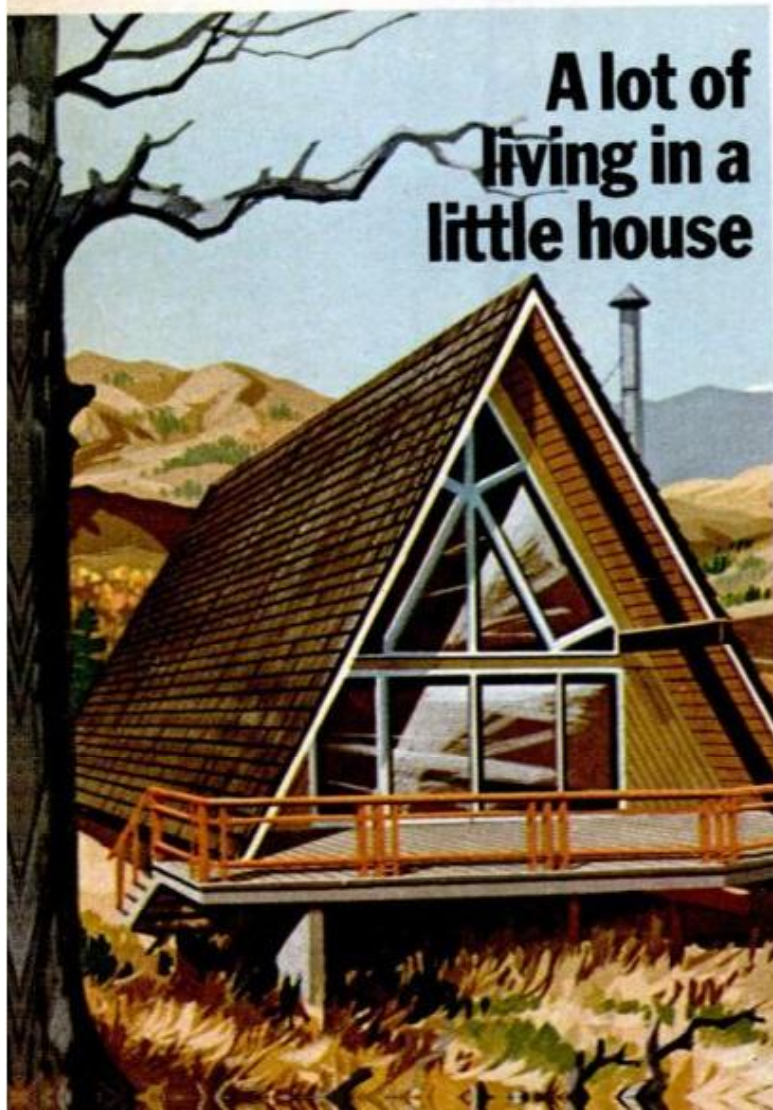

A lot of living in a little house

point of the room. Adding to the spacious look is the open staircase leading from one corner of the living room to the second floor.

A large deck space wraps around the front of the living-dining area and wide sun decks serve the two bedrooms upstairs. Plan No. 755-1 shows this house with complete basement; a variation, plan No. 755-1A, excludes the basement, but in its place provides for a laundry space under the stairway leading to the second level.

SIMPLE A-FRAME

All features considered especially important by outdoor sportsmen are incorporated in the design shown at the

SIMPLE A-FRAME
PLAN NO. WWPA-6L

**PLAN NO. 755-1
(WITH BASEMENT)**



**LAUNDRY PLAN FOR
NO. 755-1A**

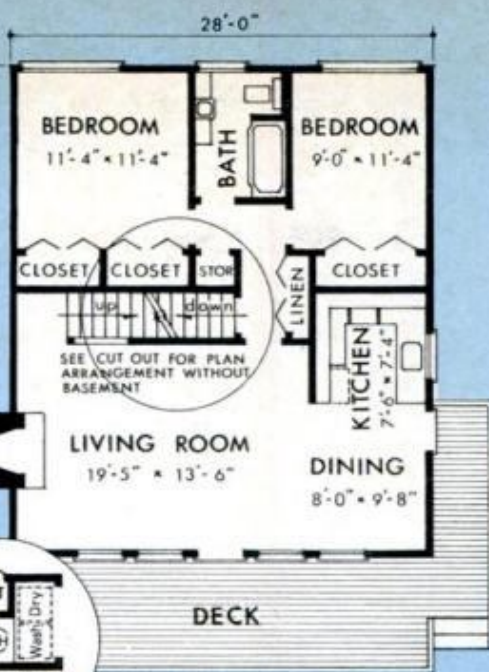
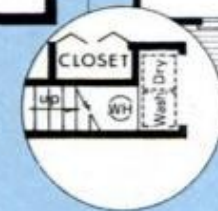

**FIRST FLOOR PLAN
896 SQUARE FEET**

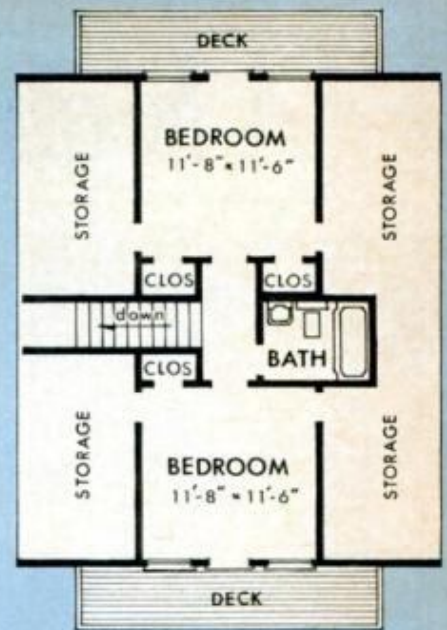

**SECOND FLOOR PLAN
450 SQUARE FEET**

HOW TO ORDER PLANS

You can purchase complete plans for any house featured in this article for \$30 per set per house or \$40 for four sets of the same plan. Add \$5 for a materials list. As a rule, four sets of plans are needed for permits, cost estimates, financing and construction. Send your order to Home Building Plan Service, Dept. PM, 2235 N.E. Sandy Blvd., Portland, Ore. 97232. Be sure that you specify the plan number for the house you want.

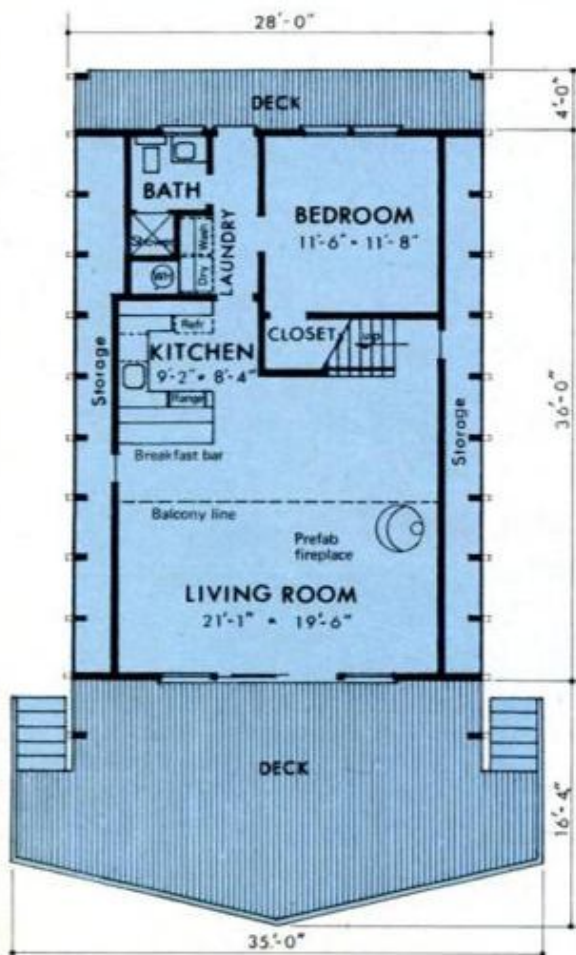

**MAIN FLOOR PLAN
760 SQUARE FEET**

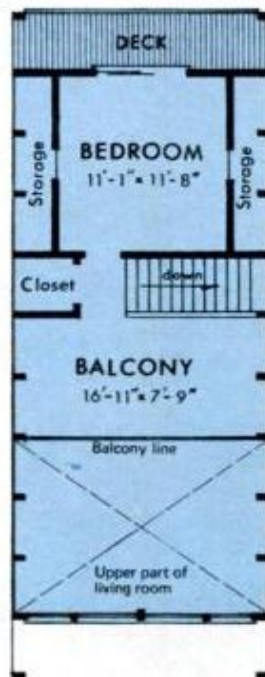

**UPPER FLOOR PLAN
303 SQUARE FEET**

PLAN NO. WWPA-6L

bottom of these two pages, including both front and rear-door access, a full bath, two bedrooms and storage area on the first floor, and a balcony sleeping loft for use by hunting companions. To order this plan, specify No. WWPA 6L.

All these vacation homes share two important points: Each can be built by a do-it-yourselfer in stages, as time and funds permit. And each home is readily adaptable to winterizing for all-year use.

Plans and materials lists are offered by Home Building Plan Service; ordering information is given above. Such plans can help you get price estimates if you decide to build a house by contracting heavy work to others and handling finishing details yourself. ★★★

A high-flying hobby really



AMAZING SKILL of homebuilders is seen in these four good-looking birds. Like the other planes shown in this article, they appeared at the Oshkosh Fly-In. Mustang replica (upper left) is two-thirds the size of the World War II fighter. The Wickham B (left), the work of a Boeing engineer, is a four-seater with a range of 400 miles. The Skybolt (above) was built for aerobatics by high-school teacher. Helistar is a prize-winning two-seat copter. Its builder, a professional test pilot, puts value at \$30,000



takes off

Thousands of homebuilt aircraft are flying—and the number is growing. They're the work of craftsmen whose main resources are skill and devotion—not a big bankroll

By HOWARD LEVY

Photos by Henry Artof and the author

THE ULTIMATE TEST of craftsmanship must surely be this: the willingness to stake your life on the quality and thoroughness of your work.

That's what members of the Experimental Aircraft Assn. do every time they take their planes up. The EAA was started in 1953 by a group of flying enthusiasts in the Milwaukee area. Today, the organization has 30,000 members in 53 countries. Among them, they've put 4000 homebuilt planes in the air and currently have some 7000 in construction.

The planes are designated "Experimental," a special category created by the Federal Aviation Administration for licensing purposes. To qualify, more than half of the plane must have been constructed by the builder.

The FAA inspects the planes during construction to make certain that structural requirements are met. Then the plane must complete 50 hours of flying within a restricted area—a shakedown program calculated to disclose elements of poor design or faulty flying characteristics. If the plane clears this hurdle, the builder-pilot, who must hold a regular pilot's license, is free to fly it where he wants.

Not only does the hobby provide a real sense of accomplishment, it permits the budget-minded craftsman to get a lot more plane for his money. A simple

[\(Please turn to page 91\)](#)



THE BANTAM —a homebuilt beauty

BILL WARWICK, a 41-year-old lab technician who lives in Torrance, Calif., started designing and building aircraft in the late '50s. The Bantam, which has been flying since 1966, is his third plane. He estimates that the basic configuration can be built for \$1200.

This slick one-seater is powered by a 65-hp Lycoming, but other engines (up to 100 hp) may be substituted. The tricycle landing gear (see below) is fixed, but a retractable type can also be used.

Except for fiberglass tips on wings, stabilizer and fin, the Bantam is an all-metal plane. It has a wing span of 18.5 feet, is 13 feet, 9 inches long

[\(Please turn to page 91\)](#)

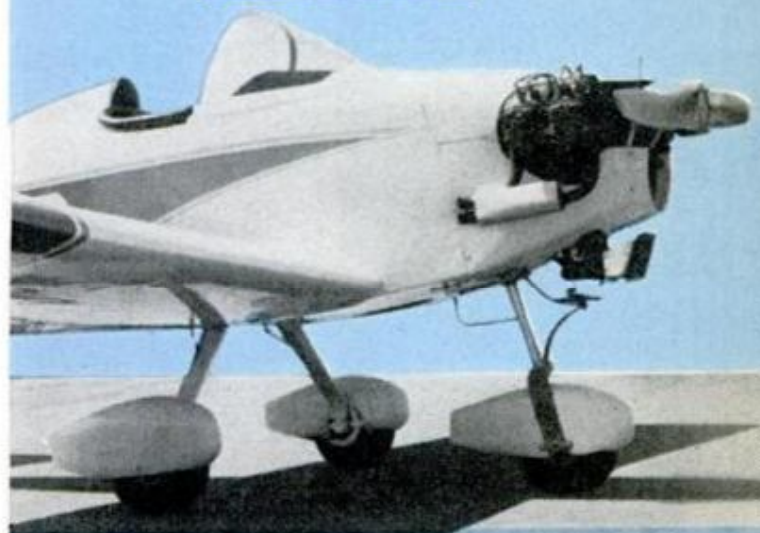

High-flying hobby

continued

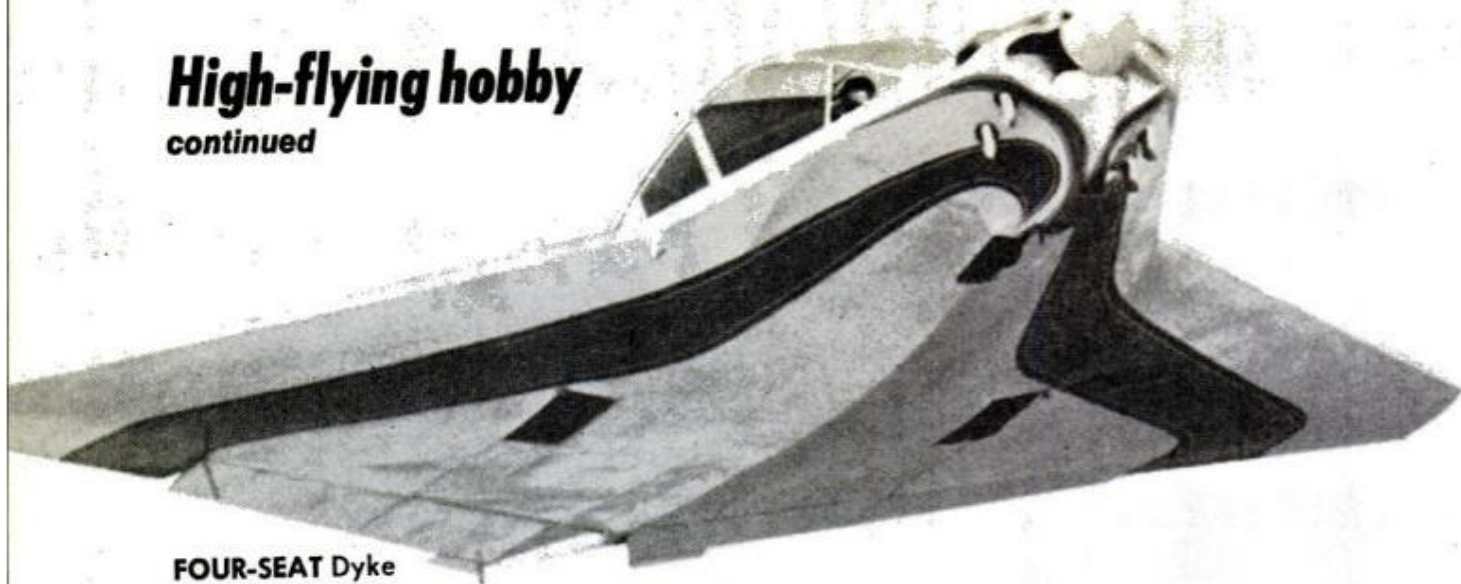

FOUR-SEAT Dyke

Delta has fiberglass covering over tubular steel frame. Clever design allows wings to fold for towing on plane's own retractable landing gear. Delta can hit 200 mph and has 700-mile range. It cost \$2000 to build. Plans are available.



EXOTIC TEAL was built by professor of aeronautical engineering. The plane cruises at 180 mph, has set closed-course speed marks, and has a range of 2000 miles. The all-metal single-seater has pusher prop driven by engine aft of wing.

SIX YEARS, three months and \$4000 were needed for completion of this award-winning Pazmany PL-1. All-metal two-seater has top speed of 150 mph and 450-mile range. Plans cost \$75.



THE BANTAM

(Continued from page 89)

and 6 feet high. Its gross weight is 790 pounds. Cruise speed is 115 mph and rate of climb 1000 feet per minute. The Bantam needs 550 feet to take off and 500 to land.

Instrumentation in a homebuilt de-



AEROBATIC WICHAWK features side-by-side seating. Twenty-four coats of dope were applied to linen covering fuselage's steel frame.

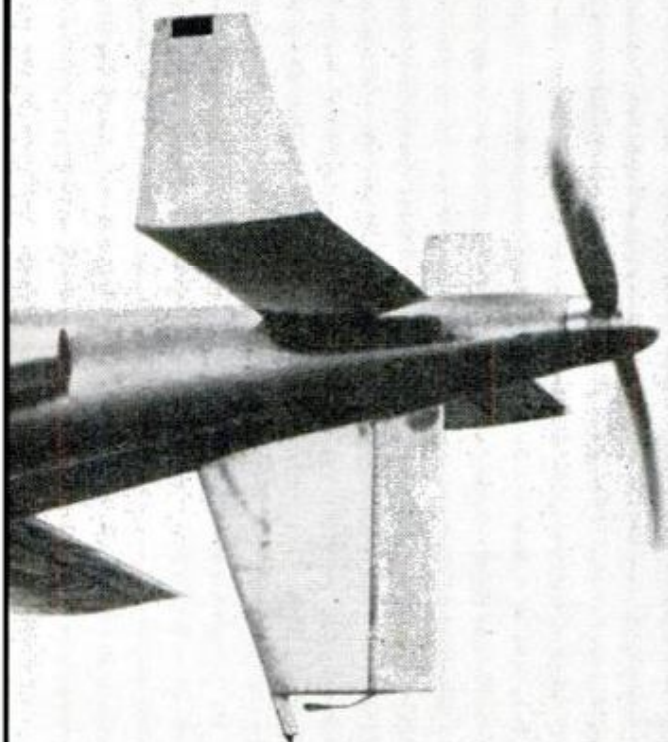

single-seater may cost from \$1500 to \$2000, while a high-performance two-seat job may run about \$3500.

Some hobbyists create their own designs. Others build from plans and kits. Plans start at \$25 and go as high as \$350, depending on the aircraft. Working at night, on weekends and vacations, some builders complete their planes within a year. The average project requires one and a half to three years to complete.

Homebuilders come from many different walks of life and more than a few are pretty gals. They work in basements, garages—even apartments.

Once a year members of the EAA get together at a Fly-In. Last year it was

(Continued on next page)



pends on how the plane will be used and on the pocketbook of the builder. (The well-heeled hobbyist may even install a small auto-pilot.) In the Bantam's cockpit (as seen in photo above), the top row is comprised of flying instruments—altimeter, air-speed gauge and such. Engine gauges, providing oil pressure, rpm and other readings, are on the console; at its bottom is the radio.

The plane can be flown without a canopy—and what could be pleasanter on a warm, sunny day? But a

(Please turn to page 93)



High-flying hobby

continued



FOR ECONOMY, it's the Scooter, which cost only \$800 to build. It's powered by a modified 58-hp VW engine, has a maximum speed of 95 mph, a range of 200 miles and a service ceiling of 10,000 feet. Hinged nose provides access to small cargo space



SHARP MIDGET MUSTANG, the work of a commercial pilot, won award at Oshkosh as best all-metal mono-plane. Construction required three years and cost \$4000. Equipped with 150-hp engine, the plane has a maximum speed of 250 mph and range of 400 miles



RED BARON, LOOK OUT! Here comes a neat replica of a World War I British fighter. It's an all-wood plane with a fuselage made of mahogany plywood and fiberglass. Engine is an 85-hp Continental. Craft took 20 months to build and cost about \$1500



A MODIFIED VW ENGINE, its horsepower upped to 65, makes it easy for the Volksplane to cruise at 90 mph. This very popular craft is of all-wood construction. There are said to be 22 of them now flying in the United States, maybe 60 by year's end

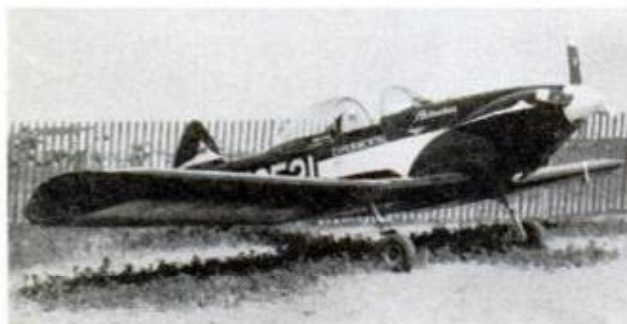

FIRST FLOWN IN '67, the Ladd-Taylor monoplane has been modified since then. First a bubble canopy was added, the retractable landing gear. Latest addition is a four-bladed propeller. Original cost of the plane was \$2000; working time, one year

held at the Oshkosh, Wis., airport, where all photos shown here—except those of the Bantam—were shot. In all, 828 planes were registered, representing these EAA classes: Homebuilt; Antique (built prior to World War II); Classic ('45 to '50) and Warbird (military-type). To see the best homebuilts, visit Oshkosh July 30 to Aug. 5 for EAA's 1972 Fly-In. ★★★

EDITOR'S NOTE: Each month PM will feature a different homebuilt. The Bantam was the first. Next month: the Taylor Coot, a handsome amphibian.

For information about plans for any planes shown or described here, write: Experimental Aircraft Assn., Box 229, Hales Corners, Wis. 53130.

POPULAR MECHANICS



A 47-YEAR-OLD FIREMAN spent four years building this Mohrbacher-Smith Miniplane. It has wingspan of about 18 feet, is better than 17 feet long and weighs 633 pounds empty. Wood was used in wings, steel in the fuselage. The plane cruises at 97 mph



BY ADDING HIS OWN MODIFICATIONS to basic plane, an air-freight salesman built this good-looking version of the Minicab. He altered landing gear and engine cowling, added fiberglass wingtip tanks. Construction of this two-seater took three years



MONNETT SONERAI was judged best formula V Racer at Oshkosh. The builder, a 28-year-old high-school teacher, says plane will do better than 160 mph. Its engine is modified 1600-cc VW that develops 65 hp. Wings fold, permitting plane to be trailered

THE BANTAM *(Continued from page 91)*



Plexiglas canopy certainly adds zip to the configuration in addition to being practical.

Close-up (below) shows steerable front wheel with its spring-leaf shock absorber.

Warwick estimates he spent 300 hours designing the plane and another 1100 in fabrication. He explains that basic tools can be used

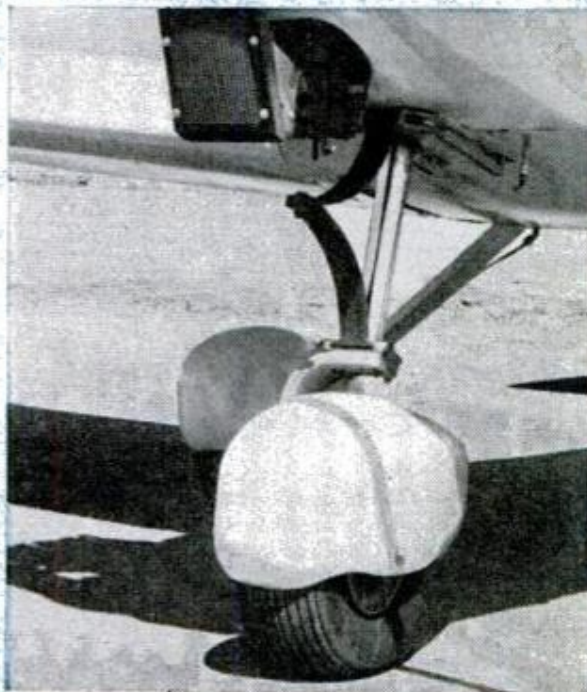

throughout—including heavy-duty straight shears and cutters, a conventional rivet gun and assorted bucking bars.

Some 50 sets of Bantam plans are in the hands of builders. About 20 planes are under construction and 5 are reported to be flying. Blueprints cost \$55. Interested? Write: Bill Warwick, 5726 Clearsite, Torrance, Calif. 90505. ★ ★ ★

PM AMC Ambassador
OWNERS REPORT...

A nationwide survey based on
1,000,000 owner-driven miles

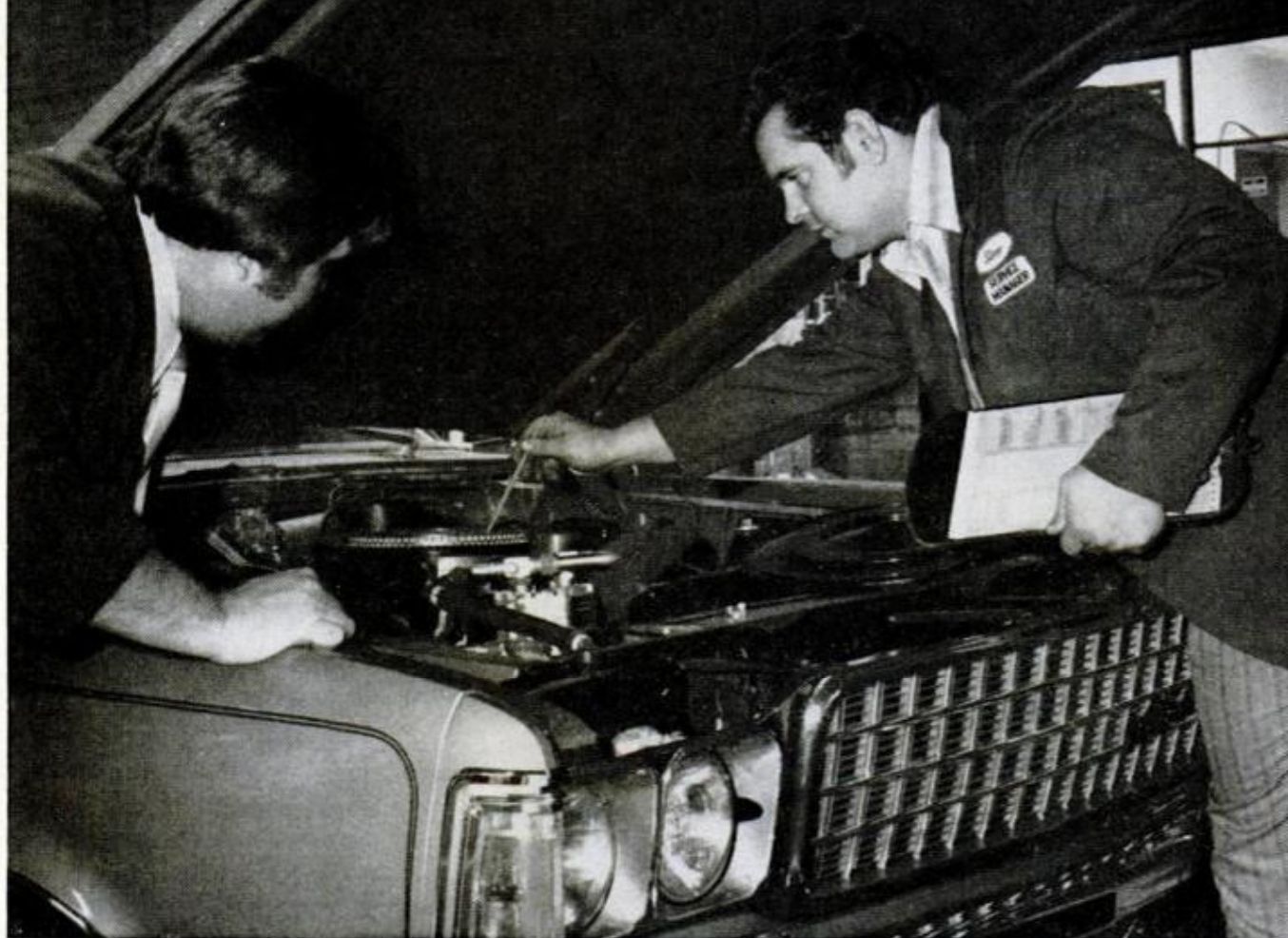

American Motors' 'Guaranteed Car.' Is it?

By MICHAEL LAMM, West Coast Editor /Photos by the author



BUYER PROTECTION PLAN covers everything but tires for 12/12, assures a free loaner on overnight fixes

94

AMERICAN MOTORS has been tooting its "guaranteed" horn since the 1972 introductions, sparking quite a bit of interest in the company's line of cars.

But how guaranteed is the Guaranteed Car? The idea sounds good, but is it? Do customers like it? How about dealers? We tried to find out by asking Ambassador owners as part of this Owners Report, specifically; we also asked dealers and factory officials.

An Independence, Wis., farmer

POPULAR MECHANICS

wrote of his dealer's service, "It's fine except the company advertises loan cars while servicing, and the dealer wouldn't accommodate us with one." We telephoned the farmer and asked why. "The dealer has this sign in his shop," he told us, "that says his insurance doesn't cover loaners."

So we called AMC in Detroit to find out if this is common. "It's not," AMC general service manager George Brown assured us. "Only about 70 dealers out of a total of 2025 aren't in our Buyer Protection Plan program. Now this could be one of those dealers. But insurance would be his responsibility, since regulations vary so greatly from state to state."

In fairness, only one other owner specifically complained that he couldn't get a loaner. When we called him, he said he was told that all the dealer's loaners were out, but it really didn't matter too much to him because he owns three other cars. Otherwise, all the rest of our surveyed owners mentioned that they either had had no need for loaners or that they got them when needed.

"How does the Buyer Protection Plan work?" we asked AMC.

"It's an amendment to the dealer's

franchise," answered George Brown. "It states that the dealer agrees to make a loaner available anytime he has to keep a customer's car overnight. Every time that happens, the factory reimburses the dealer \$2 per night per car. The loan car itself has to be a late model, and it has to be equipped with a minimum of automatic trans, air and power steering.

"In addition, if a dealer signs up for this program—and 99 percent have endorsed it enthusiastically—the factory agrees to sell him one car at a \$275 discount for every 100 he sells. That's the carrot. The net result, though, is twofold: First, it makes dealers do their darndest to give same-day service. Second, it assures our customers that they're going to either get service or wheels right away. To go along with this, we've set up 24-hour airfreight parts delivery to any point in the United States. So no owner should have to wait more than 24 hours for a part."

They shouldn't, but a few Ambassador owners have had their patience tried: An Illinois air force officer waited three weeks for a new windshield-wiper motor. And another Illinois owner, an insurance company manager,



AMBASSADOR OWNERS, divided on styling of their car, listed past experience as big reason for buying. Promise of good dealer service was also factor in purchase

says, "Work was done okay, but it took four weeks to get trim parts."

We asked AMC what can an owner do if he does run into problems or arguments on warranty service?

"Well, as you know, we maintain an Owner Hot Line. If he's got a gripe, an owner of a 1972 American Motors product is assured of getting immediate attention." (PM called the hot line and

did get a quick, friendly response.)

The most common complaint, if an owner has one at all, is with dealer prep. AMC ads and commercials stress a thorough dealer going-over before any 1972 car is released. Some buyers, though, felt this check wasn't so fine-toothed as they would have liked.

Here are some random comments about AMC service and the warranty



FOUR-DOOR SEDANS appear to be hardtops, but aren't. Owners who like the styling mentioned this finesse in design. Some owners thought that the C-pillars should be narrower in order to minimize blind spot in the rear

TOO MUCH PLASTIC used in construction, a few owners complained. They criticized ashtray locations and the gas-pedal angle, but mostly praised overall layout of the dash and instruments. Air-conditioning, power brakes and automatic transmission are standard on Ambassador

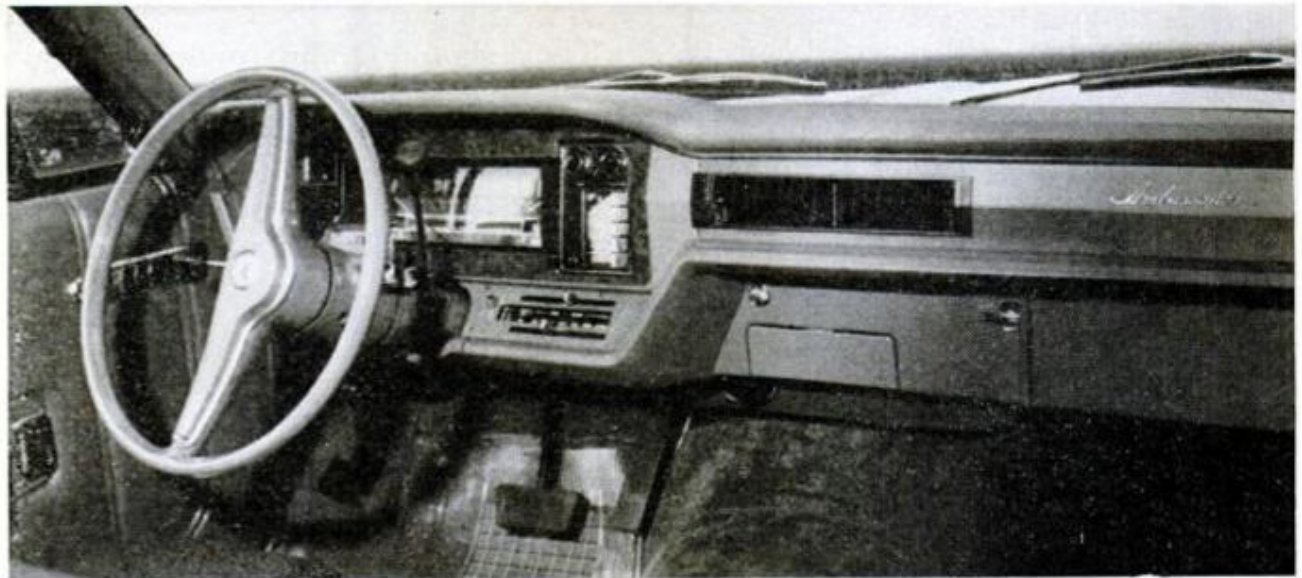

PM's AMC OWNERS REPORTS COMPARED

Car/issue	Percent owners with mechanical troubles	Percent owners satisfied by repairs
Ambassador (May '72)	42.3	78.8
Gremlin (June '71)	41.3	49.3
Hornet (Sept. '70)	31.7	53.5
Rebel (April '70)	33.3	77.8
Ambassador (July '69)	30.4	75.5
AMX (Feb. '69)	70.9	66.1

LOOKING BACK at AMC Owners Reports reveals more problems now, but service satisfaction is on upswing

situation: "Serviceman came to my home, got the car started. I drove it to dealer and waited while it was repaired."—New Jersey computer operator. A Minnesota minister says, "They were very helpful in explaining the entire AMC policy." "Our dealer has always stood behind his product, so the company policy has had no effect on us."—Michigan teacher.

An Ohio RFD mail carrier: "Bad

front brake shoe was replaced under warranty; had loan car to use." An Army captain from Arkansas mentions, "I feel the present guarantee is outstanding. Had a complete 6000-mile inspection plus adjustment to Cruise Command and sway bar reseated. Only cost was for oil and filter."

Owners satisfied with service point out that they have been treated surprisingly well and have not received arguments from service managers. "Nice—even though I didn't buy from this dealer. This I didn't expect!" exclaims a Colorado civil service employee. "Customer always given benefit of the doubt," says a New York jeweler who says he's bugged his dealer with minor complaints. A retired Ohio man telephoned his dealer about a no-start problem with his Ambassador with 4980 miles on it and received a prompt "house call" by a serviceman who replaced a defective condenser. A Massachusetts salesman was happy to receive a loaner—a loaner *radio* which he's using while his original unit is being repaired.

Among owners who had mechanical difficulties, 21.2 percent were *not* satisfied with dealer service. Biggest reason is having to make more than one trip to the dealer: "Dealer made all repairs but it took seven trips back to work out all the bugs," says a Missouri education official. "Took four appointments to complete repairs," says a Michigan man. A Wisconsin welder is unhappy because the dealer still has not boosted his fuel mileage: "Gas mileage still very low." He says he gets 11 mpg around town and 12 on trips with his 360.

How much grief have owners had in getting repairs? Less than one percent of Ambassador owners surveyed mention the necessity of their having to "come out fighting" to get their problems solved. A Michigan TV serviceman says "dealer lived up to warran-

RECESSED DOOR HANDLES can't snag clothes, take a straight pull. Several owners said they bought Ambassadors because no rival make has vent windows



OPTIONAL RECLINING SEATBACKS are real favorites with Ambassador owners, but headrests tend to stick

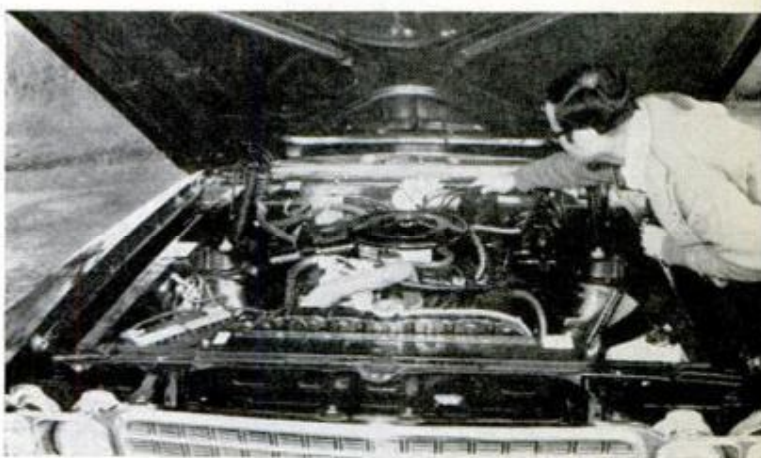

AMAZINGLY, all Ambassadors get about same gas mileage—13-16 mpg—no matter which V8 buyers get

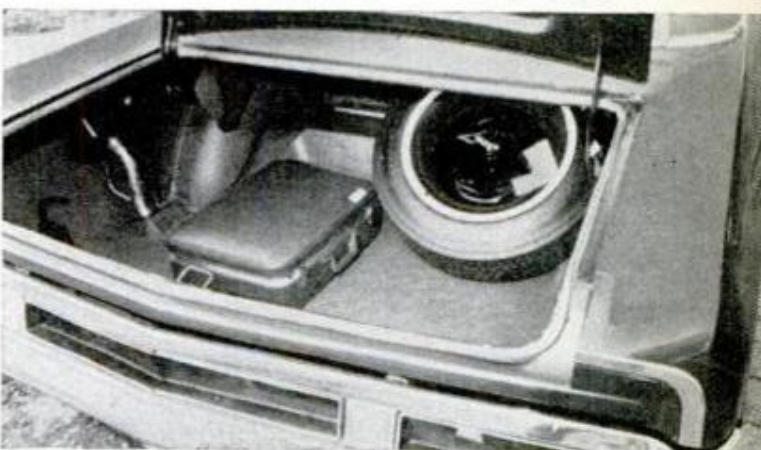

PLENTY OF ROOM back here; gripes are centered on the high trunk lip and placement of the spare tire

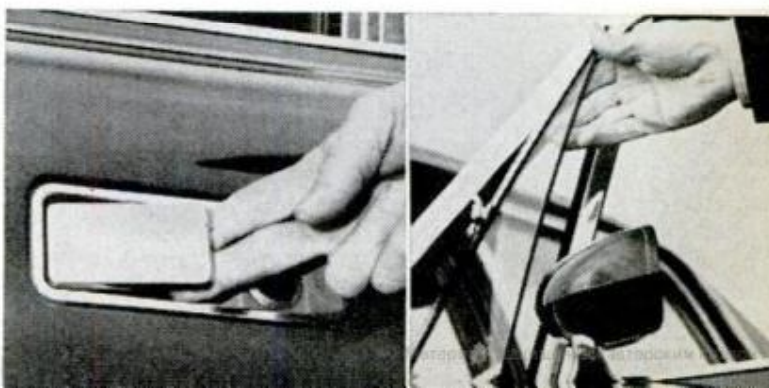

tee" even though "some personnel have been very, very discourteous." A Staten Island, N.Y., clerk tells us that his dealer "was very fresh" to his son when the boy brought in the car with a list of problems: "They asked him if he wanted a perfect car."

That's the kind of aggravation the Buyer Protection Plan is trying to eliminate. From our survey, we've found that AMC has certainly minimized it. That's a bonus for Ambassador buyers since only 8.5 percent of them listed guaranteed service as their primary reason for choosing the Ambassador. We had imagined the percentage would be higher. AMC spokesmen say it is much higher with buyers of Matadors, Hornets and Gremlins.

Ambassador owners are mostly re-

peat buyers. Over 55 percent listed "past experience" as their main reason for buying. The other AMC lines attract a good many new customers, but Ambassadors don't. This might soon become a problem, because the majority (52.6 percent) of Ambassador owners are over 50 years old—one of the highest age groups we've surveyed.

A 69-year-old retired engineer from Delaware said, "This is the 29th American Motors (Nash) car in my immediate family since 1913—and I own 700 shares of GM stock!"

What, specifically, do the owners like about their cars? "It is a luxury automobile within my means," says a Wisconsin draftsman. A Washington teacher: "The variable-ratio power steering

(Please turn to page 194)

Summary of 1972 Ambassador Owners Reports*

Total miles driven1,052,938

Average miles per gallon

304-cu.-in. V8, local driving .12.8
 long trips .15.9
 360-cu.-in. V8, local driving .12.5
 long trips .15.4
 401-cu.-in. V8, local driving .12.3
 long trips .15.8

Engines:

304-cu.-in. V851.5%
 360-cu.-in. V836.2
 401-cu.-in. V812.3

Body styles:

4-door sedan69.2%
 4-door wagon18.9
 2-door hardtop11.9

Series:

Brougham59.1%
 SST40.9

Why the Ambassador?

Past experience55.1%
 Economy9.9
 Dealer service/warranty ...8.5

Specific likes:

Handling50.0%
 Comfort32.3
 Ride27.3
 Style25.0

Economy17.7
 Performance15.0
 Power6.5

Specific dislikes:

Poor gas mileage14.1%
 Rattles12.6
 Poor workmanship8.4
 Harsh ride5.7
 Poor dealer service3.8

What changes would you like?

Different styling7.4%
 Different seat contour ...7.0
 Better workmanship7.0
 Fewer rattles7.0
 Better materials6.1
 Brake, hood releases too close4.4

Had any mechanical trouble?

No57.7%
 Yes42.3

What kind of trouble?

Carburetor12.7%
 Transmission7.6
 Electrical7.6
 Brakes6.8
 Cold starts5.9

Did you repair it yourself?

No98.3%
 Yes1.7

Dealer repairs satisfactory?

Yes78.9%
 No21.2

Is the Ambassador your only car?

Yes52.9%
 No47.1

Other cars owned:

AMC products42.7%
 Chevrolet13.2
 Ford7.4
 Plymouth5.2
 Dodge5.2

Accessories/power options:

Power steering62.3%
 Radio50.8
 Tinted glass33.5
 Disc front brakes17.7
 Padded vinyl top17.3

Age distribution of owners:

15-29 years7.3%
 30-49 years40.2
 50-plus52.6

Would you buy another Ambassador?

Yes92.0%
 No8.0

*Percentages might not equal 100% due to rounding and/or insufficient data.



AMBASSADOR FOUR-DOOR is choice of most owners. Overall satisfaction with car is reflected by 92 percent who'd buy one again

Taking the high cost out of hi-fi



ONE EXAMPLE OF A FINE BUY in hi-fi at a bargain price is this Heathkit compact combining FM/-FM stereo receiver and BSR McDonald turntable in a smartly styled rolltop walnut enclosure. With top closed (lower photo above), the parts are neatly hidden and kept free from dust. Kit price is \$169.95

Good sound doesn't have to cost an arm and a leg. The trick is to be able to tell the inexpensive from the just cheap. Here's a rundown on some real dollar-stretching bargains

By HANS FANTEL

GOOD SOUND isn't as hard to come by as it used to be. Recent advances in audio engineering now make it possible to get more hi-fi for your dollar than ever before. Some prices are so low, in fact, that you wonder how the equipment could possibly be any good. Here's where the catch comes in—some is, some isn't. In many cases, there's no direct relationship between price and performance. This works both ways—while high price doesn't guarantee good performance, good performance doesn't necessarily have to come high, either. Good bargains can be found with a little sharp-eyed shopping.

One reason why low-cost equipment

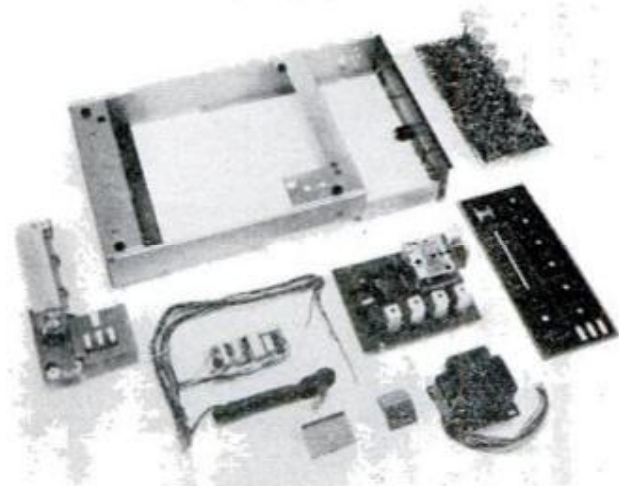

TYPICAL LOW-COST RECEIVERS FOR GOOD LISTENING



LAFAYETTE LR-100, \$154.40



PANASONIC SA-5500, \$199.95



REALISTIC STA-18, \$129.95



REALISTIC STA-36, \$119.95

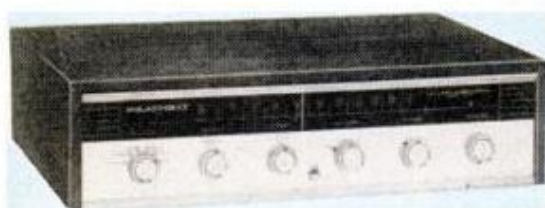

HEATHKIT AR-14, \$119.95



ALLIED 435, \$179.95



HEATHKIT AR-17, \$72.95



SANSUI 210, \$129.95



CRAIG 1506, \$84.95

INEXPENSIVE AMPLIFIERS WITH PLENTY OF POWER



REALISTIC SA-175B, \$59.95



LAFAYETTE STEREO 25, \$41.40



LAFAYETTE LA-324A, \$72.25



REALISTIC SA-500, \$99.95



HEATHKIT AA-14, \$67.95

is sounding better these days is the use of miniaturized, multifunction integrated circuits. These tiny chip-sized modules that do many jobs in one greatly reduce parts cost and assembly time without sacrificing quality. In equipment designed especially to sell at economy prices, such savings are passed on to the customer. This is not always the case in higher priced gear because the savings are often put into extra features and refinements.

Another reason for improved quality at lower cost lies in more efficient speaker designs that require less power. It used to take at least 20 watts per channel to drive an air-suspension speaker at full volume. Now many models thrive on a wattage-saving diet of half that. And watts mean dollars. They represent one of the biggest single factors in the cost of an amplifier or receiver. The less your speakers need, the less you have to pay for.

All in all, these developments make it possible to put together a basic stereo system for about half of what a comparable system cost a few years ago. A \$200 system today can sound like \$400 worth of outlay.

Bargain hunting requires careful checking of specifications, however. It pays to read the fine print. For amplifiers and receivers, a power output rating of 10 watts per channel is generally considered about minimum for good room-filling sound, or perhaps a bit less if your space is small. The reason for wanting good output is not so much that you're ever going to use it all, but that you can get room-rattling volume without having to crank your set up to full power. At peak output, an amplifier is straining, distortion sets in and your music begins to sound raspy and unpleasant. A 10-watt amplifier operated at half power will sound better than a 5-watt amplifier operated at full power even though both put out the same volume.

Also, be sure output ratings are realistically stated. The Institute of High

(Please turn to page 200)

If you've got the green, you can mow in style



Riding mowers for 1972: Makers offer wide choice of design, performance and cutting width. But it still costs more to ride than walk

By GERALD KRATSCH

THERE'S A LOT to choose from if you're shopping for a riding mower—not just in the number of machines offered, but in design, performance, horsepower and cutting size as well.

The hard starting, the pesky inconveniences and the bad design of early models has been eliminated. The industry, with years of field experience behind it, now has a line-up of riders that are attractive, functional and efficient.

You have good variety to select from, so good in fact, that it will pay you to visit as many dealers as you can to become acquainted with the range of choices awaiting you.

What's a riding mower? If you can ride on it and its primary purpose is mowing lawns, it's a riding mower. Some firms limit the classification to those machines having rear-mounted



GILSON LINE (top) offers mowers of 5 or 8 hp. Massey-Ferguson (middle) is powered by Tecumseh 5-hp engine. Jacobsen (bottom) has foot-pedal shifting

POPULAR MECHANICS

engines. Others include their small lawn tractors.

When you get down to it, what you are looking for is a machine that permits you to get the lawn cut as easily, quickly and safely as possible. Also, of course, you will want a mower that does a neat job.

Safety is more important than ever. It has always been a consideration of makers, but this year's models clearly show the results of the outdoor power equipment industry's own endeavors to "engineer in" safety features.

Safety interlock systems, separate brake and clutch pedals, external chute guards, safer steering systems—all are the result of more emphasis on safety.

Bolens, for example, has made a triple-safe starting system a feature of its riders. A key switch, a seat interlock switch and a brake-pedal interlock switch work together to prevent starting of the mower while either the drive clutch or the mower clutch is engaged.

Other manufacturers have shown equal concern for safety. Wherever logical, safety precautions have been clearly labeled. There is still the necessity for the operator to exercise

common sense and judgment in the use of this equipment. But manufacturers are doing as much as they can to raise the odds in your favor.

As for specifications you should be especially concerned with: You'll want a rider that cuts a wide-enough swath to get your mowing job done in mini-



ARIENS OFFERS redesigned Fairway rider (below), available in two 7-hp models and one 5 hp. Mowers all have safely-interlock systems. Toro's Whirlwind (top, right) has a 5-hp engine and lists at \$299.95. Electric start is extra. John Deere's Electric 90 (right) has three 12-volt batteries that run a traction motor for propulsion and two motors that power the twin-bladed mower unit. The system eliminates heat and exhaust fumes. Homelite, a new entry in the field, offers four riding machines. Shown (bottom, right) is its 5-hp RE-5, which has a gear drive and cuts 24-inch swath. It's priced at \$385



1972 RIDING MOWER SPECIFICATIONS

Make	Model	Engine	Horsepower	Electric Start	Forward Speeds	Cutting Width (in.)	Suggested Price	
AMF	1281	B&S	8	Yes	4	36	NA	
Allis-Chalmers	Scamper	B&S	8	Yes	5	36	\$619	
	Scamp	B&S	5	No	2	24	388	
Ariens	Emperor II	B&S	8	Yes	6	30	680	
		Tecumseh	7	Yes	6	30	600	
		Tecumseh	7	No	6	30	540	
		Tecumseh	7	No	6	30	480	
	Fairway	Tecumseh	7	Yes	4	26	530	
		Tecumseh	7	No	4	26	420	
		Tecumseh	5	No	4	26	350	
		Tecumseh	7	Opt.	3	28	525	
Bolens	728	Tecumseh	7	Opt.	3	28	525	
John Deere	90	Electric	8	Yes	3	34	885	
	57	Tecumseh	7	Opt.	2	34	535	
	56	Tecumseh	6	Opt.	2	28	470	
	55	Tecumseh	5	No	2	26	395	
Gilson	52015	B&S	8	Yes	3	34	NA	
	52014	B&S	8	No	3	34	NA	
	52033	B&S	8	Yes	3	30	NA	
	52032	B&S	8	No	3	30	NA	
	52031	B&S	5	No	3	25	NA	
Gravely	408	Kohler	8	Yes	4	34	NA	
	Conv. 7.6	Gravely	7.6	Opt.	2 or 4	30-40	NA	
Hahn-Eclipse	LTD. 500	B&S	7	Yes	3	30	650	
		B&S	7	Yes	3	30	600	
		B&S	5	Yes	3	26	500	
	UHD 130	B&S	7	No	3	30	550	
		UHS 130	B&S	7	No	3	30	500
		UHS 126	B&S	5	No	3	26	400
Homelite	RM-7E	B&S	7	Yes	3	30	609	
	RM-5E	B&S	5	Yes	3	26	539	
	RM-5	B&S	5	No	3	26	459	
	RE-5	B&S	5	No	2	24	385	
Huffman	H1541	B&S	8	Yes	3	32	NA	
	H1061	—	8	No	3	26	NA	
	H1014	B&S	5	No	1	24	NA	
	H1111	Tecumseh	10	Yes	3	32	NA	
International Harvester	Cadet 75	B&S	7	Yes	3	32	560	
	Cadet 75	B&S	7	No	3	32	485	
	Cadet 55	B&S	5	No	3	28	404	
Jacobsen	Mark II 730E	B&S	7	Yes	Inf.	30	610	
	Mark II 730	B&S	7	No	Inf.	30	510	
	Mark II 630	B&S	6	No	Inf.	30	470	
Lawn-Boy	9368ES	B&S	8	Yes	3	36	660	
	9368E	B&S	8	Yes	3	36	625	
	9368	B&S	8	No	3	36	540	
	9328ES	B&S	8	Yes	3	32	630	
	9328E	B&S	8	Yes	3	32	595	
	9328	B&S	8	No	3	32	510	
	9303E	Tecumseh	7	Yes	3	30	450	
	9303	B&S	7	No	3	30	400	
	9501	B&S	5	No	2	26	380	
MTD (Columbia)	436-2	B&S	8	Yes	Auto.	30	550	
	397-2	Tecumseh	8	Yes	4	30	510	
	391-2	Tecumseh	8	No	4	30	450	
	387-2	Tecumseh	5	Yes	4	25	460	
	381-2	Tecumseh	5	No	4	25	400	
	413-2	Tecumseh	5	No	1	25	370	

(Table continues on facing page)

BOLENS 728 RIDER features a safety interlock system that prevents starting unless all controls are in neutral. Though there are variations among systems, drawing shows basic setup used by most makers

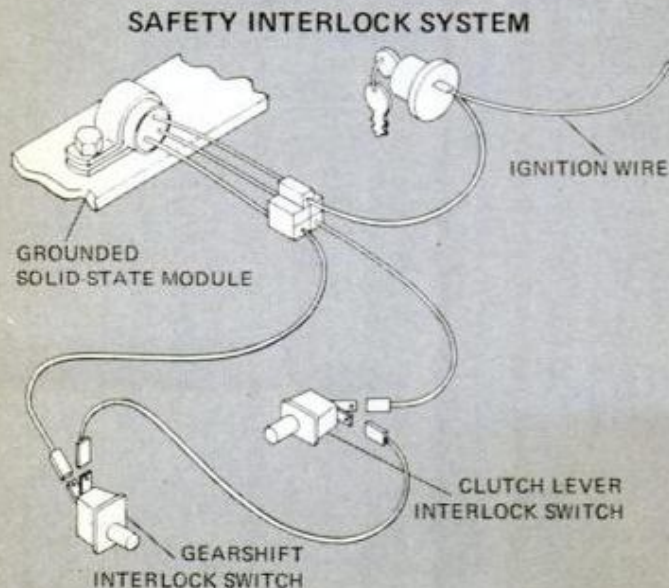

Make	Model	Engine	Horsepower	Electric Start	Forward Speeds	Cutting Width (in.)	Suggested Price
Massey-Ferguson	MF 6	Tecumseh	6	Opt.	3	32	\$450
	MF 5	Tecumseh	5	No	2	26	360
McDonough (Snapper)	308XS	B&S	8	Yes	5	30	600
	308X	B&S	8	No	5	30	480
	268XS	B&S	8	Yes	5	26	560
	268X	B&S	8	No	5	26	440
	265XS	Tecumseh	5	Yes	5	26	490
	265X	Tecumseh	5	No	5	26	390
Montgomery Ward	97	B&S	7	No	3	32	460
	95	B&S	5	No	3	25	420
	93	B&S	5	No	3	25	370
	87	B&S	5	No	1	25	290
Murray	2-3633	B&S	8	Yes	3	36	560
	2-3233	B&S	8	Yes	3	32	540
	2-3063	B&S	8	Yes	3	30	500
	2-3043	B&S	8	No	3	30	450
	2-3013	B&S	7	No	3	30	390
	2-2513	B&S	7	No	3	25	370
	2-2503	B&S	5	No	3	25	330
National Mower	—	B&S or Wisconsin	10	Opt.	2	84	NA
	—	Wisconsin	9.2	Opt.	2	84	NA
	—	B&S	8	—	1	68	NA
	—	B&S	8	—	1	30	NA
Roof	Lariat 30	B&S	7	Opt.	4	30	542
	Lariat 302	B&S	7	No	4	30	499
	Lariat 26	B&S	5	Opt.	4	26	425
Sears	96363	Craftsman	8	Yes	3	36	629
	96361	Craftsman	8	No	3	36	529
	96323	Craftsman	8	Yes	3	32	549
	96321	Craftsman	8	No	3	32	469
	96326	Craftsman	7	Yes	3	32	469
	96263	Craftsman	7	Yes	3	26	409
	96261	Craftsman	7	No	3	26	329
	96251	Craftsman	5	No	1	26	249
Sensation	R-26ES	B&S	8	Yes	3	26	545
	R-26	B&S	8	No	3	26	455
	R-26	B&S	5	No	3	26	395
Simplicity	Broadmoor 728	B&S	8	Yes	3	36	879
	Broadmoor 728	B&S	8	No	3	36	775
	Yeoman 637	B&S	7	Yes	3	32	775
	Yeoman 637	B&S	7	No	3	32	699
	Serf 535	B&S	5	Yes	3	28	630
	Serf 535	B&S	5	No	3	28	554
	Wonder Boy 365	B&S	5	Yes	3	26	475
	Wonder Boy 365	B&S	5	No	3	26	399
	Swisher	Ride King A-40	Lauson	8	No	2	40
Ride King A-32		Lauson	6	Yes	2	32	351
Toro	55275	B&S	8	Yes	0-5 mph	36	NA
	55166	B&S	8	Yes	3	36	NA
	56173	B&S	7	Yes	3	32	NA
	56108	B&S	7	No	3	32	NA
	57228	Tecumseh	7	Yes	3	32	NA
	57131	Tecumseh	7	No	3	32	NA
	57017	Tecumseh	5	Yes	3	25	NA
	57003	Tecumseh	5	No	3	25	NA
	56010	Tecumseh	5	Yes	3	25	NA
	56005	Tecumseh	5	No	3	25	NA
56500	B&S	5	No	1	25	NA	
Yard-Man	Mustang 3420	B&S	5	Yes	2	25	450
	Mustang 3197	B&S	5	No	2	25	370
	Mustang 3170	B&S	5	No	1	25	300

Key: B&S, Briggs & Stratton; NA, not available

CADET 75, made by International Harvester, has a tough fiberglass body supported by a steel chassis



mum time. After all, if you're investing from \$250 to \$600, or even more, you should in return be able to get the job done faster.

Once you've settled on the cutting width—and you'll find a range of from 24 to 40 inches—check the horsepower. There are a number of good 5-hp riders, but, generally, a few dollars more moves you up to the more logical 7 or 8-hp size.

Most manufacturers offer you some models with electric start as standard or as an option. While manual starting today is no great chore, even for the

(Please turn to page 192)

New hinged tractor with front-wheel drive

By JIM LISTON



VACUUM PICKUP is powered by GMT's engine, feeds leaves, clippings into a 20-bushel box on carryall. A 15-foot snorkel attachment reaches under shrubs



The Hesston Front Runner was designed for professional grounds keepers—but anybody can buy one.

MOST BUYERS of small tractors want machines that look like something right off the farm. So do farmers—who also mow lawns—and know that today's harvesting machines put the driver up front where he can see what he's cutting. When the Hesston Corp., one of the world's largest manufacturers of farm equipment, developed a new kind of small tractor they styled it "years ahead" like their latest harvesters.

The Front Runner GMT (general maintenance tractor) has the square, compact look of a windrower or industrial payloader. Designed for use by professional grounds keepers, its principal function is mowing, but it is a versatile multipurpose unit that handles all the jobs the maintenance contractor—or homeowner with a large lawn or acreage—expects of commercial grade equipment: plowing, snow-throwing, dozing, cultivating, aerating.

Convinced that the ideal garden tractor should be propelled by the

front wheels—so the thrust of the machine will always be in the direction of travel for mowing, snowthrowing and using a blade—Hesston put the engine and driver over the front wheels for maximum traction and combined large (12-inch) wheels with center hinge construction. There are other hinge-type tractors, but Front Runner is the first to combine this principle with front-wheel drive. Hinging makes possible a 46-inch turning radius.

The GMT is a “frame steer” tractor: Neither front nor rear wheels alone do the steering; they steer in relation to each other at the hinge point of the front and rear sections. The tractor has automotive-type ball-joint steering (Chevrolet) that is positive and effortless. But unlike automotive steering, it is not self-centering. A spinner attached to the 15-inch steering wheel is standard and makes it easy to bring the wheels back on center with one hand while the right is free to operate the hydrostatic speed-control lever.

A unit tested by Suburban Lawn and Garden, a Kansas City lawn maintenance contractor, accumulated 497

(Please turn to page 198)

EIGHT-BLADE TANDEM DISC, as well as plow, cultivator and aerator, can be raised or lowered hydraulically from driver's seat. Mowers are available in 40, 60 and 80-inch widths. Front-mounted attachments include an angle dozer, rotary broom and snow thrower; rear-mounted include disc, mold-board plow, cultivator and aerator. Dual wheels and wheel weights improve traction on severe slopes



JACOBSEN GT-14:

The frame

This smooth-looking



JACOBSEN'S NEW GT-14 has a unique frame design and construction. Each of four tractors—14-hp and 12-hp hydrostatic and 10-hp and 8-hp gear models—has a one-piece, welded, all-steel “Uni-frame.” Inside the protection of this frame are all the drive-train components of the tractor—in line with the frame as well as with one another.

The engine base, an integral part of the tractor frame, is at the frame's lowest point, resulting in a low center of gravity and a more stable, safer ride.

The first in-line component is a straddle-mounted Kohler engine. It has ball bearings at both ends of the crankshaft for longer life, a rotating intake screen that is said to keep the airflow cleaner for better cooling, and an automatic compression release to give easier starts.

Both the 12 and 14-hp Kohler engines used in the “GT” line feature Bendix-type starters and 15-amp. solid-state alternators. The hydrostatic-drive models have a “flex-coupled” driveshaft connecting the engine directly to the hydro gear with no power wasted on pulleys, belts or changes in direction.

A hydro gear provides a fluid connection between the engine and the transaxle. After the oil has passed through the hydro transmission, it is discharged into the transaxle, an arrangement called “sump cooling” because the large volume of oil in the transaxle sump insures an ample radiant cooling area.

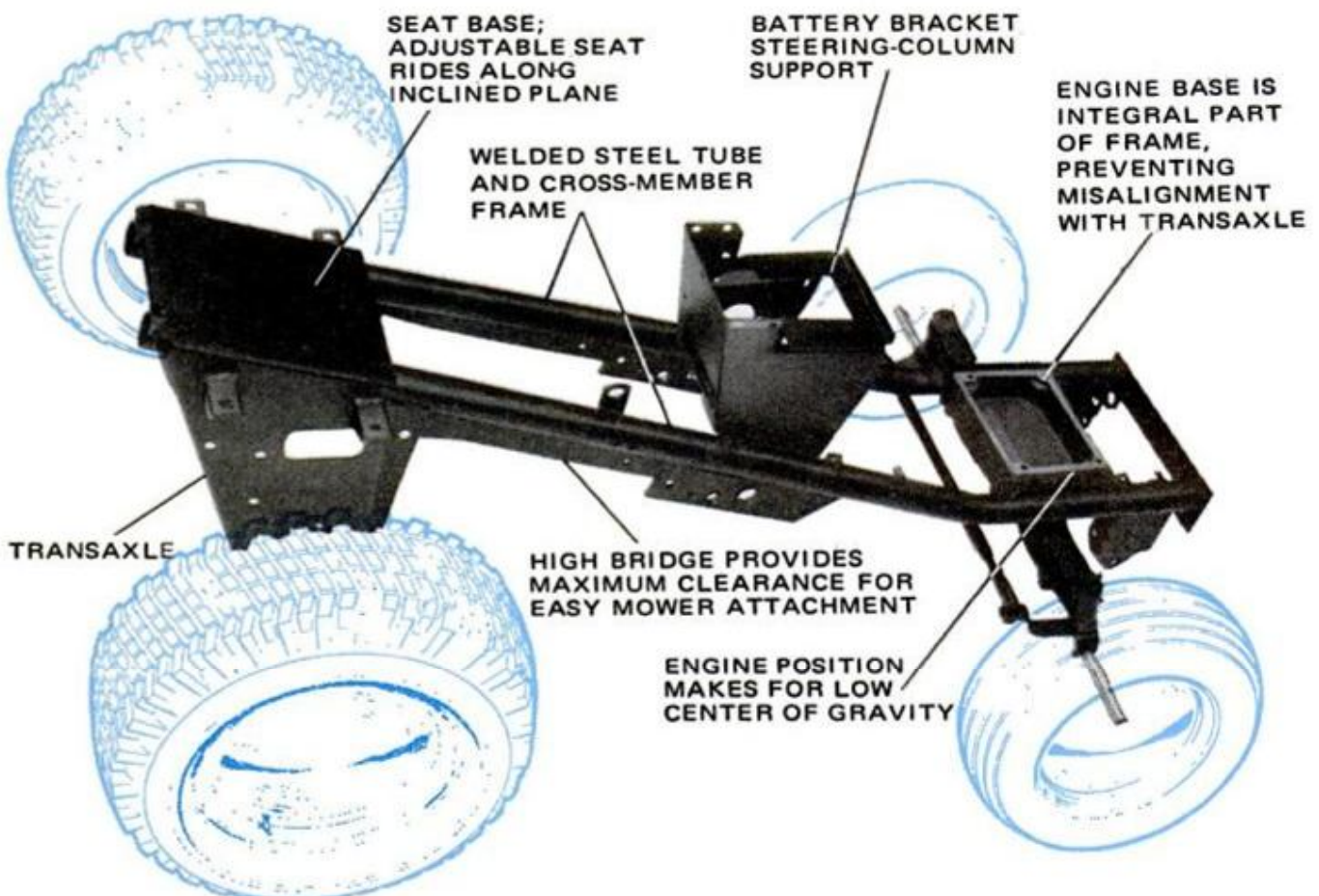

makes the difference

performer mows over 3 acres an hour at a sporty 7 mph

The transaxle is equipped with a heavy-duty differential that incorporates a traction-assist mechanism. This is claimed to increase drawbar pull by 80 percent in low range, and 35 percent in high range, under conditions where one wheel doesn't maintain traction such as on ice or wet pavement.

Jacobsen engineers have designed the tractor for a 50-inch mower to reduce time mowing large lawns. Three tempered-steel blades do the cutting. Most chances of scalping a lawn are eliminated because of a special hanger arrangement that permits the mower to float freely.

Other Jacobsen GT features include shock-mounting of the fenders and seat deck to isolate vibration; narrow, sloping hood designed to give unobstructed visibility to front and both sides; uncluttered, logical arrangement of standard controls; convenient access to battery and gas cap-fuel gauge; easy accessibility to the engine (all minor servicing can be done without removing the hood); and a seat that's adjustable for driver comfort.

The GT-14 lists at \$1625—not out of line with the competition in 14-hp hydro-drive tractors. A buyer of any garden tractor will tend to justify the substantial outlay involved by the fact that he'll get year-round use from the machine. Jacobsen offers a generous array of attachments, including an efficient snowthrower—good news for folks living in heavy snow country.

—Gerald Kratsch

A 36-INCH TILLER (top photo) is one of about 50 accessories and attachments available for the GT-14

DRAWBAR HITCH allows for the pulling of carts and other equipment. One cart offered has a tailgate

TWO SNOWTHROWER ATTACHMENTS are available. Drawbar between thrower and rear axle aids "push"

MAY 1972

109



Материал, размещенный авторским правом

PHOTOGRAPHY

Now home movies can sound good, too

By BURT MURPHY

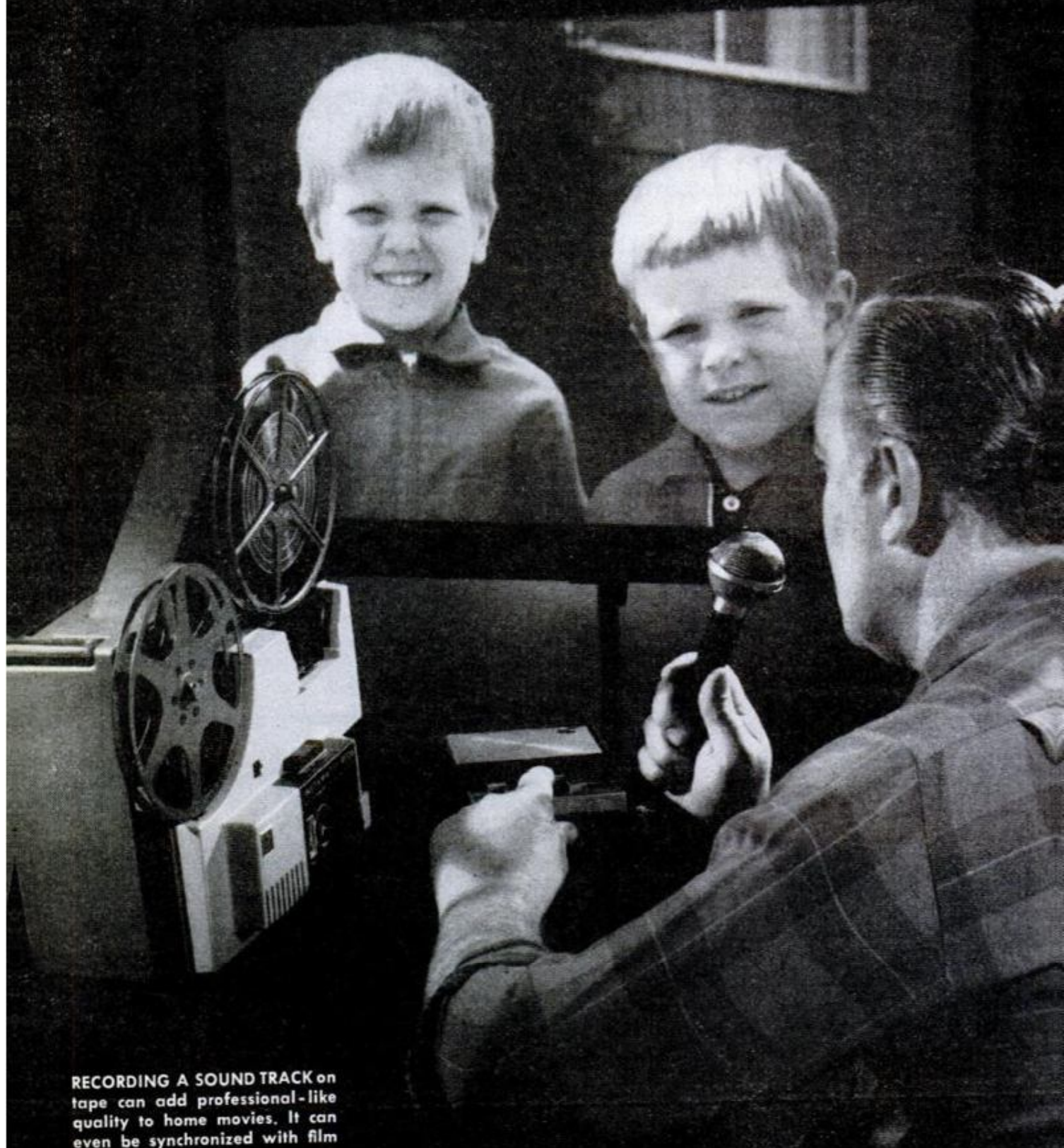

RECORDING A SOUND TRACK on tape can add professional-like quality to home movies. It can even be synchronized with film

New systems for adding synchronized sound give you professional-like results with ordinary Super-8 film.

IT'S TAKEN A LONG TIME since the first commercial "talkie" was made to get sound into home movies, too, but the day has finally come. Synchronized sound using optical recording has long been available on high-priced professional 16 and 35-mm equipment, but has never been considered feasible for low-cost Super-8 amateur use. Now, with magnetic recording, things are beginning to happen.

To date, there are at least three systems for home use that provide so-called "lip sync" sound—sound that appears to come right out of your subjects' mouths in perfect synchronization with the movement of their lips. Such sound can be just as exciting to home-movie viewers today as it was when Al Jolson first sang his famous *Mammy* to stunned theater audiences 'way back in 1927. It can make your movies come alive, adding professional-like realism and drama. What's more, it can provide a lot of fun in the process—even if your first attempts won't win any academy awards.

What system you choose depends on the type of sound you're after and the amount you're willing to invest. If you want to start out simply, you need only a small tape recorder and a silent projector. By taping a narrative sound track to go along with your movie, then playing it back as the film is projected, you can make your show more lively and interesting. While this doesn't give you synchronized sound, it does permit you to add descriptive commentary, mood-setting music, even realistic sound effects.

A step up from this is to invest in a Super-8 sound projector. Here you record directly onto a magnetically striped sound track running along the edge of the film itself. However, since

MAY 1972

OPTASOUND



SYNCHRONEX



BELL & HOWELL



SYNCHRONIZED SOUND is possible with three recently developed systems shown above. All use tape for recording original sound track, but differ in playback. With the Bell & Howell system, you play the tape along with the projected film, using a synchronizing linkage to keep the sound in step with the picture. With Optasound and Synchronex systems, the taped sound is first transferred to a magnetic sound track on the film itself, then is played back through a sound projector as the movie is viewed

the magnetic striping must be added *after* the film is shot and processed, this still limits you to post-recorded narration. The advantage is that your sound track, once recorded on the film, always stays in step with the picture. You can say, "Now watch that fish jump" and the fish will jump at precisely the right instant every time. With a separate recorder, it's not possible to keep the tape as closely synchronized with the picture so your comments must be more general.

For the ultimate in home-movie sound, there are recently developed systems that enable camera and recorder to be synchronized *at the time*

your movie is made, thus giving you true lip sync. If you want your "actors" to talk on the screen, you just place a microphone nearby and their voices are simultaneously recorded as the film is exposed. You can also pick up real-life background sounds such as wind whistling across a mountaintop or the crash of surf in a beach scene.

Three such lip-sync systems currently on the market are Optasound, Synchronex and Bell & Howell's Filmosound. All three use tape to record the initial sound track in sync with the camera, but involve important differences in method and equipment.

Bell & Howell's Filmosound is a complete, all-in-one packaged system consisting of matched camera, cassette tape recorder and projector. In the taking stage, camera and recorder are electrically linked by cable. As the film is exposed, a tiny light in the camera flashes a series of timing marks along the film's edge at spaced intervals. At the same time, it also sends to the recorder a series of electrical timing pulses that are recorded on the tape at exactly the same intervals as the timing marks on the film. In playback, the recorder is connected to the projector, and a sensing mechanism uses the timing pulses on the tape to keep the drive speed in step with the corresponding timing marks on the film. Thus film and tape run along together in perfect sync.

Bell & Howell offers its Filmosound

system in several different combinations depending on specific features desired. Cameras rigged for Filmosound sync range from about \$105 to \$160, projectors from about \$180 to \$220. The matching recorder, available in only one model, sells for \$103.95 and can be used as a conventional portable cassette machine as well. Thus, a minimum Filmosound outfit can be put together for under \$390.

The Optasound and Synchronex systems are basically similar in the taking stage, but differ in playback. Instead of using the original camera-synced tape as the final sound track, you send both the tape and exposed film to an Optasound or Synchronex processor. At the same time the film is developed, it is magnetically striped, and sound from the tape is re-recorded onto this stripe in sync with the picture. The resulting sound-striped film can be viewed—and heard—with any standard Super-8 sound projector having 18-frame image-to-sound separation. The advantage here is that you don't have to purchase a special sound projector if you already own a conventional model or wish to rent or borrow one for occasional use.

Both Optasound and Synchronex do require a means of syncing camera with recorder, but there are interesting differences here, too. Synchronex offers two matched camera-recorder packages, the Mark I and Mark IV.

The Mark I is a handy, no-frills

TWO SPECIALIZED AIDS for adding sound to movies are shown below, both produced by Optasound. One, called Optasync, is a conversion unit you can attach to an existing reel-to-reel recorder to permit taping synchronized sound. At left, it is in-

stalled in a standard Uher 4000L recorder to sync tape with camera. At right is another adapter, Edisync, a reel-type device that provides a mechanically synchronized sound-track linkage with a silent projector, eliminating need for a sound projector

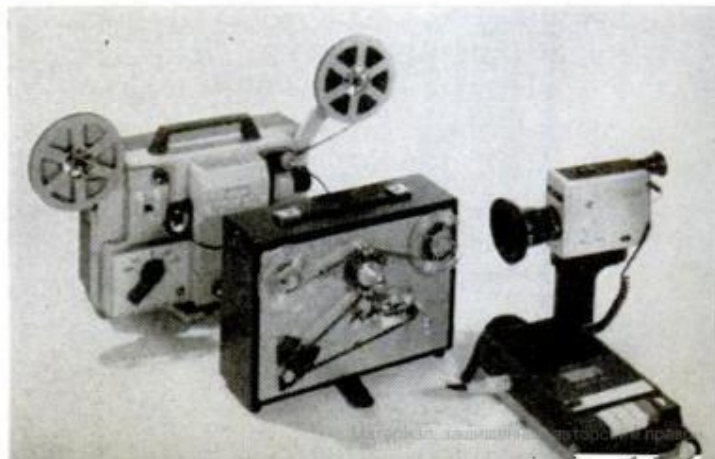

4 BASIC WAYS TO ADD SOUND TO MOVIES

1 SOUND TRACK IS RECORDED SEPARATELY ON TAPE AS FILM IS VIEWED



SMALL CASSETTE OR SIMILAR RECORDER

TAPED SOUND TRACK PLAYS BACK AS FILM IS PROJECTED BUT WITHOUT SYNC

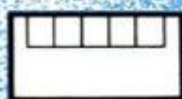

SILENT PROJECTOR

2 SOUND TRACK IS TAPED AS CAMERA FILMS SCENE

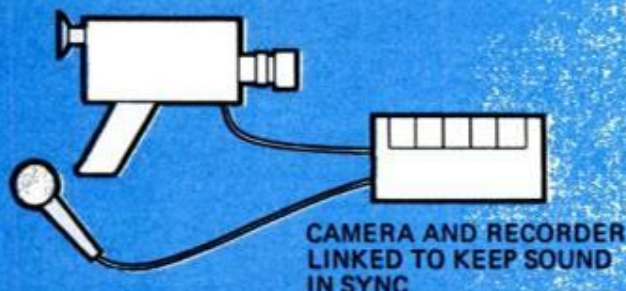

CAMERA AND RECORDER LINKED TO KEEP SOUND IN SYNC

TAPED SOUND TRACK PLAYS BACK AS FILM IS PROJECTED IN SYNC WITH IT



RECORDER AND PROJECTOR LINKED TO KEEP SOUND IN SYNC

3 SOUND TRACK IS TAPED AS CAMERA FILMS SCENE

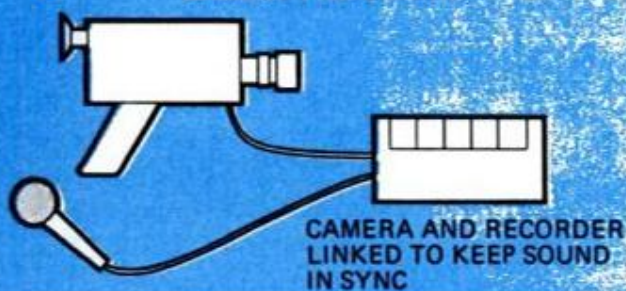

CAMERA AND RECORDER LINKED TO KEEP SOUND IN SYNC

TAPED SOUND TRACK IS TRANSFERRED TO FILM AND PLAYS BACK THROUGH PROJECTOR



SPEAKER

MAGNETICALLY STRIPED FILM



SOUND PROJECTOR

4 SOUND TRACK IS RECORDED DIRECTLY ON FILM IN SYNC WITH IT

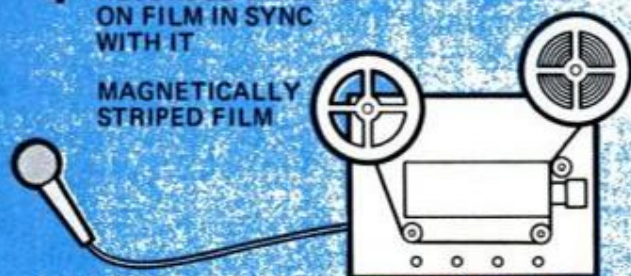

MAGNETICALLY STRIPED FILM

SOUND PROJECTOR

SOUND TRACK PLAYS BACK THROUGH PROJECTOR AS FILM IS VIEWED



SPEAKER



SOUND PROJECTOR

economy system priced at just \$99.95. It combines a fixed-focus, 2-to-1 manual zoom camera with a simplified cassette unit designed for recording only without playback facilities. The Mark IV is a more sophisticated version combining a full-focus, 4-to-1 motorized zoom camera with a cassette recorder that also doubles as a conven-

(Please turn to page 196)

YOU CAN ADD SOUND in several ways, as illustrated above. Choice depends on whether you want true "lip sync" or nonsynced commentary. Method 1 is the simplest and least expensive, requiring only a recorder to add previously taped description or music. Methods 2 and 3 let you record actual dialogue as film is made, then play it back in perfect synchronization with lip movements as movie is viewed. Both require camera and recorder to be electrically synchronized, but in method 2 original tape is used as final sound track, while in method 3 tape is transferred to a magnetic sound track on film itself. In method 4, you record directly on the film, but are limited to commentary without lip sync

PM Chrysler Town and Country OWNERS REPORT...

A nationwide survey based on
900,000 owner-driven miles



Ah, comfort and convenience, but there's a price to pay!

By MICHAEL LAMM, West Coast Editor / Photos by the author

IT TAKES ALL KINDS, so here go some of the offbeat reasons Town and Country owners bought this big wagon:

"To haul four German shepherd dogs," says a Chicago railway brakeman. A Lansing, Ill., superintendent: "For towing my race car." A dis-

gruntled Brooklyn window cleaner claims, "Because I lost my mind!" A North Carolina attorney admits, "My wife liked the color." And an Iowa ambulance driver confesses, "Because I've driven a Town and Country ambulance since 1968 for my boss, and I guess I just got used to it."

IT'S AN ELEGANT WAGON, say owners, many of whom chose Town and Country for its style. Three-seat configuration is a popular option



More typically, though, owners gave these reasons for buying: "Past success with Chrysler products." "Dual airconditioning with ducts in the rear." "The 1972 General Motors clamshell tailgate scares me, so this year we decided to try Chrysler." "Wanted a big, roomy, comfortable, heavy wagon, and that's what it is." "Like the handling of torsion-bar suspension." "To tow our boat and trailer." "I wanted the best wagon I could buy." "Holds good Blue Book (trade-in value) and recommended by police officers." "This is my fourth, and I'm well pleased."

For this Owners Report, let's give several individual Town and Country owners their full say. Here are comments from a retired grocer of Rochester, N.Y.: "Gas tank leaked at first, had to be replaced. AM/FM radio was sent to Syracuse for repairs. My dealer's salespeople are okay, but not too hot in service department. We had a difference of opinion when the taillights wouldn't work. Dealer claimed it was fault of Ziebart rustproofing people, but Ziebart said they hadn't touched the taillights. I ended up paying the \$20. I bought this wagon to tow our 31-foot Airstream. Would rate workmanship fair—bubbles in wood-grain, sloppy paint, too much black goo around.

"If I weren't trailering, I'd buy a smaller car."

A 29-year-old Illinois insurance claims manager: "When I got it, I could start the engine in any gear; made no difference where the transmission selector was. Fixed that and the power windows failed. I've owned several new cars, and this dealer excels by far. Have bought GM and Ford products, but that's why I'll buy again from Chrysler. Dollar for dollar, Chrysler offers the most, both in standard equipment and options for less money. It's a very comfortable car, but when my wife drives, she shoves the seat all the way forward so my knees are against the dash.

"Specific likes are appearance, com-

TOWN AND COUNTRY FUEL MILEAGE CHART

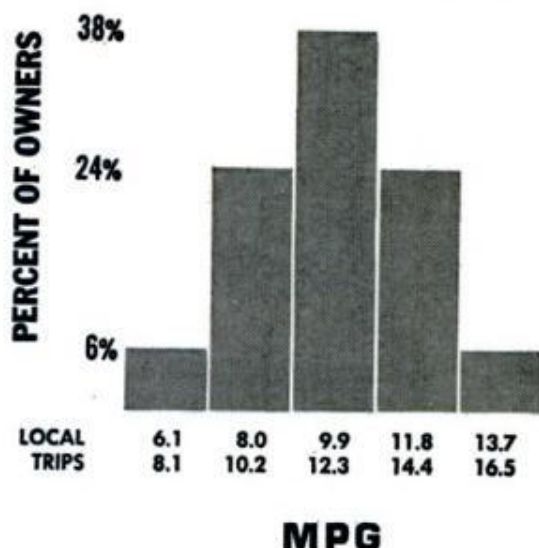

TWIN ARMRESTS up front fold for center passenger. In two-seat wagons lockable storage is under floor



AUTO-LOCK SYSTEM for tailgate keeps it locked if key is on. Gate swings open even with window up



fort, easy access to rear seat. Complaints: no guts for passing with the 400 V8, misalignment of exterior trim and lack of resale value."

A Wisconsin manufacturer's agent, age 29: "Engine refuses to quit when key is turned off, hard to start on cold nights, brakes squeaked. Dealer fixed everything, but troubles were back within three days. I'd rate dealer courtesy good, sales methods fair, and repair service horrible. I bought this wagon because I've owned four Plymouths and have had excellent luck. Ride is superior, but I'd like front vent wings and quieter brakes. I'm 6-5, and the car is comfortable, although I could never wear a hat. Specifically, I like it because it's a nice-looking car, smooth-riding, plenty of room, but I'm not crazy about the way the engine starts and stops (or doesn't start and doesn't stop). I also don't like the blower fan always being on and the noisy brakes."

A Plainfield, N.J., housewife reports: "Found the car extremely difficult to start in the morning. Also, the entire electrical system died out one week after delivery. Had the car to the dealer six times with the starting problem. They say it's plugs, but they fixed the

electrical thing immediately. I'm not too happy with my dealer, because I had an overcharge on the car at delivery for items we didn't order. Hard feelings. I always feel the dealer is socking it to us. We bought this wagon because our last Town and Country was a real gem.

"Workmanship on the '72 is good, and the car is comfortable to drive and ride in. It would be great if the automatic choke worked and if the constant airflow inside the car (hot and cold) would turn off when all other systems are turned off."

A U.S. Treasury investigator living in Indiana says: "No mechanical problems—the 440 V8 is a good engine. Some nonmechanical troubles, though, included door locks, tire balance, headlight aim.

"One thing that I found out about dealers is the big price spread. With our '68 Mercury wagon as a trade-in the dealer in Hammond wanted \$3950, the Gary dealer said \$3750, and a Mishawaka dealer said \$3500. So we ordered it from the factory. We bought a Town and Country because we have seven children, 8 to 17, and the third seat in GM and Ford wagons isn't roomy enough. Workmanship is fine

Summary of 1972 Chrysler Town and Country Owners Reports*

Total miles driven	898,389
Average miles per gallon	
Local driving	9.9
Long trips	12.3
Model	
3-seat wagon	68.0%
2-seat wagon	32.0
Why the Town and Country?	
Past experience	28.3%
Styling	21.0
Size	16.1
Towing capability	7.3
Comfort	6.8
Specific likes:	
Comfort	43.5%
Ride	43.5
Handling	39.6
Style	33.8
Performance	14.0
Spaciousness	13.0
Roadability	9.7
Specific dislikes:	
Poor gas mileage	25.9%
Poor workmanship	19.0
Rattles	18.1
Visibility	10.2

Poor dealer service	7.8
Quality of materials	6.8
What changes would you like?	
Better workmanship	12.1%
Better gas mileage	8.8
Add vent windows	7.7
Fewer rattles	6.6
Better materials	5.5
Had any mechanical trouble?	
Yes	53.5%
No	46.5
What kind of trouble?	
Electrical	25.7%
Carburetor	18.6
Airconditioning	9.7
Door locks	7.1
Cold starts	4.4
Did you repair it yourself?	
No	97.4%
Yes	2.6
Dealer repairs satisfactory?	
Yes	59.6%
No	40.4
Is the Town and Country your only car?	

No	74.9%
Yes	25.1
Other cars owned:	
Plymouth	17.3%
Chrysler	14.9
Chevrolet	10.5
Dodge	10.5
Volkswagen	8.7
Ford	8.7
Accessories/power options:	
Airconditioning	71.7%
Radio	52.6
Luggage rack	36.4
Power windows	26.6
Trailer hitch	26.0
Stereo tape deck	23.1
Tinted glass	19.7
Cruise control	18.5
Power seats	17.9
Age distribution of owners:	
15-29	17.1%
30-49	67.4
50-plus	15.6
Would you buy another Town and Country?	
Yes	80.9%
No	19.1

*Percentages might not equal 100% due to rounding and/or insufficient data.

but interior finish isn't as plush as I'd expected in a Chrysler. I'd like more interior refinement and less wind noise. Also, the gas tank sloshes.

"As for comfort, at first the front seat seemed cramped for legroom, but after a while I found it very comfortable. Same with middle and rear seats. What I particularly like is engine response, roadability and comfort. I particularly dislike air and water leaks at side and rear doors, fender skirts and constant blower operation."

A New York engineer reports: "No mechanical problems, but . . . it had a lot of little things wrong, like the radio not hooked up, automatic tailgate locking system not secured, windshield leaked. Dealer fixed everything courteously and quickly, and I consider him to be very honest in his sales methods.

"What sold me was the way it handles and that the third seat faces rearward. I miss a ledge on the dash

to set things on—like the '69s had. It's a very comfortable car, and passengers are impressed, both front and rear. My primary praises are handling, ride and flexibility of uses."

Since owners tend to take standard equipment for granted, we should mention as did only several owners, the no-cost bonuses Chrysler offers in the Town and Country. Automatic transmission, power steering, power front disc brakes, and a two-barrel 400-cu.-in. V8 head the list. Subtler items include an "Auto-Lock" tailgate that automatically locks when the ignition is on. This keeps kids from opening it with the car in motion. The dual-action tailgate can be opened like a door with the glass rolled up, and an override switch lets it open with the engine running. Then, too, there's a plastic litter bag affixed to the inside of the glovebox lid, and the T&C's cargo deck (see photos below) has four storage bins for small items. ★★★

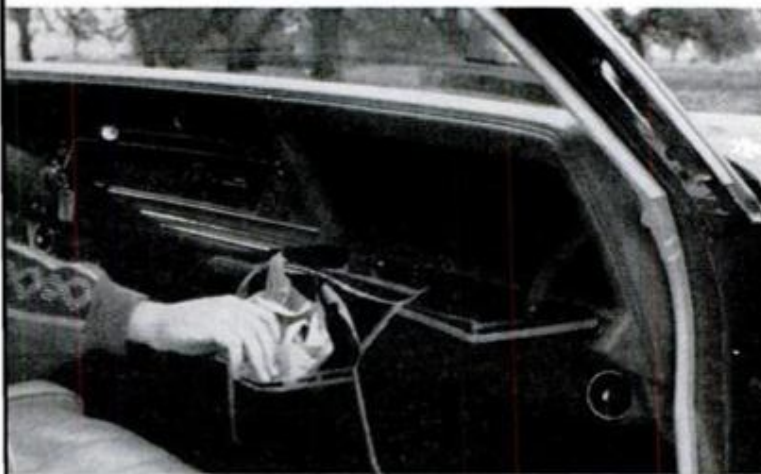

PLASTIC LITTER BAG in glovebox is temptation to leave door open; this could be lethal in panic stops

MANY COMPLAINED about gas mileage even though they knew it wouldn't be great when they bought



ASSIST GRIPS at roof make stepping into rear compartment easier. Spoiler on roof helps clear glass

FOUR HANDY BINS in rear deck hold small items; here they house speakers for optional stereo system

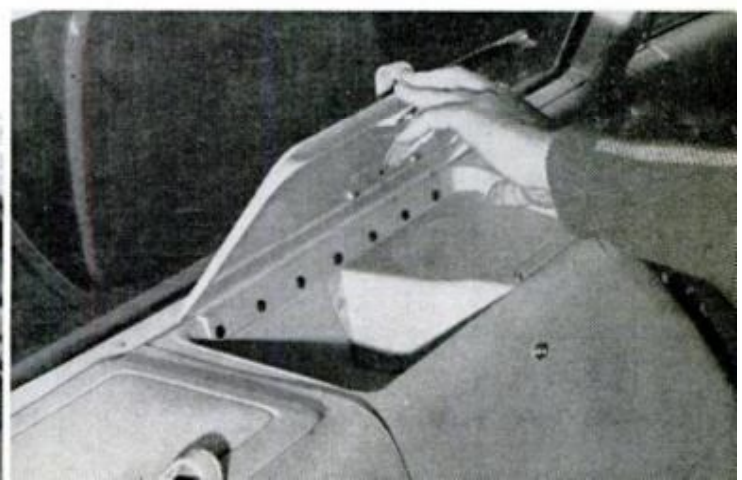

JUST PATENTED

Rocker-wing plane almost

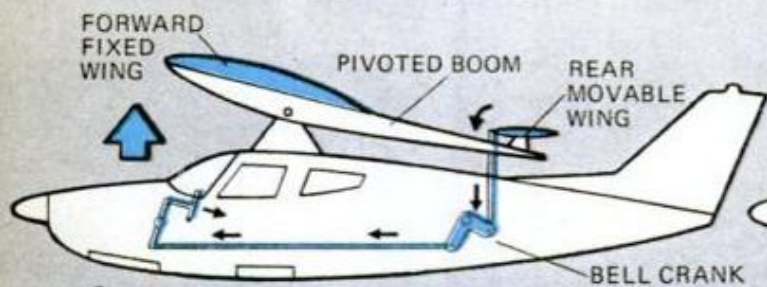
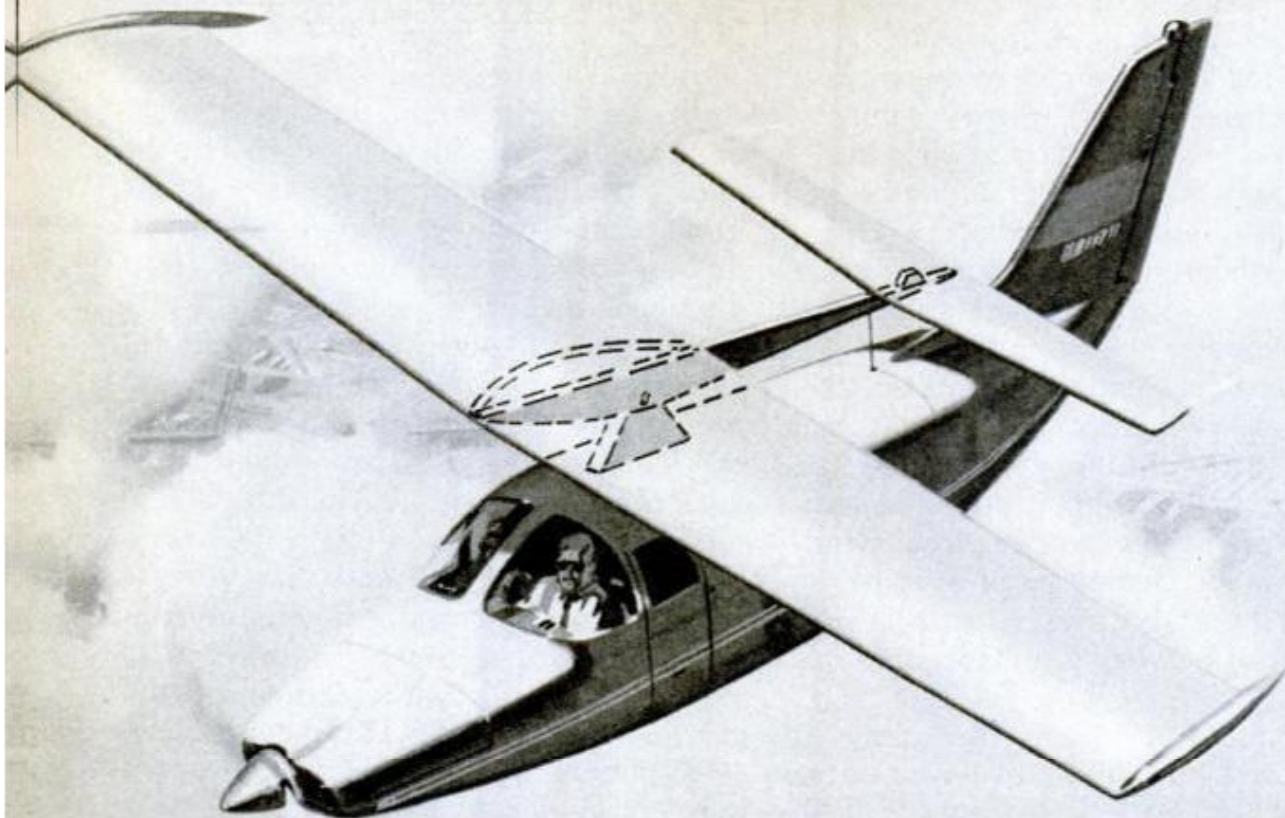

1 PULLING BACK ON CONTROL STICK TILTS REAR WING DOWNWARD, FORCING FORWARD WING UPWARD TO SHARPEN ANGLE OF ATTACK

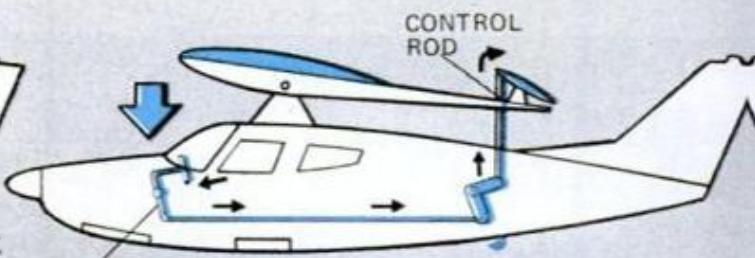

2 PUSHING FORWARD ON CONTROL STICK TILTS REAR WING UPWARD TO FLATTEN ANGLE OF ATTACK

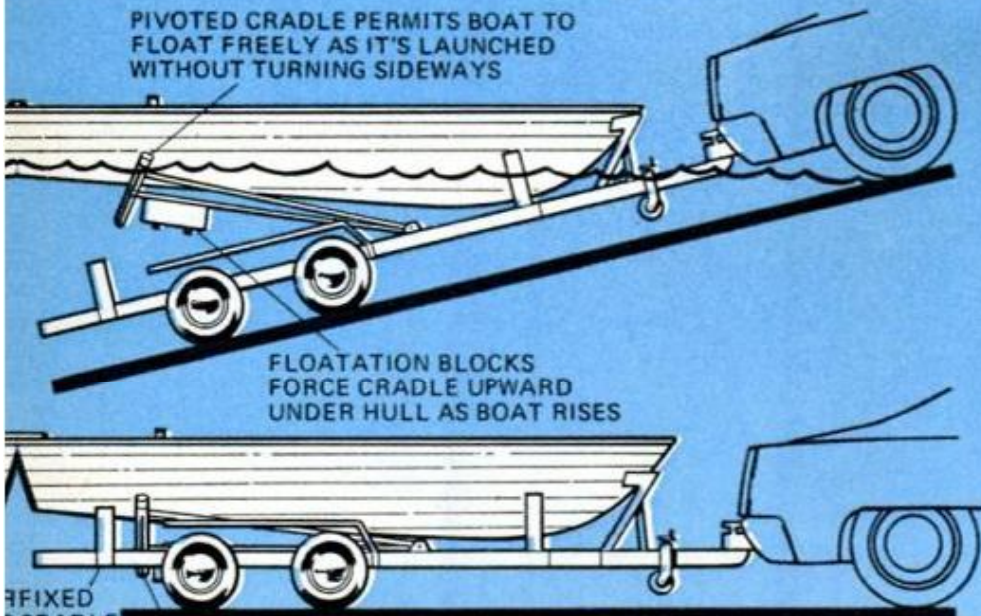

PIVOTED CRADLE PERMITS BOAT TO FLOAT FREELY AS IT'S LAUNCHED WITHOUT TURNING SIDWAYS

FLOATATION BLOCKS FORCE CRADLE UPWARD UNDER HULL AS BOAT RISES

FIXED CRADLE

IN NORMAL ROAD USE, AUXILIARY CRADLE RETRACTS BELOW HULL AND BOAT RESTS IN FIXED CRADLE

Boat launcher

You can back your boat trailer right into the water with this self-floating launcher. As the boat rises in the water, a pivoted cradle with buoyant blocks underneath is forced snugly up against the hull. This allows the boat to float freely, but keeps it from being swept sideways by wind or waves. To remove the boat from the water, just drive it onto the floating cradle. Inventor is Wallace Park, Louisville, Ky.

flies itself

A CRASHPROOF AIRPLANE? That's the astounding claim made for the unusual design at the left. Instead of a single fixed wing, it has two wings mounted on a pivoted boom, one behind the other. The rear wing is movable and is linked to a control stick in the cockpit. Pulling back on the stick tilts the boom upward, sharpening the forward wing's angle of attack for taking off and climbing. Pushing it forward tilts the boom downward for descending and landing. Once the desired angle of attack is set, the wing system attains its own state of equilibrium and the fuselage merely hangs below it like a pendulum. From then on, control is mainly by throttle: Increasing power causes the plane to climb; decreasing power causes it to descend.

Turns are made by tilting the boom sideways in the desired direction. Because the wing system is self-stabilizing, it is virtually impossible for the craft to stall out or go into a spin, says inventor Rudy Paspas of Melbourne, Australia. Other advantages: smoother rides for passengers because the fuselage remains level at all times and faster training of pilots because of the simple, goofproof control system that's easy to learn.

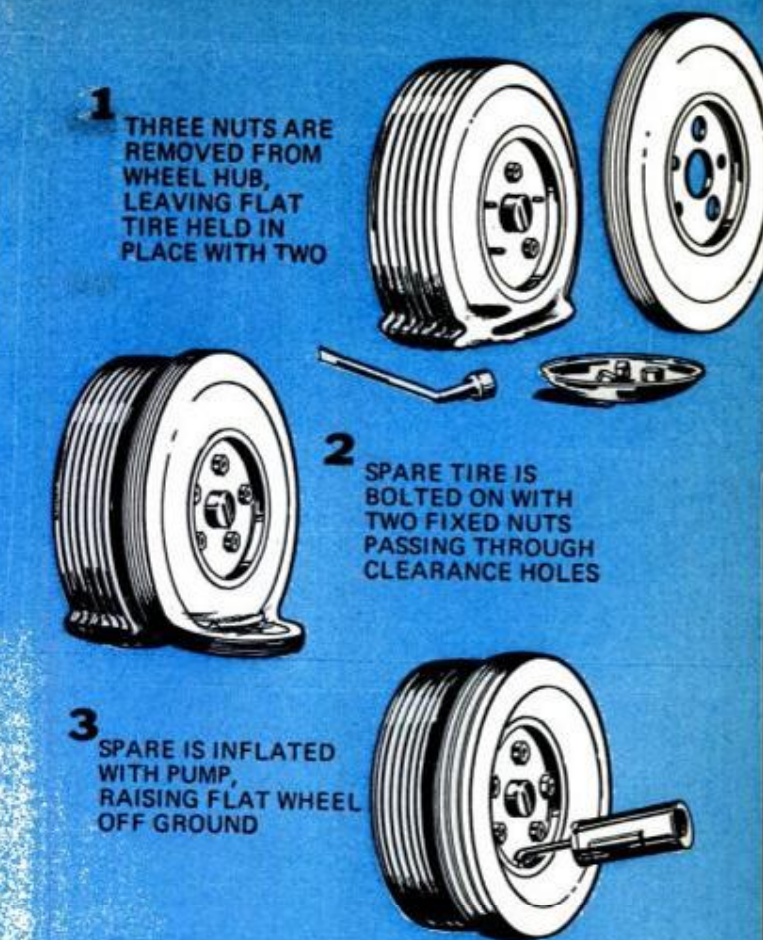

Spare tire spares you

Like to have a spare tire you could put on without jacking up the car and removing the damaged wheel? Well, here it is. It's a thin tire that bolts onto the existing wheel in a clever way. You remove three lug nuts, leaving two in place. These pass through over-size holes in the new hub, allowing you to attach the spare without taking off the flat; a pressurized hand pump inflates it. William Strumbos of Northport, N.Y., is the inventor.

Dims light glare

It's only a small strip of blue-tinted plastic, but it can do wonders to reduce annoying headlight glare from oncoming cars at night. As proof, upper photo at near right shows headlights as they normally appear; lower one shows same lights viewed through the antiglare shield. The shield, devised by Theron P. Weaver of Fort Wayne, Ind., is attached to an adjustable arm that clips on the visor. It can be positioned to dim approaching headlights without obstructing road view.





Troubleshooting by

You have to discover the cause of those strange shimmies and shakes that are transmitted back to you through your car before you can even begin to work on the repair job

By MORT SCHULTZ

BAD VIBRATIONS, whether slightly-felt quivering or car-shaking shimmying, mystify many owners. Some have written to *PM*: "My car vibrates *when idling*." "My problem is vibration that *begins* at about 67 mph." "The front end of my car vibrates as I drive along at *slow and moderate speeds*." Some owners have been to garages several times with no luck and have had no recourse but to find the cause themselves.

When doing the diagnostic job yourself it's important to analyze the condition correctly. Most times you feel vibration in the steering wheel, but you may also feel it in the seat of your pants. Determine which and then ask yourself under what circumstances you detect the sensation.

Don't mistake rough idle for a vibration, for example. Still other problems can cause a missing at high speed, slow speed or any speed. Again, this is not truly vibration. Missing and rough idle require engine service, such as a general tune-up, carburetor and distributor repair, or valve work.

There are three main causes of bad vibrations: front-wheel alignment, tire and wheel balance and shock absorbers, but many other things also cause vibration.

First check those areas that don't require a good deal of time or the use of professional equipment: Make sure that wheel lugs are properly tightened and that tire pressure is to manufacturer's specifications. Also examine tires for bulges. They can cause a vibration.



BAD SHOCKS can cause vibrations. Check for fluid leaks and that mounts are tight at top and bottom

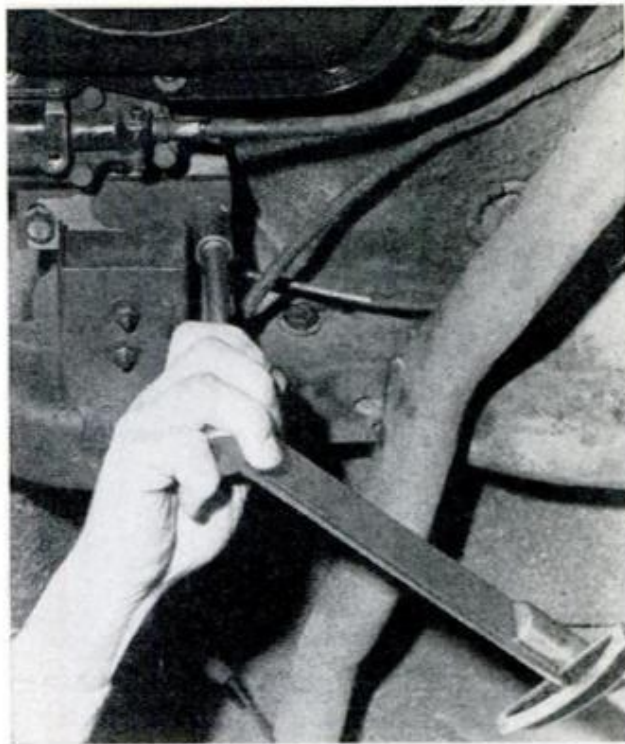

LOOSE MOTOR MOUNTS should be torqued to manufacturer's specifications. If broken, replace them

the seat of your pants

Next, check shock-absorber mounts, and check for leaking fluid indicating shock absorbers that have failed. If the car is equipped with power steering, examine the power-steering pump. Look for a worn or loose pump drive belt, a pump that has loosened up on its bracket, a loose pump pulley and a loose crankshaft pulley. There should be no play in pulleys.

If the car has airconditioning, make sure the compressor hasn't loosened up. Keep in mind that any heavy part component that has come loose in the engine compartment can create vibration.

Obviously, vibration can also occur if motor mounts are loose or defective. One way of discovering them is to start the engine and allow it to idle, pull up on the emergency brake, put the car in gear and watch the engine. If the car has a manual transmission, the engine will stall, but if mounts are loose the engine will lift violently.

A more careful way of checking motor mounts, especially if the car is equipped with automatic transmission,

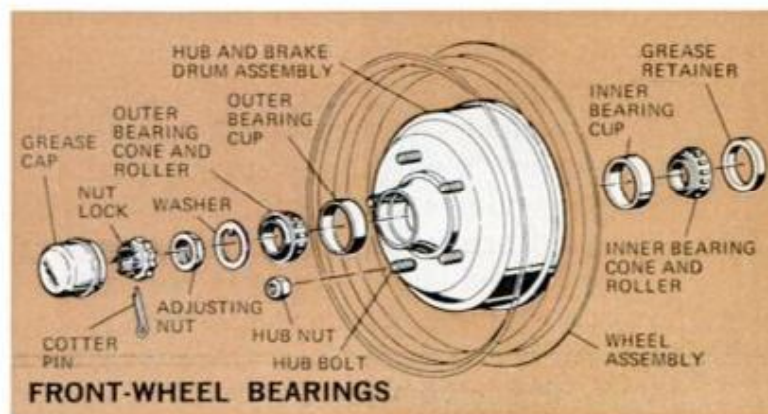
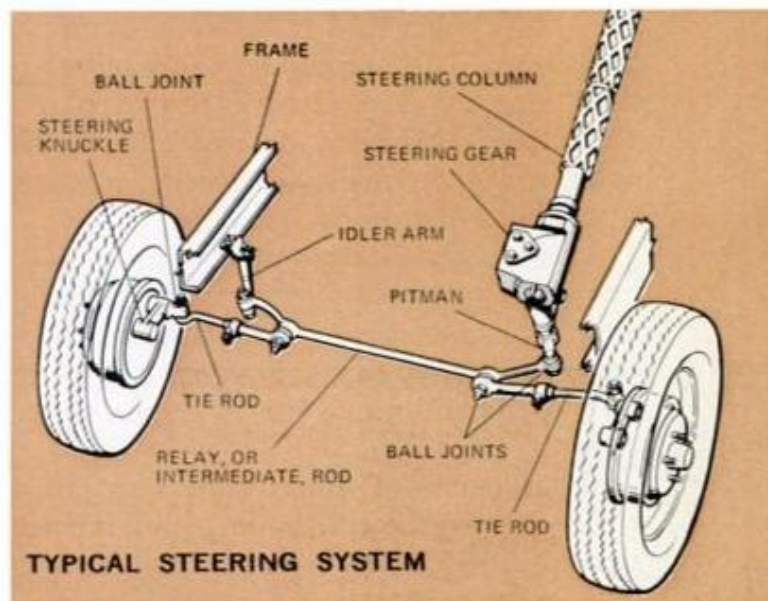



LOOSE TIE RODS are a major cause of front-end shimmy. Also check steering idler and pitman arms



FRONT-WHEEL BEARINGS that are too loose can be felt as shimmy in steering wheel. Torque to spec

is to place a hydraulic or hand jack beneath the oilpan or an accessible part of the block. Put a 2x4 between jack and engine. Carefully put pressure on the engine. If mounts are loose or defective, the engine will lift and separation will be seen between the mount and engine. Be judicious in this jacking test. Don't put excessive pressure on the oilpan. If the engine won't lift with relatively light pressure placed against it, mounts are probably okay.

Loose body mounts of a nonunitized or semi-unitized body, and broken welds of a unitized or semi-unitized body can also create vibration. Look for body bolts and make sure they are tight (photo, page 120).

If the car is of unitized or semi-unitized construction, it is very difficult to determine if a weld has broken loose. You may want to get a professional judgment, but hold off until all other conditions that can cause vibration are investigated.

One main cause of vibration is a loose or defective part in the steering linkage—particularly a tie rod, idler arm or pitman arm. Jack up the car at each front wheel and try to move the components by hand. There should be no play.

The driveshaft is another part demanding close examination. Vibration

caused by shaft trouble usually occurs only through a particular speed range. There is a test you can conduct.

If you have a tachometer that can be installed in the car, use it. If not, use the speedometer, which is not as accurate. Take the car out and note the rpm or speed at which vibration is most pronounced. Now, shift to a different gear range and run the car at that same speed or rpm. If vibration occurs at the same speed or rpm regardless of the transmission gear range, the propeller shaft is *not* causing your vibration problem. If vibration decreases or is eliminated in that different transmission gear range, the shaft should be examined closely.

By using two different gear ranges, you permit the prop shaft to operate at different speeds.

Professional tools are frequently needed to cure a propeller shaft problem. For example, an angularity gauge is required to check shaft angularity. However, take the time to wipe down the shaft with gasoline or kerosene. You may find something that's causing the shaft to whip. Grasp the shaft and try to move it back and forth. There should be no play. If there is, universal joints may be defective.

Most other conditions that create vi-



CHECK BALL JOINTS after jacking your car to remove load from the ball joint you're working on

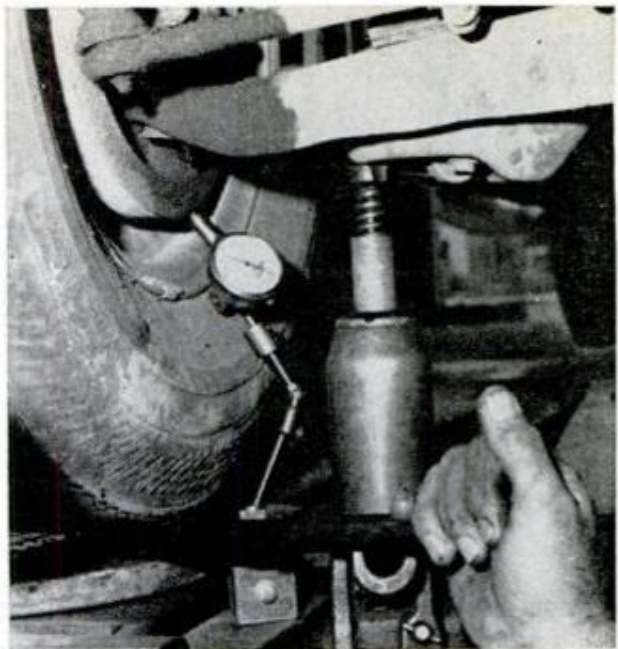

PROFESSIONAL GAUGE must be used if it's necessary to check ball-joint looseness against maker's specs

bration in a car require the use of professional equipment to detect and/or repair. But before you consult a professional, you may want to take the time to rule out the possibility of worn or loose front-wheel bearings.

Make sure first that bearings are properly adjusted. This requires the use of a torque wrench and the specification for your car. Specifications may be found in the manufacturer's service manual or a general automotive reference book.

Torque bearings to correct specification as you spin the wheel by hand. Now if vibration is still a problem, the bearings should be removed and examined for damage.

Causes of vibration—worn ball joints, out-of-balance wheels and tires or bent wheels, incorrect prop-shaft angularity or improper front-wheel alignment—may lead you to your service station or dealer. But do some work on your own first.

Ball joints should be checked particularly for vertical movement. It is possible for you to get an idea yourself if ball joints are badly worn. Take the load off the load-carrying ball joint. If the car's springs or torsion bars are attached to the lower control arms, it means that the lower ball joints carry

the load. Place a jack as close as possible to the coil spring and raise the wheel until it clears the ground. This relieves the stress on the lower ball joint.

If springs are attached to the upper control arms, the upper ball joints are the load-carrying members. To take the load off them, lift the car by placing the jack beneath the frame cross member. Slip a pry bar beneath the tire and lift up. If there is more than barely perceptible movement, the ball joint is probably worn.

Each car manufacturer has set a maximum amount of vertical movement that the ball joints should have. Specifications range from zero (no play) to .200 inch. If you suspect that the ball joints are causing vibration you should have them checked with an accurate dial indicator.

Although vertical movement of the part, which is also called its axial play, is most important, you should also have the part's horizontal (radial) movement checked. Generally, it should be no more than .250 inch, but manufacturer's specifications should be consulted. Vertical movement is of utmost importance, simply because a ball joint will usually wear out faster in that direction than horizontally. ★★★

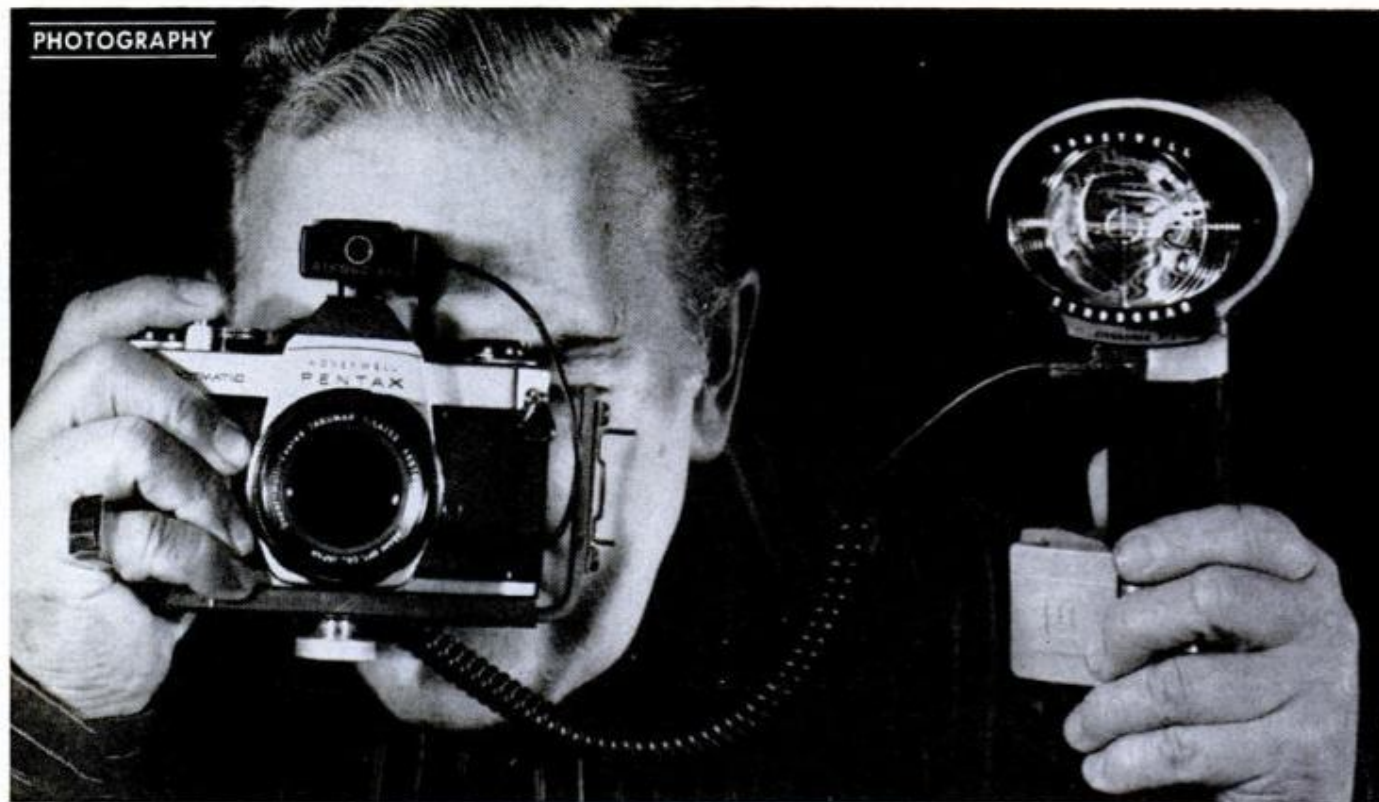

YOU COULDN'T DO THIS with old-style automatic strobes requiring gun to be attached to the camera. In new Honeywell system, small accessory light sensor clips on top of camera, allowing gun to be removed. You can shoot with the gun held in any position and the sensor will correctly read light reflected from the subject and shut off the strobe automatically when the proper exposure is reached



SENSOR ON CAMERA PICKS UP LIGHT FROM SUBJECT AND SHUTS OFF FLASH WHEN EXPOSURE IS COMPLETE

SENSOR CONNECTED TO CAMERA'S X-SYNC OUTLET



GUN'S SYNC CORD CONNECTED TO SENSOR INSTEAD OF DIRECTLY TO CAMERA OUTLET



LIGHT FROM FLASH STRIKES SUBJECT, IS REFLECTED BACK TOWARD CAMERA

DIAL ON TOP of Strobe-Eye sensor lets you set system for ASA speed of film you're using. From then on, you have a choice of four f/stops, depending on the shooting range and desired depth of field



Now: A no-miss flash you can shoot from anywhere

This ingenious new automatic strobe lets you use off-camera, bounce and multiple flash with a properly exposed result every time

By SHELDON M. GALLAGER

AUTOMATIC STROBES are great except for one problem—until now, you had to keep the flashgun on the camera. The sensing eye in the gun had to be near the lens to record reflected light from the subject and shut off the flashgun at the right instant for a proper exposure. This produced the flat, pasty, washed-out effects you typically get with on-camera flash.

Now Honeywell has come up with a clever system that lets you put the flashgun anywhere you want. Instead of having the sensing eye built into the gun, it's a separate little accessory that clips right on the camera. It correctly reads the light from the subject no matter where the gun is located. You can hold the flash off camera for side lighting, bounce it off a wall or ceiling for soft, shadowless effects, even hook several guns together for multiple-flash shots.

Initially, Honeywell is introducing the system on its bigger model guns, the Auto/Strobonar 772 at \$159.95 and 882 at \$189.95. The sensor itself sells for \$30. Later, the system will be used on smaller, lower-priced units all the way down to ministrobes the size of a cigaret pack. ★★★

MAY 1972



Photos by Robert D. Borst

ACCESSORY FLASH SENSOR is shown above with new Honeywell Auto/Strobonar 772 gun. Flash connects to sensor by means of long coil cord, and sensor, in turn, connects to camera's sync outlet. It can be used with any camera providing X-type synchronization. Photo below shows 117-volt charger that can be used either to recharge batteries in the gun or to operate the gun directly on house current



NEW HONEYWELL PENTAX will incorporate its own built-in flash sensor (small round window below), eliminating need for separate clip-on accessory. Spotmatic IIA will be \$30 more than standard model



EXCITING NEW PRODUCTS

BY CATHERINE BILSKI

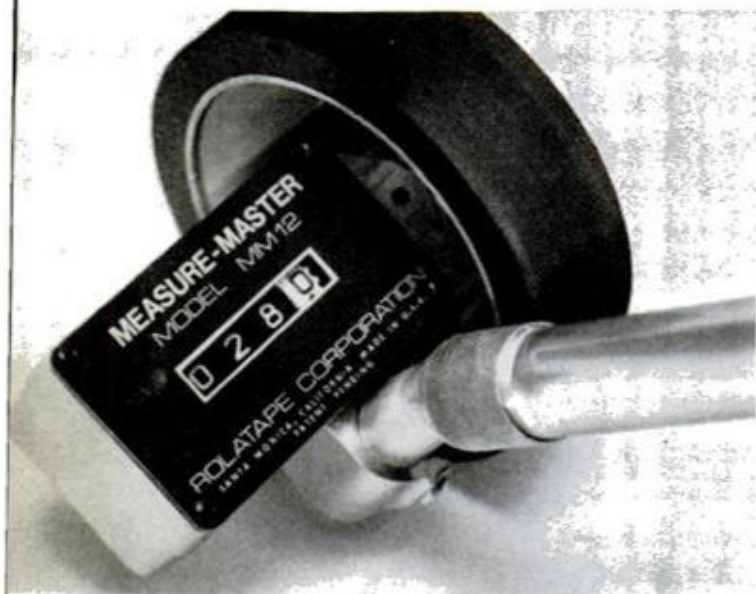

ACCURATE MEASUREMENTS of rooms, carpeting and the like can be made while you walk with the Measure-Master 12. Its handle extends to 38 in. and the counter records up to 1000 ft. in feet and inches. It can be reset to zero reading by pushing a button, and set to subtract as well as add. \$19.95 postpaid. Rolatape Corp., 1301 Olympic Blvd., Santa Monica, Calif. 90404.

LATEST VERSION of Sterno's fold-up campstove is this modern model in nonrusting aluminum. It's lightweight, portable, collapses flat and stores easily. Operates with Sterno Canned Heat, a safe cooking fuel. Handy for outdoor cooking as well as at home during power failures. Stove retails for \$2.49; 7-oz. can of heat, 60 cents. Sterno, Inc., Box 540, Jersey City, N.J. 07303.



RETREAD WORN BICYCLE TIRES easily by coating them with Black Strap adhesive. This black, pastelike material spreads on quickly and neatly, helps avoid flats, lessens the chance of wet-weather skidding and allows tight turns with very little slipping. A pint sells for \$3.95; a quart, \$5.95 postpaid. Made by Carpet Products Co., Box S, Central Square, N.Y. 13036.

HELP PREVENT THEFT of bicycles, motorcycles, spare tires, skis and other home and shop items with the Cable Lock Assembly. Made of 3/16-in.-dia. cable with 5/16-in. tough green plastic coating, it has stainless-steel terminals and hardened steel laminated lock with brass barrel and double-locking cam. \$7.95 postpaid from Cee-Jay Manufacturing Co., Box 722, Downey, Calif. 90241.





RAKING LEAVES is one of the most tedious of jobs; you can save time and work at this chore with a Wide Sweep Lawn Rake. Its 36-in. aluminum head with 36 spring-steel teeth is twice as wide as standard-size rakes, lets you clean up your lawn twice as fast. With 63-in.-long tubular steel handle, it sells for \$7.98 postpaid from Habny Products, 261 Huntington Ave., Buffalo, N.Y. 14214.



MAY 1972

MEASURE UP with this ballpoint pen that comes with a tape measure inside. The retractable tape is pulled out of the barrel of the pen. The combination tool has a carbide ball tip and is great for writing, marking and measuring all at once. It's available for \$2.95 postpaid from the David Schwartz Co., Dept. PM-11, Box 319, 340 West 42nd St., New York, N.Y. 10036.

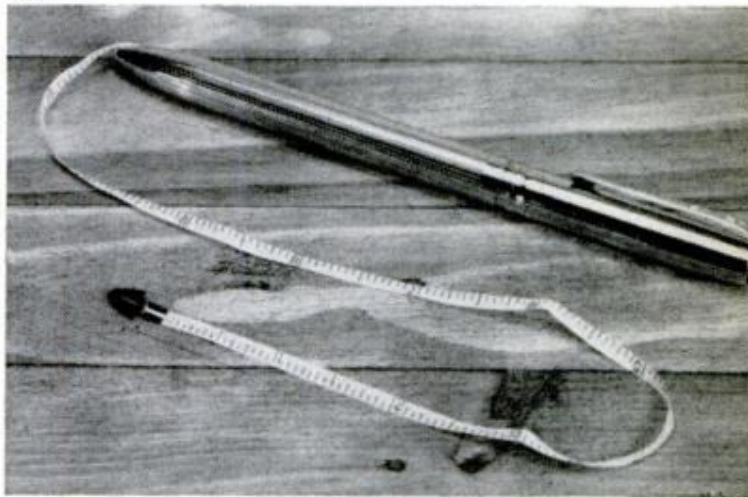

WATERING YOUR LAWN is now easier than ever because the Model K25 Rain King Automatic Traveling Sprinkler does the job for you. Hooked up to a garden hose, it travels a preset course—up hills, around corners, along terraces, sprinkles areas up to 150 feet long and 50 feet wide. Sells for \$21.95 from Sunbeam Outdoor Co., 2001 South York Rd., Oak Brook, Ill. 60521.

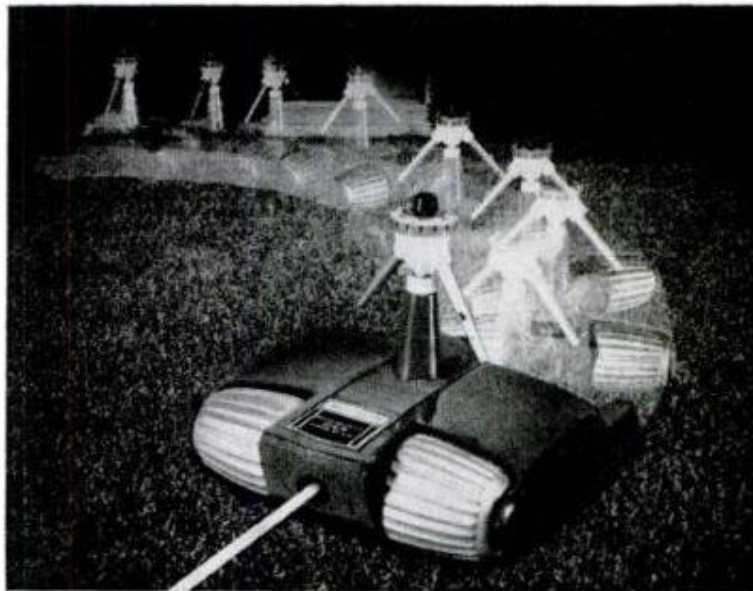

RUGGED SWEEPING JOBS can be simple tasks when you use the Wet-N-Dry Squeegee Sweep broom. A tough-wearing squeegee set in the center of the block protrudes slightly above the bristles so that wet heavy debris will be moved along with water or other liquids with one easy thrust. Patio-sweep size is \$5.98. Vistron-Oxco Corp., 1712 Midland Building, Cleveland, Ohio 44115.

127

Things to make for

Woodpecker door knocker



PRESS BUTTON and bird's head goes back and forth like a riveting hammer; box acts as sounding board

VISITORS will push the button again and again just to see this crazy woodpecker beat a most realistic rat-a-tat-tat to announce your arrival.

To make it you need four pieces of soft pine ($\frac{3}{4} \times 3 \times 6\frac{1}{4}$ in.) for the woodpecker's body. Cut $1\frac{1}{8} \times 3$ -in. openings in two of them for the operating mechanism and then cut the $\frac{3}{8}$ -in.-deep grooves in the ends for the clock spring actuating arm. When you glue the blocks together, you'll have a $\frac{1}{2} \times \frac{3}{4}$ -in. hole in the end. Glue the third block to the top of the others and attach the remaining one temporarily to the bottom with masking tape.

Make full-size paper patterns of the bird's body on $\frac{1}{2}$ -in. squares and transfer them to the built-up block with carbon paper. Bandsaw the profile outlines, tape the waste back on and bandsaw the back outlines. Complete the shaping of the body with a knife and sandpaper.

Glue the two slotted blocks together for the woodpecker's head, making certain that the slots are free of glue. Shape the head to the required size with a knife and sandpaper. The recess at the bottom of the head will permit the head to move freely on the body, yet conceal the joint between the two sections. Drill a $\frac{1}{4}$ -in. hole in the lower part of the

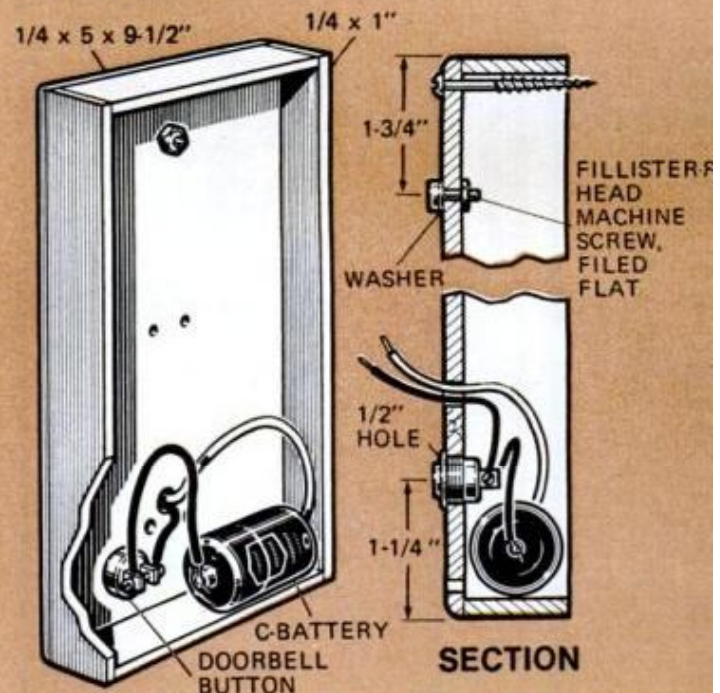
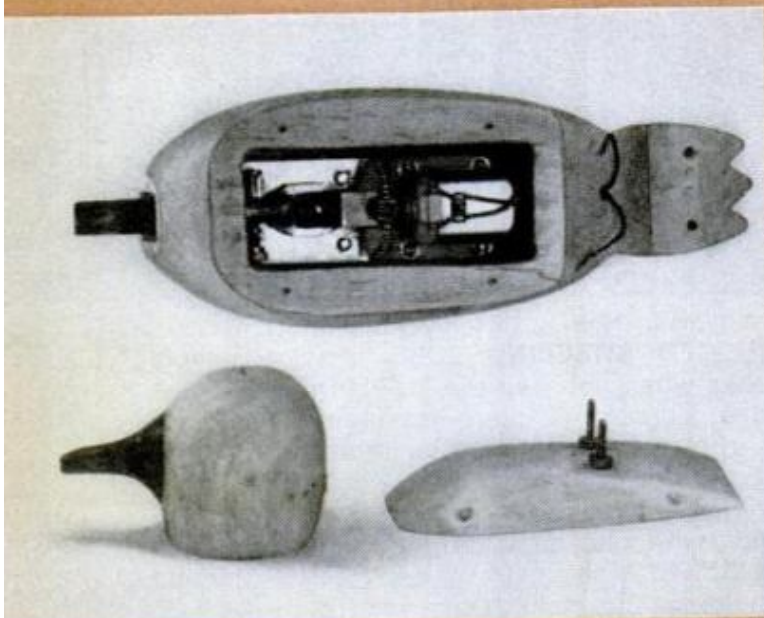

your home and yard

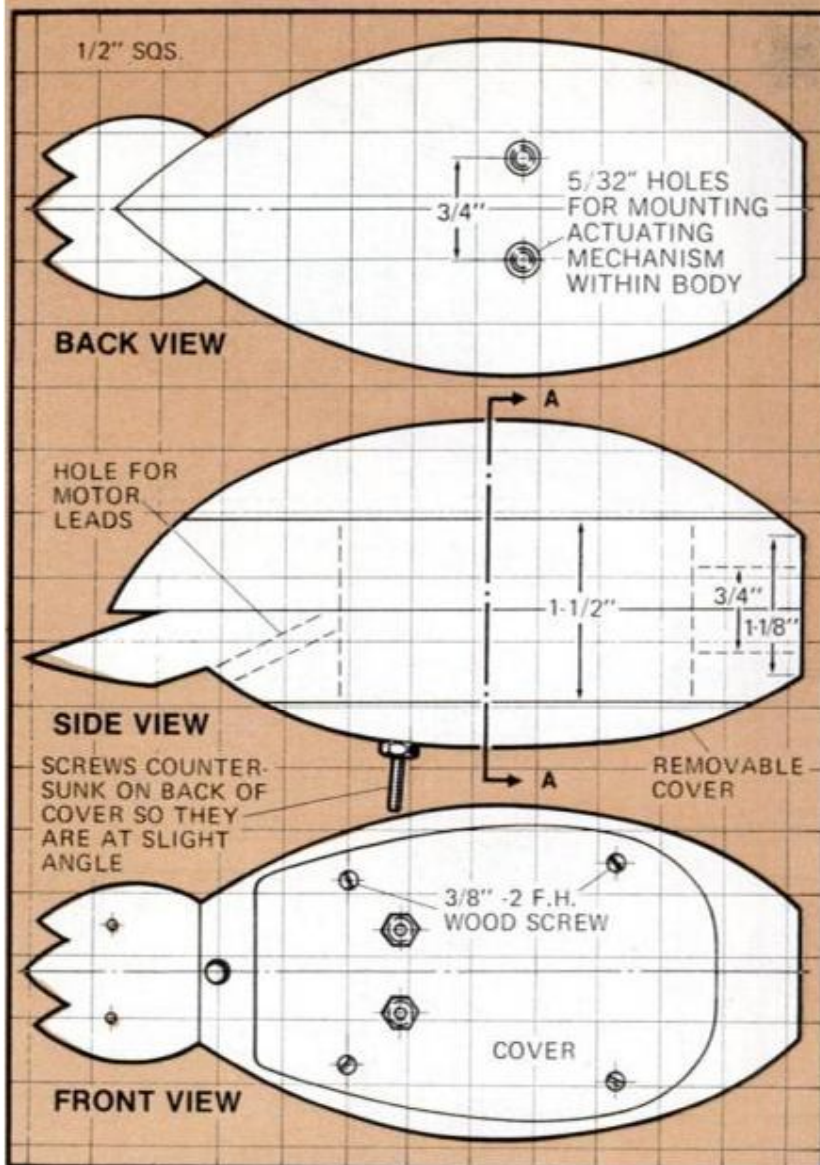

1/1-8 x 1-1/2 x 3"
 CAVITY

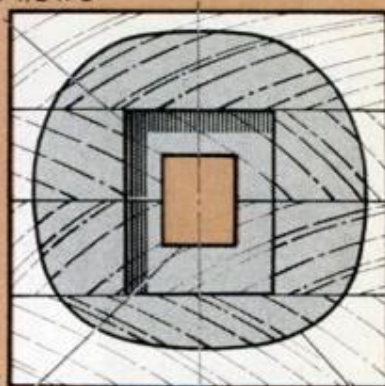

1/2 x 3/4"
 OPENING FOR ACTUATING ARM

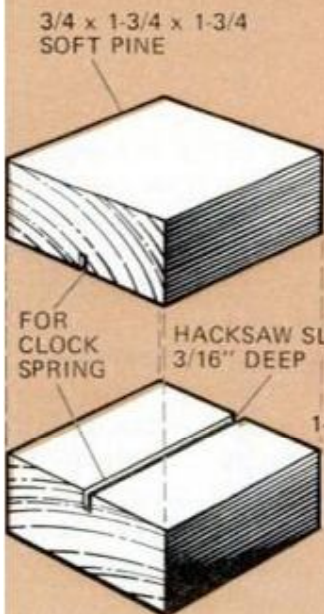
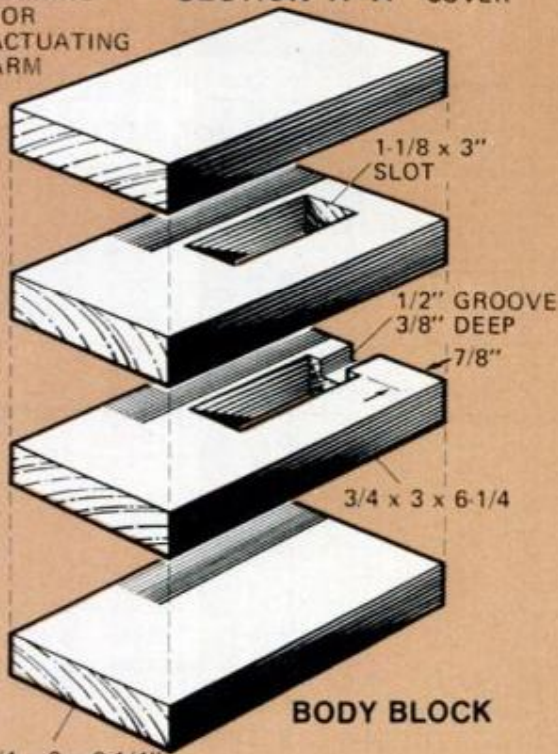

HEAD BLOCK

SLOT FOR CLOCK SPRING

3/4 x 3 x 6-1/4" SOFT PINE

BEAK FORMED OF PLASTIC WOOD

BOTTOM OF HEAD RECESSED 3/16" DEEP

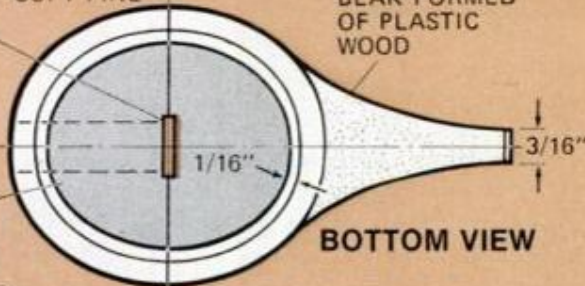

1/4 x 1/2" METAL ROD, TAPPED

BOTTOM VIEW

1-11/16"

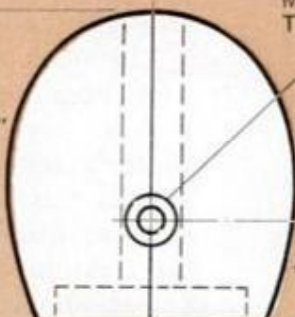

END VIEW

1/8 x 1" WOOD DOWEL, GLUED

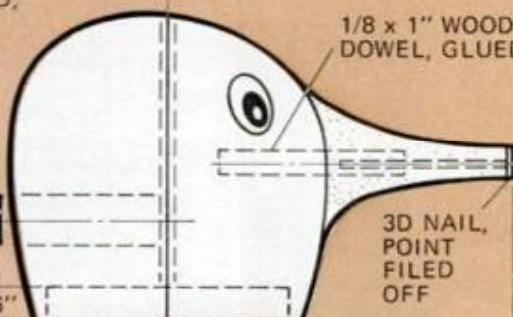

SIDE VIEW

ACTUATING MECHANISM

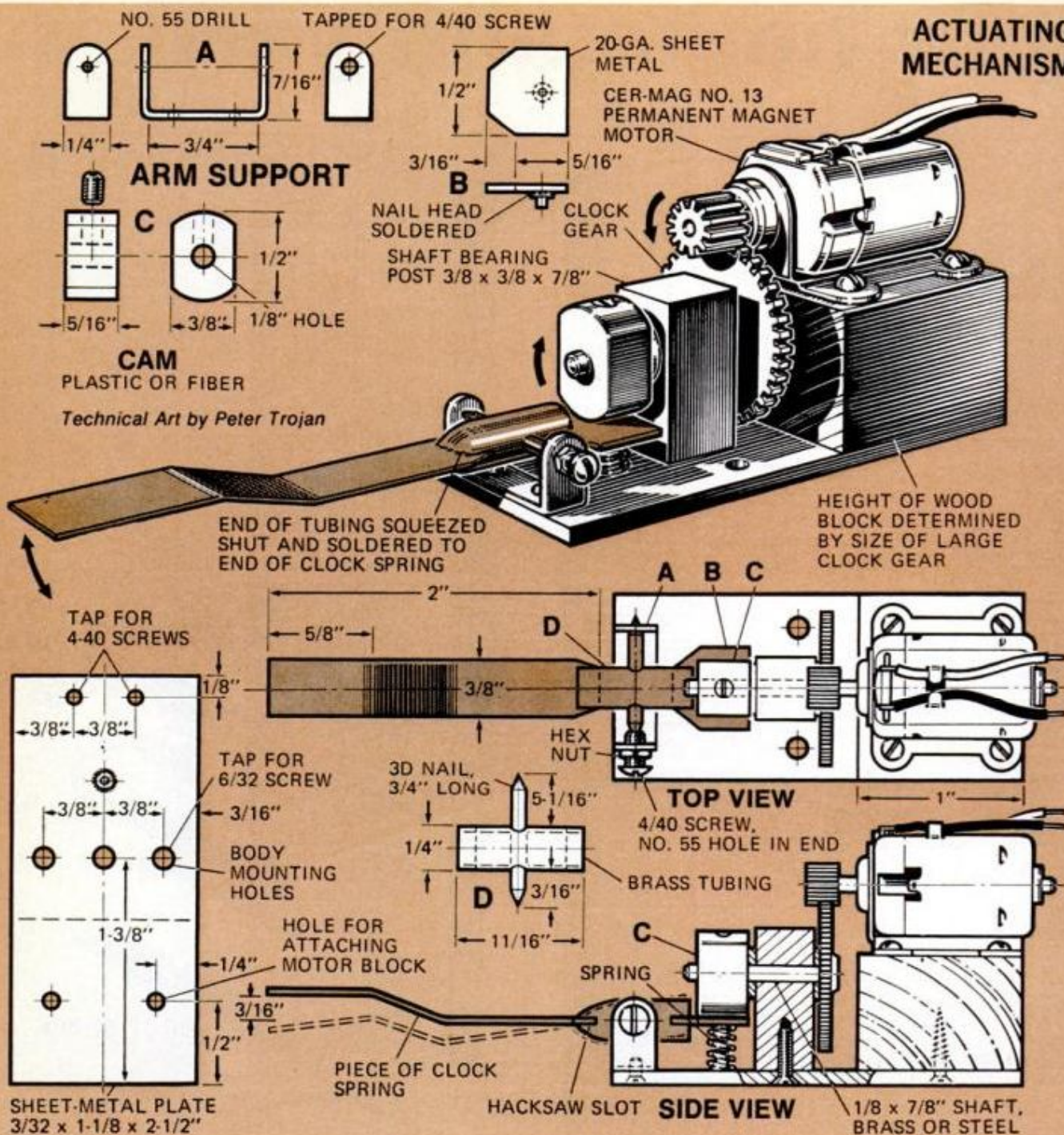

THE ACTUATING MECHANISM is operated by a tiny motor that gets its power from a single C-cell flashlight battery

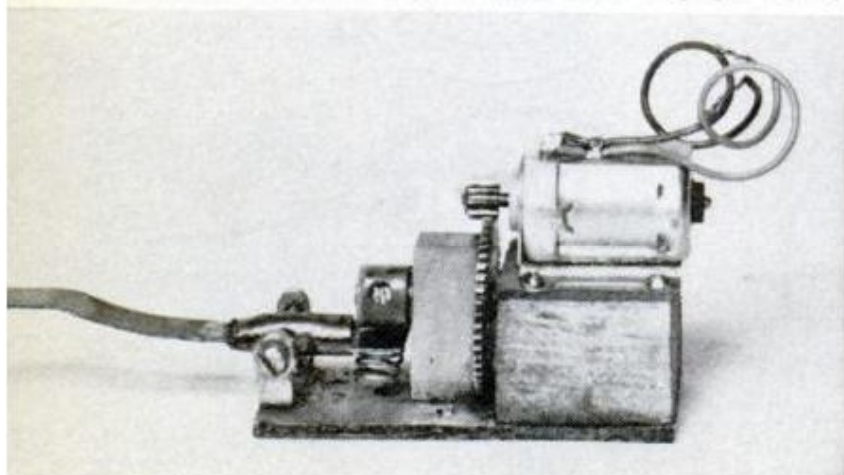

head, place epoxy glue in the notches of the metal insert and press the insert into the hole. The retaining screw which clamps the head to the clock-spring arm, is turned into the insert and concealed.

The operating mechanism consists of a small battery-type motor and a fiber cam. The cam changes the motor's rotary motion to a reciprocating one. I used a Cer-Mag permanent-magnet motor, d.c.-type No. 13, obtainable at most hobby shops for about \$1. The gears, which have a ratio of about one to five, were

(Please turn to page 191)



Jungle-gym tree house for a summer of fun

THIS COMBINATION jungle gym and tree house can be built for about \$65. The whole thing is designed to take advantage of standard lumber lengths and widths, which simplify construction to the point of merely cutting the various members to length.

The main platform is 6 ft. off the ground and supported by four 4 x 4 corner posts that are buried in 2 ft. of concrete. Each of the two levels measures 4 x 4 ft. square, which means that both plat-

forms can be cut from one 4 x 8-ft. sheet of 1/2-in. exterior-grade plywood. A 24-in.-square hole is made in the lower platform for a fireman's pole. The gym is fitted with two vertical ladders and a third one at approximately 60° to the upper levels. It also has a horizontal ladder that can be set at any height up to 6 ft. as the youngsters grow. An 8-ft. seesaw and a 12-ft. sliding pole round out the play equipment.

The pole, which is 1 1/4-in. galvanized

TREE HOUSE CONSTRUCTION

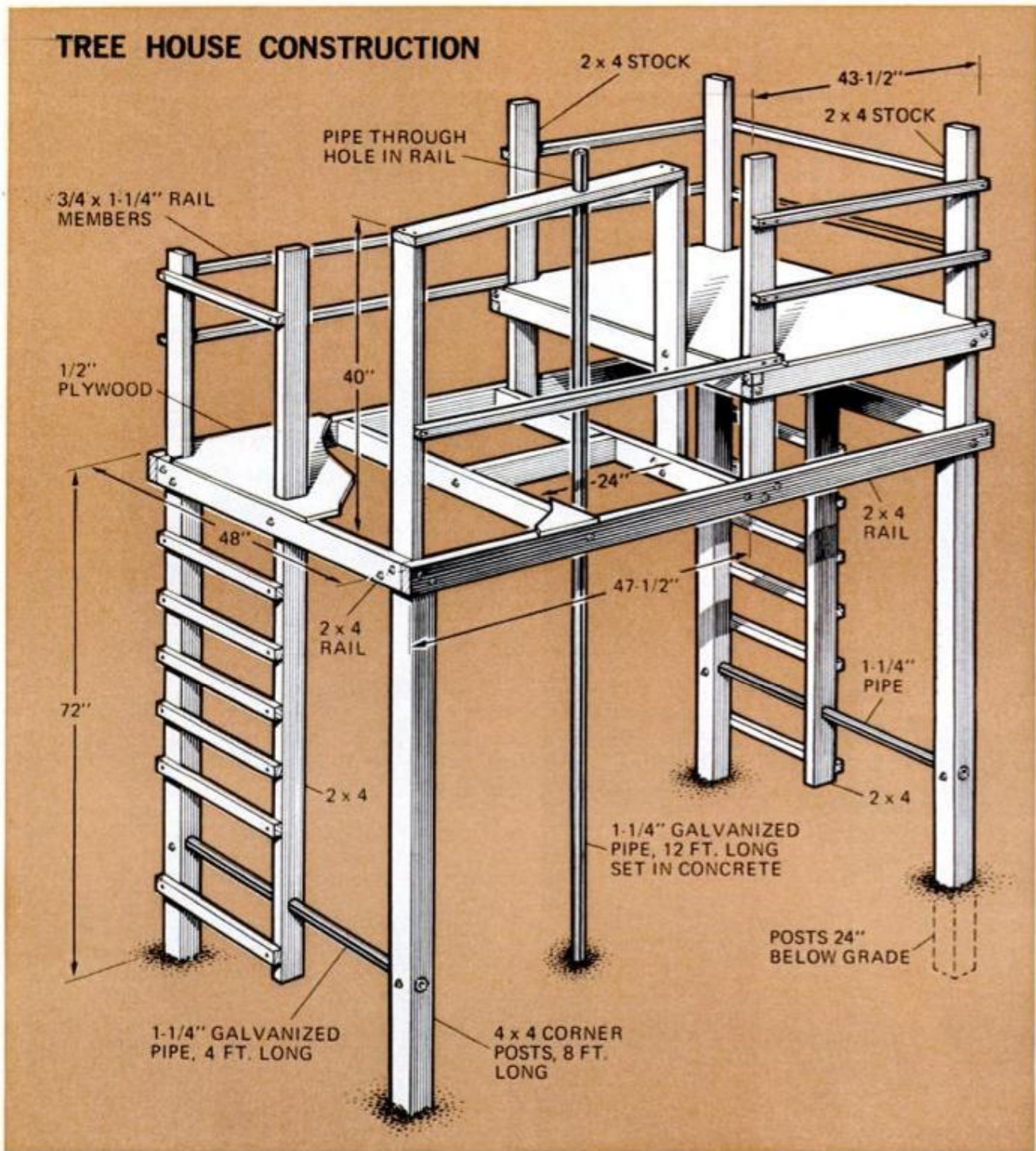

pipe, is anchored at the top in a hole in a 2x4 crossrail and is anchored at the bottom in a hole filled with concrete. The seesaw pivots on another length of the same pipe that is inserted through holes bored in the corner posts and one leg of the ladder.

You could install a second cross pipe so that the seesaw might be used at either end. The rungs of the vertical ladders were ripped from 2x3s, but they could be 1-in. dowels inserted in holes bored in the rails.

Give the whole thing two coats of good exterior house paint.

—James H. Pickerell, Washington, D.C.

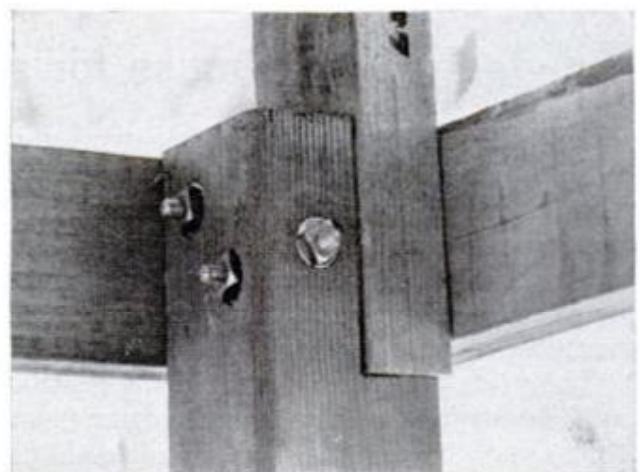

TOPS OF 4x4 POSTS are notched like this so that the 2x4 platform posts can be bolted to them flush



DATA: BARBARA GORDER

Message board keeps fat phone books handy

MOST TELEPHONE message boards forget the directories, but not this one. It has a pocket big enough to hold two big-city books (a yellow and a white) right next to the phone.

Architect Russell Zenk designed it for homeowner Peter Briggs of Minneapolis who built it into a floor-to-ceiling island wall that divides the kitchen.

The simple box frame is made of 1x6

stock fitted with a back and set into the wall to project about 2½ in. Thick insulation cork is cut to fit the length of the cabinet and fastened to the wall above it. A thinner piece of cork is glued to the front of the telephone-book pocket. While the original frame was built in, it could be made shallower and surface-mounted. In this case, no back is needed; the wall provides it.

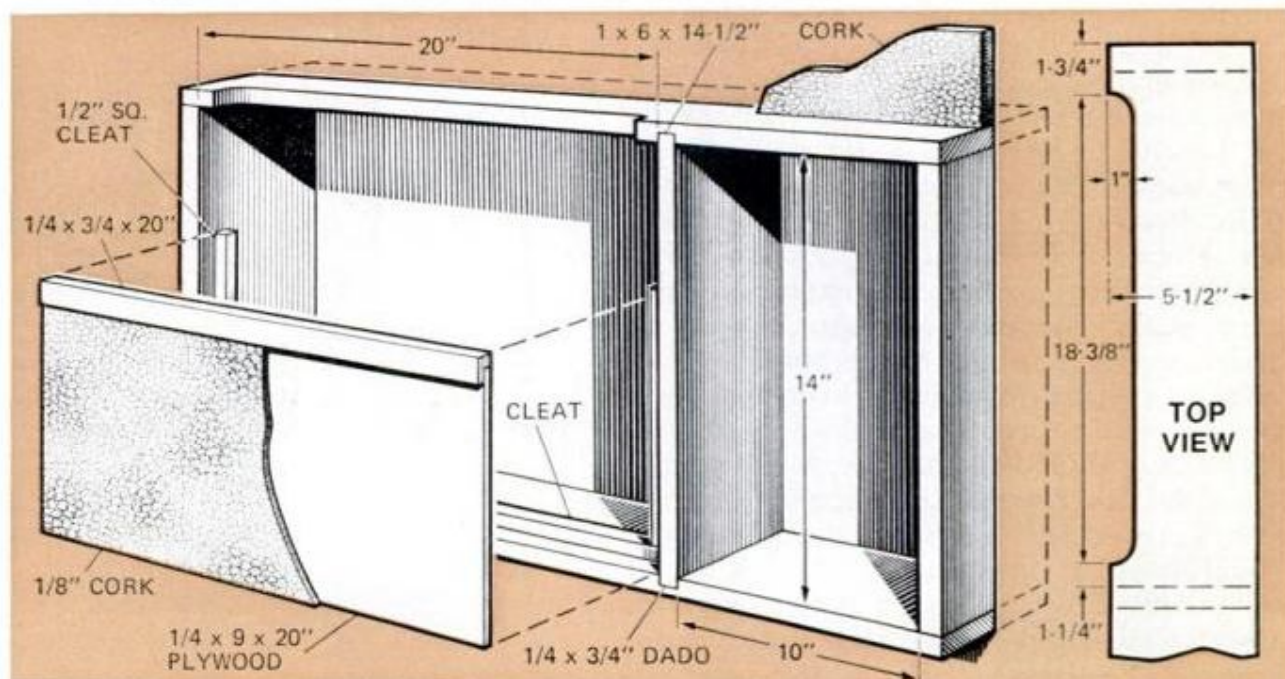



Bunk bed has built-in chest

NO NEED TO WORRY about getting this king-size bunk bed in and out of the room; it all comes apart with a twist of a screwdriver, thanks to special Selby Hardware connectors holding the 14 parts together.

The bed makes the most of space—four large drawers built in under the mattress swallow up lots of toys, extra blankets, sheets and pillow cases. Two “ladder” shelves at the foot of the bed provide still more storage space, and another shelf across the headboard will hold a lot of bedtime-story books. The bed accommodates a 36 x 75-in. foam-rubber mattress. The complete bed is built from $\frac{3}{4}$ -in. fir plywood. Half-round molding covers the exposed edges of the sides. The bed cost John Doherty of Greenlawn, N.Y., about \$75 to build.

The two-part connectors consist of a steel pin with a large head and a slotted 1-in. steel disc installed in the line with the pin. When the disc engages the pin and is turned with a screwdriver, it draws the joint tight. You'll need 28 connectors called Elite 25 with DU91 dowel. You can buy them from Albert Constantine, 2050 Eastchester Road, Bronx, N.Y.—*Laura LaBarge, Newton, N.J.*

134

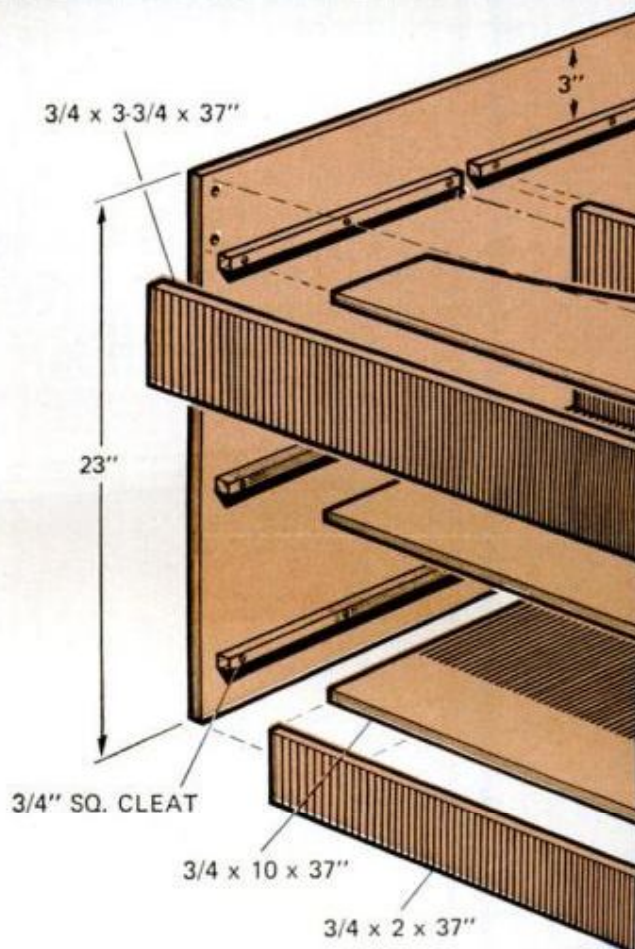

Technical Art by Peter Trojan

POPULAR MECHANICS

Материал, защищенный авторским правом



CLEATS SUPPORT PLYWOOD TOP where the mattress rests. They're glued and screwed 3 inches from top



DRAWERS ROLL SMOOTHLY on standard metal guides which are screwed to the dividers and drawer sides

BED CONSTRUCTION

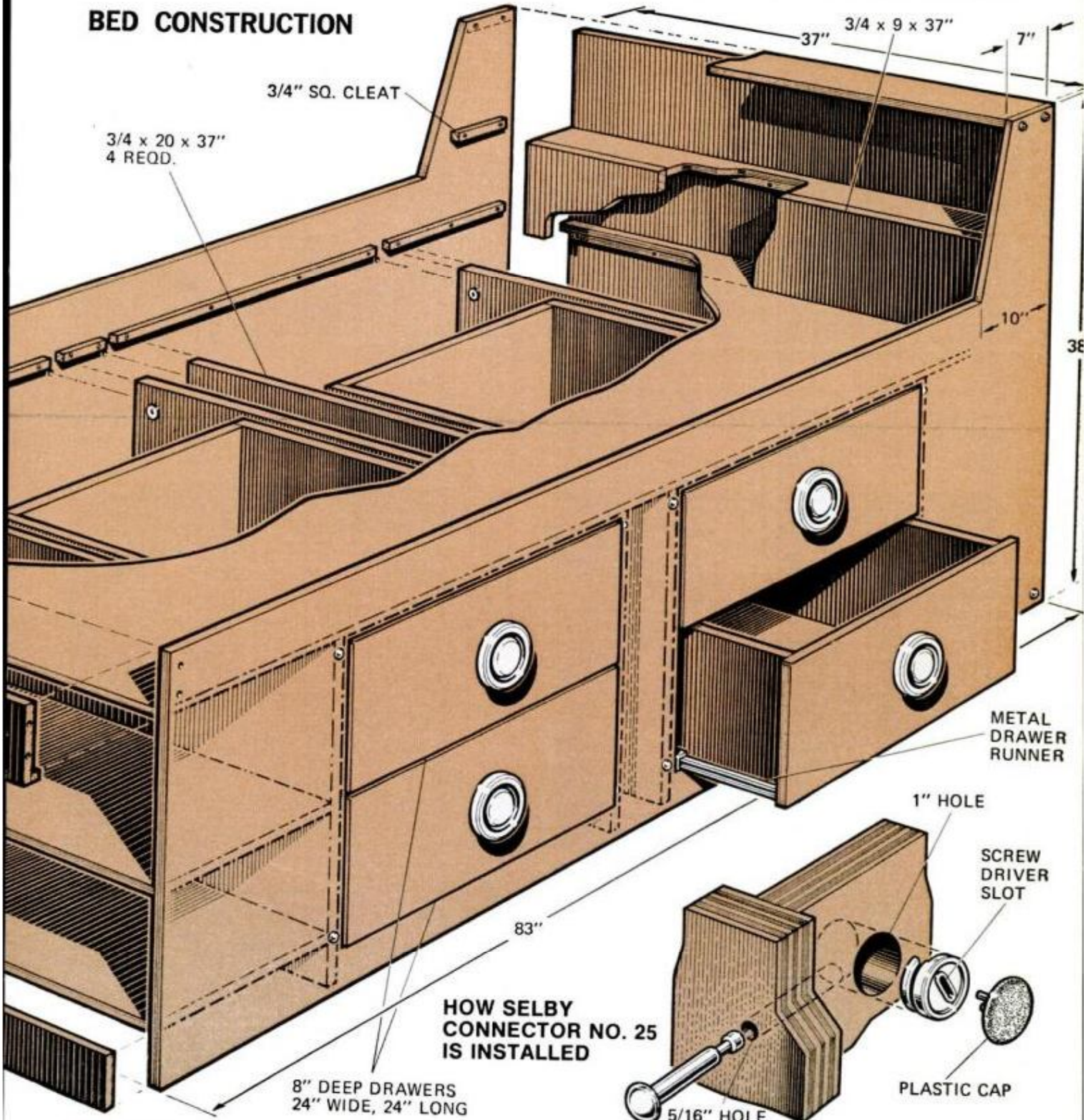

BETTER WAYS TO DO IT!



A LAWNMOWER parked in the garage can be a hazard if you have a toddler who might play with the reel. Put your mind at ease by immobilizing the reel with a bicycle lock.—*W. H. McClay, Pasadena, Calif.*



MOD BIRDBATH is fashioned from a bell-end drain tile and a discarded auto-wheel cover. Bath can be moved aside when it's time to mow. Bowl won't break if it's knocked off.—*John Krill, North Lima, Ohio*

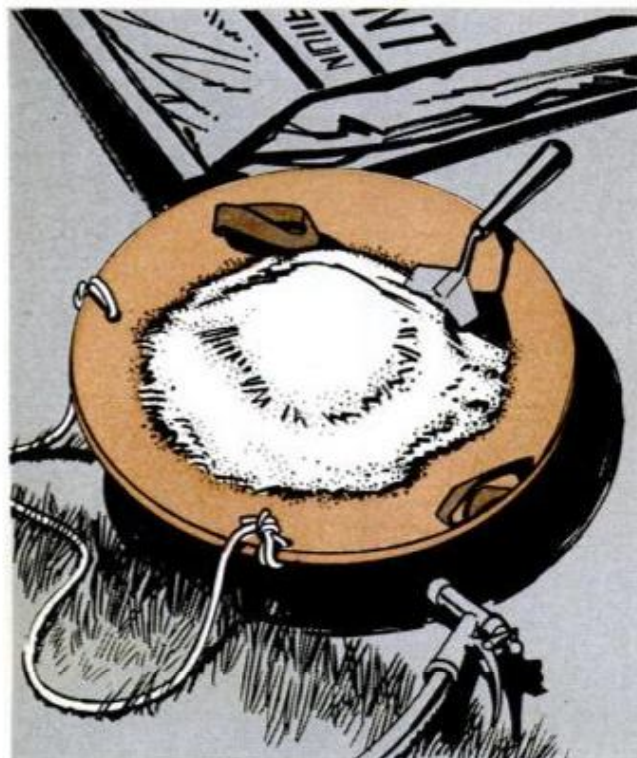

PORTABLE "MORTAR TROUGH" is actually a kid's saucer sled. Large enough for good-sized batches, it can be pulled to the job. When work is finished, hose the sled clean.—*James A. Long, Columbus, Ohio*



LEGS FROM A SNACK TABLE whose tray is shot can be put to good use. They make an ideal rubbish-bag holder for use in the yard. Same idea can be tried in the laundry.—*Marvin Duchoviner, Brockton, Mass.*



PATIO PRIVACY FENCE looks even more attractive when it's decorated with flowerpots. Just try these rustic "hooks" you can cut from short tree lengths with a branch fork.—W. H. McClay, Pasadena, Calif.

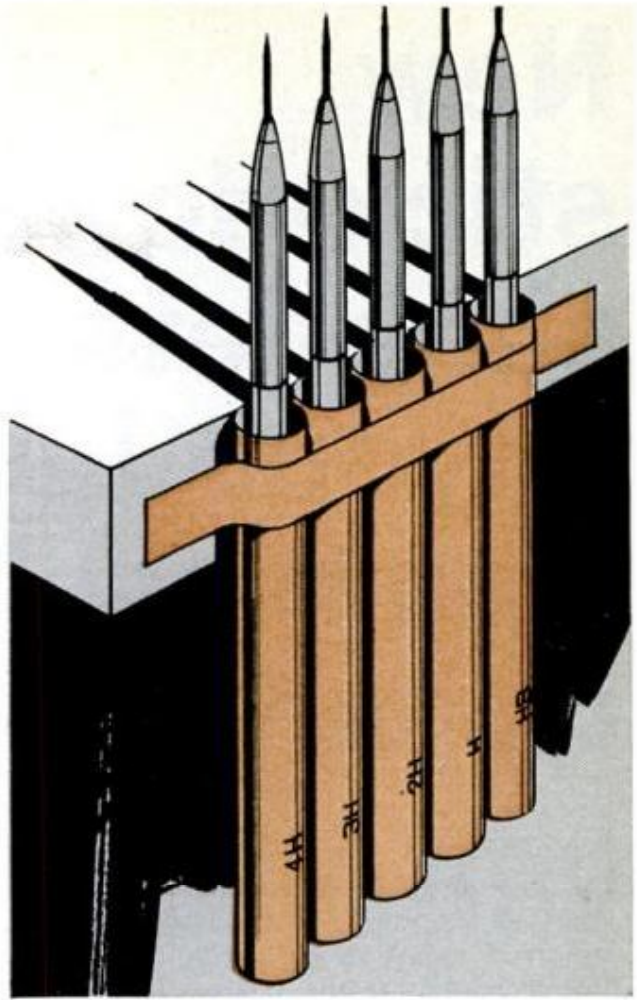

DRAFTSMEN usually keep several mechanical pencils loaded with different lead at hand. I corral them by taping empty lead containers to the edge of the drawing board as shown.—Lee Adams, Owensboro, Ky.

Illustrations by Adolph Brotman



PLASTIC CLOSERS of the kind that come on bread wrappers can serve as handy outdoor aids. At campsite or boat, they will work as clothespins on a small line.—Richard J. Cooper, British Columbia
MAY 1972



STIFF STYROFOAM BLOCKS can be used to keep the branches apart in young fruit or shade trees. Once the branches have acquired the set you desire, just remove the blocks.—John Krill, North Lima, Ohio

New stick-down shag lets anyone lay 'seamless' carpeting

LAYING seamless carpeting was always considered a job for the pros and still is when seams must be stitched with special equipment. But if you like shag carpet, Armstrong has made it easy for you to lay its new "seamless" stick-down with nothing more than scissors and tape.

Bonded to a built-in pad of foamed latex, this all-synthetic shag is merely butted at the seams and stuck to the floor with double-faced carpet tape. The thick pile laps and merges perfectly with the adjoining edge so you see no seam. Called Showboat, it's woven on a polypropylene backing impervious to moisture—ideal for basement recreation and family-room floors. It sells for \$6 to \$7 per sq. yd. For more information, write to Armstrong Cork Co., Dept PM, Lancaster, Pa. 17604. ★★★

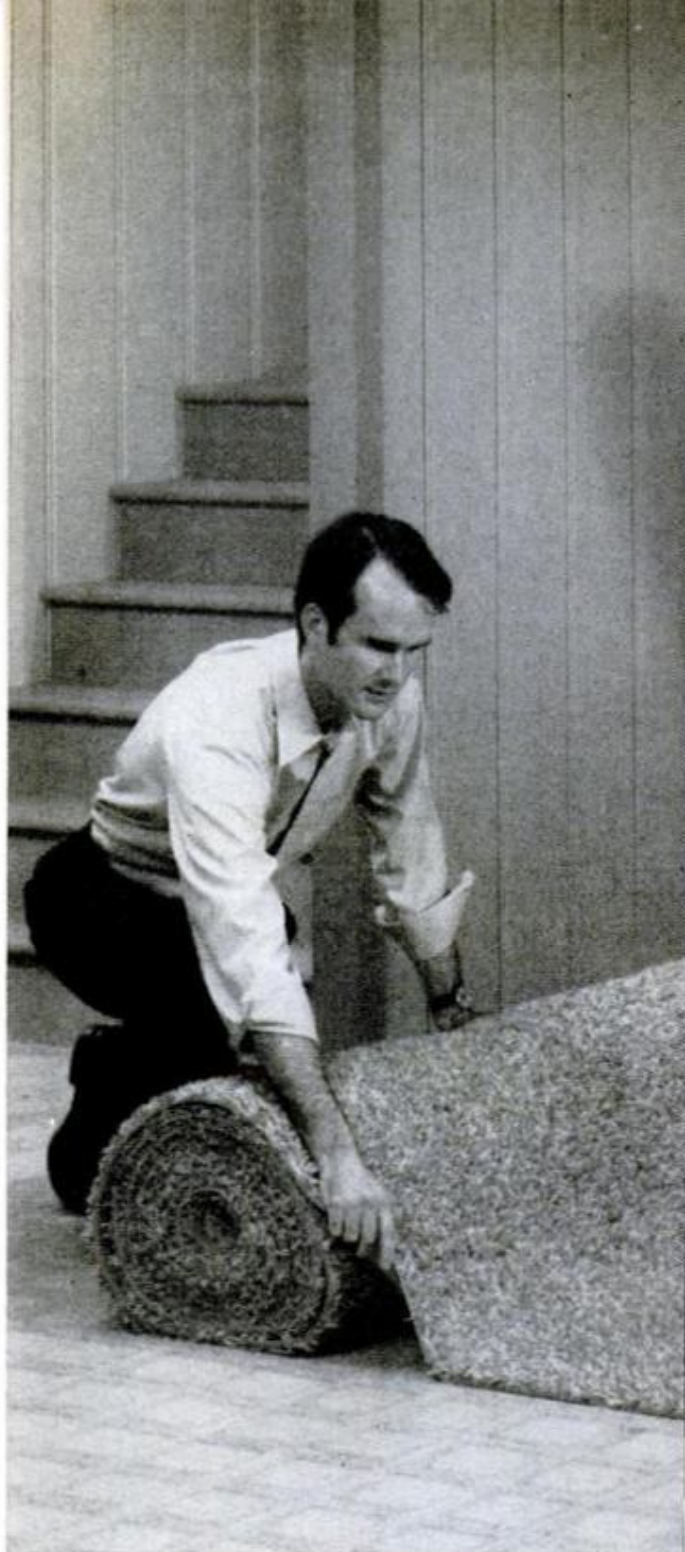

SHAG CARPET (above) comes in easy-to-handle, 6-ft.-wide rolls. Roll shag has an advantage over tile shag—there are considerably fewer seams to deal with

CARPET IS POSITIONED (left) so it laps walls a bit. Then it is trimmed while in place with ordinary household shears. It's backed with foam-rubber cushion, thus needs no separate pad

ABUTTING EDGES (right) are stuck with double-faced tape. No tape is needed under carpet or around edges to hold them flat. Shampoo won't cause seams to separate or edges to curl

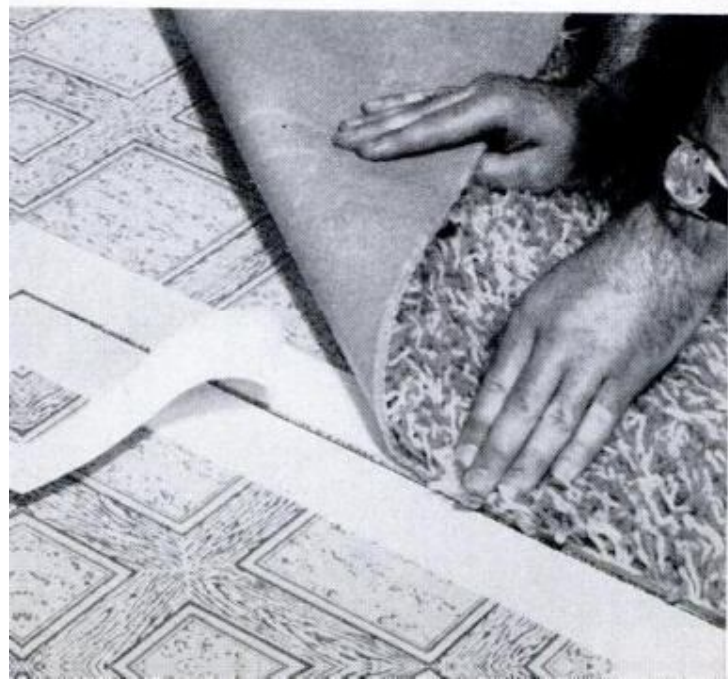

SECOND ROLL (below) is fitted in place right alongside first roll and stuck to tape that straddles the seam. Shaggy texture of carpet meshes and blends perfectly to make overall job look like a single piece



Provincial charm— and you can build it yourself for \$41

Occasional table has tambour doors
that slide open on a curved track

By C. L. WIDDICOMBE

Technical Art by Fred Wolff



rails. The feet are bandsawed from blanks of $2\frac{7}{16}$ -in.-sq. stock. These can be either laminated or solid blocks. The front and side rails are of stock thick enough to follow the contour of the tops of the legs.

In the original, I used $\frac{7}{8}$ -in. mahogany backed up by $\frac{3}{4}$ -in. maple as shown in the details. Cut the leg and rail blanks to the correct lengths and mark them for dowels. Notice that the back rail is simply a flat board cut from $\frac{3}{4}$ -in. stock. Take care that the dowel holes are positioned in such a manner that they won't show when the contours of the feet and rails are cut. Bandsaw the four legs and remove excess material from the rails on your table saw. Now assemble the base section.

Plane the rails and tops of the feet to match and finish up with a thorough sanding of all members. After attaching the four corner blocks, the completed base should look like that shown on page 143.

Now you can make the doors—they make the completed table stand out from run-of-the-mill furniture. With a little extra care along the way, you will be assured of a professional-looking piece of furniture. The slats are of $\frac{7}{16}$ -in. material; 36 slats are $\frac{7}{8}$ in. wide and two—the front ones where the knobs go—are $1\frac{1}{4}$ -in. wide.

Remove the sharp edges from all pieces and sand the front faces only. There's no

(Please turn to page 190)

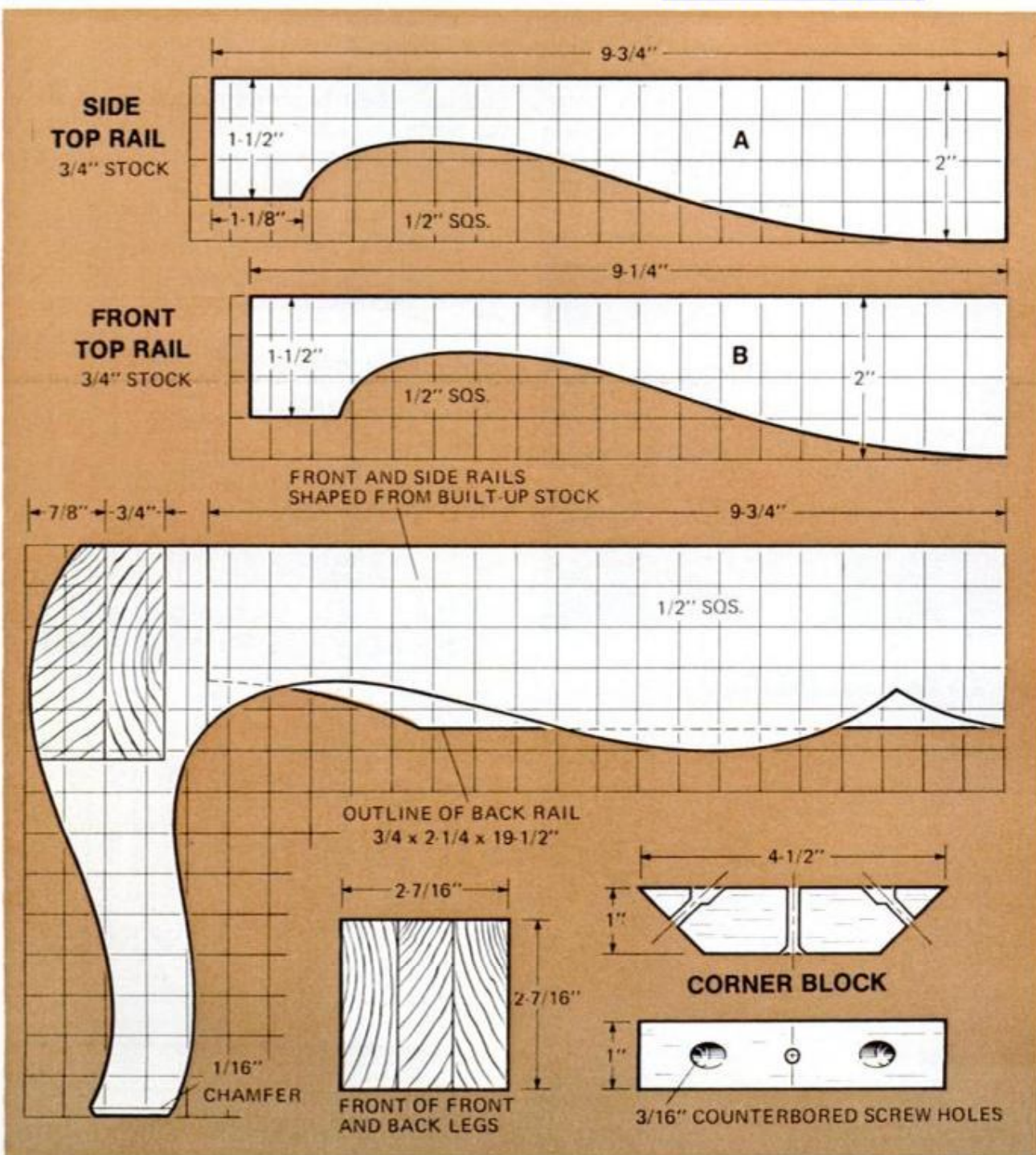

TAMBOUR TABLE

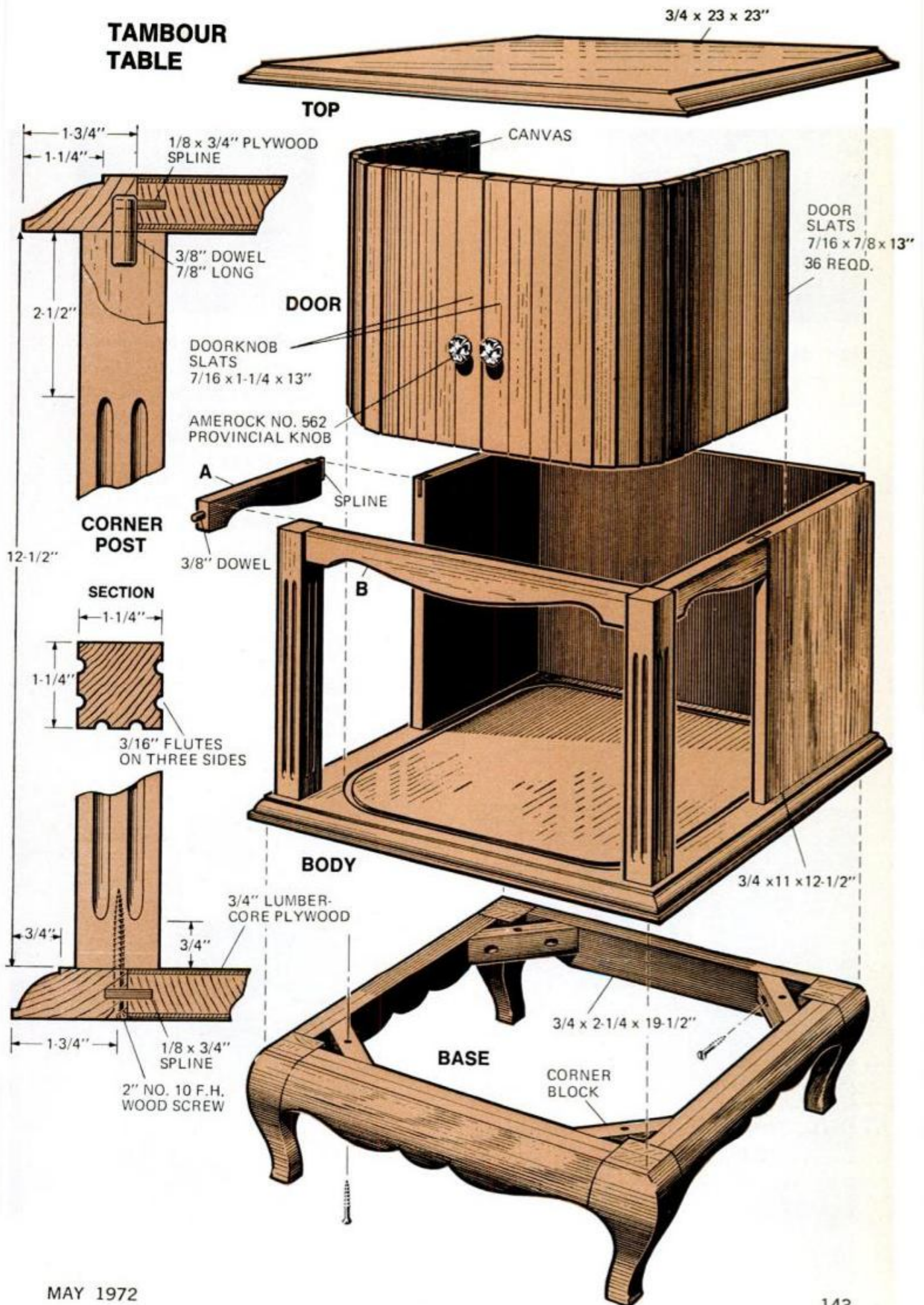

HINTS

FROM READERS



No-cost 'sky hook'

Most home handymen have a favorite way to hold a paint can when working on an extension ladder. But I've yet to see a simpler setup than the "hook" I use. I tighten a C-clamp anywhere on the ladder and hang the pail on the threaded portion.—*Jackson Hand, Westport, Conn.*



Stuck vise handle

To unfreeze a vise handle quickly use your lathe. Clamp one end of the handle in chuck with ball end inside to clear jaws and, with screw resting on a protective cloth, slide a file along handle as it turns. Reverse the handle to file the other half.—*B.W. Ervin, Kent, Ohio*



Funnel twine-holder

When soldered to a suitable wall bracket, a funnel makes a novel dispenser for a ball of twine that unwinds from the center. The twine is pulled through the spout. If you sharpen one bracket arm, you will also have a handy built-in twine cutter.—*Walter E. Burton, Akron, Ohio*

Pail makes pool-skimmer strainer basket

When the metal strainer basket for my swimming pool rusted out, I made a dandy noncorrodible one from a heavy plastic pail. I picked one that would fit the skimmer hole, cut it down to match the old basket, drilled countless $\frac{1}{16}$ -in. holes in the bottom and sides and finally attached a handle with Pop rivets. Making it saved the \$5.95 a new one would have cost me.—*John R. Orend, Orlando, Fla.*

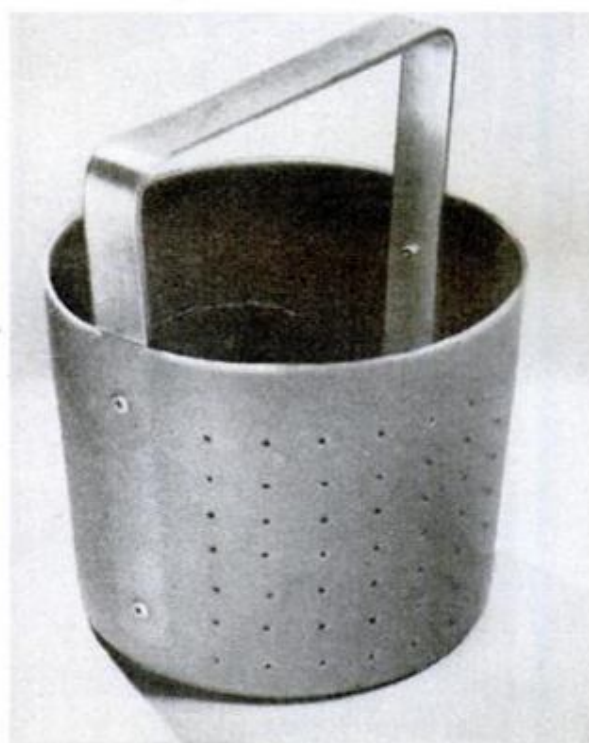
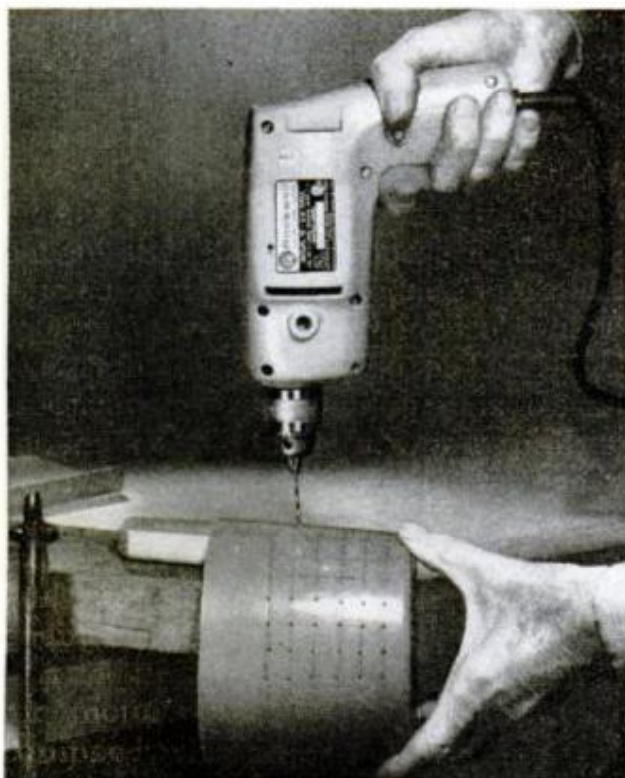

New tools you should know about



HOIST designed for do-it-yourselfers is rated at one-third ton and said to outlift comparable hoists. The Samsonite, \$19.75; American Gage & Manufacturing Co., 550 West Kinfoot St., Wausseon, Ohio 43567.

KEEP TAPS perfectly square with work plane using a Tap-Guide. Surface-hardened guides have 2-56 to $\frac{5}{8}$ -in. capacities; set sells for \$7.95. Available from MarLou Industries, Box 2177, Santa Clara, Calif. 95051.

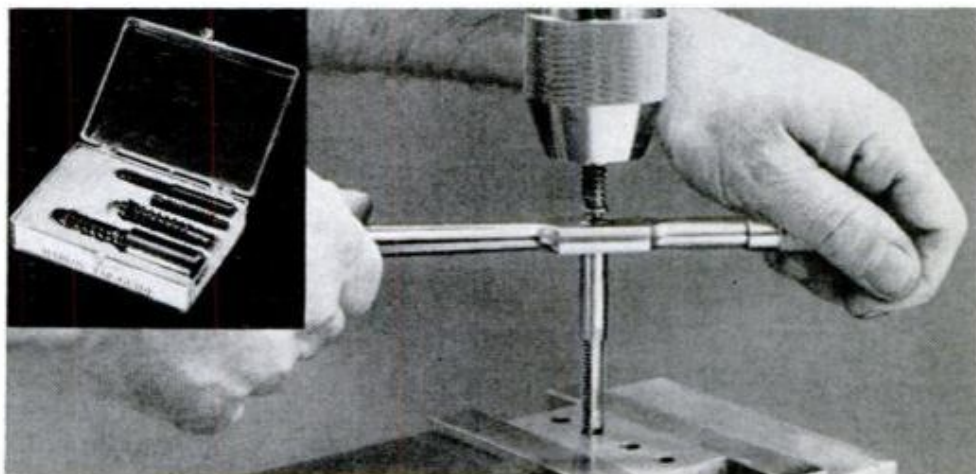

SHINGLING HATCHET now being offered by the Estwing Manufacturing Co., Rockford, Ill. 61101, features a thin blade and special gauge that adjusts every $\frac{1}{2}$ inch. \$8.60.

HANDY CLIP called the V-1 Vise Bracket quickly converts a LeverWrench into a bench vise, sells for \$3. Leverage Tools, Inc., Box 68, Glenvil, Neb. 68941, is the maker.

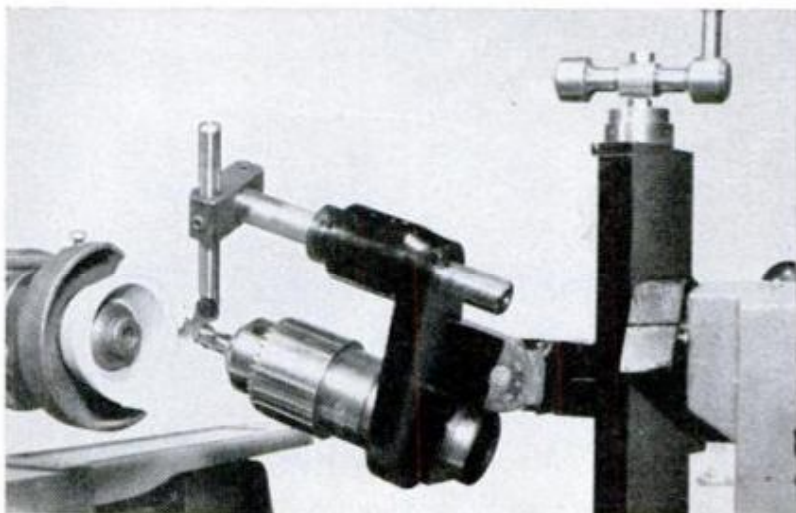
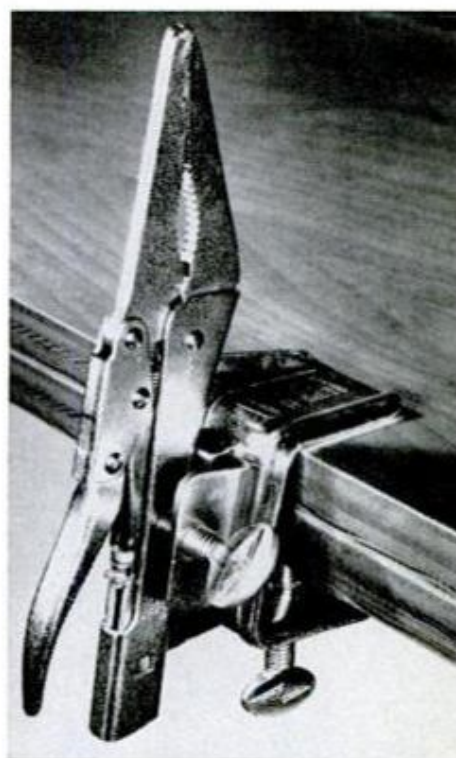

DESIGNED for the tailstock of a metalcutting lathe, ReNewAll can be used with a toolpost grinder to sharpen a variety of tools and milling cutters, reamers, T-slot cutters and more. With a special attachment, helical fluted cutters can also be resharpened. Tool uses precision bearings and vernier scales, costs \$380. For brochure and more information, write Tri-B Products, Dept. PM, Box 1032C, Canon City, Colo. 81212.

By WALTER E. BURTON



Machining aluminum?

RECENTLY, when I needed a knurl and a milling cutter in a hurry for work on aluminum, I made them quickly from small, steel helical gears in my scrap box. The gears measured $\frac{13}{16}$ in. o.d., and had a $\frac{3}{8}$ -in. hole, $\frac{1}{4}$ -in. face and 22 teeth each. They were not file-hard.

To convert a steel helical gear to either a knurl or cutter, it was necessary to re-shape the teeth. At first, I tried offhand grinding, but filing proved to be more accurate.

To make a knurl, a slope is filed on each tooth leaving a sharp edge along the center. (See drawing, opposite page.) To fashion a cutter resembling a Woodruff keyway milling cutter, a single slope is filed on each tooth to provide back clearance and a cutting edge along one side of the tooth, and some metal must be re-

...you can make cutters and

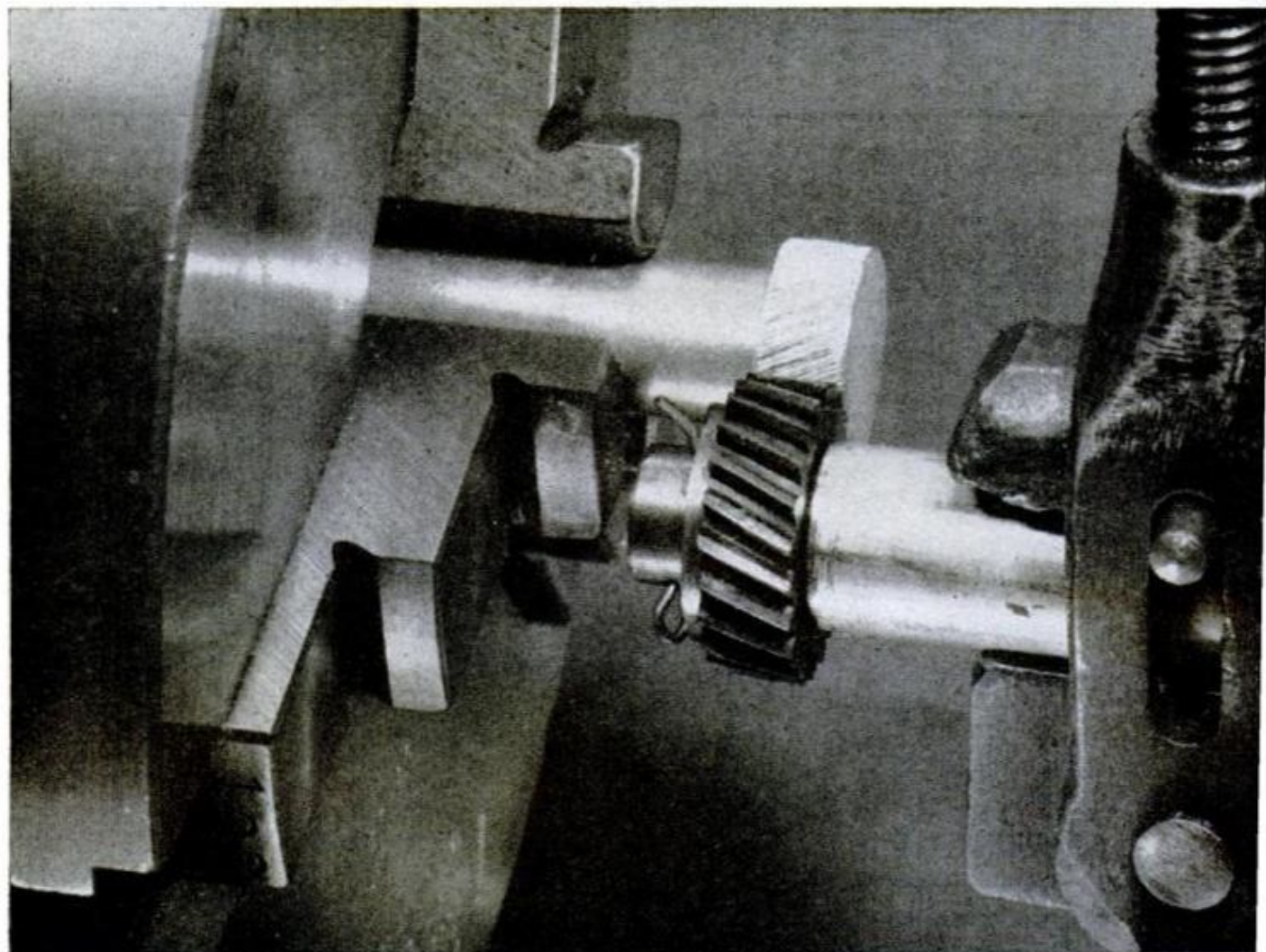

KNURLING ALUMINUM with converted gear. Ridges and valleys are finer than the knurl-teeth spacing

moved just below this edge to provide front clearance.

The modified gears were hardened in Kasenit No. 1 hardening compound. They were heated to bright redness (about 1675° F.), plunged into the compound until it thoroughly coated them, reheated to the same degree, quenched in water, and finally tempered to a light straw color (about 450° F.).

Cutters and knurls can be mounted in various ways. The knurl shown was simply mounted to rotate freely on the turned-down end of a 4-in. length of steel shafting; a cotter pin and washer hold it in place. In use, I clamped it in a boring-bar holder in the lathe toolpost, as illustrated. Where great pressure is involved, such a knurl probably should be in a "Y-type" mount fed endwise against the workpiece.

The milling cutter was similarly mounted except that a thinned-down $\frac{3}{8}$ -16

nut held it tightly against the shoulder of the $\frac{1}{2}$ x 3-in. piece of shafting. The cutter is positioned so the teeth cut as it rotates in the same direction as a conventional twist drill. Although the knurl teeth are rather widely spaced, it generally produces a pattern of rather fine ridges and valleys—apparently influenced by the workpiece diameter.

These "gear tools" have worked on aluminum that I have machined, and on some brass pieces. The milling cutter was used to form flats on soft steel. Resistance to wear, and the range of metal hardness that such knurls and cutters can handle, are influenced by the hardening and tempering treatment. This can vary with the nature of the gear metal, the hardening compound, and technique of the mechanic doing the heat-treating. Unhardened gear tools might be used on *very* soft metals and wood to a limited degree. ★ ★ ★

knurls from helical gears

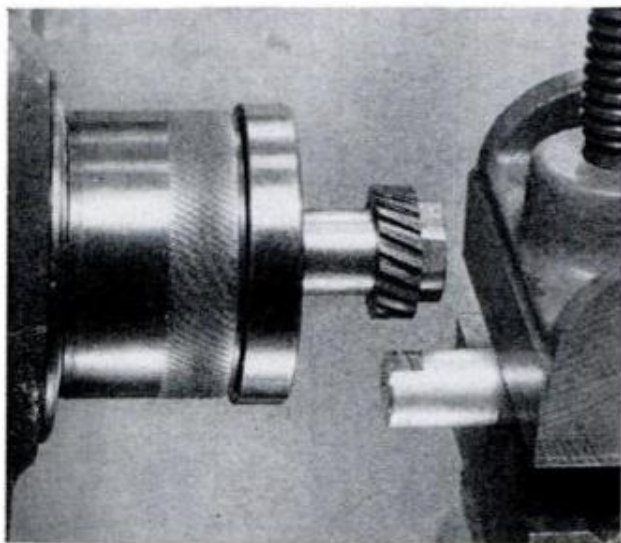

FLAT IS MILLED on aluminum rod with cutter made from gear. Tool also works on brass and soft steel

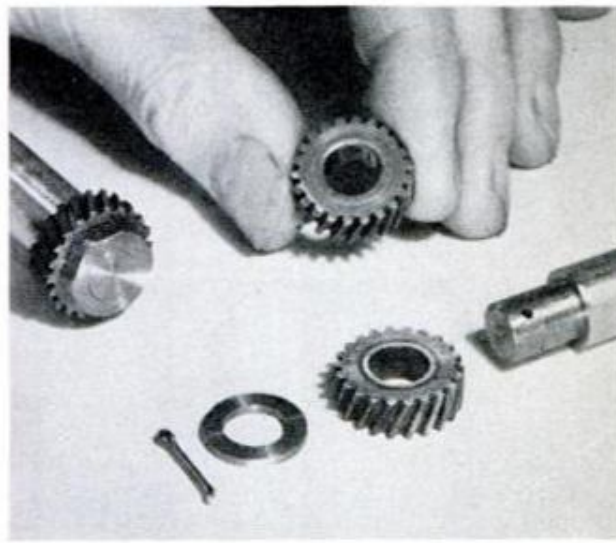

HELICAL GEARS converted into milling cutter (left) and knurling tool. Sketch shows how to file teeth

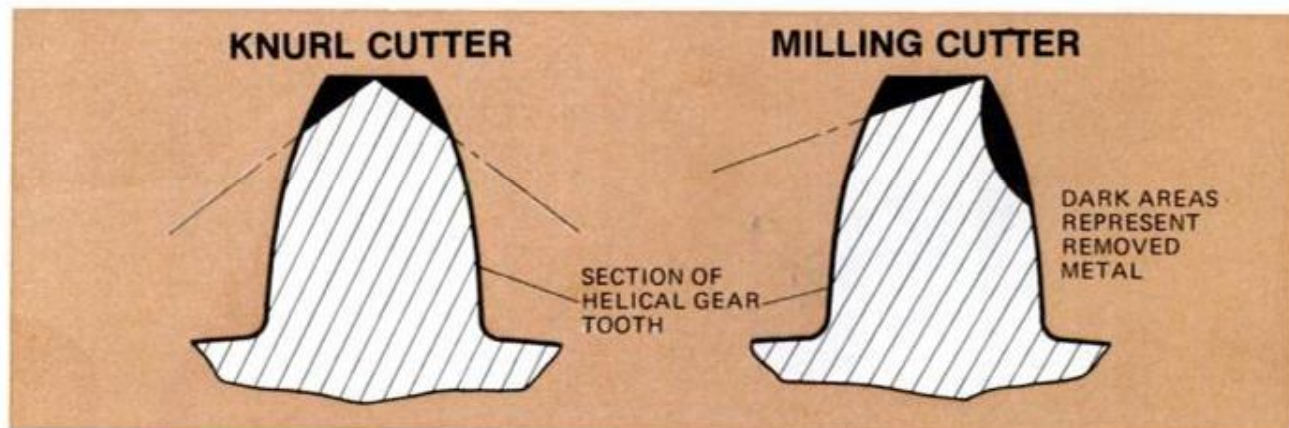

Hints from



Reinforced white glue

White glue, when mixed with a quantity of nylon or similar strong fibers, forms a useful patching compound where breaks, gaps and cracks have to be bridged and reinforced. The fibers can be obtained by cutting up yarn or cloth. Trick is useful for repairing cardboard and wood.

—B. W. Ervin, Kent, Ohio.



Wax brightens old glass

By adapting the technique used to subdue abrasions on sheet acrylic plastic, you can improve the transparency of glass articles that have become dulled by fine scratches. Apply a thin layer of auto wax with a moist cloth, wait a half hour, then polish the surface with a soft cloth. Repeat steps if necessary.

—W. B. May, Oak Park, Ill.



Shorten glue drying time

Most glues used in the workshop will set faster at warm temperatures. A good method that I have used is to place the glued parts in my car when it can be parked in the sun. As you know, an auto during summer months is a mini-furnace. Use paper to protect the seatcovers or seats, and, to keep heat around the glued parts, try aluminum foil.

—Rosario Capotosto, Greenlawn, N.Y.

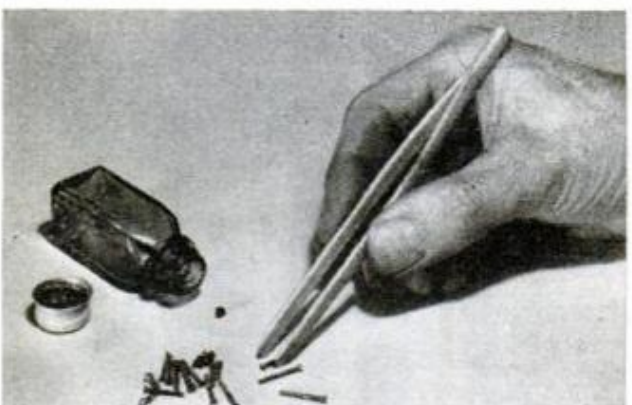

Bamboo tweezers

Serviceable tweezers for workbench use can be made from bamboo strips whittled from a retired fishing pole. The one shown here is 5½ in. long and consists of two halves. After tapering each leg from 5/16 to a scant 1/4 in., halves are heated and bent to separate tips. Then the halves are joined using a hot-melt glue gun.

—Walter E. Burton, Akron, Ohio.

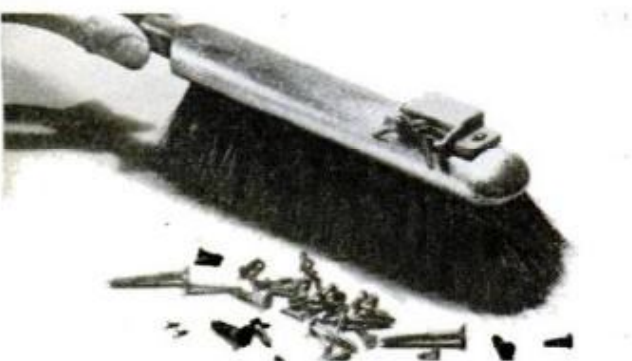

Shop-brush magnet

A magnetic door catch mounted on the back of a workbench brush is handy for picking up steel chips, sheet-metal trimming and other metallic refuse. It is particularly convenient for separating steel screws, bolts, nuts and nails from non-magnetic types. Mount magnet with short screws so the bristles will be undisturbed.

—W. B. May, Oak Park, Ill.

readers

Punch block for the shop

"Recycle" scraps of hard and soft wood by gluing them into a punch block of convenient size for use as a support when punching leather, felt and the like. Make the block of equal parts of hard and soft woods and you will have a surface selection to suit the punching operation.

—B. W. Ervin, Kent, Ohio.

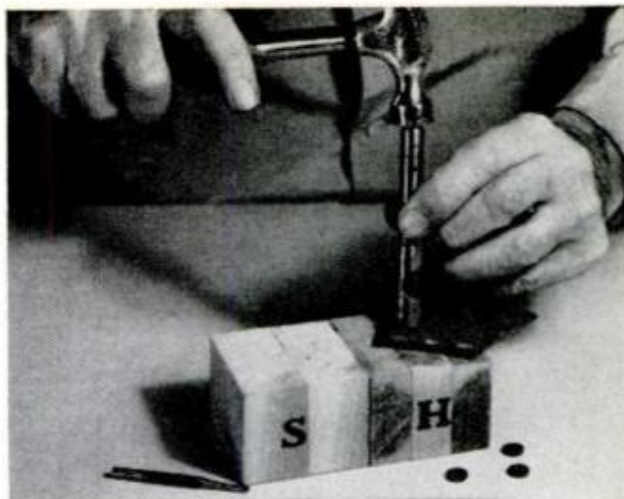

Rubber-stamp handles for tools

Handles from discarded rubber stamps can be used to make excellent grips for small shop tools such as files, awls, carving chisels and scrapers. The photo at right shows such handles fitted to an ignition file for shop use and to a scraper-type carving tool. Crimp aluminum tubing to make the tool ferrule.

—Walter E. Burton, Akron, Ohio.



Two-headed nails

For temporary fastening, when regular double-head (scaffold) nails were not at hand, I slipped each nail through a metal eyelet, with eyelet head toward nail point, and drove the nail until the eyelet was firmly against the wood (but not collapsed). Later, the projecting nail head was easily pulled with a hammer claw for quick removal.

—Walter E. Burton, Akron, Ohio.

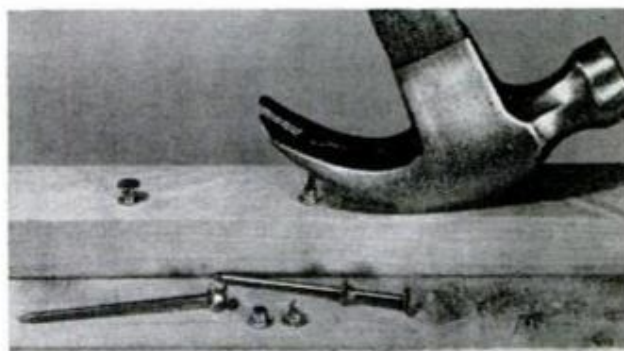

NEXT MONTH IN SHOP AND CRAFTS

THIS SHOP PAID FOR ITSELF—AND GREW. This fourth shop in *PM's* popular Great Workshops series is of factory-like proportions, yet you can duplicate it in part or wholly, as you wish. Its owner, C.E. "Doc" Bannister, of Pomona, Calif., added to his shop without straining his pocketbook by doing cabinet jobs for friends and neighbors. Learn about Doc's common-sense approach to a dream shop and how, perhaps, you can do the same.

FURNITURE WITH A TWIST. This unusual table and chair set, plus lamp, can be built quickly and inexpensively because they're made of corrugated cardboard. Complete instructions in the June *PM* will let you be first in your neighborhood to build paper furniture.

HOW TO BUILD AN AIR COMPRESSOR FOR \$70. More economical than buying a comparable commercial unit and a satisfying project to boot, this useful machine has an automatic switch that turns it off when pressure reaches 85 p.s.i. and on again at 55 p.s.i.

SPACE-SAVER DESK-BUNK BED—MAKE IT FOR \$50. Its good looks alone should start you on this project, but if not its two-in-one function will. Each youngster can have his own king-size desk—beneath his bed—so floor space serves usefully 24 hours a day.

THINGS TO MAKE IN YOUR WORKSHOP—contemporary bridge table, flame-carved candleholder, air rifle target, four-station bird feeder and illuminated watch stand.

Recreational Vehicles:



How to pick your new one

More luxuries in less space provide more kicks for compact motor camping. By BILL McKEOWN, Outdoors Editor

IN 1972, YOU CAN CHOOSE from more new motor-camping rigs than ever before. Recreational-vehicle trends show a widening span—now there are mininitrailers that seem designed for malnourished midgets up to bus vans big enough to take your favorite football team along. In between are so many vehicle variations you need a scorecard to figure what's right for you.

A selection equation could be stated: More size equals more conveniences and added cost. Not necessarily more fun and comfort. That depends on the kind of camping you enjoy. If you want to head out with everything *and* the kitchen sink along, you'll need a bigger rig. It will be handsome, too. The gypsy caravan look is long gone, and now you can go in style.

And if you're willing and happy to unfold a tent over a trailer bed, you can even hitch up behind a four-wheel drive and explore remote wilderness in your own modern covered wagon.

If in doubt about which rig, try the rental route. A week of camper living can also give you a good lead on your family's likes and dislikes as to outdoor essentials.

First, here are rigs your present car may handle:

Travel trailers are still the mobile motels that sell the most of all. Right now you can buy a conventional trailer from 40 companies, or one that looks like an astronaut's capsule from Apeco, Amerigo or Boler. There's a railroad caboose replica from Semaphore Industries, or a Boles Aero with a compartment that slides out to provide an extra room. Want a line

where you can start small and shop your way up through a dozen choices? Starcraft, Holiday, Blazon, Airstream, Avion and Boise Cascade companies and many others offer good examples of variety.

The new tiny trailers may measure only 13 to 18 feet and still sleep four or more. At about 20 feet come refinements like bathtubs and compact conveniences that may offer more than the comforts of home. While trailers are made with standing headroom, some like Larson's Rolite Retractable Wall, Snyder telescoping HiLo models, Tow-Low from Ratcliff and others lower to five feet for easy towing and fitting in a garage. Several feature an open back porch to carry snowmobiles or motorcycles, or a larger rear door to stable horses inside. The largest trailers need a



PIGGYBACK POP-UP: This 400-pound fiberglass four-sleeper, called the Tripper Car Camper, sits in car trunk after removal of its lid and rides in lowered position shown. Parked for night, its top is raised to get six-foot headroom. Canvas sides enclose cab-over double bed, dinette aft that lowers into two more berths. Garage hoist to store the \$1190 camper overhead off car is made by builder, Tripper Industries, 1533 Monrovia Ave., Newport Beach, Calif.

POPULAR MECHANICS



MINI-MOTOR HOMES (above), most rapidly growing of popular motor homes, were once called chopped vans because builders had to cut off the van body up to the cab to get a suitable chassis to overload. Now units like this 19-foot Kayot are built properly on a body prepared by the manufacturer for this use. Dodge, Chevrolet, Ford and GMC are all supplying van chassis ready for this conversion. The mini-rigs offer the walk-through passageway from the driver's seat to the camper that many pickup campers do not have and, unlike travel trailers, allow passengers to ride legally in the camper body. The rigs can travel at highway speeds, sleep four to six

VAN CONVERSIONS come in assorted types, with Travco one of the leaders in the field. New Royale Deluxe van conversion (above) is latest addition to the Travco Family Wagon line. It's a Dodge B-200 Tradesman van adaptation that allows the owner to travel and garage the vehicle with the top down and then raise it for headroom at night. The rig sleeps two in double bed that converts from the rear dinette. Power steering and brakes are standard. Travco, a division of PRF Industries, is in Michigan where the complete line of Dodge motor homes is produced as well as Commercial Travelers for business use (a popular motor-home application). Other PRF Industries companies that make RV models include Compact Equipment Co., maker of Dodge Family Wagons; Sightseer Corp., maker of Sightseer Motor Homes; and Motor Homes, Inc., producer of Ford Minihome, a popular Econoline conversion whose name has come to define an RV type



FIFTH-WHEEL TRAILERS usually hitch onto a pickup-truck cargo bed, but this new Shadow design from Harmon Industries, Warrensburg, Mo., tags onto a passenger-car rooftop. A removable steel plate, bolted to brackets along the roof gutters, takes advantage of the roll-resistance built into modern roofs to firmly anchor the trailer hitch. Great maneuverability and easy tow handling are claimed for these rigs. Models of 18, 23 and 27 feet are being produced, and unfinished units are available for extra savings. Shell for the Shadow 18-foot Mini will start at about \$1700; price is \$6500 for the completed 27-footer fully equipped. Driver reports indicate the design is aerodynamically suitable and does not buffet at speed or in strong winds



FIFTH-WHEEL TRAILER, in a conventional model of this unconventional hookup system, shows characteristic large size, split-level upper windows of two-sleeper area over cargo deck hitch, tandem wheels, large living room. Model above, the Roadcruiser V from Apeco Corp. towed by an International Harvester Travelette with six-passenger two-door crew cab for the family, comes in 26 and 28-foot lengths and optional interior layouts that can sleep six. Hooking up averages three minutes, and hitch can be removed to permit normal loading of cargo in the pickup. Airconditioning, eye-level oven and stereo are popular options for luxury travel

big car or small truck for towing. Trailer prices range from \$800 to \$10,000 and up.

Camping trailers are more familiarly known as tent trailers, the low-profile lightweights any car can tow, that open out into canvas-walled cabins to sleep as many as 11. Following Apache's lead, with plastic "solid-state" rigid walls replacing the canvas, similar models are appearing. Big names in tent trailers include Coleman, Starcraft, Nimrod and others. Costs run from \$300 to \$2000.

Fifth-wheel trailer is the strange name for a large unit that hitches to a connection in the cargo bed of a pickup truck. These, plus **mini-trailers** and **mini-motor-**

homes, are newly popular rigs discussed more fully in pages that follow. Interesting variations are a fifth-wheel trailer, called the Shadow, that hitches to the top of a passenger car. Another hooks to a post in the middle of the car trunk, or like the Tripper, sits piggyback inside.

Pickup camp covers and **pickup camper bodies** of cabover design cost \$200 and up for the caps; \$1000 to \$4000 for turtleback camp bodies that fit pickup trucks.

Motor homes, fastest growing of all RVs, range from \$5000 for van conversions and \$7000 for a Winnebago 18 up to \$25,000 and up for the biggest of camping's self-propelled palaces. ★★★





TRAVEL-TRAILER LUXURY can include extensive accessories. Holiday Rambler offers as options only upholstery color selections for its new 31-foot Royal Holiday. All other equipment aboard the \$14,210 rolling palace is included in price. Listed as standard equipment are built-in color TV, centralized vacuum cleaner system, filtered and purified water system, airconditioning, under-floor heating, name appliances, free-standing living room furniture, telephone, 26-foot fold-out awning, front and rear travel awnings, built-in stereo tape deck, AM/FM radio and power antenna, Uni/Ryde suspension, electronic sway control and more

PICKUP CAMPER CONSTRUCTION is now rugged enough to last for a number of years and suitably styled so that it no longer resembles a box. Frolic truck camper from the Frolic Homes Div. of Midas-International reduces wind resistance and offers an increase in roadability with a new slanted front window for cabover section. A brightened interior is also reported. Typical of the overall lengths that are now popular for pickup mounting, the Frolic is available in four lengths from 8 to 11 feet. Standard equipment in the 7½-foot-wide units includes an LP gas light, urethane-foam cushions, camper jacks, plus an optional shower and swing-up bunk. Midas production experience covers 180 models from Travelmaster, Noris, Volunteer, Smokey, Ken-Craft and Frolic Divs.



MOTOR HOMES, the most expensive of RVs, also have the most to offer and are the fastest growing in overall popularity. Advantages include ability to sleep six in a unit like this Chevy-chassis Chinook at far left, most of the comforts and appliances of home, a chance to ride with and talk with the driver—unlike pickup campers and trailers—and portable accommodations that require no setting up. But once parked in a campground the motor-home man may not want to pull out again and run the chance of losing his site while driving to town for a few groceries and facing the problem of finding a big enough parking space on a busy street. Many motor homers are now seen towing a family compact, like this Vega, behind the rig. The car needs manual stick-shift transmission in neutral and transmission oil topped off. Boats, horse vans or mother-in-law trailers can be similarly towed

Convert your van to an inside- outside camper

By GENE RAPP

ACCOMMODATIONS for four or more at night plus versatile arrangements that provide camping conveniences during the day are the result of the workshop project shown here. Though the installations pictured illustrate the setup for making a Ford Econoline into a camper, Dodge and Chevy vans can be fitted out equally well. Even a station-wagon family could adapt features of this arrangement to their needs.

Units shown are roof rack, a pop-up shelter to fit on it, bench-bunk with storage space under the seat and a food-storage cabinet with drop-leaf table. Without the rooftop shelter, the platform serves as an overhead luggage rack to carry supplies and camping gear. Even with the lean-to type pop-up top installed, there is still a forward luggage space the width of the car and about 43 inches long available for stowage. Since the shelter hinges to the roof rack with removable pins, it is easy to convert the platform from elevated sleeping porch to luggage carrier or spectator deck.

Starting point in the construction of the rooftop camper is the placing of 2x6s across the roof at the rib support points of your vehicle. Sketch an outline of the roof contour on each 2x6 and then cut on a bandsaw. Exact dimensions of the 1/2-inch plywood deck sections will be determined by the width of your vehicle roof. These sections are screwed to the contoured ribs and edged with 1x10 white pine side rails. White duck canvas strips are glued to the underside of the rib supports to prevent scratching of the van roof. Trailer skin sheeting

VAN becomes more versatile than ever with the addition of the easy-to-build gear shown here. Night can find five sleeping in and on top of rig



covers the side rails and the pop top; it is edged with aluminum trim. Eyebolts or loose-pin butt hinges are placed on the deck forward of the shelter top as hinges; more eyebolts or pad eyes provide anchor points for lines securing gear boxes and equipment. Turnbuckles snug the platform to hooks that catch under drip rails.

For the pop-up top, 1x10s form end-pieces, and ribs and sidepieces are of 1x4. The 1x2 longitudinal stiffeners are covered with 1/8-inch hardboard and trailer skin sheeting. Suitcase latches hold down the aft edge of the top. A light ladder can be made of tubing, or a conventional wood ladder can be cut in half for stowage under the shelter top and assembled by bolting it together with wingnut bolts that secure steel bar stiffeners.

The food-storage cabinet and combination bunk bed and bench can be altered from the measurements shown here to accommodate smaller or larger vehicles. Vinyl-covered particleboard or 3/4-inch plywood can be used for the major components of both units. Vary construction to allow for rear wheel-well positions in your own vehicle. With the spare tire removed a Coleman refrigerator can be fitted in its place next to the food cabinet.

Especially for spectator sporting events, a vehicle of this type will prove valua-



ROOF PLATFORM is light enough to allow youngsters to mount it on a cartop. The pop-up shelter follows



SETTING UP the rooftop pop-top is a simple one-man operation. Two can then sleep in this shelter

ROOF PLATFORM AND POP-UP TOP

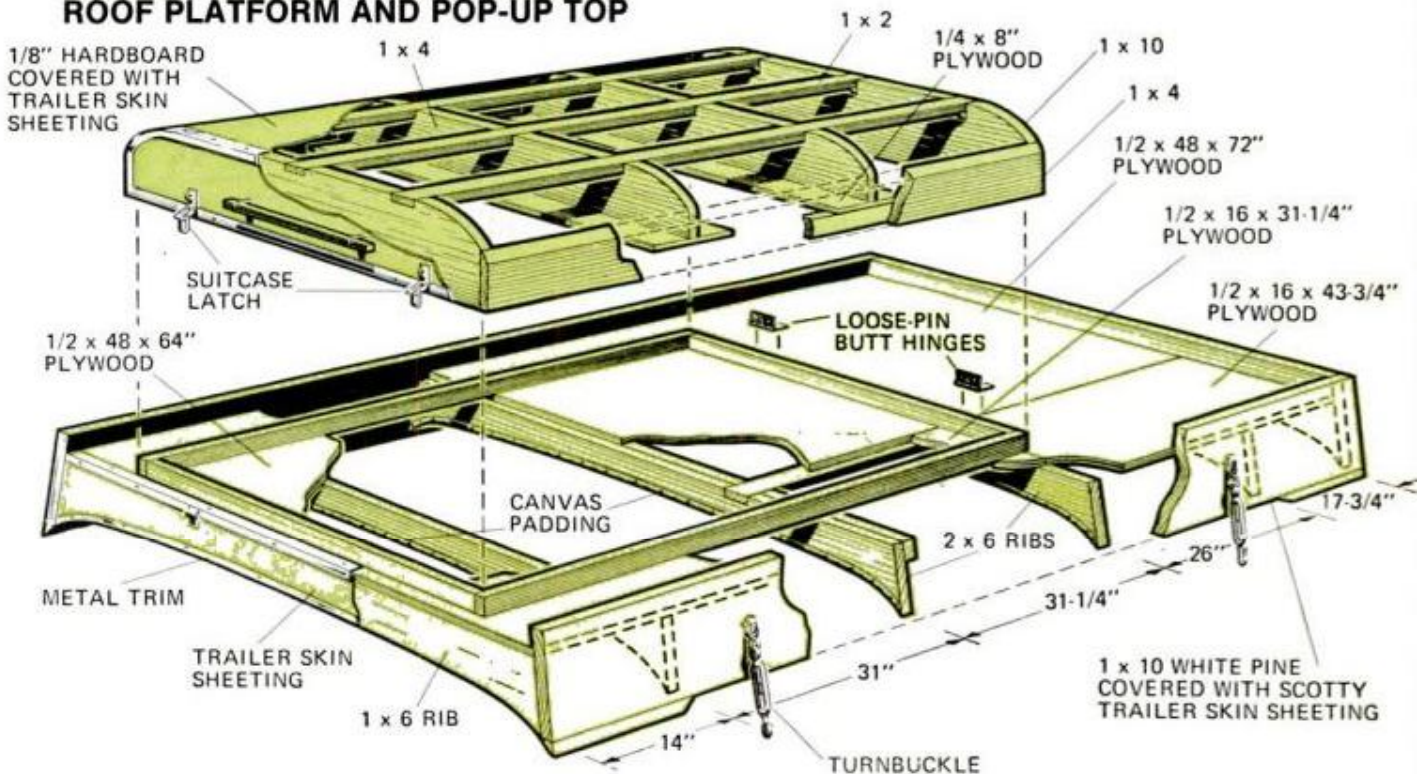



FRONT-ROW BOX for spectators at sporting events results when shelter bunks are left off and deck chairs and umbrella positioned instead (left). Add on the pop-up top, tilt it up and rig curtains, as shown above, and the kids have their own compartment

ble. While he's waiting for the action to start, a camper can stretch out on the bunk bench, out of the sun, or lift the top berth into place and watch activities outside the van through rear or side windows. Once the race or the game begins, the roof

platform, complete with sun umbrella and deck chairs, becomes an ideal vantage point. For the photographer particularly, a cartop platform affords unobstructed shots over the heads of the crowds.

Youngsters would enjoy pitching a small

SETUP FOR CAMPING requires only the removal of rear seats and sliding in of the bunk and storage units

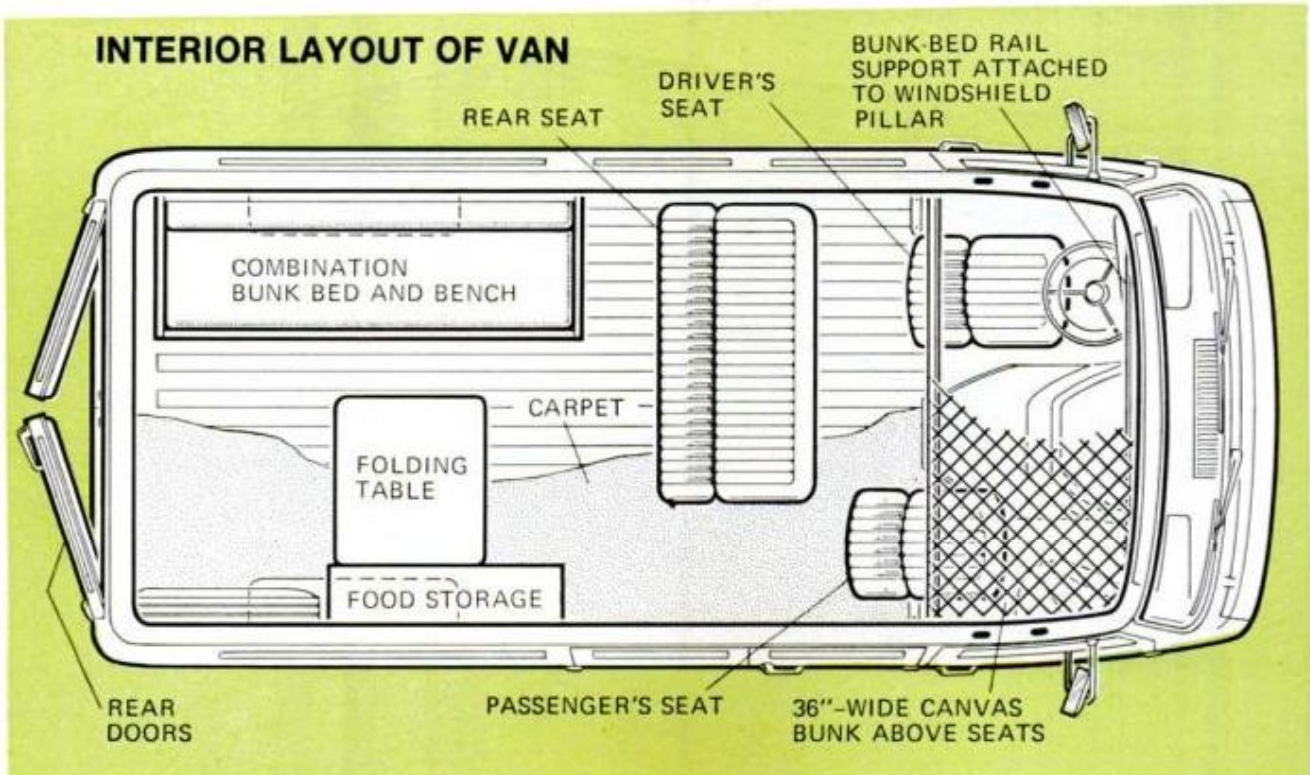
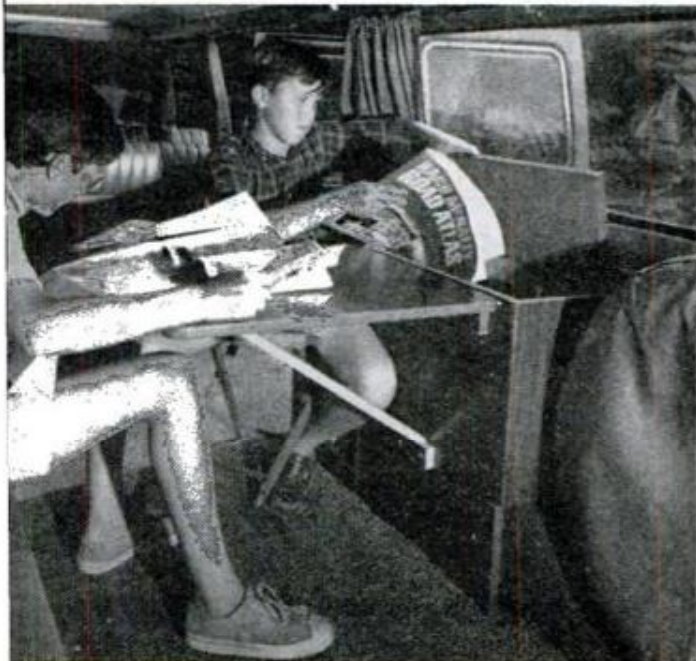
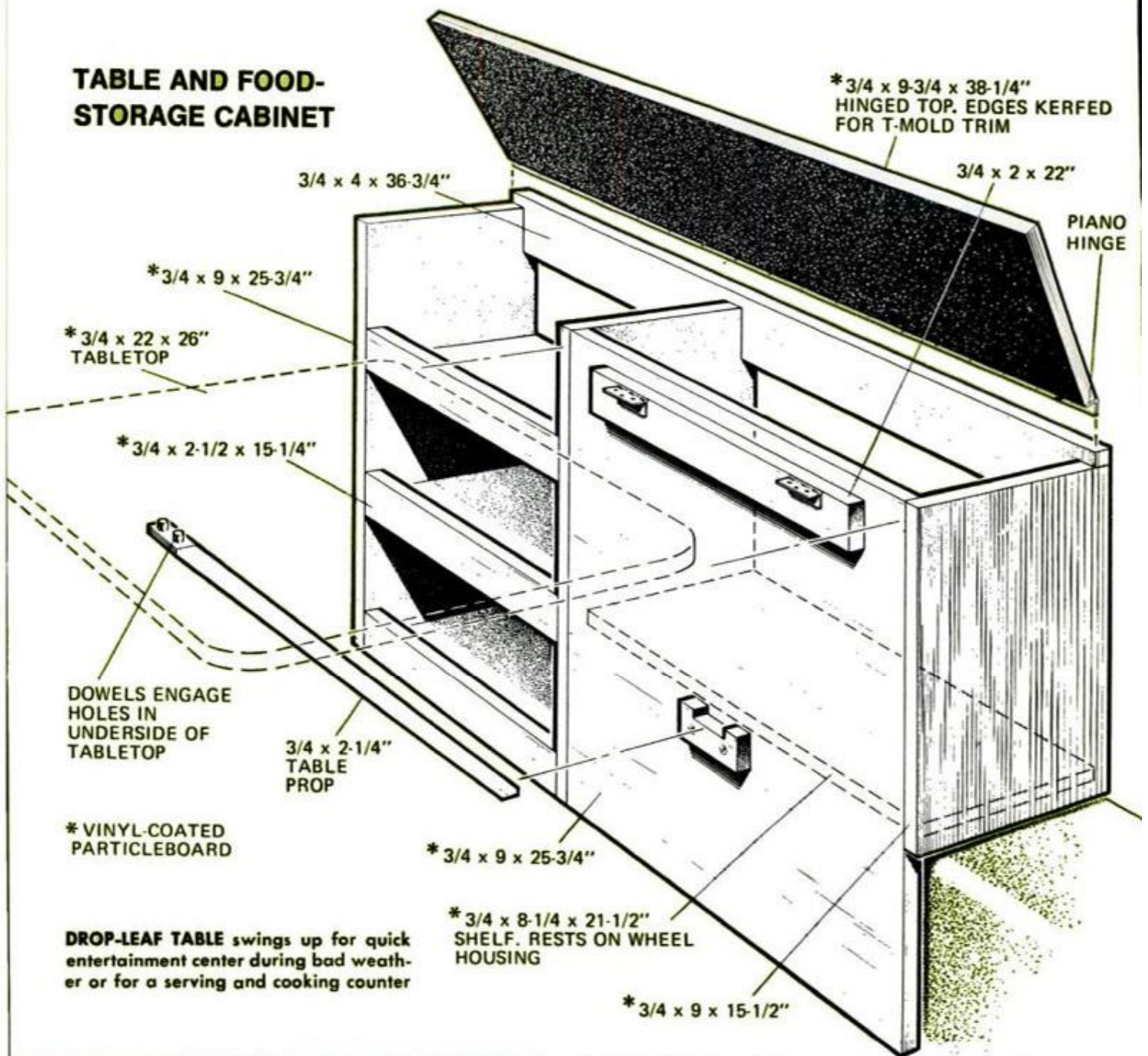

TABLE AND FOOD-STORAGE CABINET



STORAGE SPACE seldom seems sufficient in camping rig, and the addition of these easy-to-build pieces allows numerous items of gear to be stowed easily





DOUBLE-DUTY BENCH-BUNK serves three functions—as daytime seat, as upper and lower berths at night and as a spare storage bin for sleeping bags and gear at any time. Such items as flashlights, pencils, insect repellent and reading materials are stored along back in easy reach

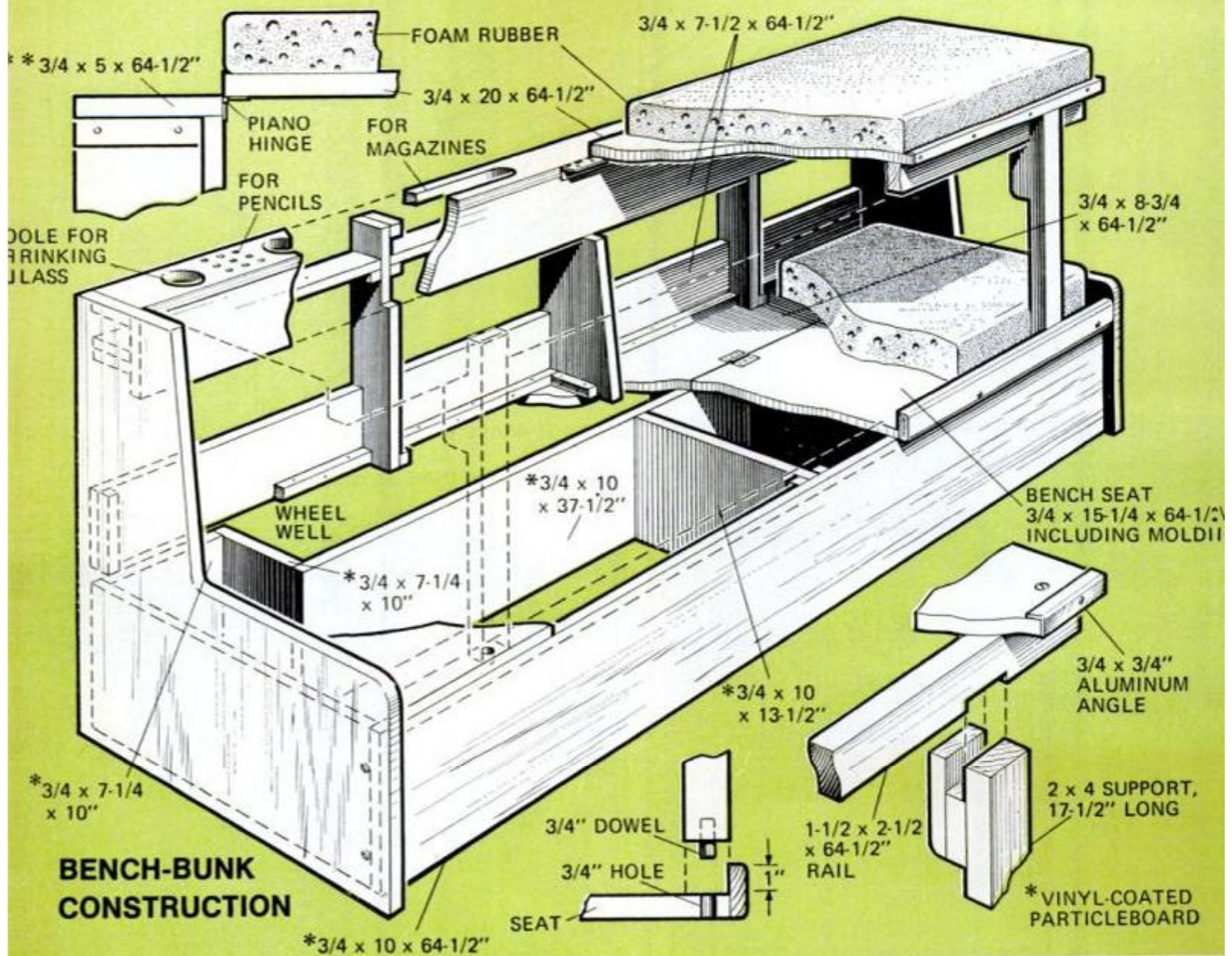

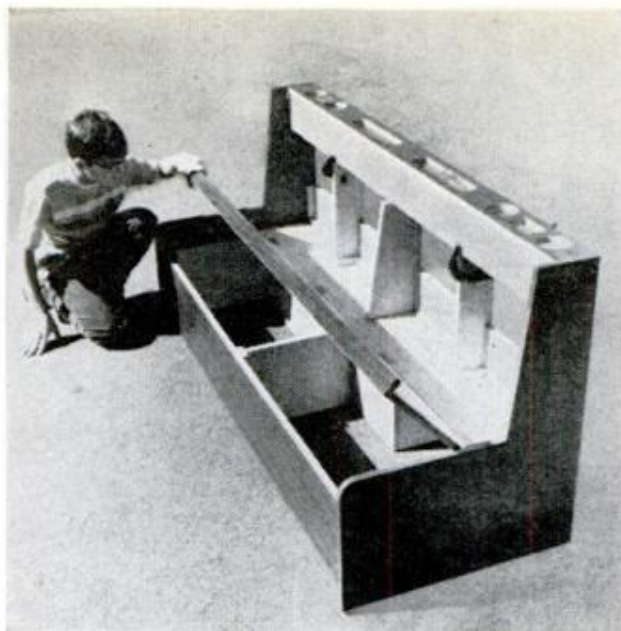

ASSEMBLED BENCH-BUNK (photos above and below) has storage areas plus cutout to fit over wheel well

pup or backpack tent on the roof platform if the pop-up top has not been brought along.

Sleeping five adults is possible if a canvas pipe berth, with rail supports secured to side and windshield pillars, is slung over the forward driver and passenger seats. Two more then sleep on the upper and lower berths of the bunk-bench, and the final two bed down up on the roof pop-up shelter after the roof has been propped up, side and front canvas curtains snapped on, and mosquito netting installed if necessary. Even with fewer campers along, the canvas berth over the

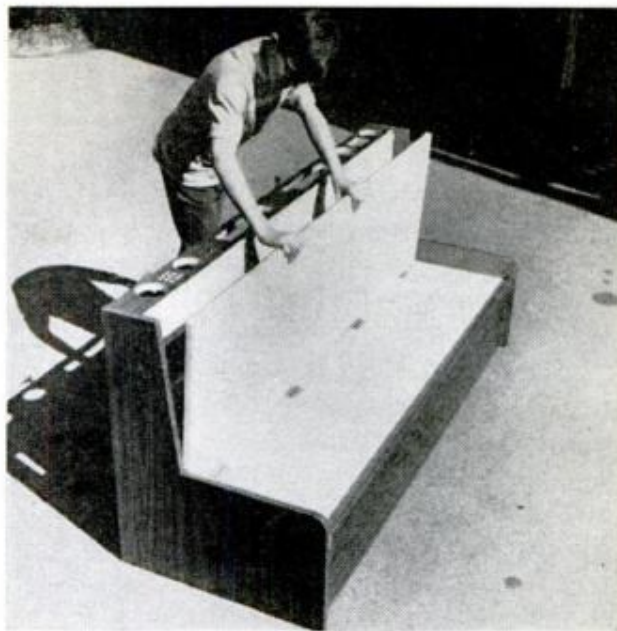

BENCH BACK becomes bottom of upper bunk when lifted out and legs dropped to make double-decker

front seats is worthwhile since it provides an ideal storage spot for gear while you're living inside during wet weather.

Headroom and a place to stretch or dress standing up can be rigged with a canvas dodger or fly stretched out from the erected pop-up top. Inside camp cooking is easy with a gas or LP stove on the drop-leaf table. Cutouts, as indicated, can be made in the back of the bench-bunk for glasses, drink cans and magazines.

Construction of these units can turn any van into a camper. Lifted out, they allow quick return of the vehicle to its former use. ★★★

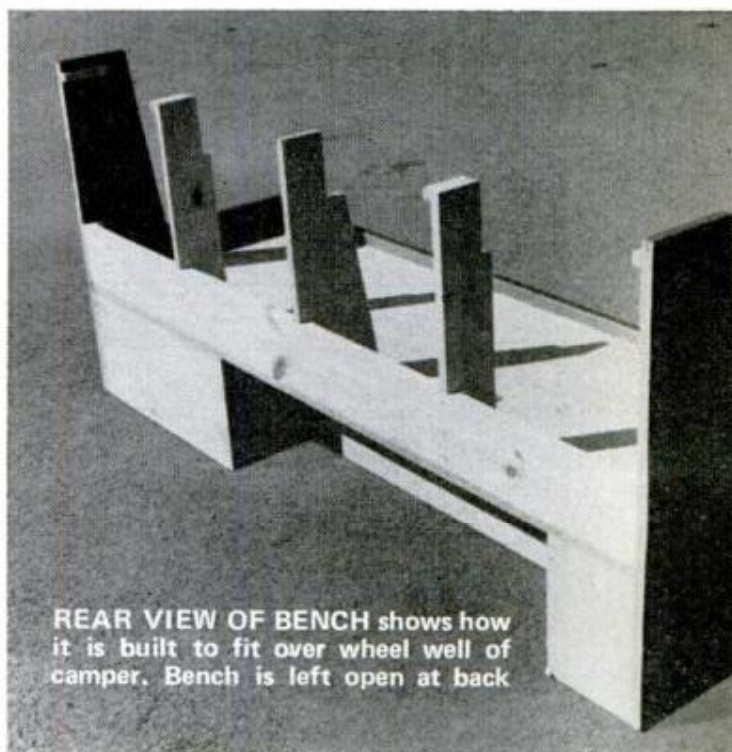
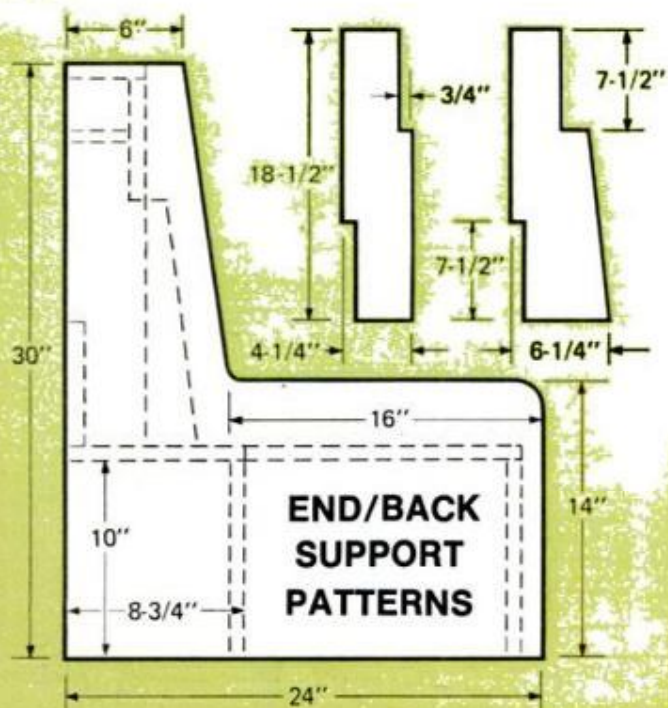

REAR VIEW OF BENCH shows how it is built to fit over wheel well of camper. Bench is left open at back

20 questions motor

By V. LEE OERTLE

Illustrations by Alnos Hall

● *What mileage do RVs get? Which is most economical?*

The car pulling a travel trailer may average 8 to 11 mpg. A pickup truck hauling a camper body can do slightly better—8 to 13 mpg. Motor homes up to 10,000 pounds average up to 7½ or as poor as 5 mpg. A car with a light tent trailer or a light van camper does best. But economy isn't everything; don't forget comfort.

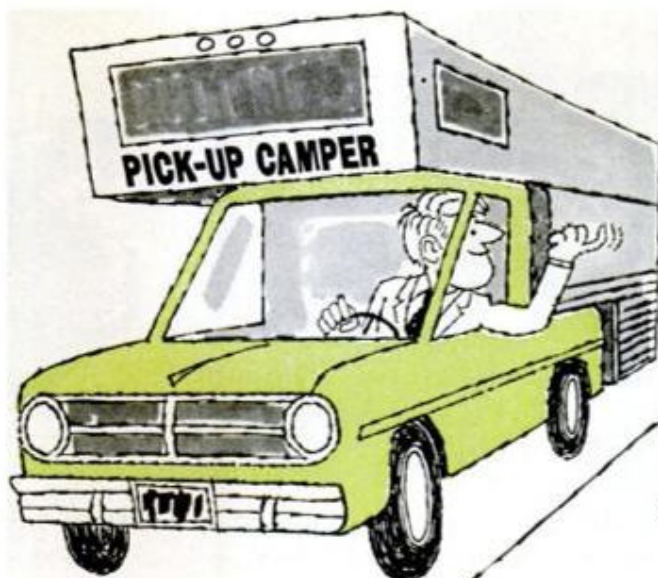

● *Are trailers made in the East better for cold weather?*

Thickness and efficiency of insulation depend on builder's standards, no matter where he's located. Check his reputation, inspect units, read the specifications. Remember you can order extra insulation built in.

● *Is wind resistance very important in picking a camper or motor home?*

No. Engine power, driver habits, tire size, tread pattern, axle ratio, highway surface, elevation, gas quality, engine efficiency have more effect on handling safety and operating economy.

● *How big a trailer will my car tow?*

Tow safely is the question. Even a compact can haul 5000 pounds, but not easily. Here's a good rule: For subcom-

pacts, tow rigs under one-third of car weight. Compacts can tow half their weight. Intermediates tow up to three-quarters of their gross weight. Standard to luxury cars can slightly exceed their own weight. A 5000-pound car should handle a 5000-pound trailer.

● *Tent-trailers look flimsy but they cost less. Are they comfortable? Durable?*

Improved synthetic side materials, metal or fiberglass tops, new lift mechanisms make them durable. Galley and sanitary provisions make them as well equipped as any other RV, and they sleep more—up to 11. Take your pick from \$500 to \$3000, and any car can tow one.

● *Are high-sided pickup campers dangerously top-heavy?*

The cab-over section usually weighs

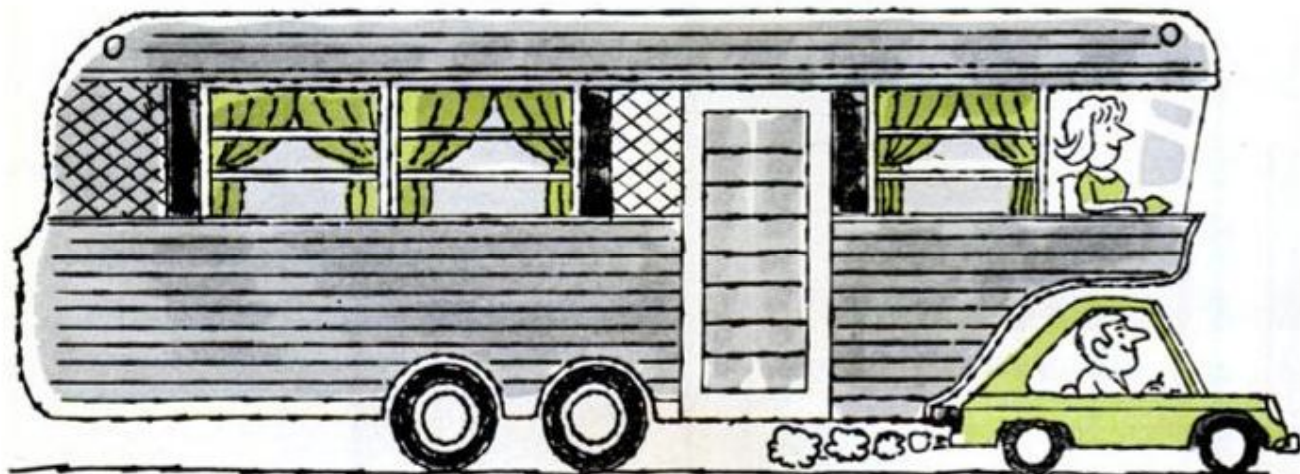

campers ask most

only 100 pounds. Heavy appliances are low and make the rig stable. Appearances are deceiving.

● *What does "self-contained" mean?*

The rig usually has a stove with oven, refrigerator, water heater, space heater, water and light systems, toilet, holding tank, and can camp without outside hook-ups for limited periods.

● *How long can a family travel in a self-contained rig before emptying the tank?*

Two adults and two children can travel about four days before dumping the average holding tank, and a careful family could stretch it to a week.

● *Is it true campsites are almost impossible to find these days?*

No. Avoid the busiest national parks on the busiest holidays; try some of the private campgrounds nearby. There are 10,000 in the country with 600,000 campsites. Many take advance reservations.

● *Is an equalizing hitch a gimmick?*

A load equalizing hitch is very worthwhile for trailers over 2000 pounds, and any rig of any weight with handling problems. Through mechanical leverage, the trailer-tongue weight is distributed between the tow car's front and back wheels.

● *Is stick-shift better than automatic?*

An automatic transmission seems to last much longer than a stick-shift clutch before overhaul, especially for inexperienced or ordinary RV drivers. It gives more efficient control, shifting when necessary and reducing engine wear.

● *Will trailering hurt my tires, brakes, engine?*

Antisway bar, load-equalizing hitch and premium-grade tires will lengthen tire life. Most of the trailers over 1500 pounds now have separate brakes; downshifting should be used on downgrades. Match car weight to trailer weight, use reasonable speeds and you should have no extra engine wear.

● *Are tandem-axle trailers better?*

Tandems are best for the largest trailers. Engineers say "every bump is just half a bump" with four wheels. The trailer body takes less of a beating.

● *What are GVW and payload factor?*

Nearly every car and truck has an identification plate with gross vehicle weight—its legal loaded limit. GVW minus gross weight (empty) is payload factor—weight of passengers and gear you can carry.

● *Do RVs pay for themselves in travel costs?*

Not exactly, but at \$11.50 a day for a family of four (campsite \$3.50, ice 50 cents, propane 50 cents, groceries \$7) plus gasoline, it's a lot less than resort expenses.

● *Is a pickup better than a trailer?*

Trailers can be towed by various vehicles, parked and left, and have more room. Pickup campers are much shorter overall, can be driven faster. Take your pick.

● *Are electric trailer brakes best?*

Hydraulic and electric are both safe if properly installed, but hydraulic should

(Please turn to page 191)

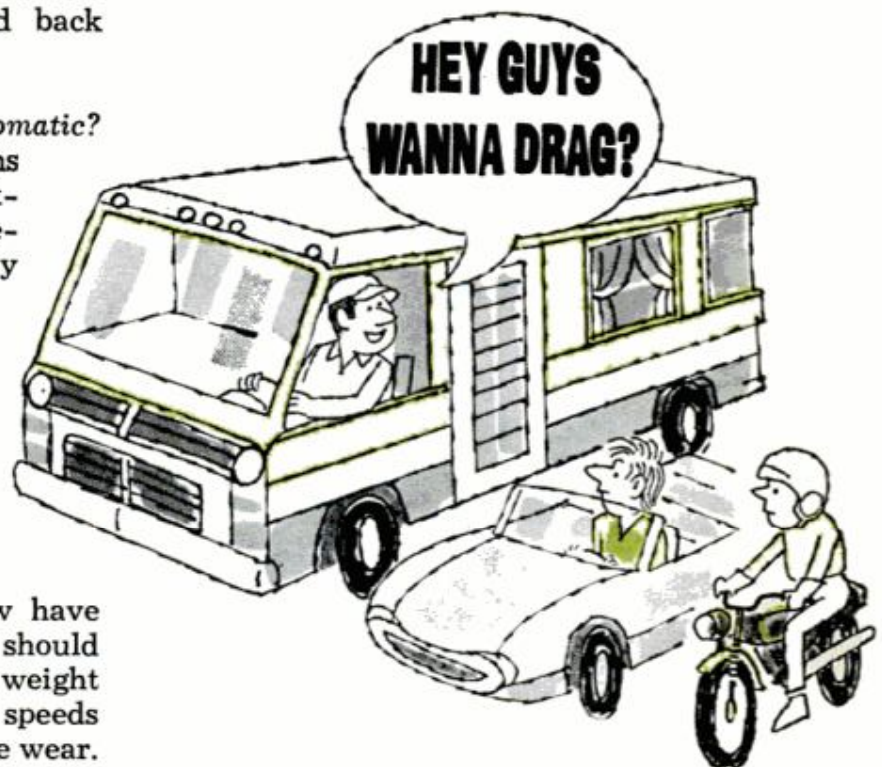

How to be a savvy RV

Try these special handling tips; they'll help



ANTISWAY CONTROLLER should be installed to keep rig from straddling white line at left, above. Trailer towers should always stay in right lane except to pass. Whipping back and forth and sway are danger signs



SUDDEN STOPS can be part of any vacation, and stopping distance is much longer with a large heavy rig. Brakes and tires must be kept in top shape, all loose gear must be secured and children kept out of aisles



TIE-DOWNS were forgotten by the driver who borrowed this pickup camper. A fierce gust of wind actually blew the camper right out of the truck cargo box. Remember your camper also requires separate insurance

pilot

By V. LEE OERTLE

you prevent most accidents



TRAILER CARGO on flatbed trailer must be secured as well. Without chain binders at all four corners, racer could plunge forward during emergency stop, crash through camper, as has sometimes happened



MIRRORS at left and right are particularly needed by the RV driver as faster cars continually pass him. Use a windshield scraper when mud and snow collect if the mirror is too far out for easy cleaning



MAY 1972

THE DAY OF MY ACCIDENT I should have noticed the clues ahead of time. Summer heat had leached oil through the blacktop pavement and patches of it made purple splotches against the ribbon of highway. Then the Utah sky ripped open with rain and the oil began to drift over the crown of the road. The bus ahead of me slowed down, yet spray from its jumbo tires opaqued my windshield with an oily film.

Then, with no warning, the back end of my pickup camper skated around and I found myself traveling backward! The driver behind me stabbed his brakes, started to skid, and I knew we were all going off the highway. Later I learned my big flotation tires had hydroplaned up onto the layer of water and oil. My truck slid sideways down the sloping shoulder as I tightened my seat belt. Then the rear wheels struck a rock and we rolled until we came to rest upside down in two feet of ditch water. I opened the belt release, fell onto the cab roof, and forced my door open to wade away unhurt in the knee-deep muck. Through my shock I heard the truck engine running wide open though upside down, and I stumbled back to shut it off as other drivers stopped above to offer help. The cab was badly damaged but the camper body holding up the truck was only dented and not crushed. The accident, however, has made me give a lot of thought to factors affecting RV safety:

While under way in any kind of recreational vehicle, make a habit of stowing away securely all loose gear in your camper. A sudden stop can throw pots and pans around like clubs. Heavy tools should be stored in a special bin; not in the cab or passenger compartment. Passengers should remain seated and preferably safety belted, away from shelf corners, handles and knobs.

Pickup camper owners should pay more attention to tie-downs. A strong wind can blow the camper out of the cargo box. Vibration can loosen turnbuckles, so they should be regularly tightened. A camper body that pulls out during an accident may then be struck by a following car.

Travel trailer accidents can result when a big trailer towed by too small a car

STABILIZER JACKS should be checked regularly. If your tent-trailer jacks are left in a down position by mistake, they could catch in a chuckhole or on railroad tracks and tear the trailer away from tow car

163

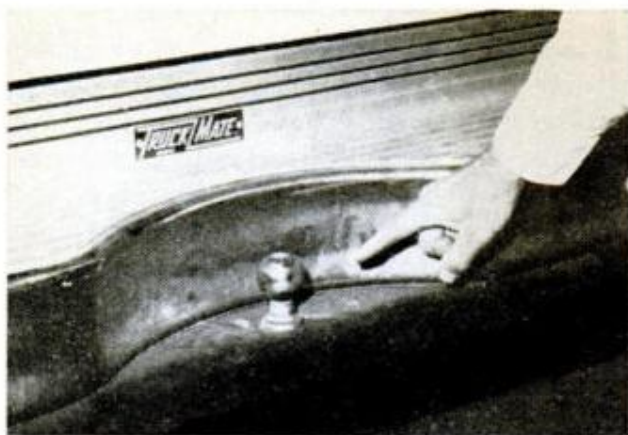

BUMPERS of cars and trucks flex too much and are not designed to take the stresses of towing unless specially braced as shown. Stiffeners should run back to frame rails if large trailers will be towed



ELECTRIC BRAKES for trailer should be adjusted regularly before any chance of emergency stop. Set them so that they come on just ahead of car brakes to prevent any possibility the trailer might jackknife

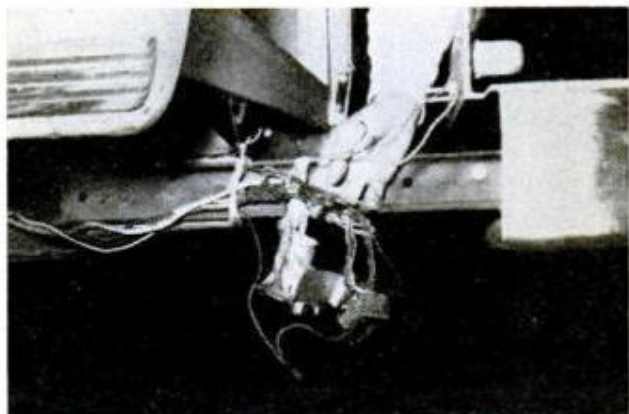

ELECTRICIAN'S NIGHTMARE of wires is typical of too many trailer hookups if boat, horse and travel trailers are towed interchangeably. Couplers could drag on pavement, cause fire. Keep connections neat



CARPORT ROOF that this pickup camper hit crumpled corner of cab-over but did not twist or buckle its frame. The accident revealed the basic strength of this somewhat fragile-looking rig. Glass did not break



ROLLED OVER three times by the author, this camper body shows surprising strength from foam-sandwich construction. Truck landed upside down but only the cab was badly damaged by the rainy-day accident



FRONT-BUMPER LOAD, like the trail-bike shown, can cause an accident if it falls in front of RV. Rear bumper mounting is better, but unit should be set in special carrying rack and double-strapped as well

starts to sway. Other causes include too much speed and cheap bumper hitches. Use equalizing hitches and antisway bars.

Motor homes should allow extra stopping distance, avoid tailgating and save brakes by using lower gears.

Tires must be the right size and with

good tread of the same pattern at each end of an axle. Slow down during heavy rains.

Strap down boats carried on camper tops, bicycles and trail bikes on bumpers, and keep yourself belted in.

Should an accident happen, make sure



TOWED VEHICLE rates special care in hooking up. Use strong safety chain plus proper brake and light couplers. Hitch should be able to take strains of the load. Extension bumper shown had too much flex

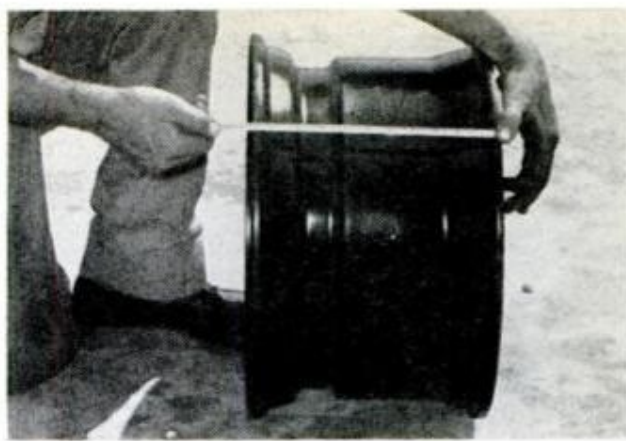

EXTRA-WIDE RIMS must be used when you switch to superwide tires or an accident could result. Rim shown fits 10-16.5 Super-Single that provides truck with the wheel strength to match tire weight capacity

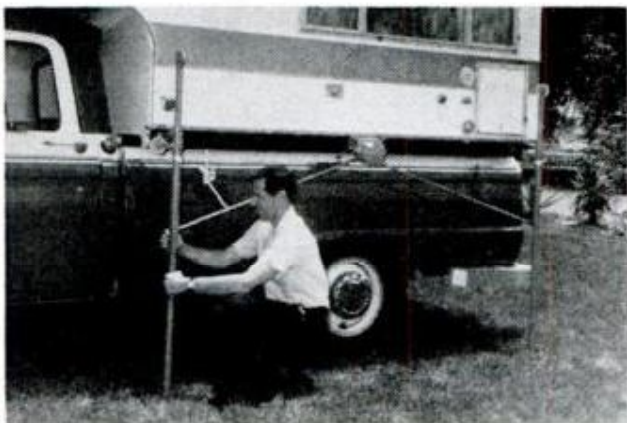

BUILT-IN JACK LEGS must be hinged up and strapped securely in place to prevent dropping and dragging camper off truck body. Sidewall brackets, floor bolts and turnbuckles can be combined to hold camper in



PROPANE SHUTOFF before starting trip is a safety precaution to prevent fire in event of an accident. The LP gas lines might be ruptured. Prechill your LP refrigerator and start it again at the campground



REAR LIGHT CHECK is important in daytime as well as at night. Examine brake stoplights and turn indicators regularly, and carry spare bulbs for them

TURNBUCKLE HOLD-DOWNS (right) can vibrate loose on a rough road, so check them at every gas stop. Don't apply leverage with a long-handled tool as it might break them. Snug turnbuckles only hand-tight

all passengers are out of the RV, shut off motor and propane supply, take pictures, record witnesses and light warning flares away from possible fumes. ★★★

MAY 1972

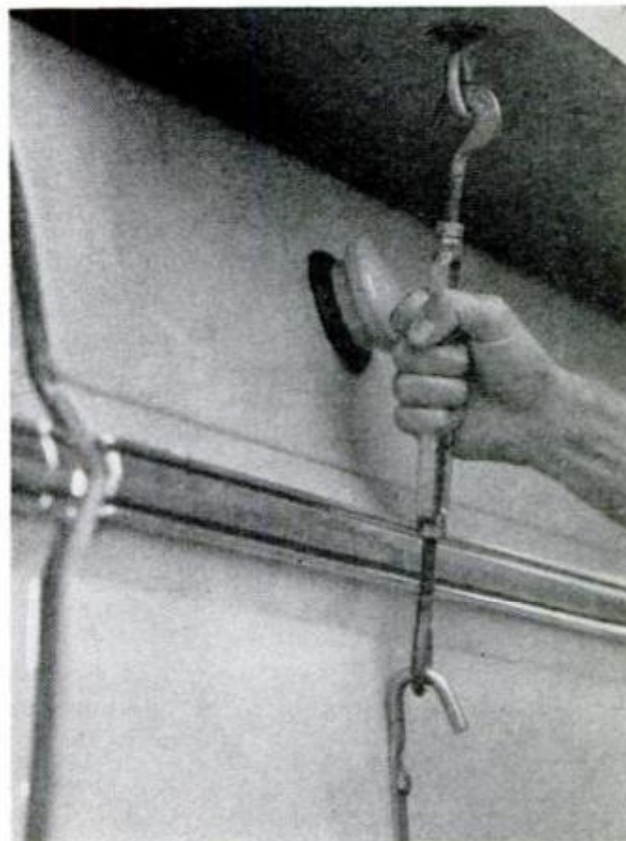

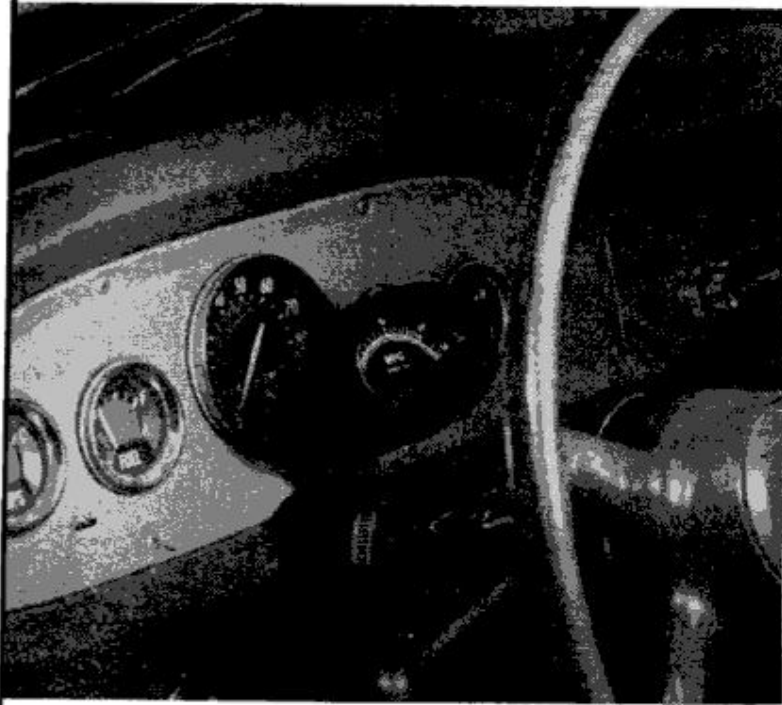

MPG meter: Constant measure for driving economy

This gadget will give you nonstop lessons on how to drive and can save you money any time that the engine's running

By MERLE E. DOWD

"**S**LOW DOWN NOW for your next gasoline refund," the miles-per-gallon meter seemed to be saying to me. "Try accelerating more slowly this time and I'll show you the difference."

I had just mounted it on the steering post of my International Travelall and was testing it out alone and while towing a trailer. Some of the featherfoot facts it has taught me include:

- Don't attempt to accelerate uphill. Of all gas-wasting habits, this is the worst.
- Maintain a constant speed while coasting downhill.
- Keep your engine tuned and timed precisely.
- Keep tires inflated to recommended pressure or slightly higher.
- Shift down to a lower gear when climbing hills with a trailer or camper.
- Change speeds gradually and learn to read the road ahead in order to avoid starts and stops.

By following these tactics, owners of pickups with campers, motor-home drivers, and trailer towers report up to 30 percent better gasoline mileage, with most of the drivers reaching a 20-percent improvement easily.

MILES-PER-GALLON METER combines readings from fuel flow into carburetor and speedometer reading

"Can you imagine how a 20-percent cut in burned gasoline could reduce air pollution?" one camper remarked recently. If a 12,000-mile-per-year driver cuts his gasoline bill by 20 percent, that's a saving of \$80 to \$90—more than enough to pay for the miles-per-gallon meter.

Cars and trucks with automatic transmission stand to benefit as much or more than cars with stick shifts. Trucks with four or more speeds can tailor their driving according to mpg meter indications even more precisely.

To get my gas-saving facts I mounted



FloScan mpg meter monitors fuel flow and speed

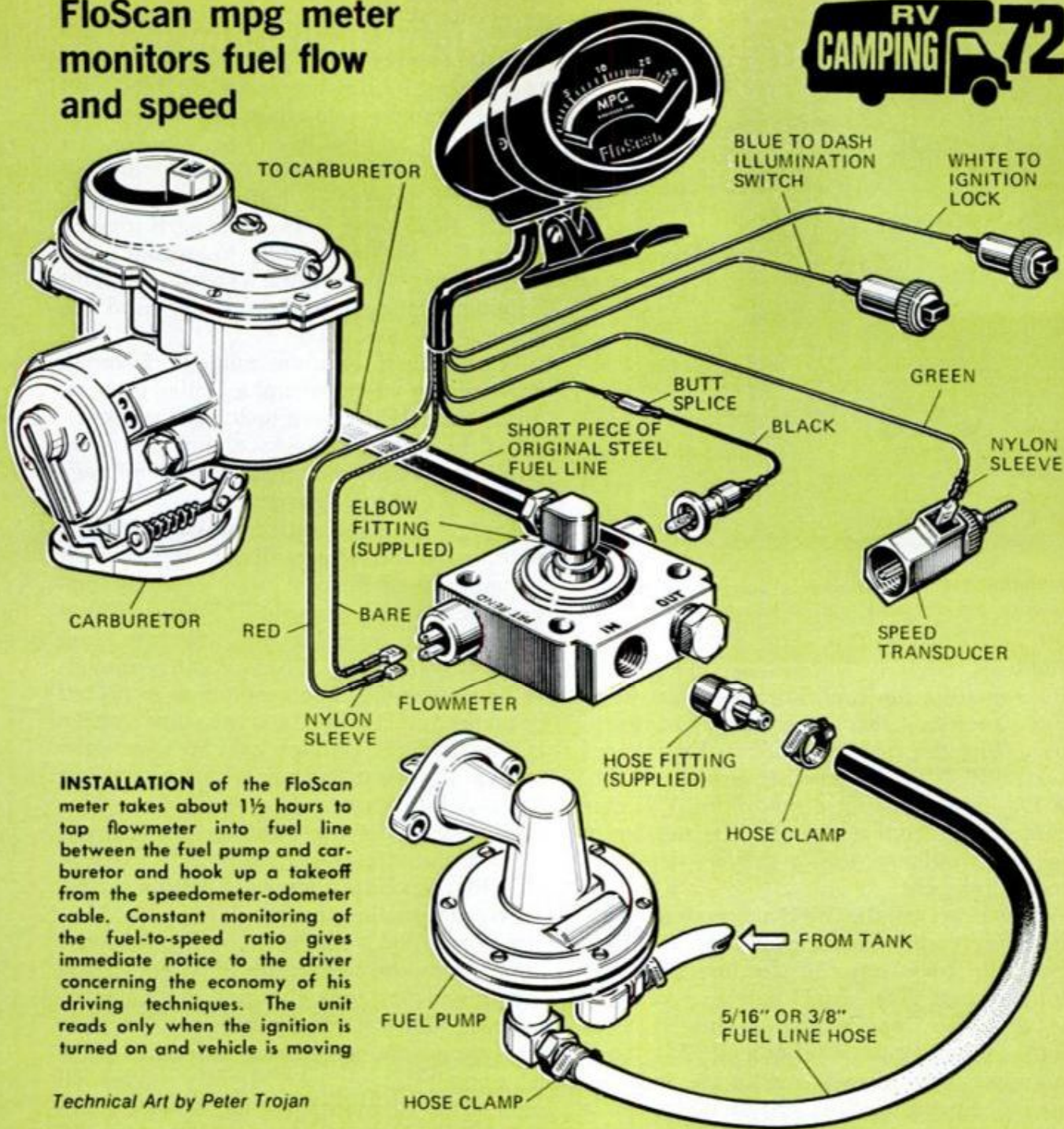

INSTALLATION of the FloScan meter takes about 1½ hours to tap flowmeter into fuel line between the fuel pump and carburetor and hook up a takeoff from the speedometer-odometer cable. Constant monitoring of the fuel-to-speed ratio gives immediate notice to the driver concerning the economy of his driving techniques. The unit reads only when the ignition is turned on and vehicle is moving

Technical Art by Peter Trojan

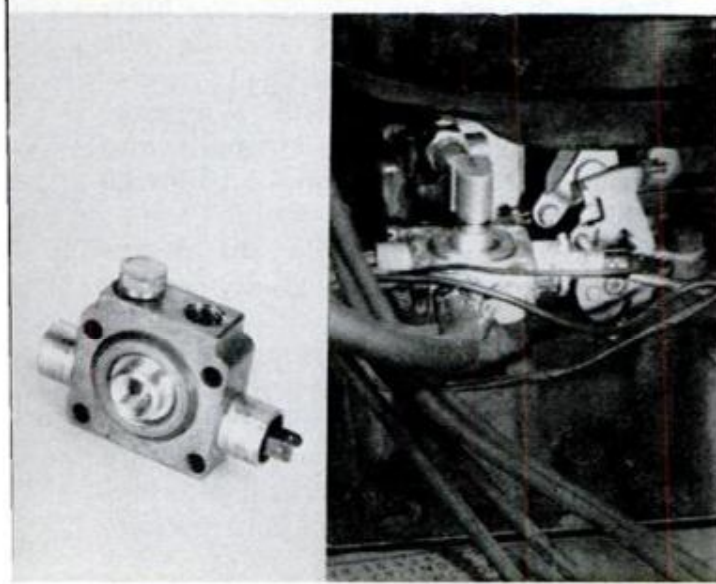

a FloScan Model 10A mpg meter, hooked the fuel-flow meter into the fuel line, and connected the speed sensor to the transmission. Total installation time was about 1½ hours. The FloScan meter operates on a simple concept—convert fuel flow and vehicle speed into electric signals, send them through a solid-state circuit, and present the constantly changing ratio as a single miles-per-gallon indication.

Such meters are not new, but until FloScan devised a low-cost transducer

FLEXIBLE HOSE in fuel line helps keep heat from vaporizing gas to cause bubbles and distort flow



AIRCRAFT-TYPE wind recording gauges showed that velocity can influence gas consumption of RV rigs

FloScan devised a low-cost transducer for signaling the fuel flow, the units were too expensive for the average driver to use. Now the maker, FloScan Instrument Co., 3016 N.E. Blakely St., Seattle, Wash. 98105, is developing a model for VW-size cars where high engine rpm is necessary for good mileage, and a gallons-per-hour meter for boats.

The heart of the FloScan system is its fuel-flow transducer which is installed near the carburetor in the line from the fuel pump. The fuel flow activates a three-blade impeller which interrupts a light signal into a photocell. Photocell impulses vary directly with the impeller speed. Speed signals originate from a switching device inserted between the transmission takeoff and the speedometer cable. The speed sensor fits General Motors, Chrysler and most truck units. An adapter is needed for most Ford and American Motors cars.

Inside the speed sensor is a molded triangular nylon cam that makes and breaks an electrical circuit in direct proportion to the speed. The signals feed directly into the circuitry of the display unit. At idle, there is no speed signal and the mpg reading is 0. When you are coasting with the accelerator pedal at idle, the reading may go the full scale to 50 or 80 miles per gallon, depending on the model.

As I learned from driving tests with the

meter, I found that an increase in gas mileage comes with a slight increase in travel time. Allowing speed to bleed off when climbing a hill cost me in average speed but I learned to compensate for this by approaching the bottom of the hill faster. On one steep hill while towing a trailer at 25 mph I was getting 6 mpg in high. By shifting down to second and maintaining the same speed without lugging, I discovered I had increased the gas mileage to 7 mpg.

Wind affects gasoline mileage, I found, particularly when towing a trailer because of its bulk. No driving technique compensated for wind resistance, but the mpg readings indicated speed for best mileage with and against the wind.

Testing for comparative gas consumption with or without the muffler in the exhaust system, the difference was scarcely noticeable on the Travelall. Neither did a switch from regular to premium fuel change the amount of consumption enough to be noticeable. The result was expected because the Travelall's truck-type engine is designed for regular gas. So save your money if your engine burns regular without knocking.

How does driving strategy affect a car with automatic transmission? I tested a 1970 Plymouth station wagon with a three-speed automatic transmission and a FloScan installed. The main difference apparent was the higher speed at which the maximum mpg was obtained during level running. Engine efficiency was shown to increase as the speed was increased until it topped out at just slightly under 60 mph. The Plymouth owner reported increasing his average gas mileage from 17 to 21 mpg on trips by following the hints we have mentioned. When climbing hills without a trailer, he found that the transmission stayed in high with a mileage drop of 5 mpg. By shifting manually into second when the speed dropped below 20 mph, his gasoline savings doubled.

Average fuel consumption can always be figured as miles traveled divided by gallons consumed after a trip. But these figures do not provide the clues for better RV driving. By seeing the results on your mpg meter, however, while they are happening, you can experiment as I have to bring about immediate and continuous benefits for your driving and your pocket-book.

★★★

\$6,700*

Feature for feature and dollar for dollar, it's your best buy in a low-cost motor home.

Maybe you'll find a motor home with a lower sticker price than Winnebago's new D-18 Brave. But if you do, compare the standard equipment. Then start adding up all the extra money you'd have to spend to bring the other unit up to Winnebago quality.

The new D-18 is compact and easy to drive—at 18'3", it's no longer than a family station wagon. It has a big 318 cu. in. Dodge V-8 engine with power brakes, power steering, automatic transmission and dual rear wheels. It's built with exclusive Thermo-Panel® construction. Yet it's priced at just \$6,700.* And it includes dozens of standard equipment features that are either not available or optional at extra cost on most other low-cost motor homes. Features like water heater and shower, pressurized water system, forced-air furnace, 3-burner stove with oven, 4 cu. ft. gas/electric refrigerator, dual 70 amp. batteries, twin 20-lb. gas bottles and 15 amp. converter.

See the D-18 Brave and 13 other 1972 Winnebago motor home models at your dealer's now. Or write to Winnebago Industries, Inc., P. O. Box 152, Forest City, Iowa 50436. This is the year to find out how much fun you can have when you go the Winnebago route.

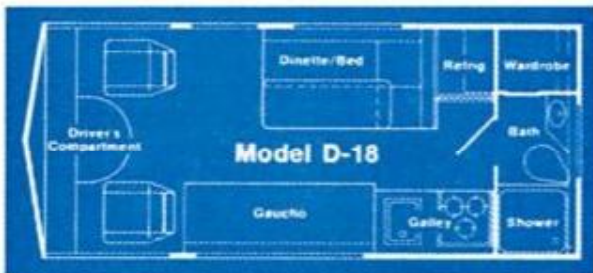

Go the Winnebago route



Winnebago Industries, Inc.
P. O. Box 152
Forest City, Iowa 50436

PX

Hey, Winnebago! Send me the name of my nearest dealer and complete information on all three lines and 14 motor home models for '72.

I'm interested in () buying () renting.

Name _____

Address _____

City _____ State _____ Zip _____

WINNEBAGO®

America's best-selling motor home

*Manufacturer's suggested retail price, F.O.B. Forest City, Iowa. Excluding federal, state, and local taxes, dealer preparation and transportation charges and optional equipment charges if applicable.

You have a lot to choose from



RV
CAMPING 72

WINNEBAGO'S new 18-foot Brave motor home at \$6795 matches rigs with fewer standard features

BOLES AERO widens living area with new Tilt-Out room for 34 and 35-footers, plus sliding glass doors

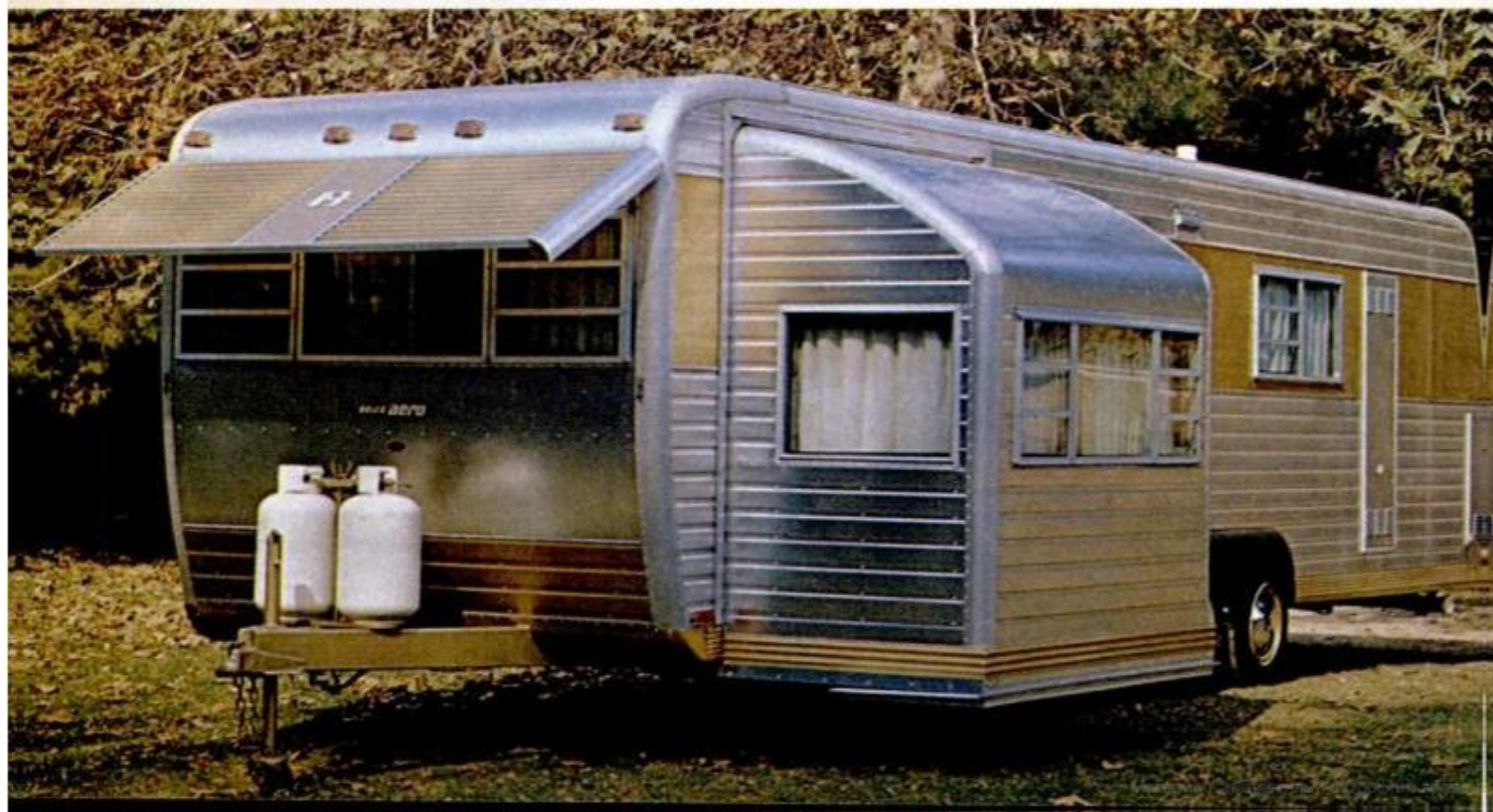

in rolling rigs this summer



SMALLER MINIS, bigger maxis and more for your money in nearly every RV are the trends for the better looking rigs for 1972. Styling outside, planned space inside, plus convenience and carefree performance, are characteristics the shopping buyer or renter can expect to get for his RV vacation.

COACHMAN camper mounted on Dodge pickup (top) offers new styling with option for choice of eight colors

DISCOVERER 25-foot six-sleeper motor home by Rectrans (center, above) rents for about \$300 a week from Avis

SMALL WORLD 16-foot mini-trailer from Apeco (below) sleeps six—or more on an enclosed hinge-down porch



RV
CAMPING 72



Mini-trailers

Compact rigs for compact cars and families are another new trailer trend for budgeteers



SMALL WORLD, from Apeco, is 16-foot space capsule with panoramic window, drop-leaf back porch (above)



TRAILERS STARTED SMALL, grew big, and are available again this year back down in midget models any car can tow. Tiny rigs like the \$975 Serro Scotty 13-footer have new competition. Starcraft, Kayot, Winnebago, Sprite, Blazon, Swinger, Compact Jr., Wheelcamper, and Midas and Boise Cascade divisions are among larger companies turning out trailers 18 feet overall or less. Some are low enough to fit your garage. Others telescope or fold for easy towing and stowing. Units like the new solid-state Apaches and Retractable-Wall Rolites offer tent-camper tow dimensions and travel-trailer walls. ★★

AMERIGO FG-16 packs into 16 feet bunks for four, enclosed toilet, refrigerator, two-burner stove, furnace



BOLER AMERICAN sleeps four in only 13 feet overall, with room left for table, icebox, stove, dinette, clothes closet

ROLITE, by Larson, opens by pushbutton from tent-camper profile to solid-wall trailer through use of Retractable-Walls

POPULAR MECHANICS

PALL MALL GOLD 100's Yes, longer yet milder.

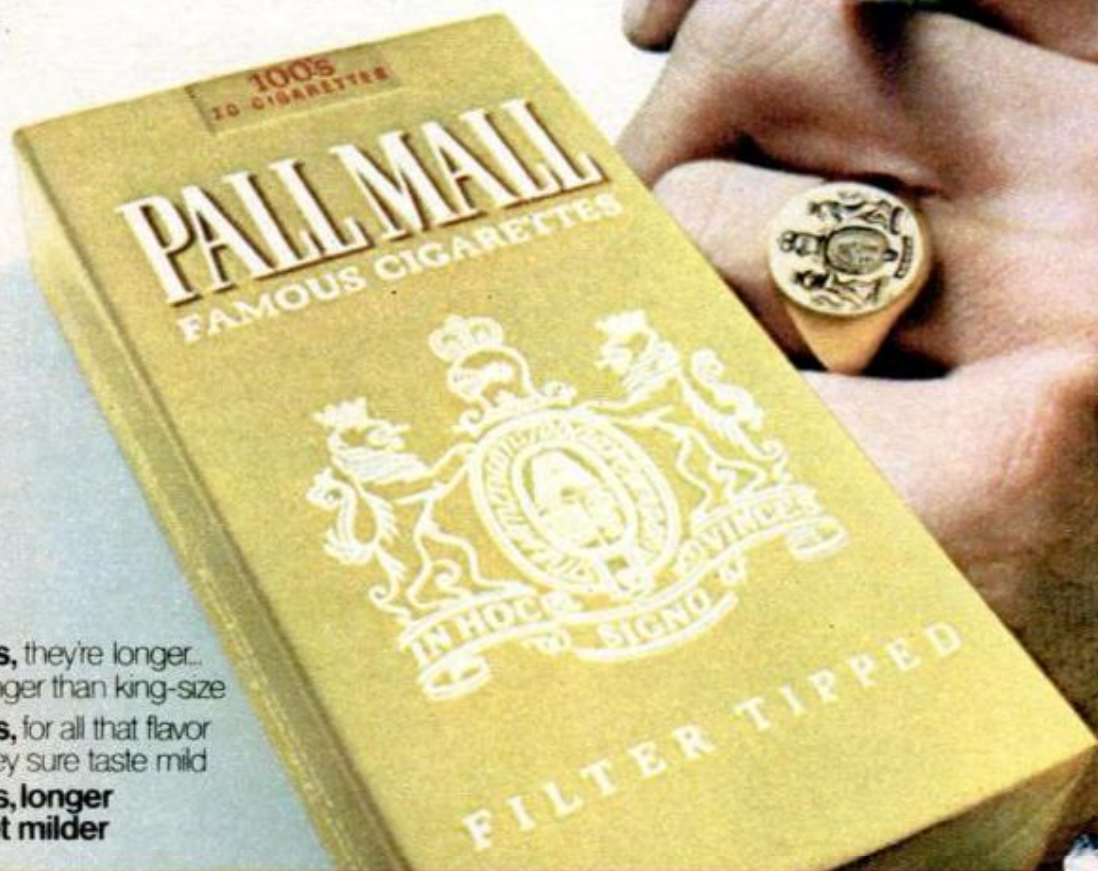

Yes, they're longer...
longer than king-size

Yes, for all that flavor
they sure taste mild

Yes, longer
yet milder

Also first class flavor in a filter king
New Pall Mall Filter King



Gold 100's.
19 mg. "tar", 1.3 mg. nicotine av. per cigarette. FTC Report AUG. '71.

20 mg. "tar", 1.4 mg. nicotine av. per cigarette by FTC method.

Mini-motor homes



Chopped vans put it all together for budget motor-homers

SHASTA is typical of new trend: has beds for six in 17-foot length



VAN-A-HOME from Harvest Coach stretches 20-foot, \$8495 unit to provide rear door, four separate beds

RV BUILDERS used to take vans and panel trucks, torch or sheer off the body behind the cab and permanently mount a pickup-type camper body. Now cab-equipped chassis are supplied by major carmakers ready for camper companies to bolt on a chassis-mounted body. "Mini-motor home" is the popular name for this new RV favorite. Such units, an outgrowth of camper vans, cost thousands less than the bigger \$10,000 to \$30,000 motor homes, still must vie with inexpensive models like Winnebago's \$6,795 18-foot Brave. Minis range from under \$5000, through pop-top and fiberglass expansions like Minihome, to the rolling homes shown here. ★★★



MINIHOME, a raised-roof van conversion from Motor Homes, Lora-in, Ohio, adds chopped-van model on Ford chassis for more room on same wheelbase

DIAMOND MINI-HOME, new unit from Coons Co., Oswego, Kans., is 19 feet long, has enclosed shower



MONITOR MINI-MOTOR HOME 19-footer, smallest in a line of seven, has luxury styling, fixtures



POPULAR MECHANICS



A better idea for
safety: Buckle up.

Works like a truck.

Ford pickups ride like no other pickup because no other pickup has Twin-I-Beam suspension. Each front wheel has a forged steel I-beam axle that works independently to step over bumps. Steering is responsive. Cornering is flat. And there is practically no nosedive when braking. In the rear, a unique leafspring suspension is offered that automatically adjusts spring stiffness to load conditions.

Rides like a car.

And loads are what Fords thrive on—92 out of every 100 Ford trucks sold in the past 12 years are still on the job. Get a fully detailed catalog as well as a revealing test drive at your Ford Dealer's.



FORD PICKUPS



Fifth-wheel trailers

Are five wheels better than two?



COBRA'S FIFTH WHEEL, the latest addition to their extensive line, is \$7500, has a 6½-foot headroom and includes a four-burner stove, bathtub and shower and many accessories as part of standard equipment

TWENTY-FOUR companies now build fifth-wheel rigs—a year ago there were four—indicating the popularity of the trailer that hooks up to the cargo bed of a pickup truck. A hitch like the connection used by tractor-trailer trucks is mounted in the truck bed. Heavier tongue weights, towing ease and stability and two-minute hookups are some advantages. Passengers can ride legally in this trailer in most states. Units are 19 to 35 feet long;

special low-profile designs are produced for Ranchero and El Camino pickups. One major builder, Wheelcamper, makes Truk Traveler trailers in 27 models. Most units have luxury camp accommodations in side, split-level layouts, stairway to a balcony bedroom. ★★



KAYOT Royal Traveler is also a two-bedroom luxury unit offering uncrowded living in a 24-foot length

SHADOW, with hitch on car roof, allows vehicle towing to completely reverse and push-park rig



POPULAR MECHANICS

Take this \$3.49 book FREE!

Let these 257 experts show you how to attain the skills of a real pro!

You get this giant 8¼" x 11" illustrated volume of exciting "how-to" projects for your family, home, garden, car, boat, vacation—as an outright gift—nothing to buy. It is crammed with reliable shop-tested, do-it-yourself techniques and practical show-how pictures. Use these hundreds of do-it-yourself plans, projects, tips and hints to polish your own shopwork and hobby skills! Here is a brief glimpse of all your FREE Volume brings:

- Having car engine trouble? Fix 8 common problems quickly without having to pay a garage mechanic anything he chooses to charge you.
- Professional tips for expert sanding show how to bring out the best finish in woods and metals with power and hand tools.
- Complete plans help you build an inexpensive 3 x 4 foot plywood table to give any small band saw big-machine capacity and flexibility.
- Need extra space? Turn an unfinished attic or basement into handsome, usable areas with practical, money-saving plans.
- Save on band saw blade costs. Build brazing fixture to make your own blades.
- Do your own auto body repair expertly with simple tools and methods.
- Build a boat designed just for fun. Step-by-step plans and materials list included.
- Home too hot for comfort? Follow complete directions for air conditioning your home.



• Bothered by a wet basement? Cure it yourself and save \$200 to \$2,000 under what professionals charge.

- Need better burglar protection? Build effective power alarm for a safer home.
- Refinish furniture perfectly. Hands-at-work pictures show you how.
- You'll wonder how you ever got along without an air supply in your shop once you've built and used the "foot-bellows" system.
- Build a gas-fired barbecue for more back-yard fun.
- New soundproofing techniques enable you to relax in quiet.
- Anyone can hand-letter signs with the "Project-A-Plan" method.
- Special trouble-shooting chart pin points malfunctions in an auto electrical system so you can fix it quickly.
- Target practice in the living room? Believe it or not you can blast away indoors without harming anything.
- Build your children model planes that fly higher than any others.
- Special tricks-of-the-trade save you time and effort in handling power tools.
- Save hundreds of dollars on buying and servicing appliances. Plus hundreds of other exciting plans and do-it-yourself ideas to save you big money and add thousands of hours of pleasure to your hobby, sport and vacation projects.

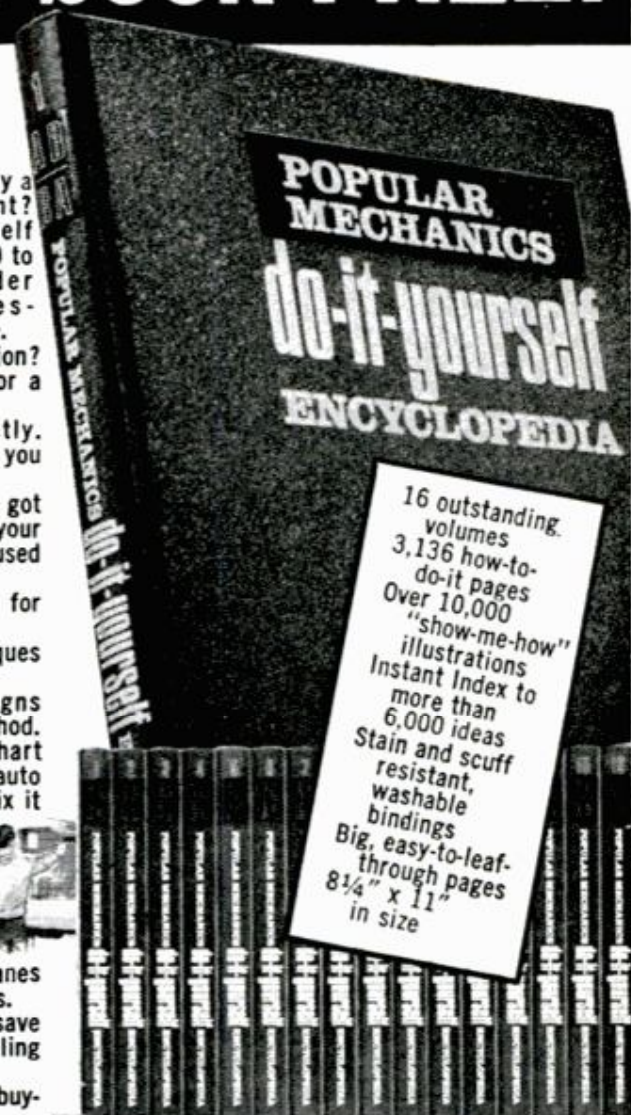

16 outstanding volumes
3,136 how-to-do-it pages
Over 10,000 "show-me-how" illustrations
Instant Index to more than 6,000 ideas
Stain and scuff resistant, washable bindings
Big, easy-to-leaf-through pages
8¼" x 11" in size

Why you receive this practical do-it-yourself handbook ABSOLUTELY FREE!

The reason you get this brand-new \$3.49 book as an outright gift is simple. This gold mine of "how-to" projects and money-saving plans is the first volume in POPULAR MECHANICS DO-IT-YOURSELF ENCYCLOPEDIA—an amazingly useful guide created by the editors of *Popular Mechanics*—experts in do-it-yourself techniques for over 65 years. The Encyclopedia gives you over 6,000 projects, repairs and improvements you can do by yourself to save hundreds of dollars on labor and materials. 257 experts lead you through every step of every project you select. They give you thousands of practical pointers to sharpen your skills in carpentry, car repair, metalwork, plumbing, masonry, electrical work, electronics, hi-fi, stereo, painting and decorating.

We believe that if you browse through the first volume—select a plan or project—use it at your workbench—try some of the money-saving shortcuts, shop-tested methods—you will be anxious to receive the others. Therefore, you may enjoy future volumes as they are published for 14 days' FREE EXAMINATION. You may buy one, two, the whole set, or none at all. But the first volume is yours to keep without obligation, no matter what you decide. Mail coupon today, to be sure of getting your FREE Volume.

FREE GIFT CERTIFICATE

Popular Mechanics Book Division, Dept. D015
250 West 55th St., New York, N.Y. 10017

This certificate entitles you to a free gift—Vol. 1 of the 16-vol. POPULAR MECHANICS DO-IT-YOURSELF ENCYCLOPEDIA, with no obligation to buy anything ever.

As a subscriber in good standing, you'll enjoy free examination of the additional volumes. In about 6 weeks we'll send you Vol. 2, and 4 weeks later Vol. 3. After that, at approximately monthly intervals, we'll send you shipments of Vols. 4-6, 7-9, and 10-16. Also, you'll receive annual supplementary volumes as they are published on free 14-day approval with no purchase obligation. This way you'll be able to complete the set in 6 months, and keep it up-to-date. You may return any volume within 14 days for full credit, and you may cancel at any time. Take as many volumes as you like—or none at all. For each volume you keep, you'll be billed just \$3.49 plus postage and handling. But you need never pay for more than 1 volume per month no matter how many you have received. There is no charge for this extended payment service.

Name _____
(Please Print)

Address _____

City _____

State _____ Zip _____

Signature _____

This offer available in Canada at a slightly higher price. Canadian residents mail coupon to New York address. Shipment of books and all services will be handled within Canada.



REAR SPEAKERS are mounted in the underside of overhead cupboards running across back end of vehicle. Though facing downward, they radiate sound in all directions to give rich, room-filling music that seems to come from everywhere. At top of the page is Craig installation kit consisting of a quadraphonic cartridge player, four speakers and connecting cables for \$154.95

You can have music

New quadraphonic tape players provide glorious four-dimensional sound for a small motor home

By **SHELDON M. GALLAGER**

THERE'S NO REASON a home-on-wheels can't sound just as good inside as a home without wheels. If you enjoy on-the-road hi-fi, you'll enjoy it even more with a four-speaker setup that creates an uncanny illusion of living-room spaciousness in the small interior of a motor home, pickup camper or camper van. While any car tape player can be hooked up to four speakers, the ideal answer is one of the new quadraphonic units that provide four separate channels of sound. These four channels, each feeding its own speaker, surround you with music from all sides so you feel like you're sitting in the middle of a rolling concert hall.

The arrangement shown here is based on Craig's Model 3129 quadraphonic player, one of the first of its kind on the market. It not only plays the new four-channel Quad-8 cartridge tapes, but will also handle standard two-channel 8-track stereo tapes. Installing quad sound in a motor home is simple because there's usually a bunk bed extending out over the cab. The hollow bunk floor makes it easy to hide wires and make connections. Since most motor homes have a switched

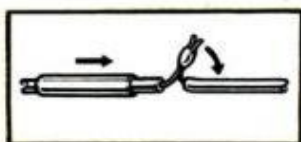
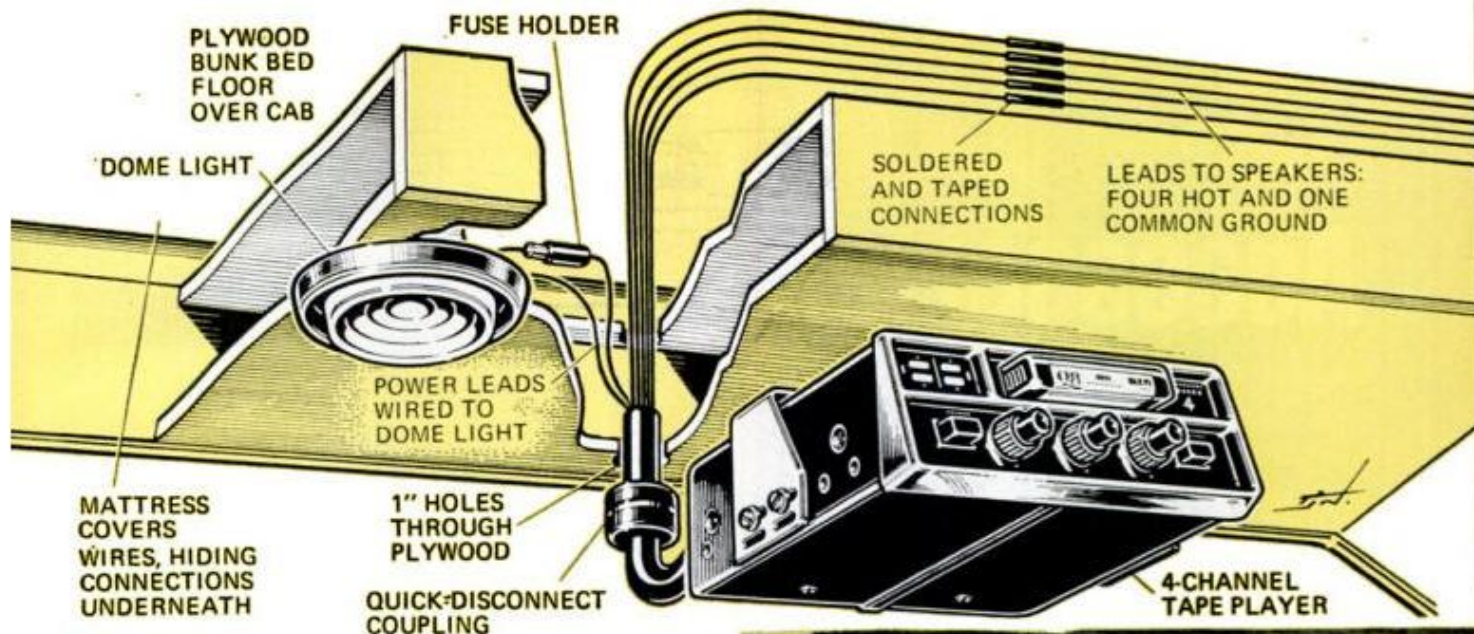

CONNECTION DETAIL:
TWIST WIRES, SOLDER
AND WRAP WITH TAPE

wherever you go

dome light in the cab roof, you can wire your power leads directly to this without affecting the operation of the light itself, as shown in the drawing above. If there's no dome light or if the light is switched from the dash, then it's necessary to run your power leads down to the fuse block or ignition terminals to tap into the vehicle's 12-volt system.

A handy location for the player itself is up under the cab roof. This puts it waist-high for easy operation from the living area in the rear and at the same time makes it readily accessible to riders up front. The bulkheads that typically separate cab from living quarters are ideal for mounting the two left and right front speakers so they face rearward. The two left and right rear speakers can be recessed into cupboards or other enclosures at the back of the vehicle. The Craig player sells for \$154.95, including four trim-looking speakers and a color-coded wiring harness that simplifies hookup. Further information can be obtained from Craig Corp., 921 West Artesia Blvd., Compton, Calif. 90220. ★★★

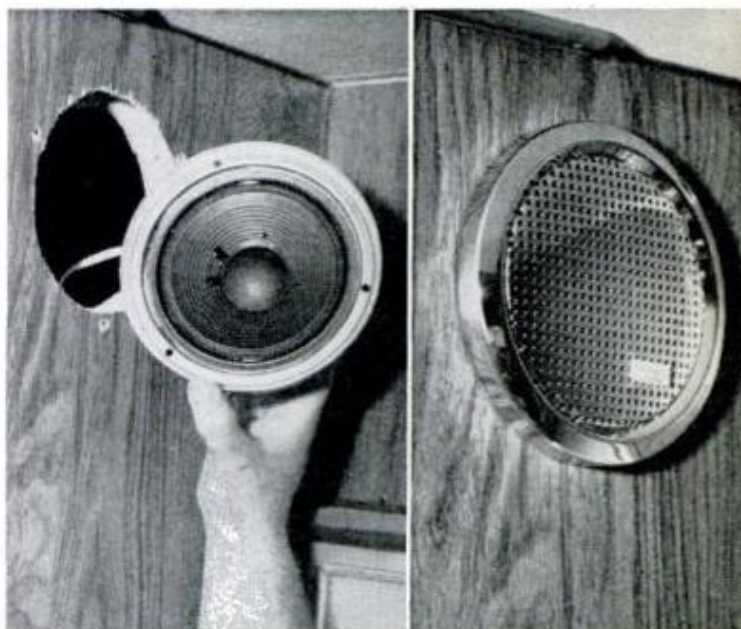
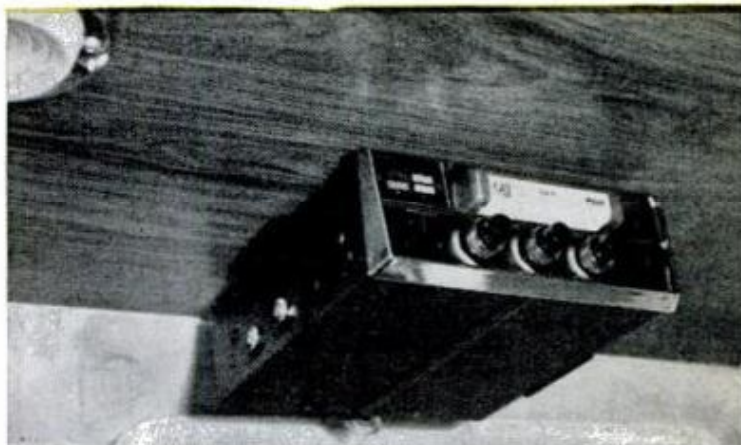

SPEAKERS ARE EASILY INSTALLED in partitions or other surfaces because they require only rough-cut circular opening made with a keyhole or sabre saw (left, above). Flange of speaker conceals opening and is held in place by three screws. A snap-on chrome grille completes the job (right, above) to give a neat, professional look. Player mounts under cab roof, as shown in photo and drawing at top. You'll find seven wires coming from player—five for speaker connections, two for hookup to power

Accessories

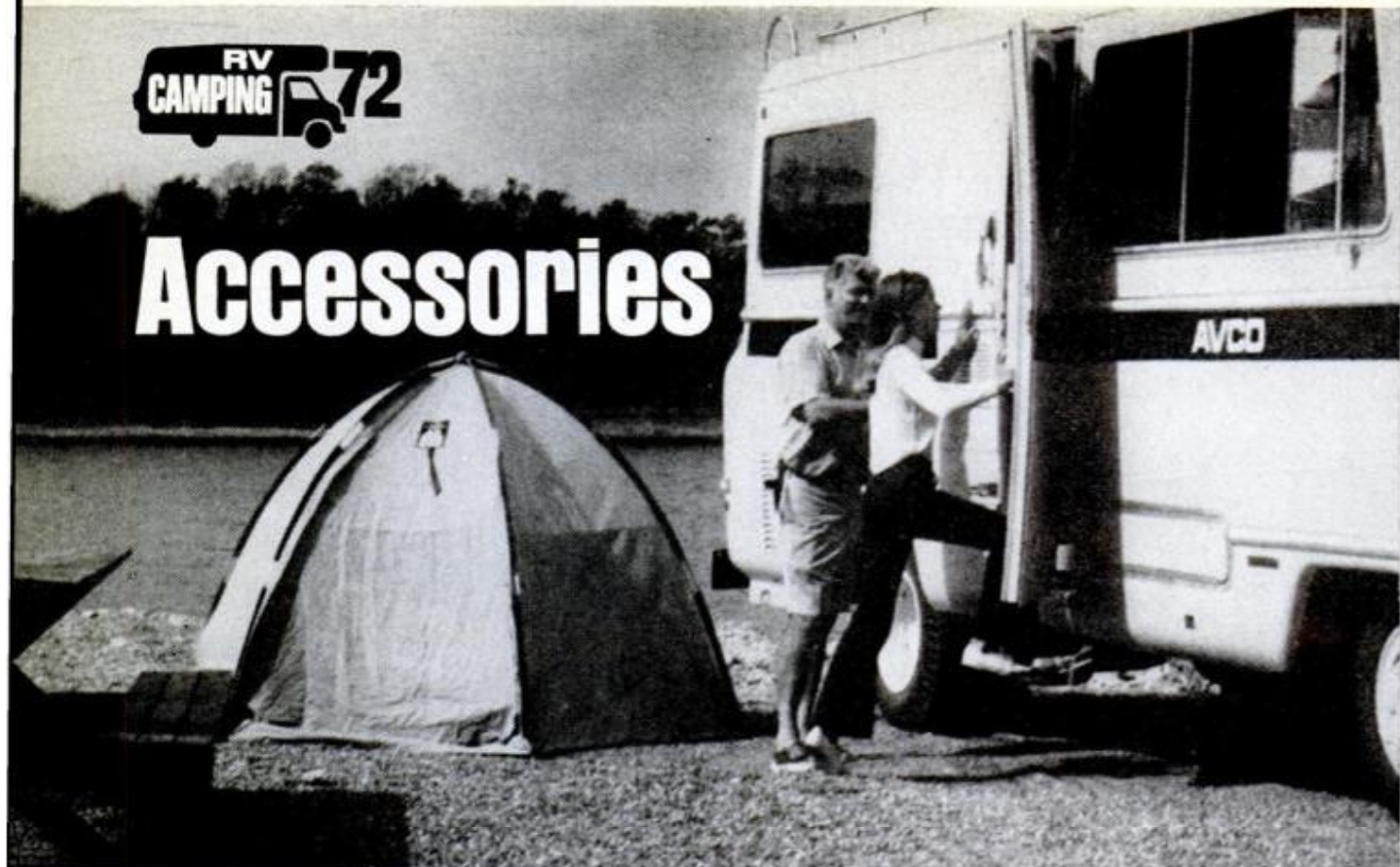

CLOTHESLINE for the camper pulls out of spring-wound reel to dry 15 feet of swim suits or laundry, or can support awning. Rig is \$10. Martin Reel, Mohawk, N.Y.

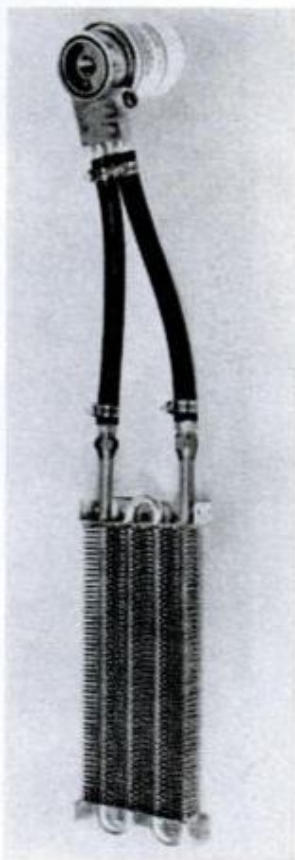

OIL COOLER unit that RV owner can install for under \$100 is by Thermo-Chem, Tulsa, Okla. 74135. Model 500 has bypass valve for cold starts, installs at oil filter.

THERMOS POP-TENTS, old camping favorites, have RV uses as campsite savers and spare rooms for juniors. Seven or 9-foot model sets up in two minutes, can hold a parking spot while storing gear when motor homer is away

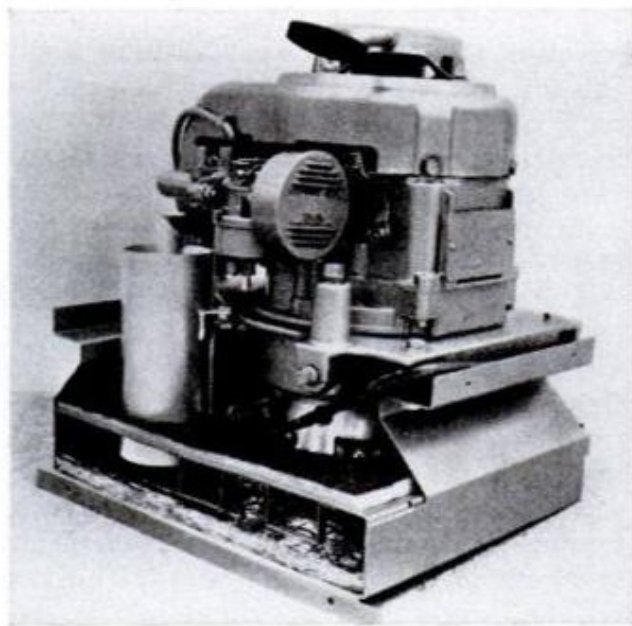

NEW ONAN BATTERY CHARGER runs on LP gas, is 300-watt d.c. unit said to charge RV battery in one to three hours at 15-20 amps. It has remote electric start (plus rope-recoil starter if battery is low), can run 22 hours on 20-pound propane bottle, weighs 90 pounds and fits in 15x16x13-inch space. Made by Onan, 1400 73rd Ave. N.E., Minneapolis, Minn.



Fabulous *Folbot* Holidays

Pictures show our home assembled Super Folbot.

Now, we marvel at her beautiful shape, the slim and trim lines, the accurate symmetry of this perfectly harmonious design, further enhanced by its colorful and tastily textured hull and deck of ELASTIC FIBER-PLASTIC. Our good neighbors and friends all shared in admiration.

The assembly was easy indeed. Quite an assortment of pre-fabricated sections, parts and frames arrived in cartons with numerous containers, and a multitude of fasteners, fittings, metal shapes, special cement, compounds, undercoating and valuable resin varnish; in fact everything from the first brass screw to the name plate, as the last. We fastened the instruction sheet on our garage wall for easy follow-through. Every step is described and pictured, which made it a cinch to proceed. In spite of expected 'bugs', there were none. With eager helpers, my wife and her visiting little brother, we had the framework up in four hours. Then we allowed a break to extoll about shape and lines of our handiwork.

We installed the double hull fabrics and decking, and ended up with a smoothly fitting job. Of course, all outside surfaces are already supplied with a substantial and beautiful VINYL coating, which provides this excellent and elegant Folbot



WORLD RECORD FISHING

Champion reports: "Caught more Tarpon because my Folbot skims over water Fast & QUIET, easily tows Tarpon and Shark for hours and SAFELY ashore, which revolutionizes fishing entirely."



WALLY TABER of High Adventure

"Folbated hundreds of miles between Ocean & Mountains. From Folbot took snook, porgo, pompano etc. Shot doves, pheasants, ducks and my Folbot performed PERFECTLY, really magnificent"

Indispensable for CAREFREE Nature Study, observation of fascinating Wildlife and EXCELLENT photography. Essential to ecology minded and educated folks, who prefer the natural glory of primeval surroundings. Efficient Folbots, featherweight paddles, dacron sailrigs, without mechanical upkeep are INEXPENSIVE to maintain. From 1 to 4 seaters in desired colors or camouflage, either FOLDING type or PORTABLE cartop are SENSIBLY priced from \$65 up with terms to suit, in PREFAB Kits for Fun at Home assembly or Factory Finished ready to go. IMPORTANT literature with colorful plates, action catalog, startling facts and figures mailed FREE without sales agents to rush you.

Most educational hobby saves bulk of labor cost and half your money

Counting everybody's time, a most enjoyable and relaxing pastime it was, it took from the prefab cartons to the BEAUTY on the lawn some 53 hours. If we value our leisure time at two dollars per hour, we SAVED over a hundred dollars this way, and would not want to miss this fun even without a saving. It all started a few months ago, when I was tired of repairing and attending to our motor boat, which took most of my free time. We also desired a more rewarding and sensible recreation, rather than constant noise and vibration of a motorised boat. We love to explore new environments and learned that folboting offers inexpensive, independent cruising on charming waterways at a reasonable pace. We have dozens of clean rivers for exploration, a moderate surf and sea, as well as lovely lakes and connecting canals. All of these we will cruise, explore and absorb over many years in our new Folbot. Only a few times out, we already realized the difference and many advantages. In the motorboat, we could never converse quietly and had to raise voices under strain; the motorboat hopped over waves and wakes, which hardly was restful. In our Folbot we relax in deepseated, cushion supported seats with swivel backs, equal to bucket seats or easy chairs. Alternating from gentle paddling to just floating and observing the scenery glide by, we are in love with our new-found way of boating. My wife and I can readily load this Folbot on our sport car with cartop rack. Every free day off, shows us a different surrounding. We bring home unusual photos, and capture nature's best

You missed it long enough .. get your Folbot now!

FREE third class mail takes 2 to 4 weeks. For INSTANT first class mail include \$1, for Airmail \$1.50. Mail coupon or address to: Folbot Corp. Stark Industrial Park, PM 572, Charleston, S. C. 29405.

NAME _____
 ADDRESS _____
 CITY _____
 STATE _____ ZIP CODE _____

RV ACCESSORIES

(Continued from page 182)



RV WINDOWS said to take a do-it-yourselfer armed with a screwdriver and sabre saw just 20 minutes each to install are available from Meksol Co., 865 17th St., Costa Mesa, Calif. 92627. They come with locks; clear, tinted or bronze safety glass and removable screens.

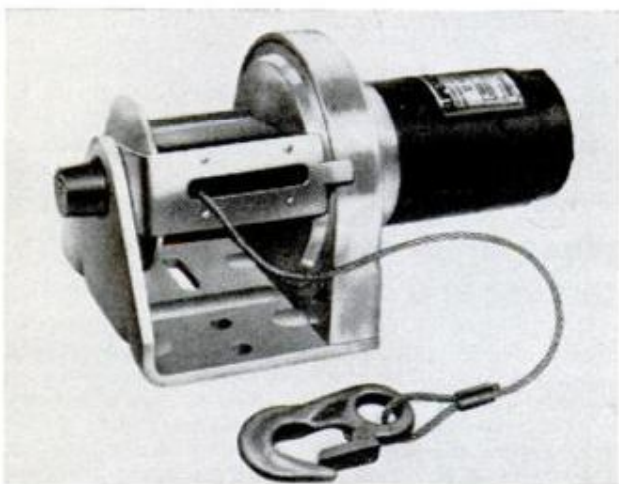

RV WINCH with useful camp accessories is offered by Superwinch, Inc., Pomfret, Conn. 06258. The 12-volt \$80 model mounts permanently or bolts to bracket fitting trailer-hitch ball. Switch can be lanyard-controlled or mounted on dash with accessory bracket.



LEVELING TRAILER without leaving driver's seat is possible with \$13 level from Tamarack Engineering, 9050 S.E. 137th Ave., Portland, Ore. 97236. Mounted in front, level is easy to see in mirror. Second unit gives correct position while tongue jack is cranked.



MOBILINK is a pickup camper intercom the RV owner can build and install himself. One unit mounted in pickup cab lets driver and front passengers talk with camper occupants or monitor youngsters riding in rear. Heathkit, Benton Harbor, Mich., makes \$26 kit.

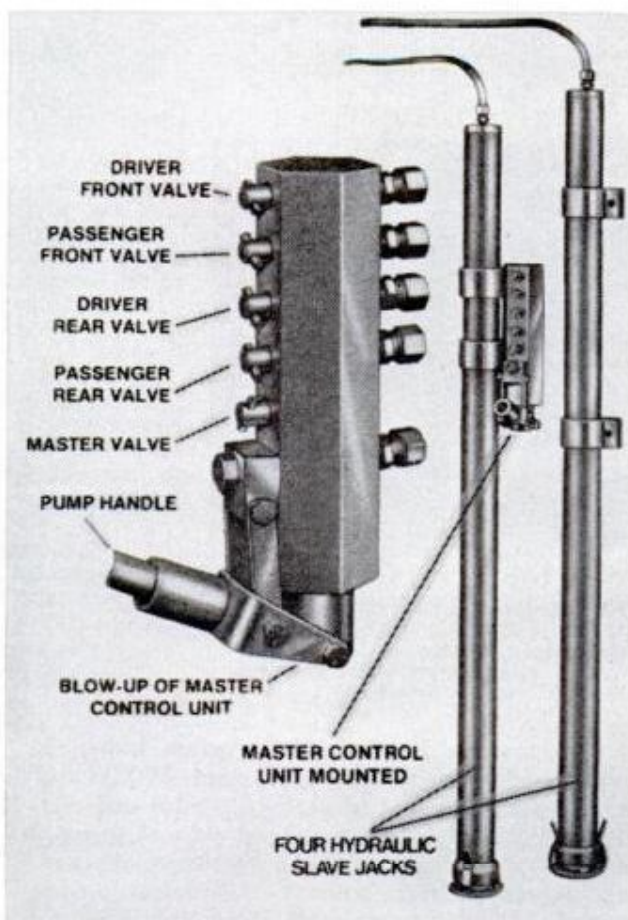

HYDRA-STAR MASTER CONTROL uses four jacks, one at each corner, to level, raise, lower or even lift off camper from pickup. All adjustments made from one position. Hellstar Corp., 1600 North Chestnut, Wahoo, Neb. 68066, makes \$220 system owner can install.

"How can a garden tractor that looks so good be so tough?"



Here's how:

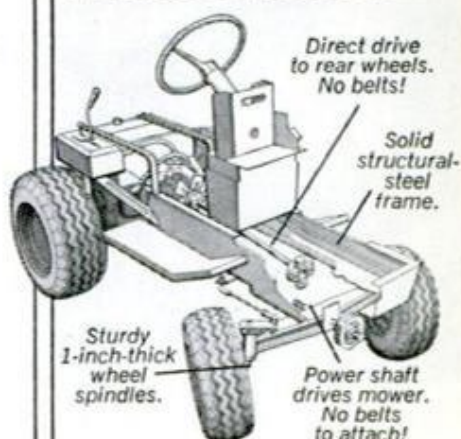

The heavy-duty frame isn't afraid of hard work. Old-fashioned belts have gone the way of rumble seats; a direct-drive power train brings power to rear wheels. A power-take-off shaft replaces belt connections for attachments—makes hookup surprisingly simple. A favorite feature of the mower: you drive the tractor up and over it to position it underneath for installation—no more struggling to shove the mower under!

Want more? The tilt-away steering wheel lets you step aboard without acrobatics . . . the hydrostatic transmission makes you an instant expert (one handle controls forward, reverse, stopping) . . . swing-up hood and rear deck expose major service areas.

A word from the sponsor. New Holland is a Division of Sperry Rand Corporation. In addition, farmers have made us the country's leading manufacturer of specialized agricultural equipment. Both good references!

For the name of the New Holland dealer nearest you, phone toll free 800/631-1972. (In New Jersey, 800/962-2803.)



The garden tractor that thinks it's a sports car!

NEW HOLLAND

 SPERRY RAND

14-hp. (shown) and 12-hp. models available with wide range of attachments: 48-inch mower, snow-thrower, tiller, 2-wheel dump trailer, dozer blade and more. New 8-hp. compact garden tractor also available.

RV ACCESSORIES

(Continued from page 184)

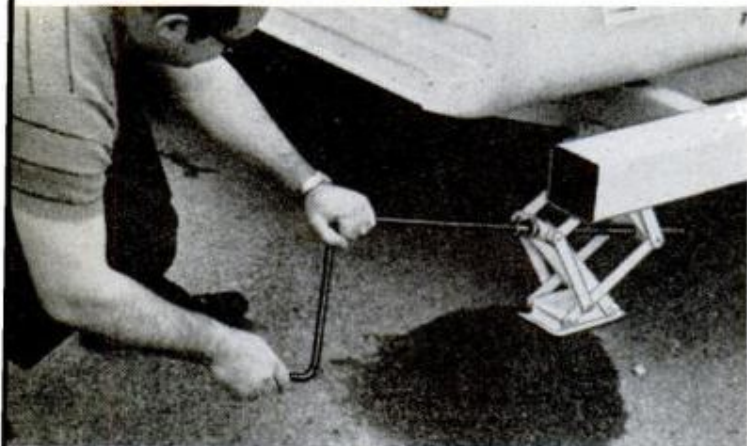

STABILIZERS for permanent mounting by bolting or welding to corners of RV are four for \$56 or two for \$30 from Trail-Line Products, 2479 Second St., Cuyahoga Falls, Ohio 44221.



MOTOR CAMPERS having no inside shower can carry this \$65 Suitcase Shower. Battery-powered 15-pound unit comes with curtain; water drains in disposable plastic bag. Mahar, 241 S.W. 21st Terrace, Fort Lauderdale, Fla.

OFF-THE-ROAD vehicles like this Bronco can benefit from front and rear-mounted winches. Rig can lift itself for servicing, winch out of ditch, haul a vehicle in trouble back on the trail. Superwinch units of graduated capacities cost up to \$160 for 12-volt models. Blocks and twin mounts boost strength.

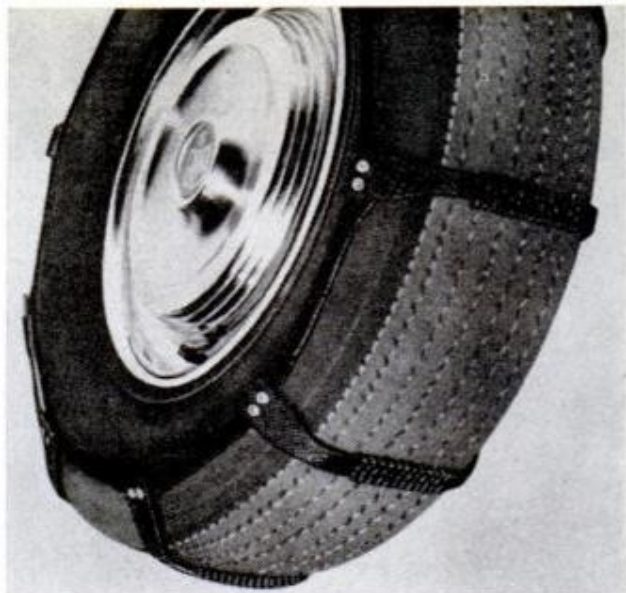

BETTER TRACTION than snow tires is claim of Detwiler Corp., 36 New York Ave., Westbury, N.Y. 11590, for Snow-Treds. Bands reported easier to mount than chains can be driven on clear pavement. Two-tire set is \$24.



PANASONIC Model CX 601 offers four-channel sound for RVs and can be converted to home use. One of the new players for automotive mountings, unit can use speakers shown in a motor home for new high in highway luxury.



POPULAR MECHANICS

Материал, защищенный авторским правом

Do-It-Yourself Siding



Learn how you can earn up to \$1000.00 for a single order showing our quality aluminum, steel, and vinyl siding on your home. Small investment required for your own siding. No further investment. Mail coupon for free information without obligation.

ALUMINUM INDUSTRIES
of ARKANSAS, Dept. P-52
Little Rock, Arkansas 72205

Please send me free information concerning your quality do-it-yourself kits.

name _____

street _____

city _____ state _____ zip _____



BUILD THESE BEAUTIFUL CLOCKS

NOW AT BIG SAVINGS!

Send just \$1 for plans & instructions to build choice of: (A) Grandfather, (B) Steeple, (C) Grandmother—plus information-packed catalog of movements, dials, parts & kits to build these & 16 other fine clocks. All 3 plans—\$2.50. Catalog alone—25¢.

MASON & SULLIVAN COMPANY
Dept. PM5, Osterville, Mass. 02655



PUMP DRAINS pools, cellars, laundry tubs
IRRIGATES — CIRCULATES — SPRAYS

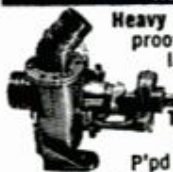

Heavy duty ball bearing pump. All metal, rust-proof Type XB. Stainless shaft. Use ¼ HP or larger. 1 HP 1,200 GPH 60' high or 3,000 GPH 25' well. 5,200 GPH max. 1¼" in; 1" out. Belt or direct drive. \$13.95
Type P won't rust or clog. Bronze bearing. To 2,400 GPH. 1" in; ¾" out. \$9.95
P'd cash with order. Money back Guarantee.

LABAWCO, Box 40, Belle Mead, N.J. 08502



HEAVY DUTY WELDER

with special \$7.00 gift offer to
Popular Mechanics readers
10-DAY FREE TRIAL
Lifetime Guarantee

Brand New **1895**
1972 Model **1895** POST PAID

Fits ordinary 110V outlet
Not one • but 3 welding heats



Weld, braze, solder or cut most anything made of metal. No experience necessary. Follow simple instructions to make repairs on cars, trailers, farm and lawn equipment, bicycles, appliances, etc. Make campers, boats, furniture, hundreds of valuable items. **NOTHING ELSE TO BUY!** Comes complete with full face shield, pack of welding and brazing rods, heavy duty power cables, special electric torch attachment, ground clamp, flux, easy-to-follow illustrated instructions, rod holder, etc. Uses standard ¼" rods to weld iron, steel, brass, bronze, aluminum, other metals. New improved HEAVY DUTY circuit gives more welding power. Gives 4 times the heat needed to melt toughest iron. Plugs into ordinary 110V outlet. **3 WELDING HEATS . . .** Not just one as with other low cost models. Use "high" for tough jobs "medium" or "regular" for lighter work. This important feature saves you money and time. Makes it possible for even beginners to start welding professionally the very first day. Pays for itself quickly. An excellent gift for any occasion. **IT'S AUTOMATIC:** Current is turned ON when arc is struck, OFF when rod is lifted from work. Eliminates need for troublesome foot switch. Speeds up work.

FREE!

Mention that you saw this ad in Popular Mechanics and receive a \$7.00 gift pack assortment of "touch weld" welding rods. Automatic arc striker. Weld with "push button" ease.
10 day MONEY BACK GUARANTEE. You must be satisfied or return for refund. Send only \$2.00 and pay postman \$16.95 plus postage when delivered or send \$13.95 cash, check or money order for immediate postpaid shipment.

WEL-DEX MFG. CO., Dept. W-203, Box 10776, Houston, Texas 77018

JUST OUT! POPULAR MECHANICS INDEX AND SHELF WRAPPER

HERE'S A GREAT IDEA THAT WILL MULTIPLY THE VALUE OF YOUR BACK ISSUES OF PM.

Want to find an article on roofing your home? Building a hacksaw or mini-bike? What the owners themselves think of the Buick Opel? Your copies of PM are chockfull of such information. The new PM INDEX AND SHELF WRAPPER solves your problems. Thousands of items that appear in PM throughout the year are not only referenced, but thoroughly cross-referenced as well. Best of all, the INDEX is bound into a handsome wrapper made of heavy board. The wrapper precisely encloses the 12 issues in the INDEX, and makes a beautiful and useful addition to your bookshelves. The entire handsome package is yours for only \$1.49. Send orders to: POPULAR MECHANICS

Dept. IX 224 W. 57th St., New York, N.Y. 10019.



A machine famous for not breaking down.



1972 Maverick 2-door Sedan shown with optional Accent and Protection Groups, white sidewall tires and tinted glass.

Seems like most machines you buy today end up costing you more money just to keep them running. That's what makes

Ford Maverick so exceptional. Maverick is a simple, uncomplicated machine—

so there's less chance of *anything* going wrong. What's

more, a good-looking, family-sized Maverick

can be yours for surprisingly little money. Standard 6 or optional V-8. 2-door, 4-door or sporty Grabber.

FORD MAVERICK

FORD DIVISION 

**If reliability
is important to you.**

SATELLITES

(Continued from page 50C)

to Spain had to be radioed over the Andes and Caribbean to Florida, then traveled via land line to New York, across the Atlantic by cable, and over telephone wires through Europe to Madrid. Provided the Atlantic cable was not broken by undersea stresses or cut by fishing trawlers, or the radio signals were not disrupted by electrical storms, ionospheric disturbances or sun spots, the Chilean caller could expect to carry on a shouted, garbled conversation with Spain three days later.

Today, however, a Santiagan can pick up his telephone, give the operator the Madrid number, and speak to his party within two or three minutes, through space, in normal conversational tones. A few years hence, satellite communicators tell us, he may not need to bother the operator. He will simply dial the number and be talking to Spain—or Senegal or Turkey, for that matter—within seconds. Every telephone will be automatically connected to every other telephone on Earth.

Matching the increase in speed and quality of communication has been the dramatic reduction in rates. So much cheaper, per circuit, are satellites to build and maintain than cables and land lines, that international telephone charges have plummeted 80 percent in six years—and when the system is fully developed you may be able to call any city in the world for the price of the change in your pocket.

Distance has no effect

Distance is of no consequence to the satellite, and its super-high-frequency transmissions are unaffected by natural cosmic or terrestrial disturbances. Whether a message from San Francisco goes halfway across the Pacific to Hawaii, or across the globe to Singapore, the operating cost and power expended are exactly the same.

Nor does it actually make the slightest difference to the bird what it is asked to bleep out. It can send telephone, television, telegraph, computer data, facsimile and any other kind of electronic message—simultaneously—to a thousand different spots on earth.

To find out how satellite communication works, I visited the world's busiest Earth station, situated in a "radio quiet" mountain valley near Etam, W. Va. Through the mazes of electronic equipment in its control room, passes more than half of all the communications

traffic between the United States, Latin America, Africa, Europe, and the Midwest as far as Iran. A staff of 30 engineers and technicians man the nerve center around the clock, constantly testing and monitoring the equipment, rerouting channels when traffic gets heavy, and coordinating operations with other stations of the Atlantic network.

Looming over the station, 10 stories high, stands the antenna, a concave metal eye 97 feet (30 meters) in diameter, with its gaze locked hypnotically on a satellite floating over the South Atlantic. Although the 470-ton dish appears to be immobile, it is actually in constant motion, readjusting its position in movements too minuscule for the eye to detect, for radio signals do not bend, and if it loses sight of the microscopic dot in space, communication is instantly broken off.

Despite the enormous distance the signals must travel, the amount of electrical energy needed is unbelievably small. It takes only 100 watts (the power of an average reading lamp) to send 240

(Please turn to page 186D)

INTELSAT IV SATELLITE is checked out at Hughes plant prior to launch last January. It was placed in circular orbit, 22,300 miles above the Pacific Ocean

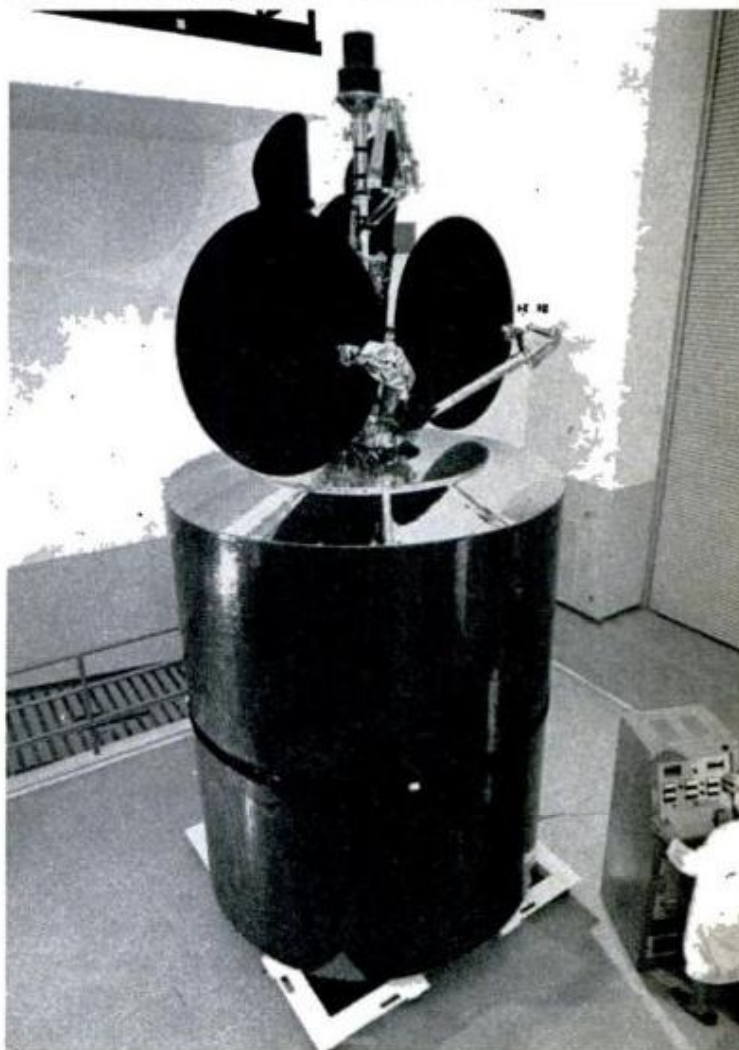

SATELLITES

(Continued from page 186C)



CONTROL CENTER in New York served as key distribution point for telecasts of China trip. Day and night, engineers maintained constant quality check

voice messages to the satellite, while the incoming signals from the satellite (whose total generating capacity would just suffice to operate a kitchen toaster) return at considerably less than one-trillionth of a watt. To make the whispers from space intelligible, they are amplified billions of times by supersensitive devices.

Simply described, the satellite is a tightly packed assembly of antennas, which both receive and transmit, telemetry equipment that measures the bird's state of health, and small tanks of hydrazine gas that are used to adjust its position or move it to a new location, when necessary. Its power is generated by thousands of solar cells which convert the raw, undiluted sunlight of space into electrical energy. To keep the satellite in permanent communication with the area it is meant to serve, it is propelled into circular orbit 22,300 miles above the equator, with its speed synchronized to keep exact pace with the Earth's rotation. Thus it remains relatively stationary over a designated spot on the globe. Each Earth antenna can look at and talk to only one satellite. However, the satellite, from its great height, can see and talk to every Earth station over one-third of the globe, either singly or all together—which is what makes simultaneous global broadcasts possible and their costs so low.

Three spacecraft, strategically stationed over the Atlantic, Pacific and Indian

Oceans, are sufficient to provide a worldwide communications network. However, the volume of traffic is such that there are now five Intelsats in orbit, with more on their way. The vehicles have also grown in size and versatility over the years. "Early Bird," the first launched in 1965, was a little drum, about 2 feet across, weighing 85 pounds, with a capacity of 240 voice circuits or 1 black-and-white TV broadcast. Intelsat IV, latest in the series, is a monster by comparison: over 17 feet high and almost 8 feet wide, weighing 1587 pounds, capable of transmitting 6000 telephone calls simultaneously, up to 12 color telecasts, or various combinations of the two.

Satellites must stay on course

Satellites must be closely watched, for they are constantly being tugged at by gravitational attractions of the sun, moon and Earth. If pulled too far off course, their hydrazine jets must be again activated to bring them back to proper position. A satellite "dies" when its booster jets run out of fuel and it can no longer be prevented from drifting. Although its communications may still be functioning, it must be abandoned and a new one put in its place.

Almost as impressive as the new mode of communications is the way in which it is administered and operated. Since the United States almost single-handedly pioneered satellite technology and, until recently, possessed the free world's only launching capability, the system might easily have become an American monopoly. That it did not is due to an act of statesmanship by President John F. Kennedy and the U.S. Congress. In 1962, they made it possible for the nations of the world to share in the benefits of space communication, with no strings attached. The unprecedented offer led to the formation of the International Telecommunications Satellite Consortium (INTELSAT), a unique commercial venture that serves as a model of what international cooperation can, and should, be.

Intelsat makes the rules for the global network and allocates the circuits, but it owns and operates only the satellites and the equipment that controls them from the ground. The Earth stations are built, owned and operated by designated government agencies or independent firms in the countries where they are located. The partnership's American member, for instance, is the Communications Satellite Corp. (COMSAT), a federally created private enterprise that leases its circuits to the major U.S. telephone, telegraph,

(Please turn to page 186F)

**Exhaust tuning
and CD ignition.**

**Two reasons
Johnson wins races
and friends
around the world.**

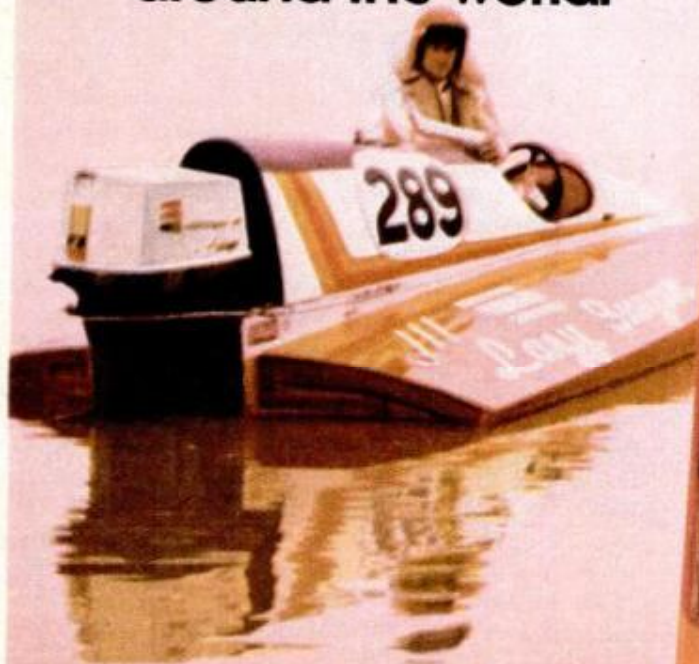

Race drivers know it takes a hot engine to push a hot hull.

So many of them use Johnson V-4 power in international races and marathons. Paris, Berlin, Lake Havasu, Miami.

Our Sea-Horse 125 hp offers the same kind of championship performance for water skiing, fishing and cruising. With features like:

Exhaust tuning. It'll give you more horsepower with less weight and fuel.

Capacitor discharge ignition. For fast, sure starts and longer plug life. And no points to change. Ever.

Single-lever power shifting that's up to 30 percent easier than manual systems.

V-4 design with happy advantages like a short, rigid crankshaft to reduce vibration and friction. Plus a compact size that's six inches shorter above the transom than some competitive motors.

If you need more reasons than that, see your Johnson dealer. He's got 'em. Along with two smaller Vs: 100 and 85 hp.

Or write for our 50th anniversary catalog.

 *First in dependability.*
Johnson

Johnson Motors, Waukegan, Ill. 60085. Dept. PM-572.

Division Outboard Marine Corporation — makers of OMC Stern Drives

SATELLITES

(Continued from page 186D)

and broadcasting companies, and also serves as manager of the Consortium.

The investment each Intelsat member makes and the weight of its vote are determined by the volume of business it contributes. Thus, Comsat—by far the largest user, operating seven Earth stations scattered from Puerto Rico to Hawaii—presently holds a 53-percent interest in the network, while some tiny nations own fractions of 1 percent. After paying its share of the costs, each member receives an annual 14-percent return on its investment, plus the revenues from its own Earth stations, which are so high that some stations have repaid their entire \$5-million construction cost in a single year. As a predictable result, the partnership that started out with 14 members and four Earth stations, now boasts 83 members and 53 Earth stations. By 1973 it will have 70 Earth stations and be serving every heavily populated area of the free world. (Any nation is privileged to join Intelsat. But, save for Yugoslavia, none of the communist countries has yet chosen to do so—perhaps because of the expected formation of a rival Soviet-led consortium, to be called Intersputnik.)

"Within this decade" predicts Comsat president Joseph V. Charyk, "electronic libraries in one country could be instantly available to scholars in another. Newspapers, magazines and books, sent by facsimile from central editorial offices, could be published in a dozen distant cities simultaneously. Schoolchildren in developing nations will have available, on command, the most advanced educational materials and techniques."

Already, doctors sitting in an amphitheater in Switzerland have watched famed specialist Dr. Michael DeBakey perform open-heart surgery in Houston, Tex., asking him questions and receiving answers as the operation proceeded. For example, cardiograms and encephalograms have been transmitted from one continent to specialists on another, and the diagnoses returned before the patients involved had finished dressing. Argentine engineers, facing a complicated bridgebuilding problem, have punched data into a keyboard in Buenos Aires and received solutions three minutes later from a computer in Massachusetts. Comsat has proposed a new set of satellites for the exclusive use of aircraft—to control air traffic, warn pilots of weather disturbances and perhaps enable passengers in flight to make telephone calls from their seats. (A space antenna recently installed aboard the

186F

liner *Queen Elizabeth II* could be the forerunner of still another electronic constellation to serve world shipping.)

And this is only a foretaste of the things to come, say the experts. When new satellites are launched to relay messages domestically as well as internationally, new forms of communication will be available to you in your home or office. Bills may be sent and letters exchanged without going through the post office. Housewives may do their banking and shopping by television. By dialing the right number, you may be able to select a play, opera, golf lesson or lecture in physics, from a pretaped library in a remote city, for showing on your home screen—and the pictures may be three-dimensional. These are not figments of a fevered imagination. They are actually under development, or have already been demonstrated, in communications laboratories in the United States and elsewhere.

Undeniably, this incredible communications system has, or shortly will, become the new nervous system of our global society. As science writer Arthur C. Clark—whose fertile brain envisioned using communications satellites long before any man-made object was propelled into space—informed the signatories of the Intelsat agreement in 1971: "Whether or not you intend or wish it, you have just signed a first draft of the Articles of Federation of the United States of Earth." ★★

WEIGHING IN at some 3000 pounds, the Intelsat IV satellite is 8 feet in diameter and nearly 18 feet high. Its solar array absorbs energy from the sun

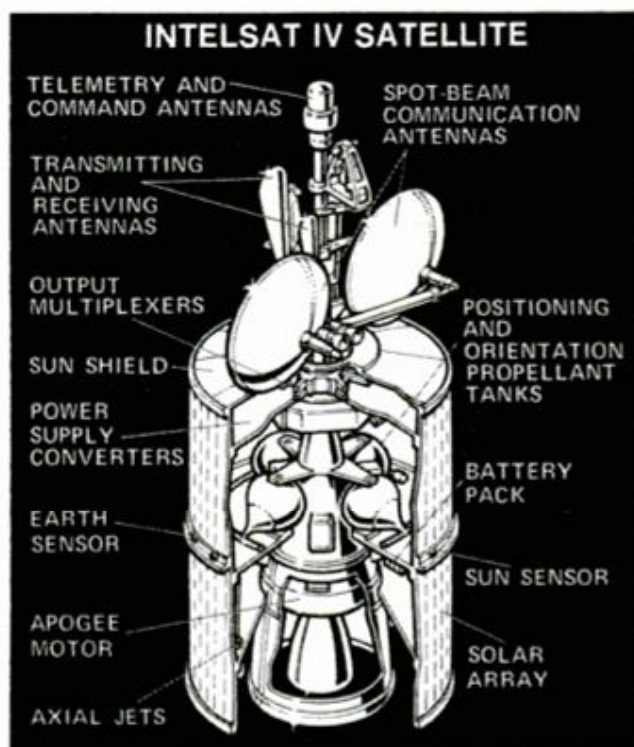

POPULAR MECHANICS

ONLY DODGE HAS A 3/4-TON PICKUP DESIGNED TO HANDLE THE LARGER CAMPERS.

BUY NOW AND GET A **FREE** AUTOMATIC TRANSMISSION.

The Trailblazer Special is a specially equipped D200 pickup with a Camper 9000 package to handle the larger slide-on campers. This unique camper has a GVW of 9000 pounds, the highest rating in the industry for a 3/4-ton pickup. It carries a total payload of up to 4645 pounds. To make it even more attractive for you to buy now, Dodge is not charging your Dealer for the automatic transmission.

So when you order a Dodge Trailblazer Special equipped with the following equipment, your

participating Dealer can offer you the automatic transmission free.

THE SPECIAL EQUIPMENT INCLUDES:

Camper 9000 package • Heavy-duty chassis package, including heavy-duty frame, axles, springs, brakes, and jack • 9.50 x 16.5 (10 PR) tires • 60-amp alternator • Stabilizer bar • Two-tone paint • Full foam seat cushion and back • Undercoating • Bright hubcaps.

See your Dodge Dealer soon, because this offer is for a limited time only.

Check out his complete line of recreational vehicles.



**BONUS
OFFER**

Get a Good Guys Trailblazer Kit at your Dodge Dealer's.

A free packet of helpful literature, called the "Good Guys Trailblazer Kit," is available now at your Dodge Dealer's. It contains: Lyle Engle's new "Complete Book of Motor Camping" • KOA Kampground Directory • National Parks Guide • Carefree Campering Guide • Trailer-Towing Booklet. To get this FREE packet, simply bring this coupon to your nearest participating Dodge Truck Dealer. Supply is limited, so act fast. Going places? Let the Good Guys guide you.





Print For Profit

Cards, Stationery, Envelopes, Advertising labels, tickets, announcements, Q.S.L. cards, greeting, sympathy, prayer cards, tags, etc. Good Profits, Pays for itself in a short time.

Own a Printing Business

We supply everything direct from factory only. Easily followed rules. Also raised printing like engraving. Have home shop. Add to income. Send 25c for catalogue. **KELSEY PRESSES Meriden, Conn. 06450**

MAIL THIS COUPON TODAY!

KELSEY PRESSES, DEPT. 72-M, Meriden, Conn. 06450

I enclose 25c send big catalog and samples.

Name _____

Address _____

City _____ State _____ Zip _____

BUILD YOUR OWN CAMPER SAVE UP TO 50%



Complete, easy to follow plans, instructions, materials list.

Camper Plans\$3.95
Travel Trailer\$3.95
Pickup Cover\$2.00
CONVERSION PLANS:
Eonoline Type Van..\$2.95
Passenger Bus or
Delivery Van.....\$2.95
Satisfaction Guaranteed

EQUIPMENT CATALOG \$1.00

Refundable on First Order. Send Dime for Details. Save 50% on Camper Kit. All items from catalog to build \$1,795 Camper, 8', 10', 10'6" or Chassis Unit.



VIKING CAMPER SUPPLY, INC.
99-87 Glenwood Ave.,
Minneapolis, Minn. 55403
Please send _____ for
which I enclose \$_____
NAME _____
ADDRESS _____
CITY _____
STATE _____ ZIP _____

Travel the SHORT way

avoid wrong turns —
save time, money
and frustration with



AIRWAY COMPASS, Mexico, Indiana 46958



... at
leading
stores
everywhere!

LIFTS
LIKE A HOIST
PULLS
LIKE A WINCH

1001
USES
VERTICALLY
OR
HORIZONTALLY

TERN ROPEHOIST

eliminates the snarls, rope burns and cuss words caused by make-shift block and tackle. Great for lifting, pulling, dragging, stretching or tying down just about anything. Ideal on farms, in garages or shops. Keep one in your car. A low cost, trouble free-helper for every home handyman. 750 lb. capacity.

Write for Bulletin 75A

**TERN, INC., Box FF347
Winona, Minn. 55987**

WELDING PERFORMANCE YOU CAN'T BEAT AT A PRICE THAT CAN'T BE MATCHED.

Only
\$18.95

for this heavy-duty welder
from Four-Way.

We've sold hundreds of thousands over the last 35 years. This rugged complete Four-Way Welder operates on 110V 30A for pennies. Yet it can weld, cut, braze or solder just about anything made of metal. It comes complete in a heavy-duty cabinet with heavy-duty cables and ground clamp, full face helmet, adjustable torch and rod holder and two big bonus packs of instant arc welding rods, brazing rods, 1/4" carbons, solder and flux. Also included is a complete, simplified welding manual. Use it free for ten days and get your money back if not satisfied. Just send \$2.00 and then pay \$16.95 C.O.D. and delivery charges. Or send \$18.95 prepaid. Shipment in Continental U.S.A. Illinois residents add 5% sales tax. **FOUR-WAY WELDER COMPANY, 1810 Federal Street Dept. PM52 Chicago, Illinois 60616**

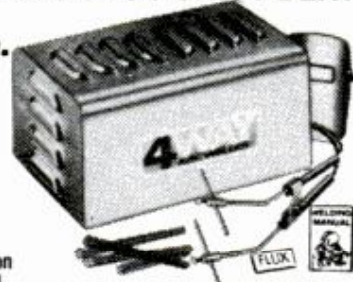

186H

POPULAR MECHANICS

WHAT'S HE DOING?

Making a Concrete
Flower Pot! ... and
SO CAN YOU!



Make and sell your own
Ornamental Concrete items.
Rush \$2.00 for book
about Aluminum Molds
with prices and production trade secrets
direct from world's largest mold manufacturer.
Over 350 designs to select from.

Send \$2.00 **CONCRETE MACHINERY COMPANY**
Today To ➔ P. O. BOX 99 • HICKORY 2, N. C. 28601

Make Rubber Stamps for BIG PAY

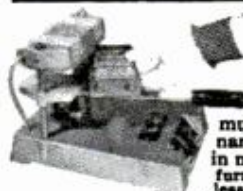

Need more money? Earn \$60-\$75 a week, spare time, at home making rubber stamps for offices, factories, individuals. Hundreds of uses. Hundreds of prospects—everywhere. Right in your own community. Turn out special stamps for names, addresses, notices, prices, etc., in minutes with table-top machine. We furnish everything and help finance you, at less than bank rates. Write for free facts. No salesman will call.

Rubber Stamp Div., 1512 Jarvis, Dept. R-2-BE, Chicago 60626

PROFIT IN YOUR SPARE TIME

SMALL ENGINE REPAIR PAYS BIG!

Outboard · Powermower · Chain Saw · Tractor

MAKE EXTRA MONEY — or fix your

own engines and SAVE! Illustrated, easy-to-

learn Home Study Course trains you expertly.

Approved for Veterans. Write today!

LINCOLN TECHNICAL INSTITUTE
SUITE 5E, 2299 VAUXHALL RD., UNION, N.J. 07083



Repair any watch

... SWISS OR AMERICAN

Unique, modern Sweazey System starts you making repairs right away. Develops skill step by step at home in spare time. Diploma awarded. Free sample lesson. No obligation.

CHICAGO SCHOOL OF WATCHMAKING
Dept. 152, Fox River Grove, Ill. 60021



EARLY AMERICAN CHARM Tupelo Coffee Table

Unique, distinctive, truly a conversation piece. For indoor or outdoor, kiln-dried, sanded and ready for finishing. Educational too, count the growth rings. (20-25" dia. \$15.50) — (25-30" dia. \$21.75) — (30-35" dia. \$39.75) Ppd. West of Miss., add \$2.



Box 826 Dept. PM
Florence, S. C. 29501

IGNORANCE is a CRIME when it results from lack of proper reading material. In today's complicated society it pays to know the "rules"—the LAW. Blackstone offers a program of reading assignments for adults who should be informed on essential law subjects. It is designed for people who are in earnest and who expect to accumulate property, lead in business, or take an active part in community life. **NOT A CORRESPONDENCE COURSE.** Program may be scheduled to your interests and time covering any or all law subjects. **FREE BOOKLET—The People vs. You** —mailed on request. No salesman will call. Dept. 55

BLACKSTONE SCHOOL,

307 N. Michigan Ave., Chicago, 60601

Two or
four-wheel drive
**JEEP OR
SCOUT**
owners

REPOWER with a 6 or V-8. H.D. ADAPTORS for using Car, Compact and some Truck engines. "State year & model, Jeep or Scout." Want fast action? Give us **FULL INFORMATION.** Send \$25.00 Dep. and we will ship correct kit, bal. COD. Send full amount for prepaid shipment. Wire, phone or write today. Details **FREE**

HOOSIER MACHINE PRODUCTS CO.

312 S. E. 6th St., Phone 276-3442. Pendleton, Oregon 97801

FREE

world's largest electronic kit catalog

Save on over 350 kits you can build

COLOR TV — Low cost tube-type and incomparable solid-state models. From 14 through 25-in. all with exclusive Heathkit built-in self-service capability. All cabinet styles, including new "hide-away" Custom Wall Mount kit.

HOME APPLIANCES — The new Heathkit "Minimizer" Waste Compactor joins the popular Microwave Oven in the kitchen. Both offer all the features of fine assembled appliances plus, since you build them, you can perform normal service and maintenance. Other kits for the home include clock radios, wireless and conventional intercoms, home protection systems and garage door openers.

TRAIL BIKES — For exciting off-the-road transportation, choose either the economical Heathkit Boonie Bike or the bold, beautiful Hilltopper. Accessories include lighting kits, automotive bumper carrier, front-wheel snow ski.

AUTOMOTIVE — A cost-saving lineup of auto accessories and tune-up kits, includes 2-way radio, siren, cab-to-camper intercom, battery charger, timing light, tune-up meter, ignition analyzer, tachometer.

PORTABLE RADIOS & PHONOS — Three portable phonos to choose from, including a Stereo/AM Radio Phono combination. Four portable solid-state radios from a simple AM kit to a 10-band AM/FM/Shortwave receiver.

TEST INSTRUMENTS — For the home hobbyist or the professional technician at substantial savings. Everything from famous Heathkit oscilloscopes and meters through vector-monitors and color bar generators. And there's sophisticated scientific equipment for educational and industrial labs.

SHORTWAVE & HAM RADIO — For the listener, Heath has a brand new solid-state SWL receiver. For the radio amateur, there's the complete line of Heathkit receivers, transmitters, transceivers, novice rigs and accessories.

FISHING & BOATING — The new Heathkit Thermo Spotter lets anglers find the specific water temperature level where trophy fish feed. The new Digital Depth Sounder reading to 199 ft., costs about half the price of other units. In addition there are Heathkit flasher-type depth sounders and fish spotters, power inverters, hailers, VHF phones, etc.

STEREO — The new Heathkit AR-1500 stereo receiver experts hail as the most sensitive and powerful, heads up a complete line of receivers, amplifiers, tuners, turntables and speakers in every price range, 4-channel and tape components, too.



More than 350 products with build-it, service-it savings.

All Heathkit products are designed around quality components... your assurance of outstanding performance, long, reliable service. And the famous Heathkit manual makes the most complex kit a simple check-by-step project. But it doesn't stop there. You're given the information you need to get your kit operating at peak efficiency, and keep it that way. (If you know someone who owns a Heathkit color TV, take a close look at that picture). Should the need arise,

technicians at every Heathkit Electronics Center, the Technical Correspondence Department here in Benton Harbor, and the new Heathkit "Plain Language" Warranty stand behind your purchase. Clip and use the coupon below to order your free 1972 Heathkit Catalog. Discover the creative fun, satisfaction, and pride of achievement that Heathkit building brings... and save yourself a bundle in the bargain. We won't let you fail.

Visit your local Heathkit Electronic Center... or send for your FREE Catalog.

HEATHKIT ELECTRONICS CENTERS

ARIZ.: Phoenix, 2727 W. Indian School Rd.; CALIF.: Anaheim, 330 E. Ball Rd.; El Cerrito, 6000 Potrero Ave.; Los Angeles, 2309 S. Flower St.; Redwood City, 2001 Middlefield Rd.; San Diego (La Mesa), 8363 Center Dr.; Woodland Hills, 22504 Ventura Blvd.; COLO.: Denver, 5940 W. 38th Ave.; FLA.: Miami (Hialeah), 4705 W. 16th Ave.; GA.: Atlanta, 5285 Roswell Rd.; ILL.: Chicago, 3462-66 W. Devon Ave.; Downers Grove, 224 Ogden Ave.; KANSAS: Kansas City (Mission), 5960 Lamar Ave.; MD.: Rockville, 5542 Nicholson Lane; MASS.: Boston (Wellesley), 165 Worcester St.; MICH.: Detroit, 18645 W. Eight Mile Rd. & 18149 E. Eight Mile Rd.; MINN.: Minneapolis (Hopkins), 101 Shady Oak Rd.; MO.: St. Louis, 9296 Gravois Ave.; N.J.: Fair Lawn, 35-07 Broadway (Rte. 4); N.Y.: Buffalo (Amherst), 3476 Sheridan Dr.; New York, 35 W. 45th St.; Jericho, L.I., 15 Jericho Turnpike; Rochester, Long Ridge Plaza; OHIO: Cincinnati (Woodlawn), 10133 Springfield Pike; Cleveland, 5444 Pearl Rd.; PA.: Philadelphia, 6318 Roosevelt Blvd.; Pittsburgh, 3482 Wm. Penn Hwy.; TEXAS: Dallas, 2715 Ross Ave.; Houston, 3705 Westheimer; WASH.: Seattle, 2221 Third Ave.; WIS.: Milwaukee, 5215 Fond du Lac.

HEATHKIT

Schlumberger

HEATH COMPANY, Dept. 17-5
Benton Harbor, Michigan 49022

Please send FREE Heathkit Catalog.

Name _____

Address _____

City _____ State _____ Zip _____

Prices & specifications subject to change without notice.

*Mail order prices; F.O.B. factory. CL-426

BELSAW PLANER • MOLDER • SAW

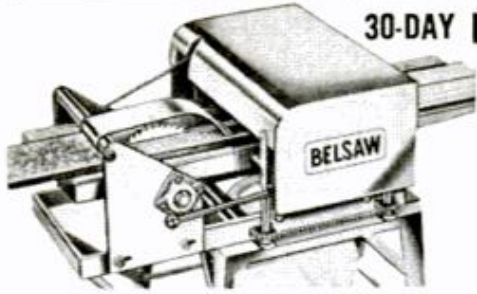

30-DAY FREE Trial!



Now you can use this ONE power-feed shop to turn rough lumber into moldings, trim, flooring, furniture... ALL popular patterns. RIP... PLANE... MOLD—separately or all at once with a single motor. Free 30-Day Trial. Low Cost—only \$35 down. Send Postcard Today — No Salesman Will Call. BELSAW POWER TOOLS, 903B Field Bldg., Kansas City, Mo. 64111

LEARN UPHOLSTERY AT HOME!



Men & Women All Ages! Send for free book on learning to reupholster chairs, divans, footstools, all furniture for BIG MONEY in spare or full time. No experience needed, no age or educational limits. We show you how and provide EVERYTHING needed to start: (1) Home training covering all phases, (2) all tools and 6 big furniture kits for practice, (3) free supplies, frames & materials to build \$300 worth of furniture, yours to keep or sell. Write TODAY for big free upholstery career book. No obligation, no salesman will call. Veteran Approved. Modern Upholstery Institute Box 999 FMD, Orange, Calif. 92669.

FIND BURIED TREASURE
Powerful electronic detector finds buried gold, silver, coins, etc. 5 new models. Write for free catalog.

RELCO, Dept. D-3 **19⁹⁵**
BOX 10839, HOUSTON, TEX. 77018

HOW TO GET RICH -- AT HOME!



There is no other business like mail order. Start on a shoestring in your spare time and make a fortune fast. It strikes like a bolt of lightning! Millions read your ad and suddenly you are swamped with cash orders from all over the country. MORE MONEY in 60 days than you could earn in a lifetime! Write for free book and complete details. Mail Order Associates, Inc. Dept. 197, Montvale, N.J. 07645

I-N-V-E-N-T-O-R-S

WE NEED INVENTIONS

Sell your invention for cash—need money for Patent?—Are technical problems holding you back? Universal Inventions has helped inventors all over the world—just like yourself—why not you? Inventions provide the magic spring-board to sudden riches. REMEMBER, we either sell your invention or pay you a cash bonus. Write for details. UNIVERSAL INVENTIONS, Dept. 13, Marion, Ohio

WRIST ROCKET™
AMERICA'S HARDEST HITTING SLING
Range 225 yd.—232 fps.
Matched replacement rubbers and LEATHER pouch assembly \$1.00
At dealers or order direct.

WRIST ROCKET™ Mfg. **\$3.00** Post. Pd. in U.S.A. No C.O.D.'s
P.O. BOX 21-B Orders outside U.S.A. add \$1.50 for postage and handling.
Columbus, Nebraska 68601

"LISTEN IN" TO POLICE-FIRE RADIO CALLS IN YOUR CAR!

WORKS with ANY CAR—Portable or HOME RADIO! Just PLUGS in—No wiring—3 minute hookup! Switch instantly from regular to ALL POLICE-FIRE-EMERGENCY-COMMERCIAL-TAXICAB-STATE-CITY-GOV'T 2 way Radio calls in YOUR AREA. DUAL-HI-LOW BANDS—OVER A MILLION Radio Cars/stations. USE Everywhere—anytime—always works!

SEND ONLY \$2.00 (cash, Ck., M.O.) and pay postman \$1.99 plus C.O.D. post. or send \$9.99 for ppd Del in U.S.A. COMPLETE, ready to use with instructions. One Year service Warranty—10 DAY MONEY BACK TRIAL (if retnd). Limited offer includes "Plug In" for All RADIOS

WESTERN RADIO Dept. BPM-5 KEARNEY, NEBR. 68847



TAMBOUR-DOOR TABLE FOR \$41

(Continued from page 142)

need to sand the backs of the slats; they're not seen because of the canvas backing. Lay all slats for one door face down on a flat piece of plywood and, using a pipe clamp, clamp them together reasonably tight. Make certain the slats are aligned and square, and clamp the ends down with C-clamps and strips of thick wood.

Cut two 2-in. widths of heavy canvas slightly shorter than the overall length of the clamped-up doors, apply two coats of contact cement to each slat and the canvas strip. When the cement sets, place the canvas strips in contact with the slats and smooth all wrinkles. Keep the assembly in clamps for at least 20 minutes. **Caution:** When you apply the contact cement to the backs of the slats, do not let any glue run onto the exposed sides (the cement will bleed through the lacquer finish).

When the doors are completed, insert each one in the routed groove or track. Apply a coat of paraffin wax to the bottoms of the slats to ensure sliding ease. It's best to make a dry run of the doors with the top temporarily secured. If necessary, sand slat ends for smooth operation.

It is a good idea to stain the parts before assembly. The original tables were given a coat of sealer and three coats of satin lacquer. However, an antique-white finish with the tambour doors in mauve, makes a handsome piece. ★★★

STEAM MINIBIKE

(Continued from page 24)

world know that this is no ordinary minibike.

Smith is primarily in the business of building to order, but sells plans of his steam system that list sources for all parts and specifications for materials. The plans are only for the steam system itself, which you can adapt to a minibike or other type of vehicle. You can write to Richard Smith at 8591 Pyle Way, Midway City, Calif. 92655. The \$20 price of the plans for the steam system includes, in addition, plans for conversion of the Ohlsson & Rice engine, plans for boilers of various sizes, feedpump plans and plans for a rotary valve for use with engines of more than one cylinder. ★★★

NEXT MONTH IN PM: Read about a shop that paid for itself and grew and grew . . . Air surfing, a nery new sport . . . The wild, wild voyage of the *Queequeg* . . . Trash compactor you can build from a kit . . . and lots more!

WOODPECKER DOOR KNOCKER

(Continued from page 130)

taken from a discarded clock. The location of the hole in the gear-shaft bearing post will be determined by the diameter of the large gear, which should not exceed 1 in.

When assembling the actuating arm, drill the brass tubing (D) so that its pointed nail shaft will fit tightly, then solder the shaft to the tubing. Note that the shaft is placed offcenter in the tubing to allow for the adjusting screw that holds the shaft in place. Clamp the slotted ends of the brass tubing (D) to the clock spring and to the spiral spring plate (B) and solder them in place. Soldered nail-heads hold in place the spiral spring which needs to be only strong enough to keep spring plate (B) in contact with the fiber cam (C). The spring may be obtained from Edmund Scientific Co., Edscorp Building, Barrington, N.J. 08007, if it's not available at your local hobby shop. Place the operating mechanism inside the bird's body to locate the mounting holes and drill the holes from the inside.

Secure the woodpecker to a shallow plywood box with the two machine screws attached to its removable breast cover, then drive two wood screws into the tail section from inside the box. Locate the hole for the beak bolt by holding the head of the bird against the box. Add or remove washers for the best response from the knocker. A screw in each corner of the box is used to attach the bird to the door. Either a size C or D cell will operate the knocker since its current consumption is very low.—Walter B. Ford, El Cajon, Calif.

MOTOR CAMPERS' QUESTIONS

(Continued from page 161)

not be tapped into tow-car lines. Electric offer completely separate control.

● How fast can RVs be safely driven?

Depending on conditions, vans and motor homes, 65; smaller trailers, 60; pickups, 75, and larger cars with tent-trailers, to 60 mph.

● How long will an RV last?

Ten to 20 years with reasonable care.

● Are RVs safe enough?

Millions of vacationers have been using them without trouble for 30 years. There's seldom an RV situation that common-sense driving can't handle safely. ★★★

GOVT. SURPLUS AND OTHER BARGAINS SAVE UP TO 90%



HYDRAULIC PUMP 3 GPM @ 1,500 RPM, 3,000 PSI. Intake port 3/4" tube, discharge port 1/2" tube, bypass 3/8" tube, 12-tooth spline drive. Variable delivery, rotates either direction. Contains automatic pressure reg. Max. RPM 3750 @ 3 GPM. Approx. 9" L x 4 1/2" dia. GOVT. cost: \$320. Govt. overhauled. Shpg. wt. 15 lbs. \$32.50 (Stk. #1011R)



HYDRAULIC CYLINDER 32 1/2" stroke, 2" bore, 1" shaft. Operating pressure 3000 P.S.I. Top and bottom of cylinder contain 1/2" ID mounting hole with self-aligning bearings. Closed 43". Inlet and outlet ports 9/16" - 18 (#6). Will produce 9000 lbs. thrust GOVT. COST \$269.60. Govt. overhaul cond. Shpg. wt. 16 lbs. (Stk. #2932) \$32.50.



DUAL DRIVE GEAR MOTOR

Heavy duty. Rated 5 HP @ 26 V.D.C. @ 270 RPM under load. Turns 125 RPM @ 12 V.D.C. Top shaft turns @ twice straight shaft speed. Shaft dia. 5/8". Gear reduction 33 to 1. Reversible. 18" L x 5" dia. Exc. for winches, capstans or small elect. car motors. Shpg. wt. 39 lbs. GOVT COST \$580 ea. Like new \$32.50 (Stk. #2391)



NEW! BIG 1972 CATALOG

Send 35c (\$1 for airmail). Catalog contains 1000's of bargains in hydraulics, electrical, marine, automotive items, etc. 90 day guarantee. ORDER FROM AD. Prices FOB Culver City, 50% dep. for COD. Cal. res. add 5% sales tax. Must incl. zip code. Satisfying customers world-wide since 1945.

AIRBORNE SALES CO.

Dept. PM572

8501 Steller Dr. • P.O. Box 2727 • Culver City, Ca. 90230

NEW WALNUT MONTE CARLO STOCK.

IT'S YOUR MONEY...

but shooters who want and expect maximum performance from an AIR RIFLE will find the

Great New BENJAMIN

combines new standards of ACCURACY AND SAFETY with SMASHING PEAK POWER AND RELIABILITY to make it the logical choice of those hankering for a BB or Pellet Gun you can trust.

A thumb operated top safety for better fire control plus a new ramp-type front sight and adjustable stepped leaf rear sight for improved target alignment are combined with Benjamin's time-tested action and adjustable power to make this exciting new Super Single Shot a plinker's dream come true. Safe, quiet, odorless. It's expertly made. Embodies other traditional Benjamin quality features which contribute to its dependability and shooting excellence. Use indoors or out. 3 calibers. Reasonably priced. Model 340 BB. Model 342 Cal. 22 Pellet. Model 347 Cal. 177 Pellet. At sporting goods dealers. Use Benjamin H-C Pellets—Sized and Lubricated for Greater Accuracy.

BENJAMIN AIR RIFLE COMPANY FREE Catalog
896 Marion St., St. Louis, Mo. 63104

You Can DEPEND on BENJAMIN

Build The BIG ONE For BIG FUN NEW VT-7 Super Bronc



Check these leadership features carefully! 7 h.p., 4-cycle engine plus automatic load-sensing torque converter assures all-terrain, all-season performance. Big 21x21x8 super-trac flotation rear tire puts the power to work on sand, snow, slope. Shock mounted 18x8.50x8 front tire provides easy handling and ride. 2-man cushion seat on heavy-duty shocks and 2 pairs of folding foot pegs. Many accessories. Kits from \$169.95. VT-7 kit, \$269.95. Free literature.

HEALD, Inc. Dept. PM-5 P.O. Box 1148
Benton Harbor, Mich. 49022

Enjoy Independence



With A Sparetime BUSINESS OF YOUR OWN

Here's a proven, practical way to earn sparetime cash while you develop a money-making business of your own. Investment is small. There's no overhead, no stock to carry, no selling involved. Automatic Foley Saw Filer, easy to operate, files combination saws, hand, band and circular saws. No experience needed.

Earn \$3 to \$6 An Hour In Sparetime

Get started now and watch your business grow! Thousands are earning cash this easy way—many build a complete sharpening service with year around profits. You can, too, with the easy-to-follow Foley Plan—write us today!



FREE BOOKLET SHOWS HOW

Fact filled booklet tells you how to start a sparetime business; how to get new business. Rush coupon, get "Money Making Facts" and details on Easy Payment Plan. No salesman will call.

Foley Manufacturing Co.
516-2 Foley Bldg., Minneapolis, Minn. 55418

Send FREE BOOK—"Money Making Facts", and Time Payment Plan.

Name _____

Address _____

City _____ State _____ Zip Code _____

THE AUTO ELECTRIC

Power-For-Tools. 110 V.D.C. Electricity from a car's alternator. Installs on—Most late model cars, trucks or tractors. Will operate power tools, light bulbs, heating devices, etc. Operates any brush-type 110 V. A.C.-D.C. electric motor. Battery charging. Easily installed.



Checks or Money Order:

\$16.95 Without 150 V. D.C. Meter

\$19.95 With 150 V. D.C. Meter

Plus Postage

\$1.25 and Sales Tax

Auto Air Equipment Inc., P.O. Box 2886PM, Amarillo, Texas 79105

A BUSINESS OF YOUR OWN REPAIR HYDRAULIC JACKS



Earn while you learn at home. Millions of jacks in gas and auto service stations, trucking firms, body shops, riggers, factories and farms need servicing . . . most of which you can learn to repair. We show you HOW. Start spare time in your basement or garage. Big opportunity for mechanics. ACT NOW! Write for folder PM-5 and free bonus offer

HYDRAULIC JACK REPAIR MANUAL CO., INC.

G.P.O. BOX 3 • STATEN ISLAND, N.Y. 10314

locksmithing and key making

PRACTICAL UP-TO-DATE COURSE—ONLY \$7.95

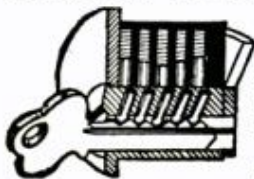

Teaches you how to pick locks, de-code, make master keys, repair, install, service, etc. New self-instruction lessons for every handyman, homeowner, carpenter, mechanic, service station operator, fix-it shop, hardware dealer, gunsmith. 53 easy illustrated lessons. Full price only \$7.95 post-paid. Satisfaction or refund guaranteed. Mail order today!

NELSON-HALL CO., Dept. EY2
325 W. Jackson Blvd., Chicago 60606

LEARN MEAT CUTTING



Train quickly in 8 short weeks at Toledo for a bright future with security in vital meat business. Big pay full-time jobs. **HAVE A PROFITABLE MARKET OF YOUR OWN!** Time payment plan available. Diploma given. Job help. Thousands of successful graduates. **OUR 49th YEAR!** Send now for big new illustrated FREE

catalog. No obligation. G.I. Approved. #0197T
NATIONAL SCHOOL OF MEAT CUTTING
Dept. 50-J, Toledo, Ohio 43604

RIDING MOWERS FOR '72

(Continued from page 105)

woman of the house, \$75 to \$100 brings you this added convenience.

Remember when changing of the cutting height on any mower was a real task? It's never been easier than on this year's riders. On most, it is a one-lever operation and can generally be accomplished while the machine is in motion. This means you can readily cut your lawn to its proper height for the type of grass, the time of the year and the use the area of lawn is put to.

A few years back, "no-scalp mowing" was somewhat of a novelty. Now almost all the makes can lay claim to it and back it up with their machines' performance.

Ariens, for one, has improved its own Flex-N-Float cutting action—which always was quite good—by a design change. The pan now moves with the front axle rather than the rear, for neater results.

Most riding mowers have rear-mounted engines. This gives better traction and better forward visibility. Even those makers who cover the frame with fiberglass—International Harvester's new riders, for example—have designed their units for good visibility. Forward visibility is important; it enables you to see foreign objects in the lawn and mow safely close to fences.

While most speed shifting is still accomplished with a shift lever, Jacobsen has gone to a foot-pedal control. When the pressure is applied the machine moves forward at speeds up to 4 mph. When heel pressure is applied the machine reverses. With no gears to shift, the operator's hands remain safely on the steering wheel. As an additional safety feature, the foot control automatically returns to a neutral-brake position when the foot is removed.

Roof Manufacturing, whose specialty has been mowers for over 25 years, has an intriguing front-axle design on its Deluxe Lariat 30. This unit has unusually large-diameter front wheels for a riding mower. It also incorporates a design which locates the spindle directly over the center of the wheel hub and axle. This eliminates the transfer of wheel shock to the steering wheel.

John Deere has come up with a rider that is an environmentalist's dream. Its new Electric 90 utilizes three 12-volt batteries, a traction motor to propel the unit and two electric motors to power the twin-bladed mower. This unit can honestly lay claim to quiet operation and the elimination of fumes and heat common to gasoline engines. ★★★

undercover job

The purpose of a sealant is simple: to keep what is in the engine in, and to keep what is out of the engine out. The problem has been the same since the first Form-A-Gasket was developed for Barney Oldfield.

New Silicone Form-A-Gasket rubber base adhesive-sealant will last longer, resist more gases and compounds, resist higher temperatures, resist higher pressures, resist lower temperatures, than any of our previous products, and *they* are the standards of the industry.

It probably has a lot more uses than we've figured out for it yet. But one thing we do know, once you use it, you can forget it. It's a real undercover worker.

New Silicone Form-A-Gasket from Permatex... the great seal of the United States.



The Permatex Company, Inc.
P.O. Box 1350, West Palm Beach, Florida 33402

Permatex® our name is our bond

NEW 1972 ARC WELDER 19⁹⁵ 5 WELDING HEATS



Plugs in any ordinary 110 volt outlet. Buy direct from the factory and save \$\$
Complete - nothing else to buy. Includes *heavy duty cables *electrode holders
*ground clamp *extra welding rods *full face mask. Heavy duty - 5 heats for
welding, soldering, cutting and heating. Easy to operate; step-by-step instructions
included. Ideal for the home handyman or craftsman - pays for itself repairing
cars, trailers, lawn equipment, boats, etc.

10-DAY MONEY BACK GUARANTEE. Send only \$2 and pay postman \$17.95
plus postage when delivered, or send \$19.95 for prompt postpaid shipment.
Return within 10 days for refund if not completely satisfied. Orders filled
promptly - check or money order. LIFETIME GUARANTEE.

MINI 5 ARC WELDER Department A, 2635 Main Street, Houston, Texas 77002

Biggest Selection Anywhere



PICKUP COVERS from WINNEBAGO®

Everything from a 24" cover to an economy slide-in camper. And models to fit most any size pickup. That's the Winnebago Kap® Pickup Cover story.

Constructed with famous Thermo-Panel® laminated material, every Kap Cover is fully insulated, with a rich paneled interior. And we've a full line of recreation and camping accessories... from boat racks to bunks, stoves and ice refrigerators.

More Winnebago Kap Covers are on the road than any other make. Find out why.

Send today for FREE catalog on complete line of
COVERS and CAMPERS

Winnebago Industries, Inc.
Thermo-Panel Materials Division, Dept. PM
Box 152, Forest City, Iowa 50436



Name _____
Address _____
City _____ State _____ Zip _____

NEW - Ninth Edition of the Universally Accepted Small Engines Service Manual



\$495
9th Edition

Factory "know-how" at your finger tips!
Complete repair information on over
1,000 models of small engines that power
lawn mowers, tillers, go-karts, etc. 328
pages with hundreds of photos and ex-
ploded view drawings. Step-by-step, easy
to follow instructions for everything from
minor tune-up to major overhaul. Over
300,000 copies sold to mechanics and do-
it-yourselfers. Save time... make money.
Order your copy today.

Money Back Guarantee
Send check or money order
and we pay postage.

Technical Publications Div. Dept. PM-572
1014 Wyandotte, Kansas City, Mo. 64105

ARROW

All-Purpose
STAPLE GUN

SHOOTS A STAPLE

Uses 6
Staple Sizes
1/4" to 9/16"
including
Ceiltile.

WHEREVER YOU'D DRIVE A NAIL!

At
Hardware,
Lumber & Building Supply,
Stationery, Variety and
other retail outlets.

ARROW FASTENER COMPANY, INC.
271 Mayhill Street, Saddle Brook, N. J. 07663

wrought iron craft kit

No heat or electricity needed to make beautiful wrought iron furniture and decorative accessories for your home. (or for profit!) Patented precision toolset cuts, punches, rivets, and makes perfect circles, scrolls and bends with practically no physical effort. 3-year guarantee. Complete with simple instructions and design handbooks. Order now, or send for an illustrated color brochure.

\$89.50 post paid, or C.O.D. (freight charges collect)
10-day money back guarantee



creative metalcraft Box 663B, West Caldwell, N.J. 07006

NEW DYNAMIC MARK 88

80 AMP INDUSTRIAL TRANSFORMER ARC WELDER

IDEAL GIFT—EDUCATIONAL, ENJOYABLE, PROFITABLE

WELD, BRAZE,
CUT, SOLDER, HEAT
STEEL, BRASS, ALUMINUM,
AND MOST OTHER METALS.

Build and repair anything of metal. Save time & money with this BRAND NEW, PROFESSIONAL ARC WELDER! Rugged metal cabinet, baked Hammerloid finish. Ideal for home, shop, farm and industrial use. POWERFUL glass insulated transformer welds most metals up to 1/2" thickness with multi-pass weld, with 3/8" rods. 4 heat settings 20 to 80 amps. Operates on 110 Volt AC line (used for 30 amps). Complete with fibre glass helmet, electrode holder, ground clamp and cables, solder, assorted rods and simplified welding manual. DOUBLE PROTECTION GUARANTEE. 10 day money back trial plus full 5-yr. warranty. If inoperative return prepaid, we will repair or replace without charge & reship collect. ORDER TODAY. Complete ready to weld. Only \$59.50 F.O.B.

SEND ONLY \$6.00. Pay Balance plus C.O.D. and Delivery Charges

FREE Write for illustrated color literature and welder details.



DYNAMIC WELDER CO. 1808 S. FEDERAL ST. Dept. PM52 CHICAGO, ILL. 60616

LEARN DRAFTING AT HOME

U.S. Labor Dept. says "42% more Draftsmen needed next 10 years." Send for FREE "DRAFTING CAREER KIT." No salesman will call.

NAME _____ AGE _____

ADDRESS _____

CITY _____ STATE _____ ZIP _____

ALL 3 FREE

NORTH AMERICAN SCHOOL OF DRAFTING, Dept. 24175
Accredited National Home Study Council 4500 Campus Drive, Newport, California 92660

At Last a New Amazingly Simple GAS TURBINE JET ENGINE

Build from easy to follow plans. Length 15", Dia. 8 1/2", Wt. 15 lbs. Fuel: Gasoline or Kero.

"Screamin' Demon" develops 20 H.P. Ideal project for serious-minded hobbyists, students, scientific and industrial arts classes. Make on 9" metal cutting lathe with milling attachment. For use on small racing boats, midget cars, etc. Full size assembly drawings with critical dimensions, bill of materials and photos. Price \$5.00. No C.O.D.

SAVOY SCIENTIFIC, BOX 1398, SANTA MONICA, CALIF. 90406



AMBASSADOR OWNERS REPORT

(Continued from page 98)

and also the fact that this car comes with drum power brakes instead of discs." (Discs are optional.) A Denver housewife: "The reclining seats." "It handles and drives so well that you never get tired behind the wheel," states a Nebraska farmer. And a Tennessee corporation vice-president opines, "Handsome car—good but not radical lines."

How about dislikes? Here are notes from those who had gripes: "Engine noise." "Workmanship isn't inspected closely enough before leaving the assembly line, otherwise body panels would line up properly and windows wouldn't leak." "Plastic in interior groans and creaks when cold." "Hood release under dash is too near emergency brake release." "Poor gas mileage." "Gas pedal uncomfortable."

What about quality and workmanship? "Very good overall." "Better than its competitors." "Body sections don't join properly." "About average." "Good, but they don't check over the car as they tell you on TV." "Excellent." "Satisfactory." "Poor—bumpers misaligned, spots had to be repainted, strap to gas tank fell off." "Upholstery is this car's weakest link—unfinished where it can't be obviously seen." "The 1972 Ambassador is by far the best car yet—have owned AMC cars since 1960."

Given a chance, what would Ambassador owners change in their cars? "Move ashtray nearer driver." "Parking-brake pedal is too high, and I catch my foot under it getting in and out." "Design an easier way to adjust headrest height." "I think all Ambassadors should have at least G78 tires. The standard F78s are too small." "A little more interior room, especially rear legroom." "Lower hood an inch or so so right front fender is visible." "I think the air-vent sliding parts should be controlled by the driver and not individually from each side."

Most owners agree their cars are very comfortable to drive and ride in. "This year's ride is hard to beat," says a New Jersey baker. "Ambassador is large, roomy, good upholstery."—Chicago salesman. "Some of my passengers have commented on my car's good headroom. Seats are very comfortable."

The overall summary shows that Ambassador owners are pleased with their cars (a very high, 92 percent would buy one again) and with AMC's Buyer Protection Plan. Many felt that, being smaller, AMC dealers had more time to be courteous and to pay personal attention to customers. ★★★

TOOLS CAN'T FIX EVERYTHING.



That's why Mystik[®] created a line of tapes that should be in every tool box.

They include an air-tight Duct Tape to seal ducts, vents and around air conditioners. A rust-proof Aluminum Tape for auto repairs and to patch drain pipes, gutters or other metal surfaces. A thick Sponge Tape for weather-stripping, cushioning lamps or to replace refrigerator door gaskets. As well as an indoors or outdoors Carpet Tape. Fiberglass-reinforced Strapping Tape. Heavy-duty Fabric Tape. And an 8,000 volt-resistant Electrical Tape.

Pick up a set wherever you see Mystik's Tool Box Tapes display. That way, if your tools can't fix it, you can always count on your tapes.



Send self-addressed stamped envelope for free booklet on "How to do it better with tape" to Mystik, Borden Chemical, Division of Borden Inc, 50 West Broad Street, Columbus, Ohio 43215.



When you see this mark you've seen the product in Popular Mechanics.

The Popular Mechanics Product Feature Mark is recognized by millions of men . . . men who respect it, and know that when they see it on a product, that product has been advertised in Popular Mechanics. It's a mark of success which

appears on hang-tags, counter cards, product stickers, window banners, and in consumer and trade advertisements. Ask for the Product Feature Mark . . . Remember it, and know and buy the products that wear it.

THERE'S ALWAYS SOMETHING NEW AT POPULAR MECHANICS

MAY 1972

195

HOME MOVIES CAN SOUND GOOD

(Continued from page 113)

tional playback machine. It sells for \$199.50. Neither package includes the necessary sound projector, which you must purchase separately. The Synchronex model sells for about \$200.

Optasound is somewhat more flexible in that it does not require you to buy a special camera. Virtually any electrically driven Super-8 silent camera can be modified to provide the necessary syncing signals to work with the Optasound system. Modifications made by Optasound technicians cost about \$40 to \$70.

While Optasound has its own matching cassette recorder, it also offers an inexpensive adapter, called Optasync, that can be used to convert an existing reel-to-reel recorder to the Optasound system—again to save having to duplicate equipment you may already own. The Optasync accessory sells for \$69.95, while the cassette machine with built-in sync is about \$140. Optasound does not at the moment offer its own sound projector, but its system, like Synchronex's, can be used with any conventional sound projector having 18-frame image-to-sound separation.

All lip-sync sound systems have one

Stamp out caulking problems

Timesaver. Use DAP Latex Caulk to seal cracks and joints around window and door frames. Fills gaps to keep cold out, heat in. Works inside and out. Can be painted in only 2 hours. Won't stain, blush or bleed through latex or other paints.

the caulk fixer from
DAP

DAP Inc., Dayton, Ohio 45401
Subsidiary of *Plough, Inc.*



Stamp out wood-finish problems

Mellow. That's the look you put to wood surfaces with Indo Satin Finish by DAP. It puts that shimmery satin glow on cabinets, furniture, antiques. Flows on smoothly. Dries fast.

the finish fixer
from
DAP

DAP Inc.,
Dayton, Ohio 45401
Subsidiary of
Plough, Inc.



drawback—since you have to record “live” with your camera grinding away, any goof you or your actors make is permanently recorded on the sound track. You either live with it or reshoot the scene.

Editing is possible, though with some minor difficulties. With magnetically striped film, there's an 18-frame separation between your sound track and the corresponding image. When you snip out a length of unwanted film, you also remove a bit of sound track belonging to other scenes you want to save. This gap lasts about three-quarters of a second, producing a slightly noticeable but not too serious “blip” as the film skips by the missing bit of sound track.

Editing Filmosound would seem simpler since you're working with a separate sound track. It must be done carefully, however, as you have to cut both film and accompanying tape at exactly the same points to maintain sync. As an aid, Bell & Howell offers a detailed booklet on proper editing techniques. Further information on all three systems can be obtained from: Bell & Howell Photo Products, 7100 McCormick Rd., Chicago, Ill.; Optasound Corp., 116 John St., New York, N.Y.; and Synchronex Corp., 635 Madison Ave., New York, N.Y. ★★★

POPULAR MECHANICS



are you headed for a time-clock number?

...or a **BIG PAY** place in

REFRIGERATION

**140,000 new servicemen needed
...you can be one of them**

Air conditioning, refrigeration and heating is one of America's fastest growing fields. Service and installation technicians are in desperate demand.

And you can join this force of men making big money right now by becoming a skilled technician with our help.

Top men are making 2 and 3 times more than unskilled workmen. Yet we can teach you these skills so quickly you'll be earning money long before you've finished learning.

AMERICA'S FOREMOST COURSE AT A MATCHLESS LOW PRICE

Learning at home is hailed by educators as being far superior to classroom work with all its mass production and distractions.

In our fine, professional 100-lesson textbook course you will receive the clearest instructions in unmistakable simple language. Plus self-provided, self exams and graded exams.

Directed by Roy Anderson whose experience with home study and

Army-Air Force training goes back to 1935, we have prepared material that will turn out top-notch graduates. And we do it at a cost so much lower than any comparable course that you simply will not believe it possible.

One way we do it is by not loading our students with costly equipment and tools — most of which you probably already have, or can buy locally for less than some schools charge you!

The Liberty School is a fine, professional and very intimate institution of learning-at-home, supervised in every tiny detail by Mr. Anderson.

We can't begin to tell you all of the advantages in this small space — but we'll give you all the details if you send in your name and address. Remember, we have NO salesmen so no one will bother you. In the privacy of your room you can study the description of our lessons and make up your own mind without any pressure whatsoever.

A big pay future is waiting for you — grab it now.

LIBERTY SCHOOL Dept. J-5

Technical Division, 1111 W. Park, Libertyville, Illinois 60048

Be Your Own BOSS course includes directions on **How to Own YOUR OWN Business!**



Roy Anderson
LIBERTY SCHOOL, Dept. J-5
Technical Division — 1111 W. Park
Libertyville, Illinois 60048

SEND ME YOUR NAME AND ADDRESS
— I'll rush you **FREE** details by mail.

Dear Mr. Anderson: Please send me description of your course on AIR CONDITIONING, REFRIGERATION AND HEATING. I understand this places me under NO obligation and that NO salesman will call.

Name _____ Age _____
Address _____
City _____ State _____ Zip _____

AUTO ELECTRICAL PROBLEMS? TROUBLE SHOOT WITH VOLT-I-CATOR

- Batteries
- Regulators
- Alternators
- Charging Systems



Made in U.S.A.

Simple installation, just plug into cigarette lighter. A precision voltmeter with an easy to read color-coded slide rule dial, and it tilts for easy visibility. Volt-i-cator also indicates at a glance if tune-up services are needed, plus other internal problems as speed, load and operating conditions vary and warns you before a major breakdown occurs.

\$12.95 plus 50¢ postage and handling. Money back guarantee. Dept. 2PM5 Add Ohio Residence State Tax

J. F. IVAN CO. 10918 Governor Ave.

Cleveland, Ohio 44111 Use Your BankAmericard

2 for 1 WAREHOUSE CLEARANCE SALE

©MCMCLXIX Viking



TWO \$1.98 \$3.96 VALUE 10 Year Guarantee
FOR TWO FOR THE PRICE OF ONE

Razor sharp lifetime steel blade opens easily and automatically locks in place. PUSH-BUTTON release. Tough, razor steel blade honed and polished to mirror-like finish. Balanced for target throwing. Legal size. Blade GUARANTEED 10 YEARS. If blade breaks we replace free. 30-day MONEY BACK GUARANTEE. A favorite with sportsmen. Priced for quick sale of 200,000 knives. Makes excellent gift for man or boy. Two for \$1.98 plus 50¢ shipping. Send cash, ck. or M.O. to VIKING KNIVES, Dept. K-3, Box 10880, Houston, Tex. 77018.

ROLLER-CRIMPER



- The Roller-Crimper is designed to reduce to a minimum the time and labor required to restore damaged fenders to new condition.
- It eliminates the need to remove windows and to cut away large segments of metal in order to restore a small portion of a crushed front or rear fender.
- In every case, the fender or metal body part repaired with the Roller-Crimper will be stronger than the original construction and will require less refinishing labor and material than methods used heretofore.

Extremely rugged, the Roller-Crimper will give you years of excellent service.

• It won't cost you — it will save you in time, labor, material and money.
• If needed, parts and service are available from the Manufacturer.

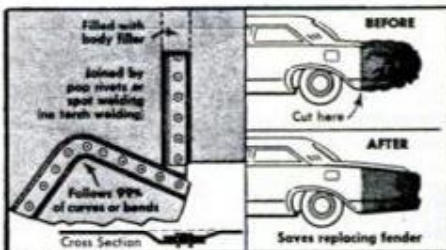

send \$39.95 with check or m.o. PPD.

LYNN DISTRIBUTORS

49 Starr's Plain Rd., Danbury, Ct. 06810

File # 2-100-101576

Name _____
Address _____
City _____ State _____ Zip _____

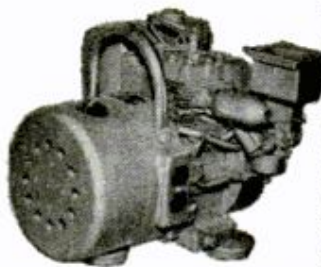
EVERLITE**World's THRIFTIEST Light Plants****THE CHAMPION****\$149.50****The Champion—1200 watts
115 volts AC for only \$149.50**

Unbelievable but true—Brand new production methods now make possible world's finest design in a service free alternator light plant at this unprecedented price. Plant puts out a steady 1200 watts of 115 volt AC power to run power tools, oil burners, pumps, TV, or anything that requires up to 1200 watts. Powered by a rugged 3 HP, 4 cycle, easy start gas engine with 1 year factory warranty. Complete with carry handle and shock mounts. Why fool with short life 2 cycle plants when you can buy this rugged top quality machine at our factory price. **\$149.50**
Item # 1265 wt. 65 lbs. SEND 25c FOR BIG CATALOG

MASTER MECHANIC MFG. CO., Dept. A-52, Burlington, Wis.
Box A, Burlington, Wis. 53105 or Box 65, Sarasota, Fla. 33578

**TECHNICAL EXCELLENCE
IN ELECTRONICS.**

On our small, friendly campus the emphasis is on Living as well as Learning. Extra-curricular social activities, student clubs, a student operated radio station, student government, new dormitory and a full sports program help provide a world of your own in which to prepare for tomorrow. Associate Degree in Engineering Electronics. B.S. obtainable. G.I. approved.

VALPARAISO TECHNICAL INSTITUTE
Dept. PE, Yellowstone Trail, Valparaiso, Indiana 46383

**TERRIFIC "BUY" IN 75 POWER
TELESCOPE—\$4.98**

3 telescopes in one
—25 power for
ultrabright images, 45X and 75X for
extra long range. Guaranteed to
bring people, sports, ships,
moon, etc. 75 times closer.
(Also use as strong
microscope.)
Most power



for the money.
NOT A KIT—ready to
use, 4 ground, polished lenses;
5 sections, brass bound, 3 feet long,
closes to 1 foot. Directions for use. Money
back guarantee. Postpaid. Order now!

Busse Sales, Dept. PM66, 331 Church St., Hartford, Conn. 06101

Be a VETERINARY ASSISTANT

... Lab Technician, Zoo Keeper, Pet Shop/Kennel Owner

MEN - WOMEN! Train at Home in Spare Time ...
Send for Career Kit—ALL FREE!

Name _____ Age _____
Address _____
City _____ State _____ Zip _____
North American School of Animal Sciences, Dept. 24175
4500 Campus Dr., Newport Beach, CA 92663



Emergency
First
Aid
For
Pets
Careers
in
Animal
Care

WHITE'S ELECTRONICS INC.

**THE
WORLD'S LARGEST
LINE OF MINERAL
& METAL DETECTORS**

PRICES START AT 69.50 AND UP.

BUDGET TERMS - BANK AMERICARD - MASTER CHARGE

**WHITE'S ELECTRONICS
INC., U.S.A. Room 512 LTD., CANADA Room 512**
1911 Pleasant Valley Road 33784 Hazel Street
Sweet Home, Oregon 97386 Abbotsford, B.C. Canada

THERE ARE NO FINER AT ANY PRICE.

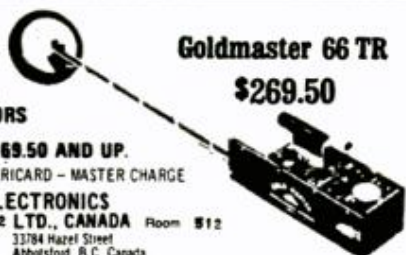

Goldmaster 66 TR
\$269.50

ELECTRIC ARC WELDER \$9.99!

**NATIONALLY ADVERTISED
\$18.95 VALUE!—NOW 1/2 PRICE!**
**WELDS—BRAZES—SOLDERS—
CUTS—ALL METALS!** Plugs into
ANY 110 volt socket. **MAKE—
REPAIR 1001 items for CAR—
HOME—BUSINESS.** Lifetime
BURNOUT GUARANTEE 10 day
money back trial (if retrnd),
postage or send \$9.99 plus \$1.00 postage for
paid del. in U.S.A. **COMPLETE READY TO USE—Includes BIG pack
steel, Brazing, Solder, Carbon "touch" rods, ELECTROFLAME ARC
TORCH! OFFER LIMITED—Order TODAY!**
MIDWAY WELDER Dept. EPM-5 Kearney, Nebr. 68847

HEAVY DUTY Design—No experience needed—FREE WELDING LESSONS!
SEND ONLY \$2.00 (cash, ck, M.O.) and pay postman \$7.95 COD
postage or send \$9.99 plus \$1.00 postage for
paid del. in U.S.A. **COMPLETE READY TO USE—Includes BIG pack
steel, Brazing, Solder, Carbon "touch" rods, ELECTROFLAME ARC
TORCH! OFFER LIMITED—Order TODAY!**
MIDWAY WELDER Dept. EPM-5 Kearney, Nebr. 68847

HINGED TRACTOR WITH FWD*(Continued from page 107)*

hours of use without major maintenance problems. At that point—a year ago—Hesston engineers tore down the tractor and evaluated wear. Some minor weak points were discovered and corrected on this year's production models. The Kansas City contractor's Front Runner now has had over 800 hours of use without breakdown. This compares to 16 years of use by the average owner who runs his tractor about 50 hours a year.

The GMT's rear section, or carrier, serves as a handy carryall for ferrying tools, fertilizer and the like to the job site without the need to tow a cart—which would have to be unhitched when mowing in tight quarters. The carryall plus a top speed of 11 mph (most compacts have a top of 8 mph) give the Front

FRONT RUNNER SPECIFICATIONS

Engine: 14-hp, 4-cycle, Briggs & Stratton
Starter: 12-volt, ignition key, solenoid
Transmission: Hydrostatic, hand control
Brakes: Hydrostatic-dynamic with transmission
parking brake
Turning radius: 46 inches on center line
Wheelbase: 38 1/2 inches
Overall length: 84 1/4 inches
Overall height: 45 inches
Overall width: 40 inches
Ground clearance: 6 1/2 inches
Tire size: 23 x 8.50 x 12
Speed range: 0-11 mph forward and reverse
Power take-off clutch: Electric
Accessory lift control: Hydraulic foot control
Weight: Approximately 800 pounds
For further information write: Hesston Corp.,
Hesston, Kans. 67062.

Runner the versatility of a small mini-pickup truck; it really scats when an operator wants to hustle widely separated chores on an acreage.

Three-blade mowers for the Front Runner are made by Wood Brothers, Oregon, Ill., an old-line manufacturer of quality mowing equipment for many tractor makers. The 48-inch mower lists at \$265; the 60-inch at \$325. An 80-inch bat-wing mower listed at \$615 is available for the 18-hp model. With its mower front-mounted, the GMT mows grass before running over it to insure a clean mowing job. The mower is raised and lowered hydraulically with a foot control.

The Front Runner isn't everybody's tractor. It's a 14-hp hydrostatic-drive tractor weighing 800 pounds; its lightest steel is 11-gauge; it's solid, unitized, welded and it lists at \$1785. (The model 180—18 hp with two-cylinder Kohler engine—lists at \$2325.) But it is a unit many a tractor owner with big grounds maintenance chores will do well to consider when he's ready to trade up. ★★★

WORTH WRITING FOR

LOOKING FOR IDEAS AND INFORMATION ON HUNTING, FISHING, CAMPING, BUILDING, TOOLS, ETC.? CHECK THESE LISTINGS, THEN USE THE COUPON BELOW.

49. NOT A STONE IS LEFT UNTURNED

In this concise, precise, authoritative guide to motor oil selection. Topics range from viscosity to oil drain practices. From the Pennsylvania Grade Crude Oil Association. Free.

50. HERE IT IS!

For the home craftsman—"How To Apply Formica®". Step-by-step instructions, tools required, etc. Free.

51. REDWOOD HOMES IDEA BOOKLET—

All-new, 16-page booklet from California Redwood Association with color illustrations of redwood homes. Impressive. Free.

52. HOW TO WATER YOUR LAWN—

Just turn on the water, right? Wrong! Get this guide to watering and lawn care from Amerace-Esna. Free.

53. 75 FULL PAGES OF INFORMATION!

All of the differences in scope sights are examined (and explained) in this well-written book . . . easy to understand and very complete. From Bausch & Lomb. Free.

54. HAVE YOUR VERY OWN—

Complete color chart of Olympic Stain Colors—for new wood or re-do. Send for it. Free.

55. LUBE TIPS

and techniques from Rislone.

Answers to some of the most-asked questions about viscosity, additives, sludge and multi-graded oils. Free.

56. WHAT IS A LOUDSPEAKER?

This and other questions concerning high fidelity design and acoustic suspension principle are answered in this booklet/catalogue from Acoustic Research, Inc. Free.

57. THE CASSETTE CULTURE IN 16 PAGES—

More news-in-depth for the cassette culture! Simplified technical information concerning mono/stereo compatibility, ranges in frequency and dynamics, even how to repair your tape cassettes. From TDK Electronics. Free.

58. SUZUKI TAKES ON ANYBODY!

A super 12-page full color booklet from Suzuki listing all the motorcycle models available in 1972! Free.

59. HAVE A NEW GRANDFATHER!

Full color brochure offering do-it-yourself plans and kits for Emperor Grandfather Clocks. Free.

60. ABSOLUTELY EVERYTHING ABOUT STEREO!

is included in this 72-page combination stereo encyclopedia/glossary/history/catalogue. By Fisher Radio. A good book! \$2.00.

61. SUPER-8 FILM-MAKING

What a lot of information! 13 different categories dealing with loads of varied filming techniques from the staff of Nikon. Free.

63. ON TARGET!

48 pages in full color including everything from the history of the air-gun to the rules of safety and good marksmanship. By Daisy, Inc., also features a complete listing of their rifles. 50¢.

64. POPULAR MECHANICS MASTER SHOP GUIDE

A necessity for every homeowner. 24 pages of illustrated information on nails, drills, lumber, plumbing, wall fasteners, electrical work, etc. On plastic-coated cards. \$3.95.

65. CATALOGUE OF HISTORICAL DOCUMENTS

Over 250 reproductions of historical papers, posters, documents, monies and Americana books. Also lists pictures of all U.S. presidents. From Huntington House. 26¢.

66. ENLARGING IS HALF THE FUN

of taking those favorite pictures! This booklet, prepared by Durst, Inc., is a complete How-to book for beginners and advanced photofinishers. 24 well-written pages in full color for \$1.50.

POPULAR MECHANICS 572
BOX 1718, SANDUSKY, OHIO 44870

Please see that I receive the items checked below. I have enclosed 35¢ for the overall service charge, plus remittance for any priced items.

- | | | | |
|-----------------------------|-----------------------------|--------------------------------------|--------------------------------------|
| <input type="checkbox"/> 49 | <input type="checkbox"/> 54 | <input type="checkbox"/> 59 | <input type="checkbox"/> 65 (26¢) |
| <input type="checkbox"/> 50 | <input type="checkbox"/> 55 | <input type="checkbox"/> 60 (\$2.00) | <input type="checkbox"/> 66 (\$1.50) |
| <input type="checkbox"/> 51 | <input type="checkbox"/> 56 | <input type="checkbox"/> 61 | |
| <input type="checkbox"/> 52 | <input type="checkbox"/> 57 | <input type="checkbox"/> 63 (50¢) | |
| <input type="checkbox"/> 53 | <input type="checkbox"/> 58 | <input type="checkbox"/> 64 (\$3.95) | |

Total items requested _____ Total money enclosed _____

Name _____
(Please Print)

Address _____

Town _____ State _____ Zip Code _____

(Please send cash, check or money order made out to POPULAR MECHANICS. No stamps, please.)

MAY 1972

MORE HI-FI FOR YOUR DOLLAR

(Continued from page 101)

Fidelity recently established standards for measuring output, and most manufacturers abide by them. A power rating followed by the designation "IHF" or "Music Power" indicates that the maker is complying with the Institute's standards. Equally reliable are the even more stringent ratings given in "RMS" or "Continuous Power."

Watch out, though, for terms like "Peak Power" and "Peak Music Power." These are inflated ratings based on an amplifier's top output during only brief bursts of thundering sound. A peak rating will appear to be about twice that of an equivalent IHF rating.

Be sure, too, that the rating is for each channel separately—not the total for the two. Look for ratings in "watts per channel." Unless this is clearly specified, you can assume the figure given is for both channels together. Another point to check

Watch out for terms like 'Peak Power' and 'Peak Music Power' . . . inflated ratings

on is the load under which output power is measured. Since most speakers have an impedance of 8 ohms, the power rating should be given for an 8-ohm load. Some makers rate power output at a 4-ohm load. This yields a much higher wattage figure that looks good on paper, but is meaningless.

Just at or slightly above minimum specifications, you'll find a surprising number of dollar-stretchers with amazingly good performance. Among amplifiers, for instance, Lafayette's Stereo 25 costs only \$41.40 and pumps out 10 watts per channel. Realistic (Allied Radio Shack) offers a neat, compact stereo amplifier, its Model SA-175B, that delivers 12 watts per channel for a modest \$59.95. A companion FM stereo tuner (Model TM 175) is an exact match in style, size and price.

Moving up the power ladder a step, Lafayette has a 20-watt-per-channel stereo amplifier (Model LA-324A) for \$72.25. Realistic's slightly heftier SA-500 boasts 22½ watts per channel for \$99.95. For the kitbuilder, Heath offers a 15-watt-per-channel stereo amplifier (Model AA-14) for \$67.95 and a companion FM stereo tuner (Model AJM-14) for \$57.95.

If you're sure you're going to want radio as well as records and tape, an all-in-one receiver is a good money-sav-

ing choice over buying a separate amplifier and tuner. The reason is that the amplifier and tuner sections in a receiver share some of the same parts, such as the power supply, helping to cut the cost.

Among moderate-priced receivers, Realistic's STA-36 gives you both AM and FM stereo reception, a respectable 18 watts per channel and walnut cabinetry—all for \$119.95. Slightly less powerful, but well designed, is Sansui's Model 210, an AM/FM stereo receiver with 11 watts per channel for \$129.95. Craig's new Model 1506 is a dandy little mini-stereo system offering AM/FM reception, input jacks for accessory equipment and sleek styling for a surprising \$84.95. Though it's modestly powered, its price, which includes two matching speakers, makes it a real catch for the bargain hunter.

Again, stepping up in power, are Allied's 435 stereo receiver with 23 watts per channel for \$179.95 and Electro-Voice's EV-1181 with 25 watts per channel for \$189. In the just under \$200 bracket (\$199.95) are Panasonic's SA-5500, Sansui's 350A, Kenwood's KR-4130 and Realistic's STA-65C—all with good power for their price. Above \$200, you're out of the economy class.

In kits, Heath again offers several fine models to choose from. Its AD-27 compact, shown at the beginning of this article, combines a 15-watts-per-channel FM/FM stereo receiver with a record player in a novel rolltop walnut cabinet for \$169.95. A similar version without rolltop styling is \$119.95. Two other economy receiver kits are the AR-17 with 7 watts per channel for \$72.95 and the AR-14 with 15 watts per channel for \$119.95. Allied's line of Knight Kits includes an amplifier with 25 watts per channel and an AM/FM receiver with a hefty 50 watts per channel for \$199.95.

When it comes to speakers, it pays not to overeconomize. Here's where a few extra dollars really count. Speakers are your system's voice, and a pair of cheapie models will just compound the limitations of moderate-quality components. Reasonably good speakers can be had for under \$30 apiece, such as Allied's 3001 for \$24.95 or Lafayette's Criterion 50A for \$29.95. For a few more bucks, you can move up to air-suspension types like KLH's 32 at \$47.50, Electro-Voice's 8-A at \$49.95 and Acoustic Research's AR-4X at \$57. Any kind you choose should have at least a tweeter and woofer for good reproduction of highs and lows, and some may have a mid-range as well. A woofer that's under six inches in diameter is just too skimpy to provide good, deep, rich bass reproduction. ★★ ★

How far can a rim fire hunter shoot accurately?

Remington research says, "150 yards."

Impossible? Not with the powerful, new 5mm Remington Rim Fire Magnum in the rifles we built to handle it. Here's the story behind our Models 591 and 592...straight from Remington designers and ballistics experts.

In experienced hands, a 22 rim fire rifle is an efficient small-game and varmint getter. But the effective range of a 22 rim fire cartridge is just about 100 yards. Beyond that, bullet drop is so severe that long-range hits are more a matter of luck than skill. (A 22 long rifle cartridge, for example, zeroed in at 100 yards, can drop 10.7 inches at 150 yards!)

Remember, a varmint's range of vision is greater than 100 yards, especially in open or flat country. So, unless you want to stay with short-range situations, you have to pack more power into the field.

Traditionally, varmint hunters looking for greater accuracy have turned to specialized center fire rifles and cartridges. But not everyone wants or can afford to give up the low noise and economies of rim fire shooting. So Remington-Peters developed a completely new rim fire cartridge—the 5mm Remington Rim Fire Magnum—and built the Models 591 and 592 to handle it.

The 5mm Remington ballistics are impressive. In fact, it's the fastest rim fire cartridge made. (For more details, check the ballistics chart above.) And its speed gives it the flat trajectory needed for long-range accuracy. (Sighted in with iron sights at 100 yards, the 5mm drops only 4.3 inches at 150 yards.) And it's the only rim fire cartridge made with the super-accurate "Power-Lokt" hollow point bullet...a perfectly balanced and concentric varmint bullet that can mushroom up to 35 caliber when it hits as a result of an inseparable bond between bullet core and jacket. The pictures give you an idea just how effective the 5mm is in the field.



Unfired 5mm—5mm recovered bullet (150yds.).

RIM FIRE BALLISTICS			
	Muzzle	100 Yds.	150 Yds.
22 Long Rifle 40 GR. "Hi-Speed"			
Velocity (fps)	1285	1025	960
Energy (Ft/lbs)	147	93	82
Trajectory* Iron Sights (.7" AB)	—	0	—11.1"
Scope Sights (1.5" AB)	—	0	—10.7"
5mm Rem. Mag. 38 GR.			
Velocity (fps)	2100	1605	1400
Energy (Ft/lbs)	372	217	165
Trajectory* Iron Sights (.7" AB)	—	0	—4.3"
Scope Sights (1.5" AB)	—	0	—3.9"

*All Rifles Sighted in at 100 yds.

(Incidentally, the full-color, 48-page 1972 Remington-Peters catalog gives the ballistics for all Remington-Peters cartridges. A copy is yours for the writing.)

The 5mm Remington Rim Fire Magnum cartridge is so powerful we had to engineer a new bolt-action rifle to handle it. Six extra-heavy rotary lugs on the bolt engage grooves in the one-piece steel receiver and lock up tight. It's the same kind of multiple-lug lockup used in some of the most powerful Remington center fire rifles. And for added accuracy, the receiver is round for more precise bedding. Speaking of accuracy...

The Models 591 and 592 have the fastest lock time of any rim fire rifles made today. That means there's hardly any chance for you to stray off target after you've squeezed the trigger. To make the most of that incredibly fast lock time, and the inherent accuracy of the "Power-Lokt" bullet, the precision-bored barrel is mated to a steady, crisp match-type trigger.

We cut no corners on the Model 591 and 592. Both have full-size Monte Carlo stocks, 24-inch ordnance-steel barrels precision-rifled, crowned at the muzzle and blued for good looks and long wear. The only differences between them are their magazines and prices. The 591 handles a four-round clip and costs \$74.95*, and the 592 has a ten-round tubular magazine and costs \$79.95*

Remington Reports are based on facts documented by the people who design and make our products. For more information, write for a copy of our 1972 catalog. Remington Arms Company, Inc., Dept. 463, Bridgeport, Conn. 06602.



Remington® DU PONT PETERS®

Model 592

Great guns deserve great ammunition. We make both.

*Price shown is suggested minimum price, subject to change without notice.

Remington®, Peters®, "Hi-Speed", and "Power-Lokt" are trademarks registered in the United States Patent Office.

Camping '72 Shopping Guide



"PLAY GUITAR"

It's fun to play the Guitar and many go on to fame. This 78 Lesson Book for Standard, Electric, Spanish or Classic Guitars is the easy and fast approach to Guitar Playing. Used by Teachers and Dealers in the USA since 1962. Contents: Use of Base Strings, tuning 5 ways, 216 Chord charts, 50 photos, and 144 slide positions. Price \$3.00 plus 25¢ for handling. (less than 4¢ per lesson). Music Dealers send for brochure

R. H. HENDRICKSON PUBLICATIONS, Dept. PM,
Box 5024, Borger, Texas 79007

DETROIT APPROVED—PICKUP TANKS

Original equip. type poly. now avail. in aux. tanks for pickups. Increase gas capacity 40 gals. Easy 1 hour installation—completely hidden—no body work necessary. Let truck discounts pay for tanks.



R.P.M. INC., Dept. PM-572
P.O. BOX 7936, Waco, Texas 76710

PROTECT YOUR PET WITH NEW

REDI-LEASH It's retractable. Your Pet wears it. It's a Leash. Name Tag. Ornament. Light. Strong. Nylon coated aircraft cable. Model = 31. \$4.98 Post Paid. Small Dogs 8-carrier Nylon Model = 30. \$4.49 Post Paid. Send model = And remittance to **REDI-LEASH** Thompson's Novelties, 560 Paradise Road, Salinas, California 93901 Calif. Res. 5% Tax



CORDLESS TABLE LAMP

A smartly styled lamp that you never plug in. Powered by a long lasting standard battery (not included) inside the base. Ideal for camping, boats, picnics or patio. Essential for use in power failures. No more dangerous kerosene lamps or candles. It could save a life or prevent a serious fire. \$8.49 P.P. Please—no C.O.D.'s. Satisfaction guaranteed or your money back!

FRANIC, 19904 ARROWHEAD,
CLEVELAND, OHIO 44119



DID YOU FORGET TO TURN OFF YOUR CAR LIGHTS AGAIN?

A Lite-Minder will always remind you to turn them off. Put an end to dead batteries and frustrations. Send for your Lite-Minder today. Easy installation. Money Back Guarantee. Specify 6 or 12 Volts. Price \$6.95 P.P.

LITE-MINDER

P.O. Box 7626, Riverside, Calif. 92503

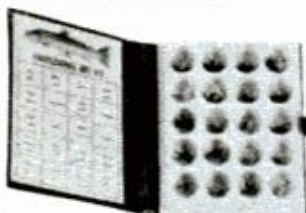

"FAMOUS TROUT FLIES"

A treasured selection of 20 of the worlds most famous trout flies—All in separate pockets, each identified by name and protected by a clear plastic cover. A simulated leather case with a snap closing. Imagine the thrill of landing whopping big Brown or Rainbow Trout and frying them over an open campfire. You'll discover the excitement of real trout fishing. A great gift for dad or son. only \$3.98 **ACT NOW • SEND TODAY** Satisfaction guaranteed or your money back.

"HUGHES AMERICAN" 330 A. R.F.D. #1, Dept. PM
Schuylerville, New York 12871

FANTASTIC SUB-MINIATURE 6 POWER BINOCULARS

Fits in shirt pocket or ladies purse but "ACTUALLY SUPERIOR" to big bulky glasses. Excellent for Campers, Sportsmen, Bird-watchers, Horse races, you name it. Features: PRECISION made POWERFUL 6X15 wide angle view, fully coated lens, wht. 5.84 ounces, smooth center focusing, plus diopter focusing for difference in eye strength. Includes: Black leather carrying case with adjustable strap, 4 protective lens caps, jeweler's lens cloth and instructions. Written Guarantee. Plus FRANKLIN'S own satisfaction money back guarantee. Send check or money order, no COD'S. Only \$27.94 complete, postage prepaid. Ohio residents only add \$1.26 tax. To: D. E. FRANKLIN, Dept. 5B, 833 E. Meadowlawn Blvd. Seven Hills, Ohio 44131



COSMOSCOPE



A telescope and magnifying glass. Have fun viewing live insects, fish, stamps magnified. Enjoy outdoor sports, baseball, bird-watching, etc. Ready to use—complete with observing dish, pincette and operating instructions. \$12.98 pp. Allow 3-4 weeks delivery. Send check or money order to

The Pilmar Co., Dept. PM, Box 774,
Hato Rey Sta., Hato Rey, P.R. 00919

FISHERMEN CAMPERS

100 Plastic worms \$4.95, postage \$1.50. Purple, Black, Red, Blue, Orange, Gold, Bullet Sinkers 1/4 oz., 3/16 oz., \$4.55 per 100, postage \$1.00. Sizes: 1/4 oz., 3/8 oz., 1/2 oz., \$6.99 per 100, postage \$1.50. Jump suits, short-sleeve, Permanent Press: Cranberry, Navy, Black, Red, Gold, Blue, Green \$12.95, postage \$1.75. Jump suits, Double Knit: Navy, Brown, Tan, Gold, Cranberry, Blue \$21.95, postage \$1.75. Sizes S, M, L, XL, Regular or Tall. Guaranteed.

SPORTSMAN'S SALES

Box 807-X, Clarksville, Tenn. 37040

YOUR NAME RIGHT ON THE FACE OF YOUR WATCH



The BUREN By Hamelton. Skin Diver 17 Jewels, Sweep second hand, Day and Date Calendar, water resistant. One year unconditional guarantee. Send your name and \$35.95 to Skin Diver, Thompson's Novelties, 560 Paradise Road, Salinas, California 93901 Post paid, Californians add 5% Tax

DEALERS OPPORTUNITY

Unique new fluorescent automatic rural mail box signal says "mail is here". Have sold over 200 a day. Retail for \$1.98. You make over \$1.00 profit ea. Send \$1.00 for sample and details.

W. R. BROWN, ENTERPRISES,
4738 Brooks St., Montclair, Calif. 91763

"A" FRAME CABIN

You build for less than \$500.

Completely illustrated manual contains step by step instructions and material list

money-back guarantee

Send \$2.00 to: Dependable Products Co. Plan #3001 Box 113, Vista, Calif. 92083

Isn't It Time You Planned To MAKE YOUR WILL?

Why delay? Make sure your possessions are handled as desired. Receive 4 Will Forms and attorney's 64-pg. booklet, "WILLS—How to Make & How to Break Them." \$1.50.

LEGAL FORMS CO., Dept. 548
1830 Guardian Bldg., Detroit, Mich. 48226

FLORIDA LAND FOR DELINQUENT TAXES:

- Most of these properties would make excellent CAMP-SITES;
- Permanent home building sites and acreage;
- Investments in tax certificates for excellent potential returns;
- Properties can be secured for pennies of actual value;
- FLORIDA today stands at the threshold of great development and you may share in this development with very little money;
- Booklet of facts, procedures and application forms for investing in these properties \$2.00
- Mail to—B. F. Ascheheimer, P.O. Box 1035, Glen Burnie, Maryland 21061

LEARN TO HANDLE AND LAND YOUR POWER BOAT SLOWLY!

Eliminate bumping, banging, bouncing and resulting damage. Concise; based upon 25 years commercial boating and instructing. Applicable to any size boat. \$5.00 postpaid.

HAPPY LANDINGS PUBLISHER
4912 W. Main, Hebron, Ohio 43025

TEN-IN-ONE-SCOPE



A useful, educational, scientific instrument for scouts, campers. Uses include directional compass, reading lens, compound microscope, adjustable telescope, solar time clock, magnifying mirror. Complete instruction. A great gift for any man. Send \$1.00.

M. HIERONS, 297 E. 10TH ST., NEW YORK, N.Y. 10009

OUTER-SPACE MAP



Follow the Space-Ships on our Giant 42"x33", 8-color space map shows our entire solar system and each planet's orbit, size and distance relationship to the sun and earth. Only \$1.00 Postpaid.

Chespa Sales, Dept. PM
P.O. Box 117, Barrington, N.J. 08007

FASCINATING SHAWNEE TOMAHAWK

A real tomahawk? Yes, and now being red-hot hand-forged by Ohio Amish blacksmiths the old way. Pick it up. by the blacksmith's hammer into the eye stock. Handle is extra select straight grained white hickory 19 inches long. Total weight is about 2 pounds. Ideal for match throwing. Also makes a decorative wall piece for early American room setting. Price is only \$13.00 Postpaid, Free Catalog. Available from

BEE-JAY'S, Box 8711MK Canton, Ohio 44711

SCALE FISH AUTOMATICALLY

Simply place fish in "ROCK-IT" tow behind your boat. That's all! Patented design removes all scales—even toughest within couple hundred yards. Water flow jets away waste; makes all fish frying-pan clean. Also use "Rock-It" as live box or carry-all. Tough all-galvanized steel construction. Will last for years. 22" long; 10" dia. Weighs only 4 1/2 lbs. Makes fishing all pleasure, no fuss. Satisfaction guaranteed. Only \$14.95 plus \$2.00 postage.



WinFar Enterprises, Dept. PM5,
1 Robinson Dr., Baldwinsville, NY 13027

Camping '72 Shopping Guide

AMERICA BY CAR

Shows scenic routes to historic sights, recommended places to eat and lodge, everything worth seeing in the U.S. Stop guessing, travel right! 170,000 words. \$3.50. **WHAT TO SEE IN ALL AMERICA** shows everything in America worth going out of your way to see. Covers every major spot and details byways and out-of-the-way points of interest. 100,000 words \$2.95. **SPECIAL**—both books for \$4.95. N.J. res. add sales tax.

MAC ENTERPRISES, Dept. H
56 Norwood Ave., Plainfield, N.J. 07060

AEROSOL FIRE EXTINGUISHERS

\$2.98 & \$3.98—Approved for all types of incipient fires, non-conductor, cannot freeze. Dists. Qty. Price 87 1/2¢ & 99 1/2¢—sample of each \$3.50 P.P.D.

G. E. WARREN CO.
Dept. P.M. 5, 6922 E. Congress,
Detroit, Michigan 48207

ELECTRIC AIR PUMP 12-VOLT

Inflates or deflates

Plug receptacle into cigarette lighter to start. Used for inflating rubber rafts, air mattress, inflatable chairs, beachware etc. Will inflate an air mattress in 3-4 min. Compact. Send \$9.95 plus 50¢ postage & handling. Refund guarantee.

BeJe Co.
P.O. Box 1042,
Waukesha, Wis. 53186



FREE PORTABLE RADIO WITH MEMBERSHIP FEE \$5.00

REFUNDABLE first order from catalog. **FREE** a roll of colorfilm for your **KODAK** or other **CAMERA**. Send \$5.00 today for that portable **RADIO** that's all refundable with first order.

UNITED WHOLESALERS SERVICE
118 Greendale Station, Worcester, Mass. 01606

ELECTRONIC IGNITION

Power Up Cars, Trucks, Bikes, Boats and Campers. Eliminate expensive tuneups. Boost engine power and reliability. Up to 35% more voltage for dependable starting. Simple hookup to your distributor and coil. Complete with all necessary hardware and instructions. Satisfaction guaranteed. Only \$14.95 ppd.

AMERICAN ELECTRO-OPTIC CO.
POB. 2002 Huntington Beach, Calif. 92647

NEW HIGH-VISIBILITY SAFETY TRIANGLE

REDUCES HIGHWAY HAZARD



Designed to meet or exceed existing and proposed state and federal motor vehicle safety regulations, represents a significant advancement in disabled vehicle warning devices. A permanent reflective coating provides high visibility, day or night.

Made of high impact molded plastic, the unit has passed wind stability tests of 40 mph. Yet it is light weight and sets up or knocks down quickly for easy storage. Available at \$5.25 postpaid, or two for \$10.00 postpaid. Satisfaction guaranteed.

FITZ MAIL ORDER HOUSE
275 Main Street, Freeville, New York 13068

"ELECTRO START"

Convert your hard-starting engines to Electro Start using Electric drill. Priced \$4.95 up.

For Information write

HEISLER PROD.
Springport,
Mich. 49284



SKINDIVER'S WATCH

This Swiss made precision watch is pressure sealed to operate 350 ft. deep! It's an automatic calendar watch! Movable bezel shows how long you've been under water! Shock protected, unbreakable mainspring, luminous dial, anti-magnetic, sweep second hand, electronically timed, underwater strap... features not found in watches costing twice this price! \$15.95 P.P. Please—no C.O.D.S. Satisfaction guaranteed or your money back!

FRANIC 19904 ARROWHEAD,
CLEVELAND, OHIO 44119

MINI-BIKE KITS SALE

Buy direct from importer. Complete mini-bike kit less engine. 3 models available. Prices start at \$47 FOB L.A. Send 25¢ for catalog

Eastern Enterprises, Inc.

509 Washington Bl.
Dept. P, Los Angeles
California 90015



EXPAND YOUR HOUSE

Double size, triple value of YOUR VACATION CAMP for \$6/foot. Complete blueprints for 1000 s/f wing, \$12.50/set. Twenty pages illustrated instructions, \$2.50. Both \$14. Write:

MONEY SAVER PROJECTS
Box 303C, Chappaqua, N.Y. 10514

Baby Food JAR HANGERS



JIFFY wire hangers engage the neck of the jar allowing jar to be hung on our pat. clips which snap into 1/8 or 1/4 perf. board. Can easily be removed. P.S. Show Gramps or Uncle this ad, they could use your extra jars. Hangers only—12 \$1.40 / \$3.80 \$5. No Jars—No C.O.D.—P.P.D.

WOBLAK P.O. Box 484B
Franklin Park, Ill. 60121

ELEVEN PART CAMPING KNIFE

(with case)



\$3.50

OPENS TO 12"!

All tools, stainless fork and spoon, saw, file, scissors, cork-screw, scaler, bottle opener, etc.

KENRUS, Dept. CK, Box 158M
Staten Island, New York 10309



THE OLYMPIA ANTIDAZZLING SUNGLASSES GLARE STOP

A top quality product which surpasses any ordinary sunglasses because of the sensational protection against glare.

This model has been developed on the occasion of the 20th Olympic Games at Munich 1972.

Available from:

RESU-SALES,

P.O. Box 101

Laval, Quebec, Canada

Special **MAY** offer only \$7.95 pp. Quebec res. add 8% Sales Tax

OUTDOOR LIFE INSURANCE!



UNIVERSAL SURVIVAL KIT: Ideal for outdoorsmen. Fits on belt. **CONTENTS:** flashlight, mirror, canned heat, metal match, cup, NRC rescue blanket, cable saw, knife, food, tape, 30' nylon cord, fish hook, 10' line, handbook, other items. **WEIGHT:** 1 1/2 lbs. Refills available. (Also available in Marine version).

Only \$19.95 Postpaid
Satisfaction or Money Back!

Order now or send for free kit brochure.

BRADCLIFF
Wickenburg, Arizona 85358

A MUST FOR EVERY TRAVELER—AutoERGENCY KIT



Includes booster cables, instant tire repair, flare, flashlight, & batteries, fuses, first aid, instructions, fluorescent flag, 2 screwdrivers, reflective tape, pencil, pre-moist towels, plus \$1.00 postage.

Order now, receive scientifically designed **MEGATRON** odor absorber for camper or refrigerator. \$1.98 value. **HOOSIER GIFTS & SPECIALTIES**
Dept. PM104, Kendallville, Ind. 46755

HOW TO PAN GOLD

Complete illustrated step-by-step **INSTRUCTION BOOK** tells you how. Actual **GOLD SAMPLE** (pieces of gold just as mined) shows what to look for. Book and sample, plus catalog of equipment and books, all for just \$1.00. Money back guarantee.

MINER'S EXCHANGE

P.O. Box 64-PM Nampa, Idaho 83651

maximum space
...minimum cost



minimax
by Monitor



Monitor

Mail my FREE 1972 catalog to:

Name _____

Address _____

City _____ State _____ ZC _____

MONITOR COACH CO., INC.
A Subsidiary of The Wickes Corp.
Dept. PM-572 St. Rd. 19,
Box 506, Wakarusa, Ind. 46573

Camping '72 Shopping Guide

JUMBO 1972 I. GOLDBERG CAMPING CATALOG NOW AVAILABLE

124 pages, more than 1800 items. Choose from the finest in camping and back-packing equipment from the U.S. and abroad.

Send 25¢ to:
I. GOLDBERG CO.
Dept.-1 902 Chestnut St., Phila., Pa. 19107

SUB-MINIATURE BINOCULAR



Fantastic 6 X 15 wide-angle quality product with fully-coated lens. Center focus and diopter control. Little larger than cigarette pack. Weighs 6 oz.—Perfect for back-packing, sports, opera, camping, bird-watching. With case and written Guarantee.

\$23.95 + \$1 post.

CHRISTOPHER'S
7551 Franklin—1282, Sacramento, Cal. 95823

BUILD YOUR OWN

Cabover Campers • Covers
16' & 20' Travel Trailers
• PLANS •
PATTERNS • KITS
★ FREE CATALOG ★
GLEN L
Recreational Vehicles



9152 P-5 Rosecrans, Bellflower, Calif. 90706



NEW! WATER PURIFIER!

Enjoy cleaner, healthier, fresher tasting water in home, boat, camper, office! Attaches in seconds! Removes dirt, chlorine, odors, bad taste! Stops bacteria! Money back guarantee. Send \$4.95 (2 for \$9.00) plus 50¢ handling.

HARVI-HOUSE SPECIALTIES,
Dept. PM502, 2241 South Holly, Denver, 80222

ELECTRONICS BUY OF CENTURY



Airforce surplus radio receivers. First offering to general public. Freq.—108 to 135 MHz. Op. voltages 24 D.C. & 115 A.C. 400 cy. Tubes—25 pcs. including 6AK5W, 6AL5W, 5751, 5887, 12AT7, OA2, 5814. Also D.C. motors, delivered (U.S. only) \$49.50 ea. No C.O.D.'s

ARTKO CORP. 6401 S. Tucson Blvd. Tucson, Arizona 85706



MIRACLE SLIMMER BELT trims your waistline without any effort. Provides comfort and support for sagging muscle. Made from elasticized cotton and comes with Velcro-Fasteners. Waist from 26" to 50". Send \$3.98 to

CARLOS RAMOS, 250 19th Street, Brooklyn, New York 11215

CAMPING, HUNTING, FISHING



equipment made like new with BIRCHWOOD CASEY metal and wood finishes, protective products, weather proofing specialties.

FREE 12-page illustrated catalog from
BIRCHWOOD CASEY DIVISION,
7900 Fuller Road, Eden Prairie, Minn. 55343

2-from-CANADA

Canada's most beautiful, most complete coast-to-coast campground and mobile home park directory. Travel-Leisure '72. \$2.50 Canada's only mobile home and rec veh Trade Index—lists mfg. brand names, suppliers, dealers etc. \$2.75

Tall-Taylor Publications Ltd.,
522-Herald Bldg., Calgary 2, Alta.

FREE FRANCHISE

Since 1957 (when *additive* was a bad word) Original Perma-Charge has saved countless batteries from early death. Our selected distributors in your area will get a free franchise, with the only guarantee of its kind known to exist. Write immediately to Clinton B. Petry II, President.

PETRY & SON, 210 Fifth Ave., N.Y.C. 10010

FOR SALE!



GOSHEN RADIATOR!

In The Heart Of Trailer Camp. Grossing Over \$24,000.00 Yearly. Due To Ill Health Reasons.

GOSHEN RADIATOR SERVICE
400 West Lincoln,
Goshen, Indiana 46526

Convert any 2 x 4 into a BIG THROAT VISE!

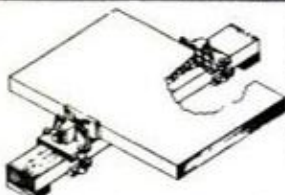

First Class Cast Aluminum Hardware Set. Two Sets Hold Anything! Includes Chart of Many Uses. Holds all big work on bench or saw horse. Quick-Adjustable as Clamp or Vise.

\$12.50 \$22.50
pp set of two pp.

Send Cash, Check or Money Order to: Y-K Tool Company
P. O. Box 11463 • Fort Worth, Texas 76109

WOULD YOU INVEST \$1 FOR THE CHANCE TO SAVE UP TO \$50 ON YOUR NEXT SET OF TIRES?



The NEW 1972 Tire Directory "WHO MAKES IT AND WHERE" shows you how. It gives you the name, address and manufacturer of almost every tire brand made in the world, both foreign and domestic. It also instantly identifies any tire brand made by the DOT code number stamped on the sidewall of all tires.

Send \$1.00 coins, check or money order to:
TIRE GUIDES
Dept. M 2119 Route 118, Farmingdale, N.Y. 11735

Satisfaction Guaranteed or your money promptly refunded



ALVA ALLEN Power Punch Presses

1 to 100 Ton Capacity
Complete line in hundreds of different style and model combinations. Write for FREE literature on presses and complete line of Punch Press accessories as — Feeds, Dies, etc.

ALVA ALLEN INDUSTRIES
Dept. PM, Clinton, Mo. 64735

USE ZIP CODES WHEN ANSWERING ADS

SAILBOAT KITS

Free color catalog of the largest selection of popular sailboats, iceboats, and sail making supplies.

TAFT MARINE CORP.
Dept. PM-5, 636 39th Ave. N.E.
Minneapolis, Minnesota 55421

COMPLETE PEST CONTROL

• COMMERCIAL • RESIDENTIAL

QUEENS RE-9-5700 NASSAU PL-6-1822 SUFFOLK MO-5-2077

Fumex Sanitation Inc.
FIRST & FOREMOST

• 24 HOURS A DAY
• IMMEDIATE SERVICE
• 5 YEAR GUARANTEE
• CONSULT US NO OBLIGATION

JUST OUT! POPULAR MECHANICS INDEX AND SHELF WRAPPER

HERE'S A GREAT IDEA THAT WILL MULTIPLY THE VALUE OF YOUR BACK ISSUES OF PM.

Want to find an article on roofing your home? Building a hacksaw or mini-bike? What the owners themselves think of the Buick Opel? Your copies of PM are chock-full of such information. The new PM INDEX AND SHELF WRAPPER solves your problems. Thousands of items that appear in PM throughout the year are not only referenced, but thoroughly cross-referenced as well. Best of all, the INDEX is bound into a handsome wrapper made of heavy board. The wrapper precisely encloses the 12 issues in the INDEX, and makes a beautiful and useful addition to your bookshelves. The entire handsome package is yours for only \$1.49. Send orders to: POPULAR MECHANICS Dept. IX, P.O. Box 1014, Radio City, New York 10019.



1

3 needed skills NRI can teach you at home . . .

NRI courses use easy "bite-size" texts to show you how to service TV-Radio Repair Cars or Appliances

"Hands-on" Training pays off

Learning TV-Radio, Automotive Servicing or Appliance Repair at home is easy, exciting, and profitable . . . the simplified NRI way.

NRI was the first to supply home study students with custom-designed training kits to give practical hands-on experience as you learn. You learn quickly with NRI, thanks to such features as the exclusive Achievement Kit (sent the day you enroll), "bite-size" texts, and custom training equipment.



2

Practical Testing Equipment Provided

Most NRI courses include professionally engineered testing equipment. With NRI's TV-Radio Servicing course, you receive your choice of black & white or color TV Kit. The Automotive Servicing Students get an NRI scope/analyzer and other tools and Training materials. Application of this equipment allows you to earn money almost from the start of your training.

Earn \$5 to \$7 an hour, in your spare time

Tens of thousands of NRI graduates are proof it is practical to train at home. Keep your present job while preparing for a better one and earn \$5 to \$7 an hour extra in spare time. Fix your own equipment, or earn money making repairs for friends and neighbors. NRI shows you how.



3

Train with the leader—NRI

The same training innovations which have made NRI the leader in technical training at home are now available to you. You'll proceed at your own pace . . . guided and assisted wherever necessary by one of NRI's staff of home training experts. It's the convenient way to learn a skill.

But *you* must make the decision. Mail the card today for a free full-color catalog in the field of your choice. No obligation. No salesman will call. If the reply card is missing, write to NRI at the address below and ask for the catalog.



NRI TRAINING

3939 Wisconsin Avenue, N.W.
Washington, D.C. 20016

The bargain hunter

CHARGER KITS for CAR-TRUCK or BOAT BATTERIES



For 6 or 12 volt batteries. Delivers up to 50% more than rated output on initial charging surge. Tapers to 2-3 Amps as power builds up in battery. All wiring with push-on terminals. Only a screwdriver needed for easy assembly. Step-by-step instructions.

Overload breaker, plastic handle, red and black case. Six foot power cord, charging cable with heavy-duty battery clips attached. Meter recessed for protection, wall mounting slots on rear. 10x6x6.

6 Amp. **\$14.95** 10 Amp. **\$19.95**
10 Lbs. 12 Lbs.

PLUS POSTAGE

Southwest Technical Products Corporation
Box 32040 • San Antonio, Texas 78284

HEARING AIDS

UP TO **50% OFF** COMPARABLE AIDS ★

BUY DIRECT • 20 DAYS FREE TRIAL Body Aids \$39.95 up. Tiny All-in-the-Ear: Behind-the-Ear; Eye Glass Aids. No salesman will call. Write LLOYDS ★ Dept. PM, 905 9th St., Rockford, Ill. 61108 ★

WATER "HOW TO DRILL YOUR OWN WATER WELL"
WATER
WATER \$1.00ppd
WATER SATISFACTION GUARANTEED
WATER
DEEPROCK CO.
OPELIKA, ALA. 36801

YOU CAN BE TALLER!



If you could grow 2-6 inches taller in one month would you spend 25¢ to discover how?

Fantastic, new breakthrough method of increasing height quickly, safely and naturally. No exhausting exercise, appliances, drugs or elevators. PLUS, results guaranteed. Air mailed Proof 25¢ only.

HEIGHT INCREASE BUREAU:
Dept. 15817
P.O. Box 146,
Brampton, Ont. Canada

BE TALLER! Girls go for tall Men.

NAME _____
ADDRESS _____
CITY _____
STATE _____ ZIP _____

HIGH SPEED DRILL BIT MIX

50 Drills For Only **\$4.00**

Add 35¢ postage & handling
A fabulous buy. You get 50 assorted American made high speed drills from 1/64" to 1/4" in varying lengths. All sharp and ready to go.

Order Today—Check or M.O.
AMERICAN TOOL CO.

Dept. DB-390-D, P.O. Box 126
BETHPAGE, L. I., N. Y. 11714

DEALER INQUIRIES INVITED



Photo Shown: Mid Engine Sports Racer

Complete construction plans for all BEACH RACING CARS

Formula Vees, Supervees, Fords, Sports Racers

Send \$1 for brochure listing plans, parts, books & information kits

AUTOSPORT DESIGN,
P.O. BOX 1311, Dept. PM
LARGO, FLORIDA 33540



Easy to Build PLANS AND INSTRUCTIONS for
Go Kart\$2.00
Mini Bike\$2.00
Mini Car\$3.00
Pedal Boat\$4.00
Sail Boat\$2.00
Snowmobile Sleigh \$3.00

Mini Vehicles Plans
Dept.-C P.O. Box 92
Chazy, N.Y. 12921

HOME BOOK OF REFINISHING FURNITURE. All your questions are answered in this authoritative volume. Price \$4.95. Send to: **POPULAR MECHANICS** Dept. FA 5, Box 1014, Radio City, N.Y. 10019

HANDY DANDY Storage Jars



Handy Dandy plastic caps hook onto 1/8" peg-board to hold popular, quarter-twist food jars (such as baby food) with 1-15/16" neck. Nothing better for storing screws, nuts, bolts, parts, buttons, etc. For those who prefer; tough, unbreakable, clear plastic jars are also available.



QTY	CAPS	JARS	CAPS & JARS
10	\$1.00	\$2.00	\$2.50
24	-	4.50	-
36	3.50	6.25	8.00
72	6.00	11.50	15.00
144	11.50	22.00	28.00

PPD USA, No C.O.D.'s
WICKLIFFE INDUSTRIES, INC.
Box 286 PM-5
Wickliffe, Ohio 44092

208



GRANDFATHER CLOCKS
SAVE 50%
BUILD YOUR OWN GRANDFATHER AND GRANDMOTHER WEIGHT DRIVEN CLOCKS

- Highest Quality Imported Movements from Germany
- Tubular or Rod Chimes
- Moving Moon Dials
- Pre-cut Semi-assembled Handcrafted Case Kits (No power tools required)
- Dials, Barometers, Hygrometers, Templates and Case Plans.

All movements and dials in stock.
Send 30¢ for complete catalog
H. DeCOVNIK & SON,
P.O. Box 68, Dept. M52
Alamo, Calif. 94507
EST. 1947

FIND BURIED TREASURE

FIVE PATENTED MONEY SAVING DETECTORS
TRANSISTORIZED FROM **17.95** to **49.95**
3 SEARCH HEADS INCREASE RANGE
Finds Coins, Jewelry, Gold, Silver, Bronze
Write For FREE Catalog
SOLIDTRONICS DEPT PAZE, TENNENT, NJ 07763

HOME BOOK OF ELECTRICAL WIRING AND REPAIR. Written for the average handyman. Price \$4.95. Send to: **POPULAR MECHANICS** Dept. FA 5, Box 1014, Radio City, N.Y. 10019

FREE BURGLAR ALARM INSTALLATION MANUAL

We will send you free with no obligation our exclusive Burglar Alarm Installation Manual. Gives you simple, easy to follow, step by step "do it yourself" instructions - saves you hundreds of dollars. No special tools or license necessary.

Send today for your FREE Installation Manual. If you also want our 1972 catalogue featuring 100's of items at fantastic savings, please enclose \$1.00 cash or money order.

ALARM DEVICE DISTRIBUTORS
P. O. Box 372-K Opa Locka, Fla. 33054

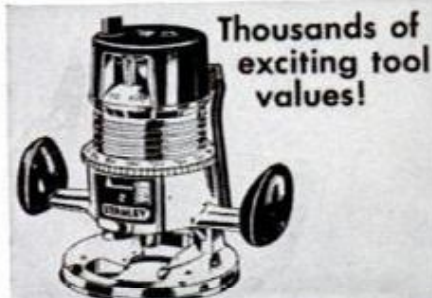

SILVO (BRAND NAME) TOOL CATALOG

Thousands of Exciting Tool Values! Stanley, Millers Falls, Skil, Thor, Wen, Disston, Wiss, Wellisaw, Dremel, Speedy Sprayers, Plumb, Huot, Kennedy, Channellock, Porter-Cable, Rockwell, Helios, Vise-Grip, Crescent, Ridgid, Pony Clamps, Unimat, Foredom and many other Nationally Advertised brands of Tools & Supplies. We ship Coast to Coast at prices Hard to Beat. Send 50¢ for our big 146 page tool catalog today. Silvo Hardware Co., PM-5 107 Walnut St., Philadelphia, Pa. 19106.

POPULAR MECHANICS

REDUCIBLE RUPTURE

AGONY Removed
(or trial COSTS YOU NOTHING)



WHEN you slip into a low-cost, contour-designed Brooks Patented Air Cushion Appliance! Your reducible rupture will be held in securely yet gently—or the trial costs you nothing! This invention has made millions of sufferers happy. You can enjoy heavenly comfort night and day at work and play—or the Appliance costs you NOTHING. Isn't this worth a no-risk trial by you? If interested, write for free facts now. **Brooks Co., Box 346-K, Marshall, Mich. 49068**

BUILD YOUR OWN CANOE

WOOD & CANVAS OR
FACTORY MOLDED
FIBERGLASS

MANY
MODELS
TO CHOOSE
FROM \$1950

FREE CATALOG

TRAILCRAFT, INC.
Box 60679, Concordia, Kansas 66901

WORLD WAR II STYLE COMBAT KNIFE Only \$2.75



Replica of the hated Nazi **COMBAT KNIFE** of World War II. Now made into a real man's hunting knife. 5½" blade, 9¾" over all length. Razor sharp high quality cutlery steel blade. Comes with Leather Sheath. Your treasure for only \$2.75 plus 25c handling charge.

WESTBURY SALES CO. Dept. NM-20
P.O. Box 434, Westbury, N.Y. 11590

YOUR OWN BUSINESS \$30 AN HOUR

says D. Carter, Lemoyne, Pa.
Complete turn-key package includes training school in radiator repair technology and business management plus special power-equipped radiator repair shop for cars, trucks, tractors.

Don Carter writes: "\$70,000 volume last year." Mail ad with name, address, phone for complete story.
INLAND MFG. CO. Dept. PM-5
1108 Jackson Street • Omaha, Nebr. 68102



Get your bills



WE CAN HELP YOU!

We are not a loan company, so poor credit is no problem! (Maximum total debt accepted is \$20,000.)

Send your name and address. We'll mail more information and a CONFIDENTIAL application.



UNITED SECURITY CORPORATION

Dep't. PM5, 36 Kennedy Pl., Providence, R.I. 02903



FREE!!! POWERFUL MUSCLES FAST!
Fantastic New Discoveries in the science of bodybuilding. Now, in the privacy of your bedroom, our method will add inches of powerful muscles to arms, chest, shoulders & legs. Learn secrets on trimming the waist with ultra-modern methods—fast! Results Guaranteed! Send for free brochure. **Universal Bodybuilding, Box 485-MI, Dearborn, Mich. 48121.**

2000 NOVELTIES Free Catalog

FREE! World famous catalog of hard-to-get Novelties, Tricks, Jokes, Pranks, Hobbies, Sports, Science, Electronics, Peace & Love Gear, Mod, Psychedelic, Cloth Patches, Shirt Transfers, Lights, Jewelry, Bargains, Gadgets, Books, Games, Photo & Optical, Tools, etc. **No letter necessary. Send ad, name address. Johnson Smith Co., Dept. C-105, Mt. Clemens, Mich. 48043**

FIRE & BURGLAR ALARMS 1972 Handbook & Catalog

Save
Hundreds
of
Dollars



Professional equipment from famous manufacturers, not readily available from local sources. **NEW & EXPANDED** to include laser photo-electronic systems, dialers, electronic sirens, perimeter controls, and a **NEW RADIO ACTUATED SYSTEM** that installs in less than 2 hours. Also includes switches, bells, control panels, wire and hardware. Save up to 75%. This handbook is a must for every homeowner and businessman. Just \$1. cash, check or M.O. \$1 refunded with first order.

ALARM COMPONENT DISTRIBUTORS
33 New Haven Ave., Dept. P.M.
Milford, Conn. 06460

LICKITY SPLITTER

ENDS WOOD SPLITTING DRUDGERY

New low cost **COMPACT MODEL**... for farmers, camps, cottagers. 10 ton ram, 2 cycles per min., splits logs 25" x 18". Carried in car trunk, placed upright or hung for storage. For details write:



295 lbs. with gas and oil
PIQUA ENGINEERING, INC., Dept. P, Box 605 Piqua, O. 45356

TOOL POWER™ 110 VOLTS D.C.

3,000 Watts 0-50 amps from your car's alternator. Operates heavy duty drills, saws, and lights, battery charging. Are welding. Does not operate A.C. motors on refrigerators and air conditioners. Installed in 10 minutes. Guaranteed 5 years. \$25.00 Postpaid. Dealerships available.



A.C. Generators
60 Cycles, 110 Volts, Fanbelt driven. Runs power tools, T.V.'s, refrigerators, radios, A.C. motors to 1½ H.P. Cannot operate air conditioners. 1,500-watt. \$60.00 plus \$5.00 postage. 3,000-watt \$89.50 plus \$6.00 postage. P.O. Box 7066, 2821 Mays St.

VIRDEN PERMA-BILT CO.
PM Amarillo, Texas 79109



HoverPacer 2-seat ACV. Build from simple Plans, Kit. Outstanding performance: 50 MPH water, 60 MPH land. Proven design. Available in open (Sport) or closed (All Weather) cockpit design. Send \$1 for photos, tech. specs, prices.

KING TECHNOLOGY

Box 231, Carmel, Indiana 46032

TRASHPACTOR

Convert your **TRASH CAN** into a manual **COMPACTOR** and reduce your trash volume by 50% or more!

***DO-IT-YOURSELF-KIT:**
Complete with all parts and instructions necessary to convert your trash can into a Compactor \$3.95 ppd.

***FACTORY ASSEMBLED UNIT:**
Complete with lid and ready for use with your trash can. (Include name and measurements of your trash can with this order. Total price ...\$12.95 ppd. Send personal check or money order to:

AKENS-ADORNETTO, INC.,
6725 West Pike, Zanesville, Ohio 43701

KWICK POWER FOR TOOLS

110 volts D.C. 3000 watts anywhere from any vehicle with an alternator. Installs permanently in 15 minutes. Operate heavy duty saws, drills, lights, heaters & many more a.c. devices. Arc weld, quick charge batteries. Will not harm alternator. \$14.95 postpaid, check or money order.



Only \$14.95

AUTO QUICK

10914 4th St., N.E.
Minneapolis, Minn. 55434

"BALANCE YOUR OWN WHEELS"

BUBBLE TYPE STATIC BALANCERS

Very Accurate Precision Made
Money Back Guarantee Thousands in Use
Versatile Model V, W & Saab
(Illustrated) For Adapter—Fits any
all wheels including cone type balancer. \$4.95.
including Saab & V. W. (4 & 5
bolt holes). Weights—10e
per 1 oz.
\$19.95. Complete Instructions.
American Model—For Prices Pre-
wheels with center holes up to 4½" dia. paid.
Delivery with in
two wks.
\$14.95. after receipt of
Heavy-Duty Model—For order. Dealer
wheels with Steel Inquiries in-
center holes up to 6" dia. vited. Steel
(small trucks). Cone: Alumi-
\$24.95. num Cast
Base. Chrome
Plated.



JACOBSEN MANUFACTURING
P. O. Box 6143, 15025 Pacific Hwy. So.
Seattle, Washington 98188

GOOD VISION

WITHOUT GLASSES

Whether you are nearsighted or farsighted, our simple, successfully tested eye training exercises will improve your vision. Find out how you can enjoy better eyesight, send only \$3.95. Get satisfactory results within two weeks or your money refunded.

GROSSI

Box 1061-PM5, Postal Station "A"
Toronto 1, Ont., Canada

RAZOSHARP®

U.S. Pat. 3,608,195

\$2.25**PRECISION TOOL
HANDLE FOR
INJECTOR RAZOR BLADES**

IDEAL POCKET KNIFE—EXCELLENT OFFICE AND HOUSEHOLD UTILITY TOOL—Only holder to use standard injector type razor blades. Only holder allowing for varying blade length exposure. Only holder allowing blade to be completely sheathed and protected. Only razor blade holder to give precision tool feel.

ALWAYS RAZOR SHARP—When blade dulls—pop in new blade. Re-use injector type razor blades. **SHAVE AND SAVE.** Inexpensive injector type razor blades always available. To expose new sharp edge—reverse blade or clip dull edge. Excellent for cutting clippings, cardboard, trimming. Ideal for opening packages, cartons, boxes. Use for carving, whittling, sharpening, erasing, etc. Shape blade to suit use—snip edge, grind or break with pliers. Nothing to break or wear out.

RAZOSHARP® Dept. A-5
421 Stockholm St., Bklyn., N.Y. 11237

Make your own gems!**Fun - Easy - Profitable**

Kit includes Gem Maker with 6" iron lap wheel, all grinding, shaping and polishing wheels, diamond blade, accessories, instr.

\$49.90 less motor, fob Fctry.

B & I MFG.

Box 1267-P, Galesburg, IL 61401

Write for literature.

THE LIGHT

... is meditation,
Contemplation,
Cerebration,
Syncopation.
THE LIGHT.

... is for dreaming music,
And the souls of painted
pictures.
THE LIGHT.

... is peace.
... is rest.

Only we have **THE LIGHT.**
Ours is ultra-ultra-violettee;
Deepest black that you may see.
Only ours is called **THE LIGHT.**

30 day money back guarantee. Send \$14.95
for the finest psychedelic black light.

THE LIGHT

Box 21008
Phila., Pa. 19154

**NON-ACID CHEMICAL ADDITIVE
RESTORES "DEAD BATTERIES"**

For 12V
or 6V
batteries
\$2.98
ppd.

In Md. add
4% sales tax

Puts new life in old batteries.
Extends life of new batteries.
Guarantees sure starting (it's like
having a spare battery!) A MUST for car and
boat owners. Easy to use. Just pour into battery.
GUARANTEED. *Mechanically sound batteries that fail
due to excessive sulphation deposits.

SEYMOUR, Dept. PM-5
928 Rambling Drive, Baltimore, Maryland 21228

**GROW YOUR OWN
MUSHROOMS**

At last you can learn the mysteries of growing your own mushrooms at home. Imagine from one planting, you harvest every week, for up to four months. Great for hobby or profit. Why pay high store prices when you can grow your own for pennies. Book gives complete instructions on growing, obtaining spores and even cooking recipes. Send \$2.00 to:

MITCHELL'S MUSHROOM CO.
P.O. BOX 103
Jenison, Mich. 49428

FACTORY CLOSEOUT!

Air Pistol \$5.95
ppd.

Shoots both pellets and darts. This fine, well made .177 cal. German air pistol is just the ticket for target or Varmints.

Accurate. No CO2 cartridges to replace, either. Once in a lifetime bargain. Order several. Supply limited. Only \$5.95 ppd.

(Secret leather holster. \$2.95 ppd.)
500 Deluxe Pellets, \$2.00 ppd.

AIR PISTOL, Dept. PM-5
4535 Huntington Dr. South
Los Angeles, Calif. 90032

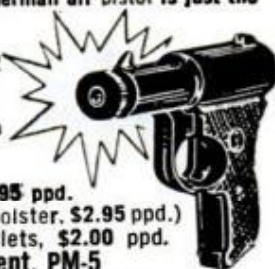

Mr. Universe
Frank
Richard
says...

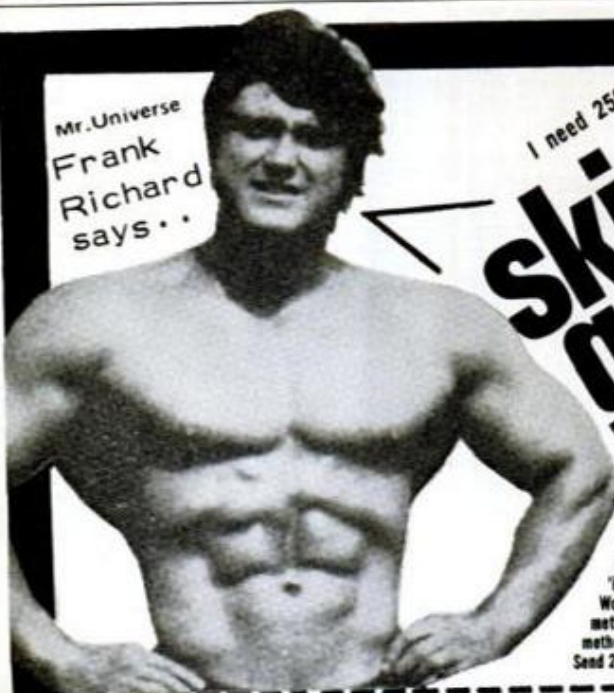

I need 250

**skinny
guys**

Yes, I need 250 skinny guys to test my fantastic Body-building secret **TENSILE CONTRACTION** — by mail. I don't care if you are young or not so young, underweight, weak or flabby. **TENSILE CONTRACTION** will transform you in just 35 days — No 'its' or 'buts'... Help me prove to the World that my safe, medically approved method is positively the **FASTEST** known method of Muscle building known to man! Send 25c coin for my special one time offer.

THE BODYBUILDING CENTER Dept. 15817
P.O. Box 146 Brampton, Ont., Canada

Dear Frank
I enclose 25c coin. Count me in on your "Mr. Universe in 35 days" Musclebuilding Secrets. I understand that I am under no obligation and that I may quit **TENSILE CONTRACTION®** at any time without having to return the course.

NAME _____ AGE _____
ADDRESS _____
CITY _____ STATE _____
ZIP _____
(please print clearly)

**POWER OUTLET**

EASILY INSTALLED IN YOUR CAR
YOU DO IT YOURSELF IN MINUTES WITH SIMPLE TOOLS

CAR POWER

3000 WATTS FROM YOUR ALTERNATOR

POWER FOR: HEAVY DUTY DRILLS • SAWS • LIGHTS
• COFFEE POT, ETC. YOU CAN EVEN CHARGE
DEAD BATTERIES OR ARC WELD

* GUARANTEED 5 YRS.
* WILL NOT DAMAGE
ALTERNATOR

\$16.95

HOLLY &
P.O. BOX 5321
PHOENIX, ARIZ.
85010

FOR MOTOROLA ALTERNATORS
AMERICAN MOTORS & JEEP
CAR POWER II

\$18.95

PLEASE SPECIFY WITH YOUR ORDER

FIX CLOCKS, WATCHES

FOR FUN & PROFIT! Fascinating new Handbook by master craftsman H. Harris gives you the knowledge skilled watch-makers learn.

OVER 200 ILLUSTRATIONS show how to install hands, dials, crystals, mainsprings, stems—rehouse old movements in modern cases—clean timepieces, etc.

INSTRUCTIONS COVER every popular watch and clock, chimes, grandfathers, cuckoo, every-day alarm and electric clocks. Handbook tells you where to buy parts... where to send "overflow" work for repairs at wholesale prices as business expands!

Friends gladly pay \$5 to \$50 for restoring cherished timepieces. Try the **HANDBOOK OF WATCH AND CLOCK REPAIRS.** Rush only \$4.95, plus 30¢ handling, on 10-day money-back guarantee. **EMERSON BOOKS, Inc.,** Dept. 965-T, 251 West 19 St., New York, N. Y. 10011.



Build this "Flying Volkswagen" in your own back yard for less than \$1,000!



Now you can have the thrilling experience of flying your own plane with this all-metal plane that even a beginner can build. With *Popular Mechanics* plans and instructions you can build the "Teenie Two" from stock items from almost any metal-products shop. No special equipment. Most work can be done with a plastic-headed hammer and a pair of tin snips, and the whole thing can be done for less than \$1,000!

Send for your instruction booklet plus the plans today!

TO: Popular Mechanics
Dept. TT
P.O. Box 1014
Radio City, N.Y. 10019

Please send me plans and instructions for building the "Teenie Two." Enclosed is \$35.00 payment.

NAME _____
ADDRESS _____
CITY _____ STATE _____ ZIP _____

MAY 1972

USE
ZIP CODE
WHEN ANSWERING
ADS

SAVE WATER

STOP WASTING 4 GALLONS OF WATER EVERY TIME YOU FLUSH A TOILET! UNIQUE PATENTED DEVICE CONTROLS THE FLUSH—USE ONLY WHAT'S NECESSARY. ALSO PREVENTS FLOODING. INSTALLS IN SECONDS. FITS ANY STANDARD TOILET.

SEND \$1.00, PLUS .25 FOR POSTAGE AND HANDLING. MONEY BACK GUARANTEE.

Control-A-Flush-Box 264-Edison, N.J.08817

NEVER WAX YOUR CAR AGAIN!!



THAT'S RIGHT! When you buy AstroShield, world's finest polish and glaze. Guaranteed in writing to last as long as you own your car. Not a wax, not a plastic, not an oil-base polish. AstroShield is a unique, exclusive blend of Space Age chemicals that lay down a virtually impenetrable coat of protective armor on your car's finish. It's almost as though you dipped your car in liquid glass. AstroShield's tough diamond bright glaze seals OUT rain, snow, salt spray, highway oils, bug stains, bird droppings . . . seals IN deep lustrous showroom color and beauty! Yet AstroShield is easier to use than any wax or polish ever developed. Just spread on, let haze form, and wipe off. Stains, dirt, grime, oxidation vanish like magic! There's no pre-cleaning, no hard rubbing, no buffing—but still that AstroShield lasts and lasts. A single quart container of AstroShield must continue to give full satisfaction for as long as you own your car, or free replacement or money back. We dare make this precedent-breaking guarantee because we know that AstroShield is the world's finest auto polish and glaze!

Order today!! \$6.25 including postage and handling, from
ROSS ENTERPRISES, Box 121, Warminster, Pa. 18974 Dept. 25

\$SAVE 3 WAYS! INSTALL IT YOURSELF

VENT-A-MATIC Thermostatically-controlled Power Ventilator as featured in April PM.

Thousands are enjoying the SAVINGS on equipment and installation costs of air conditioning. SAVES up to 1/3rd on power, keeps home cooler by removing super-heated air in attic.

In winter, VENT-A-MATIC can remove condensation, prevents frost in attic, prolongs life of roof. UL listed.

Send Check or M.O. for \$84.95; frt. prepaid in USA, to:

BUTLER ENGINEERING CO. Dept. PM572
P. O. Box 728, Mineral Wells, Texas 76067.



Vent-A-Matic®
INSTALL in less than 2 hours.

ANNOUNCING POPULAR MECHANICS INDEX AND SHELF WRAPPER A great idea that will multiply the value of your back issues of PM. The index is bound into a handsome wrapper made of heavy board and encloses the 12 issues which are cross-referenced in the Index. Makes a beautiful and useful addition to your bookshelves. Price only \$1.49. Send orders to **Popular Mechanics (Dept. I) Box 1410 Radio City, New York, N.Y. 10019.**

211

CLASSIFIED ADVERTISEMENTS

Rate: \$2.00 per word payable in advance each insertion. Capitalized words—75¢ per word additional. Minimum insertion ten words. To be inserted under the proper classification, copy must be in our office by the 15th of the second month preceding date of issue. The next available issue to place an advertisement in America's No. 1 Classified Section is July. The closing date is May 10th. Send remittance and order to C. A. Martin, Popular Mechanics, 224 West 57th Street, New York, New York 10019. Please make remittance payable to Popular Mechanics.

POPULAR MECHANICS

WHEN ANSWERING ADVERTISEMENTS PLEASE USE THE ZIP CODE NUMBER

AUTOMOBILES

PATCHES Color Catalog 25¢. Shows Hundreds. Quotes Your Design. Patches, Dept. 95, RFD 1, Littleton, N.H. 03561.

MOTOR'S Auto Repair Manual 1972 Edition \$9.95 postpaid. Book Sales, 9 S. Main St., Oberlin, Ohio 44074.

PROTECT Your Family-carbon monoxide detector warns presence of dangerous fumes. Recommended for automobile, aircraft. \$1.98. Guaranteed. Marshall Enterprises, P.O. Box 1218, Hawthorne, California 90250.

LOCKSMITHS Service Stations. Key Blanks; American, Foreign, Auto Etc., General Mixture 100 For \$7.00. KeyLock, 1522 Prospect, Cleveland, Ohio 44115.

MIDGET CARS

YOUR AD IN POPULAR MECHANICS will be seen by more than 5,000,000 active buyers for your products and services. It costs only \$2.00 per word. And, if you wish to run all or part of your ad in capital letters—you can do so for as little as 75¢ per word additional. Act now! **PLACE YOUR CLASSIFIED AD IN POPULAR MECHANICS TODAY.**

AUTO SUPPLIES AND EQUIPMENT

HYDRAULIC Jack repair kits, parts and supplies. Catalog 50¢ (in coin). Hydraulic Jack Packing & Tool Co. Inc., General P.O. Box 3, Staten Island, N.Y. 10314.

PROTEKAR!! Foil car thieves. Protects cars from being stolen. Easily installed. Parts and Details, \$3.00. Protekar, 4427 Brookfield, Houston, Texas 77045.

PARTS: Army jeep and truck parts. Spare Parts & Equipment Co., P.O. Box 751, Lexington, Kentucky 40502.

BALANCE Four car wheels perfectly for \$1.00. Instructions \$2.00. Fletcher—5105M Belmont—Dallas-75206.

REBUILT AUTOMATIC TRANSMISSIONS. Expertly Rebuilt And Scientifically Tested. Write For Price List. P.O. Box 55, E. Norwich, N.Y. 11732.

ALTERNATOR, Generator, Starter Rebuilding Kits and Rebuilding Instructions. Write: Gold Coast Alternator, P.O. Box 2127, Sepulveda, Calif. 91343.

JEEP Owners—V8 conversions. Read Jeep Owner's ad, page 186H.

MOTALOY, Ring—Valve job while driving—\$6.00. Free literature. E&G Sales, Box 18384-P, Memphis, Tenn. 38118.

ALTERNATOR/Generator Rebuilder's Course; includes Tooling & Test Equipment. Write: Hedelund Engineering, P.O. Box 1134, Reseda, Calif. 91335.

SAVE MONEY AVOID TROUBLE—Ring and Valve job while you drive—Amazing—Free information—Write Today—Ransom Baucom Company, Department 5-27-MP Raeford, North Carolina 28376.

"BUT OFFICER, My speedometer said I was only going 35 miles an hour." Have you ever said that? Be sure your speedometer is accurate. Let **CHARTCAR** help you. No need to go to an expensive, specialized mechanic either. Everything you need is provided—Charts, Time Logs, Speed Conversion Tables—to let you check the accuracy of your car's speedometer yourself. Send \$2.98 now to: **CHARTCAR,** 3809 Scoville, Berwyn, Illinois 60402.

PROTECT Painted Surfaces With A **NON-MUTILATING, HIGH IMPACT PLASTIC METAL ALIGNMENT SPOON.** Fender To Door, Hood To Grill, Etc. \$5.00. Palmco, 8416 Secura Way, Santa Fe Springs, Calif. 90670.

METAL Signs, 6"x12", painted for car's front bumper. Girl's, wife's name, anything. Specify colors, wording, style. \$4.00. Guaranteed. Hickory Lane Studio, Rt. #1, Franklinville, N.C. 27248.

RING-Valve Job while driving, \$6.50 postpaid. (Two-\$12.00). . . . Established 1951. . . . Results Guaranteed!! Motaloy, Grantham, Penna. 17027.

AUTO ELECTRIC CONVERTER Installed To your Car-Truck alternator will run power tools, lights, etc. Has two outlets. Switch, Voltmeter. 120VDC. Metal Case. \$15.95 postpaid. Phil Bowers Associates, 71 Beechwoods, Wakarusa, Ind. 46573.

ILLUSTRATED AUTO BURGLAR ALARM Plans. Key Lock. Complete Parts/Price List. Installation Instructions. Commercial Fleet Usage. \$1.00 PPD. To: Northwest Specialties, Div. X, P.O. Box 10051; Portland, Oregon, 97210.

PROSPECTIVE CAR BUYERS—About to buy a new or used car and tired of being taken again? Learn the inside tips on buying a car while getting the most for your money and saving \$\$\$ **SEND \$1.00 TO: AUTOMOTIVE CONSUMER PUBLICATIONS, P.O. BOX 7761, PITTSBURGH, PA. 15215.**

PENCIL Type Tire Gauge. \$3.00; Cazin, 526 Maple, Redwood City, Calif. 94063.

REVOLUTIONARY NEW PRODUCT—Qwik Change Oil Drain! Save dollars changing oil yourself with twist of knob inside car. Precision aircraft engineering. Universal installation and unit—Guaranteed. Send \$14.95 today!! DH Enterprises, 3931 E. 23rd, Des Moines, Iowa 50317.

AIR PUMP Attach to tail pipe of car, truck, Etc.—with 20' of hose. Pressure adjustable up to 30 Lbs. Preservative exhaust air beneficial to tires. Compact "Can be stored in glove compartment." Send \$9.95 Postpaid, Strat-O-Gem Corp., Box 771, Independence, Mo. 64052.

CHAMPION Spark plugs, new, Regular 60¢ each, lots of ten. 75¢/lot handling. Send Year, Make, Model, Displacement. Consumers', Box 51, Stafford Springs, Conn. 06076.

DON'T SPEND \$100! MOTALOY'S \$6.00 RING-VALVE JOB BOOSTS COMPRESSION, MILEAGE, OIL SAVING WHILE DRIVING OR MONEY BACK, \$6.00. FREE LITERATURE. DUNNETT ASSOCIATES, 5433 CALHOUN, ALEXANDRIA, VIRGINIA 22311.

NEW 12 Volt, 1 AMP Battery charged—safe, dependable; no overcharging—Automobiles, Snowmobiles, Motorcycles, Boats, Tractors, Guaranteed, \$7.95. N.Y. Add Tax. Brenco Enterprises, 152 West 42nd St., Suite 536, New York, New York 10036.

BETTER PERFORMANCE. AMAZING PRODUCT. Details \$1.00. Satisfaction Guaranteed. Fairco, Box 342PM, Reidsville, N. C. 27320.

NEW Highway Emergency-Safety Kit: Essential for all motorists. Contains two-pound extinguisher, tire inflater-sealer, flares, "Help" flag, handcleaners. Only \$12.85. Guaranteed!!! Marcellin, 421-X Crown St., Brooklyn 11225.

HELP! Help! Four Highway Emergency Signs, Gasoline, First Aid, Tire, Mechanical, eye-catching colors, durable plastic. Guaranteed. \$1.75 Postpaid. Gerrit, 28 McCampbell, Holmdel, New Jersey 07733.

120 VOLTS AT 3000 WATTS Of electricity from ANY alternated vehicle! Operate drills, saws, lights, plus many more ac devices! Arc weld! Charge dead batteries! Will not harm alternator! Ten minute installation! Guaranteed one year! Only \$6.95 for construction plans, \$12.95* for complete kit, \$15.95* assembled or \$18.95* with voltage indicating light—*add \$1.25 for postage—plus many more useful products—ask for **FREE** catalog—Creative Products, 1551 East Loop 820, Dept. ME, Fort Worth, Texas 76112.

NEVER WAX YOUR CAR AGAIN. New Space age Astro Shield polish contains no oil or wax. Guaranteed in writing for three years. Wipe on, wipe off. It's easy. Full quart \$5.50 postpaid. Escabar Enterprises, 202 Dodd Street, East Orange, New Jersey 07017.

"SEND HELP" Sign 10" X 12" \$1.00. Clips to Window, Stores, Glove Compartment. BSCO, 368 East View Drive, Chattanooga, Tenn. 37404.

SNOWMOBILES

SNOWMOBILE Hop up accessory **CATALOG.** Speed and performance equipment—manifolds, exhaust systems. Send 25¢. **G.E.M. PRODUCTS,** Box 845, Carol Stream, Ill. 60187.

(Continued on next page)

AUTO TRAILERS

PICKUP Camper, Trailer or Pickup—Cover . . . Build yourself. Save! Complete plans \$3.95 each Cover plans \$2.00 Conversion Plans—econoline type van \$2.95; passenger bus or delivery van \$2.95. Satisfaction Guaranteed. Equipment catalog \$1.00 (refundable). Details 10¢. Viking Camper Supply, 99-F Glenwood, Minneapolis, Minnesota 55403.

PLANS, 16' Cabin Trailer \$3.00, Plans Septic Tank \$2.00. J. B. Schultz, 16587 Freeland, Detroit, Mich. 48235.

MOTORCYCLES, BICYCLES MOTORSCOOTERS & SUPPLIES

GO-CARTS, Motorcycles, Monthly News, Bargains. 50¢. Loren Products, Danville, Illinois 61832.

HONDA! \$25 Other Bargains. Send 50¢. Motorscooter, P443, Bend, Oregon 97701.

FUN—BUGGY Catalog. Just out. World's first, biggest, featuring ATV's, Mini-bikes, Karts. \$2.00. "How-to" plans \$1.00. Complete parts stock. Bargain prices. Brown's Motorsports, 19P Central St., Worcester, Mass. 01608.

ILLUSTRATED Catalog 25¢. Parts, Accessories. Custom Stock, most makes, models. Cycle Supply, Box 192M, Fairbury, Ill. 61739.

BUILD Popular Mechanics' **MINIBIKE** featured June 1967 issue. Detail plans, photographs \$2.50 refundable. Kits, parts, engines; factory discount prices. Catalog 25¢. Gilliom Mfg.; PMC; St. Charles, Missouri 63301.

MOTORIZED Your Bicycle; Go-Kart; Snowmobile Plans! \$2.00 Each: Go-Bykco, Barnesville, Minn. 56514.

MINI-BIKE CLUTCH. \$10.95 For #35 Chain, 5/8" Or 3/4" **TOP AMERICAN BRAND**. Discount Parts Catalog Included. Catalog Only \$1.00. **MOTO CROSS ENTERPRISES**, P.O. Box 57, Philadelphia, Pennsylvania 19105.

HOTTEST Mini-Bike Plans \$1.00. **SHOPPER**, Box 706, Lawrence, Kansas 66044.

BE A Motorcycle Repair Specialist. Big earnings. Free details. Clifford, Box 1524-M, Kansas City, Missouri 64141.

PROTECT Your bicycle!! Register nationwide!! Protective emblem, recovery service assured. Send Name, Address, Bicycle Name, Serial Number. \$1.00, to: American Bicycle Registry, Dept. 428, 3053 Main Street, Buffalo, New York 14214.

MINIBIKE Clutches, \$7.95 Postpaid, 5/8 or 3/4 Bore. Discount Catalog 25¢. A-1 Service, Claypool, Indiana 46510.

SPACE, ROCKETS AND ASTRONAUTS

ROCKET TEXTBOOK: Designing, Testing, Firing, Fueling. Includes Plans for: 5 Rockets (to 20,000'), 4 Launchers, 20 Fuel Formulas. 382 pages, \$2.00. Information 25¢. York Enterprises, Box 5443-PM, Little Rock, Arkansas 72205.



AVIATION

FUTURE Flying Students! Save Time, Money! Learn Important Information Before Starting. Rush, \$1.00. R. Cooney, 2758-A Maxwell, Philadelphia, Penna. 19136.

BUILD—One-Man jet helicopter. Easy inexpensive. Detailed plans, drawings—\$5.00. Helicraft, Box 7153, Baltimore, Maryland 21218.

AIRBOAT, Propellers, Mounts, Plans, Supplies, 15-20-25-45-90-125-150-220 H.P. engines, Corvair, V-W conversions. Removable airdrives. Kit airboats \$450.00. Catalog \$1.00. Banks-Maxwell, Box 3301E, Ft. Worth, Texas 76105.

HOT AIR BALLOONING—"Info Pack" Gives you answers, costs licensing, instructors, photos—\$5.00. ABS, Inc., 113 Park, Muscatine, Iowa 52761.

ALL About Ballooning Handbook \$3.00. Aerostation, Box 141, Long Sault, Ontario, Canada.

HOVERCRAFT

AERO-CAR. Amazing Hovercraft built easily with ordinary tools. Lawnmower engine power. Carries one man plus. Hovers, flies forward, backward, sideways over land/snow/water. Complete construction plans and brochure. \$5.95. Aero-Projects, Box 5118PM, Clinton, New Jersey 08809.



BOATS AND TRAILERS

FIBERGLASS AND BOAT BUILDERS SUPPLIES At factory prices. Fiberglass, matt, resins, foams, bronze brass screws, nails, fittings, marine plywood, mahogany, trailers, boat plans. Send \$1.00 for literature or \$2.00 for large catalog plus book on fiberglass uses, boat coverings, molds, etc. to: Clark Craft, 16-Pl Aqua Lane, Tonawanda, N.Y. 14150.

COMPETITION MARINE EQUIPMENT. Over 300 items for complete auto conversions and installations in high performance SK and ski boats. Mail \$1.00 for new 72 catalog complete with photos, specifications and prices. Glenwood Marine, Dept. PM, 1627 W. El Segundo Blvd., Gardena, Calif. 90249.

FREE Catalog! Camping, Boating, Sailing Supplies; Gadgets, Hardware and Gifts. Laacke and Joys, 1439 N. Water St., Milwaukee, Wisconsin 53202.

AUTOMATIC Boat Bailer: Small Craft. No power Required. \$5.95. Note: Specify bottom hull thickness. De Persia Automatic Bailer, Grand Haven, Michigan 49417.

AIRBOATS—Engines, Propellers, Hulls, or Complete Fiberglass Airboats. Color catalogue, \$1.00. (Refundable with order). Aircat, Lake Hamilton, Florida 33851.

FIBERGLASS Canoes, Kayaks, and Duckboats. Many exciting models. Easily assembled kits. \$39.95 up. Free Literature. Riverside Canoes, Box 5595P, Riverside, Calif. 92507.

NEW 1971 Outboards . . . Top Brands . . . 4 H. P. \$139 . . . 6 . . . \$273 18 . . . \$399 . . . 40 Selectric \$638 . . . 60 Selectric \$899 . . . All Sizes . . . Literature 50¢ . . . Scott-McCulloch Parts. Electra Marine, 675 Merrick Rd., Lynbrook, New York 11563.

FIBERGLASS Cloth and resin. World's finest cloth and non-run resin, at direct mill prices Flotation foam. Complete line of plastics, silicon bronze and brass screws, save 60%. No sales tax. Boat Plans. Catalog 25¢. Freight prepaid. Stiles Boat Supply, Box 11P, Linden Ave., Mantua Hts., N.J. 08051.

CANOE! Kayaks! Factory-direct quality kits, from \$25.00. Many different models. Canvas hulls. Strongest construction materials. Free literature. Sportsraft, Box 636-P, Allentown, New Jersey 08501.

PLANS, FULL-SIZE PATTERNS, FRAME KITS With step-by-step instructions specially for amateurs. Send \$1.00 for new catalog just off press—nearly 100 pages, over 100 designs 8' to 42'; Sail, Jets, Inboards, Outboards, Cruisers, Houseboats, Hot Boats, Catamarans, Hydros, Glen Designs, 9152 Rosecrans, Bellflower, Calif. 90706.

CANOE Kits—Wood Canvas, Molded Fiberglass—Free Literature. Trailcraft, Inc., Box 60686, Concordia, Kansas 66901.

FIBERGLASS Cloth, mat, resin. Flotation foam. Complete supplies. Catalog 25¢. Kick-Shaw, Inc., 3511 Hixson Pike, Chattanooga, Tenn. 37415.

KAYAKS, Canoes, Sailboats, Surfboards, Complete plans, instructions. Free catalogue. Outdoor Sports, Box 1213-P, Tuscaloosa, Alabama 35401.

PLANS, Patterns, Kits. Plywood, Fiberglass, Ferro-cement. Catalogs: Powerboat (2) \$1.25, Sailboat 50¢, Marinecraft, Box 161-M, Brighton, Mass. 02135.

DIRECTORY: 174 Boat Plans, \$2.00. Moore, Box 852, Ashland, Oregon 97520.

FISHING/Surfing/Sailing/Power Dories Brochure/Photos 25¢. Texas Dory Boat Plans, Box 720, Galveston, Texas 77550.

ELECTRIC Trolling motor \$6. Build in three hours with hand tools. Complete plans \$1.00. Mark Schultz, 542 Minn, Ortonville, Minn. 56278.

BOAT PLANS-BOAT KITS-FRAME KITS. World's largest 1972 catalog. Over 200 top designs. Sailboats 7-45'. Windmill, Snipe, etc. Motor Sailer, Trimarans, Catamarans, Power Cruisers, Houseboats, Deep V's, Fishing Boats, Runabouts, Hydroplanes, inboard and outboard. Ferro Cement 33-57', sail and power. Send \$1.00 for Plan Kit Catalog or \$2.00 for catalog plus Boatbuilder's Guide to: Clark Craft, 16-P Aqua Lane, Tonawanda, N.Y. 14150.

BOAT KITS—Assemble yourself from factory molded fiberglass sections, save 1/2 over factory built. Satisfaction guaranteed. Send \$1.00 for beautiful 80 page fact filled color catalog showing 20 models—14' to 32'—Cruisers, Runabouts, Houseboats, Sailboats, complete Accessories, Motors, Trailers, discount prices. Luger, Dept. BC-72, 3800 West Highway 13, Burnsville, Minnesota 55378.

LEARN To Handle And Land Your Power Boat Slowly—Eliminate damage. Concise; based upon 25 years commercial boating and instructing. \$5.00 Airmail. Happy Landings Publisher, 912B W. Main, Hebron, Ohio 43025.

CAMPERS AND TRAILERS—KITS—PLANS—

STOP TRAILER SWAY! Build your own stabilizer bar for less than \$20.00. Complete plans, \$2.00. Ottny's, Route 2, Sciotoville, Ohio 45662.

CAVOVER Campers, Pick-Up Covers, 10' & 20' Trailers. Build and Save. Large scale Plans and Full-size Patterns with written & pictorial instructions. Complete accessory and aluminum covering kits. Free Literature. Glen L, 9152 PM-5 Rosecrans, Bellflower, Calif. 90706.

MOBILE Homes and Campers. Stop Tip-over and sway fears. Protect your investment at home or away. Screw in ground type Security Anchors. \$7.95 each postpaid. Active Mfg. Co., Box 352, St. Clair Shores, Mich. 48083.

MARINE EQUIPMENT AND SERVICES

MARINE Engines, conversions, parts, equipment. Catalog Free! Stokes Marine Industries, Coldwater, Michigan 49036.

CONVERT Auto engines to marine. 68 Page Catalog, 50¢. Lehman Manufacturing Company, 800 Elizabeth Avenue, Linden 4, New Jersey 07036.

MARINE Supplies, Ignition Parts. Free literature. Michael's, 991 Broadway, Bayonne, New Jersey 07002.

FREE Brochure Conversion Kits, Propellers, gears V-Drives 1/0 Drives Gas, Diesel. Starmarine, 1931 Embarcadero, Oakland, Calif. 94606.

BOAT-OWNERS, FISHERMEN! Prevent Lost Keys. Stay Afloat Luminous Key-chains. Guaranteed. Send \$1.00 To: 2855 Thessereault, Lachine, Quebec.

INFLATABLE Boats and Life Rafts (Avon, Zodiac, Winslow, etc.). Revere Inflator. Fire Fighting Equipment, Distress Flares, Life Jackets and Cushions, plus many more items. Catalog 25¢. Send to Revere Survival Products, Dept. PM, 605 West 29th Street, New York, New York 10001.

ATHLETIC AND BODY BUILDING COURSES

OLYMPIC Shirts, Running Equipment 58 Page Catalog \$1.00. Specialty Sports, New Caney, Texas 77357. Register For **FREE** Olympic Tour To Germany.

(Continued on next page)

ATHLETIC AND BODY BUILDING COURSES

(Continued from preceding page)

"GIANT Arms." Dr. Young's. D.C. revolutionary discovery. \$2. Satisfaction or refund. Gaucho, 1769-S7, Chicago 60690.

POWERFUL Muscles fast! Free brochure! Universal Bodybuilding, Box 4327-C, Dearborn, Michigan 48126.

BUILD Muscle and strength in half the time with Tsokinetics. Details 25¢. Pyramid Equipment Co., Box 05086, Detroit, Michigan 48205.

VACUUM System, Illustrated, \$1.00. Aspiral, 210 Fifth Ave., N.Y.C. 10010.

MIGHTY BODY Champs in minutes a day. \$1.25 full cost. Champagne's, Box 15322, Baton Rouge, La. 70815.

MIGHTY Muscles For Summer! Complete, muscle popping weights course. \$7.50. FREE Calisthenics Manual included 'Til July. R. Goldinger, Box 1728, Butler, Penna. 16001.

SPORTING GOODS AND EQUIPMENT

FREE 1972 Catalog! Guaranteed lowest prices! Rods, Reels, Lures, Accessories—Thousands of items. Cabela's, Inc., Dept. S-5, Sidney, Nebraska 69162.

FREE Catalog low direct factory prices, fishing, hunting, archery, reloading camping supplies. Send today. Herters Inc., Dept. CPM, Waseca, Minn. 56093.

FREE WHOLESALE CATALOG. Lure parts, molds, rod blanks, reels, archery, metal detectors. Rare Hardwoods. Finneysports (ME), Toledo, Ohio 43614.

CROSSBOWS Powerful Accurate. Catalog 25¢. Crossbowman, Box 723PM-5, Manteca, California 95336.

TELE-OPTIC Sports Knife with built-in monocular field glass. 4½ inch blade, leather sheath, \$8.95. Zelmer Enterprises, P.O. Box 135, Bronx, N.Y. 10452

CARWINCH—\$95.00—Portable, 80' Cable, Three Ton Pull. Hilmer Co., Box 3537-PM, Boulder, Colo. 80303.

INFLATABLE TENT . . . Amazing . . . Rainproof . . . Cozy shelter in seconds . . . No poles! Compact . . . International, 4877 (1B3) Compton, California 90224.



FISHING, TACKLE, LURES

CATCH FISH LIKE CRAZY. Fresh, salt water. Day, night. Year 'round. SVENGALI 'em. Unconditional never fail guarantee. Become one of thousands satisfied mail customers. 12 samples \$1.00. SVENGALI LURES, P. O. Box 144-M, Glen Head, N.Y. 11545.

MOLDS For fisherman's sinkers, jigs, squids, casting and spinning lures. Free catalog. Sweet Molds, Tonawanda 1, New York 14150.

MOLDS—For casting your own fishing sinkers. Free illustrated booklet. Reading Instrument Co., Box P78, Reading, Pa. 19603.

FISHERMAN'S DREAM BOOK—FREE. 170 page catalog just loaded with Hard-To-Find Fishing Tackle Specialties and Do-It-Yourself Goodies. Our 28th year. NETCRAFT Inc., Box 5510, Toledo, Ohio 43613.

"WORM Round-Up" Brings Them Up Alive! \$1.00 Sample Makes 10 Gallons. Crescenzo, 120 Meadow Run, Hamburg, New York 14075.

EARTHWORMS, LIVE BAIT

EARN Money raising fishworms for us! Exciting details free! Oakhaven—56. Cedar Hill, Texas 75104.

HYBRID Redworms 5000 \$10.00. 20,000 \$20.00 Postpaid with Raising Instructions, Worms, Route 9, Waco, Texas 76705.

GROW Fishworms. Outstanding new breed produces great profits. Free Literature. Fain's Hatchery-31, Edison, Ga. 31746.

GROW Larger Earthworms Free . . . Faster . . . Easier . . . Proven all profit Nograins method . . . Organics . . . Route #1-M . . . Texarkana, Arkansas 75501.

FROGS, FISH, REPTILES

\$20,000/YEAR POSSIBLE RAISING BULL-FROGS! Complete Instruction-Manual Shows You How! Only \$2! Guaranteed! Order Today! Bravco-A, Box 3511, Victoria, Texas 77901.

JUMBO BULLFROGS: GIANT breeders and young frogs for STOCKING. BAYOU FROG FARMS, Box 10PM, Waverly, La. 71290.



POULTRY & GAME BIRDS

CHICKS Ringneck Pheasants Day-Old. Send \$15.00-25 Chicks; \$25.00-50 Chicks; A-1 Stock. Write: Blonhaven Hunting Preserve, Milton Jct., Wis. 53564.

QUAILS, Incubators, cages, supplies catalog. Marsh, 14216 Brookhurst, Garden Grove, Calif. 92643.

GAMEBIRDS: Eggs, chicks, started, adult. Pheasant, quail, chukar, waterfowl, turkey; game and ornamental. Poultry and exotics. Free catalogue. Northwest Farms, Inc., P.O. Box 3003-PM, Portland, Oregon 97208.

RABBITS—CHINCHILLAS—FUR BEARING ANIMALS

RAISE Chinchillas. Guaranteed income. Catalog \$1.00. DeShon Chinchilla, Route Two, Roanoke, Indiana 46783.

\$600-UP MONTHLY. People needed. Raise rabbits, other laboratory animals for us. Huge market. We supply equipment, breeders and instructions. Details 25¢. National Research Farms, PNMA 5, Box 37, Palatine, Illinois 60067.

RAISE Rabbits for us, \$500 month home facts. 48 page illustrated book describing 25 breeds. Housing, breeding, feeding, markets, marketing etc. 25 cents. American Rabbit Association, 36 Arba Building, Pittsburgh, Penn. 15217.

AMAZING PROFITS! \$10,000 Yearly Raising Rabbits for Wool and Breeding. Details 25¢ coin. American Angora, Malta 12. Montana 59538.

MAKE Big Money Raising Chinchillas, Cavies, Rabbits for us. Catalog 25¢. Keeney Brothers, New Freedom, Pa. 17349.

\$500-\$1000 MONTH Plan Raising Rabbits For Us. Free Details. White's Rabbitry, Mt. Vernon, Ohio 43050.

CHINCHILLA INCOME GUARANTEED. Terms. 25¢. Bulletin \$1.00. Chinchilla, 11PM, Port Richey, Fla. 33568.

PETS—BIRDS, CATS, HAMSTERS, ETC.

AQUARISTS Supply Manual \$1.00. Daleco, 416-PA Glenalby, Tonawanda, N.Y. 14150.

HAWKS, Reptiles, raccoons, skunks, squirrels. Catalogue 25¢. Trails End Zoo, St. Stephens, S.C. 29479.

LIVE Seahorses, Marine Specimens, Aquarium Supplies. Illustrated catalog 30¢. Marine, Box 23158-G, Fort Lauderdale, Florida 33307.

BUY Direct—Save: Monkeys, Ocelots, Birds, Reptiles, Wildlife Books. Catalog 25¢. Exotic Animal Importers, Inc., Box 1675, Miami, Florida 33138.

1,001 AQUARIUM SUPPLIES. International Champion Guppies, Bettas. Catalog 25¢. Fishmart, Ortonville, Mich. 48462.

HORSES, LIVESTOCK

"HOW TO TRAIN HORSES"—FREE Book tells how to break, train, make money with horses. Beery School, 1105, Pleasant Hill, Ohio 45359.

VETERINARY Guide to Farmers. The only book of its kind. Send \$6.95 to POPULAR MECHANICS, Dept. VG, 224 West 57 Street, New York, N.Y. 10019.

CAMPING EQUIPMENT AND TENTS

BUDDIES TENT, Inexpensive. Free Literature. Martins, Box 141-A, Fremont, Calif. 94537.

CAMPING

PAK TENTS—Inexpensive. Free Literature. Martins—Box 141, Fremont, Calif. 94537.

JUMBO Tents sleeping bags, camping catalog. Largest selection anywhere. 25¢. I. GOLDBERG, Dept PM 374, 902 Chestnut St., Philadelphia, Pa. 19107.

TRAVEL AND RESORTS

VACATION Planning? Complete List Of Tourist Information Sources Throughout U.S., Canada, Mexico. Send \$1.00. Wilco, 4814 Welford, Bellaire, Texas 77401.

CANOE Trips—\$11.00 per day. Write, Rom's Outfitters, Ely, Minnesota 55731.

ELECTRICAL SUPPLIES

METERS—Surplus, new, used, panel and portable. Send for list. Hanchett, Box 5577, Riverside, Calif. 92507.

LAMP Parts. Catalog, prices, wiring instructions. 50¢. Refunded first order. Gyro, 5218P N.W. 35 Ave., Miami 42, Florida 33142.

SURPLUS ELECTRONIC BARGAINS 40 Page Catalog 25¢. Refunded with Order. Delta Electronics Co., Box 1, Lynn, Mass. 01903.

BATTERIES, GENERATORS

BATTERY Terminal Protectors Stops Battery Corrosion. Free Literature. Pracna's, 3301 Buchanan Road, Antioch, California 94509.

NOW STOP BATTERY TROUBLE—Car—Truck—Boat—Free Information. Write—Ransom Baucom Company, Raeford, North Carolina 28376.

PERMA-CHARGE Franchise—Free Details. National, 210 Fifth Ave., N.Y.C. 10010.

BATTERY Reconditioning Kit, includes molds, material, instructions. Battery Shop, Box 820, La Quinta, California 92253.

ENGINES, MOTORS, MAGNETS

WINDING Data, 275 motors, \$1.25. Data Company, 512 Kensington, Kansas City, Mo. 64124.

ELECTRIC MOTOR SUPPLIES! Rewinding data! Increase power! Build equipment! Catalog! Modern, Box 7266, Kansas City, Mo. 64113.

MACHINERY, TOOLS AND SUPPLIES

DISCOUNT TOOLS Vises, Mikes, Calipers, Gages, Many Accessories. Catalog 35¢. Schlesingers For Tools, 1020 East 54th, Brooklyn, New York 11234.

MICROMETERS—Indicators. Steel—Aluminum—Brass. Maximat, Unimat Lathes. Complete mailing—50¢. Campbell, 1424 Barclay, Springfield, Ohio 45505.

SMALL Foundry furnaces. Supplies. Free literature. Pyramid Products, 3736 South 7th Avenue, Phoenix, Arizona 85041.

WINCHES And HOISTS. Choice of 12 volt or 110. Reversible, compact, fast. ¼ ton to 1 ton capacity, from \$49.95. 25¢ brings 16 page full color catalog. Refundable. Superwinch, Inc., Dept. PM, Pomfret, Connecticut 06258.

UNIMAT LATHE OWNERS ATTENTION. Adjustable Tool Post Available. Details Write: Glengeneering, 239-43 66 Ave., Douglaston, N.Y. 11362.

(Continued on next page)

MACHINERY, TOOLS AND SUPPLIES

(Continued from preceding page)

METRIC 8 in 1 Socket Wrench Two revolving heads, with 12 point socket sizes 11, 13, 14, 15, 16, 17, 19, and 22 MM. Send \$4.95 to: P.O. Box 218, Spotswood, New Jersey 08884.

MAXIMAT, Unimat Sale. Amazingly low prices. Deco-M, 562 Howard Avenue, Staten Island, N.Y. 10301.

SAVE On Ram POWER TOOLS. Socket Sets, etc. Free Brochure. Glen-Bel, Route 5, Crossville, Tenn. 38555.

PORTABLE Sandblaster \$21.00 (air-compressor required). Free brochure. Inka, Box 66573-A, Houston, Texas 77006.

MIXED Assortment Machine Screws, Washers, 7 gross send \$5.95 postpaid. Wood Screws, Bolts, 10¢ price list. Nutty Co., 1576 SMS, Fairfield, Conn. 06430.

METAL Cutting Lathe \$62.50. Milling-Drilling Attachment \$27.50. Tool, Material Bargains. Complete Listings 50¢. Refundable. Taig Mfg., 15048 Proctor, Industry, Calif. 91746.

MAXIMAT, UNIMAT Save at our low prices. Pioneer Electric, Box 7X, Brentwood, New York 11717.

WELDING, SOLDERING, PLATING

MORRIS—Welders—110/220, 150 Amperes, \$53.50. 1070 Inner, Schenectady, New York 12303.

WELDERS. Convert To Heliarc. Weld All Kinds Of Metals. You Can Build This 0-225AMP High Frequency Heliarc Unit From Junk Box And Approximate \$9.00. Picture Of Completed Unit. Plans And Where To Get Parts. Send \$4.00 To: Information Supply Company, Box 166, College Park, Maryland 20740.

PLATING Equipment, Portable Platers, Supplies, and "Know-How". Build your own tanks for nickel, chrome, etc. Easy-to-install PVC liners. Rectifier components—all sizes. Schematics, parts lists, formulas, operating instructions for all plating. \$10.00 post-paid. Guaranteed to save you 25%-75% or immediate refund. Some good used units for sale. Platers Service Company, 1511-A Esperanza, Los Angeles, California 90023.

GOVERNMENT SURPLUS

GOVERNMENT SALES. How And Where To Buy SURPLUS. NATIONWIDE Locations. Post Card Brings Particulars. AUCTIONEERS, 1698 North Lexington, St. Paul, Minnesota 55113.

MAKE Money on Government Surplus. Amazing Report tells how. Send \$1.25. T. R. Heffner, Dept. PM-1A, 246 Tippecanoe Drive, Tipp City, Ohio 45371.

NO CATCHES. Buy any surplus direct from U.S. gov't. All information \$2.00. Bridgworth, P.O. Box 2292-C, Vancouver, Washington 98661.

GOVERNMENT Surplus. How and Where to buy in Your Area. Send \$1.00. Surplus Information, Headquarters Bldg., Box 30177-PM, Washington, D.C. 20014.

1972 SURPLUS Army, Navy store, 52 Page illustrated catalog. Send 50¢. Ruvel, 3037 North Clark, Dept. 5-J, Chicago, Illinois 60614.

JEEPS \$52.40, Airplanes \$75.01, Typewriters \$6.70, Boats \$7.50, Direct from Government, Directory and Surplus Catalog \$1.00 (Refundable). Midwest Surplus, Box 401-PM, Dayton, Ohio 45401.

JEEPS From—\$52.50; Typewriters from—\$4.15; Cars from—\$31.50. Walkie-talkies, motorcycles, airplanes, boats. Typical "As Is" bid bargains from Uncle Sam. Tremendous variety. Exciting free list. Write: Enterprises, Box 402/76, Jamaica, New York 11430.

JEEPS!! Government Surplus Directory And Buying Guide. Send \$1.00. Brimel Publishers, Box 93-PM, Dayton, Ohio 45405.

JEEPS & Equipment. You buy FROM GOVERNMENT. Your Area. Latest information manual #2703, sent for \$2.00. MONEY-BACK GUARANTEE. Solley, Box 597, San Marcos, California 92069.

GOVERNMENT Surplus. Complete Sales Directory \$1.00. Surplus Publications, Box 26062-M, Los Angeles, California 90026.

JEEPS!!! Pickups!!! 100,000 items direct from government. How? Where? Your area. Latest information manual #111 sent prepaid AIRMAIL for \$2.00. MONEY-BACK GUARANTEE. Dependable, Box 113, Vista, California 92083.

JEEPS Typically From \$53.90 . . . Trucks From \$78.40 . . . Airplanes, Typewriters, Boats, Clothing, Camping, Sporting, Photographic, Electronics Equipment. Wide Variety, Condition. 100,000 Bid Bargains Direct From Government Nationwide. Complete Sales Directory and Surplus Categories Catalog \$1.00 (Deductible First \$10.00 Order From Our Separate included Catalog). Surplus Service, Box 820-A, Holland, Michigan 49423.

HOBBIES AND COLLECTIONS

COLLECT Military Medals. list 25¢. Vernon, Box 387PM, Baldwin, N.Y. 11510.

HOBBY-CARVE—Home workshop wood carver—create beautiful wood reproductions of sculptures, plaques, figurines, sconces and bookends. Hundreds of work patterns available. Send 25¢ for "How To Make Quality Wood Carvings" booklet. Refunded with order. Write: Hobbi-Carve, 930 Duluth Street, Dept. PM, St. Paul, Minnesota 55106.

BUILD Your Own Reflector Telescope. Esco is back. Do-It-Yourself reflector telescope kits. See the Moon and Stars. Mirrors and Lens Kits. Send for Details. Esco Products, 171 Oak Ridge Road, Oak Ridge, New Jersey 07438.

SEASHELLS. Assortment 50 Shells \$1.00. P.O. Box 2121, Hialeah, Florida 33012.

50 GORGEOUS Jungle Butterflies \$2.90. Collectors Wonderland, Box 1170, New York 10008.



STAMP COLLECTING

1500 FOREIGN \$1.00; 5000 \$3.00; 9000 \$5.00. 5000 USA, contains airs, dues, presidentials, revenues, 19th century, high values, commemoratives, etc. \$3.00. 300 pre-1926 USA \$2.00; 700 \$4.00; 2000 \$10.00. 300 pre-1940 USA commemoratives \$2.00; 700 \$4.00. No approvals. Meyers, 5321 Fleming, Richmond, California 94804.

FREE—Mint British Colonials from Sabah, Seychelles, Tristan Cunha, Sarawak, Negri Sembilan, Caymans, South Georgia. Free with approvals. Viking, Great Neck, 8, N.Y. 11021.

ONE CENT STAMPS. Write for jumbo books of stamps at 1¢ each, mounted in Scott order. BULLOT APPROVALS, 6815 Bay Pkwy, Brooklyn, N.Y. 11204.

50 DIFFERENT U.S. Commemoratives 25¢ Approvals. We pay postage. Craig Stamps, Box 118-N, Bellmore, New York 11710.

SEND Only 10¢ for the most wonderful catalog of stamp offers in America. You will also receive a special bonus collection of 150 different stamps from St. Vincent, Rwanda, Russia, etc. Littleton Stamps, Dept. MN-1, Littleton, N.H. 03561.

RARE Stamp Free! Also new packet Aden to Urundi, with Kennedy, Triangles, Space, Sports, Ships, Dogs, Cats, Reptiles, Plus Others. All Free. Send 10¢ for mailing. Empire Stamp Co., Dept. 1, Toronto, Canada.

"AFRICA" 25 Beauties, 10¢ Approvals. Gorliz, Box 28765 PM, Memphis, Tennessee 38128.

FREE Bargain Stamp List! Box 370-A, Station "E", Toronto, Ontario.

FREE 50 Stamps Including Cayman Islands, Grenada, British Honduras, Approvals. Moulblow, 1834-G Bassett, Anaheim, California 92805.

WANTED—New Issue Subscribers, Specialty Israel, Western Europe, Great Britain. Advise your references, small advance over FACE VALUE. Franklin, P.O. Box 467 B, Jamaica, New York 11434.

U.S. STAMPS. Truly wonderful approvals to qualifying advanced or beginning adults over 21. Reasonable, worthwhile. References, please. ENGLE, Box 208-PA, Lowell, Michigan 49331.

INDONESIA 50 Different 10¢ Approvals. Lansdowne Stamp Company, Box 201, Newtown Square, Pa. 19073.

FREE List, Large Assortment \$1. High value packet \$2. Schollmeyer, 436 New York Ave., Brooklyn, N.Y. 11225.

GIANT Stamp Collection including: Astronauts, Satellites, Moonrockets, Boy Scout issue. Complete U.N. Set, recent Olympic and Sport issues from many countries, etc., Plus Big Stamp Dictionary and approvals. Everything 10¢! Stampex, Box 47-RM, White Plains, N.Y.

100 DIFFERENT United States Stamps, 25¢, with U.S., Foreign Approvals. ShelRon, Box 547C, North Miami, Fla. 33161.

WOW! 110 ALL DIFFERENT GERMANY 10¢ Commemoratives, Airmails, High Values, Big catalog, bargain lists. Also, fine stamps from our approval service, which you may return without purchases and cancel service at any time. Jamestown Stamp, Dept. A-52PM, Jamestown, N.Y. 14701.

FREE! BIG BARGAIN CATALOG—NEW EDITION listing thousands of bargains including U.S. & B.N.A. stamps, packets albums, accessories and supplies. Also, fine stamps from our approval service which you may return without purchases and cancel service at any time. Jamestown Stamp, Dept. E-52PM, Jamestown, N.Y. 14701.

225 STAMPS For only 10¢! Airmails. Pic torials: stamps from strange countries cataloging up to 25¢ each! Plus unusual stamps to examine. Buy any or none return balance, cancel service anytime. Mystic Stamp Co., Camden 80, New York 13316.

U.S. MINT Specials! Flag set, complete \$1.00. 1¢, 2¢, 3¢ famous Americans (21 different) \$1.00. Free list. Brooks, 2601 Avenue "U", Brooklyn, N.Y. 11229.

PENNY! Approvals! Regardless catalogue! Kloster, 4164 52nd St., San Diego 5, Calif. 92105.

U.S. BARGAIN, 50 Different 10¢, with beautiful worldwide, approvals. Stamp Center, Kennebunk, Maine 04043.

50 DIFFERENT Old U.S. Revenue Stamps 50¢. Winchester Stamps, Box 1592, Mansfield, Ohio 44907.

FREE Surprise collection sent with approvals. Gould, 1784 Union, San Francisco 94123.

PENNY Stamps! 1000 Mounted in book at 1¢ each! Trust Stamp Company, P.O. Box 100-P, Jamaica, New York 11435.

ABSOLUTELY Free United States Mint Souvenir Sheet When Requesting United States Approvals. K&B, Box 70, Brooklyn, N.Y. 11223.

500 DIFFERENT Stamps, \$1.00. Smith, 508-A Brooks, College Station, Texas 77840.

210 DIFFERENT U.S. Commemoratives \$1.00. Stamps, 7607 Larchview, Dallas, Texas 75240.

14,000 DIFFERENT! AMAZING New plan builds your collection systematically, country by country. Only 50¢ weekly. Ware, Monroe, Conn. 06468.

(Continued on next page)

STAMP COLLECTING

(Continued from preceding page)

TEN Different Nudes: 20¢. Approvals. Stamp Farm, 2M42, Oxford, Wis. 53952.

AMERICANS On foreign stamps, Presidents, Kennedy, Roosevelt, Lincoln, U.S. Spacemen, Princess Grace and others. 10¢ with approvals. Roseland Stamps, Dept. 57. Spring Lake, Michigan 49456.

FAR EAST ASSORTMENT—VIET NAM, JAPAN, KOREA, Formosa and others only 10¢ with world wide approvals. Clark Stamps, Dept. 57V, Muskegon, Michigan 49444.

100 CANADA 25¢. Excellent value. Approvals. Continental, Limehouse, Ontario, Canada.

FREE Duplicate Exchange—2¢ Approvals. Belden, Box 4175B, Dearborn, Michigan 48126.

"WHOLESALE" U.S.—Foreign Pricelist and catalog Free! Everything Guaranteed. Schneider, Box 1240, Grand Rapids, Michigan 49501.

100 DIFFERENT British Empire 10¢. Approvals. Gibson, Box 34, Lansdowne, Pa. 19050.

80 DIFFERENT U.S. stamps. Includes 1943 flag stamp of occupied nations. Only 25¢. Approvals included. Willett Co., Box 338-M, Yorktown Heights, N.Y. 10598.

50 YEARS Old, fifteen different United States, over fifty years old—10¢ with approvals. Jaxon, Box 145-P, Brooklyn, New York 11230.

307 DIFFERENT Triangles, Sports, Topicals, etc. Worth near \$8.00. Only 25¢. Bargain approvals. Jayto Stamps, East Syracuse, New York 13057.

MILLIONS Foreign Stamps! 2¢ each! Send for gigantic approvals! ABC, Box 6000-MB, San Francisco, California 94101.

NEW! Get scarce Vietnam, Tanzania, Cook Islands Royal Visit, Monaco Royal Wedding plus F.D.R., Stalin, Churchill memorial issues, many more. Valuable collection of 100 different stamps from far-away places. Strange beasts, famous people, rare paintings. Also stamp selections to examine. Buy any or none, return balance. Cancel service anytime. Rush 10¢ handling. Garcelon Stamp Co., PM9K, Calais, Maine 04619.

60 DIFFERENT United States (30 Commemoratives) 25¢. Seidenberg, Salem 169, Oregon 97308.

"50 FAMOUS PAINTINGS 50¢ when requesting approvals. C. F. Stamps, 655 Forbes St., East Hartford, Conn. 06118."

QUALITY AND LOW PRICE. EXCELLENT For advanced or beginner. Mounted approvals 2¢ up, all countries in Scott's Order. Preview Stamps, P.O. Box 20667, San Diego, California 92120.

RUSSIAN Space collection 25¢. Russian Approvals. Snedco, Box 68-P, Waldwick, N.J. 07463.

BEAUTIFUL TOPICAL COLLECTION—Includes Olympic sport stamps, wild animals, bicolor triangles, colorful birds, outer space stamps, Poland kitten stamp and others. 10¢ with approvals. Sunny Stamps, Dept. 57A, Fruitport, Mich. 49415.

200 DIFFERENT 10¢ With Approval. Polze, Box 5215, Milwaukee, Wisc. 53204.

VIETNAM 25 Different 10¢ approval. Sam Chazen, Box 95, Ozone Park, N.Y. 11417.

TONGA'S Banana-Shaped Stamp, Bhutan Foil, Botswana Elephant, President Kennedy, Moon Landing, Honduras Easter Flowers, German Child Painting, plus 100 others! Only 10¢ when requesting approvals. Select those desired, return balance. Cancel service anytime. Douglas Cook, Dept. PM-4, Las Vegas, Nevada 89112.

255 DIFFERENT Worldwide: 15¢ Approvals. Tibbets, 8675 Meadow, Downey, California 90242.

7 COMPLETE SETS Poland—25¢ With Approvals. Duncan Stamps, RR #1, Duncan, B. C., Canada.

SENSATIONAL Clearance Sale. 10 packets—25, 20 packets—50, 40 packets—\$1.00. No Approvals. Norge, Wyckoff, N.J. 07481.

FREE—Colonial collection. Bargain approvals. Gains, Box 788, Mattoon, Illinois 61938.

DWIGHT EISENHOWER Memorial stamp on Special U.S. first day cacheted cover addressed your name. 50¢ each. K.M. WALSH, Box 308, TUCKAHOE, N.Y. 10707.

FREE Stamp Wallet with approvals. Wide choice collections by countries. Clark, Box 38, Wilmette, Illinois 60091.

COLORFUL Romania Wildlife Set, 10¢. Approvals. Thomas, Box 1189PM, Vallejo, California 94590.

CANADA Sports Complete 10¢. Canadian Approvals. Valley Stamps, Little Valley, New York 14755.

77 MYSTERIOUS Beauties 10¢. Approvals. Stamps, Box 1444-M, Kitchener, Ontario, Canada.

100 DIFFERENT Poland—25¢. Approvals. Gobestamps, Box 402, Biddeford, Maine 04005.

100 WORLD Wide 10¢, approvals. Big M Enterprises, P.O. Box 10902-C, Ferguson, Missouri 63135.

PLANES! Trains! Cars! Ships! Space! Sports! Spectacular Stamp Collection. Just 10¢. With Great Approvals. Castle, P.O. Box 15-PMM, Flushing, N. Y. 11352.

FREE U.N. Mint Set. Approvals. Hildebrand, Box 5645, Redwood City, California 94063.

NEW AFRICAN STAMP COLLECTION including Burundi, Guinea, Mali, Rwanda, Togo and others. A colorful addition to your collection, 10¢ with approvals. Modern Stamps, Dept. 57B, Ferrysburg, Michigan 49404.

50 U.S. COMMEMORATIVES 15¢. Approvals. Cambridge, Box 2311, Heath, Ohio 43055.

FIRST 11 Stamps, United Nations \$1.00. Alpha Stamps, 960 2nd Street, Irberville, Canada.

WALT DISNEY Memorial Mint Set Plus Gigantic Mystery Packet—10¢! Attractive Bargain Approvals. Free Bonus Plan!—Write Today! Kenneth Feldman, Box 48798M, Los Angeles, California 90048.

500 DIFFERENT And hinges \$1.00 with request. **ADULT** approvals **ONLY.** Bacon, 8221 Page, St. Louis, Missouri 63130.

1¢, 2¢ APPROVALS. Other Bargains. Pam, Box 22092, Memphis, Tenn. 38122.

FREE World Collection. Over 100 stamps. Approvals. Global, Box 427, Livermore, California 94550.

U.S. BARGAIN List, Everything. Guaranteed. C&V Stamps, P.O. Box 7034, Grand Rapids, Michigan 49501.

"SPACE" Pictorials, others, 110 Different—10¢! Approvals. Shaw, Drawer E-64, Montevallo, Alabama 35115.

MAGNIFICENT PAINTINGS!!! 25 different breathtaking beauties only 25¢ with approvals. Gateway, 115-C New Montgomery, San Francisco 94105.

COLLECTION Free: Pictorials-Commemoratives. Approvals. Ross, Box 564-PM, Yonkers, New York 10702.

300 DIFFERENT Stamps 30¢ Bargain lists. No approvals. Stamps, Box 27, Fremont, Michigan 49412.

FREE 20 Different Commemoratives when requesting approvals. Eichelberger, P. O. Box 243, Santa Ana, California 92702.

CLEARANCE Prices on U.S. Foreign. Stamps, Box 573, Silverdale, Washington 98383.

100 Germany 10¢ With Approvals. U.S. Price List (102 Pages) 50¢. R. Smith, Box 617 M, Woodcliff Lake, N.J. 07675.

LOOK! Over 100 different strange and valuable stamps for just 10¢ with approvals, plus big bargain lists. Continental, Box 9413, North Hollywood, Calif. 91609.

ITALY, 100 Different only 25¢ with worldwide packet approvals. Free Duplicate Exchange Plan. Markwell Stamp Mart, P.O. Box 921, Schenectady, New York 12301.

I PAY \$250 For 1924 1¢ Green Franklin stamps rotary perforated eleven (\$2500 unused). Send 25¢ for illustrated folders showing amazing prices paid for old stamps, coins. Vincent, 85PM, Bronx, New York.

FREE! Qatar. Rwanda. Selangor. Others. Approvals. Keating, 2520 Boulevard, Jersey City, New Jersey 07304.

OVER 100 different unusual stamps. Value over \$3, yours for 10¢ with approvals. Continental, Box 9413, No. Hollywood, Calif. 91609.

COUNTRY By Country All Kinds. Low Prices. 10¢ Approvals. Send To: Stamp Company, Box 254, BUFFALO, N.Y. 14212.

225 STAMPS For only 10¢! Airmails. Pictorials: stamps from strange countries cataloging up to 25¢ each! Plus unusual stamps to examine. Buy any or none return balance, cancel service anytime. Mystic Stamp Co., Camden 80, New York 13316.

COINS, TOKENS, CURRENCY

SEND Only \$1.00 for Coin Collecting Outfit. Contains 25 new coins from 25 countries. Plus Magnifier, wooden nickel, "How To Collect Coins" booklet, special coin envelopes, foreign banknote and big catalog of coins, paper money, collectors supplies. Littleton Coins, Dept. GH-1, Littleton, New Hampshire 03561.

NINETEENTH CENTURY Cent, Nickel, Dime, Quarter And Half Dollar. All For \$8.50. Postpaid. Blueberry Company, 190 Blueberry, Hicksville, New York 11801.

3 DIFFERENT Silver Dimes, only 50¢. Stevens, Box 546F, North Miami, Fla. 33161.

LINCOLNS: 50 Mixed 1909-40 \$2.00. 35 different uncirculated \$2.00. Nayko, 172-15D Effington, Flushing, New York 11358.

SILVER DOLLARS Uncirculated, 1880-81—1883-84-85 \$4.50 Ea. Catalogue 50¢. Shultz, Salt Lake City, Utah 84110.

COMPLETE U.S. Coin List 25¢. Lincoln Starter Sets 50 Different \$1.75, 100 Different \$3.50. Schultheis, Box 151M, New Hyde Park, N.Y. 11040.

PRICE Lists of Thousands of Stamps and Coins. Send 25¢ Refundable with purchase. No Approvals. Bryson, 612M White, Toledo, Ohio 43605.

GOLD: Mexican 1865 Maximilland Peso .900F Uncirculated \$1.95. Olmsted, Terrace, Franklin, New Hampshire 03235.

INDIANHEAD Cents, Buffalo Nickels. Ten Different, \$2.00. Kedzie Coins, 5909 So. Kedzie, Chicago, Illinois 60629.

SILVER Dollar \$3.10; Large Cent \$4.50; Ten Buffaloes \$2.60; Listing 25¢. Nelson, 346-J, Rye, New York 10580.

BRILLIANT Uncirculated Silver Dollars. 1878 To 1904—Our Selection, Each \$4.98; Ten Different Dates \$46.89. Bargain Lists 18¢. Bebee's Incorp., Omaha, Nebraska 68111.

FOREIGN Crowns. Mauritius, Manx, Somalia, Caribbean, Olympics. Retailers making 25%. Lists 11¢. Payn, 966-A Fraser, Los Angeles, Calif. 90022.

TEN Indianheads \$3.50; Ten V-Nickels \$3.45; Listing 25¢. Fairway, Box 685-K, White Plains, New York 10602.

1964 UNCIRCULATED Year Set, \$2.50. Catalog 25¢. Village Coin Shop, Dept. P, Plaistow, N.H. 03865.

TWO Libertyhead Nickels, One Libertyhead Dime, plus illustrated list, all for \$1.00. Eagle Coin, Box 25231, Richmond, Virginia 23260.

(Continued on next page)

COINS, TOKENS, CURRENCY

(Continued from preceding page)

40 MIXED Indianhead And Lincoln Cents, 1890's To 1930's \$2.00. Pavley, Box 518, Cupertino, Calif. 95014.

UNCIRCULATED 'S' Lincolns, 3 Different, 10¢. Bargain Lists Included, Ron Farley, 35-PMS, Metamora, Ill. 61548.

SELLING My Barrel Of "V", Buffalo, And San Francisco Mint Nickels (1890's Thru 1950's) At \$12.95 Per Pound! Maximum 10 Pounds. Sample Bag Of 30 \$4.00. Anthony, Box 9852PE, San Jose, Calif. 95117.

22 "S" LINCOLNS Including 1955S, \$1.75. 24 1909-1939, \$1.75. 10 "S" Jeffersons, \$1.75. All different. All three \$4.95. Harris, Box 2037P, Santa Cruz, California 95060.

THREE VOLUME OFFICIAL COLLECTOR'S GUIDES Exact date, buying, selling price of every valuable U.S. coin, stamp, and paper money. Find a FORTUNE in your pocket. 480 pages \$2.98. New York add 7% tax. Brenco Enterprises, Dept. 125, 152 West 42nd., Suite 536, New York, New York 10036.

ANTIQUES, RELICS, INDIAN GOODS & CURIOS

10 BEAUTIFUL Arrowheads \$2.00. Guajardo's, 8713 Shaver, El Paso, Texas 79925.

FIREARMS REPLICAS. Appearance, weight, balance of classic Western, Military, European handguns meticulously duplicated. Cannot be fired. Disassemble like originals. Brochure \$1.00 refundable first order. Mainbrace 2523 Wilson Boulevard, Arlington, Virginia 22201.

APACHE Arrowhead Collection 9, \$2.00. 25 for \$5.00. Epanco, PM 1239, Apache Junction, Arizona 85220.

INDIAN Relic list, Arrowheads \$4.00. doz. Folsom. \$5.00 each. C. Secrist, Deerfield, Missouri 64741.

EVERYBODY LIKES DIXIE GUN WORKS.

TONS Of antique gun parts and supplies. All reproduction muzzle loading guns. Send \$2.00 for enlarged illustrated catalog No. 121. Dixie Gun Works, Union City 12, Tennessee.

LIST Indian relics. 10 Arrowheads \$3.00. Hyde's, Box 2304, Santa Fe, New Mexico 87501.

10 PERFECT Arrowheads \$4.00. Smith, 9825 Conway Drive, Indianapolis, Indiana 46236.

SELLING 20,000 Indian relics, Arrowheads, spearheads, tomahawks, ceremonies, etc. List 10¢. Lear's, Glenwood, Arkansas 71943.

INDIAN Relic List. Arrowhead Identification Guide \$3.98. Antiquities, Rt. 1, Box 14A-5M, Princeton, W. Va. 24740.

EARN EXTRA At home restoring antiques. Hobby or career. Guaranteed instructions \$2.00. P.O. Box 1013, Studio City, California 91604.

MODELS—CARS, SHIPS, TRAINS, PLANES ETC.

STUNT Flying plane Battery operated fun for the whole family. Send M.O. now for \$5.95 To: An-Cola, 530 Page Ave., Lyndhurst, N.J. 07071.

SHIP Models Kits, fittings, plans, books, tools, engines, motors. Big illustrated catalog 50¢. Mass. residents add 3% tax. James Bliss & Co., Dept. SM, Route 128, Dedham, Mass. 02026.

SHIP And yacht model fittings: Pine construction hull kits; blueprints. Send 50¢ for illustrated catalog. A. J. Fisher, Inc., 1002 Etowah Avenue, Royal Oak, Michigan 48067.

LIVE Steam powered backyard railroads! All sizes. Complete "bolt-together kits," and rough castings. Excellent drawings. 100 page catalog \$1.00. Little Engines, Lomita, California 90717.

MODEL Airplanes—Big 220 Page Catalog 50¢. Sig Company, Montezuma, Iowa 50171.

SHIP Models Catalog 25¢. Scientific, Inc., 340 Snyder, Berkeley Heights, N. J. 07922.

THE WANKEL—see-through model of Wankel rotary engine. Kit contains over 100 parts. Two AA batteries not included. \$6.75pp. Weber Co., Rt. 3, Box 126-PM, House Springs, Missouri 63051.

IDEAL Pocket Knife. Single Edge Razor Blade With Handle. \$1.00. Cazin, 526 Maple, Redwood City, Calif. 94063.

GAMES, TOYS, PUZZLES, NOVELTIES

STOP If Puzzle's Are Your Game. I Challenge You To The Wagon Wheel Puzzle. Only \$1.00. Hardy Puzzle's, 1120 East Voorhees, Danville, Illinois 61832.

"BEAT THE COMPUTER" Adult Puzzles Can Be Done Over 1500 Ways! Have Fun With Friends Finding Them! Three Different "Brain Busters", \$3.50 Postpaid; Separately \$1.50 Each. Wilman, Box 3, Middlebush, N. J. 08873.

4" ONYX CHESS SETS with storage board \$20.00. BALE'S, Box 15123, San Diego, Cal. 92115.

MAGIC TRICKS, JOKES, VENTRILOQUISM

HOUDINI'S Greatest Magic!! You can do them all!! Giant Illustrated Catalog 25¢ with Free Trick!! Vick Lawston, Box 2026P, Pompano Beach, Florida 33061.

MAGIC, Masks, Novelties, Catalog 25¢. Rizzy's, 3746 West 63rd Street, Chicago, Illinois 60629.

NEW 1972 large Catalog. Be popular! Amaze! Have fun! Send 10¢. Latest Magic for pocket, parlor, stage. Douglas Magicland, Dept. 11, Dallas, Texas 75201.

VENTRILOQUISM! Learn at home! Guaranteed! Write! Information Free! Dummy Catalog 25¢. Maher, Box 9037P, Denver, Colorado 80209.

LEARN VENTRILOQUISM! Information free. Ventriloquism, Magic Catalog 25¢. Izzy Rizzy's School of Ventriloquism, 3746 W. 63rd Street, Chicago, Illinois 60629.

COMPLETELY Illustrated catalog. 84 pages. 25¢. Manhattan Magic, Box 334-M, N.Y.C. 10011.

BE A Magician! Two booklets explaining sixty-eight tricks plus large professional catalog. \$1.00. Magic Inc., 5082 Lincoln, Chicago, Illinois 60625.

WORLD'S Finest professional magic tricks. Joker's Novelties. Giant illustrated catalog 10¢. Top Hat, Evanston, Illinois.

FREE! World's Leading Catalog 2000 Novelties, Jokes, Tricks. Scientific Gadgets, Hobbies. Johnson-Smith, C-10, Detroit, Michigan 48224.

MAGIC MAGAZINE—Monthly since 1936. 44 pages. All phases. 3 month trial \$1.00. Genii, P.O. Box 36068, Los Angeles, Calif. 90036.

FABULOUS MAGICS New 1972 catalogue 25¢. Our specialty orders shipped same day no substitutes. Fabulous Magic, 3319 East Charleston, Las Vegas, Nevada 89104.

LOWEST PRICED NOVELTIES, Catalog 25¢. Marcon Novelty, 2216 Clover Dr., Broomall, Pa. 19008.

HOUDINI'S Original Magic Shop. Established 1856. Send 25 cents for illustrated Catalog containing 5000 Tricks. Mindreading, Puzzles, and Jokes. Flossie-Hornmann, 304 West 34th St., New York 10001.

1,500,399 Tricks, Jokes, Novelties. 165 Page Catalog 25¢. Elbee, 7408-P, San Antonio, Texas 78207.

300 JOKES! SPECIAL HONG KONG HARRY BIG LAUGH CONFUCIUS Type. Make Belly Giggle Night-Day! Make You Popular! Good Gift. \$3.00 Postpaid. Order From: Valley Gifts, Box 2495, El Macero, California 95618.

BOOKS, CATALOGS, NEWSPAPERS

PUBLISH Your Book! Join our successful authors: All subjects invited. Send for free appraisal and detailed booklet. Carlton Press, Dept. PME, 84 Fifth Avenue, New York 10011.

LISTS Do It Yourself Books, K&J Associates, Pioneer Park 138-A, Fort Collins, Colorado 80521.

FREE Book List! Inexpensive, entertaining, self-improvement—all subjects. Entire family. Unique, 232A Belfield, Havertown, Pa. 19083.

SELLING Popular Mechanics dating to 1947. Jay Thomsen, Frankfort, Mich. 49635.

U.S. MARINES "Hand To Hand Combat" manual \$1.50. Catalog of Manuals 25¢. Hillcrest Publications PM-5, McDonald, Ohio 44437.

BOOKS. 10 FOR \$2.00. OVER 30 SUBJECTS—500 TITLES. FICTION. PROFIT. SCIENCE. MUSIC. LAWS. CRAFTS. EDUCATION. LANGUAGES, ETC. FREE LIST. WRITE DISCOVERY, HYWAY 12, ROUTE 2, FLEMINGTON, NEW JERSEY 08822.

SOPHISTICATED, Personalized Bookplates . . . 500 . . . \$1.00 . . . May's, Box 802G, Natchez, Mississippi 39120.

WINEMAKING IS FUN. Our Great New Book Shows How. Amazingly Easy To Make. And Delicious. Moneyback Guarantee. Send \$1.98 Now To: Thompson's Books, 560 Paradise Road, Salinas, California 93901. No C.O.D.'s.

FREE BOOK. Prophet Elijah Coming Before Christ. Megiddo Mission, Dept. 63, 481 Thurston Road, Rochester, N. Y. 14619.

NATIONAL Geographic Magazines, 1888-1971, any issue. Buxbaum, Box 465-PM, Wilmington, Delaware 19899.

FREE Catalog, Self Improvement Books, Many Others. Total Company, 6609 Kindred, Philadelphia, Penna. 19149.

HANDICAPPING Books—Thoroughbred, Harness Racing—Free literature—Vernon Publications, 61-A Sherwood Avenue, Yonkers, New York 10704.

BUILDING Your VW Based Dunebuggy. Complete 80 page illustrated manual. \$4.25. Free Brochure. Quazell, Box 6533-N, San Diego, Cal. 92106.

FREE CATALOGS!! Directory Lists Hundreds. \$1.00. CATALOGS, Box 24PM, Staten Island, New York 10304.

TERRIFIC Book Values! Self-improvement, Home improvement, Science, Crafts, etc. Free information. Vernco, Dept. PM52, Box 121, Whittier, California 90608.

HOW To Sell Books by Mail with Directory Wholesale Book Sources. Details: PARRISH, Box 11141, Kansas City, Missouri 64119.

FREE List, Inexpensive Books: Adventure, Children's, Entertainment, Fiction, Many Others. Barmar, 5409 Carfax, Lakewood, California 90713.

FREE Circulars: Automotive, Business And Career, Crafts, Hobbies, Do It Yourself, Sports, Gardening, Flowers, Books, Many Others. Alexander Advertising Agency, 5416 N. College, Suite 10P5 Indianapolis, Indiana 46220.

PLAYS, SONGS, MANUSCRIPTS

SONGS, Poems Wanted! For publishing, recording at our expense! Talent, 17-PM Longwood Road, Quincy, Mass. 02169.

SONGS, SONGPOEMS Wanted For Radio Show. Hollywood Music Productions, 6425-PM Hollywood Boulevard, Hollywood, California 90028.

SONGWRITER! Poets! Spiritual and religious poems, songs wanted for recording by Chapel Symphony Orchestra and Choir. We pay all recording costs! Dept. PM, Chapel Recording, P.O. Box 162, Wollaston, Mass. 02170.

(Continued on next page)

PLAYS, SONGS, MANUSCRIPTS

(Continued from preceding page)

HIT Records International Seeks Lyrics—Songs For Recording—National Promotion. Send Material. Box 8532, Coral Springs, Florida 33065.

POEMS Accepted for new songs recorded Without Charge, Songs/Poems Examined Free, Tin Pan Alley, Box 11647-PM, Sarasota, Florida 33578.

BUSINESS SERVICES

MAILORDER RECORDS Help get increased business! Complete 32 Page Record Book shows your inquiries, orders, advertising, expense, etc. Only \$1.00. C. A. MARTIN, POPULAR MECHANICS, DEPT. PMR, 224 WEST 57 STREET, NEW YORK, N.Y. 10019.

BUSINESS OPPORTUNITIES

\$1,000 A Day In Mail Order. Send For Free Proof. Rehill, 34 South Main, Wilkes Barre, Pennsylvania 18701.

OPPORTUNITY Knocks Only Once—Invite It!!! Free Information For Stamp. TBOR, Box 1692-D, F.D.R. Station, New York 10022.

HOMEWORKERS—Mallers Wanted. Free Information for stamp. Allen, 2418-A Lori, Santa Ana, California 92706.

SECRETS! Mail Order Success. Internationally famous expert reveals how to make home business fortunes. Beginners; Get free copy "Make Money By Mail." Discloses free advertising, profitable products. Mailco, Dept. FC705, Woodland Hills, California 91364.

FREE Millionaire Book . . . Get money in little-known, profitable businesses. Work home! SBI-7, Kerrville, Texas 78028.

EARN Money raising fishworms for us! Write: Oakhaven-38, Cedar Hill, Texas 75104.

HOW And where to get capital. \$5000+ possible in one day. Free details. James Peter, Box 571-AM, Westwood, N.J. 07675.

250,000 NEW MOTHERS EVERY MONTH! BONANZA For Bronzed Baby Shoes! \$50.00 a day profit. No investment, no inventory. Full or spare time. Exciting details Free. Senti-Metal, 1919 Memory Lane, Dept. 8E, Columbus, Ohio 43209.

FORTUNES In Herbalism! Secret, unknown MILLIONAIRE maker! Free lesson, details! Herbalism Institute, 1339 Remuda, Dept. B-1, Glendora, Cal. 91740.

PARTTIME Mailorder Will Make You Wealthy. We Guarantee It. Free Proof. Kelly, 5211-B North Kenmore, Chicago, Ill. 60640.

AMERICAN Partners Wanted. Newly Proposed, Noncompetitive Enterprise! Ornsteen, DuQuoin, Illinois 62832.

TAKE Catalog orders. We drop-ship 1001 best selling specialty products. Guaranteed lowest below wholesale prices. Fantastic spare-time home business. Free book shows you how. SMC, 6963 SPE Hayvenhurst Avenue, Van Nuys, California 91406.

EASY-To-Start rubber stamp business at home in spare time. Make up to \$16.50 an hour without experience. Facts free! Write to: Roberts, Room RC-2-BF, 1512 Jarvis, Chicago, Illinois 60626.

JOIN Unique Private Financial Club That Enables Members To Make "\$80.00 PROFIT FROM EVERY DOLLAR INVESTED" Legal Copyrighted Program Since 1970: Receive Club's Newsletter, Enrollment Form, Full Instructions, Send \$2.00 (Refundable). Baker Enterprises, 13923-P Stoneshire, Houston, Texas 77037.

WORLD'S Biggest Wholesale Bargains! 76 Countries . . . 165 free catalogs! . . . Mailorder imprints, dropshippers . . . Automobile discounts. Free "Digest." Vault International, Box 7284R, Lexington, Kentucky 40502.

\$15,000-\$30,000 YEAR, BOOK: "Raising Rabbits For Us." Rabbit Ranchers Of America, Box 265-X, Haysville, Kansas 67060.

SELL And Install VACUFLO Built-in Central Vacuum Cleaning Systems. See P.M. September 1967. Write: H-P, Louisville, Ohio 44641.

FREE 1972 100-Page Catalog waiting to bring you Big spare-time cash commissions. Sell Advertising Book Matches. Every business a prospect . . . complete selling instructions furnished Steady, repeat business. Dept. MX-572, Superior Match Company, 7530 South Greenwood, Chicago, Illinois 60619.

SEVEN Complete Mail Order Opportunities. \$2.00. Or write: AM Sales, 32-28 100th St., East Elmhurst, N.Y. 11369.

MAILORDER Millionaire helps beginners make \$500 weekly. Free report reveals secret plan! Executive (1A5), 333 North Michigan, Chicago 60601.

\$2.40 HOURLY Making simple wood novelties. Free details! Gene's, 55 Boxwood, Falmouth, Mass. 02540.

MAILORDER Dealers Wanted. Earn outstanding profits using tested promotions! Executive type business. Details 25¢. Rutward, Box 735-PG, Norwalk, Conn. 06852.

MAILERS Needed! Big money! Send 10¢ for information. Andrew Sales, Box 152, Blue Island, Ill. 60406.

MAKE Magnetic signs, Machineless method. Profits enormous. Write: R1B49APM, Bardstown, Ky. 40004.

HOLLYWOOD CEMENTCRAFT: Offers Highly Profitable Home Business. Experience Unnecessary. Unlimited Unique Pottery Designs Easily Made Without Moulds. Bird-baths, Fountains, Wishing-Wells, Waterfalls, etc. Chemical Coloring Formulas. Marble-glazing. FREE Illustrated Brochure. **CONCRETE FACTS**, 602 Athens Street, Altadena, California 91001.

MAKE A Years Income in 8 weeks Camping. No selling, Capital or Land necessary. Write Edrus, Route 5, Box 5733, Gig Harbor, Washington 98335.

PIANO Tuning Learned Quickly At Home! Tremendous field! Musical knowledge unnecessary. GI approved. Information free. Empire School, Box 327, Miami, Florida 33145.

WORLD'S Largest supply, Merchandise 25% to 40% under wholesale. Bankrupts. Closeouts 10¢ under dollar. Imports. Hong-kong clothes. Automobile discounts. Free details. International Buyers, Box 16386 MM, Portland, Oregon 97233.

ADVERTISING BUSINESS—YOU Own it. \$350 First Week or Money Back. Electric Neon Action Ad Clock, 229 W. Illinois, Chicago 60610.

SELL Lifetime, Metal, Social Security Plates. Big Profits! Sample and Sales Kit Free. Russell, Box 286-PM, Pulaski, Tennessee 38478.

COPUBLISH "Mail Sale Advertiser," leading mailorder paper. Copy and details 25¢: U.S.A. only. Vanroy Shirk, Lebanon, Pa. 17042.

DRAFTSMEN! Operate own **DRAFTING SERVICE!** Full, Part Time; Experience unnecessary; Details: Roberts Drafting, 1741 Circle Road, Baltimore, Maryland 21204.

FREE Catalogs. Repair air conditioning refrigeration. Tools, supplies, full instructions. Doolin, 2016 Canton, Dallas, Texas 75201.

I MADE \$40,000.00 Year by Mailorder! Helped others make money! Start with \$10.00—Free Proof. Torrey, Box 318-Y, Ypsilanti, Michigan 48197.

VENDING Machine big catalog. Rake, 523 A Spring Garden, Philadelphia, Pa 19123.

MAIL Baby Catalogs Imprinted with your address to New Mothers for Big Profits! Details 25¢. Volz PM, Ypsilanti, Michigan 48197.

BUILD Custom Cases at home for profit. Get orders by mail. We supply materials, instruction—everything. Free home business details. Custom Case Supply Co., 6961 CPE Hayvenhurst Avenue, Van Nuys, California 91406.

MAKE Money from old tires. Operators clearing \$800, weekly. Equipment costs \$1500. Get facts. S & S Patents, Inc., 3752 N. Damen, Chicago 60618.

MAKE \$46 From square foot plywood: jigsaw or bandsaw necessary. Free details. Woodar, Bridgewater, Mass. 02324.

SUPERIOR Auction School. Nation's top Auctioneers own and instruct. Box 1281, Decatur, Ill. 62525.

\$200.00 SPARE Time earnings with your Tablesaw. Write: Workshop Five, 3800 Harney, Vancouver, Washington 98660.

\$25.00 HUNDRED Addressing. Possible Year 'round. Complete instructions 25¢ for registration, postage. Cove, Box 1348-B, Clearwater, Florida 33517.

\$70 TO \$200 WEEKLY—Home, Spare Time Simplified Mail Bookkeeping. Immediate income. Easy. Auditax, Box 34741A, Los Angeles, Calif. 90034.

VENDING Machines. No selling. Routes earn amazing profits. Big catalogue Free. Parkway Corporation, 715PBM Ensor Street, Baltimore, Maryland 21202.

"MORTGAGE Brokerage." Lucrative Profits! Obtain Capital Sources. Chase, Uleta, Florida 33164.

MAIL Galore! Money-making offers! Your name on national mailing lists, 35¢. Three months, 50¢. Sullins, Box 206-M, Forsyth, Georgia 31029.

\$60.00 DAY. Manufacturing Concrete Posts. Blocks. Mold Equipment Catalog \$1.00 refundable. Carlyne, Route One, Box 95, Rapid City, South Dakota 57701.

MAIL Order Collection Agency can make you \$1000.00 monthly. Free Details. Continental, Box 2023-A, Des Moines, Iowa 50310.

SELL Books by mail. 400% profit. Royal, Box 450-X, Cleveland, Ohio 44127.

INEXPENSIVE, Home-Auto Fire, Burglar Alarms, Extinguishers. 200% Profits. Nation's Watchdog, Williamsburg, Ohio 45176.

WATCHMAKING Makes every day a payday. Learn this cash business at home. Free details. Sweazey, YEA, Fox River Grove, Illinois 60021.

EARN \$240.00 A month at home, spare time, doing only two \$5.00 Invisible Reweaving/Reknitting jobs a day. Big money paid for service that makes cuts, tears disappear from fabrics. Steady demand. Details free. Fabricon, 2065 Montrose, Chicago 60618.

ADDRESSERS And Mailers Needed. Details 10¢. Lindbloom, 3636 West Peterson, Chicago 60659.

OPERATE Home Mail Order Business. Write: SCHROEDER'S, Box 205, Greendale, Wisc. 53129.

\$100.00 WEEKLY Selling magnetic signs! SPN, Box 15, Murray Hill, New Jersey 07974.

SELL By Mail Order For Extra Income And Future Security. Details Free. Humphrey, P.O. Box 306, Roselle, Illinois 60172.

I MADE \$2,000.00 Monthly In Mail-order. . . . Evenings Only. You Can Too—Free Proof! Kingman JJ, 4264 Westridge, Erie, Pennsylvania 16506.

FREE Book "999 Successful, Little-known Businesses." Work Home! Plymouth-ADE, Brooklyn, New York 11218.

MOLDING Rubber Liquid Plastic. Hobby Supplies. Details 10¢. Chaney's, 5415-L San Jose Blvd., Jacksonville, Florida 32207.

FREE Booklet, "How To Sell By Mail." Write: Ransone, Box 1719, Richmond, Virginia 23214.

(Continued on next page)

BUSINESS OPPORTUNITIES

(Continued from preceding page)

"MAILORDER Bookkeeping System." Ideal for tax purposes. \$1.00. Dealers wanted. Neil H. Tasker, Shamokin, Pennsylvania.

MAILORDER! How to prepare your own catalog for pennies! Free catalog! Obie-ADD, Brooklyn, New York 11219.

FREE BOOK "How To Fail or Succeed in Mailorder!" Plymouth, MMDE, Box 111, Brooklyn, N.Y. 11223.

2000% Profit Bronzing Shoes. Free Literature. NBC, Box 11069PM, Kansas City 64119.

\$2,000.00 MONTHLY With Your Own Business. Write, Robar, 100A School Street, Watertown, Mass. 02172.

\$500-\$1000 Month Plan raising rabbits for us. Free details. White's Rabbitry, Mt. Vernon, Ohio 43050.

MAILORDER Book Publisher Wants Dealers. Details 25¢ (refunded). Jan Enterprises, 76P, Wild Rose, Wisconsin 54984.

HOW To Start Mailorder Business. Send \$2.00 For Info. 3D Enterprises, 31517 Vine St., Willowick, Ohio 44094.

ADDRESSERS Mailers \$1000 Monthlv. Send Addressed Stamped Envelope. B & E Enterprises, Box 249-A, Chanute, Kansas 67220.

RADIATOR Shop Grossing Over \$24,000.00 Yearly. Due To Health. 219-533-5132, Goshen, Ind. 46526.

MONEYMAKING Is An Art! Free Information. House of Hoke, Dept. 101-PM, Sebring, Florida 33870.

HOMEWORKERS. \$100.00 Weekly Addressing for firms. Begin immediately. Details—send stamped, addressed envelope. Hamilton, 272-TMA-5, Brooklyn 11235.

MY NEW BUSINESS Can Easily Make You \$1,500 Per-Month. Rupperts, 7530 North Seeley, Chicago, Illinois 60645.

\$25.00 HOUR Repairing Vacuum Cleaners! Free Details! Baron, Box 863A, Portales, New Mexico 88130.

EARN \$40.00 DAILY. Manufacture Concrete Bricks. Very Small Investment. Send Stamp. Free Details-Hilmar, Rt. One, Box 347-D, Valrico, Florida, 33594.

CLIP Short newspaper items. To \$10.00 each. Details free. Foster, 272-M-5, Brooklyn 11235.

FANTASTIC Profits! Your Own Advertising Specialty Business. Buy Direct . . . Hire Salesmen To Keep Up With Business! Free Details, DB Associates, Dept. PM-151, Holland, Mich. 49423.

MAILORDER—Profitable products, drop-shipped. No merchandise investment. Everything supplied—catalogs, ads, mailing lists. Gif-Guide, 1137½ Crenshaw, Dept. 283, Los Angeles 90019.

900% PROFIT For Men And Women with your own Magnetic Sign Shop! Big demand for 3-D magnetic signs on cars and trucks. Start in garage. Kitchen or camper. Soare or full time. Financing available. Write today for free details. Nationwide Plastics, Dept. 254, 4200 Panamint, Los Angeles, Calif. 90065.

MAKE Money Selling Amazing Health Chewies. Write to: Sorna Manufacturers, Box 8834, Johannesburg, South Africa.

IMPORT-EXPORT Opportunity, profitable world-wide, mail order business from home, without capital or travel abroad. We ship plan for no risk examination. Experience unnecessary. Free details. Mellinger, Dept. F2705, Woodland Hills, California 91364.

AVOID Get-Rich-Quick Schemes! Try Delta's Mailorder Method for safe, steady results! Delta, Box 19281-P, New Orleans, Louisiana 70179.

ASTONISHING Sparetime Business. \$2,000.00 Monthly by Mail. Durham, P.O. Box 7628, Dept. PM-5, Baltimore, Maryland 21207.

HOW To Make \$6.00/Hr. or more cleaning Windows. My best week paid \$253.00 Part Time! No Gimmick. For complete info Booklet, Instructions, Send \$2.00 to: Jim's Window Cleaning, 7030 15th N.W., Seattle, Wash. 98107.

MAILORDER! Make \$16.50 Hourly Selling Stamps To Collectors! Free Details. International, 6767LA South Atlanta, Tulsa 74136.

BELOW Wholesale for profit, gifts, toys, novelties, etc. Giant Catalog \$3.00. Refundable first order. Enterprises, P.O. Box 1072-PM, Beaverton, Oregon 97005.

\$10,000-\$30,000 Year! 629 proved successful plans. Write: Argosy, P.O. Box 422P, Milford, N.J. 08848.

YOUR OWN MAILORDER BUSINESS! Opportunity to Profit as Experts Do. Free Details. Powell, Box 1188-MD, Rosenberg, Texas 77471.

BE YOUR Own Boss. Earn 2 to 4 times your cost. Proven spare-full time methods. Details \$1.00. (Refundable). Specialties Wholesale, 301 East Williamson, Harlingen, Texas 78550.

SELL Books!! Complete Mailorder Plan. Vikari's, Box 1312PM2, Salt Lake City, Utah 84110.

EARN \$60.00 Daily manufacturing Concrete Fence Posts. Practically no investment. Send stamped-addressed envelope. American, Excelsior Springs, Mo. 64024.

INSTALL Burglar Alarm Systems. Big profit home business. Beginners start spare time, without mechanical experience or costly equipment. Free starter plan. Nasco, Dept. F2705, Woodland Hills, California 91364.

\$400.00 MONTHLY Raising giant fish-worms. Soilless method. Charlie Morgan. Bushnell, Florida 33513.

HOW And Where To Get Capital. Get \$500 to \$2 million. Free information. Counselor-17, Kerrville, Texas 78028.

\$75 DAILY Working only 5 minutes a day. Guaranteed, Professional Method. Details Free. NeWorld, Box 1446, Lafayette, Indiana 47901.

MAIL ORDER Specialist reveals how to start mail order business: Product selection, sources, pricing, publicity, use of publications, direct mail, catalogs, lists. Discusses seasonal factors, tricks of trade. Fascinating 54-page Manual only \$1.00; Mail Order Institute, Dept. E, 83-21 247th Street, Bellerose, New York 11426

BECOME Tax consultant. Our students earn \$1,000-\$3,000 every tax season preparing returns evenings. State approved. National Tax School, Monsey 2YC, New York 10952.

WE NEED GINSENG GROWERS! \$3,000-\$30,000 annually! We Buy Your Crop. Send \$2 for seed sample and information. Glass's Ginseng Exchange, Box 336, Rochdale Station, Jamaica, NY 11434.

MAKE 200-300% Profit on Gift Items, Novelties, Toys, Carded Merchandise, 1001 Others. Giant Catalog, \$2.00 (refundable first order). Webber Enterprises, 2322 Hillsboro, Dallas, Texas 75228.

FREE 32-page catalog: "How-To-Make-Extra-Money" books! Holden's (P5), Box 1456, Evanston, Illinois 60204.

FREE Sample Sales Aid Kit. Sell Lifetime Colored Social Security Plates. Big Profits! Ultis, 10716 Francis 1-PM, Los Angeles, California 90034.

MAKE \$1,000 Per Month From Your Own Home. Write Getman Enterprises, Avery Road, Dept. 341, Carthage, New York 13619.

50 GUARANTEED Money Making Plans. From Home Or Shop. Little Or No Capital. \$1.00. Original Consultants. 11163 South Broadway, Los Angeles, California 90061.

BURGLAR Alarms you can install. Big profits. Catalog, Instructions \$2.50. Armstrong Alarms, 300 N. E. 44 St., Ft. Lauderdale, Florida 33308.

SAVE OVER 50% ON YOUR PRINTING. Samples and Details 25¢. BalcoPrint, Box 215PM5, Sharpes, Florida 32959.

EXPORT-IMPORT Profitable mail order business work at home. Experience unnecessary **FREE DETAILS.** Morgan-Weisel Company, 227 Hollis, Dept. P42, Campbell, California 95008.

SELL Books by Mail. Complete Dealer Set-Up 20¢. Midwest Mail Sales, Box 44R2-P.M., Shawano, Wisconsin 54166.

BIG Profits! Selling Lifetime Metal Social Security Plates, Samples And Details Free. EZ-Read Plates, Box 612, Murfreesboro, Tennessee 37130.

\$500.00 Weekly Possible **SELLING PUPPIES** at Home. No Breeding Necessary. Send \$2.00 For Exciting Details. Nationwide K9 Services, P.O. Box 632, Corona, Calif.

MAKE MONEY NOW. Be Your Own Boss. Free Details. Gaymar, D-5, 3332 North Seeley, Chicago, Illinois 60618.

FREE Catalog. 1001 Products. 50% to 70% profit in Wholesale Specialty Business. \$1.00 deposit refunded first order. Ichabod's Novelties, 1508 Sleepy Hollow, Park Hills, Kentucky 41011.

GENUINE Copper Bracelets sell like Wild. Terrific demand. Free Brochure. Sample \$1.00 (Refundable). Hanson's, Box 855-PM, New York, N.Y. 10008.

HOW To Raise \$100.00 To \$1,000,000.00! Dollars, Drawer 77009-MC, Atlanta, Georgia 30309.

MAILORDER Catalogs. 150 Profitable Products Drop-Shipped Under Your Label. No Inventory. Details Free. Ram, Dept. 1105, Box 12597, Pittsburgh, Pennsylvania 15241.

\$2000.00 Monthly Mailorder Home Business. Experts successful Methods. Proof 10¢. Ross, Box 476215, Caseyville, Illinois 62232.

FREE Collection Agency Details!! \$1,000.00 Monthly Possible. Master, Drawer 77009-PM, Atlanta, Georgia 30309.

MAKE Durable building plastic easily. Waterproof, fireproof, economical. Bays Laboratory, Cedaredge, Colo. 81413.

800,000 IMPORTS, CLOSEOUTS, AVAILABLE! WRITE: Wholesalers, 1265-MC Broadway, New York, New York 10001.

MAKE Big Money In Your Own Business By Mailorder, Without Capital. Free Details. **UNIQUE**, Box 6094 P, Duluth 55806.

GOLDEN SANDS OF TIME. Brand New Profitable Home Money-making Business. Unlimited Local Demand. Steady Repeat Sales, Complete Plan And Free Sample. \$2.00. Lorig, 554 South Lake Mitchell Dr., Cadillac, Michigan 49601.

\$2000.00 MONTHLY POSSIBLE. Details. Write: Walker, 1510 Meridel, Tampa, Fla. 33612.

VACUUM Signmaker Kit \$10.00. Machineless \$5.00. Homecraft, 2350 W47, Denver, Colorado 80211.

SELL Beautifully Colored Social Security Plates. Big Profits! Free Samples! Paul Wright, 1075 Ringwood Avenue, Pompton Lakes, N. J. 07442.

"CASH Paid For Junk"—Thousands Items. Details-10¢. Nichols, Dept. PMB, 324 S. First, Alhambra, Calif. 91802.

BELOW WHOLESALE: 1001 gift items, novelties, toys, tools, jewelry. \$2.00 brings giant catalog, Refundable First Order. J. R. Enterprises, Box 833, Cherryville, Pa. 18035.

HOME PORTRAITS. Big Money. Free Information. "Photography", 5334-P, Sunset, Hollywood 90027.

TREMENDOUS Profits. Start Your Own Wholesale Business, Details Free. FN Wholesale, Silver Lake, Minn. 55381.

(Continued on next page)

BUSINESS OPPORTUNITIES

(Continued from preceding page)

BEAUTIFUL Lifetime Metal Social Security Plates. Free Sales Kit. Bilbrey Sales, Box 312, Vandalia, Ohio 45377.

\$200.00 DAILY In your mailbox! Your opportunity to do what mailorder experts do. Free details. Associates, Box 136-A, Holland, Michigan 49423.

MEN-Women Make Big Profits At Home! In Plastics, part or full time! Unique process teaches you with equipment we give you free to make hundreds of 3-D plastic products, candy and candle molds, plaques, signs. Skin and bubble package. Also resin casting. Write today for free details. Nationwide Plastics, Dept. ART, 4140 Eagle Rock Blvd., Los Angeles, Calif. 90065.

MAILORDER—Carry no stock. Companies will pack, ship under your label. One man operation capable of \$10,000-\$20,000 year. Details Free! Distributors, Box 9-A, East Rockaway, New York 11518.

\$100 Daily Possible! Wholesale Business! Free Details! Xcito Wholesalers, 5715 N. Mozart, Chicago, Illinois 60659.

LEARN Mail Order. Profits. Details. C. M. Enterprise, Box 401-P, Washington Court House, Ohio 43160.

EARN Thousands at home. How to sell books by mail. Free Details. Wisdom House, P.O. Box 1106P, LARGO, FLORIDA 33540.

EARN \$2,000. Monthly in AMAZING, interesting Businesses. Free Details: L.S. Enterprises, P.O. Box 4462-M, Rockford, Ill. 61110.

\$500—\$5000 Yearly Spare Time Income. Start Mail Order Business Without Investment. Particulars Free. Elite, Box 715-A, Lynbrook, New York 11563.

STUFF ENVELOPES!! Make 25¢ each—Complete instructions!! Send 25¢—Stamped, Self-addressed Envelope. Guaranteed! King, Box 3156, Madison, Wis. 53704.

400,000 BARGAINS Below wholesale! Many free. Liquidations . . . closeouts . . . job lots . . . single samples. Free details. Bargainhunters Opportunities, Box 730A, Holland, Michigan 49423.

CHECK US. If you're really interested in business of your own. Security of Office Cleaning Service. Show you how. No franchise. Hart Enterprise, Dept. A, Box 5245, Mission Hills, Calif. 91340.

\$300.00 Daily in your Mailbox. Follow the professional methods. Annuity profits plan. Free details. Roush Enterprises, 3567-PM 16th, Wyandotte, Mich. 48192.

BE INDEPENDENT NOW WITH!!! QUIT THE RAT RACE!!! \$1500.00 Monthly possible. Delightful Home Business. Start spare time. Amazing FREE REPORT. WHITE, Box 1966, Beverly Hills, California 90213.

CALIFORNIA MANUFACTURER NEEDS Man to assemble our product and be local agent, experience unnecessary. May start while presently employed. Five-figure income for responsible applicant. S.K.R.M. Manufacturers, 2347 West 238 Street, Torrance, California 90501.

MAILORDER Records help get increased business! Complete 32 page Record Book shows your inquiries, orders, advertising expense, etc. Only \$1.00. C. A. MARTIN, POPULAR MECHANICS, DEPT. PMR, 224 WEST 57TH STREET, NEW YORK, NEW YORK 10019.

MONEYMAKING OPPORTUNITIES

FIX Typewriters from home. Repairs available. Easily learned. Athey, Tarentum, Pa. 15084.

SELL Sensational Car Thief Signal. Lighting Seller. Samples for trial. Northwest Electric, Ave. 859, Mitchell, S. Dak. 57301.

MY New Business Can Easily Make You \$1,500 per Month. Write: Strohmeier, Box 44A, Seneca, Kansas 66538.

SELL YOUR PHOTOS! Report tells How Where. Color Slide Markets Included. Rush \$1.00 To: D and B Sales Co., Box 1057, Escondido, Calif. 92025.

SELF-Employed Man Seeks Other Men And Women Capable of Earning \$1500 to \$2000 A Month Part-Time. Bob Caron, 55 Winthrop St., Woonsocket, R.I. 02895.

BIG Money making candles in home. Complete instructions. Everything furnished. Details free. CANDLE'S, Dept. A-4, Waseca, Minn. 56093.

FANTASTIC Profits selling our Lifetime Metal Social Security Plates. No obligations. Sample and Sales Kit Free! National Engravers, P.O. Box 2221, Anderson, S.C. 29621.

\$18,000 YEARLY INCOME? Proven Success Program—48 Lessons—shows how! Sample lesson \$1.00. Money-making Brochure Free. Imperial, 146-PM Thom, Winnipeg, Canada, R2C 1A1.

\$600-UP MONTHLY. People needed. Raise rabbits, other laboratory animals for us. Huge market. We supply equipment, breeders and instructions. Details 25¢. National Research Farms, PNM5, Box 37, Palatine, Illinois 60067.

SWEESTAKES Contests. How To Win. Write For Free Particulars. General Contests, 1609-18 East Fifth, Duluth, Minnesota 55812.

HOW Much does being your own boss or making \$25,000.00 per year interest you? The Warner breakthrough in the Engraving field could be your future. Write: Warner, Room EC-2-BF, 1512 Jarvis, Chicago, Illinois 60626.

CLIP Newspaper Items. \$1.00-\$25.00 Each. Free Details. James, Box 124M, Inglewood, California 90306.

HOMEWORKERS. Make \$50. every 150 envelopes you mail. Rush 25¢. Gemco, B-21244A, Indianapolis 46221.

\$100.00 DAILY Possible Bronzing Keepsakes. Free Literature. NBC, Box 11069-PM-1, Kansas City 64119.

MONEY. Make Hundreds extra Spare-time home by mail. Opportunities, tips in magazine that tells how, leading mail-order magazine since 1929. Sample \$1. Year \$5 with free what is mailorder opportunities folio. Mail Trade, P.O. Box 1302, Springfield, Illinois 62705.

FREE—Easy Ways to make money selling exciting new products—Full—spare time. Send name, age, for 5 months free subscription. Salesman's Opportunity Magazine, 1460 Hancock Center, Dept. 17-EM, Chicago 60611.

MAKE Statuettes, novelties, imitation marble. Sell to stores or start gift shop. Free details. Marbleizing, 41 Waverton, St. Louis, Mo. 63124.

LEARN The secrets of repairing junk batteries "Fabulous Profits" at home. Battery Shop, Box 820, La Quinta, Cal. 92253.

HOW TO GET RICH!! Free "money-making Brochure"! Success International, Box 2447-C, Livonia, Mich. 48151.

\$200.00 FROM Sheet 1/4" plywood (scrap). Details 25¢. Novelties, 610 So. 24th, Elwood, Indiana 46036.

GET World's Biggest Wholesale Import Catalog. Write: World, Medina, Washington 98039.

VENDING Machines. No selling. Routes earn amazing profits. Big catalogue Free. Parkway Corporation, 715PMM Ensor Street, Baltimore, Maryland 21202.

WIN CONTESTS! Prizewinner Will Help You! Sample Copy, 25¢. Year, \$4.00. Spence, 1315 Central, St. Petersburg, Florida 33705.

HOW To Make Money Writing Short Paragraphs. Information Free. Barrett, Dept. C-27-G1, 6216 N. Clark, Chicago 60660.

CLIP Newspaper items. \$1.00-\$5.00 each. Details free. Walter, Box 1360PA, Erie, Pa. 16512.

EARN \$240.00 A month at home, spare time, doing only two \$5.00 Invisible Re-weaving/Reknitting jobs a day. Big money paid for service that makes cuts, tears disappear from fabrics. Steady demand. Details free. Fabricon, 2039 Montrose, Chicago 60618.

PENNY STOCKS Have Profit Potential. Free Information. Analyst-P.M., Box 214, Redondo Beach, California 90277.

HOMEWORKERS, Commission Mailers Wanted! Details 10¢. Rome's, B-372-PM, Webster, Massachusetts 01570.

TREMENDOUS Earning Potential. Three Unique Businesses Operated From Home. Jeboco, Box 6542ME, Surfside, Florida 33154.

"LEARN Sewing Machine, Vacuum Cleaner Repairing. Men, Women. Lucrative profits. Profession with bright future. Gresslin Correspondence School, Box 927, Spencer, Iowa 51301."

CASH From Bottles! FREE Details. Cannoncrafts, Box 1046, Reseda, Calif. 91335.

CLIP Newspaper Articles To \$5.00 each. Free Details. Dix, B38-PR, Hallandale, Florida 33009.

MAIL OUR CATALOGS. \$100. WEEKLY GUARANTEED. Complete (supplies, postage furnished) \$1.00 To: LLWJR, Box 2441, Palos Verdes Pen, California 90274. Satisfaction Guaranteed!

MAKE MONEY ON GOVERNMENT SURPLUS. Report Reveals Foreign Drop Ship Sources. World Trader's Digest. Ideal Mailorder Items. Send \$2.00 To: D. B. Sales Company, Box 1057, Escondido, California 92025.

START Your Own Profitable Wholesale Business. Gifts, Specialties, Toys, 1000 Others. \$1.00 Brings Giant Catalog. Refundable First Order. Redd's, Box 555, Colton, Calif. 92324.

SELL Power And Hand Tools By Mail, Phone, Direct Contact. We Drop Ship To Your Customers. Write: Rome, Box 486, Stanhope, N.J. 07874.

BIG Money Writing Jokes. Enormous demand. We show you how. Free Facts. Laffs, Dept. G95, Pleasant Hill, Ohio 45359.

WIN SWEEPSTAKES CONTESTS! Remarkable new book reveals prizewinner's Methods! Free details. Services, Box 644-PC4, Des Moines, Iowa 50303.

FORTUNES Made in Mail-Order. Details. Box 807-M, Clarksville, Tennessee 37040.

SECRETS Of "Smart Money" Methods now Revealed. Free Details. Rehll, 34 South Main, Wilkes Barre, Penna. 18701.

MAKE MONEY with your camera. Sell photos, color slides to newspapers, magazines, house organs. Report tells how, where to sell pictures. Color slide markets. Booklet #MO-54P, \$1.00. Thompson's, 572 19 Becky Thatcher, St. Charles, Missouri 63301.

FREE CATALOG. Buy below wholesale gifts specialties, how to make money manuals. Williams, 5275 DeLongpre, Hollywood, Calif. 90027.

WIN Contests! Amazing professional methods now revealed. \$2.98. I. Altman, P. O. Box 1009, Flushing, N.Y. 11352.

1100% PROFIT, Bronzing or Pearl Finishing Anything. Free Proof! Kiktavi, Box 2127D, Inglewood, Calif. 90305.

\$\$\$\$\$ Profit By Inspecting Product For Defect. Minimum Investment—Start Part Time. For Details Send \$1.88 To: Profit Thru Research, P.O. Box 376, Dept. P, Medina, Ohio 44256.

EARN Dollars With Your Camera. Booklet Explains How, Where, Laws And Regulations. Mail \$1.00. L. Reed, 846 Talbot, Albany, Calif. 94706.

(Continued on next page)

MONEYMAKING OPPORTUNITIES

(Continued from preceding page)

\$40,000 Year Possible Mailing Your Own Gift Catalogs. No Inventory. Products Dropshipped. Catalogs Printed With Your Name. Sample Catalog. Details 50¢ (refundable). Brimel Publishers, Box 93-PM, Dayton, Ohio 45405.

BIG PROFITS AND BONUSES Selling Life-time Metal Social Security Plates. Free Sample! Duraplate, 200-PM East 127th Street, Kansas City, Mo. 64145.

MAKE \$1,000 Per Month From Your Own Home. Write: Associative Enterprises, 2360 Calder, Suite 116, Beaumont, Texas 77704.

NEW—UNIQUE BOOK Reports Easy Home Money-making Methods Galore, Without Investing. Details: Premier Enterprises, Postbox 10597-F, Pittsburgh, Pa. 15235.

SUCCESS! You Can Operate One Of 50 Home Businesses. Start On A Shoestring. Amazing Profits. Booklet 25¢. Doubletree, Box 5839-PE, Phoenix, Arizona 85010.

UNUSUAL Home Business, Managing Consumer's Group. Write: Kenco Wholesale Products, 137 Sherman St., Denver, Colo. 80203.

AMAZING INCOME! Can you type? 6—New Ways to Secure, operate home business. \$2.00. Margar's, Box 2745, Springfield, Ill. 62708.

BABY CATALOGS Mailed To New Parents. 4 Million Prospects, Big profits! 30 Items. Details \$1.00. The Howill Co., Box 137, Dept. PM, Stratford, N.J. 08084.

MY NEW BUSINESS CAN EASILY MAKE YOU \$1,500 PER MONTH—Ideal Commodities, Post Office Box 3029, Denver, Colorado 80201.

SUCCESS Method: Make \$1,000,000—10 years. Start with \$10. Free proof. Opportunities, Box 721-A, Lynbrook, New York 11563.

\$50 DAILY Possible! Mail Order! Free Information! Xcito Mailers, 5715 N. Mozart, Chicago, Illinois 60659.

\$125.00 Weekly Correcting Pupils' Lessons! Samples, \$1.00! Reynolds, 613N Water, Salem, Indiana 47167. Trifano, RD2, #159B, Catskill, New York 12414. Long, #5257, North Birmingham, Alabama 35207. Miketic, 248 Grantham, Saint Catharines, Ontario, Johnson, 1307N Avers, Chicago, Illinois 60623.

GUARANTEED \$25,000 1st Year Mail Order Earnings. Free Details. Glenwood, 4721C Indiana, Salem, Oregon 97303.

MUSICIAN Or not, make money in music. Free Brochure! RICALA, Box 1230, Hilo-Hawaii, 96720.

REPRODUCE AT HOME! Easy!! Three Wholesale Products sent you!! Sell or Use!! Instructions!! \$3.00 Do Something!! Pamwick, Dept. 1A5, Harrellsville, N.C. 27942.

\$13.00 PUTS You In Exciting Business. CMM-220P 79th—Washington 20027.

PAPER CLIPS Bring 25¢—50¢ each. Unique, funny method. Make friends—make money! Complete details \$1.00. Box 1387, Sioux Falls, S. Dak. 57101.

MAKE Money operating home business. Directory lists 400 suppliers of Tools, Equipment, Materials. \$1.00. Finder's Katalog, 521 Rosewood, Ohio 43070.

MAKE \$1,000,000 Within Ten Years. Start with \$10. Free Trial. Moneytree, 1422-5M2 North 10th, Tacoma, Washington 98403.

NEW Product Associates **WANTS YOU** To Test/Evaluate New/Unusual Items. **YOURS FREE.** Nothing To Buy. Hurry! Only 1000/State. Send Self-Addressed Stamped Envelope Plus 25¢. N.P.A., Box 8575, Canton, Ohio 44711.

BIG Money Writing Articles, Short Stories, Fillers!! Easy! Just follow my simplified instructions. Free Details. House, Box 288 PM, Gladstone, Oregon 97027.

PROFITABLE OCCUPATIONS

LEARN GUN REPAIR GUNSMITHING In spare time. Book, details 10¢. Modern Gun Repair School, Dept. 1408, 4225 N. Brown, Scottsdale, Arizona 85251.

SECRET Loans. Get \$500 . . . \$35,000 . . . Up to \$2 million easily. Free details. Capital-25, Kerrville, Texas 78028.

EARN AS YOU LEARN. Part-time subscription representatives for leading magazines earn generous commissions while developing skills of salesmanship. For full details, send this ad with your name and address to: **POPULAR MECHANICS**, Room 1107M, 250 W. 55th St., New York, N.Y. 10019.

BECOME A Mortgage Broker. Highly respected, interesting, lucrative prestige business. For complete information write: United, Box 6284-F, Marietta, Georgia 30060.

MAKE \$300 CLEAR MONTH Few hours from 10 customers, representing us in your community. No individual selling. Repeats forever. Customers waiting. \$1 for sample, details. Our 40th year. Progressive, Box 1302, Springfield, Illinois 62705.

FT. SMITH Auction School, Ft. Smith, Ark. Residents & Home study. Veteran approved.

HOW To Make Money Writing Short Paragraphs. Information Free. Barrett, Dept. C-27-G2, 6216 N. Clark, Chicago 60660.

PRINT For Profit—The Modern Way. Booklet Tells You How—And Why—You Can Start Building A Paying Business Now. Only \$2.00. Inter-Mart, Box 882, McPherson, Kansas 67460.

PLASTERCRAFT Profitable home business. Everything including molds available. Details: Lynette, 6251-C Mentor Park, Mentor, Ohio 44060.

HOMEMADE Sawdust Products. Recipes \$1. F.W. Niebruegge, RR1, Box 5, Caseyville, Ill. 62232.

EARN AS YOU LEARN. Part-time subscription representatives for leading magazines earn generous commissions while developing skills of salesmanship. For full details, send this ad with your name and address to: **POPULAR MECHANICS**, Room 1107M, 250 W. 55th St., New York, N.Y. 10019.

SALESMEN-DISTRIBUTORS

BIG Earnings Selling Hertel Bibles. New 3-dimension cover, finest reference edition sells fast. Demonstrator furnished. Big commissions. International Book, Dept. PM, Box 118, Wichita, Kansas 67201.

MAKE Extra \$25 to \$75 spare time! Double air cushion shoes. Men's, women's line. Dress, work, play. Highest commissions. Shoes for yourself. Outfit Free. Bronson, Dept. H-52, Minneapolis, Minnesota 55408.

PYRAMID Your Earnings with self selling product having high repeat sales. Fantastic Sales Plan. 25¢. Merico, Box 5051, Pasadena, California 91107.

EARN Big Commission Full or Part Time. Show America's largest line Low Priced Business Printing and Advertising Specialties Plus Calendars in season. No experience. No investment. No collections or Deliveries. On-the-spot commissions. Big Free Sales Kit samples hundreds items used daily by businessmen. Merchandise bonuses for you. Build profitable repeat business. Start now. National Press, Dept. 72D, North Chicago, Ill. 60064.

SELL Advertising Ball Pens, Calendars, Ad-Specialties—Build Own Repeat Business—Free Details—Fleming, Dept. A, 6535 Cottage Grove, Chicago 60637.

EXCLUSIVE, Fantastic new product sold in all stores, patented, no competition, steady, profitable, repeat sales, \$2000 merchandise investment, refundable, lifetime opportunity. Comon Tatar Inc., Buffalo, N. Y. 14219, (716) 824-1646.

BIG Steady Income! Leader in business printing/advertising specialties will start you in business. No experience. No stock investment. Full, part time. Everything furnished. Write: Kaeser, Dept. B1005, 953 Martin Place, Cincinnati, Ohio 45202.

TRIPLE Your Money in 30 days or less with Merlite rings featuring fantastic man-made replicas of diamonds, rubies, emeralds, and other priceless stones. Work part time or full time. No investment or selling experience needed. For free full color selling outfit, write: Merlite, 114 E. 32nd, Dept. R66C, New York 10016.

WANTED. Part time man to contact service stations. Long needed invention. Huge profits. Write: Cyclo, 3816 Dahlia, Dept. 160, Denver, Colo.

HOUSEHOLD PRODUCTS ROUTE. EARN \$25 Or more daily. Also Party Plan opportunities for men, women full, part time. McNess, Freeport (2652) Illinois 61032.

8-TRACK Tapes \$36.00 Doz. Rock, Soul, Country. Free Catalog. Victor's, Box 10215, Cleveland, Ohio 44110.

AGENTS WANTED

MAKE Extra money representing largest manufacturer of magnetic signs for business vehicles. Details free. **TRIMETRIC**, 337 El Roblar, Ojai, California 93023.

SELL Office Supplies—Machines—Furniture—Equipment. Oseco, 3505-PM Elston, Chicago 60618.

EVERY Man a prospect. Refundable sales kit offer showing line belt buckles, tie clasps, money clips, cuff links, lapels, identification badges, individualized with customer's name and emblems. Cap badges for trucking, bus, taxi, police, firemen, also postal, letter carriers and heavy construction emblems. Choice 4000 emblems. Hook-Fast, Box 1088PM, Providence, R.I. 02901.

YOUR Own business—Used Suits \$1.50; Overcoats 65¢; Mackinaws 35¢; Shoes 12½¢; Ladies' Coats 30¢; Dresses 15¢. Enormous profits. Catalog Free. Nathan Portnoy Assoc., 2109-AA Roosevelt Road, Chicago, Illinois 60608.

PRINTING, Advertising Salesmen—Excellent moneymaking sideline selling Decalcomania Name Plates, small quantities. Advertising Specialties, sign letters. Free Samples. Balco XL, Boston, Mass. 02119.

WANT TO MAKE UP TO \$100 A WEEK Spare time, and get free shoes for life, too? No investment. Rush card for free details. Mason Shoes, K-882, Chippewa Falls, Wisconsin 54729.

LIFETIME Income. Be our loan representative. Free Copy "Financial Freedom". Send \$1.00 refundable. Financial, Suite 1204-X3, 28 E. Jackson, Chicago 60604.

SELL Unique Prison Reform Booklet. Free Sample. Dal, 31 Ramsdell, Boston 02131.

ESTABLISH Your own business. Low prices on used clothing, shoes, household goods. Unlimited profits. Free catalog. Northwestern Distributors, 2129 No. Western Avenue, Chicago, Illinois 60647.

FREE Sample Kit. Sell Metal Lifetime Social Security Plates. \$1.00. Per Sale. All Designs. Perma-Plates, 631 South Lyons Street, Indianapolis, Ind. 46241.

EXTRA Money! Sell Personalized Metal Social Security Plates. Details, Sample Free! Myers, 928-P5 Crescent Hill, Nashville, Tennessee 37206.

EMPLOYMENT INFORMATION

TRAVEL MINDED? Latest facts on employment overseas including Australia. \$3.00. Runke, Box 2207, Grand Central Station, New York, New York 10017.

(Continued on next page)

EMPLOYMENT INFORMATION

(Continued from preceding page)

AUSTRALIA WANTS YOU!!! Government Assisted Passage. 1972 Government Information and Forms—Most Complete Information Available—\$1.00. Reports on Employment, Business, Taxes, Education, Teaching, Housing, Ranching, Maps, etc. **AUSTCO**, Box 3623-E, Long Beach, California 90803.

FLORIDA Employment Opportunities! Disneyworld! Newspaper Classifieds! Booklet \$1.00. Sunshine, 4512N Jamaica, Tampa, Florida 33614.

BRITISH COLUMBIA employment and immigration information. Complete details, \$3.00. Doyle Associates, Box 2702, Williams Lake, B. C. Canada.

AUSTRALIAN Opportunities Handbook & Employment Directory. \$2.00. Box 65, Lebanon, Pa. 17042.

AUSTRALIA Needs You. Complete information plus Employers list. \$1.00. Archer Enterprises, Box 193, Denton, Texas 76201.

HOW I MADE \$250,000.00 Working for American Companies Overseas. You can too! Copyrighted report plus Employment Directory only \$2.00 (\$2.35-Airmailed). Satisfaction Guaranteed! Paul Smith, Apartado 10163, Maracaibo, ZP 2, Venezuela.

FIND Success in Australia through helpful Handbook and employment directory. \$1.00. Marc-Ella Sales, Box 2610, Hickory, N.C. 28601.

AUSTRALIA, Paid Transportation And Settling Allowance Possible. Details And Employer's List \$1.00. M & L Distributor, Box 640, Azle, Texas 76020.

AUSTRALIA CALLING: Government Aid Offered You, Application Forms, Job Contacts, Ranching, Farming, Housing, Everything Complete. Send \$1.00. Elcon, Box 266-P, Naples, Florida, 33940. Satisfaction Guaranteed.

UNUSUAL Job Opportunities! Montana-Idaho. \$1200-\$2000 Monthly. Men Needed! Detailed Report \$1.00. Mountain Service, Box 276-M, Milltown, Montana 59851.

AUSTRALIA WANTS YOU! Government assisted passage. Latest and most accurate government information available—\$1.00. Details about Transportation, government settling in allowance, jobs, taxes, housing, ranches, farms, etc. Employers list and forms. McBready, Box 11645 A5, Tampa, Florida 33610.

U.S.A. Employment information (including Alaska and Hawaii) sent on ANY city . . . receive listings of private and governmental employment agencies . . . PLUS valuable sources of correspondence concerning environment, cost of living, etc. Send \$2/requested city (list state also). Myers, 534 Rosewood, Rialto, Calif. 92376.

AUSTRALIA NEEDS YOU!!! Government Assisted Passage—forms: 1972 Most Complete Information—\$1.00. Reports concerning Employers, Businesses, Taxes, Teaching, Housing, Ranching, Maps, etc.! Holiday International, Clinton, South Carolina 29325.

AUSTRALIA NEEDS YOU! Fantastic job opportunities! Latest Australian employment directory lists employers, explains application procedures, housing and transportation. Guaranteed! Send \$3.00 now! Unico, Box 200A, Howard Beach, New York 11414.

AMAZING Opportunity. Australia Needs You: 60,000 Jobs, High Wages, Government Pays Passage; Latest Australian Employment Directory Explains Housing, Transportation, Taxes, Etc., Plus Employer's List And Forms. Guaranteed. Send \$1.00 To: Golden Eagle Company, 710 West 173rd Street, New York 32, New York.

AUSTRALIA TODAY! Employer Directory, Forms, Facts, Government Assisted Passage. Complete Immigration Answers. Rush \$1.00. Alga Company, PO Box 3273, Hialeah, Florida 33013.

AUSTRALIA NEEDS YOU! Handbook, Employer's List PLUS form for Immigration Information applying to YOU. Guaranteed. \$3.00. Lands, Box 197-M, Boones Mill, Virginia 24065.

ANCHORAGE, Alaska—Specific information—Wages, rents, etc.—\$3.00—Foote Enterprises, Box 143, Anchorage 99501.

AUSTRALIA!! AUSTRALIA!! FREE DETAILS!! Government Paid Transportation. Latest Handbook and Forms. Write: Associated, Box 17-B126, Lafayette, California 94549.

AUSTRALIAN "Employment Directory" Explains . . . Government Assisted Passage, Settling-In-Allowance, Housing, Etc. Employers List And Application Form Included. . . Avoid Delays . . . Rush—\$1.00 For Air Mail Service—To: K. Hampton, 490 School Way, Redwood Valley, California 95470.

HELP WANTED

EARN At Home Addressing Mail. Details 25¢ and Stamped Envelope. Deeco-151, Box 9308, North Hollywood, Cal. 91609.

OVERSEAS EMPLOYMENT . . . Australia, Europe, South America, Asia! All Occupations! \$700-\$3,000 monthly! Write: Employment International, Box 29217-AE, Indianapolis, Indiana 46229.

OVERSEAS Jobs—Europe, South America, Australia, Far East, etc. 2000 openings all trades. Construction, Office. Engineering Sales, etc. \$700 to \$3,000 month. Expenses paid. Free Information. Write Overseas Jobs, International Airport, Box 536-M, Miami, Florida 33148.

"AUSTRALIAN OPPORTUNITIES KIT" . . . FREE DETAILS! Paid Transportation! Handbook, Special Reports, Forms! Australian Services, Box 29263-AE, Indianapolis, Indiana 46229.

FREE DETAILS . . . AUSTRALIA . . . Government assisted transportation. Latest Handbook and forms . . . Free Details . . . Write: Associated, Box 17-BA126, Lafayette, California 94549.

WORLD-WIDE . . . U.S.A. jobs Galore!! Students, all professions and occupations. Enjoy Paris, Rome, Tokyo, Mexico City, Miami, San Francisco. \$700.00 to \$3,000.00 monthly. Paid Overtime. Travel Allowance, Sightseeing. Free Details!! Write: Global Employment, Box 706-B126, Orinda, California 94563.

REAL ESTATE AND FARMS

CANADIAN LAND INVESTMENT. FROM \$19.00 an acre. Choice properties across Canada. Low monthly payments. Ideal hunting, fishing, investment, timber, cottages. **FREE CATALOGUE.** Canadian Estate Land, Department PMC-5, 286 Lawrence Avenue West, Toronto 20, Ontario.

YOUR Own "spread" in the Old West! Vacation, retire in Beryl, Utah. Sportsman's paradise. Fish, hunt, ride year around. America's purest air. Only \$10 down . . . \$495 full price for your Beryl Estate. Send for complete information kit, maps, color brochures, no obligation, lot reservation forms—Free! Southwest Empire, Dept. A-165, Box 37, Beryl, Utah 84714.

OCALA FOREST CAMPSITES Deep in the heart of the Great Ocala National Forest. Excellent hunting and fishing. Free maps and photos. (Unavailable in States requiring separate registration). AD70LB710E, W. H. Vernor, Inc., P.O. Box 760, Dept. E, DeLand, Florida 32720.

ARKANSAS LAND Free Lists: Clear Streams, Fishing, Hunting Country. Specify Type Property. Gatlin Farm Agency, Waldron, Arkansas 72958.

FREE Catalog! PHOTOS! Coast to coast farms, business, retirement. All types, sizes & prices. **SAFE-BUY** Real Estate, Box 589-PM, Little Rock, Ark. 72203.

CARIBBEAN! ONLY \$25.00 buys 1 square foot land plus equivalent interest Luxury Hotel building scheduled construction thereon. Posh New International Resort, dazzling tropical British Honduras, Central America. Easy terms: only \$1.00 per square foot month. Unprecedented option, quadruple acquisition without increase Monthly Payment. Good income in lease-back to Hotel Company. Tax and maintenance free with fabulous vacation benefits. McEvoy, Box 2483, Dallas, Texas 75221.

PRESCOTT, Arizona. 2 Acres For Finest Country Living. \$1,995. Low terms. Mrs. Anna Young, Glenarm Land Co., 2233 North 7th St., Phoenix 85006.

GOVERNMENT LANDS Low as \$3.50 acre. Millions Acres! For exclusive "Copyrighted Report" . . . plus "Land Opportunity Digest" listing lands throughout U.S.; and **VALUABLE 17 X 22 TREASURE MAP OF U.S.;** send \$1.00. Land Disposal, Box 9091-PM, Washington, D.C. 20003. Satisfaction Guaranteed.

CANADIAN Vacation lands: Full price \$385.00. 40 acres. \$10 month. Suitable cottage sites, hunting, fishing, investment. Free information. Land Corporation, 3768-C Bathurst, Downsview, Ontario, Canada.

\$1 ACRE—Canadian border—hundreds campsites, islands, farmlands, directly from tax authorities. (Non-profit). Lists, photographs mailed. Register, Room 10, 110 Church Street, Toronto 1, Canada.

GOVERNMENT Lands . . . low as \$1.00 Acre! Millions Acres! For exclusive "Government Land Buyer's Guide" . . . plus "Land Opportunity Review" listing lands available throughout U.S., send \$1.00. Satisfaction Guaranteed! United Lands, Box 19107-AE, Washington, D.C. 20036.

CENTRAL Ontario—Choice 640 acre Sportsmen's paradises still available—\$20.00 plus \$6.50 taxes yearly. Maps, pictures. \$2.00 (Refundable). Information Bureau, Norval 4, Ontario, Canada.

BOILING Spring Lakes—America's Greatest Real Estate Value. 1/2 acre vacation or retirement homesites only \$750 cash price. Ten-years to pay. Money-back inspection guarantee. Carolina coast, multi-million dollar, 14,000 acre development. 50 fresh water lakes, private ocean beach, golf course, motel, and country club. Free literature, Dept. 1-U, Boiling Spring Lakes, North Carolina 28461. (Registered under Federal Land Sales act but not offered to residents of states requiring separate registration.)

ARKANSAS-MISSOURI. Farms, Ranches, Businesses, Investments. Beautiful 5-10-20 acre wooded tracts on 70-mile long **BEAVER LAKE.** Free catalog, **JIM TUCKER** "The Land Man", Rogers, Arkansas 72756.

BEAUTIFUL Cabin sites and land available from British Columbia government to homestead or lease. Complete details \$3.00. Sourdough Slim, Horsefly, B. C. Canada.

"A" FRAME Cabin. \$500. for material. Any lumber yard. Completely illustrated instruction manual, including material list. Moneyback Guarantee. Send \$2.00 to: Dependable, Plan #2802, Box 113, Vista, California 92083.

NEW!—FREE CATALOG! Giant **SUMMER** edition! Over 5,100 properties described, pictured—Land, Farms, Homes, Businesses—Recreation, Retirement. Selected Best thruout the U.S.! 72 Years' Service, over 600 Offices. 41 states Coast to Coast. Mailed **FREE** from the World's Largest! **STROUT REALTY, INC.,** 60-MX E. 42nd St., NY, NY 10017; 7MX S. Dearborn, Chicago, Ill. 60603; 521-MX E. Green, Pasadena, Calif. 91101.

FREE . . . New 256-Page **SUMMER** Catalog. Hundreds of top real estate values coast to coast! **UNITED FARM AGENCY,** 612-PM West 47th Street, Kansas City, Missouri 64112.

CANADIAN Land Guide eliminates middleman, saves you money. \$2.00. 99A Roxborough East, Toronto 289.

(Continued on next page)

REAL ESTATE AND FARMS

(Continued from preceding page)

FREE! Real Estate Catalog! Farms, Ranches, Business, Recreational and Investment Properties. Note State Desired. Banner Advertising, Box 3333 (19-A), Springfield, Missouri 65804.

COLORADO LAND KIT! SHOWS You the most spectacular land you've ever seen in the heart of Colorado's famed high country! Contains brochure with 17 full color photos, map, information on fishing, hunting, riding, camping. Explains how you may own 5 acres with no down payment, no interest, just \$20.00 a month! This could be your investment and recreation dream come true. Send for free land kit to: Aspen Lakes Ranch, Dent. PM-1, 1108 Alvarado N.E., Albuquerque, New Mexico 87110.

MICHIGAN 10 TO 160 ACRE TRACTS Lake Superior-Marquette Area from \$99.00 Acre. Cabins, trailers, camping welcome. (Acreage anywhere in Michigan). **FREE PICTURES.** Any Terms A-OK with **BLOCH BROTHERS** write 3650 Dixie, Drayton Plains 16, Michigan 48020.

LAWN CARE

SAVE Money and Labor. Remove harmful dead grass with Auto-Thatch. The only Thatch with a plus: Eliminates Raking. Send \$1.00. Auto-Thatch Manufacturing Co., PM, P.O. Box 1046, Tarpon Springs, Fla. 33589.

DRINKING WATER-PURIFIERS

PURE Water Filter For Home Use. \$5.95 PPD. Literature Free. Tropical Labs., P.O. Box 652, Center Moriches, New York 11934.

WOULD You like to know more about the water Your Family drinks? Test your own water. Test kit \$1.00. Saf-Water, P.O. Box 4452, Rockford, Illinois 61110.

ECOLOGICAL new Tapwater Purifier and Faucet Fountain. Fits any faucet. \$5.99 postpaid. Free information. Gilmorehouse, Box 1175, Denver, Colorado 80201.



FLOWERS, PLANTS & NURSERY SUPPLIES

LEARN Flower Arranging and Floristry. Start full or part time business or hobby. Free information on home study course. Lifetime Career Schools, Dept. B457, 2251 Barry Avenue, Los Angeles, California 90064.

LEARN Flower Arranging and Floristry. Start full or part time business or hobby. Free information on home study course. Lifetime Career Schools, Dept. B-457, 2251 Barry Avenue, Los Angeles, California 90064.

GINSENG Bringing \$20.00 pound. Have seeds roots. Goldenseal. Full information. K. Collins, Viola, Iowa 52350.

MAKE \$10,000 Annually Growing Plants In Your Backyard. Book Tells How, Free Details. Nagah Publishing, Box 493, Miller Place, N.Y. 11764.

LEARN Landscaping and the growing of plants. Start a profitable business part or full time. Free information without obligation. Lifetime Career Schools, Dept. A-140, 2251 Barry Avenue, Los Angeles, California 90064.

CONSTRUCTION PLANS, BLUEPRINTS

HOUSE EXPANSION PLANS And detail instruction book provide anything from an extra room to 1000 s/f addition. Build what you need at big do-it-yourself saving. Book with 1 set working blueprints \$14.50! with 4 sets (required by contractors) \$20.00. Money-Saver Projects, Box 303-44M, Chappaqua, New York 10514. Information available.

LOG CABINS & HOMES

"BUILD Log Cabins, rustic furniture, fireplaces!!! Complete manual. \$3.00
"A" Frame plans. \$2.00 . . . Guaranteed
. . . Beels, 956 Springdale, Atlanta, Georgia 30306."

"A" FRAME Cabin. \$500 for material. Any lumber yard. Completely illustrated instruction manual, including material list. Moneyback guarantee. Send \$2.00 to Dependable, Plan #1907, Box 113, Vista, California 92083.

HOME CRAFTSMEN

101 PATTERNS Of Smart Gifts, Novelties, Shelves, Action Windmills, plus "Make Money Jig Sawing." \$1.50. Mastercraft. 55M, 7041 Olcott, Chicago 60631.

BUILD Lawn furniture, other items in your workshop. List of plans, 10¢. B&M Enterprises, Box 23189, Columbus, Ohio 43223.

BEST WORKBENCH PLAN Ever. Plus Free Lumber Conversion Chart. \$1.00. WAY-MAR, Dept. 45, 58 Underhill Road, Scarsdale, New York 10583.

"CLOCK Kits, Movements, Dials. Catalog Three Stamps, Newport, Box 6848A, Burbank, Calif. 91505."

CABINETMAKING MADE EASY And "How to Make Formica Counter Tops." Two excellent guides let you build kitchen cabinets and counter tops like professionals. Extraordinary guides bring master craftsmen's shortcut methods. Satisfaction guaranteed. Write: Japs, 126-P Seventh North, Hopkins, Minn. 55343.

PICTURE Framing—Profitable full or spare-time business. Easy to learn with handbook-course "Guide to Picture Framing Profits." \$1.50 Guaranteed. Free framing-supplies catalog included. Japs, 126-PM Seventh North, Hopkins, Minnesota 55343

MAKE Money Building and selling Bird Houses. Send \$1.90 for 39 page book of plans covering 19 projects. Yeager, 1665 Linden, Homewood, Ill. 60430.

SKIL-CRAFTS Current 200 plus page catalog with world's largest, finest selection of Hobbycraft, leathercraft, artist supplies. Send \$1 for postage and handling; refunded on first \$15 minimum catalog order. Skil-Crafts, Box 105-P, Joplin, Mo. 64801.

WALNUT Bowls, Legs, Round Picture Frames, Gun-Stocks Lumber Moulding. Midland Walnut, Box 262, Savannah, Missouri 64485.

136 FULL SIZE FURNITURE PLANS. Traditional, Early American, Danish Modern. Catalog 50¢. Furniture Designs, Dept. P-52, 1425 Sherman, Evanston, Illinois 60201.

1/2 AND 1/3 Horsepower Discarded Appliance Motors. One, Two, Three Speed. Wire, Switch, Reverse. Instructions \$2.00. Oscillating spindle sander. Plans and instructions \$4.00. Both \$5.00. Foster, e.g. Box 2599, Des Moines, Iowa 50315.

TOOL-SHADOWS, Silhouettes For Tool Panels, Printed On Adhesive backed Paper. Sample And List 25¢. Designs, Box 226, Lumberton, North Carolina 28358.

FOUNDRYETTE 2400 F. 1 1/2 to 48 lb. capacity. Circular 25¢. Kansas City Specialties, Box 193-P5, Middleton, Wisconsin 53562.

PLANS Easy to build, ideal For Fun or Profit. Childrens Workbench or Picnic Set. \$1.50 each—both \$2.50. Quest Manor, 69B River Heights Drive, Smithtown, N.Y. 11787.

UGLY Upright Piano Made Danish Modern! Detailed Drawings and Photos. \$3.95. Mex-Tex Gifts, Box 566, Grand Prairie, Texas 75050.

POPULAR MECHANICS MASTER SHOP GUIDE. Greatest product offered to a man with a workshop. All information printed on heavy boards, punched and ready to hang above his workbench. Covers wall fasteners, nails, screws, bolts, twist drills, abrasives, lumber, moulding patterns, plywood grades, hardboard, drywall, plumbing supplies, electrical supplies. Plus information on scores of other subjects. Send \$3.95 to: **POPULAR MECHANICS**, Dept. HE, 224 West 57th Street, New York, New York 10019.

MIRACLE Bottle Cutter Turns Bottles Into Glasses. \$7.95 Postpaid, Chapman, Box 151M, Hillsdale, New Jersey 07642.

WOODEN Lantern Plans—send stamped self addressed envelope for free information. Bingaman Plans, P.O. Box 74, Langhorne, Pa. 19047.

DO-IT-YOURSELF

CENTRAL AIR CONDITIONING ANY FAMILY CAN AFFORD. Do-it-yourself kit for use with forced air furnace saves you more than \$200 in installation costs. Easily done with simple hand tools. Free brochure. McGraw-Edison Co., 714C N. Clark St., Albion, Michigan 49224.

BURGLAR PROOF YOUR HOME. Illustrated Book Gives Step-By-Step Instructions. Tells Where And What To Buy And Cost. Feel Secure Protected By Concealed System. Send \$2.00. CCC, Dept. PM, Box 66231, Los Angeles, California 90066.

WHOLESALE Burglar Alarm supplies. Catalog \$1.00 (refundable). Ellin, 161-M Bonad, Chestnut Hill, Mass. 02167.

REPAIR MINIBIKES, LAWNMOWERS, BICYCLES, Sewing Machines, Auto Engines. Build concrete, Plywood, boats, trailers. Ten additional How-To-Do books. Free brochure. Sincere, Box 10422, Phoenix, Arizona 85016.

CONVERT MOWER Engines into air compressors. Write Showalter, Box 409, Abilene, Kansas 67410.

BURGLAR-FIRE Alarm Supplies and Information. Free Catalog. Protecto Alarm Sales, Box 357A, Birch Run, Michigan 48415.

"HOW TO" Books. Catalogue 25¢ Elston House, 35 Stonycliff, Centerville, Mass. 02632.

PROTECT FAMILY AND POSSESSIONS. Send \$59.95 for your Do-It-Yourself Burglar or Fire alarm system kit. Accessory catalog 25¢. CDS, P.O. Box 790, Pearland, Texas 77581.

NEW DESIGN SHOE RACK Low Cost, Easily Made, Holds 15 Pairs and Up For Plans And Instructions. Send \$2.00. Kleyla's, Box 126, Arcadia, Ind. 46030.

POWER Saw JIGS For Rips, Crosscuts and Angles: Straight and accurate cuts with a few dollars worth of wood. Plans and Instructions, \$2.00. C Brown Co., Box 644, El Granada, Calif. 94018.

STOP BURGLARS Loud alarm sounds at slightest opening of window or door. Guaranteed. \$6.95. Bargain House Products, 825 Walnut Avenue, Trenton, N.J. 08609.

WHILE THEY LAST. Build easily for under \$20, full-size fireplace, home or apartment. Photo included, prints \$2.50. M. Dolgas, P.O. Box 453, Bronx, N.Y. 10451.

BERNZCUTTER—Cuts sheet materials easily, cleanly—perfect for formica, metals, plastics, panelling, etc. \$7.95. Vista Products, Dept. 152, R.D. 1, Norwalk, Ohio 44857.

PLANNING AN UNDERGROUND SPRINKLER SYSTEM? INSTALL YOUR OWN AND SAVE. World famous do-it-yourself Rain Jet Sprinkler equipment. Millions already installed. Available nationally. For free How to Install pamphlet, write: Rain Jet Corporation, Dept. SWZ, 301 So. Flower Street, P. O. Box 627, Burbank, Calif. 91503.

DON'T SPEND \$3.00 For New Watch Crystal. Remove scratches. Supplies for 10 crystals \$1.50. Gemkraft, 8421 N. W. 172st., Hialeah, Florida 33015.

HAVE Running Hot Water Without Plumbing. Directions \$1.00. Herbn, Route 4, Columbia, Missouri 65201.

HAVE Your own automatic underground sprinkler system for beautiful lawns and flowers. Do-it-yourself-SAVE 50%. Our Book "TURF MASTER SYSTEMS" \$3.00-PP tells how. Write-Turf Master, P. O. Box 17507, Tampa, Florida 33612.

(Continued on next page)

DO-IT-YOURSELF

(Continued from preceding page)

"MONEY Saving Summer Special" * Build Your Own. * Insect Fogger, Hooks To Lawnmower. * Tiki Insect Smudge Pots. * Outside Yard Lights. * Save Up To 75%. Plans \$2.00 Each Or 3 For \$5.00. Arthur Trimble, P.O. Box 319, Hamburg, Michigan 48139.

PARTS For Refrigerators, Freezers, Washers, Etc. Mailorder Parts, 40 E. Barclay St., Hicksville, N.Y. 11801.

FIVE WORKBENCH PLANS—New, Different Designs, Plus Toolpanels. \$1.00. Diko, Dept. 91E, Rowayton, Conn. 06853.

POPULAR MECHANICS CATALOG Of plans, publications and projects. Covers shop and home projects. Want to build a plane, a hovercraft, boats, swimming pools, patios and garden furniture. Fireplaces, kitchen cabinets. 32 pages crammed full of fascinating and useful projects. Send for this illustrated catalog to: **POPULAR MECHANICS**, Dept HE, 224 W. 57th St., New York, N. Y. 10019. Price 25¢

ARTS AND CRAFTS

FREE: New handicraft catalog. Supreme Handicrafts, Box 395-PM, Sioux Falls, South Dakota 57101.

MAKE Figurines, plaques, lawn ornaments. Molds, plastercraft kits, liquid rubber. Sample and catalogue 10¢. Wooley Company, Box 29-B, Peoria, Illinois 61601.

"GETTING Started in Stained Glass" 25¢. Whittemore, Box 2065Y, Hanover, Mass. 02339.

500 FIBERGLASS Molds for casting ornamental concrete products. Catalog \$1.00. Plycrete Molds—Elk Rapids, Michigan 49629.

LARGEST Handicrafts Supply Catalogue \$1.00 (Refundable). R.P.H. Manufacturing, 24-M-5 Winter, Stamford, Connecticut 06905.

LEARN Arts & Crafts at home. Excellent full or part time business opportunities, or hobby. Free booklets. Lifetime Career Schools, Dept. E-666, 2251 Barry Avenue, Los Angeles, California 90064.

GLASSBLOWING Equipment And Kits For Amateurs And Professionals. Illustrated Introductory Instruction Book \$1.00. (Free To Schools And Institutions). Willis Glass Supply Company, Box 3460, Dept. A, Anaheim, California 92803.

JEWELRY MAKING For hobby or profit. Send for free brochure showing complete kits and easy instructions. V. F. Ausura, 1565 Reservoir Ave., Roslyn, Pennsylvania 19001.

FREE LITERATURE For sculptors showing how to make molds, cast plastics. Adhesive Products Corporation, 1660 Boone Avenue, Bronx, N.Y. 10460.

CANDLE Making And Leather Supplies, Incense, Oils, Candles. Wholesale Catalogue. Send 10¢ For Postage. J.R.M. Leather & Candle, 26563 Hawkhurst, Palos Verdes, California 90274.

HOW To make a mold and casting of the human head. Detailed instructions only \$2.00. Nelson Research, Dept. PA25, Box 30191, Albuquerque, New Mexico 87110.

BINOCULARS, TELESCOPES, MICROSCOPES, MAGNIFIERS

MINI BINOCULARS 5/8 oz., 6 Power Wide Angle Lens, Lens Caps, Case, And Strap. Guaranteed Reg. \$29.95 Now \$26.95 No C.O.D. Burt Enterprises, P.O. Box 5466, Tucson, Arizona 85703.

FREE Binocular, Riflescope catalog. Discount sale. Save 50%. Free gift with order Write, United Binoculars, BN-4508, 9043 So. Western, Chicago 60620.

SPECIAL—40X Telescope For Beginning Astronomers—Includes Tripod and Finderscope! Only \$11.75 Postpaid. Pridecraft, Box 7153, Baltimore, Maryland 21218.

224 POPULAR MECHANICS

TELESCOPES (Reflectors) Complete Kits. Other accessories, request free literature. Criterion Manufacturing, Dept PM 29, Hartford, Connecticut 06101.



CAMERAS AND EQUIPMENT

FREE! FREE! BARGAIN BOOK—Central Camera Co., Dept. 351, 230 S. Wabash, Chicago, Ill. 60604.

POPULAR Brands Supplied! Best Prices! Mandarin, 214 Shaws Building, Hong Kong.

CAMERAS, LENSES: Original Japanese, German equipment shipped directly from oversea! Exceptional Savings. Free Price-list. Photo & Radio Imports, 24 N. Wabash, Chicago, Illinois 60602.

PHOTO & PHOTO SUPPLIES

FREE Price list of bulk films and save. Box 223, High Bridge, New Jersey 08829.

MAILORDER RECORDS help get increased business! Complete 32 Page Record Book shows your inquiries, orders, advertising, expense, etc. Only \$1.00. C. A. MARTIN, POPULAR MECHANICS, DEPT. PMR, 224 WEST 57 STREET, NEW YORK, N.Y. 10019.

SUPER NEWS FOR SUPER-EIGHT. Here comes the new quarterly for SUPER-EIGHT only! Technique, new products, how-to and how-to-save, film festivals and more! Save now at special charter subscriber rates. One year \$4.00—Two years \$7.00. Outside U.S. add \$1.50. Send check to: **SUPER-EIGHT FILM MAKER**, Dept. 110, 1190 Pershing Circle, Teaneck, New Jersey 07666.

PHOTO FINISHING

CAMERA FANS! Expert photofinishing by one of Country's largest labs at lowest prices. Fast service and free "Foto-Fan" Stamps you quickly redeem for valuable Photo Supplies. 8MM Kodachrome \$1.29; 8 Exp. Kodacolor \$1.79; 35MM Kodachrome. 20 Slides \$1.39; 8 Exp. Black White 69¢. Satisfaction guaranteed. Send exposed film or request free mailers, complete Price List and Gift Catalog. Direct Mail Photo, Box 8352-PM, Pittsburgh, Pa. 15218.

COLOR SLIDES

35MM COLOR Slides. 10,671 Individually sold. Described, Encyclopedia catalog 10¢. Wolfe Worldwide, Dept. 14-52, Los Angeles, Calif. 90025.

MOTION PICTURES AND SOUND EQUIPMENT

UNUSUAL Movie supplies. Free circular. Esor, 47th Holly, Kansas City, Missouri 64112.

16MM SOUND Features, Shorts, New used for Sale. Free Catalog. National Cinema, 333 W 57th St.—N.Y.C., N.Y. 10019.

FREE! 64-Page catalog. 8-16mm film supplies, processing equipment. Superior, 448 N. Wells, Chicago 60610.

USING Capstan Driven Recorder. Show How To Add Voice, Select Background Music, Synchronize Sounds To Scenes. Create Theatre With Remote Controlled Curtain And Lights Only \$1.00. Scherer, Box 218, Jamaica, 11434, N.Y.

RADIO, TELEVISION AND HAM EQUIPMENT

FREE! Bargain catalog. Fiber optics, LED's, transistors, diodes, rectifiers, SCR's, triacs, parts. Poly Paks, 211M Albion, Wakefield, Mass.

36¢ RADIO & TV tubes. Free catalog. Cornell, 4213-17 University, San Diego, California 92105.

SAVE Money on parts and Transmitting—receiving tubes. Foreign—domestic. Send 25¢ for giant catalog. Refunded first order. United Radio Company, 56-PM Ferry Street, Newark, N.J. 07105.

GOVERNMENT Surplus receivers, transmitters, snooperscopes, parts. Catalog. 25¢. Meshna, Nahant, Mass. 01908.

HOBBYISTS, Supersensitive, F.M. Microphone Transmitter. Picks Up Normal Voice at 30 feet. Kit \$14.95, Wired \$19.95. Write, Collin, P.O. Box 281, Route 25, Monroe, Conn. 06468.

HEAR POLICE/FIRE Dispatchers. Catalogs show receivers; exclusive directories of "confidential" channels. Send 8¢ stamp. Communications, Box 56-PM, Commack, New York 11725.

NEW! "John's Radio." Combination transistor and bathroom tissue fixture. Unique. Details free. Van's Specialties, 1020 Northwest 4th St., Madison, So. Dak. 57042.

HIFI TAPES, RECORDS AND ELECTRONICS

FREE Pamphlets And Quotes On Hitachi Stereo. Write: Disco, P.O. Box 146, Springfield, New Jersey 07081.

LATEST 8-Track Cartridge Tapes \$3.99. Send for Catalogue. Mid-Atlantic Music, Box 692M, Greenville, Penna. 16125.

OLD Radio Programs on tape. Six hours, \$7.00, Catalogue 25¢. Nostalgic Radio, Box 290, Peoria, Ill. 61601.

FREE Catalog—Electronic Kits—Amplifiers—Preamplifiers—Psychedelic Strobes—SCA Adaptors—Color Organs—Digital Instruments—Guitar Amplifiers. **FREE** Subscription, SWTPC, Box PM32040, San Antonio, Texas 78284.

FREE Catalogues, 2000 hard to find unusual records. Rose's Records, Box 7216, Louisville, Ky. 40207.

GOLDEN Age Radio. Complete taped shows. Box 8404-M, St. Louis, Missouri 63132.

OLDIES! 45 RPM Original Hits Catalog 50¢. C. & S. Record Sales, Box 197, Wampsville, New York 13163.

BEST Buy! Unrecorded Cartridges And Cassettes. **PLAYTRADE**, Box 5562, Toledo, Ohio 43613.

PHONOGRAPH Needles, All Makes, \$4.00. Sherman, 5832 Miami St., Omaha, Nebraska 68104. Dealers Wanted Also.



MUSIC AND MUSICAL INSTRUMENTS

ACCORDIONS And Amplifiers! New-Used. Cordovox, Excelsior—Top Makes! Save to 50%. Direct factory dealer. Terms. Trades accepted. 5 day home trial. Free catalog—Discount prices. Write: Accordions Unlimited, Dept. R, 3147 North Luna, Chicago 60641.

GUITARISTS!!! Fantastic Savings—Guitars: Amplifiers—Popular name brands, largest selection. Money Back Guarantee!!! 32 page illustrated discount catalog. Send 25¢ today: Guitars Unlimited, Box 343, Dept. PE, Richland, Washington 99352.

HOW To Read Music in One Evening. Complete Instruction Guide \$3.00. Guaranteed. Warren Gifts, 965 Sheffield Drive, Huntingdon Valley, Penna. 19006.

30% TO 50% DISCOUNT! Any Model: Guitar, Amp, Drum, Banjo, Dobro! Free Catalog! Warehouse P21, Box 16399, Fort Worth, Texas 76133.

PLAY CHORD PIANO In 10 Days or money refunded. Only \$1.00. Shimco, 901 Beekman, Medford, Oregon 97501.

EASY To Play And Make, Quality Dulcimers, Banjos, Thumb Pianos: Instruments And Kits. Can Be Profitable Hobby. **HERE**, Inc., #P, 410 Cedar Avenue, Minneapolis, Minn. 55404.

PUBLISHING Contract Guaranteed on Selected Songpoems. Hollywood Songwriters', 5334-T Sunset, Hollywood, California 90027.

PLAYER Piano Rebuilding—get details from: Vestal Press, Vestal 11, N.Y. 13850.

(Continued on next page)

MUSIC AND MUSICAL INSTRUMENTS

(Continued from preceding page)

ACCORDION Top brands. Buy direct. Tremendous discounts. Trades accepted. Free brochure PM. Accordion-O-Rama, 874 Broadway, N.Y.C. 10003.

ACCORDION Manufacturing, 6846-P North Avenue, Chicago, Illinois 60635. Concertinas, Hohners, Chromatics, Guitars, Drums, New, Used, Tuning, Repairing. Wholesale Catalogs Free.

VIOLIN And Guitar makers—send for latest Free Catalogue of woods & accessories. International Violin, PM1, 414 East Baltimore St., Baltimore, Md. 21202.

ELECTRIFY Player Pianos, Pump Organs Quickly, Inexpensively with Lee Silent Suction Units. Write Lee Music, 525F Venezia Avenue, Venice, California 90291.

LEARN Banjo. 5-String Bluegrass. No music. Makes learning easy. Free details. Blaylock, Box 25-M, Marietta, Georgia 30060.

POEMS Wanted for songs. Nashville Music Productions, Box 40001-P, Nashville, Tennessee 37204.

GUITAR MAKING Books. Imported Woods, Supplies, Accessories. Catalog 25¢. Guitar Center, Box 15444, Tulsa, Okla. 74115.

HOW To Make Money in Music. Free Brochure. D Sales, PM5, 8304 Octavia, Niles, Illinois 60648.

READ MUSIC In One Evening! **MOD WAY** To Master Mysteries Of Melody! Details Free. Danco, Box 436-PM, Watertown, N.Y. 13601.

"**LEARN** To Read Music In One Evening! Amazing New Book Shows How. Only \$3.00. Money-Back Guarantee." Kelly, 1182 Market Street, Suite 404, San Francisco, California 94102.

SONGPOEMS Needed, All Types—Country, Western, Popular, Romantic, Folk, Rock, Religious, Etc.—Possible Recording/Publishing. **R U S H** To: Betty's Music Makers, 1417 Park Bldg., Dept. B, Pittsburgh, Penna. 15222.

30% DISCOUNT Name Brand Musical Instruments Free Catalog. Freeport Music Inc., 127 F Sunrise H'way, Freeport, N.Y. 11520.

FREE Song Recording. Details. . . . Newart Pubs, Box 693, Syracuse, N.Y. 13201.

MUSIC: Read, Write, Play It. New Easy Method. Free Information. **TECHNICAL** Talents, Box 1554-D, Front Royal, Virginia 22630.

CONSERVATION TRAINING

GAME WARDEN, Government Hunter, Forestry, Park & Wildlife Service announce job openings regularly. Prepare at home for outdoor work, good pay, security. Approved for Veterans! Complete information Free! Write: North American School of Conservation—MPS—Newport Beach, California 92663.

EDUCATION AND INSTRUCTION

LEARN Expert Cake Decorating, Catering, Candymaking. Free details on home instruction. Candy & Cake, Dept. BLJ-PM, 1600 Cabrillo, Torrance, Calif. 90501.

LEARN To Fix Typewriters. Desperate shortage trained men. Hundreds needed. Make up to \$25 in one hour. Learn at home in spare time. Industry Approved course. Facts free. Send name. Typewriter Repair School, Dept. 3310-052, Little Falls, New Jersey 07424.

FINGERPRINTING—Investigation. Exciting, secure career. Learn at home. Free book. State age. Institute of Applied Science, 1920 Sunnyside, Dept. 165, Chicago, Illinois 60640.

BE A Real Estate Specialist, Broker, Sell, Invest. Professional Institute, Box 1524-R2, Kansas City, Missouri 64141.

WATCH REPAIRING. Learn to repair American and Swiss watches in spare time at home. Diploma awarded. Free sample lesson. No obligation. Chicago School, Dept. YE, Fox River Grove, Illinois 60021.

EXTENSION And Post-Graduate Awards in Philosophy, Art, Sciences, Botanic Medicine, Homeopathy, Radionics and others. 30 subjects. Curricular free (airmail \$1.00 refundable). Registrar, Sussex College of Technology, Highfield, DaneHill, Sussex, England.

RADIO-TV CAREER! Expert Introductory Guidance. LP Record \$4.95. Guaranteed. Bargain Basement, Dept. C., 205 West Market, Lima, Ohio 45801.

PROGRAMMING At Home. Practical courses. Actual computer use. **FREE** Booklet. CCI-D, 7600 Ledford, Falls Church, Virginia 22043.

HIGHLY EFFECTIVE Home study courses in Electronics Engineering Technology and Electronics Engineering Mathematics. Earn your Degree. Write for Free Descriptive literature. Cook's Institute of Electronics Engineering, (Dept. 10), P.O. Box 10634, Jackson, Miss. 39209. (Established 1945).

COMPLETE YOUR HIGH SCHOOL At home in spare time. Texts furnished. No classes. Diploma. Our 75th Year. Free Brochure. American School, Dept. X545, Drexel at 58th, Chicago 60637.

LIFETIME Ordination. **DOCTOR** Of **DIVINITY**, Church Charters. Details 25¢. Life Science Church, 2207 Cardinal, Rolling Meadows, Illinois 60008.

PIANO Technology—Electronic organ servicing, learned easily at home. G. I. Approved. Free booklet. Niles Bryant School, Dept. P. 3631 Stockton, Sacramento, California 95820.

EARN College degrees at home. Many Subjects. **FLORIDA STATE CHRISTIAN COLLEGE**, Post Office Box 1674, Fort Lauderdale, Florida 33302.

PIANO Tuning quickly learned with home study course. Diploma granted. American Tuning School, Gilroy, Calif. 95020.

LEARN Auctioneering. Term soon. Free catalog. Reisch Auction College, Box 850, Mason City, Iowa 50401.

DETECTIVE Course. Free Information. Universal Detectives, Box 8180-F, Universal City, California 91608.

AUCTIONEERING. Resident or home Study Course. Free Catalog. Nashville Auction School, 2004 West End, Nashville, Tennessee 37203.

AUTOSUGGESTION. Sleep-learning headquarters! Tapes, records, books. Gigantic catalog free. Research Association, Box 24PM, Olympia, Washington.

USED Courses! Books! List 10¢. Smith's, 124 Marlborough, Salem, Massachusetts 01970.

UNLOCK Your Future. Become professional Locksmith by spare time home-study. Make up to \$6 per hour. All tools, equipment incl. Facts Free. Send name. Locksmithing Inst., Dept. 1310-052, Little Falls, New Jersey 07424.

GRAPHOANALYSIS—Learn scientific handwriting analysis for profit, pleasure. Free sample lesson, catalog, reveals plan. Write: Igas Inc., 325 Jackson, Dept. 2EY-2, Chicago 60606.

LEARN Asleep or awake! Records, tapes, equipment! Free catalog! Drawer PM-400, Ruidoso, New Mexico 88345.

PERFECT Husband-wife business. Learn Upholstery at home. Make \$10 in an hour. Buy—repair—sell for even bigger profits. Kits, tools included. Free Booklet. Upholstery & Decorating School, Dept. 5310-052, Little Falls, New Jersey 07424.

RELIGIOUS VOCATION? Write: Church of Holy Light Inc., P.O. Box 4478, Pittsburgh, Pa. 15205.

DETECTIVE Profession, Easy home study; free tie-tack or lapel pin, certificate, future. GI approved. Professional Investigators, Box 41345, Dept. CP, Los Angeles, Calif. 90041.

HIGHLY Effective Specialized Home Study Courses. Fast, Inexpensive, and Complete. Many Categories: Electrical, Electronics, Mechanical, Building Trades, Etc. Diplomas Awarded. Our 27th Year. **FREE** Literature. CIEE—Dept. 25—Box 10634, Jackson, Miss. 39209.

FREE Bible Course! Degree! Request information! 708 Bragg, Monroe, North Carolina 28110.

OPERATE Profitable Bookkeeping Tax Service. Details Free. Universal, Box 664-M, Springfield, Missouri 65801.

FREE B.D., M.D., D.D. with Lifetime Ordination. Box 744 PM, McKeesport, Penna 15134.

USED Courses! Books. Catalog 10¢ (Courses Bought). Lee Mountain, Pisgah, Alabama 35765.

LEARN TO WELD—Arc, Pipe, Gas, TIG, MIG, Plasma. Free Bulletin. Write, phone or visit. Approved Ohio No. 70-12-0064-HT. **HOBART SCHOOL OF WELDING TECHNOLOGY**, BOX 72, TROY, OHIO 45373.

LEARN To Read Music In One Evening. Guaranteed. Free Details. Harris, 5116-A Wyalusing Ave., Philadelphia, Pa. 19131.

GAME WARDEN, Government Hunter, Forestry, Park & Wildlife Service announce job openings regularly. Prepare at home for outdoor work, good pay, security. Approved for Veterans! Complete information Free! Write: North American School of Conservation-AZS-Newport Beach, California 92663.

PENMANSHIP Corrector. Improve Poor Penmanship Quickly. Details Free. Ozment, Box 2344-34, St. Louis, Missouri 63114.

FREE Book tells how to qualify for secure jobs as camera repairman. Home study or classroom. **APPROVED FOR VETERANS TRAINING.** National Camera, Dept. EAB, Englewood, Colo. 80110.

LEARN Instant Memory Method. \$2.00. Guaranteed. Schockco, Dept. P255, Box 9538, San Diego, California 92109.

MY Child? Never! Narcotics and Dangerous Drugs Identification slide guide \$1.00 postpaid. **TOVAR, 108 FOURTH STREET, SANTA ROSA, CALIFORNIA 95403.**

THOMAS A. EDISON COLLEGE Master's & Doctor's "**OFF CAMPUS**" Degree Programs in Religion & General Education. Write: TAEC, Box 688, Palm Beach, Fla. 33480 For Catalogue send \$1.00.

BE A Real Estate Broker. Big Earnings. Prepare quickly, easily. GI approved. Free Catalog. Weaver School, 3519-P Broadway, Kansas City, Missouri 64111.

AUDIO-CONDITIONING® BRINGS INSTANT RESULTS Learn Success "by ear" with proven recording method. Details free. Hallstrand Enterprises, 12221 Whittier Blvd., Dept. P5, Whittier, Calif. 90602.

STUDY Elementary Electricity, Electro Biology. Educational Bureau, P.O. Box 281, Essex Sta., Boston, Mass. 02112.

ORIGINAL \$100.00 Realestate Course \$17.95. Free literature. School, Box 8585-A, Kansas City, Missouri 64114.

LOCKSMITHING—Teach Yourself. Guide For Obtaining Catalogs, Books, Tools. \$2.00. Despubs, Box 22005, Phoenix, Arizona 85028.

DISCOVER new Health, Wealth, and Happiness. Free information. **GIFTS**—Box 105B5, Richmond, Missouri 64085.

(Continued on next page)

EDUCATION AND INSTRUCTION

(Continued from preceding page)

VETERINARY ASSISTANT—Train at home for exciting animal care career. Send for FREE "Career Kit". North American School of Animal Sciences, AZS, Newport Beach, California 92663.

MATHEMATICS MADE EASY. We show you how with over 400 quick ways to find answers to all types of problems. \$2.00. M & D Supply Co., Box 4315, Pontiac, Michigan 48057.

TALENT; IQ Tests! \$2.00! (\$300.00 Scholarships For Passing Grades!) Castle's, 507-MQ Fifth, New York City 10017.

COLLEGE Degree at home. Your choice of subjects incl. law. Easy tuition plan. Williams College, 445 East Second South, Salt Lake City, Utah 84111.

RETIRED At 49! Secrets? No! Plain Facts. Everyone Can Profit By Applying Basic Ideas. FAPS, PM-5, Box 500, Victorville, California 92392.

GET A British Degree. Divinity, Philosophy, Radionics. 35 Courses. Prospectus free. Brantridge Forest School, Highfield, Dane Hill, Sussex, England.

FOR INVENTORS

U.S. PATENT Office Searches, 234 Broadway, Room 3615, New York 10017. Free invention certificates.

INVENTORS—Do you want to sell or license your invention on cash or royalty basis. Write: Kessler Corporation, C-55F1, Fremont, Ohio 43420.

PATENT Application Financing. Free patent search plan. Global Patent Division, 2420 77th, Oakland, Calif. 94605.

IMMEDIATE Cash, for patent applications. Free patent searches. Write for details. Universal Patents, 184-D Marion, Ohio 45750.

HANDLE Your patent arrangements from home, using free services of U.S. Patent Office. Illustrated instruction manual \$3.00 (refundable). Independent Inventors Association, 1199 Broadway, New York, N.Y. 10001.

LEARN How to protect, develop and sell your ideas and inventions yourself—without marketing or development fees! Free details! Create, 8500 Wilshire, Suite 1002-A1, Beverly Hills, California 90211.

PROMOTE IT YOURSELF—Complete guide for inventors. Development thru sale. Quantum Group, 1529 Greenleaf, Evanston, Illinois 60202.

FREE PAMPHLET: "Tips on Safeguarding Your Invention." Write: United States Inventors Service Company, 501F Thirteenth Street N.W., Washington, D.C. 20004.

INVENTORS: Your ideas and inventions (patented; unpatented) expertly searched, developed for commercial appeal and cash/royalty sales to manufacturers by professional Invention Developer with excellent record of experience. B. S. Industrial Engineering; United States Patent Office former Patent Examiner. United States Government former Patent Advisor. Second decade reliable service! Member: United States Council International Chamber Commerce. Free "Invention Record" and "Recommended Protection Procedure." Airmailed! Write: Raymond Lee, Invention Developer, 230P-Park Ave., New York, New York 10017.

SERVICE For Inventors By Inventor-Engineer. M. Fabish, 675 E. Granville Rd., Columbus, Ohio 43229.

PROSECUTE Your Own Patent Application. All Material, Plus Step-By-Step Procedure—\$7.00. Inventors Service, Box 3574, Washington, D.C. 20007.

INVENTOR'S Service. Everything. Booklet. Reasonable. Pen-Ink, 50 East 42, New York 10017.

INVENTORS—United States Patent Office Searches, Patent Development Engineering, marketing of inventions—ideas by Licensed Professional Engineer—Patent Engineer and United States Patent Office Former Examiner. Inventions developed for patenting and marketing. We are contacted by many manufacturers seeking to purchase appropriate new products invented by our clients. Send for Free Invention Certificates and Invention Information. Serving inventors since 1948. George Spector, Licensed Professional Engineer—Patent Engineer—3615 Woolworth Building, New York, N.Y. 10007.

INVENTIONS WANTED

IF YOUR Invention is adaptable to promoting we will contract for selling on cash or royalty. Free booklet outlines royalty rates, requirements. Kessler Corporation, C-551W, Fremont, Ohio 43420.

INVENTIONS Wanted. Patented: unpatented. Tremendous manufacturers lists. Global Marketing Service, 2420G 77th, Oakland, California 94605.

WE Either sell your invention or pay cash bonus. Write for details. Universal Inventions, 28-E, Marion, Ohio 45750.

FREE "Directory of 500 Corporations Seeking new Products." For information regarding developments, sale, licensing of your patented/unpatented inventions. Write: Raymond Lee Organization, 230-N Park Avenue, New York, New York 10017.

INVENTORS! Protect your ideas! Free "Recommended Procedures." Washington Inventors Service, 422F Washington Building, District of Columbia 20005.

MANUFACTURING

INVENTORS Ideas Developed. Research. Models. Manufacturing. Sales. Free Brochure. Since 1942. William Parker, Box 6305, Orlando, Fla. 32803.

BUYING AND SELLING

HAIR Dryers—Gun shaped \$4.00 each. Send to: Box 122, West Hill, Ontario, Canada.

50¢ Brings you complete postpaid 32 page catalog of distinctive gifts in black & white, \$1.00 for Color Catalog. Please specify. Satisfaction guaranteed. Dept. P-M, HARVARD ENTERPRISES, INC., 7743 Canfield East, Detroit, Michigan 48214.

BUY IT WHOLESALE

UNIQUE Wholesale Club!! Save on thousands of famous brands: jewelry, tools, appliances, stereos, etc. 40-50% off Retail; same wholesale prices retailers pay! Purchase for yourself or resell for fantastic profits. Free information. Homestead, Dept. 50E, 18 Westcliff Drive, Mount Sinai, New York 11766.

PLASTIC BAGS—WHOLESALE PRICES 300 Stocked sizes—fast shipment. Catalog 20¢. Milvan Company, 7921 D Enterprise, Newark, Calif. 94560.

HEARING Aids, batteries, Wholesale. Catalog 25¢. Fiston, Box 1444, New Preston, Conn. 06777.

WORLD'S Largest wholesale dropship sources. U.S., foreign. Factory suppliers dropship direct to you or customers. Now! have your own catalog for pennies. Free details. International Buyers, Box 16386-M, Portland, Oregon 97233.

CLOSE OUT DIRECTORY. Terrific Bargains. \$1.00. Winchester Enterprises, 2807PM Hargrave Street, Philadelphia, Penna. 19136.

FANTASTIC Offer. Blank Wills. Write, Change, Anytime. Sell them. Enough for ever 15 for \$2.00. JN7 Distributor, Featherbed, Boothwyn, Pa. 19061.

300,000 Products "Buy Direct" through: Midland Purchasing Services, Dept. 51, Grimes, Iowa 50111.

EIGHT Track Tape Distributors needed. Latest Titles. EATON SU 1841, Fayetteville, Ark. 72701.

BARGAINS! Buy wholesale and below. Name brands. Appliances, furniture, sports equipment, televisions, cameras, watches, jewelry, thousands more. Huge discounts to \$1,000.00 on new automobiles. All makes. Free details. Write today: Worldwide Bargainhunters, Box 730-A, Holland, Michigan 49423.

EXPORT-IMPORT

"WE SUPPLY EVERYTHING—YOU JUST MAKE MONEY!!!" Hong Kong Wholesale Directories #1 or #2—\$2.00 each. Japanese Cameras & Equipment or Japanese Toys—\$2.00 each. Japanese TV, Radio, Record Players & Recorders or Worldwide Wigs—\$2.00 each. Other Directories Available. We Operate A Finders Service. Write Us Your Needs. Dealers & Reps Welcome. Imports, Box 4665-X, San Diego 92104.

JAPAN: 1200 Products directory. Illustrated Manufacturers' names, addresses. \$3.00. Send cash, Yamagata Office. 814 Togin Bldg., Marunouchi, Tokyo.

KOALA Bears, Imported—Australian Kangaroo Fur, 6" Tall, \$7.00. Free Catalog. R. & J. World Enterprises, Box 2584-A, Pomona, Calif. 91766.

FOR THE HOME

LIKE COLD BEER? Serve it with the FLAVOR of the Gasthaus on these genuine GERMAN BEER COASTERS. 10 all-different \$2.00, 4 sets \$5.00. Unique addition to your bar. Castor, Glonnager #7 Apt #2, 8202 Bad Aibling, W. Germany.

OF INTEREST TO WOMEN

\$46.00 DAILY Possible addressing-stuffing envelopes (typewriter or longhand) information. Send stamped, self-addressed envelope. American, Excelsior Springs, Mo. 64024.

\$500 MONTHLY Possible—Clipping news at home. No experience—send stamped-addressed envelope. American, Excelsior Springs, Mo. 64024.

WANT A new car, color TV, new clothes? Learn hundreds of ways to make money. 5 month subscription FREE. Write: Salesman's Opportunity Magazine, Dept. 17-EO, 1460 Hancock Center, Chicago 60611.

\$150.00 WEEKLY Possible! Homeworkers needed urgently! Send stamped, self-addressed envelope. Schoen, Box 1963-P, Chicago, Illinois 60690.

\$100 WEEKLY Possible addressing mailing. Sparetime. Free details. Send self-addressed stamped envelope. Newby Publications, Box 20427-PM, San Antonio, Texas 78220.

\$6.00 DOZEN Paid lacing baby boots! Cowboy, Warsaw 9, Indiana 46580.

WOMEN! Make big money at home. \$10.00 profit in an hour possible with Invisible Reweaving/Reknitting. Make holes, tears disappear from fabrics. Steady year-round demand from cleaners, laundries, homes. Details free. Fabricon, 2073 Montrose, Chicago 60618.

HOW To Make Money Writing Short Paragraphs. Information Free. Barrett, Dept. C-27-G3, 6216 N. Clark, Chicago 60660.

HOMEWORKERS! \$100.00 Weekly addressing for firms. Begin immediately. Details—send stamped, addressed envelope. Hamilton, 272-TM5, Brooklyn 11235.

\$75.00 THOUSAND Addressing! Special information, plus your listing with 1,000 concerned firms. Year, \$1.00. Dixim, B38-MR, Hallandale, Florida 33009.

(Continued on next page)

OF INTEREST TO WOMEN

(Continued from preceding page)

WIN CONTESTS! New Booklet Reveals Secrets. \$1.00. JayMar, Box 646-PC, Maysville, Kentucky 41056.

HOME Newspaper clippers needed. \$500 monthly possible. Details free. Foster, 272-MA5, Brooklyn 11235.

FURNITURE SLIPCOVERS! 426 Grand Street, Brooklyn, New York 11211. Free Information Chart.

HOW To Earn At Home Addressing Envelopes. Send Addressed, Stamped Envelope. Merit, Box 3446A, Akron, Ohio 44307.

\$200.00 Week. For information send 50¢. KLR, Box 894, Kent, Washington 98031.

FABRICS: Homesever Buy Wholesale. Samples \$1.00 (Refunded First Order). Diversified, Box 171, New York 10018.

WANTED: Homeworkers to mail our sales letters. \$79.20 weekly. Send \$1.00 for registration and material. Cash, 28 E. Jackson, Suite 1204, Chicago, Ill.

GIFT SHOPPING

FREE CATALOG Of Sensational Gifts and Novelties. J. & L. Co., 73-B Main St., New Paltz, New York 12561.

FREE! Ask for the Unique Gift Catalog Write to: Paul Prause, 1793 Holly, Northbrook, Ill. 60062.

FREE Gift Catalog. Something for Everyone. Marie Vergonet, 1611 Holden, Dept. C, Orlando, Florida 32809.

SPECTACULAR Catalog of novelties and gifts, send 15¢. D & D Unlimited, 2330 1/2 T Second Street, Napa, Calif. 94558.

FREE! Amazing New Illustrated Catalog. Selected, Superior, Gifts. Act Now! Save Money! Ace, 3323 Nostrand Avenue, Brooklyn, New York 11229.

PROFITS FROM CLASSIFIED ADVERTISING! Booklet shows you how to start your own business with Classified Advertising. Only \$1.00 (Refundable with first order.) C. A. MARTIN, POPULAR MECHANICS, DEPT. PMP, 224 WEST 57 STREET, NEW YORK, N.Y. 10019.

WATCHES, OLD GOLD, JEWELRY

HIGHEST CASH For Gold, Jewelry, Gold Teeth, Rings, Diamonds, Watches, Silver, Platinum, Mail Articles Today. Free gift with Information. Chicago Gold & Precious Metals, 6 E. Monroe, Dept. 958, Chicago 60603.

COMPLETE Watchmakers'—Jewelers' Catalog \$1.00. Snell-Bengal, 205 Helm Building, Fresno, California 93721.

WATCH And clock repairing books. Free catalog. North American, Box 77-AR, Fox River Grove, Illinois 60021.

CASH Immediately for Old Gold, Jewelry, Gold Teeth, Watches, Diamonds, Spectacles, Silver, Platinum, Mercury. Free information. Rose Industries, 29-A East Madison, Chicago 60602.

WANTED . . . Gold, Silver, Platinum (any form), Coins. Information Free. Wilmot's, 1067 Bridge, Grand Rapids, Mich. 49504.

HEARING AIDS

HUGE SAVINGS. Eliminate dealer mark-ups. Free Trial. Batteries Wholesale. Terms Arranged. Lloyds-PMC, Rockford, Ill. 61108.

HEARING AIDS, Batteries, Discount Prices. Rhodes, Box 518-PM, Paducah, Ky. 42001.



SCIENCE AND CHEMISTRY

CHEMICAL CONSULTATION And Research by Accredited Chemist. Free estimates. Kenneth Burchette, Box 1114, Spring Valley, California 92077.

FIBER OP-KITS, Using the "magical optical fibers" that transmit light energy. Free catalog. Scientific Devices, 211M Albion, Wakefield, Mass. 01880.

LASER Parts. Catalog 60¢. Moynihan, 107 North Brighton, Atlantic City, New Jersey 08401.

CHEMISTRY And Biology Catalog 35¢. Boulevard Laboratories, Suite 302, 3114 E. 83rd St., Chicago, Ill. 60617.

CHEMICALS And apparatus for industrial, analytical, and private laboratories. Catalog 50¢. Dept. M-50. Biological Supply Co., 1176 Mt. Hope Ave., Rochester, N.Y. 14620.

LABORATORY Supplies at discount prices. Catalogue—35¢. Deluxe Scientific; Manitowoc, Wisconsin 54220.

CATALOGUE Of those ver-ry hard-to-find chemical products, plus things that go boom, unusual formulas, multi-stage rockets,—loads more! 50¢ (Price refundable, first order) Kenrus-C, Box 158M, Staten Island, New York 10309.

CHEMICALS Apparatus, Biology and Model Rockets. Both Catalogs for 50¢. Sheard Science, Dept. PM, Columbus, Wisconsin 53925.

LASER Tube—\$9.00. Catalog—50¢. PMA, Box 3261, San Jose, Calif. 95116.

FORMULAS, PLANS, ETC.

ANY FORMULA—\$5.00. Catalog—Manufacturing Treatise 25¢. Belfort, 192 N. Clark, Chicago 60601.

PLASTICS

CASTOLITE Pours like water, hardens like glass without heat. Crystal clear or colors. Embed natural flowers, other objects. Make fine gifts. Reproduce your own designs in plastics, wax, metal, plaster, cement, etc. Make flexible molds over any pattern, any size. Profitable Manual 25¢. CASTOLITE, 72E/PM, Woodstock, Ill. 60098.

TREASURE FINDERS

METAL Detectors, largest selection. Radiac Company, Center Moriches, N.Y. 11934.

POWERFUL Metrotech locator detect gold, silver, coins, relics. Moneyback guarantee. terms. Free information. Underground Explorations, Dept. A, Box 793, Menlo Park, California 94025.

TREASURE Hunters! Prospectors! Relco's new instruments detect buried gold, silver, coins, minerals, historical relics. Transistorized. Weighs 3 pounds. \$19.95 up. Free catalog. Relco-A40, Box 10839, Houston, Texas 77018.

GOLDAK Treasure locators—Pleasure and profit in a hobby you'll enjoy. Find coins, relics, gold, silver. Charge on BankAmericard. GOLDAK, Dept. PM 1101-A, Air Way, Glendale, California 91201.

SEARCH Treasure Finders. Locate gold, silver, coins, relics. Operate underwater. Money back guarantee. Free information. Search Electronics, Box 8396-A, St. Petersburg, Florida 33738.

FREE 140 Page Detector Catalog. General Electronic Detection Co., Box 67, Bellflower, California 90706.

TREASURE Hunters! Prospectors! Rockhounds! Hobbyists! Find gold, silver, relics with world famous Detron Metal Detectors. Free information. Delivery immediate. Detron, Dept. 5PM, Box 243, San Gabriel, California 91778.

NOW! Enjoy the great outdoors in comfort with your pocket size electronic Skeeter Skat mosquito repeller. \$9.95 postpaid. U.S.A. Satisfaction guaranteed. Detron, Dept. F-5, P.O. Box 243, San Gabriel, California 91778.

"FIND Buried treasure with revolutionary patented, analytical metal detector. Features push button and automatic tuning, negligible ground pickup, greatest range. Free catalogue. Gardiner Electronics, Dept. 9, 4729 N. 7th Avenue, Phoenix, Arizona 85018."

FISHER DETECTORS. You deserve the best! Free literature. FRL, Dept. PM-5, P.O. Box 490, Belmont, California 94002.

FREE: Jetco Electronics 24-Page treasure finder catalog. Find gold, silver, coins, metals, minerals, relics. Jetco, Dept. PMC, 3933 Barranca, El Paso, Texas 79935.

PRECIOUS STONES & MINERALS

GOLD—10 Small Nuggets Panned from Oregon Streams. \$1.00. Robert Brandt, Sweet Home, Oregon 97386.

500 POLISHED Gemstones \$5.00. Tumblecraft, 5401 James North, Minneapolis, Minn. 55430.

EARTH Science Rockhound Magazine. Subscription \$3.00. Sample \$.40. Box-550-PM, Downers Grove, Ill. 60515.

GET Free catalog no serious rockhound, gem cutter, jewelry maker, hobbyist or craftsman can be without. Full of bargains, exclusive items, low prices from largest suppliers and authorities in the field. Free new catalog just off the press, yours for the asking. Write Grieger's, Dept. C-12, 1633 E. Walnut, Pasadena, California 91106.

CARTOONING, COMMERCIAL ARTS, SHOWCARD & SIGN PAINTING

COMPACT 23 lesson Cartoon Course and Cartoonist's Magazine. \$2.00. Hartman, Box 30367, Lincoln, Nebraska 68510.

MODERN Cartooning taught by mail. Write for free brochure. Cartoonorama—Box 263-1G, Branford, Conn. 06405.

SIGN Painting—\$1000 per Month Part-Time. Free Catalogue. Kaufmann Supply, Centertown, Missouri 65023.

CARTOON For Money!! Big Free Book: Success, Box 885-C, Dearborn, Mich. 48121.

LEARN Sign painting at home. Free Talent test. Ben Kerns, Box 812-PM, Greenville, S.C. 29601.

"HOW TO MAKE MONEY WITH SIMPLE CARTOONS"—Informative book sent FREE tells way to big income. Cartoonists' Exchange, 95, Pleasant Hill, Ohio 45359.

SIGNS! Make-your-own! SIGN-RITE Vinyl Self-Adhering Letters and Numbers! 5 Large Sizes! 4 Types! 8 Colors! Over 20,000 to select from! Inexpensive! Prompt Service! FREE BROCHURE! Aircraft Mfg. Co., Box 25034 Northgate, Seattle, Wash. 98125.

ADVERTISING AGENCIES. ADV. SERVICE, MAILING LISTS

ART Talent? Don't waste it! Free brochure Y4. CC&CA Studios, Spring Park, Minn. 55384.

CIRCULARS Mailed, \$5 Per Thousand. 4x5. \$10 Per Thousand 8x10. Barnes, Box 8, Bronx, New York 10465.

ADVERTISING Ratebook leading newspapers, magazines, 25¢. Chicago Advertising Agency, 28-E Jackson, Chicago 60604.

ADVERTISE In Mail Sale Advertiser 19,000 Circulation. 30¢ Per Word, inch \$10.00. Subscription \$2.00. Copy 25¢. Martin's Service, 1148C Rives Rd., Martinsville, Va. 24112.

MAIL ORDER BUYERS' NAME LIST, 1000 Gummed Labels \$9.00. N. D'Amato, Box 385, Port Jefferson Station, New York 11776.

(Continued on next page)

RUBBER STAMPS

ADDRESS Stamp 85¢. Signature \$2.80. Catalog, Carol's, McLoud, Okla. 74851.

FREE 48 Page Catalog. Rubber stamps, printing, office supplies. Youngers Stamp Shop, Princeton, Iowa 52768.

FREE Stamp Catalog. Beckley's, 522 S. Midler Ave., Syracuse, N.Y. 13206.

FREE Stamp Catalog. 45 type styles. Fast service, low prices, Jackson's, Box 443A, Franklin Park, Illinois 60131.

NAME Stamp 75¢. Free Catalog. Rush Stamps, 132 Farmcrest, Rush, New York 14543.

OFFICE SUPPLIES

ENGRAVED Door, Desk, Badges, Name Plates. Free Catalogue. J. P. Engraving, Williamstown, New Jersey 08094.

SAVE On Office Supplies, Furniture & Equipment. Free Details. Sprint, 8101-P Pinto Trail, North Little Rock, Ark. 72116.

PRINTING PRESSES, RUBBER STAMP OUTFITS

HOBBY Printers—Exchange Printed Papers. American Amateur Press Association, 5009 Dickens, Tampa, Florida 33609.

SAME Day shipment on rubber stamp supplies. Revised wholesale price list No. 7 free. Star Stamp Supply, 732 Federal, Chicago, Ill. 60605.

SIMPLE-X RUBBER STAMP PRESSES, Hydraulic operated, electrically heated. Sizes 5"x8", 8"x12", 10"x15". Starting outfits Orders for presses, supplies shipped day received. Free catalog low supply prices. Send \$1.00 for postage and handling (refundable on first order). Custom Manufacturers, 406-P East Elm, Springfield, Missouri 65801.

RUBBER Stamp outfits, supplies. Kiewiet, 2025 Barney Road, Kalamazoo, Michigan 49007.

PRINTING Presses, type, supplies, Lists, 10¢. Turnbaugh Service, Mechanicsburg, Pennsylvania 17055.

TYPE Catalog No. 12, 120 pages. Send One Dollar. Deductible First Order. Acme Type, 732 Federal, Chicago, Illinois 60605.

LOW Priced Rubber Stamp Manufacturing Supplies, Starting Outfits. Martin, 1432 Major, Jefferson City, Missouri 65101.

MAKE Your Own Self-Molding Rubber Stamps and Printing Cuts. Plexirubber, Argyle 1, Wisconsin.

RUBBER Stamp Manufacturers Supplies. Press, starting outfits. Best prices, service, Catalog. Jackson Supply, Box 443A, Franklin Park, Illinois 60131.

PRINTING AND SUPPLIES

BUSINESS CARDS Raised Letters \$5.65 Thousand. Like Engraved. Free Samples. Kavanagh, Box 1222, Brooklyn, N.Y. 11202.

FREE Booklet "Secrets of Cutting Printing Cost" Nationwide Speed Printing, Atlanta, Illinois 61723.

GET Free literature-business cards, letterheads, envelopes, rubber stamps, labels. Big Selection. Jordan's, 552 West O'Connor, Lima, Ohio 45801.

ECONOMICAL Printing: Stationery, Business Forms, Labels, Cards. Burnfin, Weaubleau, Mo. 65774.

DELUXE Business Cards. Free Samples. Harry Romano, General Delivery, Fort Shelby Station, Detroit, Mich. 48226.

1,000 Quality BUSINESS CARDS, raised letters, \$5.95 postpaid. Fast Service. Accuracy guaranteed. Free samples. G/M Products, Box 1336-AM, Sun Valley, California 91352.

STATIONERY . . . Business/Social. Free information. Longwood Press D-47E2, Fort Johnson, N.Y. 12070.

FREE!! Giant Printing catalog. Low Prices! Steinbergen, Box 62, PM5NYC 10457.

228 POPULAR MECHANICS

MULTIGRAPH, MIMEOGRAPH

PROFITS FROM CLASSIFIED ADVERTISING! Booklet shows you how to start your own business with Classified Advertising. Only \$1.00 (Refundable with first order.) C. A. MARTIN, POPULAR MECHANICS, DEPT. PMP, 224 WEST 57 STREET, NEW YORK, N.Y. 10019.

GUMMED LABELS

1000 GOLD STRIPE Address Labels. \$1.00. Emery, Box 366PM, St. Ann, Missouri 63074.

1,000 GUMMED Address Labels \$1.00. Walt's, Box 966A, South Bend, Indiana 46624.

1,000 ADDRESS LABELS—\$1.00—GUARANTEED. SCOTT (PM-52), BOX 401, SEMINOLE, OKLAHOMA 74868.

REMAILING SERVICE

GUAM Re-airmailing \$1.00 Each. M.D.A., 126 Santa Barbara, Dededo, Guam 96910.

REMAILING And Forwarding. Very personal. Monthly rates, or 35¢ a letter. Kaye Sales, Box 674-M, Chicago, Ill. 60690.

TORONTO Remails 60¢ Each. King, Box 5662-A, Toronto 116, Canada.

RENO Remails 25¢ Guaranteed. Davis, Box 5012A, Reno, Nevada 89503.

KANSAS CITY Independence Remails 25¢. \$3.00 Monthly. Gene's, P.O. Box 112, Independence, Missouri 64051.

PUERTO RICO Remails, 50¢ Each. Special Monthly, Bulk and Parcel Rates. Bowman, GPO Box 986-PM, San Juan, Puerto Rico 00936.

ARIZONA Remails, 25¢. Robert Darnell, Box 22065-PM, Phoenix, Arizona 85028.

RECEIVING-Forwarding. Monthly rates. Hedgpeth, 324-M South First, Alhambra, Calif. 91802.

CONFIDENTIAL New York City mail address \$3.00 month. Remails 25¢. Details Free. Birnhan, 152 W. 42, New York City 10036.

SECRET. Receiving—forwarding. Discreet and confidential. Remail 25¢ single. Mail Forwarding Service, 8050 S. Main, Houston, Texas 77025.

DENVER Receiving—Forwarding. 25¢. \$3.00. Details free. Rich, Box 26099, Denver, Colorado 80226.

ENGLAND Re-airmails \$1.00. Schmidt, 701 BCM Society, London WC1.

CONFIDENTIAL Remails. Mac, Box 773, Sonoma, Calif. 95476.

MIAMI Remails 25¢. Monthly Rates. Marle, Box 1266, Coral Gables, Fla. 33134.

BOSTON Remails. Details Micley, 90 Mill Street, Newton, Mass. 02159.

REMAILS 25¢. Box 2064-C, Petaluma, California 94952. Fast, Daily, Confidential.

REMAILING Service. South America Re-Airmails 50¢ Single—Narvaez, Apartado Aereo 29280, Bogota, Colombia.

PARIS Remail single \$1.00 Shopping services, Postcards. Masters, 82 Rue Doudeauville, Paris (18), France.

CONFIDENTIAL—Remails, 25¢, \$3.00 Monthly. Maiser, Box 8906, Corpus Christi, Texas 78412.

HOUSTON, TEXAS "SPACE CITY" Remails. 25¢ Each, \$3.00 Monthly. Haynes, Box 33513, Houston, 77033.

WASHINGTON DC Remails 25¢. Monthly Rates. Confidential. Gabriel, Box 4552, Washington D.C. 20017.

ALBUQUERQUE Remails. Single 25¢. monthly \$3.00. Airmail \$1.00. 2400 Shasta Rd. S.W. Albuquerque, New Mexico 87105.

PARADISE, Angels Camp, Smartville, Rough 'n Ready, Remails. Your choice 50¢. Monthly rates. Rose, 3068 Warrington, San Jose, Calif. 95127.

RECEIVING-Forwarding-Remailing. Monthly rates. Wright, Box 2112-M, Asheville, North Carolina 28802.

REMAIL From Pennsylvania. 25¢ single. \$3.00 monthly. McWilliams, 560 North Darby, Sharon, Pennsylvania 16146.

CONFIDENTIAL Remails. Receiving-Forwarding. 25¢. Monthly Rates. N. D'Amato, Box 385, Port Jefferson Station, New York 11776.

MIAMI BEACH, Hialeah, Miami 25¢. Monthly Rates. Famailco, Box 444, Miami, Florida 33101.

REDWOOD COUNTRY Remails .25¢ ea. 5/1.00. Motion Enterprises, 347, Redwood Valley, California 95470.

TEXAS Remails 25¢. Receiving—Forwarding—Monthly Rates. Nortex, Drawer 5370, Ft. Worth, Texas 76108.

ST. PETERSBURG, Florida 25¢. Your Business/Pleasure Address, Information FREE. Brooks, 20864M, 33742.

REPAIRS AND SERVICING

PROFITS FROM CLASSIFIED ADVERTISING! Booklet shows you how to start your own business with Classified Advertising. Only \$1.00 (Refundable with first order.) C. A. MARTIN, POPULAR MECHANICS, DEPT. PMP, 224 WEST 57 STREET, NEW YORK, N.Y. 10019.

SPECIAL SERVICES

INFORMATION On anything. Ferguson Research Specialists, 83-45 Vietor Ave., Elmhurst, N.Y. 11373.

KEEP Your copies of PM—and watch for the inexpensive Annual Index, available in January 1972. It will enable you to locate any article which appeared in 1971 or find information on any particular subject in just a few seconds. The Annual Index will make your copies of PM even more valuable! Price \$1.49. Send checks to: Popular Mechanics, Dept. HE, 224 W. 57th St., New York, N. Y. 10019.

TOBACCO

BUY Direct. Save!! Free Samples Sweet Juicy Chewing Flakes, Smoking Twist, Snuff. Jolley Farms, Dresden, Tenn. 38225.

BRIAR PIPE Make or repair your own. Photocopy of article shows you all the details. Price \$1.00. Send order to POPULAR MECHANICS, DEPT. HE, 224 West 57 St., New York, N. Y. 10019.

RAZORS

MAILORDER RECORDS help get increased business! Complete 32 Page Record Book shows your inquiries, orders, advertising, expense, etc. Only \$1.00. C. A. MARTIN, POPULAR MECHANICS, DEPT. PMR, 224 WEST 57 STREET, NEW YORK, N.Y. 10019.

PERSONAL

SECRET Plan Wipes Out All Debts. Get \$600 to \$25,000 relief. Clear credit. Free details. Counselor-7, Kerrville, Texas 78028.

PAY Bills! Borrow to \$1500 by mail! Convenient terms! State licensed. Postal Finance, 6018 Military Avenue, Dept. 17-E, Omaha, Nebraska 68104.

1972 NEVADA Sporting House Guidebook, includes addresses, phone numbers, pictures, maps \$5.00. Talk of the Town Book Store, 2232 E. Charleston, Las Vegas, Nevada 89104. Ask for free catalog.

HIGH School, Birth, Will certificates. Three \$1.00. Marcellin, 421P Crown St., Brooklyn, N.Y. 11225.

COMPLAINTS To big Corporations handled fast. Send details, \$3.00 fee. Consumeraid, Box 4989, Washington, D. C. 20008.

PERSONAL

(Continued from preceding page)

BIBLE Questions answered. Stamped envelope. Bylon, 17167 Bentler, Detroit, Michigan 48219.

INVESTIGATORS. Latest electronic Aids. Free Literature. Clifton, 11500-P NW 7th Ave., Miami, Florida 33168.

RECORD Telephone conversations automatically. Leave recorder unattended. Write—Robert's, Box 49-PM5, Parkridge, Illinois 60068.

IMPROVE YOUR PERSONALITY. Write for free information: **PERSONALITY SUCCESS**, Dept. C-12, Box 1946, El Paso, Texas 79950

"RULE Others With Thoughts." (Teletype) write: Clarion, Box 1769-S7, Chicago, 60690.

HAVE Triple-A credit in thirty days! Get new credit without investigation! Continental, Box J-24, Hallandale, Florida 33009.

TATTOO Removing—Chemical Do-It-Yourself Method—Free Details: Atlanta, 907P Beachpoint, Pickering, Ontario.

FREE Gospel Literature Foretelling Second Coming Of Christ. Scheall, Box 263-PM, Duluth, Minn. 55801.

CASSIUS VINTON SMITH—Mother Deceased. Contact estate. Write c/o Richard Breen, 520 Laurel, Brainerd, Minn. 56401.

ADULTS! Free Brochure Unusual Books! (Not Smut). PPW, 2030 South Shenandoah, Los Angeles, Calif. 90034.

ASTROLOGICAL Report—Beautiful Original Reproduction, Including Detailed Description Of Your Characteristics \$2.00. Boss Systems, 3624 Elmhurst Court, Kent, Ohio 44240.

WIPE Out debts! Anyone (bankrupts included) can have excellent credit in 45 days. Free!!! Wealth Building, Box B-5, 8840 Hoyt Drive, Thornton, Colorado 80229.

EUROPEAN Pastry Recipe \$1.00. Send Self-Addressed envelope. Lytell, P.O. Box 14884, Long Beach, Calif. 90803.

DON'T DIE Without a will! Protect your family by preparing yours now! Complete kit! Send \$1.98 today — Guaranteed! Counselor, Box 17145, Salt Lake City, Utah 84117 Dept. 305.

SMORGASBORD 5 Secret Family Recipes. Send stamped, addressed envelope and \$1.00: Broel, Box 336P, Warrenville, Ill. 60555.

DON'T DIE Without A Will! Blank Will form protects your family. Only \$2.50—guaranteed! Will booklet—free!! Order today!! Wiloform, Box 457, Dept. 1G5, Albany, Louisiana 70711.

HIGH I.Q.?! Don't Miss Your Calling! Self Scoring Tests, \$2.00. Volume Discounts. Pennad, 7857-B Dudley, Taylor, Mich. 48180.

ANNOUNCING: How to WIN at POKER! \$1.00. Treasure Cove, Box 21203P, Denver, Colorado 80221.

K-Y. Huge Hospital Size, \$1.00. Clovers, 210 Fifth, N.Y.C. 10010.

DON'T DIE without a will! Blank Will Form protects your family. Only \$2.00. Guaranteed! Order Today!! White Mail Pouch, 811 Hayden Avenue, Dept. 1A5, Akron, Ohio 44320.

REDUCE Cholesterol and heart attack risk. What to eat, What to avoid. Very detailed. \$2.00. Andel, Box 32002, Cincinnati, Ohio 45232.

BONDS. Buy on installments from "Selective List". Free information. Insurance Premium Corp., 7771-A Bernard, LaSalle 660, Canada.

45 SECRET Ways To Save Up To 80% on Light Bills. \$1.00. Phase III, Box 2598-PM, Pompano Beach, Florida 33062.

CASH LOANS by mail! Up to \$2,500 on signature alone. No collateral! Secret! Union Finance Company, 3608 No. 16th St. Dept. PM, Phoenix, Ariz. 85011.

RUPTURED. Relief and comfort. No understraps, elastic or steel. Write Hand-Lock Products, Preston 4, Ont., Canada.

KEEP YOUR TEETH A LIFETIME Book shows you how to keep your teeth and prevent toothaches. Proven, simple techniques, \$3.95. Satisfaction Guaranteed. Practical Health Associates, Box 472-M, Randallstown, Maryland 21133.

WANTED-MISCELLANEOUS

MERCURY, Gold, Silver, Platinum; Ores assayed. Wholesale Terminal, Norwood, Mass. 02062.

MISCELLANEOUS

CHAMPAGNE, Wines, low cost, using kitchen items. Latest complete, simple to follow instructions \$3.00 Guaranteed—Bith, Box 386 A, Inglis, Florida 32649.

RECIPES, Sparkling Burgundy, Champagnes, Kahlua, Brandy, More. Send \$1.00. BK Enterprises, Box 992, Tacoma, Washington 98401.

WOOD BARRELS AND KEGS, Wine Barrels, Oak Planters. Send 25¢ For Illustrated Catalog. Cordell Enterprises, 1622 West Morse, Chicago, Illinois 60626.

"DON'T DIE" Without A Will! . . . Will Form Kit Protects Your Family! . . . Will Forms, Instructions . . . \$2.00 . . . Guaranteed! Order Today!! **DUNROVIN**, Dept. 4A1, Box 2263, Muncie, Indiana 47302.

OPENING Restaurant? Equipment Reasonable. Feola, 9A Pearl Street, Somerville, Massachusetts 02145.

CHAMPAGNE & WINE MAKERS HAND-BOOK Using Standard Kitchen & Household Equipment. Send \$3.98 To: Etlon Assoc., Box 145-B, Hales Corners, Wisc. 53130.

HOW IS YOUR EYESIGHT? Home exercises can help you see better. \$1.50 for booklet "Vision And How To Improve It." Special offer: Five exercises and Amazing new Visiostimulator \$5.75. Vision Enterprises, Box 5093 Station B, Victoria, B.C.

WINEMAKER'S Supply Catalog—Free. Bacchanalia, 273 Riverside Ave., Westport, Conn. 06880.

WINEMAKERS!! Fermentation locks—3/\$1.00. Free Illustrated Catalog Plus \$5.00 Credit Coupon. Werth Wine, Box 1902AV, Cedar Rapids, Iowa 52406.

WINEMAKING Kit—\$4.98 Free Catalog and Recipes. **JIMDANDY**, Box 30230M, Cincinnati, Ohio 45230.

SUFFERING From Arthritis? Try Ginseng; Information Free. Write Ginseng, Asheville 53, North Carolina.

WINEMAKERS Yeast, Recipes & Catalog 25¢; Kraus, Box 451-L, Nevada, Missouri 64772.

ORNAMENTAL Iron designs. Book of 1600 beautiful, practical designs for railings, columns, etc. Free literature. Cunningham, 3881 South 3200 West, Salt Lake City, Utah 84119.

WINEMAKERS. Free illustrated catalog of yeasts, equipment. Semplex, Box 12276, Minneapolis, Minn. 55412.

BOOKS On antiques and their prices. Free circular!! P. Warman Publishers, Uniontown, Penna. 15401.

IDENTIFICATION Cards. Send stamped self-addressed envelope for samples. Identification, Box 12117, Las Vegas, Nevada 89112.

HEARING Aid batteries wholesale. Free list. Habs, Box 51, York, Penna. 17405.

WINEMAKERS. . . . Free Illustrated Supply Catalog of Yeasts, Equipment, Recipes. Winemaker, Box 11211-PM, Indianapolis, Ind. 46201.

WINEMAKERS: Free informative catalog, recipes. Arbolyn, Box 663, West Columbia, S. C. 29169.

CREDIT Cards! Receive all kinds fast, easy. Get new credit without investigation! Continental, Box J-23, Hallandale, Florida 33009.

HOME WINE Making **SUPPLIES**, and **INGREDIENTS CATALOG** with **RECIPES** for year round winemaking. It's a fascinating Hobby. Makes A good conversation. Send for free catalog. Danenberger, Box 276B, New Berlin, Illinois 62670.

LOSING HAIR? BALDING? DANDRUFF? Get Dr. Shiffer's free copyrighted booklet, "Are You Washing More Face". **DR. SHIFFER LABORATORIES**, Dept. 536, P.O. Box 398, Punta Gorda, Florida 33950.

GUARANTEED!!! "Stanley-Steamer-Cleaner"!!! Presto-Pressed!!! Save!! Only \$9.98 + .50 postage. Del Erickson, 320 N. Hampton, Dept. PM5, Fairmont, Minn. 56031.

FANTASTIC Invention—Paint life-size oil portraits of anyone in minutes. Guaranteed! Complete Method, \$3.98: Jiffy Portrait, 1315 Ronan, Wilmington, Calif. 90744.

PRE-PACKAGED Toys complete with free self-selling display rack. Free Details. Toys, 1916 Fifth, Sacramento, California 95814.

BLANK High School Diploma identifies you as graduate. Replace lost diploma. \$2.00. Emmert, Dept. 2PB5, P.O. Box 246. Gambrins, Md. 21054.

QUIT Smoking! New Ideas! Follow instructions. Within two months finish cigarettes for good. Money back Guarantee. \$1.00. Junior, Box 102, New Wilmington, Penna. 16142.

FREEZER Owners—organize your food storage. Send \$2.50 for freezer inventory forms and instructions. **JDW Co.**, P.O. Box 7, Collinsville, Illinois 62234.

MAKE Wines & Sparkling Champagne. Inexpensively made. Complete instructions. Guaranteed delicious, \$2.50. Archer Enterprises, Box 193, Denton, Texas 76201.

AT LAST—Precision Castings by Mail Order. New Custom Casting Service for Men of all Trades and Hobbies. Free literature, "The Foundrymen," Box 5123, Garden Grove, Calif. 92645.

LEARN To SWIM! Flate-n-Float builds confidence automatically. Swimming seems natural with buoyant heavy-duty armbands. For adults or children. \$3.00. Angelo's, 251 South 8th, Steubenville, Ohio 43952.

U.S. \$1000 Bills!! Obsolete Replica's 5 for \$3.95. Genuine Quarter-Heads on Both Sides!! \$3.95. Novelties, Box 1391-X, Clearwater, Florida 33517.

STOP Smoking, My Method Works, \$1.00 Satisfaction Guaranteed. Hilton House—PM 51 Schaefer Rd., Maplewood, N.J. 07040.

DOG CHASER, Protect yourself! **POCKET**-size, Ultrasonic, \$49.95. **PCM Industries, Inc.**, 7239 Columbia Pike, Annandale, Va. 22003.

BUMPER STICKERS. Muskie, Humphrey Nixon, McGovern, Lindsay, Wallace. Send \$1.00. Campaign-72, Box 123, Prides, Massachusetts 01965.

SEE THROUGH DOORS . . . Walls without being seen!!! Large 8 x 10 inch two-way Mirror!!! Send \$2.00 today—guaranteed!! Mari Loring's, 202 Devonshire Drive, Dept. PM 5, South Bend, Indiana 46615.

WINEMAKING Made Easy! No Special Skills. \$1.00. Trans-Am, P.O. Box 1713, Birmingham, Ala. 35201.

SOLID Gold-Plated Eisenhower Silver Dollars 1971 or 1972 \$2.95. Owen Cox, 514033 U.S. 31, South Bend, Indiana 46637.

HOW Intelligent Are You? Self-scoring test reveals IQ! Send \$2 today—guaranteed! Dalmon, Route 1, Box 23, 1PM5, Monroeville, Ohio 44847.

(Continued on next page)

MISCELLANEOUS

(Continued from preceding page)

ROUT RATS, Rodents. Easy, Sanitary, Ultrasonic **RATICATOR.** \$139.50. PCM Industries, Inc., 7239 Columbia Pike, Annandale, Virginia 22003.

CIGARETTES 15¢ a pack. Improved roller makes 20 filtertip, plain, king or regular for 15¢. Facts free. Green River Tobacco, Box 954, Owensboro, Kentucky 42301.

HOW INTELLIGENT Are You? Self-scoring test reveals I, Q, in minutes! Send \$1.98 today—guaranteed!! Tests, Box 17145, Dept. 305, Salt Lake City, Utah 84117.

WINEMAKING AT HOME. Make the wine you like at home. Kit \$4.98. Thomas, 5275 DeLongpre, Hollywood, Calif. 90027.

PROTECT Your Checks! Exciting New Check Writer! Precision Built—Prints Businesslike in Red Ink. Comes Complete \$5.98. Guaranteed. Stiltner's Mail Order Service, Box 376, Ypsilanti, Mich. 48197.

STOP AUTO THEFT! GUARANTEED! Minutes to install! Instructions. \$7.95. Deactivators, 6308 Eberhart, A25, Chicago, 60637.

CUSTOM Blended Pipe Tobacco—finest tobaccos, expertly blended, factory fresh. Write for free samples. Green River Tobacco Company, Since 1914, Box 991, Owensboro, Kentucky 42301.

SUCCESSFUL WINE, CHAMPAGNE, Making Made Easy! Use Standard Kitchen Utensils. Step-By-Step Instructions: \$3.00. Bello, 3144 Rawle, Philadelphia, Penna. 19149.

HITCHHIKING? Get rides fast with **TRIPSTRIP.** \$1.00. **DAMNGOODPRODUCTS** F, PO Box 1706, La Jolla, California 92037.

EXCELLENT DOCUMENTS!!! Karate Black-belt—Birth—Marriage—Divorce Certificates. Mechanic—Plumber—Electrician Licenses. High School—College Diplomas. Rushed Airmail!!! Two—\$1.00. Five—\$2.00. Deluxe Documents (Goldseals) One—\$1.00. Five—\$4.00. Moneyback Guarantee!!! Filiforms, Box 1332-BD, Albany, New York 12201.

MAKE WINE AND CHAMPAGNE, Easy, Delicious. Use Standard Kitchen Equipment. **BONUS Book Included.** Other Exciting Recipes. Send \$2.50. E.L.M. Sales, P.O. Box 2159, Pawtucket, Rhode Island 02861.

ATTRACTIVE 3-D Magnetic Car and Truck Signs. On for Business, Off for Pleasure. Can't Damage Vehicle. 4-Line Message. Two Signs (12"x20") \$21.95 ppd. Specialty Signs, 6 West 18th Street, New York, N.Y. 10011.

BIRTH Certificates, Marriage Certificates. Diplomas! 2 blank forms \$1.00. Sample 10¢. Standard Forms, Box 482-M, Washington, D.C. 20044.

DON'T PAY INCOME TAX. Legally. No matter what your income. Rich men's methods adapted for anyone's use. Free Details. Treehouse 24, Box 3004, Duluth, Minnesota 55803.

MAGNETS, All types. Specials—20 disc magnets, or 2 stick magnets, or 10 small bar magnets, or 8 assorted magnets, \$1.00. Maryland Magnet Company, Box 192-A, Randallstown, Maryland 21133.

WINEMAKING Kit \$4.95. Free Catalog. Recipes. Calwine, Box 2209-C, Sunnyvale, Calif. 94087.

WINE & CIDER Proven, Quality Home Recipes. \$1.00. Rainbow Press, Box 59, Vashon, Wash. 98070.

AUTHENTIC BOOMERANGS With gliding instructions \$3.00. Chinese abacus \$3.00 both \$5.00. Order B-3001 or A-3001. **GUYS,** P.O. Box 12484, Philadelphia, Pa. 19151.

THROW AWAY YOUR OLD GLASSES? NEVER! Instanston can color the lenses. Special "noglare" coating will serve as fine low cost sunglasses. Your choice of colors, \$8.95—Specify grey, green, blue or tan in light, medium or dark shade. Mail your glasses with payment to: Instanston, P.O. Box 66456, Seattle, Wash. 98166.

SLEEPATRON. New device for inducing sleep. Gardiner Electronics, Dept. C, 4729 North 7th Avenue, Phoenix, Arizona 85013.

BOOKBINDING. POST OFFICE BOX 10086, FREMONT, CALIFORNIA 94538.

LEARN How-To: Stop Smoking; Win Contests; Make Champagne, Wines; Australian Employment. Each \$1.95, plus 35¢ postage, handling. Satisfaction guaranteed. J. E. Johnson, Box 526, Washington, D.C. 20315.

BURGLAR ALARMS & HOME PROTECTION

AMAZING Keyless Tamper-Proof Portable Door Lock. Use Home Or Travel. \$1.50. Security, Box 8327, Long Beach, Calif. 90808.

PROTECT Your Home Or Business From Fire And Theft. Fire And Burglar Alarm, Battery Operated. \$2.98. Redd's, Box 555, Colton, Calif. 92324.

FREE Catalog on Burglar-fire Alarm Equipment. Protecto Alarm Sales, Box 357-D, Birch Run, Michigan 48415.

ALARM SYSTEM Plans For Building Effective Protection Against Burglary, Fire, Freezer Failures, Etc. Includes Instruction Plans For: 7 Different Systems; 2 **EMERGENCY POWER SYSTEM** Plans For Lighting Inside Outside Home, And Alarm Backup Using Storage Battery During Power Failures; And 3 Cabinets. Includes Materials List. Complete Set \$4.00. American Conflux, Inc., Box 5704M, Redwood City, California 94063.

FREE CATALOG OF WATERFRONT EQUIPMENT

Docks, pontoon boats, ladders, mooring bars and other Perma-D products.

WRITE: **PERMA-D MARINE PRODUCTS DIV.** DEPT. 35, 1234 Central Ave. N.E. • Mpls., Minn. 55413



1¢ SALE GUARANTEED 10 YEARS



The knife for hunting, fishing and all around use. Mirror polished, imported stainless steel blade honed to a razor's edge. Rugged. Opens quickly, easily. Locks into position. Blade will not close when in use. Press button in handle to close. Safety finger guard. Sure-grip handle. Balanced for target throwing. **IF BROKEN WITHIN 10 YEARS WE WILL REPLACE AT NO CHARGE!** Use 30 days. Money back if not pleased. Special 1¢ sale. REG. PRICE \$1.98. Send \$1.99 & receive 2 knives. Add 49¢ postage, handling. Remit **TOTAL \$2.48** for 2 knives. **ORDER NOW!** Midwest Knife Co., 9048 S. Western Ave., Dept. DD-5508, Chicago, Ill. 60620. Est. 1936.

USE WHAT THE PROS USE!



- LUBRICATES
- PENETRATES
- PREVENTS RUST

Sold thru Auto Supply Stores

CRC CHEMICALS Div. C. J. Webb Inc. Dresher, Pa.

BASEMENT TOILET FLUSHES UP



TO OVERHEAD SEWER OR SEPTIC TANK. NO DIGGING UP FLOORS. INSTALLS EASY. Write **McPHERSON, INC., BOX 15133, TAMPA, FLORIDA 33614**

SUBSCRIBER'S

Change of Address Form

Please use this form to notify us at least six weeks before you move to your new address.

1. Present address: Attach address label from a recent issue, or print your name and address exactly as shown on the label.

NAME _____
 ADDRESS _____
 CITY _____ STATE _____ ZIP _____

2. Fill in new address:

NAME _____
 NEW ADDRESS _____
 CITY _____ STATE _____ ZIP _____

3. Mail this form to:

POPULAR MECHANICS
Subscription Service Dept.
Box No. 646
New York, N.Y. 10019



IF YOU'VE USED GUMOUT PRODUCTS BEFORE, YOU KNOW THEY REALLY WORK.

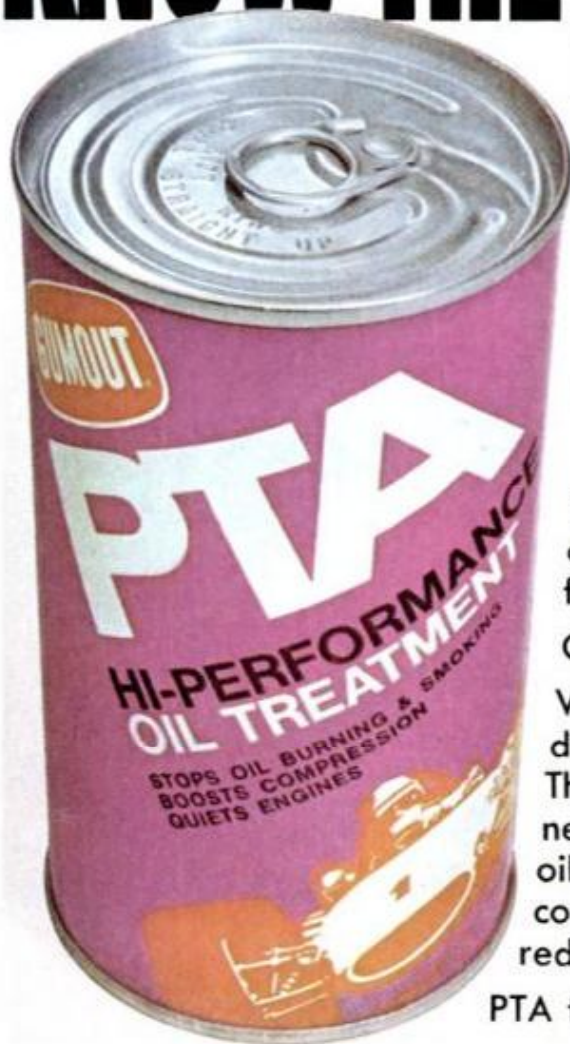

SO DOES THIS ONE!

The fact is that there are over 40 oil treatments to choose from. So what do you do?

Go with a name you know.

When Gumout makes it, it does what it's supposed to do. That's why they're switching to new PTA, the high performance oil treatment. For better compression, quieter engines, reduced oil burning, less smoke.

PTA from Gumout. It works.



Evinrude announces the all-summer vacation plan.

Some people scrimp and save all year to enjoy a few glorious days of boating — on their vacations.

And that's a shame. Because with one of the new budget-size Evinrudes — like the 50 hp Lark above — they could be enjoying vacation fun all summer long.

These compact new Evinrudes do

things only the biggest motors could do a few years ago.

They're small because they're *efficient*. Because they reclaim power from exhaust energy and from fuel that used to be drained overboard.

They start and shift with a finger's touch. Ignition is electronic. Temperature control is automatic.

You can buy a compact family-size Evinrude motor and a boat for around \$600 down. Vacation money.

You can play while you pay. You can start as early as next weekend. With a whole summer's vacation fun ahead of you.

Full line catalog free. 2 to 125 hp. Write Evinrude Motors, 4012 N. 27th St. Milwaukee, Wis. 53216.

CLEAN WATER: our future is riding on it **EVINRUDE** **first in outboards**

Div. of Outboard Marine Corp., makers of OMC Stern Drives