

At last! A powerful, quiet trail bike

**THE SPY PLANE
WE DON'T TALK
ABOUT** Page 80

Popular Mechanics

APRIL 1972
50 CENTS

BETTER WAYS TO BETTER YOUR HOME

We show you how to:

- EXPAND down as well as up
- UPDATE a dated living room
- REMODEL a tired bath
- EXTEND over an attached garage
- FACELIFT and get a new look
- ADD a great basement family room

40 PAGES that prove **THERE'S NO 'IMPOSSIBLE' HOUSE**

Begins on page 110

What owners say about Detroit's
only front-wheel drives: Eldorado and Toronado Page 100

Road racing's hottest drivers

Page 75

Denny Hulme
in McLaren M-19





We call it Triumph. Now everybody knows why.

As the first multi-cylinder, water cooled engine with loop-charging, it was an engineering triumph.

So that's what we called it. Triumph.

Then, as a stock engine, it set speed records in its own class and the next class up. Triumph again.

Now, it has become our most popular motor — outselling even the small fishing motors. Another triumph.

For 1972, we've added 5 more horses to give you a "65" with the compact size and impressive fuel economy of last year's "60"

And we gave it Evinrude's newest Firepower electronic ignition.

Underwater, its external shape and internal gearing are computer-matched. To each other and to the powerhead.

Out front, key-turn starting and power shifting add convenience and elegance to the excitement.

This year, the Triumph is a 65.

And the new Evinrude 65 is yet another triumph.

Full line catalog free. 16 Evinrudes — 2 to 125 hp. Write Evinrude Motors, 4091 N. 27th St., Milwaukee, Wis. 53216.

CLEAN WATER: *our future is riding on it* **EVINRUDE** **first in outboards**
Div. of Outboard Marine Corp. — makers of OMC Stern Drives

Winchester 22 Magnum Rim Fire cartridges were pioneered by Winchester-Western to give hunters and shooters the power of a center fire at a price that lets them get plenty of practice.

Check the new low cost of Super-X Magnum Rim Fires in both Winchester and Western brands:

\$2.95

Suggested retail price per box of 50.

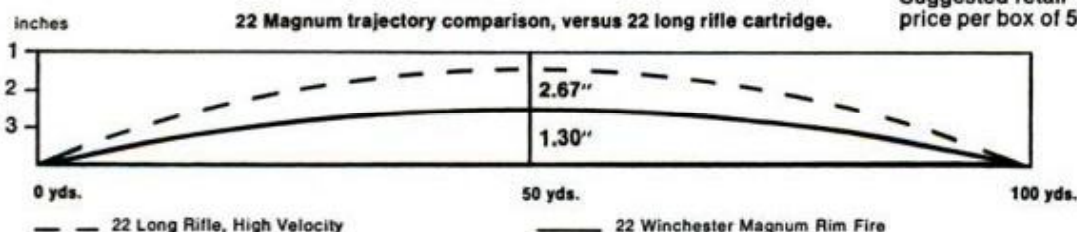

A proven performer that was first in the field. Ten years ago a new era of rim fire power and varmint shooting performance started with the introduction of 22 Winchester Magnum Rim Fires, economical loads that fit between regular 22s and costly center fires. Because of the logical simplicity of the new Magnum load, plus its wind-bucking accuracy, and extra power for shooting varmints, game, and pests, so many manufacturers brought out rifles and pistols for it that the Winchester Magnum quickly became the standard of the industry.



Choice of two bullets. Two bullets let you suit your load to your game. Perfect for the toughest varmint, the 40 grain jacketed hollow point hits with conclusive wallop . . . accuracy . . . out where the regular 22 rim fires really slow down. The 40 grain full metal case bullet delivers the same velocity, with long range performance ideal for small targets.



Not a sub small-bore. After exhaustive tests, Winchester-Western technical experts concluded that a magnum rim fire should be a full 22 caliber for maximum accuracy and top wind-bucking ability. After testing both undersized and oversized calibers, they settled on 22 as providing the best balanced load when all of the factors affecting performance are considered. When you add up all that, plus two bullet choices, powered by clean, progressive-burning Olin Ball Powder, and consistent, non-corrosive priming in a precision-drawn case, you've got a load you can shoot with confidence . . . Now at a new low price that lets you shoot it as much as you like.



New Winchester Model 9422M Magnum chambered for 22 Winchester Magnum Rim Fire loads. This new lever action 22 magnum rifle, patterned after the famed Model 94 Winchester was built specifically to handle the Winchester Magnum load, and to bring out the best in Super-X, the original brand of extra power that's never been topped. You get accuracy, reliability, and performance every time. The new Model 9422M is carved from solid steel and rich walnut with no shortcuts or substitutions. Magnum rim fire 22s available in either Winchester or Western brands. **WINCHESTER-WESTERN** 275 Winchester Avenue, New Haven, Conn. 06504.

1972 | winchester
the way you
want it

GLAS-GUARD, the double fiberglass belted tire specially made for campers... It could save your vacation



Bruise and cut-resistant rubber in sidewalls



Don't let tire trouble spoil your vacation.

Now there's a tire built to carry your loaded Camper over the long highway miles... the rough country roads.

GLAS-GUARD has a combination of features no other Goodyear tire has ever had before, for long mileage, stability and strength.

Ask your Goodyear Dealer or Goodyear Service Store for GLAS-GUARD, the tire that can take care of itself. And you.

GOODYEAR

...big on the road



Now, a rule with a drop-in cartridge.

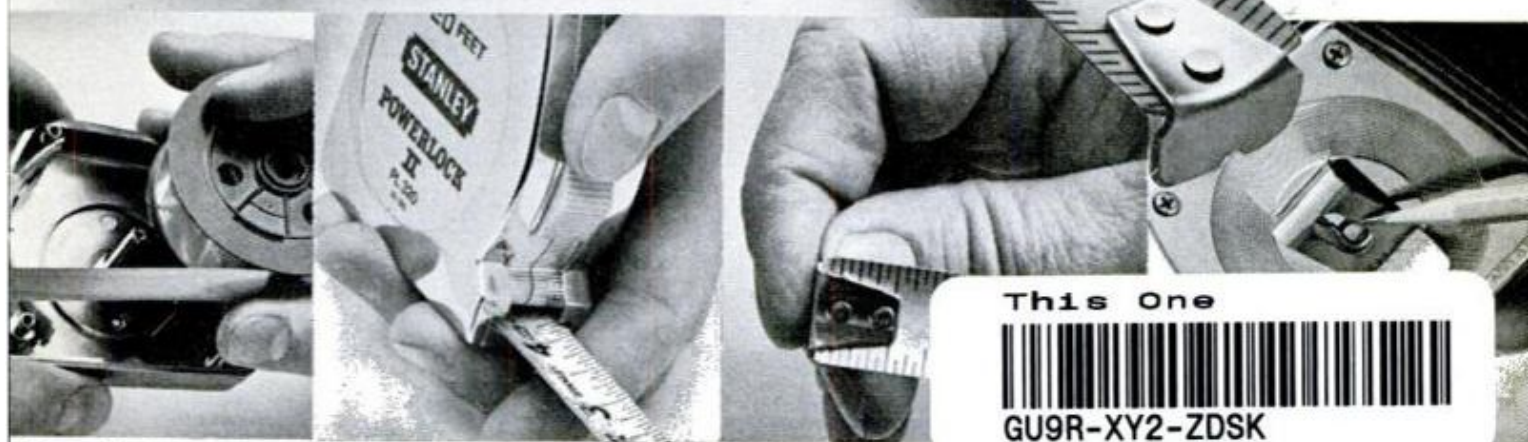

Great idea! Stanley improved its best-selling Powerlock® rule with a drop-in replacement tape. Do it in seconds, on the job.

Other famous features stay. New Powerlock II has the same power return. Locks, unlocks with your thumb.

“True Zero” hook helps measure both outside and cramped inside areas. Bold, easy-read numbers on Lifeguard® yellow blade, Mylar® protected for long life.

This One



GU9R-XY2-ZDSK

Clip on the back of your Powerlock II snaps tightly over belt or apron pocket, so you can't lose it.

STANLEY
helps you do things right

HOW TO . . .

Treat your trailer right 90



Install an outside basement entry . . 144



Troubleshoot a cooling system . . 162



Make your closets work 129

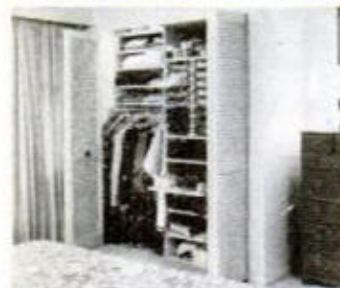

Make the right wood joints 156



AUTOMOBILES, DRIVING

- 28B Drivin' with Dan
- 54 At last, a powerful and quiet bike for the trail!
- 75 '72 road racing preview
- 100 PM Owners Reports:
Cadillac Eldorado
Oldsmobile Toronado
- 105 What's ahead for front-wheel drive?
- 162 Saturday Mechanic: Checking your cooling system
- 166 New for your car
- 189 Cartridge adapters: Play cassettes and FM, too

ELECTRONICS, RADIO, TV

- 24 Now: A TV cartridge player you can actually buy
- 169 New plug-in TV parts
- 178 Crimp-on connectors make solderless joints quickly
- 182 New in electronics
- 189 Cartridge adapters: Play cassettes and FM, too

SHOP AND CRAFTS

- 148 New building products for home improvement
- 156 Short course in wood joinery
- 160 Bed by night, toy by day
- 174 New tools for home improvement

SCIENCE, INVENTIONS

- 84 They caught a falling star
- 88 Transpo '72: How we'll keep 'em moving
- 108 Just patented

SPACE, AVIATION, MILITARY

- 80 The superfast spy plane we don't talk about

HOME AND YARD

- 52 New compact air conditioner saves the view
- 110 Better ways to get a better home
- 111 Space under the house
- 112 Simulated beams, paneling
- 113 Bath need remodeling?
- 114 Expansion over the garage
- 115 Family room ideas
- 129 Need more storage space? Make your closets work
- 132 Two patio planters for the price of one
- 134 Five ways to erase the dated look of old houses
- 139 Cool it with a power roof ventilator
- 142 Bright, low-cost lighting
- 144 Install a direct outside route to your basement
- 151 Eye-appealing shelf brackets
- 152 Better ways to do it
- 154 Exciting new products

BOATING, OUTDOORS

- 90 Treat your trailer right
- 93 Giving it the new oil
- 94 New boats and gear

PHOTOGRAPHY

- 14 Photo hints
- 96 Extra lenses for a fixed-lens camera!

EVERY MONTH

- 6 Letters
- 21 Automobile Clinic
- 28H All Outdoors
- 31 The Bicycle Shop
- 36B Homeowners' Clinic
- 40 Science Worldwide
- 44 Detroit Listening Post
- 46 Appliance Clinic

Cover photo by Richard George

Denny Hulme pilots the McLaren M19 Formula 1 car at Ontario during special road race for European Grand Prix cars and U.S. Formula A/5000 cars

AS A SERVICE TO READERS, Popular Mechanics publishes newsworthy products, techniques and scientific and technological developments. Because of possible variance in the quality and condition of materials and workmanship, Popular Mechanics cannot assume responsibility for proper application of techniques or proper and safe functioning of manufactured products or reader-built projects that result from plans published in this magazine.

JIM LISTON

Editor

SHELDON M. GALLAGER JOHN A. LINKLETTER

Executive Editor Managing Editor

WAYNE C. LECKEY

ALVIN KIETZ

Home and Shop Editor

Art Director

Published by The Hearst Corporation

RICHARD E. BERLIN, PRESIDENT

RICHARD E. DEEMS

President, Magazines Division

JOSEPH F. KERN

Publisher

BILL HARTFORD _____ Automotive
JOHN F. PEARSON _____ Science and Aerospace
WM. T. McKEOWN _____ Boating and Outdoors
SHELDON GALLAGER _____ Electronics and Photography
HARRY WICKS _____ Home Workshop
MICHAEL LAMM _____ West Coast
ROBERT LUND _____ Detroit Automotive
GARRY WINTER _____ Copy and Production
RICHARD H. FUNK _____ Associate Copy and Production
ALFREDO VEGA _____ Assistant Copy and Production
DON EVANS _____ Technical Art Director
FRED A. LEERS _____ Assistant Art Director
JOSEPH P. BEATON _____ Assistant Art Director
DAVID KOMITAU _____ Assistant Art Director
CLIFFORD B. HICKS _____ Special Projects
SOPHIE GRONOWICZ _____ Director, Bureau of Information
EVERETT JOHNSON _____ Cabinetmaker

ADDRESS ALL EDITORIAL COMMUNICATIONS TO: 224 West 57th St., New York, N.Y. 10019. For additional sources of information on the articles and products in this issue, write to Bureau of Information, Popular Mechanics, for free "Where-to-Find-It" list.

DANIEL J. COLEMAN

Director of Advertising

ADVERTISING OFFICES: New York: 224 West 57th St., 765-6850; Chicago: 520 N. Michigan Ave., 527-2400; Detroit: General Motors Bldg., TRinity 5-8711; Cleveland: 20310 Chagrin Blvd., Shaker Heights, 283-7788; Los Angeles: 601 North Vermont Ave., 666-6263.

JOHN A. REGINA _____ Advertising Production Manager

SUBSCRIPTION SERVICE: Mail all subscription orders, changes of address, correspondence concerning subscriptions, and Postmaster notices of undeliverable copies to Popular Mechanics, Box 646, New York, N.Y. 10019. Please enclose your latest address label for quickest service when writing about your subscription.

POPULAR MECHANICS IS PUBLISHED MONTHLY by The Hearst Corporation, 57th St. at 8th Ave., New York, N.Y. 10019, U.S.A. Richard E. Berlin, President; Richard E. Deems, President of Magazines; John R. Miller, Executive V-Pres. of Magazines; Raymond J. Petersen, Senior V-Pres. of Magazines; William S. Campbell, V-Pres. of Magazines; Albert A. Rachol, V-Pres. and Director of Circulation; Joseph F. Kern, V-Pres. for Popular Mechanics; Frank Massi, Executive V-Pres. and Treasurer; Harvey L. Lipton, Secy. Single copy in the United States and Canada, 50 cents. Subscription prices: United States and Possessions \$5.00 for one year; \$9.00 for two years; \$12.00 for three years. Canada, add \$2.00 for each year. All other countries, add \$4.00 for each year. When changing address, give old address as well as the new, with postal-zone number, if any, and allow six weeks for change to become effective. Second-class postage paid at New York, N.Y., and at additional mailing offices. Authorized as second-class mail by the Post Office Department, Ottawa, and for payment of postage in cash. Registered as second-class matter at the Post Office at Mexico D.F., Mexico, June 20, 1950. © 1972 by The Hearst Corporation. All rights reserved. Printed in U.S.A.

APRIL 1972

Build yourself a better drink.



CANADIAN WHISKY—A BLEND • 80 PROOF • IMPORTED BY NATIONAL DISTILLERS PRODS. CO., N. Y.

WINDSOR CANADIAN

Canada's smoothest whisky

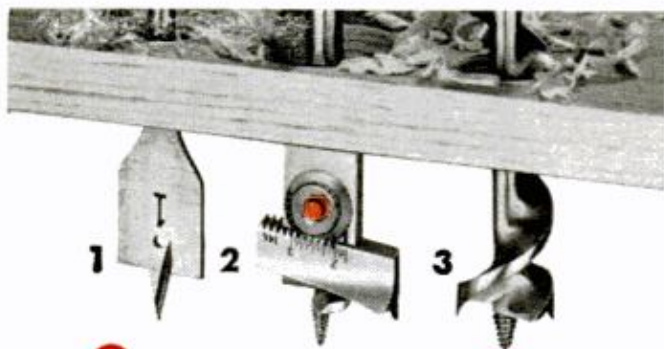

3 easy ways to bore holes faster

- 1. Irwin Speedbor "88"** for all electric drills. Bores faster in any wood at any angle. Sizes $\frac{1}{4}$ " to $\frac{5}{16}$ ", \$.90 each. $\frac{5}{8}$ " to 1", \$1.00 each. $1\frac{1}{8}$ " to $1\frac{1}{2}$ ", \$1.50 each.
 - 2. Irwin No. 22 Micro-Dial** expansive bit. Fits all hand braces. Just dial your size. Bores 35 standard holes, $\frac{7}{8}$ " to 3". Only \$5.70. No. 21 small size bores 19 standard holes, $\frac{5}{8}$ " to $1\frac{1}{4}$ ". Only \$5.00.
 - 3. Irwin 62T Solid Center** hand brace type. Only 16 turns to bore 1" holes through 1" wood. Double-cutter boring action. Sizes $\frac{1}{4}$ " to $1\frac{1}{2}$ ". As low as \$1.60 each.
- EVERY IRWIN BIT** made of high analysis tool steel, heat tempered, machine-sharpened and highly polished, too. Buy from your independent hardware, building supply or lumber dealer.

Straight-Line Chalk Line Reel Box

only \$1.35 for 50 ft. size

New and improved Irwin self-chalking design. Durable aluminum alloy box. Practically damage-proof. Fits pocket or hand. 50 ft. and 100 ft. sizes.

IRWIN every bit as good as the name

at Wilmington, Ohio 45177, since 1885



FREE H&R COLOR CATALOGS FOR HUNTERS AND FISHERMEN



Great double catalog offer for all-around sportsmen. Full-color, 44-page Harrington & Richardson Firearms Catalog features H&R sporting rifles, shotguns, revolvers plus famous Webley shotguns from Britain, an H&R exclusive. Also 44-page H&R Angler's Catalog on full line of internationally-known Hardy fly fishing rods, reels and accessories, another U.S. exclusive from H&R. Mail coupon today for your free copies.

HARRINGTON & RICHARDSON, INC.
Dept. PM472 320 Park Ave.
Worcester, Mass. 01610, U.S.A.

- Please send free copy of H&R Firearms Catalog, postage paid.
 Please send free copy of H&R Angler's Catalog, postage paid.

NAME _____
(please print)

ADDRESS _____

CITY _____

STATE _____ ZIP _____

LETTERS

TO THE EDITOR

Pioneer in tooth implants

The editors of Popular Mechanics sincerely regret that the article, Plastic teeth that 'take root' (page 82, Feb. PM), highly condensed for reasons of space, did not give adequate coverage to the pioneering work of Milton Hodosh, DMD, of the Tufts University School of Dental Medicine. As early as 1959 he published a scientific paper reporting results of the implantation of plastic teeth in four patients. He is the originator of the polymer tooth concept, and his research has been reported in numerous scientific papers.

Working with Gerald Shklar, DDS, of the Tufts University School of Dental Medicine, and Morris Povar, DVM, of Brown University, Dr. Hodosh has greatly advanced the materials technology of tooth implants. He has developed a plastic-bone mixture with a chemical composition similar to that of the natural bony substance that holds a tooth in place. By adding a foaming agent to the mixture, the researchers have made the implant's root surface more porous, permitting earlier attachment and penetration by connective tissue fibers. Their experiments also indicate that plastic implants can be used to provide increased support for extended bridgework.

In a further extension of their work, the researchers say that implants can be constructed in such a way that medications can be "sealed into" them. The medication would be absorbed very slowly by the patient's system. This method of drug therapy could be used for the administration of hormones, anticonvulsive agents, contraceptives, steroids, etc., and might well overshadow the use of transplants as replacements.

Dr. Hodosh's pioneering work has done much to advance the science of dental medicine—and we are glad to set the record straight.

No longer a carbon copy

The two-story "Box" on page 122 of *Why live in a carbon copy?* (page 118, Sept. '63 PM) was almost a copy of my house. Although my remodeling isn't quite like your "Junior Mansion," we are very pleased with the results.

We boxed in the old exposed eaves, removed the porch, installed a new window and door, added shutters, changed the corner facing boards, added a railed and

(Please turn to page 8)

"Look who's smiling now!"

Sometimes a man sets his ambitions high enough to make skeptics smile. But how often he gets the last laugh! "At the time I started studying with LaSalle, I was working as a factory clerk. Before completing the course I was transferred to cost accounting and my salary was increased by \$1800. Now, having completed the course, I'm in charge of the department and headed for the five figure bracket. LaSalle's course helped me pull myself out of a boring and ill-paid job into a position of almost unlimited opportunity."

The words in quotes come directly from one of the pleased reports that are sent to us by LaSalle graduates. LaSalle files contain many letters from men and women who have increased their earnings with the help of LaSalle training. You, too, can prepare for the career opportunity of your choice through LaSalle home study—without interfering with your present work—and by devoting only a little of your spare time.

LaSalle has been a leader in home education for more than sixty years, enrolling over 2,000,000 ambitious men and women in its many courses. You study under the supervision of LaSalle's experienced faculty. Upon satisfactory completion of your study, you receive the LaSalle diploma—a recognized and respected credential.

Mailing the LaSalle coupon below may be the first step toward preparing yourself for a better job, higher pay, and the many good things that go with success. Simply check the program in which you are most interested, and we will send you a valuable free booklet describing the opportunities in that field. There is no obligation. LaSalle, 417 S. Dearborn Street, Chicago, Illinois 60605.



© 1972 LaSalle Extension University

LA SALLE EXTENSION UNIVERSITY

A Correspondence Institution • 417 S. Dearborn Street, Dept. 76-068, Chicago, Illinois 60605

Please send me, without cost or obligation, FREE booklet and full information on the field I have checked below:

ACCOUNTING

- Complete Accounting
- Income Tax
- CPA Training
- Bookkeeping

BUSINESS MANAGEMENT

- Introduction to Business Management

DRAFTING

- Complete Drafting

REAL ESTATE

- Complete Real Estate
- Real Estate Brokerage
- Real Estate Management

DIESEL MECHANICS

- Basic Training

MUSIC INSTRUCTION

- Piano Guitar

LAW COURSES

- Bachelor of Laws Degree
- Business Law
- Insurance Law
- Claim Adjusting Law
- Law for Police Officers

No state accepts any law home study course, including LaSalle's, as sufficient education to qualify for admission to practice law.

TRAFFIC & TRANSPORTATION

- Complete Traffic Management

RESTAURANT MANAGEMENT

- Complete Executive Training

LANGUAGE INSTRUCTION

- French Spanish

COMPUTER PROGRAMMING

- Basic Training

INTERIOR DECORATING

- Complete Training

ART TRAINING

- Commercial Art
- Oil, Water Color Painting
- Complete Training

Mr.

Mrs.

Miss

Address.....

City &

State.....

HIGH SCHOOL

- High School Diploma

HOTEL/MOTEL

- Hotel Executive Training
- Motel Management

STENOTYPE

- Machine Shorthand

CAREERS FOR WOMEN

- Accounting
- Bookkeeping
- Computer Programming
- Dental Office Assistant
- Interior Decorating
- Real Estate
- Secretarial
- Stenotype

Age.....

(Circle title and please print)

Apt.No.....

Zip.....

000 3

SOLDER SEAL

LIQUID WRENCH

Liquid Wrench is the super-penetrating rust-solvent that loosens rusted nuts, bolts, screws and parts—in seconds! Safe on all metals, use it on a bulldozer or even your watch!

LAN-LIN HAND CLEANER
It melts the rust away!

TRANS-MEDIC
STOPS TRANSMISSION TROUBLES

Lan-Lin gets down deep—removes paint, grease, grime, ink!

Trans-Medic stops transmission troubles! You'll feel the difference!

RADIATOR SPECIALTY CO., CHARLOTTE, N. C. 28201

LETTERS

(Continued from page 6)



carpeted stoop and applied a little paint. Actual expense was about \$700, many hours of sweat and some few tears! I take some pride in the undertaking as I did it all myself with the help of my family only. Thanks for the inspiration!

DIXFIELD, ME. ROLAND M. DENNETT

Your letter arrived just in time for inclusion in an issue in which we're showing how to improve another series of "carbon-copy" homes. See page 134.

Fins helped the Dodges

In the January *Letters*, William Kirlin lists auto fins among "valueless changes." But having owned two 1957 Dodges and a 1959 Dodge, I found that the fins were very practical at highway speeds. They made quite a difference in handling and roadability of these cars at 70 mph.

WADENA, MINN. MERVIN SPROULS

One province too many

In the February *All Outdoors* (page 52), I came across what an American might regard as a small error but to a Canadian it is another irritating example of American ignorance of Canada and Canadians.

(Please turn to page 10)

Look for

GUNK®

when you want to clean anything!

... Like engines, power mowers, concrete driveways, parts.

There's a **GUNK** product for almost any degreasing job in factory, shop or home.

Engine Brite
Engine Cleaner. Spray it on... hose it off! "Dirt and grease wash away."

B.O.P. Small Parts Cleaner with dip basket! ... soaks parts clean.

GP cleans oil, grease, dirt from garage floors, driveways, power mowers, machinery.

GUNK LABORATORIES, 5829 W. 66, CHICAGO, ILL. 60638
Gunk Chicago Co. River Forest, Ill. Radiator Specialty Co. Charlotte, N. C.

The Great In Between Machine. For riders too big for mini's, but not ready for the heavyweights. Light, lean and hungry: the Yamaha 100cc LT-2 Enduro. With new exclusive Torque Induction.

Not too big. Not too small. The all-new LT-2 Enduro packs a lot more performance than any other 100cc production trail bike on the market. And, it's equally at home on the road, with all the stability, ease-of-handling and reliability Yamaha Enduros are famous for.

Up front, you get a set of Enduro forks that will smooth out the roughest of winding trails. Then there's the new steel alloy frame for lighter weight and greater strength. Autolube Oil Injection that mixes your gas and oil automatically. Extra-large, extra-dependable dustproof/waterproof brakes. Deep-tread tires for great traction. A simple, strong 5-speed constant-mesh gearbox. Turn signals front and rear. And, of course, the exclusive Yamaha Torque Induction.

Torque Induction.

The best thing that's happened to off-road riding since we introduced the very first dual-purpose Enduro back in 1967. Torque Induction is a high-quality stainless steel reed-valve system that delivers greater low and mid-range torque; more precise intake and exhaust; and greater fuel economy. Put it together with the most dependable 2-stroke, 100cc engine off the road, and you've got a little green bundle of dynamite charged with excitement.

It's a better machine.

All in all, the LT-2 Enduro is more trail bike for the money. The same kind of value you'll find in all the great Enduros for '72. See your nearby Yamaha dealer. He's got the in-between machine that has earned the right to be called, "great."



YAMAHA 
The great machines for '72.

Yamaha International Corporation P.O. Box 6600 Buena Park, CA 90620 

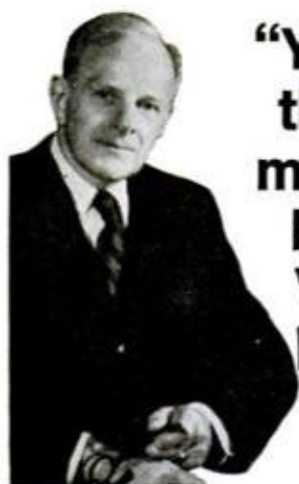

"You can have the perfect money-making business with Von Schrader Detergers"

—Francis von Schrader, President

Perfect because with Von Schrader Detergers you provide a service everybody needs: on-location cleaning of carpeting, upholstery and walls. Perfect because every home and building are potential customers—your business keeps growing.

Perfect because the equipment you use is the finest; proven to clean quickly, completely, professionally. And so easy to operate you need no special skills. (1) Von Schrader Carpet Deterger gives deep-level cleaning to carpeting; (2) Von Schrader Upholstery Deterger cleans fabrics and synthetics beautifully; (3) Von Schrader Wall Deterger cleans walls (and ceilings) five times faster than by hand.

Perfect because you can start with one Deterger. Then, as your business grows, add the other two and thus offer a complete cleaning service. Perfect because you are the boss, own your equipment, work your own hours. Perfect because there are no fees, royalties or contracts.

Perfect because your investment is so small you'll find it hard to believe. And perfect because we help you every step of the way, just as we've helped thousands of other men to financial independence for almost 40 years.

For details (without obligation) send coupon.



CARPET DETERGER

UPHOLSTERY DETERGER

WALL DETERGER

Free booklet gives you full information

Get the facts about your future in on-location cleaning. See how well Von Schrader Detergers are built, how easy they operate. Read how other Associates became financially independent, how we help you every step of the way.

Extra! Special Recorded Message from Francis von Schrader to you included.



VON SCHRADER company

1042 Place, Racine, Wisconsin 53403

Please send complete information on Von Schrader Detergers

Name _____

Address _____

City _____

State _____ Zip _____

LETTERS

(Continued from page 8)

The passage is: "Winchester Hunter's Handbook, 1972 has 100 pages of complete state and provincial game regulations, seasons and prospects for all 50 states and 11 Canadian provinces . . ."

At last count, Canada still consisted of 10 provinces and 2 territories.

VANCOUVER, B.C.

G. K. HYNEK

No center door for dog

In your February *Letters* you show a picture of a doghouse with the name *Blooper* over its door. How aptly named it is, for it is truly a blooper.

No doghouse should have a door in its center. It should be to one side. Reason? Give a dog greater space to turn around and snuggle up away from the wind. I'd also like to see a burlap curtain hung over the entrance.

ROYALTON, ILL.

C. J. MALCOLM-SMITH

One and only

In your excellent article, *Ignition timing simplified* (page 116, Feb. PM), you state that there are a number of manufacturers who produce a combination timing light, tachometer and/or dwell meter in a single case. To our knowledge, we at Orbit Laboratories are the only ones who have a portable tach, dwell and timing light instrument on the market (our 300X).

ORBIT LABORATORIES JOE SALZBURG
NEW YORK V.P. AND TREASURER

Backward space center

After visiting the Alabama Space and Rocket Center at Huntsville, we were surprised to see the whole center had been turned around in your January issue (*Space and rocket exhibit*, page 97). The picture is printed backwards.

VAN, PA.

MRS. WAYNE CHAMBERS

Yup, it is. And we checked the original photo sent to us by the center. It's backwards, too.

B-1: obsolete in the '80s?

I must take exception to several "facts" in *B-1: a flexible flyer for the '80s* (page 50D, Jan. PM). First, the R&D program "reportedly costing a bit over \$1-billion" is costing \$2.6-billion, exclusive of some of the weapons systems. Second, before it can be "loaded with the latest in electronic hardware," the hardware must be developed. Third, the range is 6000 miles, not

(Please turn to page 12)

**When it comes to toughness,
we can show you a thing or two.**



The Toyota Land Cruiser could probably sell itself sitting at a curb. It looks massive, almost indestructible. The solid steel front bumper. The skid plates underneath. The clamps that hold the hood secure. The nuts. The bolts. The cotter pins.

At a glance, you can see how it earned its reputation.

And though the Toyota Half-Ton is designed differently to do a different job, that tough Toyota quality is there, as well.

Despite its small, practical size, the Toyota Half-Ton has the same 1000-pound load capacity as bigger half-tons. And that load is supported by a rear axle with a capacity of 2390 pounds (G.A.W.R.).

Our engine is not the most powerful on the market. But it offers a lot of displacement for

the size of the truck. 1968 cc's, to be exact. So it has the ability to get a full load moving quickly. And efficiently.

Underneath the radiator, attached to the frame, is a steel splash pan designed to protect the fan and radiator from rocks and stones and other road hazards.

The bed connects to the frame at eight different points. The throttle cable is covered to help keep it lubricated and free from dust. There's a large 12 volt/60 amp. battery for campers and others who might be running a lot of accessories.

In short, our pickup is designed to withstand punishment.

And that's why the Toyota Half-Ton and the Toyota Land Cruiser have more in common than a first name.

For your nearest Toyota dealer, call 800-243-6000 toll free. (In Connecticut, 1-800-882-6500.)

LETTERS

(Continued from page 10)

10,000 (that's half as far as a B-52). If it flew at top speed for 6000 miles it would arrive in four hours, the time it would take for eight salvos of missiles. Fourth, by 1980, low flight will be matched by "look-down" radar systems that will render the plane obsolete. Fifth, the Air Force has dropped the plane's supersonic high-altitude flight.

HERSHEY, PA.

JAMES D. GRAY

Total cost of the R&D on the B-1 is \$2.6-billion. The airframe is costing "a bit over \$1-billion"; the other \$1.6-billion is for avionics, engines and flight testing.

As for range, a North American Rockwell spokesman says it's classified, but is definitely intercontinental. In 1961 the Strategic Air Command did fly a B-52 12,000 miles at high-altitude cruise (the area of optimum range for any aircraft). However, today's strategic bomber mission must be carried out at extremely low altitudes when enemy airspace is reached. The B-1's range performance at low altitude far exceeds that of the B-52. (With aerial refueling, the B-1's range is limited by the crew's endurance; missions up to 36 hours are planned.)

As for nuclear-tipped missile salvos, ICBMs are not accurate enough to hit most military targets, thus would kill millions of civilians. The B-1, on the other hand, armed with highly accurate short-range attack missiles, can pinpoint and destroy weapons of war.

The North American Rockwell spokesman states further that U.S. intelligence sources say it is highly unlikely that "look-down" radar will be developed by 1980. And, finally, the B-1 has definitely been designed to fly faster than Mach 2 at a high altitude, he says.

Make those drawers fit

The drawing on page 125 of the February issue (*A modelmaker's workshop*, page 124) has a $\frac{3}{4}$ x $\frac{3}{4}$ x 30-inch top rail spanning the front that my original cabinet did not have. Now the drawers won't fit when readers copy my cabinet.

SOMERVILLE, N.J.

RUDY KOUHOUP

We added the rail for strength—but did forget to compensate in drawer sizes. To get the drawers to fit, make the drawer schedule on page 126 read thus:

	A	B
Top drawer	1-7/16"	1-1/16"
Second drawer	2-7/16"	2-1/16"
Bottom drawers	2-13/16"	2-7/16"

These measurements give 5/16-inch clearance overall between all seven drawer fronts.

Index is a 'fine idea'

I just received my 1971 PM Index and am writing to let you know how pleased I am with this fine idea and quality product. Please continue to produce this index in the future.

NATICK, MASS.

GEORGE E. LINSKY

We're already working on the 1972 Index. Meanwhile, the 1971 Index is still

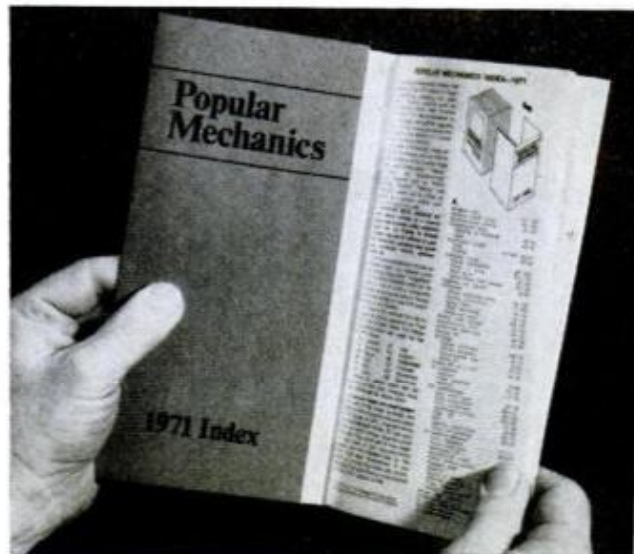

available for \$1.49 from Popular Mechanics, Dept. JL, 224 West 57th St., New York, N.Y. 10019. In all, it contains more than 5000 entries, giving references and cross-references for

every article published in PM in 1971. It comes in a handsome, heavy binder that keeps the 12 issues together on your bookshelf.

Will a footstool do?

A colonial chair you can build for \$53 (page 144, Dec. PM) is an excellent project. Would it be possible in the near future to publish an article on a colonial sofa to go with the chair?

GOBLES, MICH.

CORWIN RIFE

We don't have plans for a sofa yet, but we will be publishing a matching footstool in the summer—probably July. ★★★

POPULAR MECHANICS

the key—

to your future!

SOLVE THESE PROBLEMS FOREVER:



WAGE FREEZE!
AUTOMATION!
INFLATION!
RECESSION!
LOW WAGES!
EXTRA MONEY!
TOO OLD!
RETIREMENT INCOME!

BEA LOCKSMITH



ORVILLE PIERCE
(LaPuente, Calif.)
"While in training I earned \$200 and I now have a mobile unit which I operate in my spare time . . . enjoyed the course and think it was the best instruction one can get in this field."



HORACE H. ALBRIGHT
(Brookhaven, Miss.)
". . . average about \$4.00 per hour. I think the whole course was the greatest, the best instructor and when I retire . . . am going to do locksmith work full time. Thank you."



W. M. RAGDALE
(Conyers, Ga.) "I think the Locksmithing Institute is doing a fine job training people for the locksmithing trade. I now do all the lock repair for the County High School, with a pleasing increase in salary."

★ **Newspaper headlines tell the story.**



Pick up a paper any day. Burglary, house-breaking, vandalized homes — no wonder America is locked up tighter than ever before. And there are more homes, more stores and factories, more hotels, more cars, and more people. And that means more keys and locks.

★ **The fast way to success . . . independence.**



From the start you get practical experience doing real jobs on car locks, home locks, padlocks, and safes. Within six months you can be on the road to complete independence of bosses, low wages, layoffs, small retirement income. Don't you owe it to yourself to get the facts today? The card below won't even cost you postage. No salesman will call. You and you alone can make your decision based on the straight-forward facts you will receive.

★ **Earn as much as \$10 an hour—or more.**



Today a trained locksmith can just about write his own ticket. Earn as much as he wants to work. Earn in his spare time, in a business of his own, or in a highly-paid position with someone else. Earn in almost any part of the country he wishes to live.

★ **Learn at home—earn as you learn.**



Let Locksmithing Institute show you absolutely free how you can qualify for this exciting, action field. The information card below will bring you full details about the fast, easy course that trains you by "doing" for this highly-paid profession. See how you can learn at home, in your spare time, even while you hold down your present job. See how the key-making machine and complete set of tools included with the course can put you in business earning money right while you are learning.

LOCKSMITHING INSTITUTE

TECHNICAL HOME STUDY SCHOOLS, Little Falls, New Jersey 07424
LICENSED BY STATE OF NEW JERSEY, ACCREDITED MEMBER NATIONAL HOME STUDY COUNCIL.
STATE APPROVED DIPLOMA. APPROVED FOR VETERANS TRAINING.

↓ CUT OUT. Ready to Mail Coupon Below. ↓

YES, send me free information on opportunities in Locksmithing

Mail me sample lesson pages, details of the critical need for locksmiths. I understand there is no obligation on my part and no salesman will call upon me. Dept. 1110-042



Name _____
Address _____
City _____
State _____ Zip _____

Check here if eligible for Veteran's Benefits.

BUSINESS REPLY MAIL

No Postage Stamp Necessary if Mailed in the United States

POSTAGE WILL BE PAID BY

LOCKSMITHING INSTITUTE

Div. TECHNICAL HOME STUDY SCHOOLS

Little Falls, New Jersey 07424

First Class
Permit Number 137
Little Falls, N. J.



Photo Hints



Spill catcher for darkroom trays

A plastic boot tray, used to protect entryway floors from messy overshoes, is perfect for catching splashes of processing chemicals, saving your counter from spills.

—Walter E. Burton, Akron, Ohio



Handy storage case for filters

Delicate filters can be safely stored in an eyeglass case. Make padded dividers from cardboard faced with thin foam plastic.—Arthur L. Ramos, San Anselmo, Calif.

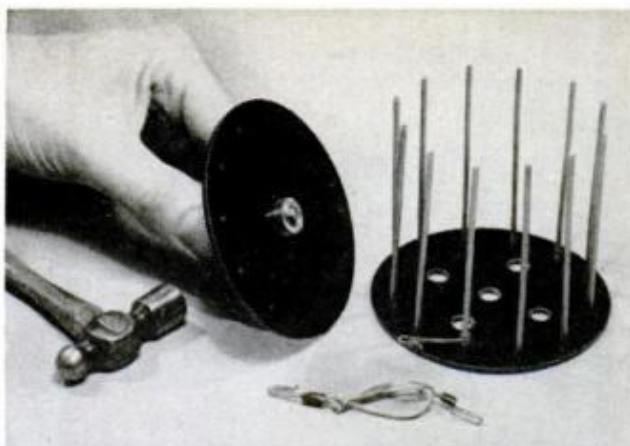
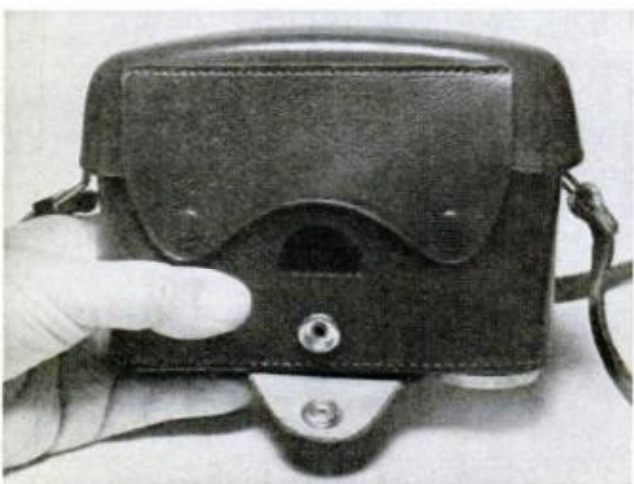

Mini-reel for developing small film

If your camera collection includes a sub-miniature pocket type using 16-mm film, you may find developing difficult without a special tank to handle such narrow strips in short lengths. An easy compromise is to make your own mini-reel to fit in a standard 35-mm tank. The one above is $3\frac{3}{8}$ inches in diameter and holds 34 inches of 16-mm film. Cut the end discs from Bakelite or similar material and the rods from $\frac{1}{8}$ -inch noncorroding wire. A short length of brass tubing or wood dowel makes a handle. The handle and rods can be cemented into holes in the discs with epoxy. Drill extra holes in the bottom disc to let developer circulate freely.

—Walter E. Burton, Akron, Ohio

Removable flap for a camera case

Some leather camera cases have a permanently riveted-on front flap that can flop around in front of the lens and be generally annoying. You can make your flap removable by drilling out the rivet and replacing it with a pull-apart snap fastener, as shown at left. Snap kits that include a handy punch tool for installing them can be found at notion counters in variety and department stores.

—Robert Hertzberg, Flushing, N. Y.

(For more Photo Hints, see page 16)

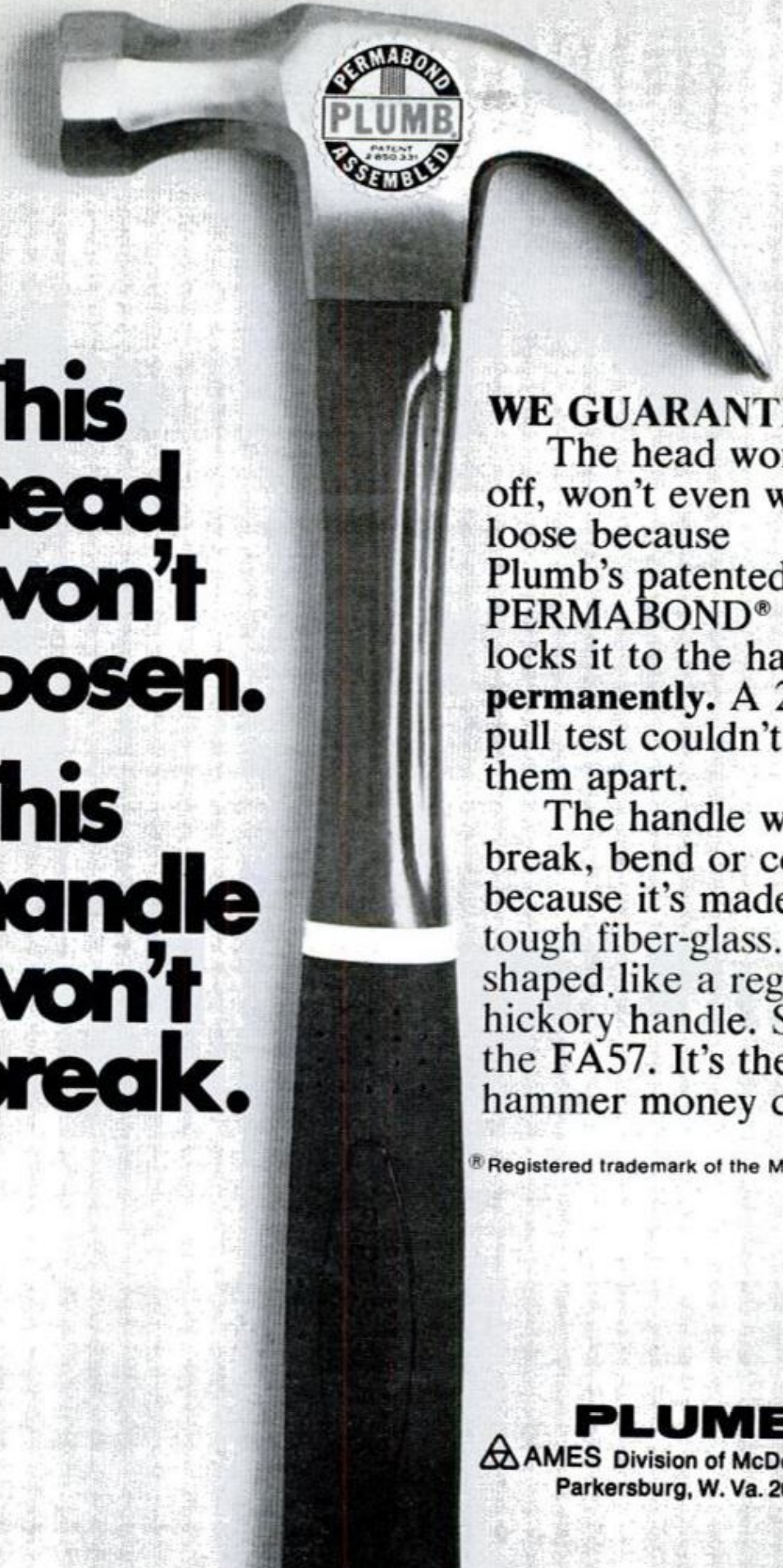

**This
head
won't
loosen.**

**This
handle
won't
break.**

WE GUARANTEE IT!

The head won't pull off, won't even work loose because Plumb's patented PERMABOND® locks it to the handle permanently. A 2-ton pull test couldn't get them apart.

The handle won't break, bend or collapse because it's made of tough fiber-glass. And shaped like a regular hickory handle. So get the FA57. It's the best hammer money can buy.

® Registered trademark of the McDonough Co.

PLUMB®
△ AMES Division of McDonough Co.
Parkersburg, W. Va. 26101

FREE! RADIO SHACK Accessories & Parts Catalog

NEW 1972 Edition!

THE buying guide for kit builders, CB'ers, installers, experimenters, fix-it men, hobbyists, electricians — anyone in electronics in any way!



Electronics A to Z—Antennas, Batteries, Capacitors, Diodes, Educational Kits, Fiber Optics, Grille Cloth, Hi-Fi Speakers, IC's, Jacks, Knobs, L-Pads, Mikes, Needles, Oscillators, P-Boxes, Quadracs, Resistors, Semiconductors, Telephones, Ultrasonic Alarms, VHF Antennas, Wire, Xenon Strobe, "Y" Adapters, Zener Diodes plus our Science Fair and Knight-Kit electronic kits!

Dept. PM-13

ALLIED RADIO SHACK
A TANDY CORPORATION COMPANY

2725 W 7th St.
Fort Worth, Texas 76107

Send me your FREE 1972 Catalog #215
Please PRINT Clearly

Name _____ Apt. # _____

Street or Rte. & Box _____

City _____

State _____ Zip



Lindal Cedar Homes. They're a natural.

Naturally beautiful, naturally easy to build, that's Lindal. By using only the finest kiln-dried Canadian cedar in more than 70 distinctive designs Lindal can assure you years of care-free beauty.

And, with parts pre-cut and numbered, erection is quick and easy wherever you build. Plus, we tailor shipping costs to meet competition anywhere.

So, whether it's chalet or bungalow let Lindal show you the natural way. Check it out for yourself. Order your colorful 36-page Plan Book today. Only \$1.

LINDAL CEDAR HOMES, Dept. PM24
10411 Empire Way S.
Seattle, Wa. 98178

Enclosed is \$1 for my Lindal Cedar Homes Plan Book.

Name _____

Address _____

City _____ State _____ Zip _____

Area Code _____ Phone _____



Lindal is represented throughout the world.

PHOTO HINTS

(Continued from page 14)

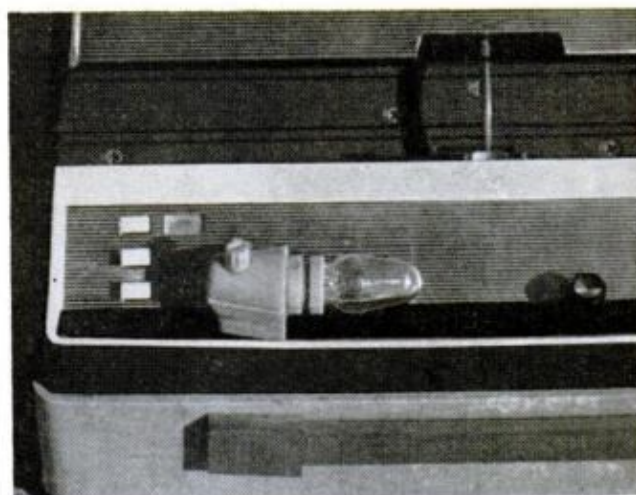

Reloading light for projectors

Many projectors have an outlet that turns on a room light when the machine is shut off so you can see to change reels or slides. However, this sudden brightness can annoy viewers accustomed to the dark. A small night light plugged into the outlet provides plenty of illumination for reloading without disturbing viewers.

—Alfred H. Honest, North Palm Beach, Fla.



Quick labels for photo chemicals

Plastic stick-on letters let you make neat, colorful labels for darkroom chemical jars. They come in punch-out sheets in various sizes and colors and are sold at stationery and office-supply stores.

—Arthur L. Ramos, San Anselmo, Calif.

'Instant' darkroom counter

Need extra darkroom work space? Just cover your processing trays with a strip of hardboard and you'll have a quick, temporary counter for cutting paper or other chores without having to move the trays.

3 COMPLETE FISHING OUTFITS

NATIONALLY ADVERTISED 1972 MODELS
2 LOADED TACKLE BOXES · 66 DEADLY LURES

411 Pcs.

FREE! If you order NOW!
2 LEAKPROOF FLOATING
TACKLE BOXES

3 EXPERTLY BALANCED RODS AND REELS

SMOOTH
POWERFUL

ARGOSY DIRECT DRIVE
TROLLING
REEL

6 ft. 2 section
BAMBOO ROD

EVERYTHING YOU NEED TO GO
FISHING AT ONCE

28 pc.
POPPING
LURE SET

POWER ACTION
BLACK MAGIC
FIBRE-GLASS RODS

STRONGER THAN
STEEL
OR BAMBOO

SENSATIONAL VALUE !

\$12⁹⁵
DELUXE
MODEL

MARK IV
LEVELWIND
CASTING
REEL

FISH KNIFE
with SHEATH

5 pc. DROPLINE
FISHING OUTFIT

NEW! SUPER "88"
AUTOMATIC
DUAL DRAG
SPINCAST
REEL

DIP NET

PUSH BUTTON
CASTING
ANTI REVERSE
NO BACKLASH

4 FAMOUS
TROUT FLIES

NEW

50 NATURAL BAIT LURES
SURE SHOT ACTION WITH SHRIMP,
MINNOWS, GRASSHOPPERS, MAYFLIES,
BUMBLEBEES, CRICKETS, LEECHES

STAR DRAG
found only
on best reels

EACH ROD
BALANCED TO PERFECTION

CRAFTY LURES
SELECTED FROM
WORLD'S MOST POPULAR
ALL TIME FAVORITES

FIELD TESTED LURES
Proven the Deadliest Dozen Yet

COMPLETE! NOTHING ELSE TO BUY!

SELECTED FOR YOU BY EXPERTS. This choice fish-getting tackle used by thousands throughout the United States and Canada. Each item carefully chosen—everything you need for all types of fishing. Deadly lures that are all time favorites. A veteran angler or an occasional fisherman can be proud of this precision-built kit. You can go fishing at once. Compare! You may not find a bargain like this anywhere.

LOOK! YOU GET EVERYTHING SHOWN. Super "88" Spincast Reel • Comet X3C Bait Cast Reel • Argosy Direct Drive Trolling Reel • 5 ft. 2 pc. Fiber Glass Spin Cast Rod • 4 ft. Fiber Glass Bait Cast Rod • 3 1/2 ft. Fiber Glass Trolling Rod • 6 ft. 2 section Bamboo Pole and 25 ft. Bank Line • 66 proven Deadly Lures • 5 pc. Furnished Line • 2 Floating Tackle Boxes with removable trays • Fish Knife and Sheath • 28 pc. Popping Lure Kit • Dip Net, Stringer, Split Shot, Clincher Sinkers, Snap Swivels, Assorted Hooks, Snelled Hooks, 3 Plastic Floats, 6—3 way Swivels, 6 Snaps, 12—36" Leader Strands (8# Test), and complete instructions. 411 pieces in all.

NIRESK DISCOUNT SALES, INC. CHICAGO 60606

MONEY BACK GUARANTEE!

NIRESK DISCOUNT SALES, Inc. DEPT. F2-133
CHICAGO, ILLINOIS 60606

ORDER TODAY! If you're not 100% pleased we'll
refund your full purchase price promptly.

YOU KEEP 2 FREE TACKLE BOXES REGARDLESS!
Please rush _____ 411 pcs. 3 Complete Fishing Sets

NAME _____
ADDRESS _____

CITY _____ STATE _____ ZIP _____

I enclose \$12.95 plus \$1.00 for postage & handling.
 Ship C.O.D. I will pay C.O.D. charges & postage.
Ill. Residents please add 5% sales tax

To Canada: \$14.95 including Postage & Duty

Friend or foe?



International Harvester Company, Chicago, Illinois



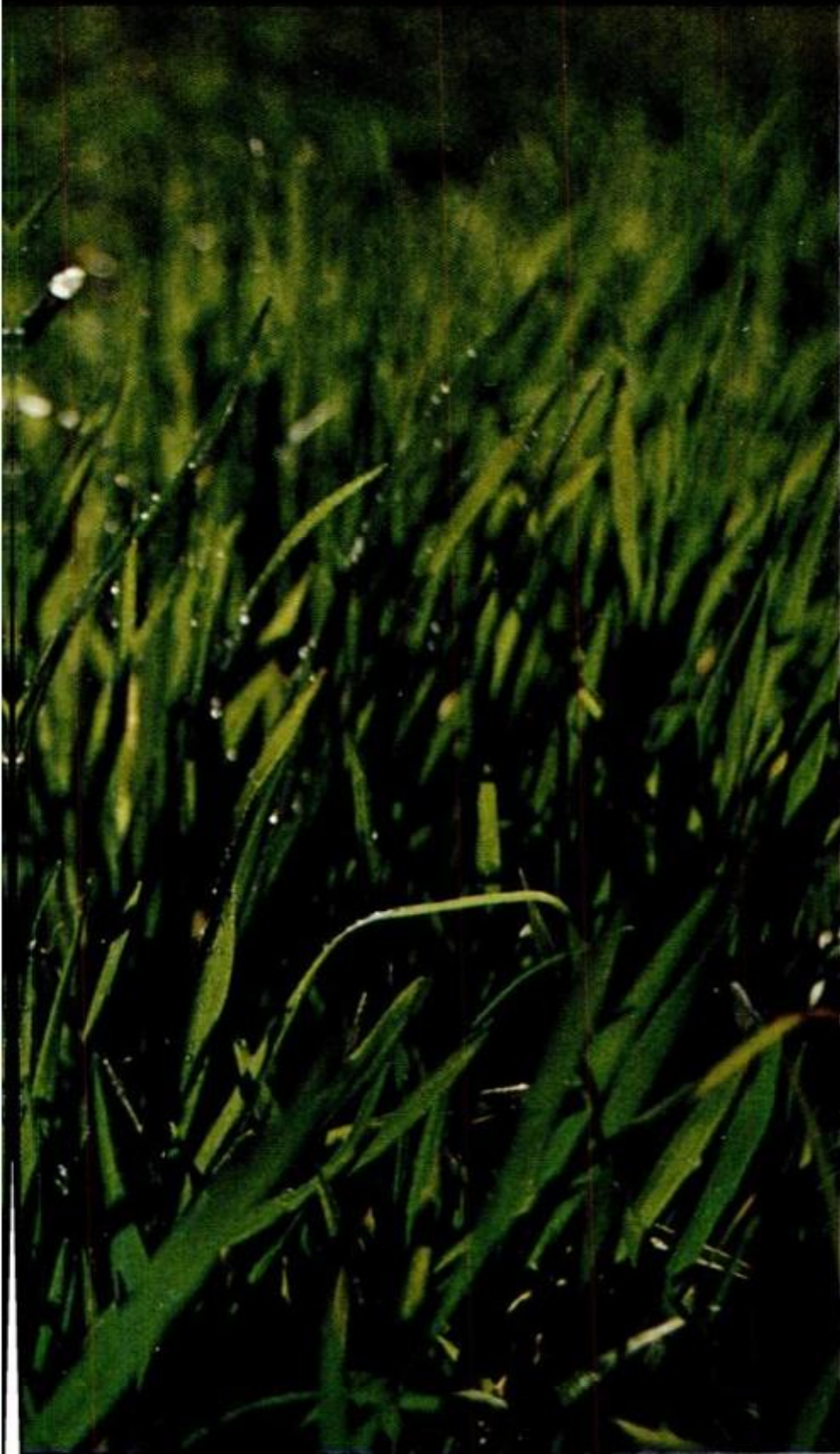

Do these lovely
green blades here
make you smile with
pleasant anticipation?

Or do they make you
want to pave
the whole back yard?

Either way, if you've
got a crop of grass
growing around your
house, chances are it
needs cutting from time
to time, and there's no
finer, faster way to
get the job done
than with a piece of
power lawn mowing
equipment from
International Harvester.
A big Cub Cadet® tractor,
possibly. A riding mower.
A walking mower.

There's one with just
the right power for you
and your grass.

Like it or not.

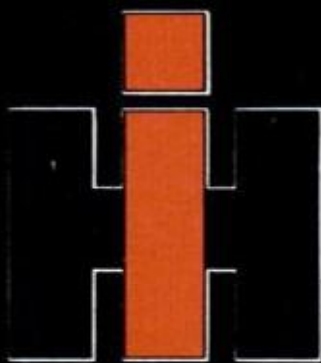

Any way you cut it.

Find the answers to 1001 workshop questions

quickly, easily with the POPULAR MECHANICS MASTER SHOP GUIDE

24 hangup boards, coated with wipe-clean plastic keep vital how-to-do-it information always at your finger tips.

Here in an easy to use, last-forever format are the answers to everything you'll ever need to know about: nails, screws, bolts, wall-fasteners, drills, abrasives, lumber, hardwoods, moldings, plywood, hardboard, gypsum, adhesives, plumbing, electrical work, floor and wall tile, glass. Facts on remodeling measurements, gutters, concrete, garden chemicals. Plus—all on one board—a ruler, protractor, 45-degree triangle, and compass for accurate circles! You'll reach for the MASTER SHOP GUIDE for every job you tackle!

What nail should you use? How many pounds will a 1/4-inch toggle bolt hold? How can you save money ordering lumber? What size quarter-rounds are available? How do you bleach close-grained hardwoods? What glue is best?

Repairs, too! Illustrations on plumbing, electrical, floor or wall tile, plastic laminates, glass, remodeling. All the basic dimensions you'll need!

By the editors of *Popular Mechanics*—order yours now—you'll use it the rest of your life!

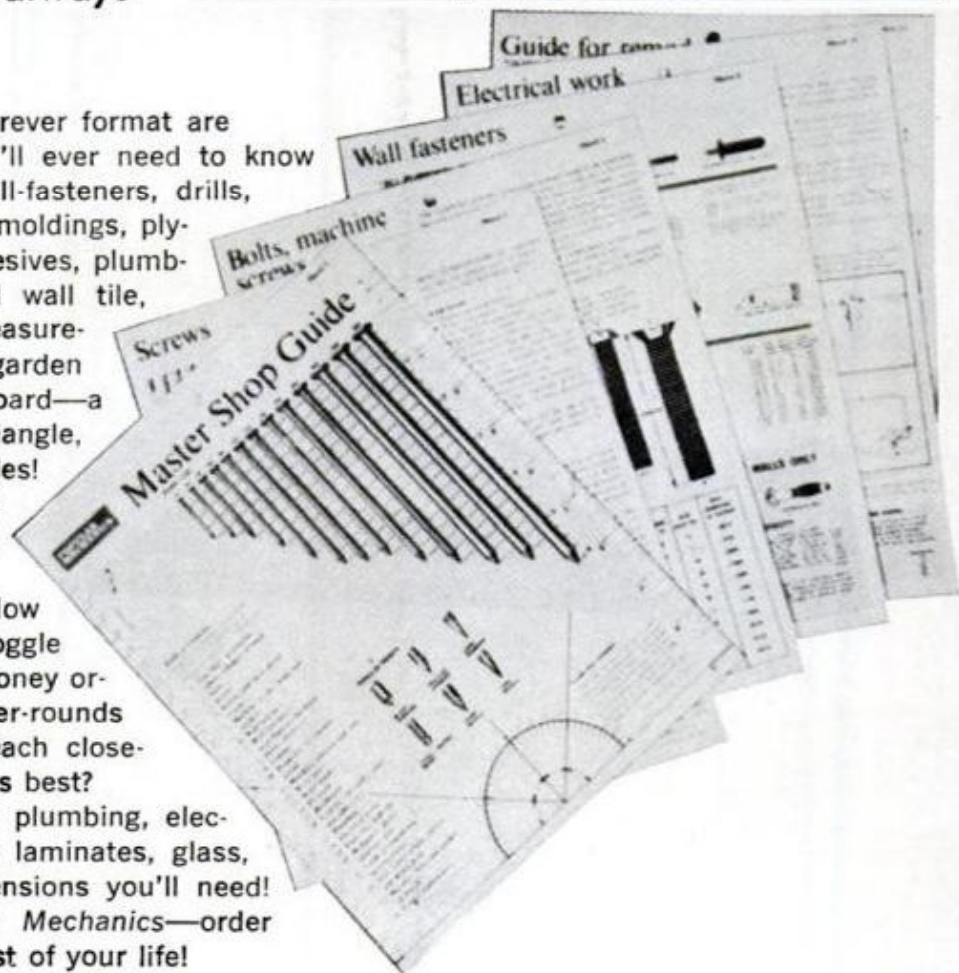
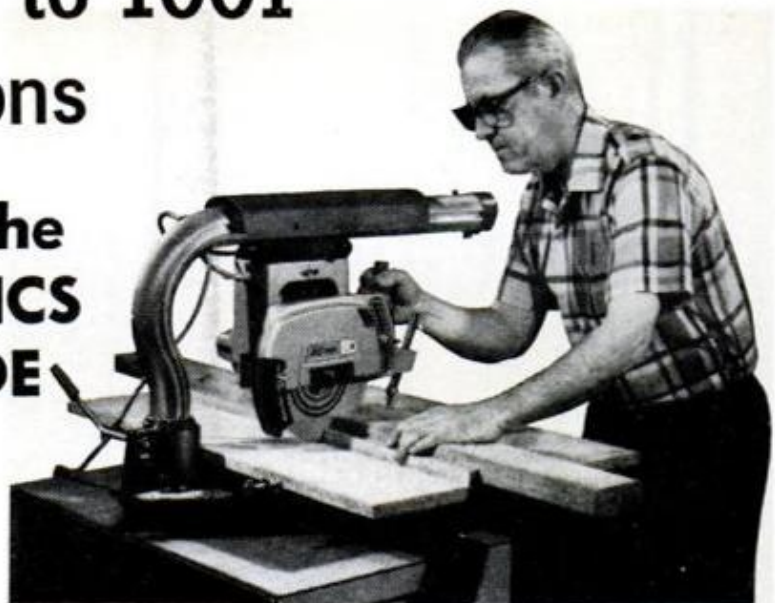

Popular Mechanics, Dept. SG
224 W. 57th St.,
New York, N.Y. 10019
Rush me _____ sets of the
MASTER SHOP GUIDE.
I enclose check or money order
for \$3.95 for each set ordered.

NAME _____

ADDRESS _____

CITY _____ STATE _____ ZIP _____

12 careers to think about. Choose one and get set for an exciting future!



Careers used to be for those who went to college. Those not so fortunate had to settle for jobs.

It's not necessarily so, today.

Take a look at the 12 careers described here—careers that should boom in the years ahead. Careers with excitement, growth, satisfaction—for those who are prepared.

ICS—the world's most experienced home study school—can help you prepare yourself in any of these 12 growth careers. With ICS you get complete thorough training in the field of your choice. Each of these programs is completely up-to-date, prepared by experts in the field. More than 8½ million men and women have enrolled with ICS...over 8,500 companies have used ICS training programs...and ICS graduates have made names for themselves in all major careers.

Here's an opportunity to learn for yourself—free and without obligation—how ICS can help you make your mark in tomorrow's world.

Just select the career that turns you on, fill in the coupon, and send it to us today.

You owe it to yourself—and to your future—to look into the career of your choice today.

International Correspondence Schools, Scranton, Pa. 18515

Accounting

Public Accounting and Industrial Accounting offer many excellent opportunities with high-income potential for the trained man or woman.

Business Management

To be a successful executive in industry or in your own business, you should be trained in many areas—accounting, law, labor relations, production controls, etc.

Computers

A marvel of the electronic age...but people are needed to make them work. Designing programs for modern computers is one of the most exciting, expanding career fields today.

Secretarial

Industry and the legal and medical professions offer exciting and rewarding careers and opportunities for high income to well-qualified secretaries.

Electrician

Qualify for any one of several jobs in this exciting, fast-moving field. There's plenty of opportunity in a wide variety of areas.

Electronics

Skilled, trained men and women are needed who can plan, design, build, install, maintain and repair the electronic machines that run the world.

TV Servicing

Learn TV and Color TV Servicing/Repair. Test and troubleshoot your own 25" (Diagonal) Motorola Quasar II Color TV training chassis.

Engineering

Prepare for a career in the basic profession, engineering. Every major area of endeavor begins with engineering...civil, mechanical, industrial, chemical and electronic.

Drafting

With ability and interest in drawing, and a technical or mechanical aptitude, you can chart your own unlimited career opportunities in the drawing field.

Auto Mechanics

There won't be any shortage of work for trained automobile mechanics in the foreseeable future! Already there is a critical lack of skilled workers!

Hotel-Motel Management

If you like traveling, meeting new people, living in exotic places, variety in your daily routine...you'll certainly enjoy a career in this exciting field.

Interior Decorating & Design

There are many rewards for you in the field of interior design. Use your skill to decorate your own home or to help your friends.

ICS...help is here.

GET THIS FREE!

1. Demonstration lesson—including sample questions, showing you exactly what it's like to learn at ICS.
2. "Turning Point"—a fascinating self-evaluation booklet, helpful in planning your future.
3. Career booklet—look at present and future prospects in the field of your choice...plus a description of the ICS Program in this field. All free—and without obligation! Send the coupon today!



Mail to ICS, Scranton, Pa. 18515

ZA126Z

Rush me free details, plus demonstration lesson, on preparing for one of these exciting careers in the comfort of my home:

Name _____ Age _____

Address _____ Apt. _____

City _____ State _____ Zip _____

- | | | |
|--|--|---|
| <input type="checkbox"/> Hotel/Motel | <input type="checkbox"/> Business Management | <input type="checkbox"/> Secretarial |
| <input type="checkbox"/> Accounting | <input type="checkbox"/> Drafting | <input type="checkbox"/> Electrician |
| <input type="checkbox"/> Engineering | <input type="checkbox"/> Electronics | <input type="checkbox"/> Interior Decorating & Design |
| <input type="checkbox"/> Computers | <input type="checkbox"/> TV Repair & Servicing | <input type="checkbox"/> Auto Mechanics |
| <input type="checkbox"/> High School (For those who would like to earn an ICS High School Diploma) | | |

Approved for Veterans for Tuition Refund.
Approved for Federally Insured Loans.
Accredited Member National Home Study Council.

It's only natural.



Only NATURAL MENTHOL...
not the artificial kind. That's what gives Salem
a taste that's never harsh or hot.
That's why Salem tastes
Springtime fresh.



0.9 mg. "tar", 1.3 mg. nicotine av. per cigarette, FTC Report AUG. '71.

© 1972 R. J. REYNOLDS TOBACCO COMPANY, WINSTON-SALEM, N. C.

SOLUTIONS FOR MECHANICAL HEADACHES

AUTOMOBILE CLINIC

BY MORT SCHULTZ

Bucking Pinto

My 1971 Pinto runs and jumps after I turn the key off. This may sound like it needs an ordinary tune-up, but I have had the car in the shop four times in the past two weeks and the mechanics have adjusted the carburetor and set the timing. I note that the carburetor is not equipped with a solenoid as is shown in my manual. The car has the 2000-cc engine with 4000 miles on it and air conditioner. Please help this sick car and tired man.—Roger Hill, Charlotte, N.C.

The fact that your car is not equipped with a solenoid is significant. This is an important part the engine should have to prevent dieseling. Improper adjustment of the carburetor and ignition timing in particular will also cause the engine to run and jump after the ignition is turned off. But without the throttle solenoid, the engine is prone to dieseling despite a perfect tune-up. Bring this to the attention of your Ford dealer. Refer him to page 68 of your Pinto Do-It-Yourself Manual or page 24-10-02 of the 1972 Ford Car Shop Manual, Volume II. If he appears argumentative, insist on talking to a factory representative and let him settle the dispute.

Chevy motor-mount problem

I own a 1965 Chevrolet and am concerned over the apparent motor-mount problem publicized recently. According to what I have read, a defective motor mount is a dangerous thing. Is there a way for an average car owner without too much mechanical ability to detect a bad motor mount?—Alfred Zebersky, Brooklyn.

I would become suspicious if I heard a loud noise when accelerating from a standing start, if there were excessive movement of the transmission control lever, or if I felt a "thump" as I backed off on the accelerator at low speed. I would immediately get the car to a shop and have the mechanic carefully lift the engine with a jack. If mount separation has occurred, it will be readily visible. The mount, of course, should be replaced.

Don't procrastinate. A bad motor mount

spells trouble. It could cause the throttle to stick. It could also allow the engine to rise far enough off the chassis to send the fan into the radiator.

High flyer

I have a 1970 Valiant Six with less than 8000 miles on the speedometer. On my first trip to the Blue Ridge Parkway the temperature of the coolant remained normal while cruising (45 mph). Upon stopping for lunch, the coolant boiled over and the temperature gauge hit the limit. This occurred everytime I stopped. Air temperature was in the 80s and the altitude was about 4000 to 6000 feet. Is this usual?—Joseph A. Lane, Durham, N.C.

I assume you're not making a common error of becoming alarmed at a high temperature reading when you stop. Your gauge should go into the red when you slow down and idle or stop. Don't worry about it and don't remove the radiator cap—that'll certainly cause the radiator to boil over. If you do much mountain driving you could equip your engine with a 22-inch, 14-quart radiator and a seven-bladed fan. Original equipment is a 10-inch, 13-quart radiator and a four-bladed fan. But before going to this expense I would look into the causes of poor coolant circulation, such as a collapsed lower radiator hose, a thermostat that is hanging up, a broken or loose water-pump impeller or a restricted radiator.

Timely tire topic

With all the glass-belted tires in use today, I'm wondering if they should be rotated, and in what order? I've received different opinions.—D. D. Waisath, Morris, Ill.

According to the Rubber Manufacturers Assn., which represents the tire industry, glass-belted tires should be rotated in the conventional manner. You will find the rotation procedure for your car in the car owner's manual.

Wrong steer

The car is a 1968 Oldsmobile Cutlass
(Please turn to page 22)

AUTOMOBILE CLINIC

(Continued from page 21)

with power steering. When I drive it over 50 mph, the steering wheel often doesn't want to turn. With some effort it suddenly moves a quarter-inch—in either direction. The trouble showed up once at 20,000 miles—again at 40,000—now at 51,000 it is doing it 40 percent of the time. Oldsmobile mechanics have lined the front end, balanced wheels, checked power-steering fluid level, mixed STP with the fluid and checked the steering column. A new belt was also put on. Help me before I kill myself.—Jack Pittman, Kansas City, Mo.

Your mechanics have only scratched the surface. Many more conditions can cause this problem. Has anyone pressure-tested the pump output? Did anyone check the power piston for wear and damage? Maybe the cause is in the steering with a binding linkage or a misadjusted cross shaft. It could also be a sticky gear spool valve, binding gear-to-column coupling, badly worn lower ball joints, or sticky pump flow-control valve. A thorough mechanic is hard to find. Keep looking.

Jittery timing light

I can't get a stationary indication with a timing light on my 1969 Pontiac with 400-cu.-in. engine and 2-bbl. carburetor. It floats as much as 20°, before and after the 9° BTDC mark. The distributor has been dismantled and rebuilt. What now?—CM. Sgt. Robert Gallik, Columbus AFB, Miss.

If timing is being done properly—specifically, if the hose from the distributor vacuum advance unit is being disconnected and plugged—then the trouble is probably in the distributor. I assume that when the unit was rebuilt it was checked for pitted and misaligned points and for proper point spring tension. A worn or loose breaker plate can cause flotation as can a worn distributor shaft or bushings which may not have been investigated. Finally, there may be excessive play in the cam gear-to-distributor gear, and the timing chain may also have too much play. Incidentally, the correct timing spec for your engine is 8° BTDC.

Shrinking seal

I have a 1970 Mercury Marquis and have just had the right-rear-wheel grease seal replaced for the fourth time. The seals hold for about 5000 miles. The dealer blames the trouble on Japanese-made seals. He says the axle and bearings are okay.—Ralph Corbin, River Falls, Wis.

Rear-wheel grease seals fail often because of worn or damaged housings—not because they are made in Japan. However, Ford has told me that severe climatic variations have caused these seals to leak because of shrinkage. A new seal has been introduced, and you should advise your dealer to see technical service bulletin 2, article 25 (10/1/71). The part number for the right-side seal is D1AZ-1177-A; for the left-side seal, D1AZ-1177-B.

Service Tips

● 1971 Dodge Colts may have a refueling problem caused by the fuel line hose being kinked between the main tank and the sub tank, or between the fuel filler neck and the sub tank. It's worth a look.

● Chevrolet makes a good point: Premature drive-belt failure may be caused not only by undertensioning, but also by use of an incorrect sequence when two belts are riding over a common pulley. On six-cylinder engines with power steering, for example, the power-steering belt rides over the Delcotron pulley. If the power-steering belt is tightened before the Delcotron belt, the result is either an overtensioned power belt or an undertensioned Delcotron belt. On a V8 with power steering and airconditioning, the airconditioner belt rides over the power steering pulley. The same trouble will occur if the airconditioner belt is tightened first.

● 1971 Oldsmobile Custom Cruiser owners are heading for trouble if the differential fluid level is checked as on other model Olds. The position of the differential housing in this car changes the checking procedure. To determine if the level is within limits, put a 90° bend into a pipe cleaner about 1½ in. from the end and insert it level into the filler plug hole. Measure from the bend down to the fluid line. It should measure no less than 5/8 in. and no more than 3/4 in. If the differential is overfilled because of a faulty checking method, you could blow the seals. ★ ★ ★

GOT A PROBLEM WITH YOUR CAR? Ask Mort about it. Send your question to Auto Clinic, Popular Mechanics, 224 West 57th St., New York, N.Y. 10019. Letters cannot be answered individually, but problems of general interest will be published in the column.

The Master Wax® shine. It survived the snows of Minnesota, the sun of Arizona, and the son of William Bailey.



What snow-melting road chemicals and blazing-hot sun do to a car's finish is nothing compared to what Bill Bailey's boy can do. Some guys baby their car. He tortures his. On dirt tracks, back roads, no roads at all. The dirt and grime he picks up are enough to tear the finish off any car. Any car not protected by Master Wax.

Master Wax protects against the worst driving conditions imaginable. Man-made, nature-made or Bailey-made. Easy-to-use Master Wax is detergent proof, too. So when he washes off the dirt he won't wash off the shine. Simoniz Master Wax has it all. The protection your car needs and the shine you want. Plus a very strong will to survive.



Simoniz® Master Wax

© 1972 Morton-Norwich Products, Inc. SIMONIZ and Master Wax are registered trademarks.

Now: A TV cartridge player you can actually buy

By JOHN PEARSON and SHELDON GALLAGER



WITH ALL THE SCRAMBLING to get television cartridge players on the market, it's probably significant that the fine old firm of Sears, Roebuck is among the first to announce one you'll soon be able to walk into a store and really buy. Starting in June, the company, which has introduced so many new products to Americans over the years, will begin distributing a complete play-your-own-TV system made especially for home use. First models will contain a 25-inch color TV and a videotape recorder/playback unit in a console, plus a small, lightweight TV camera.

With the recorder/playback unit, you can play prerecorded cartridge tapes in color and also record programs directly off the air in color. All you do is slip a cartridge into a slot on the front (center photo at right). With the accessory camera, you can make "home movies" on tape and view them on the TV screen (lower photo). These, for the moment, will be limited to black-and-white pictures.

Price for the package will be about \$1600. Later, however, Sears plans to bring out a playback-only adapter for less than half or about \$750. With this, you'll be able to play prerecorded cartridges on an existing color TV without having to buy a new set. Also coming is a color TV camera. Prerecorded cartridges will rent for \$3 to \$5, while blank tapes will be sold outright for \$13 and up. ★★★



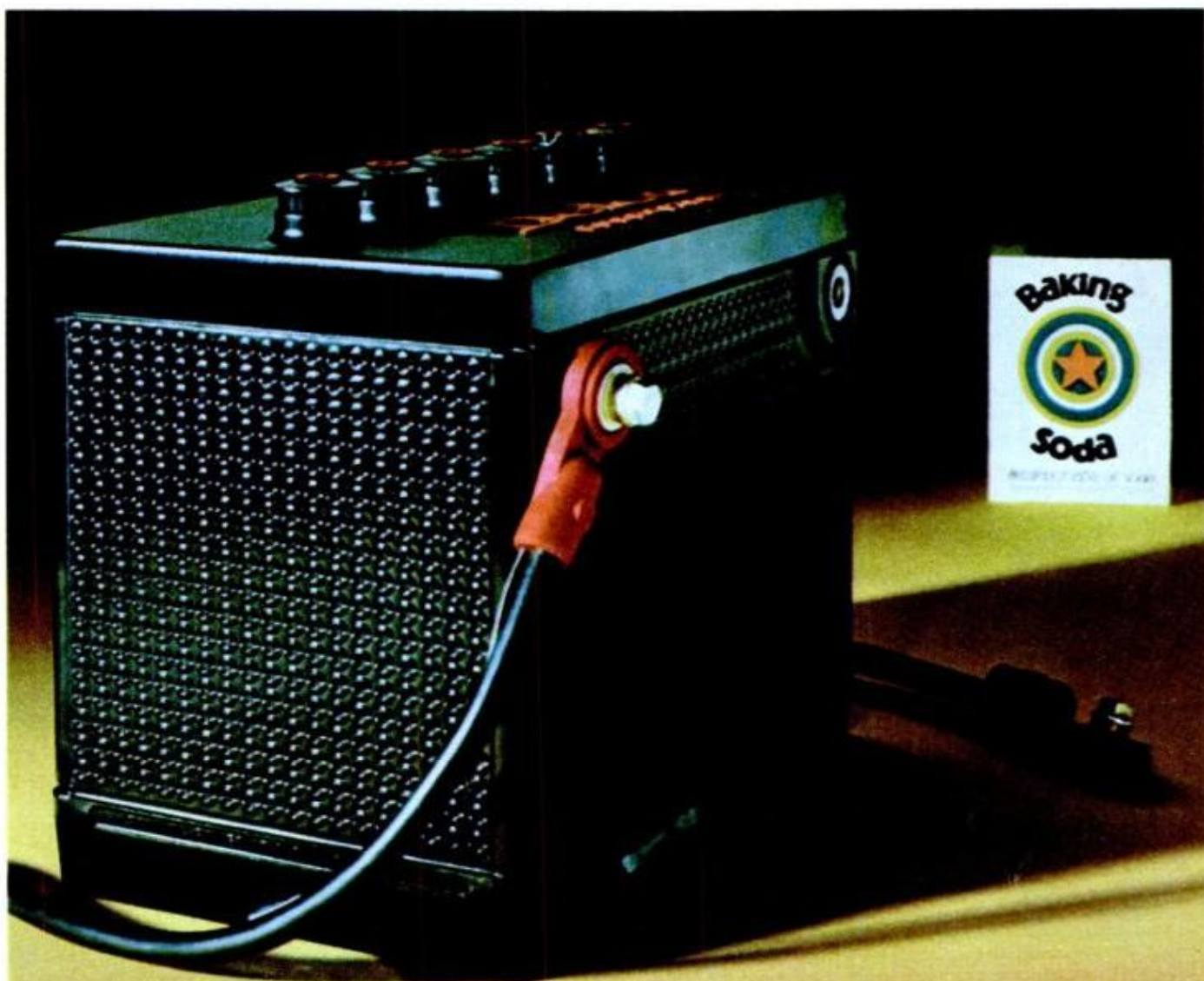

With a Delco Energizer/ST, you can leave the baking soda in the kitchen.

If you've never seen a battery that looks like this one, you've never seen a Delco Energizer/ST. The ST is unique. We moved the terminals to the side and recessed them into the casing. The cables screw right in and seal themselves. No more power-robbing corrosion. No more terminal cleaning. Anyone who works on his own car, anyone who's had a session with the baking soda sputtering, knows there are better ways to spend time.

Did someone mention power? That's what all Energizers are known for: that instantaneous burst of power

for reliable starting. Even in extremes of heat or cold. And since no corrosion can get in its way, the ST's blast of power comes through sweet and strong. Time after time.

Who's got the ST? The man at the Delco sign—there are over 100,000 outlets handling Delco batteries nationwide.

The Delco man has the ST in stock now, and he's also got the cable and connector kits to adapt current and older model cars to tomorrow's idea in batteries. Have him tell you all about the ST's tough design and construction. And get it.

The more you know,
the more you'll want Delco.





I'd like to give this to my fellow men... while I am still able to help!

I was young once, as you may be—today I am older. Not too old to enjoy the fruits of my work, but older in the sense of being wiser. And once I was poor, desperately poor. Today almost any man can stretch his income to make ends meet. Today, there are few who hunger for bread and shelter. But in my youth I knew the pinch of poverty; the emptiness of hunger; the cold stare of the creditor who would not take excuses for money. Today, all that is past. And behind my city house, my

summer home, my Cadillacs, my winter-long vacations and my sense of independence—behind all the wealth of cash and deep inner satisfaction that I enjoy—there is one simple secret. It is this secret that I would like to impart to you. If you are satisfied with a humdrum life of service to another master, turn this page now—read no more. If you are interested in a fuller life, free from bosses, free from worries, free from fears, read further. This message may be meant for you.

By Victor B. Mason

I am printing my message in a magazine. It may come to the attention of thousands of eyes. But of all those thousands, only a few will have the vision to understand. Many may read; but of a thousand only you may have the intuition, the sensitivity, to understand that what I am writing may be intended for you—may be the tide that shapes your destiny, which, taken at the crest, carries you to levels of independence beyond the dreams of avarice.

Don't misunderstand me. There is no mysticism in this. I am not speaking of occult things, of innumerable laws of nature that will sweep you to success without effort on your part. That sort of talk is *rubbish!* And anyone who tries to tell you that you can *think* your way to riches without effort is a false friend. I am too much of a realist for that. And I hope you are.

I hope you are the kind of man—if you have read this far—who knows that anything worthwhile has to be *earned!* I hope you have learned that there is no reward without effort. If you have learned this, then you may be ready to take the next step in the development of your karma—you may be ready to learn and use the secret I have to impart.

I Have All The Money I Need

In my own life I have gone beyond the need of money. I have it. I have gone beyond the need of gain. I have two businesses that pay me an income well above any amount I have need for. And, in addition, I have the satisfaction—the deep satisfaction—of knowing that I have put more than three hundred other men in businesses of their own. Since I have no need for money, the greatest satisfaction I get from life is sharing my secret of personal independence with others—seeing them achieve the same heights of happiness that have come into my own life.

Please don't misunderstand this statement. I am not a philanthropist. I believe that charity is something that no proud man will accept. I have never seen a man who was worth his salt who would accept something for nothing. I have never met a highly successful man whom the world respected who did not sacrifice something to

gain his position. And, unless you are willing to make at least half the effort, I'm not interested in giving you a "leg up" to the achievement of your goal. Frankly, I'm going to charge you something for the secret I give you. Not a lot—but enough to make me believe that you are a little above the fellows who merely "wish" for success and are not willing to sacrifice something to get it.

A Fascinating and Peculiar Business

I have a business that is peculiar—one of my businesses. The unusual thing about it is that it is needed in every little community throughout this country. But it is a business that will never be invaded by the "big fellows." It has to be handled on a local basis. No giant octopus can ever gobble up the whole thing. No big combine is ever going to destroy it. It is essentially a "one man" business that can be operated without outside help. It is a business that is good summer and winter. It is a business that is growing each year. And, it is a business that can be started on an investment so small that it is within the reach of anyone who has a television set. But it has nothing to do with television.

This business has another peculiarity. It can be started at home in spare time. No risk to present job. No risk to present income. And no need to let anyone else know you are "on your own." It can be run as a spare time business for extra money. Or, as it grows to the point where it is paying more than your present salary, it can be expanded into a full time business—overnight. It can give you a sense of personal independence that will free you forever from the fear of lay-off, loss of job, depressions, or economic reverses.

Are You Mechanically Inclined?

While the operation of this business is partly automatic, it won't run itself. If you are to use it as a stepping stone to independence, you must be able to work with your hands, use such tools as hammer and screw driver, and enjoy getting into a pair of blue jeans and rolling up your sleeves. But two hours a day of manual work will keep your "factory" running 24 hours turning out a product that has a steady and

ready sale in every community. A half dollar spent for raw materials can bring you six dollars in cash—six times a day.

In this message I'm not going to try to tell you the entire story. There is not enough space on this page. And, I am not going to ask you to spend a penny now to learn the secret. I'll send you all the information, free. If you are interested in becoming independent, in becoming your own boss, in knowing the sweet fruits of success as I know them, send me your name. That's all. Just your name. I won't ask you for a penny. I'll send you all the information about one of the most fascinating businesses you can imagine. With these facts, you will make your own investigation. You will check up on conditions in your neighborhood. You will weigh and analyze the whole proposition. Then, and then only, if you decide to take the next step, I'll allow you to invest \$15.00. And even then, if you decide that your fifteen dollars has been badly invested I'll return it to you. Don't hesitate to send your name. I have no salesmen. I will merely write you a long letter and send you complete facts about the business I have found to be so successful. After that, you make the decisions.

Does Happiness Hang on Your Decision?

Don't put this off. It may be a coincidence that you are reading these words right now. Or, it may be a matter that is more deeply connected with your destiny than either of us can say. There is only one thing certain: If you have read this far you are interested in the kind of independence I enjoy. And if that is true, then you must take the next step. No coupon on this advertisement. If you don't think enough of your future happiness and prosperity to write your name on a postcard and mail it to me, forget the whole thing. But if you think there is a destiny that shapes men's lives, send your name now. What I send you may convince you of the truth of this proverb. And what I send you will not cost a penny, now or at any other time.

VICTOR B. MASON
1512 Jarvis Ave., Suite M-2-BD
CHICAGO, ILLINOIS 60626

POPULAR MECHANICS

FREE

world's largest electronic kit catalog

Save on over 350 kits you can build

COLOR TV — Low cost tube-type and incomparable solid-state models. From 14 through 25-in. all with exclusive Heathkit built-in self-service capability. All cabinet styles, including new "hide-away" Custom Wall Mount kit.

HOME APPLIANCES — The new Heathkit "Minimizer" Waste Compactor joins the popular Microwave Oven in the kitchen. Both offer all the features of fine assembled appliances plus, since you build them, you can perform normal service and maintenance. Other kits for the home include clock radios, wireless and conventional intercoms, home protection systems and garage door openers.

TRAIL BIKES — For exciting off-the-road transportation, choose either the economical Heathkit Boonie Bike or the bold, beautiful Hilltopper. Accessories include lighting kits, automotive bumper carrier, front-wheel snow ski.

AUTOMOTIVE — A cost-saving lineup of auto accessories and tune-up kits, includes 2-way radio, siren, cab-to-camper intercom, battery charger, timing light, tune-up meter, ignition analyzer, tachometer.

PORTABLE RADIOS & PHONOS — Three portable phonos to choose from, including a Stereo/AM Radio Phono combination. Four portable solid-state radios from a simple AM kit to a 10-band AM/FM/Shortwave receiver.

TEST INSTRUMENTS — For the home hobbyist or the professional technician at substantial savings. Everything from famous Heathkit oscilloscopes and meters through vector-monitors and color bar generators. And there's sophisticated scientific equipment for educational and industrial labs.

SHORTWAVE & HAM RADIO — For the listener, Heath has a brand new solid-state SWL receiver. For the radio amateur, there's the complete line of Heathkit receivers, transmitters, transceivers, novice rigs and accessories.

FISHING & BOATING — The new Heathkit Thermo Spotter lets anglers find the specific water temperature level where trophy fish feed. The new Digital Depth Sounder reading to 199 ft., costs about half the price of other units. In addition there are Heathkit flasher-type depth sounders and fish spotters, power inverters, hailers, VHF phones, etc.

STEREO — The new Heathkit AR-1500 stereo receiver experts hail as the most sensitive and powerful, heads up a complete line of receivers, amplifiers, tuners, turntables and speakers in every price range, 4-channel and tape components, too.



More than 350 products with build-it, service-it savings.

All Heathkit products are designed around quality components... your assurance of outstanding performance, long, reliable service. And the famous Heathkit manual makes the most complex kit a simple check-by-step project. But it doesn't stop there. You're given the information you need to get your kit operating at peak efficiency, and keep it that way. (If you know someone who owns a Heathkit color TV, take a close look at that picture). Should the need arise,

technicians at every Heathkit Electronics Center, the Technical Correspondence Department here in Benton Harbor, and the new Heathkit "Plain Language" Warranty stand behind your purchase. Clip and use the coupon below to order your free 1972 Heathkit Catalog. Discover the creative fun, satisfaction, and pride of achievement that Heathkit building brings... and save yourself a bundle in the bargain. We won't let you fail.

Visit your local Heathkit Electronic Center...or send for your FREE Catalog.

HEATHKIT ELECTRONICS CENTERS

ARIZ.: Phoenix, 2727 W. Indian School Rd.; **CALIF.:** Anaheim, 330 E. Ball Rd.; El Cerrito, 6000 Potrero Ave.; Los Angeles, 2309 S. Flower St.; Redwood City, 2001 Middlefield Rd.; San Diego (La Mesa), 8363 Center Dr.; Woodland Hills, 22504 Ventura Blvd.; **COLO.:** Denver, 5940 W. 38th Ave.; **FLA.:** Miami (Hialeah), 4705 W. 16th Ave.; **GA.:** Atlanta, 5285 Roswell Rd.; **ILL.:** Chicago, 3462-66 W. Devon Ave.; Downers Grove, 224 Ogden Ave.; **KANSAS:** Kansas City (Mission), 5960 Lamar Ave.; **MD.:** Rockville, 5542 Nicholson Lane; **MASS.:** Boston (Wellesley), 165 Worcester St.; **MICH.:** Detroit, 18645 W. Eight Mile Rd. & 18149 E. Eight Mile Rd.; **MINN.:** Minneapolis (Hopkins), 101 Shady Oak Rd.; **MO.:** St. Louis, 9296 Gravois Ave.; **N.J.:** Fair Lawn, 35-07 Broadway (Rte. 4); **N.Y.:** Buffalo (Amherst), 3476 Sheridan Dr.; New York, 35 W. 45th St.; Jericho, L.I., 15 Jericho Turnpike; Rochester, Long Ridge Plaza; **OHIO:** Cincinnati (Woodlawn), 10133 Springfield Pike; Cleveland, 5444 Pearl Rd.; **PA.:** Philadelphia, 6318 Roosevelt Blvd.; Pittsburgh, 3482 Wm. Penn Hwy.; **TEXAS:** Dallas, 2715 Ross Ave.; Houston, 3705 Westheimer; **WASH.:** Seattle, 2221 Third Ave.; **WIS.:** Milwaukee, 5215 Fond du Lac.

HEATHKIT

Schlumberger

HEATH COMPANY, Dept. 17-4
Benton Harbor, Michigan 49022

Please send FREE Heathkit Catalog.

Name _____

Address _____

City _____ State _____ Zip _____

Prices & specifications subject to change without notice.

*Mail order prices; F.O.B. factory. CL-426

Drivin' with Dan

Who do you think will be this year's Can-Am champ? How did the '72 Eagle do in tests at Ontario? Can 18-year-olds do any professional road racing? Dan Gurney answers these and other automotive questions

Q. *What personal street cars do you own that you paid for yourself—actually paid hard, cold cash? Don't count those that were gifts or prizes!—Felix Rivera, Bayamon, Puerto Rico.*

A. A Ford Pinto two-liter. Red with mag wheels. My wife Evi drives it and likes it very much. I usually drive one of AAR's Chevy pickups or ride my Harley, Norton or Yamaha when weather permits.

We've been experimenting with bikes at AAR recently. One of them is shown below.

Q. *Where would you put your money if betting on one winner of this year's Can-Am series: On Donohue and Porsche? Or on Stewart and McLaren?—George Tsongas, Portland, Ore.*

A. Stewart and McLaren. Where would you put yours? There's more on this subject in Bill Hartford's cover story, '72 Road-racing preview, starting on page 75. Sounds as if he's rooting for Donohue!

I'd like to make an Eagle for Can-Am, but we are just too busy with Indy cars at this time.

Q. *How much horsepower does the Turbo-Offy and Turbo-Ford put out? Why is it that neither engine (without turbochargers and exotic fuels) is used in Formula 1 and other types of racing besides championship and dirt-track cars? Have there been any books written on your life, and if so what are they? How many Formula 1 races did you win and in what years, cars and engines?—P. Johnson, Paradise, Pa.*

A. Between 800 and 850 hp for a very good one. They are too large for Formula 1. No books, yet. I won seven Formula 1 events. One in 2.5-liter BRM four-

cylinder, two in a Porsche 1.5-liter eight-cylinder, two in a Brabham 1.5-liter V8 Coventry Climax, and two in an Eagle with a three-liter, Twelve Gurney-Weslake engine.

Q. *I've heard that last December, Dan, you spent some time at Ontario Motor Speedway testing your new championship car. Did you drive it? Can you tell me how it performed, what you feel are the car's strengths and weaknesses and how driver Bobby Unser reacted to it?—Paul Anderson, Dayton, Ohio.*

A. No, I didn't drive. I feel that it performed very well in that it bumped the record 186.7 mph up to 190.2 mph. Bobby Unser did the driving, and he says that it is the best car he has ever driven. I cannot talk about strengths and weaknesses. We do not know how fast the opposition will be able to go this year, so we are continuing our quest for

(Please turn to page 28E)

DAN RIDES FOR RELAXATION, but All American Racers has also been experimenting with motorcycles for racing, mainly working on frames for a flat-track racer. Bikes they're working with are Yamaha 750s; this one is ready to scramble!



Spend a milder moment with Raleigh.

Highest quality tobaccos—specially softened for milder taste.



You'll enjoy a day in the backwoods more if you take along an Igloo Cooler Chest like his. You can get one for free Raleigh Coupons, the valuable extra on every pack of Raleigh.

To see over 1000 other practical and valuable gifts, write for your free Gift Catalog: Box 12, Louisville, Ky. 40201.



Filter Kings, 17 mg. "tar," 1.2 mg. nicotine; Longs, 18 mg. "tar," 1.3 mg. nicotine, av. per cigarette, FTC Report Aug. '71

© 1972 BROWN & WILLIAMSON TOBACCO CORP.

**Automotive Authority
Tom McCahill says...**

"A test drive in the new MIDAS Mini convinced me.... It's a real machine... unbelievable handling characteristics... responsive, maneuverable... solid automotive worthiness... a spirited performer... comfort for the road at its best."



Tom McCahill

Automotive test writer

TEST DRIVE **the MIDAS MINI**

You may be the winner!

Here's your opportunity to try America's greatest get-away machine. This is your invitation to TEST DRIVE the MIDAS Mini.

A perfect blend of the finest RV craftsmanship and automotive engineering, the MIDAS Mini features unexcelled livability and roadability.

Easy handling and comfortable living are yours with a MIDAS Mini.

We're so confident that you'll like this new mini motor home that we're offering you a chance to test drive it and an opportunity to win a MIDAS Mini of your own.

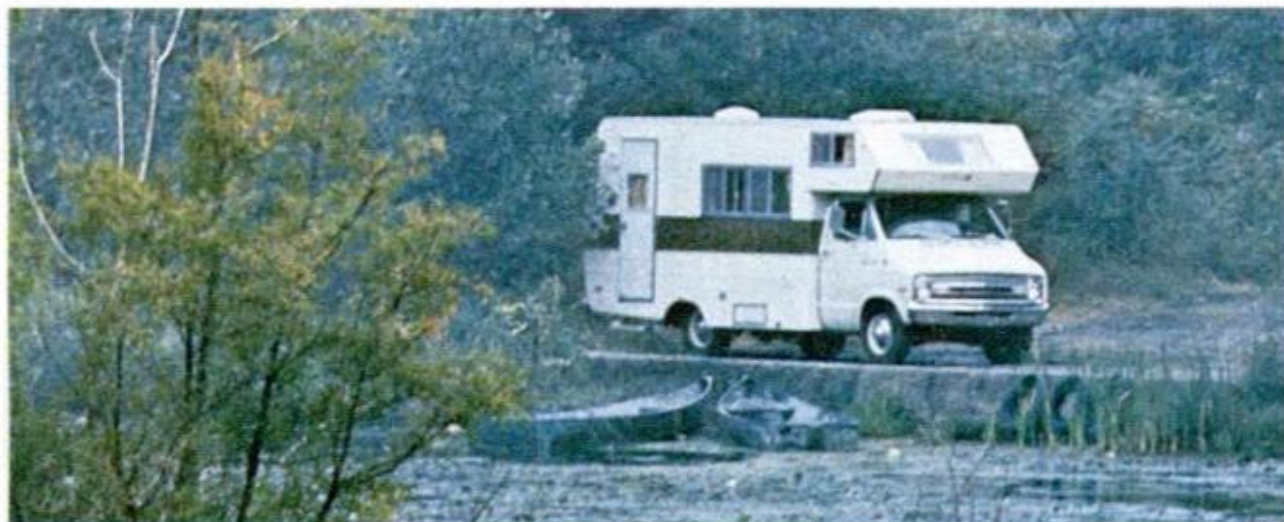

MIDAS Mini National Test Drive Sweepstakes Official Rules

1. Enter as often as you like at your participating MIDAS Mini-Home Dealer on an official entry blank or reasonable facsimile, or mail to your nearest participating dealer.
2. Winners will be determined by a random drawing. Decision of the independent judges will be final.
3. Sweepstakes are open to all licensed drivers of the United States, except the employees of Midas-International Corporation,

their dependents, agents, jobbers, dealers and their employees.
VOID in Maine, Massachusetts, Missouri, Virginia, Washington, Georgia, Maryland and Wisconsin and wherever prohibited by law. All federal, state and local laws and regulations apply.
4. No purchase is necessary. All prizes will be awarded. Prizes are non-transferable and non-redeemable for cash. No substitutes are offered. The odds of

winning will be determined by the number of entries.
5. All applicable taxes are the sole responsibility of the winners.
6. First prize is a new MIDAS Mini Motorhome, standard equipped, Model 818M. Estimated retail value \$7,995.95.
Second prize will be ten Hitachi color portable television sets. Estimated retail value \$349.95.
Third prize will be one hundred Sports-

men flashlights. Estimated retail value \$3.95.
Contest begins December 5, 1971 and ends June 1, 1972. Entries must be post-marked prior to closing date. For a list of winners, send a stamped self-addressed envelope to RV Services, Dept. M818, P.O. Box 292, Marshall, Michigan 49066. Delivery of the first prize is I.O.B. Elkhart, Indiana. All other prizes will be shipped directly to the winners.

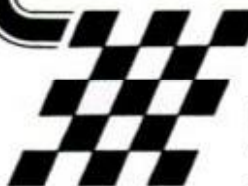

MIDAS INTERNATIONAL CORPORATION
100 WEST ADAMS STREET, CHICAGO, ILLINOIS 60603
SMOKEY / FROLIC / VOLUNTEER / MORRIS / TRAVELMASTER / KENCRAFT



MIDAS
MINI

MIDAS Mini Dealers

- Alabama**
Dothan
Camper Sales & Rentals
Montgomery
Air Flow Awning Company
of Montgomery
Phoenix City
Campers of Phoenix
Arizona
Mesa
C & L Trailer Sales
Tucson
Tradewinds Trailer Sales
California
Fylmar
Bill's Trailer Sales
Sacramento
Cost Plus Valley Trailer
Sales, Inc.
Santa Ana
Crescent Motors
Tarzana
The Trailer Show
Colorado
Lakewood
American Recreation & Mobile
Home Corporation of Colorado
Connecticut
Berlin
Mickey Finn Stores, Inc.
Delaware
Newark
Able Campers, Inc.
Florida
Brandon
Brandon Camperland, Inc.
Gulf Breeze
Squirrels, Inc.
Jacksonville
Gateway Camping Center
Lake City
Martin Campers
Melbourne
Campers Corner
Miami
Campers Paradise
North Palm Beach
Lu-Roy Mobile Home Park
& Sales
Saracota
Outdoor World
Tallahassee
James Adams, Jr.
Georgia
Augusta
Pete Rental Service, Inc.
Decatur
A & H Camper Sales
Gainesville
M & M Travel Trailers
Kennesaw
Kennesaw Campers
Savannah
Podgett Trailer Sales
Seneca
Squirrels, Inc.
Thomasville
Knapp Hardware and Sporting
Goods
Illinois
Aurora
Ed Fanning Chevrolet
Berwyn
Suburban Dodge
Big Rock
J & S Anderson Camper Sales
Bourbonnais
Berch Mobile Homes
Crystal Lake
Crystal Valley, Inc.
Danville
Lakeview Rental Sales
DuQuoin
DuQuoin Camping Center
Lincoln
Pettlow and Graue Chevrolet
Pocahontas
Davis Travel Trailers
Waukegan
Wheel Travel Camping Center
Wood Dale
Nelson Brothers International
Campers
Indiana
Elkhart
Vacationland Trailer Sales
Franklin
Vic's Camper Sales
Indianapolis
Merkin Mobile Homes
Merrillville
Campland, Inc.
Iowa
Des Moines
Frank's Trailer Sales
Fort Dodge
Morrissey Olds & Cadillac
Mt. Joy
Cheyenne Camping Center
Kansas
Kansas City
Jay Wolfe Motors, Inc.
Kentucky
Lexington
E-Z Living Camper Corral
Louisiana
Houma
Statewide Trailer Sales
New Orleans
Barrows, Inc.
Sulphur
C. Drost Trailer Sales
Maine
South Portland
Blomer Trailer Sales
Maryland
Baltimore
J & L Sporting Goods
Harwood
Camping World
Massachusetts
Rohoboth
Kemper Trailer Sales
Michigan
Drayton Plains
Jacobson Trailer Sales
Flushing
Travel Trailers of Flushing
Mt. Morris
Northwoods Trailer Sales, Inc.
Plymouth
H. W. Aate Sales
Southfield
General Trailer Manufacturing
Minnesota
St. Paul
Trailerland
Mississippi
Gulfport
Gulfport Trailer Sales
Jackson
S & S Apache Camping Center
Missouri
Bridgeton
Francis Chevrolet, Inc.
Festus
Buff Discount Center
St. Louis
A & E Mandle, Inc.
DBA' Belle Fontaine 66
Service
New Jersey
Bridgeton
Bridgeton Travel Trailer Center
Farmingdale
Schiffman Camper & Trailer
Sales
Hampton
Spruce Run Fuel & Trailer
Division
New York
Cheektowaga
Sharon Trailers, Inc.
Gowanda
Trudy Ford, Inc.
Kingston
Faxon's Trailer Sales
Oceanside
Adventures in Trailering
Dwaga
Roger F. Dibble, Inc.
Palmira
Vandermoen Sales, Inc.
Port Jervis
Ed Smith Chevy-Olds, Inc.
Syracuse
D & G Trailer Sales
North Carolina
Charlotte
Apache Camping Center
Clinton
Williams Motors, Inc.
Fayetteville
Howley's Cycle & Camping
Center
Hendersonville
Hunter Chevrolet
Newton
Wray Frazier Camping Center
Raleigh
Southeastern Travel Mart
Winston-Salem
Bill Plemmons, Inc.
Ohio
Amelia
Authorized Travel Trailer Sales
Columbus
Farber Motors, Inc.
Cortland
Jacobson Recreational Vehicles
Dayton
The Recreation Camper Sales
North Canton
J/F Motorhomes, Inc.
Perry
Pratt's Camper Sales
Springfield
Davidson Trailer Sales
Tolado
Whittaker Trailer Sales, Inc.
Waynesfield
Wayne Camping Trailer Sales
Pennsylvania
Bloomsburg
Hunsinger Homes, Inc.
Covington
Len's Trailer Sales
Mechanicsburg
Camping & Outdoor Equipment
Company
Rhode Island
Hopkinton
Langphere's, Inc.
South Carolina
Charleston
The Trail Center
Columbia
Tindell's Camping Center
Greenville
Pattain's, Inc.
Tennessee
Chattanooga
Best Camper Corral
Johnson City
K & L Trailer Sales
Knoxville
Knoxville Travel Trailer Center
Nashville
Melrose Camping Center, Inc.
Trenton
Jewell's Quality Homes
Texas
Dallas
Central Trailer Sales, Inc.
Houston
Alaskan Camper Sales
Jack Elliott Travel Homes
G. R. Grobbs Manufacturing,
Incorporated
San Antonio
O.K. Automotive, Inc.

Stan-Fran Recreational Vehicles
Virginia
Abington
Hughes Trailer Sales
Clintwood
Mountain Ford Sales
Fairfax
Ted Britt Ford Sales, Inc.
Richmond
Grady Trailer Sales
Washington
Seattle
Century Sales, Inc.
West Virginia
Huntington
Sater Homes, Inc.
Wisconsin
Chippewa Falls
Fox Trailer Sales
Middleton
Apache RV Center
Milwaukee
Livability, Inc.

If no dealer is listed for your area, write:

MIDAS Mini
P.O. Box 292
Marshall, Michigan 49068

DRIVIN' WITH DAN

(Continued from page 28B)

more performance both in speed and reliability. (We went back and ran 191.4 at Ontario on Jan. 16!)

Q. Have you ever tried your hand, or the seat of your pants, in radio-controlled model-car racing? How does it compare to actual racing?—John Frassi, Seaford, N.Y.

A. No, but I'd like to do it. Several of the men here at AAR are radio-control sailplane and glider enthusiasts. Radio-controlled model racing probably is very similar to real racing: You need a fine touch on controls or you'll "lose it!"

Q. Dan, a friend told me that 18-year-olds can now road race professionally in the United States. Is that right?—Nat Pennypacker, Philadelphia.

A. Partially right. What your friend is referring to is the Sports Car Club of America's new ruling that 18-year-olds can now get insurance and enroll in SCCA driver schools, with parents' consent, and be able to compete in club racing. It's a most welcome change from the previous 21-year-old requirement.

You still have to be 21 years old to compete in the professional series like the Can-Am, Trans-Am and Continental, however.

Q. I am considering buying a 1972 Ford Gran Torino. I would like your opinion on ordering "competition" suspension and "Traction-Lok" differential since 90 percent of my driving is on highways (60 to 70 mph) and very little driving over rough roads. Do you think these options will make my car more stable and safer?—John Pena, Nacogdoches, Tex.

A. I think you ought to get them; I would. You can read what owners have to say about this car in June when PM will run a Torino Owners Report.

Q. I am working on a 1965 VW chassis. I have already removed the body and cleaned off the chassis. My problem is where to mount the new motor, front or rear. I am going to mount a six-cylinder engine first to test out the suspension and steering. I will eventually use a Pontiac 389 engine (bored-out, tri-carb, etc.). If you suggest a rear-mounted engine, would you recommend a

(Please turn to page 28F)

DRIVIN' WITH DAN

(Continued from page 28E)

transaxle or modified driveshaft in a conventional drive train setup?—Dennis Erentsen, Bay Shore, N.Y.

A. I really can't give you a worthwhile opinion without more particulars, but I'll give one anyway! I'd say rear engine and a trans-axle. It seems as though your eyeballs are going to be very close to the windshield!

Q. Dan, can you tell me what to look for in the way of new and different cars at the USAC 500 milers this year?—John Austin, Cedar Rapids, Iowa.

A. I don't think you will see any really radically different designs in 1972. The new cars will be a lot faster than they were in '71, but the reasons for the speed increases won't be so apparent to the eye.

Q. I just heard that GM is finally making that recall on Chevrolets with the engine-mounts problem. Have you ever "recalled" any Eagle racing cars? If so, for what?—Vinnie Aviles, New York.

A. We have contacted all of our customers on one or two occasions with advice about checking certain weaknesses that have cropped up in our front hubs and our rear uprights. We have never been in a position to fix things free of charge. It is staggering to me to consider recalling cars by the millions. A momentous decision to say the least.

Q. Have you ever driven a go-kart? How fast? I've heard they're getting more sophisticated. Is that true? How?—Bob Emilian, New York.

A. Yes, I have. In fact I raced one down in Nassau in 1959. I ended up with a broken foot after losing it while in second place. I had started 28th.

Yes, like most other forms of racing, they have become quite sophisticated—engines, brakes, tires, wheels, chassis, seats, exhaust systems. Things have changed since the days of just four wheels, platform and engine. ★ ★ ★

If you have questions on racing, high-performance and everyday driving techniques, send them to "Drivin' with Dan," c/o Popular Mechanics, 224 West 57th St., New York, N.Y. 10019. Questions cannot be answered by individual letters. Questions on maintenance and repair should be addressed to the Auto Clinic (see page 21).



ALUMINUM JELLY™ is camp.

The camper's delight. It removes oxidation from aluminum tent poles, cookware, chairs and trailers. Everything aluminum. Brush it on, wash it off. Oxidation's gone and aluminum is clean and bright.

For sale wherever fix-it products are sold.



World's Finest Fix-It Products
Woodhill Chemical Sales Corp., Cleveland, Ohio 44128



Removing
old finishes
a
problem?

We've
got
the
product...



AVAILABLE WHERE PAINT IS SOLD

SAVOGRAN

Norwood, Massachusetts 02062

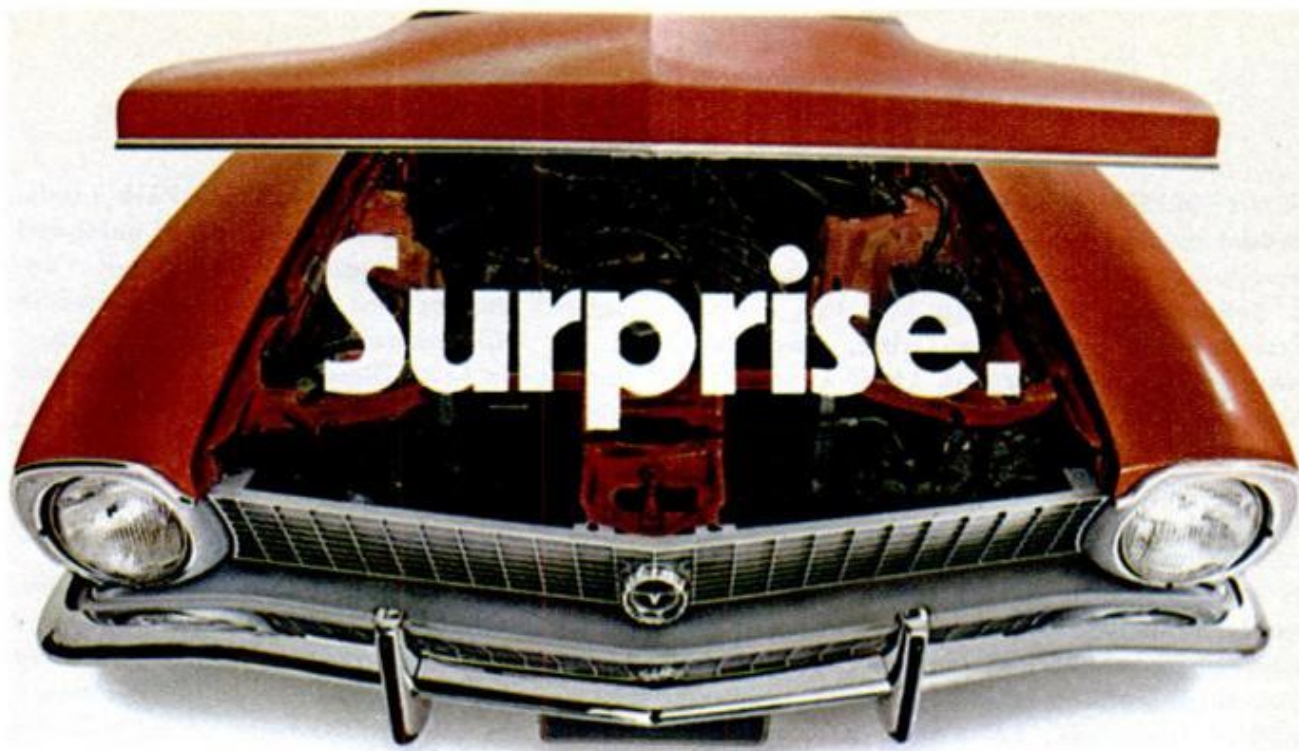

A machine famous for not breaking down.



1972 Maverick 2-door Sedan shown with optional Accent and Protection Groups, white sidewall tires and tinted glass.

Seems like most machines you buy today end up costing you more money just to keep them running. That's what makes

Ford Maverick so exceptional. Maverick is a simple, uncomplicated machine—

so there's less chance of *anything* going wrong. What's

more, a good-looking, family-sized Maverick

can be yours for surprisingly little money. Standard 6 or optional V-8. 2-door, 4-door or sporty Grabber.

FORD MAVERICK

FORD DIVISION



**If reliability
is important to you.**

ALL By BILL McKEOWN OUTDOORS

FEW SPORTSMEN recall President Grant as an ardent outdoor type in time of peace, but on March 1, 1872, he signed the act that made a Yellowstone River area into the world's first national park. John Colter, guide and trapper for the Lewis and Clark expedition, had explored this majestic wilderness region alone in 1806, and brought back tales of its mountains and canyons, hot pools and geysers that earned him a reputation as a loner and a liar. But now the National Park System is celebrating its centennial year and has grown to include 280 examples of America's natural and historical heritage. More than 100 other nations have copied our example and set aside over 1200 national parks and reserves. Chances of our park system growing or even standing pat over the next 100 years would seem to depend on outdoorsmen safeguarding what we've got.

SHOTGUN SHELL comparative tests are being conducted by Winchester, Remington and others to determine if "iron shot" (actually steel) can be substituted for the traditional lead. Waterfowl eat spent lead pellets and contract lead poisoning. Iron, on the other hand, does not seem to have the carrying power and range of lead. Use of a slightly larger iron-load shot size appears to be one answer. Shells using the iron shot are expected to be slightly more expensive than the lead-loaded shells, but sportsmen and conservationists foresee that they will eventually replace lead for all waterfowl hunting in the United States to stop waterfowl losses caused by ingested lead shot.

AIRCRAFT HUNTING has now become a Federal offense with the passage of Public Law 92-159 providing for a criminal penalty for shooting or harassing any bird, fish, or other animal from the air. The law makes exceptions for persons with permits from state or Federal governments and for those who use aircraft within state laws to protect livestock from predators. A number of states already have laws prohibiting the hunting of protected wildlife from aircraft and carrying of loaded firearms in vehicles without special permission. Motorcycles, trail bikes and snowmobiles are usually specifically included in these laws.

NATIONAL PARK FIREARMS regulations also prohibit the carrying of loaded firearms in

or out of vehicles on National Park lands. Federal law allows the transport of unloaded firearms through National Parks, but "unloaded" means no cartridge or projectile in the clip, magazine or firing chamber. Some state laws allow hunters to transport firearms in or on a vehicle with live rounds in the clip or magazine but prohibit live rounds in the firing chamber. Shooting from a vehicle or public road is often banned.

HIGH HUTS, those simple rustic structures offering primitive shelter for mountain campers and backpacking hikers, are now being considered for construction by five bureaus of the Department of the Interior. The agencies involved—the Bureau of Land Management, National Park Service, Fish and Wildlife Service, Bureau of Indian Affairs and Bureau of Reclamation—together manage more than half a billion acres of land in 48 states and Alaska. The "high huts" are fairly common in alpine areas of Europe and are usually open on one side. Department of Interior plans call for selection of sites near recreation areas, along trails and rivers in the back country, and near—but not inside—areas officially designated as wilderness, where no permanent roads or structures are permitted. Design of the huts would include use of native materials so that they would blend in well with their surroundings, be low in cost, and quickly and easily constructed. An Interior Department memorandum notes that, while the number of back-country hikers has grown enormously in the last few years, there has been no Federal program to provide more of these simple shelters.

SALTWATER SPORT FISHING is getting so big the U.S. Department of Commerce Bureau of Census recently conducted a special survey and came up with figures indicating there are 9.5 million saltwater anglers who spend an annual \$1.4 billion on their sport. Data on the number and weight of each species caught, as well as fishing method and area of fishing, are also being tabulated—assuming each fisherman gave the census taker accurate information about such mystic data as the true weight of each fish he caught and just how and where he caught it. The survey shows the greatest concentration of marine sport fishermen on the eastern seaboard with about 5 million anglers fishing the Atlantic coastal waters;

over 2 million fished the Gulf of Mexico; another 2 million plus the Pacific Coast. Average annual expenditure per man was about \$144.

THE BEST FISHING MOVIE I've ever seen and possibly the best ever made is called *The World of Sport Fishing* and is now being released nationally by Allied Artists. Watch for it. Some segments you may have originally seen on ABC television. Now fitted together by Pat Smith into a feature-length film, it shows parts of a 13-hour nonstop battle when Lee Wulff decks a world's record 597-pound bluefin tuna on 50-pound test line. Then there are other famous fishermen like Joe Brooks stalking permit off the Florida Keys, Bing Crosby landing salmon in Iceland, Jack Nicklaus taking tarpon on a flyrod, Ernest Borgnine fighting black marlin in Australia and Phil Harris rafting for trout on the Snake in Wyoming. The show turns a quiet sport into nonstop excitement.

BIG FISH FOR LAKE MICHIGAN are predicted as a result of small fry plantings of rainbow trout and king or Chinook salmon during the winter in aerated waste treatment lagoons in Illinois and Wisconsin. The system, which is reported to cost only one-fifth as much as normal stocking methods,

allows the fingerlings to grow large enough so they will not be attacked and eaten by predator perch once they are transplanted to Lake Michigan. Fish weighing 50 to 100 pounds are forecast for lakefront fishermen in the next five to seven years.

MOTOR HOMES will be converging on Eustis, Fla., this month for a rally of 1000 vehicles sponsored by the Family Motor Coach Assn. and the Dodge Recreational Vehicle Service Department. Nightly programs include a barbecue and country dancing, while servicing and maintenance seminars are to be offered during the day.

READING OF SPECIAL INTEREST for boatmen includes a recent free booklet prepared by the Michelob Beer Div. of Anheuser-Busch, St. Louis, Mo. 63118. Called *The 'Boating Bug'* it describes and diagrams boat handling and docking in helpful detail. From Dept. SS, Johnson Wax, Racine, Wis. 53403, for 50 cents is *Shipshape*, a booklet covering both seamanship and maintenance. And to scare you away from the waterfront forever, Doubleday has a new novel called *The Twelfth Mile*, by E. G. Perrault, that gives some of the best descriptions yet of the huge tidal waves named "tsunamis." ★★

Nothing by any other name is even half the same as

Spackle®



Unique — the painter's smoothing compound — first choice of the pro's — there's just one Spackle®. Works easiest, adheres to anything, dries fast, sands beautifully. Get it — and nothing but it — in the orange and blue can at paint and hardware stores.

the **muralo** company inc.

New York/Bayonne/Chicago/Los Angeles.

**EARN
HIGH
WAGES**
as a **HEAVY
EQUIPMENT
OPERATOR**



Train your way to high pay in the booming construction industry! Learn the skills you need to qualify, by actual field training on machines like the ones used by the industry. Huge training grounds in North Carolina, a million dollars worth of school-owned diesel-engined machines, experienced instructors, full 220-hour and 440-hour courses. National, the original school of heavy equipment operation, is a recognized leader. Member American Road Builders Assn., Services and Supply Division. Associate Member A.G.C. Full-time Job Advisory and Counseling Director on staff. Approved for veterans. For men ages 17 and up. Train Now-Pay Later plan . . . other payment plans also available. Write TODAY for FREE catalog and FREE copy of school newspaper reporting news of National School graduates. Accredited member National Association of Trade and Technical Schools.

NATIONAL SCHOOL Phone 704/392-1359

OF HEAVY EQUIPMENT OPERATION, Dept. D-61
P. O. Box 8529, Moores Chapel Road, Charlotte, N. C. 28208

Please send me FREE illustrated school catalog and complete information. I understand there's no obligation.

Name _____ Age _____

Address _____ Phone _____

City _____ State _____ Zip Code _____



**BUILD
THESE
BEAUTIFUL
CLOCKS**



NOW AT BIG SAVINGS!

Send just \$1 for plans & instructions to build choice of: (A) Grandfather, (B) Steeple, (C) Grandmother—plus information-packed catalog of movements, dials, parts & kits to build these & 16 other fine clocks. All 3 plans—\$2.50. Catalog alone—25¢.

MASON & SULLIVAN COMPANY
Dept. PM4, Osterville, Mass. 02655

APRIL 1972

29

For every type of yard you can think of, Huffy has thought of a mower.

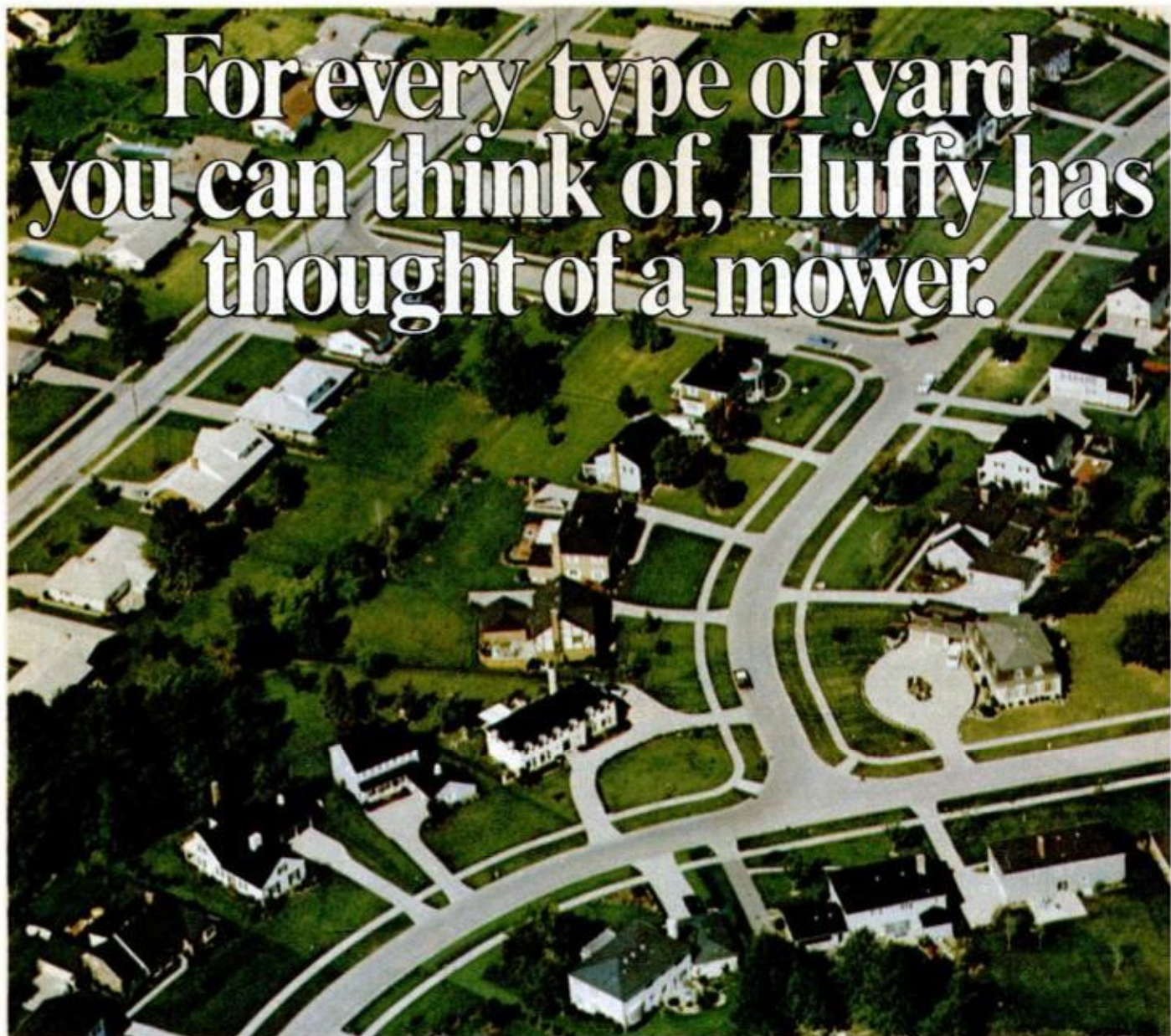

Twenty-two different models, in fact. Making the choice pretty simple, depending on what you like.

If it's economy, try the Huffy® Fairlane® push rotary mower, with a rugged steel deck, 3 horsepower engine, and easy rolling wheels.

Or take it easy with a Huffy self-propelled rotary. Like the Ranchero®, full of 3½ horses and cutting a 21-inch wide swath.

Or there's the Broadlawn® riding mower. Backed by 8 horsepower and a 26-inch cut. And it's built like all Huffy mowers. Tough. Rugged. Dependable.

To make mowing even easier and faster, take a look at the Huffy Caprice lawn tractor. With features like 8 horsepower, electric start. Cushion ride seat with shock absorber. A 32-inch cut. Pedal controls. Even a floating deck.

The point is, no matter what size or type your yard, there's a Huffy mower that's made for it. And priced for you.

You'll find them at the stores with the biggest bargains in town. Backed by over 1800 service centers. Huffman, Dayton, Ohio 45401.



Huffy mowers come in front and rear engine riders, push and self-propelled rotaries. And Huffy makes tillers, too.



If the grass looks a little greener
on our side, it is.



All Huffy mowers
carry this label.

THE BICYCLE SHOP

By EUGENE A. SLOANE

PM's newest columnist, the author of 'The Complete Book of Bicycling,' offers many valuable tips for your care of chains, freewheels and hubs

THE BICYCLE PART most exposed to dirt and grime is the chain. The one used on 10 and 15-speed derailleurs is especially vulnerable to wear because it does not have a metal dust cover.

You should clean and lubricate your chain after every long trip. If you do a lot of bicycle commuting, clean and relube it once a week. The job pays dividends in reduced wear on the chain and on parts it contacts: chain-wheel, rear-wheel gear cluster and derailleur mechanisms.

Don't try to clean and lube the chain on the bike. You'll drip kerosene and oil on the tires, which greatly shortens tire life. The chain can be properly cleaned only by agitation in a shallow pan of kerosene. (Don't use gasoline.)

Narrow, $\frac{3}{32}$ -inch derailleur chains do not have the type of master link used on conventional $\frac{1}{8}$ -inch-wide, three-speed

RIVET REMOVER is essential for working on the smaller, $\frac{3}{32}$ -inch chains used on derailleur bicycles



APRIL 1972



DERAILLEUR ARRANGEMENT shows how chain is tensioned on the freewheel gear cluster on the rear hub

bike chains. To remove a derailleur bicycle chain you will need a rivet remover (it costs about \$2). Put this chain-rivet tool on the chain so that a chain rivet is lined up with the tool. Screw the tool handle clockwise until the rivet is almost, but not quite, all the way out. *Do not push the rivet all the way out!* If you do, you will have to add another link or try to get by with one link less. (Note: do not "mix" links from other makes of chains.)

Practice with a piece of old chain until you can push the rivet out just far enough, so that when the rivet tool is removed you can take the chain apart by gently twisting the chain to one side and pulling it apart at the rivet you pushed. If you have pushed the rivet out just far enough, about $\frac{1}{64}$ th of an inch of it will be left showing on the *inside* of the link.

To reassemble the chain, simply slide the two ends of the chain together. You will feel a slight "pop" as the $\frac{1}{64}$ -in. section of the rivet slides into its link. You can then unscrew the rivet-removing tool enough to be able to put it back on the chain, lining it up with the protruding end of the rivet. Then, screw the rivet-tool handle clockwise again to force the rivet back into place. Make sure you push the rivet in only as far as the adjoining rivets. If it is pushed in too far or not far enough, it can either rub on the rear gears or pop out the next time you are straining up a steep hill.

Once the chain is back together, twist it gently from side to side to remove stiffness at the rivet and link where you took it apart. If you can't find this link, just move every link up and down until you locate the stiff one; this is important because a

(Please turn to page 32)

31

THE BICYCLE SHOP

(Continued from page 31)

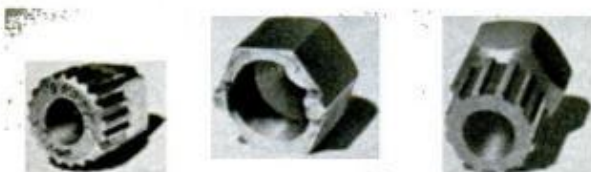

REMOVE FREEWHEEL following procedure in text. Removal tools are for Schwinn and Atom freewheels (left), for Reginas (center) and for Shimanos (right)

stiff link can cause the chain to jump off front or rear gears.

When the cleaned chain is back in place,

relubricate it with a good motorcycle chain lubricant—the type that comes in a spray can. As you slowly rotate the chain by turning the pedals, carefully spray the *inside* of the chain until all links have been lubricated. Wipe off excess lubricant with a rag. *Be careful not to get lubricant on bike tires.* Ideally, the bicycle should not be ridden for a few hours to let lubricant penetrate to all chain-link rollers.

For chain lubricant I have received excellent results with Lubriplate "Chain-lube" (a six-ounce can costs about \$2 in motorcycle shops and should lubricate your chain about 10 times).

This lubricant is a penetrating, fairly dry type I have found resists picking up dust, sand and other abrasives from the road. In my book, *The Complete Book of Bicycling*, I recommended SAE 90 viscosity rear-end oil for lubricating bike chains, and I hereby withdraw that recommendation on the basis of later experience. You have to soak a bike chain overnight in 90 viscosity oil, and this heavy oil picks up sand and dirt like a magnet.

FREEWHEELS. While the chain is off, spin the rear-wheel freewheel gear cluster to make sure it's running freely. Once

(Please turn to page 34)

Tri-Sport three wheels, a bucket seat...and thou

You and Tri-Sport and the whole outdoors. Going, baby, with the wind in your face, having fun. You can't miss. Three big bouncy tires take you over any ground. Put a ski on front and you're a snow-goer. Tri-Sport comes as you like it, too, with five great models — from a 3 hp Mini Tri-Sport to a 14 hp charger. With mini price tags. As low as \$345*. Why not send the coupon for a FREE fabulous fact-filled full color folder.



Name

Address

City

State

Zip

Alsport, Inc. 84 WHITTLESEY • NORWALK, OHIO 44857

*Price F.O.B. Norwalk, Ohio. Does not include freight, taxes, dealer preparation charges, if any. Subject to change without notice. AL-153



Now Ford gives you a choice of swinging or sliding doors.



Sales leader for 11 straight years.

Only Ford vans have so many better ideas that make vans easier to drive, to service, to use.

New Econolines now offer a choice of swinging doors or a new gliding side door



for cargo handling in cramped quarters. Three tracks, at top, bottom and center, give solid support for smooth operation.

Wider at top for built-ins. Body sides are more vertical, wider apart at top than other vans. Built-in units fit better and leave more aisle.

Shorter outside, easier to park. Compared to other makes of

similar loadspace, Econolines have significantly less overall length, for better maneuverability.



Easy, out-front servicing. Routine service points are right at hand under convenient outside hood: water, oil, battery, wiper motor, many others.

Strong, Twin-I-Beam Independent Front Suspension—Ford's exclusive design smooths the going for both load and driver.

Two forged steel I-beam axles provide strength and durability; wide wheel stance means stability in cross winds.



Engine clear forward. In Ford's clear-deck design, engine is all the way out of cargo area. Over 8½ ft. clear floor space behind driver's seat... over 10 ft. in the SuperVan. Maximum payload over two tons.



FORD ECONOLINE VANS



THE BICYCLE SHOP

(Continued from page 32)

every 500 miles or so, or once a month, the freewheel should be removed, soaked and agitated in kerosene, relubricated with a light SAE 5 viscosity oil. Heavy oil will attract dust and can also cause internal pawls to hang up so that the freewheel will spin in both directions. If it spins forward the rear wheel won't turn.

To remove your particular freewheel, you will need a tool to fit it. The three basic makes of freewheels requiring their own removing tool are Schwinn-approved and French Atom, Regina and Shimano.

1. Remove rear wheel.
2. Remove the skewer or nuts holding hub to rear drop-out.

3. If you have a Regina freewheel, insert the two teeth of the removing tool so they fit into matching recesses in the freewheel side. Reinsert the skewer or draw up wheel nuts so the freewheel tool is held snug (but loose enough so the freewheel can be backed off half a turn).

If you have a Schwinn-approved, Atom or Shimano freewheel, you will first have to remove the first locknut and all spacer washers on the freewheel side of the hub. This can be done without entirely dismantling the hub axle assembly, if you do it carefully. First put the freewheel side of the hub in a vise so that the vise holds the spacer locknut. Then put a 13, 14 or 15-centimeter thin hub wrench on the cone nut on the side *opposite* the freewheel side of the hub. Twist hub wrench on cone nut counterclockwise, and spacer locknut on the hub side should loosen.

If it doesn't, the simplest way to remove this locknut, while it's still held in the vise, is to remove the cone locknut on the hub side *opposite* the freewheel with an open end wrench, while holding the cone nut on the same side with the cone wrench so it can't turn. Then loosen the cone nut about eight or ten turns or enough to let the cone locknut on the freewheel side go far enough from the freewheel hole to slip a cone wrench on it.

At this point turn the wheel over and insert the opposite cone nut in the vise. Holding the freewheel-side cone locknut with the cone wrench so it can't move, loosen the cone spacer locknut on the freewheel side and take it off entirely. Be careful not to loosen the cone nuts so far as to permit the hub's ball bearings to roll out where they can be lost.

4. Put removing tool now on the freewheel into a vise and twist the entire wheel counterclockwise about a quarter-turn, or just enough to loosen the freewheel. Remove skewer or wheel nuts and

take the freewheel off the hub using an open-end wrench. It should come off easily.

5. When reinstalling freewheel, thread it on the hub carefully. Most good hubs are made of aluminum—far softer than the steel threads of the freewheel. It's easy to strip hub threads if you aren't careful.

HUBS. If your hub is due for lubrication, (about every 500 miles or whenever hub sounds and "feels" gritty), you can go all the way and remove one cone nut altogether. In this case, put the hub and wheel over a rag on the floor to make sure you catch all loose bearings.

1. Clean hub and bearings in kerosene.
2. Check hub races for wear, and balls for wear and cracks. Replace cracked balls with new ones; take a sample ball to a bike shop to get the right size.

3. Put a light layer of grease on both sides of hub bearing surfaces, and on balls. Insert balls in freewheel side of hub. You will have previously removed axle with cone into hub and bearings. Insert axle and cone into hub and bearings. Insert splined washer and locknut (thin one) and tighten locknut, holding the cone nut with thin cone wrench.

4. Holding the axle in place, turn the wheel over and put it in the vise so vise jaws hold locknut on the freewheel side.

5. Insert ball bearings in hub. Thread cone nut in place, tighten it by hand until snug, then back off a quarter-turn.

6. Insert washer and locknut. Hold cone nut with the thin cone wrench so it won't turn, tighten locknut with open end wrench.

7. Remove wheel from the vise and spin axle between your thumb and forefinger, and check for "binding" or rubbing. Twist axle from side to side to check for sideplay. Put tire valve at 3 o'clock position, and make sure wheel turns by weight of valve alone. If wheel binds, loosen cone locknut and cone slightly; then retighten cone locknut. If wheel has sideplay, loosen cone locknut while holding cone with wrench; tighten cone slightly, retighten cone locknut while holding cone nut as before. Wheel should be in vise, so cone locknut on freewheel side is held by vise jaws, when readjusting cone. Turn wheel over in vise and thread on freewheel and remaining spacer washer and locknut. Tighten locknut. Be sure that axle extends equally from each side of hub (about 1/4 in.).

After trying many lubricants for hubs, I've narrowed my choice to two. The first choice is Lubriplate Marine Lube "A" (at most marine supply stores) or an identical grease called Lubriplate Autolube "A" (at most auto supply shops). ★★★

**DURACELL® GIVES YOU MORE SYMPHONIES,
ROCK, FLASH PICTURES, NEWS REPORTS,
PERFECT EXPOSURES, TALK SHOWS, HOME
MOVIES AND TOY TRACTOR MILES THAN ANY
ORDINARY BATTERY IN THE WORLD.**

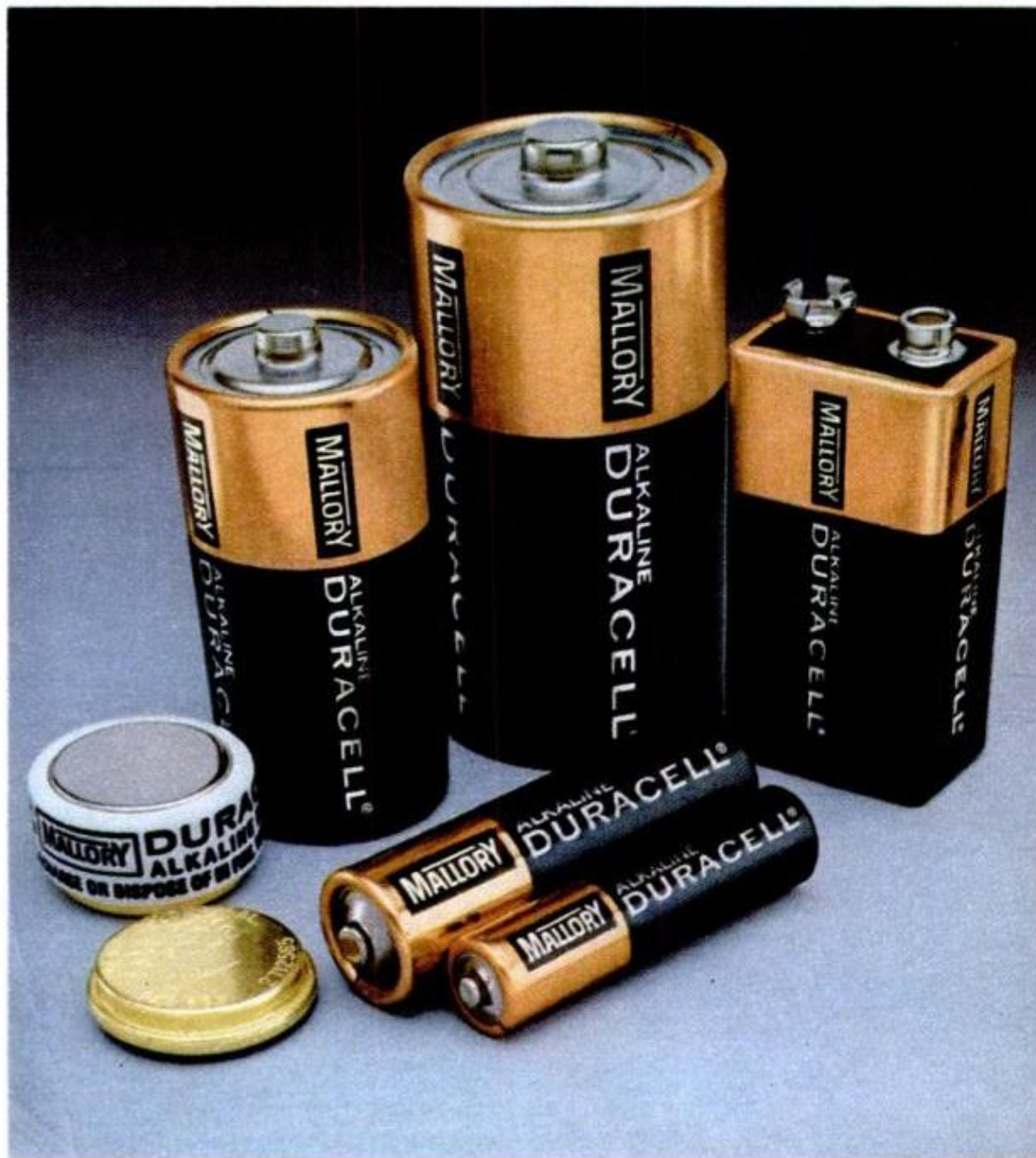

MALLORY

®Registered trademark of P. R. Mallory & Co. Inc.

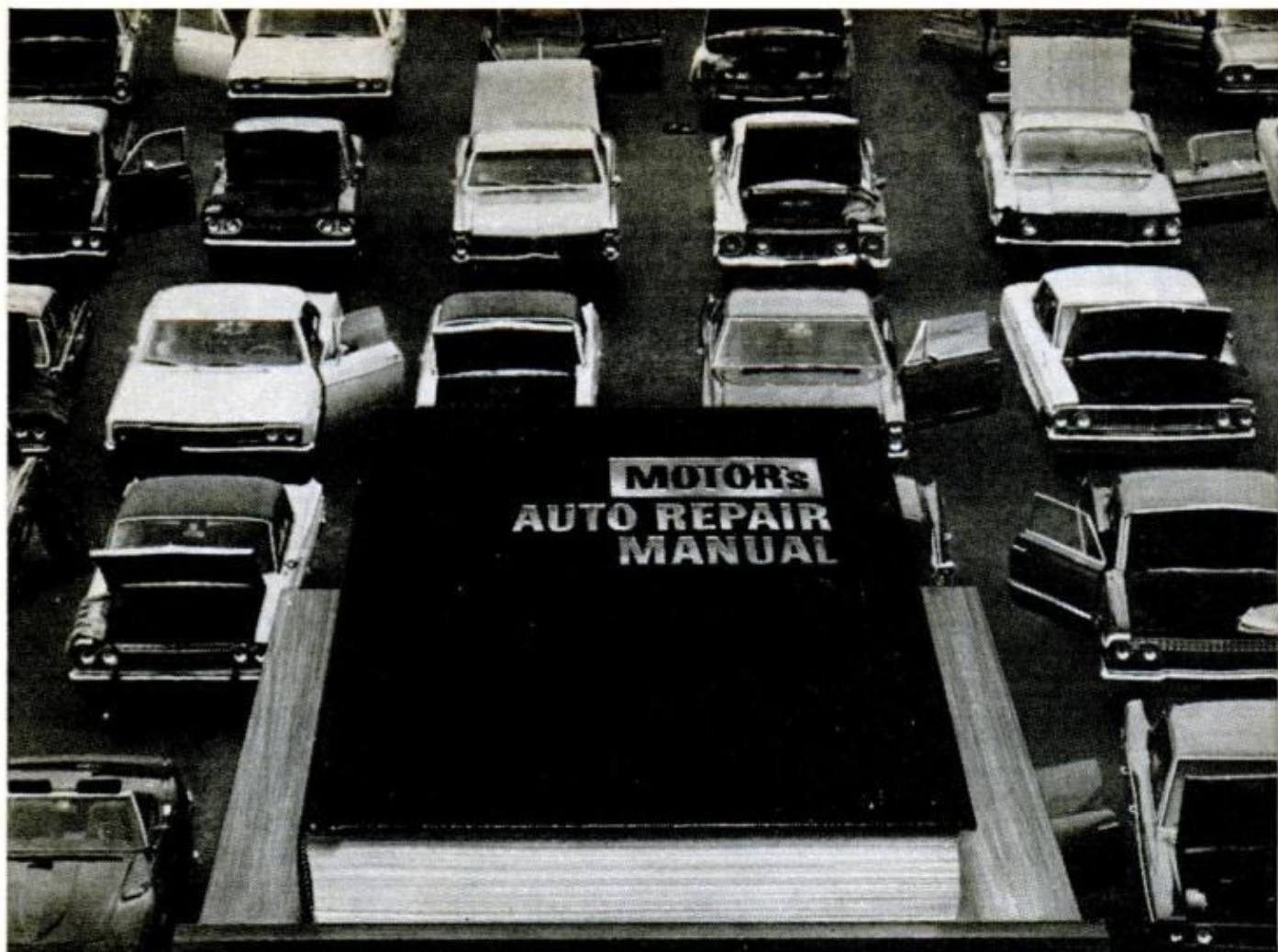

How to fix almost any part of almost any car

Now, whether you're a green beginner or expert mechanic, you can breeze through almost any auto repair job on all the cars listed here built from 1966 to 1972.

All you need is the new 1972 Edition of **MOTOR'S AUTO REPAIR MANUAL** — the famous illustrated guide that makes practically every operation on almost any car as easy to do as A-B-C.

Special Trouble-Shooter Section

The special Trouble-Shooter Section in **MOTOR'S MANUAL**, plus detailed troubleshooting information throughout, helps you pinpoint any of 4,200 car troubles in a jiffy... spots exactly where the trouble is in engines, transmissions, axles, etc.

Big New 1972 Edition Over 1,000 Pages — Over 3,000 Pictures!

This newest, most up-to-date edition covers everything you need to know to fix 2,300 car models from 1966 through 1972, including compacts and intermediate cars. Plus tune-up and front-end alignment specs on all models from 1946 through 1965. Over 1,000 giant double-sized pages, over 3,000 pictures. "Quick-Check" Specification Tables for all cars, 55,000 essential service specifications. Over 225,000 service and repair facts.

The "Meat" of 300 Official Shop Manuals

The editors of **MOTOR** gathered together a wealth of know-how from 300 official shop manuals and hundreds of factory bulletins, and boiled it down into crystal-clear terms in one big illustrated book.

All These Makes Covered

TORONADO
BARRACUDA
PONTIAC
IMPERIAL
DART
FORD
CHRYSLER
RAMBLER
PINTO
BUICK SPECIAL
MARK IV
FALCON
TEMPEST
COUGAR
VOLKSWAGEN
MAVERICK

THUNDERBIRD
CADILLAC
CONTINENTAL
CHEVROLET
PLYMOUTH
DODGE
COMET
AMERICAN
FAIRLANE
CORVETTE
MUSTANG
CHEVY II
BUICK
MERCURY
CHEVELLE
GREMLIN

OLDSMOBILE
CORVAIR
OLDS F-85
VALIANT
JAVELIN
MONTEGO
TORINO
LINCOLN
FRONT-DRIVE
CADILLAC
MARK III
AMX
CHALLENGER
HORNET
VEGA
More . . .

Not only do you get the latest up-to-the-minute "how-to" information on each car listed above, you also get service data on Transmissions, Steering, Brakes, Overdrives, Alternators, Fuel Pumps, Ignition Systems, Engines, much more!

No wonder over *six million* copies have been sold to mechanics, students, repair shops, etc.

Try This Book at Our Risk — FREE

Send no money. Just mail the coupon and we'll send the giant 1972 edition of **MOTOR'S AUTO REPAIR MANUAL** right to your home or shop. Try this famous guide for 10 full days — FREE! If this book doesn't pay for itself in the first 10 days, just return it and owe nothing.

Mail coupon to **MOTOR Book Department**, P.O. Box 2316, F.D.R. Sta., N.Y., N.Y. 10022.

Brand-New 1972 Edition * Used by Repair Shops, U.S. Armed Forces, Schools, Etc.



SAME 10-DAY FREE TRIAL ON AUTO ENGINES AND ELECTRICAL SYSTEMS. Explains engines and electrical systems thoroughly, showing how and why they work. 700 pages. Only \$10.00.

MOTOR Book Dept., Desk D 114
P.O. Box 2316, F.D.R. Station,
New York, N.Y. 10022

Please send me the Manuals checked below for ten days free examination:

MOTOR'S AUTO REPAIR MANUAL, \$10.95.

MOTOR'S AUTO ENGINES & ELECTRICAL SYSTEMS, \$10.00.

If I am not fully satisfied, I will return the shipment promptly and owe nothing. Or I will keep it and pay the total price in three monthly installments, plus a small shipping charge.

I want to save shipping charges. I am enclosing payments in full and you will pay shipping charges. (Same return privileges, refund guaranteed.)

Print Name _____

Address _____

City & State _____ Zip _____

Signature Please _____ Age _____

Prices slightly higher in Canada.
Offer available only in continental United States.
Delivery will normally be within 3-4 weeks in Eastern U.S. Please allow longer west of Miss. (M.M. Books)

Loop-Charging and power shifting.

Two reasons the Johnson 50 leads its class.

Our Sea-Horse 50 hp.

No other outboard in the mid-horsepower range can come close.

Here's why:

The Johnson 50 is Loop-Charged. That's a powerful way of saying we charge each cylinder with a cleaner fuel-air mix and exhaust the gases in a continuous power loop. The result is more horsepower, more miles per gallon.

Then there's single-lever power shifting. So smooth even a junior skipper can operate it. Our power shifting is, in fact, up to 30 percent easier than manual shifts.

Starting is easier, too. MagFlash™ CD ignition sends 40,000 volts of white-hot spark to the plugs in less than three millionths of a second. For the fastest, surest starts in the

business. Along with smoother idling, trolling and running. MagFlash has no moving mechanical parts. No belts. No points. And you get long, long plug life.

And the 50's exhaust tuning helps to make a fast boat even faster. Gives you more power and performance on less gas. Perfect.

See the man with the world's best selling outboards. Your Johnson dealer. Look over the 50 and our other Loop-Charger, the Sea-Horse 65.

We taught them everything we know. Write for our 50th anniversary catalog.

First in dependability.
Johnson



Johnson Motors, Sea-Horse Drive, Waukegan, Illinois 60085. Dept. PM-472

Division Outboard Marine Corporation — makers of OMC Stern Drives

HOMEOWNERS' CLINIC

BY W. CLYDE LAMMEY

Wood-shingle roofing

I'm having a home built this spring and I want a cedar-shingle roof. My property is outside corporate limits. Are there codes or other regulations pertaining to use of wood shingles?—Robert R. James, Pittsburgh

Most counties and municipalities now approve wood-shingle roofing if the shingles are laid over a glass-fiber-reinforced asbestos paper. However, check with local officials, also your fire-insurance underwriter, just to be doubly sure.

When to roll your lawn

My lawn is rather rough, especially under two large trees, with shallow depressions and hummocks causing the mower to skip and scalp. Soil is clayey rather than sandy and I've been told not to roll it, even though drainage should be good. What's your advice?—Manley Rupp, Dayton, Ohio

Instead of rolling I'd fill the depressions with new soil, raking it level. Scatter new seeding, and keep the soil damp by light hosing, if necessary, until the new seeding shows. I would lift the sod on any hummocks, remove a portion of the soil underneath and reset the sod level with that adjacent. This also should be kept damp until the sod reroots permanently. I hesitate to suggest rolling clay soil, although a light rolling possibly would do some good by pressing grass plants that may have been heaved by frost into closer contact.

Lacquer-thinner 'poultice'

I spilled a few drops of graphited penetrating oil on an unfinished piece of stock prepared for a home-shop project. It has resisted all means I know of for removal. Do you have a suggestion?—Don Skinner, Helena, Mont.

Can you turn the piece over and still use it, or is it good only on the discolored side? If this is not practical, your problem has no simple solution.

I've had a similar experience and finally resorted to lacquer thinner with fairly satisfactory results. Pour the thinner onto

the stain and immediately cover it with a piece of sheet metal. After a minute or two, wipe it with a clean cloth, beginning at the center of the stain and working outward. Chances are you'll have to repeat this procedure several times. After drying the area, you may be able to remove most of the graphite discoloration with an ink eraser.

Fingerprints in putty

On two steel sash in my basement the putty has been deeply fingerprinted, probably by the builders while inserting them. Is there some simple way to remove or smooth these prints without replacing the putty?—Ira Close, Louisville

Usually the putty used originally in steel sash remains soft but forms a fairly hard surface or "skin." By pressing lightly with your fingers on either side of the imprint you might force putty under the imprint and raise it to a level of that adjacent on either side. If this fails, you might try heating the putty with a propane torch; this should soften it sufficiently to permit knifing to a smooth surface. Use a needle flame and aim it so that the glass will not be heated and cracked. And, of course, do this job in warm weather.

Failing both methods, it will be necessary to replace the affected putty strip.

Different decor for milk can

I have a large-size milk or cream can I'd like to decorate—something different from the usual run of milk-can decoration. Do you have a suggestion?—R. M. Dunn, Oklahoma City

Although this is more of an artist's problem, the possibilities offer a challenge. I once saw a can decorated with four oval color illustrations obviously cut from magazine pages. It was handsome. You can draw an oval by sticking two pins into a piece of cardboard, looping a length of string loosely around the pins and striking the oval with a pencil point held against the cord. Size of oval and type of the illustration can be anything that suits your fancy. Paint the can a cream color, cut the pictures to oval shape with the cardboard pattern, stick them in place with white glue and spray them with a clear lacquer from a pressurized container. ★★

Do you have a home maintenance or repair problem? Send it to Homeowners' Clinic, Popular Mechanics, 224 West 57th St., New York, N.Y. 10019. While letters cannot be answered individually, problems of wide interest will be discussed in this column.



If you think all menthols taste alike
try the taste of extra coolness.
Come all the way up to KOOL.



18 mg. "tar," 1.4 mg. nicotine
av. per cigarette, FTC Report Aug. 71.

Says George Bignotti,
5 times winning
Indy 500 crew chief:



You're a Great One—and proud of it! Display this colorful 5" x 7" decal. Enclose 25¢ for handling and mailing. We'll also send you an illustrated catalog free.

*Suggested User Price



14-pc. Combination Wrench and S-K Magna Driver Set - No. 7214.

Complete range of combination, box end and open end chrome alloy wrenches from 1/4" to 3/4", plus magnetic screwdriver with 4 different bits. For most home, workshop and auto maintenance jobs. In vinyl pouch.

USER SAVES \$10.59
If purchased separately,
retail price would be \$24.57

\$13.98*

"Why do the great ones prefer S-K[®] Tools?"

Because a mechanic likes a tool that is easier to use and helps get the job done right! That's true if you're a racing or a garage mechanic or a Great One around the house. Best of all, you'll love those low S-K prices—and there's no better hand tool warranty!

Hall of Fame mechanic George Bignotti knows. He's the only chief mechanic with 5 Indy championships, and in '71 he became the first to win the Indy and California 500's in the same year.

"There's a difference in hand tools," says George. "For example, S-K tools have perfect balance. Helps me work faster, better... whether I'm rebuilding Al Unser's racer or fixing Mrs. Bignotti's washer. Quality? None better."

Save now on Indy Specials. On sale at leading hardware and auto parts stores. Or write to S-K Tools.



**HAND TOOL DIVISION
DRESSER INDUSTRIES, INC.**
3201 North Wolf Road,
Franklin Park, Illinois 60131

© 1972 Hand Tool Division, Dresser Industries, Inc.



24-pc. 1/4" and 3/8" drive Socket Set with famous S-K Ratchet - No. 4224-9.

Wide range of sizes (3/16" through 7/8"). Ideal set for most auto maintenance. With S-K 3/8" reversible ratchet, 9 standard 1/4", 6 standard and 3 deep 3/8" drive sockets, spinner handle, 2 extensions, adapter. Steel case.

USER SAVES \$20.43
If purchased separately,
retail price would be \$39.31

\$18.88*



20-pc. 1/2" standard drive, 3/8" metric drive Mixed Socket Set - No. 7220.

Sizes, 7/16" to 1 1/8", 10mm to 17mm for use on most domestic or import cars. Has S-K 1/2" drive reversible ratchet, 9 standard 1/2" drive and 8 metric 3/8" drive sockets, 1/2" to 3/8" adapter, 3" extension. Steel case.

USER SAVES \$18.92
If purchased separately,
retail price would be \$38.90

\$19.98*

A SIMPLE SOLUTION TO PAINT FAILURE



The trouble with paint is that it forms a film. And when the weather starts working on this film, you get paint failure:

Cracking from heat and cold that stretch paint beyond the limit.

Peeling when the paint doesn't stick to what's underneath.

Blistering when there's moisture in the wood or under the paint.

That can't happen with Olympic Solid Color Stain. *It doesn't form a film!* It sinks into the wood and it breathes — *can't crack, peel or blister.* Olympic Stain costs less than paint, but it's so rich in pigment you can actually apply light colors over dark.

Whether you apply Olympic Solid Color Stain over new wood or a properly-prepared old painted surface, the stain will last longer, look beautiful, and stay trouble-free for years.

Send us the coupon and we'll send you a free folder that gives you all the details.

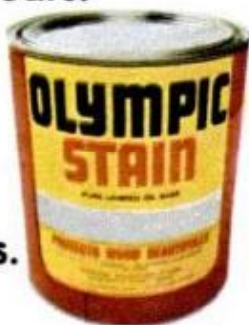

I've had it with paint failure. Please, send me the Olympic Stain color card and application folder to help me solve my paint problems.

Name _____

Address _____

City _____

State _____ Zip _____

OLYMPIC STAIN A division of COMERCO, INC. 

Mail to: Olympic Stain, 1148 Leary Way N.W., Seattle, Washington 98107

PM



GE offers three new Elec-Traks

The E8M above is one of three new tractors added to GE's Elec-Trak line this spring. With three Power Pack units powering the driver motor and a 36-inch rotary mower, the E8M will cut one acre of lawn before recharging. The heavy-duty transaxle has three forward speeds, one reverse, and it operates with a single-pedal foot clutch/brake. In addition to this 8-hp model, the new Elec-Traks include 10 and 12-hp units.



Good vibes

For years, it was rumored this British house was haunted—until new owner Stephen Barney found the source of the low moans and “voices.” The wind “played” the chimney like a musical instrument. He rebuilt the chimney—crooked—to stop the vibrations.

The Snapper Riding Mower.

Most people don't know that it can take the place of a bulky garden tractor in most instances. And that it costs far less. With the proper attachments, the Comet can doze, sweep, fertilize, aerate, even haul. And it's specifically designed to mow

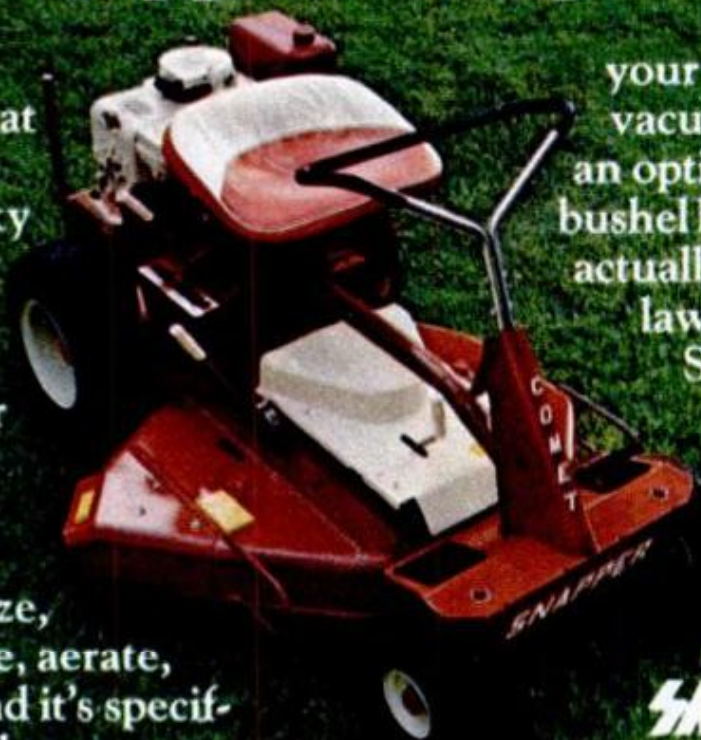

your lawn. With vacuum action and an optional, big six-bushel bag, the Comet actually cleans your lawn as it cuts.

See one for yourself. It's everything we say it is.

SNAPPER

McDonough Power Equipment, Inc., A subsidiary of Fuqua Industries, Inc., McDonough, Georgia 30253. See your yellow pages or write for a free brochure. All Snapper mowers meet A. N. S. I. safety specifications.

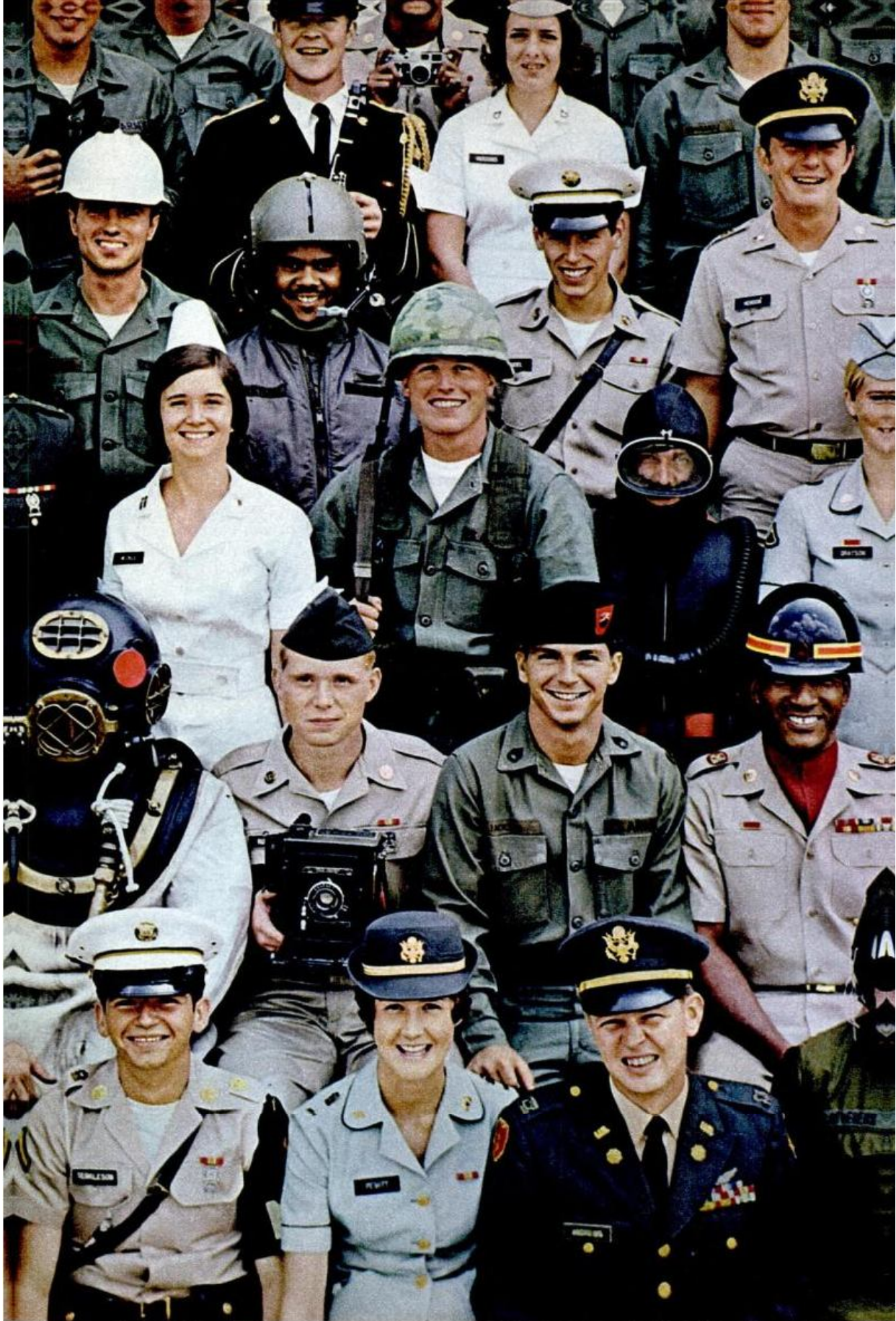

We've got over 300 good, steady jobs.

Jobs in construction, transportation, communications, computers.

Jobs for photographers, printers, truck drivers, teachers, typists, TV cameramen and repairmen. Cooks, electricians, medical aides, meteorologists. Motor and missile maintenance men.

Jobs for young men. And young women.

Jobs in Europe, Hawaii, Panama, Alaska. And just about any place in the States.

We'll train you to do the jobs. Train you well, in good schools, under excellent instructors, with the best equipment obtainable.

And you get full pay while you train.

You also get unusually good fringe benefits, including a chance to continue your education. In many cases at our expense. In most cases with at least 75% of your tuition paid.

And if you qualify we'll give you your choice of training. We'll put it in writing, before you sign up.

Today's Army wants to join you.

Army Opportunities Dept 200, Hampton, Va 23369	Date _____
I'd like to know more about the job-training and promotion opportunities in today's Army.	
Name _____	Date of birth _____
Address _____	
City _____	County _____
State _____	Zip _____ Phone _____
Education _____	

science worldwide

By JOHN PEARSON



Picture window for submersible



Space suit helps heart to pump

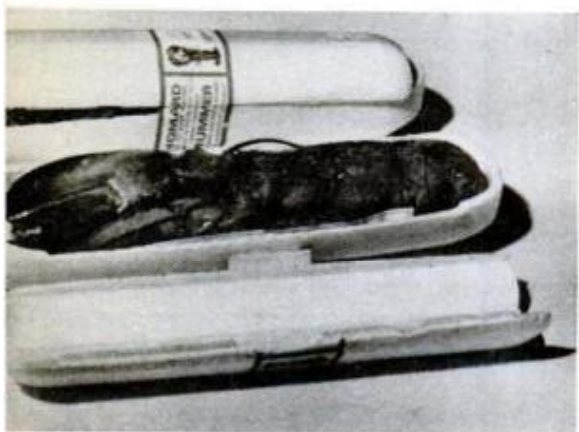

One way to order your lobster

FIRST UNDERSEA VEHICLE TO USE GLASS as a structural part of its pressure hull is *Deep View*, a two-man submersible designed at the Naval Undersea Research and Development Center, San Diego. The 44.5-inch-diameter glass nose provides the excellent visibility that also can be achieved with plastic, but permits much deeper dives—to 1500 feet—than can be made in a plastic hull. The six-ton vessel is powered by five electric motors, can maneuver in all directions and can hover. Sea trials are scheduled for this year.

A HOT TODDY MAY BE BETTER FOR YOUR TEETH than ice water or a dish of ice cream. You can draw that conclusion from the findings in a University of Utah study in which hundreds of extracted teeth were examined. Tooth enamel suffers thermal fatigue because of the hot-and-cold cycle that occurs inside the mouth. Hot drinks may raise the temperature to 140° F. while ice cream can drop it to 35° F. Enamel remains strong during thermal expansion resulting from heat, but sudden cooling makes it contract and susceptible to cracking. Tiny surface cracks tend to collect food debris and oral bacteria, thus contributing to the development of decay. This is a problem unique to man—other animals don't bother to heat and chill their food and drink.

A VITAL SPIN-OFF FROM OUR SPACE PROGRAM is a suit that encapsulates a heart patient and assists blood circulation by precise application of pressure to blood vessels in the arms and legs. Electrodes attached to the skin trigger a mechanism that inflates and deflates a series of pressure cuffs working in rhythm with the patient's heart. Tests at the University of Texas indicate that the suit can increase cardiac output by as much as 30 percent.

A BABY'S "CRY PRINT" IS A GOOD CLUE to the infant's state of health. So says a Miami phonetics specialist who for many years has studied tapes of cries of the newborn. He plays the tapes into a machine that turns sound into a visual pattern—"a cry print"—recorded on paper. The print can disclose various neurological and physiological conditions, from serious brain damage to a simple speech defect.

GOURMETS, TAKE NOTE. No longer need Maine lobsters be shipped live to insure that the tender meat is in prime condition when eaten. A Canadian company claims to have devised a method for freezing whole lobsters that keeps them "fresh" for a year and permits shipping anywhere on the globe. The crustaceans are

(Please turn to page 42)

Jeep® Wagoneer hauls everything. Even the kitchen sink.



Jeep guts are so strong, they pull big trailers easily. On or off the road.

When you head for the hills, you don't have to leave anything behind. Not if you're behind the wheel of a Jeep Wagoneer.

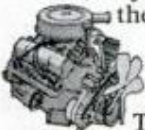

You can't get a larger standard engine in its class. And you have even mightier V-8's as options. That's Jeep guts.

The Wagoneer has multi-leaf springs all around to give you greater stability. And world-famous Jeep 4-wheel drive to give you mountain-climbing, trailer-pulling traction. That's Jeep guts.

Inside, the Wagoneer has nearly 100 cubic feet of space for anything you couldn't fit in

the trailer. Plenty of glass all around so you can see—and enjoy—where you're driving. Chair-high seats to keep you comfortable. Even after a day's drive.



And the Wagoneer has options like air-conditioning, power steering, power brakes, and automatic transmission. That's Jeep push.

No wonder the Jeep Wagoneer outsells all other 4-wheel drive family wagons combined. Test drive one today.

Toughest 4-letter word on wheels.

Jeep

Drive your Jeep vehicle with care and keep America the beautiful.

LIVE IN THE WORLD OF TOMORROW . . . TODAY!

UNUSUAL BARGAINS

NEW PRODUCTS • NEW MATERIALS • NEW IDEAS

ASTRONOMICAL TELESCOPE KITS

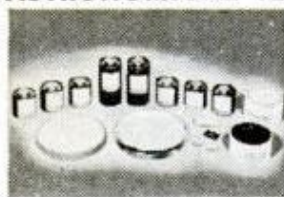

Grind your own mirror for powerful telescopes. Kits contain fine annealed pyrex mirror blank, tool, abrasives, diagonal mirror, and eyepiece lenses. Instruments you build range in value from \$75 to hundreds of dollars.

- ± 70,003H 4 1/4" dia. 3/4" Thick \$10.75 Ppd.
- ± 70,004H 6" Dia. 1" Thick \$16.95 Ppd.
- ± 70,005H 8" Dia. 1 3/8" Thick \$24.50 Ppd.
- ± 70,006H 10" Dia. 1 3/4" Thick \$44.50 FOB

PLASTIC MODEL V-8 ENGINE



Hours of fun! Get thrill of building your own easily assembled engine from over 350 parts. Then push starter and watch it run. Crankshaft revolves, pistons move, valves open and close in sequence with spark plugs. Does everything but burn oil. 1/4 scale, molded in 4 colors. Used in many auto-mechanic courses. Excellent, easy-to-understand "tech manual."

Stock No. 70,448H \$13.95 Ppd.

AMAZING NEW WANKEL ENGINE KIT!



Thrill to the fun of building your own see-through motorized model of revolutionary pistonless type engine . . . only engine experts think economically modifiable to meet new pollution standards. Replaces piston, cylinder, crank assemblies with rotating discs (sections removed for firing chambers). Smaller than conventional; fewer parts. Greater reliability, same speed w/less horsepower. Feet: flashing plugs, rubber fan belt, stick-shift on-off switch. Req. 2-1.5V batt. (not incl.).

No. 71,424H (4 1/2" X 5" X 9") \$6.75 Ppd.

GIANT WEATHER BALLOONS



"Balls of fun" for kids, traffic stoppers for stores, terrific for amateur meteorologists. Create a neighborhood sensation. Great backyard fun. Exciting beach attraction. Amateur meteorologists use to measure cloud heights, wind speed and temp. Made of heavy-duty neoprene. Inflate with vacuum cleaner or auto air hose; or locally available helium for high rise.

Stock No. 60,568H (8' size) . . . \$2.00 Ppd.
Stock No. 60,632H (16' size) \$7.00 Ppd.

AMERICAN MADE OPAQUE PROJECTOR



Projects illustrations up to 3" x 3 1/2" —enlarges them to 35" x 30" if screen is 6 1/2 ft. from projector, larger pictures if screen is farther away. No film or negatives needed. Primarily intended for children. Projects charts, diagrams, color or black-and-white in darkened room. 115 v. A.C. . . . 6 ft. cord and plug included. Size 12" x 8" x 4 1/2" wide. Weight 1 lb. 2 ozs. Plastic case.

Stock No. 70,199H \$8.75 Ppd.

"FISH" WITH A MAGNET



Go treasure hunting on the bottom! Fascinating fun & sometimes profitable! Tie a line to our 5 1/2-lb. Magnet—drop it overboard in bay, river, lake or ocean. Troll it along bottom—your "treasure" haul can be valuables. 5 1/2-lb. Magnet is war surplus—Alnico V Type—Gov't cost \$50. Lifts over 150 lbs. on land.

Stock No. 70,571H \$14.00 Ppd.

Stock No. 60,215H . . . 1 1/2 lbs. . . . \$ 5.75 Ppd.
Stock No. 70,570H . . . 3 1/2 lbs. (lifts 40 lbs.) . . . \$ 8.75 Ppd.
Stock No. 85,152H . . . 15 1/4 lbs. (lifts 350 lbs.) . . . \$33.95 FOB

'Bright Ideas' in Unique Lighting Big, new 100-page handbook packed with facts, loaded with illustrations. All latest developments, applications, equipment. 8 1/2" x 11" looseleaf paper to fit 3 rings. Stock No. 9100 H \$3.00 Ppd.

MAIL COUPON FOR GIANT FREE CATALOG

148 PAGES! MORE THAN 4,000 UNUSUAL BARGAINS. Completely new 1972 Catalog. Packed with huge selection of telescopes, microscopes, binoculars, magnets, magnifiers, prisms, photo components. Ecology and unique lighting items, parts, kits, accessories—many hard-to-get surplus bargains. 100's of charts, illustrations. For hobbyists, experimenters, schools, industry.

EDMUND SCIENTIFIC CO.
300 Edscorp Building, Barrington, N. J. 08007
Please rush Free Giant Catalog "H"

Name
Address
City State Zip

EDMUND SCIENTIFIC CO. 300 EDSCORP BLDG. BARRINGTON, NEW JERSEY 08007
ORDER BY STOCK NUMBER • SEND CHECK OR MONEY ORDER • MONEY-BACK GUARANTEE

SCIENCE WORLDWIDE

(Continued from page 40)

steamed a few seconds to kill them, then popped into icy water. Next they're placed in polystyrene "coffins" and blast-frozen. Finally they're vacuum-packed and shipped.

The Environment

IMPROPER USE OF AEROSOL SPRAYS can be dangerous. This was underscored by the results of tests by Medical College of Georgia researchers who exposed dogs to the propellant gas in hair and antiseptic sprays. Thirteen of 16 dogs developed disturbed heartbeats within "seconds to minutes of aerosol inhalation," say the researchers, and eight eventually died.

SMOKE RINGS could be used to carry smokestack pollutants to new heights and perhaps even to penetrate atmospheric inversions of the type that strangle large cities with smog. That's the thinking of Dr. George E. Mattingly Jr., a Princeton University civil engineer who has done much research with "smoke" rings. Scientifically, they're known as vortex rings and they can occur in any liquid or gas. Dr. Mattingly has found that a saltwater vortex ring easily penetrates a layer of lighter fresh water above it and remains intact while doing so. This suggests the possibility of using large, mechanically produced, industrial smoke rings to drive stack effluents through an atmospheric inversion to clearer, windy skies above. Inversions occur when the air temperature, which ordinarily decreases with height, instead increases, causing hot, polluted air to stay close to the ground.

PRISON WALLS ARE NO BAR to pollution. As a result, inmates at the Stillwater, Minn., state prison have formed an organization called Convicts Assn. for Good Environment (CAGE) and have gotten busy cleaning the institution's ventilating system and industrial areas. And, they have begun to recycle solid waste—bottles, cans and paper—which normally is buried nearby.

THROWAWAY CONTAINERS ARE OUT in Oregon. A new state law requires that all beer and soft-drink bottles, cans, jugs or whatever, carry a minimum deposit, as was the case with the returnable bottles of yesteryear. ★ ★ ★

NEWS BRIEFS

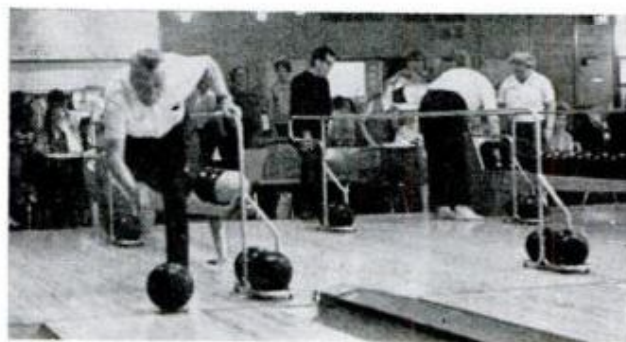

Rail helps blind to bowl

By sliding one hand along a special rail placed alongside the bowling approach, blind persons determine the time and direction to release a bowling ball and are thus able to participate in the sport. The portable rail, 12 feet long and 3 feet high, is held in place by the weight of four bowling balls. The American Blind Bowling Assn., 6327 31st Place N.W., Washington, D.C. 20015, sponsors leagues as well as national competition.

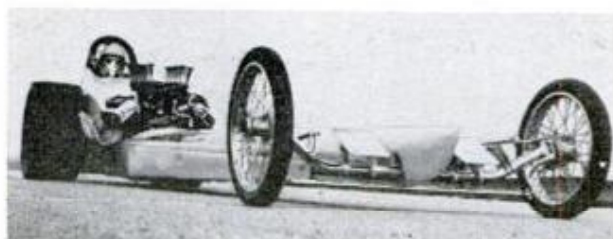

'Duckie' is mostly aluminum

Rolland McKinney, an Alcoa employe, used aluminum for the body, pistons, transmission housing, fuel tank and rear wheels of *Rubber Duckie*, his 1350-pound dragster.

APRIL 1972

**Makes Over \$60 EXTRA a Week
In Own Sharpening Shop!**

"My Belsaw Sharp-All made me \$3,500 last year just in spare time. Now I'm going full time. It's great to be your own boss."

David Swanson — Utica, Michigan



**Let Me Prove
YOU
Can Do It Too!
on our
30-DAY
FREE TRIAL**

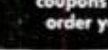
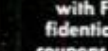
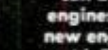
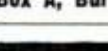
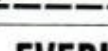
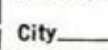
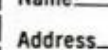
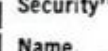
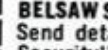
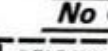

You risk nothing by accepting this offer to see how easily you can turn your spare time into Big Cash Profits with your own Complete Sharpening Shop. No selling . . . No previous experience needed. Our famous Sharp-All and show-how instruction set you up to make \$200, \$500, \$700 a month CASH sharpening SAWS, KNIVES, SCISSORS, LAWNMOWERS, Shop and Garden tools . . . all cutting edges.

Send coupon for FREE facts on this money-making business. We'll even finance you.

RUSH COUPON TODAY!

BELSAW SHARP-ALL CO.

713A Field Bldg. Kansas City, Mo. 64111

No Obligation — No Salesman Will Call

BELSAW SHARP-ALL CO. 713A Field Bldg., Kansas City, Mo. 64111
Send details of FREE TRIAL OFFER and Free Book "Lifetime Security". No obligation.

Name _____

Address _____

City _____ State _____ Zip _____

EVERLITE

World's THRIFTIEST Light Plants



THE CHAMPION

\$149.50

**The Champion — 1200 watts
115 volts AC for only \$149.50**

Unbelievable but true—Brand new production methods now make possible world's finest design in a service free alternator light plant at this unprecedented price. Plant puts out a steady 1200 watts of 115 volt AC power to run power tools, oil burners, pumps, TV, or anything that requires up to 1200 watts. Powered by a rugged 3 HP, 4 cycle, easy start gas engine with 1 year factory warranty. Complete with carry handle and shock mounts. Why fool with short life 2 cycle plants when you can buy this rugged top quality machine at our factory price.

Item # 1265 wt 65 lbs. **\$149.50**
SEND 25c FOR BIG CATALOG

MASTER MECHANIC MFG. CO., Dept. A-42, Burlington, Wis.
Box A, Burlington, Wis. 53105 or Box 65, Sarasota, Fla. 33578

KIDS!

Learn how you can buy used engines \$15 up, new engines \$30 with FREE confidential list and coupons when you order your plans

- **BUILD THIS MINI-BIKE!**
Plans reveal step by step details!
- **BUILD A RACING KART!**
Build frame for less than \$10!



RUSH \$2 (refundable) for complete plans (indicate type) or \$3 for both to Sullivans Manufacturing Company, 1199 Broadway, New York, New York 10001

DETROIT LISTENING POST

BY ROBERT LUND

HAS GM REALLY DEVELOPED SEALS for the Wankel good for 400,000 miles? That's what a high-up source in the company claims. But maybe what he intended to say is that GM believes it can produce a Wankel with a life expectancy of 400,000 miles. With periodic service and overhauling. But that's not the same as saying GM's devised a seal that'll last 400,000 miles.

OLDS GENERAL MANAGER John Beltz says forget that stuff (you read it here last month) about Olds canceling its small car, a mod and modified version of Nova, to make room for a front-wheel drive Wankel in '74. Ain't so, he avers. Olds will definitely have a Cadillac version of Nova later this year. But Beltz doesn't deny the rest of the item—that the first Wankel out the door will have front-wheel drive.

CHRYSLER'S ALREADY WORKING on second and third-generation versions of the electronic security alarm system it will offer as an option on its full-size '73 cars. First version coming this fall protects door locks, engine compartment and trunk by causing lights to flash off/on and the horn to blast intermittently if a thief attempts forced entry. Future versions may incorporate an additional alarm that will trigger if there's an attempt to tamper with the tires.

Chrysler's putting the alarm to the acid test. "The only way to test an item like this," says

Don Wolfslayer, the company's vehicle security specialist, "is to put it out and let the thieves work on it. Then you improve it, depending on what you learn from the thieves."

The 1973 version also has an occupant-protection feature: push the button on the dash and lights and horn sound off. Knowledgeable muggers will have to say, "Stick 'em up and keep your hands off the alarm button on the dash!"

BUILDING 'EM BETTER. The inventors and improvers have been hard at it and their latest predictions and promises include:

- Radiator hose that'll never blow and life-of-the-car radiator caps, heater hoses and sparkplug wires. Compliments of Dow Corning. The company says the parts will be made of silicones and be virtually indestructible. Deadline: by 1975.

- A ride-along-robot hooked into your radio speaker that tells you when you need service or a new part. The hardware consists of monitoring devices that take readings of components and a voice synthesizer with an unlimited vocabulary. When a part needs replacement or maintenance, the synthesizer cuts in on the speaker and tells you what to replace or repair. Federal Screw Works, a supplier to the auto companies, will begin production of the synthesizer this year. The first versions will be expensive—about \$3000

(Please turn to page 46)

PLYMOUTH CRICKET, available only as a four-door sedan since its introduction, now comes in a station wagon model. The overall length is 166.4 inches on wheelbase of 98 inches, and cargo space is 60 cu. ft.



ASK THE AC ENGINEERS

“ Why is it important to change my oil filter at recommended intervals? ”

Your oil and oil filter should be changed at recommended intervals to help assure protection against damaging engine wear.

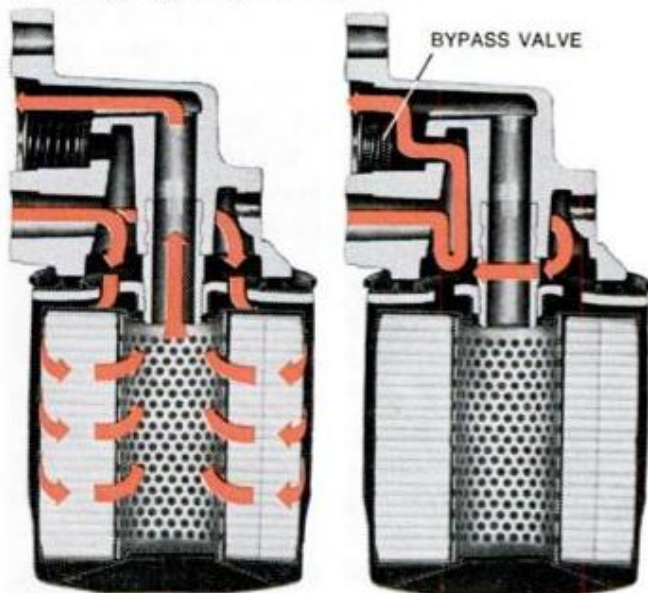

NORMAL CONDITION:
Oil flows from engine through filtering material . . . oil returns to engine after all harmful abrasives are removed.

CLOGGED CONDITION:
Pressure drop causes bypass valve to open . . . allows oil to return direct to engine. Lubrication is maintained, but with unfiltered oil.

The function of an AC Oil Filter is to collect and hold contaminants and particles that could cause wear to bearing surfaces and other vital engine parts. It assures that lubricating oil, free of harmful abrasives, circulates through the engine. However, an oil filter performs at top

efficiency for only a specified period of time or mileage . . . depending on driving conditions. Then, it should be changed to prevent driving with a clogged filter.

At AC, we design oil filters to meet specific requirements. Then, we conduct exhaustive laboratory and field tests to make certain AC Oil Filters perform efficiently.

AC's polyester-reinforced filtering material stands up to high engine oil temperatures and pressures . . . and traps dirt and particles smaller than half the diameter of a human hair.

AC Oil Filters . . . original equipment on all Chevrolets, Pontiacs, Oldsmobiles, Buicks and Cadillacs . . . are also available for most other



makes and models. For top engine protection, change your oil and AC Oil Filter at recommended intervals.



AC SPARK PLUG DIVISION OF GENERAL MOTORS

The quality performer handloaders prefer.



Winchester- Western Staynless Primers

Swift and sure ignition. Two things handloaders demand in the performance of their center fire ammunition and shot shells. That's why our non-corrosive, high-stability primers—the heart of the load—are sought by experienced shooters who custom-make their own center fire loads and shot shells.

Winchester-Western Staynless Primers have been tested under all conditions at temperatures ranging from minus 40°F. to 115°F. Handloaders share the positive results of thorough research — an ignition that's lightning fast and uniform. These quality primers are the result of the same exacting process that has made Winchester-Western loaded ammunition world-famous. Now they're part of the best available matched components system for those sportsmen who "roll their own." **WINCHESTER-Western**.
275 Winchester Ave., New Haven, Conn. 06504.

1972 | winchester
the way you
want it

DETROIT LISTENING POST

(Continued from page 44)

—but over the years Federal Screw thinks it can get the price down to \$300. The firm says it will be about five years before the gear appears on production cars.

● Finally, there's Pontiac's answer to deputy sheriff W.W. Henrick. Sheriff Henrick, who keeps the law in LaGrange, Ind., posed a question in the *Letters* column in February. Why don't automakers put a device on cars so drivers can hear train whistles and police, fire and ambulance sirens? With cars becoming more soundproof, windows permanently sealed and radio-stereos blaring, it's almost impossible to hear out-of-car audio signals.

Pontiac's answer is an electronic horn tied in to a radio transmitter-receiver. It works like a conventional horn, but the sound enters the vehicle being signaled over the radio. Pontiac says emergency vehicles and trains could be equipped with special signals to distinguish them from passenger cars. Other advantages: the horn can be heard around corners and over hills, it could be voice-modulated if police want to talk to approaching cars and the radio doesn't have to be turned on to receive the message or signal. It will take several years to get the system going, because it can't be put into operation until the FCC assigns a special frequency for the sending-receiving equipment.

SEVERAL TIMES this past winter I came within a whisker of getting rammed when my car stalled. It usually happened after slowing down or stopping preparatory to making a turn and then accelerating to complete the turn. Usually the car was cold, but not always. It's enough to make you take the bus to feel the engine go dead while the guy behind is coming on inches away from your bumper. It's no less harrowing to know thousands and maybe millions of other drivers are going through the same experience. Detroit's getting unprecedented mail complaining about cars conking out.

Engineers blame the pollution control equipment, say stalling's only part of the problem. The antismoggers are also blamed for low gas mileage, hard starting in cold weather and lack of performance. No zip when you step on it.

The companies are expected to modify their '73s to ease the problem in hope of cutting down the complaints. GM, for example, is expected to cut compression ratios and make a change in the timing.

If the corrections don't work? See you on the bus! ★ ★ ★

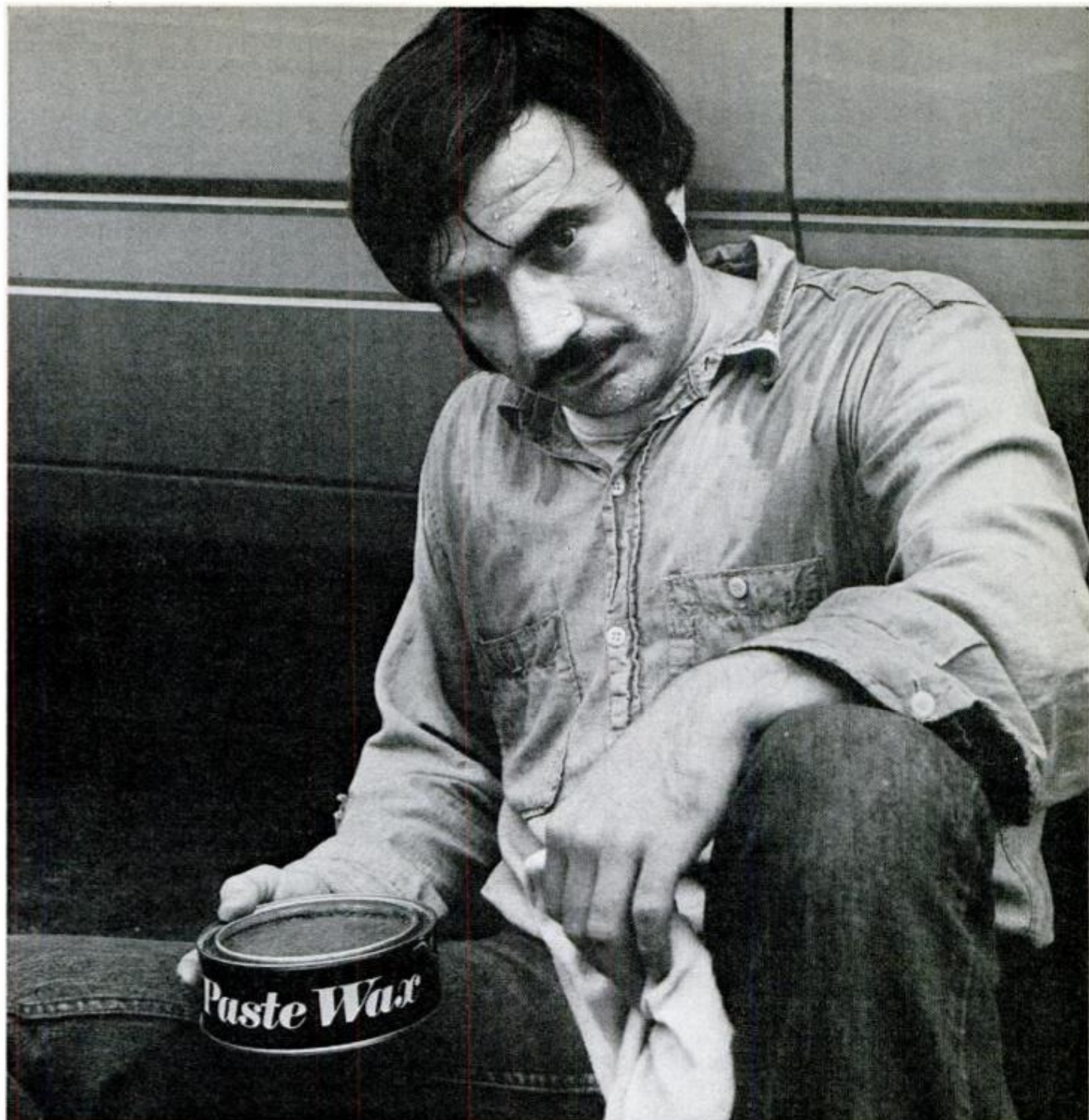

Show us a wax that outshines Vista,[®] and we'll show you a pain in the can.

For a gleaming, hard-wax kind of a shine, without the pain of hard-wax work, pick up a can of Vista Soft and Easy—10 oz. of pre-softened ease.

Soft and Easy's special formula of high-gloss silicones and jeweler's polish glides on like a liquid and buffs to a dazzling shine. A shine that lasts.

Simoniz[®] Vista Soft and Easy—for a good-looking, hard-wax shine. Painlessly.

Simoniz Vista Soft and Easy



© 1972 Morton-Norwich Products, Inc. SIMONIZ and Vista are registered trademarks.

APPLIANCE CLINIC

By PAUL MANN

Dryer won't stop

We have a Kenmore 220-v. electric clothes dryer that won't shut off automatically. Until recently the timer knob would not run down to zero, but most of the time it would and the appliance would stop. Now, however, even though the timer knob does go to zero, the unit won't shut off—not even if I open the door. The only way I can get it to stop is by pulling the plug. Can you tell me what is wrong?
—C.E. Bates, Jr., Wheeling, W. Va.

Ordinarily, this problem indicates an inoperative timer motor, a malfunction in the wiring that serves the timer or a switch that controls it. But don't overlook one other possibility. If you have the type of control that coordinates time and temperature, the timer is energized only when the heater is turned off by a thermostat. With such a unit, you can select one of several fabric designations (such as delicate, normal or heavy) on the dial. The machine will shut off automatically as soon as the clothes are dry. Failure of this type of control to stop a machine indicates a faulty thermostat as well as the other problems mentioned.

Dishwasher won't drain

I have a KitchenAid dishwasher (serial No. 57430—model No. KDI-15), and three servicemen have worked on it. After installation of two timers, a pump and a water valve the unit still will not let the water drain out. Water begins to drain on the last rinse cycle and then is shut off as the unit goes into the drying cycle before draining is completed. What is the solution?—Charles E. Murphy, Bellwood, Pa.

Perhaps you need plumbing service rather than appliance service. From an appliance standpoint I can't see what else can be done unless, of course, someone goofed and installed a wrong part.

It seems more likely to me that there's an obstruction in the drain system. Perhaps the drain hose or drainpipe is partially clogged, preventing complete drainage during the drainage cycle. Make sure that the drain hose is not kinked and has no sharp bends in it, and investigate the pos-

sibility of a blockage in the drain trap.

In this model, a short hose connects the drainpipe outlet and the drain valve inlet. This might be clogged, so have it disconnected and cleaned out.

Cold spot

Food items on the back shelf of my General Electric "all refrigerator" freeze up. Lowering the dial setting has not helped. Why does this happen and what can be done to correct it?—Dr. N. A. Newman, Lloyd Harbor, N.Y.

One good reason is a faulty temperature control. For example, the control has a bulb containing a temperature-sensitive substance. This bulb should be clamped firmly to the evaporator, because it's supposed to respond to the surface temperature of the evaporator. The bulb, in turn, allows a bellows to expand and contract, actuating the switch that starts and stops the compressor. If the bulb is loose, it may respond to the air temperature in the cabinet instead of to the evaporator temperature. There is a marked difference between the two. Have an authorized GE serviceman check this refrigerator.

All bound up

The motor of my American Standard garbage disposer will no longer rotate the cutters. The problem seems to be excessive friction, rather than electric trouble or jamming, since I can rotate the cutters with the wrench, but with some difficulty. Can this be corrected?—Charles R. Hodges, Frederick, Md.

This sounds like an electrical problem despite your thoughts to the contrary, but it's tough to troubleshoot this from afar since other things, such as bearings or jamming, may be the cause. Follow this procedure:

If the unit doesn't start and makes no sound, check that the reset button has tripped. To reset this protector, you may only need to depress the red button until it clicks and remains depressed. If this protective device has not tripped, the unit may have a defective protector or a broken connection through the run winding. If you have a lock-top model, there may be a defective switch.

If the unit doesn't start but makes a buzzing sound, test the turntable to see if it rotates freely. If not, chances are good that bearings have frozen and will have to be replaced. If the turntable rotates freely, there is probably a bad relay or broken connection through the start winding. If

(Please turn to page 50)

How to get away from everybody trying to get away from it all.

Millions of Americans crammed together in our cities and towns have made a discovery. The great outdoors. The trouble is they still usually end up elbow to jowl with their fellow man. But there is a way out.

The new INTERNATIONAL[®] SCOUT[®] II with four wheel drive not only takes you away from the noise, pollution and traffic—but from all the people who are trying to get away from it all.

The Scout II can take you to places where ordinary vehicles can't follow you. You'd be surprised what the clean air and clear streams and golden quiet can do for your mind and spirit.

The Scout II has a practical side too. All

week long it works like a wagon—zipping around to the supermarket, station and school. It even has a fold down rear seat for extra toting room.

If you're worried about creature comforts, put your mind to rest. The Scout II offers air conditioning, automatic transmission, power steering, power brakes—the works.

Test drive the new Scout II. At your International dealer.

Get 'em up Scout!

Scout II
International Harvester Company,
Chicago, Illinois 60611



FREE PLAN How to Start Your Own Business

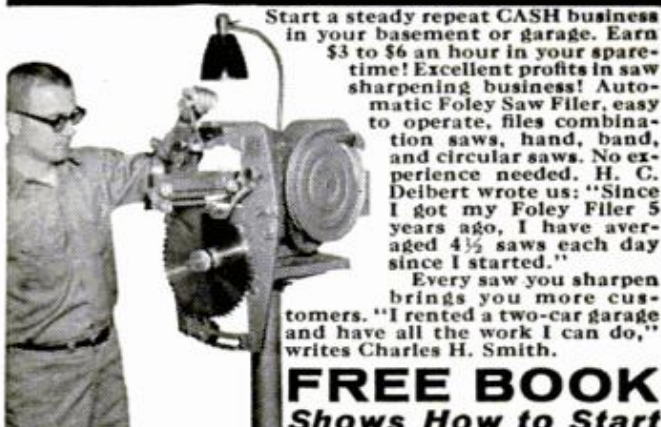

Start a steady repeat CASH business in your basement or garage. Earn \$3 to \$6 an hour in your spare-time! Excellent profits in saw sharpening business! Automatic Foley Saw Filer, easy to operate, files combination saws, hand, band, and circular saws. No experience needed. H. C. Delbert wrote us: "Since I got my Foley Filer 5 years ago, I have averaged 4½ saws each day since I started."

Every saw you sharpen brings you more customers. "I rented a two-car garage and have all the work I can do," writes Charles H. Smith.

FREE BOOK Shows How to Start

Fact filled booklet tells you how to start a sparetime business immediately; how to get new business, how to advertise. Rush coupon now; get "Money Making Facts" and details on Easy Payment Plan. No Salesman will call.

Send Coupon for FREE BOOK Money Making Facts

FOLEY MANUFACTURING CO.
416-2 Foley Bldg. Minneapolis, Minn. 55418
Send FREE BOOK—"Money Making Facts",
and Time Payment Plan.



Name _____

Address _____

MAXIMAT 7

GEARED HEAD LATHE & MILL

Turn, face, bore, thread, drill, mill, grind—to accuracies within .0002" on famous Maximat combination metal-working lathe/mill/drill machine shop! Features geared lathe & mill heads, 2 built-in 115V motors. Swings 7", 18" between centers. (10" x 26" quick-change model available.) Max. vertical cap. 10". Drill to center 12" circle.

NOW YOU CAN MACHINE ALL PARTS YOURSELF!



Maximat 7" x 18"
Send FREE literature Maximat 10" x 26"

AMERICAN EDELSTAAL, INC. TENAFLY, N.J. 07670
DEPT. BD-2

Name _____

Address _____

City _____

State _____

Zip _____

APPLIANCE CLINIC

(Continued from page 48)

you have a reversing model, the reversing switch may be defective.

One more thing—frequently overlooked. The cutters are stainless cast steel. Sometimes when not enough cold water is used in the grinding operation, small particles of food collect and tend to "freeze" the cutters. Turn off electrical current to the unit, force the food particles out from the cutters with a screwdriver and then wash the cutters with plenty of cold water.

Uptight upright

I recently inherited a Eureka upright vacuum cleaner from a relative. The machine is okay except that it vibrates. Is this something my husband can repair or should I consult a serviceman?—Mrs. John Sweeney, Fairfield, Conn.

That depends on the experience your husband has had in repairing vacuum cleaners. The degree of vibration will often provide a clue to the trouble. A slight vibration may indicate worn floor brush bearings. If the vibration is severe enough to shake the machine, the cause may be a broken fan. Between these extremes, you may feel a tingling sensation which can be caused by a bent armature shaft. The only remedy for these problems is replacement of the damaged part.

Maintenance Tips

- When splicing a line cord that's to be used in a damp area, make sure you pull the tape as tight as possible. Then spray the splice with a thin coat of acrylic plastic (sold at hardware stores). This treatment seals the tape and will make it as waterproof as possible.

- To start a nut in a spot you can't get your finger into, just stick some gum on the end of a wooden kitchen match and stick the nut to the gum. Carefully insert the nut in its hole and insert the screw from the other end, tightening it with your fingers. Then, pull off the match.

- Never use force when opening a plastic appliance case—you may break off the small molded studs around the edges. Gently pry around the seam of the case with a thin-bladed tool. ★★★

If you have a question about any appliance, send it to Appliance Clinic, Popular Mechanics, 224 West 57th St., New York, N.Y. 10019. Sorry, but letters cannot be answered individually. However, problems of widest interest will be answered in this column.



The prima ballerina of the air.

You should see Mary J. Gaffney fly. Outside snaps and rolls, triple-amazing-whammies. At speeds up to 200 mph, and upside-down forces of 8 G's.

She says it's pure joy.

"I was going into my 40's and feeling kinda grumpy about it, when Curtis Pitt asked me to test his new plane . . .

that's this one here . . . and oh, boy, it was such fun. My friends say I'm crazy, but I just love it."

For the record, Mary J. Gaffney is the only American flyer ever to win a gold medal in international aerobatic competition. She is also the U.S. National Women's Champion.

We think she is a great, great lady.

And we can't possibly explain how proud we are that she shares our belief that Champions are the finest spark plugs in the world.



20 million people have switched to Champion Spark Plugs.

New compact airconditioner saves the view

Most of today's airconditioners make a better "door" than "window." The exception is Sears' new 6000-B.T.U. Viewsaver. Measuring a mere 10 in. high, it is 20 percent smaller than others on the market, and it has several exclusive features. For one thing, this new compact bedroom-size unit leaves more window for you to see through. You can raise the window for washing without fear the unit will fall out, and with less than a 15-in. depth, it has less "hangover" to mar your home's looks and less protrusion inside to interfere with drapes.

What's more, its "Aware Conditioner" (an automatic thermostat control) lets you set it once and forget it for the season. It turns the unit on and off automatically—even its three-speed fan.

Quick-mount accordion side curtains eliminate the need to "build it in," and a simple locking device holds the center-balanced unit securely without help from the window. The unit uses 115-v. power, weighs less than 80 lbs. and sells for \$189.95.

REVERSIBLE FRONT PANEL (right) has decorative cane finish on one side, burl elm on other, to give change of decor. Sliding panel conceals the controls

OLD VERSUS NEW (below) shows how much smaller new unit is than normal 16-in. monster. Rated cooling power for each model is the same: 6000 B.T.U.

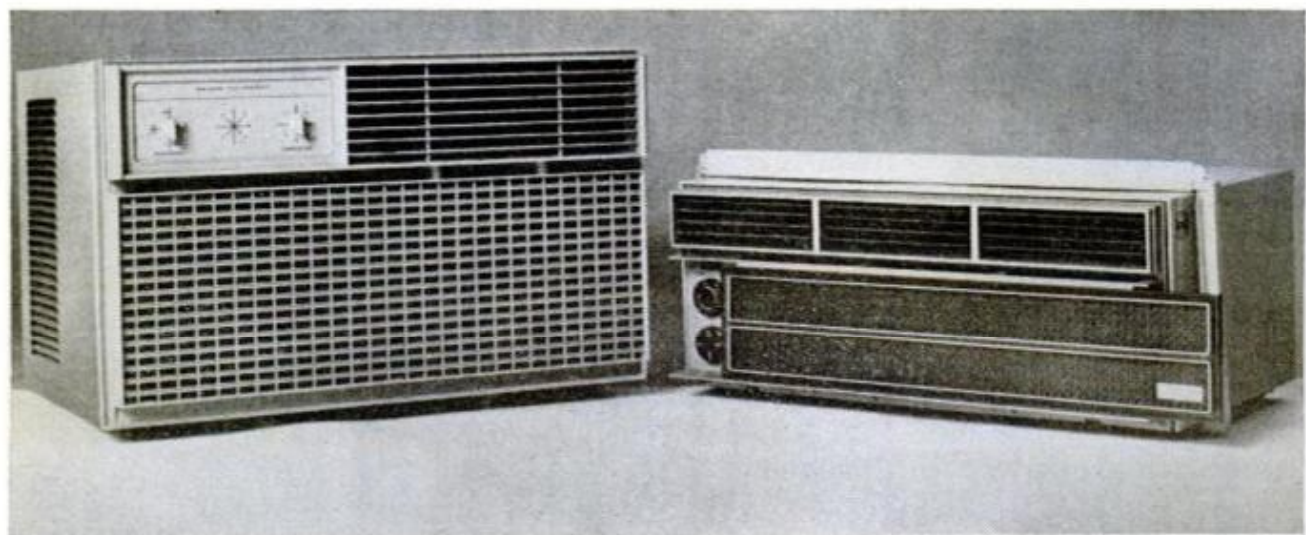
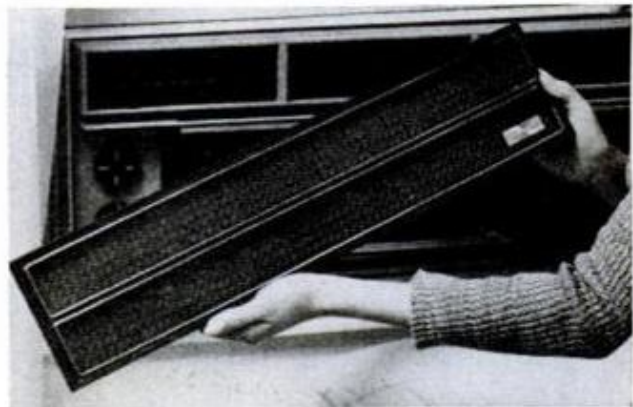
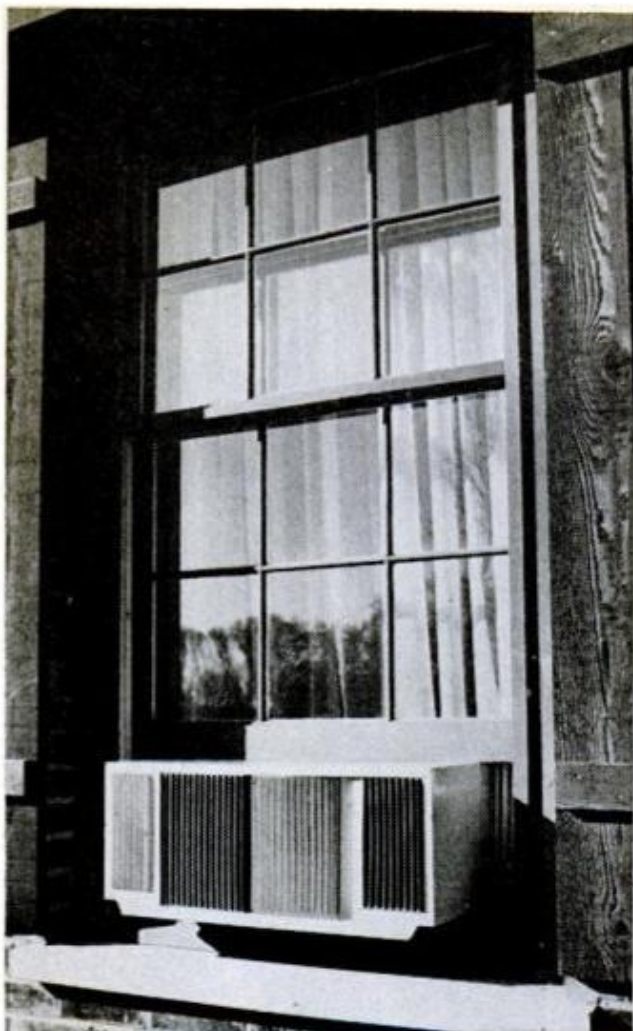



STEVE PETRASEK HAS A SYSTEM TO GET FROM OHIO TO MONTANA IN 31 HOURS.

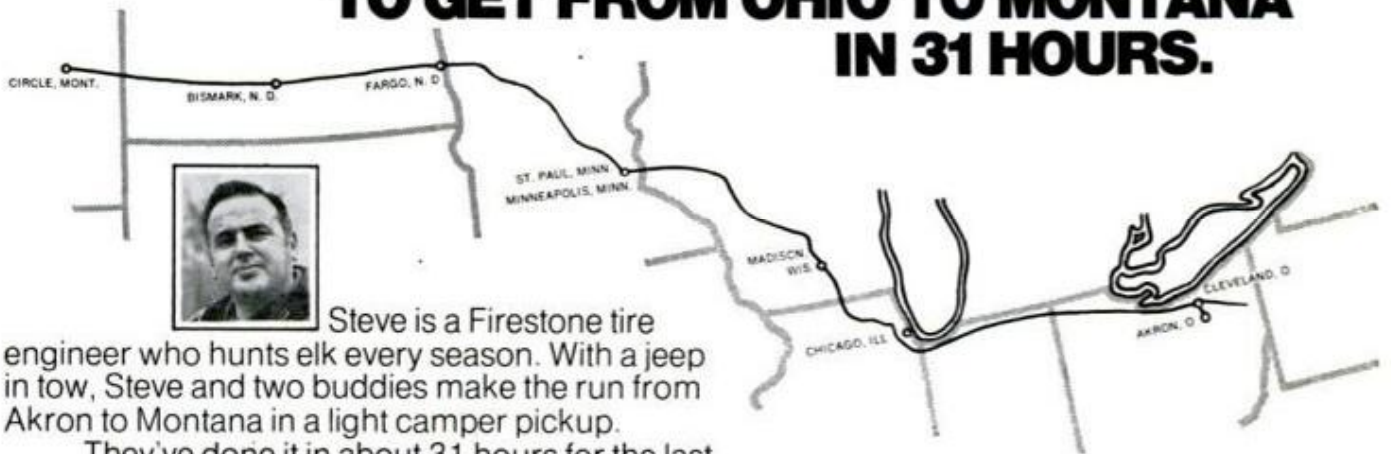

Steve is a Firestone tire engineer who hunts elk every season. With a jeep in tow, Steve and two buddies make the run from Akron to Montana in a light camper pickup.

They've done it in about 31 hours for the last nine years. Because they've systemized things down to the last spare bolt: Two-hour driving shifts, fuel records, and food and gear allotments figured to the final fresh egg.

The tires they'll be using next season are a natural part of this computer-like approach.

Firestone's Wide Oval Tire System for campers. Here's how it works:

On the front, you put Firestone's Transport 500 Wide Oval® truck tires. They're the *steering* part of The System. They have a wide, wide tread that grips the road to deliver more mileage under normal conditions than the tires they replaced in our line. (The Transport Wide Oval.)



On the rear, you put Firestone's Traction All Season™ Wide Oval™ truck tires. They're the *drive* part of The System. Their computer-designed tread lets you run along at turnpike speeds, then pull off the road (even into snow or mud or sand) and keep on going.

Two pairs of Firestone tires teamed together to provide your camper with stability, traction, and long tire life.

They work! Take it from Steve (write to him C/O Firestone, Akron, Ohio 44317 for more information). Or ask your local Firestone Dealer, the man with The System.

The Wide Oval Tire System
for Campers.

Firestone

PM's test with decibel meter and rough rider shows that Bultaco has broken the noise barrier with its new Alpina—and it's surefooted to boot!

MOTORCYCLE NOISE can be the most irritating sound anywhere, and when that noise is generated out in the woods or desert it becomes even more obnoxious. Just how noisy competition-bred two-cycle can be is illustrated by the fact that on several occasions I have heard motorcycles over five miles across the Viccaino Desert! I'm a motorcycle fan and didn't enjoy the experience at all.

The engineers at the Bultaco factory in Barcelona are fully aware of this problem, and so have devoted a great deal of care and ingenuity to silencing their new off-road bike, the Alpina. They have succeeded so well that I couldn't hear the engine, at idle, a hundred feet away. Up close the whirr of the gears was plainly apparent, something I'd never before noticed on a two-stroke machine because of the exhaust noise.

The usual two-cycle motorcycle engine gets most of its power from a tuned exhaust system that is inherently noisy in itself. It cannot be muffled and still have the engine put out maximum power. With tuned exhausts designers have been able to obtain an awesome amount of power from very small engines using very narrow power band, at the expense of creating an ear-shattering racket.

The Bultaco people went at the problem the other way around: By using a relatively large 250-cc engine, they were able to eliminate the tuned exhaust requirement for obtaining sufficient power for a go-anywhere trail bike, and they could concentrate on designing a compact and practical exhaust muffling system.

They used a large-diameter exhaust pipe leading from

**At last, a
powerful and
quiet bike
for the trail!**



AUTHOR makes quick work of a steep hill in a recent enduro competition

By **DOUG RICHMOND**
Photo by Danny MacMurray

the cylinder to the first muffler to cut down gas velocity. The pipe itself is connected to the primary muffler with a synthetic rubber sleeve. The primary muffler is coupled to a second smaller muffler by another rubber sleeve.

Two mufflers are used because it is extremely difficult to obtain efficient sound dampening over a wide frequency range with a single unit of reasonable size. The approach is not new, but Bultaco is the only manufacturer who applies it to cycles.

Since the engine is large enough to develop ample power without resorting to exhaust tuning, it could be designed with a very wide power band. It's basically a simple, four-port, two-cycle design. Extra weight was added to the flywheel to smooth the power impulses at low speed. For low-speed tractability, the carburetor is 27 mm—about the size one would expect to find on a 125-cc machine.

The result of all the hot-rodding in reverse is an engine with a rated horsepower about the same as for a hot machine

of half the displacement, with absolutely no signs of temperament, easy starting and the ability to pull strongly from walking speeds up. And it idles like an old-fashioned farm engine with a steady chug, chug, chug without a bit of loading-up.

The foot pegs are set much more to the rear than on most trail bikes to facilitate riding in a standing position, and the tank is made extremely narrow to allow the machine to be shifted readily from side to side beneath the rider. A tank of this design necessarily has small fuel capacity, and on the Alpina the capacity was increased by extending the tank back under the seat itself.

The seat has less padding than the usual run of trail cycles but the Alpina is intended to be ridden standing on the pegs in rough spots and the seat used for smooth sections.

Foot pegs and rear brake pedal are made of serrated steel with cutouts to allow them to clear themselves of mud, and

(Please turn to page 56)

BULTACO ALPINA SPECIFICATIONS

Bultaco, Box 433, Silverado, Calif. 92676.
Recommended retail price: \$895 p.o.e.

Tires: Front—2.75x21 knobby
Rear—4.00x18 knobby

Rims: Alloy

Engine: Type—piston-port, 250-cc, 2-cycle single
Bore and stroke—72x60-mm (2.83x2.36 in.)
Compression ratio—(swept) 9:1
Carburetor—27-mm Spanish Amal
Power—19.8 hp @ 5500 rpm
Lubrication—Oil in fuel

Fuel capacity: Approximately 2.6 gallons

Transmission: 5-speed, foot shift on right.
Ratios—(1) 25.75:1; (2) 17.4:1;
(3) 11.3:1; (4) 9.7:1; (5) 8.8:1

Frame: Wheelbase—52.5 in.
Ground clearance—11 in.
Weight, with fuel—220 lbs.
Seat height—31 in.

Noise level: 78.2 db (average of five runs). Sound measured 50 ft. from lane of travel with bike running at steady 40 mph.

Lights are supplied boxed for the user to install if he desires. Toolkit supplied as a waist pouch to be worn by the rider.

LARGE-DIAMETER EXHAUST PIPE, which slows exhaust velocity, marks Alpina profile



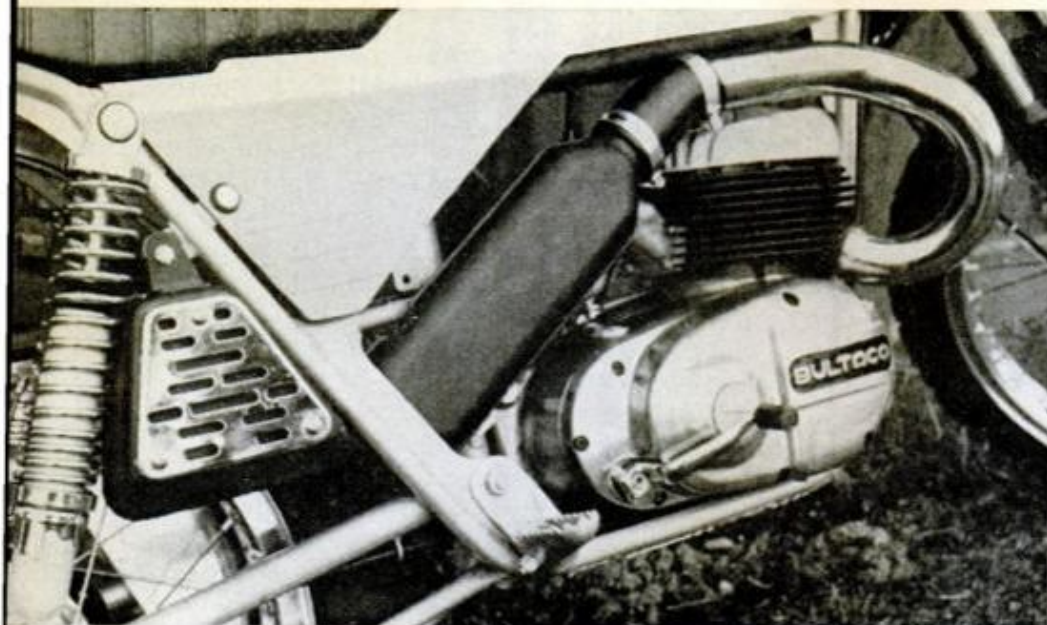

UNTUNED EXHAUST from the 250 single keeps down noise. Primary and secondary mufflers are connected by synthetic rubber sleeves. The exhaust is vented to atmosphere near the rear wheel through a short length of $\frac{7}{8}$ -inch pipe. Noise reading of 78.2 decibels (db) was obtained by running bike on gravel instead of pavement to minimize the noise of the knobby tires. Readings taken on two tuned-exhaust machines for comparison were 82 db for a 100-cc model and 90 db for a 250-cc bike. Antinoise bills pending in legislatures of many states would set maximum db levels for both street and trail bikes

QUIET BIKE FOR THE TRAIL!

(Continued from page 55)

there is a large opening in the transmission case to prevent any mud buildup and to facilitate threading a drive chain, something that can be quite a hassle with most bikes.

A spring-loaded chain tensioner is used on the rear chain to make chain adjustment

a bit less critical and to cut down jerking from power impulses at low speeds. As a secondary benefit it serves as a guide and helps prevent the chain from jumping the rear sprocket.

Gear ratios were chosen with extremely rough country in mind, and low is a real stump-puller. There is quite a long jump to second, but from second on the gears follow in fairly regular procession. Top speed in fifth is over 70 mph. The gear changes are sure and easy—we never missed a shift on the Alpina, and neutral was easy to locate.

The forks have $6\frac{3}{4}$ inches of travel and are damped in both directions. Rear suspension is five-way adjustable and allows four-inch movement at the rear axle. All suspension springs are progressively wound and the springs on the shocks are chromed.

Clutch is the usual multiple-disc, oil-bath unit and is the equal in performance and ease of operation of any we have used.

Handlebars on the Alpina are fantastically wide, 34-inchers, great for a stand-and-ride configuration. If you prefer fast riding to precise riding, there are narrower bars available as an option.

Riding the Alpina we found no flat spots anywhere in the throttle response, and it wasn't necessary to charge up every steep pitch in order to stay in the engine's usable power band as we've learned to do with other bikes. As long as the Alpina's engine is turning it will pull!

When we first inspected the bike we were a little suspicious of the modest—by today's off-road standards—ground clear-

(Please turn to page 58)



ON ROCKY HILLSIDES and creek beds Alpina proved itself repeatedly. Torque in low gears is impressive

The principle is the same. The potential is different.

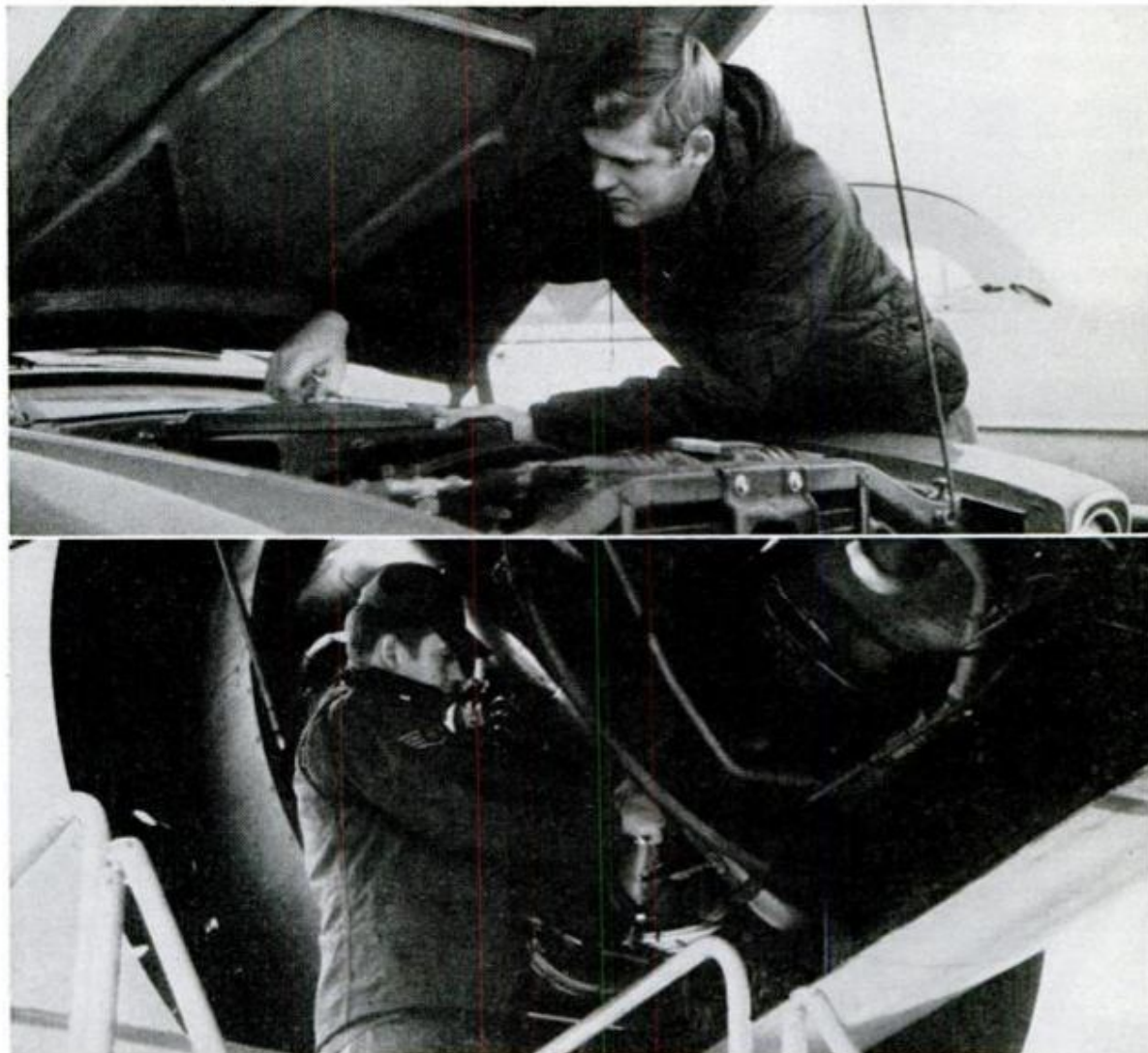

Start with an inquiring mind. Add a passion for making things work. Then combine these qualities with a love of machines and a craftsman's hands, and you've got a natural born mechanic.

When the Air Force gets hold of a guy like that, they'll spend thousands of dollars to train him to be a master at his skill. And from automotive repair to computer maintenance, the skills the Air Force teaches can be as valuable out of the service as in it.

What are you interested in? Whether you know for sure or not, you've got to be interested in what an Air Force skill can mean to your future. And right now, as a special incentive, your local Air Force recruiter has a selection of jobs that he can guarantee you *before* you enlist. You just make your choice, and the skill of your life is locked in your future.

One more good reason to go Air Force is the recent pay raise that almost doubles your starting salary as an airman.

For more information, mail in the coupon. Or, call

800-631-1972 toll free for the address of your nearest Air Force representative.*

Let the Air Force take your potential and make the most of it.

*In New Jersey call 800-962-2803

U.S. AIR FORCE RECRUITING SERVICE DIRECTORATE OF ADVERTISING (APV) RANDOLPH AIR FORCE BASE TEXAS 78148	1-PM-42
Name _____	
High School _____	
Address _____	
City _____ State _____ Zip _____	
Phone _____ Date of Birth _____	
I understand there is no obligation.	

Find yourself in the Air Force.

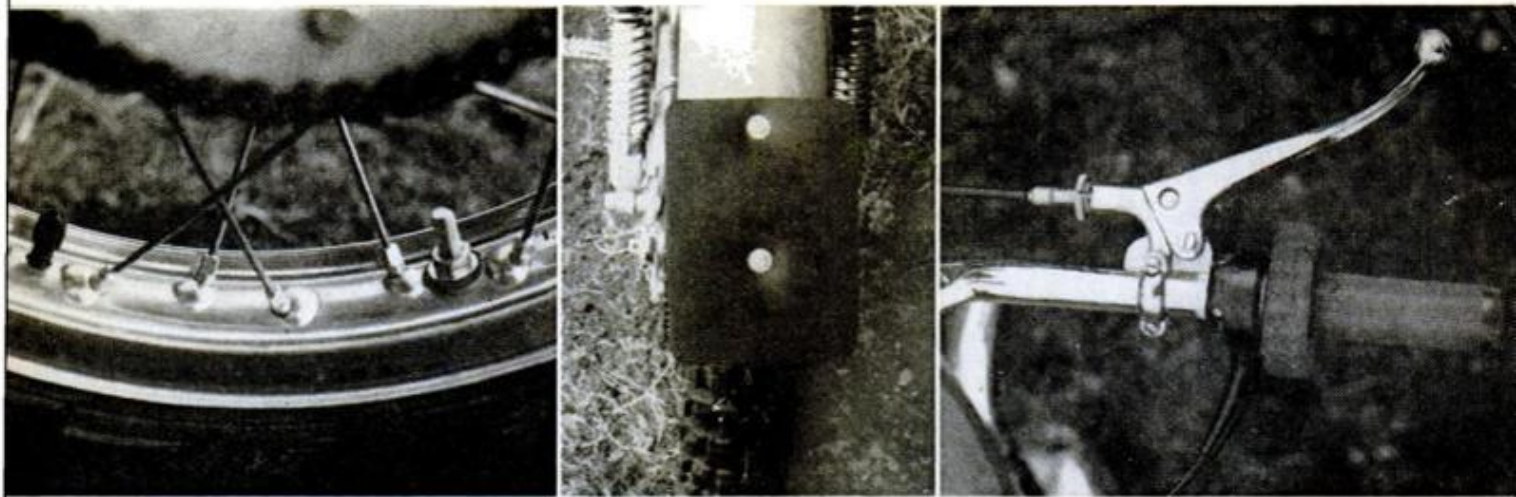

SECURITY BOLTS on tire rim, left, prevent tire from turning on rim. Tube stem has no retaining nut so it won't be jerked out of tube in case of flat. Rubber flap, center, keeps mud off rider's back. Control lever, right, is steel. Sponge-rubber pad is easy on throttle hand. Rubber boot over cable end keeps out dirt

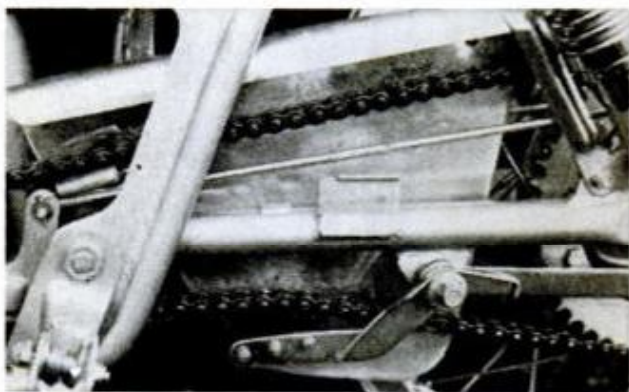

CHAIN TENSIONER is spring-loaded, reduces chain wear and contributes to easy handling at low speeds



CUTOUPS around the drive chain allow mud to escape; foot pegs and brake lever are also mud-free

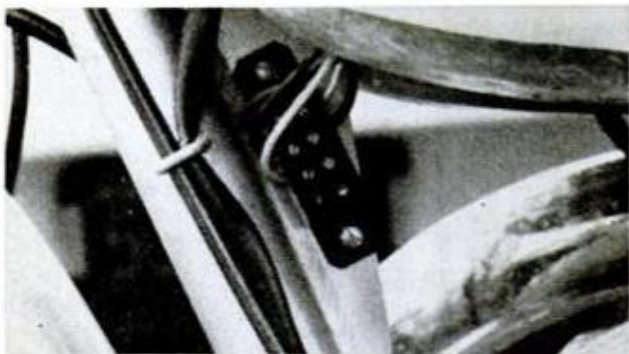

JUNCTION BLOCK makes installation of lights easy. Lights are supplied with bike but they're in a box!

QUIET BIKE FOR THE TRAIL!

(Continued from page 56)

ance of just under a foot, but riding we discovered that we could simply tweak the throttle a bit and loft the front wheel over obstacles, and this got us over obstacles higher than the measured ground clearance.

The best test of a bike's suspension and handling is its ability to negotiate rocks, and in this the Alpina has no near rival in the trail-bike field. We rode it for hours in

creek beds and on rocky hillsides just for the fun of being able to ride in places where we could only walk with difficulty!

A big, strong rider can do things with a trail bike that a smaller man will find impossible, so for our test we enlisted the services of Danny MacMurry who is five-foot-four and tips the beam at 112 pounds. He has been riding a 100-cc machine, but he made the transition to the more powerful bike like a duck to water. Partially this was because the Alpina has a seat height about the same as most 100-cc cycles, and partially because the handling characteristics make it possible to *ride* this bike instead of *muscling* it over the countryside.

The Alpina will not be everyone's cup of tea, but for the man who wants the ultimate in trail-bike handling, who regards every piece of tough terrain as a personal challenge, it is worthy of serious consideration. For the dyed-in-the-wool enduro competitor it's a natural! ★★ ★



McCulloch portable generators satisfy your secret longing for power.

Don't be ashamed to admit you're a little power-mad. After a long day's fishing, do you long for a little heat in your chilly camper? Would you love to watch a little TV out in the boondocks? Could you use your power tools more often, if you could plug them in outdoors? Would better lighting help the building project you work on at night?

McCulloch plugs you in where there's no plug. McCulloch builds super lite generators for people who need their power portable. They're light enough and small enough to easily fit in the back of your car. So you can plug in the electric drill when you're out on the east 40. Or plug in extra horsepower and candlepower for your building projects. Or have standby electric power if a lighting storm

knocks out the electricity for awhile. Why McCulloch is better than anybody. Not all current is current. Old-fashioned conventional generators can be a pain. They have brushes and slip rings that wear out. Electromagnets that can overheat. Things that can make them arc or spark or short out. McCulloch is more than current. It's a little science-fiction-y! It has a truly unique design—with only one moving part. Virtually nothing to wear out. McCulloch gives you the most reliable portable power you can buy.

Satisfy your longing for power three ways. McCulloch comes in three sizes. All super lightweight. And all with McCulloch's famous Double Warranty: a One-Year-Engine Warranty; and a One-Year-Generator Warranty.

For your nearest McCulloch Generator Dealer, see the Yellow Pages under "Saws."

Mac 1500: 1,500 watt capacity. 61 lbs. 115 volts. 60 cycles. Only \$199.95*

Mac 2000: the lightest 2,000 watt generator anywhere. 71 lbs. Four receptacles. 115 volts. 60 cycles. Volt-meter to show output. Only \$289.95*

Mac 3000: big power for big stuff like construction projects, repair crews. 129 lbs. Double-throw switch for 115 or 230 volts. 60 cycles. Fused for overload protection. New low price \$399.95*

 **McCULLOCH**

McCulloch Corporation, Los Angeles, Calif. 90045

*Manufacturers suggested list price.

WORTH WRITING FOR

LOOKING FOR IDEAS AND INFORMATION ON HUNTING, FISHING, CAMPING, BUILDING, TOOLS, ETC.? CHECK THESE LISTINGS, THEN USE THE COUPON BELOW.

29. THE WHOLE KIT AND CABOODLE—

Hunting, fishing, camping, where-to-stay—it's all there in this kit from Canada's Department of Tourism and Information. Free.

30. IT'S SOLID—YOU NEVER PAINT!

Send for this full-color brochure on solid vinyl siding, shutters, and other building products from Bird and Son. They're maintenance-free! (East of the Rockies only.) Free.

31. HERE'S THE NEWEST REMINGTON CATALOG—

48 pages illustrated in Full Color. Big and complete. Free.

32. JEEP X-RAY DRAWINGS

Pen and ink, perspective, x-ray drawings of Jeep, Commando, Wagoneer and Truck. Virtually every component detailed. Fine for office or den. Set of 4: \$5.00.

33. HOW TO INSULATE YOUR HOUSE—

These 16 pages from Owens/Corning Fiberglas tell you where to insulate, how much to use, application, vapor barriers, and other necessary information. Good book. Free.

34. TWO FOR NO MONEY—

Two catalogs, one for hunters and one for fishermen, are in this package from Harrington and Richardson. Each book 44 pages. Free.

35. ALL ABOUT BATTERIES—

32 pages of questions and answers on batteries and your car's performance. Helpful and informative from ESB Brands. 50¢.

36. WEAVER GUN SCOPES CATALOG—

32 pages of brilliant color showing models and mounts, plus information on sighting-in, trajectories, etc. Free.

37. POPULAR MECHANICS 1971 INDEX—

32-pages of cross-referenced listings of every PM editorial in 1971, and it's a shelf-binder to protect all 12 issues. Send for this! \$1.49.

38. THE EASY WAY TO INSTALL PANELING—

Here's a truly definitive, well-presented set of instructions to make paneling an easy job. From Evans Products. Free.

39. 32 PAGES OF MARLIN—

All the 1972 Sporting Firearms offered by Marlin are illustrated and described in this full-color catalog. Also covers scopes and Zane Grey Library. Free.

40. THE NAKED HOUSE—

Bare of interest, that is. Here's a 128-page book just crammed with ideas—it's a designing guide to color moods and modes. From Pittsburgh Paints. \$1.

41. ALL OUTDOORS AND ALL SEASONS—

That's the advantage of the Tri-Sport recreational vehicle from Allsport. You can also use it to mow your lawn! Full color catalog. Free.

42. HOW DO HUNTERS HELP?

This new Fact Book from the National Rifle Association covers conservation activities and objectives of the NRA. Free.

43. SHOOTING FUN THE CROSSMAN WAY—

Complete catalog of Crosman CO₂ and air-powered guns—practically noiseless, odorless and recoilless. Includes marksmanship techniques and how to set up a shooting range. Free.

44. PUT YOUR TRAILER IN TOW—

Covers basic trailer-towing tips and how to equip your Oldsmobile for trailer-towing. Covers all models and types of trailers. Free.

45. 1972 BEAR ARCHERY CATALOG

Bows, arrows, quivers, accessories—the "whole shooting match" in this full-color catalog. Free.

46. WHAT'S IN A CAMPER?

New brochure from Dodge covers just about every kind of camper. Very helpful in determining your needs, choosing equipment. Free.

47. HOW TO CHOOSE AN ATV—

All-Terrain Vehicle, that is. You've seen these 6-wheel fun machines, now get the rundown from ATTEX. Free.

48. GARDEN PROJECT BOOKLET

Step-by-step instructions on how to build planters, decorative screen block walls, flower bed edging, patio floors, seating walls, barbecues, pools, steps and walks with Sakrete Concrete and Mortar Mixes. Nineteen different projects. 25¢.



**POPULAR MECHANICS 472
BOX 1718, SANDUSKY, OHIO 44870**

This coupon expires June 30, 1972

Please see that I receive the items checked below. I have enclosed 35¢ for the overall service charge, plus remittance for any priced items.

- | | | | |
|--------------------------------------|--------------------------------------|-----------------------------------|-----------------------------------|
| <input type="checkbox"/> 29 | <input type="checkbox"/> 34 | <input type="checkbox"/> 39 | <input type="checkbox"/> 44 |
| <input type="checkbox"/> 30 | <input type="checkbox"/> 35 (50¢) | <input type="checkbox"/> 40 (\$1) | <input type="checkbox"/> 45 |
| <input type="checkbox"/> 31 | <input type="checkbox"/> 36 | <input type="checkbox"/> 41 | <input type="checkbox"/> 46 |
| <input type="checkbox"/> 32 (\$5.00) | <input type="checkbox"/> 37 (\$1.49) | <input type="checkbox"/> 42 | <input type="checkbox"/> 47 |
| <input type="checkbox"/> 33 | <input type="checkbox"/> 38 | <input type="checkbox"/> 43 | <input type="checkbox"/> 48 (25¢) |

Total items requested _____ Total money enclosed _____

Name _____
(Please Print)

Address _____

Town _____ State _____ Zip Code _____

(Please send cash, check or money order made out to POPULAR MECHANICS. No stamps, please.)



MAKE EXTRA \$\$\$ EVERY DAY!

Get into the big, year-round
EXTRA MONEY BUSINESS
that's EASY to learn—EASY to
do—and EASY ON YOU!

Be a LOCKSMITH!

You Can Make Up to \$10 an Hour—even while learning!
Train FAST at Home!

Never before have money-making opportunities been so great for qualified Locksmiths. Now lucrative regular lock and key business has multiplied a thousandfold as millions seek more protection against zooming crime. Yet there's only one Locksmith for every 17,000 people!

Start Collecting CASH PROFITS Right Away

You're "in business" ready to earn \$5 to \$10 an hour a few days after you begin Belsaw's shortcut training. Take advantage of today's unprecedented opportunities in Locksmithing for year-round EXTRA INCOME in spare-time—or fulltime in a high-profit business of your own. Hundreds we've trained have done it. So can YOU! All tools plus professional Key Machine given you with course. These plus practice materials and equipment,

**THIS PRO
KEY MACHINE—
YOURS TO KEEP—**

can add \$25 to
\$40 a week to your
income . . . and it
won't cost you a cent
with your training.



FREE



Tells how
to make
money in
Locksmithing
almost
from the
start!

**ALL TOOLS, MATERIALS AND PRACTICE
EQUIPMENT COME TO YOU WITH YOUR COURSE.**

"War injuries left me badly handicapped, but now I'm a financial success as a Locksmith, thanks to your training. Besides, the work is fascinating. If I can do it anybody can." — Glen Johnson, Larned, Kan.



plus simple, illustrated lessons, plus expert supervision, plus business-building guidance will enable you to KEEP THE MONEY COMING IN! Ideal for retirement—good jobs, too.

SEND FOR EXCITING FACTS—No Obligation

Discover what's in Locksmithing for you—how Belsaw's master-locksmith-approved training can give you the skill you can depend on to EARN MORE—ENJOY LIFE MORE. Just fill in and mail the coupon below to receive full information by return mail. Do it TODAY!

BELSAW INSTITUTE, 103A Field Bldg., Kansas City, Mo. 64111
Accredited Member National Home Study Council
Approved for all Veteran Training

MAIL THIS COUPON—NO SALESMAN WILL CALL

**BELSAW INSTITUTE, 103A Field Bldg.
Kansas City, Missouri 64111**

Please send me free of cost or obligation your publication "Keys to Your Future" on how Belsaw can quickly train me to make money in Locksmithing and how all tools and Key Machine are given me to keep.

Name _____

Address _____

City _____ State _____ Zip _____

Check here if eligible Veteran.

KNOCKING, PINGING, SLUGGISH ENGINES NEED FUEL MIX.

Pour a can in the gas tank. FUEL MIX breaks down the compounds that cement carbon particles to pistons, valves, cylinder heads. The carbon deposits loosen, flake off and are blasted out the pipes. Quickly, surely.

FUEL MIX also eliminates "dieseling" or "after run" caused by red hot carbon particles. It's great for new engine break-in and after valve and ring jobs, too. Puts needed lubrication in the hot upper cylinder areas, protects cylinders from scuffing and scoring. It really works!
It's from the makers of . . .

GUMOUT

Pennsylvania Refining Company, Cleveland, Ohio 44104
Also available in Canada



MAY **Preview** OF POPULAR MECHANICS



4 GREAT VACATION HOMES

All of these homes lend themselves to year-round casual living, and we offer you the plans.



29 PAGES: MOTOR CAMPING

New truck campers, trailers, motor homes, mini vans, mini trailers, build-it-yourself rigs—how to take to the road on a budget or in high style.



A HIGH-FLYING HOBBY ZOOMS TO NEW HEIGHTS

More people are building their own planes than ever. Monthly feature starts in this issue.



AMERICAN MOTORS' 'BUYER PROTECTION PLAN'—IS IT ALL THEY SAY IT IS?

The PM Owners Report on the AMC Ambassador answers that question—and others.



BICYCLE REPAIRS: HOW TO TAKE CARE OF THE BOTTOM BRACKET

Axle, cranks and chainwheel—an expert tells how to lube and overhaul them.

PLUS

A handsome provincial table you can build for as little as \$14 • A round-up of the best '72 riding mowers • What owners say about their Chrysler Town & Country station wagons • How to add sound to home movies • New stick-down seamless carpeting anyone can lay

Buy it on your newsstand. Better yet, make sure you'll keep getting this kind of exciting fare. Send this coupon with your check to:

POPULAR MECHANICS
250 West 55th Street
New York, New York 10019

Please enter my subscription for 1 yr. \$5 or 2 yrs. \$9

Name _____ (Please print)

Address _____

City _____ State _____ Zip _____

Payment of \$ _____ is enclosed. New Renewal

On new subscriptions, first copy will arrive in about 8 weeks.

(Above prices apply in U.S. and Possessions only. Canada, add \$2 per year. All other countries, add \$4 per year.)

WPM2D1

POPULAR MECHANICS

4 WAYS TO GET RICH! AND HAVE FUN

Join America's exciting new hobby—Treasure Finding. These sensitive instruments work through dirt, sand, wood, water, and even rock with no loss of power. Quality engineered lightweight and fully transistorized. Operates many hours on an inexpensive 9 volt battery. Order Now... all models in stock.



FREE BONUS

This \$4.00 value is yours free when you order a Jetco Treasure Finder.



Made in USA
Full 5 year Warranty

THE MUSTANG "330"

Detects a penny to 5 inches. Detects sharply with "Sound off" loud speaker. Very powerful, comes complete, ready to go.



ONLY **\$39⁹⁵***

**FIND LOST COINS, RINGS, GOLD, SILVER, AND RELICS.
WHERE: SCHOOL YARDS, PARKS, BEACHES, OLD HOUSES,
VACANT LOTS VIRTUALLY ANYWHERE. DETECT ALL METALS.**

THE SEARCHMASTER "550"

Detects a penny to 6 inches. Has sensitive Vernier tuning for detecting fringe items.



ONLY **\$69⁹⁵***

THE TREASURE HAWK "990"

Detects a penny to 8 inches and silver dollar to 12 inches. Has view meter loud speaker, sensitivity switch, battery tester, dual search loops. Power to spare.



ONLY **\$129⁹⁵***

THE HUNTMASTER "770"

Detects a penny to 7 inches. Has view meter, loud speaker, dual search loops, extra sensitivity.



ONLY **\$99⁹⁵***

TO: JETCO ELECTRONIC INDUSTRIES, INC. PM
P. O. Box 26669
EL PASO, TEXAS 79926

I enclose \$ _____ + \$2.00 shipping cost for \$ _____ total—
Rush me a

- MUSTANG SEARCHMASTER
 HUNTMASTER TREASURE HAWK
 Send me a free detailed catalog only

Name _____

Address _____

City _____ State _____ Zip _____

*Texas residents add 5% sales tax

MAKE BIG MONEY

OPERATING HEAVY EQUIPMENT



**BULLDOZERS
CLAMSHELLS
TRENCHERS
DRAGLINES
BACKHOES
SCRAPERS
GRADERS
CRANES**

The Construction Industry is Booming! Earn top money in this fast moving, action-packed field. Keep present job and train at home in spare time followed by practical training on our machines under project conditions at our facilities. Nationwide placement assistance. For FREE information fill out and mail coupon today!
Member American Road Builders' Assn.

APPROVED FOR VETERANS AND INSERVICE PERSONNEL

UNIVERSAL HEAVY CONSTRUCTION SCHOOLS, Dept. PM
1901 N.W. 7 STREET / MIAMI, FLORIDA 33125
Phone: (305) 642-0800 (24 Hours)

Please Print

Name _____ Age _____

Address _____

City _____ State _____

Phone _____ Zip _____

Print For Profit



Cards, Stationery, Envelopes, Advertising, labels, tickets, announcements, Q.S.L. cards, greeting, sympathy, prayer cards, tags, etc. Good Profits, Pays for itself in a short time.

Own a Printing Business

We supply everything direct from factory only. Easily followed rules. Also raised printing like engraving. Have home shop. Add to income. Send 25c for catalogue. **KELSEY PRESSES Meriden, Conn. 06450**

MAIL THIS COUPON TODAY!

KELSEY PRESSES, DEPT. 72-J, Meriden, Conn. 06450

I enclose 25c send big catalog and samples.

Name _____

Address _____

City _____ State _____ Zip _____

I-N-V-E-N-T-O-R-S WE NEED INVENTIONS

Sell your invention for cash—need money for Patent?—Are technical problems holding you back? Universal Inventions has helped inventors all over the world—just like yourself—why not you? Inventions provide the magic spring-board to sudden riches. REMEMBER, we either sell your invention or pay you a cash bonus. Write for details. **UNIVERSAL INVENTIONS, Dept. 13, Marion, Ohio**



Send 25¢
for Catalog

For **TOOLMAKERS**
who use the
FINEST

GERSTNER TOOL CHESTS
Dept. D2, 20 Cincinnati Street
Dayton, Ohio 45407

HEAVY DUTY WELDER

with special \$7.00 gift offer to
Popular Mechanics readers
10-DAY FREE TRIAL
Lifetime Guarantee



Brand New **1895**
1972 Model **1895**
POST PAID

Fits ordinary 110V outlet
Not one • but 3 welding heats



Weld, braze, solder or cut most anything made of metal. No experience necessary. Follow simple instructions to make repairs on cars, trailers, farm and lawn equipment, bicycles, appliances, etc. Make campers, boats, furniture, hundreds of valuable items. **NOTHING ELSE TO BUY!** Comes complete with full face shield, pack of welding and brazing rods, heavy duty power cables, special electric torch attachment, ground clamp, flux, easy-to-follow illustrated instructions, rod holder, etc. Uses standard 3/8" rods to weld iron, steel, brass, bronze, aluminum, other metals. New improved **HEAVY DUTY** circuit gives more welding power. Gives 4 times the heat needed to melt toughest iron. Plugs into ordinary 110V outlet. **3 WELDING HEATS . . .** Not just one as with other low cost models. Use "high" for tough jobs "medium" or "regular" for lighter work. This important feature saves you money and time. Makes it possible for even beginners to start welding professionally the very first day. Pays for itself quickly. An excellent gift for any occasion. **IT'S AUTOMATIC:** Current is turned ON when arc is struck, OFF when rod is lifted from work. Eliminates need for troublesome foot switch. Speeds up work.

FREE!

Mention that you saw this ad in Popular Mechanics and receive a \$7.00 gift pack assortment of "touch weld" welding rods. Automatic arc striker. Weld with "push button" ease.

10 day **MONEY BACK GUARANTEE.** You must be satisfied or return for refund. Send only \$2.00 and pay postman \$16.95 plus postage when delivered or send \$18.95 cash, check or money order for immediate postpaid shipment.

WEL-DEX MFG. CO., Dept. W-203, Box 10776, Houston, Texas 77018

LOCKSMITH
RECOMMENDED



sticky locks?

Keep 'em turning with

LUB-A-SPRAY.
GRAPHITE



Lubricate and Protect working parts, inner lock and keyways with Lub-A-Spray Graphite Lubricant in handy squeeze tube. Resists moisture, prevents lockout, broken keys. At Locksmiths, Hardware, Auto, Chain Stores. **PANEF Mfg. Co., Inc., 5700 W. Douglas, Mil., Wis. 53218**

HOW TO GET RICH -- AT HOME!



There is no other business like mail order. Start on a shoestring in your spare time and make a fortune fast. It strikes like a bolt of lightning! Millions read your ad and suddenly you are swamped with cash orders from all over the country. **MORE MONEY** in 60 days than you could earn in a lifetime! Write for free book and complete details. **Mail Order Associates, Inc. Dept. 180, Montvale, N.J. 07645**

MAGIC MAIL PLAN that comes with this Little Machine CAN MAKE YOU \$1200 AN HOUR

The machine is turning out a job that will bring operator \$2.58, by mail. Material cost, only 11¢



Write today for free facts about the newest and most fascinating of all new home operated businesses. For the first time, a simplified machine brings the fabulous profits of Plastic Sealing and Plastic Laminating within reach of the small operator. Anyone can learn to operate it with a few minutes practice. Then—with our **MAGIC MAIL PLAN**—can get mail orders pouring in daily with cash in every envelope.

No Canvassing or Selling

Fill orders at home in spare time to start. Then expand to full time business. We even supply circulars to bring back cash and orders. Rush name for all the facts you need to start. A postcard will do. No charge.

WARNER ELECTRIC CO., Dept. L-2-80
1512 Jarvis, Chicago, Ill. 60626

**New
Home Safe
Contact
Cement**
laminates
without danger
at half
the cost

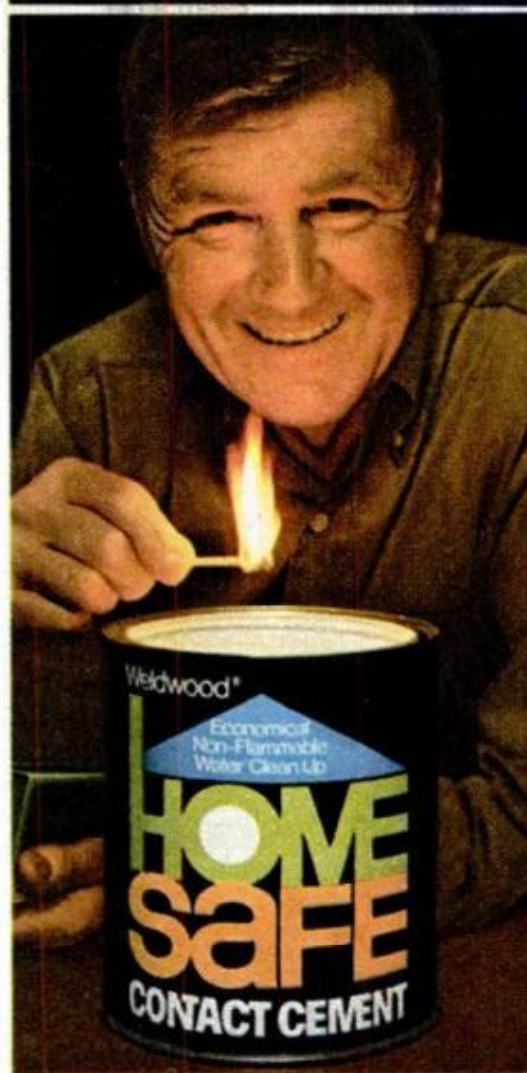

Now you can laminate with a non-flammable, non-sniff contact cement that really works.

At half the cost.

Weldwood's new Home Safe contact cement forms as strong a bond as you could want, yet goes on at half the cost of any other contact cement.

New Home Safe contact cement. Safe. Economical. Water clean-up. And it works.

You'll find it at hardware, paint and building supply stores.

Weldwood®

PACKAGED PRODUCTS

U.S. Plywood-Champion Papers Inc.
2305 Superior Avenue
Kalamazoo, Michigan 49003



**No other tool
does so much**

It's a clamp, wire cutter, super pliers, locking wrench, hand vise. Used everywhere. Adjusts to any size work. Locks with tremendous grip. Releases easily. Keep one in home, shop, car, boat, etc. Most useful tool ever made.



WISE-GRIP®

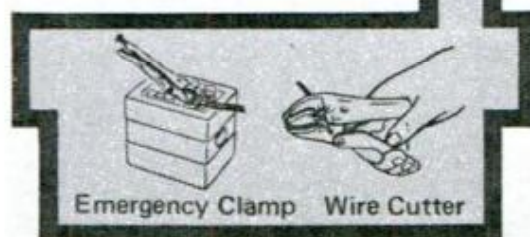
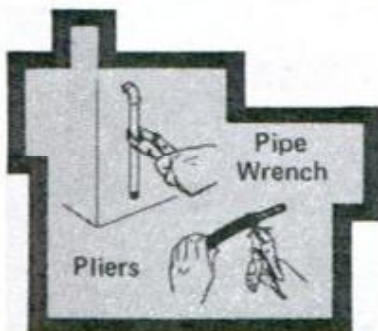

Peterson Mfg. Co., Inc., 202 William St., DeWitt, Nebraska 68341

WINSTON'S DOWN HOME TASTE!

So Real. So Rich. So Good.

**Winston tastes good
like a cigarette should.**

35 CLASS A
CIGARETTES

KING SIZE

Winston

FILTER · CIGARETTES

Winston

FULL · RICH
TOBACCO FLAVOR

Warning: The Surgeon
General Has Determined
That Cigarette Smoking Is
Dangerous to Your Health.

© 1972 R. J. REYNOLDS TOBACCO COMPANY, WINSTON-SALEM, N. C.

19 mg. "tar", 1.3 mg. nicotine av. per cigarette, FTC Report AUG. '71.

'72 Road Racing Preview:



One for the money! Two for the show!

Ready to go, side-by-side into
turn one in the Can-Am battle



for bucks is
America's best
road racer, Mark
Donohue, and the
world's best,

Jackie Stewart! If that's not
enough action, the United States
becomes the first
country ever to
run two Grand
Prix races!



Photo by
Richard George

By **BILL HARTFORD**, Auto Editor

DRIVING AT THE LIMIT is what auto racing is all about. And hanging onto a strip of twisting asphalt as it caroms off to the left and then drops out of sight to the right is what road racing is all about.

Getting around a road circuit fast takes as much brawn as it does extraordinary balance—accelerating, shutting off, hard braking, dozens of gear shifts, clipping the corners close and every lap at the car's limit of adhesion.

In the sport, the measure of man and machine is lap time. Before the ultimate test—competition with other cars and drivers—a road racer has to beat the clock.

That's just what happened earlier this year on a quiet day at Road Atlanta. There, with no one watching, during practice for the '72 Canadian-American Challenge Cup, the lap record was broken.

The driver: Last year's Trans-Am champ,



Photo by Richard George

a mechanical engineer who knows cars inside and out and doesn't like to waste his time on a loser. Mark Donohue. The car: Test configuration of a new car from the marque that's taken the World Manufacturers' Championship the last three years straight. Porsche.

When Mark qualifies the Roger Penske-prepared, factory-backed Porsche for the first Can-Am at Mosport, he'll be shooting to end the McLaren domination of the series. That, hard as it is to imagine, makes Donohue the underdog. It'll be hard for this ace to beat the Can-Am kings.

Last year Peter Revson and Denny Hulme took all the chips in the Sports Car Club of America's premier road-

UNIQUE ROAD RACE at Ontario Motor Speedway last year pitted International Formula 1 against United States Formula A/5000. Mario Andretti won

racing series. It was another year of orange monotony in the Can-Am. Another year in which the competition fizzled and failed to put a fresh color in the winners' circle. Even Jackie Stewart, the Formula One world driving champion, couldn't stop them. He did win two races in his Lola Chevrolet but since he couldn't beat 'em, he joined 'em! So, the McLaren Can-Am team for '72 is Denny Hulme, world driving champ in '67, and Jackie Stewart, ditto for 1969 and '71. (Peter Revson scooped up his 1971 Can-Am Cup and dashed off to race a McLaren car on the Grand Prix circuit.)

PORSCHE THREAT to McLaren will come from Mark Donohue in first turbocharged road racer. Flat 12 will get big boost in hp if tests are successful and principle (right) can be applied to road-racing car which must have quicker throttle response than usual with turbocharger

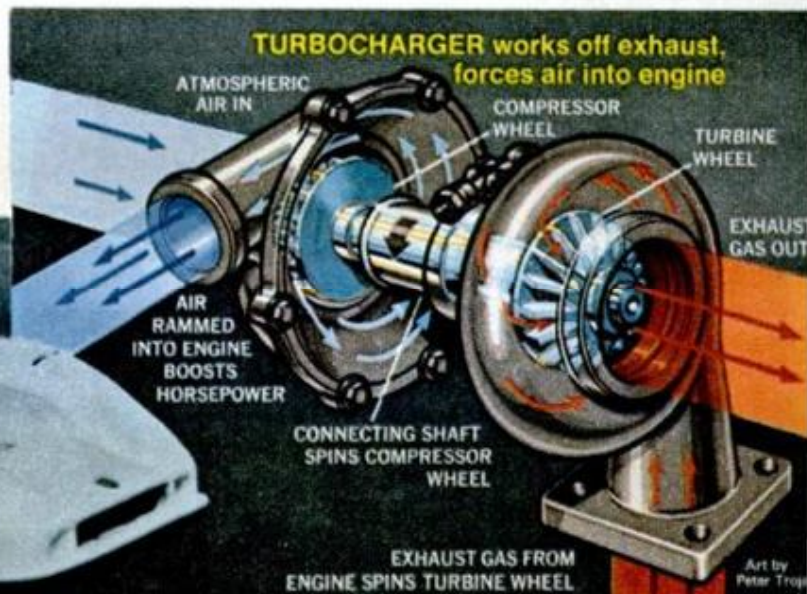
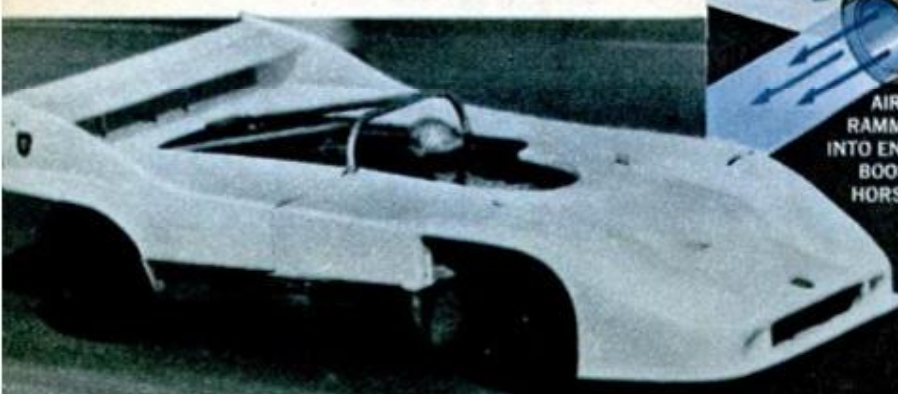

Art by Peter Trope



U.S. GRAND PRIX RACES

Apr. 9 Riverside Oct. 8 Watkins Glen

SCCA CAN-AM CHALLENGE CUP

June 11	Mosport	Aug. 27	Elkhart Lake
June 25	Open	Sept. 17	Donnybrooke
July 9	Road Atlanta	Oct. 1	Edmonton
July 23	Watkins Glen	Oct. 15	Laguna Seca
Aug. 6	Mid-Ohio	Oct. 29	Riverside

in a 12-cylinder F1 Ferrari. Here, cars coming out of the turn are No. 30, Sam Posey, FA Surtees; 25, John Cannon, F1 STP-March; 15, Howden Ganley, F1 BRM

Mark will be looking to run one of the McLarens out of the front row, and he won't be running scared. When he broke the track record at Road Atlanta (118.57 mph), he was only testing the Porsche chassis, not even running with the turbocharger that is under development for the engine. If the flat, 12-cylinder engine runs turbocharged, the Porsche will have a horsepower edge on the normally aspirated Chevy V8s in the McLaren cars. But, at this writing (mid-January), work continues toward improving throttle response of a turbocharged engine.

This is especially critical in road

PHOTO BY BILL HARTFORD →



READY TO RACE at Monaco, young F2 champ Ronnie Peterson, confers with team. He piloted the F1 STP-March to second place in the Grand Prix on the streets of Monaco last year, was second in World Drivers' Championship. At the left is the new '72 car for this driver-to-watch



racing where quick throttle response coming out of corners is essential. In oval track racing, at Indy for example, drivers are touching their brakes for control going through turn four while at the same time putting their foot down on the throttle to wind up the

SCCA TRANS-AMERICAN CHAMPIONSHIP*

- May 6—Lime Rock, Conn.
- May 29—Bryar Motorsport Park, Loudon, N.H.
- June 4—Mid-Ohio Sports Car Course, Lexington, Ohio
- June 18—Watkins Glen, N.Y.
- July 4—Donnybrooke, Brainerd, Minn.
- July 16—Road America, Elkhart Lake, Wis.
- July 30—Open
- Aug. 13—Mosport Park, Bowmanville, Ont.
- Aug. 20—Summit Point Speedway, Summit Point, W.Va.
- Sept. 3—Edmonton International Speedway, Edmonton, Alta.
- Oct. 29—Riverside International Raceway, Riverside, Calif.

*On weekend programs with all Trans-Am races in the United States are Two-Five Challenge Series races, with additional Two-Five at Laguna Seca Oct. 14-15.

turbocharger and build up power for the blast down the main straight.

Turbocharging is nothing new on the oval circuits, but would be a new and exciting breakthrough if Porsche introduces it to road racing.

On the Grand Prix circuit, the United States' only full-time representative is hard-charger Peter Revson. Not since Dan Gurney retired back in 1967 has an American driver campaigned the full schedule of world road races. (Date conflicts with his USAC schedule keep Mario Andretti from starting all the Grand Prix races.)

Revson will run all the Grand Prix races (with team-leader Hulme) and he'll be running two of them in the United States. "Impossible!" would have been the race fans' reaction to this last year. But this year the United States becomes the first country ever to get exception to the one-to-a-country rule. Watkins Glen is, as usual,

NOTE: As PM goes to press, the Grand Prix at Riverside is unsponsored and meetings are in session to determine if a year's postponement of the race will be necessary.

host to the Grand Prix East, with the traditional October date, the 8th this year (See *The Wildest Show on the Road!*, page 80, Sept. '68 PM). And for the first time, on April 9th, the U.S. Grand Prix West will run at Riverside International Raceway.

In his McLaren Ford, Revson will find himself up against much stronger competition than he faced in the Can-Am. For one thing, McLaren cars have been outstanding in Can-Am, but those designed for F1 have been just so-so. (Cars this year are white, black and brown, because of sponsorship by Yardley, the British perfumers who backed BRM last year.) Also, in Can-Am you can count the potential winners on one hand, but in F1 there is intense competition among almost a dozen high-flying pilots.

Still, Revson is not a newcomer: He had his first F1 ride in a Lotus in '63, won an F3 race at Monaco in '65, and has earned a good number of points in every type of road racing from the Manufacturers' Championship to the Trans-Am series. But he's up against the incredible talent of Grand Prix drivers like Jackie Stewart, who's defending his world title as well as running Can-Am. Then there's Ronnie Peterson, the extremely fast 28-year-old Swedish driver who roared onto the F1 scene right from F3—the first driver to make such a debut skipping Formula 2—and who last year raced Formula 2, won the championship, and placed second to Stewart for the world title in F1. We saw him start

SCCA CONTINENTAL 5000 CHAMPIONSHIP

- May 7—Laguna Seca, Monterey, Calif.
- May 21—Seattle International Raceway, Kent, Wash.
- June 4—Edmonton International Speedway, Edmonton, Alta.
- June 18—Watkins Glen, N.Y.
- July 16—Road America, Elkhart Lake, Wis.
- July 30—Donnybrooke, Brainerd, Minn.
- Aug. 20—Road Atlanta, Gainesville, Ga.
- Sept. 4—Lime Rock, Conn.
- Sept. 24—Riverside International Raceway, Riverside, Calif.

eighth on the grid at Monaco last year and pass drivers many years his senior in Grand Prix experience to finish second to Stewart by 25.6 seconds! He was always in superb control of the STP-March racer and this year in his new March 721 (see page 77) should be an even greater threat to the "old-timers."

You can hardly call Jackie Ickx an "old-timer," except in GP experience, that is! Round out the grid with drivers like Cevert, Fittipaldi, Regazzoni, Amon and his own teammate, Denny Hulme, and you know that red-white-and-blue Revson has a long, hard season ahead. Perhaps he can make a

mark in world road racing and join only a handful of American road racers, including, of course, Dan Gurney, who has won more Grands Prix than any other American driver.

The expense of campaigning on the Grand Prix circuit is the reason Dan retired from international road racing. For one reason or another, American drivers have not been a force in Grand Prix racing despite the long and colorful history of road racing in the United States—going back to the turn of the century.

The establishment of the Can-Am series in 1966 and the second United

(Please turn to page 206)

♦♦♦ and racing in the good ol' days!



AH, THE DUST AND THE GLORY! Circa 1910 there was no problem in choosing the right hardness or softness of tire compound and no choice of tread for racing in the rain; there was just the monumental problem of keeping the tires and wheels on the cars! Drivers had all they could do to hold the machines on course and the mechanics, who had to go along for the ride, were too busy pumping oil to the engine and keeping things together to even be



scared. When these pictures were taken at Brighton Beach, N.Y., by photographer Otto Klingmann, motor racing in the United States was already over 10 years old. The Vanderbilt Cup on Long Island was America's premier race and road racing was enjoying its first golden years. It was a great age when iron men on wooden wheels dared to go faster and faster to find out more and more about vehicle dynamics. The races you watch in 1972 started here!

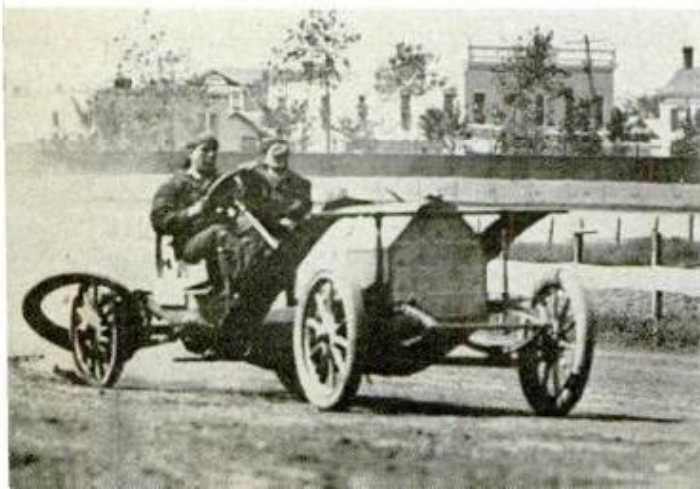



The superfast spy plane we don't talk about

The "blackbird" is said to fly at 3000 mph and hit altitudes of 20 miles. For years it has snooped on Red China, monitoring almost every nuclear test behind the Bamboo Curtain

By EDWARD HYMOFF

ASK AN AVIATION BUFF about the SR-71 and he'll probably know that this Mach-3 aircraft exists. But ask him for specifics and he'll surely draw a blank. The same holds even for government agencies on whose behalf this fast spy plane flies its lonely—and dangerous—missions through hostile skies.

For years Communist China and the Soviet Union have been trying to shoot one down—without success. The SR-71—successor to the successful but ultimately ill-fated U-2 spy plane—is the fastest recon aircraft in the world.

POPULAR MECHANICS

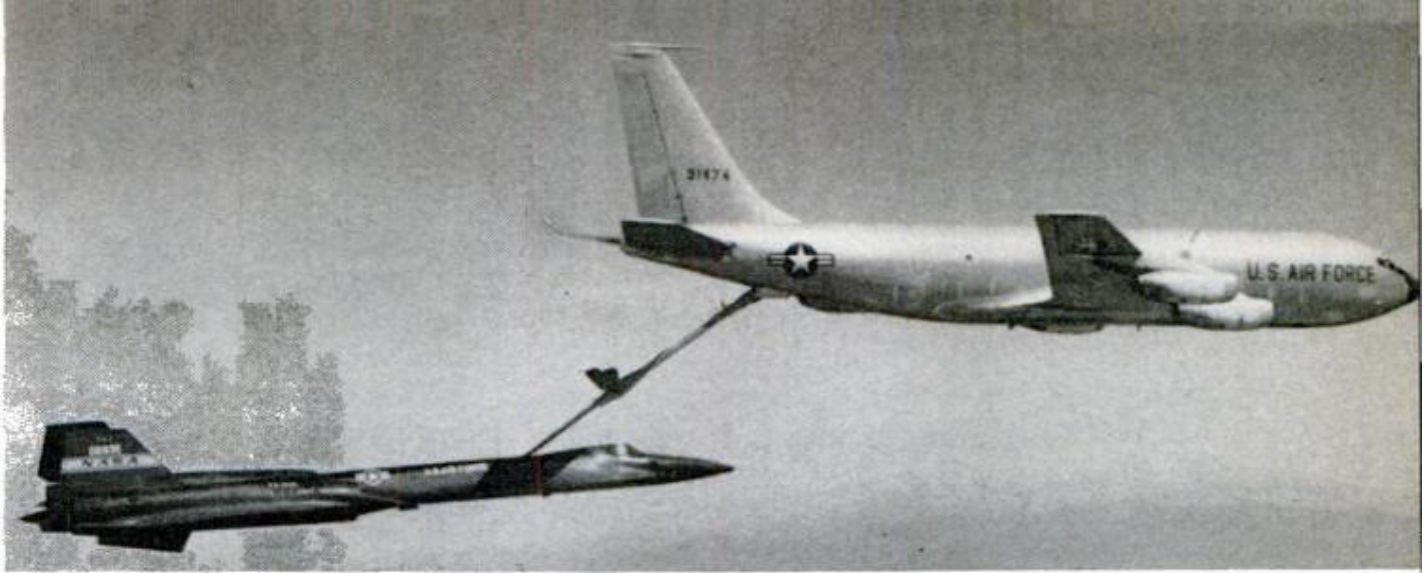

AIR FORCE VERSION OF THE SR-71—called the YF-12—is refueled by big tanker. Designed to function as an interceptor, the plane reportedly proved too fast for combat, where maneuverability is important

With afterburners and boosters on full, the SR-71 has been clocked at more than 3000 mph—too fast for the human eye to find and fix, and an elusive target even for radar.

The SR-71 came into the news last summer at a time when our government was attempting to improve its relations with Communist China. One news story leaked the information that the United States had halted all flights of reconnaissance planes over China and referred to the mysterious SR-71.

It was apparent that President Nixon wanted to avoid the kind of situation that arose when, in 1960, Francis Gary Powers was downed over the Soviet Union in a U-2 spy plane. The Russians angrily canceled a planned summit meeting and President Eisen-

hower was left with egg on his face.

But the halting of China overflights doesn't mean that America's superspy plane is grounded. There are other recon missions for these swift planes.

Even at this moment a teletype message may be clattering across the Pentagon's global communications network advising the Strategic Air Command to prepare a spy plane for a recon mission. At a base on the U.S. West Coast a long black bird with stubby wings is prepared for flight.

Meanwhile, in one corner of the sprawling SAC base on the island of Guam, a third of a world away, a bustle of activity is triggered by a priority message received at the island's underground communications center: **PREPARE FOR BLACKBIRD ARRIVAL AND FLIGHT**

SIDE-LOOKING RADAR scans in strips. Electromagnetic signals are bounced off the earth and are reflected in a nonuniform way, objects and terrain having different reflection characteristics. Aboard the plane, a converter changes the "echoed" pulses into electron beams that are displayed on a TV tube. A movie-type camera records the scan lines, producing final images similar to aerial photographs. The SR-71 carries two systems, one for each side

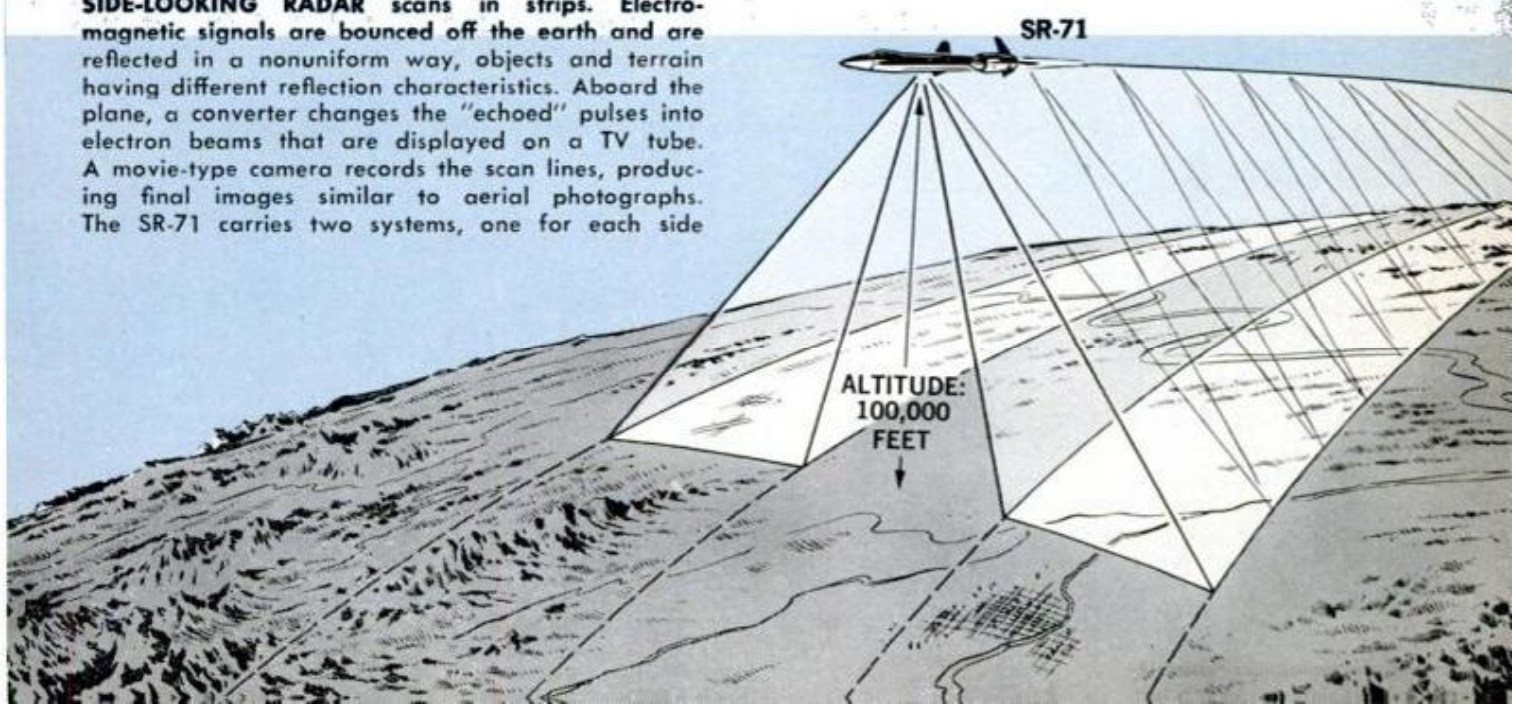

OPERATIONS. Civilian employes in a heavily guarded building begin working 'round the clock. Word quickly spreads, despite the secrecy, that "the bird" is due to arrive.

During the past seven years the bird has come and gone many times from Guam. Each trip has served to anger Communist leaders in Peking. For example, the SR-71 on a number of occasions has flown high over the rugged terrain of remote Sinkiang Province and its two-man crew has observed the test blasts of Peking's nuclear weapons—both A-bombs and the far more complex thermonuclear H-bombs.

The bird's exact specifications are still cloaked in secrecy. Official publications describe an aircraft with a wingspan of "approximately 55 feet," a length of "approximately 107 feet," standing "approximately 18 feet high" from the ground to the top of twin vertical fins or rudders. It is powered by two Pratt & Whitney J-58 engines of "about 35,000 pounds thrust each" and at Mach 3 it flies at more than 2000 mph, or slightly faster than a 30.06 rifle bullet. Finally, the SR-71 is reported to fly "above 80,000 feet" and has the ability to "survey 60,000 square miles in an hour."

Unofficially, it weighs in at between 75 and 100 tons, depending upon the mission and fuel load, and is usually refueled in skies well outside the boundaries of the nation where the target is located. On the return flight, the plane is refueled in flight as many times as necessary to reach the nearest

airstrip capable of accommodating the lengthy landing roll. Even so, a huge parachute is used for braking.

Exact performance data is top secret and known only to the two-man crews, maintenance personnel, senior engineers at Lockheed Aircraft Corp., and a small number of Air Force officers and Central Intelligence Agency operations people. But hostile observers have a good idea what the plane can do. It's a safe guess that both Soviet and Red Chinese radar operators have reported that the bird has been monitored at altitudes of 20 miles and at sustained speeds in excess of 3000 mph across distances of 5000 miles.

To date, the bird is still considered one of the nation's major military secrets. However, it's no secret that a squadron of these aircraft is assigned to the 4200th Strategic Reconnaissance Wing, a SAC unit based at Beale Air Force Base in California. Pilots and RSOs (Reconnaissance System Officers) assigned to this SAC wing are virtual mystery men continuously on the move in their black aircraft.

The SR-71 proved its capabilities on May 9, 1966, when Communist China exploded its third A-bomb. The event was monitored from start to finish by two Americans in a spy plane more than 20 miles high and close enough to the test site to "see all" and "hear all." Nearly six years ago this specially trained two-man crew climbed into one of the twin-ruddered SR-71s at Beale AFB and thundered west on a course for Guam. The blackbird was met three



LOCKHEED AIRCRAFT PHOTO

DIFFERENCE IN APPEARANCE of our two spy planes is striking. The U-2 (left) resembles a glider, but the SR-71 almost has the look of a rocket. Designed in the '50s, the U-2 has extremely long wings to provide lift at high altitudes and a jet engine built for endurance rather than speed. The plane flew so

82



high that for years neither enemy interceptors nor missiles could touch it. The SR-71 was given other capabilities. Though its wings are stubby—permitting greater speed—it has two powerful jet engines that can push it to altitudes of 100,000 feet, according to some sources. Its speed is over Mach 3

POPULAR MECHANICS

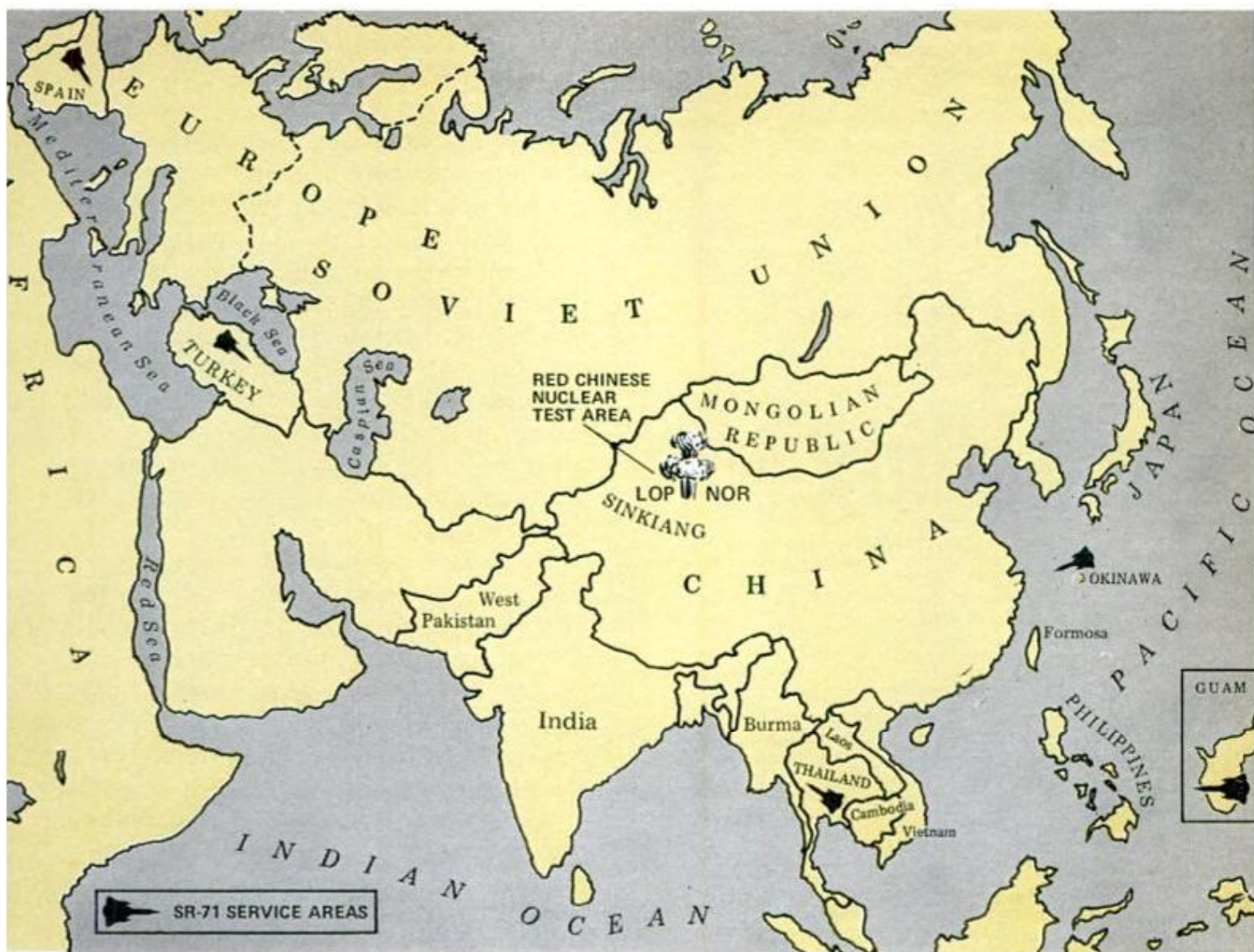

MAP BY GERHARD RICHTER

FAST-FLYING SR-71s EAT UP THE MILES on overflight missions in many parts of the world. In addition to keeping an eye on China, the planes have done surveillance work in Vietnam and, reportedly, in Mideast

times by KC-135 tankers, slowing down from a 1600-mph cruising speed to the near-glide required to nuzzle up to the lumbering jet tankers.

It landed at Guam nearly four hours and 5250 miles later. Slowly, the SR-71 taxied to the off-limits group of buildings surrounded by guards, sentry dogs and electric fences. For the next two days the pilot and RSO were briefed by representatives of the CIA and the Atomic Energy Commission. Wall maps of the Lop Nor area and blow-up photographs of the Red Chinese nuclear testing site were studied.

"We expect the device to be detonated in three days," the CIA's senior official advised the pilot and RSO. "We want to be right there when it's fired."

The pilot and RSO studied the area over which they would fly. They would

have to be on station 50 miles from the target in time to throttle up for one pass through the mushroom cloud so that delicate sensors mounted in the stubby wings could pick up samples of radioactive debris. It was imperative that one question be answered: Had China exploded a thermonuclear weapon—an H-bomb—or a conventional A-bomb?

On May 9, a few hours before the scheduled blast, the long black plane streaked westward toward a target 4500 miles away and deep inside hostile territory. On the way the blackbird met KC-135 tankers. At the final refueling point near hostile borders, Red Chinese radar operators couldn't help but sight the fast-moving blip on scopes. They reported their observations and

(Please turn to page 192)

They caught a falling star

By JAMES CORNELL

**The rock from space
trailed fire as it hit
Earth's atmosphere at
25,000 mph. It angled
toward America . . .
toward Connecticut . . .
toward a house in a
town called Wethersfield**

It happened just a year ago. Around 4:00 a. m. on April 8, 1971, a gigantic fireball streaked over Hartford, Conn., trailing dust, smoke and sonic booms. It was a supereconomy-size shooting star produced by a chunk of cosmic debris entering the atmosphere.

An estimated 1 million tons of such stuff, including what astronomers think may be bits of minor planets and the remains of disintegrated comets, fall on Earth each year. Most of it is in the form of a fine black dust that readily mixes with industrial particles and other pollutants. Slightly larger pieces produce the tiny falling stars seen briefly on a summer's night.

But occasionally much larger pieces survive the fiery plunge through the atmosphere and fall to Earth intact. These rare hunks of stone and metal, called meteorites, were man's only samples of matter from space prior to Apollo 11, when the first moon rocks were brought to Earth.

About two hours after the fireball blazed across the sky over Hartford, a man in nearby Wethersfield noticed a hole in the ceiling of his living room. Paul J. Cassarino, a 61-year-old machinist, climbed up on a chair and reached a hand into the hole.

"Almost as soon as I did," he recalls, "a little rock fell out. It was black and smooth and very heavy for its size."

Investigation revealed that the rock had ripped through the roof shingles, and penetrated a layer of three-quarter-inch plywood and four inches of insulation before lodging in the half-inch-thick plasterboard ceiling.

It clearly wasn't a case of vandalism. "This has to be something special," thought Cassarino. "The rock must have fallen out of the sky—maybe from an airplane."



But he had no time to pursue the problem. He had to get to work. Before he left he told his wife to call the police or the fire department.

Mrs. Cassarino called the police. The first officers on the scene confirmed the opinion that the damage had not been the work of vandals. They called their captain for instructions and he, in turn, contacted the Board of Health.

Meanwhile, the fire department arrived. Soon the street was filled with squad cars, fire trucks and curious on-lookers.

In time the gathered officials arrived at a consensus: The mysterious stone in the Cassarino living room was a meteorite, most likely the same one that had created the fireball and sonic booms over Hartford only hours before.

The 13-ounce gumdrop-shaped stone probably had been 10 times larger when it began its long voyage to Earth millions of years ago. When its orbit crossed Earth's, it was captured by the planet's gravity. Hitting the atmosphere 60 miles above Hartford while speeding at 25,000 mph, the rock generated enough heat to cause surrounding gases to glow and burn. The shock of entry also sent chips of stone flaking off to swirl away in the upper atmosphere.

The fireball went out when the meteorite was some five miles above the ground. Thicker air had slowed the rock, so that friction no longer ignited the gases. But the object still moved fast enough to break the sound barrier.

The odds against this meteorite striking a house were tremendous; there are no more than a dozen recorded instances of a falling star hitting a building. The Cassarinos really had something to crow about.

Their excitement was matched by



THE METEORITE RIPPED through roof shingles, a layer of three-quarter-inch plywood and four inches of insulation before punching a hole in the ceiling

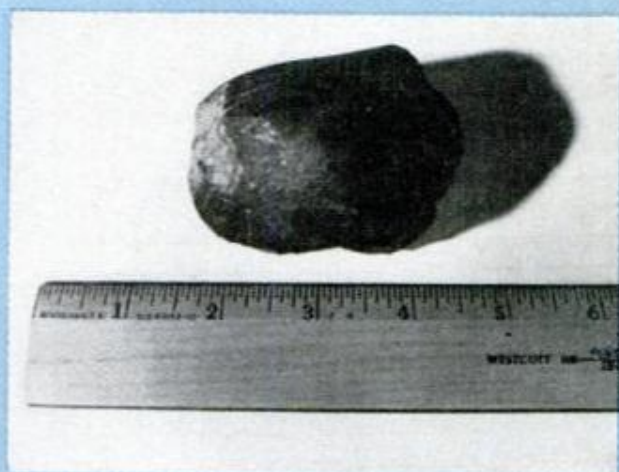

SHINY BLACK ROCK was 10 times this size, say scientists, when it started long journey to Earth

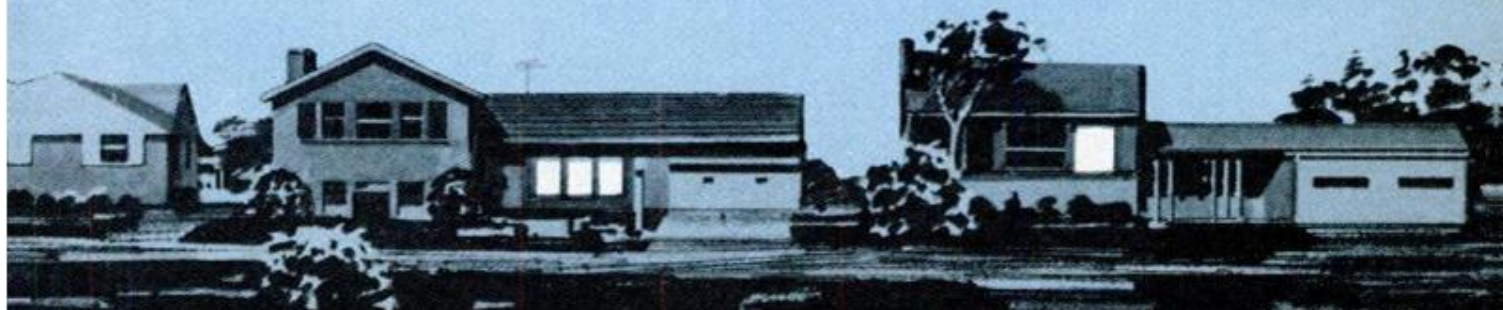

that of scientists, for the occurrence provided a rare opportunity to examine a space rock while it was still "fresh." Meteorites are radioactive because of bombardment by cosmic rays, but the radioactivity is weak (far below harmful levels) and begins to "fade" as soon as a rock lands. Specimens must be analyzed immediately if scientists are to detect clues as to where and how long they have traveled in the solar system.

Scientists rushed to Wethersfield. Among the most interested visitors were Dr. Richard McCrosky and Charles Tougas of the Smithsonian Astrophysical Observatory, located 90 miles away at Cambridge, Mass. (The observatory operates a big meteorite recovery network, including 16 unmanned camera stations, in the Midwest. In January, 1970, the network was responsible for the speedy recovery of a 22-pound meteorite that hit near Lost City, Okla.)

The two men quickly confirmed that the rock was indeed a meteorite and arranged for its purchase. It was worth \$1000 to the Smithsonian because it was so fresh. Meteorites have little intrinsic value and do not, as popular belief would have it, contain gem diamonds or precious metals.

For the most part, meteorites are

composed of either iron or stone, with both types containing high percentages of nickel. The Wethersfield rock was of the stony variety and had a gray, concretelike interior flecked with metal dots.

Using radioisotope and gas spectrometer analyses, Smithsonian researchers deduced that the rock once had been part of a far larger body, possibly a planet that was formed with the rest of the solar system about 4.5 billion years ago.

Because the stone contained few gases, the scientists surmised that the parent body must have passed quite close to the sun about a billion years ago—a flyby during which most of its gases were burned away.

About 6 million years ago—a recent date by cosmic timetables—the parent planet apparently disintegrated, either exploding or colliding with another body. It shattered into thousands of small meteoroids that became part of the great asteroid belt between Mars and Jupiter. All this was revealed by the amounts of radioactivity present.

After Smithsonian and NASA scientists had analyzed the Wethersfield space rock thoroughly, it was consigned to the Smithsonian Institution in Washington, D. C. ★★★



THIS 24.6-POUND BEAUTY was found near Lost City, Okla., by Smithsonian Observatory scientist. Path of fireball had been recorded by unmanned cameras

HOW TO SPOT A METEORITE

Think that rock in your back yard might be from space? Check this list before running off to your local museum:

1. Is the rock hard, not porous, pockmarked or flaking?
2. Is it irregularly shaped but with rounded edges?
3. Is the object heavy for its size?
4. Does the rock have a black or dark-brown crust?
5. Does the interior of the rock contain metallic iron flakes or spots?
6. Is the object very different from other nearby field stones?
7. Does the stone attract a magnet?

If all the answers are yes, your rock is almost surely a meteorite. If only some of the answers are yes, the meteoritical origin is in doubt; only lab analysis will tell for sure. If most of the answers are no, start looking again.

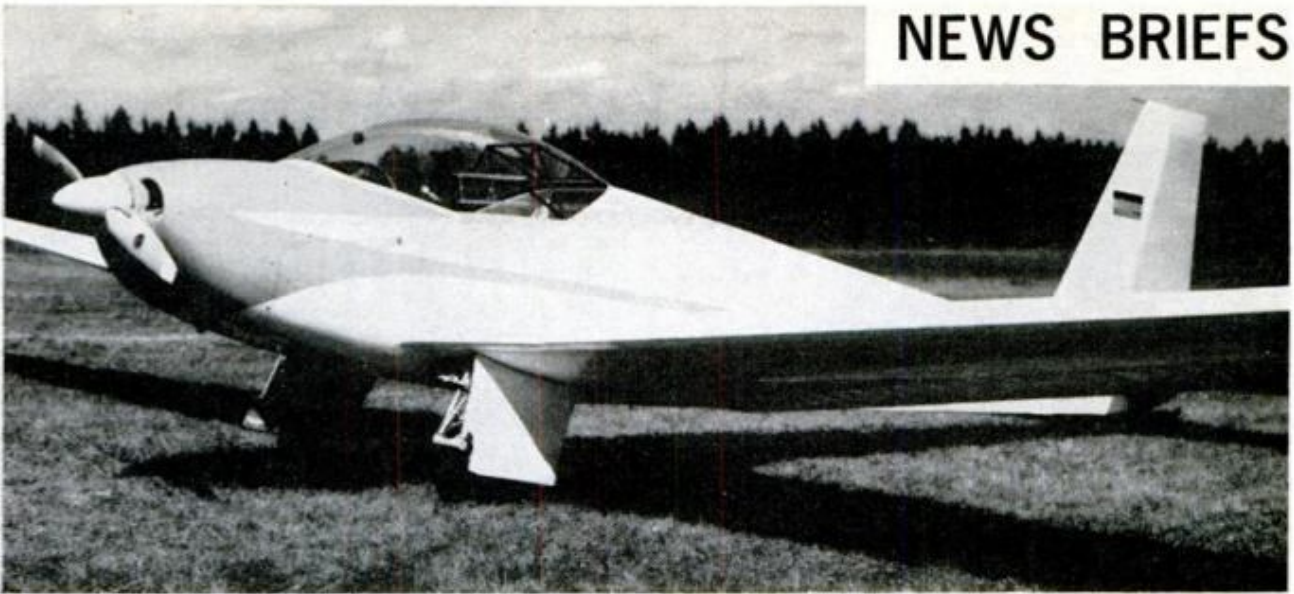

New powered craft from German sailplane builder

Built by the German firm of Alexander Schleicher, developer of sailplanes and powered sailplanes, the new ASK 16 is powered by a 68-hp engine that pulls the craft at a maximum 112 mph. Empty weight is 1010 pounds; wing loading, 7.55 pounds per square foot.



Ship preserver

A new method of preserving inactive ships has been put into use at the Philadelphia Naval Shipyard. An air-inflated plastic-treated cover was fitted over the upper portions of the attack cargo ship USS Betelgeuse. With the cover in place, dehumidified air can be circulated throughout the ship and the covered area to preserve the ship's equipment. The procedure reduces the normal amount of work needed to preserve all the equipment installed above the main deck.

Gulps up the litter

Rotating steel fingers at the end of an aluminum boom scoop up bottles, cans, paper and other trash from the roadside as the "litter gulper" moves along a highway. The new device, designed as a fast and cheap way to clear litter from the nation's highways, was recently demonstrated in Washington, D.C. Spectators here are Sen. Jennings Randolph (foreground) of West Virginia and Sen. Lowell Weicker of Connecticut.



How we'll keep 'em moving

Though the harried commuter might not think so, improved methods of transportation are on the way. If you want to see for yourself, visit Washington's big show this spring.

IF IT FLIES, FLOATS OR ROLLS—and is the latest of its type—it's sure to be at Transpo 72, a huge exposition to be staged this spring. It will be a rail and rapid transit show; an automobile, truck and bus show; a ship and boat show, and an air and space show.

Transpo 72 will be held from May 27 to June 4 at Dulles International Airport, outside of Washington, D.C. One aim of the government-sponsored extravaganza is to show what can be done to untangle the traffic mess that plagues urban areas the world over. Four personal rapid transit systems—"people movers"—will be demonstrated. These systems all employ small, independently

TRANSPORTATION
TECHNOLOGY
TRANSPORT SYSTEM

INDOOR
EXHIBITS

INDOOR
EXHIBITS

FORD MOTOR
TRANSPORT
SYSTEM

INDOOR
EXHIBITS

DASHAVEYOR
TRANSPORT
SYSTEM

INDOOR
EXHIBITS

HISTORICAL
EXHIBITS

RESTAURANT

ROHR
MONORAIL

BIG EXPOSITION will require 360 acres for exhibits, demonstration areas and parking for 50,000 cars

powered vehicles that travel at relatively slow speeds on guideways and under automatic control. Flashier vehicles will include autos that drive themselves, guided by electronic devices incorporated in the highway; advanced experimental trains powered by linear induction motors and promising a capability of 300 mph; operational air-cushion vehicles and prototypes of deep-water hydrofoils.

If you're especially interested in airplanes, you'll be confronted with an imposing array, including the new McDonnell Douglas DC-10; Lockheed's C-5A, the world's largest plane; the British Harrier, now adopted by the U.S. Marine Corps, which can fly at 600 mph and also take off and land vertically. If plans work out, the SSTs will also be on hand—the British-French Concorde and the Russian Tupelov 144. There'll be antique planes, too, including the Ford Tri-Motor, Jennie, Curtiss Pusher and more.

Plenty of action is promised. Professional race pilots will zip small planes—none heavier than 550 pounds—around a course. There will be balloon races, simulated dogfights with World War I planes, and demonstrations by the Navy Blue Angels, Air Force Thunderbirds and other aerobatic teams.

According to Transpo 72 officials, the show will be open to the public from 9:00 a.m. to 6:00 p.m. on May 27, 28 and 29; from 12:00 p.m. to 6:00 p.m. on May 30, 31 and June 1, 2; from 9:00 a.m. to 6:00 p.m. on June 3, 4. Admission will be \$3 for adults and \$1 for children. ★ ★ ★

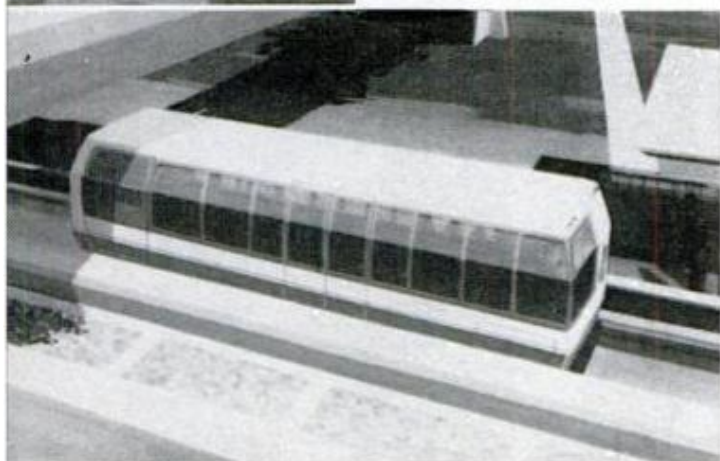

FORD MOTOR'S ENTRY in the "people mover" competition is electrically driven, 24-passenger vehicle

LINEAR INDUCTION MOTOR drives the Transportation Technology Co.'s car. Capacity is 6-10 persons

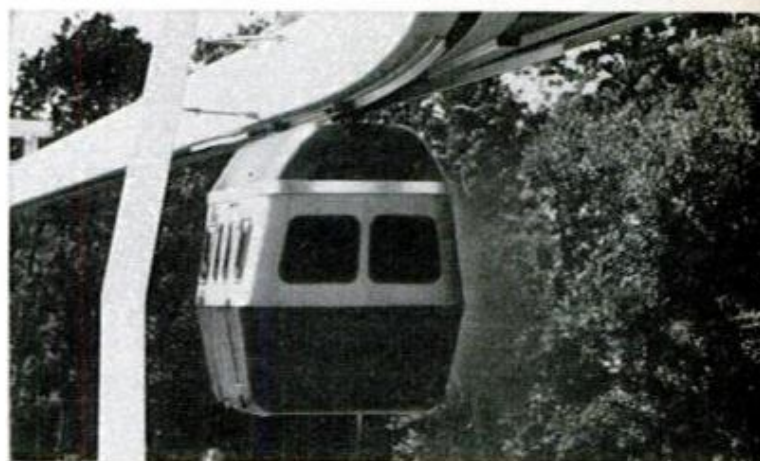

MONORAIL for carrying passengers at 17 mph is built by the Rohr Corp. System will have two cars

THIRTY-ONE PASSENGERS will ride at 20 mph in the Dashaveyor Co.'s car. Like others, it's automated

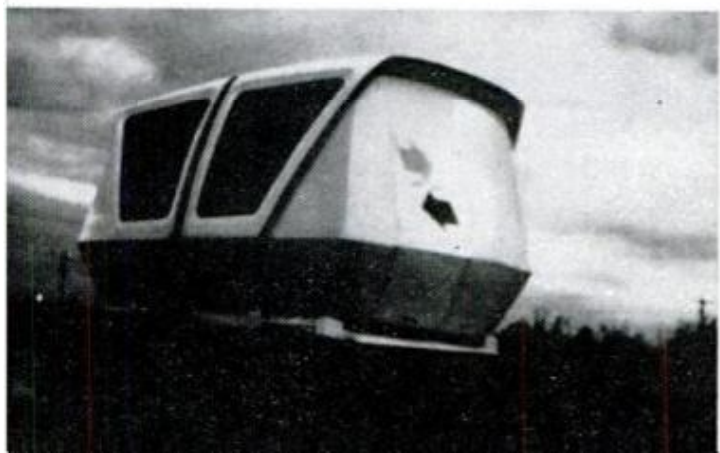

Treat your trailer right

Trailer life and fun both can be doubled with the use of simple preventive maintenance

By ROBERT D. STEARNS



TRAVELS WITH YOUR BOAT in tow can more than double your fun, and minor maintenance tips shown here and on the next two pages can add up to minimum problems with the rig.

After hauling out ashore, tilt your outboard back down into its running position. This puts less strain on the transom and prevents formation of the hairline cracks that eventually let in moisture to cause rot in the wood stiffening members imbedded in the stern. Recheck during every trip to be certain your tie-downs are not allowing movement and chafe. Check your own rig to find ways to secure boat to trailer and trailer to car to prevent theft.

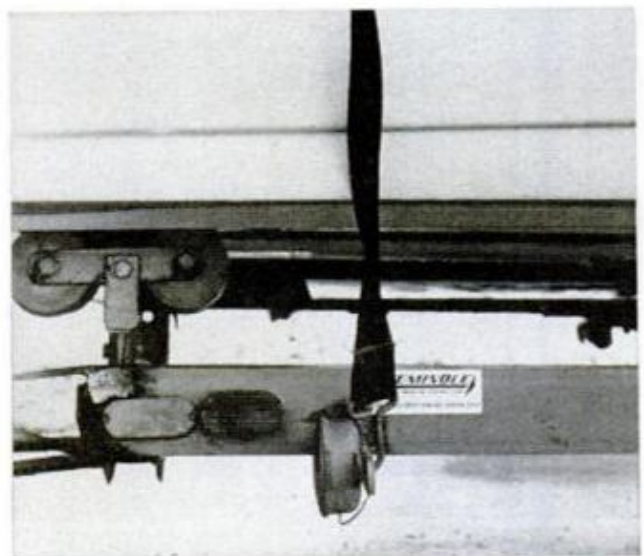

TWIST YOUR TIE-DOWNS before you secure them. This can prevent the whipping caused by the car's slipstream—which can eventually break the strap

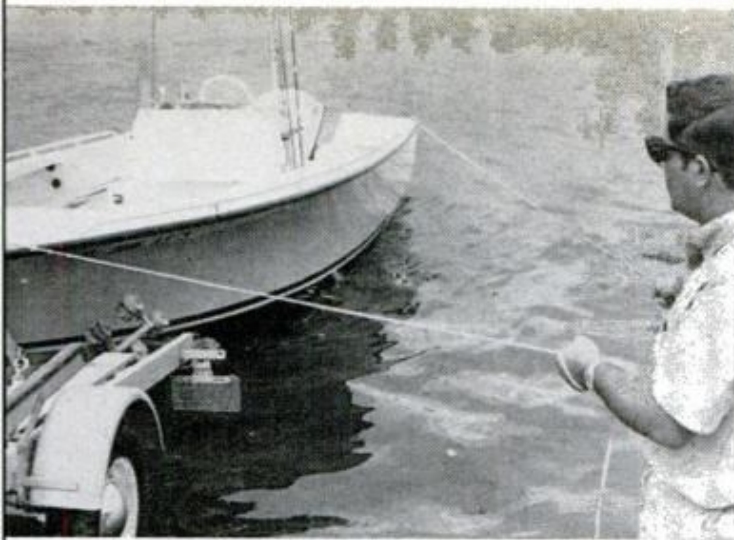

CENTERING BOAT FOR HAULING is easier if you rig bow and stern lines for your passenger to hold against any crosswind while you crank the boat in

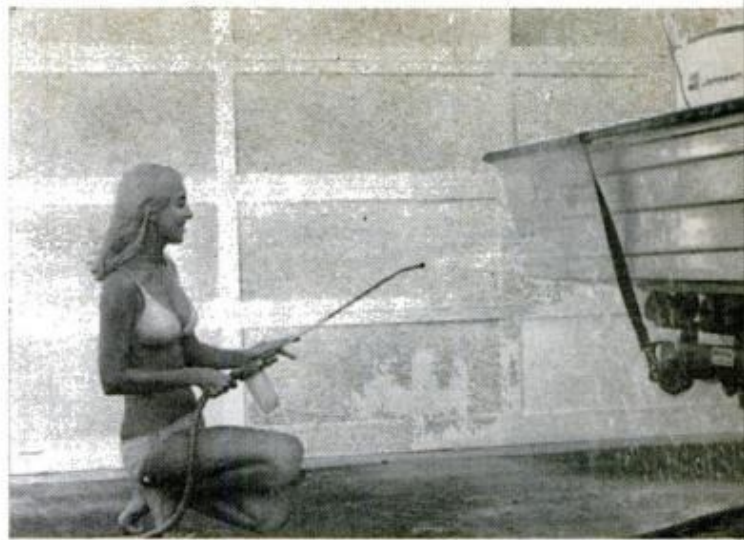

HOSING DOWN ADDS UP to longer life for a trailer, particularly around saltwater, when you add a car-wash attachment with detergent dispenser to gear

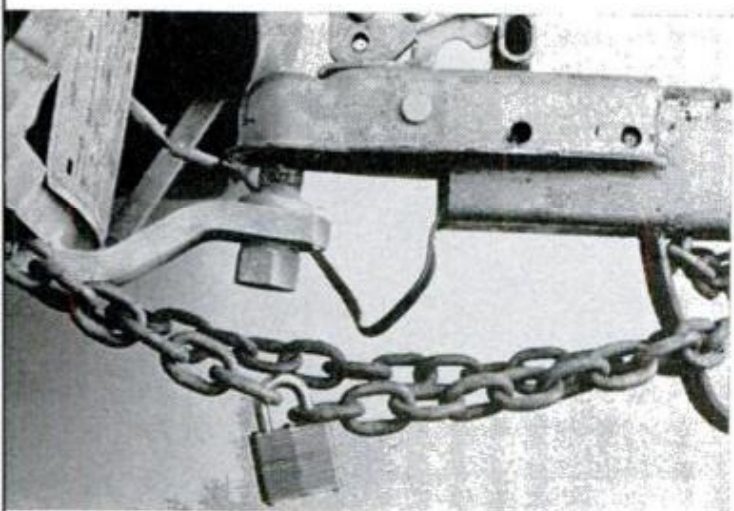

HEAVY CHAINS AND LOCKS meet the safety laws of most states just as well as the light ones, but a free-swinging lock is more difficult for a thief to cut



HUB CAPS TRAP WATER that causes rust. They can be left off for easy lug-bolt check, then replaced for a "like new" appearance when the trailer is sold



Xs MARK THE SPOT: Reflective tape makes your rig visible when it's towed or parked at night or in fog. Tape's particularly helpful on unloaded trailer



SPARE TIRE AND TRAILER JACK can be bolted to the trailer with a length of 1/2-inch rod stock and then secured with a lock and chain in a cloth sleeve



HEAVY GREASE PAINTED over the weld seams and into dips in the frame will prevent rust better than paint and it needs reapplication only once a year



LOWER UNIT OUTBOARD OIL can be applied in an emergency to an overheating dry trailer bearing. Keep your speed down until bearing can be repacked

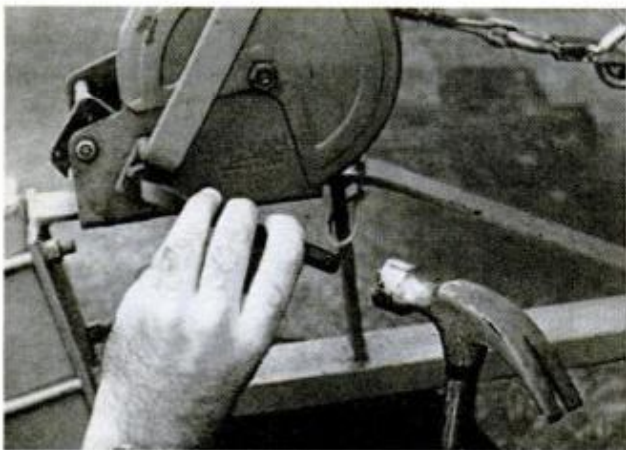

DEFORM OR BURR the threads of the bolt securing winch handle in place to prevent loss or theft. Chisel and hammer other bolts to stop loosening



PAINTING HALF-AND-HALF MIX of a heavy motor oil and mineral spirits or kerosene onto the spring leaves can keep them more limber and rust-free

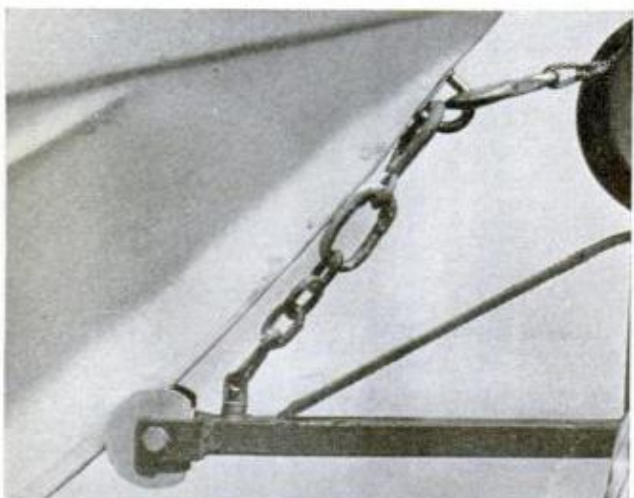

BOW STOP CHAIN or cable will prevent boat from climbing the car during emergency stop. Do not use a soft metal hook to snap to the trailer or bow eye

SALTWATER particularly can corrode the exposed metal of your trailer, yet periodic touch-ups are an easy way to control rust before it gets started. Springs and bearings also need extra attention. Moving parts heat up during high-speed runs, especially with the extra revolutions small wheels must make; bearings may suck in moisture when submerged in cold water. ★★★

POPULAR MECHANICS

Giving it the new oil

Handing your outboard, chain saw, lawnmower or snowmobile the old oil can wreck it. Today's two-cycle fuel is friend or enemy—depending on new gas/oil ratios and blends

By MARC MICHAELSON

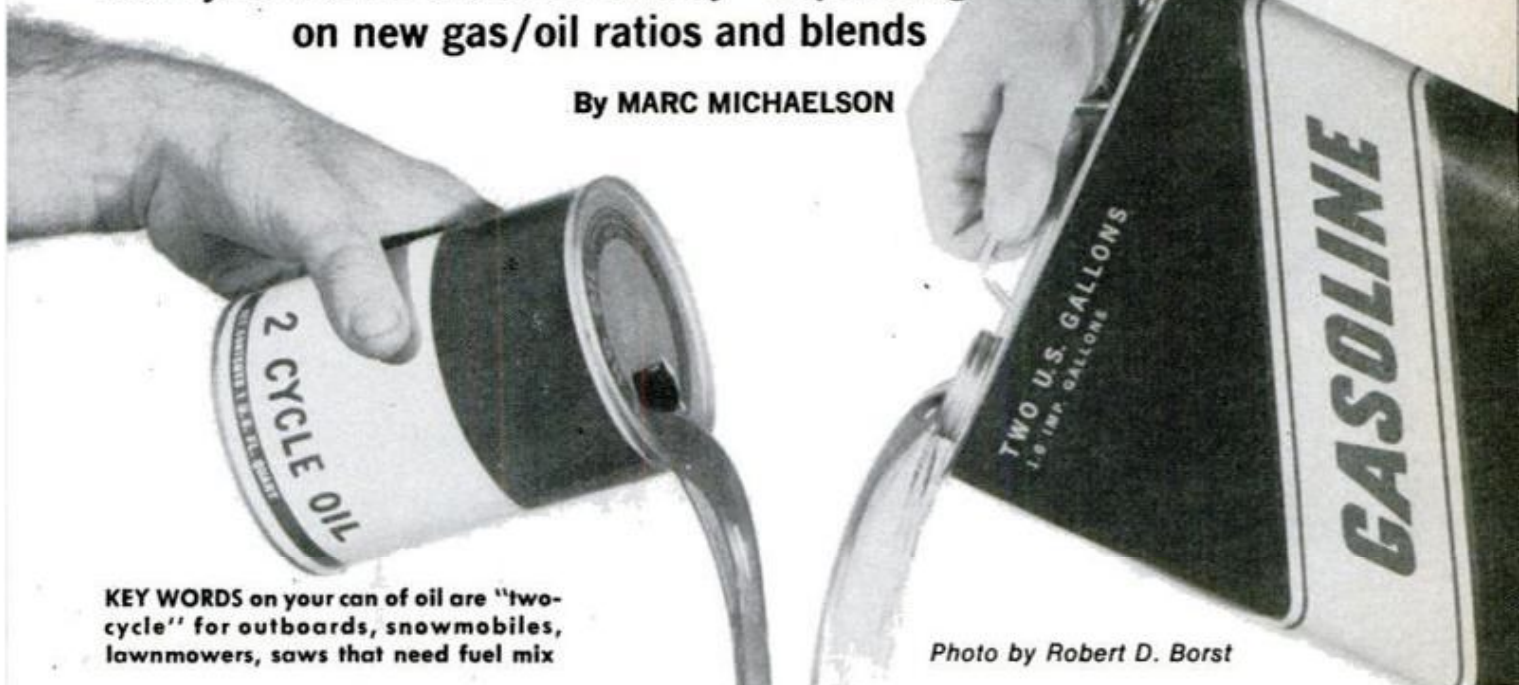

KEY WORDS on your can of oil are "two-cycle" for outboards, snowmobiles, lawnmowers, saws that need fuel mix

Photo by Robert D. Borst

THE MODERN well-made and engineered two-cycle engine—outboard motor, snowmobile, chain saw or lawn mower—could run almost forever, manufacturers claim, but thousands of the little mills are discarded every year because their owners try to feed them fuel they can't digest.

In the two-cycle engine, oil is mixed with the gasoline and burned in the cylinder. Automotive-type oils are not satisfactory. They are blended for the special problems of the four-cycle engine, and almost half of that quart can of car oil may be additives that are great for your car but can mean death for the combustion chamber of your two-cycle engine. Today's lead-free gasoline is also considered dangerous for two-cycle use at present, although most manufacturers hope to have motors that will tolerate it by 1973 or soon after. To replace the anti-knock properties of lead, substitute gasoline additives are being used that might attack some of the metals in

lightweight two-cycle mills. Present advice from outboard motor makers is: Don't use nonleaded gasoline in your two-cycle engine this year. Do mix in an oil especially recommended for your two-cycle rig, and follow directions for gas/oil ratio and proper blending.

Gassing up your two-cycle tank and then pouring in a little auto-grade oil is a first step to serious trouble. Older engines that use richer oil-to-gas ratios and do not have capacitance-discharge ignition are particularly susceptible to preignition. It can pound your motor to pieces. Carbon and metallic deposits that form on the top of pistons or near the sparkplugs glow hot and fire the fuel in the cylinder before the sparkplug goes off. This early firing catches the piston only part way up on

(Please turn to page 194)

New boats and gear



BOATS NEVER USED TO CHANGE much from year to year, but lately there has been a new look: the open utility fishing hull that has been surging ahead in popularity. Small shoal-draft models, like the bass boat descendant of the pirogue and log canoe, can handle thin-water bonefishing and gunkholing. Larger models, like AMF Slickcraft's Robalo above, can handle offshore waters. Characteristics of the type include a mid-cockpit control console, a forward fishing platform and often a self-bailing cockpit. The Custom 19 shown includes these features plus a design by Ray Hunt, father of deep-V hull forms, an optional shade canopy, and a swordfisherman's pulpit equipped with a stainless bow rail and a vinyl rubrail.

FOR TROLLING AND FOR SAFETY, a new I/O Auxiliary Motor Bracket from N. A. Taylor Co., Gloversville, N.Y., allows the use of an outboard motor of up to 10 hp right on an OMC, Volvo or MerCruiser stern drive. The I/O still steers and tilts up normally with the bracket attached, and it bolts to the outdrive without the need for transom holes. The vinyl-finished units are sold for less than \$30.

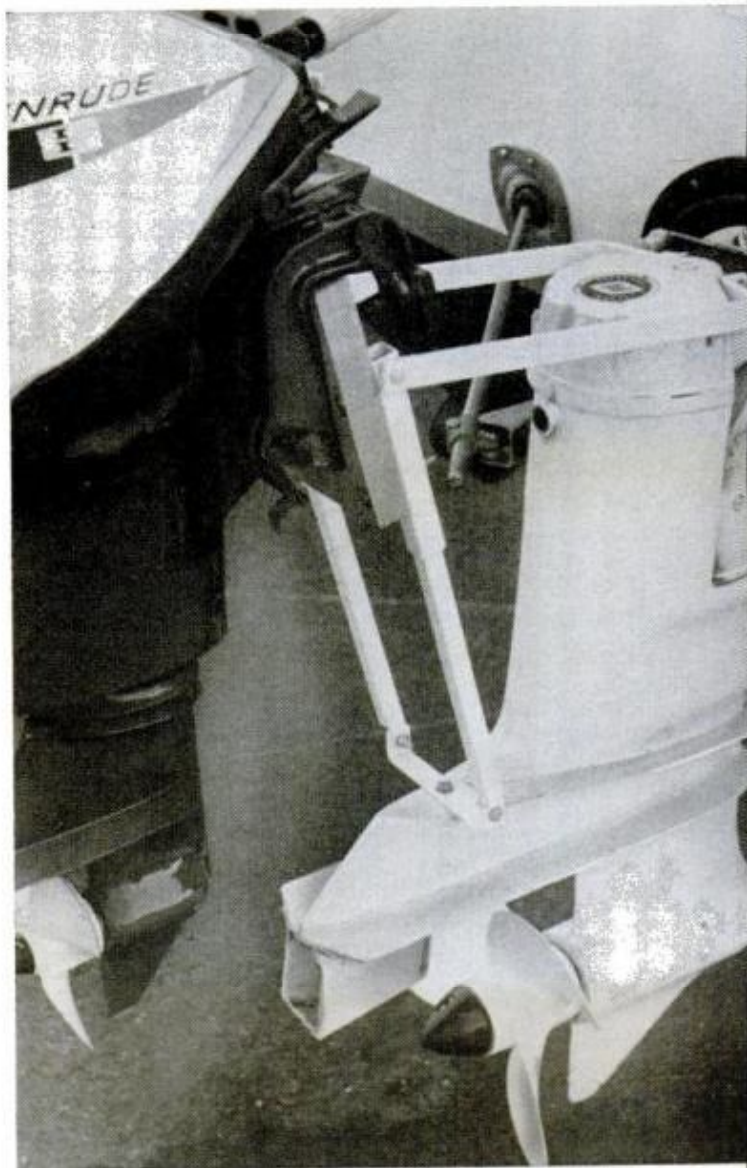

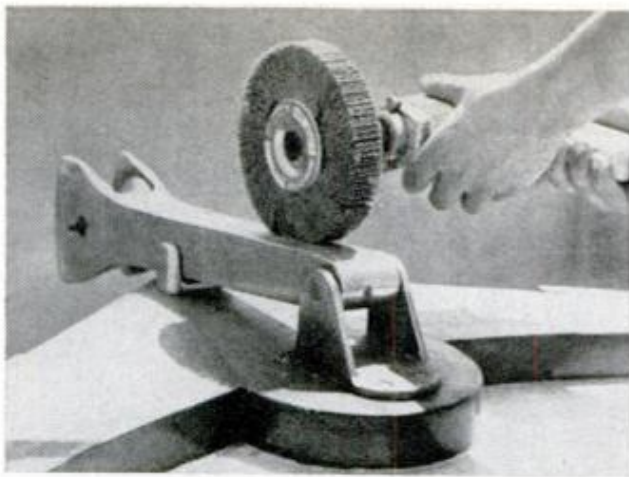

POLISHING CURVED SURFACES is reported to be easier with a Grind-O-Flex wheel made up of abrasive flaps. The multiple flexible strips, available in various grits, are claimed to shine, sharpen or grind. A six-inch wheel is \$7.65 from Merit Abrasives, Compton, Calif.



PERMANENT SAFETY is a feature of new transom ladders manufactured by Marailco Div., Allied Products, St. Petersburg, Fla. In addition to a man overboard, skiers, swimmers and divers should prefer this permanently mounted convenience. The two-step model is \$29.



TAKING A LONG LOOK is easier with Tele-Specs from Chris-Craft's Marine Accessories Div., Algonac, Mich. The \$12.95 sunglasses have telescope lenses in the earpieces that can also be used individually as chart magnifiers.

SOUP IN THE LAP is less likely while you're afloat, or at least the bowl will stay put on the table with the hull heeling as much as 30°, according to the Yachting Tableware Co., Box 546, Wilmington, Del. A nonskid 42-piece set of dishes having your boat name and flags inscribed on each piece is offered for \$85.

APRIL 1972



PURPLE CLEATS and ruby red chocks are now joining conventional chrome running lights that are equipped with corrosion-resistant chrome metal tops and Lexan bases. A variety of new Chromalex fittings is available from Perkins Marine Lamp & Hardware, Miami, Fla.



Who says you can't put extra lenses on a fixed-lens camera!



By BURT MURPHY

PUT A TELEPHOTO LENS on a snapshot camera? You might say impossible. For years, many owners of inexpensive cameras have longed to take telephoto shots, wide-angles or close-ups, but have assumed it couldn't be done. The fact is, it can. Telephoto, wide-angle and close-up accessories are available for many fixed-lens cameras from simple snapshotters to such sophisticated types as rangefinder 35s and twin-lens reflexes that are normal-

WIDE VARIETY OF SLIP-ON LENSES for fixed-lens cameras is shown below. They include telephoto, wide-angle and close-up attachments to fit Instamatic, Polaroid and other models



ly limited to one built-in lens system.

While these accessories can't be expected to equal the performance of much costlier and more powerful interchangeable lenses, they do greatly extend your shooting possibilities. They're relatively inexpensive, easy to use and can add excitement and interest to your picture-taking.

Some makers provide attachments to fit their own cameras; in other cases, such aids can be purchased from companies specializing in accessory equipment. Polaroid, for instance, offers close-up and portrait lenses for its own models, but additional telephoto and wide-angle accessories are also available from other suppliers. The first thing to do is to check on your particular camera by studying the manual that comes with it or by consulting a photo dealer. If the manufacturer does not offer auxiliary lenses, chances are good that you will still be





THREE DIFFERENT VIEWS of same scene illustrate effects you get with an Instamatic 300 camera using Kalimar's telephoto and wide-angle attachments shown at top of opposite page. Upper photo at left is with camera's normal lens unaided. One above is with telephoto lens added, showing marked increase in image size. Lower photo at left is with wide angle attachment. Note that image is slightly smaller than view with normal lens, but covers a broader area. A supplementary viewfinder, also shown at top of facing page, is designed to clip on most Instamatic models to indicate area taken in by accessory lenses

shooting subjects far away or for getting good frame-filling portrait shots. The wide-angle attachment increases picture area by about 75 percent, giving you a broader angle of view without any magnification.

Because telephoto and wide-angle attachments change a camera's normal field of view, an auxiliary viewfinder is also needed to show you what picture area the new lens combination is taking in. The accessory finder either fits over the existing viewfinder or clips on top of the camera and is used separately. The difference depends on the type of camera you have. Kalimar makes a one-piece combination lens and viewfinder for cameras whose built-in finders are located directly above the lens. You slip on the auxiliary lens and the attached finder automatically covers the viewfinder window in the camera. For cameras where the finder window is offset from the lens, a separate clip-on finder is required.

While accessory lenses are available

able to obtain them from other sources.

Kalimar, one large supplier of accessory lenses, is a good source of telephoto and wide-angle attachments for Kodak's Instamatic line and many Polaroid models. They also offer similar auxiliary lenses for rangefinder-type cameras and twin-lens reflexes such as the Rolleiflex.

Accessory lenses are designed to slip over the front of the camera's regular lens and work in combination with it. Kalimar's telephoto attachment has the effect of doubling the focal length of the original lens, giving you approximately twice the image size you'd normally get. This is handy for



ROLLEIFLEX OWNERS can take close-ups with this set of Honeywell Rolleinar accessory lenses, one for upper viewing lens and one for the lower taking lens. Resulting focusing range is 9½ to 12½ inches



individually, most are sold in sets or kits, including the necessary matched viewfinder. Some kits contain both a telephoto and wide-angle attachment along with a combination viewfinder in a convenient carrying case. Kits offered by Kalimar for Instamatics range in price from about \$27 to \$36, depending on model. Those for Polaroids run from about \$20 for the Swinger to about \$50 for auto color pack models.

For owners of Kodak's new X-series Instamatics, Kalimar has just announced a special set of attachments including telephoto and wide-angle lenses, accompanying viewfinder and carrying case for \$26.95. For twin-lens reflex owners, Kalimar offers auxiliary lenses in pairs for a telephoto or wide-angle effect. One auxiliary covers the lower taking lens, the other the upper viewing lens. Prices range from about \$20 to \$25, depending on camera make and model. Accessories are limited, however, to f/3.5 twin-lens models.

Close-up lenses for the Rolleiflex, available from Honeywell, fit both f/3.5 and f/2.8 models. Called Rolleinars, they narrow the focusing range

ADD-ON TELEPHOTO at left is designed to slip on a camera's existing lens instead of replacing it. Used with normal 50-mm lens, it gives equivalent of 350-mm telephoto. Photos below show same scene shot without attachment (left) and with it (right). Note tiny image of sign in center of left-hand picture compared to greatly enlarged view at right. Price of the Spiratone Teletach accessory is \$19.95



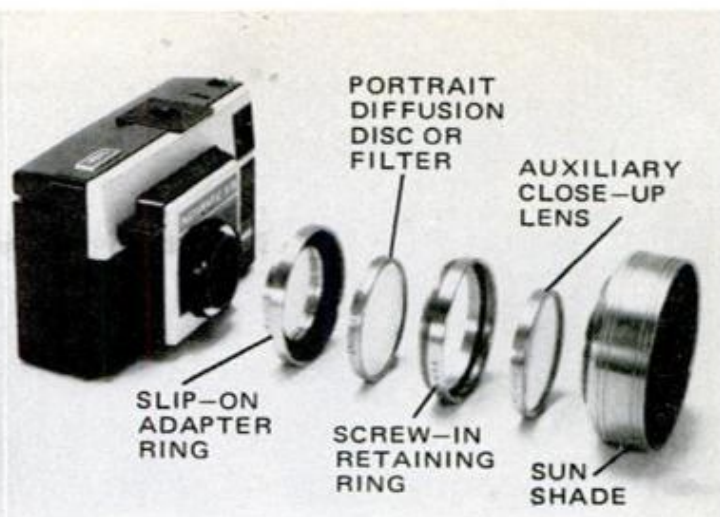

to 9½ to 12½ inches for close-in, big-image shooting. Prices are \$30 to \$40.

Polaroid's own close-up and portrait kits contain three pieces—the supplementary lens itself, a matching viewfinder attachment and a diffusion disc that slips over the flash head. The diffusion disc permits close flash shots without overexposing the subject. The portrait kit provides a focusing range from 19 to 42 inches, and the close-up kit allows even tighter shooting from 9 to 15 inches. Prices are \$9.95 to \$10.95, depending on model.

Close-up lenses are also available in standard Series V, VI and VII sizes. They vary in power from Plus-1 to Plus-10, with Plus-1, 2 and 3 being the three most common. The higher the

(Please turn to page 205)

SLIP-ON ADAPTER RINGS make it easy to mount auxiliary close-up lenses, filters and other accessories on just about any camera. The Kodak rings come in various diameters to fit many different lens sizes. By using additional retaining rings, two or more lenses and/or filters can be combined



VIEWFINDER COMES ATTACHED on this one-piece Kalimar telephoto—handy where camera's viewfinder window is centered over lens. Where window is offset, a separate auxiliary viewfinder is necessary

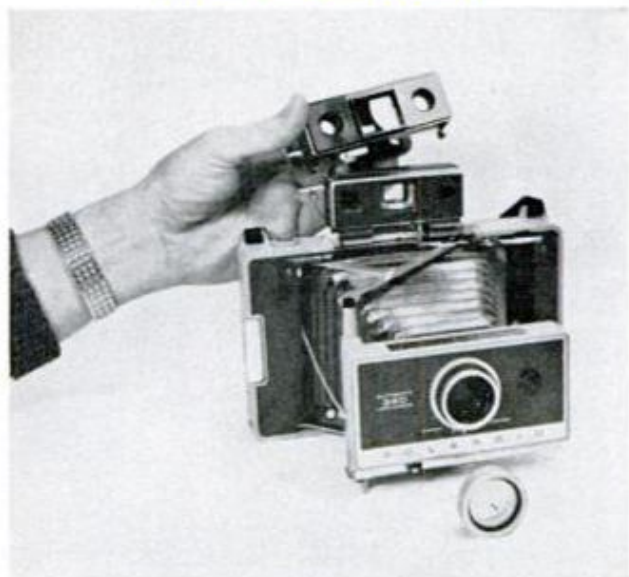

FOR POLAROID CAMERAS, there are accessory portrait and close-up kits made by Polaroid itself. These consist of a supplementary slip-on lens and auxiliary viewfinder that fits over the regular



viewfinder (left, above). Kalimar also makes telephoto and wide-angle attachments to fit Polaroids. At right is Kalimar's handy copying stand for making quick Polaroid copies of pictures and drawings

AUTOMOBILES



Two fwd giants: Both excel

By MICHAEL LAMM, West Coast Editor



AH ELDORADO! Among other absolutes, it's the biggest front-wheel-drive (fwd) automobile in the world. And it offers the only U.S. convertible in its price class. Too, it's the only fwd convertible made in America.

A mere 17.3 percent of Eldorado owners bought their cars *because* it had fwd (less than half the Toronado's percentage). Surprisingly, 26.6 percent opted for the Eldo because it comes in a convertible body style—an amazingly high figure when you consider that, industrywide, less than one percent of all cars now sold are convertibles!

(Keep in mind, though, that neither Lincoln nor Imperial nor any other Cadillac series offers a convertible, so if someone lusts after a domestic luxury soft-top, the Eldorado is it.)

What sort of person buys an Eldorado? "Got the best price out of four dealers," confides a New Jersey hand-

(Please turn to page 102)

PM CADILLAC ELDORADO OWNERS REPORT...

A nationwide survey based on 534,000 owner-driven miles

ELDORADO FUEL-MILEAGE CHART

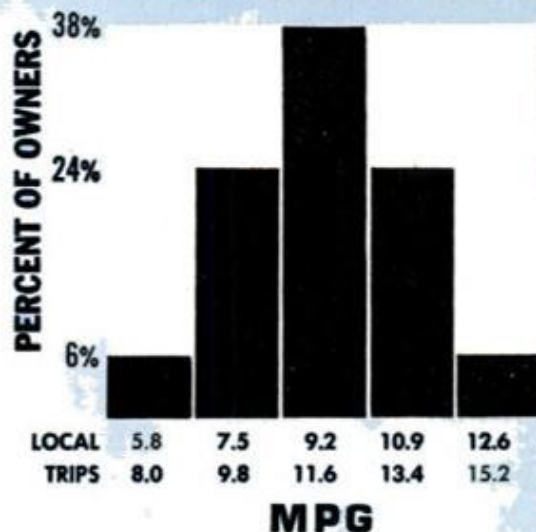

in prestige and gas guzzling

Photos by the author

WE RAN our last Toronado Owners Report in June 1970, and at that time front-wheel drive (fwd) ranked No. 1 as *the* reason for buying (41.6 percent). Today, fwd rates No. 2 at 36.8 percent, with styling now heading the list.

Even so, owners feel strongly about fwd. They think it's great, and they're very loyal to it.

Says a Cincinnati ad exec: "It has a unique feel of 'tracking' at high speeds; is far superior to the Thunderbirds and big Buicks I drove previously, particularly on snowy or wet surfaces."

And a Michigan retiree: "Have owned seven Toronados and never had any mechanical problems with any of them. My basic reason for buying was the front-wheel drive for its handling on ice, snow, rain, and in the mountains. Everyone likes the flat

APRIL 1972

PM OLDSMOBILE TORONADO OWNERS REPORT...

A nationwide survey based on 900,000 owner-driven miles

TORONADO FUEL-MILEAGE CHART

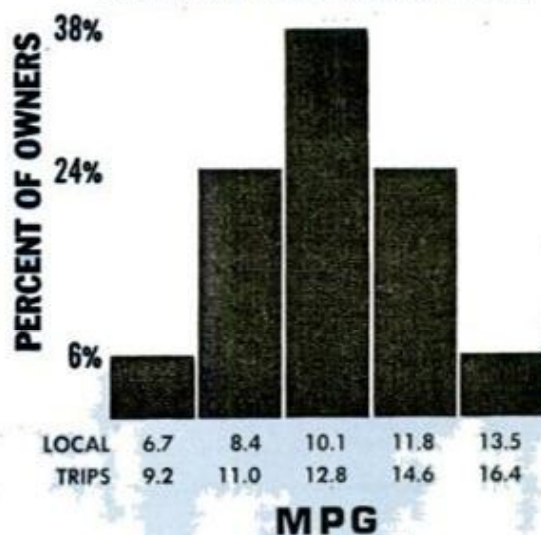



ELDORADO, Toronado now share B-body with all GM coupes. Before, they and Riviera used special E-body

Cadillac bag manufacturer. A Flushing dentist notes: "All service costs are high at the dealer; can be done for less at a local filling station." Says a White Plains cargo hauler: "\$180 for makeready is ridiculous." And 14.7 percent found gas mileage poor. It is poor: 9.2 mpg average in the city; 11.6 on the highway.

The point is the Eldorado owners watch their bucks. While they often indulge in good-natured grumbling, in

many cases they enjoy the privilege, e.g. the Detroit minister who beams, "The price is very, *very* HIGH!" That's undoubtedly part of the Eldorado's charm.

Some other charms: "Image car," says an Illinois sales rep. A retired Texas Air Force officer: "I like the styling and front-wheel-drive roadability." A California stockbroker: "It is my observation that Cadillac owners have less mechanical troubles than



TORONADO SECONDS taillights under rear window. Drivers two to three cars behind see signals easily

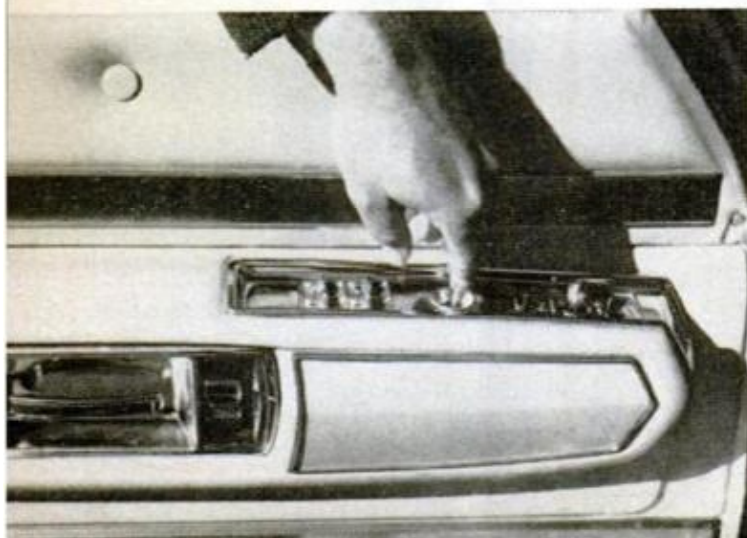

Oldsmobile floor. And the car is ideal for hauling our 31-foot Airstream."

Any problems, we asked this same gentleman, and he answered, "Could use a little more trunk space, and wheel balance is very critical. Also, some garages do not have equipment for Toronado wheels."

Let's have several owners give their total impressions of their cars. First, here's a Michigan small-town pharmacist: "Drove one and it handled very well, and when they changed the style for 1971 it appealed to me. Haven't found any defects yet. Driving appears to be more stable, especially on ice and snow. The '72 is comfortable, both back and front. My only complaints are I would like radial tires, and that the nearest Olds dealer is 50 miles away."

This from a New Jersey electrical contractor: "I had Cadillacs and be-

POWER door locks, window lifts, seat control are in door. Rear riders can no longer reach handles

WIPER CONTROL stands alone at left of dash, has mist button to give one sweep for drizzly driving

those who own other brands." An Indiana physician sums it up for many: "I enjoy the luxury of driving a heavy car."

Is front-wheel drive an important attribute in the minds of Eldo owners? Not especially, and not nearly so important as it is to Toronado owners. Most Eldorado drivers say that fwd influenced their buying not at all. They would have bought the car with rear-wheel drive without giving its locomotion a second thought.

A number of owners did, though, link their cars' good cornering, road-holding, traction, directional stability, and flat floor to fwd. An Illinois housewife: "I like the solidness of front drive, especially in snow and rain." A retired Detroit engineer: "Great steer-

RECTANGULAR PANE aids rear vision slightly, but the Eldo coupe's wide pillars make backing hazardous

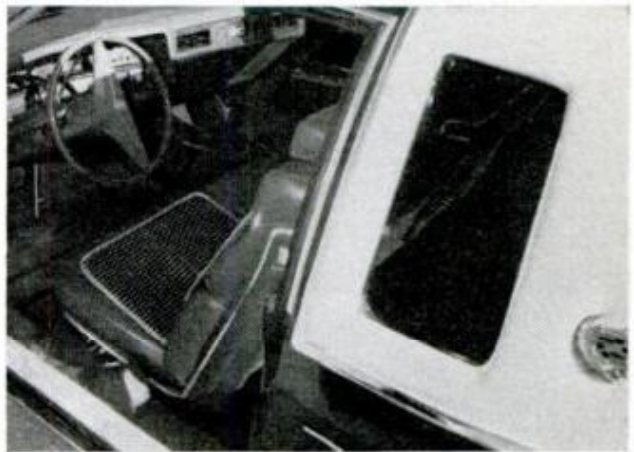

came dissatisfied. We have a farm in northern Vermont, and I drive back and forth all winter. The Toronado handles wonderfully in snow. But I dislike the position of the spare tire and feel the car needs a bigger trunk. I like a heavy car—it rides well, handles well, corners and brakes well."

A self-employed Chicagoan: "When I got the car, the front-axle grease retainer leaked, timing was off, and the left front window wouldn't shut. Got everything corrected except the seal,

and now I'm getting the stall tactic. I bought the car for its styling and wanted to try front drive. I judge quality poor and was amazed to find two dents on top of the rear quarter; also many scratches, nicks, and a large spray of adhesive material on the vinyl top. The front seat is much too high and there is wasted space in the mounting frame and thickness of the seat. It surely wasn't designed with comfort in mind."

An Arkansas agricultural chemist:

FWD USED TO RANK NO. 1 with Toronado buyers. Now it's styling. Eldorado owners aren't so hep on fwd

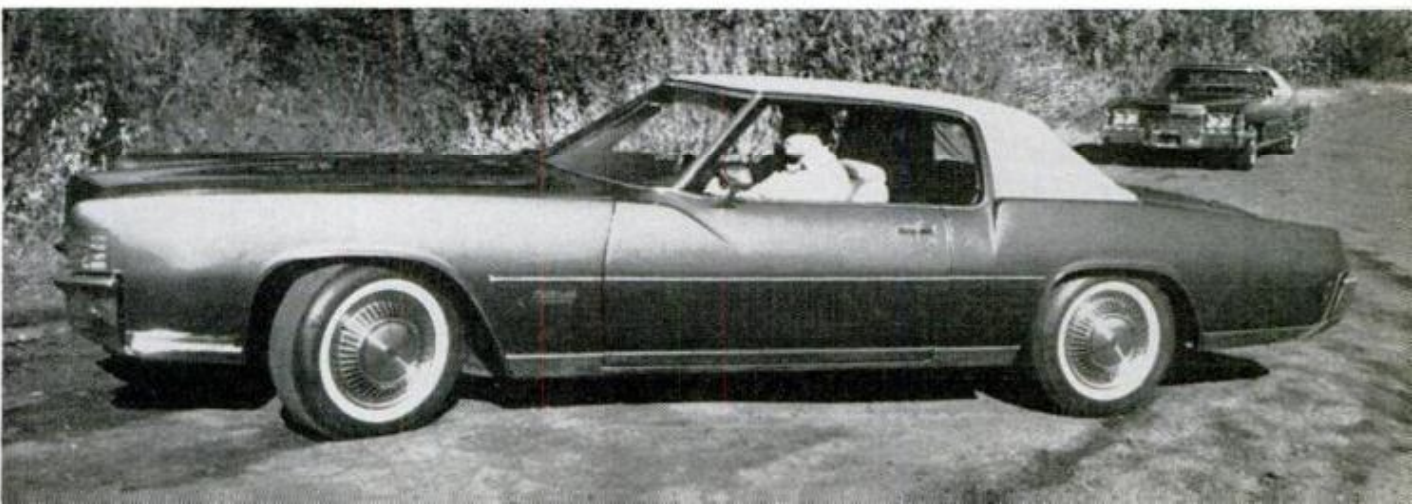



OWNERS COMPLAIN of small trunks in Eldorado and Toronado; ditto legroom in coupes' rear seats

Cadillac ing and handling on ice." No one considered fwd a drawback but for a tiny minority who complained of excessive tire wear and alignment problems.

Just what does an Eldorado owner get that the Toronado owner doesn't? In terms of measurables: 4.3 inches more wheelbase, 3.4 inches more overall length, 70 extra pounds of weight, 15 fewer rated horsepower (which

means nothing—Cadillac always underrates its engines), and two gallons more fuel capacity (27 vs. 25). The Eldo gets slightly worse gas mileage than the Toro, partly because of its lower differential ratio (3.07 vs. 2.73) and partly because it's feeding 45 more cubic inches of V8. For all this, the Eldorado owner pays a couple thousand dollars more in base price.

For prestige, luxury and state of mind, there's no measuring. Many buyers, of course, put the intangibles far ahead of all other attributes.

Cadillac has a very strong record of owner loyalty—stronger even than Toronado's, one of the strongest in the industry. Says a Massachusetts stockbroker: "This is my fifth Eldorado. I like the car very much, but at the same time I'm afraid they can become troublesome after a year, so every year in September I trade for a new one. Each car has no more than 12,000 miles on it." (This guy sounds like a used-



RUBBER BUMPER INSERTS are horizontal on Toronado, vertical on Eldorado; '72 bumpers use heavier metal

Oldsmobile "We had an electrical problem, but the dealer fixed it fine. Our dealer is very good. We bought our Toronado because it was recommended by friends. We consider quality good except the car uses oil and the trunk leaks. It also uses too much gas. I particularly like its stability on the highway and its sleek look."

A Pennsylvania executive: "Now driving my third Toronado—always

receive good dealer service. Bought because of fwd. It will go anywhere in any weather. Workmanship on a par with other cars, which leaves a lot to be desired. Needs wheel design changed because many service stations do not have equipment to remove tire from wheel. I speak from experience. Other drawbacks—I think the trunk is too small, and so is rear legroom, and I can hear all electrical noises (turn signals, wipers, foot brake) through the radio."

A Virginia medical illustrator: "When you're out in the boondocks, country mechanics don't know how to fix this car. I've had a little carburetor trouble, the radiator leaks, and the car uses about 1½ quarts of oil per 1000 miles. My dealer usually gives me the runaround, telling me stuff like they can't get a part because it's not catalogued yet. I've had the car back five times—it's still not right. Parts have been left off and mechanics are

What's ahead for front-wheel drive?

Automakers are turning to the compact Wankel as a cleaner engine for the future, and front-wheel drive is the logical drive train to use with it

AFTER 70 YEARS as an also-ran, front-wheel drive (fwd) seems destined to step out as the automotive propulsion system of the future. Why? Because the Wankel looks like the engine of the future.

As the Wankel takes over from piston engines, fwd begins to make more and more sense. A lighter, more compact powerplant leaves more space and more leeway for weight up front. Thus it will become more economical and more reasonable to produce a self-contained power unit, and that unit means fwd.

In the past and even today, piston engines together with fwd have made for front-heavy cars. Most have had a natural tendency to understeer; i.e. the car tries to keep going straight even though the front wheels are turned. This tendency will become less pronounced as smaller, lighter engines evolve.

Without a long driveshaft passing through the car (and it does pass through, not under), you get no transmission hump. The interior floor can be entirely flat. There's more trunk room because there's no differential case to allow clearance for. And the whole car can be built lower to the ground, giving better stability and less wind resistance.

Fwd has always given better directional stability in crosswinds. It's let a car pull out of ruts by simply turning the front wheels and applying power. Fwd gives good traction on slippery surfaces.

Problems with fwd have been mostly technological—adapting automatic transmissions, power steering, and in developing reliable, inexpensive axle joints. You have to remember that to drive the front wheels, the axles need to be jointed at both ends. These joints must withstand torque and braking loads, plus allowing for suspension travel and steering. Today, though, we have good axle joints, and most previous technological problems have been solved.

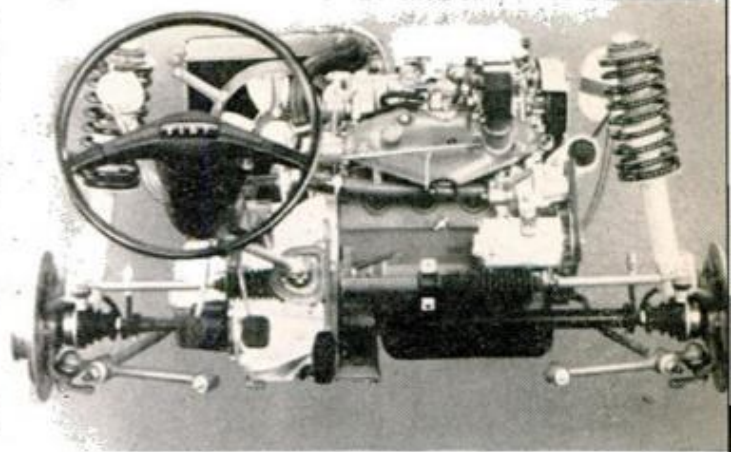

FIAT'S NEW 128 SERIES has sohc Four set crosswise ahead of axles, with transaxle alongside block, as in the BLMC minis. The point is that the entire unit is self-contained, compact, light and easy to service

Yet it's presently more expensive to manufacture a car with fwd than one having identical specs but with a rear drive. This is because the long propeller shaft and separate rear-axle unit still cost less to mass-produce than axle joints, transaxle, and suspension members needed for fwd.

Since the Wankel will permit smaller, lighter power units, once mass production of rotary engines starts, the smaller, lighter bodies allowed by fwd will offset the added expense of fwd hardware. Savings will come via fewer parts, less metal, and lower labor costs. Moreover, fwd will make it cheaper to incorporate another needed innovation—independent rear suspensions.

General Motors is working full-bore on perfecting the Wankel for wide use and mass production. And it's planning to mate the Wankel to fwd exclusively. Time schedule for the big switch is still cloudy, but Oldsmobile has a 1973-74 small car in the offing. Rumor has it that this Vega-sized model might use GM's first Wankel. Though Olds denies it, there's a good chance it'll also use front-wheel drive.

In addition to the Olds Toronado and the Cadillac Eldorado, the cars with front-wheel drive that you can buy in the United States now include Audi, Austin, Citroen, Fiat, Honda, Lancia, Peugeot, Renault, Saab and Subaru. The number of cars that are switching to fwd grows every year. The day you put snow tires on the front of your Chevrolet may be sooner than you think!—M.L.



Cadillac car buyer's delight and perhaps accounts for some of Cadillac's high resale value. Still, though Cads keep a high percentage of resale value, the actual dollar depreciation is greater than that for less expensive cars.)

Rumors around Detroit have hinted that Cadillac is considering a more compact model—something the size of

ELDO CONVERTIBLE eclipses sunroof's popularity, remains the only soft-top in domestic luxury field

a Mercedes sedan. So we asked owners, "If Detroit made a smaller, less expensive fwd car, would you be interested in buying one?" Some 63 percent said no, giving the following reasons: "I am not hung up on fwd." "I don't like small cars." "It wouldn't have my Caddy's ride." "I need a good, heavy highway car." "Once you drive an expensive car, you'd never be happy with a cheap one."

What changes would Eldorado owners like to see? "Legroom in back should be bigger." "Faster pickup." "A four-door Eldorado would be nice." "Improve the styling of the rear end. I think the front design is wonderful, but the back end stinks. Must have had two different designers. Looks like a buffalo: large in front, small behind." "More trunk room." "Don't change a thing—I like the big, bold look." ★★★

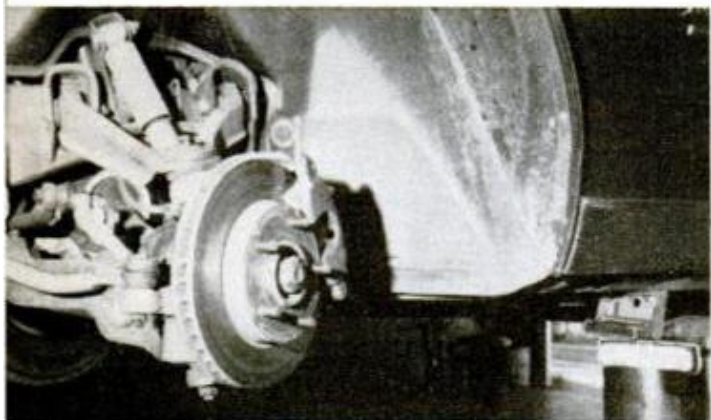

TORONADO front discs use wear indicators: metal tangs that set up a squeal when the pads wear out

Oldsmobile sloppy all around. Factory workmanship is no better. Both doors rattle, the left window doesn't close all the way, and several electrical switches were bad. I took the doors apart myself and found that no attempt had been made to insulate the rattly places, so I rubberized them."

More typically, though, Toronado owners are happy with their purchases. "All in all, it's superb," says a Minnesota lawyer, who also rates workmanship excellent; ride, steering, handling and brakes likewise. Most owners, when they do find fault, mention relatively minor items, like the North Dakota real estate man who wrote a long diatribe about the fact that he couldn't match whitewall designs between his factory tires and a new set of snow treads. He couldn't forgive Oldsmobile that oversight! ★★★



GLOVEBOX takes long reach. Coins and small items left atop dashboard fall into slots at windshield

Summary of 1972 Cadillac Eldorado Owners Reports*

Total miles driven	534,299
Average miles per gallon	
Local driving	9.2
Long trips	11.6
Body styles:	
Coupe	73.4%
Convertible	26.6
Why the Eldorado?	
Style	42.0%
Past experience	28.0
Front-wheel drive	17.3
Prestige	10.0
Quality	8.7
Specific likes:	
Styling	64.9%
Handling	39.2
Comfort	28.4
Ride	26.4
Performance	20.3
Prestige	10.1
Power	9.5
Roadability	9.5
Specific dislikes:	
Workmanship	19.6%
Poor gas mileage	14.7
Small trunk	11.9
Rattles	10.5
Poor ride	5.6
What changes would you like?	
Better workmanship	8.9%

More rear legroom	8.1
Larger trunk	6.5
Different styling	5.7
Better gas mileage	4.8
How long have you been driving fwd cars?	
Less than 1 year	40.9%
1-2 years	13.0
3-5 years	39.6
6-10 years	3.9
10-25 years	1.9
More than 25 years	0.6
Would you buy a smaller U.S. fwd car?	
No	63.3%
Yes	36.7
Why would you?	
Better handling	28.7%
Eldorado too large	6.9
Better economy	4.0
Why wouldn't you?	
Like big, heavy cars	56.4%
Would you ever buy a front-engined, rear-drive car?	
Yes	83.7%
No	16.3
Had any mechanical trouble?	
No	64.9%
Yes	35.1

What kind of trouble?	
Electrical	9.6%
Carburetor	9.6
Cold starts	9.6
Front-end alignment	9.6
Windshield wipers	7.7
Did you repair it yourself?	
No	100.0%
Dealer repairs satisfactory?	
Yes	78.4%
No	21.6
Is the Eldorado your only car?	
No	7.7%
Yes	21.3
Other cars owned:	
Cadillac	28.1%
Chevrolet	27.3
Pontiac	13.2
Ford	12.4
Buick	10.7
Oldsmobile	10.7
Age distribution of owners:	
15-29 years	8.7
30-49 years	51.3
50-plus	40.0
Would you buy another Eldorado?	
Yes	92.4%
No	7.6

*Percentages might not equal 100% due to rounding and/or insufficient data.

Summary of 1972 Oldsmobile Toronado Owners Reports*

Total miles driven	900,761
Average miles per gallon	
Local driving	10.1
Long trips	12.8
Why the Toronado?	
Style	46.0%
Front-wheel drive	36.8
Past experience	21.6
Handling	10.4
Comfort	4.8
Specific likes:	
Handling	64.1%
Styling	54.7
Comfort	24.9
Riding qualities	19.6
Front-wheel drive	15.9
Roadability	15.5
Performance	10.6
Specific dislikes:	
Poor gas mileage	17.3%
Not enough legroom	12.4
Poor workmanship	11.9
Not enough trunk room	9.5
Rattles	9.5
What changes would you like?	
More legroom	19.2%
Bigger trunk	17.8

Four-door model	9.4
Better gas mileage	4.7
Different styling	4.7
How long have you been driving fwd cars?	
Less than 1 year	51.2%
1-2 years	8.0
3-5 years	30.8
6-10 years	9.6
11-25 years	0.4
More than 25 years	0.0
Would you buy a smaller U.S. fwd car?	
Yes	50.2%
No	49.8
Why would you?	
Better handling	36.5%
Better gas mileage	10.8
Prefer smaller size	3.0
Why wouldn't you?	
Like big, heavy cars	49.8%
Would you ever buy a front-engined, rear-drive car?	
Yes	73.8%
No	26.2
Had any mechanical trouble?	
No	64.0%
Yes	36.0

What kind of trouble?	
Electrical	15.4%
Carburetor	14.3
Alternator	7.7
Oil leak	6.6
Did you repair it yourself?	
No	94.5%
Yes	5.5
Dealer repairs satisfactory?	
Yes	68.7%
No	31.3
Is the Toronado your only car?	
No	71.7%
Yes	28.3
Other cars owned:	
Oldsmobile	33.5%
Chevrolet	30.2
Ford	12.1
Volkswagen	7.7
Pontiac	7.7
Dodge	5.5
Cadillac	5.5
Age distribution of owners:	
15-29 years	15.8%
30-49 years	49.8
50-plus	34.4
Would you buy another Toronado?	
Yes	88.5%
No	11.5

*Percentages might not equal 100% due to rounding and/or insufficient data.

Motorless sub to 'fly' the

If you can glide through air, you can glide through water. A motorless submarine designed to do just that is currently under study at the Oceanic Institute at Makapuu, Hawaii. It's 72 feet long, has stubby wings and sports an airplane-like tail. It contains no engines except for two small wingtip propellers used only for docking maneuvers. At

the beginning of the "flight," the pilot takes on seawater ballast to make the sub slightly nose-heavy. The craft then glides slowly toward the bottom, reaching depths of up to 20,000 feet. At the bottom, the ballast is blown out and gas released from pressurized hydrazine tanks to make the sub buoyant. It then glides back up to the surface,

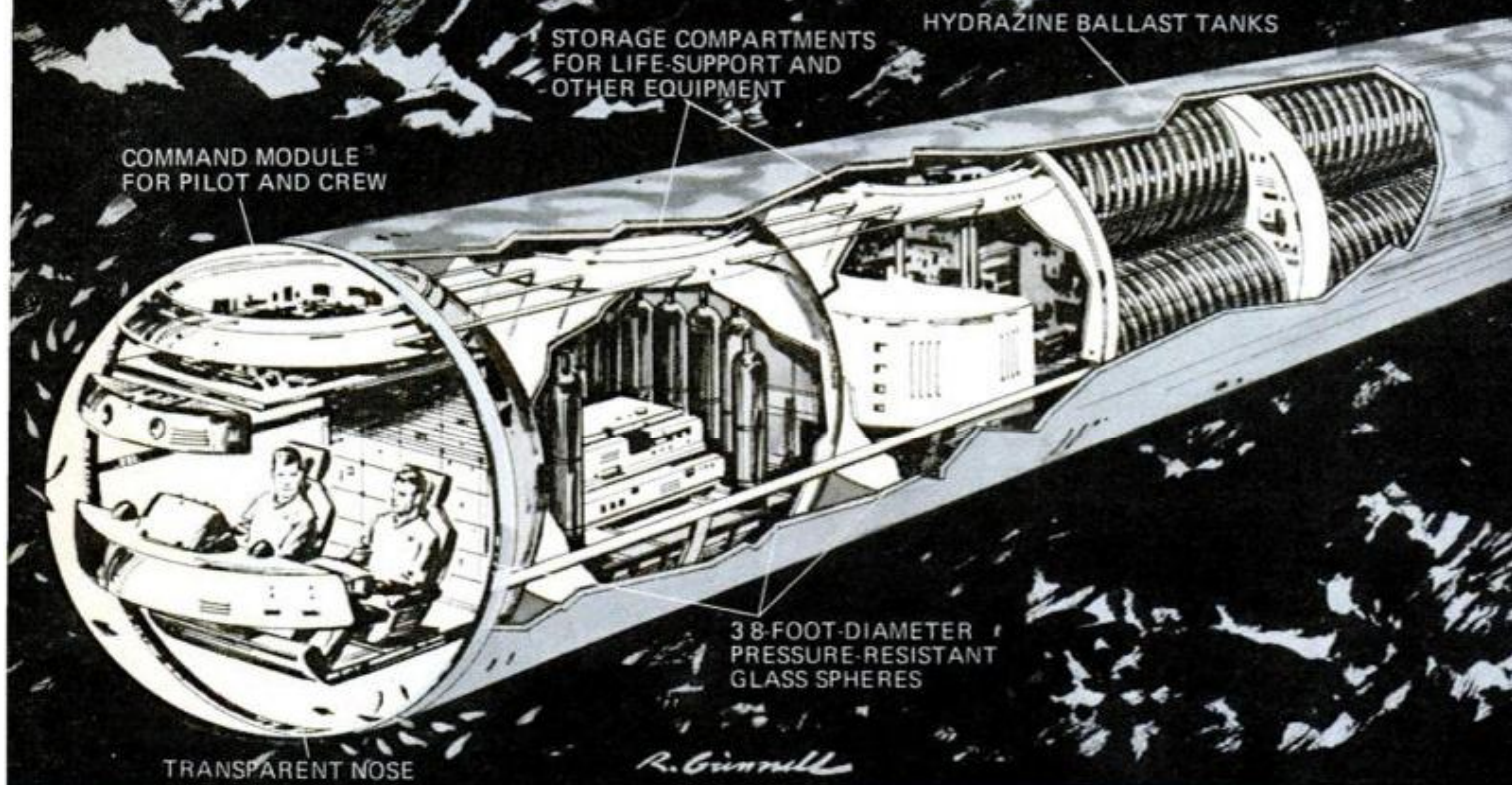

Backpack rolls like a wheelbarrow

Why carry a heavy pack on your back when you can roll it on the ground? That's the idea behind this clever convertible pack carrier designed to ease your burden on long camping hikes. On smooth, level terrain, you simply push it along like a wheelbarrow on a small wheel mounted in a

V-shaped extension on the tubular aluminum frame. When the going gets tough on steep grades or through heavy brush, you remove the quick-release wheel and slip carrying straps over your shoulders. The two-way carrier was devised by Lee, Jesse and David Tracy of Ogden, Utah.



ocean like a glider

JUST PATENTED



and the process is repeated. At this rate, it could travel 24 miles during each dive and climb, covering the distance from Hawaii to the West Coast in 16 days. Because it will be subjected to tremendous pressures at great depths, its main crew and equipment chambers are in the form of three glass spheres with 4-inch-thick walls. Behind these are the hydrazine gas tanks in a fiberglass hull. Air can't be used for buoyancy because, at 20,000 feet, it weighs as much as water and would provide no upward lift. The sub was designed for the Institute by engineer Willis R. Forman who believes the design can eventually make possible low-cost intercontinental transportation.

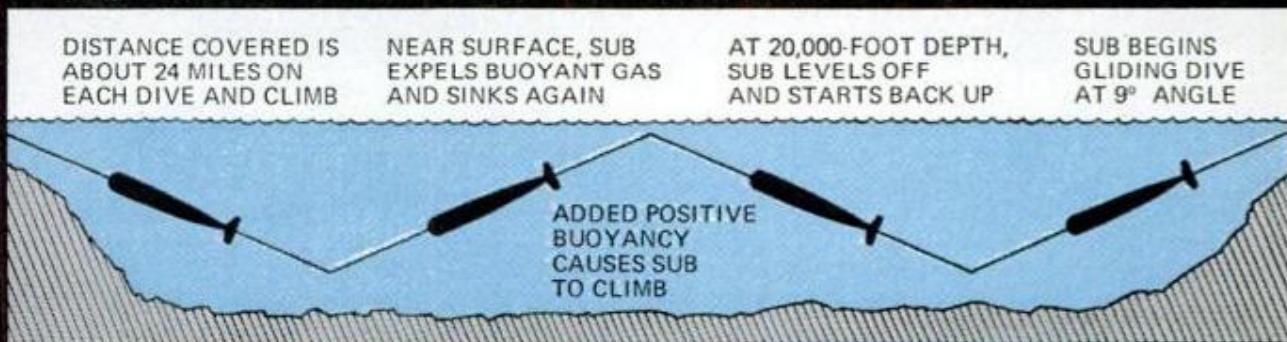

No-spill spout for a milk carton

Big gallon-size milk cartons are heavy and hard to pour—but not with this handy device. It's a combination carrying handle and pouring spout that quickly attaches to any standard gallon container. It consists of two pointed plastic end pieces that slip into openings at the top of the carton and lock together (left, below). You then screw the spout into a threaded opening, and a

toothed metal ring cuts its own hole in the container as the spout is turned (center). With the spout in place, you just remove the cap and pour (right), with no danger of spilling milk or dropping the carton. When the carton is empty, the handle and spout can be transferred to a new one for reuse. It's sold for \$2.79 postpaid by E. Z. Pour Corp., Box 149, Bayonne, N. J. 07002.

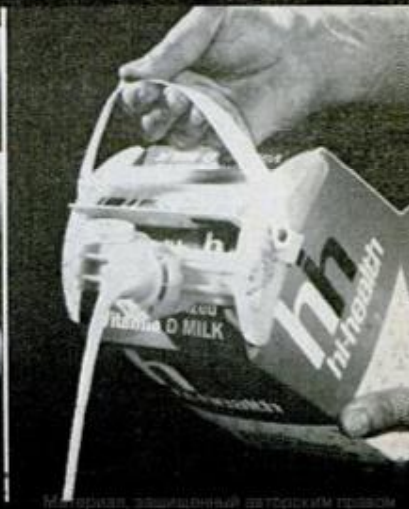

Material, защищенный авторским правом

BETTER WAYS TO GET A BETTER HOME

Your best bet for a larger, more comfortable, easier-to-live-in home may be the home you already own. Often, a well-planned home improvement will cost you far less than a move would. With do-it-yourself weather just around the corner, *PM's* editors have rounded up an outstanding collection of ideas that solve most problems. On the next 42 pages you'll see how you can:

- Expand *down* as well as up Page 111
- Update an old living room Page 112
- Remodel a tired-looking bath with an exciting new material Page 113
- Increase living space by extending over the garage. Page 114
- Add unusual touches to create an out-of-the-ordinary basement family room. Page 115
- Get more use from your closets by building efficient storage Page 129
- Make patio planters that improve the look of your outdoor "family room". Page 132
- Give an old home an exterior facelift: Five ways to erase the dated look. Page 134
- Install an automatic roof ventilator for greater summer comfort Page 139
- Build a handsome contemporary light for practically nothing Page 142
- Have the convenience of an outside basement entry — easily and inexpensively. Page 144
- Select the latest materials from this great roundup of new products for improving your home Page 148
- Dress up those bare-looking shelf standards. Page 151





Need more room? Consider that space under the house

THE EXTERIOR and interior views of the home above and at left could not have been photographed eight years ago. That's when Jack Dennis and his wife bought their "small, slightly aged home" because they "just couldn't resist its location." Before they signed the deed, they knew what they wanted—and what they would have to do to get it. To start, they raised the house and built a basement below. Next, the new-found living space was laid out to provide the rooms as shown in the exploded floor plan (page 116). A low-area between

(Please turn to page 116)





Simulated beams and paneling make a world of difference

HAPPILY, home-improvement materials offered today make it easy to create a warm living room such as the one shown above. As can be seen in the "before" photos on page 119, the major faults in the original room are those that you would expect to find in most 50-year-old living rooms: an oversized fireplace with leaded glass windows flanking it, plaster cove where walls and ceiling meet and an open,

(Please turn to page 119)



NEW STAIRWALL and a white Marbledtone paneling on outside wall make renovated room appear larger. Freestanding radiator was replaced with recessed type; the new ceiling eliminates painting and quiets the room



Bath need remodeling? Man-made marble makes it easy to maintain

PROBLEMS designed into the original bath in this 20-year-old home are what triggered its renovation by owner John Gaynor, Seaford, Long Island, N.Y. The lack of adequate storage cabinets for towels, linens and toiletries was annoying. Of even greater concern was a window over the bathtub. It eventually per-

(Please turn to page 123)



ORIGINAL DESIGNS, and plastic material that looks like marble, fill this bath with ideas you can duplicate in full or in part. Photo above shows tub enclosure and factory-made, one-piece vanity top with bowl. At left, towel closet is shop-built as is plastic-laminated medicine cabinet below. Owner altered vanity, left, so clothes hamper is behind doors at far end

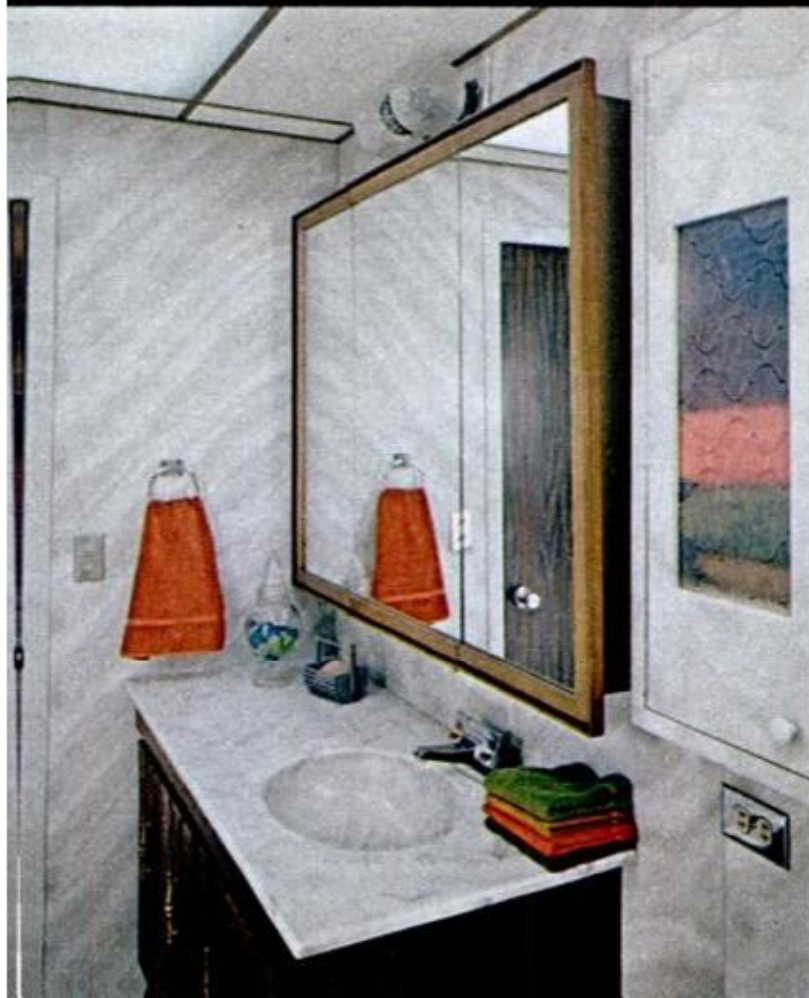



An inexpensive way to expand—over an attached garage

WHEN YOU EXPAND over an existing structure, you save a lot of trouble and expense. The basic foundation is already there, and, in some cases, so is the floor. You simply build upward on top, avoiding many of the headaches of starting from scratch. This is what Mr. and Mrs. Larry LeJeune decided to do when their fifth child arrived and they needed more space. The starting point was an attached garage. They conferred with architect Gerald C. Luedke of Minneapolis, Minn., who conceived and designed a two-stage improvement:

- The first was to add a family room, complete with woodburning fireplace, alongside the garage.
- The second was to build over the ga-

(Please turn to page 126)

COLONIAL HOME (left) was adequate when family moved in. When more room was needed, bedroom was added over garage, playroom alongside (above)



Attention to details 'makes' this family room

START WITH a little imagination, add the ability to do it yourself and you are just about assured of ending up with a home improvement project full of creative—and inexpensive—ideas. David Noyes of Deephaven, Minn., wasn't afraid to tackle the actual work, and for out-of-the-ordinary ideas, he consulted Minneapolis designer Paul Albitz. The resulting warm, informal

(Please turn to page 128)

"OLD WORLD" LOOK is achieved through the use of some dark-stained beams, a wine rack and stemware shelf

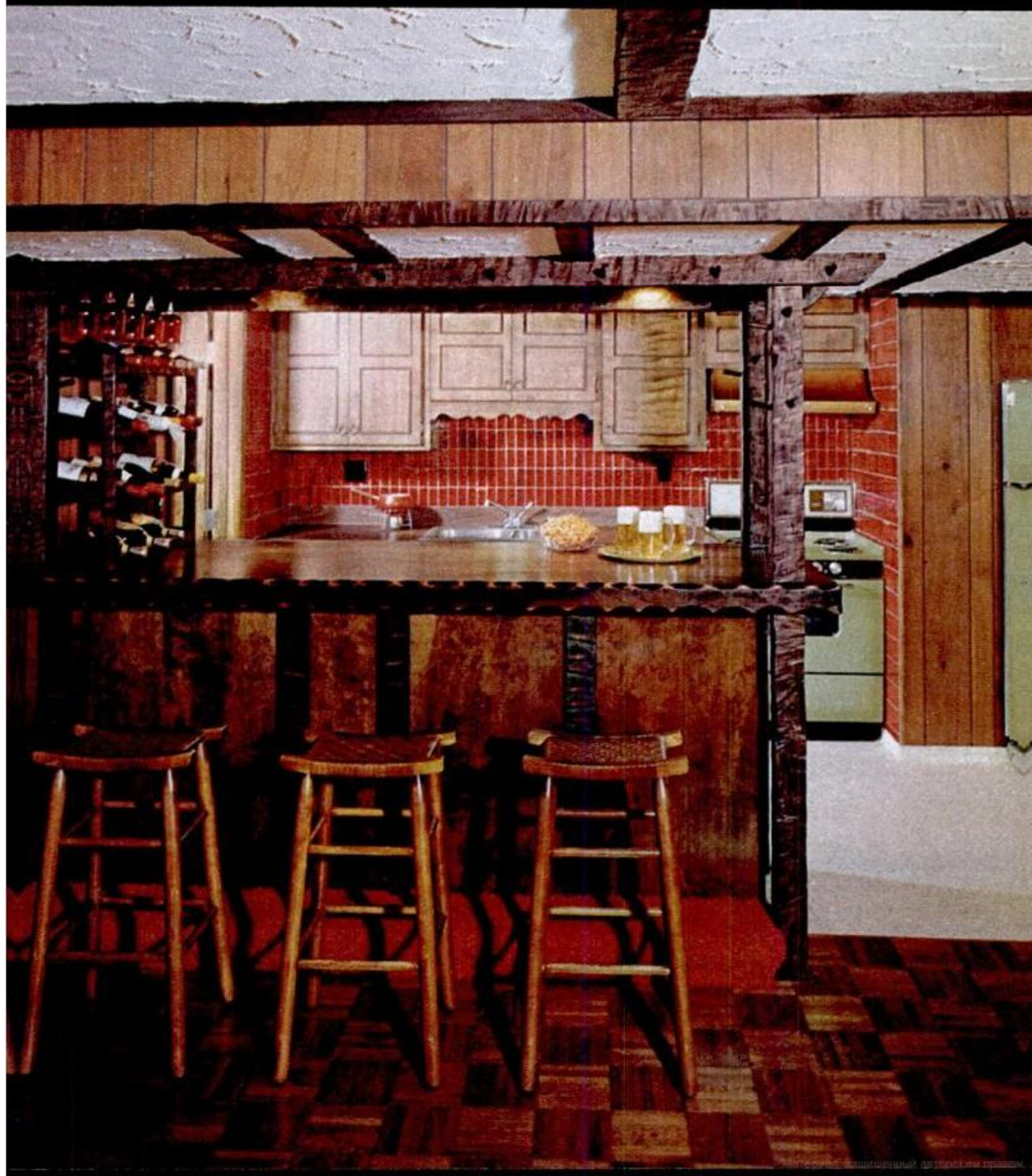

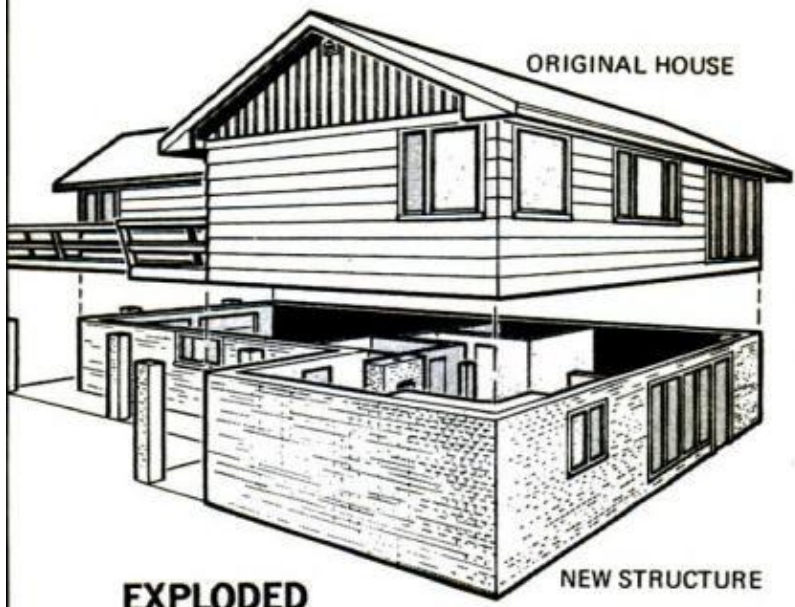

EXPLODED VIEW

SPACE UNDER THE HOUSE

(Continued from page 111)

street and house was backfilled to provide an on-grade driveway. The original house was then lowered onto the new structure (left).

The existing house was re-sided with rough-sawn cedar and the addition covered with a combination of cream-colored brick (Chaska) and varicolored brick. Hand-split shakes were installed on the roof, and old windows replaced with new.

Stair treads in the unusual, handsome entry (see drawing below) rest on a beam center-support (stringer)

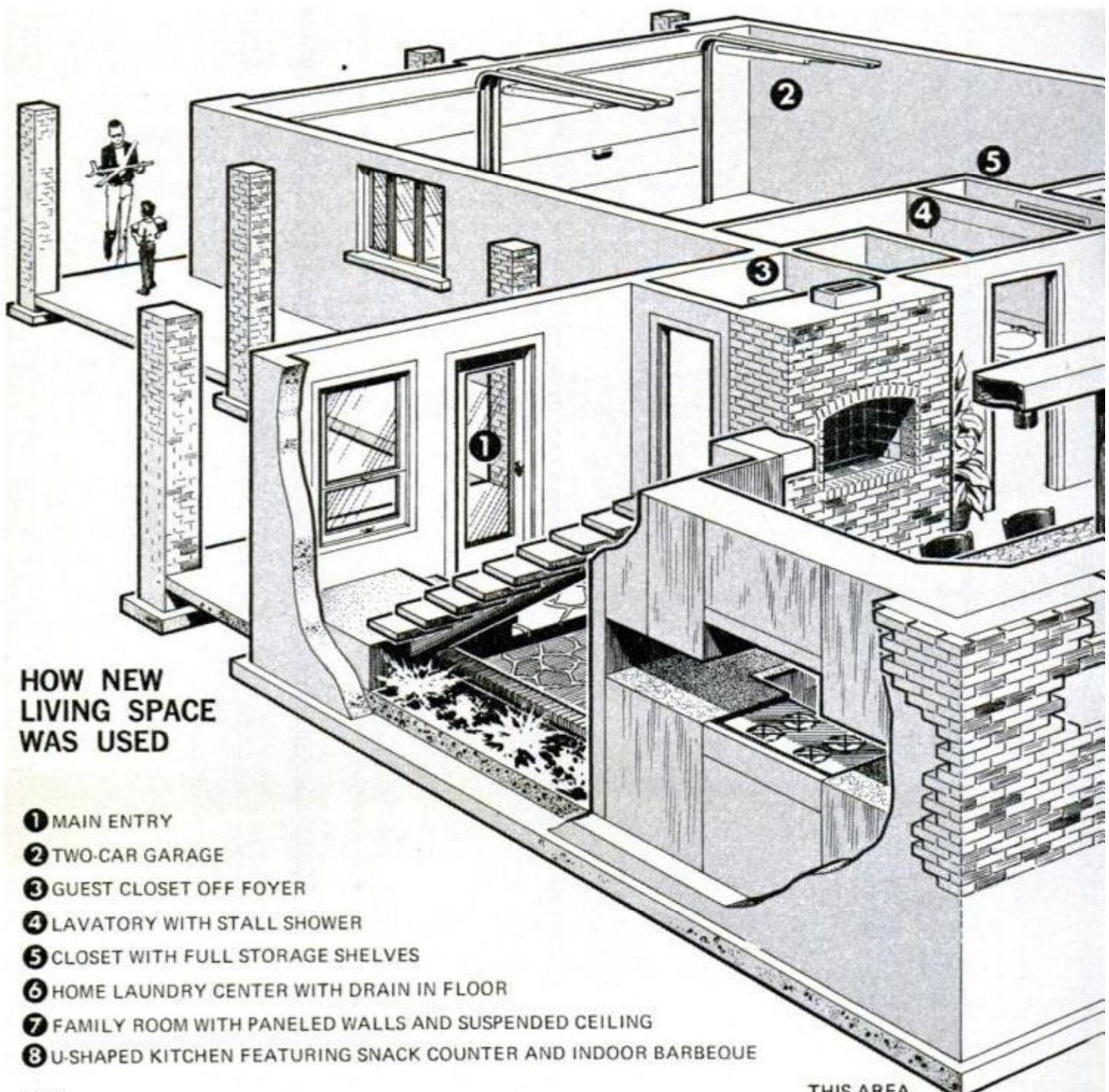

HOW NEW LIVING SPACE WAS USED

- ① MAIN ENTRY
- ② TWO-CAR GARAGE
- ③ GUEST CLOSET OFF FOYER
- ④ LAVATORY WITH STALL SHOWER
- ⑤ CLOSET WITH FULL STORAGE SHELVES
- ⑥ HOME LAUNDRY CENTER WITH DRAIN IN FLOOR
- ⑦ FAMILY ROOM WITH PANELED WALLS AND SUSPENDED CEILING
- ⑧ U-SHAPED KITCHEN FEATURING SNACK COUNTER AND INDOOR BARBEQUE

THIS AREA BACK-FILLED



VIEW THROUGH KITCHEN shows the cantilevered stairs that lead from the foyer up to the "old" home

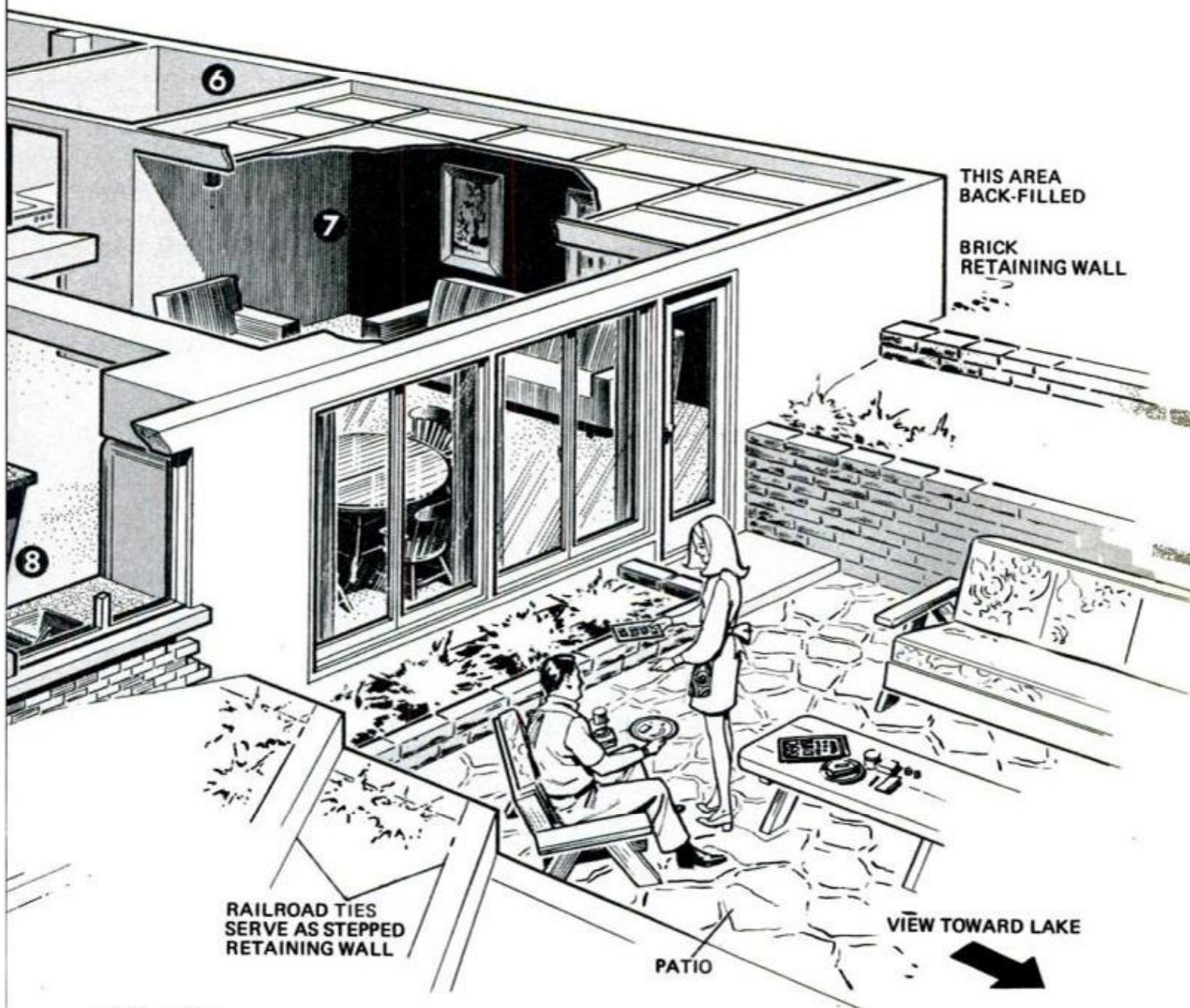



STREET SIDE OF HOUSE has pillars added, is now considered rear of house. Family room overlooks lake

anchored to the outside wall to give a cantilevered appearance. Exposed tread ends are covered with oak facing and each tread is completely wrapped in a bright orange shag rug. Under the stairs is a lighted planting section with a low, curved-brick edging.

The new space provides family activity centers—kitchen, living room,

bath and the like; the existing house was remodeled for sleeping quarters.

The biggest asset is a sweeping view of a lake from the new family room and patio. This feature alone, Dennis said, justified the ambitious undertaking. It also proves that improving a house in an ideal location can be better than moving. ★★★

NORTH ELEVATION

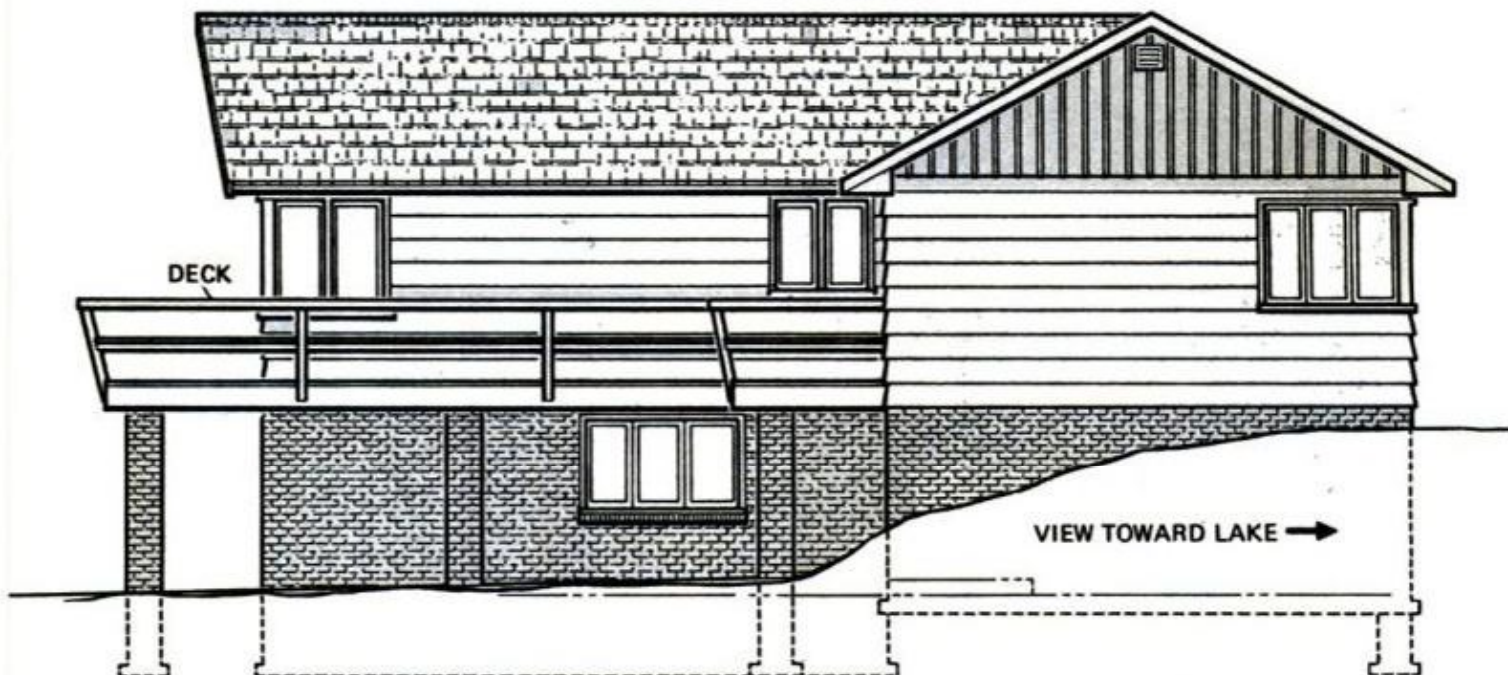

unimaginative stairway leading to the second floor. These were the problems that Harry Wicks, PM's Workshop Editor, faced when he decided to remodel the room shown. How he solved them is shown in the drawings and photos on these pages.

No changes were structural. A quick rundown of the transition reveals, in fact, that the job consisted basically of covering the floor, walls and ceiling, and redesigning the stair and fireplace walls to be more pleasing and functional. And, relying upon his experience in the home-improvement field, Wicks solved the problems using professional techniques that make the job easier and less costly. Thus the materials selected for the project have one thing in common: They are factory-finished to eliminate work steps beyond carpentry (and for years to come).

Walls. Since the existing plaster walls were in good shape—sound and with no cracking—they were simply covered with Masonite Pecan Royalcote using panel adhesive and plenty of nails. To make the job easier, vinyl-clad molding was used throughout. Because the room is 8½ ft. high, existing baseboard was also left in place and the sheets of paneling rest on it. The old base was then covered with strips of paneling ripped from waste (door and window cutouts). The existing entry, closet and bi-fold doors were hung to complement the room. The only other wall treatment required was to replace an archaic door chime with a 1972 version.

Ceiling. Two solid reasons made covering the ceiling a better solution than trying to patch what existed. The

"BEFORE" PHOTOS of stair and fireplace walls show dramatic difference remodeling made. Old fireplace was left intact but framed and skinned with paneling. Old, protruding fireplace screen (below) was replaced with recessed screen from Sears, Roebuck. (See page 122 for other manufacturers)

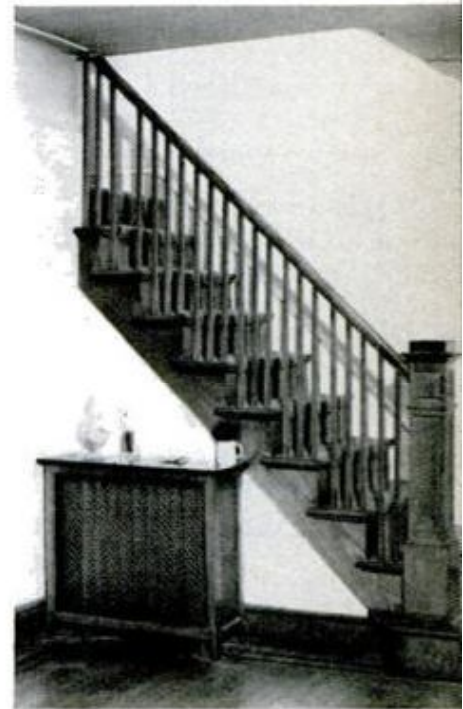

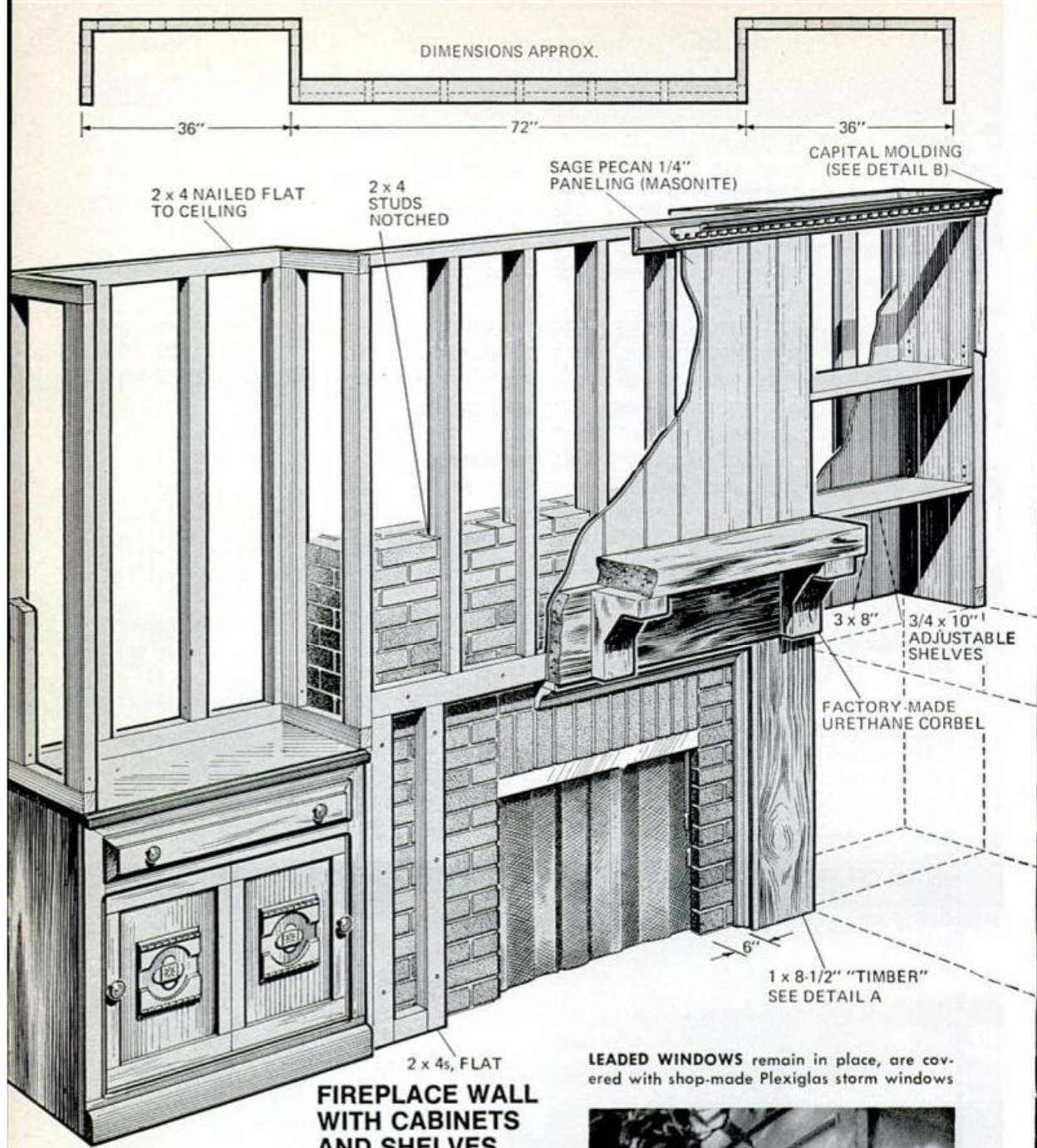

FIREPLACE WALL WITH CABINETS AND SHELVES

LEADED WINDOWS remain in place, are covered with shop-made Plexiglas storm windows



first was the dated, plaster cove and picture molding that surrounded the room. Perhaps more important, was to finally get rid of the calcimine-coated headache that *no* paint seemed to adhere to. The product chosen was a new one, Gold Bond's Brush Tex, and the choice could not have been better. Available in 4x14-ft. sheets, it is heavily textured

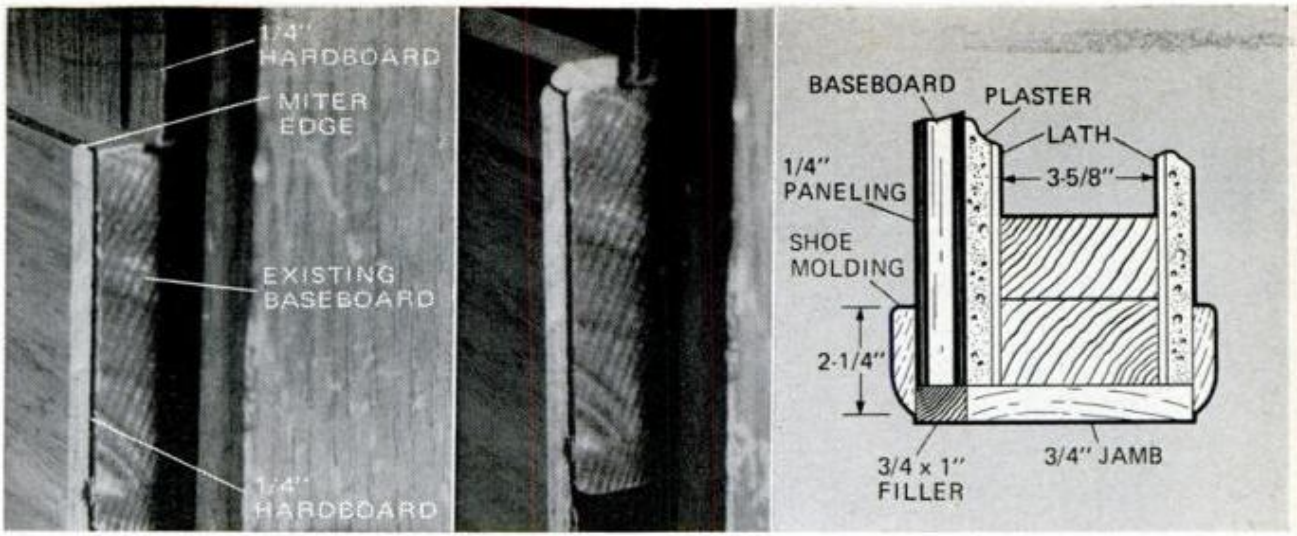

EXISTING BASEBOARD was left for 4x8-ft. panels to rest on. Base was then concealed with strips of the paneling ripped to width on table saw. Drawing shows pine filler-strip added to the existing jamb

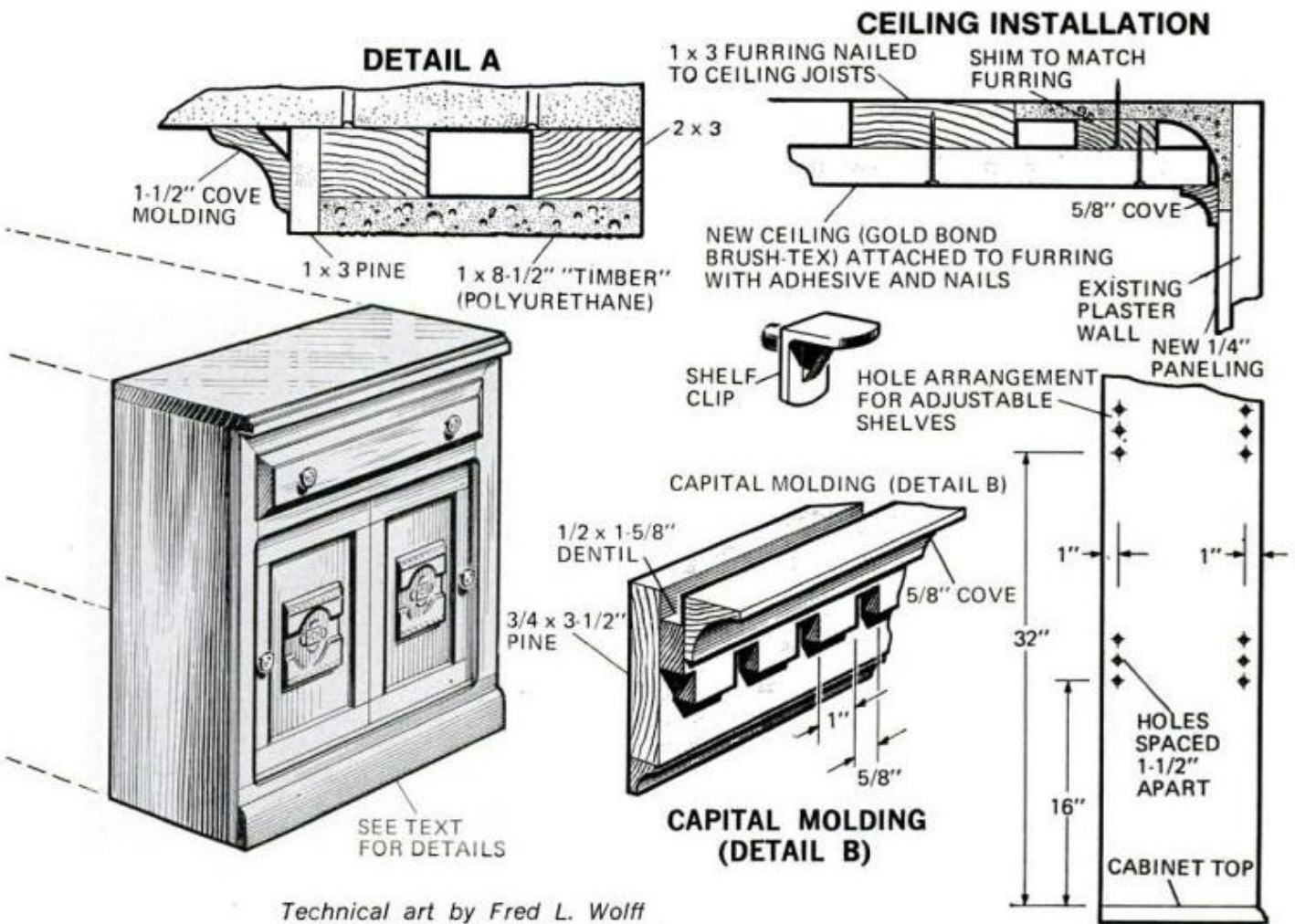

Technical art by Fred L. Wolff

so even if you miss a nailhead and give it a blow with your hammer, it is easily fixed. (A handful of Brush Tex sawdust mixed with Elmer's Glue is simply pushed into the damaged area and, when it dries, you won't even notice the repair.) Urethane beams and a handsome Early American electrical

fixture completed work on the ceiling. **New walls.** The fireplace wall was framed out to receive two cabinets (described in *An Early American Server with a Secret*, page 156, Nov. '71 PM). Then, leaving windows in place, the entire wall was skinned with paneling. Outside, the windows were fitted with



STREAMLINED LIGHT SWITCH by Slater Electric, Glen Cove, N.Y.; sold by electrical supply houses

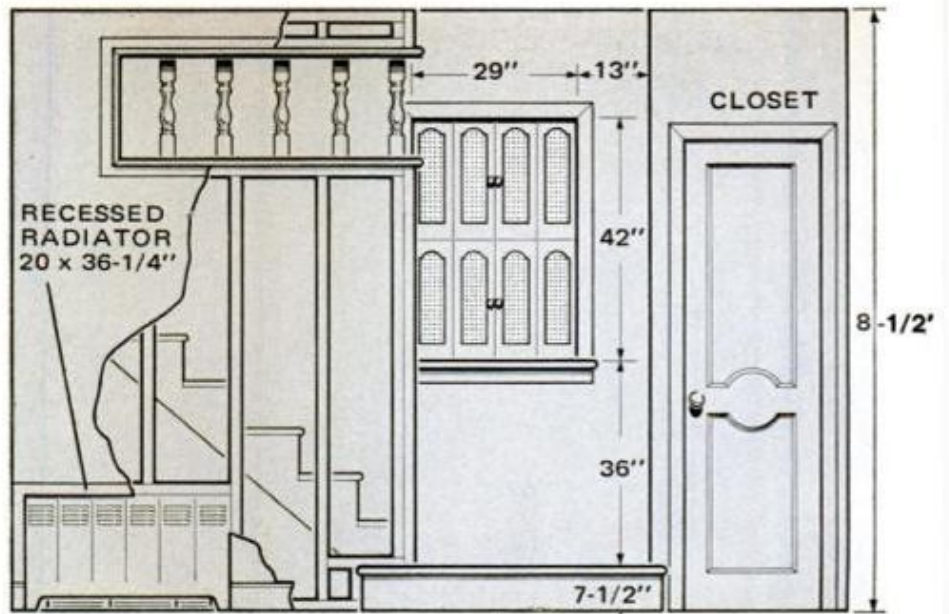

TURNT SPINDLES FASTENED WITH TWO NO. 8-2-1/2" F. H. WOOD SCREWS

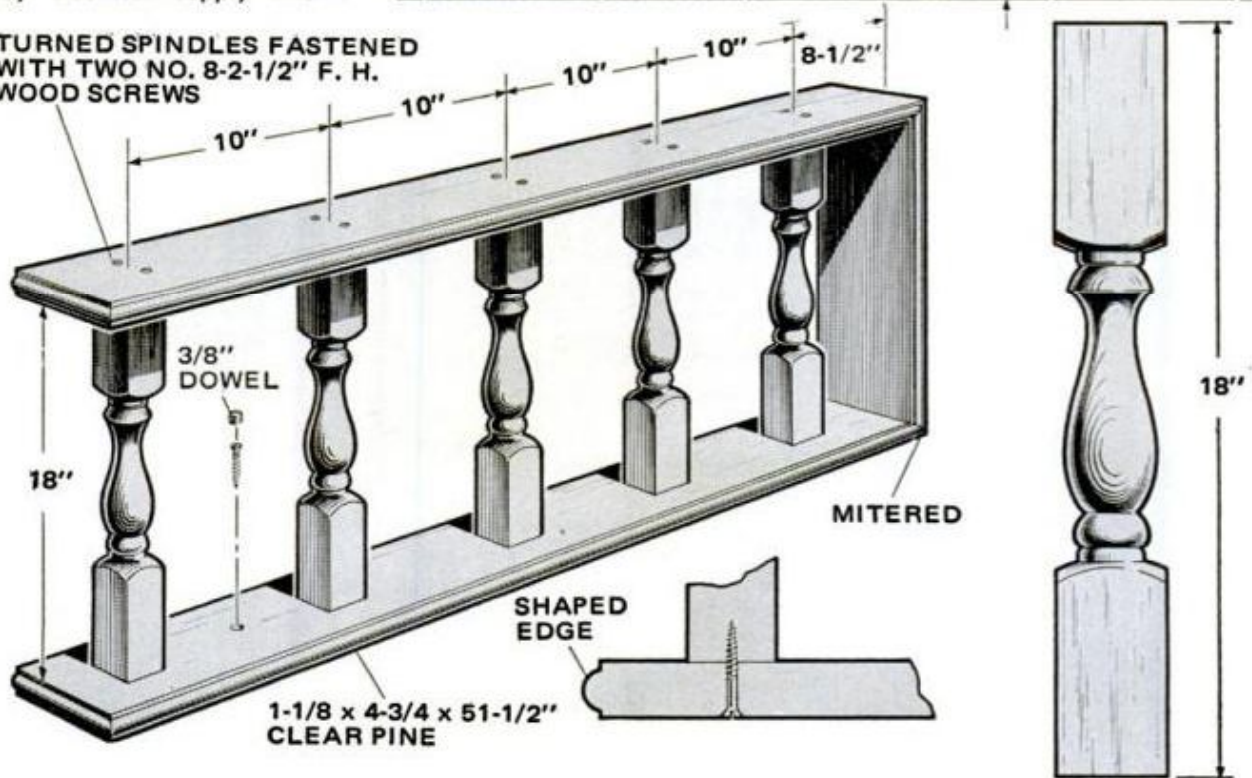

shop-made storms which are set into caulking and held by screws. The shelves on this wall are stained pieces of plywood and the edges are covered with plastic shelf edge (see moldings on page 149). Two high-hat eyeball lights on an independent switch are aimed at this wall to give sufficient light. The stairwall transformation had a big impact on the appearance of the room because it makes it seem larger. The white paneling on the outside wall is what opens it up visually. To finish, Ozite carpeting went down, wall-to-wall, to hide the old oak floor. ★ ★ ★

MATERIALS AND MANUFACTURERS

- Hearth slate—Vermont Cut Slate, Inc., Fair Haven, Vt.
- Ceiling—Gold Bond Brush Tex, National Gypsum Co., Building Products Div., 325 Delaware Ave., Buffalo, N.Y.
- Doors—Morgan Door Co., 601 Oregon St., Oshkosh, Wis. 54901 (Model M-1075).
- Ceiling and mantel beams—Lite-Beam, Haddon Ave. and Line St., Camden, N.J. (Medium colonial mahogany).
- Shutters—Cannon Craft Co., Box 558, Sulphur Springs, Tex. (Prefinished with oriental inserts).
- Stairwall spindles—E.A. Nord Co., Everett, Wash. 98206 (No. C318, colonial).
- Chandelier—Moe Light, Thomas Industries, Box 1643, Louisville, Ky. 40201. (M2198, aged tinware).
- Carpet—Ozite Corp., 1755 Butterfield Rd., Libertyville, Ill. 60048 (midnight tweed blue).
- Door chimes—Nutone Div. of Scovill, Madison and Red Bank Rds., Cincinnati, Ohio 45227 (LA-19).
- Hi-Hat eyeball lights—Sterling Lighting, 5691 Rising Sun Ave., Philadelphia, Pa. (R30, 75-w.).
- Shelf edging—Glass Laboratories, Inc., 863 65th St., Brooklyn, N.Y. 11220 (Cyclocac plastic).

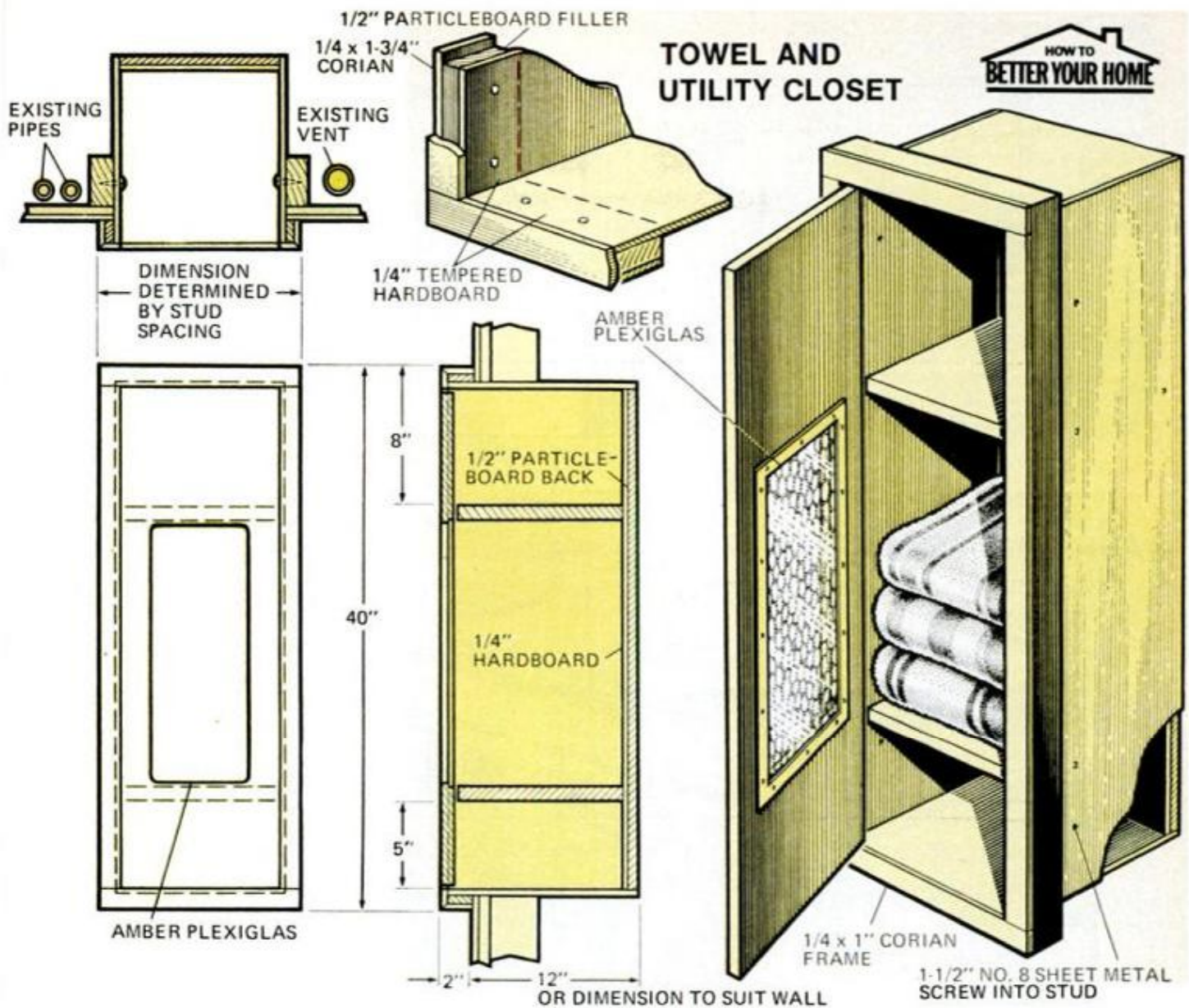

REMODELED BATH

(Continued from page 113)

mitted water seepage behind the wall covering, and the plasterboard beneath was severely damaged.

To close that drafty window, it was necessary to install an exhaust fan. The fan (with heat lamp) was wired to turn on automatically with the overhead light. And to conceal the ductwork, a suspended ceiling was installed. After replacing rotted studs and plasterboard, Gaynor used $\frac{1}{4}$ -in. Corian to cover the walls. That's a man-made plastic material that looks and feels like marble but there's a difference: It can be worked with carpentry tools. It provides a maintenance-free, waterproof room for years to come.

The bath is completely rebuilt. The only fixture remaining from the orig-

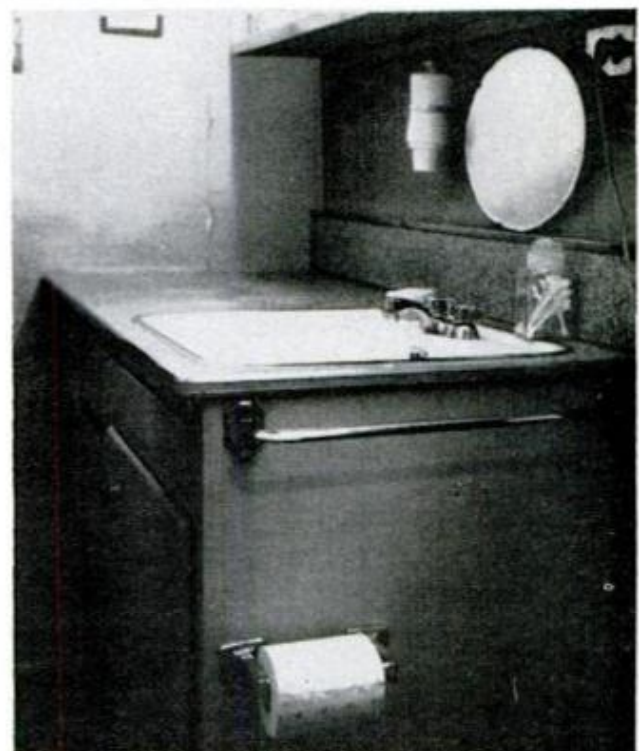

ORIGINAL VANITY (above) had dated linoleum top. New one-piece top rests on a factory-built vanity.

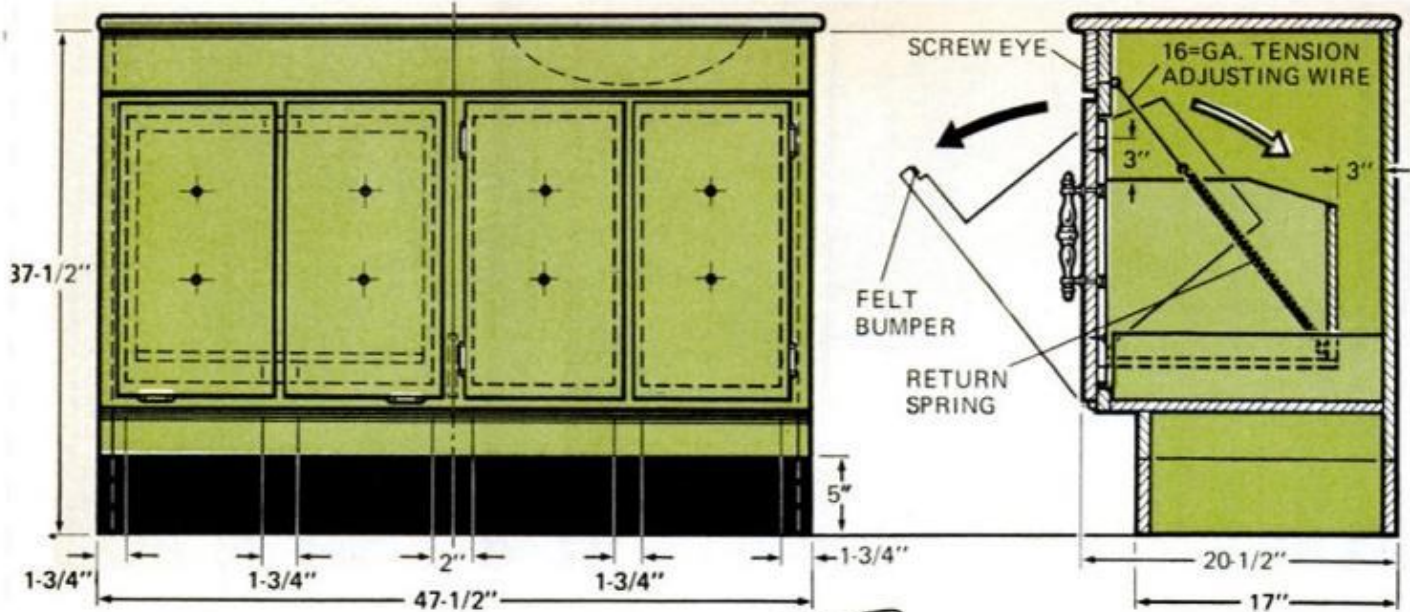

VANITY HAMPER DETAILS

CORIAN VANITY TOP

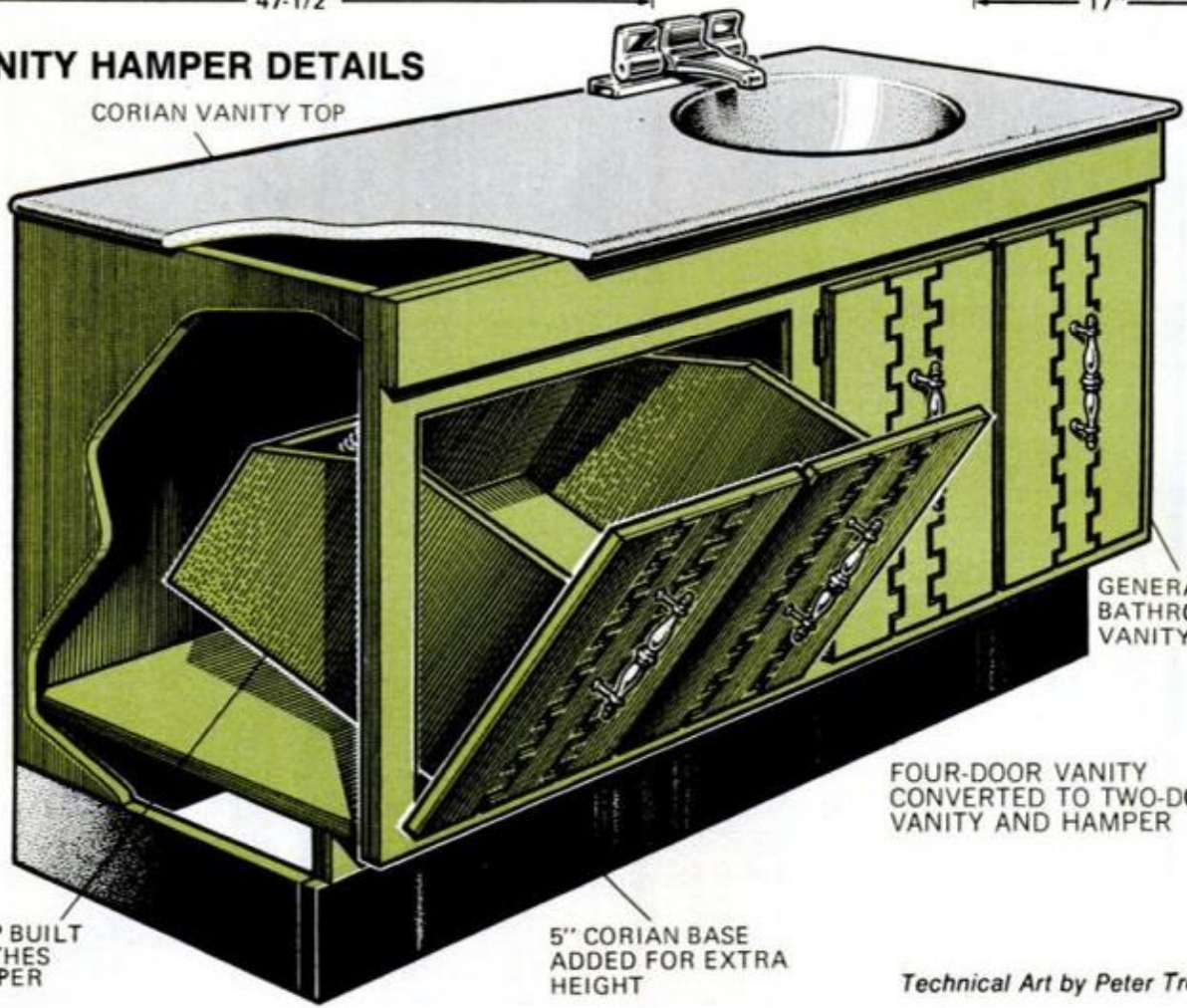

SHOP BUILT CLOTHES HAMPER

5" CORIAN BASE ADDED FOR EXTRA HEIGHT

GENERAL BATHROOM VANITY MV B-48

FOUR-DOOR VANITY CONVERTED TO TWO-DOOR VANITY AND HAMPER

Technical Art by Peter Trojan

inal room is the tub. The new toilet, as well as the ceramic floor tile, was purchased at Sears, Roebuck, and the one-piece vanity top with bowl comes as it appears in the photo. The prefinished vanity was altered slightly to provide an out-of-sight clothes hamper (see drawing) because there was insufficient space for a freestanding one.

Two wall cabinets were built in Gaynor's shop. The towel closet is of Corian

and Plexiglas and the medicine cabinet is skinned with walnut laminate. How to build them, and alter the vanity, is shown in the drawings. ★ ★ ★

MANUFACTURERS OF MATERIALS

Corian, tub-enclosure kit—DuPont Co., Dept. PM, 3301 North Market St., Wilmington, Del. 19802.
Toilet, ceramic floor tile—Sears, Roebuck & Co.
Vanity, mirror-medicine cabinet—General Bathroom Products, Dept. PM, 2201 Touhy Ave., Elk Grove Village, Ill.
Ceiling—Armstrong Cork Co., Lancaster, Pa.
Ceiling exhaust fan—Nutone, Madison and Red Bank Roads, Cincinnati, Ohio.
Walnut laminate, Melamite—Johns-Manville (available at lumberyards and building supply dealers).

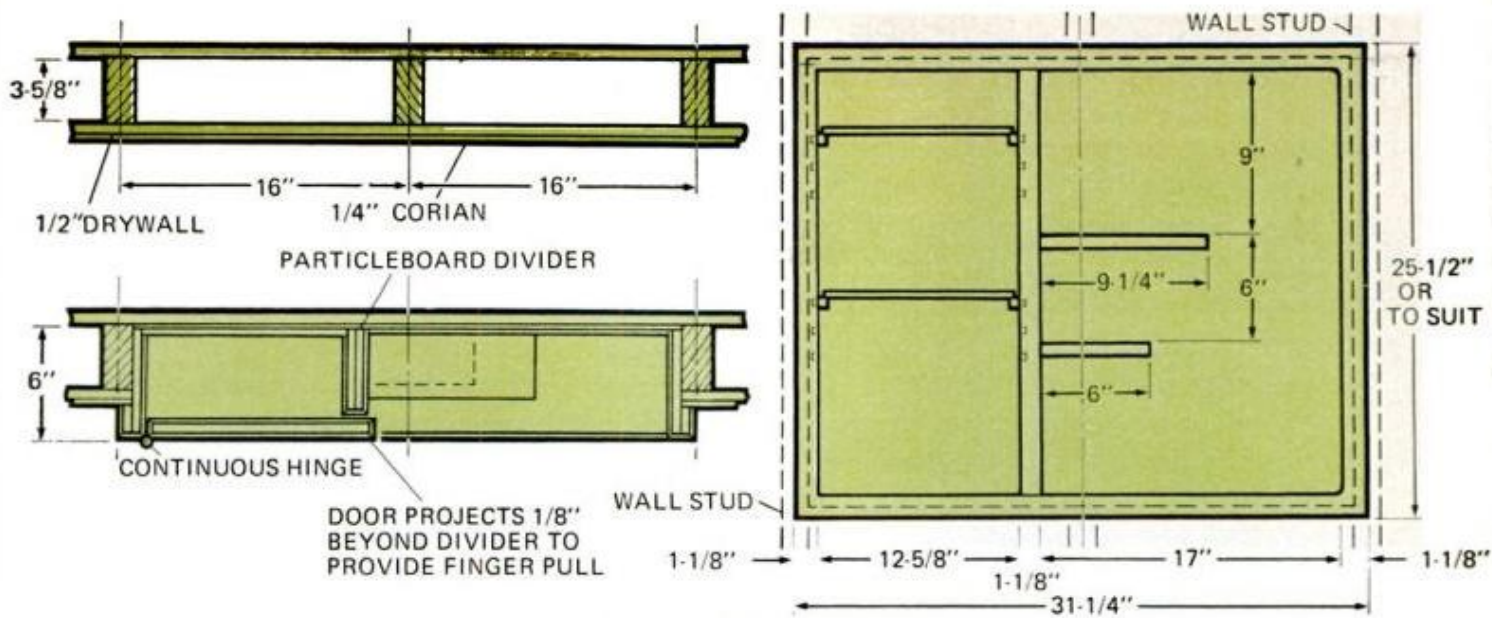

MEDICINE CABINET

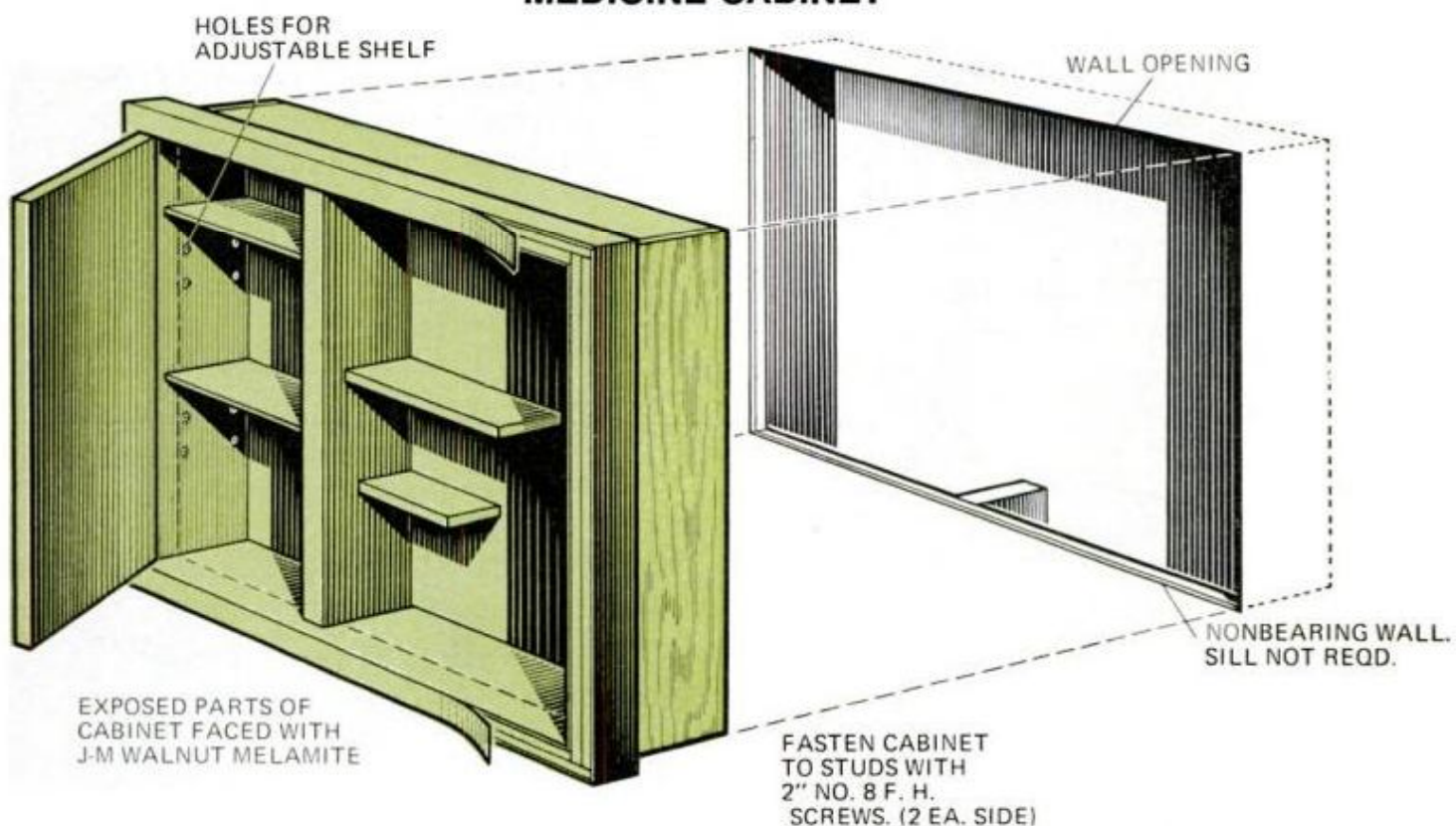

PLASTIC "MARBLE," used on walls and in tub, is fastened with adhesive. To insure neat job where panels butt, bracing is kept in place until glue dries. For durability, plastic was also used to build cabinets

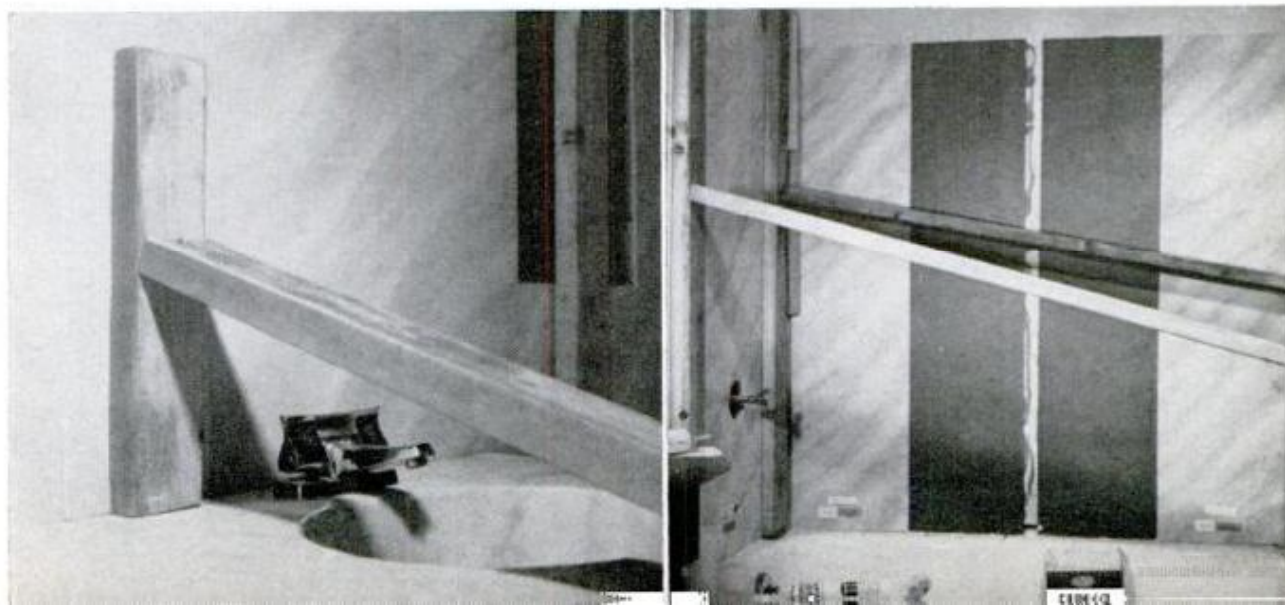

OVER-THE-GARAGE EXPANSION

(Continued from page 114)

rage to gain a master bedroom that was away from the existing four bedrooms. The new wing, which permitted construction of a private bath and sitting room as well as bedroom, also has Pella sliding doors that give access to a deck over the new playroom.

Inside it was decided to create a cathedral ceiling of rough-hewn cedar so the rafters were left exposed and stained. The entire room is paneled to eliminate future painting or papering problems.

Outside, the roof pitch follows the existing structure. The result is that the addition does not look tacked on but gives the appearance of having always been there. To keep costs down, alumi-

num siding, rather than brick veneer, was used.

Expanding up, when possible, rather than attaching a new structure is a practical approach to home improvement for several reasons. It is more economical because the footings under the garage are already there. Thus, excavation and concrete work are not required, and if desired, that money can be put toward interior luxuries or extras. And expanding up also leaves more yard area for outdoor activities.

Whether you decide to add both rooms in one project, one only, or one now and the second as time and money permit, the building concept the Le-Jeunes used is a sound one. Once either or both additions are closed to the weather, interior work can proceed as you—not the elements—dictate. ★★

COMPLETED ADDITION

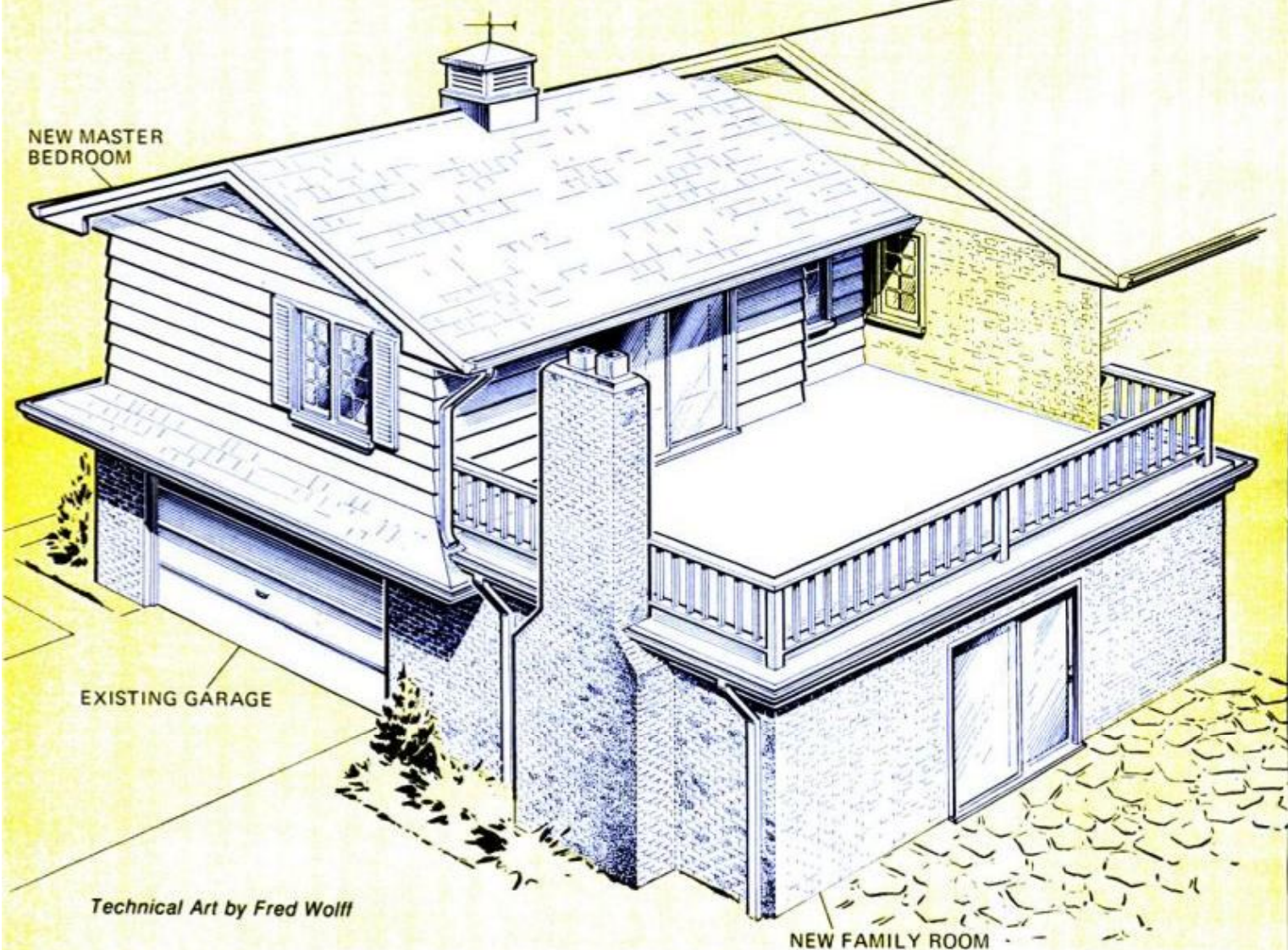

Technical Art by Fred Wolff

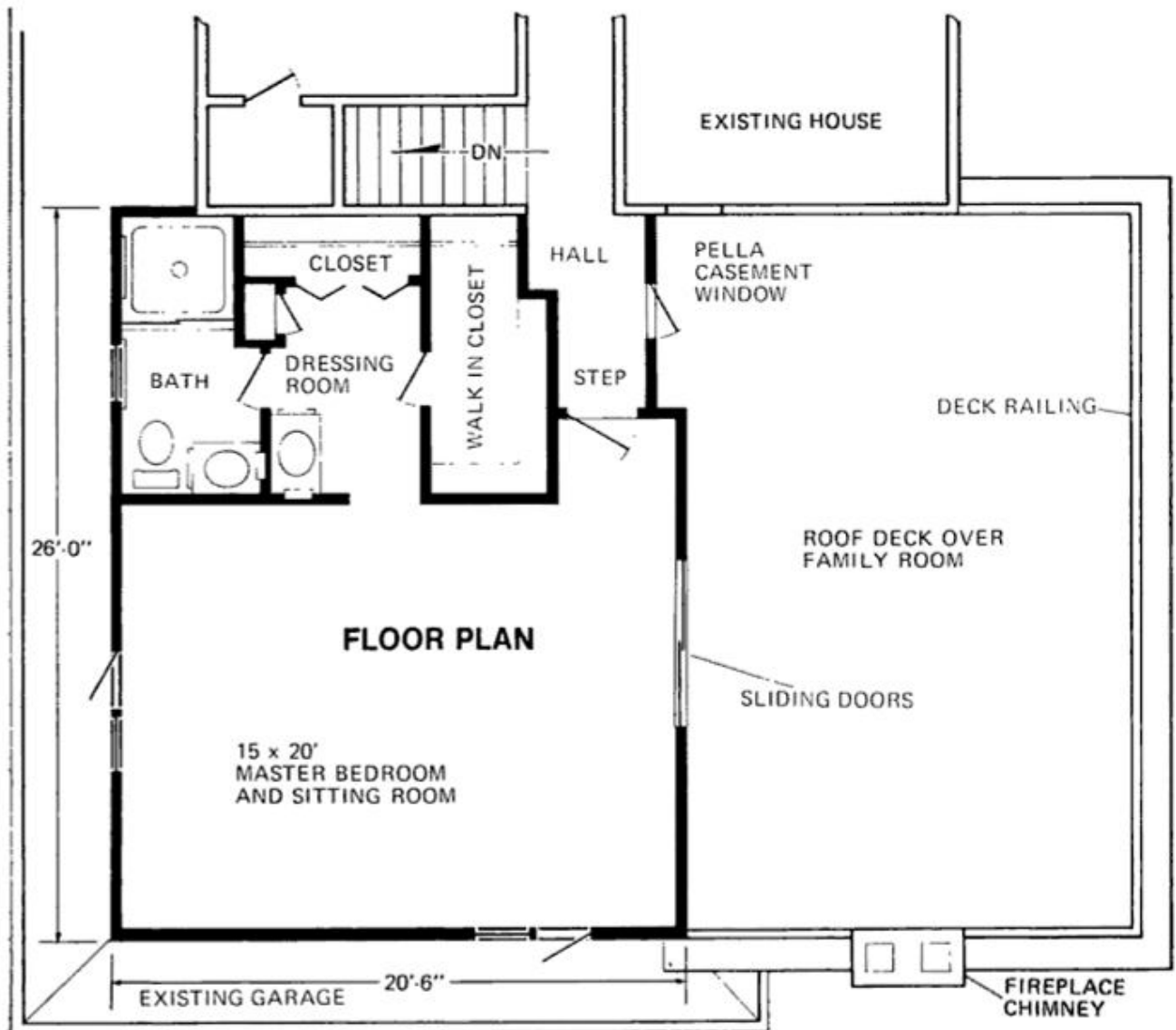
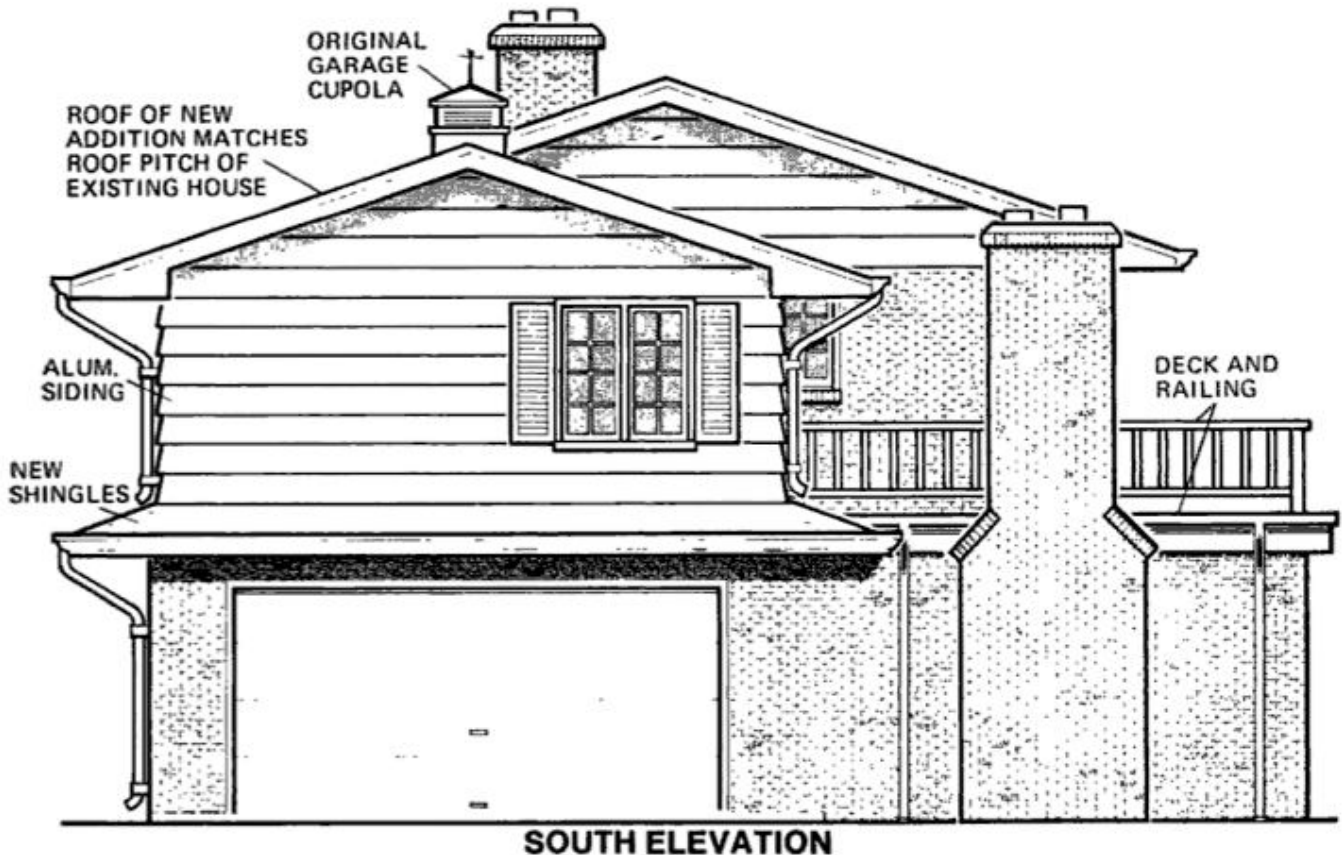

RANDOM-SPACED
LAGSCREWS PAINTED
FLAT BLACK

HAND-WHITTLED PEGS

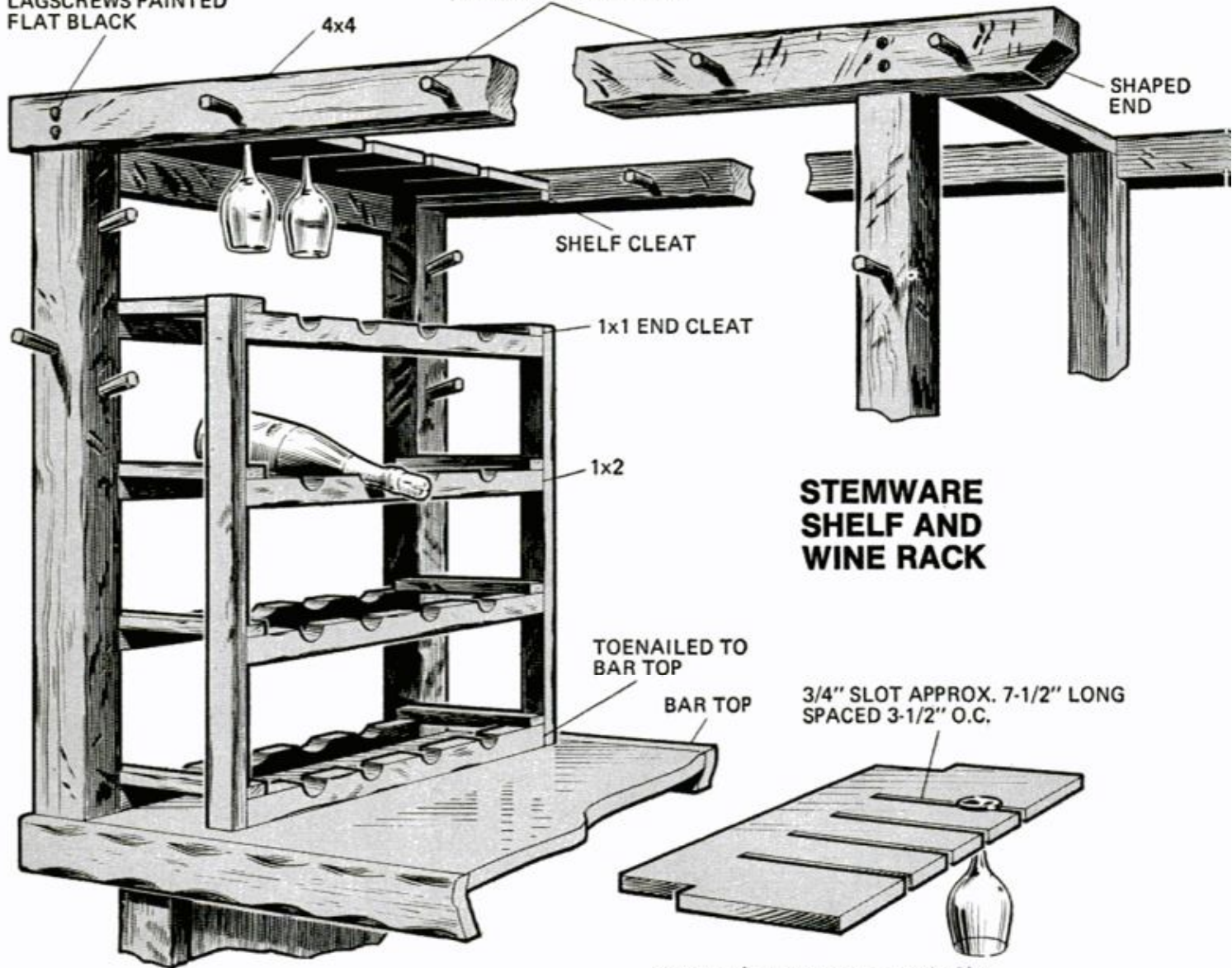

STEMWARE SHELF AND WINE RACK

STEMWARE SHELF DETAIL

3/4" SLOT APPROX. 7-1/2" LONG
SPACED 3-1/2" O.C.

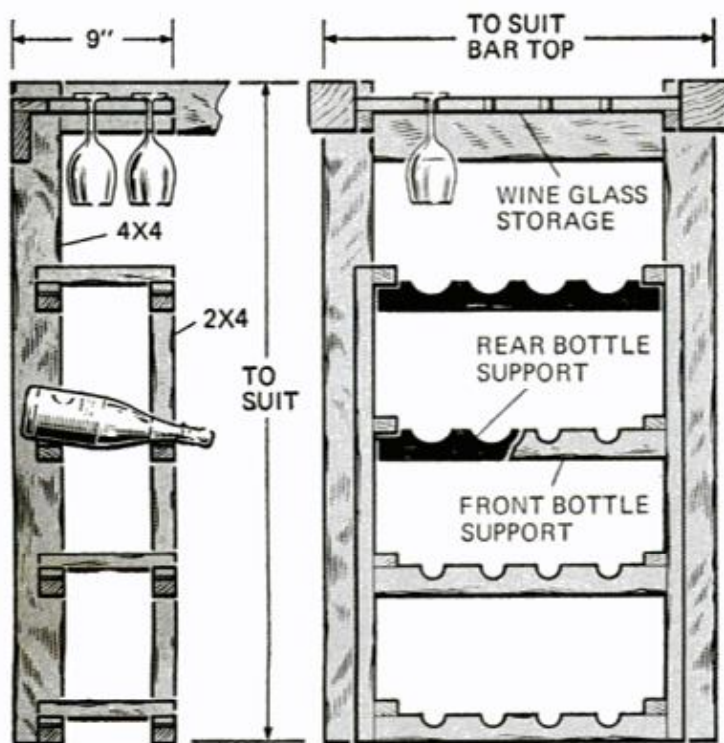

FAMILY ROOM IDEAS

(Continued from page 115)

room (page 115) proves you don't have to pour thousands into a project to get additional attractive living space.

Strategic placement of the bar enables the "bartender" to make use of appliances and sink in the kitchen that was already in the basement. Two elements that distinguish this bar are distressed beams and the combination wine-rack, stemware-storage shelf. Antiquing the beams is more a matter of time than skill; for effect, use a dark stain and semi-gloss varnish to finish. ★★★

Need more storage space? Make your closets work

Most closets have space going to waste. Add these built-ins and sliding shelves and put those 'lazy' areas to good use

IF YOU COMPILED a list of the 10 most common homeowner complaints, insufficient storage space, both for daily and seasonal use, would be high in the ratings. And, in most cases, the complaint is justified. Even new homes show a lack of thought in design and treatment of closet construction. However, since family needs vary, exactly how to get complete use of a closet depends upon what you need to store and for what length of time.

Three good ideas shown on these

pages are all in the home of Mr. and Mrs. Albert O. Foster II of Wayzata, Minn. The bedroom closet, below, makes use of what previously was (and in most homes is) wasted space. By putting down on paper the everyday items for which they needed out-of-sight storage space, the Fosters gained a functional closet. Built as shown in the sketch below, the closet holds shirts, socks, and the like on handy sliding shelves. Extra shelves were installed above the clothes hanger rod to handle

BEDROOM CLOSET has hanger space reduced and pull-out sliding shelves added to meet needs of the user

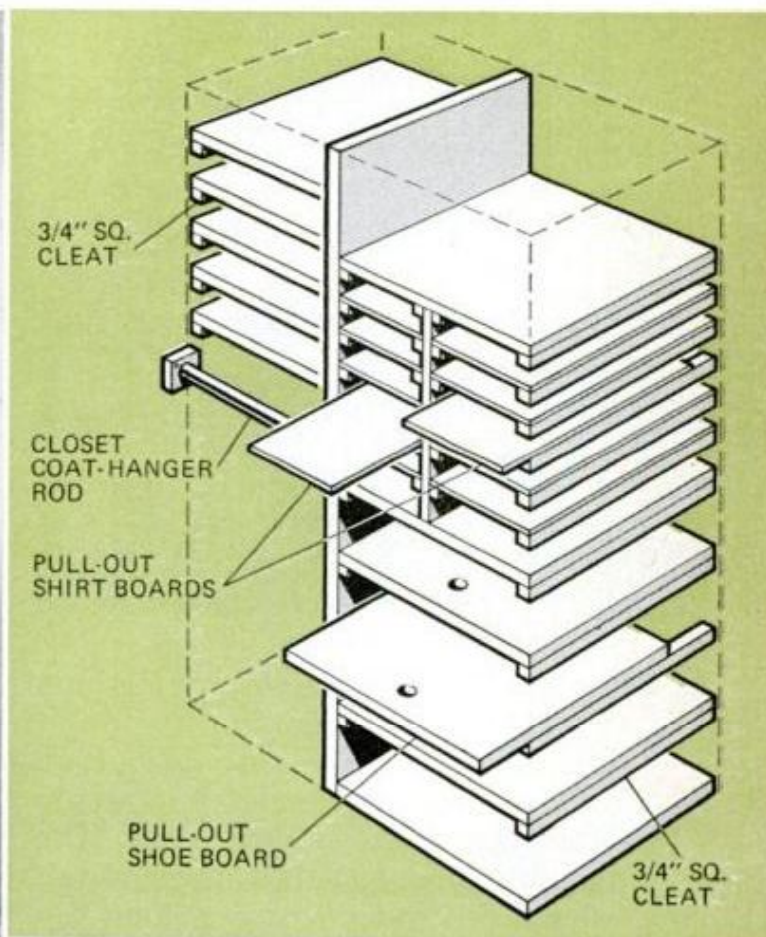

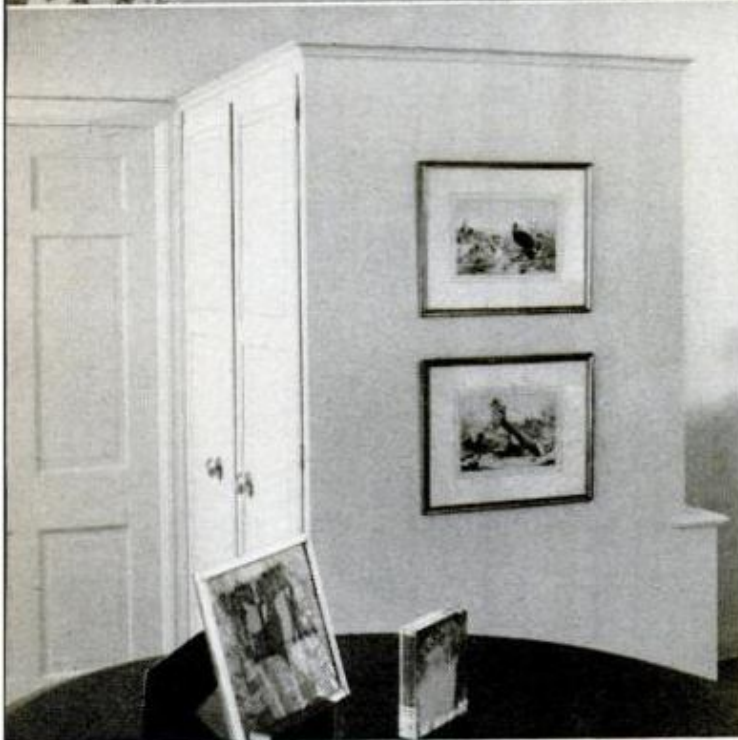

seasonal items such as heavy clothing during the summer months.

The second, and most elaborate, "closet" is the peninsula unit which was added to the living room. The project initially started as a simple wall to shield living-room users from icy

130

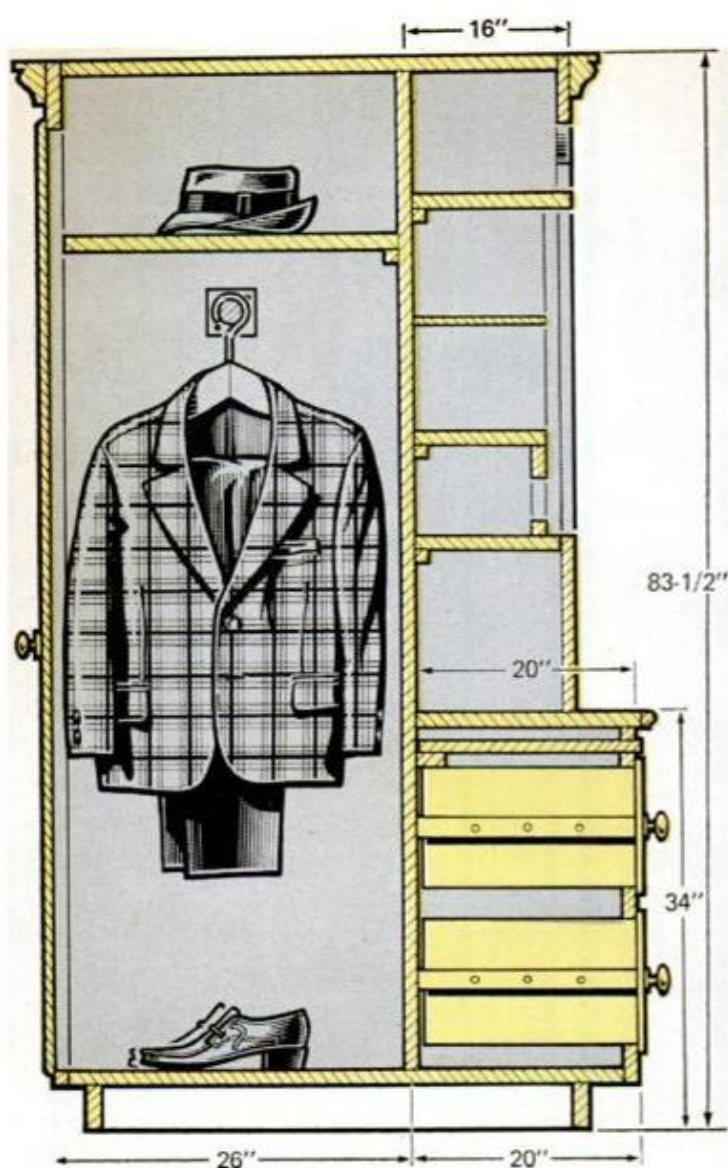

SECTION

PENINSULA CLOSET gives shelving on living-room side plus convenient hanging for coats in the foyer

blasts each time the front door was opened. Because the living room could afford the floor space and the Fosters were imaginative planners, what would have been wasted space was used.

The front side of the unit faces the foyer and provides convenient hanging space for outerwear. The back side, facing the living room, has the look of a hutch. It houses stereo equipment, books and art objects, and also has pull-out counters for additional storage.

The third storage change the Fosters made was to add a much-needed linen storage closet in the bath. Eight 15-in. open shelves are above the counter for towels and linens. Four cubes below are where two sons store boats and other kids' bathtub paraphernalia.

Other ideas you might consider:

POPULAR MECHANICS

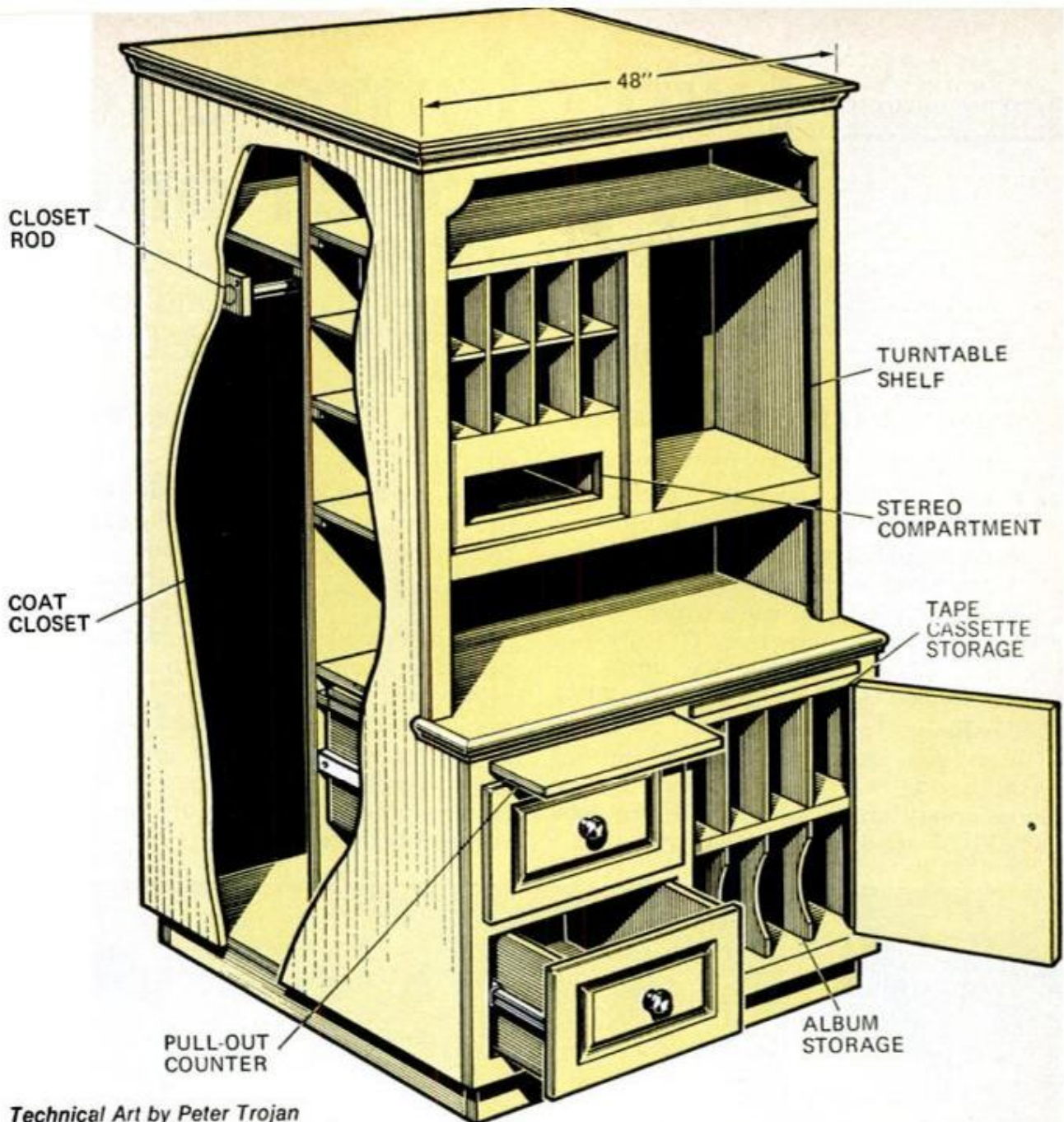

Technical Art by Peter Trojan

Many closets, though 4 ft. or more wide, have a single door for access. Why not install bypassing doors to permit easy access to the full closet?

Also, if it's structurally practical, don't overlook the possibility of using 8-ft.-high bifolds. These let you add shelves above that can make seasonal storage a snap. If you put the tall bifolds in bedrooms, each family member can then store his own clothing in one handy place instead of using the attic or basement. ★★★

CREDITS FOR PAGES 111-131

Data: Barbara Gorder, pages 114, 115, 129
Annette Sukov, page 111

Color photos: Robert D. Borst, pages 112, 113
Dean Paris, page 114
Les Turnau, pages 111, 115



TOWEL CLOSET convenient to sink has louvered bypassing doors to insure adequate circulation of air

Two planters for the price of one

Take one \$19 whiskey barrel, saw it in half and you'll wind up with two handsome patio planter tubs that would cost \$50

By WAYNE C. LECKEY, Home and Shop Editor

Photos by Robert D. Borst

WHILE YOU CAN EXPECT TO PAY up to \$50 for a pair of planter tubs like these, you can make a couple for your patio and save as much as \$31 by sawing a used whiskey barrel in half.

Where do you get a used whiskey barrel? You can order one from G. I. Frazier Co., Box 8275, Louisville, Ky. 40208 for \$18.75 prepaid (add \$5 if you're west of the Mississippi).

When you get it, the chances are its metal hoops will be rusty, but a little elbow grease and a wire brush will soon get rid of the rust (an electric sander

will speed the job). When you saw the barrel in half, you'll know it once held firewater because its charred interior will reek of bourbon. But this won't hurt your plants one bit; the smell will soon dissipate.

A homemade T-square with a thin bendable blade is used to mark the barrel around its circumference, and a sabre saw will cut the barrel in half quickly. Drain holes are required in the bottom of each tub, and you have a choice of painting the oak staves or sanding and varnishing them. ★★★



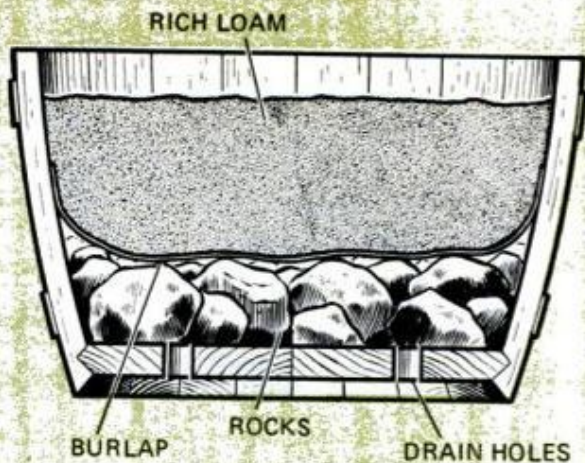

ELECTRIC SANDER and coarse abrasive paper will derust hoops in a hurry; you can also do it by hand with a wire brush. For a varnish finish, sand the staves for a new-wood look

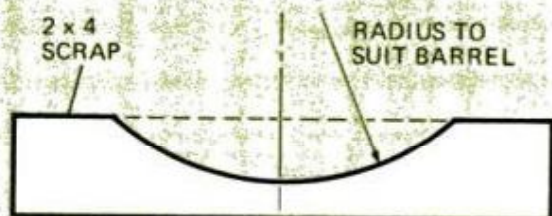

BARREL STAYS PUT for sawing when cradled with wood blocks at each end. Mark cutting line around circumference, make a plunge cut with sabre saw, then rotate barrel as you cut

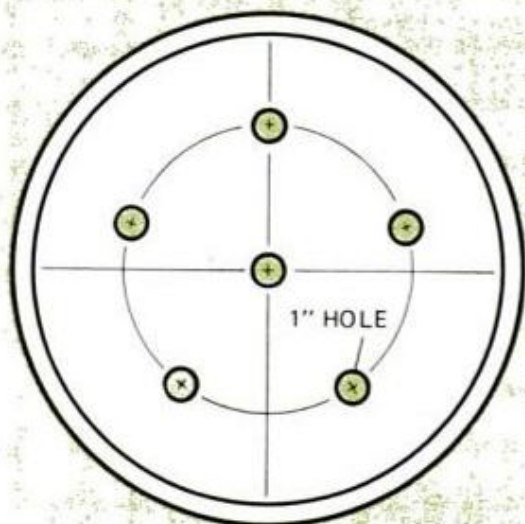

DRILL SIX DRAIN HOLES in bottom of each tub; then when you're ready to add plants, place some rocks in the bottom, cover them with burlap and fill tub with good potting soil





Farmhouse can be renovated easily for added living space and colonial charm



With the front section of the porch removed, the remaining portion provides room at the side of this house for additional first-floor living space. The house is brought closer to the ground visually by raising the level of the front grade level. The colonial entrance equipped with side lights is a stock item that can be purchased as shown at your local lumberyard. Retention of this home's colonial charm is insured by such features as clapboard siding, nine-over-nine double-hung windows, shutters and a coach-house lamp at the entry.

The major portion of the expense for this home modernization project would be the cost of replacement of all the window units.

There is no 'impossible' house

By HARRY WICKS, Workshop Editor

Photos by Robert D. Borst

WHETHER your home is 15 or 50 years old, a well-planned exterior modernization will improve its resale value as well as appearance. And if you own a tract home, you will probably be delighted to get away from that carbon-copy look. Here are five traditional homes selected by *PM's* editors for facelifting. The architect's sketches are full of ideas you can use when you're ready to remodel.

New covered deck relieves a blank look

The small ranch home at right, built 15 years ago, looks like the other homes the builder erected in the neighborhood. Converting two sliding (bedroom) windows to bypassing glass doors and adding a covered deck that conceals the garage and shelters the entry gives it a fresh, contemporary look. Andersen casement windows replace the bow window in front. Materials used to finish the exterior walls can either match or contrast with those you have in the existing house.





Typical frame house found in older suburban areas across the country is improved by moving the garage up the driveway and attaching it to the house. If desired, an access door between house and garage can be added for security. Though the house is two-stories-plus-attic high, the close-to-the-ground look that is popular today can still be achieved. To do it, the small patch of ground between house and sidewalk is raised and retained by a brick wall. For continuity, a planter of the same elevation appears at the right of the entry walk. Modern windows are added, and those on the second floor have textured paneling placed above up to the roof rake. For looks, attic venting louvers are extended to the ridge.

Home built in the twenties comes on strong in the seventies

*Drawings by
Sigman-Ward, Inc.*





Two versions of a chalet-type bungalow

The biggest change suggested for this home is in the grade level at the front. Both designs shown above include a raised wall to create the earth-nestling look that enhances a house such as this. Structural changes in the house itself are minimal. The dormer comes of age when changed from hip-type to rectangular with a pitched roof. At the top, horizontal siding is suggested, while the smaller sketch shows the results if vertical siding is to be applied. In both designs, larger win-

dows replace the existing windows on both levels to let in more light.

Since the original house was neat, trim and well-maintained, and our aim was to do a "facelift" with architectural improvements, the use of modern materials brings it up to date.

For that reason, any homeowner contemplating an exterior renovation should first visit his local lumberyard to keep abreast of the exciting new materials now being produced for house exteriors.

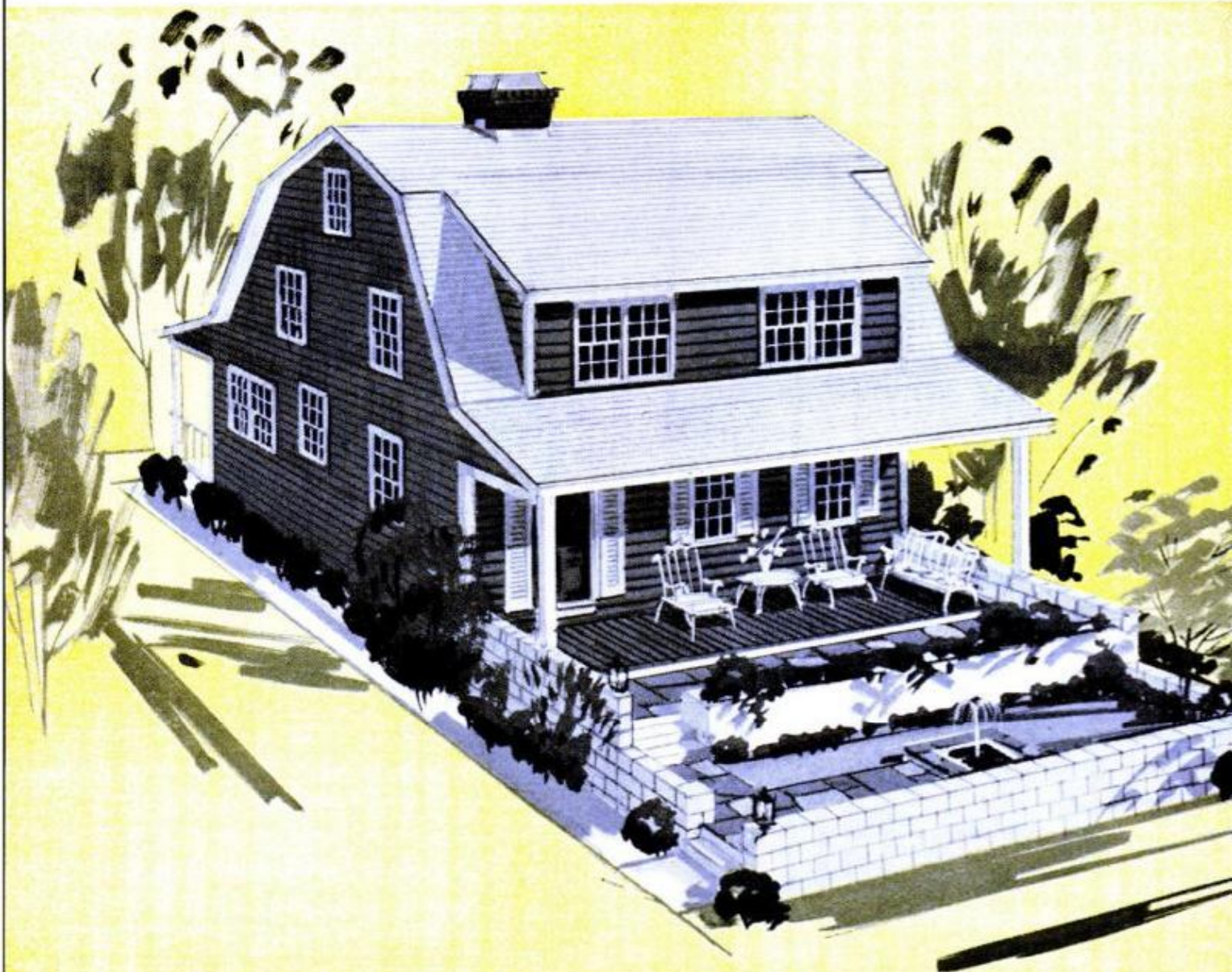

'House remodeling' calls for landscape architect



The basic design feature of this house—its gambrel roof—is desirable and one that should be retained. Thus, house-face-lifting here is minimal: A suitable size beam is snaked up under the porch roof so that the two interior posts can be removed. From there on, it is a matter of bringing the house down to earth via two new grade levels. To do it effectively, we designed the area at front for summer outdoor living. Thus, such niceties as an outdoor garden pool with fountain and raised planters are suggested. Walls can be of block or poured concrete, but for a more elegant look, they should be veneered with brick. Since plantings are important, select them with care. ★★★

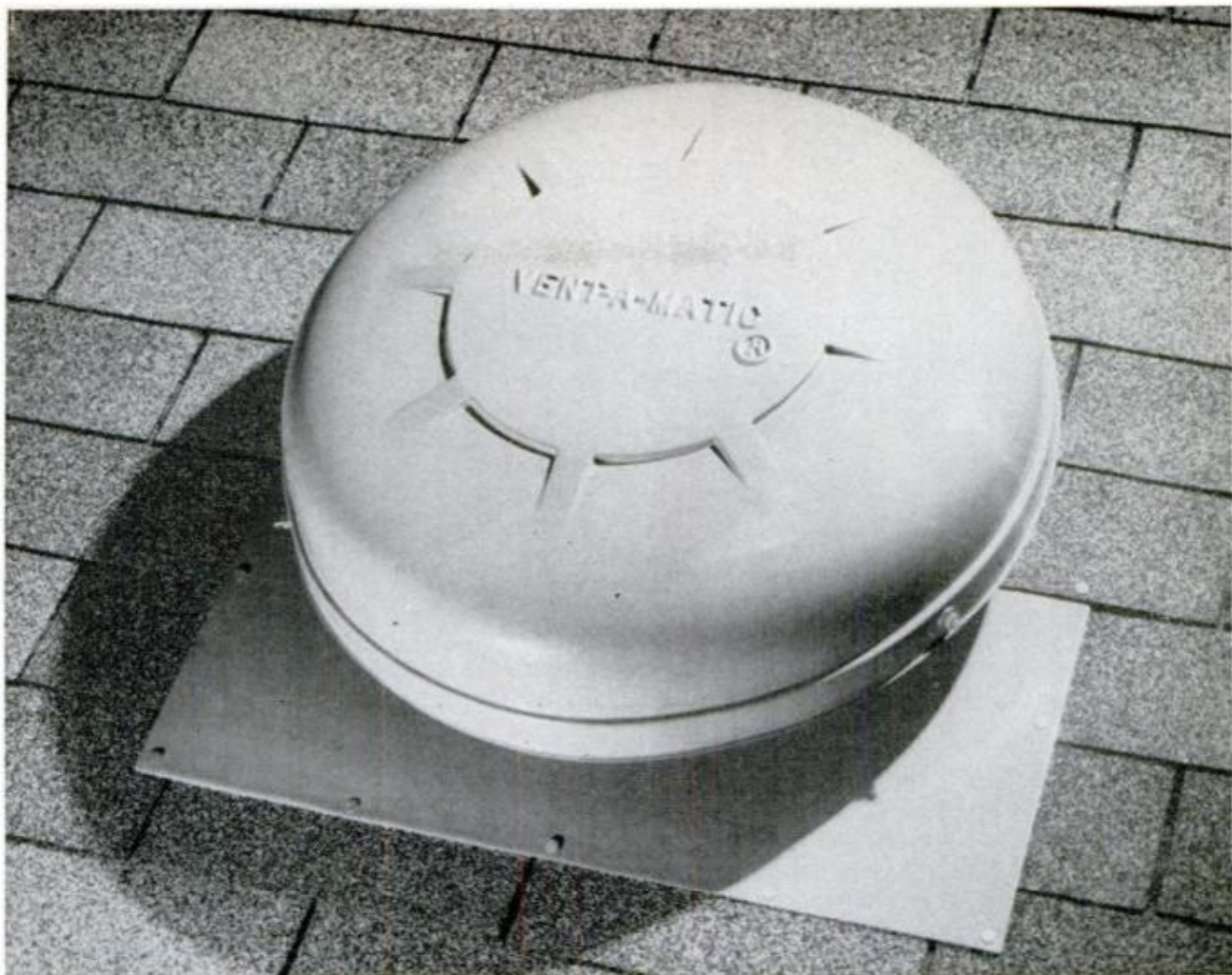

COOL IT with a power roof ventilator

This automatic fan pulls trapped heat from the attic to keep your home cooler day and night. It's thermostatically controlled and easy to install

By WAYNE C. LECKEY, Home and Shop Editor

Photos by Robert D. Borst

EVER WONDER why the house stays so blasted hot even after the sun goes down? Why the air conditioner has such a hard time keeping the house cool?

It's easily understood when you realize

that superheated air trapped in the attic is often as much as 60°F. higher than the temperature outside. When night air might be 75°, attic temperature could still be as much as 120°F. This blanket of

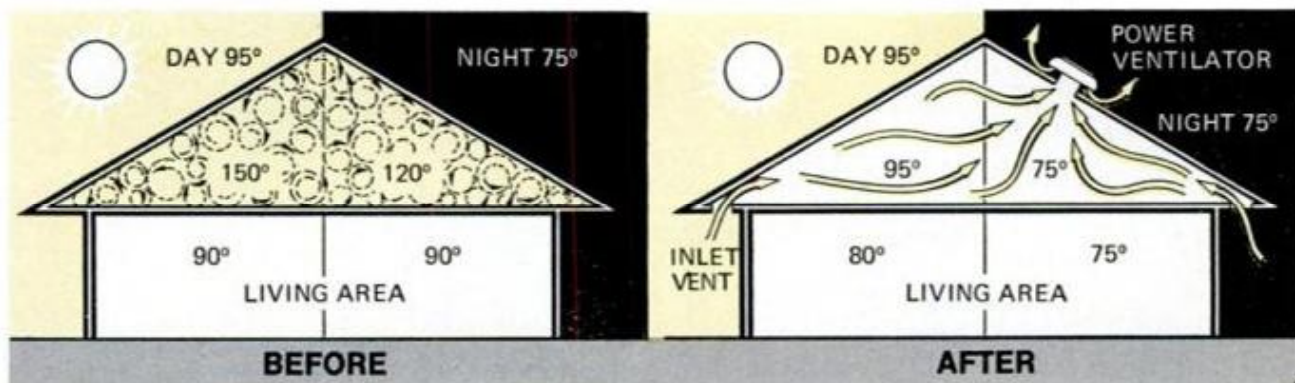



1. AFTER PLOTTING POSITION of fan on roof, drill guide hole from attic to center fan between rafters

superheated air penetrates downward into the living room and sleeping areas and keeps the whole house uncomfortably warm both day and night, putting your airconditioning system under a severe handicap. Attic temperatures often reach 150° or more during a normal summer day.

To prevent a buildup of furnacelike heat in the attic you need to draw out the hot air as it's generated. This is done with a power ventilator that's thermostatically controlled. Set to turn on automatically when the attic temperature reaches 110°F., the fan will run until the

5. DRAW SECOND CIRCLE 15 in. in diameter with the compass on roofing paper inside the cleared area



2. USE HOLE IN ROOF as reference point and draw a 27 $\frac{3}{8}$ -in.-square outline on shingles with crayon

temperature is reduced to approximately 96°F. A cool attic means a cooler house day and night, and it is claimed that the lower room temperature will reduce air-conditioning load as much as 30 percent.

Not only will a power ventilator keep your house cooler but it will reduce the possibility of spontaneous combustion in the attic. It will also prevent excessive heat and moisture from deteriorating attic insulation and even the shingles on the roof.

Operating on a preset thermostat, one Vent-A-Matic power ventilator will adequately cool a home having up to 2000 sq.

6. SAW THROUGH ROOF following the 15-in. circle, then slide flange of fan housing up under shingles





3. MAKE WOOD COMPASS and, using hole in roof as a pivot point, scribe a 17 $\frac{3}{8}$ -in. circle on the shingles



4. CUT HOLE THROUGH SHINGLES only with tin shears, then clear the shingles from inside the circle

ft. of living space. Its 14-in. fan does the best job of pulling out the excessive heat when the attic has at least 300 sq. in. of air intake located along the eaves.

The fan is enclosed in a housing of Cyclocac ABS plastic, a durable space-age material that will outlast sheet metal and never needs painting. The ventilator is made by the Butler Engineering Co., Box 728, Mineral Wells, Tex. 76067, and sells for \$84.95. It measures 27 $\frac{1}{2}$ in. sq., has a dome 8 $\frac{1}{2}$ in. high and is operated by a 1/10-hp, 115-v. motor.

The photo sequence shows how the unit

(Please turn to page 198)

7. AFTER WIRING, check thermostat with 60-w. bulb to determine if it is cycling the fan properly

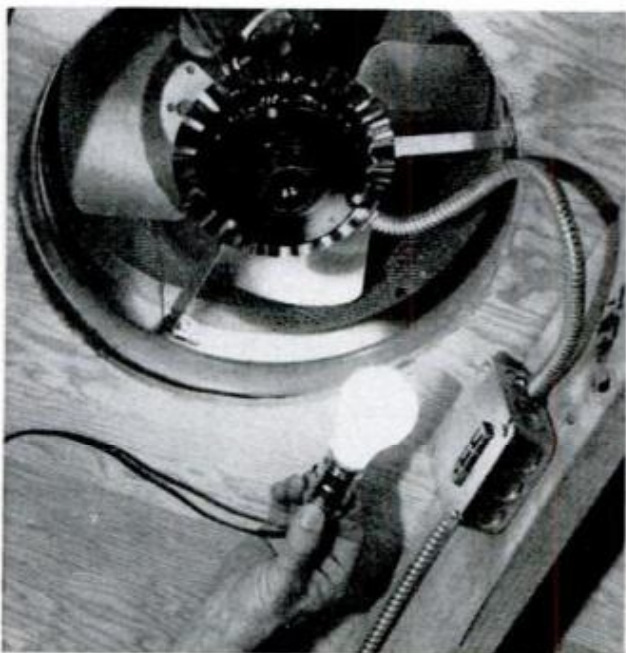

AIR INTAKE IS IMPORTANT

Unless you have adequate air intake through which cooler outside air can be pulled into the attic as hot air is exhausted, you can't expect maximum efficiency from your power ventilator. Best location for air-intake vents is in soffit of roof overhang. Openings are sabre-sawed (above), then capped with louvered cornice vents (below) made by Macklanburg-Duncan Co., Box 25188, Oklahoma City, Okla. 73125. Vents about \$1 each, come 4x16 and 8x16 in.

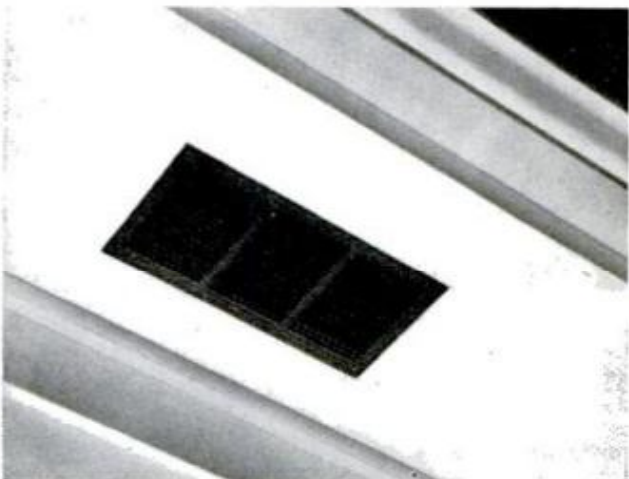

Bright, low-cost lighting idea



WHEN ARCHITECT Juris Curiskis of Edina, Minn., wanted to add a light fixture over a freestanding wall he built, he found that what he needed would cost about \$200. Even at that price, selection would have been a compromise, so he designed and built this handsome fixture.

Instead of the usual fluorescent fixture, 10 incandescent ceiling receptacles are used. These provide the warmer lighting the owner wanted and cost less in the long run. Conventional wiring is used to

build the fixture. Receptacles are mounted on 4-in. junction boxes and BX cable runs from box to box.

Fixture length is determined by need. In the 7-footer shown, 10 *low-wattage* bulbs were used, spaced equidistant and staggered on opposite sides. The frame consists of two 2x6s held together by $\frac{3}{4}$ x1-in. strips on the bottom and ends. The translucent sheet plastic simply rests on the strips. The end piece, of course, is secured with cleats. ★★★

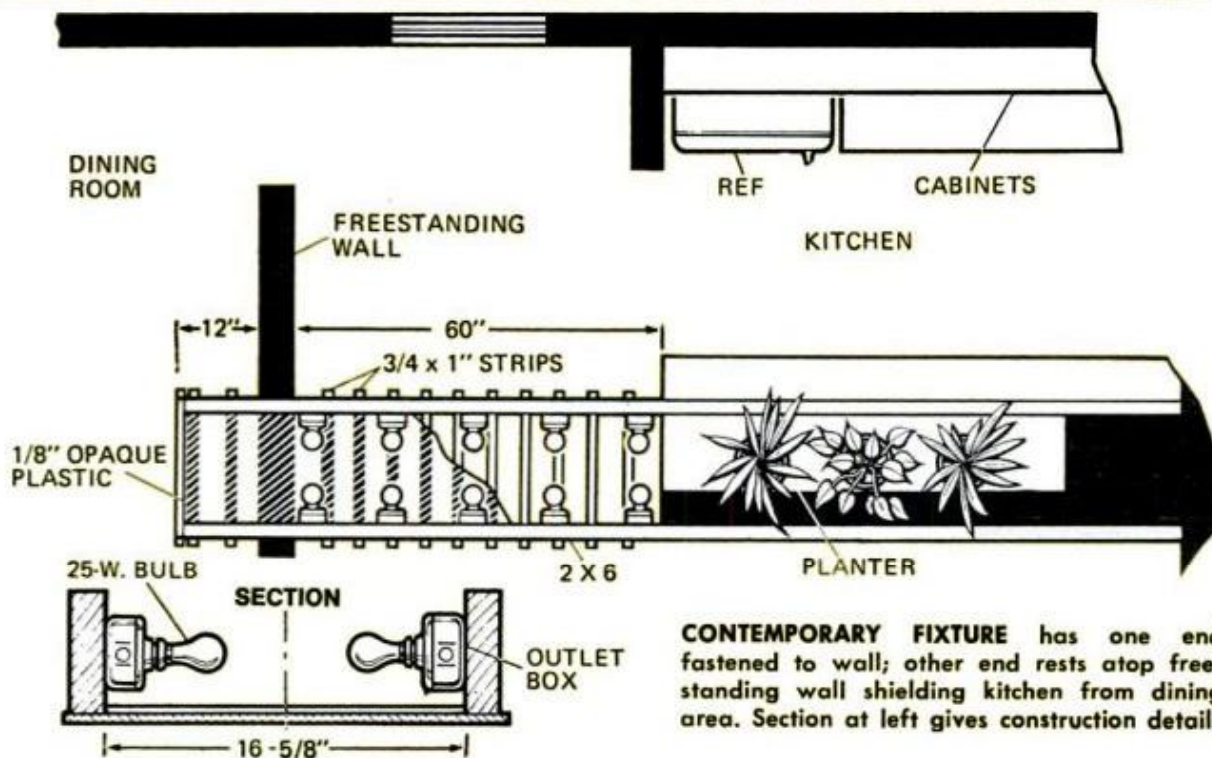

CONTEMPORARY FIXTURE has one end fastened to wall; other end rests atop freestanding wall shielding kitchen from dining area. Section at left gives construction details



If you need a direct route to your basement...

... install a prefabbed stairwell. Unlike cellar stairs of old, they're now watertight, burglarproof and maintenance-free.

By HARRY WICKS, Workshop Editor

ANY MAN with a basement workshop can quickly count off the advantages to be gained by installing an outside—direct-access—basement entry such as the one shown above. By adding this convenience to your basement you can:

- Haul lumber down to your shop effortlessly, even when the materials include 4 x 8 sheets of plywood.
- Tackle almost any-size project because you won't find yourself—as cartoonists like to depict, for example—with a completed boat in the basement instead of in the water.
- Quickly store large items such as patio

furniture and storm windows in the basement where you can work on them in comfort during the off season.

From the family viewpoint, direct access is especially important if you have a swimming pool or basement playroom. Related equipment and furnishings can then be toted in or out without any traffic through first-floor rooms. And, perhaps most important, direct-access will give you a fast route to safety should an emergency arise.

Aside from the obvious advantages of a steel installation (termite protection and minimum maintenance), the doors



DOOR FRAME is placed in its installation position and siding is marked along top to determine where to cut it



ENTRY IS POSITIONED, fastened to new foundation; joint dressed with mortar where needed

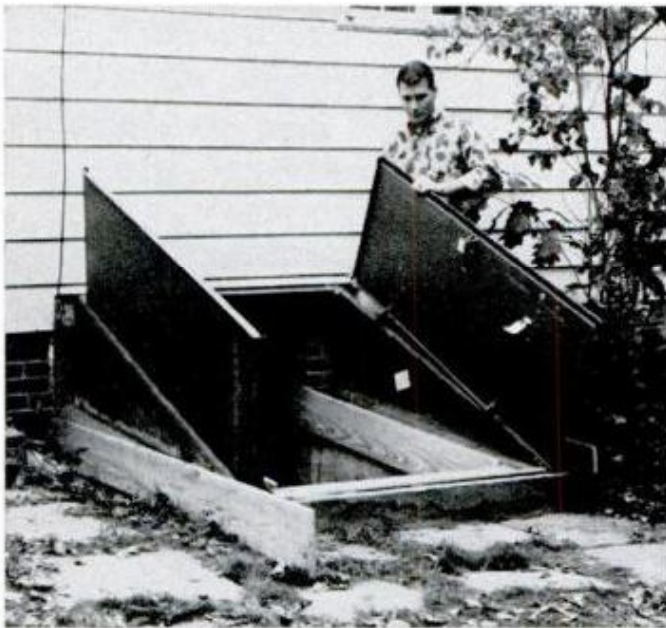

CONCRETE is allowed to set before you engage the torsion bars in clips attached to the entry sidepieces



PITCHED CONCRETE LEDGE gives positive water runoff and makes lawn edge trimming a lot easier

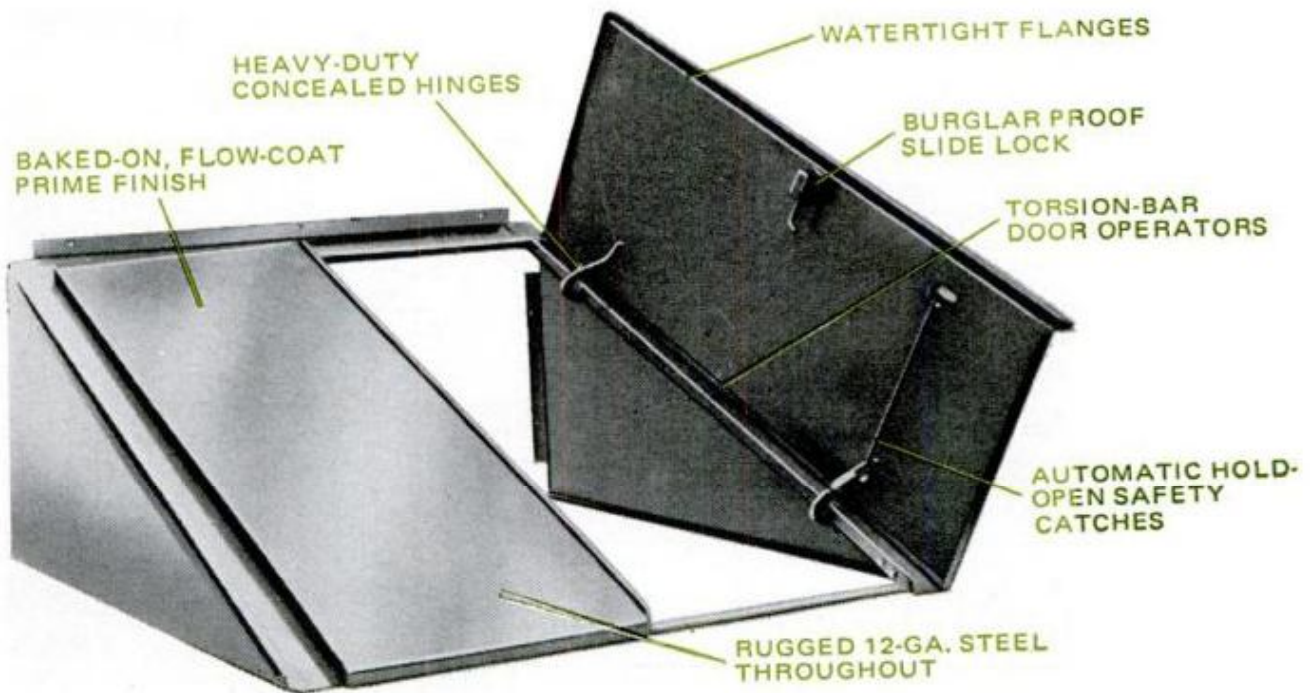

shown, which are manufactured by the Bilco Co., Dept. PM, Box 1203, New Haven, Conn. 06505, offer an additional good feature: When a particularly heavy, or bulky, item must be moved in or out of the basement, treads can be quickly removed so the object can be passed through easily.

Location of the entrance is important. If possible, it should go where the outside grade is lowest. This cuts down on the materials needed as well as the number of steps you will have to climb. And, of course, make certain that the finished grade slopes away for proper drainage. Dig the hole large enough to take the new foundation plus an extra foot all around to allow for waterproofing and

the footing. It is best to do the digging in stages, cutting the foundation as you go. This permits safer and easier handling of the cutting tool.

Electrical tools for cutting through a poured foundation can be rented from a local mason supply house or tool-rental outlet to speed up this step. A good tool for the job is Skil's Roto-Hammer which both rotates and hammers and comes with a variety of bits. The chisel attachment for example, will remove large sections with less rubble. If you have a concrete block foundation, cutting will be easier.

After excavating and breaking through the foundation, a 12-in. concrete footing goes in to provide a firm, level base for the first course of block. Simply dig a

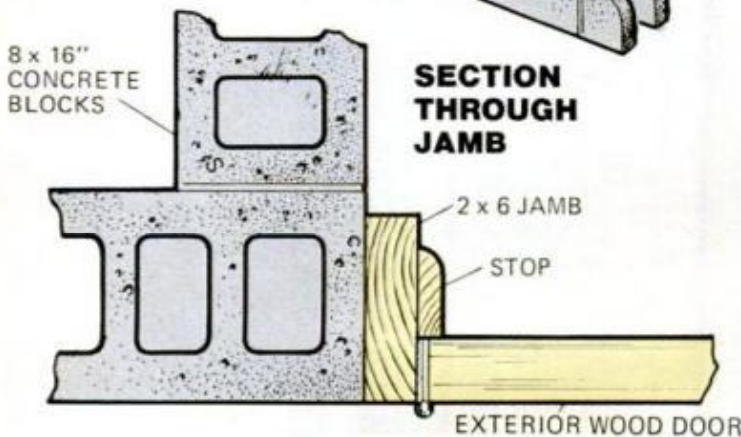
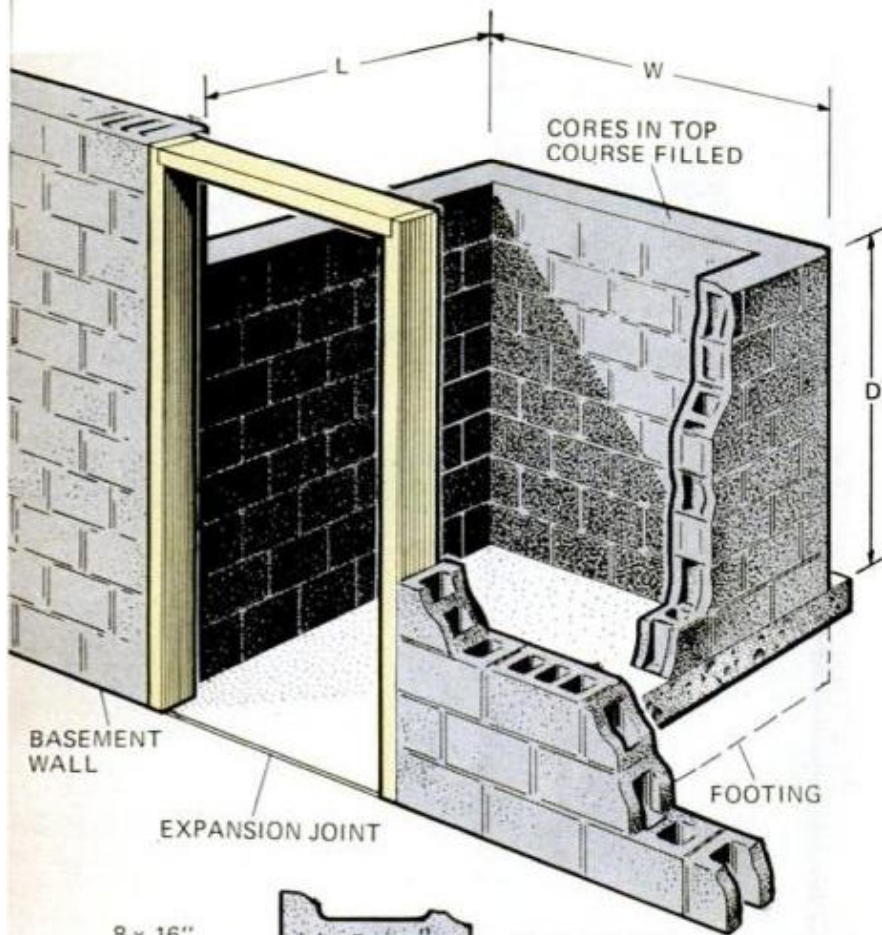

SIZE 0

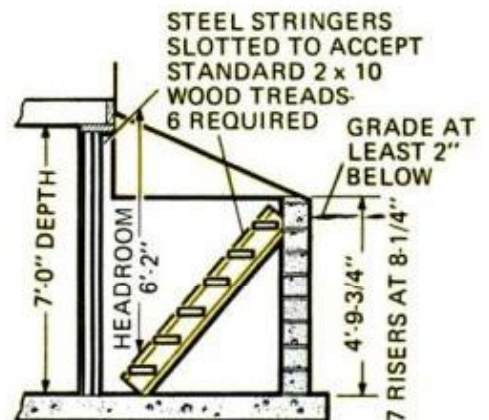
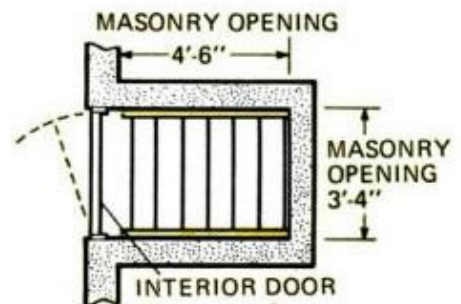
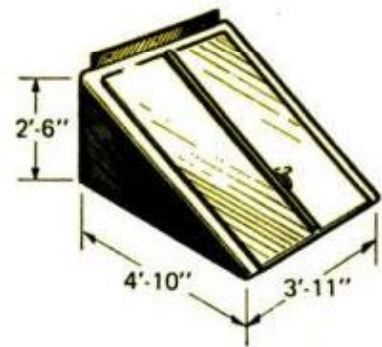

12-in.-wide trench 4 in. deep and pour the footing without forms. The top course of block should be about 4 in. above ground. After stuffing the hollow-block cores with heavy paper, trowel on a concrete cap and insert anchors as required.

Assembling the doors in place will save work. Here, make certain that the caulking strips provided are inserted between the header and sidepieces. Installation is not difficult if you read and follow the instructions packed with the doors. It's a must to follow them closely in order to validate the maker's guarantee of a weathertight door. ★★★

ALL HARDWARE, including steel step stringers, comes with doors. Owner supplies 2x10s used for treads

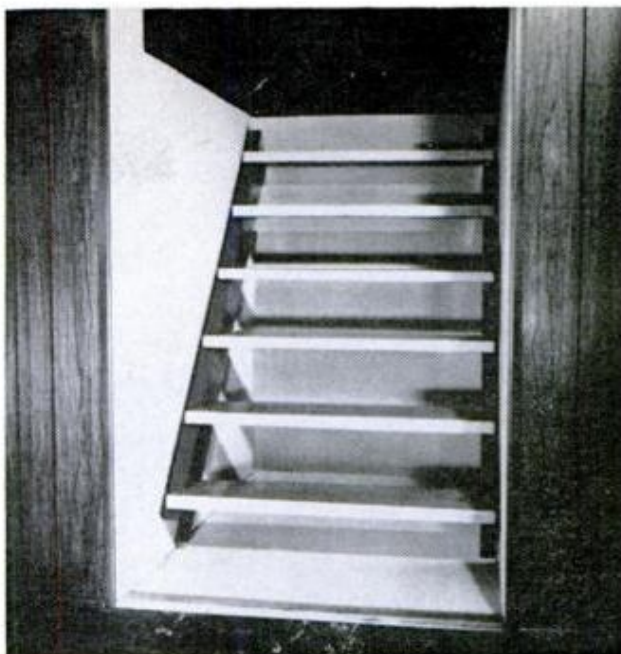

SIZE B

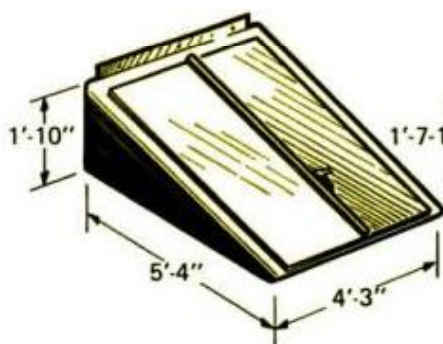

SIZE C

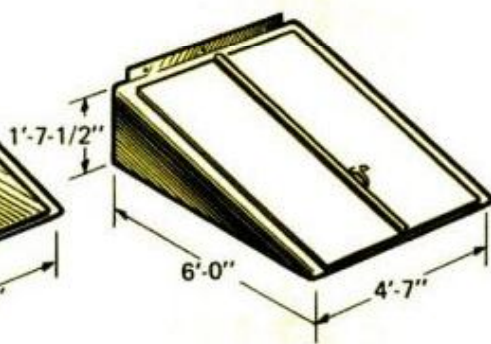

SIZE SL

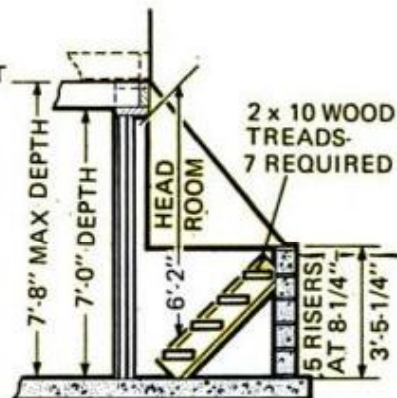
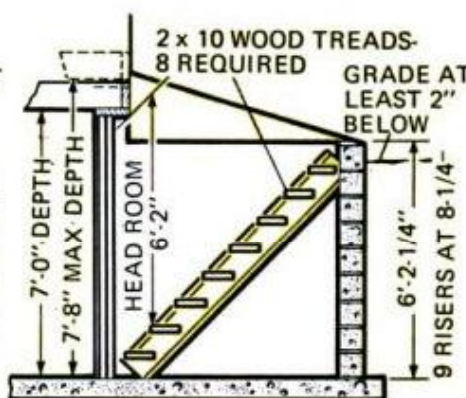
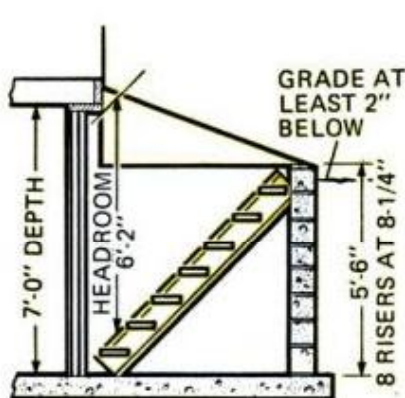
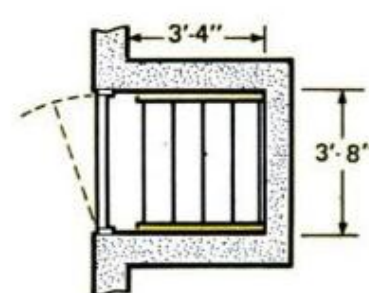
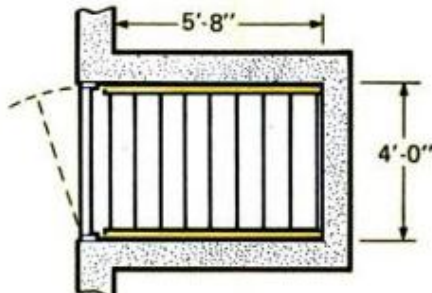
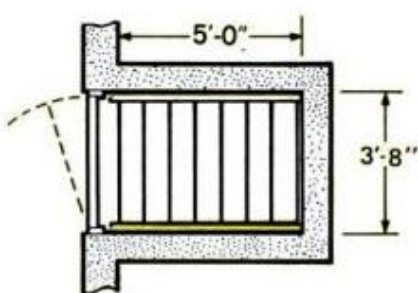

New building products

PM editors select the latest



DOOR CLOSER from the Hager Hinge Co., 139 Victor St., St. Louis, Mo. 63104, is easy to install because it simply replaces one hinge pin on the door (3½ and 4-in. hinges only). Available at hardware stores, Door Closer CD-214 is priced at \$3.49, can be used effectively on doors weighing up to 60 lbs. Package includes a tension adjustment wrench.



INTERIOR PREHUNG Vinyl Shield door units include a vinyl-wrapped split jamb, casing and stop, plus a matching vinyl door offered in four wood-grain patterns—maple, walnut, Tudor oak and driftwood. Once installed, job is complete because finishing is eliminated. In 1⅜ and 1¾-in. thicknesses, they're by Georgia-Pacific, Dept. PM, Portland, Ore.



STEP BY STEP you can install the Circle Stair which consists of individual welded iron modules that slip over a pipe column, then screw together to make a simple but sturdy assembly. Steps are wood. Standard height is 97½ in. but can be made any height. Stair sells for \$299.95 f.o.b. Toce Bros., Box 489, Broussard, La. 70518.

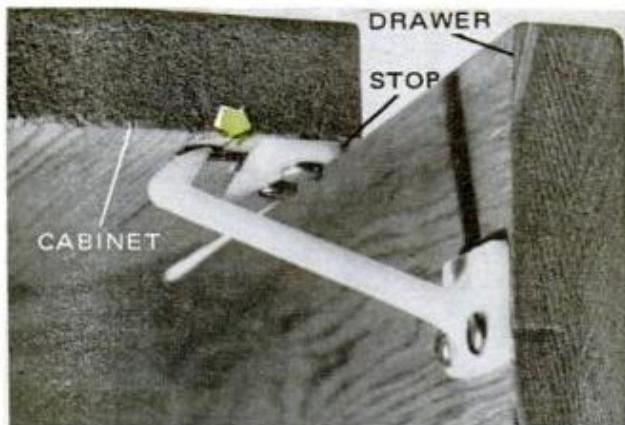

PROTECT TODDLERS from harmful and toxic home products by installing a Child Guard Latch on drawers and cabinets. This plastic device limits the drawer opening to a space needed for an adult to insert a finger to depress and release it. \$1 plus tax for two Guards. Mission Enterprises, Goliad, Tex.

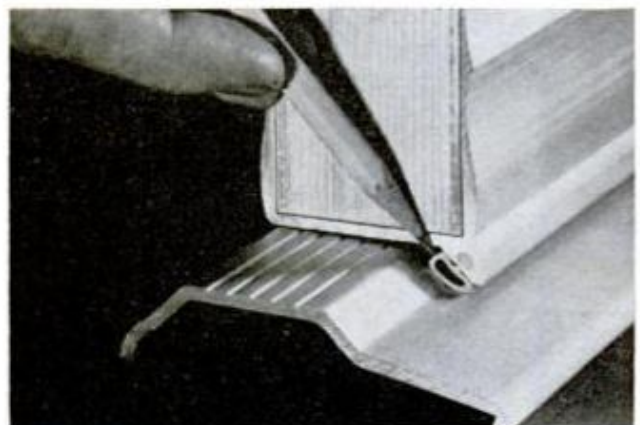

ALUMINUM THRESHOLD provides an efficient weatherstrip and insect seal, yet is easy to install and maintain. Made of high-strength aluminum extrusions, Skuff Guard is fitted with a vinyl tube for tight pressure-seal full width of door. \$6. Richmar Industries Inc., Dept. PM, 5304 N.W. 35th Ave., Miami, Fla.

for home improvement

in do-it-yourself materials

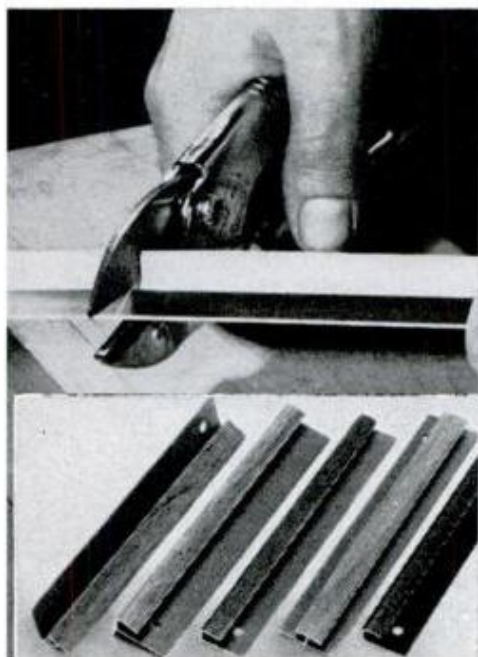

WOODGRAIN MOLDINGS, made of tough Cylolac plastic, closely match paneling. They can be applied with nails, adhesive or staples and will not split, crack or warp. Shapes include inside and outside corners, coves, divider strips and edge moldings, cost about \$1.50 per 8-ft. length. Glass Laboratories Inc., Dept. PM, 863 65th St., Brooklyn, N.Y. 11220.



EPOXY AND VINYL are combined in Poxymix to achieve a curable bonding agent for patching concrete or resurfacing sidewalks. In quart (\$2) and gallon (\$4.99.) sizes, patching material is ready for use after adding water. Surface to be patched needs no prewetting. Paint Master Brush and Roller Co., Dept. PM, 45 West 17th St., New York, N.Y. 10011.

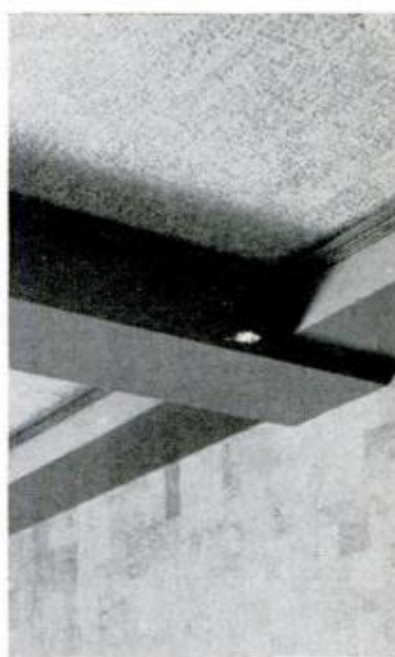

CEILING TILE labeled Chatham by Armstrong Cork Co., Lancaster, Pa. 17604, has no customary edge bevels due to a new blend of natural and man-made fibers. Rich, textured tiles shown were cemented to ceiling and false beams added for coffered (recessed) look. Price: 34 cents per sq. ft. For free illustrated ceiling booklet, write to the maker.

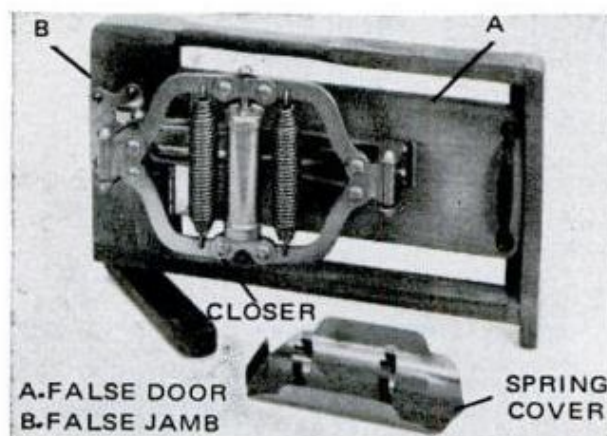

LOWEST PRICED hydraulic door check on the market is the claim made for Kant Slam Door Check. Door opened more than 90° will remain open; a single screw adjusts closing speed. Closer can be installed indoors or out; \$14.95 f.o.b. Kant Slam Door Check Co., Dept. PM-1, Bloomfield, Ind. 47424.

APRIL 1972

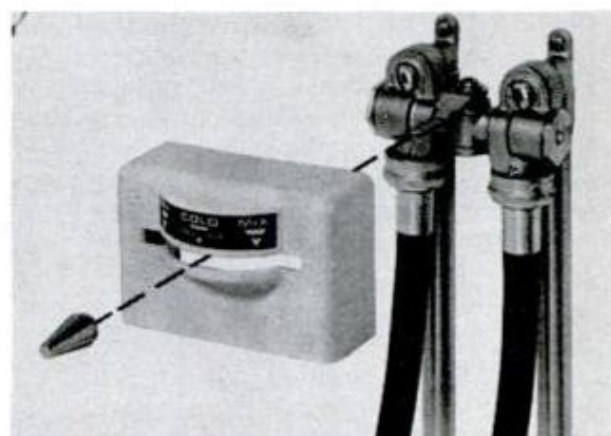

WASHING-MACHINE VALVE works like a switch, lets you select a cold-water cycle or conventional hot-and-cold mix if your machine doesn't do it automatically. When closed, Cold-Cycle protects the machine, keeps the supply hoses from bursting. \$9. Symmons Industries, 31 Brooks Drive, Braintree, Mass.

149



DRINKING FOUNTAIN designed to fit most sink faucets eliminates need for germ-collecting drinking glass. It comes ready for immediate installation on internally threaded faucets, can easily be adapted for external threads. Model DF-6001 sells for \$1. Jacklo, Inc., 35 Lafayette Ave., Brooklyn, N.Y. 11217, makes it.



ELECTRICAL CONNECTORS for splicing 18 to 10-ga. wire require pliers only for installation. Called Scotchlok, connectors Nos. 561 (14 to 18 ga.) and 562 (10 to 12 ga.) are available at hardware and discount stores for about 10 cents each. 3M Electro-Products Div., 3M Center, St. Paul, Minn. 55101.

READY-MADE RAILINGS and columns, offered in three patterns in black or white "lifetime" finish, are easily installed. Homeowner can have a custom-designed installation by selecting components from free brochure offered by maker. For brochure and nearest dealer, write Four Seasons Aluminum Railings and Columns, Bel-Met, Inc., Dept. PM, 439 South Maple Ave., Greensburg, Pa. 15601.

150

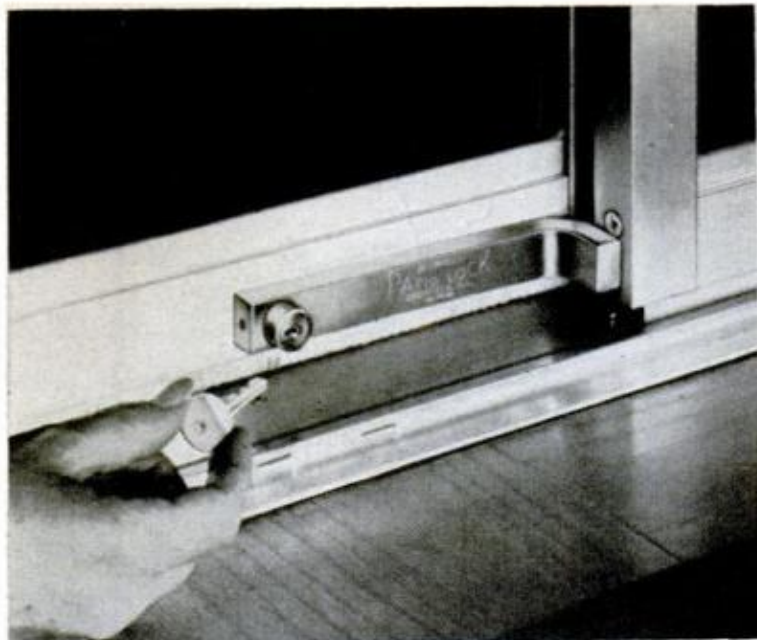

KEY-OPERATED ALUMINUM BAR LOCK fits most sliding doors with metal frame and 1 1/4-in. or wider bottom rail. Patio Lock is attached to inside of door with three metal posts that fit drilled holes, is accessible only to person with key. About \$10. Write Patio Lock, Deerfield Lock Co., Dept. PM, 945 Wayne Ave., Deerfield, Ill. 60015.



SELF-STICK CARPET TILE from the Ozite Corp., Libertyville, Ill. 60048, labeled Excello can be picked up for cleaning. High-density rubber back eliminates peeling off paper, messy adhesives and is claimed to cling to any floor. Price, 39 cents per tile.



POPULAR MECHANICS

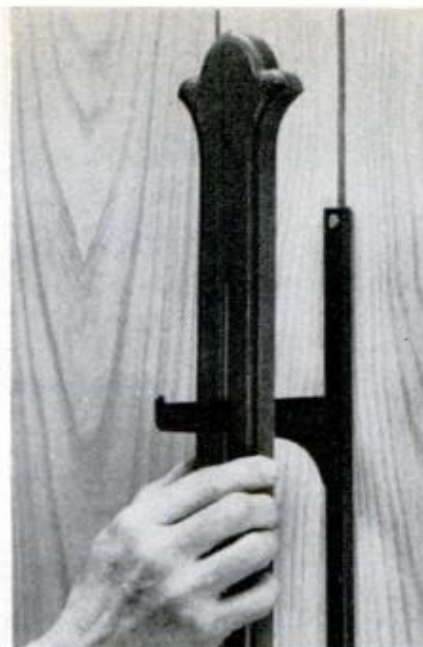

SAW SLOT lets you slip pilaster over bracket; recess on back hides standard. Slot allows bracket to be placed anywhere along length of the notched standard. Snug fit, plus shelves, holds the pilaster

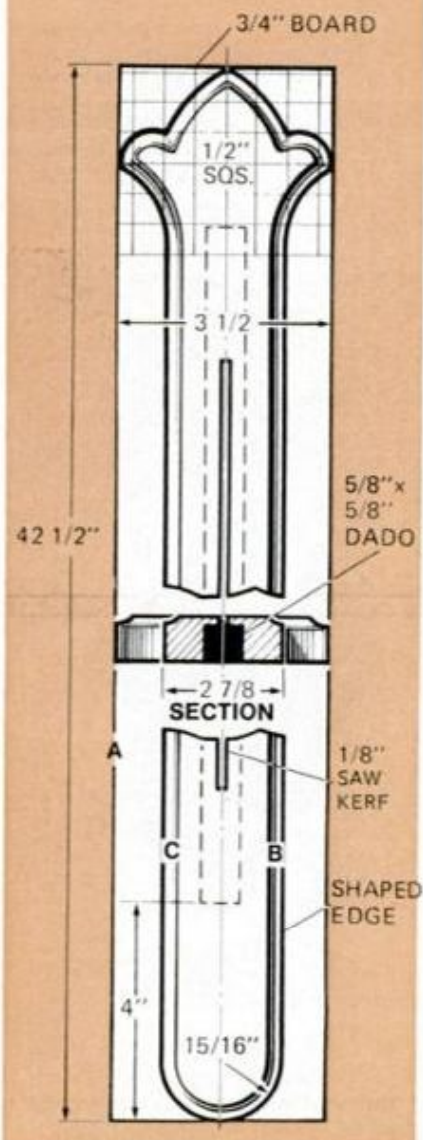
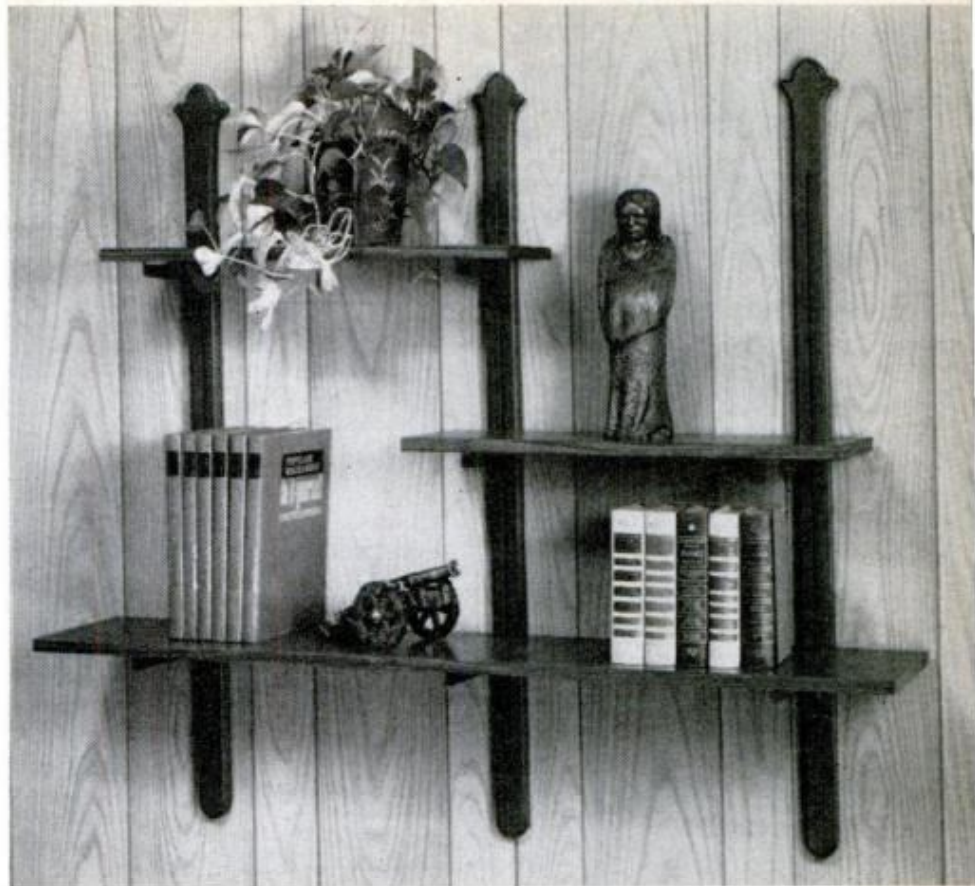

Add eye appeal to shelf brackets

By **ROBERT WORTHAM**

IF YOU WANT TO TAKE AWAY the unfinished look of plain shelf brackets, cover the notched metal standards with these attractive wood pilasters. They're recessed on the back and slotted down the front to fit over both the brackets and standards after they are screwed to the wall. They're made from 1x4 pine to suit the length and width of the particular standard (a $\frac{5}{8}$ -in.-sq. dado will fit a Knappe & Vogt standard perfectly).

Except for the top and bottom, all cutting is done on the table saw. First cut the blind dado down the middle, then center the saw kerf in the dado. Each cut is made with edge (A) always against the saw fence, even when you are ready to saw the final shape. The blind groove is cut by lowering the work down over the dado blade while it's running. The $\frac{1}{8}$ -in. saw kerf is made the same way, starting and stopping the cuts where desired. Remember that the length of the groove has to be greater than the length of the standard. Make rip cut (B), then (C) as far as you can on the table saw and finish the scroll end with your sabre saw. Finally, run a small cove around the edge. Finish the pine with an antiquing kit of the desired shade. If you use ready-made shelves, they'll have to be notched about $\frac{1}{4}$ in. deep at the back to fit around the pilasters. ★★★

BETTER WAYS TO DO IT!

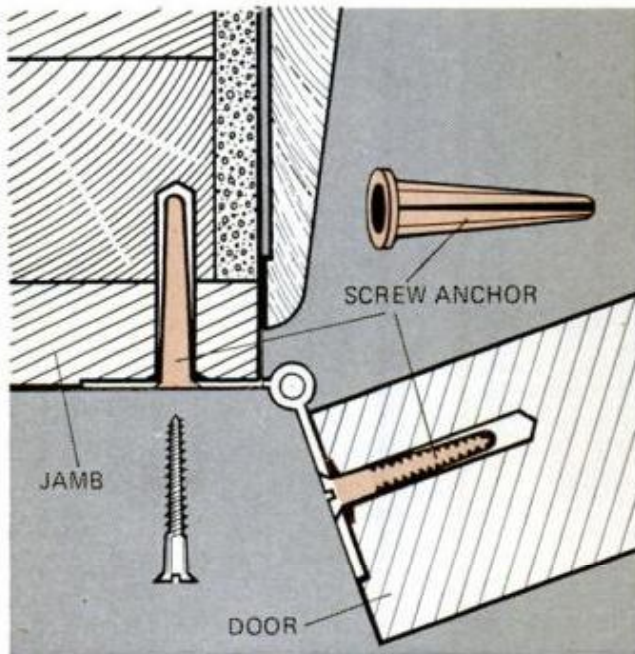

LOOSE HINGE SCREWS can be tightened quickly by using plastic drywall anchors. Just choose anchors sized to suit the screws and screw holes and drive them in the oversize holes.—Leo Niemi, Warren, Ohio



PLANING A DOOR when you have no helper to hold it steady will be a lot easier if you use bar clamps and a block of wood as shown. Then you can hold plane with both hands.—Abe Contreras, Azusa, Calif.

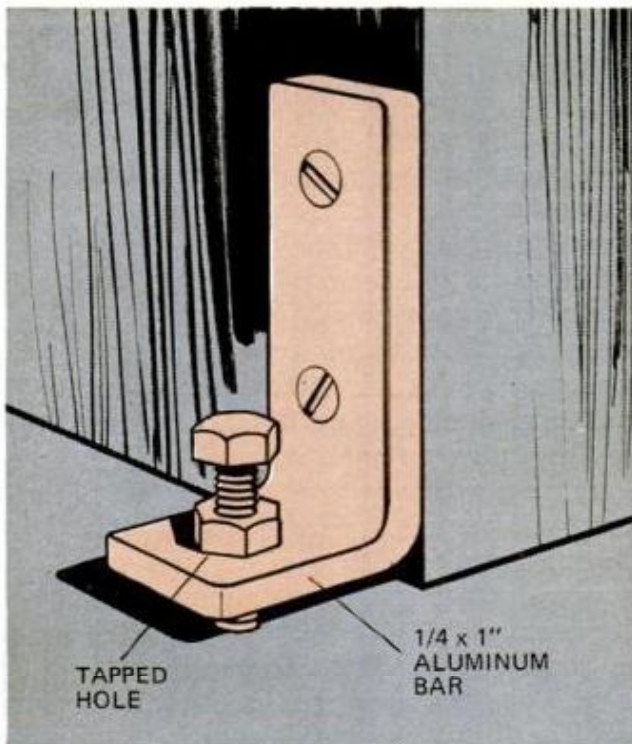

WOBBLE PROBLEM with a bench-saw cabinet or other toolstand can be eliminated with this leveler. Drill and tap one end of an L-shape bar and use a nut and bolt as shown.—Doug Blodgett, St. Charles, Mo.

152

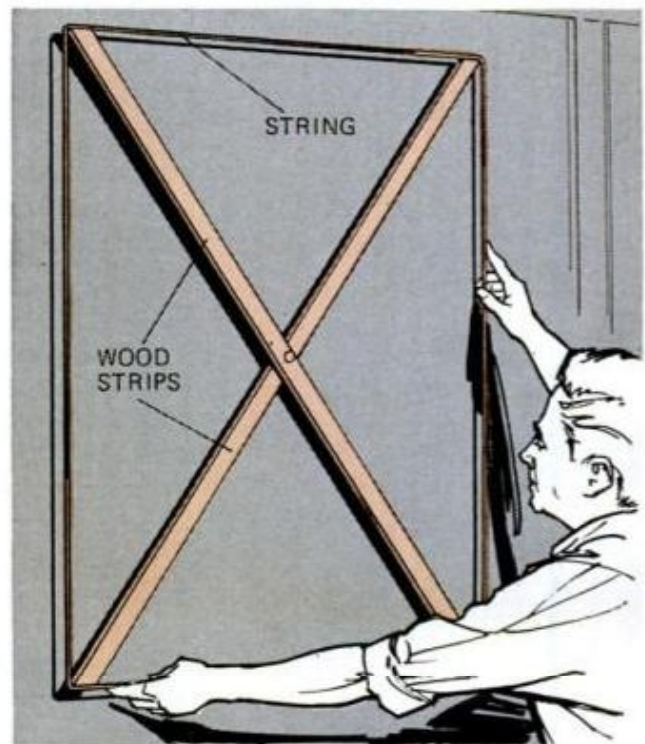

GETTING AN OPINION as to the right spot to hang a heavy mirror is a less arm-wearying task when you hold up a same-size dummy mirror made of lattice strips and string.—Fred Rittenbusch, Elsinore, Calif.

POPULAR MECHANICS



ALUMINUM TUBING



POLISHING YOUR SHOES will be easier and you'll also get a better shine if you add tubing to each side of the shoeshine box so the cloth can be pulled up instead of down.—George Walker, Nutley, N.J.



BIKE TRAINING WHEEL

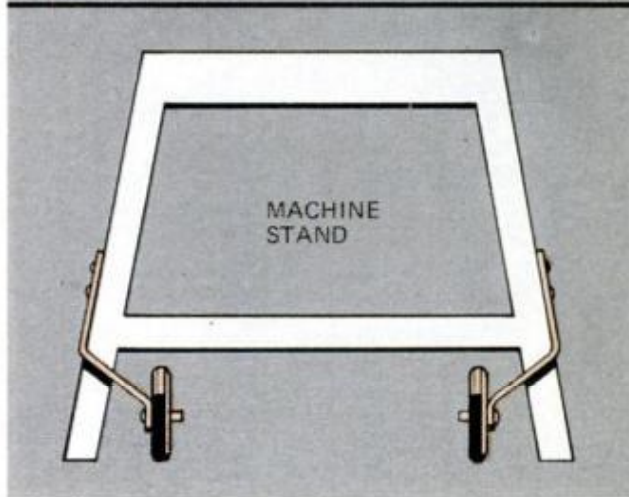

MACHINE STAND

TRAINING WHEELS no longer needed on a kid's bike will make it easy for you to roll a heavy bench saw when they're bolted to a pair of legs on the machine stand.—P. R. Bliss, Atlanta, Mich.

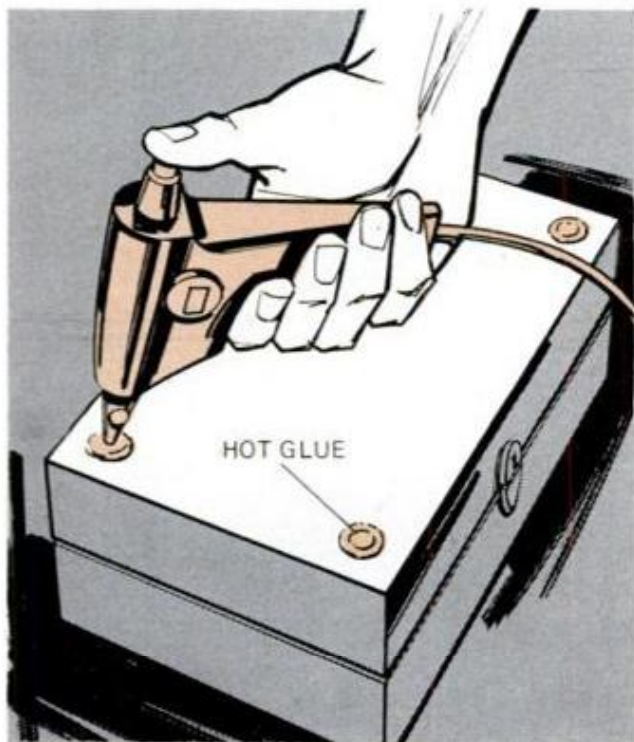

HOT GLUE

IMPROVED "FEET" for a trinket box can be mere dabs of hot-melt glue. You apply them at each corner of the base and in 20 seconds you can have nonslip, nonscratch legs.—Joel Amkraut, Palo Alto, Calif.

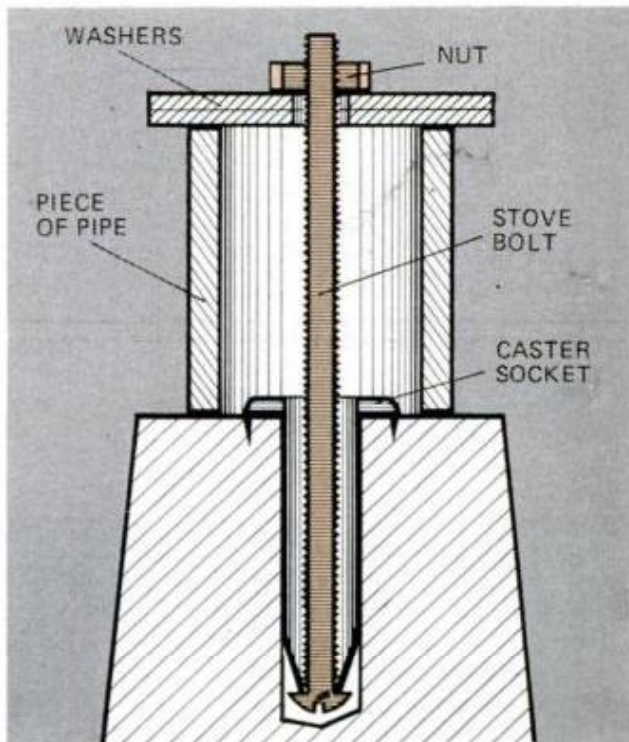

WASHERS

NUT

PIECE OF PIPE

STOVE BOLT

CASTER SOCKET

STUBBORN CASTER SOCKET can be removed by driving in a stovebolt until its head hooks over top of the socket. Then, using a spacer, turn a nut on bolt to pull it out with socket.—James Forney, Nutley, N.J.

EXCITING NEW PRODUCTS

BY CATHERINE BILSKI



CREATE THE LOOK of royal elegance in your bathroom with "Camelot" vanities and wall cabinets. Made of rigid polyurethane, with the look of real hand-rubbed oak, they're strong enough to stand even the roughest treatment. Vanity (without top), \$135; wall cabinet (recessed or surface-mount), about \$70. Sold by Williams Products, Inc., a subsidiary of Leigh Products, Inc., Coopersville, Mich. 49404.

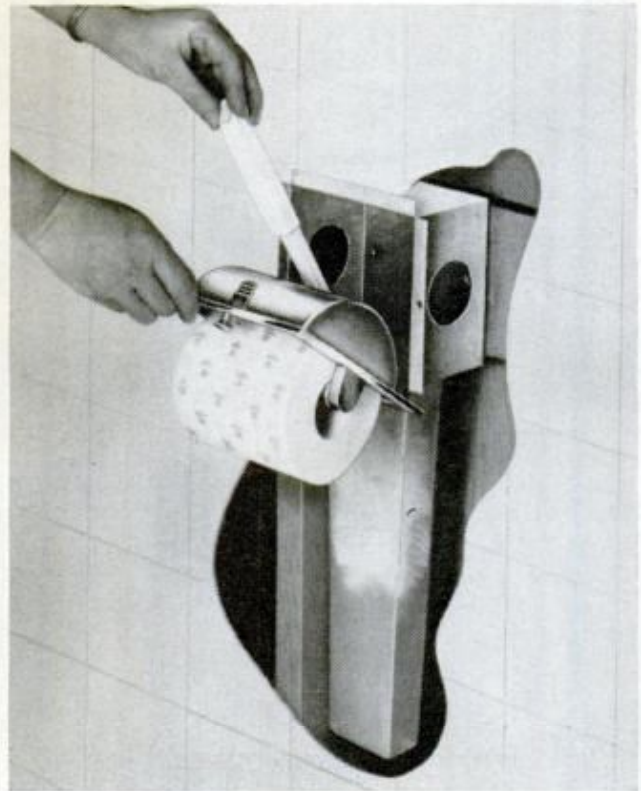

HIDE that unsightly toilet-bowl brush with the Conceal-A-Brush bathroom accessory. This standard-size, recessed paper holder with a hinge on bottom and knob on top becomes a cabinet door to a removable plastic brush container that fits inside any standard 2x4-framed wall. It's priced at \$13.95 from Herman H. Miller & Assoc., Inc., 809 West North Shore Dr., South Bend, Ind. 46617.

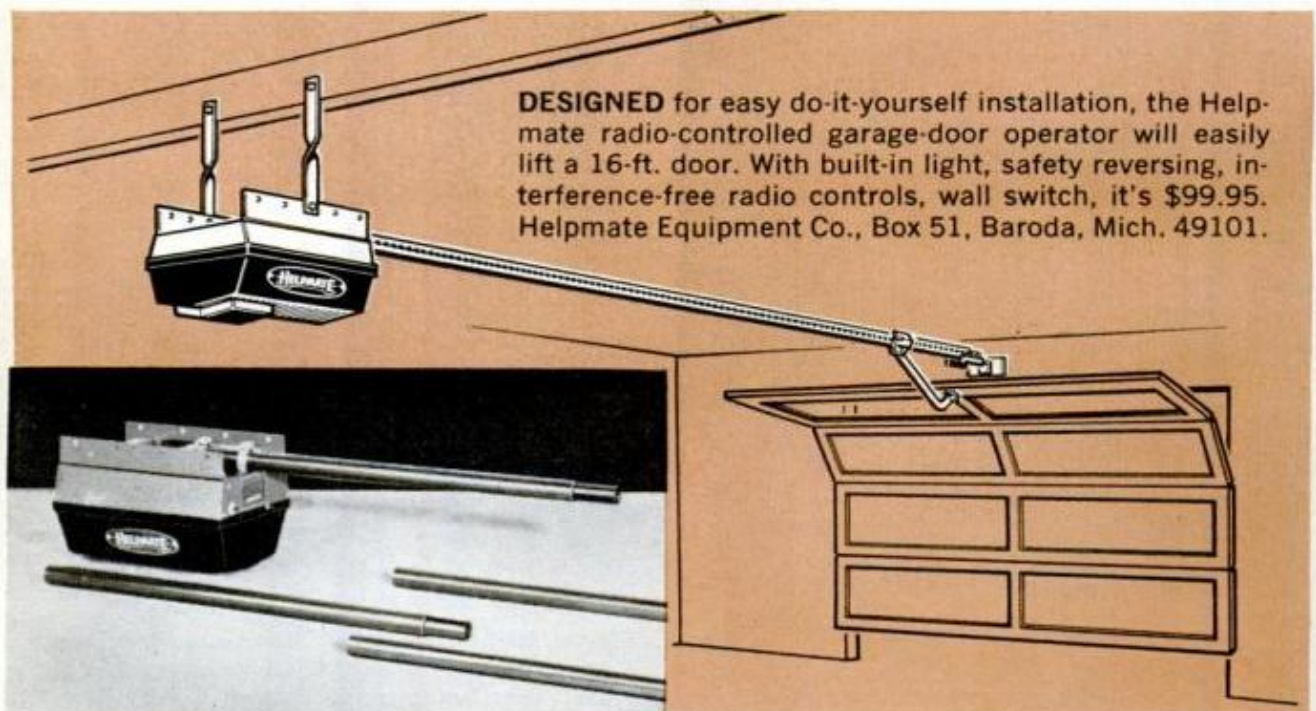

DESIGNED for easy do-it-yourself installation, the Helpmate radio-controlled garage-door operator will easily lift a 16-ft. door. With built-in light, safety reversing, interference-free radio controls, wall switch, it's \$99.95. Helpmate Equipment Co., Box 51, Baroda, Mich. 49101.



ACCENT YOUR WALLS with the authentic look and feel of real stone, mortar and all with Chapel Natural prefinished hardboard textured panels. Early American appearance is ideal for dining room, living or recreation area. The beige-colored simulated stone complements any room decor. A 4x8-foot panel sells for about \$15 from Masonite Corp., 29 North Wacker Dr., Chicago, Ill. 60606.



MINIMIZE THE RISK of accidents with the Model A Leveler. Easily attached to the sides of a stepladder with three flathead screws and nuts, the levelers can make a ladder stand straight on any surface or grade up to nine inches. Rubber feet are press-fitted for easy replacement. \$9.95 per pair postpaid from Lanier Enterprises, Inc., Box 1076, Cocoa, Fla. 32922.

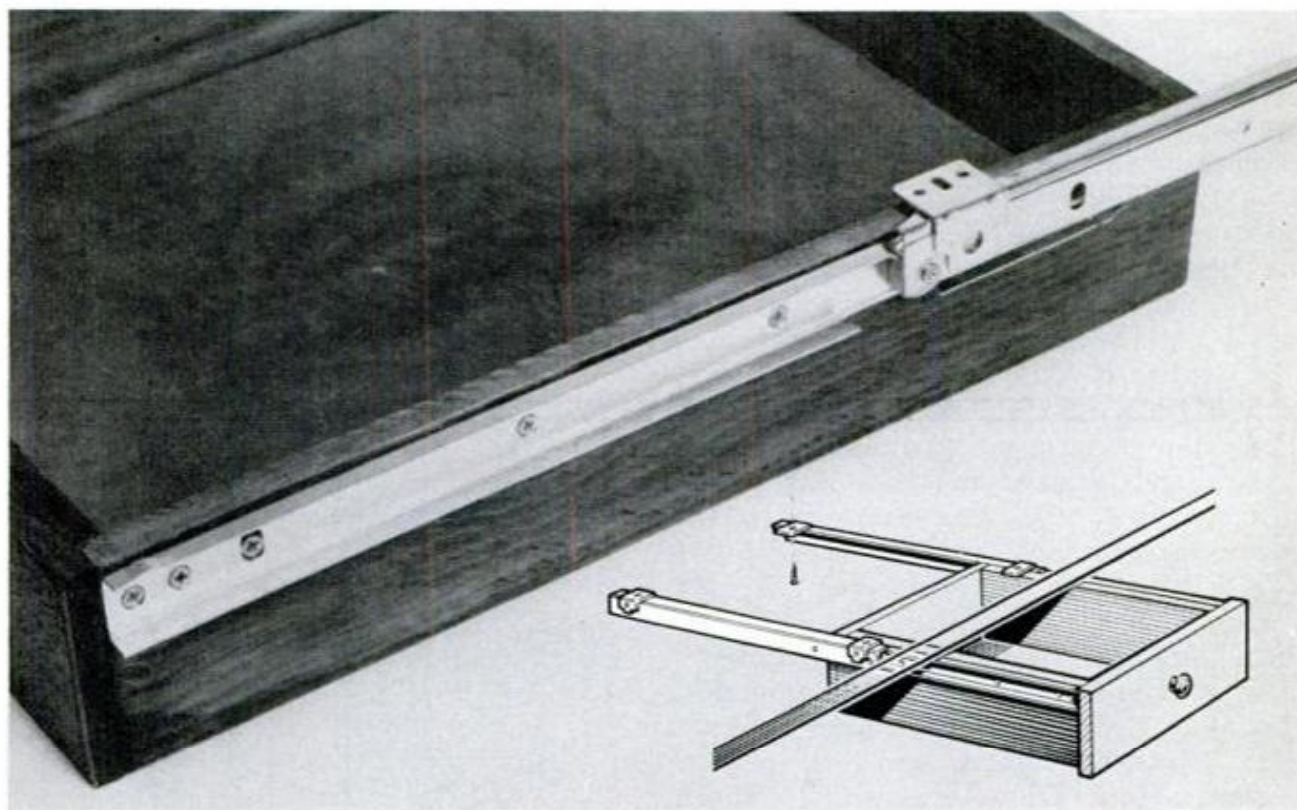

INCREASE DRAWER SPACE in home, shop or garage without making cabinets. Latest drawer slides offered by Grant Pulley and Hardware Co., High St., West Nyack, N.Y. 10994, let you "hang" a drawer under any flat surface. Available in nine lengths from 12 through 28 in., No. 344 slides have 50-lb. load capacity and are sold through hardware stores.

SHORT COURSE IN WOOD JOINERY

By WAYNE C. LECKEY
Home and Shop Editor

WILL THAT TABLE you just completed last a hundred years or more like the fine pieces produced by cabinet-makers of old? Much will depend on how well it was put together—but more importantly, on what joinery was used.

Furniture that relies on mere butt joints will never make it, for wood is known to shrink, be affected by moisture and humidity, and gradually loosen up at the joints as age sets in. Only when the parts are made integral through carefully fitted joints can you expect your cabinetry to “live” to a ripe old age.

As you see here, many different kinds of joints can be used in assembling your workshop furniture. The one you pick depends a great deal on the piece itself. Often you have a choice, one joint being as strong as the other but requiring a special tool to make it. There are dowel joints, mortise-and-tenon joints, lap joints, spline joints, pinned joints, miter joints, rabbet joints, dado joints and lock joints, to name a few. There are special joints to put drawers together, conceal corners and glue tabletops. Each shares a place in making you a master craftsman.

One of the handiest fixtures you can



Photos by Robert D. Borst

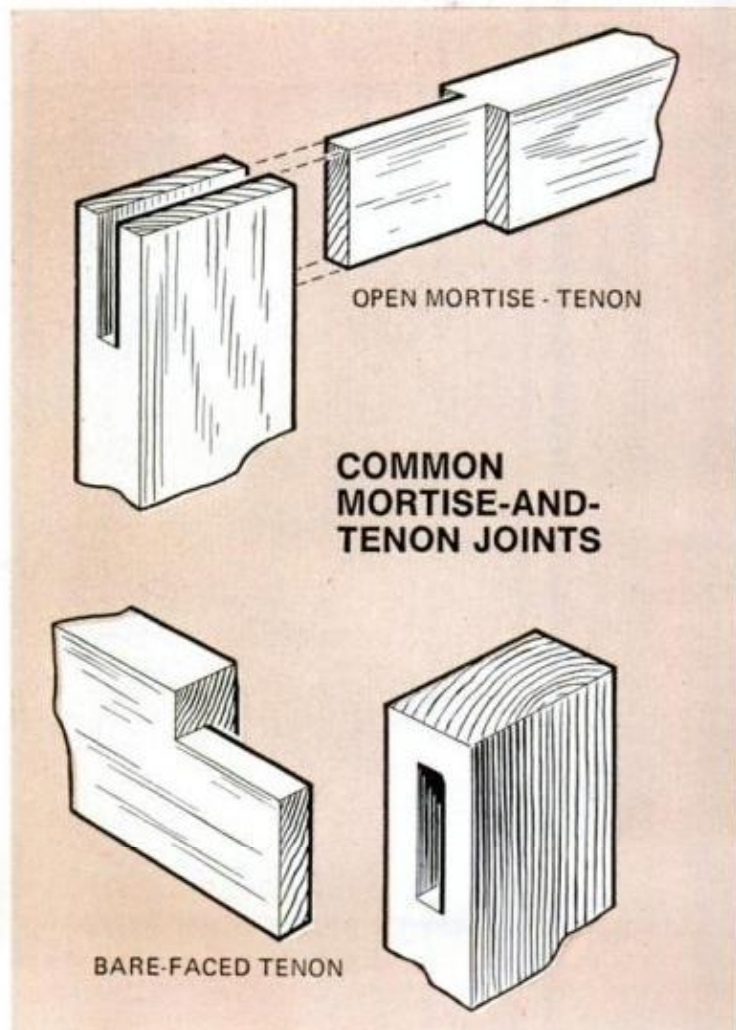

POPULAR MECHANICS

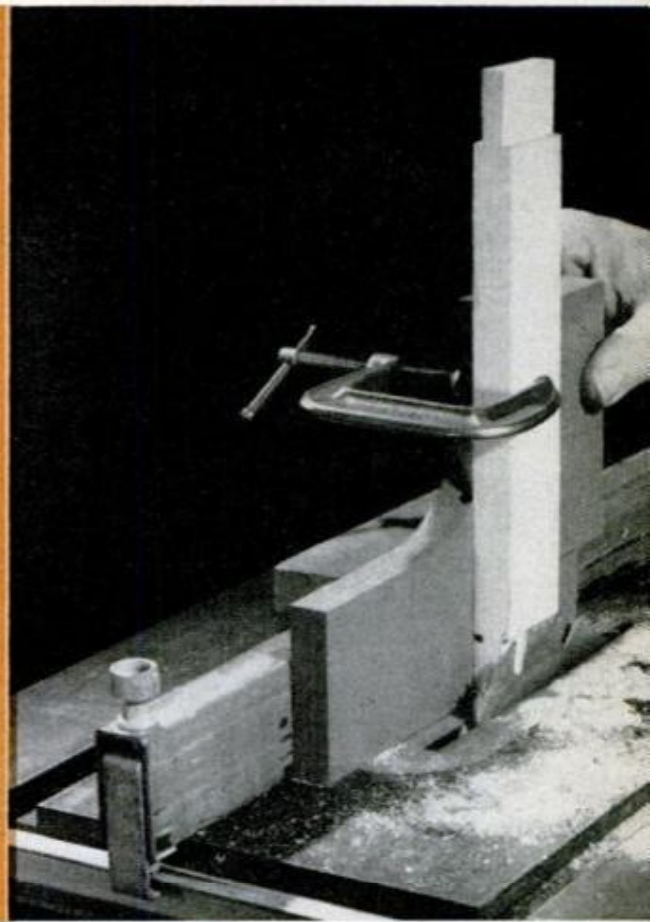
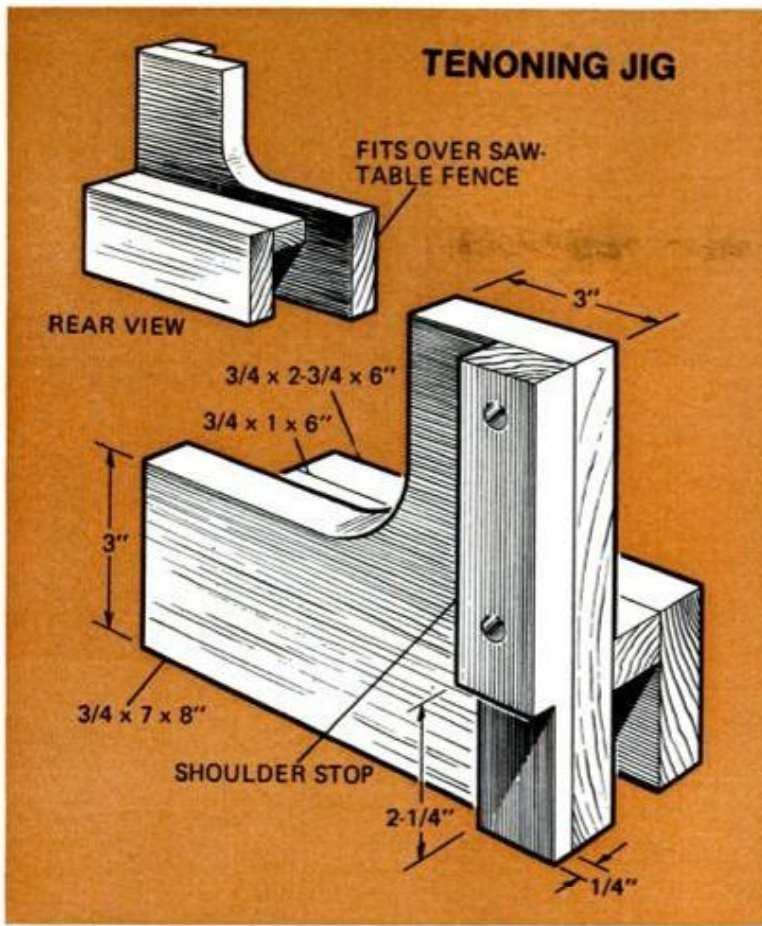

DESIGNED TO STRADDLE SAW FENCE, this homemade tenoning jig lets you cut accurate-fitting tenons safely on narrow stock. Diagrams show how jig is made from scrap wood. In use, work is clamped to jig

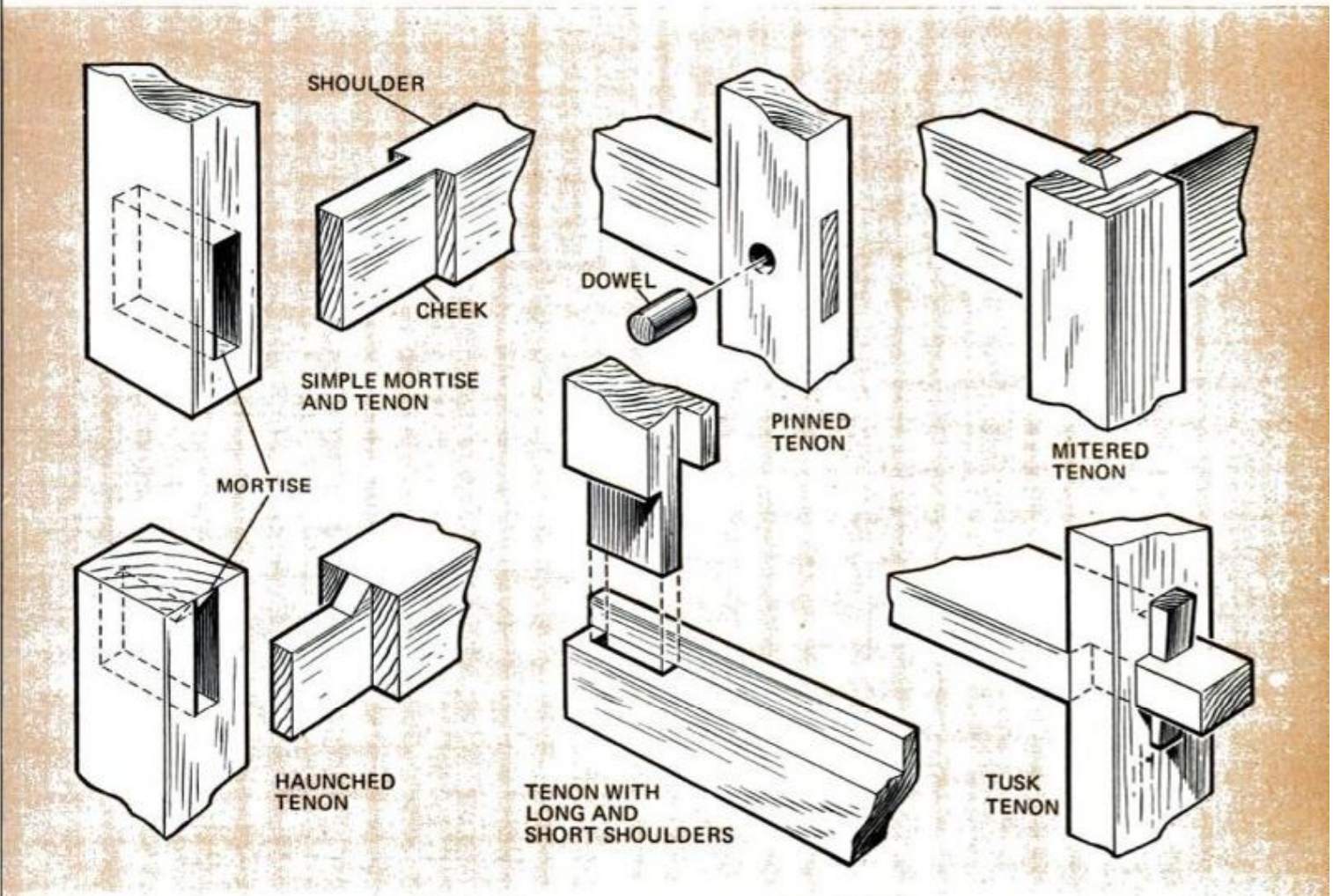

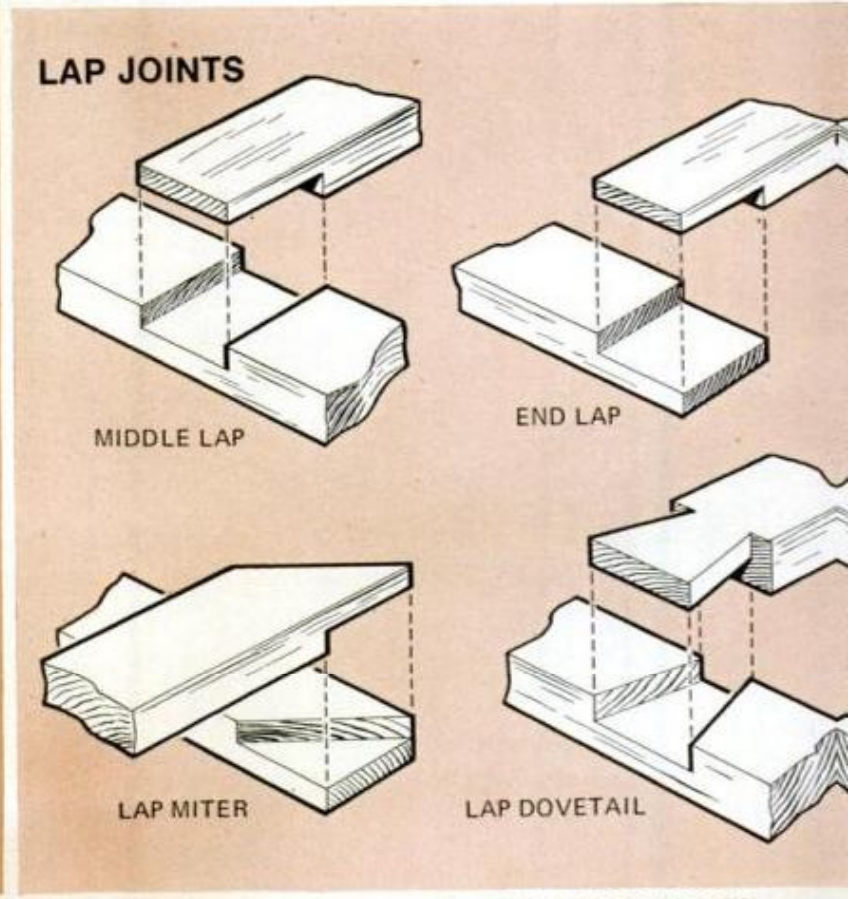
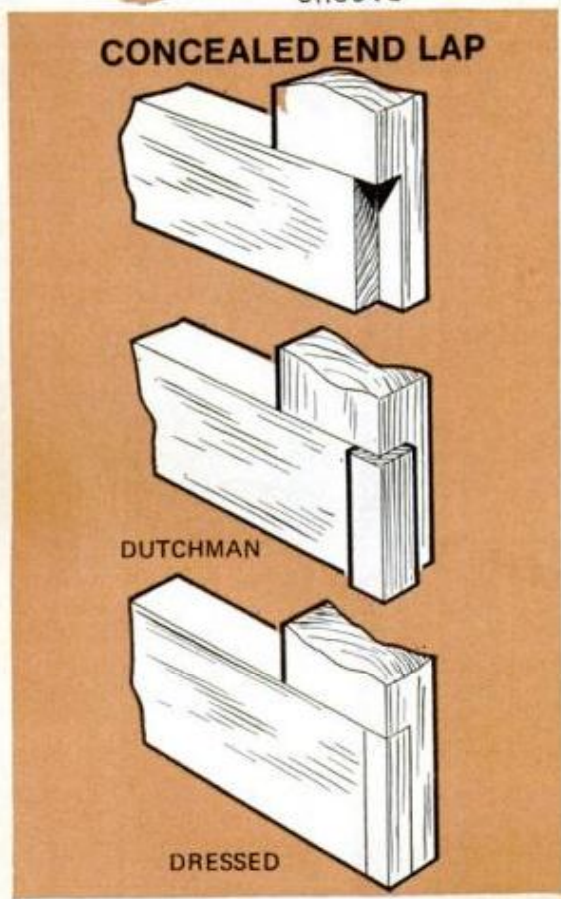
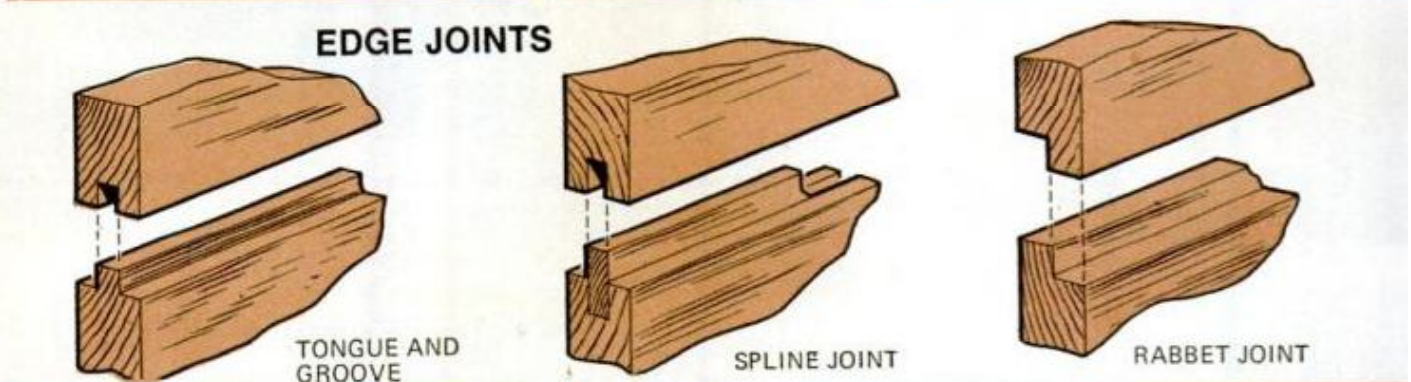
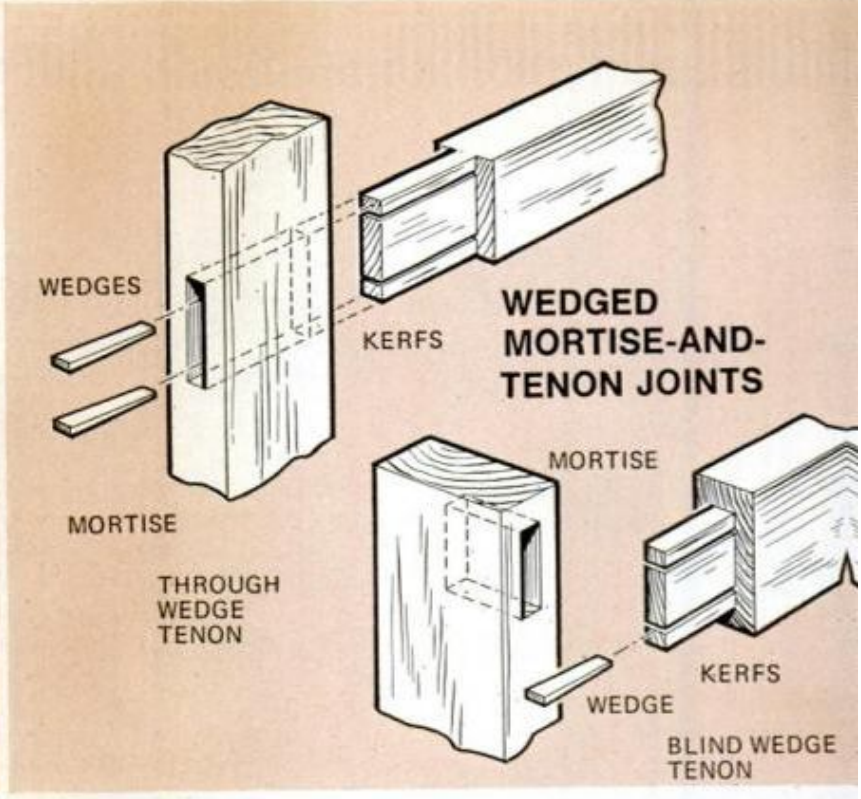
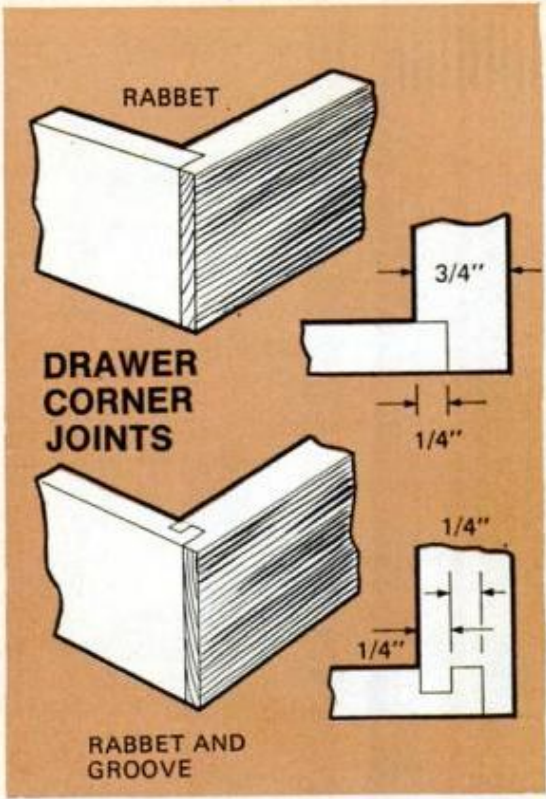

BOX JOINT

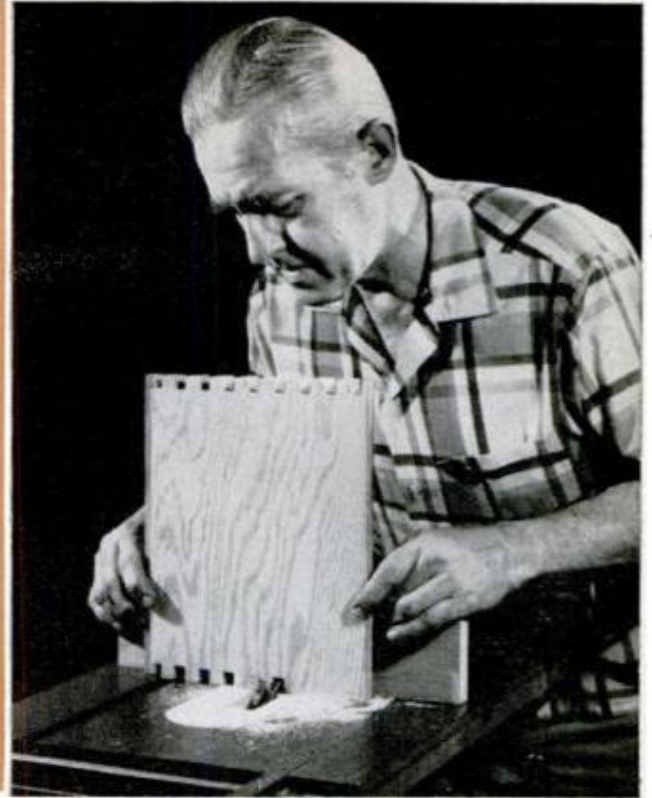
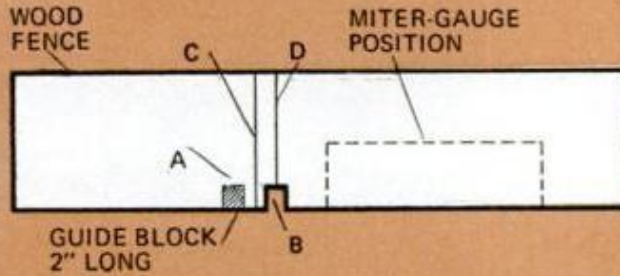
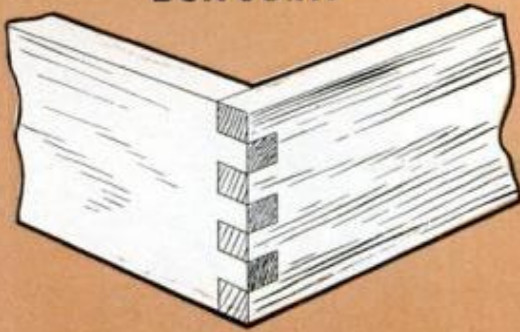

BOX JOINT is made on table saw with dado head. Jig attached to the miter gauge spaces the cuts uniformly

make for cutting tenons on a table saw is a tenoning jig. Detailed at the top of page 157, the jig is designed to straddle and slide along the saw fence so you can make cheek cuts on narrow pieces safely. Work to be tenoned is placed against the shouldered stop on the jig,

clamped and then passed through the saw. Then the work is turned around and the cut is repeated to make the second cheek cut, and finally, the work is turned end for end to cut the opposite tenon. Cheek cuts on a tenon are generally

(Please turn to page 200)

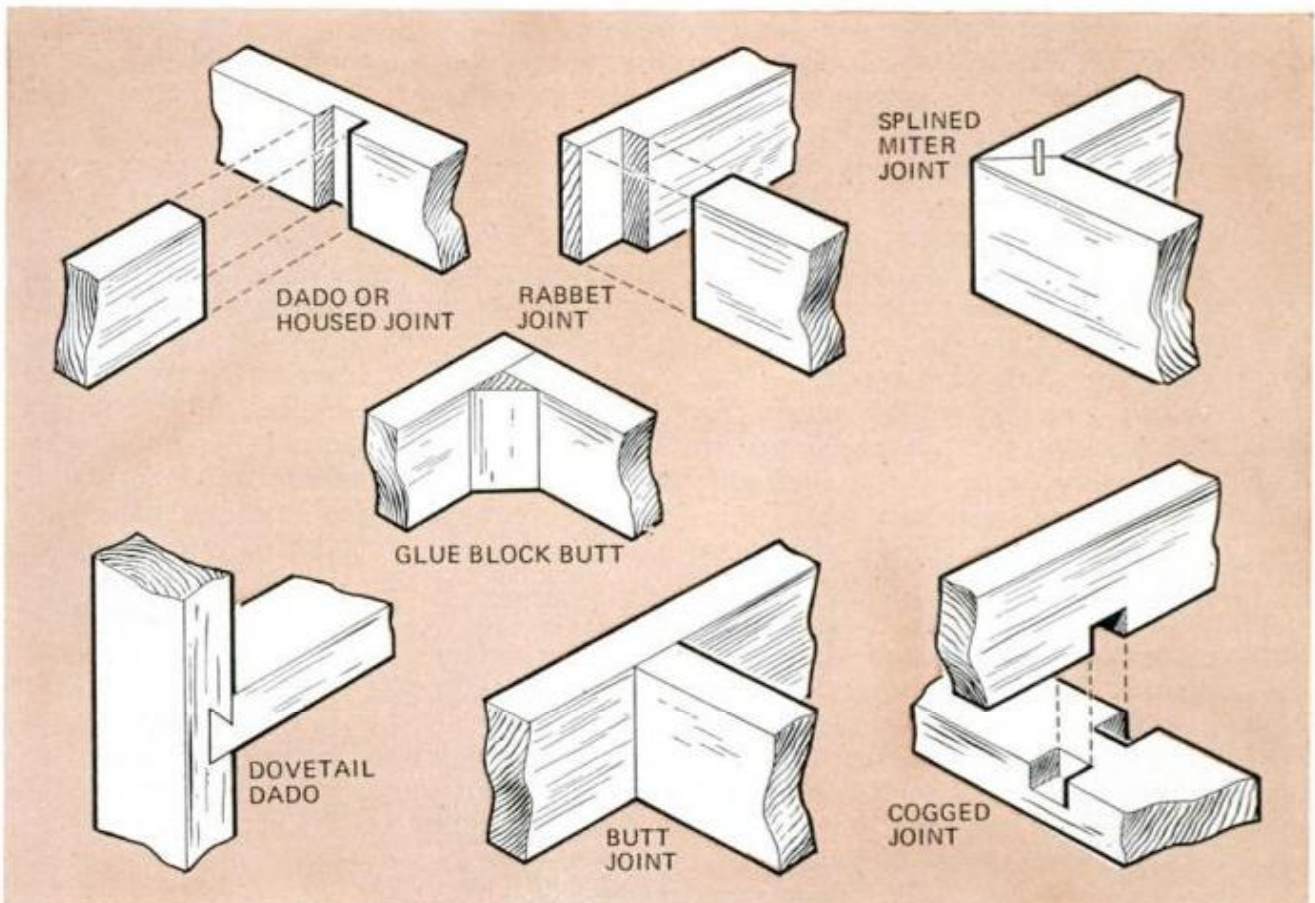



Bed by night, toy by day

By WINSTON S. GOO

BUILD THIS YOUTH BED and your youngster will be undisputed chief of the neighborhood fire department. Constructed for the most part of $\frac{3}{8}$ -in. plywood, the combination bed/fire truck can easily be made using a bench or radial saw. It provides roomy comfort for undisturbed sleep and the truck is sure to draw the preschool gang to the bedroom on rainy days for hours of fun. I've seen similar beds on the market for over \$200, but this version cost me less than \$40 (not including the mattress).

To build the bed, purchase all the non-wood parts first. Then, should your parts vary from those that I used, dimensional changes can be made. The ideal material for the headlamps is 5-in. plastic electrical conduit. If you can't get a short length of this material, the rings could be cut from cardboard tubing or a large, plastic drain pipe. The two 10-in. wheels support no weight and were bought used at a go-kart shop. With these on hand, you can measure the shaft diameter and

purchase the support dowel. The 10-in. steering wheels can be bought at an auto junkyard for about \$4 apiece.

Cut the floorboard first. Use center lines to locate the $\frac{3}{4}$ -in. slots and the $\frac{3}{8}$ -in. H-shaped slot. The side rails (1x6s) are approximately 6 ft. long. But *check mattress dimensions* before cutting them. Most of the exterior dimensions of the cab section shown are to the outer corners in the event vertical miter cuts are made. The two sides are the reverse of each other, and cannot be cut at the same time. Cut and tack together all vertical pieces first, then measure and cut the horizontal pieces to fit. Angled corners can be fastened on the inside by nailing a $\frac{3}{4}$ -in. cleat shaped at the same time the individual angled piece is cut.

The finished product should be well-sanded and primed before the final non-toxic (leadfree) color is applied. Last, cover the bumper with aluminum trim tape—either with one 3-in. strip or two overlapped 2-in. strips. ★★★

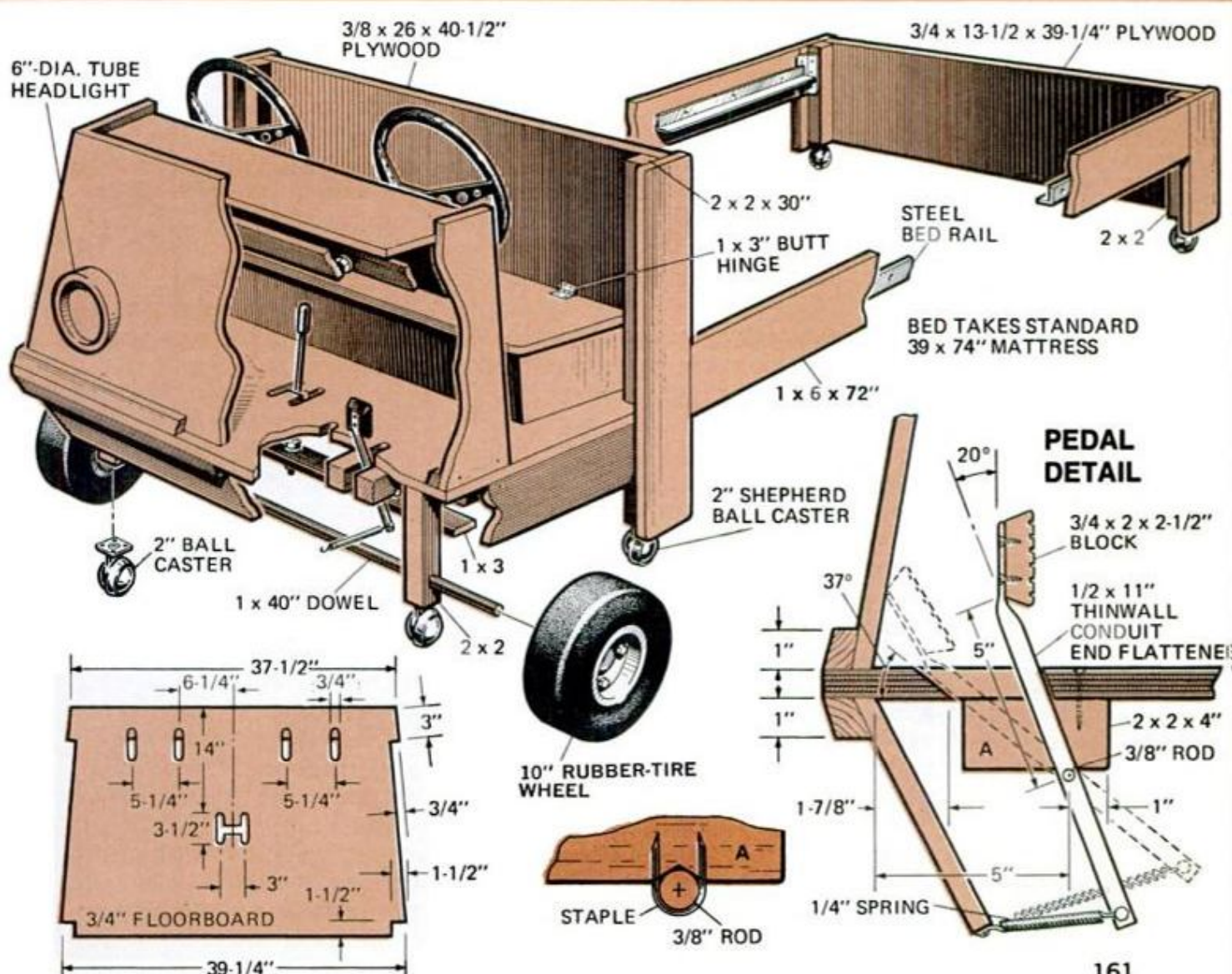
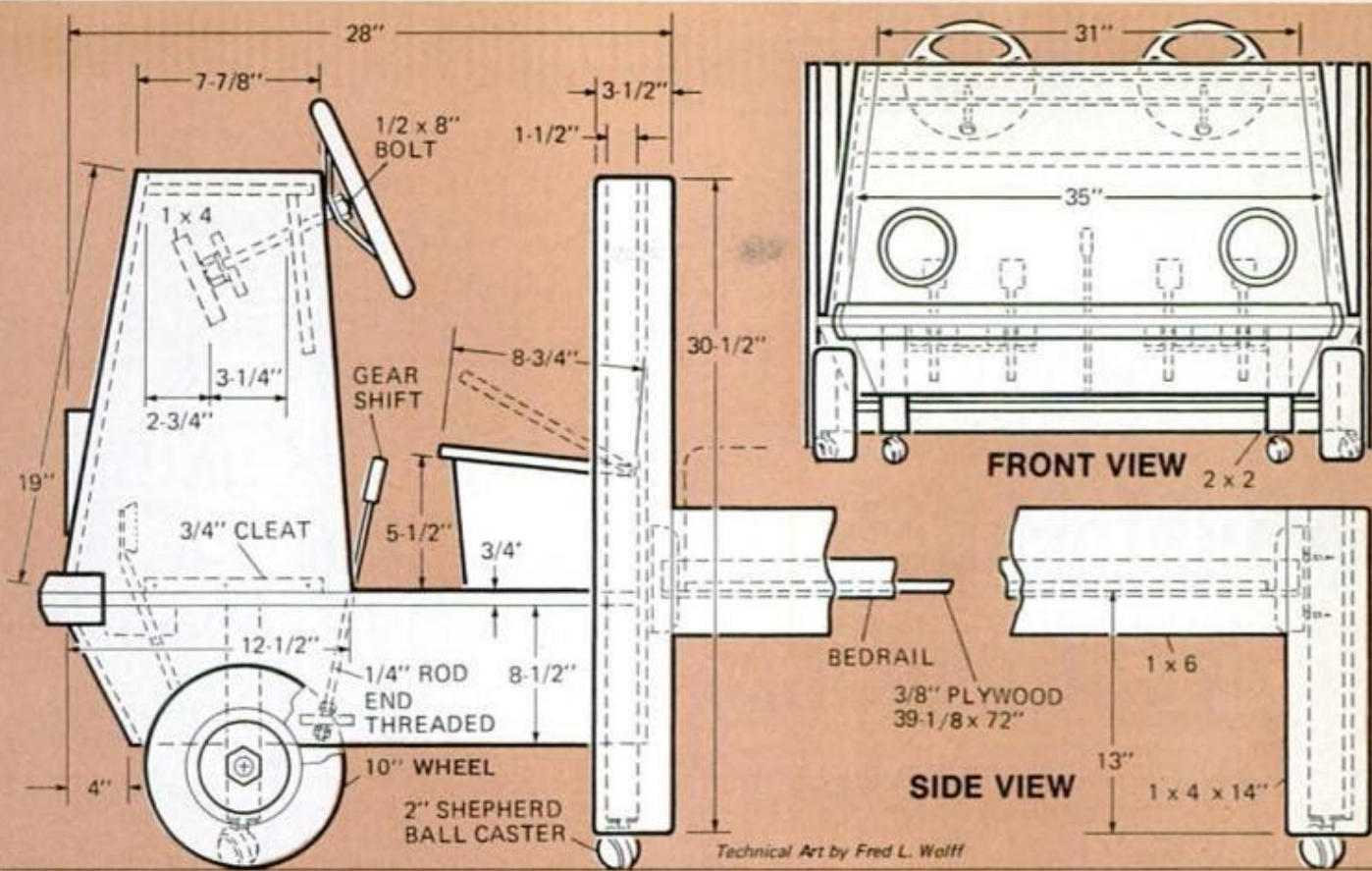

Tricks for troubleshooting your cooling system

By MORT SCHULTZ

COOLING SYSTEM MAINTENANCE usually prevents trouble. But it's no guarantee that you won't some day have an engine that overcools, overheats or loses coolant.

Take the problem of overcooling—when your temperature gauge doesn't reach operating temperature no matter how far or how hard you drive. If the problem is truly failure of the engine to heat up (and not a faulty temperature-sensing unit or gauge), the heater will blow out cool air. Most serious, though, is the fact that an engine that doesn't operate at optimum temperature won't rid the crankcase of condensation that will mix with oil and form sludge that can eventually gum up internal parts.

Usually, an engine fails to heat up or is slow to heat up because of a faulty thermostat. Thermostats in today's cars contain a temperature-sensitive pellet. As the temperature of the coolant increases, the pellet expands and pushes a piston that opens a valve to allow coolant to flow through the radiator.

When an engine is cold, the pellet is

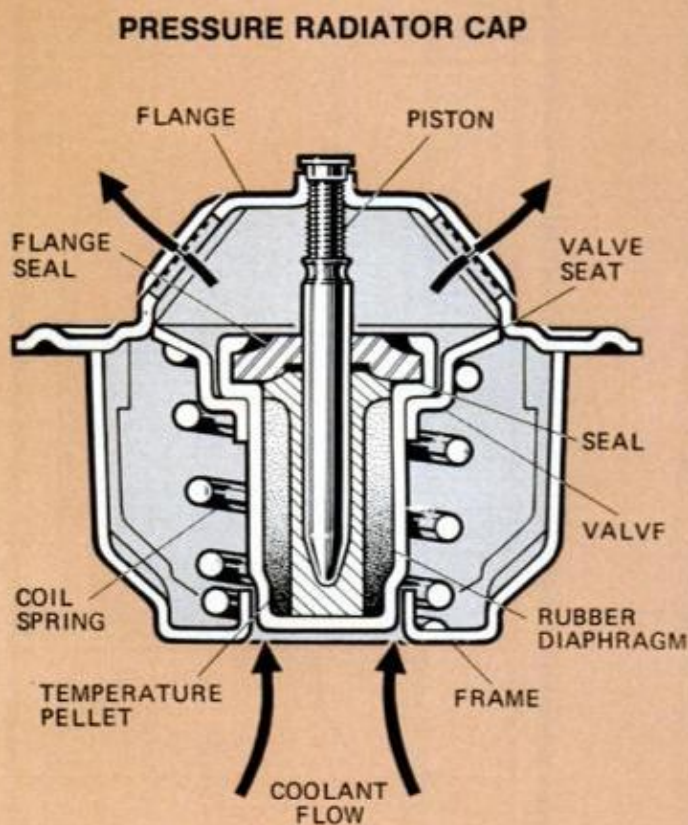

THERMOSTAT regulates temperature. If it sticks open or closed you get overheating or overcooling

constricted. This keeps pressure off the piston and, consequently, off the valve which remains closed. Coolant flows through the engine instead of the radiator, thus allowing it to reach optimum operating temperature, and as quickly as possible. If the thermostat valve is stuck in the open position, coolant will flow through the radiator instead of staying in the engine, and it will stay cool.

How do you determine if your overcooling problem is caused by the thermostat? And, if the problem is a malfunctioning thermostat, what can you do to try and salvage it? First, check the specified rating for the thermostat that should be in your car. Most today are rated at anywhere from 185° to 212° F.

Drive the car for about 10 minutes or let the engine idle for about 20 minutes. Slowly remove the radiator pressure cap. Remove the cap carefully so you don't scald yourself. Cover the cap with a rag and turn it counterclockwise to the first stop—no farther. Don't put any downward pressure on the cap and let pressure which has built up inside the radiator re-

POPULAR MECHANICS

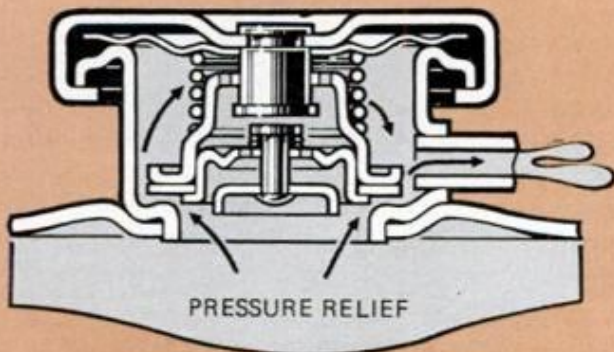
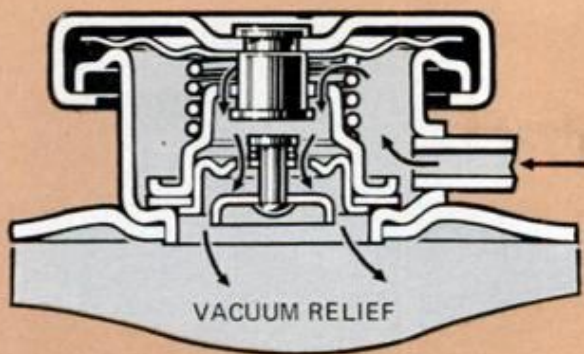

Technical Art by Peter Trojan

PRESSURE RADIATOR CAP is designed to relieve excess pressure and vacuum in your cooling system

lieve itself. This may take several minutes, depending upon how hot the coolant is. When pressure has dissipated, apply downward pressure on the cap and remove it.

Make sure the radiator is filled to the level mark. Place an accurate thermometer in the radiator filler neck so that the bulb is submerged in the coolant. The thermometer should register at least 212° F. Then run the engine at idle in neutral. If the temperature of the coolant stabilizes at 8° to 10° below the rating of the thermostat, the thermostat is okay. For example, if the rating of your thermostat is 190° and the thermometer hits a temperature of at least 180°, there is nothing wrong with the thermostat. The cause of your "overcooling" condition is either a bad temperature-sensing unit or an inaccurate temperature gauge.

On the other hand, if the coolant doesn't get hot enough, don't replace the thermostat just yet. Something may be keeping the thermostat open. To check, cover the face of the radiator with a blanket or cardboard, let the engine idle and watch

APRIL 1972



ACCURATE THERMOMETER is essential to cooling-system troubleshooting; cost is approximately \$4



LOWER RADIATOR HOSE may look good, but spring inside it may be collapsing and cause overheating

the thermometer. Allow the coolant to heat up to about 210° F. before shutting off the engine. This will open the thermostat valve fully to flush it.

Now if the engine doesn't heat up to normal operating temperature, you have evidence that the thermostat is shot and should be replaced.

The problem of overheating is much more common than overcooling. In an engine, combustion gas temperatures get as high as 4500° F., and the temperature of lubricated parts, such as pistons, can get as high as 200° above the boiling point of water. If any part of a cooling system lets down on the job, allowing the temperature of the system to exceed safe limits, the engine's valves can begin to warp and burn and pistons can score and burn.

Coolant in a modern automobile would start to boil at too low a temperature if the cooling system were not pressurized. The most important part contributing to pressurization is the radiator filler cap. The boiling point of a solution of ethylene glycol to guard an engine against freezing at minus 20° F. is 224° F. Put under pres-

163



FAN-BELT TENSION GAUGE sets tension to spec as it must be on engine with many power accessories

sure of a 15-pound pressure cap, that boiling point is increased to approximately 262° F.

The pressure cap itself contains a blow-off (pressure) valve and a vacuum (atmospheric) valve. The pressure valve protects the radiator by relieving pressure if it exceeds that for which the radiator is designed. The vacuum valve opens to relieve the vacuum created as the system cools off.

A radiator pressure cap can lose its ability to hold pressure; that's when overheating can occur. One way to check a cap is to hold it in your hand upside down and look "through" it. If you see any light between the vent valve and rubber gasket, replace the cap. If the rubber gasket is deteriorated or swollen, replace the cap. Make sure the vent valve hangs free. If not, replace the cap.

The most accurate way of testing a radiator pressure cap is with a pressure tester. If you have one (cost is about \$15) or if you can borrow one, wash the cap in clean water and attach it to the tester. Pump up the tester to the rated capacity of the cap. If the meter of the tester falls off more than two pounds under the rating of the cap, replace the cap.

Overheating can also be caused by a lower radiator hose that looks good but is malfunctioning. Inside is a reinforcing spring that keeps the hose from collapsing from suction at medium and high engine speeds. If the spring is deformed or weak and the hose collapses, coolant circulation is cut off, and the engine overheats. If your engine doesn't overheat at idle or slow speed, but does on a fast run, try replacing the hose.



AIR OR GAS LEAKS in the cooling system can be detected very simply (see procedure given in text)

Another tough one is a part that some manufacturers call a distributor vacuum-control switch and others call a temperature-operated vacuum bypass valve. Not every car has one. The distributor vacuum-control switch, temperature-operated vacuum-bypass valve or thermo-vacuum valve—whatever the manufacturer chooses to call it—is normally screwed into the front of the cylinder block. The switch consists of a manifold vacuum port, a carburetor vacuum port and a distributor vacuum advance port.

When engine coolant temperature reaches the boiling point during periods of prolonged idle in particular, a valve plunger in the switch is energized to allow both the manifold and carburetor vacuum ports to open, putting more "pull" on the distributor vacuum advance unit through the switch's distributor vacuum advance port. This allows an increase in engine speed by some 100 rpm to speed up the flow of coolant from the water pump and the speed of the fan, thus helping to cool things down. If the plunger is not operating to open the ports, replace the unit.

Fan drive has become increasingly important especially in airconditioned cars with heavy-duty cooling systems. The fan drive has a thermostatically controlled clutch with the assembly attached to the water pump.

When the full operation of the fan is not needed for cooling, such as when the airconditioner is shut off, the clutch is disengaged and fan speed is limited to a relatively low rpm (about 1200).

When the operating temperature rises, it is sensed by a bimetal temperature

coil. The coil tightens and moves a valve to open a port, permitting flow of silicone oil into the clutch chamber that engages the clutch to turn the fan at a greater speed (about 2500 rpm). This keeps the temperature of the engine within safe limits.

Fan clutches should be replaced for one of the following reasons:

1. *Noise.* If the clutch assembly locks up, there will be a good deal of noise. Try to rotate the fan by hand. If it binds or there is a rough grating feeling, replace the drive.

2. *Fluid leak.* If silicone oil is leaking from around the fan clutch bearing, replace the unit.

3. *Engine overheats or there is insufficient airconditioning cooling.* To determine if the fan drive is at fault, start with a cool engine, which will mean that the fan drive will be disengaged. Cover the radiator to induce high engine temperature, start the engine, turn on the air conditioner and operate the engine at fast idle.

You should notice a roar from the fan area when the clutch engages, which will take about 5 to 10 minutes after starting the engine. However, be sure to keep your eye on the temperature gauge or warning light. If it should reach the area of over-

heating, remove the cover from the radiator.

You can hear the fan roar most distinctly from in front of the radiator. As soon as the clutch engages, remove the cover from the radiator and shut off the air conditioner. After several minutes in which the engine will cool down, the fan clutch should disengage. If the fan drive fails to operate in this manner, there is a malfunction and the fan drive should be replaced.

Fan belt tension is very important. A loose fan belt will cause slippage and overheating. Using a belt tension gauge is advisable especially when an engine drives many power accessories. The gauge is hooked to the belt so that when the knob is pushed down the tang that is hooked to the belt causes the dial to move. With maximum hand pressure applied to the knob, the dial reads the tension of the belt. Price of a gauge varies from \$14 to \$20.

Further cooling-system tips:

● Keep the radiator core clean; blow out with compressed air.

● Coolant can boil if the radiator cap isn't tightened all the way, and it can do so without the temperature warning light coming on. In an Oldsmobile, for ex-

(Please turn to page 199)

AUTOMATIC RPM INCREASE for cooling by boosting vacuum advance at distributor is function of valve

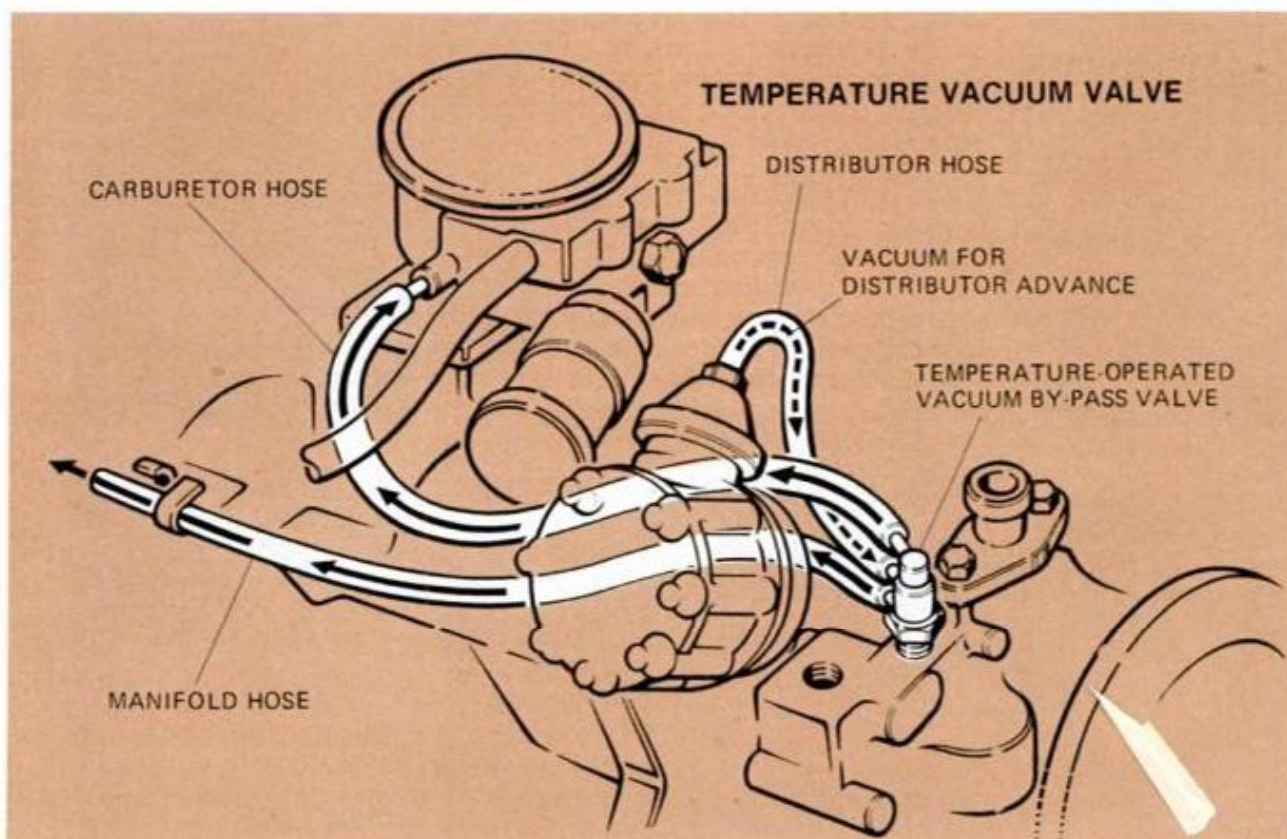

NEW FOR YOUR CAR

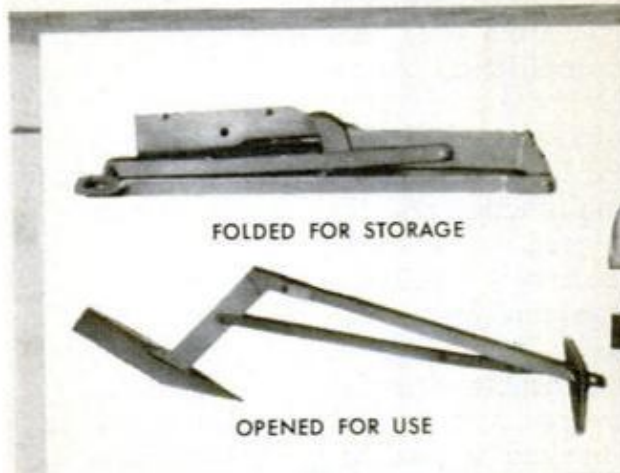

LAND ANCHOR helps pull you out of sand and other ground where there are no trees to hitch a rope to. Shaped like a plow, Pull-Pal attaches to any winch-equipped jeep or camper for off-road driving on rugged terrain. Lever action causes hook to embed itself more deeply the harder the pull. Folds to jack size for storage; about \$40. Reliable Tool & Engineering, 308 East Franklin, El Segundo, Calif. 90245.



NEW DRY-CHARGED BATTERY at left is activated by plain water instead of dangerous sulphuric acid and needs no pre-charging for use. This means motorists, campers and boaters can keep a spare battery on hand and charge it themselves to avoid being stranded. Built-in acid in dry form heats up when water is added, prewarming battery for instant use. Called Oasis, Prestolite makes it.



ADD-ON HOIST at right can be mounted in a car trunk, station wagon, pickup truck or delivery van to lift heavy objects, such as an outboard engine, into the vehicle. It has a capacity of 200 pounds, can be folded for storage, is \$89.95. Mechanical Specialty Co., 42 1st St., S.E., New Brighton, Mich. 55112.



HANDY PLUG-IN VOLTMETER fits in your dashboard's cigaret-lighter socket and gives you a quick check on battery conditions. It performs three tests: battery strength under no load, battery strength under full load and charging rate while running. Its upward-slanting dial makes it easy to read even while driving. Price is \$6.98 from Automark Industries, Inc., 641 Vermont, Palatine, Ill. 60067. A similar device not shown, called Volt-I-Cator, is made by Accurate Products Co., 2334 Production Drive, Indianapolis, Ind. 46241.



are you headed for
a time-clock number?

...or a **BIG PAY**
place in

AIR CONDITIONING

**140,000 new servicemen needed
...you can be one of them**



Be Your Own BOSS
course includes directions on
How to Own YOUR OWN Business!

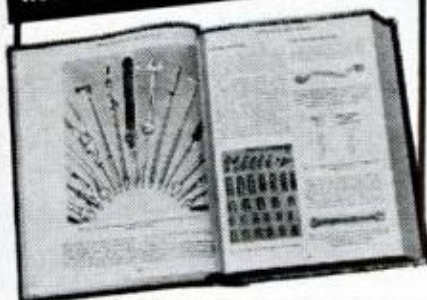

Air conditioning, refrigeration and heating is one of America's fastest growing fields. Service and installation technicians are in desperate demand.

And you can join this force of men making big money right now by becoming a skilled technician with our help.

Top men are making 2 and 3 times more than unskilled workmen. Yet we can teach you these skills so quickly you'll be earning money long before you've finished learning.

AMERICA'S FOREMOST COURSE AT A MATCHLESS LOW PRICE

Learning at home is hailed by educators as being far superior to classroom work with all its mass production and distractions.

In our fine, professional 100-lesson textbook course you will receive the clearest instructions in unmistakable simple language. Plus self-projects, self exams and graded exams.

Directed by Roy Anderson whose experience with home study and Army-Air Force training goes back to 1935, we have prepared material that will turn out top-notch graduates. And we do it at a cost so much lower than any comparable course that you simply will not believe it possible.

One way we do it is by not loading our students with costly equipment and tools — most of which you probably already have, or can buy locally for less than some schools charge you!

The Liberty School is a fine, professional and very intimate institution of learning-at-home, supervised in every tiny detail by Mr. Anderson.

We can't begin to tell you all of the advantages in this small space — but we'll give you all the details if you send in your name and address. Remember, we have NO salesmen so no one will bother you. In the privacy of your room you can study the description of our lessons and make up your own mind without any pressure whatsoever.

A big pay future is waiting for you — grab it now.

**LIBERTY SCHOOL, Dept. J-4, Technical Division, 1111 W. Park,
Libertyville, Illinois 60048**

**Roy Anderson
Liberty School, Dept. J-4
Technical Division, 1111 W. Park
Libertyville, Illinois 60048**

**SEND ME YOUR NAME AND ADDRESS — I'll rush you FREE
details by mail. WE HAVE NO SALESMEN.**

Dear Mr. Anderson: Please send me description of your course on AIR CONDITIONING, REFRIGERATION AND HEATING. I understand this places me under NO obligation and that NO salesman will call.

Name _____ Age _____

Address _____

City _____ State _____ Zip _____



Pick up America's favorite hitchhiker.

When you get away to the country, give the Honda Trail 90 a lift. Once you get to where you're going, it'll return the favor.

The Trail 90 is America's favorite trail bike because it has the most to offer. A famous Honda four-stroke engine for dependability. Swivel-lok handlebars for



Reserve Tank

easy packing. Posi-torque dual transmission for rough or smooth riding. A great new reserve tank to carry extra gas or water. A USDA-approved spark arrestor/muffler to help protect the environment. And that strong Honda warranty to help protect you. The Honda Trail 90 is at your Honda dealer's now. Drop by. It's itching to go some new places with you.

The Honda Trail 90.

New plug-in TV parts

Almost as simple as changing tubes

By SHELDON M. GALLAGER

REMEMBER BACK in the good old days when you pulled the tubes from a balky television set, checked them down at the local hardware-store tester and came home with a brand-new replacement you could put in yourself? Often you were back in business in half an hour and for only a few bucks.

Then came solid-state circuitry. While it has done much to improve TV quality, it has not made life easier for servicemen. Even a professional repairman winces when you bring in a sick solid-state color TV unless he's a factory-trained expert familiar with your particular make and model.

Now the picture is changing. TV makers, aware of the headaches repairmen face trying to unravel the intricacies of advanced

BOTH COLOR AND BLACK-AND-WHITE SETS are going in for plug-in parts. This new 19-inch GE monochrome model has three basic subassemblies that slide out at rear. From left to right in lower foreground are power supply, signal board and sweep board. At top of page is tiny IC audio module, held in clips, that can be slipped out, discarded and replaced as easily as old-fashioned tube

APRIL 1972

169

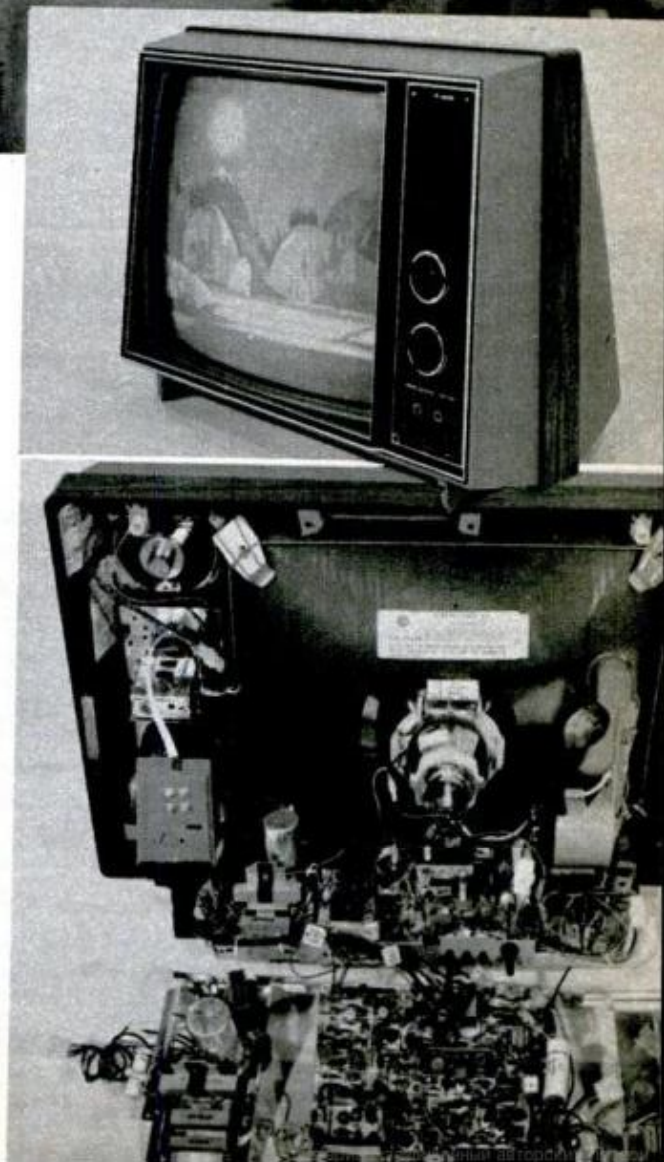

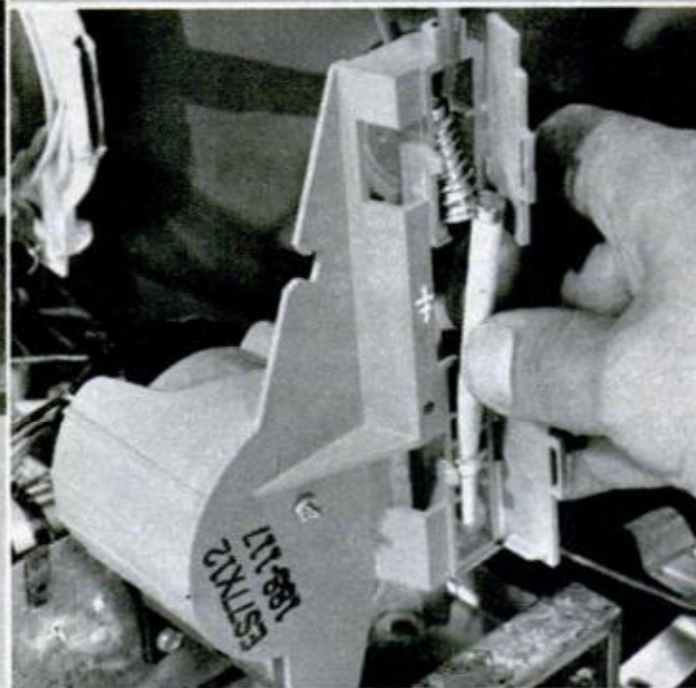
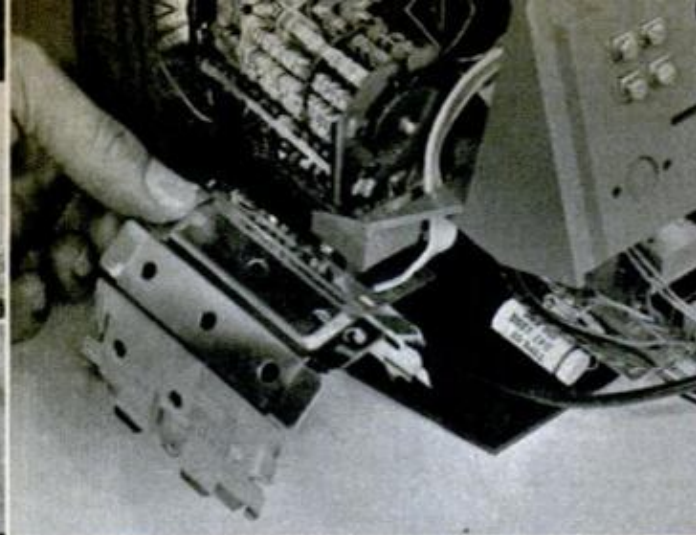
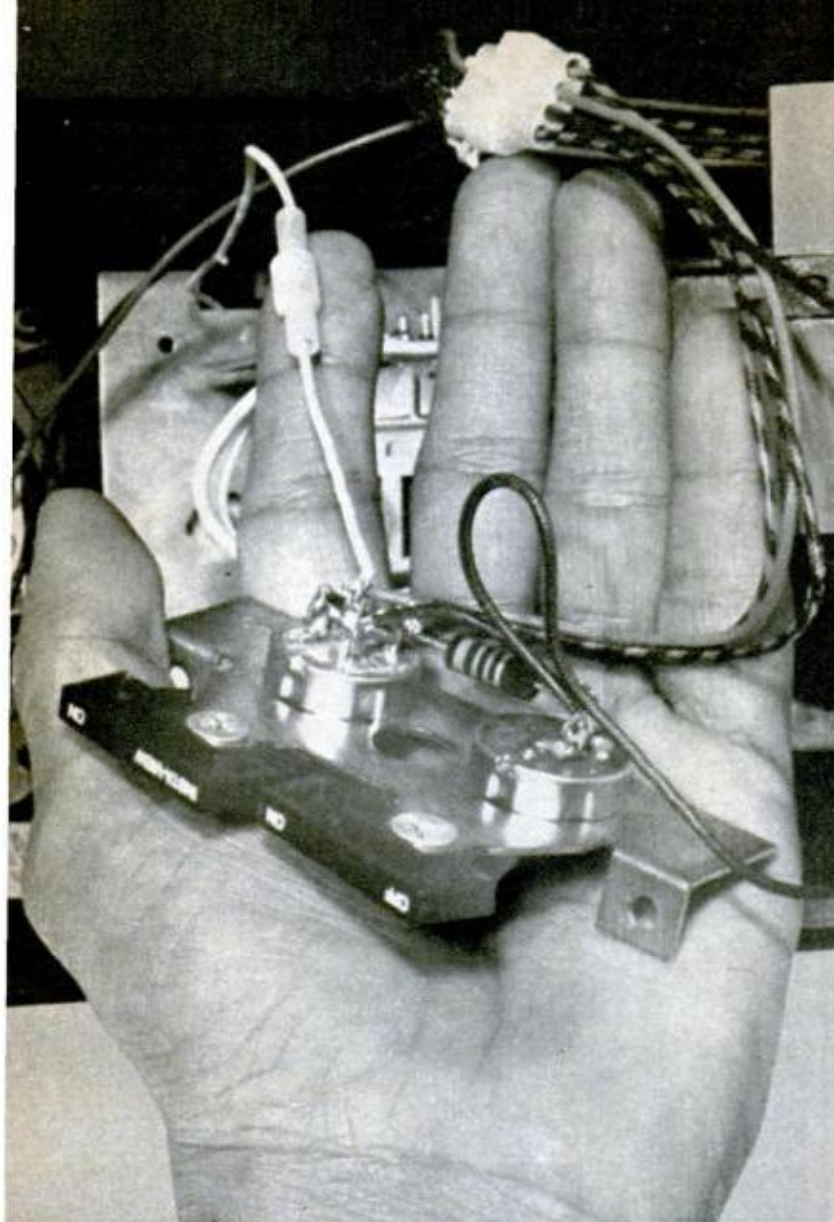

QUICK, EASY SERVICING is object of newly designed GE sets like one shown here and on page 169. Photo at left, above, shows how parts attach with slip-together connectors that unplug for fast removal. At upper right, tuner cover swings off for

instant access to contacts for cleaning. At lower right, replaceable high-voltage rectifier simply snaps into plastic holder—like changing a cartridge fuse in your home or car. The Model TR465UWD 19-inch monochrome GE table set sells for about \$160

solid-state electronics, are simplifying the job with special easy-to-service circuit parts. These consist of small printed-circuit boards in modular form that can be individually removed and replaced without cutting and soldering wires or fumbling around in hard-to-reach places. The modules plug in like tubes, are almost as easy to change, and are cheap enough to discard like a burned-out tube. All a serviceman has to do is identify the faulty part, slip it out, chuck it away and put in a new one. An entire amplifier stage, power supply or sweep circuit can, for instance, be removed and replaced as a single unit. Repairmen can stock such parts in assorted types and have them on hand for ready use—just like a supply of tubes.

While this won't necessarily bring back the old hardware-store tester, it *will* mean real benefits for TV owners. With faster, easier servicing, you'll get your set back sooner and with lower labor charges. Motorola pioneered the idea with its "works-in-a-drawer" Quasar line. The entire chassis slides out like a drawer for easy accessibility and contains many plug-in parts. Now other makers are following suit with quickly changed modular parts. GE's newest black-and-white set, its 19-inch Model TR465UWD, plugs simple serviceability as one of its main selling points. Power supply, signal board, sweep board and audio stage are all removable modules. GE's new color sets will also incorporate similar easy-fix features.

RCA, too, has announced a new XL-



Today, a man needs a good reason to walk a mile.

Start walking.



25 mg. "tar," 1.5 mg. nicotine
av. per cigarette, FTC Report AUG. '71.

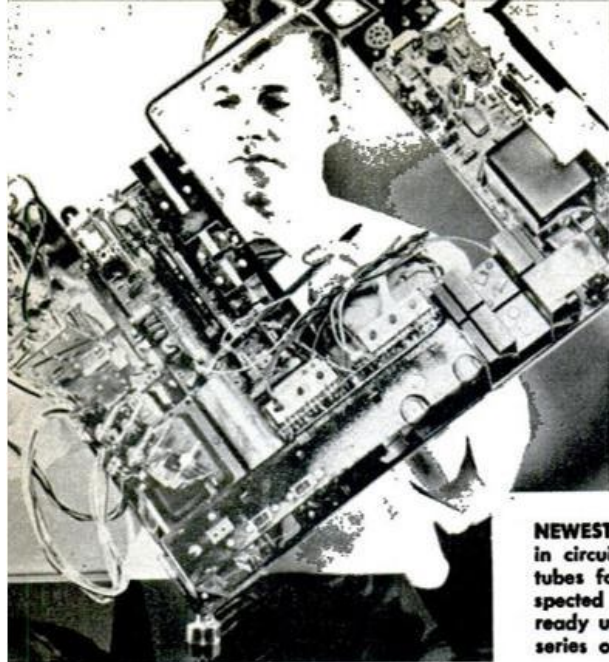

NEWEST RCA COLOR CHASSIS (left, above) contains 12 plug-in circuit modules that can be pulled out and replaced like tubes for fast servicing. Above, tiny ceramic modules are inspected at factory, can be stocked by local TV repairmen for ready use. The new XL-100 AccuColor chassis is available in a series of table and console models for about \$550 to \$1000



HEATHKIT'S FIRST ALL-SOLID-STATE color TV consists mainly of interchangeable circuit boards, plus hinged swing-out chassis for easy access. Company will repair or replace any module for nominal fee—you just slip it out and send it back to factory. Kit sells for about \$580 less cabinet, can be flush-mounted in a wall or in a choice of console styles

100 color chassis that contains 12 plug-in modules and will be used in many of its latest models. Because chassis and modules remain the same for a wide variety of set types, it means a serviceman can stock relatively few replacements and still be able to handle many different models. This helps to keep inventory costs down and can, in turn, be passed on to set owners in lower service costs. Eventually, manufacturers may be able to standardize on basic modular parts that can be used interchangeably in different makes of sets as well as in different models. If so, the old joyous days of tube-changing may really be here again. ★★★

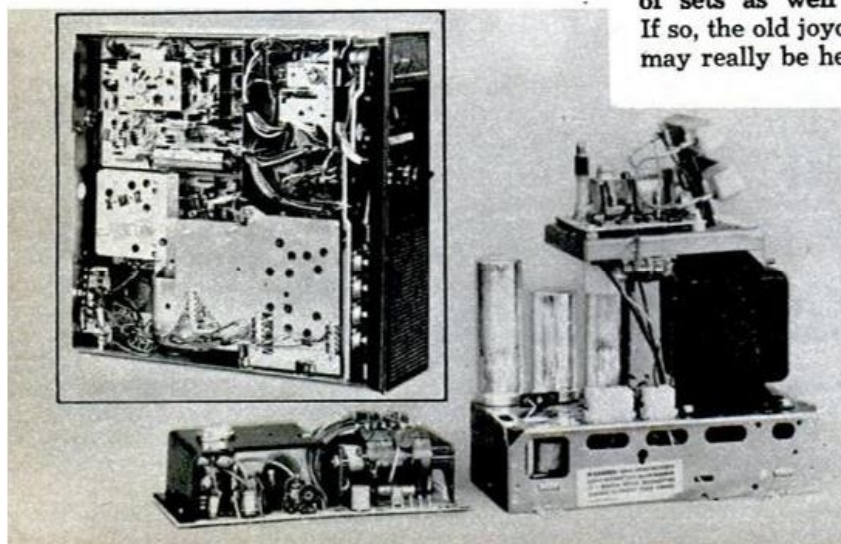

MOTOROLA'S "works-in-a-drawer" chassis (top left) slides out of color sets for easy accessibility and servicing. Many parts on the chassis are plug-in "mini-circuits" for quick removal and replacement. Two lower components show comparison between larger, heavier old-type power supply (near left) and compact new module (far left). Priced from about \$500 for table models to \$775 for the top consoles

POPULAR MECHANICS

THE DODGE MAXIVAN STRONG BOX...

Largest compact van built in the United States.

AND VERY BIG IN FEATURES, TOO.

Cargo Area

Largest of any van built in the U.S.

Brakes

New, optional power disc front brakes for improved stopping power.

Floor Space

Greatest load length between engine cover and rear door.

Engines

Largest optional V8 (360 cu.-in.).

Wider Doorway and Step

Easier entrance and exit for driver and passenger.

Independent Front Suspension

Smooth, independent front suspension can be easily aligned on passenger-car equipment, if necessary.

More Legroom

Heater is located under hood instead of under dash to give you ample legroom.

Ease of Loading

Front passenger seat does not intrude into side cargo door entrance. Side doors are widest of any domestic van.

Fuel Capacity

Largest gas tank of any domestic van (26 gallons).

Turning Circle

Tightest turning circle of any domestic van, yet has the longest wheelbase for smoother ride and handling. Easy to park.

Service Repairs

Large hood opening for outside servicing.

Plus More

The Dodge Strong Box has many more fine features which this space does not permit us to list. See your Dodge Truck Dealer. He'll be happy to show them to you.



Dodge Strong Boxes are available in 109-inch-wheelbase, 127-inch-wheelbase, and 127-inch-wheelbase Maxivan versions.

Who gives you toughness that's just your style?

Dodge. Depend on it.



New tools for home improvement

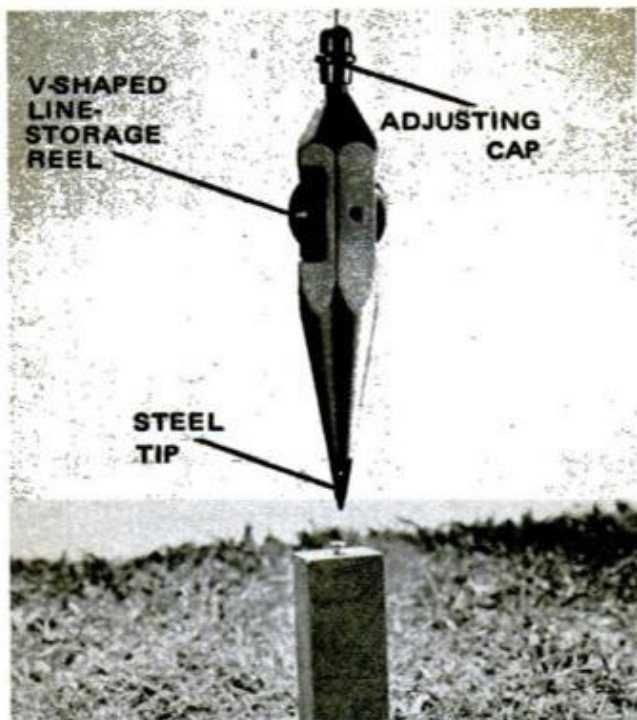

PLUMB BOB has a spool in its body for winding line to eliminate spinning when bob is dropped; adjustable cap holds bob where wanted. \$12.50 postpaid. Sensational Plumb Co., 317 Sepulveda St., San Pedro, Calif.



SCREW STARTER marks, starts and threads hole the screw will enter. With hardwood handle, tool fits neatly in nail apron for on-the-job use. At hardware stores, 79 cents. Irwin Auger Bit Co., Wilmington, Ohio 45177.

HANDY-CLAW nail remover, dubbed "cat's paw" by professionals, gets under embedded nailhead for its easy removal. Model HC-10, \$2.30, has molded-on vinyl grip, is made by Estwing Mfg. Co., Rockford, Ill., 61101.



PROFILE SCRAPER from Coastal Abrasive and Tool Co., Inc., Box 337, Trumbull, Conn. 06611, lets you quickly remove paint from irregular surfaces such as molding and chair legs. With seven blades, No. 4725 is \$2.90.

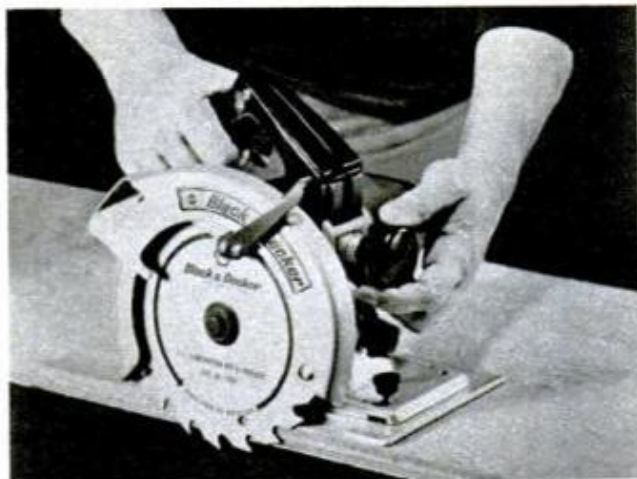

ALUMINUM SHOE that adjusts vertically has been added to Black & Decker's three heavy-duty circular saws. Available in 6½, 7¼ and 8-in. models priced at \$70, \$80 and \$90, respectively, all operate at 5500 rpm.



People pay a lot of money to these men. You can be one of them soon.



Electronics Technician.



Automotive Technician.



**Air Conditioning
Refrigeration Technician.**



**Home Appliance
Technician.**

You know what technicians charge to repair your TV set, your car, refrigerator or washing machine. The men who can do the job — and do it right — get paid very well indeed.

Join them! Be a technician and let people pay **you** for a change.

National Technical Schools will train you at home the professional way — with profes-

sional instruction, tools and test equipment, the kind of equipment you'll be using on actual jobs. It makes home training practical and more fun. And you get to **keep** all of the tools and equipment.

Choose the kind of technician you want to be. **Then** mail the card for free color catalog. No obligation. No salesman will call.



NTS Electronics Division

Multiply your income with space age skills in Computer Electronics, Color TV & Radio Servicing, Automation/Industrial Electronics or Electronic Communications. Courses include valuable kits such as 315 sq. in. Solid State Color TV, Solid State B&W TV, 2-way Radio Transceiver, Compu-Trainer, Oscilloscope, and more. Check card for new **FREE** Color Catalog, complete details.



NTS Mechanics Division

NTS puts you into America's #1 industry fast. Start earning almost as soon as you begin. You get 109-piece Socket Wrench & Tool Set with case and professional 8-unit diagnostic test equipment, yours to keep. Plus bonus Speed Shop lessons. Check card for new, free color catalog and complete details on all four courses and equipment.



NTS Air-Conditioning/ Refrigeration, Heating Division

Install and maintain today's complex air-conditioning, refrigeration, and heating systems. As an NTS master technician you can handle any job. Or you can go into your own business. "Project Method" makes your training interesting with all new Hermetic Analyzer, tester, and other valuable instruments. Send for new catalog. Check card today.



NTS Home Appliance Division

Boost your income, build a new career, start a business of your own. Learn the professional way to service ranges, washing machines, dryers, home air-conditioners, and other appliances. We'll supply everything you need, including the New Exclusive Circuit Trainer, 4 in 1 Appliance Tester and complete set of fine hand tools. Check Card.

**MAIL CARD NOW
FOR FREE
CATALOG &
SAMPLE LESSON**



High School at Home. Accredited programs. Everything included in one low tuition. Check special box on card for free catalog. **Classroom Training at Los Angeles.** Train in sunny California. NTS occupies a city block with over a million dollars in training facilities. Check box on card.

NATIONAL TECHNICAL SCHOOLS

WORLD-WIDE TRAINING SINCE 1905
4000 So. Figueroa St., Los Angeles, Calif. 90037

APPROVED FOR VETERANS

Accredited Member: National Association of
Trade & Technical Schools,
National Home Study Council.

Crimp-on connectors:

The quick way to make solderless joints

By SHELDON M. GALLAGER/Photos by Robert D. Borst

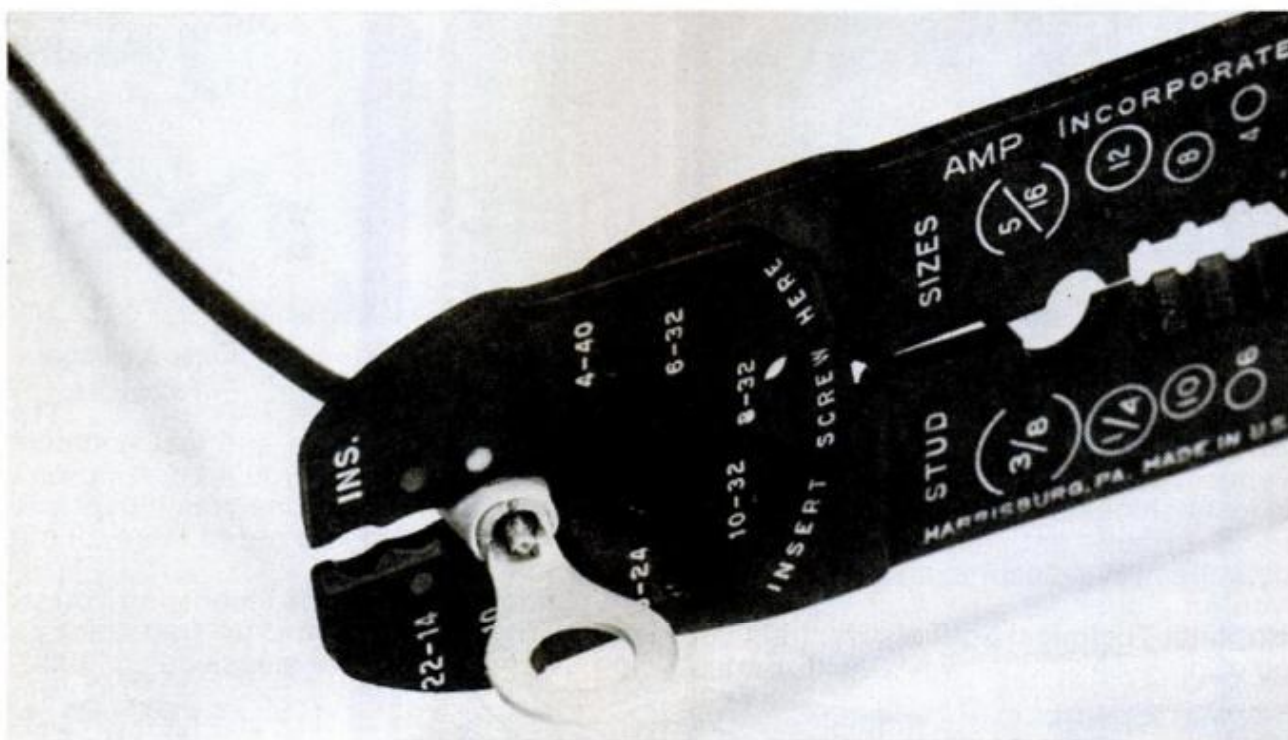

A QUICK SQUEEZE and you've permanently fastened an eye-type connector to a wire end without any

soldering. This Api tool has an extra-large crimping notch (near center) for auto-ignition cables

THE FASTEST WAY to join two wires or attach a connector is with a crimping tool. If you don't believe it, try one of these handy, inexpensive aids the next time you install a light fixture or hook up speaker leads to your hi-fi set. Widely used by professional installers and repairmen, crimp-on connectors are sometimes overlooked by do-it-yourselfers who figure there may be some special skill required. Actually, nothing could be simpler. You just slip the desired connector on the

bare end of a wire and squeeze the crimping tool around it. The tool's jaws pinch the connector onto the wire, producing a strong and durable locked-in joint.

Crimp-on connectors not only save time over soldering, but handle jobs where soldering could be difficult. When working with heavy wire, for instance, the metal draws heat away so fast it's hard to make a good soldered connection with a light-duty iron. Crimped connectors eliminate the problem. They come in a variety of types and sizes. Many have color-coded insulation sleeves for quick identification of wire gauge. Yellow is used for heavy 10 to 12-gauge wire, blue for medium 14 to 16-gauge wire and red for light 18 to 22-gauge wire. Some crimping tools have similarly color-coded crimping notches so you can tell at a glance which notch to use depending on the wire diameter you're working with.

Open-ended spade lugs are good for



TWO TYPICAL CRIMPING TOOLS are Vaco's at top left and Api's Super Champ at bottom. Both handle wire gauges from 10 to 22 and cut and strip ends

POPULAR MECHANICS

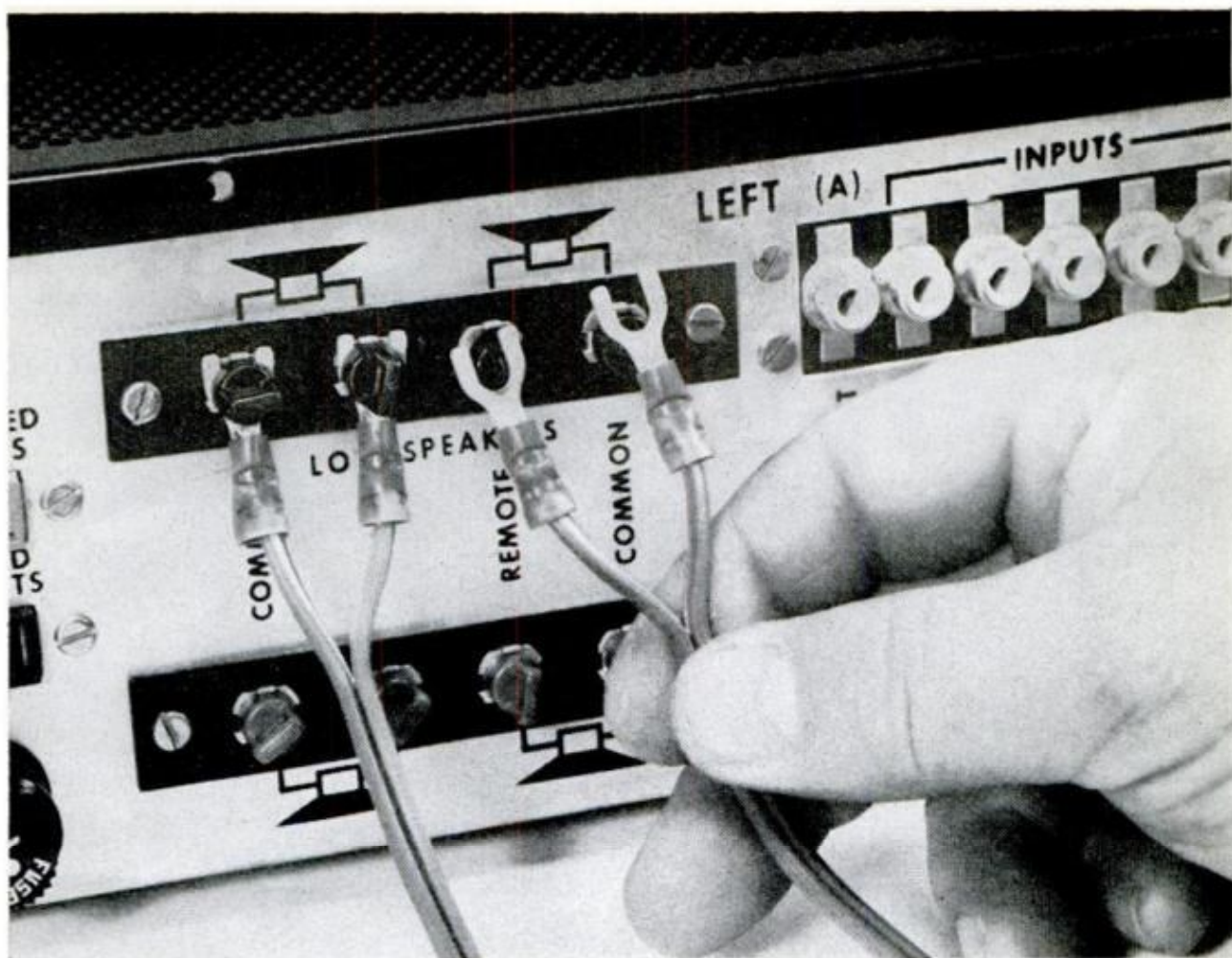

SPADE-TYPE CONNECTORS make fast work of attaching speaker or antenna leads to a hi-fi set. Note

double crimp marks—one to lock connector to wire, one to anchor connector's sleeve to the insulation

making quick connections to screw terminals since they can be slipped on or off with only a few turns of a screwdriver. Closed-ended eyes can't pull off accidentally, but take a little longer to install since the screw must be removed completely and inserted through the hole. Spades are best for connections that may be changed frequently, eyes for those likely to be more permanent. There are also several types of end-to-end con-

nectors for splicing wires together. One slip-together fitting is especially useful for wires that must be disconnected often.

Crimping tools all perform basically the same function, but vary slightly in design. Most types cut and strip wire ends in preparation for attaching connectors. In addition to crimping notches for standard wire sizes, some incorporate an extra-large notch for fastening connectors onto heavy auto-ignition cable. If you do a lot

3 types of crimp-on connectors for easy wire splicing



BELL-SHAPED SPLICER at left works like a wire nut except you crimp it on tightly instead of just screwing it on. All you do is twist wires together, slip



on connector and squeeze. At center, slip-together coupling can be quickly disconnected if the need arises. At right is a permanent end-to-end splice



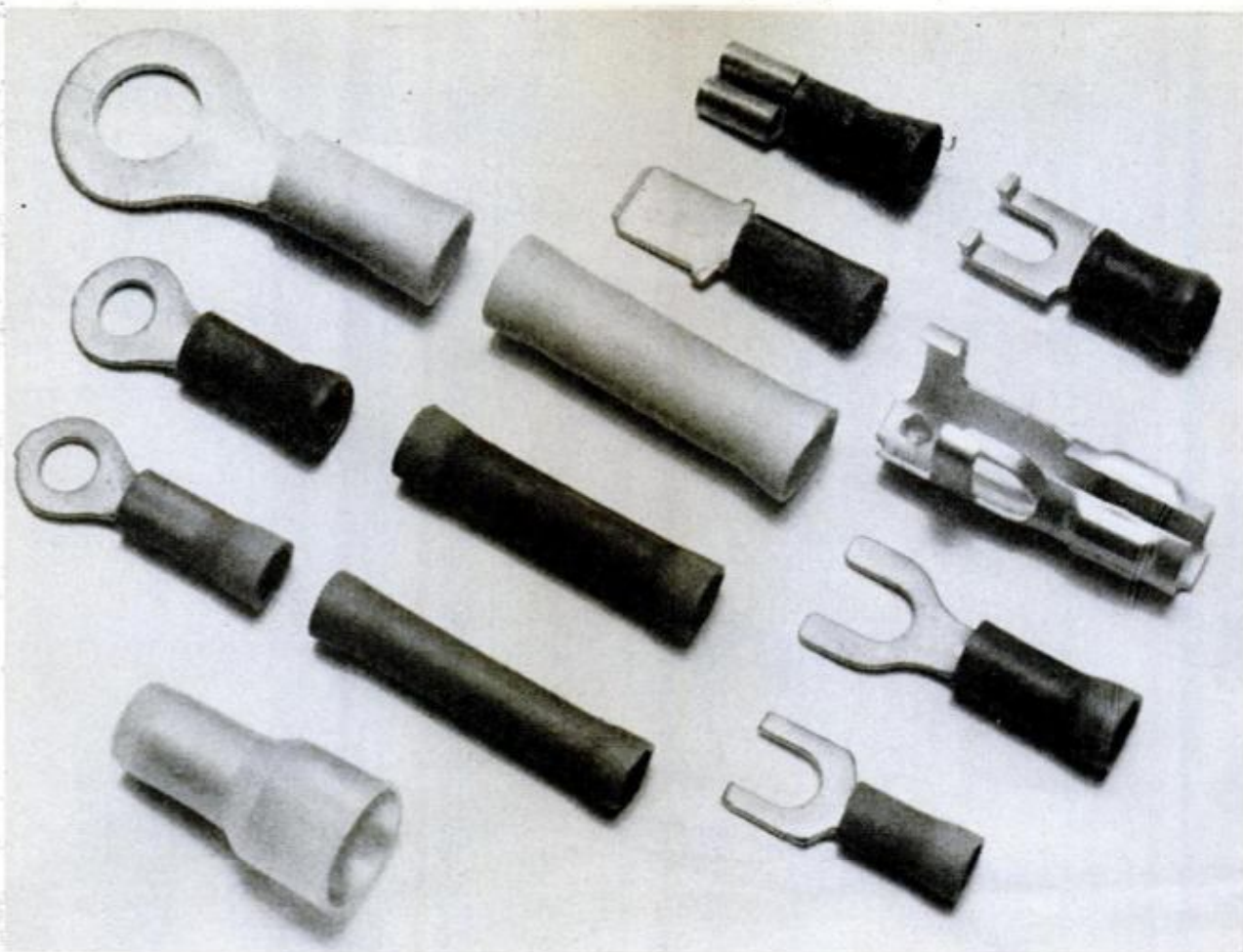

SOME OF MANY CONNECTORS AVAILABLE are shown above. Most common are round eyes, straight end-to-end couplers and slotted spade lugs. At top right is special bent-tip spade lug designed to hook under screwhead so it can't slip off. Below this is auto ignition-cable connector. At lower left: the bell-ended type for joining wires twisted together. At upper center: quick-disconnect slip-fit couplings

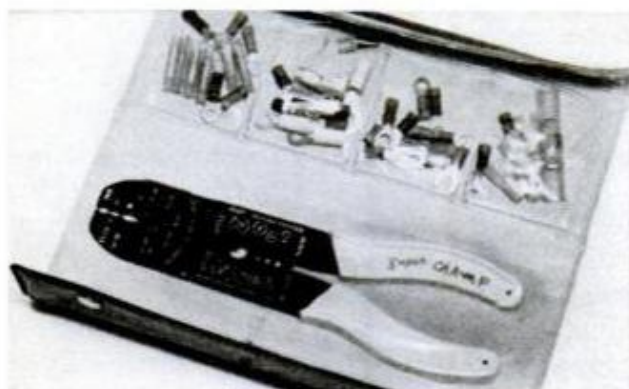

HANDY KITS include crimping tool, assorted connectors and instructions in plastic carrying case. This Api Super Champ model is by American Pamcor

of car work, this is a good feature to look for. The better models also have bolt-cutting blades that will shear a bolt to exact length—a welcome aid if you need a non-standard size. Special cutting holes handle bolts from 4/40 up to 10/24.



BOLT-SHEARING SLOTS are helpful when you don't have right length on hand and can't get to a store. Vaco and Api tools above both cut up to No. 10/24

Recommended crimping techniques vary slightly so follow the instructions that come with the particular tool you buy. Some call for a single crimp; others advise a double crimp—one around the bare wire end and a second around the insulating sleeve. Prices range from about \$5 for a tool alone to \$10 for kits that include a tool and assortment of connectors. Some typical makes are Api, sold by American Pamcor, Inc., Box 1776, Paoli, Pa. 19301; Vaco, sold by Vaco Products Co., 510 North Dearborn St., Chicago, Ill. 60610; and Waldom, sold by Lafayette Radio, 111 Jericho Turnpike, Syosset, N.Y. 11791. ★ ★ ★

Find the answers to 1001 workshop questions

quickly, easily with the POPULAR MECHANICS MASTER SHOP GUIDE

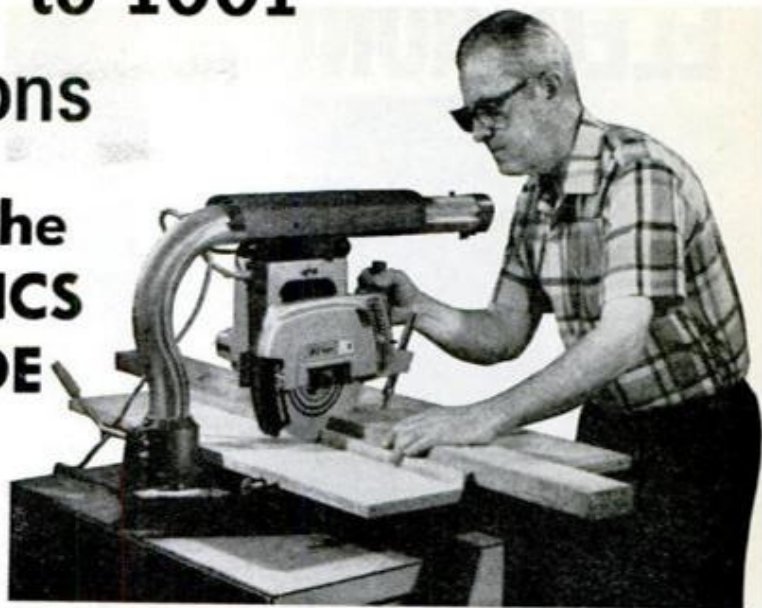

24 hangup boards, coated with wipe-clean plastic keep vital how-to-do-it information always at your finger tips.

Here in an easy to use, last-forever format are the answers to everything you'll ever need to know about: nails, screws, bolts, wall-fasteners, drills, abrasives, lumber, hardwoods, moldings, plywood, hardboard, gypsum, adhesives, plumbing, electrical work, floor and wall tile, glass. Facts on remodeling measurements, gutters, concrete, garden chemicals. Plus—all on one board—a ruler, protractor, 45-degree triangle, and compass for accurate circles! You'll reach for the MASTER SHOP GUIDE for every job you tackle!

What nail should you use? How many pounds will a 1/4-inch toggle bolt hold? How can you save money ordering lumber? What size quarter-rounds are available? How do you bleach close-grained hardwoods? What glue is best?

Repairs, too! Illustrations on plumbing, electrical, floor or wall tile, plastic laminates, glass, remodeling. All the basic dimensions you'll need!

By the editors of *Popular Mechanics*—order yours now—you'll use it the rest of your life!

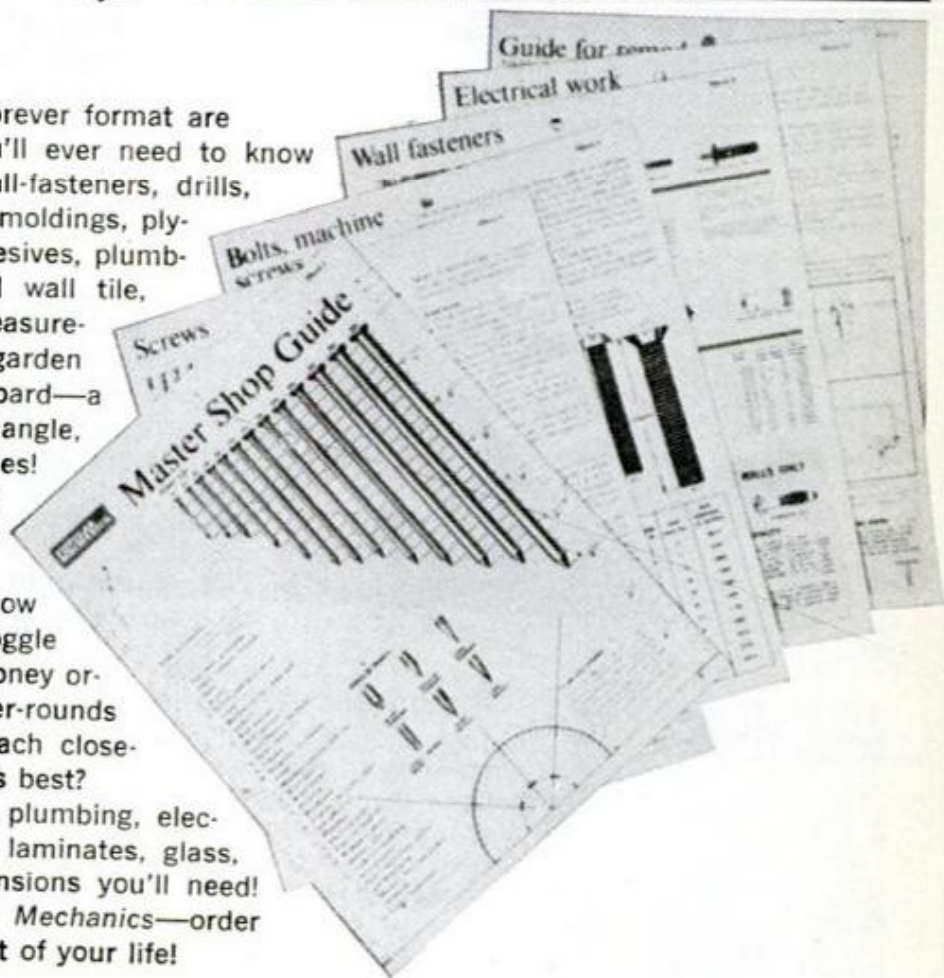

Popular Mechanics, Dept. SG-4,
224 W. 57th St.,
New York, N.Y. 10019

Rush me _____ sets of the
MASTER SHOP GUIDE.

I enclose check or money order
for \$3.95 for each set ordered.

APRIL 1972

NAME _____

ADDRESS _____

CITY _____ STATE _____ ZIP _____

NEW IN ELECTRONICS

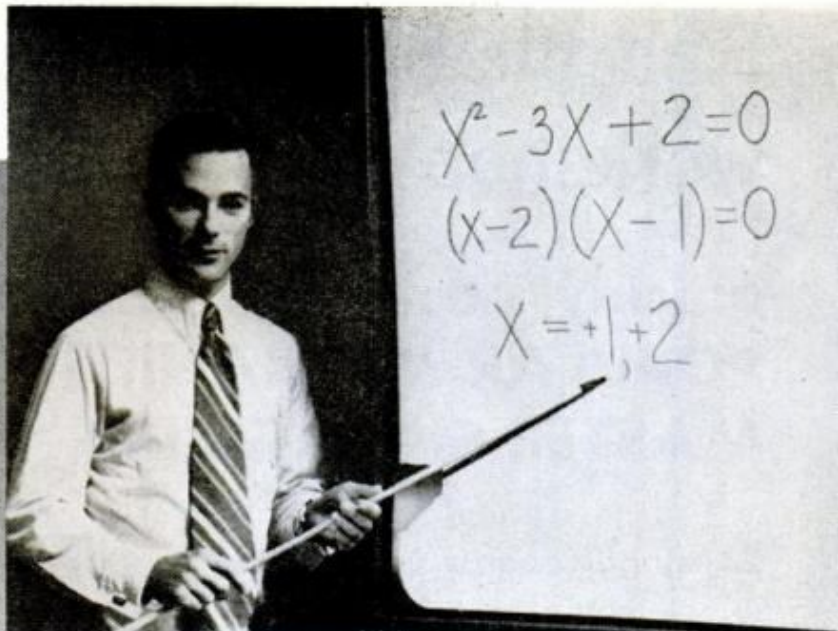
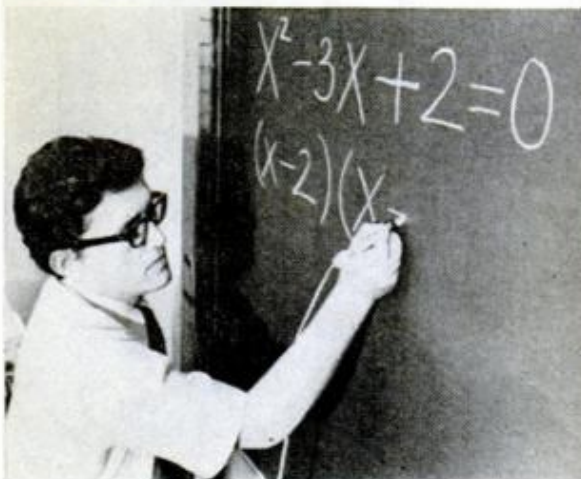

SCHOOL WAS NEVER LIKE THIS! Write on the blackboard at left, and it comes out on the "remote blackboard" at right—up to thousands of miles away. Developed by Bell Labs, the system could enable one teacher to in-

struct students in classrooms all over the country or scientists and businessmen to exchange data miles apart. Writing is translated into electrical pulses sent over phone lines, "redrawn" by moving beam of light on film.



WHO SAYS YOU CAN'T EDIT small cassette tapes? While the process takes care, it's possible to pull the tiny tape from the cassette and add or remove sections as desired. To help, two cutting and splicing blocks made especially for cassette tape have been introduced by the Audiotex division of GC Electronics, 400 South Wyman St., Rockford, Ill. 61101. An inexpensive manual-type cutting block (far left) sells for \$2.95. A semiautomatic model of the press-to-cut type (near left) is \$4.95. This version provides both a diagonal blade for making end-to-end cuts and two parallel blades for after-splice edge-trimming.



ELECTRONIC REPELLER at left is said to drive away mosquitos by emitting an inaudible signal the pests can't stand. Operating on batteries, it's effective from three to eight feet and can be clipped to a shirt pocket or worn around neck. Called Skeeter Skat, it's \$9.95. Sports Alliance, Inc., 12016 Wilshire Blvd., Los Angeles, Calif. 90025.

SLIM, STAND-UP MIKE at right, originally sold only with Ampex stereo cassette recorders, is now available as a separate accessory. Only 4½ inches tall, the low-impedance, omnidirectional dynamic design comes with removable "poker chip" base that permits use as hand-held or desktop mike. \$7.95, Ampex Corp., 2201 Estes Ave., Elk Grove Village, Ill. (More New in Electronics on page 184)

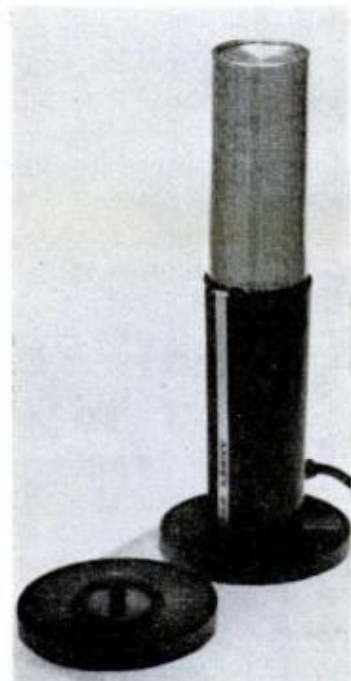

POPULAR MECHANICS

Announcing the Great Seal of the United States.

New Silicone Form-A-Gasket rubber base adhesive-sealant resists more chemicals and gases, resists higher and lower temperatures, resists higher pressures and bonds to more things than any of our previous products.

And *they* are the standards of the industry.

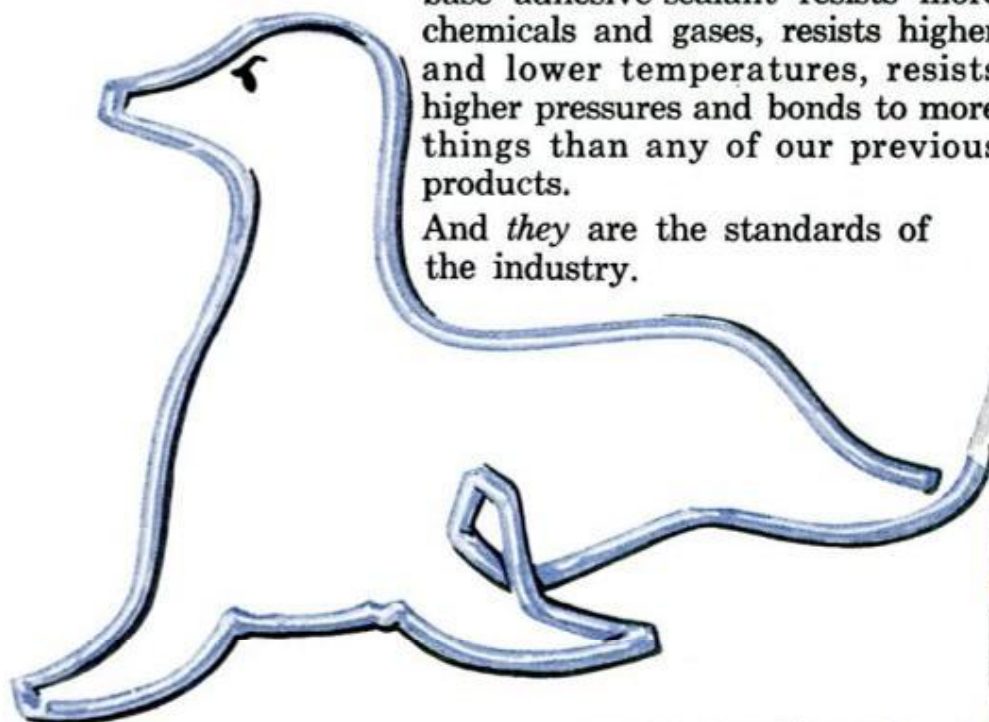

our name is our bond **Permatex**

Don't change your address without notifying us!

To insure uninterrupted service on your Popular Mechanics subscription, please notify us at least six weeks before you move.

1. Attach your address label from a recent issue in the space provided below . . . (If label not available, be sure to give us your old address, including Zip Code)
2. Print your name and new address below (be sure to include your Zip Code).

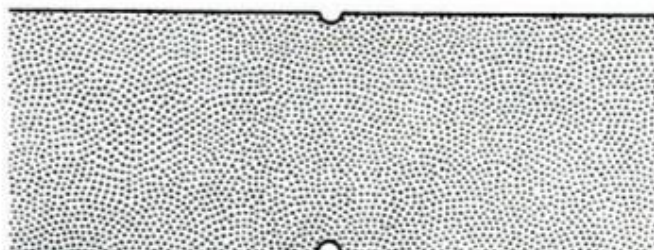

Mail entire notice to: Subscription Service Dept.
Box No. 646
New York, N.Y. 10019

Name _____ Please Print
New Address _____
City _____
State _____ Zip Code _____

APRIL 1972

NEVER WAX YOUR CAR AGAIN!!



THAT'S RIGHT! When you buy AstroShield, world's finest polish and glaze. Guaranteed in writing to last as long as you own your car. Not a wax, not a plastic, not an oil-base polish. AstroShield is a unique, exclusive blend of Space Age chemicals that lay down a virtually impenetrable coat of protective armor on your car's finish. It's almost as though you dipped your car in liquid glass. AstroShield's tough diamond bri glaze seals OUT rain, snow, salt spray, highway oils, bug stains, bird droppings . . . seals IN deep lustrous showroom color and beauty! Yes! AstroShield is easier to use than any wax or polish ever developed. Just spread on, let haze form, and wipe off. Stains, dirt, grime, oxidation vanish like magic! There's no pre-cleaning, no hard rubbing, no buffing—but still that AstroShield lasts and lasts and lasts. A single quart container of AstroShield must continue to give full satisfaction for as long as you own your car, or free replacement or money back. We dare make this precedent-breaking guarantee because we know that AstroShield is the world's finest auto polish and glaze!

Order today!! \$6.25 including postage and handling, from
ROSS ENTERPRISES, Box 121, Warminster, Pa. 18974 Dept. 24

Be an **Aircraft Mechanic** . . . in less than 17 months!

SPARTAN School of Aeronautics Dept. 24174, International Airport, Tulsa, OK 74151

Name _____ Age _____
Address _____
City _____ State _____ Zip _____

Check here if eligible for GI Bill benefits.

YOUR FUTURE in AVIATION **FREE BOOK**

Licensed by Board of Private Schools of Oklahoma. Approved for VETERANS

HOW TO GET RICH -- AT HOME!



There is no other business like mail order. Start on a shoestring in your spare time and make a fortune fast. It strikes like a bolt of lightning! Millions read your ad and suddenly you are swamped with cash orders from all over the country. **MORE MONEY** in 60 days than you could earn in a lifetime! Write for free book and complete details. **Mail Order Associates, Inc. Dept. 180, Montvale, N.J. 07645**



AUTOMATIC SHUTOFF can be added to any tape recorder with this accessory, enabling you to fall asleep or leave the machine without fear of forgetting to turn it off yourself. A motion-sensing device trips a switch the moment a tape stops, shutting off both recorder and other associated equipment such as an amplifier or phonograph. Servo-Matic is \$22.50 as kit, \$35 assembled. Cymax Audio Accessories, 162 Buffalo St., Hamburg, N. Y.

SLOPE-FRONT CLOCK RADIO (right) features AM/FM, digital time readout, automatic post-sleep shutoff, wake-to-music alarm, plus regular buzzer alarm. The RCA set is about \$50.

MORE REALISTIC RACING is the object of this slotless track for 1/32-scale Grand Prix model cars. The unique Heathkit system is based on dual rear-wheel motors that can be independently speeded up or slowed down to permit exciting turns, drifts, stunt maneuvers. Control signals are radioed to tiny receivers in cars. Basic kit includes 4x8-foot oval track, two cars, two controllers for \$129.95. Extra cars, controllers, track are available. Heath Co., Benton Harbor, Mich. 49022.



CONVERTIBLE CARTRIDGE PLAYER lets you listen to your eight-track stereo tapes either at home or in your car. For use on the road, the entire cartridge player unit slides out from the front (lower photo above) and can be slipped into a special under-dash bracket in your car for operation on 12-volt d.c. Model RE-8080 Westminster, made by Panasonic, also incorporates an AM/FM/FM stereo receiver. Price with two speakers is about \$220.

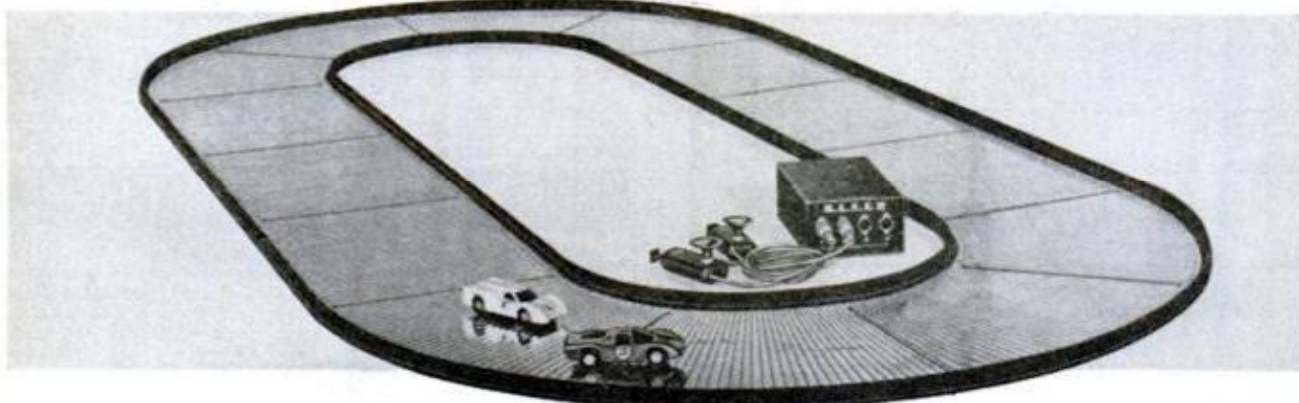

Are you with it?

In such relevant fields as ecology, medicine, communications, crime control, there are exciting new careers waiting for people with the right skills.

ELECTRONICS TRAINING can put you where the action is.

If you'd like to take an active part in solving some of the big problems facing the world — Cleveland Institute of Electronics training can be your key! Today's electronics specialists are working hand in hand with science and industry to perfect tools that will make a better life for all of us.

If you are trained in electronics, you can help develop new electronic equipment to save our lakes and rivers, to clean up the air we breathe. Help design the electronic devices that are revolutionizing medical science. Help build the electronic tools to fight crime. And in other growth fields such as aerospace, communications, agribusiness, banking — just about **everywhere** — the trained electronics technician has a growing role in "what's happening!"

We can help get you started toward a high-paying, rewarding career right now. The first big step is a CIE course in Electronics. Through our step-

by-step **AUTO-PROGRAMMED®** Lessons, you'll acquire a background in electronic principles at home in your spare time.

CIE removes the roadblocks, makes learning easier. And no matter what kind of job you want in Electronics, you ought to have your Government FCC License. It's accepted everywhere as *proof* of your education in Electronics. We back our FCC License courses with this famous Warranty: You *must* pass your FCC exam upon completion of your course or your tuition is refunded in full.

Whatever you're doing now, you owe it to yourself to look at the facts. Send us the bound-in, postpaid reply card, and we'll send you our two **FREE BOOKS** describing in detail the latest career opportunities in Electronics. If card has been detached, use the coupon below or write to: Cleveland Institute of Electronics, 1776 East 17th Street, Cleveland, Ohio 44114

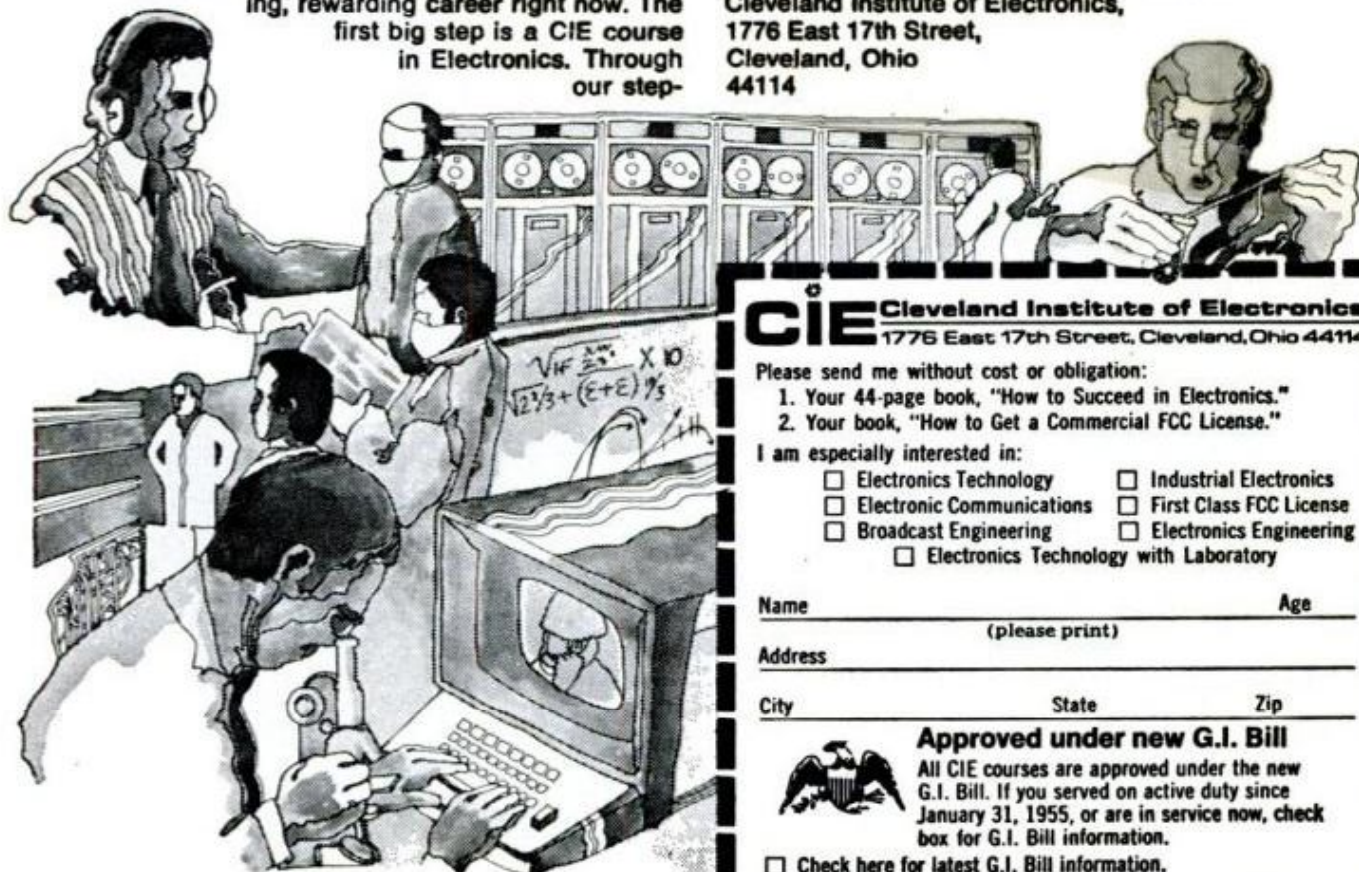

CIE Cleveland Institute of Electronics
1776 East 17th Street, Cleveland, Ohio 44114

Please send me without cost or obligation:

1. Your 44-page book, "How to Succeed in Electronics."
2. Your book, "How to Get a Commercial FCC License."

I am especially interested in:

- | | |
|---|--|
| <input type="checkbox"/> Electronics Technology | <input type="checkbox"/> Industrial Electronics |
| <input type="checkbox"/> Electronic Communications | <input type="checkbox"/> First Class FCC License |
| <input type="checkbox"/> Broadcast Engineering | <input type="checkbox"/> Electronics Engineering |
| <input type="checkbox"/> Electronics Technology with Laboratory | |

Name _____ Age _____

(please print)

Address _____

City _____ State _____ Zip _____



Approved under new G.I. Bill

All CIE courses are approved under the new G.I. Bill. If you served on active duty since January 31, 1955, or are in service now, check box for G.I. Bill information.

Check here for latest G.I. Bill information.

Accredited Member National Home Study Council

PM-65

Marlboro Red
or Longhorn 100's—
you get a lot to like.



**Come to where the flavor is.
Come to Marlboro Country.**

Warning: The Surgeon General Has
Determined That Cigarette Smoking
Is Dangerous to Your Health

Kings: 20 mg "tar," 1.3 mg. nicotine—
100's: 22 mg "tar," 1.5 mg. nicotine
av. per cigarette, FTC Report Aug '71

Зашита авторскими правами

Cartridge adapters: Now you can play cassettes and FM, too



JUST SLIP IT IN THE SLOT and this slim adapter pack converts a car-mounted 8-track cartridge player into a cassette player. Cassette's sound plays through amplifier in cartridge unit. Made by Toyo, it's \$29.95

By **SHELDON M. GALLAGER**

SO YOU'RE DRIVING ALONG listening to your eight-track tape player, only it isn't playing tape—it's playing FM radio! Manufacturers are finding clever ways to make the ubiquitous car stereo do more than just play eight-track cartridges. Slip in one type of adapter and you can enjoy your favorite cassette tapes on the road as well as at home. Another kind of slide-in adapter serves as a radio tuner, using the cartridge player's amplifier stages to provide AM or FM reception through your existing speaker system. Since stereo cartridge players already incorporate two-channel amplification, you automatically get FM stereo sound whenever such broadcasts are available.

The adapters are shaped like a standard eight-track cartridge and lock into the tape-loading slot in the same way. In most cassette converters, the tape transport mechanism is powered by the pinch roller that normally drives the cartridge tape, although at least one maker uses a separate motor to accomplish the same job. In radio adapters, you'll find differences, too. Most operate directly from the car's 12-volt electrical system, but a few require an additional 9-volt battery. The majority are designed to provide FM reception on the theory that most cars already have an AM radio as standard equip-



FM MULTIPLEX ADAPTER provides stereo reception in areas where multiplex broadcasts are being made. It has a handy roller-bar tuning knob, is sold by Audiotex for \$54. A similar AM/FM model is available for \$45



CASSETTE ADAPTER by Boman Astrosonix has built-in motor instead of being driven by cartridge player's pinch roller. Priced at about \$22, it has a wide, easy-to-feel-for pushbutton on/off switch across front



ment. For cars not so equipped, you can get a combination AM/FM adapter that provides AM reception along with FM, but usually not with FM stereo.

If you should choose the FM multiplex type, be sure there are multiplex stereo broadcasts in your area. Some such adapters offer only FM multiplex and not regular FM.

Prices range from as little as \$20 to \$50 or more. Some typical makers are Audiotech, GC Electronics, Rockford, Ill. 61101; Hitachi Sales Corp., 48-40 34th St., Long Island City, N. Y. 11101; Toyo Radio Co., 1842-B West 169th St., Gardena, Calif. 90247; Boman Astrosonix, 9426 Stewart and Gray Rd., Downey, Calif. 90241; and Lafayette Radio, 111 Jericho Turnpike, Syosset, N. Y. 11791.

How good are these little adapters? It depends on what you're looking for. At \$30 or \$40, you can't expect glorious living-room-quality stereo. PM tried several units and found them to be adequate for car use. If you take them for what they are and don't ask for miracles, they can be handy, fun to have, and will increase the usefulness of your car stereo at relatively little expense. ★★★

HOW DO YOU ATTACH an FM stereo adapter to your car's antenna without disrupting regular AM reception? Like most others of its kind, this Audiotech model comes with a special Y-type connector cable (top left) that permits both AM and FM radios to be fed from same antenna simultaneously. Male end of connector plugs into antenna socket in AM radio, while female end accepts plug from antenna cable

SLIGHTLY DIFFERENT in design is battery-powered FM stereo adapter below, sold by Lafayette Radio for \$29.95. It requires a separate 9-volt transistor battery housed in a removable clip in the side

SELF-POWERED Hitachi FM stereo adapter couples tuner's output to tape player's amplifier circuits electromagnetically without any direct connection. It works with any 12-volt player, sells for \$49.95



Your new Nova. It keeps on rolling along.

Aboard a sternwheeler, time drifts back 100 years. And you become part of the unchanging life on the river.

America. There's so much to see.

And you could hardly find a more dependable way to see it than in the Chevy Nova.

Actually, this year's Nova is pretty much unchanged from last year's Nova. The car independent auto mechanics said was "easiest to service" and had the "least mechanical problems."

(Compared to *all* cars, in a survey

conducted by *Motor Service* and *Service Station Management* magazines.)

With a car as dependable as Nova, you don't go redoing it every year.

Mechanical improvements, yes. Like better emission controls. We do what ought to be done, because we want your new Nova to be the best car you ever owned.

Take your family aboard the Nova for a trial run.

At your Chevy dealer's.



Chevrolet

*Highway safety begins at home.
Buckle up before you leave.*

1972 Nova Coupe with the famous Delta Queen riverboat.



Chevrolet. Building a better way to see the U.S.A.

SUPERFAST SPY PLANE

(Continued from page 83)

within a matter of minutes the direct line followed by the blackbird at its plus-20 miles altitude was plotted accurately by the men on the ground. It was a straight line for Lop Nor.

MiG fighters scrambled, but they quickly lost the faster blackbird, stalling out at their own maximum ceilings of 62,000 feet. The SR-71 streaked west eight miles higher. In 1966—as today—catching up to the speedy SR-71 was quite impossible.

At Lop Nor, meanwhile, the countdown continued even though defense forces in the area had been alerted. The test had reached the stage where it was too late to halt the complex technical procedures, spy plane or no. Communist Chinese security officials gathered at Lop Nor were also aware of the SAMOS (Satellite and Missile Observation System) satellite orbiting the world and overflying their country. They knew that the SR-71 would

MiG fighters scrambled, but they quickly lost the faster blackbird . . .

take low-level photos while the SAMOS, unmanned and inaccessible 300 miles in space, would photograph the results from the greater distance. And they must have reasoned that at least the world would know that the Peoples Republic of China had a nuclear weapon.

Their eyes shielded by special goggles, the pilot and RSO cruised high overhead awaiting the blast. Suddenly, a blinding light spread across the desert floor, followed by a ring of smoke that pushed skyward with increasing speed. Sensors aboard the SR-71 picked up spreading shock waves and transmitters began telemetering vital data. The telemetry was relayed thousands of miles to another American aircraft over the western Pacific. From there it was transmitted to Guam. Eight minutes after the blast the White House was advised that it had occurred. Five hours later the President received an extensive report saying that this had not been a thermonuclear explosion.

Much of the credit for this intelligence coup belongs to Clarence (Kelly) Johnson, Lockheed's top designer and the creator of the U-2. When that high-flying but slow plane fell victim to improved Russian surface-to-air missiles, Johnson returned to his drawing board. His new design, called the A-11 in the early '60s,

was a relatively light aircraft boasting high-speed performance at very high altitudes and good range. For years, the SR-71 has been the plane. Nothing can match it, not even the Soviet's latest MiG-23 "Foxbat."

Today, the supersecret spy plane regularly flies out of southern Thailand's Takhli airbase, a haven for SAC's B-52s. The blackbirds have flown over Laos and North Vietnam and, since last July, have been peeking across Communist Frontiers into China from 20 miles up.

Along with some extremely sophisticated ferret equipment used to eavesdrop and record what's happening in the communications network of any specific target area, the blackbirds carry digital data systems that process information picked up by the sensors studding the aircraft. One of the most important pieces of equipment on the SR-71 is the SLAR (side looking radar) system that can reach out 60 to 100 miles on each side of the high-flying aircraft and provide the capability to survey 60,000 square miles in an hour.

No wonder the Soviet Union and Communist China have tried to establish spies near the airfields used by the blackbirds.

In another effort to counter the flights of the SR-71, the Soviet Union has set up a "blackbird watch" in the Pacific, using sophisticated electronics aboard "fishing" trawlers. The spy ships, set up to monitor Soviet space shots and ferret out electronic intelligence, also have an early warning-system capability. Radar operators aboard the trawlers have locked in on and marked the high-altitude SR-71s.

The build-up of Soviet missiles in Egypt has been a constant target for the SR-71, which regularly flies over the Suez Canal area doing photographic and electronic surveillance of missile sites. Although the SAM-2 surface-to-air missiles have been unable to catch the SR-71 over North Vietnam because of limited speed and range, the faster SAM-3 models have given the blackbird crews an occasional scare over Egypt.

Until the SR-71 overflights of mainland China were curtailed, the blackbirds had photographed and monitored most of Peking's 11 nuclear tests. But for some months now there has been a gap in intelligence without the SR-71 overflights.

Mainland China has been building entirely new nuclear testing facilities along with missile launching sites in Tibet. SAMOS Satellites provide long-range pictures of the progress, but the Pentagon and the CIA are champing at the bit to resume blackbird overflights. Only the superspy planes can get the detailed information required by our military. ★★★

GIVING IT THE NEW OIL

(Continued from page 93)

the compression stroke, and the detonating engine will run until it melts holes in the top of the piston and literally burns up.

Or sometimes the engine will stop when wrong or excessive oil in the gas turns to carbon that bridges the sparkplug electrode gap. As you fool around, trying to start up again, the carbon may cool or the piece flake off and the engine will kick over, only to stall and run rough again along the way. This, too, can eventually destroy your motor. Changing fouled plugs used to be a routine part of keeping a two-cycle mill operating. To troubleshoot a rough engine meant a plug change first just a few years ago.

New types of plugs and ignition have helped cure part of this problem. Surface-gap sparkplugs with a flat face and central electrode that can spark out in any direc-

... wrong gas-oil mix can cause ring-sticking, scuffed piston skirts, excess smoke and deficient lubrication.

tion are much less likely to get carboned up than those with the conventional gap, and the extra-high-voltage CD ignition that makes them possible can punch through carbon deposits that would have choked an older engine.

But preignition and plug fouling, while serious, are only a few of the problems faulty fuel can generate. In addition to deposits of carbon in the combustion chamber, the wrong gas-oil mix can cause ring-sticking, scuffed piston skirts, excess smoke and deficient lubrication.

What's the answer? One is to use a fuel mixture that contains one of the new outboard (two-cycle) oils with an ashless detergent as part of its blend. Oils with ashless detergents help eliminate preignition and fouling by controlling the physical characteristics of the carbon deposits. Those that remain after ashless detergents are rather soft and the soot could be wiped off with a rag. The deposits left by some metallic detergent oils are hard and glossy and can glow in the combustion chamber causing preignition.

This is why some major outboard motor companies came out with their own outboard-motor oils. To help check for other brands of acceptable oil, look for Boating

Industry Assn. (BIA) certification on the cans.

"In the past there were some absolutely terrible two-cycle oils on the market," one outboard company engineer commented recently. "They were so inconsistent in quality that we were forced into marketing our own once our engines were perfected to a state where we could offer a two-year warranty on them." There was a time, he reported, when their service department's charts and maps of warranty problems would show clusters of complaints. When a lot of pins marked one area on their map, a factory service representative would investigate and find that just about all the owners with problems were using the same brand of local outboard oil. Switching owners to a proper fuel mix using approved oil of the ashless organic detergent type sometimes cut warranty claims to almost nothing.

For an oil to receive BIA certification, samples are submitted by the manufacturer to the BIA manager of engineering, Don Reed. He, in turn assigns the testing to one of several independent laboratories. As a final checkout after analysis, two identical outboards are run for extended periods—one with the new oil sample in the fuel mix and the other with an already-accepted control ingredient. Finally both motors are torn down and 10 areas are examined for wear, scuffing and carbon or varnish build-up. To receive final BIA acceptance for two-cycle watercooled (TC-W) certification, the oil samples must meet or exceed the performance of the control sample.

No oil can function as designed, however, unless it is properly mixed with the gasoline. This is particularly important now that many new engines can use a 50-to-1 gas to oil ratio. The manual that comes with the engine usually specifies putting one gallon of gas in a can, adding the oil, shaking well to disperse and mix the oil with the gas, and then adding the rest of the gas. Too many operators are not this careful after the first few gallons and end up by dumping in the oil to top off the tank, hoping it will mix. Two-cycle lawn mower and chain saws often get enough agitation while being operated to tolerate this treatment. But high-performance outboard and snowmobile motors can be damaged and a marina refueling man, particularly, may never have been properly instructed and will resent it when you give instructions about the way you want your gas and oil poured in.

Yet improper mix may stratify your gas and oil—you run at a 1-to-1 mixture for a few minutes and then at 400-to-1 for a

(Please turn to page 198)

10 Reasons why RCA Home Training is

your best investment for a rewarding career in electronics:



Transistor experiments
on programmed breadboard —
using oscilloscope.

1 LEADER IN ELECTRONICS TRAINING

RCA stands for dependability, integrity, and pioneering scientific advances. For over half a century, RCA Institutes Inc. has been a leader in technical training.

2 RCA AUTOTEXT TEACHES ELECTRONICS FASTER, EASIER

Beginner or refresher — AUTOTEXT, RCA Institutes' own Home Training method helps you learn electronics faster, easier, almost automatically.

3 WELL PAID JOBS ARE OPEN TO MEN SKILLED IN ELECTRONICS

There are challenging new fields that need electronics technicians... new careers in computers, automation, television, space electronics where the work is interesting and earnings can be greater.

4 WIDE CHOICE OF CAREER PROGRAMS

Select from a wide choice of career programs, each of which starts with the amazing "AUTOTEXT method of programmed instruction. Check over the attached card.

5 SPECIALIZED ADVANCED TRAINING

For those working in electronics or with previous training, RCA Institutes offers advanced courses. No wasted time on material you already know.

6 PERSONAL SUPERVISION THROUGHOUT

All during your program of home study, your training is supervised by RCA Institutes experts who become personally involved in your efforts and help you over any "rough spots" that may develop.

7 HANDS-ON TRAINING

To give practical application to your studies, a variety of kits are included in your program. You get over 250 projects and experiments and as many as 22 kits in some programs. When completed, they're yours to keep and use on the job.

8 FCC LICENSE TRAINING— MONEY BACK AGREEMENT

Take RCA's Communications Career Program — or enter with advanced standing and prepare immediately for your 1st, 2nd, or 3rd class FCC Radio-

telephone License exams. RCA Institutes' money-back agreement assures you of your money back if you fail to pass the FCC exams taken within 6 months after completing the course.

9 CONVENIENT PAYMENT PLANS

You get a selection of low-cost tuition plans. And, we are an eligible institution under the Federally Insured Student Loan Program.

10 RCA INSTITUTES IS FULLY ACCREDITED

RCA Institutes is an accredited member of the National Home Study Council. Licensed by N.Y. State—courses of study and instructional facilities are approved by the State Education Department.

Canadians: These same RCA courses are available to you in Canada. No postage. No customs. No delay. Your inquiry will be referred to our school in Canada.

VETERANS: TRAIN
UNDER NEW GI BILL

CLASSROOM TRAINING ALSO AVAIL-
ABLE. FREE CATALOG ON REQUEST.

ACCREDITED MEMBER National Home Study Council

Construction of Oscilloscope.

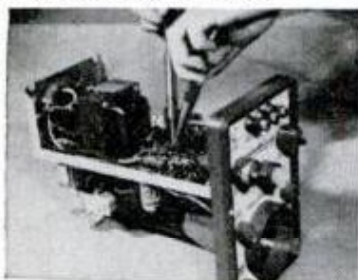

Construction of Multimeter.



RCA

APRIL 1972

If Reply Card Is Detached—Send This Coupon Today

RCA INSTITUTES, INC.

Home Study Dept. 699-204-0
320 West 31st Street
New York, N.Y. 10001

Name

Address

City.

State

Zip

Check here if interested in Classroom Training

BUILD YOUR OWN CAMPER

SAVE UP TO 50%



Complete, easy to follow plans, instructions, materials list.

- Camper Plans\$3.95
- Travel Trailer\$3.95
- Pickup Cover\$2.00
- CONVERSION PLANS:
- Economline Type Van..\$2.95
- Passenger Bus or Delivery Van.....\$2.95
- Satisfaction Guaranteed

EQUIPMENT CATALOG \$1.95

Refundable on First Order. Send Dime for Details. Save 50% on Camper Kit. All items from catalog to build \$1,795. Camper, 8', 10', 10'6" or Chassis Unit.



VIKING CAMPER SUPPLY, INC.
99-BP Glenwood Ave.,
Minneapolis, Minn. 55403
Please send _____ for
which I enclose \$_____
NAME _____
ADDRESS _____
CITY _____
STATE _____ ZIP _____

INVENTORS

INVENTIONS—NEW PRODUCTS—IDEAS
DEVELOPED & PREPARED

For Commercial appeal & sales

DESIGN—MARKETING—PATENT RESEARCH—DRAWINGS

Second Decade of Reliable Service To

INVENTORS—MANUFACTURERS—ATTORNEYS

Director: United States Patent Office Former Examiner

United States Dept. of Army Former Patent Adviser

Member: United States Council Int'l Chamber of Commerce

FREE CONSULTATION

THE RAYMOND LEE ORGANIZATION

230-Z Park Ave., New York 10017 (212) MU 6-8500

SEND FREE "Invention Record" Form &
"Product Marketing" Brochure

Name.....

Address.....

City.....State.....

Zip.....

IT'S EASY TO WELD

With the New HEAVY-DUTY

4-WAY WELDER

\$18.95

FULL PRICE!
Lifetime
Guarantee

OVER
200,000
SOLD



You can weld, braze, solder, cut almost anything made of metal, including aluminum. Operates on ordinary home 110V outlet, 30A fuse. Repair cars, boats, farm equipment, home repairs, furniture, bicycles... just about anything. Adjustable carbon arc torch easily regulates heat up to 11,000° for any type of welding without changing heats or cables. **HUNDREDS OF THOUSANDS SOLD IN 35 YEARS, PROOF YOU CAN'T BUY A BETTER WELDER FOR LESS.** Lifetime Guarantee: If ever inoperative, return prepaid, we will repair and reship without charge.

READY TO USE—NO MORE TO BUY: You get welder in rugged metal cabinet, heavy duty cables and ground clamp, full face helmet, adjustable torch and rod holder and simplified welding manual. **FREE**, two big bonus packs of instant arc welding rods, brazing rods, 1/4" carbons, solder & flux.

SPECIAL FREE TRIAL OFFER: If not completely satisfied, return in 10 days and we'll refund purchase price. Send only \$2.00, then pay \$16.95 plus C.O.D. and delivery charges, or send \$18.95 for prepaid shipment in Continental U.S.A. Illinois residents add 5% sales tax.

FOUR-WAY WELDER CO., 1810 Federal St., Dept. PM42, Chicago, Ill. 60616

GIVING IT THE NEW OIL

(Continued from page 194)

while. Predilutants now added to all approved two-cycle oils help speed the mix during cold weather, particularly for snowmobiles. But if you continue to re-fuel by dumping in a full container of oil and then topping off the tank when there is already a gallon or so of fuel in it, as many people do, before long you have too rich a mixture and a cloud of smoke trailing behind your rig.

Sticking piston rings that result from an over-rich mixture can cause reduced heat transfer, reduction in blow-by control, poor idling and a buildup of varnish and carbon on the piston skirts and the chance of increased piston scuffing. Too lean a mix may cause marginal lubrication and severe wear of the cylinder wall in the port bridge area, piston scuffing and bearing failure. Internal corrosion of the outboard is also more likely to occur, particularly around salt water.

The only possible disadvantage of using approved two-cycle oil is its extra cost—perhaps \$5 a season. That seems like a small price to pay to protect your expensive engine. ★★★

POWER ROOF VENTILATOR

(Continued from page 141)

is installed. It should be mounted close to the center of the roof and near the roof ridgeline. Keep in mind that for a neat-looking installation, the unit should be visible only from one side of the roof. This will require the unit to be moved down from the ridge line until it can't be seen from the street. Just how much it must be moved will depend on the slope or pitch of the roof.

When you have the hole cut in the roof, the ventilator is installed in the following manner: With the unit parallel to the ridgeline of the roof, slide the plastic flange up under the shingles, starting at the center of the hole. Position the unit squarely with the 27 3/8-in. outline you marked on the roof and align it with the shingle lines. Continue to slide the flange under the shingles until the round fan housing can be centered and placed in the hole. Now nail the exposed portion of the flange to the roof using galvanized roofing nails. Finally, check for water leakage with a garden hose. The unit should not leak but if it does, use butyl rubber caulking along the edges of the flange. Screw the control box to an attic rafter and follow the diagram provided to connect the 110-v. line. ★★★

COOLING SYSTEM CHECKS

(Continued from page 165)

ample, the engine-coolant temperature-sensing switch closes at 248° F. plus or minus 2°, which will switch on the warning light. If the radiator pressure cap is left loose and the strength of the coolant is at minus 20° F., the coolant will begin to boil at 224° F., which is 24° below the temperature at which the warning light will come on!

● Pure water is not recommended as a coolant. Use a good quality ethylene glycol antifreeze, because it contains rust inhibitors and water pump lubricant.

● Problems other than cooling-system trouble can cause overheating—primarily, incorrect ignition timing and dragging brakes.

● Air or combustion gas entrained in the cooling system can raise the level in the radiator and cause loss of coolant through the overflow tube. Air can be drawn into the cooling system through a leak at the water-pump seal. Gas can be forced into the cooling system through a leak at the cylinder-head gasket.

A quick check you can make to see if this is happening involves starting with a cold engine and making sure that the coolant is to the proper level. Get a plain ordinary *nonpressure* radiator cap and make sure it's on tight. Disconnect the overflow tube, which you'll find attached to the side of the radiator filler neck and extending downward along the side of the radiator.

Run the engine at a constant high idle speed until it reaches operating temperature. Without changing engine speed, place the free end of the tube into a jar of water. Make sure the tube is not bent or kinked.

If bubbles appear in the water, air is being sucked into the cooling system or exhaust gas is leaking into the system past the cylinder-head gasket.

● When you drain a cooling system, make sure that you remove all of the old coolant. Drain the block as well as the radiator.

● If you added Stop Leak to the cooling system, the presence of oil in the coolant shouldn't be cause for concern. Stop leak has an oil-soluble base. Naturally, engine or transmission oil found in the coolant is another matter. In the case of engine oil, that trouble might be a blown head gasket. In the case of transmission oil, the problem is probably a ruptured transmission oil cooler which, in a majority of cars, is actually an integral part of the radiator.

★★★

GOVT. SURPLUS AND OTHER BARGAINS **SAVE UP TO 90%**



HYDRAULIC CYLINDER 32½" stroke, 2" bore, 1" shaft. Operating pressure 3000 P.S.I. Top and bottom of cylinder contain ¼" ID mounting hole with self-aligning bearings. Closed 43". Inlet and outlet ports 9/16" - 18 (#6). Will produce 9000 lbs. thrust. GOVT. COST \$269.60. Govt. overhaul cond. Shpg. wt. 16 lbs. (Stk. #2932) **\$32.50**.



DUAL DRIVE GEAR MOTOR

Heavy duty. Rated 5 HP @ 26 V.D.C. @ 270 RPM under load. Turns 125 RPM @ 12 V.D.C. Top shaft turns @ twice straight shaft speed. Shaft dia. 5/8". Gear reduction 33 to 1. Reversible. 18" L x 5" dia. Exc. for winches, capstans or small elect. car motors. Shpg. wt. 39 lbs. GOVT COST \$580 ea. Like new **\$32.50** (Stk. #2391)



ELECTRIC PUMP WITH CONTROL SWITCH

For boats, campers & trailers. Output 300 GPH. Can be used in fuel or water. ½" pipe bronze inlet. 12 or 24 V.D.C. Explosion-proof motor. Comes with wiring diagram. Approx. GOVT COST \$150. Shpg. wt. 9 lbs. **\$14.50** (Stk. #1164)



NEW! BIG 1972 CATALOG

Send 35c (\$1 for airmail). Catalog contains 1000's of bargains in hydraulics, electrical, marine, automotive items, etc. 90 day guarantee. ORDER FROM AD. Prices FOB Culver City. 50% dep. for COD. Cal. res. add 5% sales tax. Incl. zip. Satisfying customers world-wide since 1945

AIRBORNE SALES CO.

Dept. PM472

8501 Steller Dr. • P.O. Box 2727 • Culver City, Ca. 90230

WHITE'S ELECTRONICS INC.

THE WORLDS LARGEST LINE OF MINERAL & METAL DETECTORS



Goldmaster 66 TR

\$269.50

PRICES START AT 69.50 AND UP.

BUDGET TERMS - BANK AMERICARD - MASTER CHARGE

WHITE'S ELECTRONICS

INC., U.S.A. Room 512 LTD., CANADA Room 512
1711 Pleasant Valley Road 33784 Hazel Street
Sweet Home, Oregon 97385 Abbotsford, B.C. Canada

THERE ARE NO FINER AT ANY PRICE.



LEARN MEAT CUTTING

Train quickly in 8 short weeks at Toledo for a bright future with security in vital meat business. Big pay, full-time jobs — HAVE A PROFITABLE MARKET OF YOUR OWN! Time payment plan available. Diploma given. Job help. Thousands of successful graduates. OUR 49th YEAR! Send now for big new illustrated FREE catalog. No obligation. G.I. Approved. NATIONAL SCHOOL OF MEAT CUTTING #0197T Dept. 50-H, Toledo, Ohio 43604

MOLDS

for making Ornamental Concrete Items...



Book about Aluminum Molds with prices and production trade secrets direct from world's largest mold manufacturer.

SEND **\$2.00**

CONCRETE MACHINERY COMPANY,

INC.

P. O. BOX 99 • HICKORY 2, N. C. 28601

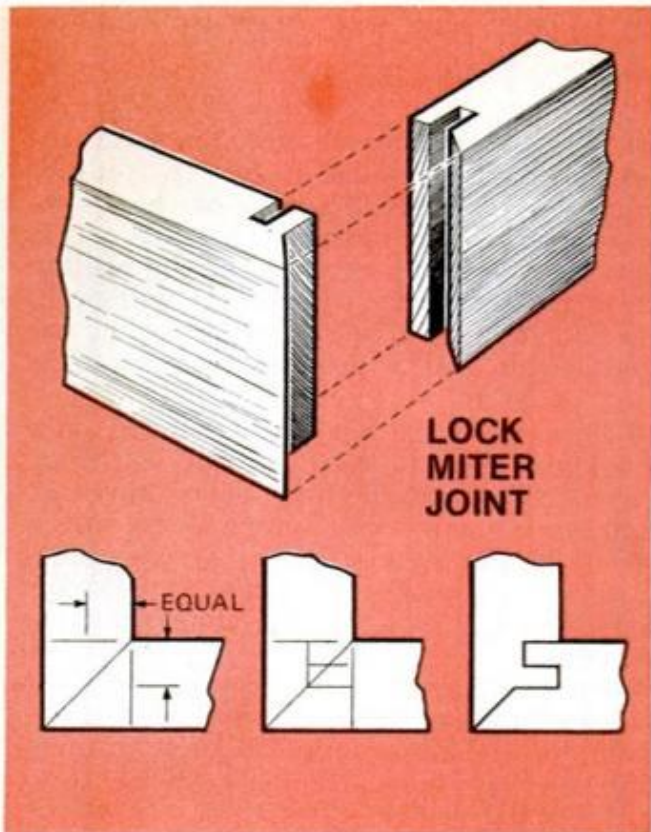
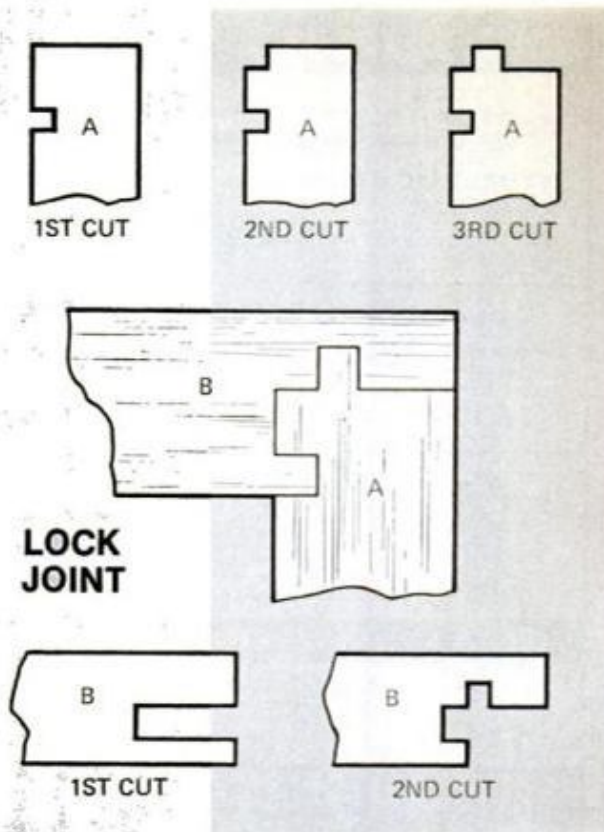

WOOD JOINERY

(Continued from page 159)

made after the shoulder cuts, and general practice in making a simple mortise-and-tenon joint is to cut the tenon first, then the mortise. While the tenon can be formed on the table saw, the mortise has to be cut with a mortising chisel on the drill press. An exception would be an open-end mortise.

Another table-saw jig for cutting perfect box, or finger, joints is detailed at the top of page 159. Similar to the dovetail joint, the box joint makes a neat-looking corner joint and is exceptionally

strong since it presents lots of gluing surfaces. To make the jig, you start with a $\frac{3}{4}$ -in. wood auxiliary fence, which is screw-fastened to the miter gauge. Then the regular saw blade is removed and replaced with a dado blade. In most cases, the width of the cut is equal to or slightly less than the thickness of the stock, and likewise when determining the depth. Make initial cut (A) in the wood fence, then remove it from the miter gauge.

Mark the position of a second cut (B) so it is spaced the same width as cut A and at the same time mark lines C and D, centering them as shown. Nail a

(Please turn to page 202)

NEXT MONTH IN SHOP AND CRAFTS

VACATION HOME ROUNDUP: YEAR-ROUND CASUAL LIVING. Today's second-home owners want more than just a shack in the woods to escape to. The hustle and bustle of urban living makes it more desirable than ever to have a home in the country or by the sea that you can use for long weekends, sea or ski vacationing or year round. Four elegant homes featured in PM's annual vacation-home roundup include a contemporary by the sea, easy-to-build A-frame, a chalet-type and a modern home that leave nothing to be desired.

THINGS TO MAKE FOR YOUR HOME AND YARD. Those who like to spend time in their workshops during summer will find complete plans for making a battery-operated, wood-pecker door knocker, a back-yard jungle gym for the youngsters, a telephone message center that holds directories and a child's bed with storage below.

NEW STICK-DOWN SHAG LETS ANYONE LAY "SEAMLESS" CARPETING. Do-it-yourselfers who have had the fun of laying carpet tile now can buy stick-down shag carpeting by the roll, 6 and 12 ft. wide. Double-back tape simplifies putting it down and taking it up. Shag makes it easy to produce invisible seams.

Before you put wood outside...

UNTREATED WOOD SIDING

put Woodlife® into it.

WOODLIFE TREATED

Actual side-by-side test, exposed 11 years.

Water-repellent Woodlife penetrates deep, protects from within. Prevents cracking, splitting, rot and decay. Extends paint life for years—dries clear for natural wood beauty. For siding, fences, decking, patio furniture, shutters—all exterior wood. Ask your paint, hardware, or lumber dealer—he knows!

Weldwood

PACKAGED PRODUCTS

U.S. Plywood—Champion Papers Inc., Kalamazoo, Michigan 49003

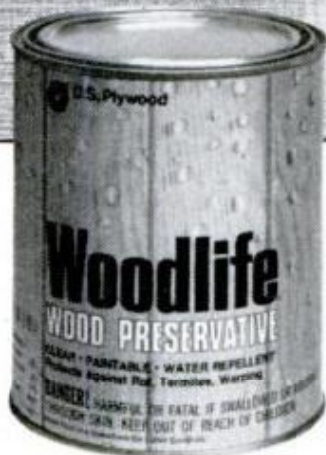

NEW 1972 ARC
WELDER
19⁹⁵ 5
WELDING HEATS



Plugs in any ordinary 110 volt outlet. Buy direct from the factory and save \$\$
Complete — nothing else to buy. Includes *heavy duty cables *electrode holders *ground clamp *extra welding rods *full face mask. Heavy duty — 5 heats for welding, soldering, cutting and heating. Easy to operate; step-by-step instructions included. Ideal for the home handyman or craftsman — pays for itself repairing cars, trailers, lawn equipment, boats, etc.

10-DAY MONEY BACK GUARANTEE. Send only \$2 and pay postman \$17.95 plus postage when delivered, or send \$19.95 for prompt postpaid shipment. Return within 10 days for refund if not completely satisfied. Orders filled promptly — check or money order. **LIFETIME GUARANTEE.**

MINI 5 ARC WELDER Department A, 2635 Main Street, Houston, Texas 77002



PLANER • MOLDER • SAW

30-DAY FREE Trial!

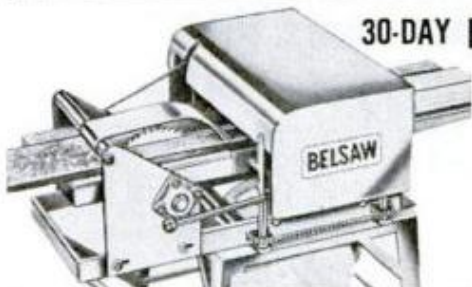

Now you can use this ONE power-feed shop to turn rough lumber into moldings, trim, flooring, furniture...ALL popular patterns. RIP...PLANE...MOLD—separately or all at once with a single motor. Free 30-Day Trial. Low Cost—only \$35 down.

Send Postcard Today — No Salesman Will Call.
BELSAW POWER TOOLS, 903A Field Bldg., Kansas City, Mo. 64111

FINISH WHAT NATURE STARTED



Nature provides us with beautiful rocks. Cutting and finishing them into gems is fascinating and exciting. LAPIDARY TECHNIQUES, a 48-page book, beautifully illustrated in color, describes collecting, cutting, polishing of stones. The new Star Diamond catalog describes the most complete line of lapidary and gem-cutting equipment available. These two books can get you into the fun of collecting rocks, and gem making for fun and profit. They're yours for just \$1.00.

Star Diamond Industries, Inc. a Craftool Company PM-4-72
1421 West 240th Street, Harbor City, California 90710

Enclosed is \$1.00 () check or () money order () cash for my copies of LAPIDARY TECHNIQUES (\$2 retail) and the 1972 Star Diamond Catalog. (\$1 retail). I understand that my \$1 will be refunded with my first order by my Star Diamond dealer or by Star Diamond.

Name _____

Address _____

City _____ State _____ Zip _____



**MAKE
\$20 to \$30
A WEEK
EXTRA
MONEY**

Here's a practical way to increase your income and build security for your family. Earn extra money every week sharpening saws with a Foley Automatic Saw Filer. You can actually build your own business with it—without special training or previous experience.

TURN YOUR SPARE TIME INTO CASH. Make from \$3 to \$6 an hour evenings, week-ends. Start in your basement or garage. No canvassing. "I advertised in our local paper and got in 83 saws"—says M. L. Thompson. Every saw you sharpen with the Foley Filer brings you more customers. Hundreds are making extra money this sure, fast, easy way. You can too.

**FREE
BOOK
SHOWS
YOU HOW
TO START**

"Money Making Facts" explains how you can get business from home owners, farmers, carpenters, schools, factories, etc., how to build your business and expand—every step of the easy way. Don't wait. Mail coupon now for this exciting book and easy pay plan. No salesman will call.

MAIL COUPON FOR FREE BOOK

FOLEY MANUFACTURING CO.
443-2 Foley Bldg. Minneapolis, Minn. 55418

Rush free book, "MONEY MAKING FACTS", and details on easy pay plan.

Name _____
Address _____
City _____ State _____



Grass Cats from Arctic

An 8-hp, 36-inch Grass Cat riding tractor (top photo) is the top-of-the-line model in Arctic Enterprises' 1972 lineup. Other lawn equipment (bottom) includes riding mowers and walk-behinds. Riders and tractors offer 32 and 36-inch cutting decks. The deluxe tractor has electric start and lights.

THE SCOTT ENGRAVER Your spare time money-maker

Scott's SM100 turns 10¢ worth of plastic laminate into a product you can sell for 75¢ to \$1.00. Every business is a prospect. Make name plates, signs, plaques and more . . . in just minutes, using just one hand. A complete, ready-to-operate engraving shop to help you make big money in your spare time!

To find out more, send for free catalog, today.
Dept. PM-72

SCOTT MACHINE DEVELOPMENT CORP.
P. O. Box 217
Walton, New York 13856

Scott fills every engraving need—
from stock to fonts.



WOOD JOINERY

(Continued from page 200)

little square of wood 2 in. long in cut A to provide a guide pin and finally attach the wood fence to the miter gauge and make cut B. You are now ready to make the box joint.

Mating pieces of stock are set against the fence, the edge of one piece being set even with line D and the edge of the second piece even with line C. Now pass the offset work across the saw. To make the second cut, as well as the third and succeeding cuts, shift the work so that the cut just made sits over the guide pin and again pass the work across the saw. Repeat the operation along the entire width of the stock. ★★

YOURS ABSOLUTELY FREE

This big, practical book of plans, projects, "how-to" ideas from the all-new, profusely illustrated POPULAR MECHANICS DO-IT-YOURSELF ENCYCLOPEDIA

Let these shopwork experts show you techniques, procedures and short-cuts you need for really satisfying results!



BARBECUES



PLUMBING



SAILBOATS



AUTO REPAIRS

As a do-it-yourselfer, you take genuine pride in what you build, improve and repair with your own hands. Now—with the help of this remarkable FREE BOOK, you'll be able to sharpen your skills...do jobs better, faster, easier—and save a pocketful of cash at the same time.

The moment you open your FREE volume, you'll start reorganizing your workshop...get going on a whole new range of exciting projects for family, house, garden, car, boat, vacation.

Need more room in your home? See how easy it is to turn an unfinished attic or basement into the most striking room in the house. Practical, step-by-step plans help you do a perfect job and pocket savings of \$300 to \$1,500.

Want professional tips on sanding? Discover how to bring out the best finish in woods and metals with both hand and power sanding. 19 hands-at-work photos show clearly how to handle open-grained woods, pad sanders, flexible rubber sanders, disc sanders...answer every question.

Build an auxiliary table to enlarge your band saw. Your 12- or 14-inch band saw will cut anything you can get under the blade guide. The problem is to support and guide a large workpiece while it is being cut. Here's a 3 x 4 foot plywood table that gives any small band saw big-machine capacity and flexibility. Plans help you do it inexpensively.

Learn arc welding basics quickly. No need to shy away from arc welding. Practical tips help you lay a good weld in 6 hours easy practice.

Children love the Free-Flight Parasol Plane. Build this model for your children and you'll get a big hand at any flying competition. It may look like a flying dinner plate, but this way-out model is a rugged performer.

Brazing fixture for band saw blades. You can save half on blade costs if you buy bulk 100-foot rolls and make

your own. But you have to know these steps to silver-solder the joints.

These are just six of more than 6,000 exciting projects, plans and ideas you'll find in the new POPULAR MECHANICS DO-IT-YOURSELF ENCYCLOPEDIA...practical pointers to improve your skills in carpentry metalwork, plumbing, masonry, electrical work, painting and decorating. Best of all, every volume in the set is a practical manual. Experts lead you step-by-step through every project you select. Without question, here is the most helpful, reliable, "how-to-do-it" guide you've ever seen—and Volume 1—a \$3.49 value—is yours ENTIRELY FREE.

You risk nothing on this free book offer!

Mail attached certificate at right, and we'll rush you the first of the 16 volumes of POPULAR MECHANICS DO-IT-YOURSELF ENCYCLOPEDIA as an outright gift. The book is yours to keep. You are not obligated to buy any other book in the set. We are giving you the first volume so you may see for yourself, at our expense, how easily you can do a better job on repairs, improvements, new projects—and save hundreds of dollars as well.

We believe that if you browse through the first volume—select a plan or project—use it at your workbench—try some of its money-saving short cuts—you will be anxious to receive the others. Therefore, we make this unusual offer. You may, if you wish, purchase the remaining volumes, at the low subscriber's price of only \$3.49 per volume.

Each new volume will come to you for 14 days' free examination entirely on approval. If you do not wish to keep it, return it and owe nothing. You may buy one, two, the whole set, or none at all.

Detach and mail the coupon at the right today to be sure of getting your free copy.

POPULAR MECHANICS do-it-yourself ENCYCLOPEDIA

16 outstanding volumes
3,136 how-to-do-it pages
Over 10,000 "show-me-how" illustrations
Instant index to more than 6,000 ideas
Stain and scuff resistant, washable bindings
Big, easy-to-leaf-through pages
8 1/4" x 11" in size

You get more than 6,000 projects, plans and ideas for better living, greater savings, including...

93 tested projects on home maintenance, repairs, services to save you up to 75% on labor costs, materials.

538 "show-how" photos, drawings, diagrams on auto care and repair.

561 pages, over 1,000 illustrations on additions, remodeling, alterations.

107 money-saving tips on

power tools. Select the best tool for your needs.

68 detailed projects on electronics, radio, TV, hi-fi, tape recorders, stereo. Repair, maintain, install your own equipment.

76 illustrated projects and plans for sail and power boats, docks, moorings, water safety, navigation.

FREE GIFT CERTIFICATE

Popular Mechanics Book Division, Dept. DO14
250 West 55th St., New York, N.Y. 10017

This certificate entitles you to a free gift—Vol. 1 of the 16-vol. POPULAR MECHANICS DO-IT-YOURSELF ENCYCLOPEDIA, with no obligation to buy anything ever.

As a subscriber in good standing, you'll enjoy free examination of the additional volumes. In about 6 weeks we'll send you Vol. 2, and 4 weeks later Vol. 3. After that, at approximately monthly intervals, we'll send you shipments of Vols. 4-6, 7-9, and 10-16. Also, you'll receive annual supplementary volumes as they are published on free 14-day approval with no purchase obligation. This way you'll be able to complete the set in 6 months, and keep it up-to-date. You may return any volume within 14 days for full credit, and you may cancel at any time. Take as many volumes as you like—or none at all. For each volume you keep, you'll be billed just \$3.49 plus postage and handling. But you need never pay for more than 1 volume per month no matter how many you have received. There is no charge for this extended payment service.

Name _____ (Please Print)

Address _____

City _____

State _____ Zip _____

Signature _____

This offer available in Canada at a slightly higher price. Canadian residents please mail the coupon to New York address. Shipment of books and all services will be handed within Canada.

ANOTHER SUPERB VALUE
from **Olson**
Electronics

ONLY **\$22⁹⁸**



SOLID STATE STEREO AMPLIFIER

Low priced stereo amplifier that looks and sounds great. An ideal unit for office, children's room, or second stereo system. Has separate volume and tone controls with inputs for phono and tuner.

Olson Electronics, Dept. J4-260

260 S. Forge St., Akron, Ohio 44308

I enclose \$22.98 plus \$1 for postage and handling. Send me the AM-400 Stereo Amplifier.

Send me the next seven issues of the Olson Catalog, without cost or obligation. **FREE**

Name _____

Address _____

City _____

State _____ Zip _____

“Making Money Raising Chinchillas For the Beginner”

by Charles Dyckes
Breeder of Champions

“I started raising chinchillas in my basement. Now I have one of the finest ranches in the world producing world famous animals. My book is based on what I have learned about raising chinchillas. Chapters include: Housing; Feeding; Mating; Care; Pelting; Selling; etc. Buy this book and read it before investing in animals.”



Send check or money order for \$3.00 to:

Duchess-Blu Chinchilla Ranch
RD 2C, Saegertown, Pa. 16433. Or write for free brochure

THE HOME BOOK OF REFINISHING FURNITURE. Clear, understandable text and photos, this tells you how to repair and refinish all kinds of furniture into showroom pieces. Fundamentals and tricks of the trade: stripping, sanding, repairing, sealing, refinishing, and the arts of hand-rubbed oiling and mixing special stains. All your questions answered in one authoritative volume! Price \$4.95. Send to: **POPULAR MECHANICS**, Dept. FA. 224 W. 57th ST. New York, N.Y. 10019.

AVOID THE OLD "NO START" HANGUP WITH DYNASTART.

You'll get fast starts everytime with this amazing little electronic unit. Fits any car with coil and distributor. A full one-year guarantee. Only \$9.95 (post paid). N.Y. State residents add sales tax.

MOTORVOLT CONVERTS YOUR CAR TO 110 VOLTS. FOR WORK OR PLAY. A SNAP TO INSTALL.

This amazing unit attaches to any vehicle with an alternator. Runs drills, saws, lights, heaters, you name it. Welds up to 1/8" metal and charges batteries quickly. A two-year guarantee included. Only \$23.50 (post paid.) N.Y. State residents add sales tax. Specify year and make of car.

Note: Will not run refrigerators, TV, or air conditioners.

HANDIPOWER CORP.

DEPT. PM
Box #3880/ROCHESTER, N.Y. 14610



"FUSE PROTECTION"
DISTRIBUTORS WANTED

Does More Than Help Shrink Swelling Of Hemorrhoidal Tissues Due To Infection

Also gives Prompt, Temporary Relief in Many Cases from Pain, Itching in Such Tissues.

Doctors have found a remarkably successful medication that actually helps shrink swelling of hemorrhoidal tissues when infected and inflamed. And it *does more*. In many cases it gives relief for hours from pain and itching in

these tissues. Tests by doctors proved this true in many cases.

The medication used in these tests was Preparation H. And no prescription is needed for Preparation H[®]. Ointment or suppositories.

FIXED-LENS CAMERA LENSES!

(Continued from page 99)

number, the greater the magnification. Used in Series-type screw-in or slip-on mounts, such supplementary lenses can be fitted to just about any camera lens. Focusing is done by careful measuring since there's no way of seeing the subject through the attachment itself on most fixed-lens cameras. Handy focusing tables come with each lens to guide you.

Series-type close-up lenses are sold by Kodak, Spiratone and other makers. To determine the size you need, take your camera to a photo dealer and have him fit the lens to it, using the appropriate adapter ring. Prices are about \$2 to \$10, depending on power. Kalimar also offers its telephoto and wide-angle attachments in Series-type mounts in the event that one of its regular mount sizes will not fit your particular camera. These sell for about \$25 to \$45 in sets.

Spiratone's Plus-20 Macrostigmat is a powerful close-up attachment that provides big frame-filling 1 to 1 images, making it ideal for shooting tiny objects. With an accessory slide duplicator, it can be used to copy favorite 35-mm color transparencies. Its price is \$14.95. Spiratone

Stamp out clogged drains

Fast acting. Get Mitee® Liquid Drain Opener and Cleaner. Frees drains by dissolving greases, fats and starches that cause most clogged drains. Harmless to plumbing or septic tanks. Not for use in garbage disposers

the drain fixer from
DAP

DAP Inc., Dayton, Ohio 45401
Subsidiary of *Plough, Inc.*



Stamp out wall cracks

Smooth. Patch cracks and holes in plaster with DAP vinyl-paste Spackling Compound. Hides seams between drywall panels. Ready-mixed. Spreads easy, dries bright white. Sands to a feather-edge for invisible repairs. Takes any paint.

the wall fixer from
DAP

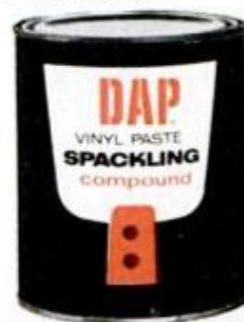

DAP Inc.,
Dayton, Ohio 45401
Subsidiary of
Plough, Inc.

also offers matched pairs of telephoto and wide-angle attachments for twin-lens reflexes. They're \$19.95 each or \$35.95 a pair.

Vivitar, another big maker of accessories, provides close-up lenses for both twin-lens reflexes and single-lens reflexes. They range in power from Plus-1 to Plus-3 and come in either threaded or bayonet mounts to fit particular lenses. Prices are about \$8 to \$25. There's also a Plus-10 Macro Adapter and a Series VII Plus-1 to Plus-10 variable-power close-up accessory. The Macro Adapter sells for \$7.50 to \$9.50; the variable lens for \$27. All of these accessories are, however, designed for reflex-type cameras where focusing can be done through the lens. Kodak also offers special close-up attachments for its Instamatic Reflex—again for through-the-lens focusing.

Vivitar accessories are sold by Ponder & Best, Inc., 11201 West Pico Blvd., Los Angeles, Calif. 90064. Rolleiflex attachments are marketed by Honeywell Photo Products, Littleton, Colo. 80120. Other makers are Kalimar, Inc., 2644 Michigan Ave., St. Louis, Mo. 63118; Polaroid Corp., Cambridge, Mass. 02139; Spiratone, Inc., 135-06 Northern Blvd., Flushing, N.Y. 11354; and Eastman Kodak Co., Rochester, N.Y. 14650. ★★★

'72 ROAD RACING PREVIEW

(Continued from page 79)

States Grand Prix in California this month are landmarks in America's road-racing history, but the Can-Am and the GP races are only the more spectacular events in a full schedule of road racing across the country featuring all types of cars.

Sedan racing, for example, is one of the most exciting forms of road racing American-style, and it started long before the SCCA set up the Trans-Am Championship. (Would you believe that Dan Gurney ran an *Impala* in England specifically to challenge the dominance of the noble Jaguar? Well, he did! In the early 1960s.)

The Trans-Am series, always a manufacturers' award, will add a drivers' championship this year. With Donohue and Penske busy on the Can-Am trail and campaigning an American Motors Matador in the NASCAR Grand Nationals, defense of the Javelin title will be in the hands of veteran George Follmer who is likely to make it two years in a row for AMC, and a new title for himself.

Road-racing sedans can be seen virtually any weekend of the season: There's the Trans-Am and the Two-Five for 2.5-liter cars, and the heavy schedule of SCCA club racing throughout the country; NASCAR runs the Grand American series for pony cars and the International Motor Sports Assn., which sanctions sports sedans, subcompacts and stock-sedan "baby grands," has an expanded schedule for '72.

In the Datsun 510, John Morton will be defending the 2.5 title, and the series this year should have the added excitement of Pintos in competition, maybe a Vega, and hopefully, later this season, the entry of Toyota and the rotary-engined Mazda.

Sedans of every shape and size participate in the popular, locally organized,



PETE CONRAD, Apollo 12 commander, is a moon-walker and race driver. He's campaigning Formula Super Vee Lola in road races during the '72 season



SCOTT HARVEY winning the 23rd annual Press On Regardless Rally in Plymouth Cricket. The 1500-mile European-type rally is in Michigan in November

American-style rallies. They're exercises in precision driving through city or countryside, on a route that's undisclosed until the driver and his navigator are under way. Interesting, but not "racing." European-type rallying, on the other hand, is an all-out race over a minimum 1200 miles in all kinds of weather on all kinds of roads—a real test for cars and drivers. The United States' only real rally of this type is the Press On Regardless International Rally that runs in Northern Michigan in November. It's on the calendar of the Federation Internationale de l'Automobile (the world governing body for motor sports) and this year the event will be included in the World Rally Championship which includes such grueling events as the Rallye Monte Carlo and the East African Safari.

Another world series, the Manufacturers Championship for sports cars, prototypes and grand touring cars, visits the United States several times with races at Daytona, Sebring and Watkins Glen. Mario Andretti and Jackie Ickx won the six-hour endurance race at Daytona in February in a Ferrari. The Sebring event runs a few days before this issue goes on the newsstands, and the Watkins Glen rolls July 23rd. This year's new three-liter limit leaves Alfa Romeo the only competition for Ferrari, since three-year-winner Porsche has taken its big-displacement blocks and gone Can-Am.

Open-wheel Formula racing in the United States includes Formula Ford, Formula Vee, Super Vee, Formula B and, for the big-bore, five-liter machines, Formula 5000, formerly FA. 1972 promises to be an intensely competitive year in F5000 with last year's champ, David Hobbs, due for lots of competition from the likes of Sam Posey and George Follmer.

Road-racing competition: dangerous dicing and lots of dropouts. A two-lane blacktop with only one winner. The '72 season is under way! ★★ ★



Do-It-Yourself Siding

Learn how you can earn up to \$1000.00 for a single order showing our quality aluminum, steel, and vinyl siding on your home. Small investment required for your own siding. No further investment. Mail coupon for free information without obligation.

ALUMINUM INDUSTRIES
of ARKANSAS, Dept. P-42
Little Rock, Arkansas 72205

Please send me free information concerning your quality do-it-yourself kits.

name _____

street _____

city _____ state _____ zip _____

BIG

YACHT-SMART
Sail Rig
DACRON
from
\$114

SPRING SAVINGS NOW

FOLBOT

TRAVEL CRAFT
fits in every home or car

FOR YOUR SPORT AND FAMILY FUN

and
RECORD FISHING

GENUINE Folbot RECREATION for just ONE small investment, WITHOUT the continuous burdens of complicated 'big rig' operation. You GO CAREFREE anytime with COMPACT Folbot . . . rocky streams, lakes, marsh, surf & open sea. Superior non-sinkable designs provide SAFEST low gravity center, balanced low & high seating, substantial construction, protective decks & EXCLUSIVE swivel-back COMFORT. ALL within your reach. In handy Folbot YOU GLIDE smoother, faster & NOISELESS with paddles, oars, or sails and ride softly w. 1 to 10 HP. motors. Many styles & sizes from 1 to 4 seaters, FOLDING or rigid PORTABLE come in PREFAB KIT, or expertly FACTORY BUILT

Just a few Dollars start YOU right away. From

ONLY \$19 NOW

for **BASIC KIT**

16 feet long

'CAYAT' car top YACHT.



NEW
Fabulous
16 foot
\$117

Factory BUILT

FREE
ACTION CATALOG

STARTLING
FACTS & FIGURES
 Mail coupon or address

to: **FOLBOT CORP.**
 Dept. PM-472, Charleston, S.C. 29405

Name _____

Address _____

City _____ State _____

NEW DYNAMIC MARK 88
80 AMP INDUSTRIAL TRANSFORMER ARC WELDER

IDEAL GIFT—EDUCATIONAL, ENJOYABLE, PROFITABLE

WELD, BRAZE,
 CUT, SOLDER, HEAT
 STEEL, BRASS, ALUMINUM,
 AND MOST OTHER METALS.



Build and repair anything of metal. Save time & money with this BRAND NEW, PROFESSIONAL ARC WELDER! Rugged metal cabinet, baked Hammerloid finish. Ideal for home, shop, farm and industrial use. POWERFUL glass insulated transformer welds most metals up to 1/2" thickness with multi-pass weld, with 3/8" rods. 4 heat settings 20 to 80 amps. Operates on 110 Volt AC line fused for 30 amps. Complete with fibre glass helmet, electrode holder, ground clamp and cables, solder, assorted rods and simplified welding manual. DOUBLE PROTECTION GUARANTEE. 10 day money back trial plus full 5-yr. warranty. If inoperative return prepaid, we will repair or replace without charge & reship collect. ORDER TODAY. Complete ready to weld. Only \$59.50 F.O.B. SEND ONLY \$6.00. Pay Balance plus C.O.D. and Delivery Charges

FREE Write for illustrated color literature and welder details.

DYNAMIC WELDER CO. 1808 S. FEDERAL ST. Dept. PM42 CHICAGO, ILL. 60616



SAILBOAT KITS

Free color catalog of the largest selection of popular sailboats, iceboats, and sail making supplies.

TAFT MARINE CORP.
 Dept. PM-4, 636 39th Ave. N.E.
 Minneapolis, Minnesota 55421



LOCKS AND KEYS MADE EASY!

COMPLETE ILLUSTRATED BOOK OF FACTS

Shows how to fit keys, change combinations, master key locks, keys by number, tools to use, etc. Fascinating trade explained in simple words, clear and complete illustrations. Satisfaction guaranteed. Get started! Order today. Dept. 1410-042 I. B. Ancele, P. O. Box 69234, Los Angeles, Calif. 90066

ONLY \$3 PPD.

NOW! BUY 1970-71 Chevs, Fords, Dodges (From \$699 to \$999)

Delivery arranged anywhere. Free catalog. Send 25¢ postage and handling to:

PAN AM CAR DIST. CORP. ME-37
 31 Hanse Ave., Freeport, N.Y. 11520

learn ACCOUNTING at home

1000's high pay "Big Future" jobs open now to men, women in Accounting. Send for FREE "ACCOUNTING CAREER KIT." No salesman will call.

GIVEN TO YOU



NAME _____ AGE _____
 ADDRESS _____
 CITY _____ STATE _____ ZIP _____
 NORTH AMERICAN SCHOOL OF ACCOUNTING, Dept. 24174
 Accredited Member, National Home Study Council • 4500 Campus Dr., Newport, CA. 92663

EARN MONEY FAST!

REPAIR HYDRAULIC JACKS

Earn while you learn at home. Millions of jacks in gas and auto service stations, trucking firms, body shops, riggers, factories and farms need servicing . . . most of which you can learn to repair. We show you HOW. Start spare time in your basement or garage. Big opportunity for mechanics. ACT NOW!

Write for folder PM4 and free bonus offer

HYDRAULIC JACK REPAIR MANUAL CO., INC.
 G. P. O. BOX 3 • STATEN ISLAND, N. Y. 10314



BLAST FURNACE 2400 F



Since 1935
 Hobbyists • Schools • Inventors, etc.
 Make your own castings of any metal from cast iron, down to lead and zinc. Available in 6 sizes, 1 1/2 to 50 lbs. Complete units from \$50.40 to \$162. Send 25¢ for circular—refundable.

KANSAS CITY SPECIALTIES CO. Dept. P-4 P.O. Box 193 Middleton, Wisc. 53562

Two or four-wheel drive
JEEP OR SCOUT OWNERS

REPOWER with a 6 or V-8. H.D. ADAPTORS for using Car, Compact and some Truck engines. "State year & model, Jeep or Scout." Want fast action? Give us FULL INFORMATION. Send \$25.00 Dep. and we will ship correct kit, bal. COD. Send full amount for prepaid shipment. Wire, phone or write today. Details FREE

HOOSIER MACHINE PRODUCTS CO.

312 S. E. 6th St., Phone 276-3442. Pendleton, Oregon 97801

HELP DRAW OUT
BOILS

Boils look unsightly and feel even worse. Soothing BOIL-EASE helps make discomfort and pain disappear fast. Protects against infection as it helps reduce swelling. Proven medication, used by thousands, helps get rid of ugly boils so you look better and feel better.

BOIL-EASE®

FIND BURIED TREASURE

Powerful electronic detector finds buried gold, silver, coins, etc. 5 new models. Write for free catalog.



RELCO, Dept. D-3 1995
 BOX 10839, HOUSTON, TEX. 77018

WRIST ROCKET®

AMERICA'S HARDEST HITTING SLING

Range 225 yd.—232 fps. Matched replacement rubbers and LEATHER pouch assembly \$1.00 At dealers or order direct.



WRIST ROCKET® Mfg. \$300 Post. Pd. in USA. No C.O.D.'s P.O. BOX 21-B Columbus, Nebraska 68601
Orders outside U.S.A. add \$1.00 for postage and handling.

PUMP DRAINS pools, cellars, laundry tubs IRRIGATES — CIRCULATES — SPRAYS



Heavy duty ball bearing pump. All metal, rust-proof Type XB. Stainless shaft. Use 1/4 HP or larger. 1 HP 1,200 GPH 60" high or 3,000 GPH 25" well. 5,200 GPH max. 1 1/4" in; 1" out. Belt or direct drive. \$13.95 Type P won't rust or clog. Bronze bearing. To 2,400 GPH. 1" in; 3/4" out. \$9.95 P'd cash with order. Money back Guarantee.

LABAWCO, Box 40, Belle Mead, N.J. 08502

THE AUTO ELECTRIC

Power-For-Tools. 110 V.D.C. Electricity from a car's alternator. Installs on—Most late model cars, trucks or tractors. Will operate power tools, light bulbs, heating devices, etc. Operates any brush-type 110 V. A.C.-D.C. electric motor. Battery charging. Easily installed.



Checks or Money Order:
\$16.95 Without 150 V. D.C. Meter
\$19.95 With 150 V. D.C. Meter

Plus Postage \$1.25 and Sales Tax
Auto Air Equipment Inc., P.O. Box 2886, Amarillo, Texas 79105

IGNORANCE is a CRIME when it results from lack of proper reading material. In today's complicated society it pays to know the "rules"—the LAW. Blackstone offers a program of reading assignments for adults who should be informed on essential law subjects. It is designed for people who are in earnest and who expect to accumulate property, lead in business, or take an active part in community life. **NOT A CORRESPONDENCE COURSE.** Program may be scheduled to your interests and time covering any or all law subjects. **FREE BOOKLET**—The People vs. You—mailed on request. No salesman will call. Dept. 54

BLACKSTONE SCHOOL,
307 N. Michigan Ave., Chicago, 60601

INSTALL ALARM SYSTEMS

Beginners Make Big Money — Your Own Boss

New plan opens multi-million dollar burglar fire alarm business to small home operators. Guides beginners step by step.

Starts you full or spare time without previous experience or big investment. See how to cash in on invisible web of protection that stops crooks cold, makes big profits. No salesman will call. Write for free details!

NASCO, 6100 Variel Avenue, Dept. F2254, Woodland Hills, Calif. 91364



MOST FLYING FUN — AT LOWEST COST!

Get in the pilot's seat of your own personal Bensen Gyrocopter and go aloft when you like — high and fast or low and slow. Pros and beginners alike praise it as the greatest thrill in flying. Wheels interchange with floats or snow skis for extra fun. Costs no more to operate than a car. Designed for building with ordinary hobbyshop tools. Make your first move now — send \$5 for Copter (\$3 for Glider) colorful "Info Packet", with 3-View Drawings; General Specifications; Design and Piloting Information; Construction Hints; in-flight photo; 6-page "Bulletin" with numerous pictures plus descriptions of Plans, Kits, Engines; Condensed Price List . . . and a Certificate for \$5 (or \$3) toward the purchase of Construction Plans.

SEND \$5 OR \$3 **BENSEN AIRCRAFT CORP., Dept. PM-42**
RDU Airport, P. O. Box 2746, Raleigh, N. C. 27602
NAME _____
ADDRESS _____



Repair any watch

... SWISS OR AMERICAN

Unique, modern Sweazey System starts you making repairs right away. Develops skill step by step at home in spare time. Diploma awarded. Free sample lesson. No obligation.

CHICAGO SCHOOL OF WATCHMAKING
Dept. 142, Fox River Grove, Ill. 60021

1¢ SALE
GUARANTEED
10 YEARS



The knife for hunting, fishing and all around use. Mirror polished, imported stainless steel blade honed to a razor's edge. Rugged. Opens quickly, easily. Locks into position. Blade will not close when in use. Press button in handle to close. Safety finger guard. Sure-grip handle. Balanced for target throwing. **IF BROKEN WITHIN 10 YEARS WE WILL REPLACE AT NO CHARGE!** Use 30 days. Money back if not pleased. Special 1¢ sale. **REG. PRICE \$1.98. Send \$1.99 & receive 2 knives. Add 49¢ postage, handling. Remit TOTAL \$2.48 for 2 knives. ORDER NOW!** Midwest Knife Co., 9043 S. Western Ave., Dept. DD-5408, Chicago, Ill. 60620. Est. 1936.

MOW AN ACRE IN 30 MINUTES!

**MAN
SIZE!**



Handles 48" and 60" mowers . . . bigger implements for gardening, dozing, removing snow. Here's why: Big 14 hp . . . extra size and traction . . . all-gear-drive with automatic clutch, transmission and differential. More for your money! Send for free catalog.

**ECONOMY
TRACTOR**

K-4 Anoka Ave.
Waukesha, Wis. 53186



POWER OUTLET

EASILY INSTALLED IN YOUR CAR

YOU DO IT YOURSELF IN MINUTES WITH SIMPLE TOOLS.

CAR POWER

3000 WATTS FROM YOUR ALTERNATOR

POWER FOR: HEAVY DUTY DRILLS • SAWS • LIGHTS
• COFFEE POTS, ETC. YOU CAN EVEN CHARGE
DEAD BATTERIES OR ARC WELD

- GUARANTEED 5 YRS.
- WILL NOT DAMAGE ALTERNATOR

\$16⁹⁵ POSTPAID

HOLLY
P.O. BOX 5321
PHOENIX, ARIZ.
85010

FOR MOTOROLA ALTERNATORS
AMERICAN MOTORS & JEEP
CAR POWER II

\$18⁹⁵ POSTPAID

PLEASE SPECIFY WITH YOUR ORDER

"New Sound" ACCORDIONS - Save 1/2

• 42 Standard and Electronic Models-Amplifiers! •

You save at least half off prices of comparable accordions! Buy direct from importer. Over 40 models! For Student, Teacher, Professional. Big savings on name brand accordion amplifiers. Buy direct at importer prices.

• Trades welcomed. • Money back guarantee and lifetime performance warranty. Rush coupon!

FREE color catalogs and latest discount price list MAIL COUPON

ACCORDION CORP. of AMERICA—Dept. R-42
5535 W. Belmont Ave., Chicago, Illinois 60641

Send FREE Color catalogs and discount prices. Include special information checked:

Accordion Amplifiers Button Accordions Cordovox

Name _____

Address _____

City _____ State _____ Zip _____

**5 DAY HOME TRIAL!
FREE ACCESSORIES!**



BUILD IT YOURSELF

MINI-DOZER®

Rugged, compact bulldozer. Smooth lawn or cleared dozer tracks. Unique transmission allows 360° turns in its own length. 7 & 12 hp engine models. Attachments include lawn mower, dozer blade, snow blower, etc. "Build-it-yourself" Plans - \$5.00.



12 hp Kit
\$698.95



12 hp Kit
\$598.95

TURF-RIDER®

Man-sized tractor for tough lawn and garden use. Attachments include lawn mower, snow blower, plow, cultivator, etc. Complete kit with 12 hp electric start engine - \$598.95. Plans - \$5.00.

TS-5 TRAIL BIKE®

Rugged 7 hp 'two-wheeler' with 12" wide x 21" dia. low pressure tires to take you there and back with safety. Plans - \$2.00.



7 hp - \$249.95

COMPLETE 48-PG CATALOG

of all 30 tractor assembly kits - \$1.00.
(Note: Plans and Catalog prices refunded on any purchase.)



\$24.95

POWER HACKSAW - KIT \$24.95

Also 51 other money-saving projects to be built for the home workshop. Lathes, drill presses, vises, etc.

Complete 28-pg 'homeshop' Catalog - 50¢.

STRUCK CORP., Dept. PM42, Cedarburg, Wis. 53012

U.S. Bureau of Labor Statistics predicts shortage of 50,000 civil engineering technicians (Surveyors, etc.) by 1975. Send for FREE "SURVEYING CAREER KIT." No salesman will call.

LEARN SURVEYING AT HOME

NAME _____ AGE _____

ADDRESS _____

CITY _____ STATE _____ ZIP _____

NORTH AMERICAN SCHOOL OF SURVEYING & MAPPING
4500 Campus Drive • Dept. 24174 Newport, Calif. 92660

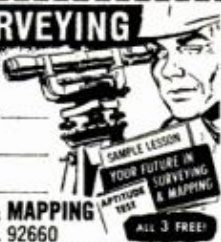

NEW Comb Gray Away



Returning your gray-studded hair to its natural color is easy with Head-Gear's COMB GRAY AWAY, patented comb-cartridge system. You can have either gradual or immediate results. One comb, two snap-in refills and vinyl pocket case for just \$3.00. Specify BLACK or BROWN. Send check or money order to: HEAD-GEAR, Box 73-M, Flint, Michigan 48501.



HEAD-GEAR®

drafting as a career

Train in everything from basic technical drawing through graphic arts and engineering mechanics. Associate degree in Machine Design Technology received upon graduation. Tri-State College also offers degrees in Engineering, Business Administration, Secondary Education, Liberal Arts, Computer Technology and Secretarial Science. Accredited. Co-educational. Approved for Veterans. For information, write Director of Admissions.



TRI-STATE COLLEGE

442 College Ave., Angola, Ind. 46703

Be an Aircraft Mechanic
... in less than 17 months!

SPARTAN School
of Aeronautics Dept. 24174,
International Airport, Tulsa, OK 74151

YOUR FUTURE in AVIATION **FREE BOOK**

Name _____ Age _____
Address _____
City _____ State _____ Zip _____
 Check here if eligible for GI Bill benefits. Approved for VETERANS

Licensed by Board of Private Schools of Oklahoma.

TECHNICAL EXCELLENCE IN ELECTRONICS.

On our small, friendly campus the emphasis is on Living as well as Learning. Extra-curricular social activities, student clubs, a student operated radio station, student government, new dormitory and a full sports program help provide a world of your own in which to prepare for tomorrow. Associate Degree in Engineering Electronics. B.S. obtainable. G.I. approved.

VALPARAISO TECHNICAL INSTITUTE
Dept. PE, Yellowstone Trail, Valparaiso, Indiana 46383



LEARN UPHOLSTERY AT HOME!

Men & Women All Ages! Send for free book on learning to reupholster chairs, divans, footstools, all furniture for BIG MONEY in spare or full time. No experience needed, no age or educational limits. We show you how and provide EVERYTHING needed to start: (1) Home training covering all phases, (2) all tools and 6 big furniture kits for practice, (3) free supplies, frames & materials to build \$300 worth of furniture, yours to keep or sell. Write TODAY for big free upholstery career book. No obligation, no salesman will call. Veteran Approved.
Modern Upholstery Institute
Box 899-FHE, Orange, Calif. 92669.

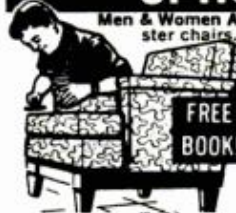

Learn PIANO TUNING

New Illustrated Self-Instruction Course
There's an acute shortage of piano tuners. Some earn up to \$20 an hour. New course by a master craftsman tells trade secrets. No musical training needed! Shows how to make pin, string, hammer repairs, use tools, etc. Includes piano repair and rebuilding; also electronic piano and organ tuning. Complete, only \$19.95. Money-back guarantee.



Est. 1909 **Nelson-Hall Co., Dept. 2DY-2**
325 W. Jackson Blvd., Chicago 60606

POPULAR MECHANICS

Материал, защищенный авторским правом

THE PARKS 12" THICKNESS PLANER

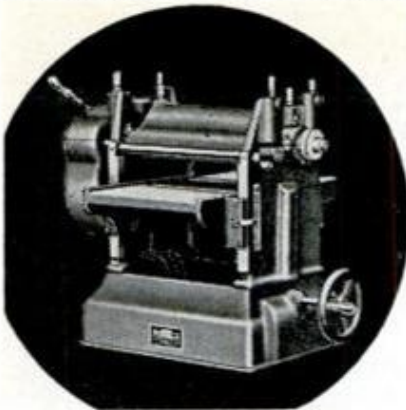

THE PARKS NO. 95

- A compact thickness planer with mill planer precision and ruggedness.

- More than 100,000 still in use around the world.

WRITE—for complete descriptive literature on the Parks No. 95 Thickness Planer

THE PARKS WOODWORKING MACHINE COMPANY
Dept. PM • 1546 Knowlton St., Cincinnati, Ohio 45223

GARAGE DOOR OPERATORS

EASY HOME INSTALLATION
RADIO CONTROLLED

\$89⁹⁵

Chain & Screw Drive Models
FOUR MODELS FROM THOUSANDS IN USE - FREE BROCHURE
HELPMATE EQUIPMENT COMPANY
Dept. P.M.-18, First & Lake St., Baroda, Mich. 49101

Shipped PP or UPS

"LISTEN IN" TO POLICE-FIRE RADIO CALLS IN YOUR CAR!

WORKS with ANY CAR—Portable or HOME RADIO! Just PLUGS in—No wiring—3 minute hookup! Switch instantly from regular to ALL POLICE-FIRE-EMERGENCY-COMMERCIAL-TAXICAB-STATE-CITY-GOV'T 2 way Radio calls in YOUR AREA. DUAL-HI-LOW BANDS—OVER A MILLION Radio Cars/stations. USE Everywhere—anytime—always works!

SEND ONLY \$2.00 (cash, Ck., M.O.) and pay postman \$7.99 plus CD! post. or send \$9.99 for ppd Del in USA. COMPLETE, ready to use with instructions. One year service Warranty—10 DAY MONEY BACK TRIAL (if retnd). Limited offer includes "Plug in" for ALL RADIOS.

WESTERN RADIO Dept. BPM-4 KEARNEY, NEBR. 68847

locksmithing and key making

PRACTICAL UP-TO-DATE COURSE — ONLY \$7.95

Teaches you how to pick locks, de-code, make master keys, repair, install, service, etc. New self-instruction lessons for every handyman, homeowner, carpenter, mechanic, service station operator, fix-it shop, hardware dealer, gunsmith. 53 easy illustrated lessons. Full price only \$7.95 post-paid. Satisfaction or refund guaranteed. Mail order today!

NELSON-HALL CO., Dept. DY2
325 W. Jackson Blvd., Chicago 60606

HOME-IMPORT BUSINESS—Make Big Profits

Men-Women, new Drop Ship Plan offers fast profits without product investment! Deal direct with overseas sources. Buy small quantities. Prices shown include duty & postage. Full or spare time. Write for FREE PLAN, state age.

MELLINGER, Dept. F2254, 6100 Variel, Woodland Hills, CA 91364

Calendar Watch 4.45
Field Glasses 5.24
Trail Cycle 149.
QUANTITY PRICES EVEN LOWER

© MCMLXXI MUSTANG

Your Mustang Welder PAID FOR...

On your first repair job. Saves you money year after year. You'll be proud to show your friends your new Mustang.

HALF-PRICE SALE

NATIONALLY ADVERTISED FOR \$39.95
NOW FOR A VERY LIMITED TIME ONLY **\$19⁹⁷** POST PAID
HEAVY DUTY PROFESSIONAL ARC WELDER

The Mustang works from an ordinary 110V outlet. It's not just a welder but a complete welder workshop with all accessories including a welder's mask, welding and brazing rods, cables, ground clamps, special combination arc torch and rod holder, flux and easy-to-follow operating instruction manual. It's easy to use. Just follow simple instructions to make repairs on cars, trailers, boats, appliances, lawn furniture, air conditioners, farm equipment, toys, etc. Welds most any metal including aluminum. With just a little practice you'll be welding like a professional. This popular American made welder is designed for easy, rugged use and burns up to 1/8" rods. The Mustang is fun to use and saves you money too.

YOU MUST BE SATISFIED OR MONEY REFUNDED! Use the Mustang for 10 full days and if not satisfied for any reason simply return for a refund. LIFETIME GUARANTEE! If the Mustang ever develops trouble due to faulty material or workmanship, simply mail it back to us and we will repair or replace at no charge. The Mustang makes an excellent gift for any occasion. Orders are shipped promptly. Order by mail or dial 1-713-682-5898 for immediate C.O.D. shipment.

CUT HERE

MUSTANG MFG. CO., Dept. G-6, Box 10947, Houston, Texas 77018

Rush the complete Mustang Welder Workshop to:

NAME _____

ADDRESS _____

CITY _____ STATE _____ ZIP _____

\$19.97 enclosed. Ship Postpaid

\$3.00 enclosed. I will pay \$16.97 plus small C.O.D. upon receipt.

NEWS BRIEFS



Never say die

Even when the ubiquitous VW Beetle passes on to a junkyard, it still has some life in it. Peter Goulding, New York designer, welds fenders and hood together, adds leather upholstery—and sells the resulting chair for \$750. (With battery-powered lights, yet!)

Driverless mine finder

A driverless Army Jeep, guided by a soldier carrying remote-control equipment (right), can sweep through a minefield without danger to personnel. The operator receives an audible signal when the detector finds a mine.



Flying 'trucks' in Alps

As in many other formerly inaccessible areas of the world, helicopters are making it possible to carry cargo to hard-to-reach spots in the Austrian Alps. Here an Austrian Air Force copter brings in equipment for a TV-relay station being built 8200 feet up in the mountains near the town of Zurs. Trucks were unable to reach the site.

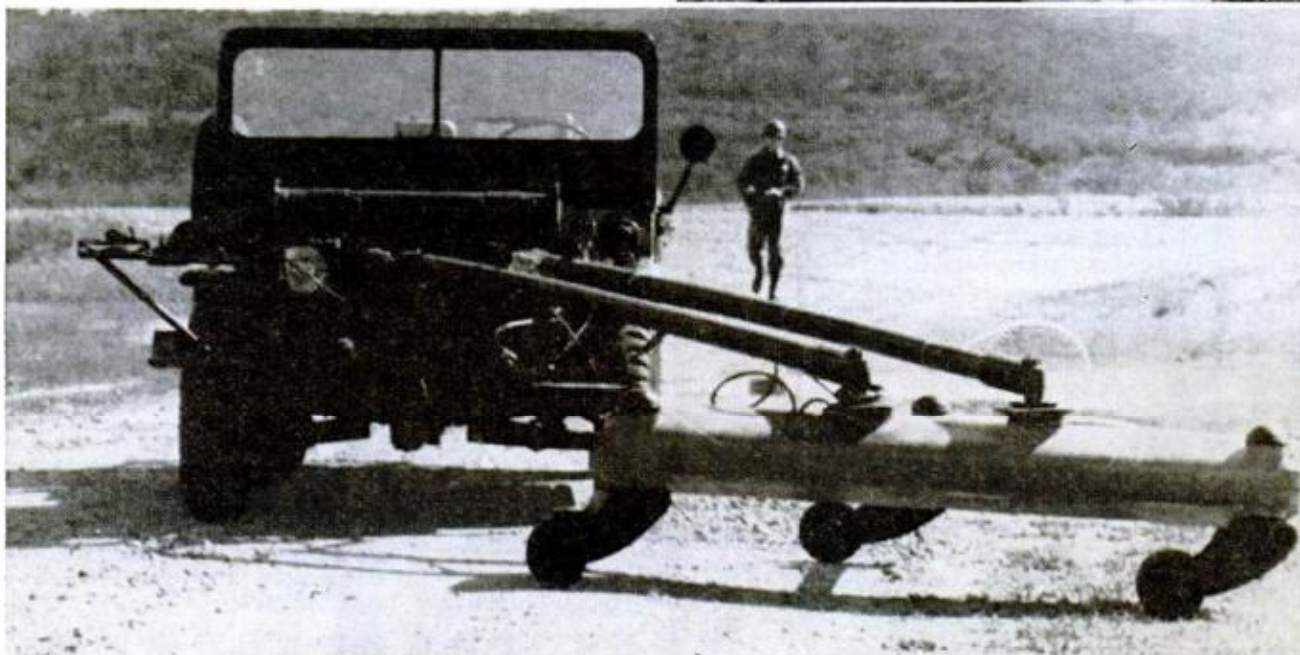

3 needed skills NRI can teach you at home

NRI courses use "bite-size" texts to show you how to service TV-Radios, Repair Cars or Appliances

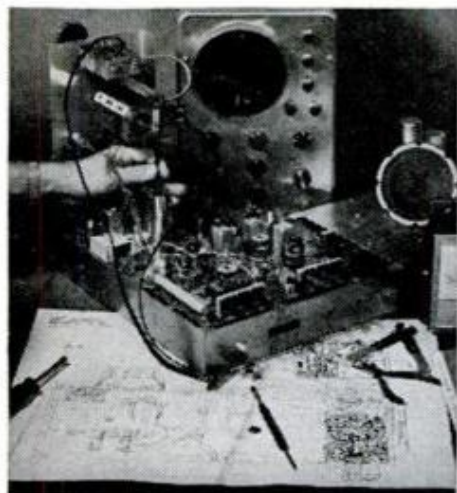

TV-Radio Servicing

The NRI TV-Radio Servicing course includes your choice of black and white or color TV training equipment. NRI courses cover FCC license preparation, complete communications electronics, aircraft electronics, mobile communications, marine electronics, amateur radio, industrial and business electronics.

Automotive Repair

Take your choice of Master Automotive Technician training or a shorter Automotive Tuneup and Electrical Systems course for the man seeking greater understanding of basic car repair. Both courses include professional equipment so that you get "hands-on" experience and the chance to earn spare-time money making repairs.

Appliance Repair

NRI trains you to fix all kinds of electrical appliances, plus air conditioners, refrigerators, house wiring, electric motors, even small gas engines. An appliance tester is included for fast trouble shooting, so you can begin earning money repairing appliances long before you finish the course.

"Hands-on" training pays off

NRI was the first to supply home study students with custom-designed training kits to give practical hands-on experience as you learn. You get more value from the exclusive Achievement Kit sent the day you enroll, to "bite-size" texts and training equipment. Learning TV-Radio, Automotive Servicing and Appliance Repair at home is easy, exciting, the simplified, dramatized NRI way.

Earn \$5 to \$7 an hour spare or full time

Tens of thousands of NRI graduates are proof it is practical to train at home in your spare time. Keep your present job while preparing for a better one and earn \$5 to \$7 an hour extra in your spare time.

Fix your own equipment, or earn money making repairs for friends and neighbors. NRI shows you how.

Train with the leader—NRI

The same training innovations which have made NRI the leader in career training at home is now available to you. Let NRI help you step up to better pay, a brighter future. Decide now to move ahead . . . the decision is yours to make. Mail the postage-free card today for a free full-color catalog in the field of your choice. No obligation. No salesman will call.



NRI TRAINING
3939 Wisconsin Avenue
Washington, D.C. 20016

The bargain hunter

Kirsten

The pipe that never loses its cool.

Kirsten's exclusive radiator stem tames the smoke... makes it milder... cooler. It also traps impurities and allows you to remove moisture with a flick of your wrist.



\$9
postpaid.

Imported aged Mediterranean briar. Hand finished vulcanite bit. Order your Kirsten pipe and you'll keep your cool forever.

KIRSTEN PIPE CO., INC.

Dept. PM4, P.O. Box 5227, Seattle, Wn. 98107

Please send me your 1972 catalog showing all of the Kirsten Pipes and accessories.

Name _____
Street _____
City _____ State _____ Zip _____

HEARING AIDS
UP TO **50% OFF** COMPARABLE AIDS ★

BUY DIRECT • 20 DAYS FREE TRIAL Body Aids \$39.95 up. Tiny All-in-the-Ear: Behind-the-Ear; Eye Glass Aids. No salesman will call. Write **LLOYDS** ★ Dept. PM, 905 9th St., Rockford, Ill. 61108 ★

Send for FREE EXAMINATION copy **HOW TO FIX IT**

By **Morton J. Schultz**. Take advantage of this complete new guide to making repairs on appliances in and around the home—air conditioners, refrigerators, radios, doorbells, lawn mowers, toasters, fluorescent fixtures, boats, and cars. Profusely illustrated with step-by-step photographs, it is filled with specific information on the best materials and tools to use, and explains the troubleshooting necessary to find the problem. In more than 90 per cent of equipment failure, even the unskilled owner can make repairs at a minimum of time, money, and trouble. And repairs today are simpler than ever, since the new, easy-to-use products are eliminating the need for professionals. **288 pages, more than 500 illustrations, \$7.95**

McGraw-Hill Book Co., Dept. 57-P4
330 West 42nd St., N.Y., N.Y. 10036

SAVE TIME...
MAKE MONEY



**SHARPEN SAWS...
YOURS AND OTHERS**

Professional workmanship comes easy with this portable precision tool which gums, joints, and then sharpens all types of circular saw blades, including cut-off, rip and combination styles as well as carbide tipped, dado heads and blades. Indexer eliminates guess work, sharpens any angle of bevel on circular saws from 4" to 24" diameter. Write for your free copy of "THE SAW FILING MAGIC OF MICRO SHARP".

MARTIN ENGINEERING CO.
P.O. Box 337, Caledonia, Mich. 49316

**HIGH SPEED
DRILL BIT MIX**

50 Drills For **\$4.00**
Only

Add 35¢ postage & handling

A fabulous buy. You get 50 assorted American made high speed drills from 1/64" to 1/4" in varying lengths. All sharp and ready to go.

Order Today—Check or M.O.
AMERICAN TOOL CO.

Dept. DB-390-C, P.O. Box 126
BETHPAGE, L. I., N. Y. 11714

DEALER INQUIRIES INVITED

ALL ABOUT LUMBER booklet. Price 35¢. Send to: **POPULAR MECHANICS Dept FA,** 224 W. 57 St. New York, N.Y. 10019.

Get your bills



WE CAN HELP YOU!

We are not a loan company, so poor credit is no problem! (Maximum total debt accepted is \$20,000.)

Send your name and address. We'll mail more information and a CONFIDENTIAL application.



UNITED SECURITY CORPORATION

Dep't. PM4, 36 Kennedy Pl. Providence, R.I. 02903

WINDWATCH™ ANEMOMETER—WIND VANE \$19.95



Neon lights in indoor indicator show wind speed and direction. Decorative gold panel indicator comes factory wired and sealed in black finished wood frame. Designed for desk use or wall mount. Outdoor instruments of durable aluminum with electrical parts enclosed in rigid vinyl housings. Easy to assemble and install. Attach directly to roof or pole. Comes with wire and materials for installation up to 60 feet. Uses regular 120V AC. Unique low amp circuit assures absolute safety. A fascinating addition to any home. Five year guarantee. 15 day trial. Your satisfaction or money back. Only \$19.95 postpaid.

Dept. 104 Heimann
WINDWATCH San Antonio, Texas 78205



NEARSIGHTED? FARSIGHTED?

No more glasses to wear! Latest discoveries! Eye training course will improve your vision. Are your eyes worth \$4.95?

Mail cheque to:
GROSSI, Box 1061-AP, Postal Station "A"
Toronto 1, Ont., Canada

GUARANTEE: Results within ten days or your money back.

FREE ALARM CATALOG

FOR THE PROFESSIONAL OR DO-IT-YOURSELF. A SUPERMARKET OF BURGLAR AND FIRE ALARM SYSTEMS AND SUPPLIES. PRODUCTS FROM 6 LEADING MANUFACTURERS INCLUDE INFRARED, RADAR, ULTRASONIC, MAGNETIC CONTACTS, CONTROLS, DESCRIPTIONS AND APPLICATION NOTES. PROMPT SHIPMENTS FROM STOCK POSTPAID. WRITE TODAY

mountain west alarm co.
4215 n. 16th st., phoenix, az. 85016



150 Real Beauties, only 10¢

Get 150 different, colorful, hand-picked stamps from exotic lands, new nations, Africa and Europe. Stamps show a view of the Mexican soccer games, two fierce fighting bison, Pope Paul VI, and a new issue picturing Britain's famous 1840 Penny Black, first adhesive postage stamp ever issued. Yours for 10¢ with most wonderful catalog of stamp offers in America.

Littleton Stamp Co.
Dept. RF-22, Littleton, N.H. 03561

Use zip code when answering ads.



For 4, 6 & 8 Cyl.

NEW for your dashboard. Electronic Speed-Control. A red warning light goes on when you go over a set speed with your car. US \$6.95 postage paid

Payment by cheque or money order to the manufacturer: **REESE Instrument (Ireland) Ltd., Patrick Street, Limerick, Ireland**

POPULAR MECHANICS

Материал, защищенный авторским правом

"\$33,000 LAST YEAR"

OPERATING AUTO RADIATOR SHOP

—Mercier Bros., Lowell, Mass.



NEW 1-PIECE SHOP

Tests • Cleans • Repairs

START SHOP OR ADD TO BUSINESS. Market growing. More cars each year. Packaged radiator shop incl.: equipment, training, 98-page manual, initial supplies. Proven merchandising attracts business. Pay-as-you-profit plan. Write.

INLAND MFG. CO., Dept. PM-4
1108 Jackson St., Omaha, Neb. 68102

WATER WATER WATER WATER WATER WATER

"HOW TO DRILL YOUR OWN WATER WELL"

\$1.00^{ppd}

SATISFACTION GUARANTEED

DEEPROCK CO.
OPELIKA, ALA. 36801

Complete construction plans for all BEACH RACING CARS

Formula Vees, Supervees, Fords, Sports Racers

Photo Shown: Mid Engine Sports Racer

Send \$1 for brochure listing plans, parts, books & information kits

AUTOSPORT DESIGN.
P.O. BOX 1311, Dept. PM
LARGO, FLORIDA 33540

PORTABLE STEAM CLEANER

Steam in 60 seconds



CLEAN: Engines—Air filters—lawn mowers—trucks—tractors

"Big enough to do the job, small enough to get there."

Fast, economical, ruggedly built. 3 year guarantee on coils & firebox. Propane fired. Weighs 120 lbs.

Auxiliary pump required on water pressures below 60 lbs. or on well systems.

WEDCO MFG., INC., Dept. M-3,

Box D, Jackson, Wyo. 83001

"BALANCE YOUR OWN WHEELS"

BUBBLE TYPE STATIC BALANCERS

Very Accurate Money Back Guarantee

Precision Made Thousands In Use

V. W. & Saab Adapter—Fits any cone type balancer, \$4.95.

Weights—10¢ per 1 oz.

Complete Instructions.

Prices Pre-paid.

Delivery within two wks. after receipt of order. Dealer inquiries invited.

Steel Cone: Aluminum Cast Base, Chrome Plated.

Very Accurate Money Back Guarantee

Versatile Model (Illustrated) For all wheels including Saab & V. W. (4 & 5 bolt holes). \$19.95.

American Model—For wheels with center holes up to 4 1/2" dia. \$14.95.

Heavy-Duty Model—For wheels with center holes up to 6" dia. (small trucks). \$24.95.



JACOBSEN MANUFACTURING

P. O. Box 6143, 15025 Pacific Hwy. So. Seattle, Washington 98188

BOAT PLANS-KITS



World's largest catalog, over 200 top designs for the amateur. Inboards, outboards, sail, deep vees, 8' to 57'—hydros, cruisers, house boats, ferro cement, plywood. Send \$1.00 for catalog or \$2.00 for catalog plus Boat Builder's Guide.

Other helpful books: Fiberglass-Boat Builder's Material, \$1.00 or send \$2.00, we include book, How to Fiberglass; Motor Installation—Boat Trailer Book with free plan, \$5.00; Ferro Cement-Plywood boat building book, \$6.00.

CLARK CRAFT BOAT CO.
16PP Aqua Lane Tonawanda, N.Y. 14150

REDUCIBLE

RUPTURE

AGONY Removed
(or trial COSTS YOU NOTHING)



WHEN you slip into a low-cost, contour-designed Brooks Patented Air Cushion Appliance! Your reducible rupture will be held in securely yet gently—or the trial costs you nothing! This invention has made millions of sufferers happy. You can enjoy heavenly comfort night and day at work and play—or the Appliance costs you NOTHING. Isn't this worth a no-risk trial by you? If interested, write for free facts now. **Brooks Co., Box 346-K, Marshall, Mich. 49068**

2000 NOVELTIES Free Catalog

FREE! World famous catalog of hard-to-get Novelties, Tricks, Jokes, Pranks, Hobbies, Sports, Science, Electronics, Peace & Love Gear, Mod, Psychedelic, Cloth Patches, Shirt Transfers, Lights, Jewelry, Bargains, Gadgets, Books, Games, Photo & Optical, Tools, etc. **No letter necessary. Send ad, name address. Johnson Smith Co., Dept. C-104, Mt. Clemens, Mich. 48043**

FIND BURIED TREASURE

FIVE PATENTED MONEY SAVING DETECTORS

TRANSISTORIZED FROM **17⁹⁵** to **49⁹⁵**



3 SEARCH HEADS INCREASE RANGE

Finds Coins, Jewelry, Gold, Silver, Bronze

Write For FREE Catalog

SOLIDTRONICS DEPT PA2D TENNENT, NJ 07763



FREE!!! POWERFUL MUSCLES FAST!

Fantastic New Discoveries in the science of bodybuilding. Now, in the privacy of your bedroom, our method will add inches of powerful muscles to arms, chest, shoulders & legs. Learn secrets on trimming the waist with ultra-modern methods—fast! Results Guaranteed! Send for free brochure. **Universal Bodybuilding, Box 485-M1, Dearborn, Mich. 48121.**

Compressed air from car lighter!

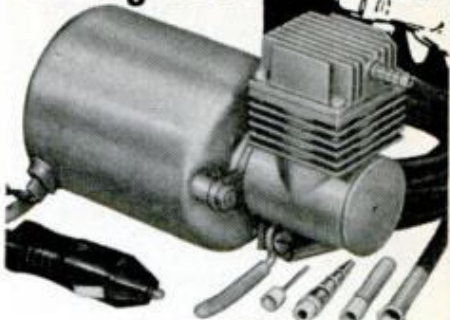

auto-flator

● Now have air wherever you go! Even remote areas. Emergency air for tires, air jacks, space-saver spare. Inflate mattresses, boats, rafts, pools. Plugs into 12-volt system in auto, trailer, truck, boat. Space-age size . . . only 6 1/2 inches long. Amazing pressure up to 60 lbs. Only \$29.95 (plus \$1.00 shipping) with air hose and inflator attachments. Send check or money order on 10-day, money-back, guarantee.

W. R. BROWN CORPORATION
2773 N. Normandy Ave., Chicago, Ill. 60635



TOOL POWER™ 110 VOLTS D.C.

3,000 Watts 0-50 amps from your car's alternator. Operates heavy duty drills, saws, and lights. battery charging. Are welding. Does not operate A.C. motors on refrigerators and air conditioners. Installed in 10 minutes. Guaranteed 5 years. \$25.00 Postpaid. Dealerships available.



A.C. Generators 60 Cycles, 110 Volts,

Fanbelt driven. Run power tools, T.V.'s, refrigerators, radios, A.C. motors to 1/2 H.P. Cannot operate air conditioners. 1,500-watt \$60.00 plus \$5.00 postage. 3,000-watt \$99.50 plus \$6.00 postage. P.O. Box 7066 2821 Mays St.

VIRDEN PERMA-BILT CO.
PM Amarillo, Texas 79109

HANDY DANDY Storage Idea



Handy Dandy plastic caps hook onto 1/8" peg-board to hold popular, quarter-twist food jars (such as baby food) with 1-15/16" neck. Nothing better for storing screws, nuts, bolts, parts, buttons, etc. For those who prefer: tough, unbreakable, clear plastic jars are also available.



QTY	CAPS	JARS	CAPS & JARS
10	\$1.00	\$2.00	\$2.50
24	-	4.50	-
36	3.50	6.25	8.00
72	6.00	11.50	15.00

PPD USA, No C.O.D.'s

WICKLIFE INDUSTRIES, INC.

Box 286 PM-4
Wickliffe, Ohio 44092

GRANDFATHER CLOCKS
SAVE 50%
BUILD YOUR OWN GRANDFATHER AND GRANDMOTHER WEIGHT DRIVEN CLOCKS

- Highest Quality Imported Movements from Germany
- Tubular or Rod Chimes
- Moving Moon Dials
- Pre-cut Semi-assembled Handcrafted Case Kits (No power tools required)
- Dials, Barometers, Hygrometers, Templates and Case Plans.

All movements and dials in stock.
 Send 50¢ for complete catalog

H. DeCOVNIK & SON.
 P.O. Box 68, Dept. M42
 Alamo, Calif. 94507
 EST. 1947

Make your own gems!

Fun - Easy - Profitable

Kit includes Gem Maker with 6" iron lap wheel, all grinding, shaping and polishing wheels, diamond blade, accessories, instr. \$49.90 less motor, lab Fctry.

B & I MFG.
 Box 1267-P, Galesburg, IL 61401

Write for literature.

CARTOON FOR MONEY

Learn from experts how easy it is to make big money at home - with easy to draw cartoons. Send 25¢ for postage & handling.

SUCCESS, Dept. 25
 Box 885, Dearborn, Mich. 48121

FREE BOOK

NAME _____ AGE _____
 ADDRESS _____ ZIP _____
 CITY _____ STATE _____

YOU CAN BE TALLER!

If you could grow 2-6 inches taller in one month would you spend 25¢ to discover how?

Fantastic, new breakthrough method of increasing height quickly, safely and naturally. No exhausting exercise, appliances, drugs or elevators. PLUS, results guaranteed. Air mailed Proof 25¢ only.

HEIGHT INCREASE BUREAU:
 Dept 15816
 P.O. Box 146,
 Brampton, Ont. Canada

BE TALLER! Girls go for tall Men.

NAME _____
 ADDRESS _____
 CITY _____
 STATE _____ ZIP _____

HUNDRED BUCK BUGGY

Practical, fun Super-Bug easy to build. Plans inc. front ski, lawn mower attach. Complete scale drawings, photo, supply sources and costs, assembly steps. Model shown carries 1000 lbs., climbs 60% hills. Orders mailed immed. \$5.00

PMD / SUPER BUG
 806 S. 80th Ave., Yakima, Wash. 98902

QUIT WORRYING
 Beat Layoffs—Be Secure

Make \$30 to \$50.00 A DAY

IN YOUR OWN SHARPENING BUSINESS

Sharpen hand saws, circular saws, tools, scissors, pinkie shears, clippers, planer and Dado blades, rotary mowers, skates, everything for EVERYBODY. Spare or full time. SIX-Machines-in-One for low price of ONE.

For 4" to 48" circular saws

GET STARTED NOW WRITE FOR NEW FREE CATALOG

TREYCO
 3687-A Lockport Rd.
 P.O. Box 588,
 Sanborn, N.Y. 14132

Money Back Guarantee

Thousands of exciting tool values!

SILVO (BRAND NAME) TOOL CATALOG

Thousands of Exciting Tool Values! Stanley, Millers Falls, Skil, Thor, Wen, Disston, Wiss, Weilsaw, Dremel, Speedy Sprayers, Plumb, Huot, Kennedy, Channellock, Porter-Cable, Rockwell, Helios, Vise-Grip, Crescent, Ridgid, Pony Clamps, Unimat, Foredom and many other Nationally Advertised brands of Tools & Supplies. We ship Coast to Coast at prices Hard to Beat. Send 50¢ for our big 148 page tool catalog today. Silvo Hardware Co., PM4 107 Walnut St., Philadelphia, Pa. 19106

WORLD WAR II STYLE COMBAT KNIFE
 Only \$2.75

Replica of the hated Nazi COMBAT KNIFE of World War II. Now made into a real man's hunting knife. 5½" blade, 9¾" over all length. Razor sharp high quality cutlery steel blade. Comes with Leather Sheath. Your treasure for only \$2.75 plus 25¢ handling charge.

WESTBURY SALES CO. Dept. NM-19
 P.O. Box 434, Westbury, N.Y. 11590

CHARGER KITS for CAR-TRUCK or BOAT BATTERIES

For 6 or 12 volt batteries. Delivers up to 50% more than rated output on initial charging surge. Tapers to 2-3 Amps as power builds up in battery. All wiring with push-on terminals. Only a screwdriver needed for easy assembly. Step-by-step instructions.

Overload breaker, plastic handle, red and black case. Six foot power cord, charging cable with heavy-duty battery clips attached. Meter recessed for protection, wall mounting slots on rear. 10x6x6.

6 Amp. \$1495
 10 Amp. \$1995
 10 Lbs. 12 Lbs.

PLUS POSTAGE

Southwest Technical Products Corporation
 Box 32040 • San Antonio, Texas 78284

BUILD YOUR OWN HOME!

Save thousands of dollars! At last, a complete do-it-yourself instruction manual for the first time amateur builder. Fully illustrated, fifty chapters cover everything you must know to build a home. Included are plans for our most popular three bedroom home. Many other plans available. Send \$5.00 now to:

HOME BUILDERS PLANS
 136 SCOTT DRIVE • DEPT. 25
 DUNDEE, ILLINOIS 60118

FACTORY CLOSEOUT!

Air Pistol \$5.95 ppd.

Shoots both pellets and darts. This fine, well made .177 cal. German air pistol is just the ticket for target or Varmints. Accurate. No CO2 cartridges to replace, either. Once in a lifetime bargain. Order several. Supply limited. Only \$5.95 ppd. (Secret leather holster, \$2.95 ppd.)

500 Deluxe Pellets, \$2.00 ppd.
AIR PISTOL, Dept. PM-4
 4535 Huntington Dr. South
 Los Angeles, Calif. 90032

BUILD YOUR OWN CANOE

WOOD & CANVAS OR FACTORY MOLDED FIBERGLASS!

MANY MODELS TO CHOOSE FROM \$1950 (BASIC WOOD KIT)

TRAILCRAFT, INC.
 Box 60679, Concordia, Kansas 66901

FREE CATALOG

WEB GUARANTEES IMMEDIATE, LASTING RUPTURE RELIEF OR YOUR MONEY BACK IN FULL!

Enjoy a stronger, happier life. Wear a Web for strong support and lasting relief of reducible inguinal rupture. If not completely satisfied, return within 30 days for full refund of purchase price.

Write for FREE book on rupture care.

WEB TRUSS Dept. PM-4 Hagerstown, Md.

WAR SONGS OF THE THIRD REICH

33 1/3 L.P.

Authentic! Recorded by Goering Music Chorus and Berlin Watch Battalion 1939-1945, U-Boat Song, Paratroopers Song, Africa Song and many others.

\$4.98

OUR TIMES

36 Truman Dr.
Novato, Calif. 94947



NEW SURFACE COATING

SAVE MONEY—REDUCE ACCIDENTS... with HESA, new miracle compound that reduces slipping on any surface. **READY-TO-USE; EASILY APPLIED; LONG LASTING:**
1/2 pt. — \$2.75
pint — \$4.95
quart — \$7.75
PPD. — no C.O.D.
AUGUST PRODUCTS INC., Dept. PM
176 Main St., Ridgefield Pk., N. 07660

DETROIT APPROVED—PICKUP TANKS

Original equip. type poly. now avail. in aux. tanks for pickups. Increase gas capacity 40 gals. Easy 1 hour installation—completely hidden—no body work necessary. Let truck dis. counts pay for tanks.



R.P.M. INC., Dept. PM-472
P.O. BOX 7936, Waco, Texas 76710

KWICK POWER FOR TOOLS

110 volts D.C. 3000 watts anywhere from any vehicle with an alternator. Installs permanently in 15 minutes. Operate heavy duty saws, drills, lights, heaters & many more a.c. devices. Arc weld, quick charge batteries. Will not harm alternator. **\$14.95** postpaid, check or money order.



Only \$14.95

AUTO QUICK
10914 4th St., N.E.
Minneapolis, Minn. 55434

\$2,000 A MONTH

It's easy to do with my new advertising and/or mail order business! Advertising is competitive but highly paid—we have a new medium with virtually no competition and you can cash in on it in a big way! Send only 25¢ postage and handling for details on how you can profit from these new high income opportunities of today. **Ropchan Advertising Systems, Dept. PM, Box 5341, Sherman Oaks, Calif. 91413.**

Baby Food JAR HANGERS JIFFY

wire hangers engage the neck of the jar allowing jar to be hung on our pat. clips which snap into 1/4 or 1/2 perf. board. Can easily be removed. P.S. Show Gramps or Uncle this ad, they could use your extra jars. Hangers only—12/\$1.40/\$3.80/\$5. No Jars—No C.O.D.—P.P.D.
WOBLAK P.O. Box 484A Franklin Park, Ill. 60131



110 Volt, 3000 Watts of Power and 35 to 55 Ampere D.C. Welder. Uses your car, truck alternator. With installation hardware welding/charging cables. Easy installation. We also have engine driven welders 60 to 600 amps and 110 volt sets to 27,000 watts.

Dealer Inquiry Invited. \$34.00. **HALDO PRODUCTS, INC. 8646 Jennings Road, Eden, New York 14057.**

FREE BURGLAR ALARM INSTALLATION MANUAL

We will send you free with no obligation our exclusive Burglar Alarm Installation Manual. Gives you simple, easy to follow, step by step "do it yourself" instructions - saves you hundreds of dollars. No special tools or license necessary. Send today for your FREE Installation Manual. If you also want our 1972 catalogue featuring 100's of items at fantastic savings, please enclose \$1.00 cash or money order.

ALARM DEVICE DISTRIBUTORS
P. O. Box 372-K Opa Locka, Fla. 33054

Sale on scarce dates



Lincoln Cents—15¢ each

1910 11 14 16 17 17D 18
1919S 19D 20S 20D 21 24 25
1925S 26 26D 27 27D 28D 29S
1929D 30S 30D 34D 35S 35D 36S 36D 37S
1937D 38 39S 40S 41S 42D 42S 43 43D
1943S 44S 45S 46S 47S 48S 49S 50S 51S
1952 52S 53D 53S 54 54S 55D 60D

Jefferson Nickels—25¢ each

1938 39 40 40S 41S 42 42D 42S 43 43S 44
1944D 44S 45 45S 45D 46S 47S 48S 49S 50
1951D 52D 52S 53S 54 54S 55D 56 56D

Roosevelt Dimes—30¢ each

1946 46D 46S 47 47S 48 48S 49 49D 50
1950S 51 51D 51S 52 52D 52S 53 53D 53S
1954 54D 54S 55S 56D 57D 58 58D 60 60D

Circle dates wanted. Minimum order \$1. Money back guarantee.

Superior Supply Co., Dept. TM-32
16 Maple Street, Littleton, N.H. 03561

NEW INVENTION SAVES YOU MONEY! NOW REPAIR YOUR CAR MUFFLER FOR LESS THAN \$2.00



Just "bandage" the damaged area with **FIXITAPE**. Heat of muffler bonds it.

Save \$25.00 or more on a new one. We have developed a tough fiberglass tape with a special epoxy impregnation that does the trick. Wrap Fixitape around damaged area like a bandage. Heat from muffler bonds it permanently. No strapping it outlasts muffler. Fixitape also repairs tailpipes, fenders, water pipes, rainpouts, etc.

Works every time or your money back. Order now direct. We pay postage. 42" length \$1.25 pkg. 2 pkgs., \$3.75. 72" length \$2.98 pkg. 2 pkgs., \$5.50.

EDWARDS PRODUCTS
Dept. PM42F,
910 Beechwood Ave.,
Cherry Hill,
New Jersey 08034

ALL ABOUT UPHOLSTERING.

This is the book for you if you want a house full of smart-looking "new" furniture. It not only tells but shows you how to upholster. Easy-to-understand charts do much of the figuring for you. All styles of furniture construction are shown, along with the type of upholstery best suited to each. Price \$5.95. Send to: **POPULAR MECHANICS, Dept. FA4, 224 W. 57th St. New York, N.Y. 10019.**

ELECTROPLATING EQUIP.

Portable Platers, Supplies & "Know-How." Build your own tanks for Nickel, Chrome, etc. Easy-to-install PVC liners. Rectifier components—all sizes. Schematic parts lists, formulas, operating instructions for all plating. Guar. to save 25%-75%. Some good used units for sale.

Send for FREE details.
PLATERS SERVICE CO.
1511-A1 Esperanza Los Angeles 90023

THIS IS IT!



Popular Mechanics said in July, 1969 (p. 166):

"Handiest Tool You Can Have in Your Shop"

It sands, grinds, polishes, sharpens. It's portable. Take it on the job. Use with any 1/4 hp motor. Model 165. Factory direct special.

Quik-Sand \$26.95 less motor

ARCO MFG. CO.

P.O. Box 817, Grand Forks, N.Dak. 58201

ATTENTION VW OWNERS!

Now fuel-injected VW's will start FAST—especially in cold weather. New electronic choke delivers more fuel to cold engine. Unit comes complete and ready for easy installation. Full instructions included. \$9.95 postpaid. (Add 55¢ tax in Calif.) Satisfaction Guaranteed or money back!

MEDCO, Dept. M42, Box 433, La.ayette, CA 94549

CLASSIFIED ADVERTISEMENTS

Rate: \$2.00 per word payable in advance each insertion. Capitalized words—75¢ per word additional. Minimum insertion ten words. To be inserted under the proper classification, copy must be in our office by the 15th of the second month preceding date of issue. The next available issue to place an advertisement in America's No. 1 Classified Section is June. The closing date is April 10th. Send remittance and order to C. A. Martin, Popular Mechanics, 224 West 57th Street, New York, New York 10019. Please make remittance payable to Popular Mechanics.

POPULAR MECHANICS

WHEN ANSWERING ADVERTISEMENTS PLEASE USE THE ZIP CODE NUMBER

AUTOMOBILES

VX-6 RESTORES Battery Life. Preserves Life of Battery. Installed In Moments. \$2.98. Martin, P.O. Box 5514, Los Angeles, California 90055.

PATCHES Color Catalog 25¢. Shows Hundreds. Quotes Your Design. Patches, Dept. 94, RFD 1, Littleton, N.H. 03561.

EXCELLENT Older-car magazine at last! Sample 25¢. "Special-Interest Autos," Box 7211-M, Stockton, Calif. 95207.

MIDGET CARS

KEEP Your copies of PM—and watch for the inexpensive Annual Index, available in January 1972. It will enable you to locate any article which appeared in 1971 or find information on any particular subject in just a few seconds. The Annual Index will make your copies of PM even more valuable! Price \$1.49. Send checks to: Popular Mechanics, Dept. HE, 224 W. 57th St., New York, N. Y. 10019.

AUTO SUPPLIES AND EQUIPMENT

GUARD AND CLEAN PRODUCTS. Restores vinyl. Protects fabric. \$6.95 kit does average car. Satisfaction Guaranteed. Lanier Assoc., Box 5535, Columbus, Ohio.

LITE-MINDER Always Reminds You To Turn Off Your Car Lights. Easy Installation. Price \$6.95. Specify 6 Or 12 Volts. Lite-Minder, Box 7626, Riverside, Calif. 92503.

REBUILT AUTOMATIC TRANSMISSIONS. Expertly Rebuilt And Scientifically Tested. Write For Price List. P.O. Box 55, E. Norwich, N.Y. 11732.

ALTERNATOR, Generator, Starter Rebuilding Kits and Rebuilding Instructions. Write: Gold Coast Alternator, P.O. Box 2127, Sepulveda, Calif. 91343.

ELECTRONIC IGNITION: Improves performance. Eliminates tuneups. Boosts spark voltage. Only \$14.95 postpaid. Box 2002, Huntington Beach, California 92647.

BURNING Oil?? ... Smoking?? ... Pep-less?? ... Hard Starting?? ... Save with Ring-Valve job while driving \$6.50. (Special: Two for \$12.00 postpaid.) Results guaranteed!! Motaloy, Grantham, Penna. 17027.

OPERATE Power Tools From Car Alternator. Plans \$2.00. Ambrose Fisher, 921 Wakefield, St. Paul, Minn. 55106.

JEEP Owners—V8 conversions. Read Jeep Owner's ad, page 208.

MOTALOY, Ring—Valve job while driving—\$6.00. Free literature. E&G Sales, Box 18384-P, Memphis, Tenn. 38118.

ALTERNATOR/Generator Rebuilder's Course; includes Tooling & Test Equipment; Write: Hedelund Engineering, P.O. Box 1134, Reseda, Calif. 91335.

SAVE MONEY AVOID TROUBLE—Ring and Valve job while you drive—Amazing—Free information—Write Today—Ransom Baucom Company, Department 4-27-MP, Raeford, North Carolina 28376.

CONVERT Volkswagen And Other 6 Volt Systems To 12 Volt Economically. Use Original Starter And Generator. Simple Instructions. Send \$2.00 To: Box 33, Brewster, Ohio 44613.

STOP THE THIEF That steals your car when protected by the new **STEAL "N" STALL** Anti theft device \$6.95 postpaid. Money Back Guarantee. Argus Alarms And Electronics, 2030 Kendall Street, Denver, Colorado 80214.

VOLKSWAGEN Parts, Metric Tools, Custom Foreign Car Radios, Save to 60%. Catalog 50¢. \$1.00 off on first order. The Wholesale Co., P. O. Box 4044, Bridgeport, Conn. 06607.

AUTO EMERGENCY KIT! Contains items needed when emergency occurs. From flats to fire. Warning blinker included. \$9.95. Taylor House, Dept. 1, 3016 22nd Street, Lubbock, Texas 79410.

"BUT OFFICER, My speedometer said I was only going 35 miles an hour." Have you ever said that? Be sure your speedometer is accurate. Let **CHARTCAR** help you. No need to go to an expensive, specialized mechanic either. Everything you need is provided—Charts, Time Logs, Speed Conversion Tables—to let you check the accuracy of your car's speedometer yourself. Send \$2.98 now to: **CHARTCAR,** 3809 Scoville, Berwyn, Illinois 60402.

AUTO ELECTRIC-POWER FOR TOOLS Alternator-Adapter Runs Brush-type 110 Volt Motors, Drills, Saws, Lights. Send \$14.95 plus \$1.25 postage to: **SPACO,** Box 58189, Houston, Texas 77058.

MOTALOY RING AND VALVE JOB. GOOD FOR THE LIFE OF YOUR ENGINE! Just drop 4 Motaloy pellets into car's gasoline tank. Motaloy works while-you-drive to replate worn, pitted pistons, rings, valves for up to 50,000 miles of improved performance. 19th year of rigorous use and proof. Guaranteed. Only \$6.00 postpaid. **GENERAL ENTERPRISES, 108 FOURTH STREET, SANTA ROSA, CALIFORNIA 95403.**

120 VOLTS AT 3000 WATTS of electricity from ANY alternated vehicle using our special adapter! Operate electric drills, lights, heaters, portable saws, ac-dc, tv's and many more ac devices! Arc weld 1/4" steel plates! Fully charge 6,12,24 volt batteries in minutes! Will not harm alternator! Installation takes only ten minutes! Guaranteed one full year! Send only \$6.95 for construction plans, \$12.95* for complete kit, \$15.95* for assembled unit or \$18.95* with voltage indicating light (comes on when alternator is producing 120 volts!) * add \$1.25 for postage.—**PLUS 15 OTHER PRODUCTS JUST AS USEFUL!**—Ask for our **FREE** color catalog—Creative Products, 1551 East Loop 820, Dept. (MD), Fort Worth, Texas 76112.

SNOWMOBILES

SNOWMOBILE Hop up accessory **CATALOG.** Speed and performance equipment—manifolds, exhaust systems. Send 25¢. **G.E.M. PRODUCTS,** Box 845, Carol Stream, Ill. 60187.

DUNE BUGGY

YOUR Ad in Popular Mechanics will be seen by more than 5,000,000 active buyers for your products and services. It costs only \$2.00 per word. And, if you wish to run all or part of your ad in capital letters—you can do so for as little as 75¢ per word additional. Act now! Place your Classified ad in Popular Mechanics today.

AUTO TRAILERS

PICKUP Camper, Trailer or Pickup—Cover . . . Build yourself. Save! Complete plans \$3.95 each Cover plans \$2.00 Conversion Plans—econoline type van \$2.95; passenger bus or delivery van \$2.95. Satisfaction Guaranteed. Equipment catalog \$1.00 (refundable). Details 10¢. Viking Camper Supply, 99-F Glenwood, Minneapolis, Minnesota 55403.

PLANS, 16' Cabin Trailer \$3.00, Plans Septic Tank \$2.00. J. B. Schultz, 16587 Freeland, Detroit, Mich. 48235.

MOTORCYCLES, BICYCLES MOTORSCOOTERS & SUPPLIES

HONDA! \$25 Other Bargains. Send 50¢. Motorscooter, P443, Bend, Oregon 97701.

FUN-BUGGY Catalog. Just out. World's first, biggest, featuring ATV's, Mini-bikes, Karts. \$1.00. "How-to" plans \$1.00. Complete parts stock. Bargain prices. Brown's Motorsports, 19P Central St., Worcester, Mass. 01608.

ILLUSTRATED Catalog 25¢. Parts, Accessories. Custom Stock, most makes, models. Cycle Supply, Box 192M, Fairbury, Ill. 61739.

BUILD Popular Mechanics' **MINIBIKE** featured June 1967 issue. Detail plans, photographs \$2.50 refundable. Kits, parts, engines; factory discount prices. Catalog 25¢. Gilliom Mfg.: PMC; St. Charles, Missouri 63301.

MOTORIZE Your Bicycle; Go-Kart; Snowmobile Plans! \$2.00 Each: Go-Bykco, Barnesville, Minn. 56514.

MINI-BIKE CLUTCH \$10.95. For #35 Chain 3/8" or 3/4". Discount Catalog Included. Catalog Only \$1.00. **MOTO CROSS ENTERPRISES,** P.O. Box 57, Philadelphia, Pa. 19105.

MINI-BIKES, Go-Carts, Motorcycles, Spare time salesmen wanted. Loren Products, Danville, Illinois 61832.

(Continued on next page)

SPACE, ROCKETS AND ASTRONAUTS

ROCKET TO ME! New, Fun-Filled Game played with "Bouncey" Rockets. Become a Great Champion Rocketeer for only \$3.00! USUA, Box 5171-PM, Clearwater, Florida 33518. Copyright.

ROCKET TEXTBOOK: Designing, Testing, Firing, Fueling. Includes Plans for: 5 Rockets (to 20,000'), 4 Launchers, 20 Fuel Formulas, 382 pages, \$2.00. Information 25¢. York Enterprises, Box 5443-PM, Little Rock, Arkansas 72205.

ANTIGRAVITY DEVICE. Free Brochure. AGD, Box 16126-PM, Wichita, Kansas 67216.



AVIATION

BUILD—One-Man jet helicopter. Easy inexpensive. Detailed plans, drawings—\$5.00. Helicraft, Box 7153, Baltimore, Maryland 21218.

AIRBOAT, Propellers, Hubs, Mounts. Plans. Supplies. 90—125—150—220 H.P. engines and parts. Corvair—Volkswagen conversions. 15—25—50 H.P. removable air-drives \$265.00 — \$341.00 — \$570.00. Catalog \$1.00. Banks-Maxwell, Box 3301E, Ft. Worth, Texas 76105.

BUILD YOUR OWN HELICOPTER From our drawings and assembled components. Not a toy. Uses aircraft engines. Send \$5.00 now for our educational information package. Contains Aerodynamics, Stress Analyses, Photos, Prices. Helicom, Inc., 4411 Calle De Carlos, Palm Springs, Cal. 92262. (Since 1954.)

FUTURE Flying Students! Save Time, Money! Learn Important Information Before Starting. Rush \$1.50. R. Cooney, 2758-A Maxwell Street, Philadelphia, Pa. 19136.

HOVERCRAFT

AERO-CAR. Amazing Hovercraft built easily with ordinary tools. Lawnmower engine power. Carries one man plus. Hovers, flies forward, backward, sideways over land/snow/water. Complete construction plans and brochure. \$5.95. Aero-Projects, Box 5118PM, Clinton, New Jersey 08809.

HOVERCRAFT. New British design adaptable for Fun, Freight, Joy Riding, Crop Spraying. Drawings, Instructions, Kit parts list. Information commercial opportunities. Airmail \$5.00 Refundable. Airflow Components Ltd., 24 Albert Rd., Manchester 19, England.

SKIPPER Hovercraft \$695.00. Plans \$5.00; 3-view photo 50¢. Kits, engines, propellers, supplies. Catalog 50¢. Arrowcraft-A. Pearland, Texas. 77581.



BOATS AND TRAILERS

FIBERGLASS AND BOAT BUILDERS SUPPLIES At factory prices. Fiberglass, matt, resins, foams, bronze brass screws, nails, fittings, marine plywood, mahogany, trailers, boat plans. Send \$1.00 for literature or \$2.00 for large catalog plus hook on fiberglass uses, boat coverings, molds, etc. to: Clark Craft, 16-P1 Aqua Lane, Tonawanda, N.Y. 14150.

AIRBOATS—Engines, Propellers, Hulls, or Complete Fiberglass Airboats. Color catalogue. \$1.00. (Refundable with order). Aircat. Lake Hamilton, Florida 33851.

FIBERGLASS Canoes, Kayaks, and Duckboats. Many exciting models. Easily assembled kits. \$39.95 up. Free Literature. Riverside Canoes, Box 5595P, Riverside, Calif. 92507.

NEW 1971 Outboards . . . Top Brands
4 H. P. \$139 . . . 6 . . . \$273 18
\$399 . . . 40 Selectric \$638 . . . 60 Selectric
\$899 . . . All Sizes . . . Literature 50¢
Scott-McCulloch Parts. Electra Marine, 675
Merrick Rd., Lynbrook, New York 11563.

FIBERGLASS Cloth and resin. World's finest cloth and non-run resin, at direct mill prices Flotation foam. Complete line of plastics, silicon bronze and brass screws, save 60%. No sales tax. Boat Plans. Catalog 25¢. Freight prepaid. Stiles Boat Supply, Box 11P, Linden Ave., Mantua Hts., N.J. 08051.

CANOEES! Kayaks! Factory-direct quality kits, from \$25.00. Many different models. Canvas hulls. Strongest construction materials. Free literature. Sportscraft, Box 636-P, Allentown, New Jersey 08501.

PLANS, FULL-SIZE PATTERNS. FRAME KITS With step-by-step instructions specially for amateurs. Send \$1.00 for new catalog just off press—nearly 100 pages, over 100 designs 8' to 42'; Sail, Jets, Inboards, Outboards, Cruisers, Houseboats, Hot Boats, Catamarans, Hydros, Glen Designs, 9152 Rosecrans, Bellflower, Calif. 90706.

CANOE Kits—Wood Canvas, Molded Fiberglass—Free Literature. Trailcraft, Inc., Box 60686, Concordia, Kansas 66901.

FIBERGLASS Cloth, mat, resin. Flotation foam. Complete supplies. Catalog 25¢. Kick-Shaw, Inc., 3511 Hixson Pike, Chattanooga, Tenn. 37415.

FISHING/Surfing/Sailing/Power/ Dories. Send 25¢ for Brochure, Photos. Texas Dory Boat Plans, Box 720, Galveston, Texas 77550.

KAYAKS, Canoes, Sailboats, Surfboards, Complete plans, instructions. Free catalogue. Outdoor Sports, Box 1213-P, Tuscaloosa, Alabama 35401.

DIRECTORY: 174 Boat Plans, \$2.00. Moore, Box 852, Ashland, Oregon 97520.

BOAT KITS—Assemble yourself from factory molded fiberglass sections, save 1/2 over factory built. Satisfaction Guaranteed. Send \$1.00 for beautiful 80 page fact filled color catalog showing 20 models—14' to 32'—Cruisers, Runabouts, Houseboats, Sailboats, complete Accessories, Motors, Trailers, discount prices. Luger, Dept. BC-72, 3800 West Highway 13, Burnsville, Minnesota 55378.

'LEARN To Handle And Land Your Power Boat Slowly.' Concise; based upon 25 years commercial boating and instructing. \$5.00 postpaid. Happy Landings Publisher, A912 W. Main, Hebron, Ohio 43025.

BOAT PLANS—BOAT KITS—FRAME KITS World's largest 1972 catalog. Over 200 top designs. Sailboats 7-45'. Windmill, Snipe, etc. Motor Sailability, Trimarans, Catamarans, Power Cruisers, Houseboats, Deep V's, Fishing Boats, Runabouts, Hydroplanes, inboard and outboard. Ferro Cement 33-57', sail and power. Send \$1.00 for Plan Kit Catalog or \$2.00 for catalog plus Boatbuilder's Guide to: Clark Craft, 16-P Aqua Lane, Tonawanda, N.Y. 14150.

PLANS, Patterns, Kits. Plywood, Fiberglass, Ferro-cement. Catalogs: Powerboat (2) \$1.25, Sailboat 50¢, Marinecraft, Box 161-M, Brighton, Mass. 02135.

PULL A BOAT OR TRAILER? Old car? Stop radiator overheating with easily built cooler. Send \$3.00 for plans to: Epis Co., Room 203, Box 676, Orinda, California 94563.

CAMPERS AND TRAILERS—KITS—PLANS—

STOP TRAILER SWAY! Build your own stabilizer bar for less than \$20.00. Complete plans, \$2.00. Ottney's, Route 2, Sciotoville, Ohio 45662.

CABOVER Campers, Pick-Up Covers, 10' & 20' Trailers. Build and Save. Large scale Plans and Full-size Patterns with written & pictorial instructions. Complete accessory and aluminum covering kits. Free Literature. Glen L, 9152 PM-4 Rosecrans, Bellflower, Calif. 90706.

MARINE EQUIPMENT AND SERVICES

MARINE Engines, conversions, parts, equipment. Catalog Free! Stokes Marine Industries, Coldwater, Michigan 49036.

CONVERT Auto engines to marine. 68 Page Catalog, 50¢. Lehman Manufacturing Company, 800 Elizabeth Avenue, Linden 4, New Jersey 07036.

MARINE Supplies, Ignition Parts. Free literature. Michael's, 991 Broadway, Bayonne, New Jersey 07002.

FREE Brochure Conversion Kits, Propellers, gears V-Drives 1/0 Drives Gas, Diesel. Starmarine, 1931 Embarcadero, Oakland, Calif. 94606.

ATHLETIC AND BODY BUILDING COURSES

"GIANT Arms." Dr. Young's. D.C. revolutionary discovery. \$2. Satisfaction or refund. Gaucho, 1769-S7, Chicago 60690.

POWERFUL Muscles fast! Free brochure! Universal Bodybuilding, Box 4327-C, Dearborn, Michigan 48126.

BUILD Muscle and strength in half the time with Tsokinetics. Details 25¢. Pyramid Equipment Co., Box 05086, Detroit, Michigan 48205.

SPORTING GOODS AND EQUIPMENT

POOL TABLES SAVE \$350.00. Build Your Own 7' or 8' Home Pool Table, PLAN'S, Complete Easy To Follow Instruction's And Part's Catalogue. Send \$10.00. Sportsman, 407 Sycamore, Clarkston, Wash. 99403.

FREE 1972 Catalog! Guaranteed lowest prices! Rods, Reels, Lures, Accessories—Thousands of items. Cabela's, Inc., Dept. S-4, Sidney, Nebraska 69162.

FREE Catalog low direct factory prices, fishing, Hunting, Archery, reloading Camping supplies. Send today. Harters Inc., Dept. CPM, Waseca, Minn. 56093.

FREE WHOLESALE CATALOG. Lure parts, Molds, Rod Blanks, Reels, Archery, Metal Detectors. Rare Hardwoods. FinnySports (ME), Toledo, Ohio 43614.

CROSSBOWS Powerful Accurate. Catalog 25¢. Crossbowman, Box 723PM-4, Manteca, California 95336.

COZY Shelter In Seconds!! Amazing INFLATABLE TENT . . . No Poles! . . . Rainproof! . . . Compact!! International, 4877 (1B2), Compton, California 90224.

DETAILED OUTDOORSMAN'S POCKET-SIZED SURVIVAL DATA \$1.00. G. Simpson Co., P.O. Box 3551, Simi, California 93063.

TELE-OPTIC Sports Knife with built-in monocular field glass. 4 1/2 inch blade, leather sheath, \$8.95. Zelmar Enterprises, P.O. Box 135, Bronx, N.Y. 10452.

SPORTSHAUS Offers exceptional savings wholesale to you. For more than 100 pages of nationally advertised sporting equipment, send \$1.00 (refundable) to: Sportshaus / Dept. A / P.O. Box 18008 / Cleveland, Ohio 44118.

NEW Safety Strap makes skiing fun, safe, and easy. **GUARANTEED.** Free info. \$2.90. Christi-eze, 16795 W. 44th Avenue, Golden, Colorado 80401.

BILLIARD CUES & Accessories, Details Free. Murphys' 34, Box 5352, Santa Monica, California 90406.



FISHING, TACKLE, LURES

MOLDS For fisherman's sinkers, jigs, squids, casting and spinning lures. Free catalog. Sweet Molds, Tonawanda 1, New York 14150.

ELEC-TRIC-LURE (Mercury battery lighted). "Fish-Catchingest" lure you ever tried—free catalog. Fen Brown Company, Box B 5, Willingboro, N. J. 08046.

MOLDS—For casting your own fishing sinkers. Free illustrated booklet. Reading Instrument Co., Box P78, Reading, Pa. 19603.

(Continued on next page)

FISHING, TACKLE, LURES

(Continued from preceding page)

FISHERMAN'S DREAM BOOK—FREE. 170 page catalog just loaded with Hard-To-Find Fishing Tackle Specialties and Do-It-Yourself Goodies. Our 28th year. **NETCRAFT Inc.**, Box 5510, Toledo, Ohio 43613.

FISHING Secrets Revealed. 36 page 1972 Fisherman's Guide. Many hot tips, top spots, much more. Plus exciting new facts about fishing with Mepps spinners, world's most popular lure. 50¢ value. Send 25¢ with name and address to: **Sheldons', Inc.**, Box (719), Antigo, Wis. 54409.

CATCH FISH LIKE CRAZY. Fresh, salt water. Day, night. Year 'round. **SVENGALI 'em.** Unconditional never fail guarantee. Become one of thousands satisfied mail customers. 12 samples \$1.00 **SVENGALI LURES**, P. O. Box 144-L, Glen Head, N.Y. 11545.

"WORM Round-Up" Brings Them Up Alive! \$1.00 Sample Makes 10 Gallons. **Crescendo**, 120 Meadow Run, Hamburg, New York 14075.

EARTHWORMS, LIVE BAIT

GROW Fishworms. Outstanding new breed produces great profits. Free Literature. **Fain's Hatchery-31**, Edison, Ga. 31746.

EARN Money raising fishworms for us! Exciting details free! **Oakhaven—56**, Cedar Hill, Texas 75104.

GROW Larger Earthworms, Faster Easier—More Profit—Nograin—Soilless Method. **Organic Enterprises** . . . Route #1-M . . . Texarkana, Arkansas . . . 75501.

HYBRID Redworms 5000 \$10.00. 20,000 \$20.00 Postpaid with Raising Instructions, Worms, Route 9, Waco, Texas 76705.

\$15,000 YEARLY Raising Fishworms, Free Literature. **Georgia Enterprises**, Dawson, Georgia 31742.

FROGS, FISH, REPTILES

\$20,000/YEAR POSSIBLE RAISING BULL-FROGS! Complete Instruction—Manual Shows You How! Only \$2! Guaranteed! Order Today! **Bravco**, Box 3511A, Victoria, Texas 77901.

JUMBO BULLFROGS: GIANT breeders and young frogs for **STOCKING**. **BAYOU FROG FARMS**, Box 10PM, Waverly, La. 71290.

HUNTING, GUNS, DECOYS

MUZZLE LOADING Pistol and Rifle Kits. Fully Shootable. From \$18.50. For brochure send stamped envelope to: **CVA**, Dept. 15, Higganum, Conn. 06441.

1850 PERCUSSION PISTOL .44 Cal. Make it yourself. Shootable! Complete plans and full instructions \$2.00. **Equipment Viel Enr.**, Box 250PM, Isle-Verte, P.Q. Canada.

FREE Hunting or Fishing & Camping Catalog Brand name merchandise at lowest discount prices. **American Express, BankAmericard, Master Charge, Uni-Card** Parker Distributors, (Dept. PMC-472), 40 Industrial Place, New Rochelle, New York 10805.



POULTRY & GAME BIRDS

GAMEBIRDS—"Everything—You Name It." Pheasant Breeders Book \$5.95. **Stromberg's**, Fort Dodge 25, Iowa 50501.

QUAILS, Incubators, cages, supplies catalog. **Marsh**, 14216 Brookhurst, Garden Grove, Calif. 92643.

GAMEBIRDS: EGGS, chicks, started, adult. Pheasant, quail, chukar, waterfowl, turkey; game and ornamental. Poultry and exotics. Free catalogue. **Northwest Farms, Inc.**, P.O. Box 3003-PM, Portland, Oregon 97208.

RABBITS—CHINCHILLAS—FUR BEARING ANIMALS

RAISE Rabbits for us, \$500 month home facts. 48 page illustrated book describing 25 breeds. Housing, breeding, feeding, markets, marketing etc. 25 cents. **American Rabbit Association**, 36 Arba Building, Pittsburgh, Penn. 15217.

AMAZING PROFITS! \$10,000 Yearly Raising Rabbits for Wool and Breeding. Details 25¢ coin. **American Angora**, Malta 12, Montana 59538.

MAKE Big Money Raising Chinchillas, Cavies, Rabbits for us. Catalog 25¢. **Keeney Brothers**, New Freedom, Pa. 17349.

\$500-\$1000 MONTH Plan Raising Rabbits For Us. Free Details. **White's Rabbitry**, Mt. Vernon, Ohio 43050.

CHINCHILLA INCOME GUARANTEED. Terms. 25¢, Bulletin \$1.00. **Chinchilla**, 11PM, Port Richey, Fla. 33568.

PETS—BIRDS, CATS, HAMSTERS, ETC.

950 PICTURE Pets, Supply Catalog 50¢. "Everything—You Name It." Color Poultry Book \$2.50; Bantams \$3.00; Guineas \$2.75. **Strombergs Pets Unlimited**, Fort Dodge 25, Iowa 50501.

HAWKS, Reptiles, raccoons, skunks, squirrels. Catalogue 25¢. **Trails End Zoo**, St. Stephens, S.C. 29479.

LIVE Seahorses, Marine Specimens, Aquarium Supplies. Illustrated catalog 30¢. **Marine**, Box 23158-G, Fort Lauderdale, Florida 33307.

AQUARIUM SUPPLIES. World Champion Guppies, Bettas, Seahorses, Catalog 25¢. **Land Hermit Crabs (Playful!)** \$4.95 pair. **Fishmart**, Ortonville, Mich. 48462.

BUY Direct—Save: Monkeys, Ocelots, Birds, Reptiles, Wildlife Books. Catalog 25¢. **Exotic Animal Importers, Inc.**, Box 1675, Miami, Florida 33138.

AQUARISTS Supply Manual \$1.00. **Daleco**, 416-P Glenalby, Tonawanda, N. Y. 14150.

AQUARIUM Plants, Supplies, Saltwater, 50¢ For Catalog—**Stanbooz**, 232-P, Southampton, Pa. 18966.

HORSES, LIVESTOCK

"HOW TO TRAIN HORSES"—FREE Book tells how to break, train, make money with horses. **Beery School**, 1104 Pleasant Hill, Ohio 45359.

VETERINARY Guide to Farmers. The only book of its kind. Send \$6.95 to **POPULAR MECHANICS**, Dept. VG, 224 West 57 Street, New York, N.Y. 10019.

CAMPING EQUIPMENT AND TENTS

FREE Catalog! Camping, Boating, Sailing Supplies; Gadgets, Hardware and Gifts. **Laacke and Joys**, 1439 N. Water St., Milwaukee, Wisconsin 53202.

CAMPING

CAMPING MUST! NEW! Guideline to camping in all 50 states. \$1.00. Money-back Guarantee. **Custer**, Box 4153A, Colorado Springs, Colorado 80909.

PAK TENTS—Inexpensive. Free Literature. **Martins**—Box 141, Fremont, Calif. 94537.

JUMBO Tents, sleeping bags, camping catalog. Largest selection anywhere. 25¢. **I. GOLDBERG**, Dept PM 373, 902 Chestnut St., Philadelphia, Pa. 19107.

TRAVEL AND RESORTS

CANOE Trips—\$11.00 per day. Write, **Rom's Outfitters**, Ely, Minnesota 55731.

VACATION TIME! PLAN AHEAD. BIGGEST COLLECTION TRAVEL OPPORTUNITIES EVER IN ONE BOOK. \$2.50. **HAUBERT-HULL**, 1428 FORT AVE., BALTIMORE, MARYLAND 21239.

"AMERICA By Car" Names Best Places to Eat and Stay. Scenic Routes, Parks, Historic Sights, 170,000 Word Book only \$2.50! **Queen City Gifts**, 5955 Belmont, Cincinnati, Ohio 45224.

ELECTRICAL SUPPLIES

METERS—Surplus, new, used, panel and portable. Send for list. **Hanchett**, Box 5577, Riverside, Calif. 92507.

LAMP Parts. Catalog, prices, wiring instructions. 50¢. Refunded first order. **Gyro**, 5218P N.W. 35 Ave., Miami 42, Florida 33142.

BATTERIES, GENERATORS

"BATTERIES" Six Used Rechargeable molds, material, instructions. **Battery Shop**, Box 820, La Quinta, California 92253.

BATTERY Terminal Protectors Stops Battery Corrosion. Free Literature. **Pracna's**, 3301 Buchanan Road, Antioch, California 94509.

ELECTRIC Generator Sets. 5-KW To 60-KW, Gasoline And Diesel. **K. A. Weimer**, Route 1, Tucker Mill Road, Conyers, Georgia 30207.

NOW STOP BATTERY TROUBLE—Car—Truck—Boat—Free Information. Write—**Ransom Baucom Company**, Raeford, North Carolina 28376.

COMPLETE Hydraulic Jack Repairing Manual \$3.00. Moneyback guarantee. **Bayerco**, 938-CT Betty Avenue, Neenah, Wisconsin 54956.

ENGINES, MOTORS, MAGNETS

ELECTRIC MOTOR SUPPLIES! Rewinding data! Catalog! **Modequip**, Box 7266, Kansas City, Mo. 64113.

WINDING Data. 275 motors, \$1.25. **Data Company**, 512 Kensington, Kansas City, Mo. 64124.

MACHINERY, TOOLS AND SUPPLIES

UNIMAT, Maximat sale. Amazingly low prices. **Dumas**, 562 Howard Avenue, Staten Island, New York 10301.

MICROMETERS—Indicators. Steel—Aluminum—Brass. **Maximat**, **Unimat** Lathes. Complete mailing—50¢. **Campbell**, 1424 Barclay, Springfield, Ohio 45505.

SMALL Foundry furnaces. Supplies. Free literature. **Pyramid Products**, 3736 South 7th Avenue, Phoenix, Arizona 85041.

WINCHES And **HOISTS**. Choice of 12 volt or 110. Reversible, compact, fast, 1/4 ton to 1 ton capacity, from \$49.95. 25¢ brings 16 page full color catalog. Refundable. **Superwinch, Inc.**, Dept. PM, Pomfret, Connecticut 06258.

END Mills. Lathe Milling Attachments: Information. **Potter**, Box 73, Cedar Rapids, Iowa 52406.

FREE Catalog—**Micrometers**, Dial Calipers, Indicators, **Unimat** Lathes—**Raymond Leung**, Room 136, 664 King's Road, Hong Kong.

UNIMAT LATHE Owners—Adjustable Tool Post Available. Details Write: **Glengineering**, 239-43 66 Ave., Douglaston, N.Y., 11362.

SUPER Tuff Lathe Cutoff Tool. Detail Drawing \$2.00 will custom build \$29.95. Unbeatable. **TOOL**, Rt 4, Box 58, Columbus, Miss. 39701.

ASSORTMENT Over Five Gross. Nuts, Bolts, Screws, Washers, In Plastic Box \$9.95 Post Paid. Price List Gross Lots 10¢. **Nutty Co.**, 1576 SMS, Fairfield, Conn. 06430.

(Continued on next page)

WELDING, SOLDERING, PLATING

MORRIS—Welders—110/220, 150 Amperes, \$53.50. 1070 Inner, Schenectady, New York 12303.

WELDERS. Convert To Heliarc. Weld All Kinds Of Metals. You Can Build This 0-225AMP High Frequency Heliarc Unit From Junk Box And Approximate \$9.00. Picture Of Completed Unit. Plans And Where To Get Parts. Send \$4.00 To: Information Supply Company, Box 166, College Park, Maryland 20740.

PLATING Equipment, Portable Platers, Supplies, and "Know-How". Build your own tanks for nickel, chrome, etc. Easy-to-install PVC liners. Rectifier components—all sizes. Schematics, parts lists, formulas, operating instructions for all plating. \$10.00 post-paid. Guaranteed to save you 25%-75% or immediate refund. Some good used units for sale. Platers Service Company, 1511-A Esperanza, Los Angeles, California 90023.

BUILD your own Portable Spot Welder for less than \$10.00. Plans \$1.00. Spot-it, Box 262, Ford City, Pa. 16226.

GOVERNMENT SURPLUS

GOVERNMENT Surplus Information \$1.00. McDaniel, 2530 Shearer, Midland, Michigan 48640.

NO CATCHES. Buy any surplus direct from U.S. gov't. All information \$2.00. Bridgworth, P.O. Box 2292-C, Vancouver, Washington 98661.

GOVERNMENT Surplus. How and Where to buy in Your Area. Send \$1.00. Surplus Information, Headquarters Bldg., Box 30177-PM, Washington, D.C. 20014.

1972 SURPLUS Army, Navy store, 52 Page illustrated catalog. Send 50¢. Ruvel, 3037 North Clark, Dept. 4-J, Chicago, Illinois 60614.

JEEPS \$52.40. Airplanes \$75.01. Typewriters \$6.70. Boats \$7.50. Direct from Government, Directory and Surplus Catalog \$1.00 (Refundable). Midwest Surplus, Box 401-PM, Dayton, Ohio 45401.

JEEPS From—\$52.50; Typewriters from—\$4.15; Cars from—\$31.50. Walkie-talkies, motorcycles, airplanes, boats. Typical "As Is" bid bargains from Uncle Sam. Tremendous variety. Exciting free list. Write: Enterprises, Box 402/75A, Jamaica, New York 11430.

JEEPS & Equipment. You buy FROM GOVERNMENT. Your Area. Latest information manual #2702 sent for \$2.00. **MONEYBACK GUARANTEE**. Solley, Box 597, San Marcos, California 92069.

JEEPS! Sporting! 100,000 bargains direct from Government. Howto? Your area. Latest instructions, Guaranteed, \$2.00. Dealerlist included. Ross Enterprises, Box 4762131, Caseyville, Illinois 62232.

GOVERNMENT Surplus. Complete Sales Directory \$1.00. Surplus Publications, Box 26062-M, Los Angeles, California 90026.

JEEPS!!! Pickups!!! 100,000 items direct from government. How? Where? Your area. Latest information manual #110 sent prepaid AIRMAIL for \$2.00. **MONEYBACK GUARANTEE**. Dependable, Box 113, Vista, California, 92083.

JEEPS Typically From \$53.90 . . . Trucks From \$78.40 . . . Airplanes, Typewriters, Boats, Clothing, Camping, Sporting, Photographic, Electronics Equipment. Wide Variety. Condition. 100,000 Bid Bargains Direct From Government Nationwide. Complete Sales Directory and Surplus Categories Catalog \$1.00 (Deductible First \$10.00 Order From Our Separate Included Catalog). Surplus Service, Box 820-A, Holland, Michigan 49423.

HOBBIES AND COLLECTIONS

NAZI Medals And Photos. Also United States War Surplus. Catalog And War Poster, 25¢. Hutchinson House, Dept. 60, Box 6411, Chicago, Illinois 60680.

LIVE Sea Monkeys, born before your eyes. Educational. Complete kit \$2.00. JN5 Distributor, Featherbed, Boothwyn, Pa. 19061.

COLLECT Military Medals. list 25¢. Vernon, Box 387PM, Baldwin, N.Y. 11510.

HOBBY-CARVE—Home workshop wood carver—create beautiful wood reproductions of sculptures, plaques, figurines, sconces and bookends. Hundreds of work patterns available. Send 25¢ for "How To Make Quality Wood Carvings" booklet. Refunded with order. Write: Hobbi-Carve, 930 Duluth Street, Dept. PM, St. Paul, Minnesota 55106.

BUILD Your Own Reflector Telescope. Esco is back. Do-It-Yourself reflector telescope kits. See the Moon and Stars. Mirrors and Lens Kits. Send for Details. Esco Products, 171 Oak Ridge Road, Oak Ridge, New Jersey 07438.

SEASHELLS. Assortment 50 Shells \$1.00. P.O. Box 2121, Hialeah, Florida 33012.



STAMP COLLECTING

YOURS FREE! 88 DIFFERENT COUNTRIES!! Incredible collection of genuine postage stamps—from Afghanistan to Zambia! Own valuable stamps nearly 100 years old, moon stamps, etc. Also, exciting stamps on approval, returnable without purchases, cancel service anytime. But this Valuable Collection plus Big Illustrated Catalog are yours to keep . . . **FREE!** Send 10¢ for mailing. H. E. Harris, Dept. SS-20, Boston, Mass. 02117.

YOURS Free! 20 Almost Rare Stamps from 12 Lost Nations—Most a Half-Century Old! Nations overrun by invaders and never freed again. Stamps so appealing that experienced and beginning collectors alike will want them. You get 110 other stamps from Britain's Lost Empire plus illustrated Album to keep as a Bonus should you buy \$1.00 from our Approval Selection. Or return Album and 110 stamps with selection and buy nothing. Cancel Service anytime. But Lost Nations stamps are yours to keep! Send 10¢ for mailing while supplies last. Kenmore, Milford LN-956, New Hampshire 03055.

SEND Only 10¢ for nice collection of U.S. stamps including "\$5.00." Issue and scarce mint Sipex Souvenir Sheet. You will also receive the most wonderful catalog of stamp offers in America. Littleton Stamps, Dept. SS1, Littleton, New Hampshire 03561.

STAMPS Free! New issues—New Countries — Triangles — Rockets — Olympics — Scouts — Birds — Flowers — Animals — Also, old Canadian and U.S. Stamps. Plus complete illustrated Canadian Stamp Catalog. Send 10¢ for mailing. Gray Stamp Co., Dept. A, Toronto, Canada.

SURPRISE Collection! Exotic mint British Colonials absolutely free with approvals. Viking, Great Neck, 8 N.Y.

INDONESIA 50 Different 10¢. Approvals. Lansdowne Stamp Company, Box 201, Newtown Square, Pa. 19073.

10 MINT Cayman Islands 25¢; Penniston, Box 5502, Arlington, Va. 22205.

NUDES Set Plus Gigantic Mystery Packet—10¢. Unique Bargain Approvals—Free Bonus Plan! Write Today! Kenneth Feldman, Box 48798-PM, Los Angeles, Calif. 90048.

LARGE US Assortment. Many Older Commemoratives 25¢. Monjar, Cincinnati, Ohio 45211.

U.N. 5 Different Mint 10¢! Approvals. Gordon Davison, Henniker, New Hamp. 03242.

SEND Only 5¢ for Worldwide Collection of over 50 different Singapore, Grenada, Chad, etc. Contains old and new issues, sports, animals, etc. You will also receive interesting lists and a certificate worth 50¢ toward purchases. Goliath Co., Dept. TP-1, Bethlehem, New Hampshire 03574.

WOW! \$30.00 Value! 1000 Different Worldwide Stamps. \$1.50 with profit sharing approvals. Universal, Box 6-MA, Kenosha, Wisconsin 53141.

FREE List. Large Assortment \$1. High value packet \$2. Schollmeyer, 436 New York Ave., Brooklyn, N.Y. 11225.

GIANT Stamp Collection including: Astronauts, Satellites, Moonrockets, Boy Scout issue. Complete U.N. Set, recent Olympic and Sport issues from many countries, etc.. Plus Big Stamp Dictionary and approvals. Everything 10¢! Stampex, Box 47-RM, White Plains, N.Y.

50 DIFFERENT Canada: 10¢ With approvals. Oroszky, P.O. Box 1-C, Sarnia, Ontario, Canada.

100 DIFFERENT United States Stamps, 25¢, with U.S. Foreign Approvals. ShelRon, Box 547C, North Miami, Fla. 33161.

WOW! 110 ALL DIFFERENT GERMANY 10¢ Commemoratives, Airmails, High Values, Big catalog, bargain lists. Also, fine stamps from our approval service, which you may return without purchases and cancel service at any time. Jamestown Stamp, Dept. A-42PM, Jamestown, N.Y. 14701.

FREE! BIG BARGAIN CATALOG—NEW EDITION listing thousands of bargains including U.S. & B.N.A. stamps, packets albums, accessories and supplies. Also, fine stamps from our approval service which you may return without purchases and cancel service at any time. Jamestown Stamp, Dept. E-42PM, Jamestown, N.Y. 14701.

225 STAMPS For only 10¢! Airmails. Pic torials: stamps from strange countries cataloging up to 25¢ each! Plus unusual stamps to examine. Buy any or none return balance, cancel service anytime. Mystic Stamp Co., Camden 80, New York 13316.

U.S. MINT Specials! Flag set, complete \$1.00. 1¢, 2¢, 3¢ famous Americans (21 different) \$1.00. Free list. Brooks, 2601 Avenue "U," Brooklyn, N.Y. 11229.

PENNY! Approvals! Regardless catalogue! Kloster, 4164 52nd St., San Diego 5. Calif. 92105.

"AFRICA." 25 Beauties, 10¢. Approvals. Gorliz, Box 1915PM, Naples, Florida 33940.

U.S. BARGAIN, 50 Different 10¢, with beautiful worldwide, approvals. Stamp Center, Kennebunk, Maine 04043.

50 DIFFERENT Old U.S. Revenue Stamps 50¢. Winchester Stamps, Box 1592, Mansfield, Ohio 44907.

FREE Surprise collection sent with approvals. Gould, 1784 Union, San Francisco 94123.

PENNY Stamps! 1000 Mounted in book at 1¢ each! Trust Stamp Company, P.O. Box 100-P, Jamaica, New York 11435.

ABSOLUTELY Free United States Mint Souvenir Sheet When Requesting United States Approvals. K&B, Box 70, Brooklyn, N.Y. 11223.

500 DIFFERENT Stamps, \$1.00. Smith, 508-A Brooks, College Station, Texas 77840.

210 DIFFERENT U.S. Commemoratives \$1.00. Stamps, 7607 Larchview, Dallas, Texas 75240.

14,000 DIFFERENT! AMAZING New plan builds your collection systematically, country by country. Only 50¢ weekly. Ware, Monroe, Conn. 06468.

(Continued on next page)

STAMP COLLECTING

(Continued from preceding page)

TEN Different Nudes: 20¢. Approvals. Stamp Farm, 2M41, Oxford, Wis. 53952.

AMERICANS On foreign stamps, Presidents, Kennedy, Roosevelt, Lincoln, U.S. Spacemen, Princess Grace and others. 10¢ with approvals. Roseland Stamps, Dept. 57, Spring Lake, Michigan 49456.

FAR EAST ASSORTMENT—VIET NAM, JAPAN, KOREA, Formosa and others only 10¢ with world wide approvals. Clark Stamps, Dept. 57V, Muskegon, Michigan 49444.

100 CANADA 25¢. Excellent value. Approvals. Continental, Limehouse, Ontario, Canada.

FREE Duplicate Exchange—2¢ Approvals. Belden, Box 4175B, Dearborn, Michigan 48126.

"WHOLESALE" U.S.—Foreign Pricelist and catalog Free! Everything Guaranteed. Schneider, Box 1240, Grand Rapids, Michigan 49501.

100 DIFFERENT British Empire 10¢. Approvals. Gibson, Box 34, Lansdowne, Pa. 19050.

"INVERTED Error" Dag Hammarskjold, 10¢ with approvals. Belmont Stamps, Washington, D. C. 20015.

1500 FOREIGN \$1.00; 5000 \$3.00; 9000 \$5.00, 5000 USA, Contains airmails, dues, presidentials, revenues, 19th Century, high values, etc. \$3.00. 300 pre-1940 USA Commemoratives \$2.00; 700 \$4.00. No approvals. Meyers, 5321 Fleming, Richmond, California 94804

80 DIFFERENT U.S. stamps. Includes 1943 flag stamp of occupied nations. Only 25¢. Approvals included. Willett Co., Box 338-M, Yorktown Heights, N.Y. 10598.

50 DIFF. U.S. Commemoratives 25¢ Approvals. We Pay Postage. Craig Stamps, Box 118-N, Bellmore, New York 11710.

50 YEARS Old, fifteen different United States, over fifty years old—10¢ with approvals. Jaxon, Box 145-P, Brooklyn, New York 11230.

307 DIFFERENT Triangles, Sports, Topicals, etc. Worth near \$8.00. Only 25¢. Bargain approvals. Jayto Stamps, East Syracuse, New York 13057.

MILLIONS Foreign Stamps! 2¢ each! Send for gigantic approvals! ABC, Box 6000-MB, San Francisco, California 94101.

NEW! Get scarce Vietnam, Tanzania, Cook Islands Royal Visit, Monaco Royal Wedding plus F.D.R., Stalin, Churchill memorial issues, many more. Valuable collection of 100 different stamps from far-away places. Strange beasts, famous people, rare paintings. Also stamp selections to examine. Buy any or none, return balance. Cancel service anytime. Rush 10¢ handling. Garcelon Stamp Co., PM9K, Calais, Maine 04619.

100 OLD United States between 1861 and 1935. \$1.00. Ed Roush, 423 Shepard, Mansfield, Ohio 44907.

60 DIFFERENT United States (30 Commemoratives) 25¢. Seidenberg, Salem 169, Oregon 97308.

"50 FAMOUS PAINTINGS 50¢ when requesting approvals. C. F. Stamps, 655 Forbes St., East Hartford, Conn. 06118."

QUALITY AND LOW PRICE. EXCELLENT For advanced or beginner. Mounted approvals 2¢ up, all countries in Scott's Order. Preview Stamps, P.O. Box 20667, San Diego, California 92120.

AUSTRALIA—Fifty Different. 10¢ When requesting approvals! Value, 10209A-Tenbrook, Silver Spring, Maryland 20901.

RUSSIAN Space collection 25¢. Russian Approvals. Snedco, Box 68-P, Waldwick, N.J. 07463.

BEAUTIFUL TOPICAL COLLECTION—Includes Olympic sport stamps, wild animals, bicolor triangles, colorful birds, outer space stamps, Poland kitten stamp and others. 10¢ with approvals. Sunny Stamps, Dept. 57A, Fruitport, Mich. 49415.

COLORFUL COLLECTION Of 75 different stamps. Includes sets, paintings, animals, flowers. 25¢ with worldwide approvals. Gibs Company, 4713 N. Albany Avenue, Chicago 60625.

FREE 50 Worldwide. Approvals. University Stamps, P.O. Box 1471, Lake Worth, Florida 33460.

200 DIFFERENT 10¢ With Approval. Polze, Box 5215, Milwaukee, Wisc. 53204.

VIETNAM 25 Different 10¢ approval. Sam Chazen, Box 95, Ozone Park, N.Y. 11417.

"CONQUEST Of Mars" Yemen's Latest Collection. 10¢ With Space Approvals. Potomac Stamps, Washington, D.C. 20015.

MILLIONS of stamps 2¢ each. Write today for gigantic selection. CSC, Box 9384, No. Hollywood, Calif. 91606.

TONGA'S Banana-Shaped Stamp. Bhutan Foil, Botswana Elephant, President Kennedy, Moon Landing, Honduras Easter Flowers, German Child Painting, plus 100 others! Only 10¢ when requesting approvals. Select those desired, return balance. Cancel service anytime. Douglas Cook, Dept. PM-3, Las Vegas, Nevada 89112.

255 DIFFERENT Worldwide: 15¢ Approvals. Tibbets, 8675 Meadow, Downey, California 90242.

7 COMPLETE SETS Poland—25¢ With Approvals. Duncan Stamps, RR #1, Duncan, B. C., Canada.

SENSATIONAL Clearance Sale. 10 packets-.25, 20 packets-.50, 40 packets-\$1.00. No Approvals. Norge, Wyckoff, N.J. 07481.

321 DIFFERENT Stamps 35¢ Bargain lists included. No Approvals. Stamps, Box 27, Fremont, Michigan 49412.

FREE—Colonial collection. Bargain approvals. Gains, Box 788, Mattoon, Illinois 61938.

APPROVALS: Plus Collections By Year. Martus, Box 251, Bushkill, Pennsylvania 18324.

ANTIQUE PISTOLS 10¢ with approvals. Lawrence, Box 7511M, Baltimore, Maryland 21207.

SURPRISE Set-Free. Approvals. Chapman Stamps, Box 487Z, Galesburg, Michigan 49053.

DWIGHT EISENHOWER Memorial stamp on Special U.S. first day cacheted cover addressed your name. 50¢ each. K.M. WALSH, Box 308, TUCKAHOE, N.Y. 10707.

FREE Stamp Wallet with approvals. Wide choice collections by countries. Clark, Box 38, Wilmette, Illinois 60091.

WORLDWIDE All Different. 1,000 \$2.00; 2,000 \$4.00; 3,000 \$7.75; 5,000 \$20.00. No Approvals. Lee Ltd., 331 W. Pender, Vancouver, Canada.

COLORFUL Romania Wildlife Set, 10¢. Approvals. Thomas, Box 1189PM, Vallejo, California 94590.

TRADE Your Duplicates! (Foreign) New "Free Bonus" Plan: NFK, Box 98-P, Newton Highlands, Mass. 02161.

VALUABLE Premium 15¢ With Worldwide Approvals. White, Box 88, Costa Mesa, California 92627.

CANADA Sports Complete 10¢. Canadian Approvals. Valley Stamps, Little Valley, New York 14755.

50 COLORFUL Animals, Birds, Flowers Only 25¢ Approvals. Gateway, 115A New Montgomery, San Francisco, 94105.

77 MYSTERIOUS Beauties 10¢. Approvals. Stamps, Box 1444-M, Kitchener, Ontario, Canada.

ONE CENT STAMPS. Write for jumbo books of stamps at 1¢ each, mounted in Scott order. **BULLOT APPROVALS**, 6815 Bay Pkwy, Brooklyn, N.Y. 11204.

50 RUSSIA 10¢. Russian Approvals. Iannuzzi, 843-A South Mariposa, Los Angeles 90005.

100 DIFFERENT Poland—25¢. Approvals. Gobestamp, Box 402, Biddeford, Maine 04005.

1500 Different World. \$1.00. Raymar, 77 Daigneault, Chambly, Quebec, Canada.

"APOLLO 15"—Poland's latest Gigantic Bicolor Commemoratives—Free! Approvals plus 101 Bonus Sets. William Deems, 226 Race, Ravenswood, West Virginia 26164.

I PAY \$250 For 1924 1¢ Green Franklin Stamps rotary perforated eleven (\$2,500 unused). Send 25¢ for illustrated folders showing amazing prices paid for old stamps, coins. Vincent, 85PM, Bronx, New York.

40,000 Different 1¢ to 5¢ each. Gordon Davison, Henniker, New Hampshire 03242.

FREE 25 Different Canada. Joseph Myers, 633 W. Michigan Ave., Marshall, Michigan 49068.

100 Different, 10¢ with Approvals. U.S. Price List (102 Pages) 50¢. R. Smith, Box 617P, Woodcliff Lake, N.J. 07675.

100 WORLD Wide 10¢. approvals. Big M Enterprises, P.O. Box 10902-B, Ferguson, Missouri 63135.

ASK For Free Price Lists, never hinged: Austria, Belgium, France, Great Britain, Italy, Lichtenstein, San Marino, Switzerland, Franklin, P.O. Box 467A, Jamaica, New York 11434.

PLANES! Trains! Cars! Ships! Space! Sports! Spectacular Stamp Collection. Just 10¢. With Great Approvals. Castle, P.O. Box 15-PMA, Flushing, N. Y. 11352.

FREE U.N. Mint Set. Approvals. Hildebrand, Box 5645, Redwood City, California 94063.

BUY Stamps at Face from 250 Philatelic Agencies Worldwide. Addresses, Instructions \$1.00. Skeet's Stamps, Fuquay-Varina, North Carolina 27526.

NEW AFRICAN STAMP COLLECTION including Burundi, Guinee, Mali, Rwanda, Togo and others. A colorful addition to your collection, 10¢ with approvals. Modern Stamps, Dept. 57B, Ferrysburg, Michigan 49404.

50 U. S. COMMEMORATIVES 15¢. Approvals. Cambridge, Box 2311, Heath, Ohio 43055.

COINS, TOKENS, CURRENCY

SEND Only 5¢ for valuable booklet "How To Collect Coins" which is loaded with expert advice. You will also receive 5 different foreign coins and your copy of the most unusual and interesting collectors catalog available anywhere. Littleton Coins, Dept. VB-1, Littleton, New Hampshire 03561.

BRILLIANT Proof Sets—1968-S \$6.89, 1969-S \$6.49, 1970-S \$8.79, 1971-S \$6.98. Bargain Lists 18¢. Bebee's Incorp., Omaha, Nebraska 68111.

INDIANHEADS: 2 Diff., Below 1900. 75¢. Stevens, Box 546F, North Miami, Fla. 33161.

SILVER DOLLARS Uncirculated, 1880-81—1883-84-85 \$5.00 Ea. Catalogue 50¢. Shultz, Salt Lake City, Utah 84110.

COIN Clearance! Bargain List 10¢. (Refundable). Economy Sales, Mansfield, Massachusetts 02048.

COMPLETE U.S. Coin List 25¢. Lincoln Starter Sets 50 Different \$1.75, 100 Different \$3.50. Schultheis, Box 151M, New Hyde Park, N.Y. 11040.

(Continued on next page)

COINS, TOKENS, CURRENCY

(Continued from preceding page)

PRICE Lists of Thousands of Stamps and Coins. Send 25¢ Refundable with purchase. No Approvals. Bryson, 612M White, Toledo, Ohio 43605.

4 PROOF Lincoln Cents, \$2.00. Catalog 25¢. Village Coin Shop, Dept. P, Plaistow, New Hampshire 03865.

LINCOLNS 1909-1955 Every year except 1922. 46 Different (Regularly \$8.25) **SPECIAL** \$3.95. **HARRIS**, Box 2037P, Santa Cruz, California 95060.

GOLD: Mexican 1865 Maximilland Peso .900F Uncirculated \$1.95. Olmsted, Terrace, Franklin, New Hampshire 03235.

CLEARANCE 10 Silver Dollars \$15.00. Lee Ltd., 331 W. Pender, Vancouver, Canada.

20 MIXED V, Buffalo, And "S" Jefferson Nickels 1900's Thru 1950's \$2.95. Anthony, Box 9852PD, San Jose, California 95117.

INDIANHEAD Cents, Buffalo Nickels. Ten Different, \$2.00. Kedzie Coins, 5909 So. Kedzie, Chicago, Illinois 60629.

SILVER Dollar \$3.10; Large Cent \$4.50; Ten Buffaloes \$2.60; Listing 25¢. Nelson, 346-J, Rye, New York 10580.

TEN Indianheads \$3.50; Ten V-Nickels \$3.45; Silver Certificate \$1.95; Listing 25¢. Fairway, 685-K, White Plains, New York 10602.

40 MIXED, Indianhead And Lincoln Cents 1890's To 1930's \$2.00. Pavley, Box 518, Cupertino, California 95014.

CENTS 28 Different "S Mints." 1919's, 1971's, Includes 1955S Plus 1943DPS, \$2.00. Free List. Krieteich, Box 34273, San Francisco, Calif. 94134.

WORLD'S GREATEST Coin Collector's Magazine And Wooden Nickel 10¢. Lawrence, Anamosa, Iowa 52205.

ANTIQUES, RELICS, INDIAN GOODS & CURIOS

OFFICIAL ANTIQUE GUIDE, WHOLESALE And retail prices listed on every item. **FEATURES** hundreds of illustrations, thousands of prices, 224 pages. **SEND** \$1.98: **CARLOS RAMOS**, 250 19th STREET, BROOKLYN, NEW YORK 11215.

APACHE Arrowhead Collection 9, \$2.00. 25 for \$5.00. Epanco, PM 1239, Apache Junction, Arizona 85220.

INDIAN Relic list, Arrowheads \$4.00. doz. Folsom, \$5.00 each. C. Secrist, Deerfield, Missouri 64741.

EVERYBODY LIKES DIXIE GUN WORKS.

TONS Of antique gun parts and supplies. All reproduction muzzle loading guns. Send \$2.00 for enlarged illustrated catalog No. 120. Dixie Gun Works, Union City 12, Tennessee.

LIST Indian relics. 10 Arrowheads \$3.00. Hyde's, Box 2304, Santa Fe, New Mexico 87501.

10 PERFECT Arrowheads \$4.00. Smith, 9825 Conway Drive, Indianapolis, Indiana 46236.

SELLING 20,000 Indian relics, Arrowheads, spearheads, tomahawks, ceremonial, etc. List 10¢. Lear's, Glenwood, Arkansas 71943.

INDIAN Relic List. Arrowhead Identification Guide \$3.98. Antiquities. Rt. 1, Box 14A-4M, Princeton, W. Va 24740.

ANTIQUE Buying Guides Refinishing Old Tyme Posters, Maps. Write: Maple Valley, R.D.2 419, Branchville, New Jersey 07826.

COMPLETE ARROW: Feathers, stone point, sinew wrapped. Satisfaction guaranteed. \$12.00 each. "INDIAN GIVER", Box 2284, Mission Viejo, Calif. 92675.

MODELS—CARS, SHIPS, TRAINS, PLANES ETC.

VINTAGE Tractor Models. 30¢ For List. Pioneers Of Power, Eldora, Iowa 50627.

UNIMAT, Maximat sale. Amazingly low prices. Duman, 562 Howard Avenue, Staten Island, New York 10301.

SHIP Models Kits, fittings, plans, books, tools, engines, motors. Big illustrated catalog 50¢. Mass, residents add 3% tax. James Bliss & Co., Dept. SM, Route 128, Dedham, Mass. 02026.

SHIP And yacht model fittings: Pine construction hull kits; blueprints. Send 50¢ for illustrated catalog. A. J. Fisher, Inc., 1002 Etowah Avenue, Royal Oak, Michigan 48067.

MODEL Airplanes—Big 220 Page Catalog 50¢. Sig Company, Montezuma, Iowa 50171.

LIVE Steam powered backyard railroads! All sizes. Complete "bolt-together kits," and rough castings. Excellent drawings. 100 page catalog \$1.00. Little Engines, Lomita, California 90717.

SHIP Models Catalog 25¢. Scientific, Inc., 340 Snyder, Berkeley Heights, N. J. 07922.

SINGLE Edge Razor Blade And Holder. \$1.00. Cazin, 526 Maple, Redwood City, California 94063.

600 PLANS, Finest authentic miniature aircraft. Two years pictorial catalog subscription, \$1.00. Cleveland Models, 10307PM Detroit, Cleveland, Ohio 44102.

GAMES, TOYS, PUZZLES, NOVELTIES

PUPPETS—Worlds Largest Selection of Hand Puppets. Catalog 25¢. 5918 Ibbetson, Lakewood, California 90713.

NEVADA Slot Machine Replica. Send \$1.00 For Details, Catalog. Refunded First Order. Meredith's, 1255 Jones, Reno, Nevada 89503.

FLYING FUZZ—"B," Spongy soaring disk, completely safe aero-dynamic fun for all ages **INDOORS** or out. Send \$1.00 to **FUZZ—"B,"** Box 14649, Portland, Oregon 97214.

MAGIC TRICKS, JOKES, VENTRILOQUISM

OCCULT—Witchcraft—Many Others, Catalog 50¢. Schwartz, 8220—21st Avenue, Brooklyn, New York 11214.

HOUDINI'S Greatest Magic!! You can do them all!! Giant Illustrated Catalog 25¢ with Free Trick!! Vick Lawston, Box 2026P, Pompano Beach, Florida 33061.

NEW 1972 large Catalog. Be popular! Amaze! Have fun! Send 10¢. Latest Magic for pocket, parlor, stage. Douglas Magicland, Dept. 11, Dallas, Texas 75201.

VENTRILOQUISM! Learn at home! Guaranteed! Write! Information Free! Dummy Catalog 25¢. Maher, Box 9037P, Denver, Colorado 80209.

LEARN VENTRILOQUISM! Information free. Ventriloquism, Magic Catalog 25¢. Izzy Rizzy's School of Ventriloquism, 3746 W. 63rd Street, Chicago, Illinois 60629.

COMPLETELY Illustrated catalog. 84 pages. 25¢. Manhattan Magic, Box 334-M, N.Y.C. 10011.

BE A Magician! Two booklets explaining sixty-eight tricks plus large professional catalog. \$1.00. Magic Inc., 5082 Lincoln, Chicago, Illinois 60625.

WORLD'S Finest professional magic tricks. Joker's Novelties. Giant illustrated catalog 10¢. Top Hat, Evanston, Illinois.

FREE! World's Leading Catalog 2000 Novelties, Jokes, Tricks, Scientific Gadgets, Hobbies. Johnson-Smith, C-10, Detroit, Michigan 48224.

MAGIC MAGAZINE—Monthly since 1936. 44 pages. All phases. 3 month trial \$1.00. Genii. P.O. Box 36068, Los Angeles, Calif. 90036.

FABULOUS MAGICS New 1972 catalog 25¢. Our specialty orders shipped same day no substitutes. Fabulous Magic, 3319 East Charleston, Las Vegas, Nevada 89104.

AMAZE Your Friends—Fantastic Magic-tricks - Illusions - Magician Supplies. We Manufacture - Buy Direct "Save." Catalog 25¢. Nico Products Co., Box 28113 - Columbus, Ohio. 43204.

HOUDINI'S Original Magic Shop. Established 1856. Send 25 cents for illustrated Catalog containing 5000 Tricks, Mindreading, Puzzles, and Jokes. Flosso-Hornmann, 304 West 34th St., New York 10001.

BOOKS, CATALOGS, NEWSPAPERS

SOPHISTICATED, Personalized Bookplates . . . 500 . . . \$1.00 . . . May's, Box 802G, Natchez, Mississippi 39120.

WINEMAKING IS FUN. Our Great New Book Shows How. Amazingly Easy To Make, And Delicious. Moneyback Guarantee. Send \$1.98 Now To: Thompson's Books, 560 Paradise Road, Salinas, California 93901. No C.O.D.'s.

FREE BOOK. Prophet Elijah Coming Before Christ. Megiddo Mission, Dept. 63, 481 Thurston Road, Rochester, N. Y. 14619.

NATIONAL Geographic Magazines, 1888-1971, any issue. Buxbaum, Box 465-PM, Wilmington, Delaware 19899.

FREE List! Hundreds Popular-Exciting-Unusual Books! Mann, 7-F Wilste, Hillsdale, New Jersey 07642.

GET SUCCESS, WEALTH, HAPPINESS, HEALTH. SOLVE PERSONAL PROBLEMS. FREE LIST LOW COST BOOKS. HAUBERT-HULL CO., 1428 FORT AVE., BALTIMORE, MARYLAND 21230.

MAGIC MADE EASY Byron Weis, \$2.00 Postage, Handling 25¢. Free List, Books. C. C. Riherd, 816 Canterbury, Kissimmee, Florida 32741.

1908 Sears Catalog...Exact Replica... \$3.58 . . . Haynes House (Z3), 201 S. Reed, Joliet, Ill. 60436.

SEND For Our Free List Of Exciting, Unusual Books! Write: John P. Rehill Company, 34 South Main Street, Wilkes Barre, Pennsylvania 18701.

PUNCHCARDS For Cataloging Hobby Collections, Inventories, Names. Over 100 Categories. Automatically cross-referenced. Inexpensive. Easy. Free Samples. Indexes, Dept. PM, Arlington, Vermont 05250.

THE Must Magazine For Policemen. For Free Brochure, Write: "TODAY'S POLICEMAN", P. O. Box 594, Kansas City, Mo. 64141.

FREE Book. Protect Your Home Against Crime. Send Name, Address. 7in. Continental, Box 268, Prospect Heights, Illinois 60070.

SELL Books!! Complete Mailorder Plan. Vikari's, Box 1312PM2, Salt Lake City, Utah 84110.

FREE Catalog. Self Improvement Books. Many Others. Total Company, 6609 Kindred, Philadelphia, Penna. 19149.

HOW TO MAKE DELICIOUS Wine, Champagne at Home. These Books contain a Variety of Recipes, Step-by-Step Instructions on This Amazing Method. Money Back Guarantee. Send \$2.75 to: H.C. Thomas Specialties Co., P.O. Box 122, Wausau, Wisconsin 54401.

PLAYS, SONGS, MANUSCRIPTS

POEMS And lyrics of religious, reverent, inspired nature wanted for immediate recording. We are only interested in songs of hope, God's love, the comfort of His words and wisdom. Cathedral Recording, P.O. Box 78-PM, North Weymouth, Mass. 02191.

(Continued on next page)

PLAYS, SONGS, MANUSCRIPTS

(Continued from preceding page)

EARNINGS Guaranteed for accepted songpoems! Castle's, 507-MS Fifth Avenue, New York City 10017.

BOOK Printing. Paperbacks Or Cloth Covers. Free Catalog and Prices. Adams Press PM, 30 West Washington, Chicago, Ill. 60602.

BUSINESS SERVICES

MAILORDER Records help get increased business! Complete 32 Page Record Book shows your inquiries orders, advertising, expense, etc. Only \$1.00. C. A. Martin, Popular Mechanics, Dept. PMR, 224 West 57 Street, New York, N.Y. 10019.

BUSINESS OPPORTUNITIES

EARN UP TO \$700 A MONTH AS A TAX PREPARER. Learn tax preparation at home in your spare time from H & R Block, America's Largest Tax Service. No previous experience needed. An ideal course for men and women of any age. Job opportunities for qualified graduates. No salesman will call. Send for free information today. Write: H & R Block Tax Training Institute, Dept. 301B-42, 4410 Main, Kansas City, Missouri 64111.

INSTALL Burglar Alarm Systems. Big profit home business. Beginners start spare time, without mechanical experience or costly equipment. Free starter plan. Nasco, Dept. F2704, Woodland Hills, California 91364.

279 FAST, Easy ways to make money! Free! Rush name, address, zip. Perry, 13263PM Ventura Blvd., Studio City, Cal. 91604.

TAKE Catalog orders. We drop-ship 1001 best selling specialty products. Guaranteed lowest below wholesale prices. Fantastic spare-time home business. Free book shows you how. SMC, 6963 SPD Hayvenhurst Avenue, Van Nuys, California 91406.

EASY-To-Start rubber stamp business at home in spare time. Make up to \$16.50 an hour without experience. Facts free! Write to: Roberts, Room RC-2-BF, 1512 Jarvis, Chicago, Illinois 60626.

HOW To Borrow \$500 To \$2 Million. Get 2,618 cash offers. Free details! Capital-17, Kerrville, Texas 78028.

JOIN Unique Private Financial Club That Enables Members To Make "\$80.00 PROFIT FROM EVERY DOLLAR INVESTED" Legal Copyrighted Program Since 1970: Receive Club's Newsletter, Enrollment Form, Full Instructions, Send \$2.00 (Refundable). Baker Enterprises, 13923-P Stoneshire, Houston, Texas 77037.

MAKE \$25.00 WITH NEW MAILORDER PLAN! QUICK AMAZING RESULTS! ONLY \$3.00. MONEYBACK GUARANTEE! LIMITED OFFER! ORDER NOW!! GOLDCO, BOX 1747, NEW YORK CITY 10022.

TWO Ways To Make \$2000 Month. Landrow, Box 923-M, Newton, Iowa 50208.

"JANITORIAL BIDDING CALCULATOR." ... Bids any size account instantly! \$4.95. AMCI-P, Box 4081, Torrance, California 90510.

GIFTS Toys Novelties Below Wholesale Catalog only \$2.00. Refundable. Gaymar, D-4, 3332 North Seeley, Chicago, Illinois 60618.

HUGE PROFITS FROM IMPORTS! New 1972 directories lists 1000's of products, manufacturers and exporters. Japan, \$3.00; Hong Kong, \$3.00; both for \$5.00. Omega Products Co., Box 2029, Lynnwood, Washington 98036.

\$1.00 Profit per sale selling metal Social Security Plates. Sales Kit Free. Barbara Gurley, Rt. 3 PM, Anderson, S. Car. 29621.

\$15,000-\$30,000 YEAR, BOOK: "Raising Rabbits For Us." Rabbit Ranchers Of America, Box 265-PM, Haysville, Kansas 67060.

WORLD'S Biggest Wholesale Bargains! 76 Countries . . . 165 free catalogs! . . . Mailorder imprints, dropshippers . . . Automobile discounts. Free "Digest." Vault International, Box 7284R, Lexington, Kentucky 40502.

SECRETS! Mail Order Success. Internationally famous expert reveals how to make home business fortunes. Beginners: Get free copy "Make Money By Mail." Discloses free advertising, profitable products. Mailco, Dept. FC704, Woodland Hills, California 91364.

SELL And Install VACUFLO Built-in Central Vacuum Cleaning Systems. See P.M. September 1967. Write: H-P, Louisville, Ohio 44641.

FORTUNES In Wild Plants! Herbalism! The unknown millionaire maker! Free lesson, details. Herbalism Institute, 1339 Remuda, Dept. B, Glendora, California 91740.

FREE 1972 100-Page Catalog waiting to bring you Big spare-time cash commissions. Sell Advertising Book Matches. Every business a prospect . . . complete selling instructions furnished Steady, repeat business. Dept. MX-472, Superior Match Company, 7530 South Greenwood, Chicago, Illinois 60619.

SEVEN Complete Mail Order Opportunities. \$2.00. Or write: AM Sales, 32-28 100th St., East Elmhurst, N.Y. 11369.

MAILORDER Millionaire helps beginners make \$500 weekly. Free report reveals secret plan! Executive (1A4), 333 North Michigan, Chicago 60601.

\$2.40 HOURLY Making simple wood novelties. Free details! Gene's, 55 Boxwood, Falmouth, Mass. 02540.

MAILORDER Dealers Wanted. Earn outstanding profits using tested promotions! Executive type business. Details 25¢. Rutward, Box 735-PF, Norwalk, Conn. 06852.

STUFF Envelopes. Average \$25.00 hundred. Experience unnecessary. Customers furnish stamped, addressed envelopes. Beginner's Kit, \$1.00. Moneythree, Box 392PM4, Brea, Calif. 92621.

MAILERS Needed! Big money! Send 10¢ for information. Andrew Sales, Box 152, Blue Island, Ill. 60406.

SPARE TIME EARNINGS!\$! With table-saw, bandsaw, etc. . . . Write: Woodcraft, 956 Springdale, Atlanta, Ga. 30306.

PORTABLE Sandblaster \$21.00 (air-compressor required). Free brochure. Inka, Box 66573-A, Houston, Texas 77006.

MAKE Magnetic signs, Machineless method. Profits enormous. Write: R1B49APM, Bardstown, Ky. 40004.

HOLLYWOOD CEMENTCRAFT: Offers Highly Profitable Home Business. Experience Unnecessary. Unlimited Unique Pottery Designs Easily Made Without Moulds. Bird-baths, Fountains, Wishing-Wells, Waterfalls, etc. Chemical Coloring Formulas. Marble-glazing. FREE Illustrated Brochure. **CONCRETE FACTS,** 602 Athens Street, Altadena, California 91001.

MAKE A Years Income in 8 weeks Camping. No selling. Capital or Land necessary. Write Edru's, Route 5, Box 5733, Gig Harbor, Washington 98335.

PIANO Tuning Learned Quickly At Home! Tremendous field! Musical knowledge unnecessary. GI approved. Information free. Empire School, Box 327, Miami, Florida 33145.

WORLD'S Largest supply, Merchandise 25% to 40% under wholesale. Bankrupt Closeouts 10¢ on dollar. Imports. Hong-kong clothes. Automobile discounts. Free details. International Buyers, Box 16386 MM, Portland, Oregon 97233.

ADVERTISING BUSINESS—YOU Own it. \$350 First Week or Money Back. Electric Neon Action Ad Clock, 229 W. Illinois, Chicago 60610.

SELL Lifetime, Metal, Social Security Plates. Big Profits! Sample and Sales Kit Free. Russell, Box 286-PM, Pulaski, Tennessee 38478.

COPUBLISH "Mail Sale Advertiser," leading mailorder paper. Copy and details 25¢: U.S.A. only. Vanroy Shirk, Lebanon, Pa. 17042.

DRAFTSMEN! Operate own **DRAFTING SERVICE!** Full, Part Time; Experience unnecessary; Details: Roberts Drafting, 1741 Circle Road, Baltimore, Maryland 21204.

FREE Catalogs. Repair air conditioning refrigeration. Tools, supplies, full instructions. Doolin, 2016 Canton, Dallas, Texas 75201.

BUILD Custom Cases at home for profit. Get orders by mail. We supply materials, instruction—everything. Free home business details. Custom Case Supply Co., 6961 CPD Hayvenhurst Avenue, Van Nuys, California 91406.

VENDING Machine big catalog. Rake, 523 A Spring Garden, Philadelphia, Pa. 19123.

I MADE \$40,000.00 Year by Mailorder! Helped others make money! Start with \$10.00—Free Proof. Torrey, Box 318-Y, Ypsilanti, Michigan 48197.

MAIL Baby Catalogs Imprinted with your address to New Mothers for Big Profits! Details 25¢. Volz PM, Ypsilanti, Michigan 48197.

MAKE Money from old tires. Operators clearing \$800, weekly. Equipment costs \$1500. Get facts. S & S Patents, Inc., 3752 N. Damen, Chicago 60618.

MAKE \$46 From square foot plywood: jigsaw or bandsaw necessary. Free details. Woodar, Bridgewater, Mass. 02324.

CALIFORNIA MANUFACTURER NEEDS Man to assemble our product and be local agent, experience unnecessary. May start while presently employed. Five-figure income for responsible applicant. S.K.R.M. Manufacturers, 2347 West 238 Street, Torrance, California 90501.

SUPERIOR Auction School. Nation's top Auctioneers own and instruct. Box 1281, Decatur, Ill. 62525.

\$200.00 SPARE Time earnings with your Tablesaw. Write: Workshop Five, 3800 Harney, Vancouver, Washington 98660.

\$25.00 HUNDRED Addressing, Possible Year 'round. Complete instructions 25¢ for registration, postage. Cove, Box 1348-B, Clearwater, Florida 33517.

\$70 TO \$200 WEEKLY—Home, Spare Time Simplified Mail Bookkeeping. Immediate Income. Easy. Auditax, Box 34741A, Los Angeles, Calif. 90034.

VENDING Machines. No selling. Routes earn amazing profits. Big catalogue Free. Parkway Corporation, 715PBM Ensor Street, Baltimore, Maryland 21202.

"MORTGAGE Brokerage." Lucrative Profits! Obtain Capital Sources. Chase, Uleta, Florida 33164.

MAIL Galore! Money-making offers! Your name on national mailing lists, 35¢. Three months, 50¢. Sullins, Box 206-M, Forsyth, Georgia 31029.

\$60.00 DAY. Manufacturing Concrete Posts. Blocks. Mold Equipment Catalog \$1.00 refundable. Carlayne, Route One, Box 95, Rapid City, South Dakota 57701.

MAIL Order Collection Agency can make you \$1000.00 monthly. Free Details. Continental, Box 2023-A, Des Moines, Iowa 50310.

SELL Books by mail. 400% profit. Royal, Box 450-X, Cleveland, Ohio 44127.

(Continued on next page)

BUSINESS OPPORTUNITIES

(Continued from preceding page)

MAILORDER Records help get increased business! Complete 32 Page Record Book shows your inquiries, orders, advertising, expense, etc. Only \$1.00. C. A. Martin, Popular Mechanics, Dept. PMR, 224 West 57 Street, New York, New York 10019.

INEXPENSIVE, Home-Auto Fire, Burglar Alarms, Extinguishers. 200% Profits. Nation's Watchdog, Williamsburg, Ohio 45176.

WATCHMAKING Makes every day a payday. Learn this cash business at home. Free details. Sweazey, YDA, Fox River Grove, Illinois 60021.

200% PROFIT. Sell Man-Made Diamonds. NO Investment. NO Obligations. Lady's Gems, Box 3333PM, Anderson, S.C. 29621.

EARN \$240.00 A month at home, spare time, doing only two \$5.00 Invisible Reweaving/Reknitting jobs a day. Big money paid for service that makes cuts, tears disappear from fabrics. Steady demand. Details free. Fabricon, 2065 Montrose, Chicago 60618.

EARN \$70.00 up Weekly. Your own Wholesale Business at home. No Investment. Details and Catalog. Send only \$3.00 (refundable). Hewitt Co., Box 75PM, Hazlet, N.J. 07730.

ADDRESSERS And Mailers Needed. Details 10¢. Lindbloom, 3636 West Peterson, Chicago 60659.

OPERATE Home Mail Order Business. Write: **SCHROEDER'S**, Box 205, Greendale, Wisc. 53129.

\$100.00 WEEKLY Selling magnetic signs! SPN, Box 15, Murray Hill, New Jersey 07974.

SELL By Mail Order For Extra Income And Future Security. Details Free. Humphrey, P.O. Box 306, Roselle, Illinois 60172.

MAKE Durable building plastic easily. Waterproof, fireproof, economical. Bays Laboratory, Cedaredge, Colo. 81413.

BURGLAR Alarms You can install. Big profits. Catalogue 25¢ Refundable. Armstrong Alarms, 300 N. E. 44 St., Ft. Lauderdale, Florida 33308.

HOW To Succeed In Mailorder! Write: Fimex, Box 1461-PM24, Ogden, Utah 84401.

I MADE \$2,000.00 Monthly In Mailorder. . . . Evenings Only. You Can Too—Free Proof! Kingman JJ, 4264 Westridge, Erie, Pennsylvania 16506.

FREE Book "999 Successful, Little-known Businesses." Work Home! Plymouth-ADD, Brooklyn, New York 11218.

IMPORT-Export Magazine, Published Monthly, Reveals Sources For Hundreds Of Products From Manufacturers Around The World. Fantastic Import Opportunities. Years Subscription \$6.00. Two Months \$1.00 Trade World, Dept. E, #209-1075 Nelson St., Vancouver 5, B.C.

BUILD Your Own Molds For Concrete Picnic Tables, Flower Pots etc., From locally purchased materials, for 10% the cost of prebuilts. You Pour Superior Merchandise. Blueprints and Instructions \$8.00. Miller's Forms, 1275 Walnut, Grand Junction, Colorado 81501.

FREE Booklet, "How To Sell By Mail." Write: Ransone, Box 1719, Richmond, Virginia 23214.

MOLDING Rubber Liquid Plastic. Hobby Supplies. Details 10¢. Chaney's, 5415-I San Jose Blvd., Jacksonville, Florida 32207.

ENGINEERS! DRAFTSMEN! YOU Deserve Big 25% RAISE! New manual "Engineers Guide To Unusual Opportunities" \$3.00. Wise Associates, 490 Tolland, East Hartford, Conn. 06108.

200% PROFIT Selling Rings. Triple Money in 30 Days or Money Back. Free Details, Anka, P.O. Box 8036-PM, Cranston, Rhode Island 02920.

"MAILORDER Bookkeeping System." Ideal for tax purposes. \$1.00. Dealers wanted. Neil H. Tasker, Shamokin, Pennsylvania.

START YOUR OWN Home Mailorder Business. Fantastic! Get Professional Guidance. Wynn, Box 298-D, Audubon, Pennsylvania 19407.

RUBBER Stamp Making Presses, Supplies, Descriptive Folder. Barco Mfg., 237 S. Evergreen, Bensenville, Ill. 60106.

MAILORDER! How to prepare your own catalog for pennies! Free catalog! Obie-ADC, Brooklyn, New York 11219.

EASY New Mailorder Business Pays Beginners \$16.50 Hourly! Free Proof! International, 6767L South Atlanta, Tulsa 74136.

FREE BOOK "How To Fail or Succeed in Mailorder!" Plymouth, MMDD, Box 111, Brooklyn, N.Y. 11223.

2000% Profit Bronzing Shoes. Free Literature. NBC, Box 11069PM, Kansas City 64119.

OPERATE Small Advertising Agency At Home. Manual Only \$3.00. Mebel, Box 8583, Boston, Mass. 02114.

YOUR Name Placed With 1000 Importers, Jobbers, Mailers, \$1.00. Payeson, 824 Avondale, Rockledge, Florida 32955.

OPPORTUNITY Knocks Once. . . . Invite It!!! TBOR, Box 1692-D, F. D. R. Station, New York 10022.

\$2,000.00 MONTHLY With Your Own Business. Write, Robar, 100A School Street, Watertown, Mass. 02172.

MAILORDER Confidential. 1001 Primary Sources. Get all the profit. List \$2.00. Bohler, 87J Christopher, New York, New York 10014.

\$500-\$1000 Month Plan raising rabbits for us. Free details. White's Rabbitry, PM, Mt. Vernon, Ohio 43050.

SUCCESS In Mail-Order, Import/Export Assured Using Our Manuals! Details Free! John P. Rehill Company, 34 South Main Street, Wilkes Barre, Pennsylvania 18701.

IMPORT-EXPORT Opportunity, profitable world-wide, mail order business from home, without capital or travel abroad. We ship plan for no risk examination. Experience unnecessary. Free details. Mellinger, Dept. F2704, Woodland Hills, California 91364.

EARN Money raising fishworms for us! Write: Oakhaven-38, Cedar Hill, Texas 75104.

MAILORDER Book Publisher Wants Dealers. Details 25¢ (refunded). Jan Enterprises, 76P, Wild Rose, Wisconsin 54984.

VACUUM Signmaker Kit, Instructions, \$10.00. Homecraft, 2350 W47, Denver, Colorado 80211.

80% Profits And More Selling Distinctive Line Of Fine Jewelry! Send For Full Color Catalog. \$1.00 Refunded On First Order. John P. Rehill Company, 34 South Main Street, Wilkes Barre, Pennsylvania 18701.

ANSWERS To MAILORDER SUCCESS! Knowledge Is The Key. Learn Secrets Of The Pros! Free Proof. Powell Enterprises, Box 1188-M4, Rosenberg, Texas 77471.

PROFITABLE Jewelry Business. Complete Instructions—\$1.00. S. Wismer, 712 West College, State College, Pa. 16801.

EXCITING Mailorder Business! Get the facts before you invest! Free Details! Delta, Box 19061-P, New Orleans, Louisiana 70179.

HOW To Start Mailorder Business. Send \$2.00 For Info. 3D Enterprises, 31517 Vine St., Willowick, Ohio 44094.

MAKE \$1,500 Per Month From Your Own Home. Write: Jo-Fran Associates, 1010 Adalee St., Tampa, Fla. 33603.

ADDRESSERS Mailers \$1000 Monthly. Send Addressed Stamped Envelope. B & E Enterprises, Box 249, Chanute, Kansas 66720.

HOME Portraits. Big Money. Free Information. "Photography", 5334-P Sunset, Hollywood 90027.

CASH!!! Money waiting for you in the growing Cosmetic field. Save in your own purchase. Very good opportunity. Bonus offer. Send for FREE Catalog. Stephen & Sons, Dept. 2G4, 276 East 31st, Brooklyn, N. Y. 11226.

\$400.00 MONTHLY Raising giant fishworms. Soilless method. Charlie Morgan, Bushnell, Florida 33513.

RADIATOR Shop Grossing Over \$24,000.00 Yearly. Due To Health. 219-533-5132, Goshen, Ind. 46526.

MONEYMAKING Is An Art! Free Information. House of Hoke, Dept. 101-PM, Sebring, Florida 33870.

MAKE Big Money Fast! Part-Full-Time By Mail Order Without Capital. Free Details. Unique, Box 6094 P, Duluth, Minnesota 55806.

HOMEWORKERS, \$100.00 Weekly Addressing for firms. Begin immediately. Details—send stamped, addressed envelope. Hamilton, 272-TMA-4, Brooklyn 11235.

MAILORDER Home-Study course. Complete How-To Program. First Chapter Free. Wentworth Publishing-35, 1700 Walnut, Philadelphia 19103.

FANTASTIC! Your Own Mail Order Business For Under \$100.00. Free Details, Island, Box 157-F, Bayside, N.Y. 11361.

MAKE \$1000. Per Month From Your Own Home. Write: Dicam's, Dept. 54, N. Myrtle Beach, South Carolina 29582.

MAILORDER Home Study Course. 24 Easy Lessons. Mosby, Box 159A, Oakland, Tenn. 38060.

FREE Ring Catalog 50% Off. Anderson, P.O. Box 32AB, Randallstown, Maryland.

EARN \$2000.00 Monthly In Amazing, Interesting Businesses. Free Details. Keel, Box 12492LH, San Antonio, Texas 78212.

MY NEW BUSINESS Can Easily Make You \$1,500 Per-Month. Rupperts, 7530 North Seeley, Chicago, Illinois 60645.

HOW To Raise \$100.00 To \$1,000,000.00!! Exciting Details Free. Dollars, Drawer 77009-M, Atlanta, Georgia 30309.

TREMENDOUS Profits. Start Your Own Wholesale Business. Details Free, FN, Wholesale, Silver Lake, Minn. 55381.

RECEIVE 25¢ EVERY ENVELOPE YOU STUFF With our advertising, plus \$1.50 bonus opportunity. Details 25¢ with stamped, self-addressed envelope. Brewster-PB, Clearwater, Florida 33517.

PREPARE Tax Returns—Housewife Jo Ann Netzey made \$5,500 last season. Train at home. VA Approved. National Tax School, Monsey, 2XC, New York 10952.

\$25.00 HOUR Repairing Vacuum Cleaners! Free Details! Baron, Box 863A, Portales, New Mexico 88130.

HUNDREDS Little Known Businesses. Details. Bakers, 313 Harrison, Sullivan, Illinois 61951.

MAILORDER Will Make You Wealthy. Part Time. Free Explanation. A. Kelly Sales Company, 5211 N. Kenmore, Chicago, Illinois 60640.

WE NEED GINSENG GROWERS! \$3,000-\$30,000 Annually! We Buy Your Crop. Send \$2 for seed sample and information. Glass's Ginseng Exchange, Box 336, Rochdale Station, Jamaica, N.Y. 11434.

(Continued on next page)

BUSINESS OPPORTUNITIES

(Continued from preceding page)

FREE! List of low cost popular books. Reveals how to get started in your own mail-order business. Write: Jasin Unlimited, Dept. PM-3, 111-22 121st Street, So. Ozone Park, New York 11420.

MAILORDER SECRETS! Expert reveals how to make big money working Home. Free Details! Avronco, 612 E. 95th, Brooklyn, New York 11236.

EARN \$40.00 DAILY, Manufacture Concrete Bricks. Very Small Investment. Send Stamp. Free Details-Hilmar, Rt. One, Box 347-D, Valrico, Florida, 33594.

CLIP Short newspaper items. To \$10.00 each. Details free. Foster, 272-M-4, Brooklyn 11235.

TOP 236 Wholesale Printers, Advertising Specialty Manufacturers. Directory \$1.00. Markets, Box 332, Bergenfield, New Jersey 07621.

\$300.00 Daily in your mailbox Possible! Follow the professional methods. Annuity Profits Plan. Details 25¢. Roush Enterprises, 3567-PM 16th, Wyandotte, Mich. 48192.

MEN-Women Make Big Profits At Home! In plastics, part or full time! Unique process teaches you with equipment we give you free to make hundreds of 3-D plastic products, candy and candle molds, plaques, signs. Skin and bubble package. Also resin casting. Write today for free details. Nationwide Plastics, Dept. ARS, 4140 Eagle Rock Blvd., Los Angeles, Calif. 90065.

FANTASTIC Profits! Your Own Advertising Specialty Business. Buy Direct . . . Hire Salesmen To Keep Up With Business! Free Details. DB Associates, Dept. PM-151, Holland, Mich. 49423.

MAILORDER—Profitable products, drop-shipped. No merchandise investment. Everything supplied—catalogs, ads, mailing lists. Gif-Guide, 1137½ Crenshaw, Dept. 283, Los Angeles 90019.

\$200.00 DAILY In your mailbox! Your opportunity to do what mailorder experts do. Free details. Associates, Box 136-A, Holland, Michigan 49423.

AEROSOL FIRE EXTINGUISHERS. \$2.98 & \$3.98—Distributors. Quantity Price 87½¢ & 99½¢. Sample Of Each \$3.50 PPD. Warne, 6922 Congress, Detroit 48207.

900% PROFIT For Men And Women with your own Magnetic Sign Shop! Big demand for 3-D magnetic signs on cars and trucks. Start in garage. Kitchen or camper. Spare or full time. Financing available. Write today for free details. Nationwide Plastics, Dept. 253, 4200 Panamint, Los Angeles, Calif 90065.

MAIL Order specialist reveals how to start mail order business: Product selection, sources, pricing, publicity, use of publications, direct mail, catalogs, lists. Discusses seasonal factors, tricks of trade. Fascinating 54-page manual only \$1.00. Mail Order Institute, Dept. E, 175 Lauman Lane, Hicksville, N.Y. 11801.

400,000 BARGAINS Below wholesale! Many free. Liquidations . . . closeouts . . . job lots . . . single samples. Free details. Bargainhunters Opportunities, Box 730A, Holland, Michigan 49423.

YOUR Own Social Security Plate Business—\$24.95! Machine, Supplies included. Free Details. Idea Products, Box 69828PD, Los Angeles 90069.

FREE Millionaire Book!! Big money in successful, little businesses. Work home! SBI-7, Kerrville, Texas 78028.

MAKE Money Selling Office Supplies and Equipment. Full or Part Time, Steady Repeat Commissions. Gosh, Drawer 9F, Milwaukee, Wisconsin 53201.

HOMEWORKERS—Mailing Wanted! Information For Stamp. Allen, 2418A Lori, Santa Ana, Calif. 92706.

MANUFACTURING Opportunity for home workshop owners. Details and Specifications \$3.00. David Nicholson, Box 125, Pearsall, Texas 78061.

MAKE Money Selling Amazing Health Chewies. Write to: Sorna Manufacturers, Box 8834, Johannesburg, South Africa.

MONEYMAKING OPPORTUNITIES

SWEESTAKES Contests. How To Win. Write For Free Particulars. General Contests, 1609-18 East Fifth, Duluth, Minnesota 55812.

MAKE \$25.00 WITH NEW MAILORDER PLAN! QUICK AMAZING RESULTS! ONLY \$3.00. MONEYBACK GUARANTEE! LIMITED OFFER! ORDER NOW!! GOLDCO, BOX 1747, NEW YORK CITY 10022.

HOW Much does being your own boss or making \$25,000.00 per year interest you? The Warner breakthrough in the Engraving field could be your future. Write: Warner, Room EC-2-BF, 1512 Jarvis, Chicago, Illinois 60626.

SHARP \$\$\$ Opportunity! One low-cost machine sharpens, serrates, knives, scissors, pinking shears. Earn \$6-\$9 hourly in spare time. Professional results without experience. Free details. Beaver Grinder, 4P2 Nielsen Building, Eugene, Oregon 97402.

EARN UP TO \$700 A MONTH AS A TAX PREPARER. Learn tax preparation at home in your spare time from H & R Block, America's Largest Tax Service. No previous experience needed. An ideal course for men and women of any age. Job opportunities for qualified graduates. No salesman will call. Send for free information today. Write: H & R Block Tax Training Institute, Dept. 301A-42, 4410 Main, Kansas City, Missouri 64111.

COLLECT Coins For Profit! How to start. Where to sell. Lists of valuable coins. Check your change! Booklet M053C, \$1.30 PPD. Oceanside Gifts, Suite 505C, 400 North Surf Road, Hollywood, Fla. 33020.

AVERAGE \$500. Each selling compactor-type baling presses. Cash in an ecology revolution! Many territories available. Box 158, Wyckoff, N.J. 07481.

\$100.00 DAILY Writing short articles. Begin immediately! Copyrighted report reveals how and where. Details \$1.00. Gajoy, Dept. B, Box 637, Red Bank, New Jersey 07701.

EASE MONEY—Old Wagon Wheels Are Valuable—\$40-\$75 each. Rush \$3.00 for complete instructions, buyers, etc. Wally Chappell, 4201 James Road, Raleigh, N.C. 27604.

MAKE MONEY On Government Surplus. How And Where. Send \$1.00. Roberto's Discounts, 1352 St. Nicholas Ave., Dept. N, New York, N.Y. 10033.

CLIP Newspaper Items. \$1.00-\$25.00 Each. Free Details. James, Box 124M, Inglewood, California 90306.

CLIP Newspaper Wedding Announcements. \$6.00 Each. Details Free. Franklin, Box 532A #1, Owosso, Michigan 48867.

BIG PROFITS! Mail baby catalogs to new mothers; lucrative year round business, details 25¢. Hierons, 297 E. 10 St., N.Y.C. 10009.

BIG Money Making Candles in Home. Complete instructions. Everything furnished. Details Free. CANDLE'S, Dept. A-4, Waseca, Minn. 56093.

FREE Stock, \$10.00 value, plus \$8.00 trade certificate with four months membership, only \$6.95. More Details for stamp. Stough, 1035 Louise, San Jose, Calif. 95125.

FREE Gifts And Catalogs. \$10.00 Value. Mastercraft, Box 392, South Lancaster, Mass. 01561.

PROFITABLE HOME BUSINESS! BABY SITTERS REGISTRY. Complete Instructions. \$3.00. Frankie, Box 2167, Nashville, Tennessee 37214.

HOMEWORKERS. Make \$50. every 150 envelopes you mail. Rush 25¢. Gemco, B-21244A, Indianapolis 46221.

\$100.00 DAILY Possible Bronzing Keepsakes. Free Literature. NBC, Box 11069-PM-1, Kansas City 64119.

WINNING Horse Racing Statistics—FREE. Duma, 562 Howard Avenue, Staten Island, New York 10301.

MONEY. Make Hundreds extra Spare-time home by mail. Opportunities, tips in magazine that tells how, leading mail-order magazine since 1929. Sample \$1. Year \$5 with free what is mailorder opportunities folio. Mail Trade, P.O. Box 1302, Springfield, Illinois 62705.

ADDRESSERS Needed! Postage, Envelopes, Etc. Furnished! Details \$1.00. New England Sales-B, P.O. Box 1573, Worcester, Mass. 01601.

FREE—Easy Ways to make money selling exciting new products—Full—spare time. Send name, age, for 5 months free subscription. Salesman's Opportunity Magazine, 1460 Hancock Center, Dept. 17-DM, Chicago 60611.

BIG Money writing Jokes. Enormous demand. We show you how. Free Facts. Laffs, Dept. G-94, Pleasant Hill, Ohio 45359.

MAKE Statuettes, novelties, imitation marble. Sell to stores or start gift shop. Free details. Marbleizing, 41 Waverton, St. Louis, Mo. 63124.

LEARN The secrets of repairing junk batteries "Fabulous Profits" at home. Battery Shop, Box 820, La Quinta, Cal. 92253.

HOW TO GET RICH!! Free "money-making Brochure"! Success International, Box 2447-C, Livonia, Mich. 48151.

\$200.00 FROM Sheet ¼" plywood (scrap). Details 25¢. Novelties, 610 So. 24th, Elwood, Indiana 46036.

GET World's Biggest Wholesale Import Catalog. Write: World, Medina, Washington 98039.

VENDING Machines. No selling. Routes earn amazing profits. Big catalogue Free. Parkway Corporation, 715PMM Ensor Street, Baltimore, Maryland 21202.

WIN CONTESTS! Prizewinner Will Help You! Sample Copy, 25¢. Year, \$4.00. Spence, 1315 Central, St. Petersburg, Florida 33705.

CLIP Newspaper items. \$1.00-\$5.00 each. Details free. Walter, Box 1360PA, Erie, Pa. 16512.

BIG Profits And Bonuses Selling Lifetime Metal Social Security Plates. Free Sample! Duraplate, 200-PM East 127th Street, Kansas City, Mo. 64145.

EARN \$240.00 A month at home, spare time, doing only two \$5.00 Invisible Re-weaving/Reknitting jobs a day. Big money paid for service that makes cuts, tears disappear from fabrics. Steady demand. Details free. Fabricon, 2039 Montrose, Chicago 60618.

HOW To Make Money Writing Short Paragraphs. Information Free. Barrett, Dept. C-27-G1, 6216 N. Clark, Chicago 60660.

FIX Typewriters from home. Repairs available. Easily learned. Athey, Tarentum, Pa. 15084.

EASIEST Money Profitable Mailorder Plans. Details 50¢. Eames Enterprises, P.O. Box 74832A, Los Angeles, Calif. 90004.

PENNY STOCKS Have Profit Potential. Free Information. Analyst-P.M., Box 214, Redondo Beach, California 90277.

(Continued on next page)

MONEYMAKING OPPORTUNITIES

(Continued from preceding page)

HOMEWORKERS. Commission Mailers Wanted! Details 10c. Rome's, B-372-PM, Webster, Massachusetts 01570.

TREMENDOUS Earning Potential. Three Unique Businesses Operated From Home. Jobco, Box 6542MD, Surfside, Florida 33154.

HOW To Prepare Your Own Mail Order Catalog Without Merchandise for Pennies, the Buyer's Service Directory, and the free bonus. Many Profitable Mail Order Businesses. All for only \$8.95 Postpaid. Money-back guarantee. A. D. Johnson Enterprises, P.O. Box 4543, Chicago, Ill. 60680.

HIGH PROFITS. Operate your own second-hand business. **FREE DETAILS** about guide to success. James Company, Box 1097, Longview, Washington 98632.

MONEY Making Idea, B-2/25c. Wise Enterprise, P.O. Box 19543, Los Angeles, Calif. 90019.

NEW Approach, Long Established Business can make you \$1000 month part time. Free Details. Voss Enterprises, 2074 E. Raines, Memphis, Tenn. 38116.

EARN Money Addressing At Home. Details 25c. GANN'S, Dept. 724, P.O. Box 1123, Denison, Texas 75020.

MAKE Money At Home, 60 New Plans \$3.00. Kiktavi, Box 2127D, Inglewood, Calif. 90305.

BOOK Has 1000 Money Building Tips. Details Free. Bugbee, 24 M Riverbend, So. Natick, Massachusetts 01760.

"LEARN Sewing Machine, Vacuum Cleaner Repairing. Men, Women. Lucrative profits. Profession with bright future. Gresslin Correspondence School, Box 927, Spencer, Iowa 51301."

MAKE \$1,000 PER MONTH From Your Own Home. Don't Delay. Write: Lee Enterprises, 884 Durham Road, Madison, Conn. 06443.

FORTUNES Made In Mailorder. Details: Box 807-M, Clarksville, Tenn. 37040.

WE PAY \$25.00 For News Items. Details \$1.00. CMM-220PM 79th, Washington 20027.

"SELL Your Photos. Report Tells How, Where, How Much They Pay. Color Slide Markets. Only \$1.00. Ernest A. Veuthey, 1140 Wilcox, Box 38477, Los Angeles, Calif. 90038.

PLANS/IDEAS EQUAL M-O-N-E-Y. Free report. Brooks, M-20864, St. Petersburg, Florida 33742.

CASH From Bottles! **FREE** Details. Cannoncrafts, Box 1046, Reseda, Calif. 91335.

MAILORDER FORTUNES Book. Top executive reveals secrets. Work home. Profits unlimited. Details **FREE**. Lee, Box 4198P2, South Daytona, Fla. 32021.

NOW! Legally don't pay tax on earnings. New report shows how. Send \$3.00. Financial Advisory, Box 371-DY, Larchmont, New York 10538.

NEW—REVEALING HUNDREDS Of easy home profitable methods. Free Premiums. Premier Enterprises, Postbox 10597-E, Pittsburgh, Pa. 15235.

MAKE MONEY With Your Camera. Sell Photos And Color Slides To Newspapers, Magazines, House Organs. Report tells How, Where To Sell Pictures. Color Slide Markets. Booklet =MO-54P, \$1.00. Thompson's, 19 Becky Thatcher, St. Charles, Missouri 63301.

MONEY At Home. Write fillers for magazines. Ten lesson course explains how: Magazines to contact, what to write, rates of pay \$5.35 P.P. RCM Enterprises, #43-E, 455E 2nd South, Salt Lake City, Utah 84111.

PROTECT IDEAS AND MONEY. Expert's investigation reports 1.) Prevent theft of your non-patentable ideas. 2.) Ill with bills? Nil in the till? New law gives complete relief. Each report \$2.00. Title Research Associates, 1057 Hancock St., Quincy, Mass 02169.

CLIP Newspaper Articles. To \$5.00 each. Free Details. Dix, B38-PD, Hallandale, Florida 33009.

\$1,500 MONTH, Home Business, Proven Results. **CARD'S,** 2920 Johns Drive, Saginaw, Mich. 48603.

MAKE MONEY Selling Beautiful **STATUE** of **LIBERTY** Postcards. 100 For Only \$4.75 Plus C.O.D. Box 365-A, Liberty, N.Y. 12754.

\$125.00 WEEKLY Correcting pupils' lessons! Samples \$1.00! Castle's, 507-ML Fifth Avenue, New York City 10017. LAngrish's, 1105-S Meyler, San Pedro, California 90731.

FLEA Market Money Making Ideas. \$1.00. Uncle Al, P.O. Box 95, Parnassus Station, New Kensington, Pa. 15068.

"ANYONE Can Win Sweepstakes" Reveals Prizewinning Methods! Free Details. Services, Box 644-PC3, Des Moines, Iowa 50303.

MAIL Letters featuring real merchandise. Get \$1200 orders in every mail, \$8.00 Profit! Everything furnished. Write: Bert Birkemark, 14362 Bushard \$140, Westminster, Calif. 92683.

YOU Can Be Rich! **HOW?** \$1.00 to: Profits, Box 51, Mechanicsburg, Ohio 43044.

SELL Magnetic Car And Truck Signs. High Profits. Write: Sanco, Box S, Westfield, New Jersey 07090.

YOU CAN MAKE BIG PROFITS AT HOME Start now! Many exciting money-making opportunities. New booklet \$1.00. Doubletree, Box 5839, Phoenix, Arizona 85010.

\$500.00 Weekly Possible **SELLING PUPPIES** at Home. No Breeding Necessary. Send \$2.00 For Exciting Details. Nationwide K9 Services, P.O. Box 632, Colona, Calif.

MAIL OUR CATALOGS. \$100. WEEKLY GUARANTEED. Complete (supplies, postage furnished) \$1.00 To: LLWJR, Box 2441, Palos Verdes Pen, California 90274. Satisfaction Guaranteed!

MAKE YOURSELF A living selling Burglar alarms that you build yourself. Very little cash outlay. Eanon Enterprises, POB 3307, Oxford, Alabama 36201.

INSTANT Wealth! Start With Only \$10.00. Details Free! International Service, (PM), Box 11796, Atlanta, Georgia 30305.

"CASH Paid For Junk"—Thousands Items. Details—25c. Nichols, Dept. PMA, Alhambra, California 91802.

NEW Amazing Product. Big Easy Profits. Write: K&F Co., Dept. 2, 1319 So. 40th, Tacoma, Washington 98408.

PROFITABLE OCCUPATIONS

HOW To Finance Your Own Business. Get \$500 to \$2 million. Free offer. Capital-25, Kerrville, Texas 78028.

MAINTENANCE SUPERVISION COURSE Home study. Prepares custodial workers for supervisory responsibilities and cleaning maintenance management careers. **APPROVED FOR VETERANS.** Accredited member National Home Study Council. Easy terms. Free brochure: American Institute of Maintenance, Dept. P, P. O. Box 2068, Glendale, Calif. 91209.

BECOME A Mortgage Broker. Highly respected, interesting, lucrative prestige business. For complete information write: United, Box 6284-F, Marietta, Georgia 30060.

BAKE New greaseless doughnuts in kitchen, sell stores. Free recipes. Michael Ray, Waseca, Minn. 56093.

MAKE \$300 CLEAR MONTH Few hours from 10 customers, representing us in your community. No individual selling. Repeats forever. Customers waiting. \$1 for sample, details. Our 40th year. Progressive, Box 1302, Springfield, Illinois 62705.

FT. SMITH Auction School, Ft. Smith, Ark. Residents & Home study. Veteran approved.

SHARPEN Scissors, Pinkers. Inexpensive equipment, tools, supplies. Blackhawk's, Sheldahl, Iowa 50243.

HOW To Make Money Writing Short Paragraphs. Information Free. Barrett, Dept. C-27-G2, 6216 N. Clark, Chicago 60660.

EXCELLENT Freelance Income. Do Pasteups For Printers, Advertising Agencies, Etc. Self-Instruction Manual. \$3.00. Halcaine Publications, Box 199PM, Jackson, New Jersey 08527.

SALESMEN-DISTRIBUTORS

SELL Hertel Bibles—Part Time. Finest reference Bible available. Demonstrator and supplies furnished. Excellent commissions. Write: International Book, Dept. PM, Box 118, Wichita, Kansas 67201.

PERSONAL Protective Devices Now In Big Demand due to increased crime rate. Proven. Sell easy to Drive-ins, Stores, Nurses, Night Workers, Notorists. Sales experience unnecessary. Get profits details now. Hagen Supply, Dept. CLA-42, St. Paul, Minn. 55107.

MAKE Extra \$25 to \$75 spare time! Double air cushion shoes. Men's, Women's line. Dress, work, play. Highest commissions. Shoes for yourself. Outfit Free. Bronson, Dept. H-42, Minneapolis, Minnesota 55408.

EARN Big money calling on business-professional men. Send us their delinquent accounts for collection. General Finance, Dept. PM-11, Columbia Bank Bldg., Kansas City, Missouri 64106.

WANTED. Man to contact service stations. Long needed invention. Huge profits. Write: Cyclo, 3816 Dahlia, Dept. 149, Denver, Colo.

CRIME Personal Protection Devices. Mass Demand, Tremendous Profits. Sheriff, Box 113, Twinsburg, Ohio 44087.

SELL Sensational Car Thief Signal Lightning Seller. Samples for trial. Northwest Electric, Ave. 813, Mitchell, S. Dak. 57301.

EARN Big Commission Full or Part Time. Show America's largest line Low Priced Business Printing and Advertising Specialities Plus Calendars in season. No experience. No investment. No collections or Deliveries. On-the-spot commissions. Big Free Sales Kit samples hundreds items used daily by businessmen. Merchandise bonuses for you. Build profitable repeat business. Start now. National Press, Dept. 72D, North Chicago, Ill. 60064.

SELL Advertising Ball Pens, Calendars, Ad-Specialties—Build Own Repeat Business—Free Details—Fleming, Dept. A, 6535 Cottage Grove, Chicago 60637.

ASK US ABOUT GETTING INTO BUSINESS FOR YOURSELF. It can be done selling our New 1972 Line of Specialty Advertising, Calendars and Executive Gifts. Every business and organization a potential customer. Part or full time. No investment, collections, quotas, reports, or District Managers. Many promotional ideas to help you get started with a 63 year old, low pressure firm rated AAA-1. Prompt, helpful cooperation. Weekly commissions. Liberal Bonus. Write: John McNeer, Dept. PM-4, Newton Mfg. Co., Newton, Iowa 50208.

HOUSEHOLD PRODUCTS ROUTE. EARN \$25 Or more daily. Also Party Plan opportunities for men, women full, part time. McNess, Freeport (2642) Illinois 61032.

(Continued on next page)

SALESMEN—DISTRIBUTORS

(Continued from preceding page)

EXCLUSIVE, Fantastic new product sold in all stores, patented, no competition, steady, profitable, repeat sales, \$2000 merchandise investment, refundable, lifetime opportunity. Comon Tatar Inc., Buffalo, N. Y. 14219, (716) 824-1646.

AGENTS WANTED

SELL Office Supplies—Machines—Furniture—Equipment. Oseco, 3505-PM Elston, Chicago 60618.

EVERY Man a prospect. Refundable sales kit offer showing line belt buckles, tie clasps, money clips, cuff links, lapels, identification badges, individualized with customer's name and emblems. Cap badges for trucking, bus, taxi, police, firemen, also postal, letter carriers and heavy construction emblems. Choice 4000 emblems. Hook-Fast, Box 1088PM, Providence, R.I. 02901.

YOUR Own business—Used Suits \$1.50; Overcoats 65c; Mackinaws 35c; Shoes 12½c; Ladies' Coats 30c; Dresses 15c. Enormous profits. Catalog Free. Nathan Portnoy Assoc., 2109-AA Roosevelt Road, Chicago, Illinois 60608.

PRINTING, Advertising Salesmen—Excellent moneymaking sideline selling Decalcomania Name Plates, small quantities. Advertising Specialties, sign letters. Free Samples. Raico XL, Boston, Mass. 02119.

WANT TO MAKE UP TO \$100 A WEEK Spare time, and get free shoes for life, too? No investment. Rush card for free details. Mason Shoes, K-882, Chippewa Falls, Wisconsin 54729.

LIFETIME Income. Be our loan representative. Free Copy "Financial Freedom". Send \$1.00 refundable. Financial, Suite 1204-X3, 28 E. Jackson, Chicago 60604.

SELL Unique Prison Reform Booklet. Free Sample. Dal, 31 Ramsdell, Boston 02131.

HIGH Profit Item. Need Agents. Details 25c. P.S. Inc., Box 605, Moorhead, Minn. 56560.

ESTABLISH Your own business. Low prices on used clothing, shoes, household goods. Unlimited profits. Free catalog. Northwestern Distributors, 2129 No. Western Avenue, Chicago, Illinois 60647.

EARN AS YOU LEARN. Sell in your spare time. As a subscription representative for leading national magazines, earn generous commissions while developing skills of salesmanship. Instructions and supplies are yours free of cost. Send this ad with your name and address to: POPULAR MECHANICS, Room 1107L, 250 W. 55th St., New York, N.Y. 10019.

EMPLOYMENT INFORMATION

AMAZING AUSTRALIA NEEDS YOU!!! Get started right. New complete information available \$2.00. Employment, Housing, Transportation, Government assisted passage, Employer's List, etc. Hedrick Enterprises, Box 39, Campbellsville, Kentucky 42718.

AUSTRALIAN HANDBOOK—Employment Directory, Application Form—\$2.00, Box 1213-M, Paducah, Kentucky 42001.

ALASKA!!! Vast Opportunities! Top Pay! Enjoy Man's Life! Adventurous Details \$2.00. Garbers, P.O. Box 8020-P, Universal City, Calif. 91608.

CHICAGO Employment. Booklet. Plus Newspaper Classifieds. Send \$3.00 to: Cinebe Press, Box 8134, Chicago, Illinois 60680.

AUSTRALIA WANTS YOU!!! Government Assisted Passage. 1972 Government Information and Forms—Most Complete Information Available—\$1.00. Reports on Employment, Business, Taxes, Education, Teaching, Housing, Ranching, Maps, etc. **AUSTCO**, Box 3623-E, Long Beach, California 90803.

FLORIDA Employment Opportunities! **Disneyworld! Newspaper Classifieds! Booklet \$1.00.** Sunshine, 4512N Jamaica, Tampa, Florida 33614.

BRITISH Columbia employment and immigration information. Complete details, \$3.00. Doyle Associates, Box 2702, Williams Lake, B. C. Canada.

OVERSEAS Jobs Directory—Now Hiring—High Pay, Adventure. \$1.00. Transworld, Box 90802-E, International Airport, Los Angeles, California 90009.

LATEST REPORTS ON BOOMING AUSTRALIA AMAZING HIGH WAGES. OVER 50,000 JOBS. HUNDREDS OF U.S. COMPANIES housing, education, **TRANSPORTATION PAID BY GOVERNMENT. EQUAL OPPORTUNITIES FOR ALL** information. **RUSH \$1.00.** Box 3164PM4, WEST TEXAS ASSOCIATES, AMARILLO, TEXAS 79106.

ARIZONA! Employment Opportunities, Newspaper Classifieds, Homes, Business Information, Send \$1.00. Vistas West, Box 1309, Phoenix, Arizona 85001.

WORK Overseas. Foreign Employment Information, Long List Only \$3.00. John Kelly, Box 8926, Boston, Massachusetts 02114.

AUSTRALIA WANTS YOU. Government Pays Transportation. Australian Handbook, **AMAZING OPPORTUNITIES**, Twenty Names, Addresses of Employers. Latest Information About Employment, Business, Farming, Land, Housing. **GUARANTEED.** Send \$1.00. J. W. Enterprises, Box 898B, Hemet, Calif. 92343.

AUSTRALIAN Opportunities Handbook & Employment Directory. \$2.00. Box 65, Lebanon, Pa. 17042.

AUSTRALIA NEEDS YOU!! Latest Australian Employment Directory explains transportation, housing, taxes, plus Employers List and Forms. **Guaranteed!** \$1.00. Marson, 1933-P Fenwood, Knoxville, Tenn. 37918.

OVERSEAS Jobs—Australia, Europe, South America, Far East, Openings in all trades and professions. Free Information Write: Foreign Jobs, Box 2235 AMF, Miami, Florida 33159.

AUSTRALIA WANTS YOU! Government Assisted Passage. Latest Australian Handbook Gives Most Accurate Information Available—\$1.00 Details About Settling-In-Allowance \$1,000 and up. Wages, Taxes, Housing, Schools, Etc. Employers List and Forms. **McBrearty Associates**, Box 11645PMA, Tampa, Florida 33610.

LIKE TO Feel Wanted? Australia Beckons! Amazing Frontiers! Fascinating jobs skip unnecessary correspondence. Complete Details Now \$1.00. Friendship, Box 973PM, Racine, Wisconsin 53405.

AUSTRALIA—Fantastic job and business opportunities. Newest, best directory \$2.00. Limited Edition. Hampshire House, Box 40069, San Francisco, Calif. 94140.

AUSTRALIA Needs You. Complete information plus Employers list. \$1.00. Archer Enterprises, Box 193, Denton, Texas 76201.

LEGITIMATE Imported Australian Publications—One Tenth The Cost Per Ounce Of USA Produced "Australian Reports". Postpaid North America Only. "Australia Yearbook"—Five Pounds, 1,292 Pages—\$2.99. 300 Page "Australia Handbook"—75c. Australian Newspapers, Recent Arrivals, All Different, Complete Editions, Largest Printed: 4 Pound Bundle—\$3.50. 7 Pounds—Contains 50,000 Ads, 9,000 Actual Job Offers—\$5.00. 10 Pounds—Nine Different Newspapers Plus Back Issues Of Leading Australian Or New Zealand Magazines—\$6.40. "Ten Times More Americans Down Under Obtain Employment Through Newspapers Than Through All USA Placement Agencies And 'Employer Lists' Combined." Australasian News, Box 6428, Torrance, California 90504.

HOW I MADE \$250,000.00 Working for American Companies Overseas. You can too! Copyrighted report plus Employment Directory only \$2.00 (\$2.35-Airmailed). Satisfaction Guaranteed! Paul Smith, Apartado 10163, Maracaibo, ZP 2, Venezuela.

EXCITING AUSTRALIA—LAST FRONTIER! Government Assisted Passage! Generous Relocation Allowance. Handbook Includes Information On Taxes, Wages, Schools, Housing Etc., Plus List Of Employers And Application Form. Send \$1.00. Desco, Box 3021, Mankato, Minnesota, 56001.

AUSTRALIA!! AUSTRALIA!! FREE DETAILS!! Government Paid Transportation. Latest Handbook and Forms. Write: Associated, Box 17-B125, Lafayette, California 94549.

HELP WANTED

EARN At Home Addressing Mail. Details 25c and Stamped Envelope. Deeco-151, Box 9308, North Hollywood, Cal. 91609.

OVERSEAS EMPLOYMENT . . . Australia, Europe, South America, Asia! All Occupations! \$700-\$3,000 monthly! Write: Employment International, Box 29217-AD, Indianapolis, Indiana 46229.

OVERSEAS Jobs—Europe, South America, Australia, Far East, etc. 2000 openings all trades. Construction, Office, Engineering Sales, etc. \$700 to \$3,000 month. Expenses paid. Free Information. Write Overseas Jobs, International Airport, Box 536-M, Miami, Florida 33148.

"AUSTRALIAN OPPORTUNITIES HANDBOOK" . . . Latest authentic information about Government Paid Transportation, Employment, Business, Farming, Housing . . . plus "Employers List" and Forms. Send \$1.00 (Guaranteed). International Services, Box 19107-AD, Washington, D.C. 20036.

FREE DETAILS . . . AUSTRALIA . . . Government assisted transportation. Latest Handbook and forms . . . Free Details . . . Write: Associated, Box 17-BA125, Lafayette, California 94549.

WORLD-WIDE . . . U.S.A. jobs Galore!! Students, all professions and occupations. Enjoy Paris, Rome, Tokyo, Mexico City, Miami, San Francisco. \$700.00 to \$3,000.00 monthly. Paid Overtime, Travel Allowance, Sightseeing, Free Details!! Write: Global Employment, Box 706-B125, Orinda, California 94563.

REAL ESTATE AND FARMS

FREE CATALOG! Big **SPRING** edition! Over 5,000 Properties described, pictured—Land, Farms, Homes, Businesses—Recreation, Retirement. Selected Best thru-out the U.S.! 72 Years' service. 582 Offices, 40 states Coast to Coast, Mailed **FREE** from the World's Largest! **STROUT REALTY**, 60-MX E. 42nd St., NY, NY 10017; 7-MX S. Dearborn, Chicago, Ill. 60603; 521-MX E. Green, Pasadena, Cal. 91101.

FREE . . . BIG . . . 256-Page Catalog. Hundreds of top real estate values coast to coast! **UNITED FARM AGENCY**, 612-PM West 47th Street, Kansas City, Missouri 64112.

FREE Catalog! **PHOTOS!** Coast to coast farms, business, retirement. All types, sizes & prices. **SAFE-BUY** Real Estate, Box 589-PM, Little Rock, Ark. 72203.

PRESCOTT, Arizona. 2 Acres For Finest Country Living. \$1,995. Low terms. Mrs. Anna Young, Glenarm Land Co., 2233 North 7th St., Phoenix 85006.

GOVERNMENT LANDS Low as \$3.50 acre. Millions Acres! For exclusive "Copyrighted Report" . . . plus "Land Opportunity Digest" listing lands throughout U.S.; and **VALUABLE 17 X 22 TREASURE MAP OF U.S.;** send \$1.00. Land Disposal, Box 9091-PM, Washington, D.C. 20003. Satisfaction Guaranteed.

(Continued on next page)

REAL ESTATE AND FARMS

(Continued from preceding page)

CANADIAN Vacation lands: Full price \$385.00. 40 acres. \$10 month. Suitable cottage sites, hunting, fishing, investment. Free information. Land Corporation, 3768-C Bathurst, Downsview, Ontario, Canada.

\$1 ACRE—Canadian border—hundreds campsites, islands, farmlands, directly from tax authorities. (Non-profit). Lists, photographs mailed. Register. Room 10, 110 Church Street, Toronto 1, Canada.

GOVERNMENT Lands . . . low as \$1.00 Acre! Millions Acres! For exclusive "Government Land Buyer's Guide" . . . plus "Land Opportunity Review" listing lands available throughout U.S., send \$1.00. Satisfaction Guaranteed! United Lands, Box 19107-AD, Washington, D.C. 20036.

CENTRAL Ontario—Choice 640 acre Sportsmen's paradises still available—\$20.00 plus \$6.50 taxes yearly. Maps, pictures. \$2.00 (Refundable). Information Bureau, Norval 4, Ontario, Canada.

BOILING Spring Lakes—America's Greatest Real Estate Value. 1/3 acre vacation or retirement homesites only \$750 cash price. Ten-years to pay. Money-back inspection guarantee. Carolina coast, multi-million dollar, 14,000 acre development. 50 fresh water lakes, private ocean beach, golf course, motel, and country club. Free literature, Dept. 1-T, Boiling Spring Lakes, North Carolina 28461. (Registered under Federal Land Sales act but not offered to residents of states requiring separate registration.)

MICHIGAN 10 TO 160 ACRE TRACTS Lake Superior-Marquette Area from \$99.00 Acre. Cabins, trailers, camping welcome. (Acreage anywhere in Michigan). **FREE PICTURES.** Any Terms A-OK with **BLOCH BROTHERS** write 3650 Dixie, Drayton Plains 16, Michigan 48020.

CANADIAN Lands, seized and sold for taxes. Our 55th annual series of lists, describe many choice properties, situated from coast to coast. Priced as low as ten dollars per acre, guaranteed perfect titles, small monthly payments, no mortgage. Beautifully situated hunting and fishing camps, where there is real sport, summer cottage sites, heavily wooded acreages. Now is the time to invest in Canada's minerals, forests and farms. Write to-day for free booklet with full explanation. Tax Sale Service, Room 301-D, 85 Bloor St. E., Toronto 5, Canada.

ARKANSAS-MISSOURI. Farms, Ranches, Businesses. Investments. Beautiful 5-10-20 acre wooded tracts on 70-mile long **BEAVER LAKE.** Free catalog. **JIM TUCKER** "The Land Man", Rogers, Arkansas 72756.

FLORIDA BOOM: In delinquent **TAX** and **DISTRESS** properties Details, procedures and applications for investing. Booklet \$2.00. B.F. Aschemeier, Box 1035, Glen Burnie, Md. 21061.

OCALA FOREST CAMPSITES Deep in the heart of the Great Ocala National Forest. Excellent hunting and fishing. Free maps and photos. (Unavailable in States requiring separate registration). AD70LB710E. W. H. Vernor, Inc., P. O. Box 760, Dept. E, DeLand, Florida 32720.

BEAUTIFUL Ozark Land. Unspoiled By Man. \$55.00 Per Acre. Mill Creek Real Estate, Box 121, Melbourne, Arkansas 72556.

BEAUTIFUL Cabin sites and land available from British Columbia government to homestead or lease. Complete details \$3.00. Sourdough Slim, Horsefly B. C. Canada.

CANADIAN HUNTING/FISHING PROPERTIES. From \$9.00 an acre. Choice properties across Canada. Low monthly payments. Ideal hunting, fishing, timber, investment. **FREE CATALOGUE.** Canadian Estate Land, Department PMC-4, 286 Lawrence Avenue West, Toronto 20, Ontario.

"A" FRAME Cabin. \$500. for material. Any lumber yard. Completely illustrated instruction manual, including material list. Moneyback Guarantee. Send \$2.00 to: Dependable, Plan #2801, Box 113, Vista, California, 92083.

LAWN CARE

SAVE Money and Labor. Remove harmful dead Grass with Auto-Thatch. The only Thatcher with a plus: Eliminates Raking. Send \$1.00. Auto-Thatch Manufacturing Co., P.M. P.O. Box 1046, Tarpon Springs, Fla. 33589.

DRINKING WATER-PURIFIERS

NEW! WATER PURIFIER—Enjoy healthier, cleaner, fresher tasting water! Attaches any faucet instantly. Ideal for home; travel. Attractive! Guaranteed! Introductory offer! Send \$5.95 (2 for \$10.95). Harvi-House, PM-4, 2241 South Holly, Denver, 80222.



FLOWERS, PLANTS & NURSERY SUPPLIES

INSECT (Meat) Eating Plants, 42 kinds, illustrated brochure 25¢ postpaid. Peter Paul Nurseries, Macedon Canandaigua, N.Y. 14424.

GINSENG Bringing \$20.00 pound. Have seeds roots. Goldenseal. Full information. K. Collins, Viola, Iowa 52350.

LEARN Landscaping and the growing of plants. Start a profitable business part or full time. Free information without obligation. Lifetime Career Schools, Dept. A-139, 2251 Barry Avenue, Los Angeles, California 90064.

MILLION CANNAS For Sale. Information Free. Write: Cannas, Carnegie, Oklahoma 73015.

BEAUTIFUL Maximum/Minimum Thermometer, Weatherproof, \$8.50 Postpaid. Free Descriptive Literature. Tanner Enterprises, 2011 Jordan Lane, Huntsville, Ala. 35805.

GROW SUPER SIZE Plants With Amazing Garden Pellets, \$2.98 Per 100. Sabal Palm Gifts, 399 Florida Avenue, Fort Lauderdale, Florida 33312.

BUILDING AID BOOKS

POPULAR MECHANICS CATALOG Of plans, publications and projects. Covers shop and home projects. Want to build a plane, a hovercraft, boats, swimming pools, patios and garden furniture. Fireplaces, kitchen cabinets. 32 pages crammed full of fascinating and useful projects. Send for this illustrated catalog to: **POPULAR MECHANICS**, Dept. HE, 224 W. 57th St., New York, N.Y. 10019. Price 25¢.

CONSTRUCTION PLANS, BLUEPRINTS

HAVE Your Home Designed By Mail. For Information Write: Home Design Studio, P.O. Box 6916, Fort Worth, Texas 76115.

HOUSE EXPANSION PLANS And detail instruction book provide anything from an extra room to 1000 s/f addition. Build what you need at big do-it-yourself saving. Book with 1 set working blueprints \$14.50! with 4 sets (required by contractors) \$20.00. Money-Saver Projects, Box 303-44B, Chappaqua, New York 10514. Information available.

LOG CABINS & HOMES

"BUILD Log Cabins, rustic furniture, fireplaces!!! Complete manual, \$3.00 "A" Frame plans, \$2.00 . . . Guaranteed . . . Beels, 956 Springdale, Atlanta, Georgia 30306."

"A" FRAME Cabin. \$500 for material. Any lumber yard. Completely illustrated instruction manual, including material list. Moneyback guarantee. Send \$2.00 to Dependable, Plan #1906, Box 113, Vista, California 92083.

HOME CRAFTSMEN

WOOD—Domestic and Imported Hardwoods! Clock, musical instrument kits. Tools . . . discount prices! Hard-to-find hardware. 144 page catalog, 50¢. Craftsman, Dept. AX-42, 2729 Mary, Chicago, Illinois 60608.

"CLOCK Kits, Movements, Dials. Catalog Three Stamps, Newport, Box 6848A, Burbank, Calif. 91505."

101 PATTERNS Of smart Gifts, Novelties, Shelves, Action Windmills, plus "Make Money Jig Sawing." \$1.50. Mastercraft, 45M, 7041 Olcott, Chicago 60631.

CABINETMAKING MADE EASY And "How to Make Formica Counter Tops." Two excellent guides let you build kitchen cabinets and counter tops like professionals. Extraordinary guides bring master craftsman's shortcut methods. Satisfaction guaranteed. Write: Japs, 126-P Seventh North, Hopkins, Minn. 55343.

PICTURE Framing—Profitable full or spare-time business. Easy to learn with handbook-course "Guide To Picture Framing Profits." \$1.50 Guaranteed. Free framing-supplies catalog included. Japs, 126-PM Seventh North, Hopkins, Minnesota 55343.

MAKE Money Building and selling Bird Houses. Send \$1.90 for 39 page book of plans covering 19 projects. Yeager, 1665 Linden, Homewood, Ill. 60430.

SKIL-CRAFTS Current 200 plus page catalog with world's largest, finest selection of Hobbycraft, leathercraft, artist supplies. Send \$1 for postage and handling; refunded on first \$15 minimum catalog order. Skil-Crafts, Box 105-P, Joplin, Mo. 64801.

WALNUT Bowls, Legs, Round Picture Frames. Gun-Stocks Lumber Moulding. Midland Walnut, Box 262, Savannah, Missouri 64485.

136 FULL SIZE FURNITURE PLANS. Traditional, Early American, Danish Modern. Catalog 50¢. Furniture Designs, Dept. P-42, 1425 Sherman, Evanston, Illinois 60201.

NEW—Clock Kits, Dials, Movements. Free Brochure. House Of Claremont, 2282 Woodville Pike, Goshen, Ohio 45122.

1/2 AND 1/3 Horsepower Discarded Appliance Motors. One, Two, Three Speed. Wire, Switch, Reverse. Instructions \$2.00. Oscillating spindle sander. Plans and instructions \$4.00. Both \$5.00. Foster, e.g. Box 2599, Des Moines, Iowa 50315.

TOOL-SHADOWS, Silhouettes For Tool Panels, Printed On Adhesive backed Paper. Sample And List 25¢. Designs, Box 226, Lumberton, North Carolina 28358.

GRAPH Paper. 1/4, 1/2, 1". Free List. Zimmer, 747 Beatrice, Akron, Ohio 44310.

BUILD Your Own Coffee Table. Complete step by step plans. Mail \$3.00 to: Frankland Enterprises; P. O. Box 61039; Houston, Texas 77061.

BUILD YOUR OWN Wood table lamps, three beautiful plans for your decor or profit. Cost only few dollars to build, retail as much as \$75.00. Plans and Details \$3.00 to: H-S Enterprises, Box 336, Clermont, Ind. 46119.

SAW BLADES AND SELECTED PROFESSIONAL CRAFT TOOLS. Direct from America's largest independent circular saw manufacturer. Full line of industrial saws for cutting wood, metal, plastics in Hi Speed Steels and Tungsten Carbide. Saw blades in wide range of sizes to fit all popular power saws. Also selected surplus items and closeouts. Send 25¢ for full catalog also including slitters, slotters, center drills and other tools. Savings up to 40% from prices you are accustomed to paying. Circular Tool Company, Inc., Department M, 765 Allens Avenue, Providence, Rhode Island 02905.

(Continued on next page)

HOME CRAFTSMEN

(Continued from preceding page)

100 JIGSAW Patterns for Pleasure—Profit—\$1.00. Lynds, Medway, Massachusetts 02053.

POPULAR MECHANICS MASTER SHOP GUIDE. Greatest product offered to a man with a workshop. All information printed on heavy boards, punched and ready to hang above his workbench. Covers wall fasteners, nails, screws, bolts, twist drills, abrasives, lumber moulding patterns, plywood grades, hardboard, drywall, plumbing supplies, electrical supplies. Plus information on scores of other subjects. Send \$3.95 to: **POPULAR MECHANICS**, Dept. HE, 224 West 57th Street, New York, New York 10019.

DO-IT-YOURSELF

AIR CONDITION YOUR HOME YOURSELF—SAVE OVER \$200. Free do-it-yourself brochure shows how to install central air conditioning in your forced air furnace quickly and easily, with ordinary hand tools. McGraw-Edison Co., 714B N. Clark St., Albion, Michigan 49224.

NEW Home Security Manual—Expert Burglary Prevention—Locks And Systems. Send \$2.50. Satisfaction Guaranteed. Francis. HSM-2, 940 Wainwright, Monterey, Calif. 93940.

BEST WORKBENCH PLAN Ever. Plus Free Lumber Conversion Chart, \$1.00. **WAY-MAR**, Dept. 46, 5R Underhill Road, Scarsdale, New York 10583.

SAVE \$20.00/Hour by assembling our tractor kits. Complete plans and kits to build your own bulldozer, lawn tractor, trail bike, ATV, etc. Catalog of 30 assembly kits—\$1.00. (Refunded on any purchase) Struck Corp., Dept. PM-42C, Cedarburg, Wis 53012.

REPAIR MINIBIKES, LAWNMOWERS, BICYCLES, Sewing Machines, Auto Engines. Build concrete, Plywood, boats, trailers. Ten additional How-To-Do books. Free brochure. Sincere, Box 10422, Phoenix, Arizona 85016.

CONVERT MOWER Engines into air compressors. Write Showalter, Box 409, Abilene, Kansas 67410.

BURGLAR-FIRE Alarm Supplies and Information. Free Catalog. Protecto Alarm Sales, Box 357D, Birch Run, Michigan 48415.

"HOW TO" Books. Catalogue 25¢ Elston House, 35 Stonycliff, Centerville, Mass. 02632.

PROTECT FAMILY AND POSSESSIONS. Send \$59.95 for your Do-It-Yourself Burglar or Fire alarm system kit. Accessory catalog 25¢. CDS, P.O. Box 790, Pearland, Texas 77581.

VOLKSWAGEN BUS Expandable Top. Solid State. Instructions And Full Size Templates \$5.00. Details 25¢. Macgeeco, Box 5403, Midland, Texas 79701.

NEW DESIGN SHOE RACK Low Cost. Easily Made, Holds 15 Pairs and Up For Plans And Instructions. Send \$2.00. Kleyla's, Box 126, Arcadia, Ind. 46030.

BOOK, Everything About Refinishing Antiques, \$1.75. Franic, 19904 Arrowhead, Cleveland, Ohio 44119.

TUNE Pianos. Instruction Book, Tools, \$39.95. Piano Man, Box 6214, Rochester, Minn. 55901.

DO-IT-YOURSELF, How-To, Self-Improvement Books. Circulars 15¢. Gift Catalog 25¢. Imperial Products Company, PM-4, P.O. Box 281, Tarrytown, New York 10591.

FIVE WORKBENCH PLANS—New. Different Designs, Plus Toolpanels. \$1.50. DIKO, Dept. 91D, Rowayton, Conn. 06853.

MAKE WINE AND CHAMPAGNE! Fun, Exciting, Delicious! In Your Own Kitchen. Guaranteed. Send \$1.00: K&K Enterprises, P.O. Box 323, Shawano, Wisconsin 54166.

BUILD A Burglar Alarm. Detailed Instructions With Illustrations. \$2.00. PEM, 16 Belmont, Chelmsford, Mass. 01824.

HOW TO BURGLAR-PROOF YOUR OWN HOME: Now available—"HOME SECURITY MANUAL" Written by a CIA expert on clandestine entry. A MUST for EVERY Homeowner. Satisfaction Guaranteed. Send \$2.95 To: Spangle Enterprises, Dept. 36, Box 3251, Bryan, Texas 77801.

POWER Saw JIGS For Rips, Crosscuts and Angles: Straight and accurate cuts with a few dollars worth of wood. Plans and Instructions, \$2.00. C. Brown Co., Box 644, El Granada, Calif. 94018.

MAKE WINE AND CHAMPAGNE! Fun, Exciting, Delicious! In your own kitchen. Moneyback Guarantee. Send \$1.00: K&K Enterprises, P.O. Box 323, Shawano, Wisconsin 54166.

ARTS AND CRAFTS

FREE: New handicraft catalog. Supreme Handicrafts, Box 395-PM, Sioux Falls, South Dakota 57101.

MAKE Figurines, plaques, lawn ornaments. Molds, plastercraft kits, liquid rubber. Sample and catalogue 10¢. Wooley Company, Box 29-B, Peoria, Illinois 61601.

"GETTING Started in Stained Glass" 25¢. Whittemore, Box 2065Y, Hanover, Mass. 02339.

500 FIBERGLASS Molds for casting ornamental concrete products. Catalog \$1.00. Plycrete Molds—Elk Rapids, Michigan 49629.

LARGEST Handicrafts Supply Catalogue \$1.00 (Refundable). R.P.H. Manufacturing. 24-M-4 Winter, Stamford, Connecticut 06905.

LEARN Arts & Crafts at home. Excellent full or part time business opportunities. or hobby. Free booklets. Lifetime Career Schools, Dept E-665, 2251 Barry Avenue, Los Angeles, California 90064.

GLASSBLOWING Equipment And Kits For Amateurs And Professionals. Illustrated Introductory Instruction Book \$1.00. (Free To Schools And Institutions). Willis Glass Supply Company, Box 3460, Dept. A, Anaheim, California 92803.

STAINED Glass Supplies & Kits. Send For Information. Art Glass, 401 Bloomfield Ave., Verona, N.J. 07044.

BINOCULARS, TELESCOPES, MICROSCOPES, MAGNIFIERS

FREE Binocular, Riflescope catalog. Discount sale. Save 50%. Free gift with order. Write, United Binoculars, BN-4408, 9043 So. Western, Chicago 60620.

TELESCOPES (Reflectors) complete kits. Other accessories, request free literature. Criterion Manufacturing, Dept PM 28, Hartford, Connecticut 06101.



CAMERAS AND EQUIPMENT

FREE! FREE! BARGAIN BOOK—Central Camera Co., Dept. 341, 230 S. Wabash, Chicago, Ill. 60604.

PHOTO & PHOTO SUPPLIES

SERIOUS CAMERA FAN? . . . Then write for free details about our **WEEKLY BULLETIN!** When you sell, buy or swap . . . there is no commission . . . no middleman! You deal directly with other camera "buffs". Write to: **CAMERA BROKER Inc.,** Dept. P-4, Box 382, Westport, Conn. 06880.

PHOTO FINISHING

CAMERA FANS! Expert photofinishing by one of Country's largest labs at lowest prices. Fast service and free "Foto-Fan" Stamps you quickly redeem for valuable Photo Supplies. 8MM Kodachrome \$1.29; 8 Exp. Kodacolor \$1.79; 35MM Kodachrome. 20 Slides \$1.39; 8 Exp. Black White 69¢. Satisfaction guaranteed. Send exposed film or request free mailers, complete Price List and Gift Catalog. Direct Mail Photo, Box 8352-PM, Pittsburgh, Pa. 15218.

COLOR SLIDES

35MM COLOR Slides. 10,671 Individually sold. Described, Encyclopedia catalog 10¢. Wolfe Worldwide, Dept. 14-42, Los Angeles, Calif. 90025.

MOTION PICTURES AND SOUND EQUIPMENT

16MM SOUND Features, Shorts, New used for Sale. Free Catalog. National Cinema, 333 W 57th St.—N.Y.C., N.Y. 10019.

FREE! 64-Page catalog. 8-16mm film supplies, processing equipment. Superior, 448 N. Wells, Chicago 60610.

RADIO, TELEVISION AND HAM EQUIPMENT

FREE! Bargain catalog. Fiber optics, LED's, transistors, diodes, rectifiers, SCR's, triacs, parts. Poly Paks, 211M Albion, Wakefield, Mass.

36¢ RADIO & TV tubes. Free catalog. Cornell, 4213-17 University, San Diego, California 92105.

GOVERNMENT Surplus receivers, transmitters, snooperscopes, parts. Catalog. 25¢. Meshna, Nahant, Mass. 01908.

SAVE Money on parts and Transmitting—receiving tubes, Foreign—domestic. Send 25¢ for giant catalog. Refunded first order. United Radio Company, 56-PM Ferry Street, Newark, N.J. 07105.

HOBBYISTS, Supersensitive, F.M. Microphone Transmitter. Picks Up Normal Voice at 30 feet. Kit \$14.95. Wired \$19.95. Write, Collin, P.O. Box 281, Route 25, Monroe, Conn. 06468.

HEAR POLICE/FIRE Dispatchers. Catalogs show receivers; exclusive directories of "confidential" channels. Send 8¢ stamp. Communications, Box 56-PM, Commack, New York 11725.

RADIOLOGICAL SURVEY INSTRUMENT; Federal Government surplus, 0.1-50 roentgen/hr. Price \$9.95 complete. Send for free catalog. Cortlandt Electronics, 16 Hudson St., New York, N.Y. 10013.

HIFI, RECORDS AND ELECTRONICS

OLD Radio Programs on tape. Six hours, \$7.00. Catalogue 25¢. Nostalgic Radio, Box 290, Peoria, Ill. 61601.

FREE Catalog—Electronic Kits—Amplifiers—Preamplifiers—Psychedelic Strobes—SCA Adaptors—Color Organs—Digital Instruments—Guitar Amplifiers. **FREE** Subscription, SWTPC, Box PM32040, San Antonio, Texas 78284.

FREE Catalogues, 2000 hard to find unusual records. Rose's Records, Box 7216, Louisville, Ky. 40207.

GOLDEN Age Radio. Complete taped shows. Box 8404-M, St. Louis, Missouri 63132.

OLDIES! 45 RPM Original Hits Catalog 50¢. C. & S. Record Sales, Box 197, Wampsville, New York 13163.

BEST Buy! Unrecorded Cartridges And Cassettes. **PLAYTRADE**, Box 5562, Toledo, Ohio 43613.

(Continued on next page)



MUSIC AND MUSICAL INSTRUMENTS

WE Pay All Recording Costs on accepted material! Need new Song Material for immediate recording! Grand Recording, 1354-PM Hancock St., Quincy, Massachusetts 02169.

ACCORDIONS And Amplifiers! Excelsior and other Famous Makes. Save 50%. Buy Direct. Factory Distributor. Terms. Trades. New-Used. Free Home Trial. Free Catalog and Discount Prices. Excelsior, Dept. R, 3147 North Luna, Chicago 60641.

EASY To Play And Make, Quality Dulcimers, Banjos, Thumb Pianos; Instruments And Kits. Can Be Profitable Hobby. **HERE**, Inc., #P, 410 Cedar Avenue, Minneapolis, Minn. 55404.

PUBLISHING Contract Guaranteed on Selected Songpoems. Hollywood Songwriters', 5334-T Sunset, Hollywood, California 90027.

ACCORDION Top brands. Buy direct. Tremendous discounts. Trades accepted. Free brochure **PM**. Accordion-O-Rama, 874 Broadway, N.Y.C. 10003.

ACCORDION Manufacturing, 6846-P North Avenue, Chicago, Illinois 60635. Concertinas, Hohners, Chromatics, Guitars, Drums. New, Used, Tuning, Repairing. Wholesale Catalogs Free.

WHOLESALE Professional Guitars, Amplifiers, PA Systems, Free Catalog. **CARVIN**, Escondido, Calif. 92027.

PLAYER Piano Rebuilding—get details from: Vestal Press, Vestal 11, N.Y. 13850.

VIOLIN And Guitar makers—send for latest Free Catalogue of woods & accessories. International Violin, PM1, 414 East Baltimore St., Baltimore, Md. 21202.

ELECTRIFY Player Pianos, Pump Organs Quickly, Inexpensively with Lee Silent Suction Units. Write Lee Music, 525F Venezia Avenue, Venice, California 90291.

LEARN Banjo. 5-String Bluegrass. No music. Makes learning easy. Free details, Blaylock, Box 25-M, Marietta, Georgia 30060.

POEMS Wanted for songs. Nashville Music Productions, Box 40001-P, Nashville, Tennessee 37204.

GUITAR MAKING Books. Imported Woods, Supplies, Accessories. Catalog 25¢. Guitar Center, Box 15444, Tulsa, Okla. 74115.

FREE Song Selling Information. Peerless Publications, Box 193-A, Bloomfield, Conn. 06002.

GUITAR, Banjo Making Books. Plans, Woods, Necks, Tools. List 25¢. Satinwood, 510 East 11th Street, New York, New York 10009.

POEMS Accepted For New Songs Recorded Without Charge. Songs/poems examined free. Tin Pan Alley, 22647 Bee Ridge Station, Sarasota, Florida 33578.

NEW Catalog of Musical Products. Send 10¢. Sam Ash Music Stores, 301 Peninsula Blvd., Hempstead, New York 11550.

SWISS Music Boxes. Movements Finest. Spielman, 55 West 42nd, New York 10036.

POEMS Wanted For New Songs And Records. Send Poems. Five Star Music, 101M Tremont, Boston, Mass. 02108.

SONGPOEMS Urgently Needed, Possible Recording/Publishing, 50-50 Agreement. Betty's Music Makers, 1417 Park Bldg., Dept. B, Pittsburgh, Penna. 15222.

FREE Discount Catalogue. Guitars, Banjos, Mandolins, Parts, Accessories. Send 50¢ postage, handling. Bell Guitars, 201 W49, New York 10019.

GUITARISTS!!! Save 30%—Guitars; amplifiers—Popular name brands, Largest selection, Money Back Guarantee!!! 32 page illustrated discount catalog. Send 25¢ today; Guitars Unlimited, Box 343, Dept. PD, Richland, Washington 99352.

FREE—First Lesson—"Teach Yourself Chords." Davidsons, 6727K Metcalf, Shawnee Mission, Kansas 66204.

INSTANT Guitar! Play Immediately. Outstanding Book "Getting Started" shows how. Send \$3.00. Leighton, Box 371-D, Larchmont, New York 10538.

YOUR Words Set To Music. Reasonable. Manon, Box 1386, Huntington Beach, Calif. 92647.

MUSIC—How to read Notes fast. Details—George Sales, 12721 Willowbrook, Compton, Calif. 90222.

30% DISCOUNT Name Brand Musical Instruments Free Catalog. Freeport Music Inc., 127 F Sunrise H'way, Freeport, N.Y. 11520.

CONSERVATION TRAINING

GAME WARDEN, Government Hunter, Forestry, Park & Wildlife Service announce job openings regularly. Prepare at home for outdoor work, good pay, security. Approved for Veterans! Complete information Free! Write: North American School of Conservation—MPS—Newport Beach, California 92663.

EDUCATION AND INSTRUCTION

EARN UP TO \$700 A MONTH AS A TAX PREPARER. Learn tax preparation at home in your spare time from H & R Block, America's Largest Tax Service. No previous experience needed. An ideal course for men and women of any age. Job opportunities for qualified graduates. No salesman will call. Send for free information today. Write: H & R Block Tax Training Institute, Dept. 301C-42, 4410 Main, Kansas City, Missouri 64111.

HIGHLY EFFECTIVE Home study courses in Electronics Engineering Technology and Electronics Engineering Mathematics. Earn your Degree. Write for Free Descriptive literature. Cook's Institute of Electronics Engineering, (Dept. 10), P.O. Box 10634, Jackson, Miss. 39209. (Established 1945).

AIRCRAFT MECHANIC—Learn engines, jets, airframes. Qualify for FAA License at nation's largest air school. Write for free catalog. Indicate if eligible for G.I. Benefits. Spartan Airschool, International Airport, Dept. AZW, Tulsa, Oklahoma 74151.

WATCH REPAIRING. Unique home study course. Free information. Chicago School, YD, Fox River Grove, Illinois 60021.

COMPLETE YOUR HIGH SCHOOL At home in spare time. Texts furnished. No classes. Diploma. Our 75th Year. Free Brochure. American School, Dept. X445, Drexel at 58th, Chicago 60637.

YOU Can Learn **TRIGONOMETRY** in one day at home with 100% accuracy. Guaranteed. No Algebra, Geometry or Square Root required. For **FREE** brochure, write: **RYBOG-90** Trig System, Dept-6, 15380 Wedgewood Station, Seattle, Wash. 98115.

PROGRAMMING at home. Practical courses. Actual computer use. **FREE** booklet. CCI-D, Box 8146, St. Paul, Minnesota 55113.

LEARN ABOUT WILLS. Save lawyer fees. Blank will form protects your family. \$2.00 Guaranteed. Bargain Basement, Dept. C, 205 West Market, Lima, Ohio 45801.

LIFETIME Ordination. **DOCTOR OF DIVINITY**, Church Charters. Details 25¢. Life Science Church, 2207 Cardinal, Rolling Meadows, Illinois 60008.

TEACH preschoolers reading! Write Gold Coach, Box 251, Sarnia, Ontario.

PIANO Technology—Electronic organ servicing, learned easily at home. G. I. Approved. Free booklet, Niles Bryant School, Dept. P, 3631 Stockton, Sacramento, California 95820.

EARN College degrees at home. Many Subjects. **FLORIDA STATE CHRISTIAN COLLEGE**, Post Office Box 1674, Fort Lauderdale, Florida 33302.

GET A British Degree. Divinity. Philosophy, Radionics. 35 Courses. Prospectus free. Brantridge Forest School, Highfield, Dane Hill, Sussex, England.

PIANO Tuning quickly learned with home study course. Diploma granted. American Tuning School, Gilroy, Calif. 95020.

LEARN Auctioneering. Term soon. Free catalog. Reisch Auction College, Box 850, Mason City, Iowa 50401.

DETECTIVE Course. Free Information. Universal Detectives, Box 8180-F, Universal City, California 91608.

AUCTIONEERING. Resident or home Study Course. Free Catalog. Nashville Auction School, 2004 West End, Nashville, Tennessee 37203.

AUTOSUGGESTION. Sleep-learning headquarters! Tapes, records, books, Gigantic catalog free. Research Association, Box 24PM, Olympia, Washington.

USED Courses! Books! List 10¢. Smith's, 124 Marlborough, Salem, Massachusetts 01970.

UNLOCK Your Future. Become professional Locksmith with spare time home-study. Make up to \$6 per hour. All tools, equipment incl. Facts Free. Send name Locksmithing Inst., Dept. 1310-042, Little Falls, New Jersey 07424.

GRAPHOANALYSIS—Learn scientific handwriting analysis for profit, pleasure. Free sample lesson, catalog, reveals plan. Write: Igas Inc., 325 Jackson, Dept. 2AY-2, Chicago 60606.

LEARN Asleep or awake! Records, tapes, equipment! Free catalog! Drawer PM-400, Ruidoso, New Mexico 88345.

PERFECT Husband-wife business. Learn Upholstery at home. Make \$10 in an hour. Buy—repair—sell for even bigger profits. Kits, tools included. Free Booklet. Upholstery & Decorating School, Dept. 5310-042, Little Falls, New Jersey 07424.

OWN Collection agency. "Little Gold Mine!" Franklin Credit, Roanoke, Virginia 24004.

RELIGIOUS VOCATION? Write: Church Of Holy Light Inc., P.O. Box 4478, Pittsburgh, Pa. 15205.

DETECTIVE Profession. Easy home study; free tie-tack or lapel pin, certificate, future. GI approved. Professional Investigators, Box 41345, Dept. CP, Los Angeles, Calif. 90041.

LEARN To Fix Typewriters. Desperate shortage trained men. Hundreds needed. Make up to \$25 in one hour. Learn at home in spare time. Industry Approved course. Facts free. Send name. Typewriter Repair School, Dept. 3310-042, Little Falls, New Jersey 07424.

HIGHLY Effective Specialized Home Study Courses. Fast, Inexpensive, and Complete. Many Categories: Electrical, Electronics, Mechanical, Building Trades, Etc. Diplomas Awarded. Our 27th Year. **FREE** Literature. **CIEE**—Dept. 25—Box 10634, Jackson, Miss. 39209.

FREE Bible Course! Degree! Request information! 708 Bragg, Monroe, North Carolina 28110.

OPERATE Profitable Bookkeeping Tax Service. Details Free. Universal, Box 664-M, Springfield, Missouri 65801.

FREE B.D., M.D., D.D. with Lifetime Ordination. Box 744 PM, McKeesport, Penna 15134.

USED Courses! Books. Catalog 10¢ (Courses Bought). Lee Mountain, Pisgah, Alabama 35765.

LEARN TO WELD—Arc. Pipe. Gas, **TIG**, **MIG**, Plasma. Free Bulletin. Write, phone or visit. Approved Ohio No. 70-12-0064-HT. **HOBERT SCHOOL OF WELDING TECHNOLOGY**, BOX 72, TROY, OHIO 45373.

(Continued on next page)

EDUCATION AND INSTRUCTION

(Continued from preceding page)

LEARN To Read Music In One Evening. Guaranteed. Free Details. Harris, 5116-A Wyalusing Ave., Philadelphia, Pa. 19131.

ADVERTISING SIMPLIFIED! Professional Methods Increase Volume, Profits! **RESULTFUL** Writing, Layouts For All Media. Simple Steps! Send \$2.95: Manual, 4532 Fairview, Des Moines, Iowa 50317.

CHILDREN—ADULTS LEARN TO READ NOTES With Musical Flash Cards. Fast—Easy—Educational. \$1.00 per set. Random Enterprises, Dept. M21, 241 East Erie Street, Milwaukee, Wisconsin 53202.

GAME WARDEN, Government Hunter, Forestry, Park & Wildlife Service announce job openings regularly. Prepare at home for outdoor work, good pay, security. Approved for Veterans! Complete information Free! Write: North American School of Conservation-AZS-Newport Beach, California 92663.

ORIGINAL \$100.00 Real Estate Course \$17.95. Free literature. School, Box 8585-A, Kansas City, Missouri 64114.

BE AN Independent Remodeler.—Build-er. Free details. Professional Institute, Box 1524-PM, Kansas City, Missouri 64141.

IF YOU Really want to succeed at life, my **LETTER FROM A FRIEND** Will help you as it has helped so many others. Send \$1.00 for this indispensable guidance. ERB, Box 21008, Philadelphia, Pa. 19154.

PENMANSHIP Corrector. Improve Poor Penmanship Quickly. Details Free. Ozment, Box 2344-34, St. Louis, Missouri 63114.

BECOME Notary Public! Free particulars. Smidt's, 1708-PM North Fifth Avenue, Evansville, Indiana 47710.

COLLEGE Degree At Home. Your Choice Of Subjects Incl. Law. Easy Tuition Plan. Williams College, Williams, Arizona 86046.

RUSSIAN MADE EASY. Anglo-Russian Cassette tape, over 300 everyday words, salutations, phrases as spoken by Russians. Send \$4.95 to: Tapetalk, Box 136, Heriot Bay, British Columbia, Canada.

FINGERPRINTING—Investigation. Exciting, secure career. Learn at home. Free book. State age. Institute of Applied Science, 1920 Sunnyside, Dept. 164, Chicago, Illinois 60640.

DO YOU HAVE ESP? ESP Test Kit. At Once Reveals Your ESP Quotient. For Only \$3.00. Capital Idea, 13926 Rath, La Puente, California 91746.

FREE Book tells how to qualify for secure jobs as camera repairman. Home study or classroom. **APPROVED FOR VETERANS TRAINING.** National Camera, Dept. EAB, Englewood, Colo. 80110.

LEARN Instant Memory Method. \$2.00. Guaranteed. Schocko, Dept. P254, Box 9538, San Diego, California 92109.

"LEARN Fast As Geniuses!" Typing! Short-hand! Songwriting! Speech! Singing! Storywriting! Music! Languages! Ballroom Dancing! Art! \$1.00 each! All for \$3.95! Castle's, 507-MA Fifth Avenue, New York City 10017.

MY Child? Never! Narcotics and Dangerous Drugs Identification slide \$1.00 postpaid. **TOVAR, 108 FOURTH STREET, SANTA ROSA, CALIFORNIA 95403.**

MINISTERS, Chaplains, urgently needed. We employ every man, woman, we ordain in religious, educational, youth work. Your area. Christian Church, 2456 West Broad, Columbus, Ohio 43204.

THOMAS A. EDISON COLLEGE Master's & Doctor's "OFF CAMPUS" Degree Programs in Religion & General Education. Write: TAEC, Box 688, Palm Beach, Fla. 33480 For Catalogue send \$1.00.

FOR INVENTORS

PATENT Application Financing. Free patent search plan. Global Patent Division, 2420 77th. Oakland, Calif. 94605.

IMMEDIATE Cash, for patent applications. Free patent searches. Write for details. Universal Patents. 184-D Marion, Ohio 45750.

LEARN How Inventors Earn Big Profits. Free Details. Apko, Box 876-G, Richardson, Texas 75080.

INVENTORS: PROFESSIONAL Engineering Development and Marketing Service of your inventions—ideas by Licensed Professional Engineer and U.S. Patent Office Former Examiner, specializing in U.S. Patent Office Searches and Patent Engineering Development of inventions—ideas for patenting and sale to manufacturers as new products. We represent inventors in presenting and selling inventions to manufacturers. Send for free Invention Certificates and Invention information. George Spector, Licensed Professional Engineer—Patent Engineer, 3615 Woolworth Building, New York, N. Y. 10007.

HANDLE Your patent arrangements from home, using free services of U.S. Patent Office. Illustrated instruction manual \$3.00 (refundable). Independent Inventors Association, 1199 Broadway, New York, N.Y. 10001.

INVENTIONS Needed immediately for manufacturers. For additional information, write: Kessler Corporation, C-54F1, Fremont, Ohio 43420.

LEARN How to protect, develop and sell your ideas and inventions yourself—without marketing or development fees! Free details! Create, 8500 Wilshire, Suite 1002-A, Beverly Hills, California 90211.

PROSECUTE Your Own Patent Application. All Materials, Plus Step-By-Step Procedure—\$7.00. Inventors Service, Box 3574, Washington, D.C. 20007.

PROMOTE IT YOURSELF—Complete guide for inventors. Development thru sale: Quantum Group, 1529 Greenleaf, Evanston, Illinois 60202.

INVENTORS: GET PROVEN FACTS! Filing for patent is only ten percent of the job. Discover why costly patents are unnecessary. Tells **ONLY** sure method for low cost protection. Send \$3.30 for informative treatise and save \$ \$ \$ \$ \$ P.O. Box 733, Inglewood, Calif. 90307.

FORTUNES Waiting. Read Inventor's Manual Ideas, Development, Sales \$2.98. Tatco, 62 Canaan, Carbondale, Pa. 18407.

FREE PAMPHLET: "Tips on Safeguarding Your Invention." Write: United States Inventors Service Company, 501P Thirteenth Street N.W., Washington, D.C. 20004.

INVENTORS: Your ideas and inventions (patented: unpatented) expertly searched, developed for commercial appeal and cash/royalty sales to manufacturers by professional Invention Developer with excellent record of experience. B. S. Industrial Engineering; United States Patent Office former Patent Examiner. United States Government former Patent Advisor. Second decade reliable service! Member: United States Council International Chamber Commerce. Free "Invention Record" and "Recommended Protection Procedure." Airmailed! Write: Raymond Lee, Invention Developer, 230P-Park Ave., New York, New York 10017.

U.S. PATENT Office Searches. 234 Broadway, Room 3615, New York 10017. Free invention certificates.

INVENTIONS WANTED

INVENTIONS Wanted. Patented: unpatented. Tremendous manufacturers lists. Global Marketing Service, 2420G 77th, Oakland, California 94605.

WE Either sell your invention or pay cash bonus. Write for details. Universal Inventions, 28-E, Marion, Ohio 45750.

INVENTORS—If you have an invention for sale, patented or unpatented, write for free brochure outlining manufacturer requirements, royalty rates. Kessler Corporation, C-54IW, Fremont, Ohio 43420.

FREE "Directory of 500 Corporations Seeking new Products." For information regarding developments, sale, licensing of your patented/unpatented inventions, Write: Raymond Lee Organization, 230-N Park Avenue, New York, New York 10017.

INVENTORS! Protect your ideas! Free "Recommended Procedures." Washington Inventors Service, 422F Washington Building, District of Columbia 20005.

MANUFACTURING

INVENTORS Ideas Developed. Research. Models. Manufacturing. Sales. Free Brochure. Since 1942. William Parker, Box 6305, Orlando, Fla. 32803.

BUYING AND SELLING

PROFITS FROM CLASSIFIED ADVERTISING! Booklet shows you how to start your own business with Classified Advertising. Only \$1.00 (Refundable with first order.) C. A. Martin, Popular Mechanics, Dept. PM, 224 West 57 Street, New York, N.Y. 10019.

BUY IT WHOLESALE

UNIQUE Wholesale Club!! Save on thousands of famous brands: jewelry, tools, appliances, stereos, etc. 40-50% off Retail; same wholesale prices retailers pay! Purchase for yourself or resell for fantastic profits. Free information. Homestead, Dept. 50D, 18 Westcliff Drive, Mount Sinai, New York 11766.

PLASTIC BAGS—WHOLESALE PRICES 300 Stocked sizes—fast shipment. Catalog 20¢. Milvan Company, 7921 D Enterprise, Newark, Calif. 94560.

HEARING Aids, batteries, Wholesale. Catalog 25¢. Fiston, Box 1444, New Preston, Conn. 06777.

WORLD'S Largest wholesale dropship sources. U.S., foreign. Factory suppliers dropship direct to you or customers. Now! have your own catalog for pennies. Free details. International Buyers, Box 16386-M, Portland, Oregon 97233.

SAVE Up to 60% on Thousands of Products! Join our Wholesale Club! Voiz-PMWC, Ypsilanti, Michigan 48197.

CLOSE OUT DIRECTORY. Terrific Bargains. \$1.00. Winchester Enterprises, 2807PM Hargrave Street, Philadelphia, Penna. 19136.

WHOLESALE—Buy 50% to 50% Off Retail—same prices retailers pay Thousands of name brands! Watches, cameras, jewelry, radios, phonographs, tape recorders, etc. Buy for yourself or resell at fat profit. Big wholesale catalog. Confidential Wholesale Price List. Free details. Wholesale Merchandise Club of America, Dept. 423, 154 Jericho Turnpike, Floral Park, N.Y. 11001.

BARGAINS! Buy wholesale and below. Name brands. Appliances, furniture, sports equipment, televisions, cameras, watches, jewelry, thousands more. Huge discounts to \$1,000.00 on new automobiles. All makes. Free details. Write today: Worldwide Bargainhunters. Box 730-A, Holland, Michigan 49423.

EXPORT-IMPORT

ORIGINAL Oil Paintings 16x20" \$72.00 dozen. Details 25¢. McDaniel, 3632 Topax, Claymont, Delaware 19703.

"WE SUPPLY EVERYTHING—YOU JUST MAKE MONEY!!!" Hong Kong Wholesale Directories #1 or #2—\$2.00 each. Japanese Cameras & Equipment or Japanese Toys—\$2.00 each. Japanese TV, Radio, Record Players & Recorders or Worldwide Wigs—\$2.00 each. Other Directories Available. We Operate A Finders Service. Write Us Your Needs. Dealers & Reps Welcome. Imports, Box 4665-X, San Diego 92104.

IMPORT Guide. 1000+ Suppliers. 60+ Countries. \$5. Intercontinental, Box 504-PM, Montreal 380, Canada.

(Continued on next page)

FOR THE HOME

50 BEAUTIFUL Unwoven Towels, \$3.00. Baker, 162 R., Thomaston, Georgia 30286.

INEXPENSIVE TIME DELAY LIGHT SWITCH. Turn switch off, light stays on 45 seconds, prevents accidents. Free brochure—Send self addressed envelope to: B & B, P.O. Box 1175, Muncie, Indiana 47305.

ZAP-STOP, Rubber door knob cover stops static electric shock from knobs and damage to walls. 2/\$1.00. **ZAP-STOP,** Box 14649, Portland, Oregon 97214.

FOR PARENTS

PLANS For pool table with extra two-face top for table tennis and model railroad. Blueprints B1209 and building instruction \$5.00. Popular Mechanics Service Bureau, 224 West 57th Street, New York, N.Y. 10019.

OF INTEREST TO WOMEN

\$\$\$\$ QUICK Mailing Circulars!! Send addressed envelope today. Fay's, 182 North Wood Street-PM, Battle Creek, Michigan 49107.

\$46.00 DAILY possible addressing-stuffing envelopes (typewriter or longhand) information. Send stamped, addressed envelope. American, Excelsior Springs, Mo. 64024.

\$500 MONTHLY possible—Clipping news at home. No experience—send stamped-addressed envelope. American, Excelsior Springs, Mo. 64024.

WANT A new car, color TV, new clothes? Learn hundreds of ways to make money. 5 month subscription **FREE**. Write: Salesman's Opportunity Magazine, Dept. 17-DO, 1460 Hancock Center, Chicago 60611.

\$150.00 WEEKLY Possible! Homeworkers needed urgently! Send stamped, self-addressed envelope. Schoen, Box 1963-P, Chicago, Illinois 60690.

\$100 WEEKLY Possible addressing mailing. Sparetime. Free details. Send self-addressed stamped envelope. Newby Publications, Box 20427-PM, San Antonio, Texas 78220.

\$6.00 DOZEN Paid lacing baby boots! Cowboy, Warsaw 9, Indiana 46580.

WOMEN! Make big money at home. \$10.00 profit in an hour possible with Invisible Reweaving/Reknitting. Make holes, tears disappear from fabrics. Steady year-round demand from cleaners, laundries, homes. Details free. Fabricon, 2073 Montrose, Chicago 60618.

HOW To Make Money Writing Short Paragraphs. Information Free. Barrett, Dept. C-27-G3, 6216 N. Clark, Chicago 60660.

SPAGHETTI SAUCE—Secret Italian Recipe For Macaroni, Raviolis. Send \$1.00. Ro Advertising Agency, P.O. Box 331, Malden, Massachusetts 02148.

HOMEWORKERS! \$100.00 Weekly addressing for firms. Begin immediately. Details—send stamped, addressed envelope. Hamilton, 272-TM4, Brooklyn 11235.

\$75.00 THOUSAND Addressing! Special information, plus your listing with 1,000 concerned firms. Year, \$1.00. Dixie, B38-MD, Hallandale, Florida 33009.

FREE RAINCOAT! Full-length, plastic. 25¢ mailing. "How To" Brochure. Ellenbogen Giftings, 450 Seventh Avenue, New York 10001.

HOMESEWERS! Buy your Fabrics Direct from Wholesaler. DFCO, Box 171, New York 10018.

WIN CONTESTS!! New Booklet Reveals Secrets. \$1.00. JayMar, Box 646-PB, Maysville, Kentucky 41056.

HOME Newspaper clippers needed. \$500 monthly possible. Details free. Foster, 272-MA4, Brooklyn 11235.

HOME Businesses . . . 85 Sources . . . \$1.00. Research, U.P.O. 401-PM, Kingston, New York 12401.

LEARN Expert Cake Decorating, Catering, Candymaking. Free details on home instruction. Candy & Cake, Dept. BKS-PM, 1600 Cabrillo, Torrance, Calif. 90501.

GIFT SHOPPING

NEW Self Powered Camera. Uses All 126 Film Cartridges. Never Needs Batteries Or Ever a Double Exposure. Only \$10.55. Pauls Gifts, 121 Greenwood Ave., Ambler, Pa. 19002.

MOUSE, MOUSE, For Your House. Cute, Decorative, Different. Handcrafted from cracked marbles. Exclusive copyright, Replacement Guarantee. Set of three, \$2.98. Blue, Green, or Crystal. Beje, Box 1042 PM, Waukesha, Wisconsin 53186.

BEAUTIFUL Cedar Chests Miniature Size. They come complete with lock and key. Made of Southern Cedar. Little Girls Love Them! Perfect for birthday gifts and for special occasions to remember. Send \$4.95 postpaid to: Shenandoah House, Dept. 235, Fork Union, Virginia 23055. Satisfaction Guaranteed or Your Money Back!

FREE: "Beautiful Gift Catalog." Color—over 250 items. Free bonus Bob Shop—PM42—5069 Meadow—Dallas, Texas 75215.

FREE CATALOG Of Sensational Gifts and Novelties. J. & L. Co., 73-B Main St., New Paltz, New York 12561.

FREE Distinctive Gift Catalog of gifts for the entire family. Kim Enterprises, 216 Second, Fordyce, Arkansas 71742.

WATCHES, OLD GOLD, JEWELRY

COMPLETE Watchmakers'—Jewelers' Catalog \$1.00. Snell-Bengal, 205 Helm Building, Fresno, California 93721.

HIGHEST CASH For Gold, Jewelry, Gold Teeth, Rings, Diamonds, Watches, Silver, Platinum. Mail Articles Today. Free gift with information. Chicago Gold & Precious Metals, 6 E. Monroe, Dept. 858, Chicago 60603.

WATCH And clock repairing books. Free catalog. North American, Box 77-AQ, Fox River Grove, Illinois 60021.

CASH Immediately for Old Gold, Jewelry, Gold Teeth, Watches, Diamonds, Spectacles, Silver, Platinum, Mercury. Free information. Rose Industries, 29-A East Madison, Chicago 60602.

WANTED . . . Gold, Silver, Platinum (any form). Coins. Information Free. Wilmot's, 1067 Bridge, Grand Rapids, Mich. 49504.

WEARING APPAREL

MAILORDER Records help get increased business! Complete 32 Page Record Book shows your inquiries orders, advertising, expense, etc. Only \$1.00. C. A. Martin, Popular Mechanics, Dept. PMR, 224 West 57 Street, New York, N.Y. 10019.

HEARING AIDS

HUGE SAVINGS. Eliminate dealer mark-ups. Free Trial. Batteries Wholesale. Terms Arranged. Lloyds-PMC, Rockford, Ill. 61108.

HEARING AIDS, Batteries, Discount Prices. Rhodes, Box 518-PM, Paducah, Ky. 42001.



SCIENCE AND CHEMISTRY

FIBER OP-KITS, Using the "magical optical fibers" that transmit light energy. Free catalog. Scientific Devices, 211M Albion, Wakefield, Mass. 01880.

LASER Parts. Catalog 60¢. Moynihan, 107 North Brighton, Atlantic City, New Jersey 08401.

CHEMISTRY And Biology Catalog 35¢. Boulevard Laboratories, Suite 302, 3114 E. 83rd St., Chicago, Ill. 60617.

CHEMICALS And apparatus for industrial, analytical, and private laboratories. Catalog 50¢. Dept. M-50. Biological Supply Co., 1176 Mt. Hope Ave., Rochester, N.Y. 14620.

LABORATORY Supplies at discount prices. Catalogue—35¢. Deluxe Scientific; Manitowoc, Wisconsin 54220.

CATALOGUE Of those very hard-to-find chemical products, plus things that go boom, unusual formulas, multi-stage rockets,—loads more! 50¢ (Price refundable, first order) Kenrus-C, Box 158M, Staten Island, New York 10309.

CHEMICALS Apparatus, Biology and Model Rockets. Both Catalogs for 50¢. Sheard Science, Dept. PM, Columbus, Wisconsin 53925.

SEARCHING For Economically Priced Laboratory Supplies? Catalog—50¢. Hagenow Laboratories, Manitowoc, Wisconsin 54220.

FIBEROPTICS . . . "The Fiber That Bends Light" . . . 1000' .020 \$25.00. Send \$1.00 (refundable) for sample and catalog. Fiberoptics, Connection Gallery, 3 Great Jones Street, New York 10012.

COMPLETE Chemistry Catalog, 25¢. Laboratory Sales, Box 161-A, Brighton, Mass. 02135.

FORMULAS, PLANS, ETC.

PROFITS FROM CLASSIFIED ADVERTISING! Booklet shows how to start your own business with Classified Advertising. Only \$1.00 (Refundable with first order.) C. A. Martin, Popular Mechanics, Dept. PM, 224 West 57 Street, New York, N.Y. 10019.

PLASTICS

CASTOLITE Pours like water, hardens like glass without heat. Crystal clear or colors. Embed natural flowers, other objects. Make fine gifts. Reproduce your own designs in plastics, wax, metal, plaster, cement, etc. Make flexible molds over any pattern, any size. Profitable. Manual 25¢. **CASTOLITE,** 72D/PM, Woodstock, Ill. 60098.

TREASURE FINDERS

METAL Detectors, largest selection. Radiac Company, Center Moriches, N.Y. 11934.

POWERFUL Metrotech locator detect gold, silver, coins, relics. Moneyback guarantee. terms. Free information. Underground Explorations, Dept. A, Box 793, Menlo Park, California 94025.

TREASURE Hunters! Prospectors! Relco's new instruments detect buried gold, silver, coins, minerals, historical relics, Transistorized. Weighs 3 pounds. \$19.95 up. Free catalog. Relco-A40, Box 10839, Houston, Texas 77018.

GOLDAK Treasure locators—Pleasure and profit in a hobby you'll enjoy. Find coins, relics, gold, silver. Charge on BankAmericard. **GOLDAK,** Dept. PM 1101-A, Air Way, Glendale, California 91201.

SEARCH Treasure Finders. Locate gold, silver, coins, relics. Operate underwater. Money back guarantee. Free information. Search Electronics, Box 8396-A, St. Petersburg, Florida 33738.

FREE 140 Page Detector Catalog. General Electronic Detection Co., Box 67, Bellflower, California 90706.

TREASURE Hunters! Prospectors! Rockhounds! Hobbyist! Find gold, silver, relics with world famous Detron Metal Detectors. Free information. Delivery immediate. Detron, Dept. 4PM, Box 243, San Gabriel, California 91778.

NOW! Enjoy the great outdoors in comfort with your pocket size electronic Skeeter Skat mosquito repeller. \$9.95 postpaid, U.S.A. Satisfaction guaranteed. Detron, Dept. F-4, P. O. Box 243, San Gabriel, California 91778.

(Continued on next page)

TREASURE FINDERS

(Continued from preceding page)

"FIND Buried treasure with revolutionary patented, analytical metal detector. Features push button and automatic tuning, negligible ground pickup, greatest range. Free catalogue. Gardiner Electronics, Dept. 9, 4729 N. 7th Avenue, Phoenix, Arizona 85018."

FISHER DETECTORS. You deserve the best! Free literature. FRL, Dept. PM-4, P.O. Box 490, Belmont, California 94002. Since 1932.

PRECIOUS STONES & MINERALS

GOLD—10 Small Nuggets Panned from Oregon Streams. \$1.00. Robert Brandt, Sweet Home, Oregon 97386.

500 POLISHED Gemstones \$5.00. Tumblecraft, 5401 James North, Minneapolis, Minn. 55430.

EARTH Science Rockhound Magazine. Subscription \$3.00. Sample \$.40. Box-550-PM, Downers Grove, Ill. 60515.

GET Free catalog no serious rockhound, gem cutter, jewelry maker, hobbyist or craftsman can be without. Full of bargains, exclusive items, low prices from largest suppliers and authorities in the field. Free new catalog just off the press, yours for the asking. Write Grieger's, Dept. C-12, 1633 E. Walnut, Pasadena, California 91106.

FREE Catalog. Diamond Look Alikes! \$15 Carat. Ree, Box 667, La Puente, California 91747.

CARTOONING, COMMERCIAL ARTS, SHOWCARD & SIGN PAINTING

"HOW TO MAKE MONEY WITH SIMPLE CARTOONS"—Informative book sent Free tells way to big income. Cartoonists' Exchange, 94, Pleasant Hill, Ohio 45359.

COMPACT 23 lesson Cartoon Course and Cartoonist's Magazine. \$2.00. Hartman, Box 30367, Lincoln, Nebraska 68510.

MODERN Cartooning taught by mail. Write for free brochure. Cartoonorama—Box 263-9F, Branford, Conn. 06405.

SIGN Painting—\$1000 per Month Part-Time. Free Catalogue. Kaufmann Supply. Centertown, Missouri 65023.

CARTOON For Money!! Big Free Book: Success, Box 885-C, Dearborn, Mich. 48121.

LEARN Sign painting at home. Free Talent test. Ben Kerns, Box 812-PM, Greenville, S.C. 29601.

CHALK Talks. 40 page Catalog 10¢. Balda The Cartoonist, Oshkosh, Wis. 54901.

ART Talent? Don't waste it! Free brochure Y4. CC&CA Studios, Spring Park, Minn. 55384.

ADVERTISING AGENCIES, ADV. SERVICE, MAILING LISTS

ADVERTISING Ratebook leading newspapers, magazines, 25¢. Chicago Advertising Agency. 28-E Jackson, Chicago 60604.

YOUR 60 Word Ad \$5.00 In: National Mail Advertiser, Box 332, Melrose Park, Illinois 60160. Sample 50¢

ADVERTISE In Mail Sale Advertiser 19,000 Circulation. 30¢ Per Word. Inch \$10.00. Subscription \$2.00. Copy 25¢. Martin's Service. 1148C Rives Rd., Martinsville, Va. 24112.

TYPEWRITERS, DUPLICATORS, OFFICE EQUIPMENT

PROFITS FROM CLASSIFIED ADVERTISING! Booklet shows how to start your own business with Classified Advertising. Only \$1.00 (Refundable with first order.) C. A. Martin, Popular Mechanics, Dept. PM, 224 West 57 Street, New York, N.Y. 10019.

RUBBER STAMPS

SMILE Stamp 75¢. Free Catalog. Rush Stamps, 132 Farmcrest, Rush, N.Y. 14543.

ADDRESS Stamp 85¢. Signature \$2.80. Catalog. Carol's, McLoud, Okla. 74851.

FREE 48 Page Catalog. Rubber stamps, printing, office supplies. Youngers Stamp Shop, Princeton, Iowa 52768.

FREE Stamp Catalog. Beckley's, 522 S. Midler Ave., Syracuse, N.Y. 13206.

FREE Stamp Catalog. 45 type styles. Fast service, low prices. Jackson's, Box 443A, Franklin Park, Illinois 60131.

OFFICE SUPPLIES

ENGRAVED Door, Desk, Badges, Name Plates. Free Catalogue. J. P. Engraving, Williamstown, New Jersey 08094.

PRINTING PRESSES, RUBBER STAMP OUTFITS

SAME Day shipment on rubber stamp supplies. Revised wholesale price list No. 7 free. Star Stamp Supply, 732 Federal, Chicago, Ill. 60605.

SIMPLE-X RUBBER STAMP PRESSES, Hydraulic operated, electrically heated. Sizes 5"x8", 8"x12", 10"x15". Starting outfits Orders for presses, supplies shipped day received. Free catalog low supply prices. Send \$1.00 for postage and handling (refundable on first order). Custom Manufacturers, 406-P East Elm, Springfield, Missouri 65801.

RUBBER Stamp outfits, supplies. Kiewiet, 2025 Barney Road, Kalamazoo, Michigan 49007.

PRINTING Presses, type, supplies, Lists, 10¢. Turnbaugh Service, Mechanicsburg, Pennsylvania 17055.

TYPE Catalog No. 12, 120 pages. Send One Dollar. Deductible First Order. Acme Type, 732 Federal, Chicago, Illinois 60605.

TYPE, Presses, Supplies. Barco Type Mfg., 237 S. Evergreen, Bensenville, Ill. 60106.

MAKE Your Own Self-Molding Rubber Stamps and Printing Cuts. Plexirubber, Argyle A, Wisconsin.

RUBBER Stamp manufacturers supplies. Press, starting outfits. Best prices, service. Catalog. Jackson Supply, Box 443A, Franklin Park, Illinois 60131.

PRINTING AND SUPPLIES

BUSINESS CARDS Raised Letters \$5.65 Thousand. Like Engraved. Free Samples. Kavanagh, Box 1222, Brooklyn, N.Y. 11202.

FREE Booklet "Secrets of Cutting Printing Cost" Nationwide Speed Printing, Atlanta, Illinois 61723.

GET Free literature-business cards, letterheads, envelopes, rubber stamps, labels. Big Selection. Jordan's, 552 West O'Connor, Lima, Ohio 45801.

PRINTING—Guaranteed 8 hour service. Allstate Press, 3733-PM North Kimball, Chicago 60618.

ECONOMICAL Printing: Stationery, Business Forms, Labels, Cards. Burnfin, Weaubleau, Mo. 65774.

FREE Information About Personalized Printing. Longwood Press, D-47D2, Fort Johnson, N.Y. 12070.

DISTINCTIVE "Embossed" Letterheads. Inexpensive. Postpaid. Universal, 226A Myrtle, Scotch Plains, New Jersey 07076.

DELUXE Business Cards. Free Samples. Harry Romano, General Delivery, Fort Shelby Station, Detroit, Mich. 48226.

SAVE TIME 1000 GUARANTEED ADDRESS LABELS \$1.00. Fairco, Box 342PM, Reidsville, North Carolina 27320.

MULTIGRAPH, MIMOGRAPH

MAILORDER Records help get increased business! Complete 32 Page Record Book shows your inquiries orders, advertising expenses, etc. Only \$1.00. C. A. Martin—Popular Mechanics, Dept. PMR, 224 West 57 Street, New York, N.Y. 10019.

GUMMED LABELS

1000 DELUXE ADDRESS LABELS 70¢. ALTON HOWELL, 1089 FARR RD., A-7, COLUMBUS, GEORGIA 31907.

1,000 GUMMED Address Labels \$1.00. Walt's, Box 966A, South Bend, Indiana 46624.

REMAILING SERVICE

PUERTO RICO Remails, 50¢ Each. Special Monthly, Bulk and Parcel Rates. Bowman, GPO Box 986-PM, San Juan, Puerto Rico 00936.

LAS VEGAS Remails 25¢. Tom Willett, 1501 Ardmore, Las Vegas, Nevada 89104.

NEVADA Remails, Confidential—25¢. Diamond-A-Ranch, Rt. 1, #21, Yerington, Nevada 89447.

ARIZONA Remails, 25¢. Robert Darnell, Box 22065-PM, Phoenix, Arizona 85028.

MIAMI! Remails 25¢. Fast Service-Vic, 1114 Genoa, Coral Gables, Florida 33134.

RENO Remails 25¢ Guaranteed. Davis, Box 5012, Reno, Nevada 89503.

RECEIVING-Forwarding. Monthly rates. Hedgpeh, 324-M South First, Alhambra, Calif. 91802.

CONFIDENTIAL New York City mail address \$3.00 month. Remails 25¢. Details Free. Birnhan, 152 W. 42, New York City 10036.

SECRET. Receiving—forwarding. Discreet and confidential. Remail 25¢ single. Mail Forwarding Service, 8050 S. Main, Houston, Texas 77025.

DENVER Receiving—Forwarding. 25¢, \$3.00. Details free. Rich, Box 26099, Denver, Colorado 80226.

TEXAS Remails 25¢. Complete mailing service, economical rates. Nortex, Drawer 5370, Fort Worth, Texas 76108.

ENGLAND Re-airmails \$1.00. Schmidt, 701 BCM Society, London WC1.

CONFIDENTIAL Remails. Mac, Box 773, Sonoma, Calif. 95476.

SAN FRANCISCO Area, 25¢ Plus Postage. Rose, 3068 Warrington, San Jose 95127.

MIAMI Remails 25¢. Monthly Rates. Marle, Box 1266, Coral Gables, Fla. 33134.

REMAILS FROM NORTH POLE. ALASKA 25¢ Monthly Rates. Confidential. Hannon's Mailservice, P. O. Box 2602, Fairbanks, Alaska 99701.

REMAIL From Pennsylvania 25¢ Single. \$3.00 Monthly. McWilliams, 560 North Darby, Sharon, Pennsylvania 16146.

BOSTON Remails. Details Mickey, 90 Mill Street, Newton, Mass. 02159.

REMAILS 25¢. Box 2064-C, Petaluma, California 94952. Fast, Daily, Confidential.

KENNEDY Space Center Remails. Special Services. Box 2130P, Satellite Beach, Florida 32935.

REMAILING Service. South America Re-airmails 50¢ Single—Narvaez, Apartado Aereo 29280, Bogota, Colombia.

MEMPHIS Remails 25¢. Receiving-Forwarding. EGS, Box 18384-R, Memphis, Tenn. 38118.

RECEIVING-Forwarding-Remailing. Monthly rates. Wright, Box 2112-M, Asheville, North Carolina 28802.

CHICAGO Remails 25¢. Monthly Rates. Hanley, 8014 Wolcott, Chicago, Illinois 60620.

PARIS Remail single \$1.00 Shopping services, Postcards. Masters, 82 Rue Doudeauville, Paris (18), France.

START Your Own Remailing Business. Complete Instructions, Send \$3.00. Tayar, Box 894 PA, Rochester, Minnesota 55901.

CONFIDENTIAL—Remails, 25¢, \$3.00 Monthly. Maiser, Box 8906, Corpus Christi, Texas 78412.

(Continued on next page)

REMAILING SERVICE

(Continued from preceding page)

HOUSTON, TEXAS "SPACE CITY" Remails. 25¢ Each, \$3.00 Monthly. Haynes, Box 33513, Houston, 77033.

WASHINGTON DC Remails 25¢. Monthly Rates. Confidential. Gabriel, Box 4552, Washington D.C. 20017.

SAN DIEGO—50¢ Each, \$5.00 Monthly. H. Lang, Box-405-San Diego, Calif 92101.

ALBUQUERQUE Remails. Single 25¢, monthly \$3.00. Airmail \$1.00. 2400 Shasta Rd. S.W. Albuquerque, New Mexico 87105.

OTTAWA, Canada Remails 60¢. Box 3792, Station C, Ottawa, Canada.

CHICAGO. Remail as instructed. Confidential. 25¢. Bascon Merchandise Mart, Rm. 550, Chicago, Ill. 60654.

JOES Remails 25¢. P. O. Box 613, Franklin Park, Illinois 60131.

REPAIRS AND SERVICING

PLAYER Piano Mechanism Rebuilt By Professionals. Also Key Recovering. Mayhew Piano Service, Mayville, Mich. 48744.

SPECIAL SERVICES

INFORMATION On anything. Ferguson Research Specialists, 83-45 Vietor Ave., Elmhurst, N.Y. 11373.

CANADIAN Information Or Service On Anything. Purchasing Services, 388 Dufferin, Winnipeg, Canada.

MASTER'S Thesis Researched, \$2.00 per page, minimum 60 pages guaranteed. Rodger Peck, 12 Barkley, Peru, Indiana 46970.

TOBACCO

I QUIT SMOKING, after 35 years of four packs a day. I'll tell you how I did it for \$2.00. Address: Fee Mail, Drawer 747-A, Roanoke, Texas 76262.

BRIAR PIPE Make or repair your own. Photocopy of article shows you all the details. Price \$1.00. Send order to **POPULAR MECHANICS**, Dept. HE, 224 West 57 St., New York, N.Y. 10019.

WALL PIPE RACK WITH HUMIDOR Make your own. Photocopy of article shows all details. Price 45¢. Send order to **POPULAR MECHANICS**, Dept. HE, 224 W. 57th St., New York, N.Y. 10019.

PERSONAL

PAY Bills! Borrow to \$1500 by mail! Convenient terms! State licensed. Postal Finance, 6018 Military Avenue, Dept. 17-E, Omaha, Nebraska 68104.

SECRET Plan Wipes Out All Debts. Get \$600 to \$25,000 relief. Clear credit. Free details. Counselor-7, Kerrville, Texas 78028.

HOW TO ATTRACT Good Luck. Provocative Book! \$2.00. Treasure Cove, P.O. Box 21203P, Denver, Colorado 80221.

DEATH Awards your property to **WHOM?** Make your will **NOW!** Forms, \$2.00. Legalprinters, Drawer 2112, Asheville, N.C. 28802.

WE'LL Pay you to quit smoking (for three weeks) and answer our questionnaires. Send 50¢ postage and handling: Hardy Labs, Box 7411, Chicago 60680.

SECRET LOANS BY MAIL. Borrow \$100 to \$1500 for any good reason in absolute privacy. No interviews, no endorsers, no co-signers. Fast service. Write Dial Finance Co., Dept. D-214, 405 South 16th Street, Omaha, Nebraska 68102.

BIBLE Questions answered. Stamped envelope. Bylon. 17167 Bentler, Detroit, Michigan 48219.

INVESTIGATORS. Latest electronic Aids. Free Literature. Clifton, 11500-P NW 7th Ave., Miami, Florida 33168.

RECORD Telephone conversations automatically. Leave recorder unattended. Write—Robert's, Box 49-PM4, Parkridge, Illinois 60068.

IMPROVE YOUR PERSONALITY. Write for free information: **PERSONALITY SUCCESS**, Dept. C-11, Box 1946, El Paso, Texas 79950.

"RULE Others With Thoughts." (Telepathy) write: Clarion, Box 1769-S7, Chicago, 60690.

HAVE Triple-A credit in thirty days! Get new credit without investigation! Continental, Box J-24, Hallandale, Florida 33009.

TATTOO Removing—Chemical Do-It-Yourself Method—Free Details: Atlanta, 907P Beachpoint, Pickering, Ontario.

FREE Gospel Literature Foretelling Second Coming Of Christ, Scheall, Box 263-PM, Duluth, Minn. 55801.

THINK BIG! Increased Income, Prestige, Power. "Thinking Big." 256 Pages, Facts that make men rich. Send \$2.00. PineTree Enterprises, Box 432-PM2, Manitowish Springs, Colorado 80829.

CASSIUS VINTON SMITH—Mother Deceased. Contact estate. Write c/o Richard Breen, 520 Laurel, Brainerd, Minn. 56401.

WIPE Out Debts! Anyone (bankrupts included) can have excellent credit in 45 days and build a fortune. Free!!! Wealth Building, Box B-4, 8840 Hoyt Drive, Thornton, Colorado 80229.

NEW Winemakers' And Champagne Handbook Contains Amazing Recipes. Use Standard Kitchen Items Only. Guaranteed Delicious Or Money Back. Send \$2.00 To: Bassett Advertising Agency, P. O. Box 3188, Panama City, Florida 32401.

DON'T DIE Without A Will! Blank will forms protects your family. Send \$2—Guaranteed!! With Instructions. Kimsco, Box 29345, Dept. 1P4, Los Angeles, 90029.

WITCHCRAFT, MAGIC, OCCULTISM, By Doctor Crow. Outstanding authority of occult sciences, \$2.00. Free brochure of popular books. Stephens, 327 North First Street, Avondale, Arizona 85323.

CANCER! You May Be Next! Stop Smoking! New Book Reveals Medical and Psychological Method. This 96 page book may save your life. Book, Stop Smoking, only \$2.00. Sandee Specialty Company, Dept. PM-2, 4100 Summers Lane, Klamath Falls, Oregon 97601.

ASTROLOGICAL Encyclopedia, Jehovah Arisen. Part-1 Dollar. F. Page., 3404 Wellington, Vancouver, Canada.

23 SECRET Ways to Save up to 80% on Light Bills. \$1.00. Phase III, Box 2598-PM, Pompano Beach, Florida 33062.

WHY BE FAT? Former U.S. Air Force Physical Training Officer discovers amazing secret—a new, easy way to control weight, be healthier! **NO** Diets, No Exercise! Free Details. Dick Clarke, (427-PM), Bedford Hills, New York 10507.

RECEIVE Lifetime Treasure "Diploma" only \$1.00. "School of Hard Knocks." P.O. Box 36532, Houston, Texas 77036.

HOW INTELLIGENT Are You? Self-scoring test reveals IQ in 45 minutes! Send \$2 today—Guaranteed!! Kimsco, Box 29345, Dept. 1P4Q, Los Angeles, 90029.

DON'T Die Without a Will! Protect your family! 2 blank forms and instructions, \$2.00. Dunrovin, Dept. 5A1, Box 2263, Muncie, Indiana 47302.

CASH LOANS by mail! Up to \$2,500 on signature alone. No collateral! Secret! Union Finance Company, 3608 No. 16th St. Dept. PM, Phoenix, Ariz. 85011.

ADULTS! Free Brochure Unusual Books! (Not Smut). PPW, 2030 South Shenandoah, Los Angeles, Calif. 90034.

NEVER Die? Not without a will! Blank will protects your family. Only \$1... guaranteed! Instructions. Order today!! King, Box 3156, Dept. 1A4, Madison, Wisconsin 53704.

\$1,000,000 IN Debts wiped out so far! Use secret law. Immediate relief. Clear credit. Free details. Legal Aid, Box 63-F, Stratford, New Jersey 08084.

WANTED-MISCELLANEOUS

MERCURY, Gold, Silver, Platinum; Ores assayed. Wholesale Terminal, Norwood, Mass. 02062.

WANTED: Old Toy Electric Trains in any condition. Robert Street, Route 8, Johnson City, Tenn. 37601.

MISCELLANEOUS

OPENING Restaurant? Equipment Reasonable. Feola, 9A Pearl Street, Somerville, Massachusetts 02145.

LEARN To Kick and Punch Like a **KARATE BLACK BELT.** For details write, Hasson, 3160 21st, Wyandotte, Mich. 48192.

WINE Pouch From Spain. Waterproof. Suede Finish. 1½ Liters. Moneyback Guarantee. \$4.95. Happy Sales, Box 181PM, Wickett, Texas 79788.

CHAMPAGNE & WINE MAKERS **HANDBOOK** Using Standard Kitchen & Household Equipment. Send \$3.98 To: Etlon Assoc., Box 145-B, Hales Corners, Wisc. 53130.

HOW IS YOUR EYESIGHT? Home exercises can help you see better. \$1.50 for booklet "Vision And How To Improve It." Special offer: Five exercises and Amazing new Visiostimulator \$5.75. Vision Enterprises, Box 5093 Station B, Victoria, B.C.

SHAVEZE Revolutionary Miracle Shaving Lubricant. 250 Fantastic Shaves. \$2.00. Cimo Products, Box 741, Corona, N.Y. 11373.

WINEMAKER'S Supply Catalog—Free. Bacchanalia, 273 Riverside Ave., Westport, Conn. 06880.

WINEMAKERS!! Fermentation locks—3/\$1.00. Free Illustrated Catalog Plus \$5.00 Credit Coupon. Werth Wine, Box 1902AV, Cedar Rapids, Iowa 52406.

CIGARETTES 15¢ a pack. Improved roller makes 20 filtertip, plain, king or regular for 15¢. Facts free. Green River Tobacco, Box 954, Owensboro, Kentucky 42301.

WINEMAKING Kit—\$4.98 Free Catalog and Recipes. **JIMDANDY**, Box 30230M, Cincinnati, Ohio 45230.

SUFFERING From Arthritis? Try Ginseng: Information Free. Write Ginseng, Asheville 53, North Carolina.

WINEMAKERS Yeast. Recipes & Catalog 25¢: Kraus, Box 451-L, Nevada, Missouri 64772.

ORNAMENTAL Iron designs. Book of 1600 beautiful, practical designs for railings, columns, etc. Free literature. Cunningham, 3881 South 3200 West, Salt Lake City, Utah 84119.

WINEMAKERS. Free illustrated catalog of yeasts, equipment. Semplex, Box 12276, Minneapolis, Minn. 55412.

BOOKS On antiques and their prices. Free circular!! P. Warman Publishers, Uniontown, Penna. 15401.

IDENTIFICATION Cards, Send stamped self-addressed envelope for samples. Identification, Box 12117, Las Vegas, Nevada 89112.

HEARING Aid batteries wholesale. Free list. Habs, Box 51, York, Penna. 17405.

WINEMAKERS. . . . Free Illustrated Supply Catalog of Yeasts, Equipment, Recipes. Winemaker, Box 11211-PM, Indianapolis, Ind. 46201.

WINEMAKERS: Free informative catalog, recipes. Arbolyn, Box 663, West Columbia, S. C. 29169.

DON'T Die Without A Will! Blank Will Form Protects Your Family. Only \$2—Guaranteed! Order Today!! Fireproof, 5531 Pulaski, Dept. 43AB-4, Philadelphia 19144.

CREDIT Cards! Receive all kinds fast, easy. Get new credit without investigation! Continental, Box J-23, Hallandale, Florida 33009.

(Continued on next page)

MISCELLANEOUS

(Continued from preceding page)

HOME WINE Making **SUPPLIES**, and **INGREDIENTS CATALOG** with **RECIPES** for year round winemaking. It's a fascinating Hobby. Makes A good conversation. Send for free catalog. Danenberger, Box 276B, New Berlin, Illinois 62670.

CASH For Full Trading Stamp Saver Books. Details, 25¢. Refundable. Armitage, 761 Meeker Ave., Brooklyn, N.Y. 11222.

LOSING HAIR? BALDING? DANDRUFF? Get Dr. Shiffer's free copyrighted booklet. "Are You Washing More Face?". **DR. SHIFFER LABORATORIES**, Dept. 536, P.O. Box 398, Punta Gorda, Florida 33950.

SWAP—BUY—SELL. Sample and Swap List 25¢. Wildcrafters, B-7-M, Looneyville, West Virginia 25259.

GUARANTEED!!! "Stanley-Steamer-Cleaner"!! Presto-Pressed!!! Save!! Only \$9.98 + .50 postage. Del Erickson, 320 N. Hampton, Dept. PM4, Fairmont, Minn. 56031.

FANTASTIC Invention—Paint life-size oil portraits of anyone in minutes. Guaranteed! Complete Method, \$3.98: Jiffy Portrait, 1315 Ronan, Wilmington, Calif. 90744.

ANTIGRAVITY, Experiment And Theory; Rushed—\$2.00. Intertech—2A1, Box 5373 Station F, Ottawa, Canada.

PRE-PACKAGED Toys complete with free self-selling display rack. Free Details. Toys, 1916 Fifth, Sacramento, California 95814.

BLANK High School Diploma identifies you as graduate. Replace lost diploma. \$2.00. Emmert, Dept. 2PB4, P.O. Box 246, Gambrius, Md. 21054.

QUIT Smoking! New Ideas! Follow Instructions. Within two months finish cigarettes for good. Money back Guarantee. \$1.00. Junior, Box 102, New Wilmington, Penna. 16142.

GOLFERS! Pro-Golf Pack carries cigarettes, gum, tees, balls, mirror; built-in stroke counter; attaches to cart handle. Weather-resistant, grain finish. \$5.95. Jay's, 628 Columbia, Dept. JP4, Council Grove, Kansas 66846.

YOUR FRIENDS Will be amazed! Multiply Big numbers in your head. Fast!!! I'll show you how, in minutes!! \$1.00 & self addressed, stamped envelope. Motion Enterprises, PX 4, Box 347, Redwood Valley, California 95470.

EXCELLENT DOCUMENTS!!! Karate Black-belt — Birth — Marriage — Divorce Certificates. Mechanic — Plumber — Electrician Licenses. High School — College Diplomas. Rushed Airmail!!! Two-\$1.00. Five-\$2.00. Deluxe Documents (Goldseals) Double Above Prices. Money-back Guarantee! Filiforms, Box 1332-BC, Albany, New York 12201.

"IT'S NOT NICE TO FOUL Mother Nature' Ecological Bumper Sticker. \$1.00. Sticker, 1730 Santee River, Piacentia, Calif. 92670."

U.S. \$1000 Bills!! Obsolete Replicas 5 For \$4.00. National, Box 1291-X, Clearwater, Florida 33517.

FREEZER Owners—organize your food storage. Send \$2.50 for freezer inventory forms and instructions. JDW Co., P.O. Box 7, Collinsville, Illinois 62234.

SMILE Stickers, Patches, Posters, 350 Novelty Buttons, T-Shirts. Catalogue 10¢. Harrison, Box 233M, Bethpage, New York 11714.

MAKE Wines & Sparkling Champagne. Inexpensively made. Complete instructions. Guaranteed delicious. \$2.50. Archer Enterprises, Box 193, Denton, Texas 76201.

WINEMAKER'S DELIGHT HANDBOOK—Instructions, simple, easy. Marvelous wines, sparkling champagne and other recipes. Finest available, only \$3.00. Hanby, Box 425-A, Morgan City, Alabama 35754.

STOP SMOKING—Trying countless ways to stop? Here is a new proven way to stop. Guaranteed. \$1.79. K&K Associates, Box 489, Ravenna, Ohio 44266.

WINEMAKING At home is fun and easy! Make Any Type Of Wine You Wish With Arborhouse Supplies And Equipment. Send For Free Catalog. "The Nation's Amateur Winemaking Supply Company". Arborhouse, Dept. ZZ, 8007 Douglas Avenue, Racine, Wisconsin 53402.

NEW—SURE KILL ROACH KILLER Guaranteed Kill All Roaches. Certified Check. M.O. \$3.25. Select Gifts, Box 215-F, Mt. Rainier, Md. 20822.

LOSE WEIGHT—But eat all you want. New. Proven. No pills. Nothing to buy. Money back guarantee. Send one dollar to: **PRESTON ENTERPRISES**, 2855 Browning Street, Sarasota, Florida 33580.

AT LAST—Precision Castings by Mail Order. New Custom Casting Service for Men of all Trades and Hobbies. Free literature. "The Foundrymen," Box 5123, Garden Grove, Calif. 92645.

BOOKBINDING. POST OFFICE BOX 10086, FREMONT, CALIFORNIA 94538.

HARGATE Natural Ingredient Insecticide. Lb. Aerosol \$3.00. Mylen, 230 East 25th, NYC 10010.

ZODIAC Handpainted paperweights felt-bases, specify sign. \$3.00 each. Handylite Ent., P.O. Box 17141, Jacksonville, Fla. 32216.

BURGLAR ALARMS & HOME PROTECTION

"CAUTION"—Alarm Sounds When Window Is Opened"—Four Stickers, And Police Whistle—\$1.00—Regis Games,—91-03J 172nd Street, Jamaica, N.Y. 11432.

AMAZING Keyless Tamper-Proof Portable Door Lock. Use Home Or Travel. \$1.50. Security, Box 8327, Long Beach, Calif. 90808.

Muscles make a man



make the muscles... in just five minutes a day

JUST FIVE MINUTES A DAY is all it takes to help build a body other men envy and women admire!

THE SECRET? A new invention called the **BULLWORKER 2**. It combines proven principles of isometric/isotonic exercising in one lightweight unit. Just follow the easy instructions for a non-tiring workout that starts building muscles to their power-packed peak.

No weights. No barbells. No long and boring exercises. Use anywhere—at home, in the office.

FREE COLOR BROCHURE shows simple step-by-step method. Action photos show how. Send for your free copy now—no obligation.



Built-in Powermeter

You can actually measure your musclepower g-r-o-w-i-n-g from the very first day.

Bullworker Service Dept. BW-297
175 Community Drive
Great Neck, N.Y. 11021

FREE BOOKLET

Please send me my **FREE** full color brochure about **BULLWORKER 2** without obligation. No salesman will call.



Name _____ Age _____
Street _____
City _____
State _____ Zip _____

Canada: Home delivery duty paid. Ask for **FREE** booklet.

A PROFESSIONAL TERMITE EXTERMINATION JOB FOR LESS THAN \$30.

Less than \$30 treats average 5 room home.

Buy **Arab** U-Do-It Termite Control at leading hardware and building supply dealers.

Send For **FREE** Illustrated Instruction Booklet. Federal Chemical Company Inc., 2530 Winthrop Ave., Indianapolis, Ind. 46205

BASEMENT TOILET FLUSHES UP



TO OVERHEAD SEWER OR SEPTIC TANK. NO DIGGING UP FLOORS. INSTALLS EASY. Write **McPHERSON, INC., BOX 15133, TAMPA, FLORIDA 33614**



MINI-BIKE PARTS

Wholesale Prices

"Build your own" kits...Big savings...Repair parts...Welded frames & forks, enameled...Chains...Clutches...Brakes & throttle controls...Wheels...Tires...Bearings...Axles...Engines...etc. Send 50¢ for illustrations and lists...**SAVE DOLLARS!**

BYCO, Dept. B, Box 6241, Omaha, Nebr. 68106

ELECTRIC ARC WELDER \$9.99!



NATIONALLY ADVERTISED \$18.95 VALUE!—NOW 1/2 PRICE! WELDS—BRAZES—SOLDERS—CUTS—ALL METALS! Plugs into ANY 110 volt socket. **MAKE—REPAIR 1001 ITEMS for CAR—HOME—BUSINESS.** Lifetime **BURNOUT GUARANTEE** 10 day money back trial (if retrd).

HEAVY DUTY Design—No experience needed—**FREE WELDING LESSONS!** (cash, ck, M.O.) and pay postman \$7.99 COD postage or send \$9.99 plus \$1.00 postage for paid del. in U.S.A.; **COMPLETE READY TO USE**—Includes **BIG** pack steel, Brazing, Solder, Carbon "to'ch" rods, **ELECTROFLAME ARC TORCH!** OFFER LIMITED—Order TODAY! **MIDWAY WELDER Dept. EPM-4**

Kearney, Nebr. 68847

3 CYLINDERS. DIRECT CHARGE. THE SURPRISE PACKAGE. MERC 650.

Put our 65-hp Merc 650 behind your boat and feel it happen. Something totally new in mid-range outboard power for skiing thrust, cruising speed, and all the action in between.

Exclusive new double-tuned exhaust system—performance-proved in Mercury's worldwide racing program—provides an extremely broad power band. Result: rapid acceleration and top speed.

Three Direct Charge cylinders for fuel economy and low operating cost. At 65 hp, the Merc 650 is lower, narrower—and shorter fore to aft—than competitors' 65-hp models. It has the same cylinder displacement as competitors' 65s, yet weighs 18 lbs. less.

See your Mercury dealer. Get ready to ski, cruise, fish, enjoy, with our newest surprise package . . . the Merc 650.



Complete range of power: 4, 7½, 9.8, 20, 40, 50, 65, 80, 115, 140 HP. • For nearest Mercury Dealer, see the Yellow Pages under "Outboard Motors."

Kiekhaefer Mercury/Division of Brunswick Corporation, Fond du Lac, Wisconsin/Canada/Australia/Belgium



MERCURY
OUTBOARDS

PALL MALL GOLD 100's Yes, longer yet milder.

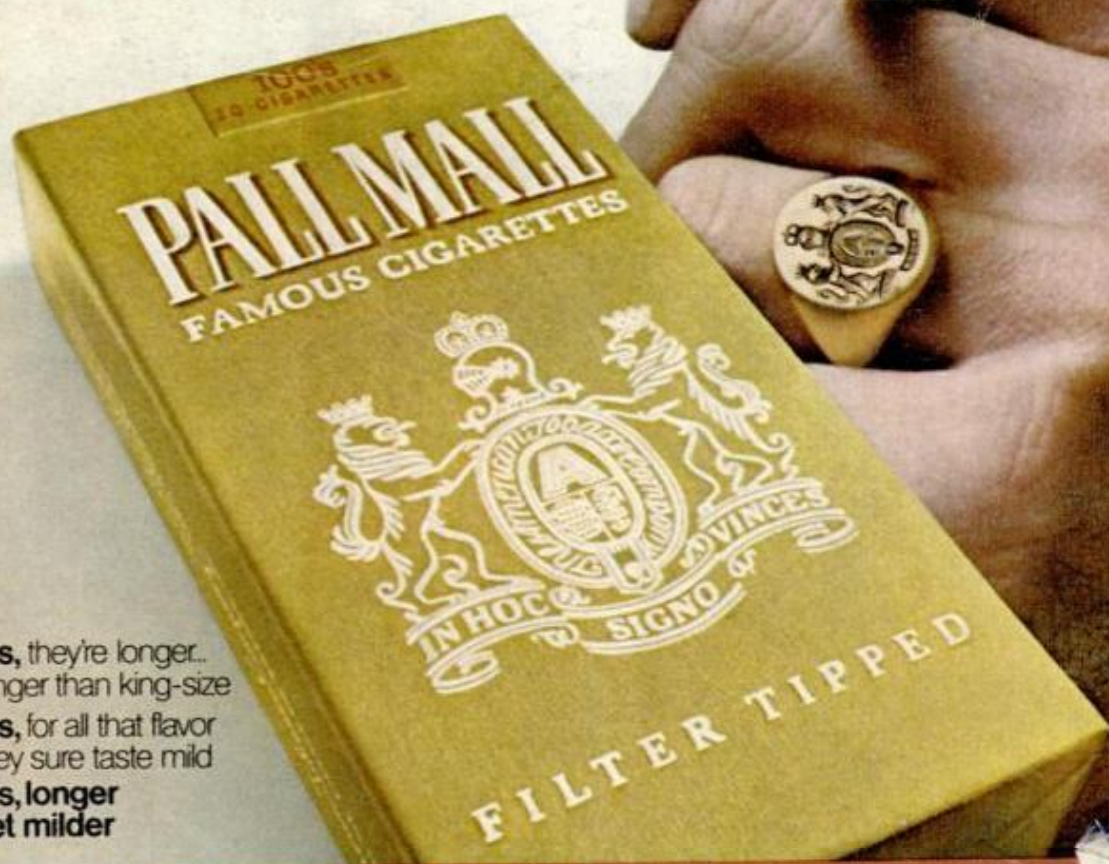

Yes, they're longer..
longer than king-size
Yes, for all that flavor
they sure taste mild
Yes, longer
yet milder

Also first class flavor in a filter king
New Pall Mall Filter King



Gold 100's:
19 mg. "tar", 1.3 mg. nicotine av. per cigarette. FTC Report AUG. '71.

20 mg. "tar", 1.4 mg. nicotine av. per cigarette by FTC method.