

The New Threat: Skyscraper Fires Page 53

POPULAR MECHANICS

AUG. 1971
50 CENTS



*'It Sprouted
Wings... So I
Flew It'* Page 87

**23 PAGES—GET MORE FUN OUT OF SUMMER
AT HOME FOR VERY LITTLE MONEY** Page 123:

3 Ways to Make Your Garage an Outdoor Family Room
■ Diving Deck for Above-Ground Pools ■ **How to Wire
Your Patio for Music** ■ A Fold-Flat Buffet Table That Can
Handle a Crowd ■ **Rollaway Wall Makes Your Driveway
a Patio** ■ Mobile 'Appliance Center' ■ Tennis, Volleyball,
Basketball, Dancing—Under Your Own Back-Yard Lights

Which hand was sprayed with Off!... 5 hours ago?



It shouldn't be too hard to guess. We'll even give you some clues. Off! has diethyl-toluamide (a fancy name for the most effective mosquito repellent ingredient ever developed).

We tested Off!, with diethyl-toluamide, in our labs. And in test after test, Off! not only kept mosquitos from biting immediately upon application—but up to five full hours later.

Off! comes in spray, foam or concentrated liquid. It repels mosquitos, chiggers, gnats and ticks hour after hour.

(Congratulations. You guessed right. The hand on the left was sprayed with Off!)

FROM **Johnson WAX**
©1970, S. C. Johnson & Son, Inc.,
Johnson™ All rights reserved.



The nice thing about our small economy truck is all the extras you can suddenly afford.



Our small economy half-ton offers you 3 big advantages. A small price. A small gas bill. And a small amount of maintenance.

But just because we're smaller and less expensive, doesn't mean we're any less tough. We hold a full 1,000-pound load just like bigger half-tons do. What's more, our small truck has a big-on-power 108-hp OHC engine that can haul that full load at maximum highway speeds. And a special heavy-duty suspension system for smoother riding. Empty or all filled up.

Our low-priced Toyota Half-Ton also

comes with an easy-to-handle 4-speed synchromesh transmission. 6-ply rated tires. Flo-thru ventilation. A full 6-foot bed. Padded dash. A towhook that bolts to the front of the truck. Tie hooks all around the bed. And a spare tire under the truck that you lower with a hand crank.

In short, when you buy our small Toyota Half-Ton, you get a lot of truck. With enough money left over for some other nice things as well.

Things you can't buy big.

This One



A087-N1U-37RA

Toyota Half-Ton. \$1971

*Manufacturer's suggested retail price. (Camper and special outside mirrors not included.)
Freight, dealer preparation, options and taxes extra.

CHANNELLOCK

Gives You More In Hand Tools Including

THE WIREMASTER

40% More Cutting Power
Perfect Cutter Alignment, Always



40% MORE CUTTING POWER
The joint rivet in a cutting plier is a fulcrum. The closer it is to the cutting edges, the greater your leverage and the greater your cutting power with less effort. In Channellock's WIREMASTER, the joint rivet is



PERFECT CUTTER ALIGNMENT
Unique enclosed joint design holds cutting edges in factory-perfect alignment for the long life of the plier. No way for the jaws to get out of line . . . ever.

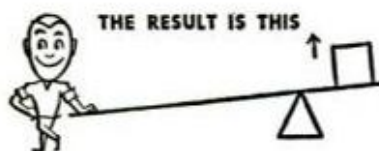

WANT TO KNOW MORE?
You'll get a lot of hand tool information in our catalog. It's yours for the asking. Write us.



TOOLS BY
CHAN NEL LOCK

MEADVILLE, PA. 16335

Make small-game hunting hard on yourself.

Hunting rabbits and squirrels with a 22 is a real challenge. Here are some tips that'll lead you to some real sharpshooting... some real sport... and put some meat in the pot, too.

Rabbits are by far our most popular small game. They are found almost everywhere and present a very sporting target—especially for riflemen. They also make good eating. There are a number of species, each with its own habits, found in America, so if you're hunting in a strange locale, the easiest way to get started is to check with the local farmers. They usually regard wild rabbits as pests and will be glad to show you where to find them. Always consult your state hunting regulations for opening and closing dates.

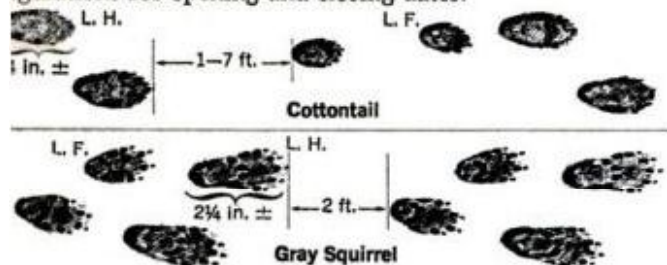

Once you're in a likely area, the fun begins. The western cottontail tends to run from a hunter—and he can reach speeds of 45 miles per hour! On the other hand, the eastern cottontail tends to hide, and you've got to make him break cover. A good dog that can go into the thickets after them is invaluable. When a cottontail comes bursting out of the brush, you're in for some real fast action that can help improve your shooting. East or west, north or south, a running rabbit is not an easy target for a rifle.

Squirrel hunting is popular, too. However, the conditions are different.

for spotting the game and sighting.

Going after rabbits and squirrels calls for a 22 that's accurate, easy to handle and fast-firing. Among the fine Remington repeaters, a good choice would be either our Model 552 "Speedmaster" Automatic or our Model 572 "Fieldmaster" Pump-Action rifle. Both are tube-fed and hold 20 short, 17 long or 15 long rifle cartridges to give you the firepower you need. Their receivers are grooved for "tip-off" scope mounts, and both have a cross-bolt safety at the rear of the trigger.



The Model 552 "Speedmaster" is a well-balanced rifle designed for fast, accurate shooting. A carbine version with a 21-inch barrel is also available. The Model 572 "Fieldmaster" is a logical choice for anyone who has a pump-action Remington Model 760 center fire rifle. Its cartridge-feeding-system design helps prevent jamming, and it can be converted to a single-shot rifle for a beginner. If you want to get the best results with either of these rifles, be sure to use Remington or Peters ammunition.

And, to make the most of the game you take, get a copy of the Remington "Wild Game Cookbook". It's available through your Remington dealer or by sending \$2.95 to: Sportsmen's Library, P.O. Box 731, Dept. FA, Bridgeport, Connecticut 06601. It's part of the Remington Sportsmen's Library and belongs on every serious hunter's bookshelf. Here are a couple of recipes (shown below) from it.

Remington Reports are based on information supplied by Remington-Peters experts. If you'd like to put them in your library, too, we'll be glad to send you a free folder to keep them in—along with our 1971 catalog. Just mail a postcard to: Remington Arms Company, Inc., Dept. 205, Bridgeport, Conn. 06602.



Model 552A

Model 572 BDL Deluxe

One-Dish Rabbit

- | | |
|---------------------------------|----------------------------------|
| 1 rabbit, cut in serving pieces | 2 medium onions, sliced |
| salt, pepper | 1/2 inch thick |
| flour | 4 or 5 small potatoes, quartered |
| oil | 1 can tomatoes |
- Sprinkle rabbit with salt and pepper and flour. Fry in oil until lightly browned. Layer rabbit, onions, potatoes in casserole. Cover with tomatoes. Bake in 350° F. oven 2 hours. Serve on hot biscuits. Serves 4 to 6.

Squirrel With White Wine

- | | |
|------------------------------------|------------------------------|
| 4 squirrels, cut in serving pieces | 1/2 teaspoon rosemary |
| 2 tablespoons butter | 1 cup dry white wine |
| 1/4 cup olive oil | 1 cup chicken broth |
| salt, pepper | 1 tablespoon chopped parsley |
| 2 cloves garlic, crushed | 2 cups sliced mushrooms |
- Sauté squirrel in butter and oil until lightly browned; add salt and pepper to taste, garlic, rosemary, wine and broth; simmer until nearly done, turning often. Add parsley and mushrooms; cook 5 minutes. Serves 4.



Remington® DU PONT PETERS®

Great guns deserve great ammunition. We make both.

"Remington", "Peters", "Speedmaster" and "Fieldmaster" are trademarks registered in the United States Patent Office.

POPULAR MECHANICS®

INTERNATIONAL EDITIONS: AUSTRALIA, BRAZIL, CARIBBEAN, DENMARK, MEXICO, SOUTHERN HEMISPHERE, SWEDEN

AUTOMOBILES AND DRIVING

- [16 Automobile Clinic](#)
- [30 Drivin' With Dan](#)
- [42 Detroit Listening Post](#)
- [58 PM Owners Report: Jeep Universal](#)
- [76 "The Racetrack Is Still Detroit's Best Test Track!"](#)
- [87 This Car Really Flies \(Aerocar III\) ... 'I Flew It!'](#)
- [96 PM Owners Report: Toyota Corona](#)
- [102 PM Owners Report: Pontiac Grand Ville](#)
- [152 Saturday Mechanic: Save Up to \\$47 on the Cost of Power-Brake Repair](#)

BOATING, OUTDOOR RECREATION

- [38 All Outdoors](#)
- [74 Inner-Tube Float Fishing](#)
- [84 A Slick New Tri-Hull: PM Tests Slickcraft's SS-185](#)
- [92 Catamarans Catch On!](#)
- [94 Boating Tips](#)
- [107 Something Really New in Revolvers](#)
- [136 Back-Yard Games: How to Lay Them Out](#)
- [137 Lights for Lawn Games](#)

ELECTRONICS, RADIO AND TV

- [66 Four-Channel Stereo—Here at Last!](#)
- [106 New in Electronics](#)
- [118 Kit-Builder's Color TV Dream Job](#)
- [142 Wire Your Patio for Sound](#)

PHOTOGRAPHY

- [112 Single Rig for Close-Up Flash](#)
- [113 Look What a Difference the Paper Can Make](#)

SPACE, AVIATION, MILITARY

- [87 This Car Really Flies \(Aerocar III\) ... 'I Flew It!'](#)

HOME AND YARD

- [22 Homeowners' Clinic](#)
- [123 How to Enjoy More Summer Fun at Home](#)
- [124 Build This Patio Appliance Center](#)
- [128 Your Garage Can Double as Your Outdoor 'Family Room'](#)
- [130 Fold-Flat Picnic Table Lets You Put It Away](#)
- [132 Slip-Proof Diving Deck Plus Storage](#)
- [136 Back-Yard Games: How to Lay Them Out](#)
- [137 Lights for Lawn Games](#)
- [140 Rollaway Party Wall](#)
- [142 Wire Your Patio for Sound](#)
- [162 Solving Home Problems](#)

SCIENCE AND INVENTIONS

- [28 Science Worldwide](#)
- [53 50-Story Firetraps](#)
- [62 Probing Hidden Depths of Your Mind](#)
- [72 26-Knot Parking Lot: the Roll-On, Roll-Off Freighter](#)
- [82 Just Patented: PM's Pick of the New Inventions](#)
- [108 How to Survive in the Desert](#)

SHOP AND CRAFTS

- [12 New Tools You Should Know About](#)
- [114 You Can Make Professional-Fitting Dowel Joints](#)
- [120 Sears' Best Radial: You Get What You Pay For](#)
- [146 Maximat V10: One-Tool Machine Shop](#)
- [164 Hints From Readers](#)

ENVIRONMENT

- [52D Pollution Fighters' Newsletter](#)

REGULAR FEATURES

- [6 Letters](#)

Cover Photo by Bob Grant

"It Sprouted Wings . . . So I Flew It!"—Testing Aerocar III, Combination Sports Car and Airplane

NEXT MONTH IN POPULAR MECHANICS

Awful Truth About Helicopters: Unsafe at Any Height. You can't bail out safely.
Convict Reveals How You Make It Easy for Burglars. Don't "invite" prowlers.
Like No Other Boat: 20 Pounds for \$60. Plus a lineup of other boats under \$100.
Appliance Clinic. Write if you're having trouble with toaster, washer, dryer . . .

ROBERT P. CROSSLEY

Editor

JAMES M. LISTON
Executive Editor

JOHN A. LINKLETTER
Managing Editor

WAYNE C. LECKEY **SHELDON M. GALLAGER**
Home and Shop Assistant Executive
Editor Editor

Published by The Hearst Corporation
RICHARD E. BERLIN, PRESIDENT

RICHARD E. DEEMS
President, Magazines Division

JOSEPH F. KERN
Publisher

BILL HARTFORD _____ Automotive
JOHN F. PEARSON _____ Science and Aerospace
GEORGE W. REIGER _____ Boating and Outdoors
SHELDON GALLAGER _____ Electronics and Photography
HARRY WICKS _____ Home Workshop
MICHAEL LAMM _____ West Coast
ROBERT LUND _____ Detroit Automotive
GARRY WINTER _____ Copy and Production
RICHARD H. FUNK _____ Associate Copy and Production
ALVIN KIETZ _____ Assistant Art Director
FRED A. LEERS _____ Assistant Art Director
JOSEPH P. BEATON _____ Assistant Art Director
DON EVANS _____ Technical Art Director
CLIFFORD B. HICKS _____ Special Projects
SOPHIE GRONOWICZ _____ Director, Bureau of Information
EVERETT JOHNSON _____ Cabinetmaker

ADDRESS ALL EDITORIAL COMMUNICATIONS TO: 224 West 57th St., New York, N.Y. 10019. For additional sources of information on the articles and products in this issue, write to Bureau of Information, Popular Mechanics, for free "Where-to-Find-It" list.

DANIEL J. COLEMAN
Director of Advertising

ADVERTISING OFFICES: New York: 224 West 57th St., 765-6850; Chicago: 520 N. Michigan Ave., 527-2400; Detroit: General Motors Bldg., TRinity 5-8711; Cleveland: 20310 Chagrin Blvd., Shaker Heights, 283-7788; Los Angeles: 601 North Vermont Ave., 666-6263.

JOHN A. REGINA _____ Advertising Production Manager

SUBSCRIPTION SERVICE: Mail all subscription orders, changes of address, correspondence concerning subscriptions, and Postmaster notices of undeliverable copies to Popular Mechanics, Box 646, New York, N.Y. 10019. Please enclose your latest address label for quickest service when writing about your subscription.

POPULAR MECHANICS IS PUBLISHED MONTHLY by The Hearst Corporation, 57th St. at 8th Ave., New York, N.Y. 10019, U.S.A. Richard E. Berlin, President; George Hearst, V-Pres.; Richard E. Deems, President of Magazines; John R. Miller, Executive V-Pres. of Magazines; Raymond J. Petersen, Senior V-Pres. of Magazines; William S. Campbell, V-Pres. of Magazines; Albert A. Rachol, V-Pres. and Director of Circulation; Joseph F. Kern, V-Pres. for Popular Mechanics. Frank Massi, Executive V-Pres. and Treasurer; Harvey L. Lipton, Secy. Single copy in the United States and Canada, 50 cents. Subscription prices: United States and Possessions \$5.00 for one year; \$9.00 for two years; \$12.00 for three years. Canada, add \$0.75 for each year. Pan American Postal Union countries, add \$1.00 for each year. All other countries, add \$2.00 for each year. When changing address, give old address as well as the new, with postal-zone number, if any, and allow six weeks for change to become effective. Second-class postage paid at New York, N.Y., and at additional mailing offices. Authorized as second-class mail by the Post Office Department, Ottawa, and for payment of postage in cash. Registered as second-class matter at the Post Office at Mexico D.F., Mexico, June 20, 1950. © 1971 by The Hearst Corporation. All rights reserved. Printed in U.S.A.

Stop puttering around. Pour

the good stuff.



Kentucky Straight Bourbon Whiskeys. 86 Proof and 100 Proof Bottled in Bond. Old Grand-Dad Distillery Company, Frankfort, Kentucky 40601.

**It's taken more
game than any
other scope.**

**Can you think
of a better
reason to buy
a K4?**



Most people can't.
Because field
performance is what
really counts in a
hunting scope.
That's why
thousands of
sportsmen have
learned to count
on our K4. For
good reason. It
delivers con-
sistent accuracy.
At long range.
At short range.
In fair weather.
In foul weather.
That's about all
there is to it.
Except to say it
costs \$49.95.
That hasn't hurt
its popularity
either.

WEAVER  **SCOPES**

Write for free 40-page catalog: W. R. Weaver Co.,
Dept. 91, El Paso, Texas 79915.

LETTERS

TO THE EDITOR

Copper for gas pipe?

Your Shop Editor had better do a little more checking before he puts anything like *Light It—and Your Barbecue's Ready* (page 136, May PM) in your magazine if he doesn't want to get someone's head blown off.

There is a building code in Wyoming about using copper pipe for a fuel line for natural gas. Natural gas has a lot of sulfur in it and sulfur eats copper up. (Copper pipe is all right for propane gas.)
BUFFALO, WYO. W. S. SCHLICHT

Adrian Conway of the Gas Appliance Manufacturers Assn. (GAMA) replies: "It would appear that Mr. Schlicht is addressing himself to a problem that is localized in his area. I have discussed this with GAMA's director of technical services, Jack Langmead. He has assured me that the use of copper tubing for the installation of gas appliances is widely accepted today and is commonly used for gas piping in most of the nation.

"As you know, the sulfur content in most natural gas is quite small. There are a couple of areas, however, where sulfur is a problem. In these areas—and evidently Wyoming is one of them—the use of copper tubing is restricted."

Two-fisted firefighter

Being a member of the Roxboro Volunteer Fire Brigade, I found *How to Choose and Use Fire Extinguishers* (page 116, June PM) particularly interesting. I go along completely with the advice and facts given in the story, but someone got his left mixed up with his right in the upper lefthand photo caption, page 117. The dry chemical extinguisher is on the left: the water extinguisher is on the right.
ROXBORO, QUE. G. R. RHODES

'Mole' comes from Seattle

That tunneling machine that appears in the news brief, *'Mole' Digs in South Africa* (page 80, May PM), is a Lawrence Hardrock Tunneler, manufactured and designed in Seattle, Wash.

LAWRENCE MFG. CO. ROBT. W. GORDON,
SEATTLE, WASH. ASST. CHIEF ENGINEER

Safer roller coaster

The idea of a *Back-Yard Roller Coaster*
(Please turn to page 8)

POPULAR MECHANICS

Материал, защищенный авторским правом

WHO ELSE WANTS A BIG RAISE IN PAY?

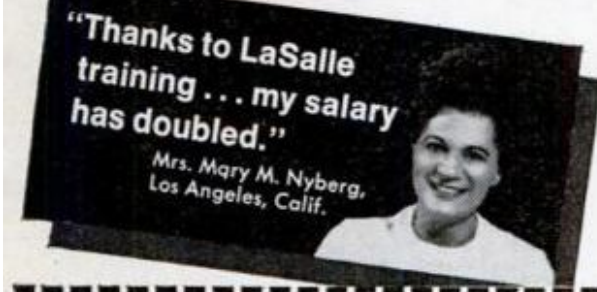
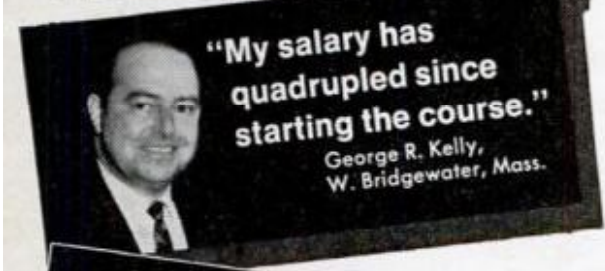
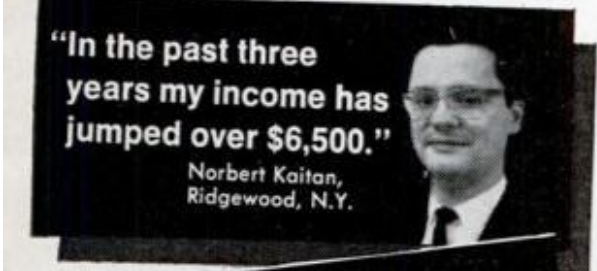
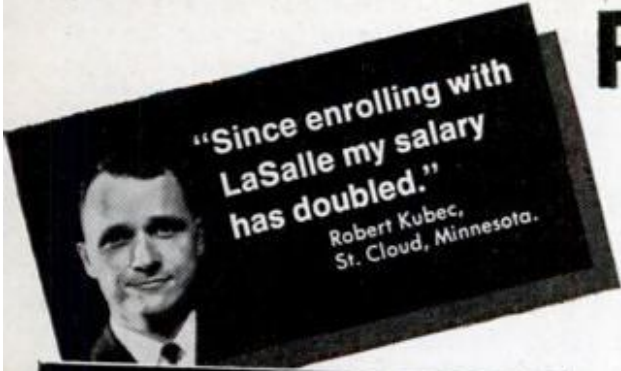

Stuck in a rut? Tired of your dead-end job? Read how LaSalle spare-time training has helped others to move up to better paying positions with increased prestige.

Look at these pleased reports from LaSalle students. Many success stories of this kind come to us every year—from people who began their career planning by mailing the LaSalle coupon for information.

LaSalle students have one ambition in common—to get out of the ranks of the untrained and earn more money and respect in a better job. Isn't that your goal too?

Without interfering with your present work—and by devoting only a little of your spare time—you too can prepare for advancement in the field of your choice through LaSalle home study. The cost is low.

LaSalle has been a leader in home education for more than sixty years, enrolling over 2,000,000 ambitious men and women in its many courses. You study under the supervision of LaSalle's experienced faculty. Upon satisfactory completion of your study, you receive the LaSalle diploma—a recognized and respected credential.

Check the subject you are interested in—then send the coupon below for FREE booklet. No obligation. Mail to LaSalle, 417 S. Dearborn Street, Chicago, Illinois 60605.

© 1970 LaSalle Extension University

LA SALLE EXTENSION UNIVERSITY

A Correspondence Institution • 417 S. Dearborn Street, Dept. 68-114, Chicago, Illinois 60605

Please send me, without cost or obligation, FREE booklet and full information on the field I have checked below:

<p>ACCOUNTING</p> <input type="checkbox"/> Complete Accounting <input type="checkbox"/> Income Tax <input type="checkbox"/> CPA Training <input type="checkbox"/> Bookkeeping	<p>LAW COURSES</p> <input type="checkbox"/> Bachelor of Laws Degree <input type="checkbox"/> Business Law <input type="checkbox"/> Insurance Law <input type="checkbox"/> Claim Adjusting Law <input type="checkbox"/> Law for Police Officers	<p>COMPUTER PROGRAMMING</p> <input type="checkbox"/> Basic Training	<p>HIGH SCHOOL</p> <input type="checkbox"/> High School Diploma	<p>CAREERS FOR WOMEN</p> <input type="checkbox"/> Accounting <input type="checkbox"/> Bookkeeping <input type="checkbox"/> Computer Programming <input type="checkbox"/> Dental Office Assistant <input type="checkbox"/> Interior Decorating <input type="checkbox"/> Real Estate <input type="checkbox"/> Secretarial <input type="checkbox"/> Stenotype
<p>BUSINESS MANAGEMENT</p> <input type="checkbox"/> Introduction to Business Management	<p>TRAFFIC & TRANSPORTATION</p> <input type="checkbox"/> Complete Traffic Management	<p>INTERIOR DECORATING</p> <input type="checkbox"/> Complete Training	<p>HOTEL/MOTEL MANAGEMENT</p> <input type="checkbox"/> Hotel Executive Training <input type="checkbox"/> Motel Management	
<p>DRAFTING</p> <input type="checkbox"/> Complete Drafting	<p>RESTAURANT MANAGEMENT</p> <input type="checkbox"/> Complete Executive Training	<p>ART TRAINING</p> <input type="checkbox"/> Commercial Art <input type="checkbox"/> Oil, Water Color Painting <input type="checkbox"/> Complete Training	<p>STENOTYPE</p> <input type="checkbox"/> Machine Shorthand	
<p>REAL ESTATE</p> <input type="checkbox"/> Complete Real Estate <input type="checkbox"/> Real Estate Brokerage <input type="checkbox"/> Real Estate Management	<p>LANGUAGE INSTRUCTION</p> <input type="checkbox"/> French <input type="checkbox"/> Spanish			
<p>DIESEL MECHANICS</p> <input type="checkbox"/> Basic Training	<p>MUSIC INSTRUCTION</p> <input type="checkbox"/> Piano <input type="checkbox"/> Guitar Other _____			

Mr. _____ Age.....
 Mrs. _____
 Miss _____ (Circle title and please print)

Address..... Apt. No.....

City & State..... Zip.....

LETTERS

(Continued from page 6)

(page 118, May *PM*) is great. However, I'd like to make a suggestion to cut down on broken legs. The ladder-type construction of the rails forms a natural trap for a youngster's feet. I would suggest a closed-box construction be used.

DENVER, COLO. RONALD E. FRANCIS

Deck builder

After reading *Enjoy the Wide Outdoors on an Open Deck* (page 140, June '70 *PM*), I've completed a deck for my home at a cost of \$125 and 25 hours of work.

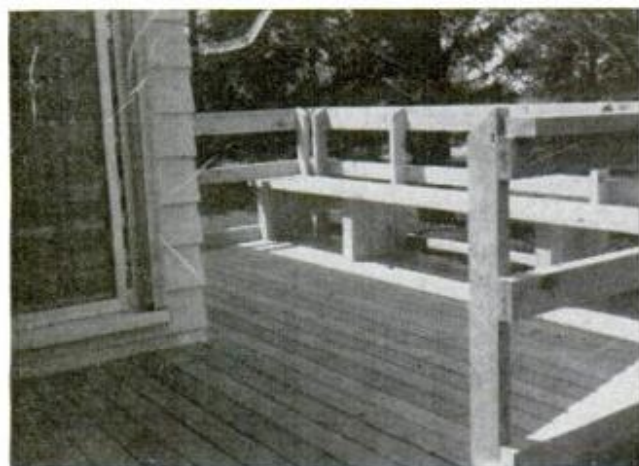

Decking is 2x4s nailed flat on 4x4 cedar beams; the beams are on 4x4 cedar posts and piers. Deck rail and bench are made of 2x4s.

MONTPELIER, OHIO RAYMOND D. FISHER

Meet Mr. Bower

I appreciate your using my photograph of Jeanie's Teenie for the cover of your May issue. However, through a misspelling of my last name, credit was given to someone else. Because this was my first major photo job, I'd appreciate a note of correction.

DECATUR, GA. ROBERT E. BOWER

There, put that in your portfolio. And tell 'em you take good pictures, too.

Keep those blocks dry!

In *Building a House?* (page 112, May *PM*) caption No. 2 states that concrete blocks should be dampened thoroughly with water before placement.

In contrast, the *Concrete Masonry Handbook* from the Portland Cement Assn. states on page 23 that concrete masonry units should never be wetted immediately before and during laying in the wall, a practice customary with some masonry materials. Also, on pages 7 and

8, the handbook goes into the importance of laying blocks dry.

EDGEWOOD ARSENAL, MD. T. P. FREEMAN

Our architect consultant says reader Freeman is right. Block is never dampened, but stone and brick are. (We've found, though, that moistening block is a common practice among professionals.)

Gaps in I-90

Read with interest *Interstate Driving* (page 82, June *PM*) but found some errors in the Cleveland area. The Interstate route I-90 is definitely NOT finished through this area. I am including some material from our local newspaper.

WESTLAKE, OHIO DONALD BORDEN

The May 27 edition of The Plain Dealer (enclosed by reader Borden) noted that the 14.39-mile Northwest Freeway (Interstate 90) will not be open until at least 1975. Only 1.72 miles are completed.

Railroad builder

I had great pleasure building a model railroad from Wayne Leckey's *A Lot of Railroad in a Little Space* (page 150, Jan. '70 *PM*).

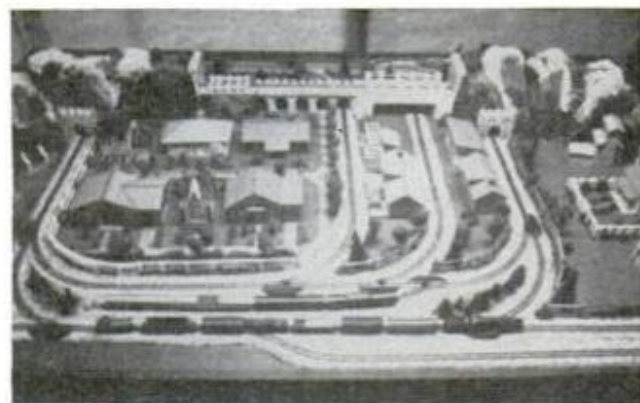

I did not follow your plans for making the mountains. I used chicken wire which was much easier to handle and much stronger and you could bend it to any shape. Without your plans I would not have been able to build the railroad.

TORONTO, ONT. WILLIAM H. TOWN

No discarded blade for metal

Having upwards of 40 years of experience in various types of machine work, I have read *PM* with much interest and have found a good many useful ideas.

However, in the May issue on page 139 (*Hints From Readers*), the idea of using a discarded hacksaw blade in a lathe cutoff toolholder for the purpose of cutting steel or other hard and tough materials is both

(Please turn to page 10)



NRI Appliance Training Division
 3939 Wisconsin Avenue
 Washington, D.C. 20016

600-081

Send me your illustrated **FREE CATALOG** that tells about opportunities in Servicing Electrical Appliances, and gives details of NRI's low-cost training plan. I understand there is no obligation. No salesman will call.

Name _____ Age _____

Address _____

City _____ State _____ Zip _____

CHECK HERE FOR FACTS ON GI BILL

If you have served since January 31, 1955, or are in service now, check box above.

MAIL COUPON ABOVE FOR THIS

FREE NRI CATALOG

Learn professional methods of appliance repair

Refrigeration and Air Conditioning included. Save on your own repairs, learn a skill in demand, earn extra income or start your own business.

Short, easy course trains you at home to make \$5 to \$7 an hour starting soon.

Mail the coupon above for your **FREE NRI Catalog**. Find out how you can prepare quickly at home to do professional appliance servicing.

After only a few lessons, you can be ready to start servicing your own appliances or start earning \$5 to \$7 an hour fixing appliances for friends and neighbors. The entire training can be finished in a few months.

NRI Appliance training is the fastest way to a new job or skill or extra income in a spare time or full time business of your own. Wherever you live or want to live, you'll find a demand for top-notch appliance servicemen.

With a billion appliances in use, there are probably thousands needing repair right in your own neighborhood. They mean



NRI APPLIANCE TRAINING DIVISION • Washington, D.C. 20016
 Accredited Member National Home Study Council

cash profits for you starting soon. Put your spare time to good use. Appliance servicing can give you the extra cash you may be seeking to do and buy the things you've always wanted.

- Low-cost NRI training covers —
- Small and large home appliances
 - Air conditioning
 - Refrigeration
 - Portable electric tools
 - Small gasoline engines
 - Farm and commercial equipment

Professional appliance testing equipment is included in your NRI course at no extra cost — to help you speed troubleshooting and repair jobs. Mail coupon now for your **FREE NRI Catalog**. No salesman will call. National Radio Institute, Appliance Training Division, Washington, D.C. 20016.

EARN BIG MONEY BE AN AUTO MECHANIC!



APPROVED FOR GI TRAINING

If you served since January 31, 1955 or are in service, check GI line in coupon.

A better job, top pay and steady work are easily within your reach. Learn how autos operate, why they break down and how to make repairs. Over 100 million cars and trucks on our highways must be serviced and repaired. Thousands of newly trained mechanics needed each year.

Make Home Your Training Center—Learn by practicing. CTI sends 15 Kits of Mechanics Tools and Testing Instruments that help locate engine and electrical system troubles quickly. The course is easy!

Earn Money As You Train—Since the CTI course includes training with real equipment, many students earn money repairing autos soon after enrolling. On completing training they go into top pay jobs. Many get started in their own business.

Mail Coupon Today for FREE book. No obligation. Prove to yourself that the Auto Repairing field is best for you—the easiest training to master and loaded with top pay opportunities.

An Eligible Institution Under the
Federal Insured Student Loan Program

COMMERCIAL TRADES INSTITUTE
Division of M-W Education Corporation
1400 Greenleaf Avenue
Chicago, Illinois 60626 Dept. PM 871



Send book, *Modern Automotive Mechanics*. No obligation.

Name _____ Age _____

Address _____ Zip _____

City _____ County _____ State _____

Check for facts on GI Bill

Accredited Member National Home Study Council

LETTERS

(Continued from page 8)

impractical and dangerous. I have, on several occasions, used such a blade for cutting plastic, nylon and wood—and it works fine. I also tried cutting soft steel and aluminum bronze rod and found this type of blade would shatter like glass. One could very readily lose an eye.

Under the circumstances, you should make clear to readers this type of tool be used only to cut nonmetallic materials.

OIL CITY, PA.

HOWARD H. FOGGAN

You're right; readers are now warned.

Planer in two months

I am very pleased with the performance of the *Wood Planer* (page 174, Aug. '70 PM). It took about two months



of my spare time; I had very little trouble with adjustments for it to work properly.

I used 1½-in. tubing rather than the recommended 1¼-in. I also added some small corner braces to the frame and changed switch locations to make them more accessible with stock in the machine.

NEWPORT NEWS, VA.

GEORGE F. KLICH

Let's have a laugh

The content of *PM* is sufficient, but I have one complaint: Your magazine is only serious. In other words, your publication lacks humor. Add a column of humorous selections.

MAPLEWOOD, N.J.

ROBERT IZENBERG

Not funny? You should meet the staff. Seriously (and we are serious, aren't we?) your suggestion is good. ★★★

POPULAR MECHANICS



Some of the best mechanics in West Los Angeles.

From left to right: Carlos Anton, Helmut Klinck, Michael Kimomoto, Jack Heyler, Henri Schneider, Winnie Boersch, Tom Grimmett, Del Wright, Ed Paskey, Les Bowen, Bob Cullen (in the truck), Bill Boliner, Bud Stanfield, Jim Jones, Barry Noland, Al Girard (kneeling), Jack Rahe, Bill Cavaness.



Toledo, Ohio 43601

**20 million people have switched to Champion Spark Plugs.
This has been 18 of them.**

NEW TOOLS

YOU SHOULD KNOW ABOUT

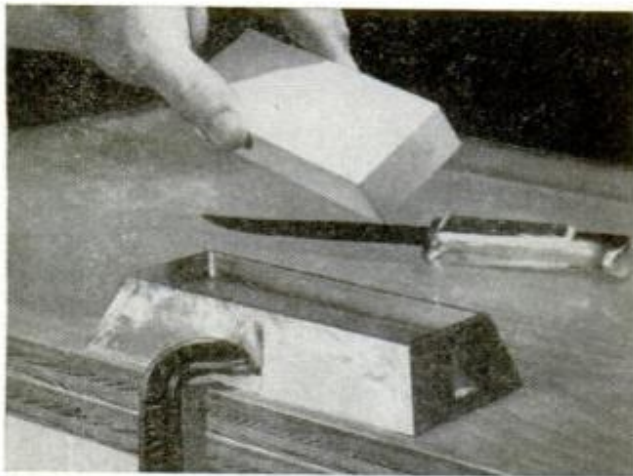

SHARPENING STONE cut from a narrow segment of Novaculite is sold with unconditional guarantee and is claimed by the maker to be the world's best sharpening stone. Available soft or hard, stones come with holder for clamp-on bench use. Russell's Arkansas Oilstones, Box 474, Fayetteville, Ark. 72701.



PAINT-CAN LIP that snaps onto any quart or gallon paint can is claimed to eliminate spills, drops and dribbles. Called No-Drip Paint Lip, the accessory is priced at 39 cents. Jet-X Corp., 2550 West 2nd Ave., Denver, Colo. 80219.



VERSATILE 1/4-IN.-SQ. DRIVE SOCKET SET contains interchangeable components that can be combined in seven different ways to drive both square and hex fasteners. Reach of components varies from 1 1/2 to 9 1/4 in. Set No. 1001 comes in a snaplock case molded of high-impact plastic. Xcelite Inc., Orchard Park, N.Y. 14127.



EXPANSION-ANCHOR WINDING KIT lets you roll your own screw-holding anchors on the job. Kit contains enough aluminum blanks to wind 200 wood and masonry anchors for No. 6 screws up to 1/2-inch lags. Refills available. Kit is \$14.95 from Ace In-The-Hole, Inc., Box 739, Lebanon, Pa. 17402.



FANCY COVE-CUTTER



BEAD-CUTTER



ROMAN OGEE-CUTTER



COVE-CUTTER



RABBIT-CUTTER



OGEE-CUTTER

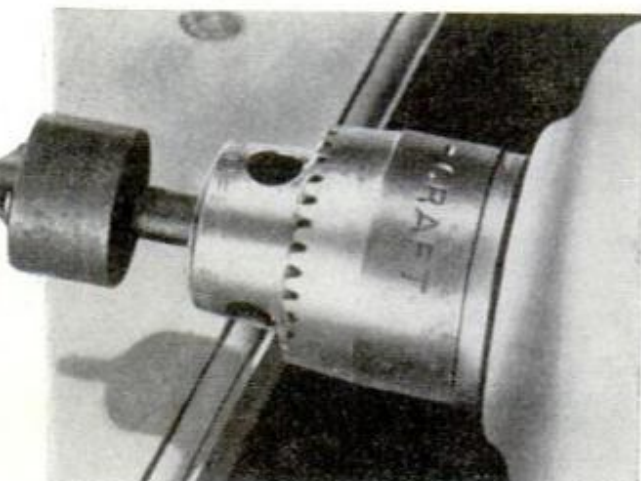

MOLDING CUTTERS for portable electric drill can be used to shape wood, plastic and soft metals. Two sets—No. 6 (left in drawing) and No. 7 (right) consist of three cutters each and sell for \$3.95 apiece. From Arco Tools, Inc., 421 West 203 St., New York, N.Y. 10034.

"Honey, the boss wants me here Saturday"

"The weekend weather: rain beginning Saturday..."

"Jim, Billy's temperature is over 100"

"...arriving around noon Saturday. Love, Aunt Lucy"

There are enough things to spoil your weekends—
We didn't want Firestone tires to be one of them.

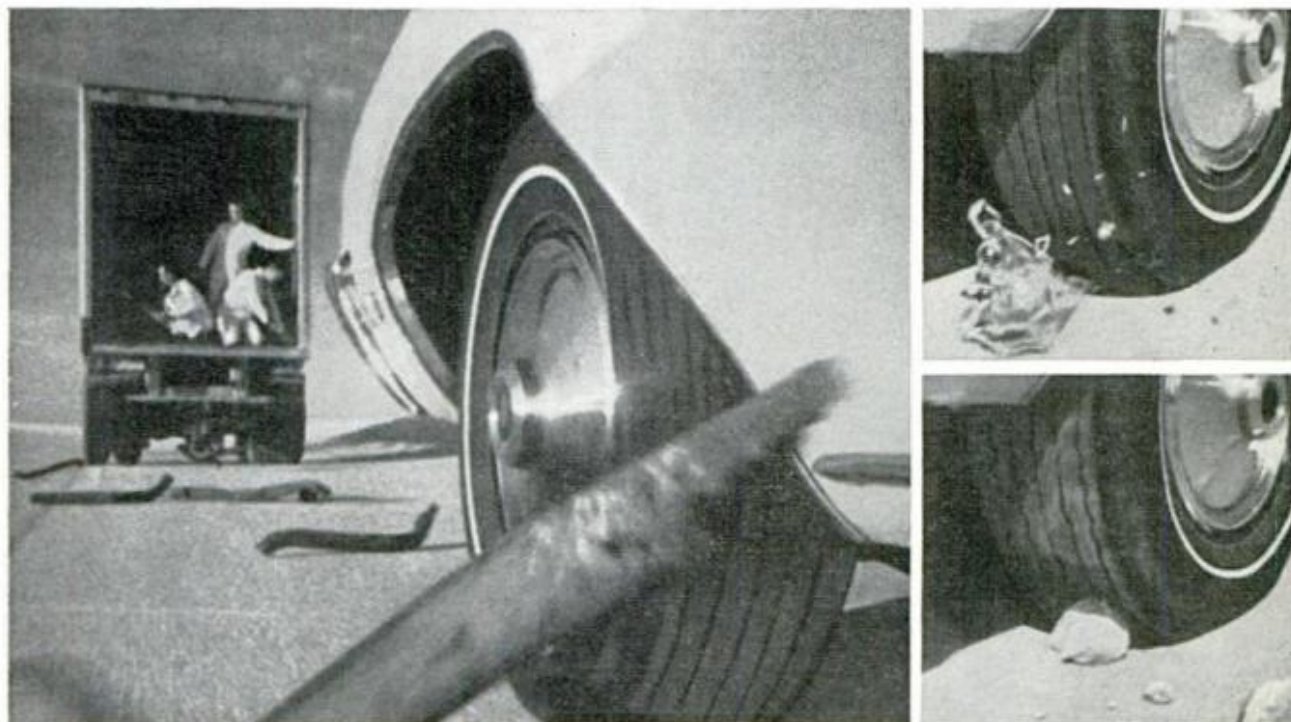

Because weekends are too short for tire trouble, we threw all kinds of things in front of double-belted Firestone tires — to show you how the strength of double belting gives you added protection against road hazards. You can get Firestone Sup-R-Belt tires on your car before next weekend wherever you see the Firestone sign, on convenient credit terms.

"have a good weekend"

Firestone

FREE... Any 3 Stereo LPs or

WITH NO OBLIGATION



66764 ELTON JOHN
Tumbleweed Connection
Uni LP, 8TR, CASS



41213 JESUS CHRIST SUPERSTAR
(2 record set)
Decca LP, 8TR, CASS



66782 BILL COSBY
When I Was A Kid
Uni LP, 8TR, CASS



67517 THREE DOG NIGHT
Golden Biscuits
Dunhi LP, 8TR, CASS



68030 CROSBY, STILLS, NASH & YOUNG
Four Way Street
(2 record set)
Atlan LP, 8TR, CASS



65797 GABOR SZABO
Blowin' Some Old Smoke
Budda LP, 8TR, CASS



42780 LED ZEPPELIN III
Atlan LP, 8TR, CASS



37833 ROD MCKUEN
In The Beginning
Sunset LP, 8TR



43871 STATLER BROS
Bed of Roses
Merco LP, 8TR, CASS



42988 ROGER WILLIAMS
Love Story
Kapp LP, 8TR, CASS



75002 JACKSON 5
Maybe Tomorrow
Motow LP, 8TR, CASS



50506 BUFFY SAINT-MARIE
Wanna Be A Ballerina
Vangu LP, 8TR, CASS



21597 RIMSKY-KORSAKOV
Scheherazade
Yorks LP, 8TR, CASS



33093 IAN & SYLVIA
Greatest Hits
(2 record set)
Vangu LP, 8TR, CASS



44765 SHIRLEY BASSEY
Is Really Something
UniAr LP, 8TR, CASS



21551 BEETHOVEN
Piano Sonatas
Yorks LP, 8TR, CASS



42986 ROGER WILLIAMS
Golden Hits
Vol. II
Kapp LP, 8TR, CASS



42665 CROSBY STILLS & NASH
Atlan LP, 8TR, CASS



32882 JOAN BAEZ
Joan Baez 5
Vangu LP, 8TR, CASS



33182 SUSAN SINGS
SESAME STREET SONGS
Scept LP, 8TR, CASS



41217 BERT KAEMP-FERT
Orange Colored Sky
Decca LP, 8TR, CASS



37837 FLIP WILSON
Flipped Out
Sunset LP, 8TR



48800 B. B. KING
Live At Cook County Jail
ABC LP, 8TR, CASS



38373 IKE & TINA TURNER
Workin' Together
Liber LP, 8TR, CASS



30618 DIANA ROSS
Motow LP, 8TR, CASS



21633 RED ARMY ENSEMBLE
Yorks LP, 8TR, CASS



38368 VENTURES
10th Anniversary Album
(2 record set)
Liber LP



39089 5th DIMENSION
Greatest Hits
SouGi LP, 8TR, CASS



43870 MELBA MOORE
Look What You're Doing
Merco LP, 8TR, CASS



68019 EMERSON, LAKE & PALMER
Cotil LP, 8TR, CASS



16595 VIRGIL FOX
Bach at the Fillmore
Decca LP, 8TR, CASS

Compare and see!

See for yourself why over 1 1/2 million record and tape collectors paid \$5 to join Record Club of America when other record or tape clubs would have accepted them free.

	Citadel Record Club (as adv. in TV Guide Oct. 3, 1970)	Columbia Stereo Tape Cartridge Service (as adv. in Esquire Nov. 1970)	Capitol Record Club (as adv. in Look Jan. 26, 1971)	Columbia Record Club (as adv. in Playboy Feb. 1971)	RCA Stereo 8 Tape Club (as adv. in Esquire Oct. 1970)	RECORD CLUB OF AMERICA
CAN YOU CHOOSE FROM ALL LABELS' LP'S OR TAPES, INCLUDING CARTRIDGE AND CASSETTE TAPES?	NO	NO	NO	NO	NO	YES! Choose any LP or tape on any label! No exceptions! Over 300 different manufacturers including Capitol, Columbia, RCA, A&R, London, etc.
MUST YOU BUY A "MINIMUM" NUMBER OF RECORDS OR TAPES? HOW MANY?	12	12	12	10	6	NONE! No obligations! No yearly quota! Take as many, as few, or nothing at all if you so desire!
HOW MUCH MUST YOU SPEND TO FULFILL YOUR LEGAL OBLIGATION?	\$59.76 to \$71.75	\$83.76 to \$95.40	\$59.76 to \$71.76	\$49.80 to \$59.80	\$41.70 to \$47.70	ZERO DOLLARS! You don't have to spend a penny—because you're not "legally obligated" to buy even a single record or tape!
CAN YOU BUY ANY RECORD OR TAPE YOU WANT AT A DISCOUNT?	NO	NO	NO	NO	NO	ALWAYS! Your discount up to 75% OFF—guaranteed never less than a third! No exceptions!
DO YOU EVER RECEIVE UNORDERED RECORDS OR TAPES?	YES	YES	YES	YES	YES	NEVER! There are no orders which you must return. Only the records and tapes you want are sent—and only when you ask us to send them.
HOW LONG MUST YOU WAIT FOR SELECTIONS TO ARRIVE?	5 to 6 weeks	5 to 6 weeks	5 to 6 weeks	5 to 6 weeks	5 to 6 weeks	NO LONG WAITS! Your order processed same day received. No shipping on cycle.

TYPICAL "EXTRA DISCOUNT" SALE

\$4.98 LPs average as low as \$1.96
\$5.98 LPs average as low as \$2.25
\$6.98 LPs average as low as \$2.56

Savings of 63% or more from recent Club sales up to \$4.42 per LP. Start these giant savings now... not after you fulfill your obligation like the other clubs.

	Label	List Price	Average Club Price
Andy Williams—Love Story	Colum	5.98	2.25
Anne Murray	Capit	5.98	2.25
Ed Ames—This Is	RCA	6.98	2.56
2001—A Space Odyssey	MGM	6.98	2.56
Mary Travers—Mary	War Br	4.98	1.96
Creedence Clearwater			
Revival—Pendulum	Fanta	4.98	1.96
Miles Davis—Bitches Brew	Colum	5.98	2.25
Love Story—Soundtrack	Param	5.98	2.25
Perry Como—It's Impossible	RCA	5.98	2.25
Bloodrock—3	Capit	5.98	2.25
Santana—Abraxas	Colum	5.98	2.25
Worst of Jefferson Airplane	RCA	5.98	2.25

RECORD CLUB OF AMERICA—The World's Largest Record and Tape Club

Any 1 Tape or Cartridge or Cassette Shown Here Worth up to \$20.94

TO BUY ANYTHING EVER!

Yes, take your pick of these great hits right now! Choose any 3 Stereo LPs (worth up to \$20.94) or any 1 Stereo Tape (cartridge or cassette, worth up to \$13.96) FREE... as your welcome gift from Record Club of America when you join at the low lifetime membership fee of \$5.00. You can defer your selection of FREE items and choose from an expanded list later if you can't find 3 LPs or 1 Tape here. We make this amazing offer to introduce you to the only record and tape club offering guaranteed discounts of 33 1/3% to 79% on all labels—with no obligation or commitment to buy anything ever. As a member of this one-of-a-kind club you will be able to order any record or tape commercially available, on every label—including all musical preferences. No automatic shipments, no cards to return. We ship only what you order. Moneyback guarantee if not satisfied.



66738 NEIL DIAMOND
Tap Root Manuscript
Uni LP, 8TR, CASS



65793 BREWER & SHIPLEY
Tarkio
KamSu LP, 8TR, CASS



38376 CANNED HEAT
'N JOHN LEE HOOKER
(2 record set) Liber LP



42784 STEPHEN STILLS
Atlan LP, 8TR, CASS



66709 ORSON WELLES
Begatting of the President
Media LP



65784 MELANIE
Leftover Wine
Budda LP, 8TR, CASS



21537 TCHAIKOVSKY
1812 Overture
Yorks LP, 8TR, CASS



41152 WHO
Tommy
(2 record set)
Decca LP, TR, CASS



33185 JOSEPH & THE AMAZING TECHNICOLOR DREAMCOAT
Scept LP, 8TR, CASS



33183 B. J. THOMAS
Most of All
Scept LP, 8TR, CASS



67519 STEPPENWOLF
Gold
Dunhi LP, 8TR, CASS



33092 BEST OF BUFFY SAINTE-MARIE
(2 record set)
Vangu LP, 8TR, CASS



44746 DUKE ELLINGTON
70th Birthday Concert
(2 record set) SolSt LP



33179 DIONNE WARWICK
I'll Never Fall in Love Again
Scept LP, 8TR, CASS



44726 FERRANTE & TEICHER
10th Anniversary Album
(2 record set) UniAr LP

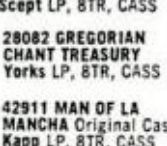

28082 GREGORIAN CHANT TREASURY
Yorks LP, 8TR, CASS

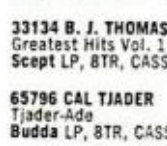

33134 B. J. THOMAS
Greatest Hits Vol. 1
Scept LP, 8TR, CASS

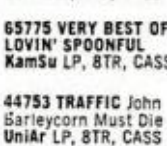

65775 VERY BEST OF LOVIN' SPOONFUL
KamSu LP, 8TR, CASS

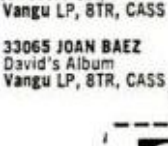

33065 JOAN BAEZ
David's Album
Vangu LP, 8TR, CASS



65796 CAL TJADER
Tjader-Ada
Budda LP, 8TR, CASS



44753 TRAFFIC
John Barleycorn Must Die
UniAr LP, 8TR, CASS

NOW YOU CAN CHARGE IT, TOO!

AT LAST A RECORD AND TAPE CLUB WITH NO "OBLIGATIONS"—ONLY BENEFITS!

Ordinary record and tape clubs make you choose from a few labels—usually their own! They make you buy up to 12 records or tapes a year—usually at list price—to fulfill your obligation. And if you forget to return their monthly card—they send you an item you don't want and a bill for \$4.98, \$5.98, \$6.98, or \$7.98! In effect, you may be charged almost double for your records and tapes.

BUT RECORD CLUB OF AMERICA ENDS ALL THAT!

We're the largest all-label record and tape club in the world. Choose any LP or tape (cartridges and cassettes), including new releases. No exceptions! Take as many, or as few, or no selections at all if you so decide. Discounts are GUARANTEED AS HIGH AS 79% OFF! You always save at least 33 1/3%. You get best sellers for as low as 99¢.

NO AUTOMATIC SHIPMENTS

With our Club there are no cards which you must return to prevent shipment of unwanted LPs or tapes (which you would have to return at your own expense if you have failed to send written notice not to ship). We send only what you order.

HOW CAN WE BREAK ALL RECORD AND TAPE CLUB RULES?

We are the only major record and tape club NOT OWNED... NOT CONTROLLED... NOT SUBSIDIZED by any record or tape manufacturer anywhere. Therefore, we are not obliged by company policy to push any one label. Nor are we prevented by distribution commitments from offering the very newest LP's and tapes.

SPECIAL INTRODUCTORY MEMBERSHIP OFFER
Join RECORD CLUB OF AMERICA now and take advantage of this special Introductory Membership Offer. Choose any 3 LPs or any 1 tape shown here (worth up to \$20.94) and mail coupon with check or money order for \$5.00 membership fee (a small handling and mailing fee for your free

LPs or tapes will be sent later. If you can't find 3 LPs or 1 tape here, you can defer your selection and choose from expanded list later. This entitles you to LIFETIME MEMBERSHIP—and you never pay another club fee. Your savings have already more than made up for the nominal membership fee.

NOW YOU CAN CHARGE IT

If you prefer, you may charge your membership to one of your credit cards. We honor four different plans. Check your preference and fill-in your account number on the coupon.

LOOK WHAT YOU GET

- **FREE Lifetime Membership Card**—guarantees you brand new LPs and tapes at discounts up to 79%... Never less than 1/3 off.
- **FREE Giant Master LP and Tape Catalog**—lists all readily available LPs and tapes (cartridges and cassettes) of all labels (including foreign)... all musical categories.
- **FREE Disc and Tape Guide**—The Club's own Magazine, and special Club sale announcements which regularly bring you news of just-issued new releases and "extra discount" specials.
- **FREE ANY 3 Stereo LPs or any 1 Tape** shown here (worth up to \$20.94) with absolutely no obligation to buy anything ever!

GUARANTEED INSTANT SERVICE

All LPs and tapes ordered by members are shipped same day received (orders from the Master Catalog may take a few days longer). ALL RECORDS AND TAPES GUARANTEED—factory new and completely satisfactory or replacements will be made without question.

MONEY BACK GUARANTEE

If you aren't absolutely delighted with our discounts (up to 79%)—return items within 10 days and membership fee will be returned AT ONCE! Join over one and one-half million budget-wise record and tape collectors now.



RECORD CLUB OF AMERICA
CLUB HEADQUARTERS
YORK, PENNSYLVANIA 17405 V051

Yes—Rush me a lifetime Membership Card, Free Giant Master LP & Tape Catalog, and Disc & Tape Guide at this Special Membership Offer. Also send me the 3 FREE LPs or 1 FREE tape which I have indicated below (with a bill for a small mailing and handling charge). I enclose my \$5.00 lifetime membership fee. This entitles me to buy any LPs or tapes at discounts up to 79%, plus a small mailing and handling charge. I am not obligated to buy any records or tapes—no yearly quota. If not completely delighted I may return items above within 10 days for immediate refund of membership fee.

3 FREE LPs

or 1 FREE TAPE

8 track
 cassette

or Defer Selection—send expanded list.

Mr. _____
Mrs. _____
Miss _____

Address _____

City _____ State _____ Zip _____

All Servicemen write Soc. Sec. # _____

CHARGE IT to my credit card. I am charging my \$5.00 membership (mailing and handling fee for each FREE LP and tape selected will be added).

Check one: Diners Club Master Charge
 American Express BankAmericard

Acct. # _____ Expiration Date _____

Signature _____

Canadians: mail coupon to above address. Orders to be serviced from Canada.

© RECORD CLUB OF AMERICA 1971 52

RECORD CLUB OF AMERICA—The World's Lowest Priced Record and Tape Club

SOLUTIONS FOR MECHANICAL HEADACHES

AUTOMOBILE CLINIC

BY MORT SCHULTZ

A shattering shudder

The front end of my 1970 Plymouth Fury III shudders when I apply the brakes at speeds above 50 mph. I've been told that all Plymouths (and other cars) do this. Must I live with the problem or is there a fix?—Edward A. Place, Danville, Iowa.

Many cars have the problem, which can be avoided. In many cases, air guns that servicemen use to run up wheel nuts are distorting brake drums. Have the drums in your car turned with wheels on and the nuts properly torqued. That should stop the present trouble. To keep it stopped, have wheel nuts tightened in the proper way—with a torque wrench. For your car, the correct wheel-nut torque is 65 ft.-lb. Just to be sure that it's not causing your problem, I would also check the lower control-arm strut front-attaching nuts for proper torque as well. Correct torque here is 52 ft.-lb.

Swampy trunk

Last summer I purchased a used 1964 Thunderbird that's in fine shape except that moisture collects on the underside of the trunk cover. What can be done?—Gunnar Jensen, Huntington Station, N.Y.

Be sure the weatherstripping is in A-1 condition and the trunk lid is aligned so that it compresses the weatherstripping firmly all around. You should have a tight seal. Otherwise heat from the exhaust system will seep into the trunk.

In a pinch

My 1970 Pontiac Catalina with three-speed (M38) transmission shifts as hard as an Army deuce-and-a-half truck. My dealer has checked linkage and all vacuum hookups, and has replaced the modulator valve many times. The last modulator change included a booster spring with washer for added strength. Can you offer any suggestions?—Rod Vallot, Lake Charles, La.

Look closely for a pinched hose from the modulator to the engine that's choking off vacuum. I've found a couple like this that were stamped too tightly at the fac-

tory. If you find a pinched area, cut it out and put a length of rubber line in its place. Also check the vacuum modulator for loose fittings, a vacuum leak or a stuck valve. Be sure the pressure regulator isn't sticking, and inspect the 1-2 and 2-3 accumulator for a sticking piston, bore damage and broken rings or springs.

Low slung rear

I ordered my 1969 Chevrolet Camaro convertible with heavy-duty suspension. It has F78-14 tires. The rear end is too close to the ground. What can be done?—David W. Martin, Fort Washington, Pa.

The rear suspension riding height of a 1969 Camaro is $2\frac{7}{16}$ in. $\pm \frac{1}{2}$ in. This measurement is the vertical distance from the top of the axle housing to a point rearward of the bend in the frame adjacent to the jounce bumper. When the measurement is taken, the car should be at curb weight—that is, a full gas tank, no passengers, and spare tire and jack in the trunk—and positioned on a smooth level floor. If the trim height is below specification, replace the springs.

When to check oil

My service station attendant insists that motor oil should be checked with the engine cold. I say that the engine should be warm, because when it is cold, oil is thick and you would get an inaccurate reading. What do you say?—Steven Terry, Covington, La.

Forget what I say. The car manufacturers state that the best time to check oil is before operating the engine or as the last step in a full stop. This allows the normal oil accumulation in the engine to drain back into the crankcase.

Sloppy steering

After I took delivery of my 1971 Plymouth Barracuda I found that water had gotten into my power-steering reservoir because of a missing power-steering cap. I had the dealer flush the system and supply me with a cap. The mechanic who did the job put in automatic transmission

(Please turn to page 18)

A man and a woman are shown in a romantic embrace at an outdoor party. The man, on the left, is wearing a light blue button-down shirt and light-colored cargo pants, holding a cigarette and a decorative fan. The woman, on the right, is wearing a patterned top and a dark blue skirt, reaching up to touch a glowing orange paper lantern. Other lanterns in shades of yellow and blue are hanging from a string above them. The background is filled with lush greenery and potted plants, creating a warm, intimate atmosphere.

Tonight it's
the Orient at home.
They like their parties
a little different. And
getting ready for them is
at least half the fun.
Their cigarette?
Viceroy. They won't settle
for less.

It's a matter of taste.

All the taste.
All the time.



Warning: The Surgeon General Has Determined
That Cigarette Smoking Is Dangerous to Your Health

AUTOMOBILE CLINIC

(Continued from page 16)

fluid. He said that it's okay to use. The fluid has turned a milky pink color. Is this normal or did it happen because the wrong fluid was used?—Thomas Langston, Glendora, N.J.

The discoloration is probably due to air or water that remained in the system after flushing. However, I would flush fluid from the system again and have the right power-steering fluid put in. According to Chrysler Corp., "Power steering fluid, part No. 2084329, or its equivalent, is recommended. Caution: Do not use automatic transmission fluid." You can't get any more explicit than that.

Window rattle

I have a 1970 Mercury Marquis with a window problem. On a slightly rough road the windows rattle as if someone were beating on them with a hammer. I'm told that other Marquis have similar troubles. Hope you can suggest a solution.—C.L. Edwards, Chester, Mont.

Try service bulletin 9 (1971 series) that tells your dealer how to correct the separation between the glass and the lower channel. The modification applies to all Mercs with the problem.

Cups and scallops

Last August I noticed wear (cupping) on the right front tire. I had the front end aligned. The same thing is happening again. Shouldn't a front end alignment have cured my problem?—Lloyd B. Douglass, Milton, Mass.

I think that wheel balancing is needed. Each tire and wheel as a unit should be statically and dynamically balanced off the car. Then the tire wheel and brake drum should be rechecked on the car. If an unbalanced condition is reflected, the brake drum is out-of-balance and should be replaced. In addition, I would rotate tires to equalize wear.

A car that hesitates . . .

I have a 1970 Opel with 1.9-liter engine and a hell of a hesitation on acceleration. The head guy at the dealership knows that

the problem exists—says it's been around for some time—but he doesn't know how to fix it. How long do we have to wait for a cure?—Walter W. Condon, Brush Prairie, Wash.

For as long as it takes you to read this. First make sure ignition timing is smack on the button—TDC at 700 rpm. It's critical. Now have your dealer apply the fix outlined in service bulletins 70-T-04 and 70-1-33, which tell him to apply a new carburetor kit that will give you a more substantial flow of gasoline into the manifold on acceleration.

LeSabre dance

The rear end of my 1970 Buick LeSabre swings around when I hit the brake. I have found myself facing the opposite way. Why?—N.C. Walters, Sherman Oaks, Calif.

Because the rear wheels are locking, while the front wheels remain unlocked. Buick recommends that you have the rear wheel cylinders replaced with those designed for the 1970 Riviera. This will permit even distribution of braking power.

Service Tips

● **1971 Capri owners**, if their cars were built before September of 1970, may have wet feet because of water entering the passenger compartment. There's a better way of handling the trouble than wearing boots. Have your dealer replace the undersize plenum drain hose as outlined in service bulletin 9.

● **1971 Chrysler and Plymouth**: A lag, stumble or die-out during acceleration with cars that have 318-cu.-in. engines is the subject of a couple of important service bulletins. The information applies to those models which are equipped with Rochester two-barrel carburetors and explains how to enlarge the idle channel and jets. The number of the bulletin applying to Dodge is D71-14-3. Bulletin 71-14-2 is for Chrysler and Plymouth.

● **Oldsmobile** has issued a new upper bypass hose-repair kit (part No. 231256) for 1964 models with 330-cu.-in. engine and all 1965 through 1970 models with V8 engines. The 1971 cars are being equipped at the factory. The cast-iron thermostat housing and pipe assembly in the new kit will outlast the aluminum parts originally used. ★ ★ ★

GOT A PROBLEM WITH YOUR CAR? Ask Mort about it. Send your question to Auto Clinic, Popular Mechanics, 224 West 57th St., New York, N.Y. 10019. Letters cannot be answered individually, but problems of general interest will be published in the column.

The new motor oil that does great things for your car. Everywhere. Always.

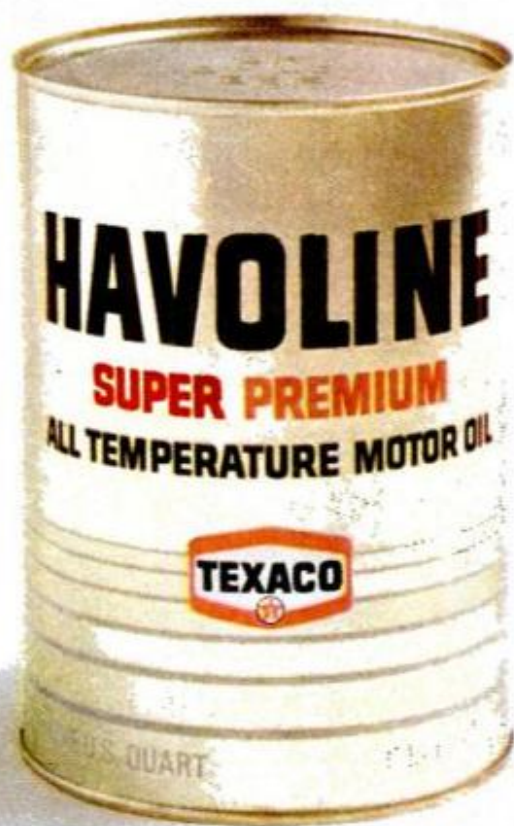

Our new Havoline Super Premium All Temperature Motor Oil does amazing things to lubricate and protect a car's engine.

New Havoline is resistant to thickening under high-temperature conditions. Such as heavy-load, high-speed driving. Next, it is also fantastic at low temperatures.

We tested it all the way down to -30°F. , and it was still flowing.

Of course, new Havoline Super Premium prevents rust, wear, and sludge deposits. And, it will also protect anti-pollution devices better than ever, helping to minimize "smog" emissions.

Now that's an oil you can really trust!



MAKE BIG MONEY

OPERATING HEAVY EQUIPMENT



**BULLDOZERS
CLAMSHELLS
TRENCHERS
DRAGLINES
BACKHOES
SCRAPERS
GRADERS
CRANES**

The Construction Industry is Booming! Earn top money in this fast moving, action-packed field. Keep present job and train at home in spare time followed by practical training on our machines under project conditions at our facilities. Nationwide placement assistance. For FREE information fill out and mail coupon today!
Member American Road Builders' Assn.

APPROVED FOR VETERANS AND INSERVICE PERSONNEL

UNIVERSAL HEAVY CONSTRUCTION SCHOOLS, Dept. PM
1901 N.W. 7 STREET / MIAMI, FLORIDA 33125
Phone: (305) 642-2332 (24 Hours)

Please Print

Name _____ Age _____

Address _____

City _____ State _____

Phone _____ Zip _____

SIX GOOD REASONS



Why You, Too, Should be an ACCIDENT INVESTIGATOR

1. You become a member of a respected fast growing profession.
 2. You meet all kinds of interesting and important people.
 3. You are not "chained" to an office desk or assembly line.
 4. You render a worthy, necessary service (NO SELLING) to the community.
 5. There are many opportunities for quick advancement.
 6. There are good openings in every state and Canada.
- Car furnished—Expenses paid—Work part-time or full time—Earn as you learn—No selling of any kind—Only average education required—Mail for Free Information.

Liberty School is approved for Veterans' and Servicemen's Benefits under the G.I. Bill

Jim Edwards, Director, Dept. 58
Liberty School
1111 W. Park Ave., Libertyville, Illinois 60048

Send me your FREE Brochure Showing how I can quickly get into the Booming Accident Investigating Field and enjoy the job security and professional prestige offered Accident Investigators. This does NOT obligate me in any way and no salesman will call.

Name _____ Age _____

Address _____

City _____ State _____ Zip _____

NEWS BRIEFS

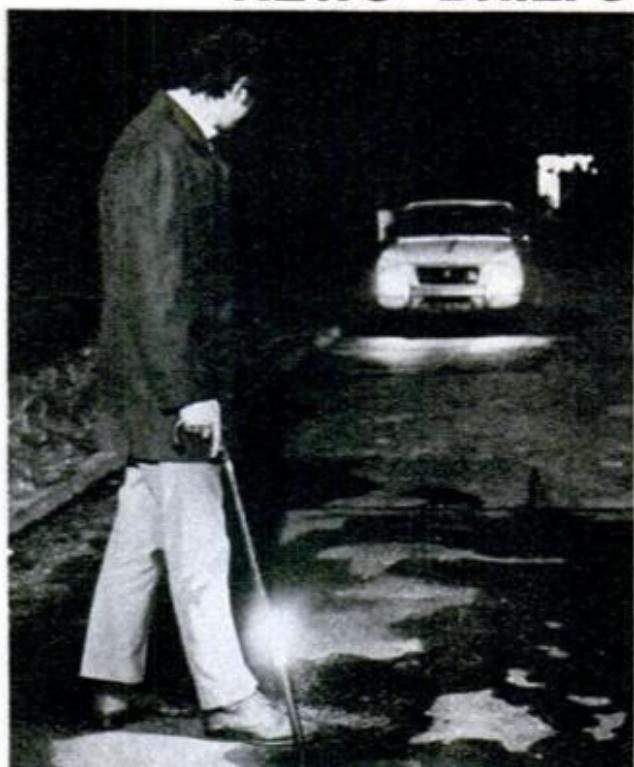

Flashing walking stick

Walking alongside a roadway at night, the user of a new British cane need only flip a switch to set off a built-in blinking light and warn drivers of his presence. The cane breaks down into two sections for storage.

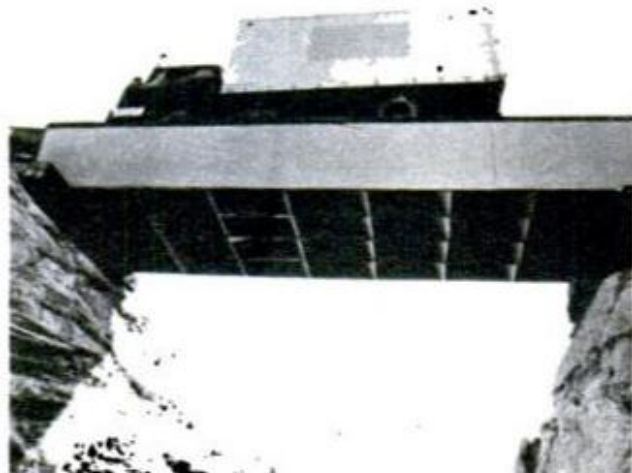

Looks great on paper

A 12,000-pound truck offers dramatic proof that a paper bridge can withstand traffic. A development of International Paper Co., the bridge required 9000 pounds of paper and glue. Environspace Corp. designed it.

Uncommon carriers

Uncommon cargoes? Don't flip. Datsun gives you two great ways to haul.

Seals to Sasswood—the tough Li'l Hustler Pickup. Penguins to Potentates—try the more luxurious 5-Door Wagon.

Both give you 96 horsepower overhead cam engines. Potent in the short haul, reliable in the long. Both have some six feet of bed and floor space.

The Li'l Hustler, for example, has a flat loading tailgate. Slide on a spinet or generator. Hay bales or surfboards. Tie them down—there are plenty of built-in hooks. Slip into the all-vinyl

upholstered cab, flick the neat 4-speed stick and away you go.

And whatever you stash in the easy-load Wagon, you don't have to worry about the easy-to-clean vinyl upholstery. You just relax in full-reclining front buckets. Cool it under tinted glass (all standard equipment). And if shifting the full-synchro 4-speed isn't your style, liberate a hand and foot with the optional 3-speed automatic.

Carry out your plans in a Datsun. The number one selling import truck's just \$1916.* The perfect-size 5-Door Wagon just \$2350.*

Drive a Datsun...then decide.

DATSUN

PRODUCT OF NISSAN



*PLUS TAX, LICENSE, LOCAL FREIGHT AND DEALER PREPARATION. SPECIFICATIONS AND PRICE SUBJECT TO CHANGE WITHOUT NOTICE.

HOMEOWNERS' CLINIC

BY W. CLYDE LAMMEY

Orienting your new house

We plan to build a new house on our lot next spring. Can you outline briefly how to place a house to gain best advantage of sunlight, air circulation and privacy?—A.L., Tex.

Consider first your local building restrictions, then plan window sizes and exposure to sunlight the year round, direction of prevailing winds, location of plantings and use of fencing or shrubbery or both to attain the desired privacy. A simple penciled plotting of these various features will help you plan your home.

Painting brick house

I own an older brick house and although the brickwork is still in good condition the structure is of a style I think would look better painted. But my wife says no. Can you help us decide?—F.M., N.Y.

This question comes up for discussion often. I'm inclined to agree with your wife. I, too, don't like painted brickwork; any painted masonry, in fact. There's another factor: Paint on masonry, also brickwork, tends to weather rather rapidly, resulting in a grayish, patchy look that's not pleasing to the eye. You can give some old brickwork a freshened appearance by coating it with a masonry sealer, which is a colorless liquid similar to clear varnish.

Softening old putty

Several windows in my home need to be reputtied. But how do I effectively soften old putty so that it can be removed easily, without damaging the wood? Can I use my propane torch?—E.W., Pa.

Yes, you can use the torch with the standard head, or nozzle, but one should keep the fire hazard in mind. It's best to remove the sash from the frames. One slow pass of the torch flame along the putty line usually does it. Knife out the softened putty immediately, also any paint on the frame that is softened; you'll have to repaint anyway. If the first pass doesn't get all the old putty, make a second sweep of the flame but be sure to keep it moving fast enough to prevent charring of the wood, or breakage of the glass pane.

Baffling fireplace problem

I like a blaze in my fireplace on those rainy fall evenings and several times when I've started the fire I can smell wood smoke in the basement, of all places! No smoke comes from the fireplace into the room. Neither I nor a neighbor have been able to figure this out. What gives?—W.N., Mich..

On those evenings when you enjoy your fireplace the air is "heavy," so to speak. Smoke from the flue trails downward, even near ground level in some instances. A slight stir of air outside can bring it in through your basement window; hence the odor of wood smoke in the basement. This is not a common atmospheric condition, but it does happen. You're fortunate that you don't get smoke in the family room.

Plaster patch shows

Before redecorating I patched an area about 1 ft. square on the ceiling. It shows under two coats of latex paint, although the second coat made it look much better than did the first. Did I omit something that should have been done?—D.E., Nebr.

I assume you used a prepared patching plaster but did you follow all the instructions? Check with a straightedge and you may find it's a little lumpy, which would cause high places to cast a shadow. Perhaps you can salvage the job by sanding flush, applying an undercoat of paint (same as used as top coat) and then spot-finishing the area. Better yet, apply another coat to the entire ceiling, as spot-finishing is not always satisfactory, although it can be done if you are careful to feather the edges.

Window sash sweats

I haven't converted to aluminum storms and screens as yet. The old, wood storm sash I have aren't the tightest fitting and, as a result, the window sash sweats in cold weather. What can I do to solve this problem?—O.L., Minn.

For a quick solution, fasten felt weatherstrip to all four edges of the poor fitting storm sash. To apply the felt, you can use a weatherproof glue or staples spaced about 6 in. apart. By applying the felt to your existing storm sash you, in effect, will create a force-fit when the window is pushed in position. Because of this, you may find it necessary to use a pair of turn-buckles per window instead of the original hangers.

★★★

Never a rough puff



Come all the way up to KOOL

Because Kool smokers like smooth taste, we thought they might like smooth sailing. So we're offering the popular Sea Snark sailboat. Ordinarily about \$120, this unsinkable 11-ft. boat is yours for only \$88 and one Kool carton end flap. So get Kool and stay cool, with the Sea Snark, and the taste of extra coolness.

COOL OFFER!

Price includes delivery of the sailboat pictured at right. Complete with 30-lb. polystyrene hull, all fittings, sail, and instructions.

Allow 6 weeks for delivery. Offer expires December 31, 1971, is limited to U.S.A., and to persons age 21 or over.

Important: Make certified check or money order payable to: Kool Sailboat Offer. Mail to P.O. Box 3000, Louisville, Kentucky 40201.

Please send me _____ SEA SNARK(S). For each boat I enclose a carton end flap from Kool plus \$88. Certified check. Money order. I am 21 years of age or over.

Name _____
Address _____
City _____ State _____ Zip _____



Warning: The Surgeon General Has Determined That Cigarette Smoking Is Dangerous to Your Health

18 mg. "tar," 1.4 mg. nicotine av. per cigarette, FTC Report Nov. 70.



I'd like to give this to my fellow men... while I am still able to help!

I was young once, as you may be—today I am older. Not too old to enjoy the fruits of my work, but older in the sense of being wiser. And once I was poor, desperately poor. Today almost any man can stretch his income to make ends meet. Today, there are few who hunger for bread and shelter. But in my youth I knew the pinch of poverty; the emptiness of hunger; the cold stare of the creditor who would not take excuses for money. Today, all that is past. And behind my city house, my

summer home, my Cadillacs, my winter-long vacations and my sense of independence—behind all the wealth of cash and deep inner satisfaction that I enjoy—there is one simple secret. It is this secret that I would like to impart to you. If you are satisfied with a humdrum life of service to another master, turn this page now—read no more. If you are interested in a fuller life, free from bosses, free from worries, free from fears, read further. This message may be meant for you.

By Victor B. Mason

I am printing my message in a magazine. It may come to the attention of thousands of eyes. But of all those thousands, only a few will have the vision to understand. Many may read; but of a thousand only you may have the intuition, the sensitivity, to understand that what I am writing may be intended for you—may be the tide that shapes your destiny, which, taken at the crest, carries you to levels of independence beyond the dreams of avarice.

Don't misunderstand me. There is no mysticism in this. I am not speaking of occult things, of innumerable laws of nature that will sweep you to success without effort on your part. That sort of talk is *rubbish!* And anyone who tries to tell you that you can *think* your way to riches without effort is a false friend. I am too much of a realist for that. And I hope you are.

I hope you are the kind of man—if you have read this far—who knows that anything worthwhile has to be *earned!* I hope you have learned that there is no reward without effort. If you have learned this, then you may be ready to take the next step in the development of your karma—you may be ready to learn and use the secret I have to impart.

I Have All The Money I Need

In my own life I have gone beyond the need of money. I have it. I have gone beyond the need of gain. I have two businesses that pay me an income well above any amount I have need for. And, in addition, I have the satisfaction—the deep satisfaction—of knowing that I have put more than three hundred other men in businesses of their own. Since I have no need for money, the greatest satisfaction I get from life is sharing my secret of personal independence with others—seeing them achieve the same heights of happiness that have come into my own life.

Please don't misunderstand this statement. I am not a philanthropist. I believe that charity is something that no proud man will accept. I have never seen a man who was worth his salt who would accept something for nothing. I have never met a highly successful man whom the world respected who did not sacrifice something to

gain his position. And, unless you are willing to make at least half the effort, I'm not interested in giving you a "leg up" to the achievement of your goal. Frankly, I'm going to charge you something for the secret I give you. Not a lot—but enough to make me believe that you are a little above the fellows who merely "wish" for success and are not willing to sacrifice something to get it.

A Fascinating and Peculiar Business

I have a business that is peculiar—one of my businesses. The unusual thing about it is that it is needed in every little community throughout this country. But it is a business that will never be invaded by the "big fellows." It has to be handled on a local basis. No giant octopus can ever gobble up the whole thing. No big combine is ever going to destroy it. It is essentially a "one man" business that can be operated without outside help. It is a business that is good summer and winter. It is a business that is growing each year. And, it is a business that can be started on an investment so small that it is within the reach of anyone who has a television set. But it has nothing to do with television.

This business has another peculiarity. It can be started at home in spare time. No risk to present job. No risk to present income. And no need to let anyone else know you are "on your own." It can be run as a spare time business for extra money. Or, as it grows to the point where it is paying more than your present salary, it can be expanded into a full time business—overnight. It can give you a sense of personal independence that will free you forever from the fear of lay-off, loss of job, depressions, or economic reverses.

Are You Mechanically Inclined?

While the operation of this business is partly automatic, it won't run itself. If you are to use it as a stepping stone to independence, you must be able to work with your hands, use such tools as hammer and screw driver, and enjoy getting into a pair of blue jeans and rolling up your sleeves. But two hours a day of manual work will keep your "factory" running 24 hours turning out a product that has a steady and

ready sale in every community. A half dollar spent for raw materials can bring you six dollars in cash—six times a day.

In this message I'm not going to try to tell you the entire story. There is not enough space on this page. And, I am not going to ask you to spend a penny now to learn the secret. I'll send you all the information, free. If you are interested in becoming independent, in becoming your own boss, in knowing the sweet fruits of success as I know them, send me your name. That's all. Just your name. I won't ask you for a penny. I'll send you all the information about one of the most fascinating businesses you can imagine. With these facts, you will make your own investigation. You will check up on conditions in your neighborhood. You will weigh and analyze the whole proposition. Then, and then only, if you decide to take the next step, I'll allow you to invest \$15.00. And even then, if you decide that your fifteen dollars has been badly invested I'll return it to you. Don't hesitate to send your name. I have no salesmen. I will merely write you a long letter and send you complete facts about the business I have found to be so successful. After that, you make the decisions.

Does Happiness Hang on Your Decision?

Don't put this off. It may be a coincidence that you are reading these words right now. Or, it may be a matter that is more deeply connected with your destiny than either of us can say. There is only one thing certain: If you have read this far you are interested in the kind of independence I enjoy. And if that is true, then you must take the next step. No coupon on this advertisement. If you don't think enough of your future happiness and prosperity to write your name on a postcard and mail it to me, forget the whole thing. But if you think there is a destiny that shapes men's lives, send your name now. What I send you may convince you of the truth of this proverb. And what I send you will not cost a penny, now or at any other time.

VICTOR B. MASON
1512 Jarvis Ave., Suite M-2-AJ
CHICAGO, ILLINOIS 60626

ICS[®]

International
Correspondence
Schools
Division of Intext

ICS, Scranton, Pa. 18515

Canadian residents:
Send coupon to Scranton.
Our affiliate in Canada
will reply.

TAKE YOUR FIRST STEP . . . MAIL THIS COUPON TODAY—ICS, SCRANTON, PA. 18515

7L054G

I'm interested in a program of independent study.
Send me, without cost, your booklet on the principles of success,
sample text demonstrating famous ICS method, and your catalog for _____
(Print name of course. See list.)

Miss _____ Age _____
Mrs. _____
Mr. _____

Address _____ Apt. _____

City _____ State _____ Zip Code _____

Occupation _____ Employed by _____ Working Hours _____ A.M. to _____ P.M.

Prepare now for a successful future!

266 ICS COURSES



Earn more money, enjoy greater security and faster promotion—and gain all the satisfaction of doing a job well that you like to do. Check the list of 266 ICS career opportunities for a better future. You receive individual

instruction, success-proved training you can apply immediately. And you earn the famous ICS diploma. Don't waste time! Send the coupon today for FREE information on a brighter career the ICS way!



LEADERS IN THE ICS SUCCESS PARADE . . .

Automobile Engine Tune-Up
Introduction to Programming the IBM System/360 Computer
Business Administration Accounting
Civil Engineering
Practical Electrician

Radio-TV Servicing
Architectural Drafting
High School Courses
High School Equivalency
Refrigeration and Air Conditioning
Aircraft and Power Plant Mechanics

ACCOUNTING
Accounting (U.S.A.)
Accounting (Canadian)
Accounting for Business Programmers
Accounting for Man'g'm't Decisions
Auditing
Business Law (U.S.A.)
Canadian Business Courses
Cost Accounting
CPA Review (U.S.A.)
General Accounting
Income Tax (U.S.A.)
Industrial Accounting
Junior Accounting
Office Accounting
Practical Accounting
Public Accounting
Small Business Accounting (U.S.A.)
Starting and Managing a Small Bookkeeping Service (U.S.A.)

Show Card and Sign Prod.
Show Card Writing
Sign Painting & Designing
Sketching and Painting

AUTOMOTIVE

Automatic Transmission Specialist
Automobile Air Conditioning Specialist
Automobile Body Rebuilding & Refinishing
Automobile Engine Tune-Up
Automobile Mechanic
Automobile Technician
Diesel-Gas Motor Vehicle Engines

BUSINESS

Advertising
Business Administration
Business Practice (Cond.)
Canadian Business Course
Direct Mail and Mail Order Advertising
Industrial Psychology
Inventory Control
Magazine & Newspaper Advertising
Managing a Retail Business
Managing a Small Store
Marketing Management
Marketing Research
Modern Exec. Management
Office Automation
Office Management
Production Management
Purchasing Agent
Retail & Local Advertising
Retail Bus. Management
Retail Merchandising
Retail Selling
Systems and Procedures Analysis

BUSINESS: SALES

Creative Salesmanship
Real Estate Salesmanship
Salesmanship
Sales Management

BUSINESS: SUPERVISION
Advanced Management
Basic Management
Industrial Foremanship
Industrial Supervision
Management, Salesmanship and Sales
Modern Woman as a Supervisor
Personality Development
Personnel-Labor Relations (U.S.A.)
Supervision

CHEMICAL
Chemical Analyst
Chemical Engineering
Chemical Laboratory Techn.
Chemical Process Equip. Design & Operation
Chemical Process Operator
Elements of Nuclear Energy
General Chemistry
Instrumental Laboratory Analysis

CIVIL ENGINEERING
Civil Engineering
Construction Eng'r'g Tech.
Highway Engineering Tech.
Principles of Surveying
Reading Highway Bl'pr'ts
Reading Structural Bl'pr'ts
Sanitary Engineering Tech.
Sewage Plant Operator
Structural Eng'r'g Tech.
Surveying and Mapping
Water Works Operator

COMPUTERS
Fundamentals of Computer Programming
COBOL Programming
Fortran Programming for Engineers
Programming for Digital Computers
Programming the IBM 1401 Computer
Programming the IBM System/360 Computer, Introduction

DRAFTING
Aircraft Drafting
Architectural Drafting
Design Drafting
Drafting Technology
Electrical Drafting
Electronic Drafting
Introductory Mech. Drafting
Mechanical Drafting
Pressure-Vessel and Tank
Print Reading

Sheet Metal Layout for Air Conditioning
Structural Drafting

ELECTRICAL
Electrical Engineering —Electronics Option —Power Option
Electrical Appliance Ser.
Electrical Appliance Ser. with Equipment Training
Electrical Contractor
Electrical Engineering Tech.
Electrical Home Maint.
Electrical Home Maint. with Equipment Training
Electrical Instrument Tech.
Electric Motor Repairman
Industrial Electrical Tech.
Industrial Electrician
Industrial Maintenance Electrician
Power-Line Design and Construction
Power Plant Operator —Hydro Option —Steam Option
Practical Electrician
Practical Electrician with Equipment Training
Practical Lineman
Reading Elec. Blueprints

ENGLISH AND WRITING
Better Business Writing
English for Spanish (U.S.A.)
Free Lance Writing for Fun and Profit
Introductory Tech. Writing
Modern Letter Writing
Practical English
Reading Improvement
Short Story Writing

HIGH SCHOOL
High School Business
High School (Canadian)
High School General
High School Mathematics
High School Secretarial
High School Vocational
High School College Preparatory—Arts
High School College Prep—Engineering and Science
Preparatory Course for High School Equivalency Test

MACHINE SHOP PRACTICE
Grinder Operator
Industrial Metallurgy
Lathe Operator
Machine Shop Inspection
Machine Shop Practice

Metallurgical Eng'r'g Tech.
Multicraft Maintenance Mechanic
Practical Millwrighting
Reading Shop Prints
Rigging
Tool & Die Making
Tool Engineering Tech.
Welding Engineering Tech.
Welding Process

MATHEMATICS
Advanced Mathematics
Math and Mechanics for Engineering Technicians
Math and Physics for Engineering Technicians
Modern Elementary Statistics

MECHANICAL
Mechanical Engineering
Aircraft and Power Plant Mechanic
Hydraulic and Pneumatic Power
Industrial Engineering
Industrial Eng'r'g Tech.
Industrial Instrumentation
Machine Design
Quality Control
Safety Engineering Tech.
Tool Design
Vibration Analysis and Control

PETROLEUM
Natural Gas Production and Transmission
Oil Well Servicing
Petroleum Production Operator
Petroleum Production Engineering Technology
Petroleum Refinery Oper.

PLASTICS
Plastics Technician

PLUMBING, HEATING AND AIR CONDITIONING
Air Conditioning
Air Conditioning Maint.
Domestic Heating with Gas and Oil
Heating
Heating & Air Conditioning with Drawing
Industrial Air Conditioning
Pipe Fitting Plumbing
Plumbing and Heating
Plumbing & Heating Est.
Practical Plumbing
Refrigeration and Air Conditioning Servicing

PULP AND PAPER
Paper Machine Operator
Paper Making Pulp Making
Pulp & Paper Eng'r'g Tech.

SECRETARIAL
Clerk-Typist Commercial Secretary, Engineering Sec'y, Legal Sec'y, Medical Secretary, Professional Shorthand Stenographic Typewriting

STEAM AND DIESEL POWER
Boiler Inspector
Industrial Building Eng'r
Power Plant Engineering
Stationary Diesel Engines
Stationary Fireman
Stationary Steam Eng'r'g

TEXTILES
Carding and Spinning
Dyeing and Finishing
Loom Fixing
Textile Designing
Textile Mill Superintendent
Textile Mill Supervision

TRAFFIC
Motor Traffic Management
Traffic Management

TV-RADIO-ELECTRONICS
Cable TV Installer
Electronics Technician
Fundamentals of Electronic Computers
General Electronics
General Electronics with Equipment Training
Hi-Fi Stereo and Sound System Servicing
Industrial Electronics
Numerical Control Electronics & Maint.
Radio & TV Servicing with Equipment Training
Solid State Electronics
Telephony

APPROVED FOR VETERANS FOR TUITION REFUND
Accredited member, National Home Study Council.
Easy pay-as-you-learn plan.
Special rates to members U.S. Armed Forces.

science worldwide

By JOHN PEARSON



Detecting tides in a teacup

A LEVEL SENSOR SO SENSITIVE that it can detect the tidal pull of the sun and moon on the liquid in a teacup has been developed by the Hughes Aircraft Co. The sensor is capable of measuring tilt angles equal to one inch in 16,000 miles. A much larger version than that shown is used to test accelerometers in the Navy's Poseidon missile inertial guidance system. Another sensor is installed in an abandoned Colorado gold mine to measure movements of the Rocky Mountains caused by snow loads, tidal pulls and Earth tremors.

THE REAL THING. Dissatisfied with lab preparations, Dr. Mary Hewitt Loveless uses live wasps to give patients booster shots after immunization with wasp venom. The Connecticut allergist says that patients get longer-lasting protection, even though the method has problems. Frequently wasps won't sting. Best way to provoke them, according to the doctor, is to hold back their wings with forceps, which "makes them furious."

A MACHINE THAT INHALES AIR, consumes oxygen and exhales carbon dioxide—and that can pant or breathe as deeply as a man playing basketball—has been developed by the IBM Corp. The device will be used to improve the testing of protective masks, resuscitating equipment and space life-support systems. Breathing rate can be controlled from 5 to 60 breaths a minute. Exhaled breath is conditioned so that temperature is maintained within two degrees of 98.6°F.

ORPHANED LAMBS USUALLY ARE REJECTED by foster mothers because the young ones don't have a familiar smell. Now a New Zealander has solved the problem, according to a report in *News in Engineering*. Just spray a local anesthetic into the ewe's nostrils, killing her sense of smell. By the time the anesthetic wears off, the ewe has fully accepted the little newcomer.

EQUIPPED WITH TAPE RECORDER, slide projector and other special equipment, the "learning egg" permits a student to escape the distractions that abound in today's schools and do a bit of studying. Created by European designers, the egg was shown at a recent exhibition of educational equipment in West Germany.

DO DAMS CAUSE EARTHQUAKES? A geophysicist with the Commerce Dept.'s National Ocean Survey studied seismic data recorded at several U.S. dams and concluded that Hoover Dam has caused earthquakes but that none resulted from the building of Flaming Gorge, Utah, and Glen Canyon, Ariz., dams. The scientist thinks the massive weight of water behind dams built near active faults triggers tremors. ★★★

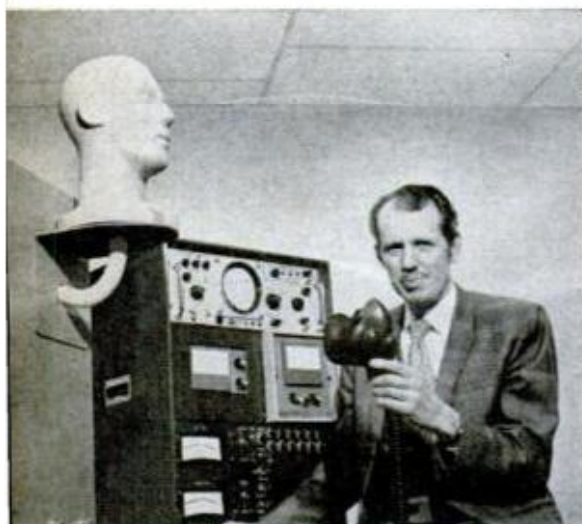

Air goes in, CO₂ comes out



Learning egg is no yoke

KEEP PACE WITH SPACE AGE! SEE MOON SHOTS—LANDINGS, SPACE FLIGHTS, CLOSE-UP!



AMAZING SCIENCE BUYS

for FUN, STUDY or PROFIT

**FREE
GIANT
CATALOG!**

1st QUALITY OPAQUE UNDER \$200



Terrific Buy! Top Quality! Projects brilliant, sharp 4 1/2 ft. sq. image from 8' using up to 5"X5" color, b/w illustrations. Retains all original colors, proportions. Enlarges drawings, coins, maps, etc. Revolutionary peanut-size quartz Halogen lamp (50hr. life), 200mm anastigmatic lens (f3.5.8" F.L.), unique internal reflecting system give maximum brightness, entire field focus. Can be used upside down. Turbo-cooled. 5 1/2 ft. cord. (Wt. 11 1/4 lbs.)

Stock No. 71,272H \$89.75 Ppd.

BLACK-LIGHT MIGHTY MITES



Relatively small (12") fixtures give surprisingly bright blacklight. Mirror-finished reflector makes instant starting 8-watt, high-intensity bulb look like 40-watter. Up to 5,000 hours of safe, long-wave (3660A) blacklight to really turn-on parties, light & theatrical shows, psychedelic decors, holiday decorations. Shockproof end-caps remove for safe, easy replacement of bulb and starter. Stands upright or horizontal. Aluminum case.

Stock No. 71,274H \$14.95 Ppd.

DELUXE OUTDOOR/INDOOR MODEL \$19.95 Ppd.

NEW! ELECTRONIC DIGITAL COMPUTER KIT!



Solve problems, play games, predict weather with this actual working model of giant electronic brains. Amazing new fun way to learn all about computer-programming... logic, decimal, binary systems. Laws of Sets—even do your own programming after completing simplified 116 page instructive booklet. Includes step-by-step assembly diagrams. Circuits easily changed. Readout from illuminated control panel. Req. 2 "D" batt. (not incl.). Best model we've seen for home, school, industry.

No. 71,434H (11"X12 1/2"X4") \$31.50 Ppd.

AMERICAN MADE OPAQUE PROJECTOR

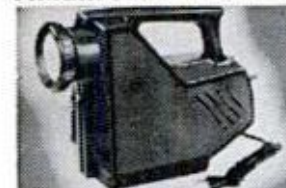

Projects illustrations up to 3" x 3 1/2" —enlarges them to 35" x 30" if screen is 6 1/2 ft. from projector, larger pictures if screen is farther away. No film or negatives needed. Primarily intended for children. Projects charts, diagrams, color or black-and-white in darkened room. 115 v. A.C. . . . 6 ft. cord and plug included. Size 12" x 8" x 4 1/2" wide. Weight 1 lb. 2 ozs. Plastic case.

Stock No. 70,199H \$8.75 Ppd.

HOT-AIR FLYING SAUCER KIT



Giant 9 ft. model rises to amazing heights. Easy to assemble and launch. Use over and over. Low cost. Lots of fun. Can carry 1 1/2 lb. objects with string tether. Fly school colors at games, use for advertising, attach mirror—play "spy in the sky." Includes complete instructions, 16 pre-cut = 1 white model paper gores, 8 red panels for portholes, wire, cord. Easily repaired if damaged.

Stock No. 71,175H \$3.00 Ppd.

9 FT. HOT AIR BALLOON KIT \$2.00 Ppd.

"FISH" WITH A MAGNET



Go treasure hunting on the bottom! Fascinating fun & sometimes profitable! Tie a line to our 5 1/2-lb. Magnet—drop it overboard in bay, river, lake or ocean. Troll it along bottom—your "treasure" haul can be outboard motors, anchors, other metal valuables, 5 1/2-lb. Magnet is war surplus—Alnico V Type—Gov't cost \$50. Lifts over 150 lbs. on land.

Stock No. 70,571H \$14.00 Ppd.

lbs. \$ 5.75 Ppd.

lbs. (lifts 40 lbs.) \$ 8.75 Ppd.

lbs. (lifts 350 lbs.) \$33.60 FOB

AMAZING NEW Wankel Engine KIT!



Thrill to the fun of building your own see-through motorized model of revolutionary pistonless type engine . . . only engine experts think economically modifiable to meet new pollution standards. Replaces piston, cylinder, crank assemblies with rotating discs (sections removed for firing chambers). Smaller than conventional; fewer parts, greater reliability, same speed w/less horsepower. Feat: flashing plugs, rubber fan belt, stick-shift on-off switch. Req. 2-1.5V batt. (not incl.).

No. 71,424H (4 1/2"X5"X9") \$6.75 Ppd.

ASTRONOMICAL TELESCOPE KITS

See Pop. Mech. Jan. Feat.

"The Sky's the Limit"

Grind your own mirror for powerful telescopes. Kits contain fine annealed pyrex mirror blank, tool, abrasives, diagonal mirror, and eyepiece lenses. Instruments you build range in value from \$75 to hundreds of dollars.

= 70,003H 4 1/4" dia. 3 3/4" Thick \$10.75 Ppd.

= 70,004H 6" Dia. 1" Thick \$13.95 Ppd.

= 70,005H 8" Dia. 1 3/4" Thick \$21.50 Ppd.

= 70,006H 10" Dia. 1 3/4" Thick \$52.50 FOB

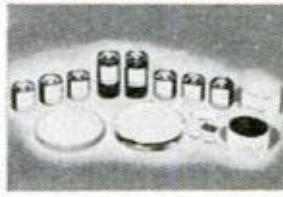

HELIUM BALLOONS MAKE A "BALL"

Anytime there's a balloon the air is festive. Especially when the "air" is helium which makes a balloon perky and adventurous. Now here's 25 times the fun—25 various colored balloons of 4, 5, or 6" diameter when inflated. With them, a pressurized (300 lbs/sq. in.) can containing 25 liters of helium to inflate all 25. For adults or kids' parties, giveaways, bazaars or just demonstrating "lighter than air". Helium is a safe non-toxic inert gas.

Stock No. 71,289H \$3.00 Ppd.



NEW MODEL DIGITAL COMPUTER

Solve problems, teach logic, play games with miniature version of giant electronic brains! Adds, subtracts, multiplies, shifts, complements, carries, memorizes. Colored plastic parts easily assembled. 12" x 3 1/2" x 4 1/2". Incl. step-by-step assembly diagrams, 32-p. instruction book covering operation computer language (binary system) programming, problems & 15 experiments.

Stock No. 70,683H \$5.98 Ppd.

ANALOG COMPUTER KIT \$18.95 Ppd.

Stock No. 70,341H \$18.95 Ppd.

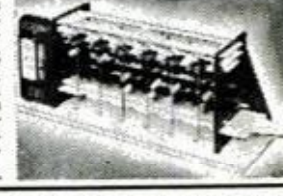

\$16.50 AIR POLLUTION TESTER!

1st low-cost survey-type instrument. Quickly provides quantitative results in threshold limit ranges set by Amer. Conf. of Gov't Industrial Hygienists. Sensitive, accurate, wide measuring range. Includes 2 ampoules each to test for CO2, CO, H2S, NO2 and SO2. Sufficient for 2 to 4 tests depending on concentration. Lightweight kit includes sturdy vacuum pump, coupling tubes, complete instructions with scales to determine results. Sets (4) of replacement ampoules available separately for \$4.75.

Stock No. 71,349H \$16.50 Ppd.



PLASTIC MODEL V-8 ENGINE

Hours of fun! Get thrill of building your own easily assembled engine from over 350 parts. Then push starter and watch it run. Crankshaft revolves, pistons move, valves open and close in sequence with spark plugs. Does everything but burn oil. 1/4 scale, molded in 4 colors. Used in many auto-mechanic courses. Excellent, easy-to-understand "tech manual."

Stock No. 70,448H \$13.50 Ppd.

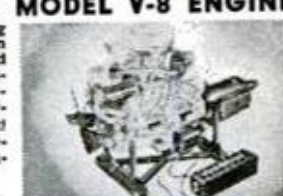

WAR SURPLUS ELECTRIC GENERATOR

Brand new Signal Corps Electric Generator. Generates up to 90 volts by turning crank. Use in high impedance relays. Charge ground & bring up night crawlers for bait or study. 2 Alnico Magnets alone now worth more than original gov't cost of \$15. Wt. 2 lbs.

Stock No. 50,225H \$8.50 Ppd.



MAIL COUPON FOR GIANT FREE CATALOG

148 PAGES! MORE THAN 4,000 UNUSUAL BARGAINS. Completely new 1971 Catalog. Packed with huge selection of telescopes, microscopes, binoculars, magnets, magnifiers, prisms, photo components, unique lighting items, parts, kits, accessories—many hard-to-get surplus bargains. 100's of charts, illustrations. For hobbyists, experimenters, schools, industry.

EDMUND SCIENTIFIC CO.
300 Edscorp Building, Barrington, N. J. 08007
Please rush Free Giant Catalog "H"

Name

Address

City

State

Zip

EDMUND SCIENTIFIC CO. ORDER BY STOCK NUMBER • SEND CHECK OR MONEY ORDER • MONEY-BACK GUARANTEE
300 EDSCORP BLDG. BARRINGTON, NEW JERSEY 08007

Drivin' with Dan

Why are few stock-car drivers running 1971 models? What's behind the Indy-car change from the cigar to wedge shape? Does bleach aid dragster traction? Dan Gurney answers these and other automotive questions

Q. Why are so few NASCAR drivers running 1971 models?—Jay Hangen, West Lawn, Pa.

A. My guess is that since the factory participation has receded, the money to make the annual model changeover is not so readily available. The older models are still very competitive and the drivers are very familiar with them. Fundamentally, older versions are not really any older, but some difference in sheet-metal styling may be better—or worse—as far as racetrack performance goes.

Q. Why do you think Indy cars are changing from cigar shapes into straight-sided, wedge-shaped cars?—William Golisch, Moscow, Pa.

A. The rules are partly responsible, as is the supercharged engines' fuel appetite. The cars have to carry 75 gallons of fuel, and this fuel comprises much of their total sprung weight. A wedged, flat-sided, wide shape lets the fuel be carried much lower than a cigar shape does. The latter has less straight-ahead wind

resistance or drag, but the wedge converts some of its drag into down force which presses tires down in the curves and gives the car better traction, thus increasing its cornering ability. At the moment, the corners seem more important than the straights.

Q. I've read that a 426 Hemi Barracuda is the fastest street car turned out by Detroit. What would you guess it would run in terms of top speed?—Marco Montovan, Windsor, Ont., Canada.

A. About 130 mph in average trim.

Q. Do you think driving schools give you the best chance to start racing for company or privately owned teams?—Craig Welty, Pekin, Ill.

A. This is a great way to get started and it stands to reason that you should be able to avoid many "pitfalls" by paying close attention to what they tell you in driving school. In the meantime, it gives you experience—the

(Please turn to page 32)



TEAM MANAGER DAN discusses the handling of the Eagle chassis with driver Bobby Unser. This was just before the Rex Mays 150 at Wisconsin State Fair Speedway. Bobby had the pole but was forced out of the race at the halfway mark with ignition trouble. Bobby's brother, Al, went on to win the USAC race

Should you be running "hot" or "cold" spark plugs in your engine?

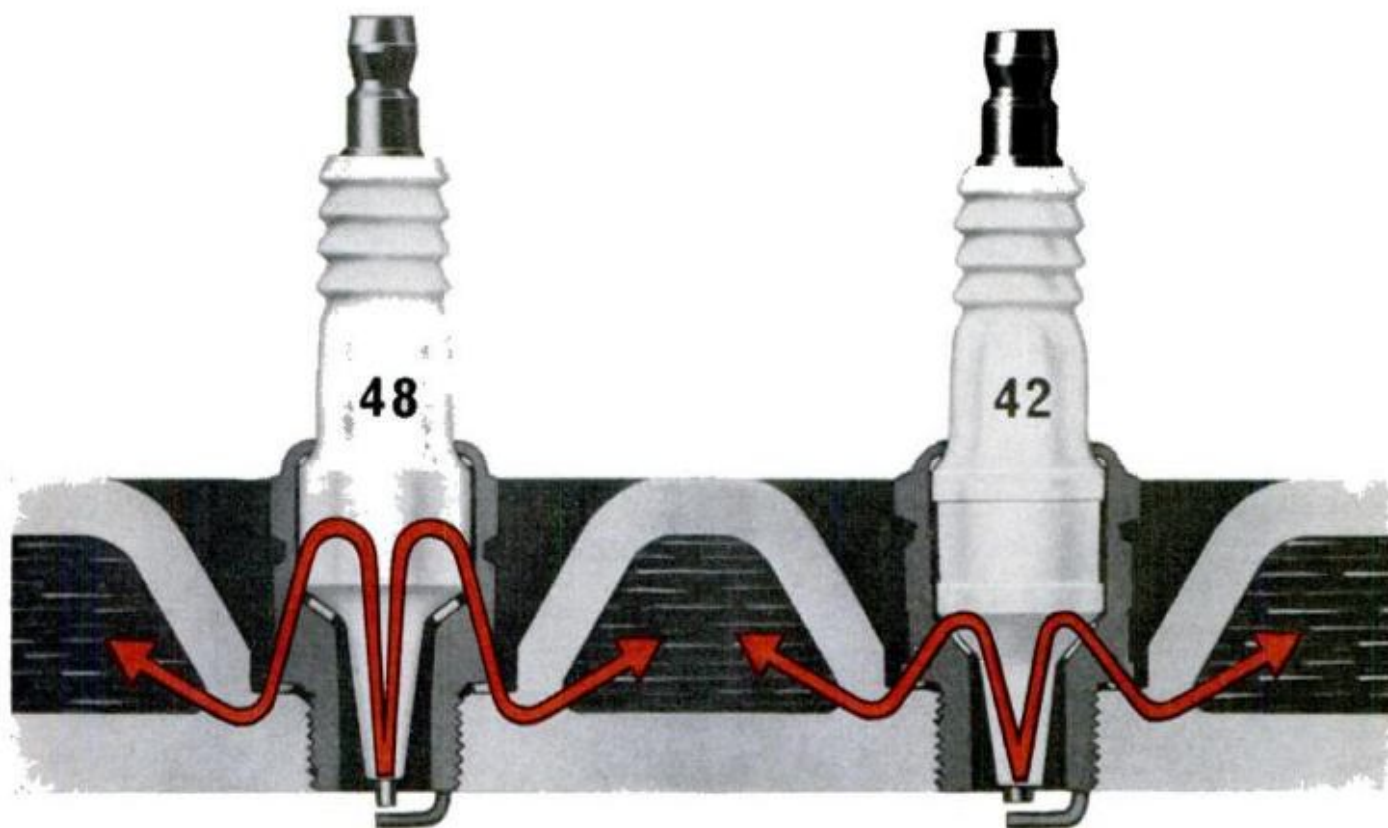

The Hot Spark Plug.

The longer heat path maintains a hotter operating temperature. Heat dissipation is slower along the long lower ceramic insulator.

The Cold Spark Plug.

The shorter heat path maintains a cooler operating temperature. Heat dissipation is quicker along the short lower ceramic insulator.

The two AC Spark Plugs shown are designed for the two operating extremes in the same engine. The second digit indicates the heat-range and is read like a thermometer: the higher the number, the hotter the heat-range. Most car manufacturers specify a spark plug that meets average driving conditions. Extreme conditions may require a change in the spark plug heat-range.

You may need a "hot"

spark plug if most of your driving is stop-and-go city driving. Combustion chamber temperatures are low and a "hotter" spark plug can help prevent fouling.

At sustained high speeds, combustion chamber temperatures are higher and a "cooler" spark plug can help prevent high-speed miss and damaging pre-ignition.

If you think you might benefit from a heat-range change, start in the middle

and move up or down one step at a time. AC makes a complete range of spark plugs for every make and model. Hot or cold, there's an AC Fire-Ring Spark Plug that'll help give you top economy and performance.



AC SPARK PLUG DIVISION OF GENERAL MOTORS

Don't Just Change Oil... Change Performance.

Whether you race or not your engine will love the cool, clean, high performance of Royal Triton Racing Oil . . . and your pocketbook will love the way it protects your investment!



ROYAL TRITON COMPANY
2200 E. Devon • Des Plaines, Illinois

DRIVIN' WITH DAN

(Continued from page 30)

thing that is so important. You must get experience somehow, for that is your apprenticeship.

Q. Does the bleach they pour out for dragsters help their traction? If so, how?—Robin Osterman, Wichita, Kans.

A. Yes, it does help traction; how much is difficult to say. I'm told that people use three things: bleach, water and resin. The bleach and water work almost equally well—they are used to clean off the oil and dirt often picked up when rolling around the pits. Spinning of the tires creates a lot of heat, which makes the rubber softer; it then becomes gummy and gets a better grip on the pavement. Drivers don't like to spin their tires in an actual race, just in the warm-up or burn-out. Resin is used to make the tires even stickier for more traction.

Q. What do you look for when you are watching a race for fun, not running in it or doing anything else?—Ben Barnaby, Wilmington, Del.

A. First, I like to get as close to the action as possible. Then I try to watch the style of the various drivers to get an idea of how hard they are trying, how many chances they are taking, what sort of judgment they use to cope with the problems that come up due to traffic and changing track conditions.

Q. What one or two main points made the McLarens so much faster at Indy this year? And why didn't other cars have them?—J.L. Foster, Omaha.

A. The McLarens were lower in center of gravity, lighter overall, shorter in polar moment of inertia and better in weight distribution. They had a better, more stable aerodynamic configuration and some excellent suspension geometry. Their designers deserve a lot of credit. They didn't win, but there was no race at all as long as Donohue was in the race. The other guys' cars didn't have these features. ★ ★ ★

If you have questions on racing, high-performance and everyday driving techniques, send them to "Drivin' with Dan," c/o Popular Mechanics, 224 West 57th St., New York, N.Y. 10019. Questions cannot be answered by individual letters. Questions on maintenance and repair should be addressed to the Auto Clinic (see page 16).



**It takes guts
to tangle with the Bayous.
Jeep guts.**

The Jeepster Commando— it hasn't found a place it can't conquer.

Turn back? Not in the Commando. With this sport buggy, you keep going. Through the mud, water and soft marshland of the bayous. That's how it is below U.S. 190, deep in the Mississippi Delta.

The Commando doesn't quit because it has what the others don't have. Jeep guts.

This means the most experienced, most traveled 4-wheel drive setup you can get. One that's a bear for

work. It carries over 600 lbs. of cargo. Yet it's narrow enough to squeeze through where others are squeezed out. You can add an automatic 3-speed transmission that also allows you to shift for yourself. Pick the gear you want or go automatic all the way. In the Commando, driving is meant to be fun, even during working hours.

And the Commando's ride is pure Southern hospitality. Bucket seats that are molded foam—not padded.

And options like air conditioning, power brakes, power steering, and automatic transmission.

The Commando is seeing an America you can't see from the highway. For a better view of the country, see your Jeep dealer.



**The toughest
4-letter word on wheels.**

Jeep

EVEN ARCHITECTS LOOK TWICE



Lindal, the pre-cut homes that even architects admire! For quality and beauty that endure, Lindal uses only the finest Canadian Cedar that is kiln-dried and virtually warp-resistant. The structural components are cut to exact lengths and part-numbered for easy, fast assembly on your site. You'll find that much of the construction you can do yourself possibly with some professional help. Shipping costs are designed to meet competition anywhere. Send for our 36-page full color Plan Book and get the details on more than 70 designs you can choose from. Only \$1.



Lindal Cedar Homes,
Dept. PM78
18601 Pacific Hwy. S.
Seattle, WA 98188
Enclosed is \$1 for my Lindal Cedar Homes Plan Book.

Name _____
Address _____
City _____ State _____
Zip _____ Phone _____

Lindal is represented throughout the world.

reach for the tub fixer™ sealing compound

DAP Kwik-Seal® Tub & Tile Caulk. Easiest and best way to put neat, white, water-tight seals around tubs, sinks, showers. Stays flexible. Points tile, fills joints around window, door frames. Money-back guarantee.



DAP
fixer™
products

DAP Inc., Dayton, Ohio 45401/Subsidiary of *Plymouth, Inc.*

Also available in Canada

compact double duty tool sets unsurpassed for precise work

Made for the skilled mechanic and craftsman who appreciate professional quality

Five different sets with variety of 6 to 10 midget drivers for delicate work with hex head screws and nuts; slotted, Phillips, hex socket, and Scrulox screws.

Each contains unique, slip-on, torque amplifier handle for added reach and driving power. Lets you do more jobs with fewer tools. Slim, trim, vest-pocket size case.

Nationwide availability through local distributors-dealers. Write for **FREE HAND TOOL CATALOG.**

XCELITE, INC., 162 Bank St., Orchard Park, N.Y. 14127



train for Machine Design Technology in two years

Graduates of our six quarter Machine Design Technology Program are employed by leading companies. Trained in everything from basic technical drawing to machine and product design, they have entry into responsible positions in important industries. Tri-State also offers four year programs in five fields of engineering . . . four areas of business administration . . . two-year programs in computer technology, arts, and science. Accredited. Approved for veterans. Moderate total costs. Enter March, June, Sept., Jan. Write Director of Admissions for Catalog, indicating career you prefer. Excellent placement record!



TRI-STATE COLLEGE

481 College Avenue, Angola, Indiana 46703

NEW 1972 WELDER WITH 5 WELDING HEATS 110 VOLTS 1995



Plugs in any ordinary 110 volt outlet. Buy direct from the factory and save \$\$. Complete - nothing else to buy. Includes *heavy duty cables *electrode holders *ground clamp *extra welding rods *full face mask. Heavy duty - 5 heats for welding, soldering, cutting and heating. Easy to operate; step-by-step instructions included. Ideal for the home handyman or craftsman - pays for itself repairing cars, trailers, lawn equipment, boats, etc.

10-DAY MONEY BACK GUARANTEE. Send only \$2 and pay postman \$17.95 plus postage when delivered, or send \$19.95 for prompt postpaid shipment. Return within 10 days for refund if not completely satisfied. Orders filled promptly - check or money order. **LIFETIME GUARANTEE.**

MINI 5 ARC WELDER Department A, 2635 Main Street, Houston, Texas 77002

locksmithing and key making

PRACTICAL UP-TO-DATE COURSE - ONLY \$7.95

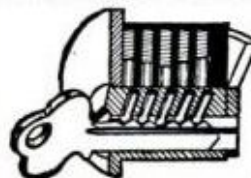

Teaches you how to pick locks, de-code, make master keys, repair, install, service, etc. New self-instruction lessons for every handyman, homeowner, carpenter, mechanic, service station operator, fix-it shop, hardware dealer, gunsmith. 53 easy illustrated lessons. Full price only \$7.95 post-paid. Satisfaction or refund guaranteed. Mail order today!

NELSON-HALL CO., Dept. HZ-2
325 W. Jackson Blvd., Chicago 60606

"LISTEN IN" TO POLICE-FIRE RADIO CALLS IN YOUR CAR!

WORKS WITH ANY CAR-Portable or HOME RADIO! Just PLUGS in-No wiring-3 minute hookup! Switch instantly from regular to ALL POLICE-FIRE-EMERGENCY-COMMERCIAL-TAXICAB-STATE-CITY-GOV'T 2 way Radio calls in YOUR AREA. DUAL-HI-LOW BANDS-OVER A MILLION Radio Cars/stations. USE Everywhere-anytime-always works!

SEND ONLY \$2.00 (cash, Ck., M.O.) and pay postman \$7.99 plus COD pstg. or send \$9.99 for ppd Del in USA. COMPLETE, ready to use with instructions. One Year Service Warranty-10 DAY MONEY BACK TRIAL (if retnd). AMAZING OFFER good only by mail-

WESTERN RADIO Dept. BPM-8 KEARNEY, NEBR. 68847



Now, two little knives do a disappearing act.

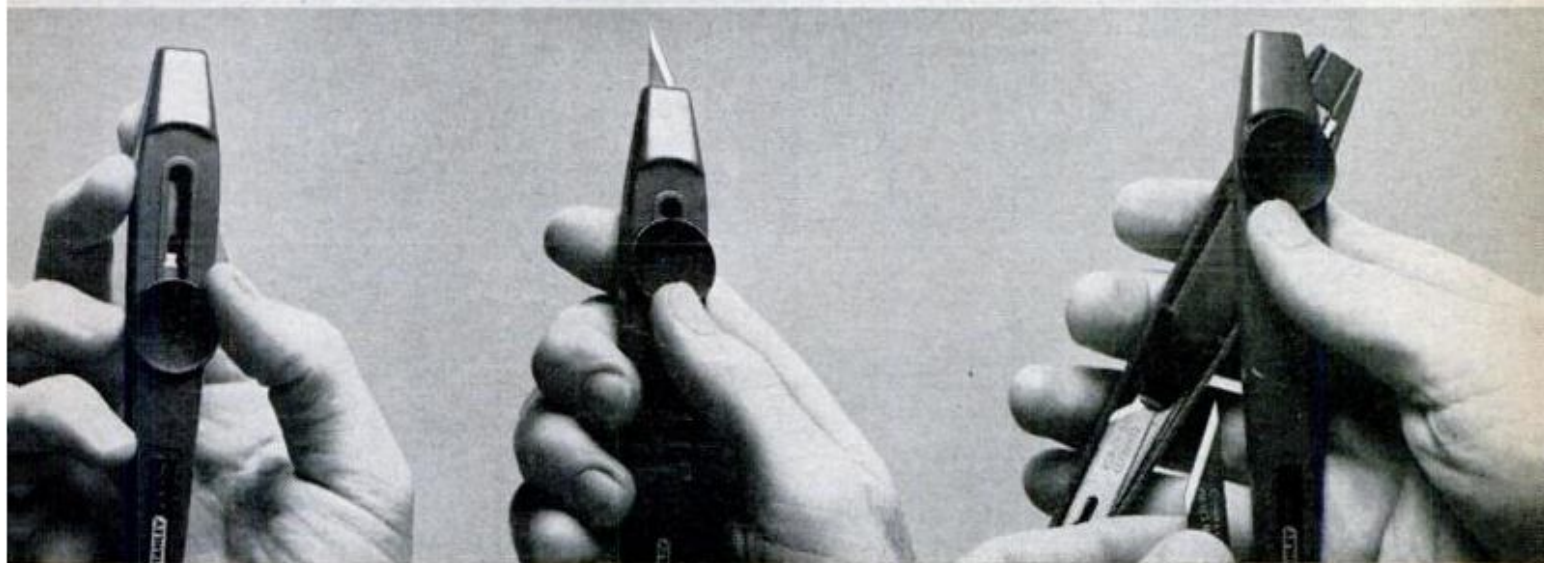
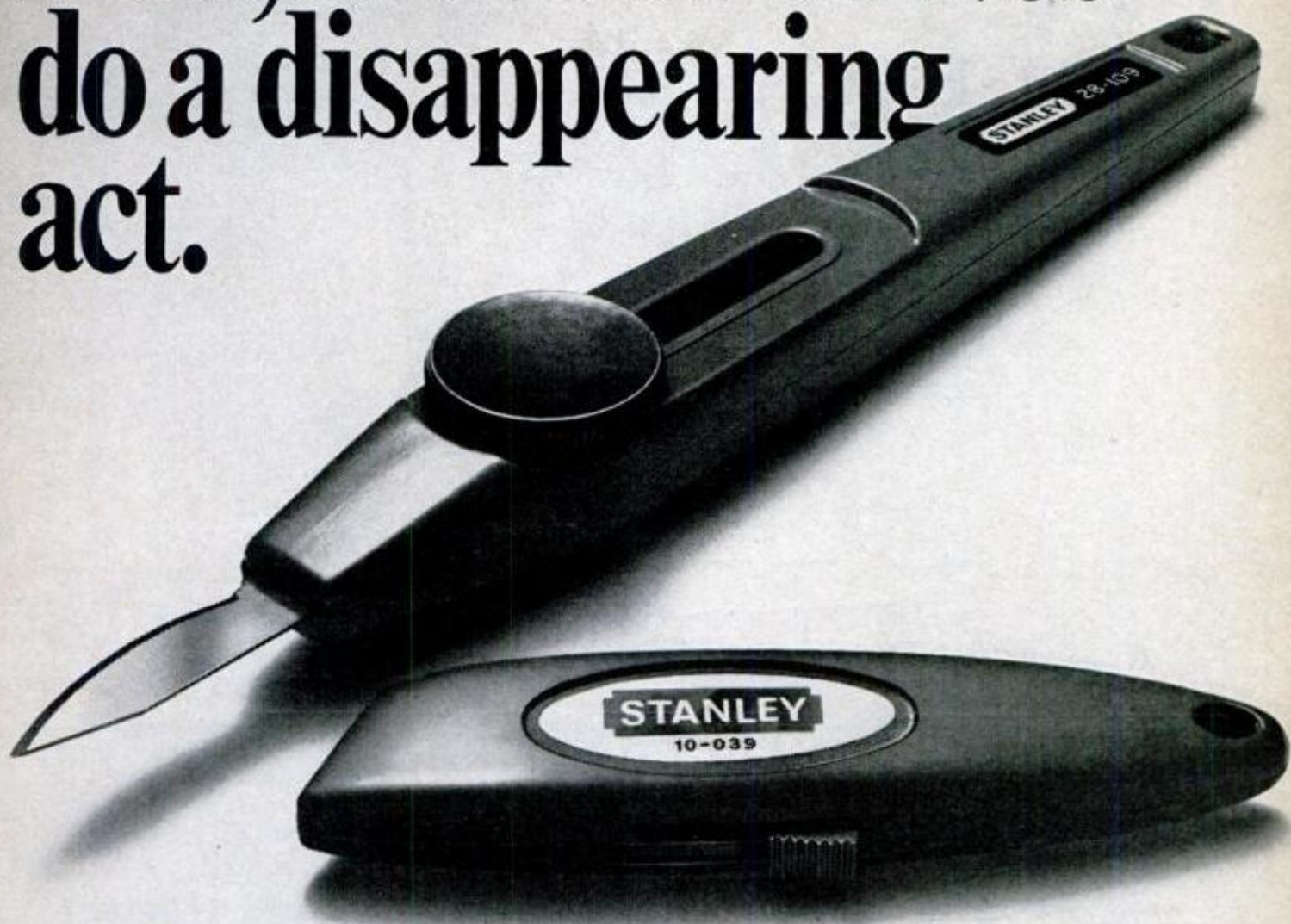

Our famous Retractable Slimknife™ and new 3½" Mitey-Knife™ both do man-sized cutting jobs. And both safely hide their heads when not in use. In either case, move the button back, and the blade's safely out of sight. Move it ahead, and you've got a sharp blade ready to whittle, cut,

carve, etc. When it dulls, replace it in a jiffy. Two spare blades come packed inside the Retractable Slimknife, one inside the Mitey-Knife. At only \$1.99 and \$.99, respectively, they're quite an act!

STANLEY
helps you do things right

GOOD REASONS for GREY-ROCK

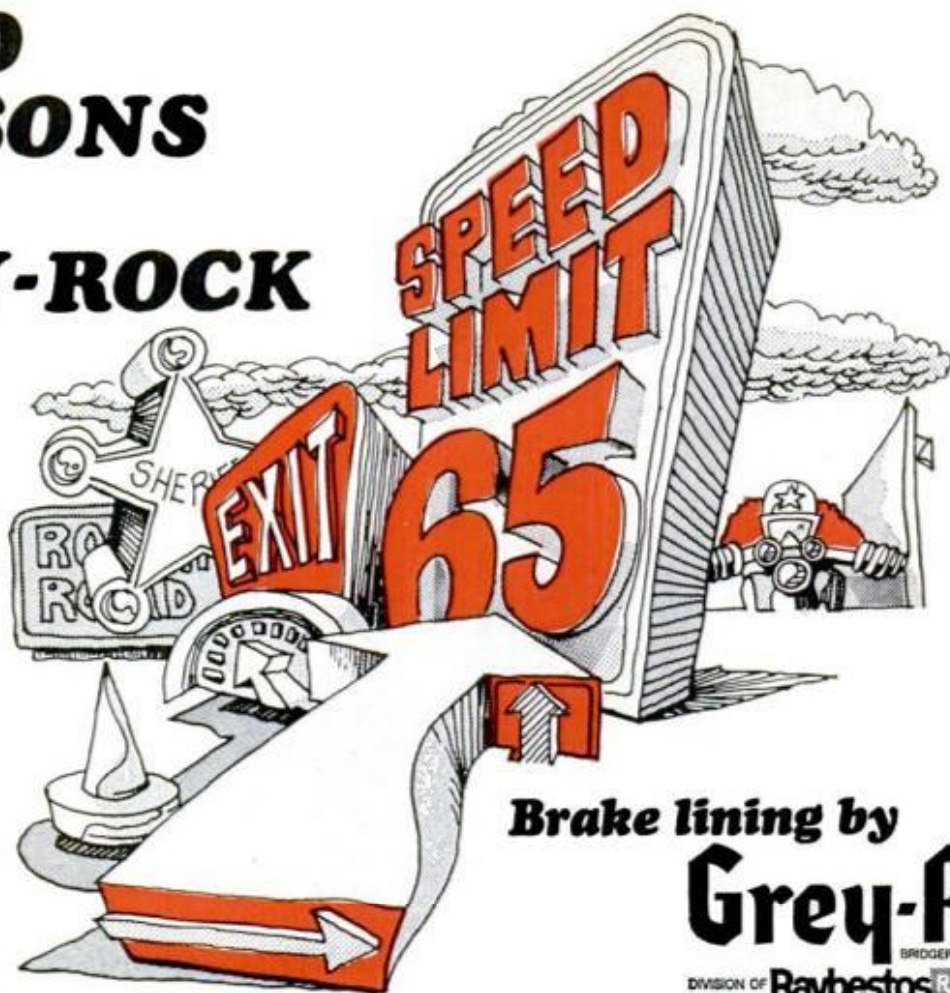

Brake lining by
Grey-Rock
BRIDGEPORT, CONN. 06603
 DIVISION OF **Raybestos** **Manhattan**

BUILD YOUR OWN CAMPER SAVE UP TO 50%



Complete, easy to follow plans. Instructions, materials list.

- Camper Plans\$3.95
 - Travel Trailer\$3.95
 - Pickup Cover\$2.00
 - CONVERSION PLANS:**
 - Economline Type Van..\$2.95
 - Passenger Bus or Delivery Van.....\$2.95
- Satisfaction Guaranteed

EQUIPMENT CATALOG \$1.00

Refundable on First Order. Send Dime for Details. Save 50% on Camper Kit. All items from catalog to build \$1,795. Camper, 8', 10', 10'6" or Chassis Unit.



VIKING CAMPER SUPPLY, INC.
 99-BP Glenwood Ave.,
 Minneapolis, Minn. 55403
 Please send _____ for which I enclose \$ _____
 NAME _____
 ADDRESS _____
 CITY _____
 STATE _____ ZIP _____

MOLDS

for making
*Ornamental Concrete
 Items...*



Book about Aluminum Molds with prices and production trade secrets direct from world's largest mold manufacturer.

SEND \$2.00

CONCRETE MACHINERY COMPANY, INC.

P. O. BOX 99 • HICKORY 2, N. C. 28601

Protect Negatives and Slides



New **PRINT FILE**

NEGATIVE PRESERVERS

Clear plastic Print File lets you contact print without removing negatives. Perfect for filing and previewing slides. For 35mm and 120 film, 2x2 slides, and other standard film sizes.

100 Print Files hold 1200 to 4200 frames or 2000 slides. Standard files \$15.00/100. 3-ring binder style files \$20.00/100. 2x2 Slide Files \$25.00/100. Specify film size. Check with order plus \$1.00 for postage and handling. FREE sample packet on request.

PRINT FILE, INC.

Dept O Box 100 Schenectady, N. Y. 12304



TOOL POWER™ 110 VOLTS D.C.

3,000 Watts 0-50 amps from your car's alternator. Operates heavy duty drills, saws, and lights, battery charging. Arc welding. Does not operate A.C. motors on refrigerators and air conditioners. Installed in 10 minutes. Guaranteed 5 years. \$25.00 Postpaid. Dealerships available.



A.C. Generators 60 Cycles, 110 Volts,

Fanbelt driven. Runs power tools, T.V.'s, refrigerators, radios, A.C. motors to 1/2 H.P. Cannot operate air conditioners. 1,500-watt. \$60.00 plus \$5.00 postage. 3,000-watt \$99.50 plus \$6.00 postage. P.O. Box 7066, 2821 Mays St. CO. PM Amarillo, Texas 79109

VIRDEN PERMA-BILT

POPULAR MECHANICS

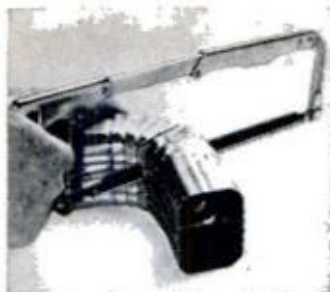

Hacksaw Blade. New! Virtually unbreakable. Makes thin, straight cuts. No need to protect the edge when you carry it in your toolbox.

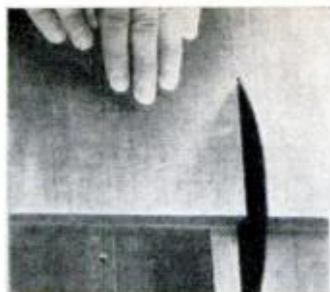

Circular Saw Blades. New! No need to change blades when you change materials. Come in 6½", 7", 8" and 10" diameters, to fit most saws.



Saber Saw Blades. Universal ¼" shank saws, coarse grit for fast cuts, fine grit for smoother cuts. Make plunge cuts in tile, cut small circles. Also available in 4" and 6", ½" shank.

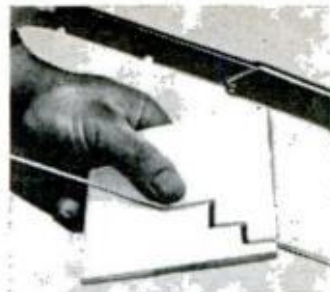

Rod Saw. Thin, round blade cuts in any direction. Ideal for contour cutting. Reversible for extended life. Ten-inch length fits standard hacksaws.

Remington "Grit-Edge" Saw Blades Have No Teeth. They're Something Else!



That's right, "GRIT-EDGE" blades have no ordinary saw teeth to snag, break or dull. Instead, an exclusive process permanently bonds tiny tungsten carbide particles to each blade. "GRIT-EDGE" blades are inherently safer than blades with conventional teeth. "GRIT-EDGE" blades cut almost everything, including things ordinary blades can't touch. They're designed to cut extremely hard or abrasive material. And they last up to ten times longer.

They can cut glass, cement-asbestos, tile, fiber glass and the hardest metals; make smoother cuts in veneers and laminates; help you do jobs you couldn't try before.

In fact, a low-cost "GRIT-EDGE" blade can do jobs that used to take expensive industrial cutting tools. See the "GRIT-EDGE" blades at your local hardware dealer's now.

Remington® DU PONT

"Remington" and "GRIT-EDGE" are trademarks of Remington Arms Company, Inc. The Du Pont oval is a trademark of E. I. du Pont de Nemours & Co. (Inc.). Made in U. S. A., U. S. Patent 3,023,490. Applications Pending.

MAKE EXTRA \$\$\$ EVERY DAY!

Get into the big, year-round
EXTRA MONEY BUSINESS
that's EASY to learn—EASY to
do—and EASY ON YOU!

Be a LOCKSMITH!

You Can Make Up to \$10 an Hour—even while learning!
Train FAST at Home!

Never before have money-making opportunities been so great for qualified Locksmiths. Now lucrative regular lock and key business has multiplied a thousandfold as millions seek more protection against zooming crime. Yet there's only one Locksmith for every 17,000 people!

Start Collecting CASH PROFITS Right Away

You're "in business" ready to earn \$5 to \$10 an hour a few days after you begin Belsaw's shortcut training. Take advantage of today's unprecedented opportunities in Locksmithing for year-round EXTRA INCOME in spare-time—or fulltime in a high-profit business of your own. Hundreds we've trained have done it. So can YOU! All tools plus professional Key Machine given you with course. These plus practice materials and equipment,

**THIS PRO
KEY MACHINE—
YOURS TO KEEP—**

can add \$25 to \$40 a week to your income . . . and it won't cost you a cent with your training.

**ALL TOOLS, MATERIALS AND PRACTICE
EQUIPMENT COME TO YOU WITH YOUR COURSE.**



FREE



Tells how to make money in Locksmithing almost from the start!

"War injuries left me badly handicapped, but now I'm a financial success as a Locksmith, thanks to your training. Besides, the work is fascinating. If I can do it anybody can." — Glen Johnson, Larned, Kan.



plus simple, illustrated lessons, plus expert supervision, plus business-building guidance will enable you to KEEP THE MONEY COMING IN! Ideal for retirement—good jobs, too.

SEND FOR EXCITING FACTS—No Obligation

Discover what's in Locksmithing for you—how Belsaw's master-locksmith-approved training can give you the skill you can depend on to EARN MORE—ENJOY LIFE MORE. Just fill in and mail the coupon below to receive full information by return mail. Do it TODAY!

BELSAW INSTITUTE, 102P Field Bldg., Kansas City, Mo. 64111
Accredited Member National Home Study Council
Approved for all Veteran Training

MAIL THIS COUPON—NO SALESMAN WILL CALL

**BELSAW INSTITUTE, 102P Field Bldg.
Kansas City, Missouri 64111**

Please send me free of cost or obligation your publication "Keys to Your Future" on how Belsaw can quickly train me to make money in Locksmithing and how all tools and Key Machine are given me to keep.

Name _____

Address _____

City _____ State _____ Zip _____

Check here if eligible Veteran.

ALL OUTDOORS

By GEORGE REIGER



NOT ONLY DO ATVs GO EVERYWHERE in the outback, but now they're planning to stay awhile. The Attex camper trailer tows behind any all-terrain vehicle and sleeps two or four (depending on which publicity release you've read) when you get where you're going. Its real advantage is in the additional space provided for all the gear you've not been able to cram into your ATV's limited space. Suggested retail price: \$595

REFRIGERATION is a hot subject these summer days. Camping expert Lee Oertle reports there's a new safety device designed for motor campers who like to run around with their gas refrigerators on. Refrig-Alarm, available from Travel Aids Manufacturing, Box 47, Pomona, Calif., provides a heat sensor on the box and a dash-mounted indicator to alert you if your reefer is not working.

Another interesting development in mobile cooling is Darwin, Inc.'s new battery-powered refrigerator. Rather than use a piston pump system, which generally means you must hermetically seal the entire unit (pump and motor) in its own metal container in order to prevent Freon loss, the Darwin system uses a diaphragm-type pump which merely confines the refrigerant to one side of an impervious diaphragm. The freezing coils are surrounded by a solution with the lowest possible melting point in a sealed plate. Coolness is retained for long periods. The Darwin system operates one hour on to eight off, so battery drain is minimal and the 1 to 4.5-cu.-ft.-capacity units thus represent a big breakthrough for battery-powered refrigerators for motor homes and boats.

Footnote: To practice what he preaches, Lee Oertle, regular contributor to *PM's* camping pages, recently opened his own

(Please turn to page 40)



PIGGYBACK PENTHOUSE from Ford sleeps two adults, two children and comes with a stove, sink and dinette. Packed on Ford sedan or Thunderbird, this pop-top camper offers 6-foot-7 headroom raised



PRAIRIE SCHOONER APPEAL is part of Thermo's new tent for pickup trucks. The 6-foot-high, \$149.95 tent uses fiberglass ribs and aluminum canopy poles to provide strength while underway at moderate speeds



"Changed My Whole Life!"

Says WM. A. TARNELLI, SR., Ossining, N.Y.
"I was a postal clerk, but I soon left the postal service to devote fulltime to Locksmithing. I now have my own shop in the main section of Ossining with plenty of work."



Be a LOCKSMITH

Train at HOME—Earn While You Learn. Add 50%-100% to YOUR INCOME with easy spare time earnings. Cash in on the nation-wide shortage—trained locksmiths in great demand! Quickly step into a big pay opportunity job or start a high-profit shop of your own.

Earn Extra Money RIGHT AWAY! All Master Locksmiths Special Tools, Equipment and Supplies Furnished FREE for use with course.

Age, education, minor physical handicaps don't matter in this growing trade. You can quickly qualify as a skilled locksmith. It's like a fascinating hobby. Study at home as little as one hour a week. Gain practical experience through complete well-illustrated lessons. Do real jobs on car locks, house locks, padlocks and safe locks, under the guidance of experts. FREE Illustrated Book, write now.

LOCKSMITHING INSTITUTE,

(Div. of Technical Home Study School)

Dept. 1110-081 • Little Falls, New Jersey 07424

MAIL
COUPON
for FREE
ILLUSTRATED
BOOK

For a future as your own boss or in a high-pay job, write now for FREE Illustrated Book. Only school of its kind. Licensed by State of New Jersey. Approved for Veterans.

Accredited, Nat'l Home Study Council.

MAIL COUPON NOW

LOCKSMITHING INSTITUTE, Dept. 1110-081
Little Falls, New Jersey 07424

Please send FREE Illustrated Book—"Your Big Opportunities in Locksmithing," complete Equipment folder and sample lesson pages—FREE of all obligation—(no salesman will call).

Name _____

Address _____

City _____

State _____

Zip _____

THE NEW FOURWAY HEAVY-DUTY COMPLETE PROFESSIONAL ARC WELDER SET

Just \$24.95 includes welder in heavy-duty metal cabinet, mask, cables, ground clamp, combination carbon arc torch & rod holder, welding instruction manual . . . and \$4.95 foot pedal control at no additional cost plus leather palmed welder's gloves.

WELD, BRAZE, SOLDER, CUT NEARLY ANY METAL INCLUDING ALUMINUM.

You can pay more—pay less—you won't find an arc welder value better than this—more complete than this. Simple instructions to make or repair countless items including furniture, toys, auto bodies, fenders, trailers, boats, farm equipment, tools. Operates on 110 v. 30A for pennies. You can REGULATE HEAT FOR EACH JOB through our Adjustable Twin Carbon Arc Torch—eliminates changing cables. Produces 11,000 degrees heat without gas torches; with no tanks to buy or refill.

LIFETIME GUARANTEE

Simply return prepaid for any defect—we repair and reship absolutely free.

Order Today on Money-back trial. Send only \$3.00 and pay \$21.95 C.O.D. plus delivery and C.O.D. charges or send \$24.95 for postpaid shipment anywhere in Continental U.S.A. If not completely satisfied return in 10 days and we will refund complete purchase price. Illinois residents add 5% sales tax.

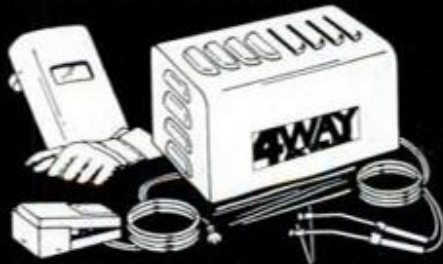

FOUR-WAY WELDER COMPANY
1810 S. Federal St., Dept. PM81, Chicago, Ill. 60616
RUSH ME MY FOURWAY COMPLETE
ARC-WELDER SET

NAME _____

ADDRESS _____

CITY _____

STATE _____

ZIP _____

Enclosed is \$3.00, I will pay \$21.95 plus C.O.D. and delivery charges upon receipt.

Enclosed is \$24.95; ship my Fourway postpaid.



This point lets you bore holes up to 1 1/2" with small electric drill

IT'S HOLLOW GROUND to bore cleaner, faster at any angle

Now step-up the boring range of your small electric drill or drill press to 1 1/2" with Irwin Speedbor "88" wood bits. 1/4" shank chucks perfectly. No wobble. No run-out. Sharp cutting edges on exclusive hollow ground point start holes faster, let spade type cutters bore up to 5 times faster. You get clean, accurate holes in any wood at any cutting angle.

Each Irwin Speedbor "88" forged from single bar of finest tool steel. Each machine-sharpened and heat tempered full length for long life. 17 sizes, 1/4" to 1 1/2", and sets. See your Irwin hardware or building supply dealer soon.

\$.90 each **\$1.00 each** **\$1.50 each**
 1/4" to 3/8" 5/8" to 1" 1 1/8" to 1 1/2"

IRWIN SPEEDBOR "88" WOOD BITS

at Wilmington, Ohio 45177, since 1885

Build The BIG ONE For BIG FUN NEW VT-7 Super Bronc



Check these leadership features carefully! 7 h.p., 4-cycle engine plus automatic load-sensing torque converter assures all-terrain, all-season performance. Big 21x21x8 super-trac flotation rear tire puts the power to work on sand, snow, slope. Shock mounted 18x8.50x8 front tire provides easy handling and ride. 2-man cushion seat on heavy-duty shocks and 2 pairs of folding foot pegs. Many accessories. Kits from \$169.95. VT-7 kit, \$269.95. Free literature.

HEALD, Inc. Dept. PM-8, P.O. Box 1148 Benton Harbor, Mich. 49022

Start your own part or full time

MONEY-MAKING BUSINESS

Every home and building offers you potential income. Clean wall-to-wall carpeting, upholstery and walls on customers' premises with Von Schrader professional cleaning equipment. Work part time or full time. No fees, no contracts to sign. You own your equipment. Proven reliable and profitable for thousands of users. Enjoy a steady, growing business with Von Schrader Detergers—and we'll help you every step of the way. Write today for full information.



VON SCHRADER CO., 1082 Racine, Wis. 53403

ALL OUTDOORS

(Continued from page 38)

Beaver Canyon Campground in Beaver, Utah. Readers are invited to drop by and express opinions—or complaints. ★★★

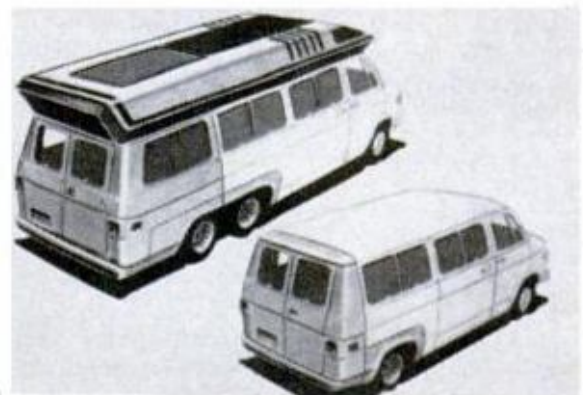

CHEVY RV DREAM MACHINES, previewed at recent recreational vehicle symposium in Mesa, Ariz., are new concepts for camping vehicles based on current stock vehicles (Chevy makes no recreational bodies now). Company's interest in living, not just traveling, outdoors, is expected to spur improvements in camper design. Basic Chevy van is shown (from top) piggybacked, pop-topped, capsulated and enlarged

POPULAR MECHANICS

Find the answers to 1001 workshop questions

quickly, easily with the POPULAR MECHANICS MASTER SHOP GUIDE

24 hangup boards, coated with wipe-clean plastic keep vital how-to-do-it information always at your finger tips.

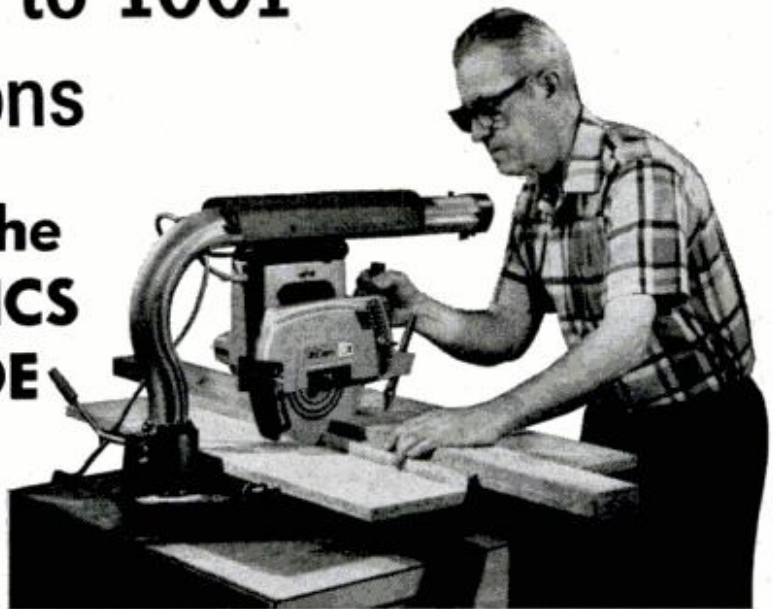

Here in an easy to use, last-forever format are the answers to everything you'll ever need to know about: nails, screws, bolts, wall-fasteners, drills, abrasives, lumber, hardwoods, moldings, plywood, hardboard, gypsum, adhesives, plumbing, electrical work, floor and wall tile, glass. Facts on remodeling measurements, gutters, concrete, garden chemicals. Plus—all on one board—a ruler, protractor, 45-degree triangle, and compass for accurate circles! You'll reach for the MASTER SHOP GUIDE for every job you tackle!

What nail should you use? How many pounds will a 1/4-inch toggle bolt hold? How can you save money ordering lumber? What size quarter-rounds are available? How do you bleach close-grained hardwoods? What glue is best?

Repairs, too! Illustrations on plumbing, electrical, floor or wall tile, plastic laminates, glass, remodeling. All the basic dimensions you'll need!

By the editors of *Popular Mechanics*—order yours now—you'll use it the rest of your life!

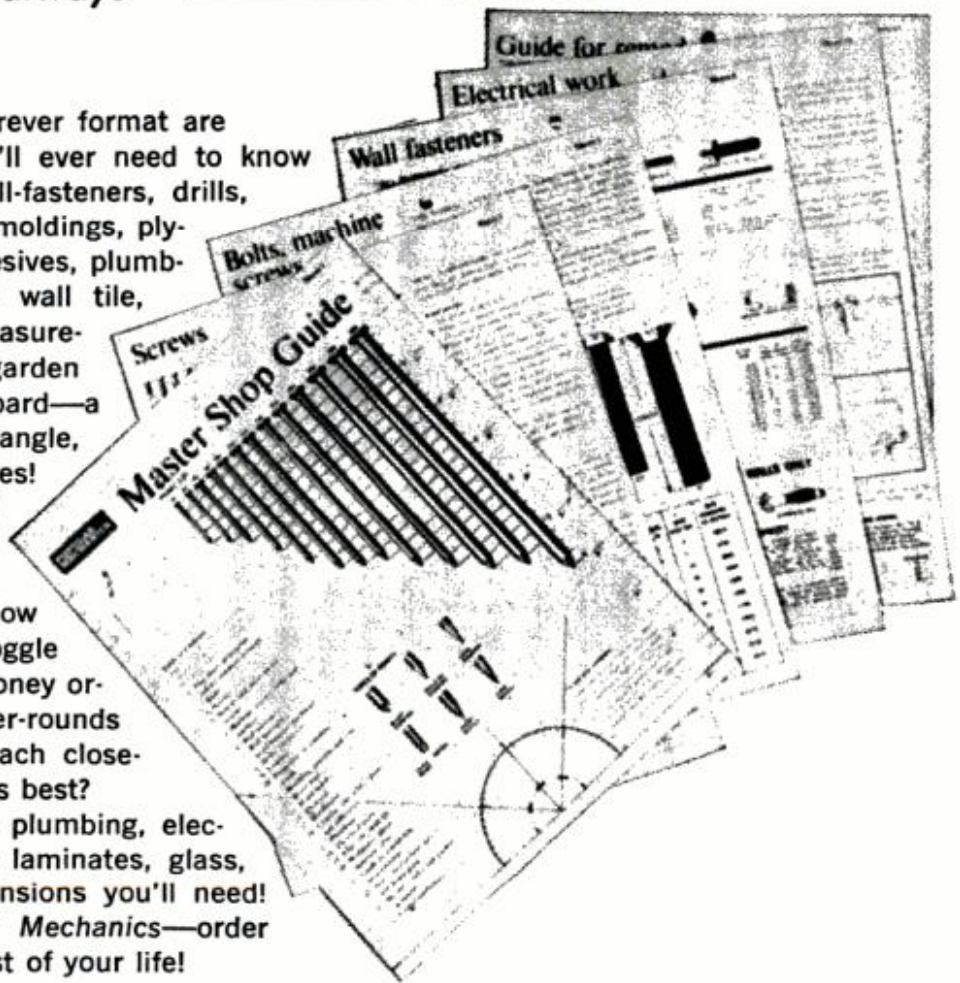

Popular Mechanics, Dept. SG8,
224 W. 57th St.,
New York, N.Y. 10019

Rush me _____ sets of the
MASTER SHOP GUIDE.

I enclose check or money order
for \$3.95 for each set ordered.

NAME _____

ADDRESS _____

CITY _____ STATE _____ ZIP _____

AUGUST 1971

41

DETROIT LISTENING POST

BY ROBERT LUND

TAKING IT ON THE CHIN for years, Detroit has been charged with too much sameness and copying, and not enough innovation and imagination. The criticism hasn't been entirely undeserved. If you thought all cars hatched out of the same egg up to now, you're likely to think that even more in the next few years. But blame Uncle this time. The government's gradually putting all carmakers on the same design cycle, so that when one brings out a new automobile, everybody follows suit. The people who write Detroit's rules probably aren't aware they're stifling initiative, but here's what's happening:

Up to now, if A came up with a new idea one year, the next time competing cars B, C and D were due to be reworked, they'd try to top A's original. It didn't always come off and the "improvements" frequently flopped. But it was a game of one-up; everybody tried. In issuing new regulations, the government doesn't consider when a particular make is scheduled for a major change. New standards are keyed to the calendar and clock: this is the rule and everybody has to fall in line.

The car companies say they can't afford to do a major overhaul every time the government blows the whistle, so they're trying to work out an agreement with Washington whereby new regulations will be pegged to a regular timetable. But the government can't tell Chrysler to do something this year, Ford next year and GM and American Motors the year after that. All the companies will have to be on the same timetable, the same design cycle. This doesn't mean the end of all competition, but it does mean less rivalry, less trying to top the other guy.

GM'S BEEN WORKING UP some preliminary numbers on what would be involved in putting a Wankel into production. The numbers are just scratch-pad estimates and GM's free to back off on the project at any time. But it's obvious from the size of the figures—over a million—that GM's thinking of the Wankel for more than one line of cars.

AT LEAST ONE AUTOMAKER is giving serious thought to offering a no-options, take-it-or-leave-it car in a last-ditch effort to keep a low-price car in the catalog in the face of rising costs. The company's been talking in terms of a small, six-cylinder job, possibly with an automatic transmis-

sion and radio as standard gear. The customer might have a choice of a couple different exterior colors, but nothing else. The target price is \$50 either side of \$2000.

LIMIT TOP SPEED TO 85 OR 90? The government's been making noise about this, but Detroit may beat Washington to the draw—do it voluntarily. Both Ford and GM have considered such a move. If it's inevitable, why not be first and then claim credit for having pioneered the idea? Make points on a fight you're going to lose anyway. Ford's usually more alert than GM to seizing a negative situation and turning it into a victory, so we'd bet on Ford making the first move.

REMEMBER BILL NEWBERG? He's the one-time mechanic who worked his way up to become president of Chrysler, only to get the bounce after a couple months on the job in a shake-out of management. That was 10 years ago. Newberg's back in the business as chairman of the board of a new company, Astro Programs, franchising tune-up centers. He's had his fingers in a lot of business pies since leaving Chrysler, so he doesn't have to do the nine-to-five to earn a living.

"What brought you back to the car business?" we asked.

"The same thing that led old Mr. Ford to build Henry Ford Hospital," he replied. "He thought the doctors overcharged him because his name was Ford. I had some trouble with the oil cooler on my power steering. A bracket had to be replaced. While waiting for the car, I looked up in the flat rate manual what the company (meaning the auto manufacturer) would pay for the job if the car was under warranty. It was three-tenths of an hour—18 minutes. You know what the dealer charged me? Ninety minutes labor time. Five times the book charge. That's murder. I think the dealers need some new competition."

Newberg no longer drives Chrysler cars. His current car is a GM product.

FORD MAY HAVE TROUBLE sticking to its promise to de-emphasize styling on future cars. The company has already worked up major changes for '73 and '74 versions of cars that will be new this year. But it's doing this by choice. Torino,

(Please turn to page 44)

This will be your place.
Not another cabin for miles around.
Peaceful. Quiet. To hunt, fish or just relax.
Especially at the end of the day...with
the quietly milder taste of a Raleigh.

Spend a milder moment with Raleigh.

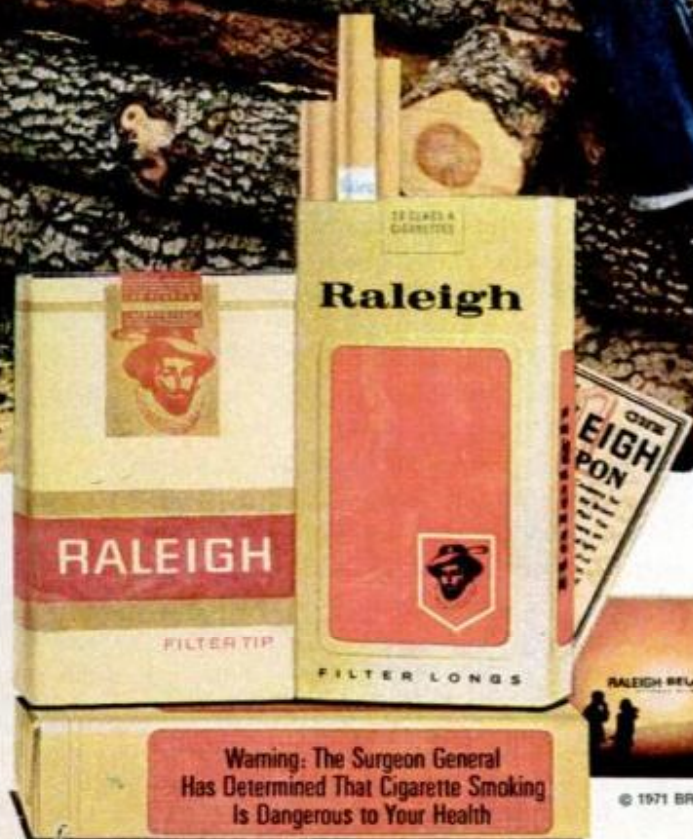
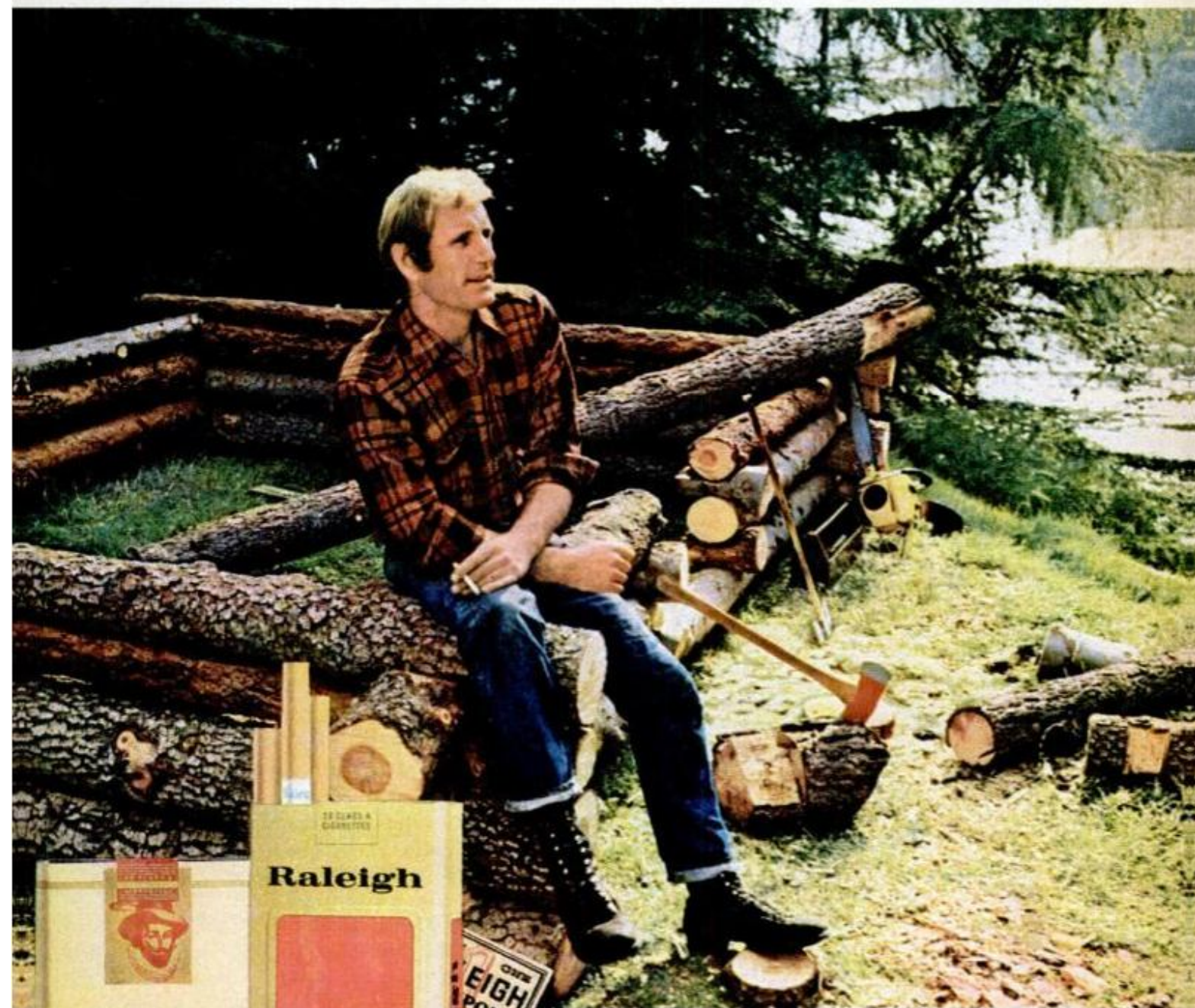

Coupons, too. The valuable extra
on Raleigh Filter Kings and Filter Longs.
Free Gift Catalog. Write Box 12, Louisville, Ky. 40201

Warning: The Surgeon General
Has Determined That Cigarette Smoking
Is Dangerous to Your Health

© 1971 BROWN & WILLIAMSON TOBACCO CORP.

Filter Kings, 17 mg. "tar," 1.2 mg. nicotine; Longs, 18 mg. "tar," 1.2 mg. nicotine, av. per cigarette, FTC Report Nov. '70

Материал защищённый авторским правом

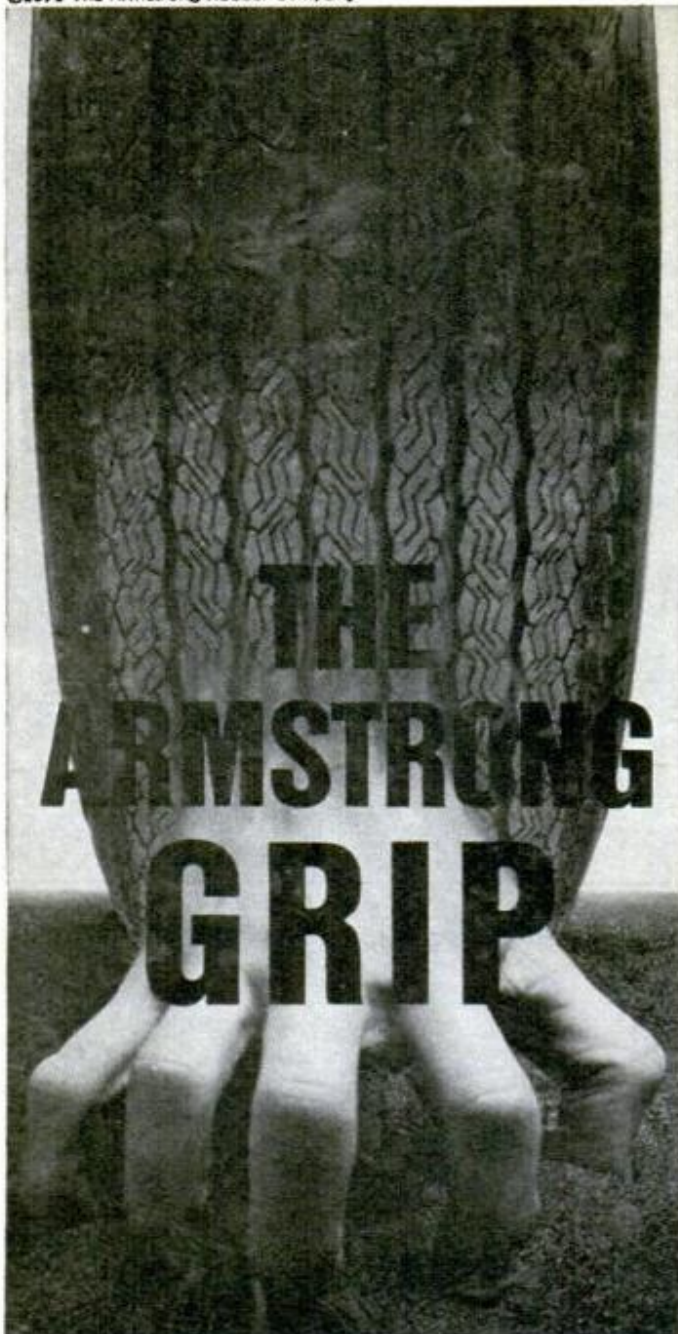

ONLY ARMSTRONG TIRES HAVE IT.

The grip that's grooved to hold the road in any weather or road condition, grab strong, grip strong. The grip you get with our great line of Armstrong Tires. We pioneered grip even before we introduced fiber glass tires. And we never stop trying to improve it. The Armstrong Grip. This year it's stronger than ever.

ARMSTRONG TIRES
FIRST IN FIBER GLASS

DETROIT LISTENING POST

(Continued from page 42)

Montego and T-bird, all new this fall, will have to be reworked in the front for 1973 to comply with the government standard on bumpers; then again for '74 models, Ford expects, when the government announces the bumper standard for the following year.

DRIVERS IN SPRINGFIELD, MO., are being convinced in a dramatic way to buckle their seat belts. The Springfield Police Safety Unit is giving rides on a roller-coaster device that stops short at 7 mph. People who've ridden the little cart, which is set up at local shopping centers, say they get a lasting impression of how belts prevent injury—and even at 7 mph!

WHAT HAPPENS TO CAR DESIGNERS with all the talk about de-emphasizing styling? In a word, nothing. There have been no mass layoffs of designers since Chrysler pink-slipped 40 of its staffers 18 months ago. But the nature of the job is changing. The goal used to be to make the part or machine look different without necessarily improving it; now the target is to make it safer, easier to repair or replace or less expensive to turn out. Same people are on the job, but they're less concerned with trifles, more concerned with building 'em better.

THE 1971 WORLD CAR CATALOG from Herald Books is a winner again this year. The 9½x11-inch volume, with its specs and pictures of over 800 models from 23 countries, is a must for car buffs. In addition to showing every 1971 production car in the world, the \$17.50 book contains useful indices and a 100-page introductory section on the auto industry, racing and prototype cars. Look for it at bookstores or write Herald Books at Box 63, Bronxville, N.Y. 10708.

LINK SPEED TO BRAKE EFFICIENCY? One of the supplier companies to auto factories is working on this idea. The device wouldn't replace the brakes. It'd supplement them. If there was a loss of braking power, the supply of fuel to the cylinders would be reduced accordingly, slowing the vehicle. Slowing the car would signal the driver to have his brakes looked at. There will be no way of bypassing the device—that is, of increasing speed of the vehicle beyond the capability of the brakes to bring the car to a safe stop. It may sound like a far-out idea, but that was said of a lot of other now-commonplace gear when it was under development. ★★★



CARPENTERS & BUILDERS GUIDES

Four all-inclusive volumes provide latest inside trade information on modern construction. Vol. 1—Tools, Steel Square, Joinery. Vol. 2—Builders Math, Drawings, Specs. Vol. 3—Layouts, Foundations, Framing. Vol. 4—Millwork, Power Tools, Windows, Doors, Roofing, Flooring. Most practical guide available. Thousands of diagrams, charts, graphs and photos. 1612 pages. 4-Vol. Set \$18.50

Circle 169 in Coupon



MACHINISTS LIBRARY

Three volumes of ready reference on all the latest shop practices for machinists and toolmakers. Vol. 1—Practical Fundamentals of Basic Machine Shop Operations. Vol. 2—Setup and Operation of all the widely used, important shop machines. Vol. 3—Toolmakers Handybook with down-to-earth data on layouts, specifications, jigs and fixtures, gear forming, cams, etc. Illus. 1218 pages. 3-Vol. Set \$16.95

Circle 174 in Coupon

Plumbers and Pipefitters Guides

3 vols. of ready reference for plumbers, pipe & gas fitters, sheet metal workers. Explains all principles of modern plumbing. Gives practical inside trade information. 540 illustrations. 928 pages. 3-Vol. Set \$12.50

Circle 155 in Coupon

Masons and Builders Guides

4 practical volumes for bricklayers, masons, cement workers, plasterers. Includes shortcuts and job estimating. Covers all the latest practices and methods. 2000 illustrations. 1488 pages. 4-Vol. Set \$14.95

Circle 876 in Coupon

Diesel Engine Manual

Complete practical guide to modern Diesel engines. Explains principles, operation, and maintenance. Covers starting and scavenging air compressors; fuel injection; valve timing; air starting and fuel valves. Illus. 544 pages. \$6.95

Circle 824 in Coupon



put know-how
in your hands

AUDEL practical guides



Home Refrigeration & Air Conditioning

Complete and practical information on installing, servicing, and maintaining gas and electric refrigerators and all types of home and auto air conditioners, water coolers, freezers. Many tables of useful data. Illustrated. 576 pages. \$6.95

Circle 133 in Coupon

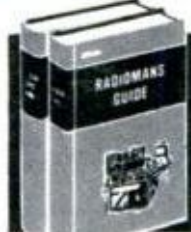

TV-Radio Library

Two vols. of practical and theoretical knowledge including basic electronics, basic radio receiver repair. Covers entire subject of television, both black & white and color, from theory through practical repair know-how. Completely illustrated. 1056 pages. 2-Vol. Set \$11.50

Circle 161 in Coupon



Home Appliance Servicing

How to test, service, and repair all modern gas & electric appliances such as refrigerators, washers, dryers, ranges, irons, hot water heaters. Gives up-to-date methods, wiring diagrams, complete servicing data. Fully illus. 608 pages. \$6.95

Circle 816 in Coupon



Auto Engine Tune-up

Complete tune-up procedures for all types of auto engines. Full adjustment data for carburetors, ignition, valves, etc. For the car owner who wants to do his own tune-up, as well as for the experienced mechanic. Fully illus. 376 pages. \$5.95

Circle 181 in Coupon

Motorcycle Service Manuals

Complete service data from brake adjustment to engine tear-down and reassembly.

Vol. 1. 2-Stroke Models. Covers over 75 popular models of 18 manufacturers. 208 pp. \$4.95

Circle 665 in Coupon

Vol. 2. 4-Stroke Models. Covers models of 16 manufacturers. 236 pages. \$4.95

Circle 666 in Coupon

Small Engines Service Manual

Shows how to repair almost any small engine used in mowers, tillers, karts, scooters, etc. Covers over 1000 models in 23 popular brands. Hundreds of illustrations. 328 pages. \$4.95

Circle 734 in Coupon



Outboard Motor Service Manuals

Full step-by-step know-how for repairing specific outboard motors in popular makes.

Vol. 1. Motors Under 30 HP. Coverage from 1960 to 1970. 31 makes. 220 pp. \$5.95

Circle 791 in Coupon

Vol. 2. Motors Over 30 HP. Coverage from 1955 to 1970. 15 makes. 260 pp. \$5.95

Circle 792 in Coupon

Snowmobile Service Manual

Updated to include nearly all 1969 and some 1970 models. Covers 47 popular makes. Includes comprehensive engine section. Fully illust. 246 pages. \$5.95

Circle 825 in Coupon

SEND NO MONEY—10-DAY FREE EXAMINATION

THEODORE AUDEL & CO.—Self Improvement Publishers Since 1879—
4300 W. 62nd Street, Indianapolis, Indiana 46268

Please mail me for 10 days' FREE EXAMINATION the books circled at right. I agree to mail \$3 in 10 days for each book or set ordered, and to mail 1/2 of the total purchase price 30 days later, with the balance plus shipping costs to be mailed within another 30 days. If I am not completely satisfied I may return the books for refund.

SAVE SHIPPING COSTS—Check here if you enclose full payment with order (plus sales tax, if any). We pay postage charges. You have same return privilege.

Name _____
Address _____
City _____ State _____ Zip _____

P-081	015	161	666
	016	169	734
	024	174	791
	076	181	792
	133	665	825
	155		

I have bought AuDEL books before

MONEY-BACK GUARANTEE

SEND NO MONEY! We'll send you any AuDEL Guides for 10-day FREE examination. If you decide to keep them, use our easy-pay plan. Absolute no-risk MONEY-BACK GUARANTEE!



THEODORE AUDEL & CO.
division of HOWARD W. SAMS & CO., INC.
Indianapolis, Ind. 46268

КАССИДИ

THE BEATLES



Машинный моторским при...

We'll make you expert at whatever turns you on.

Today's Army can make you an expert at whatever you like best. And do best.

We can teach you all there is to know about tearing down an engine, fixing a television set, forecasting the weather.

We have more horsepower than the Motor City. Cameras that can take a portrait of a bird a half-mile away. Electronic equipment so new it hasn't even been named yet.

With more than 300 job-training courses to choose from, today's Army can take that favorite talent of yours and turn it into a rewarding lifetime career. And if you qualify, we'll guarantee your choice of training in writing. Before you enlist.

If you'd like to learn more about the opportunities to learn a skill in today's Army, see your nearest Army representative. Or just send the coupon.

Today's Army wants to join you.

Army Opportunities Dept 200, Hampton, Va. 23369	Date _____ 2PM 8 71
I'd like to know more about the job training courses in today's Army. Send me your free book.	
Name _____	Date of Birth _____
Address _____	
City _____	County _____
State _____	Zip _____ Phone _____
Education _____	

START A MONEY-MAKING BUSINESS FOR LESS THAN \$50!

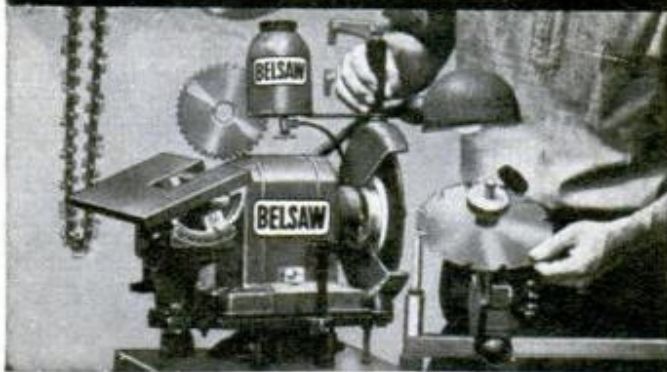

You can have your own lifetime business right at home... work in spare time... and make up to \$200 a month CASH! My FREE PLAN gives you all the facts: How to start, how to grow. You don't need previous experience. You don't have to sell. I'll even finance you. People bring you the work and pay cash. Over 90¢ of every dollar you collect is clear cash profit. And you work when you want to. Let me prove you can't find a more certain, lower cost, higher paying business of your own.

Just Mail Coupon—No Salesman Will Call

BELSAW SHARP-ALL CO., Stan Field, Pres.
712P Field Bldg., Kansas City, Mo. 64111

Name _____

Address _____

City _____ State _____ Zip _____

FREE
BOOK

"POP" RIVET TOOL

**MAKES
NUTS & BOLTS
OLD FASHIONED!**

Now fasten things in seconds. Permanently. From one side of the work!

- 1 Insert "POP" Rivet in holes
- 2 Pump Rivetool handle
- 3 "POP" it's fastened forever!

Kit includes tool and assorted rivets. At hardware dealers.



USM Corporation
Consumer Products Division

NEWS BRIEFS



Mathless jogging

You don't calculate, you just jog on the "Aerobics Life Extender" which keeps track of your steps-per-minute rate and computes your aerobic points. The jogger, by Scientific Health Instruments, does its calculations based on the Aerobics exercise program.



Foam overcoat

In areas where the temperature can quickly drop to freezing or near-freezing at night—even in summer—vegetable growers have often lost young crops to frost. Now Department of Agriculture researchers have developed a biodegradable foam that, sprayed on the shoots, protects them for 16 hours.

POPULAR MECHANICS

Материал, защищенный авторским правом

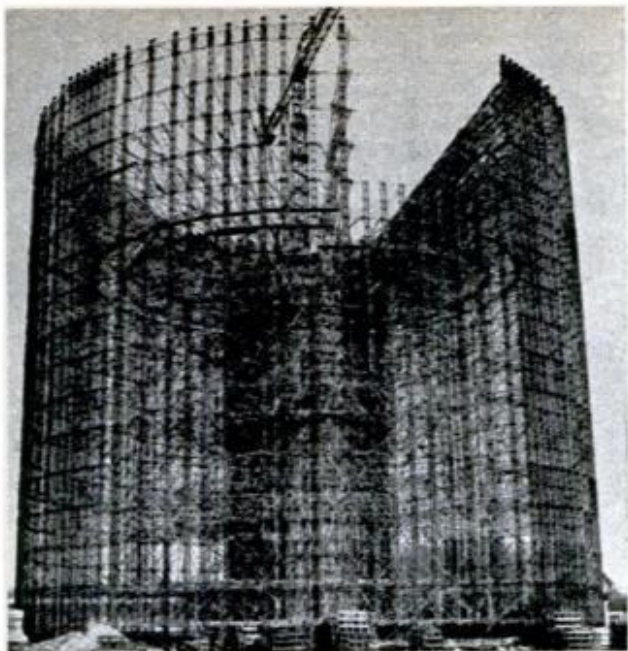

Big bucket

This lacy, 140-foot-high framework will, when finished, be a 13,000-ton water tower with a capacity of 1,700,000 gallons. It's being built in Denmark.



Quick patch for paving

Michigan Highway Dept. crews now repair a damaged section of paving by drilling away the broken area and lowering a precast slab into place. The process takes about 2 hours.



Horses on the Autobahn

Horse-drawn wagons now appear on the Frankfurt-Dresden Autobahn. So few cars used the portion of the high-speed highway in East Germany that half was closed to cars.

How to make the freshest filter cigarettes ever for less than

20¢ a pack*



1. The Laredo Filter Blend Kit contains a can of fresh vacuum-packed tobacco, a cigarette-making machine and the makings for your first five packs. Cost: less than \$2.*



2. Place one of the paper tubes over the metal spout of the cigarette-making machine. The machine is simple and easy to use. Yet, it's so sturdy, it's guaranteed for two years.



3. Next, fill the large slot with Laredo tobacco, then drop a filter in the small slot. Now you're all ready to make the freshest tasting filter cigarette you've ever smoked.



4. Push the lever forward, pull back, push again and there you have a filter cigarette that looks factory-made, tastes factory-fresh...in just seconds. Easy, wasn't it?

Refills contain filters, paper tubes, carry-around packs... and enough vacuum-fresh Laredo tobacco to make five more packs. The cost: under \$1.* Less than 20¢ a pack!*

* In most areas of the country—based on manufacturer's suggested retail price.

MENTHOL SMOKERS:
Make the freshest menthol filter cigarettes ever for less than 20¢ a pack.*

LAREDO FILTER BLEND



Regular

Menthol

© 1971 BROWN & WILLIAMSON TOBACCO CORP.

Материал, защищенный авторским правом

BELSAW PLANER • MOLDER • SAW



30-DAY FREE Trial!



Now you can use this ONE power-feed shop to turn rough lumber into moldings, trim, flooring, furniture... ALL popular patterns. RIP... PLANE... MOLD—separately or all at once with a single motor. Free 30-Day Trial. Low Cost—only \$35 down.

Send Postcard Today — No Salesman Will Call.

BELSAW POWER TOOLS, 902-P, Field Bldg., Kansas City, Mo. 64111

REFINISH MARRED OR GOUGED FURNITURE LIKE NEW.

Fill in wood gouges, nicks and scratches like professional carpenters do with GENUINE PLASTIC WOOD Cellulose Fiber Filler. Handles like putty, hardens like wood. Plane it, sandpaper it, varnish it, paint it for true, professional finish. GENUINE PLASTIC WOOD comes in walnut, oak, mahogany or natural color. At hardware stores and supermarkets.

GENUINE **PLASTIC WOOD**

CELLULOSE FIBER FILLER



New Discovery Makes Stuck Drawer Slide At Fingertip Touch—Without Oil!

A new spray lubricant so clean it won't soil linen or clothes in drawer.

One Sw-o-o-sh! And tight stuck drawers, windows and zippers slide easy when you spray new 3-IN-ONE DRY-

LUBE. Eliminates friction without oil. The secret is a new spray lubricant so clean it won't soil your best clothes. Get 3-IN-ONE DRY-LUBE at all hardware outlets.

3-IN-ONE[®]
DRY LUBE



DOUBLE YOUR INCOME

MAKE CUSTOM ENGRAVED SIGNS AT HOME, IN YOUR SPARE TIME

Anyone can make professional engraved signs in minutes. Scott engraved signs have a markup of up to 500%. Work as little as 2 hours a day and earn up to \$150 a week extra. Complete with accessories—everything you need to start your own engraving shop—at about half the cost of competitive engravers. Write for free catalog, Dept. M70

SCOTT MACHINE DEVELOPMENT CORP.
215 Prospect Ave.
P. O. Box 217
Walton, New York 13856



Don't change your address without notifying us!

To insure uninterrupted service on your Popular Mechanics subscription, please notify us at least six weeks before you move.

1. Attach your address label from a recent issue in the space provided below... (If label not available, be sure to give us your old address, including Zip Code).
2. Print your name and new address below (be sure to include your Zip Code).

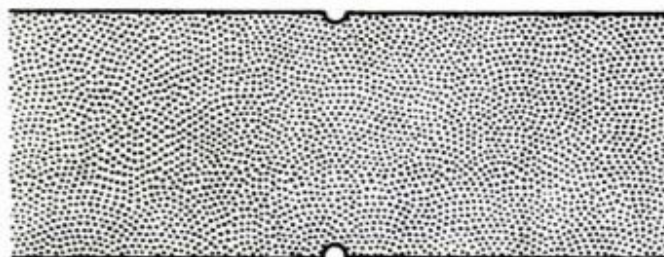

Mail entire notice to: **Subscription Service Dept.
Box No. 646
New York, N.Y. 10019**

Name _____ *Please Print*

New Address _____

City _____

State _____ Zip Code _____

POPULAR MECHANICS

THIS CAN BE YOUR "BIG BREAK"

if you're a man who's ever said...

**"I'm sick
and tired
of my Job!"**



Read here about the exciting, high-pay careers waiting in one of today's hottest growth fields—and how preparing for these great jobs can be easier than you might ever have imagined.

IT'S A SHAME to go on struggling along in the same old rut—while others around you move up to better jobs, better homes, better cars. Especially when it's now so easy for you to do something about it.

Just mail the coupon to the right and we'll send you, FREE, two books that have started thousands of men on the road to rewarding new careers. Careers they can be proud of. Careers where the work is exciting. And careers where they can earn the kind of money that many men only dream of.

Thousands of career opportunities like this exist right now in America's hottest growth industry—Electronics. It's an industry where you can take your pick of literally scores of different "glamor jobs"—in broadcasting, automation, the aerospace program, and many other areas. And it's an industry where, once you have some experience under your belt, you can earn up to \$5, \$6, \$7 an hour...\$200, \$225, \$250 a week...\$10,000, \$11,000, \$12,000 a year.

You don't need college training to break in. Our free books will show you how you can prepare right at home in your spare time. And they'll show you, too, how we can help you land the "dream job" of your choice.

Mail the postpaid reply card or coupon above today for two FREE books.

CIE Cleveland Institute of Electronics
1776 East 17th Street, Cleveland, Ohio 44114

Cleveland Institute of Electronics
1776 East 17th Street, Cleveland, Ohio 44114

Please send me 2 FREE books describing opportunities in Electronics and how to prepare for them.

Name _____
(Please Print)

Address _____

City _____ State _____

Zip _____ Age _____

Veterans & Servicemen: check here for G.I. Bill information

Accredited Member National Home Study Council

PM-56

Enjoy Independence



With A Sparetime
BUSINESS
OF YOUR OWN

Here's a proven, practical way to earn sparetime cash while you develop a money-making business of your own. Investment is small. There's no overhead, no stock to carry, no selling involved. Automatic Foley Saw Filer, easy to operate, files combination saws, hand, band and circular saws. No experience needed.

Earn \$3 to \$6 An Hour In Sparetime

Get started now and watch your business grow! Thousands are earning cash this easy way—many build a complete sharpening service with year around profits. You can, too, with the easy-to-follow Foley Plan—write us today!



FREE BOOKLET SHOWS HOW

Fact filled booklet tells you how to start a sparetime business; how to get new business. Rush coupon, get "Money Making Facts" and details on Easy Payment Plan. No salesman will call.

Foley Manufacturing Co.
816-1 Foley Bldg., Minneapolis, Minn. 55418

Send FREE BOOK—"Money Making Facts", and Time Payment Plan.

Name _____

Address _____

City _____ State _____ Zip Code _____



GUNK®

Spray
it on...
HOSE
IT OFF!

ENGINE-BRITE

Turns grease to soap that washes away! Cleans engines bilges, decks, concrete.

B-O-P

"BRUSH-ON-PARTS"
SMALL PARTS CLEANER

Includes parts basket.

At Hardware & Auto Stores

GUNK LABORATORIES, INC.
5829 W. 66TH, CHICAGO, ILL. 60638



RUSTED PARTS? REACH FOR

LIQUID WRENCH

LOOSENS RUSTED NUTS, BOLTS AND PARTS IN SECONDS!

L-S-C

LUBRICATES-STOP CORROSION
Removes moisture from electrical parts, motors, distributors, spark plugs.

At Hardware & Auto Stores

RADIATOR SPECIALTY CO., CHARLOTTE, N. C. 28201



NEWS BRIEFS



Pussy on a pedestal

All of a cat's comforts are grouped in this English invention. At the base are two un-tippable feeding bowls; a scratching pad is built into the upright section, and at top is a foam-padded bed.



Two-fisted auto driver

Confined to a chair, Kevin Whittaker, 7, invented a hand-powered car for himself. Aided by a group of students, he's had it patented, now looks for a manufacturer.

Pollution Fighters' Newsletter

Acre reclaimed for each one mined

Mined-out phosphate lands in Florida are producing crops of citrus fruit, vegetables, peanuts and timber as well as supporting catfish farms and providing public recreation, reports Continental Oil Co. Conoco's Agrico Chemical Div., near Tampa, mines the largest tract of phosphate-bearing land (65,000 acres) in the state, and follows a policy of reclaiming an acre for every acre mined.

Origins of pollution analyzed

Population size times per-capita consumption times environmental impact per unit of production equals level of pollution.

This formula, offered by Dr. Paul Ehrlich, Stanford University biologist, was used by three scientists to help analyze the origin of pollution. Dr. Barry Commoner, Washington University ecologist; Michael Corr, executive secretary of the American Assn. for the

Advancement of Science's Committee on Environmental Alterations, and Paul Stamler, a researcher for the committee, concluded: "The predominant factor in our industrial society's increased environmental degradation is neither population nor affluence, but the increasing environmental impact per unit of production due to technological changes."

Total-environment planning

Deer, muskrat, ferns and hickory trees in an industrial park? They're some of the tenants of Pureland, described as the nation's first ecologically planned and pollution controlled industrial community by the developers, State Mutual Life Assurance Co. of America and a Landtect Corp. subsidiary, LT Developers, Inc. Located on a 3000-acre site in Logan Township, N.J., Pureland features a central plant that offers assistance to the industries of the area that are unable to handle their own discharge of pollutants.

Do you know about some action being taken to fight pollution that we don't know about? In your community? On the job? Tell us about it. Write Environment Editor, Popular Mechanics, 224 W. 57th St., New York, N.Y. 10019. ★★

**New
Home Safe[™]
Contact
Cement
laminates
without danger
at half
the cost**

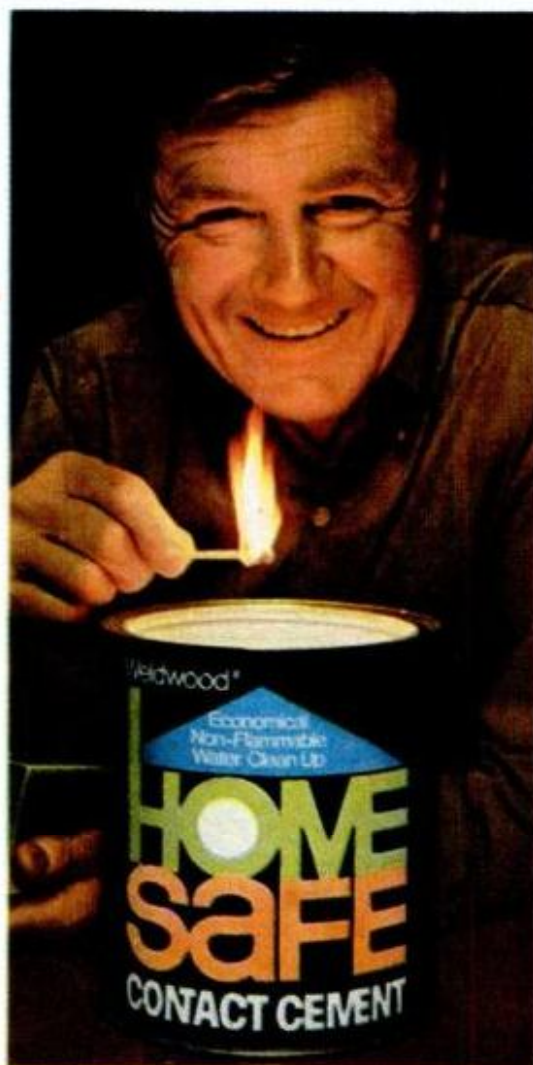

Now you can laminate with a non-flammable, non-sniff contact cement that really works. At half the cost.

Weldwood's new Home Safe contact cement forms as strong a bond as you could want, yet goes on at half the cost of any other contact cement.

New Home Safe contact cement. Safe. Economical. Water clean-up. And it works.

You'll find it at hardware, paint and building supply stores.

Weldwood[®]
PACKAGED PRODUCTS

U.S. Plywood-Champion Papers Inc.
2305 Superior Avenue
Kalamazoo, Michigan 49003

1/2 THE COST



Metal
rust
a
problem?

We've
got
the
product...



AVAILABLE WHERE PAINT IS SOLD

SAVOGRAN

Norwood, Massachusetts 02062

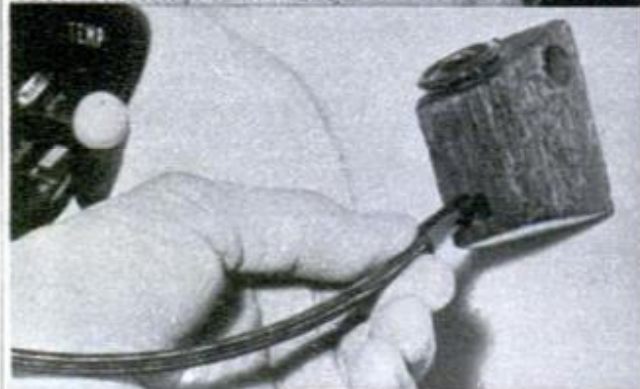
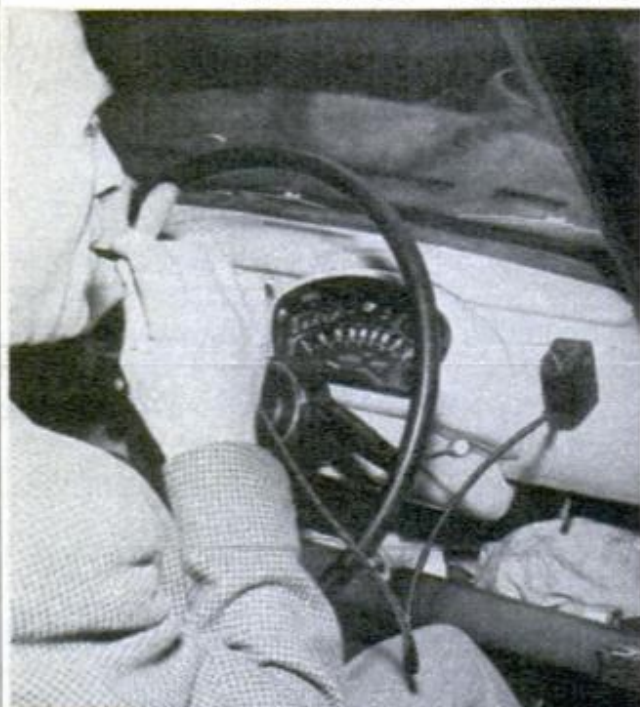

Pipe for drivers

Safer driving for pipe smokers is claimed with this magnet-mounted pipe that the driver smokes via a long tube. A vented cap on top keeps ashes from flying about. It's the invention of A. Savinelli, Turin, Italy.

EARN
**HIGH
WAGES**

as a **HEAVY
EQUIPMENT
OPERATOR**



Train your way to high pay in the booming construction industry! Learn the skills you need to qualify, by actual field training on machines like the ones used by the industry. Huge training grounds in North Carolina, a million dollars worth of school-owned diesel-engined machines, experienced instructors, full 220-hour and 440-hour courses. National, the original school of heavy equipment operation, is a recognized leader. Member American Road Builders Assn., Services and Supply Division. Associate Member A.G.C. Full-time Job Advisory and Counseling Director on staff. Accredited for VA benefits. For men ages 17 and up. Train Now-Pay Later plan . . . other payment plans also available. Write TODAY for FREE catalog and FREE copy of school newspaper reporting news of National School graduates. Accredited member National Association of Trade and Technical Schools.

NATIONAL SCHOOL Phone 704/392-1359
OF HEAVY EQUIPMENT OPERATION, Dept. D-53

P. O. Box 8529, Moores Chapel Road, Charlotte, N. C. 28201

Please send me FREE illustrated school catalog and complete information. I understand there's no obligation.

Name _____ Age _____

Address _____ Phone _____

City _____ State _____ Zip Code _____



Army joins Navy for test

A 152-mm gun-launcher and turret from a Sheridan tank have been mounted on the USS Flagstaff for test firings of an Army missile. The aim is to give small ships the firepower of a 6-inch gun without its weight.

The clean team

Take a typically dirty carburetor (like yours maybe) clean it...and get easier starting, smoother idling, no stalling, faster take-offs and better mileage.

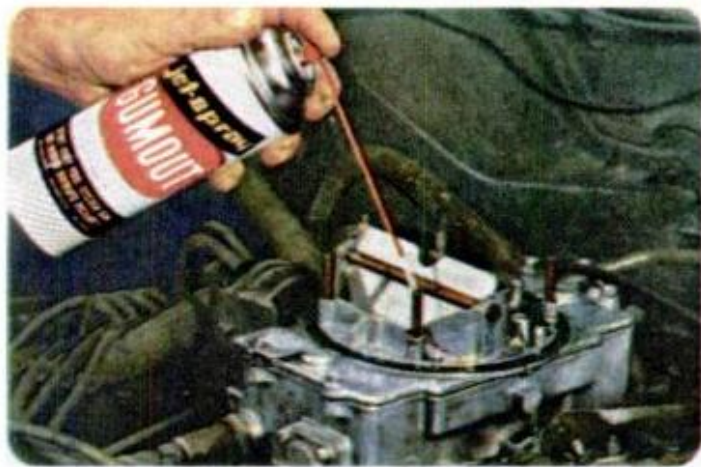

1 Clean it outside in seconds with Jet-Spray Gumout. Takes less than a minute to get this! Throat, choke valve, linkage, throttle plate—all clean like new. Grime and gum that can foul up the carburetor's job are gone. Completely.

2 Now pour a pint of Gumout in your gas tank. It does the same great job inside your carburetor as you drive. Cleans out all the jets and passages, removes the gum and varnish.

GUMOUT Division
PENNSYLVANIA REFINING COMPANY, Cleveland, Ohio 44104

Sears Kromedge® Saw Blades Stay Sharp Up to 5 Times Longer Than Synthetic Coated or Non-Coated Blades and...

From Start to Finish...

There's a Kromedge® Blade Specially Made to Cut...

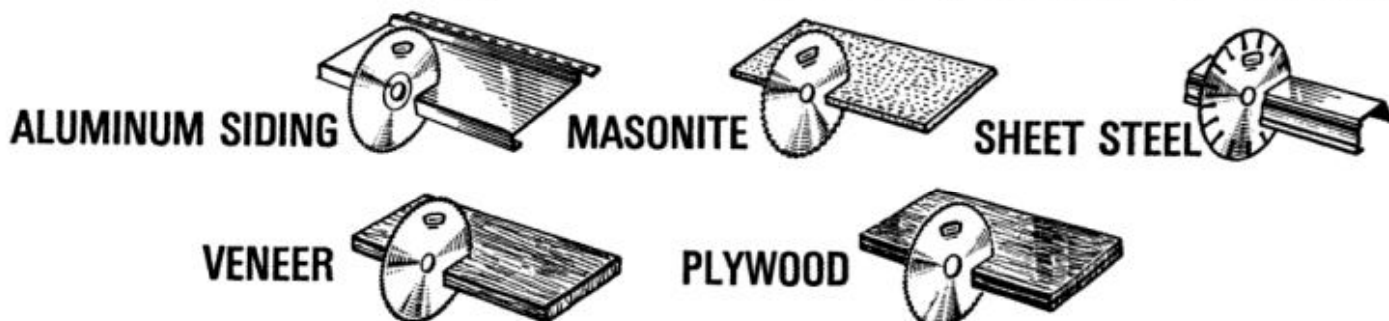

...Soft or Hard Wood, Metal or Plastic

You're Most Likely to Work With.

There's a Craftsman Blade For SABRE SAWS

CIRCULAR SAWS



BAND SAWS



RECIPROCATING SAWS



RADIAL SAWS

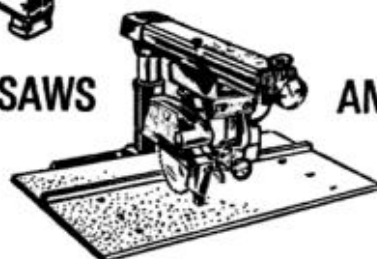

AND

BENCH SAWS



...Most Every Kind of Saw You're Likely to Use!

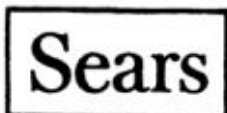

Craftsman Blades Available At Most
SEARS, ROEBUCK AND CO. Stores or in Your Catalog

CRAFTSMAN

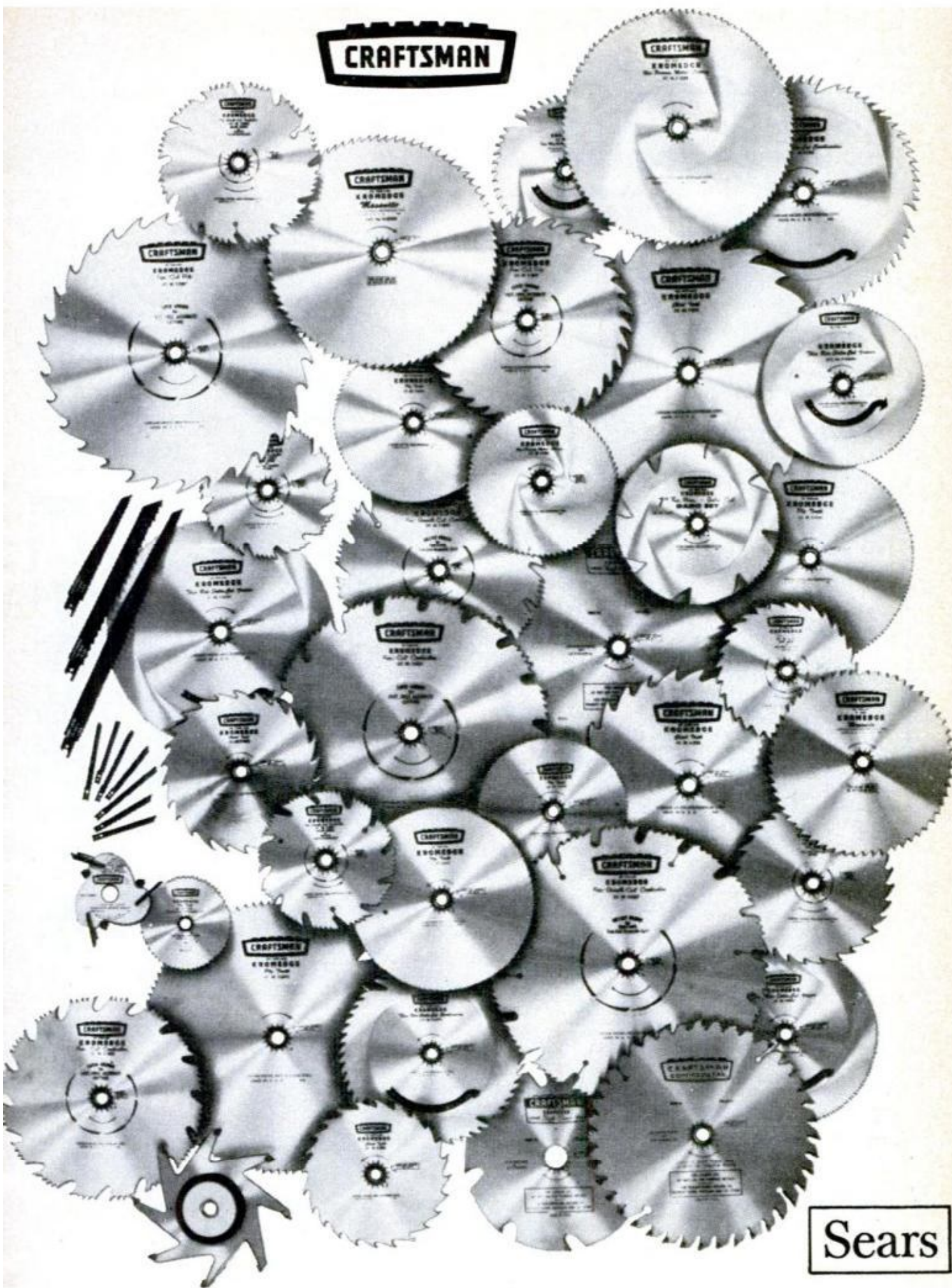

Sears

AUGUST 1971

52G

Материал, защищенный авторским правом

For true smoking enjoyment, the Great Yogi puffs wheat germ cigarettes while standing on his head.

Now everybody will puff wheat germ cigarettes while standing on their heads

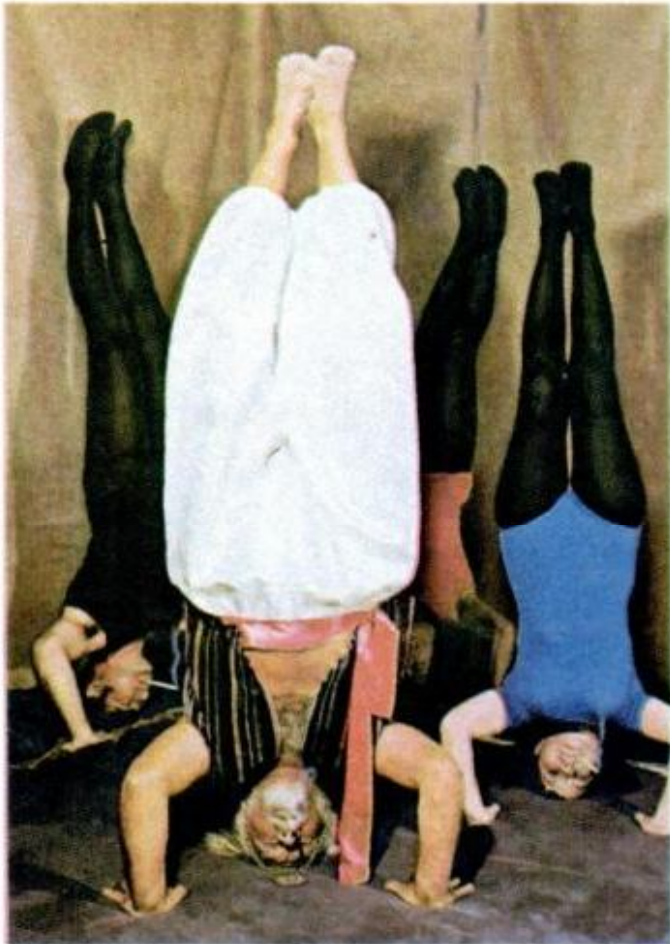

...almost everybody.

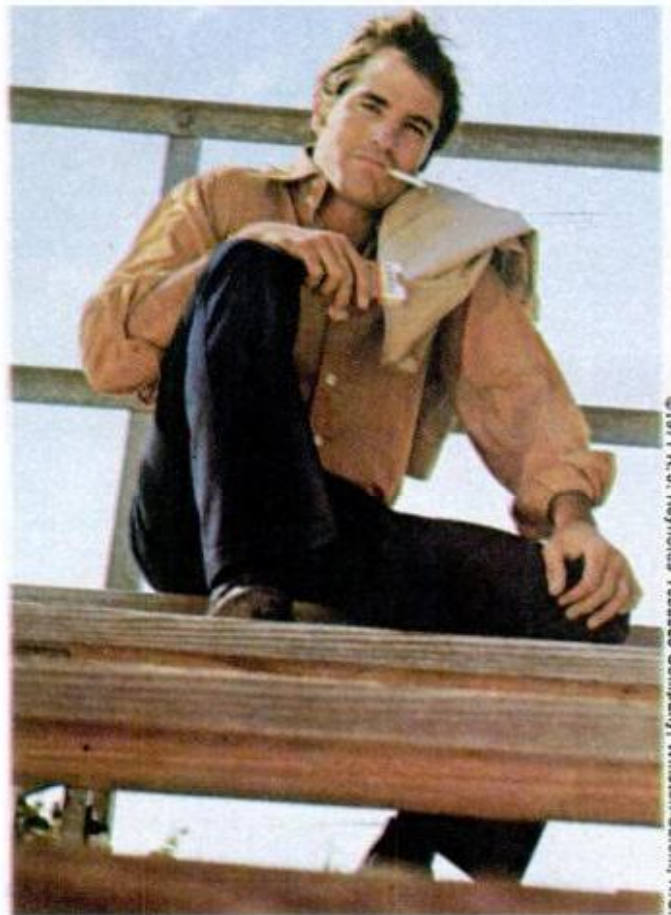

©1971 R. J. Reynolds Tobacco Company, Winston-Salem, N.C.

Camel Filters.
They're not for everybody.
(But then, they don't try to be.)



20 mg. "tar," 1.3 mg. nicotine av. per cigarette, FTC Report NOV. '70.

50-Story Firetraps

By ARTHUR S. FREESE

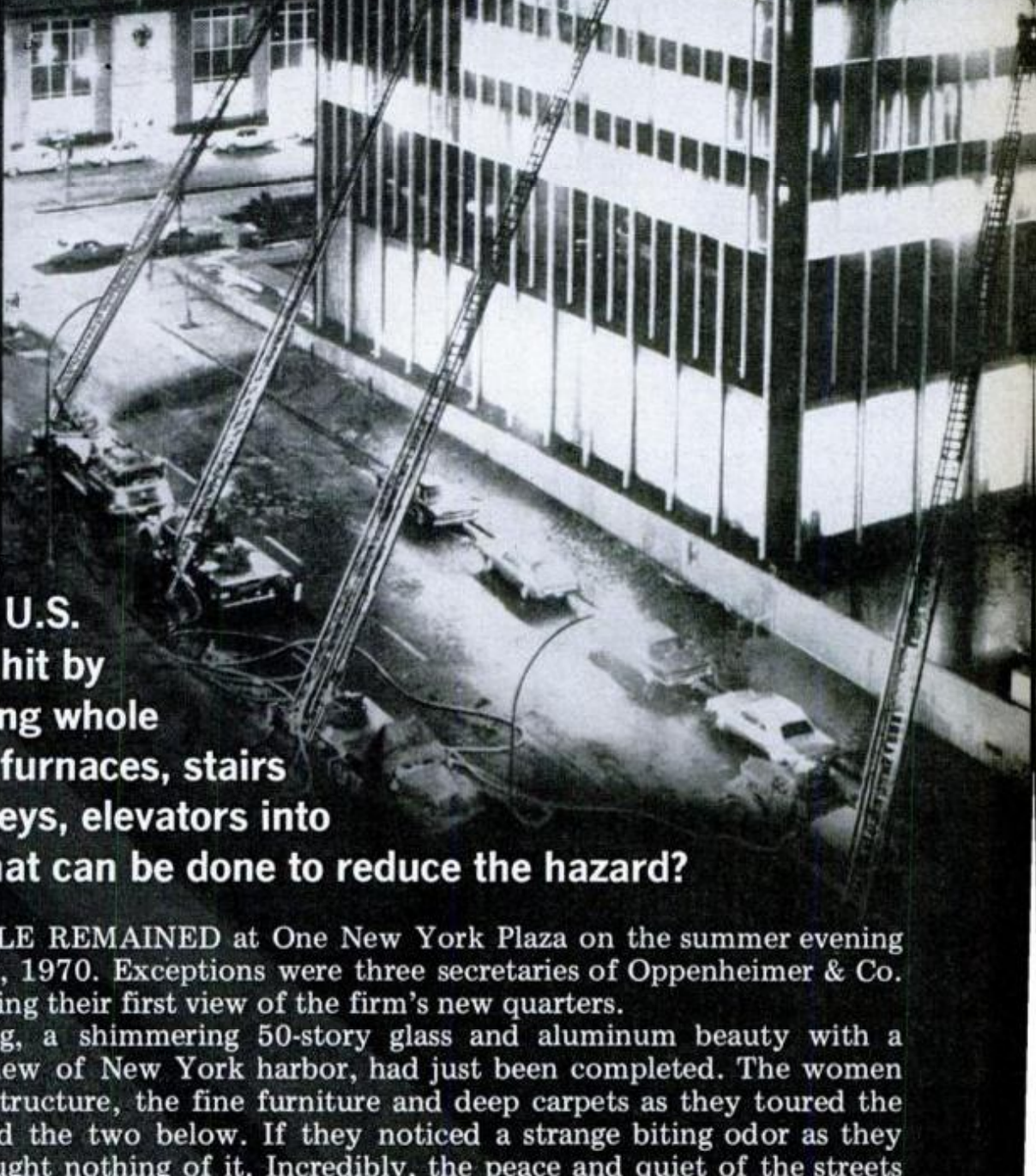

'Fireproof' high-risers across the U.S. have been hit by fires, turning whole floors into furnaces, stairs into chimneys, elevators into coffins. What can be done to reduce the hazard?

FEW PEOPLE REMAINED at One New York Plaza on the summer evening of Aug. 6, 1970. Exceptions were three secretaries of Oppenheimer & Co. who were getting their first view of the firm's new quarters.

The building, a shimmering 50-story glass and aluminum beauty with a magnificent view of New York harbor, had just been completed. The women admired the structure, the fine furniture and deep carpets as they toured the 33rd floor and the two below. If they noticed a strange biting odor as they left, they thought nothing of it. Incredibly, the peace and quiet of the streets



SMOKE BILLOWS around 50-story One New York Plaza as fire consumes three floors. Two died in \$10-million blaze



BURNED-OUT FLOOR of Plaza building reveals that "fireproof" materials do burn. Fire was traced to ceiling area.



would soon be shattered by the scream of sirens and the roar of engines, by powerful floodlights and hovering helicopters, by shattered glass falling 35 stories into the street. Fire would break out in the "fireproof" building, and two men would die. Many others would suffer from smoke inhalation. Finally, the skyscraper inferno would trigger an intensive re-examination of building practices across the country.

An Oppenheimer guard on the 33rd floor was the first to notice anything unusual. A few ceiling tiles had been removed to make a small opening, and smoke was drifting out of it. Racing to the firebox on the floor, he set off the alarm, then rode the elevator to the first floor to spread the warning. Two others—another guard and a telephone supervisor—joined him in the lobby, and all three rushed into an elevator to alert building employees working on the 39th floor.

The elevator was to become a vehicle of death. As it traveled upward, it abruptly stopped and its doors opened to the now raging fire on the 33rd floor. Heat and smoke poured into the car and the men desperately fought to close the doors and get it going again. Minutes later, close to unconsciousness from the heat and smoke, they dropped to the floor.

Their faces covered with their shirts in a last anguished attempt to breathe, the two guards died. Only the telephone foreman was alive—barely—when firemen got to him two hours later.

Meanwhile, those on the 39th floor had smelled the smoke. They packed themselves into another elevator which, as it went down, stopped for passengers on the floors below. It then stopped at the 33rd floor and the doors jammed. The smoke and fire struck at these people, too. One survivor recalls: "It was pitch black, just like night. There was nothing to breathe and I felt like dying."

Someone yelled, "Down on the floor!" and, despite their panic, the passengers obeyed. Somehow they managed to get the doors closed and—although it seemed like hours—the elevator started down minutes later and carried them to safety. Elsewhere at One New York Plaza courageous supervisors rounded up their men while executives in upper stories found their eyes smarting and tearing. All were at last

ESCAPE FROM BURNING HIGH-RISE can be almost impossible. Seven persons fell to their death in fire in Rio de Janeiro building



KEY

- ① RESCUE HELICOPTER
- ② SMOKE TOWER
- ③ SPRINKLER
- ④ FIRE CALL BOX
- ⑤ SMOKE-FREE STAIRS
- ⑥ HELICOPTER PAD
- ⑦ SKY VAN
- ⑧ FIRE SEPARATION WALL

Art by Fred Wolff

"SURVIVAL" SKYSCRAPERS MIGHT INCORPORATE features shown: areas with fire-resistant walls, smoke towers to insure clear stairways, alarm boxes on each floor, exterior emergency elevators and sprinklers

evacuated as smoke permeated the building. It took an observant guard in an adjoining structure to call the fire department.

The first group of firemen were trapped in an elevator at the fourth floor and had to chop their way out to escape the heavy smoke. Others found elevators which took them to the 30th floor. Hoses were attached to standpipes in the stairways, but the smoke was so severe that masks had to be used, the heat so great that the fire-fighters could work only for minutes at a time.

In an older building, the windows

could have been opened to vent the heat, gases and smoke. At One New York Plaza they were locked with special latches, and the firemen broke the heavy glass with great difficulty.

Five hours later the fire was under control, but only after a second and third alarm, and 25 pieces of equipment and 150 firemen had been brought in. A nearby hospital was overwhelmed with choking victims, many semiconscious and retching. Police helicopters hovered overhead to rescue possible survivors from the roof, but a floor-by-floor search disclosed no more occupants—dead or alive. One thing

was clear: Modern "fireproof" skyscrapers are not really fireproof at all but are what one authority termed "semicomcombustible."

A few months later a three-alarm blaze roared through the 35th floor of San Francisco's Bank of America Building and provided more evidence. Some 30 frightened people were trapped on the floors above. Half an hour lapsed before the windows could be broken to vent the fire (the streets below had to be cleared first) and it took two hours to get the blaze under control.

The next month—December—the fifth floor of a 49-story structure in mid-Manhattan added to the growing list of calamities. Heavy smoke reached as high as the 45th floor, and soon hundreds were staggering out into the street gasping for air. Once again elevators became potential coffins.

Six victims from upper floors were caught on a car that opened and stuck on the blazing fifth floor. Terrified and unable to see, they were rescued by firemen who formed them into a human chain and led them to safety. A less-fortunate victim perished in a stalled elevator and two more, who exited a stalled elevator, died on the fifth floor. The final toll included 39 injured.

There are other examples. A fire in a 22-story "fireproof" building in Rio de Janeiro killed five. A blaze burned out the 22nd floor of San Antonio's Life Building and then spread to the five floors above. The 9th through 12th floors of a Mexico City office building recently went up in flames and claimed one life. Finally, a spectacular conflagration in a penthouse restaurant atop a 10-story building in Montgomery, Ala., killed 25 patrons.

Again elevators malfunctioned. Firemen trapped in cars had to slide down the counterweight cables to the basement.

Modern high-rise building techniques are relatively new. "A skyscraper fire is a unique kind of fire," says John E. Plantinga, consulting engineer and chairman of the New York Building Congress's Fire Safety Committee. "These new buildings are considerably more complex than those of the 1930s. Then you just threw up some columns and concrete floors, put brick walls around them, added some windows and lights in the ceilings. When it got hot, you opened a window. If it was cold, you turned on the radiator."

Modern skyscrapers like One New York Plaza spread out around a reinforced concrete core containing the elevators and stairways. Each floor is a concrete platform supported by steel girders and beams like the fabric of an open umbrella. At the New York building, 2.5 inches of concrete rests on the steel members, which are protected from fire by sprayed asbestos fiber. The

(Please turn to page 166)

POPULAR MECHANICS

Материал, защищенный авторским правом



A NEW ESCAPE SYSTEM is called Sky Van. The elevator car clips onto exterior vertical rails, is self-powered. It can carry 4500 pounds up or down



Tests rails ultrasonically

Rolling along at 25 mph, an ultrasonic test trolley mounted between the drive wheels of a British railway car (above) probes the rails beneath for cracks and fatigue. Signals from the probes are monitored inside the car (left) and recorded on film for later study.

Executive jet

Cessna's new fan-jet business plane, Citation, carries six passengers plus two crewmen. Said to be low-cost, quiet and slow-flying, the craft cruises at 400 mph and lands in as little as 2950 feet.



Raise Hellcat after 26 years

This Navy fighter, ditched off San Diego in 1944 when its fuel system malfunctioned, was raised recently from a depth of over half a mile. Scientists from PPG Industries found the laminated glass windshield clear and intact after lengthy immersion. They're developing glass components for submersibles.

AUGUST 1971



Magnetism powers fast train

Powered by an electromagnetic field set up in its "rails" this train was tested recently in Munich. Propelled by a linear motor, the prototype reached 62 mph on a 2000-foot test run. Production models, planned for the 1980s, are expected to reach speeds of 310 to 372 mph.

PM OWNERS REPORT
JEEP UNIVERSAL

A Nationwide Survey Based on
400,000 Owner-Driven Miles

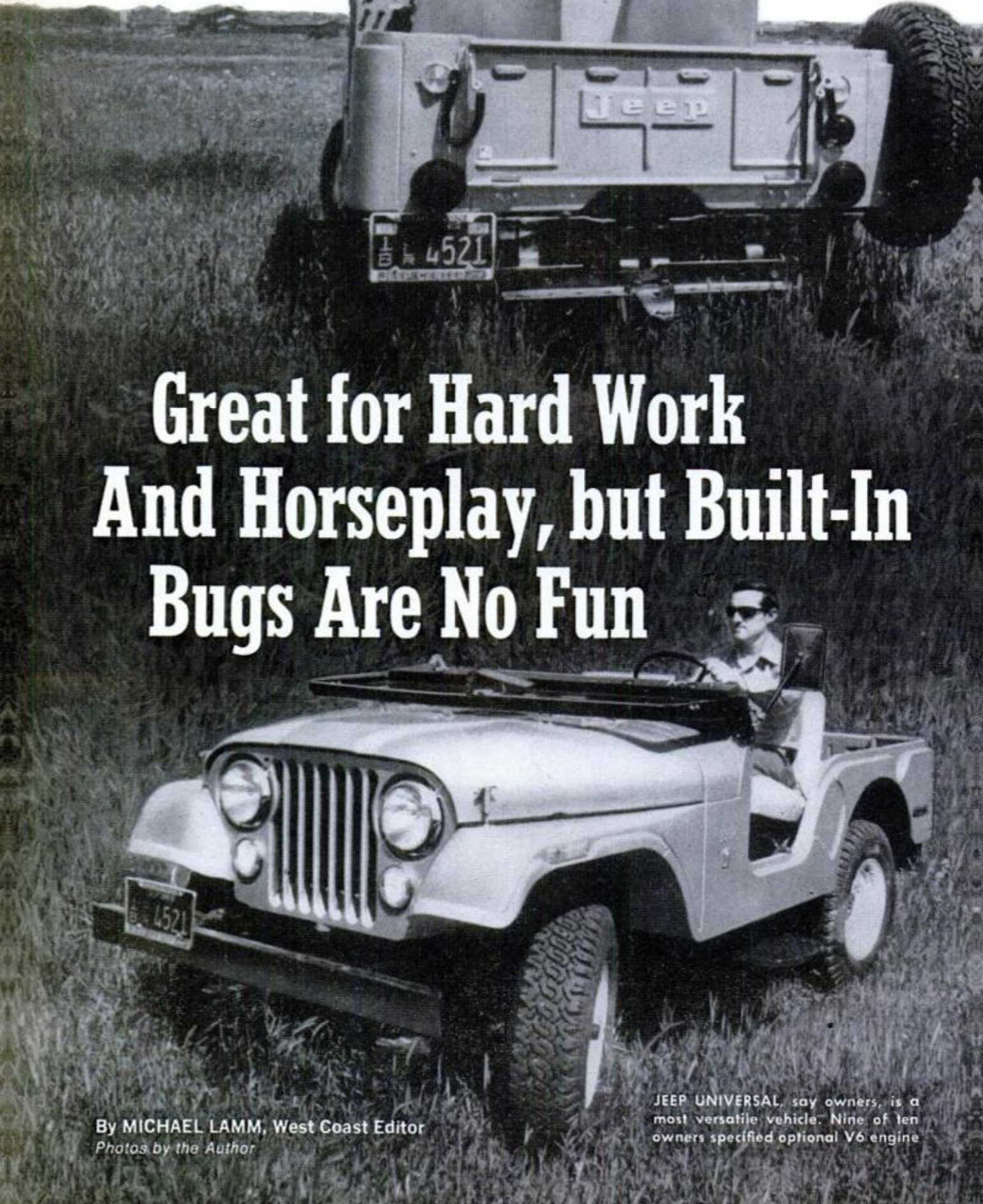

**Great for Hard Work
And Horseplay, but Built-In
Bugs Are No Fun**

By **MICHAEL LAMM**, West Coast Editor
Photos by the Author

JEEP UNIVERSAL, say owners, is a most versatile vehicle. Nine of ten owners specified optional V6 engine

THE JEEP UNIVERSAL isn't so universal that just anyone would want one. It takes a very special reason. Like:

"I own property in Colorado and bought the Jeep especially to get into the high country."—Kansas police lieutenant. A Washington logger writes: "Four-wheel drive is the only thing suitable where we live."

Many respondents, especially farmers and ranchers, said they use their Jeeps for plowing snow. Sportsmen favor the Jeep for hunting and fishing trips. One Californian said he bought his Jeep, "... because they have been manufacturing 4wd vehicles for 30 years and know their product; also the resale value is much higher compared to other 4wds." And a Florida salesman said simply, "Jeeps have been in our family since 1946."

While glancing through our questionnaires, we were struck by the devotion so many owners have to their Jeeps. It's more than just a car to them; it's like a member of the family or an old friend. A student in environmental health says, "I've covered some rough country surveying water supplies, and my ol' Jeep has been right there. It's really the two-car car. I drive it to school and to work every day, and when hunting time rolls around, off to the mountains I go." A Tennessee mechanic: "I would never be without a Jeep; wouldn't trade mine for two of any other car."

On *comfort*: "Mine's not the best riding, but it's more comfortable than the old Jeep. My wife complained about the ride at first but changed her mind after doing some backtrailing and seeing some eye-opening demonstrations."—Ohio farmer. "Jeeps aren't expected to ride smoothly—they're not luxury cars. But try a Cadillac on a mountain trail."—Tennessee steelworker.

About *quality* and *workmanship*: "Excellent."—Virginia co-op operator. "No complaints."—California superintendent. "Average to good for a vehicle of this type."—Florida electrical engi-

AUGUST 1971

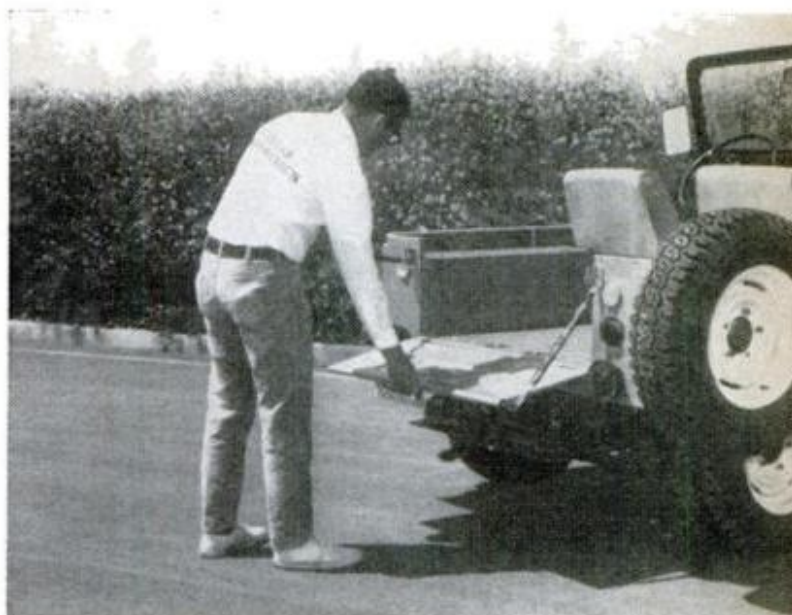

JEEP'S TAILGATE folds flat for long loads. Bed extensions are available optionally, as are a rear seat, metal cab, cloth top; 4wd is standard on CJ



LOCKABLE STORAGE BIN under the passenger's seat hold valuables. Firm, comfortable buckets place occupants above most cars. Jeep's ride is bouncy

JEEP UNIVERSAL FUEL MILEAGE CHART
V6 Engine

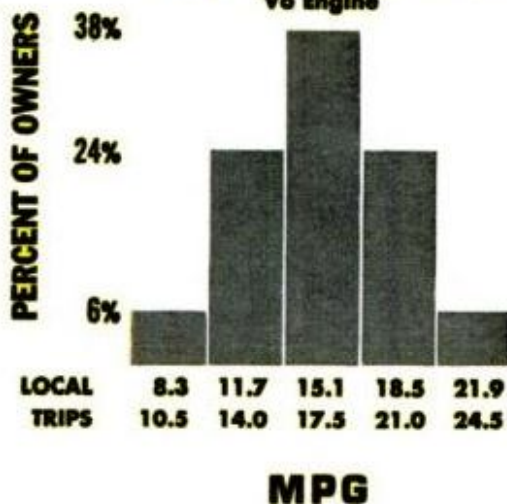

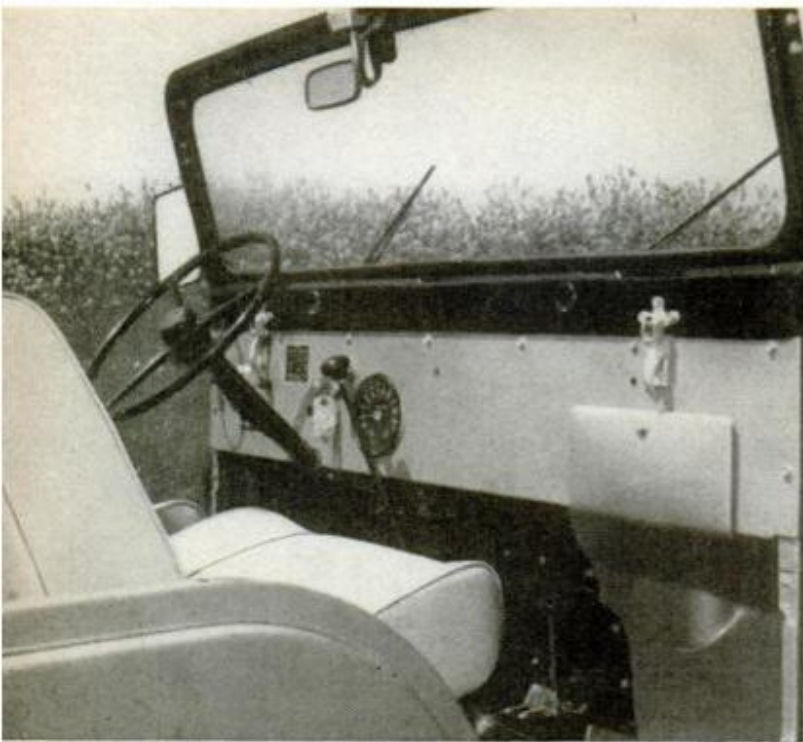

SPARTAN DASH has no provision for radio. Ashtray, lighter are extra, and several readers complained that for \$3000 base, CJ needs more standard items



JEEPSTER COMMANDO has same ruggedness and 4wd as Universal, can be made as wagon, roadster or pickup; uses same F-head 4 or V6 as regular Jeep

GLOVEBOX has more room than most, also has lock. Hasp above it secures the folding windshield

DEFROSTER vents supposedly duct hot air onto windshield, but owners feel heater and defroster aren't too hot

BASIC CJ JEEP has no doors to rattle, yet tailgate does; un-insulated body amplifies sound

neer. "The workmanship is really good, and an outstanding feature is that the Jeep is really serviceable."—New York carpenter. "Construction is very solid, but attention to quality control and finishing of body components is very poor."—Pennsylvania physicist.

Best liked features: "Dependable in all types of weather and fun to drive." "Versatility." "Simplicity of construction." "Economical and easy to drive." "We live in the mountains—no roads—and they are great fun!" "It's got a lot of guts." An 18-year-old Wisconsin student likes his Jeep because, "It makes money for me (plowing snow in winter), takes girls out, gets me around fast, gets looks from almost every one."

Least liked features: "Rattles." "Rough riding." "Mine leaks and allows air to enter cracks." "I expected better gas mileage from the V6." "Workmanship could stand improvement, especially considering the price." "Gas-tank location on 1971 models is dangerous." "Smog-control device makes engine hard to tune and causes dieseling." "Hard to get parts." "Defroster system gets no air onto windshield." "Wheel hop in sand." "I'd like to see more items made standard equipment. For instance, I had to pay extra for sun visors, top, and rear seat."

About performance: "V6 engine gives it get-up-and-go power." "Excellent on rough terrain, and it handles well on the highway right up to 70 mph." "I use my Jeep to pull a hay-baler, sometimes a horse trailer, and to

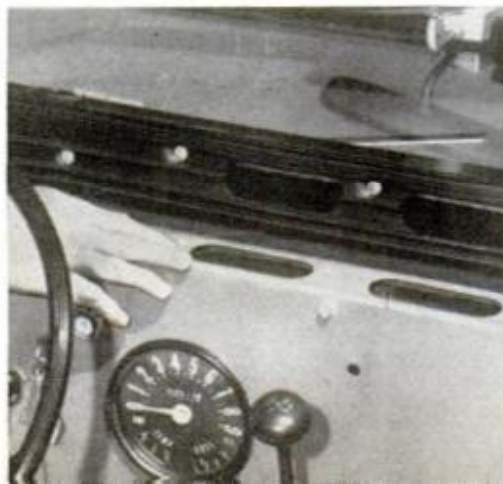

Summary of 1971 Jeep Owners Reports*

Total miles driven404,630	Economy16.5	Dealer repairs satisfactory?
Average miles per gallon	Roadability13.2	Yes67.4%
Local driving15.1	Styling11.0	No32.6
Long distance17.5	Specific dislikes:	Is the Jeep your only car?
Series:	Workmanship17.4%	No85.3%
Jeep Universal93.8%	Dealer service14.1	Yes14.7
Jeepster6.2	Window leaks10.9	Other cars owned:
Body styles:	Low gas mileage9.8	Chevrolet32.5%
Convertible81.1%	What changes would you like?	Ford18.9
Station wagon10.8	Better heater9.4%	Buick11.3
Roadster8.1	Change seat style9.4	Plymouth11.3
Engines:	Change styling8.2	Cadillac10.0
Ohv V6 (160 bhp)89.2%	Better workmanship8.2	Dodge10.0
F-head 4 (75 bhp)10.8	More options7.1	Accessories/power options:
Why the Jeep?	Better materials7.1	Free-wheeling hubs41.3%
Recreational use33.0%	Had any mechanical troubles?	Radio28.3
Four-wheel drive28.7	Yes50.0%	Roll bar27.2
Past experience17.0	No50.0	Oversized tires23.9
Performance8.5	What kind of trouble?	Rear seat20.7
Ruggedness8.5	Clutch17.4%	Age distribution of owners:
Specific likes:	Windshield wipers13.0	15-29 years52.7%
Handling45.1%	Speedometer cable10.9	30-49 years30.1
Four-wheel drive33.0	Did you repair it yourself?	50-plus17.2
Performance20.9	No93.8%	Would you buy another Jeep?
Power17.6	Yes6.3	Yes90.0%
		No10.0

*Percentages might not equal 100% due to rounding and/or insufficient data.

plow snow—now *that's* performance.” But a San Diego cab driver says, “It’s the worst possible car for highway use—short wheelbase, light weight, rough, noisy, poor gas mileage and only a 10½-gallon tank. But it’s the best 4wd there is for offroad use.”

About Jeep dealers: “We feel we got a pretty good deal. The dealer treats us courteously.”—Colorado trucker. “I have experienced the poorest dealers and the best. I am 100 percent satisfied with my present dealer.”—New York service rep. “Courtesy good, sales methods questionable, service fair to poor.”—California construction worker. “Excellent—courteous and great service.”—Colorado student. “If there were more dealers throughout the country, there would be more competition on sales and service. Parts and service for Jeeps are usually costly and slow.”—Missouri salesman.

What *improvements* do Jeep owners suggest? “More body insulation—as it is now, there’s absolutely none.” “Power steering; the Jeep is too hard to steer for most women.” “A better heater.” “Lower the price, up the quality.” “More durable materials for body and frame; also a quieter engine.”

“Larger gas tank.” “I would like to see a roll bar and a tilt indicator made standard equipment; a person doesn’t really know the value of these items until they use the Jeep for the purposes for which it was designed.” “Put skid plate under oilpan.” “A dash panel for the radio; also an ashtray and lighter as standard equipment.”

In *conclusion*: “I’ve tried every 4wd made, and Jeep has less upkeep than any.”—Illinois mechanic. “It’s the best all-around 4wd there is, and it’s just what its name says, ‘Universal.’ You can do just about anything with it—work or play. I wouldn’t buy anything else.”—Connecticut mechanic. ★★

FOLDING WINDSHIELD—one of few holdovers from WW II—adds to fun of driving Jeep in hot weather



Now They're Probing The Hidden Depths Of Your Mind

You can turn on a TV set just by thinking. You can control your heartbeat through thought alone. These are two of the amazing feats made possible by new scientific knowledge of what makes the human brain tick.

By STEVE BACON

IN A BALTIMORE HOSPITAL, a patient controls his heartbeat just by thinking about it.

- In research laboratories, test subjects turn their "alpha waves" on and off at will—and use this ability to control a TV set.

- In California, a chimp plays tic-tac-toe with a researcher. By looking at brain-wave patterns on an oscilloscope, the man can tell if his furry opponent will make the right move.

- Other fantastic discoveries: You have hidden mental capacities; it may be possible for you to increase your intelligence and your ability to learn and remember. It may also be possible to cure those with epilepsy, brain injuries and mental disorders, also

to return control to paralyzed limbs.

In a scientific bonanza, chemists, engineers, mathematicians, physicists and other researchers are joining those traditionally concerned with medicine and biology to explore a last great frontier of science—the human brain. Their tools include an arsenal of computers, electronic brain stimulators, telemetry units, drugs and new insights provided by such fields as biochemistry and molecular biology.

Although the brain is often compared to a digital computer, the similarity is more apparent than real. Instead of wires, transistors and other conductive elements, our nervous system uses traveling chemical reactions involving slight changes in electrical

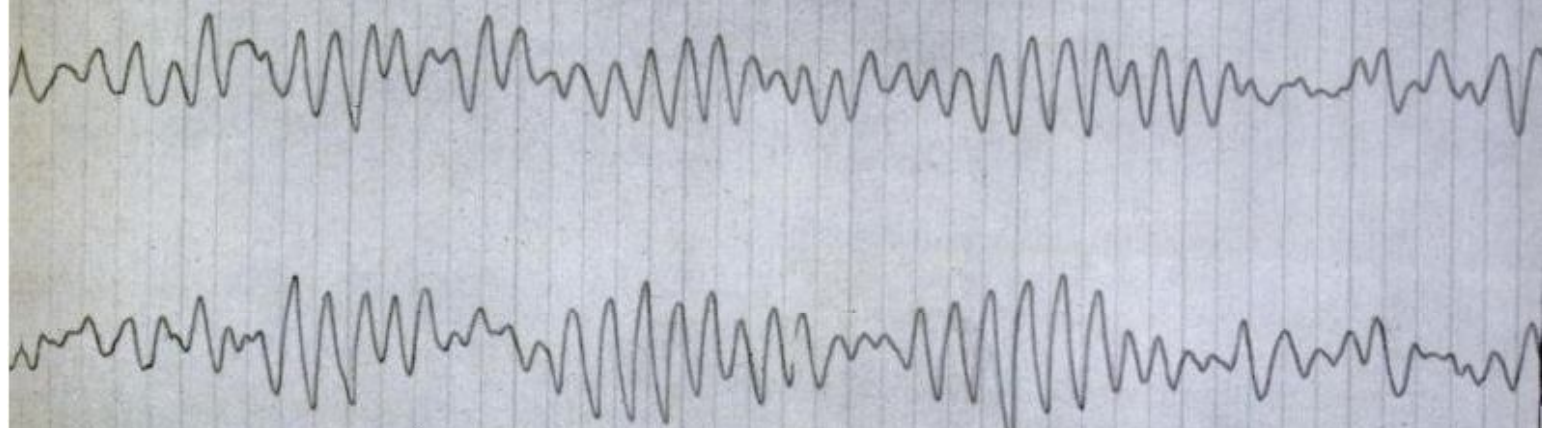

voltages. These reactions switch nerve impulses from one area of the body or brain to another. Our permanent memories, researchers theorize, are stored in an amazingly economical, high-capacity molecular form. They are converted back to electrochemical energy only when acted upon.

Human circuit elements, or neurons, are much like digital on-off switches. They are either on or off: transmitting an impulse or at rest. Regardless of their location in the body, they are tiny bulbous cells with many twisted, rootlike extensions (dendrites) for receiving impulses and a long fiber (axon) for transmitting them. When a nerve impulse arrives—via a chemical transmitter substance operating across

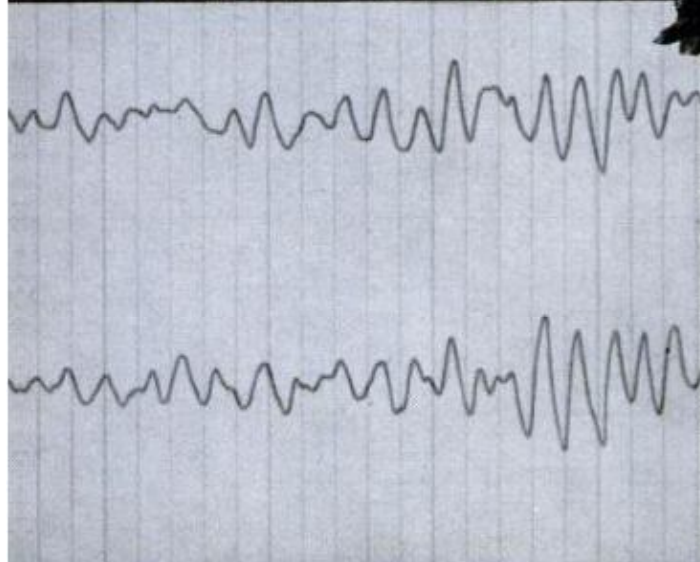

PARALYZED ARM of monkey is jolted into motion by brain stimulator. Impulses surge through electrodes implanted in the animal's brain. Dr. L. R. Pinneo sits at computer console at the Stanford Research Institute

CONSCIOUS CONTROL of alpha waves (left) enables human test subjects to turn on TV set by thinking

the small gap (synapse) between the axon of the transmitting neuron and a dendrite of the receiving neuron—it triggers an electrochemical breakdown.

This breakdown, caused by charged particles flowing through the cell membrane, literally races through the neuron and out its axon at speeds of 2 to 200 miles an hour. The cell can relay hundreds of messages every second.

It is easy to record the brain's electrical activity from scalp connections or from implanted electrodes. Although much of what goes on inside your head looks purely like electrical noise, a synchronous rhythm is often present, producing what are called alpha waves.

Alpha waves result from the simultaneous triggering of many neurons, and have a frequency of about 10 a second in a relaxed adult. Scientists speculate that they may be periodic waves of sensitization: They add to the voltages already present in the brain and those received from sensory nerves, making it easier for you to react to a loud noise, a threatening gesture or some other important stimulus.

It appears that alpha can be consciously controlled. Subjects under Dr. Joe Kamiya at the University of California Medical Center in San Francisco are actually learning to turn them on and off at will. With electroencephalograph (EEG) electrodes connected to their scalps they can control machines with their thought processes.

An elementary demonstration of such control has already been made by British researcher Grey Walter. He has shown that volunteers—with EEG electrodes, suitable amplifiers and a computer to recognize brain-wave patterns—can turn on a TV set by remote control.

In addition to alpha waves, it is now becoming possible to recognize patterns due to normal brain functioning as well as those due to brain injuries or other abnormalities. The complex wave forms can be analyzed by computer and the next action of the subject accurately predicted.

Some years ago, researcher E. Roy John of New York Medical College found that he could foretell the choices of trained cats in pressing one of two levers in response to a flickering light. He did it by studying their brain waves. Confirmation recently came from the University of California: Brain waves show whether or not chimpanzees playing tic-tac-toe are paying attention to the game and, thus, make the right choices.

It's possible that this basic work could lead to ways of improving human mental efficiency. For example, before material was presented to a student, executive or other person with a need to absorb new data, a computerized brain-wave recognition device could make sure he was alert and ready to learn. Other objectives of Dr. Kamiya's project are to determine whether alpha waves really are sensitization waves and thereby related to perception and memory, and to find out whether people might be able to do such things as put themselves to sleep or control stomach acidity.

In this area of controlling bodily functions, it's possible that "mind cures" may prove more effective than drugs in coping with certain illnesses. In Baltimore, Dr. Bernard I. Engel has cardiac patients smooth out irregular



PATIENT WATCHES "traffic signal" as he attempts to control heart action. Yellow light signals normal heart rhythm. Red is too fast; green, too slow

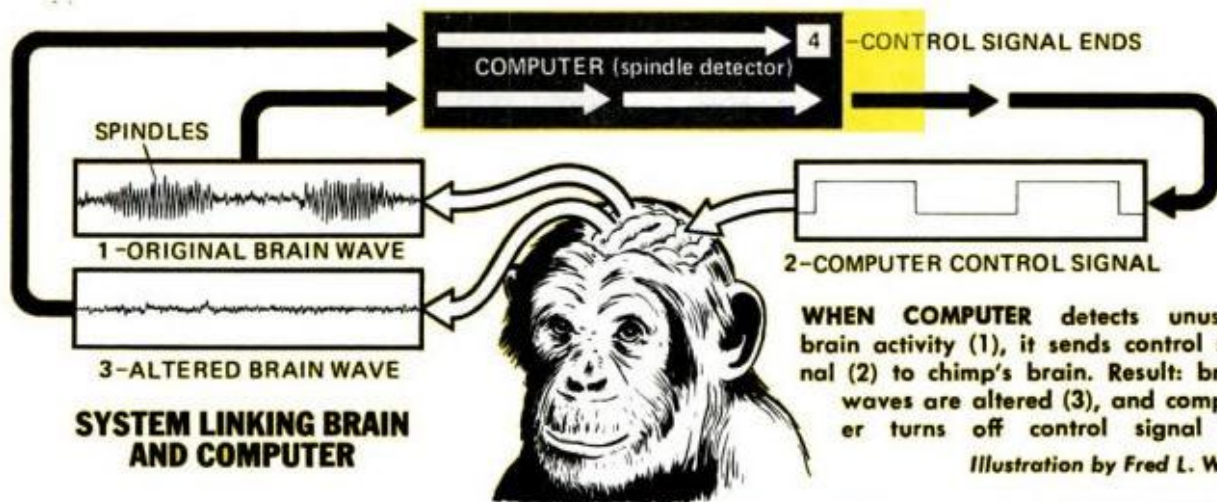

heart action just by thinking about it. They watch a small indicator resembling a miniature traffic signal with red, yellow and green lights. The patient tries to keep the yellow light on, a sign he is actually improving his heart rhythm.

If so many exciting discoveries can be made by mental control and by studying the weakened hodgepodge of brain waves at the scalp, what can researchers achieve by actually probing deep within the brain itself?

At Yale University's School of Medicine, Dr. Jose M. R. Delgado, a pioneer in using implanted electrodes and electronics to communicate with the brain, has jolted the public in recent years with impressive demonstrations of the power of electrical stimulation of the brain (ESB) to modify the behavior of cats, monkeys, chimpanzees and an angry bull.

Several years ago Dr. Delgado climbed into a bullring near Cordova, Spain, armed only with a red cape and a small transmitter. A fragile radio antenna took the place of the weapon carried by professional bullfighters. When a bull came thundering toward him, it was stopped short by a signal from the transmitter.

Dr. Delgado's real weapon included not only this device, but a receiver attached to the bull's head and connected to electrodes implanted in the animal's brain. Pulses were received and applied to an inhibitory area, triggering neu-

(Please turn to page 170)

AUGUST 1971

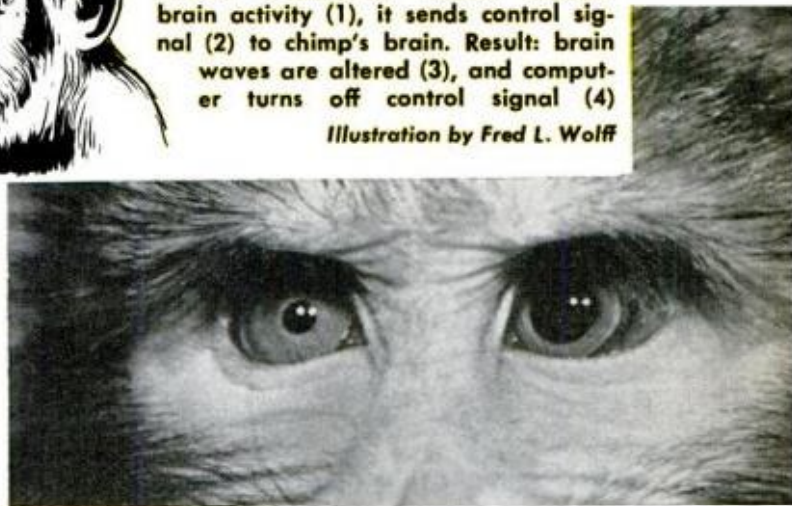

LIKE A CAMERA DIAPHRAGM, pupil of a monkey's eye enlarges in response to a current that's applied to an electrode implanted in the lab animal's brain



CHARGING BULL STOPS DEAD in tracks when Dr. Jose M. R. Delgado sends a signal from his hand-held radio transmitter. A receiver attached to the animal's head relays the signal to electrodes in the inhibitory area of the brain. Working at Yale University, Dr. Delgado is pioneer in using implanted electrodes and electronics in doing brain research

65

4-Channel Stereo —Here at Last!

Suddenly there are half a dozen different systems on the market with more on the way. You can pay as little as \$20 or up to many hundreds. Here's what you should know about this fast-growing trend in hi-fi listening.

By HANS FANTEL

Technical art by Jim Wright

A YEAR AGO, four-channel stereo was an experimental oddity—something to come along sometime, maybe, and an expensive playtoy for audio engineers and well-heeled hi-fi buffs to fool around with. Today, it's here. It's now. It's exciting. And in many forms, it's not particularly expensive.

Nearly every major hi-fi maker is coming out with some kind of four-channel equipment or accessory—some costing as little as \$20 to \$60. What's more, manufacturers are making sure your present stereo equipment and recordings

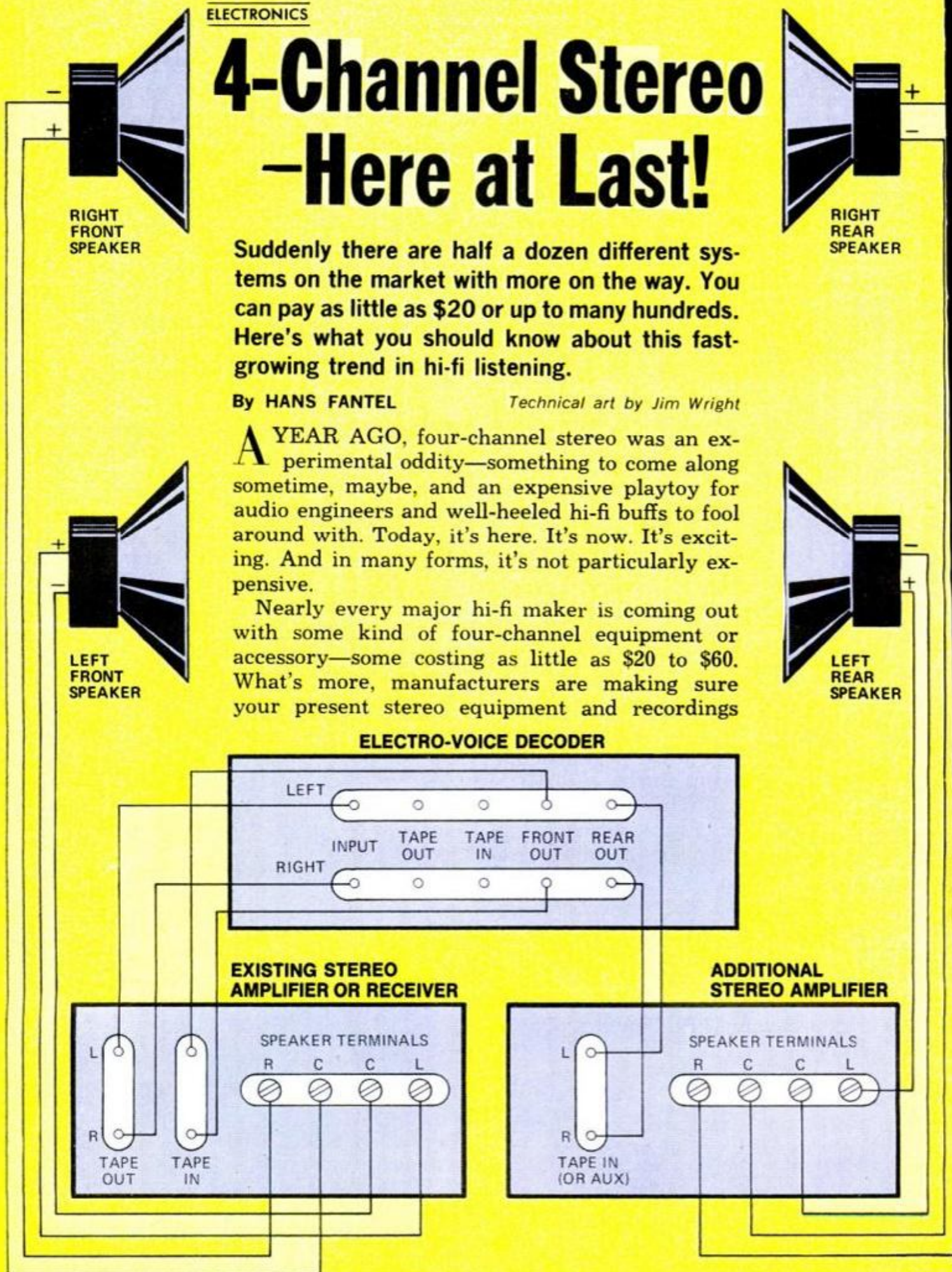



SMALL ELECTRO-VOICE DECODER, shown on top of receiver above, provides four-channel output from two- or four-channel sources, is priced at \$59.95. Diagram on facing page shows hookup requiring second stereo amplifier as well as existing one. Photo below shows various connections on back of decoder



will not be made obsolete by this new development. Most systems represent "add-on" units that can be used with existing amplifiers, receivers, phonographs and tape machines. Depending on what you want, you'll need an extra pair of speakers, a four-channel conversion adapter and probably a second amplifier. But you'll be able to listen to conventional stereo records, tapes and radio broadcasts just as before.

Why the sudden craze for four-channel sound? The original case for two-

channel stereo was that, since people listen with two ears, the sound should also come from two different directions. Hence your two stereo speakers spaced apart on opposite sides of the room. Actually, however, you don't hear in just two directions, but in many. The sound of music in a concert hall bounces around the room, reflecting off the side and rear walls and literally surrounding you from all directions. A lot comes from behind you, although you may not be aware of it. The slight delay between the direct sound waves from the front and reflected ones from the rear produces a rich, reverberant, echo-like effect, adding a quality of depth and dimension to the music.

Four-channel stereo, or quadraphonic sound, as it's called, is designed to create in your own living room the same sense of depth and richness you experience in a concert hall. The two added channels, feeding speakers placed at the back of the room, simulate the sounds heard from the sides and rear of an auditorium. The effect can range from a mild enhancement of musical realism to uncanny acoustical illusions.

One maker recently startled an audience of electronic experts by making an express train appear to roar around the room. The sound was gradually faded from the left front speaker to the right front speaker, then to the right rear speaker, the left rear speaker and finally back to the left front speaker—around and around until you'd swear the train was right in the same room with you. While such tricked-up theatrics are for demonstration purposes only, they dramatically illustrate the effects that are possible and the fun you can have experimenting with them.

Four-channel sound is also relatively easy to produce. Recording companies have for years been using multi-channel recording techniques in which microphones are placed in a variety of locations to pick up sounds from many different directions. It's not unusual for an original "master" to be recorded with up to 8, 12 or even 16 channels—

these are then "mixed down" into the final two that represent the conventional stereo recording you buy. It's thus comparatively simple to produce the same recordings in a four-channel format—or even to reissue old recordings in four channels—since the extra channels are already present in the original master.

Not all four-channel stereo is the same, however. Manufacturers have adopted many different approaches to this new-found sound dimension. There is so-called "true" or discrete four-channel stereo—four distinct and separate sound sources individually recorded and played back. Secondly, there is "matrixed" four-channel stereo in which music is originally recorded on four channels, but then electronically blended into two that can be played back on conventional stereo equipment. Finally, there is "derived" four-channel stereo that, by clever electronic trickery, produces simulated four-channel effects from standard two-channel recordings or broadcasts.



1

DIFFERING APPROACHES to four-channel sound are illustrated here. Above (1) is TEAC's rakishly styled reel-to-reel recorder that plays four separate channels through a pair of stacked stereo amplifiers. At top right (2) is Fisher's four-channel AM/FM receiver—first of its kind. At center right (3) is Sansui's QS-1 synthesizer, a highly sophisticated control that can be used with any stereo amplifier to provide derived four-channel effects. At bottom right (4) is Toyo's four-channel, eight-track cartridge player that, like RCA's, has self-contained amplifiers and requires only four speakers to complete the system



RCA'S QUAD-8 SYSTEM plays four-channel recordings from special eight-track cartridges. Self-contained player needs no additional amplifiers. It comes complete with four speakers for about \$250



A SEEMING IMPOSSIBILITY—playing four channels from a single record groove—is accomplished by this Japanese Victor decoder to be marketed soon. It will work with any high-frequency phono pickup



FOUR BASIC WAYS YOU CAN GET FOUR-CHANNEL SOUND

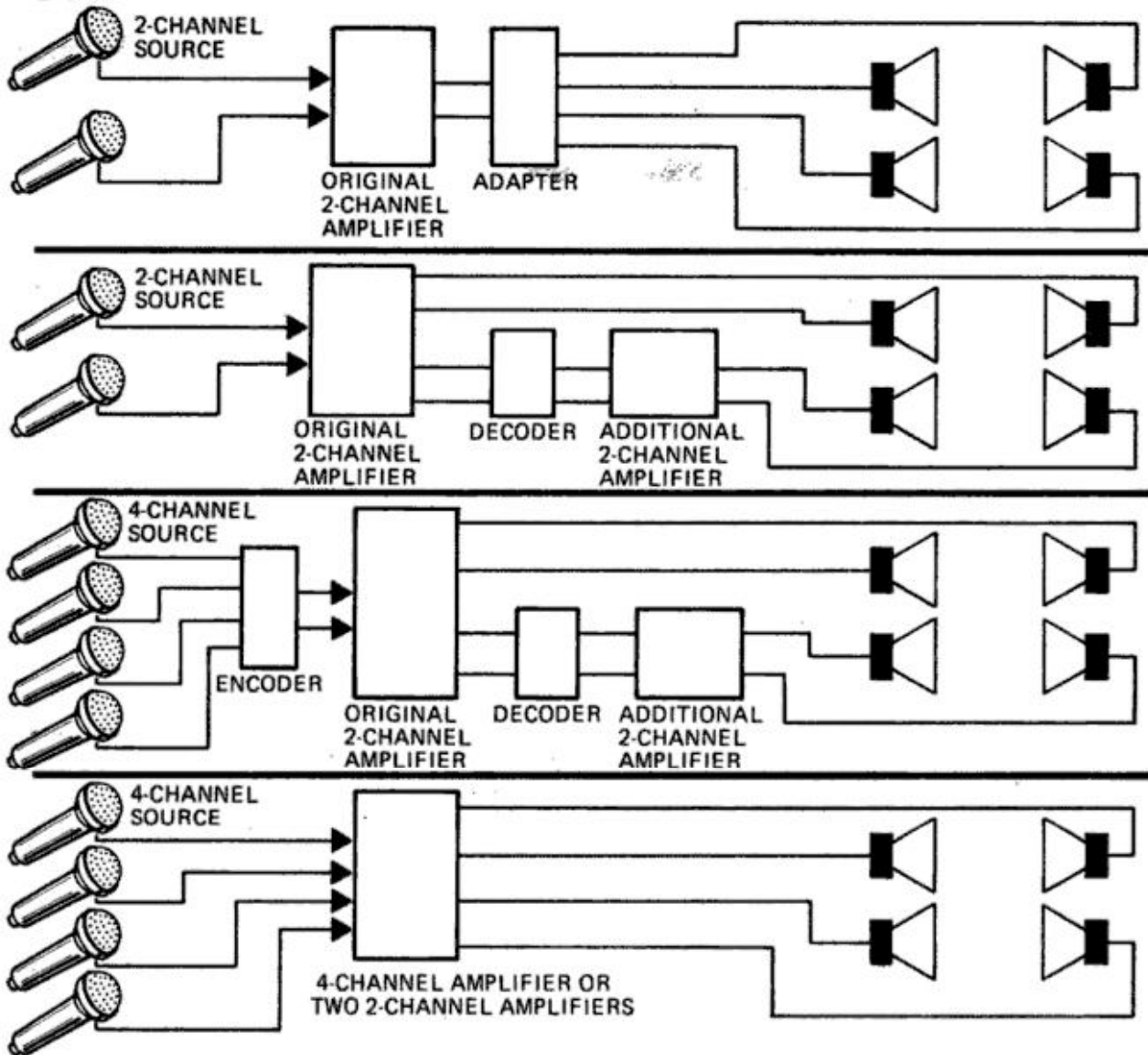

YOU GET FOUR SPEAKERS no matter which system you pick, but methods vary, as shown above. In simplest (top diagram), adapter splits regular two-channel output to feed four speakers. Two middle diagrams show how decoder used in conjunction with second stereo amplifier provides four channels from either a conventional two-channel source or four-channel source encoded into two channels. In bottom diagram, four separate channels are individually processed in four-channel amplifier with each channel feeding a speaker

Experts differ on which system is best, and many dislike the distinction between "true" and "simulated" because of the obvious implication that one is real and the other is not. The fact is, all three systems produce remarkable effects—you have to hear them to believe them. Which you pick depends mainly on how much money you want to spend and the degree of flexibility you're after. The more sophisticated machines do more things. Some let you select whichever mode of operation you desire—discrete, matrixed or derived.

One of the simplest arrangements,

pioneered by Dynaco, makes use of the so-called "difference" signal arrived at by subtracting one stereo channel from the other. This signal is extracted from the two regular stereo channels and fed to two added rear speakers. The effect is surprisingly good.

Dynaco has been offering this multi-speaker provision on some of its amplifiers for several years. Now it has just brought out an inexpensive adapter that can be attached to any stereo amplifier or receiver to provide the same four-speaker setup. All you need is the adapter and an extra pair of speakers. Called the Quadaptor, the unit will sell



for \$19.95 in kit form and \$29.95 assembled. Lafayette will also sell a similar version for \$29.95 assembled.

By far the largest number of add-on units on the market are of the matrixing type in which music actually starts out as four separate channels of information, then is reduced to two for conventional stereo playback. This is done by an encoding device that electronically adds or subtracts two signal frequencies in such a way that they produce a single third frequency representing the sum of, or difference between, the two original signals. In this way, the front and rear left signals are combined into one stereo channel, and the front and rear right signals become the other stereo channel.

It's like mixing oil and egg to make mayonnaise. The oil and egg are combined in the recording process, then in playback are separated again. This is how you can get four channels from two. To separate the mayonnaise, you need a decoding device that does the matrixing process in reverse. You also need a second stereo amplifier to handle the two additional channels and an extra pair of speakers. One amplifier feeds the left and right front speakers, and the other amplifier feeds the left and right rear speakers.

The fascinating thing about decoders is that they can also "derive" four-channel effects from ordinary two-channel sources—the records and tapes you already have. The reason this is possible is that the two conventional stereo channels contain, hidden in them, all the different pieces of musical information mixed down from the original 8, 12 or 16-channel master. Through a matrixing process in which the two channels are added and subtracted in various combinations, some of the pieces of information are separated out and fed to different channels. These derived signals supply the necessary information for the two additional rear speakers, simulating a four-channel setup. Front-to-rear separation is not

(Please turn to page 172)

POPULAR MECHANICS

KIT-BUILT DYNACO AMPLIFIER above provides for hooking up several different multispeaker arrangements. It can be wired for a third, center-channel front speaker, two added rear speakers or combination of all five, as diagrammed below. An excellent performer, the SCA-80 amplifier sells for about \$170 in kit form and \$250 assembled. A multispeaker adapter for any existing hi-fi system is also available from Dynaco for about \$20 as kit and \$30 wired

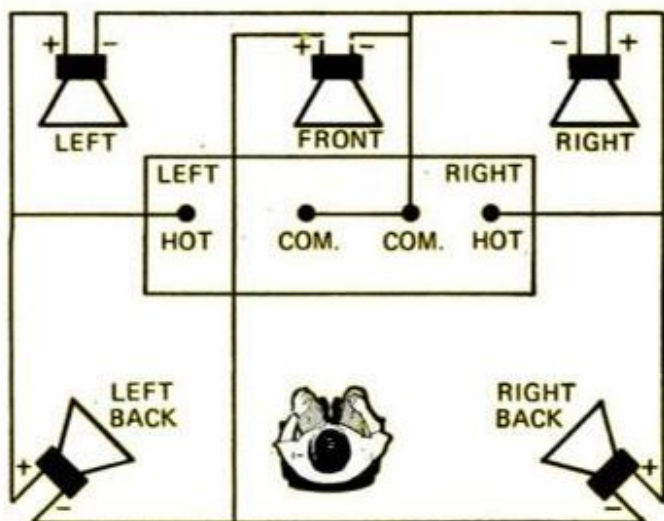



Lifejackets for torpedoes

Fitted snugly around a torpedo during practice firing, a tirelike float inflates automatically as the torpedo ends its run so Navy crews can recover the weapon. In the past, torpedoes were often lost on the bottom.



Fast smasher

You'd have to have a dandy party going to keep this bottle-crusher busy. It can crush some 1500 glass containers an hour. Designed for use in homes or restaurants, the Breakmatic is a German product.

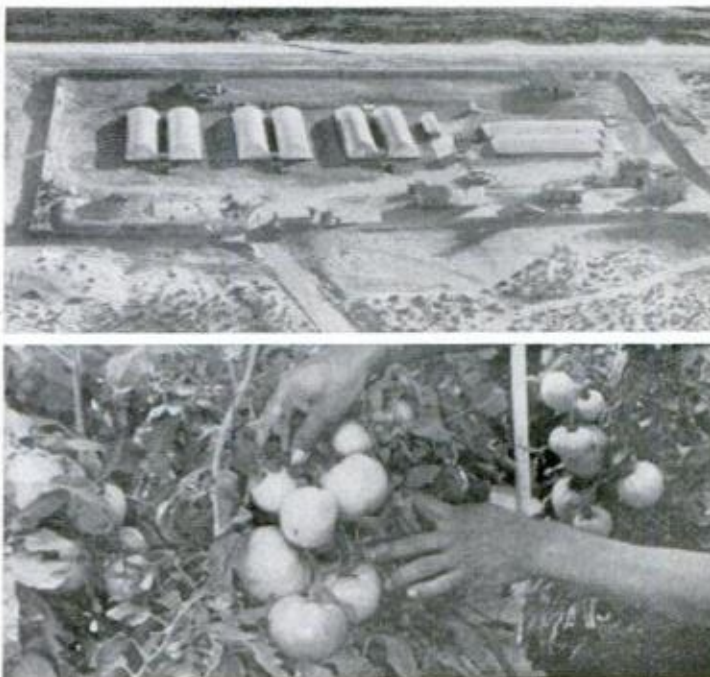
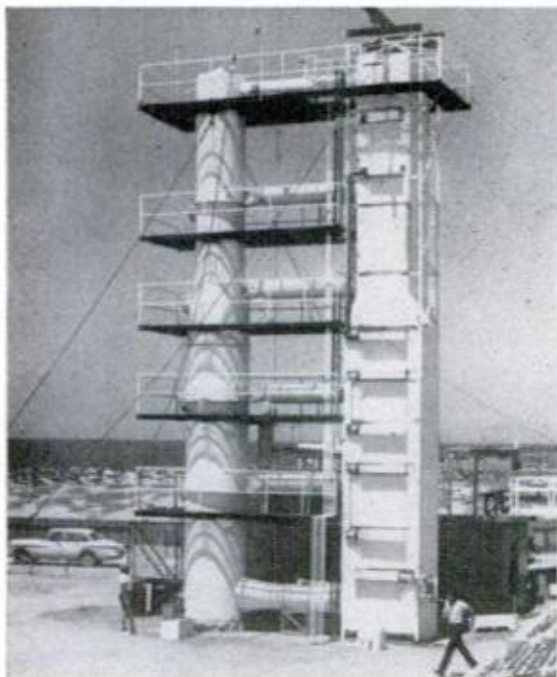

Lush vegetables grow in sand and seawater

Lush vegetables can be grown in the sands of desert coastal areas. This has been proved by the University of Arizona's Environmental Research Laboratory in an installation at Puerto Penasco, Mexico. A desalting tower (left-hand photo), powered by diesel engines, converts sea brine into fresh water for the plants. The plants are housed in plastic air-inflated structures, where humidity is high. Nutrients are fed through tubes.

TRANSPORTATION

THE ERIC K. HOLZER—700 feet long and 24,000 tons—is the world's largest capacity roll-on ship. Trailers are loaded and unloaded via ramp, towed by "yard" tractors. After they are parked, the trailers rest on specially designed stands (below, right) that provide front-end support.

A sister ship, *Ponce de Leon*, inaugurated roll-on service between New York and San Juan

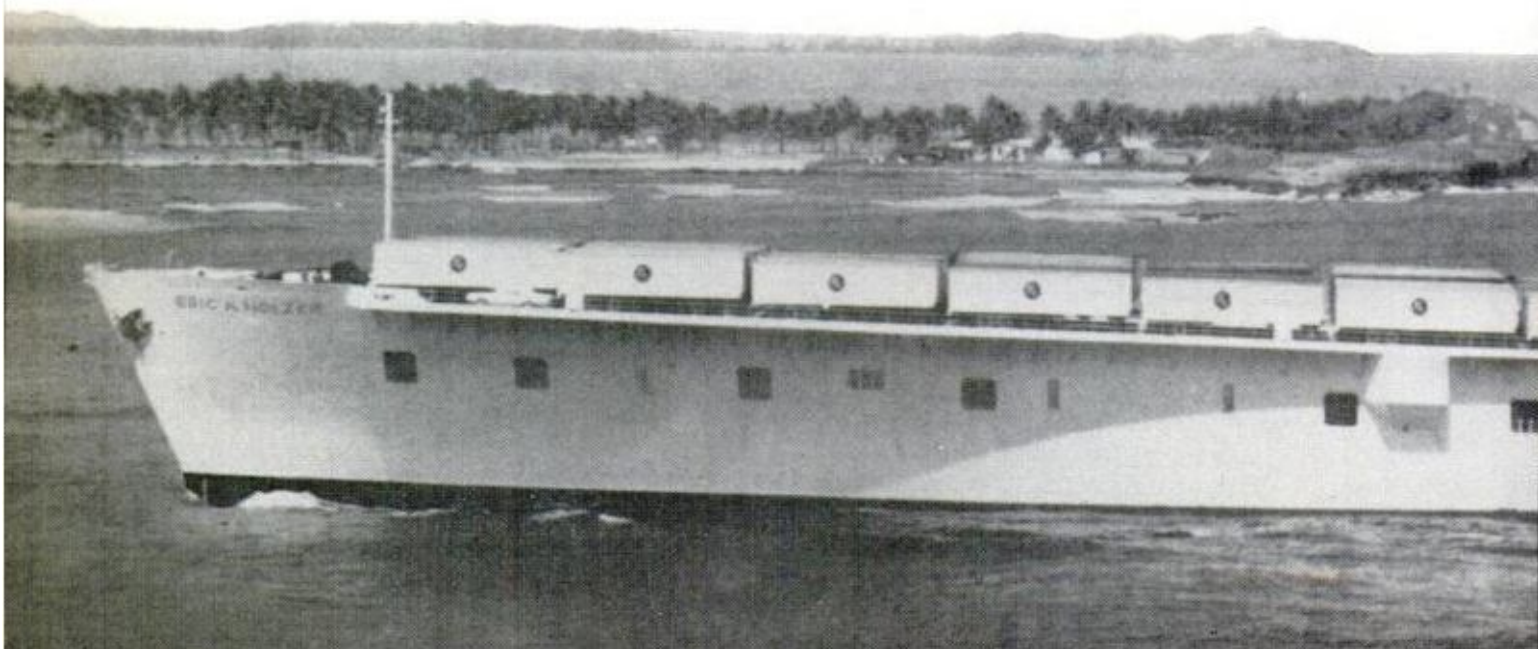
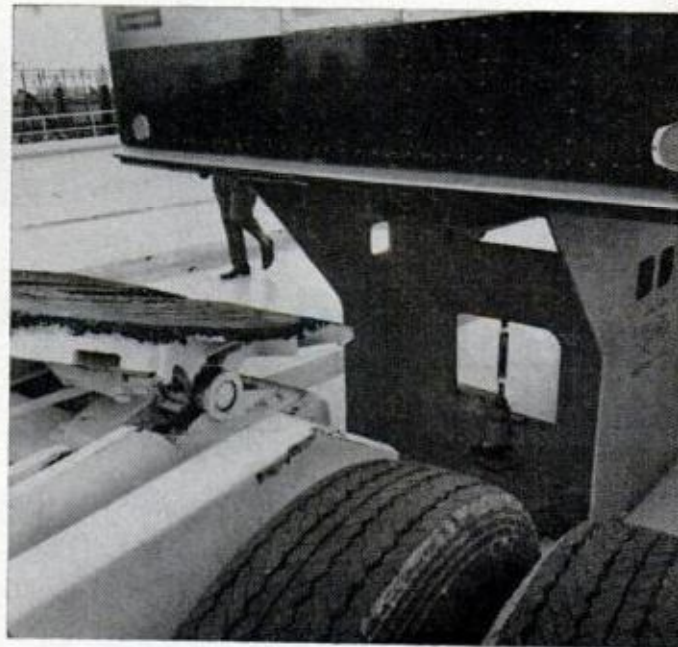



THERE'S LITTLE CHANCE that the recently launched *Eric K. Holzer* resembles any freighter you ever saw. One of the first of a new breed, the vessel has the uncluttered decks of an aircraft carrier. She's a roll-on, roll-off freighter, a big seagoing cousin of the piggyback railroad car.

In New York, the *Holzer* takes aboard 240 40-foot trailers—loaded with cargo from many parts of the country—and about 400 autos, trucks, flatbeds, steam rollers and even huge overhead cranes. Nothing is lifted aboard. Everything rolls up one of three ramps, drivers piloting vehicles to assigned parking spots. Trailers are towed by small but powerful “hustler” tractors.

It takes the *Holzer* less than 60 hours to cover the 1600 miles to San Juan, Puerto Rico, cruising at 26 knots. In from 8 to 12 hours she is unloaded and loaded again for the return trip. The *Holzer* and a roll-on sister ship shuttle between New York and Puerto Rico.

The roll-on ship is the freighter of the future, say the *Holzer's* owners, Transamerican Trailer Transport. It is more efficient and flexible than the container ship. Transamerican officials look to the day when 1000-foot roll-on freighters will carry 1600 trailers and other vehicles at 35 knots between ports in America and Europe. ★★★

26-KNOT PARKING LOT

By JOHN F. PEARSON
Science Editor



Inner-Tube Float Fishing

Here's a 'boat' that
will take you places
no outboard ever could

By CALVIN A. DEVINEY

A LARGE INNER TUBE as a fishing vehicle can be more fun, more convenient and considerably more economical than a boat! The most obvious advantage is the reduced price of making this "boat" compared to buying the conventional kind.

The tube is light for transporting in a car or for carrying through miles of fields and brushlands to your favorite, hidden fishing hole where you could never carry a heavy boat. It's also easily deflatable, so you reduce the number of bulky items you have to carry. And if you like to move around or go on combination camping-fishing trips, all you have to do is deflate the inner tube, carry it along to the next spot, and inflate it when you're ready to fish again!

For fishing in streams, you can walk across the shallow spots and then float through the deep holes. Deep rivers, canals, lakes or mud ponds—none are inaccessible to the inner-tube fisherman.

Floating also provides a quiet approach to your quarry because you eliminate the thrashing sound of a man churning his way out into a river.

Whether you're fishing with a fly, spinning or casting rod, you can manage all your tackle from a tube by filling the pockets around the sides with everything you'll need or by wearing a fishing vest to carry spare lures, fishing hooks and accessories. If you plan to be out during mealtime, fill another tube with an ice chest and picnic basket and tow it behind. No need to waste valuable fishing time to go ashore to chow.

You might want to substitute a rope sling to sit on instead of making the canvas harness—or tie a pair of large pants or the seat of old waders inside the tube.

With this novel fishing "boat," you might even convince the family to take separate tubes and join you at your favorite sport. Try it, and good fishing!

* * *



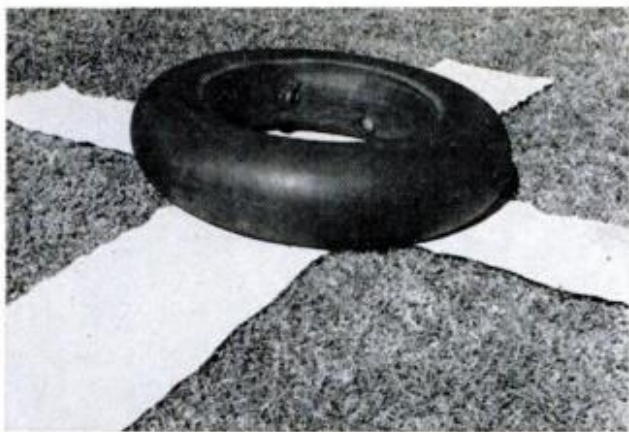

CUT TWO CANVAS STRIPS long enough to fit across and under the inner tube and to wrap around it later



MARK OFF TWO OPENINGS large enough for your legs. Remove tube and you're ready for the scissors



CUT OUT MARKED AREA NEATLY, being sure to go through both pieces of the overlapping canvas

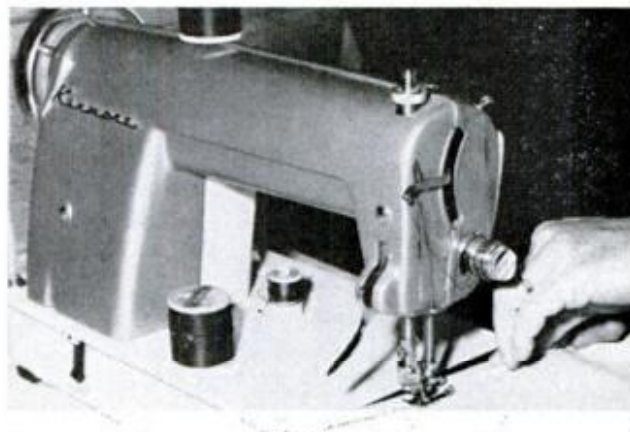

HEM OUTER EDGES AND LEG HOLES with a sewing machine and a little help from the lady of the house

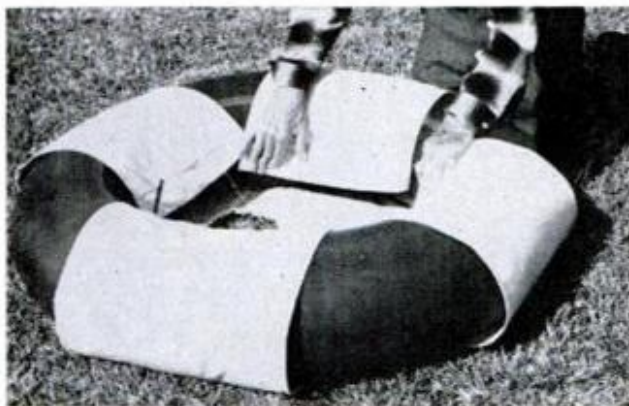

FOLD CANVAS BACK in and over tube to check for the proper length before installing the grommets



SPACE GROMMETS EVENLY to obtain the maximum strength from nylon or other long-lasting lacing

LACE INNER TUBE IN CANVAS and your instant boat is done. Try variations on this basic design

RESULTS ARE REALIZED in excitement of entering fish's domain to take your prey—and your dinner





'The Racetrack Is Still Detroit's Best Test Track!'

Jacque Passino

The former head of Ford's racing operations knows that racing on Sunday makes better cars on Monday. **By DON O'REILLY**

IN SPITE OF CUTBACKS in auto racing efforts and expenditures by the auto manufacturers, your passenger car will continue to be improved because of the sport."

That's the opinion of an expert, the man who headed the Ford Motor Co.'s racing operations from 1957 to 1970, Jacque Passino.

The quiet, taciturn industrialist is known familiarly as the "Gray Fox." He's conservative in most everything except his choice of weekend attire, when he goes for bright colors and bold stripes.

Jacque Passino can speak freely today, as he did in this exclusive *Popular Mechanics* interview, because he abruptly resigned from Ford less than a week after the Dearborn, Mich., automaker just as abruptly cut its ties to motor sports last fall.

Auto racing has contributed many passenger-car improvements beyond the oft-cited 1911 rear-view mirror on Ray Harroun's car, says Passino, speaking with the knowledge and assurance

of one in the automotive industry all his adult life. After graduating from Toledo (Ohio) University with a mechanical engineering degree, he joined Willys-Overland, moved up to vice-president for administration in the export corporation and, after eight years, joined Ford Div. in sales promotion and advertising.

Within three months, he was in charge of Ford's racing program, although he had never seen a race. Even today, Passino is not a racing fan. It was his business, but he looks on auto racing as becoming the number one spectator sport in the United States.

"The race track that has proven in the past to be the real 'test track' for production cars will continue to be so, more emphatically, in the future."

Passino explains the benefits from racing like this: "An engineer who works on a car is a unique kind of a guy who can take an automobile—or any product you sell—and minimally engineer it.

"You don't put any more into any-

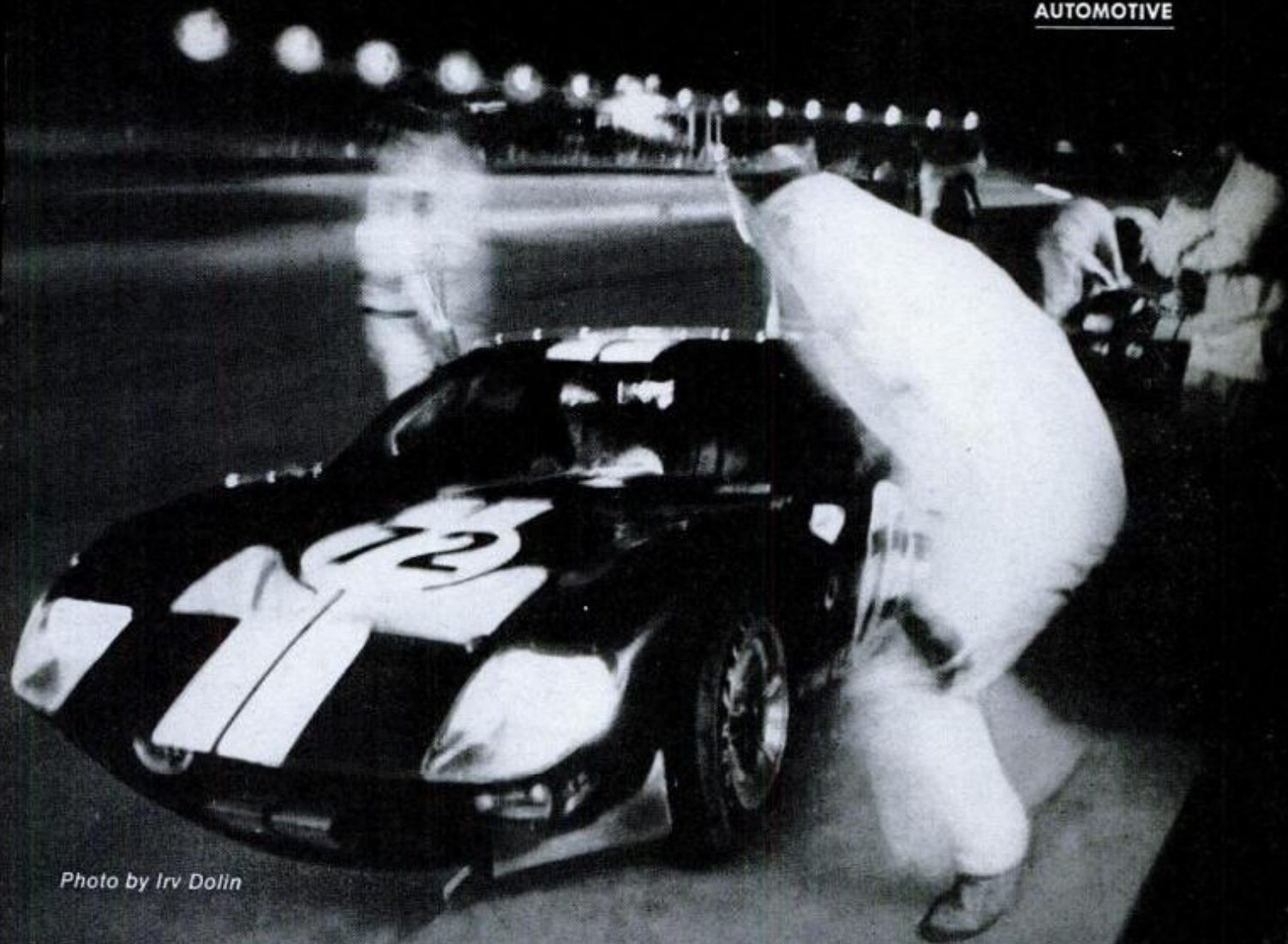

Photo by Irv Dolin

FIRST BIG WIN for Ford GT Prototypes was at Daytona in 1965. Miles/Ruby GT40 took first and the Ginther/Bondurant car No. 72, in a night pit stop here, took third in the 2000-kilometer race

thing you sell than you have to for it to do the job it's designed to do. You don't over-engineer it. On the other hand, you don't skimp. The companies have all kinds of statistics as to what it costs in terms of failure. They don't want any warranty failures, so they engineer the automobile to do what the automobile's supposed to do and at the same time to make the company the most money."

"The engineer says, 'I have engineered that car and it's perfect.' Well, fine, we take it on the track and destroy all those little things that he designed, but we improve it."

"Disc brakes have been used and proved on sports cars and foreign cars and in racing for years, but disc brakes

were slow to appear on American production cars because Kelsey-Hayes, Budd Co., Ford Motor Co. and General Motors have been dedicated to drum brakes. They have the machines, the castings, so they build drum brakes."

Everyone knew the disc brakes were better, Jacque insisted, and sooner or later, you will see four-wheel disc brakes on our domestic cars.

"So, you ask, did it come from racing? Sure, it did! When we wanted to stop a race car, dissipate heat, we used disc brakes."

Wide tires are another improvement transferred from race cars. The racers learned they got better adhesion and the automakers discovered that the passenger car was more stable with a



GRAND NATIONAL STOCK CAR, David Pearson's No. 17 Ford, described by Passino before factory pullout!

little better ride wherever the wide tires were used.

"Transmissions have also been greatly improved. Once upon a time, your kids took the car out, went drag racing on Woodward Ave. (the local, illegal drag strip in Detroit) and broke the transmission.

"'How come?' you demand to know. 'I never broke a transmission before!' That's because it's a different kind of car now: wider tires, more power. So transmissions had to be made better than they ever had to before. The improvements don't happen instantly; little by little they take something off a race car and put it on a production passenger car."

In hot Phoenix, Ariz., one summer day, Passino was amazed to see a huge supermarket display of Prestone, which is being marketed as a year-round coolant. "It all started in racing when the stock-car boys discovered antifreeze dissipates heats better than water."

"While the passenger cars will definitely continue to benefit from auto

racing in the future, the rate of progress will be slowed by the factory cut-backs because the independent racing teams won't have the finances at hand to develop the innovations they might need.

"Lacking the previously available factory technicians, engineers and large staffs, it will be difficult for an individual on a small budget, to gear up to produce a special item, even a short run item."

Regardless of the pace, improvements will continue to be made, in Passino's estimation, because "someone will always be out there on the track. And with the fierce competition, everything breaks sooner or later. The teams have to come up with better ideas and better ways."

Jacque looks back at the situation in 1962—the year Ford officially got back in racing after the "first factory pull-out" of 1957. "From 1962 it was onward and upward with Ford in racing, stocks, drags, Indianapolis, the Baja and other offroad races, and at Le Mans, France. We went to Le Mans

with a stock-car engine, the 427 push rod, a lump engine made out of iron, in a unique kind of car they said would never last. But we beat them.

"Henry Ford, you know, had tried to buy the Ferrari factory in 1963, but the famed Commendatore wouldn't sell so the goal became: If you can't buy them, beat them.

"After two years of trial-and-error experience, Ford scored the greatest team triumph in Le Mans history. In 1966, the first three cars finished almost simultaneously, close enough to be covered by the proverbial umbrella. Chris Amon/Bruce McLaren were the winners, Ken Miles/Denis Hulme, second, and Dick Hutcherson/Ronnie Bucknum, third."

That triumph belonged to Leo Beebe, then Jacque Passino's immediate boss, but as Beebe moved up in the company, Passino was placed in complete charge before the 1967 race, with his new title as special vehicles manager.

So, what do you do for an encore?

In 1967, in the black of the night, about the halfway point, "we were running one-two-three and sixth," Passino recalls.

"Mario Andretti crashed as he was braking down from 150 mph for the esses. Moments later, teammate Roger McCluskey, thinking Andretti might still be in the car, crashed his Mark II avoiding it and Frenchman Jo Schles-



AT LE MANS, where Fords had their big victories in '66 and '67, Jacque confers with John Holman

ser tried in vain to thread the needle between the two wrecks.

"There we are, running one-two-three and sixth and we lose three cars—two, three and six—in one crash. So, you expect them to ask, 'How did you work that out?' Well, that's life.

"Mr. Ford had just left the track before the crash and was gone for two or three hours. He could have said a lot of things, but when he came back he did say, 'I heard you had a bad crash.'

"Yes, we lost three cars.'

"Was anybody hurt?"

"No.'

"Fine.'

"There was no screaming at me. I might have screamed. In a 24-hour race, we're only 11 hours into the race and we lost three cars.

"We won the race with Dan Gurney

(Please turn to page 174)

TRANS-AM SERIES of SCCA races is manufacturers' championship. Factory Fords won it in '66, '67 and '70



NEWS BRIEFS



Auto engine powers 'copter

Haruaki Ozeki, a Japanese architect, built this hydrocopter in four months with the help of friends. Powered by a used-car engine, it lifted a few feet off the water, flew 25 mph.

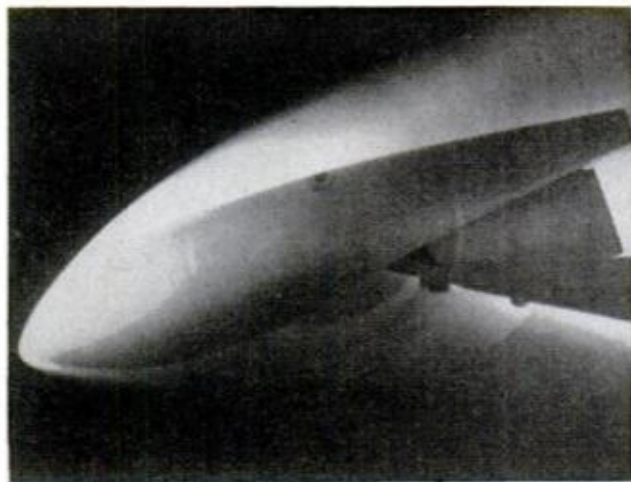

28,000-mph wind tunnel

A wind tunnel at Australian National University can deliver 28,000-mph blasts, twice the speed possible in other tunnels. Model is of a reusable German interplanetary glider.



Glider with a prop

When the AK 1's pilot wants a boost, he starts a retractable 26-hp engine that drives a pusher-type propeller. The powered glider was built by members of a Karlsruhe, West Germany, flying club in about 8000 hours.



Steam machine from junk

Morris Cleveland's 2½-ton steam monster lumbers along at only 5 mph. But the Lawrence, Kans., electrician built it from junk just for fun. The engine is an old oil-well pump; the boiler, salvaged from a cleaning plant.



Pushbuttons run train

No one is aboard the yard engine that pulls 12 cars around a Salzgitter, West Germany, steel mill. Man at the right controls it with radio signals triggered by buttons on the little switchboard around his neck.



Seeing by moonlight

An image-intensifier in this electronic spy-glass detects moonlighted objects one-third of a mile away. Light from an object is amplified 45,000 times in the three-pound device, which runs 50 hours on two dry cells.

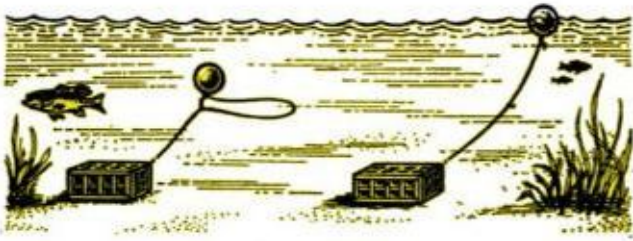

Pop-Up fools poachers

Angered by poachers who were finding his lobster traps and stealing the catch—and often the traps themselves—Spencer Meredith invented the Pop-Up, a “timer” that keeps the marker float hidden below the surface for a set period. The Pop-Up is a short rod that disintegrates in seawater. It's attached to the line from lobster trap to float so that when the trap goes to the bottom, the Pop-Up holds the float below the surface where poachers can't find it. When it disintegrates (there are overnight and two, three, five and seven-day models), the float pops to the surface where the returning lobsterman can locate it. Meredith's firm, Oceanetics International, Miami, Fla., makes the Pop-Up.

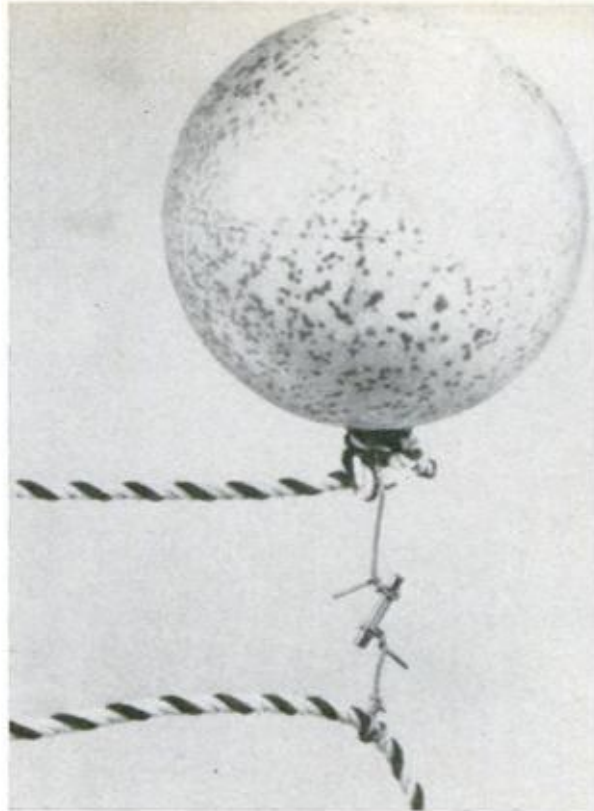

Ancestor gallery

Farmers in parts of Bavaria carve life-sized portraits of grandparents to sit on the ends of benches as memorials. The benches are destroyed when the last family member dies.



Foam for year-round home

Made of Selectrofoam polyurethane foam sprayed over inflated plastic forms, this home required no conventional framing. It was designed by architect Stan Nord Connelly; the plastic foam is by PPG Industries.

AUGUST 1971



Well, it's not stolen, anyway

A portable safe that's claimed by its makers to be burglarproof will be marketed soon in Australia. A built-in electronic system and tiny computer guard the safe so if any attempt is made to break into it, the contents are automatically rendered useless by an indelible blue dye. In the photo, money is impregnated with dye in a demonstration.

81

JUST PATENTED

They Roam

UNDERWATER
HABITAT PULLS
ITSELF ALONG
OCEAN BOTTOM

DIVERS
ENTER
AND LEAVE
THROUGH
OPEN
BOTTOM



Two-in-One Boat-Camper

You can trail both a boat and a camper with this versatile rig. The camper locks into the rear end of the boat trailer and overhangs the stern. If you want just the camper, the boat can be detached and the camper will overhang the rear deck of the car. You can also substitute a small cargo hauler for the boat and trail both it and the camper. The interchangeable arrangement is the brainchild of Leslie D. Modglin of Oneida, Ill.

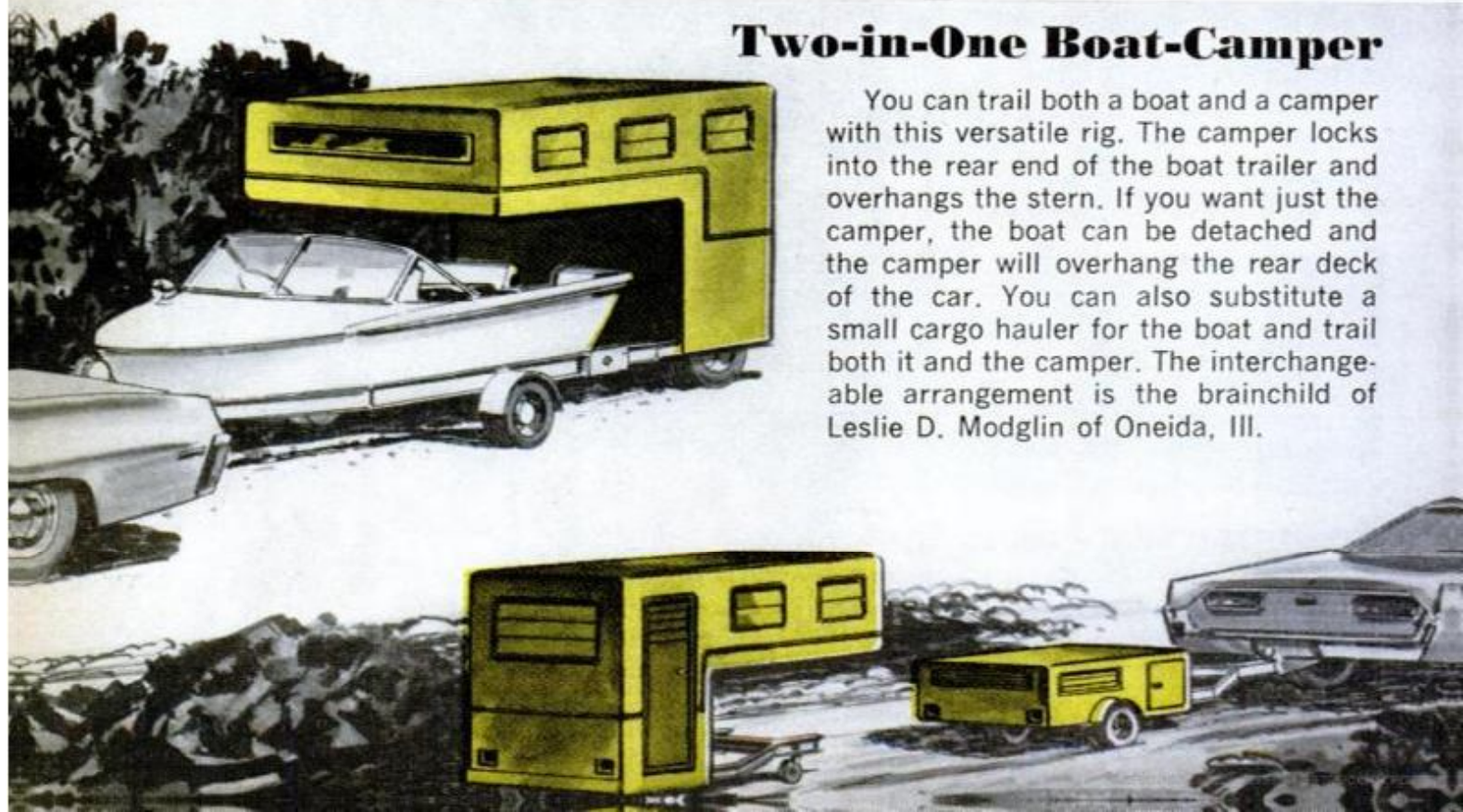

the Sea Floor on a Chain

Conventional underwater habitats are either unpowered and must remain anchored in one spot or they operate like submarines and need elaborate navigating equipment. The strange underwater craft shown here are neither. They can't navigate, yet they can roam for miles along the ocean bottom, carrying divers for pipe laying or research work. The trick is that they pull themselves along on chains laid down by ship on the desired course. A motor-driven carriage rides the chains, towing the habitat with it. The system, under study by Westinghouse, was developed by Wilbur J. O'Neill and Alan R. Krasberg of Annapolis, Md.

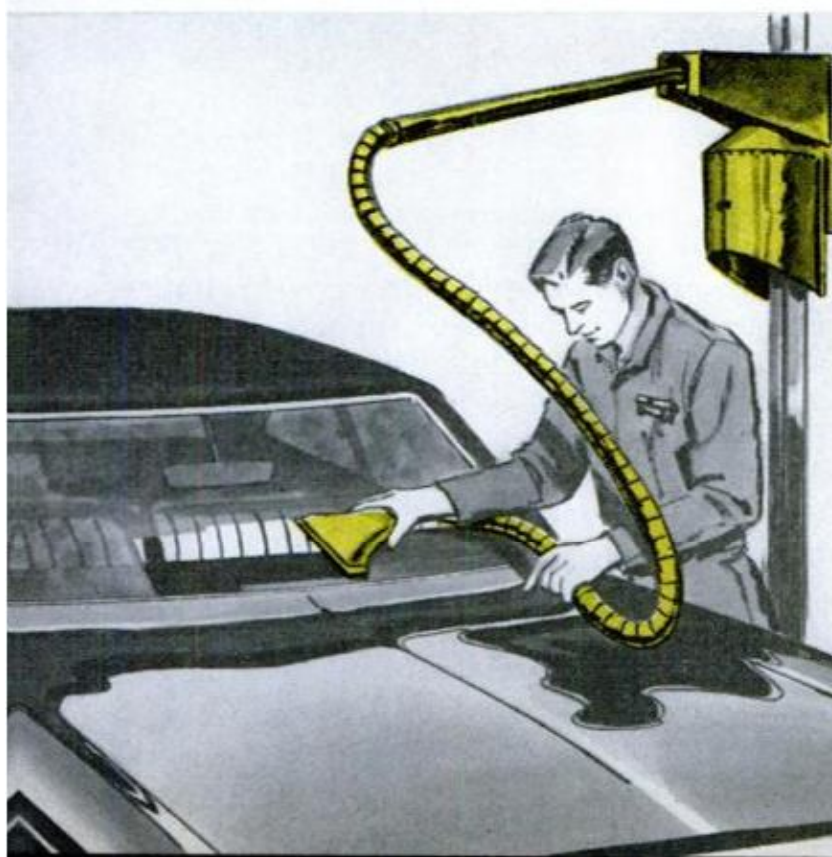
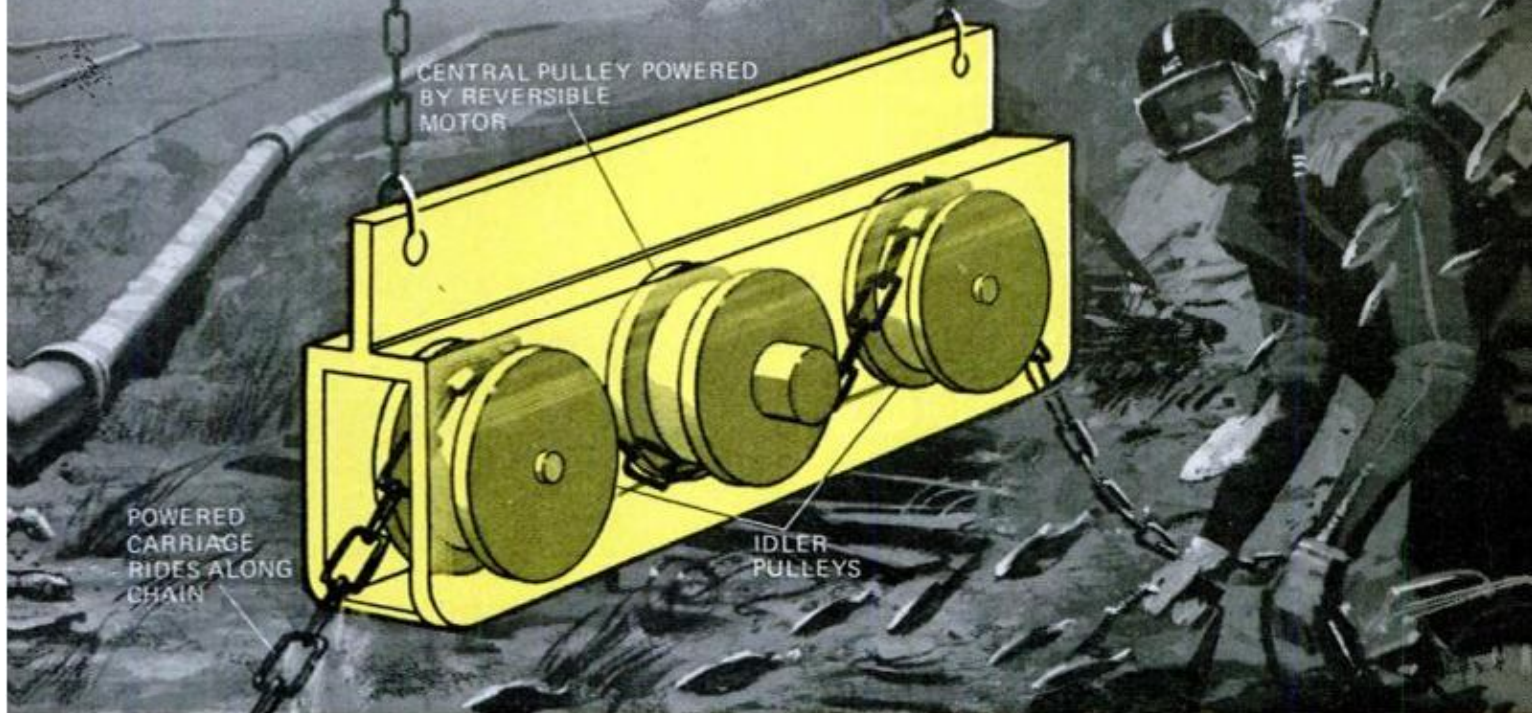

Automatic Washer

Washing windshields would be quick and easy with this automatic device for gas stations. It dispenses heated detergent, then vacuums up the dirt and suds, piping the waste to a tank. The air flow created by the vacuum also provides a drying action. Standard Oil is developing the idea from inventors Irwin Ginsburgh, Lawrence Wright and Benjamin Pennington.

Illustrations by Roy Grinnell

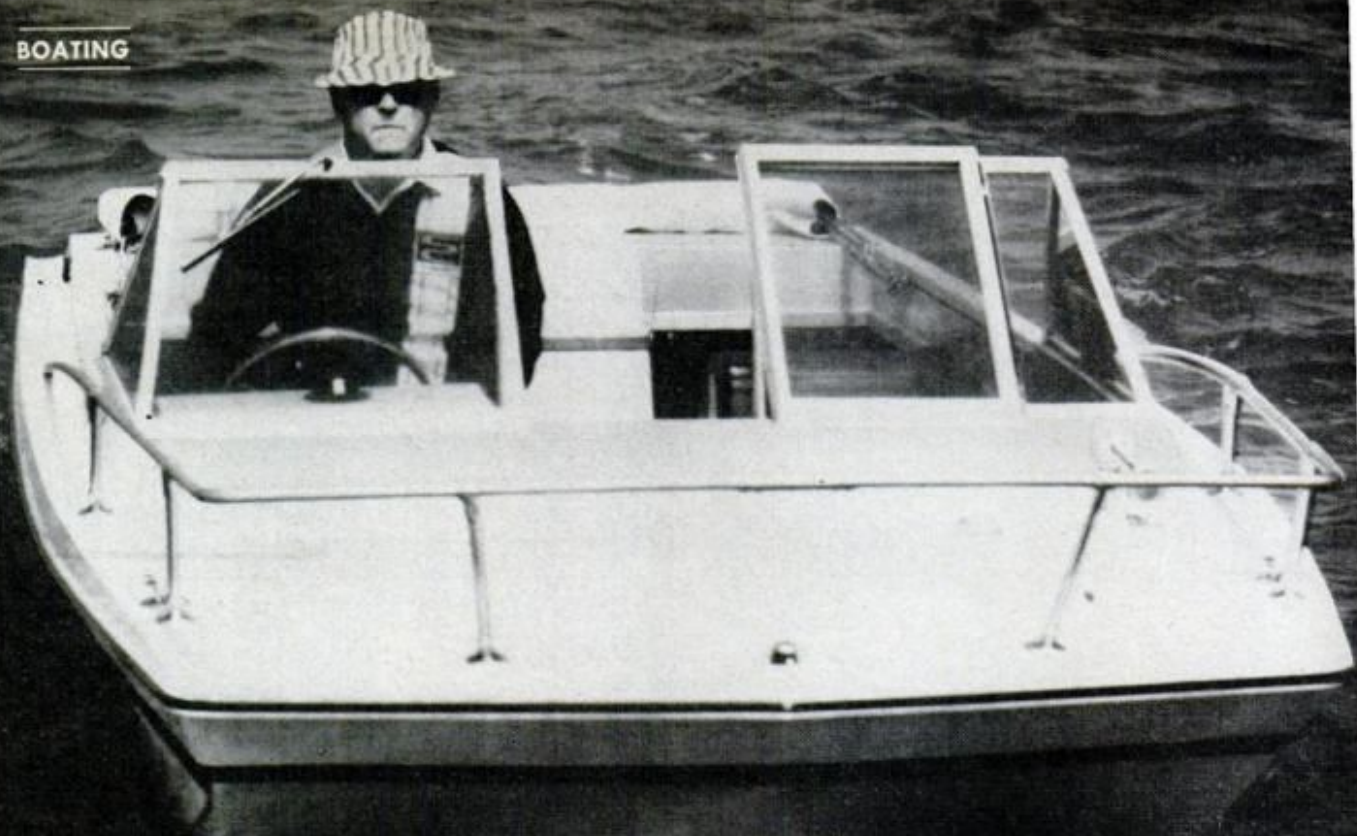

A SLICK NEW TRI-HULL

Slickcraft's SS-185 takes the hard, wet ride out of the bow

By GEORGE REIGER, Boating Editor

THE SOUTHERN COAST OF TEXAS is a great place for a boat test—and I found a three-day excursion between Port Aransas and Port Isabel to be therapeutic as well. Bob Davis, southwestern distributor for Slickcraft boats, wanted me to visit his favorite boating waters to look at a “truly different” tri-hull. I settled on one date for the trip but then called Bob to ask him for a raincheck because I had picked up a vicious cold just before flight time.

“Come on down anyway,” he insisted. “This new tri-hull is so smooth, it’s like riding on a water bed! And the trip and fresh air will do you good. You’ll be over your bug in no time.”

Bob’s water-bed claim was an exaggeration, but his prediction of improved health sure came true.

The reason for his enthusiasm was quickly apparent. Most tri-hulls have a compartment in front of the steering console where passengers are supposed to sit. Yet experience shows that most riders get too much wind, spray or bounce there to find it a pleasure on any but the calmest days. Thus, many tri-hull owners convert the well space into spare-tackle storage. But since this hardly

BOB SHOWS SS-185 near old Port Aransas lighthouse. Middle right: profile. Near right: We end journey in Port Isabel. Far right: Bob chooses tackle from Berkley travel pack

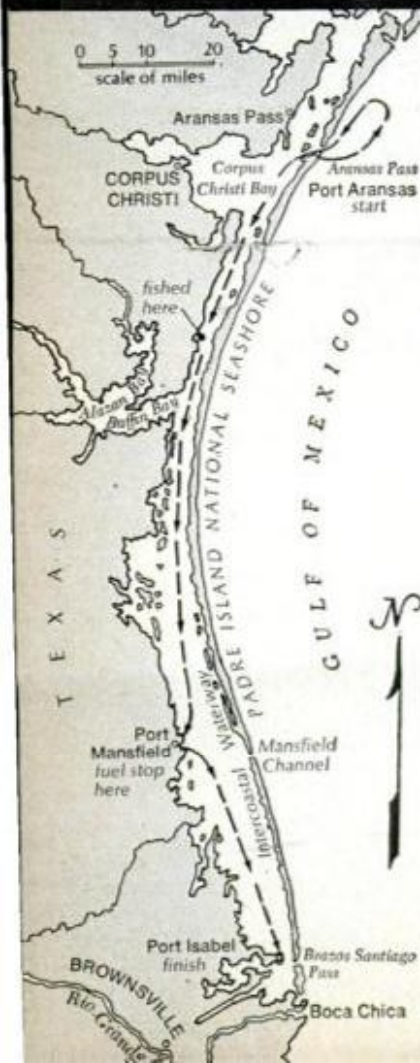





AT START OF EACH DAY Bob gave our 140-hp I/O system a thorough going-over to insure smooth running. With enough marina facilities along the way, we never had to use the spare fuel in can at center foreground



EASILY READ INSTRUMENT PANEL (including lower-unit angle indicator) helped to make trip a pleasure



CLOVEN-HOOF and low-silhouette design of Slickcraft cleats makes them less likely to stub bare toes

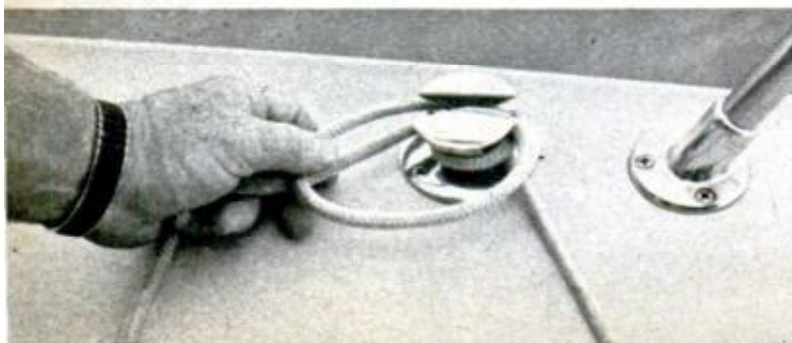

qualifies as "dry storage," any metal gear exposed to the salt-water spray quickly rusts and deteriorates.

Slickcraft has taken an 18-foot, 11-inch tri-hull, moved the fuel tanks for its 140-hp powerplant forward to the bow and decked over the space, incidentally providing the boat with an ideal casting platform for anglers.

During our run from Aransas to Isabel, I also found the weight of fuel forward countered the weight of the engine aft so that we experienced a smooth transition from plane to idle and back again. Then since we endured the discomfort of stiff winds during our first day of tests in the inlet area of Aransas Pass, I had first-hand opportunity to see the advantage of a decked-in forward compartment that sheds water rather than scooping it up from oncoming rollers. The chop was so severe that a number of whitecaps washed over the deck and the windshield before slapping me in the face or running down my neck when I ducked. If we'd had an open cockpit in front, we could have been in trouble.

The SS-185 is available for \$4745 with 140 Merc I/O unit; \$250 less with 120 hp. Write Slickcraft, 500 East 32nd St., Holland, Mich. 49423. ★★★

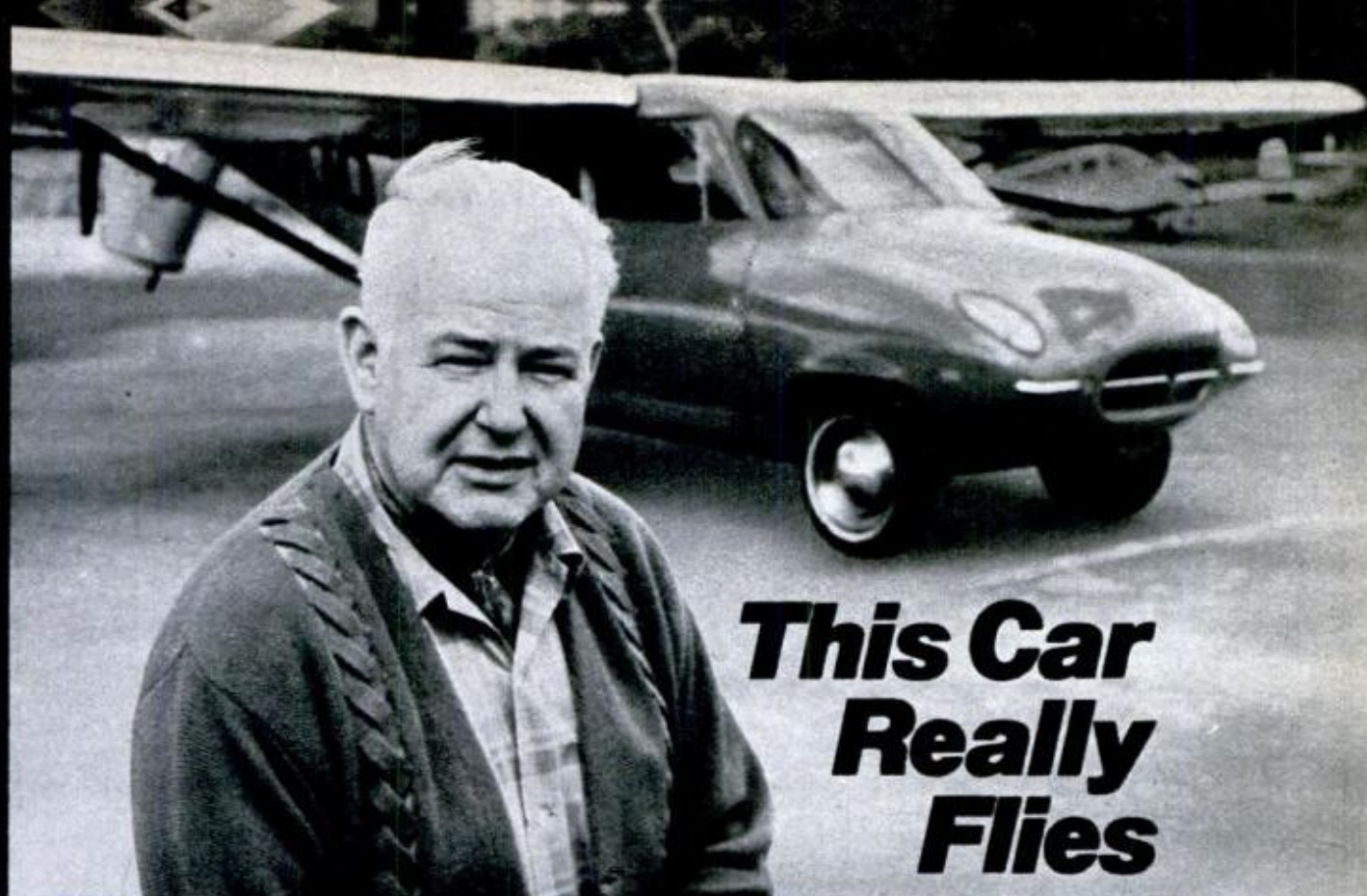

This Car Really Flies

By BOB GRANT

A FLYING AUTOMOBILE that sells for less than some luxury cars? It will happen if Moulton (Molt) P. Taylor has his way. His Aerocar III has been certified by the FAA for sale to the public, and could be produced with a price tag as low as \$10,000. The only machine of its type so certified, the Aerocar is the result of two decades of development at Taylor's little shop in Longview, Wash.

The trouble with today's private planes, says Taylor, is that "when you get where you're going, you aren't where you want to be! The Wright Brothers made a serious omission. A bird that can't walk would starve to death. Henry Ford, on the other hand, came up with a thoroughbred automobile but corralled us from the start—it's limited to highways."

The Aerocar III, a sporty little two-seater that can roll as well as fly, is basically a sleek compact fiberglass car and an aluminum flight component of wings and tail. When you land, you get out and pull a few pins and bolts. The wings fold and wheels extend to turn the flight component into a trailer. You can park it at the airport while you buzz off on business or tow it home and store

it in the garage until you're ready to fly.

Aerocar might be the answer if you have to commute anywhere. It will carry 500 pounds—two people and 100 pounds of baggage. Empty weight is about 1500, comparable to a standard four-place airplane. Some 1100 pounds is the automobile/cockpit. Gear necessary to run on the road—clutch, transmission, differential, horn, turn signals, headlights—make up about 300 pounds. It's very useful weight back on the ground.

Changing from plane to car and back takes about 10 minutes to do manually. A production model incorporating hydraulic mechanisms would do most of the work at the touch of a button.

Aerocar could make learning to fly easier than learning to drive. It is an enormously stable craft and has certain other advantages inherent in its design. By putting the prop in back, it flies through undisturbed air.

"Man has dreamed about a flying automobile for years," Taylor comments, "and Walt Disney even made a movie about one." Perhaps the Aerocar will be a dream come true. ***

(For a PM flight report, turn the page)



Photos by Bob Grant



THE FLYING AUTOMOBILE attracts startled glances in downtown traffic. It handles easily even when towing the flight trailer. A special pylon is said to keep the trailer steady up to 70 mph and in 40-mph crosswinds



'I Flew It'

By FRANK A. TINKER

IN 15 MINUTES we'll be looking down on this," said Molt Taylor as we drove past a restaurant on the way to the airport. He was right; in that time we had fixed the Aerocar III's wings in place and taken off. Try this on any other combination sports car and airplane!

My job was to test the Aerocar in the air, and, as a professional pilot weaned on distrust of any aircraft not factory built and strictly conventional, I had some qualms. In the first place, the contraption Taylor had wheeled out of his little shop in Longview, Wash., appeared to be primarily an auto. It proved to be exactly that as we drove to the airport. Except for several odd controls and instruments, the interior looked very much like a sporty compact.

The noise level was higher than an ordinary car as we drove away, but that was expected and did not approach the uncomfortable. The only



BUG BECOMES BIRD as two pins are driven in place to secure flight component and wings unfold for takeoff

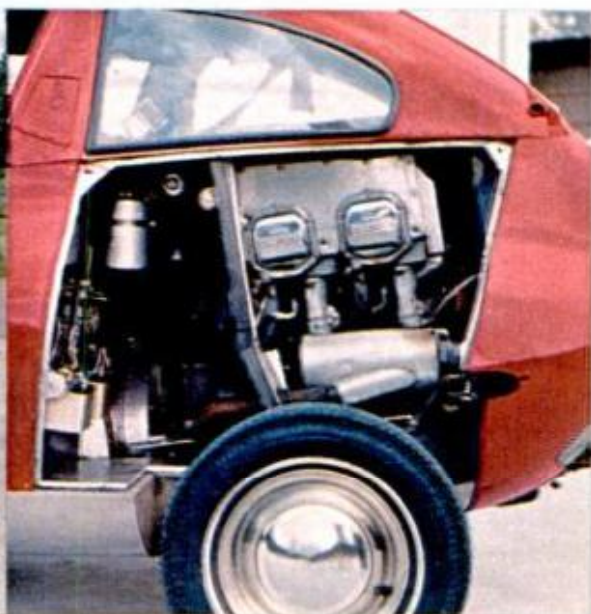

LYCOMING AIRCRAFT ENGINE with special ignition and cooling systems powers both car and plane

'I Flew It! . . .'

disconcerting item was a twitch to the front wheels in a low-speed turn. "It's the simple U-joint we have," Taylor told me. "We could cure it with a constant speed joint, but we're working on a less-expensive one to keep costs down."

Turn signals, brakes and other controls all worked normally, and the Aerocar cruised along on its undersized wheels at a comfortable 50 mph.

Naturally, I was interested in how secure the conversion from bug to bird would actually be. It turned out to be very substantial—and fast. Just unfasten the trailer wings by pulling two longeron pins, turn them around and fit the prop driveshaft into its socket. Let the wings swivel into position, lock them, and the job's done. Those same two pins hold the wings and tail section on, and the only tool needed is an ordinary hex wrench.

As I looked at the car that was no longer a car, I couldn't deny the challenge. It had sprouted wings—so I'd fly it.

It was reassuring to learn that the plane had been certified by the FAA some years ago. It is flying under an experimental tag because of a unique ignition system yet to be okayed.

To get under way, the Aerocar starts up with the engine key like a car; no



HANDSOME DASH holds car and plane instruments. Rudder pedals are outboard of clutch, accelerator

jockeying with mixture controls and throttle as with most aircraft. Molt then simply shifted into reverse and backed away from the ramp. He had already extended the wheels and/or landing gear into flight position, putting us inches higher off the runway.

To go from ground power to flying power you merely put the standard gear-shift lever into neutral. This leaves the wheels free to roll (the front brakes are also disengaged) and transmits power back to the fixed-pitch prop through a sophisticated fluid drive

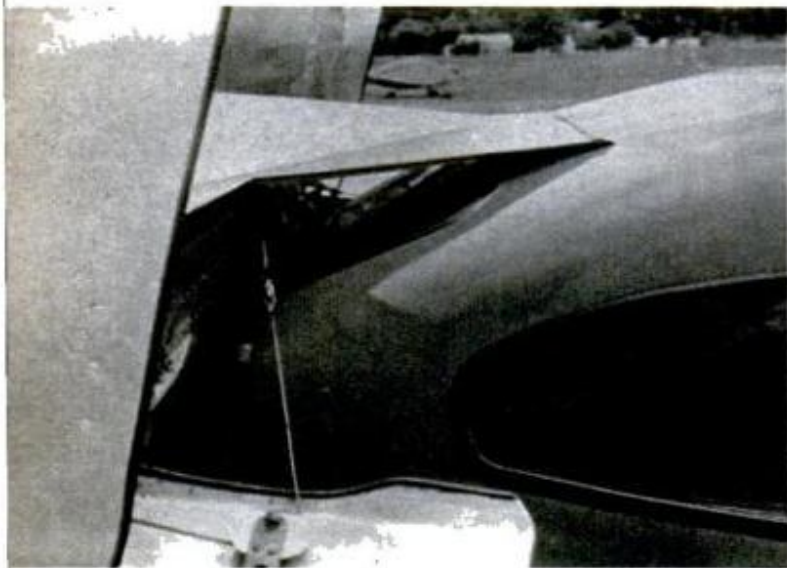

SLICK IN THE AIR, Aerocar is streamlined to aid airflow by an aluminum panel covering back window

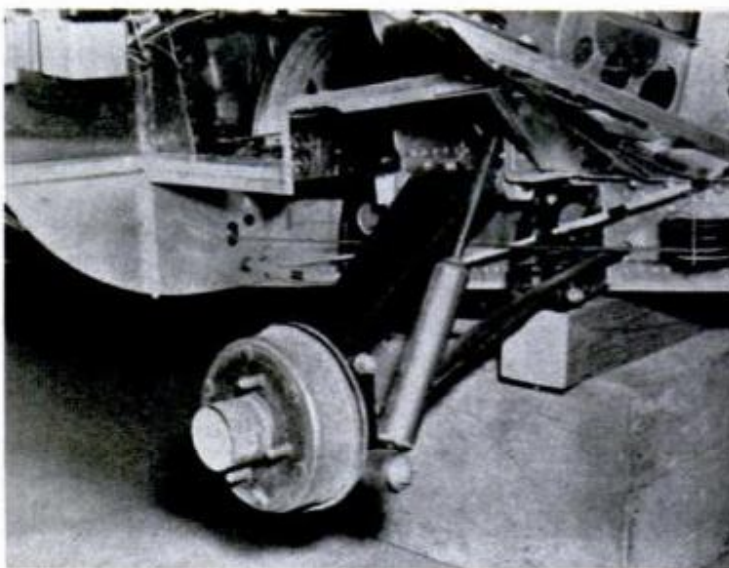

RETRACTABLE WHEELS are extended for takeoff, retracted for flight. A midposition is for road use

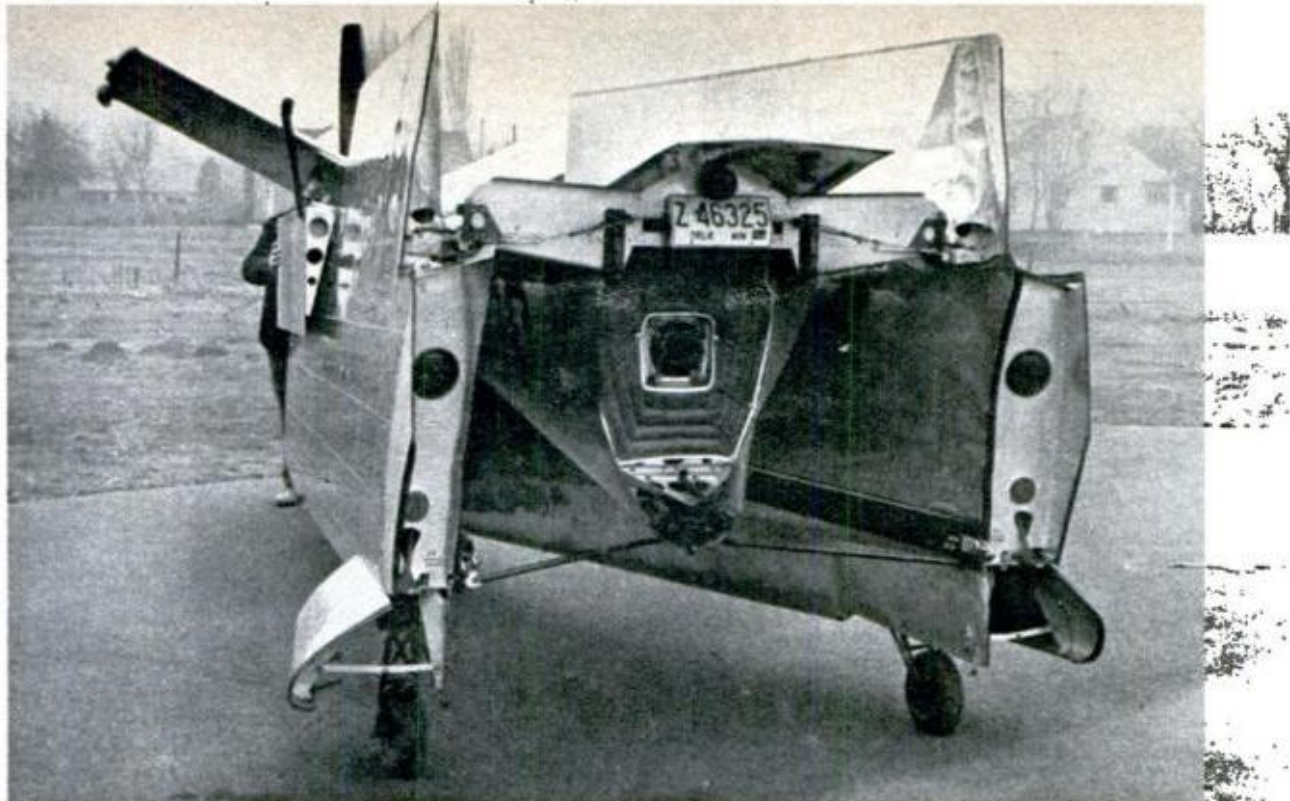

THE FLIGHT TRAILER, towed backwards on the road, is turned around on its small wheels to mate with car

known as the Flexidyne. The "fluid" is actually some 1,400,000 tiny steel balls. When rotated, they are compressed by centrifugal force into a solid mass around a wavy drive plate. In effect it's a constant-speed clutch that locks solidly with no slippage. The device neatly solves a difficult problem: Snap-torque between motor and the prop would bend or break an ordinary driveshaft.

With full power applied, we had the airspeed needle at 60 in seconds. The steering wheel—which became the control column by being unlocked and

automatically engaged to elevators and ailerons—was full back, and we left the runway at a good angle. (The specs say 650 feet for takeoff fully loaded.) Then, with elevator trim set, Molt calmly took his hands off the wheel and folded them. Not so calmly, I watched the climb-out continue with remarkable stability, the Aerocar guided only by an occasional toe-touch on the rudder pedals.

Best climb speed is about 70 mph, which gave us 800 feet per minute—that with two 200-pound pilots. The

(Please turn to page 116)

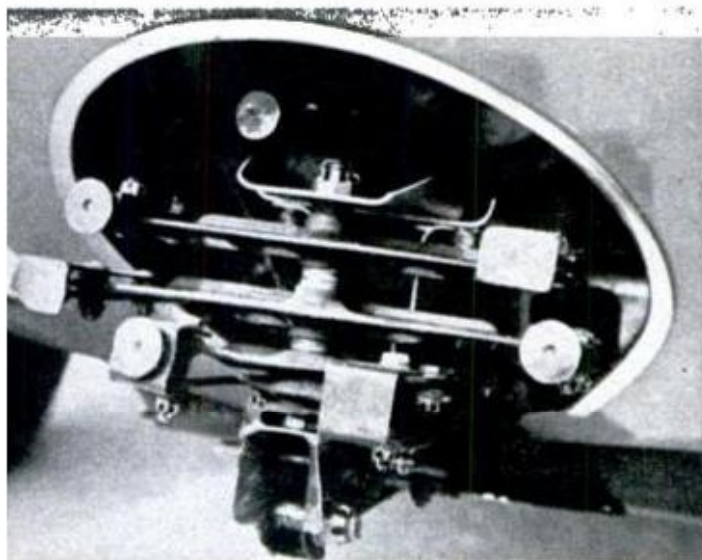

AIRCRAFT CONTROL connectors on car automatically lock to matching connectors on flight component

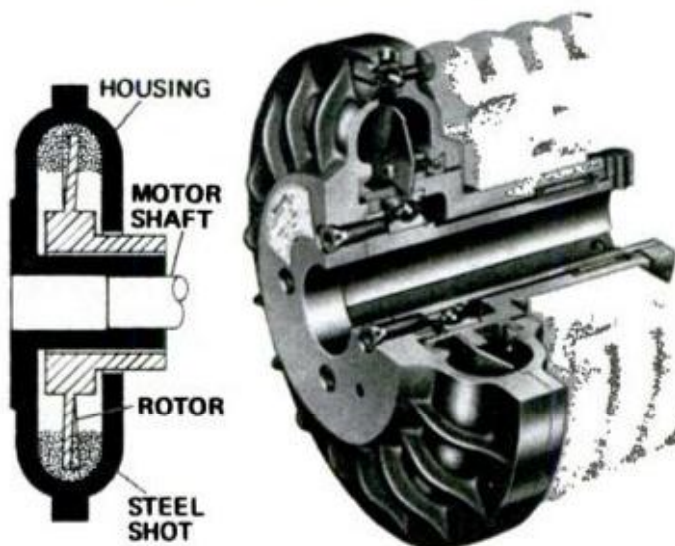

FLUID PROP DRIVE uses steel shot which pack between rotor and housing, providing no-slip coupling



No longer freaks in yachting circles, catamarans appear in everyday use with trailerable and even cargo models

CONVENIENCE is what contemporary sailors want in a boat. Fold-aways, cartoppers and easily-trailerred models are all popular with boaters pressed for time, money and storage space. Today, durable, lightweight metals and plastics are put to use in catamarans, just as in single-hull boats.

Though the Polynesians have been roaming the Pacific for centuries in the swift and graceful twin-hulled craft, it took World War II to acquaint the rest of the world with them. In July 1948 *PM* helped spread the word with a cover story about an ocean-going model made in Hawaii.

But mishaps and misunderstandings attended catamaran development in the 1950s, and many designers abandoned the concept, convinced it would never catch on. However, a California surfer by name of Hobie Alter saw that potential success for the catamaran lay

in using lightweight materials like vinyl-coated nylon and anodized aluminum and in keeping his design simple. He set out to provide surfing thrills in a sailboat for a nonexorbitant price. His result: the Hobie 14 for \$1195.

The Hobie Cat at left was packed from New Jersey to Virginia, then was assembled and set under way in less than half an hour. Both the 14-foot model and Hobie's new 16-footer can be dismantled and stored in your backyard or under your garage rafters.

Hobie's success has spawned some capable competition; in trampoline designs are Aqua Cat in Charleston, S.C.; Sea Spray in Hermosa Beach, Calif.; and Sizzler in Bedford Heights, Ohio. Then there are mini and maxi-catamarans like those pictured below. Hobie's address: Coast Catamaran Corp., 33012 Calle Perfecto, San Juan Capistrano, Calif. 92675. ★★★

SETTING UP the Hobie Cat 14 requires only some white grease, a rubber mallet, crescent wrench, screwdriver, small file and pliers. By careful loading we were able to carry the entire assembly of twin hulls, trampoline, rudders, mast and sail inside and atop an International Travelall. Assembly time? Just 20 minutes. Below: Catamarans come in all sizes from 10-ft. Frolicat (left) to ocean-going 37-ft. Poly Con (right)

Catamarans Catch On!



BOATING TIPS

By ROD RADFORD

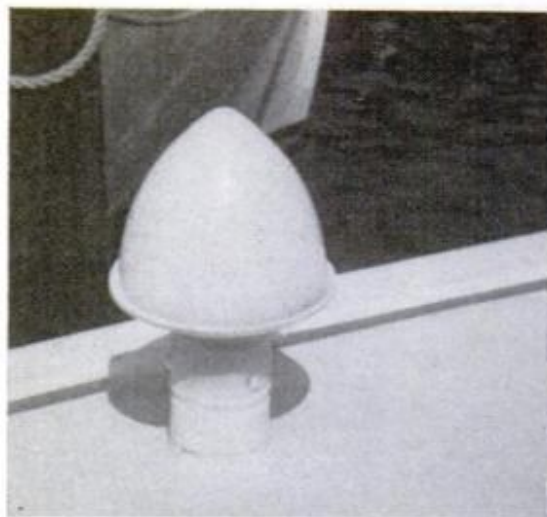

PLASTIC FLOWER URNS convert into a variety of uses. Above: I drilled holes in one and mounted it over a vent pipe to make an attractive and functional cover. Below: I bought a sealed beam headlamp from a junk dealer and set it in the bottom of another urn to make an inexpensive boat spotlight for myself

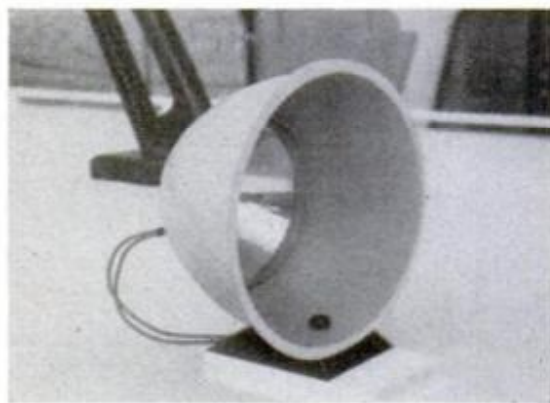

Look for 'Marine Gear' on Supermarket Shelves

Half my boating fun comes from recognizing useful marine accessories in familiar plastic, fiberglass and aluminum household items. Those plastic flower urns in a "gardener's corner" (above, left) can be converted into a number of boat devices.

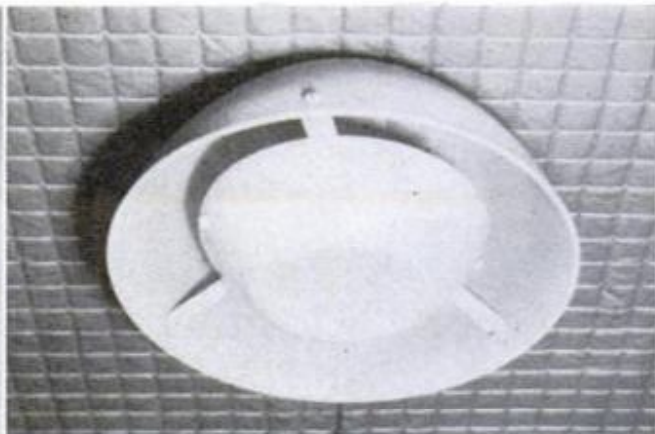
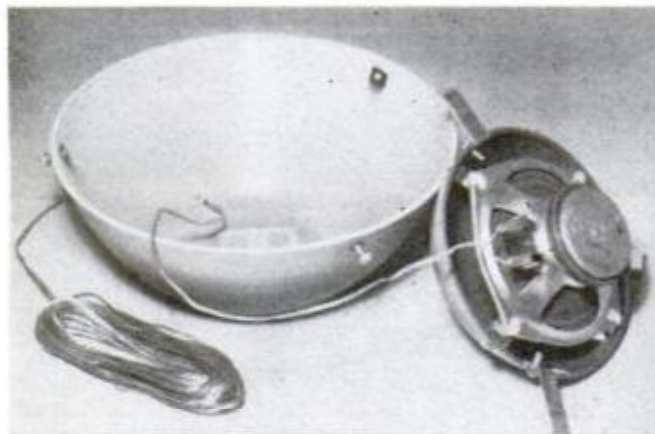

Extension speaker cover: two fruit bowls

I fastened a 3-inch-diameter speaker two inches from the bottom of a small plastic bowl, cone up. With homemade brackets I mounted this inside the rim of a larger bowl. The two-bowl cover diffuses sound nicely over my dinette table.

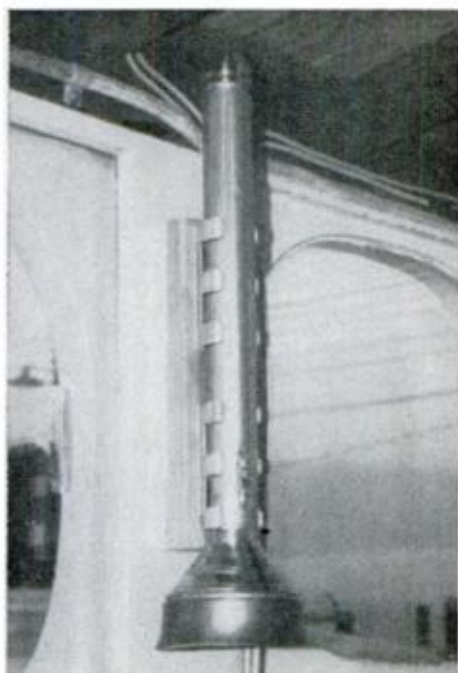

Flashlight holder

Two short bike-light brackets I picked up at a bicycle store hold an emergency flashlight handy near the boat's helm. In place, the flash also serves as a chart or instrument light. I mounted the brackets $\frac{1}{32}$ -in. out of line with one another to give them a stronger grip. Even a heavy six-cell flashlight can't be jolted out of the holder.

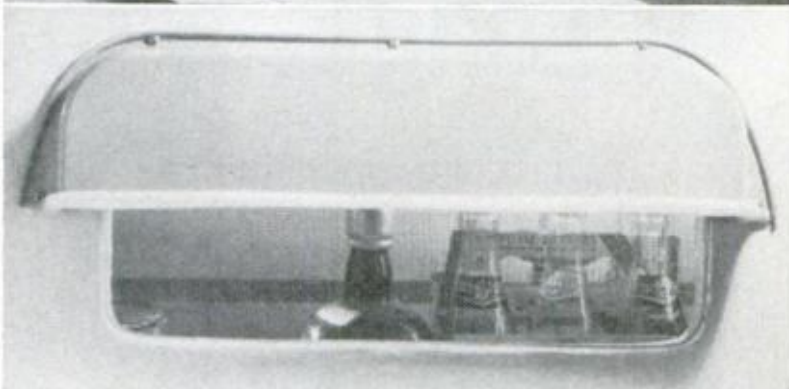

Pan converts to 'eyelid' over window

Aluminum baking pans come in many sizes. I chose one a few inches longer than the width of a window I wanted to shade from glaring sun and driving rain. After sawing it in half lengthwise with a sabre saw (a hacksaw works too), I primed the "eyelid" and spray-painted it to match the boat. Rubber or PVC tubing covers the rough edges.



Tray flashes signal

A chrome-plated serving tray doubles as an oversized mirror to signal for help if you're in distress during the daytime. The tray is easily stored.

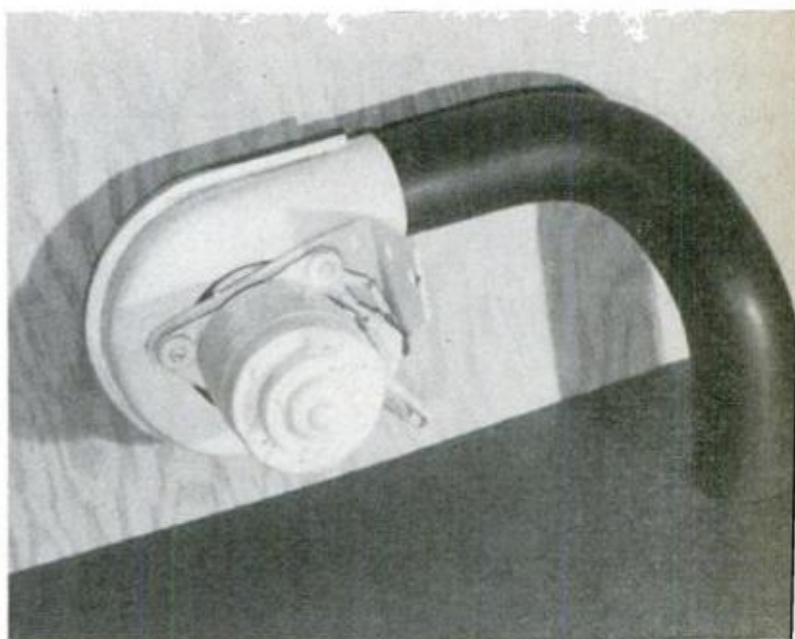

Auto parts cool cabin

My forced-air cooling system uses a fan motor from an auto heater and molded auto radiator hose. The motor is well above bilge to avoid sparking gas fumes.

Gas Goes a Long Way, But Dealer Service Has a Long Way to Go!

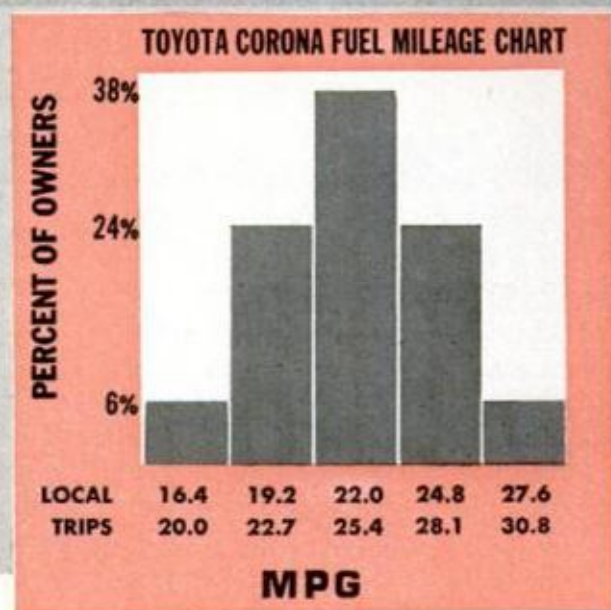

By **MICHAEL LAMM**
West Coast Editor
Photos by the Author

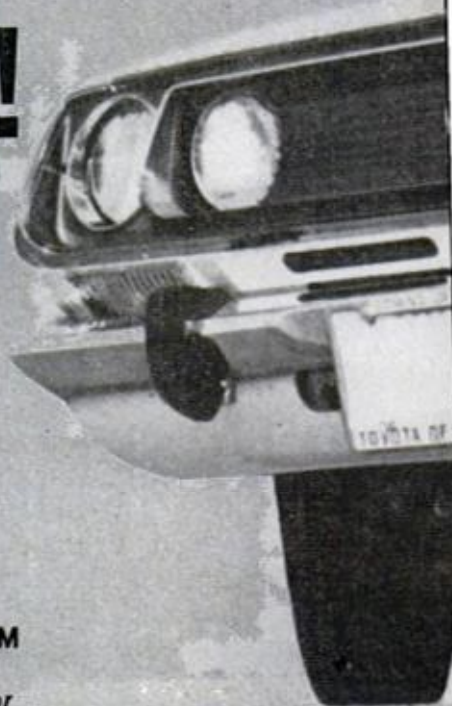

CORONA'S 108-hp engine gives snappy performance; 97.5-in. wheelbase makes ride jouncy on rough roads but, still, owners like the handling

CORONAS don't often give trouble, but when they do, service sometimes becomes a problem. Reason: Not enough competent mechanics.

We must stress that the incidence of mechanical failure is very low in Toyotas. Only 18.1 percent of all Corona owners surveyed reported that they've had to take their cars back for any repairs *at all!* That's a record for recent reports. But of those, 38.8 percent said those repairs didn't come up to snuff.

A Maine firefighter: "They seem to want to fix it, but they *don't* fix it." A New York projectionist: "It takes two or three trips to the shop to get any simple adjustment. They keep the car overnight, give it back the next day either totally untouched or done so badly it must be left or brought back again." A Nashville management con-

POPULAR MECHANICS

PM OWNERS REPORT TOYOTA CORONA

A Nationwide Survey Based on
1,250,000 Owner-Driven Miles



sultant: "They are very friendly, but I have lost confidence in my dealer's ability to service the car." Several owners said that routine service—checkups and warranty maintenance—is too expensive, often running \$40 or more.

Workmanship opinions rate very high for the Corona, with over 90 percent marking it "good" or better. Only 1.4 percent gave it a "poor" rating.

We also asked Corona owners to give their opinions on comfort; 3.7 percent termed it "excellent"; 38.1 percent said "very good"; 53.1 percent rated comfort as "good"; and only 1.5 percent put it down as "poor." (Our definition of "comfort" covers a lot of ground—it

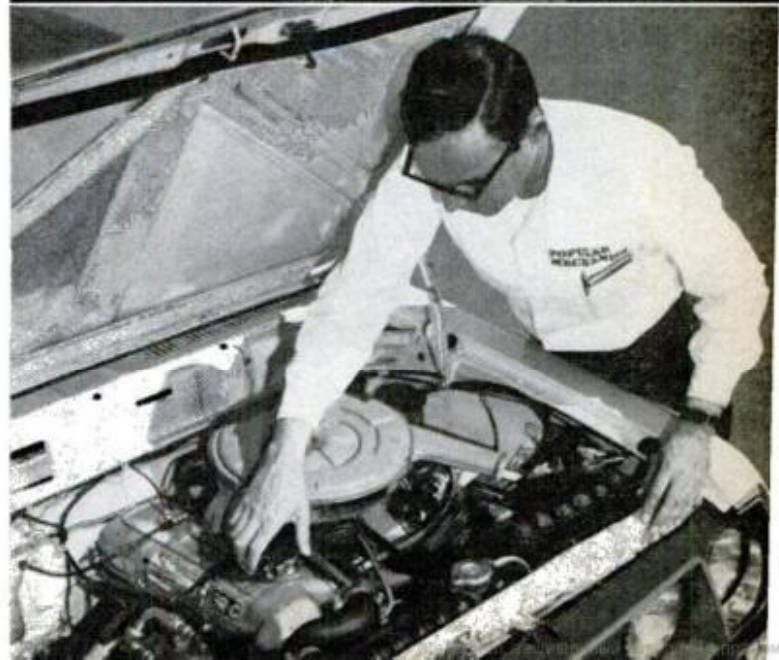

DASH LAYOUT, GENERAL VISIBILITY win high marks. The heater, though, is hard to adjust, and the seat doesn't move back far enough. Ohc Four has ample work room. Some owners feel mechanics fear engine



QUALITY OF MATERIALS and workmanship rate very high. Squared lines provide lots of usable space

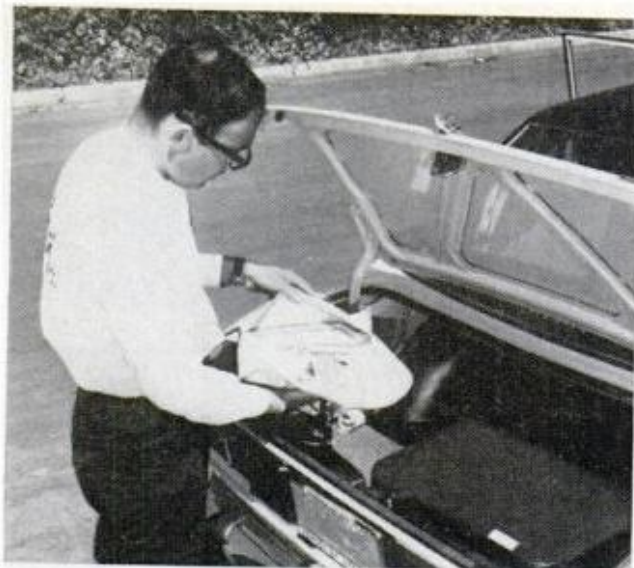

DEEP TRUNK is among largest in this class. Corona includes good tools—one of many unexpected extras



DISC BRAKES up front are standard. Jack fits into special slot, holds car steadier than bumper jacks



includes roominess, seating, ride, ventilation and visibility.)

When asked, "What was your primary reason for buying a new Toyota Corona?" more than half answered, "Economy." And most of those feel they're getting it, both in terms of gas mileage and upkeep. Except for the few grumbles about maintenance charges, no one felt he was paying too much.

Several owners pointed out all the extras that Toyota throws in as standard equipment and how "... it's refreshing to get \$1's worth of car for \$1 spent." And, "I was pleasantly surprised to learn my auto insurance had gone down as a result of my having bought a smaller car."

Several owners mentioned they had "moved up" from VWs. They said that while they liked VWs, they wanted more room, or four doors, or greater silence. Oddly enough, not one Toyota owner gave "trade-in value" as part of the Corona's economical virtues. These Japanese imports do hold their resale value as well as any U.S. car (but not so well as VWs).

A significant number of Toyota owners brought up the topic of oil consumption. It seems that about 800-1000 miles per quart is par for the Corona. It's possible, however, that after log-

RECLINING BUCKET SEATS, standard, let backrest adjust to many positions, can be converted to a bed

ging more miles (most respondents had less than 10,000 miles on their new cars), oil consumption might go down.

Under *specific likes*, here are some random comments: "It has a lot of power for a small car and will perform with the best of them." "Good city transportation." "Good visibility under all conditions." "Room for four, easy to work on myself, plenty of power; the most car for the money." "Handles beautifully." "Has a great deal of luggage space." "Gives you all those options and big-car features plus economy of purchase and operation." "No American car, including Cadillac, is built as well."

This isn't to say there aren't a few gripes, but they're mostly minor. Under *specific complaints*, we got these: "None." (18.3 percent had no complaint.) "Dealer service is a laugh." "When shifting from Park to Reverse, it has a bit of a jerk." "Whirring noises at 60 mph." "Disc brakes squeal." "Too hard to start in cold weather; also very slow to warm up." "Driver's seat doesn't move back far enough." "Steering so tight and heavy my wife complains that her arms ache." "Engine pings and keeps running on, even

with high-test gasoline." "Understeer." "Suspension is too firm to ride well and too soft to corner well."

Considering that the Corona often gets bought as a second car, we weren't too surprised by the number of Corona owners who compared it with other makes. Here's what we mean: "It tows our camping trailer better than the 1964 Dart we traded for it did." "It has everything the Caddy has except it's smaller." "More comfortable to ride in than my 1968 Thunderbird." "Our other car is a 1959 Volvo with 102,000 miles and still going strong. Hope the Corona will do the same." "There is a feeling of roominess that I did not get from the Volkswagen." "Outclasses our 1968 Buick in every way."

To summarize, Corona owners feel they're certainly getting their money's worth. In terms of economy, quality, workmanship, reliability, performance, comfort, ride, roominess and styling, the Toyota does all it's supposed to do and then some. The only grumbly area is dealer service, which runs hot and cold with any car, domestic as well as foreign. Apparently, though, Toyota could do with a few improvements in the back shop. ★★★

Summary of 1971 Toyota Corona Owners Reports*

Total miles driven	1,286,161
Average miles per gallon:	
Local driving	22.0
Long trips	25.4
Body styles:	
Two-door hardtop	1.5%
Four-door sedan	98.5
Models	
Corona Deluxe	97.9%
Corona Mark II	2.1
Why the Corona?	
Economy	50.7%
Size	21.6
Reputation	16.6
Price	14.0
Styling	12.6
Specific likes:	
Economy	63.2%
Handling	43.3
Comfort	29.2
Style	22.7
Power	19.5
Size	15.5
Workmanship	15.2
Ride	14.8

Specific dislikes:	
Dealer service	11.3%
Poor gas mileage	10.3
Rattles	8.8
Poor brakes	8.4
Cold starting	7.0
Wind noise	6.2
Steering	5.1
What changes would you like?	
Seat style	6.8%
Better service	6.4
More legroom	6.4
Lighter steering	5.9
Vent windows	3.8
Better gas mileage	3.8
Better materials	3.4
Better tires	3.4
Had any mechanical trouble?	
No	81.9%
Yes	18.1
What kind of trouble?	
Cold starting	13.0%
Other carb ills	13.0
Electrical	10.9
Valves	10.9
Transmission	8.7
Oil leaks	8.7

Did you repair it yourself?	
No	96.1%
Yes	3.9
Dealer repairs satisfactory?	
Yes	61.2%
No	38.8
Is the Corona your only car?	
No	55.5%
Yes	43.5
Other cars owned:	
Chevrolet	24.4%
Ford	15.6
Pontiac	11.2
Plymouth	8.8
Toyota	8.8
Volkswagen	8.8
Buick	6.9
Age distribution of owners:	
15-29 years	35.1%
30-49 years	39.8
50-plus	25.1
Would you buy another Corona?	
Yes	87.9%
No	12.1

*Percentages might not total 100% due to rounding and/or insufficient data.

NEWS BRIEFS



Blocks for a Dutch dike

These five-ton concrete blocks—200,000 of them—are headed for the sea bottom off the Dutch town of Brouwershaven. They're being dropped from a crane (right) to form a base for a huge dike that will close off the last big mouth of the Dutch Delta. Begun in 1963, the ambitious project is nearing completion.

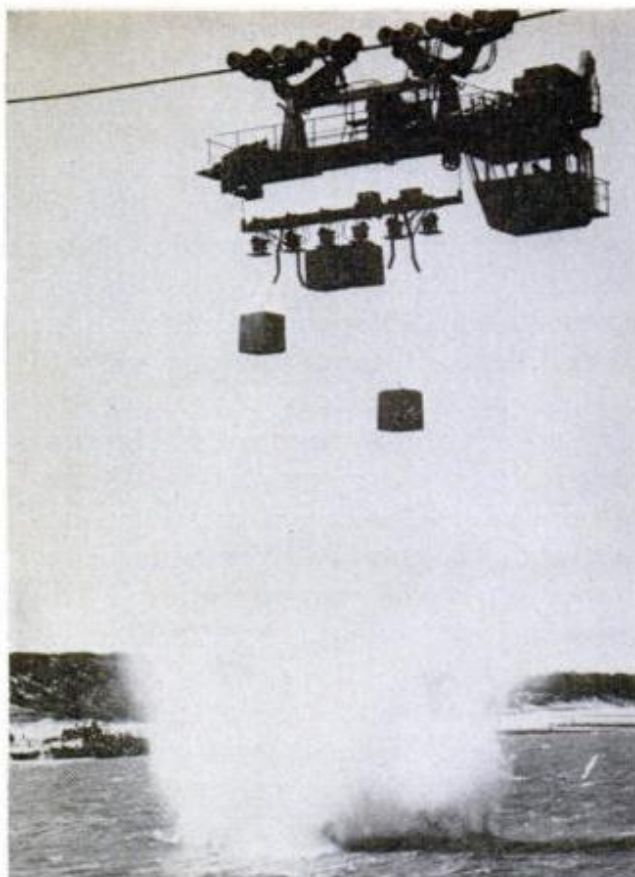

Newest British challenger

Another import will soon battle Detroit's subcompacts. The 1800 De Luxe sedan shown is one of 10 all-new Morris Marina models. They boast low-pollution exhaust, quiet running, simple upkeep, safety features.



Bulldozer works underwater

An amphibious Japanese dozer—with twin snorkels and radio remote control—rips rock and shoves dirt around in nine-foot depths. It's made by Komatsu, Ltd.



Pedal-powered chopper

Joe Tamburello of Inglewood, Calif., spent six months and \$150 building this chopper-style tricycle. Called the "draggin' wagon," it has spoked mag wheels, a handlebar-mounted compass, twin rear-view mirrors. All other parts are standard bicycle components.



New Cessna sports twin booms and a pusher prop

Still experimental, the Cessna XMC is testing some new ideas in private plane design. Its pilot sits forward of sweptback wings for better upward visibility. His view ahead and down has been improved by mounting the engine on the after end of the cabin. The cabin's wider and lower than present models, with extra-wide doors.

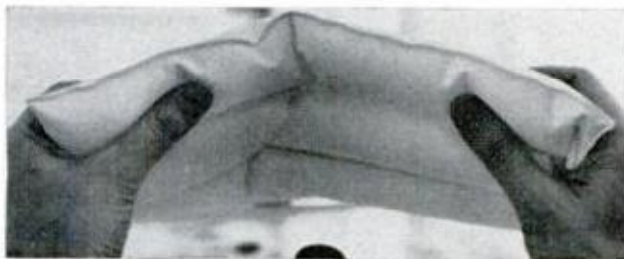

Baby's mattress alerts nurse

If a baby's rhythmic breathing movements stop, a mattress being tested at a London Hospital sets off an alarm. The movements squish tiny air currents from inflated plastic cylinders inside the mattress into a manifold. A thermistor overheats and sounds an alarm unless constantly cooled by moving air.



See-through umbrella

Called "The Birdcage," this new plastic umbrella fits over head and shoulders like a canopy. Giant Umbrella Co., New York makes it in five sizes from 17 to 29 inches across.



TV watching's a ball

A London department store designed its own completely round plastic cabinet for a 25-inch color TV chassis. Customers can order any color or pattern they want on the cabinet.

If Only That Space Ahead of the Radiator Were Added to the Trunk!

By MICHAEL LAMM, West Coast Editor

Photos by the Author

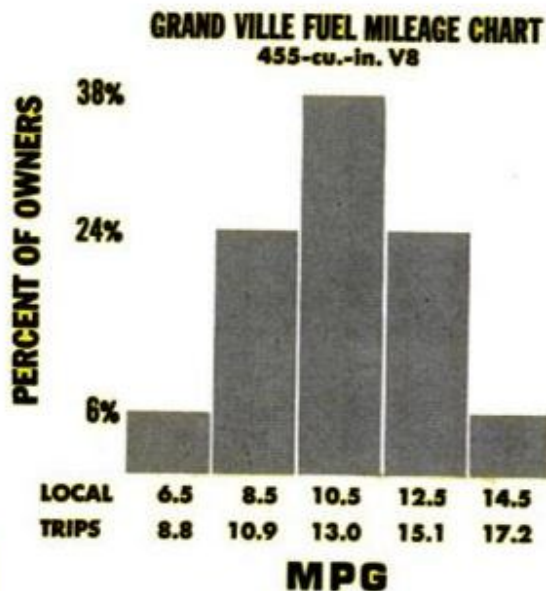

PONTIAC OFFERS 16 models this year, the most expensive being the new Grand Ville. It's a fancification of the Bonneville, sharing its wheelbase (126 inches) and basic engine, but with more horsepower (325 vs. 280 bhp).

The Grand Ville comes in three body styles—two and four-door hardtops and convertible. But no one in our sampling owned a convertible, and it appears a sad likelihood GM will build

FRONT ENSEMBLE is made of fiberglass; grille, of plastic. The snout protrudes, gets dinged in parking



no more ragtops after this model year.

The Grand Ville is one of those full-sized cars that's helping speed the swing to smaller ones. For all its hugeness, the big Pontiac doesn't satisfy the craving of 18.3 percent of its owners for trunk space. "I'd like to get back all that nice trunk," writes a Wichita engineer, "that I lost when I traded my 1968 Bonneville." The Grand Ville's designers did see fit to include many cubic feet of unusable dead space between the engine and the grille. In an effort to bring off the long-hood/short-deck look, Pontiac stylists cut trunk length this year, and the four-door Grand Ville's bustle houses too few cubic feet of storage space, say owners.

A few owners also grumbled about "... too little room inside," and "... not enough space between the front and rear seats," and a noticeable (but untallied) percentage bemoaned the lack of glovebox interior.

Another persistent complaint was poor gas mileage. Our total sampling averaged 10.5 mpg for around-town driving and 13.0 mpg on the highway. Under *specific complaints*, low gas mileage took top honors at 22.4 percent. Understandably, with 455 cubes to feed it wouldn't be reasonable to expect tremendous gas mileage.

Styling proved the main reason most buyers chose Grand Villes (37.2 percent), but it wasn't universally applauded. On the plus side, these reactions: "First year for this series, so the car clearly stands out as a 1971, while other Pontiacs changed so little they are confused with 1970 models." And, "It still looks like a Pontiac—I mean great!" But others view the G.V. through different eyes. "Rear is not in balance with front area." Or, "The grille and headlights are so square and ugly, and what makes it worse, the whole front end is made of plastic."

Owner loyalty played a big role in many owners' buying decisions. A New York salesman said this is his 23rd Pontiac. Many mentioned their satisfaction with previous models. A Michigan

AUGUST 1971



HANDLING gets top marks from owners, who praise not only cornering but also ride and ease of parking



BIG 455 V8 is only engine available, gets lousy gas mileage. Note dead space ahead of powerplant



LONGTIME PONTIAC FAITHFUL criticize too small trunk, shortened by stylists to emphasize long hood

103



MORE LEGROOM in back seat than in most cars, but some complained that rear quarters make blind spots

manufacturer's rep wrote, "I've developed a closeness with Pontiac people over these last 12 years."

But quality and workmanship didn't seem to come up to previous Pontiac standards. This could be because many owners bought their cars just after the GM strike. Yet that doesn't compensate the furniture executive who remarked, "I've had 1958-60-62-64-66-68 Bonnevilles and all were great. Not this Grand Ville. Workmanship is terrible. It's thrown together." That same owner scrawled across his questionnaire: "Pure Pontiac? Phooey!"

Another peeved respondent wrote,

"Certainly not very good for a car costing \$5700. This model is the worst for squeaks, rattles, etc. We found numerous nuts, bolts, and screws missing." Said a Texas trucker, "My biggest disappointment really is that they cheapened the quality of the car."

Most owners (76.3 percent) report no mechanical problems with their new cars, and this speaks well for Pontiac's basic mechanical design and workmanship. Where there are gripes, they generally deal with ill-fitting soft trim, runny paint, glue spills, misaligned panels, and so forth. The basic running gear is undoubtedly well put together and gives many more miles of trouble-free service than most first owners will ever use. And where mechanical problems do crop up, they're usually well taken care of. In general, 82.6 percent rate their dealers "good or above," and only 17.4 percent give them "average or worse." Those are high marks when pitted against dealers of other makes.

A few owners mentioned a certain uneasiness with warranty cutbacks—from, "Not pleased with warranty dropped 38,000 miles this year," to, "I think if the manufacturer thinks so much of his car, he ought to stand behind it longer than 12,000 miles."

Ride and handling top the list of

Summary of 1971 Grand Ville Owners Reports*

Total miles driven 855,466

Average miles per gallon

Local driving 10.5
Long trips 13.0

Body styles

Four-door hardtop 72.8%
Two-door hardtop 27.2
Convertible 0.0

Why the Grand Ville?

Styling 37.2%
Past experience 36.6
Dealer service 7.6

Specific likes:

Ride 50.9%
Handling 46.2
Styling 42.6
Comfort 34.9
Power 17.2
Performance 9.5

Specific dislikes:

Gas mileage 22.4
Workmanship 21.8

Small trunk 12.9
Quality of materials 11.8
Rattles 10.6

What changes would you like?

More trunk space 18.3%
Better workmanship 16.8
Better vent system 9.9
Change front styling 9.9
Change dash layout 9.9

Had any mechanical troubles?

No 76.3%
Yes 23.7

What kind of trouble?

Electrical 19.5%
Carburetor 19.5
Transmission 9.8
Windshield wipers 9.8

Did you repair it yourself?

No 100.0%
Yes 0.0

Dealer repairs satisfactory?

Yes 78.6%
No 21.4

Other cars owned:

Pontiac 32.8%
Chevrolet 22.7
Ford 11.8
Buick 6.7

Accessories/power options:

Airconditioning 68.8%
Power windows 52.9
Radio 47.8
Power seats 24.6
Stereo tape system 22.5

Age distribution of owners:

15-29 years 5.2%
30-49 years 49.7
50-plus 45.2

Would you buy another Grand Ville?

Yes 80.0%
No 20.0

How many cars in family?

Grand Ville only 33.1%
Two cars 59.0
Three or more cars 7.9

*Percentages might not equal 100% due to rounding and/or insufficient data.

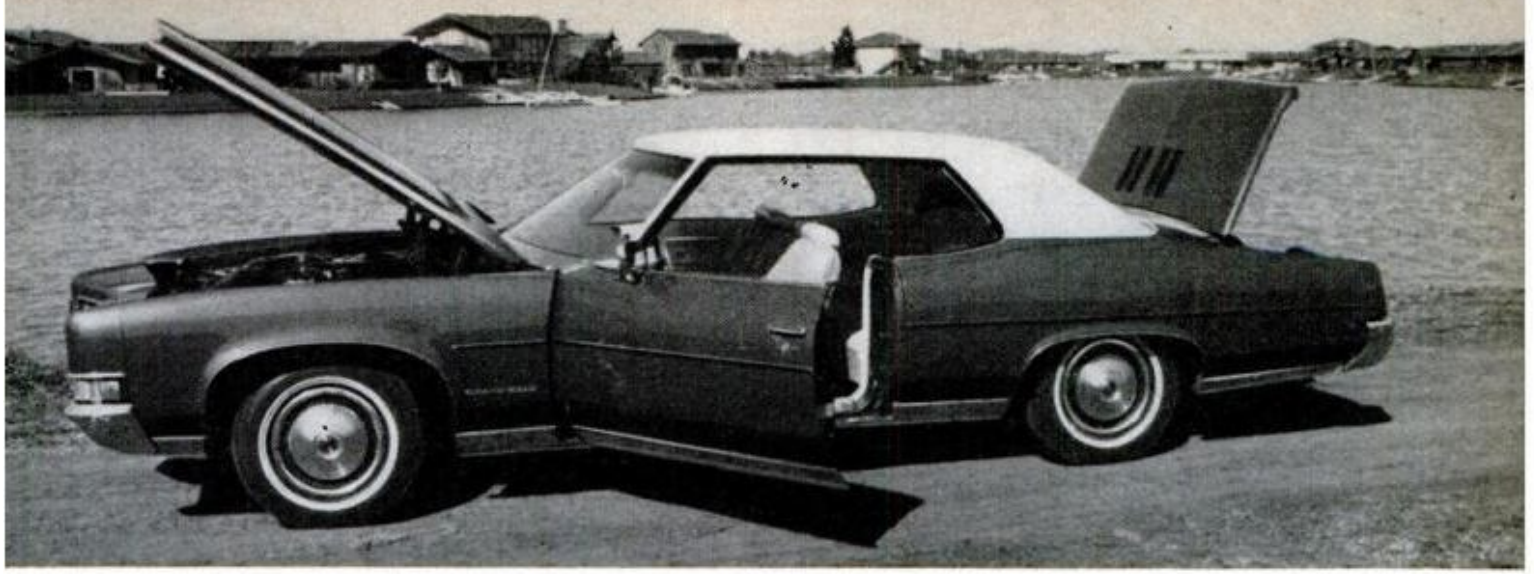

GRAND VILLE shares Bonneville's 126-in. wheelbase, chassis, overall length; has more power, fancier trim

specific likes. "Quiet, easy ride," says a North Carolina housewife. "Plenty of power, handles and turns corners great."—Mississippi chemist. "It handles wonderfully on the road, is easy to maneuver in traffic, good acceleration."—Milwaukee auditor. "Fantastic pick-up, great passing power."—Staten Island disc jockey. "Seems to have a better braking system this year."—Alabama contract administrator (and indeed it does; power discs are standard on Grand Villes).

Answers to our question *What would you like to see changed?* are always enlightening, and here are a few: "Big side windows don't fit at top; bow out at speeds above 60 mph." "Rear-view mirror obstructs driver's vision at certain times." "Change front grille and bumper so they're not so vulnerable in parking." "Better workmanship." "I would like to be able to see out the rear quarters." "A car that sells for over

\$6000 should have a speedometer that you can see, not hidden by the steering wheel." "Rear of trunk gets dirty like a station wagon without an air deflector." "Eliminate wind noise from windows." "Give me more trunk and a more convenient dashboard." "I'd like to see side vent windows used again on cars—however, this is certainly not peculiar to Pontiacs." "I definitely do not like the flow-through ventilation system. My back passengers complain of cold feet." "Improve gas mileage."

So while the Grand Ville has its share of quirks, it's generally more liked than not. "It has everything I've always wanted in a car," beams a Georgia sales manager. And a Massachusetts superintendent: "Traded a 1966 Bonneville, and I really feel this Grand Ville is the best car I have ever owned." "Perfect for our needs—a heavy, supremely comfortable, smooth-riding, good-looking big car." ★★★

STYLING was the main reason for buying, but some felt that rear of car was out of balance with front

SOME DRIVERS can't see speedometer through wheel; most find interior and stance very comfortable



NEW IN ELECTRONICS

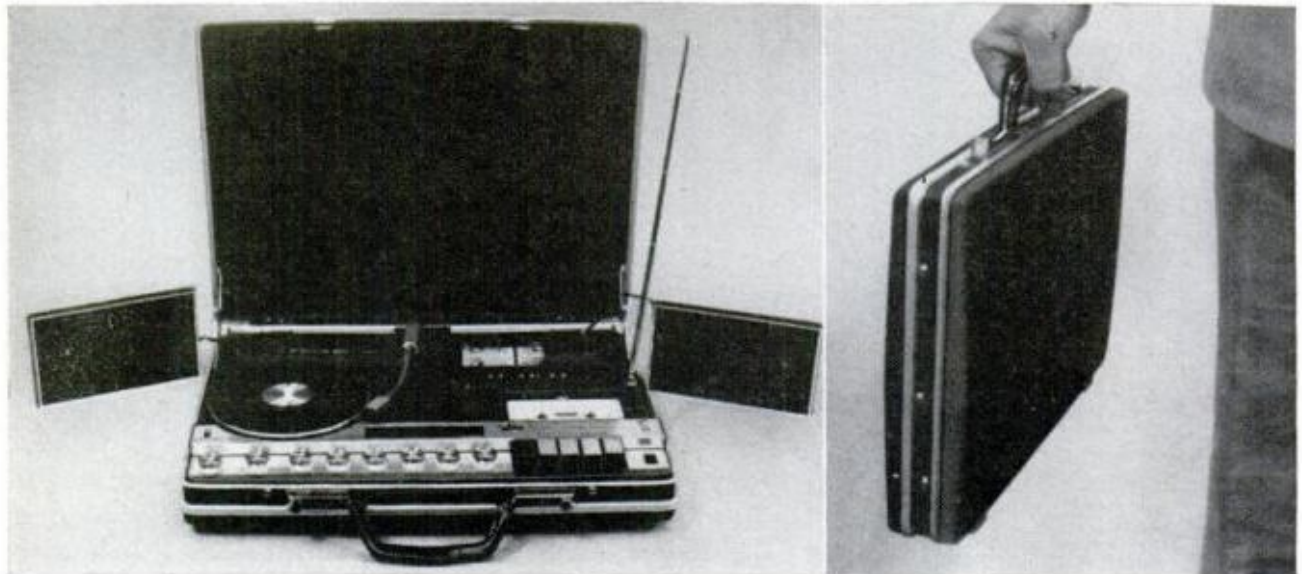

PORTABLE HI-FI SYSTEM (above) contains a stereo cassette recorder, a stereo phonograph, an AM/FM radio and twin stereo speakers—all housed in a briefcase-size carrier for easy handling. Designed for camping and travel use, the play-anywhere system operates on batteries or house current. \$175, Abbott Distributing Co., 915 Selby St., El Segundo, Calif.

POCKET-SIZE RECORDER (right) gives up to 30 minutes' taping time on mini cassettes half as big as the standard type. The new battery-powered midget Dictaphone 10 has a built-in mike and a slide-apart cover that speeds tape changing. It also has provision for plugging in an external mike and earphone. Price is about \$100. Dictaphone Corp., Rye, N.Y.

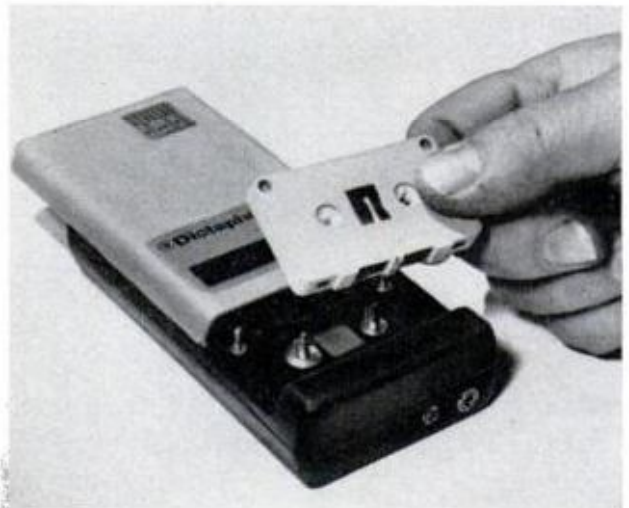

DOUBLE-DUTY SPEAKERS are styled to look like furniture and serve as end tables or hassocks with pillows on top. The walnut-finished ribbed enclosures contain a 40-watt, four-way speaker system with range of 30 to 30,000 cycles. \$79.95 each, Magitran Co., 311 E. Park St., Moonachie, N. J.



TWO-WAY PICKUP lets you record or transmit taped messages over the telephone. The ring-shaped attachment slips over the earpiece and functions as a conventional phone pickup when plugged into the recorder's input. Connected to the output, it sends pretaped messages over phone to another party. \$9.95. Trinetics, Inc., 807 West 3rd St., Mishawaka, Ind.

Something Really New In Revolvers

By MAJ. GEORGE C. NONTE JR.

W-12 Fires
Variety of
Cartridges

2½-Inch
Snub Nose

4-Inch
Medium

6-Inch Target



EVER SINCE Sam Colt's 1836 Paterson cap and ball, all six-shooters have been painstakingly assembled from individually fitted parts.

Dan Wesson of the famous gunmaking family changed that with his Wesson W-12; it uses investment-cast and sintered parts wherever possible. Each part is interchangeable except the "hand," a pawl that rotates the cylinder. Internal tolerances are concentrated in the hand, which is made over-long and trimmed until the gun works properly.

Equally unique, the W-12 has different-sized barrels that can be interchanged in a minute or so, as shown below. We used it for several weeks in all configurations with every type of .357 magnum and .38 special ammunition, found it reliable and accurate. ★★★



CHANGING from the 2½ to 4-inch barrel takes only a few minutes and a special tool. You merely remove the muzzle nut with the tool, slide the barrel housing off, and unscrew the 2½-inch barrel (above left). Then screw the 4-inch barrel into the frame (above right), slip on the longer barrel housing (below left), and snug the housing tight against the frame by tightening the serrated muzzle nut (below right).



How to Survive

By KEN ANDERSON

Illustrations by Roy Grinnell
and Fred L. Wolff

NOT LONG AGO a U.S. marine with survival training was stranded on the Great Salt Lake Desert when his car broke down. Through the rest of the day, he simply rested in the shade of his car. At sunset, he started walking along a route that he knew would lead him to a fresh-water storage tank. There he drank as much as he could and filled his canteen. He also stopped occasionally and arranged rocks to form emergency messages and arrows pointing in the direction of his travel. At dawn, he found a shady spot under which to sleep. The second evening, he started again toward a source of fresh water and left more messages along the way. Several days elapsed before the messages were noticed by a driver who followed the arrows and found the marine resting in the shade. Except for weight loss, he was as fit as when his ordeal began.

His survival of what could have been a tragic situation was not simply luck; he knew what to do, and he did everything right. And he knew where to find water.

Scarcity of water makes desert driving formidable. Intense heat is a supplementary factor, but heat and sun damage can pretty well

be avoided if you stick to the shade in the event of a car breakdown. Water is critical because the human body needs as much as a gallon a day to function effectively in desert climates. While you can exist for awhile on smaller amounts, moisture losses through perspiration quickly result in dehydration and lowered efficiency. A 180-pound man who loses 4.5 pounds of body weight by dehydration suffers a 25 percent loss of efficiency. Greater weight losses are increasingly disabling, and a 10 percent weight loss through dehydration can be fatal.

Desert physiology studies reveal that rationing small amounts of water is futile. Because of great perspiration rates during desert summers—which may be unnoticed because the moisture evaporates so quickly—a person who tries to subsist on a pint or cupful of water may extend his life by only a few hours. The Hollywood cliché of travelers staggering across a desert for days while sharing a small canteen of water is nothing more than a movie writer's fantasy.

Every driver planning a desert excursion should start with at least two gallons of fresh water. He should also have detailed maps of local water sources, ranch houses, govern-

In the Desert



People have died on the desert . . . after their cars broke down on back roads. Never travel unprepared

ment stations or other facilities that could help him in a crisis. A man who died of dehydration in his car on the California desert in 1968 was just four miles from a spot offering better shade and water. But the victim was not familiar with local geography.

Your car should be in good operating condition before starting a desert trip. The cooling system, battery and tires are among items that should be checked. Take along a set of screwdrivers: blade and Phillips; two pairs of pliers including one of the C-clamp type; pocketknife; friction tape; matches; flashlight with extra batteries; shovel; food; water; first-aid kit and a good survival manual. Some experts recommend that desert travelers also carry such items as blankets, snakebite kit, rope and wire.

Finally, make sure somebody knows where you are going and when you expect to return or arrive at your destination beyond the desert.

If you have made proper preparations, you should be able to cope with any situation if you become stranded. With basic tools and a little ingenuity, you can attract attention miles away. For example, you can remove the car's rear-view mirror and use it as a sun-

reflecting signal device. Gasoline can be drained for use as a fire starter. Engine oil can be burned to produce a column of black smoke. At night, headlights can be used as signal lights.

Hub caps can be used as water containers or cooking utensils. Many parts of the car from tires to upholstery, will serve as emergency fuel. The idea of dismantling and burning portions of your car may seem repugnant to a proud owner. But in a real emergency, survival takes precedence over pride.

If water in the radiator is not contaminated by antifreeze or other chemicals, it can be drained and used for drinking. In any event, you might try incorporating its fluid [in a desert distillation system, \(see box, page 111\)](#). [The radio antenna can serve as a spear or skewer](#); broken glass can become a makeshift knife. Bumpers and other car parts can sometimes be removed to dig with. Seat belts, electrical wiring, floor mats and uphol-

Arrows showing your direction of travel can be made with rocks or drawn in the sand





"Many parts of the car . . . will serve as emergency fuel."

stery are materials for rigging shelter against daytime heat or cold of night. The same materials are available for making splints if a member of the party suffers a fractured limb.

Cold nights are as much a part of the desert as a midday heat. The temperature after sunset may drop as much as 70°. Even on the Sahara Desert, overnight lows average 57° F. in August after daytime highs of around 125° F. And temperatures of close to zero have been recorded in the deserts of Arizona and Southern California. Although such frigid nights are rare, desert travelers should be prepared to cope with the cold.

Besides using fire—or warmth from the car heater if it is operative—the stranded driver should be most active at night. If there are tasks that require digging, lifting, or whatever, schedule them for the cool of evening. The heat energy of muscle action will keep you warm. This same activity performed in midday would be unpleasant, if not unbearable.

Whether you decide to stay with the disabled car or walk out will depend upon your own estimate of the situation. The deciding factor is water availability. With a water source and shelter, a person in good health can hold out for some time. There may even be edible plants or animals in the neighborhood. If there is no water available, no hope of immediate rescue, and you are in satisfactory physical condition, your only alternative is to seek a site where your chances for survival are better.

Leave a note in a conspicuous place about the car, telling your direction of travel and where you hope to reach safety. Travel only at night; rest in shade by day.

If you have companions, travel together

and move at the pace of the slowest person. Stop occasionally to leave markers for search parties. Take the easiest route around obstacles; don't risk injury or exhaustion by trying to fight your way through the terrain. Keep some record of your route; it will help you keep to your planned course.

Don't discard your clothing. It's your best protection against heat, cold and insects. And clothing helps retard moisture loss through perspiration. Dress like an Arab: Protect your head, neck and shoulders with a cloth or other material draped around the upper body.

If you don't have a suitable hat, you can make a functional headdress with a loop of rope that fits over your head like a hat band. Put a wadded handkerchief on top of your head, then fold a square of cloth over the handkerchief and arrange the loop of rope to hold it all in place. If the cloth, seat-cover material, whatever, is big enough to extend over your shoulders, so much the better. Wear sunglasses if you have them. If not, smear soot under your eyes to help reduce glare.

When looking for shade behind rocks, ledges, dunes or hills, make sure there are no snakes already using these cool sites. Desert snakes, like humans, have an aversion to excessive sun.

Use salt tablets if you have them—but take them sparingly. Air Force survival instructors recommend that salt tablets be avoided during desert travel unless you can drink at least three quarts of water per day during summer conditions and more than a quart of water during the winter. An exception is made when heat prostration threatens.

You can gain added comfort from daytime heat if you raise your body about a foot above the ground so that air circu-



"Hub caps can be used as water containers or cooking utensils."

lates beneath it. If you dig down about two or three feet, you should find cooler sand. And if you pile the sand from the hole on your sunny side you can produce additional shade. If you have blankets or other shelter material, you can derive fair insulation against the sun if you can arrange the material in double layers.

Most desert plants look inedible. But if there is no alternative, test the plants you find. Start with the roots of trees and shrubs. Peel off the bark. The root may be composed of soft, fleshy, or even moist material. There may even be water dripping from the cut root surfaces. Next try all the soft parts above the ground, including young shoots, bark and fruit. The barrel cactus of the southwestern United States is a known water source. If you find one, slice off the top and mash the pulp of the cactus. A refreshing watery fluid will ooze out of the plant.

But avoid all desert plants that have a milky juice. A white ooze running from a broken stem is a test. This juice also generally irritates the skin considerably.

The presence of plants is frequently a sign that water is nearby. It may be straight down, several feet beneath the desert floor, but water is needed for plant life and it's worth probing the sands around the roots. If the plants are greener, larger, or more tender than other varieties in the area, chances are that they are being nourished by ground water.

Another trick is to watch birds or animals. They usually seek out water at dawn and dusk and remain inactive during the day. Follow their trails and they may lead you to vegetation and water.

One of the most celebrated desert tragedies in recent times was the death of Bishop James Pike during a trip to Israel. Pike and his wife became trapped in the Judean desert when their car could not negotiate a rocky creek bed. According to news reports, the couple entered the desert equipped only with a map, sunglasses and a couple of bottles of soft drink. Although they were only a few miles from help and probably would have been rescued by a search party had they stayed put, the couple choose instead to walk out of the desert in 120° afternoon heat. Bishop Pike never made it, and his wife only reached safety when she happened to stumble across a roadbuilding crew the following morning.

★★★

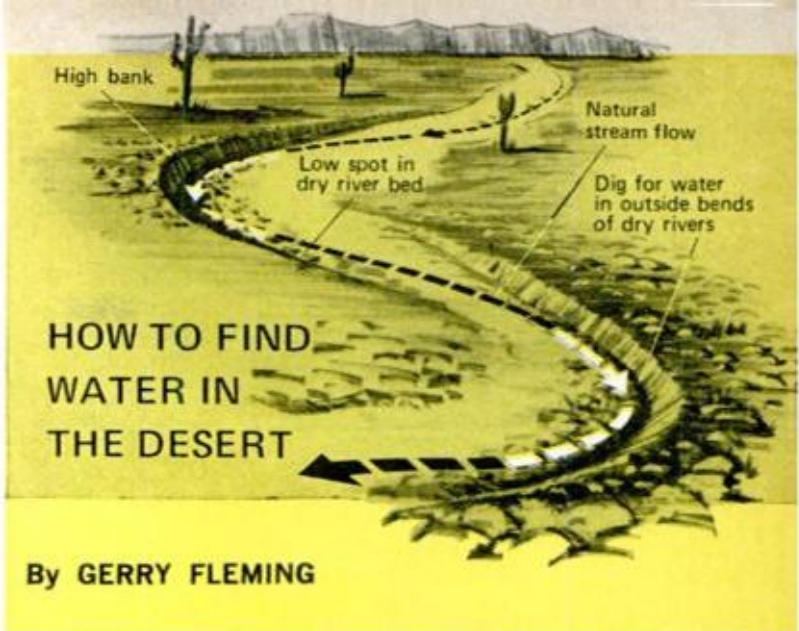

By GERRY FLEMING

GROUND MOISTURE—even seawater—can be converted to fresh water with a solar distillery made of sheet plastic and a container in the form of a coffee can, bucket or cup fashioned from canvas, plastic or aluminum foil. The plastic sheet should be about 6 feet square. The container is placed in the bottom of a hole in the ground; the hole should be about 3 feet deep and 4 feet across. The sheet is stretched over the hole and anchored at the edges with soil or sand. The plastic is weighted at the center with a small stone so that the lowest point will be directly above the container.

Finding the most likely spot to get moisture is extremely important. Choose the lowest site possible. An arroyo or dry stream bed is ideal. If the soil or sand is moist, sunlight passing through the plastic will evaporate the moisture, which will condense on the underside of the plastic and drip into the container. If pieces of fleshy plants are placed in the hole, the "still" will extract the moisture from the plants. Brackish water, radiator fluids, even human body wastes—can be converted to a potable drinking water in this manner.

Success of the still depends upon the amount of moisture beneath the plastic and the amount of sunlight available. One still can produce up to two pints of water during the day and one pint during the night, if there is enough moisture in the soil or plant life is used to prime the system. Obviously, this won't be enough water to sustain life indefinitely, so if enough material is available, make more than one still in different locations.

Finally, make sure that contaminated water does not come in contact with the plastic sheet; it may drip into the container of fresh water and pollute it. And avoid movement of the sheet as much as possible while it is producing fresh water. It takes from 30 minutes to an hour for the still to begin working again after the plastic has been disturbed.

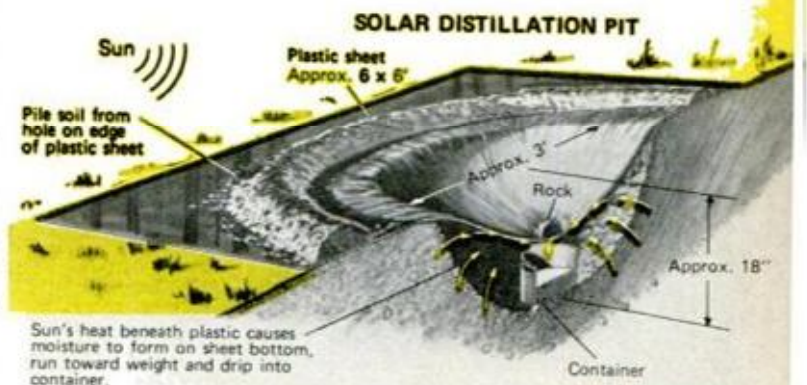

Simple Rig for Close-Up Flash

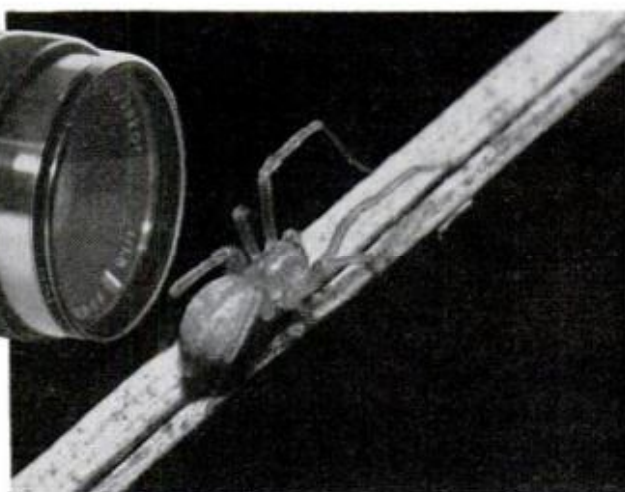

THE TROUBLE WITH TRYING to shoot close-ups with a camera-mounted flashgun is that the flash is designed to beam its light straight ahead, not down on a subject only a few inches away. With this simple flash bracket for a 35-mm camera, all you need is a set of extension tubes or a bellows attachment and you can take dramatic close-ups of flowers and insects like those shown here. The bracket holds the flash above the camera so its light clears the lengthened lens. It also lets you tilt the gun downward at any angle, depending on your focusing distance.

Exact dimensions will depend on your particular camera and flashgun. The rig shown here consists of a small block of 1x3 wood for a base and a support for the flashgun bent from metal strip. Any thin metal strip will do. I used aluminum edging made for tacking down linoleum. Two long 1/4-inch bolts with wingnuts complete the assembly. The top one tightens the metal strap around the flashgun and at the same time locks the gun at the desired angle. The bottom one anchors the bracket to the wood base.—*Edwin Borgeson*





Look What a Difference The Paper Can Make



Want to make good black-and-white prints from color negatives? Here's the secret—use this special Kodak paper made for the job.

AT FIRST GLANCE, the two photos might appear pretty similar. But take a closer look. In the lower photo, the sky and water are too light and detail is washed out. The girl's face is too dark and one stripe on her blouse is missing completely. In the upper photo, the background is darker, the face is lighter, there's good detail and the overall result is much crisper and more pleasing.

Why the difference? The lower print was made from a Kodacolor-X negative on a standard No. 3 contrast paper—the one you'd normally pick. The upper print was made from the same negative but on Kodak's Panalure paper designed for proper rendering of tones when making black-and-white prints from color negatives.

Exposing and processing Panalure is basically the same as for any prints—just follow instructions packed with the paper. With tungsten-light enlargers, no filter is usually necessary. With fluorescent-type enlargers, use a yellow filter, such as Kodak's CC20Y, to correct for the higher blue content. Filters can also be used to create special effects just as if you had one over the camera lens when taking the picture. A yellow filter, for instance, produces a darker, more dramatic sky.—*Sheldon M. Gallager*

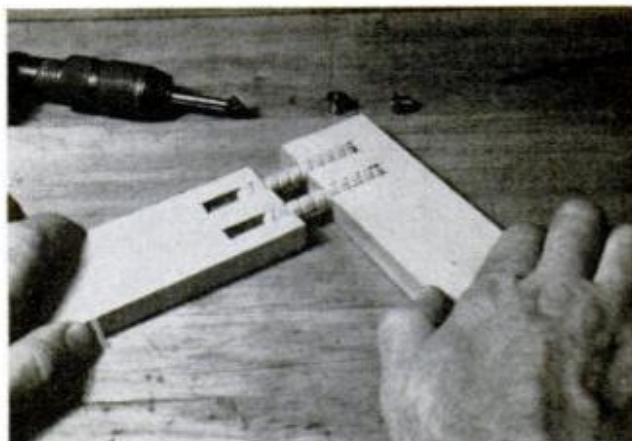

FOR MAXIMUM SHEAR STRENGTH, dowel diameter should be half the thickness of wood being joined and dowel length six to eight times its diameter

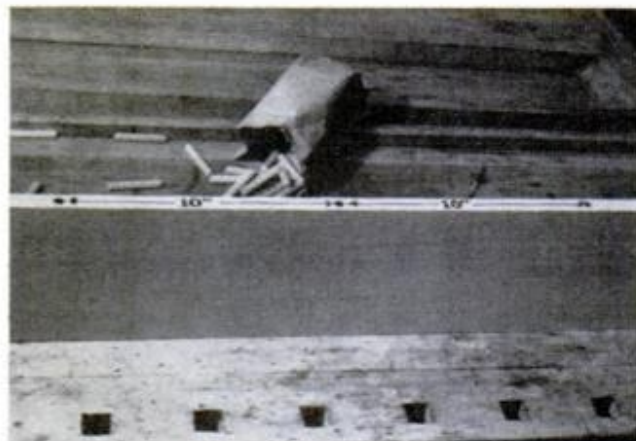

FOR MAXIMUM TORQUE STRENGTH, use at least two dowels. For a tight joint when edge-joining boards, dowels should be no more than 20 in. apart (maximum)

You Can Make Professional-Fitting

They're a good substitute for mortise-and-tenon joints, and your total cash outlay for power tools will be less

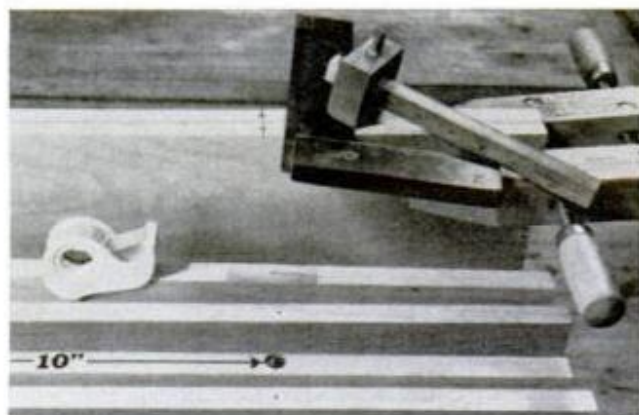

THREE WAYS TO LAY OUT DOWEL CENTERS: (at top) gauge and try square, (in middle) tape and pinheads, and (at the bottom) drilled holes and dowel centers

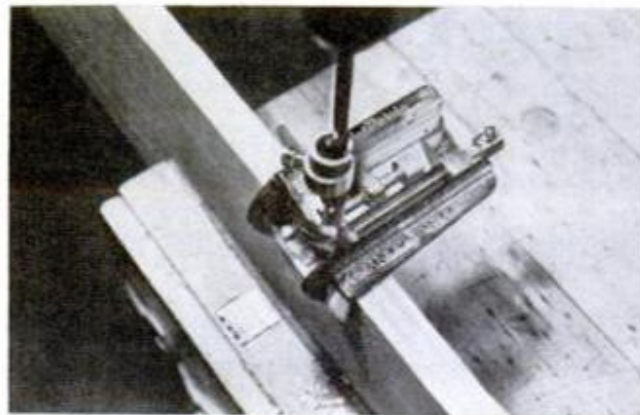

FAST WAY TO BORE PRECISE HOLES is with a spur bit chucked in a portable drill or drill press. Wrap piece of tape around bit shank for use as depth stop

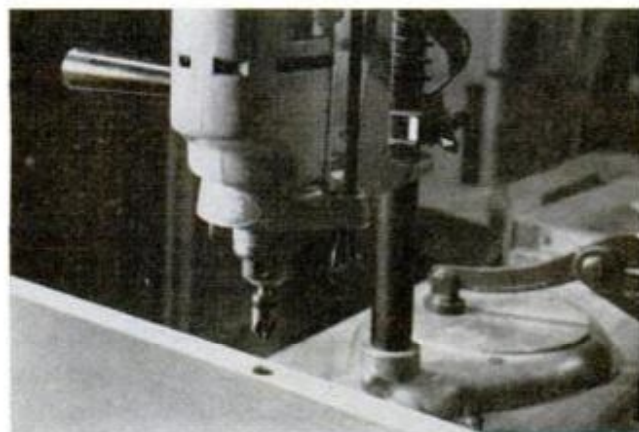

COUNTERSINK DRILLED HOLES to remove any burr that might hold joint apart, also to facilitate the board assembly and to permit excess glue to escape



FOR SHOP-MADE DOWEL PINS, measure the bored holes with a depth gauge and then mark length accordingly. To make neat cut use a fine-tooth hacksaw

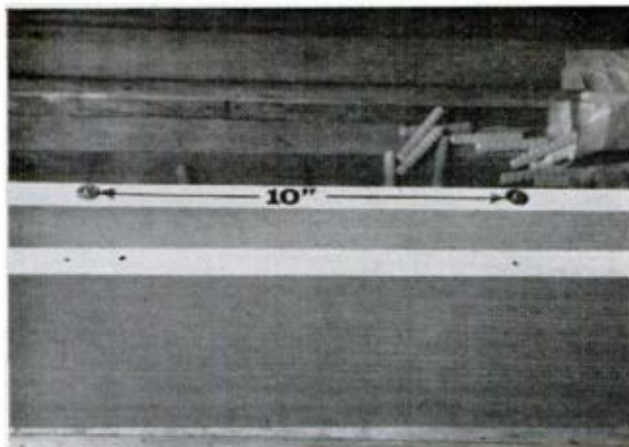

DOWEL CENTERS are slipped in holes bored in first board; then, to transfer centers to second board, both boards are lined up and tapped with a mallet

Dowel Joints

By **DAVID WARREN**
And **HARRY WICKS**

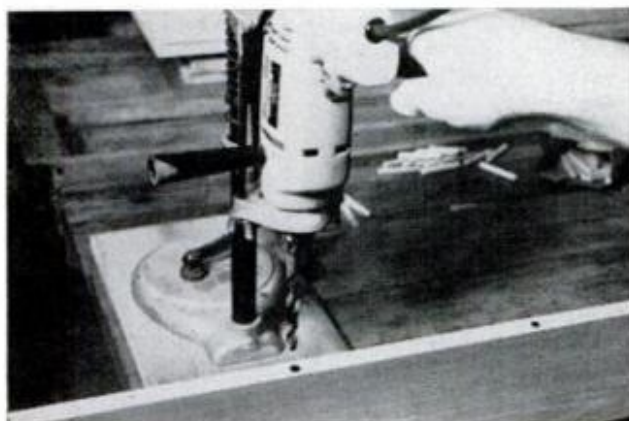

STUBBY SPUR BIT won't drift from center point as metal bits often do, and it will also drill deeper than a spade bit without piercing the other side

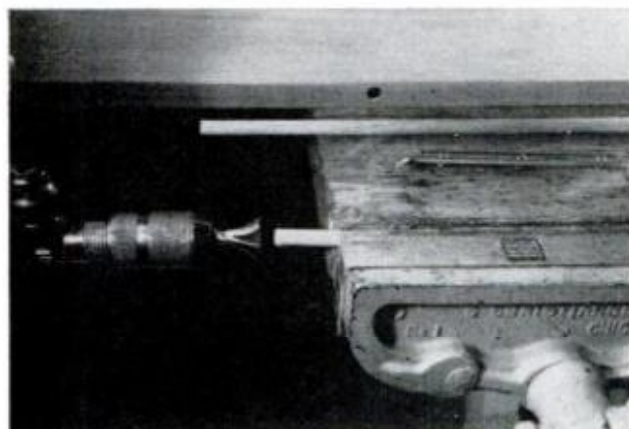

DOWEL SHARPENER is used to taper both ends of dowels, simplifying the job of inserting them into holes. Model chucked in brace above is from Stanley
AUGUST 1971

THE FAMILIAR DOWEL JOINT, now centuries old, is a good substitute for a mortise-and-tenon or a tongue-and-groove joint and, of course, is superior to screws and nail joinery. And the investment in power tools for doweling is less than that for mortising tools.

A dowel butt joint isn't quite as strong as a mortise-and-tenon, but that difference can be minimized by using good doweling techniques and modern plastic-resin glue. That's why you find that most of today's commercially manufactured furniture is doweled.

Before starting any doweling operation there are a few points to have in mind. When you're edge-gluing stock, the annular growth rings in each board (they're visible on the ends) should curve alternately. Viewed from an end, for example, if the rings on the first board arch, they should dip on second board—and so on. Such care to alternate the rings will offset the tendency of each board to cup. Also, when the edges of two boards touch, the middle two-thirds of the joint should show a sliver of light. Then, when the bar clamps draw the joint tight, the glue-line at the ends will be especially fine.

And, before picking up the drill to bore those dowel holes, sight along the edges of the boards to be joined. If a board shows even a slight bow or warp, it should be trued-up on the table saw.

As a final step before drilling, lay out the boards to be joined to get the most pleasing grain design. The ultimate, of course, (for perfectionists) is to achieve a finished surface that appears to be one wide plank. Here you will be restricted by how careful you were when you selected the planks at the lumberyard. In other words, don't let the yard man foist material upon you exactly as he takes it from the pile.

The six basic doweling steps are shown in the photos. As a rule of thumb for the size dowel to use, the dowel's diameter should equal one-half the thickness of the wood being joined. As for dowel length, you are safe if you cut it about six times the dowel diameter. Thus, to join $\frac{3}{4}$ -in. stock, you would use $\frac{3}{8}$ -in. dowels cut to $2\frac{1}{2}$ -in. lengths.

Lay out the holes to be bored so that

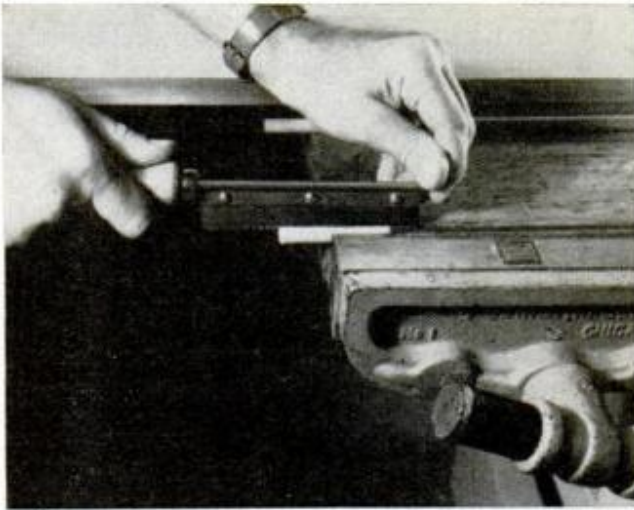

WHEN USING SOLID DOWELS, cut a groove the length of each pin to let air and glue escape. Without such relief there's a good chance of splitting wood

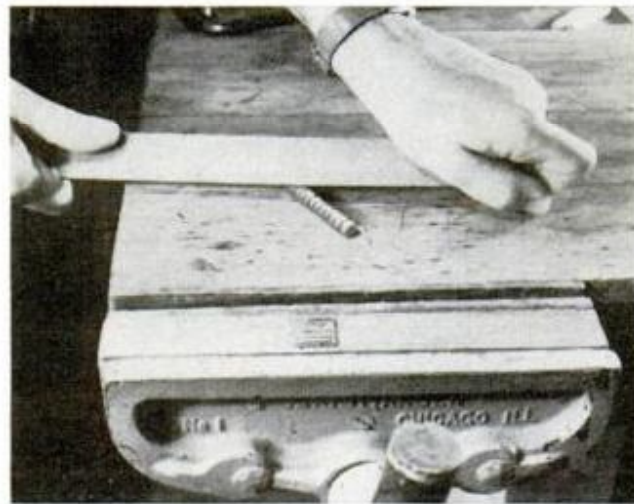

TO SCORE A SPIRAL ALONG DOWEL, you just apply a sliding-rolling pressure on dowel with the edge of a small mill file. Spiral helps to spread glue evenly

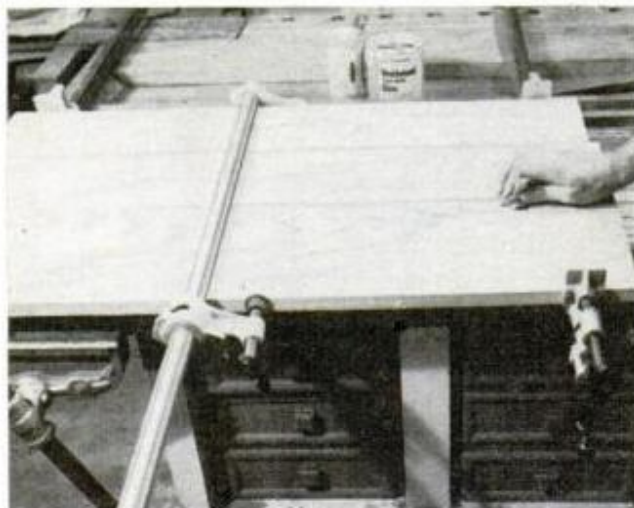

BOARDS ARE EDGE-JOINED by dripping glue in each hole, twisting the dowels in place and applying glue to mating edge. Then clamp boards until glue sets

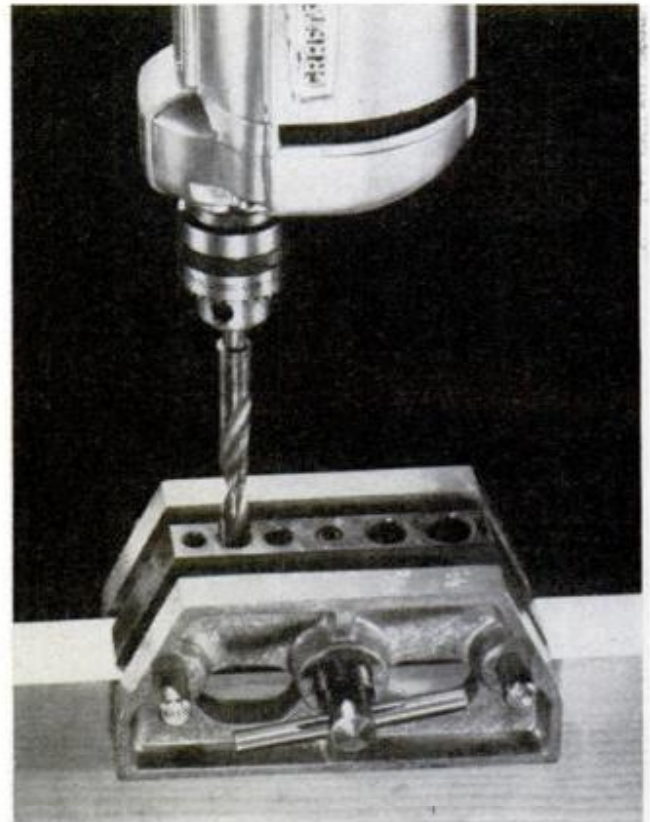

SELF-CENTERING DRILL GUIDE that boasts a heat-treatment feature will accommodate six drill sizes ranging from $\frac{1}{4}$ through $\frac{1}{2}$ in. Priced at \$12.95, the Model A Dowl-It jig is manufactured by the Dowl-It Co., 515 North Hanover St., Hastings, Mich. 49058

they are registered perfectly. You can do this with one of the simple hand methods shown on page 114 or, if your shop projects call for a lot of doweling, with a dowel jig. Five models are shown and countless other versions are probably available. (All jigs pictured were tested by *PM's* Home and Shop Editors and found to be dependable, quality tools.)

With dowel pins cut to length, chamfered and kerfed for glue ooze-out, assembly can be started. Dribble glue in the holes in the first board and tap the dowels in place. After applying glue to the board-edge and mating drill holes, press the boards together and finish with bar clamps. Don't overtighten clamps or you might cause bowing. Finally, wipe off all excess glue before it sets and set the workpiece aside overnight to dry. Next day, use a plane if necessary to smooth the surface and then finish the job with a thorough sanding.

If you take a reasonable amount of care along the way, you will have professional-looking—and fitting—dowel joints. ★★★

THAT MAKE DOWELING EASIER

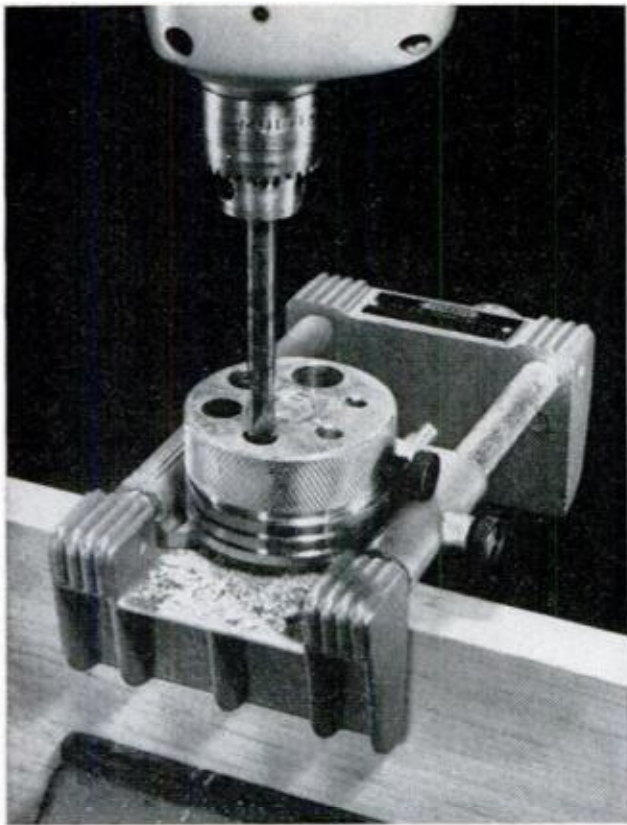

DRILLING IS SIMPLIFIED with this jig because its revolving turret adjusts quickly and eliminates loss of loose sleeves or parts. Model 840 with auger bit stop is \$8.90 at hardware stores; made by General Hardware Manufacturing Co., New York, N.Y. 10013

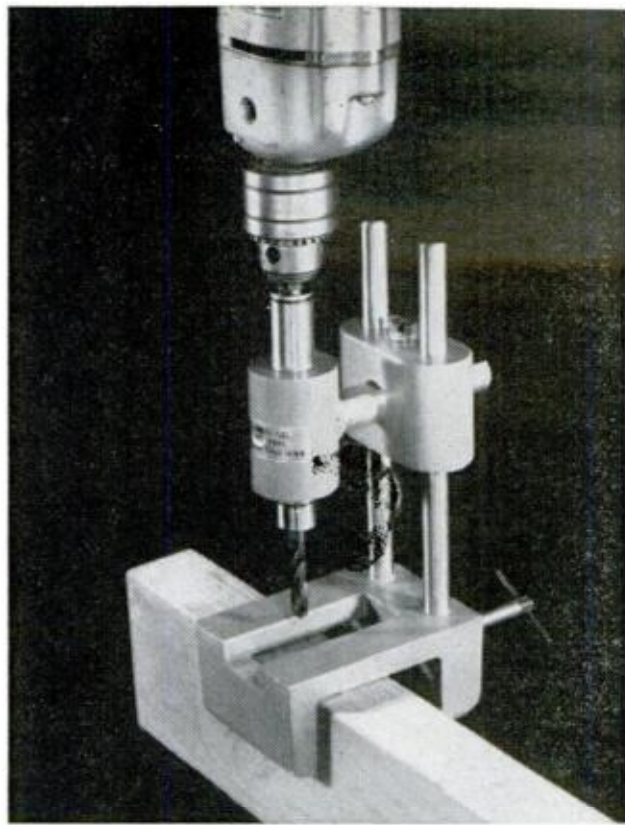

THIS DRILLING JIG provides the means to drill properly aligned holes to depths of 1-1/16 in., adapts to board thicknesses. Comes with full instructions for \$24.95 postpaid from Elder's Manufacturing Co., Dept. PM, Box 322, West Des Moines, Iowa 50265

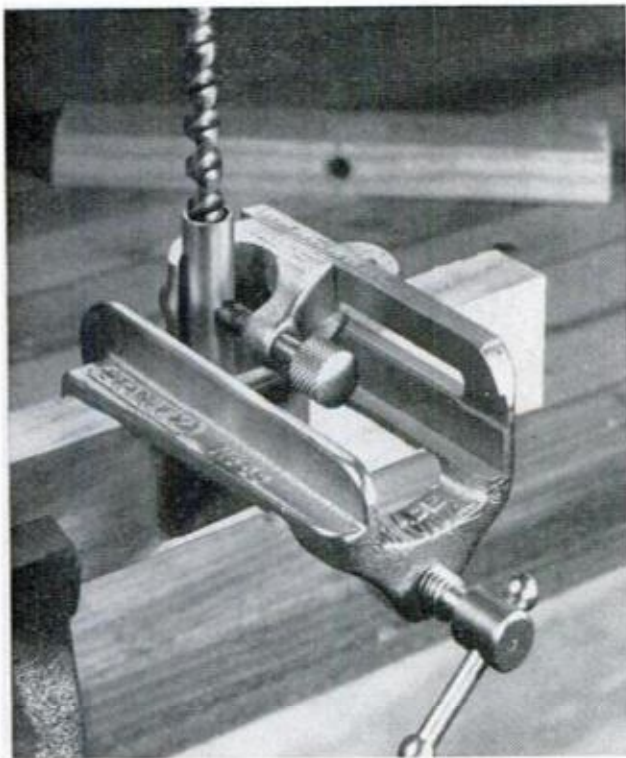

INEXPENSIVE VERSION available at building-supply houses and hardware stores, this unit accommodates most common dowel sizes, requires registration lines made with a try square. Model 59, \$11.55, is made by The Stanley Works, New Britain, Conn. 06050

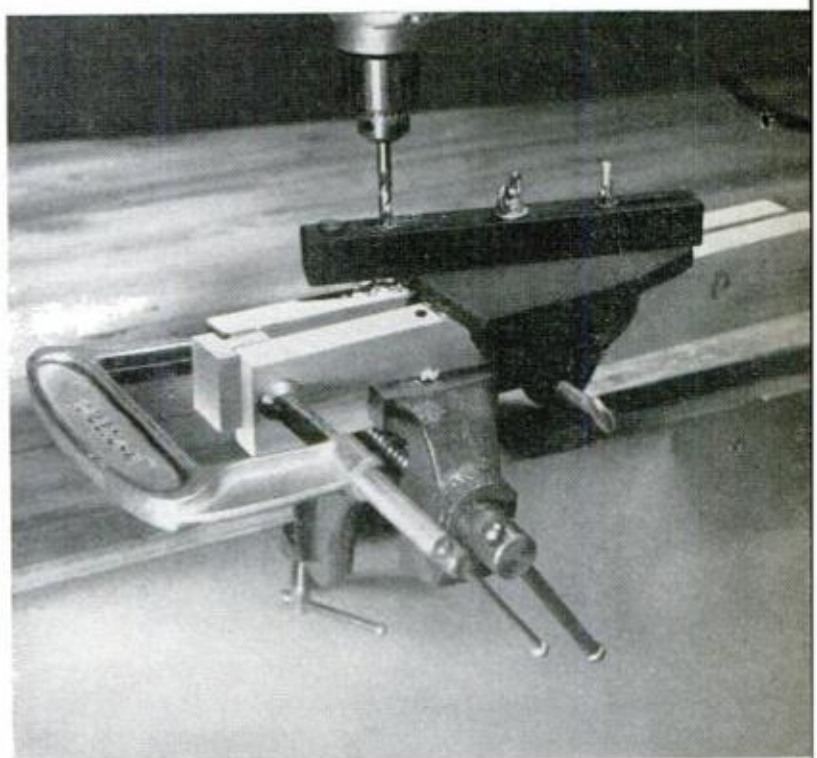

LATEST DOWEL JIG on the scene is this model by Home & Industry Tool Distributors, 2867 Long Beach Rd., Oceanside, N.Y. 11572. With guide clamped in position, the top bar swings two ways for perfectly matched holes. \$19.95. (Clamp not included in set.)

New Color TV: Kit-Builder's Dream Job

Heath's first solid-state TV kit is loaded with handy features like plug-in circuit boards, a swing-out chassis, even a built-in test meter.

By SCOTT M. GALLAGER

IT COMES PACKED in three huge cartons, consists of hundreds of parts and is accompanied by not one, but half a dozen thick instruction manuals. It looks, in short, like a hefty kit-building job.

It's Heathkit's newest color TV console—the first to employ all-solid-state circuitry and the first to incorporate modular plug-in circuit boards, a new concept in kit-built TVs. The set is available in three screen sizes—20, 23 and 25 inches. There are 10 snap-in circuit modules, 76 diodes and nearly 100 transistors.

Sounds complicated. But the minute you begin construction you realize the job isn't as hard as it seems. Everything is designed to simplify assembly and insure perfect results. You build and test each module individually before installing it. If something doesn't check out, you know exactly where the trouble is. Later, if you

118

TINY CIRCUIT BOARD in hand above is typical of kit's simple step-by-step approach—you build and test one at a time, assuring accuracy

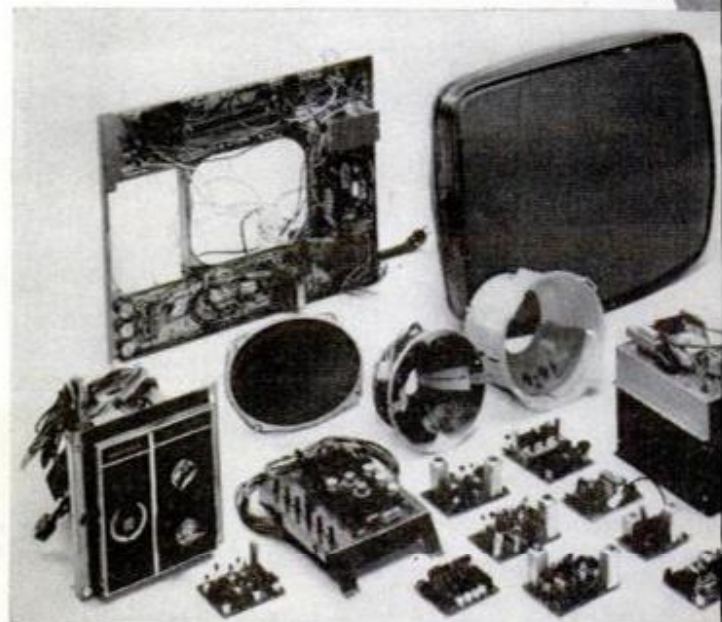

BASIC PARTS are plug-in circuit boards, tuning control, convergence panel and power supply shown in foreground. In background are picture tube and hinged main chassis into which circuit boards plug

POPULAR MECHANICS

Материал, защищенный авторским правом

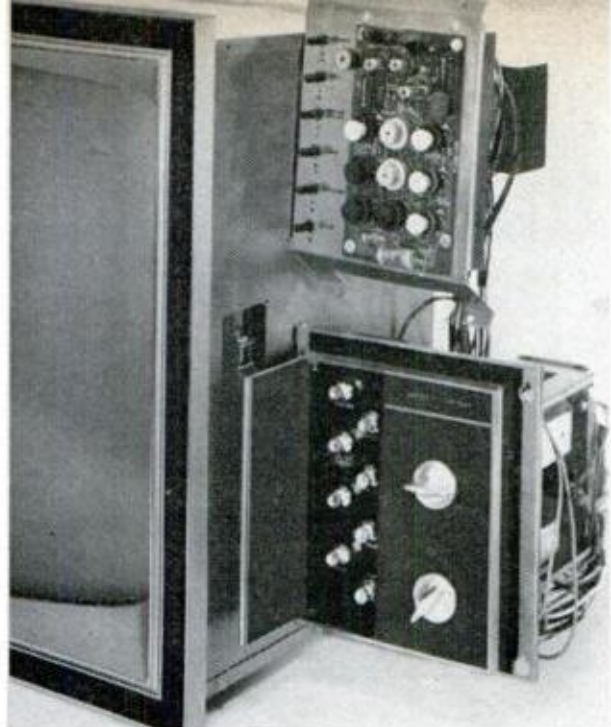

DURING CONSTRUCTION, separate tuning and control assemblies mount temporarily on side of chassis—a handy idea for keeping everything together

need a new part, Heath will repair or replace the old one for a small charge.

Critical parts like the VHF and UHF tuners, IF amplifier and high-voltage assembly come preassembled and adjusted—you don't have to worry about these at all. Other nice touches are a built-in volt-ohm test meter for checking your work as you go along, dual antenna inputs for either 300 or 75-ohm lead-in, pushbutton tuning and an output jack for piping TV sound through your hi-fi system. Controls normally in back swing out in front so you can make color convergence and oth-

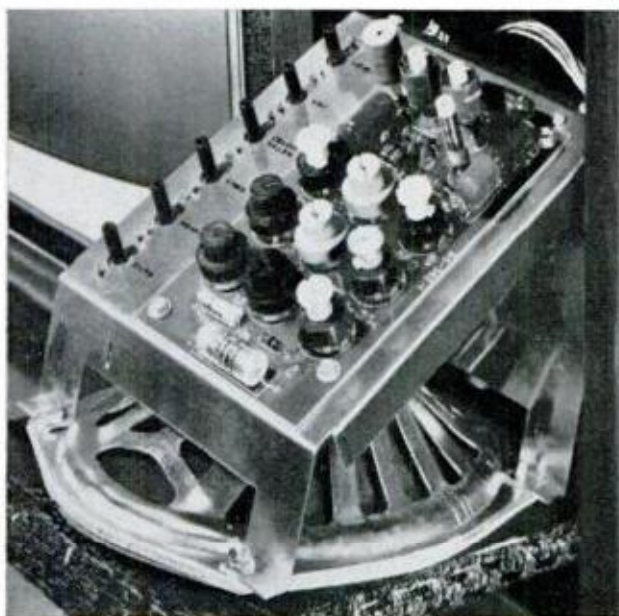

TILT-OUT CONTROL PANEL is accessible from front of cabinet, enabling you to make fine tuning and color adjustments without having to get at rear of set. Panel mounts behind swing-out speaker grille

AUGUST 1971



WIRELESS REMOTE CONTROL turns set on and off, changes channels and adjusts volume and color—all from across room without your leaving your chair

er adjustments as you watch the screen.

The models are the 20-inch GR-270, \$489.95; the 23-inch GR-370, \$559.95, and the 25-inch GR-371MX for \$579.95. Cabinets are extra and come in three styles—Contemporary, Early American and Mediterranean—for \$75 to \$130. Also available is an accessory pushbutton wireless control for \$65 that operates the set remotely through ultrasonic signals. Assembly time varies according to your working speed, but averages around 45 hours. All in all, the set is a masterpiece of design and a rewarding kit-building experience. ★★★

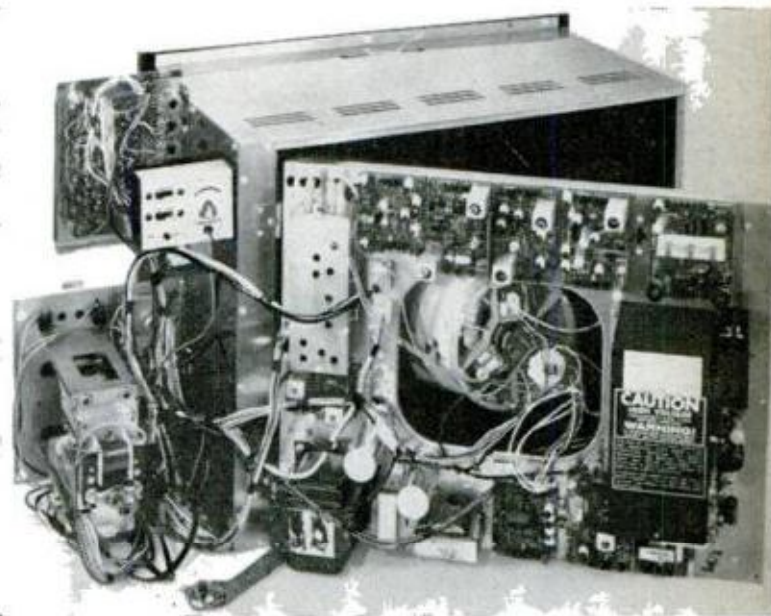

HINGED CHASSIS opens like a door at back of set for ready access to wiring inside. Modular circuit boards plug in on outside within easy reach. Note the built-in volt-ohm test meter at upper left corner

119

Sears' Best Radial: You Get What You Pay For

Plenty of power makes this new radial saw virtually unstoppable



By **HARRY WICKS**, Workshop Editor
Photos by Robert D. Borst

NOW I really am in a bind. Having spent all my shop career working with a table saw, the answer always came easy when I was asked, "Which saw should I buy, table or radial?" Until several weeks ago, my immediate answer was, "I prefer a table saw." But now, after I "put the boots" to Sears' newest radial, it's not that simple. And, since Home and Shop Editor Wayne Leckey knew of my

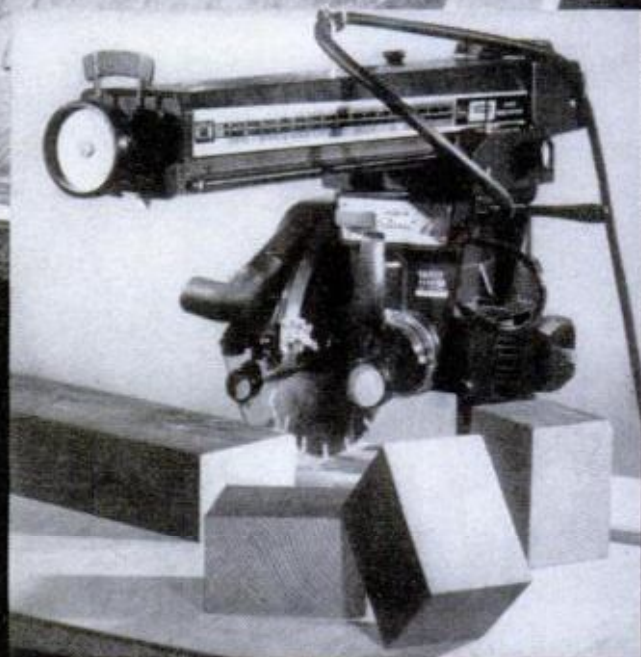

PLYWOOD PANEL (top) was easy to rip on this new saw. Tool also sliced 4x6 timber (above) effortlessly.

preference, I'm convinced that's why he assigned me to test the tool. He knew I'd go all out to find faults I could report.

Setting up the saw presented no problem. Though it weighs almost 250 lbs., I handled the tool easily and occasionally, one of my two sons (Jack and Jim, ages 7 and 9 respectively) would lend a hand getting a nut started or holding a part in position while I did the fastening. Instructions packed with the saw are clear, easy-to-follow and well illustrated.

After several all-day sessions with the saw I could find only two possible faults:

● **Noise.** It is a lot noisier than my table

saw. But a workhopper somehow comes to accept noise. (My router screeches like a banshee, for example, but I wouldn't part with it.) Once I had become familiar with the tool, and its seemingly endless variety of knobs and locking devices, I found that I turned to it automatically for jobs such as ripping a bevel edge on a long board and crosscutting hefty stock.

● **Sawdust.** Spoiled by the cabinet beneath my table saw which neatly collars and stores dust, I found that the real price you pay—for the prodigious output this 12-incher is capable of—is the sawdust that seems to fill the shop. When cross-

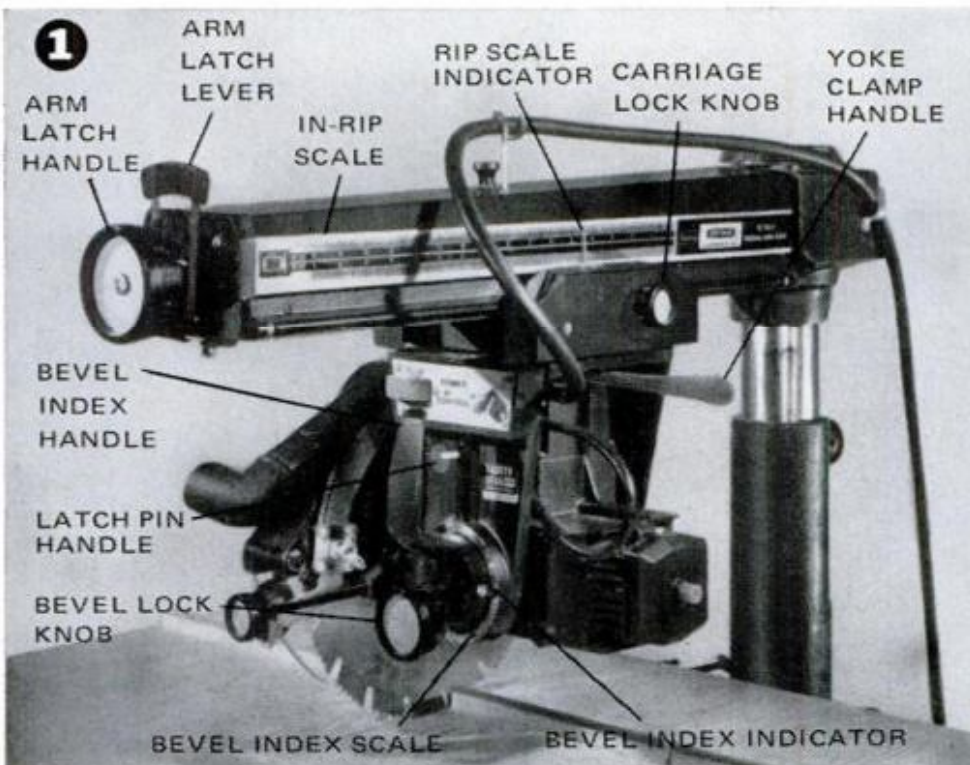

What you see is what you get...

1 Right-side view shows locking devices and 4.5-hp (developed) motor that powers rig. Notice line cord is clear of blade.

2 Left-side view shows important safety feature: the saw guard. Plastic guard reduces amount of blade that's exposed.

3 Good feature is convenient location of on-off button. Key-lock prevents young hands from turning tool on.

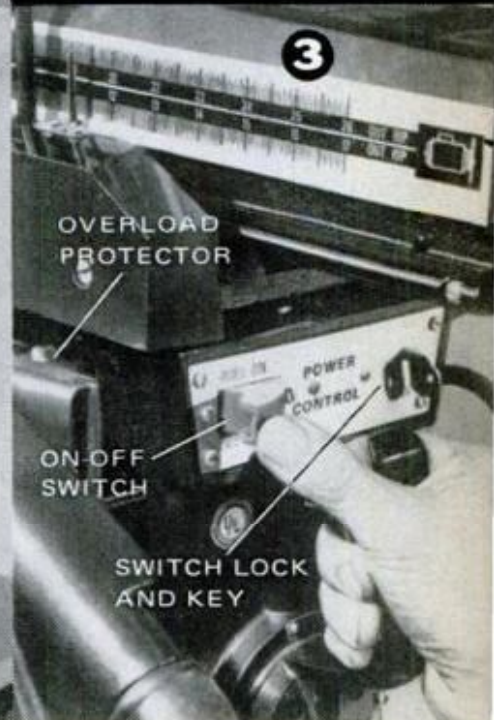
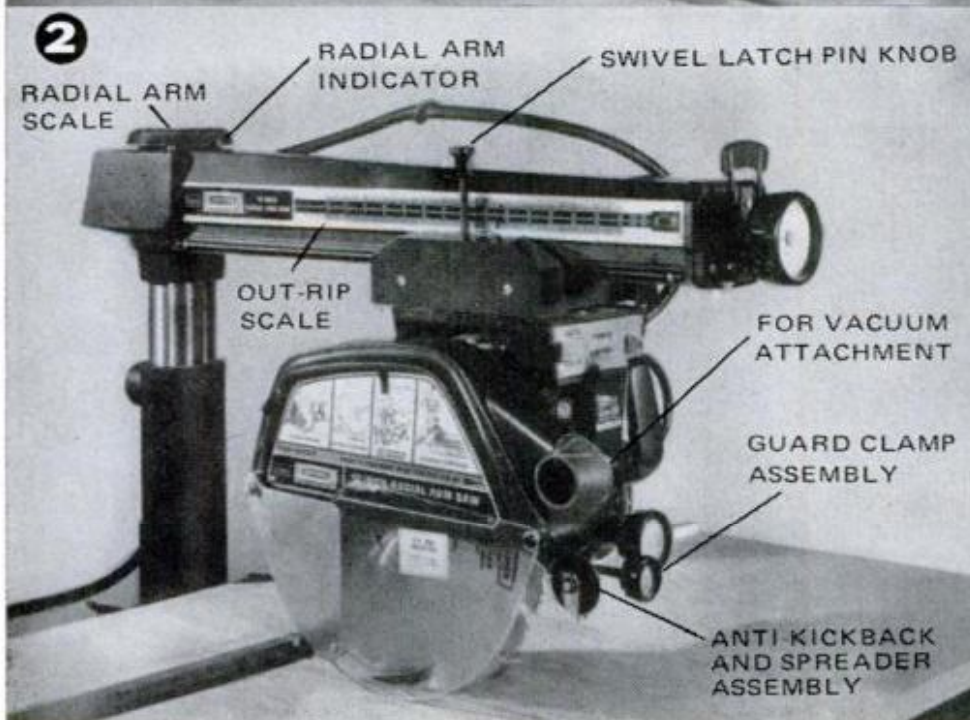

cutting it's no problem, but when ripping wide sheets of plywood—wear goggles!

Since the saw attachment for routing the sawdust to your shop vacuum is relatively inexpensive—about \$15—I strongly recommend that you buy it with the saw. I didn't, but one is on order now.

The motor. The 12-in. blade is powered by a 4.5-hp motor protected with a manual reset thermal overload switch. (The motor will kick off when its temperature exceeds a safe limit). It comes with a molded plug for 240-v. operation, connected to a 15-amp. circuit equipped with a 15-amp., time-delay circuit breaker.

In general. The saw comes equipped with a hardboard-faced particleboard top. For longer life, it is recommended that you cover it with 1/4-in. plywood. (The maker correctly advises against using hardboard as a protective surface because the glues that it contains will dull blades.) A particularly good feature, I feel, is the location of the on-off switch. When making crosscuts, it couldn't be handier. The key lock is also good; it guards against accidental starting of the machine.

PM Base. Since portability in any shop is desirable, I mounted the test unit on

(Please turn to page 179)

Where this saw excels...

A Big 12-in.-dia. blade cuts hefty timbers so easily in one pass that it takes getting used to. Sawdust from these passes shot 12 ft. across shop.

B Radial is a delight to work with when making compound miter cuts. Material being cut here is for *PM Workshop Project* coming up soon.

C Typical crosscut is easy in pine, but blade has tendency to pull when making similar cut in hardwood or two-by stock.

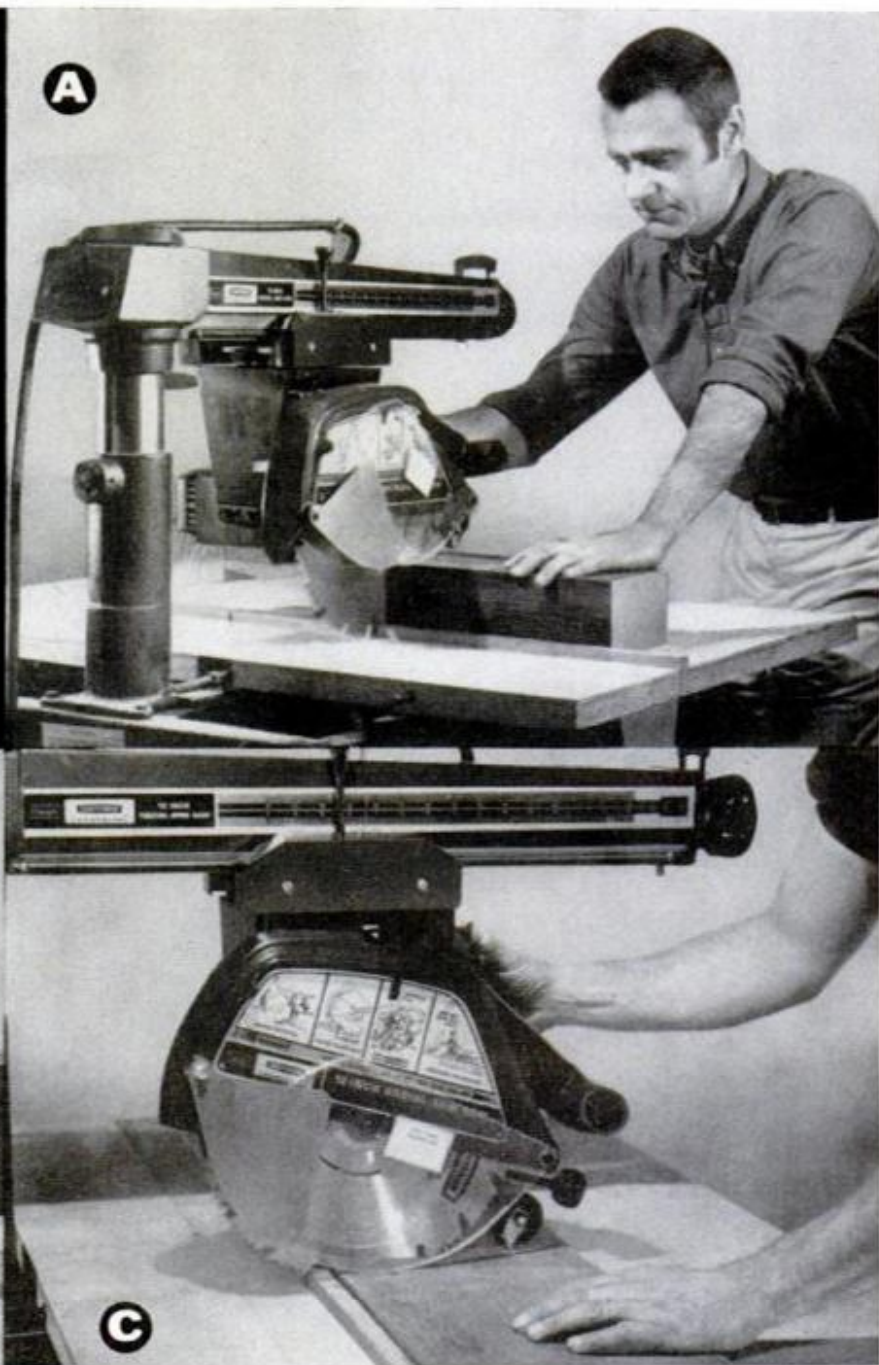

How to Enjoy More Summer Fun At Home



Your own back yard can be your low-cost vacation retreat . . . every evening, every weekend. The fun for you and the kids needn't end with darkness (or the approach of autumn); under floodlights tennis, volleyball and basketball are even more enjoyable. In the smallest back yard there's room for a patio—and The Good Life close to home. . . .



Make Every Weekend a Vacation

Electrical Appliance Center for Your Patio **Page 124**

Your Garage Can Double as Your Outdoor Family Room **Page 128**

Fold-Flat Cookout Table for a Smorgasbord **Page 130**

Slip-Proof Diving Board for Pool and Storage **Page 132**

Measurements You Need for Laying Out Yard Games . . **Page 136**

Tennis, Badminton, Basketball, Shuffleboard, Dancing—Enjoy Them in the Evening Under the Lights **Page 137**

Garage Party Wall With All the Patio Conveniences . . **Page 140**

Add Music to Your Patio **Page 142**



Build This Patio Appliance Center

By WAYNE C. LECKEY, Home and Shop Editor

*Color Photo by Ernest Silva
Styling by Robert Lofgren*

WISH YOU COULD USE your kitchen appliances out on the patio? You can with this rolling appliance center which offers a convenient plug-in counter for your electric griddle, casserole, bun warmer, fondue pot, coffeemaker and other appliances normally used indoors.

It's sure to make your fall cookouts a lot more fun and easier since you can serve such things as hamburgers, chicken and franks without the work of starting up a smelly charcoal grill. You just plug in the appliance and you're in business.

The affair provides you with the convenience of a kitchen since the roomy cabinet and counter, plus cutting block, make "dishing it out" extra handy. Lift up the hinged cutting block and there's an ice-filled cooler under it full of chilled soda and beer. A shelf across the back provides a space for all your cooking spices and condiments, and the roomy cabinet offers cupboard space galore for storing all the gear that goes with outdoor entertaining. It rolls freely on ball casters, the counter is Formica-covered and a retractable reel saves the bother of rolling up a plug-in cord. A striped-awning top adds a gay festive look to the party.

The whole idea was presented to us by the Aluminum Assn., 124

and Bud Johnson, PM's cabinetmaker, built it. Materials ran about \$100, but you can build it for less by using less expensive casters, forgetting the Formica on the counter and using softwood for the maple cutting board. Most of the cart is made from $\frac{3}{4}$ -in. exterior plywood, the lumber being common $\frac{3}{4}$ -in. (actual) white pine. The back panels are $\frac{3}{8}$ -in. plywood. The Styrofoam cooler is made by Skotch-Hamilton and sells for about \$2.50. The cover of the cooler is cemented to the underside of the cutting board. The fluorescent fixture is controlled by a separate switch and, along with the plug-in strip,

THE COUNTER features a lift-up, maple cutting block that is handy for preparing salads. Ice-filled cooler is kept under block



POPULAR MECHANICS

Материал защищен авторским правом



Patio Appliance Center

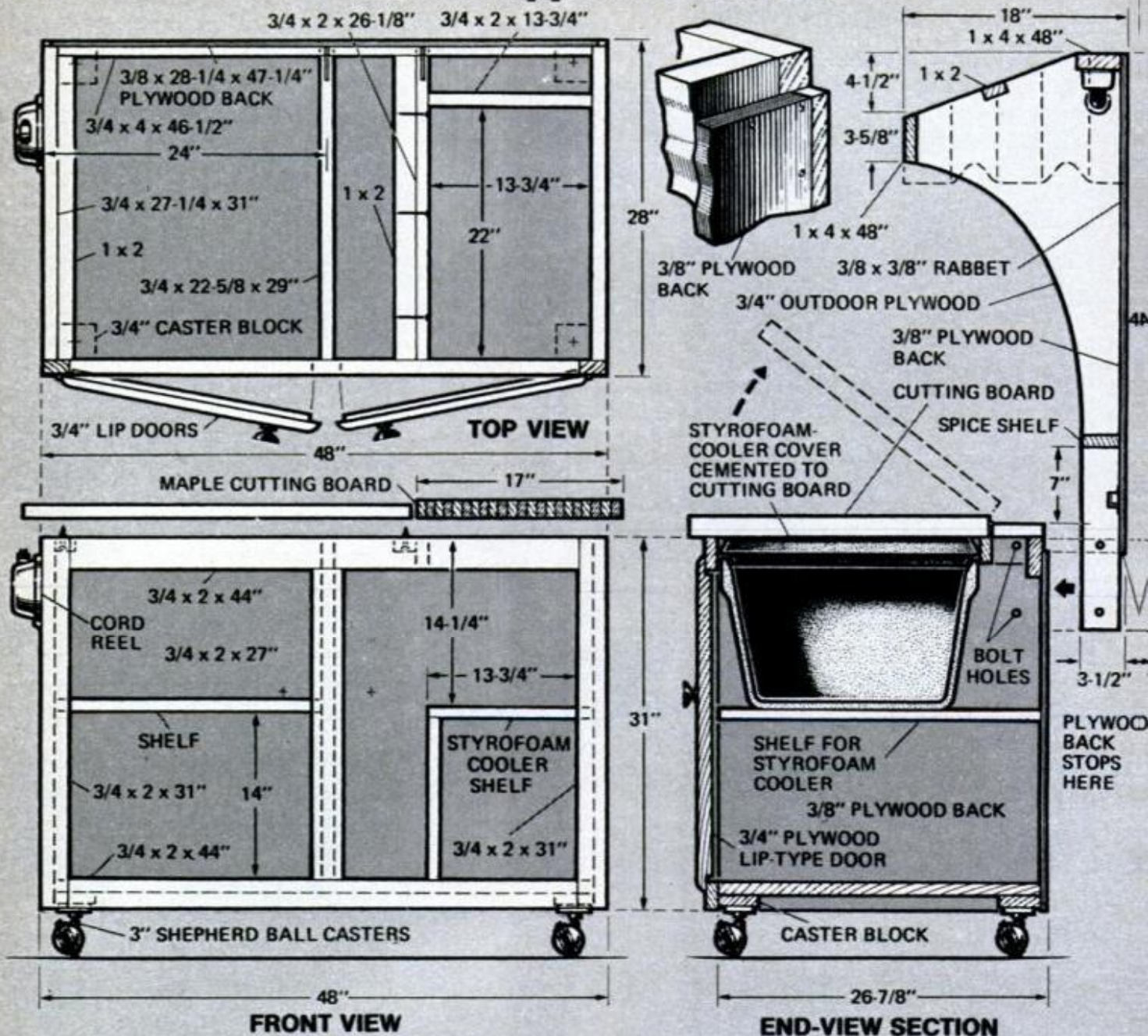

RETRACTABLE CORD REEL corrals 6-ft. plug-in cord, sells for \$15; A. A. Peters, Inc., 404 Union Blvd., Allentown, Pa. 18103

PLATE-TYPE BALL CASTERS, two having brakes, are screwed to all four corners

PHOTOS BY ROBERT BORST

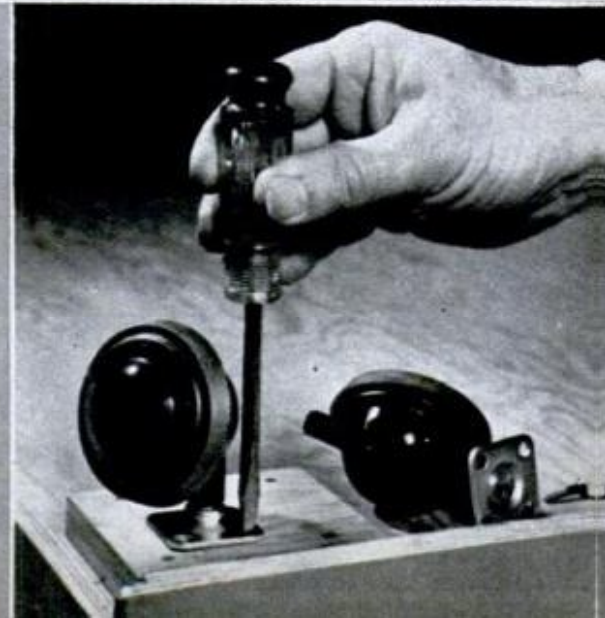
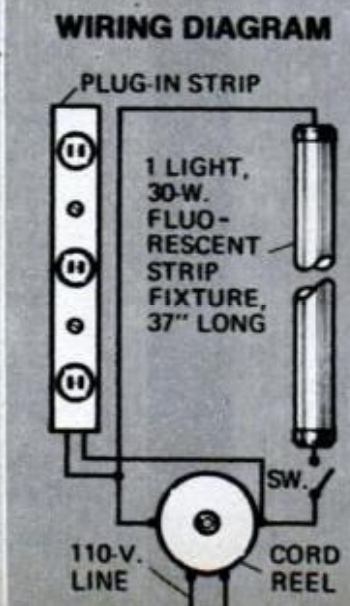

is wired to the cord reel. The canopy frame can be removed to facilitate storage.

What's more, it's not just something you can use during the summer only; if you have a big enough family room or recreation room to accommodate it, the cart can be rolled inside when winter comes and used for indoor entertaining.

Construction details on these two pages show how the cart is made. You start by making the front framework from $\frac{3}{4}$ x 2-in. pine strips. This is then glued and nailed to the plywood members which form the ends, bottom, shelf and center divider. Notice that the bottom is set even with the top of the lower rail. ★★★

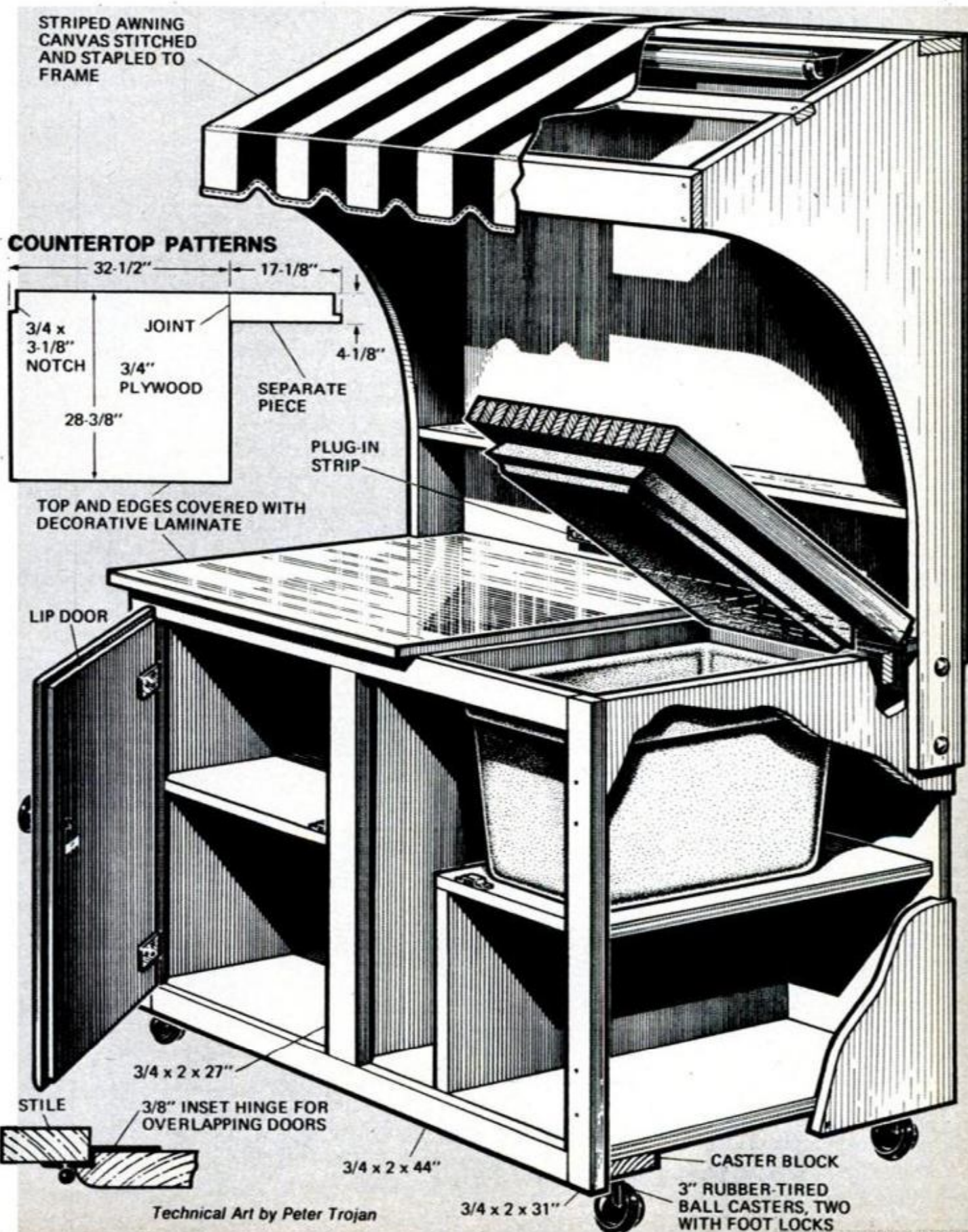

Your Garage Can Double as

Tack a patio onto your garage and build this entertainment center for months of fun

By HARRY WICKS, Workshop Editor
Illustrations by Roy Grinnell

ANYTIME YOU CAN GET DOUBLE USE from what you already own, you're ahead of the game. And that's what this concept is all about. When originally presented (page 136, April '65 *PM*), the garage-patio idea was readily accepted by readers who knew a good thing when they saw it. Three ideas are shown—the original plan (at the top of the facing page) and two new versions. Plans for the first version are available; simply send \$1.50, plus 25 cents for postage and handling, to Popular Mechanics, Dept. GP, 224 West 57th St., New York, N.Y. 10019. You can add additional comforts to suit your personal tastes and the equipment you have on hand. The important point is to have an overall plan of exactly what you want as a finished product. Then, you can tackle the job bit-by-bit as time and money allow. The result will be an outdoor "room" with a professional look. Basically, the heart of the center is the cooking and storage unit that is built into the garage. If your preference is the cooking part of entertaining you'll probably want to treat yourself to the built-in grill shown below. On the other hand, if, as far as you're concerned, cooking is just one of the necessary evils, you can simply use a portable brazier as shown on the facing page. No matter what your family preferences, you'll wind up with an outdoor room "in" which you'll be proud to do your entertaining.

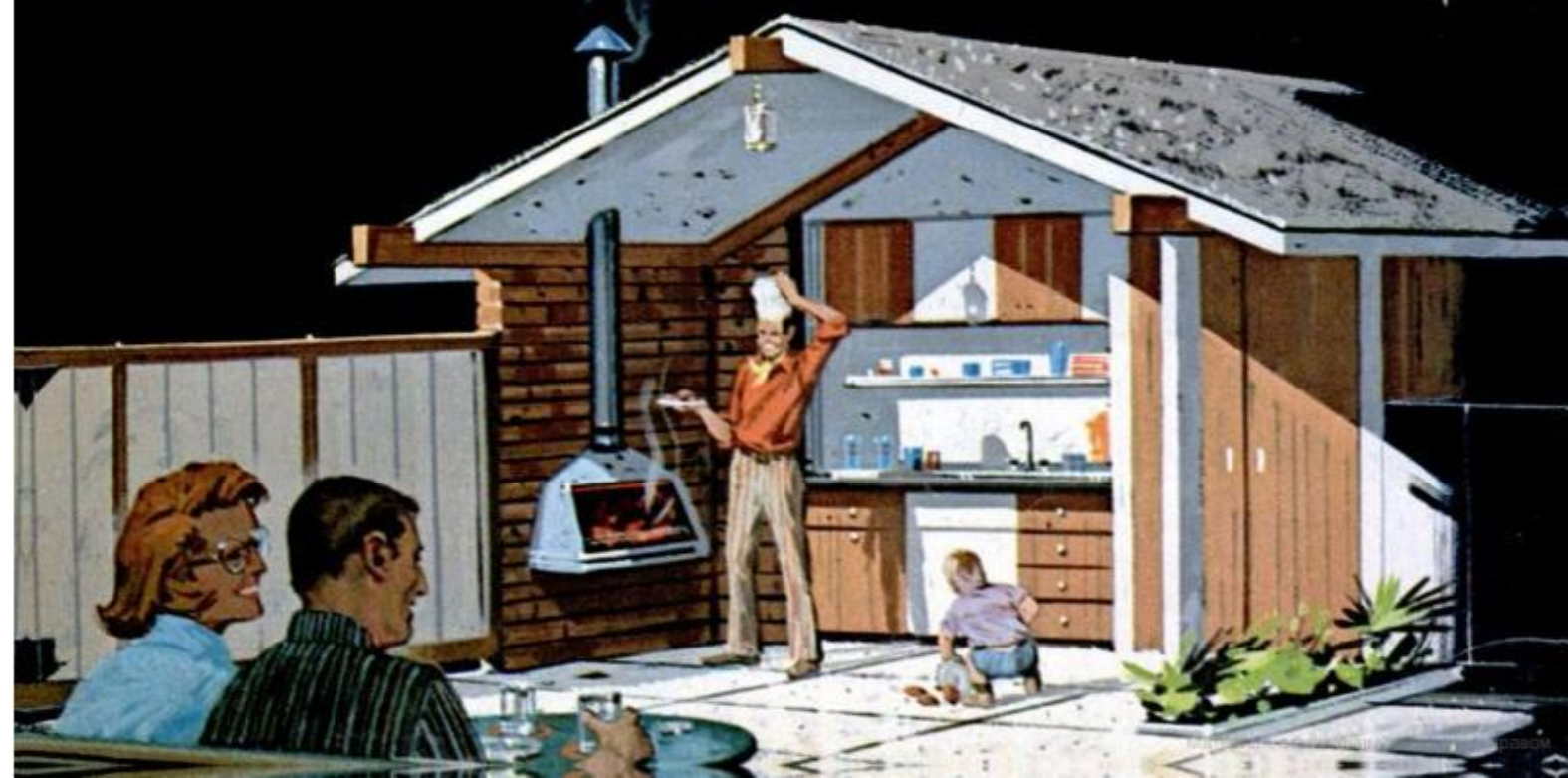

Your Outdoor 'Family Room'

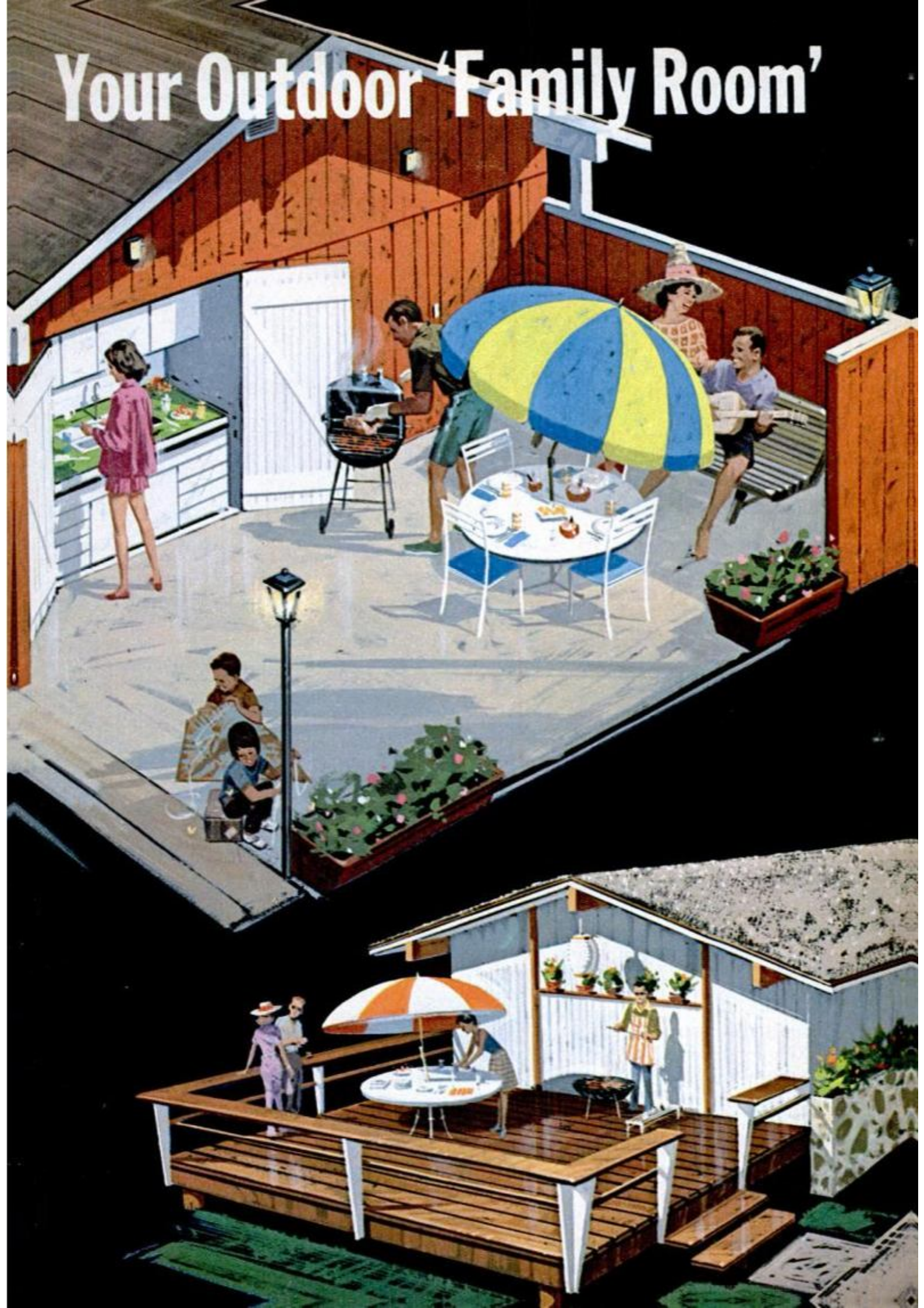

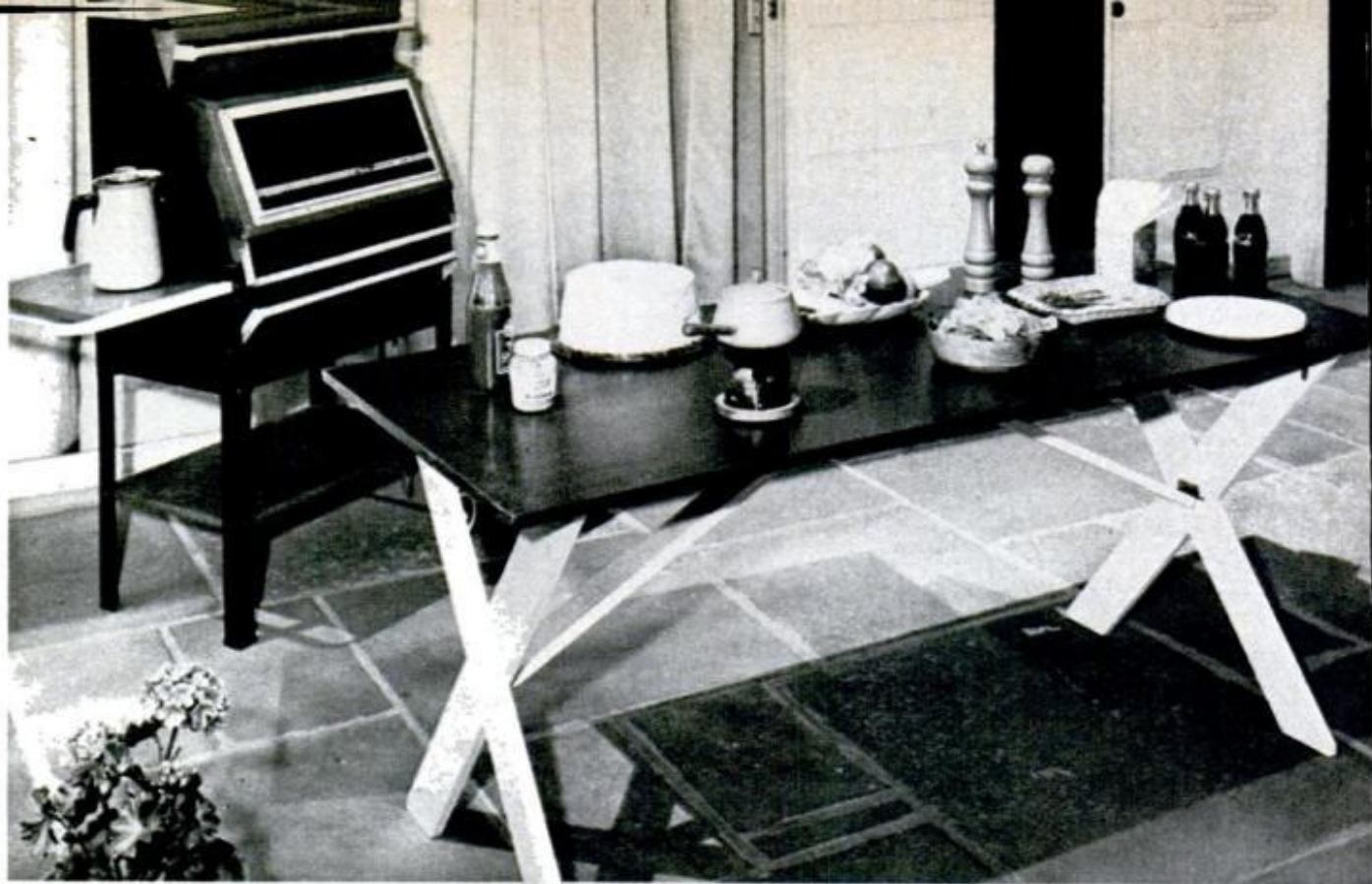

Fold-Flat Picnic Table Lets You Put It Away

THE BIG PROBLEM with a conventional back-yard picnic table is that you can't put it away between cookouts. It's just too big to store—which means it's in the way when you mow the lawn, and it takes a beating from the weather. The latter means you'll have an annual paint or stain job.

You don't have such problems with this patio table. When the party's over, it can be stored in a minimum of space in your garage. With legs folded, it takes only 2¼ in. of space.

The table is sturdy when it's set up; the sawbuck-type legs are braced by their hinged supports. The braces not only lock the legs in the open position; they also lock them when folded—by using a pair of

regular loose-pin hinges and substituting pull pins made from coathanger wire for the original hinge pins.

You can increase the size of the top, but if you maintain the 5½-in. dimension at the ends, you'll have to increase the length of the braces accordingly.

Block B is glued and screwed to the underside of the plywood top at its exact center. Although the braces are hinged to this block with plain butt hinges, you'll see in the enlarged detail that the braces are on the top of the hinge leaf and the screws are turned in from the rear side of the leaf.

The 1x4s, which are used to make the legs should lap flush at the point where the members cross. To cut the dadoes at the correct angle, set your saw miter gauge at 11°.

Use three loose-pin hinges (six leaves). One leaf is screwed to each end of the braces. Another is screwed to each block A and the other two are screwed to the inside of each leg assembly. Thus, single leaves at ends of the braces engage the single leaves screwed to the legs as well as to those screwed to blocks A. To set up the table you pull the hinge pin at blocks A, swing up the legs to engage the hinge leaf of the brace with the one on the legs and replace the wire pull pin.—Paul Bell, Clifton, N. J.



Slip-Proof Diving Deck Plus Storage

This platform can also be locked
to keep toddlers out of the pool

By HARRY WICKS, Workshop Editor

LAST SPRING, a letter received from a *PM* reader in New Jersey posed an interesting challenge. This homeowner had, he said, "an above-the-ground pool that was in dire need of some sort of diving arrangement. What do you suggest?"

So, *PM's* editors huddled and sketched some ideas. A self-imposed restriction was that no proposal would be considered valid unless the particular idea was unanimously acceptable. A package of ideas was sent to the reader and the structure you see on these pages was subsequently built entirely by him. And he let our photographer shoot pictures as he built.

Features. Since footage would be taken from the yard, it was agreed that space beneath the deck should be utilized for seasonal storage as well as to house the pool filter system. It was also decided to place the stairs behind the door to protect young ones. Extras that "make" the structure include a foot bath, indoor/outdoor carpeting and nautical rope railing.

Design is basic; there are no fancy, frilly construction techniques. Tried construction methods were used to insure maximum sturdiness, yet details were kept simple to keep costs down to a minimum. For example, careful layout permitted cutting the deck from just two 4x8-ft. sheets of exterior plywood with practically no waste.

Overall dimensions of the deck can be varied to suit the size of your family. The version shown provides ample room for sunbathing as well as diving for this

reader, his wife and their five youngsters. One critical measurement to keep in mind—when laying out your structure—is the portion of the deck that overhangs the pool. This can be altered to suit without any problems.

The four-by-four posts are anchored to footings which should be below your area frostline. Once the four-bys are in place, and the concrete has set, the post-holes can be backfilled and cutoff marks at the top located. To do this, determine desired height on one corner post and mark off the other posts using a mason's line and line-level.

Top and bottom rails are simply spiked to the posts and framing is completed with joists and bridging installed. The rails and posts are fitted with cleats positioned to give a setback (architectural shadow-line) when the exterior plywood panels are in place. (In place of cleats, the 2x4 rails can be edge-rabbeted on a table saw.)

Doors to the storage area and stairs are simply plywood panels framed with rails and stiles fastened to the structure with strap hinges. Catches to hold them closed and vertical half-round moldings complete their construction.

The stairs. A limited run made a steep riser-to-tread ratio a must. But, unlike conventional stairs, it is not a drawback. Actually, their "marine-ladder" steepness adds to the nautical design. The foot bath at bottom is optional (it's an inexpensive plastic baby bathtub from Sears, Roe-

ABOVE-GROUND POOL mandates a structure alongside for diving fun. This one has steps inside (upper right) that are inaccessible when door is locked. Space behind doors (upper left) is ample for year-round storage of bike and yard equipment plus house for pool filter. Owner built deck shown in four weekends



INDOOR-OUTDOOR CARPETING insures skidproof footing, goes over 15-lb. felt and 6-mil polyethylene

buck), but it does decrease the mud tracked up to the deck carpet by overzealous youngsters.

The deck can be finished using an exterior latex paint with some fine masonry sand mixed in for skidproofing. (Or, you can purchase a ready-mix sand paint.) But our suggestion was to cover the plywood with 15-lb. felt, followed by 6-mil polyethylene and Ozite outdoor carpeting. (The felt waterproofs the storage area while the polyethylene prevents any possible stains from the felt rising to the carpet.) Either way the finished surface is an effective safeguard against accidental skids and falls. The latter method is just more comfortable underfoot and better looking.

Since a slab wasn't used here, you'll notice in the photos that the structure walls leave space at the bottom to permit rainwater runoff. If you prefer slab construction, you are well advised to install

STORAGE DOORS are built with one-by stock and 1/4-in. plywood. Half-round moldings give a decorative touch

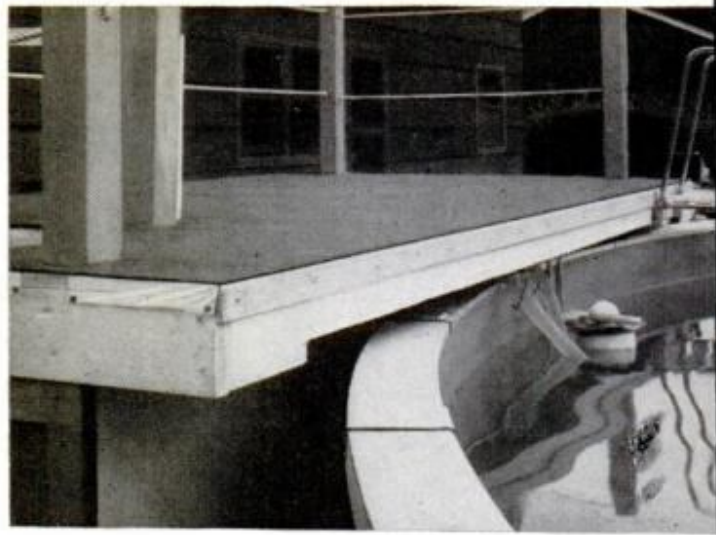
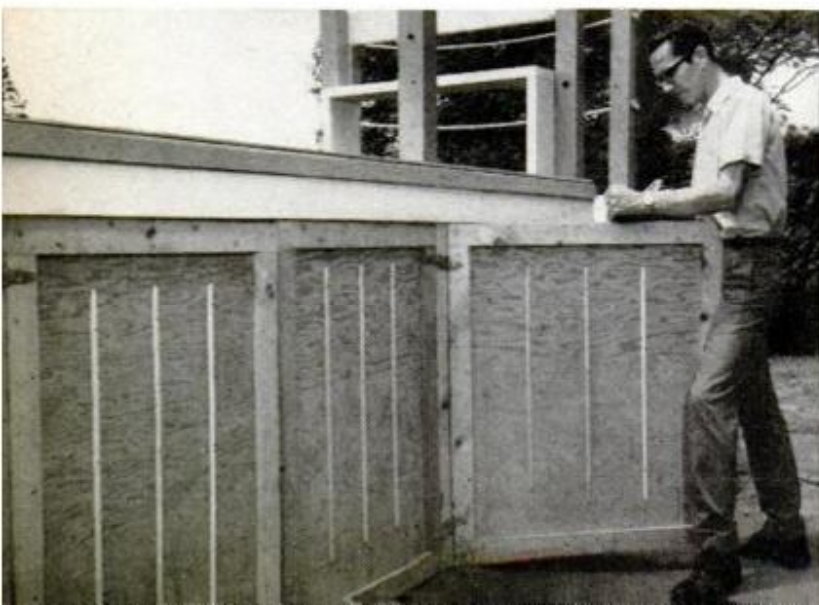

PLATFORM OVERHANGS pool slightly; measurements might vary from drawing to suit different size pool

a block wall or form the slab to create a curb. A standard soleplate can then be installed, with posts toenailed to the plates, and conventional wall framing used. But remember that a slab would require the addition of a pitched apron in front of the doors to provide positive water runoff. The apron will also make it easier to roll bikes and other wheeled vehicles in and out of the storage area.

To finish, the entire structure was primed and painted (inside and out) with a high-quality, latex house paint. (For additional safety, the stair treads could also be carpeted or coated with a sandmix paint to make them skidproof.

The prototype project shown took the owner four weekends to complete. He started it late in April 1970, and by the time the thermometer climbed to swimming temperatures he was happily spending his vacation atop his "Slip-Proof Diving Deck" in his own back yard. ★★★

HOMEOWNER-BUILDER lowers prebuilt stairs into position. There's space at bottom for small footbath



Diving Deck Construction Details

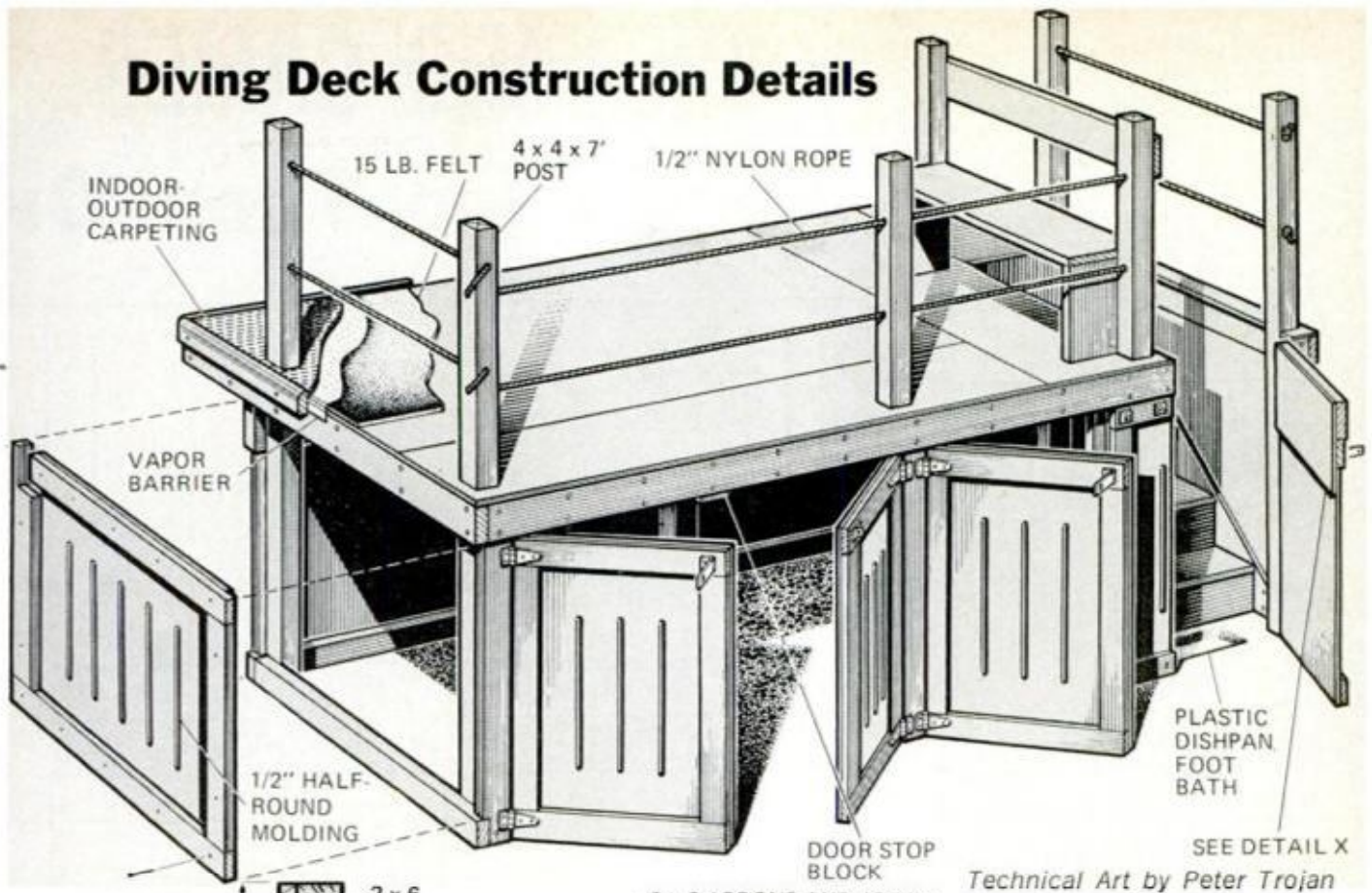

Technical Art by Peter Trojan

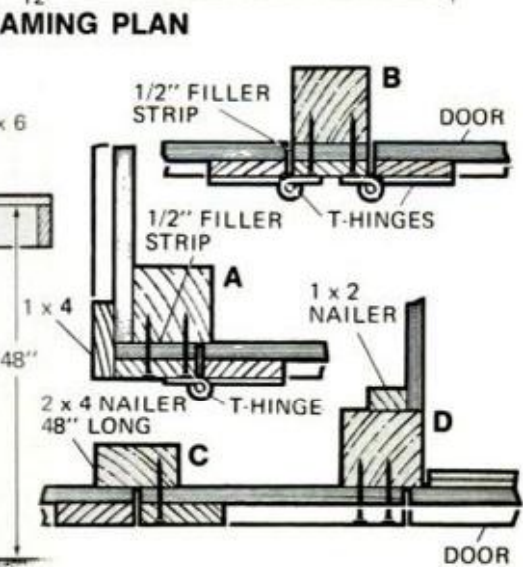
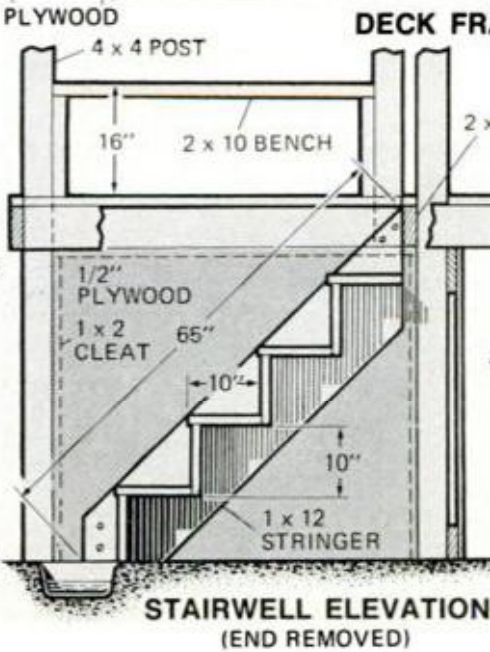
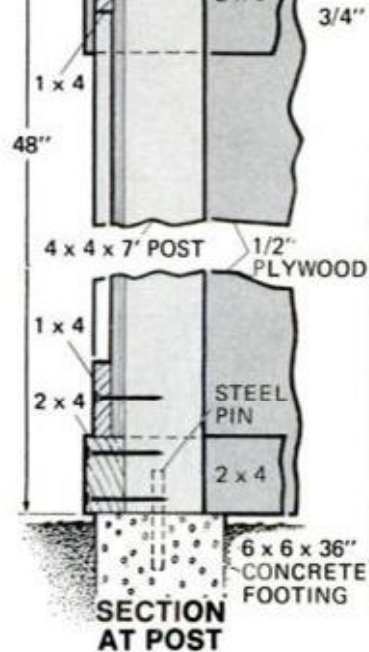
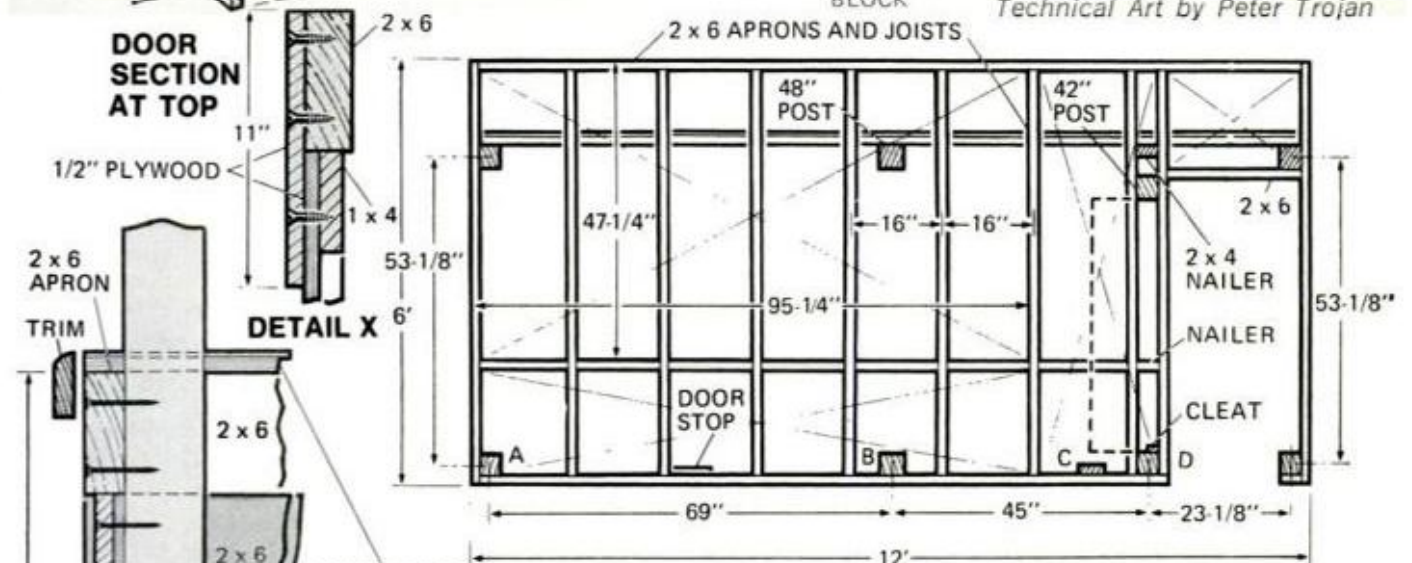

BACK-YARD GAMES

How to Lay Them Out

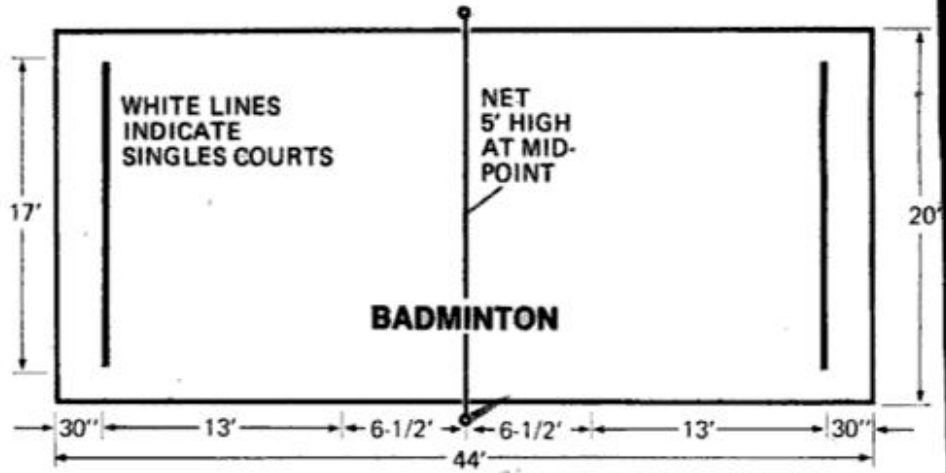
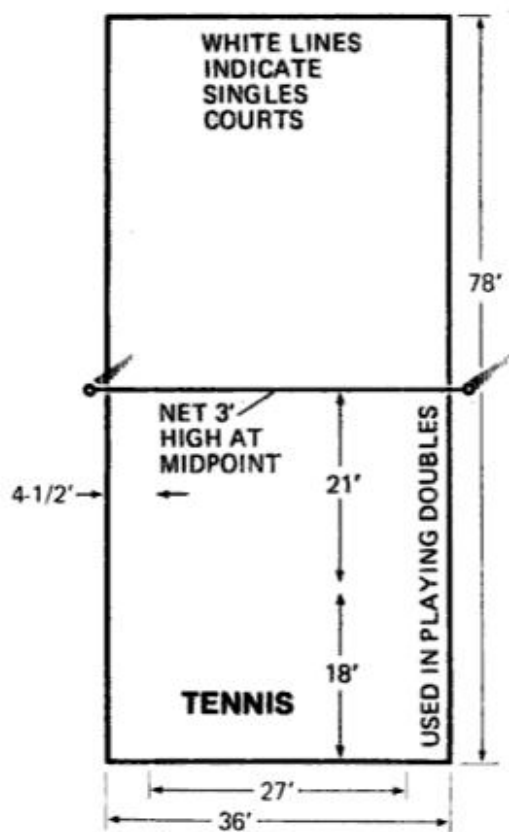

Technical Art by Peter Trojan

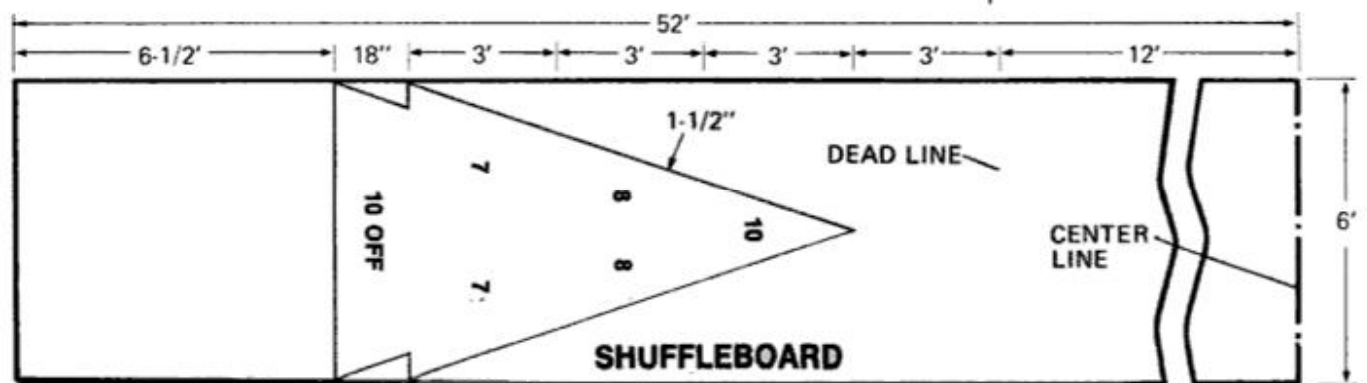
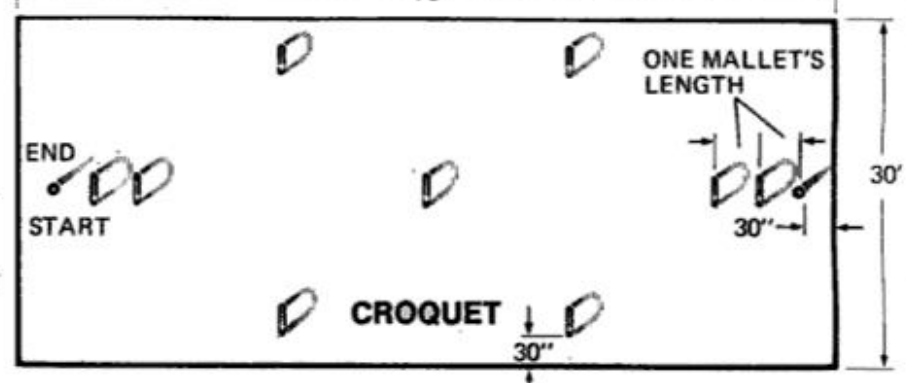
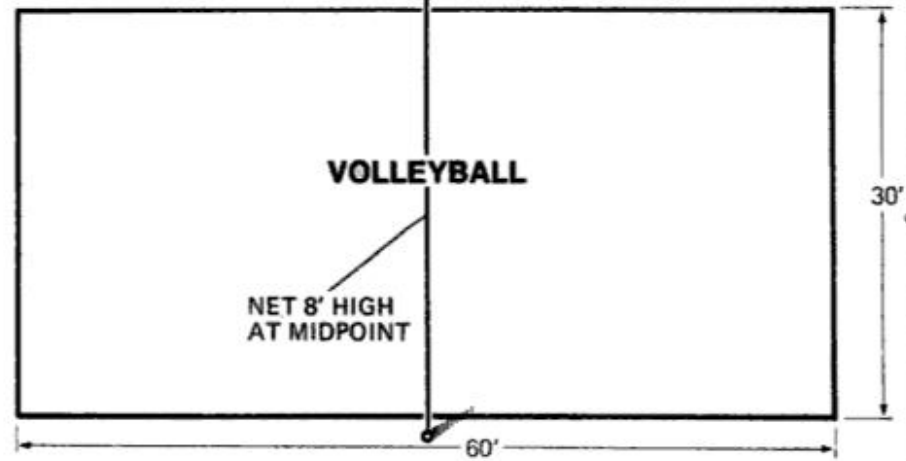
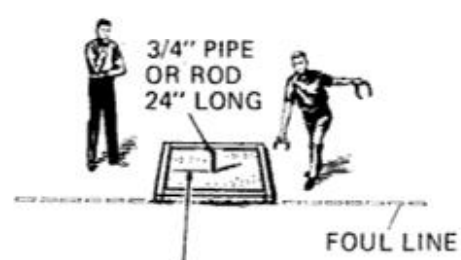

Game Not Called Because of Darkness

Adequate lighting, properly installed around those yard games, will add hours of fun to your vacation at home.

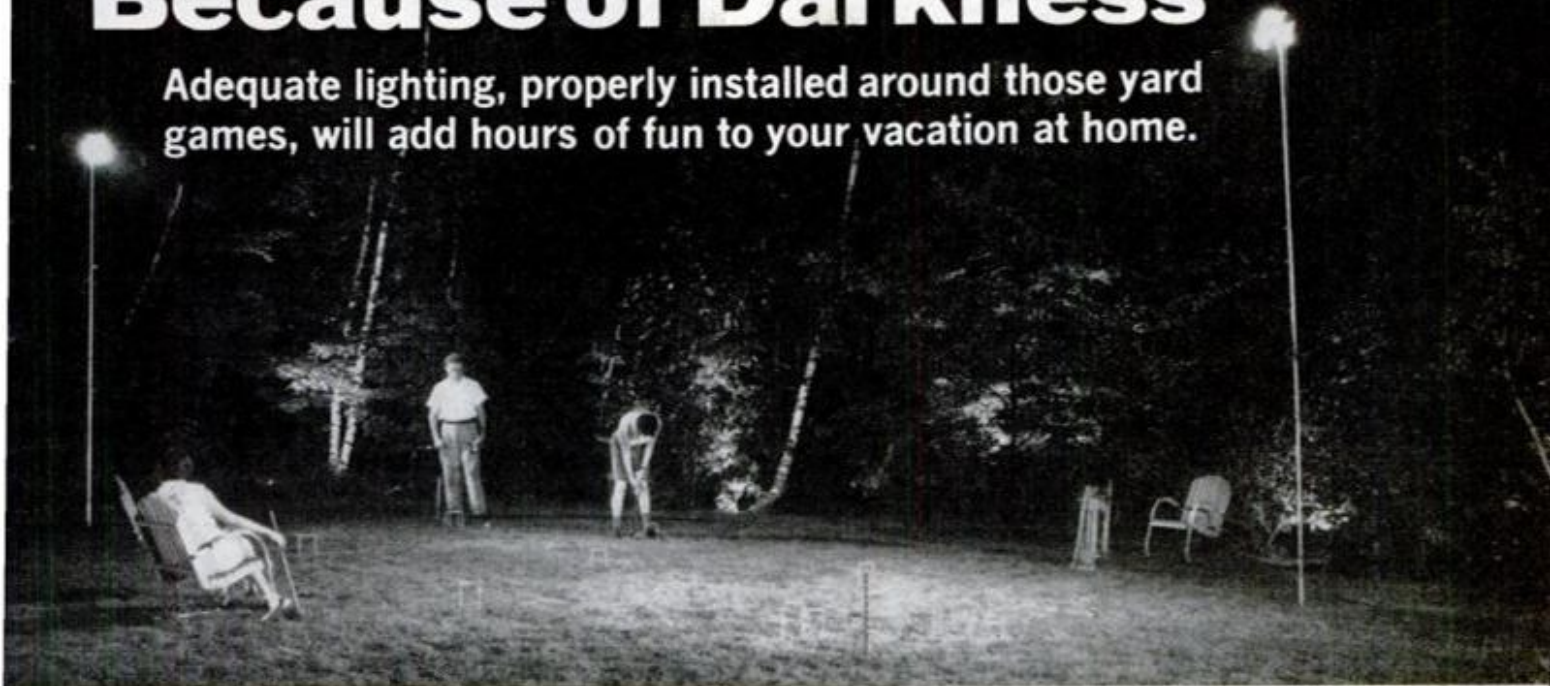

WESTINGHOUSE CORP. PHOTOS

By HARRY WICKS, Workshop Editor

ONCE YOU DECIDE to set aside a portion of your property for lawn games, and put in the time and cash to install them, it makes good sense to extend their use into the evening by providing adequate illumination. In fact, during the blistering hot months, you'll probably find the youngsters using the games more during the cool after-dinner hours.

There are several important points to keep in mind when you set out to light any yard game or swimming pool:

- First, the game's location—which of course will determine the placement of lighting standards—should be considered carefully to avoid annoying neighbors by intruding on their privacy.

- A major consideration in the design of any direct-lighting system is the uniformity of illumination over the entire playing surface. A "hot spot" can be as distracting to a player as staring directly into the sun.

- Since filament lamps tend to have a

LAWN GAMES are often more fun when played in the evening. But avoid glare on your neighbor's property

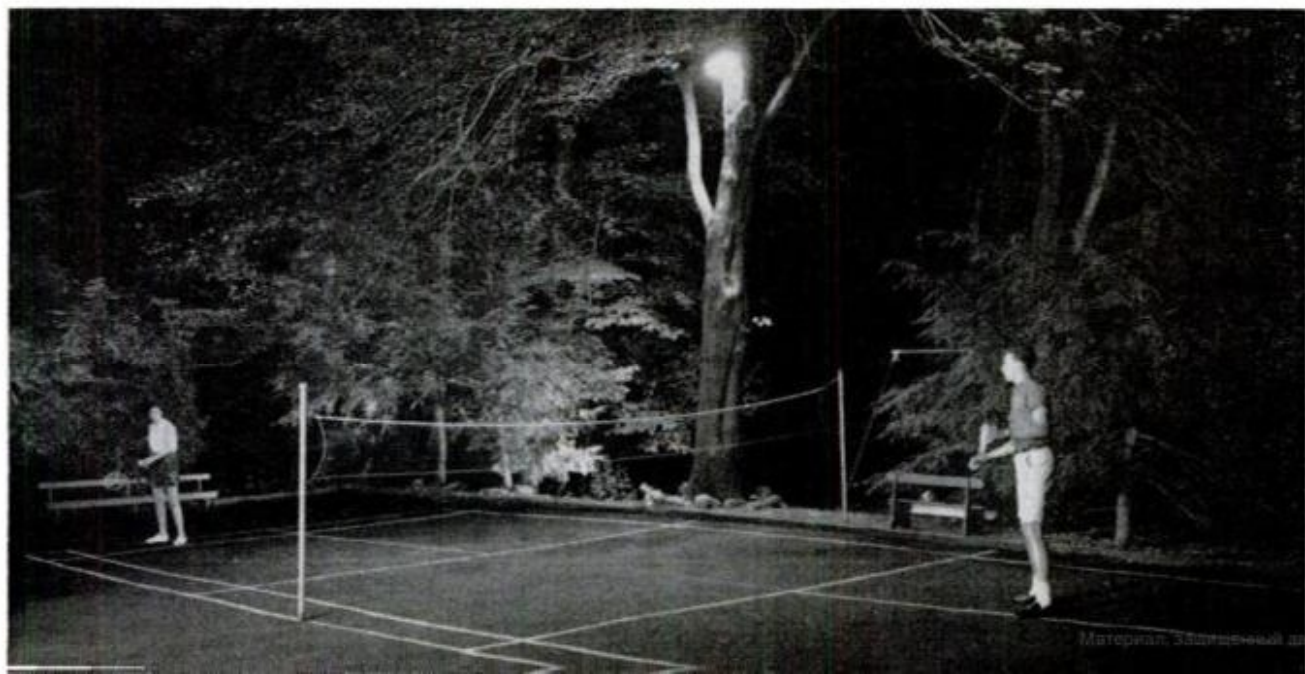

TYPICAL LIGHT STANDARD

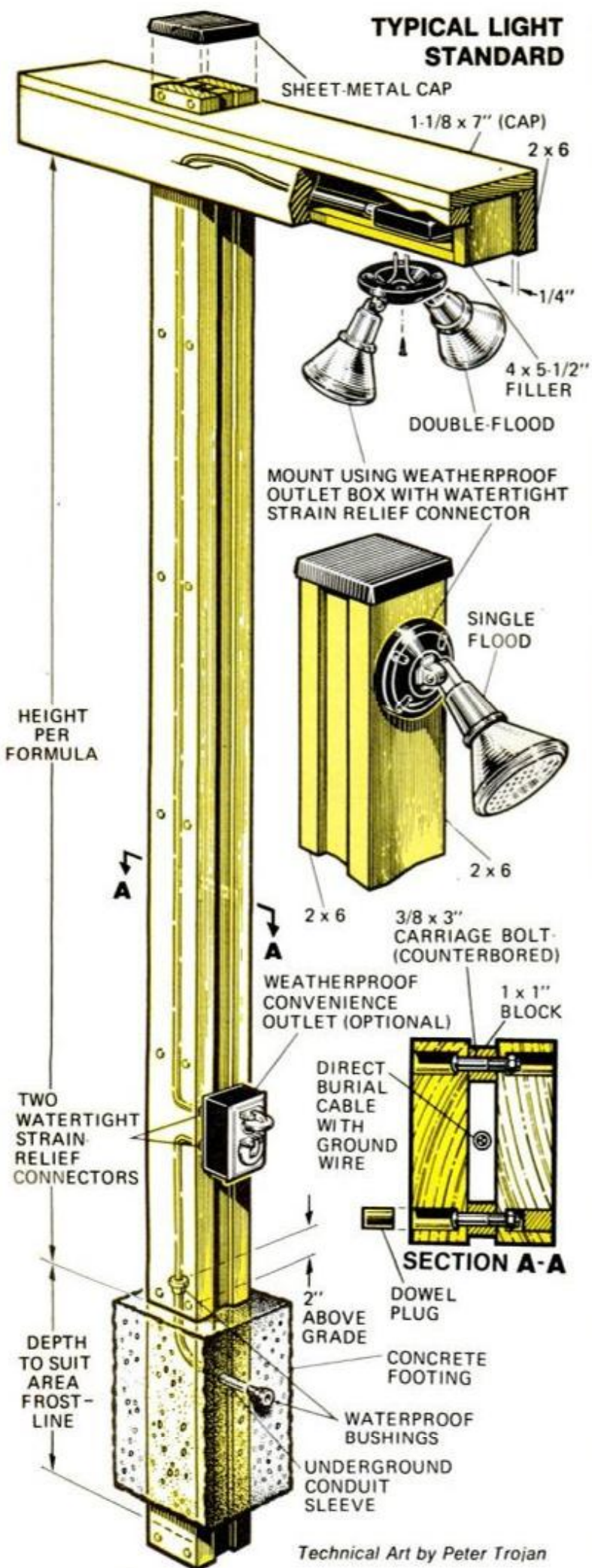

Technical Art by Peter Trojan

LAMP MOUNTING HEIGHT

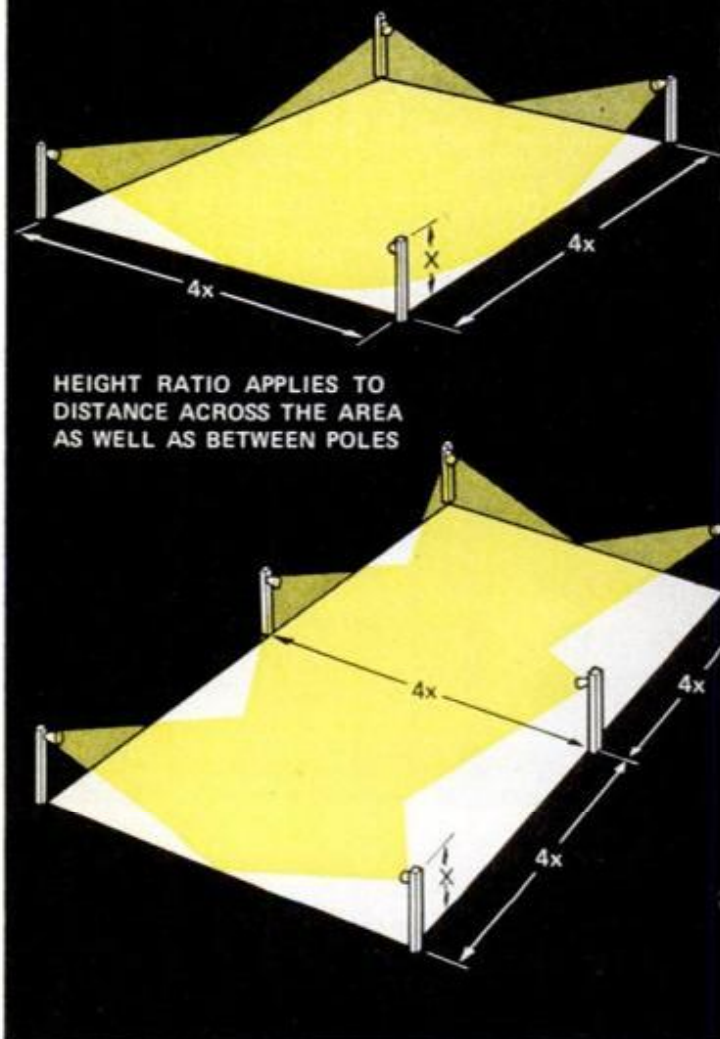

TYPICAL YARD-LIGHT STANCHION shown at left was conceived by author, can be varied to suit house architecture. The four-times mounting ratio shown above applies to width of area as well as distance between poles. For example, if the court width is 40 ft., the pole height should be 10 ft. and the poles should be spaced no more than 40 ft. apart whether mercury or filament bulbs are used for light. Any activity area should be bathed with illumination, and standards should be attractive during daylight

short lamp life, mercury luminaires, designed for 24,000 burning hours per year, are recommended by most experts.

There are other factors to bear in mind when laying out your lighting. There may be times when you do not wish to light a game but want to make aesthetic use of the light for highlighting rock gardens, fish pools and the like. For barbecues, picnics and social gatherings you will want a lower level of illumination. Thus, when possible, utilize dimmer switches in your controls. And, as shown illustrated at left in the typical light standard if at all possible, provide watertight convenience outlets wherever you think you may need

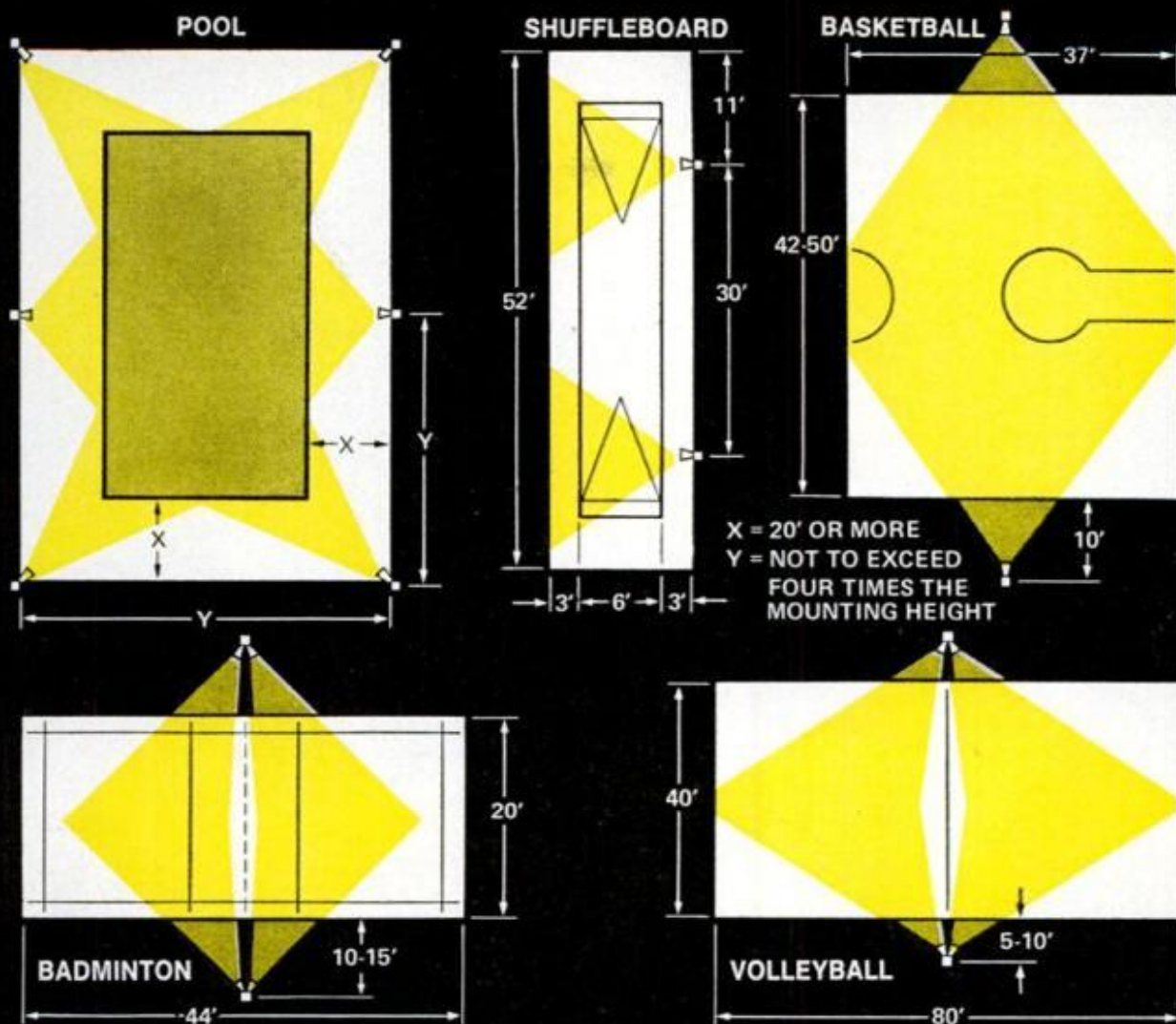

PARABOLIC ALUMINIZED REFLECTOR-type floods are best to use for outdoor lighting because they are watertight and can withstand bad weather conditions

ACTIVITY ILLUMINATION calls for high-wattage bulbs, carefully placed standards. Lights should not be controlled by the switches used for party lighting

them. At some later date, you might decide to relocate a patio or purchase an electric mower.

Though good illumination for a particular game is of primary concern, do give some thought to how the lights (and their poles) will look during the day.

Above are shown the most common back-yard games and the lighting setup best suited for each. Normally, 10 footcandles of illumination are recommended for all activities shown except shuffleboard. For this game, five footcandles are sufficient. Tennis courts (not illustrated above) require 10 footcandles of illumination.

(Ed. note: Swimming-pool lighting refers to pole lights placed around the pool, *not* in-the-pool, underwater lights).

Another advantage of well-planned ac-

tivity and general outdoor lighting, is that such illumination can be utilized for security—particularly if it is controlled from within the house. So, you might also consider installing timers or light-sensitive switches that will turn lights on and off at predetermined times.

Outdoor floodlighting can be installed with either overhead or underground wiring, but from the standpoint of appearance, and for minimal interference, the latter is more desirable. An underground system can use either direct-burial cable conductors or wire in conduit. While overhead lines can be less costly, they may require additional items. For example, extra poles may be needed to keep wires from dangling into a playing area, or guys may be required on poles where there is a change in direction of feeders or where the feeders dead-end. ★★★



Rollaway Party Wall

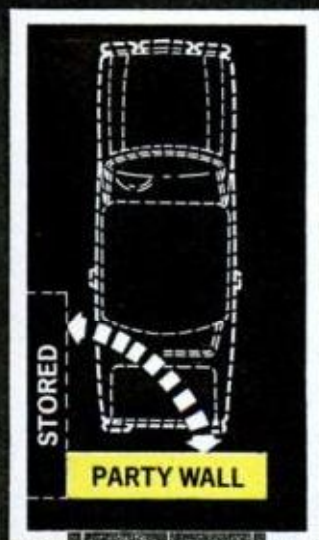

Parked in your garage doorway, this mobile wall holds everything for cookouts. After the party, it stores along the garage wall.

Illustration by Roy Grinnell

WITH A MOVABLE WALL like this, which rolls out to span the garage-door opening, your driveway can serve as a patio that expands to fit the size of the party. If you want privacy from the street, you can build a couple of light-weight 6-ft. screens and set them up across the driveway.

You'll have partial shelter in the garage from an unexpected shower, and when the party is over, you simply roll the wall out of the way and drive the car in.

Besides providing a serve-yourself buffet, the caster-fitted wall has roomy compartments for your cookout gear, a place for a portable TV set and compartments for a turntable and stereo speakers. The party wall is a step-saver

too; a lot of the gear you use can be stored in the cabinets between cookouts to save carting things back and forth. Best of all, the wall is something you'll use year after year since it stores conveniently and is protected from the weather at all times.

As the drawing shows, the party wall is nothing more than a big box on casters which is divided into compartments to accommodate the particular stereo components you have and the cookout gear you'll need. For this reason we show overall dimensions only. The whole thing is made of plywood and joint details A, B

and C show how the horizontal members join the vertical ones. Standard aluminum track is used for the sliding cupboard doors, plain butts or offset hinges for the hinged doors. Swinging doors are fitted with magnetic catches. A piano hinge provides strong support for the fold-down shelf and two desk-lid supports hold it when it's extended. Rubber-tired, ball-type plate casters make it easy to roll the wall out of the way. The back of the unit is covered with two pieces of 1/4-in. plywood. Paint the wood with an undercoater, then two coats of semigloss enamel in a bright color. ★★★

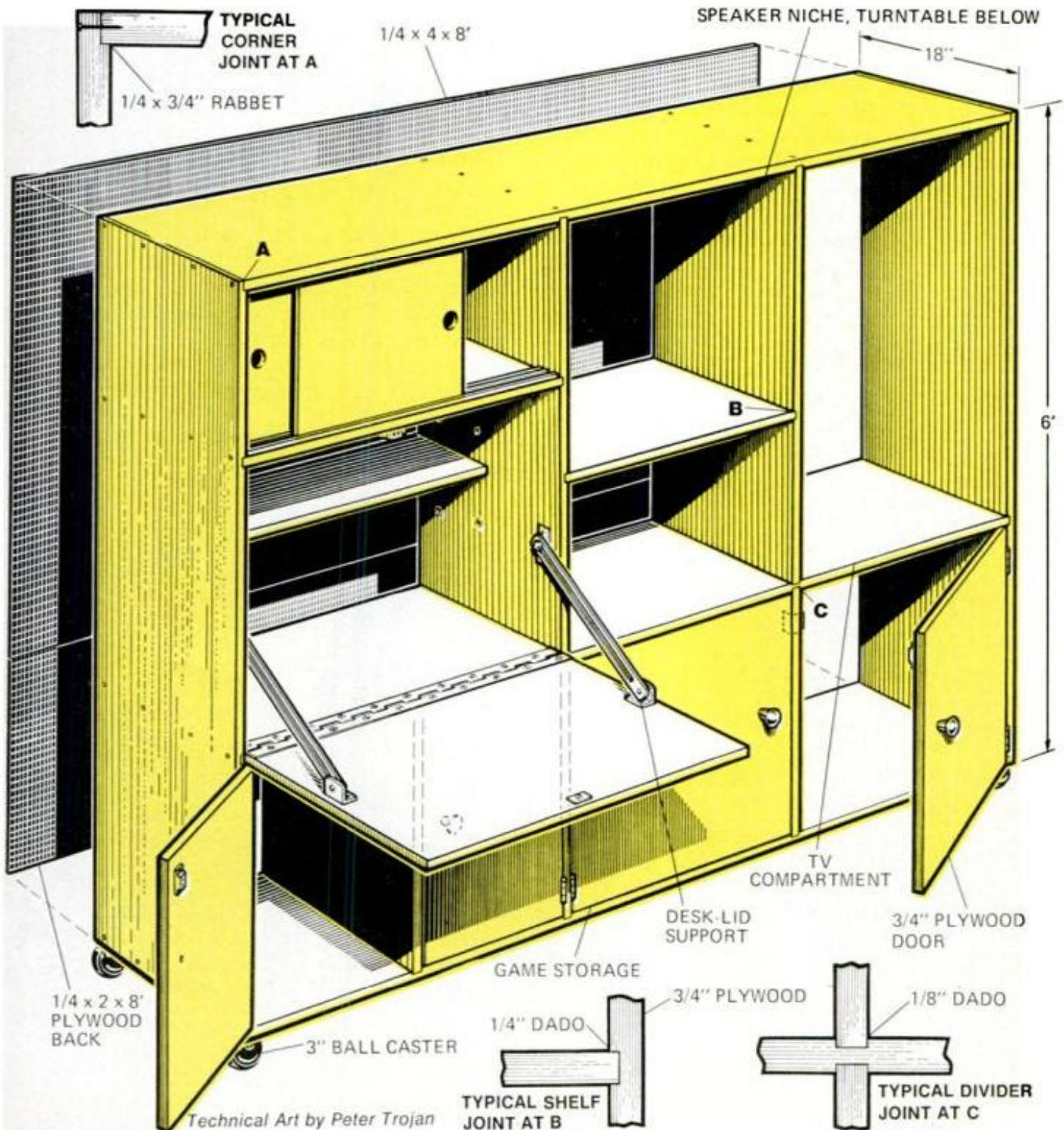

WIRE YOUR PATIO FOR SOUND

New trim, light, portable speakers make it easy to pipe your hi-fi outdoors for added listening pleasure in summer. Indoors, they double as extra extension speakers

By HANS FANTEL

Photos by Robert D. Borst

PIPING YOUR HI-FI OUTDOORS is a good way to get more fun from your home during the summer months. It will provide background music for a cookout, turn your terrace into an open-air dance floor and generally make your back-yard entertaining more pleasant.

The old-fashioned horn-type outdoor speakers, designed for public-address use, used to look as ungainly as an air-raid-warning siren and sound just as hoarse. Today's models, however, are a completely new breed. They're handsomely styled, lightweight and easy to carry. They're

capable of true hi-fi reproduction and are especially designed to perform well under the difficult conditions of rough weather and wide-open space.

Most of these trim little portables have convenient carrying handles and attractive floor stands. They have tough, weather-proof enclosures and will play right through a sudden downpour without missing a note. They also serve as extra speakers indoors. Their compact size and smart appearance make them ideal for use on a shelf or table.

Outdoors, sound energy dissipates much

BOZAK BARD
22 LBS.—\$89.50

ALTEC LANSING
MODEL 829A
10½ LBS.—\$82.50

LAFAYETTE
POLY-PLANAR
3 LBS.
\$17.95

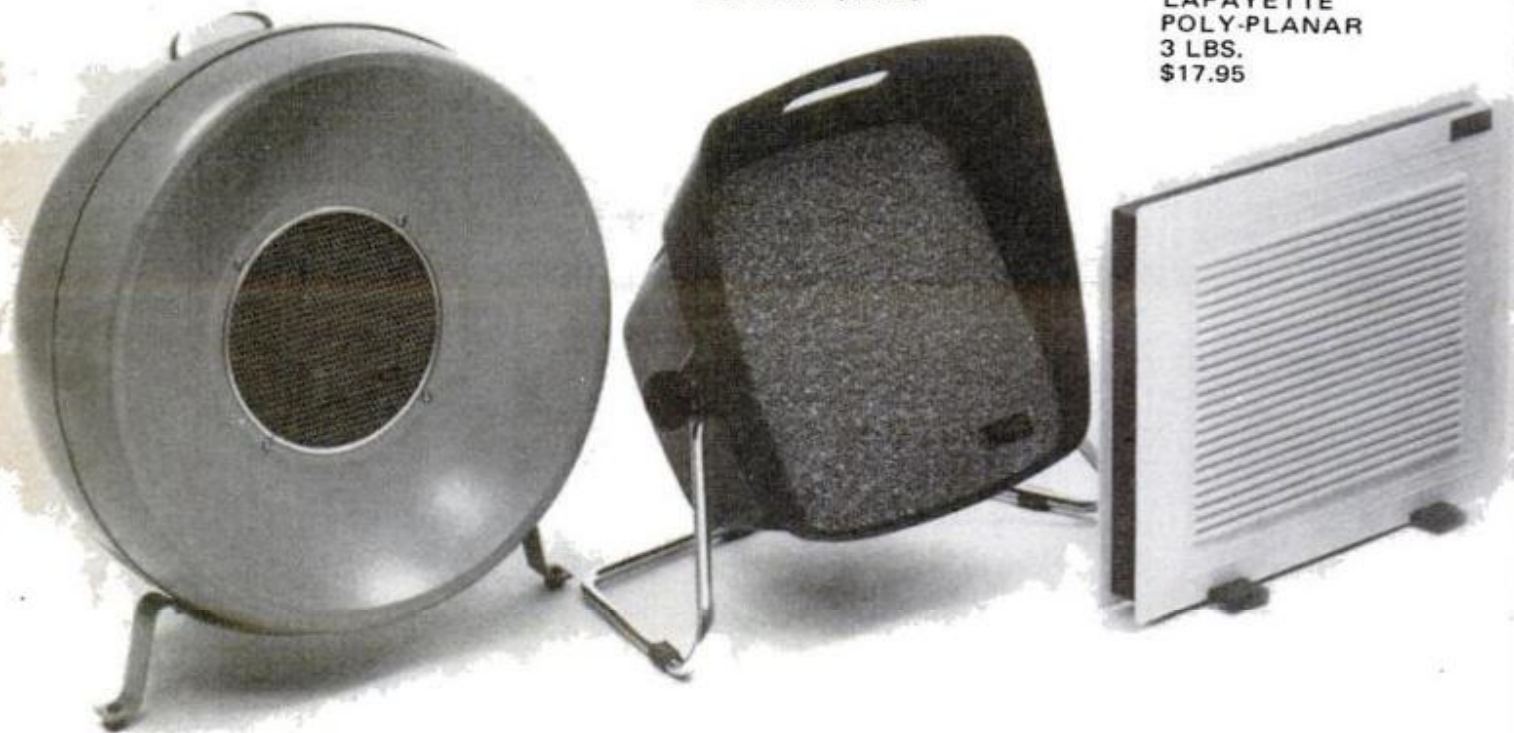

DEEPLY DISHED hemispherical enclosure on this Bozak model helps to prevent such acoustic problems as false resonances, standing waves. One of most powerful outdoor types, it contains an 8-inch speaker, handles 40 watts of power and has frequency range of 50 to 15,000 cycles. Its weatherproof outer shell is 18 inches in diameter, 12 inches deep. Weight is 22 pounds. The base adjusts to vary the speaker's angle of tilt, also serves as wall mount for permanent installation. Called the Bard, speaker is priced at \$89.50 from Bozak, Box 1166, Darien, Conn.



more rapidly in the open air than in an enclosed space indoors. To offset this loss, most outdoor speakers have a hefty power-handling capacity so you can crank up the volume without losing sound quality. Typical power ratings range from 20 watts per channel to as much as 60 watts. The higher the rating, the more power they'll handle before overloading and distortion set in.

Most outdoor models also offer good low-frequency response. This is important because full-bodied bass reproduction is difficult to maintain out in the open with

no surrounding walls to add reverberation and richness. Some models go as low as 40 cycles, with 60 to 80 cycles about average. Speakers that don't go below 150 cycles, primarily for public address use, don't have sufficient bass response for good hi-fi.

At the high end of the frequency range, most models reach a respectable 13,000 to 15,000 cycles. The majority are single-cone types, but a few have added coaxial tweeters extending the range even higher.

Can you hear stereo outdoors? Experts differ on this point. Some claim that true stereo effect is pretty much lost in open air because of the lack of room reverberation. Others contend that the very vastness of the outdoors tends to create a sense of spaciousness—a feeling of music everywhere—that's not possible in a closed-in room. In any case two speakers—even two monaural types—are bound to sound fuller and richer than one. If you want good lawn-filling sound over a large area, you may want to consider a pair of stereo speakers placed at opposite sides to flood the space from two directions. If you're in doubt, try some test setups using your regular speakers before investing in two outdoor types.

Some typical outdoor speakers are shown in the accompanying photos. These range in shape from Lafayette's waffle-thin Poly-Planar model—the lightest of the group—to Bozak's hemispherical Bard that stands on tripod legs and looks some-

**ELECTRO-VOICE
SONOCASTER
6½ LBS.—\$22.50**



**MAXIMUS
4 LBS.
\$49.95**

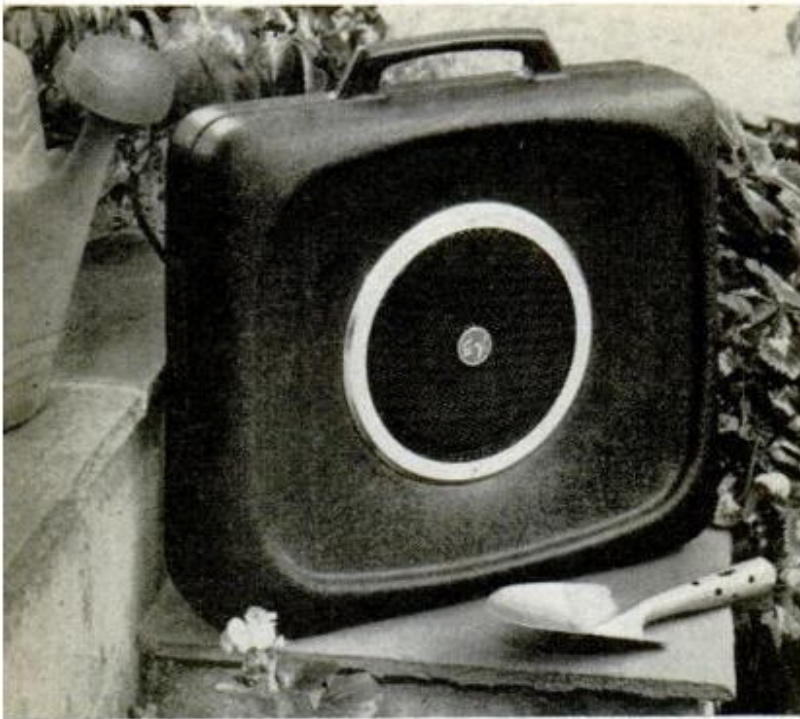

LIGHT AND HANDY, E-V's Sonocaster has suitcase-like weatherproof plastic housing, weighs under 7 pounds. Its 8-inch coaxial speaker handles 30 watts, has range of 70 to 13,000 cycles. Price is \$22.50

thing like a small kettledrum. Weights run from three to 22 pounds. Prices start at under \$20 and go to about \$90.

Resembling a trim piece of airline luggage is Electro-Voice's Sonocaster. At 6 $\frac{3}{4}$ pounds and \$22.50, it's one of the least expensive and handiest models for toting around the house and yard. The Poly-Planar also delivers surprisingly good sound for its slim shape and low cost. Though more expensive, the Bozak booms out powerfully from its deeply dished housing and is a good choice for covering large areas. Two of the smartest-looking designs are Altec Lansing's swivel-mounted model and the ball-shaped Maximus. Suspended in a chrome frame, the slickly styled Altec Lansing can be tilted up or down to any desired listening angle. The Maximus also adjusts to any angle and has a two-way base that serves as either a floor stand or wall mount. In addition, both Jensen and University, famous for military and public address speakers, have come up with home-style models designed for patio sound systems.

Outdoor speakers vary somewhat in their degree of weather resistance. Some can be left outside indefinitely without

POLE-MOUNTED SPEAKER at right has high-frequency tweeter horn mounted inside larger low-frequency driver. Made by Jensen, it handles 25 watts, has a frequency range of 60 to 15,000 cycles, is \$97.50

144

harm; others are best brought in at the end of the day or perhaps after a weekend of use outdoors to avoid prolonged exposure to the elements. All, however, will withstand an occasional shower without damage. If you're interested in permanent outside installation, be sure to pick a model for which this is recommended. Some have special brackets to permit permanent mounting on a tree, fence or outside wall. Some have clips so they can be hung temporarily on hooks outdoors, then removed for safekeeping indoors.

Connecting outdoor speakers to your amplifier is basically the same as adding extra speakers indoors. Most models have 6 or 8-inch speaker cones with an impedance of 8 ohms. A few are rated at 16 ohms. If your amplifier has a choice of output impedances—usually 4, 8 and 16 ohms—simply use the terminals that match the speaker's impedance. If the output is fixed at 8 ohms, be sure the speaker you buy is of corresponding impedance. Most are.

If your amplifier has provision for extension speakers, use these connections for your outdoor hookup, using the switch on the control panel to select whichever set of speakers you want. If there's only one set of connections, you'll need to add some sort of switching arrangement to let you turn on one or the other. Suitable speaker selector switches are available from radio-parts stores and mail-order electronics houses.

For short runs of wire, you can use



POPULAR MECHANICS

Материал, защищенный авторским правом



SUPERTHIN SPEAKER uses flat plastic baffle to move air instead of cone, is impervious to weather. Sold by Lafayette Radio, Poly-Planar has wide frequency range from 40 to 20,000 cycles. It's \$17.95

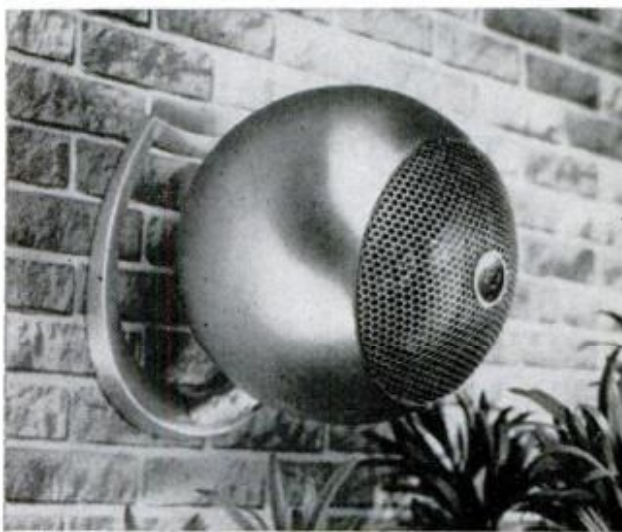
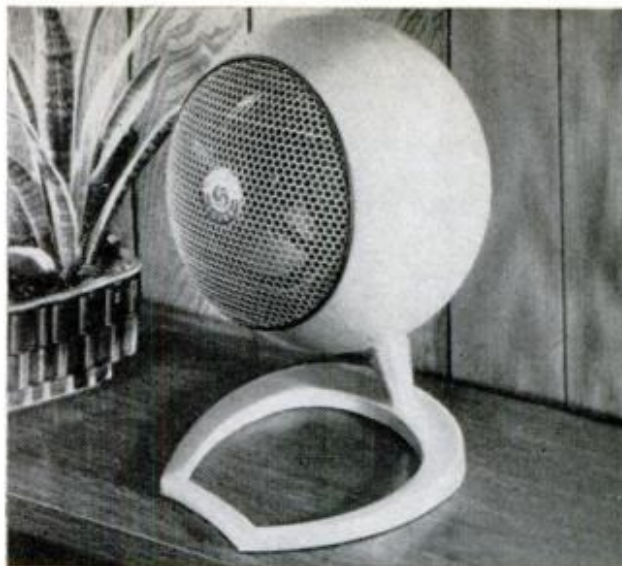

TWO-WAY BALL SPEAKER can stand on its base or mount on a wall. Ball is 8 inches in diameter and houses a 5½-inch weatherproof acoustic-suspension speaker. It handles 20 watts, has a range of 55 to 15,000 cycles, comes in five colors. It's \$49.95, Maximus Sound, 809 Stewart Ave., Garden City, N.Y.



STYLISH LINES of this swivel-mounted Altec Lansing make it just as suitable for indoor use as on the patio. Its 8-inch speaker has a frequency response of 70 to 15,000 cycles. Weight is 10½ pounds

ordinary lamp-type zip cord, just as for indoor speakers. If the distance from speaker to amplifier is greater than 40 feet, however, it's best to use a heavier gauge—no less than No. 14. Long runs of overly thin wire cause a buildup of resistance that can make the sound less clear and crisp. For permanent installations, wires can be run out of the house around window frames or through the wall in the same way as for TV lead-in. Just be sure any holes are well caulked against leaks.

If you're going to be connecting and disconnecting your speaker frequently, it will pay you to install a line connector near the speaker terminals so you won't have to keep removing the wires from the screws. This can be a phone-type plug and jack, a microphone line connector or even an ordinary household plug and socket.

If you're using stereo speakers, proper phasing is especially important outdoors because of the difficulty maintaining good bass projection in open air. Out-of-phase speakers work against each other and much of their output, particularly in the already weak bass range, is canceled out.

You can check for correct phasing by standing midway between the two speakers while playing a record that contains good bass tones, such as classical organ music. Have a friend reverse the connections on one of the speakers as you listen. The bass tones will either increase or decrease in fullness. Leave the connections whichever way they produce the fullest, richest bass sound. Switch off the set during the time the speaker is disconnected. Leaving the set on with a speaker disconnected unloads the circuit and can damage some amplifiers. ★★★

Maximat V10:

One-Tool Machine Shop

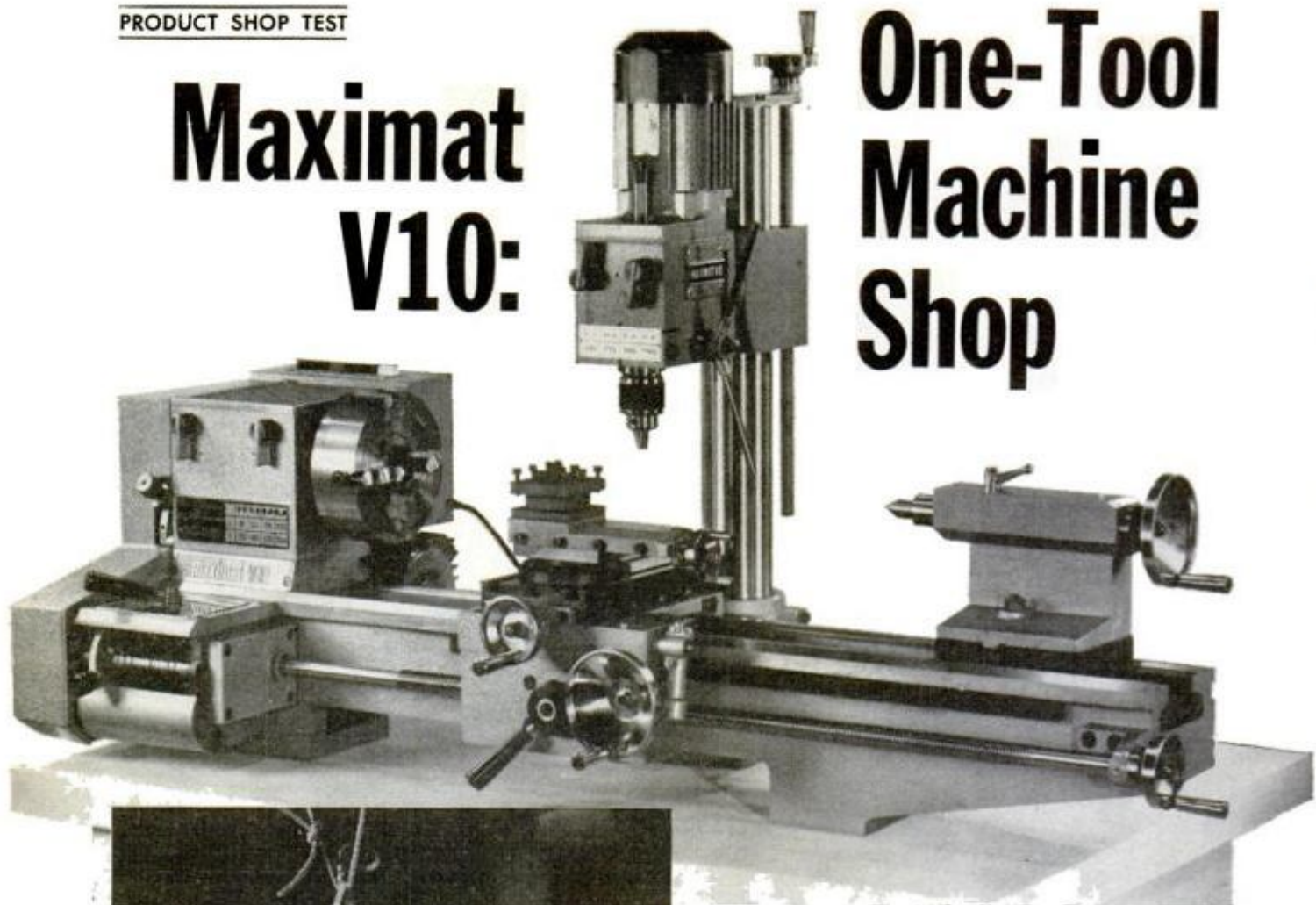

By JOHN BURROUGHS/Photos by the Author

COMBINING three precision tools in one, American Edelstaal's 10-in.-swing Maximat V10 is a compact metal-working machine that incorporates a screw-cutting metal lathe, a sensitive drill press and a vertical-spindle milling machine. The V10 performs any of the common metal-machining operations—turning, drilling, milling, even surface grinding—all with toolroom precision.

Built in Austria, this unusual universal machine tool is designed for shops where space is limited—mobile repair shops, re-

AFTER TESTING TOOL (above), the author said it's so different it has to be studied to be appreciated. at left, the unit is mounted on workbench. Then its vertical head unit is bolted to the bed casting

search labs, toolrooms or pattern shops, technical schools, and inventor's or engineer's workshops. It gives full machine-shop facility in a few square feet of bench space, yet is so easily handled that any handy craftsman can soon learn to use it like a journeyman machinist.

Two key features give the machine its extraordinary versatility:

- An independent vertical drilling-milling head on a column mounted on the back of the lathe bed.
- A hefty carriage cross slide, precision-ground and T-slotted, for use either as a mount for the lathe's compound-slide toolrest or as a precision worktable for drilling or milling.

When the machine is used as a lathe, the vertical head is swung to one side where it won't interfere with turning operations. To convert the tool for drilling or milling, the head is swung over the ways with its spindle centered above the carriage worktable, and the lathe's compound slide, which mounts on the table with two



FOR LATHEWORK, machine's vertical head can be swung out of the way. The column rotates full 360°

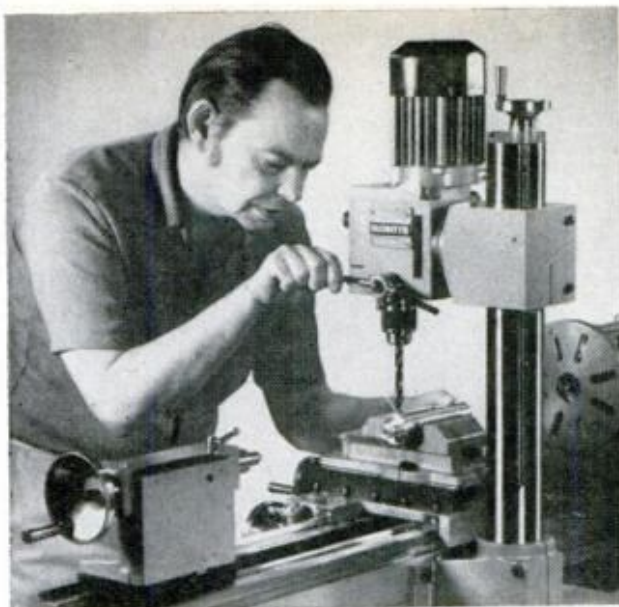

FOR DRILL-PRESS WORK, compound slide is unbolted from carriage worktable, replaced by machine vise

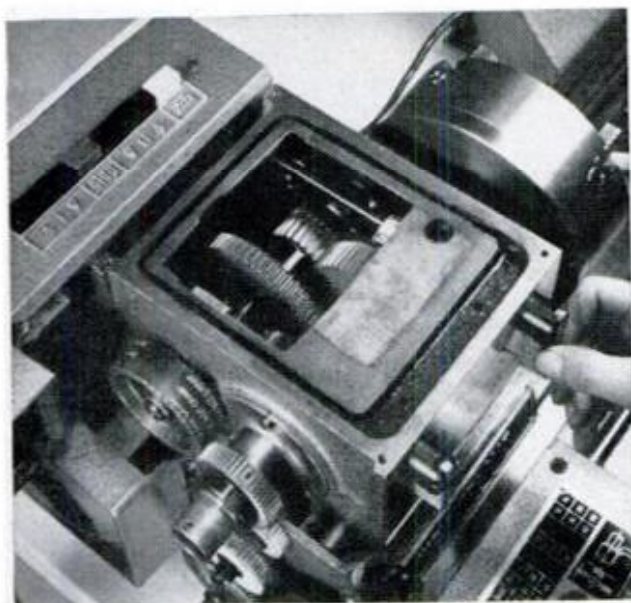

TWO-SPEED MOTOR belt-drives sliding back gears that gear-drive the spindle at one of eight speeds

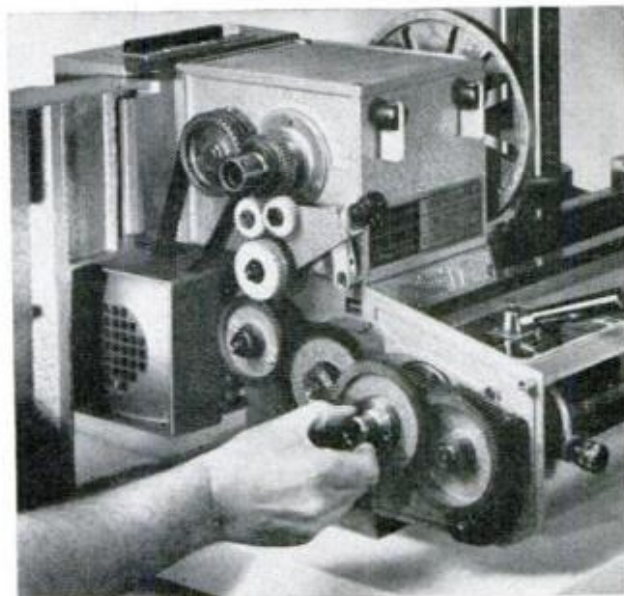

WITH SLIDING GEAR of end-gear train "in," box has 24 carriage feeds; "out" gives 24 thread pitches

T-bolts, is replaced with a machine vise.

Other unconventional features include its bed casting: Diagonally ribbed like a bridge girder, it mounts with two on-center-line bolts, which makes the tool very easy to set up. The bed doesn't have to be leveled accurately. After hoisting the lathe onto a suitable bench, you simply bolt it down on sheet-rubber pads with no risk of twisting the ways. Then you screw the vertical head unit (shipped in a separate crate) on a keyed boss on back of the lathe bed with four hex head capscrews. The vertical head's short motor cord connects to switchbox terminals.

Like an industrial lathe, the V10 has a gear-driven lathe spindle. The head-stock is built much like a four-speed auto

CORD FROM VERTICAL HEAD runs to lathe switch-box. Both starting capacitors mount below switches

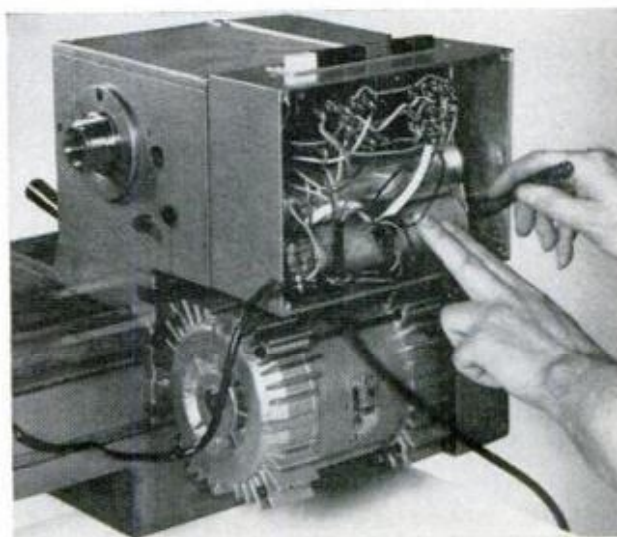

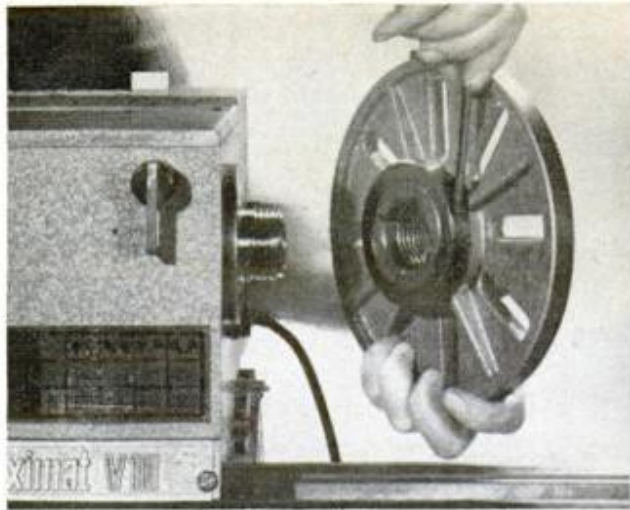

CHUCK AND FACEPLATES have split, threaded hubs. Clamp ring keeps the plate on when the lathe stops

transmission, with both spindle and backshaft completely enclosed and running in an SAE 10 oil splashbath. A pair of two-position levers on the headstock casting that shift sliding gears on the shafts give the spindle four geared speeds. A reversible two-speed (1700/3500 rpm) $\frac{3}{4}$ -hp motor, which drives the backshaft with a dogged-rubber timing belt, doubles these geared speeds to give eight spindle speeds, forward or reverse, from 60 through 2500 rpm.

Pushbutton switches (in the switchbox behind the headstock) control both motors. These can be operated separately or simultaneously. A red safety stop-button stops both motors.

The lathe's end gear train employs steel and nylon gears (which outwear steel) in combination for silent operation. A Norton-type, quick-change feedbox with eight stack gears provides 24 power carriage feeds. When a sliding gear in the

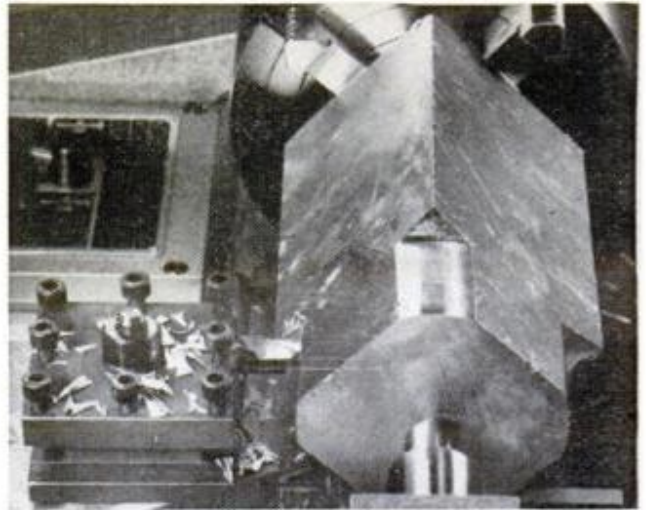

LATHE'S GEARED SPINDLE gives good power for smooth, interrupted cuts as in rounding square stock

end gear train is shifted, the quick-change feedbox engages the lead screw for cutting any of 24 thread pitches, 8 through 56 threads per inch. Other inch thread pitches and metric threads can be cut with change gears. Feedbox shafts are ball-bearing mounted and the gears run in an oil bath.

The drilling-milling head's single-speed $\frac{1}{3}$ -hp motor gear-drives a precision spindle through a compact four-speed gearcase, with two shift levers providing spindle speeds from 420 to 1740 rpms. The spindle, spring-loaded like a drill-press quill, can be advanced $1\frac{1}{16}$ in. with a removable handle. The head rotates 360° on its graduated column mount, and the entire column rotates 360° in its graduated base, so you can drill at compound angles (see photos) or use the head with the spindle horizontal.

Not only arbor-mounted drill chucks, but collet chucks, end-mill holders, bor-

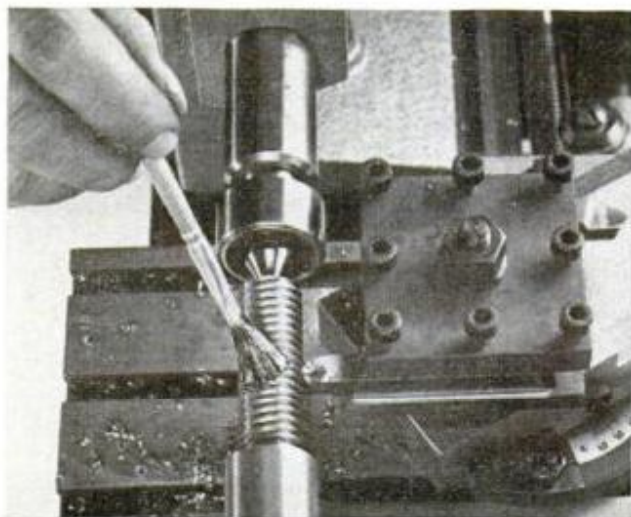

SHIFTING FEEDBOX LEVERS will cut 24 thread pitches. Other pitches can be set up with change gears

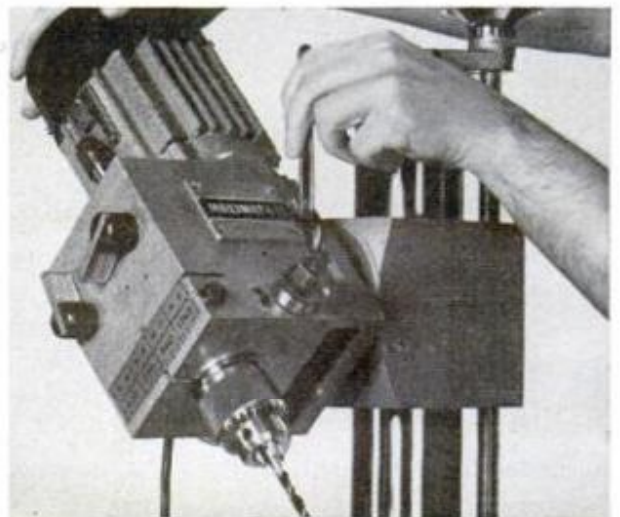

DRILLING-MILLING HEAD rotates 360° in its mount. The rotating column permits compound-angle settings

POPULAR MECHANICS



**DOWN HOME
TASTE!**
Real and rich and good



Warning: The Surgeon General Has Determined That Cigarette Smoking Is Dangerous to Your Health.

© 1971 R. J. REYNOLDS TOBACCO COMPANY, WINSTON-SALEM, N. C.
20 mg. "tar", 1.3 mg. nicotine av. per cigarette, FTC Report NOV. '70.

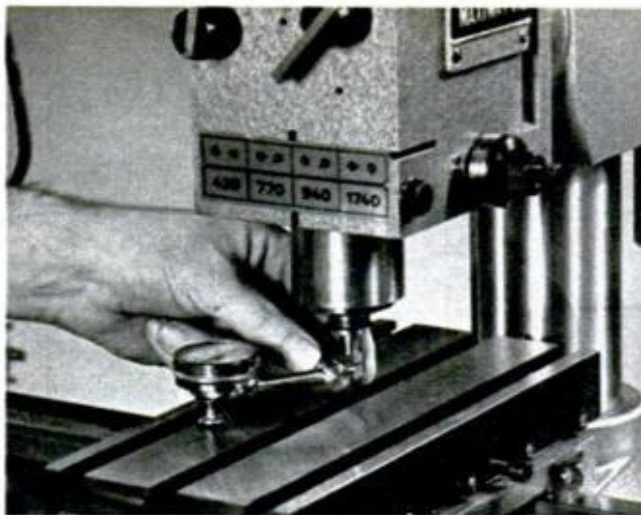

DIAL INDICATOR on an arbor makes it a simple task to set vertical spindle perpendicular to the worktable

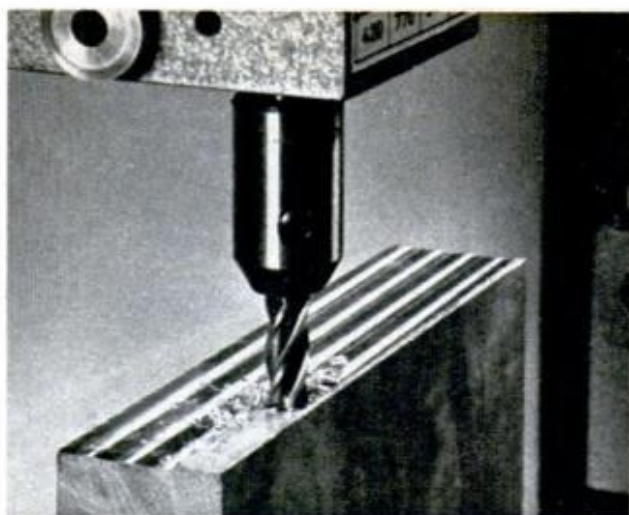

WITH DEPTH SET, end mill machines surfaces perfectly flat with successive cuts, moderate power feed

ing heads, fly-cutters, saw arbors or taper-shanked drills or reamers can also be used in the vertical spindle's internal No. 2 Morse taper. It has a cap nut used with a pushrod to screw-eject tools.

For milling, the spindle's rack-and-pinion advance is clamped tightly with a lockscrew. A feed screw calibrated in half-thousandths that slides the head the full length of the keyed 2 $\frac{3}{4}$ -in.-dia. column is used for precision depth-of-cut control. By engaging the lathe's power feed, any of 192 feed rates (carriage feeds multiplied by spindle speeds) can be used for milling, or work can be hand-fed to the cutter with the calibrated handwheel on the lathe's lead screw.

Comparing this quality machine feature by feature with ordinary bench lathes is like comparing a race car to a 10-wheel dump truck. The V10 isn't as heavily built as some 10-in. lathes. Its carriage apron is single-walled and has no power cross

feed. Though the V10 has a large 10x26-in. capacity, it's designed primarily for careful, precision work. Its lathe spindle is mounted in ultraprecision SKF Class 7 tapered roller bearings (ordinary bearings are Class 2 or 3). The drilling-milling head spindle, with a precision roller bearing below and two matched opposed angular-contact ball bearings above, turns with no play whatever.

The machine's versatility, precision and compact construction make it the near-ultimate metalworking tool for any small shop. The V10's real virtue is that it removes limitations. It equips you to do any kind of metal-machining as well as anyone else.

This probably justifies the price: \$1350 (with motors). Chucks, toolholders and other accessories are available at extra cost. For specifications, write to American Edelstaal, Inc., 1 Atwood Ave., Tenafly, N.J. 07670. ★★★

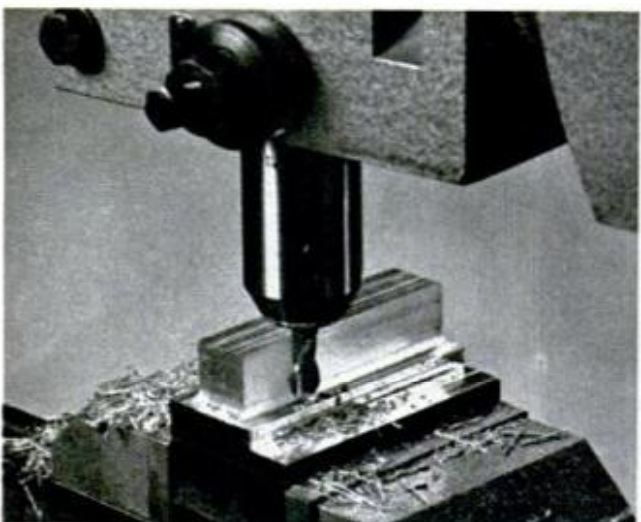

END MILLS are available in a variety of shapes, can be used to mill complex parts from solid stock

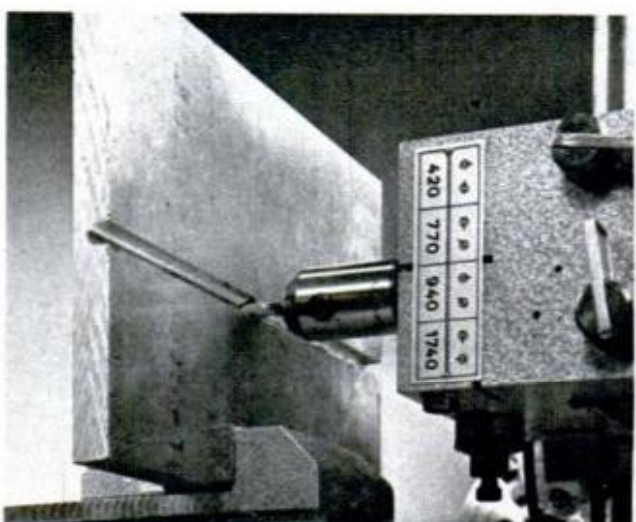

THICK METAL is easily cut if slotted with a two-flute mill until stock is thin enough for hacksawing

Choose it because it works like a truck, rides like a car

...or for many other good reasons.

Ford's Twin-I-Beam suspension is one reason. But there are many more. We call them better ideas. For instance:

Biggest cab of any pickup.

Combined headroom, legroom, shoulder room and seat height dimensions exceed those of any other pickup cab.

Only Ford has Twin-I-Beam independent front suspension.

Wheels step over bumps independently to smooth the ride.



Levellest, quietest ride of them all.

Virtually no nosedive on braking, less side-sway on curves. Independent tests proved Ford is quieter than all other leading pickup makes.

Most luxurious. Choose from four levels of luxury... all the way up to the unique Ford Ranger XLT, most luxurious pickup ever built. Distinctive good taste marks the XLT: wood-tone accents, thick-pile carpeting, deep-cushioned seats upholstered in pleated cloth and vinyl, plus luxury options like AM/FM stereo and air conditioning.



I-beam front axles.

A Ford exclusive. Both axles are drop-forged I-beam design. Everybody's big trucks use I-beam front axle design for greater strength.

Radius rods help hold alignment of the front wheels and reduce road vibration. Only Ford pickups provide radius rods.



Self-energizing brakes stop quickly, smoothly, with little pedal pressure. Self adjusting for lower service costs.

Welded, instead of bolted, pickup box stays strong, resists working loose, means greater quietness, less chance of rust.

Leaf-type rear springs, like all big trucks use, for better stability. Exclusive Flex-O-Matic rear suspension, standard on F-250 and with heavy-duty springs on F-100, keeps the ride smooth, with or without a load.



Make sure your next pickup includes the better ideas you get only from Ford. See your Ford Dealer for the pickup that works like a truck, rides like a car.

FORD
PICKUPS



A better idea for safety: Buckle up.

Save up to \$47 on the Cost of Power-Brake Repair



ESTIMATE POWER BRAKE REPAIR

New Brake Unit, Dealer- Installed	Parts:	\$46.15
	Labor:	8.00
	TOTAL	\$54.15
Rebuilt Brake Unit, Self- Installed	Rebuild Kit:	\$7.00
	Your Labor:	0.00
	TOTAL	\$7.00

YOU SAVE \$47.15

It's really quite easy to troubleshoot and fix your automobile's power-assist brake unit. But of various ways to do the job, one will save you the most money

By **MORT SCHULTZ**

THE LEAST COSTLY WAY of repairing a power brake unit is to overhaul it. For example, the parts kit that's needed to rebuild a unit from a late-model Pontiac costs \$7, while a brand-new unit purchased from a Pontiac dealer costs \$46.15!

There is only one problem: Rebuild kits are hard to find. Of the new-car dealers in my area that I surveyed, only one stocked them for his make of car, which was Dodge. None of the five independent re-

tail automotive parts supply houses that I checked carried them.

The reluctance to have an inventory of rebuild kits stems from the fact that there is no professional market for them. Most professional mechanics won't spend the time needed for overhauling power brake units, because that job takes from one to two hours. But replacing a unit requires only 15 to 30 minutes.

So what do you do if you can't find a rebuild kit and want to get around the

According to most house paint ads, the quickest and easiest job is all you care about.



The Dutch Boy believes you care about something else: a paint job that will stay looking good a long time.

We won't kid you and say there's nothing to it. Painting a house—even painting it with Dutch Boy® Latex House Paint—takes planning and work.

If the surface is new, or if it was painted with latex house paint before, your surface preparation may involve very little beyond resetting nails, putting nail holes, or removing chalk.

If your house was painted with oil paint before, or you don't know if it was and can't find out, you should consult your Dutch Boy dealer and he will advise you as to what methods of surface preparation may be in order.

Two things particularly contribute to the long-lastingness of Dutch Boy Latex House Paint. One is that since the paint "breathes," moisture can't get trapped under it. The other is that the acrylic resin base of Dutch Boy Latex House Paint has the ability to lock in colors and consequently, the colors last for the life of the job and the job lasts longer.

If you've got shutters and trim that you want to look glossy, although you want the rest of the house flat, your

Dutch Boy dealer can sell you flat and glossy colors designed to work together.

And the painting of gutters and drain pipes is no problem, either. Dutch Boy Latex House Paint clings to aluminum, galvanized and copper surfaces for the life of the paint job—no special primer is needed.

As to the quickness and ease of the painting itself, Dutch Boy Latex House Paint actually flows on easier without dragging or sticking. It doesn't leave lap-marks when you stop and start, so that if you want, you can paint every weekend for the whole summer. Paint before and after the rain. And no matter what kind of a mess you make (and you can make a mess) it will wash up with soap and water.

But we're never going to tell you that painting a house is so much fun you'll feel like running out and doing it again. You have kids to raise and living to do and our main job is to help you forget about us for a long time.

NL
INDUSTRIES



purchase of a new unit? First, try to get one on special order from a parts supply house. Your next move is to canvass the junkyards for a part taken from a wreck. I found one for the Pontiac that cost \$15, which is \$31.15 less than the cost of a new part bought from the dealer.

Mail-order vs. dealer prices

Failing this, you will have to buy a new unit. But before paying dealership prices it would be a good idea to check with a mail-order house, such as J. C. Whitney & Co. in Chicago. Its price for a Pontiac power-brake unit, for instance, is \$29.95, which is \$16.20 less than that charged by a Pontiac dealer.

No matter what you eventually pay for parts, it is less expensive to repair a power-brake unit yourself than to turn the job over to a mechanic. In the case of the Pontiac, a mechanic wanted \$54.15 to do the work—\$46.15 for the part and \$8 for labor.

This means that a saving of \$47.15 would be realized by doing it yourself with an overhaul kit; \$39.15 would be saved with a used unit from a junkyard; \$24.20 with a new unit from a mail-order house; and \$8 with a new unit from a dealer.

Naturally, you should be sure that the power-brake unit is really shot before you pay anyone for a new unit or rebuild kit. Although the brake may be hard to activate or fail to release when you take your foot off the pedal (each action indicates a malfunction), bear in mind that the power-brake unit itself is not necessarily to blame. In fact, most times the

cause of the problem lies outside the unit.

All power-brake units work on unequal pressure when activated. When the brake is not applied, pressure on both sides of a power piston assembly inside the unit is more or less equal. When the brake is applied, this equilibrium is upset, and unequal pressure forces the power piston and a hydraulic fluid from the master cylinder into the brake lines.

Actually, power brakes and nonpower brakes work the same way. The only difference between them is the presence of the power-assist unit at the rear of the master cylinder to lessen the brake pedal pressure required for the same degree of application.

Two types of power-brake units

Power-brake units for passenger cars are classified as either atmospheric or vacuum-suspended. With an atmospheric-suspended power brake, atmospheric pressure is present on both sides of the power piston with the brake off. When the brake is applied, air is evacuated on the side of the piston that's nearest the master cylinder, which creates a vacuum that allows the piston to "collapse" toward the master cylinder.

In a vacuum-suspended power-brake unit, the vacuum is present on both sides of the power piston with the brake off. When the brake is applied, air enters at the rear of the power piston, thus pushing the piston forward toward the master cylinder.

Every domestic car built in 1966 and in later years, except the 1966 Valiant and

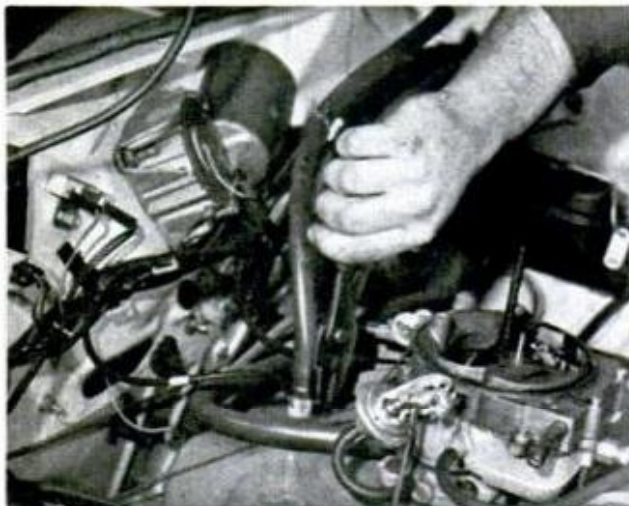

INTAKE MANIFOLD is source of vacuum for power brake. To check vacuum, remove hose at this point

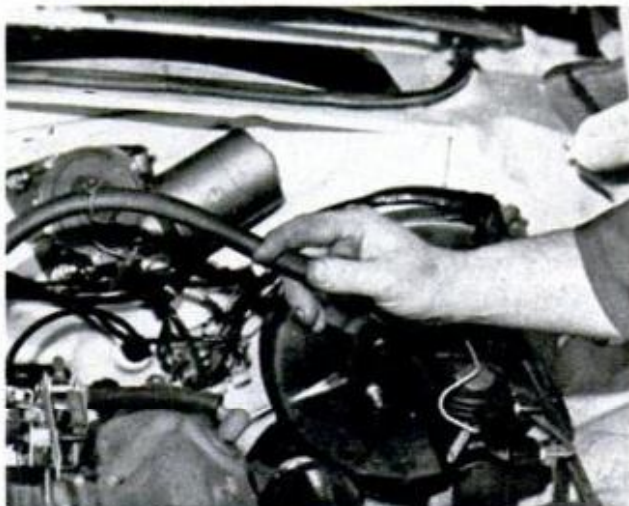

RULE-OF-THUMB is a check on vacuum when you don't have vacuum gauge to measure value precisely



Marlboro Red
or Longhorn 100's—
you get a lot to like.

**Come to where
the flavor is.
Marlboro Country.**

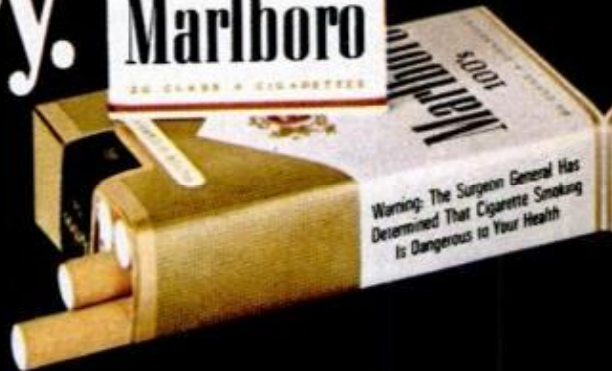

Warning: The Surgeon General Has
Determined That Cigarette Smoking
Is Dangerous to Your Health

Kings: 20 mg. tar, 1.3 mg. nicotine—
100's: 22 mg. tar, 1.5 mg. nicotine av. per cigarette, FTC Report Nov. 70

Материал, защищенный авторским правом



TRACING VACUUM back to manifold: Use your thumb over the nipple when you don't have a vacuum gauge

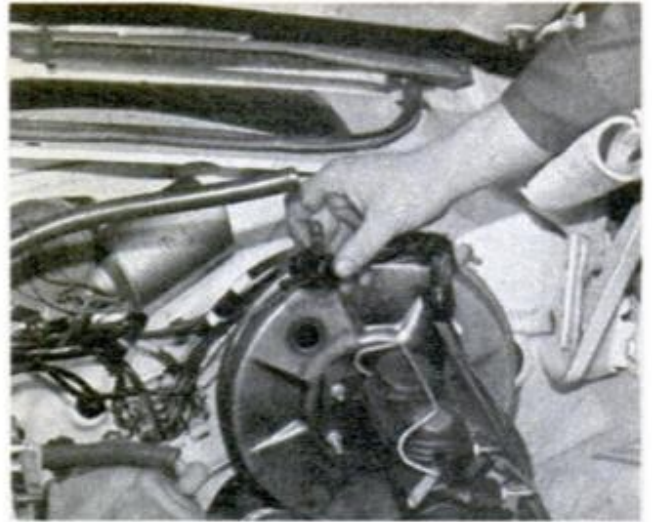

FIRST THING TO CHECK on power brake unit is the vacuum check valve. This component fails most often

Dart, uses a vacuum-suspended power-brake unit.

You can determine the condition of your power-brake unit from behind the steering wheel. Just start the engine and let it idle for a few seconds to permit the vacuum to build up. Then, shut it off and depress the brake pedal a few times, noting any increase in the amount of pressure as you do so.

If there is a noticeable increase in the amount of pressure that's needed to engage the brake as you apply and release pressure on the pedal, the power-brake unit is in good shape. However, if there is no change in the amount of pressure, something is wrong.

Check for adequate vacuum first. Use a vacuum gauge if you have one. It will give you the most accurate indication.

Take a reading at the vacuum port or fitting at the manifold by disconnecting the hose that extends from the power-brake unit and attach the vacuum gauge to the manifold.

After recording the reading, reattach the hose to the manifold, disconnect the other end of the hose from the vacuum check valve at the power-brake unit, and connect the vacuum gauge to the hose for another reading.

Readings at both spots should be a steady 15 to 20 in. with the engine running at slow idle.

If vacuum is adequate at the manifold, but low at the hose, the hose is bad. Replace it.

If you don't own a vacuum gauge, start the engine and allow it to idle. Disconnect the vacuum hose from the vacuum

check valve and place your thumb over it. Your thumb should be pulled to the hose.

If you don't experience a strong vacuum, inspect the hose for kinks and cracks. Then disconnect it from the intake manifold and hold your finger over the nipple with the engine idling. If you don't feel strong suction, the loss of vacuum is being caused by an engine problem.

The vacuum check valve can cause trouble, too. Its purpose is to help create a vacuum inside the power-brake unit. It is a one-way valve that is easy to test.

Remove the valve and blow into the end to which the vacuum hose attaches. Then draw out on it. Even maximum pucker power should not allow air to flow into the valve. Conversely, you shouldn't have to exert any force on the draw.

When vacuum has been checked, make sure that no hydraulic fluid is being pulled



VACUUM CHECK VALVE is easy to test: Blow into it and then draw out through it. (See text for details)



SEE FOR YOURSELF

How to Fix Almost Any Part of Any Car!

QUICKLY, EASILY and RIGHT on the very first try



THIS GIANT PICTURE BOOK SHOWS YOU STEP-BY-STEP HOW TO REPAIR PRACTICALLY EVERY CAR BUILT FROM 1965 THRU 1971

Whether You're a Beginner or an Expert Mechanic—This Manual Can Help You "Breeze Through" the Toughest Auto Repair Job

OVER 5,500,000 COPIES SOLD!

DON'T waste time, money, energy by trying to *guess* how to fix a car! Do what the experts do. Whether it's a simple carburetor adjustment or a complete overhaul — simply look up the job in the index of MOTOR's New AUTO REPAIR MANUAL. Turn to page covering job. Follow clear illustrated, step-by-step instructions. See for yourself how easy it is!

No guesswork! MOTOR's MANUAL takes nothing for granted. Tells you where to start. What tools to use. Then it leads you easily and quickly through the entire operation!

Over 3,000 Pictures! So Complete, So Simple, You CAN'T Go Wrong!

MOTOR's MANUAL covers all major makes, 1965 thru 1971, including compacts. Over 1,000 giant pages, 3,000 "This-Is-How" pictures, "Quick-Check" charts, 55,000 essential specifications. Over 225,000 service and repair facts. Instructions and pictures are so crystal-clear you just can't go wrong!

Some FREE 10-DAY Offer on AUTO ENGINES & ELECTRICAL SYSTEMS

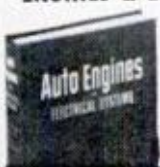

Over 700 pages, 1,300 big pictures. Clear how-to text on principles, design, maintenance of all parts of engines & entire electrical system. For FREE trial, check coupon.

Meat of 300 Official Shop Manuals

Engineers from every automobile plant in America worked out these time-saving procedures for their own motor car line. Now this wealth of "Know-How" from 300 Official Shop Manuals has been "boiled down" into crystal-clear terms in one handy indexed book! No wonder MANUAL is used by so many schools!

SEND NO MONEY Try Book for 10 Days FREE

Just mail coupon today and we'll send 1971 Edition to use FREE for 10 days. Test book in your own garage or shop. It's GUARANTEED to pay for itself in 10 days. If it doesn't, return it, and owe nothing. Rush coupon now. MOTOR BOOK DEPT., P.O. Box 2316, F.D.R. Sta., N.Y., N.Y. 10022. (SCHOOLS, BOOKSTORES: Write for discounts.)

CLEAR UP 'MYSTERIES'. "I always rely on Motor when I do a repair I am not familiar with."
—E. Jones, Minnesota (Shop Owner)



GREAT HELP FOR STUDENT. "Motor pulled me out of some rough spots in high school, and now in the Armed Forces motor pool."
—W. Bekemerer, Missouri (Apprentice)



MAIL COUPON FOR **FREE 10-DAY TRIAL** OF MOTOR'S AUTO REPAIR MANUAL

No obligation. No risk. If not delighted, return book and owe nothing.

MAIL COUPON NOW FOR 10-DAY FREE TRIAL

MOTOR BOOK DEPT., Desk C118
P.O. Box 2316, F.D.R. Sta., New York, N.Y. 10022

Please send me the Manuals checked below for ten days free examination:

- MOTOR's Auto Repair Manual, \$10.95
 MOTOR's Auto Engines & Electrical Systems, \$10.00

If I am not fully satisfied, I will return the shipment promptly and owe nothing. Or I will keep it and pay the total price in three monthly installments, plus a small shipping charge.

Print Name..... Age.....

Address.....

City & State..... Zip.....

I want to save shipping charges. I am enclosing payment in full and you will pay shipping charges. (Same return privileges, refund guaranteed.)

into the power-brake unit from the master cylinder because of bad seals existing in the master cylinder. Inspect the brake-fluid level. The correct level is approximately $\frac{1}{2}$ in. from the top of the reservoir.

To determine if lost brake fluid is being pulled into the power-brake unit, twirl the shank of a screwdriver inside the vacuum hose. The presence of fluid on the shank means that the master cylinder has to be overhauled or replaced. The power unit should be disassembled, too, so that brake fluid can be cleaned off parts. Use alcohol for this.

Naturally, if no brake fluid is found in the power-brake unit, check to see whether fluid is being lost at other points, such as at the wheel cylinders or the brake lines.

Up to this point, if the cause for a lack of power assist (a hard brake pedal) has still not been found, then you'll want to perform a general inspection of the entire braking system, looking for such things as worn linings, bad wheel cylinders, and kinked lines. If the system passes inspection, then the malfunction is inside the power-brake unit with defective power piston and other weakened parts. Overhaul or replace the unit.

The biggest problem in overhauling may be to separate the power-assist unit into its two main chambers. Some units are held together by a tight-fitting band, while others are twist-locked by off-setting lugs and will have to be opened with a strap wrench.

Once the unit is opened, an overhaul consists of replacing the parts in the unit

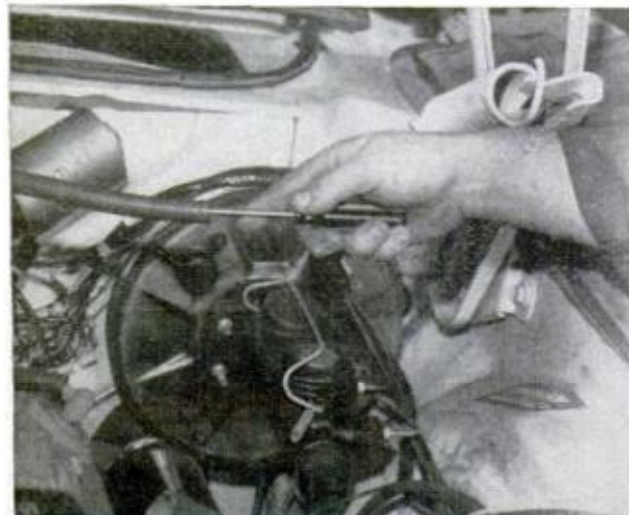

RUPTURED SECONDARY SEALS in the master cylinder can be determined by presence of brake fluid in hose

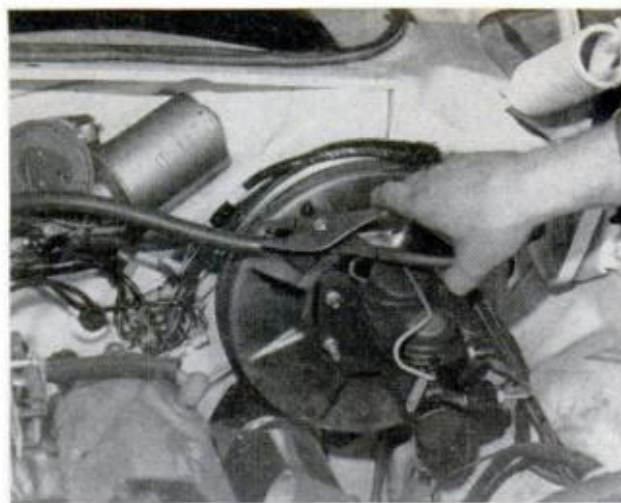

CHECK CLAMP TENSION on hose supplying vacuum to unit. Loss of hose will render the unit inoperative

with the parts that come in the rebuild kit.

If you must replace the unit, the usual procedure is to detach the master cylinder, disconnect the vacuum hose, remove the fasteners that hold the unit to the brake pedal linkage, and remove the fasteners that hold the unit to the car. The manufacturer's service manual or a general auto-repair manual, such as *Motor's*, which will be found in a public library will outline the exact procedure for your particular unit.

What do you do if your power fails while you're out on the road? First, bear in mind that most of the time failure of a power unit is gradual, and you should heed warning signs.

However, it is possible, say, for the vacuum hose to pop off. What then? To find out, I tried it.

I got the car halted okay, but it took my full 175 pounds transmitted through my size-12 clodhopper to the brake pedal to do it. A five-foot, 100-pound gal like my wife would have a hell of a time.

That's why I tell her, that if she ever does lose the power, to downshift the transmission and stand on the brake pedal with all of her strength—without, of course, locking up the brakes which may cause a skid.

To minimize your chances that a hose might pop off, you should check to make sure that those hose clamps haven't lost their tension and are positioned so that they hold the hose tightly. If you can pull the hose off the check valve or the manifold nipple by hand, it's time to get a couple of new clamps. ★★★

A million jobs have disappeared since 1960 Will Your Job be Next to Go?

Shouldn't you start your own business NOW ...while still employed?

Before more jobs disappear through mergers, automation, and mechanization, shouldn't you at least investigate the way so many men have become owners of profitable businesses—starting spare time and now are independent of bosses, strikes, layoffs and automation? All that's needed is your name on the coupon. Facts mailed free. No salesman will call.

Here are facts: With some ambition and little over a thousand dollars, you start your own Duraclean business in spare time, without risking your job or paycheck!

It's a nationally advertised, worldwide business. It does not require skill, more than an average education, or traits except the willingness to work to start grossing \$12, \$19, or \$26 profit per hour. By return mail, we will explain how.

Then you build by adding servicemen and/or servicewomen... and we pay for their equipment so you can expand rapidly.

This is a service to homeowners as well as offices and stores and institutions—a sensationally improved method of cleaning carpets and upholstered furniture right on the customer's premises—the **EXCLUSIVE DURACLEAN SYSTEM!**

When you have had your own carpet and furniture cleaned, you know that ordinary methods grind fibers with harsh scrubbing, leaving carpet soggy for days.

This exclusive **ABSORPTION METHOD** lifts out dirt and greasy soil with a gentle, almost dry foam. Do-it-yourself "so-called" cleaning methods and scrubbing drive soil deeper. You **TAKE IT OUT.** Carpets and furniture can be used again in a few hours! This is vital to stores, offices, motels.

You operate under a nationally known name—use an exclusive process recommended by the nation's leading carpet mills and in the editorial pages by House & Garden, McCall's, Parents, and House Beautiful. You receive our step by step guidance and help.

Your training shows you how to perform your 7 superior "on location" services... how to get customers, how to control your expenses, how to make the maximum profit. You become an expert in the care of furnishings. It is an interesting, exciting career.

Although in time you will wish to buy one or more trucks from your profits, no truck or office is needed to start. You can carry all equipment in your car trunk. Your phone calls can be received at home.

As a Duraclean Dealer you are the sole owner of an independent business and are your own boss. You keep all the net profits.



This business can pay you far more than most men earn—with only the talent and ambition you now possess, and you can operate in any one of three ways.

Many let servicemen do the work while they make a substantial profit on each.

Some men operate permanently in spare time for the extra money they need. Some start in spare time and quit their jobs only after they see they can make a lot more money as a full time Duraclean Specialist.

Even small one-man businesses with one or two helpers can and do bring in \$30,000 and more annually. A very high percent is clear profit to you.

The Duraclean Business can be as small as you want or it can be expanded to the level your ambition dictates. There is no limit on income for an ambitious man.

We are about to appoint a limited number of men who are truly ambitious, and anxious to do something about their futures. We want men who will follow our proven plans for success and who want—with our help—their own successful businesses.

If this opportunity interests you, please send your name, on the coupon at the right, for a **FREE 24-page booklet** which gives complete details on the Duraclean business. No salesman will call on you. After you've read the facts, decide in the privacy of your home if you wish to take the next step toward starting a business.

WE SWITCHED!

"For the first time in 20 years I've got security—without fear of losing my factory job."

H. E., Ohio

"I took in \$2880 in April. I worked from my home. My wife handles all telephone calls. We both enjoy our new-found independence and the compliments we get from satisfied customers."

J.F.A., Texas

"In our first calendar year we did a gross of \$40,000. Without constant help from the Duraclean home office such growth would not have been possible."

M.L., Illinois

"Duraclean brought security and an education for my daughters. We've done as much as \$3000 on a single job."

Mrs. B.B., Mass.

"Making 50% more than on any job I ever had. I've earned as high as \$1300 in a single week."

J.S., Fla.

"My biggest day was a sorority house that brought me \$360.00."

H.B., Texas

THESE ARE JUST A FEW OF THE LETTERS IN OUR FILES FROM MEN AND WOMEN WHO HAVE FOUND SUCCESS AS DURACLEAN DEALERS. (IN ANOTHER YEAR YOUR STATEMENT COULD BE HERE, TOO.)

Duraclean[®] International

1-168 Duraclean Bldg., Deerfield, Ill. 60015

WITHOUT OBLIGATION send me the free booklet which shows me how I can start a Duraclean business in my spare time without risking my job. No salesman is to call.

Name _____

Address _____

City _____

State & Zip _____



SOLVING

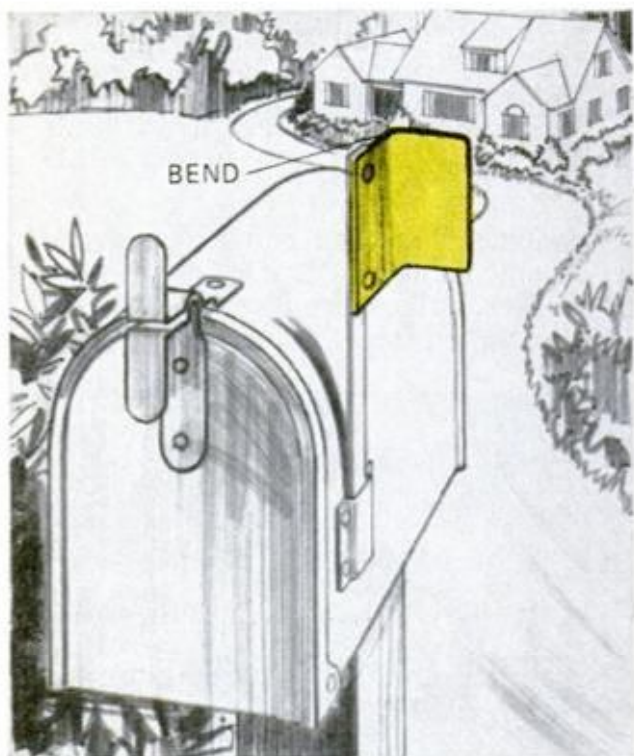

THE RAISED FLAG on your roadside mailbox will be easier to spot from the house if you bend it 90° as shown. Simply clamp a straightedge at the middle and carefully make bend.—*Ernest O. Heim, Seattle.*

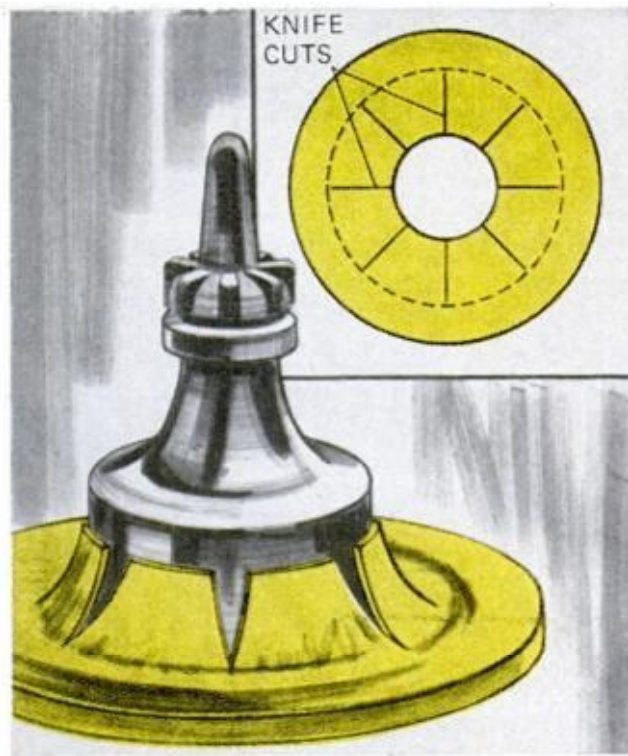

NONTIPPING BOTTLE HOLDER can be fashioned from a discarded plastic can cover. Just cut a hole at center, make several radial slits and push ink bottle through from below.—*Harry Radzinsky, Charlotte, N.C.*



SMALL SCREW can be held where you want it with this trick. Put a strip of cellophane tape across the tines of an old fork and push the screw through. Now it can't move.—*Albert A. Losack, Lakewood, N. J.*

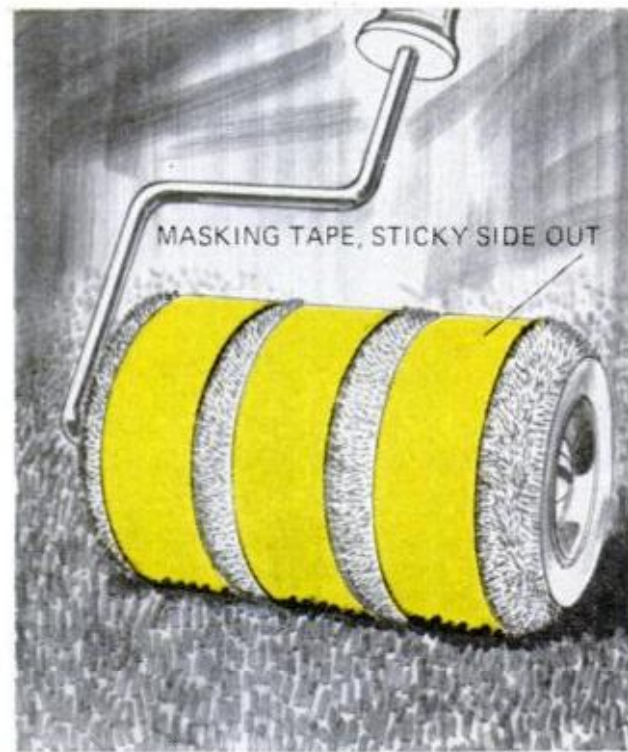

LINT-PICKER for cleaning fuzz and such from rugs can be made by putting several rows of masking tape —sticky side out—around a paint roller. When finished, discard the tapes.—*Wilfred Beaver, St. Anne, Ill.*

HOME PROBLEMS

Illustrations by Adolph Brotman, Worman Associates

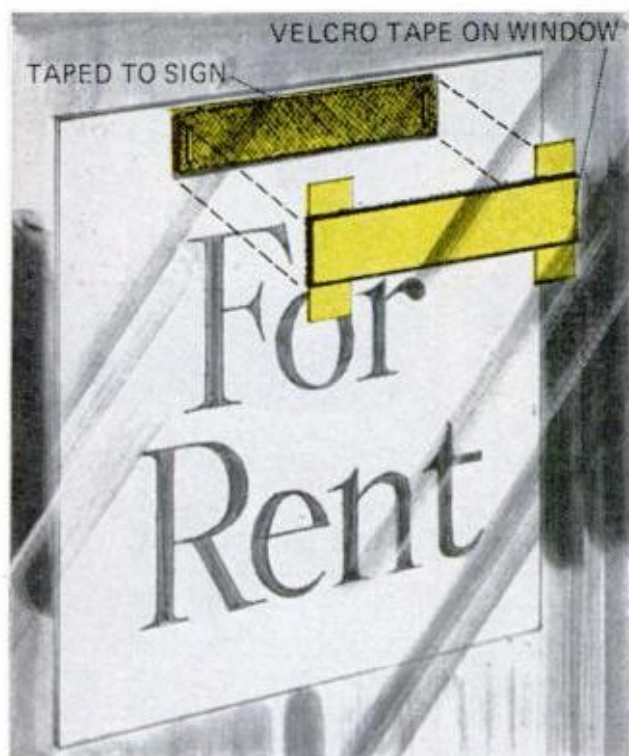

GLASS-MOUNTED SIGNS can be removed easily if they are affixed with Velcro. To do it, stick one strip of the tape on the glass and attach the other to the sign to be posted.—Harry Radzinsky, Charlotte, N. C.



OVERNIGHT PAINTBRUSH HOLDER shown in *Hints* (page 159, Jan. PM) inspired this idea. I simply cut down plastic bottles to suit brushes I'm using. Handle should fit neck snugly.—John Traube, St. Joseph, Mich.



EMERGENCY CAP, for machine oil and other small cans having plastic spouts, can be adapted from solderless wire connector. Turn connector on the spout for a force fit to avoid leaks.—Leo Niemi, Warren, Ohio

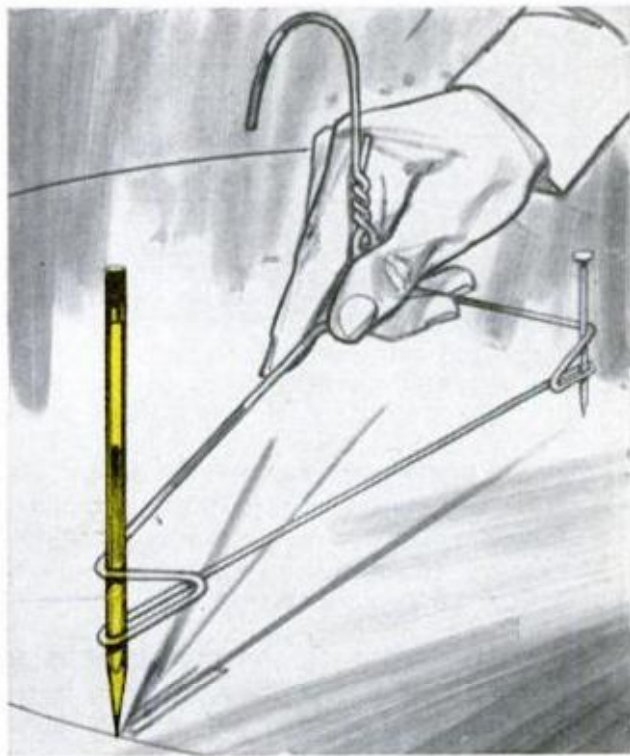

LARGE COMPASS consists of a metal coathanger bent at both ends plus nail and pencil. To vary circle size, you merely bend the coathanger at its center.—C. K. Bonds and D. K. McMannes, East Greenwich, R. I.

HINTS FROM READERS



Hooks from sash lift

A common window-sash lift, or handle, can be converted into two serviceable hooks by simply sawing it in half. Usually the cut will be in the middle, but an offset cut gives two different-length hooks. It's a good way to use a leftover handle.—*B.W. Ervin, Kent, Ohio*

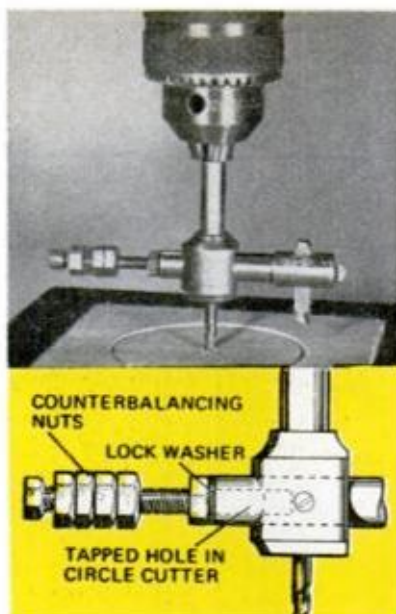

Balanced circle cutter

Loosening of the drill-press chuck—often caused by circle-cutter vibration—can be prevented by balancing the cutter. On the type shown it was done by drilling and tapping the rear of the cutter's shank for the addition of a bolt and nuts.—*Peter Legon, Malden, Mass.*



Drill-press depth chain

A ball chain, of the type used on light fixtures, can serve as a gauge for regulating hole depth when the press has no depth stop. The clip is cut from a tin can and mounted on the spindle assembly so the chain moves up and down with the chuck.—*Walter E. Burton, Akron, Ohio*

Old fishing line makes 'net' to protect strawberries

Our strawberries were literally for the birds until I hit upon this idea as a substitute for a scarecrow. I simply drove some 1-ft. stakes around the strawberry bed and ran old monofilament fishline from stake to stake over the plants. The line lasts all season and now the family gets the berries.—*Anton Barkey, Sunnyvale, Calif.*

NEXT MONTH IN SHOP AND CRAFTS

WOULD YOU BELIEVE THIS WAS ONCE A GARAGE? When the Robert M. Skares of Golden Valley, Minn., needed a family room, the already roofed-in garage was the logical place. And with some building ingenuity on the part of their contractor, they ended up with recessed-paneled walls, cathedral ceiling and sliding-door passage to their often-used patio. Next month in *PM* you'll learn how you can duplicate the job.

TWO MEDITERRANEAN-STYLE WORKSHOP PROJECTS. Though we've simplified construction details so that either piece can be built in a weekend, both are handsome and guaranteed to get raves from family and friends. The first is a sculptured chest with a marproof top and the second is a high-style coffee table that's easy to build because the "carved" plaques that "make" the table are actually factory-made.

BEAUTIFY YOUR HOME WITH MODERN BIFOLDS. There's no need to put up with dated sliding closet doors when they can be replaced so easily with modern bifolds. These good-looking folding doors are available in kits to fit almost any size opening, with everything included to make the changeover in a matter of hours. You can get them in wood, plastic or metal and in a variety of designs from simulated or open louvers.

PLUS: An abrasive cutoff machine you can make, two games for the family and more.

NEW RUBBER STAMP BUSINESS PAYS BEGINNERS UP TO \$16.50 AN HR. START AT HOME IN SPARE TIME

The multi-million dollar Rubber Stamp business—once controlled by a few big companies—is now being taken over by small operators—one in each community throughout the United States. Men and Women who have this inexpensive machine can turn out huge quantities of Rubber Stamps with special wording that buyers once were forced to buy from big cities. Material costing only 27¢ makes a stamp that sells for \$2.75. The machine that does the work is simple and easy to operate and it turns out as many as six Rubber Stamps at a time, each with different wording such as names, addresses, notices, stock numbers, prices and other "copy" needed by offices, factories and individuals. Working full capacity, it can earn as much as **\$33.00 an hour for the operator!** Now you can get into the big-pay business yourself, with your own home as headquarters. You don't need experience. We supply everything, including complete instructions and eight ways to get business coming in fast. **We even help finance your start.** Start making up to \$16.50 an hour from the very beginning. Cash in on the profitable Rubber Stamp business in your community, right away. We'll mail full particulars **FREE** and no salesman will call. Be first in your locality. Rush coupon or send your name on postcard now to:

RUBBER STAMP DIV., Dept. R-2-AJ
1512 Jarvis Ave. • Chicago, Illinois 60626

THIS LITTLE TABLE TOP MACHINE
MAKES EVERYTHING SIMPLE & EASY

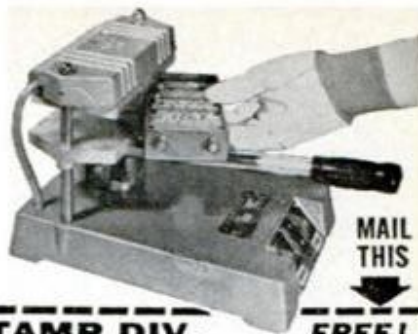

MAIL
THIS
↓

RUBBER STAMP DIV. FREE!
1512 Jarvis Avenue Dept. R-2-AJ, Chicago, Ill. 60626

Please rush full particulars about your financing plan and the little machine that can get me started in the profitable Rubber Stamp business at home in spare time. Everything you send me is **FREE** and no salesman will call.

Name _____

Address _____

City _____

State _____ Zip Code _____

SATURDAY MORNING INCOME PLAN!



Earn \$5 to \$20 extra in spare weekend or evening hours, accepting orders from friends and neighbors for our nationally famous shoes. Just show our beautiful full color catalog of over 275 exciting styles, many exclusive comfort features! No experience needed to make extra money, earn prizes, bonuses—even **FREE SHOES** for life! Rush name & address for **FREE** Starting Outfit today.

MASON SHOE, Dept. F-296, Chippewa Falls, Wis. 54729.



TREASURE

Find buried gold, silver, jewelry, and coins with revolutionary patented analytical metal detector. Will differentiate tin cans, pop top lids, nails, bottle caps, gum wrappers from treasure. Saves unnecessary digging. Also has push button and automatic tuning, negligible ground pickup, greatest detection range, etc. Free catalog.

GARDINER ELECTRONICS

Dept. 8, 4729 No. 7th Avenue
Phoenix, Arizona 85013



3 1/2" x 9 1/4"

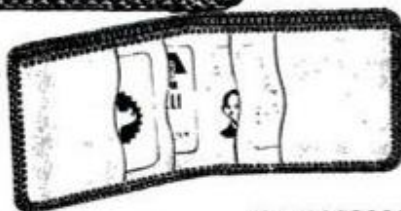

Let's Do LEATHERCRAFT!

HERE'S A GENUINE
LEATHER BILLFOLD
KIT AS A STARTER

ONLY

50¢ with
coupon
below

ONLY 50¢ IF YOU
ACT NOW!

WORTH
\$5.00
AFTER
YOU
ASSEMBLE
AND LACE!

Get all the features of expensive billfolds! Handsome design already embossed . . . has 4 roomy pockets. Kit complete. Easy n' fun to assemble and lace. You'll also receive a big full-color Leathercraft Idea Catalog and Instruction Manual showing other valuable things you can make from genuine leather.

Standy

1001 Foch, Dept. TE, Fort Worth, Texas 76107

Yes, send me your embossed billfold kit and big Idea Catalog and Instruction Manual. I'm sending 50¢ as full payment. (Limit one per family.)

NAME _____

ADDRESS _____

CITY _____ STATE _____ ZIP _____

50-STORY FIRETRAPS

(Continued from page 56)

outer rim of each floor is separated from the aluminum skin of the building by a gap of 16 inches.

Part of this gap is filled with foam plastic insulation covered on the inside by wallboard. Unfortunately, the remaining space can act like a flue to carry the fire upward with the combustible plastic insulation as fuel.

"In this space (at One New York Plaza) was found lots of paper, beer cans and everything else," says Richard Gewain, senior fire protection engineer of the American Iron and Steel Institute. "The construction workers probably just threw their lunch bags there."

Yet another airspace is hidden by hung ceilings. Crammed in the gap between the overhead acoustical tile and the floor above are air supply ducts, lighting fixtures, electrical and communications cables. Insulation on many wires is polyvinyl

When the guard "pulled" the firebox, it sounded an alarm only in the building itself.

chloride or other combustible plastic.

It was in such a concealed ceiling on the 33rd floor, near a telephone equipment room, that the One New York Plaza fire had its start. Flaming droplets of plastic from the ceiling set fire to the plastic foam furniture, which had been covered with more plastic in the form of sheets to keep it clean. Soon, everything was burning.

When the guard "pulled" the firebox, it sounded an alarm *only in the building itself*. Battalion Chief Long of the New York City Fire Dept. sums these devices up in two words: "No good." The actual alarm to the fire department came from an adjoining building.

When firefighters did arrive, they had to contend with inoperable windows; the airconditioning system was intended to recirculate either warm or cold air throughout the building. Smoke detectors should have shut the fans off in a fire, but they failed to operate. The ventilators sent smoke throughout the skyscraper.

While there is much talk of new regulations to prevent skyscraper fires—the installation of sprinkling systems, for example—a number of important questions remain unanswered:

● *Why do high-rise elevators tend to be deathtraps?* Experts tell you never to use them in a fire because they're unpredict-

able, but the reason why is not clear. Richard Stevens, chief engineer of the National Fire Protection Assn., suggests that the ionization of the air in a fire may "ground" capacitance-operated call-buttons—the type you normally rest your finger on—and cause elevators to stop at a burning floor. W. Robert Powers, investigator for the New York Board of Fire Underwriters, agrees that somehow fire, smoke or heat may actuate calling mechanisms to bring cars—and passengers—to the scene of the disaster.

● *Are emergency stairways safe?* Most experts think so, but Dr. Edward H. Blum of the Rand Institute, studying fire protection with the New York City Fire Dept., points out that they can become perfect chimneys after doors on upper floors are opened. The draft sucks the smoke up. Aside from the smoke, are you physically capable of walking down 50 or more flights of stairs?

Buildings with enclosed stairways, separate smoke towers, and more fire-resistant walls may provide part of the answer. An excellent example is the First National Bank Building in Portland, Ore. Another new development is the Sky Van, an external elevator which travels on tracks on the outside wall of a building. It could quickly evacuate the inhabitants of a burning skyscraper.

● *How do you plan for evacuation?* Fire protection engineers recommend a fire warden for each office and fire marshals for the building. Regular fire drills should be held. Such measures are difficult to effect, however, when there are a dozen offices on a floor, each with only a few people.

● *What materials should be used for insulation?* Much plastic insulation is combustible. Alternatives should be found for wall insulation, cable, air-duct coverings.

● *Should combustible furniture be banned?* Present-day furnishings are highly flammable, especially plastic-foam chairs and couches. Heated to 212° F., polyurethane, a common furniture stuffing, gives off a flammable gas that can quickly turn a room into an inferno.

● *How good are fire-alarm systems?* Each floor should be equipped with a pullbox that notifies the fire department directly, as do street boxes. Sprinklers—and their installation is considered highly desirable by many authorities—can be designed to call the fire department when activated by heat. Also needed are systems to notify all occupants that fire has broken out.

If you work in or have occasion to visit a high-rise building, you should note the location of exits and, if possible, the nearest fire-alarm box. This knowledge could save your life. ★ ★ ★

Kit for kit, text for text, dollar for dollar, your best home training buy is NRI

Discover the ease and excitement of learning Television Servicing, Communications, Electronics with equipment designed from chassis up for your education.

After nearly 60 years of training men for successful careers in various fields of Electronics, NRI knows that theory alone is not enough. To properly learn at home, your hands must be trained as well as your head.

Regardless of your educational background, you can learn the Electronics field of your choice the practical NRI way. The NRI color catalog, sent to you free and without obligation, tells you in detail how NRI combines designed-for-learning equipment with "bite-size" texts, so you can use what you build to prove out what you read. Catalog also tells you how to qualify quickly for high-pay jobs in TV-Radio Servicing, Communications, Computer Electronics.

All this is yours when you train at home with NRI

The NRI catalog you get also gives you details about the training kits included, at no extra cost, with the home training program of your choice. Shown below is the



special equipment included in a typical course: educator-acclaimed Achievement Kit, transistorized volt-ohm meter, solid-state radio, even your own custom-designed Color TV set to build and use for years of viewing pleasure. With NRI, Electronics comes alive in the most valuable, practical manner. You experiment with the same professional components and circuits you'll find on the job — not breadboard or hobby kits.

Regardless of manpower needs in other fields, Color TV Servicing continues to need trained men to keep pace with millions of sets being sold every year. You can take your choice of full-time jobs in this or other exciting fields of Electronics, or have a business of your own, or make \$5 to \$7 an hour extra in spare time starting soon after you enroll, fixing sets for friends and neighbors.

And if you choose one of five NRI courses that include FCC License preparation, you must earn your FCC License or NRI refunds your tuition in full! Here's further proof that any ambitious man, regardless of his education, can effectively learn and profit

from the Color TV, Communications or Electronics course of his choice.

Get your hands on more money — fast

Tens of thousands of NRI graduates are proof it is practical to train at home in your spare time . . . proof of why NRI continues to be the country's largest Electronics home-study school. Decide now to reap the rewards of NRI's fast, "hands-on" method of home education. Mail the postage-free card for the new NRI Catalog. No obligation. No salesman will call. NATIONAL RADIO INSTITUTE, Washington, D.C. 20016. In Canada write: NRI Canada, 330 Progress Ave., Scarborough, Ont.

APPROVED UNDER GI BILL

If you served since January 31, 1955, or are in service, check GI line on postage-free card.

MAIL CARD
FOR FREE
CATALOG
NO SALESMAN
WILL CALL

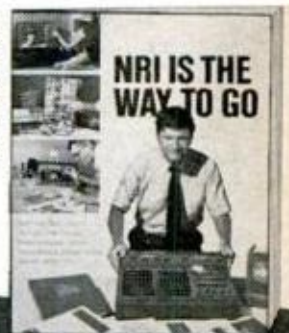

HIDDEN DEPTHS OF YOUR MIND

(Continued from page 65)

rons into action and turning the bull into a docile creature.

Now Dr. Delgado has demonstrated two-way communication between the brain of a chimpanzee and a computer. Recently a young male chimp named Paddy had 100 electrodes implanted in "primitive" parts of his brain (those under the cerebrum). Targets included the amygdala, a section responsive to odors that seems to affect all emotional behavior. Other electrodes were placed in the reticular formation, a mass of neurons at the top of the brainstem that appears to act like a telephone switching office.

A peculiar burst of waves—which looked like spindles on an oscilloscope—occurred about 16 times a minute in Paddy's amygdala, and the researchers decided to see if this unusual nervous activity could be automatically suppressed with a computer-triggered signal.

Brain contains 10 billion neurons, some with as many as 60,000 interconnections

Paddy was outfitted with Dr. Delgado's Stimoceiver, a tiny gadget that includes both a receiver to detect transmitted ESB pulses and a telemetry unit to send brain signals to a remote point. A computer was programmed to recognize Paddy's abnormal spindle waves when received and to send back inhibitory ESB pulses to the reticular formation to stop them.

Moving freely about his enclosure under the influence of computer-controlled ESB, Paddy—normally excitable and stimulated by visitors, odors and other influences—became quiet and placid. Although he could perform his regular chores, he paid them little attention. He returned to normal two weeks after the experiments ended.

One possible application of such a computer-brain link: Malfunctioning human brains—damaged or epileptic—also generate abnormal electrical activity and could signal a computer when help was needed. The computer could radio back controlling impulses that might prevent a violent epileptic seizure.

Dr. Vernon H. Mark, a well-known Boston neurosurgeon, and his colleagues at Massachusetts General Hospital have already used the Stimoceiver to record and stimulate activity at points deep within the human brain.

In one case, that of a violent young woman who had stabbed another woman with a knife and later drove a pair of scissors into a nurse's back, the clinicians were able to monitor the abnormal brain seizures that led to the patient's violent behavior and then trigger similar behavior with a small stimulating current broadcast to a Stimoceiver under her head bandage.

With the malfunctioning neurons responsible for the violent behavior identified, a tiny destructive lesion was made in the woman's amygdala. The operation appears to have cured the patient's extreme violence, although full results will not be known for a number of years.

Implantation of electrodes in the human brain is not new; first efforts date from 1953. Far from being radical surgery, such procedures are now almost routine for diagnosis or treatment of certain illnesses. Electrode implantation is painless—the brain has no sense of touch or pain—and destroys almost no brain tissue.

Stimulate certain areas in the human cortex—the brain's outer layer—and the patient sees a flash of light, hears a buzz, makes a sound or observes, to his amazement, his finger move or his leg twitch. Stimulation of other areas produces elaborate patterns of behavior or the recall in minute detail of long-forgotten memories.

So mystifying and amazing are the results of work with both humans and animals that there has been speculation that a tyrannical government could control man's every thought. Working with computers, scientists would operate people like puppets.

Fortunately, all available evidence indicates that the human brain—the most magnificently complex device known to man—will never lend itself to any type of comprehensive control. The brain contains 10 billion "circuit elements" or neurons, some with as many as 60,000 interconnections. The most advanced computer is simple-minded by comparison; it contains about one one-millionth of that number of circuit elements.

In addition, the cooperation of a subject is needed to insure the effective positioning of electrodes. And, research shows, ESB can simply trigger responses that are already in the brain, not inject new ones.

If it is possible to trigger built-in responses, however, how about restoring routine control of limbs and body to those suffering from stroke, spinal cord injuries and the like? Would it be possible, through some very sophisticated ESB, to restore sight to the blind and hearing to the deaf? These are the questions being probed by Dr. Lawrence R. Pinneo and

his fellow scientists at Stanford Research Institute. They have already enabled paralyzed primates to eat, groom themselves and function in a near-normal manner. The animals' once-useless limbs are directed by a computerized brain stimulator.

ESB is not the whole answer, however, for chemistry will play an increasingly important role in all efforts to understand the human brain and cure its illnesses. Psychoactive drugs—tranquilizers and psychic energizers—have had enormous impact on many mental disorders.

Learning and long-term memory (as distinct from short-term memory in which details are quickly forgotten) have been under intensive investigation ever since Swedish scientist Dr. Holger Hyden found that animals learning new tasks produce increased amounts of protein molecules (RNA) in their brains. Can chemicals be used to make people more intelligent or to aid the failing memories of the old? The results are inconclusive, but there are indications that biochemistry may take over where ESB leaves off.

Efforts to create a drug to aid memory have been disappointing thus far, but a recent breakthrough shows some far-out possibilities. Scotophobin, a chemical isolated from the brains of rats trained by electric shock to avoid the dark, has been found to produce a fear of the dark when injected into "untrained" animals.

What makes this experiment by Dr. George Ungar of Baylor College of Medicine so incredible is that the "anti-dark" compound is simple to make and has just been duplicated in the laboratory. Will it someday be possible to simply inoculate students with a knowledge of geography or mathematics, or cure drug addicts and alcoholics with a single injection?

These possibilities are not as fantastic as they seem. Man has learned much about his own brain in the last few decades. It's conceivable that he will ultimately know exactly how it functions and will use that knowledge to foster the development of healthier and more intelligent human beings. ★ ★ ★

NEXT MONTH IN PM

Helicopters: Unsafe at Any Height

Over a two-year period, some 2300 military 'copters crashed—about a quarter of them in non-combat accidents. The cost: more than \$500 million—and over 1200 lives.

How You Help The Burglar

Inside tips on how to protect your home against burglars. They come from experts, professional "cat men" interviewed by the convict writer over a 20-year period in prisons.

GOVT. SURPLUS AND OTHER BARGAINS SAVE UP TO 90%



FLANGE MOUNTING CYLINDER

Double acting. Inlet & outlet ports 1/4" pipe. Has welded 5" x 7" flange, with mounting holes. Exc. for use on hyd. press. Has internally threaded removable self-aligning swivel bearing with 3/4" I.D. hole. Rated for 1500 P.S.I. Bore 3 1/2" I.D. Stroke 5". Shaft dia. 2". Will develop approx. 7 tons force. New industrial surplus. List \$63.80. Shpg. wt. 34 lbs. \$29.50 (Stk. #2882)

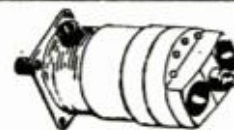

HYDRAULIC PUMP 3 GPM @

1,500 RPM, 3,000 PSI. Intake port 3/4" tube, discharge port 1/2" tube, bypass 3/8" tube. 12-tooth spline drive. Variable delivery, rotates either direction. Contains automatic pressure reg. Max. RPM 3750 @ 9 GPM. Approx. 9" L x 4 1/2" dia. GOVT. cost \$320. Govt. overhauled. Shpg. wt. 15 lbs. \$32.50 (Stk. #1011R)

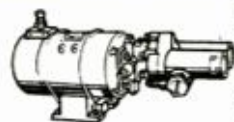

HYDRAULIC PUMP & MOTOR

Contains adjustable by-pass valve. Rated @ 1,000 PSI @ 2 3/4 GPM. Inlet and outlet ports are 3/4" standard pipe. Motor is rated for 24 V.D.C. Works extremely well on 12 V.D.C. at reduced rating. Used for car lifts or other hydraulic applications. 13" L x 5 1/2" H x 4" W. Tested prior to shipment. GOVT. COST \$225. Shpg. Wt. 15 lbs. \$29.95 (Stk #2785)



NEW! BIG 1971 CATALOG

Send 35c for amazing catalog with 1000's of bargains in hydraulics; electrical, marine, automotive items, etc. 90 day guarantee. Order from ad. All prices FOB Culver City. 50% deposit for COD. Cal. res. add 5% sales tax. Include zip. Satisfying customers world-wide since 1945.

AIRBORNE SALES CO. Dept. PM871
8501 Steller Dr., P.O. Box 2727, Culver City, Calif. 90230

REAL ESTATE BE A BROKER

PAYS BIG! SEND FOR BIG FREE CATALOG NOW! Graduates report making substantial incomes. Operate your own business quickly. Men, Women, all ages, learn easily. Course covers Sales, Appraising, Loans, Mortgages, & related subjects. **STUDY AT HOME** or in classrooms in leading cities. **Diploma Awarded. Write Today for FREE Book!** Accredited Member National Home Study Council. (Est. 1936) G. I. Approved.
WEAVER SCHOOL OF REAL ESTATE
3521-P Broadway Kansas City, Mo. 64111

FREE BOOK TELLS HOW

WHITE'S ELECTRONICS INC.

THE WORLDS LARGEST LINE OF MINERAL & METAL DETECTORS



Goldmaster 66 TR \$269.50

PRICES START AT 69.50 AND UP.

FOR FREE COLOR CATALOG WRITE TO
WHITE'S ELECTRONICS
RM. # 512 1011 PLEASANT VALLEY ROAD SWEET HOME OREGON 97386

THERE ARE NO FINER AT ANY PRICE...

INVENTORS

INVENTIONS—NEW PRODUCTS—IDEAS DEVELOPED & PREPARED
For Commercial Appeal & Sales
DESIGN—MARKETING—PATENT RESEARCH—DRAWINGS
United States Patent Office former Patent Examiner
DIRECTOR: United States Dept. of Army former Patent Adviser
Member: United States Council Int'l Chamber Commerce
Second Decade of Reliable Service to
INVENTORS—MANUFACTURERS—ATTORNEYS
FREE CONSULTATION
THE RAYMOND LEE ORGANIZATION
230-Z Park Ave., New York 10017 (212-MU 6-8500)
SEND FREE "INVENTION RECORD," Form & "PRODUCT MARKETING" BROCHURE
Name _____
Address _____
City _____ State _____ Zip _____

4-CHANNEL STEREO—AT LAST!

(Continued from page 70)

quite as pronounced as what you get from four genuinely discrete channels, but the effect is amazing and significantly enhances the sound of standard stereo recordings or broadcasts.

Decoders thus improve two-channel program sources as well as playing four-channel matrixed sources. They come in many types and are known by a variety of names. Some makers use terms like "processor," "synthesizer" or "converter." One of the least expensive models is the EVX-4 decoder sold by Electro-Voice for about \$60. A small, trimly styled box, it connects between your existing amplifier or receiver and an added second ampli-

Matrixed four-channel tapes and records are expected to be on the market later this fall.

fier (the basic hookup is shown in the illustration at the beginning of this article). It provides four derived channels from any two-channel program source and will also decode four-channel matrixed recordings and broadcasts. A kit-built version is available from Heath.

Somewhat more complex decoders are offered by Toshiba, Sansui, Harman-Kardon, Lafayette and others. In addition to decoding and matrixing circuitry, units like these employ other tricks to further enhance the four-channel effect. One is the phenomenon known as "phase shift." When two speakers are properly phased, the peaks and valleys of their sound waves march along together, arriving at the listener in step with each other.

It's important that your front speakers are wired in phase so they work together, rather than fight each other. But you *don't* hear all sound in phase. In a concert hall, the sound waves bouncing around the rear of the room travel longer paths than the direct waves and their peaks and valleys get all mixed up, arriving out of step. This out-of-phase character of reflected sound waves helps to create the effect of great spaciousness in a concert hall.

Some makers take advantage of this phenomenon and deliberately alter the phase relationship of their rear-speaker signals to give the illusion of concert-hall spaciousness. This is called phase shift, and the amount can be varied to provide different effects.

Another trick is to introduce a time delay between the front and rear-speaker

signals to simulate the delay between the direct and reflected sound waves in a concert hall. The delay is very brief—only a few milliseconds—just enough to add a slight reverberant quality to the music. Harman-Kardon, for instance, uses a 7-millisecond delay as well as a partial phase shift of 90°.

Some of the more elaborate decoders are virtually miniature sound studios and let you play at being your own audio engineer. Various factors such as speaker balance, separation, volume level, phase shift, reverb effect, high-frequency roll-off and speaker pattern are all adjustable so you can tailor the sound to your particular living-room acoustics or select different effects for different types of music. The Toshiba, Sansui and Harman-Kardon decoders are all highly sophisticated control centers incorporating their own two-channel amplifiers. The idea here is that you need only your existing stereo amplifier and two added speakers to complete the system. You don't have to buy a second, separate stereo amplifier.

The Toshiba and Sansui models sell for about \$200. Harman-Kardon's will go for about \$300. Lafayette's model differs slightly in that it incorporates a four-channel amplifier so you need only the speakers for a complete four-channel system. It sells for about \$220 by itself or \$378 with four speakers and a four-channel tape player. Scott also offers a self-contained four-channel amplifier, and Fisher has just announced a four-channel receiver with AM/FM radio.

Matrixed four-channel tapes and records have already been produced experimentally and are expected to be on the market later this fall. JVC, the Japanese Victor Co., has produced four-channel records using a different system. Instead of mixing signals by matrixing, it piggybacks two signals together by employing a carrier frequency similar to FM multiplexing. Four-channel FM broadcasts using the same method have also been proposed, but these require FCC approval because of the greater band width that the signals occupy. No FCC approval is needed for matrixed four-channel broadcasts because the signals sent out over the airwaves are, in effect, the same as those for regular FM stereo.

Meanwhile, other makers have taken still another route. RCA recently pioneered the Quad-8 cartridge tape system and since then a number of others have hopped on the bandwagon. Quad-8 recordings are standard eight-track cartridges, but instead of containing four two-channel programs, they provide two four-channel programs. Four tracks are

recorded simultaneously in one direction and four in the other. The cartridges are played back through a four-channel amplifier with four speakers.

RCA's Quad-8 player contains its own four-channel amplifier and sells, complete with four speakers, for about \$250. It will also play standard two-channel, eight-track cartridges. Similar Quad-8 players—some for car installation as well as home use—are also sold by Motorola, Toyo, Teledyne, Fisher and Lafayette.

While Quad-8 players offer one of the simplest and least expensive ways of getting into genuine four-channel sound, they do limit you to the eight-track cartridge format. They are not designed to play four-channel matrixed sources or to add special four-channel effects to ordinary two-channel sources.

One interesting variation is the development of Quad-8 playback "decks." Panasonic has just introduced one that sells for about \$130; Lafayette one for about \$80. Being decks, they do not contain their own amplification systems, but can play Quad-8 cartridges through any four-channel amplifier or decoder along with other true or matrixed program sources. This gives you the flexibility of being able to enjoy a variety of four-channel systems using basically the same equipment. Other Quad-8 decks are expected later.

In the reel-to-reel tape format, Panasonic, Telex, Crown, 3M/Wollensak, TEAC and Sony all offer quadrasonic machines that both play and record on four separate channels. While these tend to be somewhat higher in price, from \$400 to \$600, they also contain more elaborate circuitry and provide greater flexibility of control.

There's also a move on to put four-channel sound on increasingly popular cassette tapes. This is a tougher problem because of the much narrower tape width used in cassettes, but several makers are already studying the possibility. Norelco, originator of the cassette concept, has proposed a compatible four-track arrangement in which cassettes could be recorded quadrasonically, stereophonically or monophonically and all be playable on the same equipment. Ampex is also rumored to be working on such a system.

Incidentally, don't be confused by the many different spellings you'll see of the term "quadrasonic." While this is the most widely accepted version with an "a" in the middle, some makers spell it with an "i" or "quadriphonic." Some drop the middle letter completely and call it "quad-phonetic." Some still use the earlier "quadrasonic." No matter how you spell it, it all comes out the same, and it comes out sounding pretty good. ★★ ★

GI APPROVED
For Home study or Resident School!

Be a Dental Technician LEARN AT HOME!

Course includes Tools, Supplies and Materials

- Spare time home study leads to high pay profession!
 - Work for dental laboratory, dentist or open own shop!
- Since 1925 we have trained thousands of young men and women to make and repair dental plates, crowns, bridges, etc. Lack of high school education no barrier... shortage of skilled workers opens door to fabulous opportunity!

Send Now For Illustrated Brochure

McARRIE SCHOOL OF MECHANICAL DENTISTRY

PM8, 132 N. 12th St.
Philadelphia, Pa. 19107

Travel the SHORT way

avoid wrong turns —
save time, money
and frustration with



... at
leading
stores
everywhere!

AIRWAY COMPASS, Mexico, Indiana 46958

Free rent, resort living, great food, unlimited recreation... and plenty of time to enjoy them! Easy home-study plan. 1000s men, women, couples needed. Age no barrier. (Or, own your own motel.) Send for FREE "Career Kit." No salesman will call.

**NORTH AMERICAN SCHOOL OF
MOTEL-HOTEL MANAGEMENT**
4500 Campus Dr., Dept. 14178,
Newport, Ca. 92660

NAME _____ AGE _____
ADDRESS _____
CITY _____ STATE _____ ZIP _____

MOTEL-HOTEL CAREER



WRIST ROCKET

AMERICA'S Pat.
HARDEST U.S.
HITTING SLING
Range 225 yd. - 232 fps
Matched spare rubbers
and pouch assembly, \$1.00.
Write:



WRIST ROCKET®
P. O. BOX 21-B
Columbus, Nebraska 68601 **\$3.00 Post Pd.**
No C.O.D.'s

I-N-V-E-N-T-O-R-S WE NEED INVENTIONS

Sell your invention for cash—need money for Patent?—Are technical problems holding you back? Universal Inventions has helped inventors all over the world—just like yourself—why not you? Inventions provide the magic spring-board to sudden riches. REMEMBER, we either sell your invention or pay you a cash bonus. Write for details. **UNIVERSAL INVENTIONS, Dept. 13, Marion, Ohio**

NEW - Ninth Edition of the Universally Accepted Small Engines Service Manual



\$4.95
9th Edition

Factory "know-how" at your finger tips! Complete repair information on over 1,000 models of small engines that power lawn mowers, tillers, go-karts, etc. 328 pages with hundreds of photos and exploded view drawings. Step-by-step, easy to follow instructions for everything from minor tune-up to major overhaul. Over 300,000 copies sold to mechanics and do-it-yourselfers. Save time... make money. Order your copy today.

Money Back Guarantee
Send check or money order
and we pay postage.

TECHINCAL PUBLICATIONS DIV Dept. PM 871
1014 Wyandotte Kansas City, Mo 64105

DETROIT'S BEST TEST TRACK!

(Continued from page 79)

and A. J. Foyt, and it would have been nice to have those cars around at the finish, but Mr. Ford recognized how blessed we were that we didn't hurt anybody in the thing. He's a pretty realistic kind of guy.

"It's Indianapolis, of course, that is the world's greatest spectator event. They get more people, more involvement and more press coverage. That's what established the name *Ford* in the minds of so many people; it was very worthwhile."

In later years after the initial venture into Indianapolis racing, in 1963, there was some management reluctance to keep pumping money into the Indy project, and the Special Vehicles Dept. had to keep 'selling' the idea, right?

"True," Jacque agreed, but it was the fault of the (racing) system. In 1963 it was a worthwhile venture and the company dedicated a certain number of dollars

**... you can't win them all,
and if you did it would grow
monotonous for the fans ...**

to doing it, and we should have won that first race—Jimmy Clark really should have beaten Parnelli Jones.

"At that time, Goodyear got into racing with a lot of enthusiasm and the tire companies started to buy their way into racing teams, pay the drivers large sums (for exclusive contracts), pay the mechanics and even buy the automobile.

"They'd furnish the tires, buy the engines and the thing escalated itself to the point that running a race car was a many-hundred-thousand-dollar proposition!"

When asked, "Who is the greatest all-around driver?" Jacque responds that it's the guy who understands more about what's happening to him, to his car, to other people, to what's going on and that's, he says, A. J. Foyt.

"On any given day, and given place, if his frame of mind is right, he's unbeatable. He's excitable, but they're all excitable. If he thinks he's right, he tells you. He just lays it on the line; here's the way it's going to be! He's an honest kind of guy. Gets wild once in a while, but more often he's easy to work with."

Passino was asked if Foyt is really as sharp from a mechanical standpoint as he thinks he is.

"He's sharper than he thinks he is. We have a suspension expert at Ford, Klas

Arning, a German fellow, and a very theoretical engineer, who said, 'Foyt can tell me exactly what's going on in that automobile. He may not understand it as far as engineering is concerned, but he knows exactly what is going on and can describe it to me, tell me what's happening so I can suggest changes to make.'"

How about stock-car drivers?

"Well, I remember, I surprised David Pearson when I told him one reason I was glad to get him in a Ford was because he used to scare me to death when he drove the Dodge and Pontiac. I hoped his car would break, because if it didn't he was going to win.

"Pearson is a remarkable driver; he's smart and he's calm. Of course, he's getting a little older now, and he's more seasoned.

"The greatest all-time stock-car driver? It's hard to say because of the differences in equipment they ran, but I'd say Fireball Roberts has to be very close to being tops. If Fireball in his prime had been driving a car that would handle—he didn't always have the best set-up cars as far as chassis is concerned—he would have been fantastic.

"I've seen Banjo Matthews, and talked with him, after he'd gotten out of some of those cars, and Banjo's hands were literally raw from fighting the wheel. But Roberts used to drive those things like they were running on rails."

How about your choice of outstanding mechanic?

"You have to give Herb Nab (crew chief for Junior Johnson's cars with Lee Roy Yarbrough driving) a lot of credit. In terms of being clever and running the rules to the ragged edge and doing all the things, you'd have a hard time beating Herb Nab and Junior Johnson, who is also a pretty crafty guy.

"When those two guys roll that car out on the line, you just know that they've got everything in that thing that they can get in it."

If there was one outstanding problem for Jacque Passino in his 14 years as Ford Motor Co.'s leading practitioner in auto racing, it was translating to other company executives the reasons for manufacturers' involvement in the sport, the benefits to be gained.

"The expression 'race on Sunday, sell on Monday' is a pretty good description."

Obviously, the objective of an auto-racing team is to win, but practical people realize that you can't win them all, and if you did, auto racing would grow monotonous for the fans and defeat your own purpose.

"In racing, the auto manufacturer has a

whole series of audiences. You have the fellow who was there and saw it. He's the No. 1 interested guy. You have the fellow who wanted to be there and couldn't, but he's interested and reads the newspapers. He's the No. 2 interested guy.

"Later, in two or three months, you have the follow-up in the buff magazines, where they talk about the race and victory all over again.

"There is a very broad extension of the race itself that goes to the public by virtue of the news media. Of all the people I ever talked to, Bunkie Knudsen understood that best."

Knudsen became interested in racing as an activity which would benefit the automotive business when he was general manager of Pontiac, and often has credited the racing activity with scrapping the former 'old lady's car' image of Pontiac, giving it the racy image it has retained, even today, years after the racing program ended, with model names such as Bonneville, Grand Prix, Le Mans and Firebird.

"When he came in to Ford," Passino continues, "it was like a breath of spring, because he knew and loved that (racing) end of the business. He knew everybody in the sport, almost without exception.

"In fact, with the exception of John Holman and Ralph Moody, and the Wood Brothers, all of our people had at one point in time worked for Bunkie. Banjo Matthews ran Pontiacs for him. Junior Johnson had run Chevrolets for him.

"He could walk through the pit area and talk with everybody there. He knew Bill France intimately. It surely made things a lot easier and you didn't have any arguments with anybody about anything.

"We were racing strongly at that point in time, so he didn't have to change anything. It was refreshing to have a guy of his type around."

Asked about Henry Ford II's racing interest, Passino sums it up this way: "I wouldn't say Mr. Ford is a race nut, but he feels that racing is part of the car business and that's why we did it.

"As a manufacturer, of course, you race within certain boundaries: financial, publicity-wise. You have to play things cool right now, because people are concerned about safety and emissions.

"If you try to figure out what the future holds now for the automobile industry in racing, you'll need a darn good crystal ball."

You'll need the same crystal ball to determine where you'll find Jacque next: Only one thing's for sure: It'll be a job with a challenge! ★★★

RADIAL ARM SAW KIT... for under \$100

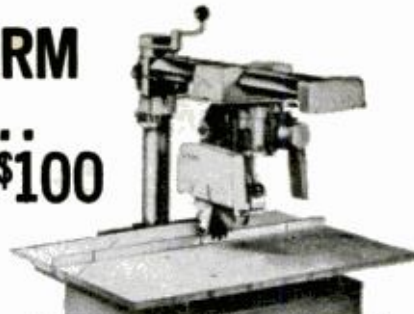

Buy direct from factory, assemble yourself. Incl. 1/2 h.p. G.E. motor, easy to follow instructions, all parts, nuts and bolts. Guar. for life pat. pend. radial arm track; twice the usual bearings for extra rigidity, greater precision. Rips 24", crosscuts 12"; belt brake. \$99. complete, freight col. Kit less motor (any stand. 1/2 h.p. or larger will do) \$84.85. With optional G.E. motor developing 1 h.p. \$108.65. Money back guaranteed by one of world's largest manufacturers of bench power tools. Write for brochure. Terms if desired or check or M.O. to American Machine & Tool Co., Dept. PM-81, Royersford, Pa. 19468



Transistor Radio with Battery \$1.70

Calendar Watch \$2.44



Derringer Pistol \$5.99

HOME-IMPORT BUSINESS—Make Big Profits

New Drop Ship Plan offers you first day profits! Deal direct with overseas sources at prices shown. Dazzling bargains with no investment. Full or spare time. Write for FREE BOOK today to...

MELLINGER, Dept. E2258, 1554 S. Sepulveda, Los Angeles, Calif. 90025

25 YRS RESULTS
\$130—PROFIT
DAY.
\$50

THE KEY TO RACING SUCCESS

Sensational book reveals secrets of 10 world's greatest professional race investors, 25 yrs. actual results included showing 7 to 10 plays won and \$130 average race day profit with \$50. Genuine copyright book supplied only by publishers. Wins at all tracks, horses, harness, dogs. Write for fascinating free brochure: include zip code.

HITCHINGS, Box 5715-HPM-I Carmel, Calif. 93921
Cut out and send this ad NOW for Honanza Offer!

POWER HACKSAW KIT ONLY \$24.95



Also 51 other money-saving projects to be built in the home workshop. Lathes, drill presses, vises, etc. Send 50¢ for 28 pg. Catalog.

C.F. STRUCK CORP., Dept. PM-791, Cedarburg, Wis. 53012

LEARN DRAFTING AT HOME

U.S. Labor Dept. says "42% more Draftsmen needed next 10 years." Send for FREE "DRAFTING CAREER KIT." No salesman will call.

NAME _____ AGE _____
ADDRESS _____
CITY _____ STATE _____ ZIP _____
NORTH AMERICAN SCHOOL OF DRAFTING, Dept. 141781
Accredited National Home Study Council 4500 Campus Drive, Newport, California 92660

Motorcycle Service Manuals

Vol. 1—2-Stroke, 2nd edition
Vol. 2—4-Stroke, 2nd edition

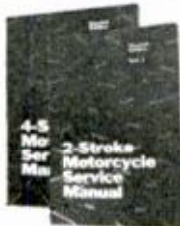

\$4.95 ea.
Both \$8.50

Money Back Guarantee

Volume 1—218 pages give complete instructions, with photos and diagrams, for everything from brake adjustment to engine tear down and reassembly. Includes nearly every 2-stroke cycle through '67 and many '68 machines. Over 75 models of 18 manufacturers.

Volume 2—232 pages covering practically all foreign and domestic 4-stroke machines. Includes specific service fundamentals peculiar only to 4-stroke engines. Complete step-by-step repair instructions for 63 models of 16 leading makes.

Send Check or Money Order and We Pay Postage

Technical Publications Div., Dept. PM-871
1014 Wyandotte, Kansas City, Mo. 64105

A New Spare Time Income For The Home Handy Man Sharpen Carbide

Saws and Tools
with famous

Foley

Carbide Grinder

Excellent potential in this super growth industry! Manufacturing firms of all sizes are switching to carbide.

They use hundreds of different carbide tipped saws and tools. All need sharpening. Amazing profits are yours for just minutes of easy work.

We Will Finance You! Easy finance plan helps you start in this highly profitable field. Part time could lead to full time. No special skills required. Foley shows you how. Write now for full information.



Foley

Carbide Service Center

Room 843-1, 3300 N.E. 5th Street
Minneapolis, Minnesota 55418

TO YOUR OWN DOCTOR'S PRESCRIPTION
EYEGLASSES
BY MAIL AT
GREAT SAVINGS!



Mail orders filled by
licensed optician from **\$10⁹⁵**

(Including single vision lenses, frame and case).

Doctor's prescription will be filled by a skilled, approved and licensed optician or your own prescription duplicated. Lenses are ground and manufactured to U.S. optical standards. Choose from complete catalog of men's, women's and children's glasses. Bifocals, trifocals, sunglasses or SAFETY HARDENED LENSES at low additional cost. We guarantee accuracy, perfect fit.

SEND FOR YOUR FREE CATALOG TODAY
PRISM OPTICAL INC.

Dept. PM-54, 135 W. 41st St., New York, N.Y. 10036

Print For Profit



Cards, Stationery, Envelopes, Advertising, labels, tickets, announcements, Q.S.L. cards, greeting, sympathy, prayer cards, tags, etc. Good Profits, Pays for itself in a short time.

Own a Printing Business

We supply everything direct from factory only. Easily followed rules. Also raised printing like engraving. Have home shop. Add to income. Send 25¢ for catalogue. **KELSEY PRESSES Meriden, Conn. 06450**

MAIL THIS COUPON TODAY!

KELSEY PRESSES, DEPT. 71-V Meriden, Conn. 06450

I enclose 25¢ send big catalog and samples.

Name _____

Address _____

City _____ State _____ Zip _____

'I FLEW IT'

(Continued from page 91)

rated service ceiling is 11,000 feet, and Molt has taken it to 15,000.

The wing is designed for high-lift and low speed. If there is a fault with the craft in turns—as I found out when I got behind the controls—it's that the ailerons are rigged for a gentle response. The reverse is true with some lightplanes.

The Aerocar recovered well from unusual attitudes with a modest application of the controls. Stalls were done both with power on and off. The Aerocar brings its nose up well with normal trim when the stick is hauled back, but as speed drops off the elevator can scarcely hold it to complete stall. Stability is such that even though the stall warning light and horn come on, there is no buffet and the plane simply mushes along at 55 mph with its nose lifted snobbishly. When power is cut, the nose drops cleanly and obediently.

Stability, which Taylor credits to the pusher prop and underslung rudder, is certainly the best flying feature. The cruising speed with the present powerplant will win no prizes and its maneuverability will not encourage aerobatics. Much of the engine power is given to auxiliary uses, which leaves about 135 hp for flight power. At an economy cruise of 2300 rpm, the engine uses 8 gallons per hour and gets about 12 mpg.

Landing is easy. You just "drive" the Aerocar onto the runway, level off a few feet up and let it settle. Approach speed used was about 72 mph, and the Aerocar rolled out evenly after touchdown. As it slows, it becomes more of a car again, with a car's superior steering ability. When speed permits, the pilot can shift into gear and move under ground power.

This is a remarkably stable lightplane, a useful vehicle for proceeding comfortably from point A to point B—all the way. Combining ground capability with good flight characteristics makes the Aerocar a unique bird. As Molt says proudly, it's a bird that can run as well as fly. ★★★

AEROCAR SPECIFICATIONS

Power: Lycoming O-320 derated to 143 hp

Cruise speed:

Air, 135 mph; road, 60 mph

Stall speed: 50 mph

Climb: 700 ft. per minute

Wing area: 190 sq. ft.

Weight:

Empty, 1500 lbs.; gross, 2100 lbs.

Fuel consumption:

Air, 8 gal. per hour; road, 15 mpg

Fuel capacity: 32 gal.

Baggage capacity: 100 lbs.

IT'S ALMOST LIKE PRINTING YOUR OWN MONEY!

**9¢ WORTH OF
RAW MATERIAL
becomes \$1²⁵ in
less than 60 seconds!**

Since 1922 Warner has enabled thousands of men and women to establish a business of their own—to reap the benefits of their own labor and have the personal satisfaction, and independence, that comes with operating a business of their own.

This new Warner Shop and Success Program shows you, step-by-step, how YOU can establish your own business... in your spare time... at home. And, without any experience because we provide everything. Now, a revolutionary new machine makes it possible for an Independent Business Man with no "PULL"... No BIG MONEY to invest... and, No Experience—to start a business of his own, at home in his spare time. Here's what J. H. of Pennsylvania says:

\$7,280.00 for 1 to 1½ hours work an evening in my spare time — and without advertising. When I start to advertise I will have my own full-time business. Right now I am using the extra income to give my family the luxuries my present job does not afford.

Yes, just one to one and a half hours of your spare time, at home, and you'll find you can make more money than you ever dreamed possible. These are products that know no season, that are as timely as tomorrow... or the day, or month, or year after that. These are products that are stainproof, non-corroding weather-resistant and washable; these are products that are worn and displayed, products that identify and inform.

Send for Free Brochure

Now, you can find out about this extraordinary money-making business without risking a penny of your own money... in fact, we will even help finance your start at less than bank rates! Cash in on this highly profitable engraving business in your own area right away. Full particulars will be mailed FREE... no salesman will call. Use the coupon at right or send your name and address on a postcard to receive your copy of the FREE ILLUSTRATED BROCHURE.

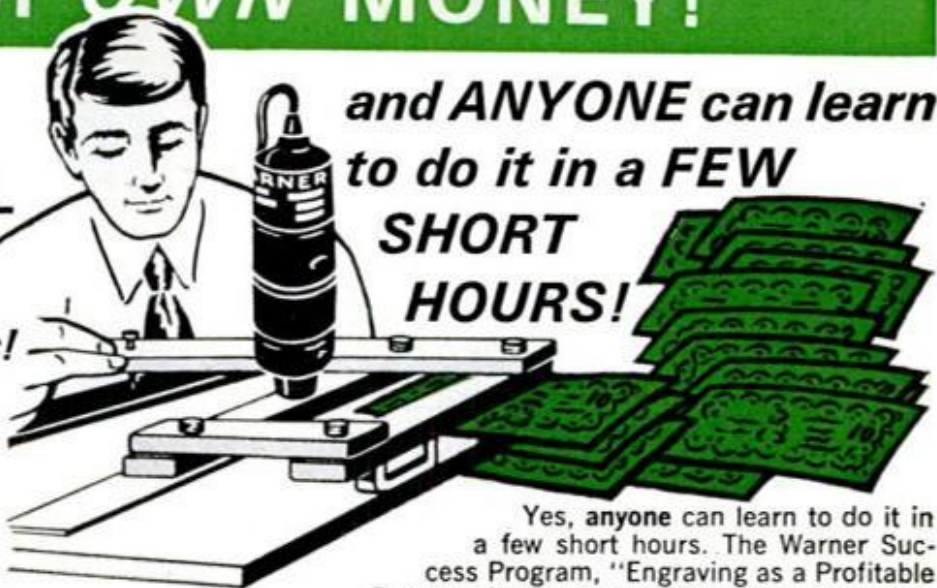

**and ANYONE can learn
to do it in a FEW
SHORT
HOURS!**

Yes, anyone can learn to do it in a few short hours. The Warner Success Program, "Engraving as a Profitable Business," shows you step-by-step with photographs and drawings, exactly how YOU can produce salable engravings the very first time. Here's what Mr. J. C. had to say about the Warner Success Program...

"I wish to take this opportunity to say thank you for all the help and encouragement you offered. The Warner Success Program is absolutely invaluable. I have never had an aptitude for anything mechanical but after reading your instructions I had no difficulty. I cannot praise this Success Program enough."

Yes, the Warner Success Program is complete in every detail. In addition to the actual mechanics of producing engravings, it shows you eight different ways to get business... it illustrates how to get orders without canvassing or house-to-house selling. It shows you how to get others to work for you, how to expand and how to make a market survey locally, before you invest any money. The Success Program enables you to get business before you invest one penny... and actually be in business the very day your shop arrives!

Don't make any decision now. Send for your FREE illustrated brochure and read all about it in the quiet of your own home... all it can cost you is a postage stamp.

**WARNER ELECTRIC CO., Dept. E-2-AJ
1512 Jarvis Ave., Chicago, Ill. 60626**



Engraving Division, Dept. E-2-AJ
1512 Jarvis Ave., Chicago, Ill. 60626

Please rush full particulars about your new Success Program, "Engraving as a Profitable Business." Tell me about your less-than-bank-rate credit plan that will help me get started in this profitable business in my spare time, at home. Everything you send me is FREE... no salesman will call.

Name _____
Address _____
City, State, Zip _____

LEARN TO FLY IN YOUR OWN BENSEN

Lowest cost—most fun too, pros and novices agree. Pilot ages range from teens on up. Economical to operate. Easier, quicker to build than an airplane. Wheels interchange with floats. Send \$5 for Copter (\$3 Glider) INFO PACKET—see why the Bensen is the world's most popular homebuilt.



SEND \$5 OR \$3
BENSEN AIRCRAFT CORP., Dept. PM-81
 RDU Airport, P. O. Box 2746, Raleigh, N. C. 27602
 NAME _____
 ADDRESS _____

THE "CRIME" OF IGNORANCE

Ignorance is a "crime" when it becomes a handicap to success. In today's society it pays to know the "rules" . . . the law. The Blackstone School offers a program of reading assignments, for adults who have completed formal schooling; especially designed for people who expect to accumulate property, lead in business or community life.

NOT A CORRESPONDENCE COURSE

Program may be scheduled to your interests and time covering any or all law subjects. **FREE BOOKLET**, "The People vs. You" mailed on request. No salesman will call.

BLACKSTONE SCHOOL OF LAW Dept. 51
 307 N. Michigan Avenue, Chicago, Illinois 60601

Are you filing your copies of PM?

If you are, you'll want an inexpensive *Annual Index*, available in December, that will make your file copies much, much more useful. Refer to any article in seconds!

And if you aren't filing your copies of PM—start now!

FEAR NO MAN!



Regardless of your age, size or strength, in just 15 minutes, I'll have you using my **TERROR-FIGHTING** secrets. **TEN TIMES MORE EFFECTIVE** than KARATE and JUDO Combined. They will turn you into a destructive **MARINE TOUGH** fighter able to protect yourself and loved ones from any hoodlum twice your size without working up a sweat — anytime — anywhere — in any and all situations.

If you really want self defense mastery and confidence, send now for amazing free booklet, revealing for the first time 5000 years of trip-hammer political, military and religious fighting orders, including Judo, Karate, Boxing, Wrestling and Rough & Tumble fighting secrets that will quickly turn you into a Terror-Fighter. You will never again get "weak in the knees" and run but stand and successfully defend yourself against even two or three attackers. Yes! from this day on YOU need never **FEAR ANY MAN**.

Mail NOW for self defense fighting secrets.

ABSOLUTELY FREE

Send only 50¢ to cover Postage and handling to

JOE WEIDER, Dept. 38-81-SD3
 25 Maple St., Norwood, N.J. 07648



FIND COINS-GOLD-RELIQS-TREASURE metal locators by JETCO!

- Lightweight
- Easy to Use
- Comes Complete
- Made in USA
- 5 yr. Guarantee
- Immediate Delivery!
- Write for FREE Catalog.

priced from
\$39.95



Jelco ELECTRONIC INDUSTRIES, INC.
 P. O. BOX 132 CM HUNTSVILLE, TEXAS 77340
 PHONE ORDER TO: 713/295-5422

FIND BURIED TREASURE

Powerful electronic detector finds buried gold, silver, coins, etc. 5 new models. Write for free catalog.



RELCO, Dept. D-3 19.95
 BOX 10839, HOUSTON, TEX. 77018

HEADQUARTERS FOR EVERY TYPE & SIZE AT REAL DOWN-TO-EARTH MONEY SAVING PRICES!



ALL FAMOUS BRANDS! AUTO TRUCK SPORT CAR FARM TRAILER
TREMENDOUS SAVINGS!
 LET US PROVE IT TO YOU! ... WRITE US TODAY ...

Send for your FREE catalog!

RELIABLE TIRE CO. 1111 Chestnut St. Camden, N. J. 08103

RECHARGE ALL BATTERIES

Only Everlite

- Charges 6 batteries
- Charges 3 times faster
- Charges all batteries

Including hearing aid, flashlight, lantern, radio, in fact any battery up to 12V. Save Money and have the convenience of fresh batteries always. Simple and 100% Safe. Plugs into any 115V. outlet. Guar. for one year. Send \$6.95 plus \$.65 for shipping

6.95



Model 75

MASTER MECHANIC MFG. CO., Dept. A-81, Burlington, Wis.

Southern Customers write Dept. A-81, Box 65, Sarasota, Florida

BORN UNDER A LUCKY STAR!
 HE STILL NEEDS PENCLIFF



\$15 WIN
 A RACE DAY \$2 WITH 2 STAKES

\$134, \$141, \$151, etc., PROFIT DAILY FOR YOU! with 82 stakes at Racetracks ALL OVER with fabulous, scientific, easy to use "PENCLIFF" world-famed race computer—12 expert race experts BRAINS BUILT INTO IT (\$20 stakes—10 times above profits). We give you PROOF—over 4,000 latest "PENCLIFF" Big Win Results. Tear out this ad now, mail it with name, address, zip: R. H. PUBLISHING CO. PME21 Box 5715, CARMEL, CALIF. 93921

HOW TO GET RICH

Secret Mail Order business brings cash by mail. Pyramid profits. No investment. Start at home in spare time. Write for full details and Free Book.

MAIL ORDER ASSOCIATES, INC.

Dept. 66, Montvale, New Jersey 07645

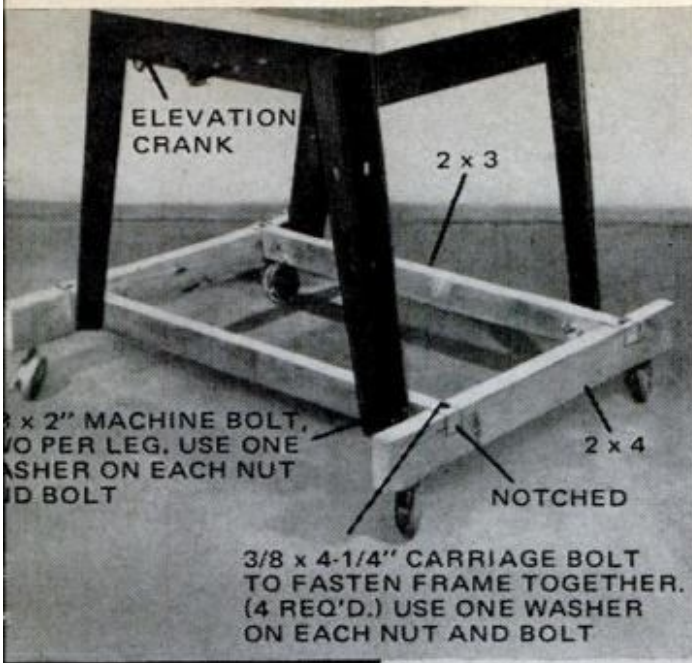

3/8 x 4-1/4" CARRIAGE BOLT TO FASTEN FRAME TOGETHER. (4 REQ'D.) USE ONE WASHER ON EACH NUT AND BOLT

SHOP-BUILT BASE

is constructed of two-by stock fastened to legs with bolts. Base is located to give table height of 36 in., then legs beneath are sawed off. The lockable casters from Shepherd (right) make it possible to roll the 250-lb. saw easily with one hand.



SEARS' BEST RADIAL

(Continued from page 122)

the base shown above. With this base added, the saw rolls about easily and can be locked in place wherever wanted. The Shepherd casters selected are top-of-the-line, industrial rated, and if your hardware dealer doesn't stock them, write the maker at the address shown below.

Summing up, I have to rate the radial saw as a best buy. In fact, having it side-by-side with my table saw almost causes pangs of guilt when I spend all day Saturday whaling away at some future PM project. ★★★

SPECIFICATIONS—SEARS 12-IN. RADIAL SAW

Model: No. 99 AT 2951N
 Blade: 12 in., 5/8 in. arbor
 Max. depth of cut: 4 in.
 Max. depth of 45° cut: 3 1/8 in.
 Max. rip width: 26 1/2 in.
 Miter index stops: Arm rotates 360°, fixed stops at 0° and 45° right and left
 Weight: 242 lbs.
 Price: About \$359.
 Casters: Model No. 400405A-BX manufactured by Shepherd Casters, Inc., St. Joseph, Mich. 49085

HEAVY DUTY WELDER

with special \$7.00 gift offer to

Popular Mechanics readers

10-DAY FREE TRIAL

Lifetime Guarantee

Brand New 1895

1971 Model 1895

Fits ordinary 110V outlet

Not one • but 3 welding heats



Weld, braze, solder or cut most anything made of metal. No experience necessary. Follow simple instructions to make repairs on cars, trailers, farm and lawn equipment, bicycles, appliances, etc. Make campers, boats, furniture, hundreds of valuable items. **NOTHING ELSE TO BUY!** Comes complete with full face shield, pack of welding and brazing rods, heavy duty power cables, special electric torch attachment, ground clamp, flux, easy-to-follow illustrated instructions, rod holder, etc. Uses standard 1/8" rods to weld iron, steel, brass, bronze, aluminum, other metals. New improved HEAVY DUTY circuit gives more welding power. Gives 4 times the heat needed to melt toughest iron. Plugs into ordinary 110V outlet. 3 WELDING HEATS . . . Not just one as with other low cost models. Use "high" for tough jobs "medium" or "regular" for lighter work. This important feature saves you money and time. Makes it possible for even beginners to start welding professionally the very first day. Pays for itself quickly. An excellent gift for any occasion. **IT'S AUTOMATIC:** Current is turned ON when arc is struck, OFF when rod is lifted from work. Eliminates need for troublesome foot switch. Speeds up work.

FREE!

Mention that you saw this ad in Popular Mechanics and receive a \$7.00 gift pack assortment of "touch weld" welding rods. Automatic arc striker. Weld with "push button" ease.

10 day MONEY BACK GUARANTEE. You must be satisfied or return for refund. Send only \$2.00 and pay postman \$16.95 plus postage when delivered or send \$18.95 cash, check or money order for immediate postpaid shipment.

WEL-DEX MFG. CO., Dept. W-203, Box 10776, Houston, Texas 77018

EARN MONEY FAST!

REPAIR HYDRAULIC JACKS

Earn while you learn at home. Millions of jacks in gas and auto service stations, trucking firms, body shops, riggers, factories and farms need servicing . . . most of which you can learn to repair. We show you HOW. Start spare time in your basement or garage. Big opportunity for mechanics. ACT NOW!

Write for folder PM-8 and free bonus offer



HYDRAULIC JACK REPAIR MANUAL CO., INC.
 G. P. O. BOX 3 • STATEN ISLAND, N. Y. 10314



GARAGE DOOR OPERATORS

EASY HOME INSTALLATION

RADIO CONTROLLED

\$109⁹⁵

Chain & Screw Drive Models

FOUR MODELS FROM

THOUSANDS IN USE - FREE BROCHURE

HELPMATE EQUIPMENT COMPANY

Dept. PM-10, First & Lake St., Baroda, Mich. 49101

Shipped PP or UPS



Two or four-wheel drive
JEEP or SCOUT
 owners

REPOWER with a 6 or V-8.

H.D. ADAPTORS for using Car, Compact and some Truck engines.

"State year & model. Jeep or Scout." Want fast action? Give us FULL INFORMATION. Send \$25.00

Dep. and we will ship correct kit, bal. COD. Send full amount for prepaid shipment. Wire, phone or write today. Details FREE

HOOSIER MACHINE PRODUCTS CO.

312 S. E. 6th St., Phone 276-3442, Pendleton, Oregon 97801

THE AUTO ELECTRIC

Power-For-Tools. 110 V.D.C. Electricity from a car's alternator. Installs on—Most late model cars, trucks or tractors. Will operate heavy power tools, light bulbs, heating devices, etc. Operates any brush-type 110 V. A.C.-D.C. electric motor. Excellent battery boosting and charging. Easily installed.



Checks or Money Order:

\$16.95 Without 150

\$19.95 With 150

V. D.C. Meter

V. D.C. Meter

Auto Air Equipment Inc., P.O. Box 2886, Amarillo, Texas 79105
 P.O. Box 38625, Dallas, Texas 75238

TERRIFIC "BUY" IN 75 POWER

TELESCOPE—\$4⁹⁸ 3 telescopes in one

—25 power for

ultrabright images, 45X and 75X for

extra long range. Guaranteed to

bring people, sports, ships,

moon, etc. 75 times closer.

(Also use as strong

microscope.)

Most power



for the money.

NOT A KIT—ready to

use, 4 ground, polished lenses;

5 sections, brass bound, 3 feet long,

closes to 1 foot. Directions for use. Money

back guarantee. Postpaid. Order now!

Criterion Co., Dept. 6 1331 Church St., Hartford, Conn. 66101

New Universal "JIFFY-GRIP"



FILTER WRENCH

Removes those hard to reach oil filters and brake cylinder caps—on cars, trucks, tractors, boats—quick as a wink! Reaches in where others fail! Also ideal for plumbing, household jobs, etc. Positive grip, either direction, up to 5" dia. Tough 1200 lb. test oil proof woven polypropylene non-slip strap. Sent postpaid U.S.A.: 1 @ \$2.00; 2 for \$3.00; 4 for \$5.00 Send check or M.O. today!

ELSON PRODS., Inc. • Box 277 • LIMA, OHIO 45802

Career in ELECTRONICS?

Career training at home the new easy way with RCA Institutes. Lab work with first lesson. Easy payment plans. Send for free 64-page book.

RCA Institutes, Dept. 699-108-0
320 W. 31 St., N.Y., N.Y. 10001



MINI-BIKE PARTS

Wholesale Prices

"Build your own" kits...Big savings...Repair parts...Welded frames & forks, enameled...Chains...Clutches...Brakes & throttle controls...Wheels...Tires...Bearings...Axles...Engines...etc. Send 50¢ for illustrations and lists...SAVE DOLLARS!

BYCO, Dept. B, Box 6241, Omaha, Nebr. 68106

LEARN UPHOLSTERY AT HOME!



Men & Women All Ages! Send for free book on learning to reupholster chairs, divans, footstools, all furniture for BIG MONEY in spare or full time. No experience needed, no age or educational limits. We show you how and provide EVERYTHING needed to start: (1) Home training covering all phases, (2) all tools and 6 big furniture kits for practice, (3) free supplies, frames & materials to build \$300 worth of furniture, yours to keep or sell. Write TODAY for big free upholstery career book. No obligation, no salesman will call. Veteran Approved. Modern Upholstery Institute Box 899-EMA, Orange, Calif. 92669.

10 WINS TO 1

10 WINS TO 1 YOURS with 'magic' '10 to 1' wonder racetrack computer. Easily works out for you 10 to 1 fab place wins, equivalent profits \$10 each \$2 invested (\$100 to each \$20). Also, investing win, BIG, BIG \$2 pays—\$20, \$30, \$50, etc. We send you PROOF. Fear this ad now. Send with name, address, zip: R.H. PUBLISHING CO., IPM-1 BOX 5715, CARMEL, CALIF., 93921



Power hand truck climbs stairs

Up and down operation, fast, safe. No cords; loads up to 600 lbs. Self-powered; overnight recharger included. If you move heavy loads up stairs, write:

ESCALERA INC.
P. O. Box 1359-M Yuba City CA 95991



ELECTRIC ARC WELDER \$9.99!



NATIONALLY ADVERTISED \$18.95 VALUE!—NOW 1/2 PRICE! WELDS—BRAZES—SOLDERS—CUTS—ALL METALS! Plugs into ANY 110 volt socket. MAKE REPAIR 1001 items for CAR—HOME—BUSINESS. Lifetime BURNOUT GUARANTEE 10 day money back trial (if retnd). HEAVY DUTY Design—No experience needed—FREE WELDING LESSONS! SEND ONLY \$2.00 (cash, ck. M.O.) and pay postman \$7.95 COD postage or send \$9.99 plus \$1.00 postage for paid del. in U.S.A.: COMPLETE READY TO USE—Includes BIG pack steel, Brazing, Solder, Carbon "touch" rods, ELECTROFLAME ARC TORCH! OFFER LIMITED—Order TODAY! MIDWAY WELDER Dept. EPM-8 Kearney, Nebr. 68847

AN EXCITING OUTDOOR CAREER — Yours if you qualify

FREE kit shows how to qualify during off duty hours for exciting outdoor career. Approved for GI's and Vets. Write National School of Conservation, 1129 20th St., N.W., Washington, D.C. 20036, Dept. 2108N



EARN BIG MONEY as a PROFESSIONAL DRAFTSMAN

Security Prestige High Pay
• Train at home in spare time... no experience needed

NEW PLAN Starts You Fast... practical, down-to-earth assignments prepare you for career opportunities in drafting.

MORE DRAFTSMEN NEEDED NOW! THOUSANDS GOOD JOBS WAITING!!

Easy to learn at home in spare time. FREE consultation, career guidance, too! Earn up to \$18,000 per year as professional draftsman. Write now for FREE details: no salesman will call.

NATIONAL ENGINEERING PLANS, Dept PM-8
1546 E. Portner Street, West Covina, CA 91791



Repair any watch

... SWISS OR AMERICAN

Unique, modern Sweazey System starts you making repairs right away. Develops skill step by step at home in spare time. Diploma awarded. Free sample lesson. No obligation.

CHICAGO SCHOOL OF WATCHMAKING
Dept. 181, Fox River Grove, Ill. 60021

BASEMENT TOILET FLUSHES UP



TO OVERHEAD SEWER OR SEPTIC TANK. NO DIGGING UP FLOORS. INSTALLS EASY. Write McPHERSON, INC., BOX 15133, TAMPA, FLORIDA 33614



LEARN MEAT CUTTING

Train quickly in 8 short weeks at Toledo for a bright future with security in vital meat business. Big pay, full-time jobs — HAVE A PROFITABLE MARKET OF YOUR OWN! Time payment plan available. Diploma given. Job help. Thousands of successful graduates. OUR 48th YEAR! Send now for big new illustrated FREE catalog. No obligation. G.I. Approved.

NATIONAL SCHOOL OF MEAT CUTTING #0197T
Dept. 50-Z, Toledo, Ohio 43604

PUMP DRAINS pools, cellars, laundry tubs IRRIGATES — CIRCULATES — SPRAYS



Heavy duty ball bearing pump. All metal, rust-proof Type XB. Stainless shaft. Use 1/4 HP or larger. 1 HP 1,200 GPH 60" high or 3,000 GPH 25" well. 5,200 GPH max. 1 1/4" in; 1" out. Belt or direct drive. \$13.95 Type P won't rust or clog. Bronze bearing. To 2,400 GPH. 1" in; 3/4" out. \$9.95 P'pd cash with order. Money back Guarantee.

LABAWCO, Box 40, Belle Mead, N.J. 08502



\$1.00 EACH COLOR FAST

Cloth Emblems

Also 3 1/2"x2 1/4" Confederate Flag, 2 3/4"x3" Coyotee, 2x3 1/4" Ecology Flag 3 for \$2.75, 6 for \$5.00. Can be Assorted. Add 25¢ for handling.

MR. EMBLEM-7,

Box 48221, Chicago, Ill. 60648

OPERATE THREE PHASE MOTORS FROM SINGLE PHASE LINES ONLY

The RELIANCE THREE PHASER allows you to operate three phase motors, 1/4 thru 7 1/2 horsepower from 220 volt single phase power sources. Rugged—heavy duty—patented unit built to give many years of satisfactory service. Thousands of satisfied users. Free literature on request. RELIANCE ELEC. MFG. CO., INC. New Albany, Miss. 38652



SAILBOAT KITS

Free color catalog of the largest selection of popular sailboats, iceboats, and sail making supplies.

TAFT MARINE CORP.

Dept. PM-8, 636 39th Ave. N.E. Minneapolis, Minnesota 55421

The bargain hunter

FREE Catalog 2000 Jokes & Novelties



World famous catalog of novelties, live animals, scientific supplies, hobbies, fun-makers, planes & boats, looms, magic tricks, joke articles, unusual seeds, gadget time-savers, cameras, optical goods, projectors, movies, lucky jewelry, religious novelties, disguises, musical instruments, stamps, coins, puzzles, fortune tellers, radios, auto & bike accessories, telescopes, magnifiers, compasses, banks, smokers' gadgets, artists supplies, printing sets, engine, motors, shockers, knives, billfolds, books, games, etc. Send this ad with coin or stamp for postage. **NO LETTER NECESSARY!**

Yes—I want FREE Catalog. My Name & Address Attached or on Envelope

Johnson Smith Company
16535 E. Warren Av., Dept. C-108
Detroit, Mich. 48224



BUILD YOUR OWN "SUPER-BUG" FOR \$98

This is not a toy. The Super Bug is a performance ATV you can build in your own garage from our step-by-step plans for under \$100 including accessories!

MANY PRACTICAL ACCESSORIES

Plans include front ski for winter use and lawn mower attachment that mounts in 4 minutes. Pick-up back aids small tote jobs, too.

OUT-PERFORMS FACTORY DESIGNS

Using suggested engine, Super Bug will carry 1000 lbs. at 25mph, climb 60% grades. Good side-hill stability.

COMPLETE PACKAGE: Plans inc. drawings, assembly steps, parts list, construction hints. Satisfaction guaranteed.

Send
\$3⁹⁸
to

PM2/SUPER-BUG
806 So. 80th Ave.
Yakima, Wash. 98902



Bartlett Flying Saucer ultra-light hovercraft powered by ordinary lawn mower engine—easy to build—fun to fly—complete plans, kit brochure, photos and supply sources \$5.00. All orders returned via airmail. Write:

HERB BARTLETT

Box 3339-M, Scottsdale, Arizona 85257

WATER WATER WATER WATER WATER

"HOW TO DRILL YOUR OWN WATER WELL"

\$1.00 ppd

SATISFACTION GUARANTEED

DEEPROCK CO.
OPELIKA, ALA. 36801

BUILD YOUR OWN BOAT & SAVE

★ BOAT PLANS
★ PATTERNS
★ FRAME KITS

SEND \$1 FOR 96 PAGE CATALOG NOW!

GLEN-L
9152 ROSECRANS'!
BELLFLOWER, CA 90706

Direct from **JACKS** Thousands In Use

Factory

Hydraulic 1½ ton \$8.50 to 20 ton \$37.50
Scissors ¾ ton \$4.95 to 2 ton \$10.50
Tripod & Bipod 5 models \$5.95 to \$11.50

Shipped PP or UPS FOB Factory

Brochure Free **HELMATE** Equip. Co.
Box 51PM, Baroda, Mich. 49101

NEARSIGHTED? FARSIGHTED?

No more glasses to wear! Latest discoveries! Eye training course will improve your vision. Are your eyes worth \$2.95? Mail cheque to:

GROSSI, Box 1061-V, Postal Station "A"
Toronto 1, Ont., Canada

GUARANTEE: Results within ten days or your money back.

LAND N' SEA CRAFT

Travel Trailer Sea-Worthy Cruiser

ON LAND ON WATER

Free Brochure! **Land N' Sea Craft Inc.**
1813 So. 10th St., San Jose, CA. 95112

VARIABLE POWER UNITS

110 volts Electricity from your car, pickup, or truck **ALTER-NATOR**. Operates drills, saws, buffers, lights, etc. Useful for almost everyone: Farmers, Ranchers, Sportsman, Contractors, Mechanics, Repairman, etc. Fused to protect your tools and **GUARANTEED**. Install in minutes. Post paid 25.00. Ph. (316) 886-5964

VARIABLE POWER (Gibson-Bryant)
508 W. Anthony,
Medicine Lodge, Kansas 67104

ARC WELDER \$12.95 Postpaid. Weld, braze, cut up to 80 easy to use heavy duty amperes as in over \$100 welders. Fits 110 volt outlet. Simple instructions, welding, brazing and cutting rods, clamp, face shield, cables 10 year guarantee included. **COMPLETE!** Save \$12.95 cost on one repair bill. Battery quick charge attachment \$4.95. **HALDO, INC.** 8646 Jennings, Eden, N.Y. 14057

DETROIT APPROVED—PICKUP TANKS

Original equip. type poly. now avail. in aux. tanks for pickups. Increase gas capacity 40 gals. Easy 1 hour installation—completely hidden—no body work necessary. Let truck discounts pay for tanks.

R.P.M. INC., Dept. PM-8
P.O. BOX 7936, Waco, Texas 76710

Folding GATE GUARDS

Steel

For Apt's., homes, stores

Fold back gates that bring you peace of mind. Sizes to fit all doors and windows. Easy Installation.

PRICES Start at \$10.84 up. (fob)

Send name & 25¢ for catalog.

GATE GUARD
1137 South California,
Chicago, Illinois 60612
Dealers Invited

FREE MUSCLE COURSE!

Want a new Jet-Charged body? In 15 minutes I'll prove you can slap on 4" of muscles to your chest—3" to each arm—give you life-guard shoulders, trim your waist to athletic size—give you speedy athletic legs. I don't care if you're short or tall (skinny or fat) young or not so young, expect a muscle building miracle when you send for my free course. Send only 25¢ to cover postage and handling to Joe Weider, Dept. 38-81 - D2.25 Maple St., Norwood, N. J. 07648

1000 NAME AND ADDRESSES 5¢

New X-Stamp costs less than labels. Put your name and address on checks, envelopes, stationery, books, records, etc. Everstamp's unique self-contained inking system produces 100,000 clear sharp impressions before re-inking. Your choice of black, blue or red. Life-tested one million impressions. \$4.95 plus 5% Calif. tax.

M B A Enterprises, Dept. A, 11201 Lida Lane, Garden Grove, Calif. 92640.



**Simple, fast
point & timing
tune-up
with engine off!
100% accurate**



\$14.95

For direct orders add 55¢ postage & handling. Calif. orders add 5% Sales Tax

COMPU-DWELL—A Major Breakthrough in Tune-Up Technology. Can Be Used By Anyone. Pays For Itself The First Time!

The only tune-up instrument which measures point dwell for each cylinder. And, indicates the precise adjustment. Both point and timing tune-up performed with the engine off! Completely safe for inexperienced home mechanics. No frustrating trial and error. Complete step-by-step instructions and engine specifications. Everything you need to do a professional job. A must when installing new tune-up kit. Compu-Dwell can be used on all 4, 6, and 8 cylinder engines—automobiles, trucks and boats. Saves on gas and engine repairs. Satisfaction guaranteed. Sold at all leading automotive outlets. Send for free literature. Dept. PM-8

Innovative Systems

222 Berkshire Ave. Pasadena, Calif. 91103



**COMPLETE SPECIAL INVESTIGATOR KIT
★ BADGE ★ CARRYING CASE
★ SPECIAL I. D. CARD ONLY \$275**

First time ever offered! Professional type detective badge kit and case. Includes professionally styled silver badge of extra heavy nickel for use by private and special investigators PLUS authentic type carrying case AND I. D. Card. Limited supply. Order Now. Satisfaction Guaranteed or immed. refund. Only \$2.75 plus 25¢ to cover post. & handling. **WESTBURY SALES CO., D. D. Dept. GK-27
P. O. Box 434, Westbury, N. Y. 11590**

182



**GRANDFATHER
CLOCKS
SAVE 50%
BUILD YOUR OWN
GRANDFATHER AND
GRANDMOTHER
WEIGHT DRIVEN CLOCKS**

- Highest Quality Imported Movements from Germany
- Tubular or Rod Chimes
- Moving Moon Dials
- Pre-cut Semi-assembled Handcrafted Case Kits (No power tools required)
- Dials, Barometers, Hygrometers, Templates and Case Plans.

All movements and dials in stock.

Send 50¢ for complete catalog

**H. DeCOVNICK & SON,
P.O. Box 68, Dept. M81
Alamo, Calif. 94507
EST. 1947**

BUMPER GUARDS



Save on repair bills. Keep your car looking new. Added safety feature. Complete "Bump" protection. The set of four "only" \$36.95.

Send for information to:

**ANDRE GUARDS, P.O. Box 263
Brooklyn, N.Y. 11216**



FREE!!! POWERFUL MUSCLES FAST!

Fantastic New Discoveries in the science of bodybuilding. Now, in the privacy of your bedroom, our method will add inches of powerful muscles to arms, chest, shoulders & legs. Learn secrets on trimming the waist with ultra-modern methods—fast! Results Guaranteed! Send for free brochure. Universal Bodybuilding, Box 485-MI, Dearborn, Mich. 48121.

BUILD YOUR OWN CAMPER

- PLANS •
- PATTERNS • KITS
- Covers to Cabovers
- ★ FREE CATALOG ★



9152 Rosecrans,
Dept. PH
Bellflower, Ca. 90706

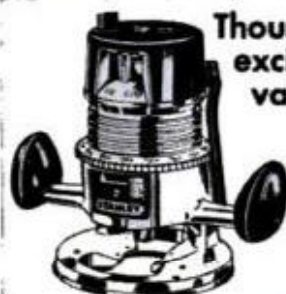

**Thousands of
exciting tool
values!**

SILVO (BRAND NAME) TOOL CATALOG

Thousands of Exciting Tool Values! Stanley, Millers Falls, Skil, Thor, Wen, Disston, Wiss, Wellisaw, Dremel, Speedy Sprayers, Plumb, Huot, Kennedy, Channellock, Porter-Cable, Rockwell, Helios, Vise-Grip, Crescent, Ridgid, Pony Clamps, Unimat, Foredom and many other Nationally Advertised brands of Tools & Supplies. We ship Coast to Coast at prices Hard to Beat. Send 50¢ for our big 146 page tool catalog today. Silvo Hardware Co., PM-8, 107 Walnut St., Philadelphia, Pa. 19106.



HoverPacer 2-seat ACV. Build from simple Plans, Kit. Outstanding performance: 50 MPH water, 60 MPH land. Proven design. Available in open (Sport) or closed (All Weather) cockpit design. Send \$1 for photos, tech. specs, prices.

KING TECHNOLOGY

Box 231, Carmel, Indiana 46032

**WIN UP TO \$3,000.
MONTHLY
WORKING PUZZLES**

FREE MEMBERSHIP DETAILS

Hundreds of our members are competing for cash prizes from \$2.00 to \$3,000 every month. Clip this coupon and we will send you membership particulars plus a free copy of the puzzle magazine. No obligation of course.

**INTERNATIONAL CONTEST CLUB
1502 Las Vegas Blvd. So. Dept. FG-59
Las Vegas, Nevada 89104**

If convenient please enclose 25¢ to cover mailing costs.

QUIT WORRYING

Why be at the mercy of layoffs and overtime cutbacks? Now is your time for ACTION

LEARN HOW

Sharpening

PAYS OFF

BIG



Neighbors, hobbyists, barbers, beauty and pet shops, farmers, sportsmen, markets, restaurants, contractors, rental shops—everybody is your cash customer. **TREYCO 6-in-1 MACHINE** hollow-grinds knives, saws, tools, scissors, pinking shears, skates, clippers, planer and Dado blades, etc. Make as much as \$6 an hour. **6 MACHINES IN 1** for price of one. World-wide satisfaction since 1966. Write for **FREE CATALOG AND Factory-To-You Prices.**

TREYCO 322-A Niagara St.
N. Tonawanda,
N.Y. 14120



Easy to Build **PLANS AND INSTRUCTIONS** for
Go Kart\$2.00
Mini Bike\$2.00
Mini Car\$3.00
Pedal Boat\$4.00
Sail Boat\$2.00



**MINI VEHICLES
PLANS "DEPT. C"
P.O. Box 92
Chazy, N.Y. 12921**

Keep your copies of PM—and watch for the inexpensive *Annual Index*, available in December. It will enable you to locate any article which appeared in 1971 or find information on any particular subject in just a few seconds.

The *Annual Index* will make your copies of PM even more valuable!

POPULAR MECHANICS

CLASSIFIED ADVERTISEMENTS

Rate: \$2.00 per word payable in advance each insertion. Capitalized words—75¢ per word additional. Minimum insertion ten words. To be inserted under the proper classification, copy must be in our office by the 15th of the second month preceding date of issue. The next available issue to place an advertisement in America's No. 1 Classified Section is October. The closing date is August 15th. Send remittance and order to C. A. Martin, Popular Mechanics, 224 West 57th Street, New York, New York 10019. Please make remittance payable to Popular Mechanics.

WHEN ANSWERING ADVERTISEMENTS PLEASE USE THE ZIP CODE NUMBER

AUTOMOBILES

CLASSIC 1955-7 THUNDERBIRDS Original replacement parts shipped anywhere. SHELL'S, Box 767, S. MONICA, California (213) 393-9840.

EMERGENCY Highway Kit—Chemical Fire Extinguisher, Tire Inflator, Puncture Sealer, 2 Flares, Emergency Flag, Hand-wipes, Compact Carrying Case. \$12.95 PP. G&W Associates, 1650 Golfview, South Daytona, Florida 32019.

DON'T Get Stung Again. Know, Fix, Repair Your Own Volks, Ford, Chev. Volumes \$4.95 Each. The Establishment Press, P.O. Box #5645, Milwaukee, Wisconsin 53211.

AUTO SUPPLIES AND EQUIPMENT

AUTO Parts for old and new Cars, All makes. Catalogue \$1.10. Antique Auto, Milwaukee, Wisconsin 53204.

PARTS: Army jeep and truck parts. Spare Parts & Equipment Co., P.O. Box 751, Lexington, Kentucky 40502.

BURNING Oil?? . . . Smoking?? . . . Pep-less?? . . . Hard Starting?? . . . Save with Ring-Valve job while driving \$6.50. (Special: Two for \$12.00 postpaid.) Results guaranteed!! Motaloy, Grantham, Penna. 17027.

PREVENT Stolen cars. AUTO BURGLAR ALARM protects hubcaps, tires, stereos, radios, luggage. Easy installation. \$3.98. Guaranteed. Triangle Specialties, Box 20588, Sacramento, California 95820.

110 V. D. C. from Auto Alternator Operate A.C.-D.C. power tools 3000 W. Alternator remains operational. Cut no wires—Most Vehicles. Specify make model. \$25. or less. D. C. Electronics, Box 51, Eastlake, Colorado 80614.

BEAT the tuneup game with novel IGLIT, Q-Arc, Box 47876, Los Angeles, Calif. 90047.

JEEP Owners—V8 conversions. Read Jeep Owner's ad, page 179.

SNOWMOBILES

SNOWMOBILE Hop up accessory CATALOG. Speed and performance equipment—manifolds, exhaust systems. Send 25¢. G.E.M. PRODUCTS, Box 845, Carol Stream, Ill. 60187.

AUTO TRAILERS

PICKUP Camper, Trailer or Pickup—Cover . . . Build yourself. Save! Complete plans \$3.95 each Cover plans \$2.00. Conversion Plans—econoline type van \$2.95; passenger bus or delivery van \$2.95. Satisfaction Guaranteed. Equipment catalog \$1.00 (refundable). Details 10¢. Viking Camper Supply, 99-F Glenwood, Minneapolis, Minn. 55403.

CAMPER Plans and full sized patterns. The most detailed available with written and pictorial instructions. Various models and accessory kits offered. Send for literature—Glen L. 9152—PMH—Rosecrans, Bellflower, California 90706.

BUILD Your Pickup Camper. Precut kits, blueprints and supplies. Literature 25¢. Comstock Camper and Trailer Supply, Dept 664, Parsons, Kansas 67357.

MOTORCYCLES, BICYCLES, MOTORSCOOTERS AND SUPPLIES

BUILD Your own 3-Wheeled ATV/Trail Bike. No welding necessary. Can be easily converted to snowmobile for winter use. Plans \$2.00. Snowmobile conversion plans plus passenger-trailer plans \$1.00. Trail-Craft Industries, Box 250-DB, Center Harbor, New Hampshire 03226.

BARGAIN PRICES. Every part, Kart or Mini-bike. Giant Fun Catalog \$1.00. New, "how to" plans \$1.00. Both, \$2.00. Brown's Motorsports, 19P Central St., Worcester, Mass. 01608.

ILLUSTRATED Catalog 25¢. Parts, Accessories. Custom Stock, most makes, models. Cycle Supply, Box 192M, Fairbury, Ill. 61739.

INDIAN PARTS. Rebuilding. Accessories. Indian Motorcycle Sales, Kansas City, Missouri 64127.

BUILD "Popular Mechanics" MINIBIKE featured June 1967 issue. Detail plans, photographs \$2.50 refundable. Kits, parts, engines; factory discount prices. Catalog 25¢. Gilliom Mfg.; PMC; St. Charles, Missouri 63301.

HONDA, \$25.00. Other bargains. Send 50¢. Motorscooter, P-443, Bend, Oregon 97701.

ELECTRIC Bicycle. Ride All Day For Nickel. Complete Plans \$3.00. Electro, Box 27203P, Indianapolis, Indiana 46227.

FABULOUS All electric mini-bike. Noiseless. No gas required. Operates for pennies a day. Easily built from complete construction plans and booklet. All parts available locally. Send \$4.95 postpaid. Lectra-Bike, P.O. Box 82 PM, Washington, New Jersey 07882.

MOTORCYCLE Turn Signals. Accessories Catalog 35¢. Houston PM Lockport, Illinois 60441.

ELECTRIC MINIBIKE Powerful, Pollution Free, Instant Starting. Fun To Build. No Welding. Bolted Together Fork. Streamline Plywood Body, Trunk Compartment, Push Button Controls. Plans \$3.00. Howard Burks, W220 N3439 Springdale, Pewaukee, Wisconsin 53072.

GO-Karts, Mini-Bikes Engines. Accessories. Catalog 25¢. Loren Products, Danville, Illinois 61832.

SPACE, ROCKETS AND ASTRONAUTS

ROCKETS: Real flying models—flights up to 2500 ft. New illustrated catalog 25¢; Singles and multistage kit, cones, engines, launchers, trackers, rocket aerial cameras, technical information. Fast service. Estes Industries, Dept. 7-H, Penrose 7, Colorado 81240.

ROCKETS!! Real flying models—2500 feet altitude with powerful motors. Terrific Science Projects. Tubes—Cones—Parachutes—Launchers—Igniters. Gigantic catalog—rocket data—diagrams—25¢. Fast Delivery. Centuri Rockets, Box 1988, Phoenix, Arizona 85001.

MOON Landing Pictures, other historic space fantasies! Free Brochure! Box 234-PM. Merritt Island, Florida 32952.

MOTORIZED Electronic Rocket Launcher, Brochure, 25¢. Lercari Engineering, Box 90894, Los Angeles 90009.

ROCKET/PLANE—"BARON" Rocket blasts plane up hundreds of feet, plane glides free while rocket parachutes down. Precision metal engine, parts, launcher, flameless fuel for repeated flights. \$9.95 postpaid (Wash. res. add 5%), or send 25¢ for catalog (free with order). Vashon Industries, Dept. 121, Box 309, Vashon, Wash. 98070.



AVIATION

AIRBOAT, Propellers, Plans, Kits, supplies. 90 to 220 H.P. engines. Corvair, V-W conversions. Propellers, hubs, mounts for snowmobile engines. Catalog \$1.00. Banks-Maxwell, Box 3301E, Ft. Worth, Texas 76105.

HELICOPTER, One-man, Portable, Bubble canopy, Kits, Plans. Information 10¢. Photos and three-view drawings \$1.00. COMPCOP, Inc., Box 1267, Redwood City, California 94064.

AMPHIBIANS, Easily Built. Specifications, Photo \$3.00. Jet, 1800 Carmelo, Carmichael, California 95608.

ALL About Ballooning, Complete Handbook \$3.00. Aerostation, Box 141, Long Sault, Ont., Canada.

AIRBOATS: Outboard airdrives; 2-blade, 3-blade, 4-blade, 6-blade propellers; Plans; Engines. Descriptive Catalog \$2.00. Hovercraft, Airboat, Gyroplane Plans \$5.00 each. Twin Engine Hovercraft Plans, \$10.00. Arrowcraft, Box 3379-K, Sarasota, Florida 33578.

BE A Government licensed aviation mechanic. Practical training. Free Information. Atlantic Aero Mechanics School, Dept. PM-081, Municipal Airport, Kansas City, Missouri 64116.

(Continued on next page)

HOVERCRAFT

AERO-CAR. Amazing Hovercraft built easily with ordinary tools. Lawnmower engine power. Carries one man plus. Hovers, flies forward, backward, Sideways over land/snow/water. Complete construction plans and brochure. \$5.95. Aero-Projects, Box 5118PM, Clinton, New Jersey 08809.



BOATS AND TRAILERS

BOAT KITS, Hull Kits, Frames, Plans And Patterns. World's largest catalog. Over 200 top designs for the amateur builder. Sailboats 7' to 45'. Windmill, Snipe, El Toro, etc. Motor Sailors to 30'. Trimarans, Catamarans to 37'. Power—Cruisers to 40'. Deep V's. Fishing Boats, Runabouts, House Boats, Hydroplanes, in-board and outboard, all classes. Ferro Cement 33' to 45', sail and power. Send \$1.00 for new Plan Kit Catalog or \$2.00 for catalog plus Boatbuilder's Guide to Clark Craft, 16-P Aqua Lane, Tonawanda, N.Y. 14150.

FIBERGLASS Canoes, Kayaks, and Duckboats. Many exciting models. Easily assembled kits. \$39.95 up. Free Literature. Riverside Canoes, Box 5595P, Riverside, Calif. 92507.

PLANS, FULL-SIZE PATTERNS, FRAME KITS With step-by-step instructions specially for amateurs. Send \$1.00 for new catalog just off press—nearly 100 pages, over 80 designs 8' to 36'. Sail, Jets, Inboards, Outboards, Cruisers, Houseboats, Hot Boats, Catamarans, Hydros. Glen Designs. 9152 Rosecrans, Bellflower, Calif. 90706.

BUILD Your own boat from our large-scale blueprints. Books of plans give how-to-build help. Hundreds of professional designs—motor, sail or auxiliary—for amateur builders. Free catalog. MoToR Boating, 959 Eighth Ave., Dept. PM-RS, New York, N.Y. 10019.

FIBERGLASS Cloth and resin. World's finest cloth and non-run resin, at direct mill prices Flotation foam. Complete line of plastics, silicon bronze and brass screws, save 60%. No sales tax. Boat Plans. Catalog 25¢. Freight prepaid. Stiles Boat Supply, Box 11P, Linden Ave., Mantua Hts., N.J. 08051.

BOAT KITS—Assemble yourself from factory molded fiberglass sections, save 1/2 over factory built. Satisfaction guaranteed. Send \$1.00 for beautiful 80-page, fact-filled color catalog showing 20 models—14' to 32'—Cruisers, Runabouts, Houseboats, Sailboats, complete Accessories, Motors, Trailers, discount prices. Luger, Dept. BC-71, 1300 East Cliff Road, Burnsville, Minnesota 55378.

FIBERGLASS Cloth, matt, polyester and epoxy resins. Wholesale catalog 25¢. Boat Molding book 30¢. Seifert's, Box 1206-M, Green Bay, Wis. 54305.

NEW Outboards 1970 McCulloch and others. 4 HP . . . \$120. 9 Electric \$308 . . . 18 \$378. 60 Electric \$878 All Sizes. Literature 50¢. Electra Marine, 675 Merrick Road, Lynbrook, N.Y. 11365.

LIGHTWEIGHT FIBERGLASS PUTTY. Write: Hollow Microspheres, Box 24184-A, Seattle 98134. SAMPLE 50¢.

34 FOOT Fiberglass Houseboat Hulls. Stringers Installed. Can Be Adapted To Inboard Or Outboard Power. Write: Bailey Marine, Incorporated, P.O. Box 13072, Airgate Branch, Sarasota, Florida 33580.

"POONTOON Boat Kits, Molded Fiberglass, Assemble With Local Material And Save, Plans And Instructions, Free Brochure. Winter Manufacturing Company, Department A, 7221 North Peoria, Tulsa, Oklahoma 74126.

CAMPERS AND TRAILERS —KITS—PLANS—

PLANS—Pickup Campers \$4.95; Pickup Covers \$3.95; Vanette conversions \$3.95; Bus conversions \$3.95. Huge 166 page Supplies, Parts, Equipment Catalog with discount prices \$1.00 (refundable). Literature for Camper, Cover KITS 25¢. Order PLANS, 166 page Catalog, Kits literature from this advertisement. Savage, Box 377-C, Savage, Minnesota 55378.

CAMPER, Trailer, Cover Kits—assemble yourself, save 1/2 over factory built. Satisfaction guaranteed. Send 25¢ for beautiful 28-page fact-filled color catalog showing 12 models—pickup campers—covers; travel-tent trailers, discount prices. Luger, Dept. TW-71, 1300 East Cliff Road, Burnsville, Minnesota 55378.

BUILDING your own camper or houseboat? We have all of the parts you need, many items priced below factory OEM prices. Honorbuilt Camping Center at 306 W. 2nd in Minneapolis, Kansas 67467.

PICKUP OWNERS—New Detroit Approved Auxilliary gas tanks increase gasoline capacity by 40 gallons—write: R. P. M. Inc., P. O. Box 7936, Dept. 4, Waco, Texas 76710.

MARINE EQUIPMENT AND SERVICES

MARINE Engines, conversions, parts, equipment. Catalog Free! Stokes Marine Industries, Coldwater, Michigan 49036.

FREE Brochure—Engines, Gears, 1/0's, Conversion Kits—Gas—Diesel, StarMarine, 1931 Embarcadero, Oakland, Calif. 94606.

CONVERT Auto engines to marine. 68 Page Catalog, 50¢. Lehman Manufacturing Company, 800 Elizabeth Avenue, Linden 4, New Jersey 07036.

MARINE Supplies, Ignition Parts. Free literature. Michael's, 991 Broadway, Bayonne, New Jersey 07002.

ATHLETIC AND BODY BUILDING COURSES

POWERFUL Muscles fast! Free brochure! Universal Bodybuilding, Box 4327-C, Dearborn, Michigan 48126.

"GIANT Arms." Dr. Young's, D.C. revolutionary discovery. \$2. Satisfaction or refund. Gaucho, 1769-S7, Chicago 60690.

WEIGHT Exercising Equipment, Free Literature, Jubinville, Box 662, Holyoke, Mass. 01040.

"YOU Can Bench Press 400 Pounds!"—\$5.00. "20 Simplified Plans Of Weight Training Equipment!"—\$5.00. Both \$9.00!!! William Hinbern, 18959 Inkster, Livonia, Michigan 48152.

SEVERAL INCHES TALLER, DR. A.S. makes his patients. Vol. I, Case & Medical Histories, \$2.98. Vol. II, Vitamins, Glands & Growth, \$1.98. Vol. III, Exercises & Movements \$1.98 Or get all three for \$5.98. Physical Culture Products-PMI., Box 1548, Pompano Beach, Florida 33060.

SPORTING GOODS AND EQUIPMENT

FREE Catalog low direct factory prices, fishing, Hunting, Archery, reloading Camping supplies. Send today. Herters Inc., Dept. CPM, Waseca, Minn. 56093.

FREE . . . Wholesale Catalog. Arrow Shafts, Broadheads, Fletchings Fisharrow Parts, Tools, Bows, Finnysports. (22G), Toledo, Ohio 43614.

ARCHERY Lowest Discount Prices. All top brands. Orders shipped same day received. Money-back guarantee. World's Largest Supplier. Free catalog. Anderson Archery Corporation, Grand Ledge, Michigan 48837.

GOLFERS' Precision Range Finder, \$6.95. Perfect Gift. Paras, 8A Gude Street, Seekonk, Mass. 02771.

HUNTING KNIFE. Make Your Own. Beautiful Design—Blueprints With Material Listing \$1.65 Complete. Knife, Box 997, Black Mountain, North Carolina 28711.

CROSSBOWS Powerful Accurate. Catalog 25¢. Crossbowman, Box 723PM7, Manteca, California 95336.



FISHING, TACKLE, LURES

ONE Fly for all trout? All waters and seasons, too! \$1.00 pair. Randolph, Box 903, Boulder, Colorado 80302.

MOLDS For fisherman's sinkers, jigs, squids, casting and spinning lures. Free catalog. Sweet Molds, Tonawanda 1, New York 14150.

SEND FOR FREE Wholesale Catalog. The most complete and fully illustrated catalog of reels, rods, beads, spinners, jigs, bodies and parts, sinker molds, feathers, tools, hooks, rod blanks, rod parts, swivels, wire, etc. FINNYSPTS, ME Sports Bldg., Toledo, Ohio 43614.

MOLDS—For casting your own fishing sinkers. Free illustrated booklet. Reading Instrument Co., Box P78, Reading, Pa. 19603.

FISHERMAN'S DREAM BOOK—FREE. 170 Pages, pocket size and loaded with Hard To Find Fishing Specialties and Do-It-Yourself Goodies. Our 27th year. NETCRAFT, Inc., Box 5510, Toledo, Ohio 43613.

CLOSE Out BARGAIN. Small gamecock neck capes. \$5 per dozen plus \$.40 postage. FEATHERS, Box 45, Eau Claire, Wis. 54701.

EARTHWORMS, LIVE BAIT

HYBRID Redworms 5000 \$10.00, 20,000 \$20.00 Postpaid with Raising Instructions, Worms, Route 9, Waco, Texas 76705.

EARN Money raising fishworms for us! Exciting details free! Oakhaven—56. Cedar Hill, Texas 75104.

UNLIMITED PROFITS—Raising better fishworms—Nograin Soilless Method. Lee's, Box 326-M, Queen City, Texas 75572.

FROGS, FISH, REPTILES

PROFITS FROM CLASSIFIED ADVERTISING! Booklet shows you how to start your own business with Classified Advertising. Only \$1.00 (Refundable with first order.) C. A. Martin, Popular Mechanics, Dept. PM, 224 West 57 Street, New York, N.Y. 10019.



HUNTING, GUNS, DECOYS

DEER! How to get them stories. 60 pages, pictures, tips, \$2. Order Now. Lew Publishers, PM8-8, Holland, Mich. 49423.



POULTRY & GAME BIRDS

EGGS, Chicks (started & adult). Pheasant, quail, chukar, waterfowl, turkey—game & ornamental, Bantams & chicken. Free price list. Northwest Farms, Inc. Box 3003 (PM), Portland, Oregon (503) 233-4659.

QUAILS, Incubators, cages, supplies catalog. Marsh, 14216 Brookhurst, Garden Grove, Calif. 92643.

RABBITS—FUR BEARING ANIMALS

\$600-UP MONTHLY. People needed. Raise rabbits, other laboratory animals for us. Huge market. We supply equipment, breeders and instructions. Details 25¢. National Research Farms, PNMA8, Box 309, Milwaukee, Wisc. 53201.

RAISE Rabbits successfully by knowing facts. 48 page illustrated book describing 25 breeds. Housing, breeding, feeding, markets, marketing etc. 25 cents. American Rabbit Association, 36 Arba Building, Pittsburgh, Penn. 15217.

AMAZING PROFITS! \$10,000 Yearly Raising Rabbits for Wool and Breeding. Details 25¢ coin. American Angora, Malta 12, Montana 59538.

(Continued on page 188)

If you can draw fairly well (but still not good enough)

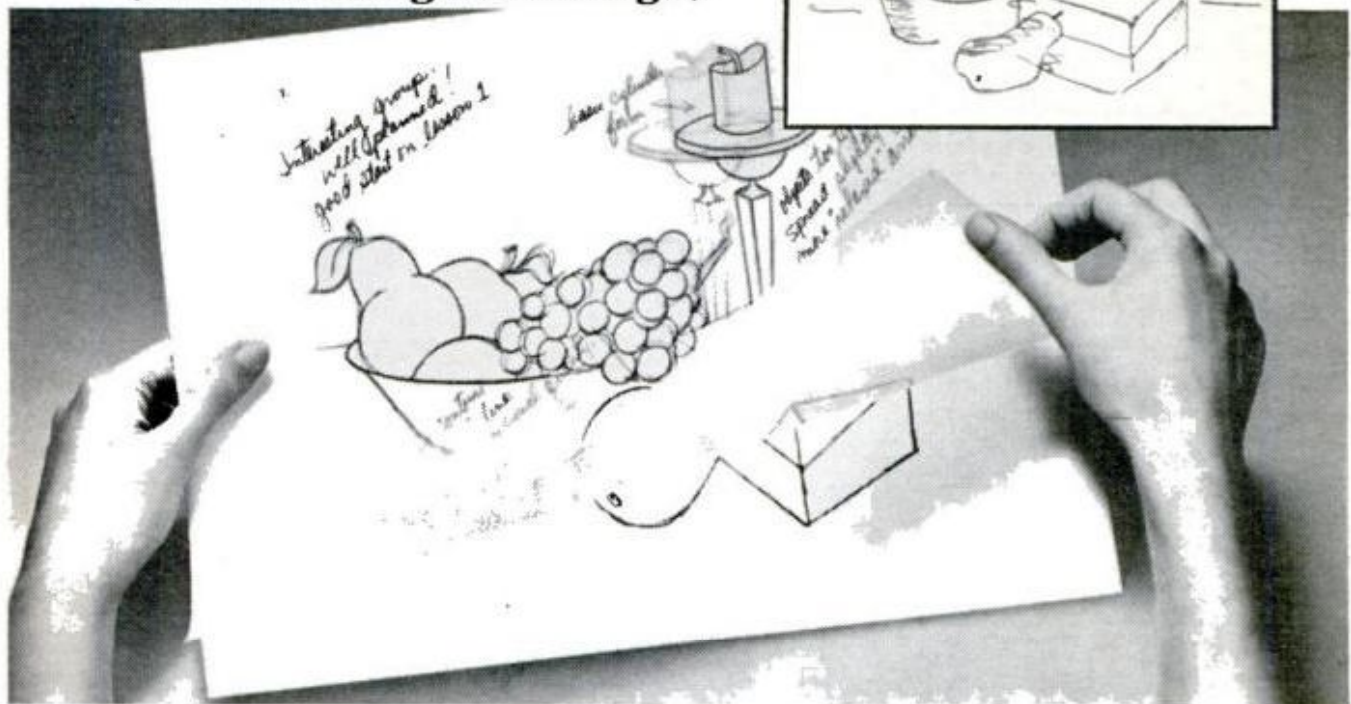

...we'll turn you into a real artist

There are thousands of people who have been drawing better than average ever since they were in grade school...but who never improve. They're "stuck" on the same plateau of amateur skill. They keep repeating the same mistakes.

And it's a shame too, because with proper professional guidance they could develop real professional skill, and start getting well paid part-time or full-time for enjoying themselves in art.

If you're one of these people, we'd like to hear from you. For 55 years we've been teaching people like you to draw and paint with professional skill. And because we teach entirely by mail, you don't have to leave your job or family to attend classes. You learn right at home in your spare time.

Our course gives you solid training in all facets of both drawing and painting. You become equipped to go wherever you want in art—whether it's into landscape painting, advertising layout work, fashion illustration, or whatever.

Our lessons show you step-by-step what to do. Then as you complete each assign-

ment, you mail it in to us for professional appraisal. Your instructor uses transparent overlays (see example above) to show exactly where you went wrong and how to improve your art.

To learn more about our course and the success of WSA students, send for our free booklet. We'll also send you two free art lessons. Just mail bound-in postpaid card—or if card is missing, use coupon.

© 1969, Washington School of Art

Send for 2 free lessons

Washington School of Art

Studio 44-005

Port Washington, New York 11050

Gentlemen: Please send me your free booklet, *Art for Pleasure and Profit*, describing your personalized home study course in art. I would also like to receive two free sample art lessons. I understand that there is no obligation.

Mr.

Mrs. _____ Age _____

Miss _____ Print Name

Address _____

City _____

743 State _____ Zip _____



Washington School of Art

For over 50 years...

a good place to "go" to art school without leaving home

RABBITS—FUR BEARING ANIMALS

(Continued from page 184)

INFORMATION 25¢/Raise for Staloch's Rabbitry, Box 6302, Rochester, Minn. 55901.

RAISE Rabbits for us on \$500 month Plan. Free details. White's Rabbitry, Mt. Vernon, Ohio 43050.

FACTS About small animal breeding. Write—Madeline, P.O. Box 1637, Brooklyn, New York 11202.

RAISE Chinchillas. Catalog—\$1.00—Refundable. De Shon Chinchilla Ranch, Dept. PM, Route Two, Roanoke, Indiana 46783.

MAKE Big Money Raising chinchillas, rabbits, guinea pigs for us. Catalog 50¢. Keeney Brothers Farms, New Freedom, Pa. 17349.

PETS—BIRDS, CATS, HAMSTERS, ETC.

BUY DIRECT—Save: Monkeys, Ocelots, Birds, Reptiles, Wildlife Books. Catalog 25¢. Exotic Animal Importers, Inc., Box 1675, Miami, Florida 33138.

950 PICTURE Pet Hobby Supply Catalog 50¢ "Everything—You Name It." Stromberg's Pets Unlimited, Fort Dodge 25, Iowa 50501.

HAWKS, Reptiles, raccoons, skunks, squirrels. Catalogue 25¢. Trails End Zoo, St. Stephens, S.C. 29479.

INTERNATIONAL Champion Cuppies, Bettas, Supplies. Send 25¢ for catalog. Fish Market, Ortonville, Michigan 48462.

HORSES, LIVESTOCK

"HOW TO TRAIN HORSES"—Everyone who likes horses or ponies should have this book; FREE. Write Beery School, 1108, Pleasant Hill, Ohio 45359.

CAMPING EQUIPMENT AND TENTS

FREE Catalog! Camping, Boating, Sailing Supplies; Gadgets, Hardware and Gifts. Laacke and Joys, 1439 N. Water St., Milwaukee, Wisconsin 53202.

CAMPING

PROFITS FROM CLASSIFIED ADVERTISING! Booklet shows you how to start your own business with Classified Advertising. Only \$1.00 (Refundable with first order.) C. A. Martin, Popular Mechanics, Dept. PM, 224 West 57 Street, New York, N.Y. 10019.

TRAVEL AND RESORTS

FLORIDA VACATION CERTIFICATE SAVES UP TO 75% OF ROOM COSTS! Available to couples under 60. Four full days in selected resorts. Send \$2.00 for detailed report. V. V. HARTON, P. O. BOX 529-PM, BATTLE CREEK, MICHIGAN 49016.

PROFITS FROM CLASSIFIED ADVERTISING! Booklet shows you how to start your own business with Classified Advertising. Only \$1.00 (Refundable with first order.) C. A. Martin, Popular Mechanics, Dept. PM, 224 West 57 Street, New York, N.Y. 10019.

ELECTRICAL SUPPLIES

LAMP Parts. Catalog, prices, wiring instructions. 50¢. Refunded first order. Gyro, 5218P N.W. 35 Ave., Miami 42, Florida 33142.

BOOK: Simplified System of Conduit Bending \$3.00. Recommended by IBEW. Goforth, P.O. Box 1592, Lakeland, Florida 33802.

LAMP Parts for building, repairing converting. Catalog 50 cents. Refunded first order. Brown Lamp Co., Box 12511, Creve Coeur, Missouri 63141.

BATTERIES, GENERATORS

BATTERY Reconditioning Kit, includes molds, material, instructions. Battery Shop, Box 820, La Quinta, California 92253.

ENGINES, MOTORS, MAGNETS

WINDING Data, 275 motors. \$1.20. Data Company, 512 Kensington, Kansas City, Mo. 64124.

MACHINERY, TOOLS AND SUPPLIES

WINCHES And **HOISTS**. Choice of 12 volt or 110. Reversible, compact, fast. 1/4 ton to 1 ton capacity, from \$49.95. 25¢ brings 16 page full color catalog. Refundable. Superwinch, Inc., Pomfret, Connecticut 06258.

ROUTER Bits, 1/4" shank, high speed, used; excellent condition, \$2.50 dozen postpaid. Lillian's, Box 17165, Chicago, Illinois 60617.

LATHE Milling attachments. Blueprints too! Write. Potter, Box 73, Cedar Rapids, Iowa 52406.

MICROMETERS—Indicators. Steel—Aluminum—Brass. Maximat, Unimat Lathes. Complete mailing—50¢. Campbell, 1424 Barclay, Springfield, Ohio 45505.

SMALL Foundry furnaces. Supplies. Free literature. Pyramid Products, 3736 South 7th Avenue, Phoenix, Arizona 85041.

FREE Catalog—Micrometers, Dial Calipers, Indicators, Unimat Lathes—Raymond Leung, Room 136, 664, King's Road, Hong Kong.

ECONOMICAL Bench Mill, Plans \$2.50. Microm, Box 2313-A, Santa Ana, California 92707.

WELDING, SOLDERING, PLATING

PLATING Equipment, Portable Platers, Supplies, and "Know-How". Build your own tanks for nickel, chrome, etc. Easy-to-install PVC liners. Rectifier components—all sizes. Schematics, parts lists, formulas, operating instructions for all plating. \$10.00 post-paid. Guaranteed to save you 25%-75% or immediate refund. Some good used units for sale. Platers Service Company, 1511-A, Esperanza, Los Angeles, California 90023.

CONVERT To Heliarc, Plans \$4.00. Convert AC Welder To DC \$3.00. Information Supplies Company, Box 166, College Park, Maryland 20740.

MORRIS—Welders—110/220, 150 Amperes, \$53.50. 1070 Inner, Schenectady, New York 12303.

GOVERNMENT SURPLUS

JEEP And Gov't. Surplus Buying Manual (Jeeps Pictured) 50¢. Surplus Bargain Catalogue 50¢. Both \$1.00. Surplus Bargain, Box PM789, York, Penna. 17405.

1971 SURPLUS Army, Navy store illustrated catalog. Send 50¢ (refundable with first \$5.00 order). Ruvel, 3037 North Clark, Dept. 8-J, Chicago, Illinois 60614.

JEeps Typically From \$53.90 . . . Trucks From \$78.40 . . . Airplanes, Typewriters, Boats, Clothing, Camping, Sporting, Photographic, Electronics Equipment, Wide Variety, Condition. 100,000 Bid Bargains Direct From Government Nationwide. Complete Sales Directory and Surplus Categories Catalog \$1.00 (Deductible First \$10.00 Order From Our Separate Included Catalog). Surplus Service, Box 820-A, Holland, Michigan 49423.

NO CATCHES. Buy any surplus direct from U.S. gov't. All information \$2.00. Bridgeworth, P.O. Box 2292-C, Vancouver, Washington 98661.

GOVERNMENT Surplus. Complete Sales Directory and Buying Guide \$1.00. Surplus Publications, Box 26062-M, Los Angeles, Calif. 90026.

GOVERNMENT Lands. . . Low as \$3.50 acre! Millions Acres throughout U.S. . . . Canada. Free Details! Land Digest, Box 11071-P, Indianapolis, Ind. 46201.

GOVERNMENT SURPLUS How and Where to buy in Your Area. Send \$1.00. Surplus Information Headquarters, Box 30177-PM, Washington, D.C. 20014.

JEeps From—\$52.50; Typewriters from \$4.15; Cars from—\$31.50. Walkie-talkies, motorcycles, airplanes, boats, Typical "As Is" bid bargains from Uncle Sam. Tremendous variety. Exciting free list. Write: Enterprises, Box 402/71, Jamaica, New York 11430.

MAKE Money on Government Surplus. Booklet \$1.00. Marion, 13217 Bellevue Street, Silver Spring, Maryland 20904.

HOW To Make Money on Government Surplus. Booklet tells How to Buy And Sell For Big Profit. \$1. Handy Products, P.O. Box 85, Raceland, Louisiana 70394.

MAKE MONEY With Government Surplus. Copyrighted Report reveals secrets. Lists sources. Send \$1.00, Potter's, 106 Bellevue, Newport, Rhode Island 02840.

HOBBIES AND COLLECTIONS

SHOULDER PATCHES—Collectors Items. Official Apollo patches three dollars each Postpaid. U. S. Army and Air Corps patches. 10 assorted patches, price list and catalog \$3.50. Catalog only 50¢. Springer's, Box 577-PM, El Paso, Texas 79944.

COLLECT Military (Medals. List 25¢. Vernon, Box 387PM, Baldwin, N.Y. 11510.

BEAUTIFUL Full color tapestry 20x40 showing astronauts planting flag on moon. \$4.95 ppd. Money back guarantee. Jagcat, Box 1023, Newark, Delaware 19711.

STARTLING NAZI PHOTOS. Sample and illustrated list only 25¢. Hutchinson House, Dept. PM99, Box 6411, Chicago, Illinois 60680.

DECALS, EMBLEMS, PATCHES

A-B EMBLEM Custom Embroidered Patches. Sew-on or Iron-on. Sensible Prices. Fast Delivery. 25 or 25 million. Write for free Design Guide. World's largest emblem makers. A-B EMBLEM CORPORATION, Box 5695, Weaverville, North Carolina 28787.



STAMP COLLECTING

YOURS FREE! 32-page Stamp Finder . . . the most useful, practical How-To-Do-It Stamp Collector's Guide ever published. Illustrated, indispensable, tells the country to which any stamp belongs and where to place stamps in your album. Plus U.S. and Foreign Identifier, dictionary, etc. Also, exciting stamps on approval; return with or without purchase, cancel service anytime. But exclusive Stamp Finder is yours to keep—FREE! Send 10¢ for handling. H. E. Harris, Dept. ST-1, Boston, Mass. 02117.

YOURS Free! 20 Almost Rare Stamps from 12 Lost Nations—Most a Half-Century Old! Nations overrun by invaders and never freed again. Stamps so appealing that experienced and beginning collectors alike will want them. You get 110 other stamps from Britain's Lost Empire plus illustrated Album to keep as a Bonus should you buy \$1 from our Approval Selection. Or return Album and 110 stamps with selection and buy nothing. Cancel Service anytime. But Lost Nations Stamps are yours to keep! Send 10¢ for mailing while supplies last. Kenmore, Milford LN-840, New Hampshire 03055.

SEND Only 10¢ for nice collection of U. S. stamps including "\$5.00." Issue and scarce mint Sipex Souvenir Sheet. You will also receive the most wonderful catalog of stamp offers in America. Littleton Stamps, Dept. SS1, Littleton, N. H. 03561.

FREE! To Approval Applicants. 55 Different, including Triangles, Space, others. L. Baird, PM-29, Box 8128, Portland, Oregon 97207.

KOREA 25 different 10¢. Approvals. Hijop, Box 505, Norristown, Pa. 19404.

FREE Mint set. Approvals accompany. Stamps, Box 22092, Memphis, Tenn. 38122.

(Continued on next page)

STAMP COLLECTING

(Continued from preceding page)

UNITED STATES Commemorative collection containing 33 different—10¢. Approvals. White, 516-A Avenue L, Brooklyn, New York 11230.

U.S. SOUVENIR Sheets, 778—797—948—1311. All 4 Unused \$1.00. Giant Stamp, 122 Brighton 11th Street, New York 11235.

FREE Apollo Color Photo. Approvals. Pickrell, Box 10129, Norfolk, Virginia 23513.

SEND Only 5¢ for Worldwide Collection of over 50 different Singapore, Grenada, Chad, etc. Contains old and new issues, sports, animals, etc. You will also receive interesting lists and a certificate worth 50¢ toward purchases. Goliath Co., Dept. TP-1, Bethlehem, N. H. 03574.

STAMPS Free! New issues—New Countries—Triangles—Rockets—Olympics—Scouts—Birds—Flowers—Animals—Also old Canadian and U.S. Stamps. Plus complete illustrated Canadian Stamp Catalog. Send 10¢ for mailing. Gray Stamp Co., Dept. A, Toronto, Canada.

FREE! RECEIVE HUNDREDS Of lists and gifts from dealers World-Wide. Send name, address, and interest(s) to: Harvey Meredith, 1249 Kentucky, Bowling Green, Kentucky 42101.

FREE! Nice worldwide collection. Discount Approvals, 447P, Chico, Texas 76030.

FAMOUS Painting collection 15 different—depicts work of art found in museums of the world—10¢ with worldwide approvals. Modern Stamps, Dept. 57H, Ferrysburg, Michigan 49409.

BEAUTIFUL TOPICAL COLLECTION—Includes Olympic sport stamps, wild animals, bicolor triangles, colorful birds, outer space stamps, Poland kitten stamp and others. 10¢ with approvals. Sunny Stamps, Dept. 57A, Fruitport, Mich. 49415.

225 STAMPS For only 10¢! Airmails. Pictorials: stamps from strange countries cataloging up to 25¢ each! Plus unusual stamps to examine. Buy any or none return balance, cancel service anytime. Mystic Stamp Co., Camden 80, New York 13316.

PAINTINGS On Stamps—25 different 25¢; approvals accompany. Northern Stamps, Box 565, Hull, Quebec, Canada.

FREE! Includes—Space Kennedys—Flowers—Birds—Animals—Sports—Triangles. Approvals Included. Send 10¢ For Mailing. Stamp-A-Nanza, 1904 Broad, Schenectady, New York 12306.

SENSATIONAL Clearance. Forty different packets \$1.00. No approvals. Norge, Wyckoff, New Jersey 07481.

FREE \$120 Zeppelin World Stamps. Details 10¢. Farmers Stamp Market, Waterville, Iowa 52170.

FREE! BIG Bargain Catalog—New Edition listing thousands of bargains including U.S. & B.N.A. stamps, packets, albums, accessories and supplies. Also, fine stamps from our approval service which you may return without purchases and cancel service at any time. Jamestown Stamp, Dept. E81PM, Jamestown, New York 14701.

U.S. MINT Specials! Flag set, complete \$1.00. 1¢, 2¢, 3¢ famous Americans (21 different) \$1.00. Free list. Brooks, 2601 Avenue "U", Brooklyn, N.Y. 11229.

"AFRICA." 25 Beauties. 10¢. Approvals. Gorfiz, Box 1915PM, Naples, Florida 33940.

PENNY! Approvals! Regardless catalogue! Kloster, 4164 52nd St., San Diego 5, Calif. 92105.

U.S. BARGAIN. 50 Different 10¢. with beautiful worldwide, approvals. Stamp Center, Kennebunk, Maine 04043.

50 DIFFERENT Old U.S. Revenue Stamps 50¢. Winchester Stamps, Box 1592, Mansfield, Ohio 44907.

FREE Surprise collection sent with approvals. Gould, 1784 Union, San Francisco 94123.

PENNY Stamps! 1000 Mounted in book at 1¢ each! Trust Stamp Company, P.O. Box 100-P, Jamaica, New York 11435.

ABSOLUTELY Free United States Mint Souvenir Sheet When Requesting United States Approvals. K&B, Box 70, Brooklyn, N.Y. 11223.

100 DIFFERENT United States, only 25¢ with Approvals. Shelron, Box 547C, North Miami, Florida 33161.

100 OLD United States between 1861 and 1935. \$1.00. Roush Stamps, 423 Shepard, Mansfield, Ohio 44907.

500 DIFFERENT Stamps, \$1.00. Smith, 508-A Brooks, College Station, Texas 77840.

QUALITY AND LOW PRICE. EXCELLENT For advanced or beginner. Mounted approvals 2¢ up, all countries in Scott's Order. Preview Stamps, P.O. Box 9809M, San Diego, California 92109.

210 DIFFERENT U.S. Commemoratives \$1.00. Stamps, 7607 Larchview, Dallas, Texas 75240.

RUSSIAN Space collection 25¢. Russian Approvals. Snedco, Box 68-P, Waldwick, N.J. 07463.

14,000 DIFFERENT! AMAZING New plan builds your collection systematically, country by country. Only 50¢ weekly. Ware, Monroe, Conn. 06468.

TEN Different Nudes: 20¢. Approvals. Stamp Farm, 2M33, Oxford, Wis. 53952.

AMERICANS On foreign stamps, Presidents, Kennedy, Roosevelt, Lincoln, U.S. Spacemen, Princess Grace and others. 10¢ with approvals. Roseland Stamps, Dept. 57, Spring Lake, Michigan 49456.

NOW Rockets, Paintings, Giant beauties, others. 10¢. Approvals. Tiquet, Box 1496 Denver, Colorado 80201.

FAR EAST ASSORTMENT—VIET NAM, JAPAN, KOREA, Formosa and others only 10¢ with world wide approvals. Clark Stamps, Dept. 57V, Muskegon, Michigan 49444.

25 U.S. FREE With Approvals. Collier, Box 755, Folkston, Georgia 31537.

100 CANADA 25¢. Excellent value. Approvals. Continental, Limehouse, Ontario, Canada.

FREE Duplicate Exchange—2¢ Approvals. Belden, Box 4175B, Dearborn, Michigan 48126.

500 WORLDWIDE \$1.00! F. Ross, 320 Rockland Road, Wayne, Penna. 19087.

FREE Stamp Wallet with approvals. Wide choice collections by countries. Clark, Box 38, Wilmette, Illinois 60091.

"WHOLESALE" U.S.—Foreign Pricelist and catalog Free! Everything Guaranteed. Schneider, Box 1240, Grand Rapids, Michigan 49501.

15 LARGE Ireland Commemoratives 25¢. Penniston, Box 5502, Arlington, Virginia 22205.

WOW! 110 ALL DIFFERENT GERMANY 10¢. Commemoratives, Airmails, High Values, Big catalog, bargain lists. Also, fine stamps from our approval service, which you may return without purchases and cancel service at any time. Jamestown Stamp, Dept. A81PM, Jamestown, N.Y. 14701.

POLAND—50 Different post-war Pictorials, including complete sets, only 10¢. Approval Applicants. Kayco, P. O. Box 437 (Dept. M) Flushing, New York 11367.

100 DIFFERENT British Empire 10¢. Approvals. Gibson, Box 34, Lansdowne, Pa. 19050.

FREE 50 Worldwide. Approvals. University Stamps, P.O. Box 1471, Lake Worth, Florida 33460.

"INVERTED Error" Dag Hammarskjold, 10¢ with approvals. Belmont Stamps, Washington, D. C. 20015.

"SPACE STAMPS" 25 Different, 10¢ Approvals. Hunt, Box 628, Stony Brook, New York 11790.

1500 FOREIGN \$1.00; 5000 \$3.00; 9000 \$5.00. 5000 USA, Contains airm, dues, presidentials, revenues, 19th Century, high values, etc. \$3.00. 300 pre-1940 USA Commemoratives \$2.00; 700 \$4.00. No approvals. Meyers, 5321 Fleming, Richmond, California 94804

OLDER UNITED STATES Approvals to adults only. Intriguing, worthwhile. Engle, Box 208P, Lowell, Michigan 49331.

102 DIFFERENT Germany 10¢. Free Apollo 11. Set approvals. Stamps, Box 11765, Phoenix, Arizona 85015.

APOLLO 11 Moonlanding. Seven multi-colored giants from Guinea, catalog value \$3.41. Only 20¢. Topical Approvals. LeBlanc, Box 110, Glen Cove, New York 11542.

50 DIFF. U.S. Commemoratives 25¢ Approvals. We Pay Postage. Craig Stamps, Box 118-N, Bellmore, New York 11710.

APPROVALS: Plus Collections By Year. Martus, Box 251, Bushkill, Pennsylvania 18324.

AMERICAN REVOLUTION Bicentennial stamp on lovely cacheted First Day Cover addressed in your name. 50¢ Each. K. M. WALSH, Box 308 G Tuckahoe, New York, 10707.

COLLECTION of 32 different Boy Scout Postage stamps showing scouts in uniform from 32 different countries. All for only 25¢ to introduce our bargain approvals. Stampex, Box 47-BM, White Plains, N.Y. 10601.

80 DIFFERENT U.S. stamps. Includes 1943 flag stamp of occupied nations. Only 25¢. Approvals included. Willett Co., Box 338-M, Yorktown Heights, N.Y. 10598.

50 YEARS Old, fifteen different United States, over fifty years old—10¢ with approvals. Jaxon, Box 145-P, Brooklyn, New York 11230.

"HUNTING Animals" Gigantic Bicolored latest 1971 Hungary Commemoratives—Free! Approvals plus 101 Bonus Sets. William Deems, 226 Race, Ravenswood, West Virginia 26164.

20% DISCOUNT Stamp Accessories And Albums. Ninetysix Page Illustrated Catalog 25¢. Quynn's, Scotland, Pennsylvania 17254.

MINT Sheets Foreign Stamps. Sample sheet plus list 25¢. Stamps, Box 27, Fremont, Michigan 49412.

50 DIFFERENT Topicals (Space, Etc.) 20¢. Approvals. Cambridge, Box 2311, Heath, Ohio 43055.

FREE—Colonial collection; request bargain approvals. Gaines, Box 788-C, Mattoon, Illinois 61938.

200 WORLDWIDE 10¢ With approvals. White, Box 26265-VA, Indianapolis, Indiana 46226.

307 DIFFERENT Triangles, Sports, Topicals, etc. Worth near \$8.00. Only 25¢. Bargain approvals. Jayto Stamps, East Syracuse, New York 13057.

PHILATELIC Quiz? Do you own a 1971 Scott's catalogue? Do you collect general foreign? Do you have duplicates you'd like to swap for stamps you need? If the answer to all 3 questions is Yes, send a postal for further information to: Potomac Stamp Exchange, Box 98A, Greenbelt, Maryland 20770.

50 DIFFERENT Plus nude set 10¢ Approvals. Paschall, 3035 McGowan, Marion, Iowa 52302.

INCREDIBLE Worldwide Collection—10¢. Includes Attractive Pictorials, Commemoratives, High Values, Old And New. Worth Dollars At Catalog Prices. Interesting Approvals Accompany. Bill, B103, Fairfield, Illinois 62837.

FINE Worldwide used Quality mounted Approvals, Reasonably priced at 2¢ up. References. Adults only. Free gift with initial selection. Franklin, Box 467B, Jamaica 11434.

(Continued on next page)

COINS, TOKENS, CURRENCY

ALL THREE Guides of U. S. Stamps, Coins, Paper Money. Only \$2.98. Prince Specialties, 54 Prince Lane, Westbury, New York 11590.

COIN Price List, send 25¢ to: Aurora Coin, Box 724-PM, Lynnwood, Washington 98036.

FREE \$3.50 Collection to member-prospects, plus guidebook, price lists, specials. Send \$1.00 registration, PP. Coin Club—C3, 2928—41 Avenue, L.I.C. New York 11101.

UNITED STATES Super Silver Package, 8 coins, Plus 15 BU foreigners, only \$2.00. Coins, Box 143, Canton, N. C. 28716.

BEAUTIFUL Brilliant Uncirculated Silver Dollars—Ten Different Dates 1878 to 1904 \$42.89. New 1972 Redbook \$2.49; List other Bargains 15¢. Bebee's, Incorporated, Omaha, Nebraska 68111.

SEND Only 5¢ for valuable booklet "How To Collect Coins" which is loaded with expert advice. You will also receive 5 different foreign coins and your copy of the most unusual and interesting collectors catalog available anywhere. Littleton Coins, Dept. VB-1, Littleton, N.H. 03561.

\$10 PER Pound! Thousands of Indian & Lincoln cents from 1860's thru 1920's. Sample mixture of 20—\$2. Mrs. A. C. Fisher, Box 1778, Encino, Calif. 91316.

FREE \$3.50 Value Collection! Official guidebook, price lists, specials, Send 50¢ pp. Numiss, C1, 4115-29th Street, LIC, New York 11101.

LINCOLN'S: 10 Different Before 1940, 25¢. Stevens, Box 546-F, North Miami, Florida 33161.

COMPLETE U.S. List: Cents to Silver Dollars + Supply List + \$1000.00 banknote 25¢. Schultheis, Box 151-M, New Hyde Park, New York 11040.

SILVER DOLLARS Uncirculated, 1880-81—1883-84-85 \$5.00 Ea. Catalogue 50¢, Shultz, Salt Lake City, Utah 84110.

ROOSEVELT Dime Specials. All Very Good Or Better. 1949S—80¢, 1955—\$1.50. 1955D—65¢, 1955—40¢. All Other Dates Are 25¢ Each. Complete Set Of 55 Different With Album For \$14.50. Satisfaction Guaranteed. Bryson Inc., 612A White, Toledo, Ohio 43605.

22 "S" Lincolns, including 1955S, \$1.75, 26 1909-1939, \$1.75. 10 "S" Jeffersons, \$1.75. All Different. All three \$5.00. HARRIS, Box 2037P, Santa Cruz, California 95060.

1955-S LINCOLN And 18 Different "S" Pennies—\$1.00. Edmund Molzan, Box 275, Alameda California 94501.

BRIGHT 1943-P-D-S Lincoln Set \$1.00. Catalog 25¢. Village Coin Shop, Dept. P., Plaistow, N.H. 03865.

UNIQUE. Netherlands Antilles square nickel, very rare, uncirculated. Airmailed anywhere \$1.00. Numismatic, P.O. Box 88, Oranjestad, Aruba, Netherlands Antilles.

"COLLECTING For Profit", Coin Bargain List. Folder and 5 U.S. coins, \$1.00. Venable, Box 673, Westminster 92683.

GOLD 1865 Mexican Peso BU \$1.95. Olmsted, 111 Terrace, Franklin, New Hampshire 03235.

BU 1954-S Cents: Nine for \$1.00, 16¢ Postage, Mustain, Box 2247P, Seal Beach, California 90740.

1955-S LINCOLN 25¢. FREE Bargain List. Ron Farley, Metamora, Illinois 61548.

BUYING Kavis-Kennedy Dollar Bills, Private Collector will pay up to \$100. Send \$1.00 for complete listings. Robert J. Kerensky, 1300 Park Newport 314 Newport Beach, Calif 92660

ANTIQUES, RELICS, INDIAN GOODS & CURIOS

EVERYBODY LIKES DIXIE GUN WORKS.

LIST Indian relics. 10 Arrowheads \$3.00. Hyde's, Box 2304, Santa Fe, New Mexico 87501.

TONS Of antique gun parts and supplies. All reproduction muzzle loading guns. Send \$2.00 for enlarged illustrated catalog No. 120. Dixie Gun Works, Union City 12, Tennessee.

10 PERFECT Arrowheads \$4.00. Smith, 9825 Conway Drive, Indianapolis, Indiana 46236.

INDIAN Relic list. Arrowheads \$4.00 doz. Folsom, \$5.00 each. C. Secrist, Muscatine, Iowa 52761.

SELLING 20,000 Indian relics, Arrowheads, spearheads, tomahawks, ceremonials, etc. List 10¢. Lear's, Glenwood, Arkansas 71943.

OLD BOTTLE MAGAZINE 60¢, \$5 Yearly, Box 243-PM, Bend, Oregon 97701.

ANTIQUe Buying Guide. Wholesale And Retail Prices Listed On Every Item. Hundreds Of Illustrations Over 200 Pages \$1.98. Clark Bradshaw's Gift Shop, 2697 Favard Road, Marietta, Georgia 30060.

MODELS—CARS, SHIPS, TRAINS, PLANES ETC.

SHIP Models Kits, fittings, plans, books, tools, engines, motors. Big illustrated catalog 50¢. Mass, residents add 3% tax. James Bliss & Co., Dept. SM, Route 128, Dedham, Mass. 02026.

ROCKETS: Real flying models—flights up to 2500 ft. New illustrated catalog 25¢. Single and multistage kits, cones, engines, launchers, trackers, rocket aerial cameras, technical information. Fast service. Estes Industries, Dept. 2-H, Penrose, Colorado 81240.

SHIP And yacht model fittings: Pine construction hull kits; blueprints. Send 50¢ for illustrated catalog. A. J. Fisher, Inc., 1002 Etowah Avenue, Royal Oak, Michigan 48067.

MODEL Airplanes—Big 220 Page Catalog 50¢. Sig Company, Montezuma, Iowa 50171.

LIVE Steam powered backyard railroads! All sizes. Complete "bolt-together kits," and rough castings. Excellent drawings. 100 page catalog \$1.00. Little Engines, Lomita, California 90717.

SHIP Models catalog 25¢. Scientific, Inc., 340 Snyder, Berkeley Heights, N. J. 07922.

AUTOKIT 1907 Fiat Racer By Pocher 1/8 Scale 20" Long. Super Detailing On All 823 Parts. Includes Working Steering, Suspension System, And Drive Chains. Parts Are Brass, Steel And Plastic. Regular \$65.00 Sale Price \$39.95 Postpaid. Jeco, 2837 Ladybird Lane, Dallas, Texas 75220.

GAMES, TOYS, PUZZLES, NOVELTIES

FASCINATING Palmistry Game, 56 Beautiful Colored Cards Revealing Lines Of The Hand. Symbolic Pictures Represent The Planets And Mythology Emblems. Complete Instructions. \$6.00. Enterprises, Box 4252, Wichita, Kansas 67204.

MAGIC TRICKS, JOKES, VENTRILOQUISM

HOUDINI'S Greatest Magic!! You can now do them!! Giant Illustrated Catalog 25¢ with Free trick. Vick Lawston, Box 2026-P, Pompano Beach, Florida 33061.

COMPLETELY Illustrated catalog. 84 pages. 25¢. Manhattan Magic, Box 334-M, N.Y.C. 10011.

BE A Magician! Two booklets explaining sixty-eight tricks plus large professional catalog. \$1.00. Magic Inc., 5082 Lincoln, Chicago, Illinois 60625.

WORLD'S Finest professional magic tricks. Joker's Novelties. Giant illustrated catalog 10¢. Top Hat, Evanston, Illinois.

FREE! World's Leading Catalog 2000 Novelties, Jokes, Tricks. Scientific Gadgets, Hobbies. Johnson-Smith, C-10, Detroit, Michigan 48224.

500 TRICKS. Douglas famous Magic Catalog, only 25¢. Better Magic for pocket, club, stage. Fastest mail service. Douglas Magicland, Dept. 11, Dallas, Texas 75221.

MAGIC Catalog. World's finest 3000 tricks. (340) pages \$2.50. Beginners, amateurs, professionals. Kanter's, A-200 South 13th St., Philadelphia, Pa. 19107.

VENTRILOQUISM! Information free! Dummy catalog 25¢. State age. Maher, Studio H, Box 9037, Denver, Colorado 80209.

MAGIC MAGAZINE—Monthly since 1936. 44 pages. All phases. 3 month trial \$1.00. Genii, P.O. Box 36068, Los Angeles, Calif. 90036.

FABULOUS MAGICS New 1971 catalogue 25¢. Our specialty orders shipped same day no substitutes. Fabulous Magic, 3319 East Charleston, Las Vegas, Nevada 89104.

LEARN VENTRILOQUISM! Booklet and Puppet \$7.98. Information FREE! Courses, Dummies, Puppets. Izzy Rizzy's School of Ventriloquism 3746 W. 63rd St., Chicago, Illinois 60629.

HOUDINI'S Original Magic Shop. Established 1856. Send 25 cents for illustrated Catalog containing 5000 Tricks. Mindreading, Puzzles, and Jokes. Flossio-Hormann, 304 West 34th St., New York 10001.

BOOKS, CATALOGS, NEWSPAPERS

PUBLISH Your book! Join our successful authors: All subjects invited. Send for free appraisal and detailed booklet. Carlton Press, Dept. PMT, 84 Fifth Avenue, New York 10011.

KNOW YOUR BEER. Facts, Fable, Folklore . . . in Falstaff's Complete Beer Book. Superbly illustrated (colored stein photos). Answers all your questions about beer. Send \$1.00 plus 25¢ handling (Sorry, no COD's) to BEER BOOK, P.O. Box 23007, Dept. (R), St. Louis, Missouri 36156.

FREE BOOK. Prophet Elijah Coming Before Christ. Megiddo Mission, Dept. 63, 481 Thurston Road, Rochester, N. Y. 14619.

NATIONAL Geographic Magazines, 1888-1967, any issue. Buxbaum, Box 465-PM, Wilmington, Delaware 19899.

FREE Brochures! Inexpensive books. Many subjects. J. B. Floyd, R1-PM2, Silverstreet, S.C. 29145.

AMAZING SELF-IMPROVEMENT BOOKS to help you achieve success, happiness and wealth: "Think and Grow Rich" \$2.00; "Psycho-Cybernetics" \$2.00; "Success-Cybernetics" \$2.00; "Thinking Big" \$2.00; "Dynamic Thinking" \$1.00. Okoro Brothers Enterprises, Dept. 519, 1731 New Hampshire Avenue, Washington D.C. 20009.

NEW! Free Illustrated Catalog! Adults only. Unusual Books, Magazines, Pictures, Brooks, Box 126-8A, Brooklyn 11229.

NEW FREE CATALOG. Many helpful kitchen-household-garden-tool items. Satisfaction guaranteed. Write today Omni-House, Dept. C6, 135 S. Morgan, Tampa, Fla. 33602.

SAVE MONEY-Interesting books-All subjects Low prices-Free catalog-Davis Enterprises, Box 35M, Salem, Utah 84653

PLAYS, SONGS, MANUSCRIPTS

SONGWRITER! Poets! Spiritual and religious poems, songs wanted for recording by Chapel Symphony Orchestra and Choir. We pay all recording costs! Dept. PM. Chapel Recording, P.O. Box 162, Wollaston, Mass. 02170.

BUSINESS OPPORTUNITIES

MAILORDER. 1,000,000 Profitable Opportunities. Free Details. King's, Dept. A71, 11679 Sherman, Northglenn, Colorado 80233.

FREE Millionaire Book!! Big money in successful, little businesses. Work home! SBI-7, Kerrville, Texas 78028.

(Continued on next page)

BUSINESS OPPORTUNITIES

(Continued from preceding page)

EARN Money as mailorder dealer. Free catalog, discount sheet, on Americana Posters, Books, Antiqued reproduction 1840 \$1,000 bill for 25¢. Authentic Distributors, Box 414P, Saint James, New York 11780.

SECRETS! Mail Order Success. Internationally famous expert reveals how to make home business fortunes. Beginners: Get free copy "Make Money By Mail." Discloses free advertising, profitable products. Mailco, 1554 Sepulveda, Dept. E2708, Los Angeles 90025.

OWNER-Manager Wanted. "Nationally advertised" business in Your area. Seven superior, "on-location" services . . . homes, offices, motels, shops, institutions. Successful worldwide. Gross \$15,000-\$30,000 yearly with First serviceman. Additional servicemen's machines furnished. Large profit Each serviceman. Little over \$1000 establishes urgently needed, growing, lifetime business. No shop, no experience needed. (Starting spare time, business profits increase job salary.) We train . . . help finance . . . guide . . . back you. Interesting, exciting, gratifying career. Inquire Today while territory open. We'll mail information. Duraclean, C1-168, Deerfield, Illinois.

INSTALL Burglar Alarm Systems. Big profit home business. Beginners start spare time, without mechanical experience or costly equipment. Free starter plan. Nasco, Dept. E2708, 11071 Massachusetts, Los Angeles 90025.

BECOME Tax consultant. Our students earn \$1,000-\$3,000 every tax season preparing returns evenings. State approved. National Tax School, Monsey, 2LC, New York 10952.

IMPORT-Export opportunity. profitable world-wide, mail order business from home, without capital; or travel abroad. We ship proven plan for no risk examination. Experience unnecessary. Free details. Mellinger, Dept. E2708, Los Angeles 90025.

FREE 1971 Full-Color Catalog waiting to bring you Big spare-time cash commissions. Sell Advertising Book Matches. Every business a prospect . . . Complete selling instructions furnished. Steady, repeat business. Dept. MX-871, Superior Match Company, 7530 South Greenwood, Chicago, Illinois 60619.

HOW To Finance A Business. Get \$500 to \$2 million. Free information Capital-17, Kerrville, Texas 78028.

279 FAST, Easy ways to make money! Free! Rush name, address, zip. Perry, 13263 ES Ventura Blvd., Studio City, Calif. 91604.

250,000 NEW MOTHERS EVERY MONTH! Bonanza for Bronzed Baby Shoes! \$50.00 a day profit. No investment, no inventory. Full or spare time. Exciting details Free. Senti-Metal, 1919 Memory Lane, Dept. 8H, Columbus, Ohio 43209.

WATCHMAKING Makes every day a payday. Learn this cash business at home. Free details. Sweazey, YVA, Fox River Grove, Illinois 60021.

1000% PROFIT—Sell Books By Mail. Free Kit. Imperial, 146-PM Thom, Winnipeg 25, Canada.

GENERATOR—ALTERNATORS—STARTERS Opportunities Unlimited. Nationwide Franchise Now forming: For Information Send \$4.50 to: Victor Electronics, P.O. Box 8295, West Palm Beach, Florida 33407.

\$1000 DAY—150% Profit. Selling by mail. No investment in inventory. Part time-full time. Unlimited potential. Complete details \$1.00. National, Box 72121, Chicago, Illinois 60680.

\$600-UP Monthly. People needed. Raise rabbits, other laboratory animals for us. Huge market. We supply equipment, breeders and instructions. Details 25¢ National Research Farms, PNMB8, Box 309, Milwaukee, Wisc. 53201.

1971 MAILORDER Goldmine!! Quick Dropship Profits! Camar, 40PM2 Driftway, Danbury, Connecticut 06810.

I MADE \$2,000.00 Monthly by mailorder—evenings only. You can too! Free proof! Kingman, Box 7227D, Erie, Pa. 16510.

BIG Profits in becoming a supplier to major industry through electroplating small parts and metalizing non-metallics. Write for free particulars: Mason, Room MC-2-AK, 1512 Jarvis, Chicago, Ill. 60626.

MAKE \$10.00 Hourly demonstrating portable sandblaster. Inkanas, Box 66573-A, Houston, Texas 77006.

MAKE Gorgeous original candles for all holidays and special occasions. Learn expert Candle decorating, candlemaking, use of professional molds. Free details on home instruction method. Candle Institute, Dept. B-73, 1600 Cabrillo, Torrance, Calif. 90501.

GROUND Floor opportunity in an Engraving business of your own—spare time or full time. One piece of raw material costing \$4.50 will produce products worth \$180.00! Free particulars! Write: Warner, Room EC-2-AK 1512 Jarvis, Chicago, Ill. 60626.

SENSATIONAL Car Thief Signal. Lighting seller. Samples for trial. Northwest Electric, Ave. 749, Mitchell, S.Dak. 57301.

\$600—\$2000 MONTHLY Raising Rabbits For BREEDING STOCK. 10 Million Sold For Meat Yearly. Small Animals For Laboratories. Send \$4.00 "For Rosedale Rabbitry" Guide Book. Frank Leidig, Box 925, Galion, Ohio 44833.

HOMEWORKERS Wanted to stuff envelopes. Send self-addressed stamped envelope. Tayco, Box 8010-IMP, Stockton, California 95204.

HOMEWORKERS-Mailers wanted. Free information. Allen-A, 2418 Lori, Santa Ana, California 92706.

MAILORDER—New Concept! Amazing re-copy, resell information service!! Write: J&D, 1442PM Berkshire, Grosse Pointe, Michigan 48230.

EARN \$60.00 Daily manufacturing Concrete Fence Posts. Practically no investment. Send stamped-addressed envelope. American, Excelsior Springs, Mo. 64024.

MAKE A Years Income in 8 weeks Camping. No selling. Capital or Land necessary. Write Edrus, Route 5, Box 5733, Gig Harbor, Washington 98335.

MAILORDER—Profitable products, dropshipped. No merchandise investment. Everything supplied—catalogs, ads, mailing lists. Gif-Guide, 1137½ Crenshaw, Dept. 283, Los Angeles 90019.

MAKE Up To 900% Profit with your own Magnetic Sign Shop! Rapidly growing demand for 3-Dimensional Magnetic Signs on cars and trucks! Start in garage, workshop, or kitchen. Full or spare time. Write today for free details. Nationwide Plastics, Dept. 82, 4200 Panamint, Los Angeles, Calif. 90065.

CLIP Newspaper items, \$1.00-\$5.00 each. Details free. Walter, Box 1360-PA, Erie, Pa. 16512.

PIANO Tuning Learned Quickly At Home! Tremendous field! Musical knowledge unnecessary. GI approved. Information free. Empire School, Box 327, Miami, Florida 33145.

\$400.00 MONTHLY Raising giant fishworms. Soilless method. Charlie Morgan, Bushnell, Florida 33513.

EARN Money raising fishworms for us! Write: Oakhaven-38, Cedar Hill, Texas 75104.

400,000 BARGAINS Below wholesale! Many free. Liquidations . . . closeouts . . . job lots . . . single samples. Free details. Bargainhunters Opportunities, Box 730A, Holland, Michigan 49423.

ADVERTISING BUSINESS—YOU Own it. \$350 First Week or Money Back. Electric Neon Action ad Clock, 229 W. Illinois, Chicago 60610.

SELL Lifetime, Metal, Social Security Plates. Big Profits! Sample and Sales Kit Free. Russell, Box 286-PM, Pulaski, Tennessee 38478.

COPUBLISH "Mail Sale Advertiser," leading mailorder paper. Copy and details 25¢: U.S.A. only. Vanroy Shirk, Lebanon, Pa. 17042.

\$200.00 DAILY in your mailbox! Your opportunity to do what mailorder experts do. Free details. Associates, Box 136-A, Holland, Michigan 49423.

DRAFTSMEN! Operate own DRAFTING SERVICE! Full, Part Time: Experience unnecessary; Details: Roberts Drafting, 1741 Circle Road, Baltimore, Maryland 21204.

RAISE Rabbits for us on \$500 month plan. Free details. White's Rabbitry, Mt. Vernon, Ohio 43050.

MAIL ORDER Sell books. Fascinating, profitable, details. Jobre, Box 27, Great Neck, N.Y. 11023.

WORLD'S Largest supply. Merchandise 25% to 40% under wholesale. Bankrupts. Closeouts 10¢ on dollar. Imports. Hong-kong clothes. Automobile discounts. Free details. International Buyers, Box 16386 MM, Portland, Oregon 97233.

HOLLYWOOD CEMENTCRAFT: Offers Highly Profitable Home Business. Experience Unnecessary. Unlimited Unique Pottery Designs Easily Made Without Moulds. Bird-baths, Fountains, Wishing-Wells, Waterfalls, etc. Chemical Coloring Formulas. Marble-glazing. FREE Illustrated Brochure. CONCRETE FACTS, 602 Athens Street, Altadena, California 91001.

FREE Catalogs. Repair air conditioning refrigeration. Tools, supplies, full instructions. Doolin, 2016 Canton, Dallas, Texas 75201.

SELL Beautifully colored Social Security Plates. Big Profits! Free Sample. Paul Wright, 1075 Ringwood Avenue, Pompton Lakes, N.J. 07442.

BUILD Custom Cases at home for profit. Get orders by mail. We supply materials, instruction—everything. Free home business details. Custom Case Supply Co., 6961 CPH Hayvenhurst Avenue, Van Nuys, California 91406.

TAKE Catalog orders. We drop-ship 1001 best selling specialty products. Guaranteed lowest below wholesale prices. Fantastic spare-full time home business. Free book shows you how. SMC, 6963 SPH, Hayvenhurst Avenue, Van Nuys, California 91406.

VENDING Machine big catalog. Rake, 523 A Spring Garden, Philadelphia, Pa. 19123.

I MADE \$40,000.00 Year by Mailorder! Helped others make money! Start with \$10.00—Free Proof. Torrey, Box 318-Y, Ypsilanti, Michigan 48197.

MAIL Baby Catalogs Imprinted with your address to New Mothers for Big Profits! Details 25¢. Volz PM, Ypsilanti, Michigan 48197.

MAKE Money from old tires. Operators clearing \$800, weekly. Equipment costs \$1500. Get facts. S & S Patents, Inc., 3752 N. Damen, Chicago 60618.

MAKE \$46 From square foot plywood: jigsaw or bandsaw necessary. Free details. Woodar, Bridgewater, Mass. 02324.

BOOKKEEPERS Earn \$500.00 week. Operate Bookkeeping Tax Service. Details free. Universal, Box 664-M, Springfield, Missouri 65801.

CALIFORNIA MANUFACTURER NEEDS Man to assemble our product and be local agent, experience unnecessary. May start while presently employed. Five-figure income for responsible applicant. S.K.R.M. Manufacturers, 2347 West 238 Street, Torrance, California 90501.

1000% PROFIT Bronzing Shoes. Free Literature—N.B.C., Box 11069-PM, Kansas City 64119.

(Continued on next page)

BUSINESS OPPORTUNITIES

(Continued from preceding page)

MAILORDER Book Publisher Wants Dealers. Jan Enterprises, 76P, Wild Rose, Wisconsin 54984.

SUPERIOR Auction School. Nation's top Auctioneers own and instruct. Box 1281, Decatur, Ill. 62525.

\$200.00 **SPARE** Time earnings with your Tablesaw. Write: Workshop Five, 3800 Harney, Vancouver, Washington 98660.

VACUUM Plastic Molding & Liquid Plastic Casting—At Home! Make Hundreds of full 3-D plastic products. Big profit in spare time. Facts. Nationwide Plastics, Dept. HF, 4140 Eagle Rock Blvd., L.A., California 90065.

\$25.00 **HUNDRED** Addressing, Possible Year 'round. Complete instructions 25¢ for registration, postage. Cove, Box 1348-B, Clearwater, Florida 33517.

\$600.00 **PROFIT!** Mailing 100 Catalogs. Sample, complete instructions, only \$1.00. Digest, Box 839-PMV, Long Beach, New York 11561.

MAKE Magnetic Signs, Big Profits. Details, Universal, Lenora, Kansas 67645.

\$1,000.00 **PROFIT** From 1,000 Mailings! George, Box 2188-PM, Cypress, California 90630.

MAKE Magnetic car signs. Write Route 1, Box PM-49A, Bardstown, Ky. 40004.

\$1000 **WEEKLY** in YOUR Mailbox!! Do What Mailorder Experts Do. Amazing Trade Secrets. Free Details. International, Box 418-PM, Riverdale, New York 10471.

\$70 to \$200 **WEEKLY**—Home, Spare Time Simplified Mail Bookkeeping. Immediate Income. Easy. Auditax, Box 34741A, Los Angeles, Calif. 90034.

VENDING Machines. No selling. Routes earn amazing profits. Big catalogue Free. Parkway Corporation, 715PBM Ensor Street, Baltimore, Maryland 21202.

HOW TO GET RICH!! Free "Success-method Details"! Associates, Box 212-B8, Stoneham, Massachusetts 02180.

WORLD'S Biggest Wholesale Bargains! 165 free catalogs. Mailorder dropshippers. Your business imprint. Closeouts. Automobiles. Free "Digest." Vault International, Box 7284M, Lexington, Kentucky 40502.

MAIL Galore! Money-making offers! Your name on national mailing lists, 25¢. Three months, 50¢. Sullins, Box 206-M, Forsyth, Georgia 31029.

MAILORDER! Make big money working home. Free report reveals millionaire's secrets! Executive (1A8), 333 North Michigan, Chicago 60601.

"**MORTGAGE** Brokerage." Lucrative Profits! Obtain Capital Sources. Chase, Uleta, Florida 33164.

\$12.00 **HOURLY** in burglar fire alarms. Get facts, send \$1.00. Security, 11920 Chapel Forest, Dallas, Texas 75234.

400% **PROFIT**—Amazing selection—300 "Antiqued" reproductions on parchment!!! Garen's, Box 2459, Zanesville, Ohio 43701.

VACUUM SIGN MACHINES 14"X24" \$65.00. Homecraft, 2350 W47, Denver, Col. 80211.

MAILORDER. Free advertising—756 Publications. Sensational Mailorder Success Program Begin Immediately. Details Free. National, POB14—M8, Brooklyn 11214.

CLIP Short newspaper items. To \$10.00 each. Details free. Foster, 272-M8, Brooklyn 11235.

HOMEWORKERS. \$100.00 Weekly Addressing for firms. Begin immediately. Details—send stamped, addressed envelope. Hamilton, 272-TMA8, Brooklyn 11235.

MAKE RUBBER STAMPS: Easy Profitable hobby or full time business, low starting cost package, free details. BARCO TYPE, 237 Evergreen, Bensenville, Ill. 60106.

\$20,000 **IN** Mailorder a year. Free details. Eiden's Enterprises, Dept. 1A8, 6613 Kimball, Waterloo, Iowa 50701.

DOUBLE Money-Back if you can't beat horseraces using my system! Strauss-BQV, Brooklyn, New York 11219.

MONEY Makers. Make new wood products. Sales tested, repeat customers. Details. Gabert, 907 Birch, Eau Claire, Wisc. 54701.

\$500.00 **MONTH-For** life! Details 25¢. Enterprises, Box 863, Portales, New Mexico 88130.

FINANCIAL ANALYSIS MADE EASY: HOW to better understand your business. COMPLETE details \$3. Profitbuilder, Box 133-M1, Lafayette, California 94549.

FREE Report: 609 Successfully known business. Associates, Box 31, Mamou, Louisiana 70554.

\$4.00 **HOURLY.** Immediate income. Stuff envelopes. Cottage, Box 3324-DA, Long Beach, Calif. 90803.

PROMOTE Yourself! Free details. Paper-promoter, Dept. ADA, 175 Fifth Avenue, New York, New York 10010.

\$19.95 **KIT** Puts You in Social Security Plate Business! (Machine included). Free Details. Idea Products, Box 69828-PV, Los Angeles 90069.

BUILD Own Business, with Unique British Industrial Liquid Plastic. Makes Elastic coatings, foams, rubbers. Major Companies use in thirty countries. Send letter and \$1.00 For Details, Sample and Proof; to Delta Plastics, 932 Underhill, Delta B.C. Canada.

SECURITY And Power 256 page book "Thinking Big" reveals secrets that make men rich. #WB-123 send \$2.00. Hamilton's Exchange, 731½ East Broadway, Long Beach, Cal. 90802.

BUSINESS Loans! Church! Whatever! Unemployment, Poor Credit Understandable! \$1.00 (Refundable) Brings Response! PROSPERITY, 50123 Mainplace-A, Dallas, Texas 75250.

"**SECRETS OF SUCCESS**". New! Reveals seven proven, amazingly successful maxims for increasing sales, profits. Booklet stimulates \$\$\$ action; helps you make more money in your business. Only \$3.00 postpaid. Guaranteed. Irving Enterprises, 243PM8 West Tulehocken, Philadelphia, Penna. 19144.

EARN \$700 Per Month Spare Time as Tax Preparer with new quick-learn income tax home training. Start now. Be ready for January earnings. Full facts by mail—no salesman. Federated Tax Service, 2065 Montrose, Chicago 60618.

COMPLETE Mailorder Course. 24 Lessons. \$2.00. Stobart, 28 East Fifth, Waterford, Penna. 16441.

\$20,000 **YEARLY** in mailorder 25¢. Gipson, Box 1172, Bakersfield, California 93302.

GRASP This Opportunity. Mail Yourself a Fortune. Details 25¢. Rieck Enterprises, Box 789PM8, New York, New York 10005.

START Immediately. Burglar-Fire Alarm Business. Fantastic Opportunity. Fast Growing Field. Safeway, 92-G Brighton 11th Street, Brooklyn, New York 11235.

EARN \$240.00 A month at home, spare time, doing only two \$5.00 Invisible Mending jobs a day. Big money paid for service that makes cuts, tears disappear from fabrics. Steady demand. Details free. Fabricon, 2065 Montrose, Chicago 60618.

WE NEED GINSENG GROWERS! \$3,000-\$30,000 annually! We Buy Your Crop. Send \$2 for seed sample and information. Glass's Ginseng Exchange, Box 336, Rochdale Station, Jamaica, New York 11434.

NEW! TABLE TOP MACHINE Stamps Lifetime Social Security Plates, Door, Auto, ID Plates; over 100 different plates and tags. Portable—operate from home or car. **BIG PROFITS** selling through agents, to stores, mail order! Rush name, address for **FREE** Sample Plate, Catalog, "Big Money" Book. Perma, Dept. CL-31, 275 N.E. 166th St., North Miami Bch., Fla. 33162.

THE Positive Advertising Agency Specializes in New Products, Mail Order and Inventions. Send for Free Information. 527 North Alexandria Avenue, Los Angeles, California 90004. Exclusive Distributorships Available.

NEW! Free Illustrated Catalog! Adults only. Unusual Books, Magazines, Pictures. Brooks, Box 126-8AA, Brooklyn 11229.

\$100. **WEEKLY.** Addressing—Details \$2.00. M. Johnson-PM, Box 21213, Los Angeles 90021.

MAILORDER MONEYMAKER, Meticulously engraved door nameplates, best black or mahogany phenolic, white lettering, beveled all around, two holes, screws. Retail \$2.00. Send \$1.00 for sample, your name, details. Richard Fitch, 36 Atherton Street, Boston, Massachusetts 02119.

BUILD Your 3D sign machine. Plans, supplies. Signmart, 7500 Evelyn, Fort Worth, Texas 76118.

HOBBY REPAIRMEN: Start spare-time \$15.00 Hourly and up. Home Vacuum Cleaner Servicing. HHS Company, 7241-1st Avenue South, Minneapolis, Minnesota 55423.

VALUABLE SECRETS REVEALED!! New 1971 Flexible Mold-making & Casting Materials Directory—Only \$2.00—GUARANTEED!! Exclusive Products; 827 Yout; Racine, Wisconsin 53402.

MAKE Durable building plastic easily. Waterproof, fireproof, economical. Bays Laboratory, Cedaredge, Colorado 81413.

LEARN Success Dynamics The Art Of Personal Advancement Write: Bodega, Box 83A, San Leandro, California 94577.

"**BECOME** PROFESSIONAL DRIVING INSTRUCTOR. Your Own Driving School. Big Money. Free Details. Write: Howard David School, 1818 Everts, Philadelphia, Pennsylvania 19152."

FREE REPORT!! 609 Unusually successful businesses, indoor-outdoor, evenings!! Write: Associated, Box 238-B81, Lafayette, California 94549.

END Money worries! Start your own business. We show you how. Free details. Data-two, Box 935, Tulsa, Oklahoma 74101.

YOU'RE CRAZY To invest one cent in mail order before you write for free information: Mail Order News, 1345 Third Avenue, New York 10021.

\$100.00 **OR MORE** WEEKLY Possible in your own business! Part time or full time! We supply everything! Details 30¢. SPN, P.O. Box 182, Gillette, N.J. 07933.

\$60.00 **DAY.** Manufacturing concrete Posts. Blocks. Mold Equipment Catalog \$1.00 refundable. Carlyne, Route One, Box 95, Rapid City, South Dakota 57701.

Molding Rubber Liquid Plastic. Hobby Supplies. Details 10¢. Chaney's, 5415-L San Jose Blvd., Jacksonville, Fla. 32207.

PROFITABLE SCREEN PRINTING \$4 To Learn. Meadowlark, 6000 Roselawn Drive, Dayton, Ohio 45430.

GUARANTEED 100% PROFIT on every sign! We provide everything! Details 30¢. S.P.N., P.O. Box 182, Gillette, N.J. 07933.

MONEYMAKING OPPORTUNITIES

CIGARETTES 15¢ A pack. Improved roller makes 20 filtertip, plain, king or regular for 15¢. Facts free. Green River Tobacco, Box 953, Owensboro, Kentucky 42301.

(Continued on next page)

MONEYMAKING OPPORTUNITIES

(Continued from preceding page)

SHARP \$\$\$ Opportunity! One low-cost machine sharpens, serrates, knives, scissors, pinking shears. Earn \$6-\$9 hourly in spare time. Professional results without experience. Free details. Beaver Grinder, 8P, Nielsen Building, Eugene, Oregon 97402.

MAKE \$5,000 Yearly, sparetime, raising mink, chinchilla, nutria, etc. Free booklet reveals proven plan. Write: Furs, Dept. E, Bewdley, Ont., Canada.

\$600-UP Monthly. People needed. Raise rabbits, other laboratory animals for us. Huge market. We supply equipment, breeders and instructions. Details 25¢. National Research Farms, PNMB, Box 309, Milwaukee, Wisc. 53201.

START A profitable subscription business in spare time! We need men and women (young and old) as representatives for all leading national magazines. Liberal commissions on all subscriptions. Supplies free. No experience needed. Send this ad with your name and address to Popular Mechanics, Room 8-0, 250 W. 55th St., New York, N.Y. 10010.

PROSPECT For Gold in Northern Ontario. \$3.00. Eastview Book Service, Box 7053, Vanier, Ontario, Canada K1L 5A0.

LEARN Secrets of making small Antique Reproductions. Master Antiquer's 32 piece Kit (Manuals, Plastic Patterns and Stencils) will teach you how. \$1.00. Heirloom, Box 2793-C, New York, New York 10001.

MONEY. Make hundreds extra sparetime, home by mail. Opportunitites, tips in magazine that tells how, leading mail-order magazine since 1929. Sample \$1. Year \$5 with free what is mailorder opportunities folio. Mail Trade, Sheboygan, Wisc. 53081.

HOMEWORKERS Wanted to stuff envelopes. Send self-addressed stamped envelope. Tayco, Box 8010-IMP, Stockton, California 95204.

PENNY STOCKS Have profit potential. Free information. Analyst-PM. 608 N. Guadalupe, Redondo Beach, Calif. 90277.

MAKE \$1.00 Per Sale selling engraved metal Social Security plates. Free Sales Kit. Engravaplates, Box 10460-7301A, Jacksonville, Florida 32207.

BLACK WIDOW Spider Ranchers needed! Guaranteed Market! Complete details \$1.00 (refundable). NBWC, Box 476 RPM-8, Rialto, California 92376.

CASH Prizes offered each month in a new contest magazine. For free copy write Multigames, Dept. P, Box 307, Ypsilanti, Michigan 48197.

SELL Lifetime Metal Social Security Plates. Sample and Sales Kit FREE. Lady McGuire, Box 3333PM, Anderson, S.C. 29621.

MAKE Statuettes, novelties, imitation marble. Sell to stores or start gift shop. Free details. Marbleizing, 41 Waverton, St. Louis, Mo. 63124.

HOW To Make money writing short paragraphs. Information free. Barrett, Dept. C-27-X1, 6216 N. Clark, Chicago 60626.

SCIENTIFIC Messages: Big Earnings uncrowded profession. Learn spare time at home. Diploma awarded. Free catalog. Write Anderson School. Dept. J-1C, Princeton, Illinois 61356.

HOW TO GET RICH!! Free "Money-making Brochure"! Success International, Box 2447-C, Livonia, Mich. 48151.

\$200.00 FROM Sheet 1/4" plywood (scrap). Details 25¢. Novelties, 610 So. 24th, Elwood, Indiana 46036.

CLIP Newspaper Articles. \$1.00—\$5.00 each. Details free. Sullins, Box 206-MP Forsyth, Georgia. 31029.

GET World's Biggest Wholesale Import Catalog. Write: World, Medina, Washington 98039.

VENDING Machines. No selling. Routes earn amazing profits. Big catalogue Free. Parkway Corporation, 715PMM Ensor Street, Baltimore, Maryland 21202.

HOW TO GET RICH!! Free "Successmethod Details"! Associates, Box 212-M8, Stoneham, Massachusetts 02180.

STUFF Envelopes make 25¢ each. No Addressing or Postage Needed. Complete Details \$1.00, Davan, Box 7P, Middle Island, New York 11953.

\$100.00 WEEKLY HOME ADDRESSING. DETAILS 25¢. Staly, Box 4008 Ampere, East Orange, New Jersey 07019.

\$2.40 HOURLY Making simple wood novelties. Free details! Gene's, 55 Boxwood, Falmouth, Mass. 02540.

MAIL ORDER—Beginners, save money with new techniques. Write PO Box 533, Ridgefield, N.J. 07657.

LEARN The secrets of repairing junk batteries "Fabulous Profits" at home. Battery Shop, Box 820, La Quinta, Cal. 92253.

WIN \$400 TO \$2,000 a week in horse racing. Result guarantee. Send for free info. C. Lang Box 60316-RPM, Los Angeles, Cal. 90060.

AMAZING Information, 315 magazines free, MacMillan, 3401-R Barr Street, Columbus, Ohio 43224.

WIN Contests! Year subscription, \$4.00. Sample, 25¢. Prizewinner, 1315 Central, St. Petersburg, Fla. 33733.

BARGAIN DIRECTORY 100,000 Low cost items \$2.00. Winchester Enterprises, 2807PM Hargrave Street, Philadelphia, Penna. 19136.

PROFIT In Coins. How To Start, Where To Sell. Valuable Coins List. Only \$1.00. Harolds Sales, 402-A Mockingbird, Longview, Texas 75601.

MAIL Order spare time. We supply everything. Send \$1.00 for sample catalog and details. Specialty Supplies, Box 998, Roswell, New Mexico 88201.

BIG PROFITS: Make several times your cost. Gifts, carded merchandise, novelties. \$1.00 brings giant catalog. Refundable on first order. Don's Friendly Sales, 3511 S. Western, Oklahoma City, Oklahoma 73109.

DOUBLE Your Income, gain Success, Popularity, Prestige. FREE Information. Bayou House, Independence, Louisiana 70443.

SELL Your Photos. Report tells How, Where. Color Slide Markets. Only \$1.00. William Enterprises, Hartley, Iowa 51346.

EARN UP TO \$700 A MONTH AS A TAX PREPARER. Learn tax preparation at home in your spare time from H&R Block, America's Largest tax service. No previous experience needed. An ideal course for men and women of any age. Job opportunities for qualified graduates. No salesman will call. Send for free information today. Write: H&R Block Tax Training Institute, Dept. 301-C8, 4410 Main, Kansas City, Mo. 64111.

EARN \$700 Per Month Spare Time as Tax Preparer with new quick-learn income tax home training. Start now. Be ready for January earnings. Full facts by mail—no salesman. Federated Tax Service, 2039 Montrose, Chicago 60618.

SELL Lifetime Metal Social Security Plates, Sales Kit Free. EZ-Read Plates, Box 612, Murfreesboro, Tenn. 37130.

ANYONE Can create money-making invention ideas now! Guaranteed new method! Free details! KM Publications, Box 3727-P, Anaheim, Calif. 92803.

NEW! \$1000.00 Monthly (Easy) from your own Home. Proven Method. Free Details. Selmar, Box 186-8D, Brooklyn 11230.

FREE. 206 Easy Ways to make money taking orders for exciting new products—spare time. Send name, age for 5 months free subscription. Opportunity Magazine, 1460 Hancock Center, Dept. 17-HM, Chicago 60611.

EARN \$240.00 A month at home, spare time, doing only two \$5.00 Invisible Mending jobs a day. Big money paid for service that makes cuts, tears disappear from fabrics. Steady demand. Details free. Fabricon, 2039 Montrose, Chicago 60618.

BECKWITH SCHOOL Of Mail Order—LEARN how to operate your own business properly and profitably. Catalogue. Dept. 31, 515 Route 46, Fairfield, New Jersey 07006.

SMART HORSE PLAYERS Use Systems. 20 proven systems, individually printed \$5.00. H. Comisar, 164 Mitchell Street, Rochester, New York 14621.

MAILORDER Great Part Time Business. FREE LITERATURE. Malcolm Fowler, East Flat Rock, North Carolina 28726.

INCOME At Home Arc Welding. How To Obtain Work Making Needed Product. Write: Franks, Department 8PS, 1160 North Baldwin Road, Owosso, Michigan 48867.

SWEEPSTAKES Contests. How to Win. Write for free particulars. General Contests, 1609-18 East Fifth, Duluth, Minnesota 55812.

MAKE BIG MONEY—Spare time into cash by mailorder. Proven methods—free details—Davis Enterprises, Box 35M, Salem, Utah 84653.

INSTANT Wealth Plan!! \$1,000.00 next year. \$1,000,000.00—10 years. Free trial: Wallace, Box 288-A8, Gladstone, Oregon 97027.

MAKE \$25.00 More a day while you're asleep! Build this amazing silver recovery unit! Complete construction plans, Send \$5.00 to Creative Products, 1708 Tierney Road, Fort Worth, Texas 76112.

MAKE 200%, Even 300% Profit on Gift Items, Novelties, Toys, Carded Merchandise. Details Free. Midtown, 5423 Field, Detroit, Michigan 48223.

PROFITABLE OCCUPATIONS

\$600-UP Monthly. People needed. Raise rabbits, other laboratory animals for us. Huge market. We supply equipment, breeders and instructions. Details 25¢. National Research Farms, PNMC8, Box 309, Milwaukee, Wisc. 53201.

\$\$\$—101 New Businesses to Start at Home, \$2.00, Essex Development Co., 15652 Kennebec, Southgate, Mich. 48195.

LEARN—How to weld, cut, braze. 1500% profit—easy! Simplified 32-page illustrated instruction booklet, catalog, 10¢. Victor Equipment, Airport Road-AV, Denton, Texas 76201.

START A magazine subscription business. Earn generous commissions on Popular Mechanics. Good Housekeeping and all others. Best commissions, bonus, all material sent free. No experience needed. Write Popular Mechanics, Room 8-P, 250 West 55th St., New York, N.Y. 10019.

SELL Your Photos. Report Tells How, Where. Color Slide Markets. Only \$1.00. Halsher Company, 11 Five Oaks, Dayton, Ohio 45405.

PROFIT From mail order with concrete programs based on real merchandise and value. We have know-how and capital to back a successful program for those who qualify. Request details. Acme Engraving, 624 Arch Street, New Britain, Conn. 06051.

MAKE \$300 CLEAR MONTH Few hours from 10 customers, representing us in your community. No individual selling. Repeats forever. Customers waiting. \$1 for sample, details. Our 40th year. Progressive, Box 1302, Springfield, Illinois 62705.

BECOME A mortgage broker, earn \$10,000 to \$50,000 a year. Details free. United, Box 6284A, Marietta, Georgia 30060.

(Continued on next page)

PROFITABLE OCCUPATIONS

(Continued from preceding page)

FREE!! FREE!! FREE REPORT!! 609 Little-known, successful businesses. Written by consultant. Indoor . . . outdoor, work home! Start small, grow big . . . many others have. Experience unnecessary, easily done!! Write: Report, Box 238-BA8, Lafayette, California 94549.

FT. SMITH Auction School, Ft. Smith, Ark. Residents & Home study. Veteran approved.

SHARPEN Scissors, Pinkers. Inexpensive equipment, tools, supplies. Blackhawk's, Sheldahl, Iowa 50243.

HOW To Make Money writing short Paragraphs. Information Free. Barrett, Dept. C-27-X2, 6216 N. Clark, Chicago 60626.

1000% PROFIT Bronzing Shoes. Free Information. NBC, Box 11069-PM1, Kansas City 64119.

CHINCHILLA INCOME GUARANTEED. 25¢ bulletin \$1.00. Chinchilla, 11PM, Port Richey, Florida 33568.

CAMERA Owners! B&W And Color Photos Bring \$\$\$—Act Now! Information \$1.00. Fortune Fancy, PM871, 118-23 205 Street, St. Albans, New York 11412.

609 LITTLE-Known, HIGHLY SUCCESSFUL Businesses, Start Small, grow big. Free Report. Unico, Box 3185, Santa Monica, Calif. 90403.

SALESMEN—DISTRIBUTORS

MAKE Extra \$25 to \$75 spare time! Double air cushion shoes. Men's, Women's line. Dress, work, play. Highest commissions. Shoes for yourself. Outfit Free. Bronson, Dept. H-81, Minneapolis, Minnesota 55408.

SELL Hertel Bibles—Part Time. Finest reference Bible available. Demonstrator and supplies furnished. Excellent commissions. Write International Book, Dept. PM, Box 118, Wichita, Kansas 67201.

EARN Big money calling on business-professional men. Send us their delinquent accounts for collection. General Finance, Dept. PM-11, Columbia Bank Bldg., Kansas City, Mo. 64106.

WANTED. Man contact service stations. Long needed invention. Full or part time. Write, Cyclo, 3816 Dahlia, Dept. 172, Denver, Colorado 80207.

SELL Advertising Ball Pens, Calendars, Ad-Specialties—Build Own Repeat Business—Free Details—Fleming, Dept. A, 6535 Cottage Grove, Chicago 60637.

MAKE \$10.00 Hourly demonstrating service station vacuum cleaner. Inkavac, Box 66573-A, Houston, Texas 77006.

EARN Big Commission Full or Part Time. Show America's largest line Low Priced Business Printing and Advertising Specialties Plus calendars in season. No experience. No investment. No collections or deliveries. On-the-spot commissions. Big Free Sales Kit samples hundreds items used daily by businessmen. Merchandise bonuses for you. Build profitable repeat business. Start now. National Press, Dept. 11D, North Chicago, Ill. 60064.

THERE'S Money in selling office supplies and equipment, full or part time. Steady repeat commissions. Free selling outfit. Write, Oseco, 3505-PM North Elston, Chicago 60618.

HOUSEHOLD Products Route. Earn \$25.00 or more daily. Larger repeat orders. Man, woman. Full, part time. McNess, Freeport 2681, Illinois 61032.

PREMIUM—Incentives—Advertising Specialty Newsletter Dealerships available free. Write: Profit Tools, Box 46A, Oshkosh, Wisconsin 54901.

TOP 119 Advertising Specialty Manufacturers. Directory \$1. Marketing—C73, Box 332, Bergenfield, New Jersey 07621.

AGENTS WANTED

WILL You test new items in your home? Surprisingly big pay. Latest conveniences for home, car. Send no money, just your name. Kristee 126, Akron, Ohio 44308.

PROFITABLE! FULL OR PART TIME. Represent largest manufacturer of magnetic signs for cars and trucks. TRIMETRIC, 345 W. El Roblar Drive, Ojai, California 93023.

THAI Jewelry. Color Catalog And Booklet Airmail \$2.00 (Refundable). IBF, Box 551, Bangkok, Thailand.

WANT TO MAKE UP TO \$100 A WEEK spare time, and get free shoes for life, too? No investment. Rush card for free details. Mason Shoes, K-856, Chippewa Falls, Wisconsin 54729.

EVERY Man a prospect. Refundable sales kit offer showing line belt buckles, tie clasps, money clips, cuff links, lapels, identification badges, individualized with customer's name and emblems. Cap badges for trucking, bus, taxi, police, firemen, also postal, letter carriers and heavy construction emblems. Choice 4000 emblems. Hook-Fast, Box 1088PM, Providence, R.I. 02901.

YOUR Own business—Used Suits \$1.50: Overcoats 65¢; Mackinaws 35¢; Shoes 12½¢; Ladies' Coats 30¢; Dresses 15¢. Enormous profits. Catalog Free. Nathan Portnoy Assoc., 2109-AA, Roosevelt Road, Chicago, Illinois 60608.

PRINTING, Advertising Salesmen—Excellent moneymaking sideline selling Decalcomania Name Plates, small quantities. Advertising Specialties, sign letters. Free Samples. Ralco XL, Boston, Mass. 02119.

LIFETIME Income. Business Loan Representative Write: Financial, 28 E. Jackson, Suite 1204-X3, Chicago 60604.

MANAGERS/Distributors needed nationwide. Male/Female. Excellent monthly part time income. Company profit sharing, references required. Details by sending stamped addressed business envelope plus \$1.00 to Bionics, P.O. Box 6, Red Oak, Georgia 30272.

EMPLOYMENT INFORMATION

FLORIDA Employment opportunities resume, \$1.00 (Refundable). Employment Research, 302 Elmwood, Holiday, Florida 33589.

FEE-PAID JOBS—Nationwide/Worldwide. Send Resume and \$1.00 Registration. Job Banks, 65 Bradley Road Extension, Braintree, Massachusetts 02184.

CANADIAN Jobs, Immigration, Government Assistance, Taxes, Land, \$1.00. Porter AQ, Box 253, Johnson City, N.Y. 13790.

ENGINEERING And Support Personal. Double your present income as **JOB SHOPPER.** Booklet \$3.00. Panciera, 15 Noyes, Westerly, Rhode Island 02891.

FREE DETAILS AUSTRALIA!!! Government assisted transportation!! Jobs Galore!! Latest Handbook. Free Details. Write: Associated, Box 17-B81, Lafayette, California 94549.

AUSTRALIA WANTS YOU!!! Government Assisted Passage. 1971 Government Information and Forms—Most Complete Information Available—\$1.00. Reports on Employment, Business, Taxes, Education, Teaching, Housing, Ranching, Maps, etc. AUSTCO, Box 3623-E, Long Beach, California 90803.

HIGH Paying overseas jobs. Construction, other projects. Bonuses. Travel Expenses. Extras. International Information, 124, Cortez, Florida 33522.

AUSTRALIA Opportunities! Government assisted transportation! New 1971 handbook includes huge employers' list, Business, Agriculture, Housing, Tax Information. Send \$1 (Refundable). Austracanada, Box 2482-P, Great Falls, Montana 59403.

BE A Merchant Seaman. **WORLD** Travel, Adventure, Good Pay. **INFORMATION** \$1.00. **SEAMANS SERVICE**, 2105 HOPPIN STREET, MOBILE, ALABAMA 36605.

EVERY WEEK TEN THOUSAND, ACTUAL, LEGITIMATE, ITEMIZED, AUSTRALIAN JOB OFFERINGS ARRIVE HERE. REPEAT: EVERY WEEK. \$5.50 Guaranteed, Postpaid Canada-USA Only. Not Airmailed. Facts—not fiction. Check us out. **AUSTRALASIAN NEWS**, Box 6428, Torrance, California 90504.

JOBS By the hundreds. Deal direct with employer. Pick yours from the Sydney (Australia) newspaper classified advertising. \$5.00. Doyle Associates, Box 2702, Williams Lake, B.C. Canada.

CANADIAN Employment Opportunities—Unlimited! Act Now! Latest Report—\$1.00. CanEmploy 108, 7 Trafalgar, St. Catharines, Ontario.

HELP WANTED

WORLD-WIDE. . . U.S.A. Jobs Galore!! Students, all professions and occupations. Enjoy Paris, Rome, Tokyo, Mexico City, Miami, San Francisco, \$700.00 to \$3,000.00 monthly. Paid Overtime, Travel Allowance, Sightseeing. Free Details!! Write: Global Employment, Box 706-B81, Orinda, California 94563.

OVERSEAS Jobs—Europe, South America, Australia, Far East, etc. 2000 openings all trades. Construction, Office. Engineering Sales, etc. \$700 to \$3,000 month. Expenses paid. Free Information. Write Overseas Jobs, International Airport, Box 536-M, Miami, Florida 33148.

OVERSEAS EMPLOYMENT. . . Australia, Europe, South America, Asia! All Occupations! \$700-\$3,000 monthly! Write: Employment International, Box 29217-AH, Indianapolis, Indiana 46229.

"AUSTRALIAN OPPORTUNITIES HANDBOOK" . . . Latest information about Government Paid Transportation, Employment, Business, Farming, Housing . . . plus "Employers List" and Forms. Send \$1.00. International Services, Box 19107-AH, Washington, D.C. 20036.

FREE DETAILS. . . AUSTRALIA. . . Government assisted transportation. Latest Handbook and forms . . . Free Details . . . Write: Associated, Box 17-BA81, Lafayette, California 94549.

OVERSEAS Jobs—Australia, Europe, South America, Far East, Openings in all trades and professions. Free information write Foreign Jobs, Box 2235 AMF, Miami, Florida 33159.

REAL ESTATE AND FARMS

LAND! EASY TERMS LESS THAN BANK RATES. NORTHWEST TIMBERED ACRES As low as \$1550 Total Price. 5-10-20-40 Acres. For people who love the land—A tract of Recreation Land to have for your very own! In Northern Idaho, Northeastern Washington, and Beautiful Montana. In the heart of lakes and big game country. All covered with growing timber. Access and Title insurance with each tract. This is select land with natural beauty, recreational and investment values. Plan for the future and retirement recreation. We have tracts of many types and sizes from which to choose, including beautiful Northwest Waterfront property. Your inspection is welcomed. Write us for free list, maps, and complete information. Write to: Dept. PC, Reforestation, Inc., P.O. Box 14006, Opportunity Station, Spokane, Wash. 99214.

CANADIAN HUNTING/FISHING PROPERTIES. From \$9.00 an acre. Choice properties across Canada. Low monthly payments. Ideal hunting, fishing, timber, investment. **FREE CATALOGUE.** Canadian Estate Land, Department PMC-8, 2200 Avenue Road, Suite 103, Toronto 380, Canada.

NEW! 1971 Fall & Winter Catalog. Coast to coast bargains in farms, retirements, business, resort, investments. Actual property photos! Your copy **FREE!** **SAFE-BUY** Real Estate Agency, Box 589-PM, Little Rock, Ark. 72203.

(Continued on next page)

REAL ESTATE AND FARMS

(Continued from preceding page)

NEW!—FREE CATALOG! Giant Fall-Holidays edition! Nearly 5,000 properties described, pictured—Land, Farms, Homes, Businesses—Recreation, Retirement. Selected Best throughout the U.S.! 71 Years' service, 571 Offices, 41 states Coast to Coast. Mailed FREE from the World's Largest! **STROUT REALTY**, 60-MX E. 42nd St., NY, NY 10017; 7-MX S. Dearborn, Chicago, Ill. 60603; 521-MX E. Green, Pasadena, Cal. 91101.

ARIZONA Walden Village. 2-acre parcels near Prescott National Forest. Ideal climate. Homesite or retirement. \$1,995 with low terms. E. G. Sweeney, Glenarm Co., 2233 No. 7th St., Phoenix. 85006.

GOVERNMENT LANDS Low as \$3.50 acre. Millions Acres! For exclusive "Copyrighted Report" . . . plus "Land Opportunity Digest" listing lands throughout U.S.; and **VALUABLE 17 X 22 TREASURE MAP OF U.S.**; send \$1.00. Land Disposal, Box 9091-PM, Washington, D.C. 20003. Satisfaction Guaranteed.

CANADIAN Vacation lands: Full price \$385.00. 40 acres. \$10 month. Suitable cottage sites, hunting, fishing, investment. Free information. Land Corporation, 3768-C Bathurst, Downsview, Ontario, Canada.

\$1 ACRE—Canadian Border—hundreds campsites, islands, farmlands, directly from tax authorities. (Non-profit). Lists, photographs mailed. Register. Room 10, 110 Church Street, Toronto 1, Canada.

GOVERNMENT Lands . . . low as \$1.00 Acre! Millions Acres! For exclusive "Government Land Buyer's Guide" . . . plus "Land Opportunity Review" listing lands available throughout U.S., send \$1.00. Satisfaction Guaranteed! United Lands, BBox 19107-AH, Washington, D.C. 20036.

CENTRAL Ontario—Choice 640 acre Sportsmen's paradises still available—\$20.00 plus \$6.50 taxes yearly. Maps, pictures. \$2.00 (Refundable). Information Bureau, Norval 4, Ontario, Canada.

BOILING Spring Lakes—America's Greatest Real Estate Value. 1/3 acre vacation or retirement homesites only \$750 cash price. Ten-years to pay. Money-back inspection guarantee. Carolina coast, multi-million dollar, 14,000 acre development. 50 fresh water lakes, private ocean beach, golf course, motel, and country club. Free literature. Dept. 1-K, Boiling Spring Lakes, North Carolina 28461. (Registered under Federal Land Sales act but not offered to residents of states requiring separate registration.)

OCALA FOREST CAMPSITES Deep in the heart of the Great Ocala National Forest. Excellent hunting and fishing. Free maps and photos. (Unavailable in States requiring separate registration). AD70LB710E. W. H. Vernor, Inc., P. O. Box 760, Dept. E, DeLand, Florida 32720.

ARKANSAS-MISSOURI. 5-10-20 acre tracts on 70 mile long Beaver Lake. Great hunting, fishing. Farms. Ranches. Homes. Low taxes. Terms. Catalog. **JIM TUCKER** "The Land Man" Rogers, Ark. 72756.

MICHIGAN 10 TO 160 ACRE TRACTS Lake Superior—Marquette area from \$99.00 Acre. Any terms A-OK. Cabins, trailers, camping welcome. (Land anywhere in Michigan). **FREE PICTURES** write Lake Acres, 3650 Dixie, Drayton Plains 16, Michigan 48020.

\$3.50 ACRE! U.S.A. & CANADA. Millions acres. For unique All States—"All Canada Government Lands Digest." plus maps . . . plus "Bargain Hunter's Review" listing lands available throughout U.S. Rush \$1.00 (Guaranteed). Can-Am Lands, 220 Delaware Ave., Buffalo, New York 14202.

FREE! Real Estate Catalog! Farms, Ranches, Business, Recreational and Investment Property. 18 states, pictures galore. Note state desired. Banner Advertising, Box 3333, 19-A, Springfield, Missouri—65804—"Real Estate Our Specialty."

TREMENDOUS BUYS! Mid-summer listings! Free property Journal! Statewide Realty Co., 507-AE Pyramid Bldg., Little Rock, Ark. 72201.

FREE. . . . Big 240-page catalog. All types real estate coast to coast! **UNITED FARM AGENCY**, 612-PM West 47th St., Kansas City, Mo. 64112.

FARM & GARDEN EQUIPMENT

PROFITS FROM CLASSIFIED ADVERTISING! Booklet shows you how to start your own business with Classified Advertising. Only \$1.00 (Refundable with first order.) C. A. Martin, Popular Mechanics, Dept. PM, 224 West 57 Street, New York, N.Y. 10019.



FLOWERS, PLANTS & NURSERY SUPPLIES

GINSENG Bringing \$20.00 pound. Have seeds roots. Goldenseal. Full information. K. Collins, Viola, Iowa 52350.

FIBERGLASS And Plastic Greenhouses—from \$89.95! (12' Long)! Accessories. Free catalog. Greenhouseman, Box 2666-MH, Santa Cruz, California 95060.

"**YOU** Can raise cactus in your home. **FIVE** Assorted plants with illustrated instruction booklet \$3.00. Also, delicious cactus candy, 1/2 pound \$1.50." Cactus Products, 3740 West Dunlap, Phoenix, Arizona 85021.

CONSTRUCTION PLANS, BLUEPRINTS

BUILD Your Dream Cabin For \$600. Complete Illustrated "A" Frame Building Plans Sent For \$2.50. "A" Frame, POM, 1701 Juliet Ave, St. Paul, Minnesota 55105.

LOG CABINS & HOMES

LOG Cabins, Homes, Cottages, Trailers. 85 plans, specifications and prices. Send \$1.00 to Bloch Brothers—Drayton Plains 5 Michigan 48020 or Phone (313) 674-4116.

HOME CRAFTSMEN

NO TWO ALIKE. Conversation pieces. Unusual tables and cricket stools of hardwood Tupelo slices. Free illustrated price list. Naturlog Originals, Box 826, Dept. PM, Florence, S. C. 29501.

101 PATTERNS Of smart Gifts, Novelties, Shelves, Action Windmills, plus "Make Money Jig Sawing". \$1.50. Mastercraft, 85M, 7041 Olcott, Chicago 60631.

WOODWORKING Catalog and Manual 25¢ Plus free "101 Project Ideas." World's most beautiful veneers, lumber plywood! Wood finishing, upholstery supplies, Cane Lamp parts. Furniture hardware. Animal whittling blocks, 2,000 workshop products. Constantine, 2051-C Eastchester Road, Bronx 10461.

WORMY CHESTNUT: \$1.50 board foot. Cut to your specifications—rough, A.D. Appalachian Maple, Cherry, Birch, Poplar, Oak—\$1.25 board foot. Plus postage and COD charges. BanCo Lumber, Inc., P.O. Box 235, Burnsville, North Carolina 28714.

FOUNDRYETTE 2400 F. 1 1/2 to 48 lb. capacity. Circular 25¢. Kansas City Specialties, Box 193-P8, Middleton, Wisconsin 53562.

CABINETMAKING MADE EASY And "How to Make Formica Counter Tops." Two excellent guides let you build kitchen cabinets and counter tops like professionals. Extraordinary guides bring master craftsmen's shortcut methods. Satisfaction guaranteed. Write: Japs, 126-P Seventh North, Hopkins, Minn. 55343.

MAKE Money Building and selling Bird Houses. Send \$1.90 for 39 page book of plans covering 19 projects. Yeager, 1665 Linden, Homewood, Ill. 60430.

PICTURE Framing—Profitable full or spare-time business. Easy to learn with handbook-course "Guide To Picture Framing Profits." \$1.50 Guaranteed. Free framing-supplies catalog included. Japs, 126-PM Seventh North, Hopkins, Minnesota 55343.

POPULAR MECHANICS MASTER SHOP GUIDE. Greatest product offered to a man with a workshop. All information printed on heavy boards, punched and ready to hang above his workbench. Covers wall fasteners, nails, screws, bolts, twist drills, abrasives, lumber, moulding patterns, plywood grades, hardboards, drywall, plumbing supplies, electrical supplies. Plus information on scores of other subjects. Send \$3.95 to: **POPULAR MECHANICS**, Dept. HE, 224 West 57th Street, New York, New York 10019.

FREE Brochure of how-to books. Numerous subjects. Daniel's, Dept. 2-27, 1121 Villaret, San Antonio, Texas 78224.

PLANTATION FURNITURE For patio and lawn. Cast iron or aluminum in kit form. Free brochure. **IRONMASTER**, Box 9644-C, Birmingham, Alabama 35215.

BEST WORKBENCH PLAN Ever. Plus Free Lumber Conversion Chart, \$1.00. **WAY-MAR**, Dept. 45, 58 Underhill Road, Scarsdale, New York 10583.

BUILD Your own furniture. **COMPLETE** illustrated book of 20 attractive designs and plans with detailed building instructions. \$3.00. Graves Furniture Company, 512 Philtower Bldg. Tulsa, Oklahoma 74103.

FREE Do It Yourself Discount Tool Catalog! Bargains Galore! Selmar, Box 126-8C, Brooklyn 11230.

118 FULL SIZE FURNITURE PLANS. Traditional, Early American, Danish Modern. Catalog 50¢. Furniture Designs, Dept. P-81, 1425 Sherman, Evanston, Illinois 60201.

ADD-A-WING. Double size, triple value of your house for \$6/foot. Complete blueprints for 1000 s/f wing, \$12.50/set. Twenty pages illustrated instructions, \$2.50. Both, \$14. Box 303F, Chappaqua, N.Y. 15014.

DO-IT-YOURSELF

TERMITES Fact Book. Complete instructions, what to look for, control. Send \$2.00 prepaid. Dodson Exterminators, P. O. Box 806, Cucamonga, California 91701.

BUILD Combination Sofa-Bed. Plans \$1.00. Sofa-Bed, Box 685, Smyrna, Georgia 30080.

CONVERT MOWER Engines into air compressors. Write Showalter, Box 409, Abilene, Kansas 67410.

BURGLAR—Fire alarm systems and supplies. Free Catalog. Informer Mfg., 200a S. Eden Street, Baltimore, Maryland 21231.

BURGLAR-FIRE Alarm Supplies and Information. Free Catalog. Protecto Alarm Sales, Box 357, Birch Run, Michigan 48415.

BURGLARY Alarm systems, components, safes, accessories. Free catalog. TPC, Box AE-5, Cupertino, California 95070.

SIDING—Aluminum, Steel, Vinyl Do-It-Yourself Kits. 48 Page instructions and catalog \$1.00, refundable with order. Aluminum Industries Of Arkansas, Dept. PM-18, Little Rock, Arkansas 72205.

SAVE MONEY. LEARN TO TUNEUP Your car. Send \$1.00 for easy Step-by-Step Tuneup Instructions for any American car or light truck, or Volkswagen, postpaid. State make, year, number cylinders, engine size. Satisfaction guaranteed. Vanus, Box 7503, Bitter Lake, Seattle, Washington 98133.

MOTORIZED Bike, Gasoline Engine, Nice Plans, \$2.00. Landin, 4608 West Fillmore Drive, Milwaukee, Wisconsin 53219.

BURGLAR Alarm Kits for homeowners with complete simplified instructions \$69.95 up. Alarms Unlimited, P.O. Box 9335, San Jose, Calif. 95117.

BURGLARY—Fire Protection. Free Catalog. (Comprehensive Installation Manual loaned Free upon request.) Safeway, 92-D Brighton 11th Street, Brooklyn, New York 11235.

(Continued on next page)

DO-IT-YOURSELF

(Continued from preceding page)

FREE Brochure! "How-to-do-it" books. Variety Center, Dept. 9-PM-2, Box 1127, North Wilkesboro, North Carolina 28659.

"WATER SOFTENERS—FILTERS. Send for plans, parts list. \$2.00 Refunded first order. McCarthy Company, P.O. Box 7012, Milwaukee, Wisconsin 53213."

FIVE Easy home projects. Toy chest, Cedar chest, Bookcase, Birdhouse, Bird feeder. Simplified plans and instructions only \$3.95 or \$1.20 each separately. D&D Enterprises, P.O. Box 112, Grand Ledge, Michigan 48837.

SAVE Build your own door and window canopy. Plans \$1.00. CANOPY, 208 11th Street South, Benson, Minnesota 56215.

ADD-A-WING. Double size, triple value of your house for \$6/foot. Complete blueprints for 1000 s/f wing, \$12.50/set. Twenty pages illustrated instructions, \$2.50. Both, \$14. Box 303F, Chappaqua, N.Y. 10514.

ARTS AND CRAFTS

FREE: New handicraft catalog. Supreme Handicrafts, Box 395-PM, Sioux Falls, South Dakota 57101.

MAKE Figurines, plaques, lawn ornaments. Molds, plastercraft kits, liquid rubber. Sample and catalogue 10c. Wooley Company, Box 29-B, Peoria, Illinois 61601.

"GETTING Started in Stained Glass" 25c. Whittemore, Box 2065Y, Hanover, Mass. 02339.

300 FIBERGLASS Molds for casting ornamental concrete products. Catalog \$1.00. Plycrete Molds—Elk Rapids, Michigan 49629.

BINOCULARS, TELESCOPES, MICROSCOPES, MAGNIFIERS

MICROSCOPE LABORATORY KIT. 36 Pieces! For young scientists. 100X to 750 magnification. All metal! Built-in light! 3 turrets! 10X-15X eye-piece. Slides, scalpel, test-tubes, alcohol lamp, probes, chemicals, etc. Instructions, Gifts, Hobby. School: \$14.89 + P&H \$1.50. Calif. Res. 5% tax. 10 day money-back guarantee. Billou's, Dept-300, 9771 Culver, Culver City, Calif. 90230.

SCIENCE Bargains! Lenses, telescopes, binoculars, microscopes, kits, parts, war surplus. Send \$1.50 for beginner's 10-lens kit with instruction booklet. Order Stock 2-CH. Request free 148 page Catalog CH. Edmund Scientific Co., 300 Edscorp Bldg., Barrington, New Jersey 08007.

TELESCOPES (Reflectors) complete kits Other accessories, request free literature. Criterion Manufacturing, Dept. PM 20, Hartford, Connecticut 06101.

MANON Means Fine Binoculars! Special sale! Manon, Dept. 16, Box 1386, Huntington Beach, California 92647.



CAMERAS AND EQUIPMENT

WORLD'S Largest Buying Guide—800 Illustrations—50c—Deductible With Your Order—Olden Camera—1265 Broadway, New York, N.Y. 10001.

FREE! FREE! BARGAIN BOOK—Central Camera Co., Dept. 381, 230 S. Wabash, Chicago, Ill. 60604.

"CAMERA Profits." Five Easy Plans; Plus 250 Markets For Your Photographs. \$1.00. Satisfaction Guaranteed! Camfield's-A, Box 1746, Indianapolis, Indiana 46206.

PHOTOGRAPHY Home Study. Announcing home study course in Photography. For professional or personal use. Fine field for men and women. Practical basic training. Approved supervised method. Low tuition. Payment plan available. Free booklet. American School Of Photography, 555 E. Lang St., Diversey Parkway, Dept. P408, Mundelein, Ill. 60060.

FILM Washers \$11.95+. Film Dryers, Electronic Thermometers, Slide, X-Ray, Film Viewers, Light Boxes. N.C. Bremer Labs, Dept. MP, Box 820, Ithaca N.Y. 14850.

PHOTO FINISHING

CAMERA FANS! Expert photofinishing by one of Country's largest labs at lowest prices. Fast service and free "Foto-Fan" Stamps you quickly redeem for valuable Photo Supplies. 8MM Kodachrome \$1.29; 8 Exp. Kodacolor \$1.79; 35MM Kodachrome. 20 Slides \$1.39; 8 Exp. Black White 69c. Satisfaction guaranteed. Send exposed film or request free mailers, complete Price List and Gift Catalog. Direct Mail Photo, Box 8352-PM, Pittsburgh, Pa. 15218.

KODACOLOR FILM Developed and twelve jumbo color prints \$1.25; twenty \$2.25. Black and White 12-exposure 65c. Trial offer. Young Photo Service, 45C, Schenectady, N.Y. 12301.

COLOR SLIDES

35MM COLOR Slides. 10,671 Individually sold. Described, Encyclopedia catalog 10c. Wolfe Worldwide, Dept. 14-81, Los Angeles, Calif. 90025.

MOTION PICTURES AND SOUND EQUIPMENT

FREE! 64-Page catalog. 8-16mm film, supplies, processing equipment. Superior, 448 N. Wells, Chicago 60610.

UNUSUAL Movie supplies. Free circular. Esor. 47th Holly, Kansas City, Missouri 64112.

RADIO, TELEVISION AND HAM EQUIPMENT

FREE Electronics Catalog. Tremendous bargains. Edu-Kits, Department C-738B, Hewlett, New York 11557.

36c RADIO & TV tubes. Free catalog. Cornell, 4213-17 University, San Diego, California 92105.

GOVERNMENT Surplus receivers, transmitters, snooperscopes, parts. Catalog. 25c. Meshna, Nahant, Mass. 01908.

SAVE Money on parts and Transmitting—receiving tubes, Foreign—domestic. Send 25c for giant catalog. Refunded first order. United Radio Company, 56-PM, Ferry Street, Newark, N.J. 07105.

HIFI, TAPES, RECORDS AND ELECTRONICS

WANTED Old Phonographs—Records—Catalogs. George Moran, Lodi, Wisconsin 53555.

FREE Catalogs, 2000 hard to find unusual records. Rose's Records, Box 7216, Louisville, Ky. 40207.

FREE Catalog—Electronic kits—amplifiers—preamplifiers—psychedelic strobes—metal detectors—color organs—digital instruments—guitar amplifiers. FREE Subscription, SWTPC, Box PM32040, San Antonio, Texas 78216.

EXPERIMENTER'S Kits. Audio, test equipment, others. PAIA Electronics, Box D14359, Oklahoma City, Okla. 73114.

CAPITOL Recording Cassettes and 8-track cartridges as low as 52c. Write for complete price list. Exhibo West, Box 5174-102, Mission Hills, Cal. 91340.

OLD Records Bought, Sold, Jazz, Blues, Country, Etc. Docks, Box 90, Lathrup Village, Michigan 48076.

110 VOLTS From Your Cars Alternator! Build Adapter For \$3.00! Plus Many Other Great Construction Plans—Free Catalog. Creative Products, 1708 Tierney Road, Fort Worth, Texas 76112.



MUSIC AND MUSICAL INSTRUMENTS

FREE, Song Selling Information. Peerless Publications, Box 193-A, Bloomfield, Conn. 06002.

WE Pay All Recording Costs on accepted material! Need new Song Material for immediate recording! Grand Recording, 1354-PM Hancock St., Quincy, Mass. 02169.

ACCORDIONS And Amplifiers! Excelsior and other Famous Makes. Save 50%. Buy Direct. Factory Distributor. Terms. Trades. New—Used. Free Home Trial. Free Catalog And Discount Prices. Excelsior, Dept. R. 3147 North Luna, Chicago 60641.

POEMS And Songs Wanted By America's Most Popular Studio. Tin Pan Alley. Broadway Music Productions PM, Lake Grove, New York 11755.

EASY To Make, Play and Sell Musical Instruments. Kits From \$5.00. Instruments From \$10.00. Here, Inc., P. 410 Cedar Avenue, Minneapolis, Minn. 55404.

VIOLIN And Guitar makers—send for latest Free Catalogue of woods & accessories. International Violin, PM1, 414 East Baltimore St., Baltimore, Md. 21202.

ACCORDION Manufacturing. 6846-P North Avenue, Chicago, Illinois 60635. Concertinas, Hohners, Chromatics, Guitars, Drums. New, Used, Tuning, Repairing. Wholesale Catalogs Free.

PLAYER Piano Rebuilding—get details from: Vestal Press, Vestal 11, N.Y. 13850.

ELECTRIFY Player Pianos, Pump Organs Quickly. Inexpensively with Lee Silent Suction Units. Write Lee Music, 525F Venezia Avenue, Venice, California 90291.

LEARN Banjo. 5-String Bluegrass. No music. Makes learning easy. Free details. Blaylock, Box 25-M, Marietta, Georgia 30060.

GUITAR, Banjo Making books, Plans, woods, necks, tools. List 25c. Satinwood, 510 East 11th Street, New York, N.Y. 10009.

ACCORDION Top brands. Buy direct. Tremendous discounts. Trade accepted. Free brochure PM. Accordion-O-Rama, 874 Broadway, N.Y.C. 10003.

WHOLESALE Professional Guitars, Amplifiers, PA Systems. Free Catalog. CARVIN, Escondido, Calif. 92027.

GUITAR MAKING Books. Imported Woods, Supplies, Accessories. Catalog 25c. Guitar Center, Box 15444, Tulsa, Okla. 74115.

GUITARISTS—Busy? Five minutes weekly, teaches strums, barras, melody. Beginner—advanced. Samples, 10c. Steele's, Box 114, San Raphael, Calif. 94902.

POEMS Wanted For songs. Nashville Music Productions, Box 40001-P, Nashville, Tennessee 37204.

SEND Poems for new songs, records. Free Examination. Five Star Music, 6M Beacon, Boston, Mass. 02108.

FREE Valuable Information Regarding Songwriting — Publishing — Records. Colonna-International, Box 888, Burbank, Calif. 91503.

FREE Catalog. Electronic musical accessory kits. PAIA Electronics, Box B14359, Oklahoma City, Okla. 73114.

LEARN To read music in one evening! Amazing method! \$3.00 Holiday House, Clinton, South Carolina 29325.

LEARN To Read Music in one evening! Amazing New Book Shows How, Only \$3.00. Money Back Guarantee. Vanco Sales, Creek Rd., Downingtown, Pa. 19335.

GREAT Guitar methods, free details. Kates, Box 718-C, Venice, California 90291.

30% TO 50% DISCOUNT! Any model: Guitar, Amp, Drum, Banjo, Dobro! FREE Catalog! Warehouse P12, Box 9352, Fort Worth, Texas 76107.

30% DISCOUNT Name Brand Musical Instruments. Free Catalog. Freeport Music, 127 F. Sunrise Highway, Freeport, New York 11520.

(Continued on next page)

TRAVEL TRAINING

TRAVEL Agents Make \$\$\$\$\$. Exciting, Booming Careers! Easy Home-Study Plan. Approved for Veterans. Free! "Travel Career Kit" Write—North American School of Travel-AZW, Newport, California 92663.

SURVEYING TRAINING

"SURVEYING Transit Level kit; Instructions, \$2.00. Box 413, Altadena, Calif. 91001."

MOTEL HOTEL MANAGEMENT TRAINING

MOTEL MANAGER TRAINING—Men, women, couples wanted by leading resorts, motels-hotels everywhere. Enjoy free rent, plenty of free time. Easy home-study plan. Free! "Motel Career Kit." No salesman will call. North American School of Motel-Hotel Management, AZ, Newport, California 92663.

ACCOUNTING TRAINING

ACCOUNTING PAYS BIG! Easy home-study plan prepares you for thousands high pay prestige positions open now to trained Accountants. Or open your own profitable full, part time Accounting practice. Send for "ACCOUNTING CAREER KIT"—ALL FREE! North American School of Accounting, AZ, Newport Beach, California 92663.

EDUCATION AND INSTRUCTION

OUTDOOR CAREER—Train at home in spare time for Conservation-Ecology Career as Game Warden, Government Hunter, Fish-Wildlife Manager, Forestry Aid or exciting outdoor Technician Type Position. Protect forests and wildlife! Arrest violators! Enforce Conservation laws! Adventure, public service, good pay, regular advances, no layoffs! Free "Conservation-Ecology Career Kit" shows how you can start now. Approved for Veterans! Write: North American School of Conservation—AZ—Newport Beach, California 92663.

SPEED-READ! . . . Rolling magnifying glass! . . . moving image can help you read quickly and comprehend!! . . . send \$2.—today—guaranteed! Wilco, Box 572, Dept. 1M8, Woodstock, Illinois 60098.

LIFETIME Ordinations. Officially chartered church. Details 25¢, Life Science Church, 2207 Cardinal, Rolling Meadows, Illinois 60008.

WATCH REPAIRING. Unique course develops skills at home. Free sample lesson. Chicago School, YV, Fox River Grove, Illinois 60021.

COMPLETE YOUR HIGH SCHOOL At home in spare time. Texts furnished. No classes. Diploma. Approved for Veteran Training. Founded 1897. Free Brochure. American School, Dept. XC45, Drexel at 58th, Chicago, Illinois 60637.

EXTENSION And Post-Graduate Awards in Philosophy, Art, Sciences, Botanic Medicine, Homeopathy, Radionics and others. 30 subjects. Curricular free (airmail \$1.00 refundable). Registrar, Sussex College of Technology, Highfield, DaneHill, Sussex, England.

COLLEGE Degrees thru extension. State Chartered, Prospectus Free, Box 688, Palm Beach, Florida 33480.

GET A British Degree. Divinity. Philosophy, Radionics. 35 Courses. Prospectus free. Brantridge Forest School, Highfield, Dane Hill, Sussex, England.

LEARN TO WELD—Arc, Pipe, Oxyacetylene, TIG, MIG, Plasma Arc. World's Outstanding (non-profit) Welding School. Free school booklet. Write, phone or visit. Approved Ohio No. 70-12-0064-HT HOBART SCHOOL OF WELDING TECHNOLOGY, BOX 71, TROY, OHIO 45373.

MISSOURI Auction School. Veteran approved. Free catalog. 1600-03 Genesee, Kansas City, Mo. 64102.

PIANO Tuning quickly learned with home study course. Diploma granted. American Tuning School, Gilroy, Calif. 95020.

LEARN Auctioneering. Term soon. Free catalog. Reisch Auction College, Box 850, Mason City, Iowa 50401.

EARN \$125 A week and up. Learn a trade with a future. Learn auto diesel mechanics in our shops. You learn with tools on real equipment. Earn while you learn. Many of our graduates earn \$125 a week and up. Write for free bulletin: Dept. 256, Auto Diesel College, Nashville, Tennessee 37219.

HIGHLY EFFECTIVE Home study courses in Electronics Engineering Technology and Electronics Engineering Mathematics. Earn your Degree. Write for Free Descriptive Literature. Cook's Institute of Electronics Engineering, (Dept. 10), P.O. Box 10634, Jackson, Miss. 39209. (Established 1945).

DETECTIVE Course. Free Information. Universal - Detectives, Box 8180-F, Universal City, California 91608.

HIGH SCHOOL Diploma at home. Licensed teachers. Send age, highest grade completed for free details. No salesman will call. Southern States Academy, 5300 W. Bellfort, Dept. 16-08, Houston, Texas 77035.

OWN Collection agency. "Little Gold Mine!" Franklin Credit, Roanoke, Virginia 24004.

USED CORRESPONDENCE Courses and Books sold and rented. Money back guarantee. Catalog free. (Courses bought.) Lee Mountain, Pisgah, Alabama 35765.

AUCTIONEERING. Resident or Home Study Course. Free Catalog. Nashville Auction School, 2004 West End, Nashville, Tennessee 37203.

AUTOSUGGESTION. Sleep-learning headquarters! Tapes, records, books, Gigantic catalog free. Research Association, Box 24PM, Olympia, Washington.

USED Courses! Books! List 10¢. Smith's, 124 Marlborough, Salem, Massachusetts 01970.

LEARN To Fix Typewriters. Desperate shortage trained men. Hundreds needed. Make up to \$25 in one hour. Learn at home in spare time. Industry Approved course. Facts free. Send name. Typewriter Repair School, Dept. 3310-081, Little Falls, New Jersey 07424.

UNLOCK Your Future. Become professional Locksmith with spare time homestudy. Make up to \$6 per hour. All tools, equipment incl. Facts Free. Send name. Locksmithing Inst., Dept. 1310-081, Little Falls, New Jersey 07424.

GRAPHOANALYSIS—Learn scientific handwriting analysis for profit, pleasure. Free sample lesson, catalog, reveals plan. Write: Igas Inc., 325 Jackson, Dept. 2EZ-2, Chicago 60606.

LEARN Real Estate At Home. Get your license. Become a Salesman or Broker. Approved for Veterans. Write National Institute Of Real Estate, Inc., 3330-M Peachtree Rd., Atlanta, Georgia 30326.

EARN University Degrees through Experience—Many Subjects—Details \$1.00—St. Matthew University, 1261 East Main St., Columbus, Ohio 43205.

"WATCHMAKING"—Approved Correspondence Courses. Watchmaking Institute, 5816-A Lankershim, North Hollywood, California 91601.

PIANO Technology—Electronic organ servicing, learned easily at home. G.I. Approved. Free booklet. Niles Bryant School, Dept. P, 3631 Stockton, Sacramento, California 95820.

LEARN Asleep or awake! Records, tapes, equipment! Free catalog! Drawer PM-400, Ruidoso, New Mexico 88345.

PERFECT Husband-wife business. Learn Upholstery at home. Make \$10 in an hour. Buy-repair-sell for even bigger profits. Kits, tools included. Free Booklet. Upholstery & Decorating School, Dept. 5310-081, Little Falls, New Jersey 07424.

PROFITABLE Camera service training at home. National Camera, Dept. PM, Englewood, Colo. 80110.

LATEST Bricklaying Bibliography, Programmed Instruction, Retirement. The Pretto Services, P. O. Box 114, Durham, North Carolina 27707.

LEARN TO READ MUSIC IN ONE EVENING. AMAZING METHOD GUARANTEED. Details free. E. R. Harris Co., 334 West 97th St., Chicago, Ill. 60628.

CAREER Guidance. Free details. Consultant, 4172 Emerald Lake Drive, Decatur, Georgia 30032.

"LEARN To Read Music In One Evening! Free details. Write: Anthony Cappelloni, 268 West Walk, West Haven, Conn. 06516.

DEGREE-Granting Correspondence School Directory; Fabulous Government Publications Catalogue; Secret Societies Guide. Free Details. Aureap, Allenhurst, New Jersey 07711.

HOW To read music in one evening. Free details. Sensational. Lemax Distributors, 713P Ohio Street, Ashland, Ohio 44805.

THOMAS A. EDISON COLLEGE Master's & Doctor's "OFF CAMPUS" Degree Programs in Religious & General Education. Write: TAEC, Box 688, Palm Beach, Fla. 33480 For Catalogue send \$1.00.

FREE D.D.—B.D.—M.D.—With Lifetime Ordination. Box 333-PM, Rillton, Pennsylvania 15678.

"SCIENTIFICALLY ACCELERATED SLEEP-LEARNING" 25¢ Per Copy. Amazingly easier, faster potential for Self-Improvement! Dr. Fowler, Box 5381, Woodbury, New Jersey 08096.

FOR INVENTORS

INVENTIONS Wanted immediately for promoting on cash or royalty. Patented, Un-Patented. Free booklet outlines royalty rates, requirements. Write Kessler Corporation, C-58-F1, Fremont, Ohio 43420.

COMPARE! We Contact Manufacturers for best deal for your invention. Information: Anderson Enterprises, Box 15731, St. Louis, Mo. 63163.

PATENT SEARCHES including maximum speed, full airmail report and closest patent copies. \$6.00. Quality searches expertly administered with complete secrecy guaranteed. Free Invention Protection forms and "Patent Information." Write Washington Patent Office Search Bureau, Dept. 15, 711 14th St., N.W. Washington, D.C. 20005.

INVENTORS: Your ideas and inventions (patented: unpatented) expertly searched, developed for commercial appeal and cash/royalty sales to manufacturers by professional Invention Developer with excellent record of experience. B.S. Industrial Engineering; United States Patent Office former Patent Examiner. United States Government former Patent Advisor, Second decade reliable service! Member: United States Council International Chamber Commerce. Free "Invention Record" and "Recommended Protection Procedure." Airmailed! Write: Raymond Lee, Invention Developer, 230P-Park Ave., New York, New York 10017.

INVENTORS! Receive free invention analysis at no risk to you. Send for free disclosure form today. New York Invention Service, Dept. 40, 160 Broadway, New York, New York 10038.

IMMEDIATE Cash, for patent applications. Free patent searches. Write for details. Universal Patents, 184-D Marion, Ohio 45750.

U.S. PATENT Office Searches, 234 Broadway, Room 3615, New York. Free invention certificates.

INVENTORS! Our free expert invention analysis saves you valuable time, helps you realize full sale value. Strictly confidential. Free Invention Certificate. Pioneer Invention Service, Dept. 30, 150 Broadway, New York, N.Y. 10038.

(Continued on next page)

FOR INVENTORS

(Continued from preceding page)

PATENT Development Engineering, Patent Research and Sales Promotion of Inventions or Ideas by Licensed Professional Engineer—Patent Engineer, with technical consultants available in the various fields of product development. To evaluate your invention, we research the United States Patent Office records. Your invention or ideas are developed by us to be operative as required for patenting and sale to manufacturers. We also promote the sale of inventions outright or for royalties to nationwide manufacturers that contact our office for new products or that we select from our market research. Further Invention Information and Invention Certificates sent Free upon request. Serving Inventors since 1954. Licensed Professional Engineer—Patent Engineer, Masters Degree in Engineering—United States Patent Office Former Examiner, George Spector, Woolworth Building, New York, N.Y. 10007.

PATENT Application Financing. Free patent search plan. Global Patent Division, 2420 77th, Oakland, Calif. 94605.

FREE PAMPHLET: "Tips on Safeguarding Your Invention." Write: United States Inventors Service Company, 501P Thirteenth Street N.W., Washington, D.C. 20004.

INVENTORS—Now you can protect your ideas by filing the U.S. Patent Disclosure Document. Send \$2.00 for disclosure forms and free disclosure brochure. You file direct. Instructions included. Write INVENTORS FORMS, P.O. Box 1625, Riverside, Calif. 92502.

MANUFACTURERS NEED New Products! FREE Literature explains "How to Submit Your Invention," Congress Invention Company, 911-C Warner Building, Washington, D.C. 20004.

INVENTIONS WANTED

INVENTIONS Wanted immediately for promoting on cash or royalty. Patented, Un-Patented. Free booklet outlines royalty rates, requirements. Write Kessler Corporation, C-58-IW, Fremont, Ohio 43420.

INVENTORS! We will develop, sell your idea or invention. Our national manufacturer-clients are urgently seeking new items for highest outright cash sale or royalties. Financial assistance available. 15 years proven performance. For free information write: Dept. 47, Wall Street Invention Brokerage, 79 Wall Street, New York, N.Y. 10005.

INVENTIONS Wanted. Patented: unpatented. Tremendous manufacturers lists. Global Marketing Service, 2420G 77th, Oakland, California 94605.

INVENTORS! Sell your invention for cash or royalties! Our client manufacturers eagerly seek new items. Patented. Unpatented. Financial assistance if needed. 25 years proven performance. For free information, write Dept. 15, Gilbert Adams, Invention Broker, 81 Wall St., New York, N.Y. 10005.

"INVENTORS, Newly formed company needs anti-pollution inventions to buy or promote. Write Room 805, 61 Broadway, New York 10006."

WE Either sell your invention or pay cash bonus. Write for details. Universal Inventions, 28-E, Marion, Ohio 45750.

INVENTIONS Wanted by top promotional firm. Complete, confidential service. Free details. Contact: Wall Street Promotions, Inc., Dept. 7, 99 Wall, New York, New York 10038.

WE OFFER reliable service for every inventor's need. Our 12th Anniversary "Special" effective throughout 1971. Write now! International Invention Institute, Dept. 21, 160 Broadway, New York, N.Y. 10038.

INVENTORS! Don't sell your invention, patented or unpatented until you receive our offer. Eagle Development Company, Dept. H, 83 Wall Street, New York, New York 10005.

INVENTORS! Protect your ideas! Free "Recommended Procedures." Washington Inventors Service, 422F Washington Building, District of Columbia 20005.

FREE "Directory of 500 Corporations Seeking new Products." For information regarding development, sale, licensing of your patented/unpatented inventions, Write: Raymond Lee Organization, 230-N Park Avenue, New York, New York 10017.

BUY IT WHOLESALE

AUTOMATIC Fishhooks, 2 models. Samples \$2.00. Aron, 61-PM, Mastic Beach, New York 11951.

WHOLESALE—Buy 40% To 50% Off Retail—same prices retailers pay! Thousands of name brands! Watches, cameras, jewelry, radios, phonographs, tape recorders, etc. Buy for yourself or resell at fat profit. Big wholesale catalog, Confidential Wholesale Price List. Free details. Wholesale Merchandise Club of America, Dept. 415, 154 Jericho Turnpike, Floral Park, N.Y. 11001.

HEARING Aids, Batteries, Wholesale. Catalog 25c. Fiston, Box 1444, New Preston, Conn. 06777.

WORLD'S Largest wholesale dropship sources. U.S., foreign. Factory suppliers dropship direct to you or customers. Now! have your own catalog for pennies. Free details. International Buyers, Box 16386-M, Portland, Oregon 97233.

BARGAINS! Buy wholesale and below. Name brands. Appliances, furniture, sports equipment, televisions, cameras, watches, jewelry, thousands more. Huge discounts to \$1,000.00 on new automobiles. All makes. Free details. Write today: Worldwide Bargainhunters, Box 730-A, Holland, Michigan 49423.

PINUP Keychains, etc. 80 different. For resale only. Free catalog. Empire, 1916 Fifth, Sacramento, California 95814.

DRAFTING Equipment catalog 20c. Amtech Inc., Box M-122, Mt. Holly, N.J. 08060.

(800,000 PRODUCTS Wholesale! Save 60%! Free details. Wholesalers, 1265-MA Broadway, New York, New York 10001).

ARTIST Supply Catalog 20c. Amtech, Inc., Box M-122, Mt. Holly, N.J. 08060.

BEAT The heat and preserve your roof with beautiful white acrylic-epoxy-titanium dioxide roof coating. Easy application. Low wholesale prices. Free information. Universal Laboratories, PM18, 1347 South 8th Street, Phoenix, Arizona 85034.

LIVE Catch Traps. Free Literature. National Live Trap Corp., Tomahawk, Wis. 54487.

1970 FORDS, Dodges \$799; 1969 cars only \$599 Ex-Taxis. For free catalog, Associated Dealers, 50 Swalm, Dept. 6, Westbury, N.Y. 11590.

EXPORT-IMPORT

BUTTERFLY Vinyl Ladies' Bag. FULL NATURAL Colors. Round, 11"x3 1/2". \$5.50. Satisfaction guaranteed. Order from: Sell, Box 959, St. Petersburg, Florida 33731.

DRESDEN Figurines, "Four Seasons". Write. Sell, Box 959, St. Petersburg, Florida 33731.

HONG KONG Directory—200 Wholesalers & Manufacturers \$2.00. Japan-Radio, TV & Recorders 149 sources \$2.00. Tokyo Directory 13,000 products \$4.00. IMPORTS, Box 4665-X, San Diego 92104.

IMPORTING SECRET Don't Learn the Hard Way. Only one dollar for Answer. Fischer Imports, 135, R.D. 1, Wrightstown, New Jersey 08562.

JAPAN: 1200 Products directory. Illustrated Manufacturers' names, addresses. \$3.00. Send cash, Yamagata Office. 814 Togin Bldg., Marunouchi, Tokyo.

FOR THE HOME

Wonderful Colored Mexican Originals Amate Bark Paintings \$2.00. Refundable. "Ortega Ruiz". Gonzalez Martinez 6-24 Mexico City.

OF INTEREST TO WOMEN

ADDRESSERS Mailers \$1000 Monthly, send addressed stamped envelope. Martin Mailorder, Box 13546-MW, Savannah, Georgia 31406.

AUTHENTIC Early American Sunbonnet Patterns. Colonial, Centennial, Pioneer. 3 Patterns With Instructions, Photos \$2.00 PPD. Jo-Ev Specialties, Box 239, Waterford, California 95386.

PALMLOOM For Pleasure or Profits Free Circular. J. L. Sales, 1761 W Lacombe Ave., Bronx, New York 10472.

CORDLESS "ELECTRIC-SCISSORS" Cut fast! accurate! safe! \$2.98 plus 60c shipping. "FOUR" J'S, Wholesalers" 914 South Helen Street, Sioux City, Iowa 51106.

HOMEWORK OPPORTUNITIES!! Addressers, Mailers needed at all times. Rush stamped self-addressed envelope and 25c handling and postage. Livingston, Box 545M2, Black Mountain, North Carolina 28711.

\$10-\$15 DOZEN Possible sewing Aprons, Lacing Billfolds. Redikut's-40, Richland Center, Wisconsin.

HOMEWORKERS Wanted to stuff envelopes. Send self-addressed stamped envelope. Tayco, Box 8010-IMP, Stockton, California 95204.

\$100 WEEKLY POSSIBLE Addressing mailing, sparetime. Free details. Send self addressed stamped envelope. Newby Publications, Box 20427-PM, San Antonio, Texas 78220.

\$46.00 DAILY possible addressing-stuffing envelopes (typewriter or longhand) information. Send stamped, addressed envelope. American, Excelsior Springs, Mo. 64024.

HOW To make money writing short paragraphs. Information free. Barrett, Dept. C-27-X3 6216 N. Clark, Chicago 60626.

GUARANTEED, \$20.00 EVERY 80 ENVELOPES you stuff. No postage, addressing required. Information, send 30c with stamped, self-addressed envelope. Econ. "CX", 629 Franklin St., Clearwater, Florida 33517.

25c EACH, STUFFING Envelopes. No postage required. No addressing necessary. Complete instructions \$1.00. Economy 629-BT, Franklin, Clearwater, Florida 33517.

HOMEWORKERS NEEDED Painting Novelties. Good Earnings. Details 10c. Roland, 10-V Lakeview, Hammonton, New Jersey 08037.

HOMEWORKERS! \$100.00 Weekly addressing for firms. Begin immediately. Details—send stamped, addressed envelope. Hamilton, 272-TM-8, Brooklyn 11235.

HOME Newspaper clippers needed. \$500 monthly possible. Details free. Foster, 272-MA-8, Brooklyn 11235.

\$500 MONTHLY Possible—Clipping news at home. No experience—send stamped-addressed envelope. American, Excelsior Springs, Mo. 64024.

DRIVE New car, wear new clothes, buy color TV. Get daily cash income. Put spare hours to work. Write for 5 months free subscription Opportunity Magazine, see hundreds easy ways to make money. Opportunity, 1460 Hancock Center, Dept. 17-HO, Chicago 60611.

FREE Catalogue, Unusual And Distinctive Gifts. Write: South Side Dry Goods, Dept. P, 126 East Dunklin, Jefferson City, Missouri 65101.

ABNORMAL Profits—making—selling cosmetics. Proven easy formulas. Free information. Lee's, Box 326-M, Queen City, Texas 75572.

(Continued on next page)

GIFT SHOPPING

FREE Catalog, exciting new gifts. Oak Tree, 4223 Crownfield, Westlake Village, Calif. 91360.

FREE Catalogue tells how to receive FREE unique gift. Write. Thomas Green, 6603 Kincheloe Avenue, Baltimore, Maryland 21207.

FANTASTIC NEW CATALOG And amazing circulars of gifts and novelties. Send 25¢. J & L Sales 1761 Lacombe Ave., Bronx, New York 10472.

CATALOG Of distinctive gift items. Send \$1.00 (refundable first order) R.K. Lawler, 5101 River Road #315, Chevy Chase, Maryland, 20016.

NEW Gift Catalog 25¢. Blake Enterprises-1M08. Box 1172, Hollywood, California 90028.

5000 YEAR Old "KEY OF LIFE" Jewelry—Gold and Silver replicas. Color card 25¢. Aladdin House, Dept. 54, 648 Ninth Ave., New York 10036.

FREE Distinctive Gift Catalog How To Get FREE Gifts. Magnificent Gift Center, 815 East Pleasant Street, Springfield, Ohio 45505.

HOLLAND Gifts! Free Brochure. Rocha's 266A W. Prosperity, Tulare, Calif. 93274.

INCENSE Oriental European Domestic Finest Quality Direct From Importer. COSAS Box 5768, San Francisco 94101.

FREE BEAUTIFUL HARDWOOD HOLDER With each distinctively embossed DESK or WALL nameplate, \$1.25 plus 50¢ shipping. Name or wording to 18 gold or maroon letters on blond wood veneer. BUY NOW for gifts, awards, PROFESSIONAL office use, etc. Satisfaction Guaranteed. Phonetic alphabet FREE With order. DeSigns 2473 Fletcher Dr., Los Angeles, California 90039.

WATCHES, OLD GOLD, JEWELRY

HIGHEST CASH for Gold, Jewelry, Gold Teeth, Rings, Diamonds, Watches, Silver, Platinum. Mail Articles Today. Free gift with information. Chicago Gold & Precious Metals, 16 E. Monroe, Dept. 1258, Chicago 60603.

CASH Immediately for old gold, jewelry, gold teeth, watches, diamonds, silverware, spectacles, platinum, mercury. Free information. Rose Industries, 29-A East Madison, Chicago 60602.

WATCH And clock repairing books. Free catalog. North American, Box 77-AH, Fox River Grove, Illinois 60021.

COMPLETE Watchmakers'-Jewelers' Catalog \$1.00. Bengal's, 5816-A, Lankershim, North Hollywood, California 91601.



SCIENCE AND CHEMISTRY

CHEMICALS Apparatus, Biology and Model Rockets. Both Catalogs for 50¢. Sheard Science, Dept. PM, Columbus, Wisconsin 53925.

SEARCHING For Economically Priced Laboratory Supplies? Conversion Charts And Catalogue—35¢. Hagenow Laboratories; Manitowoc, Wisconsin 54220.

CHEMICALS And apparatus for industrial, analytical, and private laboratories. Catalog 50¢. Dept. M-50. Biological Supply Co., 1176 Mt. Hope Ave., Rochester, N.Y. 14620.

CATALOGUE Of those ver-ry hard-to-find chemical products, plus things that go boom, unusual formulas, multi-stage rockets,—loads more! 50¢ (Price refundable, first order) Kenrus-C, Box 158M, Staten Island, New York 10309.

CHEMISTRY, Biology, Astrology Catalog 35¢. Boulevard Laboratories, 3114 East 83rd Street, Chicago, Illinois 60617.

MODEL ROCKETRY Magazine, Designs, Instrumentation, More. Sample 25¢. 12 Issues \$7.00. MRM, Box 214W, Boston, Massachusetts 02123.

LABORATORY Supplies at discount prices. Catalogue—35¢ Deluxe Scientific; Manitowoc, Wisconsin 54220.

THE PYRAMID, Mystery of the ages. A force field known to sharpen razor blades, dehydrate organic substance, etc. Conduct your own experiments. Complete kit and instructions, \$3.00 Postpaid. Pyramids, P.O. Box 387, South Lake Tahoe, California 95705.

FORMULAS, PLANS, ETC.

SEVENTY-FIVE One and two Ingredient Marketable Formulas, Complete Instructions. Satisfaction Guaranteed. \$1.00. Camfields-A, Box 1746, Indianapolis, Indiana 46206.

ANY FORMULA—\$5.00. Catalog—Manufacturing Treatise 25¢. Belfort, 192 N. Clark, Chicago 60601.

PLASTICS

CASTOLITE Pours like water, hardens like glass without heat. Embed natural flowers, photos, coins. Many other money-making projects. Manual 25¢. CASTOLITE, 71/101J, Woodstock, Ill. 60098.

PLASTIC, DECORATIVE, Mother-of-Pearl Chips Wholesale. Use for plastic embeddings. Use in making beautiful table tops, wall paneling, Decorative Novelties. Send .25 cents for Price List. Apco, P.O. Box 282, Metropolis, Illinois 62960.

PLEXIGLAS Plastic supplies, tools catalog 25¢ refundable. COSAS, Box 5768, San Francisco 94101.

POLYSAND. Amazing discovery restores scratched, hazy plastic surfaces. Use to regain full visual transparency for aircraft, boat, motorcycle, snowmobile windshields. Polishes watch crystals, signs, cultured marble, etc. Complete kit, \$10.95 ppd. Rainco, Box 20944-C, Phoenix, Arizona 85036.

LARGEST Plastics Handicrafts Supply catalogue \$1.00 (refundable). R.P.H. Mfg., 24-M8 Winter, Stamford, Connecticut 06905.

TREASURE FINDERS

"FREE: Jetco electronics Free 24 Page Treasure Finder Catalog. Find Metals, Minerals, Gold, Silver, Coins And Relics. Jetco—Box 132PM—Huntsville, Texas 77340."

FREE 128 Page detector catalog. General Electronic Detection Co., Box 67, Bellflower, California 90706.

"FIND Buried treasure with revolutionary patented, analytical metal detector. Features push button and automatic tuning, negligible ground pickup, greatest range. Free catalogue. Gardiner Electronics, Dept. 9, 4729 N. 7th Avenue, Phoenix, Arizona 85013."

POWERFUL Metrotech locator detect gold, silver, coins, relics. Moneyback guarantee, terms. Free information. Underground Explorations, Dept. A, Box 793, Menlo Park, California 94025.

TREASURE Hunters! Prospectors! Relco's new instruments detect buried gold, silver, coins, minerals, historical relics, transistorized. Weighs 3 pounds. \$19.95 up. Free catalog. Relco-A40, Box 10839, Houston, Texas 77018.

FISHER DETECTORS Has something new! Free literature. Fisher Research, Dept. PM-8, Palo Alto, Calif. 94303.

GOLDAK Treasure locators—Pleasure and profit in a hobby you'll enjoy. Find coins, relics, gold, silver. Charge on BankAmericard. GOLDAK, Dept. PM 1101-A, Air Way, Glendale, California 91201.

TREASURE LOCATORS MOST COMPLETE LINE. FREE INFORMATION. TESOROS, APARTADO 7-948, MEXICO 7, MEXICO.

TREASURE BOOKLET. Excellent information on treasure hunting and metal detectors. Send 25¢. BOOKLET, Dept. PM-8, Box 243, San Gabriel, California 91778.

SEARCH Treasure Finders. Locate gold, silver, coins, relics. Operate underwater. Money back guarantee. Free information. Search Electronics, Box 8396-A, St. Petersburg, Florida 33738.

"BOUNTY HUNTER II" \$89.95 postpaid. Free literature. L. Wilkinson, Gray, Pennsylvania 15544.

DISCOVER Buried Treasure. Ingenius, Featherweight, Foolproof; Sensitivity Beyond 9 Feet. Easy Plans \$3.95, Postpaid Complete \$7.95 (Allow 4 Weeks Delivery). Finder's Keepers, POB 21335, Houston 77026.

PRECIOUS STONES AND MINERALS

GOLD 10 Small nuggets panned from Oregon Streams \$1.00. Robert Brandt, Sweethome, Oregon 97386.

500 POLISHED Gemstones \$5.00. Tumblecraft, 5401 James North, Minneapolis, Minn. 55430.

EARTH Science Rockhound Magazine. Subscription \$3.00. Sample \$.40. Box-550-PM, Downers Grove, Ill. 60515.

500 BEAUTIFUL POLISHED GEMSTONES \$1.50. Floodstones, P.O. 1673, Fremont, California 94538.

GET Free catalog no serious rockhound, gem cutter, jewelry maker, hobbyist or craftsman can be without. Full of bargains, exclusive items, low prices from largest suppliers and authorities in the field. Free new catalog just off the press, yours for the asking. Write Grieger's, Dept. C-12, 1633 E. Walnut, Pasadena, California 91106.

CARTOONING, COMMERCIAL ARTS, SHOWCARD & SIGN PAINTING

"HOW TO MAKE MONEY WITH SIMPLE CARTOONS"—Everyone who likes to draw should have this book; FREE. Write Cartoonists' Exchange, 98, Pleasant Hill, Ohio 45359.

LEARN Cartooning at home. V. A. Approved. Write: Cartooning, Box 31760, Colorado Springs, Colorado 80907.

COMPACT 23 lesson Cartoon Course and Cartoonist's Magazine. \$2.00. Hartman, Box 30367, Lincoln, Nebraska 68510.

MODERN Cartooning taught by mail. Write for free brochure. Cartoonorama—Box 263-9D, Branford, Conn. 06405.

SIGN Painting—\$1000 per Month Part-Time. Free Catalogue. Kaufmann Supply, Centertown, Missouri 65023.

CARTOON For Money!! Big Free Book: Success, Box 885-C, Dearborn, Mich. 48121.

LEARN Sign painting at home. Free Talent test. Ben Kerns, Box 812-PM, Greenville, S.C. 29601.

ADVERTISING AGENCIES, ADV. SERVICE, MAILING LISTS

MAILING Lists, 1000/\$9.00. 1000 Circulars mailed \$7.00. Advertising placed Magazines where will click. Dixmail, King, North Carolina 27021.

ADVERTISING Ratebook leading newspapers, magazines, 25¢. Chicago Advertising Agency, 28-E Jackson, Chicago 60604.

TYPEWRITERS, DUPLICATORS, OFFICE EQUIPMENT

FREE Plan. Start printing, lettershop, Offset Presses. Mimeograph Copy machines. DixieGraph, King, N. Car. 27021.

RUBBER STAMPS

ADDRESS Stamp 85¢. Signature \$2.80. Catalog. Carol's, McCloud, Okla. 74851.

FREE 48 Page Catalog. Rubber stamps, printing, office supplies. Youngers Stamp Shop, Princeton, Iowa 52768.

(Continued on next page)

RUBBER STAMPS

(Continued from preceding page)

TYPE For rubber stamp making now available at lower prices. 10pt 12pt 20th Century Medium 12Acaps \$2.00 24alc. \$2.00 Others at low prices, complete supplies catalog. BARCO MANUFACTURING, 237 Evergreen, Bensenville, Ill. 60106.

PRINTING PRESSES, RUBBER STAMP OUTFITS

SAME Day shipment on rubber stamp supplies. Revised wholesale price list No. 7 free. Star Stamp Supply, 732 Federal, Chicago, Ill. 60605.

RUBBER Stamp manufacturers supplies. Press, starting outfits. Best prices, service. Catalog. Jackson Supply, Box 443A, Franklin Park, Illinois 60131.

SIMPLE-X RUBBER STAMP PRESSES. Hydraulic operated, electrically heated. Sizes 5"x8", 8"x12", 10"x15". Starting outfits Orders for presses, supplies shipped day received. Free catalog low supply prices. Send \$1.00 for postage and handling (refundable on first order). Custom Manufacturers, 406-P East Elm, Springfield, Missouri 65801.

RUBBER Stamp outfits, supplies. Kiewiet, 2025 Barney Road, Kalamazoo, Michigan 49007.

PRINTING Presses, type, supplies, Lists, 10c. Turnbaugh Service, Mechanicsburg, Pennsylvania 17055.

TYPE Catalog No. 12, 120 pages. Send One Dollar. Deductible First Order. Acme Type, 732 Federal, Chicago, Illinois 60605.

MAKE Your Own Self-molding rubber stamps and printing cuts. Plexirubber, Argyle, Wis. (1).

PRINTING AND SUPPLIES

NEW 1971-72 Printers Supply Catalog 320 page 9" x 12" book. Hundreds of new items. 40 pages of foundry type showings. Rubber stamp presses and supplies, hot stamping equipment, hand and power printing presses, proof presses, paper cutters, folding machines, composing room equipment, offset equipment, drawing equipment, thousands of items. The most complete Graphic Arts book published. All items illustrated. Postpaid \$6.50. American Printing Equipment & Supply Co. 42-25 Ninth Street, Long Island City, N.Y. 11101.

AMAZING Business printing values. Quotations. Print Shop, Box 576, Greenville, R.I. 02828.

FREE Literature. Address Labels. Business Cards. Printing. Rubber Stamps: Jordan's, 52 West O'Connor, Lima, Ohio 45801.

BUSINESS CARDS Raised Letters \$5.65 Thousand. Like Engraved. Free Samples. Kavanagh, Box 1222, Brooklyn, N.Y. 11202.

ECONOMICAL Business Forms, Stationery, Labels, cards, Samples. Burnfin, Weaubleau, Missouri 65774.

LOWEST Prices practical! Try Haldeman Printing, Girard, Kansas 66743.

STATIONERY . . . New, Personalized. Details Free! Longwood Press, D-4781, Fort Johnson, New York 12070.

BUSINESS Cards \$4.00 Thousand. Other Values. Price List 10c. Impressions, 249 Queen South, Minneapolis, Minnesota 55405.

FREE Booklet "Secrets of Cutting Printing Cost" Nationwide Speed Printing, Atlanta, Illinois 61723.

GUMMED LABELS

1,000 GUMMED Address Labels \$1.00. Wait's, Box 966A, South Bend, Indiana 46624.

1000 ADDRESS Labels. Gummed. \$1.00. G and K Associates, Box 903-E, Garden Grove, California 92642.

1,000 PERSONALIZED Address Labels 50c, 3,000—\$1.25. Specialties, Ora, Indiana 46968.

1000 PERSONALIZED Labels 50c. 3 Sets \$1.25. Free Catalog!! Fabrico—Dept. WH-1, 1512 N.E. 29th Street, Ocala, Florida 32670.

REMAILING SERVICE

CLEVELAND Remails 25c RJC, Dept. C, Box 20110, Cleveland, Ohio 44120.

MICHIGAN—Complete service. Information: Motor City, Drawer 890, Dearborn, Michigan 48121.

START Your own remail business. Stamped envelope for details. Box 33-A, Coral Gables, Florida 33134.

SCOTTSDALE Remails, 25c. \$3.00 monthly. Remfor, Box 1541P, Scottsdale, Arizona 85252.

MIAMI Remails 25c. Miami Beach, Coral Gables 35c. Confidential, Jami, Box 303, Miami, Florida 33145.

WASHINGTON, Baltimore, St. Louis, San Francisco, others. J. C., Box 2566B, Arlington, Virginia 22202.

CHICAGO Remails 25c. Special Services, Box 760-PM, 219 South LaSalle Street, Chicago, Illinois 60690.

PEBBLE BEACH Remails 25c Confidential, Radcliffe, Box 961, Pebble Beach, California 93953.

MIAMI Remails 25c. Monthly rates. Marie, Box 1266, Coral Gables, Fla. 33134.

CONFIDENTIAL New York City mail address \$3.00 month. Remails 25c. Details Free. Birnhan, 152 W. 42, New York City 10036.

SECRET. Receiving—forwarding. Discreet and confidential. Remail 25c single. Mail Forwarding Service, 8050 S. Main, Houston, Texas 77025.

RECEIVING—Forwarding. Monthly Rates. Hedgpath, 406-M South Second, Alhambra, Calif. 91802.

VILLA PARK & Hinsdale Remails. 25c. \$3.00 Monthly. Eliot Fad, 17 West 170 Leahy, Villa Park, Illinois 60181.

CANADA Remails 25c. \$3.00 monthly. Scotts, 204 Glen Road, Toronto 5, Ontario.

SACRAMENTO Address \$3.00 Month. Burre, 2029 Robert Way, Sacramento, California 95825.

DENVER Receiving—Forwarding. 25c. \$3.00. Details free. Rich, Box 26099, Denver, Colorado 80226.

PROMPT Remailing—Texas or Arkansas—Details Free: Lee's, Box 326-M, Queen City, Texas 75572.

SPECIAL SERVICES

INFORMATION On anything. Ferguson Research Specialists, 83-45 Vietor Ave., Elmhurst, N.Y. 11373.

CANADIAN Information or service on anything. Purchasing Services, 388 Duffield, Winnipeg, Canada.

INSURANCE INFORMATION

AUTO INSURANCE GUIDE—Don't Wait Until You Have A Claim! Learn What Your Policy Covers NOW! \$2.00. Thomas Wakefield, Box 62, Magnolia, New Jersey 08049.

PERSONAL

TATTOO Removing With Chemical Do-It-Yourself Kit—No needles. Information Free: Atlanta—907 Beachpoint, Fairport-Beach, Ontario.

SECRET Law Wipes Out All Debts. Immediate relief. Clear credit. Free details. Counselor-7. Kerrville, Texas 78028.

NATURAL Foods—El Molino Products Supplements, popular prices. Mail orders, prompt shipping. FREE details, prices. Dodson Company, P. O. Box 806, Cucamonga, California 91701.

PAY Bills! Borrow to \$1500 by mail! Convenient terms! State licensed. Postal Finance, 200 Keeline Building, Dept. 17-N, Omaha, Nebraska 68102.

HOW To retire while still young—and enjoy your retirement—without money worry. Write O-My-O Enterprises, Box 473-A, Port Huron, Mich. 48060.

CASH LOANS By mail! Up to \$1,000 on signature alone. No Collateral! Secret! Union Finance Company, 3608 No. 16th St. Dept. PM, Phoenix, Ariz. 85011.

HOW Intelligent are you? Self-scoring test reveals IQ in 45 minutes Send \$2.00 today—guaranteed! Richards, Dept. 288, 5741 Pontiac Rd., Virginia Beach, Va. 23462.

BLANK FORMS—Birth, Baptism, Marriage, Divorce; High School, College Diplomas, Power of Attorney, Will, Bill of Sale, General Agreement. Any 3 forms, \$1.00. (Others, list sent.) Legal Forms, Dept. 234, 1830 Guardian Building, Detroit, Michigan 48226.

FOLLOW That Car. Electronic Trailing Equipment, Box 220-P, Miami, Florida 33168.

BIBLE Questions answered. Stamped envelope. Bylon, 17167 Bentler, Detroit, Michigan 48219.

INVESTIGATORS. Latest electronic Aids. Free Literature. Clifton, 11500-P NW 7th Ave., Miami, Florida 33168.

RUPTURED. Relief and comfort. No understraps, elastic or steel. Write Hand-Lock Products, Preston 4, Ont., Canada.

TOO Many Debts? Want to lower your payment and pay off the bills? Write Continental, Dept. PM, Box 2116, East Chicago, Indiana 45312.

RECORD Telephone conversations automatically. Leave recorder unattended. Write—Robert's, Box 49PMA, Parkridge, Illinois 60068.

SECRET LOANS BY MAIL. Borrow \$100 to \$1500 for any good reason in absolute privacy. No interviews, no endorsers, no co-signers. Fast service. Write Dial Finance Co., Dept. H-214, 410 Kilpatrick Bldg., Omaha, Nebraska 68102.

HAVE Triple-A credit in thirty days! Get new credit without investigation! Continental, Box J-24, Hallandale, Florida 33009.

IMPROVE YOUR PERSONALITY Write for free information: PERSONALITY SUCCESS, Dept. C-3, Box 1946, El Paso, Texas 79950.

"RULE Others With Thoughts." (Teletype) write: Clarion, Box 1769-S7, Chicago, 60690.

"OVERWEIGHT—I Lost 40 lbs. you can too. Fantastic diet. \$2 Cash. Box 221A, Mississauga, Ontario, Canada."

COMMERCIAL Free Music From your FM Radio. Details, Box 220-Z, Miami, Florida 33168.

WHAT'S YOUR I.Q.? Test will tell you! \$1.00 P.P. Guaranteed. Wonder Products, Box 166, Brooklyn, New York 11210.

"RELEASE Lt. Calley" Bumper Sticker! \$1.00. Georgia Residents \$1.03. ABC Sales, Box 2683-T, Columbus, Georgia 31902.

WIPE Out Debts With Secret Law. Immediate Relief. Clear Credit. Free Details. Legal Aid, Box 63-B, Stratford, New Jersey 08084.

HOW INTELLIGENT Are you? Self scoring test reveals IQ in 15 minutes! Send \$2 today—Guaranteed! F&M Products, Box 1903, Wheaton, Maryland 20902.

HAIR HEALTH FORMULAS (A Friend Of Mine Grew New Hair). I'M Trying Them, No New Hair Yet, But Has Stopped Falling. Send \$2.00. Box 2271, Toledo, Ohio 43611.

TELEPHONE "Bugged"?? Check your telephone yourself! Write for free details! Sonic Devices, 69-29 Queens Blvd., New York 11377.

FREE Illustrated Catalog. Adults Only. Satisfaction Guaranteed. Brooks, Box 126-8B, Brooklyn, 11229.

(Continued on next page)

WANTED—MISCELLANEOUS

WE BUY HOME Workshop Equipment: Electroplating, Babyshoe Metallizers, Plastic Presses, Rubber Stamping Machines, Printing Presses, etc. Send complete description, condition. Used Equipment Division, Box 23565-A, Los Angeles 90023.

MERCURY, Gold, Silver, Platinum; Ores assayed. Wholesale Terminal, Norwood, Mass. 02062.

STAMP Collections, Accumulations, Eagle Stamp Company, Box 9675, Pittsburgh, Pennsylvania 15226.

MISCELLANEOUS

CIGARETTES 15¢ a pack. Improved roller makes 20 filtertip, plain, king or regular for 15¢. Facts free. Green River Tobacco, Box 954, Owensboro, Kentucky 42301.

GENUINE Native Texas Mesquite shavings to help flavor your Bar-b-q send \$1.00 for package. Bobbie-Jon Gifts, Dept. C, 15907 White Fawn Drive, San Antonio, Texas 78228.

WINE SKILLS, Box 1126, San Luis Obispo, California 93401. Free HOMEBREWING supplies catalog.

WINEMAKING Kit—\$4.98 Free Catalog and recipes. JIMDANDY, Box 30230M, Cincinnati, Ohio 45230.

WINEMAKERS Catalog, Free. Bacchanalia, 321-E7, Saugatuck Station, Westport, Conn. 06880.

SUFFERING From Arthritis? Try Ginseng; Information Free. Write Ginseng, Asheville 53, N.C.

YOUR Name sent to 1000 importers, publishers, mailers, wholesalers, etc. on our mailing list. Year \$1.00. Dixie Mailers, King, N. Car. 27021.

PSYCHEDELIC Catalog of Posters, Lighting, Jewelry, Etc. Send 50¢. Hole, 6055 Lankershim, N. Hollywood, Calif. 91606.

WINEMAKERS Yeast, Recipes & Catalog 25¢; Kraus, Box 451-L, Nevada, Missouri 64772.

ORNAMENTAL Iron designs. Book of 1600 beautiful, practical designs for railings, columns, etc. Free literature. Cunningham, 3881 South 3200 West, Salt Lake City, Utah 84119.

WINEMAKERS. Free illustrated catalog of yeasts, equipment. Semplex, Box 12276, Minneapolis, Minn. 55412.

BOOKS On antiques and their prices. Free circular!! P. Warman Publishers, Uniontown, Penna. 15401.

BIRTH Certificates, Marriage Certificates, Diplomas! 2 blank forms \$1.00. Sample 10¢. Standard Forms, Box 482-M, Washington, D.C. 20044.

IDENTIFICATION Cards. Send stamped self-addressed envelope for samples. Identification, Box 12117, Las Vegas, Nevada 89112.

HEARING Aid batteries wholesale. Free list. Habs, Box 51, York, Penna. 17405.

WINEMAKERS. . . . Free Illustrated Supply Catalog of Yeasts, Equipment, Recipes. Winemaker, Box 11211-PM, Indianapolis, Ind. 46201.

WINEMAKERS: Free supply catalog, recipes. Arbolyn, Box 663, Dept. PM, West Columbia, S.C. 29169.

\$134, \$141, \$151, ETC. Profit Daily For You with \$2 stakes, at Racetracks everywhere with fabulous, scientific, easy to use "Penciliff"—world famed race computer, 12 expert race experts brains built into it. (\$20 stakes 10 times above profits). Get our special offer. Tear out this ad now. Mail it with name, address, zip: R. H. Publishing Co. P10C, Box 5715, Carmel, Calif. 93921.

NOVELTIES, Toys, Games, Specialties. 50¢ brings Details. A. Wallace, Box 628, Montreal 101, Canada.

CREDIT Cards! Receive all kinds fast, easy. Get new credit without investigation! Continental, Box J-23, Hallandale, Florida 33009.

WINEMAKERS SPECIAL!! Leading University's "Homemade Wine" Booklet—10¢. Werth Wine, Box 1902P, Cedar Rapids, Iowa 52406.

WINE KITS . . . Complete with Genuine Wine Concentrate . . . Yeast . . . Air Lock . . . Fermentation Vessel. Just add sugar and water. Makes 6 Bottles. Select: Port . . . Burgundy . . . Sauterne . . . Mead . . . Claret. \$4.95 each. Continental, 3716 N. Sherman Dr., Indianapolis, Ind. 46218.

"NEW—Permanent Roach Control using harmless Drugstore Powders. Formula, Instructions, \$2.00. No-Cucaracha, Box 162, Lomita, California 90717.

TIGER RAG. Synthetic chamois. Longer wearing, wets instantly, no fuzz. Wrings easily. Large 18½ x 20½ size only \$3.50 ppd. 3/\$9.00. Rainco, Box 20944-C, Phoenix, Arizona 85036.

CHAMPAGNE And Winemaking made foolproof! Exciting recipes! Complete instructions! Use kitchen utensils only! Guaranteed delicious or money back! Send \$2. Bourdeau, box 2482, Great Falls, Montana 59403.

MOSQUITOPROOF Formula \$2.00. Odorless personal protection. Franklin Assoc., Box 3401, Fort Worth, Texas 76105.

INCREASE Business! Use Book Match Advertising! S&S Sales, 35178-M, Chicago 60635.

BAR-B-QUE TREAT Large Shaker "Big Daddy's" Western Seasoned Salt \$1.00. Box 3142, Scottsdale, Arizona 85257.

FREE Lodging Las Vegas, Reno, Tahoe. First class hotels, two nights, two people, with purchase of newest, winningest, Blackjack Strategy Book. Send \$12.50 to: Systems Research, Box 7771, Stanford, California 94305.

CHAMPAGNE & Winemaking handbook \$3.98. Easy Step-by-step instructions. Elden's Enterprises, Dept. 1A8, 6613 Kimball, Waterloo, Iowa 50701.

FREE Booklet! How to protect yourself and family against crime. PEM Enterprises, Dept. 1881, 16 Belmont, Chelmsford, Mass. 01824.

HAND Rolled Cigarettes. Old pro instructs, illustrates. Pouch favorite pipe tobacco rolls fifty, \$1.00. John, 914 Curran, Burlington, Iowa 52601.

INTELLIGENCE QUOTIENT? Self-scoring test reveals IQ in 15 minutes! Send \$2.00 today—guaranteed! Termco, Dept. 1M9, 419 5th. SW, Waverly, Iowa 50677.

DON'T PAY INCOME TAX. Legally. No matter what your income. Rich men's methods adapted for anyone's use. Free details. Treehouse, Dept. M, 5909 London Road, Duluth, Minnesota 55804.

PHOTOGRAPHERS & Users Hearing Aids. Recharge mercury cells anywhere, no power needed—charge within seconds of receipt. \$1.00 complete plan cash or money order. Weber, 128 Oldfield, Amityville, New York 11701.

MAKE Wine and Champagne! New Wine-maker's Handbook contains amazing Recipes. . . . use Kitchen Items only. Guaranteed Delicious or Money Back. Send \$3.98 to C.J. Enterprises, 1845 7th Avenue, PM-Suite 1C, New York 10026

WINES Plus CHAMPAGNE! Booklet contains amazing recipes; complete instructions, using kitchen items. Guaranteed delicious. \$3.00. Dunlap, 1626PM Forestview, Youngstown, Ohio 44505.

DON'T DIE Leaving nothing for tomorrow! Blank will form protects your family. Rush \$2.00 Guaranteed!! Uni-Forms 110208, 425 Arthur, Box 411, Tomah, Wis. 54660.

WINEMAKER'S Yeast, Kits, Grape Concentrates, Everything! Secret Methods! \$1.00 brings Guaranteed Recipes, Illustrated Manual, Complete Equipment Catalog. Namar, Box 6T, Dearborn, Michigan 48121.

WATERBEDS, King size, five year guarantee, \$49.95, free brochure. Aquawomb, Dept. C, Box 1578, Miami, Florida 33138.

BIRTH Certificates, High School Diplomas, Marriage Certificates, Divorce Certificates. College Diplomas. One—\$1.00; Five—\$3.00. FREE SURPRISE Forms with order!!! Filiforms, Box 223-A, Brooklyn, New York 11223.

NOW SAVE 50% Buying a Vito Precision Electric Vibrator. Special attachment for Scalp & Body areas. \$8.95. Also Electric Dry Shaver \$8.95. Jose Pacheco, P. O. Box 1724, NYC 10022.

HOME Wine Supplies and Ingredients. Recipes for year round winemaking. Send for Free catalog. Danenberger, Box 276B, New Berlin, Illinois 62670.



The Pure Lubricating Metal

INCREASES H.P. up to 25% in gas and diesel engines
 INCREASES RPM up to 40% in 2-cycle engines
 INCREASES GAS MILEAGE up to 35%
 INCREASES COMPRESSION up to 45 lbs./cyl
 INCREASES GEARBOX LIFE up to 10 times
 REDUCES OIL CONSUMPTION AND SMOKE
 DYNO AND VISUALLY PROVEN * U.S. PAT. NO. 3,544,314
 Engine Concentrate, Automatic Transmission Concentrate, Manual Transmission & Differential Concentrate \$9.95 ea ppd

ALL THREE FOR ONLY \$24.95 PPD

CMI Sales, Inc.
 2154 S. Jason St., Dept. 871 - PM
 Denver, Colo. 80223, (303) 936-8241
 Dealerships Also Available

Stark Bro's Fruit Trees and Landscape Catalog FREE!

Dwarf Fruit Trees, Shade Trees, Shrubs, Roses — over 400 varieties in FULL COLOR! World's biggest, America's oldest nursery (est. 1816). Mail coupon for Catalog.

MAKE EXTRA MONEY
 For extra cash spare-time, check coupon for Money-Making Stark Bro's Order-Taking Outfit—FREE!

Stark Bro's, Box A33981, Louisiana, Mo.

STARK BRO'S, BOX A33981, Louisiana, Mo. 63353

Rush Color Catalog FREE!

Miss _____
 Mrs. _____
 Mr. _____

1st name 2nd initial last name

RFD or Street _____

P.O. _____

State _____ Zip _____

CHECK HERE for Free Money-Making Outfit.

Mechanics Hate It!

This 5-Kit "Auto Lab" from Allied Radio Shack
Saves You \$\$ Every Mile You Drive!

44⁹⁵



17⁹⁵



19⁹⁵



49⁹⁵



19⁹⁵

You may never have to pay an expensive tune-up bill again! These easy-to-assemble Knight-Kits make it easy for you to troubleshoot your own car—and drive better.

Capacitive-Discharge Auto Ignition System. Similar to factory-option electronic systems costing \$50, \$60, or more! Sure-fire starts in all weather, 3-10 times longer plug life, 10% better gas mileage. Installs with NO wiring changes. "In-Out" switch—compare the performance improvement for yourself! 12 VDC.

0-8000 RPM Tachometer. Drive like the "pro's." A pointer lets you set "shift points" for fastest acceleration, best mileage. $\pm 2\%$ accuracy. Mounts on dash, panel, or steering column. Not a gimmick, but really useful.

Solid-State Timing Light. Equals factory assembled lights costing 50%-100% more! Built-in DC power supply for flashes so bright you can see them in full daylight. Comfortable "trigger grip." Includes all cables, insulated clips, instructions.

"Universal" Auto Analyzer. Checks nearly everything in your car's electrical system. Read all tests on one big 7" meter. Checks volts, amps, ohms, RPM, dwell angle, spark output and leakage. Lightweight, portable, solid state. Includes batteries, 48-page tune-up & troubleshooting guide for all U.S. cars/trucks, many foreign makes.

"Junior" Auto Analyzer. Low-cost "helper" reads volts, RPM, dwell angle. Fits in your glove box. With battery, instructions.

At 1000 Stores Nationwide . . . Or by Mail

See the Yellow Pages



Dept. PM-5

2725 West 7th Street Fort Worth, Texas 76107

I enclose check money order. Rush me the checked item(s) postpaid:

- Ignition System @ 44.95 Auto Analyzer @ 49.95
 Tachometer @ 17.95 Auto Analyzer @ 19.95
 Timing Light @ 19.95

Name (print) _____

Apt. No. _____ Route No. _____ Box No. _____

Street _____

City _____ State _____ Zip



**When you ask for Pennzoil...
it's hard to know when to stop.**

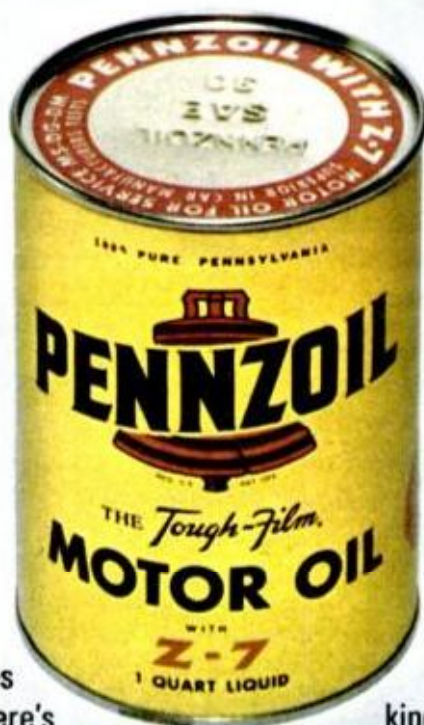

Some people think Pennzoil makes lubricants just for cars. Hardly. There's a complete family of Pennzoil lubricants for just about everything that moves—cars...boats...planes. Every product bears the name Pennzoil,

so you know it's the finest of its kind, outstanding for protection under all conditions. If you're someone on the move and you've got machinery to protect, ask for Pennzoil lubricants. Before you start your engine.

PALL MALL GOLD 100's

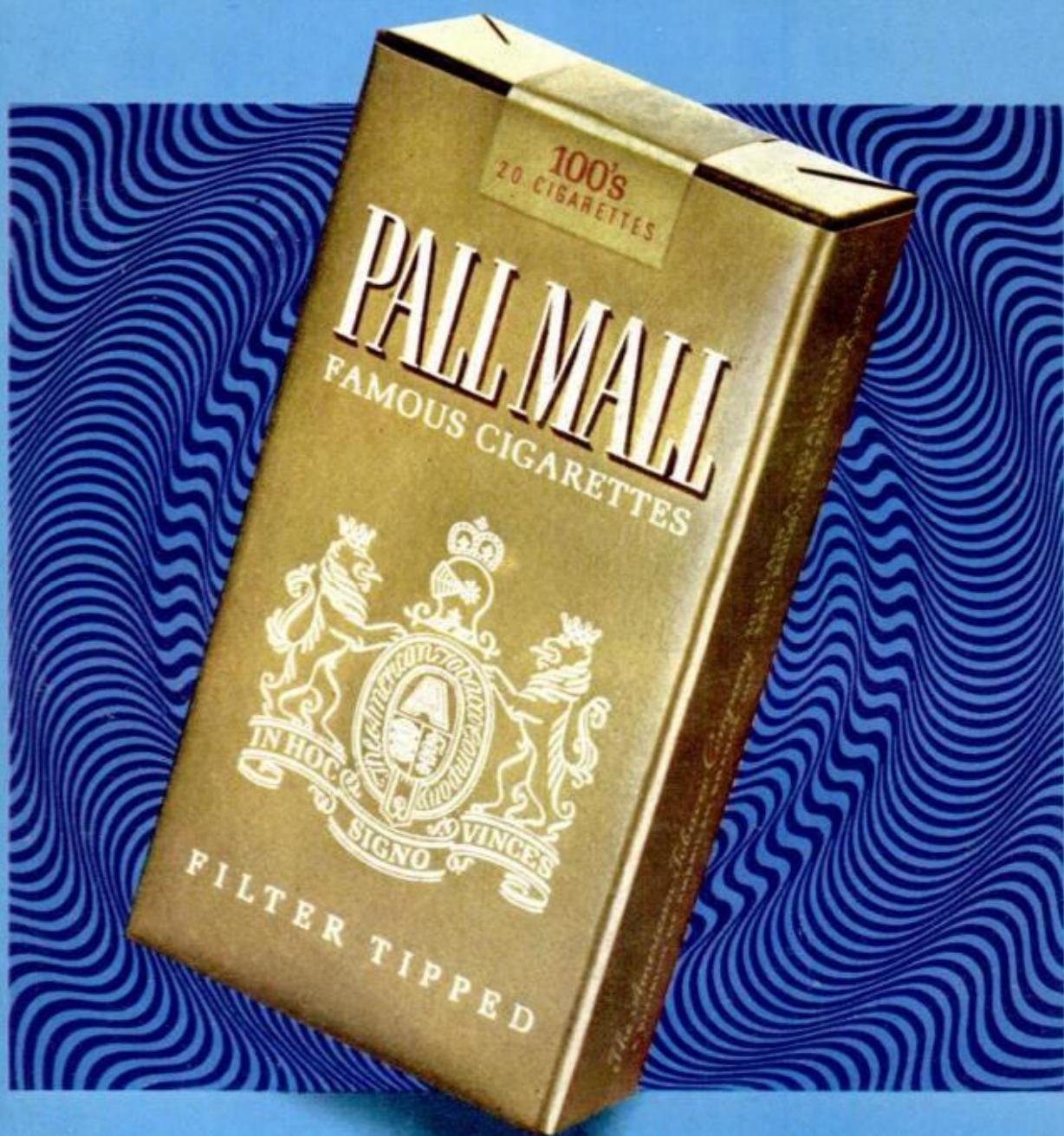

Longer...yet milder

longer length - milder taste.

You get both with

PALL MALL GOLD 100's

20 mg. "tar", 1.4 mg. nicotine
av. per cigarette, FTC Report NOV. 70