

Driving: 'Split-Second' Maneuvers to Avoid a Crash

# POPULAR MECHANICS

JULY 1971  
50 CENTS

Hit Show:  
101 Famous  
Planes  
Page 62



**Fish, Surf,  
Hunt, Ski, Travel...**

**Have It All With This Kit-Built Camper for \$800**

Page 128

An Electronic Device  
That Stops Back Pain  
Page 68

Space Research:  
How It Can  
Pay Off for You

Build-Yourself  
'Wrought-Iron'  
Furniture

Colonial Wall  
Clock: Yours for  
As Little as \$20



If you've got the time,  
we've got the beer.



One beer stands clear. Beer after beer. Miller.



A man deserves  
to be spoiled  
~~once in a while.~~  
*every day!*



The miracle plastic coating spoils you every time you shave.

**The Spoiler.<sup>®</sup>**

This One



K4W6-418-RLRH





# Quick. When was the last time you changed your motor oil?

Have you ever looked at your service sticker and found it to be so old you really couldn't tell when you last had your oil changed?

Well, don't feel bad. You're not alone.

Matter of fact, you've got lots of company. Because most people never get around to changing their motor oil when they should.

That's why there's race-proved Valvoline®. The motor oil the pros count on.

And the one that's a lot better than it really has to be.

Valvoline is a unique blend of the finest com-

ponents specifically designed to work harder, longer.

To give you added protection beyond recommended drain intervals.

Naturally, we recommend changing your motor oil at the proper time.

But should you forget (and even if you don't), you'll be glad you remembered Valvoline.

Available at fine service stations, garages and new car dealers everywhere.

Now then. Maybe you'd better go out and take a look at your service sticker.

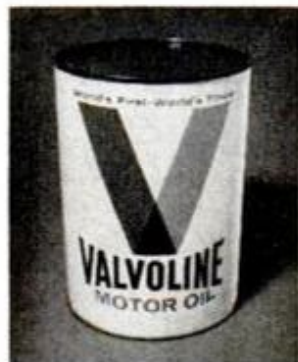

For people who don't  
always remember  
to change their motor oil.

VALVOLINE OIL COMPANY, Ashland, Ky. **Ashland** Division of Ashland Oil, Inc.

Материал, защищенный авторским правом





Allstate life  
insurance says,  
if you die, he still  
has a driveway  
to play in.

Allstate Life Insurance Company

## Allstate. The young man's life insurance.

**Allstate's Mortgage Protection Plan.**  
Helps pay off your mortgage if you die.  
Made for the young man: no high  
prices, no red tape. Here's the story:

If you're this age... You pay this much monthly for  
\$20,000 of 20-year decreasing  
term mortgage protection.

25	\$6.80
30	\$7.30
35	\$8.70
40	\$12.10



You're in good hands with Allstate

Материал, защищенный авторским правом



# POPULAR MECHANICS®

INTERNATIONAL EDITIONS: AUSTRALIA, BRAZIL, CARIBBEAN, DENMARK, MEXICO, SOUTHERN HEMISPHERE, SWEDEN

## AUTOMOBILES AND DRIVING

- 20 Add a Tag-Along Seat to Your Cycle
- 42 Detroit Listening Post
- 44B** Drivin' With Dan
- 48 Automobile Clinic
- 53 How to Steer Clear!
- 74 PM Owners Report: Buick Opel
- 84 Small-Scale Car, Big-Scale Thrills
- 100** How to Belt Your Kid—and Save His Life!
- 120** Saturday Mechanic: New Shocks . . . And You Save \$22!
- 123 New for Your Car
- 128** A \$1200 Camper From a Kit for \$800

## SCIENCE AND INVENTIONS

- 38 Science Worldwide
- 58 Bonanza From Space (Amazing Fringe Benefits From Our Space Program)
- 68 Now: An Electronic Pain Killer
- 82 Just Patented: PM's Pick of the New Inventions
- 88 They Can Take Your Temperature With a Camera

## PHOTOGRAPHY

- 78 First Look at the Navy's New Destroyer
- 87 New in Photography
- 88 They Can Take Your Temperature With a Camera
- 108** Shot in the Dark (How to Pick the Best Subjects and Exposures)
- 112** Photo Hints

## SPACE, AVIATION, MILITARY

- 62 The Wings of Brave Men (The New Air Force Museum)

## ENVIRONMENT

- 30 Pollution Fighters' Newsletter

## SHOP AND CRAFTS

- 18 New Tools You Should Know About
- 20 Add a Tag-Along Seat to Your Cycle
- 124** A Jewelry Box for Your Queen
- 135** Hints From Readers
- 138** Lathe Ball-Turning Attachment
- 143** Add This Sander Table to Your Faceplate Lathe
- 146** Build a Tenoning Attachment for Your Table Saw
- 148** Hints From Readers
- 152** You Can Make This Chair for \$15 (Building Wrought Iron Furniture)

## HOME AND YARD

- 32 Homeowners' Clinic
- 118** Exciting New Products
- 132** Make This Charming Wall Clock
- 136** Solving Home Problems
- 144** Inexpensive Alarms Scare Off Burglars
- 152** You Can Make This Chair for \$15 (Building Wrought Iron Furniture)

## BOATING, OUTDOOR RECREATION

- 16 All Outdoors
- 28 On-the-Go Camping
- 92 Back-Yard Float Trip
- 95 Boating Tips
- 96 The Seaworthy Seamaster
- 128** A \$1200 Camper From a Kit for \$800

## ELECTRONICS, RADIO AND TV

- 72 New in Electronics
- 84 Small-Scale Car, Big-Scale Thrills
- 104** Portable TVs You Can Play at a Picnic . . . on a Patio . . . by a Pool
- 114** Electronic Hints

## REGULAR FEATURES

- 6 Letters

Cover Photo by Monty Monts de Oca and Jerry Imber taken at Cypress Gardens, Fla.  
*Fish, Surf, Hunt, Ski, Travel . . . Have It All With This Kit-Built Camper for \$800*

## NEXT MONTH IN POPULAR MECHANICS

**'It Sprouted Wings, so I Flew It.'** Exclusive PM report on the flying automobile.  
**The New Threat: Skyscraper Fires.** 'Fireproof' buildings can turn into ovens.  
**Special 23-Page Section: Get a Lot More Fun Out of Summer at Home for Very Little Money.** Build an outdoor family room . . . diving deck . . . cookout table . . . appliance center . . . lighted sports area . . . and wire your patio for music.  
**Three PM Owners Reports:** Pontiac Grand Ville, Toyota Corona, Jeep Universal.



## ROBERT P. CROSSLEY

Editor

**JAMES M. LISTON**  
Executive Editor

**JOHN A. LINKLETTER**  
Managing Editor

**WAYNE C. LECKEY**   **SHELDON M. GALLAGER**  
Home and Shop   Assistant Executive  
Editor   Editor

**THOMAS G. DAUER**  
Art Director

Published by The Hearst Corporation  
**RICHARD E. BERLIN, PRESIDENT**

**RICHARD E. DEEMS**  
President, Magazines Division

**JOSEPH F. KERN**  
Publisher

**BILL HARTFORD** \_\_\_\_\_ Automotive  
**JOHN F. PEARSON** \_\_\_\_\_ Science and Aerospace  
**GEORGE W. REIGER** \_\_\_\_\_ Boating and Outdoors  
**SHELDON GALLAGER** \_\_\_\_\_ Electronics and Photography  
**HARRY WICKS** \_\_\_\_\_ Home Workshop  
**MICHAEL LAMM** \_\_\_\_\_ West Coast  
**ROBERT LUND** \_\_\_\_\_ Detroit Automotive  
**GARRY WINTER** \_\_\_\_\_ Copy and Production  
**RICHARD H. FUNK** \_\_\_\_\_ Associate Copy and Production  
**ALVIN KIETZ** \_\_\_\_\_ Assistant Art Director  
**FRED A. LEERS** \_\_\_\_\_ Assistant Art Director  
**JOSEPH P. BEATON** \_\_\_\_\_ Assistant Art Director  
**DON EVANS** \_\_\_\_\_ Technical Art Director  
**CLIFFORD B. HICKS** \_\_\_\_\_ Special Projects  
**SOPHIE GRONOWICZ** \_\_\_\_\_ Director, Bureau of Information  
**EVERETT JOHNSON** \_\_\_\_\_ Cabinetmaker

**ADDRESS ALL EDITORIAL COMMUNICATIONS TO:** 224 West 57th St., New York, N.Y. 10019. For additional sources of information on the articles and products in this issue, write to Bureau of Information, Popular Mechanics, for free "Where-to-Find-It" list.

**DANIEL J. COLEMAN**  
Director of Advertising

**ADVERTISING OFFICES:** New York: 224 West 57th St., 765-6850; Chicago: 520 N. Michigan Ave., 527-2400; Detroit: General Motors Bldg., TRinity 5-8711; Cleveland: 20310 Chagrin Blvd., Shaker Heights, 283-7788; Los Angeles: 601 North Vermont Ave., 666-6263.

**JOHN A. REGINA** \_\_\_\_\_ Advertising Production Manager

**SUBSCRIPTION SERVICE:** Mail all subscription orders, changes of address, correspondence concerning subscriptions, and Postmaster notices of undeliverable copies to Popular Mechanics, Box 646, New York, N.Y. 10019. Please enclose your latest address label for quickest service when writing about your subscription.

**POPULAR MECHANICS IS PUBLISHED MONTHLY** by The Hearst Corporation, 57th St. at 8th Ave., New York, N.Y. 10019, U.S.A. Richard E. Berlin, President; George Hearst, V-Pres.; Richard E. Deems, President of Magazines; John R. Miller, Executive V-Pres. of Magazines; Raymond J. Petersen, Senior V-Pres. of Magazines; William S. Campbell, V-Pres. of Magazines; Albert A. Bachol, V-Pres. and Director of Circulation; Joseph F. Kern, V-Pres. for Popular Mechanics; Frank Massi, Executive V-Pres. and Treasurer; Harvey L. Lipton, Secy. Single copy in the United States and Canada, 50 cents. Subscription prices: United States and Possessions \$5.00 for one year; \$9.00 for two years; \$12.00 for three years. Canada, add \$0.75 for each year. Pan American Postal Union countries, add \$1.00 for each year. All other countries, add \$2.00 for each year. When changing address, give old address as well as the new, with postal-zone number, if any, and allow six weeks for change to become effective. Second-class postage paid at New York, N.Y., and at additional mailing offices. Authorized as second-class mail by the Post Office Department, Ottawa, and for payment of postage in cash. Registered as second-class matter at the Post Office at Mexico D.F., Mexico, June 20, 1950 © 1971 by The Hearst Corporation. All rights reserved. Printed in U.S.A.

JULY 1971

# Part of the popular mechanics of making a great drink:

## the good stuff.



Old Grand-Dad  
Head of the Bourbon Family

Kentucky Straight Bourbon Whiskeys. 86 Proof and 100 Proof Bottled in Bond. Old Grand-Dad Distillery Company, Frankfort, Kentucky 40601.



# UNUSUAL BARGAINS

MANY U. S. GOV'T SURPLUS

FREE!  
GIANT  
CATALOG

## BIG BOOM & FLASH CANNON



Perfectly safe giant noisemaker for sports, games, the 4th and just plain fun produces brilliant flash and loud bang. Completely harmless—no gun powder, matches or recoil. Easily operated. Beautiful reproduction of regular Army 60 MM cannon in hefty cast iron. "Ammo" is pulverized Bangsite combined with water in cannon producing harmless gas. Cannot be ignited by hottest flame or heaviest concussion. Incl. ammo for 200 shots. Instr. Wt. 21 1/4 lbs. Stock No. 70.898H ..... \$6.75 Ppd. Extra ammo (about 400 shots) ..... \$1.30 Ppd.

Stock No. P-41.005H

## ASTRONOMICAL TELESCOPE KITS

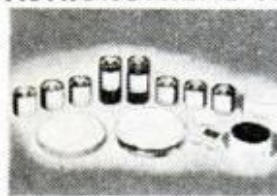

See Pop. Mech. Jan. Feat. "The Sky's the Limit"

Grind your own mirror for powerful telescopes. Kits contain fine annealed pyrex mirror blank, tool, abrasives, diagonal mirror, and eyepiece lenses. Instruments you build range in value from \$75 to hundreds of dollars.  
70.003H 4 1/2" Dia. 3 3/4" Thick \$10.75 Ppd.  
70.004H 6" Dia. 1" Thick \$13.95 Ppd.  
70.005H 8" Dia. 1 3/4" Thick \$21.50 Ppd.  
70.006H 10" Dia. 1 3/4" Thick \$52.50 FOB

## 1st QUALITY OPAQUE UNDER \$200.



Projects brilliant, sharp 4 1/2 foot square image from 8 feet away using up to 5" X 5" color, b & w illustrations. Retains all original colors and proportions. Enlarges drawings, blueprints, water-colors, pictures, stamps, coins, other objects. Features high speed, 200mm anastigmatic projection lens (E3.5, 8" F.L.); powerful peanut-size quartz halogen lamp (50hr. life); unique internal reflecting system. Gives maximum brightness, entire field focus. Flat stage and removable magnetic platen enable use upside down. Turbo-blower cools l.

Touch plastic case, 5 1/2 ft. cord.

No. 71.272H ..... (8 1/4" X 6" X 12 1/2" - 11 1/2 lbs.) ..... \$89.75 Ppd.

## GIANT WEATHER BALLOONS



"Balls of fun" for kids, traffic stoppers for stores, terrific for amateur meteorologists. Create a neighborhood sensation. Great backyard fun. Exciting beach attraction. Amateur meteorologists use to measure cloud heights, wind speed and temperature. Made of heavy duty neoprene. Inflate with vacuum cleaner or auto air hose or locally available helium for high rise.

Stock No. 60.568H ..... (8 Ft. diameter) ..... \$2.00 Ppd.  
Stock No. 60.632H ..... (16 Ft. diameter) ..... \$7.00 Ppd.

## "FISH" WITH A MAGNET



Go treasure hunting on the bottom! Fascinating fun & sometimes profitable! Tie a line to our 5-lb. Magnet—drop it overboard in bay, river, lake or ocean. Trawl it along bottom—your "treasure" haul can be outboard motors, anchors, other metal valuables. 5-lb. Magnet is war surplus—Alnico V Type—Gov't cost \$50. Lifts over 150 lbs. on land—greater weights under water.

Stock No. 70.571H ..... \$14.00 Ppd.  
Stock No. 70.570H ..... 3 1/2 lbs. (lifts 40 lbs.) ..... \$ 8.75 Ppd.  
Stock No. 85.152H ..... 15 1/4 lbs. (lifts 350 lbs.) ..... \$33.60 FOB

## AMERICAN MADE OPAQUE PROJECTOR

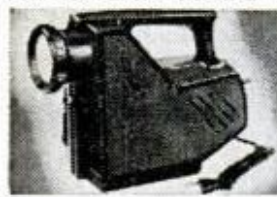

Projects illustrations up to 3" x 3 1/2" —enlarges them to 35" x 30" if screen is 6 1/2 ft. from projector, larger pictures if screen is farther away. No film or negatives needed. Primarily intended for children. Projects charts, diagrams, color or black-and-white in darkened room. 115 v. A.C. . . . 6 ft. cord and plug included. Size 12" x 8" x 4 1/2" wide. Weight 1 lb. 2 ozs. Plastic case.

Stock No. 70.199H ..... \$8.75 Ppd.

'Bright Ideas' in Unique Lighting Big, new 100-page handbook packed with facts, loaded with illustrations. All latest developments, applications, equipment. 8 1/2" x 11" looseleaf paper to fit 3 rings. Stock No. 9100 H ..... \$3.00 Ppd.

## MAIL COUPON FOR GIANT FREE CATALOG

148 PAGES! MORE THAN 4,000 UNUSUAL BARGAINS.

Completely new 1971 Catalog. Packed with huge selection of telescopes, microscopes, binoculars, magnets, magnifiers, prisms, photo components, unique lighting items, parts, kits, accessories—many hard-to-get surplus bargains. 100's of charts, illustrations. For hobbyists, experimenters, schools, industry. EDMUND SCIENTIFIC CO. 300 Edscorp Building, Barrington, N. J. 08007 Please rush Free Giant Catalog "H"

Name .....  
Address .....  
City ..... State ..... Zip .....

EDMUND SCIENTIFIC CO. 300 EDSCORP BLDG. BARRINGTON, NEW JERSEY 08007 ORDER BY STOCK NUMBER - SEND CHECK OR MONEY ORDER - MONEY-BACK GUARANTEE

# LETTERS

TO THE EDITOR

## Bad scene for pictures

I am very much against the *New Disposable Camera* (page 173, May PM). These new cameras will just be adding to the tons of waste and garbage on the Earth. LAKE PLACID, N.Y. MICHAEL NEY

## Hop and chop?

That *Prop-Powered Pogo Stick* in *Just Patented* (page 92, May PM) seems to have a lot of potential as a decapitation device.

CHICAGO

KEN GREENBERG

## Compound bow

In the News Brief *Pulleys Give Bow Added Punch* (page 75, May PM), you state that the Jennings Compound Bow "has just been legalized for competition by the NFAA."

According to the March 1971 edition of *Archery Magazine* (official publication of the NFAA), the compound bow was declared illegal in the bare-bow and competitive bow hunter divisions. It is legal only in the free-style division.

BROOKLYN, N.Y.

JEFFREY GREEN

## Takes issue 300th time

I just received my 300th *Popular Mechanics*. The first copy dates back to May 1946, and I have every copy.

MILAN, IND.

JOHN G. LATTIRE

## Just 21 cents more

In *New Tools* (page 38, May PM) you show a picture of our LRK Retractable Linoleum Utility Knife and list it for \$1.39 —our price a number of years back. Our current price is \$1.60.

ALLWAY TOOLS, INC. BRONX, N.Y.

DON GRINGER, PRESIDENT

## Unsafe trucks

I am one of the so-called "gypsy" truckers that Frank Tinker wrote about (*Unsafe Trucks Can Kill You!* page 63, May PM). He didn't do much checking.

I am sure that if he rode with me on a trip from here to New York City, he would find after riding with a "gypsy" and inspecting our trucks that we are much safer on the road than any union driver or large company.

I have before me a booklet put out by

(Please turn to page 8)

POPULAR MECHANICS



# "Look who's smiling now!"

Sometimes a man sets his ambitions high enough to make skeptics smile. But how often he gets the last laugh! "At the time I started studying with LaSalle, I was working as a factory clerk. Before completing the course I was transferred to cost accounting and my salary was increased by \$1800. Now, having completed the course, I'm in charge of the department and headed for the five figure bracket. LaSalle's course helped me pull myself out of a boring and ill-paid job into a position of almost unlimited opportunity."

The words in quotes come directly from one of the pleased reports that are sent to us by LaSalle graduates. LaSalle files contain many letters from men and women who have increased their earnings with the help of LaSalle training. You, too, can prepare for the career opportunity of your choice through LaSalle home study—without interfering with your present work—and by devoting only a little of your spare time.

LaSalle has been a leader in home education for more than sixty years, enrolling over 2,000,000 ambitious men and women in its many courses. You study under the supervision of LaSalle's experienced faculty. Upon satisfactory completion of your study, you receive the LaSalle diploma—a recognized and respected credential.

Mailing the LaSalle coupon below may be the first step toward preparing yourself for a better job, higher pay, and the many good things that go with success. Simply check the program in which you are most interested, and we will send you a valuable free booklet describing the opportunities in that field. There is no obligation. LaSalle, 417 S. Dearborn Street, Chicago, Illinois 60605.



## LA SALLE EXTENSION UNIVERSITY

A Correspondence Institution • 417 S. Dearborn Street, Dept. 67-127 • Chicago, Illinois 60605

Please send me, without cost or obligation, FREE booklet and full information on the field I have checked below:

### ACCOUNTING

- Complete Accounting
- Income Tax
- CPA Training
- Bookkeeping

### BUSINESS MANAGEMENT

- Introduction to Business Management

### DRAFTING

- Complete Drafting

### REAL ESTATE

- Complete Real Estate
- Real Estate Brokerage
- Real Estate Management

### DIESEL MECHANICS

- Basic Training

### LAW COURSES

- Bachelor of Laws Degree
- Business Law
- Insurance Law
- Claim Adjusting Law
- Law for Police Officers

### TRAFFIC & TRANSPORTATION

- Complete Traffic Management

### RESTAURANT MANAGEMENT

- Complete Executive Training

### LANGUAGE INSTRUCTION

- French  Spanish

### MUSIC INSTRUCTION

- Piano  Guitar

Other \_\_\_\_\_

### COMPUTER PROGRAMMING

- Basic Training

### INTERIOR DECORATING

- Complete Training

### ART TRAINING

- Commercial Art
- Oil, Water Color Painting
- Complete Training

### HIGH SCHOOL

- High School Diploma

### HOTEL/MOTEL MANAGEMENT

- Hotel Executive Training
- Motel Management

### STENOTYPE

- Machine Shorthand

### CAREERS FOR WOMEN

- Accounting
- Bookkeeping
- Computer Programming
- Dental Assistant
- Interior Decorating
- Real Estate
- Secretarial
- Stenotype

Mr. \_\_\_\_\_ Age.....  
Mrs. \_\_\_\_\_  
Miss \_\_\_\_\_ (Circle title and please print)

Address..... Apt.No.....

City & State..... Zip.....



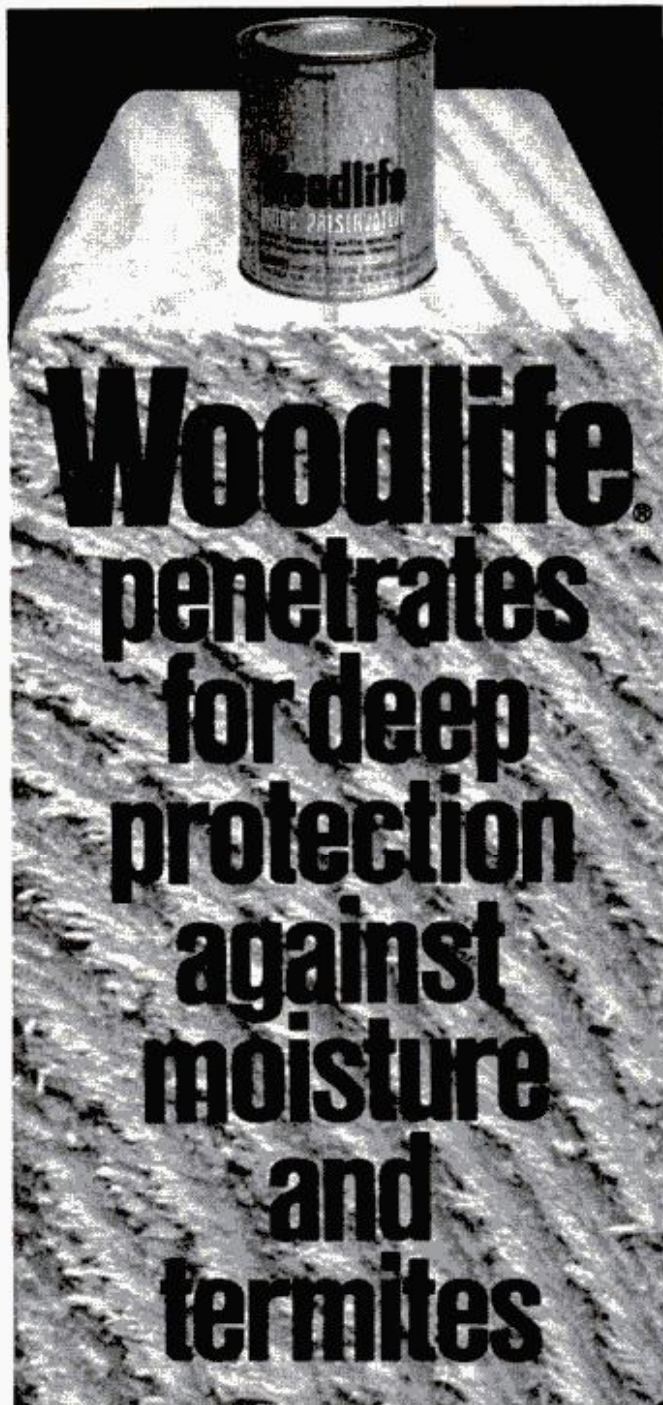

# Woodlife® penetrates for deep protection against moisture and termites

Decking • Siding • Doors • Shutters •  
Fences • Patio Furniture

Woodlife is the original paintable wood preservative that makes all exterior wood water-repellant and insect-resistant—even to termites. What's more, it fights off rot and decay, prevents wood from warping and cracking. Woodlife dries clear, leaves surfaces ready for easier painting or staining—extends paint life by years!

Use economical, job-proven Woodlife for deep penetrating protection. You'll find it at hardware, paint, and building supply dealers.

**Weldwood®**  
PACKAGED PRODUCTS

U.S. Plywood-Champion Papers Inc.  
600 N. Baldwin Park Blvd., City of Industry, Calif. 91747

## LETTERS

(Continued from page 6)

the Indiana Motor Truck Assn., of which I am a member, that states if it were not for your so-called "gypsy" you would not eat, and you would not have your house or anything that is in your house or office. Even mail is moved by truck. The next time you sit down at your table with meat, fruit and vegetables, give thanks for it—and for that so-called (by you) bennied-up killer of the highway, the "gypsy," for bringing it to you.

We gypsies kept you and all America alive during the last truck strike while your goody union drivers threw rocks at us off overpasses, shot at us and even killed a few of us. I feel this is an unfair story you have printed.

LASLEY TRUCKING      HOWARD E. LASLEY  
WOLCOTT, IND.

*"I am sure there are good, safe 'gypsy' drivers, just as there are unsafe ones," responds Author Tinker. "The figures and incidents I cited were not, however, inventions. They were corroborated by every person in the industry with whom I talked. The fact that so much of the country's commerce moves by truck means only that even more care should be taken by such an important industry. My suggestion, if you feel so strongly about it, is to work through your association to eliminate those operators who, whether you like it or not, are giving their fellow members such a poor reputation."*

The article on unsafe trucks was either badly cut or incompletely researched. The article is true, interesting and good reading, and I do not want to fault the author.

He is right about trucks that kill. Cars kill, too, for the same reasons that he pointed out.

He is wrong, however, about "gypsies." These are a rare breed in the trucking field, and have been for some years. Trucking companies, freight forwarders, independent owner-operators and easier financing of tractors and trailers have just about driven them out of the business.

This is why: A new tractor, depending on make and optional equipment, costs in monthly payments, interest and required insurance (but not the multimillion-dollar liability or cargo insurance) upwards of \$500 a month. To meet payments like those, an independent owner-operator must keep his equipment in first-class condition so he can keep working and making his living. A rig in lousy condition is generally apparent from its appearance

*(Please turn to page 10)*



# Most people buy small trucks for the same reasons they buy small cars.

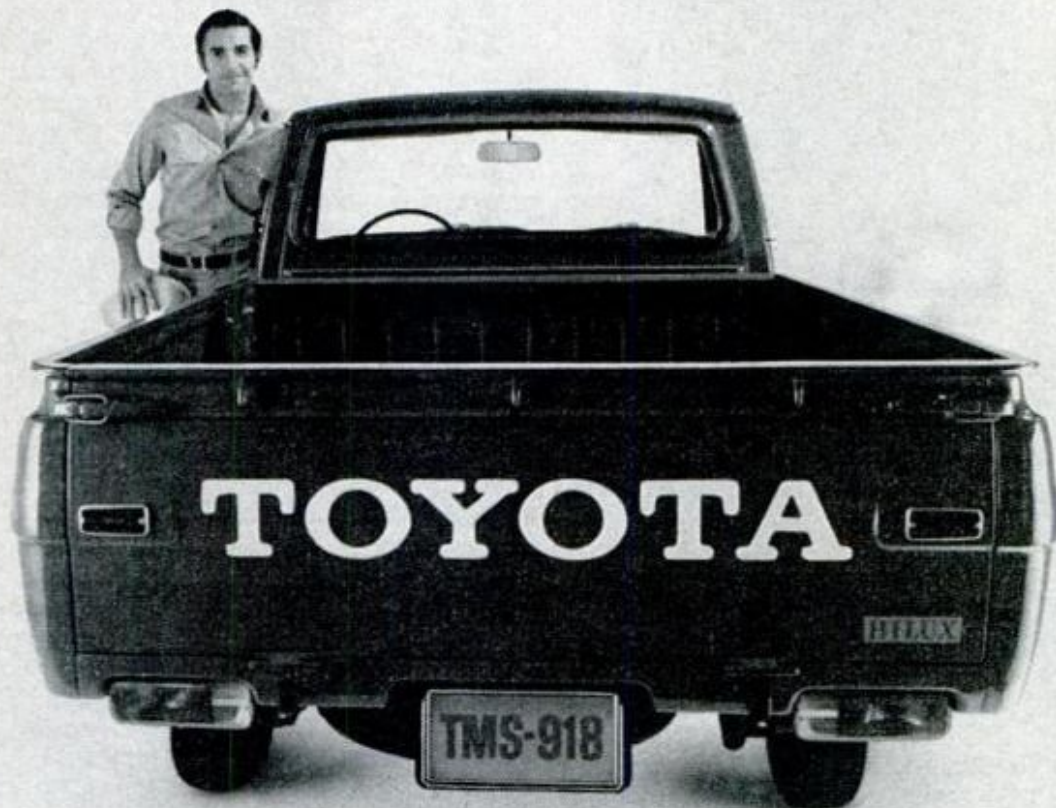

They eat less gas. Occupy less space. Are cheaper to maintain. Easier to handle. And cost much less to begin with.

In addition, some small trucks (namely our small Toyota half-tons) can do just what bigger half-tons do. We can carry a full 1,000-pound load in our 6-foot bed. And we can do it at highway speeds.

We've got an efficient 108-hp OHC engine. With 5 main bearings to help your engine live a longer, more rugged life.

And a heavy-duty suspension system for a solid ride. Empty. Or full-up.

And as you might have noticed, our small Toyota truck comes with a small Toyota price. \$1,978.\* Which includes a 4-speed synchromesh transmission. 6-ply tires. Flo-thru ventilation. Padded dash.

And some things a lot of bigger, more expensive half-tons don't have. Like a front towhook. Tie hooks all around the bed. And a spare tire under the truck that you lower with a hand crank.

Actually, there just might be more reasons to buy a small truck than there are to buy a small car.

## Toyota Half-Ton. \$1978\*

\*Manufacturer's suggested retail price. Freight, dealer preparation, options and taxes extra.



# EARN BIG MONEY IN AIR CONDITIONING REFRIGERATION & HEATING

25 KITS SENT TO BUILD THIS  
COMPLETE REFRIGERATION SYSTEM

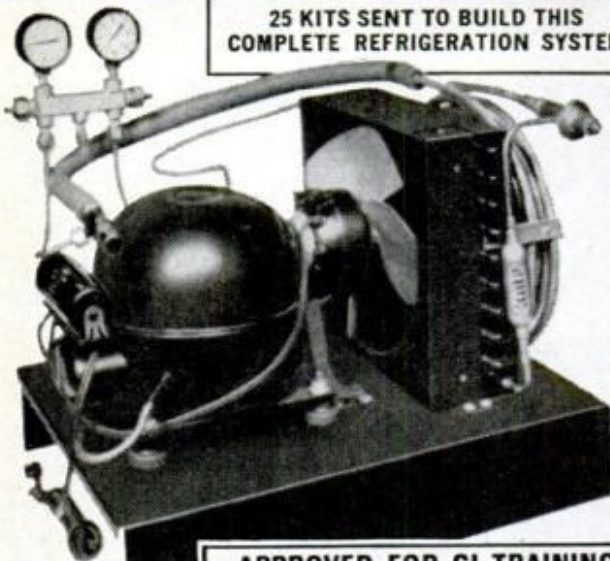

APPROVED FOR GI TRAINING

If you served since January 31, 1955 or are  
in service, check GI line in coupon

A better job, top pay and steady work are easily within your reach. Learn to repair and install air conditioning systems, refrigerators and freezers. Air conditioning is one of America's fastest-growing industries. Millions of autos and homes are being air-conditioned. The need for trained men is immediate and great.

**Make Home Your Training Center**—Learn by practicing. CTI sends 25 kits of tools and parts to build a complete refrigeration system—which you later convert into a refrigerator or freezer. The course is easy!

**Earn Money As You Train**—Since the CTI course includes training with real equipment, many students earn money repairing units soon after enrolling. On completing training they go into top pay jobs. Many get started in their own business.

**Mail Coupon Today for FREE book.** No obligation. Prove to yourself that the air conditioning, refrigeration and heating field is best for you—the easiest training to master and loaded with top pay opportunities.

Commercial Trades Institute, Chicago, Ill. 60626

**COMMERCIAL TRADES INSTITUTE**  
1400 Greenleaf Avenue  
Chicago, Illinois 60626 Dept. PM-771



Send book, Be a Success in Air Conditioning,  
Refrigeration & Heating. No obligation.

Name \_\_\_\_\_ Age \_\_\_\_\_

Address \_\_\_\_\_ Zip \_\_\_\_\_

City \_\_\_\_\_ County \_\_\_\_\_ State \_\_\_\_\_

Check for facts on GI Bill  
Accredited Member National Home Study Council

## LETTERS

(Continued from page 8)

and age. Few companies care to use older rigs for this reason.

The manufacturer cited in the article apparently didn't know the trucking business and the lawsuits that could and do result from truck accidents. He was looking for a gypsy. And he is a guy who will haul anything anywhere anytime if the price is right. But he is a rare, rare bird.  
PITTSBURGH, PA. JIM FAGAN

## How to load a trailer

You should have had *How to Tow a Trailer* (page 141, May PM) written by a person who knows something about trailers. The comments about rental trailers are inaccurate. As a U-Haul dealer for eight years, I have never let a trailer leave my lot without proper light hookups.

One gross error that you should inform your readers about is: how to load the trailer. *Don't try to balance the load over the axle of the trailer.* Always load 10 percent heavier in the front. The main reason for this is not the stress on the hitch but because an improperly loaded trailer is very unstable and apt to sway.

I don't know where you came up with your figures. Studies made for U-Haul show that by vehicle miles there are 80 percent fewer accidents with cars towing U-Haul trailers than with cars not towing trailers.

POWAY EQPT. RENTAL ROBERT CONNOR  
POWAY, CALIF. VICE-PRESIDENT

A trailer must be loaded so that 10 to 15 percent of its gross weight rests on the hitch ball. If this results in the tow vehicle's rear end being depressed excessively, this problem must be solved with an equalizing hitch or by supporting the vehicle's rear suspension.

HALF MOON BAY, CALIF. DONALD BEATY

## Wing adder

That add-on wing you published (*We Added On and Saved*, page 104, May PM) was intriguing to me and several friends who also are running out of living space. Is there any way of obtaining further information, instructions or plans?

COLORADO SPRINGS LEWIS CLARK

All reader inquiries about the PM wing addition are being handled by Money-Saver Projects Associates, Box 303, Chappaqua, N.Y. 10514. Write them for information; instructions and working drawings are available. ★ ★ ★



# No.1 Chain Saw Buy

## from the No.1 Chain Saw People



### New Homelite<sup>®</sup> 150 Automatic

**Easy to Handle** – Homelite's all-weather starter, fingertip controls, Sure-grip handlebar, perfect balance and quieter muffler make the new 150 Automatic chain saw a pleasure to use.

**Lightweight Power** – Aluminum and magnesium are the light-but-tough metals used in this super lightweight saw. The 150 Automatic will take care of every outdoor woodcutting job.

**Rugged Reliability** – The Homelite 150 Automatic is a simple-service-saw, built to last. It has the industry's only one-piece clutch – smoother, more reliable.

Here's the newest design in chain saws that includes automatic oiling for the cutting chain and guide bar at no extra cost!

Only **\$149<sup>95</sup>**

Manufacturer's suggested retail price with 12" bar & chain

The new Homelite 150 Automatic is available at more servicing dealers than any other chain saw sold. Check the Yellow Pages for your nearest Homelite chain saw dealer – drop in and see the No. 1 chain saw buy. Homelite, **Alextron** DIVISION  
12407 Riverdale Ave., Port Chester, N.Y. 10573

**HOMELITE**

No. 1 in Chain Saw Sales Worldwide



50 years  
and  
3 million  
chain saws  
old



# LEARN TO BE A SKILLED LOCKSMITH



Change combination of pin tumbler cylinder—EARN \$1.50 in 15 MIN.

**TYPICAL JOBS EARN YOU \$271 PART TIME (in only 53 hours!)**

Owner loses key; pick car trunk—EARN \$5.50 in 10 or 20 MIN.



Install new knob door lock—EARN \$15.00 in 30 MIN.

After-hour emergency opening—EARN \$2.50 to \$5.50 in 20 MIN.

## Hundreds have succeeded like these Belsaw Graduates:

**R. W. Davis, St. Louis, Mo.:** "I am doing a wonderful business thanks to your course in locksmithing. Last Saturday I took in \$110.00."

**Pierson Crook, Los Angeles, Calif.:** "I am making \$200 a month extra income with the Belsaw Locksmith Course. I would recommend your course to anyone."

Big demand for skilled Locksmiths! Earn big money spare time in your own home. Be your own boss. No layoffs. Steady year 'round income. Age and schooling are no handicap.

**BELSAW INSTITUTE** training... approved by master locksmiths... helps you start faster with easy picture lessons guided by your own mail instructor.

Get thorough job training on all types of locks. We supply tools, equipment and business help: how to start, how to charge, how to get jobs, how to earn while you learn and build a lifetime cash-profit business. Accredited Member National Home Study Council. Approved by State Board of Education. Approved for Veterans.



**This \$125 key machine is yours to keep!**

### MAIL COUPON—NO SALESMAN WILL CALL

BELSAW INSTITUTE, 102K Field Bldg.  
Kansas City, Mo. 64111

Send FREE book, "Keys To Your Future!"



Name \_\_\_\_\_

Address \_\_\_\_\_

City \_\_\_\_\_ State \_\_\_\_\_ Zip \_\_\_\_\_



## Smog lifter

Plumes of warm, moist air—rising from this laboratory model of a proposed new cooling tower—are being studied by GE Research and Development Center engineers as a means of ventilating smog-laden skies over large cities. The study shows that a massive plume would pass through atmospheric inversions (when a layer of warm air pins down a layer of cool air and won't allow polluted air to rise). The tower would also let electric power stations discharge thermal exhaust thousands of feet into the atmosphere.



## Rooftop launching

It's an old story for Ron Clayton. Like its predecessors, his third boat, *Roofus III*, was launched through the roof after he built it in the attic. The sail went up just for the photo.



ALL G.I.S. VETERANS UNDER NEW G.I. BILL

# THESE 3 BIG DRAFTING KITS\* GIVEN TO YOU!

... when you train at home with us for a

## 1 HIGH PAY JOB IN DRAFTING

CUT OUT ENTIRE ENVELOPE... BOTH PANELS...  
FOLD IN HALF... SEAL (Staple or Tape) AND MAIL

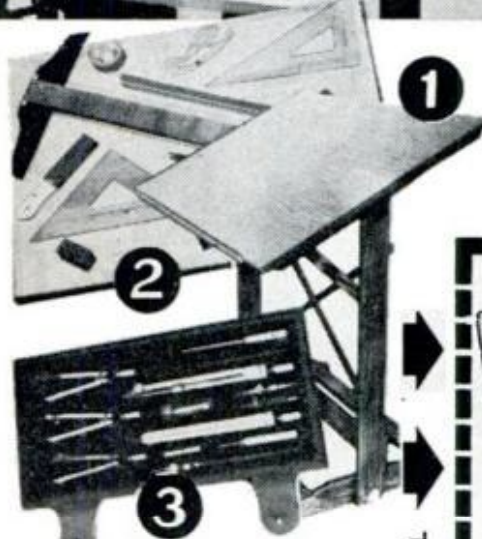

\* Precision Drawing Instrument Set, Professional Drafting Board Outfit & Fingertip Tilting Drafting Table are given to you with your complete North American Course in Drafting.

### TOP AMERICAN EMPLOYERS WELCOME NASD GRADUATES

"We would be very interested in interviewing your graduates as potential employees."

— Remington Office Machines.

"At the present time we have several openings available for qualified Draftsmen. I look forward to considering graduates of your institution."

— Westinghouse Electric

"We have immediate openings for designers and Draftsmen and have a definite interest in interviewing candidates immediately."

— American Machine & Foundry

### HERE'S WHAT STUDENTS SAY

#### Big Promotion!

"18 months ago I was a laborer. Now I am foreman of 22 people in the Drafting Room. Thanks for making this possible."  
S. D., Mass.

#### 2 Raises and \$300 Bonus!

"I've had 2 boosts in salary and a \$300 bonus in 11 months. Wish I could shake hands with your staff in person."  
A. C., Calif.

#### Job Awaits Serviceman!

"Your Drafting Course has given me a good start. I already have a job waiting for me when I leave the service."  
L. I., FPO, New York

#### Gets Three Raises!

"Since completing my course I have been transferred from the foundry to the Engineering Department and had three raises."  
R. C., Ohio

Accredited Member, National Home Study Council



(A home-study program in association with



Rush me FREE "DRAFTING CAREER KIT"

## MAIL THIS HANDY POSTAGE-PAID COUPON-ENVELOPE...

Cut out *entire* Business Reply Envelope (*both* panels) along dotted line. Fill in coupon-envelope. Seal (staple, tape or paste). Mail today! NO POSTAGE STAMP IS NECESSARY!

Please send me your FREE "Drafting Career Kit," including 20-page CAREER FACT BOOK, 5-way DRAFTING INSTRUMENT, self-scoring APTITUDE TEST and SAMPLE LESSON. I understand there is no cost or obligation on my part, now or ever, and that no salesman will call.

Dept. 14177

NAME \_\_\_\_\_ AGE \_\_\_\_\_

ADDRESS \_\_\_\_\_

CITY \_\_\_\_\_ STATE \_\_\_\_\_ ZIP \_\_\_\_\_

FOLD IN HALF HERE ↓ SEAL (STAPLE OR TAPE) AND MAIL



**BUSINESS REPLY MAIL**  
First Class Permit No. 363 NEWPORT BEACH, CALIF.

POSTAGE WILL BE PAID BY

**NORTH AMERICAN SCHOOL OF DRAFTING**  
4500 Campus Drive, University Plaza  
Newport Beach, California 92663





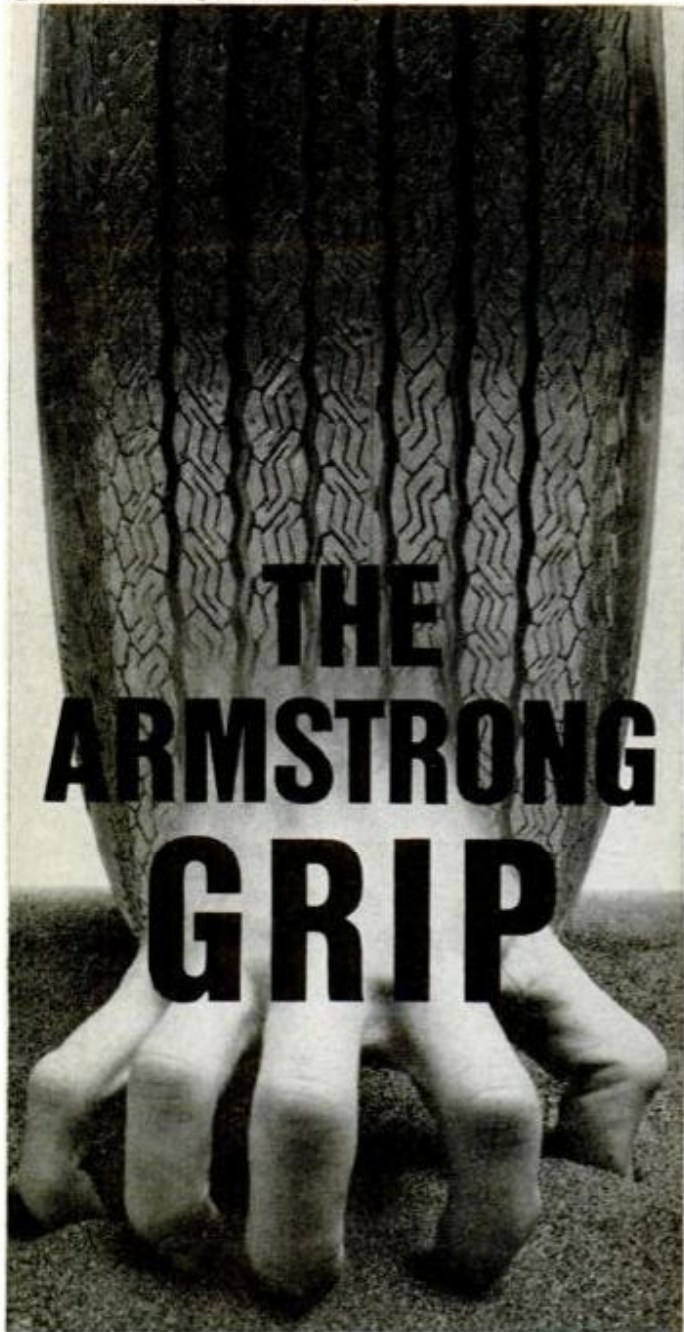

# THE ARMSTRONG GRIP

## ONLY ARMSTRONG TIRES HAVE IT.

The grip that's grooved to hold the road in any weather or road condition, grab strong, grip strong. The grip you get with our great line of Armstrong Tires. We pioneered grip even before we introduced fiber glass tires. And we never stop trying to improve it. The Armstrong Grip. This year it's stronger than ever.

**ARMSTRONG TIRES**  
FIRST IN FIBER GLASS

## NEWS BRIEFS



### Three-dimensional pun

Few people could—or would—carry a pun to the degree that Gerald Scarfe, London artist, did. Here, in the form of an overstuffed, cowhide-covered piece of furniture, is a likeness of "Chair Man" Mao.



### One way to beat tax man

Hauling contractor Neville Brandstater has figured out a way to beat an Australian road tax that's imposed on semi trailers. He loads his trailer onto the prime mover and thereby turns the rig into a "tray body" truck once he's made a delivery and is starting back. The trailer is placed on the prime mover with a crane.



# TOM McCAHILL SAYS:

**"The appliance repair field is so uncrowded it's almost lonely!"**

Someone once said that if you build a better mousetrap, the world will beat a path to your door. In the home appliance business, a lot of enterprising companies have gotten rich peddling a list of handy electrical gadgets for the home longer than Wilt Chamberlain's arm. The trouble is, the dozen or more appliances in the average American home can go on the fritz, and men with the proper training to do repairs are as scarce as knee-length skirts on teen-agers.

Good Appliance Repairmen are a rare breed these days. Those with a little ambition are booked so solidly you can wait days to get somebody to fix a balky refrigerator or cantankerous toaster. Sometimes, you have to settle for a bum job from a guy who had no business calling himself an Appliance Repairman in the first place.

This brings me to my point. If you want to make money in a field that's begging for trained technicians, there's a fine, low-cost home-study plan available that teaches you how to handle every type of Appliance repair in detail—including refrigeration, air conditioners, and even small gas engines. The course was prepared by the instructors at National Radio Institute. This is the oldest and largest home-study school in the Electronics' Electrical fields with more than fifty years' experience training men like yourself for new careers or spare-time or full-time businesses of their own.

A few years ago, NRI recognized the increasing demand for trained Appliance Repairmen. They set about preparing well-illustrated, easy-to-understand lessons that teach you how to repair home, commercial and farm Appliances. NRI even added a professional Appliance Tester that's included in their low tuition. With the Tester and a few basic tools you probably already have,

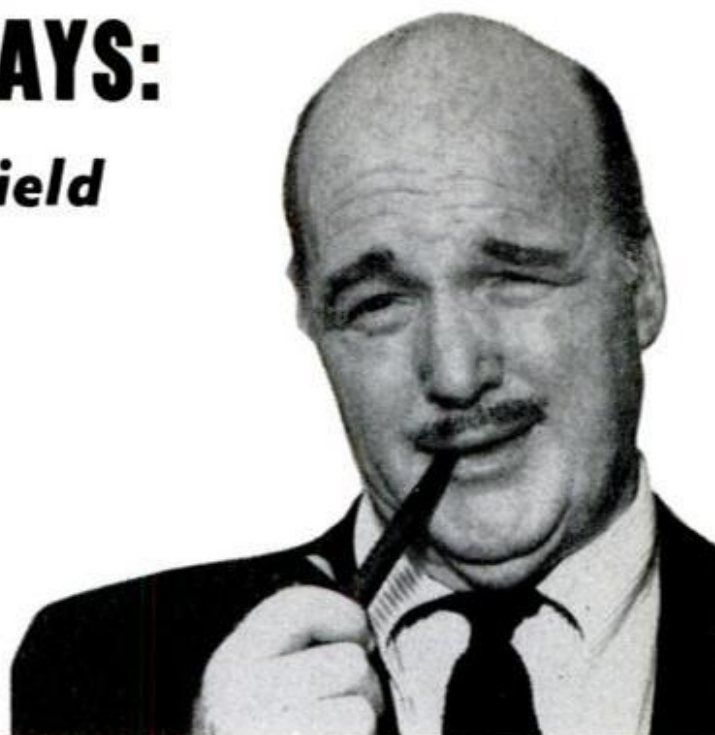

you're equipped to service most Electrical Appliances. If you aren't making as much as \$4 to \$6 an hour in spare time fixing Appliances for friends and neighbors within a few months after enrolling, my name isn't McCahill.

The reason I'm no doubting Thomas, is because the staff at NRI is composed of experienced instructors who guide you through the course with more personal attention than you'd get in many classrooms. With the kind of help they give a student and the kind of course they have, you can be the man in demand in this field—even if you've never tried to rewire a plug, or got fed up with school at the 9th grade.

The best advice I can give you is to clip the coupon below and send for the NRI Appliance Training Catalog. It's free, and there's no obligation. NRI doesn't employ salesmen, so nobody will be knocking at your door. All it will cost you is a postage stamp. Take it from Uncle Tom, the Appliance Repair field needs good men. Now.

*Tom McCahill*

TOM McCAHILL

APPLIANCE DIVISION, NATIONAL RADIO INSTITUTE  
3939 Wisconsin Avenue, Washington, D.C. 20016

APPROVED UNDER NEW GI BILL.  
If you served since January 31, 1955, or  
are in service, check GI line below.

600-071

OK—I want to see for myself. Send me the free book on Professional Appliance Servicing. No salesman will call.

Name..... Age.....

Address.....

City..... State..... Zip Code.....

Accredited Member National Home Study Council.

Check for facts on new GI Bill.



# ALL OUTDOORS

By GEORGE REIGER

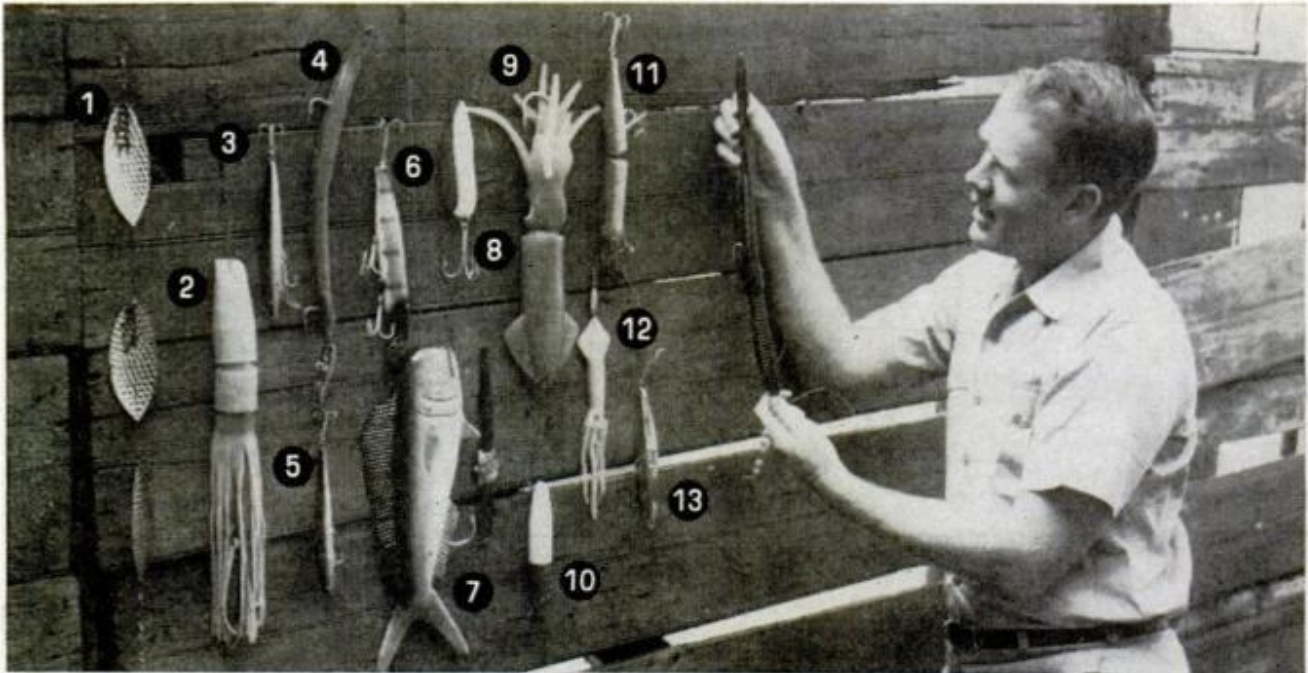

**A FEW SEASONS BACK**, an outdoor writer took a display model "flatfish" lure 26 inches long on a camping trip. He planned to troll the thing for some stunt photography. Trouble was, he kept catching fish! Bass and pickerel—not one as large as the lure!

Since World War II, popping plugs, jointed minnows and streamer flies have taken up residence in tackle boxes of saltwater anglers. Now giant versions of these lures used by ocean anglers are moving into the tackle boxes of lake trout and muskie fishermen.

Large spoons have long been used to take big trout. Will even larger spoons take even bigger fish? Plastic worms have revolutionized bass fishing. Will still larger shapes like the gag "Texas Worm" I'm holding from Sportsman's Products, Marion, Ind., land lunkers? After all, those other lures are for real, and No. 4, the Garcia Alou "Cow Killer," is much like a huge worm and has already caught its share of giant striped bass.

Why do some fish attack food imitations larger than they can swallow? It's anybody's guess. Perhaps, fish will strike to drive away something different or which seems a threat.

In any event, supersize lures get results, and they're fun to experiment with.

Others shown are: (1) Dave Davis Troller, Eddie Pope Co., Altadena, Calif.; (2) Knucklehead, Sevenstrand Tackle, Westminster, Calif.; (3) Rapala Magnum, Normark, Minneapolis, Minn.; (5) Reb 2, Norman Mfg., Fort Smith, Ark.; (6) Giant Pikie, Creek Chub, Garrett, Ind.; (7) Dolphin, Leisure Lures, North Hollywood, Calif.; (8) Huskie Devle, Lou J. Eppinger Co., Dearborn, Mich.; (9) Squid, Leisure Lures; (10) Everett Tackle Co., Waltham, Mass.; (11) Jointed Giant Pikie, Creek Chub; (12) Sportsman's Squid; (13) Diamond Jig, Bridgeport Silverware Co., Bridgeport, Conn.

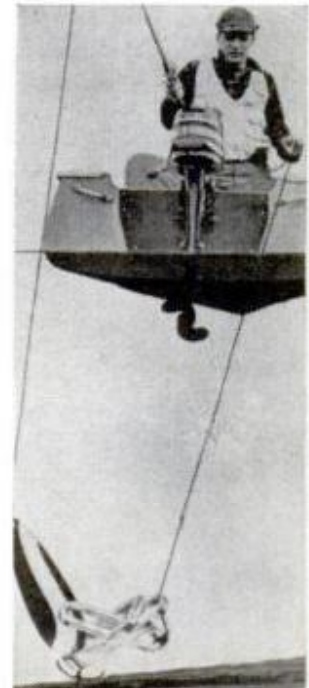

**TO SAVE LURES SNAGGED DEEP**, the Snagaway Lure Saver Kit (above, right) has 150 feet of 70-lb. test nylon and a retriever to slide down your line and lock onto lure below. \$6.95.

**REMEMBER ZONAR?** (See *Zounds! It's Zonar!* page 36, Mar. '70 PM). Mark II (left) provides salt-water anglers with air/temperature readings scaled to a species preference chart. \$99.95.





**Old Gold Filters. The cigarette for independent people.**

**"I want my cigarette to talk tobacco to me.  
But I only want it to say one thing: flavor.  
I smoke Old Gold Filters."**

19 mg. "tar," 1.2 mg. nicotine av. per cigarette, FTC Report Nov. 70.

© 1971 Lorillard



# New tools you should know about



**TAPELESS RULER** made by USM, Consumer Products Div., Box 1139, Reading, Pa. 19603, is 8½ in. long (see inset), has five 7-in. extensions to lengthen handle for use beyond normal reach. Measures feet and inches, \$30.



**WISE ACCESSORIES** called Swivel Blocks are designed for use between machine vise jaws and work that's tapered or of irregular shape. Blocks automatically adjust to transmit force as needed to eliminate the need for shims. Sold in four sizes, \$20 to \$40. Write Universal Vise & Tool Co., 8500 East Michigan Ave., Parma, Mich. 49269 for Bulletin 380-70.

**PRECISELY TAPERED BLADE** keeps this saw from binding during use. Dubbed White Knight, this 26-in. by 8-pt., \$8 saw is made of very flexible steel by Spear & Jackson Hand Tools, Inc., 30 Church St., New York, N.Y. 10007.



**WOOD-TURNING CHISELS** of high-alloy steel have precision-ground cutting edges, extra-long (10½-in.) handles. Set of eight: \$34.95 from Rockwell Manufacturing Co., 400 North Lexington Ave., Pittsburgh, Pa. 15208.

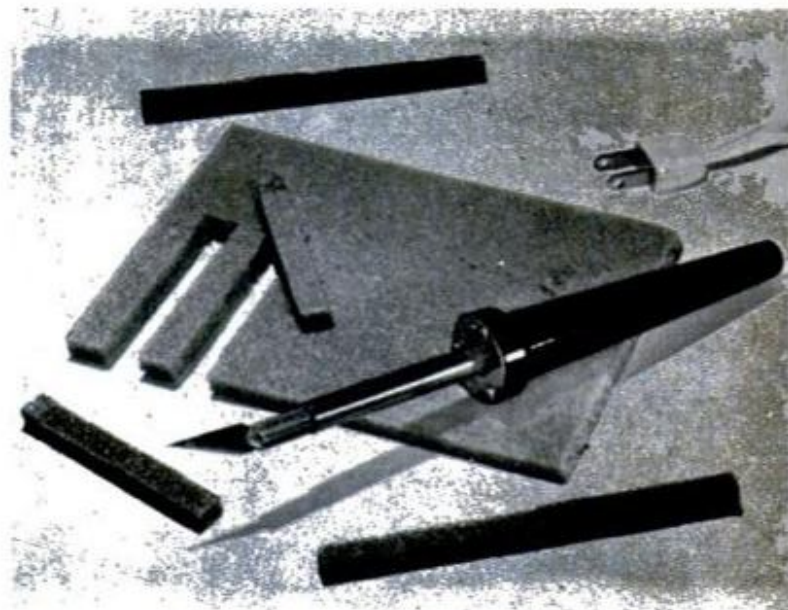

**DUAL-PURPOSE HOT KNIFE** holds standard knife blade in adapter chuck that can be removed to insert threaded end of soldering tip supplied. Knife cuts light plastics, epoxies, \$5. Weller, 100 Wellco Rd., Easton, Pa. 18042.





# According to most house paint ads, the quickest and easiest job is all you care about.



# The Dutch Boy believes you care about something else: a paint job that will stay looking good a long time.

We won't kid you and say there's nothing to it. Painting a house—even painting it with Dutch Boy® Latex House Paint—takes planning and work.

If the surface is new, or if it was painted with latex house paint before, your surface preparation may involve very little beyond resetting nails, puttying nail holes, or removing chalk.

If your house was painted with oil paint before, or you don't know if it was and can't find out, you should consult your Dutch Boy dealer and he will advise you as to what methods of surface preparation may be in order.

Two things particularly contribute to the long-lastingness of Dutch Boy Latex House Paint. One is that since the paint "breathes," moisture can't get trapped under it. The other is that the acrylic resin base of Dutch Boy Latex House Paint has the ability to lock in colors and consequently, the colors last for the life of the job and the job lasts longer.

If you've got shutters and trim that you want to look glossy, although you want the rest of the house flat, your

Dutch Boy dealer can sell you flat and glossy colors designed to work together.

And the painting of gutters and drain pipes is no problem, either. Dutch Boy Latex House Paint clings to aluminum, galvanized and copper surfaces for the life of the paint job—no special primer is needed.

As to the quickness and ease of the painting itself, Dutch Boy Latex House Paint actually flows on easier without dragging or sticking. It doesn't leave lap-marks when you stop and start, so that if you want, you can paint every weekend for the whole summer. Paint before and after the rain. And no matter what kind of a mess you make (and you can make a mess) it will wash up with soap and water.

But we're never going to tell you that painting a house is so much fun you'll feel like running out and doing it again. You have kids to raise and living to do and our main job is to help you forget about us for a long time.





# Add a Tag-Along Seat to Your Cycle

WHEN the Milton Kites bought his-and-her Hondas several years ago, they hadn't counted on their 3-year-old daughter, Vickie, wanting to get in on the fun of those cool summer-evening rides. So, Milt went to work, and, for a total cash outlay of about \$25, he added this comfortable tag-along seat for her.

Except for the back and seat cushions, the entire framework is formed from common electrical conduit. Here a conduit bender (hickey) comes in handy, but even without one, you can bend the tubing without kinking it. Simply cork one end, fill the tubing completely with dry sand and cork the other end. After you've made the bends, remove the corks and pour out the sand.

Where one length of conduit joins another, file the end to fit the mating contour. For maximum strength, use silver solder for all the joints.

The back and seat cushions are pieces of 1/2-in. plywood padded with foam rubber. The Naugahyde covering will withstand a reasonable amount of sun and rain. To finish the framework paint it to blend with your cycle or to please your wife.

Worm-gear hose clamps are used to attach the seat to the luggage rack of the cycle.—Lugman House, Walnut Creek, Calif.

## SEAT CONSTRUCTION

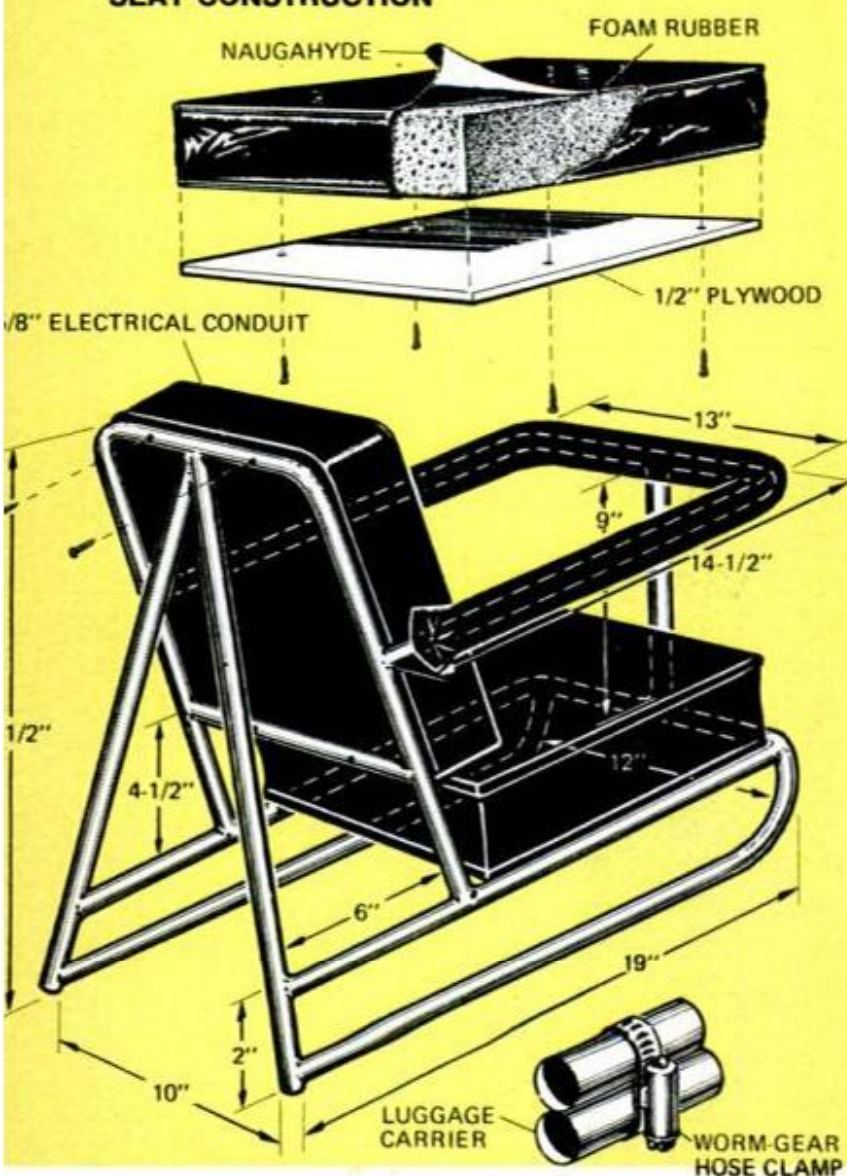



# The trucks that ride smoother

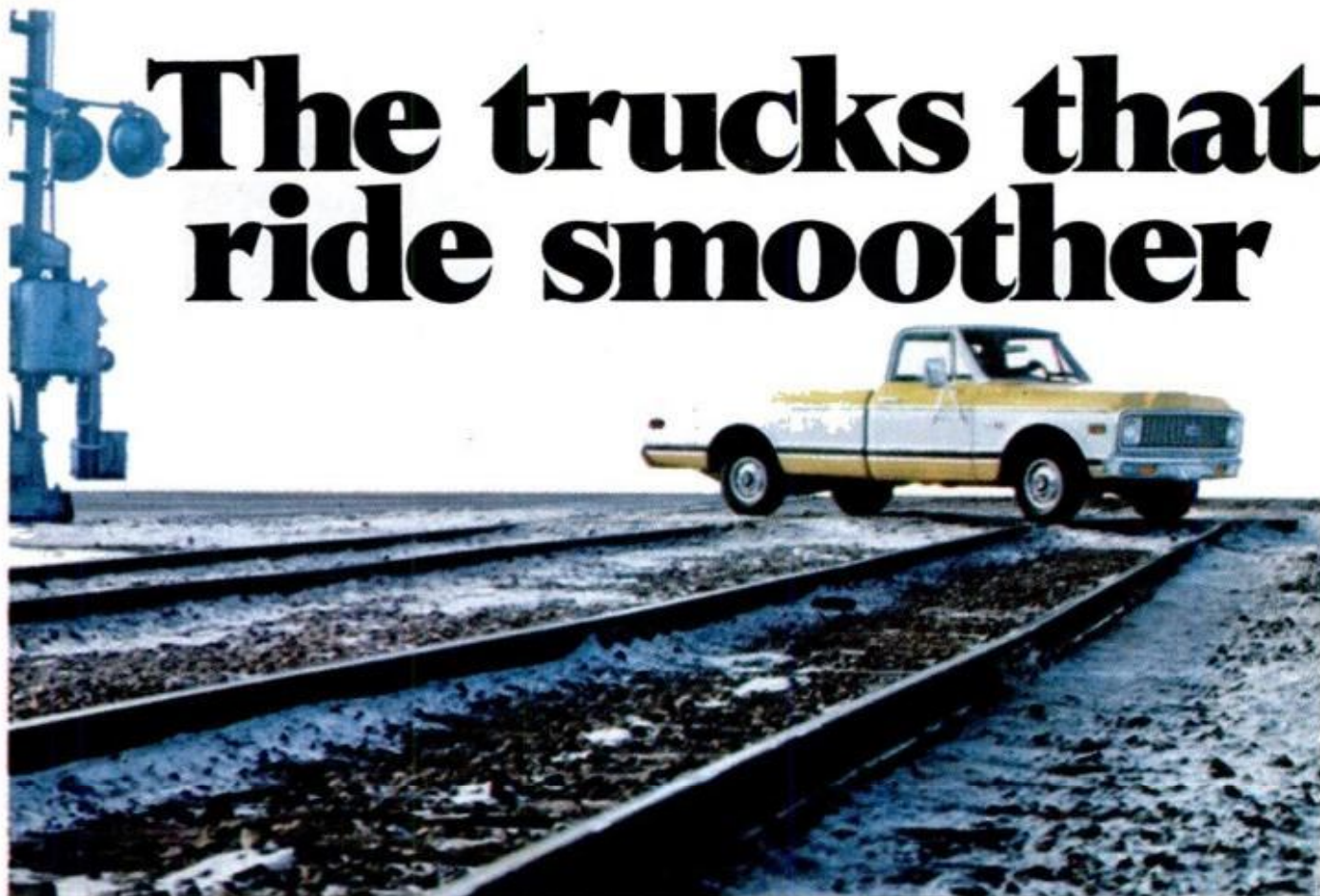

## Smoother wide-stance Super Suspension

Over the years Chevrolet has led the way in engineering a smooth truck ride.

We were the first to introduce independent front suspension. We've built 1½ million more light-duty trucks with this type of suspension than anybody else.

In the rear Chevy leads the way by making available two-stage coil or leaf springs. Most



trucks don't give you a choice. And most trucks don't give you Chevy's steady wide stance ride. Chevy's Super Suspension. The smoothest truck suspension system going. And the trucks that ride smoother, work longer. That's a fact.

## Look at Chevy's work record

The chart below, based on the latest official figures from R. L. Polk & Co\*., shows how Chevrolets outlast other trucks.

Going back as far as 1956, for example, over 55% of the Chevy trucks of that model year are still going strong.

No competitive make has as many as half of its '56 models still working. Chevrolet trucks last longer because they're built tougher.

# last longer

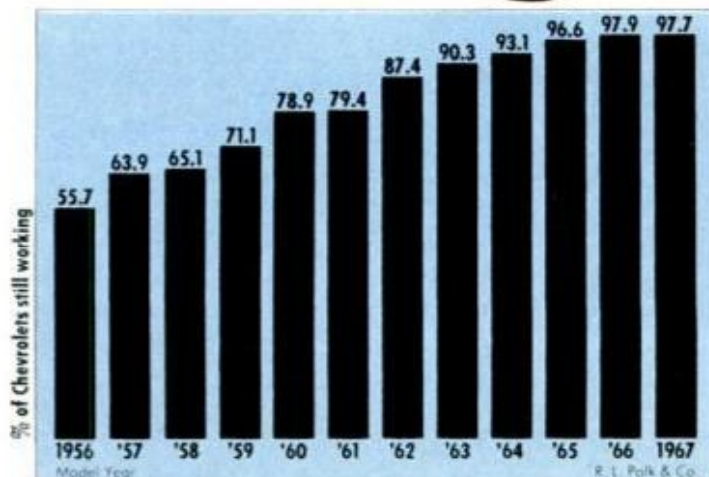

**Totally tougher trucks**

Buckle up for safety.





# HINTS FROM READERS

## Neater sandpaper tearing

An easy way to tear a sheet of sandpaper to the width that your sander requires is to use your saw table as shown. First, determine the desired paper width. Then, using a block of thin wood with a width that equals that dimension, move the rip fence over and lock in place. Now, paper is held securely while you tear.

—Robert E. Smith, Batavia, N.Y.

## Drive stud becomes scriber

A threaded drive stud of the type used for fastening to concrete can be converted to a sturdy scribe for shop use. Because of its small  $\frac{1}{4}$ -20 thread, it's easy to fashion a comfortable, easy-to-grasp handle to suit your needs. The tough and hard steel pin is long-lasting, and a replacement costs just pennies.

—Anton Barkey, Sunnyvale, Calif.



## Pill vials store dies

Plastic pill containers make fine storage "compartments" for keeping button dies handy and clean when they must be stored in drawer or toolbox. The eight-dram size holds five 1-in.-dia. dies and the five-dram vial will corral seven  $\frac{13}{16}$ -in. dies. A cotton wad saturated with oil will keep dies free of rust during storage.

—J. F. Pilznienski, Dearborn Heights, Mich.



## Faster cleanup after spackling

Next time you have to patch a plaster-board wall, try this method for making after-job cleanup a snap. Mix your patching plaster (or Spackle) in a flexible plastic freezer container. When finished patching, let remaining material harden in the container; then flex the container to loosen material for emptying.

—John F. Bachman, Columbia, Md.



## Correction fluid aids layout

The white correction fluid which typists use to block out unwanted characters can be used when you lay out shopwork. Just spread a coat of fluid (which resembles white lacquer) on the metal. In a few minutes you can use a ballpoint pen to mark on it—as for positioning center points of holes to be drilled.

—B. W. Ervin, Kent, Ohio

POPULAR MECHANICS



# Springtime!



It happens every Salem.

**NATURAL MENTHOL™**  
Not the artificial kind. That's  
what gives Salem a taste as fresh  
as Springtime. It's only natural.



# 266 ICS

## LEADERS IN THE ICS SUCCESS PARADE...

Automobile Engine Tune-Up  
Introduction to Programming the IBM System/360 Computer Business Administration Accounting Civil Engineering Practical Electrician

Radio-TV Servicing Architectural Drafting High School Courses High School Equivalency Refrigeration and Air Conditioning Aircraft and Power Plant Mechanics

**ACCOUNTING**  
Accounting (U.S.A.)  
Accounting (Canadian)  
Accounting for Business Programmers  
Accounting for Mgt. Decisions  
Auditing  
Business Law (U.S.A.)  
Canadian Business Courses  
Cost Accounting  
CPA Review (U.S.A.)  
General Accounting  
Income Tax (U.S.A.)  
Industrial Accounting  
Junior Accounting  
Office Accounting  
Practical Accounting  
Public Accounting  
Small Business Accounting (U.S.A.)  
Starting and Managing a Small Bookkeeping Service (U.S.A.)

**ARCHITECTURE AND BUILDING**  
Architectural Drawing and Designing  
Architecture  
Building Contractor  
Building Estimator  
Building Inspector  
Building Maintenance  
Carpenter-Building  
Carpentry and Millwork  
House Planning and Interior Design  
Mason  
Painting Contractor  
Reading Architectural Blueprints

**ART**  
Amateur Artist  
Commercial Art  
Commercial Cartooning  
Illustrating with Options:  
—Magazine  
—Advertising Layout and Illustration  
Interior Decorating  
Oil Painting for Pleasure  
Show Card and Sign Production

Show Card Writing  
Sign Painting and Designing  
Sketching and Painting

**AUTOMOTIVE**  
Automatic Transmission Specialist  
Automobile Air Conditioning Specialist  
Automobile Body Rebuilding & Refinishing  
Automobile Engine Tune-Up  
Automobile Mechanic  
Automobile Technician  
Diesel-Gas Motor Vehicle Engines

**BUSINESS**  
Advertising  
Business Administration  
Business Prac. (Cond.)  
Canadian Business Course  
Direct Mail and Mail Order Advertising  
Industrial Psychology  
Inventory Control  
Magazine & Newspaper Advertising  
Managing a Retail Business  
Managing a Small Store  
Marketing Management  
Marketing Research  
Modern Exec. Mgt.  
Office Automation  
Office Management  
Production Management  
Purchasing Agent  
Retail & Local Adv'ting  
Retail Bus. Management  
Retail Merchandising  
Retail Selling  
Systems and Procedures Analysis

**BUSINESS: SALES**  
Creative Salesmanship  
Real Estate Salesmanship  
Salesmanship  
Sales Management

### BUSINESS: SUPERVISION

Advanced Management  
Basic Management  
Industrial Foremanship  
Industrial Supervision  
Management, Salesmanship and Sales  
Modern Woman as a Supervisor  
Personality Development  
Personnel-Labor Relations (U.S.A.)  
Supervision

### CHEMICAL

Chemical Analyst  
Chemical Engineering  
Chemical Laboratory Technician  
Chemical Process Equip. Design & Operation  
Chemical Process Op.  
Elements of Nuclear Energy  
General Chemistry  
Instrumental Laboratory Analysis

### CIVIL ENGINEERING

Civil Engineering  
Construction Eng'r'g Tech.  
Highway Eng'r'g Tech.  
Principles of Surveying  
Reading Highway Blueprints  
Reading Structural Blueprints  
Sanitary Engineering Technician  
Sewage Plant Operator  
Structural Eng'r'g Tech.  
Surveying and Mapping  
Water Works Operator

### COMPUTERS

Fundamentals of Computer Programming  
COBOL Programming  
Fortran Programming for Engineers  
Programming for Digital Computers  
Programming the IBM 1401 Computer  
Programming the IBM System/360 Computer, Introduction

### DRAFTING

Aircraft Drafting  
Architectural Drafting  
Design Drafting  
Drafting Technology  
Electrical Drafting  
Electronic Drafting  
Introductory Mech. Drafting  
Mechanical Drafting

Pressure-Vessel and Tank Print Reading  
Sheet Metal Layout for Air Conditioning  
Structural Drafting

### ELECTRICAL

Electrical Engineering —Electronics Option  
—Power Option  
Electrical Appliance Ser.  
Electrical Appliance Ser. with Equip. Training  
Electrical Contractor  
Electrical Eng'r'g Tech.  
Electrical Home Maint.  
Electrical Home Maint. with Equip. Training  
Electrical Instrument Tech.  
Electric Motor Repairman  
Industrial Elec. Tech.  
Industrial Electrician  
Industrial Maintenance Electrician  
Power-Line Design and Construction  
Power Plant Operator —Hydro Option  
—Steam Option  
Practical Electrician  
Practical Electrician with Equipment Training  
Practical Lineman  
Reading Elec. Blueprints

### ENGLISH AND WRITING

Better Business Writing  
English for Spanish (U.S.A.)  
Free Lance Writing for Fun and Profit  
Introductory Tech. Writing  
Modern Letter Writing  
Practical English  
Reading Improvement  
Short Story Writing

### HIGH SCHOOL

High School Business  
High School (Canadian)  
High School General  
High School Math.  
High School Secretarial  
High School Vocational  
High School College Preparatory—Arts  
High School College Prep—Engineering and Science  
Preparatory Course for High School Equivalency Test

### MACHINE SHOP PRACTICE

Grinder Operator  
Industrial Metallurgy  
Lathe Operator

Mach. Shop Inspection  
Mach. Shop Practice  
Metallurgical Eng'r'g Tech.  
Multicraft Maintenance Mechanic  
Practical Millwrighting  
Reading Shop Prints  
Rigging  
Tool & Die Making  
Tool Engineering Tech.  
Welding Engineering Tech.  
Welding Process

### MATHEMATICS

Advanced Mathematics  
Math and Mechanics for Engineering Techn.  
Math and Physics for Engineering Techn.  
Modern Elementary Statistics

### MECHANICAL

Mechanical Engineering  
Aircraft and Power Plant Mechanic  
Hydraulic and Pneumatic Power  
Industrial Engineering  
Industrial Eng'r'g Tech.  
Industrial Instrumentation  
Machine Design  
Quality Control  
Safety Eng'r'g Tech.  
Tool Design  
Vibration Analysis and Control

### PETROLEUM

Natural Gas Production and Transmission  
Oil Well Servicing  
Petroleum Production Operator  
Petroleum Production Engineering Tech.  
Petroleum Refinery Op.

### PLASTICS

Plastics Techn.

### PLUMBING, HEATING AND AIR CONDITIONING

Air Conditioning  
Air Conditioning Maint.  
Domestic Heating with Gas and Oil  
Heating  
Heating & Air Conditioning with Drawing  
Industrial Air Cond.  
Pipe Fitting Plumbing  
Plumbing and Heating  
Plumbing & Heating Est.  
Practical Plumbing  
Refrigeration and Air Conditioning Serv.



# COURSES

## PULP AND PAPER

Paper Machine Operator  
Paper Making  
Pulp Making  
Pulp & Paper  
Engineering Tech.

## SECRETARIAL

Clerk-Typist Commercial  
Secretary, Engineering  
Sec'y, Legal Sec'y, Med.  
Secretary, Professional  
Shorthand Stenographic  
Typewriting

## STEAM AND DIESEL POWER

Boiler Inspector  
Industrial Building Eng'r  
Power Plant Engineering  
Stationary Diesel Eng's  
Stationary Fireman  
Stationary Steam Eng'r'g

## TEXTILES

Carding and Spinning  
Dyeing and Finishing  
Loom Fixing  
Textile Designing  
Textile Mill  
Superintendent  
Textile Mill Supervision

## TRAFFIC

Motor Traffic Man'g'm't  
Traffic Management

## TV-RADIO-ELECTRONICS

Cable TV Installer  
Commercial Radio  
Telephone License  
Electronics Technician  
Fundamentals of  
Electronic Computers  
General Electronics  
General Electronics with  
Equipment Training  
HI-FI Stereo and Sound  
System Servicing  
Industrial Electronics  
Numerical Control  
Electronics & Maint.  
Radio & TV Servicing  
Radio & TV Servicing  
with Equip. Training  
Solid State Electronics  
Telephony

## APPROVED FOR VETERANS FOR TUITION REFUND

Accredited member,  
National Home Study  
Council.

Easy pay-as-you-  
learn plan

Special rates to  
members  
U.S. Armed Forces.

**We'll send you  
complete details  
on any one of  
them...plus  
a sample lesson  
FREE!**

ICS is the oldest, largest school of its kind. 266 courses for men and women. High school, business, secretarial, automotive, computers, engineering. One for you. Direct, job-related. Bedrock facts and theory plus practical application. You learn from experts. The ICS diploma is the one recognized throughout industry. Clip and mail the coupon now or write ICS, Scranton, Pa. 18515. You'll receive, absolutely FREE, 3 valuable booklets that have helped thousands. But don't delay. Make your move for a more successful future today.

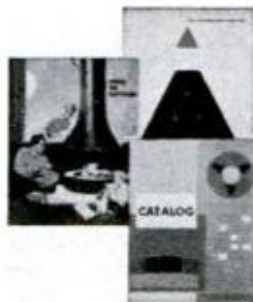
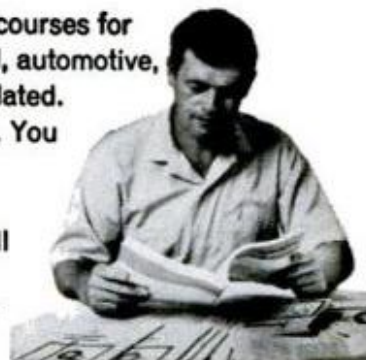

**FREE!**  
**THE ICS SUCCESS KIT!**  
Three valuable booklets sent to you free:  
1. A new, exciting booklet on the principles of success.  
2. Catalog of your choice.  
3. Sample ICS lessons.

## ICS International Correspondence Schools Division of Intert

ICS, Scranton, Pa. 18515 Canadian residents: Send coupon to Scranton. Our affiliate in Canada will reply.

### Mail this coupon today—ICS, Scranton, Pa. 18515

I'm interested in a program of independent study. Send me, without cost, your booklet on the principles of success, your illustrated brochures on the famous ICS method, and your catalog for \_\_\_\_\_

(Select from listing)

Interested in another field? Tell us: \_\_\_\_\_

Name \_\_\_\_\_ Age \_\_\_\_\_  
(Indicate Mr., Mrs., or Miss)

Address \_\_\_\_\_

City \_\_\_\_\_ State \_\_\_\_\_ Zip Code \_\_\_\_\_

Occupation \_\_\_\_\_ Working hours \_\_\_\_\_ A.M. to \_\_\_\_\_ P.M.

Employed by \_\_\_\_\_

I am a veteran, tell me how I qualify for tuition refund under the new GI Bill.

17054F





ON-THE-GO

# CAMPING

BY V. LEE OERTLE

MINI-MOTOR HOMES continue to be big items on the market, with the latest version being this Sightseer 18 from the company of the same name in Newark, Ohio. Designed to bridge the gap between small camper conversions and motor homes of 20 feet or more, this unit is built on a Dodge B-300 chassis. It's 18 feet long and inside we find the usual amenities—kitchen, toilet and compact eating-sleeping space—for a family of four. Though the company claims bunking room for six, we suspect the odd men out might be a bit cramped. Sightseer 18, fully insulated with polyurethane foam, indicates a maker hep to a growing interest in winter camping. Standard unit retails for \$5995; airconditioning and stereo are options.

**TOW TRUCK IN YOUR TRUNK?** That's what the manufacturer of Unstucker promises in the way of capability. An \$89.95 kit supplying 6000 pounds of pull will replace that electric and power-takeoff winch you've postponed buying. Once stuck, you first attach two special drums to your vehicle's drive wheels. This takes but a few minutes and requires no jacking up of your car. Then run a special high-test line between drums and an anchoring object. (If on a tundra without trees, you'll have to improvise the anchor!) That's all there is to it. You just step on the gas and the drive-wheel-mounted-drums should reel you free. From Sports Innovations, Inc., Minneapolis, Minn. 55435

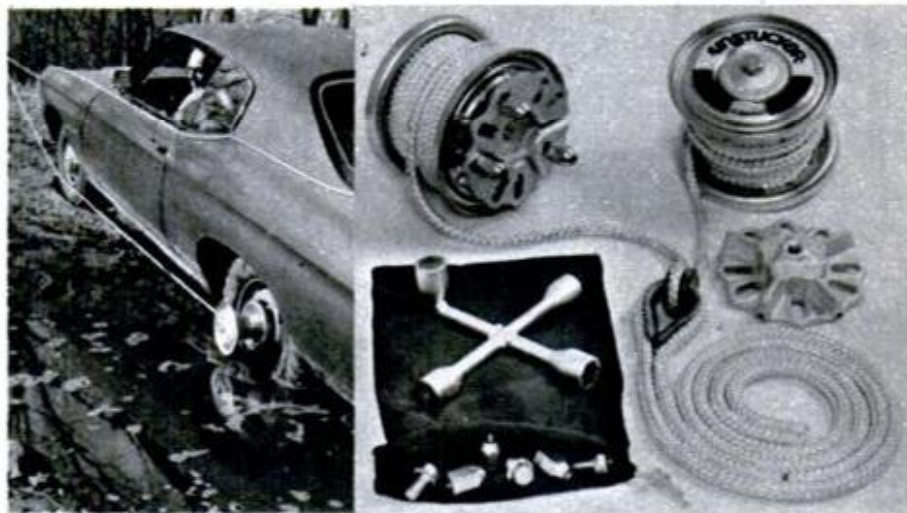

**CHANGES COMING UP** for Golden Eagle Passports—again! Secretary of the Interior Rogers C. B. Morton wants to convert the annual \$10 carload recreation entrance permit to an annual \$4 individual permit for all persons 16 years and older. He recommends the continuation of daily fees for persons who don't wish to purchase an annual permit. The present passport expires Dec. 31. Look for major changes in 1972.

**AS PM PREDICTED** in *On-the-Go Camping*, page 66, April PM, the Department of the Interior has established a National Park police force. According to Secretary Morton the new Division of Law Enforcement is "only one of several measures to cope with the increasingly difficult law enforcement situation in the National Park System." Inspector Franklin A. Arthur, a 20-year veteran of the U.S. Park Police, which is still the overall law enforcement element in the Park

Service, will head the new division devoted specifically to security in the National Parks. Recruitment is under way.

**INDEPENDENT CAMP OWNERS** now offer reservations nationwide through a new association called Pathfinder Travel Park System. Franchised campgrounds no longer have a choke-hold on cross-country reservations. Operators of privately-owned campgrounds subscribing to this system can now handle the leap-frogging tourist and assure him a place to stay from state to state.

For site reservations, campers may call 1-800-648-3011 from California, Arizona, Utah, Idaho, Oregon and Washington. From Indiana, Iowa, Michigan, Minnesota, Missouri, Ohio and Wisconsin, try 1-800-323-8111; from Illinois, 1-800-942-7071; from Nevada, 1-800-992-3501; and from all other states, 1-800-323-9111. This is a service of National Data Corp.—in some areas it's toll-free. ★★★



# To get you to drive around with a crankcase full of new Havoline, we drained ours. And we drove around Manhattan.

To prove that new Havoline Super Premium All Temperature Motor Oil is the finest engine protection money can buy, we drove a car for a mile with the crankcase full of new Havoline. Then we drained all the oil that would come out.

Off we drove around Manhattan. Up the F.D.R. Drive, then the Harlem River Drive, under the George Washington Bridge, down the Henry Hudson Parkway, around the Battery. Twenty-five miles of bumper-to-bumper, stop-and-go traffic. All the way back to where we started. The drive took almost one hour.

After a meticulous engine inspection, we discovered that not one part was harmed. So help us Havoline!

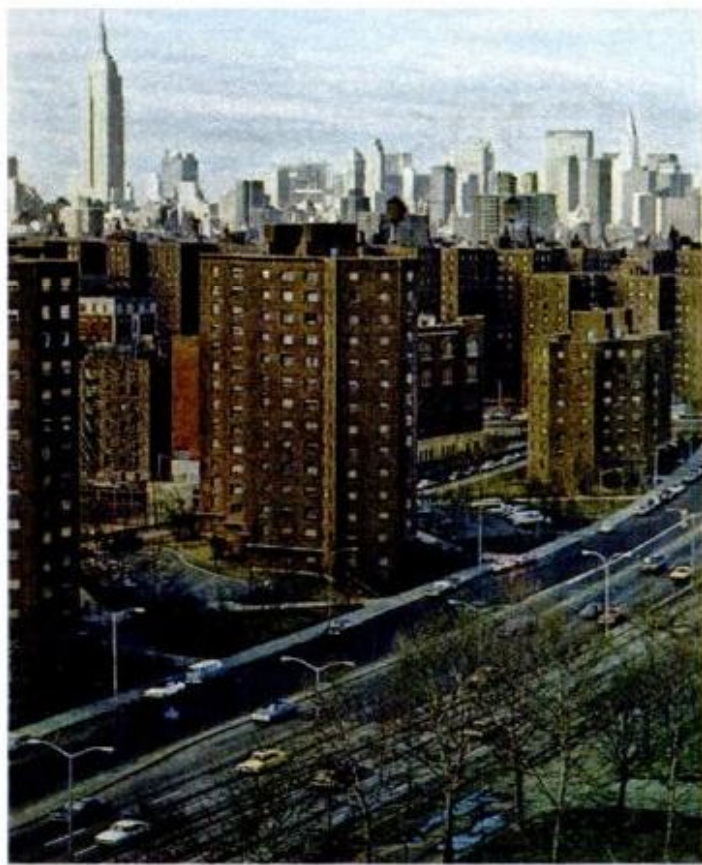

If only a thin film of new Havoline Super Premium All Temperature Motor Oil lubricated and protected our car's engine so not one part was harmed, you can imagine what a full crankcase will do for your car.

New Havoline resists thickening even under high-temperature conditions such as heavy-load, high-speed driving. That's when your car's engine works hardest. New Havoline prevents rust, wear, and sludge deposits.

We don't recommend that you try driving with your crankcase drained. You know exactly what we're recommending.



Trust Texaco to have  
the right products for your car.



# Pollution Fighters' Newsletter

## Speeding patent applications

To inspire inventors to create more devices for curbing environmental pollution, the Commerce Department's Patent Office recently established a priority processing procedure to expedite applications for antipollution patents. If you have something, write to the office at 2021 Jefferson Davis Highway, Arlington, Va. 22210.

## Recycling mercury

Hearing-aid dealers in New York have joined the antimercury pollution campaign by urging customers to return used hearing-aid batteries for recycling. Twenty-five percent of all mercury manufactured is used in hearing-aid batteries that are normally discarded (they explode if they are burned). When the cases decompose, mercury seeps into the earth and water supplies. Recycling the batteries would also save mercury, which is in short supply.

## Tires to 'gravel'

Bookmobiles, bloodmobiles . . . and soon to come—tire-pulverizing-mobiles. Prof. Norman R. Braton of the University of Wisconsin has developed a method for reducing the volume of used tires, thus making their transport to market more economical. He freezes a tire at minus 80°F. in liquid nitrogen and then drops it into a hammer mill which compacts and pulverizes it to gravel-like consistency. Prof. Braton's plan for the mobile unit is to move it to locations such as service stations, junkyards and dumps to pulverize tires on the spot.

## Tires to oil and gas

If strung out tread to tread, old tires discarded every year would circle the Earth twice at the equator! U.S. Bureau of Mines officials are continuing Firestone's idea (originally reported in *PFN*, page 42, Aug. '70 PM) to obtain large quantities of valuable chemicals, oils, gas and tar from old tires by destructive distillation. They're already recovering three barrels of oil and 1500 cubic feet of gas comparable in heating value to natural gas from a single ton of old tires.

## Pitch to powder

A sonic energy unit in operation at Merichem Corp., Houston, reduces waste refinery pitch to a powder for incineration with hydrogen sulfide. The whistle-like device generates 14,000 pounds of steam hourly, supplementing two main boilers. According to Merichem, sonic energy may soon be used to suppress smoke and dust, and to promote growth of bacteria in sewerage.

## Transparent engine for study

A unique transparent engine operating without need for oil in the crankcase is available from the Megatech Corp. The engine lets students observe combustion in the cylinder and effects of experiments with different fuels. With it, students can also measure horsepower, change compression ratios, study flame propagation, gas dynamics and emissions. Write the company at 365 Trapelo Rd., Belmont, Mass. ★★

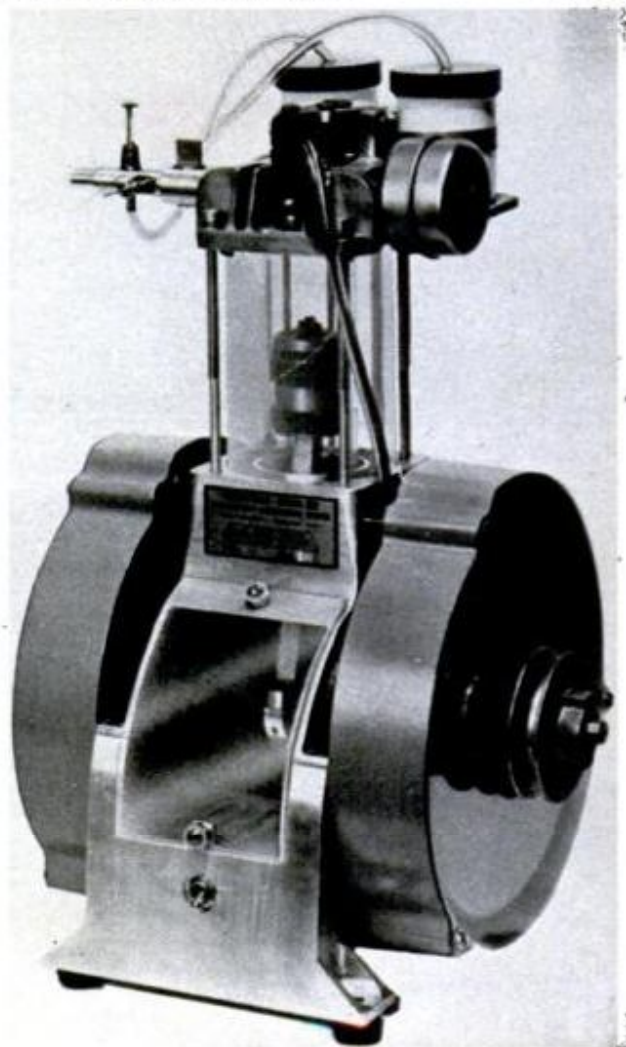



# Our brake shoes are ready to install when they're taken out of the box.

Delco brake shoes are prefitted at the factory. No additional grinding or shaping is required.



You get both new shoes and new linings properly shaped and finished, and treated with a special rust inhibitor.

The break-in period is held to a minimum. Crown Grinding provides a more uniform burnish pattern . . . the lining shapes itself quickly to the drum surface. They're engineered to prevent pulling to the right or left during break-in.

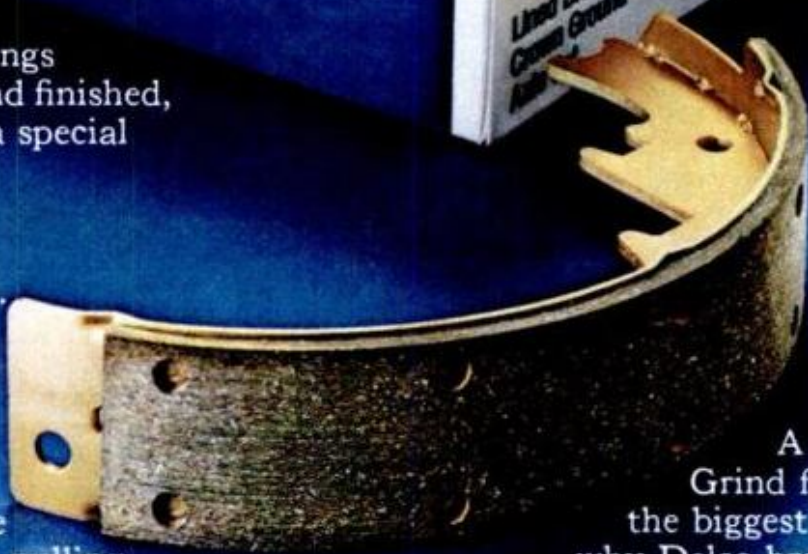

A Crown Grind finish is the biggest reason why Delco brakes go together easier. Both the edges and the ends of the lining are relieved to form a crown in the center. Nobody else has it.

Delco offers brake parts to fit all domestic and most foreign cars. Drum brakes or disc brakes, it doesn't matter.



**The more you know,  
the more you'll want Delco.**





# HOMEOWNERS' CLINIC

BY W. CLYDE LAMMEY

## Stucco 'blisters'

*My sand-stuccoed home is quite old and lately a couple of bulges or blisters, each about a foot in diameter, have appeared on one wall. How can I do the repair myself?—W.W., Ind.*

Stucco patching is rather tricky; I hesitate to get you involved. I assume that by "sand-stuccoed" you mean sand-finished and by "old" you mean the stucco is applied over wood lath.

Using a hammer and cold chisel, chip away all loose material back to solid edges and then undercut these edges to "key" new patching. Drive scaffold nails in a pattern over the opening; the projecting heads will serve as anchors.

Mix one part portland cement and three parts coarse, clean sand with just enough water to make an easy troweling mixture. Dampen opening and edges, then trowel the mixture into the opening, using enough pressure to force the material into contact well under the undercut edges. Fill to within  $\frac{1}{4}$  in. of the original surface. Score the fresh mix lightly in crisscross pattern with trowel point or a piece of heavy wire. Cure at least two days, keeping patch damp with a fine water spray.

Dampen again and apply a second coat of the mix, building it up to within  $\frac{1}{8}$  in. of the old surface. Leave this application smooth and cure it as before. For a final coat add about  $\frac{3}{4}$ -part lime to the mix and, after building it slightly above level of the surface, strike off the excess with a straightedged board. Let coat stiffen slightly, make a float by attaching a handle to a short length of 1x4, sprinkle water on the patch and work the float until you get a matching surface.

## Portable electric tools

*I want to buy four portable electric tools for my home shop, home repairs and occasional simple projects. Which should I buy? Will you outline their practical applications and limitations?—H.R., Vt.*

Books have been written about this. My answers must be limited to generalities. For portable tools I'd buy a saw with circular blade of sufficient diameter to cut through a 2x4, a drill with two-

speed switch, a belt sander and a sabre saw, also called a jigsaw.

None is designed for extreme accuracy. Even the most painstaking work with the circular saw won't quite equal the accuracy and smoothness of cut of a table or radial saw. A hand-held drill won't match the accuracy of a drill press. The portable sabre saw using coarse-toothed blades (in wood) can't equal the smoothness of cut and delicacy of curve you get with a conventional jigsaw. Extreme accuracy is not ordinarily a factor with a belt sander, which can speed hand sanding greatly.

The other three tools do their jobs with greater accuracy and in less time than you can finish the work by hand methods. They also have a considerable range of use, especially the two-speed drill which, with accessories, will drill holes in wood and metal, serve as a buffer-polisher, disc and drum sander, power screwdriver and so on.

## Playing with fire

*A friend recently showed me how to insert a coin in a fuse socket to keep the fuse from blowing. This doesn't seem right. Won't the coin pass more current than the wires are supposed to carry? Isn't this unsafe?—E.T., Okla.*

Dangers of this procedure have been so well covered in past years I thought it would no longer be approved by anyone. In older-type service boxes, fuses are your only protection against dangerous overheating of wiring and electrical shorts that may develop in lamps or appliances. Never replace a fuse with a coin or other metallic object serving the same purpose. Have your local electrician check why the fuse in your box let go before you insert a new fuse. It's extremely important to locate and eliminate the cause of a blown fuse. Otherwise, you risk a disastrous fire.

## Cleaning empty flowerpots

*I have a number of medium-size clay flowerpots that have become coated with a hard whitish substance that seems impossible to remove. Will some chemical do this without leaving a residue damaging to transplants?—L.R., N.M.*

Place the pots in a pail, cover them with clean water and then add a cupful of household bleach. Allow the pots to soak a half day or more, then remove and scrub them with a stiff-bristle brush. Rinse the pots in several waters and dry them before planting. ★★★



200 miles from a telephone. No neckties.  
No razors. No noise. Just peace and  
quiet. It's great. The time and place to relax.  
When the quietly milder taste  
of a Raleigh really makes it.

## Spend a milder moment with Raleigh.

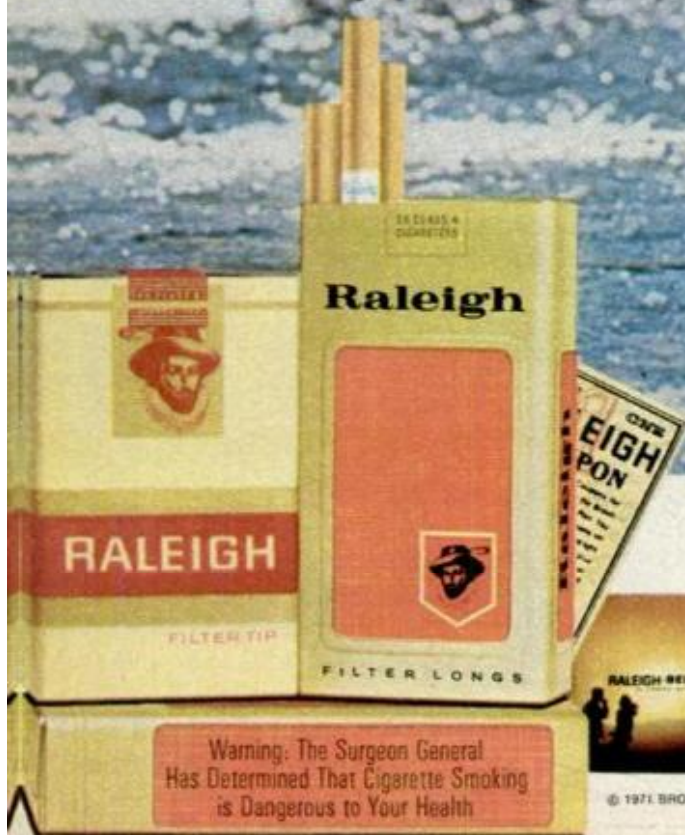

Coupons, too. The valuable extra on  
Raleigh Filter Kings and Filter Longs.  
Free Gift Catalog. Write Box 12, Louisville, Ky. 40201

Warning: The Surgeon General  
Has Determined That Cigarette Smoking  
is Dangerous to Your Health

© 1971 BROWN & WILLIAMSON TOBACCO CORP.

Filter Kings: 17 mg. "tar," 1.2 mg. nicotine; Longs: 18 mg. "tar," 1.2 mg. nicotine, av. per cigarette. FTC Report Nov. '78

Материал, защищенный авторским правом.



## NEWS BRIEFS

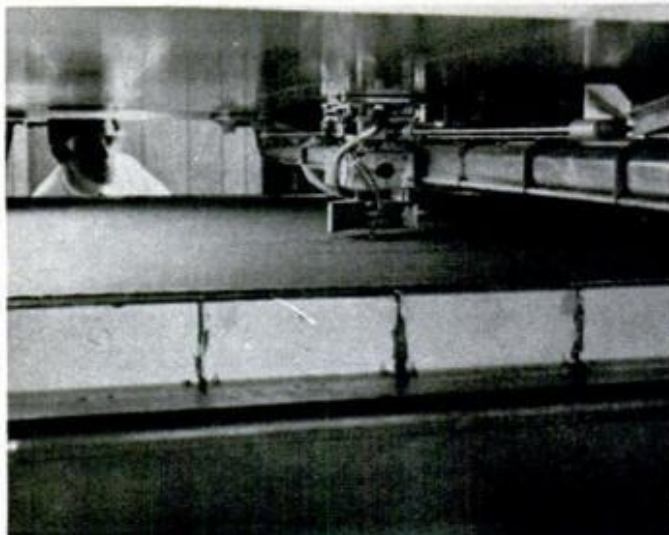

### Laser goes to work for the clothing industry

Fabric can now be cut by a laser-operated, computerized cutter, described as "the first major advance in apparel manufacturing since the invention of the sewing machine." Watched by engineer Steve Toscano (left), the labor-saving device is demonstrated at Genesco, Inc., world's largest apparel company. At right, Bruce Campbell, Genesco technician, lifts the leg of a man's suit just cut by the computer-directed laser beam.



### Lotus jet turbine

Brazilian driver Emerson Fittipaldi is shown practicing in the new Lotus 56B jet turbine car at Brands Hatch, England, before the Daily Mail Race of Champions. Unfortunately, the new racing car had to retire from the contest with a collapsed front suspension.



### Alpine Renault A-310

First showing of the new Alpine Renault A-310 was at the Geneva Auto Show this spring. The body is fiberglass and the running components are derived from Renault production cars. The engine is a 1565-cc four-cylinder with an aluminum alloy block.



### People conveyor proposed for Munich

Superimposed on a photograph of Munich is the Transurban Traffic System proposed by the Krauss-Maffei Co. as a method of transporting people in the city. Passengers would ride on a conveyor belt through plastic and steel tubes at a speed of 11 mph.



# Are you with it?

In such relevant fields as ecology, medicine, communications, crime control, there are exciting new careers waiting for people with the right skills.

**ELECTRONICS TRAINING can put you where the action is.**

If you'd like to take an active part in solving some of the big problems facing the world — Cleveland Institute of Electronics training can be your key! Today's electronics specialists are working hand in hand with science and industry to perfect tools that will make a better life for all of us.

If you are trained in electronics, you can help develop new electronic equipment to save our lakes and rivers, to clean up the air we breathe. Help design the electronic devices that are revolutionizing medical science. Help build the electronic tools to fight crime. And in other growth fields such as aerospace, communications, agribusiness, banking — just about everywhere — the trained electronics technician has a growing role in "what's happening!"

We can help get you started toward a high-paying, rewarding career right now. The first big step is a CIE course in Electronics. Through our step-

by-step AUTO-PROGRAMMED® Lessons, you'll acquire a background in electronic principles at home in your spare time.

CIE removes the roadblocks, makes learning easier. And no matter what kind of job you want in Electronics, you ought to have your Government FCC License. It's accepted everywhere as *proof* of your education in Electronics. We back our FCC License courses with this famous Warranty: You *must* pass your FCC exam upon completion of your course or your tuition is refunded in full.

Whatever you're doing now, you owe it to yourself to look at the facts. Send us the bound-in, postpaid reply card, and we'll send you our two FREE BOOKS describing in detail the latest career opportunities in Electronics. If card has been detached, use the coupon below or write to: Cleveland Institute of Electronics, 1776 East 17th Street, Cleveland, Ohio 44114

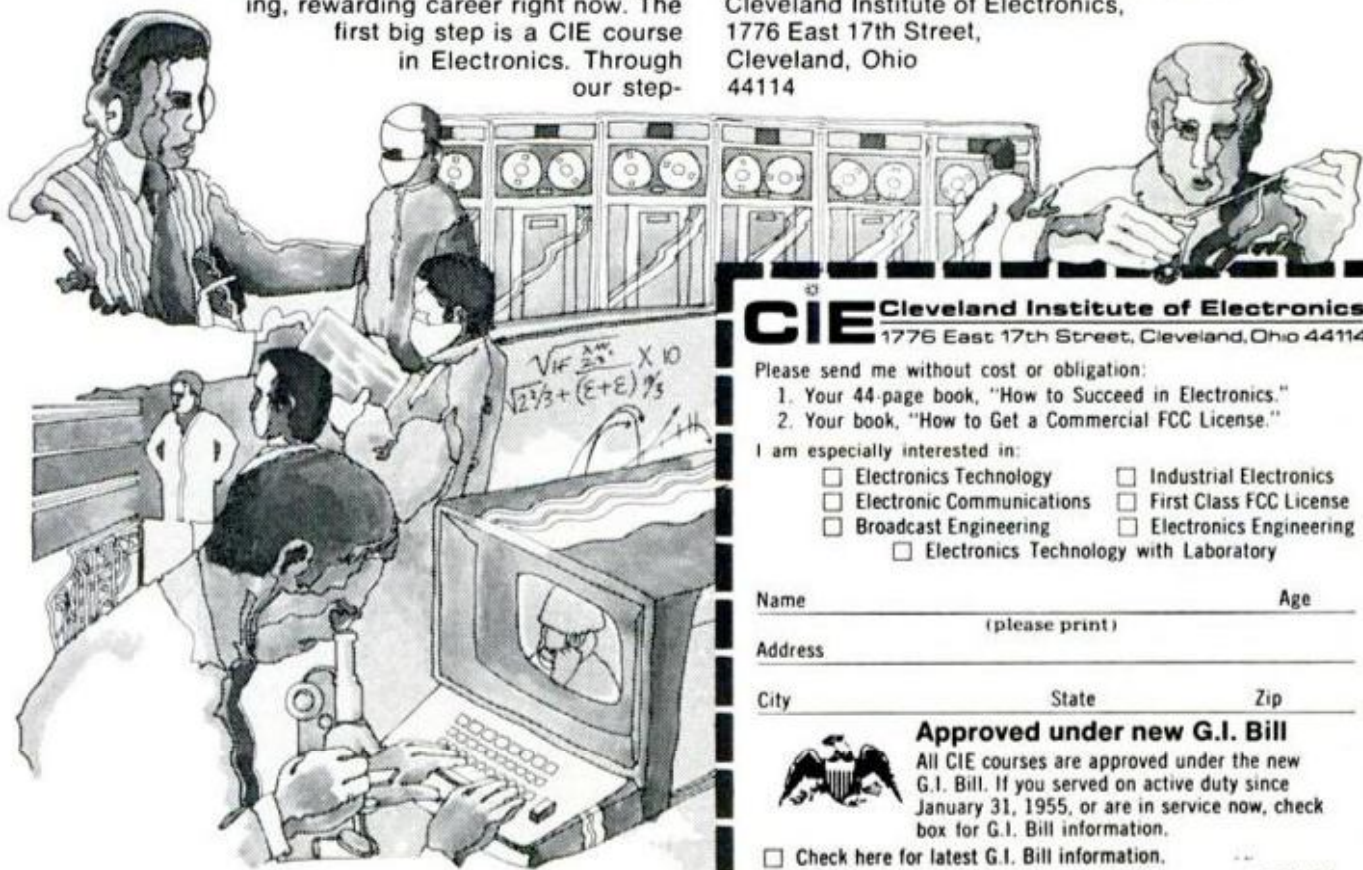

## CIE Cleveland Institute of Electronics

1776 East 17th Street, Cleveland, Ohio 44114

Please send me without cost or obligation:

1. Your 44-page book, "How to Succeed in Electronics."
2. Your book, "How to Get a Commercial FCC License."

I am especially interested in:

- |   |  |
|---|--|
| <input type="checkbox"/> Electronics Technology                 | <input type="checkbox"/> Industrial Electronics  |
| <input type="checkbox"/> Electronic Communications              | <input type="checkbox"/> First Class FCC License |
| <input type="checkbox"/> Broadcast Engineering                  | <input type="checkbox"/> Electronics Engineering |
| <input type="checkbox"/> Electronics Technology with Laboratory |  |

Name \_\_\_\_\_ Age \_\_\_\_\_

(please print)

Address \_\_\_\_\_

City \_\_\_\_\_ State \_\_\_\_\_ Zip \_\_\_\_\_



### Approved under new G.I. Bill

All CIE courses are approved under the new G.I. Bill. If you served on active duty since January 31, 1955, or are in service now, check box for G.I. Bill information.

- Check here for latest G.I. Bill information.

Accredited Member National Home Study Council

PM55



**Long hair may be fashionable for young men**—but it's also dirty. In one New York hospital, according to a report in *Medical World News*, a series of infections in patients was traced to a long-maned member of an operating team. Tests showed that his generous mop provided a comfortable environment for a bacterium—*staphylococcus aureus*—that frequently is the cause of infection in hospitals. The problem was cleared up after the young M.D. had seen a barber and used a potent shampoo. Some hospitals now require that hairy surgeons hide beard and hair under a cotton helmet that covers most of the head. The traditional surgical mask completes the cover-up job.

**Help is on the way for seabirds that become coated with oil from tanker spills.** Usually they don't last long after being cleaned up. The trouble is that detergents dissolve both the oil and the natural wax that waterproofs the birds' feathers. As a result, birds die before they have produced enough new wax to protect them in their natural environment. Now, two Swedish scientists report having developed a cleaner that—like a wax-polish for cars—contains a built-in wax similar to the birds' own. In one recent case, according to researchers, 75 birds were successfully cleaned after an oil spill and returned to their feeding grounds within two weeks.

**A timing device so accurate it will lose or gain only one second in 50 years** is under development at NASA's Manned Spacecraft Center in Houston. It "runs" on electrons—from the rubidium atom—induced to resonate at a known frequency. The experimental clock, weighing but 19 pounds, will be used for future long-duration space flights.

**Laughter consists of varying mixtures** of expiration, inspiration and interval pausing—components with characteristics that tend to give each person a unique laughing style. That's one of the findings in a study at Stanford University focused on laughter and its role in health. Dr. William F. Fry Jr., associate professor of psychiatry, wired volunteers to machines that measured physical responses as they listened to a series of taped jokes. Dr. Fry reports that laughter causes a complete disruption of the normal respiratory cycle—in excess of 10 seconds on occasion—and a faster heartbeat. It's possible that vigorous laughter could contribute to strokes in those who are susceptible, Dr. Fry notes, and he points to an already documented fact in medical literature—laughter's contribution to the precipitation of seizures in epileptics.

**How good are earthquake-resistant buildings?** The first comprehensive practical test of safety codes for such buildings occurred last February when the San Fernando quake hit California. Modern structures designed according to earthquake safety codes stood up well in regions of moderately strong ground motion, notes a report by the National Research Council. However, in regions of very strong shaking, similar buildings were severely damaged, and a few collapsed. Four hospitals were damaged so severely they became unusable just when they were needed most. Older school buildings suffered potentially hazardous damage under moderately strong ground shaking. "It is clear that existing building codes do not provide adequate damage-control features," the report states. "Such codes should be revised."

**The most accurate measurements yet made for determining size and shape of the Earth** were recently completed by U.S. and foreign researchers. Camera teams spaced 2500 miles apart took simultaneous photos of a balloon satellite. By comparing positions of the satellite against the background of stars, distances between photographic stations can be accurately determined. Analysis of the data will take about two years. ★ ★ ★



# Have the guts to be far out. Jeep guts.

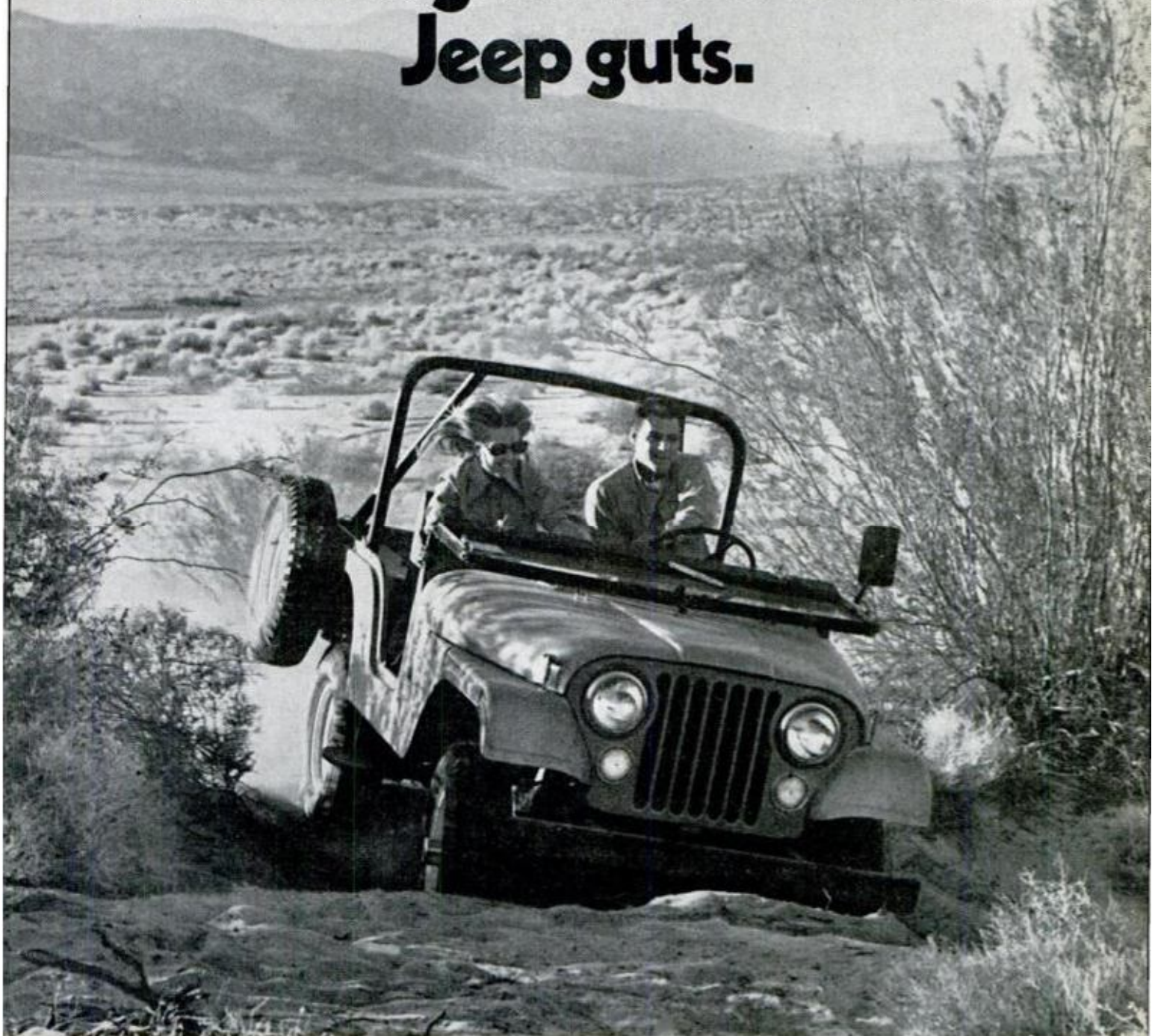

## The Jeep Universal— world's most imitated 4-wheel drive vehicle.

We wouldn't steer you wrong. The Universal packs guts. Jeep guts—to outjump, outclimb, and outfox anything on four wheels. It's like this: you either drive the Universal, or you follow its dust. If you can.

This runt runs circles around the competition in the desert—or anywhere off the road. It's got the perfect combination of weight and balance to play the steep angles. To outmaneuver any other 4-wheel

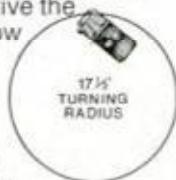

drive vehicle. Where others get hung up, the Universal doesn't. Not with its snub nose and short tail that are built to stay clear. Three decades of 4-wheel drive know-how went into this vehicle. That gives it the best resale value of anything like it on the lot.

Comes with the options you're looking for. Roll-bars. Special wide



tires. Fabric or metal tops.

And with its V-6 powerplant, the Universal is \$93 less than last year. Yes. It's priced to make the Bronco, Blazer and Scout seem far out—in price.

The toughest  
4-letter word on wheels.

# Jeep

Products from American Motors



# Build this "Flying Volkswagen" in your own back yard for less than \$1,000!



Now you can have the thrilling experience of flying your own plane with this all-metal plane that even a beginner can build. With *Popular Mechanics* plans and instructions you can build the "Teenie Two" from stock items from almost any metal-products shop. No special equipment. Most work can be done with a plastic-headed hammer and a pair of tin snips, and the whole thing can be done for less than \$1,000!

Send for your instruction booklet plus the plans today!

TO: Popular Mechanics  
Dept. TT  
224 West 57th Street  
New York, N.Y. 10019

Please send me plans and instructions for building the "Teenie Two." Enclosed is \$35.00 payment.

NAME \_\_\_\_\_

ADDRESS \_\_\_\_\_

CITY \_\_\_\_\_ STATE \_\_\_\_\_ ZIP \_\_\_\_\_

**BELSAW** PLANER • MOLDER • SAW

30-DAY FREE Trial!

Now you can use this ONE power-feed shop to turn rough lumber into moldings, trim, flooring, furniture...ALL popular patterns. RIP...PLANE...MOLD—separately or all at once with a single motor. Free 30-Day Trial. Low Cost—only \$35 down.  
Send Postcard Today — No Salesman Will Call.  
BELSAW POWER TOOLS, 902K Field Bldg., Kansas City, Mo. 64111

## New Discovery Makes Stuck Drawer Slide At Fingertip Touch— Without Oil!

A new spray lubricant so clean it won't soil linen or clothes in drawer.

One Sw-o-o-sh! And tight stuck drawers, windows and zippers slide easy when you spray new 3-IN-ONE DRY-LUBE. Eliminates friction without oil. The secret is a new spray lubricant so clean it won't soil your best clothes. Get 3-IN-ONE DRY-LUBE at all hardware outlets.

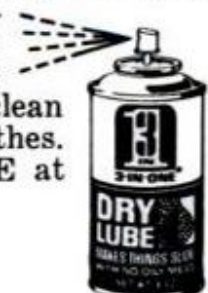

**3-IN-ONE**<sup>®</sup>  
DRY LUBE

## REFINISH MARRED OR GOUGED FURNITURE LIKE NEW.

Fill in wood gouges, nicks and scratches like professional carpenters do with GENUINE PLASTIC WOOD Cellulose Fiber Filler. Handles like putty, hardens like wood. Plane it, sandpaper it, varnish it, paint it for true, professional finish. GENUINE PLASTIC WOOD comes in walnut, oak, mahogany or natural color. At hardware stores and supermarkets.

GENUINE  
**PLASTIC  
WOOD**<sup>®</sup>  
CELLULOSE FIBER FILLER





# BREAK THE \$150 A WEEK BARRIER LEARN COLOR TELEVISION OR COMMUNICATIONS OR ELECTRONICS AT HOME IN YOUR SPARE TIME

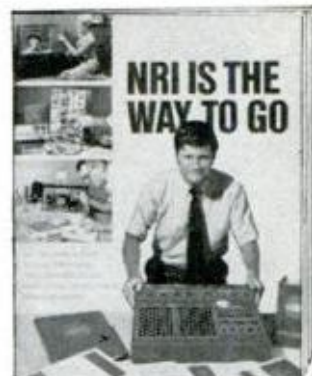

**COLOR TV SERVICING** comes alive as you build your own set (color or black and white.) Building, stage-by-stage, you get a professional understanding of all circuits through demonstration.

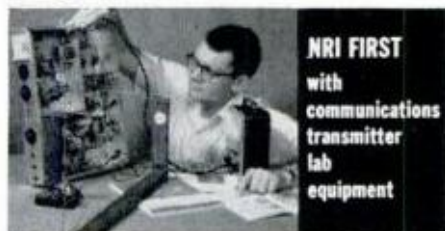

**COMMUNICATIONS** experience equal to many months on the job is yours in NRI's complete training. Build your own transmitter suitable for amateur use. FCC License preparation included. You get your license, or money back.

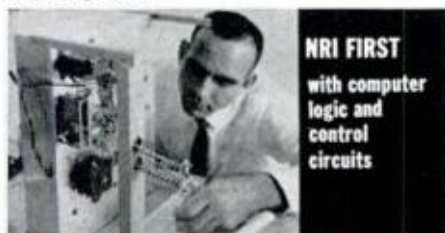

**INDUSTRIAL ELECTRONICS** includes use of transistors, solid-state devices, printed circuits. You build and use digital computer circuits, other electronic devices. Choose from several specialized courses.



**APPLIANCES & REFRIGERATION SERVICING** gives you practical experience with professional tester included at no extra cost. Learn to fix appliances, refrigeration units, air conditioners, power tools, farm and commercial equipment.

**Prepare quickly to step up your income as a skilled**

**Technician** A few years ago, an income of \$6,000 or \$7,000 a year was considered good. Not any more. Today you deserve more than that—and it's waiting for you if you're trained to take advantage of the constant demand for skilled technicians in TV Servicing or Communications or Industrial Electronics. Even if your education is limited, you can qualify quickly for higher pay by training at home the NRI "hands-on" way. Keep your job while you prepare for a brighter future.

**Professional training equipment included at no**

**extra cost** NRI pioneered the idea of supplying custom designed training equipment to give on-the-job experience as you learn. NRI training equipment can't be equalled. You learn by doing—demonstrating things you read about in "bite-size" texts as you build and use professional equipment. Electronics comes alive in a unique, fascinating, easy-to-understand way. In Color TV, for example, the end product is your own high quality set for years of viewing pleasure.

**Train with the Leader—NRI**

Tens of thousands of NRI graduates are proof it's practical to train at home. Earn \$5 to \$7 an hour extra in your spare time as you train, fixing sets for friends and neighbors. NRI shows you how. Decide NOW to move ahead, to break the \$150 a week income barrier. Check your choice of 15 training plans and mail coupon today for FREE NRI COLOR CATALOG. No obligation. *No salesman will call.* NRI, Electronics Division, Washington, D.C. 20016.



**APPROVED UNDER GI BILL**

If you served since January 31, 1955, or are in service, check GI line in coupon.

Send for **FREE**  
**COLOR CATALOG**

**15 TRAINING PLANS  
TO CHOOSE FROM**

 NATIONAL RADIO  
INSTITUTE 100-071

Electronics Division,  
Washington, D.C. 20016

Please send me your new catalog.  
I have checked the training in which  
I am interested. **NO SALESMAN  
WILL CALL.**

- Color TV Servicing
- Advanced Color TV
- Complete Communications
- FCC License
- Industrial Electronics
- Basic Electronics
- Math for Electronics
- Electronics for Automation
- Aircraft Communications
- Mobile Communications
- Marine Communications
- Amateur Radio
- Advanced Amateur Radio
- Electrical Appliance Repair
- Air Conditioning/Refrigeration

Check for facts on GI Bill

Name \_\_\_\_\_

Age \_\_\_\_\_

Address \_\_\_\_\_

City \_\_\_\_\_

State \_\_\_\_\_ Zip \_\_\_\_\_



ACCREDITED MEMBER NATIONAL  
HOME STUDY COUNCIL



DETROIT

# LISTENING POST

BY ROBERT LUND

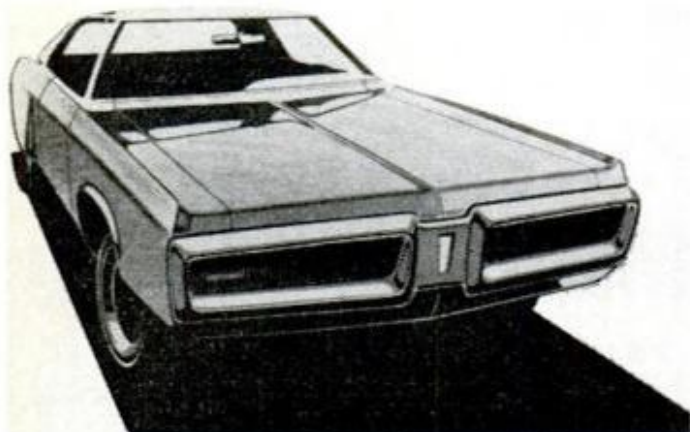

**HERE'S THE CAR** (above) that almost got away. It's the big Dodge for '72. Scheduled to come out a year ago as a '71, it was held back when Chrysler took the bread-and-water cure to ward off a case of wolf at the door. The car's newer than it looks here. Sheet metal's new below the belt line, it has a tighter-on-the-road appearance and it's a couple inches shorter than this year's Polara. The picture also gives you a fair idea of what the full-size Plymouth and Chrysler will look like in '72, because they'll share the same side panels used by Dodge.

**CAN'T LICK 'EM . . . JOIN 'EM?** It now seems virtually certain American automakers will be manufacturing cars and parts in Japan for export to the United States in three to five years. No one in Detroit will admit as much for attribution for fear of upsetting negotiations now in progress. And the Japanese government doesn't look with favor on American auto companies buying in on Japanese firms because it could mean the loss of foreign exchange for Japan. But with nine months of selling the American minis against imports, domestic auto producers have resigned themselves to the fact they can't tame the imports with U.S.-made small cars.

**MINI INTERVIEW WITH THE MAN** all the mini-makers would like to beat, Stu Perkins, president of Volkswagen of America:

**PM:** Seers on both sides of the fence—in Detroit and some of the importers—are predicting the demise of mid-size cars. They say the choice is going to narrow down to two basic machines:

*small car and luxury car. Do you think it'll come to that?*

**Perkins:** When you say two basic groups, you're talking oranges and apples. A luxury car can be small and an inexpensive car can be big. I look for just as much variety in the future as there is now, maybe even more, but cars will be smaller than they were, say, in 1968. Buyers want more variety, not more size. Look at all the specialty cars that have come out in recent years. I think there's a vast market for a relatively small Cadillac. Why should a wealthy person who wants a Cadillac have to put up with the sheer mass of a Cadillac? Why shouldn't he have the convenience of luxury in a small package? Our Audi 100LS, for example. That's the way I think the market will go.

**PM:** VW's bringing in bigger, higher priced cars—first the Audi, now the 411. Does that mean you've reached a saturation point with the Beetle in the United States?

**Perkins:** Not at all. It's just that we want a broader range of products. Many of our owners were forced to give up VW because we didn't have a four-door. That didn't make sense. You don't force a customer to go elsewhere, so we brought in four-door models, to keep owners in the family. The small-car market's expanding and we don't see a saturation point for the Beetle. Personal transportation is the trend of the future and nothing fits that better than the Beetle.

**WHAT HAPPENS TO CARS** without frames—Camaro, Firebird, Mustang and Cougar, for example—when impact-resisting bumpers become law? There's no way to install the bumpers on cars with unitized bodies so the hang-on hardware will absorb the energy. If you put an energy-absorbing bumper on a unit body car and the car gets smacked, the force is transferred to the vehicle. The bumper doesn't soften the blow.

There's a rumor the frameless cars will be dropped at the beginning of or during the '73 model year, when the bumper standard becomes law. We'd bet against it. If the cars in question

*(Please turn to page 44)*



# When you drive to Rough Rock, carry your own.



You probably won't find Rough Rock on any map. It's one of those rare spots where you can't buy Quaker State. But the fact is, you can buy Quaker State in every county or parish of every state in the country.

Quaker State—refined only from 100% Pure Pennsylvania Grade Crude Oil—has a matchless ability to protect engines. It's real peace of mind for the motorist who is a long way from home. No wonder Quaker State is America's most preferred motor oil. No wonder more dealers sell Quaker State than any other brand.

**Quaker State your car to keep it running young.**





## HOW TO SPRAY AWAY SCARS ON CARS

Refinish unsightly nicks, scars and scratches. Protect your investment and be proud of your car. Prevent rust and loss of trade-in value this easy "push-button" way with Dupli-Color® Auto Spray®.

Used by millions of car owners, Dupli-Color® duplicates your car's original color exactly. Dries in minutes to a hard high-gloss finish.

Available at auto supply stores and automotive departments everywhere in all popular car colors. Brush-in-cap bottle 69c; Auto Spray® \$1.59.

Send a self-addressed, stamped envelope for your **FREE** booklet "How to Touch-up Your Car" to:

### DUPLI-COLOR PRODUCTS

(Dept. PM-2)

1601 Nicholas Blvd. • Elk Grove Village, Ill. 60007

## START A MONEY-MAKING BUSINESS FOR LESS THAN \$50!



You can have your own lifetime business right at home . . . work in spare time . . . and make up to \$200 a month **CASH!** My **FREE PLAN** gives you all the facts: How to start, how to grow. You don't need previous experience. You don't have to sell. I'll even finance you. People bring you the work and pay cash. Over 90¢ of every dollar you collect is clear cash profit. And you work when you want to. Let me prove you can't find a more certain, lower cost, higher paying business of your own.

**Just Mail Coupon—No Salesman Will Call**  
BELSAW SHARP-ALL CO., Stan Field, Pres.  
712K Field Bldg., Kansas City, Mo. 64111

Name \_\_\_\_\_  
Address \_\_\_\_\_  
City \_\_\_\_\_ State \_\_\_\_\_ Zip \_\_\_\_\_

**FREE BOOK**

## DETROIT LISTENING POST

*(Continued from page 42)*

continue to sell in fair volume, GM and Ford aren't going to let them go under. Not the names, anyway. The cars will have to be reworked and remounted and they'll be higher off the ground than the current versions. But they'll survive in a different shape and size.

**IF YOU'VE GOT AN IDEA** for a new engine to replace the polluting piston, this isn't the time to try to sell it to Detroit. The auto companies are disappointed with the lack of results from programs they've financed to develop alternatives to the internal combustion engine—electric cars, steam engines, engines that will run on liquified petroleum and various other exotic methods of propulsion.

Carmakers are still optimistic about the turbine over the long term, but they aren't expected to allocate additional development money to outside firms working on electric and steam cars when present commitments expire.

**CAN THE AUTO INDUSTRY** go a full model year without issuing a single callback to correct a defect or problem? Probably not, considering the number of new cars sold a year—something between 9 million and 10 million this year. But if '72 is your year to buy a new one, you're less likely to receive a bring-it-back-to-be-fixed notice than in any recent year.

Auto manufacturers think their chances of running a full year without a major recall will be as good in '72 as they are likely to be for a long time. It figures, because the fewer changes in a car from the previous year, the less chance there is of something going wrong. With most car divisions standing pat on changes on the '72s, there should be fewer recalls and a reduction in service complaints on the new crop of cars.

**IF YOU LIKE TO TINKER AROUND** doing your own repairwork, you may have to get a new set of tools in another year or so, particularly if you want to work on components stored behind the dash. Although the auto companies are still arguing they don't want to install air bags, they're working to miniaturize parts mounted behind the dash to make room to install the bags if and when the law says put 'em in. This means much of the gear behind the dashboard is going to be scaled down to mini size. Some of the stuff may be so small you won't be able to handle it with tools you have on the bench now. ★★★





# MOSSBERG 500 when the going gets rough

When you can't trust the weather, you can trust *our* shotgun. Every time. Because you're shooting a rugged, dependable Mossberg. The shotgun built to do everything higher-priced, fancy Dan guns do except cost you a bundle. And one of the finest pointers ever to bag a bird.

What we did add on is extra muscle. Like extra large double extractors for positive ejection. Double slide bars in 12- and 16-gauge for faster action. Chambered for 2 $\frac{3}{4}$ " or 3" Magnum

shotshells in 12- and 20-gauge. Instantly interchangeable barrels in the same gauge. Exclusive C-LECT-CHOKE. Safety on top right under your thumb where it belongs. Recoil pad. Genuine American walnut stock and forend. Damascened bolt. And plenty more.

If those aren't enough reasons to buy a Mossberg, see your dealer. He'll give you a dozen more. We call it getting more gun for the money. For illustrated catalog, write Dept. PM.



Model 500 - in 12, 16, 20-ga.  
or 410 bore. From \$95.50 to  
\$145.00.

**Mossberg**   
© F. MOSSBERG & Sons, Inc., North Haven, Connecticut



# Drivin' with Dan

What would it be like to drive an Indy car on the road? Why can't stock cars have superchargers? Will pollution controls affect auto racing's future? Dan Gurney answers these and other automotive questions

**Q.** *What would the Championship (Indy type) race cars be like to drive on our regular roads?—Craig Siphers, Stevensville, Mont.*

**A.** Difficult at best! They're not muffled; they get approximately 2 mpg at speed. They would probably get about 10 or 15 mpg on most public roads. Fuel is methanol rather than gas. They don't have self-starters or cooling fans to prevent overheating in traffic tie-ups. The drivers' eyes are only about 30 inches above the ground, so visibility would be limited while following other cars. Ground clearance is approximately three inches so going in and out of driveways would be tough. The cars would be very vulnerable while parallel parked. It would be extremely



**DRIVING FOR DAN** while Swede Savage is recuperating (quite nicely, we're happy to report) from his accident in the Questor Grand Prix, is Lee Roy Yarbrough. Bobby Unser and Lee Roy were slated to run Eagles in Indy 500 for Dan's All American Racers

difficult to avoid exceeding speed limits. Of course they don't have any lights or windshield washers, but they would be great at drive-in restaurants!

**Q.** *Would radial tires improve the gas mileage on my '71 VW?—Ernest Wittenbreder, Catawauqua, Pa.*

**A.** They won't affect the mileage very much one way or the other. I have heard that they do improve mileage in cases where the rolling resistance of the radial is less than that of conventionally constructed tires. You would also have to check the circumference to make sure that your odometer doesn't get tricked.

**Q.** *Why won't they allow superchargers or fuel injection in stock-car racing? Wouldn't they have more speed?—Steve Schomer, Harlan, Iowa*

**A.** Mostly because it escalates the costs of racing, but it doesn't seem to make the racing any better. Yes, the speed would probably be increased.

**Q.** *We are interested in starting some off-road and handicap dune-buggy racing and need some established rules. Where could we find them?—Keith Starn, Jamestown, N.Y.*

**A.** Try writing NORRA (National Off-Road Racing Assn.), Suite 200, 1616 Victory Blvd., Glendale, Calif., 91201. It sanctions the Baja 500 and Mexican 1000 and should be able to provide you with the latest regulations.

**Q.** *Will Denis Hulme continue to have the name McLaren on his cars since the death of Bruce McLaren?—Bryan Holmes, Phoenix, Ariz.*

**A.** Yes. Denny is the No. 1 driver for the McLaren Cars racing organization, which has  
(Please turn to page 44D)



100's  
20 CIGARETTES

# PALL MALL

FAMOUS CIGARETTES



R TIPPED

20 mg. "tar", 1.4 mg. nicotine av. per cigarette, FTC Report NOV. '70

## Longer ...yet milder

longer length -  
milder taste.

You get both  
with  
PALL MALL GOLD 100's





ALLIED RADIO SHACK ISSUES A  
**NEW**  
AND DIFFERENT CATALOG!

ELECTRONICS FROM A-Z  
ANTENNAS  
BATTERIES  
CAPACITORS  
DIODES  
EDUCATIONAL KITS  
FIBER OPTICS  
GRILLE CLOTH  
HI-FI SPEAKERS  
IC'S - JACKS  
KNOBS - L-PADS  
MIKES - NEEDLES  
OSCILLOSCOPE - P-BOXES  
QUADRACS - RESISTORS  
SEMICONDUCTORS  
TELEPHONES  
ULTRASONIC ALARMS  
VHF ANTENNAS - WIRE  
XENON STROBE LIGHT  
"Y" ADAPTERS  
ZENER DIODES  
AND MUCH MORE!



a valuable "FIRST EDITION"  
...and it's **FREE!**

The new buying Guide for kit builders, Hams, hobbyists, do-it-yourselfers, "fix-it men"! Lists thousands of handy and wanted "little things" most stores don't stock. Like tubes and transistors, cables and plugs, adapters and antennas—you name it—the things that keep equipment working. Or make it work even better. Or DO MORE. If you own anything electronic or electrical, you need this catalog!

At 950 Stores Nationwide

**ALLIED RADIO SHACK** Dept. PM-2

TRADING CORPORATION COMPANY

2725 W. 7th St., Fort Worth, Texas 76107

Send me your FREE Spring/Summer Cat. 212

Name (print) \_\_\_\_\_

Route No. \_\_\_\_\_ Box No. \_\_\_\_\_

Street \_\_\_\_\_ Apt. No. \_\_\_\_\_

City \_\_\_\_\_ State \_\_\_\_\_ Zip

**DRIVIN' WITH DAN**

(Continued from page 44B)

continued to build and race cars with outstanding success in spite of the loss of Bruce. I'm sure he would be very proud.

**Q.** While it is not a major pollutant, auto racing contributes a great deal of emissions per car. What do you think will be the ultimate effect of this fact on auto racing?—Rod Hardesty, Cedar Falls, Iowa

**A.** Logically, I'd say that contribution of auto racing to pollution is infinitesimal. Two or three big jet aircraft takeoffs contribute more, in comparison. Auto racing may eventually be restricted to the use of certain fuels to the exclusion of others. I love the smells of a race. How's the air out there in Iowa?

**Q.** I never know what to say when the service station man asks me what weight oil I want? My car has run 40,000 miles. What should I say?—Cliff Middleton, Oakland, Calif.

**A.** Probably SAE 30 or a multigrade such as a 20-40W. Multi-viscosity oils like 20-40W, continuously maintain the appropriate viscosity independent of temperature.

**Q.** Can you tell me the name of the fastest funny car in the country?—Tod Snyder, Piqua, Ohio

**A.** I'm not sure if it is still fastest, but a few weeks ago it was still Don Prudhomme's Hot Wheels 'Cuda.

**Q.** Due to the high line pressures required by disc brakes, do your Eagles or other Indy cars use some sort of power-assist equipment?—Jerry Van den Honert, Pittsfield, Mass.

**A.** No, we don't use any sort of power assist—it's all muscle.

**Q.** What happens when you have your brake drums "turned"? Is this done in racing?—Mrs. I.W. Murcheson, Toledo, Ohio

**A.** This is a process of making the drums round and true so that the brake shoes have an even surface to rub against. Most racing cars use disc brakes, which must also be round, flat and true to work most efficiently. Yes, this is done in racing and also when the  
(Please turn to page 44F)



It's the same truck. Same load-lovin' overhead cam engine. Same torsion bar front and heavy-duty rear suspension. Same steel girder frame. And a split personality.

The Datsun Busy body picks up on all the tough assignments.

A six foot all-steel bed and flat-loading tailgate take on surfboards, bikes, hay bales and branding irons. Tie down hooks all 'round see that they stay on.

Your Datsun dealer will show you a variety of campers that snuggle right in there, too. Switching loads is simple. You can take this

Busy Body on vacation over the weekend and put it back to work bright and early Monday morning.

Slip into the comfortable, hi-visibility cab. Latch onto the smooth shifting 4-speed.

Up to 25 miles per gallon economy and load-proven reliability.

About the best thing you can do with the Datsun Pickup is haul off and buy one. A lot of haulers have. It's the number-one selling import truck. And there's no two ways about that.

At just \$1916\*, no wonder.

Drive a Datsun...then decide.

# Busy body



**DATSUN**  
PRODUCT OF NISSAN

\*Plus tax, license, local freight, dealer preparation. Specifications and price subject to change without notice.



reach for  
**the window**



DAP '33' elastic Glazing Compound. The best way to replace broken window glass. Stays flexible for airtight, watertight seals. For wood and metal sash. Outlasts ordinary putty by years.

**DAP**  
**fixer™**  
**products**

DAP Inc., Dayton, Ohio 45401  
Subsidiary of *Plough, Inc.*

Also available in Canada

## DRIVIN' WITH DAN

(Continued from page 44D)

drum or disc brakes are first manufactured.

**Q.** Why on earth did you stop driving Fords and start driving for Plymouth? What was the matter with Ford?—Jerry Ondrusik, Stirling, N.J.

**A.** Nothing was the matter with Ford. It was just a pure business decision.

**Q.** I have a '69 Mustang with F70-14 Polyglas tires. What can be done about the ridiculous under-steering on this bucket? The shocks are okay.—M.E. Buckney, Alderwood, Wash.

**A.** A bigger front antiroll bar, together with a rear antiroll bar, makes a great improvement. I'd say the largest standard front bar with about a 5/8-inch rear bar with adjustable connecting links would be a good place to start.

**Q.** What are the pros and cons of downshifting my '63 Chevy three-speed truck?—Bill Sanders, Garden Grove, Calif.

**A.** It should be perfectly okay if you match engine speed with car speed in various gears and don't over-rev the engine, grate gears or jerk the driveline severely. If you do it right, it should be fine.

**Q.** Why is it that American auto manufacturers have yet to develop an engine of small cubic-inch displacement with large horsepower output? Example: Ford 289 with 200 hp and Lamborghini 240 c.i.d. with 370 hp at 7300 rpm?—Richard Martinelle, Pittston, Pa.

**A.** Well, the Ford will probably run four times as long without attention, and all for about one-third the cost. It depends on what you want. A "hopped-up" 289 can probably put out approximately 500 hp at around 7800 rpm. The Lamborghini is a more sophisticated engine, to say the least, but then it was designed with different things in mind. The turbocharged Drake Indy engine can turn out more than 820 hp at 9000 rpm out of a mere 158 c.i.d.!

★★★

If you have questions on racing, high-performance and everyday driving techniques, send them to "Drivin' With Dan," c/o Popular Mechanics, 224 West 57th St., New York, N.Y. 10019. Questions cannot be answered by individual letters. Questions on maintenance and repair should be addressed to the Auto Clinic (see page 48).



For Sparetime or  
Full-Time Income  
There's Good

## MONEY IN SHARPENING

Here's a proven, practical way to earn sparetime cash while you develop a money-making business of your own. Investment is small. There's no overhead, no stock to carry, no selling involved. **FOLEY SAW FILER**—Do a perfect job every time automatically with the Foley Saw Filer—and use the Modern Lawn Mower Sharpener to earn extra cash precision-grinding all mower blades. There's no experience needed—you can begin to make money right away in your basement or garage.

### \$3 to \$6 An Hour Sparetime

Get started now and watch your business grow! Thousands are earning cash this easy way—many build a complete sharpening service with year around profits. You can, too, with the easy-to-follow Foley Plan—write us today!

**Foley Manufacturing Co.**  
Minneapolis, Minnesota



**FREE BOOK**  
Shows you how!  
Valuable book  
shows how to start  
and make profits  
fast. Mail coupon  
today. No obligation,  
no salesman  
will call.

**FOLEY MFG. CO.**  
716-1 Foley Bldg., Mpls, Minn. 55418

- Saw Filer Information  
 Mower Sharpener Information  
 Money-Making Booklet

NAME \_\_\_\_\_  
ADDRESS \_\_\_\_\_  
CITY \_\_\_\_\_ STATE \_\_\_\_\_





## The troubleshooter.

Don Woosencraft is one of Green Bay, Wisconsin's star halfbacks. He plays for Ritz's Lounge in the Industrial League.

But his real field is electricity...generators, turbines, capacitors.

He's a graduate engineer and he drives around 2,000 miles a month. "I solve problems," he said.

Naturally, he does the electrical work on his Ford. And he switched his Ford to Champion

Spark Plugs.

"Better mileage and they last longer," he said. "And no problems," he said.



Toledo, Ohio 43601

**6 million Ford owners have switched to Champion Spark Plugs.  
This has been one of them.**



## NEWS BRIEFS

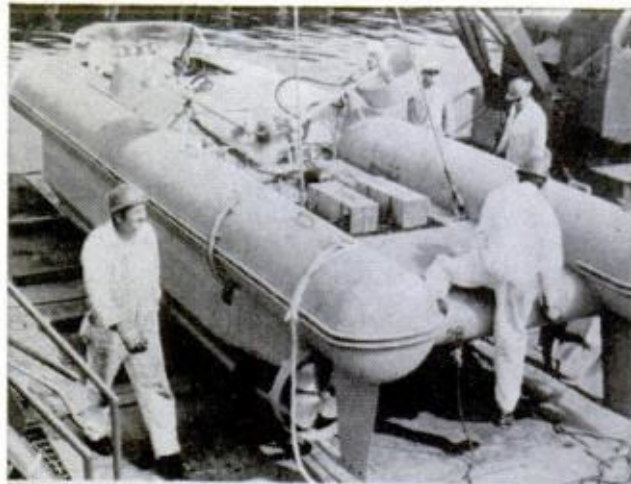

### Undersea 'pickup truck'

Scuba divers can use a new submersible as an underwater "pickup truck" to carry as much as 2000 pounds of cargo to depths of 120 feet at a speed of 2½ knots. Known as CAV (construction assistance vehicle), the 27-foot craft is being tested by the Navy. It is electro-hydraulically powered, and can supply power for divers' tools.



### Computer to watch planes

From the clutter of flight paths displayed on this TV screen, the world's fastest computer has pinpointed two planes on collision course in time to radio the pilots to take corrective action. The computer, Goodyear's Staran IV, will be installed in an FAA tower in Knoxville to demonstrate its ability to control high-density air traffic.

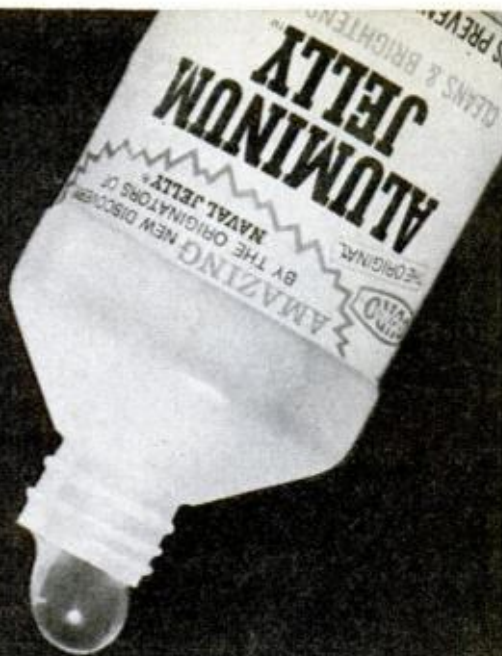

Aluminum Jelly® is a tacky gel that cleans and brightens aluminum. Spread it on. Wash it off. Oxidation is gone.

For sale wherever fix-it products are sold.



World's Finest Fix-It Products  
Woodhill Chemical Sales Corp., Cleveland, Ohio 44128

### SIX GOOD REASONS



### Why You, Too, Should be an ACCIDENT INVESTIGATOR

1. You become a member of a respected fast growing profession.
  2. You meet all kinds of interesting and important people.
  3. You are not "chained" to an office desk or assembly line.
  4. You render a worthy, necessary service (NO SELLING) to the community.
  5. There are many opportunities for quick advancement.
  6. There are good openings in every state and Canada.
- Car furnished—Expenses paid—Work part-time or full time—Earn as you learn—No selling of any kind—Only average education required—Mail for Free Information.

*Liberty School is approved for Veterans' and Servicemen's Benefits under the G.I. Bill*

Jim Edwards, Director, Dept. 57  
Liberty School  
1111 W. Park Ave., Libertyville, Illinois 60048

Send me your FREE Brochure Showing how I can quickly get into the Booming Accident Investigating Field and enjoy the job security and professional prestige offered Accident Investigators. This does NOT obligate me in any way and no salesman will call.

Name \_\_\_\_\_ Age \_\_\_\_\_  
Address \_\_\_\_\_  
City \_\_\_\_\_ State \_\_\_\_\_ Zip \_\_\_\_\_



## NEWS BRIEFS



### Shanghai makes like Detroit

When China recently allowed Western journalists to enter the country for the first time in decades, one of the points of interest for the visitors was the Shanghai Industrial Exhibition. Among the 5500 exhibits of products made in the city are the motor vehicles shown above: a bus, passenger car and several massive dump trucks. Other exhibits included printing presses, clothing, toys and power-generating equipment.



Now!  
**Laredo**  
**Menthol, too**  
 Make the freshest  
 menthol filter  
 cigarettes ever  
 for less than  
**20¢ a pack\***



This is the machine that makes the freshest menthol filter cigarettes you ever tasted.

Look for these Laredo refills—regular or menthol. Each makes 5 more packs of fresh filter cigarettes. Cost: under \$1.\* (That's less than 20¢ a pack.\*)

# LaREDO

## MENTHOL FILTER BLEND

\*In most areas of the country—based on manufacturer's suggested retail price.

© 1971 BROWN & WILLIAMSON TOBACCO CORP.



## NEWS BRIEFS

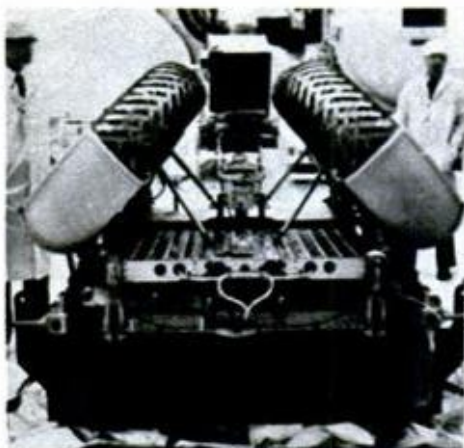

### Moon-ready

Carried to the moon by Apollo 15, the Lunar Roving Vehicle (LRV) will be unfolded after the landing (above) and used to carry two astronauts on three lunar traverses. The LRV is battery powered and weighs 480 pounds. Apollo 15 astronauts (right) are James B. Irwin, Cmdr. David R. Scott and Alfred M. Worden. Their flight is scheduled for a July 25 launch.

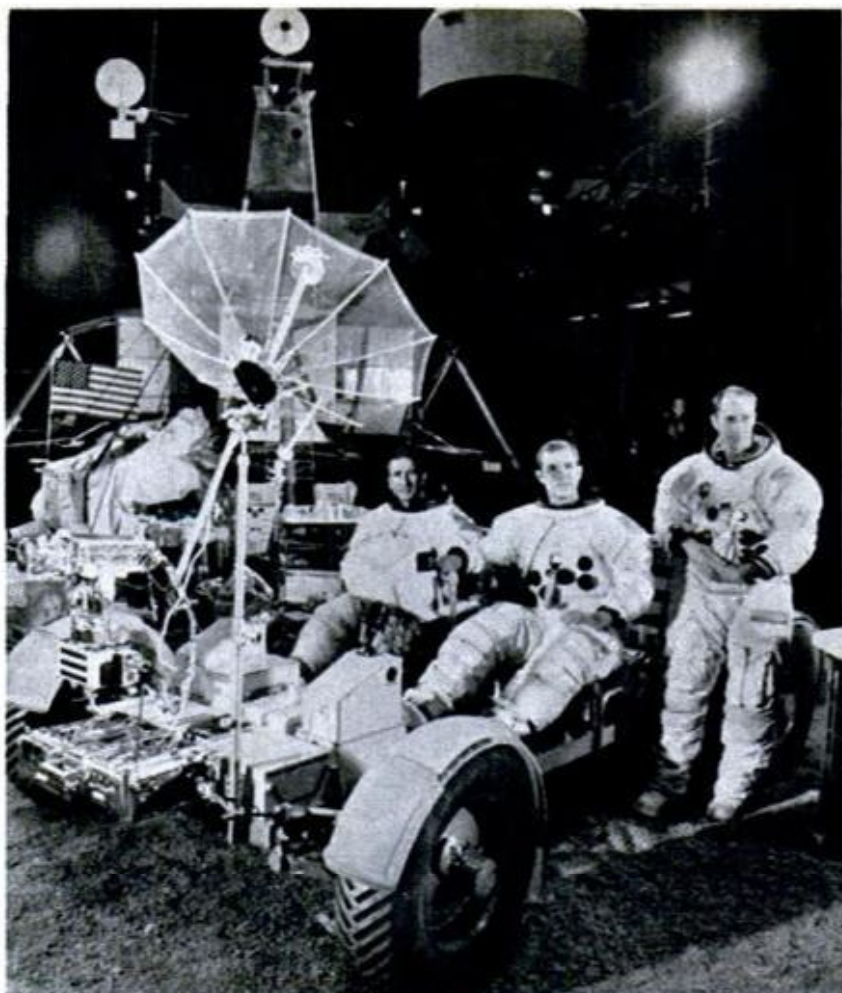

### Game of chess has faceless soldier pawns

After being a soldier all his life—and a prisoner during World War II—Henri Simon of Belgium concluded that soldiers are merely “faceless pawns” to be manipulated by others. A chess set he made, with faceless soldier pawns (inset), reflects his feeling.



# Old Crow's good taste begins with men who love to work with their hands.

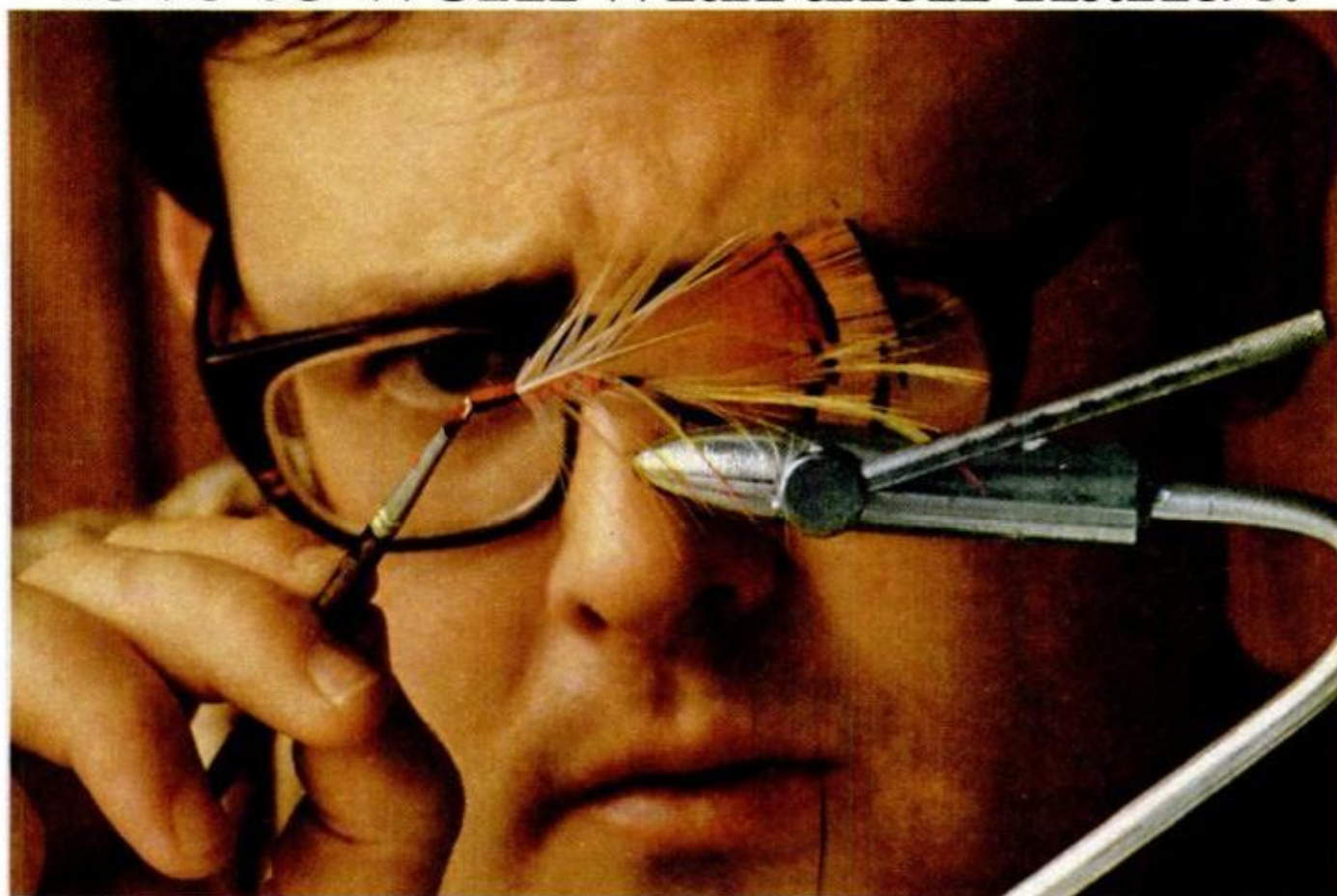

Anthony Clark has a big responsibility. One false move of his hands and he's mixed the wrong measure of grain for the Old Crow formula. Does he ever miss? The proof is in the good taste of our Bourbon.

Making Bourbon which tastes good, bottle after bottle, made Old Crow famous. Back in 1835, our people took Bourbon-making out of the hit-or-miss category. Later, they handmade the first sour mash Bourbon. We still use our hands in making Old Crow.

After work, most of our men keep on using their hands. Anthony Clark calls on the same craftsmanship mixing grain as he does tying fishing flies.

For fly-tying plans, write: Old Crow, Box 675, Frankfort, Kentucky 40601.



Clamp hook in fly-tying vise, wrap with thread.



Cut wings, tail from feather. Attach to hook.



Shape feathers to resemble bug. For plans, see address at left.



## Old Crow

Made by good Kentucky hands

KENTUCKY STRAIGHT BOURBON WHISKEY. 86 PROOF. DISTILLED AND BOTTLED AT THE FAMOUS OLD CROW DISTILLERY CO., FRANKFORT, KY.



# SOLUTIONS FOR MECHANICAL HEADACHES

# AUTOMOBILE CLINIC

BY MORT SCHULTZ

## Replacement parts

*I am restoring a 1962 Corvette that needs a new padded dash. When I tried to get one from GM I was told it was out of stock. Yet I've been informed that the law requires automobile manufacturers to provide replacement parts for 10 years after a car is built. What's the score?—Steve Keel, Murray, Ky.*

You've been misinformed, Steve. As a service, not because the law requires it, automakers keep a stock of mechanical parts on hand for a number of years after a car is built. However, this is not necessarily true of trim items, such as a padded dash. I suggest you have an auto upholstery shop make one for you.

## Hot gas

*My 1969 Ford Fairlane with 302-cu.-in. engine came equipped with a 192° F. thermostat in the cooling system. Since gasoline was boiling in the carburetor, I switched to a 180° F. thermostat. This corrected the problem, but I would like to know if it will cause inefficient operation or harm the engine.—Rev. W.E. Fears, Red Bay, Ala.*

Neither. Later on in 1969 Ford modified the carburetor of this car to provide more efficient operation of the antipercolation valve. Since you have found your own solution to the problem, you may not want to return the car to your dealer to have the modification applied.

## Got the right time?

*In setting ignition timing with a timing light, should the vacuum advance hose be left in place or be disconnected and closed off?—Robert S. Pione, Cincinnati.*

Disconnected and closed off. Why? Because if there's a problem in the vacuum source which, in most cases, is the carburetor, it won't affect the timing.

## Potted potentiometer

*I have a 1970 Oldsmobile 98 with the automatic Comfortron heater and air conditioner. My problem is with air conditioner operation. When the temperature of the day is 80° or more and the car is used*

*for the first time, the unit won't come on automatically. I have to flick the selector switch in and out of the defog position several times. Once the conditioner starts to run, it will act properly for the rest of the day. What should be done?—Dr. P.L. Everett, Columbia, S.C.*

Replace that bad potentiometer!

## Delayed reaction

*My problem is with the automatic transmission in a 1968 Plymouth Fury II. When I shift into forward gear, it will sometimes take as long as 60 seconds to engage. The dealer says that this is the way it's supposed to work. Is he right?—Steven J. Rollins, Iowa City, Iowa.*

You've got to be kidding. If the transmission shifts hard once it finally does engage, have a mechanic look for a broken front-pump gasket. Otherwise the trouble is probably a plugged filter screen, loose bands or leaky clutch seals.

## Hot cable

*I have a 1970 Pontiac GTO and a problem with the cable on my shifter. It's a TurboHydramatic transmission with the shift console on the floor. The cable has a plastic coating on the inside of the cable housing that gets so hot it melts and the cable separates. The dealer claims there is so much static electricity in the car that it welds the cable. I've replaced the ground strap from the firewall to the block with a bigger one, but still have troubles. Thus far I've replaced six cables. Please help.—Larry L. Brown, Modale, Iowa*

You're in the right forest, but on the wrong trail. The console should be grounded. Lack of a ground is allowing electrical current to take the path of least resistance, which is down the cable. Heat builds up and melts the plastic. Ground the console directly to the transmission body. It will stop the trouble.

## Coy coils

*My 1968 Volkswagen sedan has a chronic ignition problem—it burns out one coil after another. I've had the car examined*  
*(Please turn to page 50)*



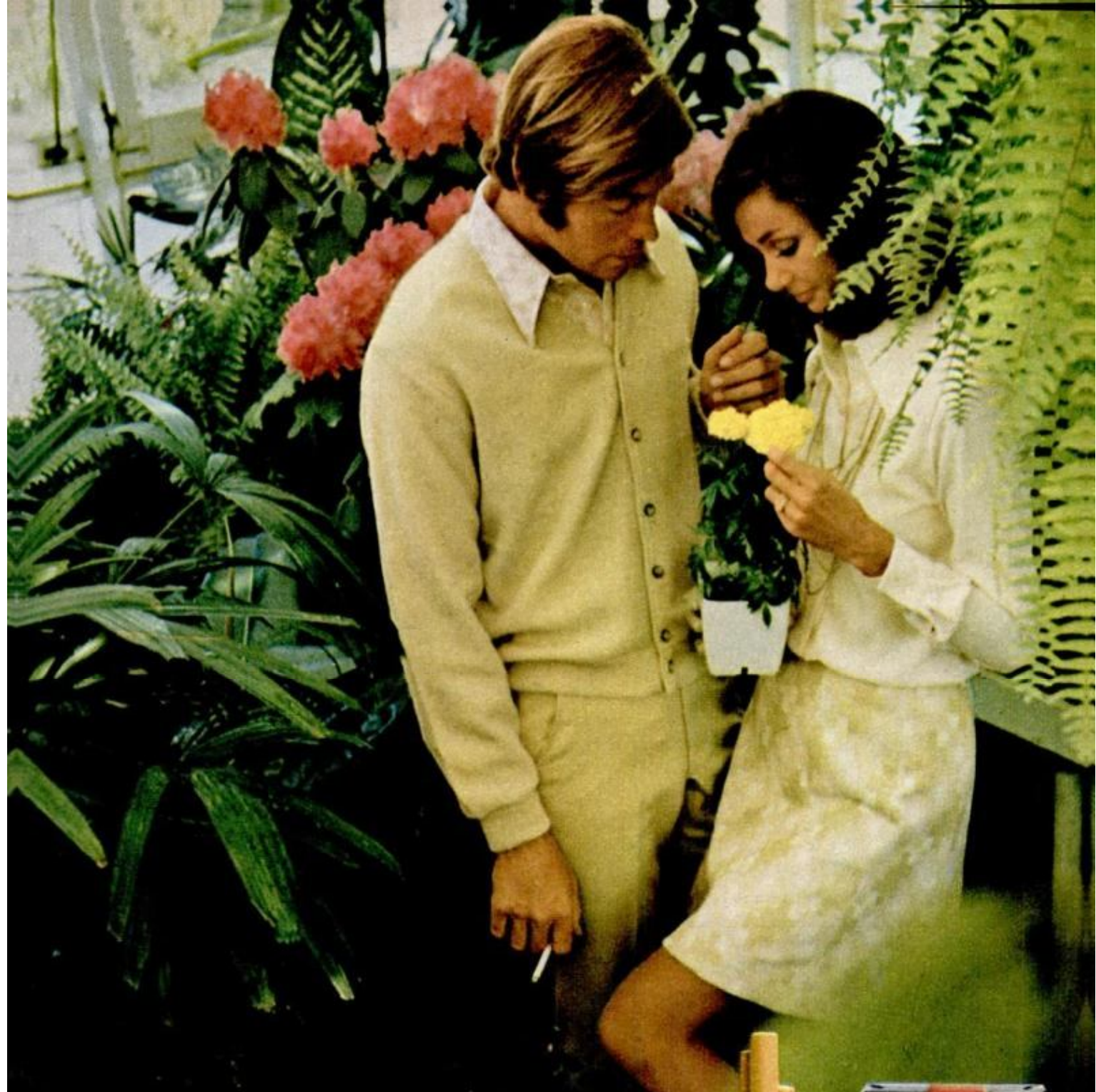

Their garden? Just a window box on a city street.  
But they're choosy. They want it splashed with color.  
All year round.

Their cigarette? Viceroy.  
They won't settle for less.  
It's a matter of taste.

Viceroy gives you all the taste, all the time.



© 1970. BROWN & WILLIAMSON TOBACCO CORP.

King Size, 17 mg. "tar," 1.2 mg. nicotine; Long Size, 19 mg. "tar," 1.4 mg. nicotine av. per cigarette, FTC Report Nov. 70.

Материал, защищенный авторским правом



## AUTOMOBILE CLINIC

(Continued from page 48)

by mechanics who replace parts, but don't solve the problem. Have you any suggestions?—Arthur C. Simon, Huntington, N.Y.

VWs have not been giving ignition-coil trouble, and there's nothing that I can point to as a cause, except for one possibility. Could it be that whoever is replacing the coil is putting on a 6-volt rather than a 12-volt coil? This might be true if he's using the part number printed on the coil to order a replacement instead of asking for a new coil by model year. VW stopped using 6-volt coils in 1966.

### Broken head bolt

*My problem is a broken head bolt that I attempted to remove by using drills. I snapped off an easy-out in the bolt and now I can't get that out, because it's of harder steel than any drill. What do you recommend?—John Parady, Millis, Mass.*

First, try to grasp the broken bolt with a cape chisel and spin it out. If that doesn't work, get a bolt that is one size smaller in diameter and of the same metal as the broken bolt. Electric weld it to the busted bolt, and then spin the whole bunch out at one time.

### Go-forward backup lights

*The backup lights on my 1969 Chevrolet Belair, with three-speed manual transmission, come on when the transmission is shifted into second as well as into reverse. They don't go out until there is a shift out of second. How do I go about correcting this?—Marshall A. Harper, Fort Seybert, W. Va.*

This happens because a dual-action switch is used that is engaged in both second gear and reverse. I suggest you remove it and put on a single-pole backup-light limiting switch you can buy in an auto supply store. Make sure it goes on the bracket in the reverse lever position, so it is engaged only in reverse.

### Low float?

*My 1964 Lincoln Continental stalls whenever I make a sharp or full turn at low speeds—for example, when turning*

*around in the middle of a street. It happens when the wheels are turned all the way in either direction, but only at low speeds. The service mechanic suggests that I have the idle set up. Is he right?—Richard J. Coughlin, Charlottesville, Va.*

He could be. Another possibility is a low float level in the carburetor.

## Service Tips

● **Chrysler Corp.** cars with 382-2 bbl. engines have had problems with engine surging and stumbling. One reason may be a warped air horn on the 1½-in. BBD carburetor that is causing a lean mixture. To find out, the air horn should be removed and a straightedge placed across the lower gasket surface of the air horn in line with the air-cleaner stud and parallel to the choke shaft. If an .011-in. or thicker feeler gauge can be inserted between the straightedge and air horn, warpage is present and the carb should be repaired with Carter Service Package No. 3579031.

● **Chevrolet** cautions you not to let anyone remove the filter-strainer assembly from the pickup tube in the gas tank without replacing it with a new one. It might solve problems you've been having because of a clogged filter, but only momentarily. If a new filter isn't inserted, water and foreign matter will travel from the gas tank and be trapped in the carburetor fuel-inlet area.

● **Speaking of filters,** Mercury says that the air-cleaner element in 1971 Montegos and Comets with six-cylinder engines should be replaced at 24,000 miles instead of 12,000 miles as originally recommended.

● **1971 engines:** The decrease in compression ratios and the retarded timing employed so that these powerplants can use unleaded and low-lead fuels present a potentially troublesome situation. As Champion Spark Plug Co. says, the 1971 models require hotter sparkplugs than previous models to compensate for the decrease in compression and horsepower. If these plugs are accidentally used in 1970 or earlier engines, you could find yourself with a ruined engine. George Galster, Champion's director of technical services, puts it this way: "If a plug for a '70 or older engine is used in a '71, plug fouling will probably result. But if some of the '71 plugs get into a '70 engine, piston damage is a real danger." ★★

---

**GOT A PROBLEM WITH YOUR CAR?** Ask Mort about it. Send your question to Auto Clinic, Popular Mechanics, 224 West 57th St., New York, N.Y. 10019. Letters cannot be answered individually, but problems of general interest will be published in the column.



# THE LITTLE CAR THAT GROWS ON YOU.

There are two ways of looking at the Vega Hatchback Coupe.

One, you can look at it as a sporty little 2-seater which, unlike most sporty little 2-seaters, has a back seat you can flip up on those rare occasions when you have three or four people aboard.

Or you can look at it as a sporty little 4-seater which, unlike a lot of sporty little 4-seaters, has a back seat you can flip down when you have a lot of stuff to haul, like on Saturday.

The Vega Hatchback was designed from the outset to be a Hatchback.

It isn't an afterthought.

It is a beautifully balanced, beautifully engineered car with a lot more than just a lot of loadspace to entice you.

There's Vega's surprisingly responsive overhead cam engine, for example. And standard front disc brakes. A double-panel steel roof, side-guard beams in the doors, a 50,000-mile air cleaner, foam-filled seats front and rear, even an electric fuel pump that cuts out to stop the car if the oil pressure ever drops too low.

Vega. It grows on you.

And it's growing on America.



Buckle your seat and shoulder belts.  
It's an idea you can live with.

JULY 1971



51

Материал, защищенный авторским правом



# Which hand was sprayed with Off!™... 5 hours ago?



Unretouched photo

It shouldn't be too hard to guess. We'll even give you some clues. Off! has diethyl-toluamide (a fancy name for the most effective mosquito repellent ingredient ever developed).

We tested Off!, with diethyl-toluamide, in our labs. And in test after test, Off! not only kept mosquitos from biting immediately upon application—but up to five full hours later.

Off! comes in spray, foam or concentrated liquid. It repels mosquitos, chiggers, gnats and ticks hour after hour.

(Congratulations. You guessed right. The hand on the left was sprayed with Off!)

FROM **Johnson WAX**

©1970, S. C. Johnson & Son, Inc.,  
Johnson™ All rights reserved.





# HOW TO STEER CLEAR!

You're an excellent driver being safely passed on a two-lane road... a car pulls out from the left... the margin for safety is at an absolute minimum... only a split-second decision can avert disaster!

By E. D. FALES JR. / Illustrations by Roy Grinnell

**Y**OU CAN SURVIVE A CLOSE CALL if, and only if, you drive like a racing-car driver! That doesn't mean driving at the high speeds it takes to win a race, but with the concentration and anticipation it takes to run with the pack and finish the race safely.

How?

First of all, if you are among the better drivers, you will not be the cause of close calls on the highway. But even the best driver can find himself in a situation not of his own making. The trick is to drive out of it.

Imagine your car is in the right lane in the illustration above. You are



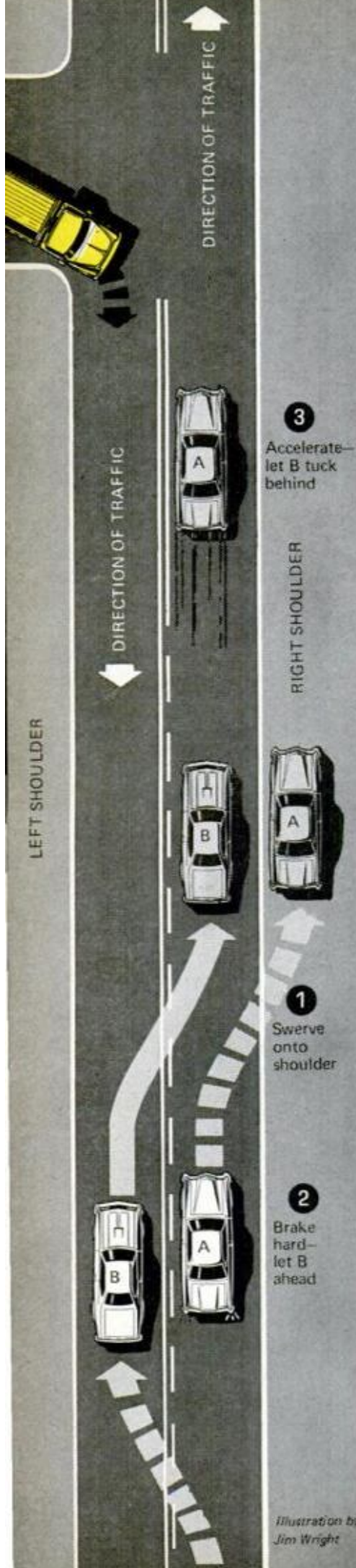

driving at a reasonable rate of speed on the two-way road and are being passed, legally and quite safely, by the car that has pulled alongside you. Then, driving side-by-side, you see a car or truck pull out of the drive ahead! The passing car (car B in the drawing at left) is committed and trapped in a crisis situation caused by the vehicle coming out of the drive. You (car A at left) are blameless, but are going to be in trouble if car B has no recourse than to squeeze you to avoid a head-on.

What do you do?

If you're slow on the uptake, not driving with concentration and anticipation when this situation arises, you may become a victim: Car B can't possibly slow down and cut back in line behind you, nor can he speed up and cut ahead. He can do neither of these things without your skill and cooperation. If you're on the ball, you have three split-second chances.

- You can whip over onto the shoulder if it's wide and clear.
- If there's no shoulder, or there's a telephone pole alongside the road, load your brakes hard and let car B dive in ahead. Fine. Okay in theory, but what if car B has the idea of diving behind you? If he gets on his brakes, too, you'll both still be side-by-side!
- You can kick the gas hard and scramble ahead, leaving room for car B behind you. But what if the driver of car B opts for a desperate attempt to get ahead of you just as you, too, accelerate?

You have to figure out what car B is going to do and then take the *opposite* action, and do it in the time it takes to blink an eye. First, do what is initially a natural move: Lift your foot off the accelerator. Your car will slow ever so slightly. If your peripheral vision shows any forward motion of car B, he's still accelerating. Get on your brakes; he'll go ahead.

But if car B's fender fails to appear, you know he's throwing out the anchor for a panic stop and tuck: Pull out all stops, stand on the gas and go! If the two of you have worked as a team, a grateful car B will pull in behind—and you'll be safe, too.

Another type of unexpected emergency occurs when your visibility is suddenly reduced to zero or near zero. It could happen when your engine hood flies open, when debris flies onto your windshield or when you suddenly drive into smoke or fog. You've got to maintain your steering in your own lane while you slow to get off the road and stop safely. All you have to

**BLOCKED PASS** occurs when car or truck pulls out suddenly from a side road or drive trapping car B in passing lane alongside car A on two-lane road. Cars A and B must cooperate so that they both can get out of the jam. Good peripheral vision, instant decision-making and quick reflexes are necessary to make one of three steer-clear moves (see text)

Illustration by  
Jim Wright



do is steer to a safe stop while looking down at the lane marker alongside your door. What's essential is presence of mind when this once-in-a-lifetime situation arises. Try it to see how it feels, and you'll avoid panic when the real situation occurs.

A tricky situation that also requires great presence of mind and the ability to put yourself in the other guy's shoes can arise when you drive into the glare of headlights at night. The problem is compounded when visibility is further reduced by rain or snow.

Refer to the illustration on the following page and imagine that you're driving on a two-lane road facing the glare of oncoming traffic. Suddenly, in the other lane, you catch a fleeting glimpse of a child on a bicycle, a wreck, boulder or other obstruction or danger. This is a setup for a disaster because the glare of your headlights minimizes the oncoming drivers' ability to perceive danger ahead in their own lane. When they do see the danger they may swerve—into your lane! If you instantly *extinguish your headlights* you may save your own life and others! Your action will reduce the glare to the oncoming driver so his own lights will illuminate the danger and he can stop in time.

At the same time activate your warning flashers to alert traffic behind to the danger. You help other drivers steer clear, but you'll minimize your chances of being involved, too.

If you're driving at high altitudes you can run into dangerous whiteouts—blinding snow squalls—even in summer. A driver who has never seen one

**BLOCKED VISIBILITY** can suddenly occur and from any number of causes. The driver who has prepared for such an eventuality will be quick to use lane markings as a guide in slowing and steering to safe stop off the road

can't believe the blinding violence of a whiteout. You lose sight of *everything* except a hypnotic tunnel of whirling snow. You get dizzy and lose the road. Whiteout drivers have gone over cliffs, have been run down by cars and trucks, have been hit by plows.

Usually the answer to steering clear is absurdly simple: Turn around and go the other way. The seeming change in weather is really startling. The violence of a whiteout is usually caused by wind speed. This makes the snow seem worse than it is. But when you turn and run before the wind, all the violence ceases. Suddenly you're in a world of gently falling flakes. You can see! Run with the wind to a safe town or service area, and wait until the storm abates.

An unskilled driver may think his brakes are the only means he has to avoid a collision. He doesn't know the technique of alternately braking and steering—the stab and steer method—of avoiding a collision. You may come upon a sudden emergency ahead on the road—a pileup or fallen boulder—and, on the basis of your speed and road surface, instantly realize that it's impossible to stop in the distance remaining! If you just jam on the brakes, your wheels are going to lock up and you'll start a long, screaming skid. You can't steer when your wheels aren't rolling and chances are you'll go straight into the object ahead. The usual tame, controlled brake pumping that the pro







**QUICK THINKING AND COOPERATION** are what driving is all about. Driver above realizes glare of his headlights may keep oncoming driver from seeing bicycle. If he turns off lights briefly, other driver can see it

uses to drop speed on slippery roads won't work here, either.

The only way to steer clear is to cut speed sharply and steer around the obstruction. No half-hearted brake pumping; the brakes must be stabbed—and hard! The wheels will lock up but before a skid begins release your brakes just for a split second—take slight evasive steering action before stabbing again. As shown in the illustration at the right, a succession of stabs and steering will get you around the obstruction.

There's a situation where "steering clear" may consist of simply hanging on and relaxing. That's when you get into a long, fast spinout on ice. If a too-sudden acceleration or deceleration starts you going around like a stopwatch, you'll be better off if you let the car spin itself out. Momentum may cause you to spin down the road a fantastic distance, but you'll spin arrow straight—providing there's no crown to the road. Just hold the steering wheel firmly until at last, as your wheels get traction, you roll slowly off the road or regain control.

You can steer clear of a bad skid in some circumstances by "catching" the skid before it starts. The rule of thumb is to steer in the same direction your rear wheels skid. Another way to put it is: Steer your car the way you want it to go. When you sense you're starting to get sideways, steer "into the skid" to get the rear end of the car back into line behind the front. This rule works only during the first second or two of the beginning skid. If you don't catch it before your car veers around more than a few degrees, you're past the point of being able to correct the skid. And always remember, you can't steer if you're braking with your wheels locked up; only rolling wheels can be steered.

If your attempts to steer clear fail, there's nothing

*(Please turn to page 162)*

**STAB AND STEER TECHNIQUE** is used when it's impossible to stop in time to avoid a collision. Locked brakes prevent steering and could start a skid, so steering increments must be made between hard-braking jobs

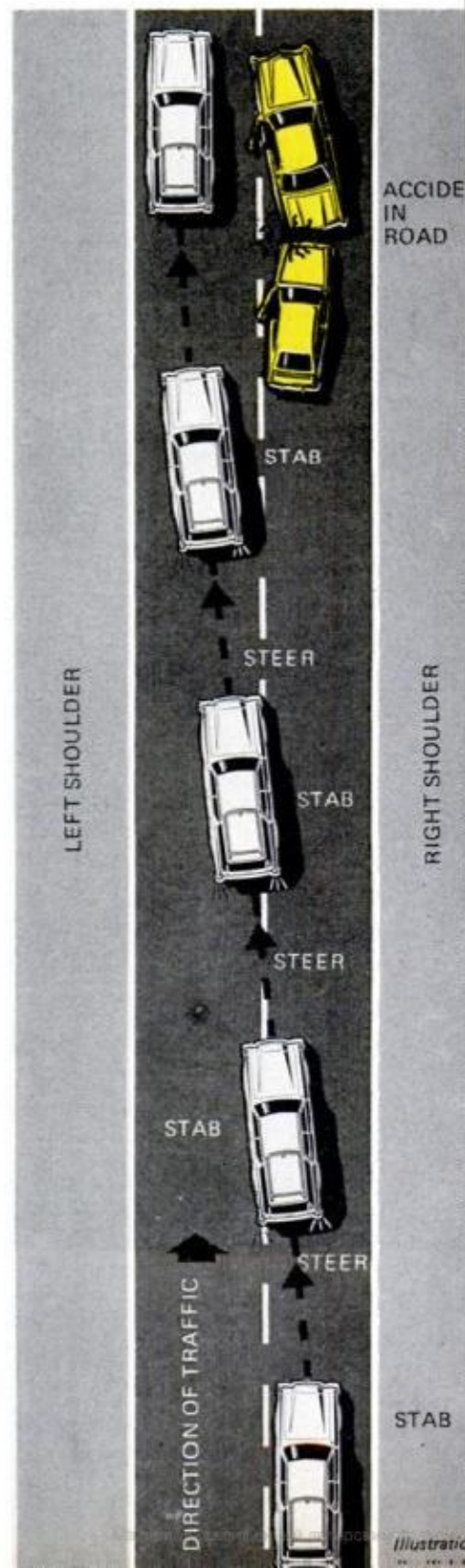



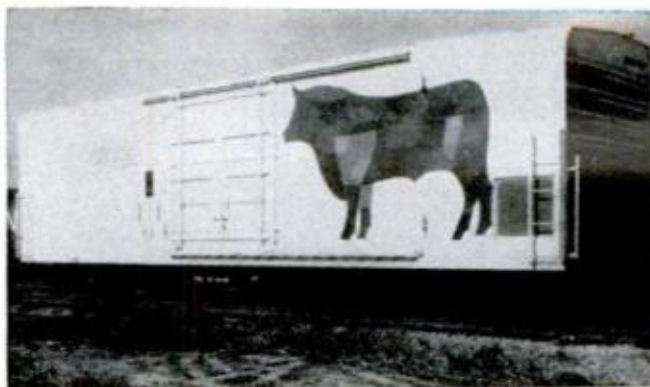

## No mistake about what's inside these freight cars

Freight cars on the Canadian National Railway have become traveling billboards that "advertise" their contents. Among the mobile signs are logotypes of newspapers displayed on newsprint-hauling cars (left) and a beef-cutting pattern that decorates refrigerated cars.

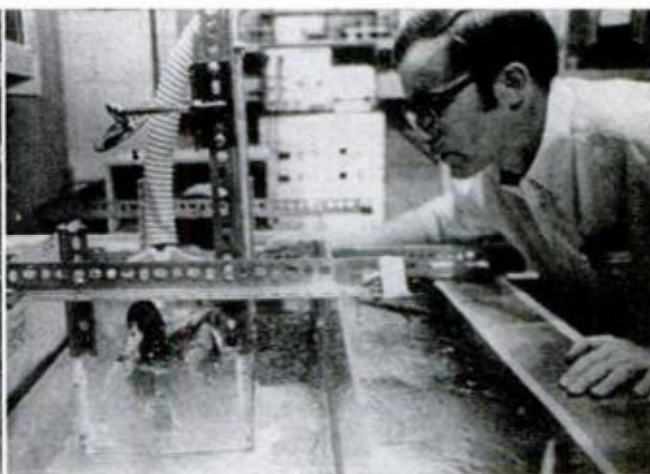

## Ducks prove to be inefficient swimmers

Ducks can swim at a top speed of 1.6 mph and are not as efficient as once believed. In fact, they use five times as much energy as a ship to reach top speed. In studies at Duke University, ducks were placed in a moving stream of water and covered with a plastic chamber so their oxygen consumption could be measured to determine the amount of energy used.



## Conversion turns Imperial into luxury RV

"Cozy Cruiser" is a Chrysler Imperial that has been converted into a comfortable camping vehicle with refrigerator, oven, water supply and sleeping space for four adults and two children. The builder says that a used Imperial can be purchased and made into a cruiser for \$1500 to \$3500—depending on luxury touches. Plans, which include instructions for cutting the car, are \$25 from Sterling Weber, 454 West Center, Logan, Utah.



# Bonanza

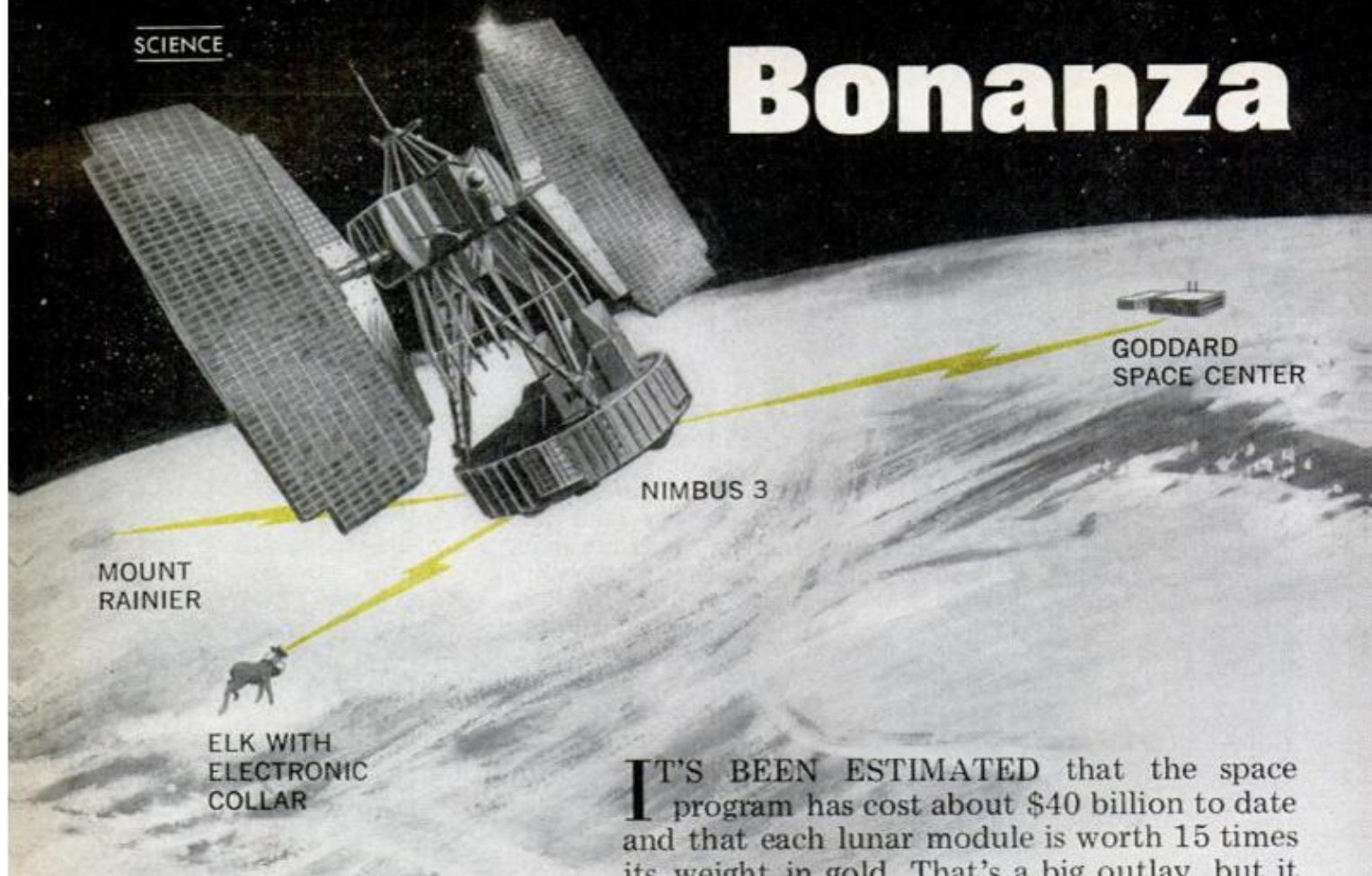

MOUNT RAINIER

ELK WITH  
ELECTRONIC  
COLLAR

NIMBUS 3

GODDARD  
SPACE CENTER

**SATELLITE WORKHORSE**, the Nimbus checks on the weather, monitors a dormant volcano atop Mount Rainier, and keeps track of radio-equipped wild animals. Coming are satellites that will spot oil and mineral deposits, crop diseases and pollution. Insulation developed for space garments can be used on Earth in torchproof gloves that are designed to withstand the heat of melting metals and in blankets and sportsmen's gear

**I**T'S BEEN ESTIMATED that the space program has cost about \$40 billion to date and that each lunar module is worth 15 times its weight in gold. That's a big outlay, but it has paid off in more than a spectacularly successful space effort. It's paid off in "fringe benefits" we all share: better cars to drive, improved communications, safer planes to fly in, more effective medical devices.

The total returns on our fringe benefits from space have been estimated at many billions of dollars annually, but some returns can't really be figured in dollar amounts. What is it worth to save a life with new ultrasound devices or with a sensor so small it can be inserted into an artery by means of a hypodermic needle?

While the tools and techniques devised for space research are being applied to everything from coal mining to medicine, NASA's efforts in developing new materials—superalloys and fiber-reinforced composite materials—promise

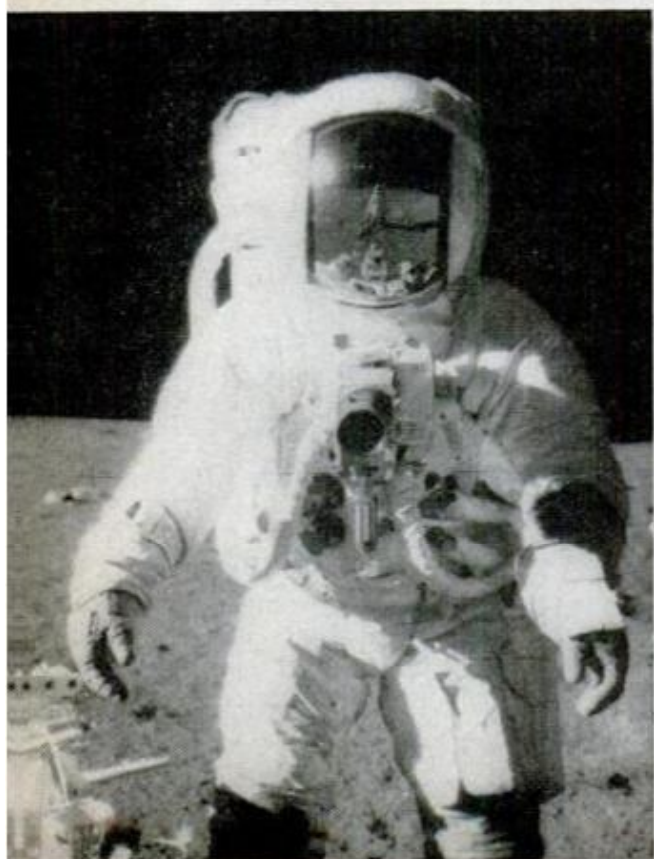



# From Space

By ARTHUR S. FREESE

Illustration by Fred L. Wolff

**Use of sound waves to detect heart defects, superalloys for advanced electrical power systems, insulating materials so efficient they keep a jug of coffee hot for a year—these are some of the dozens of amazing fringe benefits from our space program**

to make basic changes in the way machines and other devices are designed and built. Composite materials are already being used in certain airplanes, for example, and other NASA-inspired materials may add much to the crash resistance of your family car.

Special steels originally developed for rocket motor cases have now found their way into deep-diving submersibles and high-stress machines—and they have even been tried for tooth caps and dental bridges. Armco Steel Corp. has built a unique Group 7 racing vehicle with the exotic new aerospace materials. Designed as a laboratory on wheels, the stainless-steel car is now going through tests at Cornell Aeronautical Laboratories, Buffalo, N.Y.

Insulating materials have also undergone impressive development, for



**STAINLESS-STEEL RACER** (above) serves as a laboratory on wheels to find new applications for steel and titanium alloys developed for space. The Group 7 car is powered by a 445-cu.-in. Oldsmobile aluminum-block engine. Monique, a 500-pound cow elk (below), comes out of tranquilization and bounds away after being fitted with a 23-pound electronic collar which transmits her movements by radio to a Nimbus satellite





NASA has found ways to insulate a tank so well that, if filled with hot coffee the beverage would lose only one degree of heat in a year's time. Another insulating material developed for the space program has been incorporated into a line of sportsmen's blankets, a radar-reflective air-sea rescue signal and an emergency rescue blanket—all commercially available.

Our space program has even created an entirely new industry—commercial satellite communications—which has nearly tripled the number of international communications channels and brought intercontinental TV into being. Other satellites may soon be predicting earthquakes, tidal waves and hurricanes. The National Academy of Sciences sees the potential economic value of these running into some \$3 billion annually in the United States alone.

A Nimbus weather satellite takes the temperature of the dormant volcano atop 14,410-foot Mount Rainier eight times a week. Monitoring equipment at the volcano transmits detailed data to the satellite which relays it to Fairbanks, Alaska, and then to Washington, D.C. It's an important task: Early warning might have saved nearly 200 people killed in a Taal Volcano eruption near Manila in 1965.

Satellites have a number of other important applications. One of the most novel is monitoring the travels of wild elks and the bodily changes of hibernating grizzly bears. In the first experiment, a female elk named Monique was fitted with a 23-pound electronic collar and tracked by a Nimbus satellite. The red aluminum package withstood sub-freezing temperatures and dunkings in Wyoming's streams and rivers, its battery charged by solar cells, while providing scientists with a record of Monique's habits.

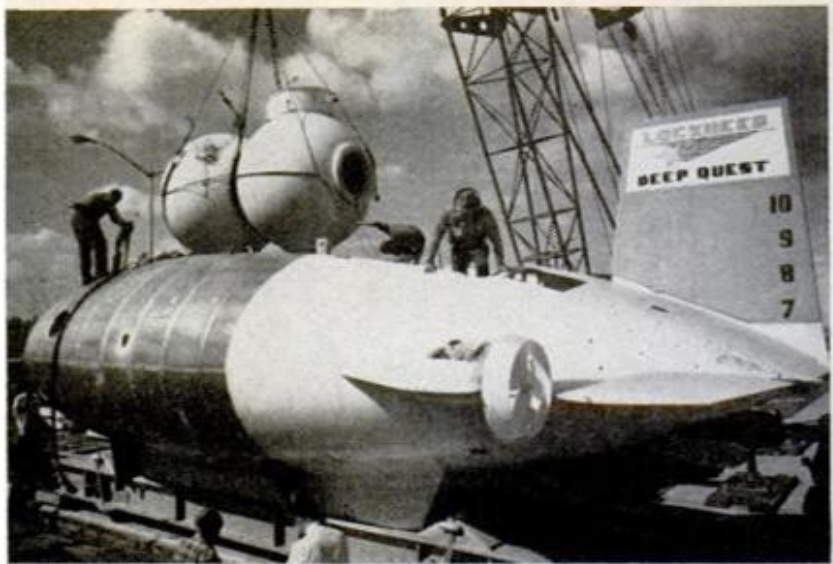

**MARAGING STEEL**, a specially processed nickel-alloy steel, gives added strength to the twin pressure hulls of Lockheed's Deep Quest

In the grizzly bear research now underway, a Nimbus is recording readings on the movements of bears in Yellowstone National Park, their body temperatures and the light, humidity and temperature variations in their dens.

In a more serious vein, Earth resources satellites are soon expected to locate new mineral and petroleum deposits, help improve agriculture by

### **You can share the space payoff**

The job of NASA's Technology Utilization Office is to give you useful information derived from the space program. *Tech Briefs*—3500 have been published—are available on request and cover new developments. Recent topics include shop techniques, welding, machining techniques, a new brushless d.c. motor, a low-cost insulation for pipes, a leakproof valve for corrosive chemicals and various electronic ideas. You can write for more details. The *NASA Technical Utilization Series* are state-of-the-art paperbacks which run up to 350 pages and cover such areas as high-velocity metalworking, magnetic tape recording technology, selected welding techniques, adhesives, sealants and gaskets, soldering electrical connections and many more. Prices range from 75 cents to \$3. A publication called *Transferable Technology* lists the books available along with other information. A letter to the Office of Technology Utilization, National Aeronautics and Space Administration, Washington, D.C. 20546, will bring this list and mailings of *Tech Briefs*.



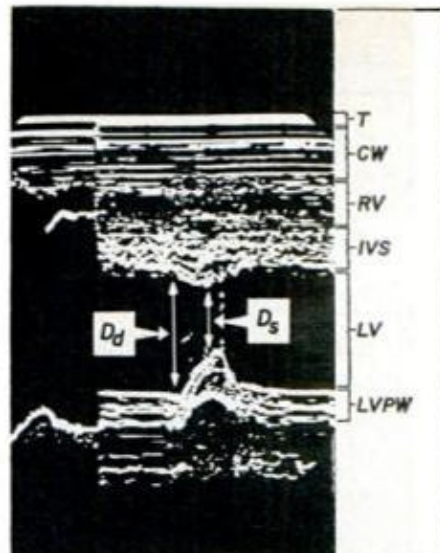
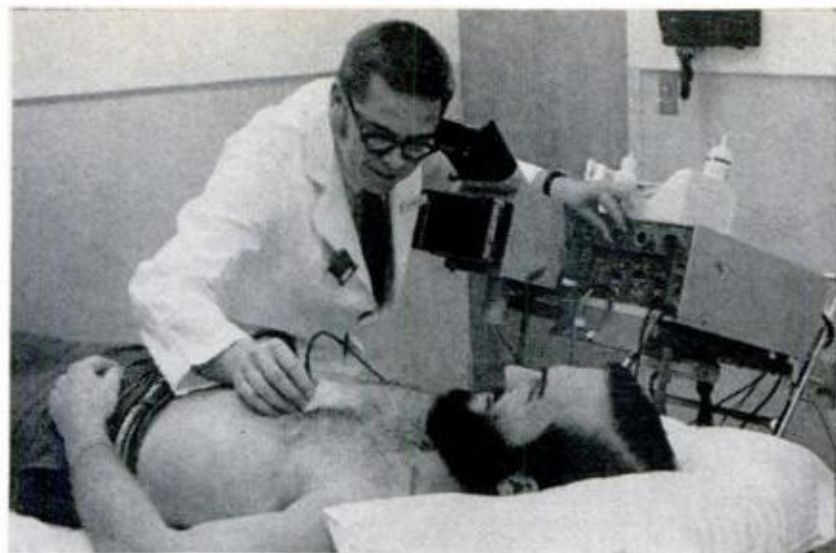

**SONAR TRANSDUCER ON PATIENT'S CHEST** receives sonic impulses bounced against his heart's interior walls. Echoes (right) show heart at rest (long arrow) and pumping (short arrow). Blood flow can be calculated

spotting crop disease, and improve conservation and pollution control.

For the individual American, medical breakthroughs are among the most important fringe benefits from space. NASA borrowed ultrasonic sound from the bat to probe for defects in spacecraft and equipment. Now biomedical scientists of NASA's Ames Research Center in Mountain View, Calif., have joined with Stanford University Medical School doctors to adapt ultrasound to study of heart and blood vessels.

Like sonar, the sound waves are sent through the body's tissues to bounce off structures they encounter and produce a picture on a cathode-ray tube. Using this instrument, Stanford's Dr. Donald C. Harrison has led a team of physicians and scientists in a study of over 50 patients to obtain basic data on human heart beat and blood circulation. The amount of blood pumped with each heartbeat can be calculated and used to determine whether the heart valves are leaking and require surgery.

But this application is just the tip of the iceberg. A sensor smaller than the head of a pin can be injected into an artery and fed into the heart with a hypodermic needle, there to send back data without interfering with circulation. Developed by Grant W. Coon of NASA's Ames Research Center, it has already been used to measure blood pressure in experimental animals.

In other medical problem areas, the principle of the air bearing in the Saturn V's guidance gyroscope has been used in the design of an examination table that floats on a thin layer of air, supporting the patient free of vibration while doctors measure the force of his heartbeats.

A design for an unmanned walking lunar vehicle with eight legs connected to push rods has become a walking wheelchair for crippled children. Powered by motorcycle batteries and electric motors, it can clear curbs and climb stairs steered by the head movement of a child who can use neither arms nor legs.

The astronaut's space helmet has been converted to measure the amount of oxygen consumed by youngsters with heart defects, and a device originally designed to measure micrometeorite strikes is recording the tiny muscle tremors which warn of Parkinson's disease. Computer-enhancement techniques used to improve pictures from outer space are now vastly improving medical X-rays.

Research follows a path that is impossible to predict, and machines, materials and techniques that result from it have applications that cannot be foreseen. The greatest fringe benefits are yet to come. There is every indication that our investment in space will repay itself many times over. ★★★





# THE WINGS

A FEW VINTAGE WORLD WAR I aircraft that no one had the heart to destroy posed a problem at Wright-Patterson Air Force Base. It was 1923, peacetime, and someone suggested that space might be found in a corner of the hangar used as an engine repair shop. The engines were moved aside.

Visitors heard about the old planes and would ask to see them. More were donated and both the collection and number of visitors constantly increased. Finally, to avoid questions, workers in the engine shop hung tags on each craft.

That was the start of the Air Force

Museum which is today the largest military museum in the world. So successful has it been—well over 600,000 visitors annually—that it has just moved into enlarged, attractive new quarters that resemble two huge hangars joined at the central entrance. The modular building, airconditioned to help preserve older fabric-and-wood aircraft, is located just a few miles from Huffman Prairie, near Dayton, Ohio, where the Wright Brothers conducted their early experiments.

Here is everything from an exact

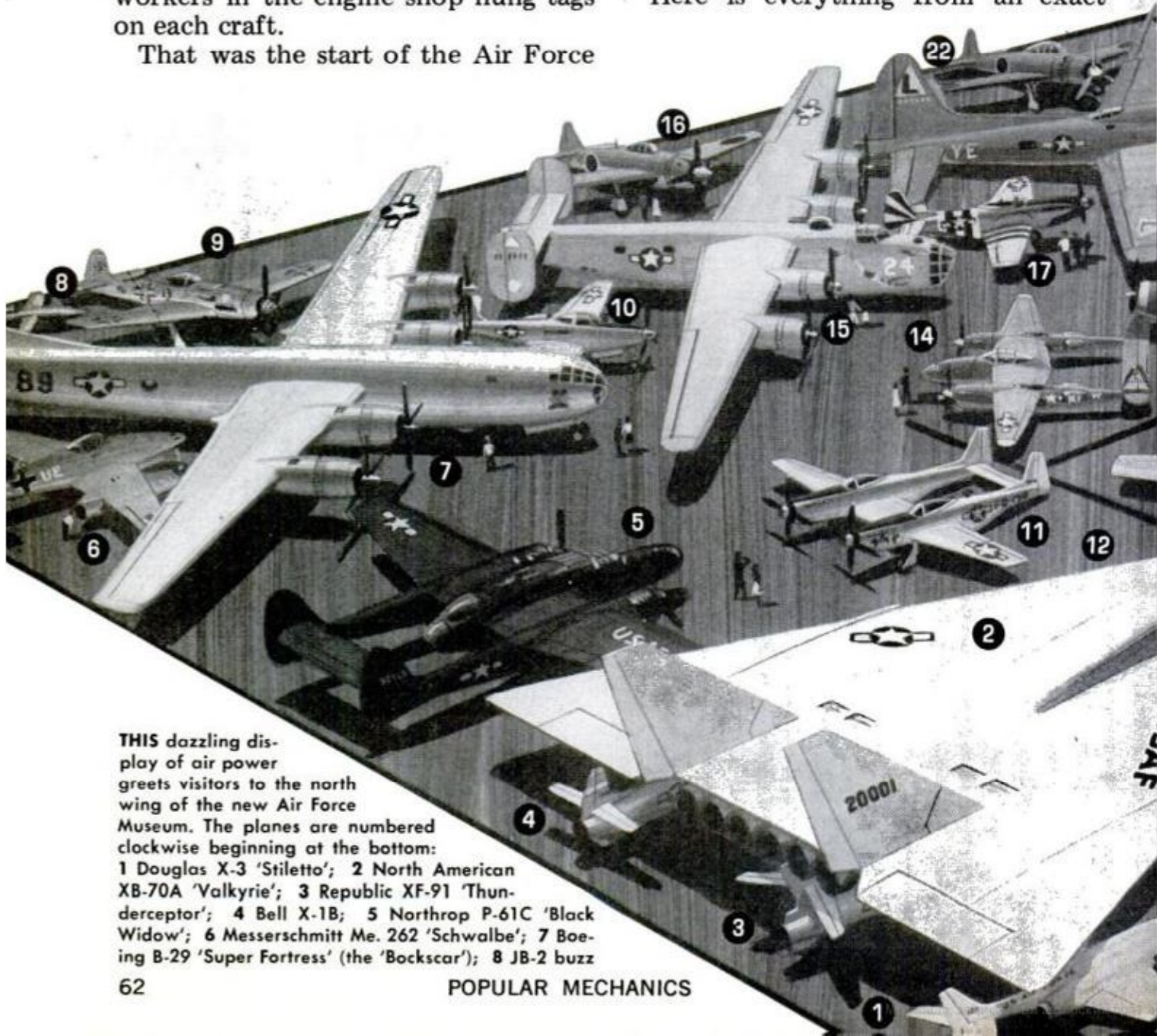

THIS dazzling display of air power greets visitors to the north wing of the new Air Force Museum. The planes are numbered clockwise beginning at the bottom: 1 Douglas X-3 'Stiletto'; 2 North American XB-70A 'Valkyrie'; 3 Republic XF-91 'Thunderceptor'; 4 Bell X-1B; 5 Northrop P-61C 'Black Widow'; 6 Messerschmitt Me. 262 'Schwalbe'; 7 Boeing B-29 'Super Fortress' (the 'Bockscar'); 8 JB-2 buzz



# OF BRAVE MEN

*If airplanes fascinate you, include the new Air Force Museum in your summer travel plans. You'll see the most complete military aviation collection in the world.*

By KEVIN V. BROWN / Art concepts by Dale Gustafson

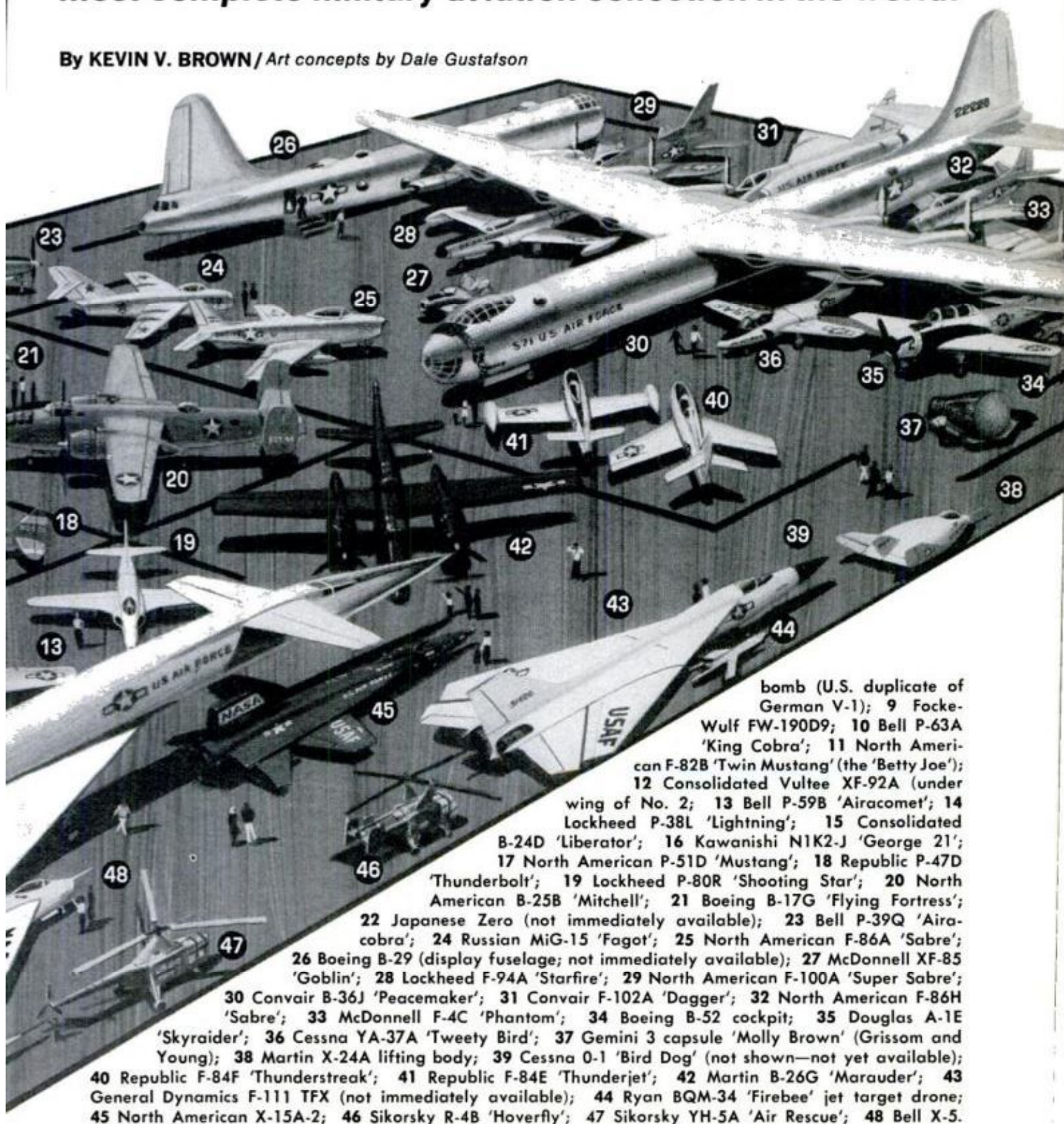

bomb (U.S. duplicate of German V-1); 9 Focke-Wulf FW-190D9; 10 Bell P-63A 'King Cobra'; 11 North American F-82B 'Twin Mustang' (the 'Betty Joe');

12 Consolidated Vultee XF-92A (under wing of No. 2; 13 Bell P-59B 'Airacomet'; 14 Lockheed P-38L 'Lightning'; 15 Consolidated B-24D 'Liberator'; 16 Kawanishi N1K2-J 'George 21'; 17 North American P-51D 'Mustang'; 18 Republic P-47D 'Thunderbolt'; 19 Lockheed P-80R 'Shooting Star'; 20 North American B-25B 'Mitchell'; 21 Boeing B-17G 'Flying Fortress'; 22 Japanese Zero (not immediately available); 23 Bell P-39Q 'Airacobra'; 24 Russian MiG-15 'Fagot'; 25 North American F-86A 'Sabre'; 26 Boeing B-29 (display fuselage; not immediately available); 27 McDonnell XF-85 'Goblin'; 28 Lockheed F-94A 'Starfire'; 29 North American F-100A 'Super Sabre'; 30 Convair B-36J 'Peacemaker'; 31 Convair F-102A 'Dagger'; 32 North American F-86H 'Sabre'; 33 McDonnell F-4C 'Phantom'; 34 Boeing B-52 cockpit; 35 Douglas A-1E 'Skyraider'; 36 Cessna YA-37A 'Tweety Bird'; 37 Gemini 3 capsule 'Molly Brown' (Grissom and Young); 38 Martin X-24A lifting body; 39 Cessna O-1 'Bird Dog' (not shown—not yet available); 40 Republic F-84F 'Thunderstreak'; 41 Republic F-84E 'Thunderjet'; 42 Martin B-26G 'Marauder'; 43 General Dynamics F-111 TFX (not immediately available); 44 Ryan BQM-34 'Firebee' jet target drone; 45 North American X-15A-2; 46 Sikorsky R-4B 'Hoverfly'; 47 Sikorsky YH-5A 'Air Rescue'; 48 Bell X-5.



replica of the first military aircraft, the Wright 1909 Military Flyer, to the Boeing B-29 "Bockscar" which dropped the second atomic bomb on Nagasaki and helped end World War II. More exotic hardware includes the surviving XB-70 bomber, a plane designed to fly three times the speed of sound at altitudes above 70,000 feet; space capsules and lifting bodies like the Martin X-24A—intended to glide back to earth from outer space.

The history connected with the planes makes them doubly fascinating. Included is the first aircraft to circumnavigate the globe in 1924, the Douglas World Cruiser "New Orleans." Then there is a sister ship of "Lady Be Good," the famous B-24D Liberator

which disappeared on a mission from North Africa in 1943 and was found in the Libyan Desert in 1959. This ship is the "Strawberry Bitch" which also flew combat missions from North Africa. Another famous plane is the F-82B Twin Mustang, "Betty Jo." It made the longest nonstop flight ever made by a fighter on Feb. 28, 1947: 5051 miles between Hawaii and New York.

The museum has the world's first guided missile in the form of the Kettering Bug. Built in 1918 for the U.S. Army Signal Corps, the unmanned Bug could carry 180 pounds of explosives at 55 mph for 40 miles. It was guided to the

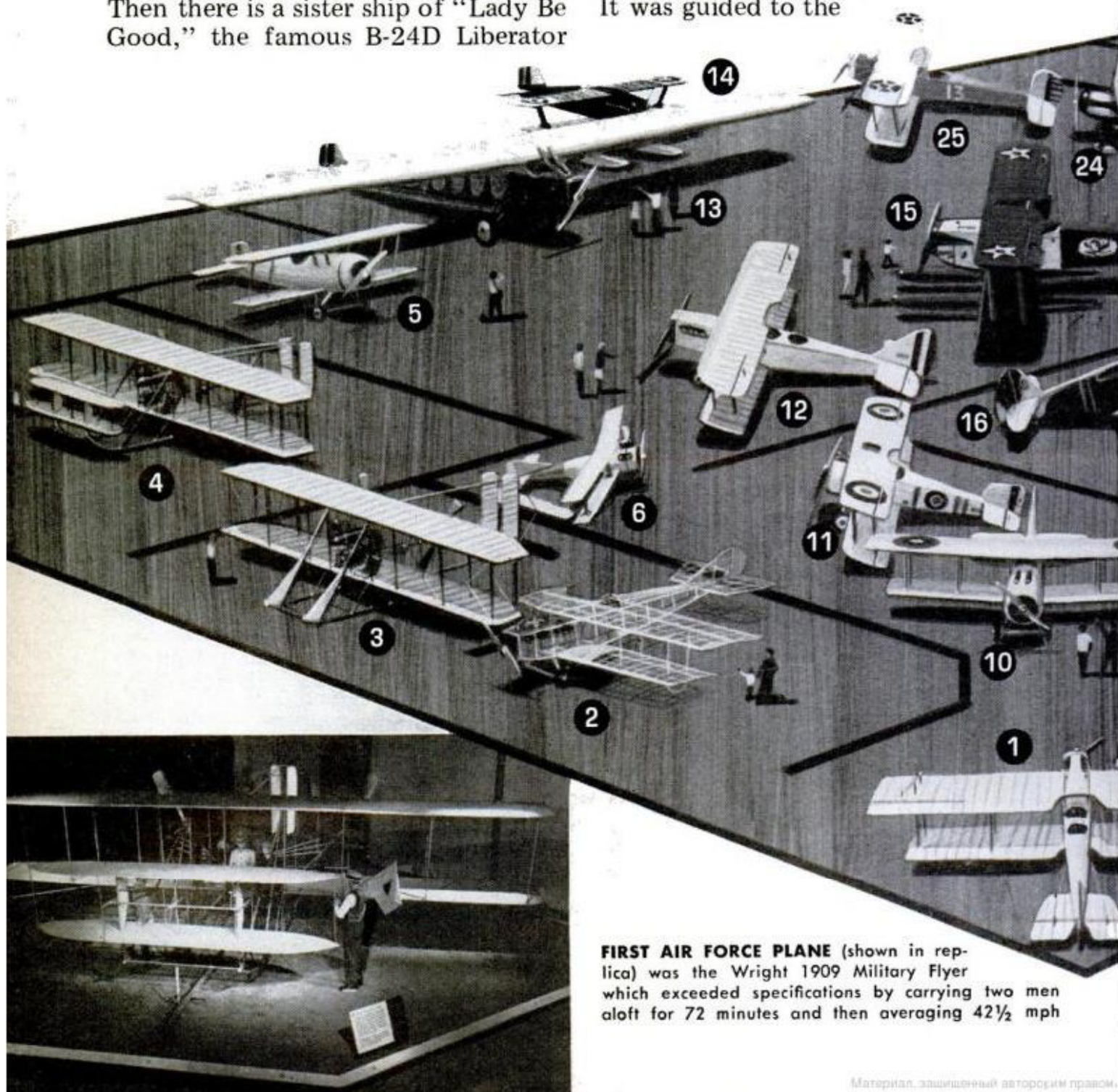

**FIRST AIR FORCE PLANE** (shown in replica) was the Wright 1909 Military Flyer which exceeded specifications by carrying two men aloft for 72 minutes and then averaging 42½ mph



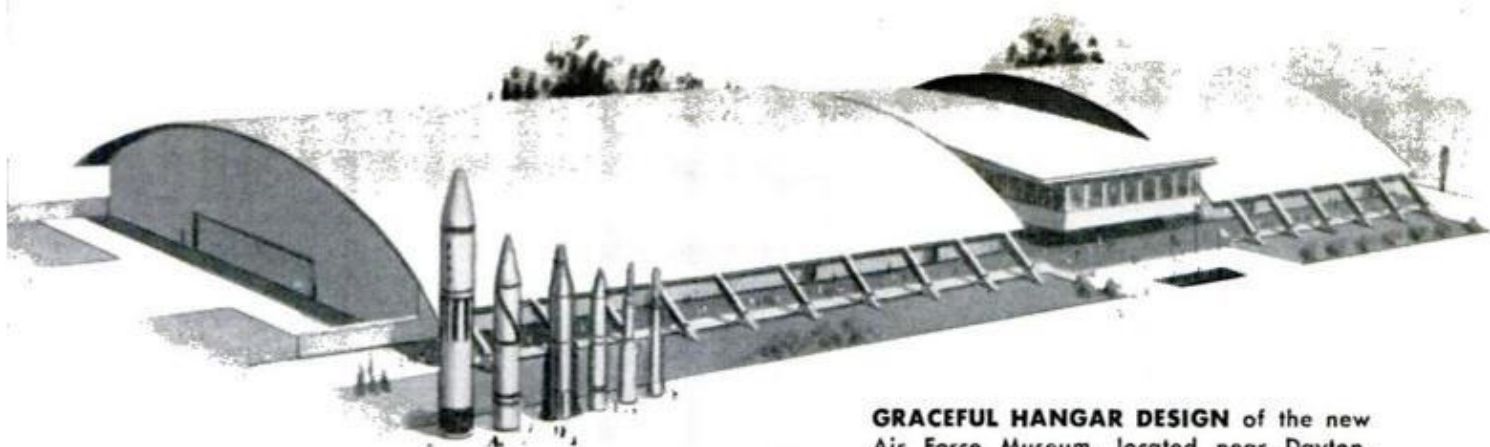

**GRACEFUL HANGAR DESIGN** of the new Air Force Museum, located near Dayton, Ohio, houses a 500-seat theater, restaurant, shops, and up to 100 airplanes in north wing (left) and south wing (right). Interior display space totals 160,000 square feet, and additional planes will be on exhibit in areas outside the building. Planned for the future are displays of the missiles shown in the drawing such as the Chrysler PGM-19 Jupiter; Convair CGM-16 Atlas; Douglas PGM-17 Thor; Martin HGM-25 Titan I, and other smaller types. Appropriately located near a runway, the museum is constantly growing and has established a want-list of planes needed to fill gaps in its presentation of aviation history

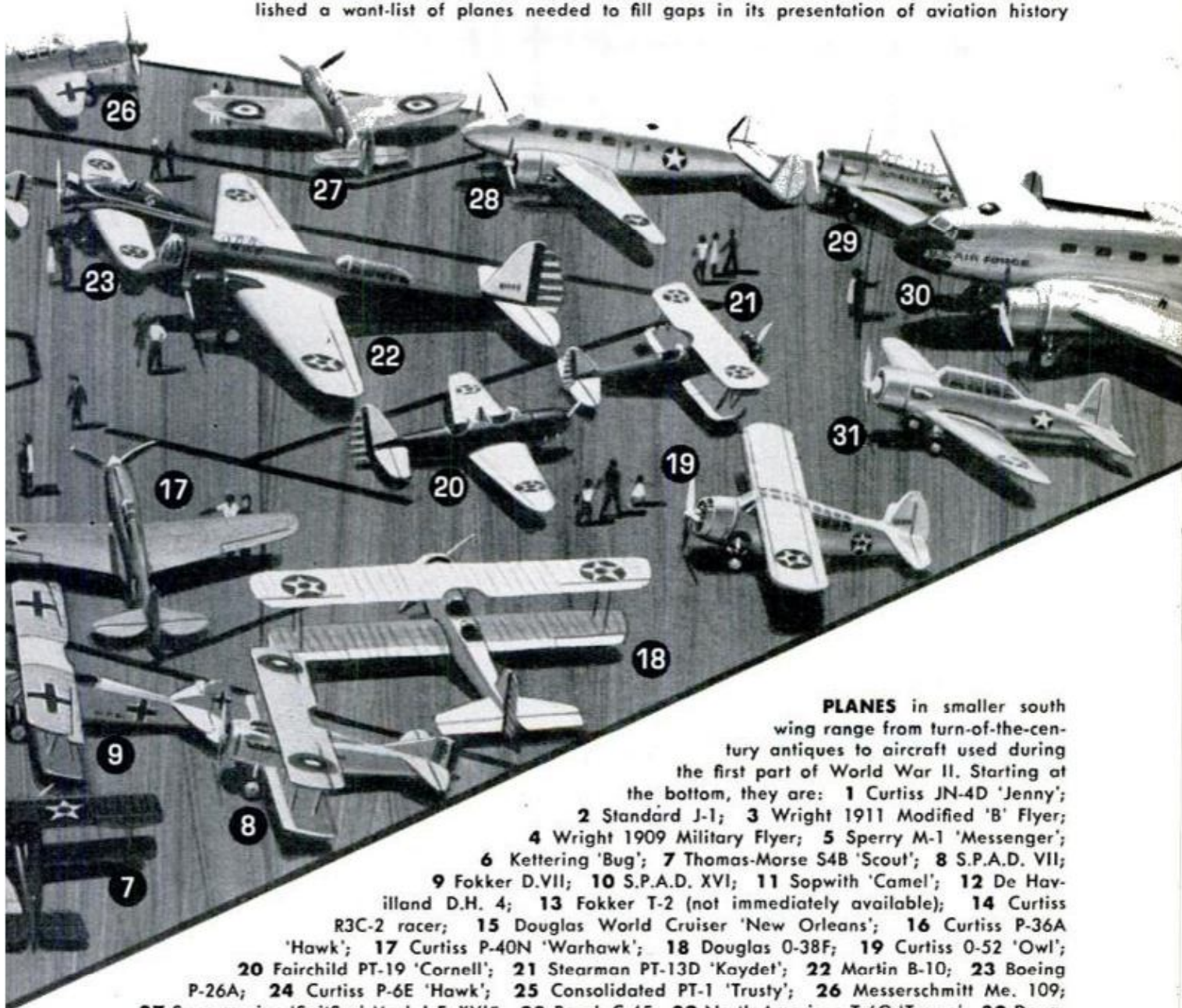

**PLANES** in smaller south wing range from turn-of-the-century antiques to aircraft used during the first part of World War II. Starting at the bottom, they are: 1 Curtiss JN-4D 'Jenny'; 2 Standard J-1; 3 Wright 1911 Modified 'B' Flyer; 4 Wright 1909 Military Flyer; 5 Sperry M-1 'Messenger'; 6 Kettering 'Bug'; 7 Thomas-Morse S4B 'Scout'; 8 S.P.A.D. VII; 9 Fokker D.VII; 10 S.P.A.D. XVI; 11 Sopwith 'Camel'; 12 De Havilland D.H. 4; 13 Fokker T-2 (not immediately available); 14 Curtiss R3C-2 racer; 15 Douglas World Cruiser 'New Orleans'; 16 Curtiss P-36A 'Hawk'; 17 Curtiss P-40N 'Warhawk'; 18 Douglas O-38F; 19 Curtiss O-52 'Owl'; 20 Fairchild PT-19 'Cornell'; 21 Stearman PT-13D 'Kaydet'; 22 Martin B-10; 23 Boeing P-26A; 24 Curtiss P-6E 'Hawk'; 25 Consolidated PT-1 'Trusty'; 26 Messerschmitt Me. 109; 27 Supermarine 'Spitfire' Mark L.F. XVIIE; 28 Beech C-45; 29 North American T-6G 'Texan'; 30 Douglas C-47A 'Skytrain'; 31 Vultee BT-13B 'Valiant'. Among the significant missing links sought by the Air Force Museum are the Fokker D.VII, the famous WWI German fighter; the Boeing P-12, a U.S. pursuit craft dating from the 1920s, and the Seversky P-35, an all-metal pursuit plane. Sources of antique planes include other museums, individuals and manufacturers. Even parts are useful: The replica of the Wright 1909 Military Flier was constructed around an engine, props, and other parts donated by the Wright estate.





**S.P.A.D. VII** was one of the best of World War I. With U.S. designs lagging, pilots like Rickenbacker flew it. Its gun was synchronized, it did 130 mph, climbed to 22,000 and stayed together in dives



**THIS MIG-15** was flown to South Korea by defector who collected a \$100,000 reward. It climbed faster and had a higher ceiling than its adversaries. U.S. planes, however, were more rugged, dived faster



target by built-in, preset controls. A "descendant" is located in another corner of the museum: a replica of the German V-1 buzz bomb.

Other memorabilia associated with the growth of aviation—far too much to display—includes engines, parachutes, uniforms, wind tunnels and miscellaneous hardware from all over the world. A prisoner-of-war exhibit tells much about the hardships experienced by American POWs in German prison camps. Other special displays are devoted to balloon flights, dirigibles, the development of the atomic bomb, the Berlin airlift and the like.

Yet another sidelight is the Aviation Hall of Fame, reproductions of awards given by the Congress of the United States to those who have made significant contributions to aviation. The chief attraction, however, remains what it has always been: the aircraft themselves.

A constantly growing, ever-changing institution, the Air Force Museum has been dubbed an open-ended history book. Work on a new collection of rockets and missiles shows the title is justified. Although the display must await pouring of concrete pads outside the building, these machines will also take their place in the history book.

While a few of the planes shown on these pages are not currently ready for display, many additional types can be seen by visitors. The museum is constantly adding antique aircraft as well as recent planes and rockets being phased out of operational use.

Entirely dependent on voluntary contributions, the Air Force Museum carries forward the work of collecting airplanes and missiles, restoring and preserving them for the benefit of future historians. Appropriately near a runway, it is a fitting final resting place for the wings of brave men. ★★★

**F-86 SABRE** was the most successful Korean fighter with a kill ratio of 14:1—some 800 MiGs against 58 losses. It was first U.S. fighter to adopt swept wings for speed and set a 670-mph record in 1948





## Breath of fresh air

How to survive in a polluted environment is the theme of this display by a group of Dusseldorf artists. Inside a large plastic "tent" is a table set up to offer the resident of the enclosure a menu of oxygen. It's served to him via a mask from a single bottle on the table.



## Domes protect builders

Construction of two new Autobahn bridges went on without delay even during the bad weather of winter because the construction sites are enclosed in plastic air-supported structures. The cover over the bridge shown above is 190 feet long. A compressor keeps air pumped in to support the dome.



## Big truck to carry little truck and lots of water

Designed to fight unusually intense blazes—such as a fully fueled jumbo jet—this truck would rush to the fire and send in a remote-controlled mini-truck to apply an extinguishing spray. The proposed truck, which would carry 4000 gallons of water and 400 gallons of foam extinguisher, is the design of a Frankfurt, Germany, fire expert.



# NOW:

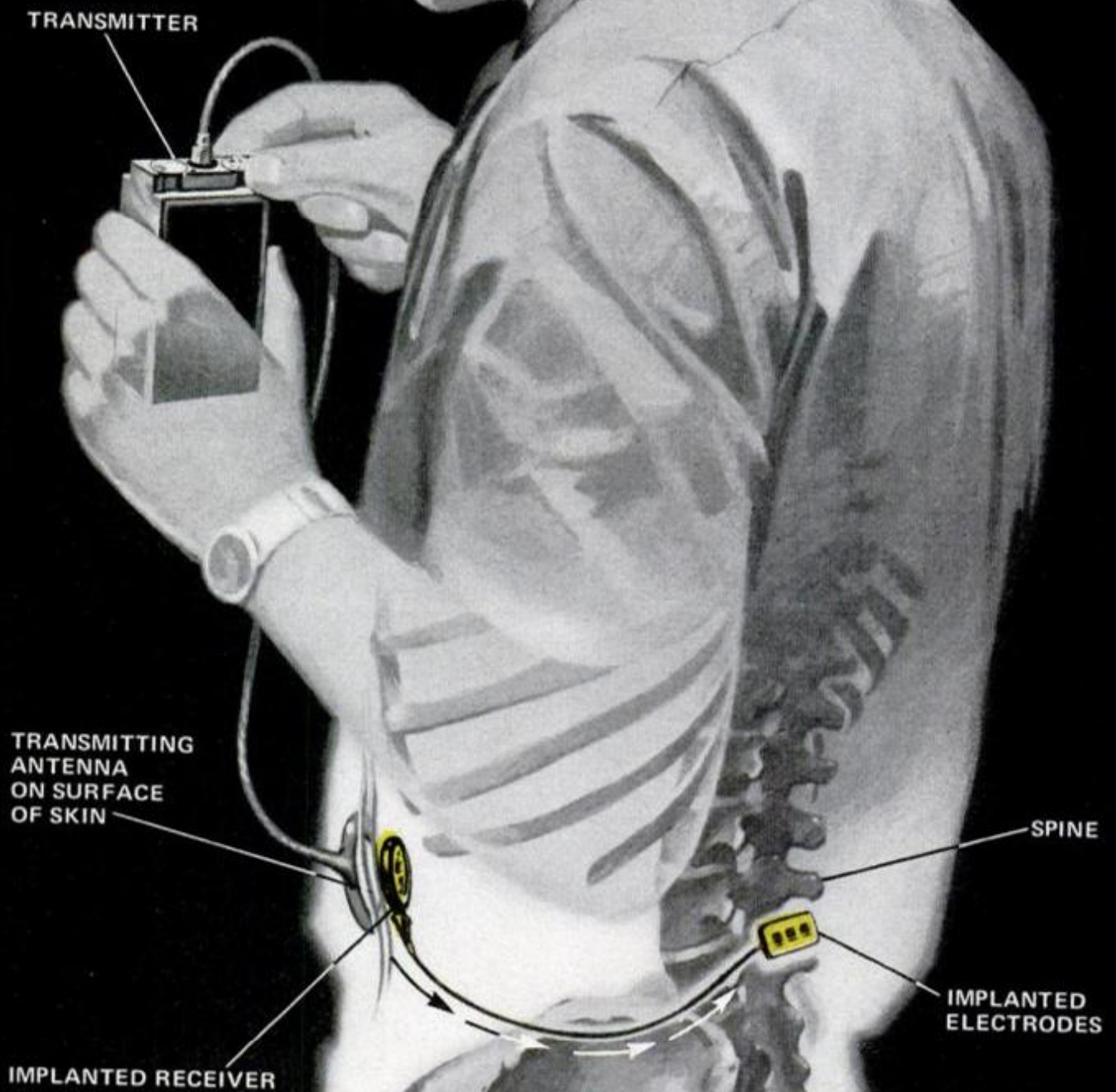



# An Electronic Pain Killer

**Many Americans suffer from pain so intense that they cannot work or even sleep. Drugs offer no relief. Now an experimental electronic device is enabling some of them to lead normal lives.**

By ARTHUR S. FREESE

Illustration by Roy Grinnell

**E**LECTRONICS AND MEDICINE are combining to give new hope to those suffering from disabling, incurable pain. The answer? An amazing receiver and wire network inside the human body that transmits electrical impulses to nerves and literally blots out pain.

Pain due to various infirmities can be classed as an epidemic—one that causes millions of man-hours to be lost each year. Every one of us suffers from some pain from time to time, but for tens of thousands the suffering is almost constant and incredibly intense. In many of these hapless victims the pain is generated by a back injury.

The experience of a Nashville, Tenn., housewife shows how effective the new electronic pain killer can be. The victim of two spinal disc ruptures while driving on primitive roads in Africa, she found herself confined to bed with terrible, "unbelievable" pain. Removal of the discs—pads of cartilage that separate the bony segments of the spine—only made things worse. The pain was so intense she could not even concentrate on reading or doing the fancy needlework of which she was so proud.

Only after a dorsal column stimulator (DCS) was implanted under her skin

**ENGINEER ROGER AVERY SHOWS WHERE ANTENNA** is taped to skin when receiver is implanted below rib cage. In use, antenna lead from shirt-pocket transmitter is slipped inside shirt, then around neck. Other photos show how transmitter is turned on, and the latest DCS model made by Avery's electronic laboratory

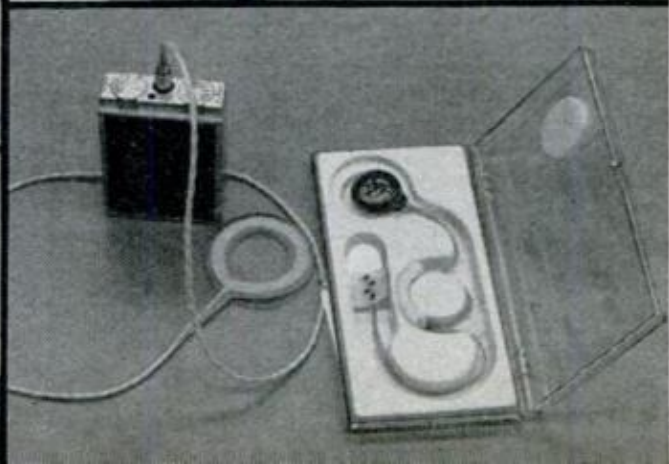
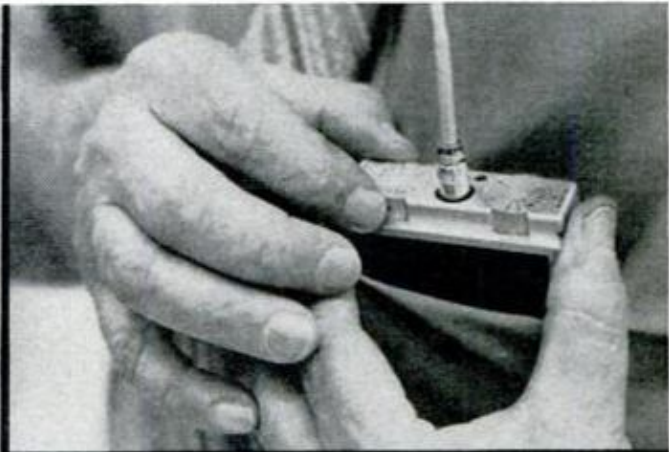
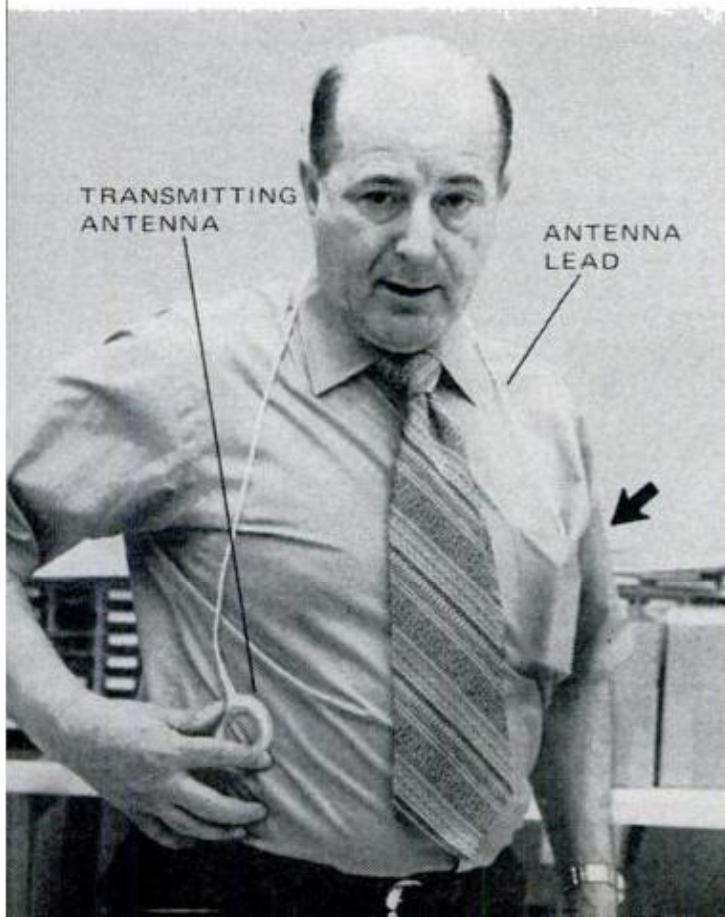



near her spine was she able to return to the normal life of a housewife.

Our nervous system is electrical in nature, and its functioning can be altered by electrical means. The wires that are implanted for the DCS are enough to make an electrician scratch his head in disbelief. They are 6 to 30-inch multiple strands of stainless steel or platinum wire, each with up to 400 filaments so fine you can hardly see one of them. A single strand has less rigidity than a rubber band and a total thickness of only three hairs (10 or 12 one-thousandths of an inch in diameter).

This "pain circuit" is tunneled under the skin of the body, and one end is connected to the electrodes that actually stimulate the nervous system. They may be located against the spinal cord or even against peripheral nerves located in more distant parts of the body.

The other end of the pain circuit connects to a receiver. It is a tiny implantable unit made up of coils, resistors, capacitors and semiconductors, and is often located under the skin on the right side of the chest. The user of the stimulator simply places a small external antenna over the implanted unit in order to activate it. The antenna, in turn, is connected to a small

transmitter slightly bigger than a pack of cigarets. Worn on a belt or in a shirt pocket, it is fully adjustable for best pain relief.

Dr. C. Norman Shealy, chief of Neurosurgery at the Gundersen Clinic of La Crosse, Wis., inventor of the dorsal column stimulator, installed the first one on a human patient in April, 1967. Their most important use now, says Dr. Shealy, is to relieve the pain of "flunkouts from disc surgery."

Medical science will undoubtedly find new applications for the pain killer, however. Not only can pain from spinal injuries and phantom (amputated) limbs be relieved, but some cancer victims can be given a measure of comfort. Similar devices may one day help anyone with pain that does not respond to simple cures. Wires could reach to the spinal column, peripheral nerves and even to electrodes implanted in the brain itself.

Dr. Shealy is enthusiastic about results of DCS. He and other surgeons conducting clinical trials have installed almost 200 units to date, and about three-fifths of the patients report excellent relief from pain. Another fifth show moderate relief and only a final fifth—many of them emotionally disturbed—have not been helped.

**SINCE THE POWER SOURCE** is not implanted—but is in the transmitter—there is no need for multiple operations to replace batteries—a boon to the patient. Unit shown is made by Medtronic, Inc., Minneapolis

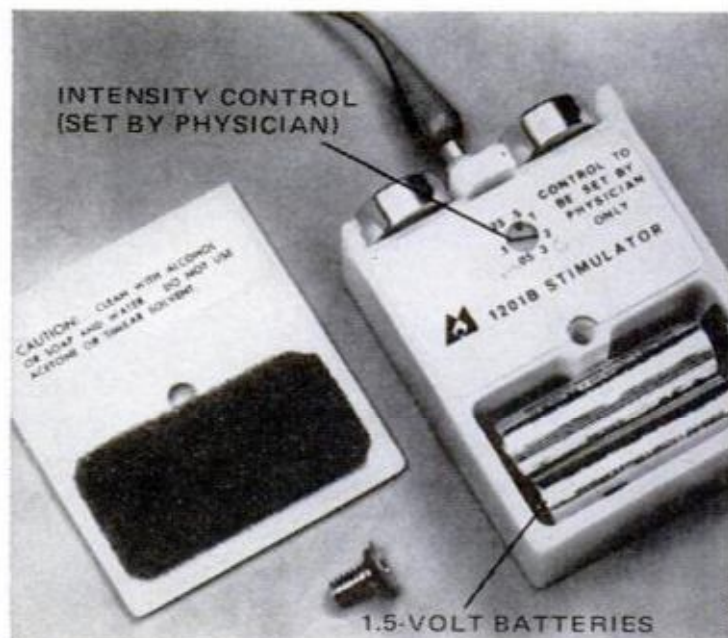
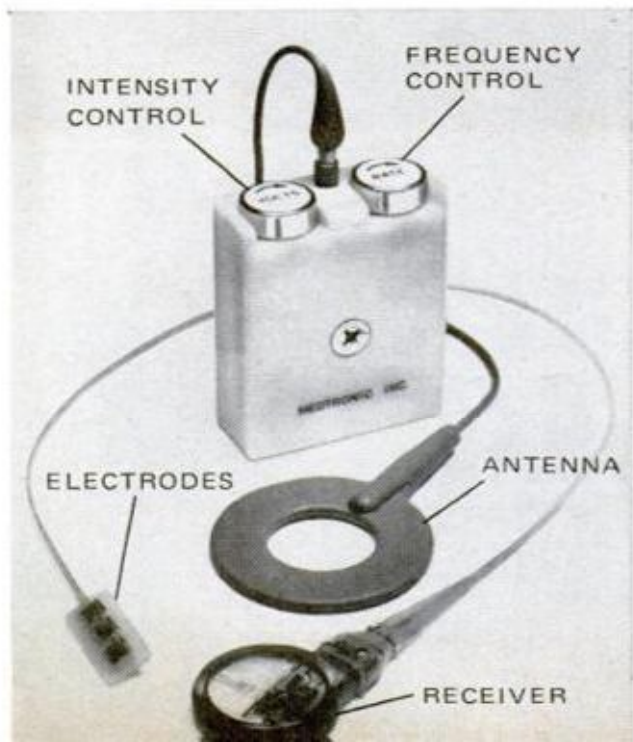



Some neurosurgeons see DCS and other electric pain killers as "the answer to certain kinds of intractable pain not responding to other known treatments." It is a measure of last resort—definitely not for such things as toothaches or broken legs.

Dr. Shealy says that the surgery—about as complex as a disc operation—presents no particular problems for either surgeon or patient. Though the procedure is still experimental, surgeons can tell you about former bed-ridden patients who now lead near-normal lives because of the effectiveness of DSC.

In his mid-50s, Elliott Gray (not his real name) had been confined to bed for seven years following disc surgery; any physical activity generated pain which no drugs could stop. Nearly three years ago, Dr. Shealy operated on Elliott, cutting a hole the size of a quarter in the skin over his spine.

The spine is actually a series of bones (vertebra) with a hole through their center for the spinal cord—the nerve tissue which carries electrical messages to and from your brain. The spinal discs are cushions of cartilage between the bones that permit you to bend and twist. When a disc ruptures or slips, however, the resulting pressure on nerves causes excruciating pain. In addition, scar tissue or bony

spurs can form and add to the pain, as in Elliott Gray's case.

In that operation, Dr. Shealy cut a slit in the outermost of the three layers of delicate tissue surrounding the spinal cord. Then he carefully placed a trimmed bit of plastic holding three platinum electrodes so that it just touched the spinal cord. Wires from the electrodes were fed along under the skin to the receiver—about the size of a man's wristwatch—placed below the rib cage on the abdomen and on a line with the arm. The incision was then sewed up.

To the skin over the receiver Elliott now tapes a doughnut-shaped plastic antenna that plugs into a battery-powered transmitter which he carries in his shirt pocket. He can turn this on or off, or adjust the power or the rate of electrical stimulation. Since the operation almost three years ago, Elliott has been leading a normal life and was laying a new roof on his house when Dr. Shealy last saw him.

Two firms—Medtronic, Inc., Minneapolis, and Avery Laboratories, Farmingdale, N.Y.—make dorsal column stimulators. Roger Avery, who has been working in medical electronics for the last decade, started his small company just three years ago. Deeply committed to his work and concerned

*(Please turn to page 162)*

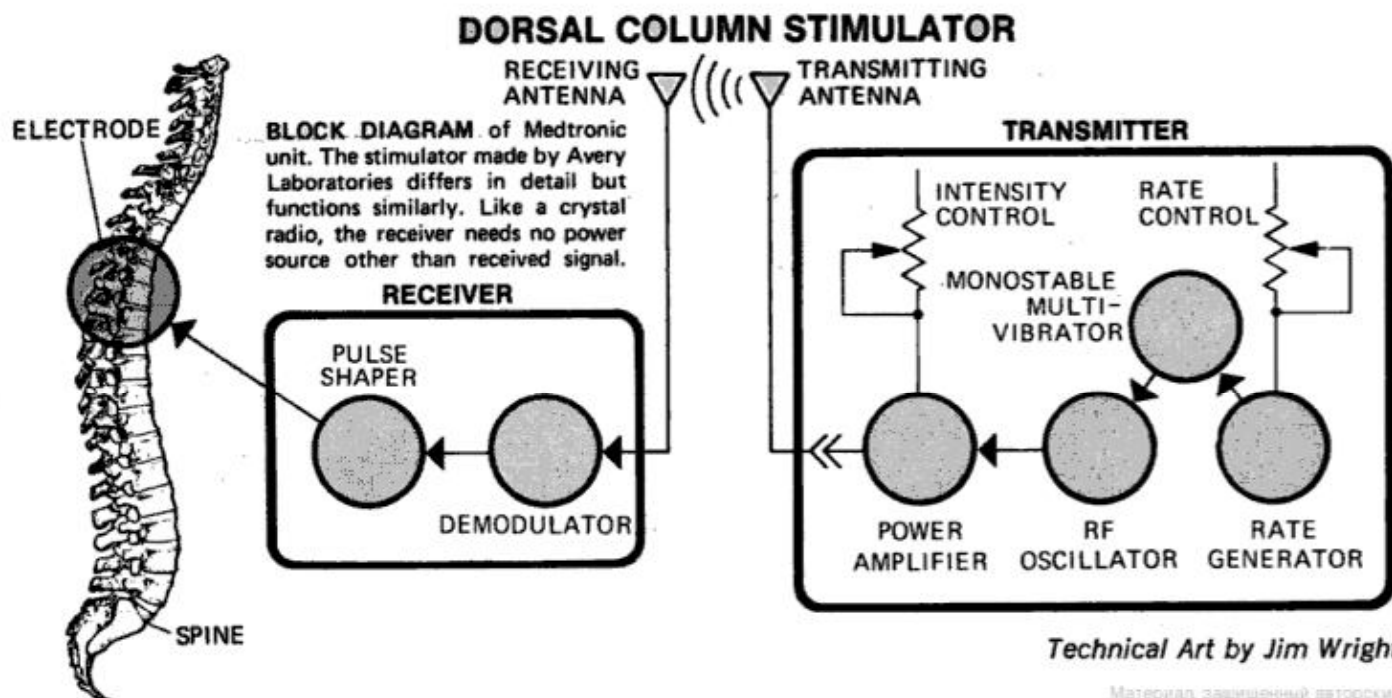



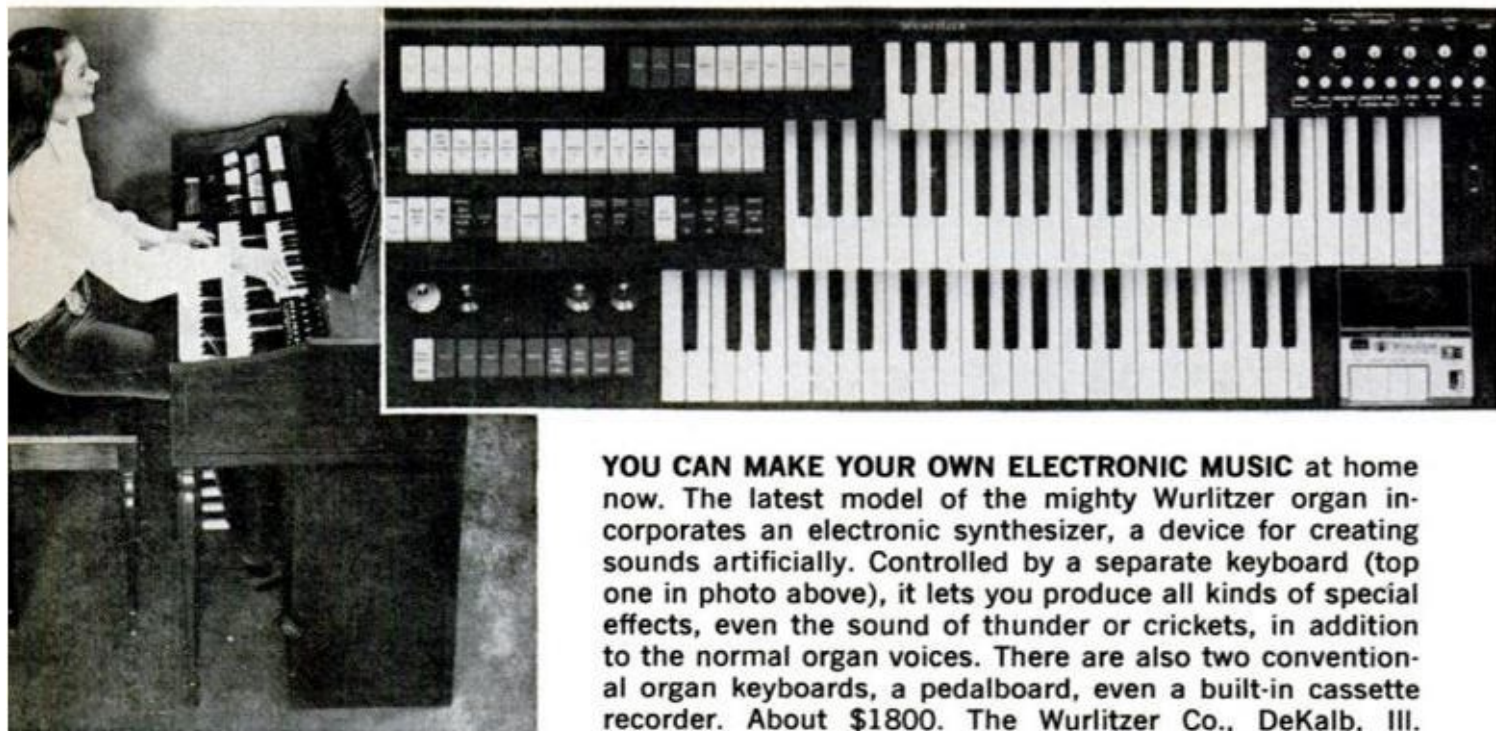

**YOU CAN MAKE YOUR OWN ELECTRONIC MUSIC** at home now. The latest model of the mighty Wurlitzer organ incorporates an electronic synthesizer, a device for creating sounds artificially. Controlled by a separate keyboard (top one in photo above), it lets you produce all kinds of special effects, even the sound of thunder or crickets, in addition to the normal organ voices. There are also two conventional organ keyboards, a pedalboard, even a built-in cassette recorder. About \$1800. The Wurlitzer Co., DeKalb, Ill.

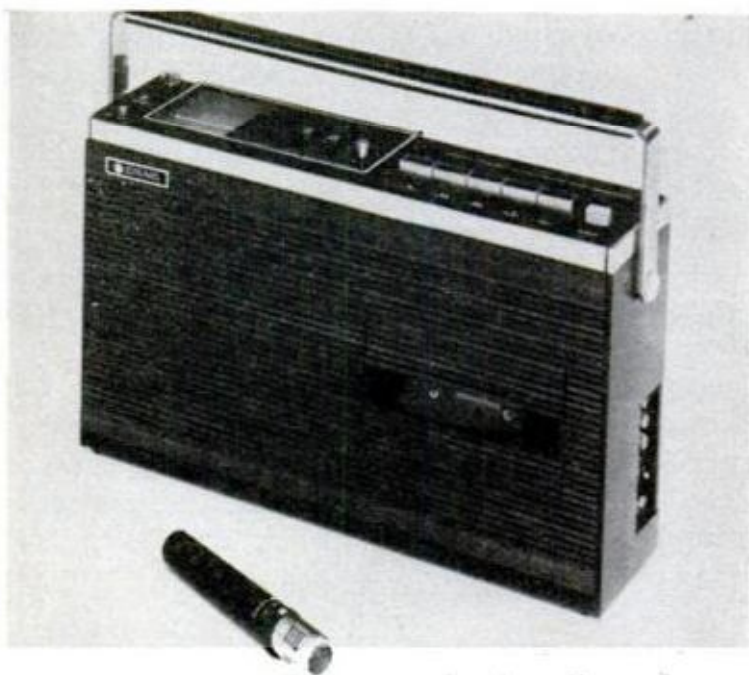

# New in

**YOU CAN STAND 30 FEET AWAY** and operate the portable cassette recorder at left without any wires between you and it. A special wireless microphone triggers an FM circuit in the recorder to start or stop it at will. All you do is press a switch on the mike and the machine begins recording or shuts off. Also included in the battery portable is an AM/FM radio. \$139.95, Craig Corp., 921 W. Artesia Blvd., Compton, Calif.

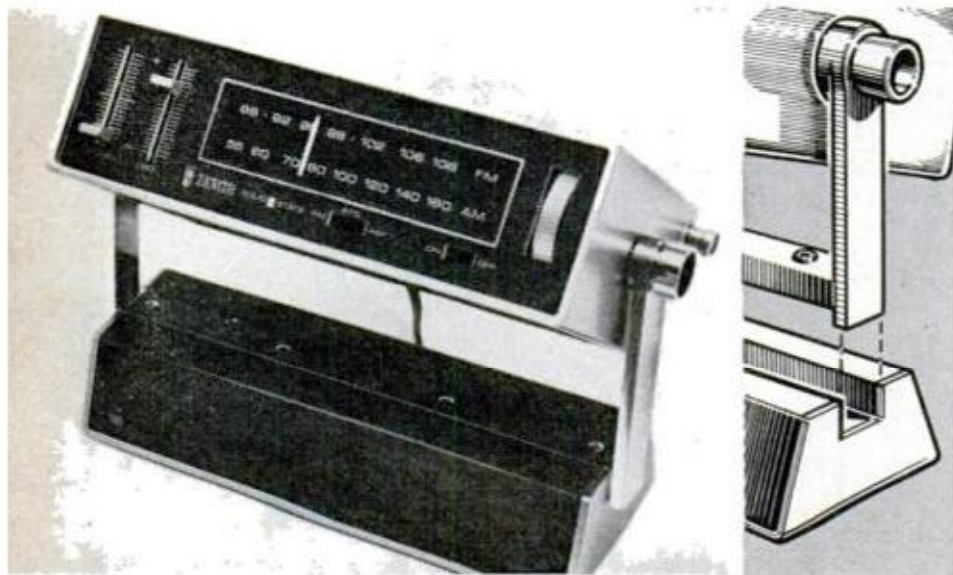

**NOVEL TWO-WAY RADIO** serves as both a table model and play-anywhere portable in one. As a portable, the AM/FM radio operates on built-in rechargeable nickel-cadmium batteries. At home, you slip pivoted handle into a slotted base that plugs into 117-volt house current. The base contains a charger that automatically restores the batteries as the radio plays on a.c. While locked in the base, the radio can be tilted to any of three angles for easy operation of its controls. \$49.95, Zenith Radio Corp., Chicago.





**IT'S SO ACCURATE** that this new quartz-controlled wristwatch varies by less than a minute a year. Instead of the usual balance wheel, it uses highly stable resonant frequencies from a tiny quartz oscillator to keep the mechanism precisely in step. It is powered by a miniature mercury battery lasting 18 months. A Longines watch made in Switzerland, it's expected to cost about \$360.



**ELECTRONIC PIANO TEACHER** tells you instantly whether you played the right note or not. Pressing each key lights up a bulb behind the corresponding note on the sheet music. If note and light don't coincide, you know you've made an error. David Beach of Stanford University developed the system.

# Electronics



**WANT TO HEAR RADIO BROADCASTS** through your car's cartridge tape player? Two new slip-in cartridge radio adapters give you a choice of AM/FM in one model or FM stereo in another. The adapters fit into the player's tape cartridge slot and operate from the car's regular antenna. Special two-way hookup cable makes it easy to attach the adapter radio to the antenna without disconnecting car's built-in radio. Sold by Audiotech, the AM/FM model is \$45 and the FM stereo model, \$54.

JULY 1971

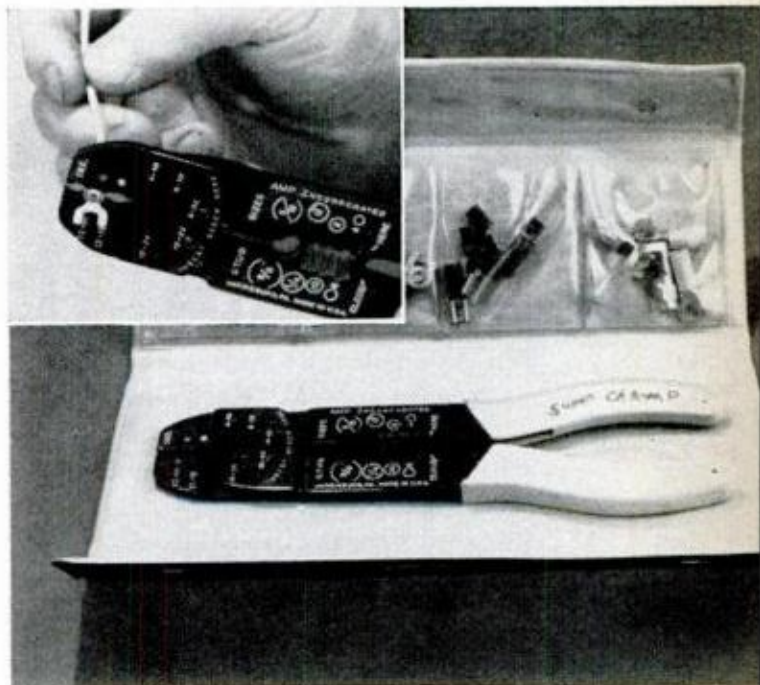

**EVERYTHING YOU NEED** to apply a variety of solderless connectors is included in this handy fold-up plastic kit. Compartments in the kit contain a selection of spade lugs, ring-type lugs, splices and slip-together connectors to fit several sizes of wire. Also included is a crimping tool that cuts and strips wire and shears bolts. Price is \$9.95, American Pamcor, Inc., Box 1776, Paoli, Pa.

73



**PM OWNERS REPORT**  
**BUICK OPEL**

A Nationwide Survey Based on  
870,000 Owner-Driven Miles



# Economy, Style and Handling Overcome the Shortcomings

By **MICHAEL LAMM**, West Coast Editor  
*Photos by Irv Dolin*

**B**UICK DEALERS offer quite a range of Opels this year—from the thrifty 1100-cc two-door (no longer called the Kadett but still the price leader at \$1878 p.o.e.) to the Vette-in-miniature GT sportster (\$3339 base and usually a wait for delivery).

Between these two, there's now the Opel 1900 series, available on these shores this year for the first time. Opel 1900s use the same 90-bhp engine as the GT and come in five body styles: two and four-door sedans, wagon, plus two coupes. All Opels have four-cylinder

**OPEL FUEL MILEAGE CHART**

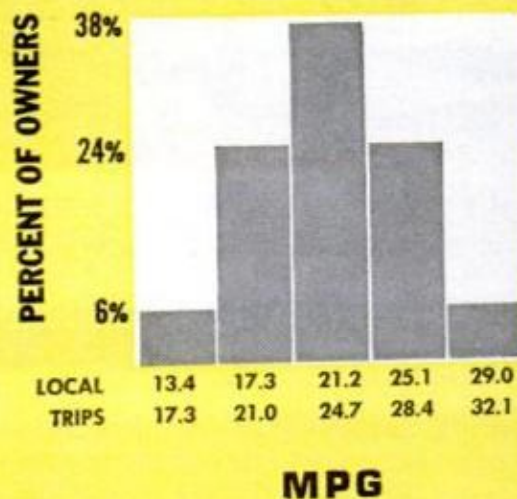



engines, four-speed transmissions, rack-and-pinion steering. All but the 1100 use disc brakes up front.

These imports are all engineered conventionally—unit body/chassis, engine up front, and rear drive. Opel, of course, is a GM subsidiary, and as such it's run by Germans with U.S. help. Opel styling of late has become quite Americanized, a reflection of Detroit talent lent to the Russelsheim studios, and all models definitely cater to U.S. tastes.

Styling, though, ranked second to economy as owners' reason for buying. Many echoed the sentiment of a Texas house mover: "I got tired of feeding gas-guzzling tanks all those years." Others pointed to ease of maintenance and repairs, and several younger owners (31.7 percent are under 25) mentioned insurance discounts.

Our questionnaires went to owners of all Opel series, including the older Kadett and fuel-mileage summaries



**REAR-SEAT HEADROOM**, say owners, is more than ample, but legroom in rear was found inadequate



and other comments had to be grouped. The photos accompanying the story, however, all show the latest 1900 coupe.

**Comfort.** "Shocks are tight, thus ride over sharp bumps is quite uncomfortable." "Car is a little unstable in crosswinds." "I am a traveling salesman and have taken the Opel on straight 600-mile trips. I have been very pleased with the ride. I tend to get drowsy when I drive my Impala for long stretches, but the Opel is fun enough to keep me alert." "Before the airconditioning was installed, front legroom was adequate, but now it's all gone." "I am 6-foot-4 and the front is comfort-

**STYLING OF 1900 COUPE**, car shown in all accompanying photos, is striking and great improvement over other models, owners agree. Interior is neat, but some ask for minor changes in seats and the dash





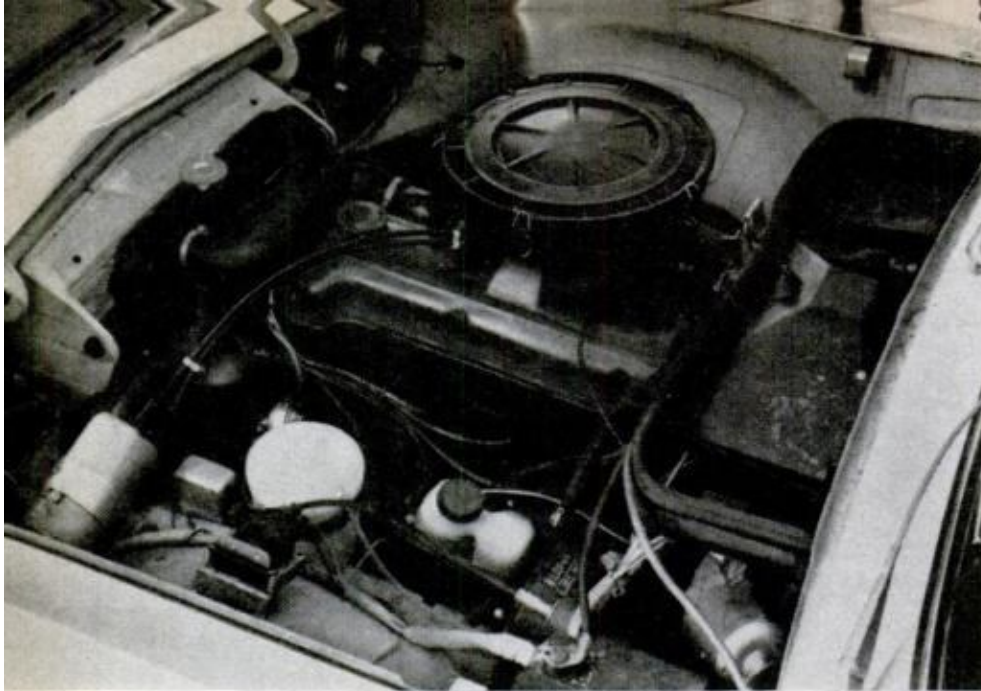

**ENGINE COMPARTMENT** of 1900 packs same 1900-cc, 90-hp, four-cylinder engine used in GT model. Car has much improved performance over 1100-cc models. All models have four-speed stick, rack-and-pinion steering; all but 1100s, front disc brakes. Owners like economy, but some want more power

able, but the rear is the same as in all small cars—if you're over seven years old, sit up front."

**Quality.** "One of the best." "Much better than most of the other cars we looked at and test drove." "Impressive, like VW. It's solid German workmanship—no rattles at all." "Good craftsmanship." "A lot of workmanship for the money." "Good, but nothing like

**REAR STYLING THEME** of 1900 coupe is well liked by owners, some of whom note similarity with GT models



**TRUNK ROOM** received specific praise from over 10 percent of owners. Efficient layout was also liked



Mercedes." "Excellent." "Better than U.S. cars." "Too many minor faults."

**Problems.** "Rear window leaks, rubber moldings improperly put on." "Oil leaks—with cast-iron block and pot-metal timing cover, expansion rates are different, causing this leak." "No room in front with factory-approved air conditioner installed . . . would never have ordered air if I had known." "I think the government's regulation to make seatbacks high enough to block whip-lash has cut vision so all cars are unsafe now. Rear passengers can't see out front and front passengers out back."

"My wagon keeps running on. Have had it back three times. Am using premium but she still diesels." "Bad ash-tray position." "Oil filter hard to change." "The way this car jacks up is ridiculous. With the screw jack and the location of lift holes, it's almost impossible to keep from scratching the paint or having the car fall off the jack."

**Specific likes.** "Easy handling and parking." "Holds road good at high speeds." "Low initial cost, excellent gas mileage, superior handling in city and on highway, good pickup, front-seat comfort." "Sporty looks." "Economical." "Well built." "Quite a large trunk for such a small car." "I keep getting over 28 mpg on regular." "I own two, a Kadett wagon and a GT. Both are well built, good-looking, easy-to-work-on cars. And both perform well."

**Recommendations.** "Windshield



washer switch should be on dash, not on floor." "Bigger glovebox." "Needs more power." "Softer suspension." "The GT shouldn't look like a midget Corvette." "Would like disc brakes all around and a larger engine." "More room in the back seat." "Shifting into fourth gear, you hit the ashtray with your hand." "Front bumper should extend out farther to prevent hood knicks from other cars while parking." "Hood support is Mickey Mouse." "A person shouldn't have to wait three months for a new taillight lens."

**Re dealers.** "Our dealer must be the best in the country; never a problem the warranty didn't take care of." "I brought the car in three times and the carburetor was still the same. The service manager blamed problem on design, said all Opel carbs had same problem." "Extremely well satisfied." "The dealer here is slow and unresponsive; it took four months to get some weatherstripping." "I did a lot of looking and got the best deal from Opel dealer." "My dealer is courteous and fair but Buick-Opel doesn't seem to have a workable parts distribution system or an effective mechanic training program. There is a tendency to call poor performance 'normal operation.'" "After



**OPEL HANDLING** got top billing from nearly 60 percent of owners who like it more than the economy!

comparing it (1900 wagon) to Datsun and Toyota, my only reason for buying Opel was availability of service."

The parting shot comes from a missionary. "We returned to the United States about a year ago after 20 years in Africa, where we drove a variety of cars—VW, Vauxhall, Daihatsu, Jeep and Opel. The last was our favorite all around. So after wrestling a 1966 Catalina for almost a year, we traded for a new Opel 1900 wagon. It is much easier to park and drive, more economical, and I have been most impressed with the way it handles in western New York's snowbelt." ★★★

## Summary of 1971 Opel Owners Reports\*

Total miles driven	871,044
<b>Average miles per gallon</b>	
Local driving	21.2
Long trips	24.7
<b>Series:</b>	
Kadett 1100	13.6%
1900 series	53.3
Rallye 1900 coupe	19.6
GT sportster	13.6
<b>Body styles:</b>	
4-dr. sedan	5.7%
2-dr. sedan	38.5
coupe	29.9
wagon	25.9
<b>Why the Opel?</b>	
Economy	50.7%
Style	36.8
Size	16.8
Past experience	11.0
Handling	8.6
Price	7.7
Performance	7.2
<b>Specific likes:</b>	
Handling	59.7%
Economy	51.5

Style	47.1
Comfort	20.4
Ride	14.1
Trunk room	10.7
Power	10.7
<b>Specific dislikes:</b>	
Economy	14.7%
Rattles	12.2
Dealer service	8.6
Power too low	7.1
Harsh ride	6.6
Carburetor problems	6.1
<b>What changes would you like?</b>	
More power	9.6%
Seat style	6.9
More legroom	6.4
Interior style	5.3
Bigger tires	5.3
Better dash layout	4.8
Better materials	4.8
<b>Had any mechanical troubles?</b>	
No	59.7%
Yes	40.3
<b>What kind of trouble?</b>	
Carburetor	29.8%
Electrical	16.7
Oil leaks	9.5

Brakes	7.1
Shifting mechanism	6.0
<b>Did you repair it yourself?</b>	
No	96.5%
Yes	3.5
<b>Dealer repairs satisfactory?</b>	
No	53.0%
Yes	47.0
<b>Is the Opel your only car?</b>	
No	62.1%
Yes	37.9
<b>Other cars owned:</b>	
Chevrolet	19.2%
Pontiac	18.5
Buick	18.5
Ford	12.3
Oldsmobile	8.5
Volkswagen	7.7
<b>Age distribution of owners:</b>	
15-29 years	48.5%
30-49 years	35.0
50-plus	16.5
<b>Would you buy another Opel?</b>	
Yes	74.3%
No	25.7

\*Percentages might not equal 100% due to rounding and/or insufficient data.



# First Look at the

By MORT SCHULTZ

Illustration by Roy Grinnell

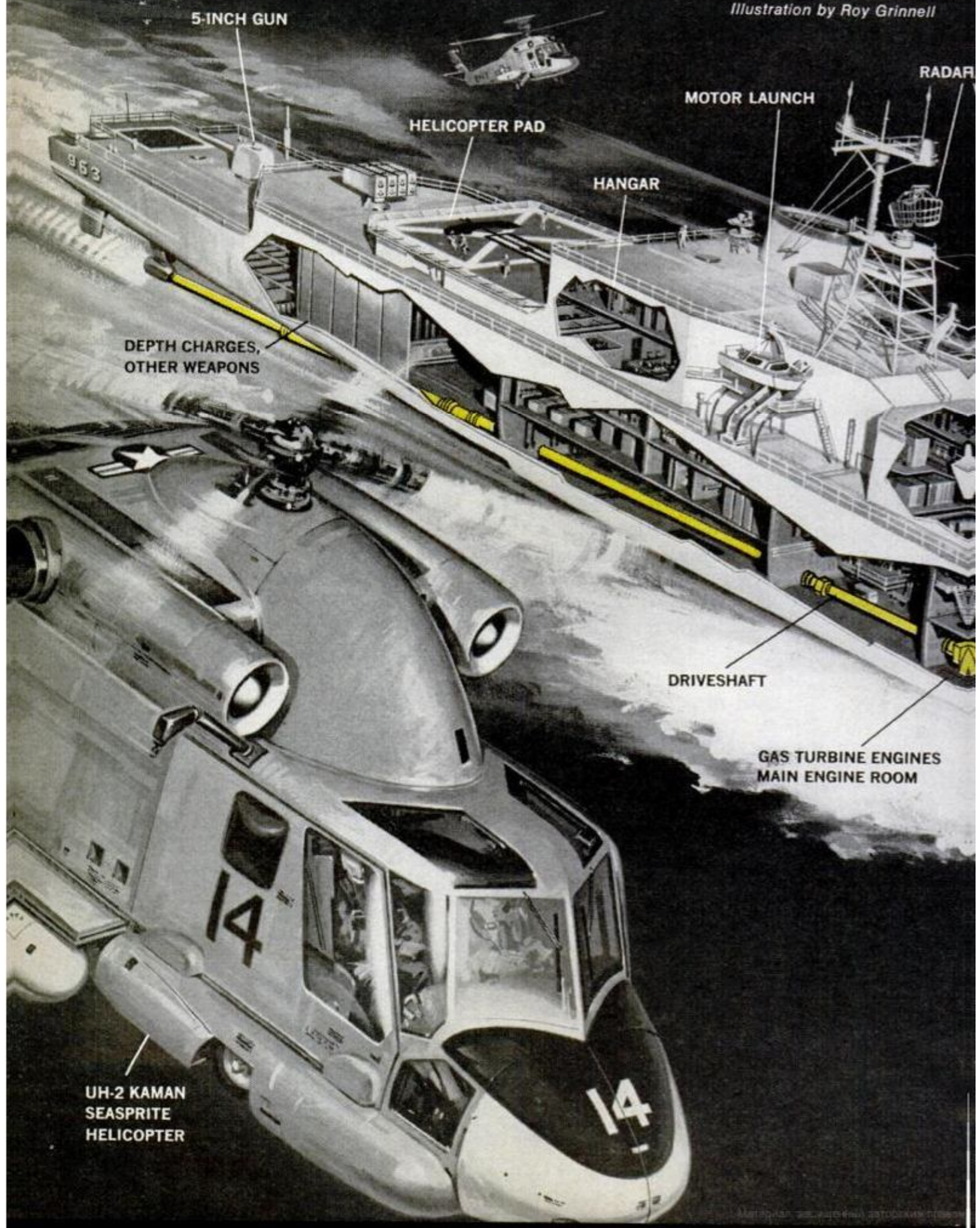

5-INCH GUN

HELICOPTER PAD

MOTOR LAUNCH

RADAR

HANGAR

DEPTH CHARGES,  
OTHER WEAPONS

DRIVESHAFT

GAS TURBINE ENGINES  
MAIN ENGINE ROOM

UH-2 KAMAN  
SEASPRITE  
HELICOPTER

14



# Navy's New Destroyer

The quietest ship in the fleet will have long eyes—her own helicopters; big ears—advanced underwater surveillance gear; and a mighty punch—rocket-assisted torpedoes that home on enemy subs.

THEY WON'T BE LAYING THE FIRST PLATE for the DD-963 until early in 1973, but the new destroyer will be ready in time to counter the growing threat of Soviet submarines.

"Our present antisubmarine warfare capability is good enough to offset today's threat," says Rear Adm. R. E. Henning, director of ship production of the Navy's bureau of ships. "It's the future that concerns us.

"Our destroyer fleet, which consists almost exclusively of World War II ships, won't be able to cope with what the Soviets will throw at it by 1975," he explains. "This is why

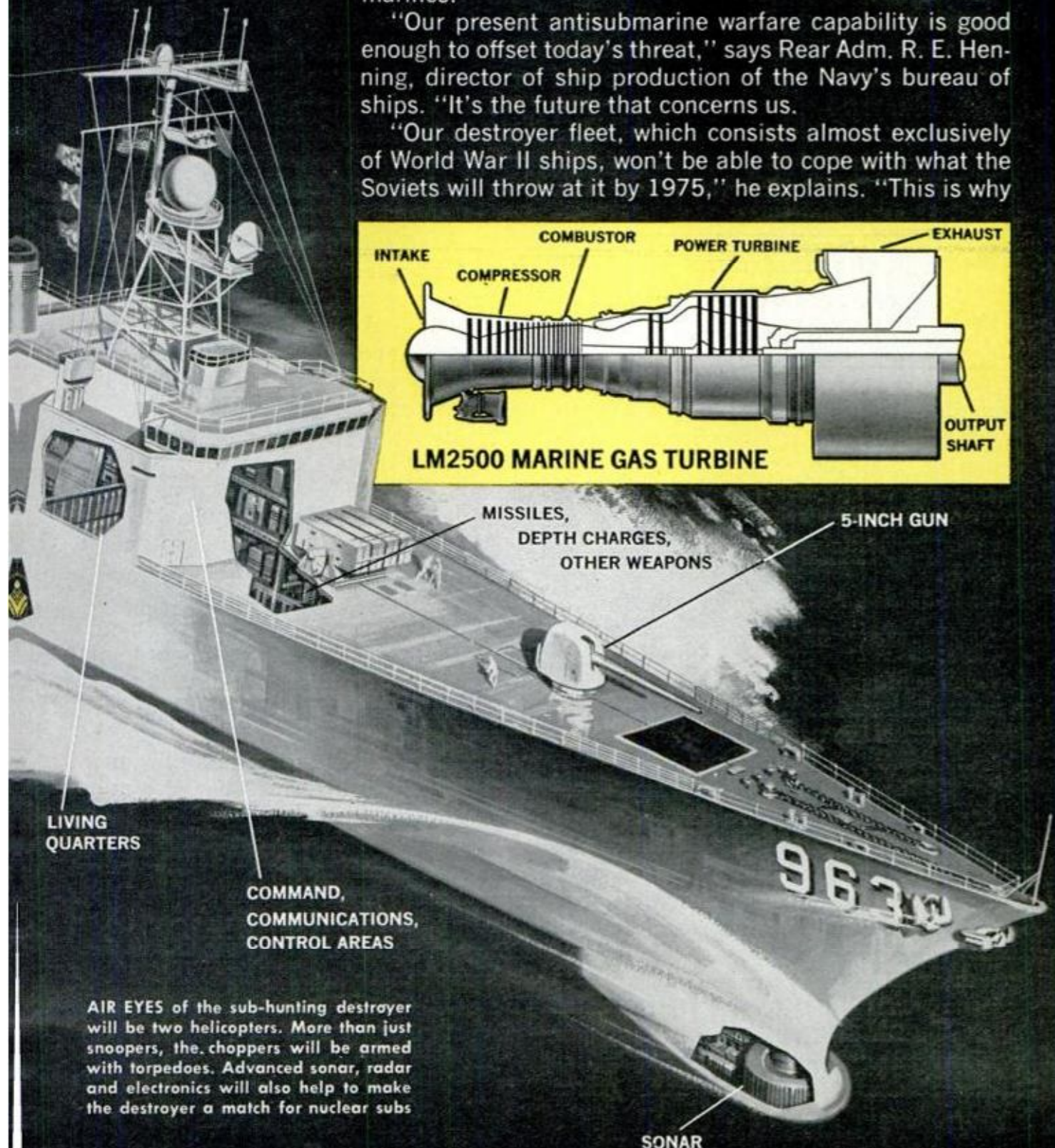

**AIR EYES** of the sub-hunting destroyer will be two helicopters. More than just snoopers, the choppers will be armed with torpedoes. Advanced sonar, radar and electronics will also help to make the destroyer a match for nuclear subs



we are about to build the DD-963."

The first DD-963, called the Spruance class in honor of the late Adm. Raymond A. Spruance, who commanded the Fifth Fleet at the Battle of the Philippine Sea, June 1944, will be launched in 1974. Thirty are planned at a cost of \$83.4 million per ship.

Vice Adm. Hyman Rickover, father of the atomic submarine and this country's leading authority on undersea craft, explains the magnitude of the Russian threat in this way:

"The Soviets in the last two years have introduced more new submarine designs than have ever been put to sea in all of naval history during a comparable period. They continue to strive for improvement in sub design."

One design the Russians are now

---

**... the destroyer will carry ... two torpedo-armed helicopters.**

---

testing is a ballistic missile with a 3000-mile range that is fired from a submarine that they call, ironically, the Yankee class. This represents a big step-up in power from the 50 or so subs the Russians now have that can hit targets 1300 miles away with ballistic missiles. From the Gulf of Mexico, these subs could blast Chicago, Detroit, New York and other targets with nuclear missiles. It's estimated that the Soviets also have about 300 nonnuclear subs. In a conventional war, they would be used to sink our ships—with torpedoes and ship-to-ship missiles—and deny us use of the seas.

Ship-to-ship missiles are referred to by Navy men as antiship cruise missiles. One type, the Russian Styx, has a 22-mile range, greater than that of many guns carried by our warships.

The Israeli navy can vouch for the effectiveness of the Styx. On the night of Oct. 21, 1967, the Israeli destroyer *Elath* was patrolling off Port Said at the mouth of the Suez Canal when

three Styx missiles fired from the Egyptian destroyer *Osa* blew her out of the water.

How the DD-963 will actually detect, track and destroy missile-firing enemy subs is obviously a secret. It's known, however, that a major weapons system the destroyer will carry is comprised of two torpedo-armed helicopters. They extend the ship's antisubmarine warfare (ASW) arm by hundreds of miles.

The use of helicopters is in line with a new Navy program called LAMPS—Light Airborne MultiPurpose System. It calls for putting helicopters on 100 or more destroyers for ASW missions.

The new destroyer will also be armed with rocket-assisted ASW torpedoes and, scuttlebutt has it, with nuclear depth charges. And, it will house the latest electronic warfare equipment.

Navy officials wince when you mention electronic warfare—it's that secret. So we have no way of knowing exactly what the DD-963 will carry. However, there undoubtedly will be equipment on board to jam guidance systems of enemy missiles and torpedoes.

No doubt, if a black box is ever developed that will cause an incoming missile or torpedo to turn around and head back to its launcher, the DD-963 will be able to accommodate it. In planning the DD-963, allowances have been made for weapons and systems that may be developed 10 years from now.

The new destroyer will be equipped with Sparrow air defense missiles and two five-inch guns. Although the primary mission will be ASW, it may be asked to carry out normal gunfire missions in support of amphibious assaults and certain land operations.

According to R. H. DuBois of Litton Industries, the company building the new destroyers, "The DD-963 will be the quietest surface warship in the Navy, which will give it a great tactical advantage during ASW missions." (DuBois is the Litton vice-president in charge of the program.)

The destroyer's silence is due mainly to its gas-turbine powerplant, which



## HOW DD-963 STACKS UP AGAINST A WORLD WAR II DESTROYER

	USS <i>Allen M. Sumner</i>	DD-963
Commission Date:	1944	1974
Length:	376' 6"	559'
Beam:	40' 10"	54'
Speed:	35 knots	40 knots (estimated)
Displacement:	2200 tons	7000 tons
Crew:	350	250
Aircraft:	None	2 helicopters
Armament:	Six 5-inch guns; Ten 21-inch torpedo tubes	Rocket assisted torpedoes Nuclear depth charges Air-to-air missiles Two 5-inch guns <i>(Above information unofficial)</i>
Propulsion:	Two main steam turbines driving two shafts	Four gas turbines driving two shafts

purrs like a kitten compared to the big steam turbines of our present day destroyers. The *Spruance* will be the first U.S. warship to use gas turbines.

Gas turbines allow "all ahead flank" one minute after start-up from cold iron. This is a far cry from the couple of hours required by the steam jobs.

The gas turbine in the DD-963—there will be four—is the General Electric LM 2500, a marine version of the jet engine that powers the giant Lockheed C-5 air transport. The four engines will produce 80,000 shp (shaft horsepower) and drive two screws.

The engines can be used together or independently. This capability, coupled with two reversible-pitch screws, adds to the destroyer's maneuverability. Reversible-pitch screws are also used because gas turbines, like jet engines, can't be put into reverse gear. Reverse thrust is used.

The gas turbines also will contribute to a cleaner environment by burning a distillate fuel instead of the Navy's standard fuel oil. The new fuel burns cleaner and doesn't coat boilers and fuel lines with sludge that has to be cleaned out and dumped overboard.

Like many other things aboard the DD-963, the LM 2500 turbine is designed with automation in mind. It is started, by pushbutton and controlled by a single power throttle. Only one helmsman is needed—not the usual two.

The *Spruance* will be equipped with automatic troubleshooting gear. For example, the combat control system will have self-testing computer hardware with indicators to pinpoint a malfunctioning module or circuit board. The ship will be made as maintenance-free as possible, with the use of the latest paints, plastics and space-age circuitry. Accordingly, it will require fewer men to run it than present destroyers—250 as compared to 350.

The destroyer will be produced at Litton's Ingalls West Shipyard in Pascagoula, Miss. It will be built in modular form, for which Japanese and Swedish shipyards are famous. Four large sections (modules)—fore, amidships, aft and superstructure—will be fabricated and joined at final assembly.

Structurally, the DD-963 compares to the light cruisers of World War II. The USS *Oakland*, for instance, commissioned in 1943, had a 6000-ton displacement. The DD-963's displacement will be about 7000 tons. Overall length of the *Oakland* was 541 feet with a beam of 52 feet 10 inches. The *Spruance* will be 559 feet long and have a beam of 54 feet. The *Oakland*, however, required a crew of over 600 men.

The DD-963 has a tough assignment: to counter Russia's nuclear sub threat of the future. Navy men think she will have the sensitive ears, high speed and big punch needed to do the job. ★★



# Just patented

## PM'S PICK OF THE NEW INVENTIONS

Prepared in cooperation with Roger S. Shashoua, Director, International Inventors Assn., Inc.

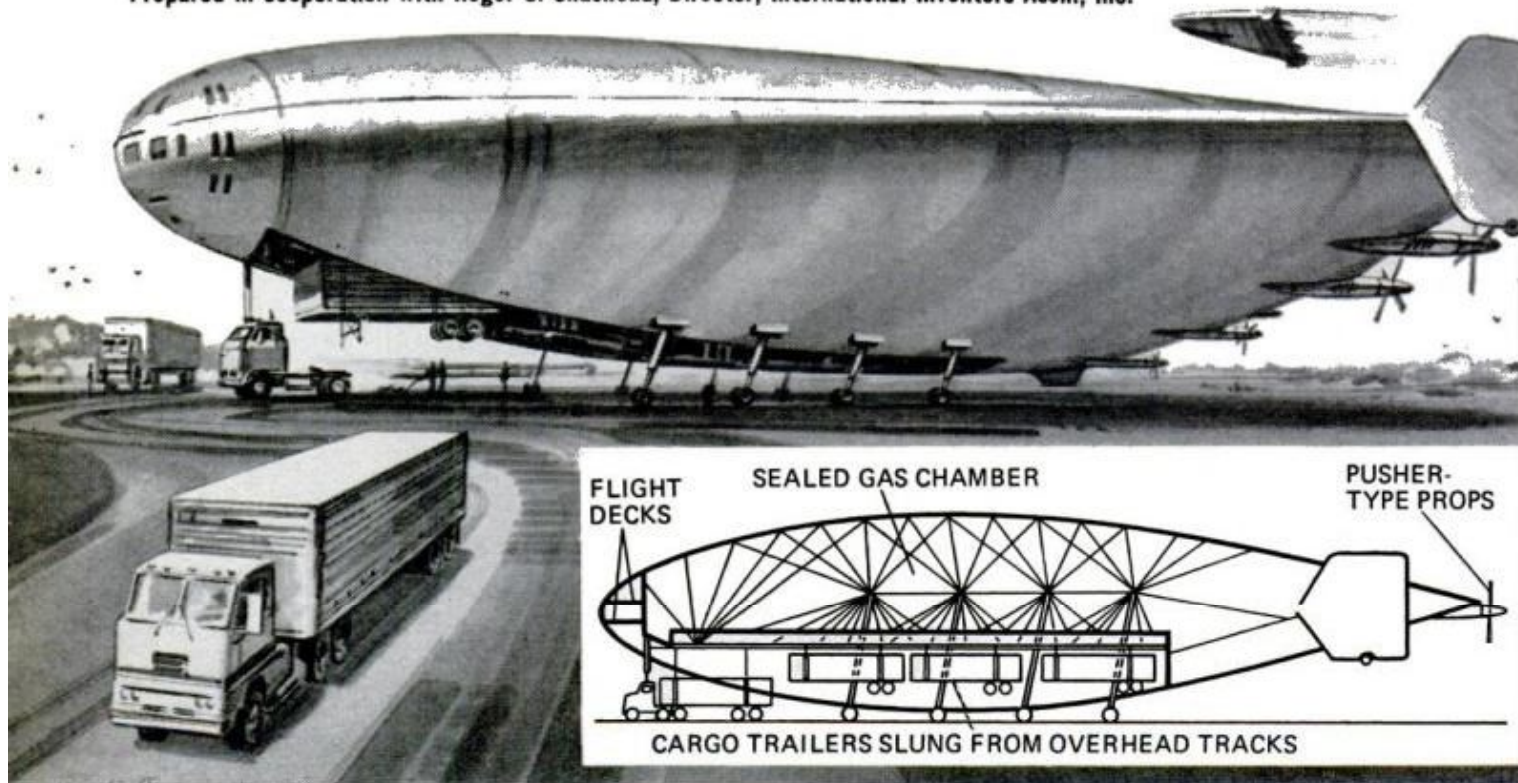

**1. HALF AIRPLANE, HALF DIRIGIBLE**, this monster hybrid is designed to combine the advantages of both. The rigid, wing-shaped fuselage has the speed of an airplane, but gets added lift from a gas-filled chamber, enabling it to carry many times more cargo weight. Huge cargo trailers are backed under

the loading doors and hoisted by cranes onto overhead tracks for fast transportation to distant points. At the landing site, tractor units pick up the trailers for delivery to local destinations, thus saving long hours of road travel. The giant ship is powered by pusher props along the trailing edge

**2. JUST FLIP IT OVER** and this two-way pickup camper becomes a small outboard-powered houseboat so you can enjoy vacation travels on either land or water. The camper's slope-sided roof doubles as a shallow hull when the structure is inverted. Inside, duplicate rows of built-ins serve as overhead

cupboards or seats and bunks, depending on which is on top. Twin sink and cooking facilities can be used in either position, and a removable table fits into a socket in the floor or roof. Hydraulic jacks are used to tip the camper body out of the pickup, like a dump truck, for launching in water

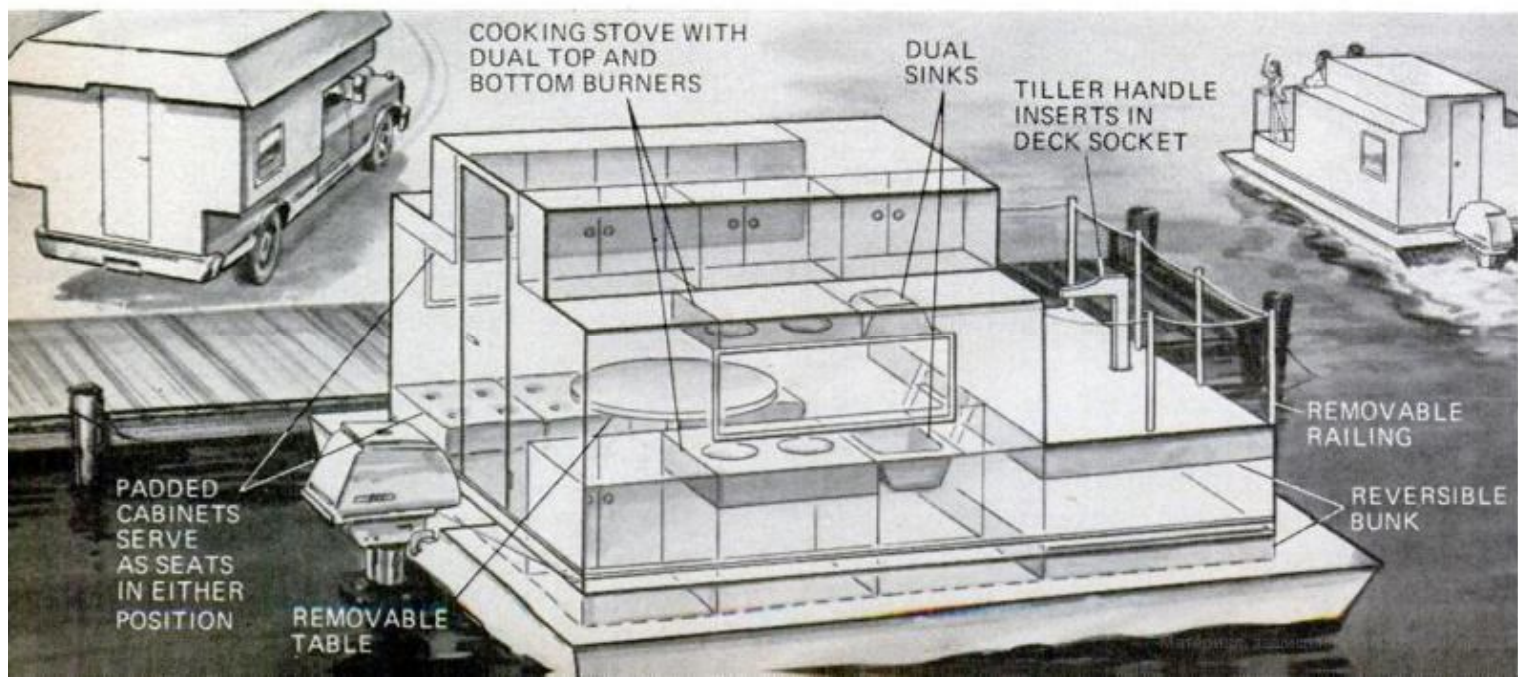



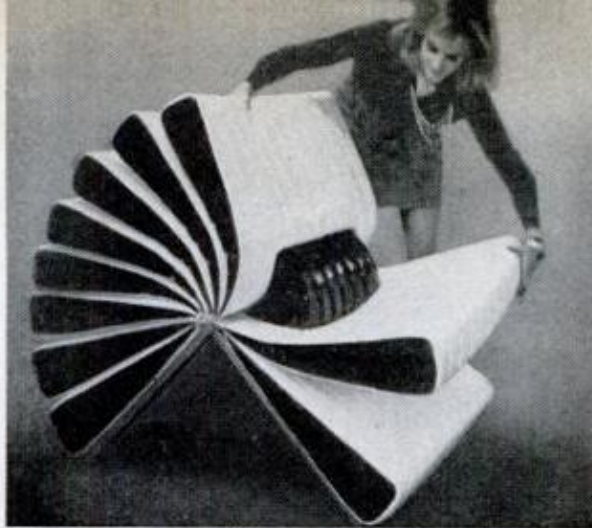

**3. IT LOOKS LIKE A GIANT BOOK**, but it's really a chair. Turning its "pages" lets you adjust its height and angle of tilt to convert it from a straight-back seat to a reclining lounge—or anywhere in between. The wedgelike plastic segments are loosely attached to a metal frame so they can be flipped over one at a time to vary the seat's shape. To reverse its direction, you merely flop it over without turning it

**5. HOW DO YOU ATTACH A ROPE** to a post when you can't reach the post? This ingenious boat hook does the job for you. As you near the dock, you slip the end around the post. The end holds a loop of rope in a spring clip. You then extend a wire

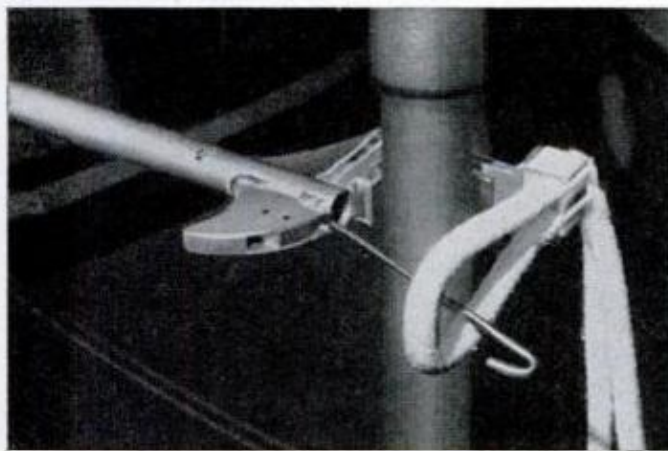

Inventors of the items shown on these pages are as follows: 1. John R. Fitzpatrick, Levittown, Pa. and Juergen K. Bock, Toms River, N. J. (No. 3,486,719); 2. Gerald R. Platt, 5909 Emigration Canyon, Salt Lake City, Utah (No. 3,522,967); 3. Pierre Cardin; 4. Pierre Tanguy, Pierre Carre and Jean Le Boulbouech, 2 Rue Bodelio, Lorient, France; 5. Rudic Products, Ltd., Moorside Rd., Winnall, Winchester, Hampshire, England. The International Inventors Assn., Inc., is located at 680 Fifth Ave., New York, N. Y. 10019.

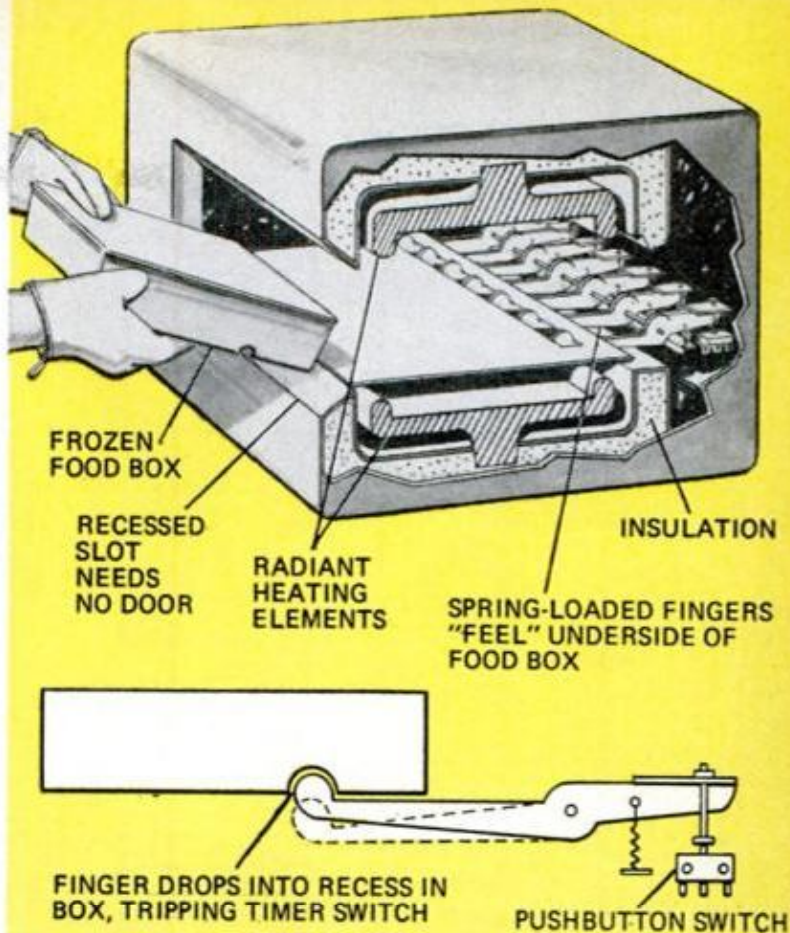

**4. AUTOMATIC COOKING** is the object of this clever self-regulating electronic oven. It's designed to take frozen foods packed in specially coded containers. Each package has a series of small recesses in the bottom arranged in a coded pattern according to the type of food it contains. Spring-loaded feeler switches inside the oven are triggered by the coded recesses, setting up a circuit that automatically determines the correct cooking time and temperature for the food

hook, as shown in the photo at left, below, snaring the loop on the opposite side of the post. As you withdraw the tool, the loop slips out of the spring clip, as in the drawing at right, and the free end is pulled back to the boat, snugly anchored around the post

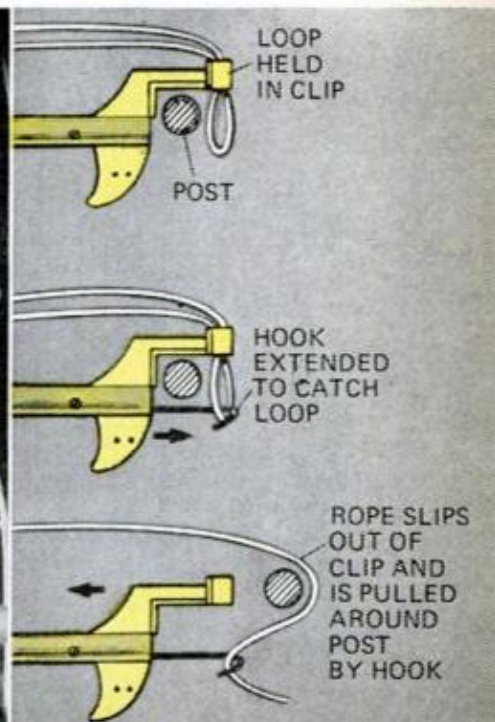



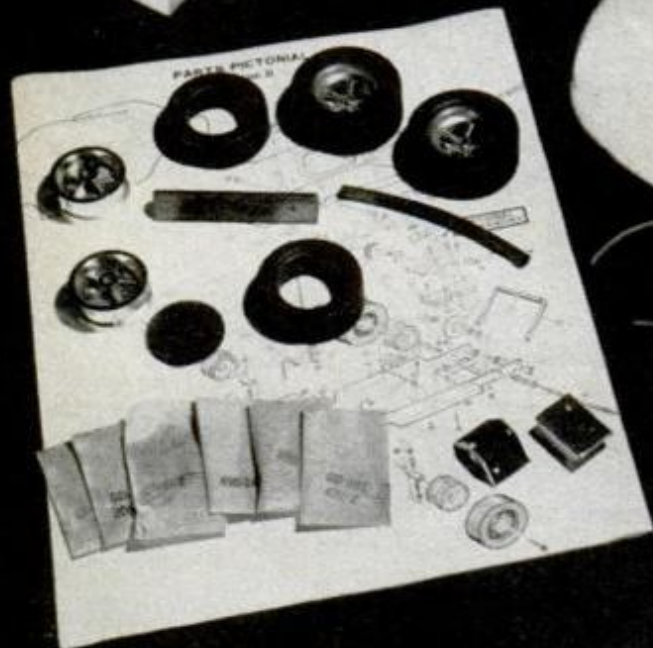

# Small-Scale Car, Big-Scale Thrills

Heath's gleaming new radio-controlled model racer hits 200 mph in scale speed and handles with all the excitement of its big brothers. You can build it from a kit

By SHELDON M. GALLAGER



**TRANSMITTER** has two joy sticks, one operating crosswise to control steering and other up and down for throttle and brake. Telescoping antenna pulls out from top

**T**WENTY-FIVE MILES AN HOUR may not sound very fast, but when it's a 20-inch-long model racing car roaring along, that's a scale speed of 200 mph! Operating two miniature control sticks, you deftly guide the screaming car through harrowing S-turns, pull it out of near-disastrous slides and slam it down straightaways just as if you were actually behind the wheel of a full-size Grand Prix racer.

This is the kind of fun you and the kids can have with Heath's sporty new speedster, the company's first R/C model car kit. Called the Spectre, the car is powered by a .19 model-airplane gasoline engine and really does hit true speeds of up to 25 mph—fast for models of this type. It's controlled remotely through a tiny radio receiver hidden under the hood. Two joy sticks on the transmitter give you control of steering, accelerating



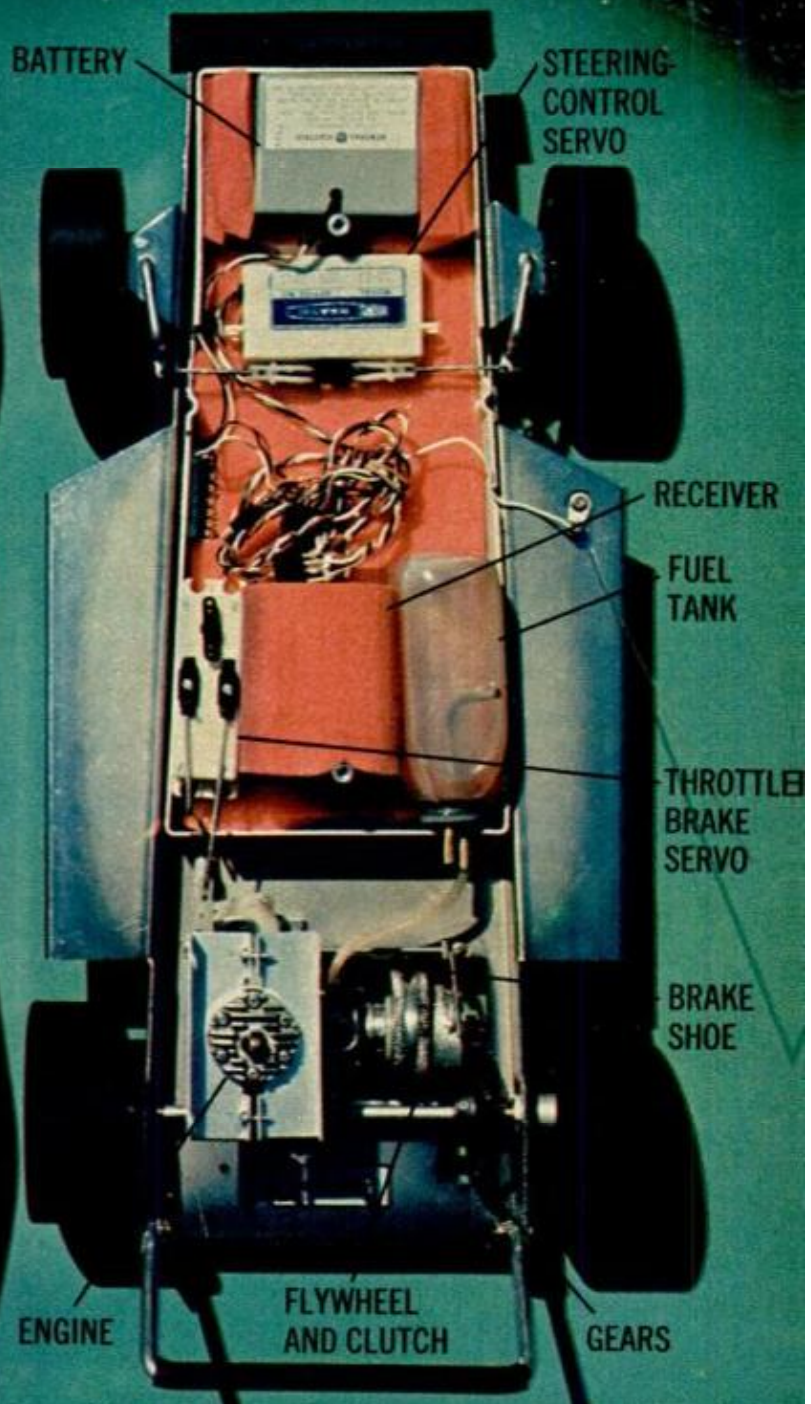
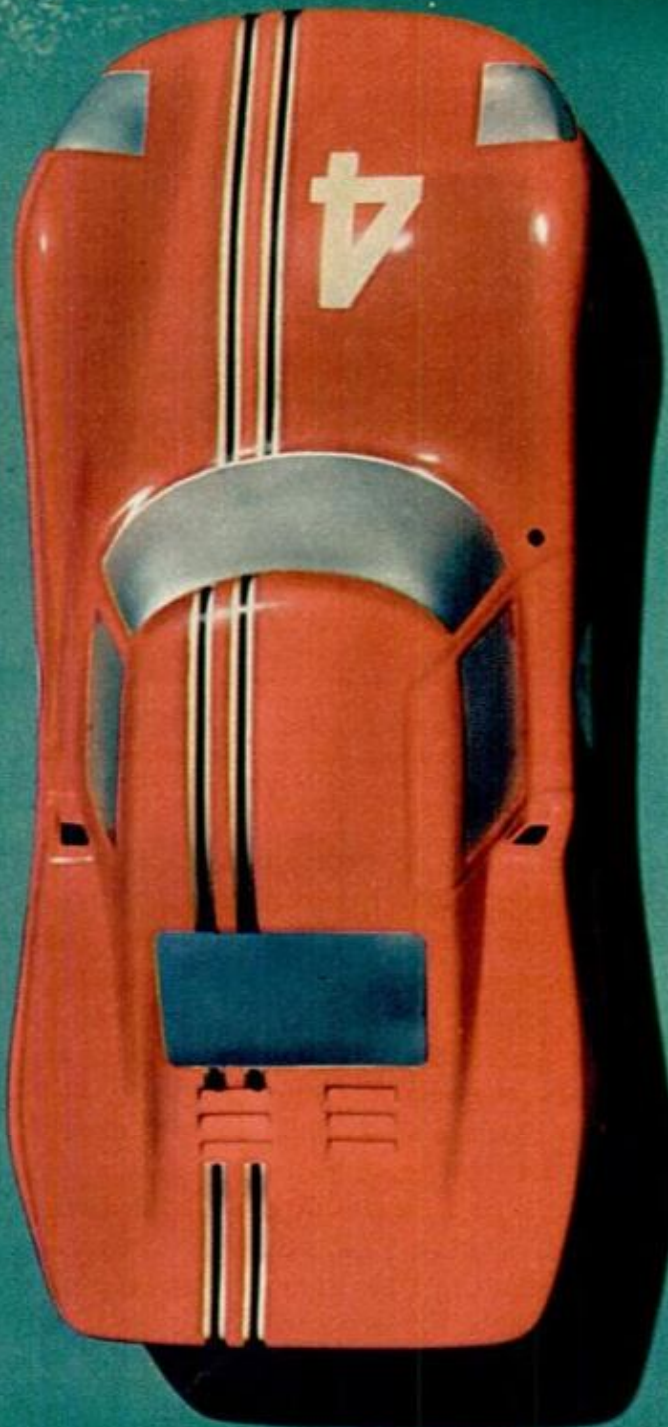

Photograph by Fred L. Wolff



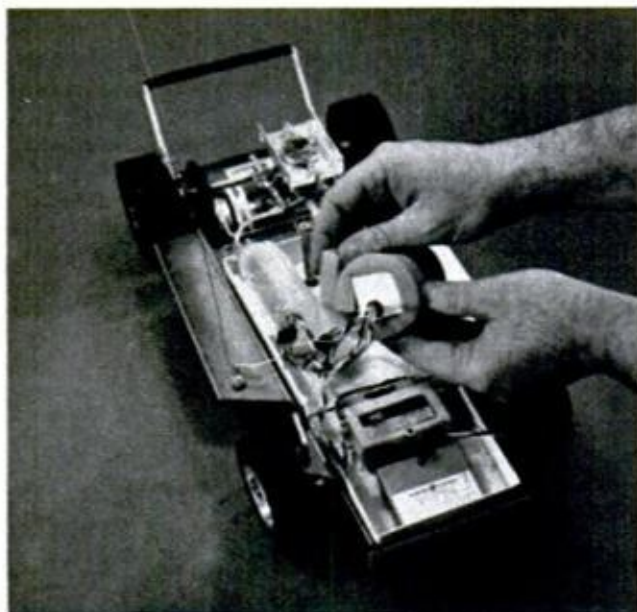

**DELICATE PARTS** are wrapped in foam padding to cushion them from road shocks. Receiver, fuel tank and throttle/brake servo go in center of the chassis

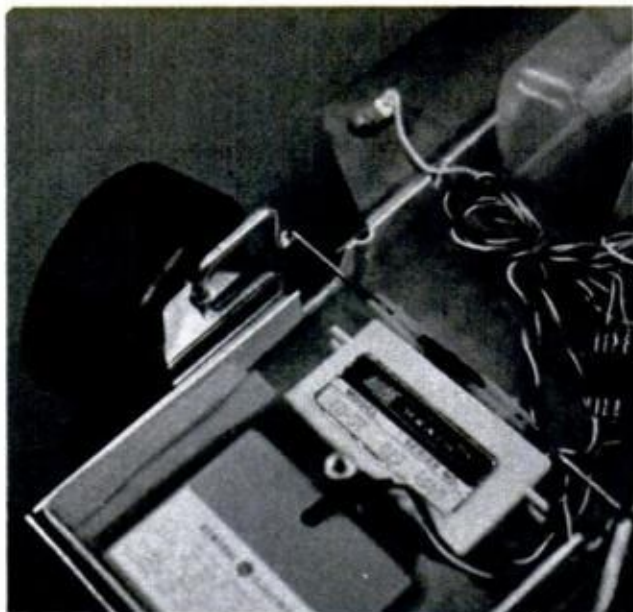

**RACER'S NOSE** houses battery and steering servo. The servo is linked to control arms on the wheels so that the wheels turn as it moves from side to side

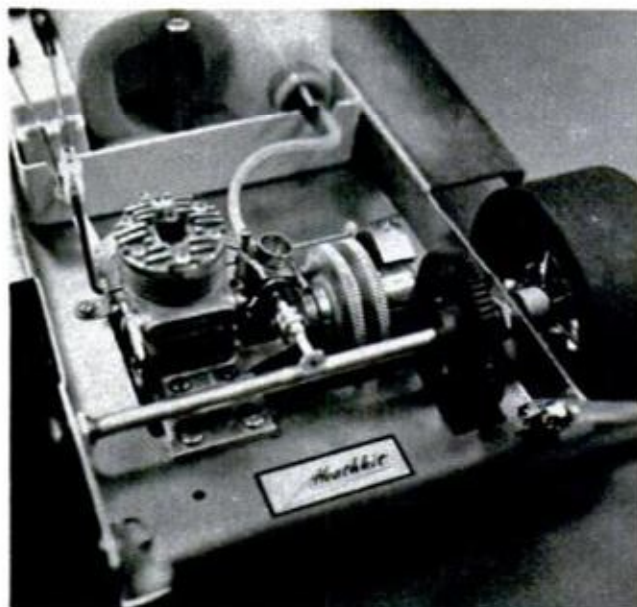

**MOUNTED SIDEWAYS**, tiny power train runs from engine at left through flywheel and clutch to gears at right. Brake shoe bears against clutch housing



**PLASTIC BODY** quickly snaps on and off chassis with no other fastening. This enables you to get inside easily to start the engine and make adjustments

and braking. You can head into a turn at full throttle, then "back down" fast by hitting the brakes just as real racers do. Controlled slides are possible through nimble handling, and occasionally you go into a spinout that's as spectacular as any you see on big tracks.

The model is built to a 1/8th scale with a wheelbase of 12 inches and an overall length of nearly 20. Fat rubber tires and a wide track of over 7 inches give it good stability at high speeds. The detailing is so fine you can actually adjust the caster and toe-in on the front wheels

for maximum performance. A gear reduction of 5.5 to 1 provides good torque. Two servomechanisms operate the steering and throttle/brake linkages.

By itself, the Model GD-101 car kit sells for \$49.95. The engine is \$19.95 and comes assembled. The Model GD-57 radio control is \$129.95 in kit form. It includes the transmitter, receiver, two servos and rechargeable batteries. While only two channels are required for operating the racer, a third channel is available for other model-control applications. ★★★



# New in Photography

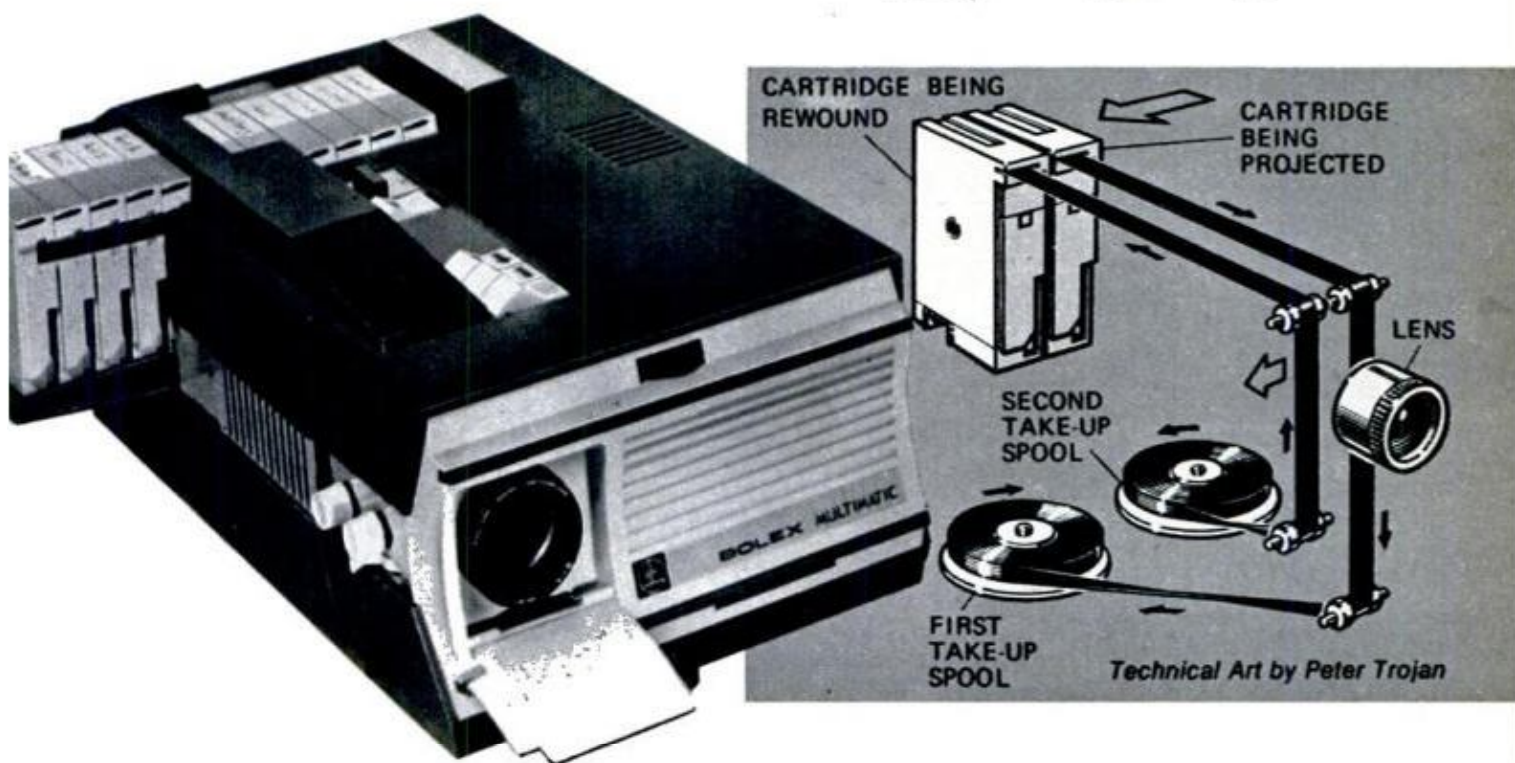

**FIRST CARTRIDGE-CHANGING MOVIE PROJECTOR** is this ingenious Bolex Multimatic. You load in up to six cartridges of Super-8 film and they're projected one after another just like a record changer. Each cartridge is automatically rewound as the next one is being shown so your viewing is uninterrupted through the whole stack. This is made possible through the use of separate take-up reels, as shown in the drawing. Plastic cartridges take standard 50-foot reels of film. Price not yet announced. Paillard, Inc., 1900 Lower Rd., Linden, N. J.

**IT'S A CAMERA GRIP, CLAMP, TRIPOD**—it's all these things in one. The versatile photo aid will serve as a camera grip for steadier hand-held shots. It will clamp a camera to any handy support, such as a table, post or fence railing. Its miniature pan-and-tilt head can be raised and lowered on a geared elevator column for precise adjustment of camera level. Clamped to accessory legs, it becomes a shorty tripod for tabletop photography. The Miida Tri-Clamp is sold by Ace Photographic Supply Corp., 132 Ipswich St., Boston, Mass. Price is \$22.50.

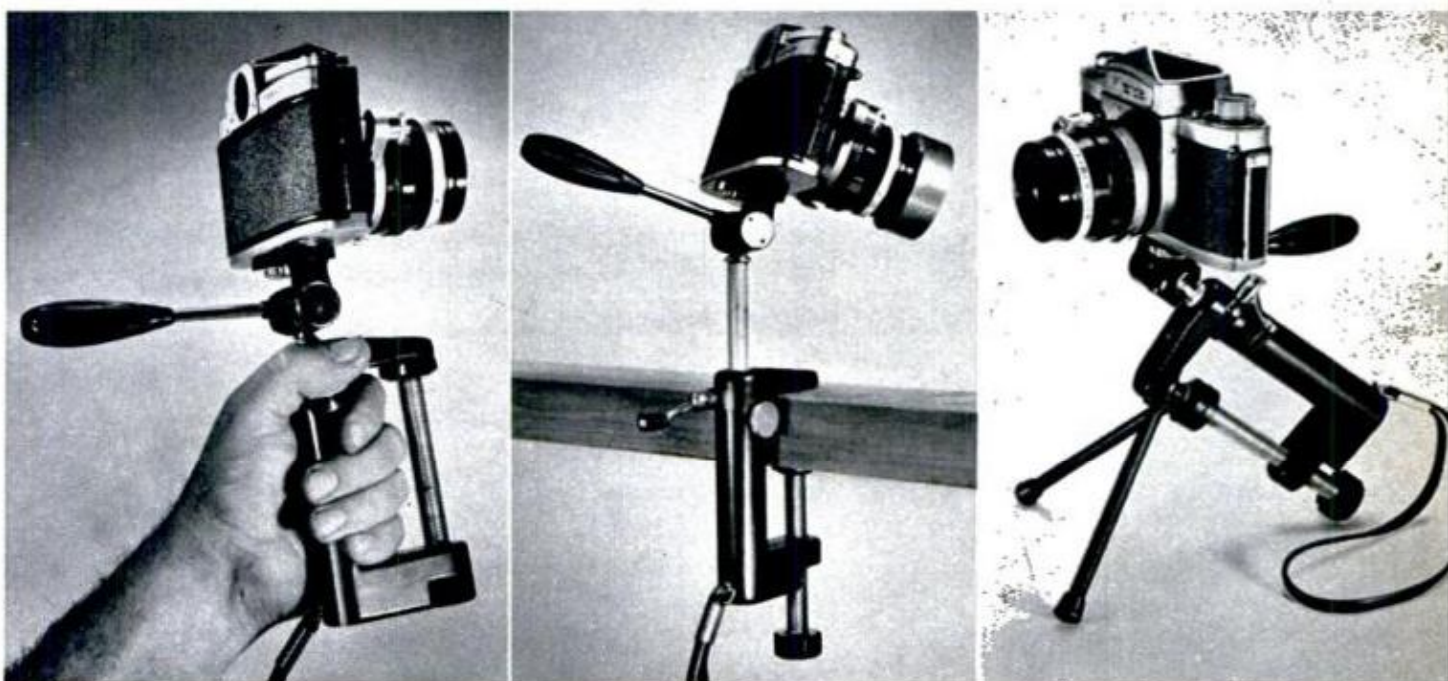



# They Can Take Your Temperature With a Camera

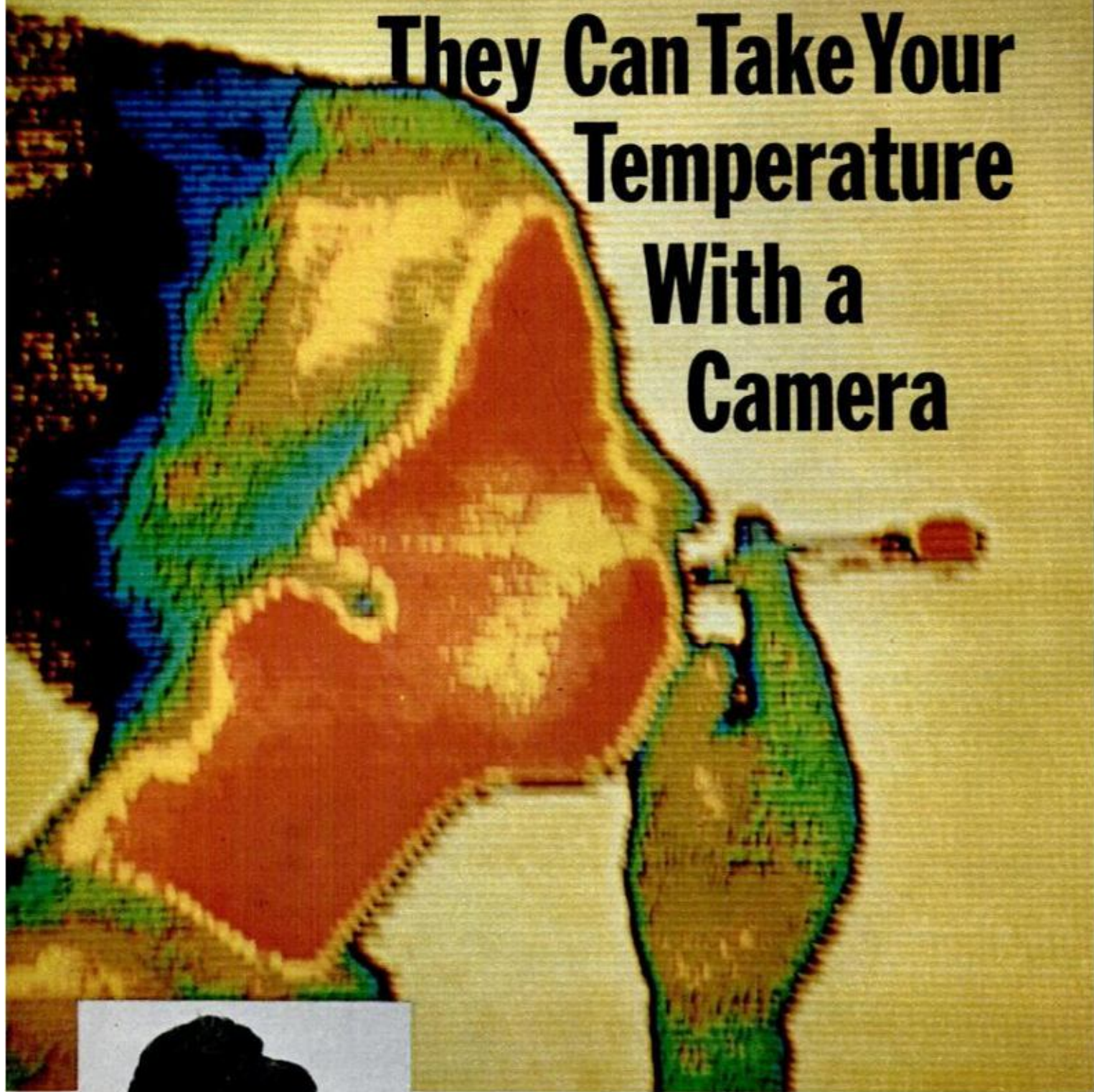

**PORTRAIT OF A LADY** smoking a cigaret. Color photo at top of page, made with infrared camera, shows hottest regions around cheeks, neck and forehead. Next hottest are the yellow and brownish areas. Coolest spots are indicated by the blue and green patches. Note red at burning tip of cigaret

Thermograms made with an infrared camera show temperatures in colors, making it possible to spot failures in equipment before something blows up or breaks down.

By **SHELDON M. GALLAGER**

**S**MUGGLERS TRYING TO CONCEAL illegal cargo inside huge tank trucks were sure nothing would be detected when police stopped them and merely photographed their rigs. To their surprise, the hidden goods clearly showed up on special film called a thermogram. As authorities



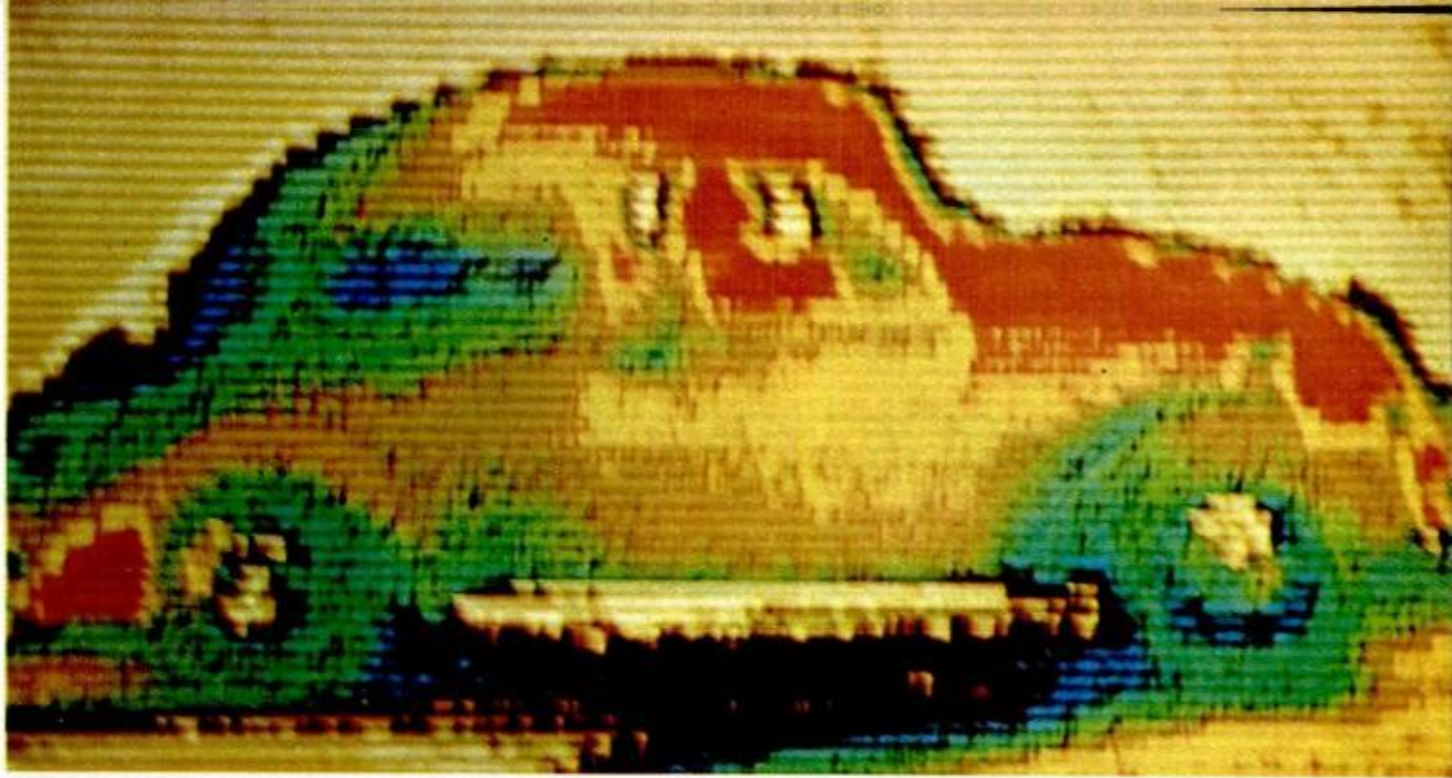

**THERMOGRAPHIC PROFILES** of common objects reveal interesting heat patterns. Telltale spot of red at rear of Volkswagen above is from car's engine and exhaust manifold. Red areas around hood and roof are radiant heat from sun. In photo of pole transformers at center right, blotchy red and yellow areas indicate uneven cooling—a possible design fault that could lead to premature failure. Two steam irons at lower right are set for identical temperatures, but one on right is much hotter and heat pattern is not uniform. Such evidence helps manufacturers to design more efficient equipment

suspected, liquid contents of the trucks remained cool, even in daytime heat, but the secret compartments warmed up and stood out as a different color.

Thermograms are "heat maps" made by a camera sensitive to infrared radiation. All substances give off some infrared and the hotter they are, the higher the intensity of radiation. The camera scans the subject and converts the various levels of intensity into different colors ranging from deep red for the hottest areas to dark blue for the coolest. Technicians studying thermograms can spot equipment failures before they happen—an overheating bearing in a generating turbine, hot spots in boiler walls, a resistor about to burn out in an electronic circuit.

In the same way, they can test the efficiency of thermal insulation or airplane de-icing equipment. The thermograms shown here were made with equipment designed by Barnes Engineering Co. of Stamford, Conn. ★★

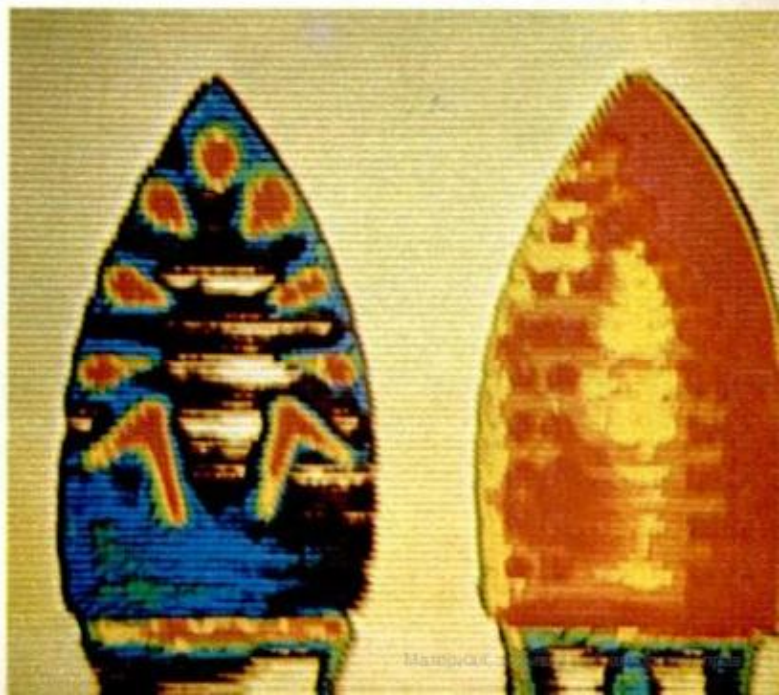
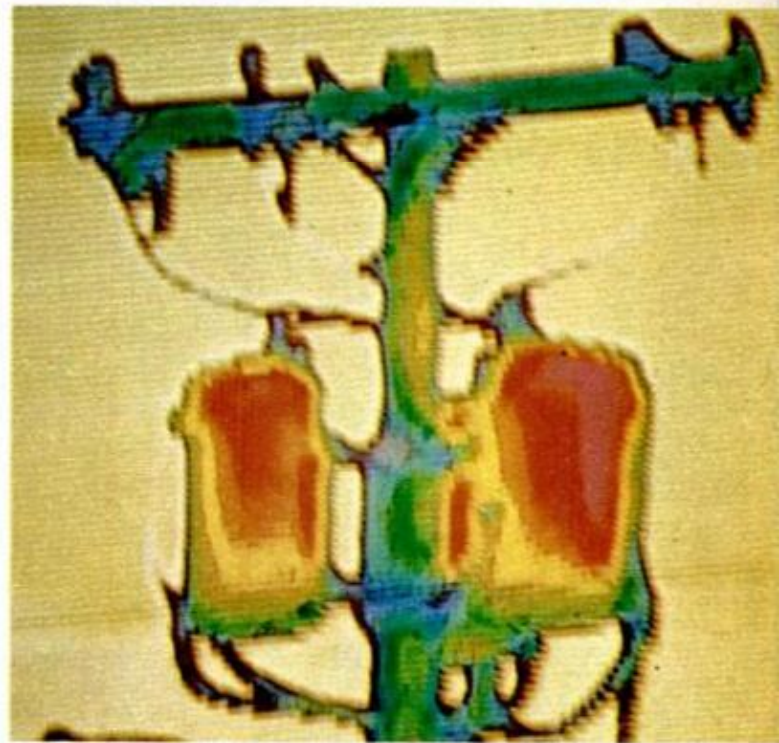



## NEWS BRIEFS

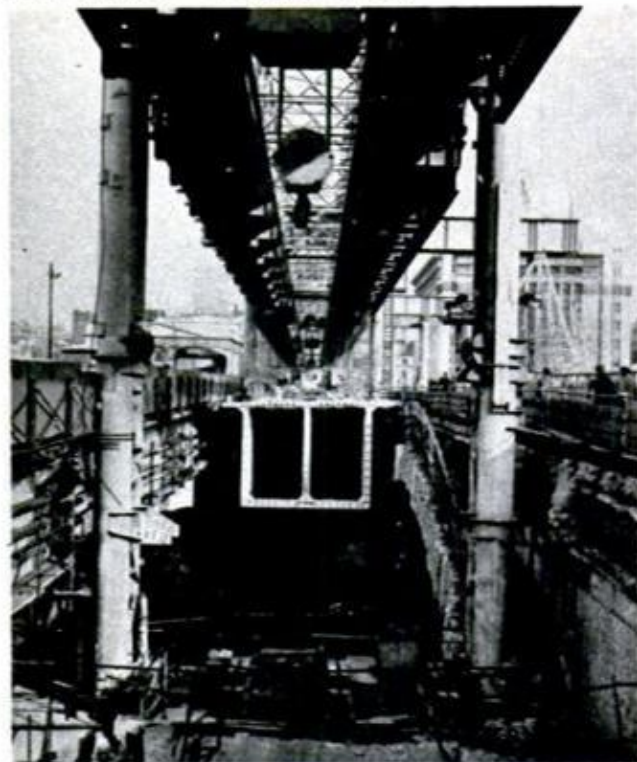

### London Bridge is going up

Taken during the final week that traffic was crossing the 140-year-old London Bridge, this photograph shows its new replacement to the left and part of the old bridge at the right. In the center is one of 356 box units of the new bridge that have been precast nearby. When completed in 1972, the \$10-million bridge will carry six lanes of traffic. Builders reported that hundreds of medieval curiosities were recovered during dredging.



### What's this all about?

Looking a bit skeptical about the whole thing, a youngster at Cincinnati General Hospital models a new plastic bag developed for the maternity ward. Newborns are placed in the bag to prevent chilling after birth, cause of death to some infants. Called the "Life-saver," the transparent bag was developed by a team of pediatricians and an electrical engineer at the University of Cincinnati Medical Center.



### No falling now

When Jim Fox of Sarasota, Fla., noticed that many novice bicyclers were too afraid of falling to rent bikes from his rental concession, he devised a side-by-side arrangement that won't tip, is pedaled by two and steered by one rider. It's so popular he's marketing a do-it-yourself conversion kit.



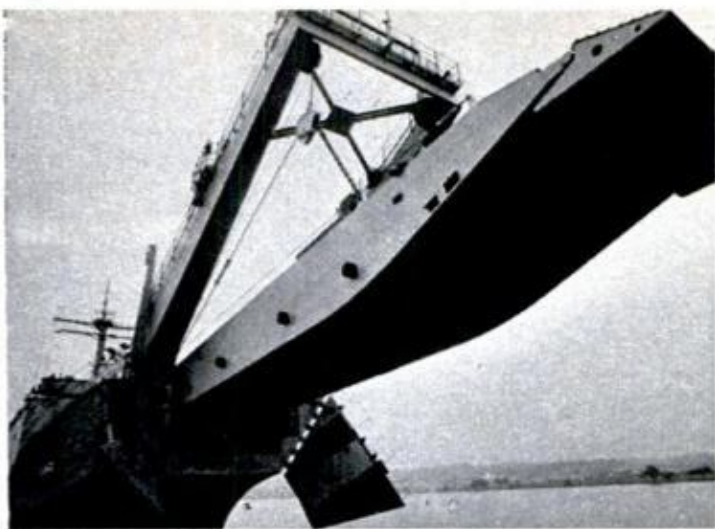

## Big gangplank for new LST

Distinguished by a rectangular catwalk extending from the bow (left), the Navy LST *Newport* lands troops and vehicles (430 men plus 2000 tons) from a huge ramp that rolls out of the bow (above) like a huge tongue. Top speed is 20 knots.



## Lady on the cleanup crew

The only woman driver on the London street-cleaning crew is a 50-year-old grandmother, Mrs. Cynthia Pipkin, who has been put in charge of one of the city's newest pieces of street-cleaning equipment. Mrs. Pipkin, who took special training in order to qualify to drive the "monster vacuum cleaner," pilots it along the streets of North London. She reports that males in the department are proud of her, rather than resentful.



## Speed-up in dugouts

Some dugout canoe builders in Central America have taken a big step in technology. They're still building the same dugouts, but nowadays they're using modern chain saws to do the digging out. They carry the saws into the jungle so they can rough out the outside and inside of the canoe; this makes the log much lighter for carrying back to their shop in the village. This boat-building team is from Mango Creek in the British Honduras.



**BOATING**

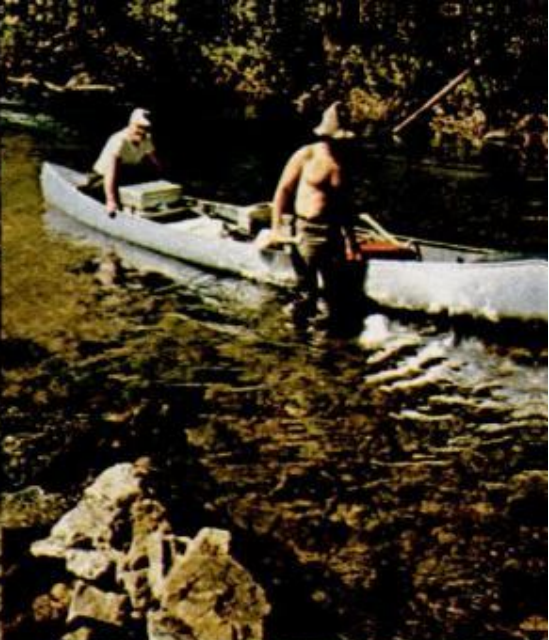
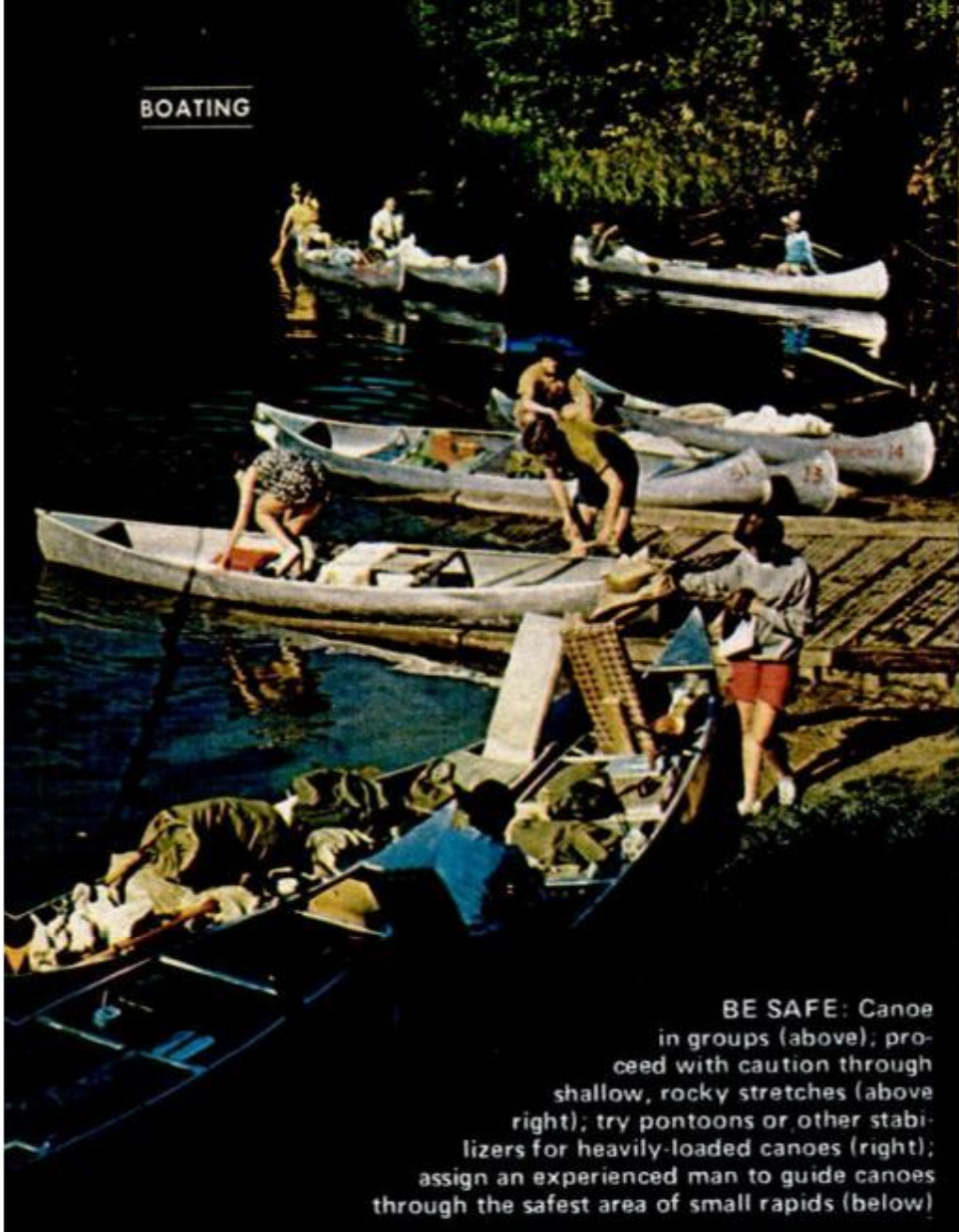

**BE SAFE:** Canoe in groups (above); proceed with caution through shallow, rocky stretches (above right); try pontoons or other stabilizers for heavily-loaded canoes (right); assign an experienced man to guide canoes through the safest area of small rapids (below)





# BACK-YARD FLOAT TRIP

You don't have to go to the Ozarks for a memorable float trip. Chances are you're within 100 miles of outstanding water overlooked by even the people who live on it.

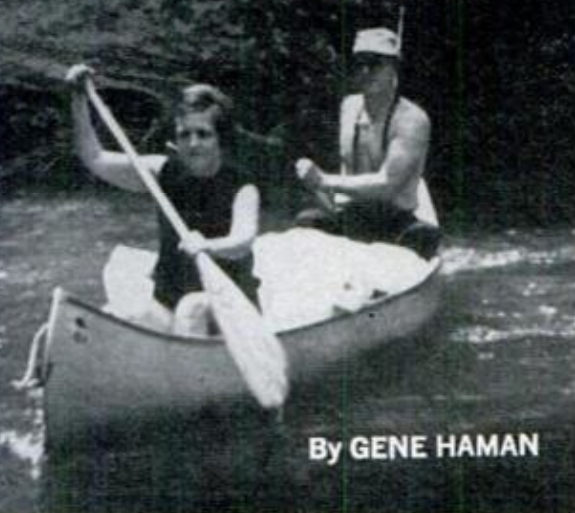

By GENE HAMAN

**WHAT MAKES** a floatable stream? Almost any river deep enough to float a canoe, flat-bottom boat, jonboat, inflatable boat or kayak, and with enough current to move the craft. The river doesn't need to be famous nor in deep wilderness.

Decide first what you want: a quiet, easy one-day trip, a weekend trip with one night of camping, a dash through white water and rapids, a week's vacation and fishing, or a wilderness vacation with gear supplied by an outfitter.

● *How much do you want to spend?* Float trips can be relatively inexpensive, particularly if you own a canoe and adequate camping gear. My wife and I and another couple last summer spent 2½ days on a river about 150 miles from home for \$20 in all.

If you don't own a craft, try to bor-



**WHEN CASTING FROM A CANOE**, it's best to have bow man fish while the stern man controls the boat



**BIG FLAT-BOTTOMED HULLS** are ideal for carrying lots of cargo and passengers, but are unwieldy



**THIS COUPLE SOLVED** their cramped quarters and weight problems by paddling canoe and towing raft

row one. You'll find few places to rent a boat unless you're near a famous float stream. Later, after you're familiar with floating, you'll know better what you need and what's available. Canoes cost from \$140 to \$400. Paddles, cushions, life jackets can add another \$20 to \$50.

If you plan to float little streams with plenty of fallen trees and sharp twists and turns, 10 to 15-foot boats are ideal, but their small carrying capacity and lack of room are long-trip nuisances.

On all other streams, 15 to 18-foot boats are advisable. Many Ozark outfitters use 20-foot jonboats for up to five men and their gear. Inflatable craft are stable, store in a car trunk, but are sluggish on water. Kayaks are fine for one-day trips, but storage is limited.

Canoe paddles are your best all-around propulsion. Oars on flat-bottom





**AS YOU APPROACH ROUGH WATER**, stop all boats safely upstream and scout rapids below from bank side. Then assign somebody in your group to stand guard by the safest chute while everyone else floats through

boats are fine, but a good long paddle will give you as much or more leverage, store out of the way easily, and can be used from any position in the craft.

Paddles cost \$3 to \$8. The correct length should reach from ground level to just below your chin when you're standing. Be sure to take at least one extra paddle on all trips; two are better. If you plan to use your paddle as a push-pole, tack a metal strip onto the toe of the paddle, or buy paddles with it mounted. Rocky stream bottoms can chew up a paddle in a hurry.

Always take patching gear for the craft you're using. And be sure to have proper tools to make repairs.

Buy good life preservers, and have them easily available if you don't wear them all the time—children should always wear them. If you're floating a rough river, keep one on.

Collect maps and data about the stream you plan to float. Many conservation departments publish excellent guides to float waters in their states, but usually don't give mile-by-mile descriptions. For more detailed maps, get county or U.S. Geological Survey maps, or ask the state conservation offices for other sources.

● *Always play safe.* Take two craft, if possible. One may be punctured or overturn, and you'll need the second for emergency work. Small, two-man canoes are just that; don't overload them. If you're new to canoes, practice



**OVERNIGHT TRIP** may involve more gear than you realize; be sure to pack heaviest items in the middle



**CHOOSE HIGH GROUND** for a campsite and be sure to allow enough daylight to get properly set up

paddling on a quiet lake. Learn the basics of canoe handling without worrying about current.

When you leave for your float trip, give an outline of your travel plans to a neighbor, a local ranger station if in Forest Service country, a conservation

*(Please turn to page 160)*



# BOATING TIPS

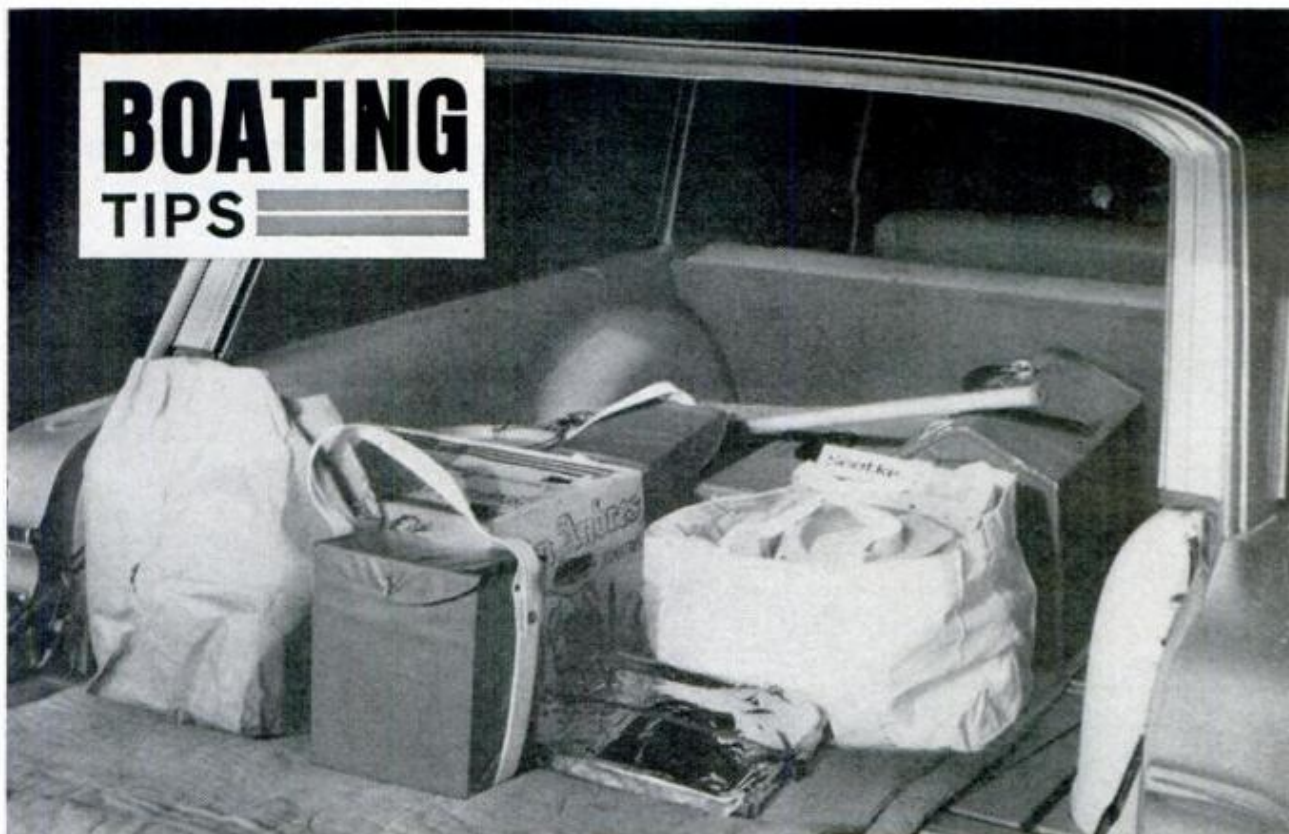

## Speedy, quiet way to carry gear

On your next outing, before you stash all the odd items of equipment in the back of your station wagon, lay an old quilt on the floor and pack your gear on it. There'll be fewer rattles, and when you're ready to unload, just pull quilt toward the tailgate and the gear will follow.

—Lee H. Schrimpf, Tulsa, Okla.

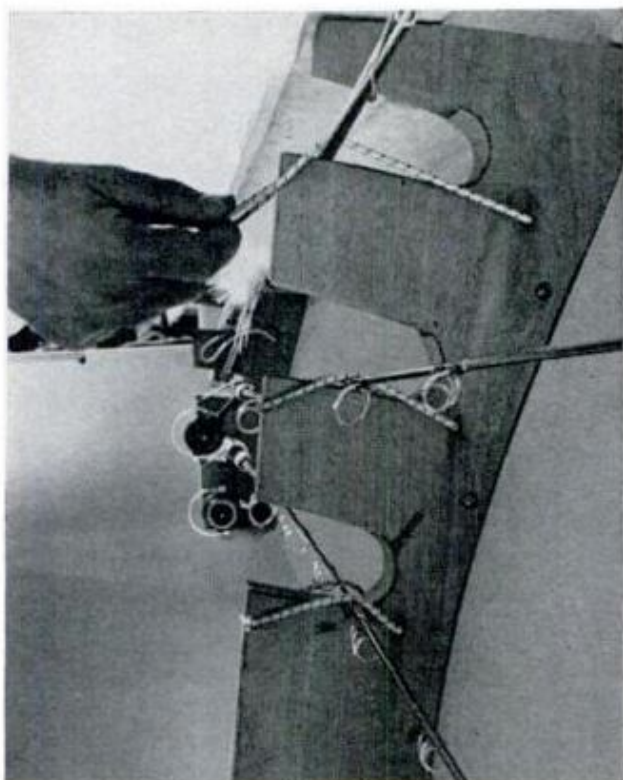

## Quick-action rod storage

Your best fishing-rod holders are sturdy and keep the rods out of the way, yet permit their speedy use when needed. This simple design (left) uses elastic shock cord, making it a snap (pun intended) to put your rods away at the end of the day or have them out when fish are spotted.

—Lefty Kreh, Miami

## Emergency dry-storage container

A perfect dry-storage compartment (right) for any boat is a plastic battery box. Its slipover cover keeps water from entering, while openings for the electric cables provide built-in "handles" and allow air circulation. Without circulation, your kit may become a swollen, corroded mess, especially in a saltwater environment.—Lefty Kreh, Miami

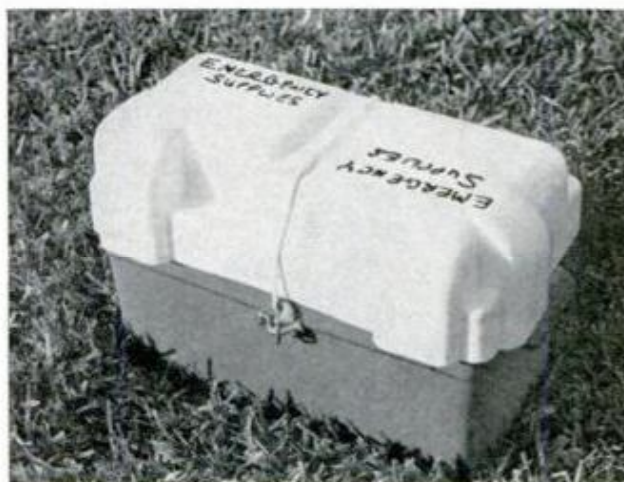



# The Seaworthy Seamaster



By **GEORGE W. REIGER**  
Boating Editor

**PM tests some original thinking about boat design on a trip through the Cape Cod Canal to the Elizabeth Isles**

**I**T'S NOT THE BIG WAVES that kill you; it's the day-after-day pounding through chop that grinds you down."

I first heard this bit of nautical wisdom from a New England lobsterman while teaching sailing one summer at Tabor Academy in Marion, Mass. Twenty years later I returned to the Bay State and found a boat designer working on a solution to the problem of bumps and bruises afloat.

"Most small-craft hulls are unnecessarily wide, have snub-nosed bows or poor weight distribution—all elements of design just begging for a rough ride while underway in choppy seas," says Bob Whittier, nationally-known boating columnist and builder of the Seamaster.

"These hulls are okay over rippled surfaces. But boaters generally find themselves pushing through one to three-foot waves anywhere there's open water and a breeze. So they bounce and get wet and cuss and have to slow down to keep from coming apart and accept this aggravation because they assume a rough ride is the



**LOW, NARROW PROFILE**, plus light weight, makes Seamaster easy to tow on a 1500-pound trailer and a cinch for one man to launch and load by himself

POPULAR MECHANICS

Материал, защищенный авторскими правами



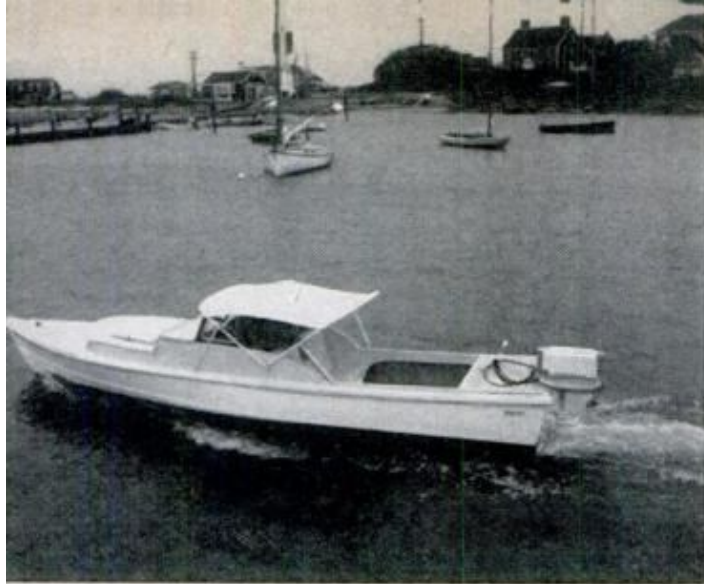

**WHILE ACCELERATING**, center of gravity remains forward, bow doesn't rear up, avoiding huge wakes



**BOB BRAVES RAIN** on the run to Plymouth for a sailor's eye view of replica *Mayflower* on display there



**CALM OF CAPE COD CANAL**, along with following tide, offered a respite from wind and storm outside



**CURRENTS ARE FIERCE** in channel off Woods Hole. Buoys are often completely keeled over by the tide

price you have to pay when boating on open water. Nonsense!

"My Seamaster is designed for the man who has owned a boat or two and is tired of being slammed around. He's no longer tempted by ads showing bikinied babes water-skiing behind a broad-beamed and overpowered hull. He's after a comfortable outboard cruiser for himself and his family."

With this as a guideline for what to expect, Bob and I made an overnight trip with a Seamaster from Duxbury Harbor, through the Cape Cod Canal and out to Cuttyhunk Island, farthest of the Elizabeth Isles stretching into the Atlantic. Along the way we visited Plymouth and Woods Hole. We didn't complete the round trip because of a dirty carburetor; not because the hull

couldn't take the ample doses of wind and rain we encountered. The Seamaster lived up to its name throughout.

Her hull is longer in proportion to her beam than any boat I've tested—canoes and kayaks excepted. One advantage of this shape is that the boat naturally planes at a flatter angle than does a short, wide hull. The point of contact between the Seamaster's bottom and the water she's riding through is ahead of, rather than below or behind, the seats—and this goes far toward taking the migraine out of speeding through choppy seas. The deep vee of her bottom forward rides low enough to perform its intended job of dividing the waves.

In addition, a long hull straddles short, choppy waves so there is prac-





**TRIP TO CUTTYHUNK** is one of the most satisfying weekend trips a boatman can make. But the sea gods, seeming to know that our excursion was a "boat test," threw wind and rain at us for 48 hours

tically no pitching or bounce. When riding over large waves we were comparable to a kayak or double-ender which tend to rock over big wave crests rather than shoot off them and come down with a jolt. Since passengers sit over the widest part of the hull amidships, their weight does not make the bow ride low when the boat is moving slowly off plane. Even with a full load of gear stowed forward, we rarely found waves washing over the bow, and not once did we "nose in."

On the run from Plymouth to the Cape Cod Canal, gale-force winds almost forced us to cancel the trip. But our stubbornness, plus a following sea that was easier to run from than fight, kept us going and helped show another advantage of the Seamaster shape.



**ENORMOUS STORAGE AREA** forward permitted us to stow pop tent, duffels, tackle boxes, fishing rods and spare water jugs—and still provided ample space for an extra seat or two in the bow for passengers



**SINCE 22-FOOT HULL PLANED** with 45-hp Chrysler engine, gas consumption was far less than it would have been with a larger outboard. With 18-gallon integral tank, we made just two fuel stops on trip

If a big-beam boat yaws in a following sea, the wave will pick her up and throw her around side on to the wind. The ultimate consequence may be a rolled-over boat. In seas that had ocean freighters picking their way cautiously to the mouth of the Canal, the Seamaster's comparatively narrow transom lifted well. No wave ever got much of a grip on her. We were never in danger of broaching.

A narrow transom has other advantages. When starting to move, the Seamaster sucks along far less water than a "beamy" boat. Thus acceleration is rapid. The stern does not dig in, so she doesn't "drag her heel" when trying to speed up. There's no "rearing up" on takeoff; the entire hull rises smoothly to plane.





**WHILE NOT LIVING IN AS HIGH STYLE** as our houseboat neighbor, we found our tent good shelter, lobster trap (foreground) a decent seat, and Bob's Thermos of coffee a great starter for early risers at Cuttyhunk

One of the most pertinent features of this unique design is its economy. Because the Seamaster's nose does not point skyward, more of her bottom remains in the water, and loading per square foot does not suddenly increase and demand high power. The bottom stays at a more efficient angle to produce lift with minimum drag. Brute force isn't needed to drive this boat.

With a 45-hp Chrysler outboard, we got at least 25 mph from the 22-foot hull. With a little more thrust, (though the hull is rated to take up to 75 hp, 65 hp will do nicely), and the correct propeller for the job, the Seamaster should do 35 mph with ease. Better yet, use a 65-hp engine, throttle back to 20-mph cruising speed and save on fuel like you never thought possible with a two-cycle engine.

Peculiarly, one advantage of the Seamaster may have cost Bob some customers. The narrow, clean-running hull produces little wake, which makes the Seamaster an ideal launch from which to monitor the efforts of college crews. Bob took a cruise one day on the Charles River and caught the experienced eyes of local rowing coaches. Almost before he could say Seamaster, he had sold boats to Harvard, the Mas-

sachusetts Institute of Technology and Boston University. Other schools saw the Seamaster when competing and, soon after, orders came from Yale, Columbia, Pennsylvania and others.

But Bob has mixed feelings about this apparently great luck: "Of course, I'm proud to have Seamasters owned and used by such fine schools. But I designed the boat as an all-purpose family outboard cruiser, and now many potential customers assume it's a crew launch and that's all."

Yet Bob's reputation and the great interest the Seamaster gets wherever she goes should find him more clients. When our stuttering outboard made the run back to Duxbury uncertain, we pulled into Woods Hole, called Mrs. Whittier and asked her to meet us with the trailer. While waiting, a small crowd gathered to admire the boat. I thought Bob would sell her on the spot!

She trailers easily (a 1500-pound rig is sufficient), handles most any sea, provides great storage space for all gear needed for a week's camping trip, and has a foldaway windshield for best visibility and breeze on nice days. Price: \$2250. For more information, write Bob Whittier, Drawer T, Duxbury, Mass. 02332. ★★★



# How

By **BILL  
HARTFORD**  
Auto  
Editor



**SAFETY SEAT**, Protecta-Tot from Firestone, is for kids weighing from 15 to 28 pounds

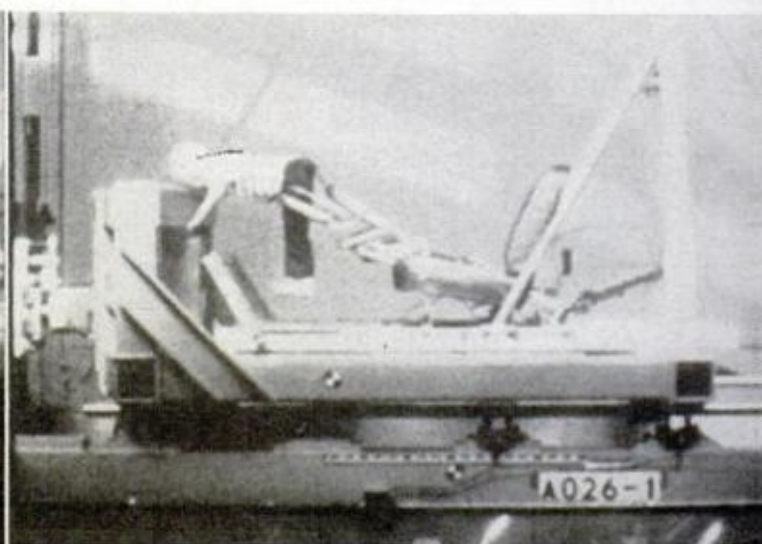

**SIMULATED COLLISION AT 16 MPH** at University of Michigan, Highway Safety Research Institute. Impact sled carries tubular-frame, hook-under-type child seat offering poor restraint for anthropometric child dummy

**SIDE PROTECTION** is given by Klippan Safety Auto Seat for kids up to about 42 inches and 50 pounds

**INFANT SAFETY CARRIER**, made by GM's Fisher Body Div., secures young ones who are not yet able to sit





# to BELT YOUR KID -and Save His Life

Here's everything that you should know about the safe restraining of children who are too young to wear the conventional lap and shoulder belts.

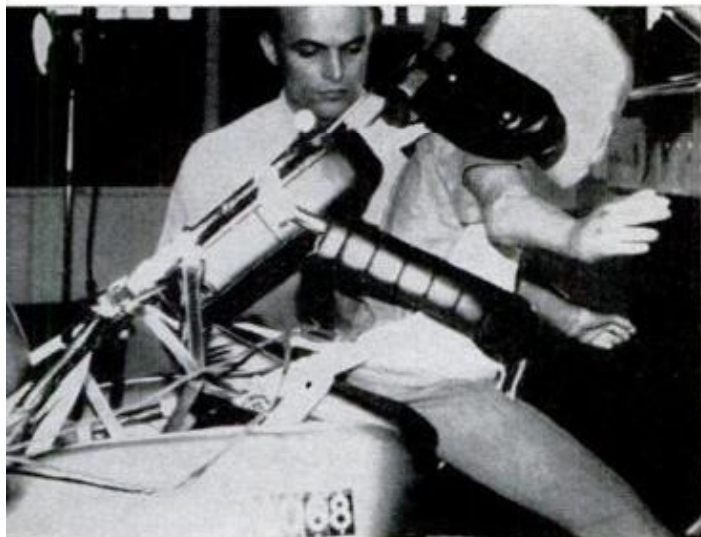

FRAME OF THIS SEAT, held in place by adult lap belt, collapsed in simulated 20-mph collision on sled

**P**ROTECTING THE KIDS is instinctive with parents—except when it comes to their riding in the family car! Raincoats and galoshes are always ready near the front door at home, but chances are the rear seat belts are buried somewhere behind the back seat when you go riding.

That's why the automobile continues to be the leading cause of accidental injury and death of tots, toddlers, pre-teens, teen-agers and young adults.

Parents aren't entirely to blame (even though allowing the kids to ride, unbelted, in the front seat is inexcusable, and allowing them to stand, nose to the windshield, is tantamount

to criminal negligence!). Even the most concerned parents have had to face a lack of information about the long-neglected subject of children's safety in the car: Should children use lap belts? At what age? What about shoulder belts? And just how good are car seats for kids? The answers have been slow in coming.

Last April a federal standard went into effect specifying the static loading requirement a child's seat must meet before it can be manufactured. The standard has banned manufacture of hook-on type seats, but hook-on types are still on the shelves. Those that have been manufactured before April 1 can still be legally sold. *Don't buy one!*

Extensive impact-sled testing by the Biosciences Div., Highway Safety Research Institute at the University of Michigan, has revealed the strengths and weaknesses of many child seat designs, and revealed specifics about a child's physiology that must be taken into account in a determination of the type of restraint system used for various ages.

A New Jersey-based organization, Physicians for Automotive Safety, is stressing the need for auto restraint systems and is putting pressure on the automobile dealer who, it found, all too often does not stock child safety seats





**DRIVING IN STATION WAGONS**, kids should be in passenger seats and belted. Unrestrained children in the rear cargo area will become missiles in collision

—even the effective ones manufactured by the dealer's own company.

A *PM* survey of New York area dealers supports this finding. Seats were in stock at less than 50 percent of the dealers called.

Effective protection is offered only by devices that distribute crash loads over as large a body area as possible; are secured to the body of the vehicle by a standard lap belt or special attachment; are sufficiently strong, energy-absorbing and free of possible injury-producing components.

Distributing crash loads widely over the body is an important factor in protecting children because they are top-heavy. Proportionately, their heads are heavier than an adult's and jackknifing of their torsos in an accident can cause spinal injury.

This fact is taken into account in two of the seats shown here—the Firestone and Ford seats. The impact cushion or shield restrains the upper body and head in a frontal impact. The Firestone seat, made by the firm's Hamill Manufacturing Div., is specified for tots between 15 and 28 pounds. The Ford seat is for youngsters up to 50 pounds.

Pediatricians recommend that children attain a weight of between 40 and 50 pounds and be about four or five years of age before making the move to standard adult lap belts. Smaller children could sustain internal injuries from the belt exerting too much pressure on the abdominal area. Even for the child of required weight, it is recommended that the child be placed on a firm cushion so that the belt falls across the pelvic area and describes a 45° angle in relation to the floor.

Shoulder belts should not be used by a child until he reaches a height of about 55 inches, which usually occurs at about age nine or ten. Here height, not age, is the important factor, according to Arnold W. Siegel, noted crash injury



**ADULT SHOULDER BELT** and combination lap belt (always wear both; never the shoulder belt without the lap belt) cannot be worn by children until they reach a height of about 55 inches. Seven-year old (above) is 47 inches tall and too small. Girl 12 years old and 59 inches (below) checks strap for tightness





investigator for the University of California at Los Angeles.

As shown on the facing page, the diagonal shoulder belt, on a wearer below a certain height, can fall dangerously across the face or neck in a collision. Further, in a frontal collision the top-heavy and still-developing child would possibly experience a spinal-cord injury if his head snapped forward while his shoulders were restrained by an adult shoulder belt.

Children who are under lap-belt age and weight but are old enough to sit by themselves require one of any number of restraint systems on the market. When you pick one make sure it meets Federal Vehicle Safety Standard No. 213 for car seats. Harnesses must conform to Standard No. 209 Type 3. The device must be so marked.

Among other seats that afford good child safety and effective lateral impact protection, in particular, are the Klippan seat and the safety seat that Volvo makes for its model line of automobiles. The Klippan seat can be installed facing forward or rearward. The Volvo seat faces rearward only after the front passenger seat is reversed on its mounts.

Infants from birth to about 20 pounds should be secured in a car cradle or infant carrier like the GM unit shown on page 100. This is a rearward-facing type

that's secured by the adult lap belt. In a frontal collision the impact is spread over the child's entire torso. He is held in the cradle by wide belts in the event of a rear impact collision or rollover.

Car-bed bassinets for infants are generally flimsy, but a good type is one that can be secured in place and the infant held in it by wide belts across his upper and lower torso, or by strong webbing that zips over the top of the bassinet.

To take children's auto safety a step further is to get into the prenatal period. Here the traditional concern has been that lap-belt pressure on the mother's womb would increase injuries to mother and fetus in a collision.

A recent study, however, of over 200 pregnant accident victims, published in the *New England Journal of Medicine*, reveals that no evidence could be found that lap belts increased the mortality of either mother or fetus! Maternal death was found to be reduced slightly while fetal loss remained about the same. The death of the mother was the leading cause of the death of the fetus, concluded the obstetrician and statistician who conducted the study.

No matter how you look at it, the belt is a safety device that, if used, would save thousands of lives each year. Don't be permissive: Belt your kid! And save his life. ★★★

**SAFETY SEAT** (below) held by lap belt, is Ford's Tot-Guard for two to five-year-olds up to 50 pounds. Volvo's safety seat (right) mounts on passenger seat after it's turned to rearward-facing position. Train kids right and they'll remind you about buckling up!





# Portable TVs You Can Play at a Picnic ... On a Patio... By a Pool



**They don't just have a handle—they run on batteries, will play anywhere and now even come in color models. Here's what you should know about these handy, take-along TVs**

By **LEN BUCKWALTER**

**A** "PORTABLE" TV SET used to be something that weighed up to 90 pounds, operated only on house current and—incidentally—had a handle on top. Some models you could actually pick up. But that's all changed now. Today there are dozens of truly portable portables that don't trail a power cord, play anywhere you want to tote them and are light enough to handle with ease. The smallest weighs less than 2 pounds with the average being around 15 to 20. At least two models offer color. Prices run from under \$100 to over \$300, with a number in the \$100 to \$120 range.

These trim, all-purpose portables operate on either 117-volt a.c. or 12-volt d.c. When you're at home, you simply plug into a wall outlet as with a conventional

TV set. In a car, boat or camper, you can take power from the 12-volt electrical system, enabling you to enjoy TV on a camping trip or cruise. Some models even come with a handy adapter cord that plugs into the cigaret-lighter socket on your car's dashboard.

When you're really off in the wilderness with no source of power, you can operate on rechargeable batteries. These may be built into the set or may be in a separate power pack that plugs into the back of the set. This depends, to some extent, on the size of the set. Power requirements go up sharply as screen size increases, necessitating heavy batteries. Thus, large sets generally have separate power packs to keep their weight manageable. Smaller sets may have built-in batteries where





**WHERE TO PUT THE BATTERIES** is the big question in a portable TV and manufacturers solve the problem in different ways. Sharp's 9-in. model (above, left) has separate power pack in a leather carrying case you can sling over a shoulder. This saves weight, eliminates need to lug batteries along when you are operating on external power. Panasonic's 5-in. model (above, right) has built-in batteries housed in a compartment in the rear. This is possible in smaller sets where battery weight is less, is handy because it makes TV self-contained with nothing extra to carry. Toshiba's 9-in. model (lower right) has a power pack in a removable base. You simply place the set on the base when you want battery operation and detach it when you don't. At top of opposite page is the 9-in. Magnavox portable that has a separate power pack and removable sun shield



the added weight is not enough to become cumbersome.

Both arrangements have their advantages. Which is best for you depends somewhat on the kind of use you're going to give your portable. Built-in batteries save having to carry around an extra pack and are handy if you plan to do most of your viewing away from a power source. On the other hand, the separate power pack frees you from having to lug batteries around when you don't need them. If most of your viewing is in a car or boat you may find the detachable pack a welcome feature. Also, since it's an optional accessory item, you don't have to purchase it right away if you don't need it, saving some money. Battery packs are \$20 to \$40 extra.

Some makers offer a third arrangement, a kind of clever compromise. The



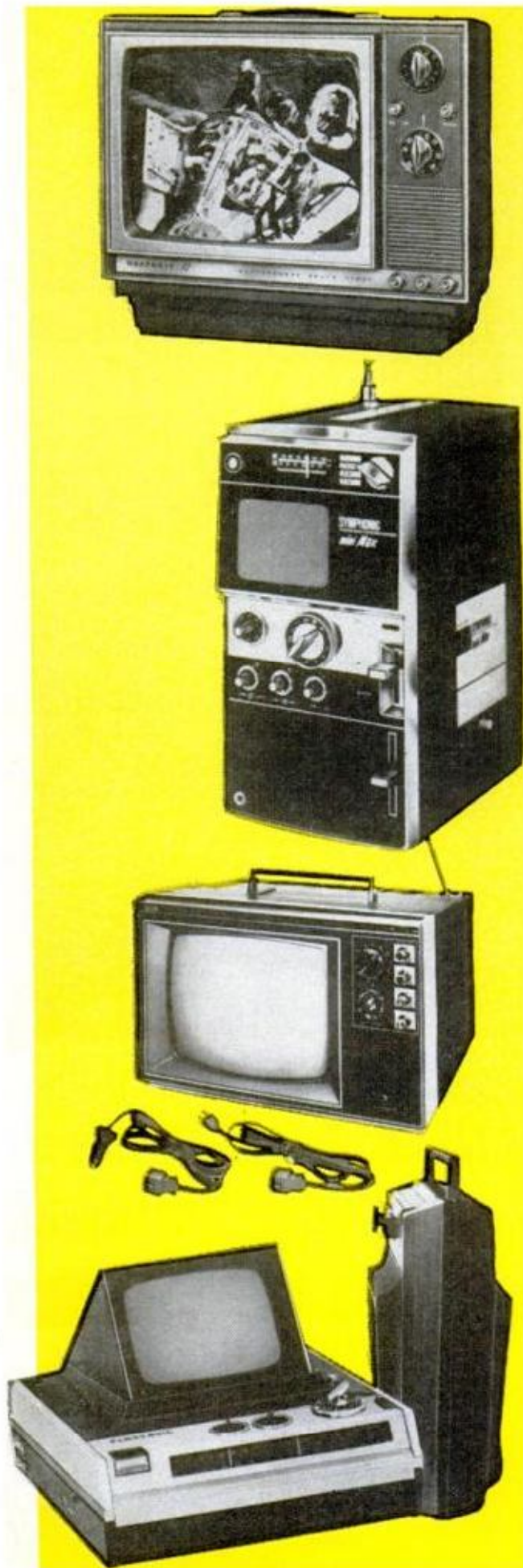

battery pack is separate, but it's in the form of a detachable base that fits under the set. With the base attached, you can carry the whole thing around as a single, self-contained unit. When you don't need the batteries, you simply release a couple of catches and slip the base off.

Most portables use rechargeable batteries, although a few of the smallest can operate on ordinary flashlight cells. A fully charged battery pack provides about four hours of viewing time. You'll clearly see when the batteries are running down—the picture starts to shrink. Recharging takes about 15 hours and can be done as you play the set on house current.

Despite recharging, batteries will not last indefinitely, however. They'll take 100 to 200 charge-discharge cycles before permanent exhaustion sets in. To conserve them, it's wise to operate on external power as much as possible. If you want to play the set in the back yard, it will pay you to install a weatherproof outdoor outlet and use house current rather than battery power. For mobile use, most car, boat and camper electrical systems will easily supply the ampere or so of power these mini sets require—about the same as a car's dome light. One caution on car installation, though: Don't operate a TV set in a moving vehicle without first checking your state's law on this point. Most states prohibit TV viewing in the front seat of a moving vehicle and many rule out the rear seat as well.

What's a good screen size? You can't apply living-room standards to a portable because your viewing habits and needs are generally different. Usually, fewer people are watching at a time and you're at close quarters with the set, such as in a tent, camper or boat. For these reasons, the screen can be smaller than you'd want at home. Portables vary in tube size from Panasonic's incredibly tiny 1½-incher up to 12 inches (measured diagonally across the tube face). As weight and cost go up sharply with tube size, most sets are in the

**SOME UNUSUAL PORTABLES** are shown in column at left. From top down, they are Heath's kit-built 12-in. model sitting on removable power-pack base; Symphonic's 3-incher with a built-in cassette tape recorder; Hitachi's 12-in. color model, first color portable to reach the market; and Panasonic's clever pop-up design in which a 5-in. screen swings up from inside the case for viewing, then folds out of sight when not in use. Both the Panasonic and Symphonic models also incorporate AM/FM radios

POPULAR MECHANICS



moderate 7 to 9-inch range. This is entirely adequate for the small-group viewing you'd have on a family outing and makes for good portability.

One helpful accessory to consider is a dark-tinted plastic window supplied by some makers. Since portables are often viewed outdoors, sunlight can be a problem, causing glare and reflections that wash out the picture. The tinted window acts as a sun shield, reducing glare. However, it also steals a little picture brightness on indoor viewing. For this reason, some shields are designed to be removable. If you plan to do most of your viewing inside, this could be an important feature to look for. A few models also come with removable plastic covers to protect the tube face from accidental knocks when traveling—another useful extra.

All portables have built-in telescoping antennas as well as connections for an external antenna. When you're home, you can hook on to your regular rooftop antenna for maximum signal-pulling power. Portables also have a built-in loop antenna for receiving UHF channels.

Several models offer an added AM/FM radio and one, the Symphonic, even boasts a built-in cassette tape recorder. The two color sets are Hitachi's 12-inch model priced at \$369.95 and Panasonic's 4½-inch size. The latter is not yet on the market, but is expected to be available soon. Its price will be announced later. If you like kit-building, Heath has a 12-inch model that can be assembled in about 15 to 20 hours. The accompanying chart lists additional portables according to screen size, weight and price. Prices and weights given do not include batteries except where the batteries are built-in.

What kind of performance can you expect from these mini portables? Operated indoors on a rooftop antenna, they'll pull in stations like a conventional TV. Even outdoors on their single rabbit ear, sets tried by *PM* proved to be remarkably good at distances up to 50 miles from the transmitting station. Reception in a moving vehicle is difficult, however, because the constantly changing flow of mountains, power lines, bridges and other structures tends to cause reflections and ghosts that make the picture fluttery and unstable. If you're determined to try, there are special antennas for car installation that may prove helpful. ★ ★ ★

## Buyers Guide to Portable Battery TVs

Make	Model	Screen Size (diag. inches)	Weight (lbs.)	List Price
Admiral	9P400	9	12	\$110
Emerson	7HP02	7	10	\$99.95
General Electric	TR120RVY	5	10½	\$149.95
	TR100TEB	9	12¼	\$114.95
Heath	GR104A	12	20	\$124.95
Hitachi	IU-53	9	12	\$109.95
	IU-54	9	16	\$149.95
	CWU-210 (Color)	12	42	\$369.95
Magnavox	IT5261	8	16	\$119.90
	IT5260	9	17	\$124.90
Motorola	XP259F	9	13½	\$119.95
Panasonic	Color (Not yet avail.)	4½	17½	(Not yet avail.)
	TR-001	1½	17⅞	\$299.95
	TR-415BA	5	10½	\$149.95
	TR-425R	5	13	\$179.95
	TR-469B	9	13¼	\$109.95
	TR-339RA	9	14	\$149.95
Philco	B321UAV	8	11¾	\$89.95
Sears	57K5060N	5	9	\$117.95
	57K5019N	8	15	\$89.95
	57K5025N	12	22	\$117.95
Sharp	SQ-65P	9	14½	\$114.95
	SU-66P	12	17½	\$119.95
Sony	TV-510U	5	7½	\$109.95
	TV-710U	7	9½	\$99.95
	TV-720U	7	9½	\$109.95
	TV-110U	11	16	\$129.95
Symphonic	TPS-5050	3	5½	\$169.95
	TPS-300	3	7	\$299.95
Toshiba	T0901C	9	11.9	\$179.95
Ward's Airline	63B11960R	9	20	\$97.95
	63B11741R	12	24	\$114.95



# Shot in the Dark

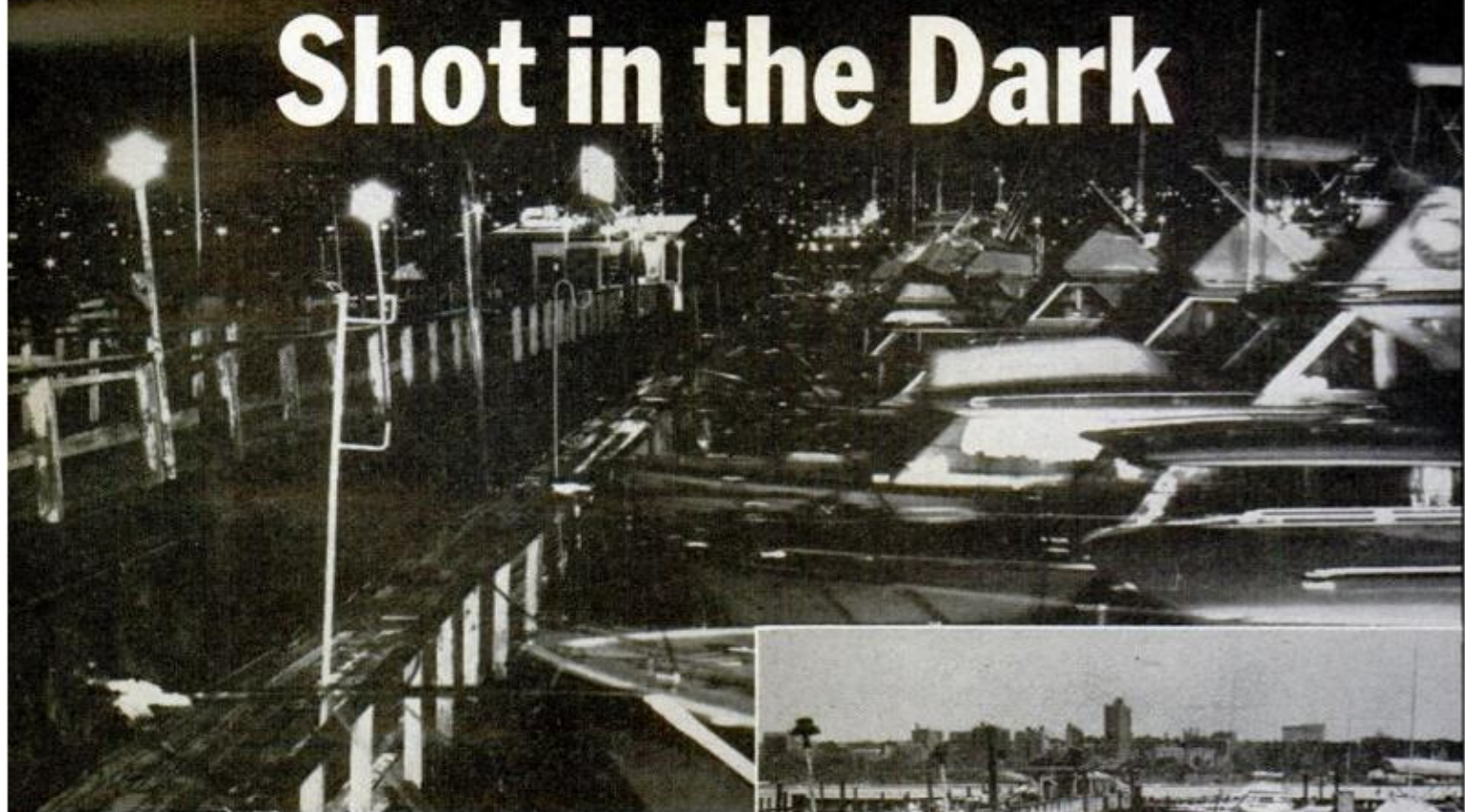

Here is proof that shooting at night often gives more dramatic results than in daylight. These useful tips will help you pick the best subjects and exposures

By BURT MURPHY

**N**IGHT ADDS A NEW DIMENSION to photography. It's like walking into another world—a world full of exciting challenges and possibilities you may never have noticed in the daytime. The reason is that night photography represents a completely different concept from normal shooting. In daylight, you are shooting subjects illuminated by light from an external source that rarely shows in the picture. At night, you are, for the most part, shooting lights themselves—flashing street signs, brightly shining windows and store fronts, glowing ribbons traced by auto headlamps, shimmering reflections on snow and water, and the like. You are mainly photographing *effects*, rather than actual scenery.

This is what makes night photography



**MARINA AT NIGHT**, made at 1/8th second and f/4 on Tri-X, is much more dramatic than same scene in daylight. Slight blur is caused by boats bobbing in water during exposure, but is not objectionable

so fascinating. Subjects that seem drab and ordinary in daylight suddenly take on new drama in the dark. A city street by day is just another street, but at night it becomes a teeming, glamorous bustle of neon signs and lighted shops full of adventure and excitement. You have to look at subjects with different eyes at night and use different techniques. Floodlighted marinas, illuminated fountains, amusement parks, airports, dingy waterfront scenes, docked ocean liners, hulking bridges outlined in necklaces of lights, city skylines, large electric billboards—all these are candidates for dramatic night pictures. Even in small towns there are many good night subjects that might easily be missed—a spotlighted church spire, an historical monument or war relic, a picturesque





**LIGHTNING IS EASIER TO SHOOT** than you'd think because it provides light to take its own picture. Instead of trying to catch it, you just open shutter on time, wait for the flash, then close shutter

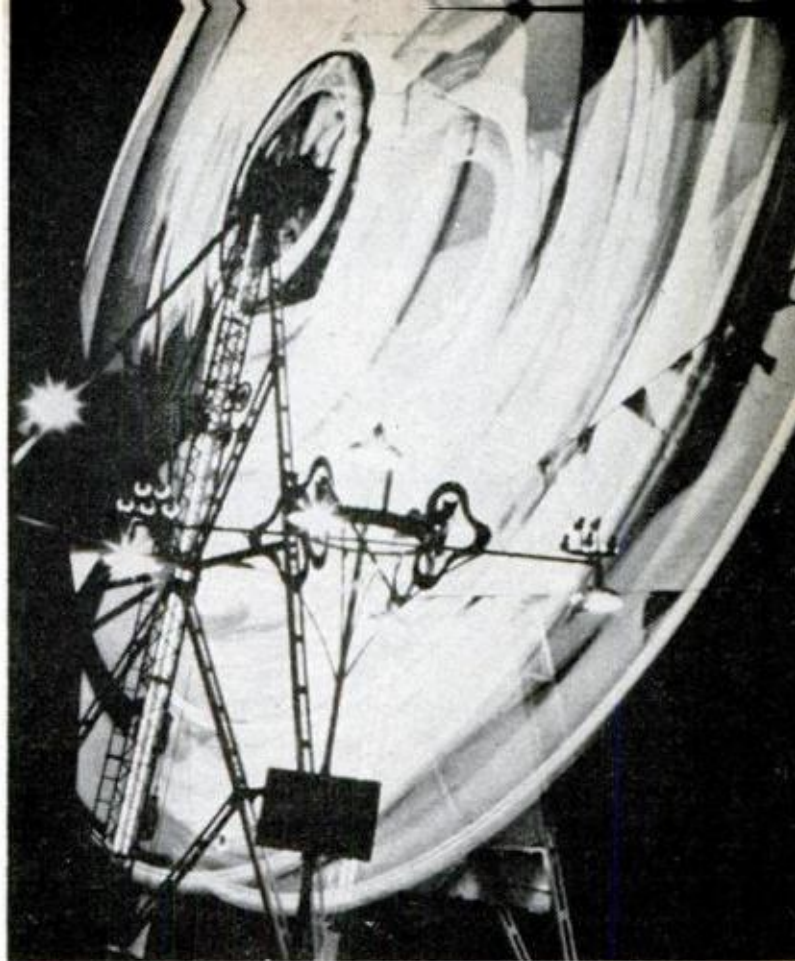

**WHIRLING WHEEL OF LIGHT** is amusement-park ride deliberately shot at long exposure—8 seconds at f/11 on High-Speed Ektachrome. Striking effects like this Kodak photo are not possible in daylight

police station or firehouse, a lonely farmhouse on a snow-blanketed hillside, or the eerie shadows cast by moonlight in an ancient graveyard.

Because you're interested in recording lights at night, flash is of little help. Flash photography is not the same as true night photography—there's an important difference. A flash picture is merely the equivalent of a daytime shot made with artificial light as a substitute for the sun. The flash will wash out the very lights and shadows—the mood-creating patterns—that you're trying to capture.

In night photography, you have to expose for the light that's available in the scene. This means using fast films, such as Tri-X for black-and-white and High-Speed Ektachrome or Ansco's D-500 for color. You can also experiment with some of the even faster films that go up to 1200 or 1600 ASA. These produce grainier results, but are three to four times more sensitive to light.

**COUNTRY CHURCH IN SNOW** makes picturesque night scene. To get enough illumination, this one by Kodak was actually shot at dusk—a trick you can use when full darkness would make shooting impossible

JULY 1971

Exact exposures are difficult to pin down in low light situations. A light meter is virtually useless. You have to be willing to experiment. The idea is to find a possible starting point, then bracket your exposures by several stops in both directions. The accompanying table lists exposure times for some typical night scenes. More detailed exposure guides are available at photo shops.

You'll find that some subjects, such as bright street signs, can be shot at speeds up to 1/250th of a second—as fast as for







**LIGHTED FIREHOUSE** standing guard in the dark is good example of local subject that goes unnoticed in the daytime, but takes on character at night. In this case, flash was fired during a time exposure to give slight added illumination. Close-up of the firehouse door (right, above) creates interesting light pattern



many daylight scenes. Most dimly lighted subjects, however, will require time exposures of one to two seconds or even longer. This calls for a camera with a Bulb or Time setting. You open the shutter, count off the appropriate number of seconds, then close it.

When you get into time exposures, you'll discover a curious fact—the time intervals can vary over a considerably wide range and still produce basically similar results. You may, for instance, go all the way from 2 seconds to 5 seconds to 10 seconds and get three usable pictures with minor variations in mood and effect. The longer the exposure, the more overall illumination will be present, but the individual sources of light will begin to burn into the film and become blotchy and indistinct. You have to strike a happy medium between the two extremes. Sometimes a single light source, such as a street lamp, is intentionally allowed to become blurred to get better illumination on the scene as a whole. On the other hand, if you want sharp pinpoints of light, go for shorter exposures even though the rest of the scene will appear darker.

The exposure times shown here are for a lens opening of  $f/4$ . This is close to wide open for many lenses, especially telephotos. Since mood rather than detail is more important in a night scene, shooting at a large opening is usually safe and gives you the benefit of faster shutter speeds. Where depth of field is critical, such as on well-lighted close-ups, you can close down two or three stops for greater sharpness. Adjust your shutter speed accordingly by increasing the time one stop for each decrease in opening.

A tripod or other camera support is virtually a must in night photography since most of your exposures will be below  $1/60$ th of a second—the cutoff point for safe hand-held shots. It's also best to use a cable release instead of pressing the shutter tripper. It will minimize camera shake when the shutter is opened and closed.

There is one exception to the no-flash rule in night photography. A flash can sometimes help to add a little extra illumination on scenes where there is not enough front light to show the subject clearly. Buildings lighted from inside, for instance, are frequently too dark on the

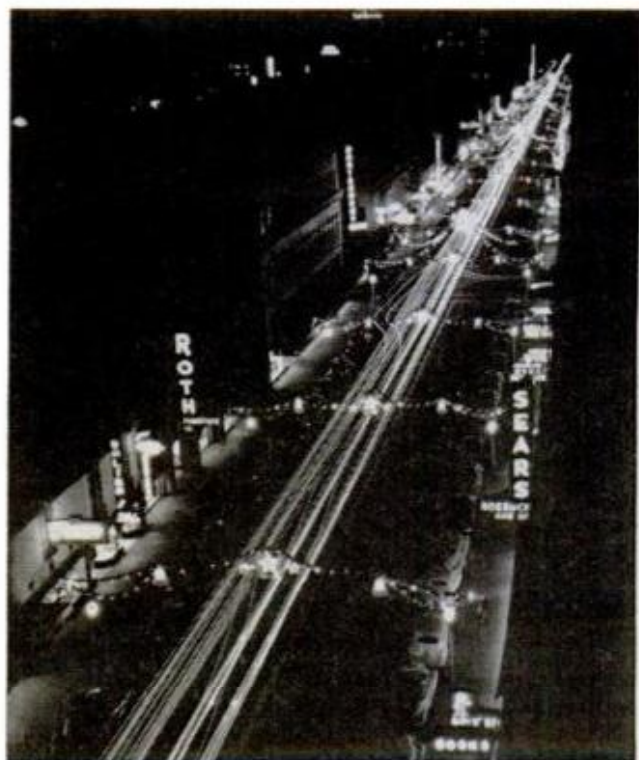

**RIBBONS OF LIGHT** are traced by automobile headlamps intentionally blurred through a time exposure of several seconds. Always use a tripod or other firm support to steady camera during such exposures



## TYPICAL EXPOSURE TIMES FOR NIGHT SCENES

(All times are for an opening of f/4. Adjust one stop shorter or longer for each stop of increase or decrease in opening.)

TYPE OF FILM	TYPE OF SCENE		
	NEON SIGNS	STREET SCENES	FLOOD-LIGHTED BUILDINGS
KODACOLOR-X KODACHROME-X EKTACHROME-X	1/30	1/15	2 sec.
HIGH-SPEED EKTACHROME	1/60	1/30	1 sec.
TRI-X	1/250	1/125	1/4

outside to register on the film. Firing a flash during a time exposure can give enough front light to outline the subject without killing the light coming from inside. The firehouse shown in one of the accompanying photos was shot in this way. The shutter was opened, the flash fired, then the shutter closed. Most flash-guns have an open flash button that permits them to be fired manually without using the camera's built-in synchronization. Do not attempt to use the normal flash setting as this will produce an ordinary flash picture, not a night picture.



**LONELY VIGIL** of a policeman on a deserted, snowy street corner is captured in this spur-of-the-moment photo shot from the window of a nearby building. Such scenes are simple, but they create strong moods

JULY 1971

There are other tricks you can use, too, to create the appearance of more light than there actually is. Deliberately long exposures will cause moving lights to blur into streaks, creating fascinating patterns of motion. The whirling amusement-park ride and ribbons of auto headlamps shown here are examples of this technique. By allowing dim lights plenty of time to register on the film, you can often take pictures that would be otherwise impossible.

Shots made in snow or after a rain also appear to have more light because of the reflective surfaces. Another dodge is to shoot at dusk when there is still a little sky light. The result will often look like a night scene, but will have sufficient added illumination to show detail that would not be apparent in full darkness.

Moon shots are difficult because the earth's movement during the exposure causes the moon to appear as a streak. The answer is to leave the moon itself out of the picture, but expose for the rays it casts. Such effects are weird and otherworldly, but can be striking. You can also simulate moon shots by shooting into a setting sun and underexposing to let the surrounding area go dark. Using a red or yellow filter will help to create the effect of a darkened night sky. ★★



**REFLECTIONS ON WATER**, here from buildings along a river, are more spectacular at night because of the shimmering lights. Wet lamplighted streets after a rain also produce eye-catching night effects

111



# PHOTO HINTS

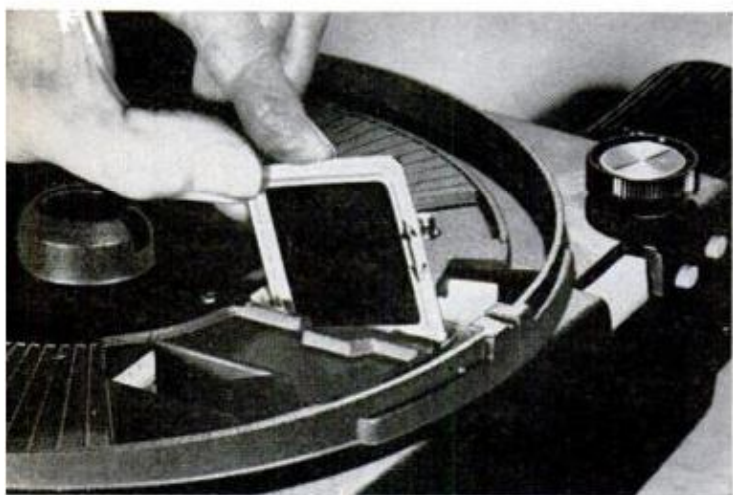
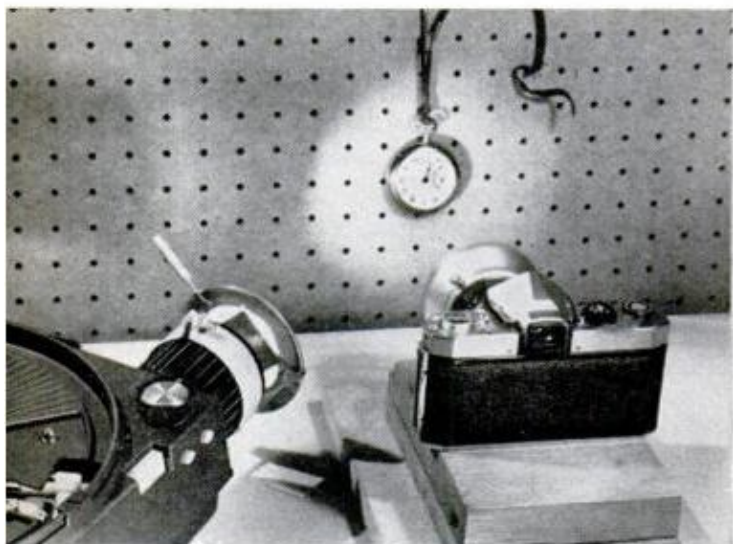

## Mounting polarizing filters

Polarizing filters are handy for reducing glare when photographing glass, metal or other shiny surfaces. You need one over the light source and one over the camera lens. Either one must be able to rotate to vary the polarizing effect. Glass filters are expensive, but you can use 2x2-inch squares of plastic polarizing material available in packs of 20 for \$2.50 from Edmund Scientific Co., Barrington, N. J. 08007. One neat dodge is to use a slide projector as the light source. Mount a square of filter material in a standard slide binder and slip it into the projector. Another square can be mounted in a circle of cardboard and taped over the lens. Fasten it to a filter ring or sunshade so it can be rotated. You can also make a rotating filter holder for either the camera or projector from scrap metal and a tin-can bottom, as shown at upper right.

—Walter E. Burton, Akron, Ohio

THIN SHEET METAL TO FIT AROUND LENS; LINE WITH FELT

SMALL HANDLE SOLDERED TO RIM

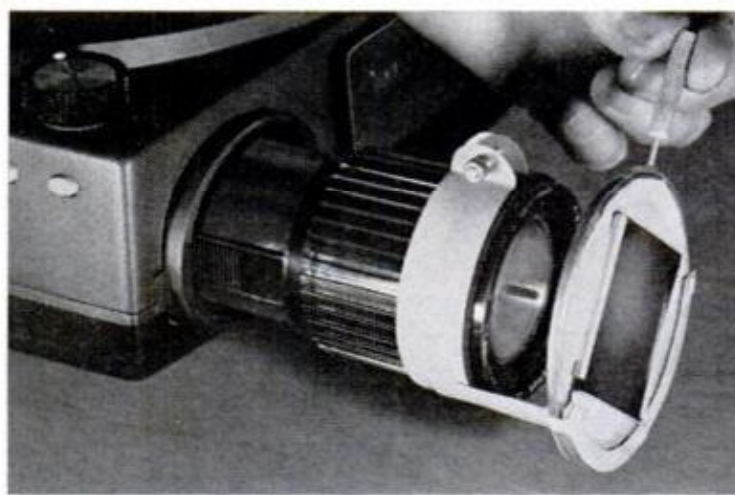
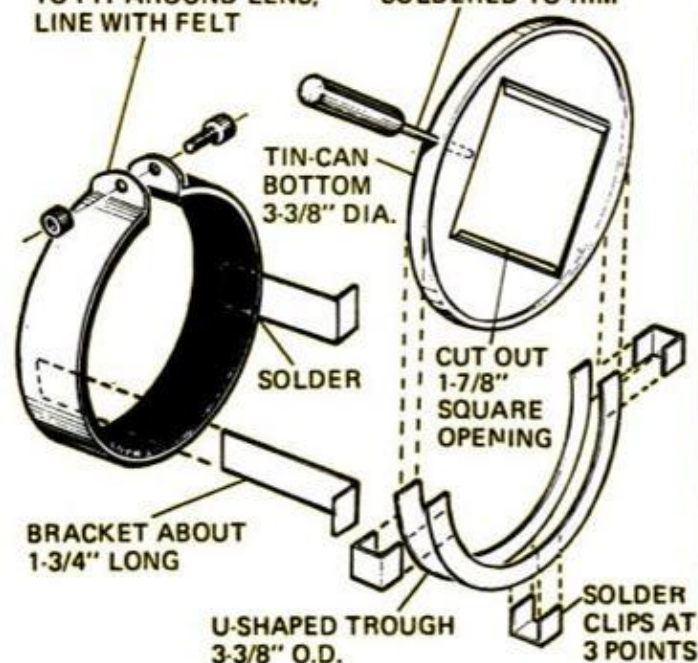

## Ever-present film reminder

You won't forget what type of film you have in the camera with this simple trick. Each time you load the camera cut off the end of the film box and fasten it inside the lens cap with clear tape as a reminder.

—Robert Hertzberg, Flushing, N. Y.



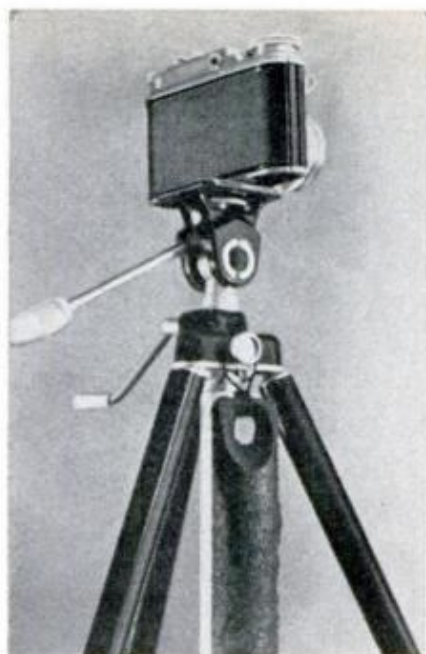

### Handy tripod weight

An old sash weight will help to steady a light tripod against breezes.—*Mike Cannon, Spokane, Wash.*



### Easy camera mount from pipe fittings

This swivel-jointed pipe stand will hold a camera at any angle for tabletop photography and can be clamped to other supports. The 1/2-inch fittings are locked with 1/4-20 thumbscrews.—*Robert Hoppough, Chico, Calif.*

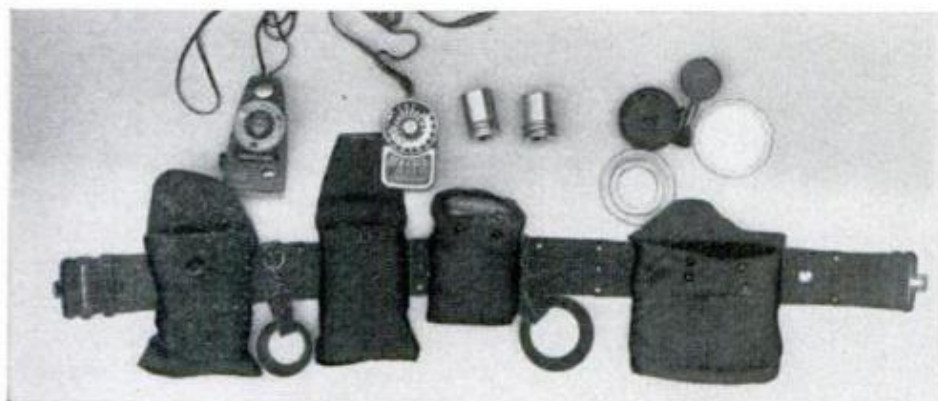

### Ammo belt holds photo aids

A web-type Army belt will put photo accessories within easy reach and save



carrying a bag. Available at sports and Army-Navy stores, it can be fitted with clip-on ammo pouches to hold film, filters, meters.—*Ed Monroe, Schuyler Lake, N. Y.*

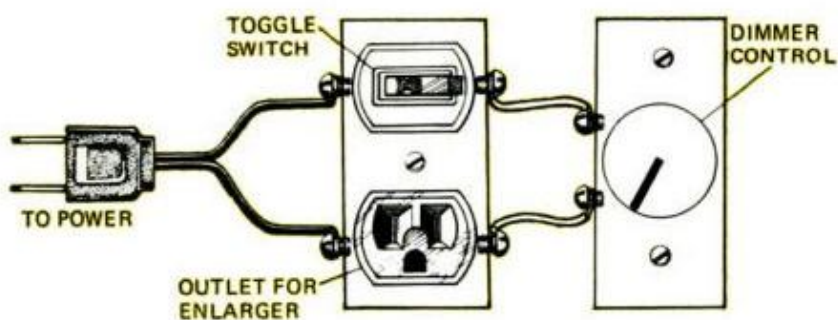

### Add your own enlarger control

If your enlarger doesn't have a variable-intensity light control for slow and fast papers, you can add one with a wall dimmer. Substitute the next higher-

wattage enlarger bulb for your present one. Using test prints, calibrate the control so it dims the new bulb to the same brightness as the old one for fast papers. For slow papers, turn up the dimmer.—*Frank Greenwald, Western Springs, Ill.*



# ELECTRONIC HINTS

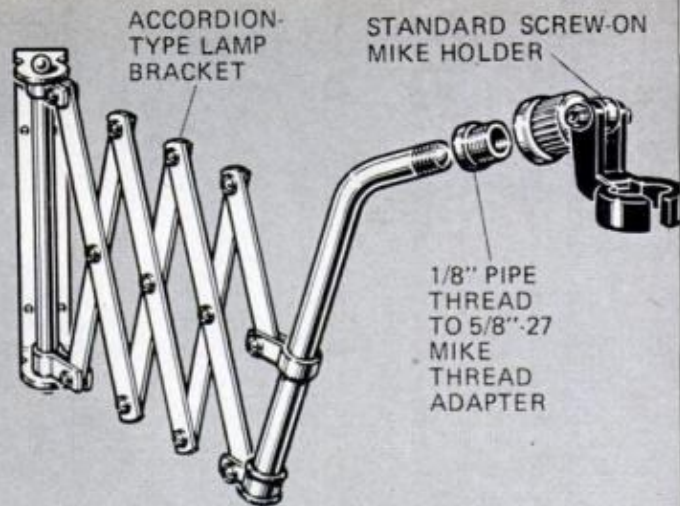
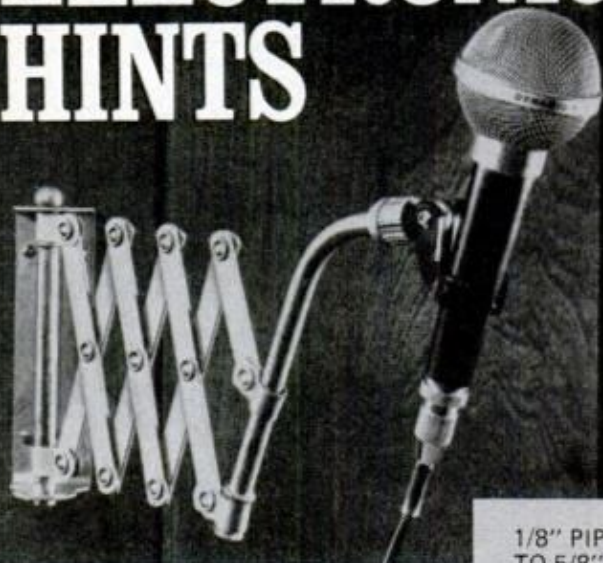

1/8" PIPE THREAD TO 5/8"-27 MIKE THREAD ADAPTER

FLATTEN END AND DRILL FOR 1/4" SCREW



## Two improvised mike holders

An old accordion-type wall lamp makes an ideal mike holder for a ham or CB rig because the mike can be extended when needed or retracted neatly out of the way. The other holder, made from a short length of 1/8-inch lamp pipe, lets you use a tripod as a floor stand when you need a tall mike support. Both require a special adapter that mates 1/8-inch lamp pipe to 5/8-27 mike thread. These are available from mail-order houses like Allied and Lafayette.—Norman Fallon, New York

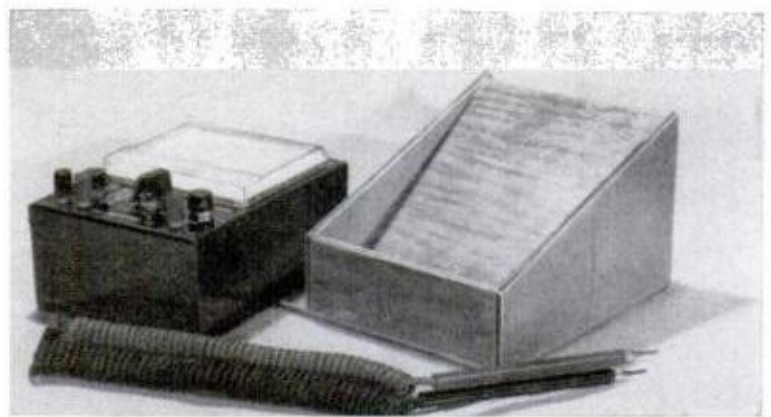
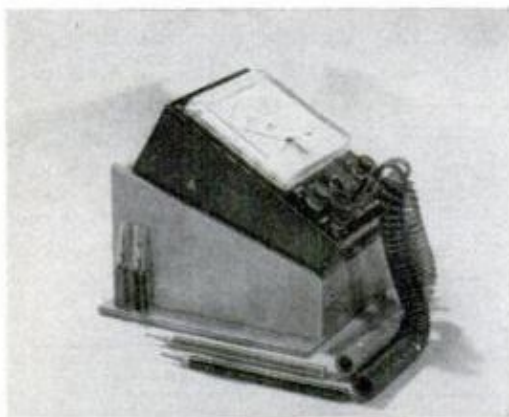

## Slope-front meter caddy for easier-to-read dial

This sloping stand holds a VOM or similar tester for easier reading, can be made of 1/4-inch plywood to fit your own meter. Sides slant from 4 1/2 inches in back to 2 inches in front. Supporting shelf is at a

slightly sharper slope so the sides form a lip to hold the meter. Bottom extends about an inch on one side, acting as a ledge for storing extra test tips.

—Marshall Lincoln, Wickenburg, Ariz.



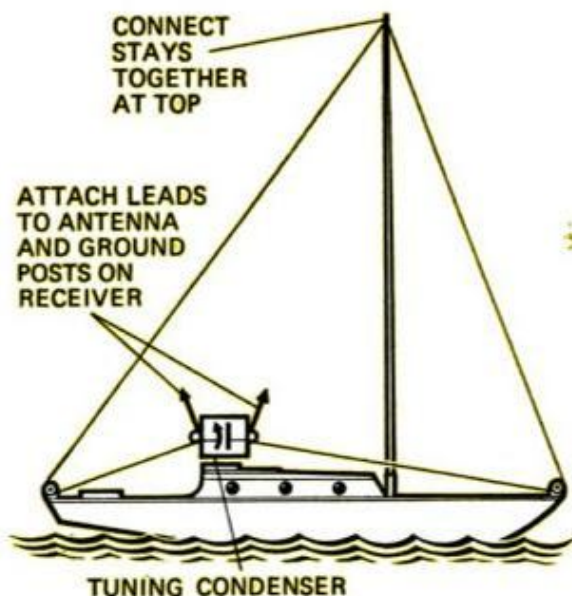

### Simple sailboat antenna

Wire sailboat stays can serve as a powerful antenna loop for a radio. Connect the stays together at the top, then run wires from the lower ends to the antenna and ground posts on the receiver. Connect a broadcast-band tuning condenser between the wires to tune loop for maximum gain.—Norman Fallon, New York

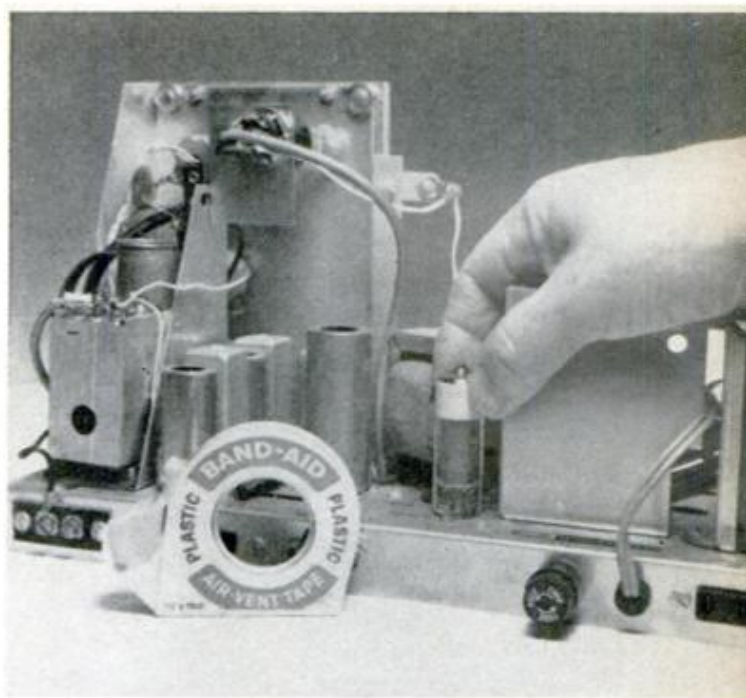

### Nonslip tube-pulling aid

Glass radio tubes are often hard to remove because your fingers slip on the smooth sides. Wrapping a ring of adhesive tape around each one near the top will give you a good grip and speed the job.—Robert Hertzberg, Flushing, N. Y.



### Handy toter for small parts

Fasten five or six glass jars to a piece of wood scrap, add a handle, and you have a convenient carrier for small electronic parts such as plugs, jacks, terminal strips and other connectors. Attach the jar lids with three screws in each and curve the ends of the wood to match the lids' shape.—Don Shelton, Chicago, Ill.

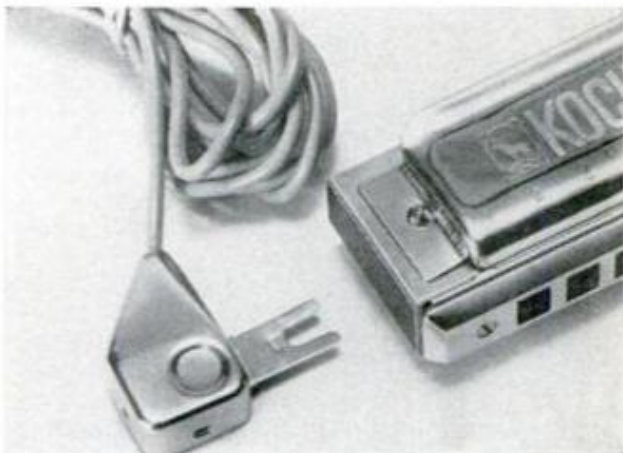
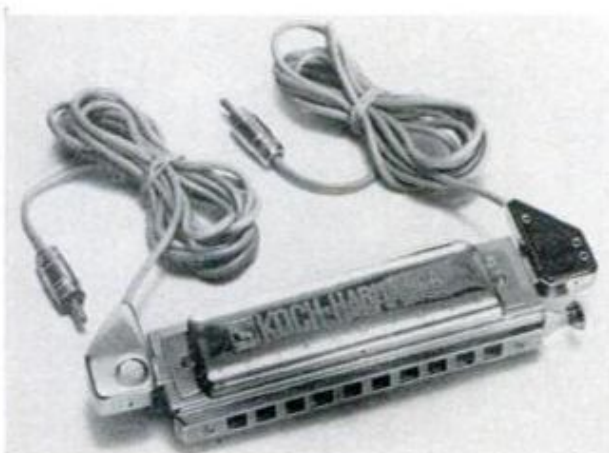

### Amplify your harmonica with your hi-fi system

You can play a mouth organ through your hi-fi system with two contact mikes having slotted mounting tabs (right, above). Loosen cover-plate screw at each end of harmonica, slip tab under plate, JULY 1971

then retighten screw. Plug mikes' cables into mike or auxiliary inputs on amplifier. Mikes are available for about \$1.50 from Lafayette Radio, 111 Jericho Turnpike, Syosset, N.Y.—S. Koblick, New City, N.Y.



## NEWS BRIEFS

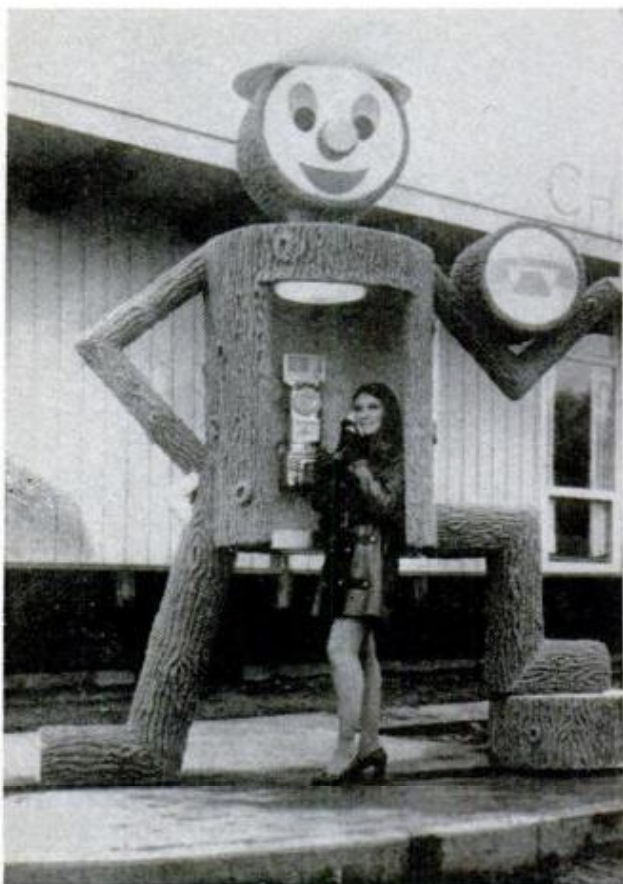

### Inside information

Anyone who makes a telephone call from the Chamber of Commerce phone booth in Prince George, B.C., can't help but be aware of the area's chief industry—lumbering. However, a close look at the timber giant will reveal the fact that he's made of fiberglass.

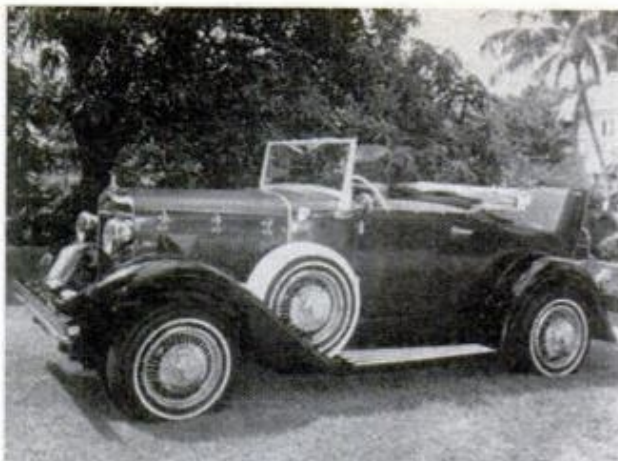

### Back to the good old days

It looks like a return to the 1930s down in Palm Beach, Fla., where Classic Industries is turning out Model A sedans, roadsters and convertibles on International Scout chassis. Body parts are molded of fiberglass, and the top frame parts are made of aluminum alloy. The cars have 111-hp, four-cylinder engines and three-speed synchromesh transmissions.



### Moon walk for \$1.95

Students in Madison-Simis School, Phoenix, can experience "moon gravity" in an ingenious device invented by science teacher Donal Tamuty and built for \$1.95. Each student is strapped into a parachute harness (left) and counterbalanced by weights (above) that total five-sixths of body weight. The connecting rope runs through two bicycle wheel rims.



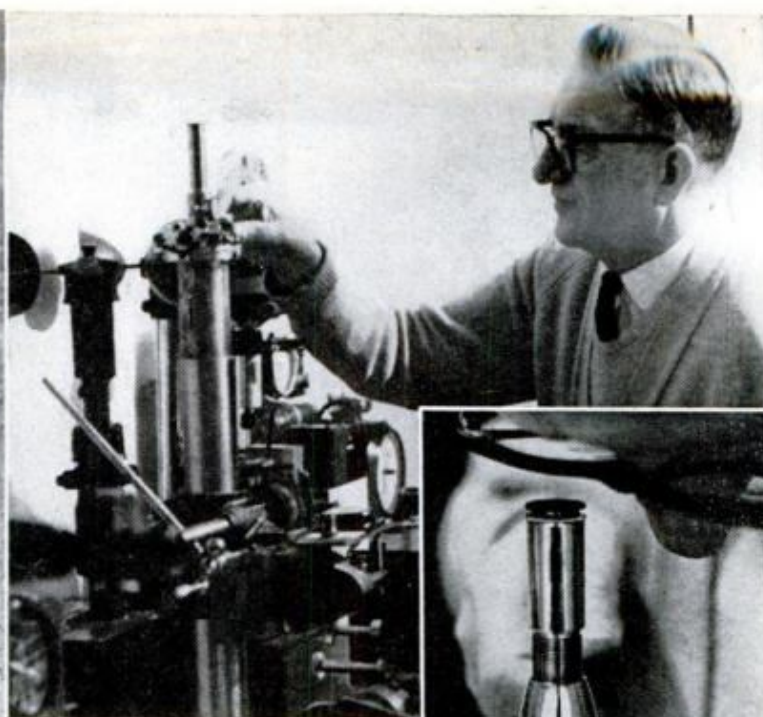

## His hobby: collecting dust

A lifelong hobby of collecting samples of dust (photo, above left) and studying them in his home laboratory (right) has made George Aitken of Worcester, England, an expert on the subject—and a consultant to pollution fighters and miners. Aitken has some \$17,000 worth of laboratory instruments for his studies.

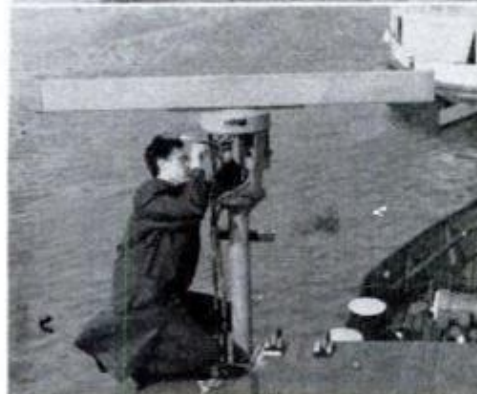

## 'Radar map' helps them cruise the Danube in foul weather

Heart of a new navigation system that enables boatmen to cruise the Danube during thick fog and at night is the "radar map" (inset). The map shows the river as it appears on a radar screen; thus, the navigator can follow his course by watching the radar (right) and checking the image on the screen with that of his map. At upper left is the riverboat of Hungarian shipmaster Karoly Szekeres, one of the inventors of the map. (Co-inventor is cartographer Beno Ratoti.) At lower left is a revolving radar antenna on the boat.



## EXCITING NEW PRODUCTS

BY CATHERINE BILSKI



**SIX TINY REPLICAS** of Spanish swords in a stand 4 inches high make this Spanish cocktail set ideal for spearing olives, onions, snacks, hors d'oeuvres and canapes. Rich gold plate and enamel finish lend a note of elegance to the small swords. Price is \$5.38 postpaid from Cazin Co., Dept. MPI, 526 Maple St., Apt. 1, Redwood City, Calif. 94063.



**NO LEAKING AND NO CLOGGING** are the advantages of the Typhoon lawn sprinkler that won't wear out, either. It's made of rugged high-impact plastic, has no moving parts and is self-cleaning. Covers up to 1250 sq. ft. in a 40-ft. diameter. Available for \$3.29 at hardware and garden stores, it's made by the AFA Corp., Box 262, Palatine, Ill. 60067.



**SOLAR ENERGY FURNACE** can be used to start campfires, charcoal briquets, or for just plain fun cooking—"sun-burgers," "sun-steaks" and the like. The Fresnel lens is approximately 1/16 in. thick, 11-1/8 in. sq. and has an effective speed of about f/1.5 producing temperatures that reach 2000°F. Stand shown is not included in the kit but you do get instructions for building it, plus a 14-page booklet on the furnace, solar energy and its applications. Ideal in science projects for setting up a demonstration of how solar energy is harnessed at present, the Solar Furnace Kit No. 70,533 sells for \$6. To order, clip this article and send it with your check to Edmund Scientific Co., 380 Edscorp Building, Barrington, N.J. 08007.

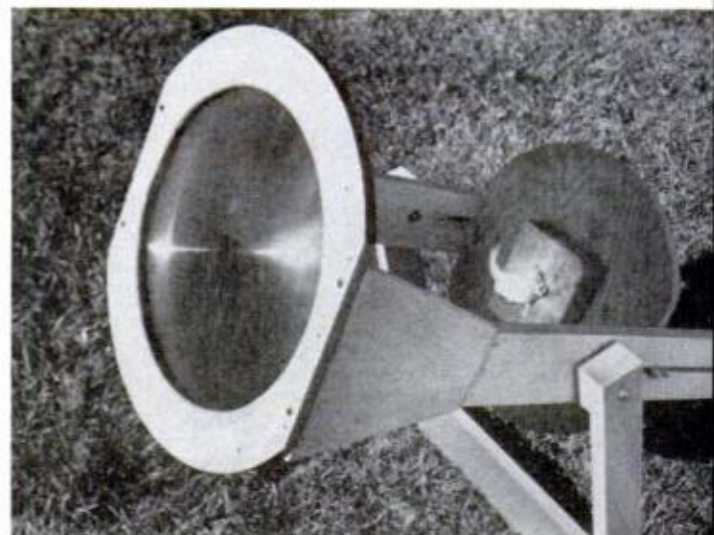





**ILLUMINATED HOUSE NUMBER**, which also lights entrance, has a photocell that automatically turns on light at dusk, off at dawn. The number plate is engraved with your house number and is replaceable for \$2.50 should you move. The unit can be wired for manual or automatic operation, comes complete with 40-watt bulb and hanging bracket for \$20.35 postpaid. Give house number when ordering from Machine Engraved Products Co., Box 3901, Charlotte, N.C. 28203.



**SHOWER-ALL**, a wall shower, a hand shower, can be used to convert an existing tub without shower, add convenience to a tub with a fixed shower or replace a worn-out showerhead. Sold at department stores; model C (shown) has a suggested price of \$24.95, including attaching hardware. Its design makes it ideal for bathing babies, for shampooing and for the infirm. Jaclo, Inc., 35 Lafayette Ave., Brooklyn, N. Y. 11217.



**ANY CLOSET** can be a pleasant-smelling, moth and insect-repellent clothes closet in a matter of minutes with an application of Rustic Cedaroma. It comes in powder form and can be applied by brush 15 minutes after mixing with warm water. Brushes and utensils will clean easily in warm water. It's priced at \$9.95 per gallon, plus \$1.50 for postage and handling. Order from Jennie Jones, Box 73, Blackridge, Va. 23916.

JULY 1971

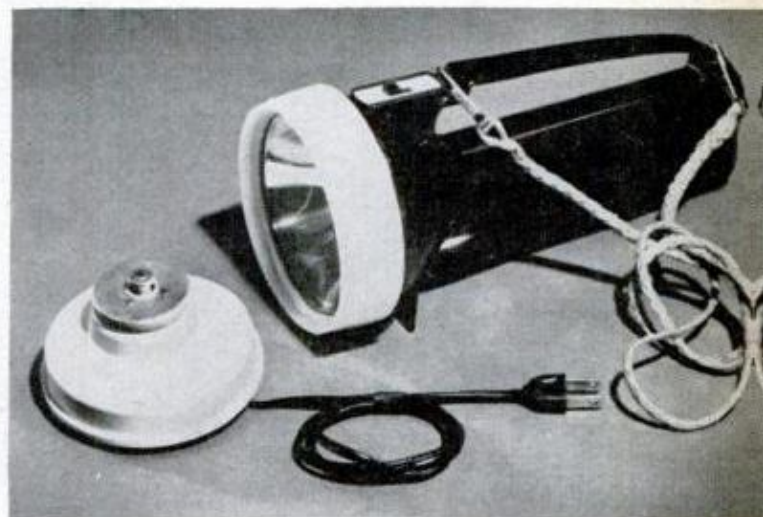

**LIGHTWEIGHT, DURABLE** and waterproof are some of the features of the Dynalite flashlight. It's battery-operated, floats in water and will not rust, dent, crack or peel. Comes with nylon shoulder sling. Model 917 with battery charger that fits in head (left) sells for \$15.50 plus 90 cents postage. Kay Lynn Gifts, Dept. 41, Worland, Wyo. 82401.

119



**ESTIMATE:  
FOUR SHOCK ABSORBERS (INSTALLED)**

Have it done		Do it yourself	
Parts:	<b>\$50</b>	Parts: (up to	<b>\$40</b>
Full list:		20% off list)	
Labor:	<b>\$12 to 14</b>	Labor:	<b>0</b>
		Your time	
Total:	<b>\$62 to 64</b>	Total:	<b>\$40</b>
<b>YOU POCKET</b>		<b>\$22</b>	

# New Shocks ... and You **SAVE \$22!**

By MORT SCHULTZ

## SATURDAY MECHANIC

**W**HEN SHOCK ABSORBERS need replacing, you can save at least \$12 in labor by replacing them yourself. This figure does not include the discount that you should get from an automotive supply house on the parts themselves. If that discount isn't 10 to 20 percent off the list price of the shocks, tell the guy to forget it.

I came up with these figures by asking an automobile dealer, a local mechanic and a chain store operator what each would charge for labor to replace front and rear shock absorbers on a 1968 Volvo 145 station wagon. The dealer and mechanic wanted \$12, the chain store, \$14.

Once you decide to do the job yourself and save this money, hunt around for a place to buy parts. Every auto parts store I visited said they'd give me 20 percent off retail list price. Standard shocks for the car cost \$12.50 each, a price comparable to that for shocks for most Detroit makes. So the saving over and above labor was another \$10. Twenty-two bucks can buy a lot of groceries.

The front shocks and rear Load-Adjusters used to illustrate this job are Koni units, more expensive than the standard shocks priced out for the Volvo wagon, but chosen by the owner for their firm ride and their ability to be adjusted for desired damping.

Bear in mind that the amount of discount on parts depends a lot on competition and whether certain makes





of replacement parts are fair traded. I live in a very competitive area where there's an auto parts store every block. But no matter where you live, you should be able to get 10 percent off retail. If you can't, you may want to deal with a mail-order house. Generally, the parts in their catalogs reflect a discount of approximately 20 percent.

When do you replace shocks? J. W. Farley, manager of service at the Chrysler-Plymouth Div. of the Chrysler Corp., says that "shock absorbers on endurance test cars, which have been operated in excess of 50,000 miles, have been inspected and tested with no detectable change in performance." Shock-absorber manufacturers have long recommended that shocks be replaced after 25,000 miles of use.

"A car that operates primarily on the freeways might get as much as 50,000 miles from a set of shocks," a spokesman for Monroe concedes. "However," he adds, "shocks on cars that are driven on rural roads very often fail in less than 25,000 miles."

You can take this to mean that the 25,000-mile figure is the average life expectancy of shocks, and that car owners who don't want to take either the time or trouble to inspect shocks should replace them at this mileage.

Once a set of shocks has completed 25,000 miles of use and still remains in service, a test should be made every 5000 miles. Bad shock absorbers can be a safety hazard.

Farley makes still another point: "It's not necessary to replace your shock absorbers in pairs," he declares. Shock-absorber manufacturers claim that shocks should be replaced not just in pairs, but in sets—that is, if you replace one, replace all four of them.

According to the spokesman for Monroe, replacement of shocks in sets (or at least in pairs) is necessary in order to allow a car to maintain its "balance." Farley calls maintenance of balance a "mistaken belief." In other words, it doesn't matter if a shock is old or new—if it's in good condition, it will allow a car to maintain "balance."

I'd recommend that you use common sense: Make sure that your shocks are really shot before you relegate them to the junk heap. Bad shock absorbers will usually reveal themselves while you're driv-



**FRONT SHOCK** is secured at its bottom end to the bottom A-arm. Two screws hold the shock's cross pin

ing. Since the purpose of these parts is to control the action of the car's suspension system, wheel bounce and/or front-end shimmy often means that the shocks have gone bad.

Chassis noise (a rattle or "clunk") also indicates shock-absorber failure, as does skidding and side-sway of the car as you go around a curve.

Bear in mind, though, that each of these problems is caused by other malfunctions. That's why the testing of shocks before replacement is advised. You could throw away perfectly good shocks and be left with the trouble.

The ultimate test is to remove each shock from the car and check it carefully on your workbench. First, clean off all

**TOP END** of front shock absorber on this car can be reached in wheel well without removing the wheel







**REAR SHOCK** is secured at bottom end to the axle-carrying control arm. Use "nut-buster" if necessary

dirt that's caked on the upper and lower mounting bolts. Removing these bolts is the toughest part of the job. Swabbing the hardware down with a penetrating oil and letting this soak in for a couple of minutes will make your task easier.

Holding a shock right side up—that is, in its mounting position—extend it fully. Now, reverse this position so that the shock is upside down and collapse it slowly. Repeat this procedure three or four times. If the shock feels loose, you should replace it.

What's a "loose" shock? It's relative: The best way for you to find out is to get your hands on a brand new part and see what it feels like.

Bench testing should be done when you aren't sure if a shock needs to be replaced, or when you decide that it does and you take it off the car. You might as well be sure before buying a new one.

However, the time-honored test of bouncing the car is still valid; that is, bounce up and down on the car, front and rear. If the car bounces more than one and a half times after you hop off, the shocks may be worn. Take them off and check them on the bench.

Whenever you're at work underneath the car, make it a point to examine each shock for oil leakage. The presence of oil



**DAMPING FORCE** of Koni shock can be increased as required by turning adjuster nut in valve assembly



**LOTS OF LEVERAGE** may be needed getting off old shocks (left). New replacement (right) for rear shock of this station wagon is heavy-duty stabilizer type intended for carrying heavy loads and for safer towing



on the outside of the shocks always means that seals are worn. Then there's no need to hesitate—replace the shock.

A shock-absorber bushing can go bad without the shock itself being affected. This will usually result in a chassis noise that sounds like "clunk." To check a bushing, grasp the shock firmly and try to move it. If it's loose, see if you can tighten up on the mounting nuts. If this doesn't help, the bushing is shot.

Shock-absorber bushings of many cars, but not all of them, can be replaced. In some models there are shocks that have irreplaceable integral bushings and cross pins, or integral bushings and sleeves. Where these go bad, the entire shocks have to be replaced.

However, if the bushings are of the conventional kind, you can get replacements at an auto parts store. To be on the safe side, take a shock with you and compare the shape and size of the new bushing with the old one.

To replace a bushing, knock the old one from the eye with a metal pin, drift or some such tool. Next, you should spray the new bushing with a liberal amount of silicone lubricant to make it pliable. Then work the bushing into the eye by hand. Be sure that you use silicone lubricant only; a petroleum-base product will cause the rubber bushing to deteriorate. ★★★



**DOUBLE TROUBLE** with this shock includes ruptured seals and well-worn bushing that caused "clunking"

JULY 1971

## NEW FOR YOUR CAR



**YOU GET A BACK RUB** as you drive along with this electric massaging device. Designed to relieve sore back muscles on long trips, the motorized backrest plugs into the cigarette-lighter socket on the dashboard and provides a gentle, rhythmic action. It's available for 6, 12 or 24-volt electrical systems. \$119.95. Niagara Therapy Corp., Adamsville, Pa.



**LIQUID LIGHT**—that's literally what you get in this chemical lantern for changing tires and other emergency use. The light is produced by two interacting chemicals in much the same way as a firefly's glow. The chemicals are kept separated in a plastic tube by a seal. Bending the tube ruptures the seal to activate the light. Developed by American Cyanamid Co., the tubes are ideal for emergencies as they last indefinitely until activated. Look for them on the market this fall.

123





# A Jewelry Box

## For Your Queen

Made of rare woods and featuring a Swiss musical movement, it is sure to become a treasured family heirloom

By TOM H. JONES

Color Photo by Robert D. Barst

**T**HERE COMES A TIME in any serious woodworker's career when he has a desire to build pieces that his family will treasure. An anniversary gift for his wife, perhaps, or a graduation present that his daughter will cherish and eventually pass on to *her* daughter. This jewelry box is just such a project.

Surprisingly, it is a lot easier to build than a first look may imply. It features a case veneered on all sides and a single-tune musical movement which plays when the lid is opened. Though veneering requires care and accurate cutting, none of the steps is particularly difficult.

● *Panels.* Cut all veneer blanks slightly

oversize. And, since it is brittle, the face of thuya, or any fragile crotch or burl veneer, should be taped (masking or

### PM'S CRAFTSMANSHIP LOGOTYPE

Starting with this handsome jewel box, *PM* will periodically present projects intended especially for the skilled woodworker. Though not necessarily hard to construct, all projects bearing *PM's* Mark of Excellence Stamp (see facing page) will have one important feature: Each will merit retention by the builder's family. In short, each will be an Heirloom Project.

—The Editors

### LID VENEERING DETAIL

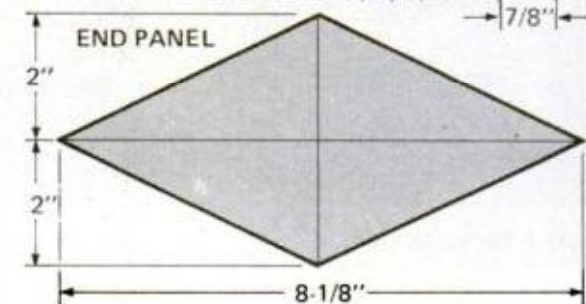
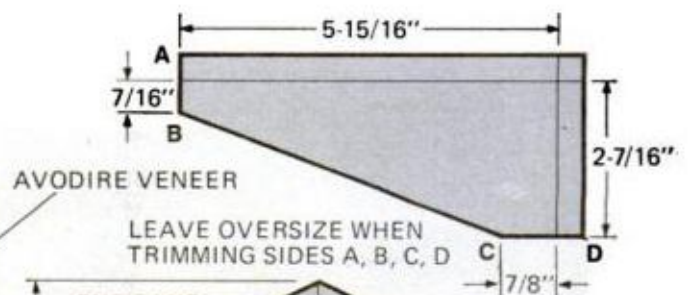
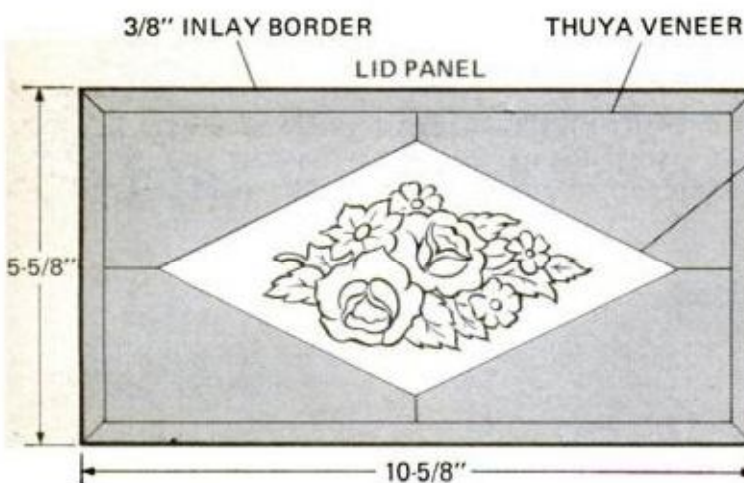



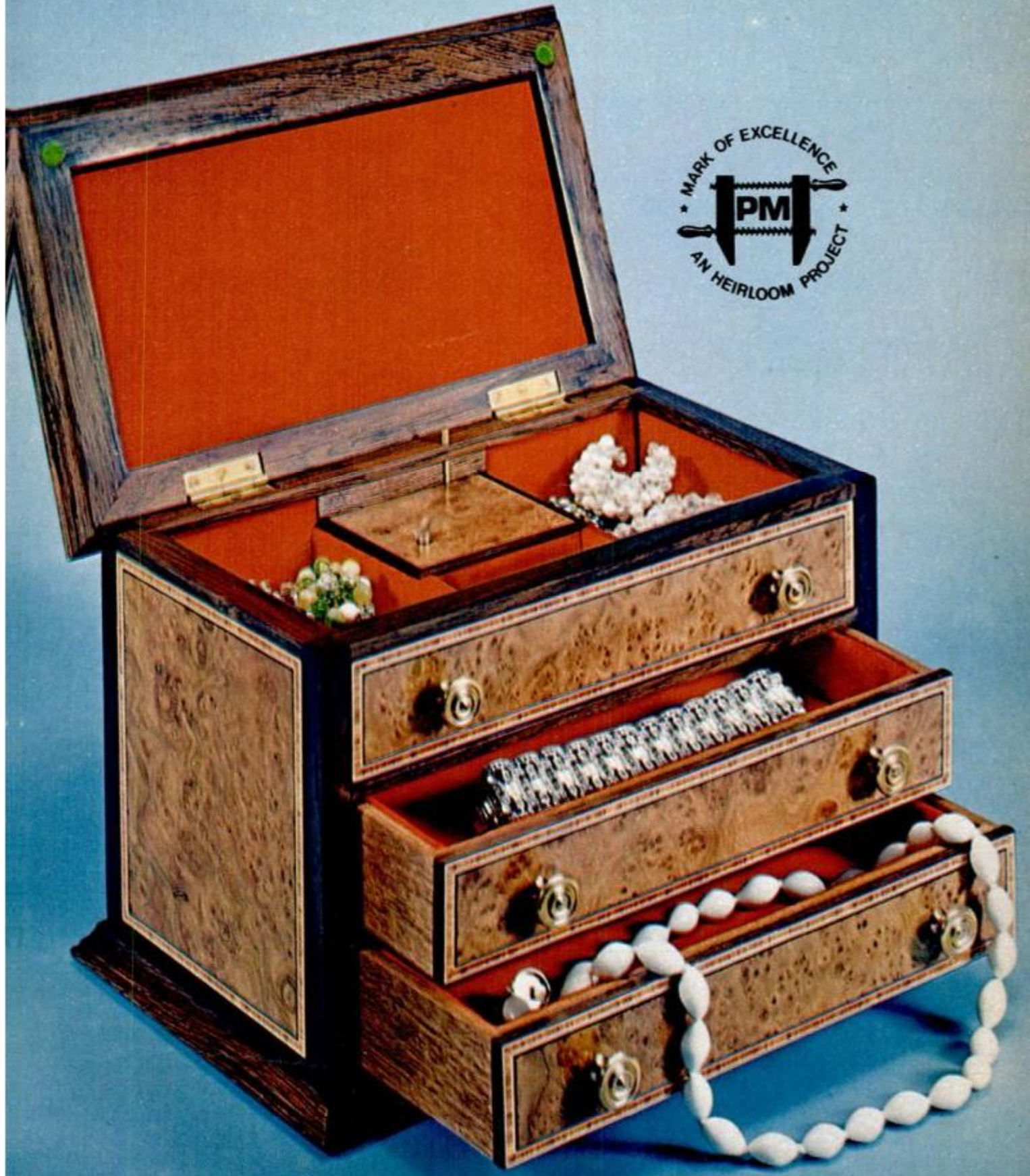



# General Assembly

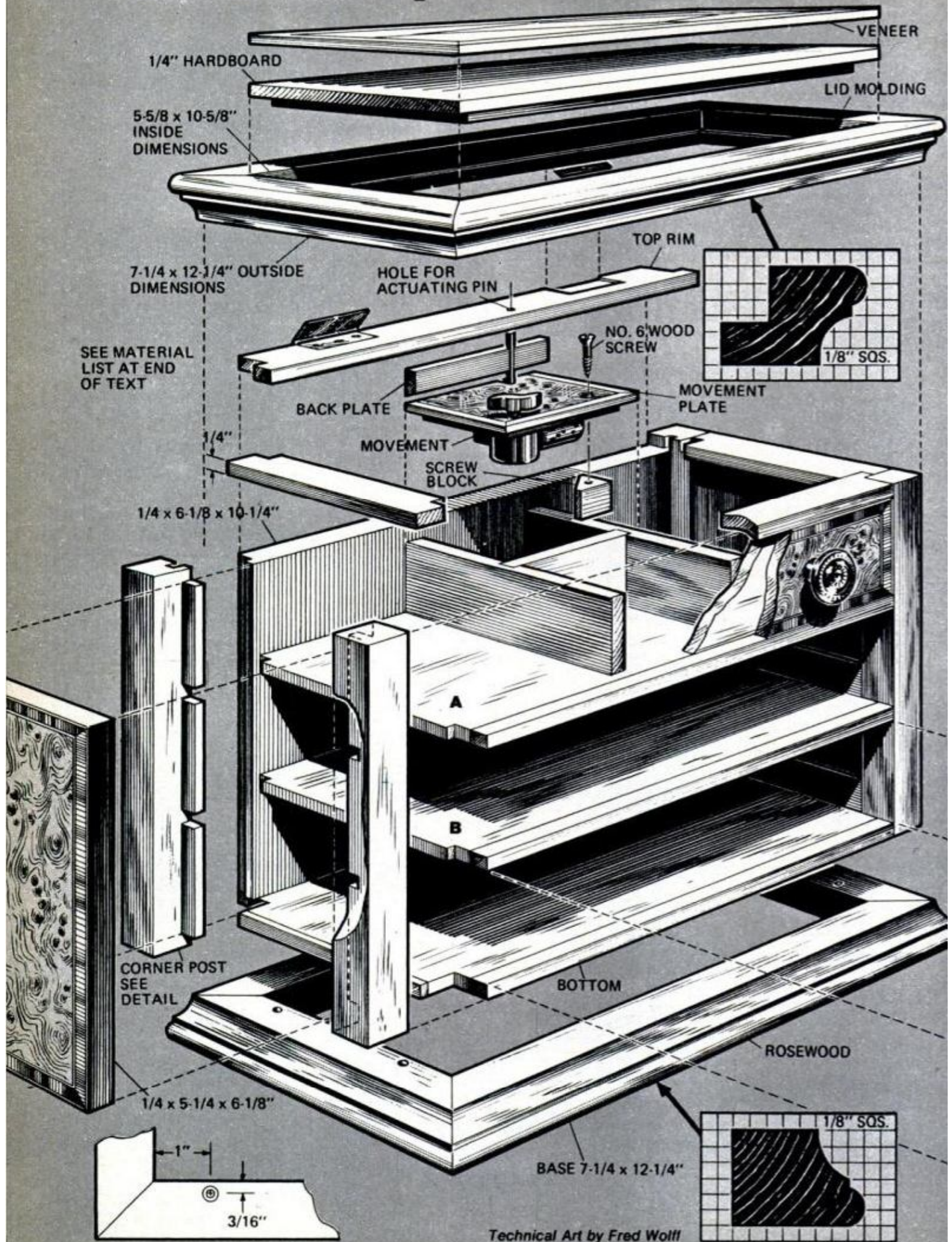

Technical Art by Fred Wolff



kraft) near all edges and across any cracks before you cut it with a knife or veneer saw. Apply white glue liberally to the veneer (remember, keep the taped side outside) and affix the veneer to hardboard. Clamp this between waxed paper and cauls and, applying pressure slowly, work from the center out.

Trim the oversize veneer blanks to remove loose veneer and excess glue from edges, peel off tape and rough-sand the veneer to remove all glue that has seeped through. Finish the blanks by trimming to dimensions shown in the drawing.

Cut oversize backing panels from plywood and glue them to the back of each veneered panel. Trim the plywood panels flush with veneered panels on all sides, except the ends of the back panel which

are trimmed  $\frac{1}{16}$  in. oversize to fit the grooves in the rear corner posts.

● **Drawers.** Cut three blanks for drawer fronts from  $\frac{1}{4}$ -in. hardboard and veneer them with thuya. After rough-sanding the veneered blanks, trim two of them for drawers and the third for the false drawer. Glue rosewood veneer to all four edges of the two drawer fronts and sand these to size. Now remove  $\frac{1}{4}$  in. of thuya from all four sides of the three drawer fronts with a sharp chisel and glue the inlay border in place. Locate knob screw holes, stack and clamp the drawer fronts and drill the holes.

Drawer parts are of  $\frac{1}{4}$ -in. mahogany and  $\frac{1}{8}$ -in. plywood. Glue drawer fronts to the drawers with the bottom edges

*(Please turn to page 170)*

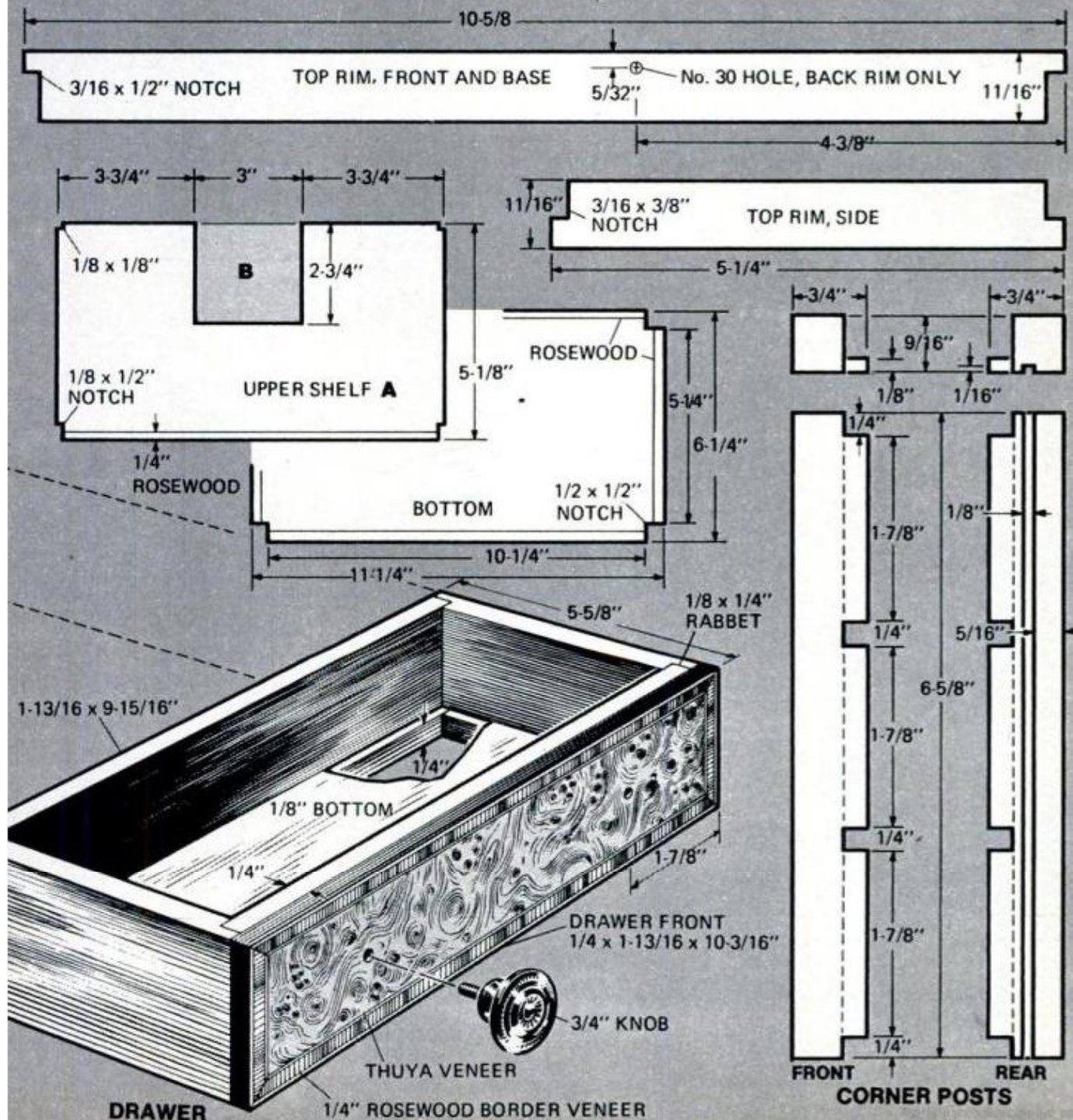





## BASIC CAMPER: \$800

### ACCESSORIES

MATTRESS FOR OVERCAB BUNK	\$33.90
DINETTE CUSHION SET	\$59.90
CONVERTIBLE BUNK	\$64.24
SINK AND WATER TANK KIT	\$28.51
BOTTLE-GAS SYSTEM	\$38.53
THREE-BURNER GAS RANGE	\$32.97
THREE-BURNER RANGE WITH OVEN	\$89.95
ICEBOX	\$33.81
REFRIGERATOR (4 cu. ft.)	\$257.95
GAS FURNACE	\$71.90
CURTAINS AND DRAPES	\$53.83
EXHAUST HOOD (VENTED)	\$6.76
EXHAUST HOOD (POWERED)	\$21.95
INTERIOR GAS LIGHT	\$10.83
ELECTRICAL CONVERTER	\$44.95
UNLOADING JACKS	\$74.95
PORTABLE TOILET	\$77.32
EXTENSION STEP BUMPER	\$67.05
INTERCOM SYSTEM	\$39.95



# A \$1200 Camper From a Kit For \$800

You can save one-third of the cost of a factory-built pickup camper by making this 9-footer from a precut kit and equipping it yourself

*Photographed at Cypress Gardens, Fla.,  
By Monty Monts de Oca and Jerry Imber*

**F**ROM KIT TO CAMPER in just 50 hours! That's the boast made by the maker of this handsome pickup camper kit. The kit costs \$800 and by putting it together you'll get a basic camper that's worth \$1200. For \$400 more (the cost of accessories) you can end up with a camper the equivalent of which would cost you \$1600 if bought ready built.

Manufactured by Luger Industries, Dept. PM, 1300 East Cliff Rd., Burnsville, Minn. 55378, the 8-ft. 10-in. Rover shown here is fun for the entire family, from building it right on through to your first camping trip. And, happily, the instructions that come with the kit are well illustrated with easy-to-understand line drawings.

You will be particularly impressed with the Luger firm's attention to detail. For example, every part you need to assemble the camper is included, from the smallest fastener up to the large, precut and factory-finished interior paneling.

Pictured on the following pages is the step-by-step assembly procedure for building the Rover Model 4085 camper which can, if desired, sleep six.

The Rover's convertible dinette offers the comforts of optional thick-padded

**LEFT:** In 50 hours, you can convert kit into camper

**RIGHT:** Dinette (top) seats three comfortably. Kitchen (second photo) can be equipped with three-burner range-oven. Optional bunk over dinette (third photo) sleeps two—as does dinette bunk (bottom)

JULY 1971

129





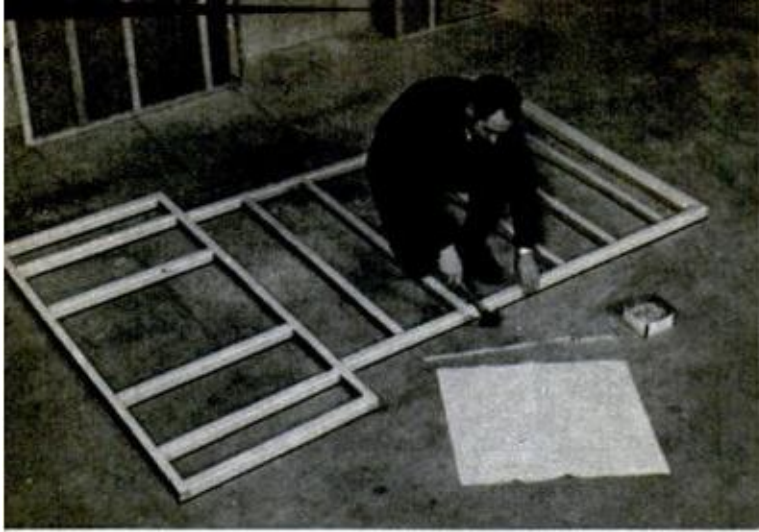

**EXTERIOR SECTIONS** are laid out first. Two by fours and precut, prefinished paneling are included in kit

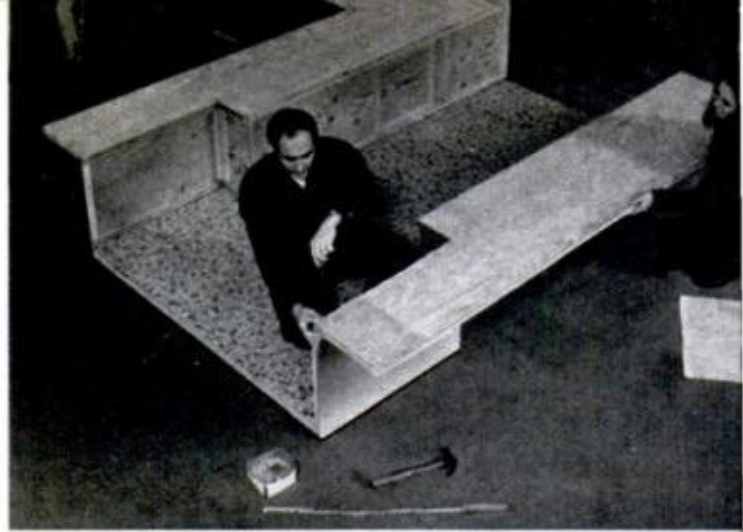

**CAMPER-FLOOR BASE** is completed and covered with linoleum. Next, wall sections are fastened to the base

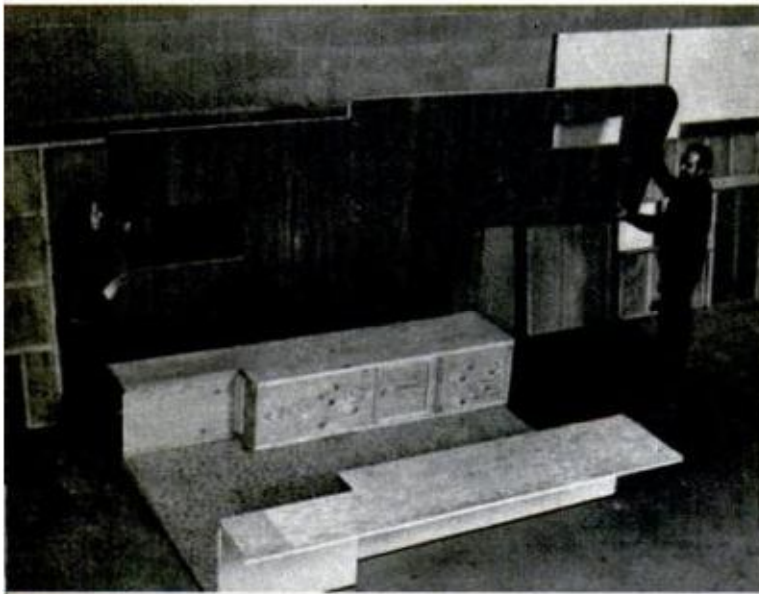

**ASSEMBLED CAMPER WALL** is placed in position on camper base. Instructions are clear, easy to follow

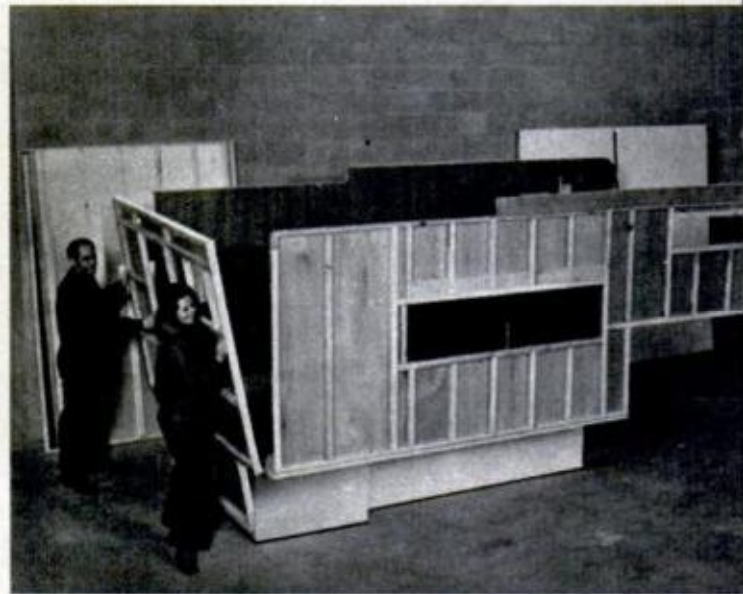

**WITH SIDES AND ENDS IN PLACE**, the kit is well on its way to becoming a finished pickup camper

## CAMPER FLOOR PLAN

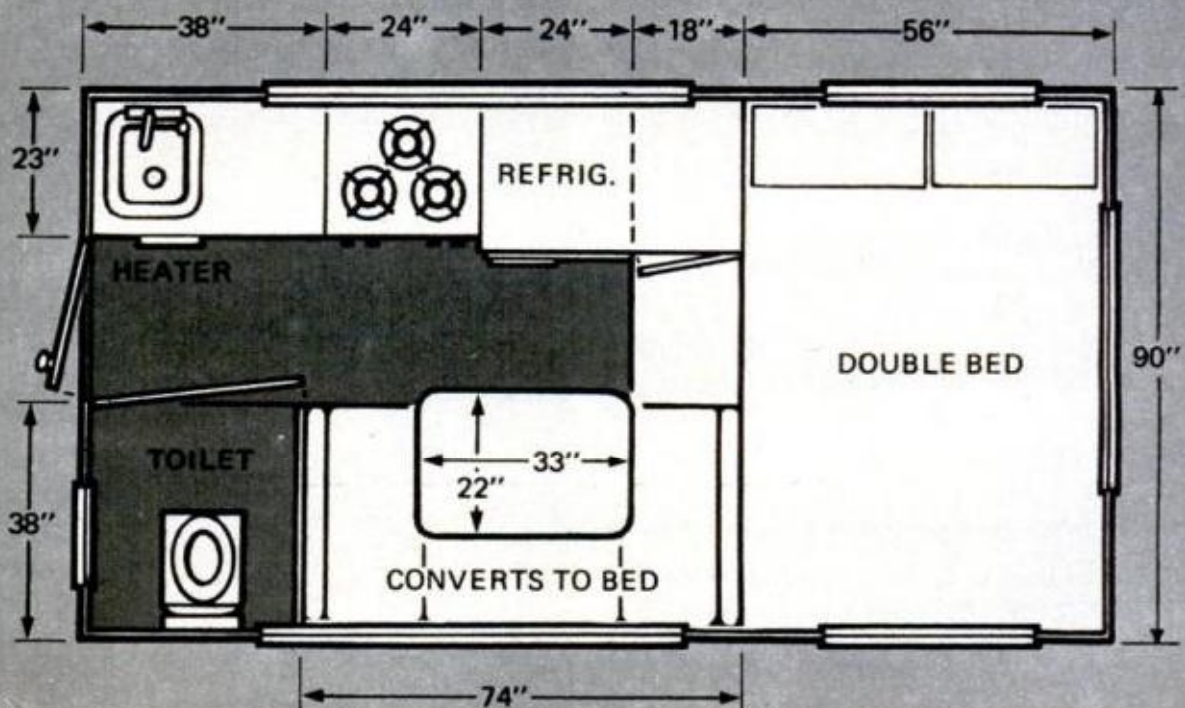



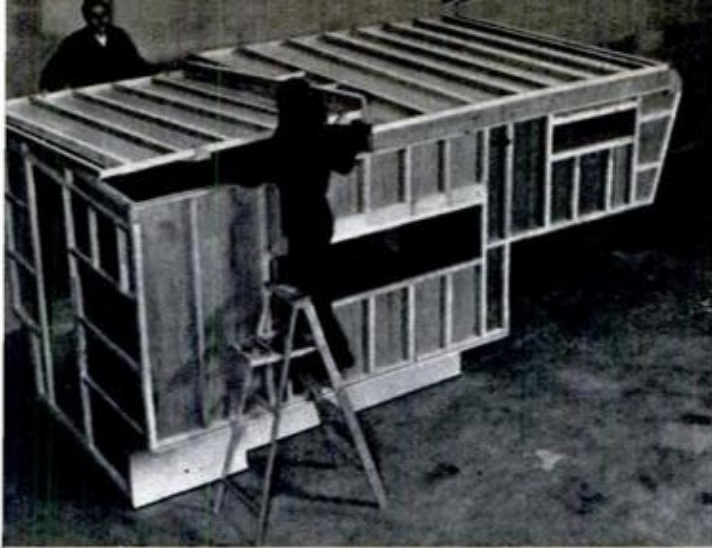

**ROOF SECTIONS** are dropped in place after the side walls have been erected. This completes basic camper



**INTERIOR PARTITIONS** are also precut and pre-finished. Camper can be assembled in about 50 hours

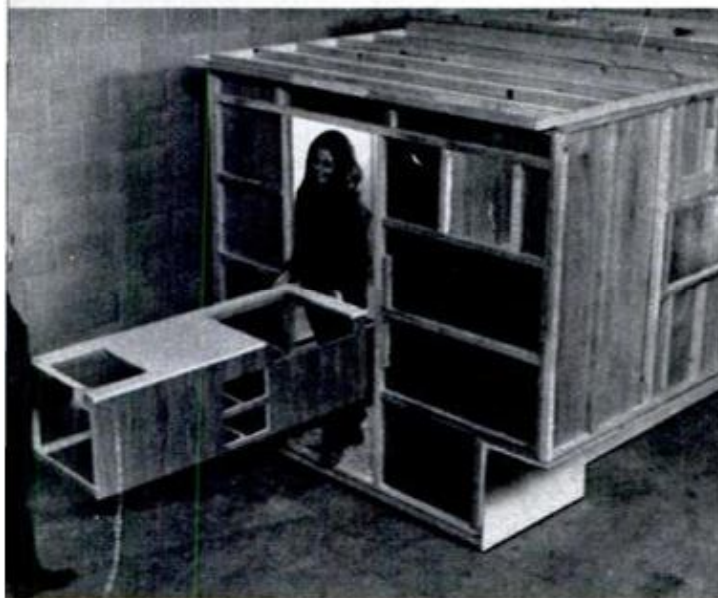

**ASSEMBLED KITCHEN COUNTER** is slid into place. Camper can be assembled using regular hand tools

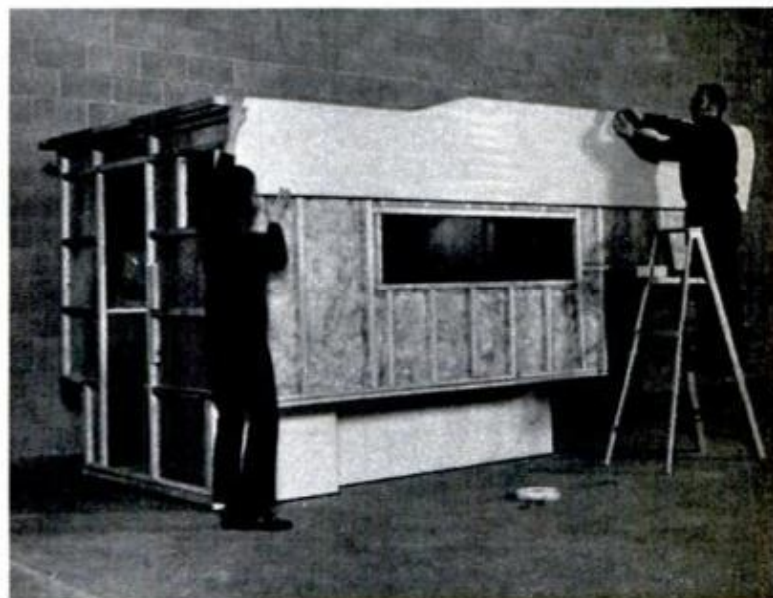

**FIBERGLASS INSULATION** goes in next, is skinned with a factory-supplied aluminum exterior covering

foam cushions, overhead light and a sturdy table topped with Formica. Accessory curtains for the cab-over bed area and windows are color coordinated with the handsome interior. The smartly styled interior features a plastic-laminated 3-ft. kitchen counter plus roomy cabinets above and below counter and sink. The optional ice box or refrigerator is of ample size for the average family's camping needs.

You can purchase optional extras immediately or, if you want to keep your initial investment low, begin with the bare essentials and add accessories as you can afford them. The breakdown on page 128 lists major accessories and what they cost.

A couple, obviously, can get by with a minimum investment. A family with four children will have to lay out a little more initially, but a couple of family vacations will quickly amortize the cash outlay.

Luger states that "any standard 3/4-ton

pickup equipped with the extra equipment recommended by its manufacturer for camper carrying use" will suit the Rover. This will usually include heavy-duty rear springs and shocks, extension rear-view side mirrors and heavy-duty tires. Other optional pickup equipment such as automatic transmission, power steering and brakes, deluxe interiors, bucket seats and the like is strictly a matter of personal taste and how far you want to stretch your vacation budget.

The kit price includes everything needed to assemble the camper as shown, but it does not include accessories listed on page 128. The kit does supply all exterior aluminum covering, insulation, structural framing members, interior paneling, cupboards, kitchen countertop and the like. For more information on the Rover, write Luger Fun Camper Kits at the address noted on page 129. ★★★







# Make This Charming Colonial Wall Clock

Photos by Robert D. Borst

**YOU'LL HAVE** a handsome timepiece for the rest of your life when you make this Early American wall clock. What's more, it's simple to make; if you have no way of forming the turnings and the moldings, you can buy them ready-made. In fact, the wood and everything else—even the finishing materials—are available in a kit. All you have to do is cut out the front and make the simple box attached to the back.

However, if you have scraps of walnut gathering dust in your woodbox, you can buy the battery movement, dial, pendulum, stars and eagle separately and make the case from your own wood.

If you start from scratch, you first must make a full-size pattern for the front of the clock by ruling off 1-in. squares on paper and enlarging the squared pattern given on page 134. To enlarge the magazine pattern you draw in each square of the large pattern the same portion of the outline that appears in the corresponding square of the small pattern. You need only draw a half-pattern.

The blank turning square for the split spindles is built up by gluing two ½-in.-thick pieces together with a piece of paper between. This trick permits prying the two halves apart with a knife blade after the turning is completed. This one turning makes both split turnings.

Ordinarily, a three-sided box open at the bottom is all that's necessary to house the movement on the back of the clock. However, should the plywood front have a slight warp or cup as it sometimes does, a fourth side on the box will help pull the plywood flat when you glue and clamp the box in place. If the bottom piece is needed, remember that it must have an opening for the pendulum.

From here on it's simply a job of adding the blocks for the eagle's perch, gluing the molding and split turnings to the jigsawed

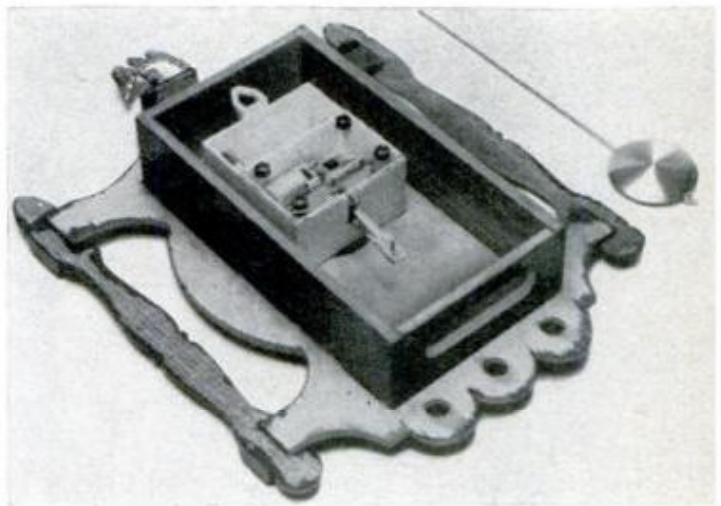

**IF BOTTOM IS USED** in box housing the movement on back of clock, a slot must be provided for pendulum

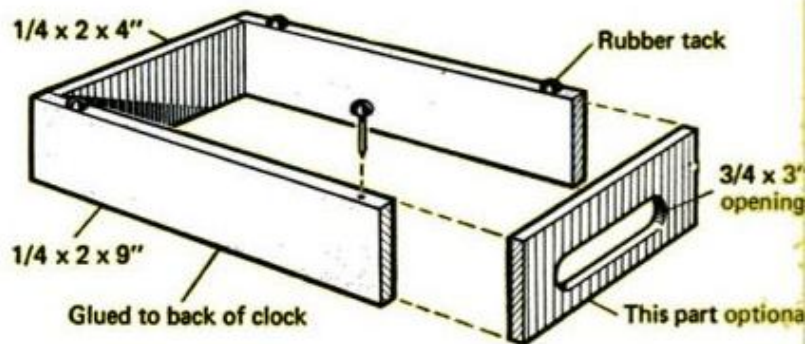

**STARS AROUND DIAL** are lightly tapped into pre-drilled holes located on 6½-in.-dia. penciled circle



# Colonial Wall Clock Plans

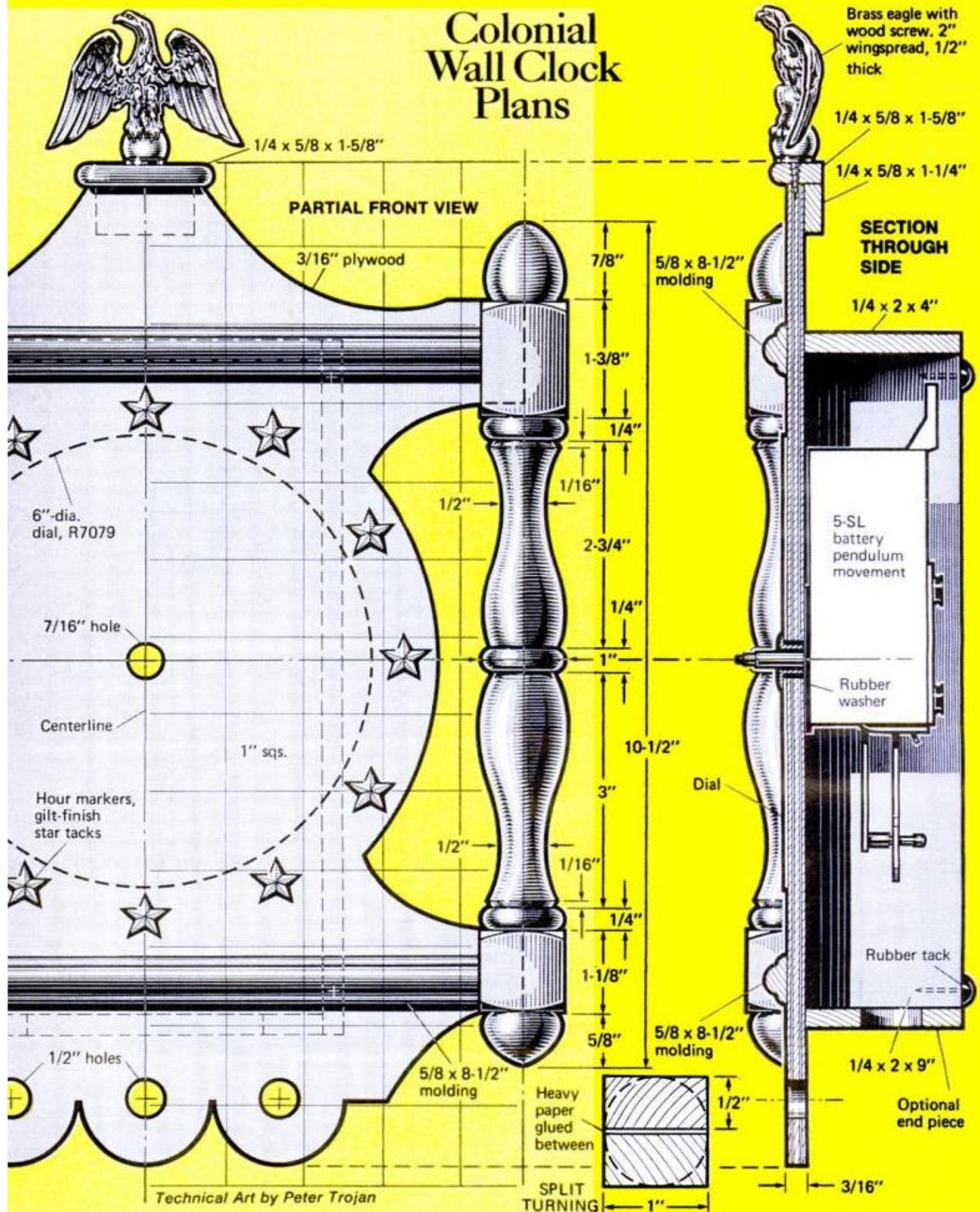

front and finishing the case by applying a combination stain-filler, followed by two coats of waxing lacquer, rubbed between coats. The dial and clock movement take only a few minutes to install.

The kit, as well as separate parts, is available from Gaston Finishes, 3630 East 10th St., Bloomington, Ind. A complete kit sells for \$29.50 postpaid; without the wood parts, it's \$19.50. ★★★



# HINTS FROM READERS

## 'Fishhook' nail holds panel

A simple way of fastening a panel over a framed opening is to use nails fishhook fashion to clamp the edges. The fasteners are ordinary finishing nails with the head-ends bent to press firmly against the panel back. The panel is not penetrated, and it can be easily removed by rotating each of the hooks about a half-turn.

—Walter E. Burton, Akron, Ohio

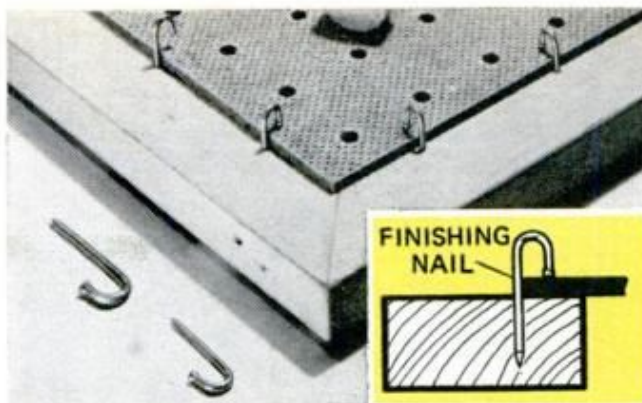

## Homemade continuous hinge

Recently, when I needed a length of piano hinge, the thought occurred that I already had the materials to provide a good substitute at no cost. I simply fastened a series of butt hinges in place and joined them by a single "pin." This pin can be a length of coathanger wire or other wire that fits the knuckle-holes snugly.

—B. W. Ervin, Kent, Ohio

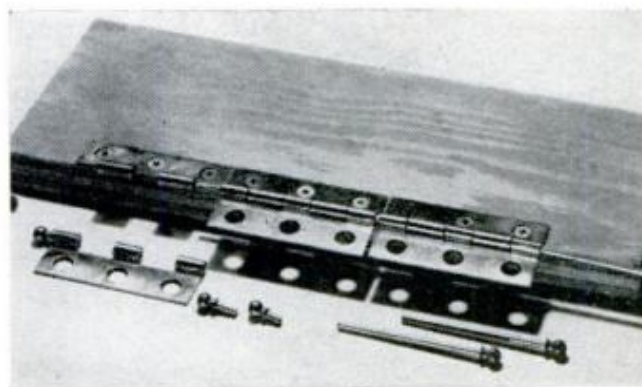

## Tap makes scale marks

A thread-cutting tap can be used as a die for imprinting scale marks in soft sheet aluminum. For example, the 3/8-16 tap shown at right gives a scale having 1/16-in. divisions. Simply squeeze the tap against an aluminum blank in a vise using hardboard as a backing between tap and jaw to prevent damage to the tap's threads.

—W. B. May, Oak Park, Ill.



## Improvised pipe wrench

Next time you can't find your pipe wrench, use your open-end wrench to turn a small pipe. Simply place a wood screw between the pipe and lower jaw of the wrench; the threads will provide enough grip to turn the pipe. If working with copper, wrap a turn or two of friction tape around threads first.

—William Swallow, Brooklyn, N.Y.

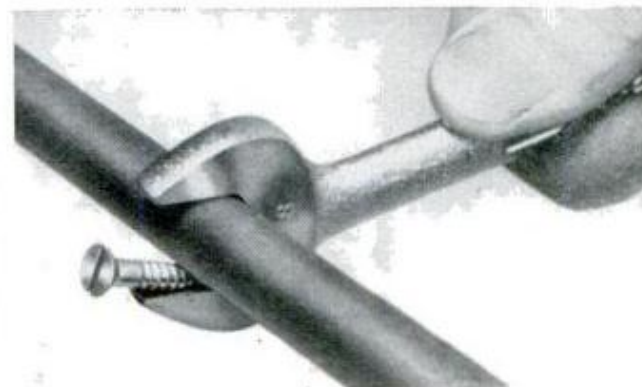

## Aluminum marks lathe work

A piece of soft aluminum wire clamped in a lathe toolpost can be used to mark positions for cuts to be made on shafting or other darkly-coated stock. Mount rod as for turning, bring wire tip against it where mark is desired, and hand-rotate the spindle. The aluminum will produce an easy-to-see shiny mark.

—Walter E. Burton, Akron, Ohio







# SOLVING

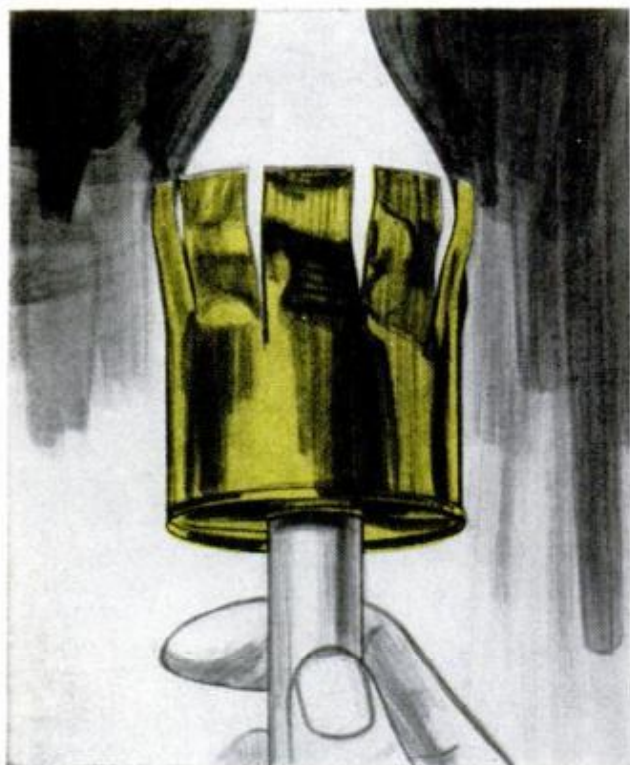

**CEILING LIGHT BULBS** are a snap to replace if you fashion a bulb gripper from a tin can. Simply make 2-in. cuts down from the can rim and fasten the can to a broomhandle.—*William Swallow, Brooklyn*

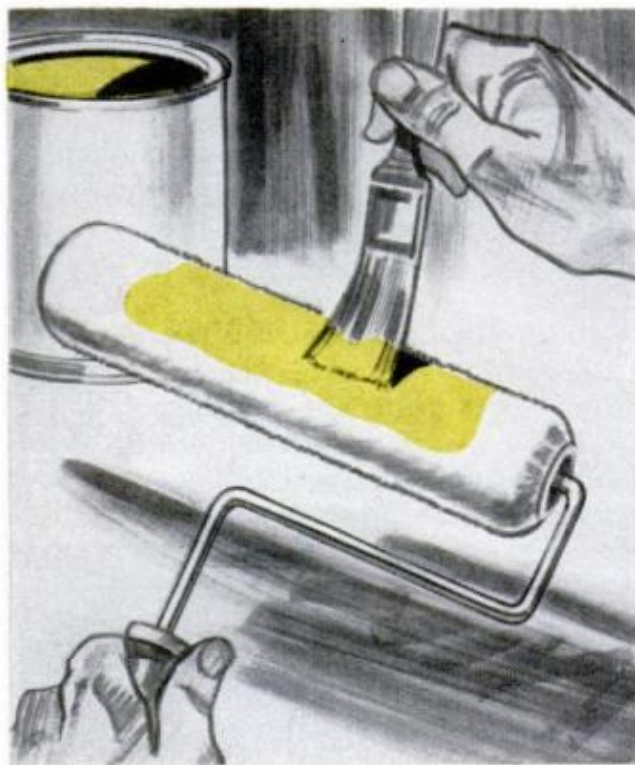

**WHEN A WALL** needs a touch-up job here and there, don't bother dirtying a paint tray. Simply transfer the paint from the bucket to the roller with a paintbrush.—*John Pilznienski, Dearborn Heights, Mich.*

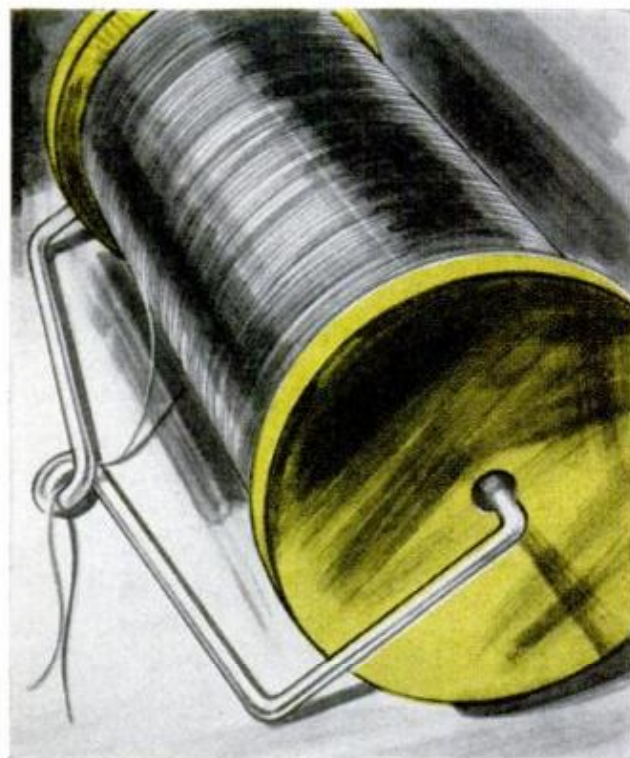

**WIRE AND THREAD SPOOLS** won't unwind and tangle if you bend and affix a short length of wire as shown. End of wire is then threaded through the loop and never gets lost.—*W. H. McClay, Pasadena, Calif.*

136

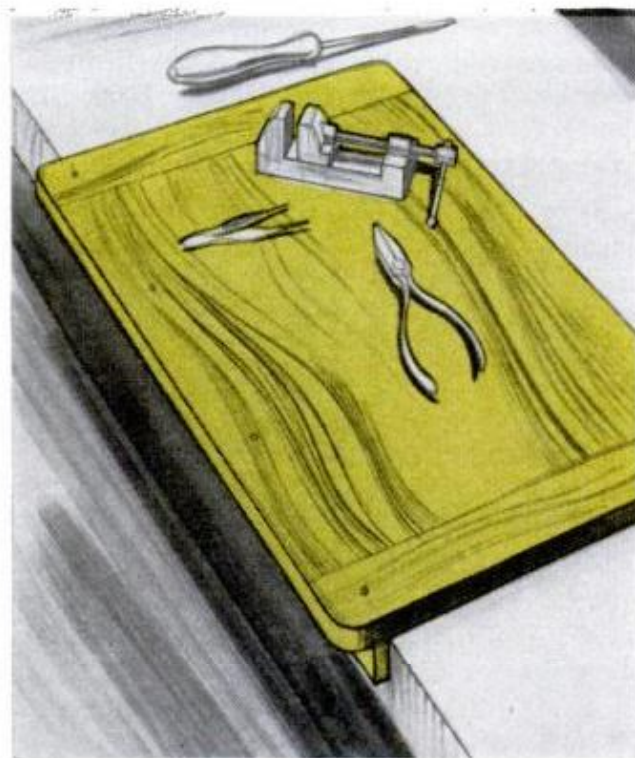

**PORTABLE "WORKBENCH"** for those fix-it jobs at the kitchen table can be made from an old cutting board or plywood scrap. Simply attach an apron to hold it in place.—*J. H. Millholland, Haverford, Pa.*

POPULAR MECHANICS



# HOME PROBLEMS

Illustrations by Adolph Brotman, Worman Associates



**ADD FLOWER POWER** to your back-yard fence by hanging potted plants the easy way. Just add a wire ring under each pot's lip and attach a bale. To hang, use a shelf bracket.—*W. H. McClay, Pasadena, Calif.*

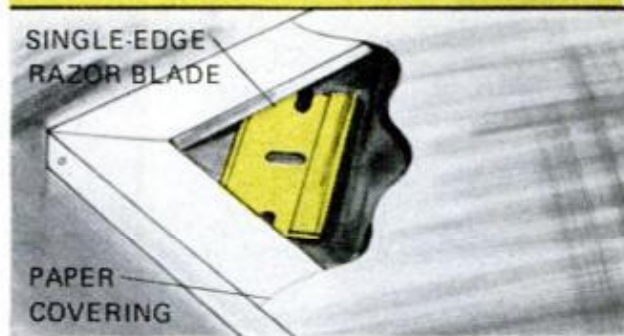
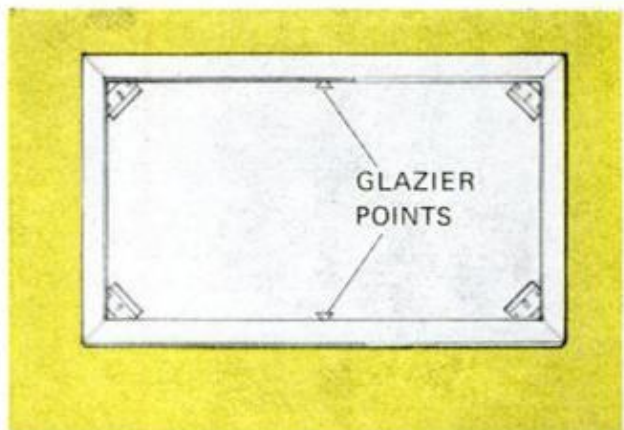

**PICTURE MOUNTING AND FRAMING** goes quicker if you substitute old single-edge razor blades for those tiny glazier's points at the corners. Trick saves looking for tools.—*M. K. Fox, Wellesley Hills, Mass.*



**LIQUID SHOE POLISH** works great as a touch-up paint when repairing rust spots on wrought-iron furniture. The idea is not recommended for items (brazier) where fire is present.—*Pat Hylas, Woodhaven, N. Y.*

JULY 1971



**EMERGENCY CANDLE HOLDERS** for a blackout can be rigged quickly by using handy cans of food as nontip bases. Place candle against can and snap hefty rubber band around both.—*William Swallow, Brooklyn*

137



You'll be able to machine a reasonably perfect ball-shaped knob or neat convex segment on a decorative spindle with this . . .



# Lathe Ball-Turning

By WALTER E. BURTON

SEVERAL EXAMPLES of what the attachment can do are shown above. Diameters here are  $\frac{1}{4}$ ,  $\frac{1}{2}$  and 1 in. Variations need be limited only by your imagination

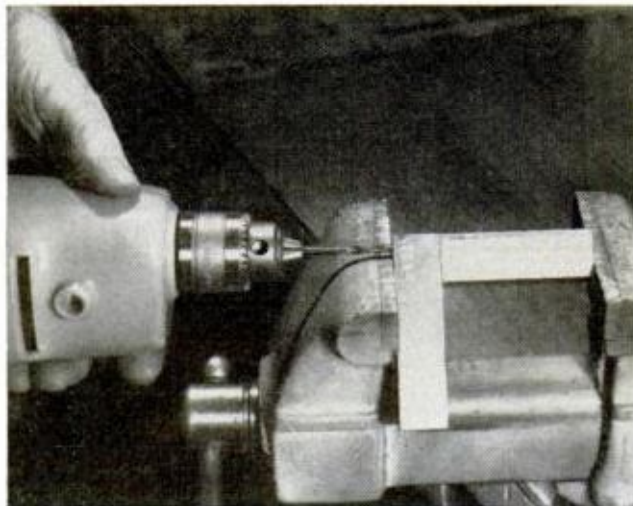

PORTABLE DRILL is used to make holes in part B (see page 140) for the two  $\frac{1}{8}$ -in.-dia. pins which help to join and align part A with the upper end of part B

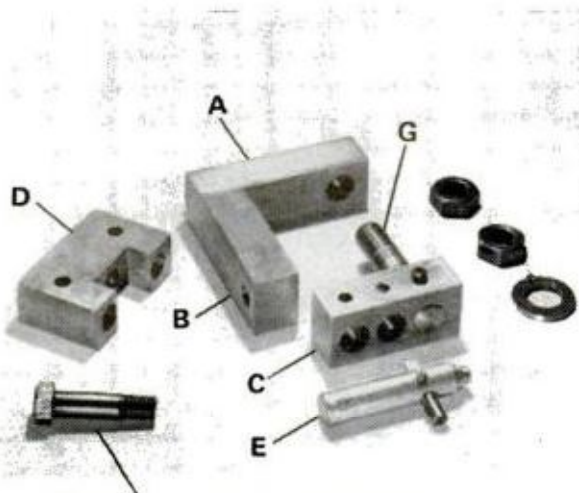

3/8-16 x 1-1/2" CAPSCREW

PARTIAL ASSEMBLY: A and B are joined and block C is attached to pivot (G). Cutter-post assembly (E in foreground) uses a section of  $\frac{1}{4}$ -in. rod as the cutter

MANY KINDS of ball-turning gadgets have been devised for lathes. I designed this bit for machining ball-shaped knobs and pulls, for forming rounded ridges and edges and for making convex segments on decorative spindles and handles. It works like a charm.

To be able to accomplish these turnings, you need a cutter that can be pivoted properly around a fixed center. The attachment shown, designed to do just that, consists essentially of a steel-bar frame supporting a lever-controlled swinging arm. Extending down from the arm is a rod in which the cutter is mounted.

Possibly this arrangement would work consistently without a support for the lower end of the cutter rod, but this end was provided with an adjustable screw whose head slides over a steel plate. The downward cutting force against the cutter is thus counteracted partially by the plate, lessening stress on the supporting frame and reducing the tendency to chatter.

The model, made from available shop stock, was dimensioned to fit a 9-in. lathe to machine balls ranging in diameter up to about  $1\frac{1}{2}$  in. Set up as shown, the attachment normally shapes most of a ball but leaves it attached to a stem. By carefully adjusting the cutter until its tip can cut to the center without the holder or other part striking the work, you can machine a ball completely, or until it breaks off.

The attachment is clamped to the compound slide of the lathe, in place of the usual toolpost assembly, by two bolts engaging a bar (J in drawing, page 140) in the T-slot. It could be manipulated to

POPULAR MECHANICS



# Attachment

Photos by the Author

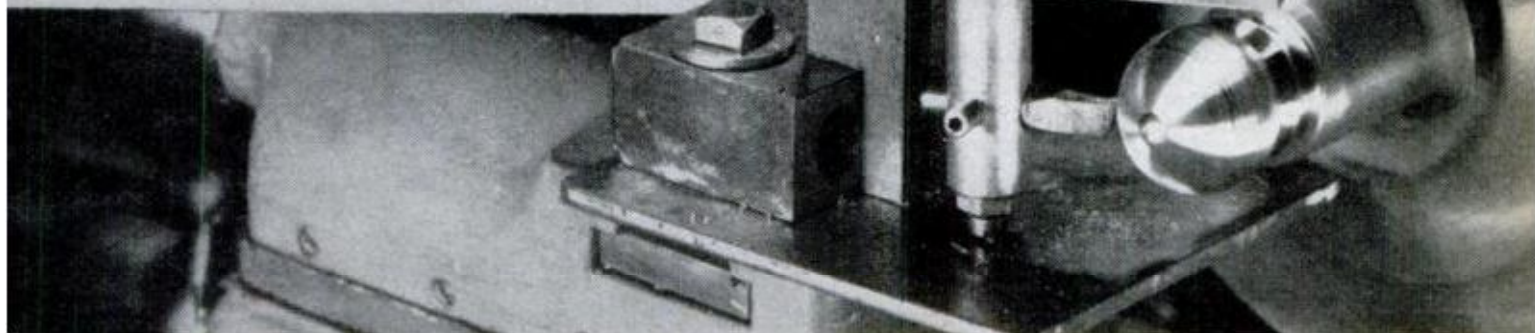

make concave cuts within a limited radius range. Even a greater range might be machined with a simpler setup described later.

Parts used in the model attachment include four steel blocks, a steel plate, and miscellaneous bolts and screws. Much of the frame, represented by pieces marked A, B and C, was made from  $\frac{3}{4}$  x 1-in. steel bar. The base block (D) is wider in order to span the T-slot in the compound slide. A steel plate (F),  $\frac{1}{8}$  in. thick, was interposed between D and the compound to serve as a platform over which the cutter-holding rod slides. Strip J was made to fit the toolpost slot of the lathe.

The  $\frac{1}{2}$ -in. shaft (G), which serves as the pivot for the swinging movement of

**BALL-SHAPED KNOB** is machined (above) with ball-turning attachment that's mounted on a 9-in. lathe

the tool, was a piece of  $\frac{1}{2}$ -20 bolt whose diameter happened to be reasonably accurate. It could have been made from drill rod or shafting threaded at one end. The cutter holder (E) was made from the same bolt. For ease of construction, bolts and pins were used to join the sections forming the frame of the model illustrated. The  $\frac{3}{8}$  and  $\frac{1}{2}$ -in. holes in A were drilled and reamed to be reasonably perpendicular to the drilled surfaces.

The joint between A and B was assembled by first drilling, in A, a  $\frac{3}{16}$ -in. hole where the bolt is to go, then flanking this with two  $\frac{1}{8}$ -in. holes for pins. The two

**BALL-TURNER DISASSEMBLED.** To fasten each of the joints, bolts and pins were used in the attachment

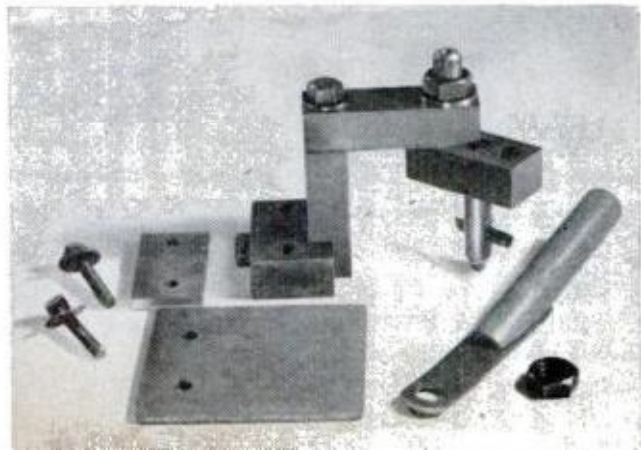

**BLOCK,** seen from below, shows how swinging block pivots so it just misses upright part on the frame





# Ball-Turning Attachment

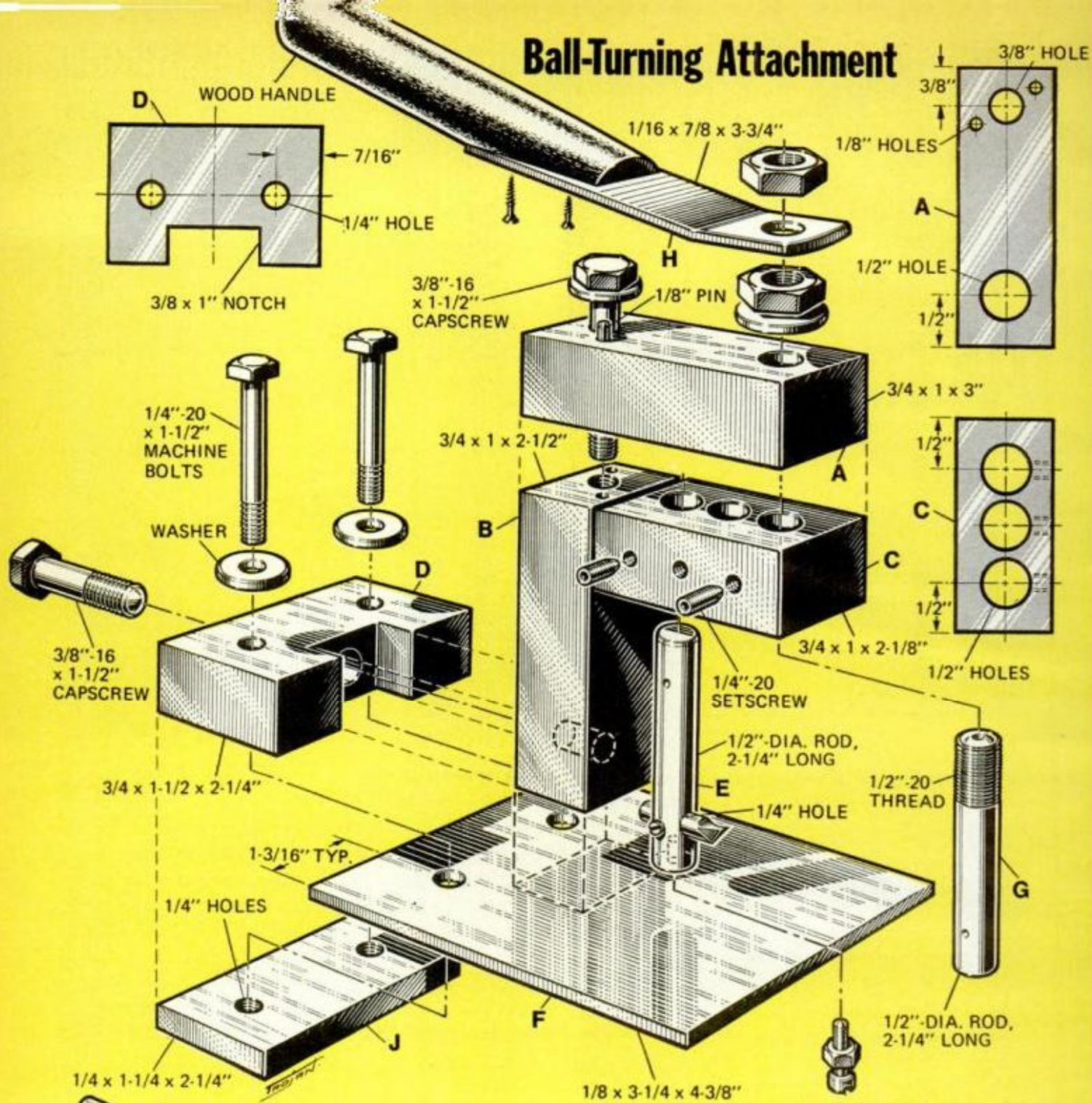

Technical Art by Peter Trojan

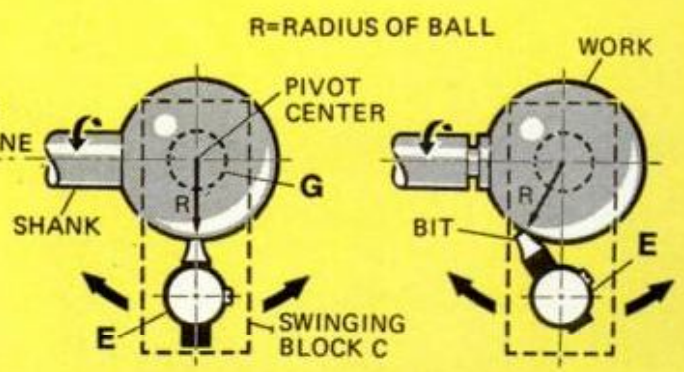
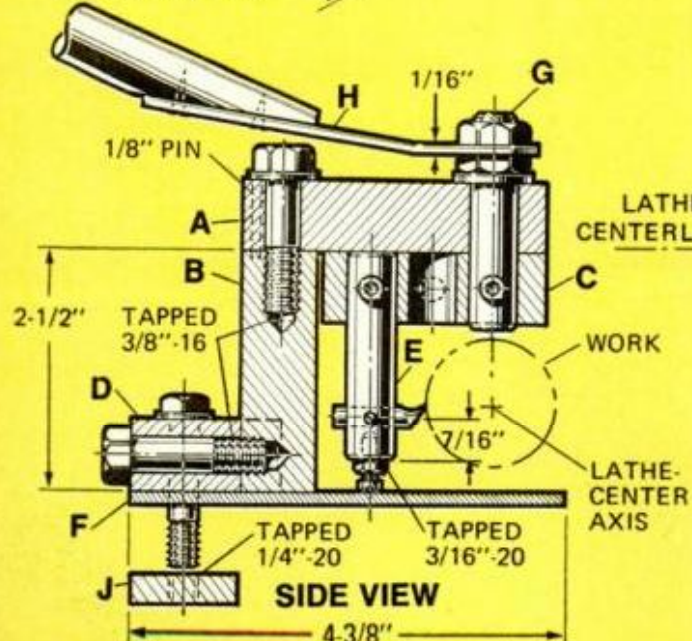

**NORMAL SETUP** has bit-point approximately in plane of bolt G and rod E. Finished ball has stem (as for a drawer pull)

**WHEN BIT** is swung to one side by rotating E, tip cuts closer to the centerline. The bit cuts on both the side and tip



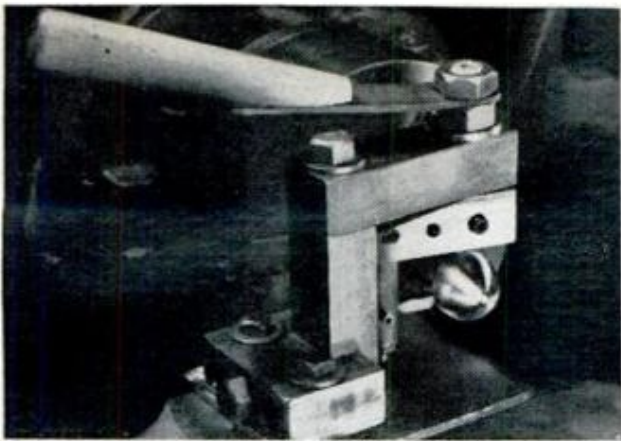

**TWO 1/4-IN. BOLTS** hold the attachment in position over the toolpost slot of the lathe carriage

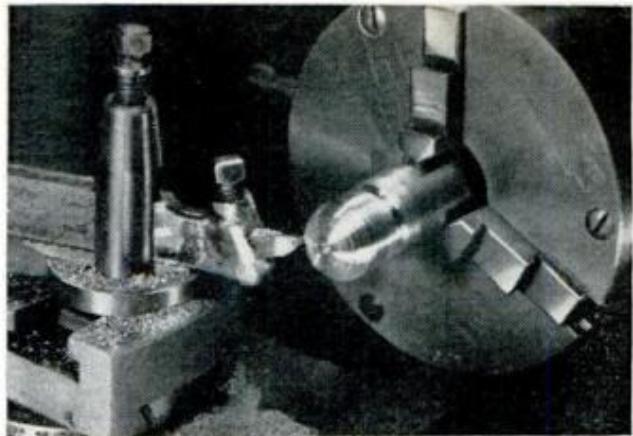

**THE 1-IN. BALL** is first roughed out with conventional tooling to save wear and tear on ball turner

parts were clamped, in alignment, in a vise, with one pinhole exposed. Each pinhole was made in B with a portable drill—the first pin being installed to help align the parts for drilling the second pinhole. The second pin was added to help hold the parts in alignment while the  $\frac{7}{16}$ -in. hole was continued into B. Then the  $\frac{7}{16}$ -in. hole in A was enlarged for a  $\frac{3}{8}$ -16 bolt, and that in B tapped for the bolt thread. Of course, the end of part B had to be square to form a right-angle joint.

The base block (D) was notched to a depth of  $\frac{3}{8}$  in. to receive the upright (B). The notch was milled but could have been made by drilling and filing. A  $\frac{3}{8}$ -in. bolt through D engages a threaded hole in B to hold the joint firmly together.

The swinging block (C) has a row of three  $\frac{1}{2}$ -in. holes, two for the cutter rod and one to attach the block to pivot bolt G. Each hole was provided with a  $\frac{1}{4}$ -20 set-screw. A handle is attached to the top of bolt G with two nuts to control swinging;

**PARTS FOR MODEL SHOWN** were shaped from available stock which was lying about the author's shop



**TO GENERATE CONCAVE CHAMFER** on 1-in. brass rod, swinging compound slide is brought into play



**CONCAVE CUTS** can be made without attachment, using bit mounted in holder and compound swing





the nuts shown were reduced to about  $\frac{3}{16}$  in. A brass washer between the lower nut and arm A acts as sort of a bearing. The handle was made by drilling a  $\frac{1}{2}$ -in. hole near one end of a  $\frac{1}{16} \times \frac{7}{8} \times 3\frac{3}{4}$ -in. steel strip and attaching a  $\frac{3}{4} \times 4$  in. wooden handle.

The cutter-holding rod (E) is approximately  $2\frac{1}{4}$  in. long in the model. Its lower end has a  $\frac{3}{16}$ -20 bolt and locknut positioned as shown. Its upper end is clamped in block C with a setscrew. The hole for the cutter was not drilled until the attachment had been assembled on the lathe. Then it was easy to mark the position of the cutter with respect to the lathe axis—using a scribe point in a tailstock chuck. The hole is placed so the cutting tip of the cutter normally is aligned with the axis.

The attachment shown uses  $\frac{1}{4}$ -in.-dia. high-speed steel bits, so a round hole was made in E. If square cutter bits had been used, the hole could, of course, have been filed square. The bit setscrew on the model is 8-32.

Two positions were provided for cutter-holder E in block C, so that a range of ball diameters could be covered without having to use cutters with very long overhang. Ball diameter is adjusted by positioning the cutter tip with respect to the centerline of bolt G. It would help to provide a tiny hole on the lower end of G to indicate its center—from which measurement could be made. Two adjustments control cutter position: selecting the hole in block C and sliding the cutter in its

hole. Care is taken that the tip of the cutter is not swung out of alignment; it usually should be in the same plane as the centerlines of bolt G and cutter-rod E. The cutter shown was ground with a fairly narrow point, a modest side rake and some back rake. It seemed to work very well on brass and steel. Because of the side rake, it cut more freely in one direction of swing than the other.

It seems desirable to have a little vertical play in bolt G. Platform F was not perfectly flat and play permitted the bolt at the bottom of cutter rod E to ride freely throughout its swing—aided by a film of oil under it. Under the cutting pressure against the cutter, everything in the prototype became rigid enough to produce nonchattering cuts.

To make concave cuts, arm C could be swung  $180^\circ$  to project outward beyond the axis of G and the cutter reversed in its hole. If this were contemplated, platform plate F should be extended far enough to support the cutter rod in its outermost position.

However, there is a way to make concave cuts on the average lathe without attachments other than the regular toolpost, cutter and holder. This is done by loosening the screws that lock the angle of the compound rest, so the compound can be swung around its pivot center while a cut is being made. The more the distance between toolpoint and center of the swing can be reduced, the shorter the radius of curvature. ★★★

## NEXT MONTH IN SHOP AND CRAFTS

**IS YOUR NEXT VACATION 30 FEET AWAY?** Will your budget allow travel and other extravagances? Instead of going into hock, why not put a few dollars into your own property and make your investment a long-range proposition? To help you, PM editors have rounded up 23 pages of ideas that let you make your home grounds your year-round vacation headquarters. Included are plans and ideas for building a slip-proof diving deck, fold-flat cookout table, patio appliance center, roll-out entertainment wall and back-yard game layouts, plus instructions for wiring your patio for sound. You're sure to get more fun from today's inflated dollar by reading the August issue.

**HOW TO MAKE TIGHT-FITTING DOWEL JOINTS.** The surest sign of knowledgeable craftsmanship in your furniture is tight, hairline joints. This article gives all the basics for working with dowels, and how to make the job even easier by using one of the low-cost, modern dowel jigs that are available.

**PM SHOP-TESTS SEARS' LATEST RADIAL SAW.** It's a rugged powerhouse built to take abuse and we proved it in PM's workshop. Bonus: We came up with a base you can build that makes this tool even more versatile. You'll find the test results next month.



# Add This Sander Table to Your Faceplate Lathe

By C. W. BALL



The basic tool appeared in PM last November. Here's how one reader increased its versatility.

WHEN *Popular Mechanics* published a story about a shopbuilt faceplate lathe (*Make This Faceplate Lathe From Odds and Ends*, page 194, Nov. '70 PM), the idea so intrigued me that I built one. Since then, I've had a lot of fun with the tool making things that previously were out of my realm.

Somewhere along the way, I chanced upon the table idea you see here—a simple affair made from  $\frac{3}{4}$ -in. plywood—an addition prompted by several free-hand sanding jobs.

I mounted the motor on my "lathe" high enough to permit the use of an  $8\frac{1}{2}$ -in.-dia. plywood disc (on a sheave) with sandpaper glued on as a disc sander. The prototype was built to fit snugly on the toolrest guides and needed no extra support. Unless the fit is tight and the wood doesn't expand or warp, it's wise to use a locking bolt. The  $\frac{1}{4}$ -20 bolt so used in the drawing (left) is threaded through one platform "leg" in order to bear against a toolrest guide.

Square work can be hand-held. To sand circular workpieces, drive a nail or screw up through the platform the appropriate distance (radius) from the disc to serve as a pivot. ★★★

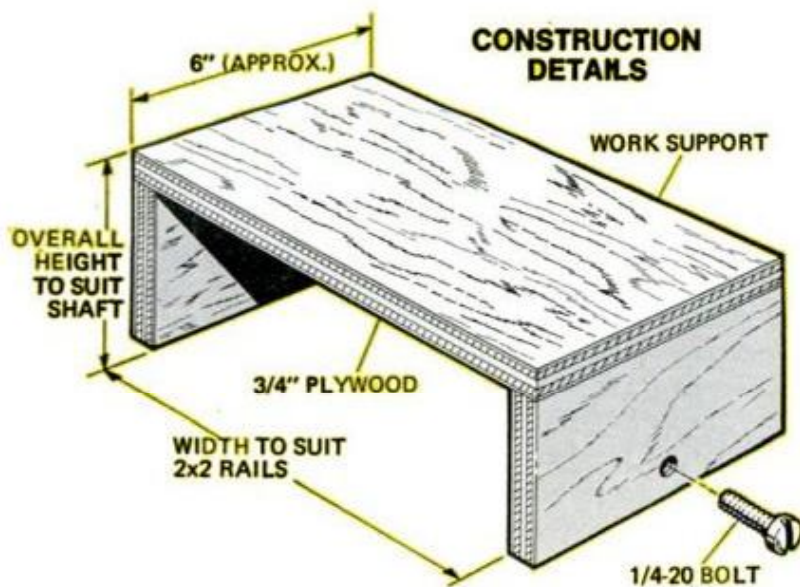



## HOME IMPROVEMENT

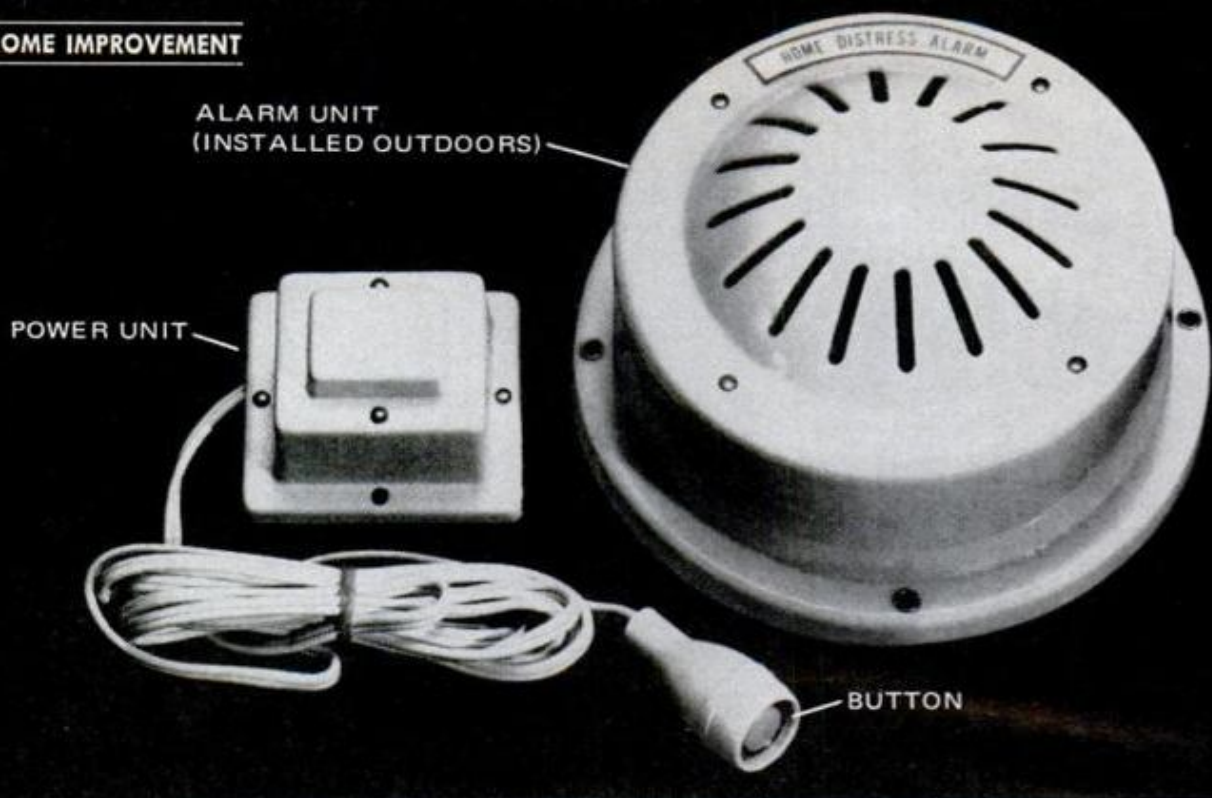

**DISTRESS ALARM** has siren and flasher in unit installed outdoors; when you trigger it with a pushbutton switch located in a bedroom or other handy spot, you alert neighbors that there's trouble present. Nox-prowl costs \$40; for brochure write Star Sprinkler Corp., Dept. PM, 4545 Tacony St., Philadelphia, Pa. 19124

# Inexpensive Alarms

By **HARRY WICKS**, Workshop Editor

Photos by Robert D. Borst

**U**NTIL RECENTLY, when you locked your house to go away for a weekend or vacation, there wasn't much else you could do—other than alert the local police department to keep an eye on things—to protect your home and property. Most anti-intrusion devices were too sophisticated in design and expensive to install.

With the annual "loot" in home burglaries now estimated at more than \$10 billion, you had good cause for concern as you pulled away from the curb. Happily, several manufacturers have turned their engineering skills to producing and marketing home intrusion products priced within reach of the average homeowner.

The alarm pictured above (unlike the others) is not actually an anti-intrusion device. But it's ideal for invalids and, therefore, is included in this roundup. It's mounted high on the exterior wall. When a prowler is spotted, you can push

a button control to set off a wildly blinking light and an ear-piercing siren. The neighbors hear the racket, the prowler heads for cover and you have the time to dial the police.

After testing the alarms shown, I recommend two things when making a choice: 1. An added feature such as a fire-alarm or pre-entry warning is a plus; and 2. an intrusion alarm operated by batteries is probably better than one plugged into house current. The latter consideration is good in event of power failure or brown-out (when break-ins are more likely), provided you make a practice of checking the alarm every 60 days.

One other point: Tell your neighbors that you have installed an alarm. If it's activated while you're away, they'll call the police. Conversely, let those within earshot know when you are testing the setup to avoid false alarms. ★★★



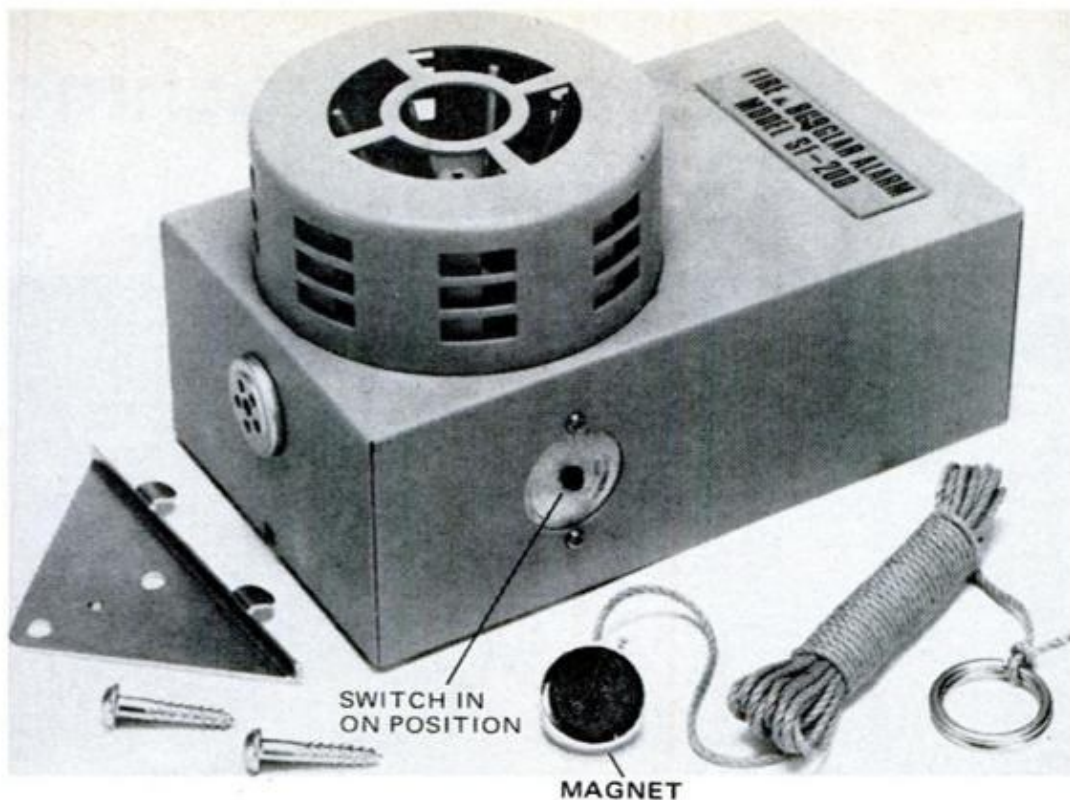

**DOOR-MOUNTED DEVICE** contains a siren, an automatic fire sensor activated if temperature reaches 135° F. and a magnetic switch to guard against intruders. Battery-operated Sensor SF 200 is available for \$18.98 and 50 cents postage from Sunnyside Shoppers, Dept. PM, 10180 S. E. Sunnyside, Clackamas, Ore. 97015

# Scare Off Burglars

**BURGLAR-ALARM GUARD** from Stanley Hardware. The Stanley Works, New Britain, Conn. 06050, is pre-entry alarm that sounds a warning before door is opened. Pressure exerted on deadbolt triggers alarm. In steel case, it's sold for \$9.99 at hardware stores

**BATTERY-OPERATED ALARM** for mounting on any door or window makes a low penetrating sound to warn of intruders. On-off switch deactivates unit when desired; \$4 postpaid from Feasline Trading Co., Dept. PM, 325 Skyline Drive, Feasterville, Pa. 19047

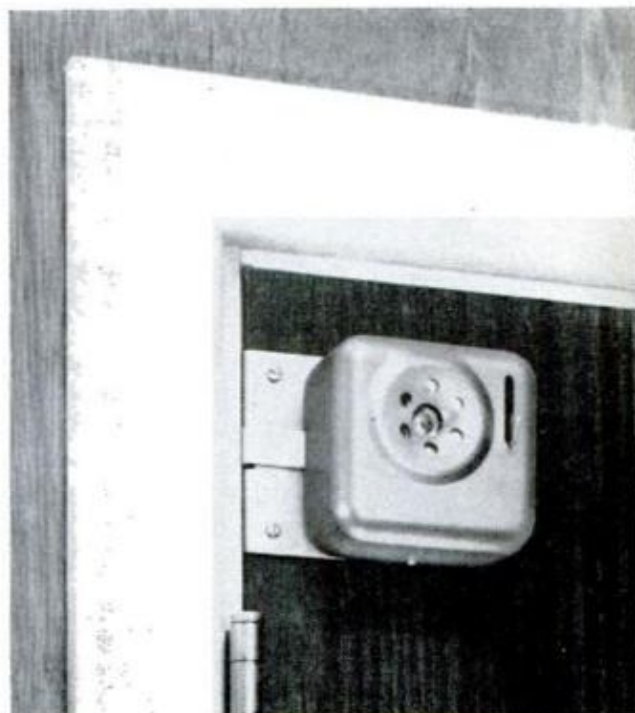



# Build a Tenoning Attachment For Your Table Saw

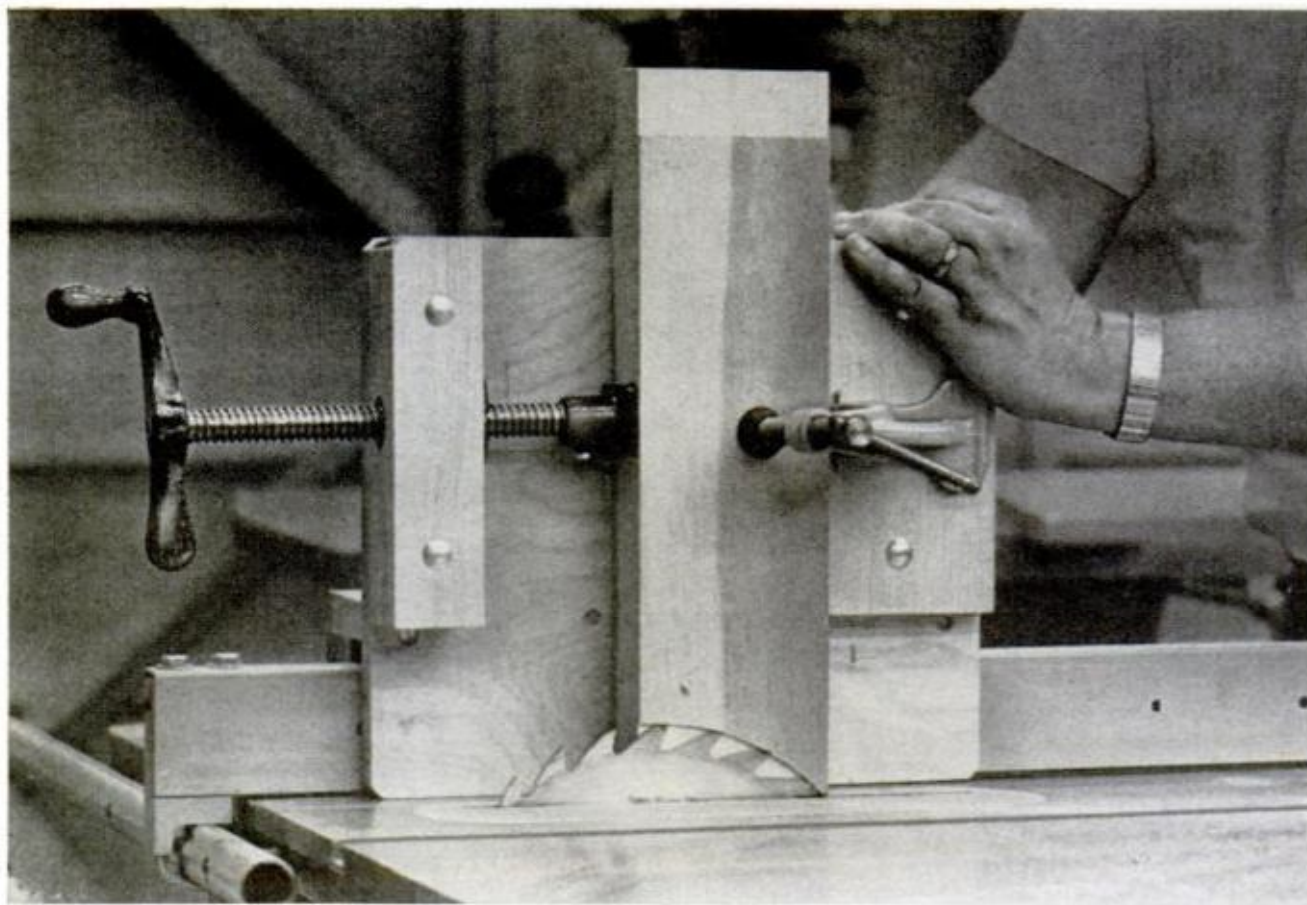

By **ROBERT K. WALLACE**

**T**HIS TENONING ATTACHMENT will quickly prove itself to be an extremely useful addition to your table saw. With the exception of the handle, all of the parts can be quickly cut on the table saw.

The main frame of the attachment is of  $\frac{3}{4}$ -in., seven-ply birch plywood. For desirable strength, the remaining parts are of maple.

Begin by cutting the main frame to the dimensions shown. It's important that this board be perfectly square (and flat) since it is actually the "backbone" of the attachment. Next, cut the front and rear clamp mounts to size and drill the required holes. Square the rear clamp to the top edge of the main frame and mount it with two  $\frac{1}{4}$ -in. carriage bolts. Align the front clamp with the front edge—and top—of the frame and also bolt this in place.

For accuracy, proper alignment of the rip fence with the attachment is a must.

The attachment must mate with the fence to allow a slide-fit without binding, yet it should not be so loose that it will cause inaccurate cutting. After cutting the guide boards to suit your rip fence, mount the handle support board with  $1\frac{1}{2}$ -in. No. 8 f.h. wood screws to the main frame. Clamp the outside guide-board to the rip fence with two layers of newspaper between the outside guide-board and the fence. When mounting is completed, remove clamps and newspaper. (The paper strips are needed to insure clearance for easy sliding.)

The front clamp is a 9-in.-long  $\frac{11}{16}$ -in.-screw assembly used in veneer presses. The rear clamp is a 3-in. hold-down clamp (Jorgensen No. 1623; the mounting bolt comes with the clamp). Both clamps are available from woodworker supply houses such as Craftsman Wood Service, 2727 South Mary St., Chicago, Ill. 60608.

To finish my attachment, I simply rubbed



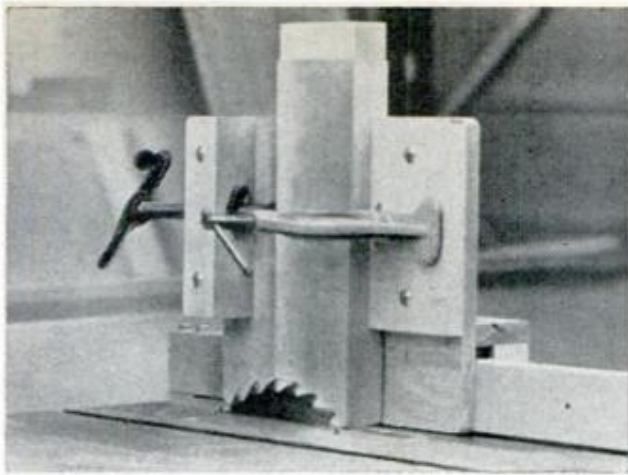

**HOLD-DOWN CLAMP** grips work securely, permits operator to work while keeping hands clear of blade

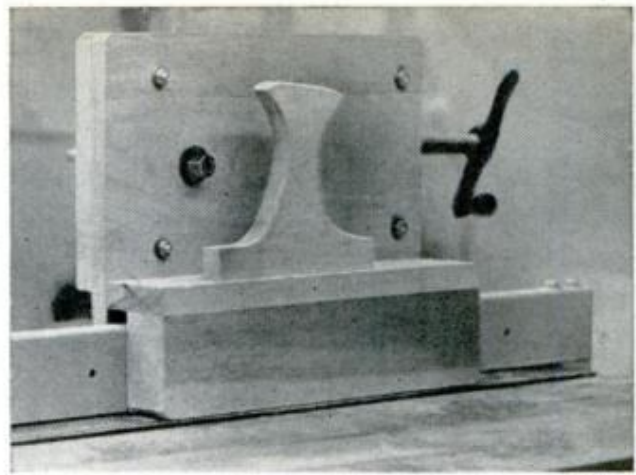

**HANDLE CAN BE CUT** as shown, then shaped and contoured to provide comfortable grip when using rig

a liberal coating of Trewax Carnuba Plus (wax) into the wood surfaces.

Both "stub" (two cheeks) and "true" (four cheeks) tenons can be cut with the attachment. To make the additional cheek cuts required for the true tenon, merely rotate the stock in the clamps.

In some instances (depending on the stock being cut) the rear clamp alone may be used to hold the stock in place. In these cases the front clamp can be removed to make the attachment lighter to push. Now, you'll be able to cut tenons in production fashion. ★★★

## SAW TENONING ATTACHMENT

Technical Art by Peter Trojan

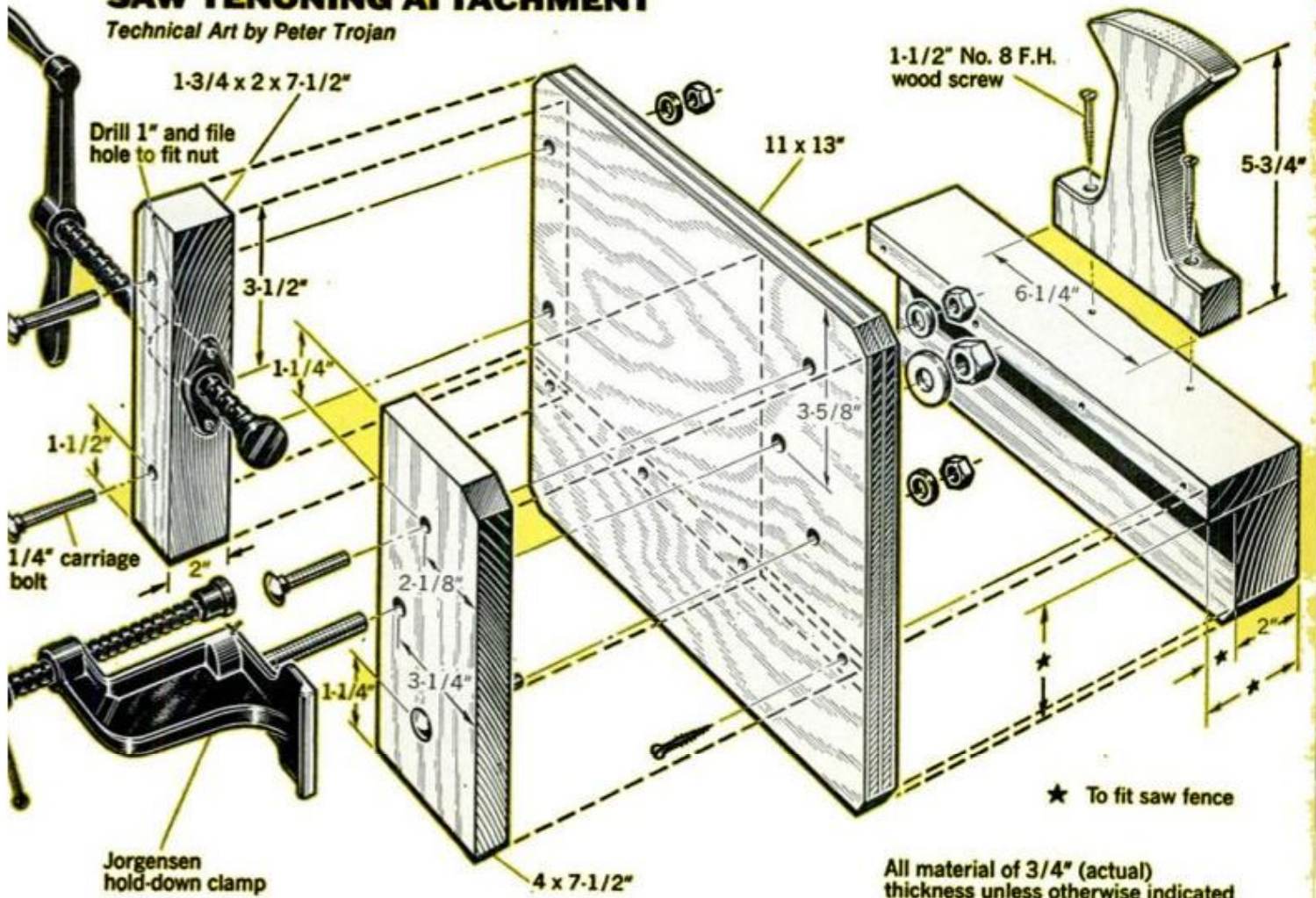



# HINTS FROM READERS

## Self-stick label aids layout

A self-sticking label can help you lay out hole positions and other details on a reasonably clean metal surface. It provides a nonslip base for the point of a compass which holds a ballpoint pen to draw easily seen lines that indicate hole centers. After punch marks are made, the label can be removed.

—Walter E. Burton, Akron, Ohio

## Clamps from garden hose

Midget C-clamps suitable for applying light pressure to glued joints in relatively thin sections can be made from garden-hose segments. When split lengthwise, a segment can be sprung open to slip over a joint. Such clamps can also be used to hold assemblies of cardboard in alignment before applying an adhesive. Long segments seem to work best.

—B. W. Ervin, Kent, Ohio

## Wrenches used in tandem

You can get extra power from an open-end wrench by linking one end of a box-end wrench in the outer jaw as shown at left. Before applying the force, make certain that the linkage will not slip and that each of the wrench handles is sturdy enough to withstand the stress.

—W. B. May, Oak Park, Ill.

## Lift-out storage bins

Here's an easy method that makes compartmentalized small-parts drawers more convenient. By lining the small "bins" with curved pieces of linoleum or vinyl floor tile, it is then an easy matter to slide out small brads, tacks and screws. The system prevents pricking your fingers.

—W. H. McClay, Pasadena, Calif.

## Hardwood serves as tap guide

A hardwood block with a hole in it often is superior to a metal one for getting a tap started straight, and if you drill the hole slightly on the small side, the tap goes through without much effort. Bore this hole to the tap's o.d. and insert tap far enough to project beyond block so it can be centered over hole to be tapped. Then secure block with clamps.

—Walter E. Burton, Akron, Ohio

POPULAR MECHANICS

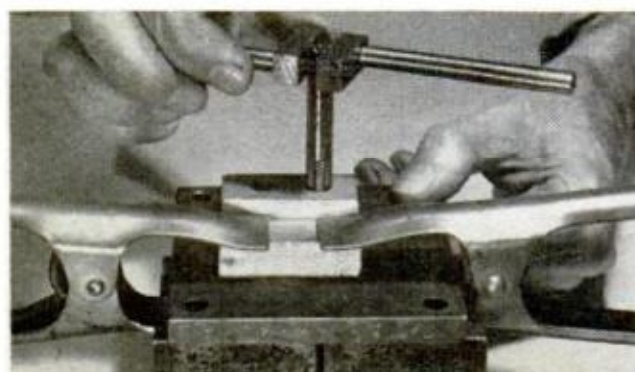
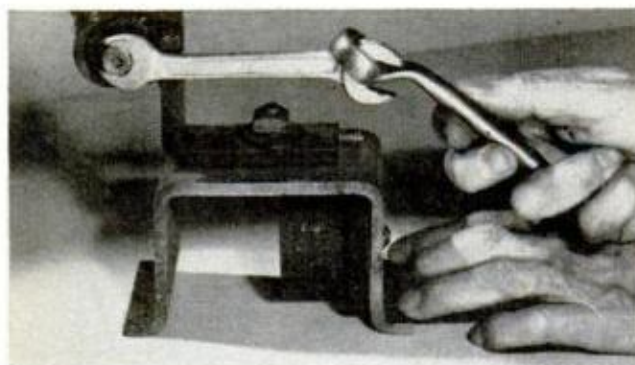
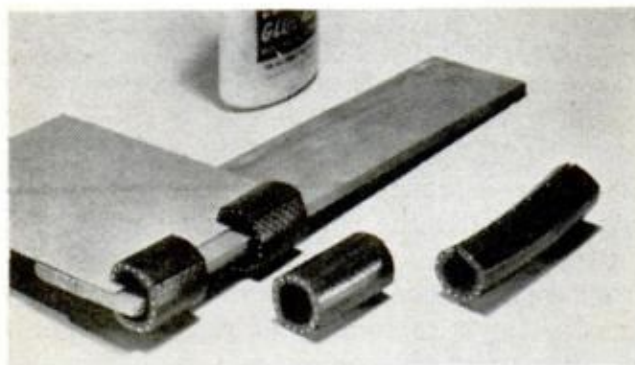
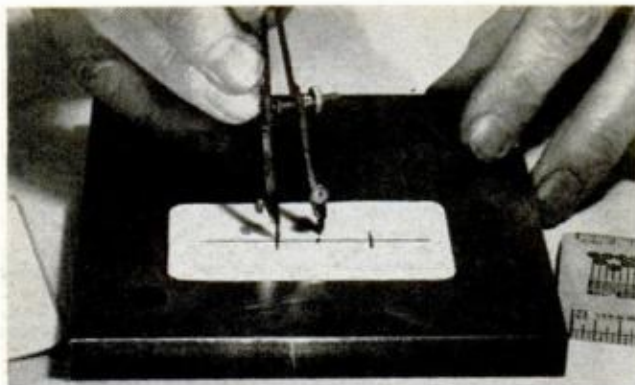



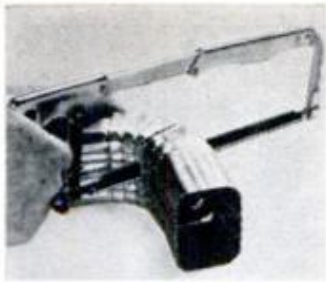

**Hacksaw Blade.** New! Virtually unbreakable. Makes thin, straight cuts. No need to protect the edge when you carry it in your toolbox.

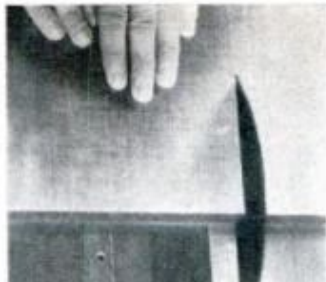

**Circular Saw Blades.** New! No need to change blades when you change materials. Come in 6½", 7", 8" and 10" diameters, to fit most saws.

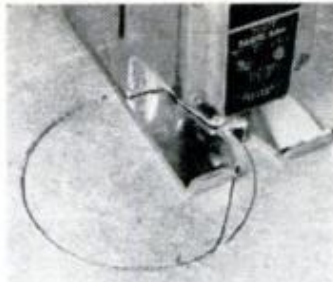

**Saber Saw Blades.** Universal ¼" shank saws, coarse grit for fast cuts, fine grit for smoother cuts. Make plunge cuts in tile, cut small circles. Also available in 4" and 6", ½" shank.

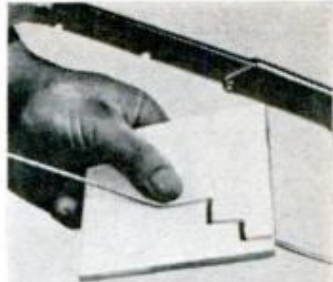

**Rod Saw.** Thin, round blade cuts in any direction. Ideal for contour cutting. Reversible for extended life. Ten-inch length fits standard hacksaws.

## Remington "GRIT-EDGE" Saw Blades Have No Teeth. They're Something Else!



That's right, "GRIT-EDGE" blades have no ordinary saw teeth to snag, break or dull. Instead, an exclusive process permanently bonds tiny tungsten carbide particles to each blade. "GRIT-EDGE" blades are inherently safer than blades with conventional teeth. "GRIT-EDGE" blades cut almost everything, including things ordinary blades can't touch. They're designed to cut extremely hard or abrasive material. And they last up to ten times longer.

They can cut glass, cement-asbestos, tile, fiber glass and the hardest metals; make smoother cuts in veneers and laminates; help you do jobs you couldn't try before.

In fact, a low-cost "GRIT-EDGE" blade can do jobs that used to take expensive industrial cutting tools. See the "GRIT-EDGE" blades at your local hardware dealer's now.

**Remington® DU PONT**

"Remington" and "GRIT-EDGE" are trademarks of Remington Arms Company, Inc. The Du Pont oval is a trademark of E. I. du Pont de Nemours & Co. (Inc.). Made in U. S. A., U. S. Patent 3,023,490. Applications Pending.

### JUST PICK THE KIND OF BODY YOU WANT

—and you can have it easily almost overnight

Dear Charles Atlas—Here's the kind of body I want:  Broad chest, Big shoulders.  Powerful arms, grip.  Powerful legs.  Slimmer waist, hips.  More weight, solid.  More energy.

Send me a free copy of your famous 32-page book showing how **DYNAMIC-TENSION** can make me a new man.

Send name and address to:  
**CHARLES ATLAS, Dept. 8U**  
115 East 23rd St., New York, N.Y. 10010



### Start your own part or full time MONEY-MAKING BUSINESS

Every home and building offers you potential income. Clean wall-to-wall carpeting, upholstery and walls on customers' premises with Von Schrader professional cleaning equipment. Work part time or full time. No fees, no contracts to sign. You own your equipment. Proven reliable and profitable for thousands of users. Enjoy a steady, growing business with Von Schrader Detergers—and we'll help you every step of the way. Write today for full information.



**VON SCHRADER CO., 1072 Racine, Wis. 53403**

JULY 1971

## MAXIMAT 7 GEARED HEAD LATHE & MILL

Turn, face, bore, thread, drill, mill, grind—to accuracies within .0002" on famous Maximat combination metal-working lathe/mill/drill machine shop! Features geared lathe & mill heads, 2 built-in 115V motors. Swings 7", 18" between centers. (10" x 26" quick-change model available.) Max. vertical cap. 10". Drill to center 12" circle. NOW YOU CAN MACHINE ALL PARTS YOURSELF!

**\$795**



Maximat 7" x 18"  
 Maximat 10" x 26"

Send FREE literature

AMERICAN EDELSTAAL, INC. TENAFLY, N.J. 07670  
DEPT. BG-1

Name \_\_\_\_\_

Address \_\_\_\_\_

City \_\_\_\_\_

State \_\_\_\_\_

Zip \_\_\_\_\_



*The Look of Classic Wrought Iron*

# You Can Make This Chair For \$15

By WAYNE C. LECKEY,  
Home and Shop Editor



**W**ith a unique metal-forming tool you can make all kinds of graceful garden furniture.



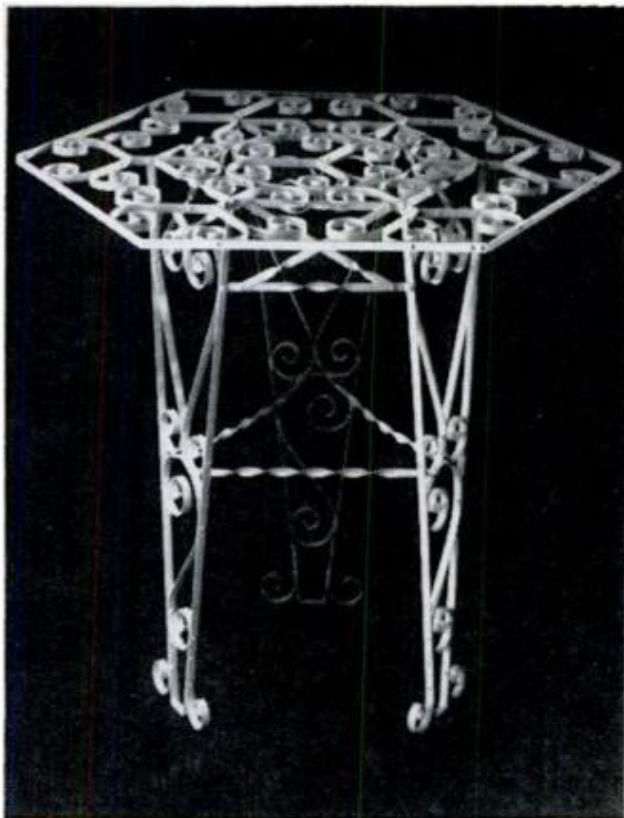

**M**AKE YOUR PATIO BLOOM this summer with flower-cushioned wrought-iron furniture; then when winter comes you can move the furniture indoors and brighten your den or sunroom.

With a three-piece toolset we described in *Ornamental Scrollwork You Can Do at Home* (page 192, March '70 PM), you can form any number of graceful pieces of furniture for your home and yard for a lot less than you can buy them in a store. Once you have acquired the toolset, you can make the chair shown on the opposite page for as little as \$15—the cost of the strap iron, cushion and paint.

Forming straight metal strips into uniform, graceful curls is actually fun, and the scroll plate makes it easy to duplicate identical S and C-shaped curls almost automatically. The punch-shear makes rivet holes in the metal, also cuts it. The riveting-forming tool sets rivets, rolls circles or curves, makes neat right-angle bends.

Although many scrolls required to make the handsome armchair are alike (see page 156 for required number of each), they must be bent to conform to a full-size paper pattern. Using the grid system of enlarging, you can "blow up" the patterns on page 156 by ruling on wrapping paper the same number of squares given and then drawing in the scrolls. (Draw in each square of the large pattern the part of the scrolls shown in the corresponding

**OTHER FINE EXAMPLES** of wrought-iron furniture you can make with the three-piece imported toolset shown on page 158 are these attractive, glass-topped tables (above) and handsome ice-cream-parlor chair (below). Full-size patterns for these and other pieces may be obtained for \$1 each from the importer, Creative Educational Services, Inc. (see text)





# Construction Details for Chair

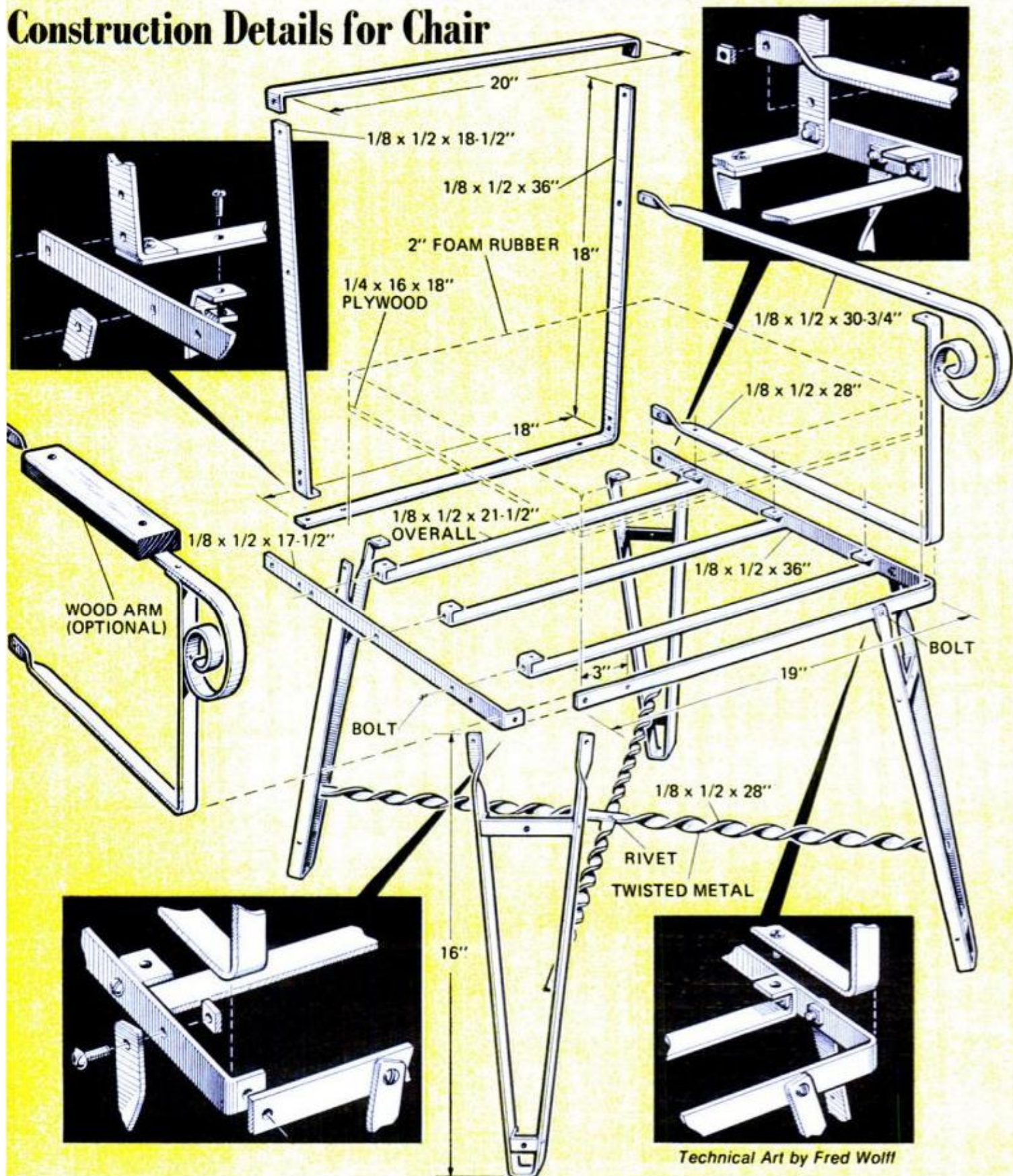

square of the small pattern. To save time, get a set of full-size bending patterns for the chair by sending \$2 to Chair-Bending Patterns, Popular Mechanics, 224 West 57th St., New York, N.Y. 10019.

Make the chair back first. Three separate strips form the outside framework (drawing, above), one bent at right angle to provide one side and bottom. Drill four pieces where indicated and fasten together

with rivets. Next, form ring D (see page 156) and rivet the butted ends together with a splice. Now place the framework on a flat surface with ring in the center. Fit scrolls in place as you make them, reshaping where necessary (note in the half-pattern on page 156 that one of the two scrolls marked A is shorter than the other and has but one curl). When all 14 scrolls nest neatly inside the frame,



# Cash in on your Air Force years.

Maybe you really thought you were making the right decision when you decided to get out. Maybe you really believed you could use your service skills to carve out the good life on the outside. But now, as you look back, maybe you have to admit that you've overlooked something that could make it all a little easier. Something called the Air Force Reserve.

Well, if that's where it's at with you, remember, it's not too late. By putting in one weekend a month

and 15 active duty days a year, you can still enjoy all the reserve benefits. Things like a second income and the chance to train yourself to do your job better.

So, if you've still got the skills the service taught you, you've still got a chance for a future you can look forward to, in the Air Force Reserve.

For all the facts, just mail in the coupon. Or, write to Hq Air Force Reserve (DPBC), Robins AFB, Georgia 31093.

HQ AIR FORCE RESERVE (DPBC)  
Robins AFB, Ga. 31093 **PM-771**

Please send me information about joining the Air Force Reserve.

I was a member of AIR FORCE  NAVY   
COAST GUARD  MARINES  ARMY

My grade was \_\_\_\_\_

My specialty was \_\_\_\_\_

NAME \_\_\_\_\_

(PLEASE PRINT)

ADDRESS \_\_\_\_\_

CITY \_\_\_\_\_

STATE \_\_\_\_\_

ZIP \_\_\_\_\_

PHONE \_\_\_\_\_

SARLA COULT

I understand there is no obligation.

**Find yourself in the Air Force Reserve.**



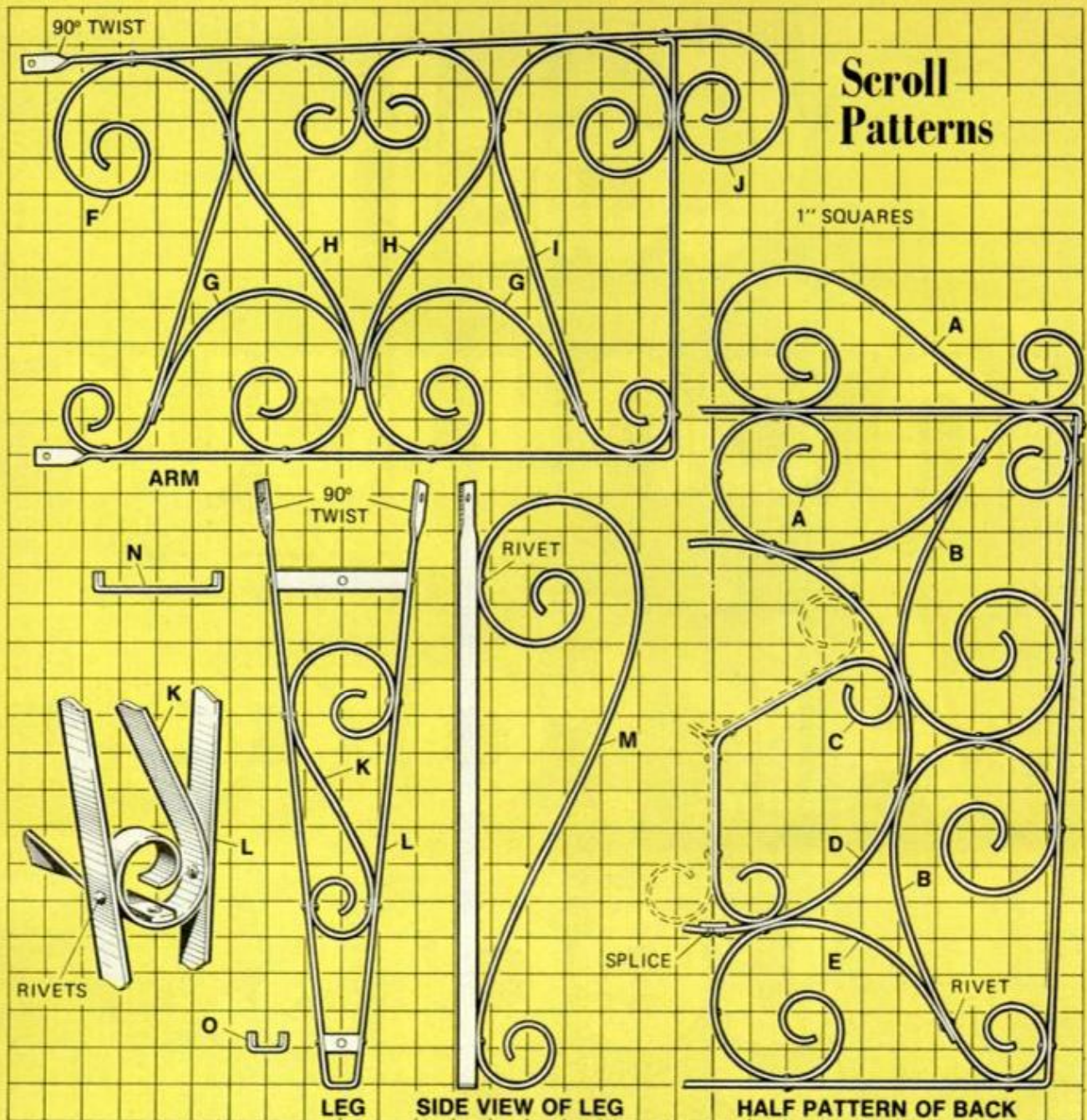

## NUMBER OF SCROLLS REQUIRED

### CHAIR BACK

A - MAKE 4  
 B - MAKE 4  
 C - MAKE 3  
 D - MAKE 1  
 E - MAKE 2

### CHAIR ARMS

F - MAKE 2  
 G - MAKE 4  
 H - MAKE 4  
 I - MAKE 2  
 J - MAKE 2

### CHAIR LEGS

K - MAKE 4  
 L - MAKE 4  
 M - MAKE 4  
 N - MAKE 4  
 O - MAKE 4

mark and punch the rivet holes and rivet all into a single unit.

Make arms similarly, the straight pieces first, then scrolls. Twist the ends 90° to attach arms to the chair back. Punch and rivet the parts of each arm into single units and set aside. If you wish, add wood armrests.

Make all four legs alike, except for the upper ends. Ends of the front legs are

twisted but one end of each rear leg is left straight and the other is angle-bent. Use rivets to join leg parts, small bolts to attach leg assemblies to the seat frame.

The latter is formed from flat strips, punched (or drilled in the case of bolts) and bent as shown. Arms are bolted to upturned ends of the seat-cushion slats.

Start assembly of the chair by bolting the arms: first to the seat frame, then to



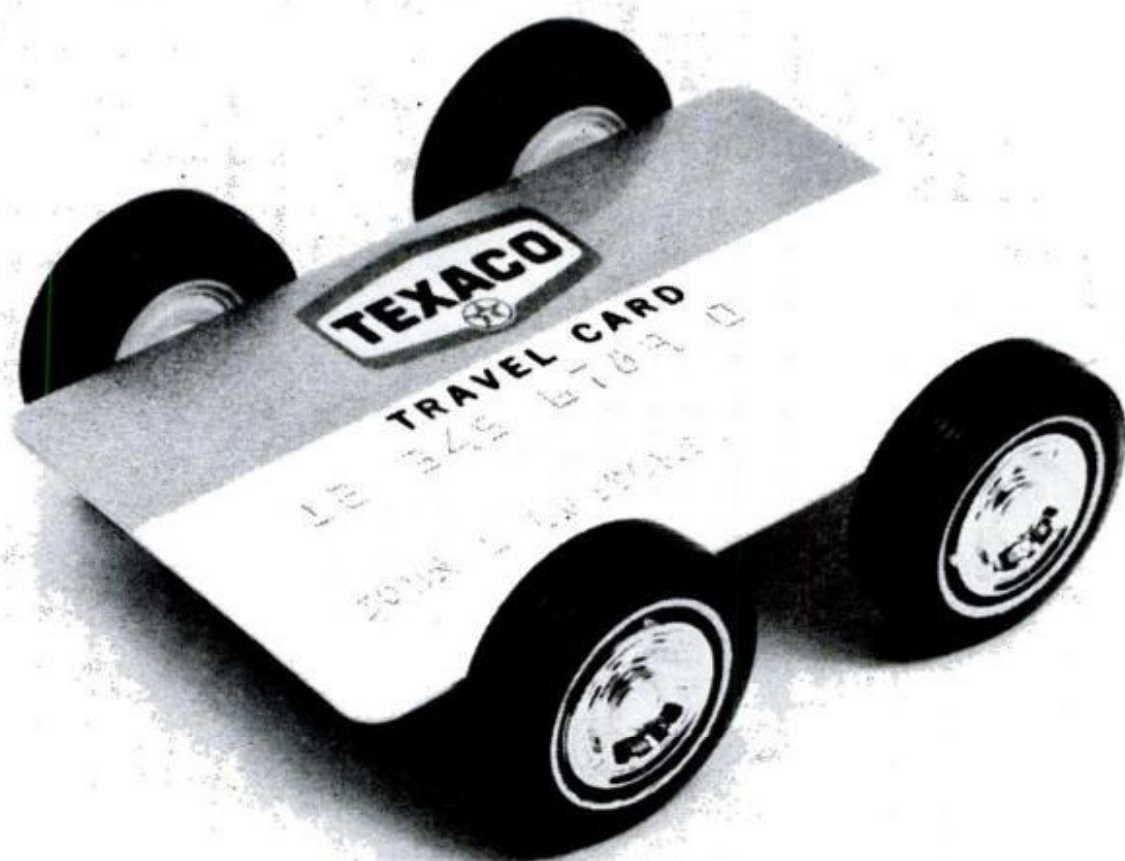

## Our latest model.

Texaco doesn't wait for Annual Shows to make important additions.

Our latest model is out now. Terrific business-builder, of course, plus many profitable new optionals.

Now Texaco's credit customers can use their Texaco Travel Cards at Howard Johnson's Motor Lodges, Quality Motels, any TraveLodge, Rodeway Inns, and Red Carpet Inns.

At Stuckey's for wonderful treats.  
And to rent cars at Hertz Rent A Car

and National Car Rental System, Inc.

More than ever, the Texaco Travel Card is probably the busiest in the industry... the only one honored under the same sign in all 50 states and Canada. One more reason why it pays to be associated with Texaco.

The local Texaco Representative can tell you about the many others. See him or write to: Manager—Retail Sales, Texaco Inc., 135 East 42nd Street, New York, New York 10017.







**TO BEND CURLS**, studs on scroller grip metal strip so you can wrap it around raised spiral on plate

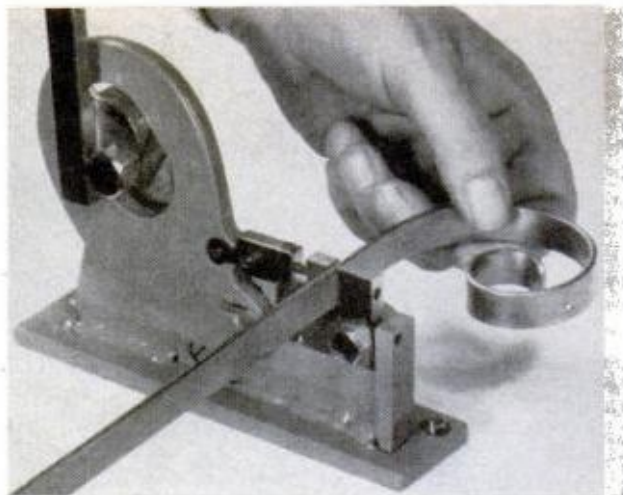

**RIVET-HOLE PUNCH** produces clean 1/8-inch holes in metal as you pull down on powerful cam-lever handle

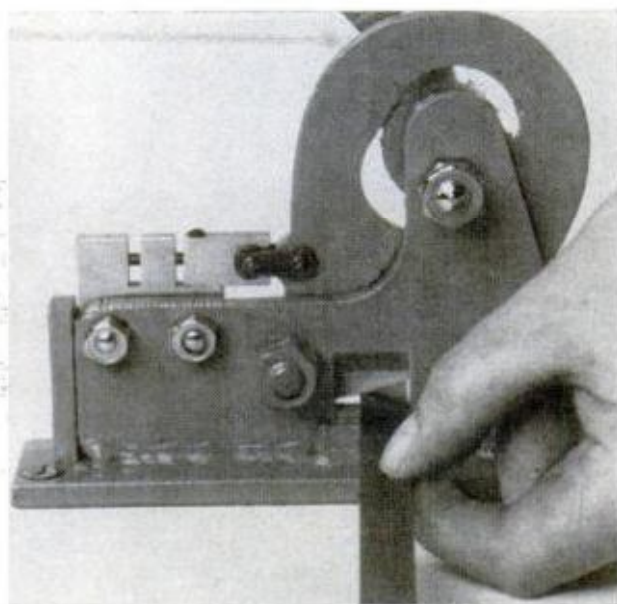

**PUNCH ALSO ACTS AS SHEAR** for cutting the metal strips. Sharpened lower edge works like a guillotine

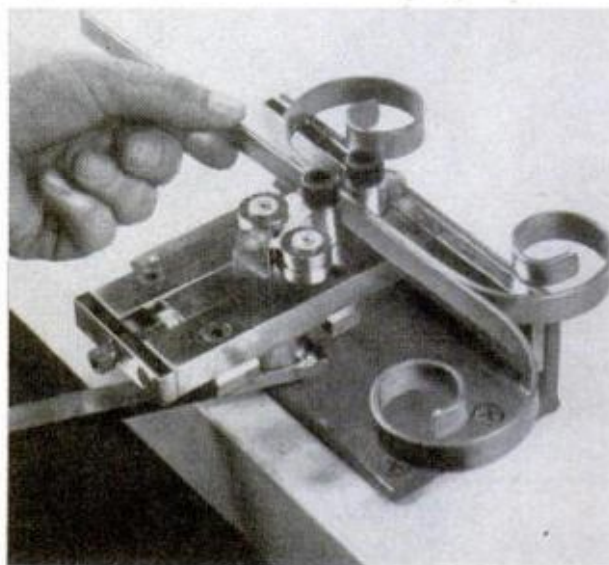

**RIVETER-FORMER** squeeze-sets rivets against anvils held by Allen-head screws when lever is pulled hard

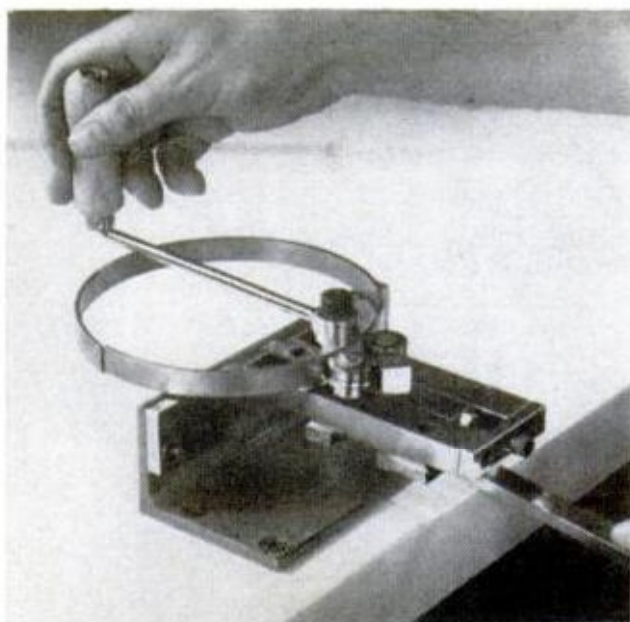

**TO ROLL RINGS**, anvils are replaced with a crank-operated roller. Lever pressure determines the radius

the chair back. Bolt the legs next and, finally, the twisted-metal stretchers.

To make a stretcher, clamp the end of a long flat strip in a vise and twist the other end with an adjustable wrench. Keep twisting until you have a spiral strip 26 inches long. Rivet stretchers together where they cross and attach ends to cross members of the legs with small bolts.

The cushion is a small board cut to fit, padded with 3-in. foam rubber and covered with a floral fabric stapled to the underside.

Spray the completed chair first with a metal primer, then with two coats of gloss-white lacquer. The toolset, imported from England, can be obtained for about \$79.50 and shipping charges from Creative Educational Services, Inc., Box 154, Parsippany, N.J. 07054. The metal is available in 3-ft. and 4-ft. lengths. ★★★



The week was a grind with phone calls and late nights and skipping lunches but now the job is done and . . .

This...is the L&M moment.



Light up, lean back and just plain don't do a thing but relax. With the easy-going richness of your L&M. It's time well-spent.

**RICH, RICH L&M**

19 mg. "tar", 1.3 mg. nicotine av. per cigarette by FTC method. (Jan. '71).

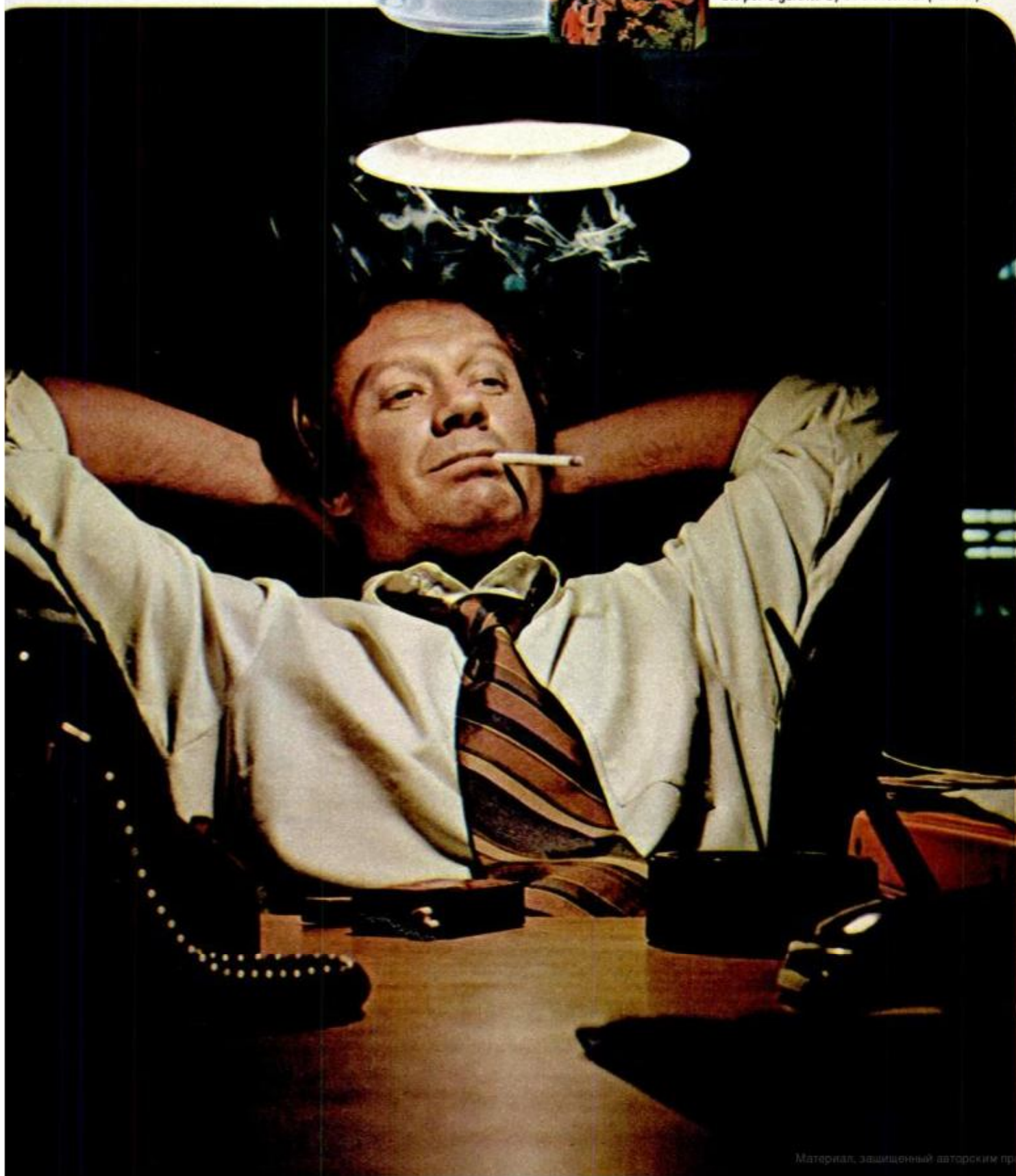



## BACK-YARD FLOAT TRIP

(Continued from page 94)

official or law enforcement office. Tell them where you are going, how long you plan to be on the river, and when and where you will come off it. Then let them know you're safe when you arrive!

Check local restrictions. Some waters may pass through Forest Service areas where you need a fire permit. During fire danger periods, you may not even be allowed on the water. Some wilderness areas have stringent woodcutting and camping rules to preserve their primitive quality.

In normal waters you can cover 10-15 miles a day. A serious fisherman will cover only six. Distances vary according to obstacles, water depth, weather, and your own physical condition.

No matter what length trip you plan, remember this: *Never hurry!* Floating is

---

**You may be required to have an ax, shovel and water bucket—essential firefighting gear.**

---

best when it's leisurely—you have more fun and won't be exhausted afterward.

● *Learn to read water.* A "V" pointing upstream means the water is moving around some obstruction; be sure you're safely to one side of it. A "V" pointing downstream nearly always points to the safest passage; water between obstructions is usually deeper, flows faster.

When you come to a really rough spot, get out of the canoe, tie a rope to each end and walk it through. You and a partner guiding the craft from shore can maintain control and float the canoe through with relative ease.

Overnight and three-day camping trips involve more work, gear and planning than one-day floats, but can be more rewarding. Many excellent float sections are too long to be covered in a day.

● *Camping takes preparation.* Store all camping and personal gear in waterproof plastic bags or duffel bags. If you are unable to locate bags, buy sheet plastic, cut it into suitably-sized squares, and be sure to knot or wire-wrap it soundly around the gear. It's advisable to tie the packages to your canoe. Put all perishable foods in a tight camp cooler.

Take at least one change of clothing and a couple of sock changes. It's cooler on a river than on land; when shadows lengthen, you may want a light wind-breaker or long-sleeve shirt. Take loafers

or extra sneakers for camp wear. Dry feet are a comfort.

Load each craft with weight amidships, and lighter material fore and aft. A well-loaded craft is easier and safer to handle.

Take a small hand ax, a collapsible saw and an army shovel. If you plan to float through Forest Service land, you may be required to have an ax, shovel and water bucket—essential fire-fighting gear.

Take plenty of parachute-type nylon cord. Large rope is unwieldy and unnecessary. Include a first-aid kit, and know how to use it. (Ideally, you will have taken a basic Red Cross style first-aid course at some time in the past.) Know which nearby towns have a doctor.

Carry drinking water if there is any doubt about the water you're floating on. Few streams now are clean enough to drink from; some can still provide cooking water. Take water purification tablets if you don't have the space for enough stored water. Carry matches in several sealed containers and store them in various places; always carry one with you personally. Carry enough cooking gear, but try to double on uses when possible. If you're using an open wood fire, soap the outside of all pots before placing them near or over the fire. They may become blackened, but the soap forms a protective layer that washes off easily.

● *The best campsite* is a clean, breezy river bar. Many officially designated floating streams, like the Eleven-Point in Missouri, have primitive campsites on their banks, built by the Forest Service or Bureau of Outdoor Recreation. Well located, they are usually quite comfortable.

Don't wander through the brush back from a stream. Much land along floatable streams is private property. And you may get lost. River banks are generally of higher elevation than the land directly behind; the jungles in the low land to the rear are quite often swampy, nearly impassable and insect infested.

If you can't find a suitable river bar, choose the highest, clearest land available near the river. Such areas are usually breezy and relatively insect-free. Remember to clear a safe zone around the firesite. If the bank is of unstable sand, don't camp too close to the lip; the bank could suddenly give way during the night. This is a rarity, but I've seen it happen.

After a few runs on local rivers, you may want to try "big time" float trips in the Ozarks. For information, write state conservation agencies in Arkansas and Missouri; also the American Canoe Assn., 400 Eastern St., New Haven, Conn. 06513, or the United States Canoe Assn., 6338 Hoover Rd., Indianapolis, Ind. 46260. ★★



# ALLIED COOL KIT INSTALL IT YOURSELF AND SAVE!



**SUPER  
COOL KIT  
\$167<sup>50</sup>**

- Quality air conditioning you can install in just hours!
- Complete, easy-to-follow instructions!
- 90-day Warranty!
- Great low prices!

Standard..... \$134.50  
Deluxe..... \$149.50  
Super Cool... \$167.50  
Ford Pickup... \$167.50  
Chevy Pickup . \$167.50

WRITE FOR YOUR HANDY ORDER BLANK TODAY! ALLIED COOL KIT, P. O. BOX 34793, FARMERS BRANCH STATION, DALLAS, TEXAS 75234

## THE NEW FOURWAY HEAVY-DUTY COMPLETE PROFESSIONAL ARC WELDER SET

Just \$24.95 includes welder in heavy-duty metal cabinet, mask, cables, ground clamp, combination carbon arc torch & rod holder, welding instruction manual . . . and \$4.95 foot pedal control at no additional cost plus leather palmed welder's gloves.

### WELD, BRAZE, SOLDER, CUT NEARLY ANY METAL INCLUDING ALUMINUM.

You can pay more—pay less—you won't find an arc welder value better than this—more complete than this. Simple instructions to make or repair countless items including furniture, toys, auto bodies, fenders, trailers, boats, farm equipment, tools. Operates on 110 v. 30A for pennies. You can REGULATE HEAT FOR EACH JOB through our Adjustable Twin Carbon Arc Torch—eliminates changing cables. Produces 11,000 degrees heat without gas torches; with no tanks to buy or refill.

### LIFETIME GUARANTEE

Simply return prepaid for any defect—we repair and reship absolutely free.

Order Today on Money-back trial. Send only \$3.00 and pay \$21.95 C.O.D. plus delivery and C.O.D. charges or send \$24.95 for postpaid shipment anywhere in Continental U.S.A. *If not completely satisfied return in 10 days and we will refund complete purchase price.* Illinois residents add 5% sales tax.



FOUR-WAY WELDER COMPANY  
1810 S. Federal St., Dept. PM71, Chicago, Ill. 60616  
RUSH ME MY FOURWAY COMPLETE  
ARC-WELDER SET

NAME \_\_\_\_\_

ADDRESS \_\_\_\_\_

CITY \_\_\_\_\_ STATE \_\_\_\_\_ ZIP \_\_\_\_\_

Enclosed is \$3.00, I will pay \$21.95 plus C.O.D. and delivery charges upon receipt.

Enclosed is \$24.95; ship my Fourway postpaid.



## ELECTRONIC PAIN KILLER

*(Continued from page 71)*

that people may expect a cure for just about anything from the devices, Avery quips that his DCS "looks as if almost anyone in the world could build it—and between you and me there's a good possibility they could."

Avery's modesty as an electrical engineer, however, is apparent from the sophistication of his DCS and other equipment produced for research on the nervous system. Reliability is critical in devices implanted in human flesh, and he guarantees his receiver and wire leads for the life of the patient. The stainless steel wires are carried in thin-walled Silastic tubes and the wristwatch-sized receiver is encapsulated in epoxy. All of the implantable devices can be sterilized with steam before they are put to use.

The transmitter, which Avery terms "the most sophisticated little pulse generator of its size," is about 4 inches long, 3 inches wide and 1½ inches thick. Its transistorized circuitry consists of a variable pulse generator feeding a radio-frequency transmitter. The electrical pulses are thus transmitted through the skin and detected by the tiny internal receiver. (An even smaller transmitting unit, powered by rechargeable nickel-cadmium batteries instead of ordinary zinc-carbon types and improved in other ways, is ready to go into production.)

The patient himself sets the transmitter for best relief from pain. He can deliver up to 25 volts to the stimulating electrodes (2.5 to 5 volts is the most common setting) over a range of pulse frequencies—usually between 30 and 60 hertz. The duration of each pulse is usually set by the doctor and ranges between 50 and 300 microseconds. Some patients use the device continuously while others will run it for half an hour and remain free of pain for as long as two days thereafter.

It is still something of a mystery how electricity works to relieve pain. Dr. Shealy believes the current passes through the spinal cord sideways and actually short-circuits pain. Another surgeon active in the field thinks that it masks pain by stimulating the nerves going to the brain. He sees the DCS as a counter-irritant like the old-fashioned mustard plaster or dental poultice. In other words, if you have a headache and someone hits your toe with a hammer, your head will stop aching—at least you won't notice it.

The DCS doesn't completely eliminate pain but does reduce it to a bearable level for those in whom it works. However the pain is replaced by a buzzing or tin-

gling sensation, a slight vibration that one wearer describes as the feeling of a cat's throat when it purrs. One of Dr. Shealy's patients gets good relief from her pain from cancer, but after three or four hours the sensation annoys her and she turns the DCS off for a while even though the pain returns. Some surgeons have even had to remove devices because patients didn't like the feeling. So, there are drawbacks, and many questions remain to be answered.

Yet, DCS does work well in some patients. Ask young Don C. who lives in New York City. He's had four operations and "with each one it's been downhill—this device is the only positive thing that's happened to me since the whole thing started." Don suffered a disc injury during judo practice in 1955, and it gradually got worse until he was unable to work.

Don's DCS was installed in January, 1971, after he had spent four years as an invalid. It cut his pain to about a quarter of what it was. "There's hope now," he says. "It has made the pain bearable and that's enough. I'm very thankful." ★★

## HOW TO STEER CLEAR!

*(Continued from page 56)*

left to do but take the impact of a frontal collision. Newer cars are designed with energy absorbing S-frames and chances can be on your side that you'll live through a collision—if you are wearing a combination lap and shoulder belt. There has yet to be a highway fatality in the United States at speeds under 50 mph when the driver was wearing lap and shoulder belts! And if you can steer out of a collision situation, your ability to do so may depend entirely on the belts' keeping you in the right position behind the wheel where you can control your car. ★★

### **FILING YOUR COPIES OF PM?**

If you are, look for the inexpensive Annual Index, available in December. In seconds, it will help you locate any article in PM this year, or find information on a particular subject. Your copies of PM will be even more valuable!

And if you aren't filing your copies of PM—start now!



# Goodyear GLAS-GUARD ... big on the road



## The new fiberglass belted tire for Panels & Vans

It's big on the road.

The fiberglass belts fight tread-wearing squirm to give you long mileage.

The belts also hold the tread firm to help give you command on wet roads for braking and cornering.

And GLAS-GUARD is a match for potholes or curbs. GLAS-GUARD's two fiberglass belts combine with four nylon cord body plies to help ward off the blows.

Ask your Goodyear Dealer or Goodyear Service Store for the GLAS-GUARD tire . . . and give your business a big lift.



# GOODYEAR

GLAS-GUARD—TM The Goodyear Tire & Rubber Company, Akron, Ohio



## NEWS BRIEFS

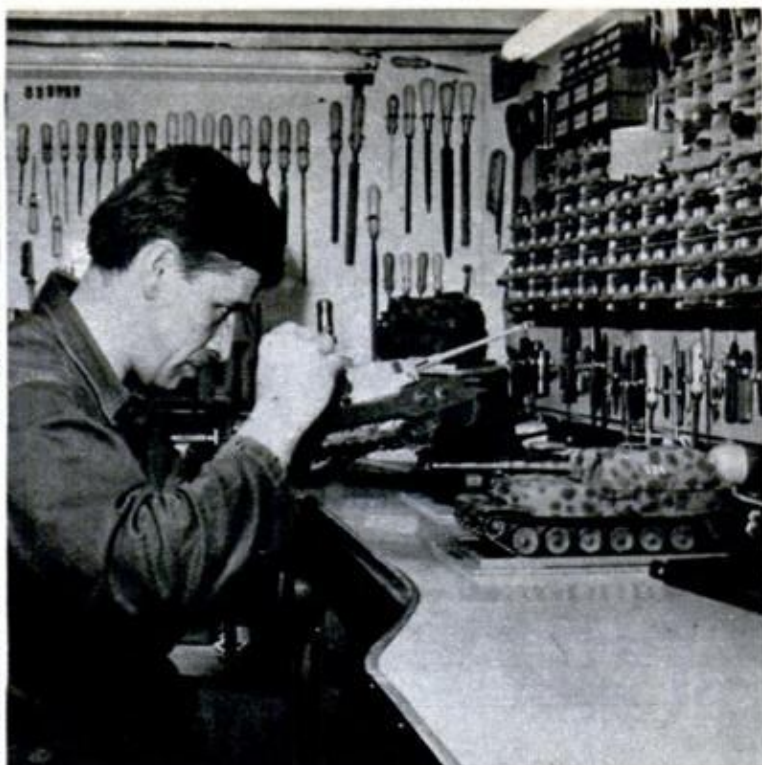

### Hair-spray cans help make up a tank corps

Using such materials as plastic from old refrigerators and the lids of spray cans (for gun turrets), Eugene de Passeroy of Antwerp fashions military tanks in 1/24th scale. Some of his models are radio-controlled; all have two gear speeds and can climb, go through water and over obstacles. So far, Passeroy has made some 50 tanks. At upper left is a German Elephant (between wheels of a Sherman); at lower left is a Russian T-34/85.



### Swiss expert skis with both feet on single ski

Hans Schmid, Swiss electrician, demonstrates that a skier can get along as well on a single ski as he can on two. At left, he's shown with Monoski, a single, raised plate that's placed on the ski to hold the bindings for both boots. At right, Schmid is shown taking a jump on the single ski.



# Vantage the no cop-out cigarette announces a menthol breakthrough.



**New Vantage Menthol.**  
**The first cigarette that lets you give up high 'tar' without  
copping out on real menthol pleasure.**

Until now you got either lots of menthol flavor and lots of 'tar' or else you got low 'tar' and very little flavor. Now there is Vantage Menthol with the ingenious Vantage filter geometrically

shaped to increase filtration. If you like authentic tobacco taste and real menthol pleasure, you owe it to yourself to smoke Vantage Menthol. It's the only no cop-out menthol.

11 mg. "tar", 0.9 mg. nicotine av. per cigarette by FTC method.



**We tell it Like it is...**

**OVER \$30,000.00 PER YEAR**

**"My income from my Warner Shop now exceeds \$30,000.00 annually. And, my supply orders to your firm will bear me out." S.D.M.**

I want you to be able to send me a letter just like this one...but you never will, until you take that first step by sending in the coupon below. Get the facts...including details, pictures, prices, profit margins and our less-than-bank-rate financing plan...FREE and postpaid. Learn how you can start at home in your spare time and expand into a full-time business just like S. D. M. Mail the coupon today—you owe it to yourself to get the facts, NOW!

**Jim B. Warner, Dept. L-2-AH  
1512 Jarvis Avenue, Chicago, Illinois 60626**

Jim B. Warner, Dept. L-2-AH      SEND NO MONEY  
1512 Jarvis Ave., Chicago, Ill. 60626  
Please rush your FREE illustrated brochure to:

Name \_\_\_\_\_

Address \_\_\_\_\_

City, State, Zip \_\_\_\_\_

**ENJOY FULLY AUTOMATIC DEFROST**



Look for  
**DOMETIC**  
refrigerators in your travel unit



Dometic is the specialist in recreational refrigeration. All units over 3 cubic feet are equipped with automatic defrost. A special convenience to help you enjoy traveling and camping more.



**Dometic** See your recreational vehicle dealer today

**New Tool Works Wonders With Wire! WIREFORMER**

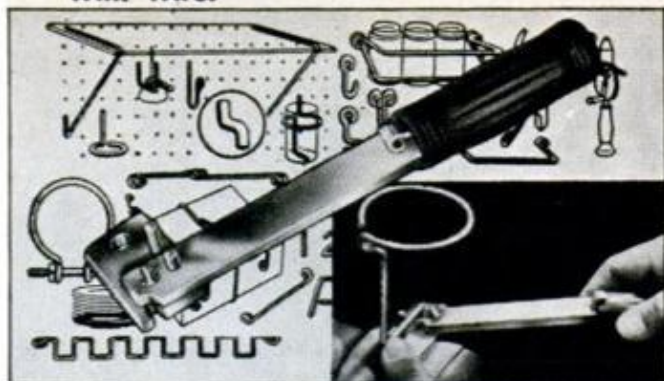

**IT BENDS! IT CUTS! IT STRAIGHTENS!**

WIREFORMER is a simple, precision made, vise-held tool of innumerable uses. Make your own peg board hooks, clamps, handles, braces, brackets, etc.—any shape you want. Forms an eye of 3-16" inside diameter (just right for any nail, screw, or bolt up to that size). Even uses coat hanger wire. No pliers needed. WIREFORMER does the work with the pressure of one finger. Straightens the wire if you make a mistake. Cuts the wire just where you want it. Forms any angle, arc or circle. Bends both right and left. Tool is case hardened, plated, with a plastic handle. Fits in your pocket. Complete instructions, illustrated brochure showing many things to make.

**SOLD ONLY BY MAIL. MONEY BACK GUARANTEE.** Four dollar bills will get you one, or send check or money order for just **\$3.98** We pay postage and handling charges.

**VINKEMULDER TOOL CO. Dept. M-6**  
2223 Estelle Dr., S.E.      Grand Rapids, Mich. 49508

**Don't change your address without notifying us!**

To insure uninterrupted service on your Popular Mechanics subscription, please notify us at least six weeks before you move.

1. Attach your address label from a recent issue in the space provided below... (If label not available, be sure to give us your old address, including Zip Code)
2. Print your name and new address below (be sure to include your Zip Code).

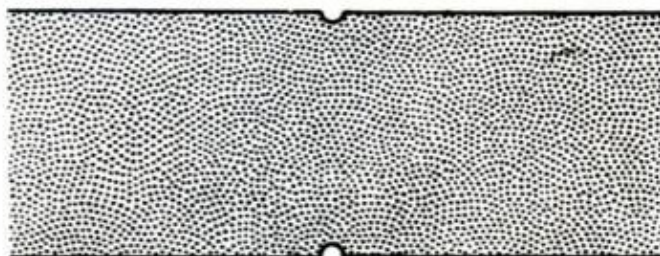

Mail entire notice to:      **Subscription Service Dept.**  
Box No. 646  
New York, N.Y. 10019

Name \_\_\_\_\_ *Please Print*

New Address \_\_\_\_\_

City \_\_\_\_\_

State \_\_\_\_\_ Zip Code \_\_\_\_\_



## 1. Spot car trouble fast



## 2. Fix it fast

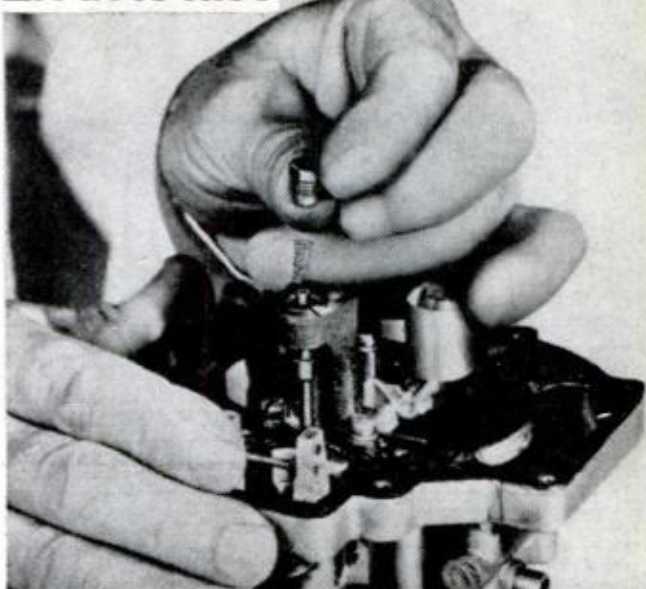

**MOTOR's easy "2-step" repair method helps you**

# Fix almost any part of any car...fast

So clear, you'll breeze through tune-ups, air conditioning, brake jobs, engine overhauls—practically any repairs on cars listed.

You just can't make mistakes with the "2-step" method in MOTOR's New 1971 Auto Repair Manual. First, the special "Trouble Shooter" section helps pinpoint in a flash the cause of trouble. Next, over 3,000 "How-To-Fix-It" close-up pictures (and plain-talk directions) show how to lick repair problems — fast and right! Even green beginner mechanics find the Manual so clear and easy to follow, they speed through the toughest jobs like real pros!

Auto Repairman's "Bible." Here's the real "meat" of facts and data distilled from over 300 official factory manuals and hundreds of service bulletins. Every job, from installing distributor points to front end jobs, is covered in minute detail for 2,300 car models of 45 series of American-made cars plus Volkswagen, from 1965 through 1971. There are over 1,000 oversize pages in this giant Manual containing 55,000 essential service specifications and adjustments. It's no wonder MOTOR's is called the auto repairman's indispensable "Bible." It's no wonder that more than 5,500,000 copies of the Manual have

been purchased by repairmen, service station operators, the U.S. Armed Forces, schools and students all over the world. Here is the help every beginner or "pro" needs to fix almost any part of any car right the very first time. And save time, work, money!

### COVERS ALL THESE CARS 1965-1971

PINTO	CAMARO	VEGA
VOLKSWAGEN	NOVA	DART
MUSTANG	CHRYSLER	CHEVELLE
BARRACUDA	PLYMOUTH	TEMPEST
CHEVY II	RAMBLER	CORVETTE
PONTIAC	DODGE	VALIANT
THUNDERBIRD	OLDSMOBILE	COUGAR
BUICK	CHEVROLET	TORONADO
IMPERIAL	AMX	LINCOLN
CADILLAC	BUICK	FRONT DRIVE
CONTINENTAL	SPECIAL	CADILLAC
MARK III	COMET	JAVELIN
MERCURY	CORVAIR	MONTEGO
FORD	AMERICAN	TORINO
CHALLENGER	OLDS F-85	GREMLIN
MAVERICK	FALCON	HORNET
	FAIRLANE	

Send No Money. The Manual costs \$10.95, but we'll send it to you for 10 days Free trial, so you can see for yourself how it makes auto repairs go quick and easy. Use it for 10 days. If it doesn't give you complete satisfaction, return it and owe nothing. Mail card today. If card is missing, write to:

**MOTOR BOOK DEPT., Desk C117**  
P.O. Box 2316, F.D.R. Station, N.Y., N.Y. 10022

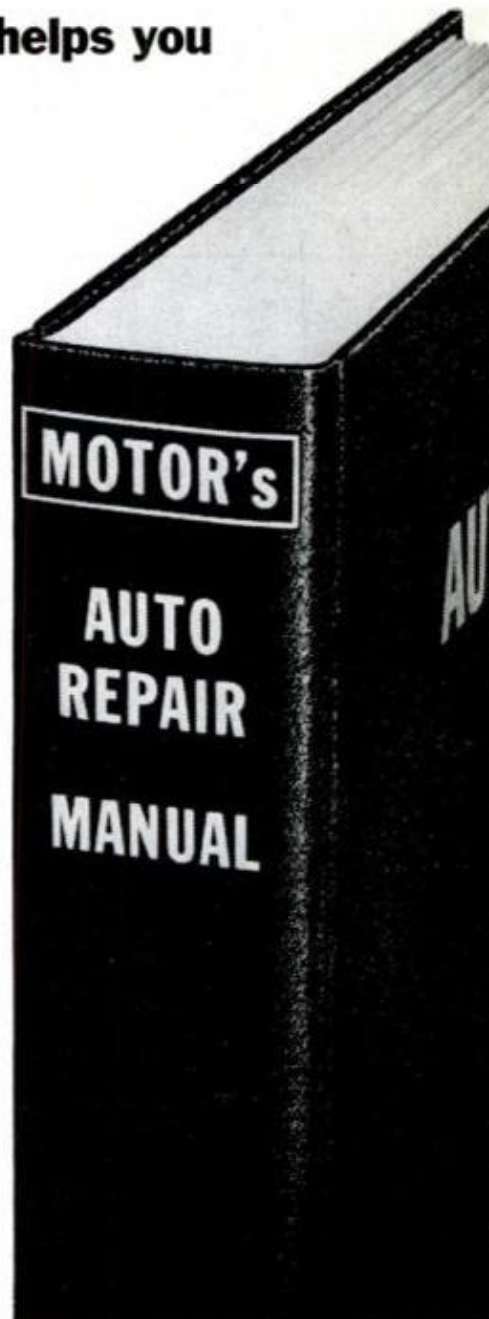



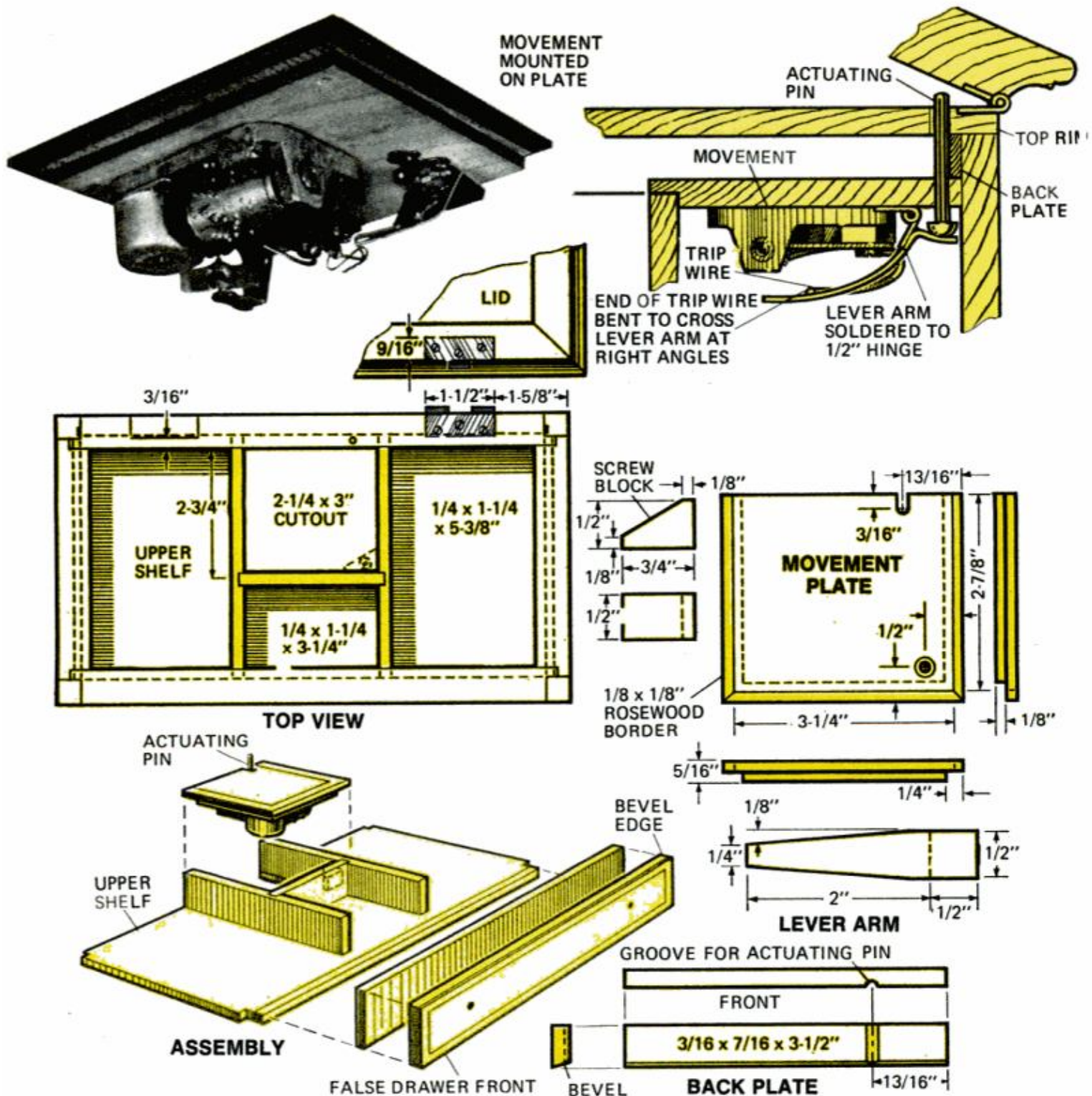

## JEWELRY BOX FOR YOUR QUEEN

(Continued from page 127)

flush. Redrill the knob screw holes and countersink them on the inside (velveteen lining will cover the screwheads).

● **Lid and base.** Select the portion of floral inlay to be used and carefully trim away mahogany background and unwanted portions with a sharp chisel. Then, lay out the pattern for the avodire diamond shape on white paper. Center the floral inlay and trace the outline with a sharp pencil. Cut avodire veneer and two pieces of scrap veneer and glue the pattern to one piece of the scrap veneer. Sandwich

the avodire veneer between the scrap pieces and tape the edges securely.

With a fine blade in your scroll saw, cut out the floral pattern and taped veneers together. After you cut to the outside of the diamond pattern, carefully separate the avodire veneer from scrap.

● **Movement.** A little trial-and-error fitting is in order here. Before cutting blanks or drilling any holes, refer to the movement that you have on hand and determine dimensions from it. (They may vary from those of the model used in the prototype.)

● **Finish.** To finish your jewel box fill any

(Please turn to page 172)



# sliding TROLL BRACKET

Inboards, outboards  
stern drive, sailers



Raised position:  
Motor stored with-  
out creating "drag".



Operating position: Motor  
quickly lowered to correct  
height for full power.

0-13

For trolling or auxiliary motors on pleasure craft, particularly for salmon and steelhead fishing. Motor and mount board are winter-stored without dismounting . . . rails remain on transom. Full sideways swing for positive steering.

No. 516 (to 10 hp) 18" rails No. 516A (to 10 hp) 24" rails  
No. 530 (to 20 hp) 18" rails No. 530A (to 20 hp) 24" rails  
See your Michigan dealer or contact:



**MICHIGAN WHEEL**

MICHIGAN WHEEL CORP., GRAND RAPIDS, MI. 49502



## HEAVY DUTY WELDER

with special \$7.00 gift offer to  
Popular Mechanics readers  
**10-DAY FREE TRIAL**  
**Lifetime Guarantee**

Brand New **1895**  
1971 Model **1895** POST  
PAID

Fits ordinary 110V outlet  
Not one • but 3 welding heats



Weld, braze, solder or cut most anything made of metal. No experience necessary. Follow simple instructions to make repairs on cars, trailers, farm and lawn equipment, bicycles, appliances, etc. Make campers, boats, furniture, hundreds of valuable items. **NOTHING ELSE TO BUY!** Comes complete with full face shield, pack of welding and brazing rods, heavy duty power cables, special electric torch attachment, ground clamp, flux, easy-to-follow illustrated instructions, rod holder, etc. Uses standard 3/8" rods to weld iron, steel, brass, bronze, aluminum, other metals. New improved HEAVY DUTY circuit gives more welding power. Gives 4 times the heat needed to melt toughest iron. Plugs into ordinary 110V outlet. **3 WELDING HEATS . . .** Not just one as with other low cost models. Use "high" for tough jobs "medium" or "regular" for lighter work. This important feature saves you money and time. Makes it possible for even beginners to start welding professionally the very first day. Pays for itself quickly. An excellent gift for any occasion. **IT'S AUTOMATIC:** Current is turned ON when arc is struck, OFF when rod is lifted from work. Eliminates need for troublesome foot switch. Speeds up work.

**FREE!** Mention that you saw this ad in Popular Mechanics and receive a \$7.00 gift pack assortment of "touch weld" welding rods. Automatic arc striker. Weld with "push button" ease.

10 day MONEY BACK GUARANTEE. You must be satisfied or return for refund. Send only \$2.00 and pay postman \$16.95 plus postage when delivered or send \$18.95 cash, check or money order for immediate postpaid shipment.

WEL-DEX MFG. CO., Dept. W-203, Box 10776, Houston, Texas 77018

## Don't waste your life in a dead-end job! Become a well-paid computer programmer— free McGraw-Hill booklet tells how.

Now you can train at home, in your spare time, for a career in this new, exciting field.

More than 50,000 programmers are needed within the next few years.

No college or technical background required. All you need is a logical mind and proper training. People from virtually every walk of life have found success in computer programming.

This new course has been developed by experts. CREI/McGraw-Hill has trained thousands of men and women for better jobs through home study and has an unmatched reputation in educational circles.



FREE BOOKLET!

Mail coupon today or write:  
CREI, Dept. P1107B, 3224 Sixteenth St., N.W.,  
Washington, D.C. 20010

APPROVED FOR TRAINING  
UNDER NEW G.I. BILL.

Founded 1927

**CREI**

Accredited Member of the  
National Home Study Council

**CREI, A Division of the McGraw-Hill  
Continuing Education Company**

Dept. P1107B, 3224 16th St., N.W., Wash., D.C. 20010

Please mail me FREE booklet with complete information on how I can learn computer programming at home. I have a high school diploma or equivalent.

Name \_\_\_\_\_ Age \_\_\_\_\_

Address \_\_\_\_\_

City \_\_\_\_\_ State \_\_\_\_\_ Zip \_\_\_\_\_

G.I. Bill



WRITE FOR OUR BIG  
FREE CATALOG

MORE THAN  
90 MODELS

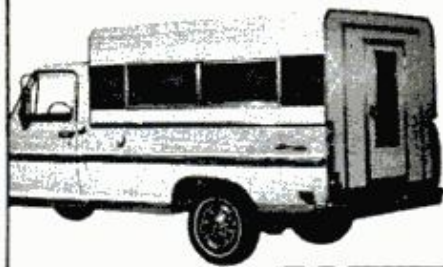

## PICKUP COVERS

FROM

# WINNEBAGO®

More Winnebago K-D Kap® pickup covers are on the road than any other make. Find out why—with our big catalog showing more than 90 models to fit most any pickup.

Constructed with famous Thermo-Panel® laminated material, every K-D Kap® cover is fully insulated with a plywood interior.

Get the facts, and the name of your dealer, right away.



FROM COVERS  
TO CAMPERS



MAIL COUPON FOR FREE CATALOG

Winnebago Industries  
Thermo-Panel Division, Dept. PM  
Box 152, Forest City, Iowa 50436

Name \_\_\_\_\_

Address \_\_\_\_\_

City \_\_\_\_\_

State \_\_\_\_\_

Zip \_\_\_\_\_



# GUNK®

Spray  
it on...  
HOSE  
IT OFF!

## ENGINE-BRITE

Turns grease to soap that washes away! Cleans engines, bilges, decks, concrete.

### G-P

Brush on... wash off!  
Degreases engines,  
parts, floors.

At Hardware & Auto Stores

GUNK LABORATORIES, INC.  
5829 W. 66TH, CHICAGO, ILL. 60638



RUSTED PARTS? REACH FOR

# LIQUID WRENCH

LOOSENS RUSTED NUTS, BOLTS AND  
PARTS IN SECONDS!

### LAN-LIN

CLEANS HANDS QUICKLY!  
Removes paint, grease,  
grime. Rub on... rinse  
or wipe off!

At Hardware & Auto Stores

RADIATOR SPECIALTY CO., CHARLOTTE, N. C. 28201



## JEWELRY BOX FOR YOUR QUEEN

(Continued from page 170)

imperfections with a wood paste such as Duratite, using colors to match adjacent wood. After sanding, dust thoroughly and apply five coats of clear lacquer diluted 20 percent with lacquer thinner. Allow each coat to dry completely, sand lightly with 8/0 paper and dust with a tack-rag. Rub down the last coat with pumice and water, follow with rottenstone and water and wipe away all traces of powder.

Attach the hardware, line the drawers and top tray with velveteen glued over cardboard, then attach the base and hinge the lid to the box. Finally, install the movement and pin. ★★★

### MATERIALS LIST

Amount	Description
5 sq. ft.	Thuya veneer
1 sq. ft.	Rosewood veneer
1 sq. ft.	Avodire veneer
1	Floral inlay (M111A)
15 ft.	1/4" inlay border (56)
3 ft.	3/8" inlay border (6)
2 sq. ft.	1/4" hardboard
2 sq. ft.	1/4" birch plywood
3 sq. ft.	1/8" birch plywood
1 sq. ft.	1/4" Honduras mahogany
1 pc.	3/4x6x36" rosewood
1	Single-tune Swiss musical instrument
1 pr.	Narrow 1 1/2" butt brass hinges
6	Brass knobs
1	Miniature brass hinge
1 pc.	.016x1/2x2 1/2" brass sheet
Misc.	Red velveteen (for lining), white glue

Note: Numbers in parentheses are from catalog of Albert Constantine & Son, Inc., 2050 Eastchester Rd., Bronx, N.Y. 10461. Musical movements are available from Constantine, from Craftsman Wood Service, 2727 S. Mary St., Chicago, Ill. 60608, and other woodworking supply mail-order houses. Rearrangement of parts on the movement panel may be necessary to compensate for different locations of trip wires in various movements.

## NEXT MONTH IN PM

### 4-Channel Stereo: Here at Last!

Suddenly there are half a dozen different systems on the market with more on the way. Here's what you should know about this fast-growing trend in hi-fi listening.

### 50-Story Firetraps

'Fireproof' skyscrapers across the country have been hit by fires, turning whole floors into furnaces, stairways into smoking chimneys and elevators into coffins. What can be done to reduce the hazard and make escape possible?

### Probing the Depths of Your Mind

You can turn on a TV set just by thinking. You can control your heartbeat through thought alone. These are two of the amazing feats made possible by new scientific knowledge of what makes the human brain tick.

### This Car Really Flies

It's a roadable car that sprouts wings and flies.



# Anyone willing to put up with this deserves some kind of reward.



We know.

Because our tobacco has been burning holes in pipe smokers' clothes for more than 30 years.

And over the years we've always gone to as much trouble making our tobacco as you will smoking it.

Take our Kentucky Club Mixture for example.

Each pouch contains no less than 38 separate aroma and flavor ingredients.

Among them the

best Turkish, Perique and White Burleys money can buy.

We cut Kentucky Club Mixture four different ways: ribbon, cube, flake and shag. It's harder than cutting it only one or two ways. But it's worth it if you're after a cool, even-burning smoke.

And now, in recognition of the labor you put into smoking a pipe, we're offering you the fruit of ours. Free.

Just send us the coupon along with an empty pouch of any competitive pipe tobacco. This small effort will be rewarded with a full pouch of Kentucky Club Mixture.

Of course your pockets will still bulge.

And with the tools you carry, you'll

continue to rattle when you walk.

Such are the penalties of pleasure.

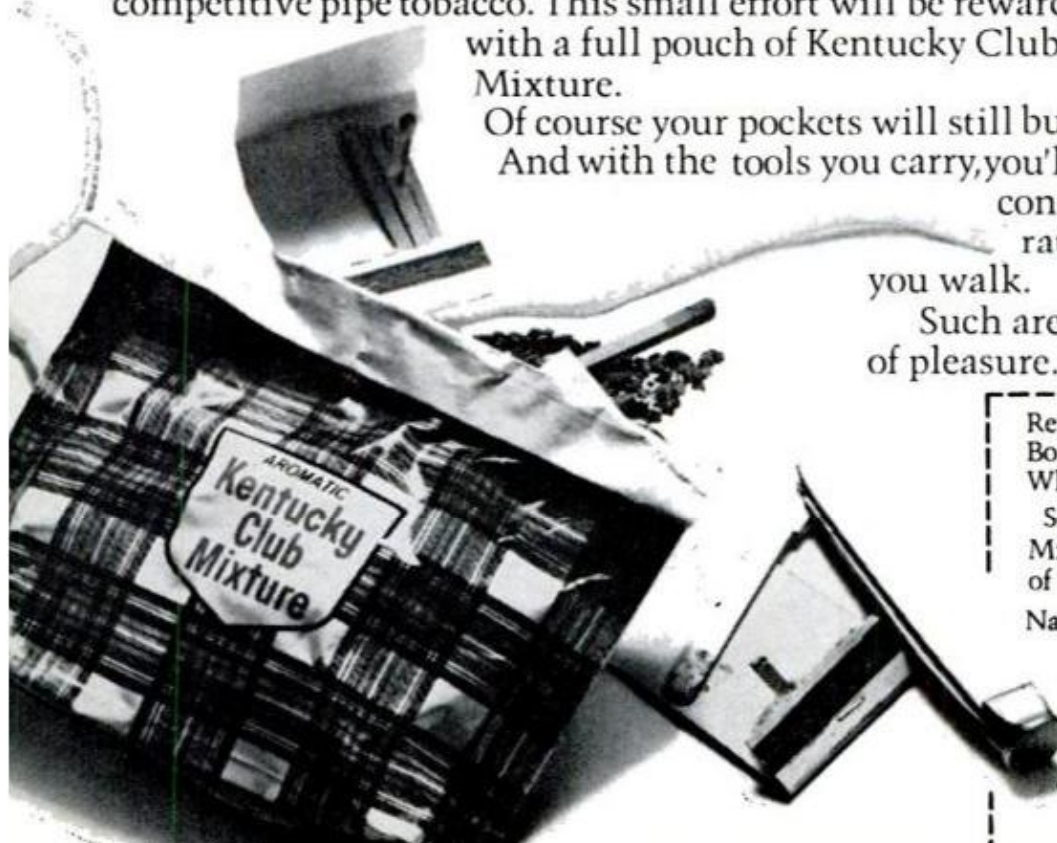

Reward  
Box 6666  
Wheeling, W. Va. 26003

Send me a free pouch of Kentucky Club Mixture. I've enclosed an empty package of a competitive brand in exchange.

Name \_\_\_\_\_

Address \_\_\_\_\_

City \_\_\_\_\_ State \_\_\_\_\_ Zip \_\_\_\_\_

© 1971 Helme Products, Inc. Offer expires 12/31/71

Материал, защищенный авторским правом



**TELESCOPE—\$4.98** 3 telescopes in one  
—25 power for

ultrabright images, 45X and 75X for extra long range. Guaranteed to bring people, sports, ships, moon, etc. 75 times closer. (Also use as strong microscope.) Most power

for the money. NOT A KIT—ready to use. 4 ground, polished lenses; 5 sections, brass bound, 3 feet long, closes to 1 foot. Directions for use. Money back guarantee. Postpaid. Order now!

Criterion Co., Dept. 400, 331 Church St., Hartford, Conn. 66101



**Be a SURVEYOR & MAP MAKER**

Join a Surveying Team—get in on planning of America's highways, bridges, dams, subdivisions, etc. Wonderful outdoor work. Ideal for those who like to work with their hands. 1000s exciting big pay jobs open now to qualified men. U.S. Bureau of Labor Statistics predicts shortage of 50,000 civil engineering technicians (Surveyors, etc.) by 1975 as construction of highways, airfields, waterways skyrockets upward. Our easy step-by-step home-study plans have helped 1000s beginners toward prestige salary security. Big 68-piece Surveying Kit (training transit, drawing, instruments, etc.) given to you when you enroll. Thousands of Surveyors got their start through home-study. You can too! Send for "SURVEYING CAREER KIT"—ALL FREE! No salesman will call.

**\* APPROVED FOR VETERANS \***

**NORTH AMERICAN SCHOOL OF SURVEYING, Dept. 1-477**  
4500 Campus Dr., University Plaza, Newport Beach, CA 92663

Rush me "Surveying Career Kit" ALL FREE!

Name \_\_\_\_\_ Age \_\_\_\_\_  
Address \_\_\_\_\_  
City \_\_\_\_\_ State \_\_\_\_\_ Zip \_\_\_\_\_

**APPROVED FOR VETERANS**

**SAMPLE LESSON**  
**YOUR FUTURE IN SURVEYING & MAPPING**  
**APTITUDE TEST**  
**ALL 3 FREE!**



**New Table Top Invention Puts You In...  
PROFITABLE RUBBER STAMP BUSINESS**

Home Operators now make **\$16.50 AN HOUR** in Business once monopolized by a few big companies

Special rubber stamps bring high prices—cost only pennies to make on new, low-cost table top machine. Take 27 cents worth of material, make perfect stamps, the kind businesses and offices now buy by the dozen at \$2.75 each. Make up to \$16.50 an hour. Start in spare time in your own home. Run machine on kitchen table using ordinary electrical outlet. Make any kind of stamp. We'll send you free information without obligation about this established, highly profitable business. **We'll even help finance your start.** For free information send name and address today on a postcard to: RubberStamp Div., 1512 Jarvis, Dept. R-2-AH, Chicago, Ill. 60626



**Gold—Copper—Silver Coins, Rings—Treasures and Mineral Deposits are detected with**

**THE FAMOUS GOLDMASTER 66T**

The finest all-around Mineral-Metal Detector in its class. Solid state Transmitter-Receiver comes equipped with both 6" and 10 1/2" weatherproof multi-coil loops. In demand by prospectors and treasure hunters alike, the 66-T can detect GOLD, SILVER or COPPER NUGGETS, COINS, JEWELRY, RINGS, ARTIFACTS of all description. This unique instrument sells for just \$269.50. Many models to choose from. WHITE'S ELECTRONICS makes the world's largest line of mineral & metal detectors. \$69.50 up. For your FREE literature, please write: **WHITE'S ELECTRONICS, INC., Rm. 503, 1011 Pleasant Valley Road, Sweet Home, Oregon 97386.**



**RADIAL ARM SAW KIT...  
for under \$100**

Buy direct from factory, assemble yourself. Incl. 1/2 h.p. G.E. motor, easy to follow instructions, all parts, nuts and bolts. Guar. for life pat. pend. radial arm track; twice the usual bearings for extra rigidity, greater precision. Rips 24", crosscuts 12"; belt brake. \$99. complete, freight col. Kit less motor (any stand. 1/2 h.p. or larger will do) \$84.85. With optional G.E. motor developing 1 h.p. \$108.65. Money back guaranteed by one of world's largest manufacturers of bench power tools. Write for brochure. Terms if desired or check or M.O. to American Machine & Tool Co., Dept. PM-71, Royersford, Pa. 19468



**HYDRAULIC JACK REPAIRS**

Earn while you learn at home. Millions of jacks in gas and auto service stations, trucking firms, body shops, riggers, factories and farms need servicing... most of which you can learn to repair. We show you HOW. Start spare time in your basement or garage. Big opportunity for mechanics. **ACT NOW!** Write for folder No. PM-7 and free bonus offer.

**HYDRAULIC JACK REPAIR MANUAL CO., INC.**  
G.P.O. BOX 3 • STATEN ISLAND, N.Y. 10314



**MINI-BIKE PARTS**

**Wholesale Prices**

"Build your own" kits... Big savings... Repair parts... Welded frames & forks, enameled... Chains... Clutches... Brakes & throttle controls... Wheels... Tires... Bearings... Axles... Engines... etc. Send 50¢ for illustrations and lists... **SAVE DOLLARS!**

**BYCO, Dept. B, Box 6241, Omaha, Nebr. 68106**



**locksmithing and key making**

**PRACTICAL UP-TO-DATE COURSE — ONLY \$7.95**

Teaches you how to pick locks, de-code, make master keys, repair, install, service, etc. New self-instruction lessons for every handyman, homeowner, carpenter, mechanic, service station operator, fix-it shop, hardware dealer, gunsmith. 53 easy illustrated lessons. Full price only \$7.95 postpaid. Satisfaction or refund guaranteed. Mail order today!

**NELSON-HALL CO., Dept. GZ-2**  
325 W. Jackson Blvd., Chicago 60606



**HOW TO GET RICH**

Secret Mail Order business brings cash by mail. Pyramid profits. No investment. Start at home in spare time. Write for full details and Free Book.

**MAIL ORDER ASSOCIATES, INC.**  
Dept. 62, Montvale, New Jersey 07645

**SAILBOAT KITS**

Free color catalog of the largest selection of popular sailboats, iceboats, and sail making supplies.

**TAFT MARINE CORP.**  
Dept. PM-7, 636 39th Ave. N.E.  
Minneapolis, Minnesota 55421



**PUMP DRAINS** pools, cellars, laundry tubs  
**IRRIGATES — CIRCULATES — SPRAYS**

Heavy duty ball bearing pump. All metal, rust-proof Type XB. Stainless shaft. Use 1/4 HP or larger. 1 HP 1,200 GPH 60" high or 3,000 GPH 25" well. 5,200 GPH max. 1 1/4" in; 1" out. Belt or direct drive. **\$13.95**

Type P won't rust or clog. Bronze bearing. To 2,400 GPH. 1" in; 3/4" out. **\$9.95**

P'd cash with order. Money back Guarantee.

**LABAWCO, Box 40, Belle Mead, N.J. 08502**







## "Changed My Whole Life!"

Says **WM. A. TARNELLI, SR., Ossining, N.Y.**  
"I was a postal clerk, but I soon left the postal service to devote fulltime to Locksmithing. I now have my own shop in the main section of Ossining with plenty of work."

# Be a LOCKSMITH

**Train at HOME—Earn While You Learn.** Add 50%-100% to YOUR INCOME with easy spare time earnings. Cash in on the nation-wide shortage—trained locksmiths in great demand! Quickly step into a big pay opportunity job or start a high-profit shop of your own.

**Earn Extra Money RIGHT AWAY!** All Master Locksmiths Special Tools, Equipment and Supplies Furnished FREE for use with course.

Age, education, minor physical handicaps don't matter in this growing trade. You can quickly qualify as a skilled locksmith. It's like a fascinating hobby. Study at home as little as one hour a week. Gain practical experience through complete well-illustrated lessons. Do real jobs on car locks, house locks, padlocks and safe locks, under the guidance of experts. FREE Illustrated Book, write now.

**LOCKSMITHING INSTITUTE,**

(Div. of Singer Communications Corp.)

Dept. 1110-071 • Little Falls, New Jersey 07424

**306**  
pieces of professional equipment  
for use with course.

Professional Equipment includes  
**LOCKS—PICKS—PARTS—KEYS  
SPECIAL TOOLS & SUPPLIES**  
all FREE for use with course.

**MAIL COUPON for FREE ILLUSTRATED BOOK**

For a future as your own boss or in a high-pay job, write now for FREE Illustrated Book. Only school of its kind. Licensed by State of New Jersey. Approved for Veterans.

Accredited, Nat'l Home Study Council.

**MAIL COUPON NOW**

**LOCKSMITHING INSTITUTE, Dept. 1110-071  
Little Falls, New Jersey 07424**

Please send FREE Illustrated Book—"Your Big Opportunities in Locksmithing," complete Equipment folder and sample lesson pages—FREE of all obligation—(no salesman will call).

Name \_\_\_\_\_

Address \_\_\_\_\_

City \_\_\_\_\_ State \_\_\_\_\_ Zip \_\_\_\_\_



## "POP" RIVETOOL

**MAKES NUTS & BOLTS OLD FASHIONED!**

Now fasten things in seconds. Permanently. From one side of the work!

- 1 Insert "POP" Rivet in holes
- 2 Pump Rivetool handle
- 3 "POP" it's fastened forever!

Kit includes tool and assorted rivets. At hardware dealers.



**USM Corporation**  
Consumer Products Division

## Allied Radio Shack makes bike riding more fun!

**ARCHER BIKE RADIO**  
**12.95**  
Post Paid

**Instant-ON/Instant-OFF Mount**

**It's a Portable Too! Bracket Stays ON Bike!**

**UNIVERSAL MOUNT FITS ALL BIKES!**

Our exclusive "Road Patrol" is a weatherized AM radio that leads a double life—on the handlebars of any bike—or as an indoor/outdoor portable. Ruggedized solid-state circuitry, built-in electric horn, 3" safety reflector out front.

At Over 950 Stores Nationwide See the Yellow Pages

**ALLIED RADIO SHACK** Ft. Worth, Texas 76107 2727 W. 7th St.  
A TRACY CORPORATION COMPANY  Bike Radios @ 12.95 Postpaid  
Dept. PM-3  Free Part & Kit Catalog

Name (print) \_\_\_\_\_  
Apt. No. \_\_\_\_\_ Route \_\_\_\_\_ Box \_\_\_\_\_  
Street \_\_\_\_\_  
City \_\_\_\_\_ State \_\_\_\_\_ Zip \_\_\_\_\_



## CAN A SHOOTER WHO IS OUT TO SCORE BULLS-EYES FIND HAPPINESS with the NEW BENJAMIN AIR RIFLE?

We think so. Indeed, shooters have told us that the accuracy and performance of our new Super Single Shot are next to fantastic! Just what makes the new Benjamin something all by itself? It's probably the retention of things the owners of its famous predecessor used to brag about. And the painstaking way we build them. For example, it has the same dependable, time-tested action. And the same adjustable firing power. It even has the same bronze barrels, machined brass and steel parts that gave our older model an amazing wallop.

Of course, there are certain new features about the rifle which further enhance shooting fun. For one thing, it has a thumb operated top safety for more efficient fire control.

And a ramp-type front sight plus adjustable stepped leaf rear sight to help bring out the full accuracy potential of the new gun. Safe. Quiet. Odorless. Shoot indoors or out. Model 340 BB. Model 342 Cal. 22 Pellet. Model 347 Cal. 177 Pellet. Find happiness at your dealer's. Use Benjamin Pellets—Sized and Lubricated

**BENJAMIN AIR RIFLE COMPANY** **FREE CATALOG**  
896 Marion St., St. Louis, Mo. 63104 **WRITE**

You Can **DEPEND** on **BENJAMIN**

RIFLE WILL SAFETY ON TOP OF RIFLE BEHIND RIFLE

## Monitor



### INSTANT ADVENTURE ALL SEASONS

20 travel trailer models. Classic beauty. Reliable roadability. Complete convenience.

WRITE FOR 20-PAGE FULL COLOR CATALOG

Monitor Coach Co., Inc., Dept. 138, Wakarusa, Ind.  
a subsidiary of The Wickes Corporation

## FEAR NO MAN!



Regardless of your age, size or strength, in just 15 minutes, I'll have you using my **TERROR-FIGHTING** secrets. **TEN TIMES MORE EFFECTIVE** than KARATE and JUDO Combined. They will turn you into a destructive **MARINE TOUGH** fighter able to protect yourself and loved ones from any hoodlum twice your size without working up a sweat — anytime — anywhere — in any and all situations.

If you really want self defense mastery and confidence, send now for amazing free booklet, revealing for the first time 5000 years of trip-hammer political, military and religious fighting orders, including Judo, Karate, Boxing, Wrestling and Rough & Tumble fighting secrets that will quickly turn you into a Terror-Fighter. You will never again get "weak in the knees" and run but stand and successfully defend yourself against even two or three attackers. Yes! from this day on YOU need never **FEAR ANY MAN**.

Mail **NOW** for self defense fighting secrets.

**ABSOLUTELY FREE**

Send only 50¢ to cover Postage and handling to

**JOE WEIDER, Dept. 38-71-SD3**

25 Maple St., Norwood, N.J. 07648



## MAKE THE LAW "SERVE" YOU

Knowing the law can be the difference between success and failure in business. The Blackstone School of Law offers a program of reading assignments planned to familiarize adults with the law.

### NOT A CORRESPONDENCE COURSE

No Formal Educational Credits Are Required

Schedule Your Program to Suit Your Needs Write for **FREE BOOKLET**, "The People vs. You." Gives complete information on the program.

**NO SALESMAN WILL CALL**

**BLACKSTONE SCHOOL OF LAW** Dept. 54

307 N. Michigan Avenue, Chicago, Illinois 60601

## REAL ESTATE BE A BROKER

**PAYS BIG! SEND FOR BIG FREE CATALOG NOW!** Graduates report making substantial incomes. Operate your own business quickly. Men, Women, all ages, learn easily. Course covers Sales, Appraising, Loans, Mortgages, & related subjects. **STUDY AT HOME** or in classrooms in leading cities. **Diploma Awarded. Write Today for FREE Book!** Accredited Member National Home Study Council. (Est. 1936) G. I. Approved.

**WEAVER SCHOOL OF REAL ESTATE**

3521-P Broadway

Kansas City, Mo. 64111

## I-N-V-E-N-T-O-R-S

### WE NEED INVENTIONS

Sell your invention for cash—need money for Patent?—Are technical problems holding you back? Universal Inventions has helped inventors all over the world—just like yourself—why not you? Inventions provide the magic spring-board to sudden riches. **REMEMBER**, we either sell your invention or pay you a cash bonus. Write for details. **UNIVERSAL INVENTIONS, Dept. 13, Marion, Ohio**



### Repair any watch

#### ... SWISS OR AMERICAN

Unique, modern Sweazey System starts you making repairs right away. Develops skill step by step at home in spare time. Diploma awarded. Free sample lesson. No obligation.

**CHICAGO SCHOOL OF WATCHMAKING**  
Dept. 171, Fox River Grove, Ill. 60021

### WRIST ROCKET

AMERICA'S Pat. HARDEST U.S. HITTING SLING

Range 225 yd.—232 fps  
Matched spare rubbers and pouch assembly, \$1.00.

Write:

WRIST ROCKET®  
P. O. BOX 21-B  
Columbus, Nebraska 68601



**\$300 Post Pd.**  
**No C.O.D.'s**

### Career in

## ELECTRONICS?

Career training at home the new easy way with RCA Institutes. Lab work with first lesson. Easy payment plans. Send for free 64-page book.

RCA Institutes, Dept. 699-007-1  
320 W. 31 St., N.Y., N.Y. 10001

# RCA



## SMALL FOUNDRY FURNACES

AND SUPPLIES  
Ideal for home craftsmen and light commercial use. Make castings of bronze, cast iron, aluminum, copper, gold, silver, brass and other similar metals for hobby or business. Free literature.

**PYRAMID PRODUCTS CO.**

3736 SOUTH 7TH AVENUE,

PHOENIX, ARIZONA 85041

176

POPULAR MECHANICS



**\$1.00 EACH  
COLOR FAST  
CLOTH EMBLEMS**

Also 2x3 3/4 U.S. Flag & 2x3 3/4 Ecology Flag. 3" Peace with Glory 3 for \$2.75. 6 for \$5.00 can be assorted. Add 25¢ for handling

**MR. EMBLEM, P-1,**  
Box 48221, Chicago, Ill. 60648

(31/4x31/8)

**LOCKS AND KEYS MADE EASY!**

**COMPLETE ILLUSTRATED BOOK OF FACTS**

Shows how to fit keys, change combinations, master key locks, keys by number, tools to use, etc. Fascinating trade explained in simple words, clear and complete illustrations. Satisfaction guaranteed. Get started! Order today. Dpt 82

**ONLY \$3 PPD.**

**I. B. Ancele, P. O. Box 69234, Los Angeles, Calif. 90069**

**FREE!**

Learn how you can buy used engines \$15 up, new engines \$30 with FREE confidential list and coupons when you order your plans

**BUILD THIS MINI-BIKE!**  
Plans reveal step by step details!

**BUILD A RACING KART!**  
Build frame for less than \$10!

**RUSH \$2 for plans (indicate type) or send 25¢ for circular describing plans PLANS, Box 793, Fremont, Nebr. 68025**

**BLAST CARBON**  
from every engine with  
**Fuel Mix Tune-Up Concentrate**  
New! from **GUMOUT**

**WHITE'S ELECTRONICS INC.**

THE WORLDS LARGEST LINE OF MINERAL & METAL DETECTORS

**Goldmaster 66 TR**  
\$269.50

PRICES START AT 69.50 AND UP.

FOR FREE COLOR CATALOG WRITE TO  
**WHITE'S ELECTRONICS**  
RM. # 512 1001 PLEASANT VALLEY ROAD SWEET HOME, OREGON 97306

**THERE ARE NO FINER AT ANY PRICE. . .**

**LEARN UPHOLSTERY AT HOME!**

Men & Women All Ages! Send for free book on learning to reupholster chairs, divans, footstools, all furniture for BIG MONEY in spare or full time. No experience needed, no age or educational limits. We show you how and provide EVERYTHING needed to start: (1) Home training covering all phases, (2) all tools and 6 big furniture kits for practice, (3) free supplies, frames & materials to build \$300 worth of furniture, yours to keep or sell. Write TODAY for big free upholstery career book. No obligation, no salesman will call. Veteran Approved. Modern Upholstery Institute Box 899ELZ, Orange, Calif. 92669.

**At Last a New Amazingly Simple  
GAS TURBINE  
JET ENGINE**

Build from easy to follow plans. Length 15", Dia. 8 1/2", Wt. 15 lbs. Fuel: Gasoline or Kero.

"Screamin' Demon" develops 20 H.P. Ideal project for serious-minded hobbyists, students; scientific and industrial arts classes. Make on 9" metal cutting lathe with milling attachment. For use on small racing boats, midget cars, etc. Full size assembly drawings with critical dimensions, bill of materials and photos. Price \$5.00. No C.O.D.

**SAVOY SCIENTIFIC, BOX 1398, SANTA MONICA, CALIF. 90406**

**GOVT. SURPLUS AND OTHER BARGAINS SAVE UP TO 90%**

**HEAVY DUTY GEAR MOTOR**  
All ball bearing construction. 3 H.P. @ 24 V.D.C. Turns 400 RPM no load on 12 VDC. 750 RPM on 24 V.D.C. Contains magnetic clutch. Free wheels with power-off. Reversible. Shaft is 1 1/8" dia. Motor 16 1/2" L x 8" Dia. Approx. GOVT. COST \$250. Shpg. Wt. 40 lbs. \$34.50 (Stk. #2410)

**HIGH VOLUME PUMP**  
Delivers a whopping 1,000 G.P.H. at up to 23 P.S.I. @ 27 V.D.C. Also runs extremely well @ 12 V.D.C. @ reduced rating. Motor section runs submerged and is explosion-proof. Outlet is 1 1/2" hose fitting. 12" H x 8" Dia. Will pump fuel, light oils, water-based insecticides. GOVT. COST \$503. Like NEW. Shpg. wt. 24 lbs. \$14.75 (Stk #2787).

**ELECTRIC PUMP WITH CONTROL SWITCH** For boats, campers & trailers. Output 300 GPH. Can be used in fuel or water. 1 1/2" pipe bronze inlet. 12 or 24 V.D.C. Explosion-proof motor. Comes with wiring diagram. Approx. GOVT COST \$150. Shpg. wt. 9 lbs. \$14.50 (Stk. #1164)

**NEW! BIG 1971 CATALOG**

Send 35¢ for amazing catalog with 1000's of bargains in hydraulics; electrical, marine, automotive items, etc. 90 day guarantee. Order from ad. All prices FOB Culver City. 50% deposit for COD. Cal. res. add 5% sales tax. Include zip.

Satisfying customers world-wide since 1945.

**AIRBORNE SALES CO.** Dept. PM771  
8501 Steller Dr., P.O. Box 2727, Culver City, Calif. 90230

**BE A TAX CONSULTANT**

Earn big money in ever growing profession. Our students are earning lucrative fees in dignified full or part time home-office business preparing income tax returns. Pays BIG in a very short time! No bookkeeping experience necessary. We train you at home and help you start. Licensed by N.Y. Education Dept. Write for free literature. Accredited Member NHSC. Vet Approved. National Tax Training School Money, 20KC, N.Y. 10952

**LUCK!** \$15 WIN A RACE DAY

NOT WITH PENCLIFF GET UP TO \$2

"THIS MAN WAS boasting he'd had wins at tracks on the day including \$874, \$1082, \$1516 with \$20 on all selections in the 9 races. Then I discovered he wasn't boasting, he had PENCLIFF world's top race computer."

SENSATIONAL—space age—scientific, we supply FACTS—over 4,000 latest CHECKABLE big win PENCLIFF results. BIG \$2 pays incl. \$66, \$70, \$82, \$90, \$96, \$104, etc. And BIG track wins—\$2 stakes on all predictions in all races incl. \$113, \$118, \$121, \$134, \$141, \$151, etc. CLEAR PROFIT ON THE DAY. Over a dozen race experts BRAINS ARE BUILT INTO PENCLIFF. Experience the pleasure of seeing this amazing instrument "think" as it works out wins for you. Not just small ones—many grand, big, BIG pays. Later, you'll accept as normal, but at first we're sure you'll find the unique way this remarkable instrument receives race information you feed in, skillfully works it out and COMPUTES it, will be one of the most wonderful experiences of your life. We programmed THOUSANDS of races to an I.B.M. computer with intensive probes into entrants—equivalent to 50 mathematicians 3 yrs. work. Due to this COLOSSAL RESEARCH fantastically successful PENCLIFF was invented. Shipped complete—full easy instructions in a genuine English leather carrying case—so cleverly designed that even if no previous experience of horseracing EASILY operated. Get full, EXCITING details of world's greatest horserace winning computer, and in future really enjoy the world's most popular sport. Money refund guarantee. Mail the coupon NOW. R.H.P. Co., PME20, Box 5715 CARMEL, CALIF. 93921.

**R.H.P. CO., PME20, Box 5715, CARMEL, CALIF. 93921**  
(Tell me everything about exciting PENCLIFF)

Name.....  
Address.....  
City..... State..... Zip.....



# MAKE BIG MONEY

## OPERATING HEAVY EQUIPMENT



**BULLDOZERS  
CLAMSHELLS  
TRENCHERS  
DRAGLINES  
BACKHOES  
SCRAPERS  
GRADERS  
CRANES**

The Construction Industry is Booming! Earn top money in this fast moving, action-packed field. Keep present job and train at home in spare time followed by practical training on our machines under project conditions at our facilities. Nationwide placement assistance. For FREE information fill out and mail coupon today!  
Member American Road Builders' Assn.

APPROVED FOR VETERANS AND INSERVICE PERSONNEL

**UNIVERSAL HEAVY CONSTRUCTION SCHOOLS, Dept. PM**  
1901 N.W. 7 STREET / MIAMI, FLORIDA 33125  
Phone: (305) 642-2332 (24 Hours)

Please Print

Name \_\_\_\_\_ Age \_\_\_\_\_

Address \_\_\_\_\_

City \_\_\_\_\_ State \_\_\_\_\_

Phone \_\_\_\_\_ Zip \_\_\_\_\_

## Train at Home for a BIG INCOME CAREER IN ACCOUNTING



Train now at home in spare time for 1000s high pay positions open to Accountants. Accountants move up fast in business. With our exclusive Computer Age Accounting Course you are given a fully automatic electric adding machine. Ours is the only home-study plan that shows you step by step how to take advantage of computers to simplify work—how to make you more valuable to company management.

You learn both Manual and Computer Accounting! You work actual problems with our IBM 360 Computer to learn exactly what information you must "feed" the computer... you learn how to interpret "print out" data our computer returns to you... you qualify for one of 1000s "Big Income" Careers awaiting trained Accountants. Whatever your previous experience or education—we show you how! Send for FREE "Accounting Career Kit." No salesman will call.

**GIVEN  
TO YOU**

Send Coupon For  
**FREE BOOK**  
NORTH AMERICAN SCHOOL OF ACCOUNTING, Dept. 14177  
4500 Campus Dr., Newport Beach, Calif. 92663  
Rush FREE "Accounting Career Kit." No salesman will call.



NAME \_\_\_\_\_ AGE \_\_\_\_\_

ADDRESS \_\_\_\_\_

CITY \_\_\_\_\_ STATE \_\_\_\_\_ ZIP \_\_\_\_\_

## MERCURY—The Mini Bike Clutch with a 6 month warranty!

Double the torque capacity of ordinary mini-bike clutches, long wearing shoes, long life Teflon-impregnated or needle bearings. INTERCHANGEABLE WITH ALL OTHER CLUTCHES. FREE CALL—Locates your Mercury dealer. In Continental U.S. 800-321-9871 In Ohio only—800-362-9844

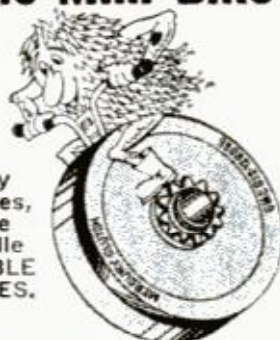

**MERCURY CLUTCH**

Div. of **espro** Inc.  
1201 Camden Ave., S.W., Canton, Ohio 44706

## BUILD THE POPULAR MECHANICS MINI-BIKE



FROM 26-IN. BICYCLE FRAME  
—with VARIABLE SPEED TRANSMISSION, as featured in June '67 issue. Step-by-Step plans, photos show you how. PLANS, \$2.50, refundable with order for wheels, engines, clutches, kits at Discount Prices. Order Plans, or send 25c for Catalog, today!

SAVE \$50 to \$150  
GILLIOM MFG. CO. Dept. PM-7 St. Charles, Mo. 63301

## ELECTRIC ARC WELDER \$9.99!



NATIONALLY ADVERTISED \$18.95 VALUE—NOW 1/2 PRICE! WELDS—BRAZES—SOLDES—CUTS—ALL METALS! Plus into ANY 110 volt socket. MAKE—REPAIR 1001 items for CAR—HOME—BUSINESS. Lifetime BURNOUT GUARANTEE 10 day money back trial (if retnd.)

HEAVY DUTY Design—No experience needed—FREE WELDING LESSONS! SEND ONLY \$2.00 (cash, ck, M.O.) and pay postman \$7.95 COD postage or send \$9.99 plus \$1.00 postage for paid del. in U.S.A.! COMPLETE READY TO USE—Includes BIG pack steel, Brazing, Solder, Carbon "touch" rods. ELECTROFLAME ARC TORCH! OFFER LIMITED—Order TODAY!  
MIDWAY WELDER Dept. EPM-7 Kearney, Nebr. 68847

Electric Razor

1.70

Calendar Watch 2.44

Auto \$954

Auto \$954

Auto \$954

Auto \$954

Auto \$954

Auto \$954

Auto \$954

Auto \$954

Auto \$954

## START IMPORTING IN 10 MINUTES

MEN/WOMEN—BIG MONEY AT HOME First day profits! Make your first import transaction order 10 minutes after you get my plan. Thousands more dazzling products from overseas. Deal direct—below wholesale prices. No product investment. Full or part time. Write for FREE BOOK today to...  
MELLINGER, Dept. E2257, 1554 S. Sepulveda, Los Angeles, CA 90025



## EARN \$20.00/HOUR

Assemble the heavy-duty TURF-RIDER tractor for resale at big profit — or use it yourself. Powerful 12 H.P. engine. "Build-it-yourself" Plans \$5.00, large, colorful catalog of full line 75¢. Refunded with any purchase. STRUCK CORP., Dept. PM-71, Cedarburg, Wisconsin 53012.

## LIFETIME "SPIN-ON" OIL CLEANER



Cleans motor oil 100 times cleaner than any other "spin-on" filter. Never drain oil again. Never buy another spin-on filter. Change 15 cent element every 3000 miles, available everywhere. Doubles engine life. Oil is 100% clean 100% of the time. Guaranteed 5 years. \$25.95 post paid. Write for the facts. Save \$8.00 every 3000 miles.

**VIRDEN PERMA-BILT**  
Box 7066 PM, Amarillo, Texas 79109

## FIND BURIED TREASURE

Powerful electronic detector finds buried gold, silver, coins, etc. 5 new models. Write for free catalog.



**RELCO, Dept. D-3**

BOX 10839, HOUSTON, TEX. 77018



REPOWER with a 6 or V-8 H.D. ADAPTORS for using Car, Compact and some Truck engines. "State year & model, Jeep or Scout." Want fast action? Give us FULL INFORMATION. Send \$25.00 Dep. and we will ship correct kit, bal. COD. Send full amount for prepaid shipment. Wire, phone or write today. Details FREE

**HOOSIER MACHINE PRODUCTS CO.**

312 S. E. 8th St., Phone 278-3442, Pendleton, Oregon 97801

## LEARN

## MEAT CUTTING



Train quickly in 8 short weeks at Toledo for a bright future with security in vital meat business. Big pay, full-time jobs — HAVE A PROFITABLE MARKET OF YOUR OWN! Time payment plan available. Diploma given. Job help. Thousands of successful graduates. OUR 48th YEAR! Send now for big new illustrated FREE catalog. No obligation. G.I. Approved. #01977

**NATIONAL SCHOOL OF MEAT CUTTING**  
Dept. 50-Y, Toledo, Ohio 43604



## Protect Negatives and Slides



### New **PRINT FILE** NEGATIVE PRESERVERS

Clear plastic Print File lets you contact print without removing negatives. Perfect for filing and previewing slides. For 35mm and 120 film, 2x2 slides, and other standard film sizes.

100 Print Files hold 1200 to 4200 frames or 2000 slides. Standard files \$15.00/100. 3-ring binder style files \$20.00/100. 2x2 Slide Files \$25.00/100. Specify film size. Check with order plus \$1.00 for postage and handling. FREE sample packet on request.

## PRINT FILE, INC.

Dept. O Box 100 Schenectady, N.Y. 12304

### 110-120 VOLT A.C. LIGHT PLANTS—60 CYCLES

Fanbelt driven from pickup or small gas engine. Operates saws, drills, pumps, freezers, T.V., X1000 Watts—Needs No Battery. Now \$70.00. 1500 Watts—6 and 12 volt vehicles. Now \$60.00. 3000 Watts—12 volt vehicles only. Now \$99.50. Guaranteed. Check or Money Order.



VIRDEN PERMA-BILT, Box 7066 P.M., Amarillo, Texas 79109

## WHAT'S HE DOING?

Making a Concrete Flower Pot! ... and SO CAN YOU!

Make and sell your own Ornamental Concrete items. Rush \$2.00 for book about Aluminum Molds with prices and production trade secrets direct from world's largest mold manufacturer. Over 350 designs to select from.



Send \$2.00 **CONCRETE MACHINERY COMPANY**  
Today To → P. O. BOX 99 • HICKORY 2, N. C. 28601

## THE AUTO ELECTRIC

Power-For-Tools. 110 V.D.C. Electricity from a car's alternator. Installs on—Most late model cars, trucks or tractors. Will operate heavy power tools, light bulbs, heating devices, etc. Operates any brush-type 110 V. A.C.-D.C. electric motor. Excellent battery boosting and charging. Easily installed.



Checks or Money Order:

\$16.95 Without 150 V. D.C. Meter  
\$19.95 With 150 V. D.C. Meter

Auto Air Equipment Inc., P.O. Box 2886, Amarillo, Texas 79105  
P.O. Box 38625, Dallas, Texas 75238

## "LISTEN IN" TO POLICE-FIRE RADIO CALLS IN YOUR CAR!

WORKS with ANY CAR—Portable or HOME RADIO! Just PLUGS in—No wiring—3 minute hookup! Switch instantly from regular to ALL POLICE-FIRE-EMERGENCY-COMMERCIAL-TAXICAB-STATE-CITY-GOV'T 2 way Radio calls in YOUR AREA. DUAL—HI-LOW BANDS—OVER a MILLION Radio Cars/stations. USE Everywhere—anytime—always works! SEND ONLY \$2.00 cash, (k., M.O.) and pay post-man \$7.99 plus COD post. or send \$9.99 for post Del in USA. COMPLETE, ready to use with instructions. One Year service Warranty—10 DAY MONEY BACK TRIAL (if retnd). AMAZING OFFER good only by mail—WESTERN RADIO Dept. BPM-7 KEARNEY, NEBR. 68847



## OPERATE THREE PHASE MOTORS FROM SINGLE PHASE LINES ONLY

The RELIANCE THREE PHASER allows you to operate three phase motors, 1/4 thru 7 1/2 horsepower from 220 volt single phase power sources. Rugged—heavy duty—patented unit built to give many years of satisfactory service. Thousands of satisfied users. Free literature on request.  
RELIANCE ELEC. MFG. CO., INC. New Albany, Miss. 38652

ONLY \$2995

# NO MONEY DOWN

## Start Profitable Business in Your Garage or Basement



Start in sparetime; build a money-making full-time business in your garage or basement. We'll start you in business with No Money Down. Your earnings easily cover the low monthly payments. Sharpening saws is an important service in any neighborhood or small town—You can earn \$3 to \$6 an hour sharpening hand, band or circular saws.

## No Experience! No Selling

The easy-to-operate Foley Saw Filer is automatic—it does the job for you. You can be doing business the day after you receive your machine. And with a saw filing business customers will come to you. No door to door selling! You are supplying a much needed service. If you'd like more information about this unique business opportunity, return coupon (no salesman will call) and we'll send you our fact-filled

### MONEY-MAKING BOOKLET FREE!



Foley Manufacturing Co.  
743-1 Foley Bldg., Minneapolis, Minn. 55418  
Send for FREE book on Money-Making facts about the sharpening business.

NAME \_\_\_\_\_  
ADDRESS \_\_\_\_\_  
CITY \_\_\_\_\_ STATE \_\_\_\_\_ ZIP CODE \_\_\_\_\_

## Print For Profit



Cards, Stationery, Envelopes, Advertising, labels, tickets, announcements, Q.S.L. cards, greeting, sympathy, prayer cards, tags, etc. Good Profits, Pays for itself in a short time.

### Own a Printing Business

We supply everything direct from factory only. Easily followed rules. Also raised printing like engraving. Have home shop. Add to income. Send 25c for catalogue. **KELSEY PRESSES Meriden, Conn. 06450**

MAIL THIS COUPON TODAY!

**KELSEY PRESSES, DEPT. 71-S Meriden, Conn. 06450**

I enclose 25c send big catalog and samples.

Name \_\_\_\_\_  
Address \_\_\_\_\_  
City \_\_\_\_\_ State \_\_\_\_\_ Zip \_\_\_\_\_

## EVERLITE® World's THRIFTIEST Light Plants

The Champion—1200 watts 115 volts AC for only \$149.50

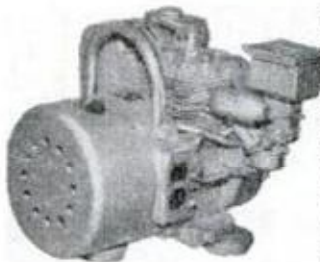

Unbelievable but true—Brand new production methods now make possible world's finest design in a service free alternator light plant at this unprecedented price. Plant puts out a steady 1200 watts of 115 volt AC power to run power tools, oil burners, pumps, TV, or anything that requires up to 1200 watts. Powered by a rugged 3 HP, 4 cycle, easy start gas engine with 1 year factory warranty. Complete with carry handle and shock mounts. Why fool with short life 2 cycle plants when you can buy this rugged top quality machine at our factory price.

THE CHAMPION \$149.50 Item # 1265 wt. 65 lbs. .... \$149.50

**MASTER MECHANIC MFG. CO., Dept. A-71, Burlington, Wis.**  
Southern Customers write Dept. A-71, Box 65, Sarasota, Florida



# Is Tarzan hanging around your attic?

If "Tarzan of the Apes," published in 1914, is there, you could be \$75 richer. But you wouldn't know this. Not unless you had a copy of the "Bookfinders' Value Guide," a brand-new listing of valuable books. Edited by Villanova Professor James Manning Bergquist, PhD., this illustrated book lists almost 1,500 books by 1,000 authors that can bring from \$25 to \$1,000 and more. It's the most complete, accurate book of its type.

"Rare books" are not rare at all. They're everywhere. Attics. Garages. Basements. Your living room. Some

books by Edgar Allan Poe or Mark Twain are worth thousands. But even books by John Steinbeck or Ernest Hemingway can bring from \$40 to \$500 from almost any book dealer. (And, if you just happen to find a signed original copy of James Joyce's "Ulysses," you can trade it for a dream vacation.)

The price of this priceless little volume is only \$3.75. One trip to the attic can repay you a hundred times.

Send check or money order today. Then start hunting for "Tarzan" and all those other not-so-rare books.

You could easily strike it rich.

## There's money in rare (and not-so-rare) books.

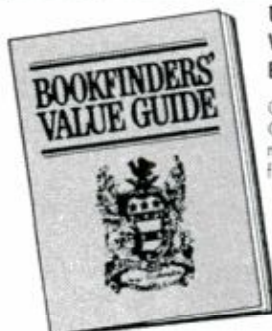

**UNIVERSAL BOOKS, Dept. PM**  
**Western Savings Bank Building,**  
**Broad and Chestnut Sts., Philadelphia, Pa. 19107**

Gentlemen: Please send me \_\_\_\_\_ copies of the "Bookfinders' Value Guide." One for \$3.75, two for \$7, six for \$18.90. I enclose my check or money order. (Makes an excellent gift for book-loving or money-loving friends.) Return the "Guide" for full refund within 10 days if not delighted.

Name \_\_\_\_\_

(please print plainly)

Address \_\_\_\_\_

City \_\_\_\_\_ State \_\_\_\_\_ Zip \_\_\_\_\_

Universal Books is a Division of PEPCO



# INVENTORS

INVENTIONS—NEW PRODUCTS—IDEAS  
DEVELOPED & PREPARED

For Commercial Appeal & Sales

DESIGN—MARKETING—PATENT RESEARCH—DRAWINGS  
DIRECTOR: United States Patent Office former Patent Examiner  
Member: United States Council Int'l Chamber Commerce  
Second Decade of Reliable Service to

INVENTORS—MANUFACTURERS—ATTORNEYS  
FREE CONSULTATION

**THE RAYMOND LEE ORGANIZATION**  
230-Z Park Ave., New York 10017 (212-MU 6-8500)

SEND FREE "INVENTION RECORD" Form &  
"PRODUCT MARKETING" BROCHURE

Name \_\_\_\_\_  
Address \_\_\_\_\_  
City \_\_\_\_\_ State \_\_\_\_\_ Zip \_\_\_\_\_

## CAMPER TRAILER KITS

- Pickup Campers 8', 8½', 10½'
- Travel Trailers 16', 19'
- Tent Trailers 4 Models
- Pickup Covers 24", 31", 36"



Save \$500 to \$2000; anyone can assemble. Use common household tools; everything furnished. Just put factory pre-assembled parts together. 12 models. Complete accessories.

10% DOWN, EASY TERMS, MONEY BACK GUARANTEE

28-PAGE  
COLOR  
CATALOG  
25¢

LUGER CAMPER & TRAILER KITS  
Dept. TA-71  
1300 E. Cliff Rd., Burnsville, Minn. 55378  
I enclose 25¢ Rush 28 pg. color catalog showing all models, accessories, camping information. Include factory discount prices.

NAME \_\_\_\_\_  
ADDRESS \_\_\_\_\_  
CITY \_\_\_\_\_ STATE \_\_\_\_\_ ZIP \_\_\_\_\_

### ROTARY FILES



U.S. Surplus High Speed Milling Files going fast. New, in G.I. Packs. Hardened steel, for filing, milling, routing, drilling—any work in light metal or wood. Use in ¼ in. drill, etc. Range in size from ¼ to 1 inch wide. Get these most useful tools now.

16 tool set—government cost \$109..... \$ 9.00 to you!  
36 tool set—government cost \$265..... \$15.00 to you!  
100% GUARANTEED. WE PAY POSTAGE. A LIFETIME BUY!!

**THE SURPLUS CENTER**  
LANCASTER, TEXAS 75146

## BASEMENT TOILET FLUSHES UP



TO OVERHEAD SEWER OR SEPTIC TANK. NO DIGGING UP FLOORS. INSTALLS EASY. Write McPHERSON, INC., BOX 15133, TAMPA, FLORIDA 33614

### NEW THERMO-TRAP®

Keeps the heat where you want it when you SOLDER, BRAZE OR WELD.



Unique heat-absorbing paste used by professionals. Slows heat transfer. Prevents damage to heat-sensitive items adjoining work surface. Just squeeze a collar of Thermo-Trap around metal surface between heat source and area to be protected. For work at home, on cars, in hobby. Anytime a heating tool is used. 10-oz. plastic squeeze tube. Just \$3.20 postpaid. Satisfaction guaranteed.

CALGON CORPORATION, Dept. T-T, Pittsburgh, Pa. 15230

## Save YOUR COPIES OF POPULAR MECHANICS

in this WALNUT WOODGRAIN  
MAGAZINE FILE!



Keeps up to 12 issues in fresh "mint" condition, ready for instant reference. Smart looking, but low-cost—crafted of durable heavy-test corrugated fiberboard, in distinctive wood-grain finish. In sizes to fit 7,000 other publications too! Any size \$2.95 ea. — 2 for \$5.50, 3 for \$7.50 postpaid.

MONEY BACK GUARANTEE!

*The Storage House* Only \$2.95 postpaid

SWING OPEN LID  
for dustproof storage

The Storage House, Dept. 802  
709 Pennsylvania Ave. S., Minneapolis, Minn. 55426

Please rush \_\_\_\_\_ files for titles listed below.

I have enclosed \$ \_\_\_\_\_ payment in full.

Titles (and how many each) \_\_\_\_\_

Print Name \_\_\_\_\_

Address \_\_\_\_\_

City \_\_\_\_\_ State \_\_\_\_\_ Zip \_\_\_\_\_

### FIND COINS-GOLD-RELIQS-TREASURE metal locators by JETCO!

- Lightweight
- Easy to Use
- Comes Complete
- Made in USA
- 5 yr. Guarantee
- Immediate Delivery!
- Write for FREE Catalog.

priced from

\$39.95



**JETCO** ELECTRONIC INDUSTRIES, INC.

P. O. BOX 132 HUNTSVILLE, TEXAS 77340  
PHONE ORDER TO: 713/295-5422

## EARN HIGH WAGES

as a HEAVY EQUIPMENT OPERATOR



Train your way to high pay in the booming construction industry! Learn the skills you need to qualify, by actual field training on machines like the ones used by the industry. Huge training grounds in North Carolina, a million dollars worth of school-owned diesel-engined machines, experienced instructors, full 220-hour and 440-hour courses. National, the original school of heavy equipment operation, is a recognized leader. Member American Road Builders Assn., Services and Supply Division. Associate Member A.G.C. Full-time Job Advisory and Counseling Director on staff. Accredited for VA benefits. For men ages 17 and up. Train Now-Pay Later plan . . . other payment plans also available. Write TODAY for FREE catalog and FREE copy of school newspaper reporting news of National School graduates. Accredited member National Association of Trade and Technical Schools.

NATIONAL SCHOOL Phone 704/392-1359  
OF HEAVY EQUIPMENT OPERATION, Dept. D-52

P. O. Box 8529, Moores Chapel Road, Charlotte, N. C. 28201

Please send me FREE illustrated school catalog and complete information. I understand there's no obligation.

Name \_\_\_\_\_ Age \_\_\_\_\_

Address \_\_\_\_\_ Phone \_\_\_\_\_

City \_\_\_\_\_ State \_\_\_\_\_ Zip Code \_\_\_\_\_



# The bargain hunter

## NEW MPG Meter



### Instant Accurate Performance Readout

Now available, an advanced precision instrument that accurately and instantly measures fuel flow and vehicle speed to give you miles-per-gallon within 2%! Unique Flow-meter installs easily in fuel line; gives visual check on fuel system. Sleek Low Profile dial instrument fits nearly anywhere, instantly indicates effect of slightest change in accelerator pressure, wind, load, tire pressure, engine tuning, putting you in complete command of your car or truck performance. Fully Guaranteed. Only \$39.95 ppd. Washington residents add 5%.

Order now giving vehicle make and model, or send for information.



**FloScan Instrument  
Company**

3016 N.E. Blakely St., Seattle, Wa. 98105

*Just off the Press!!*

### PRACTICAL GUIDE for the HERNIA PATIENT

Instructions and help for the hernia sufferer... an approach that spells hope for the ruptured, leading toward relief. Book written in simple understandable terms by a renowned M.D. Hernia Specialist.

Only \$3.00 postpaid. Send M.O., check.  
P.O. Box 1784, Guadalajara, Mexico

## "\$23,000 SERVICING RADIATORS"



... W. L. Boeing, Ferndale, Michigan. Start your own radiator repair shop. Make high profits. Factory training, promotion, guidance. Terms. Send ad with name, address, phone for complete story.

**INLAND MFG. CO. Dept. PM-7**  
1108 Jackson Street • Omaha, Nebr. 68102

## BUILD YOUR OWN CAMPER

• PLANS •  
PATTERNS • KITS  
Covers to Cabovers  
★ FREE CATALOG ★



**GLEN**

9152 Rosecrans,  
Dept. PG  
Bellflower, Ca. 90706

## \$30 to \$50 A DAY with TREYCO 6-in-1 Sharpener

**Sharpen**

HAND SAWS  
CIRCULAR SAWS  
CHAIN SAWS  
KNIVES  
PLANER BLADES  
PAPER CUTTERS  
SCISSORS  
PINKING SHEARS  
CLIPPER BLADES  
ROTARY MOWERS  
SKATES

Write for  
Factory-to-You Prices  
Money Back Guarantee



For  
3" to 48"  
circular  
saws

**TREYCO PRODUCTS, INC. Est. 1945**

332-A Niagara St.  
N. TONAWANDA, N. Y. 14120

## AUTO HOBBIES!



TWO CATALOGS—400  
Pages! Vol. 1 (Model  
cars, slot cars, tools and  
supplies) and Vol. 2  
(Sports car & racing  
equipment, hi-perform-  
ance & competition parts)  
Both Volumes \$1.00 PPD  
Money Back Guarantee

**AUTO WORLD • Dept. PM1033**  
701 N. Keyser, Scranton, Pa. 18508

## PORTABLE STEAM CLEANER

**STEAM IN 60 SECONDS**

Clean—Engines, large &  
small • Air Filters • Lawn  
Mowers • Trucks & Tractors  
• Garbage cans • Kennels



"Big enough to do the job  
small enough to get there"  
Freight collect—complete  
except for propane  
bottle

**\$198.00**

Auxiliary pump needed on  
water pressures below 60  
lbs. or on well systems—  
\$73.50 extra.

Self cleaning coils—uses liquid clean-  
ing compounds—soap by-pass for clear  
water rinsing—stainless steel firebox  
for long life—3 year guarantee on coils  
and firebox—propane fired—weighs  
only 120 lbs.

**WEDCO MANUFACTURING, INC.**

Dept. M-2, Box D,  
Jackson, Wyoming 83001

## CHINA DOLLAR only 10¢



Uncirculated nickel  
silver dollar minted  
in 1960 to Commemo-  
rate 50th anniversary of the Repub-  
lic of China (Formosa)... only one  
to a customer... a beautiful coin and  
ONLY 10¢. SUPPLY LIMITED! SEND  
TODAY. You will also receive the  
most wonderful catalog of coin offers  
in America. It lists hundreds of coins  
and collector's accessories to make  
your hobby more enjoyable. Send  
name, address & zip number and  
10¢ for your China Dollar to:  
**LITTLETON COIN CO.**  
Dept. C-9, Littleton, N. H. 03561.

## FREE Catalog 2000 Jokes & Novelties



World famous catalog of novel-  
ties, live animals, scientific  
supplies, hobbies, fun-  
makers, planes & boats,  
looms, magic tricks,  
joke articles, unusual seeds, gadget time-  
savers, cameras, optical goods, projectors,  
movies, lucky jewelry, religious novelties,  
disguises, musical instruments, stamps,  
coins, puzzles, fortune tellers, radios,  
auto & bike accessories, telescopes, mag-  
nifiers, compasses, banks, smokers' gad-  
gets, artists supplies, printing sets, en-  
gine, motors, shockers, knives, billfolds,  
books, games, etc. Send this ad with  
coin or stamp for postage. **NO LETTER  
NECESSARY!**

Yes—I want FREE Catalog. My Name  
& Address Attached or on Envelope

Johnson Smith Company  
16535 E. Warren Av., Dept. C-107  
Detroit, Mich. 48224

## GRANDFATHER CLOCKS

**SAVE 50%  
BUILD YOUR OWN  
GRANDFATHER AND  
GRANDMOTHER  
WEIGHT DRIVEN CLOCKS**

- Highest Quality Imported  
Movements from Germany
- Tubular or Rod Chimes
- Moving Moon Dials
- Pre-cut Semi-assembled  
Handcrafted Case Kits  
(No power tools required)
- Dials, Barometers,  
Hygrometers, Templates  
and Case Plans.

All movements and dials  
in stock.

Send 50¢ for complete  
catalog

**H. DeCOVNIK & SON,**  
P.O. Box 68, Dept. M71  
Alamo, Calif. 94507  
EST. 1947



Relic Collectors! Moments of the infam-  
ous 3rd Reich 7"x20" Wide. Rugged-  
cast-Solid-Aluminum NAZI eagle.  
\$10.00 Postpaid...



With our  
fully illustrated  
Catalog, Listing  
Hundreds of  
Hard-to-find Items.

Catalog  
Only \$1.00  
W.W.#2-M Ltd.  
Box 2063  
St. Louis, Mo. 63158



**FREE!!! POWERFUL MUSCLES FAST!**  
Fantastic New Discoveries in the science of  
bodybuilding. Now, in the privacy of your  
bedroom, our method will add inches of pow-  
erful muscles to arms, chest, shoulders &  
legs. Learn secrets on trimming the waist  
with ultra-modern methods—fast! Results  
Guaranteed! Send for free brochure, Universal  
Bodybuilding, Box 485-M1, Dearborn, Mich.  
48121.

POPULAR MECHANICS

Материал, защищенный авторским правом



Make Beautiful Designs With



**GENUINE  
DIAMOND  
STYLUS  
PENCIL**  
**\$4.95**  
ppd.

**NEW ART FORM**

Etch beautiful designs and scenes on glasses, glass vases, sheet glass. Trace any picture on sheet glass and frame for strikingly beautiful effect! Use as easily as a pencil.

**THE ROBERT-ALLAN CO.**  
17 Acorn Lane, Plainview, N.Y. 11803



**NEARSIGHTED? FARSIGHTED?**

No more glasses to wear! Latest discoveries! Eye training course will improve your vision. Are your eyes worth \$2.95? Mail cheque to:

**GROSSI, Box 1061-R, Postal Station "A"**  
Toronto 1, Ont., Canada

**GUARANTEE:** Results within ten days or your money back.



**MONEY BACK**

If not satisfied within 10 days Ferris Wheel for all ages. Easy to follow instructions no power needed to operate. All materials sold at most Hardware stores. Send \$2.75 to:

Ferris Wheel  
P.O. Box 575  
Folsom, California  
95630



Easy to Build **PLANS AND INSTRUCTIONS** for  
Go Kart ..... \$2.00  
Mini Bike ..... \$2.00  
Mini Car ..... \$3.00  
Pedal Boat ..... \$4.00  
Sail Boat ..... \$2.00

**MINI VEHICLES  
PLANS "DEPT. C"**  
P.O. Box 92  
Chazy, N.Y. 12921

**BLACKOUT PROTECTION - 120**

volt power for your camper. Turn your car, truck, bus or boat alternator or generator into a 3000 watt **POWERHOUSE** to run saws, drills, lights, T.V., pumps, also welds. Anyone can install in 5 minutes. Remit \$24.50 Postpaid:

**Haldo Products, Inc.**  
8646 Jennings Road, Eden, N.Y. 14057

**WINDWATCH™ ANEMOMETER - WIND VANE \$19.95**



Neon lights in indoor indicator show wind speed and direction. Decorative gold panel indicator comes factory wired and sealed in black finished wood frame. Designed for desk use or wall mount. Outdoor instruments of durable aluminum with electrical parts enclosed in rigid vinyl housings. Easy to assemble and install. Attach directly to roof or pole. Comes with wire and materials for installation up to 60 feet. Uses regular 120V AC. Unique low amp circuit assures absolute safety. A fascinating addition to any home. Five year guarantee. 15 day trial. Your satisfaction or money back. Only \$19.95 postpaid.

**WINDWATCH** Dept. F, 104 Heimann  
San Antonio, Texas 78205

JULY 1971



**BUILD YOUR OWN  
"SUPER-BUG" FOR \$98**

This is not a toy. The Super Bug is a performance ATV you can build in your own garage from our step-by-step plans for under \$100 including accessories!

**MANY PRACTICAL ACCESSORIES**

Plans include front ski for winter use and lawn mower attachment that mounts in 4 minutes. Pick-up back aids small tote jobs, too.

**OUT-PERFORMS FACTORY DESIGNS**

Using suggested engine, Super Bug will carry 1000 lbs. at 25mph, climb 60% grades. Good side-hill stability.

**COMPLETE PACKAGE:** Plans inc. drawings, assembly steps, parts list, construction hints. Satisfaction guaranteed.

Send  
**\$3.98**  
to

**PMI/SUPER-BUG**

806 So. 80th Ave.  
Yakima, Wash. 98902



Thousands of exciting tool values!

**SILVO (BRAND NAME) TOOL CATALOG**

Thousands of Exciting Tool Values! Stanley, Millers Falls, Skil, Thor, Wen, Disston, Wiss, Weisaw, Dremel, Speedy Sprayers, Plumb, Huot, Kennedy, Channellock, Porter-Cable, Rockwell, Helios, Wise-Grip, Crescent, Ridgid, Pony Clamps, Unimat, Foredom and many other Nationally Advertised brands of Tools & Supplies. We ship Coast to Coast at prices Hard to Beat. Send 50¢ for our big 146 page tool catalog today. Silvo Hardware Co., PM-7, 107 Walnut St., Philadelphia, Pa. 19106.

**SAVE  
GASOLINE**  
**\$3.00**  
P.Pd.

Installs in minutes. Will not affect engine performance! Fits any car or truck!

**GAS SAVER**  
Box 115  
Ontario, Ohio  
44682



**FREE MUSCLE COURSE!**  
Want a new Jet-Charged body? In 15 minutes I'll prove you can slap on 4" of muscles to your chest—3" to each arm—give you life-guard shoulders, trim your waist to athletic size—give you speedy athletic legs. I don't care if you're short or tall (skinny or fat) young or not so young, expect a muscle building miracle when you send for my free course. Send only 25¢ to cover postage and handling to Joe Weider, Dept.38-71-D-2.25 Maple St., Norwood, N.J. 07648

made in America by  
Americans

**TWISTY®  
KEY KEYSER**

More than just a key keeper... a beautiful jewel like accessory. Sparkling gold finished flexible cable ends broken key chains forever!!! The Trick of the Twisty, opens and closes with a simple twist, yet never lets you down by accidentally opening or breaking. **ONCE YOU OWN IT YOU'LL NEVER LET GO!!!** 2 for \$2, 6 for \$5, 13 for \$10. Includes beautiful individual gift boxes. Please add 25¢ for handling and 5% sales tax for California Residents.

**TWISTY, INC., P. O. Box 626 AI**  
Bonita, Calif. 92002



**WATER WATER WATER WATER WATER**  
**"HOW TO DRILL YOUR OWN WATER WELL"**  
**\$1.00**ppd  
SATISFACTION GUARANTEED  
**DEEPROCK CO.**  
OPELIKA, A.L.A. 36801

**lickITY SPLITTER**

**ENDS WOOD SPLITTING DRUDGERY**

New low cost **COMPACT MODEL**... for farmers, camps, cottagers. 10 ton ram, 2 cycles per min., splits logs 25" x 18". Carried in car trunk, placed upright or hung for storage. For details write:

295 lbs. with gas and oil  
**PIQUA ENGINEERING, INC., Dept. P, Box 605 Piqua, O. 45356**

**KLEEN-LINE BOTTLE CUTTER**

Make your own glasses. Sell for profit—Give as gifts. Cuts any round glass bottle in less than five minutes. Do your bit for ecology. \$10.50

**KLEEN-LINE CO., 2591 Girele Dr., Newport Beach, Calif. Dealer inquiries invited. PM-7**



**HoverPacer 2-seat ACV.** Build from simple Plans, Kit. Outstanding performance: 50 MPH water, 60 MPH land. Proven design. Available in open (Sport) or closed (All Weather) cockpit design. Send \$1 for photos, tech. specs, prices.

**KING TECHNOLOGY**

Box 231, Carmel, Indiana 46032

**DETROIT APPROVED—PICKUP TANKS**

Original equip. type poly. now avail. in aux. tanks for pickups. Increase gas capacity 40 gals. Easy 1 hour installation—completely hidden—no body work necessary. Let truck discounts pay for tanks.



**R.P.M. INC., Dept. PM-7**  
P.O. BOX 7936, Waco, Texas 76710



# Take this \$3.49 book FREE!

## Let these 257 experts show you how to attain the skills of a real pro!

You get this giant 8¼" x 11" illustrated volume of exciting "how-to" projects for your family, home, garden, car, boat, vacation—as an outright gift—nothing to buy. It is crammed with reliable shop-tested, do-it-yourself techniques and practical show-how pictures. Use these hundreds of do-it-yourself plans, projects, tips and hints to polish your own shopwork and hobby skills! Here is a brief glimpse of all your FREE Volume brings:



- Having car engine trouble? Fix 8 common problems quickly without having to pay a garage mechanic anything he chooses to charge you.

- Professional tips for expert sanding show how to bring out the best finish in woods and metals with power and hand tools.

- Complete plans help you build an inexpensive 3 x 4 foot plywood table to give any small band saw big-machine capacity and flexibility.

- Need extra space? Turn an unfinished attic or basement into handsome, usable areas with practical, money-saving plans.

- Save on band saw blade costs. Build brazing fixture to make your own blades.

- Do your own auto body repair expertly with simple tools and methods.

- Build a boat designed just for fun. Step-by-step plans and materials list included.

- Home too hot for comfort? Follow complete directions for air conditioning your home.



- Bothered by a wet basement? Cure it yourself and save \$200 to \$2,000 under what professionals charge.

- Need better burglar protection? Build effective power alarm for a safer home.

- Refinish furniture perfectly. Hands-at-work pictures show you how.

- You'll wonder how you ever got along without an air supply in your shop once you've built and used the "foot-bellows" system.

- Build a gas-fired barbecue for more back-yard fun.

- New soundproofing techniques enable you to relax in quiet.

- Anyone can hand-letter signs with the "Project-A-Plan" method.

- Special trouble-shooting chart pin points malfunctions in an auto electrical system so you can fix it quickly.

- Target practice in the living room? Believe it or not you can blast away indoors without harming anything.

- Build your children model planes that fly higher than any others.

- Special tricks-of-the-trade save you time and effort in handling power tools.

- Save hundreds of dollars on buying and servicing appliances.

Plus hundreds of other exciting plans and do-it-yourself ideas to save you big money and add thousands of hours of pleasure to your hobby, sport and vacation projects.

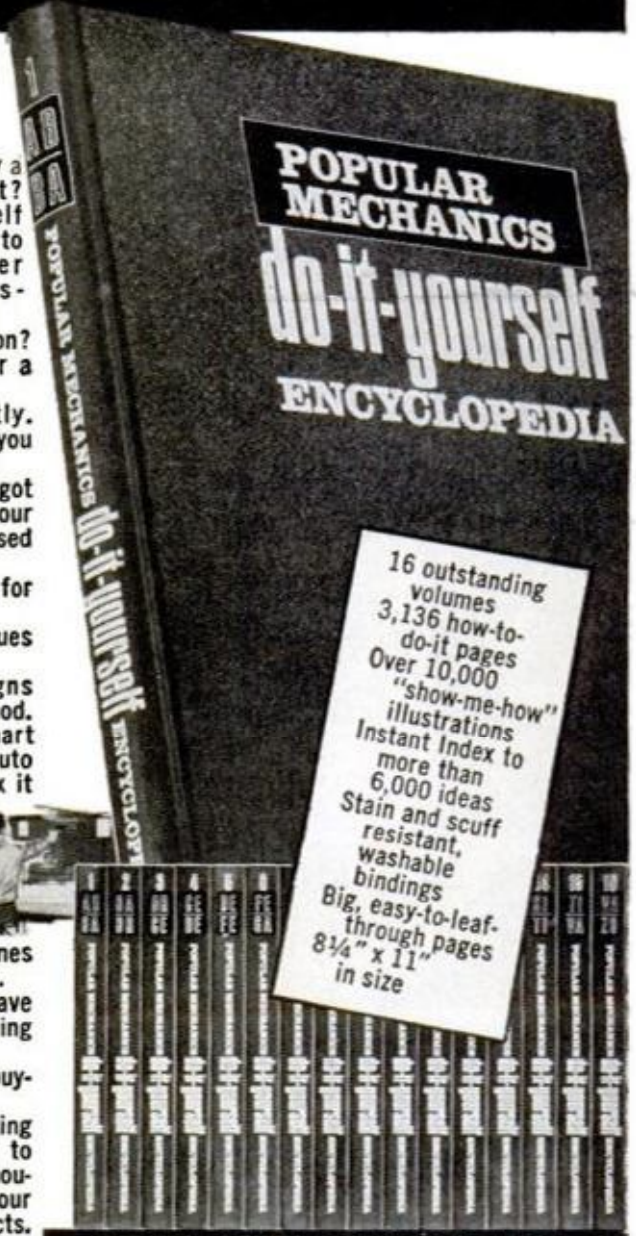

16 outstanding volumes  
3,136 how-to-do-it pages  
Over 10,000 "show-me-how" illustrations  
Instant Index to more than 6,000 ideas  
Stain and scuff resistant, washable bindings  
Big, easy-to-leaf-through pages  
8¼" x 11" in size

## Why you receive this practical do-it-yourself handbook ABSOLUTELY FREE!

The reason you get this brand-new \$3.49 book as an outright gift is simple. This gold mine of "how-to" projects and money-saving plans is the first volume in POPULAR MECHANICS DO-IT-YOURSELF ENCYCLOPEDIA—an amazingly useful guide created by the editors of *Popular Mechanics*—experts in do-it-yourself techniques for over 65 years. The Encyclopedia gives you over 6,000 projects, repairs and improvements you can do by yourself to save hundreds of dollars on labor and materials. 257 experts lead you through every step of every project you select. They give you thousands of practical pointers to sharpen your skills in carpentry, car repair, metalwork, plumbing, masonry, electrical work, electronics, hi-fi, stereo, painting and decorating.

We believe that if you browse through the first volume—select a plan or project—use it at your workbench—try some of the money-saving shortcuts, shop-tested methods—you will be anxious to receive the others. Therefore, you may enjoy future volumes as they are published for 14 days' FREE EXAMINATION. You may buy one, two, the whole set, or none at all. But the first volume is yours to keep without obligation, no matter what you decide. Mail coupon today, to be sure of getting your FREE Volume.

### FREE GIFT CERTIFICATE

Popular Mechanics Book Division, Dept. BO14  
250 West 55th St., New York, N.Y. 10019

Please send, entirely free, Volume 1 of the new, illustrated POPULAR MECHANICS DO-IT-YOURSELF ENCYCLOPEDIA. I'm not obliged to buy anything—now or later—but am entitled to receive additional volumes (including future Yearbooks), on approval as published each month. After examining each volume free for 14 days, I either return it and owe nothing—or keep it and remit low subscriber price of \$3.49 a volume, plus shipping. I reserve right to cancel any time—without obligation. Whatever I decide, Volume 1 is mine to keep free!

Name \_\_\_\_\_  
(Please Print)

Address \_\_\_\_\_

City \_\_\_\_\_

State \_\_\_\_\_ Zip \_\_\_\_\_

Signature \_\_\_\_\_

This offer available in Canada at a slightly higher price. Canadian residents mail coupon to New York address. Shipment of books and all services will be handled within Canada.



# CLASSIFIED ADVERTISEMENTS

Rate: \$2.00 per word payable in advance each insertion. Capitalized words—75¢ per word additional. Minimum insertion ten words. To be inserted under the proper classification, copy must be in our office by the 15th of the second month preceding date of issue. The next available issue to place an advertisement in America's No. 1 Classified Section is September. The closing date is July 15th. Send remittance and order to C. A. Martin, Popular Mechanics, 224 West 57th Street, New York, New York 10019. Please make remittance payable to Popular Mechanics.

POPULAR MECHANICS

WHEN ANSWERING ADVERTISEMENTS PLEASE USE THE ZIP CODE NUMBER

## AUTOMOBILES

1969-1970 CHEVROLETS, Fords, Dodges from \$699 to \$999. Free catalog. Pan Am, 31-DD Hanse Avenue, Freeport, New York 11520.

CAR Buyer's Red Book—Ex-car salesman reveals the facts. How to save \$200-\$500 on your next purchase.—A MUST! \$2.00 TEM, Box 3422, Hialeah, Fla. 33013.

## MIDGET CARS

ARE You filing your copies of PM? If you are, you'll want an inexpensive Annual Index, available in December, that will make your file copies much, much more useful. Refer to any article in seconds! And if you aren't filing your copies of PM—start now!

## AUTO SUPPLIES AND EQUIPMENT

HYDRAULIC Jack repair kits, parts and supplies. Catalog 50¢ (in coin). Hydraulic Jack Packing & Tool Co. Inc., General, P.O. Box 3, Staten Island, N.Y. 10314.

AUTO BODY REPAIR—TAPE METHOD. Repair Rust Holes and Unsightly Areas on Your Car in Minutes. The Easy Tape Method, Famous Race Car Promotor shows you how to Make Your Car Look like New. For Complete Instructions, Send \$1.00. A-K Products, 124 Howe, Barrington, Ill. 60010.

AUTO Parts for old and new Cars, All makes. Catalogue \$1.10. Antique Auto, Milwaukee, Wisconsin 53204.

PARTS: Army Jeep and truck parts. Spare Parts & Equipment Co., P.O. Box 751, Lexington, Kentucky 40502.

BURNING Oil?? . . . Smoking?? . . . Pep-less?? . . . Hard Starting?? . . . Save with Ring-Valve job while driving \$6.50. (Special: Two for \$12.00 postpaid.) Results guaranteed!! Motaloy, Grantham, Penna. 17027.

BE YOUR Own Ignition Expert With IGLIT. Q-Arc, Box 47876, Los Angeles, California 90047.

PROFESSIONAL SAFETY SIGN Use on cars, trucks, campers, boats, trailers, outdoors. Large Fluorescent letters HELP written on durable vinyl, signifies trouble. If it saves one life or one accident, it's well worth \$4.65. Fender Covers \$4.95. National Quality Products, Box 151, Provo, Utah 84601. Ten-day moneyback guarantee.

LOWEST WHOLESALE AUTO PARTS SOURCES: Seven sellable homemade automobile AID formulas. \$2.00. Wholesales, 46-P Lawrence, Farmingdale, New York 11735.

OUR FLASHLIGHTS RECHARGE Automatically in your vehicle. Easy installation. Guaranteed, reliable. TDR, 16 Maple Road, Chelmsford, Mass. 01824.

HEADLIGHT ESCORT Automatic Solid-state system operates headlights for 120 seconds after leaving car. \$6.95 Guaranteed. Box 2597, Des Moines, Iowa 50315.

AUTO BURGLAR ALARM Prevents theft of stereos, radios, hubcaps, tires, wheels, luggage. Easy installation. \$3.98. Guaranteed AUTO SPOTLIGHT: Plugs into cigarette lighter 3/4" diameter lens. 15 ft. cord. 12 volt bulb. Guaranteed. \$2.98. Triangle Specialties, Box 20588, Sacramento, California 95820.

FREE Anti-Tailgater to pickup owners. Stop rear-end collisions-back injuries. Send model pickup to Hewitt Wholesale, P.O. Drawer C, Hewitt, Texas 76643.

JEEP Owners—V8 conversions. Read Jeep Owners' ad, page 178.

## SNOWMOBILES

SNOWMOBILE Hop up accessory CATALOG. Speed and performance equipment—manifolds, exhaust systems. Send 25¢. G.E.M. PRODUCTS, Box 845, Carol Stream, Ill. 60187.

## AUTO TRAILERS

CAMPER Plans and full sized patterns. The most detailed available with written and pictorial instructions. Various models and accessory kits offered. Send for literature—Glen L. 9152—PMG—Rosecrans, Bellflower, California 90706.

BUILD Your Pickup Camper. Precut kits, blueprints and supplies. Literature 25¢. Comstock Camper and Trailer Supply, Dept. 664, Parsons, Kansas 67357.

HOW to Build Truck Campers, Trailers, Bus Conversions. Blueprints. Plans. Kamcraft, Box 1153, Milwaukee, Wisc. 53201.

## MOTORCYCLES, BICYCLES, MOTORSCOOTERS AND SUPPLIES

MINI-BIKES. Motorcycles. Go-Carts. Supplies. Discount Catalog 25¢. Loren Products, Danville, Illinois 61832.

BARGAIN PRICES. Every part. Kart or Mini-bike. Giant Fun Catalog \$1.00. New, "how to" plans \$1.00. Both, \$2.00. Brown's Motorsports, 19P Central St., Worcester, Mass. 01608.

ILLUSTRATED Catalog 25¢. Parts, Accessories. Custom Stock, most makes, models. Cycle Supply, Box 192M, Fairbury, Ill. 61739.

INDIAN PARTS. Rebuilding. Accessories. Indian Motorcycle Sales, Kansas City, Missouri 64127.

BUILD "Popular Mechanics" MINIBIKE featured June 1967 issue. Detail plans, photographs \$2.50 refundable. Kits, parts, engines: factory discount prices. Catalog 25¢. Gilliom Mfg.: PMC: St. Charles, Missouri 63301.

HONDA, \$25.00. Other bargains. Send 50¢. Motorscooter, P-443, Bend, Oregon 97701.

ELECTRIC Bicycle. Ride All Day For Nickel. Complete Plans \$3.00. Electro, Box 27203P, Indianapolis, Indiana 46227.

FABULOUS All electric mini-bike. Noiseless. No gas required. Operates for pennies a day. Easily built from complete construction plans and booklet. All parts available locally. Send \$4.95 postpaid. Lectra-Bike, P.O. Box 82 PM, Washington, New Jersey 07882.

MOTORCYCLE Turn Signals, Accessories Catalog 35¢. Houston PM Lockport, Illinois 60441.

MOTORIZED Your Bicycle with Lawn Mower Engine. No Welding. Easy Plans \$2.00. Motor's, Box 415, Baraboo, Wisconsin 53913.

BUILD 3-Wheeled ATV/Trail Bike. No welding necessary. Plans \$2.00. Plans for conversion to snowmobile \$1.00. Trail-Craft Industries, Box 250-DA, Center Harbor, New Hampshire 03226.

HONDA Factory parts. Price list—25¢. Box 15731, Charlotte, North Carolina 28210.

FREE METRIC Tool information write: MediaMetric, Box 461H, Media, Pennsylvania 19063.

BUILD Go-Kart; Motorized Bicycle; Snowmobile: Plans! \$1.00 each. Go-Bykco, Rothsay, Minn. 56579.

## SPACE, ROCKETS AND ASTRONAUTS

ROCKETS: Real flying models—flights up to 2500 ft. New illustrated catalog 25¢; Singles and multistage kit, cones, engines, launchers, trackers, rocket aerial cameras, technical information. Fast service. Estes Industries, Dept. 7-G, Penrose 7, Colorado 81240.

ROCKETS!! Real flying models—2500 feet altitude with powerful motors. Terrific Science Projects. Tubes—Cones—Parachutes—Launchers—Igniters. Gigantic catalog—rocket data—diagrams—25¢. Fast Delivery. Centuri Rockets, Box 1988, Phoenix, Arizona 85001.

MOON Landing Pictures, other historic space fantasies! Free Brochure! Box 234-PM, Merritt Island, Florida 32952.

ROCKET/PLANE—"BARON" Rocket blasts plane up hundreds of feet, plane glides free while rocket parachutes down. Precision metal engine, parts, launcher, flameless fuel for repeated flights. \$9.95 postpaid (Wash. res. add 5%), or send 25¢ for catalog (free with order). Vashon Industries, Dept. 121, Box 309, Vashon, Wash. 98070.

KIDS! Write Dear Uncle Russell; Why you like the Moon Flights. Receive free large color photos. Uncle Russell, Kennedy Space Center, P.O. Box 412, Merritt Island Florida 32952.

THE Controversial UFO Photographs obsolete? Free Details. Write: Kenneth Andrews, 3217 West Franklin Boulevard, Chicago, Illinois 60624.

(Continued on next page)





## AVIATION

BE A Government licensed aviation mechanic. Practical training. Free information. Aero Mechanics School. Municipal Airport, Kansas City, Missouri 64116.

BUILD—One-Man jet helicopter. Easy inexpensive. Detailed plans, drawings—\$5.00. Helicraft, Box 7153, Baltimore, Maryland 21218.

GLIDER 20' Wingspan, kit \$179. Assembles easily, photos and specs \$4.00. Glider, Box 1184, Topanga, California 90290.

AIRBOAT, Propellers, Plans, Kits, supplies. 90 to 220 H.P. engines. Corvair, V-W conversions. Propellers, hubs, mounts for snowmobile engines. Catalog \$1.00. Banks-Maxwell, Box 3301E, Ft. Worth, Texas 76105.

HELICOPTER, One-man, Portable, Bubble canopy, Kits, Plans, Information 10¢. Photos and three-view drawings \$1.00. COMPACOP, I.C., Box 1267, Redwood City, California 94064.

BUBBLE CANOPIES—Several sizes. Lowest prices. Send S/SA envelope. Bouwens Aerospace, Thwing Road, LeRoy, New York 14482.

## HOVERCRAFT

AERO-CAR, Amazing Hovercraft built easily with ordinary tools. Lawnmower engine power. Carries one man plus. Hovers, flies forward, backward, Sideways over land/snow/water. Complete construction plans and brochure. \$5.95. Aero-Projects, Box 5118PM, Clinton, New Jersey 08809.



## BOATS AND TRAILERS

BOAT KITS, Hull Kits, Frames, Plans And Patterns. World's largest catalog. Over 200 top designs for the amateur builder. Sailboats 7' to 45'. Windmill, Snipe, El Toro, etc. Motor Sailors to 30'. Trimarans, Catamarans to 37'. Power—Cruisers to 40'. Deep V's. Fishing Boats, Runabouts, House Boats, Hydroplanes, in-board and outboard, all classes. Ferro Cement 33' to 45', sail and power. Send \$1.00 for new Plan Kit Catalog or \$2.00 for catalog plus Boatbuilder's Guide to Clark Craft, 16-P Aqua Lane, Tonawanda, N.Y. 14150.

FREE Catalog! Camping, Boating, Sailing Supplies; Gadgets. Hardware and Gifts, Laacke and Joys, 1439 N. Water St., Milwaukee, Wisconsin 53202.

SEE The 1000 ISLANDS Dressed on their Autumn best. Spectacular Fall cruising can be yours on a rental Houseboat from Van's Motor Marine, Alexandria Bay, New York 13607. Phone-315-482-2271. Free brochures. Also inquire about our lease-back purchase plan.

NEW Outboards 1970 McCulloch and others. 4 HP . . . \$120. 9 Electric \$308 . . . 18 \$378. 60 Electric \$878. All Sizes. Literature 50¢. Electra Marine, 1427 Broadway, Brooklyn, N.Y. 11221.

FIBERGLASS Canoes, Kayaks, and Duckboats. Many exciting models. Easily assembled kits. \$39.95 up. Free Literature. Riverside Canoes, Box 5595P, Riverside, Calif. 92507.

PLANS. FULL-SIZE PATTERNS. FRAME KITS With step-by-step instructions specially for amateurs. Send \$1.00 for new catalog just off press—nearly 100 pages, over 80 designs 8' to 36': Sail, Jets, Inboards, Outboards, Cruisers, Houseboats, Hot Boats, Catamarans, Hydros. Glen Designs, 9152 Rosecrans, Bellflower, Calif. 90706.

BUILD Your own boat from our large-scale blueprints. Books of plans give how-to-build help. Hundreds of professional designs—motor, sail or auxiliary—for amateur builders. Free catalog. MoToR Boating, 959 Eighth Ave., Dept. PM-RS, New York, N.Y. 10019.

FIBERGLASS Cloth and resin. World's finest cloth and non-run resin, at direct mill prices Flotation foam. Complete line of plastics, silicon bronze and brass screws, save 60%. No sales tax. Boat Plans. Catalog 25¢. Freight prepaid. Stiles Boat Supply, Box 11P, Linden Ave., Mantua Hts., N.J. 08051.

BOAT KITS—Assemble yourself from factory molded fiberglass sections, save 1/2 over factory built. Satisfaction guaranteed. Send \$1.00 for beautiful 80-page, fact-filled color catalog showing 20 models—14' to 32'—Cruisers, Runabouts, Houseboats, Sailboats, complete Accessories, Motors, Trailers, discount prices. Luger, Dept. BC-71, 1300 East Cliff Road, Burnsville, Minnesota 55378.

FIBERGLASS Cloth, matt, polyester and epoxy resins. Wholesale catalog 25¢. Boat Molding book 30¢. Seifert's, Box 1206-M, Green Bay, Wis. 54305.

SHIP Model Kit 8 Foot 2 Inch Danish Royal Yacht "Dannebrog" Fiberglass Hull, Oak Deck Bass Cabins Designed For R.C. Detail Model write: Jylland, 4157 N. Clarendon Ave., #206 Chicago, Illinois 60613.

## CAMPERS AND TRAILERS —KITS—PLANS—

PLANS—Pickup Campers \$4.95; Pickup Covers \$3.95; Vanette conversions \$3.95; Bus conversions \$3.95. Huge 166 page Supplies, Parts, Equipment Catalog with discount prices \$1.00 (refundable). Literature for Camper, Cover KITS 25¢. Order PLANS, 166 page Catalog, KITS, literature from this advertisement. Savage, Box 377 C, Savage, Minnesota 55378.

CAMPER, Trailer, Cover Kits—assemble yourself, save 1/2 over factory built. Satisfaction guaranteed. Send 25¢ for beautiful 28-page fact-filled color catalog showing 12 models—pickup campers—covers; travel-tent trailers, discount prices. Luger, Dept. TW-71, 1300 East Cliff Road, Burnsville, Minnesota 55378.

## MARINE EQUIPMENT AND SERVICES

MARINE Engines, conversions, parts, equipment. Catalog Free! Stokes Marine Industries, Coldwater, Michigan 49036.

FREE Brochure—Engines, Gears, 1/0's, Conversion Kits—Gas—Diesel. StarMarine, 1931 Embarcadero, Oakland, Calif. 94606.

CONVERT Auto engines to marine. 68 Page Catalog. 50¢. Lehman Manufacturing Company, 800 Elizabeth Avenue, Linden 4, New Jersey 07036.

MARINE Supplies, Ignition Parts. Free literature. Michael's, 991 Broadway, Bayonne, New Jersey 07002.

## ATHLETIC AND BODY BUILDING COURSES

POWERFUL Muscles fast! Free brochure! Universal Bodybuilding. Box 4327-C, Dearborn, Michigan 48126.

"GIANT Arms." Dr. Young's, D.C. revolutionary discovery. \$2. Satisfaction or refund. Gaucho, 1769-S7, Chicago 60690.

WEIGHT Exercising Equipment. Free Literature. Jubinville, Box 662, Holyoke, Mass. 01040.

FANTASTIC HALF-PRICE SALE On famous bodybuilding course. Build herculean physique, great strength in record time. Results guaranteed! Send only \$5.00 to: Physical Culture Sales Company, P.O. Box 20010, Dept. PM, Cleveland, Ohio 44120.

ZAKAL, Russian Toughening system. \$2.00. Eastview Book Service, Box 7053, Ottawa, Canada.

## SPORTING GOODS AND EQUIPMENT

CROSSBOWS Powerful Accurate. Catalog 25¢. Crossbowman, Box 723PM6, Manteca, California 95336.

FREE Catalog low direct factory prices, fishing, Hunting, Archery, reloading Camping supplies. Send today. Helters Inc., Dept. CPM, Waseca, Minn. 56093.

FREE . . . Wholesale Catalog. Arrow Shafts, Broadheads, Fletchings Fisharrow Parts, Tools, Bows, Finnyports. (22G), Toledo, Ohio 43614.

ARCHERY Lowest Discount Prices. All top brands. Orders shipped same day received. Money-back guarantee. World's Largest Supplier. Free catalog. Anderson Archery Corporation, Grand Ledge, Michigan 48837.

FREE 1971 Catalog! Guaranteed lowest prices! Rods, Reels, Lures, Accessories—Thousands of items. Cabela's, Inc., Dept. S7, Sidney, Nebraska 69162.

KNIVES: Bargains for Hunter, Fisherman, and Outdoorsman. Modern Sportsman Company, Box 11545-B, Salt Lake City, Utah 84111.

NEW, Aqmoshu, patented. Walk on Water. Detailed information \$1.00. Mitch's Marina, Belchertown, Massachusetts 01007.

NEW, Super-Thrilling Tarsan Bars \$5.95 ppd. Free Brochure. Dorr Enterprises, 411 Moore, Zanesville, Ohio 43701.

SWISS Army Knife, Has "12" amazing tools! Now only \$3.98, Send to: Springfield Mailorder Company, 1311-A, East Edwards, Springfield, Illinois 62703.

SCUBA Dive—Complete Instructor Approved Textbook—FREE Catalog—Only \$2.98 postpaid. Skin Diving School, Box 3491, Ventura, California 93003.



## FISHING, TACKLE, LURES

MOLDS For fisherman's sinkers, jigs, squids, casting and spinning lures. Free catalog. Sweet Molds, Tonawanda 1, New York 14150.

SEND For FREE Wholesale Catalog. The most complete and fully illustrated catalog of reels, rods, beads, spinners, jigs, bodies and parts, sinker molds, feathers, tools, hooks, rod blanks, rod parts, swivels, wire, etc. FINNYSPTS, ME Sports Bldg., Toledo, Ohio 43614.

MOLDS—For casting your own fishing sinkers. Free illustrated booklet. Reading Instrument Co., Box P78, Reading, Pa. 19603.

FISHERMAN'S DREAM BOOK—FREE. 170 Pages, pocket size and loaded with Hard To Find Fishing Specialties and Do-It-Yourself Goodies. Our 27th year. NETCRAFT, Inc., Box 5510, Toledo, Ohio 43613.

BEAUTIFUL Flies, seven \$1.00, fifteen different \$2.00. Fly Offer, Box 4398, St. Louis, Missouri 63123.

## EARTHWORMS, LIVE BAIT

EARN Money raising fishworms for us! Exciting details free! Oakhaven—56, Cedar Hill, Texas 75104.

UNLIMITED Potential Profits Raising Our Better-Bred Redworms—Soilless—No-grain Method. Lee's, Box 326M—Queen City, Texas 75572.

## FROGS, FISH, REPTILES

PROFITS FROM CLASSIFIED ADVERTISING! Booklet shows you how to start your own business with Classified Advertising. Only \$1.00 (Refundable with first order.) C. A. Martin, Popular Mechanics, Dept. PM, 224 West 57 Street, New York, N.Y. 10019.



## HUNTING, GUNS, DECOYS

CARBINE, M-1. New accessories, custom stocks, combos to 60 rds. Scope mounts. New 30 rd. mags., \$2.99 ppd. Flash hider, \$6.99 ppd. Full list, 10¢. Fed-Ord, Box 36032-BW, Los Angeles, Calif. 90036.



## POULTRY & GAME BIRDS

QUAILS. Incubators, cages, supplies catalog. Marsh, 14216 Brookhurst, Garden Grove, Calif. 92643.

(Continued on next page)



## RABBITS—FUR BEARING ANIMALS

\$500 MORE Monthly. Raise Rabbits, Chinchilla, other small Animals for us. Equipment, Breeders, Instructions Supplied. Fox River Valley Research Farms, Dept. PMR-071, McHenry, Illinois 60050.

RAISE Rabbits successfully by knowing facts. 48 page illustrated book describing 25 breeds. Housing, breeding, feeding, markets, marketing etc. 25 cents. American Rabbit Association, 36 Arba Building, Pittsburgh, Penn. 15217.

INFORMATION 25¢/Raise for Staloch's Rabbitry, Box 6302, Rochester, Minn. 55901.

AMAZING PROFITS! \$10,000 Yearly Raising Rabbits for Wool and Breeding. Details 25¢ coin. American Angora, Malta 12, Montana 59538.

RAISE Rabbits for us on \$500 month plans. Free details. White's Rabbitry, Mt. Vernon, Ohio 43050.

MAKE Big Money raising chinchillas, rabbits, guinea pigs for us. Catalog 25¢. Keeney Brothers Farms, Inc., New Freedom, Pa. 17349.

\$600-UP Monthly. People needed to raise laboratory animals for us. Huge market. We supply equipment, breeders and instructions. Details 25¢. National Research Farms, PNMA-7, Box 309, Milwaukee, Wisc. 53201.

FACTS About small animal breeding. Write—Madeline, P.O. Box 1637, Brooklyn, New York 11202.

## PETS—BIRDS, CATS, HAMSTERS, ETC.

HAWKS, Reptiles, raccoons, skunks, squirrels. Catalogue 25¢. Trails End Zoo, St. Stephens, S.C. 29479.

INTERNATIONAL Champion Guppies, Bettas, Supplies. Send 25¢ for catalog. Fish Market, Ortonville, Michigan 48462.

AQUARIUMS—Build Your Own Plans \$2.00, Aquariums, Box 12564, Lake Park, Florida 33403.

## HORSES, LIVESTOCK

"HOW TO TRAIN HORSES"—Everyone who likes horses or ponies should have this book; FREE. Write Beery School, 1107, Pleasant Hill, Ohio 45359.

## CAMPING

PROFITS FROM CLASSIFIED ADVERTISING! Booklet shows you how to start your own business with Classified Advertising. Only \$1.00 (Refundable with first order.) C. A. Martin, Popular Mechanics, Dept. PM, 224 West 57 Street, New York, N.Y. 10019.

## TRAVEL AND RESORTS

PROFITS FROM CLASSIFIED ADVERTISING! Booklet shows you how to start your own business with Classified Advertising. Only \$1.00 (Refundable with first order.) C. A. Martin, Popular Mechanics, Dept. PM, 224 West 57 Street, New York, N.Y. 10019.

## ELECTRICAL SUPPLIES

LAMP Parts. Catalog, prices, wiring instructions. 50¢. Refunded first order. Gyro, 5218P N.W. 35 Ave., Miami 42, Florida 33142.

METERS—Surplus, new, used, panel and portable. Send for list. Hanchett, Box 5577, Riverside, Calif. 92507.

APPLIANCE Servicing Equipment Catalog. Free. Jacknan, (B7), Hattertown, Newtown, Connecticut 06470.

## BATTERIES, GENERATORS

BATTERY Reconditioning Kit, includes molds, material, instructions. Battery Shop, Route 1-188D, Blythe, Calif. 92225.

## ENGINES, MOTORS, MAGNETS

WINDING Data, 275 motors. \$1.20. Data Company, 512 Kensington, Kansas City, Mo. 64124.

## MACHINERY, TOOLS AND SUPPLIES

WINCHES And HOISTS. Choice of 12 volt or 110. Reversible, compact, fast. ¼ ton to 1 ton capacity, from \$49.95. 25¢ brings 16 page full color catalog. Refundable. Superwinch, Inc., Pomfret, Connecticut 06258.

ROUTER Bits. ¼" shank, high speed, used; excellent condition. \$2.50 dozen postpaid. Lillian's, Box 17165, Chicago, Illinois 60617.

LATHE Milling attachments. Blueprints too! Write. Potter, Box 73, Cedar Rapids, Iowa 52406.

MICROMETERS—Indicators. Steel—Aluminum—Brass. Maximat, Unimat Lathes. Complete mailing—50¢. Campbell, 1424 Barclay, Springfield, Ohio 45505.

STAINLESS, Brass, Steel, Nuts, Bolts, Screws, Washers, What Do You Need? Nutty Company, Box 1576 S.M.S. Fairfield, Conn. 06430.

## WELDING, SOLDERING, PLATING

MORRIS Welders—110/220—\$53.50—1070 Inner, Schenectady, New York 12303. Stamp Appreciated.

PLATING Equipment, Portable Platers, Supplies, and "Know-How". Build your own tanks for nickel, chrome, etc. Easy-to-install PVC liners. Rectifier components—all sizes. Schematics, parts lists, formulas, operating instructions for all plating. \$10.00 post-paid. Guaranteed to save you 25%-75% or immediate refund. Some good used units for sale. Platers Service Company, 1511-A, Esperanza, Los Angeles, California 90023.

CONVERT To Heliarc, Plans \$4.00. Convert AC Welder To DC \$3.00. Information Supplies Company, Box 166, College Park, Maryland 20740.

## GOVERNMENT SURPLUS

1971 SURPLUS Army, Navy store illustrated catalog. Send 50¢ (refundable with first \$5.00 order). Ruvel, 3037 North Clark, Dept. 7-J, Chicago, Illinois 60614.

JEEPS Typically From \$53.90 . . . Trucks From \$78.40 . . . Airplanes, Typewriters, Boats, Clothing, Camping, Sporting, Photographic, Electronics Equipment, Wide Variety, Condition. 100,000 Bid Bargains Direct From Government Nationwide. Complete Sales Directory and Surplus Categories Catalog \$1.00 (Deductible First \$10.00 Order From Our Separate Included Catalog). Surplus Service, Box 820-A, Holland, Michigan 49423.

NO CATCHES. Buy any surplus direct from U.S. gov't. All information \$2.00. Bridgworth, P.O. Box 2292-C, Vancouver, Washington 98661.

GOVERNMENT Surplus. Complete Sales Directory and Buying Guide \$1.00. Surplus Publications, Box 26062-M, Los Angeles, Calif. 90026.

GOVERNMENT Lands. . . . Low as \$3.50 acre! Millions Acres throughout U.S. . . . Canada. Free Details! Land Digest, Box 11071-P, Indianapolis, Ind. 46201.

GOVERNMENT SURPLUS How and Where to buy in Your Area. Send \$1.00. Surplus Information Headquarters, Box 30177-PM, Washington, D.C. 20014.

MAKE MONEY With Government Surplus. Copyrighted Report reveals secrets, lists sources. Send \$1.00. Potter's, 106 Bellevue, Newport, Rhode Island 02840.

AMAZING Bargains. Surplus Material direct from Government. We tell you how, where, your area. Satisfaction guaranteed. Send \$1.00; Dependable, Dept. 101, Box 113, Vista, Calif. 92083.

JEEPS From—\$52.50; Typewriters from—\$4.15; Cars from—\$31.50. Walkie-talkies, motorcycles, airplanes, boats, Typical "As Is" bid bargains from Uncle Sam. Tremendous variety. Exciting free list. Write: Enterprises, Box 402/70, Jamaica, New York 11430.

## HOBBIES AND COLLECTIONS

SHOULDER PATCHES—Collectors Items. Official Apollo patches three dollars each Postpaid. U. S. Army and Air Corps patches. Special patches made to order. 10 assorted patches, price list and catalog \$3.50. Catalog only 50¢. Springer's, Box 577-PM, El Paso, Texas 79944.

COLLECT Military Medals. List 25¢. Vernon, Box 387PM, Baldwin, N.Y. 11510.

ECONOMICAL Bench Mill, Plans \$2.50. Microm, Box 2313-A, Santa Ana, California 92707.

USS JOHN F. KENNEDY—Aircraft Carrier 8X10 Photo. Send \$2.50 to: RH, 11 Ruth Street, Salem, New Hampshire 03079.

EXPAND YOUR HORIZONS! Stop denying yourself while others find adventure sailing, painting, skiing, collecting antiques, etc. Join the LIVING! FREE Popular Hobbies Booklet. Write: Innovation House, Box 12146, San Francisco, California, 94112. Write Today! Enrich, expand tomorrow.



## STAMP COLLECTING

RARE Stamp Free! Also new packet Aden to Urundi, with Kennedy, Triangles, Space, Sports, Ships, Dogs, Cats, Reptiles Plus Others. All Free. Send 10¢ for mailing. Empire Stamp Co., Dept. 1, Toronto, Canada.

FREE—Mint British Colonials from Sabah, Seychelles, Tristan Cunha, Sarawak, Negri Sembilan, Caymans, South Georgia. Free with approvals. Viking, Great Neck, N.Y.

SEND Only 10¢ for the most wonderful catalog of stamp offers in America. You will also receive a special bonus collection of over 150 different stamps from Congo, Nigeria, Mauritius, etc. Littleton Stamp, Dept. MN-1, Littleton, N.H. 03561.

WHY Pay More? Write for 2¢ approvals today. CSC, Box 9384, No. Hollywood, California 91609.

SEND Full book trading stamps or 400 cigarette coupons. Receive \$20.00 catalog foreign. Nothing under 10¢. Kendall, 297 W. Utica, Buffalo, New York 14222.

FREE! Nice worldwide collection. Discount Approvals, 447P, Chico, Texas 76030.

ANTIQUE PISTOLS 10¢ with approvals. Lawrence, Box 7511, Baltimore, Maryland 21207.

FAMOUS Painting collection 15 different—depicts work of art found in museums of the world—10¢ with worldwide approvals. Modern Stamps, Dept. 57H, Ferrysburg, Michigan 49409.

5000 USA, contains airs, dues, presidentials, revenues, 19th Century, high values, etc. \$3.00. 1500 foreign \$1.00; 5000 \$3.00; 9000 \$5.00. No approvals. Meyers, 5321 Fleming, Richmond, California.

BEAUTIFUL TOPICAL COLLECTION—Includes Olympic sport stamps, wild animals, bicolor triangles, colorful birds, outer space stamps, Poland kitten stamp and others. 10¢ with approvals. Sunny Stamps, Dept. 57A, Fruitport, Mich. 49415.

225 STAMPS For only 10¢! Airmails. Pictorials: stamps from strange countries cataloging up to 25¢ each! Plus unusual stamps to examine. Buy any or none return balance, cancel service anytime. Mystic Stamp Co., Camden 80, New York 13316.

PAINTINGS On Stamps—25 different 25¢; approvals accompany. Northern Stamps, Box 565, Hull, Quebec, Canada.

FREE! Includes—Space Kennedys—Flowers—Birds—Animals—Sports—Triangles. Approvals Included. Send 10¢ For Mailing. Stamp-A-Nanza, 1904 Broad, Schenectady, New York 12306.

(Continued on next page)



## STAMP COLLECTING

(Continued from preceding page)

**SENSATIONAL Clearance.** Forty different packets \$1.00. No approvals. Norge, Wyckoff, New Jersey 07481.

**200 BEAUTIFUL BRITISH, ASIAN And WORLD** issues sent with approvals for only 20¢. Trans-Global Stamp Co., Dept. 25, P.O. Box B, Baltimore, Maryland 21228.

**FREE \$120 Zeppelin World Stamps.** Details 10¢. Farmers Stamp Market, Waterville, Iowa 52170.

**FREE! BIG Bargain Catalog—New Edition** listing thousands of bargains including U.S. & B.N.A. stamps, packets, albums, accessories and supplies. Also, fine stamps from our approval service which you may return without purchases and cancel service at any time. Jamestown Stamp, Dept. E71PM, Jamestown, New York 14701.

**U.S. MINT Specials!** Flag set, complete \$1.00. 1¢, 2¢, 3¢ famous Americans (21 different) \$1.00. Free list. Brooks, 2601 Avenue "U," Brooklyn, N.Y. 11229.

**"AFRICA," 25 Beauties, 10¢.** Approvals. Gorliz, Box 1915PM, Naples, Florida 33940.

**PENNY! Approvals!** Regardless catalogue! Kloster, 4164 52nd St., San Diego 5, Calif. 92105.

**50 YEARS Old, fifteen different United States, over fifty years old—10¢** with approvals. Jaxon, Box 145-P, Brooklyn, New York 11230.

**UNITED STATES Commemorative collection** containing 33 different—10¢. Approvals. White, 516-A Avenue L, Brooklyn 30, New York.

**U.S. BARGAIN, 50 Different 10¢,** with beautiful worldwide, approvals. Stamp Center, Kennebunk, Maine 04043.

**50 DIFFERENT Old U.S. Revenue Stamps** 50¢. Winchester Stamps, Box 1592, Mansfield, Ohio 44907.

**FREE Surprise collection** sent with approvals. Gould, 1784 Union, San Francisco 94123.

**PENNY Stamps! 1000 Mounted in book** at 1¢ each! Trust Stamp Company, P.O. Box 100-P, Jamaica, New York 11435.

**ABSOLUTELY Free United States Mint Souvenir Sheet** When Requesting United States Approvals. K&B, Box 70, Brooklyn, N.Y. 11223.

**100 DIFFERENT United States, only 25¢** with approvals. Shelron, Box 547C, North Miami, Florida 33161.

**100 OLD United States between 1861 and 1935, \$1.00.** Roush Stamps, 423 Shepard, Mansfield, Ohio 44907.

**50 DIFFERENT Stamps, \$1.00.** Smith, 508-A Brooks, College Station, Texas 77840.

**QUALITY AND LOW PRICE. EXCELLENT** For advanced or beginner. Mounted approvals 2¢ up, all countries in Scott's Order. Preview Stamps, P.O. Box 9809M, San Diego, California 92109.

**210 DIFFERENT U.S. Commemoratives** \$1.00. Stamps, 7607 Larchview, Dallas, Texas 75240.

**RUSSIAN Space collection 25¢.** Russian Approvals. Snedco, Box 68-P, Waldwick, N.J. 07463.

**14,000 DIFFERENT! AMAZING New plan** builds your collection systematically, country by country. Only 50¢ weekly. Ware, Monroe, Conn. 06468.

**TEN Different Nudes: 20¢.** Approvals. Stamp Farm, 2M32, Oxford, Wis. 53952.

**MILLIONS Foreign Stamps! 2¢ each!** Send for gigantic approvals! ABC, Box 6000-MB, San Francisco, California 94101.

**AMERICANS On foreign stamps, Presidents, Kennedy, Roosevelt, Lincoln, U.S. Spacemen, Princess Grace and others. 10¢** with approvals. Roseland Stamps, Dept. 57, Spring Lake, Michigan 49456.

**500 STAMPS 25¢.** Approvals. Eric's, Box 1444, Kitchener, Ont., Canada.

**NOW Rockets, Paintings, Giant beauties,** others. 10¢. Approvals. Tiquet, Box 1496 Denver, Colorado 80201.

**FAR EAST ASSORTMENT—VIET NAM, JAPAN, KOREA, Formosa and others only 10¢** with world wide approvals. Clark Stamps, Dept. 57V, Muskegon, Michigan 49444.

**255 DIFFERENT Worldwide: 15¢.** Approvals. Tibbets, 8675 Meadow, Downey, Calif. 90242.

**25 U.S. FREE With Approvals.** Collier, Box 755, Folkston, Georgia 31537.

**SENSATIONAL Free Offer. 20 Outer Space Stamps.** Selected Approvals. Louis Morrison, 1027 Maryland, Cape May, New Jersey 08204.

**100 CANADA 25¢.** Excellent value. Approvals. Continental, Limehouse, Ontario, Canada.

**80 DIFFERENT U.S. stamps.** Includes 1943 flag stamp of occupied nations. Only 25¢. Approvals included. Willett Co., Box 338-M, Yorktown Heights, N.Y. 10598.

**FREE Duplicate Exchange—2¢** Approvals. Belden, Box 4175B, Dearborn, Michigan 48126.

**REQUEST FREE \$1.00 CREDIT** Towards extraordinary approval selection! Scarce, worldwide, commemorative, collections—Switzerland—Afghanistan—Liechtenstein—Australia—Nicaragua—Czechoslovakia—Netherlands—Paraguay—Philippines—Jugoslavia—Luxembourg—Guatemala—Madagascar—Portugal... none higher than 3¢ each! STAMPS, Box 202, Conshohocken, Pennsylvania 19428.

**MINT Sheets Foreign Stamps.** Amazing low prices. Free list. Stamps, Box 27, Fremont, Michigan 49412.

**500 WORLDWIDE \$1.00!** F. Ross, 320 Rockland Road, Wayne, Penna. 19087.

**FREE Stamp Wallet** with approvals. Wide choice collections by countries. Clark, Box 38, Wilmette, Illinois 60091.

**"WHOLESALE" U.S.—Foreign Pricelist** and catalog Free! Everything Guaranteed. Schneider, Box 1240, Grand Rapids, Michigan 49501.

**500 DIFFERENT World, \$1.00.** 1000 different \$2.50. 1500 different, \$4.50. Free price lists, U.S. and Foreign. Faville, Box 4164, Madison, Wis. 53711.

**HORSES On Stamps. 10¢.** Approvals. Finke, Box 2834, Agana, Guam 96910.

**15 LARGE Ireland Commemoratives 25¢.** Penniston, Box 5502, Arlington, Virginia 22205.

**WOW! 110 ALL DIFFERENT GERMANY 10¢.** Commemoratives, Airmails, High Values, Big catalog, bargain lists. Also, fine stamps from our approval service, which you may return without purchases and cancel service at any time. Jamestown Stamp, Dept. A71PM, Jamestown, N.Y. 14701.

**POLAND—50 Different post-war Pictorials,** including complete sets, only 10¢. Approval Applicants, Kayco, P. O. Box 437 (Dept. M) Flushing, New York 11367.

**50 DIFFERENT U. S. Commemoratives.** 15¢. Approvals. Cambridge, Box 2311, Heath, Ohio 43055.

**102 DIFFERENT Germany 10¢.** Free Apollo 11 Set. Approvals. Stamps, Box 11765, Phoenix, Arizona 85017.

**FREE 300 Genuine postage stamps!** Worth \$10.00 at catalogue prices. Africa, Europe, Asia, British Emp.—a fascinating valuable mixture from foreign convents—banks—etc. Who knows what you will find. Also free valuable booklet. "Get-acquainted" offer to Adults only. Approvals enclosed. Frasek Co., Inc., PM7, White Plains, New York 10601.

**1000 DIFFERENT Stamps \$1.75, 2000—\$3.65.** Bargain lists—Free. Drozd, Box 3925 (PM), Bryan, Texas 77801.

**100 DIFFERENT British Empire 10¢.** Approvals. Gibson, Box 34, Lansdowne, Pa. 19050.

**400 FINE Mixed U.S. 20¢.** Wright, Box 753-M, Hagerstown, Maryland 21740.

**FREE 50 Worldwide, Approvals.** University Stamps, P.O. Box 1471, Lake Worth, Florida 33460.

**RUBBER Stamps, reading: "STAMPS FOR COLLECTOR—PLEASE CANCEL LIGHTLY".** \$1.50. Free Catalog. Jackson's, Box 443M, Franklin Park, Illinois 60131.

**160 ASIAN, African stamps 25¢.** Valerie, 122 S. Main, Pocatello, Idaho 83201.

**FREE—Colonial collection!** Request bargain approvals. Gains, Box 788, Mattoon, Illinois 61938.

**"INVERTED Error" Dag Hammarskjold,** 10¢ with approvals. Belmont Stamps, Washington, D. C. 20015.

**WORLD'S LARGEST STAMP 4-3/4"x3-1/4"—** Unusual Sanda Island Painting Plus Artistic Stamp Collection—30 Museum Masterpieces. Introductory Special. Discount Approvals 35¢. Richley, Box 444-S, Dunellen, New Jersey 08812.

**100 DIFFERENT Italy—15¢.** Approvals. Gobestamps, Box 402, Biddeford, Maine 04005.

**ADVANCED COLLECTORS!!! Quality U.S.** and foreign stamps on approval. Please state your interests. References are essential. Edward Roth, Dept. #4, Walker, W. Va. 26180.

**FINE Worldwide used Quality mounted** approvals. Reasonably priced at 2¢ up. Free gift with initial selection. Franklin, Box 467A, Jamaica, New York 11434.

**15 COMPLETE Foreign Sets 25¢.** Thimot, Box 176, Somerville, Massachusetts 02144.

**"GIGANTIC Bicolored Dogs;"** Romania's latest 1971 Commemoratives—10¢. Approvals plus 101 Bonus Sets. William Deems, 226 Race, Ravenswood, West Virginia 26164.

**100 WORLD 15¢** With budget approvals, Jana, Box 2127, Hagerstown, Maryland 21740.

**TONGA'S Exotic Banana shaped stamp,** Round Sierra Leone, Expo 70, Bhutan Steel Foil, Gambia Sports, President Kennedy, Astronaut John Glenn, Arabian Horse, Painting plus 100 different others all only 10¢ when requesting approvals. Select those you like, return rest. Cancel service any time. DOUGLAS COOK, Dept. P, Las Vegas, Nevada 89112.

**FREE Gift Set. Approvals.** Chapman Stamps, 61 Division, Galesburg, Mich. 49053.

**INCREDABLE Collection, 99 Different—** 10¢; Commemoratives, Topicals, High Values. Approvals Accompany. Ohlson, B103, Fairfield, Illinois 62837.

## COINS, TOKENS, CURRENCY

**SEND Only \$1.00 for Coin Collecting** Outfit. Contains 25 new coins from 25 countries, Plus magnifier, wooden nickel. "How To Collect Coins" booklet, special coin envelopes, foreign banknote And big catalog of coins, paper money, collectors supplies. Littleton Coins, Dept. GH-1, Littleton, New Hampshire 03561.

**FREE \$3.50 Value Collection!** Official guidebook, price lists, specials. Send 50¢ pp. Numiss, B2, 4115-29th Street, LIC, New York 11101.

**BARGAINS 1931-S Cent VF \$18.89; Uncirculated \$33.89, 1950-D Nickel Unc. \$8.89 1971-S Proof Set \$10.89.** Bargain Lists 15¢. Bebee's Incorp., Omaha, Nebraska 68111.

**LINCOLN'S: 10 Different Before 1940,** 25¢. Stevens, Box 546-F, North Miami, Florida 33161.

**COMPLETE U.S. List: Cents to Silver** Dollars + Supply List + \$1000.00 banknote 25¢. Schulteis, Box 151-M, New Hyde Park, New York 11040.

**SILVER DOLLARS Uncirculated, 1880-81—1883-84-85 \$5.00 Ea.** Catalogue 50¢, Shultz, Salt Lake City, Utah 84110.

(Continued on next page)



## COINS, TOKENS, CURRENCY

(Continued from preceding page)

**ROOSEVELT Dime Specials.** All Very Good Or Better. 1949S—80¢. 1955—\$1.50. 1955D—65¢. 1955—40¢. All Other Dates Are 25¢ Each. Complete Set Of 55 Different With Album For \$14.50. Satisfaction Guaranteed. Bryson Inc., 612A White, Toledo, Ohio 43605.

100 INDIAN And Lincoln Cents, 1920's and older \$5.00. 40 Mixed Buffalo Nickels \$5.00. 100—1943 Steel Cents \$5.00. Wes Rood, West Union, Iowa 52175.

1949-S LINCOLN 10¢. FREE Bargain List. Ron Farley, Metamora, Ill. 61548.

I PAY \$250 each for 1924 1¢ green Franklin stamps, rotary perforated eleven (\$2,500 unused). Send 25¢ for illustrated folders showing amazing prices paid for old stamps, coins collections. Vincent, 85PM, Bronx, N.Y. 10485.

1909-VDB LINCOLN, Fine, \$1.25. Catalog 25¢. Village Coin Shop, Dept. P. Plaistow, NH 03865.

TEN Indianheads \$3.25; Ten V-Nickels \$2.95; Ten Buffaloes \$2.10; Silver Dollar \$2.95; Silver Certificate \$1.85; Fairway, 121-K Rye, New York 10580.

22 "S" Lincolns, including 1955S, \$1.75. 26 1909-1939, \$1.75. 10 "S" Jeffersons, \$1.75. All Different. All three \$5.00. HARRIS, Box 2037P, Santa Cruz, California 95060.

CALIFORNIA Gold Tokens Dated 1852-1858 50¢ each. Seven diff. \$2.95. Satisfaction guaranteed. Gene Christian, 19150 Albion, Detroit, Mich. 48234.

1971S CENT, Wooden nickel, huge coin magazine, .10¢. Lawrence, Anamosa, Iowa 52205.

EISENHOWER Dollars. Order Now. Pay Later. Free Details and Bargain List. Gilbert Coins, Box 45014, Chicago, Illinois 60645.

GOLD COINS Of The World. Beautiful. Low prices. Plus thousands of United States Coins. Free price list. Please send long, airmail envelope. Self-addressed, stamped. Silver Center, Box 22171-M, San Francisco, California 94122.

1955-S LINCOLN And 18 Different "S" Pennies—\$1.00. Edmund Molzan, Box 275, Alameda California 94501.

## ANTIQUES, RELICS, INDIAN GOODS & CURIOS

FOR Sale. Original 1903 desk Telephones. (Elliot Ness Candlestick type) \$23.00. With rare brass receivers \$28.00. Postage \$1.00. Telephone Company, Turtle Lake, Wisconsin 54889.

10 BEAUTIFUL Arrowheads \$2.00. Guajardo's, 8713 Shaver, El Paso, Texas 79925.

LIST Indian relics. 10 Arrowheads \$3.00. Hyde's, Box 2304, Santa Fe, New Mexico 87501.

TONS Of antique gun parts and supplies. All reproduction muzzle loading guns. Send \$2.00 for enlarged illustrated catalog No. 120. Dixie Gun Works, Union City 12, Tennessee.

### EVERYBODY LIKES DIXIE GUN WORKS.

10 PERFECT Arrowheads \$4.00. Smith, 9825 Conway Drive, Indianapolis, Indiana 46236.

INDIAN Relic list. Arrowheads \$4.00 doz. Folsom, \$5.00 each. C. Secrist, Muscatine, Iowa 52761.

APACHE Arrowheads perfect 4-\$1.00 25-\$5.00 Epanco, PSD1239, Apache Junction, Arizona 85220.

RAILROAD Spikes 100 years old, \$2.00. Antiques, Box 669, Bremerton, Wash. 98310.

## MODELS—CARS, SHIPS, TRAINS, PLANES ETC.

SHIP Models Kits, fittings, plans, books, tools, engines, motors. Big illustrated catalog 50¢. Mass. residents add 3% tax. James Bliss & Co., Dept. SM, Route 128, Dedham, Mass. 02026.

**ROCKETS:** Real flying models—flights up to 2500 ft. New illustrated catalog 25¢. Single and multistage kits, cones, engines, launchers, trackers, rocket aerial cameras, technical information. Fast service. Estes Industries, Dept. 2-G, Penrose, Colorado 81240.

SHIP And yacht model fittings: Pine construction hull kits; blueprints. Send 50¢ for illustrated catalog. A. J. Fisher, Inc., 1002 Etowah Avenue, Royal Oak, Michigan 48067.

SHIP Models catalog 25¢. Scientific, Inc., 100 Monroe, Newark, N.J. 07105.

MODEL Airplanes—Big 220 Page Catalog 50¢. Sig Company, Montezuma, Iowa 50171.

LIVE Steam powered backyard railroads! All sizes. Complete "bolt-together kits," and rough castings. Excellent drawings. 100 page catalog \$1.00. Little Engines, Lomita, California 90717.

STUART Steam engines, castings, catalog 75¢. Carolus Models, 1131 Wilson Ave., Salt Lake City, Utah 84105.

## GAMES, TOYS, PUZZLES, NOVELTIES

SNEEKER, It's Versatile, be life of party. Even Rotten. \$1.00. Box 2026, No. St. Paul, Minn. 55109.

## MAGIC TRICKS, JOKES, VENTRILOQUISM

HOUDINI'S Greatest Magic!! You can now do them!! Giant Illustrated Catalog 25¢ with Free trick. Vick Lawston, Box 2026-P, Pompano Beach, Florida 33061.

COMPLETELY Illustrated catalog. 84 pages. 25¢. Manhattan Magic, Box 334-M, N.Y.C. 10011.

BE A Magician! Two booklets explaining sixty-eight tricks plus large professional catalog. \$1.00. Magic Inc., 5082 Lincoln, Chicago, Illinois 60625.

HOUDINI'S Original Magic Shop. Established 1856. Send 25 cents for illustrated Catalog containing 5000 Tricks, Mindreading, Puzzles, Hypnotism and Jokes. Flossie-Hornmann, 304 West 34th St., New York 10001.

WORLD'S Finest professional magic tricks. Joker's Novelties. Giant illustrated catalog 10¢. Top Hat, Evanston, Illinois.

FREE! World's Leading Catalog 2000 Novelties, Jokes, Tricks. Scientific Gadgets, Hobbies. Johnson-Smith, C-10, Detroit, Michigan 48224.

500 TRICKS, Douglas famous Magic Catalog, only 25¢. Better Magic for pocket, club, stage. Fastest mail service. Douglas Magician, Dept. 11, Dallas, Texas 75221.

MAGIC Catalog. World's finest 3000 tricks. (340) pages \$2.50. Beginners, amateurs, professionals. Kanter's, A-200 South 13th St., Philadelphia, Pa. 19107.

VENTRILOQUISM! Information free! Dummy catalog 25¢. State age. Maher, Studio G, Box 9037, Denver, Colorado 80209.

MAGIC MAGAZINE—Monthly since 1936. 44 pages. All phases. 3 month trial \$1.00. Genii, P.O. Box 36068, Los Angeles, Calif. 90036.

LEARN VENTRILOQUISM! Home Study Course includes, dummy or puppet. Information FREE. Izzy Rizzy's School of Ventriloquism 3746 W. 63rd St. Chicago, Ill. 60629.

FABULOUS MAGICS New 1971 catalogue 25¢. Our specialty orders shipped same day no substitutes. Fabulous Magic, 3319 East Charleston, Las Vegas, Nevada 89104.

## BOOKS, CATALOGS, NEWSPAPERS

KNOW YOUR BEER. Facts, Fable, Folklore... in Falstaff's Complete Beer Book. Superbly illustrated (colored stein photos). Answers all your questions about beer. Send \$1.00 plus 25¢ handling (Sorry, no COD's) to BEER BOOK, P.O. Box 23007, Dept. (R), St. Louis, Missouri 63156.

FREE BOOK. Prophet Elijah Coming Before Christ. Megiddo Mission, Dept. 63, 481 Thurston Road, Rochester, N. Y. 14619.

NATIONAL Geographic Magazines, 1888-1967, any issue. Buxbaum, Box 465-PM, Wilmington, Delaware 19899.

BOOKS—All subjects—moneymaking opportunities—free circulars—Simon, Box 627-B, Sanibel Island, Florida 33957.

FREE List! 73 low cost self improvement books. Exciting, Unique Unusual. Summit Sales, 15 Summit Avenue, Haledon, New Jersey 07508 Dept. 717A.

FREE! Hundreds of Books, Magazines, Booklets, Manuals, Plans—yours for the asking! Complete Directory, \$1.00. Jude Publications, P.O. Box 486-PM, Vancouver, Washington 98660.

FREE LIST! Low cost books. J. B. Floyd, R1-PM, Silverstreet, South Carolina 29145.

FREE Brochure—Self Improvement Books. ABC Sales, Box 2683-P, Columbus, Georgia 31902.

FREE! Booklist. Science, Hobbies, Sports, Military, Education, many more. Hofmann's B., 910 East Old Willow Road, Wheeling, Ill. 60090.

## PLAYS, SONGS, MANUSCRIPTS

SONGS, SONGPOEMS Wanted for Radio Show. Hollywood Music Productions, 6425-PM Hollywood Boulevard, Hollywood, California 90028.

SONGWRITER! Poets! Spiritual and religious poems, songs wanted for recording by Chapel Symphony Orchestra and Choir. We pay all recording costs! Dept. PM, Chapel Recording, P.O. Box 162, Wollaston, Mass. 02170.

## BUSINESS OPPORTUNITIES

I MADE \$2,000.00 Monthly by mailorder—evenings only. You can too! Free proof! Kingman, Box 7227D, Erie, Pa. 16510.

BIG Profits in becoming a supplier to major industry through electroplating small parts and metalizing non-metals. Write for free particulars: Mason, Room MC-2-AK, 1512 Jarvis, Chicago, Ill. 60626.

INSTALL Burglar Alarm Systems. Big profit home business. Beginners start spare time, without mechanical experience or costly equipment. Free starter plan. Nasco, Dept. E2707, 11071 Massachusetts, Los Angeles 90025.

MAKE \$10.00 Hourly demonstrating portable sandblaster. Inkasan, Box 66573-A, Houston, Texas 77006.

PREPARE Tax Returns—Housewife Jo Ann Netzley made \$5,500 last season. Train at home. VA Approved. National Tax School, Monsey, 2KC, New York 10952.

AGES 17-60. Learn profitable WATCH REPAIRING at home. Free sample lesson. Sweazey, YTA, Fox River Grove, Illinois 60021.

IMPORT-Export opportunity. profitable world-wide, mail order business from home, without capital; or travel abroad. We ship proven plan for no risk examination. Experience unnecessary. Free details. Mellinger, Dept. E2707, Los Angeles 90025.

FREE Book "999 Successful, Odd Unusual Businesses". Work home! Small Business Index. Dept. 7, Kerrville, Texas 78028.

MAKE Gorgeous original candles for all holidays and special occasions. Learn expert Candle decorating, candlemaking, use of professional molds. Free details on home instruction method. Candle Institute, Dept. B-63, 1600 Cabrillo, Torrance, Calif. 90501.

SECRETS! Mail Order Success. Internationally famous expert reveals how to make home business fortunes. Beginners: Get free copy "Make Money By Mail." Discloses free advertising, profitable products. Maico, 1554 Sepulveda, Dept. E2707, Los Angeles 90025.

(Continued on next page)



## BUSINESS OPPORTUNITIES

(Continued from preceding page)

**HOW To Finance Your Own Business.** Get \$500 to \$2 million. Free offer. Capital-17. Kerrville, Texas 78028.

**GROUND Floor opportunity** in an Engraving business of your own—spare time or full time. One piece of raw material costing \$4.50 will produce products worth \$180.00! Free particulars! Write: Warner, Room EC-2-AK 1512 Jarvis, Chicago, Ill. 60626.

**SENSATIONAL Car Thief Signal.** Lightening seller. Samples for trial. Northwest Electric, Ave. 742, Mitchell, S.Dak. 57301.

**RETIRE Before Fifty!** Haikey did with seven "on-location", urgently needed services. Nationally advertised. Successful worldwide. Serve homes, shops, motels, offices, institutions. No shop, no experience needed. We train . . . help finance . . . guide . . . back you. Gross \$15,000—\$30,000 yearly with First serviceman. We furnish servicemen's machines. Large profit Each serviceman. (Starting spare time, business profits increase job salary.) Little over \$1000 establishes your growing, lifetime business. Interesting, exciting, prestige career. Inquire Today while territory open. We'll mail information. Duraclean, C1-167, Deerfield, Illinois.

**BIG PROFITS!!** Get Your Share! Mail Your Own Imprinted Baby Catalogs to New Mothers, Grandparents. Full particulars, 25¢. Garcia, 509PM Cagua Southeast, Albuquerque, New Mexico 87108.

**SERVICE-Needed, Your Area,** competition rare. Send \$3.00 TS, Box 564, Buena Park, Calif. 90620.

**\$600—\$2000 MONTHLY** Raising Rabbits For BREEDING STOCK. 10 Million Sold For Meat Yearly. Small Animals For Laboratories. Send \$4.00 "For Roseda'e Rabbitry" Guide Book. Frank Leidig, Box 925, Galion, Ohio 44833.

**PRODUCT Distributors Needed** No Investment No Direct Selling Full or Spare Time Immediate Profits. Write! DJH, 7118 Don Jay, San Gabriel, Calif. 91775.

**MONEY MAKING OPPORTUNITIES—**Free listing of books on how to start and operate many profitable businesses. Informative Publications, Box P-187, Painted Post, New York 14870.

**TYPEWRITERS:** How to buy, fix, sell. New book. \$3.00. Typewriters, 12429 Southeast Stephens, Portland, Oregon 97233.

**FURNITURE Salvage.** Receive Furniture Free, Sell at Maximum Profits. Works Anywhere. Guaranteed \$2.00. Western Salvage, Box 6053 F Vancouver, Canada.

**MAILORDER** Moneymaking Kit. Start home. Capital unnecessary. Free Details. Pictures. Prudential, Box 327-PM5, Boston 02199.

**SELL Books By Mail.** Complete dealer set-up. 20¢. Midwest Mail Sales, Box 44R2-PM, Shawano, Wisconsin 54166.

**HOMEWORKERS** Wanted to stuff envelopes. Send self-addressed stamped envelope. Tayco, Box 8010-IMP, Stockton, California 95204.

**MAILORDER Dealers** Wanted. Earn outstanding profits using tested promotions! Executive type business. Details 25¢. RUTWARD, Box 735-PJ, Norwalk, Conn. 06852.

**HOMEWORKERS-Mailers** wanted. Free information. Allen-A, 2418 Lori, Santa Ana, California 92706.

**EXCEPTIONAL Mailorder Goldmine!!** Surer—Quicker—Easier Dropship Profits. Write: Camar, 40PM2 Driftway, Danbury, Connecticut 06810.

**\$6000. REBUILDING** Kirby Carpet Sweepers. Free Details. Dolken, Box 912M, Conway, Ark. 72032.

**BARGAINS Galore!** Buy Below Wholesale. Closeouts . . . Liquidations . . . Imports. Free Details. Newtron, 510B Arthur, Middleville, Mich. 49333.

**\$500 MORE Monthly.** Raise Rabbits, Chinchilla, Other small animals for us. Equipment, Breeders, Instructions Supplied. Fox River Valley Research Farms, Dept. PMO-071, McHenry, Illinois 60050.

**MAILORDER—New Concept!** Amazing re-copy, resell information service!! Write: J&D, 1442PM Berkshire, Grosse Pointe, Michigan 48230.

**EARN \$60.00 Daily** manufacturing Concrete Fence Posts. Practically no investment. Send stamped-addressed envelope. American, Excelsior Springs, Mo. 64024.

**\$25.00 HOUR** Repairing Vacuum cleaners! Baron, Box 863, Portales, New Mexico 88130.

**FREE 1971 Full-Color Catalog** waiting to bring you spare-time cash. Sell Advertising Book Matches. Every business a prospect . . . no investment. Complete selling instructions furnished to beginning sales people. Build steady, repeat business. Big cash commission. Dept. MX-771, Superior Match Company, 7530 South Greenwood, Chicago, Illinois 60619.

**MAKE A Years Income** in 8 weeks Camping. No selling, Capital or Land necessary. Write Edru's, Route 5, Box 5733, Gig Harbor, Washington 98335.

**MAILORDER!** How to prepare your own catalog for pennies! Free Catalog! Obie-MKZ, Brooklyn, New York 11219.

**MAILORDER—Profitable products,** drop-shipped. No merchandise investment. Everything supplied—catalogs, ads, mailing lists. Gif-Guide, 1137½ Crenshaw, Dept. 283, Los Angeles 90019.

**I BEAT The Horseraces!** Guaranteed you can! Strauss-CZ, Brooklyn, New York 11219.

**MAKE Up To 900% Profit** with your own Magnetic Sign Shop! Rapidly growing demand for 3-Dimensional Magnetic Signs on cars and trucks! Start in garage, workshop, or kitchen. Full or spare time. Write today for free details. Nationwide Plastics, Dept. 81, 4200 Panamint, Los Angeles, Calif. 90065.

**CLIP Newspaper items,** \$1.00-\$5.00 each. Details free. Walter, Box 1360-PA, Erie, Pa. 16512.

**PIANO Tuning Learned Quickly At Home!** Tremendous field! Musical knowledge unnecessary. GI approved. Information free. Empire School, Box 327, Miami, Florida 33145.

**\$400.00 MONTHLY** Raising giant fishworms. Soilless method. Charlie Morgan, Bushnell, Florida 33513.

**EARN Money** raising fishworms for us! Write: Oakhaven-38, Cedar Hill, Texas 75104.

**400,000 BARGAINS** Below wholesale! Many free. Liquidations . . . closeouts . . . job lots . . . single samples. Free details. Bargainhunters Opportunities, Box 730A, Holland, Michigan 49423.

**ADVERTISING BUSINESS—YOU Own it.** \$350 First Week or Money Back. Electric Neon Action ad Clock, 229 W. Illinois, Chicago 60610.

**SELL Lifetime, Metal, Social Security Plates.** Big Profits! Sample and Sales Kit Free. Russell, Box 286-PM, Pulaski, Tennessee 38478.

**COPUBLISH "Mail Sale Advertiser,"** leading mailorder paper. Copy and details 25¢. U.S.A. only. Vanroy Shirck, Lebanon, Pa. 17042.

**\$200.00 DAILY** In your mailbox! Your opportunity to do what mailorder experts do. Free details. Associates, Box 136-A, Holland, Michigan 49423.

**DRAFTSMEN!** Operate own DRAFTING SERVICE! Full, Part Time; Experience unnecessary; Details: Roberts Drafting, 1741 Circle Road, Baltimore, Maryland 21204.

**RAISE Rabbits** for us on \$500 month plan. Free details. White's Rabbitry, Mt. Vernon, Ohio 43050.

**MAIL ORDER** Sell books. Fascinating, profitable, details. Jobre, Box 27, Great Neck, N.Y. 11023.

**WORLD'S Largest supply.** Merchandise 25% to 40% under wholesale. Bankrupts. Closeouts 10¢ on dollar. Imports. Hong-kong clothes. Automobile discounts. Free details. International Buyers, Box 16386 MM, Portland, Oregon 97233.

**HOLLYWOOD CEMENTCRAFT:** Offers Highly Profitable Home Business. Experience Unnecessary. Unlimited Unique Pottery Designs Easily Made Without Moulds. Bird-baths, Fountains, Wishing-Wells, Waterfalls, etc. Chemical Coloring Formulas. Marble-glazing. FREE Illustrated Brochure. CONCRETE FACTS, 602 Athens Street, Altadena, California 91001.

**SELL Books** by mail. 400% profit. Royal, Box 450-X, Cleveland, Ohio 44127.

**FREE Catalogs.** Repair air conditioning refrigeration. Tools, supplies, full instructions. Doolin, 2016 Canton, Dallas, Texas 75201.

**ADDRESSERS** And mailers needed. Send stamp for information. Lindbloom, 3636 West Peterson, Chicago 60645.

**SELL Beautifully colored Social Security Plates.** Big Profits! Free Sample. Paul Wright, 1075 Ringwood Avenue, Pompton Lakes, N.J. 07442.

**BUILD Custom Cases** at home for profit. Get orders by mail. We supply materials, instruction—everything. Free home business details. Custom Case Supply Co., 6961 CPG Hayvenhurst Avenue, Van Nuys, California 91406.

**TAKE Catalog orders.** We drop-ship 1001 best selling specialty products. Guaranteed lowest below wholesale prices. Fantastic spare-full time home business. Free book shows you how. SMC, 6963 SPG, Hayvenhurst Avenue, Van Nuys, California 91406.

**VENDING Machine** big catalog. Rake, 523 A Spring Garden, Philadelphia, Pa. 19123.

**I MADE \$40,000.00 Year** by Mailorder! Helped others make money! Start with \$10.00—Free Proof. Torrey, Box 318-Y, Ypsilanti, Michigan 48197.

**MAIL Baby Catalogs** Imprinted with your address to New Mothers for Big Profits! Details 25¢. Volz PM, Ypsilanti, Michigan 48197.

**MAIL Order Collection Agency** can make you \$1000.00 monthly. Free Details. Continental, Box 2023-A, Des Moines, Iowa 50310.

**MAKE Money** from old tires. Operators clearing \$800, weekly. Equipment costs \$1500. Get facts. S & S Patents, Inc., 3752 N. Damen, Chicago 60618.

**MAKE \$46** From square foot plywood: jigsaw or bandsaw necessary. Free details. Woodar, Bridgewater, Mass. 02324.

**BOOKKEEPERS** Earn \$500.00 week. Operate Bookkeeping Tax Service. Details free. Universal, Box 664-M, Springfield, Missouri 65801.

**CALIFORNIA MANUFACTURER NEEDS** Man to assemble our product and be local agent, experience unnecessary. May start while presently employed. Five-figure income for responsible applicant. S.K.R.M. Manufacturers, 2347 West 238 Street, Torrance, California 90501.

**1000% PROFIT** Bronzing Shoes. Free Literature—N.B.C., Box 11069-PM, Kansas City 64119.

**MAILORDER Book Publisher** Wants Dealers. Jan Enterprises, 76P, Wild Rose, Wisconsin 54984.

**SUPERIOR Auction School.** Nation's top Auctioneers own and instruct. Box 1281, Decatur, Ill. 62525.

**\$200.00 SPARE Time** earnings with your Tablesaw. Write: Workshop Five, 3800 Harney, Vancouver, Washington 98660.

**VACUUM Plastic Molding & Liquid Plastic Casting—At Home!** Make Hundreds of full 3-D plastic products. Big profit in spare time. Facts. Nationwide Plastics, Dept. HE, 4140 Eagle Rock Blvd., L.A., California 90065.

(Continued on next page)



## BUSINESS OPPORTUNITIES

(Continued from preceding page)

**\$25.00 HUNDRED** Addressing. Possible Year 'round. Complete instructions 25¢ for registration, postage. Cove, Box 1348-B, Clearwater, Florida 33517.

**MAILORDER** Records help get increased business! Complete 32 Page Record Book shows your inquiries, orders, advertising, expense, etc. Only \$1.00. C. A. Martin, Popular Mechanics, Dept. PMR, 224 West 57 Street, New York, New York 10019.

**\$600.00 PROFIT!** Mailing 100 Catalogs. Sample, complete instructions, only \$1.00. Digest, Box 839-PM, Long Beach, New York 11561.

**MAKE** Magnetic Signs, Big Profits. Details, Universal, Lenora, Kansas 67645.

**FREE REPORT!!** 609 Unusually successful businesses, indoor-outdoor, evenings!! Write: Associated, Box 238-B71, Lafayette, California 94549.

**\$1,000.00 PROFIT** From 1,000 Mailings! George, Box 2188-PM, Cypress, California 90630.

**MAKE** Magnetic car signs. Write Route 1, Box PM-49A, Bardstown, Ky. 40004.

**\$1000 WEEKLY** in YOUR Mailbox!! Do What Mailorder Experts Do. Amazing Trade Secrets. Free Details. International, Box 418-PM, Riverdale, New York 10471.

**\$70 to \$200 WEEKLY**—Home, Spare Time Simplified Mail Bookkeeping. Immediate Income. Easy. Auditax, Box 34741A, Los Angeles, Calif. 90034.

**\$600.00 WEEKLY** Mailing illustrated letters featuring real merchandise. Everything furnished, write: Sichern, Box 44, Miami, Fla. 33161.

**\$600—UP** Monthly. People needed to raise laboratory animals for us. Huge market. We supply equipment, breeders and instructions. Details 25¢. National Research Farms, PNM-7, Box 309, Milwaukee, Wisc. 53201.

**\$48,000.00 YEARLY** No Investment. Free Proof & Details. Idrach, Box 10067-D, San Antonio, Texas 78210.

**VENDING** Machines. No selling. Routes earn amazing profits. Big catalogue Free. Parkway Corporation, 715PBM Ensor Street, Baltimore, Maryland 21202.

**HOW TO GET RICH!!** Free "Success-method Details"! Associates, Box 212-B7, Stoneham, Massachusetts 02180.

**WORLD'S** Biggest Wholesale Bargains! 165 free catalogs. Mailorder dropshippers. Your business imprint. Closeouts. Automobiles. Free "Digest." Vault International, Box 7284M, Lexington, Kentucky 40502.

**\$2000.00 MONTHLY**, Easily Done. Ropchan, Box 5341-P, Sherman Oaks, California 91413.

**START** Your Own Travel Business! Free Details! Moore Tours, Box 35665-M7, Dallas, Texas 75235.

**FORTUNE** Developing cheap recreational land. Fantastic future! Free Details. Elesco-PM-7, 8539 Rosalie, Brentwood, Missouri 63144.

**MAIL** Galore! Money-making offers! Your name on national mailing lists, 25¢. Three months, 50¢. Sullins, Box 206-M, Forsyth, Georgia 31029.

**MAKE MONEY AT HOME** METALLIZING. Baby Shoes, Plastics, Novelty, Gold, Silver, Bronze. Free Facts. Kiktavi, Box 2127-A, Inglewood, Calif. 90305.

**DISCOVER** Profitable Businesses. Unique Report highlights selected, overlooked opportunities. Free particulars. Sherwood Publications, Box 517A, Brundidge, Alabama 36010.

**WOODWORK** Profits! Tablesaw, Jigsaw, etc. . . . Guaranteed manual, \$3.00. Woodcraft, 956 Springdale, Atlanta, Ga. 30306.

**MAILORDER!** Make big money working home. Free report reveals millionaire's secrets! Executive (1A7), 333 North Michigan, Chicago 60601.

**300% PROFIT.** \$3.00 (refundable) brings airmail samples, catalog India's newest, exquisite novelties. Isharsingh Kulwantsingh, Majithmandi(Y), Amritsar-12, India.

**MAKE** To \$5000.00 Yearly sparetime with 'Proven' Home Mail Order Business. Send \$1. Bergman, 1439—12th Avenue, San Francisco, Cal. 94122.

**"MORTGAGE** Brokerage." Lucrative Profits! Obtain Capital Sources. Chase, Uleta, Florida 33164.

**\$12.00 HOURLY** In burglar fire alarms. Get facts, send \$1.00. Security, 11920 Chapel Forest, Dallas, Texas 75234.

**YOUR** Own Social Security Plate Business—\$19.95 Complete! (Embossing Machine included). Free Details. Idea Products, Box 69828-PT, Los Angeles 90069.

**START** Immediately: Burglar-Fire Alarm Business. Fantastic Opportunity. Fast Growing Field. Safeway, 92-G Brighton 11th Street, Brooklyn, New York 11235.

**NEW** Products Imported By Air. Bakers, 313 Harrison, Sullivan, Illinois 61951.

**YOU** Can Get Rich! Find buried treasure! Authentic maps! Full information! 400 treasures! Latest location clues! Details free! Amalie Enterprises, 1019 East 218 St., Bronx, N.Y. 10469.

**400% PROFIT**—Amazing selection—300 "Antiqued" reproductions on parchment!!! Garen's, Box 2459, Zanesville, Ohio 43701.

**BE A WINNER!** Complete 1971 Mail Order Dropship Course. Write: Veg Nev Enterprises, 2208 Dauphine, C-4PM7, Las Vegas, Nevada 89103.

**MAKE** All Glass Aquariums At Home. Hobbyists And Pet Shops Want Them. Complete Instructions \$1.00. Aquarist, 413 North Andrews, Ft. Lauderdale, Florida 33301.

**VACUUM SIGN MACHINES** 14"X24" \$65.00. Homecraft, 2350 W47, Denver, Col. 80211.

**ADDRESSERS MAILERS** \$1000 Monthly. Send self-addressed stamped envelope Martin Mailorder, 409-PM Inglewood Drive, Savannah, Georgia 31406.

**WANTED.** Products. For Catalog. Managerial Research, Box 240, Wheaton, Illinois 60187.

**MAKE** \$1,000,000.00 in 10 years, \$10.00 start. Free Proof!! Wallace, Box 288 A7, Gladstone, Oregon 97027.

**SELL** Your Photos! Report tells How. Where. Color Slide Markets. Only \$1.00 Booklet #M050-S Creative Gifts, 7814 Walnut, Hammond, Indiana 46324.

**PRODUCE** SIMULATED PLASTIC OBJECTS Without special equipment from ordinary, low-cost materials! Great profit potential! \$4.00 buys you a sample novelty and the complete explanation of the simple process from Simulated Plastics & Novelty, Box 2194-R, Morristown, New Jersey 07960.

**BIG** Profits. Sell Lifetime Social Security Plates, Sample, Goldthwaite, 220-PM Lawrenceburg, Tennessee. 38464.

**MAILORDER.** Free advertising—756 Publications. Sensational Mailorder Success Program Begin Immediately. Details Free. National, POB14—M7, Brooklyn 11214.

**FREE** Catalog. Over 100 best mail order products. Below wholesale prices. Givant, 8960 Comet Circle, Westminster, California 92683.

**CLIP** Short newspaper items. To \$10.00 each. Details free. Foster, 272-M7, Brooklyn 11235.

**HOMEWORKERS.** \$100.00 Weekly Addressing for firms. Begin immediately. Details—send stamped, addressed envelope. Hamilton, 272-TMA7, Brooklyn 11235.

**MAKE** MONEY Selling magnetic signs. Great profit potential! DETAILS FREE! SPN, Box 2194-R, Morristown, N.J. 07960.

**Molding** Rubber Liquid Plastic. Hobby Supplies. Details 10¢. Chaney's, 5415-L San Jose Blvd., Jacksonville, Fla. 32207.

**\$60.00 DAY.** Manufacturing concrete Posts. Blocks. Mold Equipment Catalog \$1.00 refundable. Carlayne, Route One, Box 95, Rapid City, South Dakota 57701.

## MONEYMAKING OPPORTUNITIES

**FUN** And profit raising Calves and Pigs. Buying, diseases, causes, remedies. Each Handbook \$2.00, Both Handbooks \$3.75. Gem Laboratories, Glencoe, Minnesota 55336.

**HOMEWORKERS** Wanted to stuff envelopes. Send self-addressed stamped envelope, Tayco, Box 8010-IMP, Stockton, California 95204.

**\$\$\$—101** NEW Businesses to Start at Home, \$2.00. Essex Development Co., 15652 Kennebec, Southgate, Mich. 48195.

**RETIRED** Persons, Housewives! Earn money addressing. Send stamped, addressed envelope for details. Elco Specialties, Ellington, Connecticut 06029.

**QUICK** Money! Create Decorative Candles at Home! Inexpensive "Manufacturing Manual." Free Particulars! Kaycrafters, 28639 Bartons, Garden City, Mich. 48135.

**PENNY STOCKS** Have profit potential. Free information. Analyst-PM, 608 N. Guadalupe, Redondo Beach, Calif. 90277.

**\$\$\$ SHARPENING** Scissors. Your Grinder, My Plans \$2.95. Free Details. Dolken, Box 912SPM, Conway, Ark. 72032.

**\$500 MORE** Monthly. Raise Rabbits, Chinchilla, Other small animals for us. Equipment, Breeders, Instructions Supplied. Fox River Valley Research Farms, Dept. PMM-071, McHenry, Illinois 60050.

**MAKE** \$1.00 Per Sale selling engraved metal Social Security plates. Free Sales Kit. Engravplates, Box 10460-7301A, Jacksonville, Florida 32207.

**BLACK WIDOW** Spider Ranchers needed! Guaranteed Market! Complete details \$1.00 (refundable). NBWC, Box 476 RPM-7, Rialto, California 92376.

**SWEEPSTAKES** Contests. How to Win. Write for free particulars. General Contests, 1609-18 East Fifth, Duluth, Minnesota 55812.

**CASH** Prizes offered each month in a new contest magazine. For free copy write Multigames, Dept. P, Box 307, Ypsilanti, Michigan 48197.

**SELL** Lifetime Metal Social Security Plates. Sample and Sales Kit FREE. Lady McGuire, Box 3333PM, Anderson, S.C. 29621.

**CIGARETTES** 12¢ A pack. Improved roller makes 20 filtertip, plain, king or regular for 12¢. Facts free. Green River Tobacco, Box 953, Owensboro, Kentucky 42301.

**MAKE** Statuettes, novelties, imitation marble. Sell to stores or start gift shop. Free details. Marbleizing, 41 Waverton, St. Louis, Mo. 63124.

**HOW** To Make money writing short paragraphs. Information free. Barrett, Dept. C-27-X1, 6216 N. Clark, Chicago 60626.

**FREE** Copy of world's leading contest magazine! Write Prizewinner, Box 11569, St. Petersburg, Fla. 33733.

**SCIENTIFIC** Massages: Big Earnings uncrowded profession. Learn spare time at home. Diploma awarded. Free catalog. Write Anderson School, Dept. H-1C, Princeton, Illinois 61356.

**HOW** TO GET RICH!! Free "Money-making Brochure"! Success International, Box 2447-C, Livonia, Mich. 48151.

**\$200.00 FROM** Sheet 1/4" plywood (scrap). Details 25¢. Novelty, 610 So. 24th, Elwood, Indiana 46036.

**VENDING** Machines. No selling. Routes earn amazing profits. Big catalogue Free. Parkway Corporation, 715PMM Ensor Street, Baltimore, Maryland 21202.

**MONEY MAKERS:** Groups, Individuals. Write: Boyer, Dept. PM, Yatesboro, Pennsylvania 16263.

(Continued on next page)



## MONEYMAKING OPPORTUNITIES

(Continued from preceding page)

LEARN The secrets of repairing junk batteries "Fabulous Profits" at home. Battery Shop, Route 1-188 D, Blythe, Calif. 92225.

MAKE MONEY Addressing, mailing, etc. Golden opportunity! Send stamp for money-making folder. Hicks Service, 37-215, Los Angeles 90037.

CREATE MONEY-Making invention ideas by the hundreds! Guaranteed new method! Sell your ideas! Free details. KM Publications, Box 3727-P, Anaheim, California 92803.

MONEY In your spare time. As a dealer for our complete line of stationary products, in your home. High profit potential. Enquiry loses nothing and can bring needed money. Thetford Press, 520 5th Ave., New York, New York 10036.

UNUSUAL Lucrative home business. Small basement production requires no investment, skill. Amazing literature free. Barta-RKB, Box 15083, San Francisco, California 94115.

CLIP Newspaper Articles. \$1.00-\$5.00 each. Details free. Sullins, Box 206-MP Forsyth, Georgia. 31029.

\$600-UP Monthly. People needed to raise laboratory animals for us. Huge market. We supply equipment, breeders and instructions. Details 25¢. National Research Farms, PNM-7, Box 309, Milwaukee, Wisc. 53201.

GET World's Biggest Wholesale Import Catalog. Write: World, Medina, Washington 98039.

FREE Sample Kit. Sell Lifetime Beautiful Social Security Cards. Bilbrey Sales, Route #1, Crossville, Tennessee 38555.

HOW TO GET RICH!! Free "Successmethod Details"! Associates, Box 212-M7, Stoneham, Massachusetts 02180.

FREE Cash, boxtops refund bulletin. \$1.00, money back guarantee. Golden Coins, 364PM, Muscatine, Iowa 52761.

STUFF Envelopes make 25¢ each. No Addressing or Postage Needed. Complete Details \$1.00, Davan, Box 7P, Middle Island, New York 11953.

"MONEY Can be made at home. Easy Pleasant work. No experience needed. Mastercraft, 115 Garner Road, Lilburn, Georgia 30247.

HOMEWORKERS. Make \$50. for every 150 envelopes you mail. Rush 25¢. Gemco., B-21244A, Indianapolis, 46221.

ATTRACT Riches. Use Metaphysics. Free Details. Marvco, Box 429-P, Rockdale, Texas 76567.

RAISE Chinchillas. Catalog—\$1.00—Refundable. DeShon Chinchilla Ranch, Dept. P.M. Route Two, Roanoke, Indiana 46783.

SELL Lifetime Metal Social Security Plates. \$1.25 Profit per Sale. Free Sample and Sales Kit. Capitol, Box 9091-M, Austin, Texas 78757.

CAMERA Owners! B&W And Color Photos Bring \$\$\$—Act Now! Information \$1.00. Fortune Fancy, PM7-71, 118-23 205 Street, St. Albans, New York 11412.

\$100.00 WEEKLY HOME ADDRESSING. DETAILS 25¢. Staly, Box 4008 Ampere, East Orange, New Jersey 07019.

EXTRA CASH. Sparetime. Experience unnecessary. Details, 25¢. Rieck Enterprises, Box 789PM7, New York, New York 10005.

FANTASTIC Seller 5 electricly lighted roses, Red Yellow or Pink. Sample \$3.00 Post Paid. Doz. Assorted \$24.00 Sell for \$3.98. Collier, Box 306 P, Yucca Valley, Cal. 92284.

SPARE Time profits, work home. Details 50¢ (refundable.) Rojodo Company, Publication Desk PM-2, Box 4398, St. Louis, Missouri 63123.

NEW Manufacture Simulated Decorative Wood Carvings. Brochure 25¢. Woodcast, Box 2493, Everett, Washington 98203.

CLIP Newspaper Items \$1.00-\$5.00 each. Complete Manual \$2.00 (refundable). Dall, Box 147-PB, Hanson, Mass. 02341.

BURGLAR, Riot, Weather protection for doors, windows. No investment. Start small, grow big. Details \$1.00. Allied, Box 1093, Metairie, Louisiana 70004.

\$2.40 HOURLY Making simple wood novelties. Free details! Gene's, 55 Boxwood, Falmouth, Mass. 02540.

EARN UP TO \$700 A MONTH AS A TAX PREPARER. Learn tax preparation at home in your spare time from H&R Block, America's Largest tax service. No previous experience needed. An ideal course for men and women of any age. Job opportunities for qualified graduates. No salesman will call. Send for free information today. Write: H&R Block Tax Training Institute, Dept. 301-C7, 4410 Main, Kansas City, Mo. 64111.

SECRETS Of big profits in the automotive field. Plans \$9.95. BLASCO, Box 239, Glencoe, Ill. 60022.

MAIL ORDER—Beginners, save money with new techniques. Write PO Box 533, Ridgefield, N.J. 07657.

OPPORTUNITIES PROFIT GUIDE. 100 Low cost buying sources. \$2.00 Winchester Enterprises, 2807 PM Hargrave Street, Philadelphia, Penna. 19136.

MAKE 200%. Even 300% Profit on Gift Items, Novelties, Toys, Carded Merchandise. Details Free. Midtown, 5423 Field, Detroit, Michigan 48213.

LYRIC Writers write songs with Writers who write hits for top Nashville Artists. Globe, 1313 Dickerson Road, Nashville 37207.

OPPORTUNITY Magazine offers you bargains and new product sources. Send \$2.00. Marsh, 34 West 76th Street, New York 10023.

### PROFITABLE OCCUPATIONS

PROFIT From mail order with concrete programs based on real merchandise and value. We have know-how and capital to back a successful program for those who qualify. Request details. Acme Engraving, 624 Arch Street, New Britain, Conn. 06051.

\$500 MORE Monthly. Raise rabbits, Chinchilla, other small animals for Us. Equipment, Breeders, Instructions Supplied. Fox River Valley Research Farms, Dept. PMP-071, McHenry, Illinois 60050.

MAKE \$300 CLEAR MONTH Few hours from 10 customers, representing us in your community. No individual selling. Repeats forever. Customers waiting. \$1 for sample, details. Our 40th year. Progressive, Box 1302, Springfield, Illinois 62705.

FREE!! FREE!! FREE REPORT!! 609 Little-known, successful businesses. Written by consultant. Indoor . . . outdoor, work home! Start small, grow big . . . many others have. Experience unnecessary, easily done!! Write: Report, Box 238-BA7, Lafayette, California 94549.

FT. SMITH Auction School. Ft. Smith, Ark. Residents & Home study. Veteran approved.

BECOME A mortgage broker, earn \$10,000 to \$50,000 a year. Details free. United, Box 6284A, Marietta, Georgia 30060.

SHARPEN Scissors, Pinkers. Inexpensive equipment, tools, supplies. Blackhawk's, Sheldahl, Iowa 50243.

HOW To Make Money writing short Paragraphs. Information Free. Barrett, Dept. C-27-X2, 6216 N. Clark, Chicago 60626.

1000% PROFIT Bronzing Shoes. Free Information. NBC, Box 11069—PM1, Kansas City 64119.

CHINCHILLA INCOME GUARANTEED. 25¢. bulletin \$1.00. Chinchilla, 11PM, Port Richey, Florida 33568.

\$600-UP Monthly. People needed to raise laboratory animals for us. Huge market. We supply equipment, breeders and instructions. Details 25¢. National Research Farms, PNM-7, Box 309, Milwaukee, Wisc. 53201.

LEARN—How to weld, cut, braze. 1500% profit—easy! FREE—simplified 32-page illustrated instruction booklet, catalog. Victor Equipment, Airport Road-AT, Denton, Texas 76201.

BECOME Mobile Home Park Manager. Home study. Write. National Mobile Home School, 13615 Victory Boulevard, Van Nuys, California 91401.

REPAIR Clocks Profitably. Easy Rules. Simple tools. Free Plans. Thiese, Genoa, Illinois 60135.

MAIL LETTERS FEATURING REAL MERCHANDISE. Get \$12.00 Orders in EVERY MAIL \$8.00 PROFIT. Everything Furnished. Write: T & C Goebel, P. O. Box 182, Kenil, New Jersey 07847.

### SALESMEN—DISTRIBUTORS

WANTED. Men contact service stations. Long needed invention. Huge profits. Write Cyclo, 3816-Dahlia, Dept. 163, Denver, Colorado.

MAKE \$10.00 Hourly demonstrating service station vacuum cleaner. Inkavac, Box 66573-A, Houston, Texas 77006.

BIG Earnings selling Hertel Bibles. New 3-dimension cover, finest reference edition sells fast. Demonstrator furnished. Big commissions. International Book, Dept. PM, Box 118, Wichita, Kansas 67201.

Big Steady income! Leader in business printing/advertising specialties will start you in business. No experience. No stock investment. Full, part time. Everything furnished. Write Kaeser, Dept. A1007, 953 Martin Place, Cincinnati, Ohio 45202.

MAKE Extra \$25 to \$75 spare time! Double air cushion shoes. Men's, women's line. Dress, work, play. Highest commissions. Shoes for yourself. Outfit Free. Bronson, Dept. H-71, Minneapolis, Minnesota 55408.

"IN Black America"—hottest money-maker in Black communities. Giant book . . . Negro pride, pictures, accomplishments. Easy sale. Black leaders endorse. No credit turndowns. Immediate pay. Salesmen, fund raisers, managers write Presidential Publishers, 3550 Wilshire, Los Angeles, California, 90010.

100% PROFIT—Sweet Georgia Brown Cosmetics sell fast. Write for Sample Case offer. Valmor, Dept. H, 2411 Prairie, Chicago 60616.

EARN Big Commission Full or Part Time. Show America's largest line Low Priced Business Printing and Advertising Specialties Plus calendars in season. No experience. No investment. No collections or deliveries. On-the-spot commissions. Big Free Sales Kit samples hundreds items used daily by businessmen. Merchandise bonuses for you. Build profitable repeat business. Start now. National Press, Dept. 11D, North Chicago, Ill. 60064.

THERE'S Money in selling office supplies and equipment, full or part time. Steady repeat commissions. Free selling outfit. Write. Osec. 3505-PM North Elston, Chicago 60618.

HOUSEHOLD Products Route. Earn \$25.00 or more daily. Larger repeat orders. Man, woman. Full, part time. McNess, Freeport 2661, Illinois 61032.

INCOME Security—Partnership—proprietorship in lucrative electrical appliance wholesale distribution. Investment and references required. \$30,000-\$50,000 income. Write—Vactronics, 980 Alabama Avenue, Brooklyn, N. Y. 11207.

### AGENTS WANTED

WANT TO MAKE UP TO \$100 A WEEK spare time, and get free shoes for life, too? No investment. Rush card for free details. Mason Shoes, K-856, Chippewa Falls, Wisconsin 54729.

(Continued on next page)



## AGENTS WANTED

(Continued from preceding page)

**PROFITABLE! FULL OR PART TIME.** Represent largest manufacturer of magnetic signs for cars and trucks. **TRIMETRIC**, 2640 Saddle, Oxnard, California 93030.

**BE The Popular Mechanics** representative in your neighborhood and earn big profits in your spare time. Write Popular Mechanics, Room 7A, 250 West 55th St., New York 19, N.Y.

**EVERY Man** a prospect. Refundable sales kit offer showing line belt buckles, tie clasps, money clips, cuff links, lapels, identification badges, individualized with customer's name and emblems. Cap badges for trucking, bus, taxi, police, firemen, also postal, letter carriers and heavy construction emblems. Choice 4000 emblems. **Hook-Fast**, Box 1088PM, Providence, R.I. 02901.

**YOUR Own business—Used Suits \$1.50:** Overcoats 65c; Mackinaws 35c; Shoes 12½c; Ladies' Coats 30c; Dresses 15c. Enormous profits. Catalog Free. **Nathan Portnoy Assoc.**, 2109-AA, Roosevelt Road, Chicago, Illinois 60608.

**PRINTING, Advertising Salesmen—**Excellent moneymaking sideline selling Decalcomania Name Plates, small quantities. Advertising Specialties, sign letters. Free Samples, **Ralco XL**, Boston, Mass. 02119.

**LIFETIME Income.** Business Loan Representative Write: **Financial**, 28 E. Jackson, Suite 1204-X3, Chicago 60604.

**MAGNETIC Signs—**best quality—excellent commissions. **Andrews Associates**, Lemont, Pennsylvania 16851.

## EMPLOYMENT INFORMATION

**ALASKA Job opportunities.** \$1.00 Alaska Services, 904—56th Ave., Anchorage, Alaska 99502.

**IF You want a job Houston** wants you. Send 1.00 **Placement Services**, 1521 Hamblen Rd., Humble, Texas 77338.

**CANADIAN Jobs, Immigration, Government Assistance, Taxes, Land, \$1.00.** **Porter AQ**, Box 253, Johnson City, N.Y. 13790.

**ENGINEERING And Support Personal.** Double your present income as **JOB SHOPPER**. Booklet \$3.00. **Panciera**, 15 Noyes, Westerly, Rhode Island 02891.

**FREE DETAILS AUSTRALIA!!!** Government assisted transportation!! **Jobs Galore!!** Latest Handbook. Free Details. Write: **Associated**, Box 17-871, Lafayette, California 94549.

**AUSTRALIA WANTS YOU!!!** Government Assisted Passage. 1971 Government Information and Forms—Most Complete Information Available—\$1.00. Reports on Employment, Business, Taxes, Education, Teaching, Housing, Ranching, Maps, etc. **AUSTCO**, Box 3623-E, Long Beach, California 90803.

**HIGH Paying overseas jobs.** Construction, other projects. Bonuses. Travel Expenses. Extras. International Information, 124, Cortez, Florida 33522.

**FOR A list of 100 companies** employing 200+ employees send \$1.00 and self addressed stamped envelope to P.O. Box 809, Gainesville, Florida 32601.

**GROWING AUSTRALIA WANTS YOU!!** Latest information describes living, housing, climate benefits. Employment opportunities including many U.S. companies . . . plus Government transportation, settling allowances. \$1.00 (Refundable) Value Data, Box 416, Maspeth, N.Y. 11378.

**CANADIAN Employment—unlimited!** Act now! \$1.00. **Canemploy 107**, 7 Trafalgar, St. Catharines, Ontario.

**JOBS ON SHIPS! Good Pay! Europe, Asia, Worldwide! Who to see and Where—\$1.00** Seaways, PM, Box 121, Ellicott City, Maryland 21043.

## HELP WANTED

**WORLD-WIDE . . . U.S.A. Jobs Galore!!** Students, all professions and occupations. Enjoy Paris, Rome, Tokyo, Mexico City, Miami, San Francisco. \$700.00 to \$3,000.00 monthly. Paid Overtime, Travel Allowance, Sightseeing. Free Details!! Write: **Global Employment**, Box 706-B71, Orinda, California 94563.

**OVERSEAS Jobs—Europe, South America, Australia, Far East, etc.** 2000 openings all trades. Construction, Office, Engineering Sales, etc. \$700 to \$3,000 month. Expenses paid. Free Information. Write **Overseas Jobs**, International Airport, Box 536-M, Miami, Florida 33148.

**OVERSEAS EMPLOYMENT . . . Australia, Europe, South America, Asia! All Occupations!** \$700-\$3,000 monthly! Write: **Employment International**, Box 29217-AG, Indianapolis, Indiana 46229.

**"AUSTRALIAN OPPORTUNITIES HANDBOOK"** . . . Latest information about Government Paid Transportation, Employment, Business, Farming, Housing . . . plus "Employers List" and Forms. Send \$1.00. **International Services**, Box 19107-AG, Washington, D.C. 20036.

**OVERSEAS Jobs—Australia, Europe, South America, Far East.** Openings in all trades and professions. Free information. Write: **Foreign Jobs**, Box 2235 AMF, Miami, Florida 33159.

**FREE DETAILS . . . AUSTRALIA . . .** Government assisted transportation. Latest Handbook and forms . . . Free Details . . . Write: **Associated**, Box 17-8A71, Lafayette, California 94549.

## REAL ESTATE AND FARMS

**CANADIAN LAND INVESTMENT. FROM \$9.00** an acre. Choice properties across Canada. Low monthly payments. Ideal hunting, fishing, investment, timber, cottages. **FREE CATALOGUE**, **Canadian Estate Land**, Department PMC-7, 194 Wilson Avenue, Suite 101, Toronto 380, Canada.

**FREE . . . 240-page SUMMER catalog.** All types real estate coast to coast! **UNITED FARM AGENCY**, 612-PM West 47th St., Kansas City, Mo. 64112.

**LAND! EASY TERMS LESS THAN BANK RATES. NORTHWEST TIMBERED ACREAGES** As low as \$1,550 Total Price. 5-10-20-40 Acres. For people who love the land—A tract of Recreation Land to have for your very own! In Northern Idaho, Northeastern Washington, and Beautiful Montana. In the heart of lakes and big game country. All covered with growing timber. Access and Title insurance with each tract. This is select land with natural beauty, recreational and investment values. Plan for the future and retirement recreation. We have tracts of many types and sizes from which to choose, including beautiful Northwest Waterfront property. Your inspection is welcomed. Write us for free list, maps, and complete information. Write to: **Dept. PC, Reforestation, Inc.** P.O. Box 14006, Opportunity Station, Spokane, Wash. 99214.

**FREE CATALOG! Giant SUMMER edition!** Over 4,600 properties described, pictured—Land, Farms, Homes, Businesses—Recreation, Retirement. Selected Best through the U.S.! 71 Years' service, 568 Offices, 40 states Coast to Coast. Mailed FREE from the World's Largest! **STROUT REALTY**, 60-MX E. 42nd St., NY, NY, 10017; 7-MX S. Dearborn, Chicago, Ill. 60603; 521-MX E. Green, Pasadena, Cal. 91101.

**ARIZONA. Walden Village.** 2-acre parcels near Prescott National Forest. Ideal climate. Homesite or retirement. \$1,995 with low terms. **E. G. Sweeney**, Glenarm Co., 2233 No. 7th St., Phoenix. 85006.

**FREE! New 1971 Summer Catalog!** Coast to coast bargains in farms, retirement, business, resort, investments. Actual property photos! Your copy FREE! (Zip, please.) **SAFE-BUY Real Estate Agency**, Box 589-PM, Little Rock, Ark. 72203.

**GOVERNMENT LANDS** Low as \$3.50 acre. Millions Acres! For exclusive "Copyrighted Report" . . . plus "Land Opportunity Digest" listing lands throughout U.S.; and **VALUABLE 17 X 22 TREASURE MAP OF U.S.;** send \$1.00. **Land Disposal**, Box 9091-PM, Washington, D.C. 20003. Satisfaction Guaranteed.

**CANADIAN Vacation lands:** Full price \$385.00. 40 acres. \$10 month. Suitable cottage sites, hunting, fishing, investment. Free information. **Land Corporation**, 3768-C Bathurst, Downsview, Ontario, Canada.

**\$1 ACRE—Canadian Border—**hundreds campsites, islands, farmlands, directly from tax authorities. (Non-profit). Lists, photographs mailed. Register. Room 10, 110 Church Street, Toronto 1, Canada.

**GOVERNMENT Lands . . . low as \$1.00 Acre!** Millions Acres! For exclusive "Government Land Buyer's Guide" . . . plus "Land Opportunity Review" listing lands available throughout U.S. send \$1.00. Satisfaction Guaranteed! **United Lands**, Box 19107-AG, Washington, D.C. 20036.

**CENTRAL Ontario—Choice 640 acre Sportsmen's paradises** still available—\$20.00 plus \$6.50 taxes yearly. Maps, pictures. \$2.00 (Refundable). Information Bureau, **Norval 4**, Ontario, Canada.

**\$1 ACRE—U.S.A.—CANADA Millions Acres.** Direct from Government Agencies. No middlemen. . . . Family vacationing. Fishing, Hunting, Homesteading, Investing. . . . For amazing "where" and "how" **"ALL STATES—ALL CANADA GOV'T LANDS DIGEST"** . . . plus invaluable Canadian maps. Rush \$1.00 (Guaranteed): **Can-Am-Lands**, P.O. Box 1147, Buffalo, New York 14240.

**BOILING Spring Lakes—**America's Greatest Real Estate Value. 1/3 acre vacation or retirement homesites only \$750 cash price. Ten-years to pay. Money-back inspection guarantee. Carolina coast, multi-million dollar, 14,000 acre development. 50 fresh water lakes, private ocean beach, golf course, motel, and country club. Free literature. **Dept. 1-J, Boiling Spring Lakes**, North Carolina 28461. (Registered under Federal Land Sales act but not offered to residents of states requiring separate registration.)

**BEAUTIFUL Ozark Property:** Free literature. **Mill Creek Real Estate**, Box 121, Melbourne, Arkansas 72556.

**OCALA FOREST CAMPSITES** Deep in the heart of the Great Ocala National Forest. Excellent hunting and fishing. Free maps and photos. (Unavailable in States requiring separate registration). **AD70LB710E**, **W. H. Vernor, Inc.**, P. O. Box 760, Dept. E, DeLand, Florida 32720.

**ARKANSAS-MISSOURI.** 5-10-20 acre tracts on 70 mile long Beaver Lake. Great hunting, fishing. Farms. Ranches. Homes. Low taxes. Terms. Catalog. **JIM TUCKER "The Land Man"** Rogers, Ark. 72756.

**FREE! Real Estate Catalog!** Farms, Ranches, Business, Recreational and Investment Property. 18 states, pictures galore. Note State Desired. **Banner Advertising**, Box #3333, 19-A, Springfield, Missouri—65804—"Real Estate Our Specialty."

**HOT SUMMER BARGAINS!** Best buys in **ARKANSAS!** Free Journal! **Staterwide Realty Co.**, 507-AE Pyramid Bldg., Little Rock, Ark. 72201.

**ARIZONA—Beautiful 2½ acres,** \$995, easy terms. For vacation, retirement or investment. **Lake Havasu-Kingman area.** **Ev King, Broker**, 316-M East Ocotillo Road, Phoenix 85012.

**HOMESTEAD Government Land Alaska.** Write: **Bodega**, Box 83M, San Leandro, California 94577.

**MICHIGAN 10 TO 160 ACRE TRACTS** Lake Superior—Marquette area from \$99.00 Acre. Any terms A-OK. Cabins, trailers, camping welcome. (Land Anywhere in Michigan). **FREE PICTURES** write **Lake Acres**, 3650 Dixie, Drayton Plains 16, Michigan 48020.

(Continued on next page)



## FARM & GARDEN EQUIPMENT

**PROFITS FROM CLASSIFIED ADVERTISING!** Booklet shows you how to start your own business with Classified Advertising. Only \$1.00 (Refundable with first order.) C. A. Martin, Popular Mechanics, Dept. P.M., 224 West 57 Street, New York, N.Y. 10019.



## FLOWERS, PLANTS & NURSERY SUPPLIES

**GROW Giant Sahuaro Cactus** from Arizona. Inside or Outside. Reach Heights of 40 feet. Over 150 Seeds. Complete instructions. \$2.95 Enterprises, Box 4252, Dept. 71, Wichita, Kansas 67204.

**PROPAGATE ROSES.** Bud-grafting Kit contains instructions, materials. No plants included. \$6.00. Grayton Research, Box 186, Briarcliff, New York 10510.

## CONSTRUCTION PLANS, BLUEPRINTS

**POLLUTION FIGHTER**—Build manual household trash compactor, plans \$2.00. Gafford, 140 Lone Oak, New Milford, Connecticut 06776.

**BEST WORKBENCH PLAN Ever, Plus Free Lumber Conversion Chart, \$1.00.** WAY-MAR, Dept. 44B, 58 Underhill Road, Scarsdale, New York 10583.

## VACATION HOME PLANS

**ONTARIO VACATION PARADISE** Detailed Information and maps. \$3.00: Tendex Distributing, Box 340, Mississauga, Ontario, Canada.

## LOG CABINS & HOMES

**LOG Cabins, Homes, Cottages, Trailers.** 85 plans, specifications and prices. Send \$1.00 to Bloch Brothers—Drayton Plains 5 Michigan 48020 or Phone (313) 674-4116.

## HOME CRAFTSMEN

**101 PATTERNS** Of smart Gifts, Novelties, Shelves, Action Windmills, plus "Make Money Jig Sawing". \$1.50. Mastercraft, 75M, 7041 Olcott, Chicago 60631.

**CONVERSATION PIECES.** Tables and cricket stools made of hardwood Tupelo slices. No two alike. Pictures and prices free. Naturlog Originals, Box 826, Dept. PM, Florence, S. C. 29501.

**WOODWORKING Catalog and Manual 25¢** Plus free "101 Project Ideas." World's most beautiful veneers, lumber plywood! Wood finishing, upholstery supplies, Cane Lamp parts. Furniture hardware. Animal whittling blocks, 2,000 workshop products. Constantine, 2051-C Eastchester Road, Bronx 10461.

**HOME HOBBISTS:** Fine veneers available for "facelighting" furniture. Many other uses for woodworking hobbies. Veneer Kits, 100 South Kentucky, Evansville, Indiana 47717.

**WORMY CHESTNUT:** \$1.50 board foot. Cut to your specifications—rough, A.D. Appalachian Maple, Cherry, Birch, Poplar, Oak—\$1.25 board foot. Plus postage and COD charges. BanCo Lumber, Inc., P.O. Box 235, Burnsville, North Carolina 28714.

**FOUNDRYETTE 2400 F.** 1½ to 48 lb. capacity. Circular 25¢. Kansas City Specialties, Box 193-P7, Middleton, Wisconsin 53562.

**CABINETMAKING MADE EASY** And "How to Make Formica Counter Tops." Two excellent guides let you build kitchen cabinets and counter tops like professionals. Extraordinary guides bring master craftsmen's shortcut methods. Satisfaction guaranteed. Write: Japs, 126-P Seventh North, Hopkins, Minn. 55343.

**MAKE Money Building and selling Bird Houses.** Send \$1.90 for 39 page book of plans covering 19 projects. Yeager, 1665 Linden, Homewood, Ill. 60430.

**118 FULL SIZE FURNITURE PLANS.** Traditional, Early American, Danish Modern. Catalog 50¢. Furniture Designs, Dept. P-71, 1425 Sherman, Evanston, Illinois 60201.

**PICTURE Framing**—Profitable full or spare-time business. Easy to learn with handbook-course "Guide To Picture Framing Profits." \$1.50 Guaranteed. Free framing-supplies catalog included. Japs, 126-PM Seventh North, Hopkins, Minnesota 55343.

**DECOR Rivet Kit.** Make your own custom designs on leather, canvas, wood and plastic. Kit includes 100 Rivets, Anvil Plate and setting tool in convenient carry case. Kit #1 Brass plated Steel, Kit #2 Anodized Aluminum in five assorted colors. Send \$3.00 for each kit wanted, we pay postage. American Products Company, P.O. Box #6084, Wolcott, Connecticut 06716.

**WALNUT.** Bowls, Legs, Round Picture Frames, Gun-Stocks Lumber Moulding. Midland Walnut, Box 262, Savannah, Missouri 64485.

**POPULAR MECHANICS MASTER SHOP GUIDE.** Greatest product offered to a man with a workshop. All information printed on heavy boards, punched and ready to hang above his workbench. Covers wall fasteners, nails, screws, bolts, twist drills, abrasives, lumber, moulding patterns, plywood grades, hardboards, drywall, plumbing supplies, electrical supplies. Plus information on scores of other subjects. Send \$3.95 to: POPULAR MECHANICS, Dept. HE, 224 West 57th Street, New York, New York 10019.

**FREE Brochure** of how-to books. Numerous subjects. Daniel's, Dept. 11, 1121 Villaret, San Antonio, Texas 78224.

**PLANTATION FURNITURE** For patio and lawn. Cast iron or aluminum in kit form. Free brochure. IRONMASTER, Box 9644, Birmingham, Alabama 35215.

**HOW** To make laminated fiber glass shapes, from drawings, through master models and molds, to finished parts. Circular 10¢. Wheeler Products and Services, P.O. Box 15023, Fort Worth, Texas 76119.

**AUTHENTIC Texas Longhorn Kits:** Magnificent Spans Of Genuine Texas Longhorn Cattle Horns. Complete With Instructions For Finishing And Mounting. For Free Literature And Prices Write: Longhorns, P.O. Box 1179, Department PM, New York 10022.

**PLANS**—Tool storage and workbench that requires no floor space \$1.00. Himelick, 3408 Debra Dr., Anderson, Indiana 46011.

**ADD-A-WING.** Double size, triple value of your house for \$6/foot. Complete blueprints for 1000 s/f wing, \$12.50/set. Twenty pages illustrated instructions, \$2.50. Both, \$14. Box 303E, Chappaqua, N.Y. 10514.

**BEST WORKBENCH PLAN Ever, Plus Free Lumber Conversion Chart, \$1.00.** WAY-MAR, Dept. 45, 58 Underhill Road, Scarsdale, New York 10583.

## DO-IT-YOURSELF

**ORNAMENTAL FOUNTAINS BY RAIN JET** Provide "Showers of Diamonds." Patented. Our "Junior Jet Set" includes various fountain heads for use with your pump in your pool. From \$17.75 plus tax. Send for brochure with do-it-yourself fountain items. Rain Jet Corp., 301 So. Flower St., Dept. FBB, Burbank, California 91503.

**BUILD Combination Sofa-Bed.** Plans \$1.00. Sofa-Bed, Box 685, Smyrna, Georgia 30080.

**PLANNING AN UNDERGROUND SPRINKLER SYSTEM? ORDER BY MAIL AND SAVE.** World famous do-it-yourself Rain Jet Sprinkler equipment. Millions already installed. For special offer, including free How to install pamphlet, write California Sprinkler Systems Company, Dept. SWZ, 168 W. Verdugo, P.O. Box 627, Burbank, Calif. 91503.

**MOTORIZED Bike,** any horizontal lawn mower engine, nice plans, \$2.00. Landin, 4608 W. Fillmore Dr., Milwaukee, Wis. 53219.

**CUT Air-Conditioning Electricity Bills HALF.** Guaranteed. Possible in 15 Minutes. Complete Details \$1.00. Cowand, P.O. Box 5325A, Chesapeake, Virginia 23324.

**CONVERT MOWER Engines** into air compressors. Write Showalter, Box 409, Abilene, Kansas 67410.

**BURGLAR**—Fire alarm systems and supplies. Free Catalog. Informer Mfg., 200a S. Eden Street, Baltimore, Maryland 21231.

**BURGLAR-FIRE Alarm Supplies** and Information. Free Catalog. Protecto Alarm Sales, Box 357, Birch Run, Michigan 48415.

**SAVE** Build your own door and window canopy. Plans \$1.00. CANOPY, 208 11th Street South, Benson, Minnesota 56215.

**"BUILD Log Cabins,** rustic furniture, fire-places!!! Complete manual, \$3.00 . . . "A" Frame plans, \$2.00 . . . Guaranteed . . . Beels, 956 Springdale, Atlanta, Georgia 30306."

**"SIXTEEN foot pool** for \$25.00. Three hour assembly. Easy plans \$3.00. Hughes, Box 519, Duncan, British Columbia, Canada."

**SAVE MONEY. LEARN TO TUNEUP** Your own car. Send \$1.00 for easy step-by-step Tuneup Instructions for any American car or light truck, postpaid. State make, year, number cylinders, engine size. Satisfaction guaranteed. Vanus, Box 7503 Bitter Lake, Seattle, Washington 98133.

**WALLPAPER PASTERS, "Fast!"** Regular \$24.50. Vinyl \$34.50. Morley's, Cochran, Pa. 16314.

**BURGLARY**—Fire Protection. Free Catalog. (Comprehensive Installation Manual loaned Free upon request.) Safeway, 92-D, Brighton 11th Street, Brooklyn, New York 11235.

**CHANGE THE TUMBLERS IN YOUR LOCK.** 2 New Cut Keys. Matching Color Coded Tumblers. Special Tools Needed For Combination Change. Instructions. \$6.00. Postpaid BONUS Discount Purchase Cards For Locks. Locksmith Supplies, Send Old Key, Check, Money Order, Bank America Number. JaKay Lock Company, P.O. Box 9061, Washington, D.C. 20003.

**CARNIVAL Building Plans; Rides, Shows, Games, Illusions,** 200 Page Catalog Refundable \$1.00. Brill, Box 875-P, Peoria, Illinois 61601.

**"CENTRAL Air Conditioning At \$40.00** For The Whole Season? Yes! And You Can Install It Yourself. Step By Step Instructions And Details For Forced Air Furnace Installation. \$3.00. Home Air Conditioning, 3931 L'Enfant Drive, Washington D. C. 20022."

**"BUILD A DELUXE Playhouse** toolshed for under \$50.00. Over 150 cubic feet. \$3.95 includes material list, drawings and simplified instructions. D&D Enterprises, PO Box 112, Grand Ledge, Michigan 48837."

**GARAGE Door Parts**—Rollers 1.50 — Hinges 1.50 — Cables 4.50 Specify Door Size & Material. Courter, —216 White Horse Pike, Clementon, New Jersey 08021.

**T & G. CEILING TILES** Fixed to exposed joists without furring strips. For everything needed to support 150 square feet, send \$4.00 to:—F. White, P.O. Box 4552, Richmond, Virginia 23229.

**BURGLARY Alarm systems,** components, safes, accessories. Free catalog. TPC, Box AE-5, Cupertino, California 95070.

**LEARN To Read Music** In one Evening. Amazing New Book Shows How. Free Details, Bell, 1133 Hillcrest, West Palm Beach, Fla. 33405.

**SIDING**—Aluminum, Steel, Vinyl Do-It-Yourself Kits. 48 Page instructions and catalog \$1.00, refundable with order. Aluminum Industries Of Arkansas, Dept. PM-17, Little Rock, Arkansas 72205.

**BEST WORKBENCH PLAN Ever, Plus Free Lumber Conversion Chart, \$1.00.** WAY-MAR, Dept. 46, 58 Underhill Road, Scarsdale, New York 10583.

**ADD-A-WING.** Double size, triple value of your house for \$6/foot. Complete blueprints for 1000 s/f wing, \$12.50/set. Twenty pages illustrated instructions, \$2.50. Both, \$14. Box 303E, Chappaqua, N.Y. 10514.

(Continued on next page)



## ARTS AND CRAFTS

FREE: New handicraft catalog. Supreme Handicrafts, Box 395-PM, Sioux Falls, South Dakota 57101.

MAKE Figurines, plaques, lawn ornaments. Molds, plastercraft kits, liquid rubber. Sample and catalogue 10¢. Wooley Company, Box 29-B, Peoria, Illinois 61601.

"GETTING Started in Stained Glass" 25¢. Whittemore, Box 2065Y, Hanover, Mass. 02339.

300 FIBERGLASS Molds for casting ornamental concrete products. Catalog \$1.00. Plycrete Molds—Elk Rapids, Michigan 49629.

CRAFT SUPPLIES—Molds, Casting Resin, etc., plus revolutionary breakthrough: "Enamel-Glaze without kiln, on clay-metal-Styrofoam-etc." Make useful decorative items for home-gifts—PROFITS! Catalog \$1. (refundable.) Specialty Products, Dept. B, 731 Brooks Road, Muskegon, Michigan 49442.

"DECORATION Clock Plaques, Kits, Movements, Dials. Catalog 25¢. Newport, Box 6848M, Burbank, Calif. 91505."

MAKE Beautiful, unusual belts, necklaces, home decorations, etc. by TYING KNOTS. Information, introductory belt kit, \$2.00. Lee's Fabulous Things, Box 247-MB, Newbury Park, California 91320.

## BINOCULARS, TELESCOPES, MICROSCOPES, MAGNIFIERS

DISCOUNT Sale. Free Binocular, rifle-scope catalog. Write United Binoculars, B-3508, 9043 S. Western, Chicago 60620.

MICROSCOPE LABORATORY KIT. 36 Pieces! For young scientists. 100X to 750 magnification. All metal! Built-in light! 3 turrets! 10X-15X eye-piece. Slides, scalpel, test-tubes, alcohol lamp, probes, chemicals, etc. Instructions. Gifts, Hobby. School: \$14.89 + P&H \$1.50. Calif. Res. 5% tax. 10 day money-back guarantee. Billou's, Dept-300, 9771 Culver, Culver City, Calif. 90230.

SCIENCE Bargains! Lenses, telescopes, binoculars, microscopes, kits, parts, war surplus. Send \$1.50 for beginner's 10-lens kit with instruction booklet. Order Stock 2-CH. Request free 148 page Catalog CH. Edmund Scientific Co., 300 Edscorp Bldg., Barrington, New Jersey 08007.

TELESCOPES (Reflectors) complete kits Other accessories, request free literature. Criterion Manufacturing, Dept. PM 19, Hartford, Connecticut 06101.

MANON Means fine binoculars! Special sale! Write: MANON, Dept. 16, Box 1386, Huntington Beach, Calif. 92647.



## CAMERAS AND EQUIPMENT

WORLD'S Largest Buying Guide—800 Illustrations—50¢—Deductible With Your Order—Olden Camera—1265 Broadway, New York, N.Y. 10001.

FREE! FREE! BARGAIN BOOK—Central Camera Co., Dept. 371, 230 S. Wabash, Chicago, Ill. 60604.

PHOTOGRAPHY For Pleasure or profit. Learn at home. Practical basic training. Long established school. Free booklet. American School of Photography, 835 Diversey Parkway, Dept. P407, Chicago, Illinois 60614.

"CAMERA Profits." Five Easy Plans; Plus 250 Markets For Your Photographs. \$1.00. Satisfaction Guaranteed! Camfield's-A, Box 1746, Indianapolis, Indiana 46206.

## PHOTO & PHOTO SUPPLIES

NEW Film Catalog. Write Chai Photo Supply Co., 14-03 Berdan Avenue, Fair Lawn, New Jersey 07410.

VIETNAM Color photos, 10 in album, \$1.00. Photos, Box 669, Bremerton, Wash. 98310.

## PHOTO FINISHING

CAMERA FANS! Expert photofinishing by one of Country's largest labs at lowest prices. Fast service and free "Foto-Fan" Stamps you quickly redeem for valuable Photo Supplies. 8MM Kodachrome \$1.29; 8 Exp. Kodachrome \$1.79; 35MM Kodachrome. 20 Slides \$1.39; 8 Exp. Black White 69¢. Satisfaction guaranteed. Send exposed film or request free mailers, complete Price List and Gift Catalog. Direct Mail Photo, Box 8352-PM, Pittsburgh, Pa. 15218.

KODACHROME FILM Developed and twelve jumbo color prints \$1.25; twenty \$2.25. Black and White 12-exposure 65¢. Trial offer. Young Photo Service, 45C, Schenectady, N.Y. 12301.

## COLOR SLIDES

35MM COLOR Slides. 10.671 Individually sold. Described, Encyclopedia catalog 10¢. Wolfe Worldwide, Dept. 14-61, Los Angeles, Calif. 90025.

## MOTION PICTURES AND SOUND EQUIPMENT

FREE! 64-Page catalog. 8-16mm film, supplies, processing equipment. Superior, 448 N. Wells, Chicago 60610.

16MM SOUND Features, Shorts, New, used for Sale. Free Catalog. National Cinema, 333 W 57th St.—N.Y.C., N.Y. 10019.

UNUSUAL Movie supplies. Free circular. Esor, 47th Holly, Kansas City, Missouri 64112.

## RADIO, TELEVISION AND HAM EQUIPMENT

250 WATT Linear, 10-15 Meters. Plans \$1.00. Roberts, Box 403, Whiting, Indiana 46394.

FREE Electronics Catalog. Tremendous bargains. Edu-Kits, Department C-737B, Hewlett, New York 11557.

36¢ RADIO & TV tubes. Free catalog. Cornell, 4213-17 University, San Diego, California 92105.

GOVERNMENT Surplus receivers, transmitters, snooperscopes, parts. Catalog. 25¢. Meshna, Nahant, Mass. 01908.

SAVE Money on parts and Transmitting—receiving tubes, Foreign—domestic. Send 25¢ for giant catalog. Refunded first order. United Radio Company, 56-PM, Ferry Street, Newark, N.J. 07105.

## HIFI, TAPES, RECORDS AND ELECTRONICS

REMEMBER Old Radio? Complete taped shows. Box 8404-M, Olivette, Missouri 63132.

FREE Catalogues, 2000 hard to find unusual records. Rose's Records, Box 7216, Louisville, Ky. 40207.

FREE Catalog—Electronic kits—amplifiers—preamplifiers—psychedelic strobes—metal detectors—color organs—digital instruments—guitar amplifiers. FREE Subscription, SWTPC. Box PM32040, San Antonio, Texas 78216.

RECORDING Tape. 1800' Reels, Dozen \$12.00. 1200' Reels Dozen \$10.00. Postpaid. Sample \$1.00. Guaranteed. Mitchell, Box 444PM, Flushing, New York 11367.

OLD RADIO PROGRAMS. 30 Minute program recorded on cassette tape \$1.00. Catalog included. Wireless Trader, Box 6866, Birmingham, Alabama 35210.

GOD IS ALIVE. Positive Proof on LP Record. Amazing. New Secrets will improve your life tremendously. Send \$5.00 to Success Research, PO Box 107A Northfield, Ohio 44067.

EXPERIMENTER'S Kits. Audio, test equipment, others. PAIA Electronics, Box D14359, Oklahoma City, Okla. 73114.



## MUSIC AND MUSICAL INSTRUMENTS

ACCORDIONS And Amplifiers! Excelsior and other Famous Makes. Save 50%. Buy Direct. Factory Distributor. Terms. Trades. New—Used. Free Home Trial. Free Catalog and Discount Prices. Excelsior, Dept. R, 3147 North Luna, Chicago 60641.

30% TO 50% DISCOUNT. Guitars, Banjos, Mandolins, Dobros, Steels. Any model. Free catalog, WAREHOUSE P11, Box 9352, Fort Worth, Texas 76107.

EASY To Make, Play and Sell Musical Instruments. Kits From \$5.00, Instruments From \$10.00. Here, Inc., P. 410 Cedar Avenue, Minneapolis, Minn. 55404.

VIOLIN And Guitar makers—send for latest Free Catalogue of woods & accessories. International Violin, PM1, 414 East Baltimore St., Baltimore, Md. 21202.

ACCORDION Manufacturing, 6846-P North Avenue, Chicago, Illinois 60635. Concertinas, Hohners, Chromatics, Guitars, Drums. New, Used. Tuning, Repairing. Wholesale Catalogs Free.

PLAYER Piano Rebuilding—get details from: Vestal Press, Vestal 11, N.Y. 13850.

ELECTRIFY Player Pianos, Pump Organs Quickly, Inexpensively with Lee Silent Suction Units. Write Lee Music, 525F Venezia Avenue, Venice, California 90291.

LEARN Banjo. 5-String Bluegrass. No music. Makes learning easy. Free details. Blaylock, Box 25-M, Marietta, Georgia 30060.

GUITAR, Banjo Making books, Plans, woods, necks, tools. List 25¢. Satinwood, 510 East 11th Street, New York, N.Y. 10009.

ACCORDION Top brands. Buy direct. Tremendous discounts. Trade accepted. Free brochure PM. Accordion-O-Rama, 874 Broadway, N.Y.C. 10003.

WHOLESALE Professional Guitars, Amplifiers, PA Systems, Free Catalog. CARVIN, Escondido, Calif. 92027.

GUITAR MAKING Books. Imported Woods, Supplies, Accessories. Catalog 25¢. Guitar Center, Box 15444, Tulsa, Okla. 74115.

GUITARISTS—Busy? Five minutes weekly, teaches strums, barres, melody. Beginner—advanced. Samples, 10¢. Steele's, Box 114, San Raphael, Calif. 94902.

POEMS Set to music. Songs recorded. Send poems, songs. Crown Music, 49-C West 32, New York 10001.

POEMS Wanted For songs. Nashville Music Productions, Box 40001-P, Nashville, Tennessee 37204.

POEMS And Songs wanted by America's most popular studio. Tin Pan Alley. Broadway Productions Division, PM, Lake Grove, New York 11755.

SWISS Musical Movements, Boxes. Finest. Spielman, 131 West 42nd., New York 10036.

SEND Poems for new songs, records. Free Examination. Five Star Music, 6M Beacon, Boston, Mass. 02108.

GUITARS, MANDOLINS, BANJOS. Complete stock of Gibson Martin guitars. Free 66 page catalogue, parts and accessories. Big savings. New York discount prices. Send 50¢ postage handling. Eddie Bell Guitar, Dept. PM, 201 West 49, New York 10019.

LEAD/Rock Guitar Course. Lead Chords, Tricks, Improvisation, Diagrams, Copying, Patterns, More! \$1.00. Vern, 18 Redcoat, Lexington, Mass. 02173.

FREE Valuable Information Regarding Songwriting — Publishing — Records. Colonna-International, Box 888, Burbank, Calif. 91503.

FREE Catalog. Electronic musical accessory kits. PAIA Electronics, Box B14359, Oklahoma City, Okla. 73114.

(Continued on next page)



## MUSIC AND MUSICAL INSTRUMENTS

(Continued from preceding page)

**GUITAR:** Modern rhythm. Just dial desired fret position. Highly scientific. \$100 value in shortcuts. \$3.00. Pierce Guitar Methods, 215-201 Atlantic, Long Beach, California 90802.

30% DISCOUNT Name Brand Musical Instruments. Free Catalog. Freeport Music, 127 F. Sunrise Highway, Freeport, New York 11520.

SONGPOEMS Urgently Needed, Possible Recording/Publishing, 50-50 Agreement, Betty's Music Makers, 945B Central, St. Petersburg, Florida 33705.

## TRAVEL TRAINING

**TRAVEL AGENTS.** Make \$\$\$\$\$. Exciting. Booming Careers! Easy Home-Study Plan. Approved for Veterans. Free! "Travel Career Kit" Write—North American School of Travel-AZS, Newport, California 92663.

## MOTEL HOTEL MANAGEMENT TRAINING

**MOTEL MANAGER TRAINING**—Men, women, couples wanted by leading resorts, motels-hotels everywhere. Enjoy free rent, plenty of free time. Easy home-study plan. Free! "Motel Career Kit." No salesman will call. North American School of Motel-Hotel Management, AZS, Newport, California 92663.

## ACCOUNTING TRAINING

**ACCOUNTING PAYS BIG!** Easy home-study plan prepares you for thousands high pay prestige positions open now to trained Accountants. Or open your own profitable full, part time Accounting practice. Send for "ACCOUNTING CAREER KIT"—ALL FREE! North American School of Accounting, AZ, Newport Beach, California 92663.

## EDUCATION AND INSTRUCTION

**COMPLETE YOUR HIGH SCHOOL** At home in spare time. Texts furnished. No classes. Diploma. Approved for Veteran Training. Founded 1897. Free Brochure. American School, Dept. XB45, Drexel at 58th, Chicago, Illinois 60637.

**WATCH REPAIRING.** Learn to repair American and Swiss watches in spare time at home. Diploma awarded. Free sample lesson. No obligation. Chicago School, Dept. YT, Fox River Grove, Illinois 60021.

**COLLEGE Degrees** thru extension. State Chartered, Prospectus Free, Box 688, Palm Beach, Florida 33480.

**COMPUTER Secrets!** high earnings, how to start with no experience, stamped envelope: Compulace, 429-PY Windsor Way NE, Renton, Wash. 98055.

**LIFETIME ORDINATIONS.** Send stamp for information. Church, 2207 Cardinal, Rolling Meadows, Ill. 60008.

**GET A British Degree.** Divinity. Philosophy, Radionics. 35 Courses. Prospectus free. Brantridge Forest School, Highfield, Dane Hill, Sussex, England.

**LEARN TO WELD**—Arc, Pipe, Oxyacetylene, TIG, MIG, Plasma Arc. World's Outstanding (non-profit) Welding School. Free school booklet. Write, phone or visit. Approved Ohio No. 70-12-0064-HT HOBART SCHOOL OF WELDING TECHNOLOGY, BOX 71, TROY, OHIO 45373.

**MISSOURI Auction School.** Veteran Approved. Free catalog. 1600-03 Genesee, Kansas City, Mo. 64102.

**LEARN Auctioneering.** Term soon. Free catalog. Reisch Auction College, Box 850, Mason City, Iowa 50401.

**EARN \$125 A week** and up. Learn a trade with a future. Learn auto diesel mechanics in our shops. You learn with tools on real equipment. Earn while you learn. Many of our graduates earn \$125 a week and up. Write for free bulletin: Dept. 256, Auto Diesel College, Nashville, Tennessee 37219.

**PIANO Tuning** quickly learned with home study course. Diploma granted. American Tuning School, Gilroy, Calif. 95020.

**HIGHLY EFFECTIVE** Home study courses in Electronics Engineering Technology and Electronics Engineering Mathematics. Earn your Degree. Write for Free Descriptive Literature. Cook's Institute of Electronics Engineering, (Dept. 10), P.O. Box 10634, Jackson, Miss. 39209. (Established 1945).

**DETECTIVE Course.** Free Information. Universal Detectives, Box 8180-F, Universal City, California 91608.

**HIGH SCHOOL Diploma** at home. Licensed teachers. Send age, highest grade completed for free details. No salesman will call. Southern States Academy, 5300 W. Belfort, Dept. 16-07, Houston, Texas 77035.

**OWN Collection agency.** "Little Gold Mine!" Franklin Credit, Roanoke, Virginia 24004.

**USED CORRESPONDENCE Courses** and Books sold and rented. Money back guarantee. Catalog free. (Courses bought.) Lee Mountain, Pisgah, Alabama 35765.

**AUCTIONEERING.** Resident or Home Study Course. Free Catalog. Nashville Auction School, 2004 West End, Nashville, Tennessee 37203.

**AUTOSUGGESTION.** Sleep-learning headquarters! Tapes, records, books. Gigantic catalog free. Research Association, Box 24PM, Olympia, Washington.

**SERVE God.** Lifetime Ordination. Free D.D. Dept. 25, Box 333, Rillton, Pa. 15678.

**USED Courses! Books! List 10c.** Smith's, 124 Marlborough, Salem, Massachusetts 01970.

**LEARN To Fix Typewriters.** Desperate shortage trained men. Hundreds needed. Make up to \$25 in one hour. Learn at home in spare time. Industry Approved course. Facts free. Send name. Typewriter Repair School, Dept. 3310-071, Little Falls, New Jersey 07424.

**UNLOCK Your Future.** Become professional Locksmith by spare time homestudy. Make up to \$6 per hour. All tools, equipment incl. Facts Free. Send name. Locksmithing Inst., Dept. 1310-071, Little Falls, New Jersey 07424.

**SLIDE RULE.** Complete basic training \$9.95. Box 1721, Cedar Rapids, Iowa 52406.

**GRAPHOANALYSIS**—Learn scientific handwriting analysis for profit, pleasure. Free sample lesson, catalog, reveals plan. Write: Igas Inc., 325 Jackson, Dept. 2E2-2, Chicago 60606.

**LEARN Real Estate At Home.** Get your license. Become a Salesman or Broker. Approved for Veterans. Write National Institute Of Real Estate, Inc., 3330-M Peachtree Rd., Atlanta, Georgia 30326.

**EARN University Degrees** through Experience—Many Subjects—Details \$1.00—St. Matthew University, 1261 East Main St., Columbus, Ohio 43205.

**MARRIAGE** is for happiness. Free lessons. Home Bible Studies, Box 370-PM, Elkhart, Ind. 46514.

**"WATCHMAKING"**—Approved Correspondence Courses. Watchmaking Institute, 5816-A Lankershim, North Hollywood, California 91601.

**REPAIR MINIBIKES, LAWNMOWERS, BICYCLES, Sewing Machines, Auto Engines.** Build concrete, Plywood, boats, trailers. Ten additional How-To-Do books. Free brochure. Sincere, Box 10422, Phoenix, Arizona 85016.

**WHAT'S YOUR I.Q.??** self-scoring test reveals I.Q. in minutes. 99.9% accurate. Send \$2.00 or 3 for \$5.00 guaranteed. Roberts LTD. (P7) 44-16th Street, Hermosa Beach, Calif. 90254.

**PIANO Technology**—Electronic organ servicing, learned easily at home. G.I. Approved. Free booklet. Niles Bryant School, Dept. P, 3631 Stockton, Sacramento, California 95820.

**LEARN Asleep or awake!** Records, tapes, equipment! Free catalog! Drawer PM-400, Ruidoso, New Mexico 88345.

**ASA'S DIESEL DRIVER TRAINING.** 1006 W. Adams, Phoenix, Arizona 85007. Over-the-road training; Approved for Veterans; Home study & Resident training programs.

**PERFECT Husband-wife business.** Learn Upholstery at home. Make \$10 in an hour. Buy-repair-sell for even bigger profits. Kits, tools included. Free Booklet. Upholstery & Decorating School, Dept. 5310-071, Little Falls, New Jersey 07424.

**NEED College Degree?** Adults over 26 may now earn accredited degrees through home study. For information send \$2 to University Press, P.O. Box 1847, Daytona Beach, Florida 32015.

**LEARN AirConditioning Refrigeration Plumbing Electrical Mechanics Or Engineering.** Correspondence Tutoring Licensed Teachers. Ribc, 1202 58th, Brooklyn, New York 11219.

**HIGH SCHOOL DIPLOMA** Earned by examination only. Send Stamped, self-addressed envelope for information, application. Bedford Academy, Box 221, Bedford, Virginia 24523.

**COLLEGE Degree** at Home. Law, other subjects. Easy tuition. Williams College, Riverview, Arizona 85334.

**EARN College degrees** at home. Many Subjects. FLORIDA STATE CHRISTIAN COLLEGE, Post Office Box 1674, Fort Lauderdale, Florida 33302.

**PROFITABLE Camera service training** at home. National Camera, Dept. PM, Englewood, Colo. 80110.

## FOR INVENTORS

**INVENTORS**—Do you want to sell or license your invention on cash or royalty basis. Write Kessler Corporation, C-57-F1, Fremont, Ohio 43420.

**PATENT Application Financing.** Free patent search plan. Global Patent Division. 2420 77th, Oakland, Calif. 94605.

**U.S. PATENT Office Searches,** 234 Broadway, Room 3615, New York. Free invention certificates.

**PATENT SEARCHES** including maximum speed, full airmail report and closest patent copies. \$6.00. Quality searches expertly administered with complete secrecy guaranteed. Free Invention Protection forms and "Patent Information." Write Washington Patent Office Search Bureau, Dept. 15, 711 14th St., N.W. Washington, D.C. 20005.

**PATENT And invention development** by licensed professional patent engineer and U.S. Patent Office former examiner, and engineering specialists. Your inventions and ideas engineered for patent protection and commercial value. Inventions developed by us negotiated for cash or royalties with our nationwide contacts. Send for free protection "Invention Certificates" and further interesting, valuable patent information. George Spector, Licensed Professional Patent Engineer, Woolworth Building, New York 10007.

**FREE PAMPHLET:** "Ties on Safeguarding Your Invention." Write: United States Inventors Service Company, 501P Thirteenth Street N.W., Washington, D.C. 20004.

**INVENTORS:** Your ideas and inventions (patented: unpatented) expertly searched, developed for commercial appeal and cash/royalty sales to manufacturers by professional Invention Developer with excellent record of experience. B.S. Industrial Engineering; United States Patent Office former Patent Examiner. United States Government former Patent Advisor. Second decade reliable service! Member: United States Council International Chamber Commerce. Free "Invention Record" and "Recommended Protection Procedure." Airmailed! Write: Raymond Lee, Invention Developer, 230P-Park Ave., New York, New York 10017.

(Continued on next page)



## FOR INVENTORS

(Continued from preceding page)

**IMMEDIATE Cash**, for patent applications. Free patent searches. Write for details. Universal Patents, 184-D, Marion, Ohio 45750.

**MANUFACTURERS NEED New Products!** FREE Literature explains "How to Submit Your Invention." Congress Invention Company, 911-C Warner Building, Washington, D.C. 20004.

**INVENTORS:** We will develop, sell your idea invention—cash or royalty basis. Ideas held in strict confidence. Prompt acceptance or returned within 10 days. Idiquet, Inc., 7324 Monticello, Skokie, Illinois 60076.

**SHOW And sell** at Engineering Center Inventions Conference, 3100 Chester, Cleveland, Ohio 44114. Details 25¢.

**INVENTORS—Now** you can protect your ideas by filing the U.S. Patent Disclosure Document. Send \$2.00 for disclosure forms and free disclosure brochure. You file direct. Instructions included. Write **INVENTORS FORMS**, P.O. Box 1625, Riverside, Calif. 92502.

**INVENTIONS Promoted.** No-Risk Percentage Basis. Detail. INSECO, Box 200, Monroe, Ohio 45050.

## INVENTIONS WANTED

**IF Your Invention** is adaptable to promoting we will contract for selling on cash or royalty. Free booklet outlines royalty rates, requirements. Kessler Corporation, C-57-1W, Fremont, Ohio 43420.

**INVENTORS!** We will develop, sell your idea or invention. Our national manufacturer-clients are urgently seeking new items for highest outright cash sale or royalties. Financial assistance available. 15 years proven performance. For free information write: Dept. 47, Wall Street Invention Brokerage, 79 Wall Street, New York, N.Y. 10005.

**INVENTIONS Wanted.** Patented: unpatented. Tremendous manufacturers lists. Global Marketing Service, 2420G 77th, Oakland, California 94605.

**INVENTORS!** Sell your invention for cash or royalties! Our client manufacturers eagerly seek new items. Patented. Unpatented. Financial assistance if needed. 25 years proven performance. For free information, write Dept. 15, Gilbert Adams, Invention Broker, 81 Wall St., New York, N.Y. 10005.

**WE Either** sell your invention or pay cash bonus. Write for details. Universal Inventions, 28-E, Marion, Ohio 45750.

**INVENTORS!** Don't sell your invention, patented or unpatented until you receive our offer. Eagle Development Company, Dept. H, 83 Wall Street, New York, New York 10005.

**INVENTORS!** Protect your ideas! Free "Recommended Procedures." Washington Inventors Service, 422F Washington Building, District of Columbia 20005.

**FREE "Directory of 500 Corporations Seeking new Products."** For information regarding development, sale, licensing of your patented/unpatented inventions. Write: Raymond Lee Organization, 230-N Park Avenue, New York, New York 10017.

**HAVE Manufacturers Interested** in Games, Puzzles, Toys, Fun Things. Details, Hall's, 5153 West 58th Place, Los Angeles 90056.

**SUCCESSFUL FELLOW INVENTOR** With established production sources and sales representation may get your ideas developed, produced, marketed quicker. References exchanged. Write U. U. Andi, P.O. Box 38567, Dallas, Texas 75238.

## PATENTS FOR SALE

**"IDEAL Game Score,** it's dialed your luck into Roulette or Dice. Adaptable to any systems. Selling my copyright." John Dumitrius, 166 Pierre Avenue, Windsor, Ont. Canada.

## MANUFACTURING

**MAILORDER Records** help get increased business! Complete 32 Page Record Book shows your inquiries orders, advertising, expense, etc. Only \$1.00. C. A. Martin, Popular Mechanics, Dept. PM, 224 West 57 Street, New York, N.Y. 10019.

**SELL Your Invention-Ideas \$1.00** For Details Where. Woods Engineering, Box 74453, Los Angeles, California 90004.

## BUYING AND SELLING

**PROFITS FROM CLASSIFIED ADVERTISING!** Booklet shows you how to start your own business with Classified Advertising. Only \$1.00 (Refundable with first order.) C. A. Martin, Popular Mechanics, Dept. PM, 224 West 57 Street, New York, N.Y. 10019.

## BUY IT WHOLESALE

**AUTOMATIC Fishhooks.** 2 models. Samples \$2.00. Aron, 61-PM, Mastic Beach, New York 11951.

**WHOLESALE—Buy 40% To 50% Off Retail—same prices** retailers pay! Thousands of name brands! Watches, cameras, jewelry, radios, phonographs, tape recorders, etc. Buy for yourself or resell at fat profit. Big wholesale catalog. Confidential Wholesale Price List. Free details. Wholesale Merchandise Club of America. Dept. 414, 154 Jericho Turnpike, Floral Park, N.Y. 11001.

**AUTOMATIC Fishhooks.** 400% Profits. Free Details. 2 Models. Samples \$2.00. Aron, 61-PM Mastic Beach, New York 11951.

**HEARING Aids, Batteries, Wholesale.** Catalog 25¢. Fiston, Box 1444, New Preston, Conn. 06777.

**WORLD'S Largest** wholesale dropship sources. U.S., foreign. Factory suppliers dropship direct to you or customers. Now!, have your own catalog for pennies. Free details. International Buyers, Box 16386-M, Portland, Oregon 97233.

**BARGAINS!** Buy wholesale and below. Name brands. Appliances, furniture, sports equipment, televisions, cameras, watches, jewelry, thousands more. Huge discounts to \$1,000.00 on new automobiles. All makes. Free details. Write today: Worldwide Bargainhunters, Box 730-A, Holland, Michigan 49423.

**1970 FORDS, DODGES, \$799;** 1969 cars only \$599. For free catalog. Associated Dealers, 50 Swalm, Dept. 6, Westbury, N.Y. 11590.

**DRAFTING Equipment, Templates, Slide Rules.** Catalog—50¢. Amtech, Box M-122, Mt. Holly, N.J. 08060.

**PINUP Keychains, etc.** 80 different. For resale only. Free catalog. Empire, 1916 Fifth, Sacramento, California 95814.

**GIANT NEW WHOLESALE CATALOG FREE** Over 1000 items. Send \$2.00 refundable first order. K/C Industries, 911 Farnam St., Los Angeles, Cal. 90042.

**800,000 PRODUCTS Wholesale!** Tremendous Assortment: Closeouts, Imports, Manufacturer's Clearance, Surplus, Liquidations, Dropship Merchandise. Save 75%. Free details. Wholesalers, 1265-MR Broadway, New York, N.Y. 10001.

**LIVE Catch Traps.** Free Literature. National Live Trap Corp. Tomahawk, Wis. 54487.

## EXPORT-IMPORT

**JAPAN: 1200 Products Directory.** Illustrated Manufacturers' names, addresses. \$3.00. Send cash. Yamagata Office, 814 Togin Bldg., Marunouchi, Tokyo.

**IMPORTERS BUYING GUIDE.** Sources of 200,000 sensational low-cost imports! Tells where to get FREE import samples. Thousands of EXOTIC, rare, and unusual items. Send \$3.00 Roth Enterprises—P.O. Box 3374, Midway, Washington 98031.

## FOR THE HOME

**MILDEW, Mold, Musty Odors, Gone Forever.** Inquire. DAMPP-CHASER Blue Ridge Distr., East Flat Rock, North Carolina 28726.

**COCKROACHES** Your problem? Use Sure Kill, Guaranteed 5 years against reinfestation, \$2.98 Postpaid. Haynes, Box 559A, Minoa, N.Y. 13116.

**KILL Roaches, Ants, Termites.** Professional Exterminators Kit \$19.95. Exterminators, P. O. Box 391, Tualatin, Oregon 97062.

## DEODORANT—COSMETICS

**ONE DROP—All-Purpose Household deodorant,** ½ ounce (240 drops) \$2.00 or 2 ounces \$5.00. Satisfaction Guaranteed, PPD. ARCO, Box 377, Hope, Idaho 83836.

## OF INTEREST TO WOMEN

**LEG Sore sufferers—send** for free book on proven Viscose for relief of pain and aches of leg ulcers, swelling, itch, rash, due to deep vein congestion. Works as you walk. Viscose Co., 100-PM West Chicago Avenue, Chicago, Illinois 60610.

**\$500.00 MONTHLY POSSIBLE!** Selling your favorite recipe. Detailed proof free. Send self-addressed, stamped envelope. Brewster, Box 1348-CE, Clearwater, Florida 33517.

**LEARN Expert** cake decorating, catering, candymaking. Free details on home instruction. Candy & Cake, Dept. BHE, 1600 Cabrillo, Torrance, Calif. 90501.

**\$10-\$15 DOZEN Possible** sewing Aprons, Lacing Billfolds. Redikut's-40, Richland Center, Wisconsin.

**HOMEWORK OPPORTUNITIES!!** Addressers, Mailers needed at all times. Rush stamped self-addressed envelope and 25¢ handling and postage. Livingston, Box 545M, Black Mountain, North Carolina 28711.

**HOMEWORKERS** Wanted to stuff envelopes. Send self-addressed stamped envelope. Tayco, Box 8010-IMP, Stockton, California 95204.

**\$100 WEEKLY POSSIBLE** Addressing mailing, sparetime. Free details. Send self addressed stamped envelope. Newby Publications, Box 20427-PM, San Antonio, Texas 78220.

**\$46.00 DAILY possible** addressing-stuffing envelopes (typewriter or longhand) information. Send stamped, addressed envelope. American, Excelsior Springs, Mo. 64024.

**\$500 MONTHLY Possible—clipping news** at home. No experience—send stamped-addressed envelope. American, Excelsior Springs, Mo., 64024.

**HOW To make money** writing short paragraphs. Information free. Barrett, Dept. C-27-X3 6216 N. Clark, Chicago 60626.

**GUARANTEED, \$20.00 EVERY 80 ENVELOPES** you stuff. No postage, addressing required. Information, send 30¢ with stamped, self-addressed envelope. Econ, "CX" 629 Franklin St., Clearwater, Florida 33517.

**FACTORY Recondition** your SYNTHETIC wig at home. Kit includes proper conditioning shampoo plus setting and curling concentrate. Complete instructions included. Mail \$3.00, cash or money order to: SYN-WIG Labs. P.O. Box 20-3011 Station A, Concord, Calif. 94520.

**GIRLS—MAKE BIG MONEY** As a WAITRESS. For details write: Goldstreet, Box 17005B, Wichita 67217.

**25¢ EACH, STUFFING Envelopes.** No postage required. No addressing necessary. Complete instructions \$1.00. Economy 629-BT, Franklin, Clearwater, Florida 33517.

**FREE Gift Catalog,** details on Free Gifts. Write: Felice, 359A Upper Blvd., Ridgewood, New Jersey 07450.

(Continued on next page)



## OF INTEREST TO WOMEN

(Continued from preceding page)

\$25.00 PER Hundred addressing, mailing, possible. Work from your home, any hours you choose. Sample and Instructions 25¢ and stamped self-addressed envelope. Stark, 210PM Lincoln Hill, Pomeroy, Ohio 45769.

HOMEWORKERS NEEDED Painting Novelties. Good Earnings. Details 10¢. Roland, 10-V Lakeview, Hammonton, New Jersey 08037.

HOMEWORKERS! \$100.00 Weekly addressing for firms. Begin immediately. Details—send stamped, addressed envelope. Hamilton, 272-TM-7, Brooklyn 11235.

\$150.00 WEEKLY Possible! Homeworkers needed urgently! Send stamped, self-addressed envelope. Schoen, Box 1963-P, Chicago, Illinois 60690.

\$200.00 WEEKLY!! Sparetime. Growing Beansprouts at home. Details: Tso, Box 288 A7, Gladstone, Oregon 97027.

HOME Newspaper clippers needed. \$500 monthly possible. Details free. Foster, 272-MA-7, Brooklyn 11235.

### GIFT SHOPPING

FANTASTIC NEW CATALOG And amazing circulars of gifts and novelties. Send 25¢. J & L Sales 1761 Lacombe Ave., Bronx, New York 10472.

CATALOG Of distinctive gift items. Send \$1.00 (refundable first order) R.K. Lawler, 5101 River Road #315, Chevy Chase, Maryland, 20016.

EXCITING Silk Gifts, Fabrics. Information \$1.00. LaVonne's, Box 74P, Barstow, California 92311.

FREE Send for your catalog of Distinctive Gifts. Thornton Stevens, 42 Harris St., No. Amherst, Mass. 01059.

NEW Gift Catalog 25¢. Blake Enterprises 1M07, Box 1172, Hollywood California 90028.

HANDCRAFTED PEACE SYMBOL Key-chain. Beautiful Brushed finish. \$2.00 POSTPAID. Satisfaction guaranteed. Maryann, 21830 Schroeder, East Detroit, Michigan 48021.

FREE Fabulous Gift catalog. Paras Distributors, 8 Gude Street, Seekonk, Massachusetts 02771.

CHRISTMAS SHOP BY MAIL NOW. Free Catalog, Nolan Enterprises, 10280 Vicksburg, Cupertino, Calif. 95014.

### WATCHES, OLD GOLD, JEWELRY

HIGHEST CASH for Gold, Jewelry, Gold Teeth, Rings, Diamonds, Watches, Silver, Platinum, Mail Articles Today. Free gift with Information. Chicago Gold & Precious Metals, 6 E. Monroe, Dept. 1158, Chicago 60603.

CASH Immediately for old gold, jewelry, gold teeth, watches, diamonds, silverware, spectacles, platinum, mercury. Free information, Rose Industries, 29-A East Madison, Chicago 60602.

WATCH And clock repairing books. Free catalog. North American, Box 77-AG, Fox River Grove, Illinois 60021.

COMPLETE Watchmakers'-Jewelers' Catalog \$1.00. Bengal's, 5816-A, Lankershim, North Hollywood, California 91601.

### WEARING APPAREL

MAILORDER Records help get increased business! Complete 32 Page Record Book shows your inquiries orders, advertising, expense, etc. Only \$1.00. C. A. Martin, Popular Mechanics, Dept. PM, 224 West 57 Street, New York, N.Y. 10019.

### HEARING AIDS

HEARING Aids, Batteries. Discount prices. Free Home Trial. Write: Rhodes, Box 518-PM, Paducah, Ky. 42001.



## SCIENCE AND CHEMISTRY

CHEMISTRY, Biology, Astrology Catalog 35¢. Boulevard Laboratories, 3114 East 83rd Street, Chicago, Illinois 60617.

CHEMICALS And apparatus for industrial, analytical, and private laboratories. Catalog 50¢. Dept. M-50. Biological Supply Co., 1176 Mt. Hope Ave., Rochester, N.Y. 14620.

CATALOGUE Of those ver-ry hard-to-find chemical products, plus things that go boom, unusual formulas, multi-stage rockets,—loads more! 50¢ (Price refundable, first order) Kenrus-C, Box 158M, Staten Island, New York 10309.

CHEMICALS Apparatus, Biology and Model Rockets. Both Catalogs for 50¢. Sheard Science, Dept. PM, Columbus, Wisconsin 53925.

SEARCHING For Economically Priced Laboratory Supplies? Conversion Charts And Catalogue—35¢. Hagenow Laboratories; Manitowoc, Wisconsin 54220.

### FORMULAS, PLANS, ETC.

SEVENTY-FIVE One and two Ingredient Marketable Formulas, Complete Instructions. Satisfaction Guaranteed. \$1.00. Camfields'-A, Box 1746, Indianapolis, Indiana 46206.

ANY FORMULA—\$5.00. Catalog—Manufacturing Treatise 25¢. Belfort, 192 N. Clark, Chicago 60601.

### PLASTICS

LAMINATING in plastic for permanent use. Specialists in photos, artwork. Free price list. Jacquet Laminations, 25 E. Palatine Road, Arlington Heights, Illinois 60004.

CASTOLITE Pours like water, hardens like glass without heat. Embed natural flowers, photos, coins. Many other money-making projects. Manual 25¢. CASTOLITE, 71/101H, Woodstock, Ill. 60098.

PLASTIC, DECORATIVE, Mother-of-Pearl Chips Wholesale. Use for plastic embeddings. Use in making beautiful table tops, wall paneling, Decorative Novelties. Send .25 cents for Price List. Apco, P.O. Box 282, Metropolis, Illinois 62960.

LARGEST Plastic Handicrafts Supply catalogue \$1.00 (refundable). R.P.H. Mfg., 24-M Winter, Stamford, Connecticut 06905.

PLEXIGLAS Plastic supplies, tools catalogue 25¢ refundable. COSAS, Box 5768, San Francisco 94101.

### TREASURE FINDERS

"FREE: Jetco electronics Free 24 Page Treasure Finder Catalog. Find Metals, Minerals, Gold, Silver, Coins And Relics. Jetco—Box 132PM—Huntsville, Texas 77340."

PROSPECT For Uranium in Canada \$4.25 Eastview Book Service, Box 7053, Ottawa, Canada K1L 5A0.

FREE 128 Page detector catalog. General Electronic Detection Co., Box 67, Bellflower, California 90706.

"FIND Buried treasure with revolutionary patented, analytical metal detector. Features push button and automatic tuning, negligible ground pickup, greatest range. Free catalogue. Gardiner Electronics, Dept. 9, 4729 N. 7th Avenue, Phoenix, Arizona 85013."

POWERFUL Metrotech locator detect gold, silver, coins, relics. Moneyback guarantee, terms. Free information. Underground Explorations, Dept. A, Box 793, Menlo Park, California 94025.

TREASURE Hunters! Prospectors! Relco's new instruments detect buried gold, silver, coins, minerals, historical relics. Transistorized. Weighs 3 pounds. \$19.95 up. Free catalog. Relco-A40, Box 10839, Houston, Texas 77018.

FISHER DETECTORS Has something new! Free literature. Fisher Research, Dept. PM-7, Palo Alto, Calif. 94303.

GOLDAK Treasure locators—Pleasure and profit in a hobby you'll enjoy. Find coins, relics, gold, silver. Charge on BankAmericard. GOLDAK, Dept. PM 1101-A, Air Way, Glendale, California 91201.

TREASURE BOOKLET. Excellent information on treasure hunting and metal detectors. Send 25¢. BOOKLET, Dept. PM-7, Box 243, San Gabriel, California 91778.

SEARCH Treasure Finders. Locate gold, silver, coins, relics. Operate underwater. Money back guarantee. Free information. Search Electronics, Box 8396-A, St. Petersburg, Florida 33738.

TREASURE LOCATORS MOST COMPLETE LINE. FREE INFORMATION. TESOROS, APARTADO 7-948, MEXICO 7, MEXICO.

### PRECIOUS STONES AND MINERALS

500 POLISHED Gemstones \$5.00. Tumblecraft, 5401 James North, Minneapolis, Minn. 55430.

EARTH Science Rockhound Magazine. Subscription \$3.00. Sample \$.40. Box-550-PM, Downers Grove, Ill. 60515.

500 BEAUTIFUL POLISHED GEMSTONES \$1.50. Floodstones, P.O. 1673, Fremont, California 94538.

GET Free catalog no serious rockhound, gem cutter, jewelry maker, hobbyist or craftsman can be without. Full of bargains, exclusive items, low prices from largest suppliers and authorities in the field. Free new catalog just off the press, yours for the asking. Write Grieger's, Dept. C-12, 1633 E. Walnut, Pasadena, California 91106.

NEW! Learn mineralogy the new and easy way. Receive a different identified mineral or rock each month. Each member receive a 160 page Mineral and Rock Book with 400 colored illustrations! Send only \$4.00 for 3 months, or \$6.00 for 6 months, or \$10.00 for 12 months. Satisfaction guaranteed or money refunded on unused balance! FREE: Ruby Crystal to each new member! Send cash or check today to: MINERAL OF THE MONTH CLUB, Box 487-K, Yucaipa, California 92399.

DIAMOND Crystals—choice African octahedrons. 1/16 carat—\$1.00, 1/8—\$2.00, 1/4—\$3.50. Naturalist Supplies, Box 358Q, Apalachin, New York 13732.

### CARTOONING, COMMERCIAL ARTS, SHOWCARD & SIGN PAINTING

"HOW TO MAKE MONEY WITH SIMPLE CARTOONS"—Everyone who likes to draw should have this book: FREE. Write Cartoonists' Exchange, 97, Pleasant Hill, Ohio 45359.

LEARN Cartooning at home. V. A. Approved. Write: Cartooning, Box 31760, Colorado Springs, Colorado 80907.

COMPACT 23 lesson Cartoon Course and Cartoonist's Magazine. \$2.00. Hartman, Box 30367, Lincoln, Nebraska 68510.

MODERN Cartooning taught by mail. Write for free brochure. Cartoonrama—Box 263-6D, Branford, Conn. 06405.

SIGN Painting—\$1000 per Month Part-Time. Free Catalogue. Kaufmann Supply, Centertown, Missouri 65023.

CARTOON For Money!! Big Free Book: Success, Box 885-C, Dearborn, Mich. 48121.

\$200.00 MONTHLY Sparetime possible making signs, posters, silkscreen printing. Learn quickly—easy instructions. Information free! Hampton 115PM, Box 112, New York, N.Y. 10012.

LEARN Sign painting at home. Free Talent test. Ben Kerns, Box 812-PM, Greenville, S.C. 29601.

ART TALENT? Get into Commercial Art! Free Brochure. American Studios, Dept. P, Box 1000, Excelsior, Minn. 55331.

(Continued on next page)



## ADVERTISING AGENCIES, ADV. SERVICE, MAILING LISTS

MAILING Lists, 1000/\$9.00. 1000 Circulars mailed \$7.00. Advertising placed Magazines where will click, Dixmail, King, North Carolina 27021.

ADVERTISING Ratebook leading newspapers, magazines, 25¢. Chicago Advertising Agency, 28-E Jackson, Chicago 60604.

## TYPEWRITERS, DUPLICATORS, OFFICE EQUIPMENT

FREE Plan. Start printing, lettershop, Offset Presses, Mimeograph Copy machines. DixieGraph, King, N. Car. 27021.

## RUBBER STAMPS

ADDRESS Stamp 85¢. Signature \$2.80. Catalog, Carol's, McLoud, Okla. 74851.

FREE 48 Page Catalog. Rubber stamps, printing, office supplies. Youngers Stamp Shop, Princeton, Iowa 52768.

FREE Stamp catalog. 45 type styles. Fast service, low prices. Jackson's, Box 443A, Franklin Park, Illinois 60131.

PROFESSIONAL, Industrial, Commercial. Business: Craig Stamps, Box 511, Mt. Vernon, Ill. 62864. SAMPLE \$2.00.

POCKET Stamp, Self Inking \$1.00. Colored Inks, Handle Stamp \$1.50. Martinhouse, 2052C East 24, Brooklyn 11229.

## OFFICE SUPPLIES

PROFITS FROM CLASSIFIED ADVERTISING! Booklet shows you how to start your own business with Classified Advertising. Only \$1.00 (Refundable with first order.) C. A. Martin, Popular Mechanics, Dept. PM, 224 West 57 Street, New York, N.Y. 10019.

## PRINTING PRESSES, RUBBER STAMP OUTFITS

RUBBER Stamp manufacturers supplies. Press, starting outfits. Best prices, service. Catalog. Jackson Supply, Box 443A, Franklin Park, Illinois 60131.

SIMPLE-X RUBBER STAMP PRESSES. Hydraulic operated, electrically heated. Sizes 5"x8", 8"x12", 10"x15". Starting outfits Orders for presses, supplies shipped day received. Free catalog low supply prices. Send \$1.00 for postage and handling (refundable on first order). Custom Manufacturers, 406-P East Elm, Springfield, Missouri 65801.

RUBBER Stamp outfits, supplies. Kiewiet, 2025 Barney Road, Kalamazoo, Michigan 49007.

LOW Priced Rubber Stamp Manufacturing Supplies, Starting Outfits. Martin, 1432 Major, Jefferson City, Missouri 65101.

PRINTING Presses, type, supplies, Lists, 10¢. Turnbaugh Service, Mechanicsburg, Pennsylvania 17055.

MAKE Your Own self-molding rubber stamps and printing cuts. Plexirubber, Argyle (-1-) Wisconsin.

TYPE Catalog No. 12, 120 pages. Send One Dollar. Deductible First Order. Acme Type, 732 Federal, Chicago, Illinois 60605.

LEARN Sign painting—low cost books. Free information. Sign Book Company—PMF, 470 Oak Street, St. Louis, Missouri 63119.

## PRINTING AND SUPPLIES

AMAZING Business printing values. Quotations. Print Shop, Box 576, Greenville, R.I. 02828.

FREE Literature. Address Labels. Business Cards. Printing. Rubber Stamps: Jordan's, 52 West O'Connor, Lima, Ohio 45801.

BUSINESS CARDS Raised Letters \$5.65 Thousand. Like Engraved. Free Samples. Kavanagh, Box 1222, Brooklyn, N.Y. 11202.

ECONOMICAL Business Forms, Stationery, Labels, cards, Samples. Burnfin, Weaubleau, Missouri 65774.

BEST Printing buys—find out why—samples. Hahn, 2621 Ida Avenue, Cincinnati, Ohio 45212.

LOWEST Prices practical! Try Haldeman Printing, Girard, Kansas 66743.

8 HOUR PRINTING—Free Booklet "Secrets Of Cutting Printing Cost." Nationwide Printing, 614 North Main, Bloomington, Illinois 61701.

## GUMMED LABELS

1,000 GUMMED Address Labels \$1.00. Wait's, Box 966A, South Bend, Indiana 46624.

1000 GOLD Stripe Labels \$1.00. Free Gift Catalog. BORGOS, Box 1483 FDR Station, New York, N.Y. 10022.

1,000 DELUXE Labels. Any name, address, and zip code. \$1.00. Vera-Lynn, 1630 Noriega Street, San Francisco, Cal. 94122.

## REMAILING SERVICE

WASHINGTON D.C.—Nations Capital—Remails 30¢. D'Ambrosio, Box 14217, Washington 20044.

HALIFAX Canada Remails 25¢. Riverside, Box 182, Bedford, Nova Scotia, Canada.

REMAILING And Forwarding . . . Very personal. Monthly rates or 35¢ a letter. Kaye Sales, Box 674-M, Chicago, Ill. 60690.

HOLLYWOOD, Remails 25¢. Monthly \$3.00. Dannick #7, 1725 N. Gower Street, Hollywood, California 90028.

MIAMI Remails 25¢. Monthly rates. Marle, Box 1266, Coral Gables, Fla. 33134.

CONFIDENTIAL New York City mail address \$3.00 month. Remails 25¢. Details Free. Birnhan, 152 W. 42, New York City 10036.

SECRET. Receiving—forwarding. Discreet and confidential. Remail 25¢ single. Mail Forwarding Service, 8050 S. Main, Houston, Texas 77025.

RECEIVING—Forwarding. Monthly Rates. Hedgpeh, 406-M South Second, Alhambra, Calif. 91802.

ONEIDA Remails 25¢ Each. Confidential-Dependable. Box 506, Oneida, Tennessee 37841.

MIAMI BEACH Remails 25¢ Special Services, Reeves, Box 67, Miami Beach, Florida 33139.

SAN FRANCISCO Remails 25¢. \$3.00 Monthly. Scotts, Box 5446-P, Redwood City, California 94063.

CHICAGO Remails. 25¢. \$3.00 Monthly. Kneller, Box 1080, Chicago, Illinois 60690.

SACRAMENTO 25¢ Free Details. Burres, 2029 Robert Way, Sacramento, Calif. 95825.

SAINT LOUIS remails 25¢. Confidential, Reliable, Hampshire, Drawer 14443, Saint Louis, Missouri 63178.

CALIFORNIA Mailing Service. (Licensed) Confidential Remailing-forwarding. Singles 25¢. Rates. Box 883, Whittier, California 90608.

HAWAII Remails 25¢. \$3.00 Monthly Traders Co., Box 194-M7, Honolulu, Hawaii 96810.

REMAILS 25¢. Monthly \$3.00. Filtamco, Box 1281, Lowell, Massachusetts 01853.

THAILAND. Re-airmails, Singles \$1.50. C. Newell, Air Am, Box 133, Udorn, Thailand.

## REPAIRS AND SERVICING

MAILORDER Records help get increased business! Complete 32 Page Record Book shows your inquiries orders, advertising, expense, etc. Only \$1.00. C. A. Martin, Popular Mechanics, Dept. PM, 224 West 57 Street, New York, N.Y. 10019.

## SPECIAL SERVICES

INFORMATION-We Usually Obtain Factory Wholesale Prices On General Merchandise. Product Research, 152 West 42nd Street, Suite 536, New York, New York 10036.

INFORMATION On anything. Ferguson Research Specialists, 83-45 Vietor Ave., Elmhurst, N.Y. 11373.

KEEP Your copies of PM—and watch for the inexpensive Annual Index, available in December. It will enable you to locate any article which appeared in 1971 or find information on any particular subject in just a few seconds. The Annual Index will make your copies of PM even more valuable!

HOBBY CLUBS! Advertise your club FREE in our catalog. All welcome from Boating to Antique Collecting to Psychic research. Write: Innovation House, Popular Hobbies, Box 12146, San Francisco, California 94112.

CANADIAN Information or service on anything. Purchasing Services, 388 Duffield, Winnipeg, Canada.

## PERSONAL

PAY Bills! Borrow to \$1500 by mail! Convenient terms! State licensed. Postal Finance, 200 Keeline Building, Dept. 17-N, Omaha, Nebraska 68102.

SECRET Law Wipes Out Your Debts to \$25,000 in 90 minutes. Clear credit. Free details. Counselor-7, Kerrville, Texas 78028.

CASH LOANS By mail! Up to \$1,000 on signature alone. No Collateral! Secret! Union Finance Company, 3608 No. 16th St. Dept. PM, Phoenix, Ariz. 85011.

HOW Intelligent are you? Self-scoring test reveals IQ in 45 minutes Send \$2.00 today—guaranteed! Richards, Dept 287, 5741 Pontiac Rd., Virginia Beach, Va. 23462.

DIPLOMA IN ENOLOGY. Easy 60 minute course earns beautiful diploma. Enhance knowledge, enjoyment of wine. \$3. Doctors Institute, Department of Enology, 3143 Washington, San Francisco, California 94115.

BLANK FORMS—Birth, Baptism, Marriage, Divorce; High School, College Diplomas, Power of Attorney, Will, Bill of Sale, General Agreement. Any 3 forms, \$1.00. (Others, list sent.) Legal Forms, Dept. 234, 1830 Guardian Building, Detroit, Michigan 48226.

FOLLOW That Car. Electronic Trailing Equipment, Box 220-P, Miami, Florida 33168.

MAKE YOUR WILL. Get 4 Will Forms and attorney's informative book. \$1.00. Legal Forms Company, Department 124, 1830 Guardian Building, Detroit, Michigan 48226.

BIBLE Questions answered. Stamped envelope. Bylon, 17167 Bentler, Detroit, Michigan 48219.

INVESTIGATORS. Latest electronic Aids. Free Literature. Clifton, 11500-P NW 7th Ave., Miami, Florida 33168.

RUPTURED. Relief and comfort. No understraps, elastic or steel. Write Hand-Lock Products, Preston 4, Ont., Canada.

TOO Many Debts? Want to lower your payment and pay off the bills? Write Continental, Dept. PM, Box 2116, East Chicago, Indiana 45312.

COMPUTER DATES by mail. Nationwide. Free Details. House of Hoke, Box 101-PM, Sebring, Florida 33870.

RECORD Telephone conversations automatically. Leave recorder unattended. Write—Robert's, Box 49PJ, Parkridge, Illinois 60068.

SECRET LOANS BY MAIL. Borrow \$100 to \$1500 for any good reason in absolute privacy. No interviews, no endorsers, no co-signers. Fast service. Write Dial Finance Co., Dept. G-214, 410 Kilpatrick Bldg., Omaha, Nebraska 68102.

HAVE Triple-A credit in thirty days! Get new credit without investigation! Continental, Box J-24, Hallandale, Florida 33009.

(Continued on next page)



## PERSONAL

(Continued from preceding page)

**IMPROVE YOUR PERSONALITY** Write for free information: **PERSONALITY SUCCESS**, Dept. C2, Box 1946, El Paso, Texas 79950.

**LOSING your hair?** New device from Switzerland has proven effective in preventing baldness. Free information. **R.S. & Associates, Import-Export**, P.O. Box 113, Twinsburg, Ohio 44087.

**CANCER** You may be next. Stop smoking! New book reveals medical and psychological method. Send \$2.00 **Bobbie-Jon Gifts**, 15907 White Fawn Drive, San Antonio, Texas 78228.

**LOTTERIES—Legal method!** Details \$1.00. **ORE**, Box 340, Athens, W. Virginia 24712.

**"RULE Others With Thoughts."** (Telepathy) write: **Clarion**, Box 1769-S7, Chicago, 60690.

**MAKE YOUR WILL.** Receive—Four Forms—Attorney's Book—Easily Followable Sample (GUARANTEED) \$1.00—Legal Publications Company (D-160) Plattsmouth, Nebraska 68048.

**"OVERWEIGHT—I Lost 40 lbs. you can too.** Fantastic diet. \$2 Cash. Box 221, Mississauga, Ontario, Canada."

**BANKRUPT? Bad Credit?** You can wipe it out, establish excellent credit in 45 days and build a fortune. Free details. Write: **Wealth Building**, 8840 Hoyt Drive, Thornton, Colorado 80229.

**COMMERCIAL Free Music From your FM Radio.** Details, Box 220-Z, Miami, Florida 33168.

## WANTED—MISCELLANEOUS

**WE BUY HOME Workshop Equipment:** Electroplating, Babyshoe Metallizers, Plastic Presses, Rubber Stamping Machines, Printing Presses, etc. Send complete description, condition. Used Equipment Division, Box 23565-A, Los Angeles 90023.

**MERCURY, Gold, Silver, Platinum; Ores assayed.** Wholesale Terminal, Norwood, Mass. 02062.

## MISCELLANEOUS

**MUSICAL Beer steins** shipped to you direct from Germany. Free details. **Penny Products**, Box 214, Salina Sta., Syracuse, New York 13208.

**WINEMAKERS, Bottlers—400 items** on our list. **Barrel Winery**, 1201 University Ave., Berkeley, Calif. 94702.

**EMBARRASSED With Smelling Feet,** Stop That Fungus. Treatment \$4.50 Guaranteed. **Willie Pritchett**, 640 Scoggins Street, Milton, Florida 32570.

**VOODOO DOLLS: \$3.00.** Order from: **QUEENIE**, P.O. Box 3363, Hollywood, Calif. 90028.

**WINEMAKING Kit—\$4.98** Free Catalog and recipes. **JIMDANDY**, Box 30230M, Cincinnati, Ohio 45230.

**WINEMAKER'S DELUXE KIT!!** Includes: Precision **HYDROMETER** with Testing Jar!! Illustrated Manual! Yeast . . . Campden Tablets! Equipment Catalog! Everything—\$3.00. Satisfaction Guaranteed!! Winekit, A2, 2121 Conger, Olympia, Washington 98501.

**WINEMAKERS Catalog, Free.** Bacchanalia, 321-D7, Saugatuck Station, Westport, Conn. 06880.

**SUFFERING From Arthritis? Try Ginseng:** Information Free. Write **Ginseng**, Asheville 53, N.C.

**CIGARETTES 12¢ a pack.** Improved roller makes 20 filtertip, plain, king or regular for 12¢. Facts free. **Green River Tobacco**, Box 954, Owensboro, Kentucky 42301.

**YOUR Name sent to 1000 importers, publishers, mailers, wholesalers, etc.** on our mailing list. Year \$1.00. **Dixie Mailers**, King, N. Car. 27021.

**PSYCHEDELIC Catalog of Posters, Lighting, Jewelry, Etc.** Send 50¢. **Hole**, 6055 Lankershim, N. Hollywood, Calif. 91606.

**WINEMAKERS Yeast, Recipes & Catalog 25¢;** **Kraus**, Box 451-L, Nevada, Missouri 64772.

**ORNAMENTAL Iron designs.** Book of 1600 beautiful, practical designs for railings, columns, etc. Free literature. **Cunningham**, 3881 South 3200 West, Salt Lake City, Utah 84119.

**WINEMAKERS.** Free illustrated catalog of yeasts, equipment. **Simplex**, Box 12276, Minneapolis, Minn. 55412.

**BOOKS On antiques and their prices.** Free circular!! **P. Warman Publishers**, Uniontown, Penna. 15401.

**HEARING Aid batteries wholesale.** Free list. **Habs**, Box 51, York, Penna. 17405.

**BIRTH Certificates, Marriage Certificates, Diplomas!** 2 blank forms \$1.00. Sample 10¢. **Standard Forms**, Box 482-M, Washington, D.C. 20044.

**IDENTIFICATION Cards.** Send stamped self-addressed envelope for samples. **Identification**, Box 12117, Las Vegas, Nevada 89112.

**WINEMAKERS. . . Free Illustrated Supply Catalog of Yeasts, Equipment, Recipes.** **Winemaker**, Box 11211-PM, Indianapolis, Ind. 46201.

**WINEMAKERS: Free supply catalog, recipes.** **Arboly**, Box 663, Dept. PM, West Columbia, S.C. 29169.

**\$134, \$141, \$151, ETC. Profit Daily** For You with \$2 stakes, at Racetracks everywhere with fabulous, scientific, easy to use "Pencliff"—world famed race computer, 12 expert race experts brains built into it. (\$20 stakes 10 times above profits). Get our special offer. Tear out this ad now. Mail it with name, address, zip: **R. H. Publishing Co. P10B**, Box 5715, Carmel, Calif. 93921.

**BURGLARY-THEFT-FIRE Alarms** for family, home, auto, office, boat, apartment and mobile home. Save hundreds of dollars. All name brands. Largest Catalog of its kind. Send \$1.50 to **Clipper Corporation**, Crime Control Division, P.O. 40203, Indianapolis, Indiana 46240. . .

**WINEMAKING—200 Recipes, instructions—\$1.00.** **E&G Sales**, Box 18384-T, Memphis, Tennessee 38118.

**RECIPE** for red clover wine also nine others \$1.00. **Carrabassett Novelties**, No. Anson, Maine 04958.

**BAR-B-QUE TREAT** Large shaker "Big Daddy's" Western Seasoned Salt \$1.00. Box 3142, Scottsdale, Arizona 85257.

**NOVELTIES, Toys, Games, Specialties.** 50¢ brings Details. **A. Wallace**, Box 628, Montreal 101, Canada.

**CREDIT Cards!** Receive all kinds fast, easy. Get new credit without investigation! **Continental**, Box J-23, Hallandale, Florida 33009.

**CHAMPAGNE & WINES** Home for pennies, using kitchen utensils only. Satisfaction guaranteed or money refunded. Booklet \$2.00. **C. Kashi**, Box 699, Times Sq. Stat., New York 10036.

**WINEMAKERS SPECIAL!!** Leading University's "Homemade Wine" Booklet—10¢. **Werth Wine**, Box 1902P, Cedar Rapids, Iowa 52406.

**HOME WINE And BREW** supplies and ingredients, recipes for year round wine-making. Free catalog—**Danenberger**, Box 276B, New Berlin, Illinois 62670.

**MOSQUITO—PRUF** Formula \$2.00. Perfect odorless protection. **Franklin Assoc.**, Box 3401, Fort Worth, Texas 76105.

**BEAUTIFUL 3-D Magnetic Peace Flag.** 9 1/2"x13", only \$7.95. Signs, 6706 Chisholm, Baltimore, Maryland 21207.

**WINE SKILLS**, Box 1126, San Luis Obispo, California 93401. Free Homebrewing Catalog.

**TRAVEL Calculator.** The Automark Pocket Planner for travel fun, savings, trip planning, records, etc. Conveniently sized for glove compartment. \$2.19. **Stevenson Industries**, P.O. Box 40, Dept. 16, Mira Loma, Calif. 91752.

**THE PYRAMID, Mystery of the ages.** A force field known to sharpen razor blades, dehydrate organic substance, etc. Conduct your own experiments. Complete kit and instructions. \$3.00 Postpaid. **Pyramids**, P.O. Box 387, South Lake Tahoe, California 95705.

**WATERBEDS,** King size, five year guarantee, \$49.95, free brochure, **Aquawomb**, Dept. C, Box 1578, Miami, Florida 33138.

**WINE And Champagne Handbook** Contains simple delicious recipes standard kitchen utensils needed. Guaranteed. \$2.98. **Haynes**, Box 559A, Minoa, N.Y. 13116.

**SMOKERS! FORASAN** Removes 53% nicotine, 68% tar from your cigarettes. Easy to use. Guaranteed. \$1.50. **Curtinco**, 16 Del Rey, San Carlos, California 94070.

**"CHAMPAGNE And Winemaking** handbook \$3.98. Recipes and secrets. Use standard Kitchen tools. Guaranteed. **Elden's Enterprises**, 6613 Kimball, Waterloo, Iowa 50701."

**WINEMAKER'S Manual!!** Large Discount Supplies Catalog! Packet Yeast!! 25¢. **Vintage**, PM-1, 2938C, Eastlake, Seattle, Washington 98102.

**WINEMAKERS.** Free Catalog Of Kits, Books, Yeast, Concentrates, Equipment, Supplies. **Wollersheim**, **McFarland**, Wisconsin 53558.

**COLLEGE Diploma—B.A. Blank Form.** Fill In Yourself. \$3.00. **S.C.E.**, Box 434, St. Clair Shores, Michigan 48083.

**MAGNETS.** All types. Specials—20 disc magnets, or 2 stick magnets, or 10 small bar magnets, or 8 assorted magnets, \$1.00. **Maryland Magnet Company**, Box 192-A, Randallstown, Maryland 21133.

**DENTAL Technician Needs Dentist** For Cooperation Of Highest Quality Of Dentures. **Bela Tancos**, 2695 Hibbert Avenue, Columbus, Ohio 43202.

**WINEMAKING. . . Exciting Recipes** for Grape, Dandelion, Elderberry, Clover, Brewing, etc. Illustrated **Winemaker's Manual** (Best Available!) and **Supplies Catalog** \$1.00. **Namar**, Box 6N, Dearborn, Michigan 48121.

**SAVE MONEY.** Battery recharger recharges all size batteries, for tapes, radios, Flashlights. \$5.95 **Cogburn**, Box 393-A, Tatum, New Mexico 88267.

**ALARMS, Burglar, Holdup, Fire, Bell Or Silent, Sound And Intercom Systems.** Big Money Making Opportunities. **Dealerships Available.** Send \$3.00 For Catalog (Refundable). **Northern Alarm Supply**, 1725 Woodward, Berkley, Michigan 48072.

**ANTIQUe Buying Guide.** Know the value of what you own; what you want to buy. \$1.98 brings 224 page illustrated handbook of wholesale and retail prices of thousands of antiques, curios and collectibles. **Californians** add sales tax. **Mari Mountgarden**, Room 18C, 320 Elwood Avenue, Oakland, California 94610.

**WINEMAKING** At home is fun and easy! Make any type of wine you wish with Arborhouse supplies and equipment. Send for free catalog. "The Nation's Amateur Winemaking Supply Company". **Arborhouse**, Dept. BB, 8007 Douglas Avenue, Racine, Wisconsin 53402.

**FANTASTIC TWO-WAY MIRRORS!!!** Observe others in complete secrecy. Big 8x10 plastic sheet. Send \$2.00 or 4 for \$6.00 guaranteed! **Roberts Limited**, (3P7) 44-16th St., Hermosa Beach, Calif. 90254.

**HIGH SCHOOL DIPLOMA. . .** Finest quality blank forms. **FREE** birth certificate included. . . only \$2.00. **Roberts Limited**, (2P7) 44-16th Street, Hermosa Beach, Calif. 90254.



# How can a pickup work like a truck, ride like a car?

## Consider these facts:

Ford pickups give you better ideas. And better ideas are what make a Ford a better buy. For example:

### Biggest cab of any pickup.

Combined headroom, legroom, shoulder room and seat height dimensions exceed those of any other pickup cab.

### Only Ford has Twin-I-Beam independent front suspension.

Wheels step over bumps independently to smooth the ride.



### Levellest, quietest ride of them all.

Virtually no nosedive on braking, less side-sway on curves. Independent tests proved Ford is quieter than all other leading pickup makes.

### Most luxurious.

Choose from four levels of luxury . . . all the way up to the unique Ford Ranger XLT, most luxurious pickup ever built.



Distinctive good taste marks the XLT: wood-tone accents, thick-pile carpeting, deep-cushioned seats upholstered in pleated cloth and vinyl, plus luxury options like AM/FM stereo and air conditioning.

### I-beam front axles.

A Ford exclusive. Both axles are drop-forged I-beam design. Everybody's *big* trucks use I-beam front axle design for greater strength.

### Radius rods help hold alignment

of the front wheels and reduce road vibration. Only Ford pickups provide radius rods.



**Self-energizing brakes** stop quickly, smoothly, with little pedal pressure. Self adjusting for lower service costs.

**Welded, instead of bolted, pickup box** stays strong, resists working loose, means greater quietness, less chance of rust.

**Leaf-type rear springs**, like all big trucks use, for better stability. Exclusive Flex-O-Matic rear suspension, standard on F-250 and with heavy-duty springs on F-100, keeps the ride smooth, with or without a load.



Make sure your next pickup includes the better ideas you get only from Ford. See your Ford Dealer for the pickup that works like a truck, rides like a car.



A better idea for safety: Buckle up.

**FORD  
PICKUPS**





Discover a smoother menthol.

Come all the way up to KOOL.



*Cunningham*

Warning: The Surgeon General Has Determined  
That Cigarette Smoking Is Dangerous to Your Health

King Size, 18 mg. "tar," 1.4 mg. nicotine; Long Size, 19 mg. "tar," 1.3 mg. nicotine av. per cigarette, FTC Report Nov. 70.

Материал, защищенный авторским правом